

Lenovo™ **Think**Products

PSREF



Product Specifications Reference

Version 509, July 2017

U.S.

Visit <http://psref.lenovo.com> for the latest version

Lenovo **ThinkPad** Laptops

PSREF



Product Specifications Reference

Version 509, July 2017

U.S.

Visit <http://psref.lenovo.com> for the latest version

Contents

| | | | |
|---|-----------|---|-----------|
| Cover | 1 | ThinkPad E450 - TopSeller - 20DC - 3 of 4 | 35 |
| Contents | 2 | ThinkPad E450 - TopSeller - 20DC - 4 of 4 | 36 |
| Summary Of Change | 5 | ThinkPad E460 | 37 |
| 11e Series | 6 | ThinkPad E460 Platform Specifications | 38 |
| ThinkPad 11e (3rd Gen) | 6 | ThinkPad E460 - TopSeller - 20ET | 39 |
| ThinkPad 11e (3rd Gen) Platform Specifications | 7 | ThinkPad E465 | 40 |
| ThinkPad 11e (3rd Gen) - TopSeller - 20GB | 8 | ThinkPad E465 Platform Specifications | 41 |
| ThinkPad 11e (4th Gen) | 9 | ThinkPad E465 - TopSeller - 20EX | 42 |
| ThinkPad 11e (4th Gen) Platform Specifications | 10 | ThinkPad E470 | 43 |
| ThinkPad 11e (4th Gen) - TopSeller - 20HV | 11 | ThinkPad E470 Platform Specifications | 44 |
| ThinkPad 11e Chromebook (3rd Gen) | 12 | ThinkPad E470 - TopSeller - 20H1 - 1 of 2 | 45 |
| ThinkPad 11e Chromebook (3rd Gen) Platform Specifications | 13 | ThinkPad E470 - TopSeller - 20H1 - 2 of 2 | 46 |
| ThinkPad 11e Chromebook (3rd Gen) - TopSeller - 20GF | 14 | ThinkPad E475 | 47 |
| ThinkPad 11e Chromebook (4th Gen) | 15 | ThinkPad E475 Platform Specifications | 48 |
| ThinkPad 11e Chromebook (4th Gen) Platform Specifications | 16 | ThinkPad E475 - TopSeller - 20H4 | 49 |
| ThinkPad 11e Chromebook (4th Gen) - TopSeller - 20J0 | 17 | ThinkPad E550 | 50 |
| 13 Series | 18 | ThinkPad E550 Platform Specifications | 51 |
| ThinkPad 13 | 18 | ThinkPad E550 - TopSeller - 20DF - 1 of 4 | 52 |
| ThinkPad 13 Platform Specifications | 19 | ThinkPad E550 - TopSeller - 20DF - 2 of 4 | 53 |
| ThinkPad 13 - TopSeller - 20GJ - 1 of 3 | 20 | ThinkPad E550 - TopSeller - 20DF - 3 of 4 | 54 |
| ThinkPad 13 - TopSeller - 20GJ - 2 of 3 | 21 | ThinkPad E550 - TopSeller - 20DF - 4 of 4 | 55 |
| ThinkPad 13 - TopSeller - 20GJ - 3 of 3 | 22 | ThinkPad E560 | 56 |
| ThinkPad 13 - 20GJ | 23 | ThinkPad E560 Platform Specifications | 57 |
| ThinkPad 13 (2nd Gen) | 24 | ThinkPad E560 - TopSeller - 20EV - 1 of 2 | 58 |
| ThinkPad 13 (2nd Gen) Platform Specifications | 25 | ThinkPad E560 - TopSeller - 20EV - 2 of 2 | 59 |
| ThinkPad 13 (2nd Gen) - TopSeller - 20J1 - 1 of 2 | 26 | ThinkPad E565 | 60 |
| ThinkPad 13 (2nd Gen) - TopSeller - 20J1 - 2 of 2 | 27 | ThinkPad E565 Platform Specifications | 61 |
| ThinkPad 13 Chromebook | 28 | ThinkPad E565 - TopSeller - 20EY - 1 of 2 | 62 |
| ThinkPad 13 Chromebook Platform Specifications | 29 | ThinkPad E565 - TopSeller - 20EY - 2 of 2 | 63 |
| ThinkPad 13 Chromebook - TopSeller - 20GL | 30 | ThinkPad E570 | 64 |
| E Series | 31 | ThinkPad E570 Platform Specifications | 65 |
| ThinkPad E450 | 31 | ThinkPad E570 - TopSeller - 20H5 | 66 |
| ThinkPad E450 Platform Specifications | 32 | ThinkPad E575 | 67 |
| ThinkPad E450 - TopSeller - 20DC - 1 of 4 | 33 | ThinkPad E575 Platform Specifications | 68 |
| ThinkPad E450 - TopSeller - 20DC - 2 of 4 | 34 | ThinkPad E575 - TopSeller - 20H8 | 69 |

Contents

| | | | |
|---|-----------|--|------------|
| L Series | 70 | ThinkPad P70 | 103 |
| ThinkPad L460 | 70 | ThinkPad P70 Platform Specifications | 104 |
| ThinkPad L460 Platform Specifications | 71 | ThinkPad P70 - TopSeller - 20ER - 1 of 2 | 105 |
| ThinkPad L460 - TopSeller - 20FU - 1 of 2 | 72 | ThinkPad P70 - TopSeller - 20ER - 2 of 2 | 106 |
| ThinkPad L460 - TopSeller - 20FU - 2 of 2 | 73 | ThinkPad P71 | 107 |
| ThinkPad L470 | 74 | ThinkPad P71 Platform Specifications | 108 |
| ThinkPad L470 Platform Specifications | 75 | ThinkPad P71 - TopSeller - 20HK - 1 of 2 | 109 |
| ThinkPad L470 - TopSeller - 20J4 | 76 | ThinkPad P71 - TopSeller - 20HK - 2 of 2 | 110 |
| ThinkPad L470 - TopSeller - 20JU | 77 | T Series | 111 |
| ThinkPad L560 | 78 | ThinkPad T460 | 111 |
| ThinkPad L560 Platform Specifications | 79 | ThinkPad T460 Platform Specifications | 112 |
| ThinkPad L560 - TopSeller - 20F1 - 1 of 2 | 80 | ThinkPad T460 - TopSeller - 20FN - 1 of 2 | 113 |
| ThinkPad L560 - TopSeller - 20F1 - 2 of 2 | 81 | ThinkPad T460 - TopSeller - 20FN - 2 of 2 | 114 |
| ThinkPad L570 | 82 | ThinkPad T460p | 115 |
| ThinkPad L570 Platform Specifications | 83 | ThinkPad T460p Platform Specifications | 116 |
| ThinkPad L570 - TopSeller - 20J8 | 84 | ThinkPad T460p - TopSeller - 20FW | 117 |
| ThinkPad L570 - TopSeller - 20JQ | 85 | ThinkPad T460s | 118 |
| P Series | 86 | ThinkPad T460s Platform Specifications | 119 |
| ThinkPad P50 | 86 | ThinkPad T460s - TopSeller - 20F9 - 1 of 3 | 120 |
| ThinkPad P50 Platform Specifications | 87 | ThinkPad T460s - TopSeller - 20F9 - 2 of 3 | 121 |
| ThinkPad P50 - TopSeller - 20EN - 1 of 2 | 88 | ThinkPad T460s - TopSeller - 20F9 - 3 of 3 | 122 |
| ThinkPad P50 - TopSeller - 20EN - 2 of 2 | 89 | ThinkPad T470 | 123 |
| ThinkPad P50 - TopSeller - 20EQ | 90 | ThinkPad T470 Platform Specifications | 124 |
| ThinkPad P50s | 91 | ThinkPad T470 - TopSeller - 20HD | 125 |
| ThinkPad P50s Platform Specifications | 92 | ThinkPad T470 - TopSeller - 20JM | 126 |
| ThinkPad P50s - TopSeller - 20FL | 93 | ThinkPad T470p | 127 |
| ThinkPad P51 | 94 | ThinkPad T470p Platform Specifications | 128 |
| ThinkPad P51 Platform Specifications | 95 | ThinkPad T470p - TopSeller - 20J6 | 129 |
| ThinkPad P51 - TopSeller - 20HH - 1 of 2 | 96 | ThinkPad T470s | 130 |
| ThinkPad P51 - TopSeller - 20HH - 2 of 2 | 97 | ThinkPad T470s Platform Specifications | 131 |
| ThinkPad P51s | 98 | ThinkPad T470s - TopSeller - 20HF - 1 of 2 | 132 |
| ThinkPad P51s Platform Specifications | 99 | ThinkPad T470s - TopSeller - 20HF - 2 of 2 | 133 |
| ThinkPad P51s - TopSeller - 20HB - 1 of 2 | 100 | ThinkPad T470s - TopSeller - 20JS | 134 |
| ThinkPad P51s - TopSeller - 20HB - 2 of 2 | 101 | ThinkPad T560 | 135 |
| ThinkPad P51s - TopSeller - 20JY | 102 | ThinkPad T560 Platform Specifications | 136 |

Contents

| | |
|--|------------|
| ThinkPad T560 - TopSeller - 20FH - 1 of 2 | 137 |
| ThinkPad T560 - TopSeller - 20FH - 2 of 2 | 138 |
| ThinkPad T570 | 139 |
| ThinkPad T570 Platform Specifications | 140 |
| ThinkPad T570 - TopSeller - 20H9 - 1 of 2 | 141 |
| ThinkPad T570 - TopSeller - 20H9 - 2 of 2 | 142 |
| ThinkPad T570 - TopSeller - 20JW | 143 |
| X Series | 144 |
| ThinkPad X1 Carbon (4th Gen) | 144 |
| ThinkPad X1 Carbon (4th Gen) Platform Specifications | 145 |
| ThinkPad X1 Carbon (4th Gen) - TopSeller - 20FB - 1 of 5 | 146 |
| ThinkPad X1 Carbon (4th Gen) - TopSeller - 20FB - 2 of 5 | 147 |
| ThinkPad X1 Carbon (4th Gen) - TopSeller - 20FB - 3 of 5 | 148 |
| ThinkPad X1 Carbon (4th Gen) - TopSeller - 20FB - 4 of 5 | 149 |
| ThinkPad X1 Carbon (4th Gen) - TopSeller - 20FB - 5 of 5 | 150 |
| ThinkPad X1 Carbon (5th Gen) | 151 |
| ThinkPad X1 Carbon (5th Gen) Platform Specifications | 152 |
| ThinkPad X1 Carbon (5th Gen) - TopSeller - 20HR - 1 of 2 | 153 |
| ThinkPad X1 Carbon (5th Gen) - TopSeller - 20HR - 2 of 2 | 154 |
| ThinkPad X1 Carbon (5th Gen) - TopSeller - 20K4 | 155 |
| ThinkPad X260 | 156 |
| ThinkPad X260 Platform Specifications | 157 |
| ThinkPad X260 - TopSeller - 20F6 - 1 of 4 | 158 |
| ThinkPad X260 - TopSeller - 20F6 - 2 of 4 | 159 |
| ThinkPad X260 - TopSeller - 20F6 - 3 of 4 | 160 |
| ThinkPad X260 - TopSeller - 20F6 - 4 of 4 | 161 |
| ThinkPad X270 | 162 |
| ThinkPad X270 Platform Specifications | 163 |
| ThinkPad X270 - TopSeller - 20HN | 164 |
| ThinkPad X270 - TopSeller - 20K6 | 165 |
| Legal Information | 166 |

Summary of Changes

This section describes the technical changes made in this edition.

This edition might also include minor corrections and editorial changes which are not identified.

July 12, 2017 - Version 509

Additions in this update

▶ **New product(s)**

None

▶ **New model(s)**

ThinkPad T470 new models announced July 2017

▶ **Others**

ThinkPad X270 multi-touch panel added

Withdrawals in this update

▶ **Withdrawn product(s)**

None



ThinkPad 11e (3rd Gen) Platform Specifications

Product Specifications Reference (PSREF)

| Processor | Intel® Celeron® Processor, Intel Pentium® Processor, or 6th Generation Intel Core™ i3 Processor | | | | | | | Media reader | 4-in-1 reader (MMC, SD, SDHC, SDXC) | | | | | | | | | | | | | | | | | | | | | | | | | | | | | | | | | |
|---|--|--------------|----------------|-----------------|-------|--------------|-----------------------|--|--|----------------|-----------------|-------|--------------|--------------------|-----------|---|---|---------|----------|-----|------------|-------------------|-----------|---------|----------|-----|-----------------------|-----------|---|---|---------|---|-----|-----------------------|----------|---------|---|-----|-----------------------|----------|--|--|
| | | | | | | | | Ports | Two USB 3.0, HDMI, Ethernet (RJ-45) | | | | | | | | | | | | | | | | | | | | | | | | | | | | | | | | | |
| | | | | | | | | Control buttons | Power button, volume control button | | | | | | | | | | | | | | | | | | | | | | | | | | | | | | | | | |
| | | | | | | | | Camera | HD720p resolution, low light sensitive, fixed focus | | | | | | | | | | | | | | | | | | | | | | | | | | | | | | | | | |
| | | | | | | | | Audio support | HD Audio, Realtek® ALC3245 codec / stereo speakers, 2W x 2 / monaural digital microphone, combo audio/microphone jack | | | | | | | | | | | | | | | | | | | | | | | | | | | | | | | | | |
| <table border="1"> <thead> <tr> <th>Processor Number</th> <th># of Cores</th> <th># of Threads</th> <th>Base Frequency</th> <th>Burst Frequency</th> <th>Cache</th> <th>Memory Types</th> <th>Processor Graphics</th> </tr> </thead> <tbody> <tr> <td>Cel N3150</td> <td rowspan="2">4</td> <td rowspan="2">4</td> <td>1.6 GHz</td> <td>2.08 GHz</td> <td>2MB</td> <td rowspan="4">DDR3L-1600</td> <td>Intel HD graphics</td> </tr> <tr> <td>Cel N3160</td> <td>1.6 GHz</td> <td>2.24 GHz</td> <td>2MB</td> <td>Intel HD graphics 400</td> </tr> <tr> <td>Pen 4405U</td> <td rowspan="2">2</td> <td rowspan="2">4</td> <td>2.1 GHz</td> <td>-</td> <td>2MB</td> <td>Intel HD graphics 510</td> </tr> <tr> <td>i3-6100U</td> <td>2.3 GHz</td> <td>-</td> <td>3MB</td> <td>Intel HD graphics 520</td> </tr> </tbody> </table> | | | | | | | Processor Number | # of Cores | # of Threads | Base Frequency | Burst Frequency | Cache | Memory Types | Processor Graphics | Cel N3150 | 4 | 4 | 1.6 GHz | 2.08 GHz | 2MB | DDR3L-1600 | Intel HD graphics | Cel N3160 | 1.6 GHz | 2.24 GHz | 2MB | Intel HD graphics 400 | Pen 4405U | 2 | 4 | 2.1 GHz | - | 2MB | Intel HD graphics 510 | i3-6100U | 2.3 GHz | - | 3MB | Intel HD graphics 520 | Keyboard | ThinkPad Windows keyboard, 6-row, multimedia Fn keys | |
| Processor Number | # of Cores | # of Threads | Base Frequency | Burst Frequency | Cache | Memory Types | Processor Graphics | | | | | | | | | | | | | | | | | | | | | | | | | | | | | | | | | | | |
| Cel N3150 | 4 | 4 | 1.6 GHz | 2.08 GHz | 2MB | DDR3L-1600 | Intel HD graphics | | | | | | | | | | | | | | | | | | | | | | | | | | | | | | | | | | | |
| Cel N3160 | | | 1.6 GHz | 2.24 GHz | 2MB | | Intel HD graphics 400 | | | | | | | | | | | | | | | | | | | | | | | | | | | | | | | | | | | |
| Pen 4405U | 2 | 4 | 2.1 GHz | - | 2MB | | Intel HD graphics 510 | | | | | | | | | | | | | | | | | | | | | | | | | | | | | | | | | | | |
| i3-6100U | | | 2.3 GHz | - | 3MB | | Intel HD graphics 520 | | | | | | | | | | | | | | | | | | | | | | | | | | | | | | | | | | | |
| | | | | | | | Touchpad | Buttonless touchpad below keyboard, multi-touch | | | | | | | | | | | | | | | | | | | | | | | | | | | | | | | | | | |
| Graphics | Intel HD Graphics, Intel HD Graphics 510, or Intel HD Graphics 520 in processor, supports external digital monitor via HDMI™; supports dual independent display; Max resolution: 1920X1080 (HDMI)@30Hz | | | | | | | Security | Power-on password, hard disk password, supervisor password, security keyhole | | | | | | | | | | | | | | | | | | | | | | | | | | | | | | | | | |
| Chipset | Intel SoC (System on Chip) platform | | | | | | | Security chip | <i>Win7 model:</i> discrete TPM 1.2, TCG Certified | | | | | | | | | | | | | | | | | | | | | | | | | | | | | | | | | |
| Memory | 2GB, 4GB, or 8GB / PC3-12800 1600MHz DDR3L, one DDR3L SO-DIMM socket | | | | | | | | <i>Win10 model:</i> discrete TPM 1.2 TCG Certified and Firmware TPM 2.0 in chipset | | | | | | | | | | | | | | | | | | | | | | | | | | | | | | | | | |
| Display | 11.6" (295mm) HD (1366x768), anti-glare, LED backlight, 220 nits, 16:9 aspect ratio, 500:1 contrast ratio | | | | | | | vPro | None | | | | | | | | | | | | | | | | | | | | | | | | | | | | | | | | | |
| Multi-touch | None | | | | | | | Fingerprint reader | None | | | | | | | | | | | | | | | | | | | | | | | | | | | | | | | | | |
| Hinge | Normal hinge, 180 degree | | | | | | | Battery | Integrated Lithium Polymer 3-cell (42Wh) | | | | | | | | | | | | | | | | | | | | | | | | | | | | | | | | | |
| Storage | M.2 Solid State Drive (SSD), SATA 6.0Gb/s | | | | | | | Max battery life ¹⁰ | <i>MobileMark® 2014:</i> 11.53 hr | | | | | | | | | | | | | | | | | | | | | | | | | | | | | | | | | |
| Optical | None | | | | | | | AC adapter | 45-watt AC adapter | | | | | | | | | | | | | | | | | | | | | | | | | | | | | | | | | |
| Ethernet | Realtek RTL8111GUS-CG Gigabit Network Connection | | | | | | | Preload | Windows 7 Professional 64 preinstalled through downgrade rights in Windows 10 Pro 64 • Lenovo Solution Center • ThinkVantage Product Recovery • Rescue and Recovery™ • ThinkVantage System Update • Adobe® Reader® • Microsoft® Office preloaded; purchase a product key to activate • McAfee® LiveSafe™ (30-day trial) | | | | | | | | | | | | | | | | | | | | | | | | | | | | | | | | | |
| WLAN ⁴ | <i>One of the following, configurable by model:</i> • 11ac+BT, Intel Dual Band Wireless-AC 3165, 1x1, M.2 card • 11ac+BT, Intel Dual Band Wireless-AC 7265, 2x2, M.2 card | | | | | | | • Microsoft Office preloaded; purchase a product key to activate • McAfee® LiveSafe™ (30-day trial) | | | | | | | | | | | | | | | | | | | | | | | | | | | | | | | | | | |
| Bluetooth™ | Bluetooth 4.0 wireless, integrated in Wi-Fi + Bluetooth combo adapter | | | | | | | Limited warranty ¹² | <i>One of the following, configurable by model:</i> • 1-year depot repair service • 3-year/1-yr battery depot repair service (US only) | | | | | | | | | | | | | | | | | | | | | | | | | | | | | | | | | |
| WWAN | None | | | | | | | Mil-Spec test | MIL-STD-810G military certification | | | | | | | | | | | | | | | | | | | | | | | | | | | | | | | | | |
| Dimensions ³ | WxDxH: 11.81" x 8.27" x 0.88"; 300mm x 210mm x 22.3mm | | | | | | | Environment | EPEAT™ Gold (US only); ENERGY STAR® 6.1; RoHS-compliant | | | | | | | | | | | | | | | | | | | | | | | | | | | | | | | | | |
| Weight ² | Starting at 3.3 lb (1.5kg) | | | | | | | | | | | | | | | | | | | | | | | | | | | | | | | | | | | | | | | | | |
| Case color | <i>Display cover:</i> Graphite Black or Silver; <i>Bottom:</i> Graphite Black | | | | | | | | | | | | | | | | | | | | | | | | | | | | | | | | | | | | | | | | | |
| Case material | <i>Display cover:</i> PC+40%GF+TPU; <i>Bottom:</i> PCC | | | | | | | | | | | | | | | | | | | | | | | | | | | | | | | | | | | | | | | | | |

Lenovo
November 2016

ThinkPad 11e (3rd Gen) - TopSeller - 20GB

Product Specifications Reference (PSREF)

| Model | Region | Processor | Graphics | Memory | Display | Multi-touch | Storage | Optical | WLAN + Bluetooth | Color | Camera | Keyboard | Finger-print Reader | TPM | Battery (internal) | Power Adapter | Operating System | Warranty | Ann Date (m/y) |
|------------|--------|---------------|--------------|--------|---------------------|-------------|---------------------|---------|----------------------------|-------|--------|-------------|---------------------|---------------------|--------------------|---------------|-------------------|---------------|----------------|
| 20GB000JUS | US | Celeron N3150 | Intel HD | 4GBx1 | 11.6" HD (1366x768) | None | 192GB SSD M.2 | None | Intel 7265 ac, 2x2 + BT4.0 | Black | 720p | Non-backlit | None | dTPM1.2 + FW TPM2.0 | 3-cell (42Wh) | 45W | Windows 10 Pro 64 | 1-year, Depot | 02/16 |
| 20GB000KUS | US | Celeron N3150 | Intel HD | 8GBx1 | 11.6" HD (1366x768) | None | 192GB SSD M.2 | None | Intel 7265 ac, 2x2 + BT4.0 | Black | 720p | Non-backlit | None | dTPM1.2 + FW TPM2.0 | 3-cell (42Wh) | 45W | Windows 10 Pro 64 | 1-year, Depot | 02/16 |
| 20GB000LUS | US | Celeron N3150 | Intel HD | 8GBx1 | 11.6" HD (1366x768) | None | 128GB SSD M.2 | None | Intel 7265 ac, 2x2 + BT4.0 | Black | 720p | Non-backlit | None | dTPM1.2 + FW TPM2.0 | 3-cell (42Wh) | 45W | Windows 10 Pro 64 | 1-year, Depot | 02/16 |
| 20GB000MUS | US | Celeron N3150 | Intel HD | 8GBx1 | 11.6" HD (1366x768) | None | 256GB SSD M.2 Opal2 | None | Intel 7265 ac, 2x2 + BT4.0 | Black | 720p | Non-backlit | None | dTPM1.2 + FW TPM2.0 | 3-cell (42Wh) | 45W | Windows 10 Pro 64 | 1-year, Depot | 02/16 |
| 20GB000NUS | US | Celeron N3150 | Intel HD | 4GBx1 | 11.6" HD (1366x768) | None | 128GB SSD M.2 | None | Intel 7265 ac, 2x2 + BT4.0 | Black | 720p | Non-backlit | None | dTPM1.2 + FW TPM2.0 | 3-cell (42Wh) | 45W | Windows 10 Pro 64 | 1-year, Depot | 02/16 |
| 20GB000PUS | US | i3-6100U | Intel HD 520 | 4GBx1 | 11.6" HD (1366x768) | None | 128GB SSD M.2 | None | Intel 7265 ac, 2x2 + BT4.0 | Black | 720p | Non-backlit | None | dTPM1.2 + FW TPM2.0 | 3-cell (42Wh) | 45W | Windows 10 Pro 64 | 1-year, Depot | 02/16 |
| 20GB000QUS | US | i3-6100U | Intel HD 520 | 8GBx1 | 11.6" HD (1366x768) | None | 128GB SSD M.2 | None | Intel 7265 ac, 2x2 + BT4.0 | Black | 720p | Non-backlit | None | dTPM1.2 + FW TPM2.0 | 3-cell (42Wh) | 45W | Windows 10 Pro 64 | 1-year, Depot | 02/16 |
| 20GB000RUS | US | i3-6100U | Intel HD 520 | 8GBx1 | 11.6" HD (1366x768) | None | 192GB SSD M.2 | None | Intel 7265 ac, 2x2 + BT4.0 | Black | 720p | Non-backlit | None | dTPM1.2 + FW TPM2.0 | 3-cell (42Wh) | 45W | Windows 10 Pro 64 | 1-year, Depot | 02/16 |
| 20GB000SUS | US | i3-6100U | Intel HD 520 | 8GBx1 | 11.6" HD (1366x768) | None | 256GB SSD M.2 Opal2 | None | Intel 7265 ac, 2x2 + BT4.0 | Black | 720p | Non-backlit | None | dTPM1.2 + FW TPM2.0 | 3-cell (42Wh) | 45W | Windows 10 Pro 64 | 1-year, Depot | 02/16 |
| 20GB000UUS | US | i3-6100U | Intel HD 520 | 4GBx1 | 11.6" HD (1366x768) | None | 192GB SSD M.2 | None | Intel 7265 ac, 2x2 + BT4.0 | Black | 720p | Non-backlit | None | dTPM1.2 + FW TPM2.0 | 3-cell (42Wh) | 45W | Windows 10 Pro 64 | 1-year, Depot | 02/16 |
| 20GB001HUS | US | Celeron N3160 | Intel HD 400 | 4GBx1 | 11.6" HD (1366x768) | None | 128GB SSD M.2 | None | Intel 7265 ac, 2x2 + BT4.0 | Black | 720p | Non-backlit | None | dTPM1.2 + FW TPM2.0 | 3-cell (42Wh) | 45W | Windows 10 Pro 64 | 1-year, Depot | 09/16 |
| 20GB001JUS | US | Celeron N3160 | Intel HD 400 | 4GBx1 | 11.6" HD (1366x768) | None | 256GB SSD M.2 Opal2 | None | Intel 7265 ac, 2x2 + BT4.0 | Black | 720p | Non-backlit | None | dTPM1.2 + FW TPM2.0 | 3-cell (42Wh) | 45W | Windows 10 Pro 64 | 1-year, Depot | 09/16 |
| 20GB001KUS | US | Celeron N3160 | Intel HD 400 | 8GBx1 | 11.6" HD (1366x768) | None | 128GB SSD M.2 | None | Intel 7265 ac, 2x2 + BT4.0 | Black | 720p | Non-backlit | None | dTPM1.2 + FW TPM2.0 | 3-cell (42Wh) | 45W | Windows 10 Pro 64 | 1-year, Depot | 09/16 |
| 20GB001LUS | US | Celeron N3160 | Intel HD 400 | 8GBx1 | 11.6" HD (1366x768) | None | 256GB SSD M.2 Opal2 | None | Intel 7265 ac, 2x2 + BT4.0 | Black | 720p | Non-backlit | None | dTPM1.2 + FW TPM2.0 | 3-cell (42Wh) | 45W | Windows 10 Pro 64 | 1-year, Depot | 09/16 |



ThinkPad 11e (4th Gen) Platform Specifications

Product Specifications Reference (PSREF)

| | | | | | | | | | | |
|---------------|---|-------------------------------------|--------------|----------------|------------------------|-------|--------------|-----------------------|--------------------|--|
| Processor | Intel® Celeron® processor or 7th Generation Intel Core™ i3 Processor | | | | | | | | Media reader | 4-in-1 reader (MMC, SD, SDHC, SDXC) |
| | Processor Number | # of Cores | # of Threads | Base Frequency | Burst Frequency | Cache | Memory Types | Processor Graphics | Ports | Two USB 3.1 Gen 1 (USB 3.0), HDMI 1.4b, Ethernet (RJ-45) |
| | Cel N3450 | 4 | 4 | 1.1 GHz | 2.2 GHz | 2MB | DDR3L-1600 | Intel HD Graphics 500 | Control buttons | Power button, volume control button |
| | i3-7100U | 2 | 4 | 2.4 GHz | - | 3MB | DDR4-2133 | Intel HD Graphics 620 | Camera | HD720p resolution, low light sensitive, fixed focus |
| Graphics | Intel HD Graphics 500 or 620 in processor, supports external digital monitor via HDMI™; supports dual independent display; Max resolution: 1920X1080 (HDMI) @60Hz | | | | | | | | Audio support | HD Audio, Realtek® ALC3268 codec / stereo speakers, 2W x 2 / monaural digital microphone, combo audio/microphone jack |
| | Chipset | Intel SoC (System on Chip) platform | | | | | | | Keyboard | ThinkPad Windows keyboard, 6-row, multimedia Fn keys |
| Memory | 4GB or 8GB / 1600MHz DDR3L or 2133MHz DDR4, one DDR3L or DDR4 SO-DIMM socket | | | | | | | | Touchpad | Buttonless touchpad below keyboard, multi-touch |
| Display | 11.6" (295mm) HD (1366x768), anti-glare, LED backlight, 250 nits, 16:9 aspect ratio, 500:1 contrast ratio | | | | | | | | Security | Power-on password, hard disk password, supervisor password, security keyhole |
| Multi-touch | None | | | | | | | | Security chip | Discrete TPM 2.0, TCG Certified |
| Hinge | Normal hinge, 180 degree | | | | | | | | vPro | None |
| Storage | M.2 Solid State Drive (SSD), SATA 6.0Gb/s | | | | | | | | Fingerprint reader | None |
| Optical | None | | | | | | | | Battery | Integrated Lithium Polymer 3-cell (42Wh) |
| Ethernet | Realtek RTL8111GUS-CG Gigabit Network Connection | | | | | | | | Max battery life | MobileMark® 2014: 13.65 hr |
| WLAN | Intel Dual Band Wireless-AC 7265, Wi-Fi 2x2 802.11ac + BT4.1, M.2 card | | | | | | | | AC adapter | 45W AC adapter |
| Bluetooth™ | Bluetooth 4.1 wireless, integrated in Wi-Fi + Bluetooth combo adapter | | | | | | | | Preload | Some: Windows® 10 Home 64 Some: Windows 10 Pro 64 • Lenovo Companion • Lenovo Setting • Microsoft Office preloaded; purchase a product key to activate |
| WWAN | None | | | | | | | | Limited warranty | One of the following, configurable by model: • 1-year depot repair service • 3-year/1-yr battery depot repair service |
| Dimensions | WxDxH: 11.81" x 8.27" x 0.88"; 300mm x 210mm x 22.3mm | | | | | | | | Mil-Spec test | MIL-STD-810G military certification |
| Weight | Starting at 3.3 lb (1.52kg) | | | | | | | | Environment | EPEAT™ Gold (US only); ENERGY STAR® 6.1; RoHS-compliant |
| Case color | Display cover: Graphite Black; | | | | Bottom: Graphite Black | | | | | |
| Case material | Display cover: PC+40%GF+TPU; | | | | Bottom: PC/ABS plastic | | | | | |

Lenovo
July 2017

ThinkPad 11e (4th Gen) - TopSeller - 20HV

Product Specifications Reference (PSREF)

| Model | Region | Processor | vPro | Graphics | Memory | Display | Multi-touch | Storage(HDD/SSD) | Optical | WLAN + Bluetooth | Color | Camera | Key-board | Finger-print Reader | TPM | Battery (internal) | Power Adapter | Operating System | Warranty | Ann Date (m/y) |
|------------|--------|---------------|------|--------------|------------------|---------------------|-------------|---------------------|---------|----------------------------|-------|--------|-------------|---------------------|----------|--------------------|---------------|------------------|---------------|----------------|
| 20HV0000US | US | i3-7100U | No | Intel HD 620 | 8GBx1 DDR4-2133 | 11.6" HD (1366x768) | None | 128GB SSD M.2 | None | Intel 7265 ac, 2x2 + BT4.1 | Black | 720p | Non-backlit | None | dTPM 2.0 | 3-cell (42Wh) | 45W | Win10 Pro 64 | 1-year, Depot | 03/17 |
| 20HV0001US | US | i3-7100U | No | Intel HD 620 | 4GBx1 DDR4-2133 | 11.6" HD (1366x768) | None | 128GB SSD M.2 | None | Intel 7265 ac, 2x2 + BT4.1 | Black | 720p | Non-backlit | None | dTPM 2.0 | 3-cell (42Wh) | 45W | Win10 Pro 64 | 1-year, Depot | 03/17 |
| 20HV000MUS | US | Celeron N3450 | No | Intel HD 500 | 4GBx1 DDR3L-1600 | 11.6" HD (1366x768) | None | 128GB SSD M.2 | None | Intel 7265 ac, 2x2 + BT4.1 | Black | 720p | Non-backlit | None | dTPM 2.0 | 3-cell (42Wh) | 45W | Win10 Pro 64 | 1-year, Depot | 03/17 |
| 20HV000VUS | US | Celeron N3450 | No | Intel HD 500 | 8GBx1 DDR3L-1600 | 11.6" HD (1366x768) | None | 128GB SSD M.2 | None | Intel 7265 ac, 2x2 + BT4.1 | Black | 720p | Non-backlit | None | dTPM 2.0 | 3-cell (42Wh) | 45W | Win10 Pro 64 | 1-year, Depot | 03/17 |
| 20HV000XUS | US | Celeron N3450 | No | Intel HD 500 | 8GBx1 DDR3L-1600 | 11.6" HD (1366x768) | None | 256GB SSD M.2 Opal2 | None | Intel 7265 ac, 2x2 + BT4.1 | Black | 720p | Non-backlit | None | dTPM 2.0 | 3-cell (42Wh) | 45W | Win10 Pro 64 | 1-year, Depot | 03/17 |
| 20HV0015US | US | i3-7100U | No | Intel HD 620 | 8GBx1 DDR4-2133 | 11.6" HD (1366x768) | None | 256GB SSD M.2 Opal2 | None | Intel 7265 ac, 2x2 + BT4.1 | Black | 720p | Non-backlit | None | dTPM 2.0 | 3-cell (42Wh) | 45W | Win10 Pro 64 | 1-year, Depot | 03/17 |



ThinkPad 11e Chromebook (3rd Gen) Platform Specifications

Product Specifications Reference (PSREF)

| | | | | | | | | | | |
|-------------------|--|------------|--------------|----------------|-----------------|-----------------------|--------------|--------------------|--|---|
| Processor | Intel® Celeron® Processor | | | | | | | | Dimensions ³ | <i>WxDxH:</i> 11.81" x 8.27" x 0.88"; 300mm x 210mm x 22.3mm |
| | Processor Number | # of Cores | # of Threads | Base Frequency | Burst Frequency | Cache | Memory Types | Processor Graphics | Weight ² | Starting at 3.3 lb (1.5kg) |
| | Cel N3150 | 4 | 4 | 1.6 GHz | 2.08 GHz | 2MB | DDR3L-1600 | Intel HD graphics | Case color | <i>Display cover:</i> Graphite Black or Silver; <i>Bottom:</i> Graphite Black |
| Cel N3160 | | | 1.6 GHz | 2.24 GHz | 2MB | Intel HD graphics 400 | | Case material | <i>Display cover:</i> PC+40%GF+TPU; <i>Bottom:</i> PCC | |
| Graphics | Intel HD Graphics or Intel HD Graphics 400 in processor, supports external digital monitor via HDMI™; supports dual independent display; Max resolution: 1920X1080 (HDMI)@30Hz | | | | | | | | Media reader | 4-in-1 reader (MMC, SD, SDHC, SDXC) |
| Chipset | Intel SoC (System on Chip) platform | | | | | | | | Ports | Two USB 3.0 (one Always On), HDMI |
| Memory | 2GB or 4GB / 1600MHz LPDDR3 / soldered to systemboard, no sockets | | | | | | | | Control buttons | None |
| Display | 11.6" (295mm) HD (1366x768), anti-glare, LED backlight, 220 nits, 16:9 aspect ratio, 500:1 contrast ratio | | | | | | | | Camera | HD720p resolution, low light sensitive, fixed focus |
| Multi-touch | None | | | | | | | | Audio support | Realtek® ALC5650 codec / stereo speakers, 2W x 2 / monaural digital microphone, combo audio/microphone jack |
| Hinge | Normal hinge, 180 degree | | | | | | | | Keyboard | ThinkPad Chrome keyboard, 6-row, multimedia Fn keys |
| Storage | 16GB eMMC (embedded Multi Media Card) flash memory on board | | | | | | | | Touchpad | Buttonless touchpad below keyboard, multi-touch |
| Optical | None | | | | | | | | Security | Security keyhole |
| Ethernet | None | | | | | | | | Security chip | Discrete TPM 1.2, TCG Certified |
| WLAN ⁴ | 11ac+BT, Intel Dual Band Wireless-AC 7265, 2x2, M.2 card | | | | | | | | vPro | None |
| Bluetooth™ | Bluetooth 4.0 wireless, integrated in Wi-Fi + Bluetooth combo adapter | | | | | | | | Fingerprint reader | None |
| WWAN | None | | | | | | | | Battery | Integrated Lithium Polymer 3-cell (42Wh) |
| | | | | | | | | | Max battery life ¹⁰ | Up to 12 hr |
| | | | | | | | | | AC adapter | 45-watt AC adapter |
| | | | | | | | | | Preload | Google Chrome OS |
| | | | | | | | | | Limited warranty ¹² | 1-year depot repair service |
| | | | | | | | | | Mil-Spec test | MIL-STD-810G military certification |
| | | | | | | | | | Environment | EPEAT™ Gold (US only); ENERGY STAR® 6.1; RoHS-compliant |

Lenovo
April 2017

ThinkPad 11e Chromebook (3rd Gen) - TopSeller - 20GF

Product Specifications Reference (PSREF)

| Model | Region | Processor | Graphics | Memory (Soldered) | Display | Multi-touch | Storage | Optical | WLAN + Bluetooth | Color | Camera | Key-board | Finger-print Reader | TPM | Battery (internal) | Power Adapter | Operating System | Warranty | Ann Date (m/y) |
|------------|--------|---------------|--------------|-------------------|---------------------|-------------|-----------|---------|----------------------------|-------|--------|-------------|---------------------|----------|--------------------|---------------|------------------|---------------|----------------|
| 20GF0001US | US | Celeron N3150 | Intel HD | 4GB Soldered | 11.6" HD (1366x768) | None | 16GB eMMC | None | Intel 7265 ac, 2x2 + BT4.0 | Black | 720p | Non-backlit | None | dTPM 1.2 | 3-cell (42Wh) | 45W | Chrome OS | 1-year, Depot | 03/16 |
| 20GF0003US | US | Celeron N3160 | Intel HD 400 | 4GB Soldered | 11.6" HD (1366x768) | None | 16GB eMMC | None | Intel 7265 ac, 2x2 + BT4.0 | Black | 720p | Non-backlit | None | dTPM 1.2 | 3-cell (42Wh) | 45W | Chrome OS | 1-year, Depot | 10/16 |



ThinkPad 11e Chromebook (4th Gen) Platform Specifications

Product Specifications Reference (PSREF)

| | | | | | | | | | | |
|-------------|--|------------|--------------|----------------|-----------------|-------|--------------|-----------------------|---|--|
| Processor | Intel® Celeron® Processor | | | | | | | | Dimensions | <i>WxDxH:</i> 11.81" x 8.27" x 0.90"; 300mm x 210mm x 22.8mm |
| | Processor Number | # of Cores | # of Threads | Base Frequency | Burst Frequency | Cache | Memory Types | Processor Graphics | Weight | Starting at 3.2 lb (1.45kg) |
| | Cel N3450 | 4 | 4 | 1.1 GHz | 2.2 GHz | 2MB | LPDDR4-2400 | Intel HD Graphics 500 | Case color | <i>Display cover:</i> Graphite Black; <i>Bottom:</i> Graphite Black |
| | | | | | | | | | Case material | <i>Display cover:</i> PC+40%GF+TPU; <i>Bottom:</i> PC/ABS plastic |
| Graphics | Intel HD Graphics 500 in processor | | | | | | | | Media reader | MicroSD card reader (MMC, SD, SDHC, SDXC) |
| Chipset | Intel SoC (System on Chip) platform | | | | | | | | Ports | One USB 3.1 Gen 1 (USB 3.0), two USB Type-C |
| Memory | 4GB / 3200MHz LPDDR4 / soldered to systemboard, no sockets * System clocks down for processors with lower memory controller | | | | | | | | Control buttons | None |
| Display | 11.6" (295mm) HD (1366x768), anti-glare, LED backlight, 250 nits, 16:9 aspect ratio, 500:1 contrast ratio | | | | | | | | Camera | HD720p resolution, low light sensitive, fixed focus |
| Multi-touch | None | | | | | | | | Audio support | Dialog Semiconductor DA7219 audio codec / stereo speakers, 2W x 2 / monaural digital microphone, combo audio/microphone jack |
| Hinge | Normal hinge, 180 degree | | | | | | | | Keyboard | ThinkPad Chrome keyboard, 6-row, multimedia Fn keys |
| Storage | 32GB eMMC (embedded Multi Media Card) flash memory on board | | | | | | | | Touchpad | Buttonless touchpad below keyboard, multi-touch |
| Optical | None | | | | | | | | Security | Security keyhole |
| Ethernet | None | | | | | | | | Security chip | Discrete TPM 2.0, TCG Certified |
| WLAN | Intel Dual Band Wireless-AC 7265, Wi-Fi 2x2 802.11ac + BT4.1, M.2 card | | | | | | | | vPro | None |
| Bluetooth™ | Bluetooth 4.1 wireless, integrated in Wi-Fi + Bluetooth combo adapter | | | | | | | | Fingerprint reader | None |
| WWAN | None | | | | | | | | Battery | Integrated Lithium Polymer 3-cell (42Wh) |
| | | | | | | | | Max battery life | Up to 11.84 hr | |
| | | | | | | | | AC adapter | 45W USB Type-C AC adapter | |
| | | | | | | | | Preload | Google Chrome OS | |
| | | | | | | | | Limited warranty | 1-year depot repair service | |
| | | | | | | | | Mil-Spec test | MIL-STD-810G military certification | |
| | | | | | | | | Environment | EPEAT™ Gold (US only); ENERGY STAR® 6.1; RoHS-compliant | |

Lenovo
July 2017

ThinkPad 11e Chromebook (4th Gen) - TopSeller - 20J0

Product Specifications Reference (PSREF)

| Model | Region | Processor | vPro | Graphics | Memory (Soldered) | Display | Multi-touch | Storage | Optical | WLAN + Bluetooth | Color | Camera | Key-board | Finger-print Reader | TPM | Battery (internal) | Power Adapter | Operating System | Warranty | Ann Date (m/y) |
|------------|--------|---------------|------|--------------|-------------------|---------------------|-------------|-----------|---------|----------------------------|-------|--------|-------------|---------------------|----------|--------------------|---------------|------------------|---------------|----------------|
| 20J00000US | US | Celeron N3450 | No | Intel HD 500 | 4GB Soldered | 11.6" HD (1366x768) | None | 32GB eMMC | None | Intel 7265 ac, 2x2 + BT4.1 | Black | 720p | Non-backlit | None | dTPM 2.0 | 3-cell (42Wh) | 45W USB-C | Chrome OS | 1-year, Depot | 04/17 |

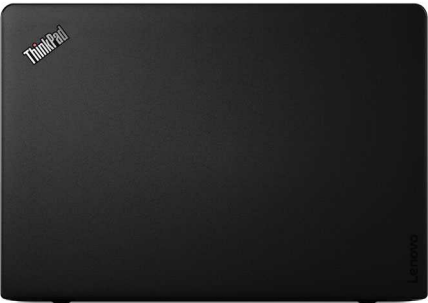

ThinkPad 13 Platform Specifications

Product Specifications Reference (PSREF)

| | | | | | | | | | | |
|-------------------------|---|------------|--------------|----------------|---------------------|-------|--------------|-----------------------|--|--|
| Processor | Intel® Celeron® Processor or 6th Generation Intel Core™ i3 / i5 Processor | | | | | | | | Smart card reader | None |
| | Processor Number | # of Cores | # of Threads | Base Frequency | Max Turbo Frequency | Cache | Memory Types | Processor Graphics | Media reader Ports | 4-in-1 reader (MMC, SD, SDHC, SDXC) Three USB 3.0 (one Always On), one USB Type-C, HDMI, Lenovo OneLink+ connector |
| | Cel 3855U | 2 | 4 | 1.6 GHz | - | 2MB | DDR4-2133 | Intel HD graphics 510 | Camera Audio support | HD720p resolution, low light sensitive, fixed focus HD Audio, Realtek® ALC3245 codec / stereo speakers, 2W x 2 / dual array microphone, combo audio/microphone jack |
| | i3-6100U | | | 2.3 GHz | - | 3MB | | Intel HD graphics 520 | | |
| | i5-6200U | | | 2.3 GHz | 2.8 GHz | 3MB | | | | |
| i5-6300U | 2.4 GHz | | | 3.0 GHz | 3MB | | | | | |
| i7-6500U | | | 2.5 GHz | 3.1 GHz | 4MB | | | Keyboard UltraNav™ | ThinkPad Windows keyboard, 6-row, multimedia Fn keys TrackPoint® pointing device and buttonless Mylar surface touchpad, multi-touch | |
| Graphics | Intel HD Graphics 510 or 520 in processor, supports external digital monitor via HDMI or USB Type-C; supports three independent displays; Max resolution: 1920x1080 (HDMI)@60Hz, 3840x2160 (USB Type-C)@60Hz | | | | | | | | Security Security chip | Power-on password, hard disk password, supervisor password, security keyhole <i>Win7 model:</i> discrete TPM 1.2, TCG Certified <i>Win10 model:</i> discrete TPM 1.2 TCG Certified and Firmware TPM 2.0 in chipset |
| Chipset Memory | Intel SoC (System on Chip) platform 16GB max / 2133MHz DDR4, two DDR4 SO-DIMM sockets | | | | | | | | vPro (optional) Fingerprint reader | Intel vPro Technology <i>Optional:</i> Swipe style fingerprint reader on the keyboard bezel |
| Display | <i>Some:</i> 13.3" (338mm) HD (1366x768), anti-glare, LED backlight, 200 nits, 16:9 aspect ratio, 500:1 contrast ratio <i>Some:</i> 13.3" (338mm) FHD (1920x1080), anti-glare, LED backlight, IPS, 220 nits, 16:9 aspect ratio, 600:1 contrast ratio, 170° viewing angle | | | | | | | | Battery | Integrated Lithium Polymer 3-cell (42Wh) |
| Multi-touch | None | | | | | | | | Max battery life ¹⁰ | <i>MobileMark® 2014:</i> 11.6 hr |
| Storage Optical | M.2 SSD / SATA 6.0Gb/s None | | | | | | | | AC adapter | 45-watt AC adapter |
| Ethernet | Gigabit Ethernet via the accessional ThinkPad OneLink+ to RJ45 Adapter (4X90K06975) or ThinkPad OneLink+ to VGA/RJ45 adapter (4X90J31060) (by native Intel Ethernet Connection I219-V (Non-vPro) or I219-LM (vPro)) | | | | | | | | Preload | <i>Some:</i> Genuine Windows® 7 Professional 64 <i>Some:</i> Windows 7 Professional 64 preinstalled through downgrade rights in Windows 10 Pro 64 <ul style="list-style-type: none"> Lenovo Solution Center Lenovo SHAREit ThinkVantage Product Recovery Rescue and Recovery™ ThinkVantage System Update Adobe® Reader® Microsoft® Office preloaded; purchase a product key to activate McAfee® LiveSafe™ (30-day trial) |
| WLAN ⁴ | <i>One of the following, configurable by model:</i> <ul style="list-style-type: none"> 11ac+BT4.0, Intel Dual Band Wireless-AC 3165, 1x1, M.2 card 11ac+BT4.1, Intel Dual Band Wireless-AC 8260, 2x2, M.2 card | | | | | | | | Limited warranty ¹² | <i>One of the following, configurable by model:</i> <ul style="list-style-type: none"> 1-year depot repair service 3-year/1-yr battery depot repair service 3-year/1-yr battery limited onsite service²⁴ |
| Bluetooth™ | Bluetooth 4.0 or 4.1 wireless, integrated in Wi-Fi + Bluetooth combo adapter | | | | | | | | Mil-Spec test | MIL-STD-810G military certification |
| WWAN | None | | | | | | | | Environment | EPEAT™ Gold (US only); ENERGY STAR® 6.1; RoHS-compliant |
| Dimensions ³ | <i>WxDxH (silver):</i> 12.69" x 8.77" x 0.75"; 322.4mm x 222.8mm x 19.1mm <i>WxDxH (black):</i> 12.69" x 8.77" x 0.78"; 322.4mm x 222.8mm x 19.8mm | | | | | | | | | |
| Weight ² | Starting at 3.17 lb / 1.44 kg | | | | | | | | | |
| Case color | Pure Black or Silver | | | | | | | | | |
| Case material | <i>Black cover:</i> PC/ABS plastic; <i>Silver cover:</i> Aluminum | | | | | | | | | |

| Model | Region | Processor | vPro | Graphics | Memory | Display | Multi-touch | Storage | Optical | WLAN + Bluetooth | Color | Camera | Keyboard | Fingerprint Reader | TPM | Battery (internal) | Power Adapter | Operating System | Warranty | Ann Date (m/y) |
|------------|--------|---------------|------|--------------|--------|---------------------------|-------------|---------------------|---------|----------------------------|--------|--------|-------------|--------------------|---------------------|--------------------|---------------|--------------------------------|---------------|----------------|
| 20GJ0006US | US | Celeron 3855U | No | Intel HD 510 | 4GBx1 | 13.3" HD (1366x768) | None | 128GB SSD M.2 | None | Intel 8260 ac, 2x2 + BT4.1 | Black | 720p | Non-backlit | Fingerprint Reader | dTPM1.2 + FW TPM2.0 | 3-cell (42Wh) | 45W | Windows 10 Pro 64 | 1-year, Depot | 03/16 |
| 20GJ0007US | US | Celeron 3855U | No | Intel HD 510 | 4GBx1 | 13.3" FHD (1920x1080) IPS | None | 128GB SSD M.2 | None | Intel 8260 ac, 2x2 + BT4.1 | Black | 720p | Non-backlit | Fingerprint Reader | dTPM1.2 + FW TPM2.0 | 3-cell (42Wh) | 45W | Windows 10 Pro 64 | 1-year, Depot | 03/16 |
| 20GJ0008US | US | i5-6200U | No | Intel HD 520 | 8GBx2 | 13.3" FHD (1920x1080) IPS | None | 512GB SSD M.2 | None | Intel 8260 ac, 2x2 + BT4.1 | Black | 720p | Non-backlit | Fingerprint Reader | dTPM1.2 + FW TPM2.0 | 3-cell (42Wh) | 45W | Windows 10 Pro 64 | 3-year, Depot | 03/16 |
| 20GJ0009US | US | Celeron 3855U | No | Intel HD 510 | 4GBx2 | 13.3" HD (1366x768) | None | 128GB SSD M.2 | None | Intel 8260 ac, 2x2 + BT4.1 | Black | 720p | Non-backlit | Fingerprint Reader | dTPM1.2 + FW TPM2.0 | 3-cell (42Wh) | 45W | Windows 10 Pro 64 | 3-year, Depot | 03/16 |
| 20GJ000AUS | US | i3-6100U | No | Intel HD 520 | 4GBx1 | 13.3" FHD (1920x1080) IPS | None | 128GB SSD M.2 | None | Intel 8260 ac, 2x2 + BT4.1 | Silver | 720p | Non-backlit | None | dTPM 1.2 | 3-cell (42Wh) | 45W | Windows 10 DG Windows 7 Pro 64 | 3-year, Depot | 03/16 |
| 20GJ000DUS | US | i3-6100U | No | Intel HD 520 | 4GBx1 | 13.3" HD (1366x768) | None | 128GB SSD M.2 | None | Intel 8260 ac, 2x2 + BT4.1 | Black | 720p | Non-backlit | Fingerprint Reader | dTPM1.2 + FW TPM2.0 | 3-cell (42Wh) | 45W | Windows 10 Pro 64 | 3-year, Depot | 03/16 |
| 20GJ000EUS | US | i3-6100U | No | Intel HD 520 | 4GBx1 | 13.3" FHD (1920x1080) IPS | None | 192GB SSD M.2 | None | Intel 8260 ac, 2x2 + BT4.1 | Black | 720p | Non-backlit | Fingerprint Reader | dTPM1.2 + FW TPM2.0 | 3-cell (42Wh) | 45W | Windows 10 Pro 64 | 3-year, Depot | 03/16 |
| 20GJ000FUS | US | i3-6100U | No | Intel HD 520 | 4GBx2 | 13.3" HD (1366x768) | None | 128GB SSD M.2 | None | Intel 8260 ac, 2x2 + BT4.1 | Silver | 720p | Non-backlit | None | dTPM 1.2 | 3-cell (42Wh) | 45W | Windows 10 DG Windows 7 Pro 64 | 3-year, Depot | 03/16 |
| 20GJ000GUS | US | i3-6100U | No | Intel HD 520 | 4GBx2 | 13.3" HD (1366x768) | None | 128GB SSD M.2 | None | Intel 8260 ac, 2x2 + BT4.1 | Silver | 720p | Non-backlit | None | dTPM 1.2 | 3-cell (42Wh) | 45W | Windows 10 DG Windows 7 Pro 64 | 3-year, Depot | 03/16 |
| 20GJ000HUS | US | i3-6100U | No | Intel HD 520 | 4GBx1 | 13.3" FHD (1920x1080) IPS | None | 128GB SSD M.2 | None | Intel 8260 ac, 2x2 + BT4.1 | Black | 720p | Non-backlit | Fingerprint Reader | dTPM1.2 + FW TPM2.0 | 3-cell (42Wh) | 45W | Windows 10 Pro 64 | 3-year, Depot | 03/16 |
| 20GJ000JUS | US | i5-6200U | No | Intel HD 520 | 4GBx1 | 13.3" FHD (1920x1080) IPS | None | 512GB SSD M.2 | None | Intel 8260 ac, 2x2 + BT4.1 | Black | 720p | Non-backlit | Fingerprint Reader | dTPM1.2 + FW TPM2.0 | 3-cell (42Wh) | 45W | Windows 10 Pro 64 | 3-year, Depot | 03/16 |
| 20GJ000KUS | US | i3-6100U | No | Intel HD 520 | 4GBx2 | 13.3" HD (1366x768) | None | 128GB SSD M.2 | None | Intel 8260 ac, 2x2 + BT4.1 | Black | 720p | Non-backlit | Fingerprint Reader | dTPM1.2 + FW TPM2.0 | 3-cell (42Wh) | 45W | Windows 10 Pro 64 | 3-year, Depot | 03/16 |
| 20GJ000LUS | US | Celeron 3855U | No | Intel HD 510 | 4GBx1 | 13.3" FHD (1920x1080) IPS | None | 128GB SSD M.2 | None | Intel 8260 ac, 2x2 + BT4.1 | Black | 720p | Non-backlit | Fingerprint Reader | dTPM 1.2 | 3-cell (42Wh) | 45W | Windows 7 Pro 64 | 3-year, Depot | 03/16 |
| 20GJ000MUS | US | Celeron 3855U | No | Intel HD 510 | 4GBx1 | 13.3" FHD (1920x1080) IPS | None | 128GB SSD M.2 | None | Intel 8260 ac, 2x2 + BT4.1 | Black | 720p | Non-backlit | Fingerprint Reader | dTPM 1.2 | 3-cell (42Wh) | 45W | Windows 10 DG Windows 7 Pro 64 | 3-year, Depot | 03/16 |
| 20GJ000NUS | US | i5-6200U | No | Intel HD 520 | 4GBx2 | 13.3" FHD (1920x1080) IPS | None | 512GB SSD M.2 | None | Intel 8260 ac, 2x2 + BT4.1 | Black | 720p | Non-backlit | Fingerprint Reader | dTPM1.2 + FW TPM2.0 | 3-cell (42Wh) | 45W | Windows 10 Pro 64 | 3-year, Depot | 03/16 |
| 20GJ000PUS | US | i5-6200U | No | Intel HD 520 | 4GBx2 | 13.3" HD (1366x768) | None | 256GB SSD M.2 Opal2 | None | Intel 8260 ac, 2x2 + BT4.1 | Black | 720p | Non-backlit | Fingerprint Reader | dTPM1.2 + FW TPM2.0 | 3-cell (42Wh) | 45W | Windows 10 Pro 64 | 3-year, Depot | 03/16 |
| 20GJ000QUS | US | Celeron 3855U | No | Intel HD 510 | 4GBx2 | 13.3" FHD (1920x1080) IPS | None | 128GB SSD M.2 | None | Intel 8260 ac, 2x2 + BT4.1 | Black | 720p | Non-backlit | Fingerprint Reader | dTPM1.2 + FW TPM2.0 | 3-cell (42Wh) | 45W | Windows 10 Pro 64 | 3-year, Depot | 03/16 |
| 20GJ000RUS | US | i5-6200U | No | Intel HD 520 | 4GBx2 | 13.3" HD (1366x768) | None | 128GB SSD M.2 | None | Intel 8260 ac, 2x2 + BT4.1 | Silver | 720p | Non-backlit | None | dTPM 1.2 | 3-cell (42Wh) | 45W | Windows 10 DG Windows 7 Pro 64 | 3-year, Depot | 03/16 |
| 20GJ000SUS | US | i5-6200U | No | Intel HD 520 | 4GBx1 | 13.3" FHD (1920x1080) IPS | None | 128GB SSD M.2 | None | Intel 8260 ac, 2x2 + BT4.1 | Black | 720p | Non-backlit | Fingerprint Reader | dTPM1.2 + FW TPM2.0 | 3-cell (42Wh) | 45W | Windows 10 Pro 64 | 3-year, Depot | 03/16 |
| 20GJ000TUS | US | i5-6200U | No | Intel HD 520 | 4GBx1 | 13.3" HD (1366x768) | None | 128GB SSD M.2 | None | Intel 8260 ac, 2x2 + BT4.1 | Black | 720p | Non-backlit | Fingerprint Reader | dTPM1.2 + FW TPM2.0 | 3-cell (42Wh) | 45W | Windows 10 Pro 64 | 3-year, Depot | 03/16 |

| Model | Region | Processor | vPro | Graphics | Memory | Display | Multi-touch | Storage | Optical | WLAN + Bluetooth | Color | Camera | Keyboard | Fingerprint Reader | TPM | Battery (internal) | Power Adapter | Operating System | Warranty | Ann Date (m/y) |
|------------|--------|---------------|------|--------------|--------|---------------------------|-------------|---------------------|---------|----------------------------|--------|--------|-------------|--------------------|---------------------|--------------------|---------------|--------------------------------|---------------|----------------|
| 20GJ000UUS | US | i3-6100U | No | Intel HD 520 | 4GBx2 | 13.3" FHD (1920x1080) IPS | None | 128GB SSD M.2 | None | Intel 8260 ac, 2x2 + BT4.1 | Silver | 720p | Non-backlit | None | dTPM 1.2 | 3-cell (42Wh) | 45W | Windows 10 DG Windows 7 Pro 64 | 3-year, Depot | 03/16 |
| 20GJ000VUS | US | i5-6200U | No | Intel HD 520 | 4GBx1 | 13.3" HD (1366x768) | None | 128GB SSD M.2 | None | Intel 8260 ac, 2x2 + BT4.1 | Black | 720p | Non-backlit | Fingerprint Reader | dTPM1.2 + FW TPM2.0 | 3-cell (42Wh) | 45W | Windows 10 Pro 64 | 3-year, Depot | 03/16 |
| 20GJ000WUS | US | i3-6100U | No | Intel HD 520 | 4GBx2 | 13.3" FHD (1920x1080) IPS | None | 256GB SSD M.2 Opal2 | None | Intel 8260 ac, 2x2 + BT4.1 | Black | 720p | Non-backlit | Fingerprint Reader | dTPM1.2 + FW TPM2.0 | 3-cell (42Wh) | 45W | Windows 10 Pro 64 | 3-year, Depot | 03/16 |
| 20GJ000XUS | US | Celeron 3855U | No | Intel HD 510 | 4GBx1 | 13.3" FHD (1920x1080) IPS | None | 128GB SSD M.2 | None | Intel 8260 ac, 2x2 + BT4.1 | Silver | 720p | Non-backlit | None | dTPM 1.2 | 3-cell (42Wh) | 45W | Windows 10 DG Windows 7 Pro 64 | 3-year, Depot | 03/16 |
| 20GJ000YUS | US | i5-6200U | No | Intel HD 520 | 4GBx2 | 13.3" HD (1366x768) | None | 128GB SSD M.2 | None | Intel 8260 ac, 2x2 + BT4.1 | Black | 720p | Non-backlit | Fingerprint Reader | dTPM1.2 + FW TPM2.0 | 3-cell (42Wh) | 45W | Windows 10 Pro 64 | 3-year, Depot | 03/16 |
| 20GJ0010US | US | Celeron 3855U | No | Intel HD 510 | 4GBx1 | 13.3" HD (1366x768) | None | 128GB SSD M.2 | None | Intel 8260 ac, 2x2 + BT4.1 | Silver | 720p | Non-backlit | None | dTPM 1.2 | 3-cell (42Wh) | 45W | Windows 10 DG Windows 7 Pro 64 | 3-year, Depot | 03/16 |
| 20GJ0011US | US | i5-6200U | No | Intel HD 520 | 4GBx2 | 13.3" FHD (1920x1080) IPS | None | 128GB SSD M.2 | None | Intel 8260 ac, 2x2 + BT4.1 | Silver | 720p | Non-backlit | None | dTPM 1.2 | 3-cell (42Wh) | 45W | Windows 10 DG Windows 7 Pro 64 | 3-year, Depot | 03/16 |
| 20GJ0012US | US | i3-6100U | No | Intel HD 520 | 4GBx1 | 13.3" HD (1366x768) | None | 128GB SSD M.2 | None | Intel 8260 ac, 2x2 + BT4.1 | Silver | 720p | Non-backlit | None | dTPM 1.2 | 3-cell (42Wh) | 45W | Windows 10 DG Windows 7 Pro 64 | 3-year, Depot | 03/16 |
| 20GJ0013US | US | i5-6200U | No | Intel HD 520 | 4GBx1 | 13.3" FHD (1920x1080) IPS | None | 256GB SSD M.2 Opal2 | None | Intel 8260 ac, 2x2 + BT4.1 | Black | 720p | Non-backlit | Fingerprint Reader | dTPM1.2 + FW TPM2.0 | 3-cell (42Wh) | 45W | Windows 10 Pro 64 | 3-year, Depot | 03/16 |
| 20GJ0014US | US | i5-6200U | No | Intel HD 520 | 4GBx2 | 13.3" FHD (1920x1080) IPS | None | 256GB SSD M.2 Opal2 | None | Intel 8260 ac, 2x2 + BT4.1 | Black | 720p | Non-backlit | Fingerprint Reader | dTPM1.2 + FW TPM2.0 | 3-cell (42Wh) | 45W | Windows 10 Pro 64 | 3-year, Depot | 03/16 |
| 20GJ0015US | US | i3-6100U | No | Intel HD 520 | 4GBx1 | 13.3" HD (1366x768) | None | 192GB SSD M.2 | None | Intel 8260 ac, 2x2 + BT4.1 | Black | 720p | Non-backlit | Fingerprint Reader | dTPM1.2 + FW TPM2.0 | 3-cell (42Wh) | 45W | Windows 10 Pro 64 | 3-year, Depot | 03/16 |
| 20GJ0016US | US | i3-6100U | No | Intel HD 520 | 4GBx2 | 13.3" FHD (1920x1080) IPS | None | 128GB SSD M.2 | None | Intel 8260 ac, 2x2 + BT4.1 | Black | 720p | Non-backlit | Fingerprint Reader | dTPM1.2 + FW TPM2.0 | 3-cell (42Wh) | 45W | Windows 10 Pro 64 | 3-year, Depot | 03/16 |
| 20GJ0019US | US | i5-6300U | vPro | Intel HD 520 | 4GBx1 | 13.3" FHD (1920x1080) IPS | None | 256GB SSD M.2 Opal2 | None | Intel 8260 ac, 2x2 + BT4.1 | Black | 720p | Non-backlit | Fingerprint Reader | dTPM 1.2 | 3-cell (42Wh) | 45W | Windows 10 DG Windows 7 Pro 64 | 3-year, Depot | 03/16 |
| 20GJ0031US | US | i5-6200U | No | Intel HD 520 | 4GBx1 | 13.3" FHD (1920x1080) IPS | None | 128GB SSD M.2 | None | Intel 8260 ac, 2x2 + BT4.1 | Black | 720p | Non-backlit | Fingerprint Reader | dTPM 1.2 | 3-cell (42Wh) | 45W | Windows 10 DG Windows 7 Pro 64 | 3-year, Depot | 03/16 |
| 20GJ0039US | US | i5-6300U | vPro | Intel HD 520 | 4GBx1 | 13.3" FHD (1920x1080) IPS | None | 128GB SSD M.2 | None | Intel 8260 ac, 2x2 + BT4.1 | Black | 720p | Non-backlit | Fingerprint Reader | dTPM 1.2 | 3-cell (42Wh) | 45W | Windows 10 DG Windows 7 Pro 64 | 3-year, Depot | 03/16 |
| 20GJ003AUS | US | i5-6300U | vPro | Intel HD 520 | 4GBx1 | 13.3" HD (1366x768) | None | 128GB SSD M.2 | None | Intel 8260 ac, 2x2 + BT4.1 | Black | 720p | Non-backlit | Fingerprint Reader | dTPM 1.2 | 3-cell (42Wh) | 45W | Windows 10 DG Windows 7 Pro 64 | 3-year, Depot | 03/16 |
| 20GJ003BUS | US | i5-6300U | vPro | Intel HD 520 | 8GBx1 | 13.3" FHD (1920x1080) IPS | None | 128GB SSD M.2 | None | Intel 8260 ac, 2x2 + BT4.1 | Black | 720p | Non-backlit | Fingerprint Reader | dTPM 1.2 | 3-cell (42Wh) | 45W | Windows 10 DG Windows 7 Pro 64 | 3-year, Depot | 03/16 |
| 20GJ003CUS | US | i5-6300U | vPro | Intel HD 520 | 8GBx1 | 13.3" FHD (1920x1080) IPS | None | 256GB SSD M.2 Opal2 | None | Intel 8260 ac, 2x2 + BT4.1 | Black | 720p | Non-backlit | Fingerprint Reader | dTPM 1.2 | 3-cell (42Wh) | 45W | Windows 10 DG Windows 7 Pro 64 | 3-year, Depot | 03/16 |
| 20GJ003WUS | US | i3-6100U | No | Intel HD 520 | 4GBx1 | 13.3" FHD (1920x1080) IPS | None | 128GB SSD M.2 | None | Intel 8260 ac, 2x2 + BT4.1 | Black | 720p | Non-backlit | Fingerprint Reader | dTPM 1.2 | 3-cell (42Wh) | 45W | Windows 10 DG Windows 7 Pro 64 | 3-year, Depot | 03/16 |
| 20GJ003XUS | US | i5-6200U | No | Intel HD 520 | 4GBx1 | 13.3" HD (1366x768) | None | 128GB SSD M.2 | None | Intel 8260 ac, 2x2 + BT4.1 | Black | 720p | Non-backlit | Fingerprint Reader | dTPM 1.2 | 3-cell (42Wh) | 45W | Windows 10 DG Windows 7 Pro 64 | 3-year, Depot | 03/16 |

| Model | Region | Processor | vPro | Graphics | Memory | Display | Multi-touch | Storage | Optical | WLAN + Bluetooth | Color | Camera | Keyboard | Fingerprint Reader | TPM | Battery (internal) | Power Adapter | Operating System | Warranty | Ann Date (m/y) |
|------------|--------|-----------|------|--------------|--------|---------------------------|-------------|---------------------|---------|----------------------------|--------|--------|-------------|--------------------|---------------------|--------------------|---------------|--------------------------------|---------------|----------------|
| 20GJ003YUS | US | i3-6100U | No | Intel HD 520 | 4GBx1 | 13.3" FHD (1920x1080) IPS | None | 128GB SSD M.2 | None | Intel 8260 ac, 2x2 + BT4.1 | Black | 720p | Non-backlit | Fingerprint Reader | dTPM 1.2 | 3-cell (42Wh) | 45W | Windows 10 DG Windows 7 Pro 64 | 3-year, Depot | 03/16 |
| 20GJ0048US | US | i5-6200U | No | Intel HD 520 | 8GBx1 | 13.3" FHD (1920x1080) IPS | None | 256GB SSD M.2 Opal2 | None | Intel 8260 ac, 2x2 + BT4.1 | Black | 720p | Non-backlit | Fingerprint Reader | dTPM1.2 + FW TPM2.0 | 3-cell (42Wh) | 45W | Windows 10 Pro 64 | 1-year, Depot | 06/16 |
| 20GJ0055US | US | i5-6200U | No | Intel HD 520 | 8GBx1 | 13.3" HD (1366x768) | None | 256GB SSD M.2 Opal2 | None | Intel 8260 ac, 2x2 + BT4.1 | Black | 720p | Non-backlit | Fingerprint Reader | dTPM1.2 + FW TPM2.0 | 3-cell (42Wh) | 45W | Windows 10 Pro 64 | 1-year, Depot | 06/16 |
| 20GJ005EUS | US | i3-6100U | No | Intel HD 520 | 4GBx1 | 13.3" HD (1366x768) | None | 128GB SSD M.2 | None | Intel 8260 ac, 2x2 + BT4.1 | Black | 720p | Non-backlit | Fingerprint Reader | dTPM1.2 + FW TPM2.0 | 3-cell (42Wh) | 45W | Windows 10 Pro 64 | 1-year, Depot | 06/16 |
| 20GJ005FUS | US | i5-6200U | No | Intel HD 520 | 4GBx1 | 13.3" HD (1366x768) | None | 128GB SSD M.2 | None | Intel 8260 ac, 2x2 + BT4.1 | Black | 720p | Non-backlit | Fingerprint Reader | dTPM1.2 + FW TPM2.0 | 3-cell (42Wh) | 45W | Windows 10 Pro 64 | 1-year, Depot | 06/16 |
| 20GJ005JUS | US | i5-6300U | vPro | Intel HD 520 | 8GBx1 | 13.3" FHD (1920x1080) IPS | None | 256GB SSD M.2 Opal2 | None | Intel 8260 ac, 2x2 + BT4.1 | Silver | 720p | Non-backlit | None | dTPM 1.2 | 3-cell (42Wh) | 45W | Windows 10 DG Windows 7 Pro 64 | 3-year, Depot | 04/16 |
| 20GJ005KUS | US | i5-6200U | No | Intel HD 520 | 8GBx1 | 13.3" FHD (1920x1080) IPS | None | 256GB SSD M.2 Opal2 | None | Intel 8260 ac, 2x2 + BT4.1 | Silver | 720p | Non-backlit | None | dTPM 1.2 | 3-cell (42Wh) | 45W | Windows 10 DG Windows 7 Pro 64 | 3-year, Depot | 04/16 |
| 20GJ005LUS | US | i5-6300U | vPro | Intel HD 520 | 8GBx2 | 13.3" FHD (1920x1080) IPS | None | 512GB SSD M.2 | None | Intel 8260 ac, 2x2 + BT4.1 | Silver | 720p | Non-backlit | None | dTPM 1.2 | 3-cell (42Wh) | 45W | Windows 10 DG Windows 7 Pro 64 | 3-year, Depot | 04/16 |
| 20GJ006MUS | US | i5-6300U | vPro | Intel HD 520 | 8GBx1 | 13.3" FHD (1920x1080) IPS | None | 512GB SSD M.2 | None | Intel 8260 ac, 2x2 + BT4.1 | Black | 720p | Non-backlit | Fingerprint Reader | dTPM1.2 + FW TPM2.0 | 3-cell (42Wh) | 45W | Windows 10 Pro 64 | 3-year, Depot | 10/16 |

| Model | Region | Processor | vPro | Graphics | Memory | Display | Multi-touch | Storage | Optical | WLAN + Bluetooth | Color | Camera | Keyboard | Fingerprint Reader | TPM | Battery (internal) | Power Adapter | Operating System | Warranty | Ann Date (m/y) |
|------------|--------|---------------|------|--------------|--------|---------------------------|-------------|---------------|---------|----------------------------|-------|--------|-------------|--------------------|---------------------|--------------------|---------------|-------------------|---------------|----------------|
| 20GJ000BUS | US | Celeron 3855U | No | Intel HD 510 | 4GBx1 | 13.3" HD (1366x768) | None | 128GB SSD M.2 | None | Intel 8260 ac, 2x2 + BT4.1 | Black | 720p | Non-backlit | Fingerprint Reader | dTPM1.2 + FW TPM2.0 | 3-cell (42Wh) | 45W | Windows 10 Pro 64 | 3-year, Depot | 03/16 |
| 20GJ000CUS | US | Celeron 3855U | No | Intel HD 510 | 4GBx1 | 13.3" FHD (1920x1080) IPS | None | 128GB SSD M.2 | None | Intel 8260 ac, 2x2 + BT4.1 | Black | 720p | Non-backlit | Fingerprint Reader | dTPM1.2 + FW TPM2.0 | 3-cell (42Wh) | 45W | Windows 10 Pro 64 | 3-year, Depot | 03/16 |



ThinkPad 13 (2nd Gen) Platform Specifications

Product Specifications Reference (PSREF)

| | | | | | | | | | | |
|-------------------|---|-------------------------------------|--------------|----------------|---------------------|-------|--------------|-----------------------|---|---|
| Processor | Intel® Celeron® Processor or 7th Generation Intel Core™ i3 / i5 / i7 Processor | | | | | | | | Smart card reader | None |
| | Processor Number | # of Cores | # of Threads | Base Frequency | Max Turbo Frequency | Cache | Memory Types | Processor Graphics | Media reader | 4-in-1 reader (MMC, SD, SDHC, SDXC) |
| | Cel 3865U | 2 | 4 | 1.8 GHz | - | 2MB | DDR4-2133 | Intel HD Graphics 610 | Ports | Three USB 3.1 Gen 1 (USB 3.0, one Always On), one USB Type-C, HDMI, Lenovo OneLink+ connector |
| | i3-7100U | | | 2.4 GHz | - | 3MB | | Intel HD Graphics 620 | | |
| | i5-7200U | | | 2.5 GHz | 3.1 GHz | 3MB | | | | |
| i5-7300U | 2.6 GHz | | | 3.5 GHz | 3MB | | | | | |
| i7-7500U | 2.7 GHz | 3.5 GHz | 4MB | | | | | Camera | HD720p resolution, low light sensitive, fixed focus | |
| Graphics | Intel HD Graphics 610 or 620 in processor, supports external digital monitor via HDMI or USB Type-C; supports three independent displays; Max resolution: 1920x1080 (HDMI)@60Hz, 3840x2160 (USB Type-C)@60Hz | | | | | | | | Audio support | HD Audio, Realtek® ALC3268 codec / stereo speakers, 2W x 2 / dual array microphone, combo audio/microphone jack |
| | Chipset | Intel SoC (System on Chip) platform | | | | | | | | Keyboard |
| Memory | 32GB max / 2133MHz DDR4, two DDR4 SO-DIMM sockets | | | | | | | | UltraNav™ | TrackPoint® pointing device and buttonless Mylar surface touchpad, multi-touch |
| Display | <i>Some:</i> 13.3" (338mm) HD (1366x768), anti-glare, LED backlight, 250 nits, 16:9 aspect ratio, 500:1 contrast ratio <i>Some:</i> 13.3" (338mm) FHD (1920x1080), anti-glare, LED backlight, IPS, 250 nits, 16:9 aspect ratio, 700:1 contrast ratio, 170° viewing angle | | | | | | | | Security | Power-on password, hard disk password, supervisor password, security keyhole |
| Multi-touch (opt) | On-cell touch, supports 10-finger gesture (FHD only) | | | | | | | | Security chip | Discrete TPM 2.0, TCG Certified |
| Storage | <i>Some:</i> M.2 SSD / SATA 6.0Gb/s (e.g. xxxG SSD) <i>Some:</i> M.2 SSD / PCIe NVMe, PCIe 3.0 x 4, 32Gb/s (e.g. xxxG SSD PCIe NVMe) | | | | | | | | vPro (optional) | Intel vPro Technology |
| Optical | None | | | | | | | | Fingerprint reader | Optional: swipe style fingerprint reader on the palm rest |
| Ethernet | Gigabit Ethernet via the accessional ThinkPad OneLink+ to RJ45 Adapter (4X90K06975) or ThinkPad OneLink+ to VGA/RJ45 adapter (4X90J31060) (by native Intel Ethernet Connection I219-V (Non-vPro) or I219-LM (vPro)) | | | | | | | | Battery | Integrated Lithium Polymer 3-cell (42Wh) |
| WLAN | Intel Dual Band Wireless-AC 8265, Wi-Fi 2x2 802.11ac + BT4.1, M.2 card | | | | | | | | Max battery life | MobileMark® 2014: 14.56 hr |
| Bluetooth™ | Bluetooth 4.1 wireless, integrated in Wi-Fi + Bluetooth combo adapter * Intel 8265ac card supports Bluetooth 4.2 but is limited to BT 4.1 by Windows OS | | | | | | | | AC adapter | 45W AC adapter |
| WWAN | None | | | | | | | | Preload | <i>Some:</i> Windows® 10 Home 64 <i>Some:</i> Windows 10 Pro 64 • Lenovo Companion • Lenovo Setting • Microsoft Office preloaded; purchase a product key to activate |
| Dimensions | <i>WxDxH (silver):</i> 12.69" x 8.77" x 0.75"; 322.4mm x 222.8mm x 19.1mm <i>WxDxH (black):</i> 12.69" x 8.77" x 0.78"; 322.4mm x 222.8mm x 19.8mm | | | | | | | | Limited warranty | <i>One of the following, configurable by model:</i> • 1-year depot repair service • 3-year/1-yr battery depot repair service • 3-year/1-yr battery limited onsite service |
| Weight | Starting at 3.17 lb / 1.44 kg | | | | | | | | Mil-Spec test | MIL-STD-810G military certification |
| Case color | Pure Black or Silver | | | | | | | | Environment | EPEAT™ Gold (US only); ENERGY STAR® 6.1; RoHS-compliant |
| Case material | <i>Black cover:</i> PC/ABS plastic; <i>Silver cover:</i> Aluminum | | | | | | | | | |

| Model | Region | Processor | vPro | Graphics | Memory | Display | Multi-touch | Storage(HDD/SSD) | Optical | WLAN + Bluetooth | Color | Camera | Keyboard | Fingerprint Reader | TPM | Battery (internal) | Power Adapter | Operating System | Warranty | Ann Date (m/y) |
|------------|--------|---------------|------|--------------|--------|---------------------------|----------------------|---------------------|---------|----------------------------|--------|--------|-------------|--------------------|----------|--------------------|---------------|-------------------|---------------|----------------|
| 20J10006US | US | i3-7100U | No | Intel HD 620 | 4GBx1 | 13.3" HD (1366x768) | None | 128GB SSD M.2 | None | Intel 8265 ac, 2x2 + BT4.1 | Black | 720p | Non-backlit | Fingerprint Reader | dTPM 2.0 | 3-cell (42Wh) | 45W | Windows 10 Pro 64 | 1-year, Depot | 12/16 |
| 20J1000AUS | US | i5-7200U | No | Intel HD 620 | 4GBx1 | 13.3" HD (1366x768) | None | 256GB SSD M.2 Opal2 | None | Intel 8265 ac, 2x2 + BT4.1 | Black | 720p | Non-backlit | Fingerprint Reader | dTPM 2.0 | 3-cell (42Wh) | 45W | Windows 10 Pro 64 | 1-year, Depot | 12/16 |
| 20J1000EUS | US | i5-7200U | No | Intel HD 620 | 8GBx1 | 13.3" HD (1366x768) | None | 256GB SSD M.2 Opal2 | None | Intel 8265 ac, 2x2 + BT4.1 | Black | 720p | Non-backlit | Fingerprint Reader | dTPM 2.0 | 3-cell (42Wh) | 45W | Windows 10 Pro 64 | 1-year, Depot | 12/16 |
| 20J1001BUS | US | i3-7100U | No | Intel HD 620 | 4GBx1 | 13.3" FHD (1920x1080) IPS | 10-point Multi-touch | 128GB SSD M.2 | None | Intel 8265 ac, 2x2 + BT4.1 | Black | 720p | Non-backlit | Fingerprint Reader | dTPM 2.0 | 3-cell (42Wh) | 45W | Windows 10 Pro 64 | 1-year, Depot | 12/16 |
| 20J1001CUS | US | i5-7200U | No | Intel HD 620 | 8GBx1 | 13.3" FHD (1920x1080) IPS | 10-point Multi-touch | 256GB SSD M.2 Opal2 | None | Intel 8265 ac, 2x2 + BT4.1 | Black | 720p | Backlit | Fingerprint Reader | dTPM 2.0 | 3-cell (42Wh) | 45W | Windows 10 Pro 64 | 3-year, Depot | 12/16 |
| 20J1001DUS | US | i5-7200U | No | Intel HD 620 | 4GBx1 | 13.3" FHD (1920x1080) IPS | 10-point Multi-touch | 128GB SSD M.2 | None | Intel 8265 ac, 2x2 + BT4.1 | Black | 720p | Non-backlit | Fingerprint Reader | dTPM 2.0 | 3-cell (42Wh) | 45W | Windows 10 Pro 64 | 1-year, Depot | 12/16 |
| 20J1001EUS | US | i3-7100U | No | Intel HD 620 | 4GBx1 | 13.3" FHD (1920x1080) IPS | 10-point Multi-touch | 128GB SSD M.2 | None | Intel 8265 ac, 2x2 + BT4.1 | Silver | 720p | Non-backlit | None | dTPM 2.0 | 3-cell (42Wh) | 45W | Windows 10 Pro 64 | 1-year, Depot | 12/16 |
| 20J1001FUS | US | i5-7200U | No | Intel HD 620 | 4GBx1 | 13.3" HD (1366x768) | None | 128GB SSD M.2 | None | Intel 8265 ac, 2x2 + BT4.1 | Silver | 720p | Non-backlit | None | dTPM 2.0 | 3-cell (42Wh) | 45W | Windows 10 Pro 64 | 1-year, Depot | 12/16 |
| 20J1001GUS | US | i5-7200U | No | Intel HD 620 | 8GBx1 | 13.3" FHD (1920x1080) IPS | 10-point Multi-touch | 256GB SSD M.2 Opal2 | None | Intel 8265 ac, 2x2 + BT4.1 | Silver | 720p | Backlit | None | dTPM 2.0 | 3-cell (42Wh) | 45W | Windows 10 Pro 64 | 3-year, Depot | 12/16 |
| 20J1001HUS | US | i3-7100U | No | Intel HD 620 | 4GBx1 | 13.3" HD (1366x768) | None | 128GB SSD M.2 | None | Intel 8265 ac, 2x2 + BT4.1 | Silver | 720p | Non-backlit | None | dTPM 2.0 | 3-cell (42Wh) | 45W | Windows 10 Pro 64 | 1-year, Depot | 12/16 |
| 20J1001JUS | US | i5-7200U | No | Intel HD 620 | 8GBx1 | 13.3" FHD (1920x1080) IPS | 10-point Multi-touch | 256GB SSD M.2 Opal2 | None | Intel 8265 ac, 2x2 + BT4.1 | Silver | 720p | Non-backlit | None | dTPM 2.0 | 3-cell (42Wh) | 45W | Windows 10 Pro 64 | 1-year, Depot | 12/16 |
| 20J10022US | US | i5-7200U | No | Intel HD 620 | 4GBx1 | 13.3" HD (1366x768) | None | 180GB SSD M.2 | None | Intel 8265 ac, 2x2 + BT4.1 | Black | 720p | Non-backlit | Fingerprint Reader | dTPM 2.0 | 3-cell (42Wh) | 45W | Windows 10 Pro 64 | 1-year, Depot | 01/17 |
| 20J10023US | US | i3-7100U | No | Intel HD 620 | 4GBx1 | 13.3" HD (1366x768) | None | 180GB SSD M.2 | None | Intel 8265 ac, 2x2 + BT4.1 | Black | 720p | Non-backlit | Fingerprint Reader | dTPM 2.0 | 3-cell (42Wh) | 45W | Windows 10 Pro 64 | 1-year, Depot | 01/17 |
| 20J10024US | US | i5-7300U | vPro | Intel HD 620 | 4GBx1 | 13.3" HD (1366x768) | None | 180GB SSD M.2 | None | Intel 8265 ac, 2x2 + BT4.1 | Black | 720p | Non-backlit | Fingerprint Reader | dTPM 2.0 | 3-cell (42Wh) | 45W | Windows 10 Pro 64 | 3-year, Depot | 03/17 |
| 20J10025US | US | i5-7300U | vPro | Intel HD 620 | 8GBx1 | 13.3" FHD (1920x1080) IPS | 10-point Multi-touch | 256GB SSD M.2 Opal2 | None | Intel 8265 ac, 2x2 + BT4.1 | Black | 720p | Backlit | Fingerprint Reader | dTPM 2.0 | 3-cell (42Wh) | 45W | Windows 10 Pro 64 | 3-year, Depot | 03/17 |
| 20J10045US | US | Celeron 3865U | No | Intel HD 610 | 4GBx1 | 13.3" HD (1366x768) | None | 128GB SSD M.2 | None | Intel 8265 ac, 2x2 + BT4.1 | Silver | 720p | Non-backlit | None | dTPM 2.0 | 3-cell (42Wh) | 45W | Windows 10 Pro 64 | 3-year, Depot | 03/17 |
| 20J10046US | US | Celeron 3865U | No | Intel HD 610 | 4GBx1 | 13.3" HD (1366x768) | None | 128GB SSD M.2 | None | Intel 8265 ac, 2x2 + BT4.1 | Black | 720p | Non-backlit | Fingerprint Reader | dTPM 2.0 | 3-cell (42Wh) | 45W | Windows 10 Pro 64 | 1-year, Depot | 03/17 |
| 20J10047US | US | Celeron 3865U | No | Intel HD 610 | 4GBx1 | 13.3" FHD (1920x1080) IPS | 10-point Multi-touch | 128GB SSD M.2 | None | Intel 8265 ac, 2x2 + BT4.1 | Black | 720p | Non-backlit | Fingerprint Reader | dTPM 2.0 | 3-cell (42Wh) | 45W | Windows 10 Pro 64 | 3-year, Depot | 03/17 |
| 20J10048US | US | Celeron 3865U | No | Intel HD 610 | 4GBx1 | 13.3" HD (1366x768) | None | 128GB SSD M.2 | None | Intel 8265 ac, 2x2 + BT4.1 | Black | 720p | Non-backlit | Fingerprint Reader | dTPM 2.0 | 3-cell (42Wh) | 45W | Windows 10 Pro 64 | 3-year, Depot | 03/17 |
| 20J10049US | US | Celeron 3865U | No | Intel HD 610 | 4GBx1 | 13.3" FHD (1920x1080) IPS | 10-point Multi-touch | 128GB SSD M.2 | None | Intel 8265 ac, 2x2 + BT4.1 | Silver | 720p | Non-backlit | None | dTPM 2.0 | 3-cell (42Wh) | 45W | Windows 10 Pro 64 | 3-year, Depot | 03/17 |

| Model | Region | Processor | vPro | Graphics | Memory | Display | Multi-touch | Storage(HDD/SSD) | Optical | WLAN + Bluetooth | Color | Camera | Keyboard | Fingerprint Reader | TPM | Battery (internal) | Power Adapter | Operating System | Warranty | Ann Date (m/y) |
|------------|--------|---------------|------|--------------|--------|---------------------------|----------------------|------------------|---------|----------------------------|-------|--------|-------------|--------------------|----------|--------------------|---------------|-------------------|---------------|----------------|
| 20J1004AUS | US | Celeron 3865U | No | Intel HD 610 | 4GBx1 | 13.3" FHD (1920x1080) IPS | 10-point Multi-touch | 128GB SSD M.2 | None | Intel 8265 ac, 2x2 + BT4.1 | Black | 720p | Non-backlit | Fingerprint Reader | dTPM 2.0 | 3-cell (42Wh) | 45W | Windows 10 Pro 64 | 1-year, Depot | 03/17 |
| 20J1004BUS | US | Celeron 3865U | No | Intel HD 610 | 4GBx2 | 13.3" FHD (1920x1080) IPS | 10-point Multi-touch | 128GB SSD M.2 | None | Intel 8265 ac, 2x2 + BT4.1 | Black | 720p | Backlit | Fingerprint Reader | dTPM 2.0 | 3-cell (42Wh) | 45W | Windows 10 Pro 64 | 3-year, Depot | 03/17 |
| 20J1004CUS | US | Celeron 3865U | No | Intel HD 610 | 4GBx2 | 13.3" HD (1366x768) | None | 128GB SSD M.2 | None | Intel 8265 ac, 2x2 + BT4.1 | Black | 720p | Backlit | Fingerprint Reader | dTPM 2.0 | 3-cell (42Wh) | 45W | Windows 10 Pro 64 | 3-year, Depot | 03/17 |



ThinkPad 13 Chromebook Platform Specifications

Product Specifications Reference (PSREF)

| | | | | | | | | | | |
|-------------------|---|------------|--------------|----------------|---------------------|-------|--------------|-----------------------|---|--|
| Processor | Intel® Celeron® Processor or 6th Generation Intel Core™ i3 / i5 Processor | | | | | | | | Dimensions ³ | <i>WxDxH:</i> 12.69" x 8.77" x 0.78"; 322.4mm x 222.8mm x 19.8mm |
| | Processor Number | # of Cores | # of Threads | Base Frequency | Max Turbo Frequency | Cache | Memory Types | Processor Graphics | Weight ² | Starting at 3.1 lb / 1.41 kg |
| | Cel 3855U | 2 | 2 | 1.6 GHz | - | 2MB | LPDDR3-1866 | Intel HD graphics 510 | Case color | Pure Black |
| | i3-6100U | | 4 | 2.3 GHz | - | 3MB | | Intel HD graphics 520 | Case material | PC/ABS plastic |
| i5-6300U | | | 2.4 GHz | 3.0 GHz | 3MB | | | | | |
| | | | | | | | | Smart card reader | None | |
| | | | | | | | | Media reader | 4-in-1 reader (MMC, SD, SDHC, SDXC) | |
| | | | | | | | | Ports | Two USB 3.0 (Always On), two USB Type-C | |
| Graphics | Intel HD Graphics 510 or 520 in processor, supports external digital monitor via USB Type-C; supports three independent displays; Max resolution: 3840X2160 (USB Type-C) @60Hz | | | | | | | | Camera | HD720p resolution, low light sensitive, fixed focus |
| | | | | | | | | | Audio support | HD Audio, Nuvoton NAU88L25B codec / stereo speakers, 2W x 2 / dual array microphone, combo audio/microphone jack |
| Chipset | Intel SoC (System on Chip) platform | | | | | | | | Keyboard | ThinkPad Chrome keyboard, 6-row, multimedia Fn keys |
| Memory | 4GB or 8GB / 1866MHz LPDDR3 / soldered to systemboard, no sockets | | | | | | | | Touchpad | Buttonless touchpad below keyboard, multi-touch |
| Display | <i>Some:</i> 13.3" (338mm) HD (1366x768), anti-glare, LED backlight, 200 nits, 16:9 aspect ratio, 500:1 contrast ratio <i>Some:</i> 13.3" (338mm) FHD (1920x1080), anti-glare, LED backlight, IPS, 220 nits, 16:9 aspect ratio, 700:1 contrast ratio, 170° viewing angle <i>Some:</i> 13.3" (338mm) FHD (1920x1080), glossy, LED backlight, IPS, multi-touch, 250 nits, 16:9 aspect ratio, 800:1 contrast ratio, 170° viewing angle | | | | | | | | Security | Security keyhole |
| | | | | | | | | | Security chip | Discrete TPM 1.2, TCG Certified |
| | | | | | | | | | vPro | None |
| Multi-touch (opt) | Capacitive-type multi-touch, supports 10-finger gesture | | | | | | | | Fingerprint reader | None |
| | | | | | | | | | Battery | Integrated Lithium Polymer 3-cell (42Wh) |
| Storage | 16GB or 32GB eMMC (embedded Multi Media Card) flash memory on board | | | | | | | | Max battery life ¹⁰ | 10 hr |
| Optical | None | | | | | | | | AC adapter | USB Type-C 45-watt AC adapter |
| Ethernet | None | | | | | | | | Preload | Google Chrome OS |
| WLAN ⁴ | 11ac+BT, Intel Dual Band Wireless-AC 7265, 2x2, M.2 card | | | | | | | | Limited warranty ¹² | 1-year depot repair service |
| Bluetooth™ | Bluetooth 4.0 wireless, integrated in Wi-Fi + Bluetooth combo adapter | | | | | | | | Mil-Spec test | MIL-STD-810G military certification |
| WWAN | None | | | | | | | | Environment | EPEAT™ Gold (US only); ENERGY STAR® 6.1; RoHS-compliant |

| Model | Region | Processor | vPro | Graphics | Memory (Soldered) | Display | Multi-touch | Storage | Optical | WLAN + Bluetooth | Color | Camera | Keyboard | Fingerprint Reader | TPM | Battery (internal) | Power Adapter | Operating System | Warranty | Ann Date (m/y) |
|------------|--------|---------------|------|----------|-------------------|--------------------------------------|----------------------|-----------|---------|----------------------------|-------|--------|-------------|--------------------|----------|--------------------|---------------|------------------|---------------|----------------|
| 20GL0000US | US | Celeron 3855U | No | Intel HD | 5104GB Soldered | 13.3" HD (1366x768) Anti-glare | None | 16GB eMMC | None | Intel 7265 ac, 2x2 + BT4.0 | Black | 720p | Non-backlit | None | dTPM 1.2 | 3-cell (42Wh) | 45W | Chrome OS | 1-year, Depot | 05/16 |
| 20GL0002US | US | i3-6100U | No | Intel HD | 5204GB Soldered | 13.3" HD (1366x768) Anti-glare | None | 16GB eMMC | None | Intel 7265 ac, 2x2 + BT4.0 | Black | 720p | Non-backlit | None | dTPM 1.2 | 3-cell (42Wh) | 45W | Chrome OS | 1-year, Depot | 05/16 |
| 20GL0004US | US | i5-6300U | No | Intel HD | 5208GB Soldered | 13.3" FHD (1920x1080) IPS Anti-glare | None | 32GB eMMC | None | Intel 7265 ac, 2x2 + BT4.0 | Black | 720p | Non-backlit | None | dTPM 1.2 | 3-cell (42Wh) | 45W | Chrome OS | 1-year, Depot | 05/16 |
| 20GL0005US | US | i5-6300U | No | Intel HD | 5208GB Soldered | 13.3" HD (1366x768) Anti-glare | None | 32GB eMMC | None | Intel 7265 ac, 2x2 + BT4.0 | Black | 720p | Non-backlit | None | dTPM 1.2 | 3-cell (42Wh) | 45W | Chrome OS | 1-year, Depot | 05/16 |
| 20GL0006US | US | Celeron 3855U | No | Intel HD | 5104GB Soldered | 13.3" FHD (1920x1080) IPS Glossy | 10-point Multi-touch | 16GB eMMC | None | Intel 7265 ac, 2x2 + BT4.0 | Black | 720p | Non-backlit | None | dTPM 1.2 | 3-cell (42Wh) | 45W | Chrome OS | 1-year, Depot | 10/16 |
| 20GL0007US | US | i5-6300U | No | Intel HD | 5208GB Soldered | 13.3" FHD (1920x1080) IPS Glossy | 10-point Multi-touch | 32GB eMMC | None | Intel 7265 ac, 2x2 + BT4.0 | Black | 720p | Non-backlit | None | dTPM 1.2 | 3-cell (42Wh) | 45W | Chrome OS | 1-year, Depot | 10/16 |
| 20GL0008US | US | i3-6100U | No | Intel HD | 5204GB Soldered | 13.3" FHD (1920x1080) IPS Glossy | 10-point Multi-touch | 16GB eMMC | None | Intel 7265 ac, 2x2 + BT4.0 | Black | 720p | Non-backlit | None | dTPM 1.2 | 3-cell (42Wh) | 45W | Chrome OS | 1-year, Depot | 10/16 |



ThinkPad E450 Platform Specifications

Product Specifications Reference (PSREF)

| | | | | | | | | | | | |
|---|--|--|--------------|----------------|---------------------|--------|--------------|---|---|---|--|
| Processor | 4th or 5th Generation Intel® Core™ i3 / i5 / i7 Processor | | | | | | | | Multicard Reader Ports | 4-in-1 reader (MMC, SD, SDHC, SDXC) | |
| | Processor Number | # of Cores | # of Threads | Base Frequency | Max Turbo Frequency | Cache | Memory speed | Processor Graphics | | Two USB 3.0, one USB 2.0 (Always On), Ethernet (RJ-45), external monitor (HDMI), Lenovo OneLink connector | |
| | i3-4005U | 2 | 4 | 1.7 GHz | - | 3MB | DDR3L-1600 | HD4400 | | None | |
| | i3-5005U | 2 | 4 | 2.0 GHz | - | 3MB | | HD5500 | | Camera | |
| | i5-5200U | 2 | 4 | 2.2 GHz | 2.7 GHz | 3MB | | HD5500 | | <i>Some:</i> 0.3-megapixel, fixed focus | |
| i7-5500U | 2 | 4 | 2.4 GHz | 3.0 GHz | 4MB | HD5500 | | <i>Some:</i> HD720p resolution, fixed focus | | | |
| Graphics | Intel HD Graphics in processor only, or AMD Radeon R5 M240 Graphics, 1GB DDR3 memory, AMD Radeon R7 M260 Graphics, 2GB DDR3 memory, digital monitor support via HDMI™ (supporting HDCP to output protected content); supports dual independent display Max resolution: 1920x1080 (HDMI) @60Hz | | | | | | | | Keyboard | 6-row, spill-resistant, multimedia Fn keys | |
| Chipset Memory | Intel SoC (System on Chip) platform 16GB max ⁷ / PC3-12800 1600MHz DDR3L, non-parity, dual-channel capable, two 204-pin SO-DIMM sockets | | | | | | | | UltraNav™ | TrackPoint® pointing device and multi-touch with 3+2 buttons click pad | |
| | Display | Some: 14.0" (355mm) HD (1366x768) color, anti-glare, LED backlight, 200 nits, 16:9 aspect ratio | | | | | | | | ThinkLight™ | None |
| Multi-touch | | Some: 14.0" (355mm) FHD (1920x1080) color, anti-glare, LED backlight, 220 nits, 16:9 aspect ratio | | | | | | | | Security | Power-on password, hard disk password, supervisor password, security keyhole |
| | Storage | Some: SSD / SATA 6.0Gb/s, 2.5" wide, 7mm high, removable, upgradable | | | | | | | | Security chip | TPM : Trusted Platform Module, TCG 1.2-compliant |
| Optical M.2 SSD | | Some: HDD / SATA 6.0Gb/s, 2.5" wide, removable, upgradable, Shock Mounted Hard Drive, Active Protection System™ | | | | | | | | vPro | None |
| | Ethernet Bluetooth™ | Some: Hybrid drive with 8GB NAND flash memory | | | | | | | | Fingerprint reader | <i>Some:</i> Fingerprint reader on the keyboard bezel, swipe sensor |
| WLAN | | Intel WGI218V Gigabit Ethernet Connection | | | | | | | | NFC | None |
| | WWAN | Bluetooth 4.0 wireless, integrated in Wi-Fi + Bluetooth combo adapter | | | | | | | | Battery type | Li-Ion 6-cell (47Wh) |
| SIM card | | <i>One of the following, configurable by model:</i> | | | | | | | | Battery life | 6-cell (47Wh): up to 9.0 hr |
| | Smart Card Read ExpressCard | <ul style="list-style-type: none"> Intel Wireless-AC 3160, 1x1, Wi-Fi + Bluetooth combo adapter, M.2 Card Intel Dual Band Wireless-AC 7265, 2x2, Wi-Fi + BT combo adapter, M.2 Card RTL8723BE, Realtek 11b/g/n, 1x1, Wi-Fi + Bluetooth combo adapter, M.2 Card BCM43162, Broadcom 11-AC, 1x1, Wi-Fi + BT combo adapter, M.2 Card | | | | | | | | AC adapter | <i>Some:</i> 45-watt AC adapter (Integrated Graphics) |
| Dimensions Weight Case color Case material | | None | | | | | | | | Preload | <i>Some:</i> No operating system |
| | None | | | | | | | | <i>Some:</i> Windows® 7 Professional 64 preinstalled through downgrade rights in Windows 8.1 Pro 64-bit | | |
| Smart Card Read ExpressCard | None | | | | | | | | Preload | <i>Some:</i> Windows 8.1 Pro 64-bit | |
| | None | | | | | | | | | <ul style="list-style-type: none"> Lenovo Solution Center Lenovo SHAREit Lenovo Companion ThinkVantage System Update Evernote Maxthon Cloud Browser Norton Studio Microsoft Office preloaded; purchase a product key to activate Norton Internet Security (30 days of virus definitions) | |
| Smart Card Read ExpressCard | None | | | | | | | | Preload | <i>Some:</i> Windows 10 Pro 64 | |
| | None | | | | | | | | | <ul style="list-style-type: none"> Lenovo Solution Center Lenovo SHAREit Lenovo Companion Microsoft Office preloaded; purchase a product key to activate McAfee LiveSafe (30 days of virus definitions) | |
| Smart Card Read ExpressCard | None | | | | | | | | Preload | <i>Some:</i> Windows 7 Professional preinstalled through downgrade rights in Windows 10 Pro 64 | |
| | None | | | | | | | | | <ul style="list-style-type: none"> Lenovo Solution Center Lenovo SHAREit ThinkVantage Product Recovery Rescue and Recovery™ | |
| Smart Card Read ExpressCard | None | | | | | | | | Preload | <i>Some:</i> Windows 10 Pro 64 | |
| | None | | | | | | | | | <ul style="list-style-type: none"> Lenovo Solution Center Lenovo SHAREit ThinkVantage Product Recovery Rescue and Recovery™ | |
| Smart Card Read ExpressCard | None | | | | | | | | Preload | <i>Some:</i> Windows 10 Pro 64 | |
| | None | | | | | | | | | <ul style="list-style-type: none"> Lenovo Solution Center Lenovo SHAREit ThinkVantage Product Recovery Rescue and Recovery™ | |
| Smart Card Read ExpressCard | None | | | | | | | | Preload | <i>Some:</i> Windows 10 Pro 64 | |
| | None | | | | | | | | | <ul style="list-style-type: none"> Lenovo Solution Center Lenovo SHAREit ThinkVantage Product Recovery Rescue and Recovery™ | |
| Smart Card Read ExpressCard | None | | | | | | | | Preload | <i>Some:</i> Windows 10 Pro 64 | |
| | None | | | | | | | | | <ul style="list-style-type: none"> Lenovo Solution Center Lenovo SHAREit ThinkVantage Product Recovery Rescue and Recovery™ | |
| Smart Card Read ExpressCard | None | | | | | | | | Preload | <i>Some:</i> Windows 10 Pro 64 | |
| | None | | | | | | | | | <ul style="list-style-type: none"> Lenovo Solution Center Lenovo SHAREit ThinkVantage Product Recovery Rescue and Recovery™ | |
| Smart Card Read ExpressCard | None | | | | | | | | Preload | <i>Some:</i> Windows 10 Pro 64 | |
| | None | | | | | | | | | <ul style="list-style-type: none"> Lenovo Solution Center Lenovo SHAREit ThinkVantage Product Recovery Rescue and Recovery™ | |
| Smart Card Read ExpressCard | None | | | | | | | | Preload | <i>Some:</i> Windows 10 Pro 64 | |
| | None | | | | | | | | | <ul style="list-style-type: none"> Lenovo Solution Center Lenovo SHAREit ThinkVantage Product Recovery Rescue and Recovery™ | |
| Smart Card Read ExpressCard | None | | | | | | | | Preload | <i>Some:</i> Windows 10 Pro 64 | |
| | None | | | | | | | | | <ul style="list-style-type: none"> Lenovo Solution Center Lenovo SHAREit ThinkVantage Product Recovery Rescue and Recovery™ | |
| Smart Card Read ExpressCard | None | | | | | | | | Preload | <i>Some:</i> Windows 10 Pro 64 | |
| | None | | | | | | | | | <ul style="list-style-type: none"> Lenovo Solution Center Lenovo SHAREit ThinkVantage Product Recovery Rescue and Recovery™ | |
| Smart Card Read ExpressCard | None | | | | | | | | Preload | <i>Some:</i> Windows 10 Pro 64 | |
| | None | | | | | | | | | <ul style="list-style-type: none"> Lenovo Solution Center Lenovo SHAREit ThinkVantage Product Recovery Rescue and Recovery™ | |
| Smart Card Read ExpressCard | None | | | | | | | | Preload | <i>Some:</i> Windows 10 Pro 64 | |
| | None | | | | | | | | | <ul style="list-style-type: none"> Lenovo Solution Center Lenovo SHAREit ThinkVantage Product Recovery Rescue and Recovery™ | |
| Smart Card Read ExpressCard | None | | | | | | | | Preload | <i>Some:</i> Windows 10 Pro 64 | |
| | None | | | | | | | | | <ul style="list-style-type: none"> Lenovo Solution Center Lenovo SHAREit ThinkVantage Product Recovery Rescue and Recovery™ | |
| Smart Card Read ExpressCard | None | | | | | | | | Preload | <i>Some:</i> Windows 10 Pro 64 | |
| | None | | | | | | | | | <ul style="list-style-type: none"> Lenovo Solution Center Lenovo SHAREit ThinkVantage Product Recovery Rescue and Recovery™ | |
| Smart Card Read ExpressCard | None | | | | | | | | Preload | <i>Some:</i> Windows 10 Pro 64 | |
| | None | | | | | | | | | <ul style="list-style-type: none"> Lenovo Solution Center Lenovo SHAREit ThinkVantage Product Recovery Rescue and Recovery™ | |
| Smart Card Read ExpressCard | None | | | | | | | | Preload | <i>Some:</i> Windows 10 Pro 64 | |
| | None | | | | | | | | | <ul style="list-style-type: none"> Lenovo Solution Center Lenovo SHAREit ThinkVantage Product Recovery Rescue and Recovery™ | |
| Smart Card Read ExpressCard | None | | | | | | | | Preload | <i>Some:</i> Windows 10 Pro 64 | |
| | None | | | | | | | | | <ul style="list-style-type: none"> Lenovo Solution Center Lenovo SHAREit ThinkVantage Product Recovery Rescue and Recovery™ | |
| Smart Card Read ExpressCard | None | | | | | | | | Preload | <i>Some:</i> Windows 10 Pro 64 | |
| | None | | | | | | | | | <ul style="list-style-type: none"> Lenovo Solution Center Lenovo SHAREit ThinkVantage Product Recovery Rescue and Recovery™ | |
| Smart Card Read ExpressCard | None | | | | | | | | Preload | <i>Some:</i> Windows 10 Pro 64 | |
| | None | | | | | | | | | <ul style="list-style-type: none"> Lenovo Solution Center Lenovo SHAREit ThinkVantage Product Recovery Rescue and Recovery™ | |
| Smart Card Read ExpressCard | None | | | | | | | | Preload | <i>Some:</i> Windows 10 Pro 64 | |
| | None | | | | | | | | | <ul style="list-style-type: none"> Lenovo Solution Center Lenovo SHAREit ThinkVantage Product Recovery Rescue and Recovery™ | |
| Smart Card Read ExpressCard | None | | | | | | | | Preload | <i>Some:</i> Windows 10 Pro 64 | |
| | None | | | | | | | | | <ul style="list-style-type: none"> Lenovo Solution Center Lenovo SHAREit ThinkVantage Product Recovery Rescue and Recovery™ | |
| Smart Card Read ExpressCard | None | | | | | | | | Preload | <i>Some:</i> Windows 10 Pro 64 | |
| | None | | | | | | | | | <ul style="list-style-type: none"> Lenovo Solution Center Lenovo SHAREit ThinkVantage Product Recovery Rescue and Recovery™ | |
| Smart Card Read ExpressCard | None | | | | | | | | Preload | <i>Some:</i> Windows 10 Pro 64 | |
| | None | | | | | | | | | <ul style="list-style-type: none"> Lenovo Solution Center Lenovo SHAREit ThinkVantage Product Recovery Rescue and Recovery™ | |
| Smart Card Read ExpressCard | None | | | | | | | | Preload | <i>Some:</i> Windows 10 Pro 64 | |
| | None | | | | | | | | | <ul style="list-style-type: none"> Lenovo Solution Center Lenovo SHAREit ThinkVantage Product Recovery Rescue and Recovery™ | |
| Smart Card Read ExpressCard | None | | | | | | | | Preload | <i>Some:</i> Windows 10 Pro 64 | |
| | None | | | | | | | | | <ul style="list-style-type: none"> Lenovo Solution Center Lenovo SHAREit ThinkVantage Product Recovery Rescue and Recovery™ | |
| Smart Card Read ExpressCard | None | | | | | | | | Preload | <i>Some:</i> Windows 10 Pro 64 | |
| | None | | | | | | | | | <ul style="list-style-type: none"> Lenovo Solution Center Lenovo SHAREit ThinkVantage Product Recovery Rescue and Recovery™ | |
| Smart Card Read ExpressCard | None | | | | | | | | Preload | <i>Some:</i> Windows 10 Pro 64 | |
| | None | | | | | | | | | <ul style="list-style-type: none"> Lenovo Solution Center Lenovo SHAREit ThinkVantage Product Recovery Rescue and Recovery™ | |
| Smart Card Read ExpressCard | None | | | | | | | | Preload | <i>Some:</i> Windows 10 Pro 64 | |
| | None | | | | | | | | | <ul style="list-style-type: none"> Lenovo Solution Center Lenovo SHAREit ThinkVantage Product Recovery Rescue and Recovery™ | |
| Smart Card Read ExpressCard | None | | | | | | | | Preload | <i>Some:</i> Windows 10 Pro 64 | |
| | None | | | | | | | | | <ul style="list-style-type: none"> Lenovo Solution Center Lenovo SHAREit ThinkVantage Product Recovery Rescue and Recovery™ | |
| Smart Card Read ExpressCard | None | | | | | | | | Preload | <i>Some:</i> Windows 10 Pro 64 | |
| | None | | | | | | | | | <ul style="list-style-type: none"> Lenovo Solution Center Lenovo SHAREit ThinkVantage Product Recovery Rescue and Recovery™ | |
| Smart Card Read ExpressCard | None | | | | | | | | Preload | <i>Some:</i> Windows 10 Pro 64 | |
| | None | | | | | | | | | <ul style="list-style-type: none"> Lenovo Solution Center Lenovo SHAREit ThinkVantage Product Recovery Rescue and Recovery™ | |
| Smart Card Read ExpressCard | None | | | | | | | | Preload | <i>Some:</i> Windows 10 Pro 64 | |
| | None | | | | | | | | | <ul style="list-style-type: none"> Lenovo Solution Center Lenovo SHAREit ThinkVantage Product Recovery Rescue and Recovery™ | |
| Smart Card Read ExpressCard | None | | | | | | | | Preload | <i>Some:</i> Windows 10 Pro 64 | |
| | None | | | | | | | | | <ul style="list-style-type: none"> Lenovo Solution Center Lenovo SHAREit ThinkVantage Product Recovery Rescue and Recovery™ | |
| Smart Card Read ExpressCard | None | | | | | | | | Preload | <i>Some:</i> Windows 10 Pro 64 | |
| | None | | | | | | | | | <ul style="list-style-type: none"> Lenovo Solution Center Lenovo SHAREit ThinkVantage Product Recovery Rescue and Recovery™ | |
| Smart Card Read ExpressCard | None | | | | | | | | Preload | <i>Some:</i> Windows 10 Pro 64 | |
| | None | | | | | | | | | <ul style="list-style-type: none"> Lenovo Solution Center Lenovo SHAREit ThinkVantage Product Recovery Rescue and Recovery™ | |
| Smart Card Read ExpressCard | None | | | | | | | | Preload | <i>Some:</i> Windows 10 Pro 64 | |
| | None | | | | | | | | | <ul style="list-style-type: none"> Lenovo Solution Center Lenovo SHAREit ThinkVantage Product Recovery Rescue and Recovery™ | |
| Smart Card Read ExpressCard | None | | | | | | | | Preload | <i>Some:</i> Windows 10 Pro 64 | |
| | None | | | | | | | | | <ul style="list-style-type: none"> Lenovo Solution Center Lenovo SHAREit ThinkVantage Product Recovery Rescue and Recovery™ | |
| Smart Card Read ExpressCard | None | | | | | | | | Preload | <i>Some:</i> Windows 10 Pro 64 | |
| | None | | | | | | | | | <ul style="list-style-type: none"> Lenovo Solution Center Lenovo SHAREit ThinkVantage Product Recovery Rescue and Recovery™ | |
| Smart Card Read ExpressCard | None | | | | | | | | Preload | <i>Some:</i> Windows 10 Pro 64 | |
| | None | | | | | | | | | <ul style="list-style-type: none"> Lenovo Solution Center Lenovo SHAREit ThinkVantage Product Recovery Rescue and Recovery™ | |
| Smart Card Read ExpressCard | None | | | | | | | | Preload | <i>Some:</i> Windows 10 Pro 64 | |
| | None | | | | | | | | | <ul style="list-style-type: none"> Lenovo Solution Center Lenovo SHAREit ThinkVantage Product Recovery Rescue and Recovery™ | |
| Smart Card Read ExpressCard | None | | | | | | | | Preload | <i>Some:</i> Windows 10 Pro 64 | |
| | None | | | | | | | | | <ul style="list-style-type: none"> Lenovo Solution Center Lenovo SHAREit ThinkVantage Product Recovery Rescue and Recovery™ | |
| Smart Card Read ExpressCard | None | | | | | | | | Preload | <i>Some:</i> Windows 10 Pro 64 | |
| | None | | | | | | | | | <ul style="list-style-type: none"> Lenovo Solution Center Lenovo SHAREit ThinkVantage Product Recovery Rescue and Recovery™ | |
| Smart Card Read ExpressCard | None | | | | | | | | Preload | <i>Some:</i> Windows 10 Pro 64 | |
| | None | | | | | | | | | <ul style="list-style-type: none"> Lenovo Solution Center Lenovo SHAREit ThinkVantage Product Recovery Rescue and Recovery™ | |
| Smart Card Read ExpressCard | None | | | | | | | | Preload | <i>Some:</i> Windows 10 Pro 64 | |
| | None | | | | | | | | | <ul style="list-style-type: none"> Lenovo Solution Center Lenovo SHAREit ThinkVantage Product Recovery Rescue and Recovery™ | |
| Smart Card Read ExpressCard | None | | | | | | | | Preload | <i>Some:</i> Windows 10 Pro 64 | |
| | None | | | | | | | | | <ul style="list-style-type: none"> Lenovo Solution Center Lenovo SHAREit ThinkVantage Product Recovery Rescue and Recovery™ | |
| Smart Card Read ExpressCard | None | | | | | | | | Preload | <i>Some:</i> Windows 10 Pro 64 | |
| | None | | | | | | | | | <ul style="list-style-type: none"> Lenovo Solution Center Lenovo SHAREit ThinkVantage Product Recovery Rescue and Recovery™ | |
| Smart Card Read ExpressCard | None | | | | | | | | Preload | <i>Some:</i> Windows 10 Pro 64 | |
| | None | | | | | | | | | <ul style="list-style-type: none"> Lenovo Solution Center Lenovo SHAREit ThinkVantage Product Recovery Rescue and Recovery™ | |
| Smart Card Read ExpressCard | None | | | | | | | | Preload | <i>Some:</i> Windows 10 Pro 64 | |
| | None | | | | | | | | | <ul style="list-style-type: none"> Lenovo Solution Center Lenovo SHAREit ThinkVantage Product Recovery Rescue and Recovery™ | |
| Smart Card Read ExpressCard | None | | | | | | | | Preload | <i>Some:</i> Windows 10 Pro 64 | |
| | None | | | | | | | | | <ul style="list-style-type: none"> Lenovo Solution Center Lenovo SHAREit ThinkVantage Product Recovery Rescue and Recovery™ | |
| Smart Card Read ExpressCard | None | | | | | | | | Preload | <i>Some:</i> Windows 10 Pro 64 | |
| | None | | | | | | | | | <ul style="list-style-type: none"> Lenovo Solution Center Lenovo SHAREit ThinkVantage Product Recovery Rescue and Recovery™ | |
| Smart Card Read ExpressCard | None | | | | | | | | Preload | <i>Some:</i> Windows 10 Pro 64 | |
| | None | | | | | | | | | <ul style="list-style-type: none"> Lenovo Solution Center Lenovo SHAREit ThinkVantage Product Recovery Rescue and Recovery™ | |
| Smart Card Read ExpressCard | None | | | | | | | | Preload | <i>Some:</i> Windows 10 Pro 64 | |
| | None | | | | | | | | | <ul style="list-style-type: none"> Lenovo Solution Center Lenovo SHAREit ThinkVantage Product Recovery Rescue and Recovery™ | |
| Smart Card Read ExpressCard | None | | | | | | | | Preload | <i>Some:</i> Windows 10 Pro 64 | |
| | None | | | | | | | | | <ul style="list-style-type: none"> Lenovo Solution Center Lenovo SHAREit ThinkVantage Product Recovery Rescue and Recovery™ | |
| Smart Card Read ExpressCard | None | | | | | | | | Preload | <i>Some:</i> Windows 10 Pro 64 | |
| | None | | | | | | | | | <ul style="list-style-type: none"> Lenovo Solution Center Lenovo SHAREit ThinkVantage Product Recovery Rescue and Recovery™ | |
| Smart Card Read ExpressCard | None | | | | | | | | Preload | <i>Some:</i> Windows 10 Pro 64 | |
| | None | | | | | | | | | <ul style="list-style-type: none"> Lenovo Solution Center Lenovo SHAREit ThinkVantage Product Recovery Rescue and Recovery™ | |
| Smart Card Read ExpressCard | None | | | | | | | | Preload | <i>Some:</i> Windows 10 Pro 64 | |
| | None | | | | | | | | | <ul style="list-style-type: none"> Lenovo Solution Center Lenovo SHAREit ThinkVantage Product Recovery Rescue and Recovery™ | |
| Smart Card Read ExpressCard | None | | | | | | | | Preload | <i>Some:</i> Windows 10 Pro 64 | |
| | None | | | | | | | | | <ul style="list-style-type: none"> Lenovo Solution Center Lenovo SHAREit ThinkVantage Product Recovery Rescue and Recovery™ | |
| Smart Card Read ExpressCard | None | | | | | | | | Preload | <i>Some:</i> Windows 10 Pro 64 | |
| | None | | | | | | | | | <ul style="list-style-type: none"> Lenovo Solution Center Lenovo SHAREit ThinkVantage Product Recovery Rescue and Recovery™ | |
| Smart Card Read ExpressCard | None | | | | | | | | Preload | <i>Some:</i> Windows 10 Pro 64 | |
| | None | | | | | | | | | <ul style="list-style-type: none"> Lenovo Solution Center Lenovo SHAREit ThinkVantage Product Recovery Rescue and Recovery™ | |
| Smart Card Read ExpressCard | None | | | | | | | | Preload | <i>Some:</i> Windows 10 Pro 64 | |
| | None | | | | | | | | | <ul style="list-style-type: none"> Lenovo Solution Center Lenovo SHAREit ThinkVantage Product Recovery Rescue and Recovery™ | |
| Smart Card Read ExpressCard | None | | | | | | | | Preload | <i>Some:</i> Windows 10 Pro 64 | |
| | None | | | | | | | | | <ul style="list-style-type: none"> Lenovo Solution Center Lenovo SHAREit ThinkVantage Product Recovery Rescue and Recovery™ | |
| Smart Card Read ExpressCard | None | | | | | | | | Preload | <i>Some:</i> Windows 10 Pro 64 | |
| | None | | | | | | | | | <ul style="list-style-type: none"> Lenovo Solution Center Lenovo SHAREit ThinkVantage Product Recovery Rescue and Recovery™ | |
| Smart Card Read ExpressCard | None | | | | | | | | Preload | <i>Some:</i> Windows 10 Pro 64 | |
| | None | | | | | | | | | <ul style="list-style-type: none"> Lenovo Solution Center Lenovo SHAREit ThinkVantage Product Recovery Rescue and Recovery™ | |
| Smart Card Read ExpressCard | None | | | | | | | | Preload | <i>Some:</i> Windows 10 Pro 64 | |
| | None | | | | | | | | | <ul style="list-style-type: none"> Lenovo Solution Center Lenovo SHAREit ThinkVantage Product Recovery Rescue and Recovery™ | |
| Smart Card Read ExpressCard | None | | | | | | | | Preload | <i>Some:</i> Windows 10 Pro 64 | |
| | None | | | | | | | | | <ul style="list-style-type: none"> Lenovo Solution Center Lenovo SHAREit ThinkVantage Product Recovery Rescue and Recovery™ | |
| Smart Card Read ExpressCard | None | | | | | | | | Preload | <i>Some:</i> Windows 10 Pro 64 | |
| | None | | | | | | | | | <ul style="list-style-type: none"> Lenovo Solution Center Lenovo SHAREit ThinkVantage Product Recovery Rescue and Recovery™ | |
| Smart Card Read ExpressCard | None | | | | | | | | Preload | <i>Some:</i> Windows 10 Pro 64 | |
| | None | | | | | | | | | <ul style="list-style-type: none"> Lenovo Solution Center Lenovo SHAREit ThinkVantage Product Recovery Rescue and Recovery™ | |
| Smart Card Read ExpressCard | None | | | | | | | | Preload | <i>Some:</i> Windows 10 Pro 64 | |
| | None | | | | | | | | | <ul style="list-style-type: none"> Lenovo Solution Center Lenovo SHAREit ThinkVantage Product Recovery Rescue and Recovery™ | |
| Smart Card Read ExpressCard | None | | | | | | | | Preload | <i>Some:</i> Windows 10 Pro 64 | |
| | None | | | | | | | | | <ul style="list-style-type: none"> Lenovo Solution Center Lenovo SHAREit ThinkVantage Product Recovery Rescue and Recovery™ | |
| Smart Card Read ExpressCard | None | | | | | | | | Preload | <i>Some:</i> Windows 10 Pro 64 | |
| | None | | | | | | | | | <ul style="list-style-type: none"> Lenovo Solution Center Lenovo SHAREit ThinkVantage Product Recovery Rescue and Recovery™ | |
| Smart Card Read ExpressCard | None | | | | | | | | Preload | <i>Some:</i> Windows 10 Pro 64 | |
| | | | | | | | | | | | |

| Model | Region | Processor | vPro | Graphics | Memory | Display | Multi-touch | Storage(HDD/SSD) | Optical | WLAN + Bluetooth | WWAN | SIM Card | Color | Case Material | Camera | Keyboard | Fingerprint Reader | TPM | Battery | Power Adapter | Operating System | Warranty | Ann Date (m/y) |
|------------|--------|-----------|------|-----------------|--------|-------------------|-------------|------------------|---------|----------------------------|------|----------|-------|---------------|--------|-------------|--------------------|----------|---------------|---------------|-----------------------|---------------|----------------|
| 20DC003FUS | US | i3-4005U | No | Intel HD 4400 | 4GBx1 | 14" HD (1366x768) | None | 500GB 7200rpm | None | Intel 3160 ac, 1x1 + BT4.0 | None | None | Black | PC/ABS | 720p | Non-backlit | None | dTPM 1.2 | 6-cell (47Wh) | 45W | Win8.1 64-bit | 1-year, Depot | 01/15 |
| 20DC003JUS | US | i3-4005U | No | Intel HD 4400 | 4GBx1 | 14" HD (1366x768) | None | 500GB 7200rpm | None | Intel 3160 ac, 1x1 + BT4.0 | None | None | Black | PC/ABS | 720p | Non-backlit | None | dTPM 1.2 | 6-cell (47Wh) | 45W | Win8.1 Pro 64-bit | 1-year, Depot | 01/15 |
| 20DC003KUS | US | i3-4005U | No | Intel HD 4400 | 8GBx1 | 14" HD (1366x768) | None | 500GB 7200rpm | None | Intel 3160 ac, 1x1 + BT4.0 | None | None | Black | PC/ABS | 720p | Non-backlit | Fingerprint Reader | dTPM 1.2 | 6-cell (47Wh) | 45W | Win8.1 Pro 64-bit | 1-year, Depot | 01/15 |
| 20DC003LUS | US | i3-4005U | No | Intel HD 4400 | 8GBx1 | 14" HD (1366x768) | None | 1TB 5400rpm | None | Intel 3160 ac, 1x1 + BT4.0 | None | None | Black | PC/ABS | 720p | Non-backlit | Fingerprint Reader | dTPM 1.2 | 6-cell (47Wh) | 45W | Win8.1 Pro 64-bit | 1-year, Depot | 01/15 |
| 20DC003MUS | US | i3-5005U | No | Intel HD 5500 | 4GBx1 | 14" HD (1366x768) | None | 500GB 7200rpm | None | Intel 3160 ac, 1x1 + BT4.0 | None | None | Black | PC/ABS | 720p | Non-backlit | Fingerprint Reader | dTPM 1.2 | 6-cell (47Wh) | 45W | Win8.1 64-bit | 1-year, Depot | 01/15 |
| 20DC003NUS | US | i3-5005U | No | Intel HD 5500 | 4GBx1 | 14" HD (1366x768) | None | 500GB 7200rpm | None | Intel 3160 ac, 1x1 + BT4.0 | None | None | Black | PC/ABS | 720p | Non-backlit | Fingerprint Reader | dTPM 1.2 | 6-cell (47Wh) | 45W | Win8.1 Pro 64-bit | 1-year, Depot | 01/15 |
| 20DC003PUS | US | i3-5005U | No | Intel HD 5500 | 4GBx1 | 14" HD (1366x768) | None | 1TB 5400rpm | None | Intel 3160 ac, 1x1 + BT4.0 | None | None | Black | PC/ABS | 720p | Non-backlit | Fingerprint Reader | dTPM 1.2 | 6-cell (47Wh) | 45W | Win8.1 Pro 64-bit | 1-year, Depot | 01/15 |
| 20DC003QUS | US | i3-5005U | No | Intel HD 5500 | 8GBx1 | 14" HD (1366x768) | None | 500GB 7200rpm | None | Intel 3160 ac, 1x1 + BT4.0 | None | None | Black | PC/ABS | 720p | Non-backlit | Fingerprint Reader | dTPM 1.2 | 6-cell (47Wh) | 45W | Win8.1 Pro 64-bit | 1-year, Depot | 01/15 |
| 20DC003RUS | US | i3-5005U | No | Intel HD 5500 | 8GBx1 | 14" HD (1366x768) | None | 1TB 5400rpm | None | Intel 3160 ac, 1x1 + BT4.0 | None | None | Black | PC/ABS | 720p | Non-backlit | Fingerprint Reader | dTPM 1.2 | 6-cell (47Wh) | 45W | Win8.1 Pro 64-bit | 1-year, Depot | 01/15 |
| 20DC003SUS | US | i5-5200U | No | Intel HD 5500 | 4GBx1 | 14" HD (1366x768) | None | 500GB 7200rpm | None | Intel 3160 ac, 1x1 + BT4.0 | None | None | Black | PC/ABS | 720p | Non-backlit | Fingerprint Reader | dTPM 1.2 | 6-cell (47Wh) | 45W | Win8.1 Pro 64-bit | 1-year, Depot | 01/15 |
| 20DC003TUS | US | i5-5200U | No | Intel HD 5500 | 4GBx1 | 14" HD (1366x768) | None | 1TB 5400rpm | None | Intel 3160 ac, 1x1 + BT4.0 | None | None | Black | PC/ABS | 720p | Non-backlit | Fingerprint Reader | dTPM 1.2 | 6-cell (47Wh) | 45W | Win8.1 Pro 64-bit | 1-year, Depot | 01/15 |
| 20DC003UUS | US | i5-5200U | No | Intel HD 5500 | 8GBx1 | 14" HD (1366x768) | None | 500GB 7200rpm | None | Intel 3160 ac, 1x1 + BT4.0 | None | None | Black | PC/ABS | 720p | Non-backlit | Fingerprint Reader | dTPM 1.2 | 6-cell (47Wh) | 45W | Win8.1 Pro 64-bit | 1-year, Depot | 01/15 |
| 20DC003VUS | US | i5-5200U | No | Intel HD 5500 | 8GBx1 | 14" HD (1366x768) | None | 1TB 5400rpm | None | Intel 3160 ac, 1x1 + BT4.0 | None | None | Black | PC/ABS | 720p | Non-backlit | Fingerprint Reader | dTPM 1.2 | 6-cell (47Wh) | 45W | Win8.1 Pro 64-bit | 1-year, Depot | 01/15 |
| 20DC003WUS | US | i3-4005U | No | Intel HD 4400 | 4GBx1 | 14" HD (1366x768) | None | 500GB 7200rpm | None | Intel 3160 ac, 1x1 + BT4.0 | None | None | Black | PC/ABS | 720p | Non-backlit | Fingerprint Reader | dTPM 1.2 | 6-cell (47Wh) | 45W | Win8.1 DG Win7 Pro 64 | 1-year, Depot | 01/15 |
| 20DC003XUS | US | i5-5200U | No | Intel HD 5500 | 4GBx1 | 14" HD (1366x768) | None | 128GB SSD | None | Intel 7265 ac, 2x2 + BT4.0 | None | None | Black | PC/ABS | 720p | Non-backlit | Fingerprint Reader | dTPM 1.2 | 6-cell (47Wh) | 45W | Win8.1 DG Win7 Pro 64 | 1-year, Depot | 01/15 |
| 20DC003YUS | US | i7-5500U | No | AMD R7 M260 2GB | 8GBx1 | 14" HD (1366x768) | None | 128GB SSD | None | Intel 7265 ac, 2x2 + BT4.0 | None | None | Black | PC/ABS | 720p | Non-backlit | Fingerprint Reader | None | 6-cell (47Wh) | 65W | Win8.1 DG Win7 Pro 64 | 1-year, Depot | 01/15 |
| 20DC0040US | US | i3-4005U | No | Intel HD 4400 | 4GBx1 | 14" HD (1366x768) | None | 500GB 7200rpm | None | Intel 3160 ac, 1x1 + BT4.0 | None | None | Black | PC/ABS | 720p | Non-backlit | None | dTPM 1.2 | 6-cell (47Wh) | 45W | Win8.1 DG Win7 Pro 64 | 1-year, Depot | 01/15 |
| 20DC0041US | US | i3-4005U | No | Intel HD 4400 | 4GBx1 | 14" HD (1366x768) | None | 1TB 5400rpm | None | Intel 3160 ac, 1x1 + BT4.0 | None | None | Black | PC/ABS | 720p | Non-backlit | Fingerprint Reader | dTPM 1.2 | 6-cell (47Wh) | 45W | Win8.1 DG Win7 Pro 64 | 1-year, Depot | 01/15 |
| 20DC0042US | US | i3-4005U | No | Intel HD 4400 | 8GBx1 | 14" HD (1366x768) | None | 500GB 7200rpm | None | Intel 3160 ac, 1x1 + BT4.0 | None | None | Black | PC/ABS | 720p | Non-backlit | Fingerprint Reader | dTPM 1.2 | 6-cell (47Wh) | 45W | Win8.1 DG Win7 Pro 64 | 1-year, Depot | 01/15 |
| 20DC0043US | US | i3-4005U | No | Intel HD 4400 | 8GBx1 | 14" HD (1366x768) | None | 1TB 5400rpm | None | Intel 3160 ac, 1x1 + BT4.0 | None | None | Black | PC/ABS | 720p | Non-backlit | Fingerprint Reader | dTPM 1.2 | 6-cell (47Wh) | 45W | Win8.1 DG Win7 Pro 64 | 1-year, Depot | 01/15 |

| Model | Region | Processor | vPro | Graphics | Memory | Display | Multi-touch | Storage(HDD/SSD) | Optical | WLAN + Bluetooth | WWAN | SIM Card | Color | Case Material | Camera | Keyboard | Fingerprint Reader | TPM | Battery | Power Adapter | Operating System | Warranty | Ann Date (m/y) |
|------------|--------|-----------|------|---------------|--------|---------------------|-------------|------------------|---------|----------------------------|------|----------|-------|---------------|--------|-------------|--------------------|----------|---------------|---------------|-----------------------|---------------|----------------|
| 20DC0044US | US | i3-5005U | No | Intel HD 5500 | 4GBx1 | 14" HD (1366x768) | None | 500GB 7200rpm | None | Intel 3160 ac, 1x1 + BT4.0 | None | None | Black | PC/ABS | 720p | Non-backlit | Fingerprint Reader | dTPM 1.2 | 6-cell (47Wh) | 45W | Win8.1 DG Win7 Pro 64 | 1-year, Depot | 01/15 |
| 20DC0045US | US | i3-5005U | No | Intel HD 5500 | 4GBx1 | 14" HD (1366x768) | None | 500GB 7200rpm | None | Intel 7265 ac, 2x2 + BT4.0 | None | None | Black | PC/ABS | 720p | Non-backlit | Fingerprint Reader | dTPM 1.2 | 6-cell (47Wh) | 45W | Win8.1 DG Win7 Pro 64 | 1-year, Depot | 01/15 |
| 20DC0046US | US | i3-5005U | No | Intel HD 5500 | 4GBx1 | 14" HD (1366x768) | None | 1TB 5400rpm | None | Intel 3160 ac, 1x1 + BT4.0 | None | None | Black | PC/ABS | 720p | Non-backlit | Fingerprint Reader | dTPM 1.2 | 6-cell (47Wh) | 45W | Win8.1 DG Win7 Pro 64 | 1-year, Depot | 01/15 |
| 20DC0047US | US | i3-5005U | No | Intel HD 5500 | 8GBx1 | 14" HD (1366x768) | None | 500GB 7200rpm | None | Intel 3160 ac, 1x1 + BT4.0 | None | None | Black | PC/ABS | 720p | Non-backlit | Fingerprint Reader | dTPM 1.2 | 6-cell (47Wh) | 45W | Win8.1 DG Win7 Pro 64 | 1-year, Depot | 01/15 |
| 20DC0048US | US | i3-5005U | No | Intel HD 5500 | 8GBx1 | 14" HD (1366x768) | None | 500GB 7200rpm | None | Intel 7265 ac, 2x2 + BT4.0 | None | None | Black | PC/ABS | 720p | Non-backlit | Fingerprint Reader | dTPM 1.2 | 6-cell (47Wh) | 45W | Win8.1 DG Win7 Pro 64 | 1-year, Depot | 01/15 |
| 20DC0049US | US | i3-5005U | No | Intel HD 5500 | 8GBx1 | 14" HD (1366x768) | None | 1TB 5400rpm | None | Intel 3160 ac, 1x1 + BT4.0 | None | None | Black | PC/ABS | 720p | Non-backlit | Fingerprint Reader | dTPM 1.2 | 6-cell (47Wh) | 45W | Win8.1 DG Win7 Pro 64 | 1-year, Depot | 01/15 |
| 20DC004CUS | US | i5-5200U | No | Intel HD 5500 | 4GBx1 | 14" HD (1366x768) | None | 500GB 7200rpm | None | Intel 3160 ac, 1x1 + BT4.0 | None | None | Black | PC/ABS | 720p | Non-backlit | Fingerprint Reader | dTPM 1.2 | 6-cell (47Wh) | 45W | Win8.1 DG Win7 Pro 64 | 1-year, Depot | 01/15 |
| 20DC004DUS | US | i5-5200U | No | Intel HD 5500 | 4GBx1 | 14" HD (1366x768) | None | 500GB 7200rpm | None | Intel 7265 ac, 2x2 + BT4.0 | None | None | Black | PC/ABS | 720p | Non-backlit | Fingerprint Reader | dTPM 1.2 | 6-cell (47Wh) | 45W | Win8.1 DG Win7 Pro 64 | 1-year, Depot | 01/15 |
| 20DC004EUS | US | i5-5200U | No | Intel HD 5500 | 4GBx1 | 14" FHD (1920x1080) | None | 500GB 7200rpm | None | Intel 7265 ac, 2x2 + BT4.0 | None | None | Black | PC/ABS | 720p | Non-backlit | Fingerprint Reader | dTPM 1.2 | 6-cell (47Wh) | 45W | Win8.1 DG Win7 Pro 64 | 1-year, Depot | 01/15 |
| 20DC004FUS | US | i5-5200U | No | Intel HD 5500 | 4GBx1 | 14" FHD (1920x1080) | None | 128GB SSD | None | Intel 7265 ac, 2x2 + BT4.0 | None | None | Black | PC/ABS | 720p | Non-backlit | Fingerprint Reader | dTPM 1.2 | 6-cell (47Wh) | 45W | Win8.1 DG Win7 Pro 64 | 1-year, Depot | 01/15 |
| 20DC004GUS | US | i5-5200U | No | Intel HD 5500 | 4GBx1 | 14" HD (1366x768) | None | 1TB 5400rpm | None | Intel 3160 ac, 1x1 + BT4.0 | None | None | Black | PC/ABS | 720p | Non-backlit | Fingerprint Reader | dTPM 1.2 | 6-cell (47Wh) | 45W | Win8.1 DG Win7 Pro 64 | 1-year, Depot | 01/15 |
| 20DC004HUS | US | i5-5200U | No | Intel HD 5500 | 4GBx1 | 14" HD (1366x768) | None | 1TB 5400rpm | None | Intel 7265 ac, 2x2 + BT4.0 | None | None | Black | PC/ABS | 720p | Non-backlit | Fingerprint Reader | dTPM 1.2 | 6-cell (47Wh) | 45W | Win8.1 DG Win7 Pro 64 | 1-year, Depot | 01/15 |
| 20DC004JUS | US | i5-5200U | No | Intel HD 5500 | 4GBx1 | 14" FHD (1920x1080) | None | 1TB 5400rpm | None | Intel 7265 ac, 2x2 + BT4.0 | None | None | Black | PC/ABS | 720p | Non-backlit | Fingerprint Reader | dTPM 1.2 | 6-cell (47Wh) | 45W | Win8.1 DG Win7 Pro 64 | 1-year, Depot | 01/15 |
| 20DC004KUS | US | i5-5200U | No | Intel HD 5500 | 8GBx1 | 14" HD (1366x768) | None | 500GB 7200rpm | None | Intel 3160 ac, 1x1 + BT4.0 | None | None | Black | PC/ABS | 720p | Non-backlit | Fingerprint Reader | dTPM 1.2 | 6-cell (47Wh) | 45W | Win8.1 DG Win7 Pro 64 | 1-year, Depot | 01/15 |
| 20DC004LUS | US | i5-5200U | No | Intel HD 5500 | 8GBx1 | 14" HD (1366x768) | None | 500GB 7200rpm | None | Intel 7265 ac, 2x2 + BT4.0 | None | None | Black | PC/ABS | 720p | Non-backlit | Fingerprint Reader | dTPM 1.2 | 6-cell (47Wh) | 45W | Win8.1 DG Win7 Pro 64 | 1-year, Depot | 01/15 |
| 20DC004MUS | US | i5-5200U | No | Intel HD 5500 | 8GBx1 | 14" FHD (1920x1080) | None | 500GB 7200rpm | None | Intel 7265 ac, 2x2 + BT4.0 | None | None | Black | PC/ABS | 720p | Non-backlit | Fingerprint Reader | dTPM 1.2 | 6-cell (47Wh) | 45W | Win8.1 DG Win7 Pro 64 | 1-year, Depot | 01/15 |
| 20DC004NUS | US | i5-5200U | No | Intel HD 5500 | 8GBx1 | 14" HD (1366x768) | None | 128GB SSD | None | Intel 7265 ac, 2x2 + BT4.0 | None | None | Black | PC/ABS | 720p | Non-backlit | Fingerprint Reader | dTPM 1.2 | 6-cell (47Wh) | 45W | Win8.1 DG Win7 Pro 64 | 1-year, Depot | 01/15 |
| 20DC004PUS | US | i5-5200U | No | Intel HD 5500 | 8GBx1 | 14" FHD (1920x1080) | None | 128GB SSD | None | Intel 7265 ac, 2x2 + BT4.0 | None | None | Black | PC/ABS | 720p | Non-backlit | Fingerprint Reader | dTPM 1.2 | 6-cell (47Wh) | 45W | Win8.1 DG Win7 Pro 64 | 1-year, Depot | 01/15 |
| 20DC004QUS | US | i5-5200U | No | Intel HD 5500 | 8GBx1 | 14" HD (1366x768) | None | 1TB 5400rpm | None | Intel 3160 ac, 1x1 + BT4.0 | None | None | Black | PC/ABS | 720p | Non-backlit | Fingerprint Reader | dTPM 1.2 | 6-cell (47Wh) | 45W | Win8.1 DG Win7 Pro 64 | 1-year, Depot | 01/15 |
| 20DC004SUS | US | i5-5200U | No | Intel HD 5500 | 8GBx1 | 14" HD (1366x768) | None | 1TB 5400rpm | None | Intel 7265 ac, 2x2 + BT4.0 | None | None | Black | PC/ABS | 720p | Non-backlit | Fingerprint Reader | dTPM 1.2 | 6-cell (47Wh) | 45W | Win8.1 DG Win7 Pro 64 | 1-year, Depot | 01/15 |

| Model | Region | Processor | vPro | Graphics | Memory | Display | Multi-touch | Storage(HDD/SSD) | Optical | WLAN + Bluetooth | WWAN | SIM Card | Color | Case Material | Camera | Keyboard | Fingerprint Reader | TPM | Battery | Power Adapter | Operating System | Warranty | Ann Date (m/y) |
|------------|--------|-----------|------|-----------------|--------|---------------------|-------------|------------------|---------|----------------------------|------|----------|-------|---------------|--------|-------------|--------------------|----------|---------------|---------------|-----------------------|---------------|----------------|
| 20DC004TUS | US | i5-5200U | No | Intel HD 5500 | 8GBx1 | 14" FHD (1920x1080) | None | 1TB 5400rpm | None | Intel 7265 ac, 2x2 + BT4.0 | None | None | Black | PC/ABS | 720p | Non-backlit | Fingerprint Reader | dTPM 1.2 | 6-cell (47Wh) | 45W | Win8.1 DG Win7 Pro 64 | 1-year, Depot | 01/15 |
| 20DC004UUS | US | i7-5500U | No | AMD R7 M260 2GB | 4GBx1 | 14" FHD (1920x1080) | None | 500GB 7200rpm | None | Intel 7265 ac, 2x2 + BT4.0 | None | None | Black | PC/ABS | 720p | Non-backlit | Fingerprint Reader | None | 6-cell (47Wh) | 65W | Win8.1 DG Win7 Pro 64 | 1-year, Depot | 01/15 |
| 20DC004VUS | US | i7-5500U | No | AMD R7 M260 2GB | 4GBx1 | 14" FHD (1920x1080) | None | 128GB SSD | None | Intel 7265 ac, 2x2 + BT4.0 | None | None | Black | PC/ABS | 720p | Non-backlit | Fingerprint Reader | None | 6-cell (47Wh) | 65W | Win8.1 DG Win7 Pro 64 | 1-year, Depot | 01/15 |
| 20DC004WUS | US | i7-5500U | No | AMD R7 M260 2GB | 4GBx1 | 14" HD (1366x768) | None | 1TB 5400rpm | None | Intel 7265 ac, 2x2 + BT4.0 | None | None | Black | PC/ABS | 720p | Non-backlit | Fingerprint Reader | None | 6-cell (47Wh) | 65W | Win8.1 DG Win7 Pro 64 | 1-year, Depot | 01/15 |
| 20DC004XUS | US | i7-5500U | No | AMD R7 M260 2GB | 4GBx1 | 14" FHD (1920x1080) | None | 1TB 5400rpm | None | Intel 7265 ac, 2x2 + BT4.0 | None | None | Black | PC/ABS | 720p | Non-backlit | Fingerprint Reader | None | 6-cell (47Wh) | 65W | Win8.1 DG Win7 Pro 64 | 1-year, Depot | 01/15 |
| 20DC004YUS | US | i7-5500U | No | AMD R7 M260 2GB | 8GBx1 | 14" HD (1366x768) | None | 500GB 7200rpm | None | Intel 7265 ac, 2x2 + BT4.0 | None | None | Black | PC/ABS | 720p | Non-backlit | Fingerprint Reader | None | 6-cell (47Wh) | 65W | Win8.1 DG Win7 Pro 64 | 1-year, Depot | 01/15 |
| 20DC0050US | US | i7-5500U | No | AMD R7 M260 2GB | 8GBx1 | 14" FHD (1920x1080) | None | 128GB SSD | None | Intel 7265 ac, 2x2 + BT4.0 | None | None | Black | PC/ABS | 720p | Non-backlit | Fingerprint Reader | None | 6-cell (47Wh) | 65W | Win8.1 DG Win7 Pro 64 | 1-year, Depot | 01/15 |
| 20DC0051US | US | i7-5500U | No | AMD R7 M260 2GB | 8GBx1 | 14" FHD (1920x1080) | None | 1TB 5400rpm | None | Intel 7265 ac, 2x2 + BT4.0 | None | None | Black | PC/ABS | 720p | Non-backlit | Fingerprint Reader | None | 6-cell (47Wh) | 65W | Win8.1 DG Win7 Pro 64 | 1-year, Depot | 01/15 |
| 20DC0099US | US | i7-5500U | No | AMD R7 M260 2GB | 4GBx1 | 14" HD (1366x768) | None | 500GB 7200rpm | None | Intel 7265 ac, 2x2 + BT4.0 | None | None | Black | PC/ABS | 720p | Non-backlit | Fingerprint Reader | None | 6-cell (47Wh) | 65W | Win8.1 DG Win7 Pro 64 | 1-year, Depot | 01/15 |
| 20DC00AVUS | US | i3-4005U | No | Intel HD 4400 | 4GBx1 | 14" HD (1366x768) | None | 500GB 7200rpm | None | Intel 3160 ac, 1x1 + BT4.0 | None | None | Black | PC/ABS | 720p | Non-backlit | Fingerprint Reader | dTPM 1.2 | 6-cell (47Wh) | 45W | Win10 DG Win7 Pro 64 | 1-year, Depot | 07/15 |
| 20DC00AWUS | US | i7-5500U | No | AMD R7 M260 2GB | 4GBx1 | 14" FHD (1920x1080) | None | 500GB 7200rpm | None | Intel 7265 ac, 2x2 + BT4.0 | None | None | Black | PC/ABS | 720p | Non-backlit | Fingerprint Reader | None | 6-cell (47Wh) | 65W | Win10 Pro 64 | 1-year, Depot | 07/15 |
| 20DC00AXUS | US | i7-5500U | No | AMD R7 M260 2GB | 4GBx1 | 14" FHD (1920x1080) | None | 500GB 7200rpm | None | Intel 7265 ac, 2x2 + BT4.0 | None | None | Black | PC/ABS | 720p | Non-backlit | Fingerprint Reader | None | 6-cell (47Wh) | 65W | Win10 DG Win7 Pro 64 | 1-year, Depot | 07/15 |
| 20DC00AYUS | US | i7-5500U | No | AMD R7 M260 2GB | 8GBx1 | 14" FHD (1920x1080) | None | 192GB SSD | None | Intel 7265 ac, 2x2 + BT4.0 | None | None | Black | PC/ABS | 720p | Non-backlit | Fingerprint Reader | None | 6-cell (47Wh) | 65W | Win10 Pro 64 | 1-year, Depot | 07/15 |
| 20DC00B0US | US | i5-5200U | No | Intel HD 5500 | 4GBx1 | 14" HD (1366x768) | None | 500GB 7200rpm | None | Intel 3160 ac, 1x1 + BT4.0 | None | None | Black | PC/ABS | 720p | Non-backlit | Fingerprint Reader | dTPM 1.2 | 6-cell (47Wh) | 45W | Win10 DG Win7 Pro 64 | 1-year, Depot | 07/15 |
| 20DC00B1US | US | i5-5200U | No | Intel HD 5500 | 4GBx1 | 14" HD (1366x768) | None | 500GB 7200rpm | None | Intel 3160 ac, 1x1 + BT4.0 | None | None | Black | PC/ABS | 720p | Non-backlit | Fingerprint Reader | dTPM 1.2 | 6-cell (47Wh) | 45W | Win10 Pro 64 | 1-year, Depot | 07/15 |
| 20DC00B2US | US | i3-4005U | No | Intel HD 4400 | 4GBx1 | 14" HD (1366x768) | None | 500GB 7200rpm | None | Intel 3160 ac, 1x1 + BT4.0 | None | None | Black | PC/ABS | 720p | Non-backlit | Fingerprint Reader | dTPM 1.2 | 6-cell (47Wh) | 45W | Win10 Pro 64 | 1-year, Depot | 07/15 |
| 20DC00BVUS | US | i3-5005U | No | Intel HD 5500 | 4GBx1 | 14" HD (1366x768) | None | 500GB 7200rpm | None | Intel 3160 ac, 1x1 + BT4.0 | None | None | Black | PC/ABS | 0.3MP | Non-backlit | None | dTPM 1.2 | 6-cell (47Wh) | 45W | Win10 Pro 64 | 1-year, Depot | 08/15 |
| 20DC00BWUS | US | i3-5005U | No | Intel HD 5500 | 4GBx1 | 14" HD (1366x768) | None | 500GB 7200rpm | None | Intel 3160 ac, 1x1 + BT4.0 | None | None | Black | PC/ABS | 720p | Non-backlit | Fingerprint Reader | dTPM 1.2 | 6-cell (47Wh) | 45W | Win10 Pro 64 | 1-year, Depot | 08/15 |
| 20DC00BXUS | US | i3-5005U | No | Intel HD 5500 | 4GBx1 | 14" HD (1366x768) | None | 500GB 7200rpm | None | Intel 3160 ac, 1x1 + BT4.0 | None | None | Black | PC/ABS | 720p | Non-backlit | Fingerprint Reader | dTPM 1.2 | 6-cell (47Wh) | 45W | Win10 DG Win7 Pro 64 | 1-year, Depot | 08/15 |
| 20DC00BYUS | US | i3-5005U | No | Intel HD 5500 | 4GBx1 | 14" HD (1366x768) | None | 500GB 7200rpm | None | Intel 3160 ac, 1x1 + BT4.0 | None | None | Black | PC/ABS | 0.3MP | Non-backlit | None | dTPM 1.2 | 6-cell (47Wh) | 45W | Win10 DG Win7 Pro 64 | 1-year, Depot | 08/15 |

| Model | Region | Processor | vPro | Graphics | Memory | Display | Multi-touch | Storage(HDD/SSD) | Optical | WLAN + Bluetooth | WWAN | SIM Card | Color | Case Material | Camera | Keyboard | Fingerprint Reader | TPM | Battery | Power Adapter | Operating System | Warranty | Ann Date (m/y) |
|------------|--------|-----------|------|---------------|--------|-------------------|-------------|------------------|---------|----------------------------|------|----------|-------|---------------|--------|-------------|--------------------|----------|---------------|---------------|-------------------------|---------------|----------------|
| 20DC00C0US | US | i3-5005U | No | Intel HD 5500 | 4GBx1 | 14" HD (1366x768) | None | 192GB SSD | None | Intel 3160 ac, 1x1 + BT4.0 | None | None | Black | PC/ABS | 0.3MP | Non-backlit | None | dTPM 1.2 | 6-cell (47Wh) | 45W | Win10 DG Win7 Pro 64 | 1-year, Depot | 08/15 |



ThinkPad E460 Platform Specifications

Product Specifications Reference (PSREF)

| | | | | | | | | | | | |
|---------------|--|------------|--------------|----------------|---------------------|---------------|--------------|-----------------------|--------------------|--|---|
| Processor | 6th Generation Intel® Core™ i3 / i5 / i7 Processor | | | | | | | | Smart Card Reader | None | |
| | Processor Number | # of Cores | # of Threads | Base Frequency | Max Turbo Frequency | Cache | Memory Types | Processor Graphics | ExpressCard | None | |
| | i3-6100U | 2 | 4 | 2.3 GHz | - | 3MB | DDR3L-1600 | Intel HD Graphics 520 | Multicard Reader | 4-in-1 reader (MMC, SD, SDHC, SDXC) | |
| | i5-6200U | | | 2.3 GHz | 2.8 GHz | 3MB | | | Ports | Three USB 3.0 (one Always On), HDMI, Ethernet (RJ-45), Lenovo OneLink connector, combo audio / microphone jack | |
| i7-6500U | 2.5 GHz | | | 3.1 GHz | 4MB | Monitor cable | | | None | | |
| Graphics | Intel HD Graphics in processor only, or AMD Radeon R5 M330 Graphics, 2GB DDR3 memory, or AMD Radeon R7 M360 Graphics, 2GB DDR3 memory, digital monitor support via HDMI™ (supporting HDCP to output protected content); supports dual independent displays; Max resolution: 1920x1080 (HDMI) @60Hz | | | | | | | | Camera | <i>Some:</i> HD720p resolution, fixed focus | |
| Chipset | Intel SoC (System on Chip) platform | | | | | | | | Audio support | HD Audio, Conexant® CX11852 codec, Dolby® Advanced Audio™ / stereo speakers, 2W x 2 / dual array microphone, combo audio / microphone jack | |
| Memory | 16GB max / PC3-12800 1600MHz DDR3L, non-parity, dual-channel capable, two 204-pin SO-DIMM sockets | | | | | | | | Keyboard | 6-row, spill-resistant, multimedia Fn keys | |
| Display | <i>Some:</i> 14.0" (355mm) HD (1366x768) color, anti-glare, LED backlight, 220 nits, 16:9 aspect ratio <i>Some:</i> 14.0" (355mm) FHD (1920x1080) color, anti-glare, LED backlight, IPS, 250 nits, 16:9 aspect ratio | | | | | | | | UltraNav™ | TrackPoint® pointing device and multi-touch with 3+2 buttons click pad | |
| Multi-touch | None | | | | | | | | ThinkLight™ | None | |
| Storage | <i>Some:</i> SSD / SATA 6.0Gb/s, 2.5" wide, 7mm high, removable, upgradable <i>Some:</i> HDD / SATA 6.0Gb/s, 2.5" wide, removable, upgradable, Active Protection System™ <i>Some:</i> SSHD with 8GB NAND flash memory | | | | | | | | Security | Power-on password, hard disk password, supervisor password, security keyhole | |
| Optical | None | | | | | | | | Security chip | TPM2.0 : Trusted Platform Module, TPM2.0 FW (firmware) | |
| M.2 SSD | None | | | | | | | | TPM1.2 : | Trusted Platform Module, TCG 1.2-compliant | |
| Ethernet | Gigabit Ethernet Connection | | | | | | | | TPM : | TPM2.0 and TPM1.2 | |
| Bluetooth™ | Bluetooth wireless, integrated in Wi-Fi + Bluetooth combo adapter | | | | | | | | vPro | None | |
| WLAN | <i>One of the following, configurable by model:</i> <ul style="list-style-type: none"> Intel Dual Band Wireless-AC 3165, 1x1, Wi-Fi + BT combo adapter, M.2 Card Intel Dual Band Wireless-AC 8260, 2x2, Wi-Fi + BT combo adapter, M.2 Card BCM, Broadcom Wireless-AC, 1x1, Wi-Fi + Bluetooth combo adapter, M.2 Card QCA, Qualcomm Wireless-AC, 2x2, Wi-Fi + Bluetooth combo adapter, M.2 Card | | | | | | | | Fingerprint reader | <i>Some:</i> Fingerprint reader on the keyboard bezel, swipe sensor | |
| WWAN | None | | | | | | | | NFC | None | |
| SIM card | None | | | | | | | | Battery type | Li-Ion 6-cell (47Wh) | |
| Dimensions | <i>Aluminum (WxDxH):</i> 13.35" x 9.41" x 0.90"; 339mm x 239mm x 22.9mm <i>PC/ABS (WxDxH):</i> 13.35" x 9.41" x 0.96"; 339mm x 239mm x 24.4mm | | | | | | | | Battery life | 6-cell (47Wh): up to 9.0 hr | |
| Weight | From 4.23 lb (1.92kg) | | | | | | | | AC adapter | <i>Some:</i> 45-watt AC adapter (Integrated Graphics) <i>Some:</i> 65-watt AC adapter (Discrete Graphics) | |
| Case color | Graphite black | | | | | | | | Preload | <i>Some:</i> No operating system <i>Some:</i> Windows® 7 Professional 64 preinstalled through downgrade rights in Windows 10 Pro 64 <ul style="list-style-type: none"> Lenovo Solution Center Lenovo SHAREit ThinkVantage Product Recovery Rescue and Recovery™ ThinkVantage System Update PC Device Stage Adobe® Reader® Microsoft® Office preloaded; purchase a product key to activate McAfee® Live Safe (30-day trial) | <i>Some:</i> Windows 10 Pro 64 <i>Some:</i> Windows 10 Home 64 <ul style="list-style-type: none"> Lenovo Solution Center Lenovo REACHit Lenovo SHAREit Lenovo Companion Lenovo Settings ThinkVantage System Update Microsoft Office preloaded; purchase a product key to activate McAfee® Live Safe (30-day trial) |
| Case material | <i>Aluminum:</i> Aluminum display cover <i>PC/ABS:</i> PolyCarbonate/Acrylonitrile-Butadiene-Styrene (PC/ABS) plastic display cover | | | | | | | | Limited warranty | 1-year - depot repair service / service upgrades available | |
| | | | | | | | | | Mil-Spec test | None | |
| | | | | | | | | | Environment | EPEAT™ Gold; ENERGY STAR®; RoHS-compliant | |

ThinkPad E460 - TopSeller - 20ET

Product Specifications Reference (PSREF)

| Model | Region | Processor | vPro | Graphics | Memory | Display | Multi-touch | Storage | Optical | WLAN + Bluetooth | WWAN | SIM Card | Color | Case Material | Camera | Keyboard | Fingerprint Reader | TPM | Battery | Power Adapter | Operating System | Warranty | Ann Date (m/y) |
|------------|--------|-----------|------|-----------------|--------|-------------------------|-------------|-----------------|---------|----------------------------|------|----------|-------|---------------|--------|-------------|--------------------|---------------------|---------------|---------------|----------------------|---------------|----------------|
| 20ET000YUS | US | i3-6100U | No | Intel HD 520 | 4GBx1 | 14" HD (1366x768) | None | 500GB 7200rpm | None | Intel 3165 ac, 1x1 + BT4.0 | None | None | Black | PC/ABS | 720p | Non-backlit | Fingerprint Reader | dTPM 1.2 | 6-cell (47Wh) | 45W | Win10 DG Win7 Pro 64 | 1-year, Depot | 11/15 |
| 20ET0010US | US | i5-6200U | No | Intel HD 520 | 8GBx1 | 14" HD (1366x768) | None | 192GB SSD | None | Intel 3165 ac, 1x1 + BT4.0 | None | None | Black | PC/ABS | 720p | Non-backlit | Fingerprint Reader | dTPM 1.2 | 6-cell (47Wh) | 45W | Win10 DG Win7 Pro 64 | 1-year, Depot | 11/15 |
| 20ET0011US | US | i3-6100U | No | Intel HD 520 | 4GBx1 | 14" HD (1366x768) | None | 500GB 7200rpm | None | Intel 3165 ac, 1x1 + BT4.0 | None | None | Black | PC/ABS | 720p | Non-backlit | Fingerprint Reader | dTPM1.2 + FW TPM2.0 | 6-cell (47Wh) | 45W | Win10 Pro 64 | 1-year, Depot | 11/15 |
| 20ET0012US | US | i5-6200U | No | Intel HD 520 | 4GBx1 | 14" HD (1366x768) | None | 500GB 7200rpm | None | Intel 3165 ac, 1x1 + BT4.0 | None | None | Black | PC/ABS | 720p | Non-backlit | Fingerprint Reader | dTPM1.2 + FW TPM2.0 | 6-cell (47Wh) | 45W | Win10 Pro 64 | 1-year, Depot | 11/15 |
| 20ET0013US | US | i7-6500U | No | AMD R7 M360 2GB | 8GBx1 | 14" FHD (1920x1080) IPS | None | 500GB 7200rpm | None | Intel 8260 ac, 2x2 + BT4.0 | None | None | Black | Aluminum | 720p | Non-backlit | Fingerprint Reader | FW TPM 2.0 | 6-cell (47Wh) | 65W | Win10 DG Win7 Pro 64 | 1-year, Depot | 11/15 |
| 20ET0014US | US | i5-6200U | No | Intel HD 520 | 4GBx1 | 14" HD (1366x768) | None | 500GB 7200rpm | None | Intel 3165 ac, 1x1 + BT4.0 | None | None | Black | PC/ABS | 720p | Non-backlit | Fingerprint Reader | dTPM 1.2 | 6-cell (47Wh) | 45W | Win10 DG Win7 Pro 64 | 1-year, Depot | 11/15 |
| 20ET0015US | US | i3-6100U | No | Intel HD 520 | 4GBx1 | 14" HD (1366x768) | None | 192GB SSD | None | Intel 3165 ac, 1x1 + BT4.0 | None | None | Black | PC/ABS | 720p | Non-backlit | Fingerprint Reader | dTPM 1.2 | 6-cell (47Wh) | 45W | Win10 DG Win7 Pro 64 | 1-year, Depot | 11/15 |
| 20ET0016US | US | i5-6200U | No | Intel HD 520 | 8GBx1 | 14" HD (1366x768) | None | 192GB SSD | None | Intel 3165 ac, 1x1 + BT4.0 | None | None | Black | PC/ABS | 720p | Non-backlit | Fingerprint Reader | dTPM1.2 + FW TPM2.0 | 6-cell (47Wh) | 45W | Win10 Pro 64 | 1-year, Depot | 11/15 |
| 20ET0017US | US | i5-6200U | No | Intel HD 520 | 4GBx1 | 14" HD (1366x768) | None | 192GB SSD | None | Intel 3165 ac, 1x1 + BT4.0 | None | None | Black | PC/ABS | 720p | Non-backlit | Fingerprint Reader | dTPM1.2 + FW TPM2.0 | 6-cell (47Wh) | 45W | Win10 Pro 64 | 1-year, Depot | 11/15 |
| 20ET0018US | US | i3-6100U | No | Intel HD 520 | 4GBx1 | 14" HD (1366x768) | None | 192GB SSD | None | Intel 3165 ac, 1x1 + BT4.0 | None | None | Black | PC/ABS | 720p | Non-backlit | Fingerprint Reader | dTPM1.2 + FW TPM2.0 | 6-cell (47Wh) | 45W | Win10 Pro 64 | 1-year, Depot | 11/15 |
| 20ET0019US | US | i7-6500U | No | AMD R7 M360 2GB | 8GBx1 | 14" FHD (1920x1080) IPS | None | 192GB SSD | None | Intel 8260 ac, 2x2 + BT4.0 | None | None | Black | Aluminum | 720p | Non-backlit | Fingerprint Reader | FW TPM 2.0 | 6-cell (47Wh) | 65W | Win10 DG Win7 Pro 64 | 1-year, Depot | 11/15 |
| 20ET001AUS | US | i5-6200U | No | Intel HD 520 | 4GBx1 | 14" HD (1366x768) | None | 192GB SSD | None | Intel 3165 ac, 1x1 + BT4.0 | None | None | Black | PC/ABS | 720p | Non-backlit | Fingerprint Reader | dTPM 1.2 | 6-cell (47Wh) | 45W | Win10 DG Win7 Pro 64 | 1-year, Depot | 11/15 |
| 20ET001BUS | US | i7-6500U | No | AMD R7 M360 2GB | 8GBx1 | 14" FHD (1920x1080) IPS | None | 192GB SSD | None | Intel 8260 ac, 2x2 + BT4.0 | None | None | Black | Aluminum | 720p | Non-backlit | Fingerprint Reader | FW TPM 2.0 | 6-cell (47Wh) | 65W | Win10 Pro 64 | 1-year, Depot | 11/15 |
| 20ET001CUS | US | i7-6500U | No | AMD R7 M360 2GB | 8GBx1 | 14" FHD (1920x1080) IPS | None | 500GB 7200rpm | None | Intel 8260 ac, 2x2 + BT4.0 | None | None | Black | Aluminum | 720p | Non-backlit | Fingerprint Reader | FW TPM 2.0 | 6-cell (47Wh) | 65W | Win10 Pro 64 | 1-year, Depot | 11/15 |
| 20ET004GUS | US | i7-6500U | No | AMD R7 M360 2GB | 8GBx1 | 14" FHD (1920x1080) IPS | None | 256GB SSD Opal2 | None | Intel 8260 ac, 2x2 + BT4.0 | None | None | Black | Aluminum | 720p | Non-backlit | Fingerprint Reader | FW TPM 2.0 | 6-cell (47Wh) | 65W | Win10 Pro 64 | 1-year, Depot | 04/16 |
| 20ET004HUS | US | i7-6500U | No | AMD R7 M360 2GB | 8GBx1 | 14" FHD (1920x1080) IPS | None | 256GB SSD Opal2 | None | Intel 8260 ac, 2x2 + BT4.0 | None | None | Black | Aluminum | 720p | Non-backlit | Fingerprint Reader | FW TPM 2.0 | 6-cell (47Wh) | 65W | Win10 DG Win7 Pro 64 | 1-year, Depot | 04/16 |
| 20ET004VUS | US | i5-6200U | No | Intel HD 520 | 4GBx1 | 14" HD (1366x768) | None | 256GB SSD Opal2 | None | Intel 8260 ac, 2x2 + BT4.0 | None | None | Black | PC/ABS | 720p | Non-backlit | Fingerprint Reader | dTPM 1.2 | 6-cell (47Wh) | 45W | Win10 DG Win7 Pro 64 | 1-year, Depot | 09/16 |
| 20ET004WUS | US | i5-6200U | No | Intel HD 520 | 8GBx1 | 14" FHD (1920x1080) IPS | None | 256GB SSD Opal2 | None | Intel 8260 ac, 2x2 + BT4.0 | None | None | Black | Aluminum | 720p | Non-backlit | Fingerprint Reader | dTPM 1.2 | 6-cell (47Wh) | 45W | Win10 DG Win7 Pro 64 | 1-year, Depot | 09/16 |
| 20ET0054US | US | i5-6200U | No | Intel HD 520 | 8GBx1 | 14" HD (1366x768) | None | 500GB 7200rpm | None | Intel 3165 ac, 1x1 + BT4.0 | None | None | Black | PC/ABS | 720p | Non-backlit | Fingerprint Reader | dTPM1.2 + FW TPM2.0 | 6-cell (47Wh) | 45W | Win10 Pro 64 | 1-year, Depot | 10/16 |
| 20ET0055US | US | i5-6200U | No | Intel HD 520 | 8GBx1 | 14" FHD (1920x1080) IPS | None | 500GB 7200rpm | None | Intel 3165 ac, 1x1 + BT4.0 | None | None | Black | Aluminum | 720p | Non-backlit | Fingerprint Reader | dTPM1.2 + FW TPM2.0 | 6-cell (47Wh) | 45W | Win10 Pro 64 | 1-year, Depot | 10/16 |



ThinkPad E465 Platform Specifications

Product Specifications Reference (PSREF)

| | | | | | | | | | | | |
|---------------|--|------------|--------------|-------------|---------------------|-------|--------------|------------------------|--------------------|---|---|
| Processor | AMD Accelerated Processor A6, A8, or A10 APU | | | | | | | | Smart Card Reader | None | |
| | Processor Number | # of Cores | # of Threads | Clock Speed | Max Turbo Frequency | Cache | Memory speed | Graphics | ExpressCard | None | |
| | A6-8500P | 2 | 6 | 1.6 GHz | 3.0 GHz | 1MB | DDR3L-1600 | R5 Graphics | Multicard Reader | 4-in-1 reader (MMC, SD, SDHC, SDXC) | |
| | A6-8500P | 2 | 6 | 1.6 GHz | 3.0 GHz | 1MB | | R5 M330 | Ports | Three USB 3.0 (one Always On), HDMI, Ethernet (RJ-45), Lenovo OneLink connector, combo audio / microphone jack | |
| | A8-8600P | 4 | 10 | 1.6 GHz | 3.0 GHz | 2MB | | R6 M335DX (R6+R5 M330) | Monitor cable | None | |
| | A10-8700P | 4 | 10 | 1.8 GHz | 3.2 GHz | 2MB | | R6 M340DX (R6+R5 M330) | Camera | HD720p resolution, fixed focus | |
| Graphics | AMD Radeon™ R5 Graphics in processor only, or AMD Radeon R5 M330 Graphics, 2GB DDR3 memory, or Dual Graphics support for A8 and A10 APU digital monitor support via HDMI™ (supporting HDCP to output protected content); supports dual independent display Max resolution: 1920x1080 (HDMI) @60Hz | | | | | | | | Audio support | HD Audio, Conexant® CX11852 codec, Dolby® Advanced Audio™ / stereo speakers, 2W x 2 / dual array microphone, combo audio / microphone jack | |
| Chipset | AMD SoC (System on Chip) platform | | | | | | | | Keyboard | 6-row, spill-resistant, multimedia Fn keys | |
| Memory | 16GB max / PC3-12800 1600MHz DDR3L, non-parity, dual-channel capable, two 204-pin SO-DIMM sockets | | | | | | | | UltraNav™ | TrackPoint® pointing device and multi-touch with 3+2 buttons click pad | |
| Display | <i>Some:</i> 14.0" (355mm) HD (1366x768) color, anti-glare, LED backlight, 220 nits, 16:9 aspect ratio <i>Some:</i> 14.0" (355mm) FHD (1920x1080) color, anti-glare, LED backlight, IPS, 250 nits, 16:9 aspect ratio | | | | | | | | ThinkLight™ | None | |
| Multi-touch | None | | | | | | | | Security | Power-on password, hard disk password, supervisor password, security keyhole | |
| Storage | <i>Some:</i> SSD / SATA 6.0Gb/s, 2.5" wide, 7mm high, removable, upgradable <i>Some:</i> HDD / SATA 6.0Gb/s, 2.5" wide, removable, upgradable, Active Protection System™ <i>Some:</i> SSHD with 8GB NAND flash memory | | | | | | | | Security chip | <i>TPM2.0:</i> Trusted Platform Module, TPM2.0 FW (firmware) <i>TPM1.2:</i> Trusted Platform Module, TCG 1.2-compliant <i>TPM:</i> TPM2.0 and TPM1.2 | |
| Optical | None | | | | | | | | vPro | None | |
| M.2 SSD | None | | | | | | | | Fingerprint reader | <i>Some:</i> Fingerprint reader on the keyboard bezel, swipe sensor | |
| Ethernet | Gigabit Ethernet Connection | | | | | | | | NFC | None | |
| Bluetooth™ | Bluetooth wireless, integrated in Wi-Fi + Bluetooth combo adapter | | | | | | | | Battery type | Li-Ion 6-cell (47Wh) | |
| WLAN | <i>One of the following, configurable by model:</i> <ul style="list-style-type: none"> • BCM, Broadcom Wireless-AC, 1x1, Wi-Fi + Bluetooth combo adapter, M.2 Card • QCA, Qualcomm Wireless-AC, 2x2, Wi-Fi + Bluetooth combo adapter, M.2 Card | | | | | | | | Battery life | Up to 6.5 hr | |
| WWAN | None | | | | | | | | AC adapter | <i>Some:</i> 45-watt AC adapter (Integrated Graphics) <i>Some:</i> 65-watt AC adapter (Discrete Graphics) | |
| SIM card | None | | | | | | | | Preload | <i>Some:</i> No operating system <i>Some:</i> Windows® 7 Professional 64 <i>Some:</i> Windows® 7 Professional 64 preinstalled through downgrade rights in Windows 10 Pro 64 <ul style="list-style-type: none"> • Lenovo Solution Center • Lenovo SHAREit • ThinkVantage Product Recovery • Rescue and Recovery™ • ThinkVantage System Update • PC Device Stage • Adobe® Reader® • Microsoft® Office preloaded; purchase a product key to activate • McAfee® Live Safe (30-day trial) | <i>Some:</i> Windows 10 Pro 64 <i>Some:</i> Windows 10 Home 64 <ul style="list-style-type: none"> • Lenovo Solution Center • Lenovo REACHit • Lenovo SHAREit • Lenovo Companion • Lenovo Settings • ThinkVantage System Update • Microsoft Office preloaded; purchase a product key to activate • McAfee® Live Safe (30-day trial) |
| Dimensions | <i>Aluminum (WxDxH):</i> 13.35" x 9.41" x 0.90"; 339mm x 239mm x 22.9mm <i>PC/ABS (WxDxH):</i> 13.35" x 9.41" x 0.96"; 339mm x 239mm x 24.4mm | | | | | | | | Limited warranty | 1-year - depot repair service / service upgrades available | |
| Weight | From 4.27 lb (1.94kg) | | | | | | | | Environment | EPEAT™ Gold; ENERGY STAR®; RoHS-compliant | |
| Case color | Graphite black | | | | | | | | | | |
| Case material | <i>Aluminum:</i> Aluminum display cover <i>PC/ABS:</i> PolyCarbonate/Acrylonitrile-Butadiene-Styrene (PC/ABS) plastic display cover | | | | | | | | | | |

ThinkPad E465 - TopSeller - 20EX

Product Specifications Reference (PSREF)

| Model | Region | Processor | vPro | Graphics | Memory | Display | Multi-touch | Storage | Optical | WLAN + Bluetooth | WWAN | SIM Card | Color | Case Material | Camera | Keyboard | Fingerprint Reader | TPM | Battery | Power Adapter | Operating System | Warranty | Ann Date (m/y) |
|------------|--------|---------------|------|-------------------|--------|-------------------------|-------------|---------------|---------|--------------------------|------|----------|-------|---------------|--------|-------------|--------------------|---------------------|---------------|---------------|----------------------|---------------|----------------|
| 20EX0008US | US | AMD A10-8700P | No | AMD R6 M340DX 2GB | 4GBx1 | 14" HD (1366x768) | None | 500GB 5400rpm | None | BCM43162 ac, 1x1 + BT4.0 | None | None | Black | PC/ABS | 720p | Non-backlit | None | FW TPM 2.0 | 6-cell (47Wh) | 65W | Win10 DG Win7 Pro 64 | 1-year, Depot | 11/15 |
| 20EX0009US | US | AMD A10-8700P | No | AMD R6 M340DX 2GB | 8GBx1 | 14" HD (1366x768) | None | 192GB SSD | None | BCM43162 ac, 1x1 + BT4.0 | None | None | Black | PC/ABS | 720p | Non-backlit | None | FW TPM 2.0 | 6-cell (47Wh) | 65W | Win10 Pro 64 | 1-year, Depot | 11/15 |
| 20EX000AUS | US | AMD A10-8700P | No | AMD R6 M340DX 2GB | 4GBx1 | 14" HD (1366x768) | None | 500GB 5400rpm | None | BCM43162 ac, 1x1 + BT4.0 | None | None | Black | PC/ABS | 720p | Non-backlit | None | FW TPM 2.0 | 6-cell (47Wh) | 65W | Win10 Pro 64 | 1-year, Depot | 11/15 |
| 20EX000BUS | US | AMD A10-8700P | No | AMD R6 M340DX 2GB | 8GBx1 | 14" HD (1366x768) | None | 500GB 5400rpm | None | BCM43162 ac, 1x1 + BT4.0 | None | None | Black | PC/ABS | 720p | Non-backlit | None | FW TPM 2.0 | 6-cell (47Wh) | 65W | Win10 DG Win7 Pro 64 | 1-year, Depot | 11/15 |
| 20EX000CUS | US | AMD A6-8500P | No | AMD R5 Graphics | 4GBx1 | 14" HD (1366x768) | None | 500GB 5400rpm | None | BCM43162 ac, 1x1 + BT4.0 | None | None | Black | PC/ABS | 720p | Non-backlit | None | dTPM 1.2 | 6-cell (47Wh) | 45W | Win10 DG Win7 Pro 64 | 1-year, Depot | 11/15 |
| 20EX000DUS | US | AMD A10-8700P | No | AMD R6 M340DX 2GB | 8GBx1 | 14" HD (1366x768) | None | 500GB 5400rpm | None | BCM43162 ac, 1x1 + BT4.0 | None | None | Black | PC/ABS | 720p | Non-backlit | None | FW TPM 2.0 | 6-cell (47Wh) | 65W | Win10 Pro 64 | 1-year, Depot | 11/15 |
| 20EX000EUS | US | AMD A10-8700P | No | AMD R6 M340DX 2GB | 8GBx1 | 14" HD (1366x768) | None | 192GB SSD | None | BCM43162 ac, 1x1 + BT4.0 | None | None | Black | PC/ABS | 720p | Non-backlit | None | FW TPM 2.0 | 6-cell (47Wh) | 65W | Win10 DG Win7 Pro 64 | 1-year, Depot | 11/15 |
| 20EX001JUS | US | AMD A10-8700P | No | AMD R6 M340DX 2GB | 4GBx1 | 14" FHD (1920x1080) IPS | None | 500GB 5400rpm | None | QCA435 ac, 1x1 + BT4.0 | None | None | Black | Aluminum | 720p | Non-backlit | None | FW TPM 2.0 | 6-cell (47Wh) | 65W | Win10 Pro 64 | 1-year, Depot | 06/16 |
| 20EX001KUS | US | AMD A10-8700P | No | AMD R6 M340DX 2GB | 8GBx1 | 14" FHD (1920x1080) IPS | None | 192GB SSD | None | QCA435 ac, 1x1 + BT4.0 | None | None | Black | Aluminum | 720p | Non-backlit | None | FW TPM 2.0 | 6-cell (47Wh) | 65W | Win10 Pro 64 | 1-year, Depot | 06/16 |
| 20EX001LUS | US | AMD A6-8500P | No | AMD R5 Graphics | 4GBx1 | 14" HD (1366x768) | None | 500GB 5400rpm | None | QCA435 ac, 1x1 + BT4.0 | None | None | Black | PC/ABS | 720p | Non-backlit | None | dTPM 1.2 | 6-cell (47Wh) | 45W | Win10 DG Win7 Pro 64 | 1-year, Depot | 06/16 |
| 20EX001MUS | US | AMD A10-8700P | No | AMD R6 M340DX 2GB | 8GBx1 | 14" HD (1366x768) | None | 192GB SSD | None | QCA435 ac, 1x1 + BT4.0 | None | None | Black | PC/ABS | 720p | Non-backlit | None | FW TPM 2.0 | 6-cell (47Wh) | 65W | Win10 DG Win7 Pro 64 | 1-year, Depot | 06/16 |
| 20EX001NUS | US | AMD A6-8500P | No | AMD R5 Graphics | 4GBx1 | 14" HD (1366x768) | None | 500GB 5400rpm | None | QCA435 ac, 1x1 + BT4.0 | None | None | Black | PC/ABS | 720p | Non-backlit | None | dTPM1.2 + FW TPM2.0 | 6-cell (47Wh) | 45W | Win10 Pro 64 | 1-year, Depot | 06/16 |
| 20EX001PUS | US | AMD A10-8700P | No | AMD R6 M340DX 2GB | 8GBx1 | 14" HD (1366x768) | None | 500GB 5400rpm | None | QCA435 ac, 1x1 + BT4.0 | None | None | Black | PC/ABS | 720p | Non-backlit | None | FW TPM 2.0 | 6-cell (47Wh) | 65W | Win10 DG Win7 Pro 64 | 1-year, Depot | 06/16 |
| 20EX001QUS | US | AMD A10-8700P | No | AMD R6 M340DX 2GB | 8GBx1 | 14" FHD (1920x1080) IPS | None | 500GB 5400rpm | None | QCA435 ac, 1x1 + BT4.0 | None | None | Black | Aluminum | 720p | Non-backlit | None | FW TPM 2.0 | 6-cell (47Wh) | 65W | Win10 Pro 64 | 1-year, Depot | 06/16 |
| 20EX001RUS | US | AMD A10-8700P | No | AMD R6 M340DX 2GB | 4GBx1 | 14" HD (1366x768) | None | 500GB 5400rpm | None | QCA435 ac, 1x1 + BT4.0 | None | None | Black | PC/ABS | 720p | Non-backlit | None | FW TPM 2.0 | 6-cell (47Wh) | 65W | Win10 DG Win7 Pro 64 | 1-year, Depot | 06/16 |

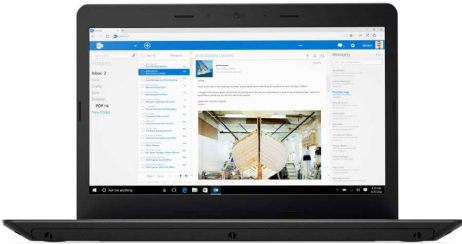

ThinkPad E470 Platform Specifications

Product Specifications Reference (PSREF)

| | | | | | | | | | |
|-------------------|--|------------|--------------|----------------|---------------------|-------|-------------------|-----------------------|--|
| Processor | 7th Generation Intel® Core™ i3 / i5 / i7 Processor | | | | | | | | Dimensions <i>Aluminum (WxDxH):</i> 13.35" x 9.53" x 0.88"; 339mm x 242mm x 22.4mm <i>PC/ABS (WxDxH):</i> 13.35" x 9.53" x 0.93"; 339mm x 242mm x 23.7mm |
| | Processor Number | # of Cores | # of Threads | Base Frequency | Max Turbo Frequency | Cache | Memory Controller | Processor Graphics | |
| | i3-6100U | 2 | 4 | 2.3 GHz | - | 3MB | DDR4-2133 | Intel HD Graphics 520 | |
| | i5-6200U | | | 2.3 GHz | 2.8 GHz | 3MB | | | |
| | i7-6500U | | | 2.5 GHz | 3.1 GHz | 4MB | | | |
| | i3-7100U | | | 2.4 GHz | - | 3MB | DDR4-2133 | Intel HD Graphics 620 | |
| | i5-7200U | | | 2.5 GHz | 3.1 GHz | 3MB | | | |
| i7-7500U | 2.7 GHz | | | 3.5 GHz | 4MB | | | | |
| Graphics | Intel HD Graphics in processor only, or NVidia GeForce 920MX Graphics, 2GB DDR3 memory, or NVidia GeForce 940MX Graphics, 2GB DDR3 memory, digital monitor support via HDMI™ (supporting HDCP to output protected content); supports dual independent displays; Max resolution: 1920x1080 (HDMI)@60Hz | | | | | | | | Keyboard UltraNav™ ThinkLight™ |
| Memory | 32GB max / 2133MHz DDR4, non-parity, dual-channel capable, two 260-pin SO-DIMM sockets * System clocks down for processors with lower memory controller | | | | | | | | Fingerprint reader NFC Security Security chip |
| Display | Some: 14.0" (355mm) HD (1366x768), anti-glare, LED backlight, 220 nits, 16:9 aspect ratio, 400:1 contrast ratio Some: 14.0" (355mm) FHD (1920x1080), anti-glare, LED backlight, IPS, 250 nits, 16:9 aspect ratio, 400:1 contrast ratio Some: 14.0" (355mm) FHD (1920x1080), anti-glare, LED backlight, 220 nits, 16:9 aspect ratio, 400:1 contrast ratio | | | | | | | | vPro |
| Multi-touch | None | | | | | | | | Battery type Battery life AC adapter |
| Storage | Some: SSD / SATA 6.0Gb/s, 2.5" wide, 7mm high, removable, upgradable Some: HDD / SATA 6.0Gb/s, 2.5" wide, removable, upgradable, Active Protection System™ | | | | | | | | Preload |
| M.2 SSD | None | | | | | | | | Limited warranty Mil-Spec test Environment |
| Optical | None | | | | | | | | |
| Ethernet | Gigabit Ethernet Connection, Realtek R8111GUS | | | | | | | | |
| WLAN | One of the following, configurable by model: • Intel Dual Band Wireless-AC 8265, 2x2, Wi-Fi + BT combo adapter, M.2 Card • QCA, Qualcomm 344A-AC, 2x2, Wi-Fi + Bluetooth combo adapter, M.2 Card • QCA, Qualcomm 435-AC, 1x1, Wi-Fi + Bluetooth combo adapter, M.2 Card | | | | | | | | |
| Bluetooth™ | Bluetooth wireless, integrated in Wi-Fi + Bluetooth combo adapter | | | | | | | | |
| WWAN | None | | | | | | | | |
| SIM card | None | | | | | | | | |
| Smart Card Reader | None | | | | | | | | |
| ExpressCard | None | | | | | | | | |
| Dock | None | | | | | | | | |
| Multicard Reader | 4-in-1 reader (MMC, SD, SDHC, SDXC) | | | | | | | | |
| Ports | Two USB 3.0 (one Always On), one USB 2.0, HDMI, Ethernet (RJ-45), combo audio / microphone jack | | | | | | | | |
| Monitor cable | None | | | | | | | | |
| | | | | | | | | | Camera Audio support |
| | | | | | | | | | Some: HD720p resolution, fixed focus HD Audio, Conexant® CX11852 codec, Dolby® Audio™ Premium / stereo speakers, 2W x 2 / dual array microphone, combo audio / microphone jack |
| | | | | | | | | | Some: Windows 10 Pro 64 Some: Windows 10 Home 64 • Lenovo Companion • Lenovo Settings • Microsoft Office preloaded; purchase a product key to activate • McAfee® Live Safe (30-day trial) |
| | | | | | | | | | 1-year - depot repair service / service upgrades available |
| | | | | | | | | | None |
| | | | | | | | | | EPEAT™ Gold; ENERGY STAR®; RoHS-compliant |

| Model | Region | Processor | vPro | Graphics | Memory | Display | Multi-touch | Storage | Optical | WLAN + Bluetooth | WWAN | SIM Card | Color | Case Material | Camera | Keyboard | Fingerprint Reader | TPM | Battery | Power Adapter | Operating System | Warranty | Ann Date (m/y) |
|------------|--------|-----------|------|--------------|--------|-------------------------|-------------|-----------------|---------|----------------------------|------|----------|-------|---------------|--------|-------------|--------------------|------------|---------------|---------------|----------------------|---------------|----------------|
| 20H10038US | US | i3-7100U | No | Intel HD 620 | 4GBx1 | 14" HD (1366x768) | None | 500GB 7200rpm | None | 11ac, 1x1 + BT4.1 | None | None | Black | PC/ABS | 720p | Non-backlit | Fingerprint Reader | dTPM 2.0 | 3-cell (45Wh) | 45W | Win10 Pro 64 | 1-year, Depot | 09/16 |
| 20H10039US | US | i5-7200U | No | Intel HD 620 | 4GBx1 | 14" HD (1366x768) | None | 500GB 7200rpm | None | 11ac, 1x1 + BT4.1 | None | None | Black | PC/ABS | 720p | Non-backlit | Fingerprint Reader | dTPM 2.0 | 3-cell (45Wh) | 45W | Win10 Pro 64 | 1-year, Depot | 09/16 |
| 20H1003AUS | US | i5-7200U | No | Intel HD 620 | 8GBx1 | 14" HD (1366x768) | None | 256GB SSD Opal2 | None | 11ac, 1x1 + BT4.1 | None | None | Black | PC/ABS | 720p | Non-backlit | Fingerprint Reader | dTPM 2.0 | 3-cell (45Wh) | 45W | Win10 Pro 64 | 1-year, Depot | 09/16 |
| 20H1003DUS | US | i3-6006U | No | Intel HD 520 | 4GBx1 | 14" HD (1366x768) | None | 500GB 7200rpm | None | 11ac, 1x1 + BT4.1 | None | None | Black | PC/ABS | 720p | Non-backlit | Fingerprint Reader | dTPM 2.0 | 3-cell (45Wh) | 45W | Win10 Pro 64 | 1-year, Depot | 11/16 |
| 20H1004RUS | US | i7-7500U | No | 940MX 2GB | 8GBx1 | 14" FHD (1920x1080) IPS | None | 500GB 7200rpm | None | Intel 8265 ac, 2x2 + BT4.1 | None | None | Black | PC/ABS | 720p | Non-backlit | Fingerprint Reader | FW TPM 2.0 | 3-cell (45Wh) | 65W | Win10 Pro 64 | 1-year, Depot | 09/16 |
| 20H1004SUS | US | i5-7200U | No | Intel HD 620 | 8GBx1 | 14" FHD (1920x1080) IPS | None | 256GB SSD Opal2 | None | 11ac, 1x1 + BT4.1 | None | None | Black | PC/ABS | 720p | Non-backlit | Fingerprint Reader | dTPM 2.0 | 3-cell (45Wh) | 45W | Win10 Pro 64 | 1-year, Depot | 09/16 |
| 20H1004TUS | US | i7-7500U | No | 940MX 2GB | 8GBx1 | 14" FHD (1920x1080) IPS | None | 256GB SSD Opal2 | None | Intel 8265 ac, 2x2 + BT4.1 | None | None | Black | PC/ABS | 720p | Non-backlit | Fingerprint Reader | FW TPM 2.0 | 3-cell (45Wh) | 65W | Win10 Pro 64 | 1-year, Depot | 09/16 |
| 20H10055US | US | i5-7200U | No | Intel HD 620 | 8GBx1 | 14" FHD (1920x1080) IPS | None | 180GB SSD Opal2 | None | 11ac, 1x1 + BT4.1 | None | None | Black | PC/ABS | 720p | Non-backlit | Fingerprint Reader | dTPM 2.0 | 3-cell (45Wh) | 45W | Win10 Pro 64 | 1-year, Depot | 03/17 |
| 20H10059US | US | i3-7100U | No | Intel HD 620 | 4GBx1 | 14" HD (1366x768) | None | 180GB SSD Opal2 | None | 11ac, 1x1 + BT4.1 | None | None | Black | PC/ABS | 720p | Non-backlit | Fingerprint Reader | dTPM 2.0 | 3-cell (45Wh) | 45W | Win10 Pro 64 | 1-year, Depot | 01/17 |
| 20H1005AUS | US | i5-7200U | No | Intel HD 620 | 4GBx1 | 14" HD (1366x768) | None | 180GB SSD Opal2 | None | 11ac, 1x1 + BT4.1 | None | None | Black | PC/ABS | 720p | Non-backlit | Fingerprint Reader | dTPM 2.0 | 3-cell (45Wh) | 45W | Win10 Pro 64 | 1-year, Depot | 01/17 |
| 20H1005BUS | US | i5-7200U | No | Intel HD 620 | 8GBx1 | 14" HD (1366x768) | None | 180GB SSD Opal2 | None | 11ac, 1x1 + BT4.1 | None | None | Black | PC/ABS | 720p | Non-backlit | Fingerprint Reader | dTPM 2.0 | 3-cell (45Wh) | 45W | Win10 Pro 64 | 1-year, Depot | 01/17 |
| 20H10065US | US | i3-6006U | No | Intel HD 520 | 4GBx1 | 14" HD (1366x768) | None | 500GB 7200rpm | None | 11ac, 1x1 + BT4.1 | None | None | Black | PC/ABS | 720p | Non-backlit | Fingerprint Reader | dTPM 2.0 | 3-cell (45Wh) | 45W | Win10 DG Win7 Pro 64 | 1-year, Depot | 03/17 |
| 20H10066US | US | i7-6500U | No | 940MX 2GB | 8GBx1 | 14" FHD (1920x1080) IPS | None | 256GB SSD Opal2 | None | Intel 8265 ac, 2x2 + BT4.1 | None | None | Black | PC/ABS | 720p | Non-backlit | Fingerprint Reader | FW TPM 2.0 | 3-cell (45Wh) | 65W | Win10 DG Win7 Pro 64 | 1-year, Depot | 03/17 |
| 20H10067US | US | i5-6200U | No | Intel HD 520 | 8GBx1 | 14" FHD (1920x1080) IPS | None | 256GB SSD Opal2 | None | 11ac, 1x1 + BT4.1 | None | None | Black | PC/ABS | 720p | Non-backlit | Fingerprint Reader | dTPM 2.0 | 3-cell (45Wh) | 45W | Win10 DG Win7 Pro 64 | 1-year, Depot | 03/17 |
| 20H10068US | US | i7-6500U | No | 940MX 2GB | 8GBx1 | 14" FHD (1920x1080) IPS | None | 500GB 7200rpm | None | Intel 8265 ac, 2x2 + BT4.1 | None | None | Black | PC/ABS | 720p | Non-backlit | Fingerprint Reader | FW TPM 2.0 | 3-cell (45Wh) | 65W | Win10 DG Win7 Pro 64 | 1-year, Depot | 03/17 |
| 20H10069US | US | i5-6200U | No | Intel HD 520 | 4GBx1 | 14" HD (1366x768) | None | 500GB 7200rpm | None | 11ac, 1x1 + BT4.1 | None | None | Black | PC/ABS | 720p | Non-backlit | Fingerprint Reader | dTPM 2.0 | 3-cell (45Wh) | 45W | Win10 DG Win7 Pro 64 | 1-year, Depot | 03/17 |
| 20H1006AUS | US | i5-6200U | No | Intel HD 520 | 8GBx1 | 14" HD (1366x768) | None | 256GB SSD Opal2 | None | 11ac, 1x1 + BT4.1 | None | None | Black | PC/ABS | 720p | Non-backlit | Fingerprint Reader | dTPM 2.0 | 3-cell (45Wh) | 45W | Win10 DG Win7 Pro 64 | 1-year, Depot | 03/17 |
| 20H1006DUS | US | i5-7200U | No | Intel HD 620 | 8GBx1 | 14" FHD (1920x1080) IPS | None | 500GB 7200rpm | None | 11ac, 1x1 + BT4.1 | None | None | Black | PC/ABS | 720p | Non-backlit | Fingerprint Reader | dTPM 2.0 | 3-cell (45Wh) | 45W | Win10 Pro 64 | 1-year, Depot | 03/17 |
| 20H1006GCA | US | i3-6006U | No | Intel HD 520 | 4GBx1 | 14" HD (1366x768) | None | 500GB 7200rpm | None | 11ac, 1x1 + BT4.1 | None | None | Black | PC/ABS | 720p | Non-backlit | None | dTPM 2.0 | 3-cell (45Wh) | 45W | Win10 DG Win7 Pro 64 | 1-year, Depot | 03/17 |
| 20H1006GCC | US | i3-6006U | No | Intel HD 520 | 4GBx1 | 14" HD (1366x768) | None | 500GB 7200rpm | None | 11ac, 1x1 + BT4.1 | None | None | Black | PC/ABS | 720p | Non-backlit | None | dTPM 2.0 | 3-cell (45Wh) | 45W | Win10 DG Win7 Pro 64 | 1-year, Depot | 03/17 |

| Model | Region | Processor | vPro | Graphics | Memory | Display | Multi-touch | Storage | Optical | WLAN + Bluetooth | WWAN | SIM Card | Color | Case Material | Camera | Keyboard | Fingerprint Reader | TPM | Battery | Power Adapter | Operating System | Warranty | Ann Date (m/y) |
|------------|--------|-----------|------|--------------|--------|-------------------|-------------|---------------|---------|-------------------|------|----------|-------|---------------|--------|-------------|--------------------|----------|---------------|---------------|----------------------|---------------|----------------|
| 20H1006GUS | US | i3-6006U | No | Intel HD 520 | 4GBx1 | 14" HD (1366x768) | None | 500GB 7200rpm | None | 11ac, 1x1 + BT4.1 | None | None | Black | PC/ABS | 720p | Non-backlit | None | dTPM 2.0 | 3-cell (45Wh) | 45W | Win10 DG Win7 Pro 64 | 1-year, Depot | 03/17 |

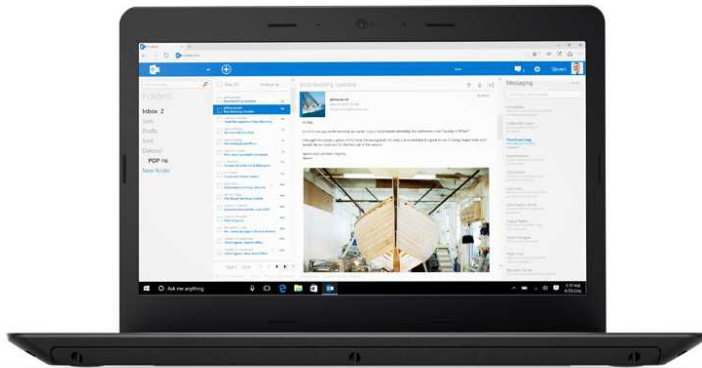

ThinkPad E475 Platform Specifications

Product Specifications Reference (PSREF)

| | | | | | | | | | | | |
|-------------------|--|------------|--------------|----------------|---------------------|---|--------------|--------------------|----------------------|---|-----------------------|
| Processor | AMD Accelerated Processor A6, or A10 APU | | | | | | | | Dimensions Weight | PC/ABS (WxDxH): 13.35" x 9.53" x 0.93"; 339mm x 242mm x 23.7mm | |
| | Processor Number | # of Cores | # of Threads | Base Frequency | Max Turbo Frequency | Cache | Memory Types | Processor Graphics | | Case color | From 4.12 lb (1.87kg) |
| | A6-9500B | 2 | 4 | 2.3 GHz | 3.2 GHz | 2MB | DDR4-1866 | R5 Graphics | | Case material | Black |
| A10-9600P | 4 | 8 | 2.4 GHz | 3.3 GHz | 2MB | PC/ABS: PolyCarbonate/Acrylonitrile-Butadiene-Styrene display cover | | | | | |
| Graphics | AMD Radeon™ R5 Graphics in processor only, or AMD Radeon R5 M430 Graphics, 2GB DDR3 memory, or digital monitor support via HDMI™ (supporting HDCP to output protected content); supports dual independent displays; Max resolution: 1920x1080 (HDMI)@60Hz | | | | | | | | Camera | HD720p resolution, fixed focus | |
| | | | | | | | | | Audio support | HD Audio, Conexant® CX11852 codec, Dolby® Audio™ Premium / stereo speakers, 2W x 2 / dual array microphone, combo audio / microphone jack | |
| Chipset | AMD SoC (System on Chip) platform 32GB max / 2133MHz DDR4, non-parity, dual-channel capable, two 260-pin SO-DIMM sockets *System automatically clocks down with 1866MHz DDR4 memory controller | | | | | | | | Keyboard | 6-row, spill-resistant, multimedia Fn keys | |
| | | | | | | | | | UltraNav™ | TrackPoint® pointing device and multi-touch with 3+2 buttons click pad | |
| Memory | | | | | | | | | ThinkLight™ | None | |
| Display | Some: 14.0" (355mm) HD (1366x768), anti-glare, LED backlight, 220 nits, 16:9 aspect ratio, 400:1 contrast ratio | | | | | | | | Fingerprint reader | None | |
| | | | | | | | | | NFC | None | |
| Multi-touch | None | | | | | | | | Security | Power-on password, hard disk password, supervisor password, security keyhole | |
| Storage | Some: SSD / SATA 6.0Gb/s, 2.5" wide, 7mm high, removable, upgradable Some: HDD / SATA 6.0Gb/s, 2.5" wide, removable, upgradable, Active Protection System™ | | | | | | | | Security chip | FW TPM2.0: Firmware TPM 2.0, integrated in chipset dTPM2.0: Discrete TPM 2.0, TCG Certified | |
| | | | | | | | | | vPro | No | |
| M.2 SSD | None | | | | | | | | Battery type | Li-Polymer 3-cell (45Wh) | |
| Optical | None | | | | | | | | Battery life | 3-cell (45Wh): up to 6.5 hr | |
| Ethernet | Gigabit Ethernet Connection, Realtek R8111GUS | | | | | | | | AC adapter | Some: 45-watt AC adapter Some: 65-watt AC adapter | |
| | | | | | | | | | Preload | Some: Windows 10 Pro 64 Some: Windows 10 Home 64 • Lenovo Companion • Lenovo Settings • Microsoft Office preloaded; purchase a product key to activate • McAfee® Live Safe (30-day trial) | |
| WLAN | One of the following, configurable by model: • QCA, Qualcomm 344A-AC, 2x2, Wi-Fi + Bluetooth combo adapter, M.2 Card • QCA, Qualcomm 435-AC, 1x1, Wi-Fi + Bluetooth combo adapter, M.2 Card Bluetooth wireless, integrated in Wi-Fi + Bluetooth combo adapter | | | | | | | | Limited warranty | 1-year - depot repair service / service upgrades available | |
| Bluetooth™ | | | | | | | | | Mil-Spec test | None | |
| WWAN | None | | | | | | | | Environment | EPEAT™ Gold; ENERGY STAR®; RoHS-compliant | |
| SIM card | None | | | | | | | | | | |
| Smart Card Reader | None | | | | | | | | | | |
| ExpressCard | None | | | | | | | | | | |
| Dock | None | | | | | | | | | | |
| Multicard Reader | 4-in-1 reader (MMC, SD, SDHC, SDXC) | | | | | | | | | | |
| Ports | Two USB 3.0 (one Always On), one USB 2.0, HDMI, Ethernet (RJ-45), combo audio / microphone jack | | | | | | | | | | |
| Monitor cable | None | | | | | | | | | | |

ThinkPad E475 - TopSeller - 20H4

Product Specifications Reference (PSREF)

| Model | Region | Processor | vPro | Graphics | Memory | Display | Multi-touch | Storage(HDD/SSD) | Optical | WLAN + Bluetooth | WWAN | SIM Card | Color | Case Material | Camera | Keyboard | Fingerprint Reader | TPM | Battery | Power Adapter | Operating System | Warranty | End of Support | Ann Date (m/y) |
|------------|--------|---------------|------|-----------------|--------|-------------------|-------------|------------------|---------|------------------------|------|----------|-------|---------------|--------|-------------|--------------------|------------|---------------|---------------|-------------------|---------------|----------------|----------------|
| 20H40006US | US | AMD A6-9500B | No | AMD R5 Graphics | 4GBx1 | 14" HD (1366x768) | None | 500GB 7200rpm | None | QCA435 ac, 1x1 + BT4.1 | None | None | Black | PC/ABS | 720p | Non-backlit | None | dTPM 2.0 | 3-cell (45Wh) | 45W | Windows 10 Pro 64 | 1-year, Depot | Nov 7, 2021 | 11/16 |
| 20H40007US | US | AMD A10-9600P | No | AMD R5 M430 2GB | 8GBx1 | 14" HD (1366x768) | None | 500GB 7200rpm | None | QCA435 ac, 1x1 + BT4.1 | None | None | Black | PC/ABS | 720p | Non-backlit | None | FW TPM 2.0 | 3-cell (45Wh) | 65W | Windows 10 Pro 64 | 1-year, Depot | Nov 7, 2021 | 11/16 |
| 20H40008US | US | AMD A10-9600P | No | AMD R5 M430 2GB | 4GBx1 | 14" HD (1366x768) | None | 500GB 7200rpm | None | QCA435 ac, 1x1 + BT4.1 | None | None | Black | PC/ABS | 720p | Non-backlit | None | FW TPM 2.0 | 3-cell (45Wh) | 65W | Windows 10 Pro 64 | 1-year, Depot | Nov 7, 2021 | 11/16 |
| 20H40009US | US | AMD A6-9500B | No | AMD R5 Graphics | 8GBx1 | 14" HD (1366x768) | None | 500GB 7200rpm | None | QCA435 ac, 1x1 + BT4.1 | None | None | Black | PC/ABS | 720p | Non-backlit | None | dTPM 2.0 | 3-cell (45Wh) | 45W | Windows 10 Pro 64 | 1-year, Depot | Nov 7, 2021 | 11/16 |
| 20H4000AUS | US | AMD A10-9600P | No | AMD R5 M430 2GB | 8GBx1 | 14" HD (1366x768) | None | 256GB SSD Opal2 | None | QCA435 ac, 1x1 + BT4.1 | None | None | Black | PC/ABS | 720p | Non-backlit | None | FW TPM 2.0 | 3-cell (45Wh) | 65W | Windows 10 Pro 64 | 1-year, Depot | Nov 7, 2021 | 11/16 |
| 20H4000DUS | US | AMD A10-9600P | No | AMD R5 M430 2GB | 8GBx1 | 14" HD (1366x768) | None | 180GB SSD Opal2 | None | QCA435 ac, 1x1 + BT4.1 | None | None | Black | PC/ABS | 720p | Non-backlit | None | FW TPM 2.0 | 3-cell (45Wh) | 65W | Windows 10 Pro 64 | 1-year, Depot | Jun 4, 2022 | 01/17 |



ThinkPad E550 Platform Specifications

Product Specifications Reference (PSREF)

| | | | | | | | | | | |
|-----------------------------|---|------------|--------------|----------------|---------------------|-------|--------------|--------------------|---|---|
| Processor | 4th or 5th Generation Intel® Core™ i3 / i5 / i7 Processor | | | | | | | | Multicard Reader Ports Monitor cable Camera Audio support | 4-in-1 reader (MMC, SD, SDHC, SDXC) Two USB 3.0 (one Always On), one USB 2.0, Ethernet (RJ-45), external monitor (VGA DB-15, HDMI), Lenovo OneLink connector None <i>Some:</i> 0.3-megapixel, fixed focus <i>Some:</i> HD720p resolution, fixed focus <i>Some:</i> 3D camera, Intel RealSense™ 3D Camera with MIC HD Audio, Conexant® CX20751 codec, Dolby® Advanced Audio™ v4 / stereo speakers or JBL speakers, 2W x 2 / dual array microphone, combo audio / microphone jack |
| | Processor Number | # of Cores | # of Threads | Base Frequency | Max Turbo Frequency | Cache | Memory speed | Processor Graphics | | |
| | i3-4005U | 2 | 4 | 1.7 GHz | - | 3MB | DDR3L-1600 | HD4400 | | |
| | i3-5005U | 2 | 4 | 2.0 GHz | - | 3MB | | HD5500 | | |
| | i3-5015U | 2 | 4 | 2.1 GHz | | 3MB | | HD5500 | | |
| | i5-5200U | 2 | 4 | 2.2 GHz | 2.7 GHz | 3MB | | HD5500 | | |
| | i7-5500U | 2 | 4 | 2.4 GHz | 3.0 GHz | 4MB | | HD5500 | | |
| Graphics | Intel HD Graphics in processor only, or AMD Radeon R7 M260 Graphics, 2GB DDR3 memory, external analog monitor support via VGA DB-15 connector and digital monitor support via HDMI™ (supporting HDCP to output protected content); supports dual independent display Max resolution: 1920x1080 (HDMI)@60Hz | | | | | | | | Keyboard UltraNav™ ThinkLight™ | 6-row, spill-resistant, multimedia Fn keys, numeric keypad TrackPoint® pointing device and multi-touch with 3+2 buttons click pad None |
| Chipset Memory | Intel SoC (System on Chip) platform 16GB max ⁷ / PC3-12800 1600MHz DDR3L, non-parity, dual-channel capable, two 204-pin SO-DIMM sockets | | | | | | | | Security Security chip vPro Fingerprint reader NFC | Power-on password, hard disk password, supervisor password, security keyhole <i>Some:</i> Trusted Platform Module, TCG 1.2-compliant None <i>Some:</i> Fingerprint reader on the keyboard bezel, swipe sensor None |
| Display | <i>Some:</i> 15.6" (396mm) HD (1366x768) color, anti-glare, LED backlight, 200 nits, 16:9 aspect ratio <i>Some:</i> 15.6" (396mm) FHD (1920x1080) color, anti-glare, LED backlight, 220 nits, 16:9 aspect ratio | | | | | | | | Battery type Battery life AC adapter | Li-Ion 6-cell (48Wh) 6-cell (48Wh): up to 9.0 hr <i>Some:</i> 45-watt AC adapter (Integrated Graphics) <i>Some:</i> 65-watt AC adapter (Discrete Graphics) |
| Multi-touch | <i>Some:</i> supports 10-finger gesture | | | | | | | | Preload | <i>Some:</i> No operating system <i>Some:</i> Windows® 7 Professional 64 preinstalled through downgrade rights in Windows 8.1 Pro 64-bit • Lenovo Solution Center • Lenovo SHAREit • ThinkVantage Product Recovery • Rescue and Recovery™ • ThinkVantage System Update • Microsoft® Office preloaded; purchase a product key to activate • Norton™ Internet Security (30 days of virus definitions) <i>Some:</i> Windows 7 Professional preinstalled through downgrade rights in Windows 10 Pro 64 • Lenovo Solution Center • Lenovo SHAREit • ThinkVantage Product Recovery • Rescue and Recovery™ <i>Some:</i> Windows 10 Pro 64 <i>Some:</i> Windows 10 Home 64 • Lenovo Solution Center • Lenovo SHAREit • Lenovo Companion • Microsoft Office preloaded; purchase a product key to activate • McAfee LiveSafe (30 days of virus definitions) |
| Storage | <i>Some:</i> SSD / SATA 6.0Gb/s, 2.5" wide, 7mm high, removable, upgradable <i>Some:</i> HDD / SATA 6.0Gb/s, 2.5" wide, removable, upgradable, Shock Mounted Hard Drive, Active Protection System™ <i>Some:</i> Hybrid drive with 8GB NAND flash memory <i>Some:</i> DVD burner, 9.0mm high, removable <i>Some:</i> Blank Bezel None | | | | | | | | | |
| Optical | | | | | | | | | | |
| M.2 SSD | | | | | | | | | | |
| Ethernet | Intel WGI218V Gigabit Ethernet Connection | | | | | | | | | |
| Bluetooth™ | Bluetooth 4.0 wireless, integrated in Wi-Fi + Bluetooth combo adapter | | | | | | | | | |
| WLAN | <i>One of the following, configurable by model:</i> • Intel Wireless-AC 3160, 1x1, Wi-Fi + Bluetooth combo adapter, M.2 Card • Intel Dual Band Wireless-AC 7265, 2x2, Wi-Fi + BT combo adapter, M.2 Card • RTL8723BE, Realtek 11b/g/n, 1x1, Wi-Fi + Bluetooth combo adapter, M.2 Card • BCM43162, Broadcom 11-AC, 1x1, Wi-Fi + BT combo adapter, M.2 Card | | | | | | | | | |
| WWAN | None | | | | | | | | | |
| SIM card | None | | | | | | | | | |
| Smart Card Read ExpressCard | None | | | | | | | | | |
| Dimensions | <i>None Touch(WxDxH):</i> 14.84" x 10.08" x 1.06"; 377mm x 256mm x 27mm | | | | | | | | | |
| Weight | <i>6-cell None Touch:</i> from 5.21 lb (2.35kg) | | | | | | | | | |
| Case color | Graphite Black | | | | | | | | | |
| Case material | PolyCarbonate/Acrylonitrile-Butadiene-Styrene (PC/ABS) plastic | | | | | | | | | |
| Limited warranty | 1-year - depot repair service / service upgrades available | | | | | | | | | |
| Environment | EPEAT™ Gold; ENERGY STAR®; RoHS-compliant | | | | | | | | | |

| Model | Region | Processor | vPro | Graphics | Memory | Display | Multi-touch | Storage(HDD/SSD) | Optical | WLAN + Bluetooth | WWAN | SIM Card | Color | Case Material | Camera | Keyboard | Fingerprint Reader | TPM | Battery | Power Adapter | Operating System | Warranty | Ann Date (m/y) |
|------------|--------|-----------|------|-----------------|--------|-----------------------|-------------|------------------|---------|----------------------------|------|----------|-------|---------------|--------|-------------|--------------------|----------|---------------|---------------|-----------------------|---------------|----------------|
| 20DF002WUS | US | i3-5005U | No | Intel HD 5500 | 4GBx1 | 15.6" HD (1366x768) | None | 500GB 7200rpm | DVD±RW | Intel 3160 ac, 1x1 + BT4.0 | None | None | Black | PC/ABS | 720p | Non-backlit | Fingerprint Reader | dTPM 1.2 | 6-cell (48Wh) | 45W | Win8.1 64-bit | 1-year, Depot | 01/15 |
| 20DF002XUS | US | i7-5500U | No | AMD R7 M260 2GB | 8GBx1 | 15.6" HD (1366x768) | None | 128GB SSD | DVD±RW | Intel 7265 ac, 2x2 + BT4.0 | None | None | Black | PC/ABS | 720p | Non-backlit | Fingerprint Reader | None | 6-cell (48Wh) | 65W | Win8.1 Pro 64-bit | 1-year, Depot | 01/15 |
| 20DF002YUS | US | i3-4005U | No | Intel HD 4400 | 4GBx1 | 15.6" HD (1366x768) | None | 500GB 7200rpm | DVD±RW | Intel 3160 ac, 1x1 + BT4.0 | None | None | Black | PC/ABS | 720p | Non-backlit | Fingerprint Reader | dTPM 1.2 | 6-cell (48Wh) | 45W | Win8.1 DG Win7 Pro 64 | 1-year, Depot | 01/15 |
| 20DF0030US | US | i5-5200U | No | Intel HD 5500 | 4GBx1 | 15.6" HD (1366x768) | None | 500GB 7200rpm | DVD±RW | Intel 3160 ac, 1x1 + BT4.0 | None | None | Black | PC/ABS | 720p | Non-backlit | Fingerprint Reader | dTPM 1.2 | 6-cell (48Wh) | 45W | Win8.1 DG Win7 Pro 64 | 1-year, Depot | 01/15 |
| 20DF0031US | US | i7-5500U | No | AMD R7 M260 2GB | 4GBx1 | 15.6" HD (1366x768) | None | 500GB 7200rpm | DVD±RW | Intel 7265 ac, 2x2 + BT4.0 | None | None | Black | PC/ABS | 720p | Non-backlit | Fingerprint Reader | None | 6-cell (48Wh) | 65W | Win8.1 DG Win7 Pro 64 | 1-year, Depot | 01/15 |
| 20DF0032US | US | i7-5500U | No | AMD R7 M260 2GB | 8GBx1 | 15.6" HD (1366x768) | None | 128GB SSD | DVD±RW | Intel 7265 ac, 2x2 + BT4.0 | None | None | Black | PC/ABS | 720p | Non-backlit | Fingerprint Reader | None | 6-cell (48Wh) | 65W | Win8.1 DG Win7 Pro 64 | 1-year, Depot | 01/15 |
| 20DF0033US | US | i3-4005U | No | Intel HD 4400 | 4GBx1 | 15.6" HD (1366x768) | None | 500GB 7200rpm | DVD±RW | Intel 3160 ac, 1x1 + BT4.0 | None | None | Black | PC/ABS | 720p | Non-backlit | None | dTPM 1.2 | 6-cell (48Wh) | 45W | Win8.1 64-bit | 1-year, Depot | 01/15 |
| 20DF0034US | US | i3-4005U | No | Intel HD 4400 | 4GBx1 | 15.6" HD (1366x768) | None | 500GB 7200rpm | DVD±RW | Intel 3160 ac, 1x1 + BT4.0 | None | None | Black | PC/ABS | 720p | Non-backlit | None | dTPM 1.2 | 6-cell (48Wh) | 45W | Win8.1 DG Win7 Pro 64 | 1-year, Depot | 01/15 |
| 20DF0035US | US | i3-4005U | No | Intel HD 4400 | 4GBx1 | 15.6" HD (1366x768) | None | 1TB 5400rpm | DVD±RW | Intel 3160 ac, 1x1 + BT4.0 | None | None | Black | PC/ABS | 720p | Non-backlit | Fingerprint Reader | dTPM 1.2 | 6-cell (48Wh) | 45W | Win8.1 DG Win7 Pro 64 | 1-year, Depot | 01/15 |
| 20DF0036US | US | i3-4005U | No | Intel HD 4400 | 8GBx1 | 15.6" HD (1366x768) | None | 500GB 7200rpm | DVD±RW | Intel 3160 ac, 1x1 + BT4.0 | None | None | Black | PC/ABS | 720p | Non-backlit | Fingerprint Reader | dTPM 1.2 | 6-cell (48Wh) | 45W | Win8.1 DG Win7 Pro 64 | 1-year, Depot | 01/15 |
| 20DF0037US | US | i3-4005U | No | Intel HD 4400 | 8GBx1 | 15.6" HD (1366x768) | None | 1TB 5400rpm | DVD±RW | Intel 3160 ac, 1x1 + BT4.0 | None | None | Black | PC/ABS | 720p | Non-backlit | Fingerprint Reader | dTPM 1.2 | 6-cell (48Wh) | 45W | Win8.1 DG Win7 Pro 64 | 1-year, Depot | 01/15 |
| 20DF0038US | US | i3-5005U | No | Intel HD 5500 | 4GBx1 | 15.6" HD (1366x768) | None | 500GB 7200rpm | DVD±RW | Intel 3160 ac, 1x1 + BT4.0 | None | None | Black | PC/ABS | 720p | Non-backlit | Fingerprint Reader | dTPM 1.2 | 6-cell (48Wh) | 45W | Win8.1 DG Win7 Pro 64 | 1-year, Depot | 01/15 |
| 20DF0039US | US | i3-5005U | No | Intel HD 5500 | 4GBx1 | 15.6" HD (1366x768) | None | 500GB 7200rpm | DVD±RW | Intel 7265 ac, 2x2 + BT4.0 | None | None | Black | PC/ABS | 720p | Non-backlit | Fingerprint Reader | dTPM 1.2 | 6-cell (48Wh) | 45W | Win8.1 DG Win7 Pro 64 | 1-year, Depot | 01/15 |
| 20DF003AUS | US | i3-5005U | No | Intel HD 5500 | 4GBx1 | 15.6" HD (1366x768) | None | 1TB 5400rpm | DVD±RW | Intel 7265 ac, 2x2 + BT4.0 | None | None | Black | PC/ABS | 720p | Non-backlit | Fingerprint Reader | dTPM 1.2 | 6-cell (48Wh) | 45W | Win8.1 DG Win7 Pro 64 | 1-year, Depot | 01/15 |
| 20DF003BUS | US | i3-5005U | No | Intel HD 5500 | 4GBx1 | 15.6" HD (1366x768) | None | 1TB 5400rpm | DVD±RW | Intel 3160 ac, 1x1 + BT4.0 | None | None | Black | PC/ABS | 720p | Non-backlit | Fingerprint Reader | dTPM 1.2 | 6-cell (48Wh) | 45W | Win8.1 DG Win7 Pro 64 | 1-year, Depot | 01/15 |
| 20DF003CUS | US | i3-5005U | No | Intel HD 5500 | 8GBx1 | 15.6" HD (1366x768) | None | 500GB 7200rpm | DVD±RW | Intel 3160 ac, 1x1 + BT4.0 | None | None | Black | PC/ABS | 720p | Non-backlit | Fingerprint Reader | dTPM 1.2 | 6-cell (48Wh) | 45W | Win8.1 DG Win7 Pro 64 | 1-year, Depot | 01/15 |
| 20DF003DUS | US | i3-5005U | No | Intel HD 5500 | 8GBx1 | 15.6" HD (1366x768) | None | 500GB 7200rpm | DVD±RW | Intel 7265 ac, 2x2 + BT4.0 | None | None | Black | PC/ABS | 720p | Non-backlit | Fingerprint Reader | dTPM 1.2 | 6-cell (48Wh) | 45W | Win8.1 DG Win7 Pro 64 | 1-year, Depot | 01/15 |
| 20DF003EUS | US | i3-5005U | No | Intel HD 5500 | 8GBx1 | 15.6" HD (1366x768) | None | 1TB 5400rpm | DVD±RW | Intel 3160 ac, 1x1 + BT4.0 | None | None | Black | PC/ABS | 720p | Non-backlit | Fingerprint Reader | dTPM 1.2 | 6-cell (48Wh) | 45W | Win8.1 DG Win7 Pro 64 | 1-year, Depot | 01/15 |
| 20DF003FUS | US | i5-5200U | No | Intel HD 5500 | 4GBx1 | 15.6" HD (1366x768) | None | 500GB 7200rpm | DVD±RW | Intel 7265 ac, 2x2 + BT4.0 | None | None | Black | PC/ABS | 720p | Non-backlit | Fingerprint Reader | dTPM 1.2 | 6-cell (48Wh) | 45W | Win8.1 DG Win7 Pro 64 | 1-year, Depot | 01/15 |
| 20DF003GUS | US | i5-5200U | No | Intel HD 5500 | 4GBx1 | 15.6" FHD (1920x1080) | None | 500GB 7200rpm | DVD±RW | Intel 7265 ac, 2x2 + BT4.0 | None | None | Black | PC/ABS | 720p | Non-backlit | Fingerprint Reader | dTPM 1.2 | 6-cell (48Wh) | 45W | Win8.1 DG Win7 Pro 64 | 1-year, Depot | 01/15 |

| Model | Region | Processor | vPro | Graphics | Memory | Display | Multi-touch | Storage(HDD/SSD) | Optical | WLAN + Bluetooth | WWAN | SIM Card | Color | Case Material | Camera | Keyboard | Fingerprint Reader | TPM | Battery | Power Adapter | Operating System | Warranty | Ann Date (m/y) |
|------------|--------|-----------|------|-----------------|--------|-----------------------|-------------|------------------|---------|----------------------------|------|----------|-------|---------------|--------|-------------|--------------------|----------|---------------|---------------|-----------------------|---------------|----------------|
| 20DF003HUS | US | i5-5200U | No | Intel HD 5500 | 4GBx1 | 15.6" HD (1366x768) | None | 128GB SSD | DVD±RW | Intel 7265 ac, 2x2 + BT4.0 | None | None | Black | PC/ABS | 720p | Non-backlit | Fingerprint Reader | dTPM 1.2 | 6-cell (48Wh) | 45W | Win8.1 DG Win7 Pro 64 | 1-year, Depot | 01/15 |
| 20DF003JUS | US | i5-5200U | No | Intel HD 5500 | 4GBx1 | 15.6" FHD (1920x1080) | None | 128GB SSD | DVD±RW | Intel 7265 ac, 2x2 + BT4.0 | None | None | Black | PC/ABS | 720p | Non-backlit | Fingerprint Reader | dTPM 1.2 | 6-cell (48Wh) | 45W | Win8.1 DG Win7 Pro 64 | 1-year, Depot | 01/15 |
| 20DF003KUS | US | i5-5200U | No | Intel HD 5500 | 4GBx1 | 15.6" HD (1366x768) | None | 1TB 5400rpm | DVD±RW | Intel 3160 ac, 1x1 + BT4.0 | None | None | Black | PC/ABS | 720p | Non-backlit | Fingerprint Reader | dTPM 1.2 | 6-cell (48Wh) | 45W | Win8.1 DG Win7 Pro 64 | 1-year, Depot | 01/15 |
| 20DF003LUS | US | i5-5200U | No | Intel HD 5500 | 4GBx1 | 15.6" HD (1366x768) | None | 1TB 5400rpm | DVD±RW | Intel 7265 ac, 2x2 + BT4.0 | None | None | Black | PC/ABS | 720p | Non-backlit | Fingerprint Reader | dTPM 1.2 | 6-cell (48Wh) | 45W | Win8.1 DG Win7 Pro 64 | 1-year, Depot | 01/15 |
| 20DF003MUS | US | i5-5200U | No | Intel HD 5500 | 4GBx1 | 15.6" FHD (1920x1080) | None | 1TB 5400rpm | DVD±RW | Intel 7265 ac, 2x2 + BT4.0 | None | None | Black | PC/ABS | 720p | Non-backlit | Fingerprint Reader | dTPM 1.2 | 6-cell (48Wh) | 45W | Win8.1 DG Win7 Pro 64 | 1-year, Depot | 01/15 |
| 20DF003NUS | US | i5-5200U | No | Intel HD 5500 | 8GBx1 | 15.6" HD (1366x768) | None | 500GB 7200rpm | DVD±RW | Intel 3160 ac, 1x1 + BT4.0 | None | None | Black | PC/ABS | 720p | Non-backlit | Fingerprint Reader | dTPM 1.2 | 6-cell (48Wh) | 45W | Win8.1 DG Win7 Pro 64 | 1-year, Depot | 01/15 |
| 20DF003PUS | US | i5-5200U | No | Intel HD 5500 | 8GBx1 | 15.6" HD (1366x768) | None | 500GB 7200rpm | DVD±RW | Intel 7265 ac, 2x2 + BT4.0 | None | None | Black | PC/ABS | 720p | Non-backlit | Fingerprint Reader | dTPM 1.2 | 6-cell (48Wh) | 45W | Win8.1 DG Win7 Pro 64 | 1-year, Depot | 01/15 |
| 20DF003QUS | US | i5-5200U | No | Intel HD 5500 | 8GBx1 | 15.6" FHD (1920x1080) | None | 500GB 7200rpm | DVD±RW | Intel 7265 ac, 2x2 + BT4.0 | None | None | Black | PC/ABS | 720p | Non-backlit | Fingerprint Reader | dTPM 1.2 | 6-cell (48Wh) | 45W | Win8.1 DG Win7 Pro 64 | 1-year, Depot | 01/15 |
| 20DF003RUS | US | i5-5200U | No | Intel HD 5500 | 8GBx1 | 15.6" HD (1366x768) | None | 128GB SSD | DVD±RW | Intel 7265 ac, 2x2 + BT4.0 | None | None | Black | PC/ABS | 720p | Non-backlit | Fingerprint Reader | dTPM 1.2 | 6-cell (48Wh) | 45W | Win8.1 DG Win7 Pro 64 | 1-year, Depot | 01/15 |
| 20DF003SUS | US | i5-5200U | No | Intel HD 5500 | 8GBx1 | 15.6" FHD (1920x1080) | None | 128GB SSD | DVD±RW | Intel 7265 ac, 2x2 + BT4.0 | None | None | Black | PC/ABS | 720p | Non-backlit | Fingerprint Reader | dTPM 1.2 | 6-cell (48Wh) | 45W | Win8.1 DG Win7 Pro 64 | 1-year, Depot | 01/15 |
| 20DF003TUS | US | i5-5200U | No | Intel HD 5500 | 8GBx1 | 15.6" HD (1366x768) | None | 1TB 5400rpm | DVD±RW | Intel 3160 ac, 1x1 + BT4.0 | None | None | Black | PC/ABS | 720p | Non-backlit | Fingerprint Reader | dTPM 1.2 | 6-cell (48Wh) | 45W | Win8.1 DG Win7 Pro 64 | 1-year, Depot | 01/15 |
| 20DF003UUS | US | i5-5200U | No | Intel HD 5500 | 8GBx1 | 15.6" HD (1366x768) | None | 1TB 5400rpm | DVD±RW | Intel 7265 ac, 2x2 + BT4.0 | None | None | Black | PC/ABS | 720p | Non-backlit | Fingerprint Reader | dTPM 1.2 | 6-cell (48Wh) | 45W | Win8.1 DG Win7 Pro 64 | 1-year, Depot | 01/15 |
| 20DF003VUS | US | i5-5200U | No | Intel HD 5500 | 8GBx1 | 15.6" FHD (1920x1080) | None | 1TB 5400rpm | DVD±RW | Intel 7265 ac, 2x2 + BT4.0 | None | None | Black | PC/ABS | 720p | Non-backlit | Fingerprint Reader | dTPM 1.2 | 6-cell (48Wh) | 45W | Win8.1 DG Win7 Pro 64 | 1-year, Depot | 01/15 |
| 20DF003WUS | US | i7-5500U | No | AMD R7 M260 2GB | 4GBx1 | 15.6" FHD (1920x1080) | None | 500GB 7200rpm | DVD±RW | Intel 7265 ac, 2x2 + BT4.0 | None | None | Black | PC/ABS | 720p | Non-backlit | Fingerprint Reader | None | 6-cell (48Wh) | 65W | Win8.1 DG Win7 Pro 64 | 1-year, Depot | 01/15 |
| 20DF003XUS | US | i7-5500U | No | AMD R7 M260 2GB | 4GBx1 | 15.6" FHD (1920x1080) | None | 128GB SSD | DVD±RW | Intel 7265 ac, 2x2 + BT4.0 | None | None | Black | PC/ABS | 720p | Non-backlit | Fingerprint Reader | None | 6-cell (48Wh) | 65W | Win8.1 DG Win7 Pro 64 | 1-year, Depot | 01/15 |
| 20DF003YUS | US | i7-5500U | No | AMD R7 M260 2GB | 4GBx1 | 15.6" FHD (1920x1080) | None | 1TB 5400rpm | DVD±RW | Intel 7265 ac, 2x2 + BT4.0 | None | None | Black | PC/ABS | 720p | Non-backlit | Fingerprint Reader | None | 6-cell (48Wh) | 65W | Win8.1 DG Win7 Pro 64 | 1-year, Depot | 01/15 |
| 20DF0040US | US | i7-5500U | No | AMD R7 M260 2GB | 8GBx1 | 15.6" FHD (1920x1080) | None | 500GB 7200rpm | DVD±RW | Intel 7265 ac, 2x2 + BT4.0 | None | None | Black | PC/ABS | 720p | Non-backlit | Fingerprint Reader | None | 6-cell (48Wh) | 65W | Win8.1 DG Win7 Pro 64 | 1-year, Depot | 01/15 |
| 20DF0041US | US | i7-5500U | No | AMD R7 M260 2GB | 8GBx1 | 15.6" FHD (1920x1080) | None | 128GB SSD | DVD±RW | Intel 7265 ac, 2x2 + BT4.0 | None | None | Black | PC/ABS | 720p | Non-backlit | Fingerprint Reader | None | 6-cell (48Wh) | 65W | Win8.1 DG Win7 Pro 64 | 1-year, Depot | 01/15 |
| 20DF0042US | US | i7-5500U | No | AMD R7 M260 2GB | 8GBx1 | 15.6" FHD (1920x1080) | None | 1TB 5400rpm | DVD±RW | Intel 7265 ac, 2x2 + BT4.0 | None | None | Black | PC/ABS | 720p | Non-backlit | Fingerprint Reader | None | 6-cell (48Wh) | 65W | Win8.1 DG Win7 Pro 64 | 1-year, Depot | 01/15 |
| 20DF0043US | US | i3-4005U | No | Intel HD 4400 | 4GBx1 | 15.6" HD (1366x768) | None | 500GB 7200rpm | DVD±RW | Intel 3160 ac, 1x1 + BT4.0 | None | None | Black | PC/ABS | 720p | Non-backlit | None | dTPM 1.2 | 6-cell (48Wh) | 45W | Win8.1 Pro 64-bit | 1-year, Depot | 01/15 |

| Model | Region | Processor | vPro | Graphics | Memory | Display | Multi-touch | Storage(HDD/SSD) | Optical | WLAN + Bluetooth | WWAN | SIM Card | Color | Case Material | Camera | Keyboard | Fingerprint Reader | TPM | Battery | Power Adapter | Operating System | Warranty | Ann Date (m/y) |
|------------|--------|-----------|------|-----------------|--------|-----------------------|-------------|------------------|---------|----------------------------|------|----------|-------|---------------|-----------|-------------|--------------------|----------|---------------|---------------|----------------------|---------------|----------------|
| 20DF0044US | US | i3-4005U | No | Intel HD 4400 | 8GBx1 | 15.6" HD (1366x768) | None | 500GB 7200rpm | DVD±RW | Intel 3160 ac, 1x1 + BT4.0 | None | None | Black | PC/ABS | 720p | Non-backlit | None | dTPM 1.2 | 6-cell (48Wh) | 45W | Win8.1 Pro 64-bit | 1-year, Depot | 01/15 |
| 20DF0045US | US | i3-4005U | No | Intel HD 4400 | 8GBx1 | 15.6" HD (1366x768) | None | 1TB 5400rpm | DVD±RW | Intel 3160 ac, 1x1 + BT4.0 | None | None | Black | PC/ABS | 720p | Non-backlit | Fingerprint Reader | dTPM 1.2 | 6-cell (48Wh) | 45W | Win8.1 Pro 64-bit | 1-year, Depot | 01/15 |
| 20DF0046US | US | i3-4005U | No | Intel HD 4400 | 8GBx1 | 15.6" HD (1366x768) | None | 500GB 7200rpm | DVD±RW | Intel 3160 ac, 1x1 + BT4.0 | None | None | Black | PC/ABS | 720p | Non-backlit | Fingerprint Reader | dTPM 1.2 | 6-cell (48Wh) | 45W | Win8.1 Pro 64-bit | 1-year, Depot | 01/15 |
| 20DF0047US | US | i3-5005U | No | Intel HD 5500 | 4GBx1 | 15.6" HD (1366x768) | None | 500GB 7200rpm | DVD±RW | Intel 3160 ac, 1x1 + BT4.0 | None | None | Black | PC/ABS | 720p | Non-backlit | Fingerprint Reader | dTPM 1.2 | 6-cell (48Wh) | 45W | Win8.1 Pro 64-bit | 1-year, Depot | 01/15 |
| 20DF0048US | US | i3-5005U | No | Intel HD 5500 | 4GBx1 | 15.6" HD (1366x768) | None | 1TB 5400rpm | DVD±RW | Intel 3160 ac, 1x1 + BT4.0 | None | None | Black | PC/ABS | 720p | Non-backlit | Fingerprint Reader | dTPM 1.2 | 6-cell (48Wh) | 45W | Win8.1 Pro 64-bit | 1-year, Depot | 01/15 |
| 20DF0049US | US | i3-5005U | No | Intel HD 5500 | 8GBx1 | 15.6" HD (1366x768) | None | 500GB 7200rpm | DVD±RW | Intel 3160 ac, 1x1 + BT4.0 | None | None | Black | PC/ABS | 720p | Non-backlit | Fingerprint Reader | dTPM 1.2 | 6-cell (48Wh) | 45W | Win8.1 Pro 64-bit | 1-year, Depot | 01/15 |
| 20DF004AUS | US | i3-5005U | No | Intel HD 5500 | 8GBx1 | 15.6" HD (1366x768) | None | 1TB 5400rpm | DVD±RW | Intel 3160 ac, 1x1 + BT4.0 | None | None | Black | PC/ABS | 720p | Non-backlit | Fingerprint Reader | dTPM 1.2 | 6-cell (48Wh) | 45W | Win8.1 Pro 64-bit | 1-year, Depot | 01/15 |
| 20DF004BUS | US | i5-5200U | No | Intel HD 5500 | 4GBx1 | 15.6" HD (1366x768) | None | 500GB 7200rpm | DVD±RW | Intel 3160 ac, 1x1 + BT4.0 | None | None | Black | PC/ABS | 720p | Non-backlit | Fingerprint Reader | dTPM 1.2 | 6-cell (48Wh) | 45W | Win8.1 Pro 64-bit | 1-year, Depot | 01/15 |
| 20DF004CUS | US | i5-5200U | No | Intel HD 5500 | 4GBx1 | 15.6" HD (1366x768) | None | 1TB 5400rpm | DVD±RW | Intel 3160 ac, 1x1 + BT4.0 | None | None | Black | PC/ABS | 720p | Non-backlit | Fingerprint Reader | dTPM 1.2 | 6-cell (48Wh) | 45W | Win8.1 Pro 64-bit | 1-year, Depot | 01/15 |
| 20DF004DUS | US | i5-5200U | No | Intel HD 5500 | 8GBx1 | 15.6" HD (1366x768) | None | 500GB 7200rpm | DVD±RW | Intel 3160 ac, 1x1 + BT4.0 | None | None | Black | PC/ABS | 720p | Non-backlit | Fingerprint Reader | dTPM 1.2 | 6-cell (48Wh) | 45W | Win8.1 Pro 64-bit | 1-year, Depot | 01/15 |
| 20DF004EUS | US | i5-5200U | No | Intel HD 5500 | 8GBx1 | 15.6" HD (1366x768) | None | 1TB 5400rpm | DVD±RW | Intel 3160 ac, 1x1 + BT4.0 | None | None | Black | PC/ABS | 720p | Non-backlit | Fingerprint Reader | dTPM 1.2 | 6-cell (48Wh) | 45W | Win8.1 Pro 64-bit | 1-year, Depot | 01/15 |
| 20DF00BXUS | US | i3-4005U | No | Intel HD 4400 | 4GBx1 | 15.6" HD (1366x768) | None | 500GB 7200rpm | DVD±RW | Intel 3160 ac, 1x1 + BT4.0 | None | None | Black | PC/ABS | 720p | Non-backlit | Fingerprint Reader | dTPM 1.2 | 6-cell (48Wh) | 45W | Win10 Pro 64 | 1-year, Depot | 07/15 |
| 20DF00BYUS | US | i7-5500U | No | AMD R7 M260 2GB | 8GBx1 | 15.6" FHD (1920x1080) | None | 500GB 7200rpm | DVD±RW | Intel 7265 ac, 2x2 + BT4.0 | None | None | Black | PC/ABS | 720p | Non-backlit | Fingerprint Reader | None | 6-cell (48Wh) | 65W | Win10 Pro 64 | 1-year, Depot | 07/15 |
| 20DF00C0US | US | i3-4005U | No | Intel HD 4400 | 4GBx1 | 15.6" HD (1366x768) | None | 500GB 7200rpm | DVD±RW | Intel 3160 ac, 1x1 + BT4.0 | None | None | Black | PC/ABS | 720p | Non-backlit | Fingerprint Reader | dTPM 1.2 | 6-cell (48Wh) | 45W | Win10 DG Win7 Pro 64 | 1-year, Depot | 07/15 |
| 20DF00C1US | US | i7-5500U | No | AMD R7 M260 2GB | 8GBx1 | 15.6" FHD (1920x1080) | None | 192GB SSD | DVD±RW | Intel 7265 ac, 2x2 + BT4.0 | None | None | Black | PC/ABS | 720p | Non-backlit | Fingerprint Reader | None | 6-cell (48Wh) | 65W | Win10 Pro 64 | 1-year, Depot | 07/15 |
| 20DF00C2US | US | i5-5200U | No | Intel HD 5500 | 4GBx1 | 15.6" HD (1366x768) | None | 500GB 7200rpm | DVD±RW | Intel 3160 ac, 1x1 + BT4.0 | None | None | Black | PC/ABS | 720p | Non-backlit | Fingerprint Reader | dTPM 1.2 | 6-cell (48Wh) | 45W | Win10 DG Win7 Pro 64 | 1-year, Depot | 07/15 |
| 20DF00C3US | US | i7-5500U | No | AMD R7 M260 2GB | 8GBx1 | 15.6" FHD (1920x1080) | None | 500GB 7200rpm | DVD±RW | Intel 7265 ac, 2x2 + BT4.0 | None | None | Black | PC/ABS | 720p | Non-backlit | Fingerprint Reader | None | 6-cell (48Wh) | 65W | Win10 DG Win7 Pro 64 | 1-year, Depot | 07/15 |
| 20DF00C4US | US | i5-5200U | No | Intel HD 5500 | 4GBx1 | 15.6" HD (1366x768) | None | 500GB 7200rpm | DVD±RW | Intel 3160 ac, 1x1 + BT4.0 | None | None | Black | PC/ABS | 720p | Non-backlit | Fingerprint Reader | dTPM 1.2 | 6-cell (48Wh) | 45W | Win10 Pro 64 | 1-year, Depot | 07/15 |
| 20DF00CAUS | US | i7-5500U | No | AMD R7 M260 2GB | 8GBx1 | 15.6" FHD (1920x1080) | None | 192GB SSD | DVD±RW | Intel 7265 ac, 2x2 + BT4.0 | None | None | Black | PC/ABS | 3D Camera | Non-backlit | Fingerprint Reader | None | 6-cell (48Wh) | 65W | Win10 Pro 64 | 1-year, Depot | 07/15 |
| 20DF00CQUS | US | i3-5005U | No | Intel HD 5500 | 4GBx1 | 15.6" HD (1366x768) | None | 500GB 7200rpm | DVD±RW | Intel 3160 ac, 1x1 + BT4.0 | None | None | Black | PC/ABS | 720p | Non-backlit | Fingerprint Reader | dTPM 1.2 | 6-cell (48Wh) | 45W | Win10 DG Win7 Pro 64 | 1-year, Depot | 08/15 |

| Model | Region | Processor | vPro | Graphics | Memory | Display | Multi-touch | Storage(HDD/SSD) | Optical | WLAN + Bluetooth | WWAN | SIM Card | Color | Case Material | Camera | Keyboard | Fingerprint Reader | TPM | Battery | Power Adapter | Operating System | Warranty | Ann Date (m/y) |
|------------|--------|-----------|------|---------------|--------|---------------------|-------------|------------------|---------|----------------------------|------|----------|-------|---------------|--------|-------------|--------------------|----------|---------------|---------------|----------------------|---------------|----------------|
| 20DF00EDUS | US | i3-5005U | No | Intel HD 5500 | 4GBx1 | 15.6" HD (1366x768) | None | 500GB 7200rpm | DVD±RW | Intel 3160 ac, 1x1 + BT4.0 | None | None | Black | PC/ABS | 0.3MP | Non-backlit | None | dTPM 1.2 | 6-cell (48Wh) | 45W | Win10 DG Win7 Pro 64 | 1-year, Depot | 08/15 |
| 20DF00EEUS | US | i3-5005U | No | Intel HD 5500 | 4GBx1 | 15.6" HD (1366x768) | None | 500GB 7200rpm | DVD±RW | Intel 3160 ac, 1x1 + BT4.0 | None | None | Black | PC/ABS | 0.3MP | Non-backlit | None | dTPM 1.2 | 6-cell (48Wh) | 45W | Win10 Pro 64 | 1-year, Depot | 08/15 |
| 20DF00EFUS | US | i3-5005U | No | Intel HD 5500 | 4GBx1 | 15.6" HD (1366x768) | None | 500GB 7200rpm | DVD±RW | Intel 3160 ac, 1x1 + BT4.0 | None | None | Black | PC/ABS | 720p | Non-backlit | Fingerprint Reader | dTPM 1.2 | 6-cell (48Wh) | 45W | Win10 Pro 64 | 1-year, Depot | 08/15 |
| 20DF00EGUS | US | i3-5005U | No | Intel HD 5500 | 4GBx1 | 15.6" HD (1366x768) | None | 192GB SSD | DVD±RW | Intel 3160 ac, 1x1 + BT4.0 | None | None | Black | PC/ABS | 0.3MP | Non-backlit | None | dTPM 1.2 | 6-cell (48Wh) | 45W | Win10 DG Win7 Pro 64 | 1-year, Depot | 08/15 |



ThinkPad E560 Platform Specifications

Product Specifications Reference (PSREF)

| | | | | | | | | | | |
|--|---|------------|--------------|----------------|---------------------|-------|--------------|-----------------------|--|--|
| Processor | 6th Generation Intel® Core™ i3 / i5 / i7 Processor and Celeron Processor | | | | | | | | Smart Card Reader ExpressCard Multicard Reader Ports Monitor cable Camera Audio support Keyboard UltraNav™ ThinkLight™ Security Security chip vPro Fingerprint reader NFC Battery type Battery life AC adapter Preload Limited warranty Mil-Spec test Environment | None None 4-in-1 reader (MMC, SD, SDHC, SDXC) Three USB 3.0 (one Always On), VGA, HDMI, Ethernet (RJ-45), Lenovo OneLink connector, combo audio/microphone jack None <i>Some:</i> HD720p resolution, fixed focus <i>Some:</i> 3D camera, Intel RealSense™ 3D Camera with MIC HD Audio, Conexant® CX11852 codec, Dolby® Advanced Audio™ / stereo speakers or JBL speakers, 2W x 2 / dual array microphone, combo audio / microphone jack 6-row, spill-resistant, multimedia Fn keys, numeric keypad TrackPoint® pointing device and multi-touch with 3+2 buttons click pad None Power-on password, hard disk password, supervisor password, security keyhole <i>TPM2.0 :</i> Trusted Platform Module, TPM2.0 FW (firmware) <i>TPM1.2:</i> Trusted Platform Module, TCG 1.2-compliant <i>TPM :</i> TPM2.0 and TPM1.2 None <i>Some:</i> Fingerprint reader on the keyboard bezel, swipe sensor None Li-Ion 6-cell (48Wh) 6-cell (48Wh): up to 9.0 hr <i>Some:</i> 45-watt AC adapter (Integrated Graphics) <i>Some:</i> 65-watt AC adapter (Discrete Graphics) <i>Some:</i> No operating system <i>Some:</i> Windows® 7 Professional 64 preinstalled through downgrade rights in Windows 10 Pro 64 • Lenovo Solution Center • Lenovo SHAREit • ThinkVantage Product Recovery • Rescue and Recovery™ • ThinkVantage System Update • PC Device Stage • Adobe® Reader® • Microsoft® Office preloaded; purchase a product key to activate • McAfee® Live Safe (30-day trial) <i>Some:</i> Windows 10 Pro 64 <i>Some:</i> Windows 10 Home 64 • Lenovo Solution Center • Lenovo REACHit • Lenovo SHAREit • Lenovo Companion • Lenovo Settings • ThinkVantage System Update • Microsoft Office preloaded; purchase a product key to activate • McAfee® Live Safe (30-day trial) 1-year - depot repair service / service upgrades available None EPEAT™ Gold; ENERGY STAR®; RoHS-compliant |
| | Processor Number | # of Cores | # of Threads | Base Frequency | Max Turbo Frequency | Cache | Memory Types | Processor Graphics | | |
| | Cel 3855U | 2 | 2 | 1.6 GHz | - | 2MB | DDR3L-1600 | Intel HD Graphics 510 | | |
| | i3-6100U | 2 | 4 | 2.3 GHz | - | 3MB | | Intel HD Graphics 520 | | |
| | i5-6200U | | | 2.3 GHz | 2.8 GHz | 3MB | | | | |
| i7-6500U | 2.5 GHz | | | 3.1 GHz | 4MB | | | | | |
| Graphics | Intel HD Graphics in processor only, or AMD Radeon R7 M370 Graphics, 2GB GDDR5 memory, external analog monitor support via VGA DB-15 connector and digital monitor support via HDMI™ (supporting HDCP to output protected content); supports dual independent displays; Max resolution: 1920x1080 (HDMI)@60Hz | | | | | | | | | |
| Chipset Memory | Intel SoC (System on Chip) platform 16GB max / PC3-12800 1600MHz DDR3L, non-parity, dual-channel capable, two 204-pin SO-DIMM sockets | | | | | | | | | |
| Display | <i>Some:</i> 15.6" (396mm) HD (1366x768) color, anti-glare, LED backlight, 220 nits, 16:9 aspect ratio <i>Some:</i> 15.6" (396mm) FHD (1920x1080) color, anti-glare, LED backlight, IPS, 250 nits, 16:9 aspect ratio | | | | | | | | | |
| Multi-touch | None | | | | | | | | | |
| Storage | <i>Some:</i> SSD / SATA 6.0Gb/s, 2.5" wide, 7mm high, removable, upgradable <i>Some:</i> HDD / SATA 6.0Gb/s, 2.5" wide, removable, upgradable, Active Protection System™ <i>Some:</i> SSHD with 8GB NAND flash memory <i>Some:</i> DVD burner, 9.0mm high, removable <i>Some:</i> Blank Bezel | | | | | | | | | |
| Optical | None | | | | | | | | | |
| M.2 SSD | None | | | | | | | | | |
| Ethernet Bluetooth™ | Gigabit Ethernet Connection Bluetooth wireless, integrated in Wi-Fi + Bluetooth combo adapter | | | | | | | | | |
| WLAN | <i>One of the following, configurable by model:</i> • Intel Dual Band Wireless-AC 3165, 1x1, Wi-Fi + BT combo adapter, M.2 Card • Intel Dual Band Wireless-AC 8260, 2x2, Wi-Fi + BT combo adapter, M.2 Card • BCM, Broadcom Wireless-AC, 1x1, Wi-Fi + Bluetooth combo adapter, M.2 Card • QCA, Qualcomm Wireless-AC, 2x2, Wi-Fi + Bluetooth combo adapter, M.2 Card | | | | | | | | | |
| WWAN | None | | | | | | | | | |
| SIM card | None | | | | | | | | | |
| Dimensions Weight Case color Case material | <i>All (WxDxH):</i> 14.84" x 10.04" x 1.07"; 377mm x 255mm x 27.1mm From 5.39 lb (2.45kg) Graphite Black PolyCarbonate/Acrylonitrile-Butadiene-Styrene (PC/ABS) plastic display cover | | | | | | | | | |

| Model | Region | Processor | vPro | Graphics | Memory | Display | Multi-touch | Storage(HDD/SSD) | Optical | WLAN + Bluetooth | WWAN | SIM Card | Color | Case Material | Camera | Keyboard | Fingerprint Reader | TPM | Battery | Power Adapter | Operating System | Warranty | Ann Date (m/y) |
|-------------|--------|-----------|------|-----------------|--------|---------------------------|-------------|------------------|---------|----------------------------|------|----------|-------|---------------|-----------|-------------|--------------------|---------------------|---------------|---------------|----------------------|---------------|----------------|
| 20EV0027US | US | i7-6500U | No | AMD R7 M370 2GB | 8GBx1 | 15.6" FHD (1920x1080) IPS | None | 192GB SSD | DVD±RW | Intel 8260 ac, 2x2 + BT4.0 | None | None | Black | PC/ABS | 3D Camera | Non-backlit | Fingerprint Reader | FW TPM 2.0 | 6-cell (48Wh) | 65W | Win10 Pro 64 | 1-year, Depot | 11/15 |
| 20EV002DUS | US | i3-6100U | No | Intel HD 520 | 4GBx1 | 15.6" HD (1366x768) | None | 500GB 7200rpm | DVD±RW | Intel 3165 ac, 1x1 + BT4.0 | None | None | Black | PC/ABS | 720p | Non-backlit | Fingerprint Reader | dTPM 1.2 | 6-cell (48Wh) | 45W | Win10 DG Win7 Pro 64 | 1-year, Depot | 11/15 |
| 20EV002EUS | US | i3-6100U | No | Intel HD 520 | 4GBx1 | 15.6" HD (1366x768) | None | 192GB SSD | DVD±RW | Intel 3165 ac, 1x1 + BT4.0 | None | None | Black | PC/ABS | 720p | Non-backlit | Fingerprint Reader | dTPM 1.2 | 6-cell (48Wh) | 45W | Win10 DG Win7 Pro 64 | 1-year, Depot | 11/15 |
| 20EV002FUS | US | i5-6200U | No | Intel HD 520 | 4GBx1 | 15.6" HD (1366x768) | None | 500GB 7200rpm | DVD±RW | Intel 3165 ac, 1x1 + BT4.0 | None | None | Black | PC/ABS | 720p | Non-backlit | Fingerprint Reader | dTPM 1.2 | 6-cell (48Wh) | 45W | Win10 DG Win7 Pro 64 | 1-year, Depot | 11/15 |
| 20EV002GUS | US | i5-6200U | No | Intel HD 520 | 4GBx1 | 15.6" HD (1366x768) | None | 192GB SSD | DVD±RW | Intel 3165 ac, 1x1 + BT4.0 | None | None | Black | PC/ABS | 720p | Non-backlit | Fingerprint Reader | dTPM 1.2 | 6-cell (48Wh) | 45W | Win10 DG Win7 Pro 64 | 1-year, Depot | 11/15 |
| 20EV002HUS | US | i5-6200U | No | Intel HD 520 | 8GBx1 | 15.6" HD (1366x768) | None | 192GB SSD | DVD±RW | Intel 3165 ac, 1x1 + BT4.0 | None | None | Black | PC/ABS | 720p | Non-backlit | Fingerprint Reader | dTPM 1.2 | 6-cell (48Wh) | 45W | Win10 DG Win7 Pro 64 | 1-year, Depot | 11/15 |
| 20EV002JUS | US | i7-6500U | No | AMD R7 M370 2GB | 8GBx1 | 15.6" FHD (1920x1080) IPS | None | 500GB 7200rpm | DVD±RW | Intel 8260 ac, 2x2 + BT4.0 | None | None | Black | PC/ABS | 720p | Non-backlit | Fingerprint Reader | FW TPM 2.0 | 6-cell (48Wh) | 65W | Win10 DG Win7 Pro 64 | 1-year, Depot | 11/15 |
| 20EV002KUS | US | i7-6500U | No | AMD R7 M370 2GB | 8GBx1 | 15.6" FHD (1920x1080) IPS | None | 192GB SSD | DVD±RW | Intel 8260 ac, 2x2 + BT4.0 | None | None | Black | PC/ABS | 720p | Non-backlit | Fingerprint Reader | FW TPM 2.0 | 6-cell (48Wh) | 65W | Win10 DG Win7 Pro 64 | 1-year, Depot | 11/15 |
| 20EV002LLUS | US | i3-6100U | No | Intel HD 520 | 4GBx1 | 15.6" HD (1366x768) | None | 500GB 7200rpm | DVD±RW | Intel 3165 ac, 1x1 + BT4.0 | None | None | Black | PC/ABS | 720p | Non-backlit | Fingerprint Reader | dTPM1.2 + FW TPM2.0 | 6-cell (48Wh) | 45W | Win10 Pro 64 | 1-year, Depot | 11/15 |
| 20EV002MUS | US | i3-6100U | No | Intel HD 520 | 4GBx1 | 15.6" HD (1366x768) | None | 192GB SSD | DVD±RW | Intel 3165 ac, 1x1 + BT4.0 | None | None | Black | PC/ABS | 720p | Non-backlit | Fingerprint Reader | dTPM1.2 + FW TPM2.0 | 6-cell (48Wh) | 45W | Win10 Pro 64 | 1-year, Depot | 11/15 |
| 20EV002NUS | US | i5-6200U | No | Intel HD 520 | 4GBx1 | 15.6" HD (1366x768) | None | 500GB 7200rpm | DVD±RW | Intel 3165 ac, 1x1 + BT4.0 | None | None | Black | PC/ABS | 720p | Non-backlit | Fingerprint Reader | dTPM1.2 + FW TPM2.0 | 6-cell (48Wh) | 45W | Win10 Pro 64 | 1-year, Depot | 11/15 |
| 20EV002PUS | US | i5-6200U | No | Intel HD 520 | 4GBx1 | 15.6" HD (1366x768) | None | 192GB SSD | DVD±RW | Intel 3165 ac, 1x1 + BT4.0 | None | None | Black | PC/ABS | 720p | Non-backlit | Fingerprint Reader | dTPM1.2 + FW TPM2.0 | 6-cell (48Wh) | 45W | Win10 Pro 64 | 1-year, Depot | 11/15 |
| 20EV002QUS | US | i5-6200U | No | Intel HD 520 | 8GBx1 | 15.6" HD (1366x768) | None | 192GB SSD | DVD±RW | Intel 3165 ac, 1x1 + BT4.0 | None | None | Black | PC/ABS | 720p | Non-backlit | Fingerprint Reader | dTPM1.2 + FW TPM2.0 | 6-cell (48Wh) | 45W | Win10 Pro 64 | 1-year, Depot | 11/15 |
| 20EV002RUS | US | i7-6500U | No | AMD R7 M370 2GB | 8GBx1 | 15.6" FHD (1920x1080) IPS | None | 500GB 7200rpm | DVD±RW | Intel 8260 ac, 2x2 + BT4.0 | None | None | Black | PC/ABS | 720p | Non-backlit | Fingerprint Reader | FW TPM 2.0 | 6-cell (48Wh) | 65W | Win10 Pro 64 | 1-year, Depot | 11/15 |
| 20EV002SUS | US | i7-6500U | No | AMD R7 M370 2GB | 8GBx1 | 15.6" FHD (1920x1080) IPS | None | 192GB SSD | DVD±RW | Intel 8260 ac, 2x2 + BT4.0 | None | None | Black | PC/ABS | 720p | Non-backlit | Fingerprint Reader | FW TPM 2.0 | 6-cell (48Wh) | 65W | Win10 Pro 64 | 1-year, Depot | 11/15 |
| 20EV003EUS | US | i7-6500U | No | AMD R7 M370 2GB | 8GBx1 | 15.6" FHD (1920x1080) IPS | None | 256GB SSD Opal2 | DVD±RW | Intel 8260 ac, 2x2 + BT4.0 | None | None | Black | PC/ABS | 720p | Non-backlit | Fingerprint Reader | FW TPM 2.0 | 6-cell (48Wh) | 65W | Win10 Pro 64 | 1-year, Depot | 04/16 |
| 20EV003FUS | US | i7-6500U | No | AMD R7 M370 2GB | 8GBx1 | 15.6" FHD (1920x1080) IPS | None | 256GB SSD Opal2 | DVD±RW | Intel 8260 ac, 2x2 + BT4.0 | None | None | Black | PC/ABS | 720p | Non-backlit | Fingerprint Reader | FW TPM 2.0 | 6-cell (48Wh) | 65W | Win10 DG Win7 Pro 64 | 1-year, Depot | 04/16 |
| 20EV003VUS | US | i5-6200U | No | Intel HD 520 | 4GBx1 | 15.6" HD (1366x768) | None | 256GB SSD Opal2 | DVD±RW | Intel 8260 ac, 2x2 + BT4.0 | None | None | Black | PC/ABS | 720p | Non-backlit | Fingerprint Reader | dTPM 1.2 | 6-cell (48Wh) | 45W | Win10 DG Win7 Pro 64 | 1-year, Depot | 09/16 |
| 20EV003WUS | US | i5-6200U | No | Intel HD 520 | 8GBx1 | 15.6" FHD (1920x1080) IPS | None | 256GB SSD Opal2 | DVD±RW | Intel 8260 ac, 2x2 + BT4.0 | None | None | Black | PC/ABS | 720p | Non-backlit | Fingerprint Reader | dTPM 1.2 | 6-cell (48Wh) | 45W | Win10 DG Win7 Pro 64 | 1-year, Depot | 09/16 |
| 20EV0043US | US | i5-6200U | No | Intel HD 520 | 8GBx1 | 15.6" FHD (1920x1080) IPS | None | 500GB 7200rpm | DVD±RW | Intel 3165 ac, 1x1 + BT4.0 | None | None | Black | PC/ABS | 720p | Non-backlit | Fingerprint Reader | dTPM1.2 + FW TPM2.0 | 6-cell (48Wh) | 45W | Win10 Pro 64 | 1-year, Depot | 11/16 |

| Model | Region | Processor | vPro | Graphics | Memory | Display | Multi-touch | Storage(HDD/SSD) | Optical | WLAN + Bluetooth | WWAN | SIM Card | Color | Case Material | Camera | Keyboard | Fingerprint Reader | TPM | Battery | Power Adapter | Operating System | Warranty | Ann Date (m/y) |
|------------|--------|-----------|------|--------------|--------|---------------------|-------------|------------------|---------|----------------------------|------|----------|-------|---------------|--------|-------------|--------------------|---------------------|---------------|---------------|------------------|---------------|----------------|
| 20EVA05UUS | US | i5-6200U | No | Intel HD 520 | 8GBx1 | 15.6" HD (1366x768) | None | 500GB 7200rpm | DVD±RW | Intel 3165 ac, 1x1 + BT4.0 | None | None | Black | PC/ABS | 720p | Non-backlit | Fingerprint Reader | dTPM1.2 + FW TPM2.0 | 6-cell (48Wh) | 45W | Win10 Pro 64 | 1-year, Depot | 10/16 |



ThinkPad E565 Platform Specifications

Product Specifications Reference (PSREF)

| | | | | | | | | | | | |
|---------------|--|------------|--------------|-------------|---------------------|------------------------|--------------|------------------------|--|---|--|
| Processor | AMD Accelerated Processor A6, A8, A10, or FX APU | | | | | | | | Smart Card Reader | None | |
| | Processor Number | # of Cores | # of Threads | Clock Speed | Max Turbo Frequency | Cache | Memory speed | Graphics | ExpressCard | None | |
| | A6-8500P | 2 | 6 | 1.6 GHz | 3.0 GHz | 1MB | DDR3L-1600 | R5 Graphics | Multicard Reader | 4-in-1 reader (MMC, SD, SDHC, SDXC) | |
| | A8-8600P | 4 | 10 | 1.6 GHz | 3.0 GHz | 2MB | | R6 Graphics | Ports | Three USB 3.0 (one Always On), VGA, HDMI, Ethernet (RJ-45), Lenovo OneLink connector, combo audio/microphone jack | |
| | A8-8600P | 4 | 10 | 1.6 GHz | 3.0 GHz | 2MB | | R6 M335DX (R6+R5 M330) | Monitor cable | None | |
| | A10-8700P | 4 | 10 | 1.8 GHz | 3.2 GHz | 2MB | | R6 M340DX (R6+R5 M330) | Camera | HD720p resolution, fixed focus | |
| FX-8800P | 4 | 12 | 2.1 GHz | 3.4 GHz | 2MB | R8 M350DX (R7+R5 M330) | | Audio support | HD Audio, Conexant® CX11852 codec, Dolby® Advanced Audio™ / stereo speakers, 2W x 2 / dual array microphone, combo audio/microphone jack | | |
| Graphics | AMD Radeon™ R5 or R6 Graphics in processor only, or AMD Radeon R5 M330 Graphics, 2GB DDR3 memory, or Dual Graphics support for A8, A10 and FX APU external analog monitor support via VGA DB-15 connector and digital monitor support via HDMI™ (supporting HDCP to output protected content); supports dual independent display | | | | | | | | Keyboard | 6-row, spill-resistant, multimedia Fn keys, numeric keypad | |
| Chipset | AMD SoC (System on Chip) platform | | | | | | | | UltraNav™ | TrackPoint® pointing device and multi-touch with 3+2 buttons click pad | |
| Memory | 16GB max / PC3-12800 1600MHz DDR3L, non-parity, dual-channel capable, two 204-pin SO-DIMM sockets | | | | | | | | ThinkLight™ | None | |
| Display | <i>Some:</i> 15.6" (396mm) HD (1366x768) color, anti-glare, LED backlight, 220 nits, 16:9 aspect ratio <i>Some:</i> 15.6" (396mm) FHD (1920x1080) color, anti-glare, LED backlight, IPS, 250 nits, 16:9 aspect ratio | | | | | | | | Security | Power-on password, hard disk password, supervisor password, security keyhole | |
| Multi-touch | None | | | | | | | | Security chip | TPM2.0 : Trusted Platform Module, TPM2.0 FW (firmware) TPM1.2: Trusted Platform Module, TCG 1.2-compliant TPM : TPM2.0 and TPM1.2 | |
| Storage | <i>Some:</i> SSD / SATA 6.0Gb/s, 2.5" wide, 7mm high, removable, upgradable <i>Some:</i> HDD / SATA 6.0Gb/s, 2.5" wide, removable, upgradable, Active Protection System™ <i>Some:</i> SSHD with 8GB NAND flash memory | | | | | | | | vPro | None | |
| Optical | <i>Some:</i> DVD burner, 9.0mm high, removable <i>Some:</i> Blank Bezel | | | | | | | | Fingerprint reader | <i>Some:</i> Fingerprint reader on the keyboard bezel, swipe sensor | |
| M.2 SSD | None | | | | | | | | NFC | None | |
| Ethernet | Gigabit Network Connection | | | | | | | | Battery type | Li-Ion 6-cell (48Wh) | |
| Bluetooth™ | Bluetooth wireless, integrated in Wi-Fi + Bluetooth combo adapter | | | | | | | | Battery life | Up to 6.5 hr <i>Some:</i> 45-watt AC adapter (Integrated Graphics) <i>Some:</i> 65-watt AC adapter (Discrete Graphics) | |
| WLAN | <i>One of the following, configurable by model:</i> • BCM, Broadcom Wireless-AC, 1x1, Wi-Fi + Bluetooth combo adapter, M.2 Card • QCA, Qualcomm Wireless-AC, 2x2, Wi-Fi + Bluetooth combo adapter, M.2 Card | | | | | | | | AC adapter | <i>Some:</i> 45-watt AC adapter (Integrated Graphics) <i>Some:</i> 65-watt AC adapter (Discrete Graphics) | |
| WWAN | None | | | | | | | | Preload | <i>Some:</i> No operating system <i>Some:</i> Windows® 7 Professional 64 preinstalled through downgrade rights in Windows 10 Pro 64 • Lenovo Solution Center • Lenovo SHAREit • ThinkVantage Product Recovery • Rescue and Recovery™ • ThinkVantage System Update • PC Device Stage • Adobe® Reader® • Microsoft® Office preloaded; purchase a product key to activate • McAfee® Live Safe (30-day trial) | <i>Some:</i> Windows 10 Pro 64 <i>Some:</i> Windows 10 Home 64 • Lenovo Solution Center • Lenovo REACHit • Lenovo SHAREit • Lenovo Companion • Lenovo Settings • ThinkVantage System Update • Microsoft Office preloaded; purchase a product key to activate • McAfee® Live Safe (30-day trial) |
| SIM card | None | | | | | | | | Limited warranty | 1-year - depot repair service / service upgrades available | |
| Dimensions | <i>All (WxDxH):</i> 14.84" x 10.04" x 1.07"; 377mm x 255mm x 27.1mm | | | | | | | | Environment | EPEAT™ Gold; ENERGY STAR®; RoHS-compliant | |
| Weight | From 5.46 lb (2.48kg) | | | | | | | | | | |
| Case color | Graphite black | | | | | | | | | | |
| Case material | PolyCarbonate/Acrylonitrile-Butadiene-Styrene (PC/ABS) plastic display cover | | | | | | | | | | |

| Model | Region | Processor | vPro | Graphics | Memory | Display | Multi-touch | Storage(HDD/SSD) | Optical | WLAN + Bluetooth | WWAN | SIM Card | Color | Case Material | Camera | Keyboard | Fingerprint Reader | TPM | Battery | Power Adapter | Operating System | Warranty | Ann Date (m/y) |
|------------|--------|---------------|------|-------------------|--------|---------------------------|-------------|------------------|---------|--------------------------|------|----------|-------|---------------|--------|-------------|--------------------|---------------------|---------------|---------------|----------------------|---------------|----------------|
| 20EY0006US | US | AMD A10-8700P | No | AMD R6 M340DX 2GB | 8GBx1 | 15.6" FHD (1920x1080) IPS | None | 500GB 5400rpm | DVD±RW | BCM43162 ac, 1x1 + BT4.0 | None | None | Black | PC/ABS | 720p | Non-backlit | None | FW TPM 2.0 | 6-cell (48Wh) | 65W | Win10 Pro 64 | 1-year, Depot | 11/15 |
| 20EY0007US | US | AMD A10-8700P | No | AMD R6 M340DX 2GB | 4GBx1 | 15.6" FHD (1920x1080) IPS | None | 192GB SSD | DVD±RW | BCM43162 ac, 1x1 + BT4.0 | None | None | Black | PC/ABS | 720p | Non-backlit | None | FW TPM 2.0 | 6-cell (48Wh) | 65W | Win10 Pro 64 | 1-year, Depot | 11/15 |
| 20EY0008US | US | AMD A6-8500P | No | AMD R5 Graphics | 8GBx1 | 15.6" HD (1366x768) | None | 500GB 5400rpm | DVD±RW | BCM43162 ac, 1x1 + BT4.0 | None | None | Black | PC/ABS | 720p | Non-backlit | None | dTPM 1.2 | 6-cell (48Wh) | 45W | Win10 DG Win7 Pro 64 | 1-year, Depot | 11/15 |
| 20EY0009US | US | AMD A10-8700P | No | AMD R6 M340DX 2GB | 8GBx1 | 15.6" HD (1366x768) | None | 500GB 5400rpm | DVD±RW | BCM43162 ac, 1x1 + BT4.0 | None | None | Black | PC/ABS | 720p | Non-backlit | None | FW TPM 2.0 | 6-cell (48Wh) | 65W | Win10 Pro 64 | 1-year, Depot | 11/15 |
| 20EY000AUS | US | AMD A6-8500P | No | AMD R5 Graphics | 4GBx1 | 15.6" HD (1366x768) | None | 500GB 5400rpm | DVD±RW | BCM43162 ac, 1x1 + BT4.0 | None | None | Black | PC/ABS | 720p | Non-backlit | None | dTPM 1.2 | 6-cell (48Wh) | 45W | Win10 DG Win7 Pro 64 | 1-year, Depot | 11/15 |
| 20EY000BUS | US | AMD A10-8700P | No | AMD R6 M340DX 2GB | 8GBx1 | 15.6" HD (1366x768) | None | 500GB 5400rpm | DVD±RW | BCM43162 ac, 1x1 + BT4.0 | None | None | Black | PC/ABS | 720p | Non-backlit | None | FW TPM 2.0 | 6-cell (48Wh) | 65W | Win10 DG Win7 Pro 64 | 1-year, Depot | 11/15 |
| 20EY000CUS | US | AMD A10-8700P | No | AMD R6 M340DX 2GB | 4GBx1 | 15.6" HD (1366x768) | None | 500GB 5400rpm | DVD±RW | BCM43162 ac, 1x1 + BT4.0 | None | None | Black | PC/ABS | 720p | Non-backlit | None | FW TPM 2.0 | 6-cell (48Wh) | 65W | Win10 DG Win7 Pro 64 | 1-year, Depot | 11/15 |
| 20EY000DUS | US | AMD A10-8700P | No | AMD R6 M340DX 2GB | 8GBx1 | 15.6" FHD (1920x1080) IPS | None | 192GB SSD | DVD±RW | BCM43162 ac, 1x1 + BT4.0 | None | None | Black | PC/ABS | 720p | Non-backlit | None | FW TPM 2.0 | 6-cell (48Wh) | 65W | Win10 DG Win7 Pro 64 | 1-year, Depot | 11/15 |
| 20EY000EUS | US | AMD A10-8700P | No | AMD R6 M340DX 2GB | 8GBx1 | 15.6" FHD (1920x1080) IPS | None | 500GB 5400rpm | DVD±RW | BCM43162 ac, 1x1 + BT4.0 | None | None | Black | PC/ABS | 720p | Non-backlit | None | FW TPM 2.0 | 6-cell (48Wh) | 65W | Win10 DG Win7 Pro 64 | 1-year, Depot | 11/15 |
| 20EY000FUS | US | AMD A6-8500P | No | AMD R5 Graphics | 8GBx1 | 15.6" HD (1366x768) | None | 500GB 5400rpm | DVD±RW | BCM43162 ac, 1x1 + BT4.0 | None | None | Black | PC/ABS | 720p | Non-backlit | None | dTPM1.2 + FW TPM2.0 | 6-cell (48Wh) | 45W | Win10 Pro 64 | 1-year, Depot | 11/15 |
| 20EY000GUS | US | AMD A10-8700P | No | AMD R6 M340DX 2GB | 4GBx1 | 15.6" FHD (1920x1080) IPS | None | 192GB SSD | DVD±RW | BCM43162 ac, 1x1 + BT4.0 | None | None | Black | PC/ABS | 720p | Non-backlit | None | FW TPM 2.0 | 6-cell (48Wh) | 65W | Win10 DG Win7 Pro 64 | 1-year, Depot | 11/15 |
| 20EY000HUS | US | AMD A10-8700P | No | AMD R6 M340DX 2GB | 8GBx1 | 15.6" FHD (1920x1080) IPS | None | 192GB SSD | DVD±RW | BCM43162 ac, 1x1 + BT4.0 | None | None | Black | PC/ABS | 720p | Non-backlit | None | FW TPM 2.0 | 6-cell (48Wh) | 65W | Win10 Pro 64 | 1-year, Depot | 11/15 |
| 20EY000JUS | US | AMD A10-8700P | No | AMD R6 M340DX 2GB | 4GBx1 | 15.6" HD (1366x768) | None | 500GB 5400rpm | DVD±RW | BCM43162 ac, 1x1 + BT4.0 | None | None | Black | PC/ABS | 720p | Non-backlit | None | FW TPM 2.0 | 6-cell (48Wh) | 65W | Win10 Pro 64 | 1-year, Depot | 11/15 |
| 20EY000KUS | US | AMD A6-8500P | No | AMD R5 Graphics | 4GBx1 | 15.6" HD (1366x768) | None | 500GB 5400rpm | DVD±RW | BCM43162 ac, 1x1 + BT4.0 | None | None | Black | PC/ABS | 720p | Non-backlit | None | dTPM1.2 + FW TPM2.0 | 6-cell (48Wh) | 45W | Win10 Pro 64 | 1-year, Depot | 11/15 |
| 20EY001EUS | US | AMD A10-8700P | No | AMD R6 M340DX 2GB | 8GBx1 | 15.6" HD (1366x768) | None | 500GB 5400rpm | DVD±RW | QCA435 ac, 1x1 + BT4.0 | None | None | Black | PC/ABS | 720p | Non-backlit | None | FW TPM 2.0 | 6-cell (48Wh) | 65W | Win10 DG Win7 Pro 64 | 1-year, Depot | 06/16 |
| 20EY001FUS | US | AMD A10-8700P | No | AMD R6 M340DX 2GB | 8GBx1 | 15.6" FHD (1920x1080) IPS | None | 500GB 5400rpm | DVD±RW | QCA435 ac, 1x1 + BT4.0 | None | None | Black | PC/ABS | 720p | Non-backlit | None | FW TPM 2.0 | 6-cell (48Wh) | 65W | Win10 DG Win7 Pro 64 | 1-year, Depot | 06/16 |
| 20EY001GUS | US | AMD A6-8500P | No | AMD R5 Graphics | 4GBx1 | 15.6" HD (1366x768) | None | 500GB 5400rpm | DVD±RW | QCA435 ac, 1x1 + BT4.0 | None | None | Black | PC/ABS | 720p | Non-backlit | None | dTPM1.2 + FW TPM2.0 | 6-cell (48Wh) | 45W | Win10 Pro 64 | 1-year, Depot | 06/16 |
| 20EY001HUS | US | AMD A6-8500P | No | AMD R5 Graphics | 8GBx1 | 15.6" HD (1366x768) | None | 500GB 5400rpm | DVD±RW | QCA435 ac, 1x1 + BT4.0 | None | None | Black | PC/ABS | 720p | Non-backlit | None | dTPM1.2 + FW TPM2.0 | 6-cell (48Wh) | 45W | Win10 Pro 64 | 1-year, Depot | 06/16 |
| 20EY001JUS | US | AMD A10-8700P | No | AMD R6 M340DX 2GB | 8GBx1 | 15.6" FHD (1920x1080) IPS | None | 192GB SSD | DVD±RW | QCA435 ac, 1x1 + BT4.0 | None | None | Black | PC/ABS | 720p | Non-backlit | None | FW TPM 2.0 | 6-cell (48Wh) | 65W | Win10 DG Win7 Pro 64 | 1-year, Depot | 06/16 |
| 20EY001KUS | US | AMD A10-8700P | No | AMD R6 M340DX 2GB | 8GBx1 | 15.6" FHD (1920x1080) IPS | None | 500GB 5400rpm | DVD±RW | QCA435 ac, 1x1 + BT4.0 | None | None | Black | PC/ABS | 720p | Non-backlit | None | FW TPM 2.0 | 6-cell (48Wh) | 65W | Win10 Pro 64 | 1-year, Depot | 06/16 |

| Model | Region | Processor | vPro | Graphics | Memory | Display | Multi-touch | Storage(HDD/SSD) | Optical | WLAN + Bluetooth | WWAN | SIM Card | Color | Case Material | Camera | Keyboard | Fingerprint Reader | TPM | Battery | Power Adapter | Operating System | Warranty | Ann Date (m/y) |
|------------|--------|---------------|------|-------------------|--------|---------------------------|-------------|------------------|---------|------------------------|------|----------|-------|---------------|--------|-------------|--------------------|------------|---------------|---------------|----------------------|---------------|----------------|
| 20EY001LUS | US | AMD A10-8700P | No | AMD R6 M340DX 2GB | 4GBx1 | 15.6" FHD (1920x1080) IPS | None | 192GB SSD | DVD±RW | QCA435 ac, 1x1 + BT4.0 | None | None | Black | PC/ABS | 720p | Non-backlit | None | FW TPM 2.0 | 6-cell (48Wh) | 65W | Win10 DG Win7 Pro 64 | 1-year, Depot | 06/16 |
| 20EY001MUS | US | AMD A10-8700P | No | AMD R6 M340DX 2GB | 4GBx1 | 15.6" FHD (1920x1080) IPS | None | 500GB 5400rpm | DVD±RW | QCA435 ac, 1x1 + BT4.0 | None | None | Black | PC/ABS | 720p | Non-backlit | None | FW TPM 2.0 | 6-cell (48Wh) | 65W | Win10 DG Win7 Pro 64 | 1-year, Depot | 06/16 |
| 20EY001NUS | US | AMD A10-8700P | No | AMD R6 M340DX 2GB | 4GBx1 | 15.6" HD (1366x768) | None | 500GB 5400rpm | DVD±RW | QCA435 ac, 1x1 + BT4.0 | None | None | Black | PC/ABS | 720p | Non-backlit | None | FW TPM 2.0 | 6-cell (48Wh) | 65W | Win10 DG Win7 Pro 64 | 1-year, Depot | 06/16 |
| 20EY001PUS | US | AMD A10-8700P | No | AMD R6 M340DX 2GB | 8GBx1 | 15.6" HD (1366x768) | None | 500GB 5400rpm | DVD±RW | QCA435 ac, 1x1 + BT4.0 | None | None | Black | PC/ABS | 720p | Non-backlit | None | FW TPM 2.0 | 6-cell (48Wh) | 65W | Win10 Pro 64 | 1-year, Depot | 06/16 |
| 20EY001QUS | US | AMD A10-8700P | No | AMD R6 M340DX 2GB | 4GBx1 | 15.6" HD (1366x768) | None | 500GB 5400rpm | DVD±RW | QCA435 ac, 1x1 + BT4.0 | None | None | Black | PC/ABS | 720p | Non-backlit | None | FW TPM 2.0 | 6-cell (48Wh) | 65W | Win10 Pro 64 | 1-year, Depot | 06/16 |
| 20EY001RUS | US | AMD A6-8500P | No | AMD R5 Graphics | 8GBx1 | 15.6" HD (1366x768) | None | 500GB 5400rpm | DVD±RW | QCA435 ac, 1x1 + BT4.0 | None | None | Black | PC/ABS | 720p | Non-backlit | None | dTPM 1.2 | 6-cell (48Wh) | 45W | Win10 DG Win7 Pro 64 | 1-year, Depot | 06/16 |
| 20EY001SUS | US | AMD A10-8700P | No | AMD R6 M340DX 2GB | 8GBx1 | 15.6" FHD (1920x1080) IPS | None | 192GB SSD | DVD±RW | QCA435 ac, 1x1 + BT4.0 | None | None | Black | PC/ABS | 720p | Non-backlit | None | FW TPM 2.0 | 6-cell (48Wh) | 65W | Win10 Pro 64 | 1-year, Depot | 06/16 |
| 20EY001TUS | US | AMD A10-8700P | No | AMD R6 M340DX 2GB | 4GBx1 | 15.6" FHD (1920x1080) IPS | None | 192GB SSD | DVD±RW | QCA435 ac, 1x1 + BT4.0 | None | None | Black | PC/ABS | 720p | Non-backlit | None | FW TPM 2.0 | 6-cell (48Wh) | 65W | Win10 Pro 64 | 1-year, Depot | 06/16 |
| 20EY001UUS | US | AMD A10-8700P | No | AMD R6 M340DX 2GB | 4GBx1 | 15.6" FHD (1920x1080) IPS | None | 500GB 5400rpm | DVD±RW | QCA435 ac, 1x1 + BT4.0 | None | None | Black | PC/ABS | 720p | Non-backlit | None | FW TPM 2.0 | 6-cell (48Wh) | 65W | Win10 Pro 64 | 1-year, Depot | 06/16 |
| 20EY001VUS | US | AMD A6-8500P | No | AMD R5 Graphics | 4GBx1 | 15.6" HD (1366x768) | None | 500GB 5400rpm | DVD±RW | QCA435 ac, 1x1 + BT4.0 | None | None | Black | PC/ABS | 720p | Non-backlit | None | dTPM 1.2 | 6-cell (48Wh) | 45W | Win10 DG Win7 Pro 64 | 1-year, Depot | 06/16 |

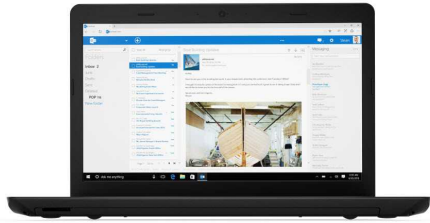

ThinkPad E570 Platform Specifications

Product Specifications Reference (PSREF)

| | | | | | | | | | |
|-----------|--|------------|--------------|----------------|---------------------|-------|-------------------|-----------------------|---|
| Processor | 7th Generation Intel® Core™ i3 / i5 / i7 Processor | | | | | | | | Dimensions <i>Aluminum (WxDxH):</i> 14.92" x 10.28" x 0.94" 379mm x 261mm x 23.9mm <i>PC/ABS (WxDxH):</i> 14.92" x 10.28" x 1.00"; 379mm x 261mm x 25.4mm |
| | Processor Number | # of Cores | # of Threads | Base Frequency | Max Turbo Frequency | Cache | Memory Controller | Processor Graphics | |
| | i3-6100U | 2 | 4 | 2.3 GHz | - | 3MB | DDR4-2133 | Intel HD Graphics 520 | |
| | i5-6200U | | | 2.3 GHz | 2.8 GHz | 3MB | | | |
| | i7-6500U | | | 2.5 GHz | 3.1 GHz | 4MB | | | |
| | i3-7100U | | | 2.4 GHz | - | 3MB | DDR4-2133 | Intel HD Graphics 620 | |
| | i5-7200U | | | 2.5 GHz | 3.1 GHz | 3MB | | | |
| | i7-7500U | | | 2.7 GHz | 3.5 GHz | 4MB | | | |
| | | | | | | | | | |

| | | | |
|--|--|--------------------------------------|---|
| Graphics | Intel HD Graphics in processor only, or NVidia GeForce 940MX Graphics, 2GB DDR5 memory, or NVidia GeForce GTX 950M Graphics, 2GB DDR5 memory, external analog monitor support via VGA DB-15 connector and digital monitor support via HDMI™ (supporting HDCP to output protected content); supports dual independent displays; Max resolution: 1920x1080 (HDMI)@60Hz | Weight Case color | From 5.07 lb (2.30kg) <i>LCD Rear :</i> Black, Silver, Gold (in EMEA only black color available) <i>Base Cover:</i> Black <i>Top Cover:</i> Black, Silver |
| Memory | 32GB max / 2133MHz DDR4, non-parity, dual-channel capable, two 260-pin SO-DIMM sockets * System clocks down for processors with lower memory controller | Case material (LCD Rear) | <i>Aluminum:</i> Aluminum display cover <i>PC/ABS:</i> PolyCarbonate/Acrylonitrile-Butadiene-Styrene display cover |
| Display | Some: 15.6" (396mm) HD (1366x768), anti-glare, LED backlight, 220 nits, 16:9 aspect ratio, 400:1 contrast ratio Some: 15.6" (396mm) FHD (1920x1080), anti-glare, LED backlight, IPS, 250 nits, 16:9 aspect ratio, 600:1 contrast ratio Some: 15.6" (396mm) FHD (1920x1080), anti-glare, LED backlight, 250 nits, 16:9 aspect ratio, 600:1 contrast ratio | Camera Audio support | <i>Some:</i> HD720p resolution, fixed focus HD Audio, Conexant® CX11852 codec, Dolby® Audio™ Premium / stereo speakers, 2W x 2 / dual array microphone, combo audio / microphone jack |
| Multi-touch | None | Keyboard UltraNav™ ThinkLight™ | 6-row, spill-resistant, multimedia Fn keys TrackPoint® pointing device and multi-touch with 3+2 buttons click pad None |
| Storage | <i>Some:</i> M.2 SSD / SATA 6.0Gb/s <i>Some:</i> M.2 SSD / PCIe NVMe <i>Some:</i> HDD / SATA 6.0Gb/s, 2.5" wide, removable, upgradable, Active Protection System™ | Fingerprint reader NFC | <i>Some:</i> Fingerprint reader on the keyboard bezel, swipe sensor None |
| Optical | <i>Some:</i> DVD burner, 9.0mm high, removable <i>Some:</i> Blank Bezel | Security Security chip | Power-on password, hard disk password, supervisor password, security keyhole <i>fTPM2.0:</i> Firmware TPM 2.0, integrated in chipset <i>dTPM2.0:</i> Discrete TPM 2.0, TCG Certified |
| Ethernet | Gigabit Ethernet Connection, Realtek R8111GUS | vPro | No |
| WLAN | <i>One of the following, configurable by model:</i> • Intel Dual Band Wireless-AC 8265, 2x2, Wi-Fi + BT combo adapter, M.2 Card • QCA, Qualcomm 344A-AC, 2x2, Wi-Fi + Bluetooth combo adapter, M.2 Card • QCA, Qualcomm 435-AC, 1x1, Wi-Fi + Bluetooth combo adapter, M.2 Card Bluetooth wireless, integrated in Wi-Fi + Bluetooth combo adapter | Battery type | <i>Some:</i> Li-Polymer 4-cell (32Wh) <i>Some:</i> Li-Ion 4-cell (41Wh) |
| Bluetooth™ | | Battery life | <i>Some:</i> Up to 5.0 hr for Li-Polymer 4-cell (32Wh) <i>Some:</i> Up to 7.0 hr for Li-Ion 4-cell (41Wh) |
| WWAN SIM card | None None | AC adapter | <i>Some:</i> 45-watt AC adapter <i>Some:</i> 65-watt AC adapter <i>Some:</i> 90-watt AC adapter |
| Smart Card Reader ExpressCard Dock | None None None | Preload | <i>Some:</i> Windows 10 Pro 64 <i>Some:</i> Windows 10 Home 64 • Lenovo Companion • Lenovo Settings • Microsoft Office preloaded; purchase a product key to activate • McAfee® Live Safe (30-day trial) <i>Some:</i> No operating system |
| Multicard Reader | 4-in-1 reader (MMC, SD, SDHC, SDXC) | Limited warranty | 1-year - depot repair service / service upgrades available |
| Ports | Two USB 3.0, one USB 2.0 (Always On), VGA, HDMI, Ethernet (RJ-45), combo audio / microphone jack, optional one USB 3.1 Type-C (standard for i5, i7 models in EMEA) | Mil-Spec test | None |
| Monitor cable | None | Environment | EPEAT™ Gold; ENERGY STAR®; RoHS-compliant |

ThinkPad E570 - TopSeller - 20H5

Product Specifications Reference (PSREF)

| Model | Region | Processor | vPro | Graphics | Optional Ports | Memory | Display | Multi-touch | Storage(HDD/SSD) | Optical | WLAN + Bluetooth | WWAN | SIM Card | Color (LCD_Rear, Top_Cover) | Case Material | Fingerprint Reader | TPM | Battery | Power Adapter | Operating System | Warranty | Ann Date (m/y) |
|------------|--------|-----------|------|--------------|----------------|--------|---------------------------|-------------|-------------------------------|---------|----------------------------|------|----------|-----------------------------|---------------|--------------------|------------|---------------|---------------|----------------------|---------------|----------------|
| 20H50042US | US | i3-7100U | No | Intel HD 620 | None | 4GBx1 | 15.6" HD (1366x768) | None | 500GB 7200rpm | DVD±RW | 11ac, 1x1 + BT4.1 | None | None | Black, Black | PC/ABS | Fingerprint Reader | dTPM 2.0 | 4-cell (41Wh) | 45W | Win10 Pro 64 | 1-year, Depot | 09/16 |
| 20H50043US | US | i7-7500U | No | GTX 950M 2GB | None | 8GBx1 | 15.6" FHD (1920x1080) IPS | None | 500GB 7200rpm | DVD±RW | Intel 8265 ac, 2x2 + BT4.1 | None | None | Black, Black | PC/ABS | Fingerprint Reader | FW TPM 2.0 | 4-cell (41Wh) | 90W | Win10 Pro 64 | 1-year, Depot | 09/16 |
| 20H50044US | US | i3-6006U | No | Intel HD 520 | None | 4GBx1 | 15.6" HD (1366x768) | None | 500GB 7200rpm | DVD±RW | 11ac, 1x1 + BT4.1 | None | None | Black, Black | PC/ABS | None | dTPM 2.0 | 4-cell (41Wh) | 45W | Win10 Pro 64 | 1-year, Depot | 11/16 |
| 20H50045US | US | i5-7200U | No | Intel HD 620 | None | 8GBx1 | 15.6" FHD (1920x1080) IPS | None | 256GB SSD M.2 PCIe NVMe Opal2 | DVD±RW | Intel 8265 ac, 2x2 + BT4.1 | None | None | Black, Black | PC/ABS | Fingerprint Reader | dTPM 2.0 | 4-cell (41Wh) | 45W | Win10 Pro 64 | 1-year, Depot | 09/16 |
| 20H50047US | US | i7-7500U | No | GTX 950M 2GB | None | 8GBx1 | 15.6" FHD (1920x1080) IPS | None | 256GB SSD M.2 PCIe NVMe Opal2 | DVD±RW | Intel 8265 ac, 2x2 + BT4.1 | None | None | Black, Black | PC/ABS | Fingerprint Reader | FW TPM 2.0 | 4-cell (41Wh) | 90W | Win10 Pro 64 | 1-year, Depot | 09/16 |
| 20H50048US | US | i5-7200U | No | Intel HD 620 | None | 4GBx1 | 15.6" HD (1366x768) | None | 500GB 7200rpm | DVD±RW | 11ac, 1x1 + BT4.1 | None | None | Black, Black | PC/ABS | Fingerprint Reader | dTPM 2.0 | 4-cell (41Wh) | 45W | Win10 Pro 64 | 1-year, Depot | 09/16 |
| 20H5007UUS | US | i3-7100U | No | Intel HD 620 | None | 4GBx1 | 15.6" HD (1366x768) | None | 180GB SSD M.2 Opal2 | DVD±RW | 11ac, 1x1 + BT4.1 | None | None | Black, Black | PC/ABS | Fingerprint Reader | dTPM 2.0 | 4-cell (41Wh) | 45W | Win10 Pro 64 | 1-year, Depot | 01/17 |
| 20H5007VUS | US | i5-6200U | No | 940MX 2GB | None | 8GBx1 | 15.6" HD (1366x768) | None | 180GB SSD M.2 Opal2 | DVD±RW | 11ac, 1x1 + BT4.1 | None | None | Black, Black | PC/ABS | Fingerprint Reader | FW TPM 2.0 | 4-cell (41Wh) | 65W | Win10 Pro 64 | 1-year, Depot | 01/17 |
| 20H5007WUS | US | i5-6200U | No | 940MX 2GB | None | 4GBx1 | 15.6" HD (1366x768) | None | 180GB SSD M.2 Opal2 | DVD±RW | 11ac, 1x1 + BT4.1 | None | None | Black, Black | PC/ABS | Fingerprint Reader | FW TPM 2.0 | 4-cell (41Wh) | 65W | Win10 Pro 64 | 1-year, Depot | 01/17 |
| 20H5009FUS | US | i3-6006U | No | Intel HD 520 | None | 4GBx1 | 15.6" HD (1366x768) | None | 500GB 7200rpm | DVD±RW | 11ac, 1x1 + BT4.1 | None | None | Black, Black | PC/ABS | Fingerprint Reader | dTPM 2.0 | 4-cell (41Wh) | 45W | Win10 DG Win7 Pro 64 | 1-year, Depot | 03/17 |
| 20H5009GUS | US | i7-6500U | No | 940MX 2GB | None | 8GBx1 | 15.6" FHD (1920x1080) IPS | None | 256GB SSD M.2 PCIe NVMe Opal2 | DVD±RW | Intel 8265 ac, 2x2 + BT4.1 | None | None | Black, Black | PC/ABS | Fingerprint Reader | FW TPM 2.0 | 4-cell (41Wh) | 65W | Win10 DG Win7 Pro 64 | 1-year, Depot | 03/17 |
| 20H5009HUS | US | i3-6006U | No | Intel HD 520 | None | 4GBx1 | 15.6" HD (1366x768) | None | 500GB 7200rpm | DVD±RW | 11ac, 1x1 + BT4.1 | None | None | Black, Black | PC/ABS | None | dTPM 2.0 | 4-cell (41Wh) | 45W | Win10 DG Win7 Pro 64 | 1-year, Depot | 03/17 |
| 20H5009JUS | US | i7-6500U | No | 940MX 2GB | None | 8GBx1 | 15.6" FHD (1920x1080) IPS | None | 128GB SSD M.2 | DVD±RW | Intel 8265 ac, 2x2 + BT4.1 | None | None | Black, Black | PC/ABS | Fingerprint Reader | FW TPM 2.0 | 4-cell (41Wh) | 65W | Win10 DG Win7 Pro 64 | 1-year, Depot | 03/17 |
| 20H5009KUS | US | i5-6200U | No | Intel HD 520 | None | 4GBx1 | 15.6" HD (1366x768) | None | 128GB SSD M.2 | DVD±RW | 11ac, 1x1 + BT4.1 | None | None | Black, Black | PC/ABS | Fingerprint Reader | dTPM 2.0 | 4-cell (41Wh) | 45W | Win10 DG Win7 Pro 64 | 1-year, Depot | 03/17 |
| 20H5009LUS | US | i5-6200U | No | Intel HD 520 | None | 8GBx1 | 15.6" FHD (1920x1080) IPS | None | 256GB SSD M.2 PCIe NVMe Opal2 | DVD±RW | Intel 8265 ac, 2x2 + BT4.1 | None | None | Black, Black | PC/ABS | Fingerprint Reader | dTPM 2.0 | 4-cell (41Wh) | 45W | Win10 DG Win7 Pro 64 | 1-year, Depot | 03/17 |
| 20H5009MUS | US | i7-6500U | No | 940MX 2GB | None | 8GBx1 | 15.6" FHD (1920x1080) IPS | None | 500GB 7200rpm | DVD±RW | Intel 8265 ac, 2x2 + BT4.1 | None | None | Black, Black | PC/ABS | Fingerprint Reader | FW TPM 2.0 | 4-cell (41Wh) | 65W | Win10 DG Win7 Pro 64 | 1-year, Depot | 03/17 |
| 20H5009NUS | US | i5-6200U | No | Intel HD 520 | None | 4GBx1 | 15.6" HD (1366x768) | None | 500GB 7200rpm | DVD±RW | 11ac, 1x1 + BT4.1 | None | None | Black, Black | PC/ABS | Fingerprint Reader | dTPM 2.0 | 4-cell (41Wh) | 45W | Win10 DG Win7 Pro 64 | 1-year, Depot | 03/17 |
| 20H500A9US | US | i5-7200U | No | Intel HD 620 | None | 8GBx1 | 15.6" FHD (1920x1080) IPS | None | 180GB SSD M.2 Opal2 | DVD±RW | 11ac, 1x1 + BT4.1 | None | None | Black, Black | PC/ABS | Fingerprint Reader | dTPM 2.0 | 4-cell (41Wh) | 45W | Win10 Pro 64 | 1-year, Depot | 03/17 |
| 20H500AAUS | US | i5-7200U | No | Intel HD 620 | None | 8GBx1 | 15.6" FHD (1920x1080) IPS | None | 500GB 7200rpm | DVD±RW | 11ac, 1x1 + BT4.1 | None | None | Black, Black | PC/ABS | Fingerprint Reader | dTPM 2.0 | 4-cell (41Wh) | 45W | Win10 Pro 64 | 1-year, Depot | 03/17 |

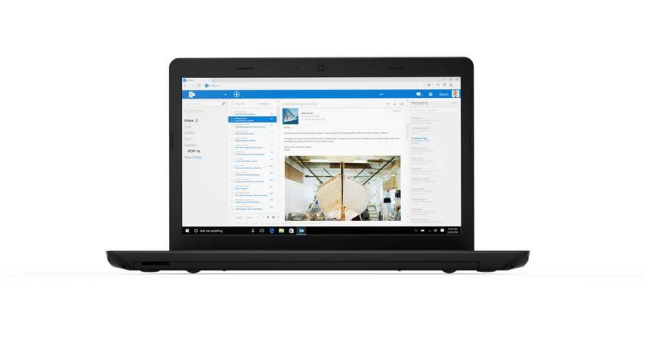

ThinkPad E575 Platform Specifications

Product Specifications Reference (PSREF)

| | | | | | | | | | | |
|-------------------|--|------------|--------------|----------------|---------------------|-------------|--------------|--------------------|---|---|
| Processor | AMD Accelerated Processor A6, A10, or A12 APU | | | | | | | | Dimensions Weight Case color Case material | <i>PC/ABS (WxDxH):</i> 14.92" x 10.28" x 1.00"; 379mm x 261mm x 25.4mm From 5.07 lb (2.30kg) Black <i>PC/ABS:</i> PolyCarbonate/Acrylonitrile-Butadiene-Styrene display cover |
| | Processor Number | # of Cores | # of Threads | Base Frequency | Max Turbo Frequency | Cache | Memory Types | Processor Graphics | | |
| | A6-9500B | 2 | 4 | 2.3 GHz | 3.2 GHz | 2MB | DDR4-1866 | R5 Graphics | | |
| | A10-9600P | 4 | 8 | 2.4 GHz | 3.3 GHz | 2MB | | R5 Graphics | | |
| A12-9700P | 4 | 8 | 2.5 GHz | 3.4 GHz | 2MB | R7 Graphics | | | | |
| Graphics | AMD Radeon™ R5 Graphics in processor only, or AMD Radeon R5 M430 Graphics, 2GB DDR3 memory, or external analog monitor support via VGA DB-15 connector and digital monitor support via HDMI™ (supporting HDCP to output protected content); supports dual independent displays; Max resolution: 1920x1080 (HDMI)@60Hz | | | | | | | | Camera Audio support | <i>Some:</i> HD720p resolution, fixed focus HD Audio, Conexant® CX11852 codec, Dolby® Audio™ Premium / stereo speakers, 2W x 2 / dual array microphone, combo audio / microphone jack |
| Chipset | AMD SoC (System on Chip) platform | | | | | | | | Keyboard | 6-row, spill-resistant, multimedia Fn keys |
| Memory | 32GB max / 2133MHz DDR4, non-parity, dual-channel capable, two 260-pin SO-DIMM sockets *System automatically clocks down with 1866MHz DDR4 memory controller | | | | | | | | UltraNav™ ThinkLight™ | TrackPoint® pointing device and multi-touch with 3+2 buttons click pad None |
| Display | Some: 15.6" (396mm) HD (1366x768), anti-glare, LED backlight, 220 nits, 16:9 aspect ratio, 400:1 contrast ratio Some: 15.6" (396mm) FHD (1920x1080), anti-glare, LED backlight, IPS, 250 nits, 16:9 aspect ratio, 600:1 contrast ratio | | | | | | | | Fingerprint reader | None |
| Multi-touch | None | | | | | | | | NFC | None |
| Storage | <i>Some:</i> SSD / SATA 6.0Gb/s, 2.5" wide, 7mm high, removable, upgradable <i>Some:</i> HDD / SATA 6.0Gb/s, 2.5" wide, removable, upgradable, Active Protection System™ | | | | | | | | Security | Power-on password, hard disk password, supervisor password, security keyhole |
| Optical | <i>Some:</i> DVD burner, 9.0mm high, removable <i>Some:</i> Blank Bezel | | | | | | | | Security chip | <i>FW TPM2.0:</i> Firmware TPM 2.0, integrated in chipset <i>dTPM2.0:</i> Discrete TPM 2.0, TCG Certified |
| Ethernet | Gigabit Ethernet Connection, Realtek R8111GUS | | | | | | | | vPro | No |
| WLAN | <i>One of the following, configurable by model:</i> • QCA, Qualcomm 344A-AC, 2x2, Wi-Fi + Bluetooth combo adapter, M.2 Card • QCA, Qualcomm 435-AC, 1x1, Wi-Fi + Bluetooth combo adapter, M.2 Card Bluetooth wireless, integrated in Wi-Fi + Bluetooth combo adapter | | | | | | | | Battery type | <i>Some:</i> Li-Ion 4-cell (41Wh) |
| Bluetooth™ | | | | | | | | | Battery life | <i>Some:</i> Up to 6.5 hr |
| WWAN | None | | | | | | | | AC adapter | <i>Some:</i> 45-watt AC adapter <i>Some:</i> 65-watt AC adapter |
| SIM card | None | | | | | | | | Preload | <i>Some:</i> Windows 10 Pro 64 <i>Some:</i> Windows 10 Home 64 • Lenovo Companion • Lenovo Settings • Microsoft Office preloaded; purchase a product key to activate • McAfee® Live Safe (30-day trial) <i>Some:</i> No operating system |
| Smart Card Reader | None | | | | | | | | Limited warranty | 1-year - depot repair service / service upgrades available |
| ExpressCard | None | | | | | | | | Mil-Spec test | None |
| Dock | None | | | | | | | | Environment | EPEAT™ Gold; ENERGY STAR®; RoHS-compliant |
| Multicard Reader | 4-in-1 reader (MMC, SD, SDHC, SDXC) | | | | | | | | | |
| Ports | Two USB 3.0, one USB 2.0 (Always On), VGA, HDMI, Ethernet (RJ-45), combo audio / microphone jack | | | | | | | | | |
| Monitor cable | None | | | | | | | | | |

ThinkPad E575 - TopSeller - 20H8

Product Specifications Reference (PSREF)

| Model | Region | Processor | vPro | Graphics | Memory | Display | Multi-touch | Storage(HDD/SSD) | Optical | WLAN + Bluetooth | WWAN | SIM Card | Color | Case Material | Camera | Keyboard | Fingerprint Reader | TPM | Battery | Power Adapter | Operating System | Warranty | End of Support | Ann Date (m/y) |
|------------|--------|---------------|------|-----------------|--------|---------------------------|-------------|------------------|---------|------------------------|------|----------|-------|---------------|--------|-------------|--------------------|------------|---------------|---------------|-------------------|---------------|----------------|----------------|
| 20H8000CUS | US | AMD A10-9600P | No | AMD R5 M430 2GB | 4GBx1 | 15.6" HD (1366x768) | None | 500GB 7200rpm | DVD±RW | QCA435 ac, 1x1 + BT4.1 | None | None | Black | PC/ABS | 720p | Non-backlit | None | FW TPM 2.0 | 4-cell (41Wh) | 65W | Windows 10 Pro 64 | 1-year, Depot | Nov 7, 2021 | 11/16 |
| 20H8000DUS | US | AMD A10-9600P | No | AMD R5 M430 2GB | 8GBx1 | 15.6" FHD (1920x1080) IPS | None | 500GB 7200rpm | DVD±RW | QCA435 ac, 1x1 + BT4.1 | None | None | Black | PC/ABS | 720p | Non-backlit | None | FW TPM 2.0 | 4-cell (41Wh) | 65W | Windows 10 Pro 64 | 1-year, Depot | Nov 7, 2021 | 11/16 |
| 20H8000EUS | US | AMD A10-9600P | No | AMD R5 M430 2GB | 8GBx1 | 15.6" HD (1366x768) | None | 500GB 7200rpm | DVD±RW | QCA435 ac, 1x1 + BT4.1 | None | None | Black | PC/ABS | 720p | Non-backlit | None | FW TPM 2.0 | 4-cell (41Wh) | 65W | Windows 10 Pro 64 | 1-year, Depot | Nov 7, 2021 | 11/16 |
| 20H8000FUS | US | AMD A6-9500B | No | AMD R5 Graphics | 8GBx1 | 15.6" HD (1366x768) | None | 500GB 7200rpm | DVD±RW | QCA435 ac, 1x1 + BT4.1 | None | None | Black | PC/ABS | 720p | Non-backlit | None | dTPM 1.2 | 4-cell (41Wh) | 45W | Windows 10 Pro 64 | 1-year, Depot | Nov 7, 2021 | 11/16 |
| 20H8000GUS | US | AMD A10-9600P | No | AMD R5 M430 2GB | 8GBx1 | 15.6" FHD (1920x1080) IPS | None | 256GB SSD Opal2 | DVD±RW | QCA435 ac, 1x1 + BT4.1 | None | None | Black | PC/ABS | 720p | Non-backlit | None | FW TPM 2.0 | 4-cell (41Wh) | 65W | Windows 10 Pro 64 | 1-year, Depot | Nov 7, 2021 | 11/16 |
| 20H8000HUS | US | AMD A6-9500B | No | AMD R5 Graphics | 4GBx1 | 15.6" HD (1366x768) | None | 500GB 7200rpm | DVD±RW | QCA435 ac, 1x1 + BT4.1 | None | None | Black | PC/ABS | 720p | Non-backlit | None | dTPM 1.2 | 4-cell (41Wh) | 45W | Windows 10 Pro 64 | 1-year, Depot | Nov 7, 2021 | 11/16 |
| 20H8000QUS | US | AMD A10-9600P | No | AMD R5 M430 2GB | 8GBx1 | 15.6" HD (1366x768) | None | 180GB SSD Opal2 | DVD±RW | QCA435 ac, 1x1 + BT4.1 | None | None | Black | PC/ABS | 720p | Non-backlit | None | FW TPM 2.0 | 4-cell (41Wh) | 65W | Windows 10 Pro 64 | 1-year, Depot | Jun 4, 2022 | 01/17 |



ThinkPad L460 Platform Specifications

Product Specifications Reference (PSREF)

| | | | | | | | | | | | | | | | |
|-------------------|--|------------|--------------|----------------|---------------------|-------|--------------|--|--|---------------------------------|--------------------------|------------------------------|------------------|---|------------------------------------|
| Processor | Intel® Celeron® Processor or 6th Generation Intel Core™ i3 / i5 / i7 Processor | | | | | | | Dimensions ³ Weight ² | WxDxH: 13.34" x 9.23" x 0.95"; 339mm x 235mm x 24.3mm | | | | | | |
| | Processor Number | # of Cores | # of Threads | Base Frequency | Max Turbo Frequency | Cache | Memory Types | | Processor Graphics | Models | 3-cell | 6-cell | | | |
| | Cel 3855U | 2 | 4 | 1.6 GHz | - | 2MB | DDR3L-1600 | Intel HD Graphics 510 | Integrated model | 4.25 lb / 1.93 kg | 4.45 lb / 2.02 kg | | | | |
| | i3-6006U | | | 2.0 GHz | - | 3MB | | | | | | | | | |
| | i3-6100U | | | 2.3 GHz | - | 3MB | | | | | | | | | |
| | i5-6200U | | | 2.3 GHz | 2.8 GHz | 3MB | | | | | | | | | |
| | i5-6300U | | | 2.4 GHz | 3.0 GHz | 3MB | | | | | | | | | |
| | i7-6500U | | | 2.5 GHz | 3.1 GHz | 4MB | | | | | | | | | |
| | i7-6600U | | | 2.6 GHz | 3.4 GHz | 4MB | | | Intel HD Graphics 520 | | discrete model | 4.3 lb / 1.95 kg | 4.5 lb / 2.04 kg | | |
| | | | | | | | | Case material | PolyCarbonate/Acrylonitrile-Butadiene-Styrene (PC/ABS) plastic | | | | | | |
| | | | | | | | | Smart card reader | Optional: Smart card reader | | | | | | |
| | | | | | | | | Media reader | 4-in-1 reader (MMC, SD, SDHC, SDXC) | | | | | | |
| | | | | | | | | Ports | Three USB 3.0 (one Always On), VGA, Mini DisplayPort, Ethernet (RJ-45), Dock connector (integrated models only) | | | | | | |
| | | | | | | | | Camera (optional) | HD720p resolution, low light sensitive, fixed focus | | | | | | |
| | | | | | | | | Audio support | HD Audio, Realtek® ALC3245 codec / stereo speakers, 2W x 2 / dual array microphone, combo audio/microphone jack | | | | | | |
| Graphics | Intel HD Graphics 510 or 520 in processor only, or Intel HD Graphics 520 in processor and AMD Exo Pro Radeon R5, 2GB memory; supports external analog monitor via VGA and digital monitor via Mini DisplayPort; supports three independent displays; Max resolution: 3840x2160@60Hz (DP via mDP cable); 1920x1200@60Hz (VGA) | | | | | | | Keyboard | 6-row, spill-resistant, multimedia Fn keys | | | | | | |
| | | | | | | | | UltraNav™ | TrackPoint® pointing device and buttonless Mylar surface multi-touch touchpad | | | | | | |
| Chipset | Intel SoC (System on Chip) platform | | | | | | | Security | Power-on password, hard disk password, supervisor password, security keyhole | | | | | | |
| Memory | 32GB max ⁷ / PC3-12800 1600MHz DDR3L, non-parity, dual-channel capable, two DDR3L SO-DIMM sockets | | | | | | | Security chip | Discrete TPM 1.2 TCG Certified and Firmware TPM 2.0 integrated in chipset | | | | | | |
| | | | | | | | | ThinkEngine | Delivers improved thermal and power efficiency, up to 30 day standby, faster resume time, enhanced security, as well as anti-tampering measures | | | | | | |
| | | | | | | | | vPro (optional) | Intel vPro Technology | | | | | | |
| Display | Some: 14.0" (355mm) HD (1366x768), anti-glare, LED backlight, 220 nits, 16:9 aspect ratio, 400:1 or 500:1 contrast ratio Some: 14.0" (355mm) FHD (1920x1080), anti-glare, LED backlight, IPS, 250 nits, 16:9 aspect ratio, 600:1 or 700:1 contrast ratio, 170° viewing angle | | | | | | | Fingerprint reader | Optional: Swipe style fingerprint reader on the keyboard bezel | | | | | | |
| Multi-touch | None | | | | | | | Battery | Li-Ion 3-cell (23Wh) or 6-cell (48Wh or 72Wh) | | | | | | |
| Storage | Some: SSD / SATA 6.0Gb/s, 2.5" wide, 7mm high Some: HDD / SATA 6.0Gb/s, 2.5" wide, 7mm or 9.5mm high, Shock Mounted Hard Drive, Active Protection System™ Some: SSHD with 8GB NAND flash memory | | | | | | | Max battery life ¹⁰ (MobileMark® 2014) | Models | 3-cell | 6-cell 48Wh | 6-cell 72Wh | | | |
| Optical | None | | | | | | | Max battery life | 6.93 hr | 12.7 hr | 20.53 hr | | | | |
| Ethernet | Non-vPro model: Intel Ethernet Connection I219-V (Jacksonville) vPro model: Intel Ethernet Connection I219-LM (Jacksonville) | | | | | | | AC adapter | 45W or 65W AC adapter | | | | | | |
| WLAN ⁴ | One of the following, configurable by model: • 11ac+BT, Broadcom BCM4356, 2x2, M.2 card • 11ac+BT, Intel Dual Band Wireless-AC 8260, 2x2, M.2 card | | | | | | | Preload | Windows 7 Professional 64 preinstalled through downgrade rights in Windows 10 Pro 64 | Windows 10 Pro 64 | • Lenovo Solution Center | • Lenovo Companion | | | |
| Bluetooth™ | Bluetooth 4.1 wireless, integrated in Wi-Fi + Bluetooth combo adapter | | | | | | | | • Lenovo Solution Center | • ThinkVantage Product Recovery | • Rescue and Recovery™ | • ThinkVantage System Update | • Adobe® Reader® | • Microsoft® Office preloaded; purchase a product key to activate | • McAfee® LiveSafe™ (30-day trial) |
| WWAN (optional) | One of the following, configurable by model: • Wireless WAN upgradable • Wireless WAN, Sierra Wireless EM7455, Qualcomm® 4G LTE-Advanced/DC-HSPA+/HSPA+/HSPA/UMTS/GNSS, M.2 card • Wireless WAN, HUAWEI ME906S, HUAWEI 4G LTE/WCDMA/HSPA/GSM/GPRS/EDGE/GNSS, M.2 card (WE only) | | | | | | | Limited warranty ¹² | One of the following, configurable by model: • 1-year depot repair service • 3-year/1-yr battery depot repair service • 3-year/1-yr battery limited onsite service ²⁴ • 3-year/1-yr battery limited onsite service, OID (Onsite International Delivery) | | | | | | |
| SIM card (opt) | Micro-SIM card slot, optional Verizon LTE (US) or Lenovo Connect (WE) SIM card | | | | | | | Mil-Spec test | MIL-STD-810G military certification | | | | | | |
| | | | | | | | | Environment | EPEAT™ Gold (US only); ENERGY STAR® 6.1; GREENGUARD®; RoHS-compliant | | | | | | |

| Model | Region | Processor | vPro | Graphics | Memory | Display | Multi-touch | Storage | Optical | WLAN + Bluetooth | WWAN | SIM Card | Smart Card Reader | Camera | Keyboard | Fingerprint Reader | Battery | Power Adapter | Operating System | Warranty | Ann Date (m/y) |
|------------|--------|-----------|------|--------------------|--------|-------------------------|-------------|-----------------|---------|----------------------------|-----------------|----------|-------------------|--------|-------------|--------------------|---------------|---------------|----------------------|---------------|----------------|
| 20FU0014US | US | i5-6200U | No | Intel HD 520 | 8GBx1 | 14" HD (1366x768) | None | 256GB SSD Opal2 | None | Intel 8260 ac, 2x2 + BT4.1 | WWAN Upgradable | None | None | 720p | Non-backlit | None | 6-cell (48Wh) | 45W | Win10 DG Win7 Pro 64 | 3-year, Depot | 01/16 |
| 20FU0015US | US | i5-6200U | No | Intel HD 520 | 8GBx1 | 14" FHD (1920x1080) IPS | None | 256GB SSD Opal2 | None | Intel 8260 ac, 2x2 + BT4.1 | WWAN Upgradable | None | None | 720p | Non-backlit | Fingerprint Reader | 6-cell (48Wh) | 45W | Win10 DG Win7 Pro 64 | 1-year, Depot | 01/16 |
| 20FU0017US | US | i3-6100U | No | Intel HD 520 | 4GBx1 | 14" HD (1366x768) | None | 192GB SSD | None | Intel 8260 ac, 2x2 + BT4.1 | WWAN Upgradable | None | None | 720p | Non-backlit | None | 6-cell (48Wh) | 45W | Win10 DG Win7 Pro 64 | 1-year, Depot | 01/16 |
| 20FU0018US | US | i5-6200U | No | Intel HD 520 | 4GBx1 | 14" HD (1366x768) | None | 192GB SSD | None | Intel 8260 ac, 2x2 + BT4.1 | WWAN Upgradable | None | None | 720p | Non-backlit | None | 6-cell (48Wh) | 45W | Win10 Pro 64 | 1-year, Depot | 01/16 |
| 20FU001BUS | US | i5-6200U | No | Intel HD 520 | 8GBx1 | 14" HD (1366x768) | None | 256GB SSD Opal2 | None | Intel 8260 ac, 2x2 + BT4.1 | WWAN Upgradable | None | None | 720p | Non-backlit | None | 6-cell (48Wh) | 45W | Win10 Pro 64 | 3-year, Depot | 01/16 |
| 20FU001CUS | US | i5-6200U | No | Intel HD 520 | 8GBx1 | 14" FHD (1920x1080) IPS | None | 256GB SSD Opal2 | None | Intel 8260 ac, 2x2 + BT4.1 | WWAN Upgradable | None | None | 720p | Non-backlit | Fingerprint Reader | 6-cell (48Wh) | 45W | Win10 Pro 64 | 1-year, Depot | 01/16 |
| 20FU001DUS | US | i5-6200U | No | Intel HD 520 | 4GBx1 | 14" HD (1366x768) | None | 192GB SSD | None | Intel 8260 ac, 2x2 + BT4.1 | WWAN Upgradable | None | None | 720p | Non-backlit | None | 6-cell (48Wh) | 45W | Win10 DG Win7 Pro 64 | 1-year, Depot | 01/16 |
| 20FU001EUS | US | i3-6100U | No | Intel HD 520 | 4GBx1 | 14" HD (1366x768) | None | 500GB 7200rpm | None | Intel 8260 ac, 2x2 + BT4.1 | WWAN Upgradable | None | None | 720p | Non-backlit | None | 6-cell (48Wh) | 45W | Win10 Pro 64 | 1-year, Depot | 01/16 |
| 20FU001GUS | US | i3-6100U | No | Intel HD 520 | 4GBx1 | 14" HD (1366x768) | None | 192GB SSD | None | Intel 8260 ac, 2x2 + BT4.1 | WWAN Upgradable | None | None | 720p | Non-backlit | None | 6-cell (48Wh) | 45W | Win10 Pro 64 | 1-year, Depot | 01/16 |
| 20FU001HUS | US | i3-6100U | No | Intel HD 520 | 4GBx1 | 14" HD (1366x768) | None | 500GB 7200rpm | None | Intel 8260 ac, 2x2 + BT4.1 | WWAN Upgradable | None | None | 720p | Non-backlit | None | 6-cell (48Wh) | 45W | Win10 DG Win7 Pro 64 | 1-year, Depot | 01/16 |
| 20FU0024US | US | i5-6300U | vPro | Intel HD 520 | 8GBx1 | 14" FHD (1920x1080) IPS | None | 256GB SSD Opal2 | None | Intel 8260 ac, 2x2 + BT4.1 | WWAN Upgradable | None | None | 720p | Non-backlit | Fingerprint Reader | 6-cell (48Wh) | 45W | Win10 Pro 64 | 1-year, Depot | 01/16 |
| 20FU0025US | US | i5-6300U | vPro | Intel HD 520 | 8GBx1 | 14" FHD (1920x1080) IPS | None | 256GB SSD Opal2 | None | Intel 8260 ac, 2x2 + BT4.1 | WWAN Upgradable | None | None | 720p | Non-backlit | Fingerprint Reader | 6-cell (48Wh) | 45W | Win10 DG Win7 Pro 64 | 1-year, Depot | 01/16 |
| 20FU0026US | US | i5-6300U | vPro | Intel HD 520 | 4GBx1 | 14" HD (1366x768) | None | 500GB 7200rpm | None | Intel 8260 ac, 2x2 + BT4.1 | WWAN Upgradable | None | None | 720p | Non-backlit | None | 6-cell (48Wh) | 45W | Win10 DG Win7 Pro 64 | 1-year, Depot | 01/16 |
| 20FU0027US | US | i5-6300U | vPro | Intel HD 520 | 4GBx1 | 14" HD (1366x768) | None | 500GB 7200rpm | None | Intel 8260 ac, 2x2 + BT4.1 | WWAN Upgradable | None | None | 720p | Non-backlit | None | 6-cell (48Wh) | 45W | Win10 Pro 64 | 1-year, Depot | 01/16 |
| 20FU0028US | US | i5-6300U | vPro | Intel HD 520 | 4GBx1 | 14" HD (1366x768) | None | 192GB SSD | None | Intel 8260 ac, 2x2 + BT4.1 | WWAN Upgradable | None | None | 720p | Non-backlit | Fingerprint Reader | 6-cell (48Wh) | 45W | Win10 DG Win7 Pro 64 | 3-year, Depot | 02/16 |
| 20FU0029US | US | i5-6200U | No | AMD Exo Pro R5 2GB | 4GBx1 | 14" HD (1366x768) | None | 500GB 7200rpm | None | Intel 8260 ac, 2x2 + BT4.1 | WWAN Upgradable | None | None | 720p | Non-backlit | None | 6-cell (48Wh) | 65W | Win10 Pro 64 | 1-year, Depot | 02/16 |
| 20FU002AUS | US | i5-6200U | No | Intel HD 520 | 4GBx1 | 14" HD (1366x768) | None | 500GB 7200rpm | None | Intel 8260 ac, 2x2 + BT4.1 | WWAN Upgradable | None | None | 720p | Non-backlit | None | 6-cell (48Wh) | 45W | Win10 DG Win7 Pro 64 | 1-year, Depot | 02/16 |
| 20FU002BUS | US | i5-6300U | vPro | Intel HD 520 | 4GBx1 | 14" HD (1366x768) | None | 192GB SSD | None | Intel 8260 ac, 2x2 + BT4.1 | WWAN Upgradable | None | None | 720p | Non-backlit | Fingerprint Reader | 6-cell (48Wh) | 45W | Win10 Pro 64 | 3-year, Depot | 02/16 |
| 20FU003PUS | US | i3-6100U | No | Intel HD 520 | 4GBx1 | 14" HD (1366x768) | None | 256GB SSD Opal2 | None | Intel 8260 ac, 2x2 + BT4.1 | WWAN Upgradable | None | None | 720p | Non-backlit | None | 6-cell (48Wh) | 45W | Win10 Pro 64 | 1-year, Depot | 10/16 |
| 20FU003QUS | US | i5-6300U | vPro | Intel HD 520 | 4GBx1 | 14" HD (1366x768) | None | 256GB SSD Opal2 | None | Intel 8260 ac, 2x2 + BT4.1 | WWAN Upgradable | None | None | 720p | Non-backlit | Fingerprint Reader | 6-cell (48Wh) | 45W | Win10 DG Win7 Pro 64 | 3-year, Depot | 10/16 |

| Model | Region | Processor | vPro | Graphics | Memory | Display | Multi-touch | Storage | Optical | WLAN + Bluetooth | WWAN | SIM Card | Smart Card Reader | Camera | Keyboard | Fingerprint Reader | Battery | Power Adapter | Operating System | Warranty | Ann Date (m/y) |
|------------|--------|-----------|------|--------------|--------|-------------------|-------------|-----------------|---------|----------------------------|-----------------|----------|-------------------|--------|-------------|--------------------|---------------|---------------|----------------------|---------------|----------------|
| 20FU003RUS | US | i5-6200U | No | Intel HD 520 | 4GBx1 | 14" HD (1366x768) | None | 256GB SSD Opal2 | None | Intel 8260 ac, 2x2 + BT4.1 | WWAN Upgradable | None | None | 720p | Non-backlit | None | 6-cell (48Wh) | 45W | Win10 DG Win7 Pro 64 | 1-year, Depot | 10/16 |
| 20FU003SUS | US | i5-6200U | No | Intel HD 520 | 4GBx1 | 14" HD (1366x768) | None | 256GB SSD Opal2 | None | Intel 8260 ac, 2x2 + BT4.1 | WWAN Upgradable | None | None | 720p | Non-backlit | None | 6-cell (48Wh) | 45W | Win10 Pro 64 | 1-year, Depot | 10/16 |
| 20FU003TUS | US | i5-6300U | vPro | Intel HD 520 | 4GBx1 | 14" HD (1366x768) | None | 256GB SSD Opal2 | None | Intel 8260 ac, 2x2 + BT4.1 | WWAN Upgradable | None | None | 720p | Non-backlit | Fingerprint Reader | 6-cell (48Wh) | 45W | Win10 Pro 64 | 3-year, Depot | 10/16 |
| 20FU003UUS | US | i3-6100U | No | Intel HD 520 | 4GBx1 | 14" HD (1366x768) | None | 256GB SSD Opal2 | None | Intel 8260 ac, 2x2 + BT4.1 | WWAN Upgradable | None | None | 720p | Non-backlit | None | 6-cell (48Wh) | 45W | Win10 DG Win7 Pro 64 | 1-year, Depot | 10/16 |
| 20FU004GUS | US | i5-6200U | No | Intel HD 520 | 4GBx1 | 14" HD (1366x768) | None | 180GB SSD Opal2 | None | Intel 8260 ac, 2x2 + BT4.1 | WWAN Upgradable | None | None | 720p | Non-backlit | None | 6-cell (48Wh) | 45W | Win10 Pro 64 | 1-year, Depot | 11/16 |
| 20FU004HUS | US | i5-6300U | vPro | Intel HD 520 | 4GBx1 | 14" HD (1366x768) | None | 180GB SSD Opal2 | None | Intel 8260 ac, 2x2 + BT4.1 | WWAN Upgradable | None | None | 720p | Non-backlit | Fingerprint Reader | 6-cell (48Wh) | 45W | Win10 DG Win7 Pro 64 | 3-year, Depot | 11/16 |
| 20FU004JUS | US | i5-6200U | No | Intel HD 520 | 4GBx1 | 14" HD (1366x768) | None | 180GB SSD Opal2 | None | Intel 8260 ac, 2x2 + BT4.1 | WWAN Upgradable | None | None | 720p | Non-backlit | None | 6-cell (48Wh) | 45W | Win10 DG Win7 Pro 64 | 1-year, Depot | 11/16 |
| 20FU004LUS | US | i5-6300U | vPro | Intel HD 520 | 4GBx1 | 14" HD (1366x768) | None | 180GB SSD Opal2 | None | Intel 8260 ac, 2x2 + BT4.1 | WWAN Upgradable | None | None | 720p | Non-backlit | Fingerprint Reader | 6-cell (48Wh) | 45W | Win10 Pro 64 | 3-year, Depot | 11/16 |



ThinkPad L470 Platform Specifications

Product Specifications Reference (PSREF)

| Processor | 6th Generation Intel® Core™ i3 / i5 / i7 Processor (i7 processor is not available in EMEA) or | | WWAN (optional) One of the following, configurable by model: | | | | | | | | | | | | | | | | | | | | | | | | | | | | | | | | | | | | |
|------------------|--|-------------------|--|---------------------|----------------|---------------------|-----------------------|------------------|--------------------|-------------------|----------------|-------------------|-------------------|---------|---------|-----------|-----------------------|----------|---------|---------|-----|-----------------------|----------|---------|---------|----------|----------|---------|---------|--|----------|---------|---------|-----|----------|---------|---------|-----|--|
| | <table border="1"> <thead> <tr> <th>Processor Number</th> <th># of Cores</th> <th># of Threads</th> <th>Base Frequency</th> <th>Max Turbo Frequency</th> <th>Cache</th> <th>Memory Types</th> <th>Processor Graphics</th> </tr> </thead> <tbody> <tr> <td>i3-6006U</td> <td rowspan="4">2</td> <td rowspan="4">4</td> <td>2.0 GHz</td> <td>-</td> <td>3MB</td> <td rowspan="4">DDR4-2133</td> <td rowspan="4">Intel HD Graphics 520</td> </tr> <tr> <td>i5-6200U</td> <td>2.3 GHz</td> <td>2.8 GHz</td> <td>3MB</td> </tr> <tr> <td>i5-6300U</td> <td>2.4 GHz</td> <td>3.0 GHz</td> <td>3MB</td> </tr> <tr> <td>i7-6600U</td> <td>2.6 GHz</td> <td>3.4 GHz</td> <td>4MB</td> </tr> </tbody> </table> | Processor Number | # of Cores | # of Threads | Base Frequency | Max Turbo Frequency | Cache | Memory Types | Processor Graphics | i3-6006U | 2 | 4 | 2.0 GHz | - | 3MB | DDR4-2133 | Intel HD Graphics 520 | i5-6200U | 2.3 GHz | 2.8 GHz | 3MB | i5-6300U | 2.4 GHz | 3.0 GHz | 3MB | i7-6600U | 2.6 GHz | 3.4 GHz | 4MB | <ul style="list-style-type: none"> Wireless WAN upgradable Integrated Mobile Broadband 4G LTE-A, Qualcomm® Snapdragon™ X7 LTE-A (Sierra Wireless EM7455), M.2 card Integrated Mobile Broadband 4G LTE, Intel XMM™ 7160 (Fibocom L831-EAU), M.2 card (EMEA only) | | | | | | | | | |
| Processor Number | # of Cores | # of Threads | Base Frequency | Max Turbo Frequency | Cache | Memory Types | Processor Graphics | | | | | | | | | | | | | | | | | | | | | | | | | | | | | | | | |
| i3-6006U | 2 | 4 | 2.0 GHz | - | 3MB | DDR4-2133 | Intel HD Graphics 520 | | | | | | | | | | | | | | | | | | | | | | | | | | | | | | | | |
| i5-6200U | | | 2.3 GHz | 2.8 GHz | 3MB | | | | | | | | | | | | | | | | | | | | | | | | | | | | | | | | | | |
| i5-6300U | | | 2.4 GHz | 3.0 GHz | 3MB | | | | | | | | | | | | | | | | | | | | | | | | | | | | | | | | | | |
| i7-6600U | | | 2.6 GHz | 3.4 GHz | 4MB | | | | | | | | | | | | | | | | | | | | | | | | | | | | | | | | | | |
| | Intel Celeron® Processor or 7th Generation Intel Core i3 / i5 / i7 Processor | | SIM card (opt) Micro-SIM card slot, opt Verizon LTE (US) or Lenovo® Connect (EMEA) SIM card | | | | | | | | | | | | | | | | | | | | | | | | | | | | | | | | | | | | |
| | <table border="1"> <thead> <tr> <th>Processor Number</th> <th># of Cores</th> <th># of Threads</th> <th>Base Frequency</th> <th>Max Turbo Frequency</th> <th>Cache</th> <th>Memory Types</th> <th>Processor Graphics</th> </tr> </thead> <tbody> <tr> <td>Cel 3965U</td> <td rowspan="6">2</td> <td rowspan="6">4</td> <td>2.2 GHz</td> <td>-</td> <td>2MB</td> <td rowspan="6">DDR4-2133</td> <td>Intel HD Graphics 610</td> </tr> <tr> <td>i3-7100U</td> <td>2.4 GHz</td> <td>-</td> <td>3MB</td> <td rowspan="5">Intel HD Graphics 620</td> </tr> <tr> <td>i5-7200U</td> <td>2.5 GHz</td> <td>3.1 GHz</td> <td>3MB</td> </tr> <tr> <td>i5-7300U</td> <td>2.6 GHz</td> <td>3.5 GHz</td> <td>3MB</td> </tr> <tr> <td>i7-7500U</td> <td>2.7 GHz</td> <td>3.5 GHz</td> <td>4MB</td> </tr> <tr> <td>i7-7600U</td> <td>2.8 GHz</td> <td>3.9 GHz</td> <td>4MB</td> </tr> </tbody> </table> | Processor Number | # of Cores | # of Threads | Base Frequency | Max Turbo Frequency | Cache | Memory Types | Processor Graphics | Cel 3965U | 2 | 4 | 2.2 GHz | - | 2MB | DDR4-2133 | Intel HD Graphics 610 | i3-7100U | 2.4 GHz | - | 3MB | Intel HD Graphics 620 | i5-7200U | 2.5 GHz | 3.1 GHz | 3MB | i5-7300U | 2.6 GHz | 3.5 GHz | 3MB | i7-7500U | 2.7 GHz | 3.5 GHz | 4MB | i7-7600U | 2.8 GHz | 3.9 GHz | 4MB | Dimensions <i>WxDxH</i> : 13.35" x 9.25" x 0.94"; 339mm x 235mm x 23.9mm |
| Processor Number | # of Cores | # of Threads | Base Frequency | Max Turbo Frequency | Cache | Memory Types | Processor Graphics | | | | | | | | | | | | | | | | | | | | | | | | | | | | | | | | |
| Cel 3965U | 2 | 4 | 2.2 GHz | - | 2MB | DDR4-2133 | Intel HD Graphics 610 | | | | | | | | | | | | | | | | | | | | | | | | | | | | | | | | |
| i3-7100U | | | 2.4 GHz | - | 3MB | | Intel HD Graphics 620 | | | | | | | | | | | | | | | | | | | | | | | | | | | | | | | | |
| i5-7200U | | | 2.5 GHz | 3.1 GHz | 3MB | | | | | | | | | | | | | | | | | | | | | | | | | | | | | | | | | | |
| i5-7300U | | | 2.6 GHz | 3.5 GHz | 3MB | | | | | | | | | | | | | | | | | | | | | | | | | | | | | | | | | | |
| i7-7500U | | | 2.7 GHz | 3.5 GHz | 4MB | | | | | | | | | | | | | | | | | | | | | | | | | | | | | | | | | | |
| i7-7600U | | | 2.8 GHz | 3.9 GHz | 4MB | | | | | | | | | | | | | | | | | | | | | | | | | | | | | | | | | | |
| | Weight | | <table border="1"> <thead> <tr> <th>Models</th> <th>3-cell</th> <th>6-cell</th> </tr> </thead> <tbody> <tr> <td>Integrated model</td> <td>4.13 lb / 1.87 kg</td> <td>4.45 lb / 2.02 kg</td> </tr> <tr> <td>discrete model</td> <td>4.16 lb / 1.89 kg</td> <td>4.48 lb / 2.03 kg</td> </tr> </tbody> </table> | | Models | 3-cell | 6-cell | Integrated model | 4.13 lb / 1.87 kg | 4.45 lb / 2.02 kg | discrete model | 4.16 lb / 1.89 kg | 4.48 lb / 2.03 kg | | | | | | | | | | | | | | | | | | | | | | | | | | |
| Models | 3-cell | 6-cell | | | | | | | | | | | | | | | | | | | | | | | | | | | | | | | | | | | | | |
| Integrated model | 4.13 lb / 1.87 kg | 4.45 lb / 2.02 kg | | | | | | | | | | | | | | | | | | | | | | | | | | | | | | | | | | | | | |
| discrete model | 4.16 lb / 1.89 kg | 4.48 lb / 2.03 kg | | | | | | | | | | | | | | | | | | | | | | | | | | | | | | | | | | | | | |
| | Case color | | Black | | | | | | | | | | | | | | | | | | | | | | | | | | | | | | | | | | | | |
| | Case material | | PC/ABS plastic | | | | | | | | | | | | | | | | | | | | | | | | | | | | | | | | | | | | |
| | Smart card reader | | Optional: Smart card reader | | | | | | | | | | | | | | | | | | | | | | | | | | | | | | | | | | | | |
| | Media reader | | 4-in-1 reader (MMC, SD, SDHC, SDXC) | | | | | | | | | | | | | | | | | | | | | | | | | | | | | | | | | | | | |
| | Ports | | Three USB 3.1 Gen 1 (USB 3.0, one Always On), VGA, Mini DisplayPort, Ethernet (RJ-45), Dock connector | | | | | | | | | | | | | | | | | | | | | | | | | | | | | | | | | | | | |
| | Camera (optional) | | HD720p resolution, fixed focus | | | | | | | | | | | | | | | | | | | | | | | | | | | | | | | | | | | | |
| | Audio support | | HD Audio, Realtek ALC3268 codec / stereo speakers, 1W x 2 / dual array microphone, combo audio/microphone jack | | | | | | | | | | | | | | | | | | | | | | | | | | | | | | | | | | | | |
| Graphics | Intel HD Graphics 610 or 620 in processor only, or Intel HD Graphics 620 in processor and AMD Radeon™ R5 M430, 2GB memory; supports external analog monitor via VGA and digital monitor via Mini DisplayPort; supports three independent displays; Max resolution: 3840x2160@60Hz (DP via mDP cable); 1920x1200@60Hz (VGA) | | Keyboard 6-row, spill-resistant, multimedia Fn keys UltraNav™ TrackPoint® pointing device and buttonless Mylar surface multi-touch touchpad | | | | | | | | | | | | | | | | | | | | | | | | | | | | | | | | | | | | |
| Chipset | Intel SoC (System on Chip) platform | | Security Power-on password, hard disk password, supervisor password, security keyhole | | | | | | | | | | | | | | | | | | | | | | | | | | | | | | | | | | | | |
| Memory | 32GB max / 2400MHz DDR4, dual-channel capable, two DDR4 SO-DIMM sockets * System clocks down for processors with lower memory controller | | Security chip Discrete TPM 2.0, TCG Certified vPro (optional) Intel vPro Technology | | | | | | | | | | | | | | | | | | | | | | | | | | | | | | | | | | | | |
| Display | Some: 14.0" (355mm) HD (1366x768), anti-glare, LED backlight, 220 nits, 16:9 aspect ratio, 500:1 contrast ratio Some: 14.0" (355mm) FHD (1920x1080), anti-glare, LED backlight, IPS, 250 nits, 16:9 aspect ratio, 700:1 contrast ratio, 170° viewing angle | | Fingerprint reader Optional: Swipe style fingerprint reader on the keyboard bezel NFC None | | | | | | | | | | | | | | | | | | | | | | | | | | | | | | | | | | | | |
| Multi-touch | None | | Battery Li-Ion 3-cell (24Wh) or 6-cell (48Wh or 72Wh) | | | | | | | | | | | | | | | | | | | | | | | | | | | | | | | | | | | | |
| Storage | System has one HDD slot or one M.2 2280 slot exclusively for storage Some: HDD / SATA 6.0Gb/s, 2.5" wide, 7mm or 9.5mm high, Active Protection System™ Some: SSD / SATA 6.0Gb/s, 2.5" wide, 7mm high (e.g. xxxGB SSD) Some: M.2 SSD / PCIe NVMe, PCIe 3.0 x 2, 16Gb/s Some: 128GB M.2 SSD / SATA 6.0Gb/s, in WWAN slot as 2nd Storage, mutually exclusive with WWAN | | Max battery life ¹⁰ (MobileMark® 2014) <table border="1"> <thead> <tr> <th>Models</th> <th>3-cell</th> <th>6-cell 48Wh</th> <th>6-cell 72Wh</th> </tr> </thead> <tbody> <tr> <td>Integrated model</td> <td>7.24 hr</td> <td>14.48 hr</td> <td>21.72 hr</td> </tr> <tr> <td>discrete model</td> <td>4.34 hr</td> <td>8.68 hr</td> <td>13.02 hr</td> </tr> </tbody> </table> | | Models | 3-cell | 6-cell 48Wh | 6-cell 72Wh | Integrated model | 7.24 hr | 14.48 hr | 21.72 hr | discrete model | 4.34 hr | 8.68 hr | 13.02 hr | | | | | | | | | | | | | | | | | | | | | | | |
| Models | 3-cell | 6-cell 48Wh | 6-cell 72Wh | | | | | | | | | | | | | | | | | | | | | | | | | | | | | | | | | | | | |
| Integrated model | 7.24 hr | 14.48 hr | 21.72 hr | | | | | | | | | | | | | | | | | | | | | | | | | | | | | | | | | | | | |
| discrete model | 4.34 hr | 8.68 hr | 13.02 hr | | | | | | | | | | | | | | | | | | | | | | | | | | | | | | | | | | | | |
| Optical | None | | AC adapter 45W or 65W AC adapter | | | | | | | | | | | | | | | | | | | | | | | | | | | | | | | | | | | | |
| Ethernet | Non-vPro model: Intel Ethernet Connection I219-V (Jacksonville) vPro model: Intel Ethernet Connection I219-LM (Jacksonville) | | Preload Windows® 7 Professional 64 preinstalled through downgrade rights in Windows 10 Pro 64 Some: Windows 10 Home 64 Some: Windows 10 Pro 64 • Lenovo Solution Center • Lenovo PowerEngage • ThinkVantage Product Recovery • ThinkVantage System Update • Adobe® Reader® • Microsoft® Office preloaded; purchase a product key to activate • McAfee® LiveSafe™ (30-day trial) | | | | | | | | | | | | | | | | | | | | | | | | | | | | | | | | | | | | |
| WLAN | One of the following, configurable by model: • Realtek® RTL8822BE, Wi-Fi 2x2 802.11ac + BT4.1, M.2 card • Intel Dual Band Wireless-AC 8260, Wi-Fi 2x2 802.11ac + BT4.1, M.2 card • Intel Dual Band Wireless-AC 8265, Wi-Fi 2x2 802.11ac + BT4.1, M.2 card | | Limited warranty One of the following, configurable by model: • 1-year depot repair service • 3-year/1-yr battery depot repair service • 3-year/1-yr battery limited onsite service | | | | | | | | | | | | | | | | | | | | | | | | | | | | | | | | | | | | |
| Bluetooth™ | Bluetooth 4.1 wireless, integrated in Wi-Fi + Bluetooth combo adapter * Intel 8265ac card supports BT4.2 but is limited to BT4.1 by Windows OS | | Mil-Spec test MIL-STD-810G military certification | | | | | | | | | | | | | | | | | | | | | | | | | | | | | | | | | | | | |
| | | | Environment EPEAT™ Gold (US only); ENERGY STAR® 6.1; RoHS-compliant | | | | | | | | | | | | | | | | | | | | | | | | | | | | | | | | | | | | |

ThinkPad L470 - TopSeller - 20J4

Product Specifications Reference (PSREF)

| Model | Region | Processor | vPro | Graphics | Memory | Display | Multi-touch | Storage(HDD/SSD) | Optical | WLAN + Bluetooth | WWAN | SIM Card | Smart Card Reader | Camera | Keyboard | Fingerprint Reader | TPM | Battery | Power Adapter | Operating System | Warranty | Ann Date (m/y) |
|------------|--------|-----------|------|--------------|--------|-------------------------|-------------|-------------------------------|---------|----------------------------|-----------------|----------|-------------------|--------|-------------|--------------------|----------|---------------|---------------|------------------|---------------|----------------|
| 20J4000RUS | US | i5-7200U | No | Intel HD 620 | 4GBx1 | 14" FHD (1920x1080) IPS | None | 500GB 7200rpm | None | Intel 8265 ac, 2x2 + BT4.1 | WWAN Upgradable | None | None | 720p | Non-backlit | None | dTPM 2.0 | 6-cell (48Wh) | 45W | Win10 Pro 64 | 1-year, Depot | 01/17 |
| 20J4000SUS | US | i5-7200U | No | Intel HD 620 | 4GBx1 | 14" FHD (1920x1080) IPS | None | 256GB SSD Opal2 | None | Intel 8265 ac, 2x2 + BT4.1 | WWAN Upgradable | None | None | 720p | Non-backlit | None | dTPM 2.0 | 6-cell (48Wh) | 45W | Win10 Pro 64 | 3-year, Depot | 01/17 |
| 20J4000TUS | US | i5-7200U | No | Intel HD 620 | 4GBx1 | 14" HD (1366x768) | None | 500GB 7200rpm | None | Intel 8265 ac, 2x2 + BT4.1 | WWAN Upgradable | None | None | 720p | Non-backlit | None | dTPM 2.0 | 6-cell (48Wh) | 45W | Win10 Pro 64 | 1-year, Depot | 01/17 |
| 20J4000UUS | US | i5-7200U | No | Intel HD 620 | 4GBx1 | 14" HD (1366x768) | None | 256GB SSD Opal2 | None | Intel 8265 ac, 2x2 + BT4.1 | WWAN Upgradable | None | None | 720p | Non-backlit | None | dTPM 2.0 | 6-cell (48Wh) | 45W | Win10 Pro 64 | 3-year, Depot | 01/17 |
| 20J40012US | US | i3-7100U | No | Intel HD 620 | 4GBx1 | 14" HD (1366x768) | None | 500GB 7200rpm | None | Intel 8265 ac, 2x2 + BT4.1 | WWAN Upgradable | None | None | 720p | Non-backlit | None | dTPM 2.0 | 6-cell (48Wh) | 45W | Win10 Pro 64 | 1-year, Depot | 01/17 |
| 20J40013US | US | i5-7200U | No | Intel HD 620 | 8GBx1 | 14" FHD (1920x1080) IPS | None | 256GB SSD Opal2 | None | Intel 8265 ac, 2x2 + BT4.1 | WWAN Upgradable | None | None | 720p | Non-backlit | Fingerprint Reader | dTPM 2.0 | 6-cell (48Wh) | 45W | Win10 Pro 64 | 1-year, Depot | 01/17 |
| 20J40014US | US | i5-7300U | vPro | Intel HD 620 | 4GBx1 | 14" HD (1366x768) | None | 500GB 7200rpm | None | Intel 8265 ac, 2x2 + BT4.1 | WWAN Upgradable | None | None | 720p | Non-backlit | None | dTPM 2.0 | 6-cell (48Wh) | 45W | Win10 Pro 64 | 1-year, Depot | 01/17 |
| 20J40015US | US | i5-7300U | vPro | Intel HD 620 | 8GBx1 | 14" FHD (1920x1080) IPS | None | 256GB SSD Opal2 | None | Intel 8265 ac, 2x2 + BT4.1 | WWAN Upgradable | None | None | 720p | Non-backlit | Fingerprint Reader | dTPM 2.0 | 6-cell (48Wh) | 45W | Win10 Pro 64 | 1-year, Depot | 01/17 |
| 20J40016US | US | i5-7200U | No | Intel HD 620 | 8GBx1 | 14" HD (1366x768) | None | 256GB SSD Opal2 | None | Intel 8265 ac, 2x2 + BT4.1 | WWAN Upgradable | None | None | 720p | Non-backlit | None | dTPM 2.0 | 6-cell (48Wh) | 45W | Win10 Pro 64 | 3-year, Depot | 01/17 |
| 20J4003EUS | US | i5-7200U | No | Intel HD 620 | 4GBx1 | 14" HD (1366x768) | None | 500GB 7200rpm | None | Intel 8265 ac, 2x2 + BT4.1 | Sierra EM7455 | None | None | 720p | Non-backlit | None | dTPM 2.0 | 6-cell (48Wh) | 45W | Win10 Pro 64 | 3-year, Depot | 04/17 |
| 20J4003FUS | US | i5-7300U | vPro | Intel HD 620 | 8GBx1 | 14" FHD (1920x1080) IPS | None | 256GB SSD M.2 PCIe NVMe Opal2 | None | Intel 8265 ac, 2x2 + BT4.1 | WWAN Upgradable | None | None | 720p | Non-backlit | Fingerprint Reader | dTPM 2.0 | 6-cell (48Wh) | 45W | Win10 Pro 64 | 3-year, Depot | 04/17 |
| 20J4003GUS | US | i5-7300U | vPro | Intel HD 620 | 8GBx1 | 14" FHD (1920x1080) IPS | None | 256GB SSD Opal2 | None | Intel 8265 ac, 2x2 + BT4.1 | Sierra EM7455 | None | None | 720p | Non-backlit | Fingerprint Reader | dTPM 2.0 | 6-cell (48Wh) | 45W | Win10 Pro 64 | 3-year, Depot | 04/17 |

ThinkPad L470 - TopSeller - 20JU

Product Specifications Reference (PSREF)

| Model | Region | Processor | vPro | Graphics | Memory | Display | Multi-touch | Storage(HDD/SSD) | Optical | WLAN + Bluetooth | WWAN | SIM Card | Smart Card Reader | Camera | Keyboard | Fingerprint Reader | TPM | Battery | Power Adapter | Operating System | Warranty | Ann Date (m/y) |
|------------|--------|-----------|------|--------------|--------|-------------------------|-------------|-------------------------------|---------|----------------------------|-----------------|----------|-------------------|--------|-------------|--------------------|----------|---------------|---------------|----------------------|---------------|----------------|
| 20JU0008US | US | i5-6200U | No | Intel HD 520 | 4GBx1 | 14" FHD (1920x1080) IPS | None | 500GB 7200rpm | None | Intel 8260 ac, 2x2 + BT4.1 | WWAN Upgradable | None | None | 720p | Non-backlit | None | dTPM 2.0 | 6-cell (48Wh) | 45W | Win10 DG Win7 Pro 64 | 3-year, Depot | 04/17 |
| 20JU0009US | US | i5-6200U | No | Intel HD 520 | 8GBx1 | 14" HD (1366x768) | None | 180GB SSD Opal2 | None | Intel 8260 ac, 2x2 + BT4.1 | WWAN Upgradable | None | None | 720p | Non-backlit | None | dTPM 2.0 | 6-cell (48Wh) | 45W | Win10 DG Win7 Pro 64 | 3-year, Depot | 04/17 |
| 20JU000AUS | US | i5-6200U | No | Intel HD 520 | 4GBx1 | 14" FHD (1920x1080) IPS | None | 128GB SSD | None | Intel 8260 ac, 2x2 + BT4.1 | WWAN Upgradable | None | None | 720p | Non-backlit | None | dTPM 2.0 | 6-cell (48Wh) | 45W | Win10 DG Win7 Pro 64 | 3-year, Depot | 04/17 |
| 20JU000BUS | US | i5-6200U | No | Intel HD 520 | 8GBx1 | 14" FHD (1920x1080) IPS | None | 180GB SSD Opal2 | None | Intel 8260 ac, 2x2 + BT4.1 | WWAN Upgradable | None | None | 720p | Non-backlit | None | dTPM 2.0 | 6-cell (48Wh) | 45W | Win10 DG Win7 Pro 64 | 3-year, Depot | 04/17 |
| 20JU000CUS | US | i5-6200U | No | Intel HD 520 | 4GBx1 | 14" HD (1366x768) | None | 128GB SSD | None | Intel 8260 ac, 2x2 + BT4.1 | WWAN Upgradable | None | None | 720p | Non-backlit | None | dTPM 2.0 | 6-cell (48Wh) | 45W | Win10 DG Win7 Pro 64 | 3-year, Depot | 04/17 |
| 20JU000DUS | US | i5-6200U | No | Intel HD 520 | 8GBx1 | 14" HD (1366x768) | None | 256GB SSD Opal2 | None | Intel 8260 ac, 2x2 + BT4.1 | WWAN Upgradable | None | None | 720p | Non-backlit | None | dTPM 2.0 | 6-cell (48Wh) | 45W | Win10 DG Win7 Pro 64 | 3-year, Depot | 04/17 |
| 20JU000EUS | US | i5-6200U | No | Intel HD 520 | 8GBx1 | 14" FHD (1920x1080) IPS | None | 256GB SSD Opal2 | None | Intel 8260 ac, 2x2 + BT4.1 | WWAN Upgradable | None | None | 720p | Non-backlit | None | dTPM 2.0 | 6-cell (48Wh) | 45W | Win10 DG Win7 Pro 64 | 3-year, Depot | 04/17 |
| 20JU000FUS | US | i5-6200U | No | Intel HD 520 | 4GBx1 | 14" HD (1366x768) | None | 500GB 7200rpm | None | Intel 8260 ac, 2x2 + BT4.1 | WWAN Upgradable | None | None | 720p | Non-backlit | None | dTPM 2.0 | 6-cell (48Wh) | 45W | Win10 DG Win7 Pro 64 | 3-year, Depot | 04/17 |
| 20JU000QUS | US | i5-6200U | No | Intel HD 520 | 4GBx1 | 14" HD (1366x768) | None | 500GB 7200rpm | None | Intel 8260 ac, 2x2 + BT4.1 | Sierra EM7455 | None | None | 720p | Non-backlit | None | dTPM 2.0 | 6-cell (48Wh) | 45W | Win10 DG Win7 Pro 64 | 3-year, Depot | 04/17 |
| 20JU000RUS | US | i5-6200U | No | Intel HD 520 | 8GBx1 | 14" FHD (1920x1080) IPS | None | 256GB SSD M.2 PCIe NVMe Opal2 | None | Intel 8260 ac, 2x2 + BT4.1 | WWAN Upgradable | None | None | 720p | Non-backlit | Fingerprint Reader | dTPM 2.0 | 6-cell (48Wh) | 45W | Win10 DG Win7 Pro 64 | 3-year, Depot | 04/17 |
| 20JU000WUS | US | i5-6300U | vPro | Intel HD 520 | 8GBx1 | 14" FHD (1920x1080) IPS | None | 256GB SSD Opal2 | None | Intel 8260 ac, 2x2 + BT4.1 | WWAN Upgradable | None | None | 720p | Non-backlit | Fingerprint Reader | dTPM 2.0 | 6-cell (48Wh) | 45W | Win10 DG Win7 Pro 64 | 1-year, Depot | 05/17 |
| 20JU0018US | US | i5-6300U | vPro | Intel HD 520 | 4GBx1 | 14" HD (1366x768) | None | 500GB 7200rpm | None | Intel 8260 ac, 2x2 + BT4.1 | WWAN Upgradable | None | None | 720p | Non-backlit | None | dTPM 2.0 | 6-cell (48Wh) | 45W | Win10 DG Win7 Pro 64 | 1-year, Depot | 05/17 |
| 20JU0019US | US | i5-6300U | vPro | Intel HD 520 | 4GBx1 | 14" HD (1366x768) | None | 180GB SSD Opal2 | None | Intel 8260 ac, 2x2 + BT4.1 | WWAN Upgradable | None | None | 720p | Non-backlit | Fingerprint Reader | dTPM 2.0 | 6-cell (48Wh) | 45W | Win10 DG Win7 Pro 64 | 3-year, Depot | 05/17 |



ThinkPad L560 Platform Specifications

Product Specifications Reference (PSREF)

| | | | | | | | | | |
|-------------------------|---|------------|--------------|----------------|---------------------|-------|--------------|-----------------------|---|
| Processor | Intel® Celeron® Processor or 6th Generation Intel Core™ i3 / i5 / i7 Processor | | | | | | | | ExpressCard (opt) One slot (ExpressCard/34) Smart card reader Optional: Smart card reader Media reader 4-in-1 reader (MMC, SD, SDHC, SDXC) Ports <i>Cel 3855U model:</i> three USB 3.0, one USB 2.0 Always On; <i>Other model:</i> four USB 3.0 (one Always On), <i>All:</i> VGA, Mini DisplayPort, Ethernet (RJ-45), Dock connector |
| | Processor Number | # of Cores | # of Threads | Base Frequency | Max Turbo Frequency | Cache | Memory Types | Processor Graphics | |
| | Cel 3855U | 2 | 4 | 1.6 GHz | - | 2MB | DDR3L-1600 | Intel HD graphics 510 | |
| | i3-6006U | | | 2.0 GHz | - | 3MB | | Intel HD graphics 520 | |
| | i3-6100U | | | 2.3 GHz | - | 3MB | | | |
| | i5-6200U | | | 2.3 GHz | 2.8 GHz | 3MB | | | |
| | i5-6300U | | | 2.4 GHz | 3.0 GHz | 3MB | | | |
| i7-6600U | 2.6 GHz | | | 3.4 GHz | 4MB | | | | |
| Graphics | Intel HD Graphics 510 or 520 in processor, supports external analog monitor via VGA and digital monitor via Mini DisplayPort; supports three independent displays; Max resolution: 3840x2160@60Hz (DP via mDP cable); 1920x1200@60Hz (VGA) | | | | | | | | Camera (optional) HD720p resolution, low light sensitive, fixed focus Audio support HD Audio, Realtek® ALC3245 codec / stereo speakers, 1.5W x 2 / dual array microphone, combo audio/microphone jack |
| Chipset | Intel SoC (System on Chip) platform | | | | | | | | Keyboard 6-row, spill-resistant, multimedia Fn keys, numeric keypad UltraNav™ TrackPoint® pointing device and buttonless Mylar surface multi-touch touchpad |
| Memory | 16GB max ⁷ / PC3-12800 1600MHz DDR3L, non-parity, dual-channel capable, two DDR3L SO-DIMM sockets | | | | | | | | Security Power-on password, hard disk password, supervisor password, security keyhole Security chip Discrete TPM 1.2 TCG Certified and Firmware TPM 2.0 integrated in chipset ThinkEngine Delivers improved thermal and power efficiency, up to 30 day standby, faster resume time, enhanced security, as well as anti-tampering measures |
| Display | <i>Some:</i> 15.6" (396mm) HD (1366x768), anti-glare, LED backlight, 220 nits, 16:9 aspect ratio, 350:1 contrast ratio <i>Some:</i> 15.6" (396mm) FHD (1920x1080), anti-glare, LED backlight, IPS, 250 nits, 16:9 aspect ratio, 600:1 contrast ratio, 160° viewing angle | | | | | | | | vPro (optional) Intel vPro Technology Fingerprint reader Optional: Swipe style fingerprint reader on the palm rest |
| Multi-touch | None | | | | | | | | Battery Li-Ion 6-cell (48Wh) Max battery life ¹⁰ <i>MobileMark® 2014:</i> 11.2 hr AC adapter 45W AC adapter |
| Storage | <i>Some:</i> SSD / SATA 6.0Gb/s, 2.5" wide, 7mm high <i>Some:</i> HDD / SATA 6.0Gb/s, 2.5" wide, 7mm high, Shock Mounted Hard Drive, Active Protection System™ <i>Some:</i> SSHD with 8GB NAND flash memory | | | | | | | | Preload Windows 7 Professional 64 preinstalled through downgrade rights in Windows 10 Pro 64 • Lenovo Solution Center • Lenovo Companion • Lenovo Setting • Microsoft Office preloaded; purchase a product key to activate • McAfee® LiveSafe™ (30-day trial) |
| Optical (optional) | DVD burner, 9mm high, fixed, not removable, tray-in | | | | | | | | Limited warranty ¹² <i>One of the following, configurable by model:</i> • 1-year depot repair service • 3-year/1-yr battery depot repair service • 3-year/1-yr battery limited onsite service ²⁴ • 3-year/1-yr battery limited onsite service, OID (Onsite International Delivery) |
| Ethernet | <i>Non-vPro model:</i> Intel Ethernet Connection I219-V (Jacksonville) <i>vPro model:</i> Intel Ethernet Connection I219-LM (Jacksonville) | | | | | | | | Mil-Spec test MIL-STD-810G military certification |
| WLAN ⁴ | <i>One of the following, configurable by model:</i> • 11ac+BT, Broadcom BCM4356, 2x2, M.2 card • 11ac+BT, Intel Dual Band Wireless-AC 8260, 2x2, M.2 card | | | | | | | | Environment EPEAT™ Gold (US); ENERGY STAR® 6.1; GREENGUARD®; RoHS-compliant |
| Bluetooth™ | Bluetooth 4.1 wireless, integrated in Wi-Fi + Bluetooth combo adapter | | | | | | | | |
| WWAN (optional) | <i>One of the following, configurable by model:</i> • Wireless WAN upgradable • Wireless WAN, Sierra Wireless EM7455, Qualcomm® 4G LTE-Advanced/DC-HSPA+/HSPA+/HSPA/UMTS/GNSS, M.2 card • Wireless WAN, HUAWEI ME906S, HUAWEI 4G LTE/WCDMA/HSPA/GSM/GPRS/EDGE/GNSS, M.2 card (WE only) | | | | | | | | |
| SIM card (opt) | Micro-SIM card slot, optional Verizon LTE (US) or Lenovo Connect (WE) SIM card | | | | | | | | |
| Dimensions ³ | <i>WxDxH:</i> 14.84" x 9.75" x 1.08-1.21"; 377mm x 255mm x 27.6-30.85mm | | | | | | | | |
| Weight ² | Starting at 5.25 lb / 2.38 kg | | | | | | | | |
| Case material | PolyCarbonate/Acrylonitrile-Butadiene-Styrene (PC/ABS) plastic | | | | | | | | |

| Model | Region | Processor | vPro | Graphics | Memory | Display | Multi-touch | Storage | Optical | WLAN + Bluetooth | WWAN | SIM Card | Smart Card Reader | Express-Card | Camera | Keyboard | Fingerprint Reader | Battery | Power Adapter | Operating System | Warranty | Ann Date (m/y) |
|------------|--------|-----------|------|--------------|--------|---------------------------|-------------|-----------------|---------|----------------------------|---------------|----------|-------------------|--------------|--------|-------------|--------------------|---------------|---------------|----------------------|---------------|----------------|
| 20F1000PUS | US | i5-6200U | No | Intel HD 520 | 4GBx1 | 15.6" HD (1366x768) | None | 192GB SSD | DVD±RW | Intel 8260 ac, 2x2 + BT4.1 | None | None | None | None | 720p | Non-backlit | None | 6-cell (48Wh) | 45W | Win10 Pro 64 | 1-year, Depot | 02/16 |
| 20F1000QUS | US | i5-6300U | vPro | Intel HD 520 | 8GBx1 | 15.6" FHD (1920x1080) IPS | None | 256GB SSD Opal2 | DVD±RW | Intel 8260 ac, 2x2 + BT4.1 | None | None | None | None | 720p | Non-backlit | Fingerprint Reader | 6-cell (48Wh) | 45W | Win10 Pro 64 | 1-year, Depot | 02/16 |
| 20F1000RUS | US | i5-6200U | No | Intel HD 520 | 4GBx1 | 15.6" HD (1366x768) | None | 128GB SSD | DVD±RW | Intel 8260 ac, 2x2 + BT4.1 | None | None | None | None | 720p | Non-backlit | None | 6-cell (48Wh) | 45W | Win10 Pro 64 | 1-year, Depot | 02/16 |
| 20F1000SUS | US | i5-6200U | No | Intel HD 520 | 4GBx1 | 15.6" HD (1366x768) | None | 500GB 7200rpm | DVD±RW | Intel 8260 ac, 2x2 + BT4.1 | None | None | None | None | 720p | Non-backlit | None | 6-cell (48Wh) | 45W | Win10 Pro 64 | 1-year, Depot | 02/16 |
| 20F1000TUS | US | i3-6100U | No | Intel HD 520 | 4GBx1 | 15.6" HD (1366x768) | None | 500GB 7200rpm | DVD±RW | Intel 8260 ac, 2x2 + BT4.1 | None | None | None | None | 720p | Non-backlit | None | 6-cell (48Wh) | 45W | Win10 Pro 64 | 1-year, Depot | 02/16 |
| 20F1000UUS | US | i5-6300U | vPro | Intel HD 520 | 4GBx1 | 15.6" HD (1366x768) | None | 128GB SSD | DVD±RW | Intel 8260 ac, 2x2 + BT4.1 | None | None | None | None | 720p | Non-backlit | None | 6-cell (48Wh) | 45W | Win10 Pro 64 | 1-year, Depot | 02/16 |
| 20F1000VUS | US | i5-6200U | No | Intel HD 520 | 8GBx1 | 15.6" FHD (1920x1080) IPS | None | 256GB SSD Opal2 | DVD±RW | Intel 8260 ac, 2x2 + BT4.1 | None | None | None | None | 720p | Non-backlit | Fingerprint Reader | 6-cell (48Wh) | 45W | Win10 Pro 64 | 1-year, Depot | 02/16 |
| 20F1000WUS | US | i3-6100U | No | Intel HD 520 | 4GBx1 | 15.6" HD (1366x768) | None | 192GB SSD | DVD±RW | Intel 8260 ac, 2x2 + BT4.1 | None | None | None | None | 720p | Non-backlit | None | 6-cell (48Wh) | 45W | Win10 Pro 64 | 1-year, Depot | 02/16 |
| 20F1000XUS | US | i5-6300U | vPro | Intel HD 520 | 4GBx1 | 15.6" HD (1366x768) | None | 500GB 7200rpm | DVD±RW | Intel 8260 ac, 2x2 + BT4.1 | None | None | None | None | 720p | Non-backlit | None | 6-cell (48Wh) | 45W | Win10 Pro 64 | 1-year, Depot | 02/16 |
| 20F1001MUS | US | i3-6100U | No | Intel HD 520 | 4GBx1 | 15.6" HD (1366x768) | None | 500GB 7200rpm | DVD±RW | Intel 8260 ac, 2x2 + BT4.1 | None | None | None | None | 720p | Non-backlit | None | 6-cell (48Wh) | 45W | Win10 DG Win7 Pro 64 | 1-year, Depot | 02/16 |
| 20F1001NUS | US | i3-6100U | No | Intel HD 520 | 4GBx1 | 15.6" HD (1366x768) | None | 192GB SSD | DVD±RW | Intel 8260 ac, 2x2 + BT4.1 | None | None | None | None | 720p | Non-backlit | None | 6-cell (48Wh) | 45W | Win10 DG Win7 Pro 64 | 1-year, Depot | 02/16 |
| 20F1001PUS | US | i5-6200U | No | Intel HD 520 | 4GBx1 | 15.6" HD (1366x768) | None | 500GB 7200rpm | DVD±RW | Intel 8260 ac, 2x2 + BT4.1 | None | None | None | None | 720p | Non-backlit | None | 6-cell (48Wh) | 45W | Win10 DG Win7 Pro 64 | 1-year, Depot | 02/16 |
| 20F1001QUS | US | i5-6200U | No | Intel HD 520 | 8GBx1 | 15.6" FHD (1920x1080) IPS | None | 256GB SSD Opal2 | DVD±RW | Intel 8260 ac, 2x2 + BT4.1 | None | None | None | None | 720p | Non-backlit | Fingerprint Reader | 6-cell (48Wh) | 45W | Win10 DG Win7 Pro 64 | 1-year, Depot | 02/16 |
| 20F1001RUS | US | i5-6200U | No | Intel HD 520 | 4GBx1 | 15.6" HD (1366x768) | None | 128GB SSD | DVD±RW | Intel 8260 ac, 2x2 + BT4.1 | None | None | None | None | 720p | Non-backlit | None | 6-cell (48Wh) | 45W | Win10 DG Win7 Pro 64 | 1-year, Depot | 02/16 |
| 20F1001SUS | US | i5-6200U | No | Intel HD 520 | 4GBx1 | 15.6" HD (1366x768) | None | 192GB SSD | DVD±RW | Intel 8260 ac, 2x2 + BT4.1 | None | None | None | None | 720p | Non-backlit | None | 6-cell (48Wh) | 45W | Win10 DG Win7 Pro 64 | 1-year, Depot | 02/16 |
| 20F1001TUS | US | i5-6300U | vPro | Intel HD 520 | 4GBx1 | 15.6" HD (1366x768) | None | 500GB 7200rpm | DVD±RW | Intel 8260 ac, 2x2 + BT4.1 | None | None | None | None | 720p | Non-backlit | None | 6-cell (48Wh) | 45W | Win10 DG Win7 Pro 64 | 1-year, Depot | 02/16 |
| 20F1001UUS | US | i5-6300U | vPro | Intel HD 520 | 4GBx1 | 15.6" HD (1366x768) | None | 128GB SSD | DVD±RW | Intel 8260 ac, 2x2 + BT4.1 | None | None | None | None | 720p | Non-backlit | None | 6-cell (48Wh) | 45W | Win10 DG Win7 Pro 64 | 1-year, Depot | 02/16 |
| 20F1001VUS | US | i5-6300U | vPro | Intel HD 520 | 8GBx1 | 15.6" FHD (1920x1080) IPS | None | 256GB SSD Opal2 | DVD±RW | Intel 8260 ac, 2x2 + BT4.1 | None | None | None | None | 720p | Non-backlit | Fingerprint Reader | 6-cell (48Wh) | 45W | Win10 DG Win7 Pro 64 | 1-year, Depot | 02/16 |
| 20F1002AUS | US | i5-6300U | vPro | Intel HD 520 | 8GBx1 | 15.6" FHD (1920x1080) IPS | None | 256GB SSD Opal2 | DVD±RW | Intel 8260 ac, 2x2 + BT4.1 | Sierra EM7455 | None | None | None | 720p | Non-backlit | Fingerprint Reader | 6-cell (48Wh) | 45W | Win10 DG Win7 Pro 64 | 1-year, Depot | 04/16 |
| 20F1002BUS | US | i5-6200U | No | Intel HD 520 | 8GBx1 | 15.6" FHD (1920x1080) IPS | None | 256GB SSD Opal2 | DVD±RW | Intel 8260 ac, 2x2 + BT4.1 | Sierra EM7455 | None | None | None | 720p | Non-backlit | Fingerprint Reader | 6-cell (48Wh) | 45W | Win10 Pro 64 | 1-year, Depot | 04/16 |

| Model | Region | Processor | vPro | Graphics | Memory | Display | Multi-touch | Storage | Optical | WLAN + Bluetooth | WWAN | SIM Card | Smart Card Reader | Express-Card | Camera | Keyboard | Fingerprint Reader | Battery | Power Adapter | Operating System | Warranty | Ann Date (m/y) |
|------------|--------|-----------|------|--------------|--------|---------------------------|-------------|-----------------|---------|----------------------------|-----------------|----------|-------------------|--------------|--------|-------------|--------------------|---------------|---------------|----------------------|---------------|----------------|
| 20F1002CUS | US | i5-6200U | No | Intel HD 520 | 8GBx1 | 15.6" FHD (1920x1080) IPS | None | 256GB SSD Opal2 | DVD±RW | Intel 8260 ac, 2x2 + BT4.1 | Sierra EM7455 | None | None | None | 720p | Non-backlit | Fingerprint Reader | 6-cell (48Wh) | 45W | Win10 DG Win7 Pro 64 | 1-year, Depot | 04/16 |
| 20F1002DUS | US | i5-6300U | vPro | Intel HD 520 | 8GBx1 | 15.6" FHD (1920x1080) IPS | None | 256GB SSD Opal2 | DVD±RW | Intel 8260 ac, 2x2 + BT4.1 | Sierra EM7455 | None | None | None | 720p | Non-backlit | Fingerprint Reader | 6-cell (48Wh) | 45W | Win10 Pro 64 | 1-year, Depot | 04/16 |
| 20F1003PUS | US | i3-6100U | No | Intel HD 520 | 4GBx1 | 15.6" HD (1366x768) | None | 256GB SSD Opal2 | DVD±RW | Intel 8260 ac, 2x2 + BT4.1 | WWAN Upgradable | None | None | None | 720p | Non-backlit | None | 6-cell (48Wh) | 45W | Win10 DG Win7 Pro 64 | 1-year, Depot | 11/16 |
| 20F1003QUS | US | i3-6100U | No | Intel HD 520 | 4GBx1 | 15.6" HD (1366x768) | None | 180GB SSD Opal2 | DVD±RW | Intel 8260 ac, 2x2 + BT4.1 | WWAN Upgradable | None | None | None | 720p | Non-backlit | None | 6-cell (48Wh) | 45W | Win10 DG Win7 Pro 64 | 1-year, Depot | 11/16 |
| 20F1003RUS | US | i5-6200U | No | Intel HD 520 | 4GBx1 | 15.6" HD (1366x768) | None | 180GB SSD Opal2 | DVD±RW | Intel 8260 ac, 2x2 + BT4.1 | WWAN Upgradable | None | None | None | 720p | Non-backlit | None | 6-cell (48Wh) | 45W | Win10 Home 64 | 1-year, Depot | 11/16 |
| 20F1003SUS | US | i3-6100U | No | Intel HD 520 | 4GBx1 | 15.6" HD (1366x768) | None | 180GB SSD Opal2 | DVD±RW | Intel 8260 ac, 2x2 + BT4.1 | WWAN Upgradable | None | None | None | 720p | Non-backlit | None | 6-cell (48Wh) | 45W | Win10 Home 64 | 1-year, Depot | 11/16 |
| 20F1003TUS | US | i5-6200U | No | Intel HD 520 | 4GBx1 | 15.6" HD (1366x768) | None | 180GB SSD Opal2 | DVD±RW | Intel 8260 ac, 2x2 + BT4.1 | WWAN Upgradable | None | None | None | 720p | Non-backlit | None | 6-cell (48Wh) | 45W | Win10 DG Win7 Pro 64 | 1-year, Depot | 11/16 |
| 20F1003UUS | US | i5-6200U | No | Intel HD 520 | 4GBx1 | 15.6" HD (1366x768) | None | 256GB SSD Opal2 | DVD±RW | Intel 8260 ac, 2x2 + BT4.1 | WWAN Upgradable | None | None | None | 720p | Non-backlit | None | 6-cell (48Wh) | 45W | Win10 Home 64 | 1-year, Depot | 11/16 |
| 20F1003VUS | US | i5-6200U | No | Intel HD 520 | 4GBx1 | 15.6" HD (1366x768) | None | 256GB SSD Opal2 | DVD±RW | Intel 8260 ac, 2x2 + BT4.1 | WWAN Upgradable | None | None | None | 720p | Non-backlit | None | 6-cell (48Wh) | 45W | Win10 DG Win7 Pro 64 | 1-year, Depot | 11/16 |
| 20F1003WUS | US | i3-6100U | No | Intel HD 520 | 4GBx1 | 15.6" HD (1366x768) | None | 256GB SSD Opal2 | DVD±RW | Intel 8260 ac, 2x2 + BT4.1 | WWAN Upgradable | None | None | None | 720p | Non-backlit | None | 6-cell (48Wh) | 45W | Win10 Home 64 | 1-year, Depot | 11/16 |
| 20F1004AUS | US | i3-6006U | No | Intel HD 520 | 4GBx1 | 15.6" HD (1366x768) | None | 256GB SSD Opal2 | DVD±RW | Intel 8260 ac, 2x2 + BT4.1 | WWAN Upgradable | None | None | None | 720p | Non-backlit | None | 6-cell (48Wh) | 45W | Win10 Pro 64 | 1-year, Depot | 12/16 |
| 20F1004BUS | US | i3-6006U | No | Intel HD 520 | 4GBx1 | 15.6" HD (1366x768) | None | 180GB SSD Opal2 | DVD±RW | Intel 8260 ac, 2x2 + BT4.1 | WWAN Upgradable | None | None | None | 720p | Non-backlit | None | 6-cell (48Wh) | 45W | Win10 DG Win7 Pro 64 | 1-year, Depot | 12/16 |
| 20F1004CUS | US | i3-6006U | No | Intel HD 520 | 4GBx1 | 15.6" HD (1366x768) | None | 256GB SSD Opal2 | DVD±RW | Intel 8260 ac, 2x2 + BT4.1 | WWAN Upgradable | None | None | None | 720p | Non-backlit | None | 6-cell (48Wh) | 45W | Win10 DG Win7 Pro 64 | 1-year, Depot | 12/16 |
| 20F1004DUS | US | i3-6006U | No | Intel HD 520 | 4GBx1 | 15.6" HD (1366x768) | None | 180GB SSD Opal2 | DVD±RW | Intel 8260 ac, 2x2 + BT4.1 | WWAN Upgradable | None | None | None | 720p | Non-backlit | None | 6-cell (48Wh) | 45W | Win10 Pro 64 | 1-year, Depot | 12/16 |



ThinkPad L570 Platform Specifications

Product Specifications Reference (PSREF)

| | | | | | | | | | | |
|--------------------|---|--------------|----------------|---------------------|---------------------|--------------|--------------------|--|--------------------|--|
| Processor | 6th Generation Intel® Core™ i3 / i5 / i7 Processor (i7 processor is not available in EMEA) or | | | | | | | WWAN (optional) <i>One of the following, configurable by model:</i> <ul style="list-style-type: none"> Wireless WAN upgradable Integrated Mobile Broadband 4G LTE-A, Qualcomm® Snapdragon™ X7 LTE-A (Sierra Wireless EM7455), M.2 card Integrated Mobile Broadband 4G LTE, Intel XMM™ 7160 (Fibocom L831-EAU), M.2 card (EMEA only) SIM card (opt) Micro-SIM card slot, opt Verizon LTE (US) or Lenovo® Connect (EMEA) SIM card | | |
| | Processor Number | # of Cores | # of Threads | Base Frequency | Max Turbo Frequency | Cache | Memory Types | | Processor Graphics | |
| | i3-6006U | 2 | 4 | 2.0 GHz | - | 3MB | DDR4-2133 | Intel HD Graphics 520 | | |
| | i3-6100U | | | 2.3 GHz | - | 3MB | | | | |
| | i5-6200U | | | 2.3 GHz | 2.8 GHz | 3MB | | | | |
| | i5-6300U | | | 2.4 GHz | 3.0 GHz | 3MB | | | | |
| | i7-6500U | | | 2.5 GHz | 3.1 GHz | 4MB | | | | |
| | i7-6600U | 2.6 GHz | 3.4 GHz | 4MB | | | | | | |
| | Intel Celeron® Processor or 7th Generation Intel Core i3 / i5 / i7 Processor | | | | | | | ExpressCard (opt) One slot (ExpressCard/34) Smart card reader <i>Optional:</i> Smart card reader Media reader 4-in-1 reader (MMC, SD, SDHC, SDXC) Ports Four USB 3.1 Gen 1 (USB 3.0, one Always On), VGA, Mini DisplayPort, Ethernet (RJ-45), Dock connector Monitor cable <i>Optional:</i> Lenovo Mini-DisplayPort to DisplayPort Monitor Cable (MiniDP to DP) Camera (optional) HD720p resolution, fixed focus Audio support HD Audio, Realtek® ALC3245 codec / stereo speakers, 1.5W x 2 / dual array microphone, combo audio/microphone jack Keyboard 6-row, spill-resistant, multimedia Fn keys, numeric keypad UltraNav™ TrackPoint® pointing device and buttonless Mylar surface multi-touch touchpad | | |
| Processor Number | # of Cores | # of Threads | Base Frequency | Max Turbo Frequency | Cache | Memory Types | Processor Graphics | | | |
| | Cel 3965U | 2 | 4 | 2.2 GHz | - | 2MB | DDR4-2133 | Intel HD Graphics 610 | | |
| | i3-7100U | | | 2.4 GHz | - | 3MB | | | | |
| | i5-7200U | | | 2.5 GHz | 3.1 GHz | 3MB | | | | |
| | i5-7300U | | | 2.6 GHz | 3.5 GHz | 3MB | | | | |
| | i7-7500U | | | 2.7 GHz | 3.5 GHz | 4MB | | | | |
| | i7-7600U | | | 2.8 GHz | 3.9 GHz | 4MB | | | | |
| | | | | | | | | | | |
| Graphics | Intel HD Graphics 520, 610, or 620 in processor only; supports external analog monitor via VGA and digital monitor via Mini DisplayPort; supports three independent displays; Max resolution: 3840x2160@60Hz (DP via mDP cable); 1920x1200@60Hz (VGA) | | | | | | | Security Power-on password, hard disk password, supervisor password, security keyhole Security chip Discrete TPM 2.0, TCG Certified vPro (optional) Intel vPro Technology Fingerprint reader <i>Optional:</i> Swiipe style fingerprint reader on the palm rest NFC None | | |
| Chipset Memory | Intel SoC (System on Chip) platform 32GB max / 2133MHz DDR4, dual-channel capable, two DDR4 SO-DIMM sockets | | | | | | | Battery Li-Ion 6-cell (48Wh) Max battery life <i>MobileMark® 2014:</i> 14.8 hr AC adapter 45W AC adapter | | |
| Display | <i>Some:</i> 15.6" (396mm) HD (1366x768), anti-glare, LED backlight, 220 nits, 16:9 aspect ratio, 350:1 contrast ratio <i>Some:</i> 15.6" (396mm) FHD (1920x1080), anti-glare, LED backlight, 220 nits, 16:9 aspect ratio, 400:1 or 500:1 contrast ratio <i>Some:</i> 15.6" (396mm) FHD (1920x1080), anti-glare, LED backlight, IPS, 250 nits, 16:9 aspect ratio, 600:1 contrast ratio, 160° viewing angle | | | | | | | Preload Windows® 7 Professional 64 preinstalled through downgrade rights in Windows 10 Pro 64 <ul style="list-style-type: none"> Lenovo Solution Center Lenovo PowerEngage ThinkVantage Product Recovery ThinkVantage System Update Adobe® Reader® Microsoft® Office preloaded; purchase a product key to activate McAfee® LiveSafe™ (30-day trial) <i>Some:</i> Windows 10 Home 64 <ul style="list-style-type: none"> Lenovo Companion Lenovo Setting Microsoft Office preloaded; purchase a product key to activate | | |
| Multi-touch | None | | | | | | | Limited warranty <i>One of the following, configurable by model:</i> <ul style="list-style-type: none"> 1-year depot repair service 3-year/1-yr battery depot repair service 3-year/1-yr battery limited onsite service | | |
| Storage | <i>Some:</i> HDD / SATA 6.0Gb/s, 2.5" wide, 7mm high, Active Protection System™ <i>Some:</i> SSD / SATA 6.0Gb/s, 2.5" wide, 7mm high (e.g. xxxGB SSD) <i>Some:</i> M.2 SSD / PCIe NVMe, PCIe 3.0 x 2, 16Gb/s <i>Some:</i> 128GB M.2 SSD / SATA 6.0Gb/s, in WWAN slot as 2nd Storage, mutually exclusive with WWAN | | | | | | | Mil-Spec test MIL-STD-810G military certification | | |
| Optical (optional) | DVD-ROM or DVD burner, 9mm high, fixed, not removable, tray-in | | | | | | | Environment EPEAT™ Gold (US only); ENERGY STAR® 6.1; RoHS-compliant | | |
| Ethernet | <i>Non-vPro model:</i> Intel Ethernet Connection I219-V (Jacksonville) <i>vPro model:</i> Intel Ethernet Connection I219-LM (Jacksonville) | | | | | | | | | |
| WLAN | <i>One of the following, configurable by model:</i> <ul style="list-style-type: none"> Realtek® RTL8822BE, Wi-Fi 2x2 802.11ac + BT4.1, M.2 card (US only) Intel Dual Band Wireless-AC 8260, Wi-Fi 2x2 802.11ac + BT4.1, M.2 card Intel Dual Band Wireless-AC 8265, Wi-Fi 2x2 802.11ac + BT4.1, M.2 card Bluetooth™ 4.1 wireless, integrated in Wi-Fi + Bluetooth combo adapter * Intel 8265ac card supports BT4.2 but is limited to BT4.1 by Windows OS | | | | | | | | | |

| Model | Region | Processor | vPro | Graphics | Memory | Display | Multi-touch | Storage(HDD/SSD) | Optical | WLAN + Bluetooth | WWAN | SIM Card | Smart Card Reader | ExpressCard | Monitor Cable | Camera | Key-board | Fingerprint Reader | TPM | Battery | Power Adapter | Operating System | Warranty | Ann Date (m/y) |
|------------|--------|-----------|------|--------------|--------|---------------------------|-------------|-------------------------------|---------|----------------------------|-----------------|----------|-------------------|------------------|---------------|--------|-------------|--------------------|----------|---------------|---------------|------------------|---------------|----------------|
| 20J8000WUS | US | i3-7100U | No | Intel HD 620 | 4GBx1 | 15.6" HD (1366x768) | None | 180GB SSD Opal2 | DVD±RW | Intel 8265 ac, 2x2 + BT4.1 | WWAN Upgradable | None | None | None | None | 720p | Non-backlit | None | dTPM 2.0 | 6-cell (48Wh) | 45W | Win10 Pro 64 | 1-year, Depot | 03/17 |
| 20J8000XUS | US | i5-7300U | vPro | Intel HD 620 | 8GBx1 | 15.6" FHD (1920x1080) IPS | None | 256GB SSD Opal2 | DVD±RW | Intel 8265 ac, 2x2 + BT4.1 | WWAN Upgradable | None | None | None | None | 720p | Non-backlit | Fingerprint Reader | dTPM 2.0 | 6-cell (48Wh) | 45W | Win10 Pro 64 | 1-year, Depot | 03/17 |
| 20J8000YUS | US | i5-7300U | vPro | Intel HD 620 | 4GBx1 | 15.6" HD (1366x768) | None | 128GB SSD | DVD±RW | Intel 8265 ac, 2x2 + BT4.1 | WWAN Upgradable | None | None | None | None | 720p | Non-backlit | None | dTPM 2.0 | 6-cell (48Wh) | 45W | Win10 Pro 64 | 1-year, Depot | 03/17 |
| 20J80010US | US | i5-7200U | No | Intel HD 620 | 4GBx1 | 15.6" HD (1366x768) | None | 500GB 7200rpm | DVD±RW | Intel 8265 ac, 2x2 + BT4.1 | WWAN Upgradable | None | None | None | None | 720p | Non-backlit | None | dTPM 2.0 | 6-cell (48Wh) | 45W | Win10 Pro 64 | 1-year, Depot | 03/17 |
| 20J80011US | US | i5-7200U | No | Intel HD 620 | 4GBx1 | 15.6" HD (1366x768) | None | 180GB SSD Opal2 | DVD±RW | Intel 8265 ac, 2x2 + BT4.1 | WWAN Upgradable | None | None | None | None | 720p | Non-backlit | None | dTPM 2.0 | 6-cell (48Wh) | 45W | Win10 Pro 64 | 1-year, Depot | 03/17 |
| 20J80012US | US | i5-7200U | No | Intel HD 620 | 4GBx1 | 15.6" HD (1366x768) | None | 128GB SSD | DVD±RW | Intel 8265 ac, 2x2 + BT4.1 | WWAN Upgradable | None | None | None | None | 720p | Non-backlit | None | dTPM 2.0 | 6-cell (48Wh) | 45W | Win10 Pro 64 | 1-year, Depot | 03/17 |
| 20J80013US | US | i5-7200U | No | Intel HD 620 | 8GBx1 | 15.6" FHD (1920x1080) IPS | None | 256GB SSD Opal2 | DVD±RW | Intel 8265 ac, 2x2 + BT4.1 | WWAN Upgradable | None | None | None | None | 720p | Non-backlit | None | dTPM 2.0 | 6-cell (48Wh) | 45W | Win10 Pro 64 | 1-year, Depot | 03/17 |
| 20J80014US | US | i5-7200U | No | Intel HD 620 | 4GBx1 | 15.6" HD (1366x768) | None | 256GB SSD Opal2 | DVD±RW | Intel 8265 ac, 2x2 + BT4.1 | WWAN Upgradable | None | None | None | None | 720p | Non-backlit | None | dTPM 2.0 | 6-cell (48Wh) | 45W | Win10 Pro 64 | 1-year, Depot | 03/17 |
| 20J80015US | US | i3-7100U | No | Intel HD 620 | 4GBx1 | 15.6" HD (1366x768) | None | 256GB SSD Opal2 | DVD±RW | Intel 8265 ac, 2x2 + BT4.1 | WWAN Upgradable | None | None | None | None | 720p | Non-backlit | None | dTPM 2.0 | 6-cell (48Wh) | 45W | Win10 Pro 64 | 1-year, Depot | 03/17 |
| 20J80016US | US | i3-7100U | No | Intel HD 620 | 4GBx1 | 15.6" HD (1366x768) | None | 500GB 7200rpm | DVD±RW | Intel 8265 ac, 2x2 + BT4.1 | WWAN Upgradable | None | None | None | None | 720p | Non-backlit | None | dTPM 2.0 | 6-cell (48Wh) | 45W | Win10 Pro 64 | 1-year, Depot | 03/17 |
| 20J80017US | US | i5-7300U | vPro | Intel HD 620 | 4GBx1 | 15.6" HD (1366x768) | None | 500GB 7200rpm | DVD±RW | Intel 8265 ac, 2x2 + BT4.1 | WWAN Upgradable | None | None | None | None | 720p | Non-backlit | None | dTPM 2.0 | 6-cell (48Wh) | 45W | Win10 Pro 64 | 1-year, Depot | 03/17 |
| 20J8002EUS | US | i5-7300U | vPro | Intel HD 620 | 8GBx1 | 15.6" FHD (1920x1080) IPS | None | 256GB SSD Opal2 | DVD±RW | Intel 8265 ac, 2x2 + BT4.1 | Sierra EM7455 | None | None | ExpressCard / 34 | None | 720p | Non-backlit | Fingerprint Reader | dTPM 2.0 | 6-cell (48Wh) | 45W | Win10 Pro 64 | 3-year, Depot | 04/17 |
| 20J8002FUS | US | i5-7200U | No | Intel HD 620 | 4GBx1 | 15.6" HD (1366x768) | None | 500GB 7200rpm | DVD±RW | Intel 8265 ac, 2x2 + BT4.1 | Sierra EM7455 | None | None | ExpressCard / 34 | None | 720p | Non-backlit | None | dTPM 2.0 | 6-cell (48Wh) | 45W | Win10 Pro 64 | 3-year, Depot | 04/17 |
| 20J8002GUS | US | i5-7300U | vPro | Intel HD 620 | 8GBx1 | 15.6" FHD (1920x1080) IPS | None | 256GB SSD M.2 PCIe NVMe Opal2 | DVD±RW | Intel 8265 ac, 2x2 + BT4.1 | WWAN Upgradable | None | None | ExpressCard / 34 | None | 720p | Non-backlit | Fingerprint Reader | dTPM 2.0 | 6-cell (48Wh) | 45W | Win10 Pro 64 | 3-year, Depot | 04/17 |
| 20J8002LUS | US | i7-7500U | No | Intel HD 620 | 8GBx1 | 15.6" FHD (1920x1080) IPS | None | 256GB SSD Opal2 | DVD±RW | Intel 8265 ac, 2x2 + BT4.1 | WWAN Upgradable | None | None | ExpressCard / 34 | None | 720p | Non-backlit | Fingerprint Reader | dTPM 2.0 | 6-cell (48Wh) | 45W | Win10 Pro 64 | 3-year, Depot | 06/17 |
| 20J8002MUS | US | i7-7600U | vPro | Intel HD 620 | 8GBx1 | 15.6" FHD (1920x1080) IPS | None | 256GB SSD Opal2 | DVD±RW | Intel 8265 ac, 2x2 + BT4.1 | WWAN Upgradable | None | None | ExpressCard / 34 | None | 720p | Non-backlit | Fingerprint Reader | dTPM 2.0 | 6-cell (48Wh) | 45W | Win10 Pro 64 | 3-year, Depot | 06/17 |

ThinkPad L570 - TopSeller - 20JQ

Product Specifications Reference (PSREF)

| Model | Region | Processor | vPro | Graphics | Memory | Display | Multi-touch | Storage(HDD/SSD) | Optical | WLAN + Bluetooth | WWAN | SIM Card | Smart Card Reader | ExpressCard | Monitor Cable | Camera | Key-board | Fingerprint Reader | TPM | Battery | Power Adapter | Operating System | Warranty | Ann Date (m/y) |
|------------|--------|-----------|------|--------------|--------|---------------------------|-------------|------------------|---------|----------------------------|-----------------|----------|-------------------|------------------|---------------|--------|-------------|--------------------|----------|---------------|---------------|----------------------|---------------|----------------|
| 20JQ000UUS | US | i3-6006U | No | Intel HD 520 | 4GBx1 | 15.6" HD (1366x768) | None | 180GB SSD Opal2 | DVD±RW | Intel 8260 ac, 2x2 + BT4.1 | WWAN Upgradable | None | None | ExpressCard / 34 | None | 720p | Non-backlit | None | dTPM 2.0 | 6-cell (48Wh) | 45W | Win10 DG Win7 Pro 64 | 1-year, Depot | 06/17 |
| 20JQ000VUS | US | i5-6300U | vPro | Intel HD 520 | 4GBx1 | 15.6" HD (1366x768) | None | 180GB SSD Opal2 | DVD±RW | Intel 8260 ac, 2x2 + BT4.1 | WWAN Upgradable | None | None | ExpressCard / 34 | None | 720p | Non-backlit | None | dTPM 2.0 | 6-cell (48Wh) | 45W | Win10 DG Win7 Pro 64 | 1-year, Depot | 06/17 |
| 20JQ000WUS | US | i5-6300U | vPro | Intel HD 520 | 4GBx1 | 15.6" FHD (1920x1080) IPS | None | 256GB SSD Opal2 | DVD±RW | Intel 8260 ac, 2x2 + BT4.1 | WWAN Upgradable | None | None | ExpressCard / 34 | None | 720p | Non-backlit | None | dTPM 2.0 | 6-cell (48Wh) | 45W | Win10 DG Win7 Pro 64 | 3-year, Depot | 06/17 |
| 20JQ000XUS | US | i3-6006U | No | Intel HD 520 | 4GBx1 | 15.6" HD (1366x768) | None | 500GB 7200rpm | DVD±RW | Intel 8260 ac, 2x2 + BT4.1 | WWAN Upgradable | None | None | ExpressCard / 34 | None | 720p | Non-backlit | None | dTPM 2.0 | 6-cell (48Wh) | 45W | Win10 DG Win7 Pro 64 | 1-year, Depot | 06/17 |
| 20JQ000YUS | US | i5-6300U | vPro | Intel HD 520 | 4GBx1 | 15.6" FHD (1920x1080) IPS | None | 500GB 7200rpm | DVD±RW | Intel 8260 ac, 2x2 + BT4.1 | WWAN Upgradable | None | None | ExpressCard / 34 | None | 720p | Non-backlit | None | dTPM 2.0 | 6-cell (48Wh) | 45W | Win10 DG Win7 Pro 64 | 3-year, Depot | 06/17 |
| 20JQ0010US | US | i5-6300U | vPro | Intel HD 520 | 8GBx1 | 15.6" FHD (1920x1080) IPS | None | 256GB SSD Opal2 | DVD±RW | Intel 8260 ac, 2x2 + BT4.1 | WWAN Upgradable | None | None | ExpressCard / 34 | None | 720p | Non-backlit | None | dTPM 2.0 | 6-cell (48Wh) | 45W | Win10 DG Win7 Pro 64 | 3-year, Depot | 06/17 |
| 20JQ0011US | US | i5-6300U | vPro | Intel HD 520 | 4GBx1 | 15.6" HD (1366x768) | None | 500GB 7200rpm | DVD±RW | Intel 8260 ac, 2x2 + BT4.1 | WWAN Upgradable | None | None | ExpressCard / 34 | None | 720p | Non-backlit | None | dTPM 2.0 | 6-cell (48Wh) | 45W | Win10 DG Win7 Pro 64 | 1-year, Depot | 06/17 |



ThinkPad P50 Platform Specifications

Product Specifications Reference (PSREF)

| Processor | 6th Generation Intel® Core™ i7 Processor or Intel Xeon® Processor E3 v5 Family | | | | | | | Smart card reader ExpressCard Media reader Ports | Optional: Smart card reader One slot (ExpressCard/34) 4-in-1 reader (MMC, SD, SDHC, SDXC), supports UHS-II SD card Four USB 3.0 (one Always On), USB Type-C / Thunderbolt 3, Mini DisplayPort, HDMI, Ethernet (RJ-45), Dock connector | | | | | | | | | |
|-------------------------------------|--|-----------------|--------------|----------------|---------------------|------------------------|--------------|---|---|------------------------|-----------|-----------------|-------------------|-------------|-----------------|-----------------|--|---------|
| | Processor Number | # of Cores | # of Threads | Base Frequency | Max Turbo Frequency | Cache | Memory Types | | | Processor Graphics | | | | | | | | |
| | i7-6700HQ | 4 | 8 | 2.6 GHz | 3.5 GHz | 6MB | DDR4-2133 | | | Intel HD Graphics 530 | | | | | | | | |
| | i7-6820HQ | | | 2.7 GHz | 3.6 GHz | 8MB | | | | Intel HD Graphics 530 | | | | | | | | |
| | E3-1505M v5 | | | 2.8 GHz | 3.7 GHz | 8MB | | | | Intel HD Graphics P530 | | | | | | | | |
| E3-1535M v5 | 2.9 GHz | | | 3.8 GHz | 8MB | Intel HD Graphics P530 | | | | | | | | | | | | |
| Graphics | Intel HD Graphics 530 or P530 in processor and NVIDIA Quadro® M1000M (2GB or 4GB memory) or M2000M (4GB memory); supports external digital monitor via HDMI, Mini DisplayPort, or Thunderbolt™; supports four independent displays; Max resolution: 3840x2160@60Hz (DisplayPort via Mini DisplayPort cable); 3840x2160@60Hz (Thunderbolt); 3840x2160@30Hz (HDMI) | | | | | | | Keyboard UltraNav™ | 6-row, spill-resistant, multimedia Fn keys, numeric keypad, optional LED backlight 3-button TrackPoint® pointing device and 3-button crystal silk surface multi-touch touchpad | | | | | | | | | |
| Chipset Memory | Mobile Intel CM236 Chipset (Intel GL82CM236 PCH) 64GB max ⁷ / 2133MHz DDR4, ECC or non-ECC (ECC function supported only on Xeon processor), dual-channel capable, four DDR4 SO-DIMM sockets | | | | | | | Security Security chip ThinkEngine | Power-on password, hard disk password, supervisor password, security keyhole Discrete TPM 1.2 TCG Certified and Firmware TPM 2.0 integrated in chipset Delivers improved thermal and power efficiency, up to 30 day standby, faster resume time, enhanced security, as well as anti-tampering measures | | | | | | | | | |
| Display | Some: 15.6" (396mm) FHD (1920x1080), anti-glare, LED backlight, IPS, 250 nits, 16:9 aspect ratio, 600:1 contrast ratio, 45% gamut, 160° viewing angle Some: 15.6" (396mm) 4K (3840x2160), anti-glare, LED backlight, IPS, 300 nits, 16:9 aspect ratio, 1000:1 contrast ratio, 100% gamut, 178° viewing angle | | | | | | | vPro (optional) Fingerprint reader Color calibration | Intel vPro Technology Touch style fingerprint reader on the palm rest Optional: Pantone® color calibrator by X-Rite® color calibration sensor in palm rest | | | | | | | | | |
| Multi-touch (opt) Pen (optional) | Capacitive-type multi-touch, supports 10-finger gesture, 220 nits ThinkPad Pen Pro, active pen for multi-touch display | | | | | | | Battery Max battery life ¹⁰ (MobileMark® 2014) | Lithium Polymer 4-cell (66Wh) or 6-cell (90Wh) | | | | | | | | | |
| Storage | Up to 3 drives (two M.2 SSD and one HDD) Some: M.2 SSD / SATA 6.0Gb/s (e.g. xxxG SSD) Some: M.2 SSD / PCIe NVMe, PCIe 3.0 x 4, 32Gb/s (e.g. xxxG SSD PCIe NVMe) Some: HDD / SATA 6.0Gb/s, 2.5" wide, 7mm high, Shock Mounted Hard Drive, Active Protection System™ | | | | | | | <table border="1"> <thead> <tr> <th>Model</th> <th>4-cell</th> <th>6-cell</th> </tr> </thead> <tbody> <tr> <td>Discrete Graphics</td> <td>7.1 hr</td> <td>9.7 hr</td> </tr> <tr> <td>Hybrid Graphics</td> <td>9.6 hr</td> <td>13.2 hr</td> </tr> </tbody> </table> | | Model | 4-cell | 6-cell | Discrete Graphics | 7.1 hr | 9.7 hr | Hybrid Graphics | 9.6 hr | 13.2 hr |
| Model | 4-cell | 6-cell | | | | | | | | | | | | | | | | |
| Discrete Graphics | 7.1 hr | 9.7 hr | | | | | | | | | | | | | | | | |
| Hybrid Graphics | 9.6 hr | 13.2 hr | | | | | | | | | | | | | | | | |
| Optical | None | | | | | | | AC adapter | 170W AC adapter | | | | | | | | | |
| Ethernet | Non-vPro model: Intel Ethernet Connection I219-V (Jacksonville) vPro model: Intel Ethernet Connection I219-LM (Jacksonville) | | | | | | | Preload | Some: Genuine Windows® 7 Professional 64 Some: Windows 7 Professional 64 preinstalled through downgrade rights in Windows 10 Pro 64 Windows 10 Pro 64 • Lenovo Solution Center • Lenovo SHAREit • Lenovo Companion • Lenovo Setting • Microsoft Office preloaded; purchase a product key to activate • McAfee® LiveSafe™ (30-day trial) | | | | | | | | | |
| WLAN ⁴ Bluetooth™ | 11ac+BT, Intel Dual Band Wireless-AC 8260, 2x2, M.2 card Bluetooth 4.1 wireless, integrated in Wi-Fi + Bluetooth combo adapter | | | | | | | • Lenovo Solution Center • Lenovo SHAREit • ThinkVantage Product Recovery • Rescue and Recovery™ • ThinkVantage System Update • Adobe® Reader® • Microsoft® Office preloaded; purchase a product key to activate • McAfee® LiveSafe™ (30-day trial) For ISV certifications, please visit www.lenovo.com/support/ISV | | | | | | | | | | |
| WWAN (optional) | Wireless WAN, Sierra Wireless EM7455, Qualcomm® 4G LTE-Advanced/DC-HSPA+/HSPA/HSPA/UMTS/GNSS, M.2 card | | | | | | | | | | | | | | | | | |
| SIM card | Micro-SIM card slot | | | | | | | | | | | | | | | | | |
| Dimensions ³ | WxDxH: 14.86" x 9.93" x 0.96-1.16"; 377.4mm x 252.3mm x 24.5-29.4mm WxDxH(Touch): 14.86" x 9.93" x 1.02-1.21"; 377.4mm x 252.3mm x 25.8-30.7mm | | | | | | | Limited warranty ¹² One of the following, configurable by model: • 3-year/1-yr battery depot repair service • 3-year/1-yr battery limited onsite service ²⁴ • 3-year/1-yr battery limited onsite service, OID (Onsite International Delivery) | | | | | | | | | | |
| Weight ² | <table border="1"> <thead> <tr> <th>Models</th> <th>4-cell</th> <th>6-cell</th> </tr> </thead> <tbody> <tr> <td>Non-touch</td> <td>5.6 lb / 2.55kg</td> <td>5.9 lb / 2.67kg</td> </tr> <tr> <td>Multi-touch</td> <td>6.2 lb / 2.82kg</td> <td>6.4 lb / 2.90kg</td> </tr> </tbody> </table> | | | | | | | Models | 4-cell | 6-cell | Non-touch | 5.6 lb / 2.55kg | 5.9 lb / 2.67kg | Multi-touch | 6.2 lb / 2.82kg | 6.4 lb / 2.90kg | Mil-Spec test MIL-STD-810G military certification | |
| Models | 4-cell | 6-cell | | | | | | | | | | | | | | | | |
| Non-touch | 5.6 lb / 2.55kg | 5.9 lb / 2.67kg | | | | | | | | | | | | | | | | |
| Multi-touch | 6.2 lb / 2.82kg | 6.4 lb / 2.90kg | | | | | | | | | | | | | | | | |
| Case material | Display cover: Glass-Fiber Reinforced Plastic; Bottom: Magnesium/Aluminum | | | | | | | Environment EPEAT™ Gold (US only); ENERGY STAR® 6.1; GREENGUARD®; RoHS-compliant | | | | | | | | | | |

| Model | Region | Processor | vPro | Graphics | Memory | Display | Multi-touch | Pen | Storage(HDD/SSD) | RAID | Optical | WLAN + Bluetooth | WWAN | SIM Card | Smart Card Reader | Camera | Keyboard | Fingerprint Reader | Color Calibrator | Battery | Power Adapter | Operating System | Warranty | Ann Date (m/y) |
|------------|--------|-----------|------|------------|----------------|---------------------------|----------------------|------|-------------------------|------|---------|----------------------------|------|----------|-------------------|--------|----------|--------------------|------------------|---------------|---------------|----------------------|---------------|----------------|
| 20EN0012US | US | i7-6700HQ | No | M1000M 2GB | 8GBx1 non-ECC | 15.6" FHD (1920x1080) IPS | None | None | 256GB SSD M.2 Opal2 | No | None | Intel 8260 ac, 2x2 + BT4.1 | None | None | None | 720p | Backlit | Fingerprint Reader | None | 6-cell (90Wh) | 170W | Win10 DG Win7 Pro 64 | 3-year, Depot | 11/15 |
| 20EN0013US | US | i7-6700HQ | No | M1000M 2GB | 8GBx1 non-ECC | 15.6" FHD (1920x1080) IPS | None | None | 500GB 7200rpm | No | None | Intel 8260 ac, 2x2 + BT4.1 | None | None | None | 720p | Backlit | Fingerprint Reader | None | 6-cell (90Wh) | 170W | Win10 DG Win7 Pro 64 | 3-year, Depot | 11/15 |
| 20EN0014US | US | i7-6700HQ | No | M1000M 2GB | 8GBx1 non-ECC | 15.6" FHD (1920x1080) IPS | None | None | 1TB 5400rpm | No | None | Intel 8260 ac, 2x2 + BT4.1 | None | None | None | 720p | Backlit | Fingerprint Reader | None | 6-cell (90Wh) | 170W | Win10 DG Win7 Pro 64 | 3-year, Depot | 11/15 |
| 20EN0015US | US | i7-6700HQ | No | M1000M 2GB | 16GBx1 non-ECC | 15.6" FHD (1920x1080) IPS | None | None | 512GB SSD M.2 PCIe NVMe | No | None | Intel 8260 ac, 2x2 + BT4.1 | None | None | None | 720p | Backlit | Fingerprint Reader | None | 6-cell (90Wh) | 170W | Win10 DG Win7 Pro 64 | 3-year, Depot | 11/15 |
| 20EN0016US | US | i7-6820HQ | vPro | M1000M 2GB | 8GBx1 non-ECC | 15.6" FHD (1920x1080) IPS | None | None | 500GB 7200rpm | No | None | Intel 8260 ac, 2x2 + BT4.1 | None | None | None | 720p | Backlit | Fingerprint Reader | None | 6-cell (90Wh) | 170W | Win10 DG Win7 Pro 64 | 3-year, Depot | 11/15 |
| 20EN0017US | US | i7-6820HQ | vPro | M1000M 2GB | 8GBx1 non-ECC | 15.6" FHD (1920x1080) IPS | None | None | 1TB 5400rpm | No | None | Intel 8260 ac, 2x2 + BT4.1 | None | None | None | 720p | Backlit | Fingerprint Reader | None | 6-cell (90Wh) | 170W | Win10 DG Win7 Pro 64 | 3-year, Depot | 11/15 |
| 20EN0018US | US | i7-6820HQ | vPro | M1000M 2GB | 8GBx1 non-ECC | 15.6" FHD (1920x1080) IPS | None | None | 256GB SSD M.2 Opal2 | No | None | Intel 8260 ac, 2x2 + BT4.1 | None | None | None | 720p | Backlit | Fingerprint Reader | None | 6-cell (90Wh) | 170W | Win10 DG Win7 Pro 64 | 3-year, Depot | 11/15 |
| 20EN0019US | US | i7-6820HQ | vPro | M1000M 2GB | 16GBx1 non-ECC | 15.6" FHD (1920x1080) IPS | None | None | 512GB SSD M.2 PCIe NVMe | No | None | Intel 8260 ac, 2x2 + BT4.1 | None | None | None | 720p | Backlit | Fingerprint Reader | None | 6-cell (90Wh) | 170W | Win10 DG Win7 Pro 64 | 3-year, Depot | 11/15 |
| 20EN001AUS | US | i7-6820HQ | vPro | M2000M 4GB | 8GBx1 non-ECC | 15.6" FHD (1920x1080) IPS | None | None | 500GB 7200rpm | No | None | Intel 8260 ac, 2x2 + BT4.1 | None | None | None | 720p | Backlit | Fingerprint Reader | None | 6-cell (90Wh) | 170W | Win10 DG Win7 Pro 64 | 3-year, Depot | 11/15 |
| 20EN001BUS | US | i7-6820HQ | vPro | M2000M 4GB | 8GBx1 non-ECC | 15.6" FHD (1920x1080) IPS | None | None | 256GB SSD M.2 Opal2 | No | None | Intel 8260 ac, 2x2 + BT4.1 | None | None | None | 720p | Backlit | Fingerprint Reader | None | 6-cell (90Wh) | 170W | Win10 DG Win7 Pro 64 | 3-year, Depot | 11/15 |
| 20EN001CUS | US | i7-6820HQ | vPro | M2000M 4GB | 16GBx1 non-ECC | 15.6" FHD (1920x1080) IPS | None | None | 512GB SSD M.2 PCIe NVMe | No | None | Intel 8260 ac, 2x2 + BT4.1 | None | None | None | 720p | Backlit | Fingerprint Reader | None | 6-cell (90Wh) | 170W | Win10 DG Win7 Pro 64 | 3-year, Depot | 11/15 |
| 20EN001DUS | US | i7-6820HQ | vPro | M2000M 4GB | 16GBx1 non-ECC | 15.6" 4K (3840x2160) IPS | None | None | 500GB 7200rpm | No | None | Intel 8260 ac, 2x2 + BT4.1 | None | None | None | 720p | Backlit | Fingerprint Reader | X-Rite | 6-cell (90Wh) | 170W | Win10 DG Win7 Pro 64 | 3-year, Depot | 11/15 |
| 20EN001EUS | US | i7-6820HQ | vPro | M2000M 4GB | 16GBx1 non-ECC | 15.6" 4K (3840x2160) IPS | None | None | 256GB SSD M.2 Opal2 | No | None | Intel 8260 ac, 2x2 + BT4.1 | None | None | None | 720p | Backlit | Fingerprint Reader | X-Rite | 6-cell (90Wh) | 170W | Win10 DG Win7 Pro 64 | 3-year, Depot | 11/15 |
| 20EN001FUS | US | i7-6820HQ | vPro | M2000M 4GB | 16GBx1 non-ECC | 15.6" 4K (3840x2160) IPS | None | None | 512GB SSD M.2 PCIe NVMe | No | None | Intel 8260 ac, 2x2 + BT4.1 | None | None | None | 720p | Backlit | Fingerprint Reader | X-Rite | 6-cell (90Wh) | 170W | Win10 DG Win7 Pro 64 | 3-year, Depot | 11/15 |
| 20EN001GUS | US | i7-6700HQ | No | M1000M 2GB | 8GBx1 non-ECC | 15.6" FHD (1920x1080) IPS | 10-point Multi-touch | None | 500GB 7200rpm | No | None | Intel 8260 ac, 2x2 + BT4.1 | None | None | None | 720p | Backlit | Fingerprint Reader | X-Rite | 6-cell (90Wh) | 170W | Win10 Pro 64 | 3-year, Depot | 11/15 |
| 20EN001HUS | US | i7-6700HQ | No | M1000M 2GB | 8GBx1 non-ECC | 15.6" FHD (1920x1080) IPS | 10-point Multi-touch | None | 256GB SSD M.2 Opal2 | No | None | Intel 8260 ac, 2x2 + BT4.1 | None | None | None | 720p | Backlit | Fingerprint Reader | X-Rite | 6-cell (90Wh) | 170W | Win10 Pro 64 | 3-year, Depot | 11/15 |
| 20EN001JUS | US | i7-6820HQ | vPro | M1000M 2GB | 8GBx1 non-ECC | 15.6" FHD (1920x1080) IPS | 10-point Multi-touch | None | 500GB 7200rpm | No | None | Intel 8260 ac, 2x2 + BT4.1 | None | None | None | 720p | Backlit | Fingerprint Reader | X-Rite | 6-cell (90Wh) | 170W | Win10 Pro 64 | 3-year, Depot | 11/15 |
| 20EN001KUS | US | i7-6820HQ | vPro | M1000M 2GB | 8GBx1 non-ECC | 15.6" FHD (1920x1080) IPS | 10-point Multi-touch | None | 256GB SSD M.2 Opal2 | No | None | Intel 8260 ac, 2x2 + BT4.1 | None | None | None | 720p | Backlit | Fingerprint Reader | X-Rite | 6-cell (90Wh) | 170W | Win10 Pro 64 | 3-year, Depot | 11/15 |
| 20EN001LUS | US | i7-6820HQ | vPro | M2000M 4GB | 16GBx1 non-ECC | 15.6" FHD (1920x1080) IPS | 10-point Multi-touch | None | 256GB SSD M.2 Opal2 | No | None | Intel 8260 ac, 2x2 + BT4.1 | None | None | None | 720p | Backlit | Fingerprint Reader | X-Rite | 6-cell (90Wh) | 170W | Win10 Pro 64 | 3-year, Depot | 11/15 |
| 20EN001MUS | US | i7-6820HQ | vPro | M2000M 4GB | 16GBx1 non-ECC | 15.6" FHD (1920x1080) IPS | 10-point Multi-touch | None | 512GB SSD M.2 PCIe NVMe | No | None | Intel 8260 ac, 2x2 + BT4.1 | None | None | None | 720p | Backlit | Fingerprint Reader | X-Rite | 6-cell (90Wh) | 170W | Win10 Pro 64 | 3-year, Depot | 11/15 |

| Model | Region | Processor | vPro | Graphics | Memory | Display | Multi-touch | Pen | Storage(HDD/SSD) | RAID | Optical | WLAN + Bluetooth | WWAN | SIM Card | Smart Card Reader | Camera | Keyboard | Fingerprint Reader | Color Calibrator | Battery | Power Adapter | Operating System | Warranty | Ann Date (m/y) |
|------------|--------|------------------|------|------------|----------------|---------------------------|----------------------|------|-------------------------|------|---------|----------------------------|------|----------|-------------------|--------|----------|--------------------|------------------|---------------|---------------|----------------------|---------------|----------------|
| 20EN001NUS | US | Xeon E3-1505M v5 | vPro | M2000M 4GB | 16GBx1 non-ECC | 15.6" FHD (1920x1080) IPS | 10-point Multi-touch | None | 256GB SSD M.2 Opal2 | No | None | Intel 8260 ac, 2x2 + BT4.1 | None | None | None | 720p | Backlit | Fingerprint Reader | X-Rite | 6-cell (90Wh) | 170W | Win10 Pro 64 | 3-year, Depot | 11/15 |
| 20EN001PUS | US | Xeon E3-1505M v5 | vPro | M2000M 4GB | 16GBx1 non-ECC | 15.6" FHD (1920x1080) IPS | 10-point Multi-touch | None | 512GB SSD M.2 PCIe NVMe | No | None | Intel 8260 ac, 2x2 + BT4.1 | None | None | None | 720p | Backlit | Fingerprint Reader | X-Rite | 6-cell (90Wh) | 170W | Win10 Pro 64 | 3-year, Depot | 11/15 |
| 20EN001QUS | US | Xeon E3-1505M v5 | vPro | M2000M 4GB | 16GBx1 non-ECC | 15.6" 4K (3840x2160) IPS | None | None | 256GB SSD M.2 Opal2 | No | None | Intel 8260 ac, 2x2 + BT4.1 | None | None | None | 720p | Backlit | Fingerprint Reader | X-Rite | 6-cell (90Wh) | 170W | Win10 DG Win7 Pro 64 | 3-year, Depot | 11/15 |
| 20EN001RUS | US | Xeon E3-1505M v5 | vPro | M2000M 4GB | 16GBx1 non-ECC | 15.6" 4K (3840x2160) IPS | None | None | 512GB SSD M.2 PCIe NVMe | No | None | Intel 8260 ac, 2x2 + BT4.1 | None | None | None | 720p | Backlit | Fingerprint Reader | X-Rite | 6-cell (90Wh) | 170W | Win10 DG Win7 Pro 64 | 3-year, Depot | 11/15 |
| 20EN001SUS | US | Xeon E3-1505M v5 | vPro | M2000M 4GB | 16GBx1 non-ECC | 15.6" FHD (1920x1080) IPS | None | None | 256GB SSD M.2 Opal2 | No | None | Intel 8260 ac, 2x2 + BT4.1 | None | None | None | 720p | Backlit | Fingerprint Reader | None | 6-cell (90Wh) | 170W | Win10 DG Win7 Pro 64 | 3-year, Depot | 11/15 |
| 20EN001TUS | US | Xeon E3-1505M v5 | vPro | M2000M 4GB | 16GBx1 non-ECC | 15.6" FHD (1920x1080) IPS | None | None | 512GB SSD M.2 PCIe NVMe | No | None | Intel 8260 ac, 2x2 + BT4.1 | None | None | None | 720p | Backlit | Fingerprint Reader | None | 6-cell (90Wh) | 170W | Win10 DG Win7 Pro 64 | 3-year, Depot | 11/15 |
| 20EN002FUS | US | i7-6700HQ | No | M1000M 2GB | 16GBx1 non-ECC | 15.6" FHD (1920x1080) IPS | None | None | 500GB 7200rpm | No | None | Intel 8260 ac, 2x2 + BT4.1 | None | None | None | 720p | Backlit | Fingerprint Reader | None | 6-cell (90Wh) | 170W | Win10 DG Win7 Pro 64 | 3-year, Depot | 11/15 |
| 20EN002GUS | US | i7-6700HQ | No | M1000M 2GB | 16GBx1 non-ECC | 15.6" FHD (1920x1080) IPS | None | None | 500GB 7200rpm | No | None | Intel 8260 ac, 2x2 + BT4.1 | None | None | None | 720p | Backlit | Fingerprint Reader | None | 6-cell (90Wh) | 170W | Win10 Pro 64 | 3-year, Depot | 11/15 |
| 20EN002HUS | US | i7-6700HQ | No | M1000M 2GB | 16GBx1 non-ECC | 15.6" FHD (1920x1080) IPS | None | None | 256GB SSD M.2 Opal2 | No | None | Intel 8260 ac, 2x2 + BT4.1 | None | None | None | 720p | Backlit | Fingerprint Reader | None | 6-cell (90Wh) | 170W | Win10 DG Win7 Pro 64 | 3-year, Depot | 11/15 |
| 20EN002JUS | US | i7-6700HQ | No | M1000M 2GB | 16GBx1 non-ECC | 15.6" FHD (1920x1080) IPS | None | None | 256GB SSD M.2 Opal2 | No | None | Intel 8260 ac, 2x2 + BT4.1 | None | None | None | 720p | Backlit | Fingerprint Reader | None | 6-cell (90Wh) | 170W | Win10 Pro 64 | 3-year, Depot | 11/15 |
| 20EN002KUS | US | i7-6820HQ | vPro | M1000M 2GB | 16GBx1 non-ECC | 15.6" FHD (1920x1080) IPS | None | None | 256GB SSD M.2 Opal2 | No | None | Intel 8260 ac, 2x2 + BT4.1 | None | None | None | 720p | Backlit | Fingerprint Reader | None | 6-cell (90Wh) | 170W | Win10 DG Win7 Pro 64 | 3-year, Depot | 11/15 |
| 20EN002LUS | US | i7-6820HQ | vPro | M1000M 2GB | 16GBx1 non-ECC | 15.6" FHD (1920x1080) IPS | None | None | 256GB SSD M.2 Opal2 | No | None | Intel 8260 ac, 2x2 + BT4.1 | None | None | None | 720p | Backlit | Fingerprint Reader | None | 6-cell (90Wh) | 170W | Win10 Pro 64 | 3-year, Depot | 11/15 |
| 20EN002MUS | US | i7-6820HQ | vPro | M2000M 4GB | 16GBx1 non-ECC | 15.6" FHD (1920x1080) IPS | None | None | 256GB SSD M.2 Opal2 | No | None | Intel 8260 ac, 2x2 + BT4.1 | None | None | None | 720p | Backlit | Fingerprint Reader | None | 6-cell (90Wh) | 170W | Win10 DG Win7 Pro 64 | 3-year, Depot | 11/15 |
| 20EN002NUS | US | i7-6820HQ | vPro | M2000M 4GB | 16GBx1 non-ECC | 15.6" FHD (1920x1080) IPS | None | None | 256GB SSD M.2 Opal2 | No | None | Intel 8260 ac, 2x2 + BT4.1 | None | None | None | 720p | Backlit | Fingerprint Reader | None | 6-cell (90Wh) | 170W | Win10 Pro 64 | 3-year, Depot | 11/15 |
| 20EN002PUS | US | Xeon E3-1505M v5 | vPro | M2000M 4GB | 16GBx1 non-ECC | 15.6" FHD (1920x1080) IPS | None | None | 256GB SSD M.2 Opal2 | No | None | Intel 8260 ac, 2x2 + BT4.1 | None | None | None | 720p | Backlit | Fingerprint Reader | None | 6-cell (90Wh) | 170W | Win10 Pro 64 | 3-year, Depot | 11/15 |
| 20EN002QUS | US | i7-6820HQ | vPro | M2000M 4GB | 16GBx1 non-ECC | 15.6" 4K (3840x2160) IPS | None | None | 256GB SSD M.2 Opal2 | No | None | Intel 8260 ac, 2x2 + BT4.1 | None | None | None | 720p | Backlit | Fingerprint Reader | X-Rite | 6-cell (90Wh) | 170W | Win10 Pro 64 | 3-year, Depot | 11/15 |
| 20EN003LUS | US | i7-6820HQ | vPro | M1000M 4GB | 8GBx4 non-ECC | 15.6" FHD (1920x1080) IPS | None | None | 512GB SSD M.2 PCIe NVMe | No | None | Intel 8260 ac, 2x2 + BT4.1 | None | None | Smart Card Reader | 720p | Backlit | Fingerprint Reader | None | 6-cell (90Wh) | 170W | Win10 Pro 64 | 3-year, Depot | 07/16 |

ThinkPad P50 - TopSeller - 20EQ

Product Specifications Reference (PSREF)

| Model | Region | Processor | vPro | Graphics | Memory | Display | Multi-touch | Pen | Storage(HDD/SSD) | RAID | Optical | WLAN + Bluetooth | WWAN | SIM Card | Smart Card Reader | Camera | Keyboard | Fingerprint Reader | Color Calibrator | Battery | Power Adapter | Operating System | Warranty | Ann Date (m/y) |
|------------|--------|------------------|------|------------|----------------|---------------------------|-------------|------|---------------------|------|---------|----------------------------|------|----------|-------------------|--------|----------|--------------------|------------------|---------------|---------------|------------------|----------------|----------------|
| 20EQ002DUS | US | Xeon E3-1505M v5 | vPro | M2000M 4GB | 16GBx1 non-ECC | 15.6" FHD (1920x1080) IPS | None | None | 256GB SSD M.2 Opal2 | No | None | Intel 8260 ac, 2x2 + BT4.1 | None | None | None | 720p | Backlit | Fingerprint Reader | X-Rite | 6-cell (90Wh) | 170W | Win10 Pro 64 | 3-year, Onsite | 08/16 |
| 20EQ002EUS | US | i7-6700HQ | No | M1000M 4GB | 8GBx1 non-ECC | 15.6" FHD (1920x1080) IPS | None | None | 500GB 7200rpm | No | None | Intel 8260 ac, 2x2 + BT4.1 | None | None | None | 720p | Backlit | Fingerprint Reader | None | 6-cell (90Wh) | 170W | Win10 Pro 64 | 3-year, Onsite | 08/16 |
| 20EQ002FUS | US | Xeon E3-1505M v5 | vPro | M2000M 4GB | 16GBx1 non-ECC | 15.6" FHD (1920x1080) IPS | None | None | 256GB SSD M.2 Opal2 | No | None | Intel 8260 ac, 2x2 + BT4.1 | None | None | None | 720p | Backlit | Fingerprint Reader | None | 6-cell (90Wh) | 170W | Win10 Pro 64 | 3-year, Onsite | 08/16 |



ThinkPad P50s Platform Specifications

Product Specifications Reference (PSREF)

| Processor | 6th Generation Intel® Core™ i5 / i7 Processor | | | | | | | Smart card reader Media reader Ports Camera (optional) Audio support | | | | | | | | |
|--|---|-------------------|-----------------|-------------------|---------------------|-------------------|--------------|---|-----------------------|------------|-----------------|-----------------|------------------|---------|---------|---------|
| | Processor Number | # of Cores | # of Threads | Base Frequency | Max Turbo Frequency | Cache | Memory Types | | Processor Graphics | | | | | | | |
| | i5-6300U | 2 | 4 | 2.4 GHz | 3 GHz | 3MB | DDR3L-1600 | | Intel HD Graphics 520 | | | | | | | |
| | i7-6500U | | | 2.5 GHz | 3.1 GHz | 4MB | | | | | | | | | | |
| i7-6600U | 2.6 GHz | | | 3.4 GHz | 4MB | | | | | | | | | | | |
| Graphics | Intel HD Graphics 520 in processor and NVIDIA Quadro® M500M, 2GB memory; supports external digital monitor via HDMI or Mini DisplayPort; supports three independent displays; Max resolution: 3840x2160@60Hz (DisplayPort via Mini DisplayPort cable); 4096x2160@24Hz (HDMI) | | | | | | | Optional: Smart card reader 4-in-1 reader (MMC, SD, SDHC, SDXC) Three USB 3.0 (one Always On), MiniDP, HDMI, Ethernet (RJ-45), Dock connector HD720p resolution, low light sensitive, fixed focus HD Audio, Realtek® ALC3245 codec / stereo speakers, 1W x 2 / dual array microphone, combo audio/microphone jack | | | | | | | | |
| Chipset | Intel SoC (System on Chip) platform | | | | | | | Keyboard UltraNav™ | | | | | | | | |
| Memory | 32GB max ⁷ / PC3-12800 1600MHz DDR3L, non-parity, dual-channel capable, two DDR3L SO-DIMM sockets | | | | | | | Security Security chip ThinkEngine | | | | | | | | |
| Display | Some: 15.6" (396mm) FHD (1920x1080), anti-glare, LED backlight, IPS, 250 nits, 16:9 aspect ratio, 400:1 or 500:1 contrast ratio, 160° viewing angle Some: 15.5" (394mm) 3K (2880x1620), anti-glare, LED backlight, IPS, 350 nits, 16:9 aspect ratio, 1000:1 contrast ratio, 160° viewing angle | | | | | | | 6-row, spill-resistant, multimedia Fn keys, numeric keypad, optional LED backlight TrackPoint® pointing device and buttonless Mylar surface touchpad, multi-touch | | | | | | | | |
| Multi-touch (opt) | In-cell touch, supports 10-finger gesture | | | | | | | vPro (optional) Fingerprint reader | | | | | | | | |
| Storage | Some: SSD / SATA 6.0Gb/s (e.g. xxxG SSD) Some: SSD / PCIe NVMe, PCIe 3.0 x 2, 16Gb/s (e.g. xxxG SSD PCIe NVMe) Some: HDD / SATA 6.0Gb/s, 2.5" wide, 7mm high, Shock Mounted Hard Drive, Active Protection System™ Some: SSHD with 8GB NAND flash memory | | | | | | | Intel vPro Technology Optional: Swipe style fingerprint reader on the palm rest | | | | | | | | |
| Optical | None | | | | | | | Internal battery External battery Max battery life ¹⁰ (MobileMark® 2014) | | | | | | | | |
| Ethernet | Non-vPro model: Intel Ethernet Connection I219-V (Jacksonville) vPro model: Intel Ethernet Connection I219-LM (Jacksonville) | | | | | | | Optional: Integrated Li-Polymer 3-cell (44Wh) Li-Ion or Li-Polymer 3-cell (23Wh) or Li-Ion 6-cell (48Wh or 72Wh) | | | | | | | | |
| WLAN ⁴ | One of the following, configurable by model: • 11ac+BT, Broadcom BCM4356, 2x2, M.2 card • 11ac+BT, Intel Dual Band Wireless-AC 8260, 2x2, M.2 card | | | | | | | <table border="1"> <thead> <tr> <th>Models</th> <th>3 + 3-cell</th> <th>3 + 6-cell 48Wh</th> <th>3 + 6-cell 72Wh</th> </tr> </thead> <tbody> <tr> <td>Max battery life</td> <td>12.0 hr</td> <td>16.3 hr</td> <td>20.5 hr</td> </tr> </tbody> </table> | Models | 3 + 3-cell | 3 + 6-cell 48Wh | 3 + 6-cell 72Wh | Max battery life | 12.0 hr | 16.3 hr | 20.5 hr |
| Models | 3 + 3-cell | 3 + 6-cell 48Wh | 3 + 6-cell 72Wh | | | | | | | | | | | | | |
| Max battery life | 12.0 hr | 16.3 hr | 20.5 hr | | | | | | | | | | | | | |
| Bluetooth™ | Bluetooth 4.1 wireless, integrated in Wi-Fi + Bluetooth combo adapter | | | | | | | AC adapter 65W Slim AC adapter or 65W AC adapter | | | | | | | | |
| WWAN (optional) | One of the following, configurable by model: • Wireless WAN upgradable • Wireless WAN, Sierra Wireless EM7455, Qualcomm® 4G LTE-Advanced/DC-HSPA+/HSPA+/HSPA/UMTS/GNSS, M.2 card • Wireless WAN, HUAWEI ME906S, HUAWEI 4G LTE/WCDMA/HSPA/GSM/GPRS/EDGE/GNSS, M.2 card (WE only) | | | | | | | Preload Windows 7 Professional 64 preinstalled through downgrade rights in Windows 10 Pro 64 • Lenovo Solution Center • Lenovo Companion • Lenovo Setting • ThinkVantage Product Recovery • Rescue and Recovery™ • ThinkVantage System Update • Adobe® Reader® • Microsoft® Office preloaded; purchase a product key to activate • McAfee® LiveSafe™ (30-day trial) For ISV certifications, please visit www.lenovo.com/support/ISV | | | | | | | | |
| SIM card (opt) | Micro-SIM card slot, optional Verizon LTE (US) or Lenovo Connect (WE) SIM card | | | | | | | Limited warranty ¹² One of the following, configurable by model: • 3-year/1-yr battery depot repair service • 3-year/1-yr battery limited onsite service ²⁴ • 3-year/1-yr battery limited onsite service, OID (Onsite International Delivery) | | | | | | | | |
| Dimensions ³ Weight ² | WxDxH: 14.98" x 10.17" x 0.88"; 380.6mm x 258.2mm x 22.45mm | | | | | | | Mil-Spec test MIL-STD-810G military certification | | | | | | | | |
| | Models | No + 6-cell | | 3-cell + 3-cell | | 3-cell + 6-cell | | Environment EPEAT™ Gold (US only); ENERGY STAR® 6.1; GREENGUARD®; RoHS-compliant | | | | | | | | |
| | Non-touch | 5.27 lb / 2.39 kg | | 4.97 lb / 2.25 kg | | 5.44 lb / 2.47 kg | | | | | | | | | | |
| | Multi-touch | - | | 5.00 lb / 2.27 kg | | 5.42 lb / 2.46 kg | | | | | | | | | | |
| Case material | Display cover: PPS; Bottom: Glass-Fiber Reinforced Plastic | | | | | | | | | | | | | | | |

ThinkPad P50s - TopSeller - 20FL

Product Specifications Reference (PSREF)

| Model | Region | Processor | vPro | Graphics | Memory | Display | Multi-touch | Storage(HDD/SSD) | Optical | WLAN + Bluetooth | WWAN | SIM Card | Smart Card Reader | Camera | Keyboard | Fingerprint Reader | Battery (internal+external) | Power Adapter | Operating System | Warranty | Ann Date (m/y) |
|------------|--------|-----------|------|-----------|--------|---------------------------|-------------|------------------|---------|----------------------------|-----------------|----------|-------------------|--------|----------|--------------------|-----------------------------|---------------|----------------------|---------------|----------------|
| 20FL000GUS | US | i7-6500U | No | M500M 2GB | 8GBx2 | 15.6" FHD (1920x1080) IPS | None | 256GB SSD Opal2 | None | Intel 8260 ac, 2x2 + BT4.1 | WWAN Upgradable | None | None | 720p | Backlit | Fingerprint Reader | 3-cell(44Wh) + 3-cell(23Wh) | 65W | Win10 DG Win7 Pro 64 | 3-year, Depot | 01/16 |
| 20FL000HUS | US | i5-6300U | vPro | M500M 2GB | 8GBx1 | 15.6" FHD (1920x1080) IPS | None | 256GB SSD Opal2 | None | Intel 8260 ac, 2x2 + BT4.1 | WWAN Upgradable | None | None | 720p | Backlit | Fingerprint Reader | None + 6-cell(72Wh) | 65W | Win10 DG Win7 Pro 64 | 3-year, Depot | 01/16 |
| 20FL000JUS | US | i7-6500U | No | M500M 2GB | 8GBx1 | 15.5" 3K (2880x1620) IPS | None | 256GB SSD Opal2 | None | Intel 8260 ac, 2x2 + BT4.1 | WWAN Upgradable | None | None | 720p | Backlit | Fingerprint Reader | 3-cell(44Wh) + 3-cell(23Wh) | 65W | Win10 DG Win7 Pro 64 | 3-year, Depot | 01/16 |
| 20FL000KUS | US | i7-6500U | No | M500M 2GB | 8GBx1 | 15.6" FHD (1920x1080) IPS | None | 500GB 7200rpm | None | Intel 8260 ac, 2x2 + BT4.1 | WWAN Upgradable | None | None | 720p | Backlit | Fingerprint Reader | 3-cell(44Wh) + 3-cell(23Wh) | 65W | Win10 DG Win7 Pro 64 | 3-year, Depot | 01/16 |
| 20FL000LUS | US | i7-6500U | No | M500M 2GB | 8GBx1 | 15.6" FHD (1920x1080) IPS | None | 1TB 5400rpm | None | Intel 8260 ac, 2x2 + BT4.1 | WWAN Upgradable | None | None | 720p | Backlit | Fingerprint Reader | None + 6-cell(48Wh) | 65W | Win10 DG Win7 Pro 64 | 3-year, Depot | 01/16 |
| 20FL000MUS | US | i7-6500U | No | M500M 2GB | 8GBx2 | 15.6" FHD (1920x1080) IPS | None | 512GB SSD | None | Intel 8260 ac, 2x2 + BT4.1 | WWAN Upgradable | None | None | 720p | Backlit | Fingerprint Reader | 3-cell(44Wh) + 3-cell(23Wh) | 65W | Win10 DG Win7 Pro 64 | 3-year, Depot | 01/16 |
| 20FL000NUS | US | i7-6600U | vPro | M500M 2GB | 8GBx2 | 15.5" 3K (2880x1620) IPS | None | 512GB SSD | None | Intel 8260 ac, 2x2 + BT4.1 | WWAN Upgradable | None | None | 720p | Backlit | Fingerprint Reader | 3-cell(44Wh) + 3-cell(23Wh) | 65W | Win10 DG Win7 Pro 64 | 3-year, Depot | 01/16 |
| 20FL0014US | US | i5-6300U | vPro | M500M 2GB | 8GBx1 | 15.6" FHD (1920x1080) IPS | None | 256GB SSD Opal2 | None | Intel 8260 ac, 2x2 + BT4.1 | WWAN Upgradable | None | None | 720p | Backlit | None | 3-cell(44Wh) + 6-cell(72Wh) | 65W | Win10 Pro 64 | 3-year, Depot | 08/16 |
| 20FL0015US | US | i7-6500U | No | M500M 2GB | 8GBx1 | 15.6" FHD (1920x1080) IPS | None | 1TB 5400rpm | None | Intel 8260 ac, 2x2 + BT4.1 | WWAN Upgradable | None | None | 720p | Backlit | None | 3-cell(44Wh) + 6-cell(72Wh) | 65W | Win10 Pro 64 | 3-year, Depot | 08/16 |
| 20FL0016US | US | i7-6500U | No | M500M 2GB | 8GBx1 | 15.5" 3K (2880x1620) IPS | None | 256GB SSD Opal2 | None | Intel 8260 ac, 2x2 + BT4.1 | WWAN Upgradable | None | None | 720p | Backlit | None | 3-cell(44Wh) + 6-cell(72Wh) | 65W | Win10 Pro 64 | 3-year, Depot | 08/16 |
| 20FL0017US | US | i7-6500U | No | M500M 2GB | 8GBx1 | 15.6" FHD (1920x1080) IPS | None | 256GB SSD Opal2 | None | Intel 8260 ac, 2x2 + BT4.1 | WWAN Upgradable | None | None | 720p | Backlit | None | 3-cell(44Wh) + 6-cell(72Wh) | 65W | Win10 Pro 64 | 3-year, Depot | 08/16 |
| 20FL0018US | US | i7-6500U | No | M500M 2GB | 8GBx1 | 15.6" FHD (1920x1080) IPS | None | 512GB SSD | None | Intel 8260 ac, 2x2 + BT4.1 | WWAN Upgradable | None | None | 720p | Backlit | None | 3-cell(44Wh) + 6-cell(72Wh) | 65W | Win10 Pro 64 | 3-year, Depot | 08/16 |
| 20FL0019US | US | i7-6500U | No | M500M 2GB | 8GBx1 | 15.6" FHD (1920x1080) IPS | None | 500GB 7200rpm | None | Intel 8260 ac, 2x2 + BT4.1 | WWAN Upgradable | None | None | 720p | Backlit | None | 3-cell(44Wh) + 6-cell(72Wh) | 65W | Win10 Pro 64 | 3-year, Depot | 08/16 |
| 20FL001AUS | US | i7-6600U | vPro | M500M 2GB | 8GBx1 | 15.6" FHD (1920x1080) IPS | None | 512GB SSD | None | Intel 8260 ac, 2x2 + BT4.1 | WWAN Upgradable | None | None | 720p | Backlit | None | 3-cell(44Wh) + 6-cell(72Wh) | 65W | Win10 Pro 64 | 3-year, Depot | 08/16 |
| 20FL001BUS | US | i7-6500U | No | M500M 2GB | 16GBx1 | 15.5" 3K (2880x1620) IPS | None | 1TB 5400rpm | None | Intel 8260 ac, 2x2 + BT4.1 | WWAN Upgradable | None | None | 720p | Backlit | None | 3-cell(44Wh) + 6-cell(72Wh) | 65W | Win10 Pro 64 | 3-year, Depot | 08/16 |



ThinkPad P51 Platform Specifications

Product Specifications Reference (PSREF)

| | | | | | | | | | |
|--|---|---------------|---------------|----------------|---------------------|-------|--------------|------------------------|---|
| Processor | 7th Generation Intel® Core™ i7 Processor or Intel Xeon® Processor E3 v6 Family | | | | | | | | Dimensions <i>WxDxH:</i> 14.86" x 9.93" x 0.96-1.16"; 377.4mm x 252.3mm x 24.5-29.4mm <i>WxDxH(Touch):</i> 14.86" x 9.93" x 1.02-1.21"; 377.4mm x 252.3mm x 25.8-30.7mm |
| | Processor Number | # of Cores | # of Threads | Base Frequency | Max Turbo Frequency | Cache | Memory Types | Processor Graphics | |
| | i7-7700HQ | 4 | 8 | 2.8 GHz | 3.8 GHz | 6MB | DDR4-2400 | Intel HD Graphics 630 | |
| | i7-7820HQ | | | 2.9 GHz | 3.9 GHz | | | Intel HD Graphics P630 | |
| | E3-1505M v6 | | | 3.0 GHz | 4.0 GHz | 8MB | | Intel HD Graphics P630 | |
| E3-1535M v6 | 3.1 GHz | | | 4.2 GHz | | | | | |
| Graphics | Intel HD Graphics 630 or P630 in processor and NVIDIA Quadro® M1200M or M2200M, 4GB memory; supports external digital monitor via HDMI, Mini DisplayPort, or Thunderbolt™; supports four independent displays; Max resolution: 3840x2160@60Hz (DisplayPort via Mini DisplayPort cable); 3840x2160@60Hz (Thunderbolt); 4096x2160@24Hz (HDMI) | | | | | | | | |
| Chipset | Mobile Intel CM238 Chipset | | | | | | | | |
| Memory | 64GB max ⁷ / 2400MHz DDR4, ECC or non-ECC (ECC function supported only on Xeon processor), dual-channel capable, four DDR4 SO-DIMM sockets | | | | | | | | |
| Display | <i>Some:</i> 15.6" (396mm) FHD (1920x1080), anti-glare, LED backlight, IPS, 250 nits, 16:9 aspect ratio, 700:1 contrast ratio, 160° viewing angle <i>Some:</i> 15.6" (396mm) 4K (3840x2160), anti-glare, LED backlight, IPS, 300 nits, 16:9 aspect ratio, 1000:1 contrast ratio, 100% gamut, 170° viewing angle | | | | | | | | |
| Multi-touch (opt) Pen (optional) | Capacitive-type multi-touch, supports 10-finger gesture, 220 nits (FHD only) ThinkPad Pen Pro, active pen for multi-touch display | | | | | | | | |
| Storage | <i>Up to 3 drives (two M.2 SSD and one HDD)</i> <i>Some:</i> M.2 SSD / PCIe NVMe, PCIe 3.0 x 4, 32Gb/s <i>Some:</i> HDD / SATA 6.0Gb/s, 2.5" wide, 7mm high, Active Protection System™ | | | | | | | | |
| Optical | None | | | | | | | | |
| Ethernet | <i>Non-vPro model:</i> Intel Ethernet Connection I219-V (Jacksonville) <i>vPro model:</i> Intel Ethernet Connection I219-LM (Jacksonville) | | | | | | | | |
| WLAN Bluetooth™ | Intel Dual Band Wireless-AC 8265, Wi-Fi 2x2 802.11ac + BT4.1, M.2 card Bluetooth 4.1 wireless, integrated in Wi-Fi + Bluetooth combo adapter * Intel 8265ac card support BT4.2 but is limited to BT4.1 by Windows OS | | | | | | | | |
| WWAN (optional) | <i>One of the following, configurable by model:</i> • Wireless WAN upgradable • Integrated Mobile Broadband 4G LTE-A, Qualcomm® Snapdragon™ X7 LTE-A (Sierra Wireless EM7455), M.2 card | | | | | | | | |
| SIM card (opt) | Micro-SIM card slot, opt Verizon LTE (US) or Lenovo® Connect (EMEA) SIM card | | | | | | | | |
| Smart card reader | <i>Optional:</i> Smart card reader | | | | | | | | |
| ExpressCard | One slot (ExpressCard/34) | | | | | | | | |
| Media reader | 4-in-1 reader (MMC, SD, SDHC, SDXC), supports UHS-II SD card | | | | | | | | |
| Ports | Four USB 3.1 Gen 1 (USB 3.0, one Always On), USB Type-C / Thunderbolt 3, Mini DisplayPort 1.2a, HDMI 1.4b, Ethernet (RJ-45), Dock connector | | | | | | | | |
| Camera (optional) | HD720p resolution, fixed focus | | | | | | | | |
| Audio support | HD Audio, Realtek® ALC3268 codec / stereo speakers, 2W x 2 / dual array microphone, combo audio/microphone jack | | | | | | | | |
| Keyboard UltraNav™ | 6-row, spill-resistant, multimedia Fn keys, numeric keypad, optional LED backlight 3-button TrackPoint® pointing device and 3-button Mylar surface multi-touch touchpad | | | | | | | | |
| Security | Power-on password, hard disk password, supervisor password, security keyhole | | | | | | | | |
| Security chip | Discrete TPM 2.0, TCG Certified | | | | | | | | |
| vPro (optional) | Intel vPro Technology | | | | | | | | |
| Fingerprint reader | Touch style match on chip fingerprint reader on the palm rest | | | | | | | | |
| Color calibration | <i>Optional:</i> Pantone® color calibrator by X-Rite® color calibration sensor in palm rest | | | | | | | | |
| NFC | None | | | | | | | | |
| Battery | Lithium Polymer 4-cell (66Wh) or 6-cell (90Wh) | | | | | | | | |
| Max battery life ¹⁰ (MobileMark® 2014) | <i>Model</i> | <i>4-cell</i> | <i>6-cell</i> | | | | | | |
| | <i>Discrete Graphics</i> | 4.5 hr | 6.1 hr | | | | | | |
| | <i>Hybrid Graphics</i> | 6.5 hr | 8.9 hr | | | | | | |
| AC adapter | 170W AC adapter | | | | | | | | |
| Preload | <i>Some:</i> Windows® 10 Home 64 <i>Some:</i> Windows 10 Pro 64 • Lenovo Companion • Lenovo Setting • Microsoft Office preloaded; purchase a product key to activate | | | | | | | | |
| Limited warranty | <i>One of the following, configurable by model:</i> • 1-year depot repair service • 3-year/1-yr battery depot repair service • 3-year/1-yr battery limited onsite service | | | | | | | | |
| Mil-Spec test | MIL-STD-810G military certification | | | | | | | | |
| Environment | EPEAT™ Gold (US only); ENERGY STAR® 6.1; RoHS-compliant | | | | | | | | |

| Model | Region | Processor | vPro | Graphics | Chipset | Memory | Display | Multi-touch | Pen | Storage (HDD/SSD) | RAID | Optical | WLAN + Bluetooth | WWAN | SIM Card | Smart Card Reader | Camera | Key-board | Finger-print Reader | NFC | Color Calibrator | TPM | Battery | Power Adapter | Operating System | Warranty | Ann Date (mly) |
|------------|--------|------------------|------|------------|-------------|---------------|---------------------------|----------------------|------|-------------------------------|------|---------|----------------------------|-----------------|----------|-------------------|--------|-----------|---------------------|------|------------------|----------|---------------|---------------|------------------|---------------|----------------|
| 20HH0004US | US | i7-7700HQ | No | M1200M 4GB | Intel CM238 | 8GBx1 non-ECC | 15.6" FHD (1920x1080) IPS | None | None | 512GB SSD M.2 PCIe NVMe Opal2 | No | None | Intel 8265 ac, 2x2 + BT4.1 | WWAN Upgradable | None | None | 720p | Backlit | Finger-print Reader | None | None | dTPM 2.0 | 6-cell (90Wh) | 170W | Win10 Pro 64 | 3-year, Depot | 03/17 |
| 20HH0005US | US | Xeon E3-1505M v6 | vPro | M2200M 4GB | Intel CM238 | 8GBx2 non-ECC | 15.6" FHD (1920x1080) IPS | None | None | 1TB 5400rpm | No | None | Intel 8265 ac, 2x2 + BT4.1 | WWAN Upgradable | None | None | 720p | Backlit | Finger-print Reader | None | None | dTPM 2.0 | 6-cell (90Wh) | 170W | Win10 Pro 64 | 3-year, Depot | 03/17 |
| 20HH0006US | US | Xeon E3-1535M v6 | vPro | M2200M 4GB | Intel CM238 | 8GBx2 non-ECC | 15.6" FHD (1920x1080) IPS | None | None | 512GB SSD M.2 PCIe NVMe Opal2 | No | None | Intel 8265 ac, 2x2 + BT4.1 | WWAN Upgradable | None | None | 720p | Backlit | Finger-print Reader | None | None | dTPM 2.0 | 6-cell (90Wh) | 170W | Win10 Pro 64 | 3-year, Depot | 03/17 |
| 20HH0007US | US | Xeon E3-1535M v6 | vPro | M2200M 4GB | Intel CM238 | 8GBx2 non-ECC | 15.6" FHD (1920x1080) IPS | None | None | 256GB SSD M.2 PCIe NVMe Opal2 | No | None | Intel 8265 ac, 2x2 + BT4.1 | WWAN Upgradable | None | None | 720p | Backlit | Finger-print Reader | None | None | dTPM 2.0 | 6-cell (90Wh) | 170W | Win10 Pro 64 | 3-year, Depot | 03/17 |
| 20HH0008US | US | Xeon E3-1535M v6 | vPro | M2200M 4GB | Intel CM238 | 8GBx2 non-ECC | 15.6" FHD (1920x1080) IPS | None | None | 1TB SSD M.2 PCIe NVMe Opal2 | No | None | Intel 8265 ac, 2x2 + BT4.1 | WWAN Upgradable | None | None | 720p | Backlit | Finger-print Reader | None | None | dTPM 2.0 | 6-cell (90Wh) | 170W | Win10 Pro 64 | 3-year, Depot | 03/17 |
| 20HH0009US | US | Xeon E3-1535M v6 | vPro | M2200M 4GB | Intel CM238 | 8GBx2 non-ECC | 15.6" FHD (1920x1080) IPS | 10-point Multi-touch | None | 512GB SSD M.2 PCIe NVMe Opal2 | No | None | Intel 8265 ac, 2x2 + BT4.1 | WWAN Upgradable | None | None | 720p | Backlit | Finger-print Reader | None | X-Rite | dTPM 2.0 | 6-cell (90Wh) | 170W | Win10 Pro 64 | 3-year, Depot | 03/17 |
| 20HH000AUS | US | i7-7700HQ | No | M1200M 4GB | Intel CM238 | 8GBx2 non-ECC | 15.6" FHD (1920x1080) IPS | None | None | 1TB SSD M.2 PCIe NVMe Opal2 | No | None | Intel 8265 ac, 2x2 + BT4.1 | WWAN Upgradable | None | None | 720p | Backlit | Finger-print Reader | None | None | dTPM 2.0 | 6-cell (90Wh) | 170W | Win10 Pro 64 | 3-year, Depot | 03/17 |
| 20HH000BUS | US | Xeon E3-1505M v6 | vPro | M2200M 4GB | Intel CM238 | 8GBx2 non-ECC | 15.6" FHD (1920x1080) IPS | None | None | 512GB SSD M.2 PCIe NVMe Opal2 | No | None | Intel 8265 ac, 2x2 + BT4.1 | WWAN Upgradable | None | None | 720p | Backlit | Finger-print Reader | None | None | dTPM 2.0 | 6-cell (90Wh) | 170W | Win10 Pro 64 | 3-year, Depot | 03/17 |
| 20HH000CUS | US | i7-7820HQ | vPro | M2200M 4GB | Intel CM238 | 8GBx2 non-ECC | 15.6" 4K (3840x2160) IPS | None | None | 512GB SSD M.2 PCIe NVMe Opal2 | No | None | Intel 8265 ac, 2x2 + BT4.1 | WWAN Upgradable | None | None | 720p | Backlit | Finger-print Reader | None | X-Rite | dTPM 2.0 | 6-cell (90Wh) | 170W | Win10 Pro 64 | 3-year, Depot | 03/17 |
| 20HH000DUS | US | Xeon E3-1535M v6 | vPro | M2200M 4GB | Intel CM238 | 8GBx2 non-ECC | 15.6" 4K (3840x2160) IPS | None | None | 512GB SSD M.2 PCIe NVMe Opal2 | No | None | Intel 8265 ac, 2x2 + BT4.1 | WWAN Upgradable | None | None | 720p | Backlit | Finger-print Reader | None | X-Rite | dTPM 2.0 | 6-cell (90Wh) | 170W | Win10 Pro 64 | 3-year, Depot | 03/17 |
| 20HH000EUS | US | Xeon E3-1505M v6 | vPro | M2200M 4GB | Intel CM238 | 8GBx2 non-ECC | 15.6" FHD (1920x1080) IPS | 10-point Multi-touch | None | 1TB SSD M.2 PCIe NVMe Opal2 | No | None | Intel 8265 ac, 2x2 + BT4.1 | WWAN Upgradable | None | None | 720p | Backlit | Finger-print Reader | None | X-Rite | dTPM 2.0 | 6-cell (90Wh) | 170W | Win10 Pro 64 | 3-year, Depot | 03/17 |
| 20HH000FUS | US | i7-7700HQ | No | M1200M 4GB | Intel CM238 | 8GBx1 non-ECC | 15.6" FHD (1920x1080) IPS | None | None | 1TB 5400rpm | No | None | Intel 8265 ac, 2x2 + BT4.1 | WWAN Upgradable | None | None | 720p | Backlit | Finger-print Reader | None | None | dTPM 2.0 | 6-cell (90Wh) | 170W | Win10 Pro 64 | 3-year, Depot | 03/17 |
| 20HH000GUS | US | i7-7820HQ | vPro | M1200M 4GB | Intel CM238 | 8GBx1 non-ECC | 15.6" FHD (1920x1080) IPS | None | None | 256GB SSD M.2 PCIe NVMe Opal2 | No | None | Intel 8265 ac, 2x2 + BT4.1 | WWAN Upgradable | None | None | 720p | Backlit | Finger-print Reader | None | None | dTPM 2.0 | 6-cell (90Wh) | 170W | Win10 Pro 64 | 3-year, Depot | 03/17 |
| 20HH000HUS | US | Xeon E3-1535M v6 | vPro | M2200M 4GB | Intel CM238 | 8GBx1 non-ECC | 15.6" FHD (1920x1080) IPS | None | None | 512GB SSD M.2 PCIe NVMe Opal2 | No | None | Intel 8265 ac, 2x2 + BT4.1 | WWAN Upgradable | None | None | 720p | Backlit | Finger-print Reader | None | None | dTPM 2.0 | 6-cell (90Wh) | 170W | Win10 Pro 64 | 3-year, Depot | 03/17 |
| 20HH000JUS | US | Xeon E3-1535M v6 | vPro | M2200M 4GB | Intel CM238 | 8GBx1 non-ECC | 15.6" FHD (1920x1080) IPS | None | None | 256GB SSD M.2 PCIe NVMe Opal2 | No | None | Intel 8265 ac, 2x2 + BT4.1 | WWAN Upgradable | None | None | 720p | Backlit | Finger-print Reader | None | None | dTPM 2.0 | 6-cell (90Wh) | 170W | Win10 Pro 64 | 3-year, Depot | 03/17 |
| 20HH000KUS | US | Xeon E3-1505M v6 | vPro | M2200M 4GB | Intel CM238 | 8GBx2 non-ECC | 15.6" FHD (1920x1080) IPS | 10-point Multi-touch | None | 1TB 5400rpm | No | None | Intel 8265 ac, 2x2 + BT4.1 | WWAN Upgradable | None | None | 720p | Backlit | Finger-print Reader | None | X-Rite | dTPM 2.0 | 6-cell (90Wh) | 170W | Win10 Pro 64 | 3-year, Depot | 03/17 |
| 20HH000LUS | US | Xeon E3-1505M v6 | vPro | M2200M 4GB | Intel CM238 | 8GBx2 non-ECC | 15.6" 4K (3840x2160) IPS | None | None | 512GB SSD M.2 PCIe NVMe Opal2 | No | None | Intel 8265 ac, 2x2 + BT4.1 | WWAN Upgradable | None | None | 720p | Backlit | Finger-print Reader | None | X-Rite | dTPM 2.0 | 6-cell (90Wh) | 170W | Win10 Pro 64 | 3-year, Depot | 03/17 |
| 20HH000MUS | US | i7-7700HQ | No | M1200M 4GB | Intel CM238 | 8GBx1 non-ECC | 15.6" FHD (1920x1080) IPS | None | None | 1TB SSD M.2 PCIe NVMe Opal2 | No | None | Intel 8265 ac, 2x2 + BT4.1 | WWAN Upgradable | None | None | 720p | Backlit | Finger-print Reader | None | None | dTPM 2.0 | 6-cell (90Wh) | 170W | Win10 Pro 64 | 3-year, Depot | 03/17 |
| 20HH000NUS | US | i7-7820HQ | vPro | M1200M 4GB | Intel CM238 | 8GBx1 non-ECC | 15.6" FHD (1920x1080) IPS | None | None | 512GB SSD M.2 PCIe NVMe Opal2 | No | None | Intel 8265 ac, 2x2 + BT4.1 | WWAN Upgradable | None | None | 720p | Backlit | Finger-print Reader | None | None | dTPM 2.0 | 6-cell (90Wh) | 170W | Win10 Pro 64 | 3-year, Depot | 03/17 |
| 20HH000PUS | US | Xeon E3-1505M v6 | vPro | M2200M 4GB | Intel CM238 | 8GBx1 non-ECC | 15.6" FHD (1920x1080) IPS | None | None | 256GB SSD M.2 PCIe NVMe Opal2 | No | None | Intel 8265 ac, 2x2 + BT4.1 | WWAN Upgradable | None | None | 720p | Backlit | Finger-print Reader | None | None | dTPM 2.0 | 6-cell (90Wh) | 170W | Win10 Pro 64 | 3-year, Depot | 03/17 |

| Model | Region | Processor | vPro | Memory | Graphics | Chipset | Display | Multi-touch | Pen | Storage (HDD/SSD) | RAID | Optical | WLAN + Bluetooth | WWAN | SIM Card | Smart Card Reader | Camera | Keyboard | Finger-print Reader | NFC | Color Calibrator | TPM | Battery | Power Adapter | Operating System | Warranty | Ann Date (m/y) |
|------------|--------|------------------|------|------------|-------------|---------------|---------------------------|----------------------|------|-------------------------------|------|---------|----------------------------|-----------------|----------|-------------------|--------|----------|---------------------|------|------------------|----------|---------------|---------------|------------------|---------------|----------------|
| 20HH000QUS | US | Xeon E3-1505M v6 | vPro | M2200M 4GB | Intel CM238 | 8GBx1 non-ECC | 15.6" FHD (1920x1080) IPS | None | None | 256GB SSD M.2 PCIe NVMe Opal2 | No | None | Intel 8265 ac, 2x2 + BT4.1 | WWAN Upgradable | None | None | 720p | Backlit | Finger-print Reader | None | None | dTPM 2.0 | 6-cell (90Wh) | 170W | Win10 Pro 64 | 3-year, Depot | 03/17 |
| 20HH000RUS | US | Xeon E3-1505M v6 | vPro | M2200M 4GB | Intel CM238 | 8GBx1 non-ECC | 15.6" FHD (1920x1080) IPS | None | None | 512GB SSD M.2 PCIe NVMe Opal2 | No | None | Intel 8265 ac, 2x2 + BT4.1 | WWAN Upgradable | None | None | 720p | Backlit | Finger-print Reader | None | None | dTPM 2.0 | 6-cell (90Wh) | 170W | Win10 Pro 64 | 3-year, Depot | 03/17 |
| 20HH000SUS | US | Xeon E3-1535M v6 | vPro | M2200M 4GB | Intel CM238 | 8GBx2 non-ECC | 15.6" FHD (1920x1080) IPS | None | None | 512GB SSD M.2 PCIe NVMe Opal2 | No | None | Intel 8265 ac, 2x2 + BT4.1 | WWAN Upgradable | None | None | 720p | Backlit | Finger-print Reader | None | None | dTPM 2.0 | 6-cell (90Wh) | 170W | Win10 Pro 64 | 3-year, Depot | 03/17 |
| 20HH000TUS | US | i7-7700HQ | No | M1200M 4GB | Intel CM238 | 8GBx2 non-ECC | 15.6" FHD (1920x1080) IPS | None | None | 512GB SSD M.2 PCIe NVMe Opal2 | No | None | Intel 8265 ac, 2x2 + BT4.1 | WWAN Upgradable | None | None | 720p | Backlit | Finger-print Reader | None | None | dTPM 2.0 | 6-cell (90Wh) | 170W | Win10 Pro 64 | 3-year, Depot | 03/17 |
| 20HH000UUS | US | Xeon E3-1505M v6 | vPro | M2200M 4GB | Intel CM238 | 8GBx2 non-ECC | 15.6" FHD (1920x1080) IPS | None | None | 512GB SSD M.2 PCIe NVMe Opal2 | No | None | Intel 8265 ac, 2x2 + BT4.1 | WWAN Upgradable | None | None | 720p | Backlit | Finger-print Reader | None | None | dTPM 2.0 | 6-cell (90Wh) | 170W | Win10 Pro 64 | 3-year, Depot | 03/17 |
| 20HH000VUS | US | Xeon E3-1505M v6 | vPro | M2200M 4GB | Intel CM238 | 8GBx1 non-ECC | 15.6" FHD (1920x1080) IPS | None | None | 1TB 5400rpm | No | None | Intel 8265 ac, 2x2 + BT4.1 | WWAN Upgradable | None | None | 720p | Backlit | Finger-print Reader | None | None | dTPM 2.0 | 6-cell (90Wh) | 170W | Win10 Pro 64 | 3-year, Depot | 03/17 |
| 20HH000WUS | US | i7-7700HQ | No | M1200M 4GB | Intel CM238 | 8GBx1 non-ECC | 15.6" FHD (1920x1080) IPS | None | None | 256GB SSD M.2 PCIe NVMe Opal2 | No | None | Intel 8265 ac, 2x2 + BT4.1 | WWAN Upgradable | None | None | 720p | Backlit | Finger-print Reader | None | None | dTPM 2.0 | 6-cell (90Wh) | 170W | Win10 Pro 64 | 3-year, Depot | 03/17 |
| 20HH000XUS | US | i7-7700HQ | No | M1200M 4GB | Intel CM238 | 8GBx1 non-ECC | 15.6" FHD (1920x1080) IPS | None | None | 512GB SSD M.2 PCIe NVMe Opal2 | No | None | Intel 8265 ac, 2x2 + BT4.1 | WWAN Upgradable | None | None | 720p | Backlit | Finger-print Reader | None | None | dTPM 2.0 | 6-cell (90Wh) | 170W | Win10 Pro 64 | 3-year, Depot | 03/17 |
| 20HH000YUS | US | i7-7700HQ | No | M1200M 4GB | Intel CM238 | 8GBx2 non-ECC | 15.6" FHD (1920x1080) IPS | None | None | 1TB 5400rpm | No | None | Intel 8265 ac, 2x2 + BT4.1 | WWAN Upgradable | None | None | 720p | Backlit | Finger-print Reader | None | None | dTPM 2.0 | 6-cell (90Wh) | 170W | Win10 Pro 64 | 3-year, Depot | 03/17 |
| 20HH0010US | US | Xeon E3-1505M v6 | vPro | M2200M 4GB | Intel CM238 | 8GBx1 non-ECC | 15.6" FHD (1920x1080) IPS | None | None | 512GB SSD M.2 PCIe NVMe Opal2 | No | None | Intel 8265 ac, 2x2 + BT4.1 | WWAN Upgradable | None | None | 720p | Backlit | Finger-print Reader | None | None | dTPM 2.0 | 6-cell (90Wh) | 170W | Win10 Pro 64 | 3-year, Depot | 03/17 |
| 20HH0011US | US | i7-7700HQ | No | M1200M 4GB | Intel CM238 | 8GBx1 non-ECC | 15.6" FHD (1920x1080) IPS | None | None | 500GB 7200rpm | No | None | Intel 8265 ac, 2x2 + BT4.1 | WWAN Upgradable | None | None | 720p | Backlit | Finger-print Reader | None | None | dTPM 2.0 | 6-cell (90Wh) | 170W | Win10 Pro 64 | 3-year, Depot | 03/17 |
| 20HH0012US | US | i7-7820HQ | vPro | M1200M 4GB | Intel CM238 | 8GBx1 non-ECC | 15.6" FHD (1920x1080) IPS | None | None | 1TB SSD M.2 PCIe NVMe Opal2 | No | None | Intel 8265 ac, 2x2 + BT4.1 | WWAN Upgradable | None | None | 720p | Backlit | Finger-print Reader | None | None | dTPM 2.0 | 6-cell (90Wh) | 170W | Win10 Pro 64 | 3-year, Depot | 03/17 |
| 20HH0013US | US | Xeon E3-1505M v6 | vPro | M2200M 4GB | Intel CM238 | 8GBx2 non-ECC | 15.6" FHD (1920x1080) IPS | None | None | 1TB SSD M.2 PCIe NVMe Opal2 | No | None | Intel 8265 ac, 2x2 + BT4.1 | WWAN Upgradable | None | None | 720p | Backlit | Finger-print Reader | None | None | dTPM 2.0 | 6-cell (90Wh) | 170W | Win10 Pro 64 | 3-year, Depot | 03/17 |
| 20HH002LUS | US | i7-7820HQ | vPro | M2200M 4GB | Intel CM238 | 8GBx1 non-ECC | 15.6" FHD (1920x1080) IPS | None | None | 1TB SSD M.2 PCIe NVMe Opal2 | No | None | Intel 8265 ac, 2x2 + BT4.1 | WWAN Upgradable | None | None | 720p | Backlit | Finger-print Reader | None | X-Rite | dTPM 2.0 | 6-cell (90Wh) | 170W | Win10 Pro 64 | 3-year, Depot | 05/17 |
| 20HH002MUS | US | i7-7700HQ | No | M1200M 4GB | Intel CM238 | 8GBx1 non-ECC | 15.6" FHD (1920x1080) IPS | None | None | 512GB SSD M.2 PCIe NVMe Opal2 | No | None | Intel 8265 ac, 2x2 + BT4.1 | WWAN Upgradable | None | None | 720p | Backlit | Finger-print Reader | None | X-Rite | dTPM 2.0 | 6-cell (90Wh) | 170W | Win10 Pro 64 | 3-year, Depot | 05/17 |
| 20HH002NUS | US | i7-7820HQ | vPro | M2200M 4GB | Intel CM238 | 8GBx1 non-ECC | 15.6" FHD (1920x1080) IPS | None | None | 512GB SSD M.2 PCIe NVMe Opal2 | No | None | Intel 8265 ac, 2x2 + BT4.1 | WWAN Upgradable | None | None | 720p | Backlit | Finger-print Reader | None | X-Rite | dTPM 2.0 | 6-cell (90Wh) | 170W | Win10 Pro 64 | 3-year, Depot | 05/17 |
| 20HH002PUS | US | i7-7820HQ | vPro | M2200M 4GB | Intel CM238 | 8GBx1 non-ECC | 15.6" FHD (1920x1080) IPS | 10-point Multi-touch | None | 512GB SSD M.2 PCIe NVMe Opal2 | No | None | Intel 8265 ac, 2x2 + BT4.1 | WWAN Upgradable | None | None | 720p | Backlit | Finger-print Reader | None | X-Rite | dTPM 2.0 | 6-cell (90Wh) | 170W | Win10 Pro 64 | 3-year, Depot | 05/17 |
| 20HH002QUS | US | i7-7700HQ | No | M1200M 4GB | Intel CM238 | 8GBx2 non-ECC | 15.6" FHD (1920x1080) IPS | 10-point Multi-touch | None | 512GB SSD M.2 PCIe NVMe Opal2 | No | None | Intel 8265 ac, 2x2 + BT4.1 | WWAN Upgradable | None | None | 720p | Backlit | Finger-print Reader | None | X-Rite | dTPM 2.0 | 6-cell (90Wh) | 170W | Win10 Pro 64 | 3-year, Depot | 05/17 |



ThinkPad P51s Platform Specifications

Product Specifications Reference (PSREF)

| | | | | | | | | |
|-------------------|---|------------|--------------|----------------|---------------------|-------|--------------|--|
| Processor | 6th Generation Intel® Core™ i7 Processor | | | | | | | Dimensions WxDxH: 14.40" x 9.95" x 0.79-0.80"; 365.8mm x 252.8mm x 19.95-20.2mm |
| | Processor Number | # of Cores | # of Threads | Base Frequency | Max Turbo Frequency | Cache | Memory Types | |
| | i7-6500U | 2 | 4 | 2.5 GHz | 3.1 GHz | 4MB | DDR4-2133 | Intel HD Graphics 520 |
| | i7-6600U | | | 2.6 GHz | 3.4 GHz | 4MB | | |
| | or 7th Generation Intel Core i5 / i7 Processor | | | | | | | |
| | Processor Number | # of Cores | # of Threads | Base Frequency | Max Turbo Frequency | Cache | Memory Types | Processor Graphics |
| | i5-7300U | 2 | 4 | 2.6 GHz | 3.5 GHz | 3MB | DDR4-2133 | Intel HD Graphics 620 |
| | i7-7500U | | | 2.7 GHz | 3.5 GHz | 4MB | | |
| | i7-7600U | | | 2.8 GHz | 3.9 GHz | 4MB | | |
| Graphics | Intel HD Graphics 520 or 620 in processor and NVIDIA Quadro® M520M, 2GB 2.5GHz GDDR5 memory; supports external digital monitor via HDMI or USB Type-C; supports three independent displays; Max resolution: 4096x2304@60Hz (USB Type-C); 3840x2160@30Hz (HDMI) | | | | | | | Case color Case material |
| Chipset | Intel SoC (System on Chip) platform | | | | | | | Smart card reader |
| Memory | 32GB max / 2400MHz DDR4, dual-channel capable, two DDR4 SO-DIMM sockets * System clocks down for processors with lower memory controller | | | | | | | Media reader |
| Display | Some: 15.6" (396mm) FHD (1920x1080), anti-glare, LED backlight, IPS, 250 nits, 16:9 aspect ratio, 700:1 contrast ratio, 170° viewing angle Some: 15.6" (396mm) 4K (3840x2160), anti-glare, LED backlight, IPS, 300 nits, 16:9 aspect ratio, 1000:1 contrast ratio, 72% gamut, 170° viewing angle | | | | | | | Ports |
| Multi-touch (opt) | On-cell touch, supports 10-finger gesture (FHD only) | | | | | | | WiGig dock (opt) |
| Storage | System has one HDD slot or one M.2 2280 slot exclusively for storage Some: HDD / SATA 6.0Gb/s, 2.5" wide, 7mm high, Active Protection System™ Some: SSD / SATA 6.0Gb/s, 2.5" wide, 7mm high (e.g. xxxGB SSD) Some: M.2 SSD / PCIe NVMe, PCIe 3.0 x 2, 16Gb/s Some: 128GB M.2 SSD / SATA 6.0Gb/s, in WWAN slot as 2nd Storage, mutually exclusive with WWAN and WiGig | | | | | | | Monitor cable (optional) |
| Optical | None | | | | | | | Camera (optional) |
| Ethernet | Non-vPro model: Intel Ethernet Connection I219-V (Jacksonville) vPro model: Intel Ethernet Connection I219-LM (Jacksonville) | | | | | | | Audio support |
| WLAN | One of the following, configurable by model (WiGig can coexist with WWAN): • Realtek® RTL8822BE, Wi-Fi 2x2 802.11ac + BT4.1, M.2 card • Intel Dual Band Wireless-AC 8260, Wi-Fi 2x2 802.11ac + BT4.1, M.2 card • Intel Dual Band Wireless-AC 8265, Wi-Fi 2x2 802.11ac + BT4.1, M.2 card • Intel Tri-Band Wireless-AC 18265, WiGig 802.11ad + Wi-Fi 2x2 802.11ac + BT4.1, M.2 card | | | | | | | Keyboard |
| Bluetooth™ | Bluetooth 4.1 wireless, integrated in Wi-Fi + Bluetooth combo adapter * Intel 8265ac / 18265ac card support BT4.2 but is limited to BT4.1 by Windows OS | | | | | | | UltraNav™ |
| WWAN (optional) | One of the following, configurable by model (WWAN can coexist with WiGig): • Wireless WAN upgradable • Integrated Mobile Broadband 4G LTE-A, Qualcomm® Snapdragon™ X7 LTE-A (Sierra Wireless EM7455), M.2 card • Integrated Mobile Broadband 4G LTE, Intel XMM™ 7160 (Fibocom L831-EAU), M.2 card (EMEA only) | | | | | | | Security |
| SIM card (opt) | Micro-SIM card slot, opt Verizon LTE (US) or Lenovo® Connect (EMEA) SIM card | | | | | | | Security chip |
| | | | | | | | | vPro (optional) |
| | | | | | | | | Fingerprint reader |
| | | | | | | | | NFC (optional) |
| | | | | | | | | Internal battery |
| | | | | | | | | External battery |
| | | | | | | | | Max battery life (MobileMark® 2014) |
| | | | | | | | | AC adapter |
| | | | | | | | | Preload |
| | | | | | | | | Limited warranty |
| | | | | | | | | Mil-Spec test |
| | | | | | | | | Environment |

| Model | Region | Processor | vPro | Graphics | Memory | Display | Multi-touch | Storage(HDD/SSD) | Optical | WLAN + Bluetooth | WWAN | SIM Card | Smart Card Reader | Dock | Monitor Cable | Camera | Key-board | Finger-print Reader | NFC | TPM | Battery (internal+external) | Power Adapter | Operating System | Warranty | Ann Date (m/y) |
|------------|--------|-----------|------|-----------|--------|---------------------------|----------------------|-------------------------------|---------|----------------------------|-----------------|----------|-------------------|------|---------------|----------|-----------|---------------------|------|----------|-----------------------------|---------------|------------------|---------------|----------------|
| 20HB0004US | US | i7-7500U | No | M520M 2GB | 8GBx1 | 15.6" FHD (1920x1080) IPS | None | 1TB 5400rpm | None | Intel 8265 ac, 2x2 + BT4.1 | WWAN Upgradable | None | None | None | None | 720p | Backlit | Finger-print Reader | None | dTPM 2.0 | 4-cell(32Wh) + 3-cell(24Wh) | 65W | Win10 Pro 64 | 3-year, Depot | 03/17 |
| 20HB000AUS | US | i7-7500U | No | M520M 2GB | 8GBx1 | 15.6" FHD (1920x1080) IPS | None | 256GB SSD M.2 PCIe NVMe Opal2 | None | Intel 8265 ac, 2x2 + BT4.1 | WWAN Upgradable | None | None | None | None | 720p | Backlit | Finger-print Reader | None | dTPM 2.0 | 4-cell(32Wh) + 3-cell(24Wh) | 65W | Win10 Pro 64 | 3-year, Depot | 03/17 |
| 20HB000WUS | US | i7-7600U | vPro | M520M 2GB | 8GBx1 | 15.6" FHD (1920x1080) IPS | None | 256GB SSD M.2 PCIe NVMe Opal2 | None | Intel 8265 ac, 2x2 + BT4.1 | WWAN Upgradable | None | None | None | None | 720p | Backlit | Finger-print Reader | None | dTPM 2.0 | 4-cell(32Wh) + 3-cell(24Wh) | 65W | Win10 Pro 64 | 3-year, Depot | 03/17 |
| 20HB000XUS | US | i5-7300U | vPro | M520M 2GB | 8GBx1 | 15.6" FHD (1920x1080) IPS | 10-point Multi-touch | 256GB SSD M.2 PCIe NVMe Opal2 | None | Intel 8265 ac, 2x2 + BT4.1 | WWAN Upgradable | None | None | None | None | 720p | Backlit | Finger-print Reader | None | dTPM 2.0 | 4-cell(32Wh) + 3-cell(24Wh) | 65W | Win10 Pro 64 | 3-year, Depot | 03/17 |
| 20HB000YUS | US | i5-7300U | vPro | M520M 2GB | 8GBx1 | 15.6" 4K (3840x2160) IPS | None | 1TB 5400rpm | None | Intel 8265 ac, 2x2 + BT4.1 | WWAN Upgradable | None | None | None | None | IR &720p | Backlit | Finger-print Reader | None | dTPM 2.0 | 4-cell(32Wh) + 3-cell(24Wh) | 65W | Win10 Pro 64 | 3-year, Depot | 03/17 |
| 20HB0010US | US | i5-7300U | vPro | M520M 2GB | 8GBx1 | 15.6" FHD (1920x1080) IPS | None | 512GB SSD M.2 PCIe NVMe Opal2 | None | Intel 8265 ac, 2x2 + BT4.1 | WWAN Upgradable | None | None | None | None | 720p | Backlit | Finger-print Reader | None | dTPM 2.0 | 4-cell(32Wh) + 3-cell(24Wh) | 65W | Win10 Pro 64 | 3-year, Depot | 03/17 |
| 20HB0011US | US | i7-7600U | vPro | M520M 2GB | 8GBx2 | 15.6" FHD (1920x1080) IPS | None | 1TB SSD M.2 PCIe NVMe Opal2 | None | Intel 8265 ac, 2x2 + BT4.1 | WWAN Upgradable | None | None | None | None | IR &720p | Backlit | Finger-print Reader | None | dTPM 2.0 | 4-cell(32Wh) + 3-cell(24Wh) | 65W | Win10 Pro 64 | 3-year, Depot | 03/17 |
| 20HB0012US | US | i7-7600U | vPro | M520M 2GB | 8GBx2 | 15.6" FHD (1920x1080) IPS | None | 512GB SSD M.2 PCIe NVMe Opal2 | None | Intel 8265 ac, 2x2 + BT4.1 | WWAN Upgradable | None | None | None | None | IR &720p | Backlit | Finger-print Reader | None | dTPM 2.0 | 4-cell(32Wh) + 3-cell(24Wh) | 65W | Win10 Pro 64 | 3-year, Depot | 03/17 |
| 20HB0013US | US | i7-7600U | vPro | M520M 2GB | 8GBx1 | 15.6" 4K (3840x2160) IPS | None | 256GB SSD M.2 PCIe NVMe Opal2 | None | Intel 8265 ac, 2x2 + BT4.1 | WWAN Upgradable | None | None | None | None | IR &720p | Backlit | Finger-print Reader | None | dTPM 2.0 | 4-cell(32Wh) + 3-cell(24Wh) | 65W | Win10 Pro 64 | 3-year, Depot | 03/17 |
| 20HB0014US | US | i5-7300U | vPro | M520M 2GB | 8GBx1 | 15.6" FHD (1920x1080) IPS | None | 256GB SSD M.2 PCIe NVMe Opal2 | None | Intel 8265 ac, 2x2 + BT4.1 | WWAN Upgradable | None | None | None | None | 720p | Backlit | Finger-print Reader | None | dTPM 2.0 | 4-cell(32Wh) + 3-cell(24Wh) | 65W | Win10 Pro 64 | 3-year, Depot | 03/17 |
| 20HB0015US | US | i7-7500U | No | M520M 2GB | 8GBx1 | 15.6" FHD (1920x1080) IPS | None | 512GB SSD M.2 PCIe NVMe Opal2 | None | Intel 8265 ac, 2x2 + BT4.1 | WWAN Upgradable | None | None | None | None | 720p | Backlit | Finger-print Reader | None | dTPM 2.0 | 4-cell(32Wh) + 3-cell(24Wh) | 65W | Win10 Pro 64 | 3-year, Depot | 03/17 |
| 20HB0016US | US | i7-7600U | vPro | M520M 2GB | 8GBx1 | 15.6" FHD (1920x1080) IPS | 10-point Multi-touch | 1TB SSD M.2 PCIe NVMe Opal2 | None | Intel 8265 ac, 2x2 + BT4.1 | WWAN Upgradable | None | None | None | None | 720p | Backlit | Finger-print Reader | None | dTPM 2.0 | 4-cell(32Wh) + 3-cell(24Wh) | 65W | Win10 Pro 64 | 3-year, Depot | 03/17 |
| 20HB0017US | US | i5-7300U | vPro | M520M 2GB | 8GBx1 | 15.6" FHD (1920x1080) IPS | None | 256GB SSD M.2 PCIe NVMe Opal2 | None | Intel 8265 ac, 2x2 + BT4.1 | WWAN Upgradable | None | None | None | None | 720p | Backlit | Finger-print Reader | None | dTPM 2.0 | 4-cell(32Wh) + 6-cell(72Wh) | 65W | Win10 Pro 64 | 3-year, Depot | 03/17 |
| 20HB0018US | US | i5-7300U | vPro | M520M 2GB | 8GBx1 | 15.6" FHD (1920x1080) IPS | None | 500GB 7200rpm | None | Intel 8265 ac, 2x2 + BT4.1 | WWAN Upgradable | None | None | None | None | 720p | Backlit | Finger-print Reader | None | dTPM 2.0 | 4-cell(32Wh) + 3-cell(24Wh) | 65W | Win10 Pro 64 | 3-year, Depot | 03/17 |
| 20HB0019US | US | i5-7300U | vPro | M520M 2GB | 8GBx1 | 15.6" FHD (1920x1080) IPS | None | 1TB 5400rpm | None | Intel 8265 ac, 2x2 + BT4.1 | WWAN Upgradable | None | None | None | None | 720p | Backlit | Finger-print Reader | None | dTPM 2.0 | 4-cell(32Wh) + 3-cell(24Wh) | 65W | Win10 Pro 64 | 3-year, Depot | 03/17 |
| 20HB001AUS | US | i5-7300U | vPro | M520M 2GB | 8GBx1 | 15.6" FHD (1920x1080) IPS | None | 1TB SSD M.2 PCIe NVMe Opal2 | None | Intel 8265 ac, 2x2 + BT4.1 | WWAN Upgradable | None | None | None | None | 720p | Backlit | Finger-print Reader | None | dTPM 2.0 | 4-cell(32Wh) + 3-cell(24Wh) | 65W | Win10 Pro 64 | 3-year, Depot | 03/17 |
| 20HB001BUS | US | i7-7600U | vPro | M520M 2GB | 8GBx1 | 15.6" FHD (1920x1080) IPS | None | 1TB 5400rpm | None | Intel 8265 ac, 2x2 + BT4.1 | WWAN Upgradable | None | None | None | None | 720p | Backlit | Finger-print Reader | None | dTPM 2.0 | 4-cell(32Wh) + 3-cell(24Wh) | 65W | Win10 Pro 64 | 3-year, Depot | 03/17 |
| 20HB001CUS | US | i7-7600U | vPro | M520M 2GB | 8GBx2 | 15.6" FHD (1920x1080) IPS | None | 256GB SSD M.2 PCIe NVMe Opal2 | None | Intel 8265 ac, 2x2 + BT4.1 | WWAN Upgradable | None | None | None | None | IR &720p | Backlit | Finger-print Reader | None | dTPM 2.0 | 4-cell(32Wh) + 3-cell(24Wh) | 65W | Win10 Pro 64 | 3-year, Depot | 03/17 |
| 20HB001DUS | US | i5-7300U | vPro | M520M 2GB | 8GBx2 | 15.6" FHD (1920x1080) IPS | None | 512GB SSD M.2 PCIe NVMe Opal2 | None | Intel 8265 ac, 2x2 + BT4.1 | WWAN Upgradable | None | None | None | None | IR &720p | Backlit | Finger-print Reader | None | dTPM 2.0 | 4-cell(32Wh) + 3-cell(24Wh) | 65W | Win10 Pro 64 | 3-year, Depot | 03/17 |
| 20HB001EUS | US | i7-7600U | vPro | M520M 2GB | 8GBx1 | 15.6" FHD (1920x1080) IPS | None | 1TB SSD M.2 PCIe NVMe Opal2 | None | Intel 8265 ac, 2x2 + BT4.1 | WWAN Upgradable | None | None | None | None | 720p | Backlit | Finger-print Reader | None | dTPM 2.0 | 4-cell(32Wh) + 3-cell(24Wh) | 65W | Win10 Pro 64 | 3-year, Depot | 03/17 |

| Model | Region | Processor | vPro | Graphics | Memory | Display | Multi-touch | Storage(HDD/SSD) | Optical | WLAN + Bluetooth | WWAN | SIM Card | Smart Card Reader | Dock | Monitor Cable | Camera | Key-board | Finger-print Reader | NFC | TPM | Battery (internal+external) | Power Adapter | Operating System | Warranty | Ann Date (m/y) |
|------------|--------|-----------|------|-----------|--------|---------------------------|----------------------|-------------------------------|---------|----------------------------|-----------------|----------|-------------------|------|---------------|----------|-----------|---------------------|------|----------|-----------------------------|---------------|------------------|---------------|----------------|
| 20HB001FUS | US | i5-7300U | vPro | M520M 2GB | 8GBx2 | 15.6" FHD (1920x1080) IPS | None | 256GB SSD M.2 PCIe NVMe Opal2 | None | Intel 8265 ac, 2x2 + BT4.1 | WWAN Upgradable | None | None | None | None | IR &720p | Backlit | Finger-print Reader | None | dTPM 2.0 | 4-cell(32Wh) + 3-cell(24Wh) | 65W USB-C | Win10 Pro 64 | 3-year, Depot | 03/17 |
| 20HB001GUS | US | i7-7600U | vPro | M520M 2GB | 8GBx1 | 15.6" FHD (1920x1080) IPS | None | 512GB SSD M.2 PCIe NVMe Opal2 | None | Intel 8265 ac, 2x2 + BT4.1 | WWAN Upgradable | None | None | None | None | 720p | Backlit | Finger-print Reader | None | dTPM 2.0 | 4-cell(32Wh) + 3-cell(24Wh) | 65W USB-C | Win10 Pro 64 | 3-year, Depot | 03/17 |
| 20HB001HUS | US | i5-7300U | vPro | M520M 2GB | 4GBx1 | 15.6" FHD (1920x1080) IPS | None | 500GB 7200rpm | None | Intel 8265 ac, 2x2 + BT4.1 | WWAN Upgradable | None | None | None | None | 720p | Backlit | Finger-print Reader | None | dTPM 2.0 | 4-cell(32Wh) + 3-cell(24Wh) | 65W USB-C | Win10 Pro 64 | 3-year, Depot | 03/17 |
| 20HB001JUS | US | i5-7300U | vPro | M520M 2GB | 8GBx1 | 15.6" 4K (3840x2160) IPS | None | 256GB SSD M.2 PCIe NVMe Opal2 | None | Intel 8265 ac, 2x2 + BT4.1 | WWAN Upgradable | None | None | None | None | IR &720p | Backlit | Finger-print Reader | None | dTPM 2.0 | 4-cell(32Wh) + 3-cell(24Wh) | 65W USB-C | Win10 Pro 64 | 3-year, Depot | 03/17 |
| 20HB001KUS | US | i7-7500U | No | M520M 2GB | 8GBx1 | 15.6" FHD (1920x1080) IPS | None | 500GB 7200rpm | None | Intel 8265 ac, 2x2 + BT4.1 | WWAN Upgradable | None | None | None | None | 720p | Backlit | Finger-print Reader | None | dTPM 2.0 | 4-cell(32Wh) + 3-cell(24Wh) | 65W | Win10 Pro 64 | 3-year, Depot | 03/17 |
| 20HB001NUS | US | i5-7300U | vPro | M520M 2GB | 8GBx1 | 15.6" FHD (1920x1080) IPS | None | 500GB 7200rpm | None | Intel 8265 ac, 2x2 + BT4.1 | WWAN Upgradable | None | None | None | None | 720p | Backlit | Finger-print Reader | None | dTPM 2.0 | 4-cell(32Wh) + 3-cell(24Wh) | 65W | Win10 Pro 64 | 3-year, Depot | 05/17 |
| 20HB001PUS | US | i7-7500U | No | M520M 2GB | 16GBx1 | 15.6" FHD (1920x1080) IPS | 10-point Multi-touch | 500GB 7200rpm | None | Intel 8265 ac, 2x2 + BT4.1 | WWAN Upgradable | None | None | None | None | 720p | Backlit | Finger-print Reader | None | dTPM 2.0 | 4-cell(32Wh) + 3-cell(24Wh) | 65W | Win10 Pro 64 | 3-year, Depot | 05/17 |
| 20HB001QUS | US | i7-7500U | No | M520M 2GB | 8GBx1 | 15.6" FHD (1920x1080) IPS | 10-point Multi-touch | 500GB 7200rpm | None | Intel 8265 ac, 2x2 + BT4.1 | WWAN Upgradable | None | None | None | None | 720p | Backlit | Finger-print Reader | None | dTPM 2.0 | 4-cell(32Wh) + 3-cell(24Wh) | 65W | Win10 Pro 64 | 3-year, Depot | 05/17 |
| 20HB001RUS | US | i5-7300U | vPro | M520M 2GB | 8GBx1 | 15.6" FHD (1920x1080) IPS | 10-point Multi-touch | 500GB 7200rpm | None | Intel 8265 ac, 2x2 + BT4.1 | WWAN Upgradable | None | None | None | None | 720p | Backlit | Finger-print Reader | None | dTPM 2.0 | 4-cell(32Wh) + 3-cell(24Wh) | 65W | Win10 Pro 64 | 3-year, Depot | 05/17 |
| 20HB001SUS | US | i7-7500U | No | M520M 2GB | 16GBx1 | 15.6" FHD (1920x1080) IPS | None | 512GB SSD M.2 PCIe NVMe Opal2 | None | Intel 8265 ac, 2x2 + BT4.1 | WWAN Upgradable | None | None | None | None | IR &720p | Backlit | Finger-print Reader | None | dTPM 2.0 | 4-cell(32Wh) + 3-cell(24Wh) | 65W | Win10 Pro 64 | 3-year, Depot | 05/17 |
| 20HB001TUS | US | i7-7500U | No | M520M 2GB | 8GBx1 | 15.6" FHD (1920x1080) IPS | 10-point Multi-touch | 256GB SSD M.2 PCIe NVMe Opal2 | None | Intel 8265 ac, 2x2 + BT4.1 | WWAN Upgradable | None | None | None | None | 720p | Backlit | Finger-print Reader | None | dTPM 2.0 | 4-cell(32Wh) + 3-cell(24Wh) | 65W | Win10 Pro 64 | 3-year, Depot | 05/17 |
| 20HB001UUS | US | i7-7500U | No | M520M 2GB | 16GBx1 | 15.6" FHD (1920x1080) IPS | 10-point Multi-touch | 512GB SSD M.2 PCIe NVMe Opal2 | None | Intel 8265 ac, 2x2 + BT4.1 | WWAN Upgradable | None | None | None | None | 720p | Backlit | Finger-print Reader | None | dTPM 2.0 | 4-cell(32Wh) + 3-cell(24Wh) | 65W | Win10 Pro 64 | 3-year, Depot | 05/17 |
| 20HB001VUS | US | i7-7500U | No | M520M 2GB | 16GBx1 | 15.6" FHD (1920x1080) IPS | None | 512GB SSD M.2 PCIe NVMe Opal2 | None | Intel 8265 ac, 2x2 + BT4.1 | WWAN Upgradable | None | None | None | None | 720p | Backlit | Finger-print Reader | None | dTPM 2.0 | 4-cell(32Wh) + 3-cell(24Wh) | 65W | Win10 Pro 64 | 3-year, Depot | 05/17 |
| 20HB001XUS | US | i7-7500U | No | M520M 2GB | 16GBx1 | 15.6" FHD (1920x1080) IPS | None | 512GB SSD M.2 PCIe NVMe Opal2 | None | Intel 8265 ac, 2x2 + BT4.1 | WWAN Upgradable | None | None | None | None | IR &720p | Backlit | Finger-print Reader | None | dTPM 2.0 | 4-cell(32Wh) + 3-cell(24Wh) | 65W | Win10 Pro 64 | 3-year, Depot | 05/17 |

ThinkPad P51s - TopSeller - 20JY

Product Specifications Reference (PSREF)

| Model | Region | Processor | vPro | Graphics | Memory | Display | Multi-touch | Storage(HDD/SSD) | Optical | WLAN + Bluetooth | WWAN | SIM Card | Smart Card Reader | Dock | Monitor Cable | Camera | Key-board | Finger-print Reader | NFC | TPM | Battery (internal+external) | Power Adapter | Operating System | Warranty | Ann Date (m/y) |
|------------|--------|-----------|------|-----------|--------|---------------------------|-------------|-------------------------------|---------|----------------------------|-----------------|----------|-------------------|------|---------------|--------|-----------|---------------------|------|----------|-----------------------------|---------------|----------------------|---------------|----------------|
| 20JY0004US | US | i7-6500U | No | M520M 2GB | 8GBx2 | 15.6" FHD (1920x1080) IPS | None | 512GB SSD M.2 PCIe NVMe Opal2 | None | Intel 8260 ac, 2x2 + BT4.1 | WWAN Upgradable | None | None | None | None | 720p | Backlit | Finger-print Reader | None | dTPM 2.0 | 4-cell(32Wh) + 3-cell(24Wh) | 65W | Win10 DG Win7 Pro 64 | 3-year, Depot | 03/17 |
| 20JY0005US | US | i7-6500U | No | M520M 2GB | 8GBx2 | 15.6" FHD (1920x1080) IPS | None | 256GB SSD M.2 PCIe NVMe Opal2 | None | Intel 8260 ac, 2x2 + BT4.1 | WWAN Upgradable | None | None | None | None | 720p | Backlit | Finger-print Reader | None | dTPM 2.0 | 4-cell(32Wh) + 3-cell(24Wh) | 65W | Win10 DG Win7 Pro 64 | 3-year, Depot | 03/17 |
| 20JY0006US | US | i7-6500U | No | M520M 2GB | 8GBx1 | 15.6" FHD (1920x1080) IPS | None | 256GB SSD M.2 PCIe NVMe Opal2 | None | Intel 8260 ac, 2x2 + BT4.1 | WWAN Upgradable | None | None | None | None | 720p | Backlit | Finger-print Reader | None | dTPM 2.0 | 4-cell(32Wh) + 3-cell(24Wh) | 65W | Win10 DG Win7 Pro 64 | 3-year, Depot | 03/17 |
| 20JY0007US | US | i7-6500U | No | M520M 2GB | 8GBx2 | 15.6" 4K (3840x2160) IPS | None | 256GB SSD M.2 PCIe NVMe Opal2 | None | Intel 8260 ac, 2x2 + BT4.1 | WWAN Upgradable | None | None | None | None | 720p | Backlit | Finger-print Reader | None | dTPM 2.0 | 4-cell(32Wh) + 3-cell(24Wh) | 65W | Win10 DG Win7 Pro 64 | 3-year, Depot | 03/17 |
| 20JY0008US | US | i7-6500U | No | M520M 2GB | 8GBx2 | 15.6" 4K (3840x2160) IPS | None | 500GB 7200rpm | None | Intel 8260 ac, 2x2 + BT4.1 | WWAN Upgradable | None | None | None | None | 720p | Backlit | Finger-print Reader | None | dTPM 2.0 | 4-cell(32Wh) + 3-cell(24Wh) | 65W | Win10 DG Win7 Pro 64 | 3-year, Depot | 03/17 |
| 20JY0009US | US | i7-6500U | No | M520M 2GB | 8GBx1 | 15.6" FHD (1920x1080) IPS | None | 500GB 7200rpm | None | Intel 8260 ac, 2x2 + BT4.1 | WWAN Upgradable | None | None | None | None | 720p | Backlit | Finger-print Reader | None | dTPM 2.0 | 4-cell(32Wh) + 3-cell(24Wh) | 65W | Win10 DG Win7 Pro 64 | 3-year, Depot | 03/17 |
| 20JY000AUS | US | i7-6500U | No | M520M 2GB | 16GBx2 | 15.6" FHD (1920x1080) IPS | None | 1TB SSD M.2 PCIe NVMe Opal2 | None | Intel 8260 ac, 2x2 + BT4.1 | WWAN Upgradable | None | None | None | None | 720p | Backlit | Finger-print Reader | None | dTPM 2.0 | 4-cell(32Wh) + 3-cell(24Wh) | 65W | Win10 DG Win7 Pro 64 | 3-year, Depot | 03/17 |
| 20JY000BUS | US | i7-6500U | No | M520M 2GB | 8GBx2 | 15.6" 4K (3840x2160) IPS | None | 512GB SSD M.2 PCIe NVMe Opal2 | None | Intel 8260 ac, 2x2 + BT4.1 | WWAN Upgradable | None | None | None | None | 720p | Backlit | Finger-print Reader | None | dTPM 2.0 | 4-cell(32Wh) + 3-cell(24Wh) | 65W | Win10 DG Win7 Pro 64 | 3-year, Depot | 03/17 |
| 20JY000CUS | US | i7-6500U | No | M520M 2GB | 16GBx2 | 15.6" FHD (1920x1080) IPS | None | 512GB SSD M.2 PCIe NVMe Opal2 | None | Intel 8260 ac, 2x2 + BT4.1 | WWAN Upgradable | None | None | None | None | 720p | Backlit | Finger-print Reader | None | dTPM 2.0 | 4-cell(32Wh) + 3-cell(24Wh) | 65W | Win10 DG Win7 Pro 64 | 3-year, Depot | 03/17 |



ThinkPad P70 Platform Specifications

Product Specifications Reference (PSREF)

| Processor | 6th Generation Intel® Core™ i7 Processor or Intel Xeon® Processor E3 v5 Family | | | | | | | Smart card reader ExpressCard Media reader Ports | Optional: Smart card reader One slot (ExpressCard/34) 4-in-1 reader (MMC, SD, SDHC, SDXC), supports UHS-II SD card Four USB 3.0 (one Always On), two USB Type-C / Thunderbolt 3, Mini DisplayPort, HDMI, Ethernet (RJ-45), Dock connector | | | | | | |
|-------------------------------------|---|-----------------|--------------|----------------|---------------------|-------|--------------|---|---|-------------------------------|-------------------|-----------------|------------------|--------|---------|
| | Processor Number | # of Cores | # of Threads | Base Frequency | Max Turbo Frequency | Cache | Memory Types | | | Processor Graphics | | | | | |
| | i7-6700HQ | 4 | 8 | 2.6 GHz | 3.5 GHz | 6MB | DDR4-2133 | | | Intel HD Graphics 530 | | | | | |
| | i7-6820HQ | | | 2.7 GHz | 3.6 GHz | 8MB | | | | Intel HD Graphics P530 | | | | | |
| | E3-1505M v5 | | | 2.8 GHz | 3.7 GHz | 8MB | | | | Intel Iris™ Pro Graphics P580 | | | | | |
| E3-1575M v5 | 3 GHz | | | 3.9 GHz | | | | | | | | | | | |
| Graphics | Intel HD Graphics 530, Intel HD Graphics P530, or Intel Iris™ Pro Graphics P580 in processor and NVIDIA Quadro® M600M (2GB memory), M3000M (4GB memory), M4000M (4GB memory), or M5000M (8GB memory); supports external digital monitor via HDMI, Mini DisplayPort, or Thunderbolt™; supports five independent displays; Max resolution: 3840x2160@60Hz (DisplayPort via Mini DisplayPort cable); 3840x2160@60Hz (Thunderbolt); 3840x2160@30Hz (HDMI) | | | | | | | Camera (optional) Audio support | HD720p resolution, low light sensitive, fixed focus HD Audio, Realtek® ALC3268 codec / stereo speakers, 2W x 2 / dual array microphone, combo audio/microphone jack | | | | | | |
| Chipset | Mobile Intel CM236 Chipset (Intel GL82CM236 PCH) | | | | | | | Keyboard UltraNav™ | 6-row, spill-resistant, multimedia Fn keys, numeric keypad, optional LED backlight 3-button TrackPoint® pointing device and 3-button crystal silk surface multi-touch touchpad | | | | | | |
| Memory | 64GB max ⁷ / 2133MHz DDR4, ECC or non-ECC (ECC function supported only on Xeon processor), dual-channel capable, four DDR4 SO-DIMM sockets | | | | | | | Security Security chip ThinkEngine | Power-on password, hard disk password, supervisor password, security keyhole Discrete TPM 1.2 TCG Certified and Firmware TPM 2.0 integrated in chipset Delivers improved thermal and power efficiency, up to 30 day standby, faster resume time, enhanced security, as well as anti-tampering measures | | | | | | |
| Display | Some: 17.3" (439mm) FHD (1920x1080), anti-glare, LED backlight, IPS, 300 nits, 16:9 aspect ratio, 800:1 contrast ratio, 72% gamut, 170° viewing angle Some: 17.3" (439mm) 4K (3840x2160), anti-glare, LED backlight, IPS, 300 nits, 16:9 aspect ratio, 800:1 contrast ratio, 90% gamut, 170° viewing angle | | | | | | | vPro (optional) Fingerprint reader Color calibration | Intel vPro Technology Touch style fingerprint reader on the keyboard bezel Optional: Pantone® color calibrator by X-Rite® color calibration sensor in palm rest | | | | | | |
| Multi-touch (opt) Pen (optional) | Capacitive-type multi-touch, supports 10-finger gesture, 270 nits ThinkPad Pen Pro, active pen for multi-touch display | | | | | | | Battery Max battery life ¹⁰ (MobileMark® 2014) | Li-Ion 8-cell (96Wh) <table border="1"> <thead> <tr> <th>Mode</th> <th>Discrete Graphics</th> <th>Hybrid Graphics</th> </tr> </thead> <tbody> <tr> <td>Max battery life</td> <td>8.5 hr</td> <td>10.8 hr</td> </tr> </tbody> </table> | Mode | Discrete Graphics | Hybrid Graphics | Max battery life | 8.5 hr | 10.8 hr |
| Mode | Discrete Graphics | Hybrid Graphics | | | | | | | | | | | | | |
| Max battery life | 8.5 hr | 10.8 hr | | | | | | | | | | | | | |
| Storage | Up to 4 drives (two M.2 SSD and two HDD, one of which is in the optical bay) Some: M.2 SSD / SATA 6.0Gb/s (e.g. xxxG SSD) Some: M.2 SSD / PCIe NVMe, PCIe 3.0 x 4, 32Gb/s (e.g. xxxG SSD PCIe NVMe) Some: HDD / SATA 6.0Gb/s, 2.5" wide, 7mm high, Shock Mounted Hard Drive, Active Protection System™ | | | | | | | AC adapter | 170W or 230W AC adapter | | | | | | |
| Optical (optional) | DVD burner, 9.5mm high, fixed, tray-in | | | | | | | Preload | Some: Genuine Windows® 7 Professional 64 Some: Windows 7 Professional 64 preinstalled through downgrade rights in Windows 10 Pro 64 • Lenovo Solution Center • Lenovo SHAREit • ThinkVantage Product Recovery • Rescue and Recovery™ • ThinkVantage System Update • Adobe® Reader® • Microsoft® Office preloaded; purchase a product key to activate • McAfee® LiveSafe™ (30-day trial) For ISV certifications, please visit www.lenovo.com/support/ISV | | | | | | |
| Ethernet | Non-vPro model: Intel Ethernet Connection I219-V (Jacksonville) vPro model: Intel Ethernet Connection I219-LM (Jacksonville) | | | | | | | Limited warranty ¹² | One of the following, configurable by model: • 3-year/1-yr battery depot repair service • 3-year/1-yr battery limited onsite service ²⁴ • 3-year/1-yr battery limited onsite service, OID (Onsite International Delivery) | | | | | | |
| WLAN ⁴ Bluetooth™ | 11ac+BT, Intel Dual Band Wireless-AC 8260, 2x2, M.2 card Bluetooth 4.1 wireless, integrated in Wi-Fi + Bluetooth combo adapter | | | | | | | Mil-Spec test | MIL-STD-810G military certification | | | | | | |
| WWAN (optional) | Wireless WAN, Sierra Wireless EM7455, Qualcomm® 4G LTE-Advanced/DC-HSPA+/HSPA+/HSPA/UMTS/GNSS, M.2 card | | | | | | | Environment | EPEAT™ Gold (US only); ENERGY STAR® 6.1; GREENGUARD®; RoHS-compliant | | | | | | |
| SIM card | Micro-SIM card slot | | | | | | | | | | | | | | |
| Dimensions ³ | WxDxH: 16.38" x 10.85" x 1.18-1.35"; 416mm x 275.5mm x 29.9-34.2mm WxDxH(Touch): 16.38" x 10.85" x 1.20-1.37"; 416mm x 275.5mm x 30.6-34.9mm | | | | | | | | | | | | | | |
| Weight ² | Non-touch model: starting at 7.3 lb (3.3kg); Multi-touch model: starting at 8.1 lb (3.7kg) | | | | | | | | | | | | | | |
| Case material | Display cover: Glass-Fiber + PPS; Bottom: Magnesium/Aluminum | | | | | | | | | | | | | | |

| Model | Region | Processor | vPro | Graphics | Memory | Display | Multi-touch | Pen | Storage(HDD/SSD) | RAID | Optical | WLAN + Bluetooth | WWAN | SIM Card | Smart Card Reader | Camera | Keyboard | Fingerprint Reader | Color Calibrator | Battery | Power Adapter | Operating System | Warranty | Ann Date (m/y) |
|------------|--------|------------------|------|------------|----------------|---------------------------|----------------------|------------------|-------------------------------|------|-------------|----------------------------|------|----------|-------------------|--------|----------|--------------------|------------------|---------------|---------------|----------------------|---------------|----------------|
| 20ER000FUS | US | i7-6700HQ | No | M600M 2GB | 8GBx1 non-ECC | 17.3" FHD (1920x1080) IPS | None | None | 500GB 7200rpm | No | DVD±RW | Intel 8260 ac, 2x2 + BT4.1 | None | None | None | 720p | Backlit | Fingerprint Reader | None | 8-cell (96Wh) | 170W | Win10 DG Win7 Pro 64 | 3-year, Depot | 10/15 |
| 20ER000GUS | US | i7-6700HQ | No | M3000M 4GB | 8GBx1 non-ECC | 17.3" FHD (1920x1080) IPS | None | None | 500GB 7200rpm | No | DVD±RW | Intel 8260 ac, 2x2 + BT4.1 | None | None | None | 720p | Backlit | Fingerprint Reader | None | 8-cell (96Wh) | 230W | Win10 DG Win7 Pro 64 | 3-year, Depot | 10/15 |
| 20ER000HUS | US | i7-6820HQ | vPro | M600M 2GB | 8GBx1 non-ECC | 17.3" FHD (1920x1080) IPS | None | None | 500GB 7200rpm | No | DVD±RW | Intel 8260 ac, 2x2 + BT4.1 | None | None | None | 720p | Backlit | Fingerprint Reader | None | 8-cell (96Wh) | 170W | Win10 DG Win7 Pro 64 | 3-year, Depot | 10/15 |
| 20ER000JUS | US | i7-6820HQ | vPro | M3000M 4GB | 8GBx1 non-ECC | 17.3" FHD (1920x1080) IPS | None | None | 500GB 7200rpm | No | DVD±RW | Intel 8260 ac, 2x2 + BT4.1 | None | None | None | 720p | Backlit | Fingerprint Reader | None | 8-cell (96Wh) | 230W | Win10 DG Win7 Pro 64 | 3-year, Depot | 10/15 |
| 20ER000KUS | US | i7-6820HQ | vPro | M3000M 4GB | 8GBx1 non-ECC | 17.3" FHD (1920x1080) IPS | 10-point Multi-touch | ThinkPad Pen Pro | 256GB SSD M.2 Opal2 | No | DVD±RW | Intel 8260 ac, 2x2 + BT4.1 | None | None | None | 720p | Backlit | Fingerprint Reader | X-Rite | 8-cell (96Wh) | 230W | Win10 DG Win7 Pro 64 | 3-year, Depot | 10/15 |
| 20ER000LUS | US | Xeon E3-1505M v5 | vPro | M600M 2GB | 8GBx1 ECC | 17.3" FHD (1920x1080) IPS | None | None | 256GB SSD M.2 PCIe NVMe Opal2 | No | DVD±RW | Intel 8260 ac, 2x2 + BT4.1 | None | None | None | 720p | Backlit | Fingerprint Reader | None | 8-cell (96Wh) | 170W | Win10 DG Win7 Pro 64 | 3-year, Depot | 11/15 |
| 20ER000MUS | US | Xeon E3-1505M v5 | vPro | M3000M 4GB | 8GBx1 ECC | 17.3" FHD (1920x1080) IPS | None | None | 256GB SSD M.2 PCIe NVMe Opal2 | No | DVD±RW | Intel 8260 ac, 2x2 + BT4.1 | None | None | None | 720p | Backlit | Fingerprint Reader | None | 8-cell (96Wh) | 230W | Win10 DG Win7 Pro 64 | 3-year, Depot | 11/15 |
| 20ER000NUS | US | Xeon E3-1505M v5 | vPro | M3000M 4GB | 16GBx1 ECC | 17.3" 4K (3840x2160) IPS | None | None | 512GB SSD M.2 PCIe NVMe | No | DVD±RW | Intel 8260 ac, 2x2 + BT4.1 | None | None | Smart Card Reader | 720p | Backlit | Fingerprint Reader | X-Rite | 8-cell (96Wh) | 230W | Win10 DG Win7 Pro 64 | 3-year, Depot | 11/15 |
| 20ER000PUS | US | i7-6820HQ | vPro | M600M 2GB | 8GBx1 non-ECC | 17.3" FHD (1920x1080) IPS | 10-point Multi-touch | ThinkPad Pen Pro | 500GB 7200rpm | No | DVD±RW | Intel 8260 ac, 2x2 + BT4.1 | None | None | None | 720p | Backlit | Fingerprint Reader | X-Rite | 8-cell (96Wh) | 170W | Win10 Pro 64 | 3-year, Depot | 10/15 |
| 20ER000QUS | US | i7-6820HQ | vPro | M3000M 4GB | 8GBx1 non-ECC | 17.3" FHD (1920x1080) IPS | 10-point Multi-touch | ThinkPad Pen Pro | 256GB SSD M.2 Opal2 | No | DVD±RW | Intel 8260 ac, 2x2 + BT4.1 | None | None | None | 720p | Backlit | Fingerprint Reader | X-Rite | 8-cell (96Wh) | 230W | Win10 Pro 64 | 3-year, Depot | 10/15 |
| 20ER000RUS | US | i7-6820HQ | vPro | M3000M 4GB | 16GBx1 non-ECC | 17.3" 4K (3840x2160) IPS | None | None | 512GB SSD M.2 PCIe NVMe | No | DVD±RW | Intel 8260 ac, 2x2 + BT4.1 | None | None | Smart Card Reader | 720p | Backlit | Fingerprint Reader | X-Rite | 8-cell (96Wh) | 230W | Win10 DG Win7 Pro 64 | 3-year, Depot | 11/15 |
| 20ER000SUS | US | i7-6820HQ | vPro | M3000M 4GB | 8GBx1 non-ECC | 17.3" FHD (1920x1080) IPS | None | None | 256GB SSD M.2 Opal2 | No | DVD±RW | Intel 8260 ac, 2x2 + BT4.1 | None | None | None | 720p | Backlit | Fingerprint Reader | None | 8-cell (96Wh) | 230W | Win10 DG Win7 Pro 64 | 3-year, Depot | 10/15 |
| 20ER000TUS | US | i7-6700HQ | No | M600M 2GB | 8GBx1 non-ECC | 17.3" FHD (1920x1080) IPS | None | None | 1TB 5400rpm | No | DVD±RW | Intel 8260 ac, 2x2 + BT4.1 | None | None | None | 720p | Backlit | Fingerprint Reader | None | 8-cell (96Wh) | 170W | Win10 DG Win7 Pro 64 | 3-year, Depot | 10/15 |
| 20ER000UUS | US | i7-6700HQ | No | M3000M 4GB | 16GBx1 non-ECC | 17.3" FHD (1920x1080) IPS | None | None | 256GB SSD M.2 Opal2 | No | DVD±RW | Intel 8260 ac, 2x2 + BT4.1 | None | None | None | 720p | Backlit | Fingerprint Reader | None | 8-cell (96Wh) | 230W | Win10 DG Win7 Pro 64 | 3-year, Depot | 10/15 |
| 20ER000VUS | US | i7-6700HQ | No | M600M 2GB | 8GBx1 non-ECC | 17.3" FHD (1920x1080) IPS | None | None | 500GB 7200rpm | No | Blank Bezel | Intel 8260 ac, 2x2 + BT4.1 | None | None | None | 720p | Backlit | Fingerprint Reader | None | 8-cell (96Wh) | 170W | Win10 DG Win7 Pro 64 | 3-year, Depot | 10/15 |
| 20ER000WUS | US | i7-6820HQ | vPro | M4000M 4GB | 16GBx1 non-ECC | 17.3" 4K (3840x2160) IPS | None | None | 512GB SSD M.2 PCIe NVMe | No | Blank Bezel | Intel 8260 ac, 2x2 + BT4.1 | None | None | Smart Card Reader | 720p | Backlit | Fingerprint Reader | X-Rite | 8-cell (96Wh) | 230W | Win10 DG Win7 Pro 64 | 3-year, Depot | 11/15 |
| 20ER000XUS | US | Xeon E3-1505M v5 | vPro | M4000M 4GB | 16GBx1 ECC | 17.3" 4K (3840x2160) IPS | None | None | 512GB SSD M.2 PCIe NVMe | No | Blank Bezel | Intel 8260 ac, 2x2 + BT4.1 | None | None | Smart Card Reader | 720p | Backlit | Fingerprint Reader | X-Rite | 8-cell (96Wh) | 230W | Win10 DG Win7 Pro 64 | 3-year, Depot | 11/15 |
| 20ER000YUS | US | i7-6820HQ | vPro | M3000M 4GB | 8GBx1 non-ECC | 17.3" FHD (1920x1080) IPS | None | None | 1TB 5400rpm | No | DVD±RW | Intel 8260 ac, 2x2 + BT4.1 | None | None | None | 720p | Backlit | Fingerprint Reader | None | 8-cell (96Wh) | 230W | Win10 DG Win7 Pro 64 | 3-year, Depot | 10/15 |
| 20ER002FUS | US | i7-6700HQ | No | M600M 2GB | 8GBx1 non-ECC | 17.3" FHD (1920x1080) IPS | None | None | 500GB 7200rpm | No | DVD±RW | Intel 8260 ac, 2x2 + BT4.1 | None | None | None | 720p | Backlit | Fingerprint Reader | X-Rite | 8-cell (96Wh) | 170W | Win10 Pro 64 | 3-year, Depot | 10/15 |
| 20ER002GUS | US | Xeon E3-1505M v5 | vPro | M600M 2GB | 16GBx1 non-ECC | 17.3" FHD (1920x1080) IPS | None | None | 256GB SSD M.2 Opal2 | No | DVD±RW | Intel 8260 ac, 2x2 + BT4.1 | None | None | None | 720p | Backlit | Fingerprint Reader | None | 8-cell (96Wh) | 170W | Win10 DG Win7 Pro 64 | 3-year, Depot | 10/15 |

| Model | Region | Processor | vPro | Graphics | Memory | Display | Multi-touch | Pen | Storage(HDD/SSD) | RAID | Optical | WLAN + Bluetooth | WWAN | SIM Card | Smart Card Reader | Camera | Keyboard | Fingerprint Reader | Color Calibrator | Battery | Power Adapter | Operating System | Warranty | Ann Date (m/y) |
|------------|--------|------------------|------|------------|----------------|---------------------------|-------------|------|-----------------------|------|-------------|----------------------------|------|----------|-------------------|--------|----------|--------------------|------------------|---------------|---------------|----------------------|---------------|----------------|
| 20ER002HUS | US | Xeon E3-1505M v5 | vPro | M3000M 4GB | 16GBx1 non-ECC | 17.3" FHD (1920x1080) IPS | None | None | 256GB SSD M.2 Opal2 | No | DVD±RW | Intel 8260 ac, 2x2 + BT4.1 | None | None | None | 720p | Backlit | Fingerprint Reader | None | 8-cell (96Wh) | 230W | Win10 Pro 64 | 3-year, Depot | 10/15 |
| 20ER002JUS | US | i7-6820HQ | vPro | M3000M 4GB | 16GBx1 non-ECC | 17.3" FHD (1920x1080) IPS | None | None | 256GB SSD M.2 Opal2 | No | DVD±RW | Intel 8260 ac, 2x2 + BT4.1 | None | None | None | 720p | Backlit | Fingerprint Reader | None | 8-cell (96Wh) | 230W | Win10 Pro 64 | 3-year, Depot | 10/15 |
| 20ER002KUS | US | i7-6700HQ | No | M600M 2GB | 16GBx1 non-ECC | 17.3" FHD (1920x1080) IPS | None | None | 500GB 7200rpm | No | DVD±RW | Intel 8260 ac, 2x2 + BT4.1 | None | None | None | 720p | Backlit | Fingerprint Reader | None | 8-cell (96Wh) | 170W | Win10 DG Win7 Pro 64 | 3-year, Depot | 10/15 |
| 20ER002LUS | US | i7-6820HQ | vPro | M3000M 4GB | 16GBx1 non-ECC | 17.3" FHD (1920x1080) IPS | None | None | 256GB SSD M.2 Opal2 | No | DVD±RW | Intel 8260 ac, 2x2 + BT4.1 | None | None | None | 720p | Backlit | Fingerprint Reader | None | 8-cell (96Wh) | 230W | Win10 DG Win7 Pro 64 | 3-year, Depot | 10/15 |
| 20ER002MUS | US | Xeon E3-1505M v5 | vPro | M3000M 4GB | 16GBx1 non-ECC | 17.3" FHD (1920x1080) IPS | None | None | 256GB SSD M.2 Opal2 | No | DVD±RW | Intel 8260 ac, 2x2 + BT4.1 | None | None | None | 720p | Backlit | Fingerprint Reader | None | 8-cell (96Wh) | 230W | Win10 DG Win7 Pro 64 | 3-year, Depot | 10/15 |
| 20ER002NUS | US | i7-6700HQ | No | M600M 2GB | 16GBx1 non-ECC | 17.3" FHD (1920x1080) IPS | None | None | 500GB 7200rpm | No | DVD±RW | Intel 8260 ac, 2x2 + BT4.1 | None | None | None | 720p | Backlit | Fingerprint Reader | X-Rite | 8-cell (96Wh) | 170W | Win10 Pro 64 | 3-year, Depot | 10/15 |
| 20ER003KUS | US | Xeon E3-1575M v5 | vPro | M3000M 4GB | 16GBx2 non-ECC | 17.3" FHD (1920x1080) IPS | None | None | 1TB SSD M.2 PCIe NVMe | No | Blank Bezel | Intel 8260 ac, 2x2 + BT4.1 | None | None | None | 720p | Backlit | Fingerprint Reader | X-Rite | 8-cell (96Wh) | 230W | Win10 Pro 64 | 3-year, Depot | 08/16 |



ThinkPad P71 Platform Specifications

Product Specifications Reference (PSREF)

| Processor | 7th Generation Intel® Core™ i7 Processor or Intel Xeon® Processor E3 v6 Family | | | | | | | Dimensions | <i>WxDxH:</i> 16.38" x 10.85" x 1.18-1.35"; 416mm x 275.5mm x 29.9-34.2mm | | | | | | | |
|-----------------------------|--|-----------------|--------------|----------------|---------------------|------------------------|--|---|---|----------------------------|-----------------|------------------|--------|----------|--|--|
| | Processor Number | # of Cores | # of Threads | Base Frequency | Max Turbo Frequency | Cache | Memory Types | Processor Graphics | Weight | Starting at 7.3 lb (3.3kg) | | | | | | |
| | i7-7700HQ | 4 | 8 | 2.8 GHz | 3.8 GHz | 6MB | DDR4-2400 | Intel HD Graphics 630 | Case color | Black | | | | | | |
| | i7-7820HQ | | | 2.9 GHz | 3.9 GHz | | | Case material | <i>Display cover:</i> Glass-Fiber + PPS; <i>Bottom:</i> Magnesium/Aluminum | | | | | | | |
| E3-1505M v6 | 3.0 GHz | | | 4.0 GHz | 8MB | Intel HD Graphics P630 | | Smart card reader | <i>Optional:</i> Smart card reader | | | | | | | |
| E3-1535M v6 | 3.1 GHz | | | 4.2 GHz | | ExpressCard | | One slot (ExpressCard/34) | | | | | | | | |
| Graphics | Intel HD Graphics 630 or P630 in processor and NVIDIA Quadro® M620M (2GB memory), P3000M (6GB memory), P4000M (8GB memory), or P5000M (16GB memory); supports external digital monitor via HDMI, Mini DisplayPort, or Thunderbolt™; supports four independent displays; Max resolution: 3840x2160@60Hz (DisplayPort via Mini DisplayPort cable); 3840x2160@60Hz (Thunderbolt); 4096x2160@24Hz (HDMI) | | | | | | | Media reader | 4-in-1 reader (MMC, SD, SDHC, SDXC), supports UHS-II SD card | | | | | | | |
| Chipset | Mobile Intel CM238 Chipset | | | | | | | Ports | Four USB 3.1 Gen 1 (USB 3.0, one Always On), two USB Type-C / Thunderbolt 3, Mini DisplayPort 1.2a, HDMI 1.4b, Ethernet (RJ-45), Dock connector | | | | | | | |
| Memory | 64GB max / 2400MHz DDR4, ECC or non-ECC (ECC function supported only on Xeon processor), dual-channel capable, four DDR4 SO-DIMM sockets | | | | | | | Camera (<i>optional</i>) | HD720p resolution, fixed focus | | | | | | | |
| Display | <i>Some:</i> 17.3" (439mm) FHD (1920x1080), anti-glare, LED backlight, IPS, 300 nits, 16:9 aspect ratio, 800:1 contrast ratio, 72% gamut, 170° viewing angle <i>Some:</i> 17.3" (439mm) 4K (3840x2160), anti-glare, LED backlight, IPS, 300 nits, 16:9 aspect ratio, 800:1 contrast ratio, 90% gamut, 170° viewing angle | | | | | | | Audio support | HD Audio, Realtek® ALC3268 codec / stereo speakers, 2W x 2 / dual array microphone, combo audio/microphone jack | | | | | | | |
| Multi-touch Pen | None | | | | | | | Keyboard | 6-row, spill-resistant, multimedia Fn keys, numeric keypad, optional LED backlight | | | | | | | |
| Storage | <i>Up to 4 drives (two M.2 SSD and two HDD, one of which is in the optical bay)</i> <i>Some:</i> M.2 SSD / PCIe NVMe, PCIe 3.0 x 4, 32Gb/s <i>Some:</i> HDD / SATA 6.0Gb/s, 2.5" wide, 7mm high, Active Protection System™ | | | | | | | UltraNav™ | 3-button TrackPoint® pointing device and 3-button Mylar surface multi-touch touchpad | | | | | | | |
| Optical (<i>optional</i>) | DVD burner, 9.5mm high, fixed, tray-in | | | | | | | Security | Power-on password, hard disk password, supervisor password, security keyhole | | | | | | | |
| Ethernet | <i>Non-vPro model:</i> Intel Ethernet Connection I219-V (Jacksonville) <i>vPro model:</i> Intel Ethernet Connection I219-LM (Jacksonville) | | | | | | | Security chip | Discrete TPM 2.0, TCG Certified | | | | | | | |
| WLAN Bluetooth™ | Intel Dual Band Wireless-AC 8265, Wi-Fi 2x2 802.11ac + BT4.1, M.2 card Bluetooth 4.1 wireless, integrated in Wi-Fi + Bluetooth combo adapter * Intel 8265ac card support BT4.2 but is limited to BT4.1 by Windows OS | | | | | | | vPro (<i>optional</i>) | Intel vPro Technology | | | | | | | |
| WWAN (<i>optional</i>) | <i>One of the following, configurable by model:</i> • Wireless WAN upgradable • Integrated Mobile Broadband 4G LTE-A, Qualcomm® Snapdragon™ X7 LTE-A (Sierra Wireless EM7455), M.2 card | | | | | | | Fingerprint reader | Touch style match on chip fingerprint reader on the keyboard bezel | | | | | | | |
| SIM card (<i>opt</i>) | Micro-SIM card slot, opt Verizon LTE (US) or Lenovo® Connect (EMEA) SIM card | | | | | | | Color calibration | <i>Optional:</i> Pantone® color calibrator by X-Rite® color calibration sensor in palm rest | | | | | | | |
| | | | | | | | NFC | None | | | | | | | | |
| | | | | | | | Battery | Li-Ion 8-cell (96Wh) | | | | | | | | |
| | | | | | | | Max battery life (<i>MobileMark® 2014</i>) | <table border="1"> <thead> <tr> <th>Mode</th> <th>Discrete Graphics</th> <th>Hybrid Graphics</th> </tr> </thead> <tbody> <tr> <td>Max battery life</td> <td>9.8 hr</td> <td>14.25 hr</td> </tr> </tbody> </table> | Mode | Discrete Graphics | Hybrid Graphics | Max battery life | 9.8 hr | 14.25 hr | | |
| Mode | Discrete Graphics | Hybrid Graphics | | | | | | | | | | | | | | |
| Max battery life | 9.8 hr | 14.25 hr | | | | | | | | | | | | | | |
| | | | | | | | AC adapter | 170W or 230W AC adapter | | | | | | | | |
| | | | | | | | Preload | <i>Some:</i> Windows® 10 Home 64 <i>Some:</i> Windows 10 Pro 64 • Lenovo Companion • Lenovo Setting • Microsoft Office preloaded; purchase a product key to activate | | | | | | | | |
| | | | | | | | Limited warranty | <i>One of the following, configurable by model:</i> • 1-year depot repair service • 3-year/1-yr battery depot repair service • 3-year/1-yr battery limited onsite service | | | | | | | | |
| | | | | | | | Mil-Spec test | MIL-STD-810G military certification | | | | | | | | |
| | | | | | | | Environment | EPEAT™ Gold (US only); ENERGY STAR® 6.1; RoHS-compliant | | | | | | | | |

| Model | Region | Processor | Pro | Graphics | Chipset | Memory | Display | Multi-touch | Pen | Storage | (HDD/SSD) | RAID | Optical | WLAN + Bluetooth | WWAN | SIM Card | Smart Card Reader | Camera | Key-board | Color Calibrator | Finger-print Reader | NFC | TPM | Battery | Power Adapter | Operating System | Warranty | Ann Date (m/y) |
|------------|--------|------------------|------|-------------|-------------|---------------|---------------------------|-------------|------|-------------------------------|-----------|-------------|----------------------------|------------------|------|-------------------|-------------------|---------|-----------|---------------------|---------------------|----------|---------------|---------|---------------|------------------|----------|----------------|
| 20HK000VUS | US | Xeon E3-1535M v6 | vPro | P3000M 6GB | Intel CM238 | 8GBx2 ECC | 17.3" 4K (3840x2160) IPS | None | None | 512GB SSD M.2 PCIe NVMe Opal2 | No | Blank Bezel | Intel 8265 ac, 2x2 + BT4.1 | WWAN Upgradable | None | None | 720p | Backlit | X-Rite | Finger-print Reader | None | dTPM 2.0 | 8-cell (96Wh) | 230W | Win10 Pro 64 | 3-year, Depot | 04/17 | |
| 20HK000WUS | US | Xeon E3-1505M v6 | vPro | P4000M 8GB | Intel CM238 | 16GBx2 ECC | 17.3" FHD (1920x1080) IPS | None | None | 1TB SSD M.2 PCIe NVMe Opal2 | No | Blank Bezel | Intel 8265 ac, 2x2 + BT4.1 | WWAN Upgradable | None | Smart Card Reader | 720p | Backlit | None | Finger-print Reader | None | dTPM 2.0 | 8-cell (96Wh) | 230W | Win10 Pro 64 | 3-year, Depot | 04/17 | |
| 20HK000XUS | US | Xeon E3-1535M v6 | vPro | P5000M 16GB | Intel CM238 | 16GBx1 ECC | 17.3" 4K (3840x2160) IPS | None | None | 1TB SSD M.2 PCIe NVMe Opal2 | No | Blank Bezel | Intel 8265 ac, 2x2 + BT4.1 | WWAN Upgradable | None | None | 720p | Backlit | X-Rite | Finger-print Reader | None | dTPM 2.0 | 8-cell (96Wh) | 230W | Win10 Pro 64 | 3-year, Depot | 04/17 | |
| 20HK000YUS | US | Xeon E3-1535M v6 | vPro | P4000M 8GB | Intel CM238 | 8GBx2 ECC | 17.3" 4K (3840x2160) IPS | None | None | 512GB SSD M.2 PCIe NVMe Opal2 | No | Blank Bezel | Intel 8265 ac, 2x2 + BT4.1 | WWAN Upgradable | None | None | 720p | Backlit | X-Rite | Finger-print Reader | None | dTPM 2.0 | 8-cell (96Wh) | 230W | Win10 Pro 64 | 3-year, Depot | 04/17 | |
| 20HK0010US | US | Xeon E3-1535M v6 | vPro | P5000M 16GB | Intel CM238 | 16GBx1 ECC | 17.3" FHD (1920x1080) IPS | None | None | 512GB SSD M.2 PCIe NVMe Opal2 | No | Blank Bezel | Intel 8265 ac, 2x2 + BT4.1 | WWAN Upgradable | None | Smart Card Reader | 720p | Backlit | None | Finger-print Reader | None | dTPM 2.0 | 8-cell (96Wh) | 230W | Win10 Pro 64 | 3-year, Depot | 04/17 | |
| 20HK0011US | US | i7-7700HQ | No | M620M 2GB | Intel CM238 | 8GBx1 non-ECC | 17.3" FHD (1920x1080) IPS | None | None | 1TB 5400rpm | No | Blank Bezel | Intel 8265 ac, 2x2 + BT4.1 | WWAN Upgradable | None | None | 720p | Backlit | None | Finger-print Reader | None | dTPM 2.0 | 8-cell (96Wh) | 170W | Win10 Pro 64 | 3-year, Depot | 04/17 | |
| 20HK0012US | US | Xeon E3-1535M v6 | vPro | P4000M 8GB | Intel CM238 | 16GBx1 ECC | 17.3" FHD (1920x1080) IPS | None | None | 512GB SSD M.2 PCIe NVMe Opal2 | No | Blank Bezel | Intel 8265 ac, 2x2 + BT4.1 | WWAN Upgradable | None | Smart Card Reader | 720p | Backlit | None | Finger-print Reader | None | dTPM 2.0 | 8-cell (96Wh) | 230W | Win10 Pro 64 | 3-year, Depot | 04/17 | |
| 20HK0013US | US | i7-7700HQ | No | M620M 2GB | Intel CM238 | 8GBx1 non-ECC | 17.3" FHD (1920x1080) IPS | None | None | 500GB 7200rpm | No | Blank Bezel | Intel 8265 ac, 2x2 + BT4.1 | WWAN Upgradable | None | None | 720p | Backlit | None | Finger-print Reader | None | dTPM 2.0 | 8-cell (96Wh) | 170W | Win10 Pro 64 | 3-year, Depot | 04/17 | |
| 20HK0014US | US | Xeon E3-1505M v6 | vPro | P3000M 6GB | Intel CM238 | 8GBx2 ECC | 17.3" FHD (1920x1080) IPS | None | None | 1TB SSD M.2 PCIe NVMe Opal2 | No | Blank Bezel | Intel 8265 ac, 2x2 + BT4.1 | WWAN Upgradable | None | Smart Card Reader | 720p | Backlit | None | Finger-print Reader | None | dTPM 2.0 | 8-cell (96Wh) | 230W | Win10 Pro 64 | 3-year, Depot | 04/17 | |
| 20HK0015US | US | Xeon E3-1505M v6 | vPro | M620M 2GB | Intel CM238 | 8GBx2 ECC | 17.3" FHD (1920x1080) IPS | None | None | 256GB SSD M.2 PCIe NVMe Opal2 | No | Blank Bezel | Intel 8265 ac, 2x2 + BT4.1 | WWAN Upgradable | None | Smart Card Reader | 720p | Backlit | None | Finger-print Reader | None | dTPM 2.0 | 8-cell (96Wh) | 170W | Win10 Pro 64 | 3-year, Depot | 04/17 | |
| 20HK0016US | US | Xeon E3-1505M v6 | vPro | M620M 2GB | Intel CM238 | 8GBx1 ECC | 17.3" FHD (1920x1080) IPS | None | None | 256GB SSD M.2 PCIe NVMe Opal2 | No | Blank Bezel | Intel 8265 ac, 2x2 + BT4.1 | WWAN Upgradable | None | Smart Card Reader | 720p | Backlit | None | Finger-print Reader | None | dTPM 2.0 | 8-cell (96Wh) | 170W | Win10 Pro 64 | 3-year, Depot | 04/17 | |
| 20HK0017US | US | i7-7820HQ | vPro | M620M 2GB | Intel CM238 | 8GBx1 non-ECC | 17.3" FHD (1920x1080) IPS | None | None | 500GB 7200rpm | No | Blank Bezel | Intel 8265 ac, 2x2 + BT4.1 | WWAN Upgradable | None | None | 720p | Backlit | None | Finger-print Reader | None | dTPM 2.0 | 8-cell (96Wh) | 170W | Win10 Pro 64 | 3-year, Depot | 04/17 | |
| 20HK0018US | US | i7-7700HQ | No | M620M 2GB | Intel CM238 | 8GBx2 non-ECC | 17.3" FHD (1920x1080) IPS | None | None | 512GB SSD M.2 PCIe NVMe Opal2 | No | Blank Bezel | Intel 8265 ac, 2x2 + BT4.1 | WWAN Upgradable | None | Smart Card Reader | 720p | Backlit | X-Rite | Finger-print Reader | None | dTPM 2.0 | 8-cell (96Wh) | 170W | Win10 Pro 64 | 3-year, Depot | 04/17 | |
| 20HK0019US | US | Xeon E3-1505M v6 | vPro | P4000M 8GB | Intel CM238 | 8GBx2 ECC | 17.3" FHD (1920x1080) IPS | None | None | 1TB SSD M.2 PCIe NVMe Opal2 | No | Blank Bezel | Intel 8265 ac, 2x2 + BT4.1 | WWAN Upgradable | None | Smart Card Reader | 720p | Backlit | None | Finger-print Reader | None | dTPM 2.0 | 8-cell (96Wh) | 230W | Win10 Pro 64 | 3-year, Depot | 04/17 | |
| 20HK001AUS | US | Xeon E3-1535M v6 | vPro | P3000M 6GB | Intel CM238 | 16GBx1 ECC | 17.3" 4K (3840x2160) IPS | None | None | 512GB SSD M.2 PCIe NVMe Opal2 | No | Blank Bezel | Intel 8265 ac, 2x2 + BT4.1 | WWAN Upgradable | None | None | 720p | Backlit | X-Rite | Finger-print Reader | None | dTPM 2.0 | 8-cell (96Wh) | 230W | Win10 Pro 64 | 3-year, Depot | 04/17 | |
| 20HK001BUS | US | Xeon E3-1505M v6 | vPro | P3000M 6GB | Intel CM238 | 8GBx2 ECC | 17.3" FHD (1920x1080) IPS | None | None | 256GB SSD M.2 PCIe NVMe Opal2 | No | Blank Bezel | Intel 8265 ac, 2x2 + BT4.1 | WWAN Upgradable | None | Smart Card Reader | 720p | Backlit | None | Finger-print Reader | None | dTPM 2.0 | 8-cell (96Wh) | 230W | Win10 Pro 64 | 3-year, Depot | 04/17 | |
| 20HK001CUS | US | Xeon E3-1505M v6 | vPro | P3000M 6GB | Intel CM238 | 8GBx2 ECC | 17.3" FHD (1920x1080) IPS | None | None | 512GB SSD M.2 PCIe NVMe Opal2 | No | Blank Bezel | Intel 8265 ac, 2x2 + BT4.1 | WWAN Upgradable | None | Smart Card Reader | 720p | Backlit | None | Finger-print Reader | None | dTPM 2.0 | 8-cell (96Wh) | 230W | Win10 Pro 64 | 3-year, Depot | 04/17 | |
| 20HK001DUS | US | Xeon E3-1535M v6 | vPro | P3000M 6GB | Intel CM238 | 16GBx1 ECC | 17.3" FHD (1920x1080) IPS | None | None | 512GB SSD M.2 PCIe NVMe Opal2 | No | Blank Bezel | Intel 8265 ac, 2x2 + BT4.1 | WWAN Upgradable | None | Smart Card Reader | 720p | Backlit | None | Finger-print Reader | None | dTPM 2.0 | 8-cell (96Wh) | 230W | Win10 Pro 64 | 3-year, Depot | 04/17 | |
| 20HK001EUS | US | i7-7820HQ | vPro | M620M 2GB | Intel CM238 | 8GBx1 non-ECC | 17.3" FHD (1920x1080) IPS | None | None | 1TB 5400rpm | No | Blank Bezel | Intel 8265 ac, 2x2 + BT4.1 | WWAN Upgradable | None | None | 720p | Backlit | None | Finger-print Reader | None | dTPM 2.0 | 8-cell (96Wh) | 170W | Win10 Pro 64 | 3-year, Depot | 04/17 | |
| 20HK001FUS | US | Xeon E3-1535M v6 | vPro | P5000M 16GB | Intel CM238 | 16GBx2 ECC | 17.3" 4K (3840x2160) IPS | None | None | 1TB SSD M.2 PCIe NVMe Opal2 | No | Blank Bezel | Intel 8265 ac, 2x2 + BT4.1 | WWAN Upgradable | None | None | 720p | Backlit | X-Rite | Finger-print Reader | None | dTPM 2.0 | 8-cell (96Wh) | 230W | Win10 Pro 64 | 3-year, Depot | 04/17 | |

| Model | Region | Processor | vPro | Graphics | Chipset | Memory | Display | Multi-touch | Pen | Storage(HDD/SSD) | RAID | Optical | WLAN + Bluetooth | WWAN | SIM Card | Smart Card Reader | Camera | Key-board | Color Calibrator | Finger-print Reader | NFC | TPM | Battery | Power Adapter | Operating System | Warranty | Ann Date (m/y) |
|------------|--------|------------------|------|-------------|-------------|---------------|---------------------------|-------------|------|-------------------------------|------|-------------|----------------------------|-----------------|----------|-------------------|--------|-----------|------------------|---------------------|------|----------|---------------|---------------|------------------|---------------|----------------|
| 20HK001GUS | US | i7-7700HQ | No | M620M 2GB | Intel CM238 | 8GBx2 non-ECC | 17.3" FHD (1920x1080) IPS | None | None | 512GB SSD M.2 PCIe NVMe Opal2 | No | Blank Bezel | Intel 8265 ac, 2x2 + BT4.1 | WWAN Upgradable | None | Smart Card Reader | 720p | Backlit | None | Finger-print Reader | None | dTPM 2.0 | 8-cell (96Wh) | 170W | Win10 Pro 64 | 3-year, Depot | 04/17 |
| 20HK001HUS | US | Xeon E3-1535M v6 | vPro | P5000M 16GB | Intel CM238 | 8GBx2 ECC | 17.3" 4K (3840x2160) IPS | None | None | 512GB SSD M.2 PCIe NVMe Opal2 | No | Blank Bezel | Intel 8265 ac, 2x2 + BT4.1 | WWAN Upgradable | None | None | 720p | Backlit | X-Rite | Finger-print Reader | None | dTPM 2.0 | 8-cell (96Wh) | 230W | Win10 Pro 64 | 3-year, Depot | 04/17 |
| 20HK001JUS | US | i7-7700HQ | No | M620M 2GB | Intel CM238 | 8GBx2 non-ECC | 17.3" FHD (1920x1080) IPS | None | None | 256GB SSD M.2 PCIe NVMe Opal2 | No | Blank Bezel | Intel 8265 ac, 2x2 + BT4.1 | WWAN Upgradable | None | Smart Card Reader | 720p | Backlit | None | Finger-print Reader | None | dTPM 2.0 | 8-cell (96Wh) | 170W | Win10 Pro 64 | 3-year, Depot | 04/17 |
| 20HK001KUS | US | i7-7820HQ | vPro | M620M 2GB | Intel CM238 | 8GBx1 non-ECC | 17.3" FHD (1920x1080) IPS | None | None | 512GB SSD M.2 PCIe NVMe Opal2 | No | Blank Bezel | Intel 8265 ac, 2x2 + BT4.1 | WWAN Upgradable | None | None | 720p | Backlit | None | Finger-print Reader | None | dTPM 2.0 | 8-cell (96Wh) | 170W | Win10 Pro 64 | 3-year, Depot | 04/17 |
| 20HK001LUS | US | Xeon E3-1535M v6 | vPro | P4000M 8GB | Intel CM238 | 16GBx2 ECC | 17.3" 4K (3840x2160) IPS | None | None | 1TB SSD M.2 PCIe NVMe Opal2 | No | Blank Bezel | Intel 8265 ac, 2x2 + BT4.1 | WWAN Upgradable | None | None | 720p | Backlit | X-Rite | Finger-print Reader | None | dTPM 2.0 | 8-cell (96Wh) | 230W | Win10 Pro 64 | 3-year, Depot | 04/17 |
| 20HK001MUS | US | i7-7820HQ | vPro | M620M 2GB | Intel CM238 | 8GBx2 non-ECC | 17.3" FHD (1920x1080) IPS | None | None | 256GB SSD M.2 PCIe NVMe Opal2 | No | Blank Bezel | Intel 8265 ac, 2x2 + BT4.1 | WWAN Upgradable | None | None | 720p | Backlit | None | Finger-print Reader | None | dTPM 2.0 | 8-cell (96Wh) | 170W | Win10 Pro 64 | 3-year, Depot | 04/17 |
| 20HK001PUS | US | Xeon E3-1505M v6 | vPro | P3000M 6GB | Intel CM238 | 8GBx2 non-ECC | 17.3" 4K (3840x2160) IPS | None | None | 512GB SSD M.2 PCIe NVMe Opal2 | No | Blank Bezel | Intel 8265 ac, 2x2 + BT4.1 | WWAN Upgradable | None | None | 720p | Backlit | X-Rite | Finger-print Reader | None | dTPM 2.0 | 8-cell (96Wh) | 230W | Win10 Pro 64 | 3-year, Depot | 05/17 |
| 20HK001QUS | US | i7-7820HQ | vPro | P3000M 6GB | Intel CM238 | 8GBx2 non-ECC | 17.3" FHD (1920x1080) IPS | None | None | 1TB SSD M.2 PCIe NVMe Opal2 | No | Blank Bezel | Intel 8265 ac, 2x2 + BT4.1 | WWAN Upgradable | None | None | 720p | Backlit | None | Finger-print Reader | None | dTPM 2.0 | 8-cell (96Wh) | 230W | Win10 Pro 64 | 3-year, Depot | 05/17 |
| 20HK001RUS | US | i7-7820HQ | vPro | P3000M 6GB | Intel CM238 | 8GBx2 non-ECC | 17.3" FHD (1920x1080) IPS | None | None | 512GB SSD M.2 PCIe NVMe Opal2 | No | Blank Bezel | Intel 8265 ac, 2x2 + BT4.1 | WWAN Upgradable | None | None | 720p | Backlit | None | Finger-print Reader | None | dTPM 2.0 | 8-cell (96Wh) | 230W | Win10 Pro 64 | 3-year, Depot | 05/17 |
| 20HK001SUS | US | i7-7820HQ | vPro | P3000M 6GB | Intel CM238 | 8GBx2 non-ECC | 17.3" 4K (3840x2160) IPS | None | None | 512GB SSD M.2 PCIe NVMe Opal2 | No | Blank Bezel | Intel 8265 ac, 2x2 + BT4.1 | WWAN Upgradable | None | None | 720p | Backlit | X-Rite | Finger-print Reader | None | dTPM 2.0 | 8-cell (96Wh) | 230W | Win10 Pro 64 | 3-year, Depot | 05/17 |
| 20HK001TUS | US | i7-7820HQ | vPro | P3000M 6GB | Intel CM238 | 8GBx2 non-ECC | 17.3" FHD (1920x1080) IPS | None | None | 500GB 7200rpm | No | Blank Bezel | Intel 8265 ac, 2x2 + BT4.1 | WWAN Upgradable | None | None | 720p | Backlit | None | Finger-print Reader | None | dTPM 2.0 | 8-cell (96Wh) | 230W | Win10 Pro 64 | 3-year, Depot | 05/17 |



ThinkPad T460 Platform Specifications

Product Specifications Reference (PSREF)

| Processor | 6th Generation Intel® Core™ i3 / i5 / i7 Processor (i7-6500U for discrete models only) | | | | | | | | Smart card reader <i>Optional</i> : Smart card reader | | | | | | | | | | | | | | | | | | | | | | | | | |
|-------------------------------|---|-------------------|-------------------|-----------------|---------------------|-------|--------------|-----------------------|--|---|-----------------|-----------------|-----------------------------|-------------------|-------------------|-------------------|-------------------------------|-------------------|-------------------|-------------------|---------------------------|-------------------|-------------------|-------------------|-----------------------------|-------------------|-----------------------|-------------------|-------|---------|---------|---------|--|--|
| | Processor Number | # of Cores | # of Threads | Base Frequency | Max Turbo Frequency | Cache | Memory Types | Processor Graphics | Media reader | 4-in-1 reader (MMC, SD, SDHC, SDXC) | | | | | | | | | | | | | | | | | | | | | | | | |
| | i3-6100U | 2 | 4 | 2.3 GHz | - | 3MB | DDR3L-1600 | Intel HD graphics 520 | Ports | Three USB 3.0 (one Always On), MiniDP, HDMI, Ethernet (RJ-45), Dock connector | | | | | | | | | | | | | | | | | | | | | | | | |
| | i5-6200U | | | 2.3 GHz | 2.8 GHz | 3MB | | | WiGig dock (<i>opt</i>) | WiGig dock, coexists with WWAN (WE only) | | | | | | | | | | | | | | | | | | | | | | | | |
| | i5-6300U | | | 2.4 GHz | 3.0 GHz | 3MB | | | Camera (<i>optional</i>) | HD720p resolution, low light sensitive, fixed focus | | | | | | | | | | | | | | | | | | | | | | | | |
| | i7-6500U | | | 2.5 GHz | 3.1 GHz | 4MB | | | Audio support | HD Audio, Realtek® ALC3245 codec / stereo speakers, 2W x 2 / dual array microphone, combo audio/microphone jack | | | | | | | | | | | | | | | | | | | | | | | | |
| | i7-6600U | | | 2.6 GHz | 3.4 GHz | 4MB | | | Keyboard | 6-row, spill-resistant, multimedia Fn keys, optional LED backlight | | | | | | | | | | | | | | | | | | | | | | | | |
| Graphics | Intel HD Graphics 520 in processor only, or Intel HD Graphics 520 in processor and NVIDIA GeForce® 940MX, 2GB memory (discrete graphics is only available in US); supports external digital monitor via HDMI or Mini DisplayPort; supports three independent displays; Max resolution: 3840x2160@60Hz (DisplayPort via Mini DisplayPort cable); 1920x1080@60Hz (HDMI) | | | | | | | | UltraNav™ TrackPoint® pointing device and buttonless Mylar surface multi-touch touchpad | | | | | | | | | | | | | | | | | | | | | | | | | |
| Chipset | Intel SoC (System on Chip) platform | | | | | | | | Security | | | | | | | | | | | | | | | | | | | | | | | | | |
| Memory | 32GB max ⁷ / PC3-12800 1600MHz DDR3L, non-parity, dual-channel capable, two DDR3L SO-DIMM sockets | | | | | | | | Security chip ThinkEngine | | | | | | | | | | | | | | | | | | | | | | | | | |
| Display | <i>Some</i> : 14.0" (355mm) HD (1366x768), anti-glare, LED backlight, 200 nits, 16:9 aspect ratio, 350:1 contrast ratio <i>Some</i> : 14.0" (355mm) FHD (1920x1080), anti-glare, LED backlight, IPS, 250 nits, 16:9 aspect ratio, 700:1 contrast ratio, 160° viewing angle | | | | | | | | vPro (<i>optional</i>) Intel vPro Technology | | | | | | | | | | | | | | | | | | | | | | | | | |
| Multi-touch (<i>opt</i>) | In-cell touch, supports 10-finger gesture, 250 nits | | | | | | | | Fingerprint reader <i>Optional</i> : Swipe style fingerprint reader on the keyboard bezel | | | | | | | | | | | | | | | | | | | | | | | | | |
| Storage | <i>Some</i> : SSD / SATA 6.0Gb/s (e.g. xxxG SSD) <i>Some</i> : SSD / PCIe NVMe, PCIe 3.0 x 2, 16Gb/s (e.g. xxxG SSD PCIe NVMe) <i>Some</i> : HDD / SATA 6.0Gb/s, 2.5" wide, 7mm or 9.5mm high, Shock Mounted Hard Drive, Active Protection System™ <i>Some</i> : SSHD with 8GB NAND flash memory (WE only) | | | | | | | | Internal battery External battery Max battery life (<i>MobileMark® 2014</i>) | | | | | | | | | | | | | | | | | | | | | | | | | |
| Optical | None | | | | | | | | <table border="1"> <thead> <tr> <th>Models</th> <th>6-cell 48Wh</th> <th>6-cell 72Wh</th> <th>3 + 3-cell</th> <th>3 + 6-cell 48Wh</th> <th>3 + 6-cell 72Wh</th> </tr> </thead> <tbody> <tr> <td><i>Integrated model</i></td> <td>10.8 hr</td> <td>15.3 hr</td> <td>10.4 hr</td> <td>15.1 hr</td> <td>20.2 hr</td> </tr> <tr> <td><i>discrete model</i></td> <td>10.5 hr</td> <td>15 hr</td> <td>10.1 hr</td> <td>14.7 hr</td> <td>19.7 hr</td> </tr> </tbody> </table> | | | | | | Models | 6-cell 48Wh | 6-cell 72Wh | 3 + 3-cell | 3 + 6-cell 48Wh | 3 + 6-cell 72Wh | <i>Integrated model</i> | 10.8 hr | 15.3 hr | 10.4 hr | 15.1 hr | 20.2 hr | <i>discrete model</i> | 10.5 hr | 15 hr | 10.1 hr | 14.7 hr | 19.7 hr | | |
| Models | 6-cell 48Wh | 6-cell 72Wh | 3 + 3-cell | 3 + 6-cell 48Wh | 3 + 6-cell 72Wh | | | | | | | | | | | | | | | | | | | | | | | | | | | | | |
| <i>Integrated model</i> | 10.8 hr | 15.3 hr | 10.4 hr | 15.1 hr | 20.2 hr | | | | | | | | | | | | | | | | | | | | | | | | | | | | | |
| <i>discrete model</i> | 10.5 hr | 15 hr | 10.1 hr | 14.7 hr | 19.7 hr | | | | | | | | | | | | | | | | | | | | | | | | | | | | | |
| Ethernet | <i>Non-vPro model</i> : Intel Ethernet Connection I219-V (Jacksonville) <i>vPro model</i> : Intel Ethernet Connection I219-LM (Jacksonville) | | | | | | | | AC adapter 45W or 65W Slim AC adapter | | | | | | | | | | | | | | | | | | | | | | | | | |
| WLAN ⁴ | <i>One of the following, configurable by model (WiGig can coexist with WWAN):</i> • 11ac+BT, Broadcom BCM4356, 2x2, M.2 card • 11ac+BT, Intel Dual Band Wireless-AC 8260, 2x2, M.2 card • WiGig™+11ac+BT, Intel Tri-Band Wireless-AC 18260, 2x2 WLAN, WiGig, M.2 card | | | | | | | | Preload | | | | | | | | | | | | | | | | | | | | | | | | | |
| Bluetooth™ | Bluetooth 4.1 wireless, integrated in Wi-Fi + Bluetooth combo adapter | | | | | | | | Windows 7 Professional 64 preinstalled through downgrade rights in Windows 10 Pro 64 • Lenovo Solution Center • Lenovo Companion • Lenovo Setting • ThinkVantage Product Recovery • Rescue and Recovery™ • ThinkVantage System Update • Adobe® Reader® • Microsoft® Office preloaded; purchase a product key to activate • McAfee® LiveSafe™ (30-day trial) | | | | | | | | | | | | | | | | | | | | | | | | | |
| WWAN (<i>optional</i>) | <i>One of the following, configurable by model (WWAN can coexist with WiGig):</i> • Wireless WAN upgradable • Wireless WAN, Sierra Wireless EM7455, Qualcomm® 4G LTE-Advanced/DC-HSPA+/HSPA+/HSPA/UMTS/GNSS, M.2 card • Wireless WAN, HUAWEI ME906S, HUAWEI 4G LTE/WCDMA/HSPA/GSM/GPRS/EDGE/GNSS, M.2 card (WE only) | | | | | | | | Limited warranty ¹² <i>One of the following, configurable by model:</i> • 1-year depot repair service • 3-year/1-yr battery depot repair service • 3-year/1-yr battery limited onsite service ²⁴ • 3-year/1-yr battery limited onsite service, OID (Onsite International Delivery) | | | | | | | | | | | | | | | | | | | | | | | | | |
| SIM card (<i>opt</i>) | Micro-SIM card slot, optional Verizon LTE (US) or Lenovo Connect (WE) SIM card | | | | | | | | MIL-Spec test MIL-STD-810G military certification | | | | | | | | | | | | | | | | | | | | | | | | | |
| Dimensions ³ | <i>WxDxH</i> : 13.35" x 9.15" x 0.83"; 339mm x 232.5mm x 21mm | | | | | | | | Environment EPEAT™ Gold (US only); ENERGY STAR® 6.1; GREENGUARD®; RoHS-compliant | | | | | | | | | | | | | | | | | | | | | | | | | |
| Weight ² | <table border="1"> <thead> <tr> <th>Models</th> <th>No + 6-cell</th> <th>3-cell + 3-cell</th> <th>3-cell + 6-cell</th> </tr> </thead> <tbody> <tr> <td><i>Integrated Non-touch</i></td> <td>3.84 lb / 1.74 kg</td> <td>3.82 lb / 1.73 kg</td> <td>4.13 lb / 1.87 kg</td> </tr> <tr> <td><i>Integrated Multi-touch</i></td> <td>3.91 lb / 1.77 kg</td> <td>3.88 lb / 1.76 kg</td> <td>4.20 lb / 1.90 kg</td> </tr> <tr> <td><i>Discrete Non-touch</i></td> <td>3.86 lb / 1.75 kg</td> <td>3.90 lb / 1.77 kg</td> <td>4.22 lb / 1.91 kg</td> </tr> <tr> <td><i>Discrete Multi-touch</i></td> <td>3.93 lb / 1.78 kg</td> <td>3.97 lb / 1.80 kg</td> <td>4.28 lb / 1.94 kg</td> </tr> </tbody> </table> | | | | | | | | Models | No + 6-cell | 3-cell + 3-cell | 3-cell + 6-cell | <i>Integrated Non-touch</i> | 3.84 lb / 1.74 kg | 3.82 lb / 1.73 kg | 4.13 lb / 1.87 kg | <i>Integrated Multi-touch</i> | 3.91 lb / 1.77 kg | 3.88 lb / 1.76 kg | 4.20 lb / 1.90 kg | <i>Discrete Non-touch</i> | 3.86 lb / 1.75 kg | 3.90 lb / 1.77 kg | 4.22 lb / 1.91 kg | <i>Discrete Multi-touch</i> | 3.93 lb / 1.78 kg | 3.97 lb / 1.80 kg | 4.28 lb / 1.94 kg | | | | | | |
| Models | No + 6-cell | 3-cell + 3-cell | 3-cell + 6-cell | | | | | | | | | | | | | | | | | | | | | | | | | | | | | | | |
| <i>Integrated Non-touch</i> | 3.84 lb / 1.74 kg | 3.82 lb / 1.73 kg | 4.13 lb / 1.87 kg | | | | | | | | | | | | | | | | | | | | | | | | | | | | | | | |
| <i>Integrated Multi-touch</i> | 3.91 lb / 1.77 kg | 3.88 lb / 1.76 kg | 4.20 lb / 1.90 kg | | | | | | | | | | | | | | | | | | | | | | | | | | | | | | | |
| <i>Discrete Non-touch</i> | 3.86 lb / 1.75 kg | 3.90 lb / 1.77 kg | 4.22 lb / 1.91 kg | | | | | | | | | | | | | | | | | | | | | | | | | | | | | | | |
| <i>Discrete Multi-touch</i> | 3.93 lb / 1.78 kg | 3.97 lb / 1.80 kg | 4.28 lb / 1.94 kg | | | | | | | | | | | | | | | | | | | | | | | | | | | | | | | |
| Case material | Glass-Fiber Reinforced Plastic | | | | | | | | | | | | | | | | | | | | | | | | | | | | | | | | | |

| Model | Region | Processor | vPro | Graphics | Memory | Display | Multi-touch | Storage | Optical | WLAN + Bluetooth | WWAN | SIM Card | Smart Card Reader | Dock | Camera | Keyboard | Fingerprint Reader | Battery (internal+ external) | Power Adapter | Operating System | Warranty | Ann Date (m/y) |
|------------|--------|-----------|------|--------------|--------|-------------------------|----------------------|-----------------|---------|----------------------------|-----------------|----------|-------------------|------|--------|-------------|--------------------|------------------------------|---------------|----------------------|---------------|----------------|
| 20FN002JUS | US | i5-6300U | vPro | Intel HD 520 | 8GBx1 | 14" FHD (1920x1080) IPS | None | 256GB SSD Opal2 | None | Intel 8260 ac, 2x2 + BT4.1 | WWAN Upgradable | None | None | None | 720p | Backlit | Fingerprint Reader | 3-cell(23Wh) + 3-cell(23Wh) | 45W | Win10 DG Win7 Pro 64 | 3-year, Depot | 01/16 |
| 20FN002KUS | US | i7-6600U | vPro | Intel HD 520 | 8GBx2 | 14" FHD (1920x1080) IPS | None | 512GB SSD | None | Intel 8260 ac, 2x2 + BT4.1 | WWAN Upgradable | None | None | None | 720p | Backlit | Fingerprint Reader | 3-cell(23Wh) + 3-cell(23Wh) | 45W | Win10 DG Win7 Pro 64 | 3-year, Depot | 01/16 |
| 20FN002LUS | US | i7-6600U | vPro | Intel HD 520 | 8GBx2 | 14" FHD (1920x1080) IPS | 10-point Multi-touch | 512GB SSD | None | Intel 8260 ac, 2x2 + BT4.1 | WWAN Upgradable | None | None | None | 720p | Backlit | Fingerprint Reader | 3-cell(23Wh) + 3-cell(23Wh) | 45W | Win10 DG Win7 Pro 64 | 3-year, Depot | 01/16 |
| 20FN002MUS | US | i5-6300U | vPro | Intel HD 520 | 8GBx1 | 14" FHD (1920x1080) IPS | None | 180GB SSD Opal2 | None | Intel 8260 ac, 2x2 + BT4.1 | WWAN Upgradable | None | None | None | 720p | Backlit | Fingerprint Reader | 3-cell(23Wh) + 3-cell(23Wh) | 45W | Win10 DG Win7 Pro 64 | 3-year, Depot | 01/16 |
| 20FN002NUS | US | i5-6300U | vPro | Intel HD 520 | 8GBx1 | 14" FHD (1920x1080) IPS | None | 500GB 7200rpm | None | Intel 8260 ac, 2x2 + BT4.1 | WWAN Upgradable | None | None | None | 720p | Backlit | Fingerprint Reader | 3-cell(23Wh) + 3-cell(23Wh) | 45W | Win10 DG Win7 Pro 64 | 3-year, Depot | 01/16 |
| 20FN002PUS | US | i5-6300U | vPro | Intel HD 520 | 8GBx1 | 14" FHD (1920x1080) IPS | 10-point Multi-touch | 256GB SSD Opal2 | None | Intel 8260 ac, 2x2 + BT4.1 | WWAN Upgradable | None | None | None | 720p | Backlit | Fingerprint Reader | 3-cell(23Wh) + 3-cell(23Wh) | 45W | Win10 Pro 64 | 3-year, Depot | 01/16 |
| 20FN002QUS | US | i5-6300U | vPro | Intel HD 520 | 4GBx1 | 14" FHD (1920x1080) IPS | None | 500GB 7200rpm | None | Intel 8260 ac, 2x2 + BT4.1 | WWAN Upgradable | None | None | None | 720p | Backlit | Fingerprint Reader | 3-cell(23Wh) + 3-cell(23Wh) | 45W | Win10 DG Win7 Pro 64 | 3-year, Depot | 01/16 |
| 20FN002RUS | US | i7-6600U | vPro | Intel HD 520 | 8GBx2 | 14" FHD (1920x1080) IPS | 10-point Multi-touch | 512GB SSD | None | Intel 8260 ac, 2x2 + BT4.1 | WWAN Upgradable | None | None | None | 720p | Backlit | Fingerprint Reader | 3-cell(23Wh) + 3-cell(23Wh) | 45W | Win10 Pro 64 | 3-year, Depot | 01/16 |
| 20FN002SUS | US | i5-6200U | No | Intel HD 520 | 4GBx1 | 14" HD (1366x768) | None | 500GB 7200rpm | None | Intel 8260 ac, 2x2 + BT4.1 | WWAN Upgradable | None | None | None | 720p | Non-backlit | Fingerprint Reader | 3-cell(23Wh) + 3-cell(23Wh) | 45W | Win10 DG Win7 Pro 64 | 1-year, Depot | 01/16 |
| 20FN002TUS | US | i5-6300U | vPro | Intel HD 520 | 4GBx1 | 14" HD (1366x768) | None | 500GB 7200rpm | None | Intel 8260 ac, 2x2 + BT4.1 | WWAN Upgradable | None | None | None | 720p | Non-backlit | Fingerprint Reader | 3-cell(23Wh) + 3-cell(23Wh) | 45W | Win10 DG Win7 Pro 64 | 1-year, Depot | 01/16 |
| 20FN002UUS | US | i5-6300U | vPro | Intel HD 520 | 4GBx1 | 14" FHD (1920x1080) IPS | None | 180GB SSD Opal2 | None | Intel 8260 ac, 2x2 + BT4.1 | WWAN Upgradable | None | None | None | 720p | Backlit | Fingerprint Reader | 3-cell(23Wh) + 3-cell(23Wh) | 45W | Win10 DG Win7 Pro 64 | 3-year, Depot | 01/16 |
| 20FN002VUS | US | i7-6600U | vPro | Intel HD 520 | 8GBx1 | 14" FHD (1920x1080) IPS | None | 256GB SSD Opal2 | None | Intel 8260 ac, 2x2 + BT4.1 | WWAN Upgradable | None | None | None | 720p | Backlit | Fingerprint Reader | 3-cell(23Wh) + 3-cell(23Wh) | 45W | Win10 DG Win7 Pro 64 | 3-year, Depot | 01/16 |
| 20FN003CUS | US | i5-6200U | No | Intel HD 520 | 8GBx1 | 14" HD (1366x768) | None | 128GB SSD | None | Intel 8260 ac, 2x2 + BT4.1 | WWAN Upgradable | None | None | None | 720p | Backlit | Fingerprint Reader | 3-cell(23Wh) + 3-cell(23Wh) | 45W | Win10 DG Win7 Pro 64 | 3-year, Depot | 01/16 |
| 20FN003DUS | US | i5-6200U | No | Intel HD 520 | 8GBx1 | 14" HD (1366x768) | None | 192GB SSD | None | Intel 8260 ac, 2x2 + BT4.1 | WWAN Upgradable | None | None | None | 720p | Backlit | Fingerprint Reader | 3-cell(23Wh) + 3-cell(23Wh) | 45W | Win10 DG Win7 Pro 64 | 3-year, Depot | 01/16 |
| 20FN003EUS | US | i5-6300U | vPro | Intel HD 520 | 8GBx1 | 14" FHD (1920x1080) IPS | None | 240GB SSD Opal2 | None | Intel 8260 ac, 2x2 + BT4.1 | WWAN Upgradable | None | None | None | 720p | Backlit | Fingerprint Reader | 3-cell(23Wh) + 3-cell(23Wh) | 45W | Win10 DG Win7 Pro 64 | 3-year, Depot | 01/16 |
| 20FN003FUS | US | i5-6300U | vPro | Intel HD 520 | 8GBx1 | 14" FHD (1920x1080) IPS | None | 192GB SSD | None | Intel 8260 ac, 2x2 + BT4.1 | WWAN Upgradable | None | None | None | 720p | Backlit | Fingerprint Reader | 3-cell(23Wh) + 3-cell(23Wh) | 45W | Win10 DG Win7 Pro 64 | 3-year, Depot | 01/16 |
| 20FN003RUS | US | i5-6200U | No | Intel HD 520 | 4GBx2 | 14" HD (1366x768) | None | 128GB SSD | None | Intel 8260 ac, 2x2 + BT4.1 | WWAN Upgradable | None | None | None | 720p | Backlit | Fingerprint Reader | 3-cell(23Wh) + 3-cell(23Wh) | 45W | Win10 DG Win7 Pro 64 | 3-year, Depot | 01/16 |
| 20FN003SUS | US | i5-6200U | No | Intel HD 520 | 4GBx2 | 14" FHD (1920x1080) IPS | None | 192GB SSD | None | Intel 8260 ac, 2x2 + BT4.1 | WWAN Upgradable | None | None | None | 720p | Backlit | Fingerprint Reader | 3-cell(23Wh) + 3-cell(23Wh) | 45W | Win10 DG Win7 Pro 64 | 3-year, Depot | 01/16 |
| 20FN003TUS | US | i5-6300U | vPro | Intel HD 520 | 4GBx2 | 14" FHD (1920x1080) IPS | None | 192GB SSD | None | Intel 8260 ac, 2x2 + BT4.1 | WWAN Upgradable | None | None | None | 720p | Backlit | Fingerprint Reader | 3-cell(23Wh) + 3-cell(23Wh) | 45W | Win10 DG Win7 Pro 64 | 3-year, Depot | 01/16 |
| 20FN003UUS | US | i5-6300U | vPro | Intel HD 520 | 4GBx2 | 14" FHD (1920x1080) IPS | None | 240GB SSD Opal2 | None | Intel 8260 ac, 2x2 + BT4.1 | WWAN Upgradable | None | None | None | 720p | Backlit | Fingerprint Reader | 3-cell(23Wh) + 3-cell(23Wh) | 45W | Win10 DG Win7 Pro 64 | 3-year, Depot | 01/16 |

| Model | Region | Processor | vPro | Graphics | Memory | Display | Multi-touch | Storage | Optical | WLAN + Bluetooth | WWAN | SIM Card | Smart Card Reader | Dock | Camera | Keyboard | Fingerprint Reader | Battery (internal+ external) | Power Adapter | Operating System | Warranty | Ann Date (m/y) |
|------------|--------|-----------|------|--------------|--------|-------------------------|----------------------|---------------------|---------|----------------------------|-----------------|----------|-------------------|------|--------|-------------|--------------------|------------------------------|---------------|----------------------|---------------|----------------|
| 20FN004UUS | US | i5-6300U | vPro | Intel HD 520 | 8GBx1 | 14" FHD (1920x1080) IPS | None | 180GB SSD Opal2 | None | Intel 8260 ac, 2x2 + BT4.1 | WWAN Upgradable | None | None | None | 720p | Backlit | Fingerprint Reader | 3-cell(23Wh) + 3-cell(23Wh) | 45W | Win10 Pro 64 | 3-year, Depot | 08/16 |
| 20FN004VUS | US | i5-6200U | No | Intel HD 520 | 4GBx1 | 14" HD (1366x768) | None | 500GB 7200rpm Opal2 | None | Intel 8260 ac, 2x2 + BT4.1 | WWAN Upgradable | None | None | None | 720p | Non-backlit | Fingerprint Reader | 3-cell(23Wh) + 3-cell(23Wh) | 45W | Win10 Pro 64 | 1-year, Depot | 08/16 |
| 20FN0056US | US | i5-6300U | vPro | Intel HD 520 | 8GBx1 | 14" FHD (1920x1080) IPS | None | 256GB SSD Opal2 | None | Intel 8260 ac, 2x2 + BT4.1 | WWAN Upgradable | None | None | None | 720p | Backlit | Fingerprint Reader | 3-cell(23Wh) + 3-cell(23Wh) | 45W | Win10 Pro 64 | 3-year, Depot | 10/16 |
| 20FN0057US | US | i5-6200U | No | Intel HD 520 | 4GBx1 | 14" HD (1366x768) | None | 500GB 7200rpm | None | Intel 8260 ac, 2x2 + BT4.1 | WWAN Upgradable | None | None | None | 720p | Non-backlit | Fingerprint Reader | 3-cell(23Wh) + 3-cell(23Wh) | 45W | Win10 Pro 64 | 1-year, Depot | 10/16 |
| 20FN0059US | US | i5-6200U | No | Intel HD 520 | 8GBx1 | 14" FHD (1920x1080) IPS | 10-point Multi-touch | 256GB SSD Opal2 | None | Intel 8260 ac, 2x2 + BT4.1 | WWAN Upgradable | None | None | None | 720p | Backlit | Fingerprint Reader | 3-cell(23Wh) + 3-cell(23Wh) | 45W | Win10 Pro 64 | 3-year, Depot | 10/16 |
| 20FN005AUS | US | i5-6200U | No | Intel HD 520 | 8GBx1 | 14" HD (1366x768) | None | 500GB 7200rpm | None | Intel 8260 ac, 2x2 + BT4.1 | WWAN Upgradable | None | None | None | 720p | Non-backlit | None | 3-cell(23Wh) + 3-cell(23Wh) | 45W | Win10 Pro 64 | 1-year, Depot | 10/16 |
| 20FN005BUS | US | i5-6200U | No | Intel HD 520 | 8GBx1 | 14" FHD (1920x1080) IPS | None | 256GB SSD Opal2 | None | Intel 8260 ac, 2x2 + BT4.1 | WWAN Upgradable | None | None | None | 720p | Backlit | Fingerprint Reader | 3-cell(23Wh) + 3-cell(23Wh) | 45W | Win10 DG Win7 Pro 64 | 3-year, Depot | 11/16 |
| 20FN005CUS | US | i5-6200U | No | Intel HD 520 | 4GBx1 | 14" FHD (1920x1080) IPS | None | 180GB SSD Opal2 | None | Intel 8260 ac, 2x2 + BT4.1 | WWAN Upgradable | None | None | None | 720p | Backlit | Fingerprint Reader | 3-cell(23Wh) + 3-cell(23Wh) | 45W | Win10 DG Win7 Pro 64 | 3-year, Depot | 11/16 |
| 20FN005DUS | US | i5-6200U | No | Intel HD 520 | 4GBx1 | 14" FHD (1920x1080) IPS | None | 256GB SSD Opal2 | None | Intel 8260 ac, 2x2 + BT4.1 | WWAN Upgradable | None | None | None | 720p | Backlit | Fingerprint Reader | 3-cell(23Wh) + 3-cell(23Wh) | 45W | Win10 DG Win7 Pro 64 | 3-year, Depot | 11/16 |
| 20FN005EUS | US | i5-6200U | No | Intel HD 520 | 8GBx1 | 14" FHD (1920x1080) IPS | None | 180GB SSD Opal2 | None | Intel 8260 ac, 2x2 + BT4.1 | WWAN Upgradable | None | None | None | 720p | Backlit | Fingerprint Reader | 3-cell(23Wh) + 3-cell(23Wh) | 45W | Win10 DG Win7 Pro 64 | 3-year, Depot | 11/16 |
| 20FN005FUS | US | i5-6300U | vPro | Intel HD 520 | 4GBx1 | 14" FHD (1920x1080) IPS | None | 256GB SSD Opal2 | None | Intel 8260 ac, 2x2 + BT4.1 | WWAN Upgradable | None | None | None | 720p | Backlit | Fingerprint Reader | 3-cell(23Wh) + 3-cell(23Wh) | 45W | Win10 DG Win7 Pro 64 | 3-year, Depot | 11/16 |
| 20FN005GUS | US | i5-6300U | vPro | Intel HD 520 | 4GBx1 | 14" FHD (1920x1080) IPS | None | 500GB 7200rpm | None | Intel 8260 ac, 2x2 + BT4.1 | WWAN Upgradable | None | None | None | 720p | Non-backlit | Fingerprint Reader | 3-cell(23Wh) + 3-cell(23Wh) | 45W | Win10 DG Win7 Pro 64 | 1-year, Depot | 12/16 |
| 20FN005HUS | US | i5-6200U | No | Intel HD 520 | 4GBx2 | 14" FHD (1920x1080) IPS | None | 128GB SSD | None | Intel 8260 ac, 2x2 + BT4.1 | WWAN Upgradable | None | None | None | 720p | Backlit | Fingerprint Reader | 3-cell(23Wh) + 3-cell(23Wh) | 45W | Win10 DG Win7 Pro 64 | 3-year, Depot | 12/16 |
| 20FN005JUS | US | i5-6200U | No | Intel HD 520 | 4GBx1 | 14" FHD (1920x1080) IPS | None | 500GB 7200rpm | None | Intel 8260 ac, 2x2 + BT4.1 | WWAN Upgradable | None | None | None | 720p | Non-backlit | Fingerprint Reader | 3-cell(23Wh) + 3-cell(23Wh) | 45W | Win10 DG Win7 Pro 64 | 1-year, Depot | 12/16 |
| 20FN005KUS | US | i5-6200U | No | Intel HD 520 | 8GBx1 | 14" FHD (1920x1080) IPS | None | 500GB 7200rpm | None | Intel 8260 ac, 2x2 + BT4.1 | WWAN Upgradable | None | None | None | 720p | Non-backlit | Fingerprint Reader | 3-cell(23Wh) + 3-cell(23Wh) | 45W | Win10 Pro 64 | 1-year, Depot | 12/16 |
| 20FN005LUS | US | i5-6200U | No | Intel HD 520 | 4GBx1 | 14" FHD (1920x1080) IPS | None | 500GB 7200rpm | None | Intel 8260 ac, 2x2 + BT4.1 | WWAN Upgradable | None | None | None | 720p | Non-backlit | Fingerprint Reader | 3-cell(23Wh) + 3-cell(23Wh) | 45W | Win10 Pro 64 | 1-year, Depot | 12/16 |
| 20FN005MUS | US | i5-6200U | No | Intel HD 520 | 4GBx1 | 14" FHD (1920x1080) IPS | None | 500GB 7200rpm Opal2 | None | Intel 8260 ac, 2x2 + BT4.1 | WWAN Upgradable | None | None | None | 720p | Non-backlit | Fingerprint Reader | 3-cell(23Wh) + 3-cell(23Wh) | 45W | Win10 Pro 64 | 1-year, Depot | 12/16 |
| 20FNA04PUS | US | i7-6600U | vPro | Intel HD 520 | 8GBx1 | 14" FHD (1920x1080) IPS | None | 256GB SSD Opal2 | None | Intel 8260 ac, 2x2 + BT4.1 | WWAN Upgradable | None | None | None | 720p | Backlit | Fingerprint Reader | 3-cell(23Wh) + 3-cell(23Wh) | 45W | Win10 Pro 64 | 3-year, Depot | 08/16 |



ThinkPad T460p Platform Specifications

Product Specifications Reference (PSREF)

| Processor | 6th Generation Intel® Core™ i5 / i7 Processor | | | | | | | Smart card reader Media reader Ports Camera (optional) Audio support Keyboard UltraNav™ | Optional: Smart card reader 4-in-1 reader (MMC, SD, SDHC, SDXC) Three USB 3.0 (one Always On), MiniDP, HDMI, Ethernet (RJ-45), Dock connector HD720p resolution, low light sensitive, fixed focus HD Audio, Realtek® ALC3245 codec / stereo speakers, 1W x 2 / dual array microphone, combo audio/microphone jack 6-row, spill-resistant, multimedia Fn keys, LED backlight TrackPoint® pointing device and buttonless Mylar surface multi-touch touchpad | | | | | | | | | | | | |
|--|---|-------------------|--------------|----------------|---------------------|---------|--------------|--|---|-----------------------|--------|-------------|------------------|-------------------|-------------------|----------------|-------------------|-------------------|--------|--------|-------|
| | Processor Number | # of Cores | # of Threads | Base Frequency | Max Turbo Frequency | Cache | Memory Types | | | Processor Graphics | | | | | | | | | | | |
| | i5-6300HQ | 4 | 4 | 2.3 GHz | 3.2 GHz | 6MB | DDR4-2133 | | | Intel HD Graphics 530 | | | | | | | | | | | |
| | i5-6440HQ | | | 2.6 GHz | 3.5 GHz | | | | | | | | | | | | | | | | |
| | i7-6700HQ | | | 8 | 2.6 GHz | 3.5 GHz | | | | | 6MB | | | | | | | | | | |
| i7-6820HQ | 2.7 GHz | | | | 3.6 GHz | 8MB | | | | | | | | | | | | | | | |
| Graphics | Intel HD Graphics 530 in processor only, or Intel HD Graphics 530 in processor and NVIDIA GeForce® 940MX, 2GB memory; supports external digital monitor via HDMI or Mini DisplayPort; supports three independent displays; Max resolution: 3840x2160 @60Hz (DisplayPort via Mini DisplayPort cable); 4096x2160 @24Hz (HDMI) | | | | | | | Security Security chip ThinkEngine vPro (optional) Fingerprint reader | Power-on password, hard disk password, supervisor password, security keyhole Discrete TPM 1.2 TCG Certified and Firmware TPM 2.0 integrated in chipset Delivers improved thermal and power efficiency, up to 30 day standby, faster resume time, enhanced security, as well as anti-tampering measures Intel vPro Technology Optional: Touch style fingerprint reader on the keyboard bezel | | | | | | | | | | | | |
| Chipset Memory | Mobile Intel QM170 Chipset 32GB max ⁷ / 2133MHz DDR4, dual-channel capable, two DDR4 SO-DIMM sockets | | | | | | | Battery Max battery life ¹⁰ (MobileMark® 2014) | Li-Ion 3-cell (23Wh) or 6-cell (48Wh or 72Wh) | | | | | | | | | | | | |
| Display | Some: 14.0" (355mm) FHD (1920x1080), anti-glare, LED backlight, IPS, 250 nits, 16:9 aspect ratio, 600:1 contrast ratio, 160° viewing angle Some: 14.0" (355mm) WQHD (2560x1440), anti-glare, LED backlight, IPS, 300 nits, 16:9 aspect ratio, 700:1 or 800:1 contrast ratio, 160° viewing angle | | | | | | | <table border="1"> <thead> <tr> <th>Models</th> <th>3-cell</th> <th>6-cell 48Wh</th> <th>6-cell 72Wh</th> </tr> </thead> <tbody> <tr> <td>Integrated model</td> <td>4.34 hr</td> <td>8.58 hr</td> <td>13 hr</td> </tr> <tr> <td>discrete model</td> <td>4.1 hr</td> <td>8.5 hr</td> <td>13 hr</td> </tr> </tbody> </table> | | Models | 3-cell | 6-cell 48Wh | 6-cell 72Wh | Integrated model | 4.34 hr | 8.58 hr | 13 hr | discrete model | 4.1 hr | 8.5 hr | 13 hr |
| Models | 3-cell | 6-cell 48Wh | 6-cell 72Wh | | | | | | | | | | | | | | | | | | |
| Integrated model | 4.34 hr | 8.58 hr | 13 hr | | | | | | | | | | | | | | | | | | |
| discrete model | 4.1 hr | 8.5 hr | 13 hr | | | | | | | | | | | | | | | | | | |
| Multi-touch | None | | | | | | | AC adapter | 90W or 135W AC adapter | | | | | | | | | | | | |
| Storage | Some: SSD / SATA 6.0Gb/s (e.g. xxxG SSD) Some: SSD / PCIe NVMe, PCIe 3.0 x 2, 16Gb/s (e.g. xxxG SSD PCIe NVMe) Some: HDD / SATA 6.0Gb/s, 2.5" wide, 7mm or 9.5mm high, Shock Mounted Hard Drive, Active Protection System™ | | | | | | | Preload | Windows 7 Professional 64 preinstalled through downgrade rights in Windows 10 Pro 64 • Lenovo Solution Center • Lenovo Companion • Lenovo Setting • ThinkVantage Product Recovery • Rescue and Recovery™ • ThinkVantage System Update • Adobe® Reader® • Microsoft® Office preloaded; purchase a product key to activate • McAfee® LiveSafe™ (30-day trial) | | | | | | | | | | | | |
| Optical | None | | | | | | | Limited warranty ¹² One of the following, configurable by model: • 1-year depot repair service • 3-year/1-yr battery depot repair service • 3-year/1-yr battery limited onsite service ²⁴ • 3-year/1-yr battery limited onsite service, OID (Onsite International Delivery) | Mil-Spec test MIL-STD-810G military certification | | | | | | | | | | | | |
| Ethernet | Intel Ethernet Connection I219-LM (Jacksonville) | | | | | | | | | | | | | | | | | | | | |
| WLAN ⁴ | One of the following, configurable by model: • 11ac+BT, Broadcom BCM4356, 2x2, M.2 card • 11ac+BT, Intel Dual Band Wireless-AC 8260, 2x2, M.2 card | | | | | | | | | | | | | | | | | | | | |
| Bluetooth™ | Bluetooth 4.1 wireless, integrated in Wi-Fi + Bluetooth combo adapter | | | | | | | | | | | | | | | | | | | | |
| WWAN (optional) | One of the following, configurable by model: • Wireless WAN upgradable • Wireless WAN, Sierra Wireless EM7455, Qualcomm® 4G LTE-Advanced/DC-HSPA+/HSPA+/HSPA/UMTS/GNSS, M.2 card • Wireless WAN, HUAWEI ME906S, HUAWEI 4G LTE/WCDMA/HSPA/GSM/GPRS/EDGE/GNSS, M.2 card (WE only) | | | | | | | | | | | | | | | | | | | | |
| SIM card (opt) | Micro-SIM card slot, optional Verizon LTE (US) or Lenovo Connect (WE) SIM card | | | | | | | Environment | EPEAT™ Gold (US only); ENERGY STAR® 6.1; GREENGUARD®; RoHS-compliant | | | | | | | | | | | | |
| Dimensions ³ Weight ² | WxDxH: 13.54" x 9.41" x 0.96"; 344mm x 239mm x 24.4mm | | | | | | | <table border="1"> <thead> <tr> <th>Models</th> <th>3-cell</th> <th>6-cell</th> </tr> </thead> <tbody> <tr> <td>Integrated model</td> <td>3.99 lb / 1.81 kg</td> <td>4.70 lb / 2.13 kg</td> </tr> <tr> <td>discrete model</td> <td>4.04 lb / 1.83 kg</td> <td>4.75 lb / 2.15 kg</td> </tr> </tbody> </table> | | Models | 3-cell | 6-cell | Integrated model | 3.99 lb / 1.81 kg | 4.70 lb / 2.13 kg | discrete model | 4.04 lb / 1.83 kg | 4.75 lb / 2.15 kg | | | |
| Models | 3-cell | 6-cell | | | | | | | | | | | | | | | | | | | |
| Integrated model | 3.99 lb / 1.81 kg | 4.70 lb / 2.13 kg | | | | | | | | | | | | | | | | | | | |
| discrete model | 4.04 lb / 1.83 kg | 4.75 lb / 2.15 kg | | | | | | | | | | | | | | | | | | | |
| Case material | Display cover: PolyCarbonate/Acrylonitrile-Butadiene-Styrene (PC/ABS) plastic; Bottom: Magnesium alloy | | | | | | | | | | | | | | | | | | | | |

| Model | Region | Processor | vPro | Graphics | Memory | Display | Multi-touch | Storage | Optical | WLAN + Bluetooth | WWAN | SIM Card | Smart Card Reader | Camera | Keyboard | Fingerprint Reader | Battery | Power Adapter | Operating System | Warranty | Ann Date (m/y) |
|------------|--------|-----------|------|--------------|--------|-------------------------|-------------|-----------------|---------|----------------------------|-----------------|----------|-------------------|--------|----------|--------------------|---------------|---------------|----------------------|---------------|----------------|
| 20FW000SUS | US | i5-6440HQ | vPro | Intel HD 530 | 8GBx1 | 14" FHD (1920x1080) IPS | None | 192GB SSD | None | Intel 8260 ac, 2x2 + BT4.1 | WWAN Upgradable | None | None | 720p | Backlit | Fingerprint Reader | 3-cell (23Wh) | 90W | Win10 DG Win7 Pro 64 | 3-year, Depot | 03/16 |
| 20FW000TUS | US | i7-6820HQ | vPro | 940MX 2GB | 16GBx1 | 14" FHD (1920x1080) IPS | None | 512GB SSD | None | Intel 8260 ac, 2x2 + BT4.1 | WWAN Upgradable | None | None | 720p | Backlit | Fingerprint Reader | 6-cell (48Wh) | 135W | Win10 DG Win7 Pro 64 | 3-year, Depot | 03/16 |
| 20FW000UUS | US | i5-6440HQ | vPro | Intel HD 530 | 8GBx1 | 14" FHD (1920x1080) IPS | None | 192GB SSD | None | Intel 8260 ac, 2x2 + BT4.1 | WWAN Upgradable | None | None | 720p | Backlit | Fingerprint Reader | 6-cell (72Wh) | 90W | Win10 DG Win7 Pro 64 | 3-year, Depot | 03/16 |
| 20FW000VUS | US | i5-6440HQ | vPro | Intel HD 530 | 8GBx1 | 14" FHD (1920x1080) IPS | None | 256GB SSD Opal2 | None | Intel 8260 ac, 2x2 + BT4.1 | WWAN Upgradable | None | None | 720p | Backlit | Fingerprint Reader | 6-cell (48Wh) | 90W | Win10 DG Win7 Pro 64 | 3-year, Depot | 03/16 |
| 20FW000WUS | US | i7-6820HQ | vPro | 940MX 2GB | 8GBx1 | 14" FHD (1920x1080) IPS | None | 256GB SSD Opal2 | None | Intel 8260 ac, 2x2 + BT4.1 | WWAN Upgradable | None | None | 720p | Backlit | Fingerprint Reader | 6-cell (48Wh) | 135W | Win10 DG Win7 Pro 64 | 3-year, Depot | 03/16 |
| 20FW002DUS | US | i5-6440HQ | vPro | Intel HD 530 | 8GBx1 | 14" FHD (1920x1080) IPS | None | 256GB SSD Opal2 | None | Intel 8260 ac, 2x2 + BT4.1 | WWAN Upgradable | None | Smart Card Reader | 720p | Backlit | Fingerprint Reader | 6-cell (48Wh) | 90W | Win10 Pro 64 | 3-year, Depot | 03/16 |
| 20FW003QUS | US | i5-6440HQ | vPro | 940MX 2GB | 8GBx1 | 14" FHD (1920x1080) IPS | None | 256GB SSD Opal2 | None | Intel 8260 ac, 2x2 + BT4.1 | WWAN Upgradable | None | None | 720p | Backlit | Fingerprint Reader | 6-cell (48Wh) | 135W | Win10 Pro 64 | 3-year, Depot | 04/16 |
| 20FW003RUS | US | i5-6440HQ | vPro | 940MX 2GB | 8GBx1 | 14" FHD (1920x1080) IPS | None | 256GB SSD Opal2 | None | Intel 8260 ac, 2x2 + BT4.1 | WWAN Upgradable | None | None | 720p | Backlit | Fingerprint Reader | 6-cell (48Wh) | 135W | Win10 DG Win7 Pro 64 | 3-year, Depot | 04/16 |
| 20FW003SUS | US | i5-6440HQ | vPro | 940MX 2GB | 8GBx1 | 14" FHD (1920x1080) IPS | None | 512GB SSD | None | Intel 8260 ac, 2x2 + BT4.1 | WWAN Upgradable | None | None | 720p | Backlit | Fingerprint Reader | 6-cell (48Wh) | 135W | Win10 DG Win7 Pro 64 | 3-year, Depot | 04/16 |
| 20FW003TUS | US | i5-6440HQ | vPro | 940MX 2GB | 8GBx1 | 14" FHD (1920x1080) IPS | None | 512GB SSD | None | Intel 8260 ac, 2x2 + BT4.1 | WWAN Upgradable | None | None | 720p | Backlit | Fingerprint Reader | 6-cell (48Wh) | 135W | Win10 Pro 64 | 3-year, Depot | 04/16 |
| 20FW0054US | US | i5-6440HQ | vPro | Intel HD 530 | 8GBx1 | 14" FHD (1920x1080) IPS | None | 180GB SSD Opal2 | None | Intel 8260 ac, 2x2 + BT4.1 | WWAN Upgradable | None | None | 720p | Backlit | Fingerprint Reader | 6-cell (48Wh) | 90W | Win10 DG Win7 Pro 64 | 3-year, Depot | 11/16 |
| 20FW0055US | US | i5-6440HQ | vPro | Intel HD 530 | 8GBx1 | 14" FHD (1920x1080) IPS | None | 180GB SSD Opal2 | None | Intel 8260 ac, 2x2 + BT4.1 | WWAN Upgradable | None | None | 720p | Backlit | Fingerprint Reader | 3-cell (23Wh) | 90W | Win10 DG Win7 Pro 64 | 3-year, Depot | 11/16 |
| 20FW0056US | US | i5-6440HQ | vPro | Intel HD 530 | 8GBx1 | 14" FHD (1920x1080) IPS | None | 256GB SSD Opal2 | None | Intel 8260 ac, 2x2 + BT4.1 | WWAN Upgradable | None | None | 720p | Backlit | Fingerprint Reader | 3-cell (23Wh) | 90W | Win10 DG Win7 Pro 64 | 3-year, Depot | 11/16 |
| 20FW0057US | US | i7-6820HQ | vPro | 940MX 2GB | 8GBx1 | 14" FHD (1920x1080) IPS | None | 256GB SSD Opal2 | None | Intel 8260 ac, 2x2 + BT4.1 | WWAN Upgradable | None | None | 720p | Backlit | Fingerprint Reader | 6-cell (48Wh) | 135W | Win10 Pro 64 | 3-year, Depot | 12/16 |



ThinkPad T460s Platform Specifications

Product Specifications Reference (PSREF)

| | | | | | | | | | | |
|-------------------------|--|------------|--------------|----------------|---------------------|-------|--------------|--|--|-----------------------|
| Processor | 6th Generation Intel® Core™ i5 / i7 Processor | | | | | | | Smart card reader Media reader Ports WiGig dock (opt) | Optional: Smart card reader 4-in-1 reader (MMC, SD, SDHC, SDXC) Three USB 3.0 (one Always On), MiniDP, HDMI, Ethernet (RJ-45), Dock connector WiGig dock, mutually exclusive with WWAN | |
| | Processor Number | # of Cores | # of Threads | Base Frequency | Max Turbo Frequency | Cache | Memory Types | | | Processor Graphics |
| | i5-6200U | 2 | 4 | 2.3 GHz | 2.8 GHz | 3MB | DDR4-2133 | | | Intel HD Graphics 520 |
| | i5-6300U | | | 2.4 GHz | 3 GHz | 3MB | | | | |
| i7-6600U | 2.6 GHz | | | 3.4 GHz | 4MB | | | | | |
| Graphics | Intel HD Graphics 520 in processor only, or Intel HD Graphics 520 in processor and NVIDIA GeForce® 930M, 2GB memory (discrete graphics is only available in US); supports external digital monitor via HDMI or Mini DisplayPort; supports three independent displays; Max resolution: 3840x2160@60Hz (DisplayPort via Mini DisplayPort cable); 4096x2160@24Hz (HDMI) | | | | | | | Camera (optional) Audio support | HD720p resolution, low light sensitive, fixed focus HD Audio, Realtek® ALC3245 codec / stereo speakers, 1W x 2 / dual array microphone, combo audio/microphone jack | |
| Chipset | Intel SoC (System on Chip) platform | | | | | | | Keyboard | 6-row, spill-resistant, multimedia Fn keys, optional LED backlight | |
| Memory | 20GB or 24GB max ⁷ / 2133MHz DDR4, dual-channel capable, 4GB or 8GB memory soldered to systemboard, one DDR4 SO-DIMM socket | | | | | | | UltraNav™ | TrackPoint® pointing device and buttonless crystal silk surface multi-touch touchpad | |
| Display | Some: 14.0" (355mm) FHD (1920x1080), anti-glare, LED backlight, IPS, 250 nits, 16:9 aspect ratio, 700:1 contrast ratio, 160° viewing angle Some: 14.0" (355mm) WQHD (2560x1440), anti-glare, LED backlight, IPS, 300 nits, 16:9 aspect ratio, 700:1 contrast ratio, 160° viewing angle | | | | | | | Security | Power-on password, hard disk password, supervisor password, security keyhole | |
| Multi-touch (opt) | In-cell touch, supports 10-finger gesture, 250 nits | | | | | | | Security chip | Discrete TPM 1.2 TCG Certified and Firmware TPM 2.0 integrated in chipset | |
| Storage | Some: M.2 SSD / SATA 6.0Gb/s (e.g. xxxG SSD) Some: M.2 SSD / PCIe NVMe, PCIe 3.0 x 4, 32Gb/s (e.g. xxxG SSD PCIe NVMe) | | | | | | | ThinkEngine | Delivers improved thermal and power efficiency, up to 30 day standby, faster resume time, enhanced security, as well as anti-tampering measures | |
| Optical | None | | | | | | | vPro (optional) | Intel vPro Technology | |
| Ethernet | Non-vPro model: Intel Ethernet Connection I219-V (Jacksonville) vPro model: Intel Ethernet Connection I219-LM (Jacksonville) | | | | | | | Fingerprint reader | Optional: Touch style fingerprint reader on the palm rest | |
| WLAN ⁴ | One of the following, configurable by model (WiGig is mutually exclusive with WWAN): • 11ac+BT, Broadcom BCM4356, 2x2, M.2 card • 11ac+BT, Intel Dual Band Wireless-AC 8260, 2x2, M.2 card • WiGig™+11ac+BT, Intel Tri-Band Wireless-AC 18260, 2x2 WLAN, WiGig, M.2 card | | | | | | | Internal battery | Front Li-Polymer 3-cell (23Wh) and rear Li-Ion 3-cell (26Wh), both Integrated | |
| Bluetooth™ | Bluetooth 4.1 wireless, integrated in Wi-Fi + Bluetooth combo adapter | | | | | | | Max battery life ¹⁰ | MobileMark® 2014: up to 10.5 hr | |
| WWAN (optional) | One of the following, configurable by model (mutually exclusive with WiGig): • Wireless WAN upgradable • Wireless WAN, Sierra Wireless EM7455, Qualcomm® 4G LTE-Advanced/DC-HSPA+/HSPA+/HSPA/UMTS/GNSS, M.2 card • Wireless WAN, HUAWEI ME906S, HUAWEI 4G LTE/WCDMA/HSPA/GSM/GPRS/EDGE/GNSS, M.2 card (WE only) | | | | | | | AC adapter | 45W or 65W AC adapter | |
| SIM card (opt) | Micro-SIM card slot, optional Verizon LTE (US) or Lenovo Connect (WE) SIM card | | | | | | | Preload | Windows 7 Professional 64 preinstalled through downgrade rights in Windows 10 Pro 64 • Lenovo Solution Center • Lenovo Companion • Lenovo Setting • Microsoft Office preloaded; purchase a product key to activate • McAfee® LiveSafe™ (30-day trial) | |
| Dimensions ³ | WxDxH: 13.03" x 8.93" x 0.67-0.74"; 331mm x 226.8mm x 16.9-18.8mm | | | | | | | Limited warranty ¹² | One of the following, configurable by model: • 1-year depot repair service • 3-year/1-yr battery depot repair service • 3-year/1-yr battery limited onsite service ²⁴ • 3-year/1-yr battery limited onsite service, OID (Onsite International Delivery) | |
| Weight ² | Integrated model: starting at 3.0 lb (1.36kg); Discrete model: starting at 3.3 lb (1.50kg) | | | | | | | Mil-Spec test | MIL-STD-810G military certification | |
| Case material | Display cover: Carbon-Fiber Reinforced Plastic; Bottom: Magnesium alloy | | | | | | | Environment | EPEAT™ Gold (US only); ENERGY STAR® 6.1; GREENGUARD®; RoHS-compliant | |

| Model | Region | Processor | vPro | Graphics | Memory (Soldered +DIMM) | Display | Multi-touch | Storage(HDD/SSD) | Optical | WLAN + Bluetooth | WWAN | SIM Card | Smart Card Reader | Dock | Camera | Keyboard | Fingerprint Reader | Battery (internal) | Power Adapter | Operating System | Warranty | Ann Date (m/y) |
|------------|--------|-----------|------|--------------|-------------------------|--------------------------|----------------------|---------------------|---------|----------------------------|-----------------|----------|-------------------|------|--------|-------------|--------------------|-----------------------------|---------------|----------------------|---------------|----------------|
| 20F90017US | US | i5-6200U | No | Intel HD 520 | 4GB + 4GB | 14" FHD (1920x1080) IPS | None | 256GB SSD M.2 Opal2 | None | Intel 8260 ac, 2x2 + BT4.1 | WWAN Upgradable | None | None | None | 720p | Backlit | Fingerprint Reader | 3-cell(23Wh) + 3-cell(26Wh) | 45W | Win10 Pro 64 | 3-year, Depot | 10/16 |
| 20F90018US | US | i5-6200U | No | Intel HD 520 | 4GB + 4GB | 14" FHD (1920x1080) IPS | None | 256GB SSD M.2 Opal2 | None | Intel 8260 ac, 2x2 + BT4.1 | WWAN Upgradable | None | None | None | 720p | Backlit | Fingerprint Reader | 3-cell(23Wh) + 3-cell(26Wh) | 45W | Win10 DG Win7 Pro 64 | 3-year, Depot | 10/16 |
| 20F90019US | US | i7-6600U | vPro | Intel HD 520 | 4GB + 8GB | 14" WQHD (2560x1440) IPS | None | 512GB SSD M.2 | None | Intel 8260 ac, 2x2 + BT4.1 | WWAN Upgradable | None | None | None | 720p | Backlit | Fingerprint Reader | 3-cell(23Wh) + 3-cell(26Wh) | 45W | Win10 Pro 64 | 3-year, Depot | 02/16 |
| 20F9001CUS | US | i7-6600U | vPro | Intel HD 520 | 4GB + 4GB | 14" FHD (1920x1080) IPS | None | 256GB SSD M.2 Opal2 | None | Intel 8260 ac, 2x2 + BT4.1 | WWAN Upgradable | None | None | None | 720p | Backlit | Fingerprint Reader | 3-cell(23Wh) + 3-cell(26Wh) | 45W | Win10 Pro 64 | 3-year, Depot | 02/16 |
| 20F9001DUS | US | i7-6600U | vPro | Intel HD 520 | 4GB + 8GB | 14" FHD (1920x1080) IPS | None | 512GB SSD M.2 | None | Intel 8260 ac, 2x2 + BT4.1 | WWAN Upgradable | None | None | None | 720p | Backlit | Fingerprint Reader | 3-cell(23Wh) + 3-cell(26Wh) | 45W | Win10 DG Win7 Pro 64 | 3-year, Depot | 02/16 |
| 20F90033US | US | i7-6600U | vPro | Intel HD 520 | 4GB + 4GB | 14" WQHD (2560x1440) IPS | None | 512GB SSD M.2 | None | Intel 8260 ac, 2x2 + BT4.1 | WWAN Upgradable | None | None | None | 720p | Backlit | Fingerprint Reader | 3-cell(23Wh) + 3-cell(26Wh) | 45W | Win10 DG Win7 Pro 64 | 3-year, Depot | 02/16 |
| 20F90034US | US | i5-6300U | vPro | Intel HD 520 | 4GB Soldered | 14" FHD (1920x1080) IPS | None | 128GB SSD M.2 | None | Intel 8260 ac, 2x2 + BT4.1 | WWAN Upgradable | None | None | None | 720p | Non-backlit | Fingerprint Reader | 3-cell(23Wh) + 3-cell(26Wh) | 45W | Win10 DG Win7 Pro 64 | 3-year, Depot | 02/16 |
| 20F90035US | US | i7-6600U | vPro | Intel HD 520 | 4GB + 4GB | 14" FHD (1920x1080) IPS | None | 512GB SSD M.2 | None | Intel 8260 ac, 2x2 + BT4.1 | WWAN Upgradable | None | None | None | 720p | Backlit | Fingerprint Reader | 3-cell(23Wh) + 3-cell(26Wh) | 45W | Win10 DG Win7 Pro 64 | 3-year, Depot | 02/16 |
| 20F90036US | US | i5-6300U | vPro | Intel HD 520 | 4GB + 4GB | 14" FHD (1920x1080) IPS | None | 128GB SSD M.2 | None | Intel 8260 ac, 2x2 + BT4.1 | WWAN Upgradable | None | None | None | 720p | Backlit | Fingerprint Reader | 3-cell(23Wh) + 3-cell(26Wh) | 45W | Win10 DG Win7 Pro 64 | 3-year, Depot | 02/16 |
| 20F90037US | US | i7-6600U | vPro | Intel HD 520 | 4GB + 4GB | 14" FHD (1920x1080) IPS | None | 180GB SSD M.2 Opal2 | None | Intel 8260 ac, 2x2 + BT4.1 | WWAN Upgradable | None | None | None | 720p | Backlit | Fingerprint Reader | 3-cell(23Wh) + 3-cell(26Wh) | 45W | Win10 DG Win7 Pro 64 | 3-year, Depot | 02/16 |
| 20F90038US | US | i5-6300U | vPro | Intel HD 520 | 4GB + 4GB | 14" FHD (1920x1080) IPS | 10-point Multi-touch | 256GB SSD M.2 Opal2 | None | Intel 8260 ac, 2x2 + BT4.1 | WWAN Upgradable | None | None | None | 720p | Backlit | Fingerprint Reader | 3-cell(23Wh) + 3-cell(26Wh) | 45W | Win10 Pro 64 | 3-year, Depot | 02/16 |
| 20F90039US | US | i5-6200U | No | Intel HD 520 | 4GB Soldered | 14" FHD (1920x1080) IPS | None | 128GB SSD M.2 | None | Intel 8260 ac, 2x2 + BT4.1 | WWAN Upgradable | None | None | None | 720p | Non-backlit | Fingerprint Reader | 3-cell(23Wh) + 3-cell(26Wh) | 45W | Win10 DG Win7 Pro 64 | 1-year, Depot | 02/16 |
| 20F9003AUS | US | i7-6600U | vPro | Intel HD 520 | 4GB + 4GB | 14" WQHD (2560x1440) IPS | None | 256GB SSD M.2 Opal2 | None | Intel 8260 ac, 2x2 + BT4.1 | WWAN Upgradable | None | None | None | 720p | Backlit | Fingerprint Reader | 3-cell(23Wh) + 3-cell(26Wh) | 45W | Win10 DG Win7 Pro 64 | 3-year, Depot | 02/16 |
| 20F9003BUS | US | i5-6300U | vPro | Intel HD 520 | 4GB Soldered | 14" FHD (1920x1080) IPS | None | 180GB SSD M.2 Opal2 | None | Intel 8260 ac, 2x2 + BT4.1 | WWAN Upgradable | None | None | None | 720p | Backlit | Fingerprint Reader | 3-cell(23Wh) + 3-cell(26Wh) | 45W | Win10 DG Win7 Pro 64 | 3-year, Depot | 02/16 |
| 20F9003CUS | US | i7-6600U | vPro | Intel HD 520 | 4GB + 4GB | 14" FHD (1920x1080) IPS | None | 256GB SSD M.2 Opal2 | None | Intel 8260 ac, 2x2 + BT4.1 | WWAN Upgradable | None | None | None | 720p | Backlit | Fingerprint Reader | 3-cell(23Wh) + 3-cell(26Wh) | 45W | Win10 DG Win7 Pro 64 | 3-year, Depot | 02/16 |
| 20F9003DUS | US | i5-6300U | vPro | Intel HD 520 | 4GB + 4GB | 14" FHD (1920x1080) IPS | None | 192GB SSD M.2 | None | Intel 8260 ac, 2x2 + BT4.1 | WWAN Upgradable | None | None | None | 720p | Backlit | Fingerprint Reader | 3-cell(23Wh) + 3-cell(26Wh) | 45W | Win10 DG Win7 Pro 64 | 3-year, Depot | 02/16 |
| 20F9003EUS | US | i5-6300U | vPro | Intel HD 520 | 4GB + 4GB | 14" FHD (1920x1080) IPS | None | 128GB SSD M.2 | None | Intel 8260 ac, 2x2 + BT4.1 | WWAN Upgradable | None | None | None | 720p | Non-backlit | Fingerprint Reader | 3-cell(23Wh) + 3-cell(26Wh) | 45W | Win10 DG Win7 Pro 64 | 3-year, Depot | 02/16 |
| 20F9003FUS | US | i7-6600U | vPro | Intel HD 520 | 4GB + 4GB | 14" FHD (1920x1080) IPS | 10-point Multi-touch | 256GB SSD M.2 Opal2 | None | Intel 8260 ac, 2x2 + BT4.1 | WWAN Upgradable | None | None | None | 720p | Backlit | Fingerprint Reader | 3-cell(23Wh) + 3-cell(26Wh) | 45W | Win10 Pro 64 | 3-year, Depot | 02/16 |
| 20F9003GUS | US | i5-6300U | vPro | Intel HD 520 | 4GB + 4GB | 14" FHD (1920x1080) IPS | None | 256GB SSD M.2 Opal2 | None | Intel 8260 ac, 2x2 + BT4.1 | WWAN Upgradable | None | None | None | 720p | Backlit | Fingerprint Reader | 3-cell(23Wh) + 3-cell(26Wh) | 45W | Win10 DG Win7 Pro 64 | 3-year, Depot | 02/16 |
| 20F9003HUS | US | i5-6300U | vPro | Intel HD 520 | 4GB + 4GB | 14" FHD (1920x1080) IPS | None | 180GB SSD M.2 Opal2 | None | Intel 8260 ac, 2x2 + BT4.1 | WWAN Upgradable | None | None | None | 720p | Backlit | Fingerprint Reader | 3-cell(23Wh) + 3-cell(26Wh) | 45W | Win10 DG Win7 Pro 64 | 3-year, Depot | 02/16 |

| Model | Region | Processor | vPro | Graphics | Memory (Soldered +DIMM) | Display | Multi-touch | Storage(HDD/SSD) | Optical | WLAN + Bluetooth | WWAN | SIM Card | Smart Card Reader | Dock | Camera | Keyboard | Fingerprint Reader | Battery (Internal) | Power Adapter | Operating System | Warranty | Ann Date (m/y) |
|------------|--------|-----------|------|--------------|-------------------------|--------------------------|-------------|---------------------|---------|-----------------------------|-----------------|----------|-------------------|------------|--------|-------------|--------------------|-----------------------------|---------------|----------------------|---------------|----------------|
| 20F9003JUS | US | i5-6300U | vPro | Intel HD 520 | 4GB Soldered | 14" FHD (1920x1080) IPS | None | 128GB SSD M.2 | None | Intel 8260 ac, 2x2 + BT4.1 | WWAN Upgradable | None | None | None | 720p | Backlit | Fingerprint Reader | 3-cell(23Wh) + 3-cell(26Wh) | 45W | Win10 DG Win7 Pro 64 | 3-year, Depot | 02/16 |
| 20F9004DUS | US | i7-6600U | vPro | Intel HD 520 | 4GB + 8GB | 14" FHD (1920x1080) IPS | None | 512GB SSD M.2 | None | Intel 8260 ac, 2x2 + BT4.1 | WWAN Upgradable | None | None | None | 720p | Backlit | Fingerprint Reader | 3-cell(23Wh) + 3-cell(26Wh) | 45W | Win10 Pro 64 | 3-year, Depot | 02/16 |
| 20F9004EUS | US | i5-6300U | vPro | Intel HD 520 | 4GB + 4GB | 14" FHD (1920x1080) IPS | None | 192GB SSD M.2 | None | Intel 8260 ac, 2x2 + BT4.1 | WWAN Upgradable | None | None | None | 720p | Backlit | Fingerprint Reader | 3-cell(23Wh) + 3-cell(26Wh) | 45W | Win10 Pro 64 | 3-year, Depot | 02/16 |
| 20F9004FUS | US | i5-6200U | No | Intel HD 520 | 4GB + 4GB | 14" FHD (1920x1080) IPS | None | 192GB SSD M.2 | None | Intel 8260 ac, 2x2 + BT4.1 | WWAN Upgradable | None | None | None | 720p | Backlit | Fingerprint Reader | 3-cell(23Wh) + 3-cell(26Wh) | 45W | Win10 DG Win7 Pro 64 | 3-year, Depot | 02/16 |
| 20F9004GUS | US | i7-6600U | vPro | Intel HD 520 | 4GB + 8GB | 14" WQHD (2560x1440) IPS | None | 512GB SSD M.2 | None | Intel 18260 ac, 2x2 + BT4.1 | None | None | None | WiGig Dock | 720p | Backlit | Fingerprint Reader | 3-cell(23Wh) + 3-cell(26Wh) | 45W | Win10 Pro 64 | 3-year, Depot | 02/16 |
| 20F9004JUS | US | i5-6200U | No | Intel HD 520 | 4GB Soldered | 14" FHD (1920x1080) IPS | None | 128GB SSD M.2 | None | Intel 8260 ac, 2x2 + BT4.1 | WWAN Upgradable | None | None | None | 720p | Non-backlit | Fingerprint Reader | 3-cell(23Wh) + 3-cell(26Wh) | 45W | Win10 Pro 64 | 1-year, Depot | 02/16 |
| 20F9004LUS | US | i5-6200U | No | Intel HD 520 | 4GB + 4GB | 14" FHD (1920x1080) IPS | None | 192GB SSD M.2 | None | Intel 8260 ac, 2x2 + BT4.1 | WWAN Upgradable | None | None | None | 720p | Backlit | Fingerprint Reader | 3-cell(23Wh) + 3-cell(26Wh) | 45W | Win10 Pro 64 | 3-year, Depot | 02/16 |
| 20F9004MUS | US | i7-6600U | vPro | Intel HD 520 | 4GB + 8GB | 14" WQHD (2560x1440) IPS | None | 512GB SSD M.2 | None | Intel 8260 ac, 2x2 + BT4.1 | WWAN Upgradable | None | None | None | 720p | Backlit | Fingerprint Reader | 3-cell(23Wh) + 3-cell(26Wh) | 45W | Win10 DG Win7 Pro 64 | 3-year, Depot | 02/16 |
| 20F9004NUS | US | i5-6300U | vPro | Intel HD 520 | 4GB + 4GB | 14" FHD (1920x1080) IPS | None | 256GB SSD M.2 Opal2 | None | Intel 8260 ac, 2x2 + BT4.1 | WWAN Upgradable | None | None | None | 720p | Backlit | Fingerprint Reader | 3-cell(23Wh) + 3-cell(26Wh) | 45W | Win10 Pro 64 | 3-year, Depot | 02/16 |
| 20F9004PUS | US | i7-6600U | vPro | Intel HD 520 | 4GB + 8GB | 14" WQHD (2560x1440) IPS | None | 512GB SSD M.2 | None | Intel 18260 ac, 2x2 + BT4.1 | None | None | None | WiGig Dock | 720p | Backlit | Fingerprint Reader | 3-cell(23Wh) + 3-cell(26Wh) | 45W | Win10 DG Win7 Pro 64 | 3-year, Depot | 02/16 |
| 20F9005AUS | US | i7-6600U | vPro | Intel HD 520 | 4GB + 16GB | 14" WQHD (2560x1440) IPS | None | 512GB SSD M.2 | None | Intel 8260 ac, 2x2 + BT4.1 | WWAN Upgradable | None | None | None | 720p | Backlit | Fingerprint Reader | 3-cell(23Wh) + 3-cell(26Wh) | 45W | Win10 Pro 64 | 3-year, Depot | 03/16 |
| 20F9005BUS | US | i7-6600U | vPro | Intel HD 520 | 4GB + 16GB | 14" WQHD (2560x1440) IPS | None | 512GB SSD M.2 | None | Intel 8260 ac, 2x2 + BT4.1 | WWAN Upgradable | None | None | None | 720p | Backlit | Fingerprint Reader | 3-cell(23Wh) + 3-cell(26Wh) | 45W | Win10 DG Win7 Pro 64 | 3-year, Depot | 03/16 |
| 20F9005DUS | US | i7-6600U | vPro | Intel HD 520 | 4GB + 8GB | 14" WQHD (2560x1440) IPS | None | 256GB SSD M.2 Opal2 | None | Intel 18260 ac, 2x2 + BT4.1 | None | None | None | WiGig Dock | 720p | Backlit | Fingerprint Reader | 3-cell(23Wh) + 3-cell(26Wh) | 45W | Win10 Pro 64 | 3-year, Depot | 04/16 |
| 20F9005EUS | US | i5-6300U | vPro | 930M 2GB | 4GB + 4GB | 14" FHD (1920x1080) IPS | None | 256GB SSD M.2 Opal2 | None | Intel 8260 ac, 2x2 + BT4.1 | WWAN Upgradable | None | None | None | 720p | Backlit | Fingerprint Reader | 3-cell(23Wh) + 3-cell(26Wh) | 65W | Win10 DG Win7 Pro 64 | 3-year, Depot | 04/16 |
| 20F9005FUS | US | i7-6600U | vPro | 930M 2GB | 8GB Soldered | 14" WQHD (2560x1440) IPS | None | 512GB SSD M.2 | None | Intel 8260 ac, 2x2 + BT4.1 | WWAN Upgradable | None | None | None | 720p | Backlit | Fingerprint Reader | 3-cell(23Wh) + 3-cell(26Wh) | 65W | Win10 DG Win7 Pro 64 | 3-year, Depot | 04/16 |
| 20F9005GUS | US | i5-6300U | vPro | 930M 2GB | 4GB + 4GB | 14" FHD (1920x1080) IPS | None | 256GB SSD M.2 Opal2 | None | Intel 8260 ac, 2x2 + BT4.1 | WWAN Upgradable | None | None | None | 720p | Backlit | Fingerprint Reader | 3-cell(23Wh) + 3-cell(26Wh) | 65W | Win10 Pro 64 | 3-year, Depot | 04/16 |
| 20F9005HUS | US | i7-6600U | vPro | 930M 2GB | 8GB Soldered | 14" FHD (1920x1080) IPS | None | 256GB SSD M.2 Opal2 | None | Intel 8260 ac, 2x2 + BT4.1 | WWAN Upgradable | None | None | None | 720p | Backlit | Fingerprint Reader | 3-cell(23Wh) + 3-cell(26Wh) | 65W | Win10 Pro 64 | 3-year, Depot | 04/16 |
| 20F9005JUS | US | i7-6600U | vPro | 930M 2GB | 8GB Soldered | 14" WQHD (2560x1440) IPS | None | 512GB SSD M.2 | None | Intel 8260 ac, 2x2 + BT4.1 | WWAN Upgradable | None | None | None | 720p | Backlit | Fingerprint Reader | 3-cell(23Wh) + 3-cell(26Wh) | 65W | Win10 Pro 64 | 3-year, Depot | 04/16 |
| 20F9005KUS | US | i7-6600U | vPro | 930M 2GB | 8GB Soldered | 14" FHD (1920x1080) IPS | None | 256GB SSD M.2 Opal2 | None | Intel 8260 ac, 2x2 + BT4.1 | WWAN Upgradable | None | None | None | 720p | Backlit | Fingerprint Reader | 3-cell(23Wh) + 3-cell(26Wh) | 65W | Win10 DG Win7 Pro 64 | 3-year, Depot | 04/16 |
| 20F9005LUS | US | i7-6600U | vPro | Intel HD 520 | 4GB + 8GB | 14" WQHD (2560x1440) IPS | None | 256GB SSD M.2 Opal2 | None | Intel 18260 ac, 2x2 + BT4.1 | None | None | None | WiGig Dock | 720p | Backlit | Fingerprint Reader | 3-cell(23Wh) + 3-cell(26Wh) | 45W | Win10 DG Win7 Pro 64 | 3-year, Depot | 04/16 |

| Model | Region | Processor | vPro | Graphics | Memory (Soldered +DIMM) | Display | Multi-touch | Storage(HDD/SSD) | Optical | WLAN + Bluetooth | WWAN | SIM Card | Smart Card Reader | Dock | Camera | Keyboard | Fingerprint Reader | Battery (internal) | Power Adapter | Operating System | Warranty | Ann Date (m/y) |
|------------|--------|-----------|------|--------------|-------------------------|--------------------------|-------------|---------------------|---------|----------------------------|-----------------|----------|-------------------|------|--------|----------|--------------------|-----------------------------|---------------|----------------------|---------------|----------------|
| 20F9006XUS | US | i5-6200U | No | Intel HD 520 | 4GB + 4GB | 14" FHD (1920x1080) IPS | None | 180GB SSD M.2 Opal2 | None | Intel 8260 ac, 2x2 + BT4.1 | WWAN Upgradable | None | None | None | 720p | Backlit | Fingerprint Reader | 3-cell(23Wh) + 3-cell(26Wh) | 45W | Win10 DG Win7 Pro 64 | 3-year, Depot | 10/16 |
| 20F9006YUS | US | i5-6200U | No | Intel HD 520 | 4GB + 4GB | 14" FHD (1920x1080) IPS | None | 180GB SSD M.2 Opal2 | None | Intel 8260 ac, 2x2 + BT4.1 | WWAN Upgradable | None | None | None | 720p | Backlit | Fingerprint Reader | 3-cell(23Wh) + 3-cell(26Wh) | 45W | Win10 Pro 64 | 3-year, Depot | 10/16 |
| 20F90076US | US | i5-6200U | No | Intel HD 520 | 4GB + 4GB | 14" WQHD (2560x1440) IPS | None | 180GB SSD M.2 Opal2 | None | Intel 8260 ac, 2x2 + BT4.1 | WWAN Upgradable | None | None | None | 720p | Backlit | Fingerprint Reader | 3-cell(23Wh) + 3-cell(26Wh) | 45W | Win10 DG Win7 Pro 64 | 3-year, Depot | 10/16 |
| 20F90077US | US | i5-6300U | vPro | Intel HD 520 | 4GB + 4GB | 14" FHD (1920x1080) IPS | None | 180GB SSD M.2 Opal2 | None | Intel 8260 ac, 2x2 + BT4.1 | WWAN Upgradable | None | None | None | 720p | Backlit | Fingerprint Reader | 3-cell(23Wh) + 3-cell(26Wh) | 45W | Win10 Pro 64 | 3-year, Depot | 11/16 |



ThinkPad T470 Platform Specifications

Product Specifications Reference (PSREF)

| Processor | <p>6th Generation Intel® Core™ i5 / i7 Processor (<i>i7-6500U is not available in EMEA</i>)</p> <table border="1"> <thead> <tr> <th>Processor Number</th> <th># of Cores</th> <th># of Threads</th> <th>Base Frequency</th> <th>Max Turbo Frequency</th> <th>Cache</th> <th>Memory Types</th> <th>Processor Graphics</th> </tr> </thead> <tbody> <tr> <td>i5-6200U</td> <td rowspan="4">2</td> <td rowspan="4">4</td> <td>2.3 GHz</td> <td>2.8 GHz</td> <td>3MB</td> <td rowspan="4">DDR4-2133</td> <td rowspan="4">Intel HD Graphics 520</td> </tr> <tr> <td>i5-6300U</td> <td>2.4 GHz</td> <td>3.0 GHz</td> <td>3MB</td> </tr> <tr> <td>i7-6500U</td> <td>2.5 GHz</td> <td>3.1 GHz</td> <td>4MB</td> </tr> <tr> <td>i7-6600U</td> <td>2.6 GHz</td> <td>3.4 GHz</td> <td>4MB</td> </tr> </tbody> </table> <p>or 7th Generation Intel Core i3 / i5 / i7 Processor</p> <table border="1"> <thead> <tr> <th>Processor Number</th> <th># of Cores</th> <th># of Threads</th> <th>Base Frequency</th> <th>Max Turbo Frequency</th> <th>Cache</th> <th>Memory Types</th> <th>Processor Graphics</th> </tr> </thead> <tbody> <tr> <td>i3-7100U</td> <td rowspan="5">2</td> <td rowspan="5">4</td> <td>2.4 GHz</td> <td>-</td> <td>3MB</td> <td rowspan="5">DDR4-2133</td> <td rowspan="5">Intel HD Graphics 620</td> </tr> <tr> <td>i5-7200U</td> <td>2.5 GHz</td> <td>3.1 GHz</td> <td>3MB</td> </tr> <tr> <td>i5-7300U</td> <td>2.6 GHz</td> <td>3.5 GHz</td> <td>3MB</td> </tr> <tr> <td>i7-7500U</td> <td>2.7 GHz</td> <td>3.5 GHz</td> <td>4MB</td> </tr> <tr> <td>i7-7600U</td> <td>2.8 GHz</td> <td>3.9 GHz</td> <td>4MB</td> </tr> </tbody> </table> | Processor Number | # of Cores | # of Threads | Base Frequency | Max Turbo Frequency | Cache | Memory Types | Processor Graphics | i5-6200U | 2 | 4 | 2.3 GHz | 2.8 GHz | 3MB | DDR4-2133 | Intel HD Graphics 520 | i5-6300U | 2.4 GHz | 3.0 GHz | 3MB | i7-6500U | 2.5 GHz | 3.1 GHz | 4MB | i7-6600U | 2.6 GHz | 3.4 GHz | 4MB | Processor Number | # of Cores | # of Threads | Base Frequency | Max Turbo Frequency | Cache | Memory Types | Processor Graphics | i3-7100U | 2 | 4 | 2.4 GHz | - | 3MB | DDR4-2133 | Intel HD Graphics 620 | i5-7200U | 2.5 GHz | 3.1 GHz | 3MB | i5-7300U | 2.6 GHz | 3.5 GHz | 3MB | i7-7500U | 2.7 GHz | 3.5 GHz | 4MB | i7-7600U | 2.8 GHz | 3.9 GHz | 4MB | Dimensions Weight <table border="1"> <tr> <td><i>WxDxH:</i></td> <td colspan="2">13.25" x 9.15" x 0.79"; 336.6mm x 232.5mm x 19.95mm</td> </tr> <tr> <td><i>Models</i></td> <td>3-cell or 3 + 3-cell</td> <td>6-cell or 3 + 6-cell</td> </tr> <tr> <td><i>Magnesium</i></td> <td>3.49 lb / 1.58 kg</td> <td>3.92 lb / 1.78 kg</td> </tr> <tr> <td><i>PPS</i></td> <td>3.63 lb / 1.65 kg</td> <td>4.35 lb / 1.85 kg</td> </tr> </table> Case color Case material <p>Black <i>Display cover:</i> Magnesium Hybrid or PPS; <i>Bottom:</i> Glass-Fiber Reinforced Plastic</p> | <i>WxDxH:</i> | 13.25" x 9.15" x 0.79"; 336.6mm x 232.5mm x 19.95mm | | <i>Models</i> | 3-cell or 3 + 3-cell | 6-cell or 3 + 6-cell | <i>Magnesium</i> | 3.49 lb / 1.58 kg | 3.92 lb / 1.78 kg | <i>PPS</i> | 3.63 lb / 1.65 kg | 4.35 lb / 1.85 kg |
|--|--|--|----------------|---------------------|-----------------|---------------------|-----------------------|-----------------|--------------------|-------------------|--------|---------|---------|---------|---------|-----------|-----------------------|----------|---------|---------|---------|----------|---------|---------|-----|----------|---------|---------|-----|------------------|------------|--------------|----------------|---------------------|-------|--------------|--------------------|----------|---|---|---------|---|-----|-----------|-----------------------|----------|---------|---------|-----|----------|---------|---------|-----|----------|---------|---------|-----|----------|---------|---------|-----|---|---------------|---|--|---------------|----------------------|----------------------|------------------|-------------------|-------------------|------------|-------------------|-------------------|
| Processor Number | # of Cores | # of Threads | Base Frequency | Max Turbo Frequency | Cache | Memory Types | Processor Graphics | | | | | | | | | | | | | | | | | | | | | | | | | | | | | | | | | | | | | | | | | | | | | | | | | | | | | | | | | | | | | | | | | | | |
| i5-6200U | 2 | 4 | 2.3 GHz | 2.8 GHz | 3MB | DDR4-2133 | Intel HD Graphics 520 | | | | | | | | | | | | | | | | | | | | | | | | | | | | | | | | | | | | | | | | | | | | | | | | | | | | | | | | | | | | | | | | | | | |
| i5-6300U | | | 2.4 GHz | 3.0 GHz | 3MB | | | | | | | | | | | | | | | | | | | | | | | | | | | | | | | | | | | | | | | | | | | | | | | | | | | | | | | | | | | | | | | | | | | | | |
| i7-6500U | | | 2.5 GHz | 3.1 GHz | 4MB | | | | | | | | | | | | | | | | | | | | | | | | | | | | | | | | | | | | | | | | | | | | | | | | | | | | | | | | | | | | | | | | | | | | | |
| i7-6600U | | | 2.6 GHz | 3.4 GHz | 4MB | | | | | | | | | | | | | | | | | | | | | | | | | | | | | | | | | | | | | | | | | | | | | | | | | | | | | | | | | | | | | | | | | | | | | |
| Processor Number | # of Cores | # of Threads | Base Frequency | Max Turbo Frequency | Cache | Memory Types | Processor Graphics | | | | | | | | | | | | | | | | | | | | | | | | | | | | | | | | | | | | | | | | | | | | | | | | | | | | | | | | | | | | | | | | | | | |
| i3-7100U | 2 | 4 | 2.4 GHz | - | 3MB | DDR4-2133 | Intel HD Graphics 620 | | | | | | | | | | | | | | | | | | | | | | | | | | | | | | | | | | | | | | | | | | | | | | | | | | | | | | | | | | | | | | | | | | | |
| i5-7200U | | | 2.5 GHz | 3.1 GHz | 3MB | | | | | | | | | | | | | | | | | | | | | | | | | | | | | | | | | | | | | | | | | | | | | | | | | | | | | | | | | | | | | | | | | | | | | |
| i5-7300U | | | 2.6 GHz | 3.5 GHz | 3MB | | | | | | | | | | | | | | | | | | | | | | | | | | | | | | | | | | | | | | | | | | | | | | | | | | | | | | | | | | | | | | | | | | | | | |
| i7-7500U | | | 2.7 GHz | 3.5 GHz | 4MB | | | | | | | | | | | | | | | | | | | | | | | | | | | | | | | | | | | | | | | | | | | | | | | | | | | | | | | | | | | | | | | | | | | | | |
| i7-7600U | | | 2.8 GHz | 3.9 GHz | 4MB | | | | | | | | | | | | | | | | | | | | | | | | | | | | | | | | | | | | | | | | | | | | | | | | | | | | | | | | | | | | | | | | | | | | | |
| <i>WxDxH:</i> | 13.25" x 9.15" x 0.79"; 336.6mm x 232.5mm x 19.95mm | | | | | | | | | | | | | | | | | | | | | | | | | | | | | | | | | | | | | | | | | | | | | | | | | | | | | | | | | | | | | | | | | | | | | | | | | |
| <i>Models</i> | 3-cell or 3 + 3-cell | 6-cell or 3 + 6-cell | | | | | | | | | | | | | | | | | | | | | | | | | | | | | | | | | | | | | | | | | | | | | | | | | | | | | | | | | | | | | | | | | | | | | | | | |
| <i>Magnesium</i> | 3.49 lb / 1.58 kg | 3.92 lb / 1.78 kg | | | | | | | | | | | | | | | | | | | | | | | | | | | | | | | | | | | | | | | | | | | | | | | | | | | | | | | | | | | | | | | | | | | | | | | | |
| <i>PPS</i> | 3.63 lb / 1.65 kg | 4.35 lb / 1.85 kg | | | | | | | | | | | | | | | | | | | | | | | | | | | | | | | | | | | | | | | | | | | | | | | | | | | | | | | | | | | | | | | | | | | | | | | | |
| Graphics | <p>Intel HD Graphics 520 or 620 in processor only, or Intel HD Graphics 620 in processor and NVIDIA GeForce® 940MX, 2GB 2.5GHz GDDR5 memory (discrete models are NOT available in EMEA); supports external digital monitor via HDMI or USB Type-C; supports three independent displays; Max resolution: 4096x2304@60Hz (USB Type-C); 4096x2160@24Hz (HDMI)</p> | Smart card reader Media reader Ports WiGig dock (opt) Monitor cable Camera (optional) Audio support Keyboard UltraNav™ Security Security chip vPro (optional) Fingerprint reader NFC (optional) | | | | | | | | | | | | | | | | | | | | | | | | | | | | | | | | | | | | | | | | | | | | | | | | | | | | | | | | | | | | | | | | | | | | | | | | |
| Chipset Memory | <p>Intel SoC (System on Chip) platform 32GB max / 2400MHz DDR4, dual-channel capable, two DDR4 SO-DIMM sockets * System clocks down for processors with lower memory controller</p> | 720p: HD720p resolution, fixed focus <i>IR & 720p:</i> IR camera and HD720p camera (mutually exclusive with WiGig) HD Audio, Realtek ALC3268 codec / stereo speakers, 2W x 2 / dual array microphone, combo audio/microphone jack 6-row, spill-resistant, multimedia Fn keys, optional LED backlight TrackPoint® pointing device and buttonless Mylar surface multi-touch touchpad Power-on password, hard disk password, supervisor password, security keyhole Discrete TPM 2.0, TCG Certified Intel vPro Technology <i>Optional:</i> Touch style match on chip fingerprint reader on the keyboard bezel Near Field Communication | | | | | | | | | | | | | | | | | | | | | | | | | | | | | | | | | | | | | | | | | | | | | | | | | | | | | | | | | | | | | | | | | | | | | | | | |
| Display Multi-touch (opt) | <p><i>Some:</i> 14.0" (355mm) HD (1366x768), anti-glare, LED backlight, 220 nits, 16:9 aspect ratio, 400:1 contrast ratio <i>Some:</i> 14.0" (355mm) FHD (1920x1080), anti-glare, LED backlight, 220 nits, 16:9 aspect ratio, 400:1 or 500:1 contrast ratio <i>Some:</i> 14.0" (355mm) FHD (1920x1080), anti-glare, LED backlight, IPS, 250 nits, 16:9 aspect ratio, 700:1 contrast ratio, 170° viewing angle</p> <p>On-cell touch, supports 10-finger gesture (FHD only)</p> | Internal battery External battery Max battery life (MobileMark® 2014) <table border="1"> <thead> <tr> <th><i>Models</i></th> <th>3-cell</th> <th>3 + 3-cell</th> <th>6-cell 48Wh</th> <th>6-cell 72Wh</th> <th>3 + 6-cell 48Wh</th> <th>3 + 6-cell 72Wh</th> </tr> </thead> <tbody> <tr> <td><i>Integrated</i></td> <td>6.9 hr</td> <td>13.9 hr</td> <td>13.9 hr</td> <td>20.9 hr</td> <td>20.9 hr</td> <td>27.1 hr</td> </tr> <tr> <td><i>Discrete</i></td> <td>6.9 hr</td> <td>13.9 hr</td> <td>14.3 hr</td> <td>21.6 hr</td> <td>21.2 hr</td> <td>28.6 hr</td> </tr> </tbody> </table> | <i>Models</i> | 3-cell | 3 + 3-cell | 6-cell 48Wh | 6-cell 72Wh | 3 + 6-cell 48Wh | 3 + 6-cell 72Wh | <i>Integrated</i> | 6.9 hr | 13.9 hr | 13.9 hr | 20.9 hr | 20.9 hr | 27.1 hr | <i>Discrete</i> | 6.9 hr | 13.9 hr | 14.3 hr | 21.6 hr | 21.2 hr | 28.6 hr | | | | | | | | | | | | | | | | | | | | | | | | | | | | | | | | | | | | | | | | | | | | | | | | | | | |
| <i>Models</i> | 3-cell | 3 + 3-cell | 6-cell 48Wh | 6-cell 72Wh | 3 + 6-cell 48Wh | 3 + 6-cell 72Wh | | | | | | | | | | | | | | | | | | | | | | | | | | | | | | | | | | | | | | | | | | | | | | | | | | | | | | | | | | | | | | | | | | | | |
| <i>Integrated</i> | 6.9 hr | 13.9 hr | 13.9 hr | 20.9 hr | 20.9 hr | 27.1 hr | | | | | | | | | | | | | | | | | | | | | | | | | | | | | | | | | | | | | | | | | | | | | | | | | | | | | | | | | | | | | | | | | | | | |
| <i>Discrete</i> | 6.9 hr | 13.9 hr | 14.3 hr | 21.6 hr | 21.2 hr | 28.6 hr | | | | | | | | | | | | | | | | | | | | | | | | | | | | | | | | | | | | | | | | | | | | | | | | | | | | | | | | | | | | | | | | | | | | |
| Storage Optical | <p><i>System has one HDD slot or one M.2 2280 slot exclusively for storage</i> <i>Some:</i> HDD / SATA 6.0Gb/s, 2.5" wide, 7mm high, Active Protection System™ <i>Some:</i> SSD / SATA 6.0Gb/s, 2.5" wide, 7mm high (e.g. xxxGB SSD) <i>Some:</i> M.2 SSD / PCIe NVMe, PCIe 3.0 x 2, 16Gb/s <i>Some:</i> 128GB M.2 SSD / SATA 6.0Gb/s, in WWAN slot as 2nd Storage, mutually exclusive with WWAN and WiGig</p> <p>None</p> | AC adapter Preload <p>45W or 65W AC adapter (slim tip), 45W or 65W USB Type-C AC adapter</p> <p>Windows® 7 Professional 64 preinstalled through downgrade rights in Windows 10 Pro 64 <i>Some:</i> Windows 10 Home 64 <i>Some:</i> Windows 10 Pro 64</p> <ul style="list-style-type: none"> • Lenovo Solution Center • Lenovo PowerEngage • ThinkVantage Product Recovery • ThinkVantage System Update • Adobe® Reader® • Microsoft® Office preloaded; purchase a product key to activate • McAfee® LiveSafe™ (30-day trial) | | | | | | | | | | | | | | | | | | | | | | | | | | | | | | | | | | | | | | | | | | | | | | | | | | | | | | | | | | | | | | | | | | | | | | | | |
| Ethernet WLAN | <p><i>Non-vPro model:</i> Intel Ethernet Connection I219-V (Jacksonville) <i>vPro model:</i> Intel Ethernet Connection I219-LM (Jacksonville)</p> <p><i>One of the following, configurable by model (WiGig can coexist with WWAN):</i></p> <ul style="list-style-type: none"> • Realtek® RTL8822BE, Wi-Fi 2x2 802.11ac + BT4.1, M.2 card • Intel Dual Band Wireless-AC 8260, Wi-Fi 2x2 802.11ac + BT4.1, M.2 card • Intel Dual Band Wireless-AC 8265, Wi-Fi 2x2 802.11ac + BT4.1, M.2 card • Intel Tri-Band Wireless-AC 18265, WiGig 802.11ad + Wi-Fi 2x2 802.11ac + BT4.1, M.2 card | Limited warranty Mil-Spec test Environment <p><i>One of the following, configurable by model:</i></p> <ul style="list-style-type: none"> • 1-year depot repair service • 3-year/1-yr battery depot repair service • 3-year/1-yr battery limited onsite service <p>MIL-STD-810G military certification</p> <p>EPEAT™ Gold (US only); ENERGY STAR® 6.1; RoHS-compliant</p> | | | | | | | | | | | | | | | | | | | | | | | | | | | | | | | | | | | | | | | | | | | | | | | | | | | | | | | | | | | | | | | | | | | | | | | | |
| Bluetooth™ WWAN (optional) SIM card (opt) | <p>Bluetooth 4.1 wireless, integrated in Wi-Fi + Bluetooth combo adapter * Intel 8265ac / 18265ac card support BT4.2 but is limited to BT4.1 by Windows OS</p> <p><i>One of the following, configurable by model (WWAN can coexist with WiGig):</i></p> <ul style="list-style-type: none"> • Wireless WAN upgradable • Integrated Mobile Broadband 4G LTE-A, Qualcomm® Snapdragon™ X7 LTE-A (Sierra Wireless EM7455), M.2 card • Integrated Mobile Broadband 4G LTE, Intel XMM™ 7160 (Fibocom L831-EAU), M.2 card (EMEA only) <p>Micro-SIM card slot, opt Verizon LTE (US) or Lenovo® Connect (EMEA) SIM card</p> | | | | | | | | | | | | | | | | | | | | | | | | | | | | | | | | | | | | | | | | | | | | | | | | | | | | | | | | | | | | | | | | | | | | | | | | | |

ThinkPad T470 - TopSeller - 20HD

Product Specifications Reference (PSREF)

| Model | Region | Processor | vPro | Graphics | Memory | Display | Multi-touch | Storage (HDD/SSD) | Optical | WLAN + Bluetooth | WWAN | SIM Card | Smart Card Reader | Dock | Monitor Cable | Case Material | Camera | Key-board | Finger-print Reader | NFC | TPM | Battery (internal-external) | Power Adapter | Operating System | Warranty | Ann Date (m/y) |
|------------|--------|-----------|------|--------------|--------|-------------------------|----------------------|-------------------------------|---------|----------------------------|-----------------|----------|-------------------|------|---------------|---------------|-----------|-------------|---------------------|------|----------|-----------------------------|---------------|------------------|---------------|----------------|
| 20HD000QUS | US | i5-7200U | No | Intel HD 620 | 8GBx1 | 14" FHD (1920x1080) IPS | None | 500GB 7200rpm | None | Intel 8265 ac, 2x2 + BT4.1 | WWAN Upgradable | None | None | None | None | PPS | 720p | Non-backlit | Finger-print Reader | None | dTPM 2.0 | 3-cell(24Wh) + 3-cell(24Wh) | 45W | Win10 Pro | 1-year, Depot | 01/17 |
| 20HD000RUS | US | i5-7300U | vPro | Intel HD 620 | 8GBx1 | 14" FHD (1920x1080) IPS | None | 256GB SSD M.2 PCIe NVMe Opal2 | None | Intel 8265 ac, 2x2 + BT4.1 | WWAN Upgradable | None | None | None | None | PPS | 720p | Backlit | Finger-print Reader | None | dTPM 2.0 | 3-cell(24Wh) + 3-cell(24Wh) | 45W | Win10 Pro | 3-year, Depot | 01/17 |
| 20HD000SUS | US | i5-7200U | No | Intel HD 620 | 8GBx1 | 14" FHD (1920x1080) IPS | None | 128GB SSD | None | Intel 8265 ac, 2x2 + BT4.1 | WWAN Upgradable | None | None | None | None | PPS | 720p | Backlit | Finger-print Reader | None | dTPM 2.0 | 3-cell(24Wh) + 3-cell(24Wh) | 45W | Win10 Pro | 3-year, Depot | 01/17 |
| 20HD000TUS | US | i5-7200U | No | Intel HD 620 | 8GBx1 | 14" HD (1366x768) | None | 500GB 7200rpm | None | Intel 8265 ac, 2x2 + BT4.1 | WWAN Upgradable | None | None | None | None | PPS | 720p | Non-backlit | Finger-print Reader | None | dTPM 2.0 | 3-cell(24Wh) + 3-cell(24Wh) | 45W | Win10 Pro | 1-year, Depot | 01/17 |
| 20HD000UUS | US | i5-7200U | No | Intel HD 620 | 8GBx1 | 14" HD (1366x768) | None | 128GB SSD | None | Intel 8265 ac, 2x2 + BT4.1 | WWAN Upgradable | None | None | None | None | PPS | 720p | Backlit | Finger-print Reader | None | dTPM 2.0 | 3-cell(24Wh) + 3-cell(24Wh) | 45W | Win10 Pro | 3-year, Depot | 01/17 |
| 20HD000VUS | US | i5-7300U | vPro | Intel HD 620 | 8GBx1 | 14" FHD (1920x1080) IPS | None | 512GB SSD M.2 PCIe NVMe Opal2 | None | Intel 8265 ac, 2x2 + BT4.1 | WWAN Upgradable | None | None | None | None | PPS | 720p | Backlit | Finger-print Reader | None | dTPM 2.0 | 3-cell(24Wh) + 3-cell(24Wh) | 45W | Win10 Pro | 3-year, Depot | 01/17 |
| 20HD000WUS | US | i5-7200U | No | Intel HD 620 | 8GBx1 | 14" FHD (1920x1080) IPS | None | 256GB SSD M.2 PCIe NVMe Opal2 | None | Intel 8265 ac, 2x2 + BT4.1 | WWAN Upgradable | None | None | None | None | PPS | 720p | Backlit | Finger-print Reader | None | dTPM 2.0 | 3-cell(24Wh) + 3-cell(24Wh) | 45W | Win10 Pro | 3-year, Depot | 01/17 |
| 20HD000XUS | US | i5-7300U | vPro | Intel HD 620 | 8GBx1 | 14" FHD (1920x1080) IPS | None | 500GB 7200rpm | None | Intel 8265 ac, 2x2 + BT4.1 | WWAN Upgradable | None | None | None | None | PPS | 720p | Backlit | Finger-print Reader | None | dTPM 2.0 | 3-cell(24Wh) + 3-cell(24Wh) | 45W | Win10 Pro | 3-year, Depot | 01/17 |
| 20HD004AUS | US | i5-7300U | vPro | Intel HD 620 | 8GBx1 | 14" HD (1366x768) | None | 500GB 7200rpm | None | Intel 8265 ac, 2x2 + BT4.1 | WWAN Upgradable | None | None | None | None | PPS | 720p | Non-backlit | Finger-print Reader | None | dTPM 2.0 | 3-cell(24Wh) + 3-cell(24Wh) | 45W | Win10 Pro | 1-year, Depot | 03/17 |
| 20HD004BUS | US | i5-7300U | vPro | Intel HD 620 | 8GBx1 | 14" FHD (1920x1080) IPS | None | 180GB SSD Opal2 | None | Intel 8265 ac, 2x2 + BT4.1 | WWAN Upgradable | None | None | None | None | PPS | 720p | Backlit | Finger-print Reader | None | dTPM 2.0 | 3-cell(24Wh) + 3-cell(24Wh) | 45W | Win10 Pro | 3-year, Depot | 03/17 |
| 20HD0056US | US | i5-7300U | vPro | Intel HD 620 | 8GBx1 | 14" FHD (1920x1080) IPS | None | 256GB SSD M.2 PCIe NVMe Opal2 | None | Intel 8265 ac, 2x2 + BT4.1 | WWAN Upgradable | None | None | None | None | Magnesium | IR & 720p | Backlit | Finger-print Reader | None | dTPM 2.0 | 3-cell(24Wh) + 3-cell(24Wh) | 45W | Win10 Pro | 3-year, Depot | 04/17 |
| 20HD0057US | US | i7-7600U | vPro | Intel HD 620 | 8GBx1 | 14" FHD (1920x1080) IPS | None | 256GB SSD M.2 PCIe NVMe Opal2 | None | Intel 8265 ac, 2x2 + BT4.1 | WWAN Upgradable | None | None | None | None | Magnesium | IR & 720p | Backlit | Finger-print Reader | None | dTPM 2.0 | 3-cell(24Wh) + 3-cell(24Wh) | 45W | Win10 Pro | 3-year, Depot | 04/17 |
| 20HD0058US | US | i7-7600U | vPro | Intel HD 620 | 8GBx1 | 14" FHD (1920x1080) IPS | 10-point Multi-touch | 256GB SSD M.2 PCIe NVMe Opal2 | None | Intel 8265 ac, 2x2 + BT4.1 | WWAN Upgradable | None | None | None | None | PPS | 720p | Backlit | Finger-print Reader | None | dTPM 2.0 | 3-cell(24Wh) + 3-cell(24Wh) | 45W | Win10 Pro | 3-year, Depot | 04/17 |
| 20HD005AUS | US | i5-7300U | vPro | Intel HD 620 | 8GBx1 | 14" FHD (1920x1080) IPS | None | 256GB SSD M.2 PCIe NVMe Opal2 | None | Intel 8265 ac, 2x2 + BT4.1 | WWAN Upgradable | None | None | None | None | PPS | 720p | Backlit | Finger-print Reader | None | dTPM 2.0 | 3-cell(24Wh) + 3-cell(24Wh) | 45W | Win10 Pro | 3-year, Depot | 04/17 |
| 20HD005BUS | US | i7-7600U | vPro | Intel HD 620 | 8GBx1 | 14" FHD (1920x1080) IPS | None | 256GB SSD M.2 PCIe NVMe Opal2 | None | Intel 8265 ac, 2x2 + BT4.1 | Sierra EM7455 | None | None | None | None | PPS | 720p | Backlit | Finger-print Reader | None | dTPM 2.0 | 3-cell(24Wh) + 3-cell(24Wh) | 45W | Win10 Pro | 3-year, Depot | 04/17 |
| 20HD005CUS | US | i5-7300U | vPro | Intel HD 620 | 8GBx1 | 14" FHD (1920x1080) IPS | None | 256GB SSD M.2 PCIe NVMe Opal2 | None | Intel 8265 ac, 2x2 + BT4.1 | Sierra EM7455 | None | None | None | None | PPS | 720p | Backlit | Finger-print Reader | None | dTPM 2.0 | 3-cell(24Wh) + 3-cell(24Wh) | 45W | Win10 Pro | 3-year, Depot | 04/17 |
| 20HD005DUS | US | i7-7600U | vPro | Intel HD 620 | 8GBx1 | 14" FHD (1920x1080) IPS | 10-point Multi-touch | 256GB SSD M.2 PCIe NVMe Opal2 | None | Intel 8265 ac, 2x2 + BT4.1 | Sierra EM7455 | None | None | None | None | PPS | 720p | Backlit | Finger-print Reader | None | dTPM 2.0 | 3-cell(24Wh) + 3-cell(24Wh) | 45W | Win10 Pro | 3-year, Depot | 04/17 |
| 20HD005EUS | US | i7-7600U | vPro | Intel HD 620 | 16GBx1 | 14" FHD (1920x1080) IPS | 10-point Multi-touch | 512GB SSD M.2 PCIe NVMe Opal2 | None | Intel 8265 ac, 2x2 + BT4.1 | WWAN Upgradable | None | None | None | None | PPS | 720p | Backlit | Finger-print Reader | None | dTPM 2.0 | 3-cell(24Wh) + 3-cell(24Wh) | 45W | Win10 Pro | 3-year, Depot | 04/17 |
| 20HD005FUS | US | i7-7600U | vPro | Intel HD 620 | 8GBx1 | 14" FHD (1920x1080) IPS | 10-point Multi-touch | 256GB SSD M.2 PCIe NVMe Opal2 | None | Intel 8265 ac, 2x2 + BT4.1 | WWAN Upgradable | None | None | None | None | PPS | IR & 720p | Backlit | Finger-print Reader | None | dTPM 2.0 | 3-cell(24Wh) + 3-cell(24Wh) | 45W | Win10 Pro | 3-year, Depot | 04/17 |
| 20HD005GUS | US | i7-7600U | vPro | Intel HD 620 | 16GBx1 | 14" FHD (1920x1080) IPS | None | 512GB SSD M.2 PCIe NVMe Opal2 | None | Intel 8265 ac, 2x2 + BT4.1 | WWAN Upgradable | None | None | None | None | PPS | 720p | Backlit | Finger-print Reader | None | dTPM 2.0 | 3-cell(24Wh) + 3-cell(24Wh) | 45W | Win10 Pro | 3-year, Depot | 04/17 |

ThinkPad T470 - TopSeller - 20JM

Product Specifications Reference (PSREF)

| Model | Region | Processor | vPro | Graphics | Memory | Display | Multi-touch | Storage(HDD/SSD) | Optical | WLAN + Bluetooth | WWAN | SIM Card | Smart Card Reader | Dock | Monitor Cable | Case Material | Camera | Key-board | Finger-print Reader | NFC | TPM | Battery (internal+external) | Power Adapter | Operating System | Warranty | Ann Date (m/y) |
|------------|--------|-----------|------|--------------|--------|-------------------------|----------------------|-------------------------------|---------|----------------------------|-----------------|----------|-------------------|------|---------------|---------------|--------|-------------|---------------------|------|----------|-----------------------------|---------------|----------------------|---------------|----------------|
| 20JM0009US | US | i5-6300U | vPro | Intel HD 520 | 8GBx1 | 14" FHD (1920x1080) IPS | None | 256GB SSD M.2 PCIe NVMe Opal2 | None | Intel 8260 ac, 2x2 + BT4.1 | WWAN Upgradable | None | None | None | None | PPS | 720p | Backlit | Finger-print Reader | None | dTPM 2.0 | 3-cell(24Wh) + 3-cell(24Wh) | 45W | Win10 DG Win7 Pro 64 | 3-year, Depot | 03/17 |
| 20JM000AUS | US | i7-6600U | vPro | Intel HD 520 | 8GBx1 | 14" FHD (1920x1080) IPS | None | 256GB SSD M.2 PCIe NVMe Opal2 | None | Intel 8260 ac, 2x2 + BT4.1 | WWAN Upgradable | None | None | None | None | PPS | 720p | Backlit | Finger-print Reader | None | dTPM 2.0 | 3-cell(24Wh) + 3-cell(24Wh) | 45W | Win10 DG Win7 Pro 64 | 3-year, Depot | 03/17 |
| 20JM000BUS | US | i7-6500U | No | Intel HD 520 | 8GBx1 | 14" FHD (1920x1080) IPS | None | 256GB SSD M.2 PCIe NVMe Opal2 | None | Intel 8260 ac, 2x2 + BT4.1 | WWAN Upgradable | None | None | None | None | PPS | 720p | Backlit | Finger-print Reader | None | dTPM 2.0 | 3-cell(24Wh) + 3-cell(24Wh) | 45W | Win10 DG Win7 Pro 64 | 3-year, Depot | 03/17 |
| 20JM000CUS | US | i5-6200U | No | Intel HD 520 | 4GBx1 | 14" HD (1366x768) | None | 500GB 7200rpm | None | Intel 8260 ac, 2x2 + BT4.1 | WWAN Upgradable | None | None | None | None | PPS | 720p | Non-backlit | Finger-print Reader | None | dTPM 2.0 | 3-cell(24Wh) + 3-cell(24Wh) | 45W | Win10 DG Win7 Pro 64 | 1-year, Depot | 03/17 |
| 20JM000EUS | US | i5-6300U | vPro | Intel HD 520 | 8GBx1 | 14" FHD (1920x1080) IPS | None | 256GB SSD M.2 PCIe NVMe Opal2 | None | Intel 8260 ac, 2x2 + BT4.1 | WWAN Upgradable | None | None | None | None | PPS | 720p | Backlit | Finger-print Reader | None | dTPM 2.0 | 3-cell(24Wh) + 3-cell(24Wh) | 45W | Win10 DG Win7 Pro 64 | 3-year, Depot | 04/17 |
| 20JM000FUS | US | i7-6600U | vPro | Intel HD 520 | 8GBx1 | 14" FHD (1920x1080) IPS | None | 256GB SSD M.2 PCIe NVMe Opal2 | None | Intel 8260 ac, 2x2 + BT4.1 | WWAN Upgradable | None | None | None | None | PPS | 720p | Backlit | Finger-print Reader | None | dTPM 2.0 | 3-cell(24Wh) + 3-cell(24Wh) | 45W | Win10 DG Win7 Pro 64 | 3-year, Depot | 04/17 |
| 20JM000GUS | US | i7-6600U | vPro | Intel HD 520 | 8GBx1 | 14" FHD (1920x1080) IPS | 10-point Multi-touch | 256GB SSD M.2 PCIe NVMe Opal2 | None | Intel 8260 ac, 2x2 + BT4.1 | WWAN Upgradable | None | None | None | None | PPS | 720p | Backlit | Finger-print Reader | None | dTPM 2.0 | 3-cell(24Wh) + 3-cell(24Wh) | 45W | Win10 DG Win7 Pro 64 | 3-year, Depot | 04/17 |
| 20JM000HUS | US | i5-6300U | vPro | Intel HD 520 | 8GBx1 | 14" FHD (1920x1080) IPS | None | 256GB SSD M.2 PCIe NVMe Opal2 | None | Intel 8260 ac, 2x2 + BT4.1 | Sierra EM7455 | None | None | None | None | PPS | 720p | Backlit | Finger-print Reader | None | dTPM 2.0 | 3-cell(24Wh) + 3-cell(24Wh) | 45W | Win10 DG Win7 Pro 64 | 3-year, Depot | 04/17 |
| 20JM000JUS | US | i7-6600U | vPro | Intel HD 520 | 8GBx1 | 14" FHD (1920x1080) IPS | 10-point Multi-touch | 256GB SSD M.2 PCIe NVMe Opal2 | None | Intel 8260 ac, 2x2 + BT4.1 | Sierra EM7455 | None | None | None | None | PPS | 720p | Backlit | Finger-print Reader | None | dTPM 2.0 | 3-cell(24Wh) + 3-cell(24Wh) | 45W | Win10 DG Win7 Pro 64 | 3-year, Depot | 04/17 |
| 20JM000KUS | US | i7-6600U | vPro | Intel HD 520 | 8GBx1 | 14" FHD (1920x1080) IPS | None | 256GB SSD M.2 PCIe NVMe Opal2 | None | Intel 8260 ac, 2x2 + BT4.1 | Sierra EM7455 | None | None | None | None | PPS | 720p | Backlit | Finger-print Reader | None | dTPM 2.0 | 3-cell(24Wh) + 3-cell(24Wh) | 45W | Win10 DG Win7 Pro 64 | 3-year, Depot | 04/17 |
| 20JM000LUS | US | i7-6600U | vPro | Intel HD 520 | 16GBx1 | 14" FHD (1920x1080) IPS | 10-point Multi-touch | 512GB SSD M.2 PCIe NVMe Opal2 | None | Intel 8260 ac, 2x2 + BT4.1 | WWAN Upgradable | None | None | None | None | PPS | 720p | Backlit | Finger-print Reader | None | dTPM 2.0 | 3-cell(24Wh) + 3-cell(24Wh) | 45W | Win10 DG Win7 Pro 64 | 3-year, Depot | 04/17 |
| 20JM000MUS | US | i7-6600U | vPro | Intel HD 520 | 16GBx1 | 14" FHD (1920x1080) IPS | None | 512GB SSD M.2 PCIe NVMe Opal2 | None | Intel 8260 ac, 2x2 + BT4.1 | WWAN Upgradable | None | None | None | None | PPS | 720p | Backlit | Finger-print Reader | None | dTPM 2.0 | 3-cell(24Wh) + 3-cell(24Wh) | 45W | Win10 DG Win7 Pro 64 | 3-year, Depot | 04/17 |



ThinkPad T470p Platform Specifications

Product Specifications Reference (PSREF)

| | | | | | | | | | | | | | | | | | | |
|-----------------------|--|-------------------|-------------------|----------------|---------------------|-----------|-----------------------|---|---|---------------|---------------|---------------|-------------------------|-------------------|-------------------|-----------------------|-------------------|-------------------|
| Processor | 7th Generation Intel® Core™ i5 / i7 Processor | | | | | | | Dimensions <i>FHD (WxDxH):</i> 13.35" x 9.25" x 0.94"; 339mm x 235mm x 24mm <i>WQHD (WxDxH):</i> 13.35" x 9.25" x 0.96"; 339mm x 235mm x 24.4mm | | | | | | | | | | |
| | Processor Number | # of Cores | # of Threads | Base Frequency | Max Turbo Frequency | Cache | Memory Types | | Weight <table border="1"> <tr> <td><i>Models</i></td> <td><i>3-cell</i></td> <td><i>6-cell</i></td> </tr> <tr> <td><i>Integrated model</i></td> <td>3.83 lb / 1.74 kg</td> <td>4.16 lb / 1.89 kg</td> </tr> <tr> <td><i>discrete model</i></td> <td>4.01 lb / 1.82 kg</td> <td>4.33 lb / 1.96 kg</td> </tr> </table> | <i>Models</i> | <i>3-cell</i> | <i>6-cell</i> | <i>Integrated model</i> | 3.83 lb / 1.74 kg | 4.16 lb / 1.89 kg | <i>discrete model</i> | 4.01 lb / 1.82 kg | 4.33 lb / 1.96 kg |
| | <i>Models</i> | <i>3-cell</i> | <i>6-cell</i> | | | | | | | | | | | | | | | |
| | <i>Integrated model</i> | 3.83 lb / 1.74 kg | 4.16 lb / 1.89 kg | | | | | | | | | | | | | | | |
| <i>discrete model</i> | 4.01 lb / 1.82 kg | 4.33 lb / 1.96 kg | | | | | | | | | | | | | | | | |
| i5-7300HQ | 4 | 4 | 2.5 GHz | 3.5 GHz | 6MB | DDR4-2400 | Intel HD Graphics 630 | | | | | | | | | | | |
| i5-7440HQ | | | 2.8 GHz | 3.8 GHz | 6MB | | | | | | | | | | | | | |
| i7-7700HQ | | 8 | 2.8 GHz | 3.8 GHz | 6MB | | | | | | | | | | | | | |
| i7-7820HQ | 2.9 GHz | | 3.9 GHz | 8MB | | | | | | | | | | | | | | |
| Graphics | Intel HD Graphics 630 in processor only, or Intel HD Graphics 630 in processor and NVIDIA GeForce® 940MX, 2GB 2.5GHz GDDR5 memory; supports external digital monitor via HDMI or Mini DisplayPort; supports three independent displays; Max resolution: 4096x2304@60Hz (DisplayPort via Mini DisplayPort cable); 4096x2160@24Hz (HDMI) | | | | | | | Case color Case material | | | | | | | | | | |
| Chipset | Mobile Intel QM175 Chipset | | | | | | | Smart card reader | | | | | | | | | | |
| Memory | 32GB max / 2400MHz DDR4, dual-channel capable, two DDR4 SO-DIMM sockets | | | | | | | Media reader | | | | | | | | | | |
| Display | <i>Some:</i> 14.0" (355mm) FHD (1920x1080), anti-glare, LED backlight, IPS, 250 nits, 16:9 aspect ratio, 600:1 contrast ratio, 160° viewing angle <i>Some:</i> 14.0" (355mm) WQHD (2560x1440), anti-glare, LED backlight, IPS, 300 nits, 16:9 aspect ratio, 700:1 contrast ratio, 160° viewing angle | | | | | | | Ports | | | | | | | | | | |
| Multi-touch (opt) | On-cell touch, supports 10-finger gesture (FHD only) | | | | | | | Monitor cable (optional) | | | | | | | | | | |
| Storage | <i>System has one HDD slot or one M.2 2280 slot exclusively for storage</i> <i>Some:</i> HDD / SATA 6.0Gb/s, 2.5" wide, 7mm or 9.5mm high, Active Protection System™ <i>Some:</i> SSD / SATA 6.0Gb/s, 2.5" wide, 7mm high (e.g. xxxGB SSD) <i>Some:</i> M.2 SSD / PCIe NVMe, PCIe 3.0 x 2, 16Gb/s <i>Some:</i> 128GB M.2 SSD / SATA 6.0Gb/s, in WWAN slot as 2nd Storage, mutually exclusive with WWAN | | | | | | | Camera | | | | | | | | | | |
| Optical | None | | | | | | | Audio support | | | | | | | | | | |
| Ethernet | <i>Non-vPro model:</i> Intel Ethernet Connection I219-V (Jacksonville) <i>vPro model:</i> Intel Ethernet Connection I219-LM (Jacksonville) | | | | | | | Keyboard | | | | | | | | | | |
| WLAN | <i>One of the following, configurable by model:</i> <ul style="list-style-type: none"> Realtek® RTL8822BE, Wi-Fi 2x2 802.11ac + BT4.1, M.2 card Intel Dual Band Wireless-AC 8265, Wi-Fi 2x2 802.11ac + BT4.1, M.2 card | | | | | | | UltraNav™ | | | | | | | | | | |
| Bluetooth™ | Bluetooth 4.1 wireless, integrated in Wi-Fi + Bluetooth combo adapter * Intel 8265ac card support BT4.2 but is limited to BT4.1 by Windows OS | | | | | | | Security | | | | | | | | | | |
| WWAN (optional) | <i>One of the following, configurable by model:</i> <ul style="list-style-type: none"> Wireless WAN upgradable Integrated Mobile Broadband 4G LTE-A, Qualcomm® Snapdragon™ X7 LTE-A (Sierra Wireless EM7455), M.2 card | | | | | | | Security chip | | | | | | | | | | |
| SIM card (opt) | Micro-SIM card slot, opt Verizon LTE (US) or Lenovo® Connect (EMEA) SIM card | | | | | | | vPro (optional) | | | | | | | | | | |
| | | | | | | | | Fingerprint reader | | | | | | | | | | |
| | | | | | | | | NFC | | | | | | | | | | |
| | | | | | | | | Battery | | | | | | | | | | |
| | | | | | | | | Max battery life | | | | | | | | | | |
| | | | | | | | | AC adapter | | | | | | | | | | |
| | | | | | | | | Preload | | | | | | | | | | |
| | | | | | | | | Limited warranty | | | | | | | | | | |
| | | | | | | | | Mil-Spec test | | | | | | | | | | |
| | | | | | | | | Environment | | | | | | | | | | |

| Model | Region | Processor | vPro | Graphics | Chipset | Memory | Display | Multi-touch | Storage(HDD/SSD) | Optical | WLAN + Bluetooth | WWAN | SIM Card | Smart Card Reader | Monitor Cable | Camera | Key-board | Finger-print Reader | NFC | TPM | Battery | Power Adapter | Operating System | Warranty | Ann Date (m/y) |
|------------|--------|-----------|------|--------------|-------------|--------|--------------------------|----------------------|-------------------------------|---------|----------------------------|-----------------|----------|-------------------|---------------|--------|-----------|---------------------|------|----------|---------------|---------------|------------------|---------------|----------------|
| 20J6001BUS | US | i5-7440HQ | vPro | 940MX 2GB | Intel QM175 | 8GBx1 | 14" FHD (1920x1080) IPS | 10-point Multi-touch | 512GB SSD M.2 PCIe NVMe Opal2 | None | Intel 8265 ac, 2x2 + BT4.1 | WWAN Upgradable | None | None | None | 720p | Backlit | Finger-print Reader | None | dTPM 2.0 | 6-cell (48Wh) | 135W | Win10 Pro 64 | 3-year, Depot | 03/17 |
| 20J6001CUS | US | i5-7440HQ | vPro | 940MX 2GB | Intel QM175 | 8GBx1 | 14" FHD (1920x1080) IPS | None | 256GB SSD M.2 PCIe NVMe Opal2 | None | Intel 8265 ac, 2x2 + BT4.1 | WWAN Upgradable | None | None | None | 720p | Backlit | Finger-print Reader | None | dTPM 2.0 | 6-cell (48Wh) | 135W | Win10 Pro 64 | 3-year, Depot | 02/17 |
| 20J6001DUS | US | i5-7440HQ | vPro | Intel HD 630 | Intel QM175 | 4GBx2 | 14" FHD (1920x1080) IPS | 10-point Multi-touch | 256GB SSD M.2 PCIe NVMe Opal2 | None | Intel 8265 ac, 2x2 + BT4.1 | WWAN Upgradable | None | None | None | 720p | Backlit | Finger-print Reader | None | dTPM 2.0 | 3-cell (24Wh) | 90W | Win10 Pro 64 | 3-year, Depot | 03/17 |
| 20J6001EUS | US | i5-7440HQ | vPro | 940MX 2GB | Intel QM175 | 8GBx1 | 14" FHD (1920x1080) IPS | None | 512GB SSD M.2 PCIe NVMe Opal2 | None | Intel 8265 ac, 2x2 + BT4.1 | WWAN Upgradable | None | None | None | 720p | Backlit | Finger-print Reader | None | dTPM 2.0 | 6-cell (48Wh) | 135W | Win10 Pro 64 | 3-year, Depot | 02/17 |
| 20J6001FUS | US | i5-7440HQ | vPro | Intel HD 630 | Intel QM175 | 4GBx2 | 14" FHD (1920x1080) IPS | None | 256GB SSD M.2 PCIe NVMe Opal2 | None | Intel 8265 ac, 2x2 + BT4.1 | WWAN Upgradable | None | None | None | 720p | Backlit | Finger-print Reader | None | dTPM 2.0 | 6-cell (48Wh) | 90W | Win10 Pro 64 | 3-year, Depot | 02/17 |
| 20J6001GUS | US | i5-7440HQ | vPro | Intel HD 630 | Intel QM175 | 4GBx2 | 14" FHD (1920x1080) IPS | 10-point Multi-touch | 256GB SSD M.2 PCIe NVMe Opal2 | None | Intel 8265 ac, 2x2 + BT4.1 | WWAN Upgradable | None | None | None | 720p | Backlit | Finger-print Reader | None | dTPM 2.0 | 6-cell (48Wh) | 90W | Win10 Pro 64 | 3-year, Depot | 03/17 |
| 20J6001HUS | US | i5-7440HQ | vPro | Intel HD 630 | Intel QM175 | 4GBx2 | 14" FHD (1920x1080) IPS | None | 256GB SSD M.2 PCIe NVMe Opal2 | None | Intel 8265 ac, 2x2 + BT4.1 | WWAN Upgradable | None | None | None | 720p | Backlit | Finger-print Reader | None | dTPM 2.0 | 3-cell (24Wh) | 90W | Win10 Pro 64 | 3-year, Depot | 02/17 |
| 20J6001JUS | US | i5-7440HQ | vPro | 940MX 2GB | Intel QM175 | 4GBx2 | 14" FHD (1920x1080) IPS | 10-point Multi-touch | 256GB SSD M.2 PCIe NVMe Opal2 | None | Intel 8265 ac, 2x2 + BT4.1 | WWAN Upgradable | None | None | None | 720p | Backlit | Finger-print Reader | None | dTPM 2.0 | 6-cell (48Wh) | 135W | Win10 Pro 64 | 3-year, Depot | 03/17 |
| 20J6003JUS | US | i7-7820HQ | vPro | 940MX 2GB | Intel QM175 | 16GBx1 | 14" WQHD (2560x1440) IPS | None | 512GB SSD M.2 PCIe NVMe Opal2 | None | Intel 8265 ac, 2x2 + BT4.1 | WWAN Upgradable | None | None | None | 720p | Backlit | Finger-print Reader | None | dTPM 2.0 | 6-cell (48Wh) | 135W | Win10 Pro 64 | 3-year, Depot | 04/17 |
| 20J6003KUS | US | i7-7820HQ | vPro | 940MX 2GB | Intel QM175 | 16GBx1 | 14" FHD (1920x1080) IPS | None | 512GB SSD M.2 PCIe NVMe Opal2 | None | Intel 8265 ac, 2x2 + BT4.1 | WWAN Upgradable | None | None | None | 720p | Backlit | Finger-print Reader | None | dTPM 2.0 | 6-cell (48Wh) | 135W | Win10 Pro 64 | 3-year, Depot | 04/17 |
| 20J6003LUS | US | i7-7820HQ | vPro | 940MX 2GB | Intel QM175 | 8GBx1 | 14" FHD (1920x1080) IPS | None | 256GB SSD M.2 PCIe NVMe Opal2 | None | Intel 8265 ac, 2x2 + BT4.1 | WWAN Upgradable | None | None | None | 720p | Backlit | Finger-print Reader | None | dTPM 2.0 | 6-cell (48Wh) | 135W | Win10 Pro 64 | 3-year, Depot | 04/17 |
| 20J6003MUS | US | i5-7440HQ | vPro | Intel HD 630 | Intel QM175 | 8GBx1 | 14" FHD (1920x1080) IPS | None | 256GB SSD M.2 PCIe NVMe Opal2 | None | Intel 8265 ac, 2x2 + BT4.1 | WWAN Upgradable | None | None | None | 720p | Backlit | Finger-print Reader | None | dTPM 2.0 | 6-cell (48Wh) | 90W | Win10 Pro 64 | 3-year, Depot | 04/17 |
| 20J6003NUS | US | i5-7440HQ | vPro | Intel HD 630 | Intel QM175 | 8GBx1 | 14" FHD (1920x1080) IPS | None | 256GB SSD M.2 PCIe NVMe Opal2 | None | Intel 8265 ac, 2x2 + BT4.1 | Sierra EM7455 | None | None | None | 720p | Backlit | Finger-print Reader | None | dTPM 2.0 | 6-cell (48Wh) | 90W | Win10 Pro 64 | 3-year, Depot | 04/17 |
| 20J6003PUS | US | i7-7820HQ | vPro | 940MX 2GB | Intel QM175 | 8GBx1 | 14" FHD (1920x1080) IPS | None | 256GB SSD M.2 PCIe NVMe Opal2 | None | Intel 8265 ac, 2x2 + BT4.1 | Sierra EM7455 | None | None | None | 720p | Backlit | Finger-print Reader | None | dTPM 2.0 | 6-cell (48Wh) | 135W | Win10 Pro 64 | 3-year, Depot | 04/17 |
| 20J6003UUS | US | i7-7820HQ | vPro | 940MX 2GB | Intel QM175 | 8GBx1 | 14" FHD (1920x1080) IPS | 10-point Multi-touch | 256GB SSD M.2 PCIe NVMe Opal2 | None | Intel 8265 ac, 2x2 + BT4.1 | WWAN Upgradable | None | None | None | 720p | Backlit | Finger-print Reader | None | dTPM 2.0 | 6-cell (48Wh) | 135W | Win10 Pro 64 | 3-year, Depot | 06/17 |
| 20J6003VUS | US | i7-7820HQ | vPro | 940MX 2GB | Intel QM175 | 8GBx1 | 14" FHD (1920x1080) IPS | None | 256GB SSD M.2 PCIe NVMe Opal2 | None | Intel 8265 ac, 2x2 + BT4.1 | WWAN Upgradable | None | None | None | 720p | Backlit | Finger-print Reader | None | dTPM 2.0 | 6-cell (48Wh) | 135W | Win10 Pro 64 | 3-year, Depot | 06/17 |
| 20J6003WUS | US | i5-7440HQ | vPro | Intel HD 630 | Intel QM175 | 8GBx1 | 14" FHD (1920x1080) IPS | None | 180GB SSD Opal2 | None | Intel 8265 ac, 2x2 + BT4.1 | WWAN Upgradable | None | None | None | 720p | Backlit | Finger-print Reader | None | dTPM 2.0 | 6-cell (48Wh) | 90W | Win10 Pro 64 | 3-year, Depot | 06/17 |
| 20J6003XUS | US | i7-7820HQ | vPro | 940MX 2GB | Intel QM175 | 16GBx1 | 14" FHD (1920x1080) IPS | 10-point Multi-touch | 512GB SSD M.2 PCIe NVMe Opal2 | None | Intel 8265 ac, 2x2 + BT4.1 | WWAN Upgradable | None | None | None | 720p | Backlit | Finger-print Reader | None | dTPM 2.0 | 6-cell (48Wh) | 135W | Win10 Pro 64 | 3-year, Depot | 06/17 |
| 20J6003YUS | US | i5-7440HQ | vPro | Intel HD 630 | Intel QM175 | 8GBx1 | 14" FHD (1920x1080) IPS | None | 180GB SSD Opal2 | None | Intel 8265 ac, 2x2 + BT4.1 | WWAN Upgradable | None | None | None | 720p | Backlit | Finger-print Reader | None | dTPM 2.0 | 3-cell (24Wh) | 90W | Win10 Pro 64 | 3-year, Depot | 06/17 |



ThinkPad T470s Platform Specifications

Product Specifications Reference (PSREF)

| | | | | | | | | | |
|----------------------------|--|------------|--------------|----------------|---------------------|-------|--------------|--|--|
| Processor | 6th Generation Intel® Core™ i5 / i7 Processor | | | | | | | Dimensions Weight Case color Case material | <i>WxDxH:</i> 13.03" x 8.93" x 0.67-0.74"; 331mm x 226.8mm x 16.9-18.8mm Starting at 2.9 lb (1.32kg) Black or Silver <i>Display cover:</i> CFRP Hybrid; <i>Bottom:</i> Magnesium |
| | Processor Number | # of Cores | # of Threads | Base Frequency | Max Turbo Frequency | Cache | Memory Types | | |
| | i5-6300U | 2 | 4 | 2.4 GHz | 3.0 GHz | 3MB | DDR4-2133 | Intel HD Graphics 520 | |
| | i7-6600U | | | 2.6 GHz | 3.4 GHz | 4MB | | | |
| | or 7th Generation Intel Core i5 / i7 Processor | | | | | | | Smart card reader Media reader Ports | <i>Optional:</i> Smart card reader 4-in-1 reader (MMC, SD, SDHC, SDXC) Three USB 3.1 Gen 1 (USB 3.0, one Always On), USB 3.1 Type-C Gen 2 / Thunderbolt 3, HDMI 1.4b, Ethernet (RJ-45), Dock connector |
| | Processor Number | # of Cores | # of Threads | Base Frequency | Max Turbo Frequency | Cache | Memory Types | | |
| | i5-7200U | 2 | 4 | 2.5 GHz | 3.1 GHz | 3MB | DDR4-2133 | Intel HD Graphics 620 | |
| | i5-7300U | | | 2.6 GHz | 3.5 GHz | 3MB | | | |
| | i7-7500U | | | 2.7 GHz | 3.5 GHz | 4MB | | | |
| | i7-7600U | | | 2.8 GHz | 3.9 GHz | 4MB | | | |
| Graphics | Intel HD Graphics 520 or 620 in processor; supports external digital monitor via HDMI or USB Type-C; supports three independent displays; Max resolution: 4096x2304@60Hz (USB Type-C); 4096x2160@24Hz (HDMI) | | | | | | | WiGig dock (<i>opt</i>) Monitor cable (<i>optional</i>) | ThinkPad WiGig dock, mutually exclusive with WWAN <i>HDMI to VGA:</i> Lenovo HDMI to VGA Monitor Adapter <i>USB-C to VGA:</i> Lenovo USB-C to VGA Adapter |
| Chipset | Intel SoC (System on Chip) platform | | | | | | | Camera (<i>optional</i>) | HD720p resolution, fixed focus (models without camera are unavailable in EMEA) |
| Memory | 20GB or 24GB max ⁷ / 2400MHz DDR4, dual-channel capable, 4GB or 8GB memory soldered to systemboard, one DDR4 SO-DIMM socket * System clocks down for processors with lower memory controller | | | | | | | Audio support | HD Audio, Realtek® ALC3268 codec / stereo speakers, 1W x 2 / dual array microphone, combo audio/microphone jack |
| Display | <i>Some:</i> 14.0" (355mm) FHD (1920x1080), anti-glare, LED backlight, IPS, 250 nits, 16:9 aspect ratio, 700:1 contrast ratio, 160° viewing angle <i>Some:</i> 14.0" (355mm) WQHD (2560x1440), anti-glare, LED backlight, IPS, 300 nits, 16:9 aspect ratio, 700:1 contrast ratio, 160° viewing angle | | | | | | | Keyboard UltraNav™ | 6-row, spill-resistant, multimedia Fn keys, optional LED backlight TrackPoint® pointing device and buttonless Mylar surface multi-touch touchpad |
| Multi-touch (<i>opt</i>) | On-cell touch, supports 10-finger gesture, 250 nits (FHD only) | | | | | | | Security Security chip vPro (<i>optional</i>) Fingerprint reader NFC (<i>optional</i>) | Power-on password, hard disk password, supervisor password, security keyhole Discrete TPM 2.0, TCG Certified Intel vPro Technology <i>Optional:</i> Touch style match on chip fingerprint reader on the palm rest Near Field Communication |
| Storage | <i>Some:</i> M.2 SSD / SATA 6.0Gb/s (e.g. xxxG SSD) <i>Some:</i> M.2 SSD / PCIe NVMe, PCIe 3.0 x 4, 32Gb/s (e.g. xxxG SSD PCIe NVMe) | | | | | | | Internal battery Max battery life AC adapter | Front Li-Polymer 3-cell (23Wh) and rear Li-Ion 3-cell (26Wh), both Integrated <i>MobileMark® 2014:</i> up to 10.5 hr 45W AC adapter (slim tip), 45W or 65W USB Type-C AC adapter |
| Optical | None | | | | | | | Preload | Windows® 7 Professional 64 preinstalled through downgrade rights in Windows 10 Pro 64 • Lenovo Solution Center • Lenovo PowerEngage • ThinkVantage Product Recovery • ThinkVantage System Update • Adobe® Reader® • Microsoft® Office preloaded; purchase a product key to activate • McAfee® LiveSafe™ (30-day trial) |
| Ethernet | <i>Non-vPro model:</i> Intel Ethernet Connection I219-V (Jacksonville) <i>vPro model:</i> Intel Ethernet Connection I219-LM (Jacksonville) | | | | | | | Limited warranty | <i>Some:</i> Windows 10 Home 64 <i>Some:</i> Windows 10 Pro 64 • Lenovo Companion • Lenovo Setting • Microsoft Office preloaded; purchase a product key to activate |
| WLAN | <i>One of the following, configurable by model (WiGig is mutually exclusive with WWAN):</i> • Intel Dual Band Wireless-AC 8260, Wi-Fi 2x2 802.11ac + BT4.1, M.2 card • Intel Dual Band Wireless-AC 8265, Wi-Fi 2x2 802.11ac + BT4.1, M.2 card • Intel Tri-Band Wireless-AC 18265, WiGig 802.11ad + Wi-Fi 2x2 802.11ac + BT4.1, M.2 card | | | | | | | Mil-Spec test | MIL-STD-810G military certification |
| Bluetooth™ | Bluetooth 4.1 wireless, integrated in Wi-Fi + Bluetooth combo adapter * Intel 8265ac / 18265ac card support BT4.2 but is limited to BT4.1 by Windows OS | | | | | | | Environment | EPEAT™ Gold (US only); ENERGY STAR® 6.1; RoHS-compliant |
| WWAN (<i>optional</i>) | <i>One of the following, configurable by model (mutually exclusive with WiGig):</i> • Wireless WAN upgradable • Integrated Mobile Broadband 4G LTE-A, Qualcomm® Snapdragon™ X7 LTE-A (Sierra Wireless EM7455), M.2 card • Micro-SIM card slot, opt Verizon LTE (US) or Lenovo® Connect (EMEA) SIM card | | | | | | | | |
| SIM card (<i>opt</i>) | | | | | | | | | |

| Model | Region | Processor | vPro | Graphics | Memory (Soldered +DIMM) | Display | Multi-touch | Storage(HDD/SSD) | Optical | WLAN + Bluetooth | WWAN | SIM Card | Smart Card Reader | Dock | Monitor Cable | Color | Camera | Key-board | Finger-print Reader | NFC | TPM | Battery (internal) | Power Adapter | Operating System | Warranty | Ann Date (m/y) |
|------------|--------|-----------|------|--------------|-------------------------|--------------------------|----------------------|-------------------------------|---------|----------------------------|-----------------|----------|-------------------|------|---------------|--------|--------|-----------|---------------------|------|----------|-----------------------------|---------------|------------------|---------------|----------------|
| 20HF0010US | US | i7-7600U | vPro | Intel HD 620 | 4GB + 8GB | 14" WQHD (2560x1440) IPS | None | 512GB SSD M.2 PCIe NVMe Opal2 | None | Intel 8265 ac, 2x2 + BT4.1 | WWAN Upgradable | None | None | None | None | Black | 720p | Backlit | Finger-print Reader | None | dTPM 2.0 | 3-cell(23Wh) + 3-cell(26Wh) | 45W | Win10 Pro 64 | 3-year, Depot | 02/17 |
| 20HF0011US | US | i5-7300U | vPro | Intel HD 620 | 4GB + 4GB | 14" FHD (1920x1080) IPS | None | 256GB SSD M.2 PCIe NVMe Opal2 | None | Intel 8265 ac, 2x2 + BT4.1 | WWAN Upgradable | None | None | None | None | Black | 720p | Backlit | Finger-print Reader | None | dTPM 2.0 | 3-cell(23Wh) + 3-cell(26Wh) | 45W | Win10 Pro 64 | 3-year, Depot | 02/17 |
| 20HF0012US | US | i5-7300U | vPro | Intel HD 620 | 4GB + 4GB | 14" FHD (1920x1080) IPS | 10-point Multi-touch | 256GB SSD M.2 PCIe NVMe Opal2 | None | Intel 8265 ac, 2x2 + BT4.1 | WWAN Upgradable | None | None | None | None | Black | 720p | Backlit | Finger-print Reader | None | dTPM 2.0 | 3-cell(23Wh) + 3-cell(26Wh) | 45W | Win10 Pro 64 | 3-year, Depot | 02/17 |
| 20HF0013US | US | i7-7600U | vPro | Intel HD 620 | 4GB + 4GB | 14" FHD (1920x1080) IPS | None | 256GB SSD M.2 PCIe NVMe Opal2 | None | Intel 8265 ac, 2x2 + BT4.1 | WWAN Upgradable | None | None | None | None | Black | 720p | Backlit | Finger-print Reader | None | dTPM 2.0 | 3-cell(23Wh) + 3-cell(26Wh) | 45W | Win10 Pro 64 | 3-year, Depot | 02/17 |
| 20HF0014US | US | i5-7200U | No | Intel HD 620 | 4GB Soldered | 14" FHD (1920x1080) IPS | None | 128GB SSD M.2 | None | Intel 8265 ac, 2x2 + BT4.1 | WWAN Upgradable | None | None | None | None | Black | 720p | Backlit | Finger-print Reader | None | dTPM 2.0 | 3-cell(23Wh) + 3-cell(26Wh) | 45W | Win10 Pro 64 | 1-year, Depot | 02/17 |
| 20HF0015US | US | i7-7600U | vPro | Intel HD 620 | 4GB + 4GB | 14" FHD (1920x1080) IPS | 10-point Multi-touch | 256GB SSD M.2 PCIe NVMe Opal2 | None | Intel 8265 ac, 2x2 + BT4.1 | WWAN Upgradable | None | None | None | None | Black | 720p | Backlit | Finger-print Reader | None | dTPM 2.0 | 3-cell(23Wh) + 3-cell(26Wh) | 45W | Win10 Pro 64 | 3-year, Depot | 02/17 |
| 20HF001DUS | US | i7-7600U | vPro | Intel HD 620 | 8GB + 16GB | 14" FHD (1920x1080) IPS | None | 1TB SSD M.2 PCIe NVMe Opal2 | None | Intel 8265 ac, 2x2 + BT4.1 | WWAN Upgradable | None | None | None | None | Black | 720p | Backlit | Finger-print Reader | None | dTPM 2.0 | 3-cell(23Wh) + 3-cell(26Wh) | 45W | Win10 Pro 64 | 3-year, Depot | 04/17 |
| 20HF003QUS | US | i7-7600U | vPro | Intel HD 620 | 4GB + 8GB | 14" WQHD (2560x1440) IPS | None | 512GB SSD M.2 PCIe NVMe Opal2 | None | Intel 8265 ac, 2x2 + BT4.1 | WWAN Upgradable | None | None | None | None | Silver | 720p | Backlit | Finger-print Reader | None | dTPM 2.0 | 3-cell(23Wh) + 3-cell(26Wh) | 45W | Win10 Pro 64 | 3-year, Depot | 02/17 |
| 20HF003RUS | US | i5-7200U | No | Intel HD 620 | 4GB + 4GB | 14" WQHD (2560x1440) IPS | None | 180GB SSD M.2 Opal2 | None | Intel 8265 ac, 2x2 + BT4.1 | WWAN Upgradable | None | None | None | None | Black | 720p | Backlit | Finger-print Reader | None | dTPM 2.0 | 3-cell(23Wh) + 3-cell(26Wh) | 45W | Win10 Pro 64 | 3-year, Depot | 03/17 |
| 20HF003SUS | US | i5-7200U | No | Intel HD 620 | 4GB + 4GB | 14" WQHD (2560x1440) IPS | None | 180GB SSD M.2 Opal2 | None | Intel 8265 ac, 2x2 + BT4.1 | WWAN Upgradable | None | None | None | None | Silver | 720p | Backlit | Finger-print Reader | None | dTPM 2.0 | 3-cell(23Wh) + 3-cell(26Wh) | 45W | Win10 Pro 64 | 3-year, Depot | 03/17 |
| 20HF003TUS | US | i7-7600U | vPro | Intel HD 620 | 4GB + 4GB | 14" FHD (1920x1080) IPS | None | 256GB SSD M.2 PCIe NVMe Opal2 | None | Intel 8265 ac, 2x2 + BT4.1 | WWAN Upgradable | None | None | None | None | Silver | 720p | Backlit | Finger-print Reader | None | dTPM 2.0 | 3-cell(23Wh) + 3-cell(26Wh) | 45W | Win10 Pro 64 | 3-year, Depot | 02/17 |
| 20HF003UUS | US | i5-7300U | vPro | Intel HD 620 | 4GB + 4GB | 14" FHD (1920x1080) IPS | 10-point Multi-touch | 256GB SSD M.2 PCIe NVMe Opal2 | None | Intel 8265 ac, 2x2 + BT4.1 | WWAN Upgradable | None | None | None | None | Silver | 720p | Backlit | Finger-print Reader | None | dTPM 2.0 | 3-cell(23Wh) + 3-cell(26Wh) | 45W | Win10 Pro 64 | 3-year, Depot | 02/17 |
| 20HF003VUS | US | i5-7200U | No | Intel HD 620 | 4GB Soldered | 14" FHD (1920x1080) IPS | None | 128GB SSD M.2 | None | Intel 8265 ac, 2x2 + BT4.1 | WWAN Upgradable | None | None | None | None | Silver | 720p | Backlit | Finger-print Reader | None | dTPM 2.0 | 3-cell(23Wh) + 3-cell(26Wh) | 45W | Win10 Pro 64 | 1-year, Depot | 02/17 |
| 20HF003WUS | US | i5-7300U | vPro | Intel HD 620 | 4GB + 4GB | 14" FHD (1920x1080) IPS | None | 256GB SSD M.2 PCIe NVMe Opal2 | None | Intel 8265 ac, 2x2 + BT4.1 | WWAN Upgradable | None | None | None | None | Silver | 720p | Backlit | Finger-print Reader | None | dTPM 2.0 | 3-cell(23Wh) + 3-cell(26Wh) | 45W | Win10 Pro 64 | 3-year, Depot | 02/17 |
| 20HF005GUS | US | i5-7300U | vPro | Intel HD 620 | 8GB Soldered | 14" FHD (1920x1080) IPS | None | 256GB SSD M.2 PCIe NVMe Opal2 | None | Intel 8265 ac, 2x2 + BT4.1 | Sierra EM7455 | None | None | None | None | Black | 720p | Backlit | Finger-print Reader | None | dTPM 2.0 | 3-cell(23Wh) + 3-cell(26Wh) | 45W | Win10 Pro 64 | 3-year, Depot | 04/17 |
| 20HF005HUS | US | i7-7600U | vPro | Intel HD 620 | 8GB Soldered | 14" FHD (1920x1080) IPS | 10-point Multi-touch | 256GB SSD M.2 PCIe NVMe Opal2 | None | Intel 8265 ac, 2x2 + BT4.1 | Sierra EM7455 | None | None | None | None | Black | 720p | Backlit | Finger-print Reader | None | dTPM 2.0 | 3-cell(23Wh) + 3-cell(26Wh) | 45W | Win10 Pro 64 | 3-year, Depot | 04/17 |
| 20HF005JUS | US | i7-7600U | vPro | Intel HD 620 | 8GB Soldered | 14" FHD (1920x1080) IPS | None | 256GB SSD M.2 PCIe NVMe Opal2 | None | Intel 8265 ac, 2x2 + BT4.1 | Sierra EM7455 | None | None | None | None | Black | 720p | Backlit | Finger-print Reader | None | dTPM 2.0 | 3-cell(23Wh) + 3-cell(26Wh) | 45W | Win10 Pro 64 | 3-year, Depot | 04/17 |
| 20HF005KUS | US | i7-7600U | vPro | Intel HD 620 | 8GB + 16GB | 14" FHD (1920x1080) IPS | 10-point Multi-touch | 1TB SSD M.2 PCIe NVMe Opal2 | None | Intel 8265 ac, 2x2 + BT4.1 | WWAN Upgradable | None | None | None | None | Silver | 720p | Backlit | Finger-print Reader | None | dTPM 2.0 | 3-cell(23Wh) + 3-cell(26Wh) | 45W | Win10 Pro 64 | 3-year, Depot | 04/17 |
| 20HF005LUS | US | i7-7600U | vPro | Intel HD 620 | 8GB + 16GB | 14" FHD (1920x1080) IPS | 10-point Multi-touch | 1TB SSD M.2 PCIe NVMe Opal2 | None | Intel 8265 ac, 2x2 + BT4.1 | WWAN Upgradable | None | None | None | None | Black | 720p | Backlit | Finger-print Reader | None | dTPM 2.0 | 3-cell(23Wh) + 3-cell(26Wh) | 45W | Win10 Pro 64 | 3-year, Depot | 04/17 |
| 20HF005MUS | US | i7-7600U | vPro | Intel HD 620 | 8GB + 16GB | 14" WQHD (2560x1440) IPS | None | 1TB SSD M.2 PCIe NVMe Opal2 | None | Intel 8265 ac, 2x2 + BT4.1 | WWAN Upgradable | None | None | None | None | Black | 720p | Backlit | Finger-print Reader | None | dTPM 2.0 | 3-cell(23Wh) + 3-cell(26Wh) | 45W | Win10 Pro 64 | 3-year, Depot | 04/17 |

| Model | Region | Processor | vPro | Graphics | Memory (Soldered +DIMM) | Display | Multi-touch | Storage(HDD/SSD) | Optical | WLAN + Bluetooth | WWAN | SIM Card | Smart Card Reader | Dock | Monitor Cable | Color | Camera | Key-board | Finger-print Reader | NFC | TPM | Battery (internal) | Power Adapter | Operating System | War-ranty | Ann Date (m/y) |
|------------|--------|-----------|------|--------------|-------------------------|-------------------------|----------------------|-------------------------------|---------|----------------------------|-----------------|----------|-------------------|------|---------------|-------|--------|-----------|---------------------|------|----------|-----------------------------|---------------|------------------|---------------|----------------|
| 20HF005NUS | US | i5-7200U | No | Intel HD 620 | 4GB Soldered | 14" FHD (1920x1080) IPS | None | 180GB SSD M.2 Opal2 | None | Intel 8265 ac, 2x2 + BT4.1 | WWAN Upgradable | None | None | None | None | Black | 720p | Backlit | Finger-print Reader | None | dTPM 2.0 | 3-cell(23Wh) + 3-cell(26Wh) | 45W | Win10 Pro 64 | 1-year, Depot | 04/17 |
| 20HF0063US | US | i5-7300U | vPro | Intel HD 620 | 8GB Soldered | 14" FHD (1920x1080) IPS | 10-point Multi-touch | 256GB SSD M.2 PCIe NVMe Opal2 | None | Intel 8265 ac, 2x2 + BT4.1 | WWAN Upgradable | None | None | None | None | Black | 720p | Backlit | Finger-print Reader | None | dTPM 2.0 | 3-cell(23Wh) + 3-cell(26Wh) | 45W | Win10 Pro 64 | 3-year, Depot | 06/17 |

ThinkPad T470s - TopSeller - 20JS

| Model | Region | Processor | vPro | Graphics | Memory (Soldered +DIMM) | Display | Multi-touch | Storage(HDD/SSD) | Optical | WLAN + Bluetooth | WWAN | SIM Card | Smart Card Reader | Dock | Monitor Cable | Color | Camera | Key-board | Finger-print Reader | NFC | TPM | Battery (internal) | Power Adapter | Operating System | Warranty | Ann Date (m/y) |
|------------|--------|-----------|------|--------------|-------------------------|-------------------------|----------------------|-------------------------------|---------|----------------------------|-----------------|----------|-------------------|------|---------------|-------|--------|-----------|---------------------|------|----------|-----------------------------|---------------|----------------------|---------------|----------------|
| 20JS0004US | US | i7-6600U | vPro | Intel HD 520 | 4GB + 4GB | 14" FHD (1920x1080) IPS | None | 256GB SSD M.2 PCIe NVMe Opal2 | None | Intel 8260 ac, 2x2 + BT4.1 | WWAN Upgradable | None | None | None | None | Black | 720p | Backlit | Finger-print Reader | None | dTPM 2.0 | 3-cell(23Wh) + 3-cell(26Wh) | 45W | Win10 DG Win7 Pro 64 | 3-year, Depot | 03/17 |
| 20JS000MUS | US | i7-6600U | vPro | Intel HD 520 | 4GB + 4GB | 14" FHD (1920x1080) IPS | None | 256GB SSD M.2 PCIe NVMe Opal2 | None | Intel 8260 ac, 2x2 + BT4.1 | WWAN Upgradable | None | None | None | None | Black | 720p | Backlit | Finger-print Reader | None | dTPM 2.0 | 3-cell(23Wh) + 3-cell(26Wh) | 45W | Win10 DG Win7 Pro 64 | 3-year, Depot | 06/17 |
| 20JS0014US | US | i5-6300U | vPro | Intel HD 520 | 4GB Soldered | 14" FHD (1920x1080) IPS | None | 128GB SSD M.2 | None | Intel 8260 ac, 2x2 + BT4.1 | WWAN Upgradable | None | None | None | None | Black | 720p | Backlit | Finger-print Reader | None | dTPM 2.0 | 3-cell(23Wh) + 3-cell(26Wh) | 45W | Win10 DG Win7 Pro 64 | 1-year, Depot | 03/17 |
| 20JS0015US | US | i5-6300U | vPro | Intel HD 520 | 4GB + 4GB | 14" FHD (1920x1080) IPS | None | 256GB SSD M.2 PCIe NVMe Opal2 | None | Intel 8260 ac, 2x2 + BT4.1 | WWAN Upgradable | None | None | None | None | Black | 720p | Backlit | Finger-print Reader | None | dTPM 2.0 | 3-cell(23Wh) + 3-cell(26Wh) | 45W | Win10 DG Win7 Pro 64 | 3-year, Depot | 03/17 |
| 20JS0016US | US | i5-6300U | vPro | Intel HD 520 | 4GB Soldered | 14" FHD (1920x1080) IPS | None | 180GB SSD M.2 Opal2 | None | Intel 8260 ac, 2x2 + BT4.1 | WWAN Upgradable | None | Smart Card Reader | None | None | Black | 720p | Backlit | Finger-print Reader | None | dTPM 2.0 | 3-cell(23Wh) + 3-cell(26Wh) | 45W | Win10 DG Win7 Pro 64 | 1-year, Depot | 03/17 |
| 20JS0017US | US | i5-6300U | vPro | Intel HD 520 | 4GB + 4GB | 14" FHD (1920x1080) IPS | None | 180GB SSD M.2 Opal2 | None | Intel 8260 ac, 2x2 + BT4.1 | WWAN Upgradable | None | Smart Card Reader | None | None | Black | 720p | Backlit | Finger-print Reader | None | dTPM 2.0 | 3-cell(23Wh) + 3-cell(26Wh) | 45W | Win10 DG Win7 Pro 64 | 3-year, Depot | 03/17 |
| 20JS0018US | US | i5-6300U | vPro | Intel HD 520 | 4GB Soldered | 14" FHD (1920x1080) IPS | None | 180GB SSD M.2 Opal2 | None | Intel 8260 ac, 2x2 + BT4.1 | WWAN Upgradable | None | None | None | None | Black | 720p | Backlit | Finger-print Reader | None | dTPM 2.0 | 3-cell(23Wh) + 3-cell(26Wh) | 45W | Win10 DG Win7 Pro 64 | 1-year, Depot | 03/17 |
| 20JS0019US | US | i5-6300U | vPro | Intel HD 520 | 4GB + 4GB | 14" FHD (1920x1080) IPS | None | 256GB SSD M.2 PCIe NVMe Opal2 | None | Intel 8260 ac, 2x2 + BT4.1 | Sierra EM7455 | None | None | None | None | Black | 720p | Backlit | Finger-print Reader | None | dTPM 2.0 | 3-cell(23Wh) + 3-cell(26Wh) | 45W | Win10 DG Win7 Pro 64 | 3-year, Depot | 04/17 |
| 20JS001AUS | US | i7-6600U | vPro | Intel HD 520 | 4GB + 4GB | 14" FHD (1920x1080) IPS | None | 256GB SSD M.2 PCIe NVMe Opal2 | None | Intel 8260 ac, 2x2 + BT4.1 | Sierra EM7455 | None | None | None | None | Black | 720p | Backlit | Finger-print Reader | None | dTPM 2.0 | 3-cell(23Wh) + 3-cell(26Wh) | 45W | Win10 DG Win7 Pro 64 | 3-year, Depot | 04/17 |
| 20JS001BUS | US | i7-6600U | vPro | Intel HD 520 | 4GB + 4GB | 14" FHD (1920x1080) IPS | 10-point Multi-touch | 256GB SSD M.2 PCIe NVMe Opal2 | None | Intel 8260 ac, 2x2 + BT4.1 | Sierra EM7455 | None | None | None | None | Black | 720p | Backlit | Finger-print Reader | None | dTPM 2.0 | 3-cell(23Wh) + 3-cell(26Wh) | 45W | Win10 DG Win7 Pro 64 | 3-year, Depot | 04/17 |
| 20JS001CUS | US | i7-6600U | vPro | Intel HD 520 | 4GB + 16GB | 14" FHD (1920x1080) IPS | 10-point Multi-touch | 1TB SSD M.2 PCIe NVMe Opal2 | None | Intel 8260 ac, 2x2 + BT4.1 | Sierra EM7455 | None | None | None | None | Black | 720p | Backlit | Finger-print Reader | None | dTPM 2.0 | 3-cell(23Wh) + 3-cell(26Wh) | 45W | Win10 DG Win7 Pro 64 | 3-year, Depot | 04/17 |
| 20JS001DUS | US | i7-6600U | vPro | Intel HD 520 | 4GB + 16GB | 14" FHD (1920x1080) IPS | None | 1TB SSD M.2 PCIe NVMe Opal2 | None | Intel 8260 ac, 2x2 + BT4.1 | Sierra EM7455 | None | None | None | None | Black | 720p | Backlit | Finger-print Reader | None | dTPM 2.0 | 3-cell(23Wh) + 3-cell(26Wh) | 45W | Win10 DG Win7 Pro 64 | 3-year, Depot | 04/17 |
| 20JS001GUS | US | i5-6300U | vPro | Intel HD 520 | 4GB + 4GB | 14" FHD (1920x1080) IPS | None | 256GB SSD M.2 PCIe NVMe Opal2 | None | Intel 8260 ac, 2x2 + BT4.1 | WWAN Upgradable | None | None | None | None | Black | 720p | Backlit | Finger-print Reader | None | dTPM 2.0 | 3-cell(23Wh) + 3-cell(26Wh) | 45W | Win10 DG Win7 Pro 64 | 3-year, Depot | 06/17 |



ThinkPad T560 Platform Specifications

Product Specifications Reference (PSREF)

| | | | | | | | | | | |
|--|--|-------------------|--------------|-------------------|--|-------------------|--------------|-----------------------|--|---|
| Processor | 6th Generation Intel® Core™ i5 / i7 Processor | | | | | | | | Smart card reader Media reader Ports Camera (optional) Audio support Keyboard UltraNav™ Security Security chip ThinkEngine vPro (optional) Fingerprint reader | Optional: Smart card reader 4-in-1 reader (MMC, SD, SDHC, SDXC) Three USB 3.0 (one Always On), MiniDP, HDMI, Ethernet (RJ-45), Dock connector HD720p resolution, low light sensitive, fixed focus HD Audio, Realtek® ALC3245 codec / stereo speakers, 1W x 2 / dual array microphone, combo audio/microphone jack 6-row, spill-resistant, multimedia Fn keys, numeric keypad, optional LED backlight TrackPoint® pointing device and buttonless Mylar surface touchpad, multi-touch Power-on password, hard disk password, supervisor password, security keyhole Discrete TPM 1.2 TCG Certified and Firmware TPM 2.0 integrated in chipset Delivers improved thermal and power efficiency, up to 30 day standby, faster resume time, enhanced security, as well as anti-tampering measures Intel vPro Technology Optional: Swipe style fingerprint reader on the palm rest |
| | Processor Number | # of Cores | # of Threads | Base Frequency | Max Turbo Frequency | Cache | Memory Types | Processor Graphics | | |
| | i5-6200U | 2 | 4 | 2.3 GHz | 2.8 GHz | 3MB | DDR3L-1600 | Intel HD Graphics 520 | | |
| | i5-6300U | | | 2.4 GHz | 3 GHz | 3MB | | | | |
| | i7-6500U | | | 2.5 GHz | 3.1 GHz | 4MB | | | | |
| i7-6600U | 2.6 GHz | | | 3.4 GHz | 4MB | | | | | |
| Graphics | Intel HD Graphics 520 in processor only, or Intel HD Graphics 520 in processor and NVIDIA GeForce® 940MX, 2GB memory; supports external digital monitor via HDMI or Mini DisplayPort; supports three independent displays; Max resolution: 3840x2160@60Hz (DisplayPort via Mini DisplayPort cable); 4096x2160@24Hz (HDMI) | | | | | | | | | |
| Chipset | Intel SoC (System on Chip) platform | | | | | | | | | |
| Memory | 32GB max ⁷ / PC3-12800 1600MHz DDR3L, non-parity, dual-channel capable, two DDR3L SO-DIMM sockets | | | | | | | | | |
| Display | <i>Some:</i> 15.6" (396mm) HD (1366x768), anti-glare, LED backlight, 220 nits, 16:9 aspect ratio, 400:1 contrast ratio | | | | | | | | | |
| | <i>Some:</i> 15.6" (396mm) FHD (1920x1080), anti-glare, LED backlight, IPS, 250 nits, 16:9 aspect ratio, 600:1 contrast ratio, 160° viewing angle | | | | | | | | | |
| | <i>Some:</i> 15.5" (394mm) 3K (2880x1620), anti-glare, LED backlight, IPS, 350 nits, 16:9 aspect ratio, 1000:1 contrast ratio, 160° viewing angle | | | | | | | | | |
| Multi-touch (opt) | In-cell touch, supports 10-finger gesture | | | | | | | | | |
| Storage | <i>Some:</i> SSD / SATA 6.0Gb/s (e.g. xxxG SSD) | | | | | | | | | |
| | <i>Some:</i> SSD / PCIe NVMe, PCIe 3.0 x 2, 16Gb/s (e.g. xxxG SSD PCIe NVMe) <i>Some:</i> HDD / SATA 6.0Gb/s, 2.5" wide, 7mm high, Shock Mounted Hard Drive, Active Protection System™ <i>Some:</i> SSHD with 8GB NAND flash memory | | | | | | | | | |
| Optical | None | | | | | | | | | |
| Ethernet | <i>Non-vPro model:</i> Intel Ethernet Connection I219-V (Jacksonville) <i>vPro model:</i> Intel Ethernet Connection I219-LM (Jacksonville) | | | | | | | | | |
| WLAN ⁴ | <i>One of the following, configurable by model:</i> • 11ac+BT, Broadcom BCM4356, 2x2, M.2 card • 11ac+BT, Intel Dual Band Wireless-AC 8260, 2x2, M.2 card | | | | | | | | | |
| Bluetooth™ | Bluetooth 4.1 wireless, integrated in Wi-Fi + Bluetooth combo adapter | | | | | | | | | |
| WWAN (optional) | <i>One of the following, configurable by model:</i> • Wireless WAN upgradable • Wireless WAN, Sierra Wireless EM7455, Qualcomm® 4G LTE-Advanced/DC-HSPA+/HSPA+/HSPA/UMTS/GNSS, M.2 card • Wireless WAN, HUAWEI ME906S, HUAWEI 4G LTE/WCDMA/HSPA/GSM/GPRS/EDGE/GNSS, M.2 card (WE only) | | | | | | | | | |
| SIM card (opt) | Micro-SIM card slot, optional Verizon LTE (US) or Lenovo Connect (WE) SIM card | | | | | | | | | |
| Dimensions ³ | WxDxH: 14.98" x 10.17" x 0.88"; 380.6mm x 258.2mm x 22.45mm | | | | | | | | | |
| Weight ² | Models | No + 6-cell | | 3-cell + 3-cell | | 3-cell + 6-cell | | | | |
| | Integrated Non-touch | 5.18 lb / 2.35 kg | | 4.88 lb / 2.22 kg | | 5.35 lb / 2.43 kg | | | | |
| | Integrated Multi-touch | - | | 4.92 lb / 2.23 kg | | 5.33 lb / 2.42 kg | | | | |
| | Discrete Non-touch | 5.27 lb / 2.39 kg | | 4.97 lb / 2.25 kg | | 5.44 lb / 2.47 kg | | | | |
| | Discrete Multi-touch | - | | 5.00 lb / 2.27 kg | | 5.42 lb / 2.46 kg | | | | |
| Case material | <i>Display cover:</i> PPS; <i>Bottom:</i> Glass-Fiber Reinforced Plastic | | | | | | | | | |
| Internal battery | Optional: Integrated Li-Polymer 3-cell (44Wh) | | | | | | | | | |
| External battery | Li-Ion or Li-Polymer 3-cell (23Wh) or Li-Ion 6-cell (48Wh or 72Wh) | | | | | | | | | |
| Max battery life ¹⁰ (MobileMark® 2014) | Models | 3 + 3-cell | | 3 + 6-cell 48Wh | | 3 + 6-cell 72Wh | | | | |
| | Integrated model | 13.2 hr | | 18.0 hr | | 22.7 hr | | | | |
| | discrete model | 13.5 hr | | 18.3 hr | | 24.3 hr | | | | |
| AC adapter | 45W AC adapter, 65W Slim AC adapter, or 65W AC adapter | | | | | | | | | |
| Preload | Windows 7 Professional 64 preinstalled through downgrade rights in Windows 10 Pro 64 | | | | Windows 10 Pro 64 | | | | | |
| | <ul style="list-style-type: none"> • Lenovo Solution Center • ThinkVantage Product Recovery • Rescue and Recovery™ • ThinkVantage System Update • Adobe® Reader® • Microsoft® Office preloaded; purchase a product key to activate • McAfee® LiveSafe™ (30-day trial) | | | | <ul style="list-style-type: none"> • Lenovo Solution Center • Lenovo Companion • Lenovo Setting • Microsoft Office preloaded; purchase a product key to activate • McAfee® LiveSafe™ (30-day trial) | | | | | |
| Limited warranty ¹² | <i>One of the following, configurable by model:</i> • 1-year depot repair service • 3-year/1-yr battery depot repair service • 3-year/1-yr battery limited onsite service ²⁴ • 3-year/1-yr battery limited onsite service, OID (Onsite International Delivery) | | | | | | | | | |
| Mil-Spec test | MIL-STD-810G military certification | | | | | | | | | |
| Environment | EPEAT™ Gold (US only); ENERGY STAR® 6.1; GREENGUARD®; RoHS-compliant | | | | | | | | | |

| Model | Region | Processor | vPro | Graphics | Memory | Display | Multi-touch | Storage | Optical | WLAN + Bluetooth | WWAN | SIM Card | Smart Card Reader | Camera | Keyboard | Fingerprint Reader | Battery (internal+external) | Power Adapter | Operating System | Warranty | Ann Date (m/y) |
|------------|--------|-----------|------|--------------|--------|---------------------------|----------------------|-----------------|---------|----------------------------|-----------------|----------|-------------------|--------|----------|--------------------|-----------------------------|---------------|----------------------|---------------|----------------|
| 20FH001QUS | US | i5-6200U | No | Intel HD 520 | 4GBx1 | 15.6" HD (1366x768) | None | 500GB 7200rpm | None | Intel 8260 ac, 2x2 + BT4.1 | WWAN Upgradable | None | None | 720p | Backlit | Fingerprint Reader | 3-cell(44Wh) + 3-cell(23Wh) | 45W | Win10 DG Win7 Pro 64 | 3-year, Depot | 01/16 |
| 20FH001RUS | US | i5-6300U | vPro | Intel HD 520 | 8GBx1 | 15.6" FHD (1920x1080) IPS | None | 256GB SSD Opal2 | None | Intel 8260 ac, 2x2 + BT4.1 | WWAN Upgradable | None | None | 720p | Backlit | Fingerprint Reader | 3-cell(44Wh) + 3-cell(23Wh) | 45W | Win10 DG Win7 Pro 64 | 3-year, Depot | 01/16 |
| 20FH001SUS | US | i5-6300U | vPro | Intel HD 520 | 4GBx1 | 15.6" HD (1366x768) | None | 180GB SSD Opal2 | None | Intel 8260 ac, 2x2 + BT4.1 | WWAN Upgradable | None | None | 720p | Backlit | Fingerprint Reader | 3-cell(44Wh) + 3-cell(23Wh) | 45W | Win10 DG Win7 Pro 64 | 3-year, Depot | 01/16 |
| 20FH001TUS | US | i7-6600U | vPro | Intel HD 520 | 8GBx1 | 15.6" FHD (1920x1080) IPS | None | 256GB SSD Opal2 | None | Intel 8260 ac, 2x2 + BT4.1 | WWAN Upgradable | None | None | 720p | Backlit | Fingerprint Reader | 3-cell(44Wh) + 3-cell(23Wh) | 45W | Win10 DG Win7 Pro 64 | 3-year, Depot | 01/16 |
| 20FH001UUS | US | i5-6300U | vPro | Intel HD 520 | 4GBx1 | 15.5" 3K (2880x1620) IPS | None | 192GB SSD | None | Intel 8260 ac, 2x2 + BT4.1 | WWAN Upgradable | None | None | 720p | Backlit | Fingerprint Reader | 3-cell(44Wh) + 3-cell(23Wh) | 45W | Win10 DG Win7 Pro 64 | 3-year, Depot | 01/16 |
| 20FH001VUS | US | i5-6300U | vPro | Intel HD 520 | 4GBx1 | 15.6" HD (1366x768) | None | 500GB 7200rpm | None | Intel 8260 ac, 2x2 + BT4.1 | WWAN Upgradable | None | None | 720p | Backlit | Fingerprint Reader | 3-cell(44Wh) + 3-cell(23Wh) | 45W | Win10 DG Win7 Pro 64 | 3-year, Depot | 01/16 |
| 20FH001WUS | US | i7-6600U | vPro | Intel HD 520 | 8GBx1 | 15.5" 3K (2880x1620) IPS | None | 256GB SSD Opal2 | None | Intel 8260 ac, 2x2 + BT4.1 | WWAN Upgradable | None | None | 720p | Backlit | Fingerprint Reader | 3-cell(44Wh) + 3-cell(23Wh) | 45W | Win10 DG Win7 Pro 64 | 3-year, Depot | 01/16 |
| 20FH001XUS | US | i5-6300U | vPro | Intel HD 520 | 4GBx1 | 15.6" FHD (1920x1080) IPS | None | 180GB SSD Opal2 | None | Intel 8260 ac, 2x2 + BT4.1 | WWAN Upgradable | None | None | 720p | Backlit | Fingerprint Reader | 3-cell(44Wh) + 3-cell(23Wh) | 45W | Win10 DG Win7 Pro 64 | 3-year, Depot | 01/16 |
| 20FH001YUS | US | i5-6300U | vPro | Intel HD 520 | 8GBx1 | 15.6" FHD (1920x1080) IPS | None | 180GB SSD Opal2 | None | Intel 8260 ac, 2x2 + BT4.1 | WWAN Upgradable | None | None | 720p | Backlit | Fingerprint Reader | 3-cell(44Wh) + 3-cell(23Wh) | 45W | Win10 DG Win7 Pro 64 | 3-year, Depot | 01/16 |
| 20FH0020US | US | i5-6300U | vPro | Intel HD 520 | 4GBx1 | 15.6" HD (1366x768) | None | 256GB SSD Opal2 | None | Intel 8260 ac, 2x2 + BT4.1 | WWAN Upgradable | None | None | 720p | Backlit | Fingerprint Reader | 3-cell(44Wh) + 3-cell(23Wh) | 45W | Win10 DG Win7 Pro 64 | 3-year, Depot | 01/16 |
| 20FH0021US | US | i5-6300U | vPro | Intel HD 520 | 8GBx1 | 15.5" 3K (2880x1620) IPS | None | 256GB SSD Opal2 | None | Intel 8260 ac, 2x2 + BT4.1 | WWAN Upgradable | None | None | 720p | Backlit | Fingerprint Reader | 3-cell(44Wh) + 3-cell(23Wh) | 45W | Win10 DG Win7 Pro 64 | 3-year, Depot | 01/16 |
| 20FH002CUS | US | i5-6300U | vPro | Intel HD 520 | 8GBx1 | 15.6" FHD (1920x1080) IPS | None | 256GB SSD Opal2 | None | Intel 8260 ac, 2x2 + BT4.1 | WWAN Upgradable | None | None | 720p | Backlit | Fingerprint Reader | 3-cell(44Wh) + 3-cell(23Wh) | 45W | Win10 Pro 64 | 3-year, Depot | 01/16 |
| 20FH002DUS | US | i5-6300U | vPro | Intel HD 520 | 8GBx1 | 15.6" FHD (1920x1080) IPS | 10-point Multi-touch | 256GB SSD Opal2 | None | Intel 8260 ac, 2x2 + BT4.1 | WWAN Upgradable | None | None | 720p | Backlit | Fingerprint Reader | 3-cell(44Wh) + 3-cell(23Wh) | 45W | Win10 Pro 64 | 3-year, Depot | 01/16 |
| 20FH002EUS | US | i5-6200U | No | Intel HD 520 | 4GBx1 | 15.6" HD (1366x768) | None | 192GB SSD | None | Intel 8260 ac, 2x2 + BT4.1 | WWAN Upgradable | None | None | 720p | Backlit | Fingerprint Reader | 3-cell(44Wh) + 3-cell(23Wh) | 45W | Win10 DG Win7 Pro 64 | 3-year, Depot | 01/16 |
| 20FH002FUS | US | i7-6600U | vPro | Intel HD 520 | 8GBx2 | 15.6" FHD (1920x1080) IPS | 10-point Multi-touch | 512GB SSD | None | Intel 8260 ac, 2x2 + BT4.1 | WWAN Upgradable | None | None | 720p | Backlit | Fingerprint Reader | 3-cell(44Wh) + 3-cell(23Wh) | 45W | Win10 Pro 64 | 3-year, Depot | 01/16 |
| 20FH002GUS | US | i5-6200U | No | Intel HD 520 | 4GBx1 | 15.6" HD (1366x768) | None | 500GB 7200rpm | None | Intel 8260 ac, 2x2 + BT4.1 | WWAN Upgradable | None | None | 720p | Backlit | Fingerprint Reader | 3-cell(44Wh) + 3-cell(23Wh) | 45W | Win10 Pro 64 | 3-year, Depot | 01/16 |
| 20FH002HUS | US | i7-6600U | vPro | Intel HD 520 | 8GBx2 | 15.6" FHD (1920x1080) IPS | None | 512GB SSD | None | Intel 8260 ac, 2x2 + BT4.1 | WWAN Upgradable | None | None | 720p | Backlit | Fingerprint Reader | 3-cell(44Wh) + 3-cell(23Wh) | 45W | Win10 Pro 64 | 3-year, Depot | 01/16 |
| 20FH002JUS | US | i7-6600U | vPro | Intel HD 520 | 8GBx2 | 15.5" 3K (2880x1620) IPS | None | 512GB SSD | None | Intel 8260 ac, 2x2 + BT4.1 | WWAN Upgradable | None | None | 720p | Backlit | Fingerprint Reader | 3-cell(44Wh) + 3-cell(23Wh) | 45W | Win10 Pro 64 | 3-year, Depot | 01/16 |
| 20FH002KUS | US | i7-6600U | vPro | Intel HD 520 | 8GBx2 | 15.5" 3K (2880x1620) IPS | None | 512GB SSD | None | Intel 8260 ac, 2x2 + BT4.1 | WWAN Upgradable | None | None | 720p | Backlit | Fingerprint Reader | 3-cell(44Wh) + 3-cell(23Wh) | 45W | Win10 DG Win7 Pro 64 | 3-year, Depot | 01/16 |
| 20FH002LUS | US | i7-6600U | vPro | Intel HD 520 | 8GBx1 | 15.6" FHD (1920x1080) IPS | None | 256GB SSD Opal2 | None | Intel 8260 ac, 2x2 + BT4.1 | WWAN Upgradable | None | None | 720p | Backlit | Fingerprint Reader | 3-cell(44Wh) + 3-cell(23Wh) | 45W | Win10 Pro 64 | 3-year, Depot | 01/16 |

| Model | Region | Processor | vPro | Graphics | Memory | Display | Multi-touch | Storage | Optical | WLAN + Bluetooth | WWAN | SIM Card | Smart Card Reader | Camera | Keyboard | Fingerprint Reader | Battery (internal+external) | Power Adapter | Operating System | Warranty | Ann Date (m/y) |
|------------|--------|-----------|------|--------------|--------|---------------------------|----------------------|-----------------|---------|----------------------------|-----------------|----------|-------------------|--------|----------|--------------------|-----------------------------|---------------|----------------------|---------------|----------------|
| 20FH002MUS | US | i5-6200U | No | Intel HD 520 | 4GBx1 | 15.6" HD (1366x768) | None | 192GB SSD | None | Intel 8260 ac, 2x2 + BT4.1 | WWAN Upgradable | None | None | 720p | Backlit | Fingerprint Reader | 3-cell(44Wh) + 3-cell(23Wh) | 45W | Win10 Pro 64 | 3-year, Depot | 01/16 |
| 20FH002NUS | US | i7-6600U | vPro | Intel HD 520 | 8GBx2 | 15.6" FHD (1920x1080) IPS | None | 512GB SSD | None | Intel 8260 ac, 2x2 + BT4.1 | WWAN Upgradable | None | None | 720p | Backlit | Fingerprint Reader | 3-cell(44Wh) + 3-cell(23Wh) | 45W | Win10 DG Win7 Pro 64 | 3-year, Depot | 01/16 |
| 20FH002WUS | US | i7-6600U | vPro | 940MX 2GB | 8GBx1 | 15.6" FHD (1920x1080) IPS | None | 512GB SSD | None | Intel 8260 ac, 2x2 + BT4.1 | WWAN Upgradable | None | None | 720p | Backlit | Fingerprint Reader | 3-cell(44Wh) + 3-cell(23Wh) | 65W | Win10 DG Win7 Pro 64 | 3-year, Depot | 04/16 |
| 20FH002XUS | US | i7-6600U | vPro | 940MX 2GB | 8GBx1 | 15.5" 3K (2880x1620) IPS | None | 512GB SSD | None | Intel 8260 ac, 2x2 + BT4.1 | WWAN Upgradable | None | None | 720p | Backlit | Fingerprint Reader | 3-cell(44Wh) + 3-cell(23Wh) | 65W | Win10 DG Win7 Pro 64 | 3-year, Depot | 04/16 |
| 20FH002YUS | US | i7-6600U | vPro | 940MX 2GB | 8GBx1 | 15.6" FHD (1920x1080) IPS | None | 256GB SSD Opal2 | None | Intel 8260 ac, 2x2 + BT4.1 | WWAN Upgradable | None | None | 720p | Backlit | Fingerprint Reader | 3-cell(44Wh) + 3-cell(23Wh) | 65W | Win10 DG Win7 Pro 64 | 3-year, Depot | 04/16 |
| 20FH0030US | US | i5-6300U | vPro | 940MX 2GB | 8GBx1 | 15.6" FHD (1920x1080) IPS | None | 256GB SSD Opal2 | None | Intel 8260 ac, 2x2 + BT4.1 | WWAN Upgradable | None | None | 720p | Backlit | Fingerprint Reader | 3-cell(44Wh) + 3-cell(23Wh) | 65W | Win10 DG Win7 Pro 64 | 3-year, Depot | 04/16 |
| 20FH0031US | US | i7-6600U | vPro | 940MX 2GB | 8GBx1 | 15.5" 3K (2880x1620) IPS | None | 256GB SSD Opal2 | None | Intel 8260 ac, 2x2 + BT4.1 | WWAN Upgradable | None | None | 720p | Backlit | Fingerprint Reader | 3-cell(44Wh) + 3-cell(23Wh) | 65W | Win10 DG Win7 Pro 64 | 3-year, Depot | 04/16 |
| 20FH0032US | US | i5-6300U | vPro | 940MX 2GB | 8GBx1 | 15.6" FHD (1920x1080) IPS | None | 512GB SSD | None | Intel 8260 ac, 2x2 + BT4.1 | WWAN Upgradable | None | None | 720p | Backlit | Fingerprint Reader | 3-cell(44Wh) + 3-cell(23Wh) | 65W | Win10 DG Win7 Pro 64 | 3-year, Depot | 04/16 |
| 20FH003BUS | US | i5-6300U | vPro | Intel HD 520 | 8GBx1 | 15.6" FHD (1920x1080) IPS | None | 500GB 7200rpm | None | Intel 8260 ac, 2x2 + BT4.1 | WWAN Upgradable | None | None | 720p | Backlit | Fingerprint Reader | 3-cell(44Wh) + 3-cell(23Wh) | 45W | Win10 DG Win7 Pro 64 | 3-year, Depot | 07/16 |
| 20FH0043US | US | i5-6200U | No | Intel HD 520 | 8GBx1 | 15.6" FHD (1920x1080) IPS | 10-point Multi-touch | 256GB SSD Opal2 | None | Intel 8260 ac, 2x2 + BT4.1 | WWAN Upgradable | None | None | 720p | Backlit | Fingerprint Reader | 3-cell(44Wh) + 3-cell(23Wh) | 45W | Win10 Pro 64 | 3-year, Depot | 10/16 |
| 20FH0044US | US | i5-6300U | vPro | Intel HD 520 | 4GBx1 | 15.5" 3K (2880x1620) IPS | None | 180GB SSD Opal2 | None | Intel 8260 ac, 2x2 + BT4.1 | WWAN Upgradable | None | None | 720p | Backlit | Fingerprint Reader | 3-cell(44Wh) + 3-cell(23Wh) | 45W | Win10 DG Win7 Pro 64 | 3-year, Depot | 11/16 |
| 20FH0045US | US | i5-6200U | No | Intel HD 520 | 4GBx1 | 15.6" HD (1366x768) | None | 256GB SSD Opal2 | None | Intel 8260 ac, 2x2 + BT4.1 | WWAN Upgradable | None | None | 720p | Backlit | Fingerprint Reader | 3-cell(44Wh) + 3-cell(23Wh) | 45W | Win10 Pro 64 | 3-year, Depot | 11/16 |
| 20FH0046US | US | i5-6200U | No | Intel HD 520 | 4GBx1 | 15.6" HD (1366x768) | None | 180GB SSD Opal2 | None | Intel 8260 ac, 2x2 + BT4.1 | WWAN Upgradable | None | None | 720p | Backlit | Fingerprint Reader | 3-cell(44Wh) + 3-cell(23Wh) | 45W | Win10 Pro 64 | 3-year, Depot | 11/16 |
| 20FH0047US | US | i5-6200U | No | Intel HD 520 | 4GBx1 | 15.6" HD (1366x768) | None | 180GB SSD Opal2 | None | Intel 8260 ac, 2x2 + BT4.1 | WWAN Upgradable | None | None | 720p | Backlit | Fingerprint Reader | 3-cell(44Wh) + 3-cell(23Wh) | 45W | Win10 DG Win7 Pro 64 | 3-year, Depot | 11/16 |
| 20FH0048US | US | i5-6200U | No | Intel HD 520 | 4GBx1 | 15.6" HD (1366x768) | None | 256GB SSD Opal2 | None | Intel 8260 ac, 2x2 + BT4.1 | WWAN Upgradable | None | None | 720p | Backlit | Fingerprint Reader | 3-cell(44Wh) + 3-cell(23Wh) | 45W | Win10 DG Win7 Pro 64 | 3-year, Depot | 11/16 |
| 20FH0049US | US | i5-6300U | vPro | Intel HD 520 | 4GBx1 | 15.5" 3K (2880x1620) IPS | None | 256GB SSD Opal2 | None | Intel 8260 ac, 2x2 + BT4.1 | WWAN Upgradable | None | None | 720p | Backlit | Fingerprint Reader | 3-cell(44Wh) + 3-cell(23Wh) | 45W | Win10 DG Win7 Pro 64 | 3-year, Depot | 11/16 |
| 20FHA01KUS | US | i5-6300U | vPro | Intel HD 520 | 8GBx1 | 15.6" FHD (1920x1080) IPS | None | 500GB 7200rpm | None | Intel 8260 ac, 2x2 + BT4.1 | WWAN Upgradable | None | None | 720p | Backlit | Fingerprint Reader | 3-cell(44Wh) + 3-cell(23Wh) | 45W | Win10 Pro 64 | 3-year, Depot | 07/16 |



ThinkPad T570 Platform Specifications

Product Specifications Reference (PSREF)

| Processor | 6th Generation Intel® Core™ i5 / i7 Processor | | | | | | | Dimensions Weight Case color Case material | <i>WxDxH:</i> 14.40" x 9.95" x 0.79-0.80"; 365.8mm x 252.8mm x 19.95-20.2mm Starting at 4.34 lb / 1.97 kg Black <i>Display cover:</i> Glass-Fiber Reinforced Plastic (PPS); <i>Bottom:</i> Glass-Fiber Reinforced Plastic | | | | | | | | | | | | | | | | | | |
|----------------------------|---|-------------|--------------|-----------------|---------------------|-------|--------------|---|---|--------------------|------------|-------------|-------------|-----------------|-----------------|-------------------|---------|---------|---------|---------|---------|-----------------|---------|---------|---------|---------|---------|
| | Processor Number | # of Cores | # of Threads | Base Frequency | Max Turbo Frequency | Cache | Memory Types | | | Processor Graphics | | | | | | | | | | | | | | | | | |
| | i5-6300U | 2 | 4 | 2.4 GHz | 3.0 GHz | 3MB | DDR4-2133 | Intel HD Graphics 520 | | | | | | | | | | | | | | | | | | | |
| | i7-6600U | | | 2.6 GHz | 3.4 GHz | 4MB | | | | | | | | | | | | | | | | | | | | | |
| | or 7th Generation Intel Core i5 / i7 Processor | | | | | | | Smart card reader Media reader Ports | <i>Optional:</i> Smart card reader 4-in-1 reader (MMC, SD, SDHC, SDXC), supports SD 3.0, UHS-I Three USB 3.1 Gen 1 (USB 3.0, one Always On), USB 3.1 Type-C Gen 2 / Thunderbolt 3, HDMI 1.4b, Ethernet (RJ-45), Dock connector ThinkPad WiGig dock (US only) <i>HDMI to VGA:</i> Lenovo HDMI to VGA Monitor Adapter <i>USB-C to VGA:</i> Lenovo USB-C to VGA Adapter | | | | | | | | | | | | | | | | | | |
| | Processor Number | # of Cores | # of Threads | Base Frequency | Max Turbo Frequency | Cache | Memory Types | | | Processor Graphics | | | | | | | | | | | | | | | | | |
| | i5-7200U | 2 | 4 | 2.5 GHz | 3.1 GHz | 3MB | DDR4-2133 | Intel HD Graphics 620 | | | | | | | | | | | | | | | | | | | |
| | i5-7300U | | | 2.6 GHz | 3.5 GHz | 3MB | | | | | | | | | | | | | | | | | | | | | |
| | i7-7500U | | | 2.7 GHz | 3.5 GHz | 4MB | | | | | | | | | | | | | | | | | | | | | |
| | i7-7600U | | | 2.8 GHz | 3.9 GHz | 4MB | | | | | | | | | | | | | | | | | | | | | |
| Graphics | Intel HD Graphics 520 or 620 in processor only, or Intel HD Graphics 520 or 620 in processor and NVIDIA GeForce® 940MX, 2GB 2.5GHz GDDR5 memory; supports external digital monitor via HDMI or USB Type-C; supports three independent displays; Max resolution: 4096x2304@60Hz (USB Type-C); 4096x2160@24Hz (HDMI) | | | | | | | Camera (<i>optional</i>) | 720p: HD720p resolution, fixed focus IR & 720p: IR camera and HD720p camera (mutually exclusive with WiGig) | | | | | | | | | | | | | | | | | | |
| Chipset | Intel SoC (System on Chip) platform | | | | | | | Audio support | HD Audio, Realtek ALC3268 codec / stereo speakers, 2W x 2 / dual array microphone, combo audio/microphone jack | | | | | | | | | | | | | | | | | | |
| Memory | 32GB max / 2400MHz DDR4, dual-channel capable, two DDR4 SO-DIMM sockets * System clocks down for processors with lower memory controller | | | | | | | Keyboard | 6-row, spill-resistant, multimedia Fn keys, numeric keypad, optional LED backlight | | | | | | | | | | | | | | | | | | |
| Display | <i>Some:</i> 15.6" (396mm) HD (1366x768), anti-glare, LED backlight, 220 nits, 16:9 aspect ratio, 400:1 contrast ratio <i>Some:</i> 15.6" (396mm) FHD (1920x1080), anti-glare, LED backlight, IPS, 250 nits, 16:9 aspect ratio, 700:1 contrast ratio, 170° viewing angle <i>Some:</i> 15.6" (396mm) 4K (3840x2160), anti-glare, LED backlight, IPS, 300 nits, 16:9 aspect ratio, 1000:1 contrast ratio, 72% gamut, 170° viewing angle | | | | | | | UltraNav™ | TrackPoint® pointing device and buttonless Mylar surface multi-touch touchpad | | | | | | | | | | | | | | | | | | |
| Multi-touch (<i>opt</i>) | On-cell touch, supports 10-finger gesture (FHD only) | | | | | | | Security | Power-on password, hard disk password, supervisor password, security keyhole | | | | | | | | | | | | | | | | | | |
| Storage | <i>System has one HDD slot or one M.2 2280 slot exclusively for storage</i> <i>Some:</i> HDD / SATA 6.0Gb/s, 2.5" wide, 7mm high, Active Protection System™ <i>Some:</i> SSD / SATA 6.0Gb/s, 2.5" wide, 7mm high (e.g. xxxGB SSD) <i>Some:</i> M.2 SSD / PCIe NVMe, PCIe 3.0 x 2, 16Gb/s <i>Some:</i> 128GB M.2 SSD / SATA 6.0Gb/s, in WWAN slot as 2nd Storage, mutually exclusive with WWAN and WiGig | | | | | | | Security chip | Discrete TPM 2.0, TCG Certified | | | | | | | | | | | | | | | | | | |
| | | | | | | | | vPro (<i>optional</i>) | Intel vPro Technology | | | | | | | | | | | | | | | | | | |
| | | | | | | | | Fingerprint reader | <i>Optional:</i> Touch style match on chip fingerprint reader on the palm rest | | | | | | | | | | | | | | | | | | |
| | | | | | | | | NFC (<i>optional</i>) | Near Field Communication | | | | | | | | | | | | | | | | | | |
| | | | | | | | | Internal battery | <i>Optional:</i> Integrated Li-Polymer 4-cell (32Wh) | | | | | | | | | | | | | | | | | | |
| | | | | | | | | External battery | Li-Polymer 3-cell (24Wh) or Li-Ion 6-cell (48Wh or 72Wh) | | | | | | | | | | | | | | | | | | |
| | | | | | | | | Max battery life (<i>MobileMark® 2014</i>) | <table border="1"> <thead> <tr> <th>Models</th> <th>4 + 3-cell</th> <th>6-cell 48Wh</th> <th>6-cell 72Wh</th> <th>4 + 6-cell 48Wh</th> <th>4 + 6-cell 72Wh</th> </tr> </thead> <tbody> <tr> <td><i>Integrated</i></td> <td>13.8 hr</td> <td>12.5 hr</td> <td>18.5 hr</td> <td>20.3 hr</td> <td>27.1 hr</td> </tr> <tr> <td><i>discrete</i></td> <td>13.8 hr</td> <td>12.5 hr</td> <td>18.5 hr</td> <td>20.0 hr</td> <td>26.8 hr</td> </tr> </tbody> </table> | Models | 4 + 3-cell | 6-cell 48Wh | 6-cell 72Wh | 4 + 6-cell 48Wh | 4 + 6-cell 72Wh | <i>Integrated</i> | 13.8 hr | 12.5 hr | 18.5 hr | 20.3 hr | 27.1 hr | <i>discrete</i> | 13.8 hr | 12.5 hr | 18.5 hr | 20.0 hr | 26.8 hr |
| Models | 4 + 3-cell | 6-cell 48Wh | 6-cell 72Wh | 4 + 6-cell 48Wh | 4 + 6-cell 72Wh | | | | | | | | | | | | | | | | | | | | | | |
| <i>Integrated</i> | 13.8 hr | 12.5 hr | 18.5 hr | 20.3 hr | 27.1 hr | | | | | | | | | | | | | | | | | | | | | | |
| <i>discrete</i> | 13.8 hr | 12.5 hr | 18.5 hr | 20.0 hr | 26.8 hr | | | | | | | | | | | | | | | | | | | | | | |
| | | | | | | | | AC adapter | 45W or 65W AC adapter (slim tip), 45W or 65W USB Type-C AC adapter | | | | | | | | | | | | | | | | | | |
| Optical | None | | | | | | | Preload | Windows® 7 Professional 64 preinstalled through downgrade rights in Windows 10 Pro 64 <ul style="list-style-type: none"> Lenovo Solution Center Lenovo PowerEngage ThinkVantage Product Recovery ThinkVantage System Update Adobe® Reader® Microsoft® Office preloaded; purchase a product key to activate McAfee® LiveSafe™ (30-day trial) <i>Some:</i> Windows 10 Home 64 <i>Some:</i> Windows 10 Pro 64 <ul style="list-style-type: none"> Lenovo Companion Lenovo Setting Microsoft Office preloaded; purchase a product key to activate | | | | | | | | | | | | | | | | | | |
| Ethernet | <i>Non-vPro model:</i> Intel Ethernet Connection I219-V (Jacksonville) <i>vPro model:</i> Intel Ethernet Connection I219-LM (Jacksonville) | | | | | | | Limited warranty | <i>One of the following, configurable by model:</i> <ul style="list-style-type: none"> 1-year depot repair service 3-year/1-yr battery depot repair service 3-year/1-yr battery limited onsite service | | | | | | | | | | | | | | | | | | |
| WLAN | <i>One of the following, configurable by model (WiGig can coexist with WWAN):</i> <ul style="list-style-type: none"> Realtek® RTL8822BE, Wi-Fi 2x2 802.11ac + BT4.1, M.2 card (US only) Intel Dual Band Wireless-AC 8260, Wi-Fi 2x2 802.11ac + BT4.1, M.2 card Intel Dual Band Wireless-AC 8265, Wi-Fi 2x2 802.11ac + BT4.1, M.2 card Intel Tri-Band Wireless-AC 18265, WiGig 802.11ad + Wi-Fi 2x2 802.11ac + BT4.1, M.2 card | | | | | | | Mil-Spec test | MIL-STD-810G military certification | | | | | | | | | | | | | | | | | | |
| Bluetooth™ | Bluetooth 4.1 wireless, integrated in Wi-Fi + Bluetooth combo adapter * Intel 8265ac / 18265ac card support BT4.2 but is limited to BT4.1 by Windows OS | | | | | | | Environment | EEPEAT™ Gold (US only); ENERGY STAR® 6.1; RoHS-compliant | | | | | | | | | | | | | | | | | | |
| WWAN (<i>optional</i>) | <i>One of the following, configurable by model (WWAN can coexist with WiGig):</i> <ul style="list-style-type: none"> Wireless WAN upgradable Integrated Mobile Broadband 4G LTE-A, Qualcomm® Snapdragon™ X7 LTE-A (Sierra Wireless EM7455), M.2 card Integrated Mobile Broadband 4G LTE, Intel XMM™ 7160 (Fibocom L831-EAU), M.2 card (EMEA only) | | | | | | | | | | | | | | | | | | | | | | | | | | |
| SIM card (<i>opt</i>) | Micro-SIM card slot, opt Verizon LTE (US) or Lenovo® Connect (EMEA) SIM card | | | | | | | | | | | | | | | | | | | | | | | | | | |

| Model | Region | Processor | vPro | Graphics | Memory | Display | Multi-touch | Storage(HDD/SSD) | Optical | WLAN + Bluetooth | WWAN | SIM Card | Smart Card Reader | Dock | Monitor Cable | Camera | Key-board | Finger-print Reader | NFC | TPM | Battery (internal+ external) | Power Adapter | Operating System | Warranty | Ann Date (m/y) |
|------------|--------|-----------|------|--------------|--------|---------------------------|----------------------|-------------------------------|---------|----------------------------|-----------------|----------|-------------------|------|---------------|-----------|-----------|---------------------|------|----------|------------------------------|---------------|------------------|---------------|----------------|
| 20H9000MUS | US | i5-7200U | No | Intel HD 620 | 8GBx1 | 15.6" FHD (1920x1080) IPS | None | 256GB SSD M.2 PCIe NVMe Opal2 | None | Intel 8265 ac, 2x2 + BT4.1 | WWAN Upgradable | None | None | None | None | 720p | Backlit | Finger-print Reader | None | dTPM 2.0 | 4-cell(32Wh) + 3-cell(24Wh) | 45W | Win10 Pro 64 | 3-year, Depot | 01/17 |
| 20H9000NUS | US | i7-7600U | vPro | Intel HD 620 | 8GBx1 | 15.6" FHD (1920x1080) IPS | None | 256GB SSD M.2 PCIe NVMe Opal2 | None | Intel 8265 ac, 2x2 + BT4.1 | WWAN Upgradable | None | None | None | None | 720p | Backlit | Finger-print Reader | None | dTPM 2.0 | 4-cell(32Wh) + 3-cell(24Wh) | 45W | Win10 Pro 64 | 3-year, Depot | 01/17 |
| 20H9000PUS | US | i5-7300U | vPro | Intel HD 620 | 8GBx1 | 15.6" FHD (1920x1080) IPS | None | 256GB SSD M.2 PCIe NVMe Opal2 | None | Intel 8265 ac, 2x2 + BT4.1 | WWAN Upgradable | None | None | None | None | 720p | Backlit | Finger-print Reader | None | dTPM 2.0 | 4-cell(32Wh) + 3-cell(24Wh) | 45W | Win10 Pro 64 | 3-year, Depot | 01/17 |
| 20H9000QUS | US | i5-7200U | No | Intel HD 620 | 4GBx1 | 15.6" FHD (1920x1080) IPS | 10-point Multi-touch | 500GB 7200rpm | None | Intel 8265 ac, 2x2 + BT4.1 | WWAN Upgradable | None | None | None | None | 720p | Backlit | Finger-print Reader | None | dTPM 2.0 | 4-cell(32Wh) + 3-cell(24Wh) | 45W | Win10 Pro 64 | 3-year, Depot | 01/17 |
| 20H9000RUS | US | i5-7200U | No | Intel HD 620 | 8GBx1 | 15.6" FHD (1920x1080) IPS | 10-point Multi-touch | 256GB SSD M.2 PCIe NVMe Opal2 | None | Intel 8265 ac, 2x2 + BT4.1 | WWAN Upgradable | None | None | None | None | 720p | Backlit | Finger-print Reader | None | dTPM 2.0 | 4-cell(32Wh) + 3-cell(24Wh) | 45W | Win10 Pro 64 | 3-year, Depot | 01/17 |
| 20H9000SUS | US | i5-7200U | No | Intel HD 620 | 4GBx1 | 15.6" FHD (1920x1080) IPS | None | 500GB 7200rpm | None | Intel 8265 ac, 2x2 + BT4.1 | WWAN Upgradable | None | None | None | None | 720p | Backlit | Finger-print Reader | None | dTPM 2.0 | 4-cell(32Wh) + 3-cell(24Wh) | 45W | Win10 Pro 64 | 1-year, Depot | 01/17 |
| 20H9000TUS | US | i7-7600U | vPro | Intel HD 620 | 8GBx1 | 15.6" FHD (1920x1080) IPS | 10-point Multi-touch | 256GB SSD M.2 PCIe NVMe Opal2 | None | Intel 8265 ac, 2x2 + BT4.1 | WWAN Upgradable | None | None | None | None | 720p | Backlit | Finger-print Reader | None | dTPM 2.0 | 4-cell(32Wh) + 3-cell(24Wh) | 45W | Win10 Pro 64 | 3-year, Depot | 01/17 |
| 20H9000UUS | US | i5-7300U | vPro | Intel HD 620 | 8GBx1 | 15.6" FHD (1920x1080) IPS | 10-point Multi-touch | 256GB SSD M.2 PCIe NVMe Opal2 | None | Intel 8265 ac, 2x2 + BT4.1 | WWAN Upgradable | None | None | None | None | 720p | Backlit | Finger-print Reader | None | dTPM 2.0 | 4-cell(32Wh) + 3-cell(24Wh) | 45W | Win10 Pro 64 | 3-year, Depot | 01/17 |
| 20H9004FUS | US | i5-7200U | No | Intel HD 620 | 4GBx1 | 15.6" FHD (1920x1080) IPS | None | 500GB 7200rpm | None | Intel 8265 ac, 2x2 + BT4.1 | WWAN Upgradable | None | None | None | None | 720p | Backlit | Finger-print Reader | None | dTPM 2.0 | 4-cell(32Wh) + 3-cell(24Wh) | 45W | Win10 Pro 64 | 3-year, Depot | 03/17 |
| 20H9004NUS | US | i7-7600U | vPro | Intel HD 620 | 8GBx1 | 15.6" FHD (1920x1080) IPS | None | 256GB SSD M.2 PCIe NVMe Opal2 | None | Intel 8265 ac, 2x2 + BT4.1 | WWAN Upgradable | None | None | None | None | IR & 720p | Backlit | Finger-print Reader | None | dTPM 2.0 | 4-cell(32Wh) + 3-cell(24Wh) | 45W | Win10 Pro 64 | 3-year, Depot | 04/17 |
| 20H9004PUS | US | i7-7600U | vPro | Intel HD 620 | 8GBx1 | 15.6" FHD (1920x1080) IPS | 10-point Multi-touch | 256GB SSD M.2 PCIe NVMe Opal2 | None | Intel 8265 ac, 2x2 + BT4.1 | WWAN Upgradable | None | None | None | None | IR & 720p | Backlit | Finger-print Reader | None | dTPM 2.0 | 4-cell(32Wh) + 3-cell(24Wh) | 45W | Win10 Pro 64 | 3-year, Depot | 04/17 |
| 20H9004QUS | US | i5-7300U | vPro | Intel HD 620 | 8GBx1 | 15.6" FHD (1920x1080) IPS | None | 256GB SSD M.2 PCIe NVMe Opal2 | None | Intel 8265 ac, 2x2 + BT4.1 | WWAN Upgradable | None | None | None | None | IR & 720p | Backlit | Finger-print Reader | None | dTPM 2.0 | 4-cell(32Wh) + 3-cell(24Wh) | 45W | Win10 Pro 64 | 3-year, Depot | 04/17 |
| 20H9004RUS | US | i7-7600U | vPro | Intel HD 620 | 16GBx1 | 15.6" 4K (3840x2160) IPS | None | 512GB SSD M.2 PCIe NVMe Opal2 | None | Intel 8265 ac, 2x2 + BT4.1 | WWAN Upgradable | None | None | None | None | IR & 720p | Backlit | Finger-print Reader | None | dTPM 2.0 | 4-cell(32Wh) + 3-cell(24Wh) | 45W | Win10 Pro 64 | 3-year, Depot | 04/17 |
| 20H9004SUS | US | i7-7600U | vPro | Intel HD 620 | 16GBx1 | 15.6" FHD (1920x1080) IPS | 10-point Multi-touch | 512GB SSD M.2 PCIe NVMe Opal2 | None | Intel 8265 ac, 2x2 + BT4.1 | WWAN Upgradable | None | None | None | None | 720p | Backlit | Finger-print Reader | None | dTPM 2.0 | 4-cell(32Wh) + 3-cell(24Wh) | 45W | Win10 Pro 64 | 3-year, Depot | 04/17 |
| 20H9004TUS | US | i7-7600U | vPro | Intel HD 620 | 16GBx1 | 15.6" FHD (1920x1080) IPS | None | 512GB SSD M.2 PCIe NVMe Opal2 | None | Intel 8265 ac, 2x2 + BT4.1 | WWAN Upgradable | None | None | None | None | 720p | Backlit | Finger-print Reader | None | dTPM 2.0 | 4-cell(32Wh) + 3-cell(24Wh) | 45W | Win10 Pro 64 | 3-year, Depot | 04/17 |
| 20H9004UUS | US | i7-7600U | vPro | Intel HD 620 | 8GBx1 | 15.6" FHD (1920x1080) IPS | 10-point Multi-touch | 256GB SSD M.2 PCIe NVMe Opal2 | None | Intel 8265 ac, 2x2 + BT4.1 | Sierra EM7455 | None | None | None | None | 720p | Backlit | Finger-print Reader | None | dTPM 2.0 | 4-cell(32Wh) + 3-cell(24Wh) | 45W | Win10 Pro 64 | 3-year, Depot | 04/17 |
| 20H9004VUS | US | i5-7300U | vPro | Intel HD 620 | 8GBx1 | 15.6" FHD (1920x1080) IPS | None | 256GB SSD M.2 PCIe NVMe Opal2 | None | Intel 8265 ac, 2x2 + BT4.1 | Sierra EM7455 | None | None | None | None | 720p | Backlit | Finger-print Reader | None | dTPM 2.0 | 4-cell(32Wh) + 3-cell(24Wh) | 45W | Win10 Pro 64 | 3-year, Depot | 04/17 |
| 20H9004WUS | US | i7-7600U | vPro | Intel HD 620 | 8GBx1 | 15.6" FHD (1920x1080) IPS | None | 256GB SSD M.2 PCIe NVMe Opal2 | None | Intel 8265 ac, 2x2 + BT4.1 | Sierra EM7455 | None | None | None | None | 720p | Backlit | Finger-print Reader | None | dTPM 2.0 | 4-cell(32Wh) + 3-cell(24Wh) | 45W | Win10 Pro 64 | 3-year, Depot | 04/17 |
| 20H90056US | US | i5-7200U | No | Intel HD 620 | 4GBx1 | 15.6" HD (1366x768) | None | 500GB 7200rpm | None | Intel 8265 ac, 2x2 + BT4.1 | WWAN Upgradable | None | None | None | None | 720p | Backlit | Finger-print Reader | None | dTPM 2.0 | 4-cell(32Wh) + 3-cell(24Wh) | 45W | Win10 Pro 64 | 3-year, Depot | 06/17 |
| 20H90057US | US | i5-7300U | vPro | Intel HD 620 | 8GBx1 | 15.6" FHD (1920x1080) IPS | None | 256GB SSD M.2 PCIe NVMe Opal2 | None | Intel 8265 ac, 2x2 + BT4.1 | WWAN Upgradable | None | None | None | None | 720p | Backlit | Finger-print Reader | None | dTPM 2.0 | 4-cell(32Wh) + 3-cell(24Wh) | 45W | Win10 Pro 64 | 3-year, Depot | 06/17 |

| Model | Region | Processor | vPro | Graphics | Memory | Display | Multi-touch | Storage(HDD/SSD) | Optical | WLAN + Bluetooth | WWAN | SIM Card | Smart Card Reader | Dock | Monitor Cable | Camera | Key-board | Finger-print Reader | NFC | TPM | Battery (internal+external) | Power Adapter | Operating System | Warranty | Ann Date (m/y) |
|------------|--------|-----------|------|--------------|--------|---------------------------|----------------------|-------------------------------|---------|----------------------------|-----------------|----------|-------------------|------|---------------|--------|-----------|---------------------|------|----------|-----------------------------|---------------|------------------|---------------|----------------|
| 20H90058US | US | i5-7200U | No | Intel HD 620 | 4GBx1 | 15.6" HD (1366x768) | None | 180GB SSD Opal2 | None | Intel 8265 ac, 2x2 + BT4.1 | WWAN Upgradable | None | None | None | None | 720p | Backlit | Finger-print Reader | None | dTPM 2.0 | 4-cell(32Wh) + 3-cell(24Wh) | 45W | Win10 Pro 64 | 3-year, Depot | 06/17 |
| 20H90059US | US | i7-7600U | vPro | Intel HD 620 | 8GBx1 | 15.6" FHD (1920x1080) IPS | 10-point Multi-touch | 256GB SSD M.2 PCIe NVMe Opal2 | None | Intel 8265 ac, 2x2 + BT4.1 | WWAN Upgradable | None | None | None | None | 720p | Backlit | Finger-print Reader | None | dTPM 2.0 | 4-cell(32Wh) + 3-cell(24Wh) | 45W | Win10 Pro 64 | 3-year, Depot | 06/17 |

ThinkPad T570 - TopSeller - 20JW

Product Specifications Reference (PSREF)

| Model | Region | Processor | vPro | Graphics | Memory | Display | Multi-touch | Storage(HDD/SSD) | Optical | WLAN + Bluetooth | WWAN | SIM Card | Smart Card Reader | Dock | Monitor Cable | Camera | Key-board | Finger-print Reader | NFC | TPM | Battery (internal+external) | Power Adapter | Operating System | Warranty | Ann Date (m/y) |
|------------|--------|-----------|------|--------------|--------|---------------------------|-------------|-------------------------------|---------|----------------------------|-----------------|----------|-------------------|------|---------------|--------|-----------|---------------------|------|----------|-----------------------------|---------------|----------------------|---------------|----------------|
| 20JW0004US | US | i7-6600U | vPro | Intel HD 520 | 8GBx1 | 15.6" FHD (1920x1080) IPS | None | 256GB SSD M.2 PCIe NVMe Opal2 | None | Intel 8260 ac, 2x2 + BT4.1 | WWAN Upgradable | None | None | None | None | 720p | Backlit | Finger-print Reader | None | dTPM 2.0 | 4-cell(32Wh) + 3-cell(24Wh) | 45W | Win10 DG Win7 Pro 64 | 3-year, Depot | 03/17 |
| 20JW0005US | US | i5-6300U | vPro | Intel HD 520 | 4GBx1 | 15.6" FHD (1920x1080) IPS | None | 500GB 7200rpm | None | Intel 8260 ac, 2x2 + BT4.1 | WWAN Upgradable | None | None | None | None | 720p | Backlit | Finger-print Reader | None | dTPM 2.0 | 4-cell(32Wh) + 3-cell(24Wh) | 45W | Win10 DG Win7 Pro 64 | 3-year, Depot | 03/17 |
| 20JW0006US | US | i5-6300U | vPro | Intel HD 520 | 8GBx1 | 15.6" FHD (1920x1080) IPS | None | 256GB SSD M.2 PCIe NVMe Opal2 | None | Intel 8260 ac, 2x2 + BT4.1 | WWAN Upgradable | None | None | None | None | 720p | Backlit | Finger-print Reader | None | dTPM 2.0 | 4-cell(32Wh) + 3-cell(24Wh) | 45W | Win10 DG Win7 Pro 64 | 3-year, Depot | 03/17 |
| 20JW0007US | US | i7-6600U | vPro | Intel HD 520 | 16GBx1 | 15.6" FHD (1920x1080) IPS | None | 512GB SSD M.2 PCIe NVMe Opal2 | None | Intel 8260 ac, 2x2 + BT4.1 | WWAN Upgradable | None | None | None | None | 720p | Backlit | Finger-print Reader | None | dTPM 2.0 | 4-cell(32Wh) + 3-cell(24Wh) | 45W | Win10 DG Win7 Pro 64 | 3-year, Depot | 04/17 |
| 20JW0008US | US | i5-6300U | vPro | Intel HD 520 | 8GBx1 | 15.6" FHD (1920x1080) IPS | None | 256GB SSD M.2 PCIe NVMe Opal2 | None | Intel 8260 ac, 2x2 + BT4.1 | Sierra EM7455 | None | None | None | None | 720p | Backlit | Finger-print Reader | None | dTPM 2.0 | 4-cell(32Wh) + 3-cell(24Wh) | 45W | Win10 DG Win7 Pro 64 | 3-year, Depot | 04/17 |
| 20JW0009US | US | i7-6600U | vPro | Intel HD 520 | 8GBx1 | 15.6" FHD (1920x1080) IPS | None | 256GB SSD M.2 PCIe NVMe Opal2 | None | Intel 8260 ac, 2x2 + BT4.1 | Sierra EM7455 | None | None | None | None | 720p | Backlit | Finger-print Reader | None | dTPM 2.0 | 4-cell(32Wh) + 3-cell(24Wh) | 45W | Win10 DG Win7 Pro 64 | 3-year, Depot | 04/17 |
| 20JW000CUS | US | i7-6600U | vPro | Intel HD 520 | 8GBx1 | 15.6" FHD (1920x1080) IPS | None | 256GB SSD M.2 PCIe NVMe Opal2 | None | Intel 8260 ac, 2x2 + BT4.1 | WWAN Upgradable | None | None | None | None | 720p | Backlit | Finger-print Reader | None | dTPM 2.0 | 4-cell(32Wh) + 3-cell(24Wh) | 45W | Win10 DG Win7 Pro 64 | 3-year, Depot | 06/17 |
| 20JW000DUS | US | i5-6300U | vPro | Intel HD 520 | 8GBx1 | 15.6" FHD (1920x1080) IPS | None | 256GB SSD M.2 PCIe NVMe Opal2 | None | Intel 8260 ac, 2x2 + BT4.1 | WWAN Upgradable | None | None | None | None | 720p | Backlit | Finger-print Reader | None | dTPM 2.0 | 4-cell(32Wh) + 3-cell(24Wh) | 45W | Win10 DG Win7 Pro 64 | 3-year, Depot | 06/17 |



ThinkPad X1 Carbon (4th Gen) Platform Specifications

Product Specifications Reference (PSREF)

| Processor | 6th Generation Intel® Core™ i5 / i7 Processor | | | | | | | | Media reader Ports WiGig dock (opt) Monitor cable (optional) Adapter (optional) | MicroSD card reader, supports UHS-II microSD card Three USB 3.0 (one Always On), MiniDP, HDMI, Lenovo OneLink+ connector WiGig dock, mutually exclusive with WWAN HDMI to VGA: Lenovo HDMI to VGA Monitor Cable mDP to VGA: Lenovo Mini DisplayPort to VGA Monitor Cable OneLink+ to RJ45: ThinkPad OneLink+ to RJ45 adapter OneLink+ to VGA/RJ45: ThinkPad OneLink+ to VGA/RJ45 adapter | | | | | | | | | | | | |
|---|--|------------|--------------|----------------|---------------------|-------|--------------|-----------------------|---|--|------------|-----|----------|-----|---------------|-------------|--------|--------|----------------|-------------|--------|--------|
| | Processor Number | # of Cores | # of Threads | Base Frequency | Max Turbo Frequency | Cache | Memory Types | Processor Graphics | | | | | | | | | | | | | | |
| | i5-6200U | 2 | 4 | 2.3 GHz | 2.8 GHz | 3MB | LPDDR3-1866 | Intel HD Graphics 520 | | | | | | | | | | | | | | |
| | i5-6300U | | | 2.4 GHz | 3.0 GHz | 3MB | | | | | | | | | | | | | | | | |
| | i7-6500U | | | 2.5 GHz | 3.1 GHz | 4MB | | | | | | | | | | | | | | | | |
| i7-6600U | 2.6 GHz | | | 3.4 GHz | 4MB | | | | | | | | | | | | | | | | | |
| Graphics | Intel HD Graphics 520 in processor, external digital monitor support via Mini DisplayPort or HDMI™; supports three independent displays; Max resolution: 3840x2160 (Mini DisplayPort) @60Hz; 4096x2304 (HDMI) @24Hz | | | | | | | | Camera Audio support | HD720p resolution, low light sensitive, fixed focus HD Audio, Conexant® CX11852 codec / stereo speakers, 1 watt x 2 / dual array microphone, combo audio/microphone jack | | | | | | | | | | | | |
| Chipset Memory | Intel SoC (System on Chip) platform 4GB, 8GB, or 16GB / 1866MHz LPDDR3 / soldered to systemboard, no sockets | | | | | | | | Keyboard UltraNav™ | 6-row, spill-resistant, multimedia Fn keys, LED backlight TrackPoint® pointing device and buttonless glass surface touchpad, multi-touch | | | | | | | | | | | | |
| Display | <i>Some:</i> 14.0" (355mm) FHD (1920x1080), anti-glare, LED backlight, IPS, 300 nits, 16:9 aspect ratio, 700:1 contrast ratio, 170° viewing angle <i>Some:</i> 14.0" (355mm) WQHD (2560x1440), anti-glare, LED backlight, IPS, 300 nits, 16:9 aspect ratio, 700:1 contrast ratio, 72% gamut, 170° viewing angle | | | | | | | | Security | Power-on password, hard disk password, supervisor password, security keyhole, reset switch | | | | | | | | | | | | |
| Multi-touch Hinge | None Normal hinge, 180 degree | | | | | | | | Security chip ThinkEngine | Discrete TPM 1.2 TCG Certified and Firmware TPM 2.0 integrated in chipset Delivers improved thermal and power efficiency, up to 30 day standby, faster resume time, enhanced security, as well as anti-tampering measures | | | | | | | | | | | | |
| Storage | <i>Some:</i> M.2 SSD / SATA 6.0Gb/s (e.g. xxxG SSD) <i>Some:</i> M.2 SSD / PCIe NVMe, PCIe 3.0 x 4, 32Gb/s (e.g. xxxG SSD PCIe NVMe) | | | | | | | | vPro (optional) Fingerprint reader | Intel vPro Technology Touch style fingerprint reader on the palm rest | | | | | | | | | | | | |
| Optical | None | | | | | | | | Battery | Integrated Lithium Polymer 4-cell (52Wh) RapidCharge battery | | | | | | | | | | | | |
| Ethernet | Gigabit Ethernet via optional Ethernet (RJ-45) adapter (by native Intel Ethernet Connection I219-V (Non-vPro) or I219-LM (vPro)) | | | | | | | | Max battery life ¹⁰ | MobileMark® 2014: 11 hr | | | | | | | | | | | | |
| WLAN ⁴ | <i>One of the following, configurable by model (WiGig is mutually exclusive with WWAN):</i> <ul style="list-style-type: none"> 11ac+BT, Intel Dual Band Wireless-AC 8260, 2x2, M.2 card WiGig™+11ac+BT, Intel Tri-Band Wireless-AC 18260, 2x2 WLAN, WiGig, M.2 card | | | | | | | | AC adapter | 45W AC adapter, 65W Slim AC adapter, or 65W AC adapter | | | | | | | | | | | | |
| Bluetooth™ | Bluetooth 4.1 wireless, integrated in Wi-Fi + Bluetooth combo adapter | | | | | | | | RapidCharge | <table border="1"> <thead> <tr> <th>AC adapter</th> <th>45W</th> <th>65W Slim</th> <th>65W</th> </tr> </thead> <tbody> <tr> <td>Charge to 80%</td> <td>Not support</td> <td>1.0 hr</td> <td>1.0 hr</td> </tr> <tr> <td>Charge to 100%</td> <td>Not support</td> <td>2.5 hr</td> <td>2.5 hr</td> </tr> </tbody> </table> | AC adapter | 45W | 65W Slim | 65W | Charge to 80% | Not support | 1.0 hr | 1.0 hr | Charge to 100% | Not support | 2.5 hr | 2.5 hr |
| AC adapter | 45W | 65W Slim | 65W | | | | | | | | | | | | | | | | | | | |
| Charge to 80% | Not support | 1.0 hr | 1.0 hr | | | | | | | | | | | | | | | | | | | |
| Charge to 100% | Not support | 2.5 hr | 2.5 hr | | | | | | | | | | | | | | | | | | | |
| WWAN (optional) | <i>One of the following, configurable by model (mutually exclusive with WiGig):</i> <ul style="list-style-type: none"> Wireless WAN upgradable Wireless WAN, Sierra Wireless EM7455, Qualcomm® 4G LTE-Advanced/DC-HSPA+/HSPA+/HSPA/UMTS/GNSS, M.2 card Wireless WAN, HUAWEI ME906S, HUAWEI 4G LTE/WCDMA/HSPA/GSM/GPRS/EDGE/GNSS, M.2 card (WE only) | | | | | | | | Preload | Windows 7 Professional 64 preinstalled through downgrade rights in Windows 10 Pro 64 Windows 10 Pro 64 <ul style="list-style-type: none"> Lenovo Solution Center Lenovo Companion Lenovo Setting Microsoft Office preloaded; purchase a product key to activate McAfee® LiveSafe™ (30-day trial) | | | | | | | | | | | | |
| SIM card (opt) | Micro-SIM card slot, optional Verizon LTE (US) or Lenovo Connect (WE) SIM card | | | | | | | | Limited warranty ¹² | <i>One of the following, configurable by model:</i> <ul style="list-style-type: none"> 1-year depot repair service 3-year/1-yr battery depot repair service 3-year/1-yr battery limited onsite service²⁴ 3-year/1-yr battery limited onsite service, OID (Onsite International Delivery) | | | | | | | | | | | | |
| Dimensions ³ Weight ² Case material | <i>WxDxH:</i> 13.11" x 9.02" x 0.59-0.65"; 333.0mm x 229.0mm x 14.95-16.45mm <i>Starting at:</i> 2.579 lb / 1.17 kg <i>Display cover:</i> Carbon-Fiber Reinforced Plastic; <i>Bottom:</i> Super magnesium | | | | | | | | Mil-Spec test | MIL-STD-810G military certification | | | | | | | | | | | | |
| | | | | | | | | | Environment | EPEAT™ Gold (US only); ENERGY STAR® 6.1; GREENGUARD®; RoHS-compliant | | | | | | | | | | | | |

Lenovo
June 2017

| Model | Region | Processor | vPro | Graphics | Memory (Soldered) | Display | Multi-touch | Storage(HDD/SSD) | Optical | WLAN + Bluetooth | WWAN | SIM Card | Monitor Cable | Adapter | Dock | Camera | Keyboard | Fingerprint Reader | Battery (internal) | Power Adapter | Operating System | Warranty | Ann Date (m/y) |
|------------|--------|-----------|------|--------------|-------------------|--------------------------|-------------|-------------------------------|---------|----------------------------|-----------------|----------|---------------|---------|------|--------|----------|--------------------|--------------------|---------------|----------------------|---------------|----------------|
| 20FB002JUS | US | i5-6300U | vPro | Intel HD 520 | 8GB Soldered | 14" FHD (1920x1080) IPS | None | 256GB SSD M.2 PCIe NVMe Opal2 | None | Intel 8260 ac, 2x2 + BT4.1 | WWAN Upgradable | None | None | None | None | 720p | Backlit | Fingerprint Reader | 4-cell (52Wh) | 65W | Win10 DG Win7 Pro 64 | 3-year, Depot | 02/16 |
| 20FB002KUS | US | i5-6200U | No | Intel HD 520 | 8GB Soldered | 14" FHD (1920x1080) IPS | None | 256GB SSD M.2 PCIe NVMe Opal2 | None | Intel 8260 ac, 2x2 + BT4.1 | WWAN Upgradable | None | None | None | None | 720p | Backlit | Fingerprint Reader | 4-cell (52Wh) | 65W | Win10 DG Win7 Pro 64 | 3-year, Depot | 02/16 |
| 20FB002LUS | US | i7-6600U | vPro | Intel HD 520 | 16GB Soldered | 14" WQHD (2560x1440) IPS | None | 512GB SSD M.2 | None | Intel 8260 ac, 2x2 + BT4.1 | WWAN Upgradable | None | None | None | None | 720p | Backlit | Fingerprint Reader | 4-cell (52Wh) | 65W | Win10 DG Win7 Pro 64 | 3-year, Depot | 02/16 |
| 20FB002MUS | US | i5-6200U | No | Intel HD 520 | 8GB Soldered | 14" FHD (1920x1080) IPS | None | 128GB SSD M.2 | None | Intel 8260 ac, 2x2 + BT4.1 | WWAN Upgradable | None | None | None | None | 720p | Backlit | Fingerprint Reader | 4-cell (52Wh) | 65W | Win10 DG Win7 Pro 64 | 3-year, Depot | 02/16 |
| 20FB002NUS | US | i7-6600U | vPro | Intel HD 520 | 16GB Soldered | 14" WQHD (2560x1440) IPS | None | 256GB SSD M.2 PCIe NVMe Opal2 | None | Intel 8260 ac, 2x2 + BT4.1 | WWAN Upgradable | None | None | None | None | 720p | Backlit | Fingerprint Reader | 4-cell (52Wh) | 65W | Win10 DG Win7 Pro 64 | 3-year, Depot | 02/16 |
| 20FB002PUS | US | i5-6200U | No | Intel HD 520 | 8GB Soldered | 14" FHD (1920x1080) IPS | None | 512GB SSD M.2 | None | Intel 8260 ac, 2x2 + BT4.1 | WWAN Upgradable | None | None | None | None | 720p | Backlit | Fingerprint Reader | 4-cell (52Wh) | 65W | Win10 DG Win7 Pro 64 | 3-year, Depot | 02/16 |
| 20FB002QUS | US | i7-6600U | vPro | Intel HD 520 | 8GB Soldered | 14" WQHD (2560x1440) IPS | None | 256GB SSD M.2 Opal2 | None | Intel 8260 ac, 2x2 + BT4.1 | WWAN Upgradable | None | None | None | None | 720p | Backlit | Fingerprint Reader | 4-cell (52Wh) | 65W | Win10 DG Win7 Pro 64 | 3-year, Depot | 02/16 |
| 20FB002RUS | US | i5-6200U | No | Intel HD 520 | 8GB Soldered | 14" FHD (1920x1080) IPS | None | 256GB SSD M.2 Opal2 | None | Intel 8260 ac, 2x2 + BT4.1 | WWAN Upgradable | None | None | None | None | 720p | Backlit | Fingerprint Reader | 4-cell (52Wh) | 65W | Win10 DG Win7 Pro 64 | 3-year, Depot | 02/16 |
| 20FB002SUS | US | i7-6600U | vPro | Intel HD 520 | 8GB Soldered | 14" WQHD (2560x1440) IPS | None | 512GB SSD M.2 | None | Intel 8260 ac, 2x2 + BT4.1 | WWAN Upgradable | None | None | None | None | 720p | Backlit | Fingerprint Reader | 4-cell (52Wh) | 65W | Win10 DG Win7 Pro 64 | 3-year, Depot | 02/16 |
| 20FB0044US | US | i7-6600U | vPro | Intel HD 520 | 16GB Soldered | 14" WQHD (2560x1440) IPS | None | 180GB SSD M.2 Opal2 | None | Intel 8260 ac, 2x2 + BT4.1 | None | None | None | None | None | 720p | Backlit | Fingerprint Reader | 4-cell (52Wh) | 65W | Win10 Pro 64 | 3-year, Depot | 02/16 |
| 20FB0045US | US | i7-6600U | vPro | Intel HD 520 | 16GB Soldered | 14" FHD (1920x1080) IPS | None | 256GB SSD M.2 Opal2 | None | Intel 8260 ac, 2x2 + BT4.1 | WWAN Upgradable | None | None | None | None | 720p | Backlit | Fingerprint Reader | 4-cell (52Wh) | 65W | Win10 DG Win7 Pro 64 | 3-year, Depot | 02/16 |
| 20FB0046US | US | i7-6600U | vPro | Intel HD 520 | 8GB Soldered | 14" FHD (1920x1080) IPS | None | 256GB SSD M.2 Opal2 | None | Intel 8260 ac, 2x2 + BT4.1 | WWAN Upgradable | None | None | None | None | 720p | Backlit | Fingerprint Reader | 4-cell (52Wh) | 65W | Win10 Pro 64 | 3-year, Depot | 02/16 |
| 20FB0047US | US | i5-6300U | vPro | Intel HD 520 | 8GB Soldered | 14" FHD (1920x1080) IPS | None | 128GB SSD M.2 | None | Intel 8260 ac, 2x2 + BT4.1 | WWAN Upgradable | None | None | None | None | 720p | Backlit | Fingerprint Reader | 4-cell (52Wh) | 65W | Win10 Pro 64 | 3-year, Depot | 02/16 |
| 20FB0048US | US | i7-6600U | vPro | Intel HD 520 | 16GB Soldered | 14" FHD (1920x1080) IPS | None | 512GB SSD M.2 | None | Intel 8260 ac, 2x2 + BT4.1 | WWAN Upgradable | None | None | None | None | 720p | Backlit | Fingerprint Reader | 4-cell (52Wh) | 65W | Win10 DG Win7 Pro 64 | 3-year, Depot | 02/16 |
| 20FB0049US | US | i7-6600U | vPro | Intel HD 520 | 16GB Soldered | 14" WQHD (2560x1440) IPS | None | 256GB SSD M.2 Opal2 | None | Intel 8260 ac, 2x2 + BT4.1 | WWAN Upgradable | None | None | None | None | 720p | Backlit | Fingerprint Reader | 4-cell (52Wh) | 65W | Win10 Pro 64 | 3-year, Depot | 02/16 |
| 20FB004AUS | US | i5-6300U | vPro | Intel HD 520 | 8GB Soldered | 14" FHD (1920x1080) IPS | None | 128GB SSD M.2 | None | Intel 8260 ac, 2x2 + BT4.1 | WWAN Upgradable | None | None | None | None | 720p | Backlit | Fingerprint Reader | 4-cell (52Wh) | 65W | Win10 DG Win7 Pro 64 | 3-year, Depot | 02/16 |
| 20FB004BUS | US | i5-6300U | vPro | Intel HD 520 | 8GB Soldered | 14" FHD (1920x1080) IPS | None | 180GB SSD M.2 Opal2 | None | Intel 8260 ac, 2x2 + BT4.1 | WWAN Upgradable | None | None | None | None | 720p | Backlit | Fingerprint Reader | 4-cell (52Wh) | 65W | Win10 DG Win7 Pro 64 | 3-year, Depot | 02/16 |
| 20FB004CUS | US | i5-6300U | vPro | Intel HD 520 | 8GB Soldered | 14" WQHD (2560x1440) IPS | None | 256GB SSD M.2 PCIe NVMe Opal2 | None | Intel 8260 ac, 2x2 + BT4.1 | WWAN Upgradable | None | None | None | None | 720p | Backlit | Fingerprint Reader | 4-cell (52Wh) | 65W | Win10 Pro 64 | 3-year, Depot | 02/16 |
| 20FB004DUS | US | i7-6600U | vPro | Intel HD 520 | 8GB Soldered | 14" FHD (1920x1080) IPS | None | 192GB SSD M.2 | None | Intel 8260 ac, 2x2 + BT4.1 | WWAN Upgradable | None | None | None | None | 720p | Backlit | Fingerprint Reader | 4-cell (52Wh) | 65W | Win10 Pro 64 | 3-year, Depot | 02/16 |
| 20FB004EUS | US | i7-6600U | vPro | Intel HD 520 | 8GB Soldered | 14" FHD (1920x1080) IPS | None | 512GB SSD M.2 | None | Intel 8260 ac, 2x2 + BT4.1 | WWAN Upgradable | None | None | None | None | 720p | Backlit | Fingerprint Reader | 4-cell (52Wh) | 65W | Win10 DG Win7 Pro 64 | 3-year, Depot | 02/16 |

| Model | Region | Processor | vPro | Graphics | Memory (Soldered) | Display | Multi-touch | Storage(HDD/SSD) | Optical | WLAN + Bluetooth | WWAN | SIM Card | Monitor Cable | Adapter | Dock | Camera | Keyboard | Fingerprint Reader | Battery (internal) | Power Adapter | Operating System | Warranty | Ann Date (m/y) |
|------------|--------|-----------|------|--------------|-------------------|--------------------------|-------------|-------------------------------|---------|----------------------------|-----------------|----------|---------------|---------|------|--------|----------|--------------------|--------------------|---------------|----------------------|---------------|----------------|
| 20FB004FUS | US | i5-6300U | vPro | Intel HD 520 | 8GB Soldered | 14" WQHD (2560x1440) IPS | None | 128GB SSD M.2 | None | Intel 8260 ac, 2x2 + BT4.1 | None | None | None | None | None | 720p | Backlit | Fingerprint Reader | 4-cell (52Wh) | 65W | Win10 Pro 64 | 3-year, Depot | 02/16 |
| 20FB004GUS | US | i5-6300U | vPro | Intel HD 520 | 8GB Soldered | 14" WQHD (2560x1440) IPS | None | 256GB SSD M.2 Opal2 | None | Intel 8260 ac, 2x2 + BT4.1 | None | None | None | None | None | 720p | Backlit | Fingerprint Reader | 4-cell (52Wh) | 65W | Win10 Pro 64 | 3-year, Depot | 02/16 |
| 20FB004HUS | US | i7-6600U | vPro | Intel HD 520 | 16GB Soldered | 14" WQHD (2560x1440) IPS | None | 240GB SSD M.2 Opal2 | None | Intel 8260 ac, 2x2 + BT4.1 | None | None | None | None | None | 720p | Backlit | Fingerprint Reader | 4-cell (52Wh) | 65W | Win10 Pro 64 | 3-year, Depot | 02/16 |
| 20FB004JUS | US | i5-6300U | vPro | Intel HD 520 | 8GB Soldered | 14" FHD (1920x1080) IPS | None | 256GB SSD M.2 Opal2 | None | Intel 8260 ac, 2x2 + BT4.1 | WWAN Upgradable | None | None | None | None | 720p | Backlit | Fingerprint Reader | 4-cell (52Wh) | 65W | Win10 DG Win7 Pro 64 | 3-year, Depot | 02/16 |
| 20FB004KUS | US | i7-6600U | vPro | Intel HD 520 | 8GB Soldered | 14" WQHD (2560x1440) IPS | None | 512GB SSD M.2 PCIe NVMe | None | Intel 8260 ac, 2x2 + BT4.1 | None | None | None | None | None | 720p | Backlit | Fingerprint Reader | 4-cell (52Wh) | 65W | Win10 Pro 64 | 3-year, Depot | 02/16 |
| 20FB004LUS | US | i5-6200U | No | Intel HD 520 | 8GB Soldered | 14" FHD (1920x1080) IPS | None | 180GB SSD M.2 Opal2 | None | Intel 8260 ac, 2x2 + BT4.1 | WWAN Upgradable | None | None | None | None | 720p | Backlit | Fingerprint Reader | 4-cell (52Wh) | 65W | Win10 DG Win7 Pro 64 | 3-year, Depot | 02/16 |
| 20FB004MUS | US | i7-6600U | vPro | Intel HD 520 | 8GB Soldered | 14" FHD (1920x1080) IPS | None | 512GB SSD M.2 PCIe NVMe | None | Intel 8260 ac, 2x2 + BT4.1 | WWAN Upgradable | None | None | None | None | 720p | Backlit | Fingerprint Reader | 4-cell (52Wh) | 65W | Win10 DG Win7 Pro 64 | 3-year, Depot | 02/16 |
| 20FB004NUS | US | i7-6600U | vPro | Intel HD 520 | 16GB Soldered | 14" WQHD (2560x1440) IPS | None | 512GB SSD M.2 | None | Intel 8260 ac, 2x2 + BT4.1 | WWAN Upgradable | None | None | None | None | 720p | Backlit | Fingerprint Reader | 4-cell (52Wh) | 65W | Win10 Pro 64 | 3-year, Depot | 02/16 |
| 20FB004PUS | US | i5-6300U | vPro | Intel HD 520 | 8GB Soldered | 14" FHD (1920x1080) IPS | None | 192GB SSD M.2 | None | Intel 8260 ac, 2x2 + BT4.1 | WWAN Upgradable | None | None | None | None | 720p | Backlit | Fingerprint Reader | 4-cell (52Wh) | 65W | Win10 Pro 64 | 3-year, Depot | 02/16 |
| 20FB004QUS | US | i7-6600U | vPro | Intel HD 520 | 16GB Soldered | 14" FHD (1920x1080) IPS | None | 512GB SSD M.2 PCIe NVMe | None | Intel 8260 ac, 2x2 + BT4.1 | WWAN Upgradable | None | None | None | None | 720p | Backlit | Fingerprint Reader | 4-cell (52Wh) | 65W | Win10 Pro 64 | 3-year, Depot | 02/16 |
| 20FB004RUS | US | i7-6600U | vPro | Intel HD 520 | 16GB Soldered | 14" FHD (1920x1080) IPS | None | 256GB SSD M.2 PCIe NVMe Opal2 | None | Intel 8260 ac, 2x2 + BT4.1 | WWAN Upgradable | None | None | None | None | 720p | Backlit | Fingerprint Reader | 4-cell (52Wh) | 65W | Win10 Pro 64 | 3-year, Depot | 02/16 |
| 20FB004SUS | US | i5-6300U | vPro | Intel HD 520 | 8GB Soldered | 14" WQHD (2560x1440) IPS | None | 180GB SSD M.2 Opal2 | None | Intel 8260 ac, 2x2 + BT4.1 | None | None | None | None | None | 720p | Backlit | Fingerprint Reader | 4-cell (52Wh) | 65W | Win10 Pro 64 | 3-year, Depot | 02/16 |
| 20FB004TUS | US | i5-6300U | vPro | Intel HD 520 | 8GB Soldered | 14" FHD (1920x1080) IPS | None | 192GB SSD M.2 | None | Intel 8260 ac, 2x2 + BT4.1 | WWAN Upgradable | None | None | None | None | 720p | Backlit | Fingerprint Reader | 4-cell (52Wh) | 65W | Win10 DG Win7 Pro 64 | 3-year, Depot | 02/16 |
| 20FB004UUS | US | i7-6600U | vPro | Intel HD 520 | 8GB Soldered | 14" FHD (1920x1080) IPS | None | 512GB SSD M.2 PCIe NVMe | None | Intel 8260 ac, 2x2 + BT4.1 | WWAN Upgradable | None | None | None | None | 720p | Backlit | Fingerprint Reader | 4-cell (52Wh) | 65W | Win10 Pro 64 | 3-year, Depot | 02/16 |
| 20FB004VUS | US | i5-6300U | vPro | Intel HD 520 | 8GB Soldered | 14" WQHD (2560x1440) IPS | None | 256GB SSD M.2 Opal2 | None | Intel 8260 ac, 2x2 + BT4.1 | WWAN Upgradable | None | None | None | None | 720p | Backlit | Fingerprint Reader | 4-cell (52Wh) | 65W | Win10 Pro 64 | 3-year, Depot | 02/16 |
| 20FB004WUS | US | i5-6300U | vPro | Intel HD 520 | 8GB Soldered | 14" FHD (1920x1080) IPS | None | 180GB SSD M.2 Opal2 | None | Intel 8260 ac, 2x2 + BT4.1 | WWAN Upgradable | None | None | None | None | 720p | Backlit | Fingerprint Reader | 4-cell (52Wh) | 65W | Win10 Pro 64 | 3-year, Depot | 02/16 |
| 20FB004XUS | US | i7-6600U | vPro | Intel HD 520 | 16GB Soldered | 14" FHD (1920x1080) IPS | None | 240GB SSD M.2 Opal2 | None | Intel 8260 ac, 2x2 + BT4.1 | WWAN Upgradable | None | None | None | None | 720p | Backlit | Fingerprint Reader | 4-cell (52Wh) | 65W | Win10 Pro 64 | 3-year, Depot | 02/16 |
| 20FB004YUS | US | i7-6600U | vPro | Intel HD 520 | 16GB Soldered | 14" FHD (1920x1080) IPS | None | 512GB SSD M.2 | None | Intel 8260 ac, 2x2 + BT4.1 | WWAN Upgradable | None | None | None | None | 720p | Backlit | Fingerprint Reader | 4-cell (52Wh) | 65W | Win10 Pro 64 | 3-year, Depot | 02/16 |
| 20FB0050US | US | i5-6300U | vPro | Intel HD 520 | 8GB Soldered | 14" FHD (1920x1080) IPS | None | 512GB SSD M.2 | None | Intel 8260 ac, 2x2 + BT4.1 | WWAN Upgradable | None | None | None | None | 720p | Backlit | Fingerprint Reader | 4-cell (52Wh) | 65W | Win10 DG Win7 Pro 64 | 3-year, Depot | 02/16 |
| 20FB0051US | US | i7-6600U | vPro | Intel HD 520 | 16GB Soldered | 14" FHD (1920x1080) IPS | None | 256GB SSD M.2 Opal2 | None | Intel 8260 ac, 2x2 + BT4.1 | WWAN Upgradable | None | None | None | None | 720p | Backlit | Fingerprint Reader | 4-cell (52Wh) | 65W | Win10 Pro 64 | 3-year, Depot | 02/16 |

| Model | Region | Processor | vPro | Graphics | Memory (Soldered) | Display | Multi-touch | Storage(HDD/SSD) | Optical | WLAN + Bluetooth | WWAN | SIM Card | Monitor Cable | Adapter | Dock | Camera | Keyboard | Fingerprint Reader | Battery (internal) | Power Adapter | Operating System | Warranty | Ann Date (m/y) |
|------------|--------|-----------|------|--------------|-------------------|--------------------------|-------------|-------------------------------|---------|----------------------------|-----------------|----------|---------------|---------|------|--------|----------|--------------------|--------------------|---------------|----------------------|---------------|----------------|
| 20FB0052US | US | i7-6600U | vPro | Intel HD 520 | 16GB Soldered | 14" WQHD (2560x1440) IPS | None | 256GB SSD M.2 PCIe NVMe Opal2 | None | Intel 8260 ac, 2x2 + BT4.1 | WWAN Upgradable | None | None | None | None | 720p | Backlit | Fingerprint Reader | 4-cell (52Wh) | 65W | Win10 Pro 64 | 3-year, Depot | 02/16 |
| 20FB0053US | US | i5-6300U | vPro | Intel HD 520 | 8GB Soldered | 14" WQHD (2560x1440) IPS | None | 512GB SSD M.2 PCIe NVMe | None | Intel 8260 ac, 2x2 + BT4.1 | None | None | None | None | None | 720p | Backlit | Fingerprint Reader | 4-cell (52Wh) | 65W | Win10 Pro 64 | 3-year, Depot | 02/16 |
| 20FB0054US | US | i7-6600U | vPro | Intel HD 520 | 16GB Soldered | 14" WQHD (2560x1440) IPS | None | 256GB SSD M.2 PCIe NVMe Opal2 | None | Intel 8260 ac, 2x2 + BT4.1 | None | None | None | None | None | 720p | Backlit | Fingerprint Reader | 4-cell (52Wh) | 65W | Win10 Pro 64 | 3-year, Depot | 02/16 |
| 20FB0055US | US | i5-6300U | vPro | Intel HD 520 | 8GB Soldered | 14" WQHD (2560x1440) IPS | None | 512GB SSD M.2 | None | Intel 8260 ac, 2x2 + BT4.1 | None | None | None | None | None | 720p | Backlit | Fingerprint Reader | 4-cell (52Wh) | 65W | Win10 Pro 64 | 3-year, Depot | 02/16 |
| 20FB0056US | US | i7-6500U | No | Intel HD 520 | 8GB Soldered | 14" FHD (1920x1080) IPS | None | 256GB SSD M.2 Opal2 | None | Intel 8260 ac, 2x2 + BT4.1 | WWAN Upgradable | None | None | None | None | 720p | Backlit | Fingerprint Reader | 4-cell (52Wh) | 65W | Win10 Pro 64 | 3-year, Depot | 02/16 |
| 20FB0057US | US | i7-6600U | vPro | Intel HD 520 | 8GB Soldered | 14" FHD (1920x1080) IPS | None | 256GB SSD M.2 PCIe NVMe Opal2 | None | Intel 8260 ac, 2x2 + BT4.1 | WWAN Upgradable | None | None | None | None | 720p | Backlit | Fingerprint Reader | 4-cell (52Wh) | 65W | Win10 Pro 64 | 3-year, Depot | 02/16 |
| 20FB0058US | US | i7-6600U | vPro | Intel HD 520 | 16GB Soldered | 14" WQHD (2560x1440) IPS | None | 240GB SSD M.2 Opal2 | None | Intel 8260 ac, 2x2 + BT4.1 | WWAN Upgradable | None | None | None | None | 720p | Backlit | Fingerprint Reader | 4-cell (52Wh) | 65W | Win10 Pro 64 | 3-year, Depot | 02/16 |
| 20FB005AUS | US | i7-6600U | vPro | Intel HD 520 | 8GB Soldered | 14" FHD (1920x1080) IPS | None | 192GB SSD M.2 | None | Intel 8260 ac, 2x2 + BT4.1 | WWAN Upgradable | None | None | None | None | 720p | Backlit | Fingerprint Reader | 4-cell (52Wh) | 65W | Win10 DG Win7 Pro 64 | 3-year, Depot | 02/16 |
| 20FB005BUS | US | i7-6600U | vPro | Intel HD 520 | 16GB Soldered | 14" WQHD (2560x1440) IPS | None | 192GB SSD M.2 | None | Intel 8260 ac, 2x2 + BT4.1 | None | None | None | None | None | 720p | Backlit | Fingerprint Reader | 4-cell (52Wh) | 65W | Win10 Pro 64 | 3-year, Depot | 02/16 |
| 20FB005CUS | US | i7-6600U | vPro | Intel HD 520 | 8GB Soldered | 14" FHD (1920x1080) IPS | None | 128GB SSD M.2 | None | Intel 8260 ac, 2x2 + BT4.1 | WWAN Upgradable | None | None | None | None | 720p | Backlit | Fingerprint Reader | 4-cell (52Wh) | 65W | Win10 DG Win7 Pro 64 | 3-year, Depot | 02/16 |
| 20FB005DUS | US | i7-6500U | No | Intel HD 520 | 8GB Soldered | 14" FHD (1920x1080) IPS | None | 256GB SSD M.2 PCIe NVMe Opal2 | None | Intel 8260 ac, 2x2 + BT4.1 | WWAN Upgradable | None | None | None | None | 720p | Backlit | Fingerprint Reader | 4-cell (52Wh) | 65W | Win10 Pro 64 | 3-year, Depot | 02/16 |
| 20FB005EUS | US | i5-6300U | vPro | Intel HD 520 | 8GB Soldered | 14" FHD (1920x1080) IPS | None | 240GB SSD M.2 Opal2 | None | Intel 8260 ac, 2x2 + BT4.1 | WWAN Upgradable | None | None | None | None | 720p | Backlit | Fingerprint Reader | 4-cell (52Wh) | 65W | Win10 Pro 64 | 3-year, Depot | 02/16 |
| 20FB005FUS | US | i7-6500U | No | Intel HD 520 | 8GB Soldered | 14" FHD (1920x1080) IPS | None | 192GB SSD M.2 | None | Intel 8260 ac, 2x2 + BT4.1 | WWAN Upgradable | None | None | None | None | 720p | Backlit | Fingerprint Reader | 4-cell (52Wh) | 65W | Win10 Pro 64 | 3-year, Depot | 02/16 |
| 20FB005GUS | US | i7-6600U | vPro | Intel HD 520 | 16GB Soldered | 14" WQHD (2560x1440) IPS | None | 256GB SSD M.2 Opal2 | None | Intel 8260 ac, 2x2 + BT4.1 | None | None | None | None | None | 720p | Backlit | Fingerprint Reader | 4-cell (52Wh) | 65W | Win10 Pro 64 | 3-year, Depot | 02/16 |
| 20FB005HUS | US | i5-6300U | vPro | Intel HD 520 | 8GB Soldered | 14" WQHD (2560x1440) IPS | None | 128GB SSD M.2 | None | Intel 8260 ac, 2x2 + BT4.1 | WWAN Upgradable | None | None | None | None | 720p | Backlit | Fingerprint Reader | 4-cell (52Wh) | 65W | Win10 Pro 64 | 3-year, Depot | 02/16 |
| 20FB005JUS | US | i5-6300U | vPro | Intel HD 520 | 8GB Soldered | 14" WQHD (2560x1440) IPS | None | 512GB SSD M.2 | None | Intel 8260 ac, 2x2 + BT4.1 | WWAN Upgradable | None | None | None | None | 720p | Backlit | Fingerprint Reader | 4-cell (52Wh) | 65W | Win10 Pro 64 | 3-year, Depot | 02/16 |
| 20FB005KUS | US | i7-6600U | vPro | Intel HD 520 | 8GB Soldered | 14" FHD (1920x1080) IPS | None | 256GB SSD M.2 PCIe NVMe Opal2 | None | Intel 8260 ac, 2x2 + BT4.1 | WWAN Upgradable | None | None | None | None | 720p | Backlit | Fingerprint Reader | 4-cell (52Wh) | 65W | Win10 DG Win7 Pro 64 | 3-year, Depot | 02/16 |
| 20FB005LUS | US | i7-6600U | vPro | Intel HD 520 | 16GB Soldered | 14" WQHD (2560x1440) IPS | None | 512GB SSD M.2 PCIe NVMe | None | Intel 8260 ac, 2x2 + BT4.1 | WWAN Upgradable | None | None | None | None | 720p | Backlit | Fingerprint Reader | 4-cell (52Wh) | 65W | Win10 Pro 64 | 3-year, Depot | 02/16 |
| 20FB005MUS | US | i5-6300U | vPro | Intel HD 520 | 8GB Soldered | 14" FHD (1920x1080) IPS | None | 512GB SSD M.2 | None | Intel 8260 ac, 2x2 + BT4.1 | WWAN Upgradable | None | None | None | None | 720p | Backlit | Fingerprint Reader | 4-cell (52Wh) | 65W | Win10 Pro 64 | 3-year, Depot | 02/16 |
| 20FB005NUS | US | i7-6600U | vPro | Intel HD 520 | 16GB Soldered | 14" WQHD (2560x1440) IPS | None | 512GB SSD M.2 PCIe NVMe | None | Intel 8260 ac, 2x2 + BT4.1 | None | None | None | None | None | 720p | Backlit | Fingerprint Reader | 4-cell (52Wh) | 65W | Win10 Pro 64 | 3-year, Depot | 02/16 |

| Model | Region | Processor | vPro | Graphics | Memory (Soldered) | Display | Multi-touch | Storage(HDD/SSD) | Optical | WLAN + Bluetooth | WWAN | SIM Card | Monitor Cable | Adapter | Dock | Camera | Keyboard | Fingerprint Reader | Battery (internal) | Power Adapter | Operating System | Warranty | Ann Date (m/y) |
|------------|--------|-----------|------|--------------|-------------------|--------------------------|-------------|-------------------------------|---------|----------------------------|-----------------|----------|---------------|---------|------|--------|----------|--------------------|--------------------|---------------|----------------------|---------------|----------------|
| 20FB005PUS | US | i7-6600U | vPro | Intel HD 520 | 16GB Soldered | 14" FHD (1920x1080) IPS | None | 256GB SSD M.2 PCIe NVMe Opal2 | None | Intel 8260 ac, 2x2 + BT4.1 | WWAN Upgradable | None | None | None | None | 720p | Backlit | Fingerprint Reader | 4-cell (52Wh) | 65W | Win10 DG Win7 Pro 64 | 3-year, Depot | 02/16 |
| 20FB005QUS | US | i5-6300U | vPro | Intel HD 520 | 8GB Soldered | 14" WQHD (2560x1440) IPS | None | 256GB SSD M.2 PCIe NVMe Opal2 | None | Intel 8260 ac, 2x2 + BT4.1 | None | None | None | None | None | 720p | Backlit | Fingerprint Reader | 4-cell (52Wh) | 65W | Win10 Pro 64 | 3-year, Depot | 02/16 |
| 20FB005RUS | US | i7-6600U | vPro | Intel HD 520 | 8GB Soldered | 14" WQHD (2560x1440) IPS | None | 512GB SSD M.2 | None | Intel 8260 ac, 2x2 + BT4.1 | None | None | None | None | None | 720p | Backlit | Fingerprint Reader | 4-cell (52Wh) | 65W | Win10 Pro 64 | 3-year, Depot | 02/16 |
| 20FB005SUS | US | i7-6600U | vPro | Intel HD 520 | 16GB Soldered | 14" FHD (1920x1080) IPS | None | 512GB SSD M.2 PCIe NVMe | None | Intel 8260 ac, 2x2 + BT4.1 | WWAN Upgradable | None | None | None | None | 720p | Backlit | Fingerprint Reader | 4-cell (52Wh) | 65W | Win10 DG Win7 Pro 64 | 3-year, Depot | 02/16 |
| 20FB005TUS | US | i5-6200U | No | Intel HD 520 | 8GB Soldered | 14" FHD (1920x1080) IPS | None | 128GB SSD M.2 | None | Intel 8260 ac, 2x2 + BT4.1 | WWAN Upgradable | None | None | None | None | 720p | Backlit | Fingerprint Reader | 4-cell (52Wh) | 65W | Win10 Pro 64 | 3-year, Depot | 02/16 |
| 20FB005UUS | US | i7-6500U | No | Intel HD 520 | 8GB Soldered | 14" FHD (1920x1080) IPS | None | 512GB SSD M.2 | None | Intel 8260 ac, 2x2 + BT4.1 | WWAN Upgradable | None | None | None | None | 720p | Backlit | Fingerprint Reader | 4-cell (52Wh) | 65W | Win10 Pro 64 | 3-year, Depot | 02/16 |
| 20FB005VUS | US | i7-6600U | vPro | Intel HD 520 | 16GB Soldered | 14" WQHD (2560x1440) IPS | None | 512GB SSD M.2 | None | Intel 8260 ac, 2x2 + BT4.1 | None | None | None | None | None | 720p | Backlit | Fingerprint Reader | 4-cell (52Wh) | 65W | Win10 Pro 64 | 3-year, Depot | 02/16 |
| 20FB005WUS | US | i7-6600U | vPro | Intel HD 520 | 8GB Soldered | 14" FHD (1920x1080) IPS | None | 256GB SSD M.2 Opal2 | None | Intel 8260 ac, 2x2 + BT4.1 | WWAN Upgradable | None | None | None | None | 720p | Backlit | Fingerprint Reader | 4-cell (52Wh) | 65W | Win10 DG Win7 Pro 64 | 3-year, Depot | 02/16 |
| 20FB005XUS | US | i5-6300U | vPro | Intel HD 520 | 8GB Soldered | 14" FHD (1920x1080) IPS | None | 256GB SSD M.2 PCIe NVMe Opal2 | None | Intel 8260 ac, 2x2 + BT4.1 | WWAN Upgradable | None | None | None | None | 720p | Backlit | Fingerprint Reader | 4-cell (52Wh) | 65W | Win10 Pro 64 | 3-year, Depot | 02/16 |
| 20FB005YUS | US | i7-6500U | No | Intel HD 520 | 8GB Soldered | 14" FHD (1920x1080) IPS | None | 512GB SSD M.2 PCIe NVMe | None | Intel 8260 ac, 2x2 + BT4.1 | WWAN Upgradable | None | None | None | None | 720p | Backlit | Fingerprint Reader | 4-cell (52Wh) | 65W | Win10 Pro 64 | 3-year, Depot | 02/16 |
| 20FB0060US | US | i7-6600U | vPro | Intel HD 520 | 8GB Soldered | 14" FHD (1920x1080) IPS | None | 128GB SSD M.2 | None | Intel 8260 ac, 2x2 + BT4.1 | WWAN Upgradable | None | None | None | None | 720p | Backlit | Fingerprint Reader | 4-cell (52Wh) | 65W | Win10 Pro 64 | 3-year, Depot | 02/16 |
| 20FB0061US | US | i5-6300U | vPro | Intel HD 520 | 8GB Soldered | 14" WQHD (2560x1440) IPS | None | 192GB SSD M.2 | None | Intel 8260 ac, 2x2 + BT4.1 | None | None | None | None | None | 720p | Backlit | Fingerprint Reader | 4-cell (52Wh) | 65W | Win10 Pro 64 | 3-year, Depot | 02/16 |
| 20FB0062US | US | i7-6600U | vPro | Intel HD 520 | 8GB Soldered | 14" FHD (1920x1080) IPS | None | 512GB SSD M.2 | None | Intel 8260 ac, 2x2 + BT4.1 | WWAN Upgradable | None | None | None | None | 720p | Backlit | Fingerprint Reader | 4-cell (52Wh) | 65W | Win10 Pro 64 | 3-year, Depot | 02/16 |
| 20FB0063US | US | i7-6600U | vPro | Intel HD 520 | 8GB Soldered | 14" WQHD (2560x1440) IPS | None | 256GB SSD M.2 PCIe NVMe Opal2 | None | Intel 8260 ac, 2x2 + BT4.1 | None | None | None | None | None | 720p | Backlit | Fingerprint Reader | 4-cell (52Wh) | 65W | Win10 Pro 64 | 3-year, Depot | 02/16 |
| 20FB0064US | US | i7-6600U | vPro | Intel HD 520 | 8GB Soldered | 14" WQHD (2560x1440) IPS | None | 256GB SSD M.2 Opal2 | None | Intel 8260 ac, 2x2 + BT4.1 | None | None | None | None | None | 720p | Backlit | Fingerprint Reader | 4-cell (52Wh) | 65W | Win10 Pro 64 | 3-year, Depot | 02/16 |
| 20FB0065US | US | i7-6600U | vPro | Intel HD 520 | 16GB Soldered | 14" FHD (1920x1080) IPS | None | 128GB SSD M.2 | None | Intel 8260 ac, 2x2 + BT4.1 | WWAN Upgradable | None | None | None | None | 720p | Backlit | Fingerprint Reader | 4-cell (52Wh) | 65W | Win10 DG Win7 Pro 64 | 3-year, Depot | 02/16 |
| 20FB006RUS | US | i7-6600U | vPro | Intel HD 520 | 8GB Soldered | 14" WQHD (2560x1440) IPS | None | 256GB SSD M.2 Opal2 | None | Intel 8260 ac, 2x2 + BT4.1 | Sierra EM7455 | None | None | None | None | 720p | Backlit | Fingerprint Reader | 4-cell (52Wh) | 65W | Win10 Pro 64 | 3-year, Depot | 05/16 |
| 20FB006SUS | US | i7-6500U | No | Intel HD 520 | 8GB Soldered | 14" FHD (1920x1080) IPS | None | 256GB SSD M.2 Opal2 | None | Intel 8260 ac, 2x2 + BT4.1 | Sierra EM7455 | None | None | None | None | 720p | Backlit | Fingerprint Reader | 4-cell (52Wh) | 65W | Win10 Pro 64 | 3-year, Depot | 05/16 |
| 20FB006TUS | US | i7-6500U | No | Intel HD 520 | 8GB Soldered | 14" WQHD (2560x1440) IPS | None | 256GB SSD M.2 PCIe NVMe Opal2 | None | Intel 8260 ac, 2x2 + BT4.1 | Sierra EM7455 | None | None | None | None | 720p | Backlit | Fingerprint Reader | 4-cell (52Wh) | 65W | Win10 Pro 64 | 3-year, Depot | 05/16 |
| 20FB006UUS | US | i7-6600U | vPro | Intel HD 520 | 16GB Soldered | 14" WQHD (2560x1440) IPS | None | 512GB SSD M.2 PCIe NVMe | None | Intel 8260 ac, 2x2 + BT4.1 | Sierra EM7455 | None | None | None | None | 720p | Backlit | Fingerprint Reader | 4-cell (52Wh) | 65W | Win10 Pro 64 | 3-year, Depot | 05/16 |

| Model | Region | Processor | vPro | Graphics | Memory (Soldered) | Display | Multi-touch | Storage(HDD/SSD) | Optical | WLAN + Bluetooth | WWAN | SIM Card | Monitor Cable | Adapter | Dock | Camera | Keyboard | Fingerprint Reader | Battery (internal) | Power Adapter | Operating System | Warranty | Ann Date (m/y) |
|------------|--------|-----------|------|--------------|-------------------|--------------------------|-------------|---------------------|---------|-----------------------------|-----------------|----------|---------------|---------|------------|--------|----------|--------------------|--------------------|---------------|----------------------|---------------|----------------|
| 20FB006VUS | US | i5-6300U | vPro | Intel HD 520 | 8GB Soldered | 14" WQHD (2560x1440) IPS | None | 256GB SSD M.2 Opal2 | None | Intel 8260 ac, 2x2 + BT4.1 | Sierra EM7455 | None | None | None | None | 720p | Backlit | Fingerprint Reader | 4-cell (52Wh) | 65W | Win10 Pro 64 | 3-year, Depot | 05/16 |
| 20FB006WUS | US | i5-6200U | No | Intel HD 520 | 8GB Soldered | 14" FHD (1920x1080) IPS | None | 256GB SSD M.2 Opal2 | None | Intel 8260 ac, 2x2 + BT4.1 | Sierra EM7455 | None | None | None | None | 720p | Backlit | Fingerprint Reader | 4-cell (52Wh) | 65W | Win10 Pro 64 | 3-year, Depot | 05/16 |
| 20FB006XUS | US | i7-6600U | vPro | Intel HD 520 | 16GB Soldered | 14" WQHD (2560x1440) IPS | None | 512GB SSD M.2 | None | Intel 8260 ac, 2x2 + BT4.1 | Sierra EM7455 | None | None | None | None | 720p | Backlit | Fingerprint Reader | 4-cell (52Wh) | 65W | Win10 Pro 64 | 3-year, Depot | 05/16 |
| 20FB0071US | US | i7-6600U | vPro | Intel HD 520 | 8GB Soldered | 14" WQHD (2560x1440) IPS | None | 256GB SSD M.2 Opal2 | None | Intel 18260 ac, 2x2 + BT4.1 | None | None | None | None | WiGig Dock | 720p | Backlit | Fingerprint Reader | 4-cell (52Wh) | 65W | Win10 Pro 64 | 3-year, Depot | 07/16 |
| 20FB007DUS | US | i5-6300U | vPro | Intel HD 520 | 8GB Soldered | 14" WQHD (2560x1440) IPS | None | 256GB SSD M.2 Opal2 | None | Intel 18260 ac, 2x2 + BT4.1 | None | None | None | None | WiGig Dock | 720p | Backlit | Fingerprint Reader | 4-cell (52Wh) | 65W | Win10 DG Win7 Pro 64 | 3-year, Depot | 07/16 |
| 20FB007EUS | US | i7-6600U | vPro | Intel HD 520 | 16GB Soldered | 14" WQHD (2560x1440) IPS | None | 512GB SSD M.2 | None | Intel 18260 ac, 2x2 + BT4.1 | None | None | None | None | WiGig Dock | 720p | Backlit | Fingerprint Reader | 4-cell (52Wh) | 65W | Win10 DG Win7 Pro 64 | 3-year, Depot | 07/16 |
| 20FB007FUS | US | i7-6600U | vPro | Intel HD 520 | 8GB Soldered | 14" WQHD (2560x1440) IPS | None | 256GB SSD M.2 Opal2 | None | Intel 18260 ac, 2x2 + BT4.1 | None | None | None | None | WiGig Dock | 720p | Backlit | Fingerprint Reader | 4-cell (52Wh) | 65W | Win10 DG Win7 Pro 64 | 3-year, Depot | 07/16 |
| 20FB007GUS | US | i7-6600U | vPro | Intel HD 520 | 16GB Soldered | 14" WQHD (2560x1440) IPS | None | 512GB SSD M.2 | None | Intel 18260 ac, 2x2 + BT4.1 | None | None | None | None | WiGig Dock | 720p | Backlit | Fingerprint Reader | 4-cell (52Wh) | 65W | Win10 Pro 64 | 3-year, Depot | 07/16 |
| 20FB007HUS | US | i5-6300U | vPro | Intel HD 520 | 8GB Soldered | 14" WQHD (2560x1440) IPS | None | 256GB SSD M.2 Opal2 | None | Intel 18260 ac, 2x2 + BT4.1 | None | None | None | None | WiGig Dock | 720p | Backlit | Fingerprint Reader | 4-cell (52Wh) | 65W | Win10 Pro 64 | 3-year, Depot | 07/16 |
| 20FB007QUS | US | i5-6200U | No | Intel HD 520 | 8GB Soldered | 14" FHD (1920x1080) IPS | None | 180GB SSD M.2 Opal2 | None | Intel 8260 ac, 2x2 + BT4.1 | WWAN Upgradable | None | None | None | None | 720p | Backlit | Fingerprint Reader | 4-cell (52Wh) | 65W | Win10 Pro 64 | 3-year, Depot | 08/16 |
| 20FB007RUS | US | i5-6200U | No | Intel HD 520 | 8GB Soldered | 14" FHD (1920x1080) IPS | None | 256GB SSD M.2 Opal2 | None | Intel 8260 ac, 2x2 + BT4.1 | None | None | None | None | None | 720p | Backlit | Fingerprint Reader | 4-cell (52Wh) | 65W | Win10 Pro 64 | 3-year, Depot | 11/16 |
| 20FBA043US | US | i5-6200U | No | Intel HD 520 | 8GB Soldered | 14" FHD (1920x1080) IPS | None | 256GB SSD M.2 Opal2 | None | Intel 8260 ac, 2x2 + BT4.1 | WWAN Upgradable | None | None | None | None | 720p | Backlit | Fingerprint Reader | 4-cell (52Wh) | 65W | Win10 Pro 64 | 3-year, Depot | 08/16 |



ThinkPad X1 Carbon (5th Gen) Platform Specifications

Product Specifications Reference (PSREF)

| | | | | | | | | | | | |
|-----------------|---|------------|--------------|----------------|---------------------|-------|--------------|-----------------------|--|--|--|
| Processor | 6th Generation Intel® Core™ i5 / i7 Processor | | | | | | | | Smart card reader None | Media reader MicroSD card reader, supports UHS-II microSD card | Ports Two USB 3.1 Gen 1 (USB 3.0, one Always On), two USB 3.1 Type-C Gen 2 / Thunderbolt 3 (support data, video, and power delivery), HDMI 1.4b, Ethernet extension connector |
| | Processor Number | # of Cores | # of Threads | Base Frequency | Max Turbo Frequency | Cache | Memory Types | Processor Graphics | | | |
| | i5-6200U | 2 | 4 | 2.3 GHz | 2.8 GHz | 3MB | LPDDR3-1866 | Intel HD Graphics 520 | WiGig dock (opt) ThinkPad WiGig dock | Monitor cable (optional) HDMI to VGA: Lenovo HDMI to VGA Monitor Adapter USB-C to VGA: Lenovo USB-C to VGA Adapter USB-C to DP: Lenovo USB-C to DisplayPort Adapter | |
| | i5-6300U | | | 2.4 GHz | 3.0 GHz | 3MB | | | | | |
| | i7-6500U | | | 2.5 GHz | 3.1 GHz | 4MB | | | | | |
| | i7-6600U | | | 2.6 GHz | 3.4 GHz | 4MB | | | | | |
| | or 7th Generation Intel Core i5 / i7 Processor | | | | | | | | Camera (optional) 720p: HD720p resolution, fixed focus IR & 720p: IR camera and HD720p camera | Audio support HD Audio, Conexant® CX11871 codec / stereo speakers, 2W x 2 / dual array microphone, combo audio/microphone jack | |
| | Processor Number | # of Cores | # of Threads | Base Frequency | Max Turbo Frequency | Cache | Memory Types | Processor Graphics | | | |
| | i5-7200U | 2 | 4 | 2.5 GHz | 3.1 GHz | 3MB | LPDDR3-1866 | Intel HD Graphics 620 | Keyboard 6-row, spill-resistant, multimedia Fn keys, LED backlight | UltraNav™ TrackPoint® pointing device and buttonless Glass surface multi-touch touchpad | |
| | i5-7300U | | | 2.6 GHz | 3.5 GHz | 3MB | | | | | |
| | i7-7500U | | | 2.7 GHz | 3.5 GHz | 4MB | | | | | |
| | i7-7600U | | | 2.8 GHz | 3.9 GHz | 4MB | | | | | |
| Graphics | Intel HD Graphics 520 or 620 in processor; supports external digital monitor via HDMI or USB Type-C; supports three independent displays; Max resolution: 4096x2304@60Hz (USB Type-C); 4096x2160@24Hz (HDMI) | | | | | | | | Security Security chip vPro (optional) Intel vPro Technology | Fingerprint reader Touch style match on chip fingerprint reader on the palm rest | NFC (optional) Near Field Communication |
| Chipset | Intel SoC (System on Chip) platform | | | | | | | | Battery Integrated Li-Polymer 3-cell (57Wh) RapidCharge battery | Max battery life MobileMark® 2014: 15.5 hr | |
| Memory | 8GB or 16GB / 1866MHz LPDDR3 / soldered to systemboard, no sockets | | | | | | | | AC adapter 45W or 65W USB Type-C adapter | RapidCharge | |
| Display | Some: 14.0" (355mm) FHD (1920x1080), anti-glare, LED backlight, IPS, 300 nits, 16:9 aspect ratio, 700:1 contrast ratio, 170° viewing angle Some: 14.0" (355mm) WQHD (2560x1440), anti-glare, LED backlight, IPS, 300 nits, 16:9 aspect ratio, 700:1 contrast ratio, 170° viewing angle | | | | | | | | AC adapter | 45W USB-C | 65W USB-C |
| Multi-touch | None | | | | | | | | Charge to 80% | Not support | 1.0 hr |
| Storage | Some: M.2 SSD / SATA 6.0Gb/s (e.g. xxxG SSD) Some: M.2 SSD / PCIe NVMe, PCIe 3.0 x 4, 32Gb/s (e.g. xxxG SSD PCIe NVMe) | | | | | | | | Charge to 100% | Not support | 2.5 hr |
| Optical | None | | | | | | | | Preload | Windows® 7 Professional 64 preinstalled through downgrade rights in Windows 10 Pro 64 Some: Windows 10 Home 64 Some: Windows 10 Pro 64 • Lenovo Companion • Lenovo Setting • Microsoft Office preloaded; purchase a product key to activate | |
| Ethernet | Native Intel Ethernet Connection I219-V (Non-vPro) or I219-LM (vPro) via optional ThinkPad Ethernet Extension Cable | | | | | | | | • Lenovo Solution Center • Lenovo PowerEngage • ThinkVantage Product Recovery • ThinkVantage System Update • Adobe® Reader® • Microsoft® Office preloaded; purchase a product key to activate • McAfee® LiveSafe™ (30-day trial) | | |
| WLAN | One of the following, configurable by model (WiGig can coexist with WWAN): • Intel Dual Band Wireless-AC 8260, Wi-Fi 2x2 802.11ac + BT4.1, M.2 card • Intel Dual Band Wireless-AC 8265, Wi-Fi 2x2 802.11ac + BT4.1, M.2 card • Intel Tri-Band Wireless-AC 18265, WiGig 802.11ad + Wi-Fi 2x2 802.11ac + BT4.1, M.2 card | | | | | | | | Limited warranty | One of the following, configurable by model: • 1-year depot repair service • 3-year/1-yr battery depot repair service • 3-year/1-yr battery limited onsite service | |
| Bluetooth™ | Bluetooth 4.1 wireless, integrated in Wi-Fi + Bluetooth combo adapter * Intel 8265ac / 18265ac card support BT4.2 but is limited to BT4.1 by Windows OS | | | | | | | | Mil-Spec test | MIL-STD-810G military certification | |
| WWAN (optional) | Integrated Mobile Broadband 4G LTE-A, Qualcomm® Snapdragon™ X7 LTE-A (Sierra Wireless EM7455) | | | | | | | | Environment | EPEAT™ Gold (US only); ENERGY STAR® 6.1; RoHS-compliant | |
| SIM card (opt) | Micro-SIM card slot, opt Verizon LTE (US) or Lenovo® Connect (EMEA) SIM card | | | | | | | | | | |
| Dimensions | WxDxH: 12.74" x 8.55" x 0.63"; 323.5mm x 217.1mm x 15.95mm | | | | | | | | | | |
| Weight | Starting at 2.49 lb / 1.13 kg | | | | | | | | | | |
| Case color | Black or Silver (silver is not available in EMEA) | | | | | | | | | | |
| Case material | Display cover: CFRP/GFRP hybrid; Bottom: magnesium alloy hybrid | | | | | | | | | | |

| Model | Region | Processor | vPro | Graphics | Memory (Soldered) | Display | Multi-touch | Storage(HDD/SSD) | Optical | WLAN + Bluetooth | WWAN | SIM Card | Dock | Monitor Cable | Adapter | Color | Camera | Key-board | Finger-print Reader | NFC | TPM | Battery (internal) | Power Adapter | Operating System | Warranty | Ann Date (m/y) |
|------------|--------|-----------|------|--------------|-------------------|--------------------------|-------------|-------------------------------|---------|----------------------|---------------|----------|------|---------------|---------|--------|--------|-----------|---------------------|------|----------|--------------------|---------------|------------------|---------------|----------------|
| 20HR000DUS | US | i5-7300U | vPro | Intel HD 620 | 8GB Soldered | 14" FHD (1920x1080) IPS | None | 256GB SSD M.2 PCIe NVMe Opal2 | None | 8265 ac, 2x2 + BT4.1 | None | None | None | None | None | Black | 720p | Backlit | Finger-print Reader | None | dTPM 2.0 | 3-cell (57Wh) | 65W USB-C | Win10 Pro 64 | 3-year, Depot | 02/17 |
| 20HR000EUS | US | i7-7600U | vPro | Intel HD 620 | 8GB Soldered | 14" FHD (1920x1080) IPS | None | 256GB SSD M.2 PCIe NVMe Opal2 | None | 8265 ac, 2x2 + BT4.1 | None | None | None | None | None | Silver | 720p | Backlit | Finger-print Reader | None | dTPM 2.0 | 3-cell (57Wh) | 65W USB-C | Win10 Pro 64 | 3-year, Depot | 03/17 |
| 20HR000FUS | US | i7-7600U | vPro | Intel HD 620 | 16GB Soldered | 14" FHD (1920x1080) IPS | None | 512GB SSD M.2 PCIe NVMe Opal2 | None | 8265 ac, 2x2 + BT4.1 | None | None | None | None | None | Black | 720p | Backlit | Finger-print Reader | None | dTPM 2.0 | 3-cell (57Wh) | 65W USB-C | Win10 Pro 64 | 3-year, Depot | 02/17 |
| 20HR000GUS | US | i5-7200U | No | Intel HD 620 | 8GB Soldered | 14" FHD (1920x1080) IPS | None | 256GB SSD M.2 PCIe NVMe Opal2 | None | 8265 ac, 2x2 + BT4.1 | None | None | None | None | None | Silver | 720p | Backlit | Finger-print Reader | None | dTPM 2.0 | 3-cell (57Wh) | 65W USB-C | Win10 Pro 64 | 3-year, Depot | 03/17 |
| 20HR000HUS | US | i7-7600U | vPro | Intel HD 620 | 8GB Soldered | 14" FHD (1920x1080) IPS | None | 256GB SSD M.2 PCIe NVMe Opal2 | None | 8265 ac, 2x2 + BT4.1 | None | None | None | None | None | Black | 720p | Backlit | Finger-print Reader | None | dTPM 2.0 | 3-cell (57Wh) | 65W USB-C | Win10 Pro 64 | 3-year, Depot | 02/17 |
| 20HR000JUS | US | i7-7600U | vPro | Intel HD 620 | 16GB Soldered | 14" FHD (1920x1080) IPS | None | 512GB SSD M.2 PCIe NVMe Opal2 | None | 8265 ac, 2x2 + BT4.1 | None | None | None | None | None | Silver | 720p | Backlit | Finger-print Reader | None | dTPM 2.0 | 3-cell (57Wh) | 65W USB-C | Win10 Pro 64 | 3-year, Depot | 03/17 |
| 20HR000KUS | US | i5-7300U | vPro | Intel HD 620 | 16GB Soldered | 14" FHD (1920x1080) IPS | None | 256GB SSD M.2 PCIe NVMe Opal2 | None | 8265 ac, 2x2 + BT4.1 | None | None | None | None | None | Silver | 720p | Backlit | Finger-print Reader | None | dTPM 2.0 | 3-cell (57Wh) | 65W USB-C | Win10 Pro 64 | 3-year, Depot | 03/17 |
| 20HR000LUS | US | i5-7300U | vPro | Intel HD 620 | 8GB Soldered | 14" FHD (1920x1080) IPS | None | 256GB SSD M.2 PCIe NVMe Opal2 | None | 8265 ac, 2x2 + BT4.1 | None | None | None | None | None | Silver | 720p | Backlit | Finger-print Reader | None | dTPM 2.0 | 3-cell (57Wh) | 65W USB-C | Win10 Pro 64 | 3-year, Depot | 03/17 |
| 20HR000MUS | US | i5-7300U | vPro | Intel HD 620 | 16GB Soldered | 14" FHD (1920x1080) IPS | None | 256GB SSD M.2 PCIe NVMe Opal2 | None | 8265 ac, 2x2 + BT4.1 | None | None | None | None | None | Black | 720p | Backlit | Finger-print Reader | None | dTPM 2.0 | 3-cell (57Wh) | 65W USB-C | Win10 Pro 64 | 3-year, Depot | 02/17 |
| 20HR000WUS | US | i5-7200U | No | Intel HD 620 | 8GB Soldered | 14" FHD (1920x1080) IPS | None | 256GB SSD M.2 PCIe NVMe Opal2 | None | 8265 ac, 2x2 + BT4.1 | None | None | None | None | None | Black | 720p | Backlit | Finger-print Reader | None | dTPM 2.0 | 3-cell (57Wh) | 65W USB-C | Win10 Pro 64 | 3-year, Depot | 02/17 |
| 20HR0011US | US | i5-7200U | No | Intel HD 620 | 8GB Soldered | 14" FHD (1920x1080) IPS | None | 128GB SSD M.2 | None | 8265 ac, 2x2 + BT4.1 | None | None | None | None | None | Black | 720p | Backlit | Finger-print Reader | None | dTPM 2.0 | 3-cell (57Wh) | 65W USB-C | Win10 Pro 64 | 3-year, Depot | 02/17 |
| 20HR003CUS | US | i5-7300U | vPro | Intel HD 620 | 16GB Soldered | 14" FHD (1920x1080) IPS | None | 512GB SSD M.2 PCIe NVMe Opal2 | None | 8265 ac, 2x2 + BT4.1 | None | None | None | None | None | Black | 720p | Backlit | Finger-print Reader | None | dTPM 2.0 | 3-cell (57Wh) | 65W USB-C | Win10 Pro 64 | 3-year, Depot | 02/17 |
| 20HR003DUS | US | i7-7600U | vPro | Intel HD 620 | 8GB Soldered | 14" FHD (1920x1080) IPS | None | 512GB SSD M.2 PCIe NVMe Opal2 | None | 8265 ac, 2x2 + BT4.1 | None | None | None | None | None | Black | 720p | Backlit | Finger-print Reader | None | dTPM 2.0 | 3-cell (57Wh) | 65W USB-C | Win10 Pro 64 | 3-year, Depot | 02/17 |
| 20HR003EUS | US | i5-7300U | vPro | Intel HD 620 | 8GB Soldered | 14" FHD (1920x1080) IPS | None | 512GB SSD M.2 PCIe NVMe Opal2 | None | 8265 ac, 2x2 + BT4.1 | None | None | None | None | None | Black | 720p | Backlit | Finger-print Reader | None | dTPM 2.0 | 3-cell (57Wh) | 65W USB-C | Win10 Pro 64 | 3-year, Depot | 02/17 |
| 20HR0053US | US | i7-7500U | No | Intel HD 620 | 8GB Soldered | 14" WQHD (2560x1440) IPS | None | 256GB SSD M.2 PCIe NVMe Opal2 | None | 8265 ac, 2x2 + BT4.1 | None | None | None | None | None | Black | 720p | Backlit | Finger-print Reader | None | dTPM 2.0 | 3-cell (57Wh) | 65W USB-C | Win10 Pro 64 | 3-year, Depot | 03/17 |
| 20HR0054US | US | i7-7500U | No | Intel HD 620 | 16GB Soldered | 14" WQHD (2560x1440) IPS | None | 512GB SSD M.2 PCIe NVMe Opal2 | None | 8265 ac, 2x2 + BT4.1 | None | None | None | None | None | Black | 720p | Backlit | Finger-print Reader | None | dTPM 2.0 | 3-cell (57Wh) | 65W USB-C | Win10 Pro 64 | 3-year, Depot | 03/17 |
| 20HR0057US | US | i7-7500U | No | Intel HD 620 | 8GB Soldered | 14" FHD (1920x1080) IPS | None | 256GB SSD M.2 PCIe NVMe Opal2 | None | 8265 ac, 2x2 + BT4.1 | None | None | None | None | None | Black | 720p | Backlit | Finger-print Reader | None | dTPM 2.0 | 3-cell (57Wh) | 65W USB-C | Win10 Pro 64 | 3-year, Depot | 03/17 |
| 20HR0058US | US | i7-7500U | No | Intel HD 620 | 8GB Soldered | 14" FHD (1920x1080) IPS | None | 512GB SSD M.2 PCIe NVMe Opal2 | None | 8265 ac, 2x2 + BT4.1 | None | None | None | None | None | Black | 720p | Backlit | Finger-print Reader | None | dTPM 2.0 | 3-cell (57Wh) | 65W USB-C | Win10 Pro 64 | 3-year, Depot | 03/17 |
| 20HR005FUS | US | i7-7600U | vPro | Intel HD 620 | 16GB Soldered | 14" FHD (1920x1080) IPS | None | 512GB SSD M.2 PCIe NVMe Opal2 | None | 8265 ac, 2x2 + BT4.1 | Sierra EM7455 | None | None | None | None | Black | 720p | Backlit | Finger-print Reader | None | dTPM 2.0 | 3-cell (57Wh) | 65W USB-C | Win10 Pro 64 | 3-year, Depot | 04/17 |
| 20HR005HUS | US | i7-7600U | vPro | Intel HD 620 | 8GB Soldered | 14" FHD (1920x1080) IPS | None | 256GB SSD M.2 PCIe NVMe Opal2 | None | 8265 ac, 2x2 + BT4.1 | Sierra EM7455 | None | None | None | None | Black | 720p | Backlit | Finger-print Reader | None | dTPM 2.0 | 3-cell (57Wh) | 65W USB-C | Win10 Pro 64 | 3-year, Depot | 04/17 |

| Model | Region | Processor | vPro | Graphics | Memory (Soldered) | Display | Multi-touch | Storage(HDD/SSD) | Optical | WLAN + Bluetooth | WWAN | SIM Card | Dock | Monitor Cable | Adapter | Color | Camera | Key-board | Finger-print Reader | NFC | TPM | Battery (internal) | Power Adapter | Operating System | War-ranty | Ann Date (m/y) |
|------------|--------|-----------|------|--------------|-------------------|-------------------------|-------------|-------------------------------|---------|----------------------|---------------|----------|------|---------------|---------|-------|--------|-----------|---------------------|------|----------|--------------------|---------------|------------------|---------------|----------------|
| 20HR005KUS | US | i5-7300U | vPro | Intel HD 620 | 8GB Soldered | 14" FHD (1920x1080) IPS | None | 256GB SSD M.2 PCIe NVMe Opal2 | None | 8265 ac, 2x2 + BT4.1 | Sierra EM7455 | None | None | None | None | Black | 720p | Backlit | Finger-print Reader | None | dTPM 2.0 | 3-cell (57Wh) | 65W USB-C | Win10 Pro 64 | 3-year, Depot | 04/17 |

ThinkPad X1 Carbon (5th Gen) - TopSeller - 20K4

Product Specifications Reference (PSREF)

| Model | Region | Processor | vPro | Graphics | Memory (Soldered) | Display | Multi-touch | Storage(HDD/SSD) | Optical | WLAN + Bluetooth | WWAN | SIM Card | Dock | Monitor Cable | Adapter | Color | Camera | Key-board | Finger-print Reader | NFC | TPM | Battery (internal) | Power Adapter | Operating System | Warranty | Ann Date (m/y) |
|------------|--------|-----------|------|--------------|-------------------|--------------------------|-------------|-------------------------------|---------|----------------------|------|----------|------|---------------|---------|-------|--------|-----------|---------------------|------|----------|--------------------|---------------|----------------------|---------------|----------------|
| 20K4001WUS | US | i5-6200U | No | Intel HD 520 | 8GB Soldered | 14" FHD (1920x1080) IPS | None | 512GB SSD M.2 PCIe NVMe Opal2 | None | 8260 ac, 2x2 + BT4.1 | None | None | None | None | None | Black | 720p | Backlit | Finger-print Reader | None | dTPM 2.0 | 3-cell (57Wh) | 65W USB-C | Win10 DG Win7 Pro 64 | 3-year, Depot | 03/17 |
| 20K4001XUS | US | i5-6300U | vPro | Intel HD 520 | 8GB Soldered | 14" FHD (1920x1080) IPS | None | 256GB SSD M.2 PCIe NVMe Opal2 | None | 8260 ac, 2x2 + BT4.1 | None | None | None | None | None | Black | 720p | Backlit | Finger-print Reader | None | dTPM 2.0 | 3-cell (57Wh) | 65W USB-C | Win10 DG Win7 Pro 64 | 3-year, Depot | 03/17 |
| 20K4001YUS | US | i7-6600U | vPro | Intel HD 520 | 8GB Soldered | 14" FHD (1920x1080) IPS | None | 256GB SSD M.2 PCIe NVMe Opal2 | None | 8260 ac, 2x2 + BT4.1 | None | None | None | None | None | Black | 720p | Backlit | Finger-print Reader | None | dTPM 2.0 | 3-cell (57Wh) | 65W USB-C | Win10 DG Win7 Pro 64 | 3-year, Depot | 03/17 |
| 20K40020US | US | i7-6600U | vPro | Intel HD 520 | 8GB Soldered | 14" FHD (1920x1080) IPS | None | 512GB SSD M.2 PCIe NVMe Opal2 | None | 8260 ac, 2x2 + BT4.1 | None | None | None | None | None | Black | 720p | Backlit | Finger-print Reader | None | dTPM 2.0 | 3-cell (57Wh) | 65W USB-C | Win10 DG Win7 Pro 64 | 3-year, Depot | 03/17 |
| 20K40021US | US | i5-6200U | No | Intel HD 520 | 8GB Soldered | 14" FHD (1920x1080) IPS | None | 256GB SSD M.2 PCIe NVMe Opal2 | None | 8260 ac, 2x2 + BT4.1 | None | None | None | None | None | Black | 720p | Backlit | Finger-print Reader | None | dTPM 2.0 | 3-cell (57Wh) | 65W USB-C | Win10 DG Win7 Pro 64 | 3-year, Depot | 03/17 |
| 20K4002RUS | US | i7-6500U | No | Intel HD 520 | 8GB Soldered | 14" FHD (1920x1080) IPS | None | 256GB SSD M.2 PCIe NVMe Opal2 | None | 8260 ac, 2x2 + BT4.1 | None | None | None | None | None | Black | 720p | Backlit | Finger-print Reader | None | dTPM 2.0 | 3-cell (57Wh) | 65W USB-C | Win10 DG Win7 Pro 64 | 3-year, Depot | 03/17 |
| 20K4002SUS | US | i7-6500U | No | Intel HD 520 | 8GB Soldered | 14" FHD (1920x1080) IPS | None | 512GB SSD M.2 PCIe NVMe Opal2 | None | 8260 ac, 2x2 + BT4.1 | None | None | None | None | None | Black | 720p | Backlit | Finger-print Reader | None | dTPM 2.0 | 3-cell (57Wh) | 65W USB-C | Win10 DG Win7 Pro 64 | 3-year, Depot | 03/17 |
| 20K4002TUS | US | i7-6500U | No | Intel HD 520 | 8GB Soldered | 14" WQHD (2560x1440) IPS | None | 512GB SSD M.2 PCIe NVMe Opal2 | None | 8260 ac, 2x2 + BT4.1 | None | None | None | None | None | Black | 720p | Backlit | Finger-print Reader | None | dTPM 2.0 | 3-cell (57Wh) | 65W USB-C | Win10 DG Win7 Pro 64 | 3-year, Depot | 03/17 |
| 20K4002UUS | US | i5-6200U | No | Intel HD 520 | 8GB Soldered | 14" FHD (1920x1080) IPS | None | 180GB SSD M.2 Opal2 | None | 8260 ac, 2x2 + BT4.1 | None | None | None | None | None | Black | 720p | Backlit | Finger-print Reader | None | dTPM 2.0 | 3-cell (57Wh) | 65W USB-C | Win10 DG Win7 Pro 64 | 3-year, Depot | 03/17 |



ThinkPad X260 Platform Specifications

Product Specifications Reference (PSREF)

| Processor | 6th Generation Intel® Core™ i3 / i5 / i7 Processor | | | | | | | | Smart card reader | Optional: Smart card reader | | | | | | | | | | |
|-------------------------|--|-------------------|----------------------|----------------------|---------------------|--|--------------|-----------------------|---|--|-----------------|-----------------|----------------------|----------------------|----------------------|-------------------|-------------------|-------------------|---------|-------|
| | Processor Number | # of Cores | # of Threads | Base Frequency | Max Turbo Frequency | Cache | Memory Types | Processor Graphics | Media reader | 4-in-1 reader (MMC, SD, SDHC, SDXC) | | | | | | | | | | |
| | i3-6006U | 2 | 4 | 2.0 GHz | - | 3MB | DDR4-2133 | Intel HD graphics 520 | Ports | Three USB 3.0 (one Always On), HDMI, MiniDP, Ethernet (RJ-45), Dock connector | | | | | | | | | | |
| | i3-6100U | | | 2.3 GHz | - | 3MB | | | WiGig dock | None | | | | | | | | | | |
| | i5-6200U | | | 2.3 GHz | 2.8 GHz | 3MB | | | Monitor cable | Optional: HDMI to VGA Monitor Cable or Mini DisplayPort to VGA Monitor Cable | | | | | | | | | | |
| | i5-6300U | | | 2.4 GHz | 3.0 GHz | 3MB | | | Camera (optional) | HD720p resolution, low light sensitive, fixed focus | | | | | | | | | | |
| | i7-6500U | | | 2.5 GHz | 3.1 GHz | 4MB | | | Audio support | HD Audio, Realtek® ALC3245 codec / stereo speakers, 1W x 2 / dual array microphone, combo audio/microphone jack | | | | | | | | | | |
| | i7-6600U | | | 2.6 GHz | 3.4 GHz | 4MB | | | Keyboard | 6-row, spill-resistant, multimedia Fn keys, optional LED backlight | | | | | | | | | | |
| | | | | | UltraNav™ | TrackPoint® pointing device and buttonless Mylar surface touchpad, multi-touch | | | | | | | | | | | | | | |
| Graphics | Intel HD Graphics 520 in processor; supports external digital monitor via HDMI or Mini DisplayPort; supports three independent displays; Max resolution: 3840x2160@60Hz (DisplayPort via Mini DisplayPort cable); 1920x1080@60Hz (HDMI) | | | | | | | | Security | Power-on password, hard disk password, supervisor password, security keyhole | | | | | | | | | | |
| Chipset | Intel SoC (System on Chip) platform | | | | | | | | Security chip | Discrete TPM 1.2 TCG Certified and Firmware TPM 2.0 integrated in chipset | | | | | | | | | | |
| Memory | 16GB max / 2133MHz DDR4, one DDR4 SO-DIMM socket | | | | | | | | ThinkEngine | Delivers improved thermal and power efficiency, up to 30 day standby, faster resume time, enhanced security, as well as anti-tampering measures | | | | | | | | | | |
| Display | <i>Some:</i> 12.5" (317.5mm) HD (1366x768), anti-glare, LED backlight, 200 nits, 16:9 aspect ratio, 300:1 contrast ratio <i>Some:</i> 12.5" (317.5mm) HD (1366x768), anti-glare, LED backlight, IPS, 300 nits, 16:9 aspect ratio, 700:1 contrast ratio, 170° viewing angle <i>Some:</i> 12.5" (317.5mm) FHD (1920x1080), anti-glare, LED backlight, IPS, 300 nits, 16:9 aspect ratio, 700:1 contrast ratio, 170° viewing angle | | | | | | | | vPro (optional) | Intel vPro Technology | | | | | | | | | | |
| | | | | | | | | | Fingerprint reader | Optional: Swipe style fingerprint reader on the keyboard bezel | | | | | | | | | | |
| Multi-touch | None | | | | | | | | Internal battery | Optional: Integrated Li-Ion or Li-Polymer 3-cell (23Wh) | | | | | | | | | | |
| Storage | <i>Some:</i> SSD / SATA 6.0Gb/s (e.g. xxxG SSD) <i>Some:</i> SSD / PCIe NVMe, PCIe 3.0 x 2, 16Gb/s (e.g. xxxG SSD PCIe NVMe) <i>Some:</i> HDD / SATA 6.0Gb/s, 2.5" wide, 7mm or 9.5mm high, Shock Mounted Hard Drive, Active Protection System™ <i>Some:</i> SSHD with 8GB NAND flash memory | | | | | | | | External battery | Li-Ion 3-cell (23Wh) or 6-cell (48Wh or 72Wh) | | | | | | | | | | |
| Optical | None | | | | | | | | Max battery life ¹⁰ (MobileMark® 2014) | <table border="1"> <thead> <tr> <th>Models</th> <th>No + 3-cell</th> <th>3-cell + 3-cell</th> <th>3-cell + 6-cell 48Wh</th> <th>3-cell + 6-cell 72Wh</th> </tr> </thead> <tbody> <tr> <td>Max battery life</td> <td>6 hr</td> <td>12 hr</td> <td>18.5 hr</td> <td>25 hr</td> </tr> </tbody> </table> | Models | No + 3-cell | 3-cell + 3-cell | 3-cell + 6-cell 48Wh | 3-cell + 6-cell 72Wh | Max battery life | 6 hr | 12 hr | 18.5 hr | 25 hr |
| Models | No + 3-cell | 3-cell + 3-cell | 3-cell + 6-cell 48Wh | 3-cell + 6-cell 72Wh | | | | | | | | | | | | | | | | |
| Max battery life | 6 hr | 12 hr | 18.5 hr | 25 hr | | | | | | | | | | | | | | | | |
| Ethernet | <i>Non-vPro model:</i> Intel Ethernet Connection I219-V (Jacksonville) <i>vPro model:</i> Intel Ethernet Connection I219-LM (Jacksonville) | | | | | | | | AC adapter | 45W AC adapter | | | | | | | | | | |
| WLAN ⁴ | <i>One of the following, configurable by model:</i> • 11ac+BT, Broadcom BCM4356, 2x2, M.2 card • 11ac+BT, Intel Dual Band Wireless-AC 8260, 2x2, M.2 card | | | | | | | | Preload | Windows® 7 Professional 64 preinstalled through downgrade rights in Windows 10 Pro 64 • Lenovo Solution Center • Lenovo SHAREit • Lenovo Companion • Lenovo Setting • ThinkVantage Product Recovery • Rescue and Recovery™ • ThinkVantage System Update • Adobe® Reader® • Microsoft® Office preloaded; purchase a product key to activate • McAfee® LiveSafe™ (30-day trial) | | | | | | | | | | |
| Bluetooth™ | Bluetooth 4.1 wireless, integrated in Wi-Fi + Bluetooth combo adapter | | | | | | | | Limited warranty ¹² | <i>One of the following, configurable by model:</i> • 1-year depot repair service • 3-year/1-yr battery depot repair service • 3-year/1-yr battery limited onsite service ²⁴ • 3-year/1-yr battery limited onsite service, OID (Onsite International Delivery) | | | | | | | | | | |
| WWAN (optional) | <i>One of the following, configurable by model (mutually exclusive with WiGig):</i> • Wireless WAN upgradable • Wireless WAN, Sierra Wireless EM7455, Qualcomm® 4G LTE-Advanced/DC-HSPA+/HSPA+/HSPA/UMTS/GNSS, M.2 card • Wireless WAN, HUAWEI ME906S, HUAWEI 4G LTE/WCDMA/HSPA/GSM/GPRS/EDGE/GNSS, M.2 card (WE only) | | | | | | | | Mil-Spec test | MIL-STD-810G military certification | | | | | | | | | | |
| SIM card (opt) | Micro-SIM card slot, optional Verizon LTE (US) or Lenovo Connect (WE) SIM card | | | | | | | | Environment | EPPEAT™ Gold (US only); ENERGY STAR® 6.1; GREENGUARD®; RoHS-compliant | | | | | | | | | | |
| Dimensions ³ | WxDxH: 12.03" x 8.21" x 0.80"; 305.5mm x 208.5mm x 20.3mm | | | | | | | | | | | | | | | | | | | |
| Weight ² | <table border="1"> <thead> <tr> <th>Models</th> <th>No + 3-cell</th> <th>3-cell + 3-cell</th> <th>3 + 6-cell 48Wh</th> <th>3-cell + 6-cell 72Wh</th> </tr> </thead> <tbody> <tr> <td>Weight</td> <td>2.94 lb / 1.34 kg</td> <td>3.18 lb / 1.44 kg</td> <td>3.51 lb / 1.59 kg</td> <td>3.58 lb / 1.62 kg</td> </tr> </tbody> </table> | | | | | | | | Models | No + 3-cell | 3-cell + 3-cell | 3 + 6-cell 48Wh | 3-cell + 6-cell 72Wh | Weight | 2.94 lb / 1.34 kg | 3.18 lb / 1.44 kg | 3.51 lb / 1.59 kg | 3.58 lb / 1.62 kg | | |
| Models | No + 3-cell | 3-cell + 3-cell | 3 + 6-cell 48Wh | 3-cell + 6-cell 72Wh | | | | | | | | | | | | | | | | |
| Weight | 2.94 lb / 1.34 kg | 3.18 lb / 1.44 kg | 3.51 lb / 1.59 kg | 3.58 lb / 1.62 kg | | | | | | | | | | | | | | | | |
| Case material | Glass-Fiber Reinforced Plastic | | | | | | | | | | | | | | | | | | | |

| Model | Region | Processor | vPro | Graphics | Memory | Display | Multi-touch | Storage(HDD/SSD) | Optical | WLAN + Bluetooth | WWAN | SIM Card | Smart Card Reader | Camera | Keyboard | Fingerprint Reader | Battery (internal+ external) | Power Adapter | Operating System | Warranty | Ann Date (m/y) |
|------------|--------|-----------|------|--------------|--------|-------------------------|-------------|--------------------|---------|----------------------------|-----------------|----------|-------------------|--------|----------|--------------------|------------------------------|---------------|----------------------|---------------|----------------|
| 20F6005EUS | US | i5-6200U | No | Intel HD 520 | 4GBx1 | 12.5" HD (1366x768) | None | 500GB 7200rpm | None | Intel 8260 ac, 2x2 + BT4.1 | WWAN Upgradable | None | None | 720p | Backlit | Fingerprint Reader | 3-cell(23Wh) + 3-cell(23Wh) | 45W | Win10 DG Win7 Pro 64 | 3-year, Depot | 01/16 |
| 20F6005FUS | US | i3-6100U | No | Intel HD 520 | 4GBx1 | 12.5" HD (1366x768) IPS | None | 500GB 7200rpm | None | Intel 8260 ac, 2x2 + BT4.1 | WWAN Upgradable | None | None | 720p | Backlit | Fingerprint Reader | 3-cell(23Wh) + 3-cell(23Wh) | 45W | Win10 DG Win7 Pro 64 | 3-year, Depot | 01/16 |
| 20F6005GUS | US | i5-6300U | vPro | Intel HD 520 | 8GBx1 | 12.5" HD (1366x768) | None | 256GB SSD Opal2 | None | Intel 8260 ac, 2x2 + BT4.1 | WWAN Upgradable | None | None | 720p | Backlit | Fingerprint Reader | 3-cell(23Wh) + 3-cell(23Wh) | 45W | Win10 DG Win7 Pro 64 | 3-year, Depot | 01/16 |
| 20F6005HUS | US | i5-6200U | No | Intel HD 520 | 8GBx1 | 12.5" HD (1366x768) | None | 500GB 7200rpm | None | Intel 8260 ac, 2x2 + BT4.1 | WWAN Upgradable | None | None | 720p | Backlit | Fingerprint Reader | 3-cell(23Wh) + 3-cell(23Wh) | 45W | Win10 DG Win7 Pro 64 | 3-year, Depot | 01/16 |
| 20F6005JUS | US | i7-6600U | vPro | Intel HD 520 | 8GBx1 | 12.5" HD (1366x768) | None | 512GB SSD | None | Intel 8260 ac, 2x2 + BT4.1 | WWAN Upgradable | None | None | 720p | Backlit | Fingerprint Reader | 3-cell(23Wh) + 3-cell(23Wh) | 45W | Win10 DG Win7 Pro 64 | 3-year, Depot | 01/16 |
| 20F6005KUS | US | i7-6600U | vPro | Intel HD 520 | 8GBx1 | 12.5" HD (1366x768) | None | 192GB SSD | None | Intel 8260 ac, 2x2 + BT4.1 | WWAN Upgradable | None | None | 720p | Backlit | Fingerprint Reader | 3-cell(23Wh) + 3-cell(23Wh) | 45W | Win10 DG Win7 Pro 64 | 3-year, Depot | 01/16 |
| 20F6005LUS | US | i5-6300U | vPro | Intel HD 520 | 8GBx1 | 12.5" HD (1366x768) | None | 128GB SSD | None | Intel 8260 ac, 2x2 + BT4.1 | WWAN Upgradable | None | None | 720p | Backlit | Fingerprint Reader | 3-cell(23Wh) + 3-cell(23Wh) | 45W | Win10 DG Win7 Pro 64 | 3-year, Depot | 01/16 |
| 20F6005MUS | US | i7-6600U | vPro | Intel HD 520 | 16GBx1 | 12.5" HD (1366x768) | None | 512GB SSD | None | Intel 8260 ac, 2x2 + BT4.1 | WWAN Upgradable | None | None | 720p | Backlit | Fingerprint Reader | 3-cell(23Wh) + 3-cell(23Wh) | 45W | Win10 DG Win7 Pro 64 | 3-year, Depot | 01/16 |
| 20F6005NUS | US | i5-6300U | vPro | Intel HD 520 | 8GBx1 | 12.5" HD (1366x768) | None | 192GB SSD | None | Intel 8260 ac, 2x2 + BT4.1 | WWAN Upgradable | None | None | 720p | Backlit | Fingerprint Reader | 3-cell(23Wh) + 3-cell(23Wh) | 45W | Win10 DG Win7 Pro 64 | 3-year, Depot | 01/16 |
| 20F6005QUS | US | i3-6100U | No | Intel HD 520 | 4GBx1 | 12.5" HD (1366x768) | None | 500GB 7200rpm | None | Intel 8260 ac, 2x2 + BT4.1 | WWAN Upgradable | None | None | 720p | Backlit | Fingerprint Reader | 3-cell(23Wh) + 3-cell(23Wh) | 45W | Win10 DG Win7 Pro 64 | 3-year, Depot | 01/16 |
| 20F6005RUS | US | i7-6600U | vPro | Intel HD 520 | 8GBx1 | 12.5" HD (1366x768) | None | 256GB SSD Opal2 | None | Intel 8260 ac, 2x2 + BT4.1 | WWAN Upgradable | None | None | 720p | Backlit | Fingerprint Reader | 3-cell(23Wh) + 3-cell(23Wh) | 45W | Win10 DG Win7 Pro 64 | 3-year, Depot | 01/16 |
| 20F6005SUS | US | i5-6300U | vPro | Intel HD 520 | 8GBx1 | 12.5" HD (1366x768) | None | 500GB 7200rpm | None | Intel 8260 ac, 2x2 + BT4.1 | WWAN Upgradable | None | None | 720p | Backlit | Fingerprint Reader | 3-cell(23Wh) + 3-cell(23Wh) | 45W | Win10 DG Win7 Pro 64 | 3-year, Depot | 01/16 |
| 20F60068US | US | i5-6200U | No | Intel HD 520 | 8GBx1 | 12.5" HD (1366x768) IPS | None | 128GB SSD | None | Intel 8260 ac, 2x2 + BT4.1 | WWAN Upgradable | None | None | 720p | Backlit | Fingerprint Reader | 3-cell(23Wh) + 3-cell(23Wh) | 45W | Win10 Pro 64 | 3-year, Depot | 03/16 |
| 20F60069US | US | i5-6300U | No | Intel HD 520 | 8GBx1 | 12.5" HD (1366x768) IPS | None | 128GB SSD | None | Intel 8260 ac, 2x2 + BT4.1 | WWAN Upgradable | None | None | 720p | Backlit | Fingerprint Reader | 3-cell(23Wh) + 3-cell(23Wh) | 45W | Win10 Pro 64 | 3-year, Depot | 03/16 |
| 20F6006AUS | US | i5-6300U | No | Intel HD 520 | 8GBx1 | 12.5" HD (1366x768) IPS | None | 256GB SSD Opal2 | None | Intel 8260 ac, 2x2 + BT4.1 | WWAN Upgradable | None | None | 720p | Backlit | Fingerprint Reader | 3-cell(23Wh) + 3-cell(23Wh) | 45W | Win10 Pro 64 | 3-year, Depot | 03/16 |
| 20F6006BUS | US | i5-6200U | No | Intel HD 520 | 8GBx1 | 12.5" HD (1366x768) IPS | None | 500GB SSHD 5400rpm | None | Intel 8260 ac, 2x2 + BT4.1 | WWAN Upgradable | None | None | 720p | Backlit | Fingerprint Reader | 3-cell(23Wh) + 3-cell(23Wh) | 45W | Win10 Pro 64 | 3-year, Depot | 03/16 |
| 20F6006CUS | US | i5-6300U | No | Intel HD 520 | 8GBx1 | 12.5" HD (1366x768) | None | 500GB SSHD 5400rpm | None | Intel 8260 ac, 2x2 + BT4.1 | WWAN Upgradable | None | None | 720p | Backlit | Fingerprint Reader | 3-cell(23Wh) + 3-cell(23Wh) | 45W | Win10 Pro 64 | 3-year, Depot | 03/16 |
| 20F6006DUS | US | i5-6200U | No | Intel HD 520 | 8GBx1 | 12.5" HD (1366x768) | None | 500GB SSHD 5400rpm | None | Intel 8260 ac, 2x2 + BT4.1 | WWAN Upgradable | None | None | 720p | Backlit | Fingerprint Reader | 3-cell(23Wh) + 3-cell(23Wh) | 45W | Win10 Pro 64 | 3-year, Depot | 03/16 |
| 20F6006EUS | US | i5-6300U | No | Intel HD 520 | 8GBx1 | 12.5" HD (1366x768) IPS | None | 500GB SSHD 5400rpm | None | Intel 8260 ac, 2x2 + BT4.1 | WWAN Upgradable | None | None | 720p | Backlit | Fingerprint Reader | 3-cell(23Wh) + 3-cell(23Wh) | 45W | Win10 Pro 64 | 3-year, Depot | 03/16 |
| 20F6006FUS | US | i5-6200U | No | Intel HD 520 | 8GBx1 | 12.5" HD (1366x768) | None | 256GB SSD Opal2 | None | Intel 8260 ac, 2x2 + BT4.1 | WWAN Upgradable | None | None | 720p | Backlit | Fingerprint Reader | 3-cell(23Wh) + 3-cell(23Wh) | 45W | Win10 DG Win7 Pro 64 | 3-year, Depot | 03/16 |

ThinkPad X260 - TopSeller - 20F6 - 2 of 4

Product Specifications Reference (PSREF)

| Model | Region | Processor | vPro | Graphics | Memory | Display | Multi-touch | Storage(HDD/SSD) | Optical | WLAN + Bluetooth | WWAN | SIM Card | Smart Card Reader | Camera | Keyboard | Fingerprint Reader | Battery (internal+external) | Power Adapter | Operating System | Warranty | Ann Date (m/y) |
|------------|--------|-----------|------|--------------|--------|---------------------------|-------------|---------------------------|---------|----------------------------|-----------------|----------|-------------------|--------|-------------|--------------------|-----------------------------|---------------|----------------------|---------------|----------------|
| 20F6006GUS | US | i7-6600U | vPro | Intel HD 520 | 16GBx1 | 12.5" HD (1366x768) IPS | None | 512GB SSD | None | Intel 8260 ac, 2x2 + BT4.1 | WWAN Upgradable | None | None | 720p | Backlit | Fingerprint Reader | 3-cell(23Wh) + 3-cell(23Wh) | 45W | Win10 DG Win7 Pro 64 | 3-year, Depot | 03/16 |
| 20F6006HUS | US | i5-6300U | vPro | Intel HD 520 | 8GBx1 | 12.5" HD (1366x768) | None | 180GB SSD Opal2 | None | Intel 8260 ac, 2x2 + BT4.1 | WWAN Upgradable | None | None | 720p | Backlit | Fingerprint Reader | 3-cell(23Wh) + 3-cell(23Wh) | 45W | Win10 DG Win7 Pro 64 | 3-year, Depot | 03/16 |
| 20F6006JUS | US | i7-6600U | vPro | Intel HD 520 | 16GBx1 | 12.5" HD (1366x768) | None | 192GB SSD | None | Intel 8260 ac, 2x2 + BT4.1 | WWAN Upgradable | None | None | 720p | Backlit | Fingerprint Reader | 3-cell(23Wh) + 3-cell(23Wh) | 45W | Win10 DG Win7 Pro 64 | 3-year, Depot | 03/16 |
| 20F6006KUS | US | i7-6600U | vPro | Intel HD 520 | 16GBx1 | 12.5" HD (1366x768) | None | 256GB SSD Opal2 | None | Intel 8260 ac, 2x2 + BT4.1 | WWAN Upgradable | None | None | 720p | Backlit | Fingerprint Reader | 3-cell(23Wh) + 3-cell(23Wh) | 45W | Win10 DG Win7 Pro 64 | 3-year, Depot | 03/16 |
| 20F6006LUS | US | i7-6600U | vPro | Intel HD 520 | 16GBx1 | 12.5" HD (1366x768) IPS | None | 256GB SSD Opal2 | None | Intel 8260 ac, 2x2 + BT4.1 | WWAN Upgradable | None | None | 720p | Backlit | Fingerprint Reader | 3-cell(23Wh) + 3-cell(23Wh) | 45W | Win10 DG Win7 Pro 64 | 3-year, Depot | 03/16 |
| 20F6006NUS | US | i7-6600U | vPro | Intel HD 520 | 16GBx1 | 12.5" HD (1366x768) IPS | None | 192GB SSD | None | Intel 8260 ac, 2x2 + BT4.1 | WWAN Upgradable | None | None | 720p | Backlit | Fingerprint Reader | 3-cell(23Wh) + 3-cell(23Wh) | 45W | Win10 DG Win7 Pro 64 | 3-year, Depot | 03/16 |
| 20F6006PUS | US | i7-6600U | vPro | Intel HD 520 | 16GBx1 | 12.5" HD (1366x768) | None | 180GB SSD Opal2 | None | Intel 8260 ac, 2x2 + BT4.1 | WWAN Upgradable | None | None | 720p | Backlit | Fingerprint Reader | 3-cell(23Wh) + 3-cell(23Wh) | 45W | Win10 DG Win7 Pro 64 | 3-year, Depot | 03/16 |
| 20F6006QUS | US | i5-6200U | No | Intel HD 520 | 8GBx1 | 12.5" HD (1366x768) | None | 128GB SSD | None | Intel 8260 ac, 2x2 + BT4.1 | WWAN Upgradable | None | None | 720p | Backlit | Fingerprint Reader | 3-cell(23Wh) + 3-cell(23Wh) | 45W | Win10 DG Win7 Pro 64 | 3-year, Depot | 03/16 |
| 20F6006RUS | US | i5-6300U | vPro | Intel HD 520 | 4GBx1 | 12.5" HD (1366x768) | None | 500GB 7200rpm | None | Intel 8260 ac, 2x2 + BT4.1 | WWAN Upgradable | None | None | 720p | Backlit | Fingerprint Reader | 3-cell(23Wh) + 3-cell(23Wh) | 45W | Win10 DG Win7 Pro 64 | 3-year, Depot | 03/16 |
| 20F6006SUS | US | i7-6600U | vPro | Intel HD 520 | 8GBx1 | 12.5" HD (1366x768) IPS | None | 500GB 7200rpm | None | Intel 8260 ac, 2x2 + BT4.1 | WWAN Upgradable | None | None | 720p | Backlit | Fingerprint Reader | 3-cell(23Wh) + 6-cell(48Wh) | 45W | Win10 DG Win7 Pro 64 | 3-year, Depot | 03/16 |
| 20F6006TUS | US | i7-6600U | vPro | Intel HD 520 | 16GBx1 | 12.5" HD (1366x768) IPS | None | 500GB 7200rpm | None | Intel 8260 ac, 2x2 + BT4.1 | WWAN Upgradable | None | None | 720p | Backlit | Fingerprint Reader | 3-cell(23Wh) + 3-cell(23Wh) | 45W | Win10 DG Win7 Pro 64 | 3-year, Depot | 03/16 |
| 20F6008GUS | US | i7-6600U | vPro | Intel HD 520 | 8GBx1 | 12.5" HD (1366x768) IPS | None | 128GB SSD | None | Intel 8260 ac, 2x2 + BT4.1 | WWAN Upgradable | None | None | 720p | Non-backlit | Fingerprint Reader | 3-cell(23Wh) + 3-cell(23Wh) | 45W | Win10 DG Win7 Pro 64 | 3-year, Depot | 04/16 |
| 20F6008HUS | US | i5-6200U | No | Intel HD 520 | 8GBx1 | 12.5" HD (1366x768) IPS | None | 128GB SSD | None | Intel 8260 ac, 2x2 + BT4.1 | WWAN Upgradable | None | None | 720p | Non-backlit | Fingerprint Reader | 3-cell(23Wh) + 3-cell(23Wh) | 45W | Win10 DG Win7 Pro 64 | 3-year, Depot | 04/16 |
| 20F6008JUS | US | i7-6500U | No | Intel HD 520 | 8GBx1 | 12.5" HD (1366x768) IPS | None | 128GB SSD | None | Intel 8260 ac, 2x2 + BT4.1 | WWAN Upgradable | None | None | 720p | Non-backlit | Fingerprint Reader | 3-cell(23Wh) + 3-cell(23Wh) | 45W | Win10 DG Win7 Pro 64 | 3-year, Depot | 04/16 |
| 20F6008KUS | US | i7-6500U | No | Intel HD 520 | 8GBx1 | 12.5" FHD (1920x1080) IPS | None | 500GB 7200rpm | None | Intel 8260 ac, 2x2 + BT4.1 | WWAN Upgradable | None | None | 720p | Non-backlit | Fingerprint Reader | 3-cell(23Wh) + 3-cell(23Wh) | 45W | Win10 DG Win7 Pro 64 | 3-year, Depot | 04/16 |
| 20F6008LUS | US | i7-6600U | vPro | Intel HD 520 | 8GBx1 | 12.5" FHD (1920x1080) IPS | None | 256GB SSD PCIe NVMe Opal2 | None | Intel 8260 ac, 2x2 + BT4.1 | WWAN Upgradable | None | None | 720p | Non-backlit | Fingerprint Reader | 3-cell(23Wh) + 3-cell(23Wh) | 45W | Win10 DG Win7 Pro 64 | 3-year, Depot | 05/16 |
| 20F6008MUS | US | i7-6500U | No | Intel HD 520 | 8GBx1 | 12.5" FHD (1920x1080) IPS | None | 256GB SSD Opal2 | None | Intel 8260 ac, 2x2 + BT4.1 | WWAN Upgradable | None | None | 720p | Non-backlit | Fingerprint Reader | 3-cell(23Wh) + 3-cell(23Wh) | 45W | Win10 DG Win7 Pro 64 | 3-year, Depot | 04/16 |
| 20F6008NUS | US | i5-6200U | No | Intel HD 520 | 8GBx1 | 12.5" HD (1366x768) IPS | None | 256GB SSD Opal2 | None | Intel 8260 ac, 2x2 + BT4.1 | WWAN Upgradable | None | None | 720p | Non-backlit | Fingerprint Reader | 3-cell(23Wh) + 3-cell(23Wh) | 45W | Win10 DG Win7 Pro 64 | 3-year, Depot | 04/16 |
| 20F6008PUS | US | i5-6300U | vPro | Intel HD 520 | 8GBx1 | 12.5" HD (1366x768) IPS | None | 128GB SSD | None | Intel 8260 ac, 2x2 + BT4.1 | WWAN Upgradable | None | None | 720p | Non-backlit | Fingerprint Reader | 3-cell(23Wh) + 3-cell(23Wh) | 45W | Win10 DG Win7 Pro 64 | 3-year, Depot | 04/16 |
| 20F6008QUS | US | i3-6100U | No | Intel HD 520 | 8GBx1 | 12.5" HD (1366x768) IPS | None | 128GB SSD | None | Intel 8260 ac, 2x2 + BT4.1 | WWAN Upgradable | None | None | 720p | Non-backlit | Fingerprint Reader | 3-cell(23Wh) + 3-cell(23Wh) | 45W | Win10 DG Win7 Pro 64 | 3-year, Depot | 04/16 |

| Model | Region | Processor | vPro | Graphics | Memory | Display | Multi-touch | Storage(HDD/SSD) | Optical | WLAN + Bluetooth | WWAN | SIM Card | Smart Card Reader | Camera | Keyboard | Fingerprint Reader | Battery (Internal+external) | Power Adapter | Operating System | Warranty | Ann Date (m/y) |
|------------|--------|-----------|------|--------------|--------|---------------------------|-------------|---------------------------|---------|----------------------------|-----------------|----------|-------------------|--------|-------------|--------------------|-----------------------------|---------------|----------------------|---------------|----------------|
| 20F6008RUS | US | i3-6100U | No | Intel HD 520 | 8GBx1 | 12.5" HD (1366x768) IPS | None | 128GB SSD | None | Intel 8260 ac, 2x2 + BT4.1 | WWAN Upgradable | None | None | 720p | Non-backlit | Fingerprint Reader | 3-cell(23Wh) + 3-cell(23Wh) | 45W | Win10 DG Win7 Pro 64 | 3-year, Depot | 04/16 |
| 20F6008SUS | US | i3-6100U | No | Intel HD 520 | 8GBx1 | 12.5" HD (1366x768) IPS | None | 500GB 7200rpm | None | Intel 8260 ac, 2x2 + BT4.1 | WWAN Upgradable | None | None | 720p | Non-backlit | Fingerprint Reader | 3-cell(23Wh) + 3-cell(23Wh) | 45W | Win10 DG Win7 Pro 64 | 3-year, Depot | 04/16 |
| 20F6008TUS | US | i7-6500U | No | Intel HD 520 | 8GBx1 | 12.5" HD (1366x768) IPS | None | 256GB SSD Opal2 | None | Intel 8260 ac, 2x2 + BT4.1 | WWAN Upgradable | None | None | 720p | Non-backlit | Fingerprint Reader | 3-cell(23Wh) + 3-cell(23Wh) | 45W | Win10 DG Win7 Pro 64 | 3-year, Depot | 04/16 |
| 20F6008UUS | US | i5-6300U | vPro | Intel HD 520 | 8GBx1 | 12.5" HD (1366x768) IPS | None | 256GB SSD Opal2 | None | Intel 8260 ac, 2x2 + BT4.1 | WWAN Upgradable | None | None | 720p | Non-backlit | Fingerprint Reader | 3-cell(23Wh) + 3-cell(23Wh) | 45W | Win10 DG Win7 Pro 64 | 3-year, Depot | 04/16 |
| 20F6008VUS | US | i7-6500U | No | Intel HD 520 | 8GBx1 | 12.5" HD (1366x768) IPS | None | 500GB 7200rpm | None | Intel 8260 ac, 2x2 + BT4.1 | WWAN Upgradable | None | None | 720p | Non-backlit | Fingerprint Reader | 3-cell(23Wh) + 3-cell(23Wh) | 45W | Win10 DG Win7 Pro 64 | 3-year, Depot | 04/16 |
| 20F6008WUS | US | i5-6200U | No | Intel HD 520 | 8GBx1 | 12.5" HD (1366x768) IPS | None | 128GB SSD | None | Intel 8260 ac, 2x2 + BT4.1 | WWAN Upgradable | None | None | 720p | Non-backlit | Fingerprint Reader | 3-cell(23Wh) + 3-cell(23Wh) | 45W | Win10 DG Win7 Pro 64 | 3-year, Depot | 04/16 |
| 20F6008XUS | US | i7-6600U | vPro | Intel HD 520 | 16GBx1 | 12.5" FHD (1920x1080) IPS | None | 256GB SSD PCIe NVMe Opal2 | None | Intel 8260 ac, 2x2 + BT4.1 | WWAN Upgradable | None | None | 720p | Non-backlit | Fingerprint Reader | 3-cell(23Wh) + 3-cell(23Wh) | 45W | Win10 DG Win7 Pro 64 | 3-year, Depot | 05/16 |
| 20F60092US | US | i5-6300U | vPro | Intel HD 520 | 8GBx1 | 12.5" FHD (1920x1080) IPS | None | 180GB SSD Opal2 | None | Intel 8260 ac, 2x2 + BT4.1 | WWAN Upgradable | None | None | 720p | Backlit | Fingerprint Reader | 3-cell(23Wh) + 3-cell(23Wh) | 45W | Win10 DG Win7 Pro 64 | 3-year, Depot | 05/16 |
| 20F60093US | US | i5-6300U | vPro | Intel HD 520 | 8GBx1 | 12.5" FHD (1920x1080) IPS | None | 256GB SSD Opal2 | None | Intel 8260 ac, 2x2 + BT4.1 | WWAN Upgradable | None | None | 720p | Backlit | Fingerprint Reader | 3-cell(23Wh) + 3-cell(23Wh) | 45W | Win10 DG Win7 Pro 64 | 3-year, Depot | 05/16 |
| 20F60094US | US | i5-6300U | vPro | Intel HD 520 | 8GBx1 | 12.5" FHD (1920x1080) IPS | None | 500GB 7200rpm | None | Intel 8260 ac, 2x2 + BT4.1 | WWAN Upgradable | None | None | 720p | Backlit | Fingerprint Reader | 3-cell(23Wh) + 3-cell(23Wh) | 45W | Win10 DG Win7 Pro 64 | 3-year, Depot | 05/16 |
| 20F60095US | US | i5-6200U | No | Intel HD 520 | 8GBx1 | 12.5" FHD (1920x1080) IPS | None | 256GB SSD Opal2 | None | Intel 8260 ac, 2x2 + BT4.1 | WWAN Upgradable | None | None | 720p | Backlit | Fingerprint Reader | 3-cell(23Wh) + 3-cell(23Wh) | 45W | Win10 DG Win7 Pro 64 | 3-year, Depot | 05/16 |
| 20F60096US | US | i7-6600U | vPro | Intel HD 520 | 8GBx1 | 12.5" FHD (1920x1080) IPS | None | 256GB SSD Opal2 | None | Intel 8260 ac, 2x2 + BT4.1 | WWAN Upgradable | None | None | 720p | Backlit | Fingerprint Reader | 3-cell(23Wh) + 3-cell(23Wh) | 45W | Win10 DG Win7 Pro 64 | 3-year, Depot | 05/16 |
| 20F60097US | US | i7-6600U | vPro | Intel HD 520 | 16GBx1 | 12.5" FHD (1920x1080) IPS | None | 256GB SSD Opal2 | None | Intel 8260 ac, 2x2 + BT4.1 | WWAN Upgradable | None | None | 720p | Backlit | Fingerprint Reader | 3-cell(23Wh) + 3-cell(23Wh) | 45W | Win10 DG Win7 Pro 64 | 3-year, Depot | 05/16 |
| 20F60098US | US | i5-6300U | vPro | Intel HD 520 | 8GBx1 | 12.5" HD (1366x768) IPS | None | 180GB SSD Opal2 | None | Intel 8260 ac, 2x2 + BT4.1 | WWAN Upgradable | None | None | 720p | Backlit | Fingerprint Reader | 3-cell(23Wh) + 3-cell(23Wh) | 45W | Win10 DG Win7 Pro 64 | 3-year, Depot | 05/16 |
| 20F60099US | US | i7-6600U | vPro | Intel HD 520 | 8GBx1 | 12.5" HD (1366x768) IPS | None | 256GB SSD Opal2 | None | Intel 8260 ac, 2x2 + BT4.1 | WWAN Upgradable | None | None | 720p | Backlit | Fingerprint Reader | 3-cell(23Wh) + 3-cell(23Wh) | 45W | Win10 DG Win7 Pro 64 | 3-year, Depot | 05/16 |
| 20F6009AUS | US | i5-6200U | No | Intel HD 520 | 8GBx1 | 12.5" HD (1366x768) IPS | None | 500GB 7200rpm | None | Intel 8260 ac, 2x2 + BT4.1 | WWAN Upgradable | None | None | 720p | Backlit | Fingerprint Reader | 3-cell(23Wh) + 3-cell(23Wh) | 45W | Win10 DG Win7 Pro 64 | 3-year, Depot | 05/16 |
| 20F6009BUS | US | i5-6300U | vPro | Intel HD 520 | 8GBx1 | 12.5" HD (1366x768) IPS | None | 256GB SSD Opal2 | None | Intel 8260 ac, 2x2 + BT4.1 | WWAN Upgradable | None | None | 720p | Backlit | Fingerprint Reader | 3-cell(23Wh) + 3-cell(23Wh) | 45W | Win10 DG Win7 Pro 64 | 3-year, Depot | 05/16 |
| 20F6009CUS | US | i5-6200U | No | Intel HD 520 | 8GBx1 | 12.5" HD (1366x768) IPS | None | 256GB SSD Opal2 | None | Intel 8260 ac, 2x2 + BT4.1 | WWAN Upgradable | None | None | 720p | Backlit | Fingerprint Reader | 3-cell(23Wh) + 3-cell(23Wh) | 45W | Win10 DG Win7 Pro 64 | 3-year, Depot | 05/16 |
| 20F6009DUS | US | i5-6200U | No | Intel HD 520 | 8GBx1 | 12.5" FHD (1920x1080) IPS | None | 500GB 7200rpm | None | Intel 8260 ac, 2x2 + BT4.1 | WWAN Upgradable | None | None | 720p | Backlit | Fingerprint Reader | 3-cell(23Wh) + 3-cell(23Wh) | 45W | Win10 DG Win7 Pro 64 | 3-year, Depot | 05/16 |
| 20F6009EUS | US | i5-6300U | vPro | Intel HD 520 | 8GBx1 | 12.5" HD (1366x768) IPS | None | 500GB 7200rpm | None | Intel 8260 ac, 2x2 + BT4.1 | WWAN Upgradable | None | None | 720p | Backlit | Fingerprint Reader | 3-cell(23Wh) + 3-cell(23Wh) | 45W | Win10 DG Win7 Pro 64 | 3-year, Depot | 05/16 |

| Model | Region | Processor | vPro | Graphics | Memory | Display | Multi-touch | Storage(HDD/SSD) | Optical | WLAN + Bluetooth | WWAN | SIM Card | Smart Card Reader | Camera | Keyboard | Fingerprint Reader | Battery (internal+external) | Power Adapter | Operating System | Warranty | Ann Date (m/y) |
|------------|--------|-----------|------|--------------|--------|---------------------------|-------------|------------------|---------|----------------------------|-----------------|----------|-------------------|--------|----------|--------------------|-----------------------------|---------------|------------------|---------------|----------------|
| 20F600A8US | US | i7-6600U | vPro | Intel HD 520 | 16GBx1 | 12.5" FHD (1920x1080) IPS | None | 256GB SSD Opal2 | None | Intel 8260 ac, 2x2 + BT4.1 | WWAN Upgradable | None | None | 720p | Backlit | Fingerprint Reader | 3-cell(23Wh) + 3-cell(23Wh) | 45W | Win10 Pro 64 | 3-year, Depot | 10/16 |
| 20F600A9US | US | i5-6300U | vPro | Intel HD 520 | 8GBx1 | 12.5" FHD (1920x1080) IPS | None | 256GB SSD Opal2 | None | Intel 8260 ac, 2x2 + BT4.1 | WWAN Upgradable | None | None | 720p | Backlit | Fingerprint Reader | 3-cell(23Wh) + 3-cell(23Wh) | 45W | Win10 Pro 64 | 3-year, Depot | 10/16 |
| 20F600AAUS | US | i5-6200U | No | Intel HD 520 | 8GBx1 | 12.5" HD (1366x768) IPS | None | 180GB SSD Opal2 | None | Intel 8260 ac, 2x2 + BT4.1 | WWAN Upgradable | None | None | 720p | Backlit | Fingerprint Reader | 3-cell(23Wh) + 3-cell(23Wh) | 45W | Win10 Pro 64 | 3-year, Depot | 10/16 |
| 20F600ABUS | US | i7-6600U | vPro | Intel HD 520 | 8GBx1 | 12.5" FHD (1920x1080) IPS | None | 256GB SSD Opal2 | None | Intel 8260 ac, 2x2 + BT4.1 | WWAN Upgradable | None | None | 720p | Backlit | Fingerprint Reader | 3-cell(23Wh) + 3-cell(23Wh) | 45W | Win10 Pro 64 | 3-year, Depot | 10/16 |

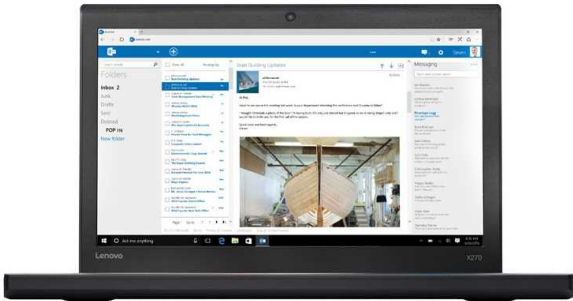

ThinkPad X270 Platform Specifications

Product Specifications Reference (PSREF)

| | | | | | | | | | |
|-----------|---|------------|--------------|----------------|---------------------|-------|--------------|-----------------------|--|
| Processor | 6th Generation Intel® Core™ i3 / i5 / i7 Processor | | | | | | | | WWAN (optional) <i>One of the following, configurable by model (mutually exclusive with WiGig):</i> <ul style="list-style-type: none"> Wireless WAN upgradable Integrated Mobile Broadband 4G LTE-A, Qualcomm® Snapdragon™ X7 LTE-A (Sierra Wireless EM7455) Integrated Mobile Broadband 4G LTE, Intel XMM™ 7160 (Fibocom L831-EAU) (EMEA only) SIM card (opt) Micro-SIM card slot, opt Verizon LTE (US) or Lenovo® Connect (EMEA) SIM card |
| | Processor Number | # of Cores | # of Threads | Base Frequency | Max Turbo Frequency | Cache | Memory Types | Processor Graphics | |
| | i3-6006U | 2 | 4 | 2.0 GHz | - | 3MB | DDR4-2133 | Intel HD Graphics 520 | |
| | i3-6100U | | | 2.3 GHz | - | 3MB | | | |
| | i5-6200U | | | 2.3 GHz | 2.8 GHz | 3MB | | | |
| | i5-6300U | | | 2.4 GHz | 3.0 GHz | 3MB | | | |
| | i7-6500U | | | 2.5 GHz | 3.1 GHz | 4MB | | | |
| | i7-6600U | | | 2.6 GHz | 3.4 GHz | 4MB | | | |
| | or 7th Generation Intel Core i3 / i5 / i7 Processor | | | | | | | | |
| | Processor Number | # of Cores | # of Threads | Base Frequency | Max Turbo Frequency | Cache | Memory Types | Processor Graphics | |
| | i3-7100U | 2 | 4 | 2.4 GHz | - | 3MB | DDR4-2133 | Intel HD Graphics 620 | |
| | i5-7200U | | | 2.5 GHz | 3.1 GHz | 3MB | | | |
| | i5-7300U | | | 2.6 GHz | 3.5 GHz | 3MB | | | |
| | i7-7500U | | | 2.7 GHz | 3.5 GHz | 4MB | | | |
| | i7-7600U | | | 2.8 GHz | 3.9 GHz | 4MB | | | |

| | |
|-------------------|---|
| Graphics | Intel HD Graphics 520 or 620 in processor; supports external digital monitor via HDMI or USB Type-C; supports three independent displays; Max resolution: 4096x2160@60Hz (USB Type-C); 4096x2160@24Hz (HDMI) |
| Chipset Memory | Intel SoC (System on Chip) platform 16GB max / 2400MHz DDR4, one DDR4 SO-DIMM socket * System clocks down for processors with lower memory controller |
| Display | <i>Some:</i> 12.5" (317.5mm) HD (1366x768), anti-glare, LED backlight, 200 nits, 16:9 aspect ratio, 500:1 contrast ratio <i>Some:</i> 12.5" (317.5mm) HD (1366x768), anti-glare, LED backlight, IPS, 300 nits, 16:9 aspect ratio, 800:1 contrast ratio, 170° viewing angle <i>Some:</i> 12.5" (317.5mm) FHD (1920x1080), anti-glare, LED backlight, IPS, 300 nits, 16:9 aspect ratio, 700:1 contrast ratio, 170° viewing angle |
| Multi-touch (opt) | On-cell touch, supports 10-finger gesture (FHD only) |
| Storage | <i>System has one HDD slot or one M.2 2280 slot exclusively for storage</i> <i>Some:</i> HDD / SATA 6.0Gb/s, 2.5" wide, 7mm high, Active Protection System™ <i>Some:</i> SSD / SATA 6.0Gb/s, 2.5" wide, 7mm high (e.g. xxxGB SSD) <i>Some:</i> M.2 SSD / PCIe NVMe, PCIe 3.0 x 2, 16Gb/s <i>Some:</i> 128GB M.2 SSD / SATA 6.0Gb/s, in WWAN slot as 2nd Storage, mutually exclusive with WWAN and WiGig |
| Optical | None |
| Ethernet | <i>Non-vPro model:</i> Intel Ethernet Connection I219-V (Jacksonville) <i>vPro model:</i> Intel Ethernet Connection I219-LM (Jacksonville) |
| WLAN | <i>One of the following, configurable by model (WiGig is mutually exclusive with WWAN):</i> <ul style="list-style-type: none"> Realtek® RTL8822BE, Wi-Fi 2x2 802.11ac + BT4.1 Intel Dual Band Wireless-AC 8260, Wi-Fi 2x2 802.11ac + BT4.1 Intel Dual Band Wireless-AC 8265, Wi-Fi 2x2 802.11ac + BT4.1 Intel Tri-Band Wireless-AC 18265, WiGig 802.11ad + Wi-Fi 2x2 802.11ac + BT4.1 (US only) |
| Bluetooth™ | Bluetooth 4.1 wireless, integrated in Wi-Fi + Bluetooth combo adapter * Intel 8265ac / 18265ac card support BT4.2 but is limited to BT4.1 by Windows OS |

| | | | | |
|-------------------------------------|--|--|------------------------|-----------------------------|
| Dimensions | <i>WxDxH:</i> 12.03" x 8.21" x 0.80"; 305.5mm x 208.5mm x 20.3mm | | | |
| Weight | <i>Models</i> | <i>No + 3-cell</i> | <i>3-cell + 3-cell</i> | <i>3 + 6-cell</i> |
| | <i>Weight</i> | 2.79 lb / 1.27 kg | 2.98 lb / 1.36 kg | 3.33 lb / 1.52 kg |
| Case color | Black | | | |
| Case material | Glass-Fiber Reinforced Plastic | | | |
| Smart card reader | <i>Optional:</i> Smart card reader | | | |
| Media reader | 4-in-1 reader (MMC, SD, SDHC, SDXC) | | | |
| Ports | Two USB 3.1 Type-A Gen 1 / USB 3.0 (one Always On), USB 3.1 Type-C Gen 1, HDMI 1.4b, Ethernet (RJ-45), Dock connector | | | |
| WiGig dock (opt) | ThinkPad WiGig dock, mutually exclusive with WWAN (US only) | | | |
| Monitor cable (optional) | <i>HDMI to VGA:</i> Lenovo HDMI to VGA Monitor Adapter <i>USB-C to VGA:</i> Lenovo USB-C to VGA Adapter <i>USB-C to DP:</i> Lenovo USB-C to DisplayPort Adapter | | | |
| Camera (optional) | HD720p resolution, fixed focus | | | |
| Audio support | HD Audio, Realtek ALC3268 codec / stereo speakers, 1.5W x 2 / dual array microphone, combo audio/microphone jack | | | |
| Keyboard UltraNav™ | 6-row, spill-resistant, multimedia Fn keys, optional LED backlight TrackPoint® pointing device and buttonless Mylar surface multi-touch touchpad | | | |
| Security | Power-on password, hard disk password, supervisor password, security keyhole | | | |
| Security chip | Discrete TPM 2.0, TCG Certified | | | |
| vPro (optional) | Intel vPro Technology | | | |
| Fingerprint reader | <i>Optional:</i> Touch style match on chip fingerprint reader on the palm rest | | | |
| NFC (optional) | Near Field Communication | | | |
| Internal battery | <i>Optional:</i> Integrated Li-Ion or Li-Polymer 3-cell (23Wh) | | | |
| External battery | Li-Ion 3-cell (23Wh) or 6-cell (48Wh or 72Wh) | | | |
| Max battery life (MobileMark® 2014) | <i>Models</i> | <i>No + 3-cell</i> | <i>3-cell + 3-cell</i> | <i>3-cell + 6-cell 48Wh</i> |
| | <i>Max battery life</i> | 6.52 hr | 13.04 hr | 20.1 hr |
| AC adapter | 45W AC adapter (slim tip) or 45W USB Type-C AC adapter | | | |
| Preload | Windows® 7 Professional 64 preinstalled through downgrade rights in Windows 10 Pro 64 | <i>Some:</i> Windows 10 Home 64 <i>Some:</i> Windows 10 Pro 64 | | |
| | <ul style="list-style-type: none"> Lenovo Solution Center Lenovo PowerEngage ThinkVantage Product Recovery ThinkVantage System Update Adobe® Reader® Microsoft® Office preloaded; purchase a product key to activate McAfee® LiveSafe™ (30-day trial) | <ul style="list-style-type: none"> Lenovo Companion Lenovo Setting Microsoft Office preloaded; purchase a product key to activate | | |
| Limited warranty | <i>One of the following, configurable by model:</i> <ul style="list-style-type: none"> 1-year depot repair service 3-year/1-yr battery depot repair service 3-year/1-yr battery limited onsite service | | | |
| Mil-Spec test | MIL-STD-810G military certification | | | |
| Environment | EPEAT™ Gold (US only); ENERGY STAR® 6.1; RoHS-compliant | | | |

ThinkPad X270 - TopSeller - 20HN

Product Specifications Reference (PSREF)

| Model | Region | Processor | vPro | Graphics | Memory | Display | Multi-touch | Storage(HDD/SSD) | Optical | WLAN + Bluetooth | WWAN | SIM Card | Smart Card Reader | Dock | Monitor Cable | Camera | Key-board | Finger-print Reader | NFC | TPM | Battery (internal+external) | Power Adapter | Operating System | Warranty | Ann Date (m/y) |
|------------|--------|-----------|------|--------------|--------|---------------------------|-------------|-------------------------------|---------|----------------------------|-----------------|----------|-------------------|------|---------------|--------|-----------|---------------------|------|----------|-----------------------------|---------------|------------------|---------------|----------------|
| 20HN001FUS | US | i5-7200U | No | Intel HD 620 | 8GBx1 | 12.5" FHD (1920x1080) IPS | None | 256GB SSD M.2 PCIe NVMe Opal2 | None | Intel 8265 ac, 2x2 + BT4.1 | WWAN Upgradable | None | None | None | None | 720p | Backlit | Finger-print Reader | None | dTPM 2.0 | 3-cell(23Wh) + 3-cell(23Wh) | 45W | Win10 Pro 64 | 3-year, Depot | 02/17 |
| 20HN001GUS | US | i7-7600U | vPro | Intel HD 620 | 16GBx1 | 12.5" FHD (1920x1080) IPS | None | 512GB SSD M.2 PCIe NVMe Opal2 | None | Intel 8265 ac, 2x2 + BT4.1 | WWAN Upgradable | None | None | None | None | 720p | Backlit | Finger-print Reader | None | dTPM 2.0 | 3-cell(23Wh) + 3-cell(23Wh) | 45W | Win10 Pro 64 | 3-year, Depot | 02/17 |
| 20HN001HUS | US | i7-7500U | No | Intel HD 620 | 16GBx1 | 12.5" FHD (1920x1080) IPS | None | 256GB SSD M.2 PCIe NVMe Opal2 | None | Intel 8265 ac, 2x2 + BT4.1 | WWAN Upgradable | None | None | None | None | 720p | Backlit | Finger-print Reader | None | dTPM 2.0 | 3-cell(23Wh) + 3-cell(23Wh) | 45W | Win10 Pro 64 | 3-year, Depot | 02/17 |
| 20HN001JUS | US | i5-7300U | vPro | Intel HD 620 | 8GBx1 | 12.5" FHD (1920x1080) IPS | None | 256GB SSD M.2 PCIe NVMe Opal2 | None | Intel 8265 ac, 2x2 + BT4.1 | WWAN Upgradable | None | None | None | None | 720p | Backlit | Finger-print Reader | None | dTPM 2.0 | 3-cell(23Wh) + 3-cell(23Wh) | 45W | Win10 Pro 64 | 3-year, Depot | 02/17 |
| 20HN001KUS | US | i5-7200U | No | Intel HD 620 | 8GBx1 | 12.5" HD (1366x768) IPS | None | 500GB 7200rpm | None | Intel 8265 ac, 2x2 + BT4.1 | WWAN Upgradable | None | None | None | None | 720p | Backlit | Finger-print Reader | None | dTPM 2.0 | 3-cell(23Wh) + 3-cell(23Wh) | 45W | Win10 Pro 64 | 3-year, Depot | 02/17 |
| 20HN001LUS | US | i5-7300U | vPro | Intel HD 620 | 8GBx1 | 12.5" HD (1366x768) IPS | None | 256GB SSD M.2 PCIe NVMe Opal2 | None | Intel 8265 ac, 2x2 + BT4.1 | WWAN Upgradable | None | None | None | None | 720p | Backlit | Finger-print Reader | None | dTPM 2.0 | 3-cell(23Wh) + 3-cell(23Wh) | 45W | Win10 Pro 64 | 3-year, Depot | 02/17 |
| 20HN001MUS | US | i7-7500U | No | Intel HD 620 | 16GBx1 | 12.5" FHD (1920x1080) IPS | None | 512GB SSD M.2 PCIe NVMe Opal2 | None | Intel 8265 ac, 2x2 + BT4.1 | WWAN Upgradable | None | None | None | None | 720p | Backlit | Finger-print Reader | None | dTPM 2.0 | 3-cell(23Wh) + 3-cell(23Wh) | 45W | Win10 Pro 64 | 3-year, Depot | 02/17 |
| 20HN001NUS | US | i7-7600U | vPro | Intel HD 620 | 16GBx1 | 12.5" FHD (1920x1080) IPS | None | 256GB SSD M.2 PCIe NVMe Opal2 | None | Intel 8265 ac, 2x2 + BT4.1 | WWAN Upgradable | None | None | None | None | 720p | Backlit | Finger-print Reader | None | dTPM 2.0 | 3-cell(23Wh) + 3-cell(23Wh) | 45W | Win10 Pro 64 | 3-year, Depot | 02/17 |
| 20HN001PUS | US | i3-7100U | No | Intel HD 620 | 4GBx1 | 12.5" HD (1366x768) IPS | None | 500GB 7200rpm | None | Intel 8265 ac, 2x2 + BT4.1 | WWAN Upgradable | None | None | None | None | 720p | Backlit | Finger-print Reader | None | dTPM 2.0 | 3-cell(23Wh) + 3-cell(23Wh) | 45W | Win10 Pro 64 | 3-year, Depot | 02/17 |
| 20HN001QUS | US | i7-7600U | vPro | Intel HD 620 | 8GBx1 | 12.5" FHD (1920x1080) IPS | None | 256GB SSD M.2 PCIe NVMe Opal2 | None | Intel 8265 ac, 2x2 + BT4.1 | WWAN Upgradable | None | None | None | None | 720p | Backlit | Finger-print Reader | None | dTPM 2.0 | 3-cell(23Wh) + 3-cell(23Wh) | 45W | Win10 Pro 64 | 3-year, Depot | 02/17 |
| 20HN001RUS | US | i7-7500U | No | Intel HD 620 | 8GBx1 | 12.5" FHD (1920x1080) IPS | None | 256GB SSD M.2 PCIe NVMe Opal2 | None | Intel 8265 ac, 2x2 + BT4.1 | WWAN Upgradable | None | None | None | None | 720p | Backlit | Finger-print Reader | None | dTPM 2.0 | 3-cell(23Wh) + 3-cell(23Wh) | 45W | Win10 Pro 64 | 3-year, Depot | 02/17 |
| 20HN004UUS | US | i5-7200U | No | Intel HD 620 | 8GBx1 | 12.5" FHD (1920x1080) IPS | None | 180GB SSD Opal2 | None | Intel 8265 ac, 2x2 + BT4.1 | WWAN Upgradable | None | None | None | None | 720p | Backlit | Finger-print Reader | None | dTPM 2.0 | 3-cell(23Wh) + 3-cell(23Wh) | 45W | Win10 Pro 64 | 3-year, Depot | 03/17 |
| 20HN004VUS | US | i5-7200U | No | Intel HD 620 | 8GBx1 | 12.5" HD (1366x768) IPS | None | 180GB SSD Opal2 | None | Intel 8265 ac, 2x2 + BT4.1 | WWAN Upgradable | None | None | None | None | 720p | Backlit | Finger-print Reader | None | dTPM 2.0 | 3-cell(23Wh) + 3-cell(23Wh) | 45W | Win10 Pro 64 | 3-year, Depot | 03/17 |

ThinkPad X270 - TopSeller - 20K6

Product Specifications Reference (PSREF)

| Model | Region | Processor | vPro | Graphics | Memory | Display | Multi-touch | Storage(HDD/SSD) | Optical | WLAN + Bluetooth | WWAN | SIM Card | Smart Card Reader | Dock | Monitor Cable | Camera | Key-board | Finger-print Reader | NFC | TPM | Battery (internal+external) | Power Adapter | Operating System | Warranty | Ann Date (m/y) |
|------------|--------|-----------|------|--------------|--------|---------------------------|-------------|-------------------------------|---------|----------------------------|-----------------|----------|-------------------|------|---------------|--------|-----------|---------------------|------|----------|-----------------------------|---------------|----------------------|---------------|----------------|
| 20K6000LUS | US | i7-6600U | vPro | Intel HD 520 | 16GBx1 | 12.5" FHD (1920x1080) IPS | None | 512GB SSD M.2 PCIe NVMe Opal2 | None | Intel 8260 ac, 2x2 + BT4.1 | WWAN Upgradable | None | None | None | None | 720p | Backlit | Finger-print Reader | None | dTPM 2.0 | 3-cell(23Wh) + 3-cell(23Wh) | 45W | Win10 DG Win7 Pro 64 | 3-year, Depot | 03/17 |
| 20K6000MUS | US | i5-6200U | No | Intel HD 520 | 8GBx1 | 12.5" FHD (1920x1080) IPS | None | 256GB SSD M.2 PCIe NVMe Opal2 | None | Intel 8260 ac, 2x2 + BT4.1 | WWAN Upgradable | None | None | None | None | 720p | Backlit | Finger-print Reader | None | dTPM 2.0 | 3-cell(23Wh) + 3-cell(23Wh) | 45W | Win10 DG Win7 Pro 64 | 3-year, Depot | 03/17 |
| 20K6000NUS | US | i7-6600U | vPro | Intel HD 520 | 8GBx1 | 12.5" FHD (1920x1080) IPS | None | 256GB SSD M.2 PCIe NVMe Opal2 | None | Intel 8260 ac, 2x2 + BT4.1 | WWAN Upgradable | None | None | None | None | 720p | Backlit | Finger-print Reader | None | dTPM 2.0 | 3-cell(23Wh) + 3-cell(23Wh) | 45W | Win10 DG Win7 Pro 64 | 3-year, Depot | 03/17 |
| 20K6000PUS | US | i5-6300U | vPro | Intel HD 520 | 8GBx1 | 12.5" HD (1366x768) | None | 256GB SSD M.2 PCIe NVMe Opal2 | None | Intel 8260 ac, 2x2 + BT4.1 | WWAN Upgradable | None | None | None | None | 720p | Backlit | Finger-print Reader | None | dTPM 2.0 | 3-cell(23Wh) + 3-cell(23Wh) | 45W | Win10 DG Win7 Pro 64 | 3-year, Depot | 03/17 |
| 20K6000QUS | US | i5-6300U | vPro | Intel HD 520 | 8GBx1 | 12.5" FHD (1920x1080) IPS | None | 256GB SSD M.2 PCIe NVMe Opal2 | None | Intel 8260 ac, 2x2 + BT4.1 | WWAN Upgradable | None | None | None | None | 720p | Backlit | Finger-print Reader | None | dTPM 2.0 | 3-cell(23Wh) + 3-cell(23Wh) | 45W | Win10 DG Win7 Pro 64 | 3-year, Depot | 03/17 |
| 20K6000RUS | US | i7-6500U | No | Intel HD 520 | 8GBx1 | 12.5" FHD (1920x1080) IPS | None | 512GB SSD M.2 PCIe NVMe Opal2 | None | Intel 8260 ac, 2x2 + BT4.1 | WWAN Upgradable | None | None | None | None | 720p | Backlit | Finger-print Reader | None | dTPM 2.0 | 3-cell(23Wh) + 3-cell(23Wh) | 45W | Win10 DG Win7 Pro 64 | 3-year, Depot | 03/17 |
| 20K6000SUS | US | i7-6500U | No | Intel HD 520 | 8GBx1 | 12.5" FHD (1920x1080) IPS | None | 256GB SSD M.2 PCIe NVMe Opal2 | None | Intel 8260 ac, 2x2 + BT4.1 | WWAN Upgradable | None | None | None | None | 720p | Backlit | Finger-print Reader | None | dTPM 2.0 | 3-cell(23Wh) + 3-cell(23Wh) | 45W | Win10 DG Win7 Pro 64 | 3-year, Depot | 03/17 |
| 20K6000TUS | US | i7-6600U | vPro | Intel HD 520 | 16GBx1 | 12.5" FHD (1920x1080) IPS | None | 256GB SSD M.2 PCIe NVMe Opal2 | None | Intel 8260 ac, 2x2 + BT4.1 | WWAN Upgradable | None | None | None | None | 720p | Backlit | Finger-print Reader | None | dTPM 2.0 | 3-cell(23Wh) + 3-cell(23Wh) | 45W | Win10 DG Win7 Pro 64 | 3-year, Depot | 05/17 |
| 20K6000UUS | US | i5-6200U | No | Intel HD 520 | 8GBx1 | 12.5" HD (1366x768) | None | 500GB 7200rpm | None | Intel 8260 ac, 2x2 + BT4.1 | WWAN Upgradable | None | None | None | None | 720p | Backlit | Finger-print Reader | None | dTPM 2.0 | 3-cell(23Wh) + 3-cell(23Wh) | 45W | Win10 DG Win7 Pro 64 | 3-year, Depot | 03/17 |
| 20K6000VUS | US | i7-6500U | No | Intel HD 520 | 16GBx1 | 12.5" FHD (1920x1080) IPS | None | 512GB SSD M.2 PCIe NVMe Opal2 | None | Intel 8260 ac, 2x2 + BT4.1 | WWAN Upgradable | None | None | None | None | 720p | Backlit | Finger-print Reader | None | dTPM 2.0 | 3-cell(23Wh) + 3-cell(23Wh) | 45W | Win10 DG Win7 Pro 64 | 3-year, Depot | 03/17 |

This publication was developed for products and services offered in the United States and E.M.E.A countries. Lenovo may not offer the products, services or features discussed in this document in other countries. Lenovo may withdraw an offering at any time. Information is subject to change without notice. Consult your local representative for information on offerings available in your area.

Lenovo reserves the right to change specifications or other product information without notice. Lenovo is not responsible for photographic or typographical errors.

LENOVO PROVIDES THIS PUBLICATION "AS IS," WITHOUT WARRANTY OF ANY KIND, EITHER EXPRESS OR IMPLIED, INCLUDING THE IMPLIED WARRANTIES OF MERCHANTABILITY OR FITNESS FOR A PARTICULAR PURPOSE.

Some jurisdictions do not allow disclaimer of express or implied warranties in certain transactions, therefore this disclaimer may not apply to you.

Availability: All offers subject to availability. Lenovo reserves the right to alter product offerings and specifications at any time, without notice. Lenovo is not responsible for photographic or typographic errors.

General: Review key information provided by Microsoft that may apply to your system purchase, including details on Windows 10, Windows 8, Windows 7, and potential upgrades/downgrades. Lenovo makes no representation or warranty regarding third-party products or services.

Trademarks: Lenovo, ThinkPad, ThinkCentre, ThinkStation and the Lenovo logo are trademarks of Lenovo. Microsoft, Windows, Windows NT, and the Windows logo are trademarks of Microsoft Corporation. Ultrabook, Celeron, Celeron Inside, Core Inside, Intel, Intel Logo, Intel Atom, Intel Atom Inside, Intel Core, Intel Inside, Intel Inside Logo, Intel vPro, Itanium, Itanium Inside, Pentium, Pentium Inside, vPro Inside, Xeon, Xeon Phi, and Xeon Inside are trademarks of Intel Corporation in the U.S. and/or other countries. Other company, product or service names may be trademarks or service marks of others.

Warranty: For a copy of applicable warranties, write to: Lenovo Warranty Information, 1009 Think Place, Morrisville, NC, 27560. Lenovo makes no representation or warranty regarding third party products or services. The Lenovo Limited Warranty applies only to Lenovo hardware products purchased for your own use, and does not transfer upon resale.

Limited warranty: Support unrelated to a warranty issue may be subject to additional charges.

Lenovo Services:

Carry-in or Mail-in Service: Parts and labor repair coverage where the customer is responsible for shipping (including packaging) or delivery to authorized warranty provider or repair center.

Depot or Courier Service: Parts and labor repair coverage where shipping (including packaging) or delivery to the repair center is paid for by Lenovo.

Expedited Depot: Parts and labor coverage with expedited turnaround. Shipping (including packaging) or delivery to the repair center is paid for by Lenovo.

Onsite / In-home Service: Parts and labor repair coverage where labor is provided onsite at your place of business.

If Lenovo determines your product problem is covered by the product warranty and cannot be resolved over the telephone, a technician will be dispatched to arrive onsite, typically the next day.

International Warranty Service (IWS): PC repair coverage for customers who require a critical warranty repair while travelling internationally. Visit www.lenovo.com/internationalwarranty for details. Visit www.lenovo.com/warranty for Lenovo Warranty Services terms and conditions for complete details and restrictions.

Included software: may differ from its retail version (if available), and may not include user manuals or all program functionality. Software license agreements may apply.

Battery life: Battery life (and recharge times) will vary based on many factors including screen brightness, applications, features, power management, battery conditioning, and other customer preferences.

Visit <http://psref.lenovo.com/> for the latest version of Product Specifications Reference.

© Lenovo, 2017. All rights reserved.
Lenovo 1009 Think Place Morrisville, NC 27560 U.S.A.

Lenovo **ThinkPad** Tablets
Convertibles

PSREF



Product Specifications Reference

Version 509, July 2017

U.S.

Visit <http://psref.lenovo.com> for the latest version

Contents

| | |
|--|-----------|
| Cover | 1 |
| Contents | 2 |
| Summary Of Change | 3 |
| ThinkPad Tablets | 4 |
| ThinkPad X1 Tablet (2nd Gen) | 4 |
| ThinkPad X1 Tablet (2nd Gen) Platform Specifications | 5 |
| ThinkPad X1 Tablet (2nd Gen) - TopSeller - 20JB | 6 |
| ThinkPad Yoga | 7 |
| ThinkPad X1 Yoga (2nd Gen) | 7 |
| ThinkPad X1 Yoga (2nd Gen) Platform Specifications | 8 |
| ThinkPad X1 Yoga (2nd Gen) - TopSeller - 20JD | 9 |
| ThinkPad X1 Yoga (2nd Gen) - TopSeller - 20JF | 10 |
| ThinkPad Yoga 11e (3rd Gen) | 11 |
| ThinkPad Yoga 11e (3rd Gen) Platform Specifications | 12 |
| ThinkPad Yoga 11e (3rd Gen) - TopSeller - 20GA | 13 |
| ThinkPad Yoga 11e (4th Gen) | 14 |
| ThinkPad Yoga 11e (4th Gen) Platform Specifications | 15 |
| ThinkPad Yoga 11e (4th Gen) - TopSeller - 20HU | 16 |
| ThinkPad Yoga 11e Chromebook (3rd Gen) | 17 |
| ThinkPad Yoga 11e Chromebook (3rd Gen) Platform Specifications | 18 |
| ThinkPad Yoga 11e Chromebook (3rd Gen) - TopSeller - 20GE | 19 |
| ThinkPad Yoga 11e Chromebook (4th Gen) | 20 |
| ThinkPad Yoga 11e Chromebook (4th Gen) Platform Specifications | 21 |
| ThinkPad Yoga 11e Chromebook (4th Gen) - TopSeller - 20HY | 22 |
| ThinkPad Yoga 370 | 23 |
| ThinkPad Yoga 370 Platform Specifications | 24 |
| ThinkPad Yoga 370 - TopSeller - 20JH - 1 of 2 | 25 |
| ThinkPad Yoga 370 - TopSeller - 20JH - 2 of 2 | 26 |
| Legal Information | 27 |

Summary of Changes

This section describes the technical changes made in this edition.

This edition might also include minor corrections and editorial changes which are not identified.

July 12, 2017 - Version 509

Additions in this update

▶ **New product(s)**

None

▶ **New model(s)**

None

▶ **Others**

None

Changes in this update

▶ None

Withdrawals in this update

▶ **Withdrawn product(s)**

ThinkPad Yoga 260 withdraw July 2017

ThinkPad Yoga 460 withdraw July 2017

ThinkPad P40 Yoga withdraw July 2017

ThinkPad X1 Yoga (1st Gen) withdraw July 2017

ThinkPad X1 Tablet withdraw July 2017

ThinkPad 10 (2nd Gen) withdraw July 2017



ThinkPad X1 Tablet (2nd Gen) Platform Specifications

Product Specifications Reference (PSREF)

| | | | | | | | | | | | | |
|--------------------------|--|------------|--------------|-------------|-----------------|-------|--------------|-----------------------|--------------------------|--|--|---|
| Processor | 7th Generation Intel® Core™ Processor | | | | | | | | Ports | One standard USB 3.1 Gen 1 / USB 3.0, one Mini DisplayPort, one USB 3.1 Type-C Gen 1 / Power Delivery 2.0, one Pogo keyboard connector, one cartrige connector for optional modules, one nano-SIM slot | | |
| | Processor Number | # of Cores | # of Threads | Clock Speed | Burst Frequency | Cache | Memory Types | Processor Graphics | vPro | Control buttons | Power button, volume control button, reset switch | |
| | m3-7Y30 | 2 | 4 | 1.0 GHz | 2.6 GHz | 4MB | LPDDR3-1866 | Intel HD Graphics 615 | No | WiGig dock | <i>Optional:</i> ThinkPad WiGig dock | |
| | i5-7Y54 | 2 | 4 | 1.2 GHz | 3.2 GHz | 4MB | | | No | Monitor Cable | <i>mDP-HDMI:</i> Lenovo Mini DisplayPort to HDMI Monitor Cable | |
| | i5-7Y57 | 2 | 4 | 1.2 GHz | 3.3 GHz | 4MB | | | Yes | Adapter (<i>optional</i>) | <i>mDP-VGA:</i> Lenovo Mini DisplayPort to VGA Monitor Cable | |
| | i7-7Y75 | 2 | 4 | 1.3 GHz | 3.6 GHz | 4MB | | | Yes | | <i>USB-RJ45:</i> USB 3.0 to RJ45 adapter | |
| Graphics | Intel HD Graphics 615 in processor, supports 1080p video out via Mini DisplayPort connector | | | | | | | | | | <i>USB-C-VGA:</i> USB-C to VGA plus power adapter | <i>USB-C-HDMI:</i> USB-C to HDMI plus power adapter |
| Chipset | Intel SoC (System on Chip) platform | | | | | | | | Camera | <i>Front camera:</i> 2.0-megapixel, fixed focus | | |
| Memory | <i>Some:</i> 4GB / 1866MHz LPDDR3, mobile DDR / soldered to systemboard | | | | | | | | Video capture | <i>Rear camera:</i> 8.0-megapixel, auto focus, flash LED | | |
| | <i>Some:</i> 8GB / 1866MHz LPDDR3, mobile DDR / soldered to systemboard | | | | | | | | Audio support | 1080p video capture | | |
| | <i>Some:</i> 16GB / 1866MHz LPDDR3, mobile DDR / soldered to systemboard | | | | | | | | | Realtek® ALC3268 codec / stereo speakers, 0.5 watt x 2 / three microphones, combo audio/microphone jack | | |
| | <i>All:</i> no sockets, dual-channel capable | | | | | | | | Pogo Keyboard | Magnetic attached thin keyboard, with TrackPoint® pointing device and buttonless Mylar surface touchpad, multi-touch, backlit | | |
| Display | 12.0" (304.8mm) FHD+ (2160x1440), glossy, LED backlight, IPS, anti-fingerprint display with Corning® Gorilla® Glass, WideView (170° viewing), 360 nits, 3:2 aspect ratio, 800:1 contrast ratio | | | | | | | | Keyboard color | Black, red, and silver | | |
| Multi-touch | Capacitive touch panel, supports ten-finger gesture | | | | | | | | Security | Kensington lock slot | | |
| Pen | <i>Optional:</i> ThinkPad Pen Pro, active pen for multi-touch display | | | | | | | | Security chip | Discrete TPM 2.0 TCG Certified | | |
| Kick stand | Opening angle up to 90 degrees | | | | | | | | vPro (<i>optional</i>) | Intel vPro Technology | | |
| Storage | <i>Some:</i> M.2 SSD / SATA 6.0Gb/s | | | | | | | | Fingerprint reader | <i>Optional:</i> Touch style Fingerprint reader | | |
| | <i>Some:</i> M.2 SSD / PCIe NVMe, PCIe 3.0 x 4, 32Gb/s | | | | | | | | NFC | None | | |
| Optical | None | | | | | | | | Module | <i>One of the following, configurable by model</i> | | |
| Storage extension | One microSD card slot, supports up to 64GB | | | | | | | | | <ul style="list-style-type: none"> Productivity module, USB3.0 x 1, HDMI, OneLink+, 5 hrs battery (24Whr) Presenter module, Pico projector, HDMI and 10Whr battery for presenter | | |
| Ethernet | None | | | | | | | | Battery - type | Lithium polymer, 2 cell, 37Whr | | |
| WLAN(<i>soldered</i>) | Intel Dual Band Wireless-AC 8265, Wi-Fi 2x2, 802.11ac + BT4.1 | | | | | | | | Battery - life | up to 10 hr (local video playback) | | |
| | <i>*Intel Wi-Fi card supports Bluetooth 4.2 but is limited to BT 4.1 by Windows OS</i> | | | | | | | | AC adapter | <i>Some:</i> 45-watt USB Type-C adapter | | |
| WiGig(<i>soldered</i>) | Intel Wireless Gigabit W11000, WiGig 802.11ad | | | | | | | | | <i>Some:</i> 65-watt USB Type-C adapter | | |
| Bluetooth™ | Bluetooth wireless, integrated in Wi-Fi + Bluetooth combo chip | | | | | | | | Light sensor | Ambient Light Sensor | | |
| WWAN | <i>One of the following, configurable by model:</i> | | | | | | | | G-sensor | 3D accelerometer | | |
| | <ul style="list-style-type: none"> Wireless WAN, Sierra Wireless EM7455, Qualcomm® 4G LTE-Advanced/DC-HSPA+/HSPA+/HSPA/UMTS/GNSS, M.2 card | | | | | | | | Compass | 3D compass | | |
| SIM card | Nano-SIM, optional Lenovo Connect (WE) SIM card | | | | | | | | Gyroscope | 3D gyrometer | | |
| Dimensions | <i>Tablet only:</i> 11.48" x 8.25" x 0.34"; 291.5mm x 209.5mm x 8.45mm | | | | | | | | GPS | GPS function is integrated into WWAN module | | |
| Weight | <i>Tablet only:</i> from 1.69 lb, 767g; | | | | | | | | Preload | <i>Some:</i> Windows 10 Pro 64 | | |
| | <i>Tablet+keyboard:</i> from 2.35 lb, 1.07kg (767g+300g); | | | | | | | | | <i>Some:</i> Windows 10 Home 64 | | |
| Case color | Black | | | | | | | | | <ul style="list-style-type: none"> Lenovo Connect Lenovo Companion Lenovo Setting Microsoft® Office preloaded; purchase a product key to activate | | |
| Case material | Mg + PCGF Hybrid | | | | | | | | Limited warranty | 1-year - depot repair service/ service upgrades available | | |
| Smart Card Read | None | | | | | | | | | 3-year - depot repair service/ service upgrades available | | |
| Media reader | One microSD card slot (micro SD/SDXC/SDHC), supports up to 64GB | | | | | | | | Mil-Spec test | MIL-STD-810G military certification | | |
| | | | | | | | | | Environment | EPEAT™ Gold, RoHS, GREENGUARD, Low Halogen | | |

ThinkPad X1 Tablet (2nd Gen) - TopSeller - 20JB

Product Specifications Reference (PSREF)

| Model | Region | Processor | vPro | Graphics | Memory | Display | Multi-touch | Storage(HDD/SSD) | WLAN + Bluetooth | WWAN | SIM Card | Dock | Monitor Cable | Camera (Front / Rear) | Keyboard Docking | Pen | Fingerprint Reader | Module | Power Adapter | Operating System | Warranty | Global | Ann Date (mm/yy) |
|------------|--------|-----------|------|--------------|---------------|--------------------------|----------------------|-------------------------------|----------------------|---------------|----------|------|---------------|-----------------------|------------------|----------|--------------------|--------|---------------|------------------|---------------|--------|------------------|
| 20JB0027US | US | i5-7Y57 | vPro | Intel HD 615 | 8GB Soldered | 12" FHD+ (2160x1440) IPS | 10-point Multi-touch | 512GB SSD M.2 PCIe NVMe Opal2 | 8265 ac, 2x2 + BT4.1 | None | None | None | None | 2.0MP / 8.0MP | Black Keyboard | Pogo Pen | Fingerprint Reader | None | 45W | Win10 Pro 64 | 3-year, Depot | No | 03/17 |
| 20JB0029US | US | i7-7Y75 | vPro | Intel HD 615 | 16GB Soldered | 12" FHD+ (2160x1440) IPS | 10-point Multi-touch | 256GB SSD M.2 PCIe NVMe Opal2 | 8265 ac, 2x2 + BT4.1 | None | None | None | None | 2.0MP / 8.0MP | Black Keyboard | Pogo Pen | Fingerprint Reader | None | 45W | Win10 Pro 64 | 3-year, Depot | No | 03/17 |
| 20JB002BUS | US | i7-7Y75 | vPro | Intel HD 615 | 16GB Soldered | 12" FHD+ (2160x1440) IPS | 10-point Multi-touch | 256GB SSD M.2 PCIe NVMe Opal2 | 8265 ac, 2x2 + BT4.1 | Sierra EM7455 | None | None | None | 2.0MP / 8.0MP | Black Keyboard | Pogo Pen | Fingerprint Reader | None | 45W | Win10 Pro 64 | 3-year, Depot | No | 03/17 |
| 20JB002CUS | US | i5-7Y54 | No | Intel HD 615 | 8GB Soldered | 12" FHD+ (2160x1440) IPS | 10-point Multi-touch | 256GB SSD M.2 PCIe NVMe Opal2 | 8265 ac, 2x2 + BT4.1 | None | None | None | None | 2.0MP / 8.0MP | Black Keyboard | Pogo Pen | Fingerprint Reader | None | 45W | Win10 Pro 64 | 1-year, Depot | No | 03/17 |
| 20JB002DUS | US | i5-7Y54 | No | Intel HD 615 | 8GB Soldered | 12" FHD+ (2160x1440) IPS | 10-point Multi-touch | 512GB SSD M.2 PCIe NVMe Opal2 | 8265 ac, 2x2 + BT4.1 | None | None | None | None | 2.0MP / 8.0MP | Black Keyboard | Pogo Pen | Fingerprint Reader | None | 45W | Win10 Pro 64 | 1-year, Depot | No | 03/17 |
| 20JB002EUS | US | i7-7Y75 | vPro | Intel HD 615 | 16GB Soldered | 12" FHD+ (2160x1440) IPS | 10-point Multi-touch | 512GB SSD M.2 PCIe NVMe Opal2 | 8265 ac, 2x2 + BT4.1 | None | None | None | None | 2.0MP / 8.0MP | Black Keyboard | Pogo Pen | Fingerprint Reader | None | 45W | Win10 Pro 64 | 3-year, Depot | No | 03/17 |
| 20JB002FUS | US | i5-7Y57 | vPro | Intel HD 615 | 8GB Soldered | 12" FHD+ (2160x1440) IPS | 10-point Multi-touch | 256GB SSD M.2 PCIe NVMe Opal2 | 8265 ac, 2x2 + BT4.1 | Sierra EM7455 | None | None | None | 2.0MP / 8.0MP | Black Keyboard | Pogo Pen | Fingerprint Reader | None | 45W | Win10 Pro 64 | 3-year, Depot | No | 03/17 |
| 20JB002JUS | US | i5-7Y57 | vPro | Intel HD 615 | 8GB Soldered | 12" FHD+ (2160x1440) IPS | 10-point Multi-touch | 256GB SSD M.2 PCIe NVMe Opal2 | 8265 ac, 2x2 + BT4.1 | None | None | None | None | 2.0MP / 8.0MP | Black Keyboard | Pogo Pen | Fingerprint Reader | None | 45W | Win10 Pro 64 | 3-year, Depot | No | 03/17 |
| 20JB002KUS | US | i7-7Y75 | vPro | Intel HD 615 | 8GB Soldered | 12" FHD+ (2160x1440) IPS | 10-point Multi-touch | 512GB SSD M.2 PCIe NVMe Opal2 | 8265 ac, 2x2 + BT4.1 | Sierra EM7455 | None | None | None | 2.0MP / 8.0MP | Black Keyboard | Pogo Pen | Fingerprint Reader | None | 45W | Win10 Pro 64 | 3-year, Depot | No | 03/17 |
| 20JB002LUS | US | i7-7Y75 | vPro | Intel HD 615 | 8GB Soldered | 12" FHD+ (2160x1440) IPS | 10-point Multi-touch | 256GB SSD M.2 PCIe NVMe Opal2 | 8265 ac, 2x2 + BT4.1 | None | None | None | None | 2.0MP / 8.0MP | Black Keyboard | Pogo Pen | Fingerprint Reader | None | 45W | Win10 Pro 64 | 3-year, Depot | No | 03/17 |
| 20JB002MUS | US | i7-7Y75 | vPro | Intel HD 615 | 8GB Soldered | 12" FHD+ (2160x1440) IPS | 10-point Multi-touch | 256GB SSD M.2 PCIe NVMe Opal2 | 8265 ac, 2x2 + BT4.1 | Sierra EM7455 | None | None | None | 2.0MP / 8.0MP | Black Keyboard | Pogo Pen | Fingerprint Reader | None | 45W | Win10 Pro 64 | 3-year, Depot | No | 03/17 |
| 20JB002NUS | US | i7-7Y75 | vPro | Intel HD 615 | 8GB Soldered | 12" FHD+ (2160x1440) IPS | 10-point Multi-touch | 256GB SSD M.2 PCIe NVMe Opal2 | 8265 ac, 2x2 + BT4.1 | None | None | None | None | 2.0MP / 8.0MP | Black Keyboard | Pogo Pen | Fingerprint Reader | None | 45W | Win10 Pro 64 | 1-year, Depot | No | 03/17 |
| 20JB0035US | US | i7-7Y75 | vPro | Intel HD 615 | 8GB Soldered | 12" FHD+ (2160x1440) IPS | 10-point Multi-touch | 512GB SSD M.2 PCIe NVMe Opal2 | 8265 ac, 2x2 + BT4.1 | None | None | None | None | 2.0MP / 8.0MP | Black Keyboard | Pogo Pen | Fingerprint Reader | None | 45W | Win10 Pro 64 | 3-year, Depot | No | 03/17 |
| 20JB003RUS | US | i7-7Y75 | vPro | Intel HD 615 | 16GB Soldered | 12" FHD+ (2160x1440) IPS | 10-point Multi-touch | 512GB SSD M.2 PCIe NVMe Opal2 | 8265 ac, 2x2 + BT4.1 | Sierra EM7455 | None | None | None | 2.0MP / 8.0MP | Black Keyboard | Pogo Pen | Fingerprint Reader | None | 45W | Win10 Pro 64 | 1-year, Depot | No | 05/17 |



ThinkPad X1 Yoga (2nd Gen) Platform

Product Specifications Reference (PSREF)

| | | | | | | | | | | | |
|-----------------|---|------------|--------------|----------------|---------------------|-------|--------------|-----------------------|------|--------------------|---|
| Processor | 7th Generation Intel® Core™ i5 / i7 Processor | | | | | | | | | Smart card reader | None |
| | Processor Number | # of Cores | # of Threads | Base Frequency | Max Turbo Frequency | Cache | Memory Types | Processor Graphics | vPro | Media reader | Micro SD, supports UHS-II SD card |
| | i5-7200U | 2 | 4 | 2.5 GHz | 3.1 GHz | 3MB | LPDDR3-1866 | Intel HD Graphics 620 | No | Ports | Three USB 3.1 Gen 1 / USB 3.0 (one Always On), two USB 3.1 Type-C Gen 2 / Thunderbolt 3 (support data, video, and power delivery), Mini RJ45, HDMI, combo audio / microphone jack |
| | i5-7300U | | | 2.6 GHz | 3.5 GHz | 3MB | | | vPro | | |
| | i7-7500U | | | 2.7 GHz | 3.5 GHz | 4MB | | | No | | |
| | i7-7600U | | | 2.8 GHz | 3.9 GHz | 4MB | | | vPro | | |
| Graphics | Intel HD Graphics 620 in processor only, supports external digital monitor via HDMI or USB Type-C; supports three independent displays; Max resolution: 4096x2304@60Hz (USB Type-C); 4096x2160@24Hz (HDMI) | | | | | | | | | WiGig dock (opt) | ThinkPad WiGig dock |
| Chipset | Intel SoC (System on Chip) platform | | | | | | | | | Adapter (optional) | USB-C-VGA: USB-C to VGA adapter USB-C-DP: USB-C to DisplayPort adapter HDMI-VGA: Lenovo HDMI to VGA Monitor Cable |
| Memory | 16GB max / 1866MHz LPDDR3 / soldered to systemboard | | | | | | | | | Camera (optional) | 720p: HD720p resolution, fixed focus IR & 720p: IR camera and HD720p camera (Narrow Bezel FHD panels only) |
| Display | <i>Some:</i> 14.0" (355mm) WQHD (2560x1440), glossy / anti-reflection, OLED, 300 nits, 16:9 aspect ratio, 54000:1 contrast ratio <i>Some:</i> 14.0" (355mm) WQHD (2560x1440), glossy / anti-reflection, LED backlight, 270 nits, 16:9 aspect ratio, 700:1 contrast ratio, IPS <i>Some:</i> 14.0" (355mm) FHD (1920x1080), glossy / anti-reflection, LED backlight, 270 nits, 16:9 aspect ratio, 700:1 contrast ratio, IPS <i>Some:</i> 14.0" (355mm) FHD (1920x1080), glossy / anti-reflection, LED backlight, 270 nits, 16:9 aspect ratio, 700:1 contrast ratio (Narrow Bezel FHD panel), IPS | | | | | | | | | Audio support | HD Audio, Conexant® CX11771 codec, Dolby® Audio Premium / stereo speakers, 2W x 2 / dual array microphone, combo audio / microphone jack |
| Multi-touch | Capacitive touch panel, supports 10-finger gesture | | | | | | | | | Keyboard | 6-row wave keyboard (rise & fall), spill-resistant, multimedia Fn keys, LED backlit |
| Hinge | Yoga hinge, 360 degree | | | | | | | | | UltraNav™ | TrackPoint® pointing device and multi-touch with 3+2 buttons click pad, multi-touch |
| Convert-mode | Laptop, tent, stand, and tablet | | | | | | | | | Security | Power-on password, hard disk password, supervisor password, security keyhole |
| Pen (optional) | ThinkPad Pen Pro, active pen for multi-touch display | | | | | | | | | Security chip | Discrete TPM 2.0 TCG Certified |
| Storage | <i>Some:</i> M.2 SSD / SATA 6.0Gb/s <i>Some:</i> M.2 SSD / PCIe NVMe, PCIe 3.0 x 4, 32Gb/s | | | | | | | | | vPro (optional) | Intel vPro Technology |
| Optical | None | | | | | | | | | Fingerprint reader | Touch style fingerprint reader on the keyboard bezel |
| Ethernet | Native Intel Ethernet Connection I219-V (Non-vPro) or I219-LM (vPro) via optional ThinkPad Ethernet Extension Cable | | | | | | | | | NFC (optional) | Near Field Communication |
| WLAN | <i>One of the following, configurable by model (WiGig is mutually exclusive with WWAN):</i> <ul style="list-style-type: none"> Intel Dual Band Wireless-AC 8265, Wi-Fi 2x2, 802.11ac + BT4.1, M.2 Card Intel Tri-Band Wireless-AC 18265, WiGig™ 802.11ad + Wi-Fi 2x2, 802.11ac + BT4.1, M.2 Card | | | | | | | | | Battery type | Li-Polymer 4-cell (56Wh) |
| Bluetooth™ | <i>*WiGig adapter is only available in selected countries*</i> Bluetooth wireless, integrated in Wi-Fi + Bluetooth combo adapter <i>*Intel Wi-Fi card supports Bluetooth 4.2 but is limited to BT 4.1 by Windows OS</i> | | | | | | | | | Battery life | Up to 15.5 hr |
| WWAN (optional) | <i>One of the following, configurable by model (mutually exclusive with WiGig):</i> <ul style="list-style-type: none"> Wireless WAN, Sierra Wireless EM7455, Qualcomm® 4G LTE-Advanced/DC-HSPA+/HSPA/UMTS/GNSS, M.2 card | | | | | | | | | AC adapter | <i>Some:</i> 45-watt USB Type-C adapter <i>Some:</i> 65-watt USB Type-C adapter |
| SIM card | Micro-SIM card slot, Lenovo Connect (WE) SIM card | | | | | | | | | Light sensor | Ambient Light Sensor |
| Dimensions | WxDxH: 13.11" x 9.02" x 0.69"; 333mm x 229mm x 17.4mm | | | | | | | | | G-sensor | 3D accelerometer and 3D magnetometer |
| Weight | From 2.99 lb (1.36kg) for OLED model; 3.15 lb (1.42kg) for other model | | | | | | | | | Compass | 3D compass |
| Case color | Black or silver | | | | | | | | | Gyroscope | 3D gyrometer |
| Case material | Carbon-Fiber Hybrid | | | | | | | | | Preload | <i>Some:</i> Windows 10 Pro 64 <i>Some:</i> Windows 10 Home 64 <ul style="list-style-type: none"> Lenovo Companion Lenovo Settings Microsoft Office preloaded; purchase a product key to activate McAfee® Live Safe (30-day trial) |
| | | | | | | | | | | Limited warranty | <i>One of the following, configurable by model:</i> <ul style="list-style-type: none"> 1-year depot repair service 3-year/1-yr battery depot repair service 3-year/1-yr battery limited onsite service |
| | | | | | | | | | | Mil-Spec test | MIL-STD-810G military certification |
| | | | | | | | | | | Environment | EPEAT™ Gold; ENERGY STAR®; RoHS-compliant |

ThinkPad X1 Yoga (2nd Gen) - TopSeller - 20JD

Product Specifications Reference (PSREF)

| Model | Region | Processor | vPro | Graphics | Memory | Display | Multi-touch | Storage(HDD/SSD) | WLAN + Bluetooth | WWAN | SIM Card | Dock | Monitor Cable | Adapter | Color | Camera | Keyboard | Pen | Finger-print Reader | NFC | Power Adapter | Operating System | Warranty | Global | Ann Date (m/y) |
|------------|--------|-----------|------|--------------|---------------|---------------------------------|----------------------|-------------------------------|----------------------------|---------------|----------|------|---------------|---------|-------|--------|----------|---------|---------------------|------|---------------|------------------|---------------|--------|----------------|
| 20JD000PUS | US | i5-7300U | vPro | Intel HD 620 | 8GB Soldered | 14" FHD (1920x1080) IPS NB | 10-point Multi-touch | 256GB SSD M.2 PCIe NVMe Opal2 | Intel 8265 ac, 2x2 + BT4.1 | None | None | None | None | None | Black | 720p | Backlit | Pen Pro | Finger-print Reader | None | 65W | Win10 Pro 64 | 3-year, Depot | No | 04/17 |
| 20JD000QUS | US | i7-7600U | vPro | Intel HD 620 | 8GB Soldered | 14" FHD (1920x1080) IPS NB | 10-point Multi-touch | 256GB SSD M.2 PCIe NVMe Opal2 | Intel 8265 ac, 2x2 + BT4.1 | None | None | None | None | None | Black | 720p | Backlit | Pen Pro | Finger-print Reader | None | 65W | Win10 Pro 64 | 3-year, Depot | No | 04/17 |
| 20JD000RUS | US | i5-7300U | vPro | Intel HD 620 | 8GB Soldered | 14" FHD (1920x1080) IPS Gloss | 10-point Multi-touch | 256GB SSD M.2 PCIe NVMe Opal2 | Intel 8265 ac, 2x2 + BT4.1 | Sierra EM7455 | None | None | None | None | Black | 720p | Backlit | Pen Pro | Finger-print Reader | None | 65W | Win10 Pro 64 | 3-year, Depot | No | 04/17 |
| 20JD000SUS | US | i7-7600U | vPro | Intel HD 620 | 16GB Soldered | 14" WQHD (2560x1440) IPS Gloss | 10-point Multi-touch | 512GB SSD M.2 PCIe NVMe Opal2 | Intel 8265 ac, 2x2 + BT4.1 | Sierra EM7455 | None | None | None | None | Black | 720p | Backlit | Pen Pro | Finger-print Reader | None | 65W | Win10 Pro 64 | 3-year, Depot | No | 04/17 |
| 20JD000TUS | US | i7-7600U | vPro | Intel HD 620 | 16GB Soldered | 14" WQHD (2560x1440) IPS Gloss | 10-point Multi-touch | 512GB SSD M.2 PCIe NVMe Opal2 | Intel 8265 ac, 2x2 + BT4.1 | None | None | None | None | None | Black | 720p | Backlit | Pen Pro | Finger-print Reader | None | 65W | Win10 Pro 64 | 3-year, Depot | No | 04/17 |
| 20JD000UUS | US | i5-7300U | vPro | Intel HD 620 | 16GB Soldered | 14" FHD (1920x1080) IPS NB | 10-point Multi-touch | 256GB SSD M.2 PCIe NVMe Opal2 | Intel 8265 ac, 2x2 + BT4.1 | None | None | None | None | None | Black | 720p | Backlit | Pen Pro | Finger-print Reader | None | 65W | Win10 Pro 64 | 3-year, Depot | No | 04/17 |
| 20JD000VUS | US | i7-7600U | vPro | Intel HD 620 | 8GB Soldered | 14" WQHD (2560x1440) IPS Gloss | 10-point Multi-touch | 512GB SSD M.2 PCIe NVMe Opal2 | Intel 8265 ac, 2x2 + BT4.1 | None | None | None | None | None | Black | 720p | Backlit | Pen Pro | Finger-print Reader | None | 65W | Win10 Pro 64 | 3-year, Depot | No | 04/17 |
| 20JD000WUS | US | i7-7600U | vPro | Intel HD 620 | 16GB Soldered | 14" WQHD (2560x1440) OLED Gloss | 10-point Multi-touch | 512GB SSD M.2 PCIe NVMe Opal2 | Intel 8265 ac, 2x2 + BT4.1 | None | None | None | None | None | Black | 720p | Backlit | Pen Pro | Finger-print Reader | None | 65W | Win10 Pro 64 | 3-year, Depot | No | 04/17 |
| 20JD000XUS | US | i5-7200U | No | Intel HD 620 | 8GB Soldered | 14" WQHD (2560x1440) IPS Gloss | 10-point Multi-touch | 512GB SSD M.2 PCIe NVMe Opal2 | Intel 8265 ac, 2x2 + BT4.1 | None | None | None | None | None | Black | 720p | Backlit | Pen Pro | Finger-print Reader | None | 65W | Win10 Pro 64 | 3-year, Depot | No | 04/17 |
| 20JD000YUS | US | i5-7300U | vPro | Intel HD 620 | 16GB Soldered | 14" FHD (1920x1080) IPS Gloss | 10-point Multi-touch | 256GB SSD M.2 PCIe NVMe Opal2 | Intel 8265 ac, 2x2 + BT4.1 | Sierra EM7455 | None | None | None | None | Black | 720p | Backlit | Pen Pro | Finger-print Reader | None | 65W | Win10 Pro 64 | 3-year, Depot | No | 04/17 |
| 20JD0015US | US | i5-7200U | No | Intel HD 620 | 8GB Soldered | 14" FHD (1920x1080) IPS NB | 10-point Multi-touch | 256GB SSD M.2 PCIe NVMe Opal2 | Intel 8265 ac, 2x2 + BT4.1 | None | None | None | None | None | Black | 720p | Backlit | Pen Pro | Finger-print Reader | None | 65W | Win10 Pro 64 | 3-year, Depot | No | 04/17 |
| 20JD0022US | US | i5-7200U | No | Intel HD 620 | 8GB Soldered | 14" FHD (1920x1080) IPS NB | 10-point Multi-touch | 180GB SSD M.2 SATA3 Opal2 | Intel 8265 ac, 2x2 + BT4.1 | None | None | None | None | None | Black | 720p | Backlit | Pen Pro | Finger-print Reader | None | 65W | Win10 Pro 64 | 3-year, Depot | No | 05/17 |
| 20JD004UUS | US | i7-7500U | No | Intel HD 620 | 8GB Soldered | 14" WQHD (2560x1440) IPS Gloss | 10-point Multi-touch | 512GB SSD M.2 PCIe NVMe Opal2 | Intel 8265 ac, 2x2 + BT4.1 | None | None | None | None | None | Black | 720p | Backlit | Pen Pro | Finger-print Reader | None | 65W | Win10 Pro 64 | 3-year, Depot | No | 05/17 |
| 20JD004VUS | US | i5-7300U | vPro | Intel HD 620 | 8GB Soldered | 14" FHD (1920x1080) IPS NB | 10-point Multi-touch | 180GB SSD M.2 SATA3 Opal2 | Intel 8265 ac, 2x2 + BT4.1 | None | None | None | None | None | Black | 720p | Backlit | Pen Pro | Finger-print Reader | None | 65W | Win10 Pro 64 | 3-year, Depot | No | 05/17 |

ThinkPad X1 Yoga (2nd Gen) - TopSeller - 20JF

Product Specifications Reference (PSREF)

| Model | Region | Processor | vPro | Graphics | Memory | Display | Multi-touch | Storage(HDD/SSD) | WLAN + Bluetooth | WWAN | SIM Card | Dock | Monitor Cable | Adapter | Color | Camera | Keyboard | Pen | Finger-print Reader | NFC | Power Adapter | Operating System | Warranty | Global | Ann Date (m/y) |
|------------|--------|-----------|------|--------------|---------------|---------------------------------|----------------------|-------------------------------|----------------------------|---------------|----------|------|---------------|---------|--------|--------|----------------|---------|---------------------|------|---------------|------------------|---------------|--------|----------------|
| 20JF000BUS | US | i5-7200U | No | Intel HD 620 | 8GB Soldered | 14" FHD (1920x1080) IPS NB | 10-point Multi-touch | 256GB SSD M.2 PCIe NVMe Opal2 | Intel 8265 ac, 2x2 + BT4.1 | None | None | None | None | None | Silver | 720p | Backlit Silver | Pen Pro | Finger-print Reader | None | 65W | Win10 Pro 64 | 3-year, Depot | No | 04/17 |
| 20JF000CUS | US | i5-7300U | vPro | Intel HD 620 | 16GB Soldered | 14" FHD (1920x1080) IPS Gloss | 10-point Multi-touch | 256GB SSD M.2 PCIe NVMe Opal2 | Intel 8265 ac, 2x2 + BT4.1 | Sierra EM7455 | None | None | None | None | Silver | 720p | Backlit Silver | Pen Pro | Finger-print Reader | None | 65W | Win10 Pro 64 | 3-year, Depot | No | 04/17 |
| 20JF000DUS | US | i7-7600U | vPro | Intel HD 620 | 16GB Soldered | 14" WQHD (2560x1440) IPS Gloss | 10-point Multi-touch | 512GB SSD M.2 PCIe NVMe Opal2 | Intel 8265 ac, 2x2 + BT4.1 | None | None | None | None | None | Silver | 720p | Backlit Silver | Pen Pro | Finger-print Reader | None | 65W | Win10 Pro 64 | 3-year, Depot | No | 04/17 |
| 20JF000EUS | US | i7-7600U | vPro | Intel HD 620 | 8GB Soldered | 14" FHD (1920x1080) IPS NB | 10-point Multi-touch | 256GB SSD M.2 PCIe NVMe Opal2 | Intel 8265 ac, 2x2 + BT4.1 | None | None | None | None | None | Silver | 720p | Backlit Silver | Pen Pro | Finger-print Reader | None | 65W | Win10 Pro 64 | 3-year, Depot | No | 04/17 |
| 20JF000FUS | US | i5-7300U | vPro | Intel HD 620 | 16GB Soldered | 14" FHD (1920x1080) IPS NB | 10-point Multi-touch | 256GB SSD M.2 PCIe NVMe Opal2 | Intel 8265 ac, 2x2 + BT4.1 | None | None | None | None | None | Silver | 720p | Backlit Silver | Pen Pro | Finger-print Reader | None | 65W | Win10 Pro 64 | 3-year, Depot | No | 04/17 |
| 20JF000GUS | US | i5-7300U | vPro | Intel HD 620 | 8GB Soldered | 14" FHD (1920x1080) IPS Gloss | 10-point Multi-touch | 256GB SSD M.2 PCIe NVMe Opal2 | Intel 8265 ac, 2x2 + BT4.1 | Sierra EM7455 | None | None | None | None | Silver | 720p | Backlit Silver | Pen Pro | Finger-print Reader | None | 65W | Win10 Pro 64 | 3-year, Depot | No | 04/17 |
| 20JF000HUS | US | i7-7600U | vPro | Intel HD 620 | 16GB Soldered | 14" WQHD (2560x1440) OLED Gloss | 10-point Multi-touch | 512GB SSD M.2 PCIe NVMe Opal2 | Intel 8265 ac, 2x2 + BT4.1 | None | None | None | None | None | Silver | 720p | Backlit Silver | Pen Pro | Finger-print Reader | None | 65W | Win10 Pro 64 | 3-year, Depot | No | 04/17 |
| 20JF000JUS | US | i7-7600U | vPro | Intel HD 620 | 8GB Soldered | 14" WQHD (2560x1440) IPS Gloss | 10-point Multi-touch | 512GB SSD M.2 PCIe NVMe Opal2 | Intel 8265 ac, 2x2 + BT4.1 | None | None | None | None | None | Silver | 720p | Backlit Silver | Pen Pro | Finger-print Reader | None | 65W | Win10 Pro 64 | 3-year, Depot | No | 04/17 |
| 20JF000KUS | US | i5-7200U | No | Intel HD 620 | 8GB Soldered | 14" WQHD (2560x1440) IPS Gloss | 10-point Multi-touch | 512GB SSD M.2 PCIe NVMe Opal2 | Intel 8265 ac, 2x2 + BT4.1 | None | None | None | None | None | Silver | 720p | Backlit Silver | Pen Pro | Finger-print Reader | None | 65W | Win10 Pro 64 | 3-year, Depot | No | 04/17 |
| 20JF000LUS | US | i5-7300U | vPro | Intel HD 620 | 8GB Soldered | 14" FHD (1920x1080) IPS NB | 10-point Multi-touch | 256GB SSD M.2 PCIe NVMe Opal2 | Intel 8265 ac, 2x2 + BT4.1 | None | None | None | None | None | Silver | 720p | Backlit Silver | Pen Pro | Finger-print Reader | None | 65W | Win10 Pro 64 | 3-year, Depot | No | 04/17 |
| 20JF000MUS | US | i7-7600U | vPro | Intel HD 620 | 16GB Soldered | 14" WQHD (2560x1440) IPS Gloss | 10-point Multi-touch | 512GB SSD M.2 PCIe NVMe Opal2 | Intel 8265 ac, 2x2 + BT4.1 | Sierra EM7455 | None | None | None | None | Silver | 720p | Backlit Silver | Pen Pro | Finger-print Reader | None | 65W | Win10 Pro 64 | 3-year, Depot | No | 04/17 |



ThinkPad Yoga 11e (3rd Gen) Platform Specifications

Product Specifications Reference (PSREF)

| | | | | | | | | | | |
|-------------------------|---|------------|--------------|----------------|------------------------|-----------------------|--------------|-----------------------|--|---|
| Processor | Intel® Celeron® processor, Intel Pentium® Processor, or 6th Generation Intel Core™ i3 Processor | | | | | | | | Media reader | 4-in-1 reader (MMC, SD, SDHC, SDXC) |
| | Processor Number | # of Cores | # of Threads | Base Frequency | Burst Frequency | Cache | Memory Types | Processor Graphics | Ports | Two USB 3.0, HDMI, Ethernet (RJ-45) |
| | Cel N3150 | 4 | 4 | 1.6 GHz | 2.08 GHz | 2MB | DDR3L-1600 | Intel HD graphics | Control buttons | Power button, volume control button |
| | Cel N3160 | 4 | 4 | 1.6 GHz | 2.24 GHz | 2MB | | Intel HD graphics | Camera | HD720p resolution, low light sensitive, fixed focus |
| | Pen 4405U | 2 | 4 | 2.1 GHz | - | 2MB | | Intel HD graphics 510 | Audio support | HD Audio, Realtek® ALC3245 codec / stereo speakers, 2W x 2 / monaural digital microphone, combo audio/microphone jack |
| i3-6100U | 2.3 GHz | | | - | 3MB | Intel HD graphics 520 | | Keyboard | ThinkPad Windows keyboard, 6-row, multimedia Fn keys | |
| | | | | | | | | UltraNav™ | Buttonless touchpad below keyboard, multi-touch | |
| Graphics | Intel HD Graphics, Intel HD Graphics 510, or Intel HD Graphics 520 in processor, supports external digital monitor via HDMI™; supports dual independent display; Max resolution: 1920X1080 (HDMI) @30Hz | | | | | | | | Security | Power-on password, hard disk password, supervisor password, security keyhole |
| Chipset | Intel SoC (System on Chip) platform | | | | | | | | Security chip | Trusted Platform Module, TCG 1.2-compliant |
| Memory | 2GB, 4GB, or 8GB / PC3-12800 1600MHz DDR3L, one DDR3L SO-DIMM socket | | | | | | | | vPro | None |
| Display | 11.6" (295mm) HD (1366x768), glare, LED backlight, IPS 250 nits, 16:9 aspect ratio, 800:1 contrast ratio | | | | | | | | Fingerprint reader | None |
| MultiTouch | Yes, support 10 fingers | | | | | | | | Battery | Integrated Lithium Polymer 3-cell (42Wh) |
| Hinge | Yoga hinge, 360 degree | | | | | | | | Max battery life ¹⁰ | MobileMark® 2014: 11.53 hr |
| Convertible mode | Laptop, tent, stand and tablet | | | | | | | | AC adapter | 45-watt AC adapter |
| Pen | Some: Active pen, batteries required | | | | | | | | Preload | Some: Windows 10 Home 64 Some: Windows 10 Pro 64 • Lenovo Solution Center • Lenovo Companion • Lenovo Setting • Microsoft Office preloaded; purchase a product key to activate • McAfee® LiveSafe™ (30-day trial) |
| Storage | M.2 Solid State Drive (SSD), SATA 6.0Gb/s | | | | | | | | Limited warranty ¹² | One of the following, configurable by model: • 1-year depot repair service • 3-year/1-yr battery depot repair service (US only) |
| Optical | None | | | | | | | | Mil-Spec test | MIL-STD-810G military certification |
| Ethernet | Realtek RTL8111GUS-CG Gigabit Network Connection | | | | | | | | Environment | EPEAT™ Gold (US only); ENERGY STAR® 6.1; RoHS-compliant |
| WLAN ⁴ | One of the following, configurable by model: • 11ac+BT, Intel Dual Band Wireless-AC 3165, 1x1, M.2 card • 11ac+BT, Intel Dual Band Wireless-AC 7265, 2x2, M.2 card | | | | | | | | | |
| Bluetooth™ | Bluetooth 4.0 wireless, integrated in Wi-Fi + Bluetooth combo adapter | | | | | | | | | |
| WWAN | None | | | | | | | | | |
| Dimensions ³ | WxDxH: 11.81" x 8.27" x 0.90"; 300mm x 210mm x 22.9mm | | | | | | | | | |
| Weight ² | from 3.5 lb (1.59kg) | | | | | | | | | |
| Case color | Display cover: Graphite Black or Silver; | | | | Bottom: Graphite Black | | | | | |
| Case material | Display cover: PC+40%GF+TPU; | | | | Bottom: PCC | | | | | |

Lenovo
July 2017

ThinkPad Yoga 11e (3rd Gen) - TopSeller - 20GA

Product Specifications Reference (PSREF)

| Model | Region | Processor | Graphics | Memory | Display | Multi-touch | Storage | Optical | WLAN + Bluetooth | Color | Camera | Pen | Finger-print Reader | Battery | Power Adapter | Operating System | Warranty | Global | Ann Date (m/y) |
|------------|--------|---------------|--------------|--------|-------------------------|----------------------|-----------------|---------|----------------------------|-------|--------|------|---------------------|---------------|---------------|-------------------|---------------|--------|----------------|
| 20GA000KUS | US | Celeron N3150 | Intel HD | 4GBx1 | 11.6" HD (1366x768) IPS | 10-point Multi-touch | 128GB SSD | None | Intel 7265 ac, 2x2 + BT4.0 | Black | 720p | None | None | 3-cell (42Wh) | 45W | Windows 10 Pro 64 | 1-year, Depot | No | 03/16 |
| 20GA000LUS | US | Celeron N3150 | Intel HD | 8GBx1 | 11.6" HD (1366x768) IPS | 10-point Multi-touch | 128GB SSD | None | Intel 7265 ac, 2x2 + BT4.0 | Black | 720p | None | None | 3-cell (42Wh) | 45W | Windows 10 Pro 64 | 1-year, Depot | No | 03/16 |
| 20GA000MUS | US | i3-6100U | Intel HD 520 | 8GBx1 | 11.6" HD (1366x768) IPS | 10-point Multi-touch | 128GB SSD | None | Intel 7265 ac, 2x2 + BT4.0 | Black | 720p | None | None | 3-cell (42Wh) | 45W | Windows 10 Pro 64 | 1-year, Depot | No | 03/16 |
| 20GA000NUS | US | i3-6100U | Intel HD 520 | 8GBx1 | 11.6" HD (1366x768) IPS | 10-point Multi-touch | 256GB SSD Opal2 | None | Intel 7265 ac, 2x2 + BT4.0 | Black | 720p | None | None | 3-cell (42Wh) | 45W | Windows 10 Pro 64 | 1-year, Depot | No | 03/16 |
| 20GA000QUS | US | i3-6100U | Intel HD 520 | 8GBx1 | 11.6" HD (1366x768) IPS | 10-point Multi-touch | 192GB SSD | None | Intel 7265 ac, 2x2 + BT4.0 | Black | 720p | None | None | 3-cell (42Wh) | 45W | Windows 10 Pro 64 | 1-year, Depot | No | 03/16 |
| 20GA000YUS | US | i3-6100U | Intel HD 520 | 4GBx1 | 11.6" HD (1366x768) IPS | 10-point Multi-touch | 192GB SSD | None | Intel 7265 ac, 2x2 + BT4.0 | Black | 720p | None | None | 3-cell (42Wh) | 45W | Windows 10 Pro 64 | 1-year, Depot | No | 03/16 |
| 20GA001EUS | US | Celeron N3160 | Intel HD | 8GBx1 | 11.6" HD (1366x768) IPS | 10-point Multi-touch | 128GB SSD | None | Intel 7265 ac, 2x2 + BT4.0 | Black | 720p | None | None | 3-cell (42Wh) | 45W | Windows 10 Pro 64 | 1-year, Depot | No | 09/16 |
| 20GA001FUS | US | Celeron N3160 | Intel HD | 4GBx1 | 11.6" HD (1366x768) IPS | 10-point Multi-touch | 128GB SSD | None | Intel 7265 ac, 2x2 + BT4.0 | Black | 720p | None | None | 3-cell (42Wh) | 45W | Windows 10 Pro 64 | 1-year, Depot | No | 09/16 |



ThinkPad Yoga 11e (4th Gen) Platform Specifications

Product Specifications Reference (PSREF)

| | | | | | | | | | | |
|------------------|--|------------|--------------|------------------------|-----------------|---------------|-------------------|-----------------------|--|---|
| Processor | Intel® Celeron® processor, or 7th Generation Intel Core™ i3 / i5 Processor | | | | | | | Media reader | 4-in-1 reader (MMC, SD, SDHC, SDXC) | |
| | Processor Number | # of Cores | # of Threads | Base Frequency | Burst Frequency | Cache | Memory Controller | Processor Graphics | Ports | Two USB 3.1 Gen 1 / USB 3.0, HDMI, Ethernet (RJ-45) |
| | Cel N3450 | 4 | 4 | 1.1 GHz | 2.2 GHz | 2MB | DDR3L-1866 | Intel HD graphics 500 | Control buttons | Power button, volume control button |
| | i3-7100U | 2 | 4 | 2.4 GHz | - | 3MB | DDR4-2133 | Intel HD graphics 620 | Camera | HD720p resolution, low light sensitive, fixed focus |
| i5-7200U | 2.5 GHz | | | 3.1 GHz | 3MB | Audio support | | | HD Audio, Realtek® ALC3268 codec / stereo speakers, 2W x 2 / monaural microphone, combo audio/microphone jack | |
| Graphics | Intel HD Graphics 500, or Intel HD Graphics 620 in processor, supports external digital monitor via HDMI™; supports dual independent display; Max resolution: 1920X1080 (HDMI) @30Hz | | | | | | | Keyboard | ThinkPad Windows keyboard, 6-row, multimedia Fn keys | |
| Chipset | Intel SoC (System on Chip) platform | | | | | | | UltraNav™ | Two buttons click pad below keyboard, multi-touch | |
| Memory | 4GB or 8GB / 1600MHz DDR3L or 2133MHz DDR4, one DDR3L or DDR4 SO-DIMM socket * System clocks down for processors with lower memory controller | | | | | | | Security | Power-on password, hard disk password, supervisor password, security keyhole | |
| Display | 11.6" (295mm) HD (1366x768), anti-glare, LED backlight, IPS 250 nits, 16:9 aspect ratio, 800:1 contrast ratio | | | | | | | Security chip | Discrete TPM 2.0, TCG Certified | |
| MultiTouch | Yes, support 10 fingers | | | | | | | vPro | None | |
| Hinge | Yoga hinge, 360 degree | | | | | | | Fingerprint reader | None | |
| Convertible mode | Laptop, tent, stand and tablet | | | | | | | Battery | Integrated Lithium Polymer 3-cell (42Wh) | |
| Pen | Some: Active pen, batteries required | | | | | | | Max battery life | MobileMark® 2014: 11 hr | |
| Storage | M.2 Solid State Drive (SSD), SATA 6.0Gb/s | | | | | | | AC adapter | 45-watt AC adapter | |
| Optical | None | | | | | | | Preload | Some: Windows 10 Home 64 Some: Windows 10 Pro 64 • Lenovo Connect • Lenovo Companion • Lenovo Setting • Microsoft Office preloaded; purchase a product key to activate | |
| Ethernet | Realtek RTL8111GUS-CG Gigabit Network Connection | | | | | | | Limited warranty | One of the following, configurable by model: • 1-year depot repair service • 3-year depot repair service | |
| WLAN | One of the following, configurable by model: • 11ac+BT, QCA NFA435, 1x1, M.2 card • 11ac+BT, Intel Dual Band Wireless-AC 7265, 2x2, M.2 card | | | | | | | Mil-Spec test | MIL-STD-810G military certification | |
| Bluetooth™ | Bluetooth 4.1 wireless, integrated in Wi-Fi + Bluetooth combo adapter *Intel 7265ac card supports Bluetooth 4.2 but is limited to BT 4.1 by Windows OS | | | | | | | Environment | EPEAT™ Gold; ENERGY STAR® 6.1; RoHS-compliant | |
| WWAN | None | | | | | | | | | |
| Dimensions | WxDxH: 11.81" x 8.27" x 0.90"; 300mm x 210mm x 22.9mm | | | | | | | | | |
| Weight | from 3.5 lb (1.59kg) | | | | | | | | | |
| Case color | Display cover: Graphite Black; | | | Bottom: Graphite Black | | | | | | |
| Case material | Display cover: PC+40%GF+TPU; | | | Bottom: PC+ABS | | | | | | |

ThinkPad Yoga 11e (4th Gen) - TopSeller - 20HU

Product Specifications Reference (PSREF)

| Model | Product | Region | Processor | Graphics | Memory | Display | Multi-touch | Color | Storage | Optical | WLAN + Bluetooth | Camera | Pen | Fingerprint Reader | Battery | Power Adapter | Operating System | Warranty | Global | Ann Date (mm/yy) |
|------------|-----------------------------|--------|---------------|--------------|--------|-------------------------|----------------------|-------|-----------------|---------|----------------------------|--------|------|--------------------|---------------|---------------|-------------------|---------------|--------|------------------|
| 20HU0000US | ThinkPad Yoga 11e (4th Gen) | US | i3-7100U | Intel HD 620 | 8GBx1 | 11.6" HD (1366x768) IPS | 10-point Multi-touch | Black | 128GB SSD | None | Intel 7265 ac, 2x2 + BT4.1 | 720p | None | None | 3-cell (42Wh) | 45W | Windows 10 Pro 64 | 1-year, Depot | No | 03/17 |
| 20HU0001US | ThinkPad Yoga 11e (4th Gen) | US | i3-7100U | Intel HD 620 | 8GBx1 | 11.6" HD (1366x768) IPS | 10-point Multi-touch | Black | 256GB SSD Opal2 | None | Intel 7265 ac, 2x2 + BT4.1 | 720p | None | None | 3-cell (42Wh) | 45W | Windows 10 Pro 64 | 1-year, Depot | No | 03/17 |
| 20HU0003US | ThinkPad Yoga 11e (4th Gen) | US | Celeron N3450 | Intel HD 500 | 4GBx1 | 11.6" HD (1366x768) IPS | 10-point Multi-touch | Black | 128GB SSD | None | Intel 7265 ac, 2x2 + BT4.1 | 720p | None | None | 3-cell (42Wh) | 45W | Windows 10 Pro 64 | 1-year, Depot | No | 03/17 |
| 20HU0004US | ThinkPad Yoga 11e (4th Gen) | US | Celeron N3450 | Intel HD 500 | 8GBx1 | 11.6" HD (1366x768) IPS | 10-point Multi-touch | Black | 128GB SSD | None | Intel 7265 ac, 2x2 + BT4.1 | 720p | None | None | 3-cell (42Wh) | 45W | Windows 10 Pro 64 | 1-year, Depot | No | 03/17 |



ThinkPad Yoga 11e Chromebook (3rd Gen) Platform Specifications

Product Specifications Reference (PSREF)

| | | | | | | | | | | |
|-------------------|--|------------|--------------|----------------|-----------------|-------|--------------|---|--|--------------------|
| Processor | Intel® Celeron® processor | | | | | | | Dimensions ³ Weight ² Case color Case material | WxDxH: 11.81" x 8.27" x 0.88"; 300mm x 210mm x 22.3mm from 3.3 lb (1.50kg) Display cover: Graphite Black or Silver; Bottom: Graphite Black Display cover: PC+40%GF+TPU; Bottom: PCC | |
| | Processor Number | # of Cores | # of Threads | Base Frequency | Burst Frequency | Cache | Memory Types | | | Processor Graphics |
| | Cel N3150 | 4 | 4 | 1.6 GHz | 2.08 GHz | 2MB | LPDDR3-1600 | | | Intel HD graphics |
| | Cel N3160 | 4 | 4 | 1.6 GHz | 2.24 GHz | 2MB | LPDDR3-1600 | Intel HD graphics | | |
| Graphics | Intel HD Graphics in processor, supports external digital monitor via HDMI™; supports dual independent display; Max resolution: 1920X1080 (HDMI) @30Hz | | | | | | | Media reader | 4-in-1 reader (MMC, SD, SDHC, SDXC) | |
| | | | | | | | | Ports | Two USB 3.0 (one Always On), HDMI | |
| | | | | | | | | Control buttons | Power button, volume control button | |
| | | | | | | | | Camera | HD720p resolution, low light sensitive, fixed focus | |
| | | | | | | | | Audio support | Realtek® ALC5650 codec / stereo speakers, 2W x 2 / monaural digital microphone, combo audio/microphone jack | |
| Chipset | Intel SoC (System on Chip) platform | | | | | | | Keyboard | ThinkPad Chrome keyboard, 6-row, multimedia Fn keys | |
| Memory | 2GB or 4GB / 1600MHz LPDDR3 / soldered to systemboard, no sockets | | | | | | | UltraNav™ | Buttonless touchpad below keyboard, multi-touch | |
| Display | 11.6" (295mm) HD (1366x768), glare, LED backlight, IPS 200 nits, 16:9 aspect ratio, 800:1 contrast ratio | | | | | | | Security | Security keyhole | |
| MultiTouch | Yes, support 10 fingers | | | | | | | Security chip | Trusted Platform Module, TCG 1.2-compliant | |
| Hinge | Yoga hinge, 360 degree | | | | | | | vPro | None | |
| Convertible mode | Laptop, tent, stand and tablet | | | | | | | Fingerprint reader | None | |
| Pen | None | | | | | | | Battery | Integrated Lithium Polymer 3-cell (42Wh) | |
| Storage | 16GB eMMC (embedded Multi Media Card) flash memory on board | | | | | | | Max battery life ¹⁰ | Up to 12 hr | |
| Optical | None | | | | | | | AC adapter | 45-watt AC adapter | |
| Ethernet | None | | | | | | | Preload | Google Chrome OS | |
| WLAN ⁴ | 11ac+BT, Intel Dual Band Wireless-AC 7265, 2x2, M.2 card | | | | | | | Limited warranty ¹² | 1-year depot repair service | |
| Bluetooth™ | Bluetooth 4.0 wireless, integrated in Wi-Fi + Bluetooth combo adapter | | | | | | | Mil-Spec test | MIL-STD-810G military certification | |
| WWAN | None | | | | | | | Environment | EPEAT™ Gold (US only); ENERGY STAR® 6.1; RoHS-compliant | |

ThinkPad Yoga 11e Chromebook (3rd Gen) - TopSeller - 20GE

Product Specifications Reference (PSREF)

| Model | Region | Processor | Graphics | Memory | Display | Multi-touch | Storage | Optical | WLAN + Bluetooth | Color | Camera | Pen | Finger-print Reader | Battery | Power Adapter | Operating System | Warranty | Global | Ann Date (m/y) |
|------------|--------|---------------|----------|--------|-------------------------|----------------------|-----------|---------|----------------------------|-------|--------|------|---------------------|---------------|---------------|------------------|---------------|--------|----------------|
| 20GE0002US | US | Celeron N3150 | Intel HD | 4GBx1 | 11.6" HD (1366x768) IPS | 10-point Multi-touch | 16GB eMMC | None | Intel 7265 ac, 2x2 + BT4.0 | Black | 720p | None | None | 3-cell (42Wh) | 45W | Chrome OS | 1-year, Depot | No | 03/16 |
| 20GE0003US | US | Celeron N3160 | Intel HD | 4GBx1 | 11.6" HD (1366x768) IPS | 10-point Multi-touch | 16GB eMMC | None | Intel 7265 ac, 2x2 + BT4.0 | Black | 720p | None | None | 3-cell (42Wh) | 45W | Chrome OS | 1-year, Depot | No | 10/16 |

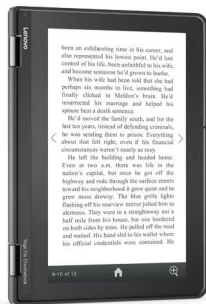

ThinkPad Yoga 11e Chromebook (4th Gen) Platform Specifications

Product Specifications Reference (PSREF)

| | | | | | | | | | | |
|------------------|---|------------|--------------|----------------|------------------------|-------|-------------------|-----------------------|--------------------|---|
| Processor | Intel® Celeron® processor | | | | | | | | Media reader | 3-in-1 reader (SD, SDHC, SDXC) |
| | Processor Number | # of Cores | # of Threads | Base Frequency | Burst Frequency | Cache | Memory Controller | Processor Graphics | Ports | Two USB 3.1 Type-C Gen 1, one USB 3.1 Gen 1 / USB 3.0 |
| | Cel N3450 | 4 | 4 | 1.1 GHz | 2.2 GHz | 2MB | LPDDR4-2400 | Intel HD graphics 500 | Control buttons | Power button, volume control button |
| Graphics | Intel HD Graphics 500 in processor | | | | | | | | Camera | HD720p resolution, low light sensitive, fixed focus |
| Chipset | Intel SoC (System on Chip) platform | | | | | | | | Audio support | HD Audio, DA7219 codec / stereo speakers, 2W x 2 / monaural microphone, combo audio/microphone jack |
| Memory | 4GB or 8GB 3200MHz LPDDR4 / soldered to systemboard, no sockets * System clocks down for processors with lower memory controller | | | | | | | | Keyboard | ThinkPad Chrome keyboard, 6-row, multimedia Fn keys |
| Display | 11.6" (295mm) HD (1366x768), anti-glare, LED backlight, IPS 250 nits, 16:9 aspect ratio, 800:1 contrast ratio | | | | | | | | UltraNav™ | Two buttons click pad below keyboard, multi-touch |
| MultiTouch | Yes, support 10 fingers | | | | | | | | Security | Power-on password, hard disk password, supervisor password, security keyhole |
| Hinge | Yoga hinge, 360 degree | | | | | | | | Security chip | None |
| Convertible mode | Laptop, tent, stand and tablet | | | | | | | | vPro | None |
| Pen | Some: Active pen, batteries required | | | | | | | | Fingerprint reader | None |
| Storage | 32GB eMMC (embedded Multi Media Card) flash memory on board | | | | | | | | Battery | Integrated Lithium Polymer 3-cell (42Wh) |
| Optical | None | | | | | | | | Max battery life | Up to 10 hr |
| Ethernet | None | | | | | | | | AC adapter | 45-watt USB Type-C adapter |
| WLAN | 11ac+BT, Intel Dual Band Wireless-AC 7265, 2x2, M.2 card | | | | | | | | Preload | Google Chrome OS |
| Bluetooth™ | Bluetooth 4.2 wireless, integrated in Wi-Fi + Bluetooth combo adapter | | | | | | | | Limited warranty | • 1-year depot repair service |
| WWAN | None | | | | | | | | Mil-Spec test | MIL-STD-810G military certification |
| Dimensions | WxDxH: 11.81" x 8.27" x 0.92"; 300mm x 210mm x 23.4mm | | | | | | | | Environment | EPEAT™ Gold; ENERGY STAR® 6.1; RoHS-compliant |
| Weight | from 3.5 lb (1.59kg) | | | | | | | | | |
| Case color | Display cover: Graphite Black; | | | | Bottom: Graphite Black | | | | | |
| Case material | Display cover: PC+40%GF+TPU; | | | | Bottom: PC+ABS | | | | | |

Lenovo
July 2017

ThinkPad Yoga 11e Chromebook (4th Gen) - TopSeller - 20HY

Product Specifications Reference (PSREF)

| Model | Region | Processor | Graphics | Memory | Display | Multi-touch | Color | Storage | Optical | WLAN + Bluetooth | Camera | Pen | Finger-print Reader | Battery | Power Adapter | Operating System | Warranty | Global | Ann Date (m/y) |
|------------|--------|---------------|--------------|--------------|-------------------------|----------------------|-------|-----------|---------|----------------------------|--------|------|---------------------|---------------|---------------|------------------|---------------|--------|----------------|
| 20HY0000US | US | Celeron N3450 | Intel HD 500 | 4GB Soldered | 11.6" HD (1366x768) IPS | 10-point Multi-touch | Black | 32GB eMMC | None | Intel 7265 ac, 2x2 + BT4.2 | 720p | None | None | 3-cell (42Wh) | 45W | Chrome OS | 1-year, Depot | No | 04/17 |



ThinkPad Yoga 370 Platform Specifications

Product Specifications Reference (PSREF)

| | | | | | | | | | | |
|-----------------|--|------------|--------------|----------------|---------------------|-------|--------------|-----------------------|--------------------------|--|
| Processor | 7th Generation Intel® Core™ i3 / i5 / i7 Processor | | | | | | | | Smart Card Reader | Some: Smart Card Reader |
| | Processor Number | # of Cores | # of Threads | Base Frequency | Max Turbo Frequency | Cache | Memory Types | Processor Graphics | ExpressCard | None |
| | i3-7100U | 2 | 4 | 2.4 GHz | - | 3MB | DDR4-2133 | Intel HD Graphics 620 | Media reader | Micro SD, supports UHS-I SD card |
| | i5-7200U | | | 2.5 GHz | 3.1 GHz | 3MB | | | Ports | Two USB 3.1 Gen 1 / USB 3.0 (one Always On), HDMI, Mini RJ45, one USB 3.1 Type-C Gen 2 / Thunderbolt 3 |
| | i5-7300U | | | 2.6 GHz | 3.5 GHz | 3MB | | | WiGig dock | Optional: ThinkPad WiGig dock |
| | i7-7500U | | | 2.7 GHz | 3.5 GHz | 4MB | | | Adapter (optional) | ThinkPad Ethernet Extension Cable |
| | i7-7600U | | | 2.8 GHz | 3.9 GHz | 4MB | | | Monitor Cable (optional) | USB-C-VGA: USB-C to VGA adapter USB-C-DP: USB-C to DisplayPort adapter HDMI-VGA: Lenovo HDMI to VGA Monitor Cable |
| Graphics | Intel HD Graphics 620 in processor only, supports external digital monitor via HDMI; supports dual independent display Max resolution: 4096x2160 (HDMI)@24Hz | | | | | | | | Camera | HD720p resolution, fixed focus |
| Chipset | Intel SoC (System on Chip) platform | | | | | | | | Audio support | HD Audio, Conexant® CX11771 codec, Dolby® DAXII / stereo speakers, 2W x 2 / dual array microphone, combo audio / microphone jack |
| Memory | 16GB max / 2133MHz DDR4, one DDR4 SO-DIMM socket (None WWAN models), or 8GB 2133MHz DDR4 soldered to systemboard for WWAN models | | | | | | | | Keyboard | 6-row, LED backlit, spill-resistant, multimedia Fn keys |
| Display | 13.3" (337.8mm) FHD (1920x1080) color, glossy, LED backlight, IPS 300 nits, 16:9 aspect ratio, IPS | | | | | | | | UltraNav™ | TrackPoint® pointing device and multi-touch with 3+2 buttons click pad |
| Multi-touch | Supports 10-finger gesture | | | | | | | | Keyboard color | Black or silver |
| Hinge | Yoga hinge, 360 degree | | | | | | | | Security | Power-on password, hard disk password, supervisor password, security keyhole |
| Convert-mode | Laptop, tent, stand, yoga and tablet | | | | | | | | Security chip | Discrete TPM 2.0 TCG Certified |
| Pen | Some: ThinkPad Pen Pro, active pen for multi-touch display, on-Board charging | | | | | | | | vPro | Some: Intel vPro Technology |
| Storage | Some: M.2 SSD / SATA 6.0Gb/s Some: M.2 SSD / PCIe NVMe 32Gb/s | | | | | | | | Fingerprint reader | Some: Touch style fingerprint reader on the keyboard bezel Some: Near Field Communication |
| Optical | None | | | | | | | | NFC | |
| Ethernet | Native Intel Ethernet Connection I219-V (Non-vPro) or I219-LM (vPro) via optional ThinkPad Ethernet Extension Cable | | | | | | | | Battery type | Li-Polymer 4-cell (51Wh) |
| WLAN | One of the following, configurable by model (WiGig is mutually exclusive with WWAN): • Intel Dual Band Wireless-AC 8265, Wi-Fi 2x2, 802.11ac + BT4.1, M.2 Card • Intel Tri-Band Wireless-AC 18265, WiGig™ 802.11ad + Wi-Fi 2x2, 802.11ac + BT4.1, M.2 Card <i>*WiGig adapter is only available in selected countries*</i> | | | | | | | | Battery life | Up to 12.5 hr |
| Bluetooth™ | Bluetooth wireless, integrated in Wi-Fi + Bluetooth combo adapter <i>*Intel Wi-Fi card supports Bluetooth 4.2 but is limited to BT 4.1 by Windows OS</i> | | | | | | | | AC adapter | Some: 45-watt AC adapter Some: 65-watt AC adapter Some: 65-watt USB Type-C adapter |
| WWAN (optional) | Wireless WAN, Sierra Wireless EM7455, Qualcomm® 4G LTE-Advanced/DC-HSPA+/HSPA+/HSPA/UMTS/GNSS, M.2 card <i>*WWAN models are only available with i5, i7 processors, WWAN models is not available in North America*</i> | | | | | | | | Light sensor | Ambient Light Sensor |
| SIM card | Micro-SIM card slot, optional Lenovo Connect (WE) SIM card | | | | | | | | G-sensor/ eCompass | 3D accelerometer and 3D magnetometer 3D compass |
| Dimensions | 13.3" (WxDxH): 12.30" x 8.75" x 0.70" (313.5mm x 222.2mm x 18.2mm) | | | | | | | | Gyroscope | 3D gyrometer |
| Weight | From 3.03 lb (1.37kg) | | | | | | | | Preload | Some: Windows 10 Pro 64 Some: Windows 10 Home 64 • Lenovo Connect • Lenovo Companion • Lenovo Setting • Microsoft Office preloaded; purchase a product key to activate |
| Case color | Midnight black or silver | | | | | | | | Limited warranty | 1-year - depot repair service / service upgrades available 3-year - depot repair service / service upgrades available 3-year - onsite repair service / service upgrades available |
| Case Material | Carbon-Fiber Hybrid | | | | | | | | Mil-Spec test | MIL-STD-810G military certification |
| | | | | | | | | | Environment | EPEAT™ Gold; ENERGY STAR®; RoHS-compliant |

| Model | Region | Processor | vPro | Graphics | Memory | Display | Case Material | Storage(HDD/SSD) | WLAN + Bluetooth | WWAN | SIM Card | Smart Card Reader | Dock | Monitor Cable | Adapter | Color | Pen | Fingerprint Reader | NFC | TPM | Power Adapter | Operating System | Warranty | Global | End of Support | Ann Date (mm/yy) |
|------------|--------|-----------|------|--------------|--------|---------------------------|---------------|-------------------------------|----------------------------|------|----------|-------------------|------|---------------|---------|--------|---------|--------------------|------|----------|---------------|------------------|---------------|--------|----------------|------------------|
| 20JH001VUS | US | i5-7300U | vPro | Intel HD 620 | 16GBx1 | 13.3" FHD (1920x1080) IPS | Carbon | 512GB SSD M.2 PCIe NVMe Opal2 | Intel 8265 ac, 2x2 + BT4.1 | None | None | None | None | None | None | Silver | Pen Pro | Fingerprint Reader | None | dTPM 2.0 | 45W | Win10 Pro 64 | 1-year, Depot | No | Apr 14, 2023 | 03/17 |
| 20JH001WUS | US | i5-7200U | No | Intel HD 620 | 8GBx1 | 13.3" FHD (1920x1080) IPS | Carbon | 256GB SSD M.2 PCIe NVMe Opal2 | Intel 8265 ac, 2x2 + BT4.1 | None | None | None | None | None | None | Silver | Pen Pro | Fingerprint Reader | None | dTPM 2.0 | 45W | Win10 Pro 64 | 1-year, Depot | No | Apr 14, 2023 | 03/17 |
| 20JH001XUS | US | i5-7300U | vPro | Intel HD 620 | 8GBx1 | 13.3" FHD (1920x1080) IPS | Carbon | 256GB SSD M.2 PCIe NVMe Opal2 | Intel 8265 ac, 2x2 + BT4.1 | None | None | None | None | None | None | Silver | Pen Pro | Fingerprint Reader | None | dTPM 2.0 | 45W | Win10 Pro 64 | 1-year, Depot | No | Apr 14, 2023 | 03/17 |
| 20JH001YUS | US | i7-7600U | vPro | Intel HD 620 | 16GBx1 | 13.3" FHD (1920x1080) IPS | Carbon | 512GB SSD M.2 PCIe NVMe Opal2 | Intel 8265 ac, 2x2 + BT4.1 | None | None | None | None | None | None | Silver | Pen Pro | Fingerprint Reader | None | dTPM 2.0 | 45W | Win10 Pro 64 | 1-year, Depot | No | Apr 14, 2023 | 03/17 |
| 20JH0020US | US | i7-7500U | No | Intel HD 620 | 8GBx1 | 13.3" FHD (1920x1080) IPS | Carbon | 256GB SSD M.2 PCIe NVMe Opal2 | Intel 8265 ac, 2x2 + BT4.1 | None | None | None | None | None | None | Silver | Pen Pro | Fingerprint Reader | None | dTPM 2.0 | 45W | Win10 Pro 64 | 1-year, Depot | No | Apr 14, 2023 | 03/17 |
| 20JH0021US | US | i7-7500U | No | Intel HD 620 | 16GBx1 | 13.3" FHD (1920x1080) IPS | Carbon | 512GB SSD M.2 PCIe NVMe Opal2 | Intel 8265 ac, 2x2 + BT4.1 | None | None | None | None | None | None | Silver | Pen Pro | Fingerprint Reader | None | dTPM 2.0 | 45W | Win10 Pro 64 | 1-year, Depot | No | Apr 14, 2023 | 03/17 |
| 20JH0022US | US | i7-7600U | vPro | Intel HD 620 | 8GBx1 | 13.3" FHD (1920x1080) IPS | Carbon | 256GB SSD M.2 PCIe NVMe Opal2 | Intel 8265 ac, 2x2 + BT4.1 | None | None | None | None | None | None | Silver | Pen Pro | Fingerprint Reader | None | dTPM 2.0 | 45W | Win10 Pro 64 | 1-year, Depot | No | Apr 14, 2023 | 03/17 |
| 20JH0023US | US | i5-7200U | No | Intel HD 620 | 4GBx1 | 13.3" FHD (1920x1080) IPS | Carbon | 128GB SSD M.2 SATA3 | Intel 8265 ac, 2x2 + BT4.1 | None | None | None | None | None | None | Silver | Pen Pro | Fingerprint Reader | None | dTPM 2.0 | 45W | Win10 Pro 64 | 1-year, Depot | No | Apr 14, 2023 | 03/17 |
| 20JH0024US | US | i5-7200U | No | Intel HD 620 | 8GBx1 | 13.3" FHD (1920x1080) IPS | Carbon | 256GB SSD M.2 PCIe NVMe Opal2 | Intel 8265 ac, 2x2 + BT4.1 | None | None | None | None | None | None | Black | Pen Pro | Fingerprint Reader | None | dTPM 2.0 | 45W | Win10 Pro 64 | 1-year, Depot | No | Apr 14, 2023 | 03/17 |
| 20JH0025US | US | i5-7200U | No | Intel HD 620 | 4GBx1 | 13.3" FHD (1920x1080) IPS | Carbon | 128GB SSD M.2 SATA3 | Intel 8265 ac, 2x2 + BT4.1 | None | None | None | None | None | None | Black | Pen Pro | Fingerprint Reader | None | dTPM 2.0 | 45W | Win10 Pro 64 | 1-year, Depot | No | Apr 14, 2023 | 03/17 |
| 20JH0026US | US | i5-7200U | No | Intel HD 620 | 8GBx1 | 13.3" FHD (1920x1080) IPS | Carbon | 512GB SSD M.2 PCIe NVMe Opal2 | Intel 8265 ac, 2x2 + BT4.1 | None | None | None | None | None | None | Black | Pen Pro | Fingerprint Reader | None | dTPM 2.0 | 45W | Win10 Pro 64 | 1-year, Depot | No | Apr 14, 2023 | 03/17 |
| 20JH0027US | US | i7-7500U | No | Intel HD 620 | 16GBx1 | 13.3" FHD (1920x1080) IPS | Carbon | 512GB SSD M.2 PCIe NVMe Opal2 | Intel 8265 ac, 2x2 + BT4.1 | None | None | None | None | None | None | Black | Pen Pro | Fingerprint Reader | None | dTPM 2.0 | 45W | Win10 Pro 64 | 1-year, Depot | No | Apr 14, 2023 | 03/17 |
| 20JH0028US | US | i7-7500U | No | Intel HD 620 | 16GBx1 | 13.3" FHD (1920x1080) IPS | Carbon | 256GB SSD M.2 PCIe NVMe Opal2 | Intel 8265 ac, 2x2 + BT4.1 | None | None | None | None | None | None | Black | Pen Pro | Fingerprint Reader | None | dTPM 2.0 | 45W | Win10 Pro 64 | 1-year, Depot | No | Apr 14, 2023 | 03/17 |
| 20JH0029US | US | i7-7600U | vPro | Intel HD 620 | 16GBx1 | 13.3" FHD (1920x1080) IPS | Carbon | 512GB SSD M.2 PCIe NVMe Opal2 | Intel 8265 ac, 2x2 + BT4.1 | None | None | None | None | None | None | Black | Pen Pro | Fingerprint Reader | None | dTPM 2.0 | 45W | Win10 Pro 64 | 1-year, Depot | No | Apr 14, 2023 | 03/17 |
| 20JH002AUS | US | i5-7300U | vPro | Intel HD 620 | 8GBx1 | 13.3" FHD (1920x1080) IPS | Carbon | 256GB SSD M.2 PCIe NVMe Opal2 | Intel 8265 ac, 2x2 + BT4.1 | None | None | None | None | None | None | Black | Pen Pro | Fingerprint Reader | None | dTPM 2.0 | 45W | Win10 Pro 64 | 1-year, Depot | No | Apr 14, 2023 | 03/17 |
| 20JH002BUS | US | i5-7300U | vPro | Intel HD 620 | 16GBx1 | 13.3" FHD (1920x1080) IPS | Carbon | 512GB SSD M.2 PCIe NVMe Opal2 | Intel 8265 ac, 2x2 + BT4.1 | None | None | None | None | None | None | Black | Pen Pro | Fingerprint Reader | None | dTPM 2.0 | 45W | Win10 Pro 64 | 1-year, Depot | No | Apr 14, 2023 | 03/17 |
| 20JH002CUS | US | i5-7200U | No | Intel HD 620 | 4GBx1 | 13.3" FHD (1920x1080) IPS | Carbon | 256GB SSD M.2 PCIe NVMe Opal2 | Intel 8265 ac, 2x2 + BT4.1 | None | None | None | None | None | None | Black | Pen Pro | Fingerprint Reader | None | dTPM 2.0 | 45W | Win10 Pro 64 | 1-year, Depot | No | Apr 14, 2023 | 03/17 |
| 20JH002DUS | US | i7-7600U | vPro | Intel HD 620 | 8GBx1 | 13.3" FHD (1920x1080) IPS | Carbon | 256GB SSD M.2 PCIe NVMe Opal2 | Intel 8265 ac, 2x2 + BT4.1 | None | None | None | None | None | None | Black | Pen Pro | Fingerprint Reader | None | dTPM 2.0 | 45W | Win10 Pro 64 | 1-year, Depot | No | Apr 14, 2023 | 03/17 |
| 20JH002FUS | US | i7-7500U | No | Intel HD 620 | 8GBx1 | 13.3" FHD (1920x1080) IPS | Carbon | 256GB SSD M.2 PCIe NVMe Opal2 | Intel 8265 ac, 2x2 + BT4.1 | None | None | None | None | None | None | Black | Pen Pro | Fingerprint Reader | None | dTPM 2.0 | 45W | Win10 Pro 64 | 1-year, Depot | No | Apr 14, 2023 | 03/17 |
| 20JH002GUS | US | i5-7300U | vPro | Intel HD 620 | 8GBx1 | 13.3" FHD (1920x1080) IPS | Carbon | 512GB SSD M.2 PCIe NVMe Opal2 | Intel 8265 ac, 2x2 + BT4.1 | None | None | None | None | None | None | Black | Pen Pro | Fingerprint Reader | None | dTPM 2.0 | 45W | Win10 Pro 64 | 1-year, Depot | No | Apr 14, 2023 | 03/17 |

| Model | Region | Processor | vPro | Graphics | Memory | Display | Case Material | Storage(HDD/SSD) | WLAN + Bluetooth | WWAN | SIM Card | Smart Card Reader | Dock | Monitor Cable | Adapter | Color | Pen | Fingerprint Reader | NFC | TPM | Power Adapter | Operating System | Warranty | Global | End of Support | Ann Date (mm/yy) |
|------------|--------|-----------|------|--------------|--------|---------------------------|---------------|-------------------------------|----------------------------|------|----------|-------------------|------|---------------|---------|--------|---------|--------------------|------|----------|---------------|------------------|---------------|--------|----------------|------------------|
| 20JH002JUS | US | i7-7600U | vPro | Intel HD 620 | 8GBx1 | 13.3" FHD (1920x1080) IPS | Carbon | 512GB SSD M.2 PCIe NVMe Opal2 | Intel 8265 ac, 2x2 + BT4.1 | None | None | None | None | None | None | Black | Pen Pro | Fingerprint Reader | None | dTPM 2.0 | 45W | Win10 Pro 64 | 1-year, Depot | No | Apr 14, 2023 | 03/17 |
| 20JH002WUS | US | i5-7200U | No | Intel HD 620 | 8GBx1 | 13.3" FHD (1920x1080) IPS | Carbon | 180GB SSD M.2 SATA3 Opal2 | Intel 8265 ac, 2x2 + BT4.1 | None | None | None | None | None | None | Black | Pen Pro | Fingerprint Reader | None | dTPM 2.0 | 45W | Win10 Pro 64 | 3-year, Depot | No | Mar 14, 2022 | 03/17 |
| 20JH002XUS | US | i5-7200U | No | Intel HD 620 | 8GBx1 | 13.3" FHD (1920x1080) IPS | Carbon | 180GB SSD M.2 SATA3 Opal2 | Intel 8265 ac, 2x2 + BT4.1 | None | None | None | None | None | None | Silver | Pen Pro | Fingerprint Reader | None | dTPM 2.0 | 45W | Win10 Pro 64 | 3-year, Depot | No | Mar 14, 2022 | 03/17 |

This publication was developed for products and services offered in the United States and E.M.E.A countries. Lenovo may not offer the products, services or features discussed in this document in other countries. Lenovo may withdraw an offering at any time. Information is subject to change without notice. Consult your local representative for information on offerings available in your area.

Lenovo reserves the right to change specifications or other product information without notice. Lenovo is not responsible for photographic or typographical errors.

LENOVO PROVIDES THIS PUBLICATION "AS IS," WITHOUT WARRANTY OF ANY KIND, EITHER EXPRESS OR IMPLIED, INCLUDING THE IMPLIED WARRANTIES OF MERCHANTABILITY OR FITNESS FOR A PARTICULAR PURPOSE.

Some jurisdictions do not allow disclaimer of express or implied warranties in certain transactions, therefore this disclaimer may not apply to you.

Availability: All offers subject to availability. Lenovo reserves the right to alter product offerings and specifications at any time, without notice. Lenovo is not responsible for photographic or typographic errors.

General: Review key information provided by Microsoft that may apply to your system purchase, including details on Windows 10, Windows 8, Windows 7, and potential upgrades/downgrades. Lenovo makes no representation or warranty regarding third-party products or services.

Trademarks: Lenovo, ThinkPad, ThinkCentre, ThinkStation and the Lenovo logo are trademarks of Lenovo. Microsoft, Windows, Windows NT, and the Windows logo are trademarks of Microsoft Corporation. Ultrabook, Celeron, Celeron Inside, Core Inside, Intel, Intel Logo, Intel Atom, Intel Atom Inside, Intel Core, Intel Inside, Intel Inside Logo, Intel vPro, Itanium, Itanium Inside, Pentium, Pentium Inside, vPro Inside, Xeon, Xeon Phi, and Xeon Inside are trademarks of Intel Corporation in the U.S. and/or other countries. Other company, product or service names may be trademarks or service marks of others.

Warranty: For a copy of applicable warranties, write to: Lenovo Warranty Information, 1009 Think Place, Morrisville, NC, 27560. Lenovo makes no representation or warranty regarding third party products or services. The Lenovo Limited Warranty applies only to Lenovo hardware products purchased for your own use, and does not transfer upon resale.

Limited warranty: Support unrelated to a warranty issue may be subject to additional charges.

Lenovo Services:

Carry-in or Mail-in Service: Parts and labor repair coverage where the customer is responsible for shipping (including packaging) or delivery to authorized warranty provider or repair center.

Depot or Courier Service: Parts and labor repair coverage where shipping (including packaging) or delivery to the repair center is paid for by Lenovo.

Expedited Depot: Parts and labor coverage with expedited turnaround. Shipping (including packaging) or delivery to the repair center is paid for by Lenovo.

Onsite / In-home Service: Parts and labor repair coverage where labor is provided onsite at your place of business.

If Lenovo determines your product problem is covered by the product warranty and cannot be resolved over the telephone, a technician will be dispatched to arrive onsite, typically the next day.

International Warranty Service (IWS): PC repair coverage for customers who require a critical warranty repair while travelling internationally. Visit www.lenovo.com/internationalwarranty for details. Visit www.lenovo.com/warranty for Lenovo Warranty Services terms and conditions for complete details and restrictions.

Included software: may differ from its retail version (if available), and may not include user manuals or all program functionality. Software license agreements may apply.

Battery life: Battery life (and recharge times) will vary based on many factors including screen brightness, applications, features, power management, battery conditioning, and other customer preferences.

Visit <http://psref.lenovo.com/> for the latest version of Product Specifications Reference.

© Lenovo, 2017. All rights reserved.
Lenovo 1009 Think Place Morrisville, NC 27560 U.S.A.

Lenovo™ **ThinkCentre**®

PSREF



Product Specifications Reference

Version 509, July 2017

U.S.

Visit <http://psref.lenovo.com> for the latest version

Contents

| | | | |
|---|----|--|-----------|
| Cover | 1 | ThinkCentre M600 Tiny - TopSeller - 10G9 - 2 of 2 | 36 |
| Contents | 2 | ThinkCentre M600 Tiny - TopSeller - 10GB | 37 |
| Summary Of Change | 5 | ThinkCentre M600 Tiny - TopSeller - 10KH - 1 of 2 | 38 |
| M Series AIO | 6 | ThinkCentre M600 Tiny - TopSeller - 10KH - 2 of 2 | 39 |
| ThinkCentre M700z AIO | 6 | ThinkCentre M600 Tiny - 10G8 | 40 |
| ThinkCentre M700z AIO Platform Specifications | 7 | ThinkCentre M600 Tiny - 10GA | 41 |
| ThinkCentre M700z AIO - TopSeller - 10EY - 1 of 2 | 8 | ThinkCentre M600 Tiny - 10GC | 42 |
| ThinkCentre M700z AIO - TopSeller - 10EY - 2 of 2 | 9 | ThinkCentre M600 Tiny - 10GE | 43 |
| ThinkCentre M700z AIO - 10F1 | 10 | ThinkCentre M700 SFF | 44 |
| ThinkCentre M800z AIO | 11 | ThinkCentre M700 SFF Platform Specifications | 45 |
| ThinkCentre M800z AIO Platform Specifications | 12 | ThinkCentre M700 SFF - TopSeller - 10GT - 1 of 3 | 46 |
| ThinkCentre M800z AIO - TopSeller - 10ET - 1 of 2 | 13 | ThinkCentre M700 SFF - TopSeller - 10GT - 2 of 3 | 47 |
| ThinkCentre M800z AIO - TopSeller - 10ET - 2 of 2 | 14 | ThinkCentre M700 SFF - TopSeller - 10GT - 3 of 3 | 48 |
| ThinkCentre M800z AIO - TopSeller - 10EU - 1 of 2 | 15 | ThinkCentre M700 Tiny | 49 |
| ThinkCentre M800z AIO - TopSeller - 10EU - 2 of 2 | 16 | ThinkCentre M700 Tiny Platform Specifications | 50 |
| ThinkCentre M800z AIO - 10EW | 17 | ThinkCentre M700 Tiny - TopSeller - 10HY - 1 of 4 | 51 |
| ThinkCentre M810z AIO | 18 | ThinkCentre M700 Tiny - TopSeller - 10HY - 2 of 4 | 52 |
| ThinkCentre M810z AIO Platform Specifications | 19 | ThinkCentre M700 Tiny - TopSeller - 10HY - 3 of 4 | 53 |
| ThinkCentre M810z AIO - TopSeller - 10NX | 20 | ThinkCentre M700 Tiny - TopSeller - 10HY - 4 of 4 | 54 |
| ThinkCentre M810z AIO - TopSeller - 10NY - 1 of 2 | 21 | ThinkCentre M700 Tiny - TopSeller - 10JQ | 55 |
| ThinkCentre M810z AIO - TopSeller - 10NY - 2 of 2 | 22 | ThinkCentre M700 Tower | 56 |
| ThinkCentre M900z AIO | 23 | ThinkCentre M700 Tower Platform Specifications | 57 |
| ThinkCentre M900z AIO Platform Specifications | 24 | ThinkCentre M700 Tower - TopSeller - 10GR - 1 of 3 | 58 |
| ThinkCentre M900z AIO - TopSeller - 10F2 | 25 | ThinkCentre M700 Tower - TopSeller - 10GR - 2 of 3 | 59 |
| ThinkCentre M900z AIO - TopSeller - 10F3 | 26 | ThinkCentre M700 Tower - TopSeller - 10GR - 3 of 3 | 60 |
| ThinkCentre M900z AIO - 10F4 | 27 | ThinkCentre M710 SFF | 61 |
| ThinkCentre M900z AIO - 10F5 | 28 | ThinkCentre M710 SFF Platform Specifications | 62 |
| ThinkCentre M910z AIO | 29 | ThinkCentre M710 SFF - TopSeller - 10M7 - 1 of 3 | 63 |
| ThinkCentre M910z AIO Platform Specifications | 30 | ThinkCentre M710 SFF - TopSeller - 10M7 - 2 of 3 | 64 |
| ThinkCentre M910z AIO - TopSeller - 10NR | 31 | ThinkCentre M710 SFF - TopSeller - 10M7 - 3 of 3 | 65 |
| ThinkCentre M910z AIO - TopSeller - 10NS | 32 | ThinkCentre M710 Tiny | 66 |
| M Series Desktop | 33 | ThinkCentre M710 Tiny Platform Specifications | 67 |
| ThinkCentre M600 Tiny | 33 | ThinkCentre M710 Tiny - TopSeller - 10MR - 1 of 3 | 68 |
| ThinkCentre M600 Tiny Platform Specifications | 34 | ThinkCentre M710 Tiny - TopSeller - 10MR - 2 of 3 | 69 |
| ThinkCentre M600 Tiny - TopSeller - 10G9 - 1 of 2 | 35 | ThinkCentre M710 Tiny - TopSeller - 10MR - 3 of 3 | 70 |

Contents

| | | | |
|--|------------|--|------------|
| ThinkCentre M710 Tower | 71 | ThinkCentre M800 Tower - TopSeller - 10FW - 2 of 2 | 106 |
| ThinkCentre M710 Tower Platform Specifications | 72 | ThinkCentre M800 Tower - 10FV | 107 |
| ThinkCentre M710 Tower - TopSeller - 10M9 - 1 of 3 | 73 | ThinkCentre M900 SFF | 108 |
| ThinkCentre M710 Tower - TopSeller - 10M9 - 2 of 3 | 74 | ThinkCentre M900 SFF Platform Specifications | 109 |
| ThinkCentre M710 Tower - TopSeller - 10M9 - 3 of 3 | 75 | ThinkCentre M900 SFF - TopSeller - 10FH - 1 of 2 | 110 |
| ThinkCentre M715 SFF | 76 | ThinkCentre M900 SFF - TopSeller - 10FH - 2 of 2 | 111 |
| ThinkCentre M715 SFF Platform Specifications | 77 | ThinkCentre M900 SFF - 10FG | 112 |
| ThinkCentre M715 SFF - TopSeller - 10MB - 1 of 4 | 78 | ThinkCentre M900 Tiny | 113 |
| ThinkCentre M715 SFF - TopSeller - 10MB - 2 of 4 | 79 | ThinkCentre M900 Tiny Platform Specifications | 114 |
| ThinkCentre M715 SFF - TopSeller - 10MB - 3 of 4 | 80 | ThinkCentre M900 Tiny - TopSeller - 10FM - 1 of 3 | 115 |
| ThinkCentre M715 SFF - TopSeller - 10MB - 4 of 4 | 81 | ThinkCentre M900 Tiny - TopSeller - 10FM - 2 of 3 | 116 |
| ThinkCentre M715 Tiny | 82 | ThinkCentre M900 Tiny - TopSeller - 10FM - 3 of 3 | 117 |
| ThinkCentre M715 Tiny Platform Specifications | 83 | ThinkCentre M900 Tiny - TopSeller - 10NE | 118 |
| ThinkCentre M715 Tiny - TopSeller - 10M3 - 1 of 2 | 84 | ThinkCentre M900 Tiny - 10FL | 119 |
| ThinkCentre M715 Tiny - TopSeller - 10M3 - 2 of 2 | 85 | ThinkCentre M900 Tower | 120 |
| ThinkCentre M79 SFF | 86 | ThinkCentre M900 Tower Platform Specifications | 121 |
| ThinkCentre M79 SFF Platform Specifications | 87 | ThinkCentre M900 Tower - TopSeller - 10FD - 1 of 2 | 122 |
| ThinkCentre M79 SFF - TopSeller - 10CV | 88 | ThinkCentre M900 Tower - TopSeller - 10FD - 2 of 2 | 123 |
| ThinkCentre M79 SFF - TopSeller - 10JB | 89 | ThinkCentre M900 Tower - 10FC | 124 |
| ThinkCentre M79 SFF - 10CT | 90 | ThinkCentre M900x Tiny | 125 |
| ThinkCentre M79 SFF - 10CW | 91 | ThinkCentre M900x Tiny Platform Specifications | 126 |
| ThinkCentre M79 Tower | 92 | ThinkCentre M900x Tiny - TopSeller - 10LX | 127 |
| ThinkCentre M79 Tower Platform Specifications | 93 | ThinkCentre M910 SFF | 128 |
| ThinkCentre M79 Tower - TopSeller - 10CN | 94 | ThinkCentre M910 SFF Platform Specifications | 129 |
| ThinkCentre M79 Tower - TopSeller - 10J7 | 95 | ThinkCentre M910 SFF - TopSeller - 10MK - 1 of 2 | 130 |
| ThinkCentre M79 Tower - 10CQ | 96 | ThinkCentre M910 SFF - TopSeller - 10MK - 2 of 2 | 131 |
| ThinkCentre M79 Tower - 10CS | 97 | ThinkCentre M910 Tiny | 132 |
| ThinkCentre M800 SFF | 98 | ThinkCentre M910 Tiny Platform Specifications | 133 |
| ThinkCentre M800 SFF Platform Specifications | 99 | ThinkCentre M910 Tiny - TopSeller - 10MV - 1 of 3 | 134 |
| ThinkCentre M800 SFF - TopSeller - 10FY - 1 of 2 | 100 | ThinkCentre M910 Tiny - TopSeller - 10MV - 2 of 3 | 135 |
| ThinkCentre M800 SFF - TopSeller - 10FY - 2 of 2 | 101 | ThinkCentre M910 Tiny - TopSeller - 10MV - 3 of 3 | 136 |
| ThinkCentre M800 SFF - 10FX | 102 | ThinkCentre M910 Tower | 137 |
| ThinkCentre M800 Tower | 103 | ThinkCentre M910 Tower Platform Specifications | 138 |
| ThinkCentre M800 Tower Platform Specifications | 104 | ThinkCentre M910 Tower - TopSeller - 10MM - 1 of 2 | 139 |
| ThinkCentre M800 Tower - TopSeller - 10FW - 1 of 2 | 105 | ThinkCentre M910 Tower - TopSeller - 10MM - 2 of 2 | 140 |

Contents

| | |
|---|------------|
| ThinkCentre M910x Tiny | 141 |
| ThinkCentre M910x Tiny Platform Specifications | 142 |
| ThinkCentre M910x Tiny - TopSeller - 10N0 - 1 of 2 | 143 |
| ThinkCentre M910x Tiny - TopSeller - 10N0 - 2 of 2 | 144 |
| Tiny-In-One | 145 |
| ThinkCentre Tiny-In-One 22 | 145 |
| ThinkCentre Tiny-In-One 22 Platform Specifications | 146 |
| ThinkCentre Tiny-In-One 22 - 10LK | 147 |
| ThinkCentre Tiny-In-One 22 Gen3 | 148 |
| ThinkCentre Tiny-In-One 22 Gen3 Platform Specifications | 149 |
| ThinkCentre Tiny-In-One 24 | 150 |
| ThinkCentre Tiny-In-One 24 Platform Specifications | 151 |
| ThinkCentre Tiny-In-One 24 - 10LL | 152 |
| ThinkCentre Tiny-In-One 24 Gen3 | 153 |
| ThinkCentre Tiny-In-One 24 Gen3 Platform Specifications | 154 |
| X Series AIO | 155 |
| ThinkCentre X1 AIO | 155 |
| ThinkCentre X1 AIO Platform Specifications | 156 |
| ThinkCentre X1 AIO - TopSeller - 10KE | 157 |
| Legal Information | 158 |

Summary of Changes

This section describes the technical changes made in this edition.

This edition might also include minor corrections and editorial changes which are not identified.

July 2017 - Version 509

Additions in this update

▶ **New product(s)**

ThinkCentre Tiny-In-One 22 Gen3

ThinkCentre Tiny-In-One 24 Gen3

ThinkCentre M715 SFF

ThinkCentre M715 Tower

▶ **New model(s)**

None

▶ **Others**

None

Withdrawals in this update

▶ **Withdrawn product(s)**

None



ThinkCentre M700z Platform Specifications

Product Specifications Reference (PSREF)

| Processor | Intel® Celeron®, Intel Pentium®, or 6th Generation Intel Core™ i3 / i5 / i7 Processor | | | | | | Keyboard | <i>Some:</i> Preferred Pro USB Keyboard (USB connector), Lenovo logo <i>Some:</i> Lenovo Slim USB Keyboard (USB connector), black <i>Some:</i> Ultralim Plus Wireless Keyboard (2.4GHz via USB receiver), black <i>Some:</i> Enhanced Optical USB Mouse, black, Lenovo logo <i>Some:</i> Ultralim Plus Wireless Mouse (2.4GHz via USB receiver), black | | | | | | | | | | | | | | | | | | |
|--------------------|--|---|-------------------------|---|--------------|-------------------------------|---|---|--|--|--|--------------------|----------------------|-------------|----------------|--|-------------|-----|---------------------------|---|------------|--------------------------------|-----------------------------------|---|-------------|---|
| | Processor | Cores / Threads | Frequency Base/Max(GHz) | Cache | Memory Types | Integrated Graphics | Mouse | | | | | | | | | | | | | | | | | | | |
| | Celeron G3900T | 2 / 2 | 2.6 G | 2 MB | DDR4-2133 | HD 510 | Mechanical | <ul style="list-style-type: none"> • Business black color • Toolless stand • Support VESA mount (100mm) | | | | | | | | | | | | | | | | | | |
| | Pentium G4400T | 2 / 2 | 2.9 G | 3 MB | DDR4-2133 | HD 510 | | <table border="1"> <thead> <tr> <th></th> <th>Dimensions (WxDxH)</th> <th>Max weight (lb / kg)</th> <th>Adjustments</th> </tr> </thead> <tbody> <tr> <td>Without stand:</td> <td>19.8 X 1.5 X 13.5 (inch); 503 X 38 X 344 (mm)</td> <td>10.2 / 4.62</td> <td>N/A</td> </tr> <tr> <td>With Basic Monitor stand:</td> <td>19.8 X 9.6 X 16.2 (inch); 503 X 245 X 412 (mm)</td> <td>14.6 / 6.6</td> <td>Tilt: 45° back, -5° forward</td> </tr> <tr> <td>With Full Function Monitor stand:</td> <td>19.8 X 9.6 X 15.7 (inch); 503 X 245 X 400 (mm)</td> <td>14.9 / 6.77</td> <td>Tilt: 45° back, -5° forward; Lift: 110mm; Swivel: +/-45°</td> </tr> </tbody> </table> | | | | Dimensions (WxDxH) | Max weight (lb / kg) | Adjustments | Without stand: | 19.8 X 1.5 X 13.5 (inch); 503 X 38 X 344 (mm) | 10.2 / 4.62 | N/A | With Basic Monitor stand: | 19.8 X 9.6 X 16.2 (inch); 503 X 245 X 412 (mm) | 14.6 / 6.6 | Tilt: 45° back, -5° forward | With Full Function Monitor stand: | 19.8 X 9.6 X 15.7 (inch); 503 X 245 X 400 (mm) | 14.9 / 6.77 | Tilt: 45° back, -5° forward; Lift: 110mm; Swivel: +/-45° |
| | | Dimensions (WxDxH) | Max weight (lb / kg) | Adjustments | | | | | | | | | | | | | | | | | | | | | | |
| | Without stand: | 19.8 X 1.5 X 13.5 (inch); 503 X 38 X 344 (mm) | 10.2 / 4.62 | N/A | | | | | | | | | | | | | | | | | | | | | | |
| | With Basic Monitor stand: | 19.8 X 9.6 X 16.2 (inch); 503 X 245 X 412 (mm) | 14.6 / 6.6 | Tilt: 45° back, -5° forward | | | | | | | | | | | | | | | | | | | | | | |
| | With Full Function Monitor stand: | 19.8 X 9.6 X 15.7 (inch); 503 X 245 X 400 (mm) | 14.9 / 6.77 | Tilt: 45° back, -5° forward; Lift: 110mm; Swivel: +/-45° | | | | | | | | | | | | | | | | | | | | | | |
| Core i3-6100T | 2 / 4 | 3.2 G | 3 MB | DDR4-2133 | HD 530 | Power supply | 120 watts adapter, autosensing, 89% PSU | | | | | | | | | | | | | | | | | | | |
| Core i5-6400T | 4 / 4 | 2.2 G / 2.8 G | 6 MB | DDR4-2133 | HD 530 | Limited warranty ³ | <i>Some:</i> 1-year or 3-year, depot repair service <i>Some:</i> 1-year or 3-year, limited onsite service <i>Some:</i> 3-years, limited onsite service, OID (Onsite International Delivery) / <i>For Lenovo service upgrade options, please go to S-TC sheet</i> | | | | | | | | | | | | | | | | | | | |
| Core i5-6500T | 4 / 4 | 2.5 G / 3.1 G | 6 MB | DDR4-2133 | HD 530 | Preload | Preloaded operating system <i>Some:</i> Windows® 7 Professional 64 preinstalled through downgrade rights in Windows 10 Pro 64-bit <i>Some:</i> Windows 7 Professional 64 <i>Some:</i> Windows 10 Pro 64-bit <i>Some:</i> Windows 10 Home 64-bit | | | | | | | | | | | | | | | | | | | |
| Core i5-6600T | 4 / 4 | 2.7 G / 3.5 G | 6 MB | DDR4-2133 | HD 530 | | Preloaded applications (only some listed) <ul style="list-style-type: none"> • Desktop Power Manager • Lenovo Solution Center • Lenovo REACHit • Lenovo SHAREit • Lenovo Bluetooth Lock (for models with Wi-Fi/BT card) • McAfee® LiveSafe™ (30-day trial) • Microsoft Office preloaded; purchase a product key to activate • PowerDVD Create (DVD±RW) • Lenovo ThinkVantage Tools - Only for Window 10 • Lenovo Companion • Cyberlink PowerDVD (DVD, DVD±RW) • Lenovo QuickOptimizer - Only for Window 7 • Rescue and Recovery • Password Manager • ThinkVantage System Update • Lenovo Message Center Plus • Adobe® Reader® | | | | | | | | | | | | | | | | | | | |
| Core i7-6700T | 4 / 8 | 2.8 G / 3.6 G | 8 MB | DDR4-2133 | HD 530 | Environment | EPEAT™ Gold rating; ENERGY STAR® 6.1; TCO Certified; ErP Lot 3; GREENGUARD® certified; RoHS-compliant | | | | | | | | | | | | | | | | | | | |
| Memory | 32GB max, DDR4 2133, two 260-pin SO-DIMM sockets, dual-channel capable | | | | | | MIL-SPEC test | MIL-STD-810G military certification (Low Pressure [Altitude], High Temperature, Low Temperature, Temperature Shock, Humidity, Sand and Dust, Vibration, Shock) | | | | | | | | | | | | | | | | | | |
| Disk | <i>Some:</i> SATA 6.0Gb/s, 2.5" Wide, 5400 rpm or 7200 rpm <i>Some:</i> Solid State Hybrid Drive (SSHD) / with 8GB MLC NAND flash memory, SATA 6.0Gb/s, 2.5" Wide, 5400 rpm <i>Some:</i> Solid State Drive (SSD) / SATA 6.0Gb/s, 2.5" Wide | | | | | | Accessories | For compatible accessories, please go to TC-AQP sheet | | | | | | | | | | | | | | | | | | |
| Optical | <i>Some:</i> DVD, SATA 1.5Gb/s, 9.5mm high <i>Some:</i> DVD burner, SATA 1.5Gb/s, 9.5mm high | | | | | | | | | | | | | | | | | | | | | | | | | |
| Media reader | Optional 9-in-1 media card reader | | | | | | | | | | | | | | | | | | | | | | | | | |
| Graphics | Intel HD Graphics 510/530 in processor, uses main memory, DirectX® 12, external monitor support via DisplayPort™; <i>Max resolution:</i> 4096x2304 (DP)@60Hz | | | | | | | | | | | | | | | | | | | | | | | | | |
| Display | 20" (508mm) HD+ (1600x900) TFT color , wide viewing angle 178° (Horizontal), LED backlight, 250 nits, 16:9 aspect ratio, 1000:1 contrast ratio, anti-glare | | | | | | | | | | | | | | | | | | | | | | | | | |
| Light sensor | None | | | | | | | | | | | | | | | | | | | | | | | | | |
| Multi-touch | None | | | | | | | | | | | | | | | | | | | | | | | | | |
| Camera | Optional 1.0-megapixel camera, fixed focus, supports 720p, with digital microphone, LED indicator, physical switch on/off | | | | | | | | | | | | | | | | | | | | | | | | | |
| Controls | Microphone mute, brightness up/down buttons, and power button | | | | | | | | | | | | | | | | | | | | | | | | | |
| Chipset | Intel H110 Chipset | | | | | | | | | | | | | | | | | | | | | | | | | |
| Rear ports | Four USB 2.0, ethernet (RJ-45), DisplayPort, optional serial (9-pin), Two USB 3.0 (one is Always On and fast charge), optional card reader, one headphone / microphone combo jack (3.5mm) | | | | | | | | | | | | | | | | | | | | | | | | | |
| Side ports | One M.2 Card slot (for WLAN) | | | | | | | | | | | | | | | | | | | | | | | | | |
| M.2 card slot | High Definition (HD) Audio, Realtek ALC233 / two internal stereo speakers (2W x 2), Dolby® Audio™ certified | | | | | | | | | | | | | | | | | | | | | | | | | |
| Audio support | <i>Some:</i> 11ac wireless, M.2 Card, Qualcomm Atheros QCA9377 (dual band), Wi-Fi + Bluetooth 4.1 combo adapter, 1x1 <i>Some:</i> 11ac wireless, M.2 Card, Qualcomm Atheros QCA6174 (dual band), Wi-Fi + Bluetooth 4.1 combo adapter, 2x2 <i>Some:</i> 11ac wireless, M.2 Card, Intel Dual Band Wireless-AC 3165, Wi-Fi + Bluetooth 4.0 combo adapter, 1x1 <i>Some:</i> 11ac wireless, M.2 Card, Intel Dual Band Wireless-AC 8260, Wi-Fi + Bluetooth 4.1 combo adapter, 2x2 | | | | | | | | | | | | | | | | | | | | | | | | | |
| WLAN ¹³ | <i>Some:</i> Bluetooth 4.0 or 4.1 wireless, integrated in Wi-Fi + Bluetooth combo adapter | | | | | | | | | | | | | | | | | | | | | | | | | |
| Bluetooth™ | Gigabit ethernet, Realtek RTL8111G, Wake on LAN® | | | | | | | | | | | | | | | | | | | | | | | | | |
| Ethernet | None | | | | | | | | | | | | | | | | | | | | | | | | | |
| Manageability | Trusted Platform Module (TPM 1.2-compliant) | | | | | | | | | | | | | | | | | | | | | | | | | |
| Security chip | <ul style="list-style-type: none"> • Security slot (in rear for attachment of optional Kensington® MicroSaver® cable; Kensington lock also locks chassis) • Smart USB protection, allows keyboard/mouse only, blocks all storage devices • Power-on, admin, hard disk password • Boot sequence control • Boot without keyboard and mouse • Individual USB port disablement • Optional Chassis intrusion switch | | | | | | | | | | | | | | | | | | | | | | | | | |
| Security features | | | | | | | | | | | | | | | | | | | | | | | | | | |

See footnotes for more detailed information

| Model | Region | Processor | vPro | Graphics | Monitor Cable | Memory | Display | Multi-touch | Storage(HDD/SSD) | Optical | Media Reader | WLAN + Bluetooth | Optional Rear Ports | Camera | Chassis Intrusion Switch | Keyboard / Mouse | Stand | Power Supply | Operating System | Warranty | Ann Date (m/y) |
|------------|--------|----------------|------|--------------|---------------|--------|-----------------------------|-------------|--------------------|---------|--------------|----------------------|---------------------|--------|--------------------------|------------------|---------------|------------------|----------------------|----------------|----------------|
| 10EY0006US | US | i3-6100T | No | Intel HD 530 | None | 8GBx1 | 20.0" HD+ (1600x900) WVA AG | None | 256GB SSD | DVD±RW | 9-in-1 | 3165 ac, 1x1 + BT4.0 | None | 720p | None | USB / USB | Monitor Stand | 120W 89% Adapter | Win10 DG Win7 Pro 64 | 3-year, Onsite | 12/15 |
| 10EY0007US | US | i3-6100T | No | Intel HD 530 | None | 4GBx1 | 20.0" HD+ (1600x900) WVA AG | None | 120GB SSD | DVD±RW | 9-in-1 | 3165 ac, 1x1 + BT4.0 | None | 720p | None | USB / USB | Monitor Stand | 120W 89% Adapter | Win10 DG Win7 Pro 64 | 3-year, Onsite | 12/15 |
| 10EY0008US | US | i5-6400T | No | Intel HD 530 | None | 4GBx1 | 20.0" HD+ (1600x900) WVA AG | None | 120GB SSD | DVD±RW | 9-in-1 | 3165 ac, 1x1 + BT4.0 | None | 720p | None | USB / USB | Monitor Stand | 120W 89% Adapter | Win10 DG Win7 Pro 64 | 3-year, Onsite | 12/15 |
| 10EY0009US | US | Celeron G3900T | No | Intel HD 510 | None | 4GBx1 | 20.0" HD+ (1600x900) WVA AG | None | 500GB 7200rpm 2.5" | DVD±RW | 9-in-1 | 3165 ac, 1x1 + BT4.0 | None | 720p | None | USB / USB | Monitor Stand | 120W 89% Adapter | Win10 Pro 64 | 3-year, Onsite | 12/15 |
| 10EY000AUS | US | i7-6700T | No | Intel HD 530 | None | 8GBx1 | 20.0" HD+ (1600x900) WVA AG | None | 256GB SSD | DVD±RW | 9-in-1 | 3165 ac, 1x1 + BT4.0 | None | 720p | None | USB / USB | Monitor Stand | 120W 89% Adapter | Win10 DG Win7 Pro 64 | 3-year, Onsite | 12/15 |
| 10EY000BUS | US | i3-6100T | No | Intel HD 530 | None | 8GBx1 | 20.0" HD+ (1600x900) WVA AG | None | 500GB 7200rpm 2.5" | DVD±RW | 9-in-1 | 3165 ac, 1x1 + BT4.0 | None | 720p | None | USB / USB | Monitor Stand | 120W 89% Adapter | Win10 DG Win7 Pro 64 | 3-year, Onsite | 12/15 |
| 10EY000CUS | US | i7-6700T | No | Intel HD 530 | None | 4GBx1 | 20.0" HD+ (1600x900) WVA AG | None | 500GB 7200rpm 2.5" | DVD±RW | 9-in-1 | 3165 ac, 1x1 + BT4.0 | None | 720p | None | USB / USB | Monitor Stand | 120W 89% Adapter | Win10 Pro 64 | 3-year, Onsite | 12/15 |
| 10EY000DUS | US | i7-6700T | No | Intel HD 530 | None | 4GBx1 | 20.0" HD+ (1600x900) WVA AG | None | 120GB SSD | DVD±RW | 9-in-1 | 3165 ac, 1x1 + BT4.0 | None | 720p | None | USB / USB | Monitor Stand | 120W 89% Adapter | Win10 DG Win7 Pro 64 | 3-year, Onsite | 12/15 |
| 10EY000EUS | US | i3-6100T | No | Intel HD 530 | None | 4GBx1 | 20.0" HD+ (1600x900) WVA AG | None | 500GB 7200rpm 2.5" | DVD±RW | 9-in-1 | 3165 ac, 1x1 + BT4.0 | None | 720p | None | USB / USB | Monitor Stand | 120W 89% Adapter | Win10 DG Win7 Pro 64 | 3-year, Onsite | 12/15 |
| 10EY000FUS | US | i5-6400T | No | Intel HD 530 | None | 8GBx1 | 20.0" HD+ (1600x900) WVA AG | None | 500GB 7200rpm 2.5" | DVD±RW | 9-in-1 | 3165 ac, 1x1 + BT4.0 | None | 720p | None | USB / USB | Monitor Stand | 120W 89% Adapter | Win10 DG Win7 Pro 64 | 3-year, Onsite | 12/15 |
| 10EY000GUS | US | i7-6700T | No | Intel HD 530 | None | 4GBx1 | 20.0" HD+ (1600x900) WVA AG | None | 500GB 7200rpm 2.5" | DVD±RW | 9-in-1 | 3165 ac, 1x1 + BT4.0 | None | 720p | None | USB / USB | Monitor Stand | 120W 89% Adapter | Win10 DG Win7 Pro 64 | 3-year, Onsite | 12/15 |
| 10EY000HUS | US | Pentium G4400T | No | Intel HD 510 | None | 4GBx1 | 20.0" HD+ (1600x900) WVA AG | None | 500GB 7200rpm 2.5" | DVD±RW | 9-in-1 | 3165 ac, 1x1 + BT4.0 | None | 720p | None | USB / USB | Monitor Stand | 120W 89% Adapter | Win10 Pro 64 | 3-year, Onsite | 12/15 |
| 10EY000JUS | US | i5-6400T | No | Intel HD 530 | None | 8GBx1 | 20.0" HD+ (1600x900) WVA AG | None | 256GB SSD | DVD±RW | 9-in-1 | 3165 ac, 1x1 + BT4.0 | None | 720p | None | USB / USB | Monitor Stand | 120W 89% Adapter | Win10 DG Win7 Pro 64 | 3-year, Onsite | 12/15 |
| 10EY000KUS | US | Celeron G3900T | No | Intel HD 510 | None | 4GBx1 | 20.0" HD+ (1600x900) WVA AG | None | 500GB 7200rpm 2.5" | DVD±RW | 9-in-1 | 3165 ac, 1x1 + BT4.0 | None | 720p | None | USB / USB | Monitor Stand | 120W 89% Adapter | Win10 DG Win7 Pro 64 | 3-year, Onsite | 12/15 |
| 10EY000LUS | US | i5-6400T | No | Intel HD 530 | None | 4GBx1 | 20.0" HD+ (1600x900) WVA AG | None | 500GB 7200rpm 2.5" | DVD±RW | 9-in-1 | 3165 ac, 1x1 + BT4.0 | None | 720p | None | USB / USB | Monitor Stand | 120W 89% Adapter | Win10 DG Win7 Pro 64 | 3-year, Onsite | 12/15 |
| 10EY000MUS | US | i3-6100T | No | Intel HD 530 | None | 4GBx1 | 20.0" HD+ (1600x900) WVA AG | None | 500GB 7200rpm 2.5" | DVD±RW | 9-in-1 | 3165 ac, 1x1 + BT4.0 | None | 720p | None | USB / USB | Monitor Stand | 120W 89% Adapter | Win10 Pro 64 | 3-year, Onsite | 12/15 |
| 10EY000NUS | US | i7-6700T | No | Intel HD 530 | None | 8GBx1 | 20.0" HD+ (1600x900) WVA AG | None | 500GB 7200rpm 2.5" | DVD±RW | 9-in-1 | 3165 ac, 1x1 + BT4.0 | None | 720p | None | USB / USB | Monitor Stand | 120W 89% Adapter | Win10 DG Win7 Pro 64 | 3-year, Onsite | 12/15 |
| 10EY000PUS | US | i5-6400T | No | Intel HD 530 | None | 4GBx1 | 20.0" HD+ (1600x900) WVA AG | None | 500GB 7200rpm 2.5" | DVD±RW | 9-in-1 | 3165 ac, 1x1 + BT4.0 | None | 720p | None | USB / USB | Monitor Stand | 120W 89% Adapter | Win10 Pro 64 | 3-year, Onsite | 12/15 |
| 10EY000QUS | US | Pentium G4400T | No | Intel HD 510 | None | 4GBx1 | 20.0" HD+ (1600x900) WVA AG | None | 500GB 7200rpm 2.5" | DVD±RW | 9-in-1 | 3165 ac, 1x1 + BT4.0 | None | 720p | None | USB / USB | Monitor Stand | 120W 89% Adapter | Win10 DG Win7 Pro 64 | 3-year, Onsite | 12/15 |
| 10EY002LUS | US | i5-6400T | No | Intel HD 530 | None | 8GBx1 | 20.0" HD+ (1600x900) WVA AG | None | 256GB SSD Opal | DVD±RW | 9-in-1 | 3165 ac, 1x1 + BT4.0 | None | 720p | None | USB / USB | Monitor Stand | 120W 89% Adapter | Win10 DG Win7 Pro 64 | 3-year, Onsite | 12/16 |

| Model | Region | Processor | vPro | Graphics | Monitor Cable | Memory | Display | Multi-touch | Storage(HDD/SSD) | Optical | Media Reader | WLAN + Bluetooth | Optional Rear Ports | Camera | Chassis Intrusion Switch | Keyboard / Mouse | Stand | Power Supply | Operating System | Warranty | Ann Date (m/y) |
|------------|--------|-----------|------|--------------|---------------|--------|-----------------------------|-------------|------------------|---------|--------------|----------------------|---------------------|--------|--------------------------|------------------|---------------|------------------|----------------------|----------------|----------------|
| 10EY002MUS | US | i7-6700T | No | Intel HD 530 | None | 8GBx1 | 20.0" HD+ (1600x900) WVA AG | None | 256GB SSD Opal | DVD±RW | 9-in-1 | 3165 ac, 1x1 + BT4.0 | None | 720p | None | USB / USB | Monitor Stand | 120W 89% Adapter | Win10 DG Win7 Pro 64 | 3-year, Onsite | 12/16 |
| 10EY002NUS | US | i3-6100T | No | Intel HD 530 | None | 8GBx1 | 20.0" HD+ (1600x900) WVA AG | None | 256GB SSD Opal | DVD±RW | 9-in-1 | 3165 ac, 1x1 + BT4.0 | None | 720p | None | USB / USB | Monitor Stand | 120W 89% Adapter | Win10 DG Win7 Pro 64 | 3-year, Onsite | 12/16 |

| Model | Region | Processor | vPro | Graphics | Monitor Cable | Memory | Display | Multi-touch | Storage(HDD/SSD) | Optical | Media Reader | WLAN + Bluetooth | Optional Rear Ports | Camera | Chassis Intrusion Switch | Keyboard / Mouse | Stand | Power Supply | Operating System | Warranty | Ann Date (m/y) |
|------------|--------|-----------|------|--------------|---------------|--------|-----------------------------|-------------|--------------------|---------|--------------|----------------------------|---------------------|--------|--------------------------|------------------|---------------------|------------------|----------------------|---------------------|----------------|
| 10F10001US | US | i5-6600T | No | Intel HD 530 | None | 4GBx2 | 20.0" HD+ (1600x900) WVA AG | None | 120GB SSD | DVD±RW | 9-in-1 | 8260 ac, 2x2, vPro + BT4.1 | None | 720p | Switch | 2.4G / 2.4G | Monitor Stand | 120W 89% Adapter | Win10 DG Win7 Pro 64 | 3-year, Onsite, OID | 12/15 |
| 10F10002US | US | i5-6600T | No | Intel HD 530 | None | 4GBx2 | 20.0" HD+ (1600x900) WVA AG | None | 128GB SSD | DVD±RW | 9-in-1 | 8260 ac, 2x2, vPro + BT4.1 | None | 720p | Switch | 2.4G / 2.4G | Monitor Stand | 120W 89% Adapter | Win10 Pro 64 | 3-year, Onsite, OID | 12/15 |
| 10F10003US | US | i5-6400T | No | Intel HD 530 | None | 4GBx1 | 20.0" HD+ (1600x900) WVA AG | None | 1TB 5400rpm 2.5" | DVD±RW | 9-in-1 | 8260 ac, 2x2, vPro + BT4.1 | None | 720p | Switch | USB / USB | Monitor Stand | 120W 89% Adapter | Win10 DG Win7 Pro 64 | 3-year, Onsite, OID | 12/15 |
| 10F10004US | US | i5-6400T | No | Intel HD 530 | None | 4GBx1 | 20.0" HD+ (1600x900) WVA AG | None | 500GB 5400rpm 2.5" | DVD | None | 3165 ac, 1x1 + BT4.0 | None | 720p | Switch | USB / USB | Basic Monitor Stand | 120W 89% Adapter | Win10 DG Win7 Pro 64 | 3-year, Onsite, OID | 12/15 |
| 10F10005US | US | i5-6400T | No | Intel HD 530 | None | 4GBx1 | 20.0" HD+ (1600x900) WVA AG | None | 1TB 5400rpm 2.5" | DVD±RW | 9-in-1 | 8260 ac, 2x2, vPro + BT4.1 | None | 720p | Switch | USB / USB | Monitor Stand | 120W 89% Adapter | Win10 Pro 64 | 3-year, Onsite, OID | 12/15 |
| 10F10006US | US | i5-6400T | No | Intel HD 530 | None | 4GBx1 | 20.0" HD+ (1600x900) WVA AG | None | 500GB 5400rpm 2.5" | DVD | 9-in-1 | 3165 ac, 1x1 + BT4.0 | None | 720p | Switch | USB / USB | Basic Monitor Stand | 120W 89% Adapter | Win10 Pro 64 | 3-year, Onsite, OID | 12/15 |



ThinkCentre M800z Platform Specifications

Product Specifications Reference (PSREF)

| Processor | Intel® Celeron®, Intel Pentium®, or 6th Generation Intel Core™ i3 / i5 / i7 Processor | Keyboard | <i>Some:</i> Preferred Pro USB Keyboard (USB connector), Lenovo logo <i>Some:</i> Lenovo Slim USB Keyboard (USB connector), black <i>Some:</i> Ultralim Plus Wireless Keyboard (2.4GHz via USB receiver), black <i>Some:</i> Enhanced Optical USB Mouse, black, Lenovo logo <i>Some:</i> Ultralim Plus Wireless Mouse (2.4GHz via USB receiver), black | | | | | | | | | | | | | | | | | | | | | | | | | | | | | | | | | | | | | | | | | | | | | | | | | | | | | | | | | | | | |
|---------------------------|--|--|---|-------------------------|---------------------|--------------------|----------------------|---------------|----------------|--|--|-----------|---------------------------|---|------------------------|--------------------------------|--------------------------|---|--|---|-------|-------|------|-----------|--------|--------------|-------|-------|------|-----------|--------|--------------|-------|-------|------|-----------|--------|--------------|-------|---------------|------|-----------|--------|--------------|-------|---------------|------|-----------|--------|--------------|-------|---------------|------|-----------|--------|--------------|-------|---------------|------|-----------|--------|-------|--|
| | <table border="1"> <thead> <tr> <th>Processor</th> <th>Cores / Threads</th> <th>Frequency Base/Max(GHz)</th> <th>Cache</th> <th>Memory Types</th> <th>Integrated Graphics</th> </tr> </thead> <tbody> <tr> <td>Celeron G3900</td> <td>2 / 2</td> <td>2.8 G</td> <td>2 MB</td> <td>DDR4-2133</td> <td>HD 510</td> </tr> <tr> <td>Pentium G4400</td> <td>2 / 2</td> <td>3.3 G</td> <td>3 MB</td> <td>DDR4-2133</td> <td>HD 510</td> </tr> <tr> <td>Pentium G4500</td> <td>2 / 2</td> <td>3.5 G</td> <td>3 MB</td> <td>DDR4-2133</td> <td>HD 530</td> </tr> <tr> <td>Core i3-6100</td> <td>2 / 4</td> <td>3.7 G</td> <td>3 MB</td> <td>DDR4-2133</td> <td>HD 530</td> </tr> <tr> <td>Core i3-6300</td> <td>2 / 4</td> <td>3.8 G</td> <td>4 MB</td> <td>DDR4-2133</td> <td>HD 530</td> </tr> <tr> <td>Core i5-6400</td> <td>4 / 4</td> <td>2.7 G / 3.3 G</td> <td>6 MB</td> <td>DDR4-2133</td> <td>HD 530</td> </tr> <tr> <td>Core i5-6500</td> <td>4 / 4</td> <td>3.2 G / 3.6 G</td> <td>6 MB</td> <td>DDR4-2133</td> <td>HD 530</td> </tr> <tr> <td>Core i5-6600</td> <td>4 / 4</td> <td>3.3 G / 3.9 G</td> <td>6 MB</td> <td>DDR4-2133</td> <td>HD 530</td> </tr> <tr> <td>Core i7-6700</td> <td>4 / 8</td> <td>3.4 G / 4.0 G</td> <td>8 MB</td> <td>DDR4-2133</td> <td>HD 530</td> </tr> </tbody> </table> | Processor | Cores / Threads | Frequency Base/Max(GHz) | Cache | Memory Types | Integrated Graphics | Celeron G3900 | 2 / 2 | 2.8 G | 2 MB | DDR4-2133 | HD 510 | Pentium G4400 | 2 / 2 | 3.3 G | 3 MB | DDR4-2133 | HD 510 | Pentium G4500 | 2 / 2 | 3.5 G | 3 MB | DDR4-2133 | HD 530 | Core i3-6100 | 2 / 4 | 3.7 G | 3 MB | DDR4-2133 | HD 530 | Core i3-6300 | 2 / 4 | 3.8 G | 4 MB | DDR4-2133 | HD 530 | Core i5-6400 | 4 / 4 | 2.7 G / 3.3 G | 6 MB | DDR4-2133 | HD 530 | Core i5-6500 | 4 / 4 | 3.2 G / 3.6 G | 6 MB | DDR4-2133 | HD 530 | Core i5-6600 | 4 / 4 | 3.3 G / 3.9 G | 6 MB | DDR4-2133 | HD 530 | Core i7-6700 | 4 / 8 | 3.4 G / 4.0 G | 8 MB | DDR4-2133 | HD 530 | Mouse | |
| Processor | Cores / Threads | Frequency Base/Max(GHz) | Cache | Memory Types | Integrated Graphics | | | | | | | | | | | | | | | | | | | | | | | | | | | | | | | | | | | | | | | | | | | | | | | | | | | | | | | | | | |
| Celeron G3900 | 2 / 2 | 2.8 G | 2 MB | DDR4-2133 | HD 510 | | | | | | | | | | | | | | | | | | | | | | | | | | | | | | | | | | | | | | | | | | | | | | | | | | | | | | | | | | |
| Pentium G4400 | 2 / 2 | 3.3 G | 3 MB | DDR4-2133 | HD 510 | | | | | | | | | | | | | | | | | | | | | | | | | | | | | | | | | | | | | | | | | | | | | | | | | | | | | | | | | | |
| Pentium G4500 | 2 / 2 | 3.5 G | 3 MB | DDR4-2133 | HD 530 | | | | | | | | | | | | | | | | | | | | | | | | | | | | | | | | | | | | | | | | | | | | | | | | | | | | | | | | | | |
| Core i3-6100 | 2 / 4 | 3.7 G | 3 MB | DDR4-2133 | HD 530 | | | | | | | | | | | | | | | | | | | | | | | | | | | | | | | | | | | | | | | | | | | | | | | | | | | | | | | | | | |
| Core i3-6300 | 2 / 4 | 3.8 G | 4 MB | DDR4-2133 | HD 530 | | | | | | | | | | | | | | | | | | | | | | | | | | | | | | | | | | | | | | | | | | | | | | | | | | | | | | | | | | |
| Core i5-6400 | 4 / 4 | 2.7 G / 3.3 G | 6 MB | DDR4-2133 | HD 530 | | | | | | | | | | | | | | | | | | | | | | | | | | | | | | | | | | | | | | | | | | | | | | | | | | | | | | | | | | |
| Core i5-6500 | 4 / 4 | 3.2 G / 3.6 G | 6 MB | DDR4-2133 | HD 530 | | | | | | | | | | | | | | | | | | | | | | | | | | | | | | | | | | | | | | | | | | | | | | | | | | | | | | | | | | |
| Core i5-6600 | 4 / 4 | 3.3 G / 3.9 G | 6 MB | DDR4-2133 | HD 530 | | | | | | | | | | | | | | | | | | | | | | | | | | | | | | | | | | | | | | | | | | | | | | | | | | | | | | | | | | |
| Core i7-6700 | 4 / 8 | 3.4 G / 4.0 G | 8 MB | DDR4-2133 | HD 530 | | | | | | | | | | | | | | | | | | | | | | | | | | | | | | | | | | | | | | | | | | | | | | | | | | | | | | | | | | |
| | | Mechanical | <ul style="list-style-type: none"> • Business black color • Toolless stand • Support VESA mount (100mm) <table border="1"> <thead> <tr> <th></th> <th>Dimensions (WxDxH)</th> <th>Max weight (lb / kg)</th> <th>Adjustments</th> </tr> </thead> <tbody> <tr> <td>Without stand:</td> <td>21.1 X 1.8 X 14.3 (inch); 535 X 45 X 363 (mm)</td> <td>(Touch) 14.6 / 6.6 (Non-touch) 12.8 / 5.8</td> <td>N/A</td> </tr> <tr> <td>With Basic Monitor stand:</td> <td>21.1 X 9.6 X 17.0 (inch); 535 X 245 X 431 (mm)</td> <td>(Non-touch) 17.0 / 7.7</td> <td>Tilt: 45° back, -5° forward</td> </tr> <tr> <td>With UltraFlex II stand:</td> <td>21.1X 10.0 X 19.3 (inch); 535 X 253 X 489 (mm)</td> <td>(Touch) 20.3 / 9.2 (Non-touch) 18.3 / 8.3</td> <td>Tilt: 61° back, -5° forward; Lift: 160mm; Swivel: +/-45°</td> </tr> </tbody> </table> | | | Dimensions (WxDxH) | Max weight (lb / kg) | Adjustments | Without stand: | 21.1 X 1.8 X 14.3 (inch); 535 X 45 X 363 (mm) | (Touch) 14.6 / 6.6 (Non-touch) 12.8 / 5.8 | N/A | With Basic Monitor stand: | 21.1 X 9.6 X 17.0 (inch); 535 X 245 X 431 (mm) | (Non-touch) 17.0 / 7.7 | Tilt: 45° back, -5° forward | With UltraFlex II stand: | 21.1X 10.0 X 19.3 (inch); 535 X 253 X 489 (mm) | (Touch) 20.3 / 9.2 (Non-touch) 18.3 / 8.3 | Tilt: 61° back, -5° forward; Lift: 160mm; Swivel: +/-45° | | | | | | | | | | | | | | | | | | | | | | | | | | | | | | | | | | | | | | | | | | | |
| | Dimensions (WxDxH) | Max weight (lb / kg) | Adjustments | | | | | | | | | | | | | | | | | | | | | | | | | | | | | | | | | | | | | | | | | | | | | | | | | | | | | | | | | | | | |
| Without stand: | 21.1 X 1.8 X 14.3 (inch); 535 X 45 X 363 (mm) | (Touch) 14.6 / 6.6 (Non-touch) 12.8 / 5.8 | N/A | | | | | | | | | | | | | | | | | | | | | | | | | | | | | | | | | | | | | | | | | | | | | | | | | | | | | | | | | | | | |
| With Basic Monitor stand: | 21.1 X 9.6 X 17.0 (inch); 535 X 245 X 431 (mm) | (Non-touch) 17.0 / 7.7 | Tilt: 45° back, -5° forward | | | | | | | | | | | | | | | | | | | | | | | | | | | | | | | | | | | | | | | | | | | | | | | | | | | | | | | | | | | | |
| With UltraFlex II stand: | 21.1X 10.0 X 19.3 (inch); 535 X 253 X 489 (mm) | (Touch) 20.3 / 9.2 (Non-touch) 18.3 / 8.3 | Tilt: 61° back, -5° forward; Lift: 160mm; Swivel: +/-45° | | | | | | | | | | | | | | | | | | | | | | | | | | | | | | | | | | | | | | | | | | | | | | | | | | | | | | | | | | | | |
| Memory | 32GB max, DDR4 2133, two 260-pin SO-DIMM sockets, dual-channel capable | Power supply | 150 watts, autosensing, 85% PSU | | | | | | | | | | | | | | | | | | | | | | | | | | | | | | | | | | | | | | | | | | | | | | | | | | | | | | | | | | | | |
| Disk | <i>Some:</i> SATA 6.0Gb/s, 2.5" Wide, 5400 rpm or 7200 rpm <i>Some:</i> Solid State Hybrid Drive (SSHD) / with 8GB MLC NAND flash memory, SATA 6.0Gb/s, 2.5" Wide, 5400 rpm <i>Some:</i> Solid State Drive (SSD) / SATA 6.0Gb/s, 2.5" Wide | Limited warranty ³ | <i>Some:</i> 1-year or 3-year, depot repair service <i>Some:</i> 1-year or 3-year, limited onsite service <i>Some:</i> 3-years, limited onsite service, OID (Onsite International Delivery) / <i>For Lenovo service upgrade options, please go to S-TC sheet</i> | | | | | | | | | | | | | | | | | | | | | | | | | | | | | | | | | | | | | | | | | | | | | | | | | | | | | | | | | | | | |
| Optical | <i>Some:</i> DVD, SATA 1.5Gb/s, 9.5mm high <i>Some:</i> DVD burner, SATA 1.5Gb/s, 9.5mm high | Preload | Preloaded operating system <i>Some:</i> Windows® 7 Professional 64 preinstalled through downgrade rights in Windows 10 Pro 64-bit <i>Some:</i> Windows 7 Professional 64 <i>Some:</i> Windows 10 Pro 64-bit <i>Some:</i> Windows 10 Home 64-bit | | | | | | | | | | | | | | | | | | | | | | | | | | | | | | | | | | | | | | | | | | | | | | | | | | | | | | | | | | | | |
| Media reader | Optional 9-in-1 media card reader | | Preloaded applications (only some listed) <ul style="list-style-type: none"> • Desktop Power Manager • Lenovo Solution Center • Lenovo REACHit • Lenovo SHAREit • Lenovo Bluetooth Lock (for models with Wi-Fi/BT card) • McAfee® LiveSafe™ (30-day trial) • Microsoft Office preloaded; purchase a product key to activate • PowerDVD Create (DVD±RW) • Lenovo ThinkVantage Tools <ul style="list-style-type: none"> - Only for Window 10 • Lenovo Companion • Cyberlink PowerDVD (DVD, DVD±RW) • Lenovo QuickOptimizer - Only for Window 7 • Rescue and Recovery • Password Manager • ThinkVantage System Update • Lenovo Message Center Plus • Adobe® Reader® | | | | | | | | | | | | | | | | | | | | | | | | | | | | | | | | | | | | | | | | | | | | | | | | | | | | | | | | | | | | |
| Graphics | Intel HD Graphics 510/530 in processor, uses main memory, DirectX® 12, external monitor support via DisplayPort™; <i>Max resolution:</i> 4096x2304 (DP)@60Hz | | | | | | | | | | | | | | | | | | | | | | | | | | | | | | | | | | | | | | | | | | | | | | | | | | | | | | | | | | | | | | |
| Display | 21.5" (546.1mm) Full HD 1080p (1920x1080) TFT color , MVA panel, wide viewing angle (+/- 89°), LED backlight, 250 nits, 16:9 aspect ratio, 1000:1 contrast ratio, anti-glare for both touch models and non-touch models | | | | | | | | | | | | | | | | | | | | | | | | | | | | | | | | | | | | | | | | | | | | | | | | | | | | | | | | | | | | | | |
| Light sensor | None | | | | | | | | | | | | | | | | | | | | | | | | | | | | | | | | | | | | | | | | | | | | | | | | | | | | | | | | | | | | | | |
| Multi-touch | Optional Projected Capacitive Touch (PCT) technology, supports 10-point touch | | | | | | | | | | | | | | | | | | | | | | | | | | | | | | | | | | | | | | | | | | | | | | | | | | | | | | | | | | | | | | |
| Camera | Optional 1.0-megapixel camera, fixed focus, supports 720p, with digital microphone, LED indicator, physical switch on/off | | | | | | | | | | | | | | | | | | | | | | | | | | | | | | | | | | | | | | | | | | | | | | | | | | | | | | | | | | | | | | |
| Controls | Microphone mute, brightness up/down buttons, and power button | | | | | | | | | | | | | | | | | | | | | | | | | | | | | | | | | | | | | | | | | | | | | | | | | | | | | | | | | | | | | | |
| Chipset | Intel H110 Chipset | | | | | | | | | | | | | | | | | | | | | | | | | | | | | | | | | | | | | | | | | | | | | | | | | | | | | | | | | | | | | | |
| Rear ports | Four USB 2.0, ethernet (RJ-45), DisplayPort, optional serial (9-pin), | | | | | | | | | | | | | | | | | | | | | | | | | | | | | | | | | | | | | | | | | | | | | | | | | | | | | | | | | | | | | | |
| Side ports | Two USB 3.0 (one is Always On and fast charge), optional card reader, one headphone / microphone combo jack (3.5mm) | | | | | | | | | | | | | | | | | | | | | | | | | | | | | | | | | | | | | | | | | | | | | | | | | | | | | | | | | | | | | | |
| M.2 card slot | One M.2 Card slot (for WLAN) | | | | | | | | | | | | | | | | | | | | | | | | | | | | | | | | | | | | | | | | | | | | | | | | | | | | | | | | | | | | | | |
| Audio support | High Definition (HD) Audio, Realtek ALC233 / two internal stereo speakers (2W x 2), Dolby® Audio™ certified | | | | | | | | | | | | | | | | | | | | | | | | | | | | | | | | | | | | | | | | | | | | | | | | | | | | | | | | | | | | | | |
| WLAN ¹³ | <i>Some:</i> 11ac wireless, M.2 Card, Qualcomm Atheros QCA9377 (dual band), Wi-Fi + Bluetooth 4.1 combo adapter, 1x1 <i>Some:</i> 11ac wireless, M.2 Card, Qualcomm Atheros QCA6174 (dual band), Wi-Fi + Bluetooth 4.1 combo adapter, 2x2 <i>Some:</i> 11ac wireless, M.2 Card, Intel Dual Band Wireless-AC 3165, Wi-Fi + Bluetooth 4.0 combo adapter, 1x1 <i>Some:</i> 11ac wireless, M.2 Card, Intel Dual Band Wireless-AC 8260, Wi-Fi + Bluetooth 4.1 combo adapter, 2x2 | Environment | EPEAT™ Gold rating; ENERGY STAR® 6.1; TCO Certified; ErP Lot 3; GREENGUARD® certified; RoHS-compliant | | | | | | | | | | | | | | | | | | | | | | | | | | | | | | | | | | | | | | | | | | | | | | | | | | | | | | | | | | | | |
| Bluetooth™ | <i>Some:</i> Bluetooth 4.0 or 4.1 wireless, integrated in Wi-Fi + Bluetooth combo adapter | MIL-SPEC test | MIL-STD-810G military certification (Low Pressure [Altitude], High Temperature, Low Temperature, Temperature Shock, Humidity, Sand and Dust, Vibration, Shock) | | | | | | | | | | | | | | | | | | | | | | | | | | | | | | | | | | | | | | | | | | | | | | | | | | | | | | | | | | | | |
| Ethernet | Gigabit ethernet, Realtek RTL8111G, Wake on LAN® | Accessories | For compatible accessories, please go to TC-AQP sheet | | | | | | | | | | | | | | | | | | | | | | | | | | | | | | | | | | | | | | | | | | | | | | | | | | | | | | | | | | | | |
| Manageability | None | | | | | | | | | | | | | | | | | | | | | | | | | | | | | | | | | | | | | | | | | | | | | | | | | | | | | | | | | | | | | | |
| Security chip | Trusted Platform Module (TPM 1.2-compliant) | | | | | | | | | | | | | | | | | | | | | | | | | | | | | | | | | | | | | | | | | | | | | | | | | | | | | | | | | | | | | | |
| Security features | <ul style="list-style-type: none"> • Security slot (in rear for attachment of optional Kensington® MicroSaver® cable; Kensington lock also locks chassis) • Smart USB protection, allows keyboard/ mouse only, blocks all storage devices • Power-on, admin, hard disk password • Boot sequence control • Boot without keyboard and mouse • Individual USB port disablement • Optional Chassis intrusion switch | | | | | | | | | | | | | | | | | | | | | | | | | | | | | | | | | | | | | | | | | | | | | | | | | | | | | | | | | | | | | | |

See footnotes for more detailed information

| Model | Region | Processor | vPro | Graphics | Monitor Cable | Memory | Display | Multi-touch | Storage(HDD/SSD) | Optical | Media Reader | WLAN + Bluetooth | Optional Rear Ports | Camera | Chassis Intrusion Switch | Keyboard / Mouse | Stand | Power Supply | Operating System | Warranty | Ann Date (m/y) |
|------------|--------|---------------|------|--------------|---------------|--------|------------------------------|----------------------|--------------------|---------|--------------|----------------------|---------------------|--------|--------------------------|------------------|--------------------|------------------|----------------------|----------------|----------------|
| 10ET0002US | US | i5-6500 | No | Intel HD 530 | DP to HDMI | 4GBx1 | 21.5" FHD (1920x1080) WVA AG | 10-point Multi-touch | 500GB 7200rpm 2.5" | DVD±RW | 9-in-1 | 8260 ac, 2x2 + BT4.1 | None | 720p | None | USB / USB | UltraFlex II Stand | 150W 85% Adapter | Win10 DG Win7 Pro 64 | 3-year, Onsite | 11/15 |
| 10ET0003US | US | i7-6700 | No | Intel HD 530 | None | 4GBx1 | 21.5" FHD (1920x1080) WVA AG | 10-point Multi-touch | 500GB 7200rpm 2.5" | DVD±RW | 9-in-1 | 8260 ac, 2x2 + BT4.1 | None | 720p | None | USB / USB | UltraFlex II Stand | 150W 85% Adapter | Win10 DG Win7 Pro 64 | 3-year, Onsite | 11/15 |
| 10ET0004US | US | i5-6500 | No | Intel HD 530 | None | 4GBx1 | 21.5" FHD (1920x1080) WVA AG | 10-point Multi-touch | 500GB 7200rpm 2.5" | DVD±RW | 9-in-1 | 8260 ac, 2x2 + BT4.1 | None | 720p | None | USB / USB | UltraFlex II Stand | 150W 85% Adapter | Win10 Pro 64 | 3-year, Onsite | 11/15 |
| 10ET0005US | US | i7-6700 | No | Intel HD 530 | None | 8GBx1 | 21.5" FHD (1920x1080) WVA AG | 10-point Multi-touch | 500GB 7200rpm 2.5" | DVD±RW | 9-in-1 | 8260 ac, 2x2 + BT4.1 | None | 720p | None | USB / USB | UltraFlex II Stand | 150W 85% Adapter | Win10 DG Win7 Pro 64 | 3-year, Onsite | 11/15 |
| 10ET0007US | US | i5-6500 | No | Intel HD 530 | DP to HDMI | 8GBx1 | 21.5" FHD (1920x1080) WVA AG | 10-point Multi-touch | 500GB 7200rpm 2.5" | DVD±RW | 9-in-1 | 8260 ac, 2x2 + BT4.1 | None | 720p | None | USB / USB | UltraFlex II Stand | 150W 85% Adapter | Win10 DG Win7 Pro 64 | 3-year, Onsite | 11/15 |
| 10ET0009US | US | i5-6400 | No | Intel HD 530 | None | 4GBx1 | 21.5" FHD (1920x1080) WVA AG | 10-point Multi-touch | 500GB 7200rpm 2.5" | DVD±RW | 9-in-1 | 8260 ac, 2x2 + BT4.1 | None | 720p | None | USB / USB | UltraFlex II Stand | 150W 85% Adapter | Win10 Pro 64 | 3-year, Onsite | 11/15 |
| 10ET000AUS | US | i5-6400 | No | Intel HD 530 | None | 4GBx1 | 21.5" FHD (1920x1080) WVA AG | 10-point Multi-touch | 500GB 7200rpm 2.5" | DVD±RW | 9-in-1 | 8260 ac, 2x2 + BT4.1 | None | 720p | None | USB / USB | UltraFlex II Stand | 150W 85% Adapter | Win10 DG Win7 Pro 64 | 3-year, Onsite | 11/15 |
| 10ET000CUS | US | i5-6400 | No | Intel HD 530 | None | 8GBx1 | 21.5" FHD (1920x1080) WVA AG | 10-point Multi-touch | 500GB 7200rpm 2.5" | DVD±RW | 9-in-1 | 8260 ac, 2x2 + BT4.1 | None | 720p | None | USB / USB | UltraFlex II Stand | 150W 85% Adapter | Win10 DG Win7 Pro 64 | 3-year, Onsite | 11/15 |
| 10ET001AUS | US | Pentium G4400 | No | Intel HD 510 | None | 4GBx1 | 21.5" FHD (1920x1080) WVA AG | 10-point Multi-touch | 500GB 7200rpm 2.5" | DVD±RW | 9-in-1 | 8260 ac, 2x2 + BT4.1 | None | 720p | None | USB / USB | UltraFlex II Stand | 150W 85% Adapter | Win10 DG Win7 Pro 64 | 3-year, Onsite | 12/15 |
| 10ET001BUS | US | i7-6700 | No | Intel HD 530 | None | 8GBx1 | 21.5" FHD (1920x1080) WVA AG | 10-point Multi-touch | 256GB SSD | DVD±RW | 9-in-1 | 8260 ac, 2x2 + BT4.1 | None | 720p | None | USB / USB | UltraFlex II Stand | 150W 85% Adapter | Win10 DG Win7 Pro 64 | 3-year, Onsite | 11/15 |
| 10ET001CUS | US | i3-6100 | No | Intel HD 530 | None | 4GBx1 | 21.5" FHD (1920x1080) WVA AG | 10-point Multi-touch | 120GB SSD | DVD±RW | 9-in-1 | 8260 ac, 2x2 + BT4.1 | None | 720p | None | USB / USB | UltraFlex II Stand | 150W 85% Adapter | Win10 DG Win7 Pro 64 | 3-year, Onsite | 12/15 |
| 10ET001DUS | US | i3-6100 | No | Intel HD 530 | None | 8GBx1 | 21.5" FHD (1920x1080) WVA AG | 10-point Multi-touch | 500GB 7200rpm 2.5" | DVD±RW | 9-in-1 | 8260 ac, 2x2 + BT4.1 | None | 720p | None | USB / USB | UltraFlex II Stand | 150W 85% Adapter | Win10 DG Win7 Pro 64 | 3-year, Onsite | 12/15 |
| 10ET001EUS | US | i5-6400 | No | Intel HD 530 | None | 8GBx1 | 21.5" FHD (1920x1080) WVA AG | 10-point Multi-touch | 256GB SSD | DVD±RW | 9-in-1 | 8260 ac, 2x2 + BT4.1 | None | 720p | None | USB / USB | UltraFlex II Stand | 150W 85% Adapter | Win10 DG Win7 Pro 64 | 3-year, Onsite | 11/15 |
| 10ET001FUS | US | i3-6100 | No | Intel HD 530 | None | 4GBx1 | 21.5" FHD (1920x1080) WVA AG | 10-point Multi-touch | 500GB 7200rpm 2.5" | DVD±RW | 9-in-1 | 8260 ac, 2x2 + BT4.1 | None | 720p | None | USB / USB | UltraFlex II Stand | 150W 85% Adapter | Win10 Pro 64 | 3-year, Onsite | 12/15 |
| 10ET001GUS | US | Celeron G3900 | No | Intel HD 510 | None | 4GBx1 | 21.5" FHD (1920x1080) WVA AG | 10-point Multi-touch | 500GB 7200rpm 2.5" | DVD±RW | 9-in-1 | 8260 ac, 2x2 + BT4.1 | None | 720p | None | USB / USB | UltraFlex II Stand | 150W 85% Adapter | Win10 DG Win7 Pro 64 | 3-year, Onsite | 12/15 |
| 10ET001HUS | US | i7-6700 | No | Intel HD 530 | None | 4GBx1 | 21.5" FHD (1920x1080) WVA AG | 10-point Multi-touch | 500GB 7200rpm 2.5" | DVD±RW | 9-in-1 | 8260 ac, 2x2 + BT4.1 | None | 720p | None | USB / USB | UltraFlex II Stand | 150W 85% Adapter | Win10 Pro 64 | 3-year, Onsite | 11/15 |
| 10ET001JUS | US | i7-6700 | No | Intel HD 530 | None | 4GBx1 | 21.5" FHD (1920x1080) WVA AG | 10-point Multi-touch | 120GB SSD | DVD±RW | 9-in-1 | 8260 ac, 2x2 + BT4.1 | None | 720p | None | USB / USB | UltraFlex II Stand | 150W 85% Adapter | Win10 DG Win7 Pro 64 | 3-year, Onsite | 11/15 |
| 10ET001KUS | US | i5-6400 | No | Intel HD 530 | None | 4GBx1 | 21.5" FHD (1920x1080) WVA AG | 10-point Multi-touch | 120GB SSD | DVD±RW | 9-in-1 | 8260 ac, 2x2 + BT4.1 | None | 720p | None | USB / USB | UltraFlex II Stand | 150W 85% Adapter | Win10 DG Win7 Pro 64 | 3-year, Onsite | 11/15 |
| 10ET001LUS | US | i3-6100 | No | Intel HD 530 | None | 8GBx1 | 21.5" FHD (1920x1080) WVA AG | 10-point Multi-touch | 256GB SSD | DVD±RW | 9-in-1 | 8260 ac, 2x2 + BT4.1 | None | 720p | None | USB / USB | UltraFlex II Stand | 150W 85% Adapter | Win10 DG Win7 Pro 64 | 3-year, Onsite | 12/15 |
| 10ET001MUS | US | i3-6100 | No | Intel HD 530 | None | 4GBx1 | 21.5" FHD (1920x1080) WVA AG | 10-point Multi-touch | 500GB 7200rpm 2.5" | DVD±RW | 9-in-1 | 8260 ac, 2x2 + BT4.1 | None | 720p | None | USB / USB | UltraFlex II Stand | 150W 85% Adapter | Win10 DG Win7 Pro 64 | 3-year, Onsite | 12/15 |

| Model | Region | Processor | vPro | Graphics | Monitor Cable | Memory | Display | Multi-touch | Storage(HDD/SSD) | Optical | Media Reader | WLAN + Bluetooth | Optional Rear Ports | Camera | Chassis Intrusion Switch | Keyboard / Mouse | Stand | Power Supply | Operating System | Warranty | Ann Date (m/y) |
|------------|--------|-----------|------|--------------|---------------|--------|------------------------------|----------------------|------------------|---------|--------------|----------------------|---------------------|--------|--------------------------|------------------|--------------------|------------------|----------------------|----------------|----------------|
| 10ET0026US | US | i7-6700 | No | Intel HD 530 | None | 8GBx1 | 21.5" FHD (1920x1080) WVA AG | 10-point Multi-touch | 256GB SSD Opal | DVD±RW | 9-in-1 | 8260 ac, 2x2 + BT4.1 | None | 720p | None | USB / USB | UltraFlex II Stand | 150W 85% Adapter | Win10 DG Win7 Pro 64 | 3-year, Onsite | 12/16 |
| 10ET0027US | US | i5-6400 | No | Intel HD 530 | None | 8GBx1 | 21.5" FHD (1920x1080) WVA AG | 10-point Multi-touch | 256GB SSD Opal | DVD±RW | 9-in-1 | 8260 ac, 2x2 + BT4.1 | None | 720p | None | USB / USB | UltraFlex II Stand | 150W 85% Adapter | Win10 DG Win7 Pro 64 | 3-year, Onsite | 12/16 |
| 10ET0028US | US | i3-6100 | No | Intel HD 530 | None | 8GBx1 | 21.5" FHD (1920x1080) WVA AG | 10-point Multi-touch | 256GB SSD Opal | DVD±RW | 9-in-1 | 8260 ac, 2x2 + BT4.1 | None | 720p | None | USB / USB | UltraFlex II Stand | 150W 85% Adapter | Win10 DG Win7 Pro 64 | 3-year, Onsite | 12/16 |

| Model | Region | Processor | vPro | Graphics | Monitor Cable | Memory | Display | Multi-touch | Storage(HDD/SSD) | Optical | Media Reader | WLAN + Bluetooth | Optional Rear Ports | Camera | Chassis Intrusion Switch | Keyboard / Mouse | Stand | Power Supply | Operating System | Warranty | Ann Date (m/y) |
|------------|--------|---------------|------|--------------|---------------|--------|------------------------------|-------------|--------------------|---------|--------------|----------------------|---------------------|--------|--------------------------|------------------|---------------------|------------------|----------------------|----------------|----------------|
| 10EU001PUS | US | i5-6400 | No | Intel HD 530 | None | 4GBx1 | 21.5" FHD (1920x1080) WVA AG | None | 500GB 7200rpm 2.5" | DVD±RW | 9-in-1 | 8260 ac, 2x2 + BT4.1 | None | 720p | None | USB / USB | Basic Monitor Stand | 150W 85% Adapter | Win10 Pro 64 | 3-year, Onsite | 11/15 |
| 10EU001QUS | US | i7-6700 | No | Intel HD 530 | None | 4GBx1 | 21.5" FHD (1920x1080) WVA AG | None | 500GB 7200rpm 2.5" | DVD±RW | 9-in-1 | 8260 ac, 2x2 + BT4.1 | None | 720p | None | USB / USB | UltraFlex II Stand | 150W 85% Adapter | Win10 DG Win7 Pro 64 | 3-year, Onsite | 11/15 |
| 10EU001RUS | US | i7-6700 | No | Intel HD 530 | None | 4GBx1 | 21.5" FHD (1920x1080) WVA AG | None | 500GB 7200rpm 2.5" | DVD±RW | 9-in-1 | 8260 ac, 2x2 + BT4.1 | None | 720p | None | USB / USB | Basic Monitor Stand | 150W 85% Adapter | Win10 Pro 64 | 3-year, Onsite | 11/15 |
| 10EU001SUS | US | i5-6400 | No | Intel HD 530 | None | 4GBx1 | 21.5" FHD (1920x1080) WVA AG | None | 500GB 7200rpm 2.5" | DVD±RW | 9-in-1 | 8260 ac, 2x2 + BT4.1 | None | 720p | None | USB / USB | UltraFlex II Stand | 150W 85% Adapter | Win10 Pro 64 | 3-year, Onsite | 11/15 |
| 10EU001TUS | US | i5-6400 | No | Intel HD 530 | None | 4GBx1 | 21.5" FHD (1920x1080) WVA AG | None | 500GB 7200rpm 2.5" | DVD±RW | 9-in-1 | 8260 ac, 2x2 + BT4.1 | None | 720p | None | USB / USB | UltraFlex II Stand | 150W 85% Adapter | Win10 DG Win7 Pro 64 | 3-year, Onsite | 11/15 |
| 10EU001UUS | US | i7-6700 | No | Intel HD 530 | None | 4GBx1 | 21.5" FHD (1920x1080) WVA AG | None | 500GB 7200rpm 2.5" | DVD±RW | 9-in-1 | 8260 ac, 2x2 + BT4.1 | None | 720p | None | USB / USB | UltraFlex II Stand | 150W 85% Adapter | Win10 Pro 64 | 3-year, Onsite | 11/15 |
| 10EU001VUS | US | i7-6700 | No | Intel HD 530 | None | 8GBx1 | 21.5" FHD (1920x1080) WVA AG | None | 500GB 7200rpm 2.5" | DVD±RW | 9-in-1 | 8260 ac, 2x2 + BT4.1 | None | 720p | None | USB / USB | UltraFlex II Stand | 150W 85% Adapter | Win10 DG Win7 Pro 64 | 3-year, Onsite | 11/15 |
| 10EU001WUS | US | i5-6400 | No | Intel HD 530 | None | 8GBx1 | 21.5" FHD (1920x1080) WVA AG | None | 500GB 7200rpm 2.5" | DVD±RW | 9-in-1 | 8260 ac, 2x2 + BT4.1 | None | 720p | None | USB / USB | UltraFlex II Stand | 150W 85% Adapter | Win10 DG Win7 Pro 64 | 3-year, Onsite | 11/15 |
| 10EU002WUS | US | i7-6700 | No | Intel HD 530 | None | 4GBx1 | 21.5" FHD (1920x1080) WVA AG | None | 120GB SSD | DVD±RW | 9-in-1 | 8260 ac, 2x2 + BT4.1 | None | 720p | None | USB / USB | UltraFlex II Stand | 150W 85% Adapter | Win10 DG Win7 Pro 64 | 3-year, Onsite | 11/15 |
| 10EU002XUS | US | i3-6100 | No | Intel HD 530 | None | 8GBx1 | 21.5" FHD (1920x1080) WVA AG | None | 256GB SSD | DVD±RW | 9-in-1 | 8260 ac, 2x2 + BT4.1 | None | 720p | None | USB / USB | UltraFlex II Stand | 150W 85% Adapter | Win10 DG Win7 Pro 64 | 3-year, Onsite | 12/15 |
| 10EU002YUS | US | i5-6400 | No | Intel HD 530 | None | 8GBx1 | 21.5" FHD (1920x1080) WVA AG | None | 256GB SSD | DVD±RW | 9-in-1 | 8260 ac, 2x2 + BT4.1 | None | 720p | None | USB / USB | UltraFlex II Stand | 150W 85% Adapter | Win10 DG Win7 Pro 64 | 3-year, Onsite | 11/15 |
| 10EU0030US | US | Pentium G4400 | No | Intel HD 510 | None | 4GBx1 | 21.5" FHD (1920x1080) WVA AG | None | 500GB 7200rpm 2.5" | DVD±RW | 9-in-1 | 8260 ac, 2x2 + BT4.1 | None | 720p | None | USB / USB | UltraFlex II Stand | 150W 85% Adapter | Win10 DG Win7 Pro 64 | 3-year, Onsite | 12/15 |
| 10EU0031US | US | i3-6100 | No | Intel HD 530 | None | 8GBx1 | 21.5" FHD (1920x1080) WVA AG | None | 500GB 7200rpm 2.5" | DVD±RW | 9-in-1 | 8260 ac, 2x2 + BT4.1 | None | 720p | None | USB / USB | UltraFlex II Stand | 150W 85% Adapter | Win10 DG Win7 Pro 64 | 3-year, Onsite | 12/15 |
| 10EU0032US | US | Celeron G3900 | No | Intel HD 510 | None | 4GBx1 | 21.5" FHD (1920x1080) WVA AG | None | 500GB 7200rpm 2.5" | DVD±RW | 9-in-1 | 8260 ac, 2x2 + BT4.1 | None | 720p | None | USB / USB | UltraFlex II Stand | 150W 85% Adapter | Win10 DG Win7 Pro 64 | 3-year, Onsite | 03/16 |
| 10EU0033US | US | i5-6400 | No | Intel HD 530 | None | 4GBx1 | 21.5" FHD (1920x1080) WVA AG | None | 120GB SSD | DVD±RW | 9-in-1 | 8260 ac, 2x2 + BT4.1 | None | 720p | None | USB / USB | UltraFlex II Stand | 150W 85% Adapter | Win10 DG Win7 Pro 64 | 3-year, Onsite | 11/15 |
| 10EU0034US | US | i3-6100 | No | Intel HD 530 | None | 4GBx1 | 21.5" FHD (1920x1080) WVA AG | None | 500GB 7200rpm 2.5" | DVD±RW | 9-in-1 | 8260 ac, 2x2 + BT4.1 | None | 720p | None | USB / USB | UltraFlex II Stand | 150W 85% Adapter | Win10 DG Win7 Pro 64 | 3-year, Onsite | 12/15 |
| 10EU0035US | US | i3-6100 | No | Intel HD 530 | None | 4GBx1 | 21.5" FHD (1920x1080) WVA AG | None | 120GB SSD | DVD±RW | 9-in-1 | 8260 ac, 2x2 + BT4.1 | None | 720p | None | USB / USB | UltraFlex II Stand | 150W 85% Adapter | Win10 DG Win7 Pro 64 | 3-year, Onsite | 12/15 |
| 10EU0036US | US | i7-6700 | No | Intel HD 530 | None | 8GBx1 | 21.5" FHD (1920x1080) WVA AG | None | 256GB SSD | DVD±RW | 9-in-1 | 8260 ac, 2x2 + BT4.1 | None | 720p | None | USB / USB | UltraFlex II Stand | 150W 85% Adapter | Win10 DG Win7 Pro 64 | 3-year, Onsite | 11/15 |
| 10EU0037US | US | i3-6100 | No | Intel HD 530 | None | 4GBx1 | 21.5" FHD (1920x1080) WVA AG | None | 500GB 7200rpm 2.5" | DVD±RW | 9-in-1 | 8260 ac, 2x2 + BT4.1 | None | 720p | None | USB / USB | UltraFlex II Stand | 150W 85% Adapter | Win10 Pro 64 | 3-year, Onsite | 12/15 |
| 10EU0048US | US | i7-6700 | No | Intel HD 530 | None | 8GBx1 | 21.5" FHD (1920x1080) WVA AG | None | 256GB SSD Opal | DVD±RW | 9-in-1 | 8260 ac, 2x2 + BT4.1 | None | 720p | None | USB / USB | UltraFlex II Stand | 150W 85% Adapter | Win10 DG Win7 Pro 64 | 3-year, Onsite | 12/16 |

| Model | Region | Processor | vPro | Graphics | Monitor Cable | Memory | Display | Multi-touch | Storage(HDD/SSD) | Optical | Media Reader | WLAN + Bluetooth | Optional Rear Ports | Camera | Chassis Intrusion Switch | Keyboard / Mouse | Stand | Power Supply | Operating System | Warranty | Ann Date (m/y) |
|------------|--------|-----------|------|--------------|---------------|--------|------------------------------|-------------|------------------|---------|--------------|----------------------|---------------------|--------|--------------------------|------------------|--------------------|------------------|----------------------|----------------|----------------|
| 10EU0049US | US | i3-6100 | No | Intel HD 530 | None | 8GBx1 | 21.5" FHD (1920x1080) WVA AG | None | 256GB SSD Opal | DVD±RW | 9-in-1 | 8260 ac, 2x2 + BT4.1 | None | 720p | None | USB / USB | UltraFlex II Stand | 150W 85% Adapter | Win10 DG Win7 Pro 64 | 3-year, Onsite | 12/16 |
| 10EU004AUS | US | i5-6400 | No | Intel HD 530 | None | 8GBx1 | 21.5" FHD (1920x1080) WVA AG | None | 256GB SSD Opal | DVD±RW | 9-in-1 | 8260 ac, 2x2 + BT4.1 | None | 720p | None | USB / USB | UltraFlex II Stand | 150W 85% Adapter | Win10 DG Win7 Pro 64 | 3-year, Onsite | 12/16 |

| Model | Region | Processor | vPro | Graphics | Monitor Cable | Memory | Display | Multi-touch | Storage(HDD/SSD) | Optical | Media Reader | WLAN + Bluetooth | Optional Rear Ports | Camera | Chassis Intrusion Switch | Keyboard / Mouse | Stand | Power Supply | Operating System | Warranty | Ann Date (m/y) |
|------------|--------|-----------|------|--------------|---------------|--------|------------------------------|-------------|--------------------|---------|--------------|----------------------|---------------------|--------|--------------------------|------------------|---------------------|------------------|----------------------|---------------------|----------------|
| 10EW000UUS | US | i5-6400 | No | Intel HD 530 | None | 4GBx1 | 21.5" FHD (1920x1080) WVA AG | None | 1TB 5400rpm 2.5" | DVD±RW | 9-in-1 | 8260 ac, 2x2 + BT4.1 | None | 720p | Switch | USB / USB | UltraFlex II Stand | 150W 85% Adapter | Win10 DG Win7 Pro 64 | 3-year, Onsite, OID | 11/15 |
| 10EW000VUS | US | i5-6400 | No | Intel HD 530 | None | 4GBx1 | 21.5" FHD (1920x1080) WVA AG | None | 1TB 5400rpm 2.5" | DVD±RW | 9-in-1 | 8260 ac, 2x2 + BT4.1 | None | 720p | Switch | USB / USB | UltraFlex II Stand | 150W 85% Adapter | Win10 Pro 64 | 3-year, Onsite, OID | 11/15 |
| 10EW000WUS | US | i5-6400 | No | Intel HD 530 | None | 4GBx1 | 21.5" FHD (1920x1080) WVA AG | None | 500GB 5400rpm 2.5" | DVD | None | 8260 ac, 2x2 + BT4.1 | None | 720p | Switch | USB / USB | Basic Monitor Stand | 150W 85% Adapter | Win10 DG Win7 Pro 64 | 3-year, Onsite, OID | 11/15 |
| 10EW000XUS | US | i5-6400 | No | Intel HD 530 | None | 4GBx1 | 21.5" FHD (1920x1080) WVA AG | None | 500GB 5400rpm 2.5" | DVD | None | 8260 ac, 2x2 + BT4.1 | None | 720p | Switch | USB / USB | Basic Monitor Stand | 150W 85% Adapter | Win10 Pro 64 | 3-year, Onsite, OID | 11/15 |



ThinkCentre M810z Platform Specifications

Product Specifications Reference (PSREF)

| Processor | Intel® Celeron®, Intel Pentium®, or 6th / 7th Gen Intel Core™ i3 / i5 / i7 Processor | | | | | | Security features <ul style="list-style-type: none"> Security slot (in rear for attachment of optional Kensington® MicroSaver® cable; Kensington lock also locks chassis) Smart USB protection, allows keyboard/mouse only, blocks all storage devices Optional cable lock to physically lock keyboard and mouse Power-on, admin, hard disk password Boot sequence control Boot without keyboard and mouse Individual USB port disablement Optional Chassis intrusion switch | | | | | | | | | | | | | | | |
|-------------------------------|---|--|--|-----------|------------------------|---------------------|---|--------------------|----------------------|-------------|----------------|--|--|-----|---------------------------|---|------------------------|-----------------------------|--------------------------|---|--|--|
| | Processor | Cores / Threads | Frequency Base/Max(GHz) | Cache | Memory Support (Up to) | Integrated Graphics | | | | | | | | | | | | | | | | |
| | Pentium G4400 | 2 / 2 | 3.3G | 3 MB | DDR4-2133 | HD 510 | | | | | | | | | | | | | | | | |
| | Pentium G4560 | 2 / 4 | 3.5G | 3 MB | DDR4-2400 | HD 610 | | | | | | | | | | | | | | | | |
| | Pentium G4600 | 2 / 4 | 3.6G | 3 MB | DDR4-2400 | HD 630 | | | | | | | | | | | | | | | | |
| | Core i3-6100 | 2 / 4 | 3.7G | 3 MB | DDR4-2133 | HD 530 | | | | | | | | | | | | | | | | |
| | Core i5-6500 | 4 / 4 | 3.2G / 3.6G | 6 MB | DDR4-2133 | HD 530 | | | | | | | | | | | | | | | | |
| | Core i7-6700 | 4 / 8 | 3.4G / 4.0G | 8 MB | DDR4-2133 | HD 530 | | | | | | | | | | | | | | | | |
| | Core i3-7100 | 2 / 4 | 3.9G | 3 MB | DDR4-2400 | HD 630 | | | | | | | | | | | | | | | | |
| | Core i5-7400 | 4 / 4 | 3.0G / 3.5G | 6 MB | DDR4-2400 | HD 630 | | | | | | | | | | | | | | | | |
| Core i5-7500 | 4 / 4 | 3.4G / 3.8G | 6 MB | DDR4-2400 | HD 630 | | | | | | | | | | | | | | | | | |
| Core i5-7600 | 4 / 4 | 3.5G / 4.1G | 6 MB | DDR4-2400 | HD 630 | | | | | | | | | | | | | | | | | |
| Core i7-7700 | 4 / 8 | 3.6G / 4.2G | 8 MB | DDR4-2400 | HD 630 | | | | | | | | | | | | | | | | | |
| Memory | 32GB max, DDR4-2400*, two 260-pin SO-DIMM sockets, dual-channel capable * System clocks down for the processors with lower memory controller | | | | | | | | | | | | | | | | | | | | | |
| Storage | <i>Some:</i> Hard Drive / SATA 6.0Gb/s, 2.5", 5400 rpm or 7200 rpm <i>Some:</i> Solid State Drive (SSD) / SATA 6.0Gb/s, 2.5" <i>Some:</i> M.2 Solid State Drive (SSD) / PCIe NVMe, PCIe 3.0 x 4, 32Gb/s <i>Some:</i> Intel Optane™ Memory Ready (models with 7th gen Core processor), M.2 <i>Some:</i> DVD-ROM SATA 1.5Gb/s Drive, slim (9.5mm) | | | | | | | | | | | | | | | | | | | | | |
| Optical | <i>Some:</i> DVD Burner (DVD±RW), SATA 1.5Gb/s Drive, slim (9.5mm) | | | | | | | | | | | | | | | | | | | | | |
| Media reader | Optional 9-in-1 media card reader | | | | | | | | | | | | | | | | | | | | | |
| Graphics | Intel HD Graphics 510/530/610/630 in processor, uses main memory, DirectX® 12, external monitor support via DisplayPort™; <i>Max resolution:</i> 4096x2304 (DP)@60Hz, 1920x1080 (Panel)@60Hz | | | | | | | | | | | | | | | | | | | | | |
| Display | 21.5" (546.1mm) Full HD 1080p (1920x1080) TFT color , MVA panel, wide viewing angle (+/- 89°), LED backlight, 250 nits, 16:9 aspect ratio, 1000:1 contrast ratio, anti-glare, support Low Blue Light Mode | | | | | | | | | | | | | | | | | | | | | |
| Multi-touch | Optional Projected Capacitive Touch (PCT) technology, supports 10-point touch | | | | | | | | | | | | | | | | | | | | | |
| Camera | Optional 1080p camera, fixed focus, with dual microphone, LED indicator, physical switch on/off | | | | | | | | | | | | | | | | | | | | | |
| Controls | Physical buttons for Microphone mute, brightness up/down, and power on/off | | | | | | | | | | | | | | | | | | | | | |
| Chipset | Intel B250 Chipset | | | | | | | | | | | | | | | | | | | | | |
| Rear ports | Four USB 3.1 Gen1, ethernet (RJ-45), DisplayPort, optional serial (9-pin), | | | | | | | | | | | | | | | | | | | | | |
| Side ports | Two USB 3.1 Gen1 (one is Always On and fast charge), optional card reader, one headphone / microphone combo jack (3.5mm) | | | | | | | | | | | | | | | | | | | | | |
| M.2 card slot | Two M.2 Card slots (one for WLAN, one for SSD/Optane) | | | | | | | | | | | | | | | | | | | | | |
| Audio support | High Definition (HD) Audio, Realtek ALC233 / two internal speakers (2W x 2), Dolby® Audio™ certified | | | | | | | | | | | | | | | | | | | | | |
| WLAN ¹³ | <i>Some:</i> 11ac wireless, M.2 Card, Qualcomm Atheros QCA9377A (dual band), Wi-Fi + Bluetooth 4.1 combo adapter, 1x1 <i>Some:</i> 11ac wireless, M.2 Card, Qualcomm Atheros QCA6174A (dual band), Wi-Fi + Bluetooth 4.1 combo adapter, 2x2 <i>Some:</i> 11ac wireless, M.2 Card, Intel Dual Band Wireless-AC 3165, Wi-Fi + Bluetooth 4.1 combo adapter, 1x1 <i>Some:</i> 11ac wireless, M.2 Card, Intel Dual Band Wireless-AC 8265, Wi-Fi + Bluetooth 4.1 combo adapter, 2x2 | | | | | | | | | | | | | | | | | | | | | |
| Bluetooth™ | <i>Some:</i> Bluetooth 4.1 wireless, integrated in Wi-Fi + Bluetooth combo adapter | | | | | | | | | | | | | | | | | | | | | |
| Ethernet | Gigabit ethernet, Realtek RTL8111G, Wake on LAN® | | | | | | | | | | | | | | | | | | | | | |
| Manageability | None | | | | | | | | | | | | | | | | | | | | | |
| Security chip | TPM (Trusted Platform Module) 2.0, TCG Certified * Downgrade to TPM1.2 for the models with Win10 DG Win7 32 OS | | | | | | | | | | | | | | | | | | | | | |
| Keyboard | <i>Some:</i> Lenovo Calliope Keyboard (USB connector), black <i>Some:</i> Lenovo Traditional Keyboard (USB connector), black <i>Some:</i> Lenovo Calliope Wireless Keyboard (2.4GHz via USB receiver), black | | | | | | | | | | | | | | | | | | | | | |
| Mouse | <i>Some:</i> Lenovo Calliope Mouse (USB connector), black <i>Some:</i> Lenovo Calliope Wireless Mouse (2.4GHz via USB receiver), black | | | | | | | | | | | | | | | | | | | | | |
| Mechanical | <ul style="list-style-type: none"> Business black color Toolless stand Support VESA mount (100mm) <table border="1"> <thead> <tr> <th></th> <th>Dimensions (WxDxH)</th> <th>Max weight (lb / kg)</th> <th>Adjustments</th> </tr> </thead> <tbody> <tr> <td>Without stand:</td> <td>21.1 X 1.8 X 14.3 (inch); 535 X 45 X 363 (mm)</td> <td>(Touch) 14.6 / 6.6 (Non-touch) 12.8 / 5.8</td> <td>N/A</td> </tr> <tr> <td>With Basic Monitor stand:</td> <td>21.1 X 9.6 X 17.0 (inch); 535 X 245 X 431 (mm)</td> <td>(Non-touch) 17.0 / 7.7</td> <td>Tilt: 45° back, -5° forward</td> </tr> <tr> <td>With UltraFlex II stand:</td> <td>21.1X 10.0 X 19.3 (inch); 535 X 253 X 489 (mm)</td> <td>(Touch) 20.3 / 9.2 (Non-touch) 18.3 / 8.3</td> <td>Tilt: 61° back, -5° forward; Lift: 110mm; Swivel: +/-45°</td> </tr> </tbody> </table> | | | | | | | Dimensions (WxDxH) | Max weight (lb / kg) | Adjustments | Without stand: | 21.1 X 1.8 X 14.3 (inch); 535 X 45 X 363 (mm) | (Touch) 14.6 / 6.6 (Non-touch) 12.8 / 5.8 | N/A | With Basic Monitor stand: | 21.1 X 9.6 X 17.0 (inch); 535 X 245 X 431 (mm) | (Non-touch) 17.0 / 7.7 | Tilt: 45° back, -5° forward | With UltraFlex II stand: | 21.1X 10.0 X 19.3 (inch); 535 X 253 X 489 (mm) | (Touch) 20.3 / 9.2 (Non-touch) 18.3 / 8.3 | Tilt: 61° back, -5° forward; Lift: 110mm; Swivel: +/-45° |
| | Dimensions (WxDxH) | Max weight (lb / kg) | Adjustments | | | | | | | | | | | | | | | | | | | |
| Without stand: | 21.1 X 1.8 X 14.3 (inch); 535 X 45 X 363 (mm) | (Touch) 14.6 / 6.6 (Non-touch) 12.8 / 5.8 | N/A | | | | | | | | | | | | | | | | | | | |
| With Basic Monitor stand: | 21.1 X 9.6 X 17.0 (inch); 535 X 245 X 431 (mm) | (Non-touch) 17.0 / 7.7 | Tilt: 45° back, -5° forward | | | | | | | | | | | | | | | | | | | |
| With UltraFlex II stand: | 21.1X 10.0 X 19.3 (inch); 535 X 253 X 489 (mm) | (Touch) 20.3 / 9.2 (Non-touch) 18.3 / 8.3 | Tilt: 61° back, -5° forward; Lift: 110mm; Swivel: +/-45° | | | | | | | | | | | | | | | | | | | |
| Power supply | 150 watts, autosensing, 85% PSU | | | | | | | | | | | | | | | | | | | | | |
| Limited warranty ³ | <i>Some:</i> 1-year or 3-year, depot repair service / service upgrades available <i>Some:</i> 1-year or 3-year, limited onsite service / service upgrades available | | | | | | | | | | | | | | | | | | | | | |
| Preload | Preloaded operating system <i>Some:</i> Windows® 7 Professional 32/64 preinstalled through downgrade rights in Windows 10 Pro 64-bit <i>Some:</i> Windows 10 Pro 64-bit <i>Some:</i> Windows 10 Home 64-bit | | | | | | | | | | | | | | | | | | | | | |
| | Preloaded applications (only some listed) <ul style="list-style-type: none"> Microsoft Office preloaded; purchase a product key to activate Cyberlink PowerDVD Create (DVD±RW) - Only for Window 10 <ul style="list-style-type: none"> Lenovo Companion Lenovo ID Lenovo Settings Cyberlink PowerDVD (DVD, DVD±RW) - Only for Window 7 <ul style="list-style-type: none"> Lenovo Solution Center Lenovo ThinkVantage Tools ThinkVantage System Update Create Recovery Media Adobe® Reader® | | | | | | | | | | | | | | | | | | | | | |
| Environment | EPEAT™ Gold rating (North America); ENERGY STAR® 6.1; TCO AIO Computer Certified; ErP Lot 3; GREENGUARD® certified; RoHS-compliant | | | | | | | | | | | | | | | | | | | | | |
| MIL-SPEC test | MIL-STD-810G military certification (Low Pressure [Altitude], High Temperature, Low Temperature, Temperature Shock, Humidity, Sand and Dust, Vibration, Shock) | | | | | | | | | | | | | | | | | | | | | |
| Accessories | For compatible accessories, please go to http://www.lenovoquickpick.com | | | | | | | | | | | | | | | | | | | | | |

See footnotes for more detailed information

| Model | Region | Processor | Graphics | Monitor Cable | Memory | Display | Multi-touch | Power Supply | Storage(HDD/SSD) | Optical | Media Reader | USB Type-C | WLAN + Bluetooth | Optional Rear Ports | Camera | Chassis Intrusion Switch | Cable Lock | Keyboard / Mouse | Stand | Operating System | Warranty | End of Support | Ann Date (m/y) |
|------------|--------|---------------|--------------|---------------|--------|------------------------------|----------------------|------------------|------------------------------|---------|--------------|------------|----------------------|---------------------|--------|--------------------------|------------|------------------|--------------------|------------------|----------------|----------------|----------------|
| 10NX0000US | US | i5-7400 | Intel HD 630 | None | 8GBx1 | 21.5" FHD (1920x1080) WVA AG | 10-point Multi-touch | 150W 85% Adapter | 256GB SSD M.2 PCIe NVMe | DVD±RW | 9-in-1 | None | 8265 ac, 2x2 + BT4.1 | None | 1080p | None | None | USB / USB | UltraFlex II Stand | Win10 Pro 64 | 3-year, Onsite | Apr 7, 2023 | 03/17 |
| 10NX0001US | US | i5-7500 | Intel HD 630 | None | 8GBx1 | 21.5" FHD (1920x1080) WVA AG | 10-point Multi-touch | 150W 85% Adapter | 256GB SSD M.2 PCIe NVMe | DVD±RW | 9-in-1 | None | 8265 ac, 2x2 + BT4.1 | None | 1080p | None | None | USB / USB | UltraFlex II Stand | Win10 Pro 64 | 3-year, Onsite | Apr 7, 2023 | 03/17 |
| 10NX0002US | US | i5-7400 | Intel HD 630 | None | 4GBx1 | 21.5" FHD (1920x1080) WVA AG | 10-point Multi-touch | 150W 85% Adapter | 500GB 7200rpm 2.5" PCIe NVMe | DVD±RW | 9-in-1 | None | 8265 ac, 2x2 + BT4.1 | None | 1080p | None | None | USB / USB | UltraFlex II Stand | Win10 Pro 64 | 3-year, Onsite | Apr 7, 2023 | 03/17 |
| 10NX0003US | US | i7-7700 | Intel HD 630 | None | 8GBx1 | 21.5" FHD (1920x1080) WVA AG | 10-point Multi-touch | 150W 85% Adapter | 512GB SSD M.2 PCIe NVMe | DVD±RW | 9-in-1 | None | 8265 ac, 2x2 + BT4.1 | None | 1080p | None | None | USB / USB | UltraFlex II Stand | Win10 Pro 64 | 3-year, Onsite | Apr 7, 2023 | 03/17 |
| 10NX0005US | US | i7-7700 | Intel HD 630 | None | 8GBx1 | 21.5" FHD (1920x1080) WVA AG | 10-point Multi-touch | 150W 85% Adapter | 500GB 7200rpm 2.5" PCIe NVMe | DVD±RW | 9-in-1 | None | 8265 ac, 2x2 + BT4.1 | None | 1080p | None | None | USB / USB | UltraFlex II Stand | Win10 Pro 64 | 3-year, Onsite | Apr 7, 2023 | 03/17 |
| 10NX0006US | US | i5-7400 | Intel HD 630 | None | 8GBx1 | 21.5" FHD (1920x1080) WVA AG | 10-point Multi-touch | 150W 85% Adapter | 500GB 7200rpm 2.5" PCIe NVMe | DVD±RW | 9-in-1 | None | 8265 ac, 2x2 + BT4.1 | None | 1080p | None | None | USB / USB | UltraFlex II Stand | Win10 Pro 64 | 3-year, Onsite | Apr 7, 2023 | 03/17 |
| 10NX0007US | US | i5-7500 | Intel HD 630 | None | 8GBx1 | 21.5" FHD (1920x1080) WVA AG | 10-point Multi-touch | 150W 85% Adapter | 500GB 7200rpm 2.5" PCIe NVMe | DVD±RW | 9-in-1 | None | 8265 ac, 2x2 + BT4.1 | None | 1080p | None | None | USB / USB | UltraFlex II Stand | Win10 Pro 64 | 3-year, Onsite | Apr 7, 2023 | 03/17 |
| 10NX0008US | US | i7-7700 | Intel HD 630 | None | 8GBx1 | 21.5" FHD (1920x1080) WVA AG | 10-point Multi-touch | 150W 85% Adapter | 256GB SSD M.2 PCIe NVMe | DVD±RW | 9-in-1 | None | 8265 ac, 2x2 + BT4.1 | None | 1080p | None | None | USB / USB | UltraFlex II Stand | Win10 Pro 64 | 3-year, Onsite | Apr 7, 2023 | 03/17 |
| 10NX0009US | US | i5-7500 | Intel HD 630 | None | 8GBx1 | 21.5" FHD (1920x1080) WVA AG | 10-point Multi-touch | 150W 85% Adapter | 512GB SSD M.2 PCIe NVMe | DVD±RW | 9-in-1 | None | 8265 ac, 2x2 + BT4.1 | None | 1080p | None | None | USB / USB | UltraFlex II Stand | Win10 Pro 64 | 3-year, Onsite | Apr 7, 2023 | 03/17 |
| 10NX000MUS | US | i5-7400 | Intel HD 630 | None | 4GBx1 | 21.5" FHD (1920x1080) WVA AG | 10-point Multi-touch | 150W 85% Adapter | 128GB SSD M.2 PCIe NVMe | DVD±RW | 9-in-1 | None | 8265 ac, 2x2 + BT4.1 | None | 1080p | None | None | USB / USB | UltraFlex II Stand | Win10 Pro 64 | 3-year, Onsite | May 7, 2023 | 04/17 |
| 10NX000NUS | US | i5-7500 | Intel HD 630 | None | 4GBx1 | 21.5" FHD (1920x1080) WVA AG | 10-point Multi-touch | 150W 85% Adapter | 128GB SSD M.2 PCIe NVMe | DVD±RW | 9-in-1 | None | 8265 ac, 2x2 + BT4.1 | None | 1080p | None | None | USB / USB | UltraFlex II Stand | Win10 Pro 64 | 3-year, Onsite | May 7, 2023 | 04/17 |
| 10NX000PUS | US | Pentium G4560 | Intel HD 610 | None | 4GBx1 | 21.5" FHD (1920x1080) WVA AG | 10-point Multi-touch | 150W 85% Adapter | 500GB 7200rpm 2.5" PCIe NVMe | DVD±RW | 9-in-1 | None | 8265 ac, 2x2 + BT4.1 | None | 1080p | None | None | USB / USB | UltraFlex II Stand | Win10 Pro 64 | 3-year, Onsite | May 7, 2023 | 04/17 |
| 10NX000QUS | US | i3-7100 | Intel HD 630 | None | 8GBx1 | 21.5" FHD (1920x1080) WVA AG | 10-point Multi-touch | 150W 85% Adapter | 500GB 7200rpm 2.5" PCIe NVMe | DVD±RW | 9-in-1 | None | 8265 ac, 2x2 + BT4.1 | None | 1080p | None | None | USB / USB | UltraFlex II Stand | Win10 Pro 64 | 3-year, Onsite | May 7, 2023 | 04/17 |
| 10NX000RUS | US | i3-7100 | Intel HD 630 | None | 4GBx1 | 21.5" FHD (1920x1080) WVA AG | 10-point Multi-touch | 150W 85% Adapter | 500GB 7200rpm 2.5" PCIe NVMe | DVD±RW | 9-in-1 | None | 8265 ac, 2x2 + BT4.1 | None | 1080p | None | None | USB / USB | UltraFlex II Stand | Win10 Pro 64 | 3-year, Onsite | May 7, 2023 | 04/17 |

| Model | Region | Processor | Graphics | Monitor Cable | Memory | Display | Multi-touch | Power Supply | Storage(HDD/SSD) | Optical | Media Reader | USB Type-C | WLAN + Bluetooth | Optional Rear Ports | Camera | Chassis Intrusion Switch | Cable Lock | Keyboard / Mouse | Stand | Operating System | Warranty | End of Support | Ann Date (m/y) |
|------------|--------|---------------|--------------|---------------|--------|------------------------------|-------------|------------------|---------------------------|---------|--------------|------------|----------------------|---------------------|--------|--------------------------|------------|------------------|--------------------|----------------------|----------------|----------------|----------------|
| 10NY0002US | US | i5-7500 | Intel HD 630 | None | 8GBx1 | 21.5" FHD (1920x1080) WVA AG | None | 150W 85% Adapter | 512GB SSD M.2 PCIe NVMe | DVD±RW | 9-in-1 | None | 8265 ac, 2x2 + BT4.1 | None | 1080p | None | None | USB / USB | UltraFlex II Stand | Win10 Pro 64 | 3-year, Onsite | Apr 7, 2023 | 03/17 |
| 10NY0003US | US | i7-7700 | Intel HD 630 | None | 8GBx1 | 21.5" FHD (1920x1080) WVA AG | None | 150W 85% Adapter | 512GB SSD M.2 PCIe NVMe | DVD±RW | 9-in-1 | None | 8265 ac, 2x2 + BT4.1 | None | 1080p | None | None | USB / USB | UltraFlex II Stand | Win10 Pro 64 | 3-year, Onsite | Apr 7, 2023 | 03/17 |
| 10NY0004US | US | i5-7500 | Intel HD 630 | None | 8GBx1 | 21.5" FHD (1920x1080) WVA AG | None | 150W 85% Adapter | 256GB SSD M.2 PCIe NVMe | DVD±RW | 9-in-1 | None | 8265 ac, 2x2 + BT4.1 | None | 1080p | None | None | USB / USB | UltraFlex II Stand | Win10 Pro 64 | 3-year, Onsite | Apr 7, 2023 | 03/17 |
| 10NY0005US | US | i7-7700 | Intel HD 630 | None | 8GBx1 | 21.5" FHD (1920x1080) WVA AG | None | 150W 85% Adapter | 500GB 7200rpm 2.5" DVD±RW | DVD±RW | 9-in-1 | None | 8265 ac, 2x2 + BT4.1 | None | 1080p | None | None | USB / USB | UltraFlex II Stand | Win10 Pro 64 | 3-year, Onsite | Apr 7, 2023 | 03/17 |
| 10NY0006US | US | i5-7400 | Intel HD 630 | None | 8GBx1 | 21.5" FHD (1920x1080) WVA AG | None | 150W 85% Adapter | 500GB 7200rpm 2.5" DVD±RW | DVD±RW | 9-in-1 | None | 8265 ac, 2x2 + BT4.1 | None | 1080p | None | None | USB / USB | UltraFlex II Stand | Win10 Pro 64 | 3-year, Onsite | Apr 7, 2023 | 03/17 |
| 10NY0007US | US | i5-7500 | Intel HD 630 | None | 8GBx1 | 21.5" FHD (1920x1080) WVA AG | None | 150W 85% Adapter | 500GB 7200rpm 2.5" DVD±RW | DVD±RW | 9-in-1 | None | 8265 ac, 2x2 + BT4.1 | None | 1080p | None | None | USB / USB | UltraFlex II Stand | Win10 Pro 64 | 3-year, Onsite | Apr 7, 2023 | 03/17 |
| 10NY0008US | US | i5-7400 | Intel HD 630 | None | 4GBx1 | 21.5" FHD (1920x1080) WVA AG | None | 150W 85% Adapter | 500GB 7200rpm 2.5" DVD±RW | DVD±RW | 9-in-1 | None | 8265 ac, 2x2 + BT4.1 | None | 1080p | None | None | USB / USB | UltraFlex II Stand | Win10 Pro 64 | 3-year, Onsite | Apr 7, 2023 | 03/17 |
| 10NY0009US | US | i5-7400 | Intel HD 630 | None | 8GBx1 | 21.5" FHD (1920x1080) WVA AG | None | 150W 85% Adapter | 256GB SSD M.2 PCIe NVMe | DVD±RW | 9-in-1 | None | 8265 ac, 2x2 + BT4.1 | None | 1080p | None | None | USB / USB | UltraFlex II Stand | Win10 Pro 64 | 3-year, Onsite | Apr 7, 2023 | 03/17 |
| 10NY000BUS | US | i7-7700 | Intel HD 630 | None | 8GBx1 | 21.5" FHD (1920x1080) WVA AG | None | 150W 85% Adapter | 256GB SSD M.2 PCIe NVMe | DVD±RW | 9-in-1 | None | 8265 ac, 2x2 + BT4.1 | None | 1080p | None | None | USB / USB | UltraFlex II Stand | Win10 Pro 64 | 3-year, Onsite | Apr 7, 2023 | 03/17 |
| 10NY000CUS | US | i5-7500 | Intel HD 630 | None | 4GBx1 | 21.5" FHD (1920x1080) WVA AG | None | 150W 85% Adapter | 500GB 7200rpm 2.5" DVD±RW | DVD±RW | 9-in-1 | None | 8265 ac, 2x2 + BT4.1 | None | 1080p | None | None | USB / USB | UltraFlex II Stand | Win10 Pro 64 | 3-year, Onsite | Apr 7, 2023 | 03/17 |
| 10NY000QUS | US | Pentium G4400 | Intel HD 510 | None | 4GBx1 | 21.5" FHD (1920x1080) WVA AG | None | 150W 85% Adapter | 500GB 7200rpm 2.5" DVD±RW | DVD±RW | 9-in-1 | None | 8265 ac, 2x2 + BT4.1 | None | 1080p | None | None | USB / USB | UltraFlex II Stand | Win10 DG Win7 Pro 64 | 3-year, Onsite | Apr 29, 2023 | 03/17 |
| 10NY000RUS | US | i5-6500 | Intel HD 530 | None | 4GBx1 | 21.5" FHD (1920x1080) WVA AG | None | 150W 85% Adapter | 500GB 7200rpm 2.5" DVD±RW | DVD±RW | 9-in-1 | None | 8265 ac, 2x2 + BT4.1 | None | 1080p | None | None | USB / USB | UltraFlex II Stand | Win10 DG Win7 Pro 64 | 3-year, Onsite | Apr 29, 2023 | 03/17 |
| 10NY000SUS | US | i5-7400 | Intel HD 630 | None | 4GBx1 | 21.5" FHD (1920x1080) WVA AG | None | 150W 85% Adapter | 128GB SSD M.2 PCIe NVMe | DVD±RW | 9-in-1 | None | 8265 ac, 2x2 + BT4.1 | None | 1080p | None | None | USB / USB | UltraFlex II Stand | Win10 Pro 64 | 3-year, Onsite | May 7, 2023 | 04/17 |
| 10NY000TUS | US | i5-6500 | Intel HD 530 | None | 4GBx1 | 21.5" FHD (1920x1080) WVA AG | None | 150W 85% Adapter | 128GB SSD M.2 PCIe NVMe | DVD±RW | 9-in-1 | None | 8265 ac, 2x2 + BT4.1 | None | 1080p | None | None | USB / USB | UltraFlex II Stand | Win10 DG Win7 Pro 64 | 3-year, Onsite | Apr 29, 2023 | 03/17 |
| 10NY000UUS | US | i7-6700 | Intel HD 530 | None | 8GBx1 | 21.5" FHD (1920x1080) WVA AG | None | 150W 85% Adapter | 512GB SSD M.2 PCIe NVMe | DVD±RW | 9-in-1 | None | 8265 ac, 2x2 + BT4.1 | None | 1080p | None | None | USB / USB | UltraFlex II Stand | Win10 DG Win7 Pro 64 | 3-year, Onsite | Apr 29, 2023 | 03/17 |
| 10NY000VUS | US | i7-6700 | Intel HD 530 | None | 8GBx1 | 21.5" FHD (1920x1080) WVA AG | None | 150W 85% Adapter | 500GB 7200rpm 2.5" DVD±RW | DVD±RW | 9-in-1 | None | 8265 ac, 2x2 + BT4.1 | None | 1080p | None | None | USB / USB | UltraFlex II Stand | Win10 DG Win7 Pro 64 | 3-year, Onsite | Apr 29, 2023 | 03/17 |
| 10NY000WUS | US | i7-6700 | Intel HD 530 | None | 8GBx1 | 21.5" FHD (1920x1080) WVA AG | None | 150W 85% Adapter | 256GB SSD M.2 PCIe NVMe | DVD±RW | 9-in-1 | None | 8265 ac, 2x2 + BT4.1 | None | 1080p | None | None | USB / USB | UltraFlex II Stand | Win10 DG Win7 Pro 64 | 3-year, Onsite | Apr 29, 2023 | 03/17 |
| 10NY000XUS | US | i5-6500 | Intel HD 530 | None | 8GBx1 | 21.5" FHD (1920x1080) WVA AG | None | 150W 85% Adapter | 256GB SSD M.2 PCIe NVMe | DVD±RW | 9-in-1 | None | 8265 ac, 2x2 + BT4.1 | None | 1080p | None | None | USB / USB | UltraFlex II Stand | Win10 DG Win7 Pro 64 | 3-year, Onsite | Apr 29, 2023 | 03/17 |
| 10NY000YUS | US | i3-6100 | Intel HD 530 | None | 4GBx1 | 21.5" FHD (1920x1080) WVA AG | None | 150W 85% Adapter | 500GB 7200rpm 2.5" DVD±RW | DVD±RW | 9-in-1 | None | 8265 ac, 2x2 + BT4.1 | None | 1080p | None | None | USB / USB | UltraFlex II Stand | Win10 DG Win7 Pro 64 | 3-year, Onsite | Apr 29, 2023 | 03/17 |
| 10NY0010US | US | i3-6100 | Intel HD 530 | None | 8GBx1 | 21.5" FHD (1920x1080) WVA AG | None | 150W 85% Adapter | 500GB 7200rpm 2.5" DVD±RW | DVD±RW | 9-in-1 | None | 8265 ac, 2x2 + BT4.1 | None | 1080p | None | None | USB / USB | UltraFlex II Stand | Win10 DG Win7 Pro 64 | 3-year, Onsite | Apr 29, 2023 | 03/17 |

| Model | Region | Processor | Graphics | Monitor Cable | Memory | Display | Multi-touch | Power Supply | Storage(HDD/SSD) | Optical | Media Reader | USB Type-C | WLAN + Bluetooth | Optional Rear Ports | Camera | Chassis Intrusion Switch | Cable Lock | Keyboard / Mouse | Stand | Operating System | Warranty | End of Support | Ann Date (m/y) |
|------------|--------|---------------|--------------|---------------|--------|------------------------------|-------------|------------------|------------------------------|---------|--------------|------------|----------------------|---------------------|--------|--------------------------|------------|------------------|--------------------|----------------------|----------------|----------------|----------------|
| 10NY0011US | US | i5-7500 | Intel HD 630 | None | 4GBx1 | 21.5" FHD (1920x1080) WVA AG | None | 150W 85% Adapter | 128GB SSD M.2 PCIe NVMe | DVD±RW | 9-in-1 | None | 8265 ac, 2x2 + BT4.1 | None | 1080p | None | None | USB / USB | UltraFlex II Stand | Win10 Pro 64 | 3-year, Onsite | May 7, 2023 | 04/17 |
| 10NY0012US | US | i5-6500 | Intel HD 530 | None | 8GBx1 | 21.5" FHD (1920x1080) WVA AG | None | 150W 85% Adapter | 500GB 7200rpm 2.5" PCIe NVMe | DVD±RW | 9-in-1 | None | 8265 ac, 2x2 + BT4.1 | None | 1080p | None | None | USB / USB | UltraFlex II Stand | Win10 DG Win7 Pro 64 | 3-year, Onsite | Apr 29, 2023 | 03/17 |
| 10NY0013US | US | Pentium G4560 | Intel HD 610 | None | 4GBx1 | 21.5" FHD (1920x1080) WVA AG | None | 150W 85% Adapter | 500GB 7200rpm 2.5" PCIe NVMe | DVD±RW | 9-in-1 | None | 8265 ac, 2x2 + BT4.1 | None | 1080p | None | None | USB / USB | UltraFlex II Stand | Win10 Pro 64 | 3-year, Onsite | May 7, 2023 | 04/17 |
| 10NY0014US | US | i3-7100 | Intel HD 630 | None | 8GBx1 | 21.5" FHD (1920x1080) WVA AG | None | 150W 85% Adapter | 500GB 7200rpm 2.5" PCIe NVMe | DVD±RW | 9-in-1 | None | 8265 ac, 2x2 + BT4.1 | None | 1080p | None | None | USB / USB | UltraFlex II Stand | Win10 Pro 64 | 3-year, Onsite | May 7, 2023 | 04/17 |
| 10NY0015US | US | i3-7100 | Intel HD 630 | None | 4GBx1 | 21.5" FHD (1920x1080) WVA AG | None | 150W 85% Adapter | 500GB 7200rpm 2.5" PCIe NVMe | DVD±RW | 9-in-1 | None | 8265 ac, 2x2 + BT4.1 | None | 1080p | None | None | USB / USB | UltraFlex II Stand | Win10 Pro 64 | 3-year, Onsite | May 7, 2023 | 04/17 |

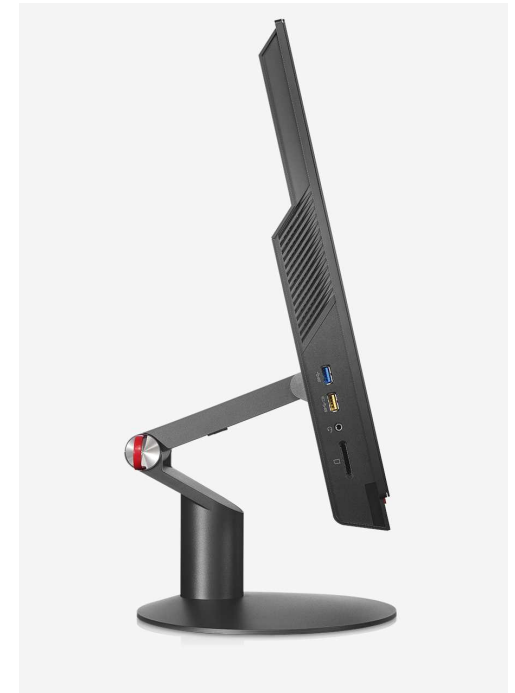
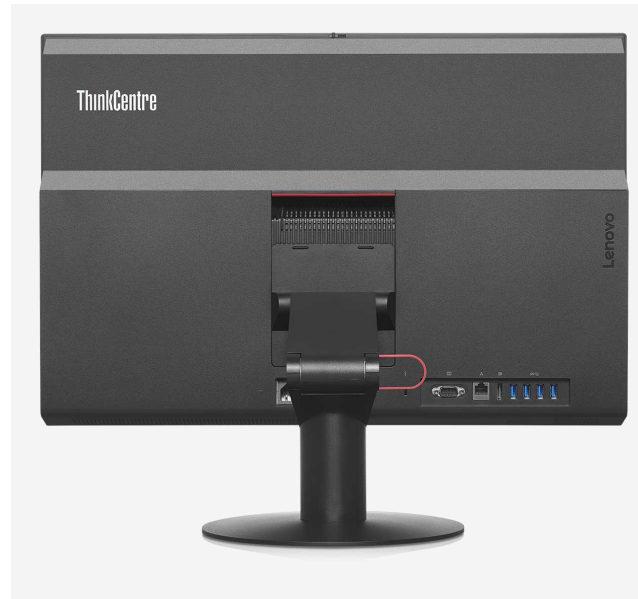

ThinkCentre M900z Platform Specifications

Product Specifications Reference (PSREF)

| Processor | Intel® Celeron®, Intel Pentium®, or 6th Generation Intel Core™ i3 / i5 / i7 Processor | | | | | | | Security chip | Trusted Platform Module (TPM 1.2-compliant) | | | | | | | | | | | | | | | | | | |
|---------------------------|---|---|---|-----------|--------------|---------------------|------------|--|---|--|--|--|--------------------|----------------------|-------------|----------------|--|--|-----|---------------------------|---|------------------------|--------------------------------|--------------------------|---|---|---|
| | Processor | Cores / Threads | Frequency Base/Max(GHz) | Cache | Memory Types | Integrated Graphics | Intel vPro | Security features | <ul style="list-style-type: none"> Security slot (in rear for attachment of Kensington lock also locks chassis) Power-on, admin, hard disk password Smart USB protection, allows keyboard/mouse only, blocks all storage devices Boot sequence control Boot without keyboard and mouse Individual USB port disablement Optional Chassis intrusion switch | | | | | | | | | | | | | | | | | | |
| | Pentium G4400 | 2 / 2 | 3.3G | 3 MB | DDR4-2133 | HD 510 | No | | | | | | | | | | | | | | | | | | | | |
| | Pentium G4500 | 2 / 2 | 3.5G | 3 MB | DDR4-2133 | HD 530 | No | | | | | | | | | | | | | | | | | | | | |
| | Core i3-6100 | 2 / 4 | 3.7 G | 3 MB | DDR4-2133 | HD 530 | No | | | | | | | | | | | | | | | | | | | | |
| | Core i3-6300 | 2 / 4 | 3.8 G | 4 MB | DDR4-2133 | HD 530 | No | | | | | | | | | | | | | | | | | | | | |
| | Core i5-6400 | 4 / 4 | 2.7 G / 3.3 G | 6 MB | DDR4-2133 | HD 530 | No | | | | | | | | | | | | | | | | | | | | |
| | Core i5-6500 | 4 / 4 | 3.2 G / 3.6 G | 6 MB | DDR4-2133 | HD 530 | vPro | | | | | | | | | | | | | | | | | | | | |
| Core i5-6600 | 4 / 4 | 3.3 G / 3.9 G | 6 MB | DDR4-2133 | HD 530 | vPro | | | | | | | | | | | | | | | | | | | | | |
| Core i7-6700 | 4 / 8 | 3.4 G / 4.0 G | 8 MB | DDR4-2133 | HD 530 | vPro | | | | | | | | | | | | | | | | | | | | | |
| Memory | 32GB max, DDR4 2133, two 260-pin SO-DIMM sockets, dual-channel capable | | | | | | | Keyboard | <i>Some:</i> Preferred Pro USB Keyboard (USB connector), Lenovo logo <i>Some:</i> Lenovo Slim USB Keyboard (USB connector), black <i>Some:</i> Ultralim Plus Wireless Keyboard (2.4GHz via USB receiver), black | | | | | | | | | | | | | | | | | | |
| Disk | <i>Some:</i> SATA 6.0Gb/s, 2.5" Wide, 5400 rpm or 7200 rpm <i>Some:</i> Solid State Hybrid Drive (SSHD) / with 8GB MLC NAND flash memory, SATA 6.0Gb/s, 2.5" Wide, 5400 rpm <i>Some:</i> Solid State Drive (SSD) / SATA 6.0Gb/s, 2.5" Wide | | | | | | | Mouse | <i>Some:</i> Enhanced Optical USB Mouse, black, Lenovo logo <i>Some:</i> Ultralim Plus Wireless Mouse (2.4GHz via USB receiver), black | | | | | | | | | | | | | | | | | | |
| Optical | <i>Some:</i> DVD, SATA 1.5Gb/s, 9.5mm high <i>Some:</i> DVD burner, SATA 1.5Gb/s, 9.5mm high | | | | | | | Mechanical | <ul style="list-style-type: none"> Business black color Toolless back cover, stand, disk, memory removal Support VESA mount (100mm) | | | | | | | | | | | | | | | | | | |
| Media reader | Optional 9-in-1 media card reader | | | | | | | | <table border="1"> <thead> <tr> <th></th> <th>Dimensions (WxDxH)</th> <th>Max weight (lb / kg)</th> <th>Adjustments</th> </tr> </thead> <tbody> <tr> <td>Without stand:</td> <td>23.0 X 1.8 X 15.4 (inch); 584 X 45 X 390 (mm)</td> <td>(Touch) 17.2 / 7.8 (Non-touch) 15.0 / 6.8</td> <td>N/A</td> </tr> <tr> <td>With Basic Monitor stand:</td> <td>23.0 X 9.6 X 18.0 (inch); 584 X 245 X 458 (mm)</td> <td>(Non-touch) 19.4 / 8.8</td> <td>Tilt: 45° back, -5° forward</td> </tr> <tr> <td>With UltraFlex II stand:</td> <td>23.0X 10.0 X 19.9 (inch); 584 X 253 X 505 (mm)</td> <td>(Touch) 22.7 / 10.3 (Non-touch) 20.7 / 9.4</td> <td>Tilt: 61° back, -5° forward; Lift: 160mm; Swivel: +/-45°</td> </tr> </tbody> </table> | | | | Dimensions (WxDxH) | Max weight (lb / kg) | Adjustments | Without stand: | 23.0 X 1.8 X 15.4 (inch); 584 X 45 X 390 (mm) | (Touch) 17.2 / 7.8 (Non-touch) 15.0 / 6.8 | N/A | With Basic Monitor stand: | 23.0 X 9.6 X 18.0 (inch); 584 X 245 X 458 (mm) | (Non-touch) 19.4 / 8.8 | Tilt: 45° back, -5° forward | With UltraFlex II stand: | 23.0X 10.0 X 19.9 (inch); 584 X 253 X 505 (mm) | (Touch) 22.7 / 10.3 (Non-touch) 20.7 / 9.4 | Tilt: 61° back, -5° forward; Lift: 160mm; Swivel: +/-45° |
| | Dimensions (WxDxH) | Max weight (lb / kg) | Adjustments | | | | | | | | | | | | | | | | | | | | | | | | |
| Without stand: | 23.0 X 1.8 X 15.4 (inch); 584 X 45 X 390 (mm) | (Touch) 17.2 / 7.8 (Non-touch) 15.0 / 6.8 | N/A | | | | | | | | | | | | | | | | | | | | | | | | |
| With Basic Monitor stand: | 23.0 X 9.6 X 18.0 (inch); 584 X 245 X 458 (mm) | (Non-touch) 19.4 / 8.8 | Tilt: 45° back, -5° forward | | | | | | | | | | | | | | | | | | | | | | | | |
| With UltraFlex II stand: | 23.0X 10.0 X 19.9 (inch); 584 X 253 X 505 (mm) | (Touch) 22.7 / 10.3 (Non-touch) 20.7 / 9.4 | Tilt: 61° back, -5° forward; Lift: 160mm; Swivel: +/-45° | | | | | | | | | | | | | | | | | | | | | | | | |
| Graphics | Intel HD Graphics 510/530 in processor, uses main memory, DirectX® 12, external monitor support via DisplayPort™; <i>Max resolution:</i> 4096x2304 (DP)@60Hz | | | | | | | Power supply | | | | | | | | | | | | | | | | | | | |
| Display | 23.8" (604.5mm) Full HD 1080p (1920x1080) TFT color , WVA panel, wide viewing angle (+/- 89°), LED backlight, 250 nits, 16:9 aspect ratio, 1000:1 contrast ratio, anti-glare for both touch models and non-touch models, work as standalone monitor via DisplayPort (DP in / out combo) | | | | | | | 150 watts, autosensing, 85% PSU Limited warranty ³ <i>Some:</i> 1-year or 3-year, depot repair service <i>Some:</i> 1-year or 3-year, limited onsite service <i>Some:</i> 3-years, limited onsite service, OID (Onsite International Delivery) / <i>For Lenovo service upgrade options, please go to S-TC sheet</i> | | | | | | | | | | | | | | | | | | | |
| Light sensor | None | | | | | | | Preload | Preloaded operating system <i>Some:</i> Windows® 7 Professional 32/64 preinstalled through downgrade rights in Windows 10 Pro 64-bit <i>Some:</i> Windows 7 Professional 64 <i>Some:</i> Windows 10 Pro 64-bit <i>Some:</i> Windows 10 Home 64-bit | | | | | | | | | | | | | | | | | | |
| Multi-touch | Optional Projected Capacitive Touch (PCT) technology, supports 10-point touch | | | | | | | | Preloaded applications (only some listed) <ul style="list-style-type: none"> Desktop Power Manager Lenovo Solution Center Lenovo REACHit Lenovo SHAREit Lenovo Bluetooth Lock (for models with Wi-Fi/BT card) McAfee® LiveSafe™ (30-day trial) Microsoft Office preloaded; purchase a product key to activate PowerDVD Create (DVD±RW) Lenovo ThinkVantage Tools - Only for Window 10 Lenovo Companion Cyberlink PowerDVD (DVD, DVD±RW) Lenovo QuickOptimizer - Only for Window 7 Rescue and Recovery Password Manager ThinkVantage System Update Lenovo Message Center Plus Adobe® Reader® | | | | | | | | | | | | | | | | | | |
| Camera | Optional 2.0-megapixel camera, fixed focus, supports 1080p, with dual array digital microphone, LED indicator, physical switch on/off, Skype for Business certified | | | | | | | Environment | | | | | | | | | | | | | | | | | | | |
| Controls | Microphone mute, monitor mode switch, brightness up/down buttons, and power button | | | | | | | EPEAT™ Gold rating; ENERGY STAR® 6.1; TCO Certified Edge; TUV Green Mark; ULE Gold; ErP Lot 3; GREENGUARD® certified; RoHS-compliant | | | | | | | | | | | | | | | | | | | |
| Chipset | Intel Q170 Chipset | | | | | | | MIL-SPEC test | MIL-STD-810G military certification (Low Pressure [Altitude], High Temperature, Low Temperature, Temperature Shock, Humidity, Sand and Dust, Vibration, Shock) | | | | | | | | | | | | | | | | | | |
| Rear ports | Four USB 3.0, ethernet (RJ-45), DisplayPort in/out combo port, optional serial (9-pin), | | | | | | | Accessories | For compatible accessories, please go to TC-AQP sheet | | | | | | | | | | | | | | | | | | |
| Side ports | Two USB 3.0 (one is Always On and fast charge), optional card reader, one headphone / microphone combo jack (3.5mm) | | | | | | | | | | | | | | | | | | | | | | | | | | |
| M.2 card slot | One M.2 Card slot (for WLAN) | | | | | | | | | | | | | | | | | | | | | | | | | | |
| Audio support | High Definition (HD) Audio, Realtek ALC286 / two internal stereo speakers (3W x 2), Dolby® Audio™ certified, Skype for Business certified | | | | | | | | | | | | | | | | | | | | | | | | | | |
| WLAN ¹³ | <i>Some:</i> 11ac wireless, M.2 Card, Qualcomm Atheros QCA9377 (dual band), Wi-Fi + Bluetooth 4.1 combo adapter, 1x1 <i>Some:</i> 11ac wireless, M.2 Card, Qualcomm Atheros QCA6174 (dual band), Wi-Fi + Bluetooth 4.1 combo adapter, 2x2 <i>Some:</i> 11ac wireless, M.2 Card, Intel Dual Band Wireless-AC 3165, Wi-Fi + Bluetooth 4.0 combo adapter, 1x1 <i>Some:</i> 11ac wireless, M.2 Card, Intel Dual Band Wireless-AC 8260, Wi-Fi + Bluetooth 4.1 combo adapter, 2x2 <i>Some:</i> 11ac wireless, M.2 Card, Intel Dual Band Wireless-AC 8260, Wi-Fi + Bluetooth 4.1 combo adapter, Intel vPro technology support, 2x2 | | | | | | | | | | | | | | | | | | | | | | | | | | |
| Bluetooth™ | <i>Some:</i> Bluetooth 4.0 or 4.1 wireless, integrated in Wi-Fi + Bluetooth combo adapter | | | | | | | | | | | | | | | | | | | | | | | | | | |
| Ethernet | Gigabit ethernet, Intel Ethernet Connection I219-LM (Jacksonville), Wake on LAN® | | | | | | | | | | | | | | | | | | | | | | | | | | |
| Manageability | Intel Active Management Technology 11.0 (Intel AMT 11.0); Intel vPro technology on some models (require choosing a vPro-support Wi-Fi adapter to enable vPro function through wireless connection) | | | | | | | | | | | | | | | | | | | | | | | | | | |

See footnotes for more detailed information

| Model | Region | Processor | vPro | Graphics | Monitor Cable | Memory | Display | Multi-touch | Storage(HDD/SSD) | Optical | Media Reader | WLAN + Bluetooth | Optional Rear Ports | Camera | Chassis Intrusion Switch | Keyboard / Mouse | Stand | Power Supply | Operating System | Warranty | Ann Date (m/y) |
|------------|--------|-----------|------|--------------|---------------|--------|------------------------------|----------------------|--------------------|---------|--------------|----------------------------|---------------------|--------|--------------------------|------------------|--------------------|------------------|----------------------|----------------|----------------|
| 10F20005US | US | i7-6700 | vPro | Intel HD 530 | None | 8GBx1 | 23.8" FHD (1920x1080) WVA AG | 10-point Multi-touch | 500GB 7200rpm 2.5" | DVD±RW | 9-in-1 | 8260 ac, 2x2, vPro + BT4.1 | None | 1080p | Switch | USB / USB | UltraFlex II Stand | 150W 85% Adapter | Win10 DG Win7 Pro 64 | 3-year, Onsite | 11/15 |
| 10F20006US | US | i5-6500 | vPro | Intel HD 530 | None | 8GBx1 | 23.8" FHD (1920x1080) WVA AG | 10-point Multi-touch | 500GB 7200rpm 2.5" | DVD±RW | 9-in-1 | 8260 ac, 2x2, vPro + BT4.1 | None | 1080p | None | USB / USB | UltraFlex II Stand | 150W 85% Adapter | Win10 DG Win7 Pro 64 | 3-year, Onsite | 11/15 |
| 10F20008US | US | i5-6500 | vPro | Intel HD 530 | None | 4GBx1 | 23.8" FHD (1920x1080) WVA AG | 10-point Multi-touch | 500GB 7200rpm 2.5" | DVD±RW | 9-in-1 | 8260 ac, 2x2, vPro + BT4.1 | None | 1080p | None | USB / USB | UltraFlex II Stand | 150W 85% Adapter | Win10 DG Win7 Pro 64 | 3-year, Onsite | 11/15 |
| 10F20009US | US | i7-6700 | vPro | Intel HD 530 | None | 4GBx1 | 23.8" FHD (1920x1080) WVA AG | 10-point Multi-touch | 500GB 7200rpm 2.5" | DVD±RW | 9-in-1 | 8260 ac, 2x2, vPro + BT4.1 | None | 1080p | Switch | USB / USB | UltraFlex II Stand | 150W 85% Adapter | Win10 DG Win7 Pro 64 | 3-year, Onsite | 11/15 |
| 10F2000AUS | US | i5-6600 | vPro | Intel HD 530 | None | 4GBx1 | 23.8" FHD (1920x1080) WVA AG | 10-point Multi-touch | 500GB 7200rpm 2.5" | DVD±RW | 9-in-1 | 8260 ac, 2x2, vPro + BT4.1 | None | 1080p | None | USB / USB | UltraFlex II Stand | 150W 85% Adapter | Win10 DG Win7 Pro 32 | 3-year, Onsite | 11/15 |
| 10F2000YUS | US | i5-6500 | vPro | Intel HD 530 | None | 4GBx1 | 23.8" FHD (1920x1080) WVA AG | 10-point Multi-touch | 500GB 7200rpm 2.5" | DVD±RW | 9-in-1 | 8260 ac, 2x2, vPro + BT4.1 | None | 1080p | None | USB / USB | UltraFlex II Stand | 150W 85% Adapter | Win10 Pro 64 | 3-year, Onsite | 11/15 |
| 10F20010US | US | i7-6700 | vPro | Intel HD 530 | None | 4GBx1 | 23.8" FHD (1920x1080) WVA AG | 10-point Multi-touch | 500GB 7200rpm 2.5" | DVD±RW | 9-in-1 | 8260 ac, 2x2, vPro + BT4.1 | None | 1080p | None | USB / USB | UltraFlex II Stand | 150W 85% Adapter | Win10 Pro 64 | 3-year, Onsite | 11/15 |
| 10F2001BUS | US | i7-6700 | vPro | Intel HD 530 | None | 4GBx2 | 23.8" FHD (1920x1080) WVA AG | 10-point Multi-touch | 128GB SSD | DVD±RW | 9-in-1 | 8260 ac, 2x2, vPro + BT4.1 | None | 1080p | None | USB / USB | UltraFlex II Stand | 150W 85% Adapter | Win10 Pro 64 | 1-year, Onsite | 11/15 |
| 10F20022US | US | i5-6500 | vPro | Intel HD 530 | None | 4GBx1 | 23.8" FHD (1920x1080) WVA AG | 10-point Multi-touch | 128GB SSD | DVD±RW | 9-in-1 | 8260 ac, 2x2, vPro + BT4.1 | None | 1080p | None | USB / USB | UltraFlex II Stand | 150W 85% Adapter | Win10 DG Win7 Pro 64 | 3-year, Onsite | 03/16 |
| 10F20023US | US | i7-6700 | vPro | Intel HD 530 | None | 4GBx1 | 23.8" FHD (1920x1080) WVA AG | 10-point Multi-touch | 128GB SSD | DVD±RW | 9-in-1 | 8260 ac, 2x2, vPro + BT4.1 | None | 1080p | None | USB / USB | UltraFlex II Stand | 150W 85% Adapter | Win10 Pro 64 | 3-year, Onsite | 03/16 |
| 10F20024US | US | i7-6700 | vPro | Intel HD 530 | None | 8GBx1 | 23.8" FHD (1920x1080) WVA AG | 10-point Multi-touch | 256GB SSD | DVD±RW | 9-in-1 | 8260 ac, 2x2, vPro + BT4.1 | None | 1080p | None | USB / USB | UltraFlex II Stand | 150W 85% Adapter | Win10 DG Win7 Pro 64 | 3-year, Onsite | 03/16 |
| 10F20025US | US | i5-6500 | vPro | Intel HD 530 | None | 4GBx1 | 23.8" FHD (1920x1080) WVA AG | 10-point Multi-touch | 128GB SSD | DVD±RW | 9-in-1 | 8260 ac, 2x2, vPro + BT4.1 | None | 1080p | None | USB / USB | UltraFlex II Stand | 150W 85% Adapter | Win10 Pro 64 | 3-year, Onsite | 03/16 |
| 10F20026US | US | i7-6700 | vPro | Intel HD 530 | None | 4GBx1 | 23.8" FHD (1920x1080) WVA AG | 10-point Multi-touch | 128GB SSD | DVD±RW | 9-in-1 | 8260 ac, 2x2, vPro + BT4.1 | None | 1080p | None | USB / USB | UltraFlex II Stand | 150W 85% Adapter | Win10 DG Win7 Pro 64 | 3-year, Onsite | 03/16 |
| 10F20027US | US | i5-6500 | vPro | Intel HD 530 | None | 8GBx1 | 23.8" FHD (1920x1080) WVA AG | 10-point Multi-touch | 256GB SSD | DVD±RW | 9-in-1 | 8260 ac, 2x2, vPro + BT4.1 | None | 1080p | None | USB / USB | UltraFlex II Stand | 150W 85% Adapter | Win10 Pro 64 | 3-year, Onsite | 03/16 |
| 10F20028US | US | i5-6500 | vPro | Intel HD 530 | None | 8GBx1 | 23.8" FHD (1920x1080) WVA AG | 10-point Multi-touch | 256GB SSD | DVD±RW | 9-in-1 | 8260 ac, 2x2, vPro + BT4.1 | None | 1080p | None | USB / USB | UltraFlex II Stand | 150W 85% Adapter | Win10 DG Win7 Pro 64 | 3-year, Onsite | 03/16 |
| 10F20029US | US | i7-6700 | vPro | Intel HD 530 | None | 8GBx1 | 23.8" FHD (1920x1080) WVA AG | 10-point Multi-touch | 256GB SSD | DVD±RW | 9-in-1 | 8260 ac, 2x2, vPro + BT4.1 | None | 1080p | None | USB / USB | UltraFlex II Stand | 150W 85% Adapter | Win10 Pro 64 | 3-year, Onsite | 03/16 |
| 10F2002PUS | US | i7-6700 | vPro | Intel HD 530 | None | 8GBx1 | 23.8" FHD (1920x1080) WVA AG | 10-point Multi-touch | 256GB SSD Opal | DVD±RW | 9-in-1 | 8260 ac, 2x2, vPro + BT4.1 | None | 1080p | None | USB / USB | UltraFlex II Stand | 150W 85% Adapter | Win10 DG Win7 Pro 64 | 3-year, Onsite | 12/16 |
| 10F2002QUS | US | i5-6500 | vPro | Intel HD 530 | None | 8GBx1 | 23.8" FHD (1920x1080) WVA AG | 10-point Multi-touch | 256GB SSD Opal | DVD±RW | 9-in-1 | 8260 ac, 2x2, vPro + BT4.1 | None | 1080p | None | USB / USB | UltraFlex II Stand | 150W 85% Adapter | Win10 Pro 64 | 3-year, Onsite | 12/16 |
| 10F2002RUS | US | i5-6500 | vPro | Intel HD 530 | None | 8GBx1 | 23.8" FHD (1920x1080) WVA AG | 10-point Multi-touch | 256GB SSD Opal | DVD±RW | 9-in-1 | 8260 ac, 2x2, vPro + BT4.1 | None | 1080p | None | USB / USB | UltraFlex II Stand | 150W 85% Adapter | Win10 DG Win7 Pro 64 | 3-year, Onsite | 12/16 |
| 10F2002SUS | US | i7-6700 | vPro | Intel HD 530 | None | 8GBx1 | 23.8" FHD (1920x1080) WVA AG | 10-point Multi-touch | 256GB SSD Opal | DVD±RW | 9-in-1 | 8260 ac, 2x2, vPro + BT4.1 | None | 1080p | None | USB / USB | UltraFlex II Stand | 150W 85% Adapter | Win10 Pro 64 | 3-year, Onsite | 12/16 |

| Model | Region | Processor | vPro | Graphics | Monitor Cable | Memory | Display | Multi-touch | Storage(HDD/SSD) | Optical | Media Reader | WLAN + Bluetooth | Optional Rear Ports | Camera | Chassis Intrusion Switch | Keyboard / Mouse | Stand | Power Supply | Operating System | Warranty | Ann Date (m/y) |
|------------|--------|-----------|------|--------------|---------------|--------|------------------------------|-------------|--------------------|---------|--------------|----------------------------|---------------------|--------|--------------------------|------------------|--------------------|------------------|----------------------|----------------|----------------|
| 10F30005US | US | i5-6500 | vPro | Intel HD 530 | None | 4GBx1 | 23.8" FHD (1920x1080) WVA AG | None | 500GB 7200rpm 2.5" | DVD±RW | 9-in-1 | 8260 ac, 2x2, vPro + BT4.1 | None | 1080p | None | USB / USB | UltraFlex II Stand | 150W 85% Adapter | Win10 DG Win7 Pro 64 | 3-year, Onsite | 11/15 |
| 10F30006US | US | i5-6500 | vPro | Intel HD 530 | None | 8GBx1 | 23.8" FHD (1920x1080) WVA AG | None | 500GB 7200rpm 2.5" | DVD±RW | 9-in-1 | 8260 ac, 2x2, vPro + BT4.1 | None | 1080p | None | USB / USB | UltraFlex II Stand | 150W 85% Adapter | Win10 DG Win7 Pro 64 | 3-year, Onsite | 11/15 |
| 10F30009US | US | i5-6500 | vPro | Intel HD 530 | None | 4GBx1 | 23.8" FHD (1920x1080) WVA AG | None | 500GB 7200rpm 2.5" | DVD±RW | 9-in-1 | 8260 ac, 2x2, vPro + BT4.1 | None | 1080p | None | USB / USB | UltraFlex II Stand | 150W 85% Adapter | Win10 Pro 64 | 3-year, Onsite | 11/15 |
| 10F3000AUS | US | i7-6700 | vPro | Intel HD 530 | None | 4GBx1 | 23.8" FHD (1920x1080) WVA AG | None | 500GB 7200rpm 2.5" | DVD±RW | 9-in-1 | 8260 ac, 2x2, vPro + BT4.1 | None | 1080p | None | USB / USB | UltraFlex II Stand | 150W 85% Adapter | Win10 Pro 64 | 3-year, Onsite | 11/15 |
| 10F3001FUS | US | i7-6700 | vPro | Intel HD 530 | None | 4GBx1 | 23.8" FHD (1920x1080) WVA AG | None | 128GB SSD | DVD±RW | 9-in-1 | 8260 ac, 2x2, vPro + BT4.1 | None | 1080p | None | USB / USB | UltraFlex II Stand | 150W 85% Adapter | Win10 Pro 64 | 3-year, Onsite | 05/16 |
| 10F3001GUS | US | i5-6500 | vPro | Intel HD 530 | None | 4GBx1 | 23.8" FHD (1920x1080) WVA AG | None | 128GB SSD | DVD±RW | 9-in-1 | 8260 ac, 2x2, vPro + BT4.1 | None | 1080p | None | USB / USB | UltraFlex II Stand | 150W 85% Adapter | Win10 Pro 64 | 3-year, Onsite | 05/16 |
| 10F3001HUS | US | i7-6700 | vPro | Intel HD 530 | None | 8GBx1 | 23.8" FHD (1920x1080) WVA AG | None | 256GB SSD | DVD±RW | 9-in-1 | 8260 ac, 2x2, vPro + BT4.1 | None | 1080p | None | USB / USB | UltraFlex II Stand | 150W 85% Adapter | Win10 Pro 64 | 3-year, Onsite | 05/16 |
| 10F3001JUS | US | i5-6500 | vPro | Intel HD 530 | None | 8GBx1 | 23.8" FHD (1920x1080) WVA AG | None | 256GB SSD | DVD±RW | 9-in-1 | 8260 ac, 2x2, vPro + BT4.1 | None | 1080p | None | USB / USB | UltraFlex II Stand | 150W 85% Adapter | Win10 Pro 64 | 3-year, Onsite | 05/16 |
| 10F30023US | US | i7-6700 | vPro | Intel HD 530 | None | 8GBx1 | 23.8" FHD (1920x1080) WVA AG | None | 256GB SSD Opal | DVD±RW | 9-in-1 | 8260 ac, 2x2, vPro + BT4.1 | None | 1080p | None | USB / USB | UltraFlex II Stand | 150W 85% Adapter | Win10 Pro 64 | 3-year, Onsite | 12/16 |
| 10F30024US | US | i5-6500 | vPro | Intel HD 530 | None | 8GBx1 | 23.8" FHD (1920x1080) WVA AG | None | 256GB SSD Opal | DVD±RW | 9-in-1 | 8260 ac, 2x2, vPro + BT4.1 | None | 1080p | None | USB / USB | UltraFlex II Stand | 150W 85% Adapter | Win10 Pro 64 | 3-year, Onsite | 12/16 |

| Model | Region | Processor | vPro | Graphics | Monitor Cable | Memory | Display | Multi-touch | Storage(HDD/SSD) | Optical | Media Reader | WLAN + Bluetooth | Optional Rear Ports | Camera | Chassis Intrusion Switch | Keyboard / Mouse | Stand | Power Supply | Operating System | Warranty | Ann Date (m/y) |
|------------|--------|-----------|------|--------------|---------------|--------|------------------------------|----------------------|------------------|---------|--------------|----------------------------|---------------------|--------|--------------------------|------------------|--------------------|------------------|----------------------|---------------------|----------------|
| 10F40013US | US | i7-6700 | vPro | Intel HD 530 | None | 4GBx2 | 23.8" FHD (1920x1080) WVA AG | 10-point Multi-touch | 128GB SSD | DVD±RW | 9-in-1 | 8260 ac, 2x2, vPro + BT4.1 | None | 1080p | Switch | 2.4G / 2.4G | UltraFlex II Stand | 150W 85% Adapter | Win10 Pro 64 | 3-year, Onsite, OID | 11/15 |
| 10F40014US | US | i7-6700 | vPro | Intel HD 530 | None | 4GBx2 | 23.8" FHD (1920x1080) WVA AG | 10-point Multi-touch | 128GB SSD | DVD±RW | 9-in-1 | 8260 ac, 2x2, vPro + BT4.1 | None | 1080p | Switch | 2.4G / 2.4G | UltraFlex II Stand | 150W 85% Adapter | Win10 DG Win7 Pro 64 | 3-year, Onsite, OID | 11/15 |

| Model | Region | Processor | vPro | Graphics | Monitor Cable | Memory | Display | Multi-touch | Storage(HDD/SSD) | Optical | Media Reader | WLAN + Bluetooth | Optional Rear Ports | Camera | Chassis Intrusion Switch | Keyboard / Mouse | Stand | Power Supply | Operating System | Warranty | Ann Date (m/y) |
|------------|--------|-----------|------|--------------|---------------|--------|------------------------------|-------------|------------------|---------|--------------|----------------------------|---------------------|--------|--------------------------|------------------|--------------------|------------------|----------------------|---------------------|----------------|
| 10F5000XUS | US | i5-6500 | vPro | Intel HD 530 | None | 4GBx1 | 23.8" FHD (1920x1080) WVA AG | None | 1TB 5400rpm 2.5" | DVD±RW | 9-in-1 | 8260 ac, 2x2, vPro + BT4.1 | None | 1080p | None | USB / USB | UltraFlex II Stand | 150W 85% Adapter | Win10 Pro 64 | 3-year, Onsite, OID | 11/15 |
| 10F5000YUS | US | i5-6500 | vPro | Intel HD 530 | None | 4GBx1 | 23.8" FHD (1920x1080) WVA AG | None | 1TB 5400rpm 2.5" | DVD±RW | 9-in-1 | 8260 ac, 2x2, vPro + BT4.1 | None | 1080p | Switch | USB / USB | UltraFlex II Stand | 150W 85% Adapter | Win10 DG Win7 Pro 64 | 3-year, Onsite, OID | 11/15 |

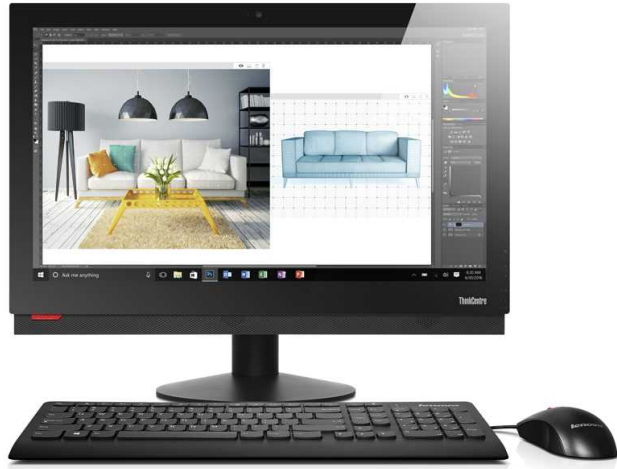

ThinkCentre M910z Platform Specifications

Product Specifications Reference (PSREF)

| | | | | | | | | | | | |
|---------------------|---|-----------------|-------------------------|-----------|------------------------|---------------------|---|--|---|---|--------------------------------|
| Processor | Intel® Celeron®, Intel Pentium®, or 6th / 7th Gen Intel Core™ i3 / i5 / i7 Processor | | | | | | Security chip | TPM (Trusted Platform Module) 2.0, TCG Certified * Downgrade to TPM1.2 for the models with Win10 DG Win7 32 OS | | | |
| | Processor | Cores / Threads | Frequency Base/Max(GHz) | Cache | Memory Support (Up to) | Integrated Graphics | Security features | <ul style="list-style-type: none"> Security slot (in rear for attachment of optional Kensington® MicroSaver® cable; Kensington lock also locks chassis) Smart USB protection, allows keyboard/mouse only, blocks all storage devices Optional cable lock to physically lock keyboard and mouse Power-on, admin, hard disk password Boot sequence control Boot without keyboard and mouse Individual USB port disablement Optional Chassis intrusion switch | | | |
| | Core i5-6500 | 4 / 4 | 3.2G / 3.6G | 6 MB | DDR4-2133 | HD 530 | | | | | |
| | Core i7-6700 | 4 / 8 | 3.4G / 4.0G | 8 MB | DDR4-2133 | HD 530 | | | | | |
| | Core i5-7400 | 4 / 4 | 3.0G / 3.5G | 6 MB | DDR4-2400 | HD 630 | | | | | |
| | Core i5-7500 | 4 / 4 | 3.4G / 3.8G | 6 MB | DDR4-2400 | HD 630 | | | | | |
| | Core i5-7600 | 4 / 4 | 3.5G / 4.1G | 6 MB | DDR4-2400 | HD 630 | | | | | |
| Core i7-7700 | 4 / 8 | 3.6G / 4.2G | 8 MB | DDR4-2400 | HD 630 | | | | | | |
| Memory | 32GB max, DDR4-2400*, two 260-pin SO-DIMM sockets, dual-channel capable * System clocks down for the processors with lower memory controller | | | | | | Keyboard | <i>Some:</i> Lenovo Calliope Keyboard (USB connector), black <i>Some:</i> Lenovo Traditional Keyboard (USB connector), black <i>Some:</i> Lenovo Calliope Wireless Keyboard (2.4GHz via USB receiver), black | | | |
| Storage | <i>Some:</i> Hard Drive / SATA 6.0Gb/s, 2.5", 5400 rpm or 7200 rpm <i>Some:</i> Solid State Drive (SSD) / SATA 6.0Gb/s, 2.5" <i>Some:</i> M.2 Solid State Drive (SSD) / PCIe NVMe, PCIe 3.0 x 4, 32Gb/s <i>Some:</i> Intel Optane™ Memory Ready (models with 7th gen Core processor), M.2 <i>Some:</i> DVD-ROM SATA 1.5Gb/s Drive, slim (9.5mm) <i>Some:</i> DVD Burner (DVD±RW), SATA 1.5Gb/s Drive, slim (9.5mm) Optional 9-in-1 media card reader | | | | | | Mouse | <i>Some:</i> Lenovo Calliope Mouse (USB connector), black <i>Some:</i> Lenovo Calliope Wireless Mouse (2.4GHz via USB receiver), black | | | |
| Optical | | | | | | | Mechanical | <ul style="list-style-type: none"> Business black color Toolless back cover, stand, disk, memory removal Support VESA mount (100mm) | | | |
| Media reader | | | | | | | | | Dimensions (WxDxH) | Max weight (lb / kg) | Adjustments |
| Graphics | Intel HD Graphics 510/530/610/630 in processor, uses main memory, DirectX® 12, external monitor support via DisplayPort™; <i>Max resolution:</i> 4096x2304 (DP) @60Hz, 1920x1080 (Panel) @60Hz 23.8" (604.5mm) Full HD 1080p (1920x1080) TFT color , WVA panel, wide viewing angle (+/- 89°), LED backlight, 250 nits, 16:9 aspect ratio, 1000:1 contrast ratio, anti-glare, support Low Blue Light Mode, work as standalone monitor via DisplayPort (DP in / out combo) | | | | | | | Without stand: | 23.0 X 1.8 X 15.4 (inch); 584 X 45 X 390 (mm) | (Touch) 17.2 / 7.8 (Non-touch) 15.0 / 6.8 | N/A |
| | | | | | | | | With Basic Monitor stand: | 23.0 X 9.6 X 18.0 (inch); 584 X 245 X 458 (mm) | (Non-touch) 19.4 / 8.8 | Tilt: 45° back, -5° forward |
| Display | | | | | | | With UltraFlex II stand: | 23.0X 10.0 X 19.9 (inch); 584 X 253 X 505 (mm) | (Touch) 22.7 / 10.3 (Non-touch) 20.7 / 9.4 | Tilt: 61° back, -5° forward; Lift: 110mm; Swivel: +/-45° | |
| Multi-touch Camera | Optional Projected Capacitive Touch (PCT) technology, supports 10-point touch Optional 1080p camera, fixed focus, with dual microphone, LED indicator, physical switch on/off | | | | | | Power supply | 150 watts, autosensing, 85% PSU | | | |
| Controls | Physical buttons for Microphone mute, monitor mode switch, brightness up/down, and power on/off | | | | | | Limited warranty ³ | <i>Some:</i> 1-year or 3-year, depot repair service / service upgrades available <i>Some:</i> 1-year or 3-year, limited onsite service / service upgrades available | | | |
| Chipset | Intel Q270 Chipset | | | | | | Preload | Preloaded operating system <i>Some:</i> Windows® 7 Professional 32/64 preinstalled through downgrade rights in Windows 10 Pro 64-bit <i>Some:</i> Windows 10 Pro 64-bit <i>Some:</i> Windows 10 Home 64-bit | | | |
| Rear ports | Four USB 3.1 Gen1, ethernet (RJ-45), DisplayPort in/out combo port, optional serial (9-pin) | | | | | | Preloaded applications (only some listed) | | | | |
| Side ports | Two USB 3.1 Gen1 (one is Always On and fast charge), optional card reader, one headphone / microphone combo jack (3.5mm), optional USB 3.1 Type-C Gen1 | | | | | | <ul style="list-style-type: none"> Microsoft Office preloaded; purchase a product key to activate Cyberlink PowerDVD Create (DVD±RW) - Only for Window 10 Lenovo Companion Lenovo ID Lenovo Settings Cyberlink PowerDVD (DVD, DVD±RW) - Only for Window 7 Lenovo Solution Center Lenovo ThinkVantage Tools ThinkVantage System Update Create Recovery Media Adobe® Reader® | | | | |
| M.2 card slot | Two M.2 Card slots (one for WLAN, one for SSD/Optane) | | | | | | Environment | EPEAT™ Gold rating (North America); ENERGY STAR® 6.1; TCO AIO Computer Certified; ULE Gold; ErP Lot 3; GREENGUARD® certified; RoHS-compliant | | | |
| Audio support | High Definition (HD) Audio, Realtek ALC233 / two internal speakers (3W x 2), Dolby® Audio™ certified | | | | | | MIL-SPEC test | MIL-STD-810G military certification (Low Pressure [Altitude], High Temperature, Low Temperature, Temperature Shock, Humidity, Sand and Dust, Vibration, Shock) | | | |
| WLAN ¹³ | <i>Some:</i> 11ac wireless, M.2 Card, Qualcomm Atheros QCA9377A (dual band), Wi-Fi + Bluetooth 4.1 combo adapter, 1x1 <i>Some:</i> 11ac wireless, M.2 Card, Qualcomm Atheros QCA6174A (dual band), Wi-Fi + Bluetooth 4.1 combo adapter, 2x2 <i>Some:</i> 11ac wireless, M.2 Card, Intel Dual Band Wireless-AC 3165, Wi-Fi + Bluetooth 4.1 combo adapter, 1x1 <i>Some:</i> 11ac wireless, M.2 Card, Intel Dual Band Wireless-AC 8265, Wi-Fi + Bluetooth 4.1 combo adapter, 2x2 <i>Some:</i> 11ac wireless, M.2 Card, Intel Dual Band Wireless-AC 8265, Wi-Fi + Bluetooth 4.1 combo adapter, Intel vPro technology support, 2x2 | | | | | | Accessories | For compatible accessories, please go to http://www.lenovoquickpick.com | | | |
| Bluetooth™ Ethernet | <i>Some:</i> Bluetooth 4.1 wireless, integrated in Wi-Fi + Bluetooth combo adapter Gigabit ethernet, Intel Ethernet Connection I219-LM (Jacksonville), Wake on LAN® | | | | | | Manageability | Intel Active Management Technology 11.0 (Intel AMT 11.0); Intel vPro technology on some models (require choosing a vPro-support Wi-Fi adapter to enable vPro function through wireless connection) | | | |

See footnotes for more detailed information

© Lenovo
(M910z-Spec) February 2017

| Model | Region | Processor | vPro | Graphics | Monitor Cable | Memory | Display | Multi-touch | Power Supply | Storage(HDD/SSD) | Optical | Media Reader | USB Type-C | WLAN + Bluetooth | Optional Rear Ports | Camera | Chassis Intrusion Switch | Cable Lock | Keyboard / Mouse | Stand | Operating System | Warranty | End of Support | Ann Date (m/y) |
|------------|--------|-----------|------|--------------|---------------|--------|------------------------------|----------------------|------------------|------------------------------|---------|--------------|------------|----------------------------|---------------------|--------|--------------------------|------------|------------------|--------------------|------------------|----------------|----------------|----------------|
| 10NR000HUS | US | i5-7500 | vPro | Intel HD 630 | None | 8GBx1 | 23.8" FHD (1920x1080) WVA AG | 10-point Multi-touch | 150W 85% Adapter | 256GB SSD M.2 PCIe NVMe Opal | DVD±RW | 9-in-1 | None | 8265 ac, 2x2, vPro + BT4.1 | None | 1080p | None | None | USB / USB | UltraFlex II Stand | Win10 Pro 64 | 3-year, Onsite | Mar 28, 2023 | 02/17 |
| 10NR000KUS | US | i5-7500 | vPro | Intel HD 630 | None | 8GBx1 | 23.8" FHD (1920x1080) WVA AG | 10-point Multi-touch | 150W 85% Adapter | 512GB SSD M.2 PCIe NVMe Opal | DVD±RW | 9-in-1 | None | 8265 ac, 2x2, vPro + BT4.1 | None | 1080p | None | None | USB / USB | UltraFlex II Stand | Win10 Pro 64 | 3-year, Onsite | Mar 28, 2023 | 02/17 |
| 10NR000LUS | US | i7-7700 | vPro | Intel HD 630 | None | 8GBx1 | 23.8" FHD (1920x1080) WVA AG | 10-point Multi-touch | 150W 85% Adapter | 256GB SSD M.2 PCIe NVMe Opal | DVD±RW | 9-in-1 | None | 8265 ac, 2x2, vPro + BT4.1 | None | 1080p | None | None | USB / USB | UltraFlex II Stand | Win10 Pro 64 | 3-year, Onsite | Mar 28, 2023 | 02/17 |
| 10NR000MUS | US | i5-7500 | vPro | Intel HD 630 | None | 8GBx1 | 23.8" FHD (1920x1080) WVA AG | 10-point Multi-touch | 150W 85% Adapter | 500GB 7200rpm 2.5" | DVD±RW | 9-in-1 | None | 8265 ac, 2x2, vPro + BT4.1 | None | 1080p | None | None | USB / USB | UltraFlex II Stand | Win10 Pro 64 | 3-year, Onsite | Mar 28, 2023 | 02/17 |
| 10NR000PUS | US | i7-7700 | vPro | Intel HD 630 | None | 8GBx1 | 23.8" FHD (1920x1080) WVA AG | 10-point Multi-touch | 150W 85% Adapter | 512GB SSD M.2 PCIe NVMe Opal | DVD±RW | 9-in-1 | None | 8265 ac, 2x2, vPro + BT4.1 | None | 1080p | None | None | USB / USB | UltraFlex II Stand | Win10 Pro 64 | 3-year, Onsite | Mar 28, 2023 | 02/17 |
| 10NR000QUS | US | i7-7700 | vPro | Intel HD 630 | None | 8GBx1 | 23.8" FHD (1920x1080) WVA AG | 10-point Multi-touch | 150W 85% Adapter | 500GB 7200rpm 2.5" | DVD±RW | 9-in-1 | None | 8265 ac, 2x2, vPro + BT4.1 | None | 1080p | None | None | USB / USB | UltraFlex II Stand | Win10 Pro 64 | 3-year, Onsite | Mar 28, 2023 | 02/17 |
| 10NR000RUS | US | i5-7500 | vPro | Intel HD 630 | None | 4GBx1 | 23.8" FHD (1920x1080) WVA AG | 10-point Multi-touch | 150W 85% Adapter | 500GB 7200rpm 2.5" | DVD±RW | 9-in-1 | None | 8265 ac, 2x2, vPro + BT4.1 | None | 1080p | None | None | USB / USB | UltraFlex II Stand | Win10 Pro 64 | 3-year, Onsite | Mar 28, 2023 | 02/17 |
| 10NR0017US | US | i5-7500 | vPro | Intel HD 630 | None | 4GBx1 | 23.8" FHD (1920x1080) WVA AG | 10-point Multi-touch | 150W 85% Adapter | 128GB SSD M.2 PCIe NVMe | DVD±RW | 9-in-1 | None | 8265 ac, 2x2, vPro + BT4.1 | None | 1080p | None | None | USB / USB | UltraFlex II Stand | Win10 Pro 64 | 3-year, Onsite | May 7, 2023 | 04/17 |
| 10NR0018US | US | i7-7700 | vPro | Intel HD 630 | None | 8GBx1 | 23.8" FHD (1920x1080) WVA AG | 10-point Multi-touch | 150W 85% Adapter | 128GB SSD M.2 PCIe NVMe | DVD±RW | 9-in-1 | None | 8265 ac, 2x2, vPro + BT4.1 | None | 1080p | None | None | USB / USB | UltraFlex II Stand | Win10 Pro 64 | 3-year, Onsite | May 7, 2023 | 04/17 |

| Model | Region | Processor | vPro | Graphics | Monitor Cable | Memory | Display | Multi-touch | Power Supply | Storage(HDD/SSD) | Optical | Media Reader | USB Type-C | WLAN + Bluetooth | Optional Rear Ports | Camera | Chassis Intrusion Switch | Cable Lock | Keyboard / Mouse | Stand | Operating System | Warranty | End of Support | Ann Date (m/y) |
|------------|--------|-----------|------|--------------|---------------|--------|------------------------------|-------------|------------------|------------------------------|---------|--------------|------------|----------------------------|---------------------|--------|--------------------------|------------|------------------|--------------------|----------------------|----------------|----------------|----------------|
| 10NS0001US | US | i5-7500 | vPro | Intel HD 630 | None | 4GBx1 | 23.8" FHD (1920x1080) WVA AG | None | 150W 85% Adapter | 500GB 7200rpm 2.5" DVD±RW | DVD±RW | 9-in-1 | None | 8265 ac, 2x2, vPro + BT4.1 | None | 1080p | None | None | USB / USB | UltraFlex II Stand | Win10 Pro 64 | 3-year, Onsite | Mar 28, 2023 | 02/17 |
| 10NS0003US | US | i5-7500 | vPro | Intel HD 630 | None | 8GBx1 | 23.8" FHD (1920x1080) WVA AG | None | 150W 85% Adapter | 256GB SSD M.2 PCIe NVMe Opal | DVD±RW | 9-in-1 | None | 8265 ac, 2x2, vPro + BT4.1 | None | 1080p | None | None | USB / USB | UltraFlex II Stand | Win10 Pro 64 | 3-year, Onsite | Mar 28, 2023 | 02/17 |
| 10NS0004US | US | i7-7700 | vPro | Intel HD 630 | None | 8GBx1 | 23.8" FHD (1920x1080) WVA AG | None | 150W 85% Adapter | 512GB SSD M.2 PCIe NVMe Opal | DVD±RW | 9-in-1 | None | 8265 ac, 2x2, vPro + BT4.1 | None | 1080p | None | None | USB / USB | UltraFlex II Stand | Win10 Pro 64 | 3-year, Onsite | Mar 28, 2023 | 02/17 |
| 10NS0006US | US | i7-7700 | vPro | Intel HD 630 | None | 8GBx1 | 23.8" FHD (1920x1080) WVA AG | None | 150W 85% Adapter | 500GB 7200rpm 2.5" DVD±RW | DVD±RW | 9-in-1 | None | 8265 ac, 2x2, vPro + BT4.1 | None | 1080p | None | None | USB / USB | UltraFlex II Stand | Win10 Pro 64 | 3-year, Onsite | Mar 28, 2023 | 02/17 |
| 10NS0007US | US | i5-7500 | vPro | Intel HD 630 | None | 8GBx1 | 23.8" FHD (1920x1080) WVA AG | None | 150W 85% Adapter | 500GB 7200rpm 2.5" DVD±RW | DVD±RW | 9-in-1 | None | 8265 ac, 2x2, vPro + BT4.1 | None | 1080p | None | None | USB / USB | UltraFlex II Stand | Win10 Pro 64 | 3-year, Onsite | Mar 28, 2023 | 02/17 |
| 10NS0008US | US | i5-7500 | vPro | Intel HD 630 | None | 8GBx1 | 23.8" FHD (1920x1080) WVA AG | None | 150W 85% Adapter | 512GB SSD M.2 PCIe NVMe Opal | DVD±RW | 9-in-1 | None | 8265 ac, 2x2, vPro + BT4.1 | None | 1080p | None | None | USB / USB | UltraFlex II Stand | Win10 Pro 64 | 3-year, Onsite | Mar 28, 2023 | 02/17 |
| 10NS000AUS | US | i7-7700 | vPro | Intel HD 630 | None | 8GBx1 | 23.8" FHD (1920x1080) WVA AG | None | 150W 85% Adapter | 256GB SSD M.2 PCIe NVMe Opal | DVD±RW | 9-in-1 | None | 8265 ac, 2x2, vPro + BT4.1 | None | 1080p | None | None | USB / USB | UltraFlex II Stand | Win10 Pro 64 | 3-year, Onsite | Mar 28, 2023 | 02/17 |
| 10NS000UUS | US | i5-6500 | vPro | Intel HD 530 | None | 8GBx1 | 23.8" FHD (1920x1080) WVA AG | None | 150W 85% Adapter | 128GB SSD M.2 PCIe NVMe | DVD±RW | 9-in-1 | None | 8265 ac, 2x2, vPro + BT4.1 | None | 1080p | None | None | USB / USB | UltraFlex II Stand | Win10 DG Win7 Pro 64 | 3-year, Onsite | Apr 29, 2023 | 03/17 |
| 10NS000VUS | US | i7-6700 | vPro | Intel HD 530 | None | 8GBx1 | 23.8" FHD (1920x1080) WVA AG | None | 150W 85% Adapter | 500GB 7200rpm 2.5" DVD±RW | DVD±RW | 9-in-1 | None | 8265 ac, 2x2, vPro + BT4.1 | None | 1080p | None | None | USB / USB | UltraFlex II Stand | Win10 DG Win7 Pro 64 | 3-year, Onsite | Apr 29, 2023 | 03/17 |
| 10NS000WUS | US | i5-6500 | vPro | Intel HD 530 | None | 8GBx1 | 23.8" FHD (1920x1080) WVA AG | None | 150W 85% Adapter | 256GB SSD M.2 PCIe NVMe Opal | DVD±RW | 9-in-1 | None | 8265 ac, 2x2, vPro + BT4.1 | None | 1080p | None | None | USB / USB | UltraFlex II Stand | Win10 DG Win7 Pro 64 | 3-year, Onsite | Apr 29, 2023 | 03/17 |
| 10NS000XUS | US | i5-6500 | vPro | Intel HD 530 | None | 4GBx1 | 23.8" FHD (1920x1080) WVA AG | None | 150W 85% Adapter | 500GB 7200rpm 2.5" DVD±RW | DVD±RW | 9-in-1 | None | 8265 ac, 2x2, vPro + BT4.1 | None | 1080p | None | None | USB / USB | UltraFlex II Stand | Win10 DG Win7 Pro 64 | 3-year, Onsite | Apr 29, 2023 | 03/17 |
| 10NS000YUS | US | i7-6700 | vPro | Intel HD 530 | None | 8GBx1 | 23.8" FHD (1920x1080) WVA AG | None | 150W 85% Adapter | 256GB SSD M.2 PCIe NVMe Opal | DVD±RW | 9-in-1 | None | 8265 ac, 2x2, vPro + BT4.1 | None | 1080p | None | None | USB / USB | UltraFlex II Stand | Win10 DG Win7 Pro 64 | 3-year, Onsite | Apr 29, 2023 | 03/17 |
| 10NS0010US | US | i5-6500 | vPro | Intel HD 530 | None | 8GBx1 | 23.8" FHD (1920x1080) WVA AG | None | 150W 85% Adapter | 500GB 7200rpm 2.5" DVD±RW | DVD±RW | 9-in-1 | None | 8265 ac, 2x2, vPro + BT4.1 | None | 1080p | None | None | USB / USB | UltraFlex II Stand | Win10 DG Win7 Pro 64 | 3-year, Onsite | Apr 29, 2023 | 03/17 |
| 10NS0011US | US | i5-7500 | vPro | Intel HD 630 | None | 8GBx1 | 23.8" FHD (1920x1080) WVA AG | None | 150W 85% Adapter | 128GB SSD M.2 PCIe NVMe | DVD±RW | 9-in-1 | None | 8265 ac, 2x2, vPro + BT4.1 | None | 1080p | None | None | USB / USB | UltraFlex II Stand | Win10 Pro 64 | 3-year, Onsite | May 7, 2023 | 04/17 |
| 10NS0012US | US | i7-6700 | vPro | Intel HD 530 | None | 8GBx1 | 23.8" FHD (1920x1080) WVA AG | None | 150W 85% Adapter | 512GB SSD M.2 PCIe NVMe Opal | DVD±RW | 9-in-1 | None | 8265 ac, 2x2, vPro + BT4.1 | None | 1080p | None | None | USB / USB | UltraFlex II Stand | Win10 DG Win7 Pro 64 | 3-year, Onsite | Apr 29, 2023 | 03/17 |
| 10NS0013US | US | i7-7700 | vPro | Intel HD 630 | None | 8GBx1 | 23.8" FHD (1920x1080) WVA AG | None | 150W 85% Adapter | 128GB SSD M.2 PCIe NVMe | DVD±RW | 9-in-1 | None | 8265 ac, 2x2, vPro + BT4.1 | None | 1080p | None | None | USB / USB | UltraFlex II Stand | Win10 Pro 64 | 3-year, Onsite | May 7, 2023 | 04/17 |
| 10NS0014US | US | i5-6500 | vPro | Intel HD 530 | None | 8GBx1 | 23.8" FHD (1920x1080) WVA AG | None | 150W 85% Adapter | 512GB SSD M.2 PCIe NVMe Opal | DVD±RW | 9-in-1 | None | 8265 ac, 2x2, vPro + BT4.1 | None | 1080p | None | None | USB / USB | UltraFlex II Stand | Win10 DG Win7 Pro 64 | 3-year, Onsite | Apr 29, 2023 | 03/17 |
| 10NS0015US | US | i7-6700 | vPro | Intel HD 530 | None | 8GBx1 | 23.8" FHD (1920x1080) WVA AG | None | 150W 85% Adapter | 128GB SSD M.2 PCIe NVMe | DVD±RW | 9-in-1 | None | 8265 ac, 2x2, vPro + BT4.1 | None | 1080p | None | None | USB / USB | UltraFlex II Stand | Win10 DG Win7 Pro 64 | 3-year, Onsite | Apr 29, 2023 | 03/17 |
| 10NS0016US | US | i5-7500 | vPro | Intel HD 630 | None | 4GBx1 | 23.8" FHD (1920x1080) WVA AG | None | 150W 85% Adapter | 128GB SSD M.2 PCIe NVMe | DVD±RW | 9-in-1 | None | 8265 ac, 2x2, vPro + BT4.1 | None | 1080p | None | None | USB / USB | UltraFlex II Stand | Win10 Pro 64 | 3-year, Onsite | May 7, 2023 | 04/17 |
| 10NS0017US | US | i5-6500 | vPro | Intel HD 530 | None | 4GBx1 | 23.8" FHD (1920x1080) WVA AG | None | 150W 85% Adapter | 128GB SSD M.2 PCIe NVMe | DVD±RW | 9-in-1 | None | 8265 ac, 2x2, vPro + BT4.1 | None | 1080p | None | None | USB / USB | UltraFlex II Stand | Win10 DG Win7 Pro 64 | 3-year, Onsite | Apr 29, 2023 | 03/17 |



ThinkCentre M600 Tiny Platform Specifications

Product Specifications Reference (PSREF)

| Processor | Intel® Celeron® Processor N3000 Series or Intel Pentium® Processor N3000 Series | Keyboard | Some: PS/2 Keyboard (PS/2 connector), Lenovo logo Some: Preferred Pro USB Keyboard (USB connector), Lenovo logo Some: Lenovo USB Fingerprint Keyboard (USB connector) Some: Ultralim Plus Wireless Keyboard (2.4GHz via USB receiver), black | | | | | | | | | | | | | | | | | | | | | | | | | | | | | | | | | | | | |
|--|---|---|---|----------------------|---------------------|----------------------|---------------------|---|-----------------|---------------------|---|-----------------|--|--|-------------------|--|--|------------------|--------------|---------------|-------|----------------|-----|------------|----------|---------------|-------|---------------|-----|------------|----------|---------------|-------|----------------|-----|------------|--------------|-------|---|
| | <table border="1"> <thead> <tr> <th>Processor</th> <th>Cores / Threads</th> <th>Frequency (Base/Max)</th> <th>Cache</th> <th>Memory Types</th> <th>Integrated Graphics</th> </tr> </thead> <tbody> <tr> <td>Celeron N3000</td> <td>2 / 2</td> <td>1.04 / 2.08 GHz</td> <td>2MB</td> <td>DDR3L-1600</td> <td>Intel HD</td> </tr> <tr> <td>Celeron N3010</td> <td>2 / 2</td> <td>1.04 / 2.24 GHz</td> <td>2MB</td> <td>DDR3L-1600</td> <td>Intel HD 400</td> </tr> <tr> <td>Celeron N3050</td> <td>2 / 2</td> <td>1.6 / 2.16 GHz</td> <td>2MB</td> <td>DDR3L-1600</td> <td>Intel HD</td> </tr> <tr> <td>Pentium N3700</td> <td>4 / 4</td> <td>1.6 / 2.4 GHz</td> <td>2MB</td> <td>DDR3L-1600</td> <td>Intel HD</td> </tr> <tr> <td>Pentium J3710</td> <td>4 / 4</td> <td>1.6 / 2.64 GHz</td> <td>2MB</td> <td>DDR3L-1600</td> <td>Intel HD 405</td> </tr> </tbody> </table> | Processor | Cores / Threads | Frequency (Base/Max) | Cache | Memory Types | Integrated Graphics | Celeron N3000 | 2 / 2 | 1.04 / 2.08 GHz | 2MB | DDR3L-1600 | Intel HD | Celeron N3010 | 2 / 2 | 1.04 / 2.24 GHz | 2MB | DDR3L-1600 | Intel HD 400 | Celeron N3050 | 2 / 2 | 1.6 / 2.16 GHz | 2MB | DDR3L-1600 | Intel HD | Pentium N3700 | 4 / 4 | 1.6 / 2.4 GHz | 2MB | DDR3L-1600 | Intel HD | Pentium J3710 | 4 / 4 | 1.6 / 2.64 GHz | 2MB | DDR3L-1600 | Intel HD 405 | Mouse | Some: PS/2 Optical Wheel Mouse, black, Lenovo logo Some: Enhanced Optical USB Mouse, black, Lenovo logo Some: Ultralim Plus Wireless Mouse (2.4GHz via USB receiver), black |
| Processor | Cores / Threads | Frequency (Base/Max) | Cache | Memory Types | Integrated Graphics | | | | | | | | | | | | | | | | | | | | | | | | | | | | | | | | | | |
| Celeron N3000 | 2 / 2 | 1.04 / 2.08 GHz | 2MB | DDR3L-1600 | Intel HD | | | | | | | | | | | | | | | | | | | | | | | | | | | | | | | | | | |
| Celeron N3010 | 2 / 2 | 1.04 / 2.24 GHz | 2MB | DDR3L-1600 | Intel HD 400 | | | | | | | | | | | | | | | | | | | | | | | | | | | | | | | | | | |
| Celeron N3050 | 2 / 2 | 1.6 / 2.16 GHz | 2MB | DDR3L-1600 | Intel HD | | | | | | | | | | | | | | | | | | | | | | | | | | | | | | | | | | |
| Pentium N3700 | 4 / 4 | 1.6 / 2.4 GHz | 2MB | DDR3L-1600 | Intel HD | | | | | | | | | | | | | | | | | | | | | | | | | | | | | | | | | | |
| Pentium J3710 | 4 / 4 | 1.6 / 2.64 GHz | 2MB | DDR3L-1600 | Intel HD 405 | | | | | | | | | | | | | | | | | | | | | | | | | | | | | | | | | | |
| Chipset | Intel Architecture (IA) SoC that integrates Intel processor core, graphics, memory controller, and I/O interfaces into a single system-on-chip solution | Mechanical | <ul style="list-style-type: none"> Tiny (1L or 2L), black color; metal case <table border="1"> <thead> <tr> <th></th> <th>Dimensions (WxDxH)</th> <th>Max weight (lb / kg)</th> </tr> </thead> <tbody> <tr> <td>M600 Tiny only (1L)</td> <td>7.05" X 7.20" X 1.36" 179mm X 182.9mm X 34.5mm</td> <td>2.9 lb (1.3 kg)</td> </tr> <tr> <td>M600 Tiny only (2L)</td> <td>7.05" X 7.20" X 3.15" 179mm X 182.9mm X 80mm</td> <td>4.2 lb (1.9 kg)</td> </tr> <tr> <td>M600 Tiny (1L) with VESA mount & ODD box</td> <td>7.42" X 7.30" X 2.48" 188.4mm X 185.38mm X 63mm</td> <td>4.12 lb (1.87 kg)</td> </tr> <tr> <td>M600 Tiny (1L) with VESA mount & I/O box</td> <td>7.42" X 7.30" X 2.62" 188.4mm X 185.38mm X 66.6mm</td> <td>3.53 lb (1.6 kg)</td> </tr> </tbody> </table> | | Dimensions (WxDxH) | Max weight (lb / kg) | M600 Tiny only (1L) | 7.05" X 7.20" X 1.36" 179mm X 182.9mm X 34.5mm | 2.9 lb (1.3 kg) | M600 Tiny only (2L) | 7.05" X 7.20" X 3.15" 179mm X 182.9mm X 80mm | 4.2 lb (1.9 kg) | M600 Tiny (1L) with VESA mount & ODD box | 7.42" X 7.30" X 2.48" 188.4mm X 185.38mm X 63mm | 4.12 lb (1.87 kg) | M600 Tiny (1L) with VESA mount & I/O box | 7.42" X 7.30" X 2.62" 188.4mm X 185.38mm X 66.6mm | 3.53 lb (1.6 kg) | | | | | | | | | | | | | | | | | | | | | |
| | Dimensions (WxDxH) | Max weight (lb / kg) | | | | | | | | | | | | | | | | | | | | | | | | | | | | | | | | | | | | | |
| M600 Tiny only (1L) | 7.05" X 7.20" X 1.36" 179mm X 182.9mm X 34.5mm | 2.9 lb (1.3 kg) | | | | | | | | | | | | | | | | | | | | | | | | | | | | | | | | | | | | | |
| M600 Tiny only (2L) | 7.05" X 7.20" X 3.15" 179mm X 182.9mm X 80mm | 4.2 lb (1.9 kg) | | | | | | | | | | | | | | | | | | | | | | | | | | | | | | | | | | | | | |
| M600 Tiny (1L) with VESA mount & ODD box | 7.42" X 7.30" X 2.48" 188.4mm X 185.38mm X 63mm | 4.12 lb (1.87 kg) | | | | | | | | | | | | | | | | | | | | | | | | | | | | | | | | | | | | | |
| M600 Tiny (1L) with VESA mount & I/O box | 7.42" X 7.30" X 2.62" 188.4mm X 185.38mm X 66.6mm | 3.53 lb (1.6 kg) | | | | | | | | | | | | | | | | | | | | | | | | | | | | | | | | | | | | | |
| Graphics | Intel HD Graphics in processor, uses main memory, DirectX® 11.1, twoDisplayPort™, one optional 3rd DP (not support DP to HDMI dongle) or VGA, supports triple independent display; Maximum resolution: 3840x2160(DP)@30Hz; 1920x1200(optional VGA)@60Hz; 1920x1080(DP to VGA dongle)@60Hz; 1920x1080(DP to DVI dongle)@60Hz; 3840x2160(DP to HDMI dongle)@30Hz | VESA mount | Optional VESA mount bracket kit, supports VESA 75mm and 100mm | | | | | | | | | | | | | | | | | | | | | | | | | | | | | | | | | | | | |
| Monitor cable | Optional DP to VGA, DP to DVI-D (single link), or DP to HDMI 1.4 dongle | Floor Stand | Optional system floor stand for vertical orientation | | | | | | | | | | | | | | | | | | | | | | | | | | | | | | | | | | | | |
| Memory | 8GB max / DDR3 Low Voltage, DDR3L-1600, non-parity, one 204-pin SO-DIMM socket | Power supply | 65 watts AC/DC adapter, autosensing, 88% PSU (not included for TIO models) 90 watts AC/DC adapter, autosensing, 88% PSU (only for models with I/O box) | | | | | | | | | | | | | | | | | | | | | | | | | | | | | | | | | | | | |
| Storage | Some: M.2 Solid State Drive (SSD), SATA interface Some: hard disk, 5400 or 7200 rpm, SATA 6.0Gb/s, 2.5" Wide Some: 500GB (5400 rpm) Solid State Hybrid Drive (SSHD) / with 8GB MLC NAND flash memory, SATA 6.0Gb/s, 2.5" wide | Limited warranty ³ | Some: 1-year or 3-year, depot service / service upgrades available Some: 1-year or 3-year, limited onsite service / service upgrades available Some: 3-year, limited onsite service, OI (Onsite International Delivery) / service upgrades available For Lenovo service upgrade options, please go to S-TC sheet | | | | | | | | | | | | | | | | | | | | | | | | | | | | | | | | | | | | |
| Optical | Some: Solid State Drive (SSD) / SATA 6.0Gb/s, 2.5" Wide Some: external ODD box with DVD-ROM, 9.5mm high, via USB Some: external ODD box with DVD±RW, 9.5mm high, via USB Some: external ODD box (for TIO) with DVD-ROM, 9.5mm high, via USB Some: external ODD box (for TIO) with DVD±RW, 9.5mm high, via USB | Preload | Some: Windows® 7 Professional 64 preinstalled through downgrade rights in Windows 10 Pro 64-bit Some: Windows 7 Professional 64 Some: Windows 10 Pro 64-bit Some: Windows 10 Home 64-bit Preloaded applications (only some listed): <ul style="list-style-type: none"> Desktop Power Manager Lenovo Solution Center Lenovo REACHit Lenovo SHAREit Lenovo Bluetooth Lock McAfee® LiveSafe™ (30-day trial) Microsoft Office preloaded; purchase a product key to activate PowerDVD Create (DVD±RW) Lenovo ThinkVantage Tools Only for Window 10 Lenovo Companion (Win10) Cyberlink PowerDVD (DVD, DVD±RW) Lenovo QuickOptimizer Only for Window 7 Rescue and Recovery Password Manager ThinkVantage System Update Lenovo Message Center Plus Adobe® Reader® | | | | | | | | | | | | | | | | | | | | | | | | | | | | | | | | | | | | |
| Onboard SATA Media reader | SATA 6.0Gb/s controller, one connectors on planar None | | Some: Windows Embedded Standard 7 (WES 7) Some: Windows 10 IoT Enterprise Some: LeTOS (Lenovo Terminal Operating System, Linux-based) Preloaded applications (only some listed): <ul style="list-style-type: none"> WES 7 only: RDP Client (RDP 8.1 support) Citrix Client VMware Client Internet Explorer 11 Java Flash .Net Framework Microsoft® Silverlight Echo Agent (client for LTM, Lenovo Thin Client Manager) Adobe Reader UltraVNC LeTOS only: xFreeRDP Citrix ICA Client VMware View Client Java Mozilla Firefox | | | | | | | | | | | | | | | | | | | | | | | | | | | | | | | | | | | | |
| Front ports | Two USB 3.0 (one is Always On and fast charge), one microphone (stereo, 3.5mm), one headphone / microphone combo jack (stereo, 3.5mm) | | | | | | | | | | | | | | | | | | | | | | | | | | | | | | | | | | | | | | |
| Rear ports | Two USB 2.0, two USB 3.0 (optional external optical box or I/O box occupies one or two specific USB on some models), ethernet (RJ-45), two DisplayPort, one optional port (VGA, 3rd DP, or serial on some models), one headphone; additional four serial (9-pin), one parallel (25-pin), and two PS/2 ports on 2L models | | | | | | | | | | | | | | | | | | | | | | | | | | | | | | | | | | | | | | |
| I/O box | Optional external I/O box, extends two USB 2.0, two USB 3.0, and one serial on rear, two USB 2.0 on front, via USB (occupy two specific USB 3.0 of M600 Tiny) | | | | | | | | | | | | | | | | | | | | | | | | | | | | | | | | | | | | | | |
| Audio support | High Definition (HD) Audio, Realtek ALC223 / optional internal speaker (1 watt) | | | | | | | | | | | | | | | | | | | | | | | | | | | | | | | | | | | | | | |
| WLAN ¹³ | Some: 11ac wireless, M.2 Card, Realtek RTL8821AE (dual band), Wi-Fi + Bluetooth 4.0 combo adapter, 1x1 Some: 11ac wireless, M.2 Card, Qualcomm Atheros QCA9377 (dual band), Wi-Fi + Bluetooth 4.1 combo adapter, 1x1 Some: 11ac wireless, M.2 Card, Qualcomm Atheros QCA6174 (dual band), Wi-Fi + Bluetooth 4.1 combo adapter, 2x2 Some: 11ac wireless, M.2 Card, Intel Dual Band Wireless-AC 3165, Wi-Fi + Bluetooth 4.0 combo adapter, 1x1 Some: 11ac wireless, M.2 Card, Intel Dual Band Wireless-AC 8260, Wi-Fi + Bluetooth 4.1 combo adapter, 2x2 | | | | | | | | | | | | | | | | | | | | | | | | | | | | | | | | | | | | | | |
| Bluetooth™ | Some: Bluetooth 4.0 or 4.1 wireless, integrated in Wi-Fi + BT combo adapter | | | | | | | | | | | | | | | | | | | | | | | | | | | | | | | | | | | | | | |
| Ethernet Modem | One gigabit ethernet port, Realtek RTL8111GN, Wake on LAN® None | | | | | | | | | | | | | | | | | | | | | | | | | | | | | | | | | | | | | | |
| Manageability | None | | | | | | | | | | | | | | | | | | | | | | | | | | | | | | | | | | | | | | |
| Security chip | Trusted Platform Module, TCG 1.2-compliant | | | | | | | | | | | | | | | | | | | | | | | | | | | | | | | | | | | | | | |
| Security features | <ul style="list-style-type: none"> Security slot (in rear for optional Kensington® MicroSaver® cable) Padlock loop Smart USB protection, allows keyboard/mouse only, blocks all storage devices Power-on password | <ul style="list-style-type: none"> Administrator password Hard disk password Boot sequence control Boot without keyboard and mouse Individual USB port disablement Chassis intrusion switch | | | | | | | | | | | | | | | | | | | | | | | | | | | | | | | | | | | | | |
| Environment | | | ENERGY STAR® 6.0*, EPEAT™ Gold rating* (*for Windows models only); GREENGUARD®; RoHS-compliant; Cisco EnergyWise compatible; ErP Lot 3 | | | | | | | | | | | | | | | | | | | | | | | | | | | | | | | | | | | | |
| Accessories | | | For compatible accessories, please go to TC-AQP sheet | | | | | | | | | | | | | | | | | | | | | | | | | | | | | | | | | | | | |

See footnotes for more detailed information

| Model | Region | Case 1L/2L | Processor | vPro | Graphics | Monitor Cable | Memory | Storage | External Optical / I/O Box | WLAN + Bluetooth | Optional Rear Ports | Chassis Intrusion Switch | Kensington Cable Lock | Speaker | Adapter Cage | Toolless Chassis Screw | Keyboard / Mouse | VESA Mount | Stand | Power Supply | Operating System | Warranty | Ann Date (m/y) |
|------------|--------|------------|---------------|------|--------------|---------------|--------|--------------------------|----------------------------|----------------------------------|---------------------|--------------------------|-----------------------|---------|--------------|------------------------|------------------|------------|----------------|-----------------------|----------------------------|-------------------|----------------|
| 10G9000NUS | US | 1L | Pentium N3700 | No | Intel HD | None | 4GBx1 | 500GB 7200rpm 2.5" | None | Intel 8260 ac, 2x2 + BT4.1 | None | Switch | None | 1Wx1 | None | None | USB / USB | None | Floor Stand | 65W Adapter 88% | Win10 DG Win7 Pro 64 | 1-year, Onsite | 10/15 |
| 10G9000WUS | US | 1L | Pentium N3700 | No | Intel HD | None | 4GBx1 | 500GB 7200rpm 2.5" | None | Intel 3165 ac, 1x1 + BT4.0 | Serial | Switch | None | 1Wx1 | None | None | USB / USB | None | Floor Stand | 65W Adapter 88% | Win10 DG Win7 Pro 64 | 1-year, Onsite | 04/16 |
| 10G9000XUS | US | 1L | Pentium N3700 | No | Intel HD | None | 4GBx1 | 500GB 7200rpm 2.5" | None | Intel 3165 ac, 1x1 + BT4.0 | VGA | Switch | None | 1Wx1 | None | None | USB / USB | None | Floor Stand | 65W Adapter 88% | Win10 DG Win7 Pro 64 | 1-year, Onsite | 05/16 |
| 10G9000YUS | US | 1L | Pentium N3700 | No | Intel HD | None | 4GBx1 | 500GB 7200rpm 2.5" | None | Intel 3165 ac, 1x1 + BT4.0 | 3rd DP | Switch | None | 1Wx1 | None | None | USB / USB | None | Floor Stand | 65W Adapter 88% | Win10 Pro 64 | 1-year, Onsite | 05/16 |
| 10G90010US | US | 1L | Pentium N3700 | No | Intel HD | None | 4GBx1 | 500GB 7200rpm 2.5" | None | Intel 3165 ac, 1x1 + BT4.0 | Serial | Switch | None | 1Wx1 | None | None | USB / USB | None | Floor Stand | 65W Adapter 88% | Win10 Pro 64 | 1-year, Onsite | 05/16 |
| 10G90011US | US | 1L | Pentium N3700 | No | Intel HD | None | 4GBx1 | 128GB SSD | None | Intel 3165 ac, 1x1 + BT4.0 | None | Switch | None | 1Wx1 | None | None | USB / USB | None | Floor Stand | 65W Adapter 88% | Win10 Pro 64 | 1-year, Onsite | 05/16 |
| 10G90012US | US | 1L | Pentium N3700 | No | Intel HD | None | 4GBx1 | 500GB 7200rpm 2.5" | None | Intel 3165 ac, 1x1 + BT4.0 | None | Switch | None | 1Wx1 | None | None | USB / USB | None | Floor Stand | 65W Adapter 88% | Win10 Pro 64 | 1-year, Onsite | 05/16 |
| 10G90013US | US | 1L | Pentium N3700 | No | Intel HD | None | 4GBx1 | 128GB SSD | None | Intel 3165 ac, 1x1 + BT4.0 | None | Switch | None | 1Wx1 | None | None | USB / USB | None | Floor Stand | 65W Adapter 88% | Win10 DG Win7 Pro 64 | 1-year, Onsite | 05/16 |
| 10G90014US | US | 1L | Pentium N3700 | No | Intel HD | None | 4GBx1 | 500GB 7200rpm 2.5" | None | Intel 3165 ac, 1x1 + BT4.0 | None | Switch | None | 1Wx1 | None | None | USB / USB | None | Floor Stand | 65W Adapter 88% | Win10 DG Win7 Pro 64 | 1-year, Onsite | 05/16 |
| 10G90015US | US | 1L | Pentium N3700 | No | Intel HD | None | 4GBx1 | 500GB 7200rpm 2.5" | None | Intel 3165 ac, 1x1 + BT4.0 | VGA | Switch | None | 1Wx1 | None | None | USB / USB | None | Floor Stand | 65W Adapter 88% | Win10 Pro 64 | 1-year, Onsite | 05/16 |
| 10G90016US | US | 1L | Pentium N3700 | No | Intel HD | None | 4GBx1 | 500GB 7200rpm 2.5" | None | Intel 3165 ac, 1x1 + BT4.0 | 3rd DP | Switch | None | 1Wx1 | None | None | USB / USB | None | Floor Stand | 65W Adapter 88% | Win10 DG Win7 Pro 64 | 1-year, Onsite | 05/16 |
| 10G9001CUS | US | 1L | Pentium J3710 | No | Intel HD 405 | None | 4GBx1 | 128GB SSD | None | Intel 8260 ac, 2x2 + BT4.1 | 3rd DP | Switch | None | 1Wx1 | None | None | USB / USB | None | Floor Stand | 65W Adapter 88% | Win10 Pro 64 | 1-year, Onsite | 07/16 |
| 10G9001DUS | US | 1L | Pentium J3710 | No | Intel HD 405 | None | 4GBx1 | 500GB 7200rpm 2.5" | None | Intel 3165 ac, 1x1 + BT4.0 | 3rd DP | Switch | None | 1Wx1 | None | None | USB / USB | None | Floor Stand | 65W Adapter 88% | Win10 Pro 64 | 1-year, Onsite | 07/16 |
| 10G9001EUS | US | 1L | Pentium J3710 | No | Intel HD 405 | None | 4GBx1 | 500GB 7200rpm 2.5" | None | Intel 3165 ac, 1x1 + BT4.0 | VGA | Switch | None | 1Wx1 | None | None | USB / USB | None | Floor Stand | 65W Adapter 88% | Win10 Pro 64 | 1-year, Onsite | 07/16 |
| 10G9001FUS | US | 1L | Pentium J3710 | No | Intel HD 405 | None | 4GBx1 | 500GB 7200rpm 2.5" | None | Intel 3165 ac, 1x1 + BT4.0 | None | Switch | None | 1Wx1 | None | None | USB / USB | None | Floor Stand | 65W Adapter 88% | Win10 Pro 64 | 1-year, Onsite | 07/16 |
| 10G9001GUS | US | 1L | Pentium J3710 | No | Intel HD 405 | None | 4GBx1 | 128GB SSD | None | Intel 3165 ac, 1x1 + BT4.0 | None | Switch | None | 1Wx1 | None | None | USB / USB | None | Floor Stand | 65W Adapter 88% | Win10 Pro 64 | 1-year, Onsite | 07/16 |
| 10G9001HUS | US | 1L | Pentium J3710 | No | Intel HD 405 | None | 4GBx1 | 500GB 7200rpm 2.5" | None | Intel 3165 ac, 1x1 + BT4.0 | Serial | Switch | None | 1Wx1 | None | None | USB / USB | None | Floor Stand | 65W Adapter 88% | Win10 Pro 64 | 1-year, Onsite | 07/16 |
| 10G9001QUS | US | 1L | Pentium J3710 | No | Intel HD 405 | None | 4GBx1 | 500GB 7200rpm 2.5" | None | Intel 8260 ac, 2x2 + BT4.1 | 3rd DP | Switch | None | 1Wx1 | None | None | USB / USB | None | Floor Stand | 65W Adapter 88% | Win10 DG Win7 Pro 64 | 1-year, Onsite | 09/16 |
| 10G9001RUS | US | 1L | Pentium J3710 | No | Intel HD 405 | None | 4GBx1 | 128GB SSD | None | Intel 3165 ac, 1x1 + BT4.0 | None | Switch | None | 1Wx1 | None | None | USB / USB | None | Floor Stand | 65W Adapter 88% | Win10 DG Win7 Pro 64 | 1-year, Onsite | 09/16 |
| 10G9001SUS | US | 1L | Pentium J3710 | No | Intel HD 405 | None | 4GBx1 | 500GB 7200rpm 2.5" | None | Intel 3165 ac, 1x1 + BT4.0 | 3rd DP | Switch | None | 1Wx1 | None | None | USB / USB | None | Floor Stand | 65W Adapter 88% | Win10 DG Win7 Pro 64 | 1-year, Onsite | 09/16 |

| Model | Region | Case 1L/2L | Processor | vPro | Graphics | Monitor Cable | Memory | Storage | External Optical / I/O Box | WLAN + Bluetooth | Optional Rear Ports | Chassis Intrusion Switch | Kensington Cable Lock | Speaker | Adapter Cage | Toolless Chassis Screw | Keyboard / Mouse | VESA Mount | Stand | Power Supply | Operating System | Warranty | Ann Date (m/y) |
|------------|--------|------------|---------------|------|--------------|---------------|--------|--------------------|----------------------------|----------------------------|---------------------|--------------------------|-----------------------|---------|--------------|------------------------|------------------|------------|-------------|-----------------|----------------------|----------------|----------------|
| 10G9001TUS | US | 1L | Pentium J3710 | No | Intel HD 405 | None | 4GBx1 | 128GB SSD | None | Intel 8260 ac, 2x2 + BT4.1 | 3rd DP | Switch | None | 1Wx1 | None | None | USB / USB | None | Floor Stand | 65W Adapter 88% | Win10 DG Win7 Pro 64 | 1-year, Onsite | 09/16 |
| 10G9001UUS | US | 1L | Pentium J3710 | No | Intel HD 405 | None | 4GBx1 | 500GB 7200rpm 2.5" | None | Intel 3165 ac, 1x1 + BT4.0 | None | Switch | None | 1Wx1 | None | None | USB / USB | None | Floor Stand | 65W Adapter 88% | Win10 DG Win7 Pro 64 | 1-year, Onsite | 09/16 |
| 10G9001VUS | US | 1L | Pentium J3710 | No | Intel HD 405 | None | 4GBx1 | 500GB 7200rpm 2.5" | None | Intel 3165 ac, 1x1 + BT4.0 | Serial | Switch | None | 1Wx1 | None | None | USB / USB | None | Floor Stand | 65W Adapter 88% | Win10 DG Win7 Pro 64 | 1-year, Onsite | 09/16 |
| 10G9001WUS | US | 1L | Pentium J3710 | No | Intel HD 405 | None | 4GBx1 | 500GB 7200rpm 2.5" | None | Intel 3165 ac, 1x1 + BT4.0 | VGA | Switch | None | 1Wx1 | None | None | USB / USB | None | Floor Stand | 65W Adapter 88% | Win10 DG Win7 Pro 64 | 1-year, Onsite | 09/16 |

ThinkCentre M600 Tiny - TopSeller - 10GB

Product Specifications Reference (PSREF)

| Model | Region | Case 1L/2L | Processor | vPro | Graphics | Monitor Cable | Memory | Storage | External Optical / I/O Box | WLAN + Bluetooth | Optional Rear Ports | Chassis Intrusion Switch | Kensington Cable Lock | Speaker | Adapter Cage | Toolless Chassis Screw | Keyboard / Mouse | VESA Mount | Stand | Power Supply | Operating System | Warranty | Ann Date (m/y) |
|------------|--------|------------|---------------|------|----------|---------------|--------|--------------------|----------------------------|----------------------------|---------------------|--------------------------|-----------------------|---------|--------------|------------------------|------------------|------------|-------------|-----------------|----------------------|----------------|----------------|
| 10GB000JUS | US | 1L | Celeron N3050 | No | Intel HD | None | 4GBx1 | 500GB 7200rpm 2.5" | None | Intel 8260 ac, 2x2 + BT4.1 | None | Switch | None | 1Wx1 | None | None | USB / USB | None | Floor Stand | 65W Adapter 88% | Win10 Pro 64 | 3-year, Onsite | 10/15 |
| 10GB000KUS | US | 1L | Celeron N3050 | No | Intel HD | None | 4GBx1 | 500GB 7200rpm 2.5" | None | Intel 8260 ac, 2x2 + BT4.1 | None | Switch | None | 1Wx1 | None | None | USB / USB | None | Floor Stand | 65W Adapter 88% | Win10 DG Win7 Pro 64 | 3-year, Onsite | 10/15 |
| 10GB000LUS | US | 1L | Celeron N3050 | No | Intel HD | None | 4GBx1 | 120GB SSD | None | Intel 8260 ac, 2x2 + BT4.1 | None | Switch | None | 1Wx1 | None | None | USB / USB | None | Floor Stand | 65W Adapter 88% | Win10 DG Win7 Pro 64 | 3-year, Onsite | 10/15 |
| 10GB000MUS | US | 1L | Celeron N3050 | No | Intel HD | None | 4GBx1 | 120GB SSD | None | Intel 8260 ac, 2x2 + BT4.1 | None | Switch | None | 1Wx1 | None | None | USB / USB | None | Floor Stand | 65W Adapter 88% | Win10 Pro 64 | 3-year, Onsite | 10/15 |

| Model | Region | Case 1L/2L | Processor | vPro | Graphics | Monitor Cable | Memory | Storage | External Optical / I/O Box | WLAN + Bluetooth | Optional Rear Ports | Chassis Intrusion Switch | Kensington Cable Lock | Speaker | Adapter Cage | Toolless Chassis Screw | Keyboard / Mouse | VESA Mount | Stand | Power Supply | Operating System | Warranty | Ann Date (m/y) |
|------------|--------|------------|---------------|------|--------------|---------------|--------|--------------|----------------------------|---------------------------|---------------------|--------------------------|-----------------------|---------|--------------|------------------------|------------------|------------|-------------|-----------------|------------------|----------------|----------------|
| 10KH0001US | US | 1L | Celeron N3000 | No | Intel HD | None | 2GBx1 | 16GB SSD M.2 | None | RTL8821AE ac, 1x1 + BT4.0 | None | Switch | None | 1Wx1 | None | None | USB / USB | None | Floor Stand | 65W Adapter 88% | WES 7 | 1-year, Onsite | 01/16 |
| 10KH0003US | US | 1L | Celeron N3000 | No | Intel HD | None | 4GBx1 | 16GB SSD M.2 | None | RTL8821AE ac, 1x1 + BT4.0 | VGA | Switch | None | 1Wx1 | None | None | USB / USB | None | Floor Stand | 65W Adapter 88% | WES 7 | 1-year, Onsite | 01/16 |
| 10KH0007US | US | 1L | Celeron N3000 | No | Intel HD | None | 4GBx1 | 16GB SSD M.2 | None | RTL8821AE ac, 1x1 + BT4.0 | None | Switch | None | 1Wx1 | None | None | USB / USB | None | Floor Stand | 65W Adapter 88% | WES 7 | 1-year, Onsite | 01/16 |
| 10KH0008US | US | 1L | Celeron N3000 | No | Intel HD | None | 4GBx1 | 16GB SSD M.2 | None | RTL8821AE ac, 1x1 + BT4.0 | 3rd DP | Switch | None | 1Wx1 | None | None | USB / USB | None | Floor Stand | 65W Adapter 88% | WES 7 | 1-year, Onsite | 01/16 |
| 10KH000BUS | US | 1L | Celeron N3000 | No | Intel HD | None | 2GBx1 | 16GB SSD M.2 | None | RTL8821AE ac, 1x1 + BT4.0 | None | Switch | None | 1Wx1 | None | None | USB / USB | None | Floor Stand | 65W Adapter 88% | LeTOS | 1-year, Onsite | 01/16 |
| 10KH000CUS | US | 1L | Celeron N3000 | No | Intel HD | None | 4GBx1 | 16GB SSD M.2 | None | RTL8821AE ac, 1x1 + BT4.0 | 3rd DP | Switch | None | 1Wx1 | None | None | USB / USB | None | Floor Stand | 65W Adapter 88% | LeTOS | 1-year, Onsite | 01/16 |
| 10KH000FUS | US | 1L | Celeron N3000 | No | Intel HD | None | 4GBx1 | 16GB SSD M.2 | None | RTL8821AE ac, 1x1 + BT4.0 | None | Switch | None | 1Wx1 | None | None | USB / USB | None | Floor Stand | 65W Adapter 88% | LeTOS | 1-year, Onsite | 01/16 |
| 10KH0023US | US | 1L | Celeron N3010 | No | Intel HD 400 | None | 2GBx1 | 16GB SSD M.2 | None | RTL8821AE ac, 1x1 + BT4.0 | None | Switch | None | 1Wx1 | None | None | USB / USB | None | Floor Stand | 65W Adapter 88% | LeTOS | 1-year, Onsite | 07/16 |
| 10KH0024US | US | 1L | Celeron N3010 | No | Intel HD 400 | None | 4GBx1 | 16GB SSD M.2 | None | RTL8821AE ac, 1x1 + BT4.0 | VGA | Switch | None | 1Wx1 | None | None | USB / USB | None | Floor Stand | 65W Adapter 88% | LeTOS | 1-year, Onsite | 07/16 |
| 10KH0025US | US | 1L | Celeron N3010 | No | Intel HD 400 | None | 4GBx1 | 16GB SSD M.2 | None | RTL8821AE ac, 1x1 + BT4.0 | None | Switch | None | 1Wx1 | None | None | USB / USB | None | Floor Stand | 65W Adapter 88% | WES 7 | 1-year, Onsite | 07/16 |
| 10KH0026US | US | 1L | Celeron N3010 | No | Intel HD 400 | None | 4GBx1 | 16GB SSD M.2 | None | RTL8821AE ac, 1x1 + BT4.0 | VGA | Switch | None | 1Wx1 | None | None | USB / USB | None | Floor Stand | 65W Adapter 88% | WES 7 | 1-year, Onsite | 07/16 |
| 10KH0027US | US | 1L | Celeron N3010 | No | Intel HD 400 | None | 4GBx1 | 16GB SSD M.2 | None | RTL8821AE ac, 1x1 + BT4.0 | Serial | Switch | None | 1Wx1 | None | None | USB / USB | None | Floor Stand | 65W Adapter 88% | LeTOS | 1-year, Onsite | 07/16 |
| 10KH0028US | US | 1L | Celeron N3010 | No | Intel HD 400 | None | 4GBx1 | 16GB SSD M.2 | None | RTL8821AE ac, 1x1 + BT4.0 | 3rd DP | Switch | None | 1Wx1 | None | None | USB / USB | None | Floor Stand | 65W Adapter 88% | WES 7 | 1-year, Onsite | 07/16 |
| 10KH0029US | US | 1L | Celeron N3010 | No | Intel HD 400 | None | 4GBx1 | 16GB SSD M.2 | None | RTL8821AE ac, 1x1 + BT4.0 | Serial | Switch | None | 1Wx1 | None | None | USB / USB | None | Floor Stand | 65W Adapter 88% | WES 7 | 1-year, Onsite | 07/16 |
| 10KH002VUS | US | 1L | Celeron N3010 | No | Intel HD 400 | None | 2GBx1 | 16GB SSD M.2 | None | RTL8821AE ac, 1x1 + BT4.0 | None | Switch | None | 1Wx1 | None | None | USB / USB | None | Floor Stand | 65W Adapter 88% | LeTOS | 1-year, Onsite | 01/17 |
| 10KH002WUS | US | 1L | Celeron N3010 | No | Intel HD 400 | None | 4GBx1 | 16GB SSD M.2 | None | RTL8821AE ac, 1x1 + BT4.0 | None | Switch | None | 1Wx1 | None | None | USB / USB | None | Floor Stand | 65W Adapter 88% | LeTOS | 1-year, Onsite | 01/17 |
| 10KH002XUS | US | 1L | Celeron N3010 | No | Intel HD 400 | None | 4GBx1 | 16GB SSD M.2 | None | RTL8821AE ac, 1x1 + BT4.0 | 3rd DP | Switch | None | 1Wx1 | None | None | USB / USB | None | Floor Stand | 65W Adapter 88% | LeTOS | 1-year, Onsite | 01/17 |
| 10KH002YUS | US | 1L | Celeron N3010 | No | Intel HD 400 | None | 4GBx1 | 32GB SSD M.2 | None | RTL8821AE ac, 1x1 + BT4.0 | VGA | Switch | None | 1Wx1 | None | None | USB / USB | None | Floor Stand | 65W Adapter 88% | WES 7 | 1-year, Onsite | 01/17 |
| 10KH0030US | US | 1L | Celeron N3010 | No | Intel HD 400 | None | 4GBx1 | 16GB SSD M.2 | None | RTL8821AE ac, 1x1 + BT4.0 | VGA | Switch | None | 1Wx1 | None | None | USB / USB | None | Floor Stand | 65W Adapter 88% | LeTOS | 1-year, Onsite | 01/17 |
| 10KH0031US | US | 1L | Celeron N3010 | No | Intel HD 400 | None | 4GBx1 | 32GB SSD M.2 | None | RTL8821AE ac, 1x1 + BT4.0 | Serial | Switch | None | 1Wx1 | None | None | USB / USB | None | Floor Stand | 65W Adapter 88% | WES 7 | 1-year, Onsite | 01/17 |

| Model | Region | Case 1L/2L | Processor | vPro | Graphics | Monitor Cable | Memory | Storage | External Optical / I/O Box | WLAN + Bluetooth | Optional Rear Ports | Chassis Intrusion Switch | Kensington Cable Lock | Speaker | Adapter Cage | Toolless Chassis Screw | Keyboard / Mouse | VESA Mount | Stand | Power Supply | Operating System | Warranty | Ann Date (m/y) |
|------------|--------|------------|---------------|------|--------------|---------------|--------|--------------|----------------------------|---------------------------|---------------------|--------------------------|-----------------------|---------|--------------|------------------------|------------------|------------|-------------|-----------------|---------------------------|----------------|----------------|
| 10KH0032US | US | 1L | Celeron N3010 | No | Intel HD 400 | None | 4GBx1 | 16GB SSD M.2 | None | RTL8821AE ac, 1x1 + BT4.0 | Serial | Switch | None | 1Wx1 | None | None | USB / USB | None | Floor Stand | 65W Adapter 88% | LeTOS | 1-year, Onsite | 01/17 |
| 10KH0033US | US | 1L | Celeron N3010 | No | Intel HD 400 | None | 4GBx1 | 32GB SSD M.2 | None | RTL8821AE ac, 1x1 + BT4.0 | 3rd DP | Switch | None | 1Wx1 | None | None | USB / USB | None | Floor Stand | 65W Adapter 88% | WES 7 | 1-year, Onsite | 01/17 |
| 10KH0034US | US | 1L | Celeron N3010 | No | Intel HD 400 | None | 4GBx1 | 32GB SSD M.2 | None | RTL8821AE ac, 1x1 + BT4.0 | None | Switch | None | 1Wx1 | None | None | USB / USB | None | Floor Stand | 65W Adapter 88% | WES 7 | 1-year, Onsite | 01/17 |
| 10KH003MUS | US | 1L | Celeron N3010 | No | Intel HD 400 | None | 4GBx1 | 32GB SSD M.2 | None | None | None | Switch | None | 1Wx1 | None | None | USB / USB | None | Floor Stand | 65W Adapter 88% | Windows 10 IoT Enterprise | 1-year, Onsite | 03/17 |
| 10KH003PUS | US | 1L | Celeron N3010 | No | Intel HD 400 | None | 4GBx1 | 32GB SSD M.2 | None | RTL8821AE ac, 1x1 + BT4.0 | 3rd DP | Switch | None | 1Wx1 | None | None | USB / USB | None | Floor Stand | 65W Adapter 88% | Windows 10 IoT Enterprise | 1-year, Onsite | 04/17 |
| 10KH003QUS | US | 1L | Celeron N3010 | No | Intel HD 400 | None | 4GBx1 | 32GB SSD M.2 | None | RTL8821AE ac, 1x1 + BT4.0 | None | Switch | None | 1Wx1 | None | None | USB / USB | None | Floor Stand | 65W Adapter 88% | Windows 10 IoT Enterprise | 1-year, Onsite | 04/17 |
| 10KH003RUS | US | 1L | Celeron N3010 | No | Intel HD 400 | None | 4GBx1 | 32GB SSD M.2 | None | RTL8821AE ac, 1x1 + BT4.0 | VGA | Switch | None | 1Wx1 | None | None | USB / USB | None | Floor Stand | 65W Adapter 88% | Windows 10 IoT Enterprise | 1-year, Onsite | 04/17 |
| 10KH003SUS | US | 1L | Celeron N3010 | No | Intel HD 400 | None | 8GBx1 | 32GB SSD M.2 | None | RTL8821AE ac, 1x1 + BT4.0 | 3rd DP | Switch | None | 1Wx1 | None | None | USB / USB | None | Floor Stand | 65W Adapter 88% | Windows 10 IoT Enterprise | 1-year, Onsite | 04/17 |
| 10KH0047US | US | 1L | Celeron N3010 | No | Intel HD 400 | None | 4GBx1 | 32GB SSD M.2 | None | RTL8821AE ac, 1x1 + BT4.0 | 3rd DP | Switch | None | 1Wx1 | None | None | USB / USB | None | Floor Stand | 65W Adapter 88% | LeTOS | 1-year, Onsite | 05/17 |
| 10KH0048US | US | 1L | Celeron N3010 | No | Intel HD 400 | None | 4GBx1 | 32GB SSD M.2 | None | RTL8821AE ac, 1x1 + BT4.0 | None | Switch | None | 1Wx1 | None | None | USB / USB | None | Floor Stand | 65W Adapter 88% | LeTOS | 1-year, Onsite | 05/17 |
| 10KH0049US | US | 1L | Celeron N3010 | No | Intel HD 400 | None | 2GBx1 | 32GB SSD M.2 | None | RTL8821AE ac, 1x1 + BT4.0 | None | Switch | None | 1Wx1 | None | None | USB / USB | None | Floor Stand | 65W Adapter 88% | LeTOS | 1-year, Onsite | 05/17 |
| 10KH004AUS | US | 1L | Celeron N3010 | No | Intel HD 400 | None | 4GBx1 | 32GB SSD M.2 | None | RTL8821AE ac, 1x1 + BT4.0 | Serial | Switch | None | 1Wx1 | None | None | USB / USB | None | Floor Stand | 65W Adapter 88% | LeTOS | 1-year, Onsite | 05/17 |
| 10KH004BUS | US | 1L | Celeron N3010 | No | Intel HD 400 | None | 4GBx1 | 32GB SSD M.2 | None | RTL8821AE ac, 1x1 + BT4.0 | VGA | Switch | None | 1Wx1 | None | None | USB / USB | None | Floor Stand | 65W Adapter 88% | LeTOS | 1-year, Onsite | 05/17 |

| Model | Region | Case 1L/2L | Processor | vPro | Graphics | Monitor Cable | Memory | Storage | External Optical / I/O Box | WLAN + Bluetooth | Optional Rear Ports | Chassis Intrusion Switch | Kensington Cable Lock | Speaker | Adapter Cage | Toolless Chassis Screw | Keyboard / Mouse | VESA Mount | Stand | Power Supply | Operating System | Warranty | Ann Date (m/y) |
|------------|--------|------------|---------------|------|----------|---------------|--------|--------------------------|----------------------------|-------------------------------|---------------------|--------------------------|-----------------------|---------|--------------|------------------------|------------------|---------------|-------|-----------------------|----------------------------|---------------------------|----------------|
| 10G8000QUS | US | 1L | Pentium N3700 | No | Intel HD | None | 4GBx1 | 500GB 7200rpm 2.5" | DVD±RW | QCA6174 ac, 2x2 + BT4.1 | None | Switch | None | 1Wx1 | None | None | USB / USB | VESA Mount | None | 65W Adapter 88% | Win10 DG Win7 Pro 64 | 3-year, Onsite, OID | 10/15 |
| 10G8000RUS | US | 1L | Pentium N3700 | No | Intel HD | None | 4GBx1 | 500GB 7200rpm 2.5" | DVD±RW | QCA6174 ac, 2x2 + BT4.1 | None | Switch | None | 1Wx1 | None | None | USB / USB | VESA Mount | None | 65W Adapter 88% | Win10 Pro 64 | 3-year, Onsite, OID | 10/15 |
| 10G8000SUS | US | 1L | Pentium N3700 | No | Intel HD | None | 2GBx1 | 500GB 7200rpm 2.5" | None | QCA9377 ac, 1x1 + BT4.1 | None | Switch | None | 1Wx1 | None | None | USB / USB | None | None | 65W Adapter 88% | Win10 Pro 64 | 3-year, Onsite, OID | 10/15 |
| 10G8000TUS | US | 1L | Pentium N3700 | No | Intel HD | None | 2GBx1 | 500GB 7200rpm 2.5" | None | QCA9377 ac, 1x1 + BT4.1 | None | Switch | None | 1Wx1 | None | None | USB / USB | None | None | 65W Adapter 88% | Win10 DG Win7 Pro 64 | 3-year, Onsite, OID | 10/15 |

ThinkCentre M600 Tiny - 10GA

Product Specifications Reference (PSREF)

| Model | Region | Case 1L/2L | Processor | vPro | Graphics | Monitor Cable | Memory | Storage | External Optical / I/O Box | WLAN + Bluetooth | Optional Rear Ports | Chassis Intrusion Switch | Kensington Cable Lock | Speaker | Adapter Cage | Toolless Chassis Screw | Keyboard / Mouse | VESA Mount | Stand | Power Supply | Operating System | Warranty | Ann Date (m/y) |
|------------|--------|------------|---------------|------|----------|---------------|--------|--------------------------|----------------------------|------------------|---------------------|--------------------------|-----------------------|---------|--------------|------------------------|------------------|---------------|-------|-----------------------|----------------------------|---------------------------|----------------|
| 10GA000JUS | US | 1L | Celeron N3050 | No | Intel HD | None | 2GBx1 | 500GB 7200rpm 2.5" | None | None | None | Switch | None | 1Wx1 | None | None | USB / USB | None | None | 65W Adapter 88% | Win10 DG Win7 Pro 64 | 3-year, Onsite, OID | 10/15 |
| 10GA000KUS | US | 1L | Celeron N3050 | No | Intel HD | None | 2GBx1 | 500GB 7200rpm 2.5" | DVD±RW | None | None | Switch | None | 1Wx1 | None | None | USB / USB | VESA Mount | None | 65W Adapter 88% | Win10 Pro 64 | 3-year, Onsite, OID | 10/15 |

ThinkCentre M600 Tiny - 10GC

Product Specifications Reference (PSREF)

| Model | Region | Case 1L/2L | Processor | vPro | Graphics | Monitor Cable | Memory | Storage | External Optical / I/O Box | WLAN + Bluetooth | Optional Rear Ports | Chassis Intrusion Switch | Kensington Cable Lock | Speaker | Adapter Cage | Toolless Chassis Screw | Keyboard / Mouse | VESA Mount | Stand | Power Supply | Operating System | Warranty | Ann Date (m/y) |
|------------|--------|------------|---------------|------|----------|---------------|--------|--------------------|----------------------------|-------------------------|---------------------|--------------------------|-----------------------|---------|--------------|------------------------|------------------|------------|-------|--------------|----------------------|---------------------|----------------|
| 10GC0001US | US | 1L | Pentium N3700 | No | Intel HD | None | 4GBx1 | 500GB 7200rpm 2.5" | DVD±RW (TIO) | QCA6174 ac, 2x2 + BT4.1 | None | Switch | None | 1Wx1 | None | None | USB / USB | None | None | None | Win10 Pro 64 | 3-year, Onsite, OID | 10/15 |
| 10GC0002US | US | 1L | Pentium N3700 | No | Intel HD | None | 4GBx1 | 500GB 7200rpm 2.5" | None | QCA6174 ac, 2x2 + BT4.1 | None | Switch | None | 1Wx1 | None | None | USB / USB | None | None | None | Win10 DG Win7 Pro 64 | 3-year, Onsite, OID | 10/15 |

ThinkCentre M600 Tiny - 10GE

Product Specifications Reference (PSREF)

| Model | Region | Case 1L/2L | Processor | vPro | Graphics | Monitor Cable | Memory | Storage | External Optical / I/O Box | WLAN + Bluetooth | Optional Rear Ports | Chassis Intrusion Switch | Kensington Cable Lock | Speaker | Adapter Cage | Toolless Chassis Screw | Keyboard / Mouse | VESA Mount | Stand | Power Supply | Operating System | Warranty | Ann Date (m/y) |
|------------|--------|------------|---------------|------|----------|---------------|--------|--------------------------|----------------------------|-------------------------------|---------------------|--------------------------|-----------------------|---------|--------------|------------------------|------------------|------------|-------|--------------|-------------------------|---------------------------|----------------|
| 10GE0001US | US | 1L | Celeron N3050 | No | Intel HD | None | 2GBx1 | 500GB 7200rpm 2.5" | None | QCA9377 ac, 1x1 + BT4.1 | None | Switch | None | 1Wx1 | None | None | USB / USB | None | None | None | Win10 DG Win7 Pro 64 | 3-year, Onsite, OID | 10/15 |



ThinkCentre M700 SFF Platform Specifications

Product Specifications Reference (PSREF)

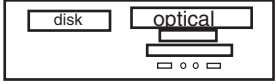
| Processor | Intel® Celeron®, Intel Pentium®, or 6th Generation Intel Core™ i3 / i5 / i7 Processor | Security features | <ul style="list-style-type: none"> One lock to secure both cover and entire system to fixed object: <ul style="list-style-type: none"> -Padlock loop (in rear for opt padlock) -Security slot (in rear for optional Kensington® MicroSaver® cable) Optional cable lock to physically lock both keyboard and mouse Power-on password Administrator password Hard disk password Boot sequence control Boot without keyboard and mouse Individual USB port disablement Optional chassis intrusion switch | | | | | | | | | | | | | | | | | | | | | | | | | | | | | | | | | | | | | | | | | | | | | | | | | | | | | | | | | | | | |
|--------------------|--|-------------------------------|---|-------------------------|---------------------|--------------|---------------------|---------------|-------|-------|------|-----------|--------|---------------|-------|-------|------|-----------|--------|---------------|-------|-------|------|-----------|--------|--------------|-------|-------|------|-----------|--------|--------------|-------|-------|------|-----------|--------|--------------|-------|---------------|------|-----------|--------|--------------|-------|---------------|------|-----------|--------|--------------|-------|---------------|------|-----------|--------|--------------|-------|---------------|------|-----------|--------|----------|---|
| | <table border="1"> <thead> <tr> <th>Processor</th> <th>Cores / Threads</th> <th>Frequency Base/Max(GHz)</th> <th>Cache</th> <th>Memory Types</th> <th>Integrated Graphics</th> </tr> </thead> <tbody> <tr> <td>Celeron G3900</td> <td>2 / 2</td> <td>2.8 G</td> <td>2 MB</td> <td>DDR4-2133</td> <td>HD 510</td> </tr> <tr> <td>Pentium G4400</td> <td>2 / 2</td> <td>3.3 G</td> <td>3 MB</td> <td>DDR4-2133</td> <td>HD 510</td> </tr> <tr> <td>Pentium G4500</td> <td>2 / 2</td> <td>3.5 G</td> <td>3 MB</td> <td>DDR4-2133</td> <td>HD 530</td> </tr> <tr> <td>Core i3-6100</td> <td>2 / 4</td> <td>3.7 G</td> <td>3 MB</td> <td>DDR4-2133</td> <td>HD 530</td> </tr> <tr> <td>Core i3-6300</td> <td>2 / 4</td> <td>3.8 G</td> <td>4 MB</td> <td>DDR4-2133</td> <td>HD 530</td> </tr> <tr> <td>Core i5-6400</td> <td>4 / 4</td> <td>2.7 G / 3.3 G</td> <td>6 MB</td> <td>DDR4-2133</td> <td>HD 530</td> </tr> <tr> <td>Core i5-6500</td> <td>4 / 4</td> <td>3.2 G / 3.6 G</td> <td>6 MB</td> <td>DDR4-2133</td> <td>HD 530</td> </tr> <tr> <td>Core i5-6600</td> <td>4 / 4</td> <td>3.3 G / 3.9 G</td> <td>6 MB</td> <td>DDR4-2133</td> <td>HD 530</td> </tr> <tr> <td>Core i7-6700</td> <td>4 / 8</td> <td>3.4 G / 4.0 G</td> <td>8 MB</td> <td>DDR4-2133</td> <td>HD 530</td> </tr> </tbody> </table> | Processor | Cores / Threads | Frequency Base/Max(GHz) | Cache | Memory Types | Integrated Graphics | Celeron G3900 | 2 / 2 | 2.8 G | 2 MB | DDR4-2133 | HD 510 | Pentium G4400 | 2 / 2 | 3.3 G | 3 MB | DDR4-2133 | HD 510 | Pentium G4500 | 2 / 2 | 3.5 G | 3 MB | DDR4-2133 | HD 530 | Core i3-6100 | 2 / 4 | 3.7 G | 3 MB | DDR4-2133 | HD 530 | Core i3-6300 | 2 / 4 | 3.8 G | 4 MB | DDR4-2133 | HD 530 | Core i5-6400 | 4 / 4 | 2.7 G / 3.3 G | 6 MB | DDR4-2133 | HD 530 | Core i5-6500 | 4 / 4 | 3.2 G / 3.6 G | 6 MB | DDR4-2133 | HD 530 | Core i5-6600 | 4 / 4 | 3.3 G / 3.9 G | 6 MB | DDR4-2133 | HD 530 | Core i7-6700 | 4 / 8 | 3.4 G / 4.0 G | 8 MB | DDR4-2133 | HD 530 | Keyboard | <i>Some:</i> PS/2 Keyboard (PS/2 connector), Lenovo logo <i>Some:</i> Preferred Pro USB Keyboard (USB connector), Lenovo logo <i>Some:</i> Lenovo USB Fingerprint Keyboard (USB connector) <i>Some:</i> Ultralim Plus Wireless Keyboard (2.4GHz via USB receiver), black |
| Processor | Cores / Threads | Frequency Base/Max(GHz) | Cache | Memory Types | Integrated Graphics | | | | | | | | | | | | | | | | | | | | | | | | | | | | | | | | | | | | | | | | | | | | | | | | | | | | | | | | | | |
| Celeron G3900 | 2 / 2 | 2.8 G | 2 MB | DDR4-2133 | HD 510 | | | | | | | | | | | | | | | | | | | | | | | | | | | | | | | | | | | | | | | | | | | | | | | | | | | | | | | | | | |
| Pentium G4400 | 2 / 2 | 3.3 G | 3 MB | DDR4-2133 | HD 510 | | | | | | | | | | | | | | | | | | | | | | | | | | | | | | | | | | | | | | | | | | | | | | | | | | | | | | | | | | |
| Pentium G4500 | 2 / 2 | 3.5 G | 3 MB | DDR4-2133 | HD 530 | | | | | | | | | | | | | | | | | | | | | | | | | | | | | | | | | | | | | | | | | | | | | | | | | | | | | | | | | | |
| Core i3-6100 | 2 / 4 | 3.7 G | 3 MB | DDR4-2133 | HD 530 | | | | | | | | | | | | | | | | | | | | | | | | | | | | | | | | | | | | | | | | | | | | | | | | | | | | | | | | | | |
| Core i3-6300 | 2 / 4 | 3.8 G | 4 MB | DDR4-2133 | HD 530 | | | | | | | | | | | | | | | | | | | | | | | | | | | | | | | | | | | | | | | | | | | | | | | | | | | | | | | | | | |
| Core i5-6400 | 4 / 4 | 2.7 G / 3.3 G | 6 MB | DDR4-2133 | HD 530 | | | | | | | | | | | | | | | | | | | | | | | | | | | | | | | | | | | | | | | | | | | | | | | | | | | | | | | | | | |
| Core i5-6500 | 4 / 4 | 3.2 G / 3.6 G | 6 MB | DDR4-2133 | HD 530 | | | | | | | | | | | | | | | | | | | | | | | | | | | | | | | | | | | | | | | | | | | | | | | | | | | | | | | | | | |
| Core i5-6600 | 4 / 4 | 3.3 G / 3.9 G | 6 MB | DDR4-2133 | HD 530 | | | | | | | | | | | | | | | | | | | | | | | | | | | | | | | | | | | | | | | | | | | | | | | | | | | | | | | | | | |
| Core i7-6700 | 4 / 8 | 3.4 G / 4.0 G | 8 MB | DDR4-2133 | HD 530 | | | | | | | | | | | | | | | | | | | | | | | | | | | | | | | | | | | | | | | | | | | | | | | | | | | | | | | | | | |
| | | Mouse | <i>Some:</i> PS/2 Optical Wheel Mouse, black, Lenovo logo <i>Some:</i> Enhanced Optical USB Mouse, black, Lenovo logo <i>Some:</i> Ultralim Plus Wireless Mouse (2.4GHz via USB receiver), black | | | | | | | | | | | | | | | | | | | | | | | | | | | | | | | | | | | | | | | | | | | | | | | | | | | | | | | | | | | | |
| Memory | 32GB max, UDIMM, DDR4 2133, two 288-pin DIMM sockets, dual-channel capable | Mechanical | <ul style="list-style-type: none"> SFF (9.7L), black color; metal case (WxDxH) 13.31" X 14.05" X 3.46"; 338mm X 357mm X 88mm 12.3 lb (5.6 kg) Toolless cover, disk, optical removal Toolless graphics, PCI adapter retention Optional dust filter Bay 1: N/A, 9.5mm high, external, std optical Bay 2: 3.5", 1" high, internal, std disk Bay 3: 2.5", N/A, internal, opt 2nd 2.5" disk (optional bay) Bay 4: N/A, N/A, external, opt reader Slot 1: Low Profile, PCI Express 3.0 x16 Slot 2: Low Profile, PCIe 2.0 x1 Slot 3: Low Profile, PCIe 2.0 x1 | | | | | | | | | | | | | | | | | | | | | | | | | | | | | | | | | | | | | | | | | | | | | | | | | | | | | | | | | | | | |
| Disk | <i>Some:</i> Hard disk, SATA 6.0Gb/s, 2.5"/ 3.5" wide, 5400 / 7200 rpm <i>Some:</i> Solid State Hybrid Drive (SSHD), 500GB (5400 rpm, 2.5") / 1TB or 2TB (7200 rpm, 3.5"), with 8GB NAND flash memory, SATA 6.0Gb/s <i>Some:</i> Solid State Drive (SSD) / SATA 6.0Gb/s, 2.5" Wide | |  | | | | | | | | | | | | | | | | | | | | | | | | | | | | | | | | | | | | | | | | | | | | | | | | | | | | | | | | | | | | |
| Optical | <i>Some:</i> DVD-ROM SATA 1.5Gb/s Drive <i>Some:</i> Super Multi-Burner DVD±RW SATA 1.5Gb/s Drive | | | | | | | | | | | | | | | | | | | | | | | | | | | | | | | | | | | | | | | | | | | | | | | | | | | | | | | | | | | | | | |
| Onboard SATA | Three onboard SATA 6.0Gb/s connectors | | | | | | | | | | | | | | | | | | | | | | | | | | | | | | | | | | | | | | | | | | | | | | | | | | | | | | | | | | | | | | |
| Media reader | Optional 9-in-1 media reader | | | | | | | | | | | | | | | | | | | | | | | | | | | | | | | | | | | | | | | | | | | | | | | | | | | | | | | | | | | | | | |
| Graphics | Intel HD Graphics 510/530 in processor, uses main memory, DirectX® 12, one VGA, one DisplayPort™, supports two independent displays, works along with discrete graphics to support more displays; <i>Max resolution:</i> 4096x2304 (DP)@60Hz; 1920x1200 (VGA)@60Hz <i>Some:</i> NVIDIA® Quadro® K420 , DirectX 12, 2GB, PCIe 2.0 x16 adapter, one DVI-I, one DisplayPort, 41 watts; <i>Max resolution:</i> 3840x2160 (DisplayPort)@60Hz; 2560x1600 (DVI-I)@60Hz <i>Some:</i> NVIDIA GeForce® GT 720 , DirectX 12, 2GB, PCIe 2.0 x8 adapter, one VGA, one HDMI, 25 watts; <i>Max resolution:</i> 1920x1080 (HDMI)@60Hz; 2048x1536 (VGA)@85Hz <i>Some:</i> NVIDIA GeForce GT 720 , DirectX 12, 1GB, PCIe 2.0 x8 adapter, two DisplayPort, 25 watts; <i>Max resolution:</i> 3840x2160 (DisplayPort)@60Hz; | | | | | | | | | | | | | | | | | | | | | | | | | | | | | | | | | | | | | | | | | | | | | | | | | | | | | | | | | | | | | | |
| DP cable | Optional DP to VGA, DP to DVI-D (single link), or DP to HDMI 1.4 dongle | Floor Stand | Optional system floor stand for vertical orientation | | | | | | | | | | | | | | | | | | | | | | | | | | | | | | | | | | | | | | | | | | | | | | | | | | | | | | | | | | | | |
| Chipset | Intel H110 Chipset | Power supply | <i>Some:</i> 180 watts, autosensing, 85% PSU <i>Some:</i> 210 watts, autosensing, 85% PSU | | | | | | | | | | | | | | | | | | | | | | | | | | | | | | | | | | | | | | | | | | | | | | | | | | | | | | | | | | | | |
| Front ports | Two USB 3.0, two optional USB 2.0, microphone (3.5mm), headphone (3.5mm) | Limited warranty ³ | <i>Some:</i> 1-year or 3-year, depot service / service upgrades available <i>Some:</i> 1-year or 3-year, limited onsite service / service upgrades available <i>Some:</i> 3-year, limited onsite service, OID (Onsite International Delivery) / service upgrades available <i>For Lenovo service upgrade options, please go to S-TC sheet</i> | | | | | | | | | | | | | | | | | | | | | | | | | | | | | | | | | | | | | | | | | | | | | | | | | | | | | | | | | | | | |
| Rear ports | Two USB 3.0, two USB 2.0, two optional USB 2.0, serial (9-pin), optional 2nd serial (9-pin), optional parallel (25-pin), ethernet (RJ-45), one VGA, one DisplayPort, two PS/2 ports (keyboard/mouse); additional VGA, DisplayPort, DVI-I or HDMI on optional graphics on some models | Preload | Preloaded operating system <i>Some:</i> Windows® 7 Professional 32/64 preinstalled through downgrade rights in Windows 10 Pro 64-bit <i>Some:</i> Windows 7 Professional 32/64 <i>Some:</i> Windows 10 Pro 64-bit <i>Some:</i> Windows 10 Home 64-bit Preloaded applications (only some listed) <ul style="list-style-type: none"> Desktop Power Manager Lenovo Solution Center Lenovo REACHit Lenovo SHAREit Lenovo Bluetooth Lock (for models with Wi-Fi/BT card) McAfee® LiveSafe™ (30-day trial) Microsoft Office preloaded; purchase a product key to activate PowerDVD Create (DVD±RW) Lenovo ThinkVantage Tools <ul style="list-style-type: none"> - Only for Window 10 Lenovo Companion Cyberlink PowerDVD (DVD, DVD±RW) Lenovo QuickOptimizer <ul style="list-style-type: none"> - Only for Window 7 Rescue and Recovery Password Manager ThinkVantage System Update Lenovo Message Center Plus Adobe® Reader® | | | | | | | | | | | | | | | | | | | | | | | | | | | | | | | | | | | | | | | | | | | | | | | | | | | | | | | | | | | | |
| Rear audio ports | Line-in (3.5mm), line-out (3.5mm), microphone-in (3.5mm) | Environment | ENERGY STAR® 6.0*, EPEAT™ Gold rating* (*Need 85% PSU and Windows OS); ErP Lot 3; GREENGUARD®; RoHS-compliant | | | | | | | | | | | | | | | | | | | | | | | | | | | | | | | | | | | | | | | | | | | | | | | | | | | | | | | | | | | | |
| IEEE 1394 | None | Accessories | For compatible accessories, please go to TC-AQP sheet | | | | | | | | | | | | | | | | | | | | | | | | | | | | | | | | | | | | | | | | | | | | | | | | | | | | | | | | | | | | |
| Audio support | High Definition (HD) Audio, Realtek ALC662 / optional internal speaker (1.5 watt) | | | | | | | | | | | | | | | | | | | | | | | | | | | | | | | | | | | | | | | | | | | | | | | | | | | | | | | | | | | | | | |
| WLAN ¹³ | <i>Some:</i> 11ac wireless, M.2 Card, Qualcomm Atheros QCA9377 (dual band), Wi-Fi + Bluetooth 4.1 combo adapter, 1x1 <i>Some:</i> 11ac wireless, M.2 Card, Qualcomm Atheros QCA6174 (dual band), Wi-Fi + Bluetooth 4.1 combo adapter, 2x2 <i>Some:</i> 11ac wireless, M.2 Card, Intel Dual Band Wireless-AC 3165, Wi-Fi + Bluetooth 4.0 combo adapter, 1x1 <i>Some:</i> 11ac wireless, M.2 Card, Intel Dual Band Wireless-AC 8260, Wi-Fi + Bluetooth 4.1 combo adapter, 2x2 | | | | | | | | | | | | | | | | | | | | | | | | | | | | | | | | | | | | | | | | | | | | | | | | | | | | | | | | | | | | | | |
| Bluetooth™ | <i>Some:</i> Bluetooth 4.0 or 4.1 wireless, integrated in Wi-Fi + BT combo adapter | | | | | | | | | | | | | | | | | | | | | | | | | | | | | | | | | | | | | | | | | | | | | | | | | | | | | | | | | | | | | | |
| Ethernet | Gigabit ethernet, Realtek RTL8111GN, Wake on LAN® | | | | | | | | | | | | | | | | | | | | | | | | | | | | | | | | | | | | | | | | | | | | | | | | | | | | | | | | | | | | | | |
| Modem | None | | | | | | | | | | | | | | | | | | | | | | | | | | | | | | | | | | | | | | | | | | | | | | | | | | | | | | | | | | | | | | |
| Manageability | None | | | | | | | | | | | | | | | | | | | | | | | | | | | | | | | | | | | | | | | | | | | | | | | | | | | | | | | | | | | | | | |
| Security chip | Trusted Platform Module, TCG 1.2-compliant | | | | | | | | | | | | | | | | | | | | | | | | | | | | | | | | | | | | | | | | | | | | | | | | | | | | | | | | | | | | | | |

See footnotes for more detailed information

| Model | Region | Processor | vPro | Graphics | Monitor Cable | Memory | Storage | Optical | Optional 2nd 2.5" Bay | Media Reader | WLAN + Bluetooth | Optional Front Ports | Optional Rear Ports | Chassis Intrusion Switch | Cable Lock | Dust Filter | Keyboard / Mouse | Stand | Power Supply | Operating System | Warranty | Ann Date (m/y) |
|------------|--------|---------------|------|---------------|---------------|--------|--------------------------|---------|-----------------------|--------------|----------------------------------|----------------------|---------------------|--------------------------|------------|-------------|------------------|-------------|--------------|-------------------------|-------------------|----------------|
| 10GT002DUS | US | i3-6100 | No | Intel HD 530 | None | 4GBx1 | 500GB 7200rpm 3.5" | DVD±RW | Optional 2nd 2.5" Bay | None | None | None | None | None | None | None | USB / USB | Floor Stand | 210W 85% | Win10 DG Win7 Pro 64 | 3-year, Onsite | 01/16 |
| 10GT002EUS | US | i5-6400 | No | Intel HD 530 | None | 4GBx1 | 500GB 7200rpm 3.5" | DVD±RW | Optional 2nd 2.5" Bay | None | None | None | None | None | None | None | USB / USB | Floor Stand | 210W 85% | Win10 DG Win7 Pro 64 | 3-year, Onsite | 01/16 |
| 10GT002FUS | US | Pentium G4400 | No | Intel HD 510 | None | 4GBx1 | 500GB 7200rpm 3.5" | DVD±RW | Optional 2nd 2.5" Bay | None | None | None | None | None | None | None | USB / USB | Floor Stand | 210W 85% | Win10 DG Win7 Pro 64 | 3-year, Onsite | 01/16 |
| 10GT002GUS | US | i7-6700 | No | Intel HD 530 | None | 8GBx1 | 1TB 7200rpm 3.5" | DVD±RW | Optional 2nd 2.5" Bay | None | None | None | None | None | None | None | USB / USB | Floor Stand | 210W 85% | Win10 DG Win7 Pro 64 | 3-year, Onsite | 01/16 |
| 10GT002HUS | US | i5-6400 | No | Intel HD 530 | None | 8GBx1 | 128GB SSD | DVD±RW | Optional 2nd 2.5" Bay | None | None | None | None | None | None | None | USB / USB | Floor Stand | 210W 85% | Win10 DG Win7 Pro 64 | 3-year, Onsite | 01/16 |
| 10GT002JUS | US | i7-6700 | No | Intel HD 530 | None | 8GBx1 | 1TB 7200rpm 3.5" | DVD±RW | None | None | None | None | None | None | None | None | USB / USB | Floor Stand | 210W 85% | Win10 DG Win7 Pro 64 | 3-year, Onsite | 01/16 |
| 10GT002KUS | US | i7-6700 | No | Intel HD 530 | None | 8GBx1 | 192GB SSD | DVD±RW | None | None | None | None | None | None | None | None | USB / USB | Floor Stand | 210W 85% | Win10 DG Win7 Pro 64 | 3-year, Onsite | 01/16 |
| 10GT002LUS | US | i7-6700 | No | GT 720 1GB | None | 8GBx1 | 1TB 7200rpm 3.5" | DVD±RW | None | None | Intel 8260 ac, 2x2 + BT4.1 | None | None | None | None | None | USB / USB | Floor Stand | 210W 85% | Win10 DG Win7 Pro 64 | 3-year, Onsite | 01/16 |
| 10GT002MUS | US | i7-6700 | No | Intel HD 530 | None | 8GBx1 | 1TB 7200rpm 3.5" | DVD±RW | None | None | Intel 8260 ac, 2x2 + BT4.1 | None | None | None | None | None | USB / USB | Floor Stand | 210W 85% | Win10 DG Win7 Pro 64 | 3-year, Onsite | 01/16 |
| 10GT002NUS | US | i5-6400 | No | GT 720 2GB | None | 8GBx1 | 1TB 7200rpm 3.5" | DVD±RW | None | None | Intel 8260 ac, 2x2 + BT4.1 | None | None | None | None | None | USB / USB | Floor Stand | 210W 85% | Win10 DG Win7 Pro 64 | 3-year, Onsite | 01/16 |
| 10GT002PUS | US | i5-6400 | No | Intel HD 530 | None | 4GBx1 | 500GB 7200rpm 3.5" | DVD±RW | None | None | None | None | None | None | None | None | USB / USB | Floor Stand | 210W 85% | Win10 DG Win7 Pro 64 | 3-year, Onsite | 01/16 |
| 10GT002QUS | US | i7-6700 | No | Intel HD 530 | None | 8GBx1 | 120GB SSD | DVD±RW | None | None | None | None | None | None | None | None | USB / USB | Floor Stand | 210W 85% | Win10 DG Win7 Pro 64 | 3-year, Onsite | 01/16 |
| 10GT002RUS | US | i7-6700 | No | Intel HD 530 | None | 8GBx1 | 500GB 7200rpm 3.5" | DVD±RW | None | None | None | None | None | None | None | None | USB / USB | Floor Stand | 210W 85% | Win10 DG Win7 Pro 64 | 3-year, Onsite | 01/16 |
| 10GT002SUS | US | i5-6400 | No | Intel HD 530 | None | 8GBx1 | 1TB 7200rpm 3.5" | DVD±RW | None | None | None | None | None | None | None | None | USB / USB | Floor Stand | 210W 85% | Win10 DG Win7 Pro 64 | 3-year, Onsite | 01/16 |
| 10GT002TUS | US | i7-6700 | No | Intel HD 530 | None | 8GBx1 | 256GB SSD Opal | DVD±RW | None | None | None | None | None | None | None | None | USB / USB | Floor Stand | 210W 85% | Win10 DG Win7 Pro 64 | 3-year, Onsite | 01/16 |
| 10GT002UUS | US | i5-6400 | No | Intel HD 530 | None | 4GBx1 | 500GB 7200rpm 3.5" | DVD±RW | None | None | Intel 8260 ac, 2x2 + BT4.1 | None | None | None | None | None | USB / USB | Floor Stand | 210W 85% | Win10 DG Win7 Pro 64 | 3-year, Onsite | 01/16 |
| 10GT002VUS | US | i5-6400 | No | Intel HD 530 | None | 8GBx1 | 500GB 7200rpm 3.5" | DVD±RW | None | None | Intel 8260 ac, 2x2 + BT4.1 | None | None | None | None | None | USB / USB | Floor Stand | 210W 85% | Win10 DG Win7 Pro 64 | 3-year, Onsite | 01/16 |
| 10GT002WUS | US | i5-6400 | No | Intel HD 530 | None | 8GBx1 | 500GB 7200rpm 3.5" | DVD±RW | None | None | None | None | None | None | None | None | USB / USB | Floor Stand | 210W 85% | Win10 DG Win7 Pro 64 | 3-year, Onsite | 01/16 |
| 10GT0036US | US | i5-6400 | No | Intel HD 530 | None | 8GBx1 | 256GB SSD Opal | DVD±RW | None | None | None | None | None | None | None | None | USB / USB | Floor Stand | 210W 85% | Win10 DG Win7 Pro 64 | 3-year, Onsite | 01/16 |
| 10GT0037US | US | i5-6400 | No | Intel HD 530 | None | 8GBx1 | 192GB SSD | DVD±RW | None | None | None | None | None | None | None | None | USB / USB | Floor Stand | 210W 85% | Win10 DG Win7 Pro 64 | 3-year, Onsite | 01/16 |

| Model | Region | Processor | vPro | Graphics | Monitor Cable | Memory | Storage | Optical | Optional 2nd 2.5" Bay | Media Reader | WLAN + Bluetooth | Optional Front Ports | Optional Rear Ports | Chassis Intrusion Switch | Cable Lock | Dust Filter | Keyboard / Mouse | Stand | Power Supply | Operating System | Warranty | Ann Date (m/y) |
|------------|--------|---------------|------|--------------|---------------|--------|--------------------|---------|-----------------------|--------------|----------------------------|----------------------|---------------------|--------------------------|------------|-------------|------------------|-------------|--------------|----------------------|----------------|----------------|
| 10GT0038US | US | i5-6400 | No | Intel HD 530 | None | 8GBx1 | 120GB SSD | DVD±RW | None | None | None | None | None | None | None | None | USB / USB | Floor Stand | 210W 85% | Win10 DG Win7 Pro 64 | 3-year, Onsite | 01/16 |
| 10GT0039US | US | i3-6100 | No | Intel HD 530 | None | 4GBx1 | 500GB 7200rpm 3.5" | DVD±RW | None | None | None | None | None | None | None | None | USB / USB | Floor Stand | 210W 85% | Win10 DG Win7 Pro 64 | 3-year, Onsite | 01/16 |
| 10GT003AUS | US | i3-6100 | No | Intel HD 530 | None | 4GBx1 | 500GB 7200rpm 3.5" | DVD±RW | None | None | Intel 3165 ac, 1x1 + BT4.0 | None | None | None | None | None | USB / USB | Floor Stand | 210W 85% | Win10 DG Win7 Pro 64 | 3-year, Onsite | 01/16 |
| 10GT003BUS | US | i3-6100 | No | Intel HD 530 | None | 4GBx1 | 500GB 7200rpm 3.5" | DVD±RW | None | None | Intel 8260 ac, 2x2 + BT4.1 | None | None | None | None | None | USB / USB | Floor Stand | 210W 85% | Win10 DG Win7 Pro 64 | 3-year, Onsite | 01/16 |
| 10GT003CUS | US | Pentium G4400 | No | Intel HD 510 | None | 4GBx1 | 500GB 7200rpm 3.5" | DVD±RW | None | None | None | None | None | None | None | None | USB / USB | Floor Stand | 210W 85% | Win10 DG Win7 Pro 64 | 3-year, Onsite | 01/16 |
| 10GT003DUS | US | i7-6700 | No | Intel HD 530 | None | 8GBx1 | 1TB 7200rpm 3.5" | DVD±RW | None | None | Intel 8260 ac, 2x2 + BT4.1 | None | None | None | None | None | None / USB | Floor Stand | 210W 85% | Win10 Pro 64 | 3-year, Onsite | 01/16 |
| 10GT003EUS | US | i5-6400 | No | Intel HD 530 | None | 4GBx1 | 500GB 7200rpm 3.5" | DVD±RW | None | None | Intel 8260 ac, 2x2 + BT4.1 | None | None | None | None | None | None / USB | Floor Stand | 210W 85% | Win10 Pro 64 | 3-year, Onsite | 01/16 |
| 10GT003FUS | US | i3-6100 | No | Intel HD 530 | None | 4GBx1 | 500GB 7200rpm 3.5" | DVD±RW | None | None | Intel 3165 ac, 1x1 + BT4.0 | None | None | None | None | None | None / USB | Floor Stand | 210W 85% | Win10 Pro 64 | 3-year, Onsite | 01/16 |
| 10GT003GUS | US | Pentium G4400 | No | Intel HD 510 | None | 4GBx1 | 500GB 7200rpm 3.5" | DVD±RW | None | None | Intel 3165 ac, 1x1 + BT4.0 | None | None | None | None | None | None / USB | Floor Stand | 210W 85% | Win10 Pro 64 | 3-year, Onsite | 01/16 |
| 10GT004GUS | US | i5-6500 | No | Intel HD 530 | None | 8GBx1 | 128GB SSD | DVD±RW | Optional 2nd 2.5" Bay | None | None | None | None | None | None | None | USB / USB | Floor Stand | 210W 85% | Win10 DG Win7 Pro 64 | 3-year, Onsite | 03/16 |
| 10GT004HUS | US | i5-6500 | No | Intel HD 530 | None | 8GBx1 | 500GB 7200rpm 3.5" | DVD±RW | Optional 2nd 2.5" Bay | None | None | None | None | None | None | None | USB / USB | Floor Stand | 210W 85% | Win10 DG Win7 Pro 64 | 3-year, Onsite | 03/16 |
| 10GT004YUS | US | i5-6400 | No | Intel HD 530 | None | 4GBx1 | 500GB 7200rpm 3.5" | DVD±RW | Optional 2nd 2.5" Bay | None | Intel 3165 ac, 1x1 + BT4.0 | None | None | None | None | None | USB / USB | Floor Stand | 210W 85% | Win10 Pro 64 | 3-year, Onsite | 05/16 |
| 10GT0050US | US | i3-6100 | No | Intel HD 530 | None | 4GBx1 | 500GB 7200rpm 3.5" | DVD±RW | Optional 2nd 2.5" Bay | None | None | None | None | None | None | None | USB / USB | Floor Stand | 210W 85% | Win10 Pro 64 | 3-year, Onsite | 05/16 |
| 10GT0051US | US | i5-6400 | No | Intel HD 530 | None | 8GBx1 | 1TB 7200rpm 3.5" | DVD±RW | Optional 2nd 2.5" Bay | None | None | None | None | None | None | None | USB / USB | Floor Stand | 210W 85% | Win10 Pro 64 | 3-year, Onsite | 05/16 |
| 10GT0052US | US | i7-6700 | No | Intel HD 530 | None | 8GBx1 | 1TB 7200rpm 3.5" | DVD±RW | Optional 2nd 2.5" Bay | None | None | None | None | None | None | None | USB / USB | Floor Stand | 210W 85% | Win10 Pro 64 | 3-year, Onsite | 05/16 |
| 10GT0053US | US | i7-6700 | No | Intel HD 530 | None | 8GBx1 | 256GB SSD Opal | DVD±RW | Optional 2nd 2.5" Bay | None | None | None | None | None | None | None | USB / USB | Floor Stand | 210W 85% | Win10 Pro 64 | 3-year, Onsite | 05/16 |
| 10GT0054US | US | i7-6700 | No | Intel HD 530 | None | 8GBx1 | 180GB SSD Opal | DVD±RW | Optional 2nd 2.5" Bay | None | None | None | None | None | None | None | USB / USB | Floor Stand | 210W 85% | Win10 Pro 64 | 3-year, Onsite | 05/16 |
| 10GT0055US | US | i7-6700 | No | Intel HD 530 | None | 4GBx1 | 128GB SSD | DVD±RW | Optional 2nd 2.5" Bay | None | None | None | None | None | None | None | USB / USB | Floor Stand | 210W 85% | Win10 Pro 64 | 3-year, Onsite | 05/16 |
| 10GT0056US | US | i7-6700 | No | GT 720 1GB | None | 8GBx1 | 1TB 7200rpm 3.5" | DVD±RW | Optional 2nd 2.5" Bay | None | None | None | None | None | None | None | USB / USB | Floor Stand | 210W 85% | Win10 Pro 64 | 3-year, Onsite | 05/16 |
| 10GT005EUS | US | i7-6700 | No | GT 720 1GB | None | 8GBx1 | 1TB 7200rpm 3.5" | DVD±RW | Optional 2nd 2.5" Bay | None | None | None | None | None | None | None | USB / USB | Floor Stand | 210W 85% | Win10 Pro 64 | 3-year, Onsite | 10/16 |

| Model | Region | Processor | vPro | Graphics | Monitor Cable | Memory | Storage | Optical | Optional 2nd 2.5" Bay | Media Reader | WLAN + Bluetooth | Optional Front Ports | Optional Rear Ports | Chassis Intrusion Switch | Cable Lock | Dust Filter | Keyboard / Mouse | Stand | Power Supply | Operating System | Warranty | Ann Date (m/y) |
|------------|--------|-----------|------|------------|---------------|--------|------------------------|---------|-----------------------|--------------|----------------------------|----------------------|---------------------|--------------------------|------------|-------------|------------------|-------------|--------------|----------------------|----------------|----------------|
| 10GT005FUS | US | i7-6700 | No | GT 720 1GB | None | 8GBx1 | 1TB 7200rpm 3.5" | DVD±RW | Optional 2nd 2.5" Bay | None | Intel 8260 ac, 2x2 + BT4.1 | None | None | None | None | None | USB / USB | Floor Stand | 210W 85% | Win10 DG Win7 Pro 64 | 3-year, Onsite | 10/16 |
| 10GT005GUS | US | i7-6700 | No | GT 720 1GB | None | 8GBx1 | 1TB 7200rpm 3.5" | DVD±RW | Optional 2nd 2.5" Bay | None | None | None | None | None | None | None | USB / USB | Floor Stand | 210W 85% | Win10 DG Win7 Pro 64 | 3-year, Onsite | 10/16 |
| 10GT005HUS | US | i7-6700 | No | GT 720 1GB | None | 8GBx1 | 1TB 7200rpm 3.5" | DVD±RW | Optional 2nd 2.5" Bay | None | Intel 8260 ac, 2x2 + BT4.1 | None | None | None | None | None | USB / USB | Floor Stand | 210W 85% | Win10 Pro 64 | 3-year, Onsite | 10/16 |



ThinkCentre M700 Tiny Platform Specifications

Product Specifications Reference (PSREF)

| Processor | Intel® Celeron®, Intel Pentium®, or 6th Generation Intel Core™ i3 / i5 / i7 Processor | Keyboard | Some: Preferred Pro USB Keyboard (USB connector), Lenovo logo Some: Lenovo Slim USB Keyboard (USB connector), black, Lenovo logo Some: Lenovo USB Fingerprint Keyboard (USB connector) Some: Ultrasmil Plus Wireless Keyboard (2.4GHz via USB receiver), black Some: Enhanced Optical USB Mouse, black, Lenovo logo Some: Ultrasmil Plus Wireless Mouse (2.4GHz via USB receiver), black | | | | | | | | | | | | | | | | | | | | | | | | | | | | | | | | | | | | | | | | | | | | | | | | | | | | | | |
|--------------------|---|---|---|-------------------------|---------------------|--------------|---------------------|----------------|-------|-------|------|-----------|--------|----------------|-------|-------|------|-----------|--------|---------------|-------|-------|------|-----------|--------|---------------|-------|-------|------|-----------|--------|---------------|-------|---------------|------|-----------|--------|---------------|-------|---------------|------|-----------|--------|---------------|-------|---------------|------|-----------|--------|---------------|-------|---------------|------|-----------|--------|-------|--|
| | <table border="1"> <thead> <tr> <th>Processor</th> <th>Cores / Threads</th> <th>Frequency Base/Max(GHz)</th> <th>Cache</th> <th>Memory Types</th> <th>Integrated Graphics</th> </tr> </thead> <tbody> <tr> <td>Pentium G4400T</td> <td>2 / 2</td> <td>2.9 G</td> <td>3 MB</td> <td>DDR4-2133</td> <td>HD 510</td> </tr> <tr> <td>Pentium G4500T</td> <td>2 / 2</td> <td>3.0 G</td> <td>3 MB</td> <td>DDR4-2133</td> <td>HD 530</td> </tr> <tr> <td>Core i3-6100T</td> <td>2 / 4</td> <td>3.2 G</td> <td>3 MB</td> <td>DDR4-2133</td> <td>HD 530</td> </tr> <tr> <td>Core i3-6300T</td> <td>2 / 4</td> <td>3.3 G</td> <td>4 MB</td> <td>DDR4-2133</td> <td>HD 530</td> </tr> <tr> <td>Core i5-6400T</td> <td>4 / 4</td> <td>2.2 G / 2.8 G</td> <td>6 MB</td> <td>DDR4-2133</td> <td>HD 530</td> </tr> <tr> <td>Core i5-6500T</td> <td>4 / 4</td> <td>2.5 G / 3.1 G</td> <td>6 MB</td> <td>DDR4-2133</td> <td>HD 530</td> </tr> <tr> <td>Core i5-6600T</td> <td>4 / 4</td> <td>2.7 G / 3.5 G</td> <td>6 MB</td> <td>DDR4-2133</td> <td>HD 530</td> </tr> <tr> <td>Core i7-6700T</td> <td>4 / 8</td> <td>2.8 G / 3.6 G</td> <td>8 MB</td> <td>DDR4-2133</td> <td>HD 530</td> </tr> </tbody> </table> | Processor | Cores / Threads | Frequency Base/Max(GHz) | Cache | Memory Types | Integrated Graphics | Pentium G4400T | 2 / 2 | 2.9 G | 3 MB | DDR4-2133 | HD 510 | Pentium G4500T | 2 / 2 | 3.0 G | 3 MB | DDR4-2133 | HD 530 | Core i3-6100T | 2 / 4 | 3.2 G | 3 MB | DDR4-2133 | HD 530 | Core i3-6300T | 2 / 4 | 3.3 G | 4 MB | DDR4-2133 | HD 530 | Core i5-6400T | 4 / 4 | 2.2 G / 2.8 G | 6 MB | DDR4-2133 | HD 530 | Core i5-6500T | 4 / 4 | 2.5 G / 3.1 G | 6 MB | DDR4-2133 | HD 530 | Core i5-6600T | 4 / 4 | 2.7 G / 3.5 G | 6 MB | DDR4-2133 | HD 530 | Core i7-6700T | 4 / 8 | 2.8 G / 3.6 G | 8 MB | DDR4-2133 | HD 530 | Mouse | |
| Processor | Cores / Threads | Frequency Base/Max(GHz) | Cache | Memory Types | Integrated Graphics | | | | | | | | | | | | | | | | | | | | | | | | | | | | | | | | | | | | | | | | | | | | | | | | | | | | |
| Pentium G4400T | 2 / 2 | 2.9 G | 3 MB | DDR4-2133 | HD 510 | | | | | | | | | | | | | | | | | | | | | | | | | | | | | | | | | | | | | | | | | | | | | | | | | | | | |
| Pentium G4500T | 2 / 2 | 3.0 G | 3 MB | DDR4-2133 | HD 530 | | | | | | | | | | | | | | | | | | | | | | | | | | | | | | | | | | | | | | | | | | | | | | | | | | | | |
| Core i3-6100T | 2 / 4 | 3.2 G | 3 MB | DDR4-2133 | HD 530 | | | | | | | | | | | | | | | | | | | | | | | | | | | | | | | | | | | | | | | | | | | | | | | | | | | | |
| Core i3-6300T | 2 / 4 | 3.3 G | 4 MB | DDR4-2133 | HD 530 | | | | | | | | | | | | | | | | | | | | | | | | | | | | | | | | | | | | | | | | | | | | | | | | | | | | |
| Core i5-6400T | 4 / 4 | 2.2 G / 2.8 G | 6 MB | DDR4-2133 | HD 530 | | | | | | | | | | | | | | | | | | | | | | | | | | | | | | | | | | | | | | | | | | | | | | | | | | | | |
| Core i5-6500T | 4 / 4 | 2.5 G / 3.1 G | 6 MB | DDR4-2133 | HD 530 | | | | | | | | | | | | | | | | | | | | | | | | | | | | | | | | | | | | | | | | | | | | | | | | | | | | |
| Core i5-6600T | 4 / 4 | 2.7 G / 3.5 G | 6 MB | DDR4-2133 | HD 530 | | | | | | | | | | | | | | | | | | | | | | | | | | | | | | | | | | | | | | | | | | | | | | | | | | | | |
| Core i7-6700T | 4 / 8 | 2.8 G / 3.6 G | 8 MB | DDR4-2133 | HD 530 | | | | | | | | | | | | | | | | | | | | | | | | | | | | | | | | | | | | | | | | | | | | | | | | | | | | |
| Memory | 32GB max, DDR4 2133, two 260-pin SO-DIMM sockets, dual-channel capable | Mechanical | Tiny (1L), black color; metal case M700 Tiny only: 7.05" W X 7.20" D X 1.36" H 179mm W X 182.9mm D X 34.5mm H 2.9 lb (1.3 kg), weight may vary by configuration With VESA mount & ODD box: 7.42" W X 7.30" D X 2.48" H 188.4mm W X 185.38mm D X 63mm H 4.12 lb (1.87 kg), weight may vary by configuration With VESA mount & I/O box: 7.42" W X 7.30" D X 2.62" H 188.4mm W X 185.38mm D X 66.6mm H 3.53 lb (1.6 kg), weight may vary by configuration Optional VESA mount bracket kit, supports VESA 75mm and 100mm Optional system floor stand for vertical orientation | | | | | | | | | | | | | | | | | | | | | | | | | | | | | | | | | | | | | | | | | | | | | | | | | | | | | | |
| Disk | Some: SATA 6.0Gb/s, 2.5" Wide, 5400 rpm or 7200 rpm Some: 500GB (5400 rpm) Solid State Hybrid Drive (SSHD) / with 8GB MLC NAND flash memory, SATA 6.0Gb/s, 2.5" wide Some: Solid State Drive (SSD) / SATA 6.0Gb/s, 2.5" Wide Some: M.2 Solid State Drive (SSD) / SATA interface | VESA mount | | | | | | | | | | | | | | | | | | | | | | | | | | | | | | | | | | | | | | | | | | | | | | | | | | | | | | | |
| Optical | Some: external ODD box with DVD-ROM, 9.5mm high, via USB Some: external ODD box with DVD±RW, 9.5mm high, via USB Some: external ODD box (for TIO) with DVD-ROM, 9.5mm high, via USB Some: external ODD box (for TIO) with DVD±RW, 9.5mm high, via USB | Floor Stand | | | | | | | | | | | | | | | | | | | | | | | | | | | | | | | | | | | | | | | | | | | | | | | | | | | | | | | |
| Onboard SATA | One SATA cable (1-drop to device), one SATA 6.0Gb/s connector on planar | Power supply | 65 watts AC/DC adapter, autosensing, 88% PSU (not included for TIO models) 90 watts AC/DC adapter, autosensing, 88% PSU (only for models with I/O box) | | | | | | | | | | | | | | | | | | | | | | | | | | | | | | | | | | | | | | | | | | | | | | | | | | | | | | |
| Media reader | None | Limited warranty ³ | Some: 1-year or 3-year, depot service / service upgrades available Some: 1-year or 3-year, limited onsite service / service upgrades available Some: 3-year, limited onsite service, OID (Onsite International Delivery) / service upgrades available <i>For Lenovo service upgrade options, please go to S-TC sheet</i> | | | | | | | | | | | | | | | | | | | | | | | | | | | | | | | | | | | | | | | | | | | | | | | | | | | | | | |
| Graphics | Intel HD Graphics 510/530 in processor, uses main memory, DirectX® 12, two DisplayPort™, one optional HDMI, VGA, or 3rd DP, up to 3 independent displays; Max resolution: 4096x2304 (DP) @60Hz; 4096x2160 (HDMI) @24Hz; 1920x1200 (VGA) @60Hz | Preload | Some: Windows® 7 Professional 32/64 preinstalled through downgrade rights in Windows 10 Pro 64-bit Some: Windows 7 Professional 32/64 Some: Windows 10 Pro 64-bit Some: Windows 10 Home 64-bit Preloaded applications (only some listed) <ul style="list-style-type: none"> Desktop Power Manager Lenovo Solution Center Lenovo REACHit Lenovo SHAREit Lenovo Bluetooth Lock (for models with Wi-Fi/BT card) McAfee® LiveSafe™ (30-day trial) Microsoft Office preloaded; purchase a product key to activate PowerDVD Create (DVD±RW) Lenovo ThinkVantage Tools Intel Unite (vPro models only) | | | | | | | | | | | | | | | | | | | | | | | | | | | | | | | | | | | | | | | | | | | | | | | | | | | | | | |
| DP cable | Optional DP to VGA, DP to DVI-D (single link), or DP to HDMI 1.4 dongle | | Some: Windows® Embedded Standard 7 (WES 7) Some: LeTOS (Lenovo Terminal Operating System, Linux-based) Preloaded applications (only some listed) <ul style="list-style-type: none"> - WES 7 only: <ul style="list-style-type: none"> RDP Client (RDP 8.1 support) Citrix Client VMware Client Internet Explorer 11 Java Flash .Net Framework Microsoft® Silverlight Echo Agent (client for LTM, Lenovo Thin Client Manager) Adobe Reader UltraVNC - LeTOS only: <ul style="list-style-type: none"> xFreeRDP Citrix ICA Client VMware View Client Java Mozilla Firefox | | | | | | | | | | | | | | | | | | | | | | | | | | | | | | | | | | | | | | | | | | | | | | | | | | | | | | |
| Chipset | Intel B150 Chipset | | | | | | | | | | | | | | | | | | | | | | | | | | | | | | | | | | | | | | | | | | | | | | | | | | | | | | | | |
| Front ports | Two USB 3.0 (one is Always On and fast charge), one microphone (stereo, 3.5mm), one headphone / microphone combo jack (stereo, 3.5mm) | | | | | | | | | | | | | | | | | | | | | | | | | | | | | | | | | | | | | | | | | | | | | | | | | | | | | | | | |
| Rear ports | Four USB 3.0 (optional external optical box or external I/O box occupies one or two specific USB 3.0 on some models), ethernet (RJ-45), two DisplayPort, one optional port (VGA, 3rd DP, HDMI, or serial on some models), one headphone | | | | | | | | | | | | | | | | | | | | | | | | | | | | | | | | | | | | | | | | | | | | | | | | | | | | | | | | |
| I/O box | Optional external I/O box, extends two USB 2.0, two USB 3.0, and one serial on rear, two USB 2.0 on front, via USB (occupy two specific USB 3.0 of M700 Tiny) | | | | | | | | | | | | | | | | | | | | | | | | | | | | | | | | | | | | | | | | | | | | | | | | | | | | | | | | |
| Audio support | High Definition (HD) Audio, Realtek ALC223 / optional internal speaker (1 watt) | | | | | | | | | | | | | | | | | | | | | | | | | | | | | | | | | | | | | | | | | | | | | | | | | | | | | | | | |
| WLAN ¹³ | Some: 11ac wireless, M.2 Card, Realtek RTL8821AE (dual band), Wi-Fi + Bluetooth 4.0 combo adapter, 1x1 Some: 11ac wireless, M.2 Card, Qualcomm Atheros QCA9377 (dual band), Wi-Fi + Bluetooth 4.1 combo adapter, 1x1 Some: 11ac wireless, M.2 Card, Qualcomm Atheros QCA6174 (dual band), Wi-Fi + Bluetooth 4.1 combo adapter, 2x2 Some: 11ac wireless, M.2 Card, Intel Dual Band Wireless-AC 3165, Wi-Fi + Bluetooth 4.0 combo adapter, 1x1 Some: 11ac wireless, M.2 Card, Intel Dual Band Wireless-AC 8260, Wi-Fi + Bluetooth 4.1 combo adapter, 2x2 | | | | | | | | | | | | | | | | | | | | | | | | | | | | | | | | | | | | | | | | | | | | | | | | | | | | | | | | |
| Bluetooth™ | Some: Bluetooth 4.0 or 4.1 wireless, integrated in Wi-Fi + BT combo adapter | | | | | | | | | | | | | | | | | | | | | | | | | | | | | | | | | | | | | | | | | | | | | | | | | | | | | | | | |
| Ethernet | Gigabit ethernet, Intel Ethernet Connection I219-LV (Jacksonville), Wake on LAN® | | | | | | | | | | | | | | | | | | | | | | | | | | | | | | | | | | | | | | | | | | | | | | | | | | | | | | | | |
| Modem | None | | | | | | | | | | | | | | | | | | | | | | | | | | | | | | | | | | | | | | | | | | | | | | | | | | | | | | | | |
| Manageability | None | | | | | | | | | | | | | | | | | | | | | | | | | | | | | | | | | | | | | | | | | | | | | | | | | | | | | | | | |
| Security chip | Trusted Platform Module, TCG 1.2-compliant | | | | | | | | | | | | | | | | | | | | | | | | | | | | | | | | | | | | | | | | | | | | | | | | | | | | | | | | |
| Security features | <ul style="list-style-type: none"> Security slot (in rear for optional Kensington® MicroSaver® cable) Padlock loop Smart USB protection, allows keyboard/mouse only, blocks all storage devices Power-on password | <ul style="list-style-type: none"> Administrator password Hard disk password Boot sequence control Boot without keyboard and mouse Individual USB port disablement Chassis intrusion switch | | | | | | | | | | | | | | | | | | | | | | | | | | | | | | | | | | | | | | | | | | | | | | | | | | | | | | | |
| Environment | | | ENERGY STAR® 6.0*, EPEAT™ Gold rating* (*for Windows models only); ErP Lot 3; GREENGUARD®; RoHS-compliant | | | | | | | | | | | | | | | | | | | | | | | | | | | | | | | | | | | | | | | | | | | | | | | | | | | | | | |
| MIL-SPEC test | | | MIL-STD-810G military certification (Low Pressure [Altitude], High Temperature, Low Temperature, Temperature Shock, Humidity, Sand and Dust, Vibration, Shock) | | | | | | | | | | | | | | | | | | | | | | | | | | | | | | | | | | | | | | | | | | | | | | | | | | | | | | |
| Accessories | | | For compatible accessories, please go to TC-AQP sheet | | | | | | | | | | | | | | | | | | | | | | | | | | | | | | | | | | | | | | | | | | | | | | | | | | | | | | |

| Model | Region | Processor | vPro | Graphics | Monitor Cable | Memory | Storage(HDD/SSD) | External Optical / I/O Box | WLAN + Bluetooth | Optional Rear Ports | Chassis Intrusion Switch | Kensington Cable Lock | Speaker | Adapter Cage | Toolless Chassis Screw | Dust Filter | Keyboard / Mouse | VESA Mount | Stand | Power Supply | Operating System | Warranty | Ann Date (m/y) |
|------------|--------|-----------|------|--------------|---------------|--------|--------------------|----------------------------|----------------------------|---------------------|--------------------------|-----------------------|---------|--------------|------------------------|-------------|------------------|------------|-------------|-----------------|----------------------|----------------|----------------|
| 10HY0004US | US | i5-6400T | No | Intel HD 530 | None | 4GBx1 | 120GB SSD | None | Intel 8260 ac, 2x2 + BT4.1 | None | Switch | None | 1Wx1 | None | None | None | USB / USB | None | Floor Stand | 65W Adapter 88% | Win10 Pro 64 | 3-year, Onsite | 01/16 |
| 10HY0005US | US | i5-6400T | No | Intel HD 530 | None | 4GBx1 | 180GB SSD Opal | None | Intel 8260 ac, 2x2 + BT4.1 | None | Switch | None | 1Wx1 | None | None | None | USB / USB | None | Floor Stand | 65W Adapter 88% | Win10 Pro 64 | 3-year, Onsite | 01/16 |
| 10HY0006US | US | i5-6500T | No | Intel HD 530 | None | 4GBx1 | 120GB SSD | None | Intel 8260 ac, 2x2 + BT4.1 | None | Switch | None | 1Wx1 | None | None | None | USB / USB | None | Floor Stand | 65W Adapter 88% | Win10 Pro 64 | 3-year, Onsite | 01/16 |
| 10HY0007US | US | i5-6500T | No | Intel HD 530 | None | 4GBx1 | 500GB 7200rpm 2.5" | None | Intel 8260 ac, 2x2 + BT4.1 | None | Switch | None | 1Wx1 | None | None | None | USB / USB | None | Floor Stand | 65W Adapter 88% | Win10 Pro 64 | 3-year, Onsite | 01/16 |
| 10HY0008US | US | i5-6400T | No | Intel HD 530 | None | 4GBx1 | 500GB 7200rpm 2.5" | None | Intel 8260 ac, 2x2 + BT4.1 | None | Switch | None | 1Wx1 | None | None | None | USB / USB | None | Floor Stand | 65W Adapter 88% | Win10 Pro 64 | 3-year, Onsite | 01/16 |
| 10HY0009US | US | i5-6400T | No | Intel HD 530 | None | 4GBx1 | 500GB 7200rpm 2.5" | DVD±RW | Intel 8260 ac, 2x2 + BT4.1 | None | Switch | None | 1Wx1 | None | None | None | USB / USB | VESA Mount | None | 65W Adapter 88% | Win10 Pro 64 | 3-year, Onsite | 01/16 |
| 10HY000AUS | US | i7-6700T | No | Intel HD 530 | None | 8GBx1 | 500GB 7200rpm 2.5" | None | Intel 8260 ac, 2x2 + BT4.1 | None | Switch | None | 1Wx1 | None | None | None | USB / USB | None | Floor Stand | 65W Adapter 88% | Win10 Pro 64 | 3-year, Onsite | 01/16 |
| 10HY000BUS | US | i7-6700T | No | Intel HD 530 | None | 8GBx1 | 120GB SSD | DVD±RW | Intel 8260 ac, 2x2 + BT4.1 | None | Switch | None | 1Wx1 | None | None | None | USB / USB | VESA Mount | None | 65W Adapter 88% | Win10 Pro 64 | 3-year, Onsite | 01/16 |
| 10HY000CUS | US | i7-6700T | No | Intel HD 530 | None | 8GBx1 | 120GB SSD | None | Intel 8260 ac, 2x2 + BT4.1 | None | Switch | None | 1Wx1 | None | None | None | USB / USB | None | Floor Stand | 65W Adapter 88% | Win10 Pro 64 | 3-year, Onsite | 01/16 |
| 10HY000DUS | US | i5-6400T | No | Intel HD 530 | None | 4GBx1 | 500GB 7200rpm 2.5" | DVD±RW | Intel 8260 ac, 2x2 + BT4.1 | None | Switch | None | 1Wx1 | None | None | None | USB / USB | VESA Mount | None | 65W Adapter 88% | Win10 DG Win7 Pro 64 | 3-year, Onsite | 01/16 |
| 10HY000EUS | US | i7-6700T | No | Intel HD 530 | None | 8GBx1 | 120GB SSD | None | Intel 8260 ac, 2x2 + BT4.1 | None | Switch | None | 1Wx1 | None | None | None | USB / USB | None | Floor Stand | 65W Adapter 88% | Win10 DG Win7 Pro 64 | 3-year, Onsite | 01/16 |
| 10HY000FUS | US | i7-6700T | No | Intel HD 530 | None | 8GBx1 | 120GB SSD | DVD±RW | Intel 8260 ac, 2x2 + BT4.1 | None | Switch | None | 1Wx1 | None | None | None | USB / USB | VESA Mount | None | 65W Adapter 88% | Win10 DG Win7 Pro 64 | 3-year, Onsite | 01/16 |
| 10HY000GUS | US | i5-6400T | No | Intel HD 530 | None | 4GBx1 | 500GB 7200rpm 2.5" | None | Intel 8260 ac, 2x2 + BT4.1 | None | Switch | None | 1Wx1 | None | None | None | USB / USB | None | Floor Stand | 65W Adapter 88% | Win10 DG Win7 Pro 64 | 3-year, Onsite | 01/16 |
| 10HY000HUS | US | i5-6500T | No | Intel HD 530 | None | 4GBx1 | 120GB SSD | None | Intel 8260 ac, 2x2 + BT4.1 | None | Switch | None | 1Wx1 | None | None | None | USB / USB | None | Floor Stand | 65W Adapter 88% | Win10 DG Win7 Pro 64 | 3-year, Onsite | 01/16 |
| 10HY000JUS | US | i5-6400T | No | Intel HD 530 | None | 4GBx1 | 120GB SSD | None | Intel 8260 ac, 2x2 + BT4.1 | None | Switch | None | 1Wx1 | None | None | None | USB / USB | None | Floor Stand | 65W Adapter 88% | Win10 DG Win7 Pro 64 | 3-year, Onsite | 01/16 |
| 10HY000KUS | US | i5-6500T | No | Intel HD 530 | None | 4GBx1 | 500GB 7200rpm 2.5" | None | Intel 8260 ac, 2x2 + BT4.1 | None | Switch | None | 1Wx1 | None | None | None | USB / USB | None | Floor Stand | 65W Adapter 88% | Win10 DG Win7 Pro 64 | 3-year, Onsite | 01/16 |
| 10HY0013US | US | i7-6700T | No | Intel HD 530 | None | 8GBx1 | 500GB 7200rpm 2.5" | None | Intel 8260 ac, 2x2 + BT4.1 | VGA | Switch | None | 1Wx1 | None | None | None | USB / USB | None | Floor Stand | 65W Adapter 88% | Win10 Pro 64 | 3-year, Onsite | 01/16 |
| 10HY0014US | US | i7-6700T | No | Intel HD 530 | None | 8GBx1 | 500GB 7200rpm 2.5" | None | Intel 8260 ac, 2x2 + BT4.1 | HDMI | Switch | None | 1Wx1 | None | None | None | USB / USB | None | Floor Stand | 65W Adapter 88% | Win10 Pro 64 | 3-year, Onsite | 01/16 |
| 10HY0015US | US | i5-6400T | No | Intel HD 530 | None | 4GBx1 | 500GB 7200rpm 2.5" | None | Intel 8260 ac, 2x2 + BT4.1 | HDMI | Switch | None | 1Wx1 | None | None | None | USB / USB | None | Floor Stand | 65W Adapter 88% | Win10 Pro 64 | 3-year, Onsite | 01/16 |
| 10HY0016US | US | i5-6400T | No | Intel HD 530 | None | 4GBx1 | 500GB 7200rpm 2.5" | None | Intel 8260 ac, 2x2 + BT4.1 | 3rd DP | Switch | None | 1Wx1 | None | None | None | USB / USB | None | Floor Stand | 65W Adapter 88% | Win10 Pro 64 | 3-year, Onsite | 01/16 |

| Model | Region | Processor | vPro | Graphics | Monitor Cable | Memory | Storage(HDD/SSD) | External Optical / I/O Box | WLAN + Bluetooth | Optional Rear Ports | Chassis Intrusion Switch | Kensington Cable Lock | Speaker | Adapter Cage | Toolless Chassis Screw | Dust Filter | Keyboard / Mouse | VESA Mount | Stand | Power Supply | Operating System | Warranty | Ann Date (m/y) |
|------------|--------|-----------|------|--------------|---------------|--------|--------------------|----------------------------|----------------------------|---------------------|--------------------------|-----------------------|---------|--------------|------------------------|-------------|------------------|------------|-------------|-----------------|----------------------|----------------|----------------|
| 10HY0017US | US | i5-6400T | No | Intel HD 530 | None | 4GBx1 | 500GB 7200rpm 2.5" | None | Intel 8260 ac, 2x2 + BT4.1 | VGA | Switch | None | 1Wx1 | None | None | None | USB / USB | None | Floor Stand | 65W Adapter 88% | Win10 Pro 64 | 3-year, Onsite | 01/16 |
| 10HY0018US | US | i7-6700T | No | Intel HD 530 | None | 8GBx1 | 500GB 7200rpm 2.5" | None | Intel 8260 ac, 2x2 + BT4.1 | 3rd DP | Switch | None | 1Wx1 | None | None | None | USB / USB | None | Floor Stand | 65W Adapter 88% | Win10 Pro 64 | 3-year, Onsite | 01/16 |
| 10HY0019US | US | i5-6400T | No | Intel HD 530 | None | 4GBx1 | 500GB 7200rpm 2.5" | None | Intel 8260 ac, 2x2 + BT4.1 | 3rd DP | Switch | None | 1Wx1 | None | None | None | USB / USB | None | Floor Stand | 65W Adapter 88% | Win10 DG Win7 Pro 64 | 3-year, Onsite | 01/16 |
| 10HY001AUS | US | i7-6700T | No | Intel HD 530 | None | 8GBx1 | 500GB 7200rpm 2.5" | None | Intel 8260 ac, 2x2 + BT4.1 | HDMI | Switch | None | 1Wx1 | None | None | None | USB / USB | None | Floor Stand | 65W Adapter 88% | Win10 DG Win7 Pro 64 | 3-year, Onsite | 01/16 |
| 10HY001BUS | US | i7-6700T | No | Intel HD 530 | None | 8GBx1 | 500GB 7200rpm 2.5" | None | Intel 8260 ac, 2x2 + BT4.1 | VGA | Switch | None | 1Wx1 | None | None | None | USB / USB | None | Floor Stand | 65W Adapter 88% | Win10 DG Win7 Pro 64 | 3-year, Onsite | 01/16 |
| 10HY001CUS | US | i7-6700T | No | Intel HD 530 | None | 8GBx1 | 128GB SSD | None | Intel 8260 ac, 2x2 + BT4.1 | HDMI | Switch | None | 1Wx1 | None | None | None | USB / USB | None | Floor Stand | 65W Adapter 88% | Win10 DG Win7 Pro 64 | 3-year, Onsite | 01/16 |
| 10HY001DUS | US | i5-6400T | No | Intel HD 530 | None | 4GBx1 | 500GB 7200rpm 2.5" | None | Intel 8260 ac, 2x2 + BT4.1 | VGA | Switch | None | 1Wx1 | None | None | None | USB / USB | None | Floor Stand | 65W Adapter 88% | Win10 DG Win7 Pro 64 | 3-year, Onsite | 01/16 |
| 10HY001EUS | US | i7-6700T | No | Intel HD 530 | None | 8GBx1 | 180GB SSD Opal | None | Intel 8260 ac, 2x2 + BT4.1 | None | Switch | None | 1Wx1 | None | None | None | USB / USB | None | Floor Stand | 65W Adapter 88% | Win10 DG Win7 Pro 64 | 3-year, Onsite | 01/16 |
| 10HY001FUS | US | i5-6400T | No | Intel HD 530 | None | 4GBx1 | 180GB SSD Opal | None | Intel 8260 ac, 2x2 + BT4.1 | None | Switch | None | 1Wx1 | None | None | None | USB / USB | None | Floor Stand | 65W Adapter 88% | Win10 DG Win7 Pro 64 | 3-year, Onsite | 01/16 |
| 10HY001GUS | US | i7-6700T | No | Intel HD 530 | None | 8GBx1 | 500GB 7200rpm 2.5" | None | Intel 8260 ac, 2x2 + BT4.1 | 3rd DP | Switch | None | 1Wx1 | None | None | None | USB / USB | None | Floor Stand | 65W Adapter 88% | Win10 DG Win7 Pro 64 | 3-year, Onsite | 01/16 |
| 10HY001HUS | US | i7-6700T | No | Intel HD 530 | None | 8GBx1 | 128GB SSD | DVD±RW | Intel 8260 ac, 2x2 + BT4.1 | HDMI | Switch | None | 1Wx1 | None | None | None | USB / USB | VESA Mount | None | 65W Adapter 88% | Win10 DG Win7 Pro 64 | 3-year, Onsite | 01/16 |
| 10HY001JUS | US | i5-6400T | No | Intel HD 530 | None | 4GBx1 | 500GB 7200rpm 2.5" | None | Intel 8260 ac, 2x2 + BT4.1 | HDMI | Switch | None | 1Wx1 | None | None | None | USB / USB | None | Floor Stand | 65W Adapter 88% | Win10 DG Win7 Pro 64 | 3-year, Onsite | 01/16 |
| 10HY001KUS | US | i7-6700T | No | Intel HD 530 | None | 8GBx1 | 180GB SSD Opal | None | Intel 8260 ac, 2x2 + BT4.1 | 3rd DP | Switch | None | 1Wx1 | None | None | None | USB / USB | None | Floor Stand | 65W Adapter 88% | Win10 DG Win7 Pro 64 | 3-year, Onsite | 01/16 |
| 10HY001LUS | US | i7-6700T | No | Intel HD 530 | None | 8GBx1 | 128GB SSD | None | Intel 8260 ac, 2x2 + BT4.1 | None | Switch | None | 1Wx1 | None | None | None | USB / USB | None | Floor Stand | 65W Adapter 88% | Win10 DG Win7 Pro 64 | 3-year, Onsite | 01/16 |
| 10HY001MUS | US | i5-6500T | No | Intel HD 530 | None | 4GBx1 | 180GB SSD Opal | None | Intel 8260 ac, 2x2 + BT4.1 | None | Switch | None | 1Wx1 | None | None | None | USB / USB | None | Floor Stand | 65W Adapter 88% | Win10 DG Win7 Pro 64 | 3-year, Onsite | 01/16 |
| 10HY001NUS | US | i5-6400T | No | Intel HD 530 | None | 4GBx1 | 500GB 7200rpm 2.5" | DVD±RW | Intel 8260 ac, 2x2 + BT4.1 | HDMI | Switch | None | 1Wx1 | None | None | None | USB / USB | VESA Mount | None | 65W Adapter 88% | Win10 DG Win7 Pro 64 | 3-year, Onsite | 01/16 |
| 10HY001PUS | US | i5-6400T | No | Intel HD 530 | None | 4GBx1 | 128GB SSD | None | Intel 8260 ac, 2x2 + BT4.1 | None | Switch | None | 1Wx1 | None | None | None | USB / USB | None | Floor Stand | 65W Adapter 88% | Win10 Pro 64 | 3-year, Onsite | 01/16 |
| 10HY001QUS | US | i5-6400T | No | Intel HD 530 | None | 8GBx1 | 128GB SSD | None | Intel 8260 ac, 2x2 + BT4.1 | None | Switch | None | 1Wx1 | None | None | None | USB / USB | None | None | 65W Adapter 88% | Win10 DG Win7 Pro 64 | 3-year, Onsite | 01/16 |
| 10HY001RUS | US | i5-6500T | No | Intel HD 530 | None | 8GBx1 | 128GB SSD | None | Intel 8260 ac, 2x2 + BT4.1 | None | Switch | None | 1Wx1 | None | None | None | USB / USB | None | None | 65W Adapter 88% | Win10 DG Win7 Pro 64 | 3-year, Onsite | 01/16 |
| 10HY001SUS | US | i3-6100T | No | Intel HD 530 | None | 4GBx1 | 500GB 7200rpm 2.5" | None | Intel 3165 ac, 1x1 + BT4.0 | None | Switch | None | 1Wx1 | None | None | None | USB / USB | None | Floor Stand | 65W Adapter 88% | Win10 DG Win7 Pro 64 | 3-year, Onsite | 01/16 |

| Model | Region | Processor | vPro | Graphics | Monitor Cable | Memory | Storage(HDD/SSD) | External Optical / I/O Box | WLAN + Bluetooth | Optional Rear Ports | Chassis Intrusion Switch | Kensington Cable Lock | Speaker | Adapter Cage | Toolless Chassis Screw | Dust Filter | Keyboard / Mouse | VESA Mount | Stand | Power Supply | Operating System | Warranty | Ann Date (m/y) |
|------------|--------|----------------|------|--------------|---------------|--------|--------------------|----------------------------|----------------------------|---------------------|--------------------------|-----------------------|---------|--------------|------------------------|-------------|------------------|------------|-------------|-----------------|----------------------|----------------|----------------|
| 10HY001TUS | US | i3-6100T | No | Intel HD 530 | None | 4GBx1 | 128GB SSD | None | Intel 3165 ac, 1x1 + BT4.0 | 3rd DP | Switch | None | 1Wx1 | None | None | None | USB / USB | None | Floor Stand | 65W Adapter 88% | Win10 Pro 64 | 3-year, Onsite | 01/16 |
| 10HY001UUS | US | i3-6100T | No | Intel HD 530 | None | 4GBx1 | 500GB 7200rpm 2.5" | DVD±RW | Intel 3165 ac, 1x1 + BT4.0 | 3rd DP | Switch | None | 1Wx1 | None | None | None | USB / USB | VESA Mount | None | 65W Adapter 88% | Win10 Pro 64 | 3-year, Onsite | 01/16 |
| 10HY001VUS | US | i3-6100T | No | Intel HD 530 | None | 4GBx1 | 128GB SSD | None | Intel 3165 ac, 1x1 + BT4.0 | None | Switch | None | 1Wx1 | None | None | None | USB / USB | None | Floor Stand | 65W Adapter 88% | Win10 DG Win7 Pro 64 | 3-year, Onsite | 01/16 |
| 10HY001WUS | US | i3-6100T | No | Intel HD 530 | None | 4GBx1 | 128GB SSD | None | Intel 3165 ac, 1x1 + BT4.0 | 3rd DP | Switch | None | 1Wx1 | None | None | None | USB / USB | None | Floor Stand | 65W Adapter 88% | Win10 DG Win7 Pro 64 | 3-year, Onsite | 01/16 |
| 10HY001XUS | US | i3-6100T | No | Intel HD 530 | None | 4GBx1 | 500GB 7200rpm 2.5" | None | Intel 3165 ac, 1x1 + BT4.0 | 3rd DP | Switch | None | 1Wx1 | None | None | None | USB / USB | None | Floor Stand | 65W Adapter 88% | Win10 DG Win7 Pro 64 | 3-year, Onsite | 01/16 |
| 10HY001YUS | US | i3-6100T | No | Intel HD 530 | None | 4GBx1 | 500GB 7200rpm 2.5" | None | Intel 3165 ac, 1x1 + BT4.0 | 3rd DP | Switch | None | 1Wx1 | None | None | None | USB / USB | None | Floor Stand | 65W Adapter 88% | Win10 Pro 64 | 3-year, Onsite | 01/16 |
| 10HY0020US | US | i3-6100T | No | Intel HD 530 | None | 4GBx1 | 500GB 7200rpm 2.5" | None | Intel 3165 ac, 1x1 + BT4.0 | VGA | Switch | None | 1Wx1 | None | None | None | USB / USB | None | Floor Stand | 65W Adapter 88% | Win10 DG Win7 Pro 64 | 3-year, Onsite | 01/16 |
| 10HY0021US | US | i3-6100T | No | Intel HD 530 | None | 8GBx1 | 128GB SSD | None | Intel 3165 ac, 1x1 + BT4.0 | None | Switch | None | 1Wx1 | None | None | None | USB / USB | None | Floor Stand | 65W Adapter 88% | Win10 DG Win7 Pro 64 | 3-year, Onsite | 01/16 |
| 10HY0022US | US | i3-6100T | No | Intel HD 530 | None | 4GBx1 | 500GB 7200rpm 2.5" | DVD±RW | Intel 3165 ac, 1x1 + BT4.0 | 3rd DP | Switch | None | 1Wx1 | None | None | None | USB / USB | VESA Mount | None | 65W Adapter 88% | Win10 DG Win7 Pro 64 | 3-year, Onsite | 01/16 |
| 10HY0023US | US | i3-6100T | No | Intel HD 530 | None | 4GBx1 | 128GB SSD | DVD±RW | Intel 3165 ac, 1x1 + BT4.0 | 3rd DP | Switch | None | 1Wx1 | None | None | None | USB / USB | VESA Mount | None | 65W Adapter 88% | Win10 DG Win7 Pro 64 | 3-year, Onsite | 01/16 |
| 10HY0024US | US | i5-6500T | No | Intel HD 530 | None | 4GBx1 | 128GB SSD | None | Intel 8260 ac, 2x2 + BT4.1 | None | Switch | None | 1Wx1 | None | None | None | USB / USB | None | Floor Stand | 65W Adapter 88% | Win10 DG Win7 Pro 64 | 3-year, Onsite | 01/16 |
| 10HY0025US | US | i7-6700T | No | Intel HD 530 | None | 8GBx1 | 128GB SSD | DVD±RW | Intel 8260 ac, 2x2 + BT4.1 | None | Switch | None | 1Wx1 | None | None | None | USB / USB | VESA Mount | None | 65W Adapter 88% | Win10 Pro 64 | 3-year, Onsite | 01/16 |
| 10HY0026US | US | i7-6700T | No | Intel HD 530 | None | 8GBx1 | 128GB SSD | None | Intel 8260 ac, 2x2 + BT4.1 | None | Switch | None | 1Wx1 | None | None | None | USB / USB | None | Floor Stand | 65W Adapter 88% | Win10 Pro 64 | 3-year, Onsite | 01/16 |
| 10HY0027US | US | Pentium G4400T | No | Intel HD 510 | None | 4GBx1 | 500GB 7200rpm 2.5" | None | Intel 3165 ac, 1x1 + BT4.0 | None | Switch | None | 1Wx1 | None | None | None | USB / USB | None | Floor Stand | 65W Adapter 88% | Win10 DG Win7 Pro 64 | 3-year, Onsite | 01/16 |
| 10HY0028US | US | i5-6400T | No | Intel HD 530 | None | 4GBx1 | 256GB SSD Opal | None | Intel 8260 ac, 2x2 + BT4.1 | 3rd DP | Switch | None | 1Wx1 | None | None | None | USB / USB | None | Floor Stand | 65W Adapter 88% | Win10 DG Win7 Pro 64 | 3-year, Onsite | 01/16 |
| 10HY0029US | US | i5-6500T | No | Intel HD 530 | None | 4GBx1 | 256GB SSD Opal | None | Intel 8260 ac, 2x2 + BT4.1 | 3rd DP | Switch | None | 1Wx1 | None | None | None | USB / USB | None | Floor Stand | 65W Adapter 88% | Win10 DG Win7 Pro 64 | 3-year, Onsite | 01/16 |
| 10HY002AUS | US | i5-6500T | No | Intel HD 530 | None | 8GBx1 | 256GB SSD Opal | None | Intel 8260 ac, 2x2 + BT4.1 | 3rd DP | Switch | None | 1Wx1 | None | None | None | USB / USB | None | Floor Stand | 65W Adapter 88% | Win10 DG Win7 Pro 64 | 3-year, Onsite | 01/16 |
| 10HY002BUS | US | i5-6400T | No | Intel HD 530 | None | 8GBx1 | 256GB SSD Opal | None | Intel 8260 ac, 2x2 + BT4.1 | 3rd DP | Switch | None | 1Wx1 | None | None | None | USB / USB | None | Floor Stand | 65W Adapter 88% | Win10 DG Win7 Pro 64 | 3-year, Onsite | 01/16 |
| 10HY002CUS | US | i5-6400T | No | Intel HD 530 | None | 4GBx1 | 128GB SSD | None | Intel 8260 ac, 2x2 + BT4.1 | None | Switch | None | 1Wx1 | None | None | None | USB / USB | None | Floor Stand | 65W Adapter 88% | Win10 DG Win7 Pro 64 | 3-year, Onsite | 01/16 |
| 10HY003HUS | US | i5-6500T | No | Intel HD 530 | None | 8GBx1 | 128GB SSD | None | Intel 8260 ac, 2x2 + BT4.1 | VGA | Switch | None | 1Wx1 | None | None | None | USB / USB | None | Floor Stand | 65W Adapter 88% | Win10 DG Win7 Pro 64 | 3-year, Onsite | 03/16 |

| Model | Region | Processor | vPro | Graphics | Monitor Cable | Memory | Storage(HDD/SSD) | External Optical / I/O Box | WLAN + Bluetooth | Optional Rear Ports | Chassis Intrusion Switch | Kensington Cable Lock | Speaker | Adapter Cage | Toolless Chassis Screw | Dust Filter | Keyboard / Mouse | VESA Mount | Stand | Power Supply | Operating System | Warranty | Ann Date (m/y) |
|------------|--------|-----------|------|--------------|---------------|--------|--------------------|----------------------------|----------------------------|---------------------|--------------------------|-----------------------|---------|--------------|------------------------|-------------|------------------|------------|-------------|-----------------|----------------------|----------------|----------------|
| 10HY003JUS | US | i5-6600T | No | Intel HD 530 | None | 8GBx1 | 500GB 7200rpm 2.5" | None | Intel 8260 ac, 2x2 + BT4.1 | 3rd DP | Switch | None | 1Wx1 | None | None | None | USB / USB | None | Floor Stand | 65W Adapter 88% | Win10 DG Win7 Pro 64 | 3-year, Onsite | 03/16 |
| 10HY003KUS | US | i5-6600T | No | Intel HD 530 | None | 8GBx1 | 128GB SSD | None | Intel 8260 ac, 2x2 + BT4.1 | 3rd DP | Switch | None | 1Wx1 | None | None | None | USB / USB | None | Floor Stand | 65W Adapter 88% | Win10 DG Win7 Pro 64 | 3-year, Onsite | 03/16 |
| 10HY0057US | US | i5-6500T | No | Intel HD 530 | None | 8GBx1 | 256GB SSD Opal | None | Intel 8260 ac, 2x2 + BT4.1 | 3rd DP | Switch | None | 1Wx1 | None | None | None | USB / USB | None | Floor Stand | 65W Adapter 88% | Win10 Pro 64 | 3-year, Onsite | 07/16 |
| 10HY0058US | US | i5-6500T | No | Intel HD 530 | None | 8GBx1 | 128GB SSD | None | Intel 8260 ac, 2x2 + BT4.1 | None | Switch | None | 1Wx1 | None | None | None | USB / USB | None | Floor Stand | 65W Adapter 88% | Win10 Pro 64 | 3-year, Onsite | 07/16 |
| 10HY0059US | US | i3-6100T | No | Intel HD 530 | None | 8GBx1 | 128GB SSD | None | Intel 3165 ac, 1x1 + BT4.0 | None | Switch | None | 1Wx1 | None | None | None | USB / USB | None | Floor Stand | 65W Adapter 88% | Win10 Pro 64 | 3-year, Onsite | 07/16 |
| 10HY0068US | US | i3-6100T | No | Intel HD 530 | None | 8GBx1 | 500GB 7200rpm 2.5" | None | Intel 3165 ac, 1x1 + BT4.0 | VGA | Switch | None | 1Wx1 | None | None | None | USB / USB | None | Floor Stand | 65W Adapter 88% | Win10 Pro 64 | 3-year, Onsite | 10/16 |
| 10HY0069US | US | i3-6100T | No | Intel HD 530 | None | 8GBx1 | 500GB 7200rpm 2.5" | None | Intel 3165 ac, 1x1 + BT4.0 | 3rd DP | Switch | None | 1Wx1 | None | None | None | USB / USB | None | Floor Stand | 65W Adapter 88% | Win10 Pro 64 | 3-year, Onsite | 10/16 |

| Model | Region | Processor | vPro | Graphics | Monitor Cable | Memory | Storage(HDD/SSD) | External Optical / I/O Box | WLAN + Bluetooth | Optional Rear Ports | Chassis Intrusion Switch | Kensington Cable Lock | Speaker | Adapter Cage | Toolless Chassis Screw | Dust Filter | Keyboard / Mouse | VESA Mount | Stand | Power Supply | Operating System | Warranty | Ann Date (m/y) |
|------------|--------|----------------|------|--------------|---------------|--------|------------------|----------------------------|-------------------------|---------------------|--------------------------|-----------------------|---------|--------------|------------------------|-------------|------------------|------------|-------------|-----------------|------------------|----------------|----------------|
| 10JQ0000US | US | Pentium G4400T | No | Intel HD 510 | None | 4GBx1 | 16GB SSD M.2 | None | QCA6174 ac, 2x2 + BT4.1 | None | Switch | None | 1Wx1 | None | None | None | USB / USB | None | Floor Stand | 65W Adapter 88% | WES 7 | 3-year, Onsite | 03/16 |
| 10JQ0001US | US | Pentium G4400T | No | Intel HD 510 | None | 4GBx1 | 16GB SSD M.2 | None | QCA6174 ac, 2x2 + BT4.1 | VGA | Switch | None | 1Wx1 | None | None | None | USB / USB | None | Floor Stand | 65W Adapter 88% | WES 7 | 3-year, Onsite | 03/16 |
| 10JQ0002US | US | i3-6100T | No | Intel HD 530 | None | 4GBx1 | 16GB SSD M.2 | None | QCA6174 ac, 2x2 + BT4.1 | 3rd DP | Switch | None | 1Wx1 | None | None | None | USB / USB | None | Floor Stand | 65W Adapter 88% | WES 7 | 3-year, Onsite | 03/16 |
| 10JQ0003US | US | Pentium G4400T | No | Intel HD 510 | None | 4GBx1 | 16GB SSD M.2 | None | QCA6174 ac, 2x2 + BT4.1 | 3rd DP | Switch | None | 1Wx1 | None | None | None | USB / USB | None | Floor Stand | 65W Adapter 88% | WES 7 | 3-year, Onsite | 03/16 |
| 10JQ0004US | US | Pentium G4400T | No | Intel HD 510 | None | 4GBx1 | 16GB SSD M.2 | None | QCA6174 ac, 2x2 + BT4.1 | Serial | Switch | None | 1Wx1 | None | None | None | USB / USB | None | Floor Stand | 65W Adapter 88% | WES 7 | 3-year, Onsite | 03/16 |
| 10JQ0005US | US | Pentium G4400T | No | Intel HD 510 | None | 4GBx1 | 16GB SSD M.2 | None | QCA6174 ac, 2x2 + BT4.1 | VGA | Switch | None | 1Wx1 | None | None | None | USB / USB | None | Floor Stand | 65W Adapter 88% | LeTOS | 3-year, Onsite | 03/16 |
| 10JQ0006US | US | Pentium G4400T | No | Intel HD 510 | None | 4GBx1 | 16GB SSD M.2 | None | QCA6174 ac, 2x2 + BT4.1 | 3rd DP | Switch | None | 1Wx1 | None | None | None | USB / USB | None | Floor Stand | 65W Adapter 88% | LeTOS | 3-year, Onsite | 03/16 |
| 10JQ0007US | US | Pentium G4400T | No | Intel HD 510 | None | 4GBx1 | 16GB SSD M.2 | None | QCA6174 ac, 2x2 + BT4.1 | Serial | Switch | None | 1Wx1 | None | None | None | USB / USB | None | Floor Stand | 65W Adapter 88% | LeTOS | 3-year, Onsite | 03/16 |
| 10JQ0008US | US | i3-6100T | No | Intel HD 530 | None | 4GBx1 | 16GB SSD M.2 | None | QCA6174 ac, 2x2 + BT4.1 | 3rd DP | Switch | None | 1Wx1 | None | None | None | USB / USB | None | Floor Stand | 65W Adapter 88% | LeTOS | 3-year, Onsite | 03/16 |
| 10JQ000EUS | US | Pentium G4400T | No | Intel HD 510 | None | 4GBx1 | 16GB SSD M.2 | None | QCA6174 ac, 2x2 + BT4.1 | None | Switch | None | 1Wx1 | None | None | None | USB / USB | None | Floor Stand | 65W Adapter 88% | WES 7 | 3-year, Onsite | 01/17 |
| 10JQ000FUS | US | Pentium G4400T | No | Intel HD 510 | None | 4GBx1 | 16GB SSD M.2 | None | QCA6174 ac, 2x2 + BT4.1 | 3rd DP | Switch | None | 1Wx1 | None | None | None | USB / USB | None | Floor Stand | 65W Adapter 88% | LeTOS | 3-year, Onsite | 01/17 |
| 10JQ000GUS | US | Pentium G4400T | No | Intel HD 510 | None | 4GBx1 | 16GB SSD M.2 | None | QCA6174 ac, 2x2 + BT4.1 | VGA | Switch | None | 1Wx1 | None | None | None | USB / USB | None | Floor Stand | 65W Adapter 88% | WES 7 | 3-year, Onsite | 01/17 |
| 10JQ000HUS | US | i3-6100T | No | Intel HD 530 | None | 4GBx1 | 16GB SSD M.2 | None | QCA6174 ac, 2x2 + BT4.1 | 3rd DP | Switch | None | 1Wx1 | None | None | None | USB / USB | None | Floor Stand | 65W Adapter 88% | WES 7 | 3-year, Onsite | 01/17 |
| 10JQ000JUS | US | Pentium G4400T | No | Intel HD 510 | None | 4GBx1 | 16GB SSD M.2 | None | QCA6174 ac, 2x2 + BT4.1 | Serial | Switch | None | 1Wx1 | None | None | None | USB / USB | None | Floor Stand | 65W Adapter 88% | LeTOS | 3-year, Onsite | 01/17 |
| 10JQ000KUS | US | Pentium G4400T | No | Intel HD 510 | None | 4GBx1 | 16GB SSD M.2 | None | QCA6174 ac, 2x2 + BT4.1 | VGA | Switch | None | 1Wx1 | None | None | None | USB / USB | None | Floor Stand | 65W Adapter 88% | LeTOS | 3-year, Onsite | 01/17 |
| 10JQ000LUS | US | Pentium G4400T | No | Intel HD 510 | None | 4GBx1 | 16GB SSD M.2 | None | QCA6174 ac, 2x2 + BT4.1 | 3rd DP | Switch | None | 1Wx1 | None | None | None | USB / USB | None | Floor Stand | 65W Adapter 88% | WES 7 | 3-year, Onsite | 01/17 |
| 10JQ000MUS | US | Pentium G4400T | No | Intel HD 510 | None | 4GBx1 | 16GB SSD M.2 | None | QCA6174 ac, 2x2 + BT4.1 | Serial | Switch | None | 1Wx1 | None | None | None | USB / USB | None | Floor Stand | 65W Adapter 88% | WES 7 | 3-year, Onsite | 01/17 |
| 10JQ000NUS | US | Pentium G4400T | No | Intel HD 510 | None | 4GBx1 | 16GB SSD M.2 | None | QCA6174 ac, 2x2 + BT4.1 | None | Switch | None | 1Wx1 | None | None | None | USB / USB | None | Floor Stand | 65W Adapter 88% | LeTOS | 3-year, Onsite | 01/17 |



ThinkCentre M700 Tower Platform Specifications

Product Specifications Reference (PSREF)

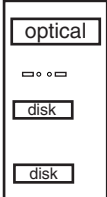
| Processor | Intel® Celeron®, Intel Pentium®, or 6th Generation Intel Core™ i3 / i5 / i7 Processor | Security features | <ul style="list-style-type: none"> One lock to secure both cover and entire system to fixed object: <ul style="list-style-type: none"> -Padlock loop (in rear for opt padlock) -Security slot (in rear for optional Kensington® MicroSaver® cable) Optional cable lock to physically lock both keyboard and mouse <ul style="list-style-type: none"> Power-on password Administrator password Hard disk password Boot sequence control Boot without keyboard and mouse Individual USB port disablement Optional chassis intrusion switch | | | | | | | | | | | | | | | | | | | | | | | | | | | | | | | | | | | | | | | | | | | | | | | | | | | | | | | | | | | | |
|---------------------------|--|-------------------------------|---|-------------------------|---------------------|--------------|---------------------|---------------|-------|-------|------|-----------|--------|---------------|-------|------|------|-----------|--------|---------------|-------|------|------|-----------|--------|--------------|-------|-------|------|-----------|--------|--------------|-------|-------|------|-----------|--------|--------------|-------|---------------|------|-----------|--------|--------------|-------|---------------|------|-----------|--------|--------------|-------|---------------|------|-----------|--------|--------------|-------|---------------|------|-----------|--------|----------|---|
| | <table border="1"> <thead> <tr> <th>Processor</th> <th>Cores / Threads</th> <th>Frequency Base/Max(GHz)</th> <th>Cache</th> <th>Memory Types</th> <th>Integrated Graphics</th> </tr> </thead> <tbody> <tr> <td>Celeron G3900</td> <td>2 / 2</td> <td>2.8 G</td> <td>2 MB</td> <td>DDR4-2133</td> <td>HD 510</td> </tr> <tr> <td>Pentium G4400</td> <td>2 / 2</td> <td>3.3G</td> <td>3 MB</td> <td>DDR4-2133</td> <td>HD 510</td> </tr> <tr> <td>Pentium G4500</td> <td>2 / 2</td> <td>3.5G</td> <td>3 MB</td> <td>DDR4-2133</td> <td>HD 530</td> </tr> <tr> <td>Core i3-6100</td> <td>2 / 4</td> <td>3.7 G</td> <td>3 MB</td> <td>DDR4-2133</td> <td>HD 530</td> </tr> <tr> <td>Core i3-6300</td> <td>2 / 4</td> <td>3.8 G</td> <td>4 MB</td> <td>DDR4-2133</td> <td>HD 530</td> </tr> <tr> <td>Core i5-6400</td> <td>4 / 4</td> <td>2.7 G / 3.3 G</td> <td>6 MB</td> <td>DDR4-2133</td> <td>HD 530</td> </tr> <tr> <td>Core i5-6500</td> <td>4 / 4</td> <td>3.2 G / 3.6 G</td> <td>6 MB</td> <td>DDR4-2133</td> <td>HD 530</td> </tr> <tr> <td>Core i5-6600</td> <td>4 / 4</td> <td>3.3 G / 3.9 G</td> <td>6 MB</td> <td>DDR4-2133</td> <td>HD 530</td> </tr> <tr> <td>Core i7-6700</td> <td>4 / 8</td> <td>3.4 G / 4.0 G</td> <td>8 MB</td> <td>DDR4-2133</td> <td>HD 530</td> </tr> </tbody> </table> | Processor | Cores / Threads | Frequency Base/Max(GHz) | Cache | Memory Types | Integrated Graphics | Celeron G3900 | 2 / 2 | 2.8 G | 2 MB | DDR4-2133 | HD 510 | Pentium G4400 | 2 / 2 | 3.3G | 3 MB | DDR4-2133 | HD 510 | Pentium G4500 | 2 / 2 | 3.5G | 3 MB | DDR4-2133 | HD 530 | Core i3-6100 | 2 / 4 | 3.7 G | 3 MB | DDR4-2133 | HD 530 | Core i3-6300 | 2 / 4 | 3.8 G | 4 MB | DDR4-2133 | HD 530 | Core i5-6400 | 4 / 4 | 2.7 G / 3.3 G | 6 MB | DDR4-2133 | HD 530 | Core i5-6500 | 4 / 4 | 3.2 G / 3.6 G | 6 MB | DDR4-2133 | HD 530 | Core i5-6600 | 4 / 4 | 3.3 G / 3.9 G | 6 MB | DDR4-2133 | HD 530 | Core i7-6700 | 4 / 8 | 3.4 G / 4.0 G | 8 MB | DDR4-2133 | HD 530 | Keyboard | <i>Some:</i> PS/2 Keyboard (PS/2 connector), Lenovo logo <i>Some:</i> Preferred Pro USB Keyboard (USB connector), Lenovo logo <i>Some:</i> Lenovo USB Fingerprint Keyboard (USB connector) <i>Some:</i> Ultralim Plus Wireless Keyboard (2.4GHz via USB receiver), black |
| Processor | Cores / Threads | Frequency Base/Max(GHz) | Cache | Memory Types | Integrated Graphics | | | | | | | | | | | | | | | | | | | | | | | | | | | | | | | | | | | | | | | | | | | | | | | | | | | | | | | | | | |
| Celeron G3900 | 2 / 2 | 2.8 G | 2 MB | DDR4-2133 | HD 510 | | | | | | | | | | | | | | | | | | | | | | | | | | | | | | | | | | | | | | | | | | | | | | | | | | | | | | | | | | |
| Pentium G4400 | 2 / 2 | 3.3G | 3 MB | DDR4-2133 | HD 510 | | | | | | | | | | | | | | | | | | | | | | | | | | | | | | | | | | | | | | | | | | | | | | | | | | | | | | | | | | |
| Pentium G4500 | 2 / 2 | 3.5G | 3 MB | DDR4-2133 | HD 530 | | | | | | | | | | | | | | | | | | | | | | | | | | | | | | | | | | | | | | | | | | | | | | | | | | | | | | | | | | |
| Core i3-6100 | 2 / 4 | 3.7 G | 3 MB | DDR4-2133 | HD 530 | | | | | | | | | | | | | | | | | | | | | | | | | | | | | | | | | | | | | | | | | | | | | | | | | | | | | | | | | | |
| Core i3-6300 | 2 / 4 | 3.8 G | 4 MB | DDR4-2133 | HD 530 | | | | | | | | | | | | | | | | | | | | | | | | | | | | | | | | | | | | | | | | | | | | | | | | | | | | | | | | | | |
| Core i5-6400 | 4 / 4 | 2.7 G / 3.3 G | 6 MB | DDR4-2133 | HD 530 | | | | | | | | | | | | | | | | | | | | | | | | | | | | | | | | | | | | | | | | | | | | | | | | | | | | | | | | | | |
| Core i5-6500 | 4 / 4 | 3.2 G / 3.6 G | 6 MB | DDR4-2133 | HD 530 | | | | | | | | | | | | | | | | | | | | | | | | | | | | | | | | | | | | | | | | | | | | | | | | | | | | | | | | | | |
| Core i5-6600 | 4 / 4 | 3.3 G / 3.9 G | 6 MB | DDR4-2133 | HD 530 | | | | | | | | | | | | | | | | | | | | | | | | | | | | | | | | | | | | | | | | | | | | | | | | | | | | | | | | | | |
| Core i7-6700 | 4 / 8 | 3.4 G / 4.0 G | 8 MB | DDR4-2133 | HD 530 | | | | | | | | | | | | | | | | | | | | | | | | | | | | | | | | | | | | | | | | | | | | | | | | | | | | | | | | | | |
| | | Mouse | <i>Some:</i> PS/2 Optical Wheel Mouse, black, Lenovo logo <i>Some:</i> Enhanced Optical USB Mouse, black, Lenovo logo <i>Some:</i> Ultralim Plus Wireless Mouse (2.4GHz via USB receiver), black | | | | | | | | | | | | | | | | | | | | | | | | | | | | | | | | | | | | | | | | | | | | | | | | | | | | | | | | | | | | |
| Memory | 32GB max, UDIMM, DDR4 2133, two 288-pin DIMM sockets, dual-channel capable | Mechanical | <ul style="list-style-type: none"> Tower (20L), black color, metal case (WxDxH) 6.3" X 15.5" X 15.7"; 160mm X 394.5mm X 398mm 19.8 lb (9.0 kg) Optional handle Optional dust filter <p>Bay 1: 5.25", 1.6" high, access, std optical / opt front access HDD Bay 2: 3.5", 1" high, no access, std disk Bay 3: 3.5", 1" high, no access, opt disk Bay 4: N/A, N/A, external, opt reader Slot 1: half-length, full-height, PCIe 3.0 x16 Slot 2: half-length, full-height, PCIe 2.0 x1 Slot 3: half-length, full-height, PCIe 2.0 x1</p>  | | | | | | | | | | | | | | | | | | | | | | | | | | | | | | | | | | | | | | | | | | | | | | | | | | | | | | | | | | | | |
| Disk | <i>Some:</i> Hard disk, SATA 6.0Gb/s, 2.5"/ 3.5" wide, 5400 / 7200 rpm <i>Some:</i> Solid State Hybrid Drive (SSHD), 500GB (5400 rpm, 2.5") / 1TB or 2TB (7200 rpm, 3.5"), with 8GB NAND flash memory, SATA 6.0Gb/s <i>Some:</i> Solid State Drive (SSD) / SATA 6.0Gb/s, 2.5" Wide <i>Some:</i> Front accessible and removable HDD, 3.5", lockable via physical key | | | | | | | | | | | | | | | | | | | | | | | | | | | | | | | | | | | | | | | | | | | | | | | | | | | | | | | | | | | | | | |
| Optical | <i>Some:</i> DVD-ROM SATA 1.5Gb/s Drive <i>Some:</i> Super Multi-Burner DVD±RW SATA 1.5Gb/s Drive | | | | | | | | | | | | | | | | | | | | | | | | | | | | | | | | | | | | | | | | | | | | | | | | | | | | | | | | | | | | | | |
| Onboard SATA Media reader | Three onboard SATA 6.0Gb/s connectors, Optional 9-in-1 media reader | Power supply | <i>Some:</i> 180 watts, autosensing, 85% PSU <i>Some:</i> 250 watts, autosensing, 85% PSU | | | | | | | | | | | | | | | | | | | | | | | | | | | | | | | | | | | | | | | | | | | | | | | | | | | | | | | | | | | | |
| Graphics | Intel HD Graphics 510/530 in processor, uses main memory, DirectX® 12, one VGA, one DisplayPort™, supports two independent displays, works along with discrete graphics to support more displays; <i>Max resolution:</i> 4096x2304 (DP) @60Hz; 1920x1200 (VGA) @60Hz <i>Some:</i> NVIDIA® Quadro® K420 , DirectX 12, 2GB, PCIe 2.0 x16 adapter, one DVI-I, one DisplayPort, 41 watts; <i>Max resolution:</i> 3840x2160 (DisplayPort) @60Hz; 2560x1600 (DVI-I) @60Hz <i>Some:</i> NVIDIA GeForce® GT 720 , DirectX 12, 2GB, PCIe 2.0 x8 adapter, one VGA, one HDMI, 25 watts; <i>Max resolution:</i> 1920x1080 (HDMI) @60Hz; 2048x1536 (VGA) @85Hz <i>Some:</i> NVIDIA GeForce GT 720 , DirectX 12, 1GB, PCIe 2.0 x8 adapter, two DisplayPort, 25 watts; <i>Max resolution:</i> 3840x2160 (DisplayPort) @60Hz; | Limited warranty ³ | <i>Some:</i> 1-year or 3-year, depot service / service upgrades available <i>Some:</i> 1-year or 3-year, limited onsite service / service upgrades available <i>Some:</i> 3-year, limited onsite service, OID (Onsite International Delivery) / service upgrades available <i>For Lenovo service upgrade options, please go to S-TC sheet</i> | | | | | | | | | | | | | | | | | | | | | | | | | | | | | | | | | | | | | | | | | | | | | | | | | | | | | | | | | | | | |
| DP cable | Optional DP to VGA, DP to DVI-D (single link), or DP to HDMI 1.4 dongle | Preload | Preloaded operating system <i>Some:</i> Windows® 7 Professional 32/64 preinstalled through downgrade rights in Windows 10 Pro 64-bit <i>Some:</i> Windows 7 Professional 32/64 <i>Some:</i> Windows 10 Pro 64-bit <i>Some:</i> Windows 10 Home 64-bit | | | | | | | | | | | | | | | | | | | | | | | | | | | | | | | | | | | | | | | | | | | | | | | | | | | | | | | | | | | | |
| Chipset | Intel H110 Chipset | | Preloaded applications (only some listed) <ul style="list-style-type: none"> Desktop Power Manager Lenovo Solution Center Lenovo REACHit Lenovo SHAREit Lenovo Bluetooth Lock (for models with Wi-Fi/BT card) McAfee® LiveSafe™ (30-day trial) Microsoft Office preloaded; purchase a product key to activate PowerDVD Create (DVD±RW) Lenovo ThinkVantage Tools - Only for Window 10 Lenovo Companion Cyberlink PowerDVD (DVD, DVD±RW) Lenovo QuickOptimizer - Only for Window 7 Rescue and Recovery Password Manager ThinkVantage System Update Lenovo Message Center Plus Adobe® Reader® | | | | | | | | | | | | | | | | | | | | | | | | | | | | | | | | | | | | | | | | | | | | | | | | | | | | | | | | | | | | |
| Front ports | Two USB 3.0, two optional USB 2.0, microphone (3.5mm), headphone (3.5mm) | Environment | ENERGY STAR® 6.0*, EPEAT™ Gold rating* (*Need 85% PSU and Windows OS); ErP Lot 3; GREENGUARD ; RoHS-compliant | | | | | | | | | | | | | | | | | | | | | | | | | | | | | | | | | | | | | | | | | | | | | | | | | | | | | | | | | | | | |
| Rear ports | Two USB 3.0, two USB 2.0, two optional USB 2.0, serial (9-pin), optional 2nd serial (9-pin), optional parallel (25-pin), ethernet (RJ-45), one VGA, one DisplayPort, two PS/2 ports (keyboard/mouse); additional VGA, DisplayPort, DVI-I or HDMI on optional graphics on some models | Accessories | For compatible accessories, please go to TC-AQP sheet | | | | | | | | | | | | | | | | | | | | | | | | | | | | | | | | | | | | | | | | | | | | | | | | | | | | | | | | | | | | |
| Rear audio ports | Line-in (3.5mm), line-out (3.5mm), microphone-in (3.5mm) | | | | | | | | | | | | | | | | | | | | | | | | | | | | | | | | | | | | | | | | | | | | | | | | | | | | | | | | | | | | | | |
| IEEE 1394 | None | | | | | | | | | | | | | | | | | | | | | | | | | | | | | | | | | | | | | | | | | | | | | | | | | | | | | | | | | | | | | | |
| Audio support | High Definition (HD) Audio, Realtek ALC662 / optional internal speaker (1.5 watt) | | | | | | | | | | | | | | | | | | | | | | | | | | | | | | | | | | | | | | | | | | | | | | | | | | | | | | | | | | | | | | |
| WLAN ¹³ | <i>Some:</i> 11ac wireless, M.2 Card, Qualcomm Atheros QCA9377 (dual band), Wi-Fi + Bluetooth 4.1 combo adapter, 1x1 <i>Some:</i> 11ac wireless, M.2 Card, Qualcomm Atheros QCA6174 (dual band), Wi-Fi + Bluetooth 4.1 combo adapter, 2x2 <i>Some:</i> 11ac wireless, M.2 Card, Intel Dual Band Wireless-AC 3165, Wi-Fi + Bluetooth 4.0 combo adapter, 1x1 <i>Some:</i> 11ac wireless, M.2 Card, Intel Dual Band Wireless-AC 8260, Wi-Fi + Bluetooth 4.1 combo adapter, 2x2 | | | | | | | | | | | | | | | | | | | | | | | | | | | | | | | | | | | | | | | | | | | | | | | | | | | | | | | | | | | | | | |
| Bluetooth™ | <i>Some:</i> Bluetooth 4.0 or 4.1 wireless, integrated in Wi-Fi + BT combo adapter | | | | | | | | | | | | | | | | | | | | | | | | | | | | | | | | | | | | | | | | | | | | | | | | | | | | | | | | | | | | | | |
| Ethernet | Gigabit ethernet, Realtek RTL8111GN, Wake on LAN® | | | | | | | | | | | | | | | | | | | | | | | | | | | | | | | | | | | | | | | | | | | | | | | | | | | | | | | | | | | | | | |
| Modem | None | | | | | | | | | | | | | | | | | | | | | | | | | | | | | | | | | | | | | | | | | | | | | | | | | | | | | | | | | | | | | | |
| Manageability | None | | | | | | | | | | | | | | | | | | | | | | | | | | | | | | | | | | | | | | | | | | | | | | | | | | | | | | | | | | | | | | |
| Security chip | Trusted Platform Module, TCG 1.2-compliant | | | | | | | | | | | | | | | | | | | | | | | | | | | | | | | | | | | | | | | | | | | | | | | | | | | | | | | | | | | | | | |

See footnotes for more detailed information

| Model | Region | Processor | vPro | Graphics | Monitor Cable | Memory | Storage | Optical | Media Reader | WLAN + Bluetooth | Optional Front Ports | Optional Rear Ports | Chassis Intrusion Switch | Cable Lock | Front Access HDD | Dust Filter | Keyboard / Mouse | Carry Handle | Power Supply | Operating System | Warranty | Ann Date (m/y) |
|------------|--------|---------------|------|---------------|---------------|--------|--------------------------|---------|--------------|----------------------------------|----------------------|---------------------|--------------------------|------------|------------------|-------------|------------------|--------------|--------------|-------------------------|-------------------|----------------|
| 10GR001MUS | US | i7-6700 | No | Intel HD 530 | None | 8GBx1 | 1TB 7200rpm 3.5" | DVD±RW | None | None | None | None | None | None | None | None | None / USB | Carry Handle | 250W 85% | Win10 DG Win7 Pro 64 | 3-year, Onsite | 01/16 |
| 10GR001NUS | US | Pentium G4400 | No | Intel HD 510 | None | 4GBx1 | 500GB 7200rpm 3.5" | DVD±RW | None | None | None | None | None | None | None | None | None / USB | Carry Handle | 250W 85% | Win10 DG Win7 Pro 64 | 3-year, Onsite | 01/16 |
| 10GR001PUS | US | i3-6100 | No | Intel HD 530 | None | 4GBx1 | 500GB 7200rpm 3.5" | DVD±RW | None | None | None | None | None | None | None | None | None / USB | Carry Handle | 250W 85% | Win10 DG Win7 Pro 64 | 3-year, Onsite | 01/16 |
| 10GR001QUS | US | i5-6400 | No | Intel HD 530 | None | 4GBx1 | 500GB 7200rpm 3.5" | DVD±RW | None | None | None | None | None | None | None | None | None / USB | Carry Handle | 250W 85% | Win10 DG Win7 Pro 64 | 3-year, Onsite | 01/16 |
| 10GR001RUS | US | i7-6700 | No | Intel HD 530 | None | 8GBx1 | 256GB SSD Opal | DVD±RW | None | None | None | None | None | None | None | None | USB / USB | Carry Handle | 250W 85% | Win10 DG Win7 Pro 64 | 3-year, Onsite | 01/16 |
| 10GR001SUS | US | i7-6700 | No | Intel HD 530 | None | 8GBx1 | 500GB 7200rpm 3.5" | DVD±RW | None | None | None | None | None | None | None | None | USB / USB | Carry Handle | 250W 85% | Win10 DG Win7 Pro 64 | 3-year, Onsite | 01/16 |
| 10GR001TUS | US | i7-6700 | No | GT 720 1GB | None | 8GBx1 | 1TB 7200rpm 3.5" | DVD±RW | None | Intel 8260 ac, 2x2 + BT4.1 | None | None | None | None | None | None | USB / USB | Carry Handle | 250W 85% | Win10 DG Win7 Pro 64 | 3-year, Onsite | 01/16 |
| 10GR001UUS | US | i7-6700 | No | Intel HD 530 | None | 8GBx1 | 1TB 7200rpm 3.5" | DVD±RW | None | None | None | None | None | None | None | None | USB / USB | Carry Handle | 250W 85% | Win10 DG Win7 Pro 64 | 3-year, Onsite | 01/16 |
| 10GR001VUS | US | i7-6700 | No | Intel HD 530 | None | 8GBx1 | 120GB SSD | DVD±RW | None | None | None | None | None | None | None | None | USB / USB | Carry Handle | 250W 85% | Win10 DG Win7 Pro 64 | 3-year, Onsite | 01/16 |
| 10GR001WUS | US | i7-6700 | No | Intel HD 530 | None | 8GBx1 | 128GB SSD | DVD±RW | None | None | None | None | None | None | None | None | USB / USB | Carry Handle | 250W 85% | Win10 DG Win7 Pro 64 | 3-year, Onsite | 01/16 |
| 10GR001XUS | US | i7-6700 | No | Intel HD 530 | None | 8GBx1 | 1TB 7200rpm 3.5" | DVD±RW | None | Intel 8260 ac, 2x2 + BT4.1 | None | None | None | None | None | None | USB / USB | Carry Handle | 250W 85% | Win10 DG Win7 Pro 64 | 3-year, Onsite | 01/16 |
| 10GR001YUS | US | i5-6400 | No | Intel HD 530 | None | 8GBx1 | 500GB 7200rpm 3.5" | DVD±RW | None | Intel 8260 ac, 2x2 + BT4.1 | None | None | None | None | None | None | USB / USB | Carry Handle | 250W 85% | Win10 DG Win7 Pro 64 | 3-year, Onsite | 01/16 |
| 10GR0020US | US | i5-6400 | No | Intel HD 530 | None | 4GBx1 | 500GB 7200rpm 3.5" | DVD±RW | None | None | None | None | None | None | None | None | USB / USB | Carry Handle | 250W 85% | Win10 DG Win7 Pro 64 | 3-year, Onsite | 01/16 |
| 10GR0021US | US | i5-6400 | No | Intel HD 530 | None | 4GBx1 | 500GB 7200rpm 3.5" | DVD±RW | None | Intel 8260 ac, 2x2 + BT4.1 | None | None | None | None | None | None | USB / USB | Carry Handle | 250W 85% | Win10 DG Win7 Pro 64 | 3-year, Onsite | 01/16 |
| 10GR0022US | US | i5-6400 | No | Intel HD 530 | None | 8GBx1 | 192GB SSD | DVD±RW | None | None | None | None | None | None | None | None | USB / USB | Carry Handle | 250W 85% | Win10 DG Win7 Pro 64 | 3-year, Onsite | 01/16 |
| 10GR0023US | US | i5-6400 | No | Intel HD 530 | None | 8GBx1 | 1TB 7200rpm 3.5" | DVD±RW | None | None | None | None | None | None | None | None | USB / USB | Carry Handle | 250W 85% | Win10 DG Win7 Pro 64 | 3-year, Onsite | 01/16 |
| 10GR0024US | US | i5-6400 | No | Intel HD 530 | None | 8GBx1 | 500GB 7200rpm 3.5" | DVD±RW | None | None | None | None | None | None | None | None | USB / USB | Carry Handle | 250W 85% | Win10 DG Win7 Pro 64 | 3-year, Onsite | 01/16 |
| 10GR0025US | US | i5-6400 | No | GT 720 1GB | None | 8GBx1 | 1TB 7200rpm 3.5" | DVD±RW | None | Intel 8260 ac, 2x2 + BT4.1 | None | None | None | None | None | None | USB / USB | Carry Handle | 250W 85% | Win10 DG Win7 Pro 64 | 3-year, Onsite | 01/16 |
| 10GR0026US | US | i5-6400 | No | Intel HD 530 | None | 8GBx1 | 120GB SSD | DVD±RW | None | None | None | None | None | None | None | None | USB / USB | Carry Handle | 250W 85% | Win10 DG Win7 Pro 64 | 3-year, Onsite | 01/16 |
| 10GR0027US | US | i5-6400 | No | Intel HD 530 | None | 8GBx1 | 256GB SSD Opal | DVD±RW | None | None | None | None | None | None | None | None | USB / USB | Carry Handle | 250W 85% | Win10 DG Win7 Pro 64 | 3-year, Onsite | 01/16 |

| Model | Region | Processor | vPro | Graphics | Monitor Cable | Memory | Storage | Optical | Media Reader | WLAN + Bluetooth | Optional Front Ports | Optional Rear Ports | Chassis Intrusion Switch | Cable Lock | Front Access HDD | Dust Filter | Keyboard / Mouse | Carry Handle | Power Supply | Operating System | Warranty | Ann Date (m/y) |
|------------|--------|---------------|------|---------------|---------------|--------|--------------------------|---------|--------------|----------------------------------|----------------------|---------------------|--------------------------|------------|------------------|-------------|------------------|--------------|--------------|-------------------------|-------------------|----------------|
| 10GR0028US | US | i3-6100 | No | Intel HD 530 | None | 4GBx1 | 500GB 7200rpm 3.5" | DVD±RW | None | Intel 8260 ac, 2x2 + BT4.1 | None | None | None | None | None | None | USB / USB | Carry Handle | 250W 85% | Win10 DG Win7 Pro 64 | 3-year, Onsite | 01/16 |
| 10GR0029US | US | i3-6100 | No | Intel HD 530 | None | 4GBx1 | 500GB 7200rpm 3.5" | DVD±RW | None | None | None | None | None | None | None | None | USB / USB | Carry Handle | 250W 85% | Win10 DG Win7 Pro 64 | 3-year, Onsite | 01/16 |
| 10GR002AUS | US | i3-6100 | No | Intel HD 530 | None | 4GBx1 | 500GB 7200rpm 3.5" | DVD±RW | None | Intel 3165 ac, 1x1 + BT4.0 | None | None | None | None | None | None | USB / USB | Carry Handle | 250W 85% | Win10 DG Win7 Pro 64 | 3-year, Onsite | 01/16 |
| 10GR002BUS | US | Pentium G4400 | No | Intel HD 510 | None | 4GBx1 | 500GB 7200rpm 3.5" | DVD±RW | None | None | None | None | None | None | None | None | USB / USB | Carry Handle | 250W 85% | Win10 DG Win7 Pro 64 | 3-year, Onsite | 01/16 |
| 10GR002CUS | US | i7-6700 | No | Intel HD 530 | None | 8GBx1 | 1TB 7200rpm 3.5" | DVD±RW | None | Intel 8260 ac, 2x2 + BT4.1 | None | None | None | None | None | None | USB / USB | Carry Handle | 250W 85% | Win10 Pro 64 | 3-year, Onsite | 01/16 |
| 10GR002DUS | US | Pentium G4400 | No | Intel HD 510 | None | 4GBx1 | 500GB 7200rpm 3.5" | DVD±RW | None | Intel 3165 ac, 1x1 + BT4.0 | None | None | None | None | None | None | USB / USB | Carry Handle | 250W 85% | Win10 Pro 64 | 3-year, Onsite | 01/16 |
| 10GR002EUS | US | i5-6400 | No | Intel HD 530 | None | 4GBx1 | 500GB 7200rpm 3.5" | DVD±RW | None | Intel 8260 ac, 2x2 + BT4.1 | None | None | None | None | None | None | USB / USB | Carry Handle | 250W 85% | Win10 Pro 64 | 3-year, Onsite | 01/16 |
| 10GR004FUS | US | i7-6700 | No | GT 720 1GB | None | 8GBx1 | 1TB 7200rpm 3.5" | DVD±RW | None | None | None | None | None | None | None | None | USB / USB | Carry Handle | 250W 85% | Win10 Pro 64 | 3-year, Onsite | 06/16 |
| 10GR004GUS | US | Pentium G4400 | No | Intel HD 510 | None | 4GBx1 | 500GB 7200rpm 3.5" | DVD±RW | None | None | None | None | None | None | None | None | USB / USB | Carry Handle | 250W 85% | Win10 Pro 64 | 3-year, Onsite | 06/16 |
| 10GR004HUS | US | i5-6400 | No | Intel HD 530 | None | 4GBx1 | 500GB 7200rpm 3.5" | DVD±RW | None | None | None | None | None | None | None | None | USB / USB | Carry Handle | 250W 85% | Win10 Pro 64 | 3-year, Onsite | 06/16 |
| 10GR004JUS | US | i3-6100 | No | Intel HD 530 | None | 4GBx1 | 500GB 7200rpm 3.5" | DVD±RW | None | None | None | None | None | None | None | None | USB / USB | Carry Handle | 250W 85% | Win10 Pro 64 | 3-year, Onsite | 06/16 |
| 10GR004KUS | US | i3-6100 | No | Intel HD 530 | None | 4GBx1 | 128GB SSD | DVD±RW | None | None | None | None | None | None | None | None | USB / USB | Carry Handle | 250W 85% | Win10 Pro 64 | 3-year, Onsite | 06/16 |
| 10GR004LUS | US | i5-6400 | No | GT 720 1GB | None | 8GBx1 | 1TB 7200rpm 3.5" | DVD±RW | None | None | None | None | None | None | None | None | USB / USB | Carry Handle | 250W 85% | Win10 Pro 64 | 3-year, Onsite | 06/16 |
| 10GR004MUS | US | i5-6400 | No | Intel HD 530 | None | 8GBx1 | 1TB 7200rpm 3.5" | DVD±RW | None | None | None | None | None | None | None | None | USB / USB | Carry Handle | 250W 85% | Win10 Pro 64 | 3-year, Onsite | 06/16 |
| 10GR004NUS | US | i5-6400 | No | Intel HD 530 | None | 8GBx1 | 256GB SSD Opal | DVD±RW | None | None | None | None | None | None | None | None | USB / USB | Carry Handle | 250W 85% | Win10 Pro 64 | 3-year, Onsite | 06/16 |
| 10GR004PUS | US | i5-6400 | No | Intel HD 530 | None | 8GBx1 | 128GB SSD | DVD±RW | None | None | None | None | None | None | None | None | USB / USB | Carry Handle | 250W 85% | Win10 Pro 64 | 3-year, Onsite | 06/16 |
| 10GR004QUS | US | Pentium G4400 | No | Intel HD 510 | None | 4GBx1 | 128GB SSD | DVD±RW | None | None | None | None | None | None | None | None | USB / USB | Carry Handle | 250W 85% | Win10 Pro 64 | 3-year, Onsite | 06/16 |
| 10GR004RUS | US | i7-6700 | No | Intel HD 530 | None | 8GBx1 | 1TB 7200rpm 3.5" | DVD±RW | None | None | None | None | None | None | None | None | USB / USB | Carry Handle | 250W 85% | Win10 Pro 64 | 3-year, Onsite | 06/16 |
| 10GR004SUS | US | i7-6700 | No | Intel HD 530 | None | 8GBx1 | 256GB SSD Opal | DVD±RW | None | None | None | None | None | None | None | None | USB / USB | Carry Handle | 250W 85% | Win10 Pro 64 | 3-year, Onsite | 06/16 |
| 10GR004TUS | US | i3-6100 | No | Intel HD 530 | None | 8GBx1 | 128GB SSD | DVD±RW | None | None | None | None | None | None | None | None | USB / USB | Carry Handle | 250W 85% | Win10 Pro 64 | 3-year, Onsite | 06/16 |

| Model | Region | Processor | vPro | Graphics | Monitor Cable | Memory | Storage | Optical | Media Reader | WLAN + Bluetooth | Optional Front Ports | Optional Rear Ports | Chassis Intrusion Switch | Cable Lock | Front Access HDD | Dust Filter | Keyboard / Mouse | Carry Handle | Power Supply | Operating System | Warranty | Ann Date (m/y) |
|------------|--------|-----------|------|---------------|---------------|--------|--------------------------|---------|--------------|----------------------------------|----------------------|---------------------|--------------------------|------------|------------------|-------------|------------------|--------------|--------------|-------------------------|-------------------|----------------|
| 10GR004UUS | US | i5-6400 | No | Intel HD 530 | None | 8GBx1 | 1TB 7200rpm 3.5" | DVD±RW | None | Intel 3165 ac, 1x1 + BT4.0 | None | None | None | None | None | None | USB / USB | Carry Handle | 250W 85% | Win10 Pro 64 | 3-year, Onsite | 06/16 |
| 10GR0056US | US | i7-6700 | No | GT 720 1GB | None | 8GBx1 | 1TB 7200rpm 3.5" | DVD±RW | None | None | None | None | None | None | None | None | USB / USB | Carry Handle | 250W 85% | Win10 DG Win7 Pro 64 | 3-year, Onsite | 10/16 |
| 10GR0057US | US | i5-6400 | No | GT 720 1GB | None | 8GBx1 | 1TB 7200rpm 3.5" | DVD±RW | None | Intel 8260 ac, 2x2 + BT4.1 | None | None | None | None | None | None | USB / USB | Carry Handle | 250W 85% | Win10 Pro 64 | 3-year, Onsite | 10/16 |
| 10GR0058US | US | i7-6700 | No | GT 720 1GB | None | 8GBx1 | 1TB 7200rpm 3.5" | DVD±RW | None | Intel 8260 ac, 2x2 + BT4.1 | None | None | None | None | None | None | USB / USB | Carry Handle | 250W 85% | Win10 Pro 64 | 3-year, Onsite | 10/16 |
| 10GR0059US | US | i5-6400 | No | GT 720 1GB | None | 8GBx1 | 1TB 7200rpm 3.5" | DVD±RW | None | Intel 8260 ac, 2x2 + BT4.1 | None | None | None | None | None | None | USB / USB | Carry Handle | 250W 85% | Win10 DG Win7 Pro 64 | 3-year, Onsite | 10/16 |
| 10GR005AUS | US | i7-6700 | No | GT 720 1GB | None | 8GBx1 | 1TB 7200rpm 3.5" | DVD±RW | None | None | None | None | None | None | None | None | USB / USB | Carry Handle | 250W 85% | Win10 Pro 64 | 3-year, Onsite | 10/16 |
| 10GR005BUS | US | i5-6400 | No | GT 720 1GB | None | 8GBx1 | 1TB 7200rpm 3.5" | DVD±RW | None | None | None | None | None | None | None | None | USB / USB | Carry Handle | 250W 85% | Win10 DG Win7 Pro 64 | 3-year, Onsite | 10/16 |
| 10GR005CUS | US | i7-6700 | No | GT 720 1GB | None | 8GBx1 | 1TB 7200rpm 3.5" | DVD±RW | None | Intel 8260 ac, 2x2 + BT4.1 | None | None | None | None | None | None | USB / USB | Carry Handle | 250W 85% | Win10 DG Win7 Pro 64 | 3-year, Onsite | 10/16 |
| 10GR005DUS | US | i5-6400 | No | GT 720 1GB | None | 8GBx1 | 1TB 7200rpm 3.5" | DVD±RW | None | None | None | None | None | None | None | None | USB / USB | Carry Handle | 250W 85% | Win10 Pro 64 | 3-year, Onsite | 10/16 |
| 10GR005EUS | US | i3-6100 | No | Intel HD 530 | None | 8GBx1 | 500GB 7200rpm 3.5" | DVD±RW | None | None | None | None | None | None | None | None | USB / USB | Carry Handle | 250W 85% | Win10 Pro 64 | 3-year, Onsite | 10/16 |

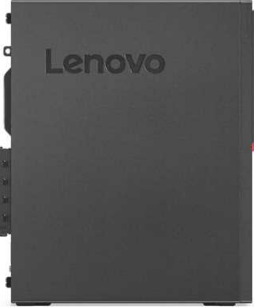

ThinkCentre M710 SFF Platform Specifications

Product Specifications Reference (PSREF)

| Processor | Intel® Celeron®, Intel Pentium®, or 6/7th Generation Intel Core™ i3 / i5 / i7 Processor | Security features | <ul style="list-style-type: none"> Security slot (in rear for optional Kensington® MicroSaver® cable) Padlock loop Smart USB protection, allows keyboard/mouse only, blocks all storage devices Optional cable lock to physically lock both keyboard and mouse Power-on password Administrator password Hard disk password Boot sequence control Boot without keyboard and mouse Individual USB port disablement Optional chassis intrusion switch | | | | | | | | | | | | | | | | | | | | | | | | | | | | | | | | | | | | | | | | | | | | | | | | | | | | | | | | | | | | | | | | | | | | | | | | |
|-----------------------------|---|-------------------------------|--|-------------------------|---------------------|------------------------|---------------------|---------------|-------|------|------|-----------|--------|---------------|-------|------|------|-----------|--------|---------------|-------|------|------|-----------|--------|--------------|-------|------|------|-----------|--------|--------------|-------|-------------|------|-----------|--------|--------------|-------|-------------|------|-----------|--------|--------------|-------|------|------|-----------|--------|--------------|-------|-------------|------|-----------|--------|--------------|-------|-------------|------|-----------|--------|--------------|-------|-------------|------|-----------|--------|--------------|-------|-------------|------|-----------|--------|----------|---|
| | <table border="1"> <thead> <tr> <th>Processor</th> <th>Cores / Threads</th> <th>Frequency Base/Max(GHz)</th> <th>Cache</th> <th>Memory Support (Up to)</th> <th>Integrated Graphics</th> </tr> </thead> <tbody> <tr> <td>Pentium G4400</td> <td>2 / 2</td> <td>3.3G</td> <td>3 MB</td> <td>DDR4-2133</td> <td>HD 510</td> </tr> <tr> <td>Pentium G4560</td> <td>2 / 4</td> <td>3.5G</td> <td>3 MB</td> <td>DDR4-2400</td> <td>HD 610</td> </tr> <tr> <td>Pentium G4600</td> <td>2 / 4</td> <td>3.6G</td> <td>3 MB</td> <td>DDR4-2400</td> <td>HD 630</td> </tr> <tr> <td>Core i3-6100</td> <td>2 / 4</td> <td>3.7G</td> <td>3 MB</td> <td>DDR4-2133</td> <td>HD 530</td> </tr> <tr> <td>Core i5-6500</td> <td>4 / 4</td> <td>3.2G / 3.6G</td> <td>6 MB</td> <td>DDR4-2133</td> <td>HD 530</td> </tr> <tr> <td>Core i7-6700</td> <td>4 / 8</td> <td>3.4G / 4.0G</td> <td>8 MB</td> <td>DDR4-2133</td> <td>HD 530</td> </tr> <tr> <td>Core i3-7100</td> <td>2 / 4</td> <td>3.9G</td> <td>3 MB</td> <td>DDR4-2400</td> <td>HD 630</td> </tr> <tr> <td>Core i5-7400</td> <td>4 / 4</td> <td>3.0G / 3.5G</td> <td>6 MB</td> <td>DDR4-2400</td> <td>HD 630</td> </tr> <tr> <td>Core i5-7500</td> <td>4 / 4</td> <td>3.4G / 3.8G</td> <td>6 MB</td> <td>DDR4-2400</td> <td>HD 630</td> </tr> <tr> <td>Core i5-7600</td> <td>4 / 4</td> <td>3.5G / 4.1G</td> <td>6 MB</td> <td>DDR4-2400</td> <td>HD 630</td> </tr> <tr> <td>Core i7-7700</td> <td>4 / 8</td> <td>3.6G / 4.2G</td> <td>8 MB</td> <td>DDR4-2400</td> <td>HD 630</td> </tr> </tbody> </table> | Processor | Cores / Threads | Frequency Base/Max(GHz) | Cache | Memory Support (Up to) | Integrated Graphics | Pentium G4400 | 2 / 2 | 3.3G | 3 MB | DDR4-2133 | HD 510 | Pentium G4560 | 2 / 4 | 3.5G | 3 MB | DDR4-2400 | HD 610 | Pentium G4600 | 2 / 4 | 3.6G | 3 MB | DDR4-2400 | HD 630 | Core i3-6100 | 2 / 4 | 3.7G | 3 MB | DDR4-2133 | HD 530 | Core i5-6500 | 4 / 4 | 3.2G / 3.6G | 6 MB | DDR4-2133 | HD 530 | Core i7-6700 | 4 / 8 | 3.4G / 4.0G | 8 MB | DDR4-2133 | HD 530 | Core i3-7100 | 2 / 4 | 3.9G | 3 MB | DDR4-2400 | HD 630 | Core i5-7400 | 4 / 4 | 3.0G / 3.5G | 6 MB | DDR4-2400 | HD 630 | Core i5-7500 | 4 / 4 | 3.4G / 3.8G | 6 MB | DDR4-2400 | HD 630 | Core i5-7600 | 4 / 4 | 3.5G / 4.1G | 6 MB | DDR4-2400 | HD 630 | Core i7-7700 | 4 / 8 | 3.6G / 4.2G | 8 MB | DDR4-2400 | HD 630 | Keyboard | <i>Some:</i> Lenovo Calliope Keyboard (USB connector), black <i>Some:</i> Lenovo Traditional Keyboard (USB connector), black <i>Some:</i> Lenovo Calliope Wireless Keyboard (2.4GHz via USB receiver), black <i>Some:</i> Lenovo Calliope Mouse (USB connector), black <i>Some:</i> Lenovo Calliope Wireless Mouse (2.4GHz via USB receiver), black |
| Processor | Cores / Threads | Frequency Base/Max(GHz) | Cache | Memory Support (Up to) | Integrated Graphics | | | | | | | | | | | | | | | | | | | | | | | | | | | | | | | | | | | | | | | | | | | | | | | | | | | | | | | | | | | | | | | | | | | | | | |
| Pentium G4400 | 2 / 2 | 3.3G | 3 MB | DDR4-2133 | HD 510 | | | | | | | | | | | | | | | | | | | | | | | | | | | | | | | | | | | | | | | | | | | | | | | | | | | | | | | | | | | | | | | | | | | | | | |
| Pentium G4560 | 2 / 4 | 3.5G | 3 MB | DDR4-2400 | HD 610 | | | | | | | | | | | | | | | | | | | | | | | | | | | | | | | | | | | | | | | | | | | | | | | | | | | | | | | | | | | | | | | | | | | | | | |
| Pentium G4600 | 2 / 4 | 3.6G | 3 MB | DDR4-2400 | HD 630 | | | | | | | | | | | | | | | | | | | | | | | | | | | | | | | | | | | | | | | | | | | | | | | | | | | | | | | | | | | | | | | | | | | | | | |
| Core i3-6100 | 2 / 4 | 3.7G | 3 MB | DDR4-2133 | HD 530 | | | | | | | | | | | | | | | | | | | | | | | | | | | | | | | | | | | | | | | | | | | | | | | | | | | | | | | | | | | | | | | | | | | | | | |
| Core i5-6500 | 4 / 4 | 3.2G / 3.6G | 6 MB | DDR4-2133 | HD 530 | | | | | | | | | | | | | | | | | | | | | | | | | | | | | | | | | | | | | | | | | | | | | | | | | | | | | | | | | | | | | | | | | | | | | | |
| Core i7-6700 | 4 / 8 | 3.4G / 4.0G | 8 MB | DDR4-2133 | HD 530 | | | | | | | | | | | | | | | | | | | | | | | | | | | | | | | | | | | | | | | | | | | | | | | | | | | | | | | | | | | | | | | | | | | | | | |
| Core i3-7100 | 2 / 4 | 3.9G | 3 MB | DDR4-2400 | HD 630 | | | | | | | | | | | | | | | | | | | | | | | | | | | | | | | | | | | | | | | | | | | | | | | | | | | | | | | | | | | | | | | | | | | | | | |
| Core i5-7400 | 4 / 4 | 3.0G / 3.5G | 6 MB | DDR4-2400 | HD 630 | | | | | | | | | | | | | | | | | | | | | | | | | | | | | | | | | | | | | | | | | | | | | | | | | | | | | | | | | | | | | | | | | | | | | | |
| Core i5-7500 | 4 / 4 | 3.4G / 3.8G | 6 MB | DDR4-2400 | HD 630 | | | | | | | | | | | | | | | | | | | | | | | | | | | | | | | | | | | | | | | | | | | | | | | | | | | | | | | | | | | | | | | | | | | | | | |
| Core i5-7600 | 4 / 4 | 3.5G / 4.1G | 6 MB | DDR4-2400 | HD 630 | | | | | | | | | | | | | | | | | | | | | | | | | | | | | | | | | | | | | | | | | | | | | | | | | | | | | | | | | | | | | | | | | | | | | | |
| Core i7-7700 | 4 / 8 | 3.6G / 4.2G | 8 MB | DDR4-2400 | HD 630 | | | | | | | | | | | | | | | | | | | | | | | | | | | | | | | | | | | | | | | | | | | | | | | | | | | | | | | | | | | | | | | | | | | | | | |
| Memory | 64GB max, UDIMM, DDR4-2400, four 288-pin DIMM sockets, non-ECC, dual-channel capable* * System automatically clocks down for the processors with lower memory controller | Mouse | | | | | | | | | | | | | | | | | | | | | | | | | | | | | | | | | | | | | | | | | | | | | | | | | | | | | | | | | | | | | | | | | | | | | | | | | |
| Storage | <i>Some:</i> Hard Drive / SATA 6.0Gb/s, 2.5" or 3.5", 5400 rpm or 7200 rpm <i>Some:</i> Solid State Drive (SSD) / SATA 6.0Gb/s, 2.5" <i>Some:</i> M.2 Solid State Drive (SSD) / PCIe NVMe, PCIe 3.0 x 4, 32Gb/s <i>Some:</i> Intel Optane™ Memory Ready (models with 7th gen Core processor), M.2 <i>Some:</i> DVD-ROM SATA 1.5Gb/s Drive, slim (9.0mm) <i>Some:</i> DVD Burner (DVD±RW), SATA 1.5Gb/s Drive, slim (9.0mm) | Mechanical | <ul style="list-style-type: none"> SFF (8.4L), black color; metal case (WxDxH) 3.6" X 11.4" X 13.5"; 92.5mm X 290.5mm X 343.5mm Approx. 13.2 lb (6.0 kg), weight may vary by configuration Toolless cover, disk, optical removal Optional dust filter Bay 1: Slim external ODD bay Bay 2: 3.5", 1" high, internal, HDD/SSD Bay 3: 2.5", internal, HDD/SSD (optional bay) Slot 1: low-profile (length < 150mm, height < 68mm), PCIe 3.0 x16* Slot 2: low-profile (length < 150mm, height < 68mm), PCIe 3.0 x1* Slot 3: low-profile (length < 150mm, height < 68mm), PCIe 3.0 x1* Slot 4: no slot, only bracket for optional port extension* M.2 card slots: Two (one for WLAN, one for SSD/Optane) * Optional front USB3.1 Type-C x2 module occupies PCIe x16 slot (x4 card), optional rear 2x USB2.0 / parallel / 2nd serial occupies one expansion slot | | | | | | | | | | | | | | | | | | | | | | | | | | | | | | | | | | | | | | | | | | | | | | | | | | | | | | | | | | | | | | | | | | | | | | | | |
| Optical | Three onboard SATA 6.0Gb/s connectors Optional 7-in-1 media reader | Floor Stand | Optional system floor stand for vertical orientation | | | | | | | | | | | | | | | | | | | | | | | | | | | | | | | | | | | | | | | | | | | | | | | | | | | | | | | | | | | | | | | | | | | | | | | | |
| Onboard SATA Media reader | | Power supply | <i>Some:</i> 180 watts, autosensing, 85% PSU <i>Some:</i> 210 watts, autosensing, 85% PSU <i>Some:</i> 210 watts, autosensing, 92% PSU (only available via special bid) | | | | | | | | | | | | | | | | | | | | | | | | | | | | | | | | | | | | | | | | | | | | | | | | | | | | | | | | | | | | | | | | | | | | | | | | |
| Graphics | Intel HD Graphics 510/530/610/630 in processor, uses main memory, DirectX® 12, one VGA, two DisplayPort™, supports 3 independent displays, works along with discrete graphics to support more displays; Max resolution: 4096x2304 (DP) @60Hz; 2048x1536 (VGA) @50Hz <i>Some:</i> NVIDIA GeForce® GT 730, DirectX 12, 2GB, PCIe 2.0 x8 adapter, two DisplayPort, 35 watts; Max resolution: 3840x2160 (DisplayPort) @60Hz; | Limited warranty ³ | <i>Some:</i> 1-year or 3-year, depot service / service upgrades available <i>Some:</i> 1-year or 3-year, limited onsite service / service upgrades available | | | | | | | | | | | | | | | | | | | | | | | | | | | | | | | | | | | | | | | | | | | | | | | | | | | | | | | | | | | | | | | | | | | | | | | | |
| Monitor cable | Optional DP to VGA, DP to DVI-D (single link), DP to dual DP, or DP to HDMI 1.4 | Preload | Preloaded operating system <i>Some:</i> Windows® 7 Professional 32/64 preinstalled through downgrade rights in Windows 10 Pro 64-bit (not available with 7th Gen Intel processor) <i>Some:</i> Windows 10 Pro 64-bit <i>Some:</i> Windows 10 Home 64-bit Preloaded applications (only some listed) <ul style="list-style-type: none"> Microsoft Office preloaded; purchase a product key to activate Cyberlink PowerDVD Create (DVD±RW) - Only for Window 10 Lenovo Companion Lenovo ID Cyberlink PowerDVD (DVD, DVD±RW) - Only for Window 7 Lenovo Solution Center Lenovo ThinkVantage Tools Create Recovery Media Adobe® Reader® | | | | | | | | | | | | | | | | | | | | | | | | | | | | | | | | | | | | | | | | | | | | | | | | | | | | | | | | | | | | | | | | | | | | | | | | |
| Chipset | Intel B250 Chipset | Environment | ENERGY STAR® 6.1, EPEAT™ Gold rating (North America), ErP Lot 3, GREENGUARD®, RoHS-compliant, TUV low noise verified (on some models) | | | | | | | | | | | | | | | | | | | | | | | | | | | | | | | | | | | | | | | | | | | | | | | | | | | | | | | | | | | | | | | | | | | | | | | | |
| Front ports | Four USB 3.1 Gen1, optional two USB 3.1 Type-C Gen 2 (only available via special bid), microphone (3.5mm), headphone (3.5mm) | Accessories | For compatible accessories, please go to http://www.lenovoquickpick.com | | | | | | | | | | | | | | | | | | | | | | | | | | | | | | | | | | | | | | | | | | | | | | | | | | | | | | | | | | | | | | | | | | | | | | | | |
| Rear ports | Two USB 3.1 Gen1, two USB 2.0, optional two USB 2.0, serial (9-pin), optional 2nd serial (9-pin), optional parallel (25-pin), ethernet (RJ-45), one VGA, two DisplayPort, two PS/2 ports (keyboard/mouse); additional DisplayPort on optional graphics on some models | | | | | | | | | | | | | | | | | | | | | | | | | | | | | | | | | | | | | | | | | | | | | | | | | | | | | | | | | | | | | | | | | | | | | | | | | | |
| Rear audio ports IEEE 1394 | Line-in (3.5mm), line-out (3.5mm), microphone-in (3.5mm) None | | | | | | | | | | | | | | | | | | | | | | | | | | | | | | | | | | | | | | | | | | | | | | | | | | | | | | | | | | | | | | | | | | | | | | | | | | |
| Audio support | High Definition (HD) Audio, Realtek ALC662 / optional internal speaker (1.5 watt) | | | | | | | | | | | | | | | | | | | | | | | | | | | | | | | | | | | | | | | | | | | | | | | | | | | | | | | | | | | | | | | | | | | | | | | | | | |
| WLAN ¹³ | <i>Some:</i> 11ac wireless, M.2 Card, Qualcomm Atheros QCA9377A (dual band), Wi-Fi + Bluetooth 4.1 combo adapter, 1x1 <i>Some:</i> 11ac wireless, M.2 Card, Qualcomm Atheros QCA6174A (dual band), Wi-Fi + Bluetooth 4.1 combo adapter, 2x2 <i>Some:</i> 11ac wireless, M.2 Card, Intel Dual Band Wireless-AC 3165, Wi-Fi + Bluetooth 4.1 combo adapter, 1x1 <i>Some:</i> 11ac wireless, M.2 Card, Intel Dual Band Wireless-AC 8265, Wi-Fi + Bluetooth 4.1 combo adapter, 2x2 | | | | | | | | | | | | | | | | | | | | | | | | | | | | | | | | | | | | | | | | | | | | | | | | | | | | | | | | | | | | | | | | | | | | | | | | | | |
| Bluetooth™ Ethernet Modem | <i>Some:</i> Bluetooth 4.1 wireless, integrated in Wi-Fi + BT combo adapter Gigabit ethernet, Realtek RTL8111GN, Wake on LAN® None | | | | | | | | | | | | | | | | | | | | | | | | | | | | | | | | | | | | | | | | | | | | | | | | | | | | | | | | | | | | | | | | | | | | | | | | | | |
| Manageability Security chip | None TPM (Trusted Platform Module) 2.0, TCG Certified * Downgrade to TPM1.2 for the models with Win10 DG Win7 32 OS | | | | | | | | | | | | | | | | | | | | | | | | | | | | | | | | | | | | | | | | | | | | | | | | | | | | | | | | | | | | | | | | | | | | | | | | | | |

See footnotes for more detailed information

| Model | Region | Processor | vPro | Graphics | Monitor Cable | Memory | Storage(HDD/SSD) | Optical | Optional 2nd 2.5" Bay | Media Reader | WLAN + Bluetooth | Optional Front Ports | Optional Rear Ports | Chassis Intrusion Switch | Cable Lock | Speaker | Dust Filter | Keyboard / Mouse | Stand | Power Supply | Operating System | Warranty | Ann Date (mm/yy) |
|------------|--------|---------------|------|--------------|---------------|--------|------------------------------|---------|-----------------------|--------------|----------------------|----------------------|---------------------|--------------------------|------------|---------|-------------|------------------|-------------|--------------|----------------------|----------------|------------------|
| 10M7000DUS | US | i7-7700 | No | GT 730 2GB | None | 8GBx1 | 1TB 7200rpm 3.5" | DVD±RW | Optional 2nd 2.5" Bay | None | 3165 ac, 1x1 + BT4.0 | None | None | None | None | 1.5Wx1 | None | USB / USB | Floor Stand | 210W 85% | Win10 Pro 64 | 3-year, Onsite | 02/17 |
| 10M7000EUS | US | i7-7700 | No | Intel HD 630 | None | 8GBx1 | 256GB SSD M.2 PCIe NVMe Opal | DVD±RW | Optional 2nd 2.5" Bay | None | 3165 ac, 1x1 + BT4.0 | None | None | None | None | 1.5Wx1 | None | USB / USB | Floor Stand | 210W 85% | Win10 Pro 64 | 3-year, Onsite | 02/17 |
| 10M7000FUS | US | i7-7700 | No | Intel HD 630 | None | 8GBx1 | 1TB 7200rpm 3.5" | DVD±RW | Optional 2nd 2.5" Bay | None | None | None | None | None | None | 1.5Wx1 | None | USB / USB | Floor Stand | 210W 85% | Win10 Pro 64 | 3-year, Onsite | 02/17 |
| 10M7000GUS | US | i7-7700 | No | Intel HD 630 | None | 8GBx1 | 512GB SSD M.2 PCIe NVMe Opal | DVD±RW | Optional 2nd 2.5" Bay | None | None | None | None | None | None | 1.5Wx1 | None | USB / USB | Floor Stand | 210W 85% | Win10 Pro 64 | 3-year, Onsite | 02/17 |
| 10M7000HUS | US | i5-7400 | No | Intel HD 630 | None | 4GBx1 | 500GB 7200rpm 3.5" | DVD±RW | Optional 2nd 2.5" Bay | None | 3165 ac, 1x1 + BT4.0 | None | None | None | None | 1.5Wx1 | None | USB / USB | Floor Stand | 210W 85% | Win10 Pro 64 | 3-year, Onsite | 02/17 |
| 10M7000JUS | US | i5-7400 | No | Intel HD 630 | None | 8GBx1 | 512GB SSD M.2 PCIe NVMe Opal | DVD±RW | Optional 2nd 2.5" Bay | None | 3165 ac, 1x1 + BT4.0 | None | None | None | None | 1.5Wx1 | None | USB / USB | Floor Stand | 210W 85% | Win10 Pro 64 | 3-year, Onsite | 02/17 |
| 10M7000KUS | US | i7-7700 | No | GT 730 2GB | None | 8GBx1 | 256GB SSD M.2 PCIe NVMe Opal | DVD±RW | Optional 2nd 2.5" Bay | None | 3165 ac, 1x1 + BT4.0 | None | None | None | None | 1.5Wx1 | None | USB / USB | Floor Stand | 210W 85% | Win10 Pro 64 | 3-year, Onsite | 02/17 |
| 10M7000LUS | US | i5-7400 | No | Intel HD 630 | None | 8GBx1 | 256GB SSD M.2 PCIe NVMe Opal | DVD±RW | Optional 2nd 2.5" Bay | None | 3165 ac, 1x1 + BT4.0 | None | None | None | None | 1.5Wx1 | None | USB / USB | Floor Stand | 210W 85% | Win10 Pro 64 | 3-year, Onsite | 02/17 |
| 10M7000MUS | US | i7-7700 | No | GT 730 2GB | None | 8GBx1 | 1TB 7200rpm 3.5" | DVD±RW | Optional 2nd 2.5" Bay | None | None | None | None | None | None | 1.5Wx1 | None | USB / USB | Floor Stand | 210W 85% | Win10 Pro 64 | 3-year, Onsite | 02/17 |
| 10M7000NUS | US | i7-7700 | No | GT 730 2GB | None | 8GBx1 | 256GB SSD M.2 PCIe NVMe Opal | DVD±RW | Optional 2nd 2.5" Bay | None | None | None | None | None | None | 1.5Wx1 | None | USB / USB | Floor Stand | 210W 85% | Win10 Pro 64 | 3-year, Onsite | 02/17 |
| 10M7000PUS | US | i5-7400 | No | Intel HD 630 | None | 4GBx1 | 500GB 7200rpm 3.5" | DVD±RW | Optional 2nd 2.5" Bay | None | None | None | None | None | None | 1.5Wx1 | None | USB / USB | Floor Stand | 210W 85% | Win10 Pro 64 | 3-year, Onsite | 02/17 |
| 10M7000QUS | US | i5-7400 | No | Intel HD 630 | None | 8GBx1 | 256GB SSD M.2 PCIe NVMe Opal | DVD±RW | Optional 2nd 2.5" Bay | None | None | None | None | None | None | 1.5Wx1 | None | USB / USB | Floor Stand | 210W 85% | Win10 Pro 64 | 3-year, Onsite | 02/17 |
| 10M7000RUS | US | i7-7700 | No | Intel HD 630 | None | 8GBx1 | 256GB SSD M.2 PCIe NVMe Opal | DVD±RW | Optional 2nd 2.5" Bay | None | None | None | None | None | None | 1.5Wx1 | None | USB / USB | Floor Stand | 210W 85% | Win10 Pro 64 | 3-year, Onsite | 02/17 |
| 10M7000SUS | US | i5-7400 | No | Intel HD 630 | None | 8GBx1 | 1TB 7200rpm 3.5" | DVD±RW | Optional 2nd 2.5" Bay | None | None | None | None | None | None | 1.5Wx1 | None | USB / USB | Floor Stand | 210W 85% | Win10 Pro 64 | 3-year, Onsite | 02/17 |
| 10M7000TUS | US | i7-7700 | No | Intel HD 630 | None | 8GBx1 | 1TB 7200rpm 3.5" | DVD±RW | Optional 2nd 2.5" Bay | None | 3165 ac, 1x1 + BT4.0 | None | None | None | None | 1.5Wx1 | None | USB / USB | Floor Stand | 210W 85% | Win10 Pro 64 | 3-year, Onsite | 02/17 |
| 10M7002WUS | US | i5-7400 | No | Intel HD 630 | None | 8GBx1 | 1TB 7200rpm 3.5" | DVD±RW | Optional 2nd 2.5" Bay | None | 3165 ac, 1x1 + BT4.0 | None | None | None | None | 1.5Wx1 | None | USB / USB | Floor Stand | 210W 85% | Win10 Pro 64 | 3-year, Onsite | 03/17 |
| 10M7002XUS | US | Pentium G4560 | No | Intel HD 610 | None | 4GBx1 | 500GB 7200rpm 3.5" | DVD±RW | Optional 2nd 2.5" Bay | None | 3165 ac, 1x1 + BT4.0 | None | None | None | None | 1.5Wx1 | None | USB / USB | Floor Stand | 210W 85% | Win10 Pro 64 | 3-year, Onsite | 03/17 |
| 10M7002YUS | US | i3-7100 | No | Intel HD 630 | None | 8GBx1 | 128GB SSD M.2 PCIe NVMe | DVD±RW | Optional 2nd 2.5" Bay | None | None | None | None | None | None | 1.5Wx1 | None | USB / USB | Floor Stand | 210W 85% | Win10 Pro 64 | 3-year, Onsite | 03/17 |
| 10M70030US | US | i5-6500 | No | Intel HD 530 | None | 8GBx1 | 1TB 7200rpm 3.5" | DVD±RW | Optional 2nd 2.5" Bay | None | None | None | None | None | None | 1.5Wx1 | None | USB / USB | Floor Stand | 210W 85% | Win10 DG Win7 Pro 64 | 3-year, Onsite | 03/17 |
| 10M70031US | US | i3-7100 | No | Intel HD 630 | None | 4GBx1 | 500GB 7200rpm 3.5" | DVD±RW | Optional 2nd 2.5" Bay | None | None | None | None | None | None | 1.5Wx1 | None | USB / USB | Floor Stand | 210W 85% | Win10 Pro 64 | 3-year, Onsite | 03/17 |

| Model | Region | Processor | vPro | Graphics | Monitor Cable | Memory | Storage(HDD/SSD) | Optical | Optional 2nd 2.5" Bay | Media Reader | WLAN + Bluetooth | Optional Front Ports | Optional Rear Ports | Chassis Intrusion Switch | Cable Lock | Speaker | Dust Filter | Keyboard / Mouse | Stand | Power Supply | Operating System | Warranty | Ann Date (mm/yy) |
|------------|--------|---------------|------|--------------|---------------|--------|------------------------------|---------|-----------------------|--------------|----------------------|----------------------|---------------------|--------------------------|------------|---------|-------------|------------------|-------------|--------------|----------------------|----------------|------------------|
| 10M70032US | US | i7-6700 | No | GT 730 2GB | None | 8GBx1 | 256GB SSD M.2 PCIe NVMe Opal | DVD±RW | Optional 2nd 2.5" Bay | None | 3165 ac, 1x1 + BT4.0 | None | None | None | None | 1.5Wx1 | None | USB / USB | Floor Stand | 210W 85% | Win10 DG Win7 Pro 64 | 3-year, Onsite | 03/17 |
| 10M70033US | US | i7-6700 | No | GT 730 2GB | None | 8GBx1 | 1TB 7200rpm 3.5" | DVD±RW | Optional 2nd 2.5" Bay | None | 3165 ac, 1x1 + BT4.0 | None | None | None | None | 1.5Wx1 | None | USB / USB | Floor Stand | 210W 85% | Win10 DG Win7 Pro 64 | 3-year, Onsite | 03/17 |
| 10M70034US | US | i5-7400 | No | Intel HD 630 | None | 4GBx1 | 128GB SSD M.2 PCIe NVMe | DVD±RW | Optional 2nd 2.5" Bay | None | None | None | None | None | None | 1.5Wx1 | None | USB / USB | Floor Stand | 210W 85% | Win10 Pro 64 | 3-year, Onsite | 03/17 |
| 10M70035US | US | i7-6700 | No | GT 730 2GB | None | 8GBx1 | 256GB SSD M.2 PCIe NVMe Opal | DVD±RW | Optional 2nd 2.5" Bay | None | None | None | None | None | None | 1.5Wx1 | None | USB / USB | Floor Stand | 210W 85% | Win10 DG Win7 Pro 64 | 3-year, Onsite | 03/17 |
| 10M70036US | US | Pentium G4400 | No | Intel HD 510 | None | 4GBx1 | 500GB 7200rpm 3.5" | DVD±RW | Optional 2nd 2.5" Bay | None | 3165 ac, 1x1 + BT4.0 | None | None | None | None | 1.5Wx1 | None | USB / USB | Floor Stand | 210W 85% | Win10 DG Win7 Pro 64 | 3-year, Onsite | 03/17 |
| 10M70037US | US | i3-6100 | No | Intel HD 530 | None | 8GBx1 | 1TB 7200rpm 3.5" | DVD±RW | Optional 2nd 2.5" Bay | None | None | None | None | None | None | 1.5Wx1 | None | USB / USB | Floor Stand | 210W 85% | Win10 DG Win7 Pro 64 | 3-year, Onsite | 03/17 |
| 10M70038US | US | i5-6500 | No | Intel HD 530 | None | 8GBx1 | 1TB 7200rpm 3.5" | DVD±RW | Optional 2nd 2.5" Bay | None | 3165 ac, 1x1 + BT4.0 | None | None | None | None | 1.5Wx1 | None | USB / USB | Floor Stand | 210W 85% | Win10 DG Win7 Pro 64 | 3-year, Onsite | 03/17 |
| 10M70039US | US | i5-6500 | No | Intel HD 530 | None | 4GBx1 | 500GB 7200rpm 3.5" | DVD±RW | Optional 2nd 2.5" Bay | None | None | None | None | None | None | 1.5Wx1 | None | USB / USB | Floor Stand | 210W 85% | Win10 DG Win7 Pro 64 | 3-year, Onsite | 03/17 |
| 10M7003AUS | US | i7-6700 | No | Intel HD 530 | None | 8GBx1 | 256GB SSD M.2 PCIe NVMe Opal | DVD±RW | Optional 2nd 2.5" Bay | None | 3165 ac, 1x1 + BT4.0 | None | None | None | None | 1.5Wx1 | None | USB / USB | Floor Stand | 210W 85% | Win10 DG Win7 Pro 64 | 3-year, Onsite | 03/17 |
| 10M7003BUS | US | Pentium G4560 | No | Intel HD 610 | None | 4GBx1 | 500GB 7200rpm 3.5" | DVD±RW | Optional 2nd 2.5" Bay | None | None | None | None | None | None | 1.5Wx1 | None | USB / USB | Floor Stand | 210W 85% | Win10 Pro 64 | 3-year, Onsite | 03/17 |
| 10M7003CUS | US | i3-6100 | No | Intel HD 530 | None | 8GBx1 | 1TB 7200rpm 3.5" | DVD±RW | Optional 2nd 2.5" Bay | None | 3165 ac, 1x1 + BT4.0 | None | None | None | None | 1.5Wx1 | None | USB / USB | Floor Stand | 210W 85% | Win10 DG Win7 Pro 64 | 3-year, Onsite | 03/17 |
| 10M7003DUS | US | i3-7100 | No | Intel HD 630 | None | 8GBx1 | 1TB 7200rpm 3.5" | DVD±RW | Optional 2nd 2.5" Bay | None | 3165 ac, 1x1 + BT4.0 | None | None | None | None | 1.5Wx1 | None | USB / USB | Floor Stand | 210W 85% | Win10 Pro 64 | 3-year, Onsite | 03/17 |
| 10M7003EUS | US | i7-6700 | No | Intel HD 530 | None | 8GBx1 | 512GB SSD M.2 PCIe NVMe Opal | DVD±RW | Optional 2nd 2.5" Bay | None | None | None | None | None | None | 1.5Wx1 | None | USB / USB | Floor Stand | 210W 85% | Win10 DG Win7 Pro 64 | 3-year, Onsite | 03/17 |
| 10M7003FUS | US | i3-6100 | No | Intel HD 530 | None | 8GBx1 | 128GB SSD M.2 PCIe NVMe | DVD±RW | Optional 2nd 2.5" Bay | None | None | None | None | None | None | 1.5Wx1 | None | USB / USB | Floor Stand | 210W 85% | Win10 DG Win7 Pro 64 | 3-year, Onsite | 03/17 |
| 10M7003GUS | US | i7-6700 | No | Intel HD 530 | None | 8GBx1 | 256GB SSD M.2 PCIe NVMe Opal | DVD±RW | Optional 2nd 2.5" Bay | None | None | None | None | None | None | 1.5Wx1 | None | USB / USB | Floor Stand | 210W 85% | Win10 DG Win7 Pro 64 | 3-year, Onsite | 03/17 |
| 10M7003HUS | US | i7-6700 | No | Intel HD 530 | None | 8GBx1 | 1TB 7200rpm 3.5" | DVD±RW | Optional 2nd 2.5" Bay | None | 3165 ac, 1x1 + BT4.0 | None | None | None | None | 1.5Wx1 | None | USB / USB | Floor Stand | 210W 85% | Win10 DG Win7 Pro 64 | 3-year, Onsite | 03/17 |
| 10M7003JUS | US | i5-6500 | No | Intel HD 530 | None | 4GBx1 | 500GB 7200rpm 3.5" | DVD±RW | Optional 2nd 2.5" Bay | None | 3165 ac, 1x1 + BT4.0 | None | None | None | None | 1.5Wx1 | None | USB / USB | Floor Stand | 210W 85% | Win10 DG Win7 Pro 64 | 3-year, Onsite | 03/17 |
| 10M7003KUS | US | Pentium G4400 | No | Intel HD 510 | None | 4GBx1 | 500GB 7200rpm 3.5" | DVD±RW | Optional 2nd 2.5" Bay | None | None | None | None | None | None | 1.5Wx1 | None | USB / USB | Floor Stand | 210W 85% | Win10 DG Win7 Pro 64 | 3-year, Onsite | 03/17 |
| 10M7003LUS | US | i3-7100 | No | Intel HD 630 | None | 8GBx1 | 1TB 7200rpm 3.5" | DVD±RW | Optional 2nd 2.5" Bay | None | None | None | None | None | None | 1.5Wx1 | None | USB / USB | Floor Stand | 210W 85% | Win10 Pro 64 | 3-year, Onsite | 03/17 |
| 10M7003MUS | US | i5-6500 | No | Intel HD 530 | None | 8GBx1 | 256GB SSD M.2 PCIe NVMe Opal | DVD±RW | Optional 2nd 2.5" Bay | None | None | None | None | None | None | 1.5Wx1 | None | USB / USB | Floor Stand | 210W 85% | Win10 DG Win7 Pro 64 | 3-year, Onsite | 03/17 |

| Model | Region | Processor | vPro | Graphics | Monitor Cable | Memory | Storage(HDD/SSD) | Optical | Optional 2nd 2.5" Bay | Media Reader | WLAN + Bluetooth | Optional Front Ports | Optional Rear Ports | Chassis Intrusion Switch | Cable Lock | Speaker | Dust Filter | Keyboard / Mouse | Stand | Power Supply | Operating System | Warranty | Ann Date (mm/yy) |
|------------|--------|-----------|------|--------------|---------------|--------|------------------------------|---------|-----------------------|--------------|----------------------|----------------------|---------------------|--------------------------|------------|---------|-------------|------------------|-------------|--------------|----------------------|----------------|------------------|
| 10M7003NUS | US | i7-6700 | No | GT 730 2GB | None | 8GBx1 | 1TB 7200rpm 3.5" | DVD±RW | Optional 2nd 2.5" Bay | None | None | None | None | None | None | 1.5Wx1 | None | USB / USB | Floor Stand | 210W 85% | Win10 DG Win7 Pro 64 | 3-year, Onsite | 03/17 |
| 10M7003PUS | US | i3-6100 | No | Intel HD 530 | None | 4GBx1 | 1TB 7200rpm 3.5" | DVD±RW | Optional 2nd 2.5" Bay | None | None | None | None | None | None | 1.5Wx1 | None | USB / USB | Floor Stand | 210W 85% | Win10 DG Win7 Pro 64 | 3-year, Onsite | 03/17 |
| 10M7003QUS | US | i7-6700 | No | Intel HD 530 | None | 8GBx1 | 1TB 7200rpm 3.5" | DVD±RW | Optional 2nd 2.5" Bay | None | None | None | None | None | None | 1.5Wx1 | None | USB / USB | Floor Stand | 210W 85% | Win10 DG Win7 Pro 64 | 3-year, Onsite | 03/17 |
| 10M7003RUS | US | i5-6500 | No | Intel HD 530 | None | 4GBx1 | 128GB SSD M.2 PCIe NVMe | DVD±RW | Optional 2nd 2.5" Bay | None | None | None | None | None | None | 1.5Wx1 | None | USB / USB | Floor Stand | 210W 85% | Win10 DG Win7 Pro 64 | 3-year, Onsite | 03/17 |
| 10M7003SUS | US | i5-6500 | No | Intel HD 530 | None | 8GBx1 | 256GB SSD M.2 PCIe NVMe Opal | DVD±RW | Optional 2nd 2.5" Bay | None | 3165 ac, 1x1 + BT4.0 | None | None | None | None | 1.5Wx1 | None | USB / USB | Floor Stand | 210W 85% | Win10 DG Win7 Pro 64 | 3-year, Onsite | 03/17 |
| 10M7003TUS | US | i3-6100 | No | Intel HD 530 | None | 4GBx1 | 500GB 7200rpm 3.5" | DVD±RW | Optional 2nd 2.5" Bay | None | None | None | None | None | None | 1.5Wx1 | None | USB / USB | Floor Stand | 210W 85% | Win10 DG Win7 Pro 64 | 3-year, Onsite | 03/17 |
| 10M7003UUS | US | i3-7100 | No | Intel HD 630 | None | 4GBx1 | 1TB 7200rpm 3.5" | DVD±RW | Optional 2nd 2.5" Bay | None | None | None | None | None | None | 1.5Wx1 | None | USB / USB | Floor Stand | 210W 85% | Win10 Pro 64 | 3-year, Onsite | 03/17 |



ThinkCentre M710 Tiny Platform Specifications

Product Specifications Reference (PSREF)

| | | | | | | | |
|-------------------------------|--|-----------------|-------------------------|-----------|------------------------|---------------------|---|
| Processor | Intel® Celeron®, Intel Pentium®, or 6/7th Generation Intel Core™ i3 / i5 / i7 Processor | | | | | | Security features <ul style="list-style-type: none"> Security slot (in rear for optional Kensington® MicroSaver® cable) Smart USB protection, allows keyboard/mouse only, blocks all storage devices Power-on password Administrator password Hard disk password Boot sequence control Boot without keyboard and mouse Individual USB port disablement Chassis intrusion switch |
| | Processor | Cores / Threads | Frequency Base/Max(GHz) | Cache | Memory Support (Up to) | Integrated Graphics | |
| | Pentium G4400T | 2 / 2 | 2.9G | 3 MB | DDR4-2133 | HD 510 | |
| | Pentium G4560T | 2 / 4 | 2.9G | 3 MB | DDR4-2400 | HD 610 | |
| | Pentium G4600T | 2 / 4 | 3.0G | 3 MB | DDR4-2400 | HD 630 | |
| | Core i3-6100T | 2 / 4 | 3.2G | 3 MB | DDR4-2133 | HD 530 | |
| | Core i5-6500T | 4 / 4 | 2.5G / 3.1G | 6 MB | DDR4-2133 | HD 530 | |
| | Core i7-6700T | 4 / 8 | 2.8G / 3.6G | 8 MB | DDR4-2133 | HD 530 | |
| | Core i3-7100T | 2 / 4 | 3.4G | 3 MB | DDR4-2400 | HD 630 | |
| | Core i5-7400T | 4 / 4 | 2.4G / 3.0G | 6 MB | DDR4-2400 | HD 630 | |
| Core i5-7500T | 4 / 4 | 2.7G / 3.3G | 6 MB | DDR4-2400 | HD 630 | | |
| Core i5-7600T | 4 / 4 | 2.8G / 3.7G | 6 MB | DDR4-2400 | HD 630 | | |
| Core i7-7700T | 4 / 8 | 2.9G / 3.8G | 8 MB | DDR4-2400 | HD 630 | | |
| Memory | 32GB max, DDR4-2400*, two 260-pin SO-DIMM sockets, non-ECC, dual-channel capable * System automatically clocks down for the processors with lower memory controller | | | | | | |
| Storage | <i>Some:</i> Hard Drive / SATA 6.0Gb/s, 2.5", 5400 rpm or 7200 rpm <i>Some:</i> Solid State Drive (SSD) / SATA 6.0Gb/s, 2.5" <i>Some:</i> M.2 Solid State Drive (SSD) / PCIe NVMe, PCIe 3.0 x 4, 32Gb/s <i>Some:</i> Intel Optane™ Memory Ready (models with 7th gen Core processor), M.2 <i>Some:</i> DVD-ROM, slim (9.0mm), via USB external ODD box <i>Some:</i> DVD Burner (DVD±RW), slim (9.0mm), via USB external ODD box | | | | | | |
| Optical | None | | | | | | |
| Onboard SATA Media reader | One onboard SATA 6.0Gb/s connector | | | | | | |
| Graphics | Intel HD Graphics 510/530/610/630 in processor, uses main memory, DirectX® 12, two DisplayPort™, one optional video port (HDMI, VGA, 3rd DP, or USB 3.1 Type-C with DisplayPort Alternate Mode), up to 3 independent displays; <i>Max resolution:</i> 4096x2304 (DP) @60Hz; 4096x2304 (Type-C) @60Hz; 4096x2160 (HDMI) @24Hz; 1920x1200 (VGA) @60Hz | | | | | | |
| VESA mount Floor Stand | Optional VESA mount bracket kit, supports VESA 75mm and 100mm Optional system floor stand for vertical orientation | | | | | | |
| Power supply | 65 watts AC/DC adapter, autosensing, 88% PSU (not included for TIO models) 90 watts AC/DC adapter, autosensing, 88% PSU (only for models with I/O box) | | | | | | |
| Limited warranty ³ | <i>Some:</i> 1-year or 3-year, depot service / service upgrades available <i>Some:</i> 1-year or 3-year, limited onsite service / service upgrades available | | | | | | |
| Monitor cable | Optional DP to VGA, DP to DVI-D (single link), DP to dual DP, or DP to HDMI 1.4 | | | | | | |
| Chipset | Intel B250 Chipset | | | | | | |
| Front ports | Two USB 3.1 Gen1 (one is Always On and fast charge), one microphone (3.5mm), one headphone / microphone combo jack (3.5mm) | | | | | | |
| Rear ports | Four USB 3.1 Gen1 (optional external optical box or external I/O box occupies one or two specific USB 3.1 Gen1 on some models), ethernet (RJ-45), two DisplayPort, two optional ports (Port 1 for VGA / 3rd DP / HDMI / serial / USB 3.1 Type-C Gen 1 (with DisplayPort Alternate Mode), Port 2 for serial) | | | | | | |
| I/O box | Optional external I/O box, extends two USB 2.0, two USB 3.1 Gen1, and one serial on rear, two USB 2.0 on front, via USB cable (occupy two specific USB 3.1 Gen1 of Tiny) | | | | | | |
| Audio support | High Definition (HD) Audio, Realtek ALC294 / optional internal speaker (1w or 2w) | | | | | | |
| WLAN ¹³ | <i>Some:</i> 11ac wireless, M.2 Card, Qualcomm Atheros QCA9377A (dual band), Wi-Fi + Bluetooth 4.1 combo adapter, 1x1 <i>Some:</i> 11ac wireless, M.2 Card, Qualcomm Atheros QCA6174A (dual band), Wi-Fi + Bluetooth 4.1 combo adapter, 2x2 <i>Some:</i> 11ac wireless, M.2 Card, Intel Dual Band Wireless-AC 3165, Wi-Fi + Bluetooth 4.1 combo adapter, 1x1 <i>Some:</i> 11ac wireless, M.2 Card, Intel Dual Band Wireless-AC 8265, Wi-Fi + Bluetooth 4.1 combo adapter, 2x2 | | | | | | |
| Bluetooth™ Ethernet Modem | <i>Some:</i> Bluetooth 4.1 wireless, integrated in Wi-Fi + BT combo adapter Gigabit ethernet, Intel Ethernet Connection I219-V (Jacksonville), Wake on LAN® None | | | | | | |
| Manageability Security chip | None TPM (Trusted Platform Module) 2.0*, TCG Certified * Downgrade to TPM1.2 for the models with Win10 DG Win7 32 OS | | | | | | |
| Environment | ENERGY STAR® 6.1, EPEAT™ Gold rating (North America), ErP Lot 3, GREENGUARD®, RoHS-compliant, TUV low noise verified (on some models) | | | | | | |
| MIL-SPEC test | MIL-STD-810G military certification (Low Pressure [Altitude], High Temperature, Low Temperature, Temperature Shock, Humidity, Sand and Dust, Vibration, Shock, Fungus, Solar Radiation) | | | | | | |
| Accessories | For compatible accessories, please go to http://www.lenovoquickpick.com | | | | | | |

See footnotes for more detailed information

| Model | Region | Processor | vPro | Graphics | Monitor Cable | Memory | Storage(HDD/SSD) | External Optical / I/O Box | WLAN + Bluetooth | Optional Rear Ports | Chassis Intrusion Switch | Kensington Cable Lock | Speaker | Adapter Cage | Toolless Chassis Screw | Dust Filter | Keyboard / Mouse | VESA Mount | Stand | Power Supply | Operating System | Warranty | End of Support | Ann Date (mm/yy) |
|------------|--------|-----------|------|--------------|---------------|--------|------------------------------|----------------------------|----------------------|---------------------|--------------------------|-----------------------|---------|--------------|------------------------|-------------|------------------|------------|-------------|-----------------|------------------|----------------|----------------|------------------|
| 10MR0001US | US | i7-7700T | No | Intel HD 630 | None | 8GBx1 | 500GB 7200rpm 2.5" | DVD±RW | 8265 ac, 2x2 + BT4.1 | HDMI | Switch | None | 1Wx1 | None | None | None | USB / USB | VESA Mount | None | 65W Adapter 88% | Win10 Pro 64 | 3-year, Onsite | Mar 21, 2023 | 02/17 |
| 10MR0002US | US | i5-7500T | No | Intel HD 630 | None | 4GBx1 | 500GB 7200rpm 2.5" | None | 3165 ac, 1x1 + BT4.0 | VGA | Switch | None | 1Wx1 | None | None | None | USB / USB | None | Floor Stand | 65W Adapter 88% | Win10 Pro 64 | 3-year, Onsite | Mar 21, 2023 | 02/17 |
| 10MR0003US | US | i7-7700T | No | Intel HD 630 | None | 8GBx1 | 256GB SSD M.2 PCIe NVMe Opal | None | 8265 ac, 2x2 + BT4.1 | 3rd DP | Switch | None | 1Wx1 | None | None | None | USB / USB | None | Floor Stand | 65W Adapter 88% | Win10 Pro 64 | 3-year, Onsite | Mar 21, 2023 | 02/17 |
| 10MR0004US | US | i5-7500T | No | Intel HD 630 | None | 8GBx1 | 256GB SSD M.2 PCIe NVMe Opal | None | 8265 ac, 2x2 + BT4.1 | 3rd DP | Switch | None | 1Wx1 | None | None | None | USB / USB | None | Floor Stand | 65W Adapter 88% | Win10 Pro 64 | 3-year, Onsite | Feb 21, 2022 | 02/17 |
| 10MR0005US | US | i5-7500T | No | Intel HD 630 | None | 8GBx1 | 128GB SSD M.2 PCIe NVMe | None | 3165 ac, 1x1 + BT4.0 | 3rd DP | Switch | None | 1Wx1 | None | None | None | USB / USB | None | Floor Stand | 65W Adapter 88% | Win10 Pro 64 | 3-year, Onsite | Mar 21, 2023 | 02/17 |
| 10MR0006US | US | i5-7500T | No | Intel HD 630 | None | 8GBx1 | 500GB 7200rpm 2.5" | DVD±RW | 8265 ac, 2x2 + BT4.1 | HDMI | Switch | None | 1Wx1 | None | None | None | USB / USB | VESA Mount | None | 65W Adapter 88% | Win10 Pro 64 | 3-year, Onsite | Mar 21, 2023 | 02/17 |
| 10MR0007US | US | i5-7500T | No | Intel HD 630 | None | 4GBx1 | 500GB 7200rpm 2.5" | None | 8265 ac, 2x2 + BT4.1 | 3rd DP | Switch | None | 1Wx1 | None | None | None | USB / USB | None | Floor Stand | 65W Adapter 88% | Win10 Pro 64 | 3-year, Onsite | Mar 21, 2023 | 02/17 |
| 10MR0008US | US | i5-7500T | No | Intel HD 630 | None | 4GBx1 | 500GB 7200rpm 2.5" | None | 3165 ac, 1x1 + BT4.0 | None | Switch | None | 1Wx1 | None | None | None | USB / USB | None | Floor Stand | 65W Adapter 88% | Win10 Pro 64 | 3-year, Onsite | Mar 21, 2023 | 02/17 |
| 10MR0009US | US | i5-7500T | No | Intel HD 630 | None | 4GBx1 | 500GB 7200rpm 2.5" | None | 3165 ac, 1x1 + BT4.0 | HDMI | Switch | None | 1Wx1 | None | None | None | USB / USB | None | Floor Stand | 65W Adapter 88% | Win10 Pro 64 | 3-year, Onsite | Mar 21, 2023 | 02/17 |
| 10MR000AUS | US | i5-7500T | No | Intel HD 630 | None | 4GBx1 | 500GB 7200rpm 2.5" | None | 8265 ac, 2x2 + BT4.1 | None | Switch | None | 1Wx1 | None | None | None | USB / USB | None | Floor Stand | 65W Adapter 88% | Win10 Pro 64 | 3-year, Onsite | Mar 21, 2023 | 02/17 |
| 10MR000BUS | US | i7-7700T | No | Intel HD 630 | None | 8GBx1 | 500GB 7200rpm 2.5" | None | 8265 ac, 2x2 + BT4.1 | 3rd DP | Switch | None | 1Wx1 | None | None | None | USB / USB | None | Floor Stand | 65W Adapter 88% | Win10 Pro 64 | 3-year, Onsite | Mar 21, 2023 | 02/17 |
| 10MR000CUS | US | i5-7500T | No | Intel HD 630 | None | 8GBx1 | 256GB SSD M.2 PCIe NVMe Opal | None | 8265 ac, 2x2 + BT4.1 | HDMI | Switch | None | 1Wx1 | None | None | None | USB / USB | None | Floor Stand | 65W Adapter 88% | Win10 Pro 64 | 3-year, Onsite | Mar 21, 2023 | 02/17 |
| 10MR000DUS | US | i5-7500T | No | Intel HD 630 | None | 8GBx1 | 128GB SSD M.2 PCIe NVMe | None | 8265 ac, 2x2 + BT4.1 | HDMI | Switch | None | 1Wx1 | None | None | None | USB / USB | None | Floor Stand | 65W Adapter 88% | Win10 Pro 64 | 3-year, Onsite | Mar 21, 2023 | 02/17 |
| 10MR000EUS | US | i7-7700T | No | Intel HD 630 | None | 8GBx1 | 256GB SSD M.2 PCIe NVMe Opal | None | 8265 ac, 2x2 + BT4.1 | HDMI | Switch | None | 1Wx1 | None | None | None | USB / USB | None | Floor Stand | 65W Adapter 88% | Win10 Pro 64 | 3-year, Onsite | Mar 21, 2023 | 02/17 |
| 10MR000FUS | US | i5-7500T | No | Intel HD 630 | None | 4GBx1 | 500GB 7200rpm 2.5" | None | 3165 ac, 1x1 + BT4.0 | 3rd DP | Switch | None | 1Wx1 | None | None | None | USB / USB | None | Floor Stand | 65W Adapter 88% | Win10 Pro 64 | 3-year, Onsite | Mar 21, 2023 | 02/17 |
| 10MR000GUS | US | i5-7500T | No | Intel HD 630 | None | 4GBx1 | 500GB 7200rpm 2.5" | None | 8265 ac, 2x2 + BT4.1 | HDMI | Switch | None | 1Wx1 | None | None | None | USB / USB | None | Floor Stand | 65W Adapter 88% | Win10 Pro 64 | 3-year, Onsite | Mar 21, 2023 | 02/17 |
| 10MR000HUS | US | i7-7700T | No | Intel HD 630 | None | 8GBx1 | 500GB 7200rpm 2.5" | None | 8265 ac, 2x2 + BT4.1 | HDMI | Switch | None | 1Wx1 | None | None | None | USB / USB | None | Floor Stand | 65W Adapter 88% | Win10 Pro 64 | 3-year, Onsite | Mar 21, 2023 | 02/17 |
| 10MR000JUS | US | i5-7500T | No | Intel HD 630 | None | 8GBx1 | 500GB 7200rpm 2.5" | None | 8265 ac, 2x2 + BT4.1 | 3rd DP | Switch | None | 1Wx1 | None | None | None | USB / USB | None | Floor Stand | 65W Adapter 88% | Win10 Pro 64 | 3-year, Onsite | Mar 21, 2023 | 02/17 |
| 10MR000KUS | US | i5-7500T | No | Intel HD 630 | None | 4GBx1 | 500GB 7200rpm 2.5" | None | 3165 ac, 1x1 + BT4.0 | Serial | Switch | None | 1Wx1 | None | None | None | USB / USB | None | Floor Stand | 65W Adapter 88% | Win10 Pro 64 | 3-year, Onsite | Mar 21, 2023 | 02/17 |
| 10MR002PUS | US | i3-7100T | No | Intel HD 630 | None | 8GBx1 | 500GB 7200rpm 2.5" | None | 3165 ac, 1x1 + BT4.0 | VGA | Switch | None | 1Wx1 | None | None | None | USB / USB | None | Floor Stand | 65W Adapter 88% | Win10 Pro 64 | 3-year, Onsite | Apr 6, 2023 | 03/17 |

| Model | Region | Processor | vPro | Graphics | Monitor Cable | Memory | Storage(HDD/SSD) | External Optical / I/O Box | WLAN + Bluetooth | Optional Rear Ports | Chassis Intrusion Switch | Kensington Cable Lock | Speaker | Adapter Cage | Toolless Chassis Screw | Dust Filter | Keyboard / Mouse | VESA Mount | Stand | Power Supply | Operating System | Warranty | End of Support | Ann Date (mm/yy) |
|------------|--------|----------------|------|--------------|---------------|--------|------------------------------|----------------------------|----------------------|---------------------|--------------------------|-----------------------|---------|--------------|------------------------|-------------|------------------|------------|-------------|-----------------|----------------------|----------------|----------------|------------------|
| 10MR002QUS | US | i3-7100T | No | Intel HD 630 | None | 8GBx1 | 500GB 7200rpm 2.5" | None | 3165 ac, 1x1 + BT4.0 | 3rd DP | Switch | None | 1Wx1 | None | None | None | USB / USB | None | Floor Stand | 65W Adapter 88% | Win10 Pro 64 | 3-year, Onsite | Apr 6, 2023 | 03/17 |
| 10MR002RUS | US | Pentium G4560T | No | Intel HD 610 | None | 4GBx1 | 500GB 7200rpm 2.5" | None | 3165 ac, 1x1 + BT4.0 | None | Switch | None | 1Wx1 | None | None | None | USB / USB | None | Floor Stand | 65W Adapter 88% | Win10 Pro 64 | 3-year, Onsite | Apr 6, 2023 | 03/17 |
| 10MR002SUS | US | i3-7100T | No | Intel HD 630 | None | 8GBx1 | 500GB 7200rpm 2.5" | None | 3165 ac, 1x1 + BT4.0 | None | Switch | None | 1Wx1 | None | None | None | USB / USB | None | Floor Stand | 65W Adapter 88% | Win10 Pro 64 | 3-year, Onsite | Apr 6, 2023 | 03/17 |
| 10MR002TUS | US | i3-7100T | No | Intel HD 630 | None | 8GBx1 | 256GB SSD M.2 PCIe NVMe Opal | None | 3165 ac, 1x1 + BT4.0 | 3rd DP | Switch | None | 1Wx1 | None | None | None | USB / USB | None | Floor Stand | 65W Adapter 88% | Win10 Pro 64 | 3-year, Onsite | Apr 6, 2023 | 03/17 |
| 10MR002UUS | US | i3-7100T | No | Intel HD 630 | None | 8GBx1 | 500GB 7200rpm 2.5" | None | 3165 ac, 1x1 + BT4.0 | Serial | Switch | None | 1Wx1 | None | None | None | USB / USB | None | Floor Stand | 65W Adapter 88% | Win10 Pro 64 | 3-year, Onsite | Apr 6, 2023 | 03/17 |
| 10MR002VUS | US | i3-7100T | No | Intel HD 630 | None | 4GBx1 | 500GB 7200rpm 2.5" | None | 3165 ac, 1x1 + BT4.0 | None | Switch | None | 1Wx1 | None | None | None | USB / USB | None | Floor Stand | 65W Adapter 88% | Win10 Pro 64 | 3-year, Onsite | Apr 6, 2023 | 03/17 |
| 10MR002WUS | US | i3-7100T | No | Intel HD 630 | None | 8GBx1 | 128GB SSD M.2 PCIe NVMe | None | 3165 ac, 1x1 + BT4.0 | None | Switch | None | 1Wx1 | None | None | None | USB / USB | None | Floor Stand | 65W Adapter 88% | Win10 Pro 64 | 3-year, Onsite | Apr 6, 2023 | 03/17 |
| 10MR002XUS | US | i3-7100T | No | Intel HD 630 | None | 8GBx1 | 128GB SSD M.2 PCIe NVMe | None | 3165 ac, 1x1 + BT4.0 | 3rd DP | Switch | None | 1Wx1 | None | None | None | USB / USB | None | Floor Stand | 65W Adapter 88% | Win10 Pro 64 | 3-year, Onsite | Apr 6, 2023 | 03/17 |
| 10MR003UUS | US | i5-7500T | No | Intel HD 630 | None | 8GBx1 | 128GB SSD M.2 PCIe NVMe | None | 8265 ac, 2x2 + BT4.1 | 3rd DP | Switch | None | 1Wx1 | None | None | None | USB / USB | None | Floor Stand | 65W Adapter 88% | Win10 Pro 64 | 3-year, Onsite | Apr 21, 2023 | 03/17 |
| 10MR003VUS | US | i5-7500T | No | Intel HD 630 | None | 8GBx1 | 512GB SSD M.2 PCIe NVMe Opal | None | 8265 ac, 2x2 + BT4.1 | 3rd DP | Switch | None | 1Wx1 | None | None | None | USB / USB | None | Floor Stand | 65W Adapter 88% | Win10 Pro 64 | 3-year, Onsite | Apr 21, 2023 | 03/17 |
| 10MR003WUS | US | i7-7700T | No | Intel HD 630 | None | 8GBx1 | 512GB SSD M.2 PCIe NVMe Opal | None | 8265 ac, 2x2 + BT4.1 | 3rd DP | Switch | None | 1Wx1 | None | None | None | USB / USB | None | Floor Stand | 65W Adapter 88% | Win10 Pro 64 | 3-year, Onsite | Apr 21, 2023 | 03/17 |
| 10MR003XUS | US | i5-7400T | No | Intel HD 630 | None | 4GBx1 | 500GB 7200rpm 2.5" | None | 8265 ac, 2x2 + BT4.1 | 3rd DP | Switch | None | 1Wx1 | None | None | None | USB / USB | None | Floor Stand | 65W Adapter 88% | Win10 Pro 64 | 3-year, Onsite | Apr 21, 2023 | 03/17 |
| 10MR003YUS | US | i5-7400T | No | Intel HD 630 | None | 8GBx1 | 500GB 7200rpm 2.5" | None | 8265 ac, 2x2 + BT4.1 | 3rd DP | Switch | None | 1Wx1 | None | None | None | USB / USB | None | Floor Stand | 65W Adapter 88% | Win10 Pro 64 | 3-year, Onsite | Apr 21, 2023 | 03/17 |
| 10MR0040US | US | i5-7400T | No | Intel HD 630 | None | 4GBx1 | 500GB 7200rpm 2.5" | None | 3165 ac, 1x1 + BT4.0 | 3rd DP | Switch | None | 1Wx1 | None | None | None | USB / USB | None | Floor Stand | 65W Adapter 88% | Win10 Pro 64 | 3-year, Onsite | Apr 21, 2023 | 03/17 |
| 10MR0041US | US | i5-7400T | No | Intel HD 630 | None | 8GBx1 | 500GB 7200rpm 2.5" | None | 3165 ac, 1x1 + BT4.0 | 3rd DP | Switch | None | 1Wx1 | None | None | None | USB / USB | None | Floor Stand | 65W Adapter 88% | Win10 Pro 64 | 3-year, Onsite | Apr 21, 2023 | 03/17 |
| 10MR0042US | US | i5-7400T | No | Intel HD 630 | None | 8GBx1 | 128GB SSD M.2 PCIe NVMe | None | 3165 ac, 1x1 + BT4.0 | 3rd DP | Switch | None | 1Wx1 | None | None | None | USB / USB | None | Floor Stand | 65W Adapter 88% | Win10 Pro 64 | 3-year, Onsite | Apr 21, 2023 | 03/17 |
| 10MR0043US | US | i5-7400T | No | Intel HD 630 | None | 8GBx1 | 128GB SSD M.2 PCIe NVMe | None | 8265 ac, 2x2 + BT4.1 | 3rd DP | Switch | None | 1Wx1 | None | None | None | USB / USB | None | Floor Stand | 65W Adapter 88% | Win10 Pro 64 | 3-year, Onsite | Apr 21, 2023 | 03/17 |
| 10MR0044US | US | i5-7400T | No | Intel HD 630 | None | 8GBx1 | 256GB SSD M.2 PCIe NVMe Opal | None | 8265 ac, 2x2 + BT4.1 | 3rd DP | Switch | None | 1Wx1 | None | None | None | USB / USB | None | Floor Stand | 65W Adapter 88% | Win10 Pro 64 | 3-year, Onsite | Apr 21, 2023 | 03/17 |
| 10MR0045US | US | i3-6100T | No | Intel HD 530 | None | 4GBx1 | 500GB 7200rpm 2.5" | None | 3165 ac, 1x1 + BT4.0 | None | Switch | None | 1Wx1 | None | None | None | USB / USB | None | Floor Stand | 65W Adapter 88% | Win10 DG Win7 Pro 64 | 3-year, Onsite | Apr 21, 2023 | 03/17 |
| 10MR0046US | US | i7-6700T | No | Intel HD 530 | None | 8GBx1 | 256GB SSD M.2 PCIe NVMe Opal | None | 8265 ac, 2x2 + BT4.1 | 3rd DP | Switch | None | 1Wx1 | None | None | None | USB / USB | None | Floor Stand | 65W Adapter 88% | Win10 DG Win7 Pro 64 | 3-year, Onsite | Apr 21, 2023 | 03/17 |

| Model | Region | Processor | vPro | Graphics | Monitor Cable | Memory | Storage(HDD/SSD) | External Optical / I/O Box | WLAN + Bluetooth | Optional Rear Ports | Chassis Intrusion Switch | Kensington Cable Lock | Speaker | Adapter Cage | Toolless Chassis Screw | Dust Filter | Keyboard / Mouse | VESA Mount | Stand | Power Supply | Operating System | Warranty | End of Support | Ann Date (mm/yy) |
|------------|--------|-----------|------|--------------|---------------|--------|------------------------------|----------------------------|----------------------|---------------------|--------------------------|-----------------------|---------|--------------|------------------------|-------------|------------------|------------|-------------|-----------------|----------------------|----------------|----------------|------------------|
| 10MR0047US | US | i5-6500T | No | Intel HD 530 | None | 8GBx1 | 256GB SSD M.2 PCIe NVMe Opal | None | 8265 ac, 2x2 + BT4.1 | 3rd DP | Switch | None | 1Wx1 | None | None | None | USB / USB | None | Floor Stand | 65W Adapter 88% | Win10 DG Win7 Pro 64 | 3-year, Onsite | Mar 21, 2022 | 03/17 |
| 10MR0048US | US | i5-6500T | No | Intel HD 530 | None | 8GBx1 | 500GB 7200rpm 2.5" | None | 3165 ac, 1x1 + BT4.0 | 3rd DP | Switch | None | 1Wx1 | None | None | None | USB / USB | None | Floor Stand | 65W Adapter 88% | Win10 DG Win7 Pro 64 | 3-year, Onsite | Apr 21, 2023 | 03/17 |
| 10MR0049US | US | i3-6100T | No | Intel HD 530 | None | 4GBx1 | 500GB 7200rpm 2.5" | None | 3165 ac, 1x1 + BT4.0 | 3rd DP | Switch | None | 1Wx1 | None | None | None | USB / USB | None | Floor Stand | 65W Adapter 88% | Win10 DG Win7 Pro 64 | 3-year, Onsite | Apr 21, 2023 | 03/17 |
| 10MR004AUS | US | i3-6100T | No | Intel HD 530 | None | 4GBx1 | 128GB SSD M.2 PCIe NVMe | None | 3165 ac, 1x1 + BT4.0 | 3rd DP | Switch | None | 1Wx1 | None | None | None | USB / USB | None | Floor Stand | 65W Adapter 88% | Win10 DG Win7 Pro 64 | 3-year, Onsite | Apr 21, 2023 | 03/17 |
| 10MR004BUS | US | i5-6500T | No | Intel HD 530 | None | 8GBx1 | 512GB SSD M.2 PCIe NVMe Opal | None | 8265 ac, 2x2 + BT4.1 | 3rd DP | Switch | None | 1Wx1 | None | None | None | USB / USB | None | Floor Stand | 65W Adapter 88% | Win10 DG Win7 Pro 64 | 3-year, Onsite | Apr 21, 2023 | 03/17 |
| 10MR004CUS | US | i5-6500T | No | Intel HD 530 | None | 8GBx1 | 500GB 7200rpm 2.5" | DVD±RW | 8265 ac, 2x2 + BT4.1 | HDMI | Switch | None | 1Wx1 | None | None | None | USB / USB | VESA Mount | None | 65W Adapter 88% | Win10 DG Win7 Pro 64 | 3-year, Onsite | Apr 21, 2023 | 03/17 |
| 10MR004DUS | US | i7-6700T | No | Intel HD 530 | None | 8GBx1 | 500GB 7200rpm 2.5" | None | 8265 ac, 2x2 + BT4.1 | 3rd DP | Switch | None | 1Wx1 | None | None | None | USB / USB | None | Floor Stand | 65W Adapter 88% | Win10 DG Win7 Pro 64 | 3-year, Onsite | Apr 21, 2023 | 03/17 |
| 10MR004EUS | US | i3-6100T | No | Intel HD 530 | None | 8GBx1 | 500GB 7200rpm 2.5" | None | 3165 ac, 1x1 + BT4.0 | 3rd DP | Switch | None | 1Wx1 | None | None | None | USB / USB | None | Floor Stand | 65W Adapter 88% | Win10 DG Win7 Pro 64 | 3-year, Onsite | Apr 21, 2023 | 03/17 |
| 10MR004FUS | US | i5-6500T | No | Intel HD 530 | None | 4GBx1 | 500GB 7200rpm 2.5" | None | 3165 ac, 1x1 + BT4.0 | 3rd DP | Switch | None | 1Wx1 | None | None | None | USB / USB | None | Floor Stand | 65W Adapter 88% | Win10 DG Win7 Pro 64 | 3-year, Onsite | Apr 21, 2023 | 03/17 |
| 10MR004GUS | US | i3-6100T | No | Intel HD 530 | None | 8GBx1 | 500GB 7200rpm 2.5" | DVD±RW | 3165 ac, 1x1 + BT4.0 | HDMI | Switch | None | 1Wx1 | None | None | None | USB / USB | VESA Mount | None | 65W Adapter 88% | Win10 DG Win7 Pro 64 | 3-year, Onsite | Apr 21, 2023 | 03/17 |
| 10MR004HUS | US | i5-6500T | No | Intel HD 530 | None | 8GBx1 | 128GB SSD M.2 PCIe NVMe | None | 8265 ac, 2x2 + BT4.1 | 3rd DP | Switch | None | 1Wx1 | None | None | None | USB / USB | None | Floor Stand | 65W Adapter 88% | Win10 DG Win7 Pro 64 | 3-year, Onsite | Apr 21, 2023 | 03/17 |
| 10MR004JUS | US | i3-6100T | No | Intel HD 530 | None | 8GBx1 | 128GB SSD M.2 PCIe NVMe | None | 3165 ac, 1x1 + BT4.0 | 3rd DP | Switch | None | 1Wx1 | None | None | None | USB / USB | None | Floor Stand | 65W Adapter 88% | Win10 DG Win7 Pro 64 | 3-year, Onsite | Apr 21, 2023 | 03/17 |
| 10MR004KUS | US | i7-6700T | No | Intel HD 530 | None | 8GBx1 | 512GB SSD M.2 PCIe NVMe Opal | None | 8265 ac, 2x2 + BT4.1 | 3rd DP | Switch | None | 1Wx1 | None | None | None | USB / USB | None | Floor Stand | 65W Adapter 88% | Win10 DG Win7 Pro 64 | 3-year, Onsite | Apr 21, 2023 | 03/17 |
| 10MR004LUS | US | i7-6700T | No | Intel HD 530 | None | 8GBx1 | 500GB 7200rpm 2.5" | DVD±RW | 8265 ac, 2x2 + BT4.1 | HDMI | Switch | None | 1Wx1 | None | None | None | USB / USB | VESA Mount | None | 65W Adapter 88% | Win10 DG Win7 Pro 64 | 3-year, Onsite | Apr 21, 2023 | 03/17 |
| 10MR004MUS | US | i5-6500T | No | Intel HD 530 | None | 8GBx1 | 128GB SSD M.2 PCIe NVMe | None | 3165 ac, 1x1 + BT4.0 | 3rd DP | Switch | None | 1Wx1 | None | None | None | USB / USB | None | Floor Stand | 65W Adapter 88% | Win10 DG Win7 Pro 64 | 3-year, Onsite | Apr 21, 2023 | 03/17 |

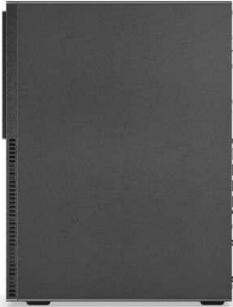

ThinkCentre M710 Tower Platform Specifications

Product Specifications Reference (PSREF)

| | | | | | | | |
|----------------------------|---|-----------------|-------------------------|-----------|------------------------|---------------------|--|
| Processor | Intel® Celeron®, Intel Pentium®, or 6/7th Generation Intel Core™ i3 / i5 / i7 Processor | | | | | | Manageability None Security chip TPM (Trusted Platform Module) 2.0, TCG Certified * Downgrade to TPM1.2 for the models with Win10 DG Win7 32 OS Security features • Security slot (in rear for optional Kensington® MicroSaver® cable) • Padlock loop • Smart USB protection, allows keyboard/mouse only, blocks all storage devices • Optional cable lock to physically lock both keyboard and mouse • Power-on password • Administrator password • Hard disk password • Boot sequence control • Boot without keyboard and mouse • Individual USB port disablement • Optional chassis intrusion switch |
| | Processor | Cores / Threads | Frequency Base/Max(GHz) | Cache | Memory Support (Up to) | Integrated Graphics | |
| | Pentium G4400 | 2 / 2 | 3.3G | 3 MB | DDR4-2133 | HD 510 | |
| | Pentium G4560 | 2 / 4 | 3.5G | 3 MB | DDR4-2400 | HD 610 | |
| | Pentium G4600 | 2 / 4 | 3.6G | 3 MB | DDR4-2400 | HD 630 | |
| | Core i3-6100 | 2 / 4 | 3.7G | 3 MB | DDR4-2133 | HD 530 | |
| | Core i5-6500 | 4 / 4 | 3.2G / 3.6G | 6 MB | DDR4-2133 | HD 530 | |
| | Core i7-6700 | 4 / 8 | 3.4G / 4.0G | 8 MB | DDR4-2133 | HD 530 | |
| | Core i3-7100 | 2 / 4 | 3.9G | 3 MB | DDR4-2400 | HD 630 | |
| | Core i5-7400 | 4 / 4 | 3.0G / 3.5G | 6 MB | DDR4-2400 | HD 630 | |
| | Core i5-7500 | 4 / 4 | 3.4G / 3.8G | 6 MB | DDR4-2400 | HD 630 | |
| Core i5-7600 | 4 / 4 | 3.5G / 4.1G | 6 MB | DDR4-2400 | HD 630 | | |
| Core i7-7700 | 4 / 8 | 3.6G / 4.2G | 8 MB | DDR4-2400 | HD 630 | | |
| Memory | 64GB max, UDIMM, DDR4-2400*, four 288-pin DIMM sockets, non-ECC, dual-channel capable * System automatically clocks down for the processors with lower memory controller | | | | | | Mechanical • Tower (15L), black color, metal case • (WxDxH) 5.7" X 11.5" X 14.4"; 145mm X 292.7mm X 366mm • Approx. 14.3 lb (6.5 kg), weight may vary by configuration • Optional dust filter Bay 1: Slim external ODD bay Bay 2: 3.5", 1" high, internal, HDD/SSD Bay 3: 3.5", 1" high, internal, HDD/SSD Slot 1: half-length full-height (length < 189mm, height < 104mm), PCIe 3.0 x16* Slot 2: half-length full-height (length < 189mm, height < 104mm), PCIe 3.0 x1* Slot 3: half-length full-height (length < 189mm, height < 104mm), PCIe 3.0 x1* Slot 4: no slot, only bracket for optional port extension* M.2 card slots: Two (one for WLAN, one for SSD/Optane) * Optional front USB3.1 Type-C x2 module occupies PCIe x16 slot (x4 card), optional rear 2x USB2.0 / parallel occupies one expansion slot Power supply <i>Some:</i> 180 watts, autosensing, 85% PSU <i>Some:</i> 210 watts, autosensing, 85% PSU <i>Some:</i> 210 watts, autosensing, 92% PSU (only available via special bid) Limited warranty ³ <i>Some:</i> 1-year or 3-year, depot service / service upgrades available <i>Some:</i> 1-year or 3-year, limited onsite service / service upgrades available Preload Preloaded operating system <i>Some:</i> Windows® 7 Professional 32/64 preinstalled through downgrade rights in Windows 10 Pro 64-bit (not available with 7th Gen Intel processor) <i>Some:</i> Windows 10 Pro 64-bit <i>Some:</i> Windows 10 Home 64-bit Preloaded applications (only some listed) • Microsoft Office preloaded; purchase a product key to activate • Cyberlink PowerDVD Create (DVD±RW) - Only for Window 10 • Lenovo Companion • Lenovo ID • Cyberlink PowerDVD (DVD, DVD±RW) - Only for Window 7 • Lenovo Solution Center • Lenovo ThinkVantage Tools • Create Recovery Media • Adobe® Reader® Environment ENERGY STAR® 6.1, EPEAT™ Gold rating (North America), ErP Lot 3, GREENGUARD®, RoHS-compliant, TUV low noise verified (on some models) Accessories For compatible accessories, please go to http://www.lenovoquickpick.com |
| Storage | <i>Some:</i> Hard Drive / SATA 6.0Gb/s, 2.5" or 3.5", 5400 rpm or 7200 rpm <i>Some:</i> Solid State Drive (SSD) / SATA 6.0Gb/s, 2.5" <i>Some:</i> M.2 Solid State Drive (SSD) / PCIe NVMe, PCIe 3.0 x 4, 32Gb/s | | | | | | |
| Optical | <i>Some:</i> Intel Optane™ Memory Ready (models with 7th gen Core processor), M.2 <i>Some:</i> DVD-ROM SATA 1.5Gb/s Drive, slim (9.0mm) <i>Some:</i> DVD Burner (DVD±RW), SATA 1.5Gb/s Drive, slim (9.0mm) | | | | | | |
| Onboard SATA Media reader | Three onboard SATA 6.0Gb/s connectors Optional 7-in-1 media reader | | | | | | |
| Graphics | Intel HD Graphics 510/530/610/630 in processor, uses main memory, DirectX® 12, one VGA, two DisplayPort™, supports 3 independent displays, works along with discrete graphics to support more displays; <i>Max resolution:</i> 4096x2304 (DP) @60Hz; 2048x1536 (VGA) @50Hz <i>Some:</i> NVIDIA GeForce® GT 730 , DirectX 12, 2GB, PCIe 2.0 x8 adapter, two DisplayPort, 35 watts; <i>Max resolution:</i> 3840x2160 (DisplayPort) @60Hz; <i>Some:</i> AMD Radeon™ R7 350 , DirectX 11, 2GB, PCIe 3.0 x8 adapter, one VGA, one HDMI, 75 watts, occupies two slots; <i>Max resolution:</i> 4096x2160 (HDMI) @24Hz; 2048x1536 (VGA) @85Hz | | | | | | |
| Monitor Cable | Optional DP to VGA, DP to DVI-D (single link), DP to dual DP, or DP to HDMI 1.4 | | | | | | |
| Chipset | Intel B250 Chipset | | | | | | |
| Front ports | Four USB 3.1 Gen1, optional two USB 3.1 Type-C Gen 2 (only available via special bid), microphone (3.5mm), headphone (3.5mm) | | | | | | |
| Rear ports | Two USB 3.1 Gen1, two USB 2.0, optional two USB 2.0, serial (9-pin), optional 2nd serial (9-pin), optional parallel (25-pin), ethernet (RJ-45), one VGA, two DisplayPort, two PS/2 ports (keyboard/mouse); additional VGA, DisplayPort, or HDMI on optional graphics on some models | | | | | | |
| Rear audio ports IEEE 1394 | Line-in (3.5mm), line-out (3.5mm), microphone-in (3.5mm) None | | | | | | |
| Audio support | High Definition (HD) Audio, Realtek ALC662 / optional internal speaker (1.5 watt) | | | | | | |
| WLAN ¹³ | <i>Some:</i> 11ac wireless, M.2 Card, Qualcomm Atheros QCA9377A (dual band), Wi-Fi + Bluetooth 4.1 combo adapter, 1x1 <i>Some:</i> 11ac wireless, M.2 Card, Qualcomm Atheros QCA6174A (dual band), Wi-Fi + Bluetooth 4.1 combo adapter, 2x2 <i>Some:</i> 11ac wireless, M.2 Card, Intel Dual Band Wireless-AC 3165, Wi-Fi + Bluetooth 4.1 combo adapter, 1x1 <i>Some:</i> 11ac wireless, M.2 Card, Intel Dual Band Wireless-AC 8265, Wi-Fi + Bluetooth 4.1 combo adapter, 2x2 | | | | | | |
| Bluetooth™ | <i>Some:</i> Bluetooth 4.1 wireless, integrated in Wi-Fi + BT combo adapter | | | | | | |
| Ethernet | Gigabit ethernet, Realtek RTL8111GN, Wake on LAN® | | | | | | |
| Modem | None | | | | | | |

See footnotes for more detailed information

| Model | Region | Processor | vPro | Graphics | Monitor Cable | Memory | Storage(HDD/SSD) | Optical | Media Reader | WLAN + Bluetooth | Optional Front Ports | Optional Rear Ports | Chassis Intrusion Switch | Cable Lock | Speaker | Dust Filter | Keyboard / Mouse | Power Supply | Operating System | Warranty | Ann Date (mm/yy) |
|------------|--------|---------------|------|--------------|---------------|--------|------------------------------|---------|--------------|----------------------|----------------------|---------------------|--------------------------|------------|---------|-------------|------------------|--------------|----------------------|----------------|------------------|
| 10M9000EUS | US | i7-7700 | No | GT 730 2GB | None | 8GBx1 | 256GB SSD M.2 PCIe NVMe Opal | DVD±RW | None | 3165 ac, 1x1 + BT4.0 | None | None | None | None | 1.5Wx1 | None | USB / USB | 210W 85% | Win10 Pro 64 | 3-year, Onsite | 02/17 |
| 10M9000FUS | US | i5-7400 | No | Intel HD 630 | None | 8GBx1 | 256GB SSD M.2 PCIe NVMe Opal | DVD±RW | None | None | None | None | None | None | 1.5Wx1 | None | USB / USB | 210W 85% | Win10 Pro 64 | 3-year, Onsite | 02/17 |
| 10M9000GUS | US | i7-7700 | No | GT 730 2GB | None | 8GBx1 | 1TB 7200rpm 3.5" | DVD±RW | None | None | None | None | None | None | 1.5Wx1 | None | USB / USB | 210W 85% | Win10 Pro 64 | 3-year, Onsite | 02/17 |
| 10M9000HUS | US | i5-7400 | No | Intel HD 630 | None | 8GBx1 | 256GB SSD M.2 PCIe NVMe Opal | DVD±RW | None | 3165 ac, 1x1 + BT4.0 | None | None | None | None | 1.5Wx1 | None | USB / USB | 210W 85% | Win10 Pro 64 | 3-year, Onsite | 02/17 |
| 10M9000JUS | US | i5-7400 | No | GT 730 2GB | None | 8GBx1 | 1TB 7200rpm 3.5" | DVD±RW | None | None | None | None | None | None | 1.5Wx1 | None | USB / USB | 210W 85% | Win10 Pro 64 | 3-year, Onsite | 02/17 |
| 10M9000KUS | US | i7-7700 | No | Intel HD 630 | None | 8GBx1 | 256GB SSD M.2 PCIe NVMe Opal | DVD±RW | None | 3165 ac, 1x1 + BT4.0 | None | None | None | None | 1.5Wx1 | None | USB / USB | 210W 85% | Win10 Pro 64 | 3-year, Onsite | 02/17 |
| 10M9000LUS | US | i7-7700 | No | Intel HD 630 | None | 8GBx1 | 256GB SSD M.2 PCIe NVMe Opal | DVD±RW | None | None | None | None | None | None | 1.5Wx1 | None | USB / USB | 210W 85% | Win10 Pro 64 | 3-year, Onsite | 02/17 |
| 10M9000MUS | US | i5-7400 | No | Intel HD 630 | None | 8GBx1 | 512GB SSD M.2 PCIe NVMe Opal | DVD±RW | None | None | None | None | None | None | 1.5Wx1 | None | USB / USB | 210W 85% | Win10 Pro 64 | 3-year, Onsite | 02/17 |
| 10M9000NUS | US | i5-7400 | No | Intel HD 630 | None | 4GBx1 | 500GB 7200rpm 3.5" | DVD±RW | None | None | None | None | None | None | 1.5Wx1 | None | USB / USB | 210W 85% | Win10 Pro 64 | 3-year, Onsite | 02/17 |
| 10M9000PUS | US | i5-7400 | No | GT 730 2GB | None | 8GBx1 | 256GB SSD M.2 PCIe NVMe Opal | DVD±RW | None | None | None | None | None | None | 1.5Wx1 | None | USB / USB | 210W 85% | Win10 Pro 64 | 3-year, Onsite | 02/17 |
| 10M9000QUS | US | i7-7700 | No | Intel HD 630 | None | 8GBx1 | 512GB SSD M.2 PCIe NVMe Opal | DVD±RW | None | None | None | None | None | None | 1.5Wx1 | None | USB / USB | 210W 85% | Win10 Pro 64 | 3-year, Onsite | 02/17 |
| 10M9000RUS | US | i5-7400 | No | Intel HD 630 | None | 8GBx1 | 1TB 7200rpm 3.5" | DVD±RW | None | None | None | None | None | None | 1.5Wx1 | None | USB / USB | 210W 85% | Win10 Pro 64 | 3-year, Onsite | 02/17 |
| 10M9000SUS | US | i5-7400 | No | GT 730 2GB | None | 8GBx1 | 256GB SSD M.2 PCIe NVMe Opal | DVD±RW | None | 3165 ac, 1x1 + BT4.0 | None | None | None | None | 1.5Wx1 | None | USB / USB | 210W 85% | Win10 Pro 64 | 3-year, Onsite | 02/17 |
| 10M9000TUS | US | i7-7700 | No | Intel HD 630 | None | 8GBx1 | 1TB 7200rpm 3.5" | DVD±RW | None | None | None | None | None | None | 1.5Wx1 | None | USB / USB | 210W 85% | Win10 Pro 64 | 3-year, Onsite | 02/17 |
| 10M9000UUS | US | i7-7700 | No | GT 730 2GB | None | 8GBx1 | 256GB SSD M.2 PCIe NVMe Opal | DVD±RW | None | None | None | None | None | None | 1.5Wx1 | None | USB / USB | 210W 85% | Win10 Pro 64 | 3-year, Onsite | 02/17 |
| 10M9002UUS | US | i3-6100 | No | Intel HD 530 | None | 4GBx1 | 1TB 7200rpm 3.5" | DVD±RW | None | None | None | None | None | None | 1.5Wx1 | None | USB / USB | 210W 85% | Win10 DG Win7 Pro 64 | 3-year, Onsite | 03/17 |
| 10M9002VUS | US | i3-6100 | No | Intel HD 530 | None | 8GBx1 | 1TB 7200rpm 3.5" | DVD±RW | None | None | None | None | None | None | 1.5Wx1 | None | USB / USB | 210W 85% | Win10 DG Win7 Pro 64 | 3-year, Onsite | 03/17 |
| 10M9002WUS | US | Pentium G4400 | No | Intel HD 510 | None | 4GBx1 | 500GB 7200rpm 3.5" | DVD±RW | None | None | None | None | None | None | 1.5Wx1 | None | USB / USB | 210W 85% | Win10 DG Win7 Pro 64 | 3-year, Onsite | 03/17 |
| 10M9002XUS | US | i5-6500 | No | Intel HD 530 | None | 8GBx1 | 256GB SSD M.2 PCIe NVMe Opal | DVD±RW | None | 3165 ac, 1x1 + BT4.0 | None | None | None | None | 1.5Wx1 | None | USB / USB | 210W 85% | Win10 DG Win7 Pro 64 | 3-year, Onsite | 03/17 |
| 10M9002YUS | US | i7-6700 | No | Intel HD 530 | None | 8GBx1 | 512GB SSD M.2 PCIe NVMe Opal | DVD±RW | None | None | None | None | None | None | 1.5Wx1 | None | USB / USB | 210W 85% | Win10 DG Win7 Pro 64 | 3-year, Onsite | 03/17 |

| Model | Region | Processor | vPro | Graphics | Monitor Cable | Memory | Storage(HDD/SSD) | Optical | Media Reader | WLAN + Bluetooth | Optional Front Ports | Optional Rear Ports | Chassis Intrusion Switch | Cable Lock | Speaker | Dust Filter | Keyboard / Mouse | Power Supply | Operating System | Warranty | Ann Date (mm/yy) |
|------------|--------|---------------|------|--------------|---------------|--------|------------------------------|---------|--------------|----------------------|----------------------|---------------------|--------------------------|------------|---------|-------------|------------------|--------------|----------------------|----------------|------------------|
| 10M90030US | US | i7-6700 | No | GT 730 2GB | None | 8GBx1 | 1TB 7200rpm 3.5" | DVD±RW | None | None | None | None | None | None | 1.5Wx1 | None | USB / USB | 210W 85% | Win10 DG Win7 Pro 64 | 3-year, Onsite | 03/17 |
| 10M90031US | US | i5-6500 | No | Intel HD 530 | None | 8GBx1 | 256GB SSD M.2 PCIe NVMe Opal | DVD±RW | None | None | None | None | None | None | 1.5Wx1 | None | USB / USB | 210W 85% | Win10 DG Win7 Pro 64 | 3-year, Onsite | 03/17 |
| 10M90032US | US | i5-7400 | No | Intel HD 630 | None | 4GBx1 | 128GB SSD M.2 PCIe NVMe | DVD±RW | None | None | None | None | None | None | 1.5Wx1 | None | USB / USB | 210W 85% | Win10 Pro 64 | 3-year, Onsite | 03/17 |
| 10M90033US | US | i7-6700 | No | GT 730 2GB | None | 8GBx1 | 256GB SSD M.2 PCIe NVMe Opal | DVD±RW | None | 3165 ac, 1x1 + BT4.0 | None | None | None | None | 1.5Wx1 | None | USB / USB | 210W 85% | Win10 DG Win7 Pro 64 | 3-year, Onsite | 03/17 |
| 10M90034US | US | i7-6700 | No | Intel HD 530 | None | 8GBx1 | 256GB SSD M.2 PCIe NVMe Opal | DVD±RW | None | 3165 ac, 1x1 + BT4.0 | None | None | None | None | 1.5Wx1 | None | USB / USB | 210W 85% | Win10 DG Win7 Pro 64 | 3-year, Onsite | 03/17 |
| 10M90035US | US | i3-7100 | No | Intel HD 630 | None | 8GBx1 | 128GB SSD M.2 PCIe NVMe | DVD±RW | None | None | None | None | None | None | 1.5Wx1 | None | USB / USB | 210W 85% | Win10 Pro 64 | 3-year, Onsite | 03/17 |
| 10M90036US | US | i5-6500 | No | Intel HD 530 | None | 4GBx1 | 500GB 7200rpm 3.5" | DVD±RW | None | None | None | None | None | None | 1.5Wx1 | None | USB / USB | 210W 85% | Win10 DG Win7 Pro 64 | 3-year, Onsite | 03/17 |
| 10M90037US | US | i3-7100 | No | Intel HD 630 | None | 8GBx1 | 1TB 7200rpm 3.5" | DVD±RW | None | None | None | None | None | None | 1.5Wx1 | None | USB / USB | 210W 85% | Win10 Pro 64 | 3-year, Onsite | 03/17 |
| 10M90038US | US | i5-6500 | No | GT 730 2GB | None | 8GBx1 | 256GB SSD M.2 PCIe NVMe Opal | DVD±RW | None | 3165 ac, 1x1 + BT4.0 | None | None | None | None | 1.5Wx1 | None | USB / USB | 210W 85% | Win10 DG Win7 Pro 64 | 3-year, Onsite | 03/17 |
| 10M90039US | US | i5-6500 | No | Intel HD 530 | None | 8GBx1 | 1TB 7200rpm 3.5" | DVD±RW | None | None | None | None | None | None | 1.5Wx1 | None | USB / USB | 210W 85% | Win10 DG Win7 Pro 64 | 3-year, Onsite | 03/17 |
| 10M9003AUS | US | i3-6100 | No | Intel HD 530 | None | 4GBx1 | 500GB 7200rpm 3.5" | DVD±RW | None | None | None | None | None | None | 1.5Wx1 | None | USB / USB | 210W 85% | Win10 DG Win7 Pro 64 | 3-year, Onsite | 03/17 |
| 10M9003BUS | US | i3-6100 | No | Intel HD 530 | None | 8GBx1 | 128GB SSD M.2 PCIe NVMe | DVD±RW | None | None | None | None | None | None | 1.5Wx1 | None | USB / USB | 210W 85% | Win10 DG Win7 Pro 64 | 3-year, Onsite | 03/17 |
| 10M9003CUS | US | i3-7100 | No | Intel HD 630 | None | 4GBx1 | 500GB 7200rpm 3.5" | DVD±RW | None | None | None | None | None | None | 1.5Wx1 | None | USB / USB | 210W 85% | Win10 Pro 64 | 3-year, Onsite | 03/17 |
| 10M9003DUS | US | Pentium G4560 | No | Intel HD 610 | None | 4GBx1 | 500GB 7200rpm 3.5" | DVD±RW | None | None | None | None | None | None | 1.5Wx1 | None | USB / USB | 210W 85% | Win10 Pro 64 | 3-year, Onsite | 03/17 |
| 10M9003EUS | US | i7-6700 | No | Intel HD 530 | None | 8GBx1 | 1TB 7200rpm 3.5" | DVD±RW | None | None | None | None | None | None | 1.5Wx1 | None | USB / USB | 210W 85% | Win10 DG Win7 Pro 64 | 3-year, Onsite | 03/17 |
| 10M9003FUS | US | i7-6700 | No | Intel HD 530 | None | 8GBx1 | 256GB SSD M.2 PCIe NVMe Opal | DVD±RW | None | None | None | None | None | None | 1.5Wx1 | None | USB / USB | 210W 85% | Win10 DG Win7 Pro 64 | 3-year, Onsite | 03/17 |
| 10M9003GUS | US | i5-6500 | No | Intel HD 530 | None | 4GBx1 | 128GB SSD M.2 PCIe NVMe | DVD±RW | None | None | None | None | None | None | 1.5Wx1 | None | USB / USB | 210W 85% | Win10 DG Win7 Pro 64 | 3-year, Onsite | 03/17 |
| 10M9003HUS | US | i5-6500 | No | GT 730 2GB | None | 8GBx1 | 1TB 7200rpm 3.5" | DVD±RW | None | None | None | None | None | None | 1.5Wx1 | None | USB / USB | 210W 85% | Win10 DG Win7 Pro 64 | 3-year, Onsite | 03/17 |
| 10M9003JUS | US | i5-6500 | No | GT 730 2GB | None | 8GBx1 | 256GB SSD M.2 PCIe NVMe Opal | DVD±RW | None | None | None | None | None | None | 1.5Wx1 | None | USB / USB | 210W 85% | Win10 DG Win7 Pro 64 | 3-year, Onsite | 03/17 |
| 10M9003KUS | US | i7-6700 | No | GT 730 2GB | None | 8GBx1 | 256GB SSD M.2 PCIe NVMe Opal | DVD±RW | None | None | None | None | None | None | 1.5Wx1 | None | USB / USB | 210W 85% | Win10 DG Win7 Pro 64 | 3-year, Onsite | 03/17 |

| Model | Region | Processor | vPro | Graphics | Monitor Cable | Memory | Storage(HDD/SSD) | Optical | Media Reader | WLAN + Bluetooth | Optional Front Ports | Optional Rear Ports | Chassis Intrusion Switch | Cable Lock | Speaker | Dust Filter | Keyboard / Mouse | Power Supply | Operating System | Warranty | Ann Date (mm/yy) |
|------------|--------|-----------|------|--------------|---------------|--------|------------------|---------|--------------|------------------|----------------------|---------------------|--------------------------|------------|---------|-------------|------------------|--------------|------------------|----------------|------------------|
| 10M9003LUS | US | i3-7100 | No | Intel HD 630 | None | 4GBx1 | 1TB 7200rpm 3.5" | DVD±RW | None | None | None | None | None | None | 1.5Wx1 | None | USB / USB | 210W 85% | Win10 Pro 64 | 3-year, Onsite | 03/17 |

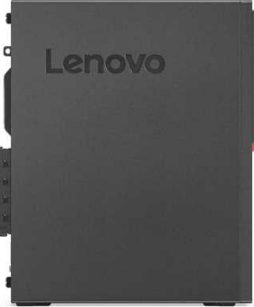

ThinkCentre M715 SFF Platform Specifications

Product Specifications Reference (PSREF)

| Processor | AMD A6 / A8 / A10 / A12 series APU and Ryzen 3 / 5 / 7 series processor | Security features | <ul style="list-style-type: none"> Security slot (in rear for optional Kensington® MicroSaver® cable) Padlock loop Smart USB protection, allows keyboard/mouse only, blocks all storage devices Optional cable lock to physically lock both keyboard and mouse Power-on password Administrator password Hard disk password Boot sequence control Boot without keyboard and mouse Individual USB port disablement Optional chassis intrusion switch | | | | | | | | | | | | | | | | | | | | | | | | | | | | | | | | | | | | | | | | | | | | | | | | | | | | | | | | | | | | |
|-----------------------------|---|----------------------|---|----------------------|----------|---------------------|------------------|-------|-----------|-----|------|------------------|-------|-----------|-----|------|------------------|-------|-----------|-----|------|------------------|--------|-----------|-----|------|-------------|-------|-----------|-----|------------------|--------------|-------|-----------|-----|------------------|--------------|-------|-----------|-----|------------------|-------------|-------|-----------|-----|------------------|-------------|-------|-----------|-----|------------------|--------------|-------|-----------|-----|------------------|--------------|-------|-----------|-----|------------------|----------|--|
| | <table border="1"> <thead> <tr> <th>APU / processor</th> <th>Cores / Threads</th> <th>Frequency (Base/Max)</th> <th>L2 Cache</th> <th>Integrated Graphics</th> </tr> </thead> <tbody> <tr> <td>Ryzen 3 PRO 1200</td> <td>4 / 4</td> <td>3.1 / 3.4</td> <td>2MB</td> <td>None</td> </tr> <tr> <td>Ryzen 3 PRO 1300</td> <td>4 / 4</td> <td>3.5 / 3.7</td> <td>2MB</td> <td>None</td> </tr> <tr> <td>Ryzen 5 PRO 1500</td> <td>4 / 8</td> <td>3.5 / 3.7</td> <td>2MB</td> <td>None</td> </tr> <tr> <td>Ryzen 7 PRO 1700</td> <td>8 / 16</td> <td>3.0 / 3.7</td> <td>4MB</td> <td>None</td> </tr> <tr> <td>PRO A6-8570</td> <td>2 / 2</td> <td>3.5 / 3.8</td> <td>1MB</td> <td>Radeon R5 Series</td> </tr> <tr> <td>PRO A10-8770</td> <td>4 / 4</td> <td>3.5 / 3.8</td> <td>2MB</td> <td>Radeon R7 Series</td> </tr> <tr> <td>PRO A12-8870</td> <td>4 / 4</td> <td>3.7 / 4.2</td> <td>2MB</td> <td>Radeon R7 Series</td> </tr> <tr> <td>PRO A6-9500</td> <td>2 / 2</td> <td>3.5 / 3.8</td> <td>1MB</td> <td>Radeon R5 Series</td> </tr> <tr> <td>PRO A8-9600</td> <td>4 / 4</td> <td>3.1 / 3.4</td> <td>2MB</td> <td>Radeon R7 Series</td> </tr> <tr> <td>PRO A10-9700</td> <td>4 / 4</td> <td>3.5 / 3.8</td> <td>2MB</td> <td>Radeon R7 Series</td> </tr> <tr> <td>PRO A12-9800</td> <td>4 / 4</td> <td>3.8 / 4.2</td> <td>2MB</td> <td>Radeon R7 Series</td> </tr> </tbody> </table> | APU / processor | Cores / Threads | Frequency (Base/Max) | L2 Cache | Integrated Graphics | Ryzen 3 PRO 1200 | 4 / 4 | 3.1 / 3.4 | 2MB | None | Ryzen 3 PRO 1300 | 4 / 4 | 3.5 / 3.7 | 2MB | None | Ryzen 5 PRO 1500 | 4 / 8 | 3.5 / 3.7 | 2MB | None | Ryzen 7 PRO 1700 | 8 / 16 | 3.0 / 3.7 | 4MB | None | PRO A6-8570 | 2 / 2 | 3.5 / 3.8 | 1MB | Radeon R5 Series | PRO A10-8770 | 4 / 4 | 3.5 / 3.8 | 2MB | Radeon R7 Series | PRO A12-8870 | 4 / 4 | 3.7 / 4.2 | 2MB | Radeon R7 Series | PRO A6-9500 | 2 / 2 | 3.5 / 3.8 | 1MB | Radeon R5 Series | PRO A8-9600 | 4 / 4 | 3.1 / 3.4 | 2MB | Radeon R7 Series | PRO A10-9700 | 4 / 4 | 3.5 / 3.8 | 2MB | Radeon R7 Series | PRO A12-9800 | 4 / 4 | 3.8 / 4.2 | 2MB | Radeon R7 Series | Keyboard | <i>Some:</i> Lenovo Calliope Keyboard (USB connector), black <i>Some:</i> Lenovo Traditional Keyboard (USB connector), black <i>Some:</i> Lenovo Calliope Wireless Keyboard (2.4GHz via USB receiver), black |
| APU / processor | Cores / Threads | Frequency (Base/Max) | L2 Cache | Integrated Graphics | | | | | | | | | | | | | | | | | | | | | | | | | | | | | | | | | | | | | | | | | | | | | | | | | | | | | | | | | | | |
| Ryzen 3 PRO 1200 | 4 / 4 | 3.1 / 3.4 | 2MB | None | | | | | | | | | | | | | | | | | | | | | | | | | | | | | | | | | | | | | | | | | | | | | | | | | | | | | | | | | | | |
| Ryzen 3 PRO 1300 | 4 / 4 | 3.5 / 3.7 | 2MB | None | | | | | | | | | | | | | | | | | | | | | | | | | | | | | | | | | | | | | | | | | | | | | | | | | | | | | | | | | | | |
| Ryzen 5 PRO 1500 | 4 / 8 | 3.5 / 3.7 | 2MB | None | | | | | | | | | | | | | | | | | | | | | | | | | | | | | | | | | | | | | | | | | | | | | | | | | | | | | | | | | | | |
| Ryzen 7 PRO 1700 | 8 / 16 | 3.0 / 3.7 | 4MB | None | | | | | | | | | | | | | | | | | | | | | | | | | | | | | | | | | | | | | | | | | | | | | | | | | | | | | | | | | | | |
| PRO A6-8570 | 2 / 2 | 3.5 / 3.8 | 1MB | Radeon R5 Series | | | | | | | | | | | | | | | | | | | | | | | | | | | | | | | | | | | | | | | | | | | | | | | | | | | | | | | | | | | |
| PRO A10-8770 | 4 / 4 | 3.5 / 3.8 | 2MB | Radeon R7 Series | | | | | | | | | | | | | | | | | | | | | | | | | | | | | | | | | | | | | | | | | | | | | | | | | | | | | | | | | | | |
| PRO A12-8870 | 4 / 4 | 3.7 / 4.2 | 2MB | Radeon R7 Series | | | | | | | | | | | | | | | | | | | | | | | | | | | | | | | | | | | | | | | | | | | | | | | | | | | | | | | | | | | |
| PRO A6-9500 | 2 / 2 | 3.5 / 3.8 | 1MB | Radeon R5 Series | | | | | | | | | | | | | | | | | | | | | | | | | | | | | | | | | | | | | | | | | | | | | | | | | | | | | | | | | | | |
| PRO A8-9600 | 4 / 4 | 3.1 / 3.4 | 2MB | Radeon R7 Series | | | | | | | | | | | | | | | | | | | | | | | | | | | | | | | | | | | | | | | | | | | | | | | | | | | | | | | | | | | |
| PRO A10-9700 | 4 / 4 | 3.5 / 3.8 | 2MB | Radeon R7 Series | | | | | | | | | | | | | | | | | | | | | | | | | | | | | | | | | | | | | | | | | | | | | | | | | | | | | | | | | | | |
| PRO A12-9800 | 4 / 4 | 3.8 / 4.2 | 2MB | Radeon R7 Series | | | | | | | | | | | | | | | | | | | | | | | | | | | | | | | | | | | | | | | | | | | | | | | | | | | | | | | | | | | |
| | | Mouse | <i>Some:</i> Lenovo Calliope Mouse (USB connector), black <i>Some:</i> Lenovo Calliope Wireless Mouse (2.4GHz via USB receiver), black <i>Some:</i> Lenovo Fingerprint Mouse (USB connector), Windows Hello support, black | | | | | | | | | | | | | | | | | | | | | | | | | | | | | | | | | | | | | | | | | | | | | | | | | | | | | | | | | | | | |
| Memory | 64GB max, UDIMM, DDR4-2400, four 288-pin DIMM sockets, non-ECC, dual-channel capable* * System automatically clocks down for the processors with lower memory controller | Mechanical | <ul style="list-style-type: none"> SFF (8.4L), black color; metal case (WxDxH) 3.6" X 11.4" X 13.5"; 92.5mm X 290.5mm X 343.5mm Approx. 13.2 lb (6.0 kg), weight may vary by configuration Toolless cover, disk, optical removal Optional dust filter Bay 1: Slim external ODD bay Bay 2: 3.5", internal, HDD/SSD Bay 3: 2.5", internal, HDD/SSD (bay only comes with 2.5" 2nd disk) Slot 1: low-profile (length < 150mm, height < 68mm), PCIe 3.0 x16* Slot 2: low-profile (length < 150mm, height < 68mm), PCIe 2.0 x1* Slot 3: low-profile (length < 150mm, height < 68mm), PCIe 2.0 x1* Slot 4: no slot, only bracket for optional port extension* M.2 card slots: two (one for WLAN, one for SSD) * Optional front USB3.1 Type-C x2 module occupies PCIe x16 slot (x4 card), optional rear 2x USB2.0 / parallel / 2nd serial occupies one expansion slot | | | | | | | | | | | | | | | | | | | | | | | | | | | | | | | | | | | | | | | | | | | | | | | | | | | | | | | | | | | | |
| Storage | <i>Some:</i> Hard Drive / SATA 6.0Gb/s, 2.5" or 3.5", 5400 rpm or 7200 rpm <i>Some:</i> Solid State Drive (SSD) / SATA 6.0Gb/s, 2.5" <i>Some:</i> M.2 Solid State Drive (SSD) / PCIe NVMe, PCIe 3.0 x 4, 32Gb/s | Floor Stand | Optional system floor stand for vertical orientation | | | | | | | | | | | | | | | | | | | | | | | | | | | | | | | | | | | | | | | | | | | | | | | | | | | | | | | | | | | | |
| Optical | <i>Some:</i> DVD-ROM SATA 1.5Gb/s Drive, slim (9.0mm) <i>Some:</i> DVD Burner (DVD±RW), SATA 1.5Gb/s Drive, slim (9.0mm) | Power supply | <i>Some:</i> 180 watts, autosensing, 85% PSU <i>Some:</i> 210 watts, autosensing, 85% PSU <i>Some:</i> 210 watts, autosensing, 92% PSU (only available via special bid) | | | | | | | | | | | | | | | | | | | | | | | | | | | | | | | | | | | | | | | | | | | | | | | | | | | | | | | | | | | | |
| Onboard SATA Media reader | Three onboard SATA 6.0Gb/s connectors Optional 7-in-1 media reader | Limited warranty | <i>Some:</i> 1-year or 3-year, depot service / service upgrades available <i>Some:</i> 1-year or 3-year, limited onsite service / service upgrades available | | | | | | | | | | | | | | | | | | | | | | | | | | | | | | | | | | | | | | | | | | | | | | | | | | | | | | | | | | | | |
| Graphics | AMD Radeon™ Graphics in processor (not for AMD Ryzen processor), uses main memory, DirectX® 12, one VGA, two DisplayPort™ (Onboard VGA and DP ports are invalid on the models with AMD Ryzen processor), supports 3 independent displays, works along with AMD discrete graphics to support more displays; <i>Max resolution:</i> 4096x2160 (DP)@60Hz; 1920x1200 (VGA)@60Hz <i>Some:</i> NVIDIA GeForce® GT 730 , DirectX 12, 2GB, PCIe 2.0 x8 adapter, two DisplayPort, 35 watts; <i>Max resolution:</i> 3840x2160 (DisplayPort)@60Hz; | Preload | Preloaded operating system <i>Some:</i> Windows® 7 Professional 32/64 preinstalled through downgrade rights in Windows 10 Pro 64-bit (Only available with Pro A6/A10/A12-8xxx APUs) <i>Some:</i> Windows 10 Pro 64-bit <i>Some:</i> Windows 10 Home 64-bit Preloaded applications (only some listed) <ul style="list-style-type: none"> Microsoft Office preloaded; purchase a product key to activate Only for Window 10 Lenovo Companion Lenovo ID Only for Window 7 Lenovo Solution Center Lenovo ThinkVantage Tools Create Recovery Media Adobe® Reader® Cyberlink PowerDVD Create (DVD±RW) | | | | | | | | | | | | | | | | | | | | | | | | | | | | | | | | | | | | | | | | | | | | | | | | | | | | | | | | | | | | |
| Monitor cable | Optional DP to VGA, DP to DVI-D (single link), DP to dual DP, or DP to HDMI 1.4 | Environment | ENERGY STAR® 6.1, EPEAT™ Gold rating (North America), ErP Lot 3, GREENGUARD®, RoHS-compliant | | | | | | | | | | | | | | | | | | | | | | | | | | | | | | | | | | | | | | | | | | | | | | | | | | | | | | | | | | | | |
| Chipset | AMD B350 Chipset | Accessories | For compatible accessories, please go to http://www.lenovoquickpick.com | | | | | | | | | | | | | | | | | | | | | | | | | | | | | | | | | | | | | | | | | | | | | | | | | | | | | | | | | | | | |
| Front ports | Two USB 3.1 Gen2, two USB 3.1 Gen1, optional two USB 3.1 Type-C Gen 2 (only available via special bid), microphone (3.5mm), headphone (3.5mm) | | | | | | | | | | | | | | | | | | | | | | | | | | | | | | | | | | | | | | | | | | | | | | | | | | | | | | | | | | | | | | |
| Rear ports | Two USB 3.1 Gen1, two USB 2.0, optional two USB 2.0, serial (9-pin), optional 2nd serial (9-pin), optional parallel (25-pin), ethernet (RJ-45), one VGA and two DisplayPort (not available on models with AMD Ryzen processor), two PS/2 ports (keyboard / mouse); additional DisplayPort on optional graphics on some models | | | | | | | | | | | | | | | | | | | | | | | | | | | | | | | | | | | | | | | | | | | | | | | | | | | | | | | | | | | | | | |
| Rear audio ports IEEE 1394 | Line-in (3.5mm), line-out (3.5mm), microphone-in (3.5mm) None | | | | | | | | | | | | | | | | | | | | | | | | | | | | | | | | | | | | | | | | | | | | | | | | | | | | | | | | | | | | | | |
| Audio support | High Definition (HD) Audio, Realtek ALC662 / optional internal speaker (1.5 watt) | | | | | | | | | | | | | | | | | | | | | | | | | | | | | | | | | | | | | | | | | | | | | | | | | | | | | | | | | | | | | | |
| WLAN | <i>Some:</i> 11ac wireless, M.2 Card, Realtek RTL8821AE (dual band), Wi-Fi + Bluetooth 4.0 combo adapter, 1x1 <i>Some:</i> 11ac wireless, M.2 Card, Qualcomm Atheros QCA6174A (dual band), Wi-Fi + Bluetooth 4.1 combo adapter, 2x2 <i>Some:</i> 11ac wireless, M.2 Card, Qualcomm Atheros QCA9377 (dual band), Wi-Fi + Bluetooth 4.1 combo adapter, 1x1 | | | | | | | | | | | | | | | | | | | | | | | | | | | | | | | | | | | | | | | | | | | | | | | | | | | | | | | | | | | | | | |
| Bluetooth™ Ethernet Modem | <i>Some:</i> Bluetooth 4.0 or 4.1 wireless, integrated in Wi-Fi + BT combo adapter Gigabit ethernet, Realtek RTL8111EPV, Wake on LAN® None | | | | | | | | | | | | | | | | | | | | | | | | | | | | | | | | | | | | | | | | | | | | | | | | | | | | | | | | | | | | | | |
| Manageability Security chip | DASH TPM (Trusted Platform Module) 2.0, TCG Certified * Downgrade to TPM1.2 for the models with Win10 DG Win7 32 OS | | | | | | | | | | | | | | | | | | | | | | | | | | | | | | | | | | | | | | | | | | | | | | | | | | | | | | | | | | | | | | |

| Model | Region | Processor | vPro | Graphics | Monitor Cable | Memory | Storage(HDD/SSD) | Optical | Media Reader | WLAN + Bluetooth | Optional Front Ports | Optional Rear Ports | Chassis Intrusion Switch | Cable Lock | Speaker | Dust Filter | Keyboard / Mouse | Stand | Power Supply | Operating System | Warranty | Ann Date (mm/yy) |
|------------|--------|------------------|------|-----------------|---------------|--------|------------------------------|---------|--------------|------------------|----------------------|---------------------|--------------------------|------------|---------|-------------|------------------|-------------|--------------|----------------------|----------------|------------------|
| 10MB0018US | US | AMD PRO A8-9600 | No | AMD R7 Graphics | None | 4GBx1 | 1TB 7200rpm 3.5" | DVD±RW | None | None | None | None | None | None | 1.5Wx1 | None | USB / USB | Floor Stand | 210W 85% | Win10 Pro 64 | 3-year, Onsite | 06/17 |
| 10MB0019US | US | AMD PRO A12-9800 | No | AMD R7 Graphics | None | 4GBx1 | 1TB 7200rpm 3.5" | DVD±RW | None | None | None | None | None | None | 1.5Wx1 | None | USB / USB | Floor Stand | 210W 85% | Win10 Pro 64 | 3-year, Onsite | 06/17 |
| 10MB001AUS | US | AMD PRO A10-9700 | No | AMD R7 Graphics | None | 8GBx1 | 256GB SSD M.2 PCIe NVMe Opal | DVD±RW | None | None | None | None | None | None | 1.5Wx1 | None | USB / USB | Floor Stand | 210W 85% | Win10 Pro 64 | 3-year, Onsite | 06/17 |
| 10MB001BUS | US | AMD PRO A12-9800 | No | AMD R7 Graphics | None | 8GBx1 | 256GB SSD M.2 PCIe NVMe Opal | DVD±RW | None | None | None | None | None | None | 1.5Wx1 | None | USB / USB | Floor Stand | 210W 85% | Win10 Pro 64 | 3-year, Onsite | 06/17 |
| 10MB001CUS | US | AMD PRO A8-9600 | No | AMD R7 Graphics | None | 4GBx1 | 500GB 7200rpm 3.5" | DVD±RW | None | None | None | None | None | None | 1.5Wx1 | None | USB / USB | Floor Stand | 210W 85% | Win10 Pro 64 | 3-year, Onsite | 06/17 |
| 10MB001DUS | US | AMD PRO A10-9700 | No | AMD R7 Graphics | None | 8GBx1 | 128GB SSD M.2 PCIe NVMe | DVD±RW | None | None | None | None | None | None | 1.5Wx1 | None | USB / USB | Floor Stand | 210W 85% | Win10 Pro 64 | 3-year, Onsite | 06/17 |
| 10MB001EUS | US | AMD PRO A6-9500 | No | AMD R5 Graphics | None | 4GBx1 | 1TB 7200rpm 3.5" | DVD±RW | None | None | None | None | None | None | 1.5Wx1 | None | USB / USB | Floor Stand | 210W 85% | Win10 Pro 64 | 3-year, Onsite | 06/17 |
| 10MB001FUS | US | AMD PRO A6-9500 | No | AMD R5 Graphics | None | 8GBx1 | 1TB 7200rpm 3.5" | DVD±RW | None | None | None | None | None | None | 1.5Wx1 | None | USB / USB | Floor Stand | 210W 85% | Win10 Pro 64 | 3-year, Onsite | 06/17 |
| 10MB001GUS | US | AMD PRO A12-9800 | No | AMD R7 Graphics | None | 4GBx1 | 500GB 7200rpm 3.5" | DVD±RW | None | None | None | None | None | None | 1.5Wx1 | None | USB / USB | Floor Stand | 210W 85% | Win10 Pro 64 | 3-year, Onsite | 06/17 |
| 10MB001HUS | US | AMD PRO A10-9700 | No | AMD R7 Graphics | None | 8GBx1 | 1TB 7200rpm 3.5" | DVD±RW | None | None | None | None | None | None | 1.5Wx1 | None | USB / USB | Floor Stand | 210W 85% | Win10 Pro 64 | 3-year, Onsite | 06/17 |
| 10MB001JUS | US | AMD PRO A6-9500 | No | AMD R5 Graphics | None | 4GBx1 | 500GB 7200rpm 3.5" | DVD±RW | None | None | None | None | None | None | 1.5Wx1 | None | USB / USB | Floor Stand | 210W 85% | Win10 Pro 64 | 3-year, Onsite | 06/17 |
| 10MB001KUS | US | AMD PRO A6-9500 | No | AMD R5 Graphics | None | 8GBx1 | 128GB SSD M.2 PCIe NVMe | DVD±RW | None | None | None | None | None | None | 1.5Wx1 | None | USB / USB | Floor Stand | 210W 85% | Win10 Pro 64 | 3-year, Onsite | 06/17 |
| 10MB001LUS | US | AMD PRO A8-9600 | No | AMD R7 Graphics | None | 8GBx1 | 128GB SSD M.2 PCIe NVMe | DVD±RW | None | None | None | None | None | None | 1.5Wx1 | None | USB / USB | Floor Stand | 210W 85% | Win10 Pro 64 | 3-year, Onsite | 06/17 |
| 10MB001MUS | US | AMD PRO A12-9800 | No | AMD R7 Graphics | None | 8GBx1 | 128GB SSD M.2 PCIe NVMe | DVD±RW | None | None | None | None | None | None | 1.5Wx1 | None | USB / USB | Floor Stand | 210W 85% | Win10 Pro 64 | 3-year, Onsite | 06/17 |
| 10MB001NUS | US | AMD PRO A8-9600 | No | AMD R7 Graphics | None | 8GBx1 | 1TB 7200rpm 3.5" | DVD±RW | None | None | None | None | None | None | 1.5Wx1 | None | USB / USB | Floor Stand | 210W 85% | Win10 Pro 64 | 3-year, Onsite | 06/17 |
| 10MB001PUS | US | AMD PRO A10-9700 | No | AMD R7 Graphics | None | 4GBx1 | 1TB 7200rpm 3.5" | DVD±RW | None | None | None | None | None | None | 1.5Wx1 | None | USB / USB | Floor Stand | 210W 85% | Win10 Pro 64 | 3-year, Onsite | 06/17 |
| 10MB001QUS | US | AMD PRO A10-9700 | No | AMD R7 Graphics | None | 4GBx1 | 500GB 7200rpm 3.5" | DVD±RW | None | None | None | None | None | None | 1.5Wx1 | None | USB / USB | Floor Stand | 210W 85% | Win10 Pro 64 | 3-year, Onsite | 06/17 |
| 10MB001RUS | US | AMD PRO A12-9800 | No | AMD R7 Graphics | None | 8GBx1 | 1TB 7200rpm 3.5" | DVD±RW | None | None | None | None | None | None | 1.5Wx1 | None | USB / USB | Floor Stand | 210W 85% | Win10 Pro 64 | 3-year, Onsite | 06/17 |
| 10MB001SUS | US | AMD PRO A6-8570 | No | AMD R5 Graphics | None | 8GBx1 | 1TB 7200rpm 3.5" | DVD±RW | None | None | None | None | None | None | 1.5Wx1 | None | USB / USB | Floor Stand | 210W 85% | Win10 DG Win7 Pro 64 | 3-year, Onsite | 07/17 |
| 10MB001TUS | US | AMD PRO A12-8870 | No | AMD R7 Graphics | None | 8GBx1 | 128GB SSD M.2 PCIe NVMe | DVD±RW | None | None | None | None | None | None | 1.5Wx1 | None | USB / USB | Floor Stand | 210W 85% | Win10 DG Win7 Pro 64 | 3-year, Onsite | 07/17 |

| Model | Region | Processor | vPro | Graphics | Monitor Cable | Memory | Storage(HDD/SSD) | Optical | Media Reader | WLAN + Bluetooth | Optional Front Ports | Optional Rear Ports | Chassis Intrusion Switch | Cable Lock | Speaker | Dust Filter | Keyboard / Mouse | Stand | Power Supply | Operating System | Warranty | Ann Date (mm/yy) |
|------------|--------|------------------|------|-----------------|---------------|--------|------------------------------|---------|--------------|---------------------------|----------------------|---------------------|--------------------------|------------|---------|-------------|------------------|-------------|--------------|----------------------|----------------|------------------|
| 10MB001UUS | US | AMD PRO A6-8570 | No | AMD R5 Graphics | None | 8GBx1 | 128GB SSD M.2 PCIe NVMe | DVD±RW | None | None | None | None | None | None | 1.5Wx1 | None | USB / USB | Floor Stand | 210W 85% | Win10 DG Win7 Pro 64 | 3-year, Onsite | 07/17 |
| 10MB001VUS | US | AMD PRO A10-8770 | No | AMD R7 Graphics | None | 8GBx1 | 128GB SSD M.2 PCIe NVMe | DVD±RW | None | None | None | None | None | None | 1.5Wx1 | None | USB / USB | Floor Stand | 210W 85% | Win10 DG Win7 Pro 64 | 3-year, Onsite | 07/17 |
| 10MB001WUS | US | AMD PRO A10-8770 | No | AMD R7 Graphics | None | 4GBx1 | 500GB 7200rpm 3.5" | DVD±RW | None | None | None | None | None | None | 1.5Wx1 | None | USB / USB | Floor Stand | 210W 85% | Win10 DG Win7 Pro 64 | 3-year, Onsite | 07/17 |
| 10MB001XUS | US | AMD PRO A12-8870 | No | AMD R7 Graphics | None | 4GBx1 | 1TB 7200rpm 3.5" | DVD±RW | None | None | None | None | None | None | 1.5Wx1 | None | USB / USB | Floor Stand | 210W 85% | Win10 DG Win7 Pro 64 | 3-year, Onsite | 07/17 |
| 10MB001YUS | US | AMD PRO A10-8770 | No | AMD R7 Graphics | None | 8GBx1 | 1TB 7200rpm 3.5" | DVD±RW | None | RTL8821AE ac, 1x1 + BT4.0 | None | None | None | None | 1.5Wx1 | None | USB / USB | Floor Stand | 210W 85% | Win10 DG Win7 Pro 64 | 3-year, Onsite | 07/17 |
| 10MB0020US | US | AMD PRO A12-8870 | No | AMD R7 Graphics | None | 4GBx1 | 500GB 7200rpm 3.5" | DVD±RW | None | None | None | None | None | None | 1.5Wx1 | None | USB / USB | Floor Stand | 210W 85% | Win10 DG Win7 Pro 64 | 3-year, Onsite | 07/17 |
| 10MB0021US | US | AMD PRO A10-8770 | No | AMD R7 Graphics | None | 8GBx1 | 256GB SSD M.2 PCIe NVMe Opal | DVD±RW | None | RTL8821AE ac, 1x1 + BT4.0 | None | None | None | None | 1.5Wx1 | None | USB / USB | Floor Stand | 210W 85% | Win10 DG Win7 Pro 64 | 3-year, Onsite | 07/17 |
| 10MB0022US | US | AMD PRO A6-8570 | No | AMD R5 Graphics | None | 4GBx1 | 500GB 7200rpm 3.5" | DVD±RW | None | None | None | None | None | None | 1.5Wx1 | None | USB / USB | Floor Stand | 210W 85% | Win10 DG Win7 Pro 64 | 3-year, Onsite | 07/17 |
| 10MB0023US | US | AMD PRO A6-8570 | No | AMD R5 Graphics | None | 4GBx1 | 1TB 7200rpm 3.5" | DVD±RW | None | RTL8821AE ac, 1x1 + BT4.0 | None | None | None | None | 1.5Wx1 | None | USB / USB | Floor Stand | 210W 85% | Win10 DG Win7 Pro 64 | 3-year, Onsite | 07/17 |
| 10MB0024US | US | AMD PRO A12-8870 | No | AMD R7 Graphics | None | 8GBx1 | 1TB 7200rpm 3.5" | DVD±RW | None | RTL8821AE ac, 1x1 + BT4.0 | None | None | None | None | 1.5Wx1 | None | USB / USB | Floor Stand | 210W 85% | Win10 DG Win7 Pro 64 | 3-year, Onsite | 07/17 |
| 10MB0025US | US | AMD PRO A10-8770 | No | AMD R7 Graphics | None | 4GBx1 | 1TB 7200rpm 3.5" | DVD±RW | None | RTL8821AE ac, 1x1 + BT4.0 | None | None | None | None | 1.5Wx1 | None | USB / USB | Floor Stand | 210W 85% | Win10 DG Win7 Pro 64 | 3-year, Onsite | 07/17 |
| 10MB0026US | US | AMD PRO A12-8870 | No | AMD R7 Graphics | None | 8GBx1 | 256GB SSD M.2 PCIe NVMe Opal | DVD±RW | None | None | None | None | None | None | 1.5Wx1 | None | USB / USB | Floor Stand | 210W 85% | Win10 DG Win7 Pro 64 | 3-year, Onsite | 07/17 |
| 10MB0027US | US | AMD PRO A10-8770 | No | AMD R7 Graphics | None | 8GBx1 | 1TB 7200rpm 3.5" | DVD±RW | None | None | None | None | None | None | 1.5Wx1 | None | USB / USB | Floor Stand | 210W 85% | Win10 DG Win7 Pro 64 | 3-year, Onsite | 07/17 |
| 10MB0028US | US | AMD PRO A10-8770 | No | AMD R7 Graphics | None | 8GBx1 | 256GB SSD M.2 PCIe NVMe Opal | DVD±RW | None | None | None | None | None | None | 1.5Wx1 | None | USB / USB | Floor Stand | 210W 85% | Win10 DG Win7 Pro 64 | 3-year, Onsite | 07/17 |
| 10MB0029US | US | AMD PRO A6-8570 | No | AMD R5 Graphics | None | 4GBx1 | 1TB 7200rpm 3.5" | DVD±RW | None | None | None | None | None | None | 1.5Wx1 | None | USB / USB | Floor Stand | 210W 85% | Win10 DG Win7 Pro 64 | 3-year, Onsite | 07/17 |
| 10MB002AUS | US | AMD PRO A12-8870 | No | AMD R7 Graphics | None | 8GBx1 | 1TB 7200rpm 3.5" | DVD±RW | None | None | None | None | None | None | 1.5Wx1 | None | USB / USB | Floor Stand | 210W 85% | Win10 DG Win7 Pro 64 | 3-year, Onsite | 07/17 |
| 10MB002BUS | US | AMD PRO A10-8770 | No | AMD R7 Graphics | None | 4GBx1 | 1TB 7200rpm 3.5" | DVD±RW | None | None | None | None | None | None | 1.5Wx1 | None | USB / USB | Floor Stand | 210W 85% | Win10 DG Win7 Pro 64 | 3-year, Onsite | 07/17 |
| 10MB002CUS | US | AMD PRO A12-8870 | No | AMD R7 Graphics | None | 8GBx1 | 256GB SSD M.2 PCIe NVMe Opal | DVD±RW | None | RTL8821AE ac, 1x1 + BT4.0 | None | None | None | None | 1.5Wx1 | None | USB / USB | Floor Stand | 210W 85% | Win10 DG Win7 Pro 64 | 3-year, Onsite | 07/17 |
| 10MB002DUS | US | AMD PRO A10-9700 | No | AMD R7 Graphics | None | 4GBx1 | 1TB 7200rpm 3.5" | DVD±RW | None | RTL8821AE ac, 1x1 + BT4.0 | None | None | None | None | 1.5Wx1 | None | USB / USB | Floor Stand | 210W 85% | Win10 Pro 64 | 3-year, Onsite | 06/17 |
| 10MB002EUS | US | AMD PRO A10-9700 | No | AMD R7 Graphics | None | 8GBx1 | 256GB SSD M.2 PCIe NVMe Opal | DVD±RW | None | RTL8821AE ac, 1x1 + BT4.0 | None | None | None | None | 1.5Wx1 | None | USB / USB | Floor Stand | 210W 85% | Win10 Pro 64 | 3-year, Onsite | 07/17 |

| Model | Region | Processor | vPro | Graphics | Monitor Cable | Memory | Storage(HDD/SSD) | Optical | Media Reader | WLAN + Bluetooth | Optional Front Ports | Optional Rear Ports | Chassis Intrusion Switch | Cable Lock | Speaker | Dust Filter | Keyboard / Mouse | Stand | Power Supply | Operating System | Warranty | Ann Date (mm/yy) |
|------------|--------|----------------------|------|-----------------|---------------|--------|------------------------------|---------|--------------|---------------------------|----------------------|---------------------|--------------------------|------------|---------|-------------|------------------|-------------|--------------|------------------|----------------|------------------|
| 10MB002FUS | US | AMD PRO A8-9600 | No | AMD R7 Graphics | None | 4GBx1 | 1TB 7200rpm 3.5" | DVD±RW | None | RTL8821Ae ac, 1x1 + BT4.0 | None | None | None | None | 1.5Wx1 | None | USB / USB | Floor Stand | 210W 85% | Win10 Pro 64 | 3-year, Onsite | 06/17 |
| 10MB002GUS | US | AMD PRO A8-9600 | No | AMD R7 Graphics | None | 8GBx1 | 1TB 7200rpm 3.5" | DVD±RW | None | RTL8821Ae ac, 1x1 + BT4.0 | None | None | None | None | 1.5Wx1 | None | USB / USB | Floor Stand | 210W 85% | Win10 Pro 64 | 3-year, Onsite | 06/17 |
| 10MB002HUS | US | AMD PRO A12-9800 | No | AMD R7 Graphics | None | 8GBx1 | 1TB 7200rpm 3.5" | DVD±RW | None | RTL8821Ae ac, 1x1 + BT4.0 | None | None | None | None | 1.5Wx1 | None | USB / USB | Floor Stand | 210W 85% | Win10 Pro 64 | 3-year, Onsite | 06/17 |
| 10MB002JUS | US | AMD PRO A10-9700 | No | AMD R7 Graphics | None | 8GBx1 | 1TB 7200rpm 3.5" | DVD±RW | None | RTL8821Ae ac, 1x1 + BT4.0 | None | None | None | None | 1.5Wx1 | None | USB / USB | Floor Stand | 210W 85% | Win10 Pro 64 | 3-year, Onsite | 06/17 |
| 10MB002KUS | US | AMD PRO A12-9800 | No | AMD R7 Graphics | None | 8GBx1 | 256GB SSD M.2 PCIe NVMe Opal | DVD±RW | None | RTL8821Ae ac, 1x1 + BT4.0 | None | None | None | None | 1.5Wx1 | None | USB / USB | Floor Stand | 210W 85% | Win10 Pro 64 | 3-year, Onsite | 06/17 |
| 10MB002LUS | US | AMD PRO A8-9600 | No | AMD R7 Graphics | None | 8GBx1 | 128GB SSD M.2 PCIe NVMe | DVD±RW | None | RTL8821Ae ac, 1x1 + BT4.0 | None | None | None | None | 1.5Wx1 | None | USB / USB | Floor Stand | 210W 85% | Win10 Pro 64 | 3-year, Onsite | 06/17 |
| 10MB002MUS | US | AMD PRO A6-9500 | No | AMD R5 Graphics | None | 4GBx1 | 1TB 7200rpm 3.5" | DVD±RW | None | RTL8821Ae ac, 1x1 + BT4.0 | None | None | None | None | 1.5Wx1 | None | USB / USB | Floor Stand | 210W 85% | Win10 Pro 64 | 3-year, Onsite | 06/17 |
| 10MB002PUS | US | AMD Ryzen 5 PRO 1500 | No | GT 730 2GB | None | 8GBx1 | 1TB 7200rpm 3.5" | DVD±RW | None | None | None | None | None | None | 1.5Wx1 | None | USB / USB | Floor Stand | 210W 85% | Win10 Pro 64 | 3-year, Onsite | 07/17 |
| 10MB002QUS | US | AMD Ryzen 5 PRO 1500 | No | GT 730 2GB | None | 8GBx1 | 128GB SSD M.2 PCIe NVMe | DVD±RW | None | None | None | None | None | None | 1.5Wx1 | None | USB / USB | Floor Stand | 210W 85% | Win10 Pro 64 | 3-year, Onsite | 07/17 |
| 10MB002RUS | US | AMD Ryzen 5 PRO 1500 | No | GT 730 2GB | None | 8GBx1 | 1TB 7200rpm 3.5" | DVD±RW | None | RTL8821Ae ac, 1x1 + BT4.0 | None | None | None | None | 1.5Wx1 | None | USB / USB | Floor Stand | 210W 85% | Win10 Pro 64 | 3-year, Onsite | 07/17 |
| 10MB002SUS | US | AMD Ryzen 3 PRO 1200 | No | GT 730 2GB | None | 8GBx1 | 256GB SSD M.2 PCIe NVMe Opal | DVD±RW | None | None | None | None | None | None | 1.5Wx1 | None | USB / USB | Floor Stand | 210W 85% | Win10 Pro 64 | 3-year, Onsite | 07/17 |
| 10MB002TUS | US | AMD Ryzen 3 PRO 1200 | No | GT 730 2GB | None | 4GBx1 | 1TB 7200rpm 3.5" | DVD±RW | None | RTL8821Ae ac, 1x1 + BT4.0 | None | None | None | None | 1.5Wx1 | None | USB / USB | Floor Stand | 210W 85% | Win10 Pro 64 | 3-year, Onsite | 07/17 |
| 10MB002UUS | US | AMD Ryzen 3 PRO 1200 | No | GT 730 2GB | None | 4GBx1 | 128GB SSD | DVD±RW | None | None | None | None | None | None | 1.5Wx1 | None | USB / USB | Floor Stand | 210W 85% | Win10 Pro 64 | 3-year, Onsite | 07/17 |
| 10MB002VUS | US | AMD Ryzen 3 PRO 1200 | No | GT 730 2GB | None | 8GBx1 | 128GB SSD M.2 PCIe NVMe | DVD±RW | None | None | None | None | None | None | 1.5Wx1 | None | USB / USB | Floor Stand | 210W 85% | Win10 Pro 64 | 3-year, Onsite | 07/17 |
| 10MB002WUS | US | AMD Ryzen 5 PRO 1500 | No | GT 730 2GB | None | 8GBx1 | 128GB SSD | DVD±RW | None | None | None | None | None | None | 1.5Wx1 | None | USB / USB | Floor Stand | 210W 85% | Win10 Pro 64 | 3-year, Onsite | 07/17 |
| 10MB002XUS | US | AMD Ryzen 7 PRO 1700 | No | GT 730 2GB | None | 8GBx1 | 1TB 7200rpm 3.5" | DVD±RW | None | RTL8821Ae ac, 1x1 + BT4.0 | None | None | None | None | 1.5Wx1 | None | USB / USB | Floor Stand | 210W 85% | Win10 Pro 64 | 3-year, Onsite | 07/17 |
| 10MB002YUS | US | AMD Ryzen 5 PRO 1500 | No | GT 730 2GB | None | 4GBx1 | 500GB 7200rpm 3.5" | DVD±RW | None | RTL8821Ae ac, 1x1 + BT4.0 | None | None | None | None | 1.5Wx1 | None | USB / USB | Floor Stand | 210W 85% | Win10 Pro 64 | 3-year, Onsite | 07/17 |
| 10MB0030US | US | AMD Ryzen 5 PRO 1500 | No | GT 730 2GB | None | 8GBx1 | 512GB SSD M.2 PCIe NVMe Opal | DVD±RW | None | None | None | None | None | None | 1.5Wx1 | None | USB / USB | Floor Stand | 210W 85% | Win10 Pro 64 | 3-year, Onsite | 07/17 |
| 10MB0031US | US | AMD Ryzen 3 PRO 1200 | No | GT 730 2GB | None | 8GBx1 | 256GB SSD M.2 PCIe NVMe Opal | DVD±RW | None | RTL8821Ae ac, 1x1 + BT4.0 | None | None | None | None | 1.5Wx1 | None | USB / USB | Floor Stand | 210W 85% | Win10 Pro 64 | 3-year, Onsite | 07/17 |
| 10MB0032US | US | AMD Ryzen 5 PRO 1500 | No | GT 730 2GB | None | 8GBx1 | 256GB SSD M.2 PCIe NVMe Opal | DVD±RW | None | None | None | None | None | None | 1.5Wx1 | None | USB / USB | Floor Stand | 210W 85% | Win10 Pro 64 | 3-year, Onsite | 07/17 |

| Model | Region | Processor | vPro | Graphics | Monitor Cable | Memory | Storage(HDD/SSD) | Optical | Media Reader | WLAN + Bluetooth | Optional Front Ports | Optional Rear Ports | Chassis Intrusion Switch | Cable Lock | Speaker | Dust Filter | Keyboard / Mouse | Stand | Power Supply | Operating System | Warranty | Ann Date (mm/yy) |
|------------|--------|----------------------|------|------------|---------------|--------|------------------------------|---------|--------------|---------------------------|----------------------|---------------------|--------------------------|------------|---------|-------------|------------------|-------------|--------------|------------------|----------------|------------------|
| 10MB0033US | US | AMD Ryzen 7 PRO 1700 | No | GT 730 2GB | None | 8GBx1 | 1TB 7200rpm 3.5" | DVD±RW | None | None | None | None | None | None | 1.5Wx1 | None | USB / USB | Floor Stand | 210W 85% | Win10 Pro 64 | 3-year, Onsite | 07/17 |
| 10MB0034US | US | AMD Ryzen 5 PRO 1500 | No | GT 730 2GB | None | 4GBx1 | 500GB 7200rpm 3.5" | DVD±RW | None | None | None | None | None | None | 1.5Wx1 | None | USB / USB | Floor Stand | 210W 85% | Win10 Pro 64 | 3-year, Onsite | 07/17 |
| 10MB0035US | US | AMD Ryzen 3 PRO 1200 | No | GT 730 2GB | None | 8GBx1 | 1TB 7200rpm 3.5" | DVD±RW | None | None | None | None | None | None | 1.5Wx1 | None | USB / USB | Floor Stand | 210W 85% | Win10 Pro 64 | 3-year, Onsite | 07/17 |
| 10MB0036US | US | AMD Ryzen 3 PRO 1200 | No | GT 730 2GB | None | 8GBx1 | 128GB SSD | DVD±RW | None | None | None | None | None | None | 1.5Wx1 | None | USB / USB | Floor Stand | 210W 85% | Win10 Pro 64 | 3-year, Onsite | 07/17 |
| 10MB0037US | US | AMD Ryzen 7 PRO 1700 | No | GT 730 2GB | None | 8GBx1 | 256GB SSD M.2 PCIe NVMe Opal | DVD±RW | None | None | None | None | None | None | 1.5Wx1 | None | USB / USB | Floor Stand | 210W 85% | Win10 Pro 64 | 3-year, Onsite | 07/17 |
| 10MB0038US | US | AMD Ryzen 3 PRO 1200 | No | GT 730 2GB | None | 4GBx1 | 500GB 7200rpm 3.5" | DVD±RW | None | None | None | None | None | None | 1.5Wx1 | None | USB / USB | Floor Stand | 210W 85% | Win10 Pro 64 | 3-year, Onsite | 07/17 |
| 10MB0039US | US | AMD Ryzen 5 PRO 1500 | No | GT 730 2GB | None | 4GBx1 | 128GB SSD M.2 PCIe NVMe | DVD±RW | None | None | None | None | None | None | 1.5Wx1 | None | USB / USB | Floor Stand | 210W 85% | Win10 Pro 64 | 3-year, Onsite | 07/17 |
| 10MB003AUS | US | AMD Ryzen 7 PRO 1700 | No | GT 730 2GB | None | 8GBx1 | 256GB SSD M.2 PCIe NVMe Opal | DVD±RW | None | RTL8821AE ac, 1x1 + BT4.0 | None | None | None | None | 1.5Wx1 | None | USB / USB | Floor Stand | 210W 85% | Win10 Pro 64 | 3-year, Onsite | 07/17 |
| 10MB003BUS | US | AMD Ryzen 3 PRO 1200 | No | GT 730 2GB | None | 4GBx1 | 1TB 7200rpm 3.5" | DVD±RW | None | None | None | None | None | None | 1.5Wx1 | None | USB / USB | Floor Stand | 210W 85% | Win10 Pro 64 | 3-year, Onsite | 07/17 |
| 10MB003CUS | US | AMD Ryzen 5 PRO 1500 | No | GT 730 2GB | None | 4GBx1 | 128GB SSD | DVD±RW | None | None | None | None | None | None | 1.5Wx1 | None | USB / USB | Floor Stand | 210W 85% | Win10 Pro 64 | 3-year, Onsite | 07/17 |
| 10MB003DUS | US | AMD Ryzen 5 PRO 1500 | No | GT 730 2GB | None | 8GBx1 | 256GB SSD M.2 PCIe NVMe Opal | DVD±RW | None | RTL8821AE ac, 1x1 + BT4.0 | None | None | None | None | 1.5Wx1 | None | USB / USB | Floor Stand | 210W 85% | Win10 Pro 64 | 3-year, Onsite | 07/17 |
| 10MB003EUS | US | AMD Ryzen 3 PRO 1200 | No | GT 730 2GB | None | 4GBx1 | 128GB SSD M.2 PCIe NVMe | DVD±RW | None | RTL8821AE ac, 1x1 + BT4.0 | None | None | None | None | 1.5Wx1 | None | USB / USB | Floor Stand | 210W 85% | Win10 Pro 64 | 3-year, Onsite | 07/17 |
| 10MB003FUS | US | AMD Ryzen 3 PRO 1200 | No | GT 730 2GB | None | 4GBx1 | 128GB SSD M.2 PCIe NVMe | DVD±RW | None | None | None | None | None | None | 1.5Wx1 | None | USB / USB | Floor Stand | 210W 85% | Win10 Pro 64 | 3-year, Onsite | 07/17 |
| 10MB003GUS | US | AMD Ryzen 7 PRO 1700 | No | GT 730 2GB | None | 8GBx1 | 512GB SSD M.2 PCIe NVMe Opal | DVD±RW | None | None | None | None | None | None | 1.5Wx1 | None | USB / USB | Floor Stand | 210W 85% | Win10 Pro 64 | 3-year, Onsite | 07/17 |
| 10MB003HUS | US | AMD Ryzen 3 PRO 1200 | No | GT 730 2GB | None | 8GBx1 | 1TB 7200rpm 3.5" | DVD±RW | None | RTL8821AE ac, 1x1 + BT4.0 | None | None | None | None | 1.5Wx1 | None | USB / USB | Floor Stand | 210W 85% | Win10 Pro 64 | 3-year, Onsite | 07/17 |



ThinkCentre M715 Tiny Platform Specifications

Product Specifications Reference (PSREF)

| | | | | | | | | | |
|---------------------------|--|---------------|---|-----------|------------------|---------------------|--|---|--|
| Processor | AMD A6, A10, or A12 series APUs | | | | | | Keyboard | <i>Some:</i> Fullsize USB Keyboard (USB connector), Lenovo logo <i>Some:</i> Lenovo New Slim USB Keyboard (USB connector), black, Lenovo logo <i>Some:</i> USB Optical Wheel Mouse, black, Lenovo logo | |
| | APU | Cores | Frequency Base/Max | L2 Cache | Memory Types | Integrated Graphics | Mouse | | |
| | PRO A6-9500E | 2 | 3.0 / 3.4 GHz | 1 MB | DDR4-2400 | Radeon R5 Series | Mechanical | Tiny (1L), black color; metal case M715 Tiny only: 7.05" W X 7.20" D X 1.36" H 179mm W X 182.9mm D X 34.5mm H 2.9 lb (1.3 kg), weight may vary by configuration With VESA mount & ODD box: 7.42" W X 7.30" D X 2.48" H 188.4mm W X 185.38mm D X 63mm H 4.12 lb (1.87 kg), weight may vary by configuration With VESA mount & I/O box: 7.42" W X 7.30" D X 2.62" H 188.4mm W X 185.38mm D X 66.6mm H 3.53 lb (1.6 kg), weight may vary by configuration Optional VESA mount bracket kit, supports VESA 75mm and 100mm Optional system floor stand for vertical orientation | |
| | PRO A10-9700E | 4 | 3.0 / 3.5 GHz | 2 MB | DDR4-2400 | Radeon R7 Series | VESA mount | | |
| | PRO A12-9800E | 4 | 3.1 / 3.8 GHz | 2 MB | DDR4-2400 | Radeon R7 Series | Floor Stand | | |
| | PRO A6-8570E | 2 | 3.0 / 3.4 GHz | 1 MB | DDR4-2400 | Radeon R5 Series | Power supply | 65 watts AC/DC adapter, autosensing, 88% PSU (not included for TIO models) 90 watts AC/DC adapter, autosensing, 88% PSU (only for models with I/O box) | |
| | PRO A10-8770E | 4 | 2.8 / 3.5 GHz | 2 MB | DDR4-2400 | Radeon R7 Series | Limited warranty ³ | <i>Some:</i> 1-year or 3-year, depot service / service upgrades available <i>Some:</i> 1-year or 3-year, limited onsite service / service upgrades available | |
| PRO A12-8870E | 4 | 2.9 / 3.8 GHz | 2 MB | DDR4-2400 | Radeon R7 Series | Preload | Preloaded operating system <i>Some:</i> Windows 10 Pro 64-bit <i>Some:</i> Windows 10 Home 64-bit Preloaded applications (only some listed) <ul style="list-style-type: none"> Lenovo Companion Lenovo ID Lenovo ThinkVantage Tools Microsoft Office preloaded; purchase a product key to activate Cyberlink PowerDVD (DVD, DVD±RW) PowerDVD Create (DVD±RW) Preloaded operating system <i>Some:</i> Windows® 7 Professional 64 preinstalled through downgrade rights in Windows 10 Pro 64-bit Preloaded applications (only some listed) <ul style="list-style-type: none"> Lenovo Solution Center ThinkVantage System Update Lenovo Display Manager Create Recovery Media Lenovo ThinkVantage Tools Cyberlink PowerDVD (DVD, DVD±RW) PowerDVD Create (DVD±RW) Microsoft Office preloaded; purchase a product key to activate Adobe® Reader® | | |
| Memory | 32GB max, DDR4 2400, two 260-pin SO-DIMM sockets, dual-channel capable *16GB single SO-DIMM is only available via special bid models | | | | | | | | |
| Disk | <i>Some:</i> SATA 6.0Gb/s, 2.5" Wide, 5400 rpm or 7200 rpm <i>Some:</i> M.2 Solid State Drive (SSD) / PCIe interface, NVMe <i>Some:</i> DVD-ROM, 9.0mm high, via USB external ODD box <i>Some:</i> DVD±RW, 9.0mm high, via USB external ODD box | | | | | | | | |
| Optical | One SATA cable (1-drop to device), one SATA 6.0Gb/s connector on planar | | | | | | | | |
| Onboard SATA Media reader | None | | | | | | | | |
| Graphics | AMD Radeon™ Graphics in processor, uses main memory, DirectX® 12, two DisplayPort™, one optional port (HDMI, VGA, or 3rd DP), supports 3 independent displays (supports maximum of 2 concurrent HDMI/DVI displays when using HDMI port or DP to DVI/HDMI dongles); <i>Max resolution:</i> 4096x2160 (DP)@60Hz; 4096x2160 (HDMI)@60Hz; 1920x1200 (VGA)@60Hz | | | | | | | | |
| DP cable | Optional DP to VGA, DP to DVI-D (single link), or DP to HDMI 1.4 dongle | | | | | | | | |
| Chipset | AMD B300 Chipset | | | | | | | | |
| Front ports | Two USB 3.0 (one is Always On and fast charge), one microphone (stereo, 3.5mm), one headphone / microphone combo jack (stereo, 3.5mm) | | | | | | | | |
| Rear ports | One USB 3.0 and three USB 2.0 (optional external optical box or I/O box occupies one specific USB 2.0 on some models), ethernet (RJ-45), two DisplayPort, one optional port (VGA, 3rd DP, HDMI, or serial on some models), one headphone | | | | | | | | |
| I/O box | Optional external I/O box, extends four USB 2.0 (two on front and two on rear), one serial, and two PS/2, via USB port (occupy one specific USB 2.0 of M715q Tiny) | | | | | | | | |
| Audio support | High Definition (HD) Audio, Realtek ALC233-CG / internal speaker (1.5 watt) | | | | | | | | |
| WLAN ¹³ | <i>Some:</i> 11ac wireless, M.2 Card, Realtek RTL8821AE (dual band), Wi-Fi + Bluetooth 4.0 combo adapter, 1x1 <i>Some:</i> 11ac wireless, M.2 Card, Realtek RTL8822BE (dual band), Wi-Fi + Bluetooth 4.1 combo adapter, 2x2 <i>Some:</i> 11ac wireless, M.2 Card, Qualcomm Atheros QCA9377 (dual band), Wi-Fi + Bluetooth 4.1 combo adapter, 1x1 | | | | | | | | |
| Bluetooth™ | <i>Some:</i> Bluetooth 4.0 or 4.1 wireless, integrated in Wi-Fi + BT combo adapter | | | | | | | | |
| Ethernet Modem | Gigabit ethernet, Realtek RTL8111EPV, Wake on LAN® None | | | | | | | | |
| Manageability | DASH 1.0/1.1 | | | | | | | | |
| Security chip | Discrete TPM 2.0, TCG Certified | | | | | | | | |
| Security features | <ul style="list-style-type: none"> Security slot (in rear for optional Kensington® MicroSaver® cable) Padlock loop Smart USB protection, allows keyboard/ mouse only, blocks all storage devices Power-on password | | <ul style="list-style-type: none"> Administrator password Hard disk password Boot sequence control Boot without keyboard and mouse Individual USB port disablement Chassis intrusion switch | | | | | | |
| Environment | ENERGY STAR® 6.1*, EPEAT™ Gold rating* (*for Windows models only); ErP Lot 3; GREENGUARD®; RoHS-compliant | | | | | | | | |
| Accessories | For compatible accessories, please go to http://www.lenovoquickpick.com | | | | | | | | |

See footnotes for more detailed information

(M715 Tiny-Spec) May 2017 © Lenovo

| Model | Region | Processor | vPro | Graphics | Monitor Cable | Memory | Storage(HDD/SSD) | External Optical / I/O Box | WLAN + Bluetooth | Optional Rear Ports | Speaker | Adapter Cage | Toolless Chassis Screw | Dust Filter | Keyboard / Mouse | VESA Mount | Stand | Power Supply | OS | Warranty | Ann Date (m/y) |
|------------|--------|-------------------|------|-----------------|---------------|--------|-------------------------|----------------------------|---------------------------|---------------------|---------|--------------|------------------------|-------------|------------------|------------|-------------|-----------------|----------------------|----------------|----------------|
| 10M30001US | US | AMD PRO A6-9500E | No | AMD R5 Graphics | None | 4GBx1 | 500GB 7200rpm 2.5" | None | RTL8821AE ac, 1x1 + BT4.0 | None | 1Wx1 | None | None | None | USB / USB | None | Floor Stand | 65W Adapter 88% | Win10 Pro 64 | 3-year, Onsite | 11/16 |
| 10M30002US | US | AMD PRO A10-9700E | No | AMD R7 Graphics | None | 4GBx1 | 500GB 7200rpm 2.5" | None | RTL8821AE ac, 1x1 + BT4.0 | Serial | 1Wx1 | None | None | None | USB / USB | None | Floor Stand | 65W Adapter 88% | Win10 Pro 64 | 3-year, Onsite | 10/16 |
| 10M30003US | US | AMD A10-9700E | No | AMD R7 Graphics | None | 4GBx1 | 500GB 7200rpm 2.5" | None | RTL8821AE ac, 1x1 + BT4.0 | VGA | 1Wx1 | None | None | None | USB / USB | None | Floor Stand | 65W Adapter 88% | Win10 Pro 64 | 3-year, Onsite | 10/16 |
| 10M30004US | US | AMD A10-9700E | No | AMD R7 Graphics | None | 4GBx1 | 500GB 7200rpm 2.5" | None | RTL8821AE ac, 1x1 + BT4.0 | 3rd DP | 1Wx1 | None | None | None | USB / USB | None | Floor Stand | 65W Adapter 88% | Win10 Pro 64 | 3-year, Onsite | 10/16 |
| 10M30005US | US | AMD PRO A12-9800E | No | AMD R7 Graphics | None | 4GBx1 | 500GB 7200rpm 2.5" | None | RTL8821AE ac, 1x1 + BT4.0 | 3rd DP | 1Wx1 | None | None | None | USB / USB | None | Floor Stand | 65W Adapter 88% | Win10 Pro 64 | 3-year, Onsite | 10/16 |
| 10M30006US | US | AMD PRO A10-9700E | No | AMD R7 Graphics | None | 8GBx1 | 128GB SSD M.2 PCIe NVMe | None | RTL8821AE ac, 1x1 + BT4.0 | 3rd DP | 1Wx1 | None | None | None | USB / USB | None | Floor Stand | 65W Adapter 88% | Win10 Pro 64 | 3-year, Onsite | 10/16 |
| 10M30007US | US | AMD PRO A6-9500E | No | AMD R5 Graphics | None | 4GBx1 | 500GB 7200rpm 2.5" | None | RTL8821AE ac, 1x1 + BT4.0 | None | 1Wx1 | None | None | None | USB / USB | None | Floor Stand | 65W Adapter 88% | Win10 Pro 64 | 3-year, Onsite | 10/16 |
| 10M30008US | US | AMD PRO A10-9700E | No | AMD R7 Graphics | None | 8GBx1 | 500GB 7200rpm 2.5" | None | RTL8821AE ac, 1x1 + BT4.0 | None | 1Wx1 | None | None | None | USB / USB | None | Floor Stand | 65W Adapter 88% | Win10 Pro 64 | 3-year, Onsite | 10/16 |
| 10M30009US | US | AMD PRO A12-9800E | No | AMD R7 Graphics | None | 8GBx1 | 128GB SSD M.2 PCIe NVMe | None | RTL8821AE ac, 1x1 + BT4.0 | 3rd DP | 1Wx1 | None | None | None | USB / USB | None | Floor Stand | 65W Adapter 88% | Win10 Pro 64 | 3-year, Onsite | 10/16 |
| 10M3000AUS | US | AMD PRO A12-9800E | No | AMD R7 Graphics | None | 4GBx1 | 128GB SSD M.2 PCIe NVMe | None | RTL8821AE ac, 1x1 + BT4.0 | None | 1Wx1 | None | None | None | USB / USB | None | Floor Stand | 65W Adapter 88% | Win10 Pro 64 | 3-year, Onsite | 10/16 |
| 10M3000BUS | US | AMD A10-9700E | No | AMD R7 Graphics | None | 4GBx1 | 500GB 7200rpm 2.5" | None | RTL8821AE ac, 1x1 + BT4.0 | None | 1Wx1 | None | None | None | USB / USB | None | Floor Stand | 65W Adapter 88% | Win10 Pro 64 | 3-year, Onsite | 10/16 |
| 10M3000CUS | US | AMD PRO A10-9700E | No | AMD R7 Graphics | None | 4GBx1 | 128GB SSD M.2 PCIe NVMe | None | RTL8821AE ac, 1x1 + BT4.0 | 3rd DP | 1Wx1 | None | None | None | USB / USB | None | Floor Stand | 65W Adapter 88% | Win10 Pro 64 | 3-year, Onsite | 10/16 |
| 10M3000DUS | US | AMD PRO A10-9700E | No | AMD R7 Graphics | None | 4GBx1 | 500GB 7200rpm 2.5" | DVD±RW | RTL8821AE ac, 1x1 + BT4.0 | HDMI | 1Wx1 | None | None | None | USB / USB | VESA Mount | None | 65W Adapter 88% | Win10 Pro 64 | 3-year, Onsite | 10/16 |
| 10M3000NUS | US | AMD PRO A12-8870E | No | AMD R7 Graphics | None | 8GBx2 | 512GB SSD M.2 PCIe NVMe | None | RTL8821AE ac, 1x1 + BT4.0 | None | 1Wx1 | None | None | None | USB / USB | None | Floor Stand | 65W Adapter 88% | Win10 DG Win7 Pro 64 | 3-year, Onsite | 01/17 |
| 10M3000PUS | US | AMD PRO A12-9800E | No | AMD R7 Graphics | None | 8GBx2 | 512GB SSD M.2 PCIe NVMe | None | RTL8821AE ac, 1x1 + BT4.0 | None | 1Wx1 | None | None | None | USB / USB | None | Floor Stand | 65W Adapter 88% | Win10 Pro 64 | 3-year, Onsite | 01/17 |
| 10M3000QUS | US | AMD PRO A10-8770E | No | AMD R7 Graphics | None | 8GBx1 | 256GB SSD M.2 PCIe NVMe | None | RTL8821AE ac, 1x1 + BT4.0 | None | 1Wx1 | None | None | None | USB / USB | None | Floor Stand | 65W Adapter 88% | Win10 DG Win7 Pro 64 | 3-year, Onsite | 01/17 |
| 10M3000RUS | US | AMD PRO A10-8770E | No | AMD R7 Graphics | None | 8GBx1 | 500GB 7200rpm 2.5" | None | RTL8821AE ac, 1x1 + BT4.0 | None | 1Wx1 | None | None | None | USB / USB | None | Floor Stand | 65W Adapter 88% | Win10 DG Win7 Pro 64 | 3-year, Onsite | 01/17 |
| 10M3000SUS | US | AMD PRO A10-8770E | No | AMD R7 Graphics | None | 8GBx1 | 500GB 7200rpm 2.5" | DVD±RW | RTL8821AE ac, 1x1 + BT4.0 | 3rd DP | 1Wx1 | None | None | None | USB / USB | VESA Mount | None | 65W Adapter 88% | Win10 DG Win7 Pro 64 | 3-year, Onsite | 01/17 |
| 10M3000TUS | US | AMD PRO A10-8770E | No | AMD R7 Graphics | None | 4GBx1 | 500GB 7200rpm 2.5" | None | RTL8821AE ac, 1x1 + BT4.0 | None | 1Wx1 | None | None | None | USB / USB | None | Floor Stand | 65W Adapter 88% | Win10 DG Win7 Pro 64 | 3-year, Onsite | 01/17 |

| Model | Region | Processor | vPro | Graphics | Monitor Cable | Memory | Storage(HDD/SSD) | External Optical / I/O Box | WLAN + Bluetooth | Optional Rear Ports | Speaker | Adapter Cage | Toolless Chassis Screw | Dust Filter | Keyboard / Mouse | VESA Mount | Stand | Power Supply | OS | Warranty | Ann Date (m/y) |
|------------|--------|-------------------|------|-----------------|---------------|--------|-------------------------|----------------------------|---------------------------|---------------------|---------|--------------|------------------------|-------------|------------------|------------|-------------|-----------------|----------------------|----------------|----------------|
| 10M3000UUS | US | AMD PRO A10-8770E | No | AMD R7 Graphics | None | 8GBx1 | 128GB SSD M.2 PCIe NVMe | None | RTL8821AE ac, 1x1 + BT4.0 | 3rd DP | 1Wx1 | None | None | None | USB / USB | None | Floor Stand | 65W Adapter 88% | Win10 DG Win7 Pro 64 | 3-year, Onsite | 01/17 |
| 10M3000VUS | US | AMD PRO A10-8770E | No | AMD R7 Graphics | None | 8GBx1 | 256GB SSD M.2 PCIe NVMe | None | RTL8821AE ac, 1x1 + BT4.0 | 3rd DP | 1Wx1 | None | None | None | USB / USB | None | Floor Stand | 65W Adapter 88% | Win10 DG Win7 Pro 64 | 3-year, Onsite | 01/17 |
| 10M3000WUS | US | AMD PRO A10-9700E | No | AMD R7 Graphics | None | 8GBx1 | 256GB SSD M.2 PCIe NVMe | None | RTL8821AE ac, 1x1 + BT4.0 | None | 1Wx1 | None | None | None | USB / USB | None | Floor Stand | 65W Adapter 88% | Win10 Pro 64 | 3-year, Onsite | 01/17 |
| 10M3000XUS | US | AMD PRO A12-8870E | No | AMD R7 Graphics | None | 8GBx1 | 256GB SSD M.2 PCIe NVMe | None | RTL8821AE ac, 1x1 + BT4.0 | 3rd DP | 1Wx1 | None | None | None | USB / USB | None | Floor Stand | 65W Adapter 88% | Win10 DG Win7 Pro 64 | 3-year, Onsite | 01/17 |
| 10M3000YUS | US | AMD PRO A10-8770E | No | AMD R7 Graphics | None | 8GBx1 | 500GB 7200rpm 2.5" | None | RTL8821AE ac, 1x1 + BT4.0 | 3rd DP | 1Wx1 | None | None | None | USB / USB | None | Floor Stand | 65W Adapter 88% | Win10 DG Win7 Pro 64 | 3-year, Onsite | 01/17 |
| 10M30010US | US | AMD PRO A10-9700E | No | AMD R7 Graphics | None | 4GBx1 | 500GB 7200rpm 2.5" | None | RTL8821AE ac, 1x1 + BT4.0 | None | 1Wx1 | None | None | None | USB / USB | None | Floor Stand | 65W Adapter 88% | Win10 Pro 64 | 3-year, Onsite | 01/17 |
| 10M30011US | US | AMD PRO A12-8870E | No | AMD R7 Graphics | None | 8GBx1 | 128GB SSD M.2 PCIe NVMe | None | RTL8821AE ac, 1x1 + BT4.0 | None | 1Wx1 | None | None | None | USB / USB | None | Floor Stand | 65W Adapter 88% | Win10 DG Win7 Pro 64 | 3-year, Onsite | 01/17 |



ThinkCentre M79 SFF Platform Specifications

Product Specifications Reference (PSREF)

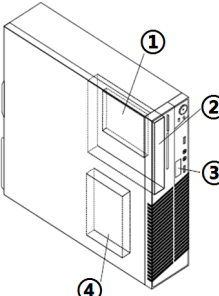
| Processor | AMD A4, A6, A8, or A10 series APUs | <ul style="list-style-type: none"> • Cable lock to physically lock both keyboard and mouse (optional) • Power-on password • Boot without keyboard and mouse • Individual USB port disablement • Optional Chassis intrusion switch | | | | | | | | | | | | | | | | | | | | | | | | | | | | | | | | | | | | | | | | | | | | | | | | | | | | | | | | | | | | | | | | | | | | | | | | |
|--------------------|--|--|----------|----------------------|---------------------|--------------|---------------------|----------|---|-----------|-----|-----------|----------|--------------|---|-----------|-----|-----------|----------|--------------|---|-----------|-----|-----------|------------------|----------|---|-----------|-----|-----------|----------|--------------|---|-----------|-----|-----------|------------------|--------------|---|-----------|-----|-----------|------------------|----------|---|-----------|-----|-----------|----------|--------------|---|-----------|-----|-----------|------------------|--------------|---|-----------|-----|-----------|------------------|---------------|---|-----------|-----|-----------|------------------|---------------|---|-----------|-----|-----------|------------------|---|
| | <table border="1"> <thead> <tr> <th>APU</th> <th>Cores</th> <th>Frequency (Max/Base)</th> <th>L2 Cache</th> <th>Memory Types</th> <th>Integrated Graphics</th> </tr> </thead> <tbody> <tr> <td>A4-6300B</td> <td>2</td> <td>3.9 / 3.7</td> <td>1MB</td> <td>DDR3-1600</td> <td>HD 8370D</td> </tr> <tr> <td>A4 PRO-7300B</td> <td>2</td> <td>4.0 / 3.8</td> <td>1MB</td> <td>DDR3-1600</td> <td>HD 8470D</td> </tr> <tr> <td>PRO A4-8350B</td> <td>2</td> <td>3.9 / 3.5</td> <td>1MB</td> <td>DDR3-1866</td> <td>Radeon R5 Series</td> </tr> <tr> <td>A6-6400B</td> <td>2</td> <td>4.1 / 3.9</td> <td>1MB</td> <td>DDR3-1866</td> <td>HD 8470D</td> </tr> <tr> <td>A6 PRO-7400B</td> <td>2</td> <td>3.9 / 3.5</td> <td>1MB</td> <td>DDR3-1866</td> <td>Radeon R5 Series</td> </tr> <tr> <td>PRO A6-8550B</td> <td>2</td> <td>4.0 / 3.7</td> <td>1MB</td> <td>DDR3-2133</td> <td>Radeon R5 Series</td> </tr> <tr> <td>A8-6500B</td> <td>4</td> <td>4.1 / 3.5</td> <td>4MB</td> <td>DDR3-1866</td> <td>HD 8570D</td> </tr> <tr> <td>A8 PRO-7600B</td> <td>4</td> <td>3.8 / 3.1</td> <td>4MB</td> <td>DDR3-2133</td> <td>Radeon R7 Series</td> </tr> <tr> <td>PRO A8-8650B</td> <td>4</td> <td>3.9 / 3.2</td> <td>4MB</td> <td>DDR3-2133</td> <td>Radeon R7 Series</td> </tr> <tr> <td>A10 PRO-7800B</td> <td>4</td> <td>3.9 / 3.5</td> <td>4MB</td> <td>DDR3-2133</td> <td>Radeon R7 Series</td> </tr> <tr> <td>PRO A10-8750B</td> <td>4</td> <td>4.0 / 3.6</td> <td>4MB</td> <td>DDR3-2133</td> <td>Radeon R7 Series</td> </tr> </tbody> </table> | APU | Cores | Frequency (Max/Base) | L2 Cache | Memory Types | Integrated Graphics | A4-6300B | 2 | 3.9 / 3.7 | 1MB | DDR3-1600 | HD 8370D | A4 PRO-7300B | 2 | 4.0 / 3.8 | 1MB | DDR3-1600 | HD 8470D | PRO A4-8350B | 2 | 3.9 / 3.5 | 1MB | DDR3-1866 | Radeon R5 Series | A6-6400B | 2 | 4.1 / 3.9 | 1MB | DDR3-1866 | HD 8470D | A6 PRO-7400B | 2 | 3.9 / 3.5 | 1MB | DDR3-1866 | Radeon R5 Series | PRO A6-8550B | 2 | 4.0 / 3.7 | 1MB | DDR3-2133 | Radeon R5 Series | A8-6500B | 4 | 4.1 / 3.5 | 4MB | DDR3-1866 | HD 8570D | A8 PRO-7600B | 4 | 3.8 / 3.1 | 4MB | DDR3-2133 | Radeon R7 Series | PRO A8-8650B | 4 | 3.9 / 3.2 | 4MB | DDR3-2133 | Radeon R7 Series | A10 PRO-7800B | 4 | 3.9 / 3.5 | 4MB | DDR3-2133 | Radeon R7 Series | PRO A10-8750B | 4 | 4.0 / 3.6 | 4MB | DDR3-2133 | Radeon R7 Series | <p>Keyboard</p> <p>Some: Preferred Pro USB Keyboard (USB connector), Lenovo logo Some: Lenovo USB Fingerprint Keyboard (USB connector) Some: Ultralim Plus Wireless Keyboard (2.4GHz via USB receiver), black</p> <p>Mouse</p> <p>Some: Enhanced Optical USB Mouse, black, Lenovo logo Some: Ultralim Plus Wireless Mouse (2.4GHz via USB receiver), black</p> <p>Mechanical</p> <ul style="list-style-type: none"> • Business black color; metal case, 11L • 13.2" W X 15.0" D X 3.9" H • 335mm W X 382mm D X 101mm H • 14.6 lb (6.6 kg) in maximum configuration Bay 1: N/A, N/A, internal, opt SSD Bay 2: 5.25", 1.6" high, external, std optical Bay 3: N/A, N/A, external, opt reader Bay 4: 3.5", 1" high, internal, std disk <p>*bay only available on models with HDD/SSD/reader installed</p> <p>Slot 1: Low Profile, PCI Express 3.0 x16 (40w max) Slot 2: Low Profile, PCIe 2.0 x1 Slot 2: Low Profile, PCIe 2.0 x1 Slot 4: Low Profile, 32-bit PCI 2.3</p> <p>Floor Stand</p> <p>Optional system floor stand for vertical orientation</p>  <p>Power supply</p> <p>Some: 180 watts, autosensing, 100-240V (50-60Hz) Some: 240 watts, autosensing, 100-240V (50-60Hz) Some: 240 watts, autosensing, 85% PSU, 100-240V (50-60Hz)</p> <p>Limited warranty³</p> <p>Some: 3-years, limited onsite service / service upgrades available Some: 3-years, limited onsite service, OID (Onsite International Delivery) / service upgrades available For Lenovo service upgrade options, please go to S-TC sheet</p> <p>Preload</p> <p>Some: Windows[®] 7 Professional 32/64 preinstalled through downgrade rights in Windows 8.1 Pro 64-bit Some: Windows 7 Professional 32 Some: Windows 7 Professional 64</p> <p>Ready to install applications (only some listed)</p> <ul style="list-style-type: none"> • Rescue and Recovery™ • Password Manager <p>Preloaded applications (only some listed)</p> <ul style="list-style-type: none"> • ThinkVantage[®] Product Recovery • ThinkVantage System Update • ThinkVantage Communication Utility • ThinkVantage Device Experience • Desktop Power Manager • View Management Utility • Lenovo Solution Center • Lenovo Message Center Plus • Norton™ Internet Security (30 days of virus definitions) • Adobe[®] Reader[®] • Skype™ • Microsoft Office preloaded; purchase a product key to activate • Cyberlink Power2Go (DVD±RW) • Cyberlink PowerProducer (DVD±RW) • Evernote[®] • Nitro Pro <p>Some: Windows 8.1 64-bit Some: Windows 8.1 Pro 64-bit Some: Windows 10 Pro 64-bit</p> <p>Preloaded applications (only some listed)</p> <ul style="list-style-type: none"> • Desktop Power Manager • Lenovo Solution Center • Lenovo Companion • Lenovo SHAREit • Lenovo REACHit • McAfee[®] LiveSafe™(30-day trial) • Microsoft Office preloaded; purchase a product key to activate • Cyberlink PowerDVD (DVD±RW, DVD) • PowerDVD Create (DVD±RW) • PC Device Stage |
| APU | Cores | Frequency (Max/Base) | L2 Cache | Memory Types | Integrated Graphics | | | | | | | | | | | | | | | | | | | | | | | | | | | | | | | | | | | | | | | | | | | | | | | | | | | | | | | | | | | | | | | | | | | | | |
| A4-6300B | 2 | 3.9 / 3.7 | 1MB | DDR3-1600 | HD 8370D | | | | | | | | | | | | | | | | | | | | | | | | | | | | | | | | | | | | | | | | | | | | | | | | | | | | | | | | | | | | | | | | | | | | | |
| A4 PRO-7300B | 2 | 4.0 / 3.8 | 1MB | DDR3-1600 | HD 8470D | | | | | | | | | | | | | | | | | | | | | | | | | | | | | | | | | | | | | | | | | | | | | | | | | | | | | | | | | | | | | | | | | | | | | |
| PRO A4-8350B | 2 | 3.9 / 3.5 | 1MB | DDR3-1866 | Radeon R5 Series | | | | | | | | | | | | | | | | | | | | | | | | | | | | | | | | | | | | | | | | | | | | | | | | | | | | | | | | | | | | | | | | | | | | | |
| A6-6400B | 2 | 4.1 / 3.9 | 1MB | DDR3-1866 | HD 8470D | | | | | | | | | | | | | | | | | | | | | | | | | | | | | | | | | | | | | | | | | | | | | | | | | | | | | | | | | | | | | | | | | | | | | |
| A6 PRO-7400B | 2 | 3.9 / 3.5 | 1MB | DDR3-1866 | Radeon R5 Series | | | | | | | | | | | | | | | | | | | | | | | | | | | | | | | | | | | | | | | | | | | | | | | | | | | | | | | | | | | | | | | | | | | | | |
| PRO A6-8550B | 2 | 4.0 / 3.7 | 1MB | DDR3-2133 | Radeon R5 Series | | | | | | | | | | | | | | | | | | | | | | | | | | | | | | | | | | | | | | | | | | | | | | | | | | | | | | | | | | | | | | | | | | | | | |
| A8-6500B | 4 | 4.1 / 3.5 | 4MB | DDR3-1866 | HD 8570D | | | | | | | | | | | | | | | | | | | | | | | | | | | | | | | | | | | | | | | | | | | | | | | | | | | | | | | | | | | | | | | | | | | | | |
| A8 PRO-7600B | 4 | 3.8 / 3.1 | 4MB | DDR3-2133 | Radeon R7 Series | | | | | | | | | | | | | | | | | | | | | | | | | | | | | | | | | | | | | | | | | | | | | | | | | | | | | | | | | | | | | | | | | | | | | |
| PRO A8-8650B | 4 | 3.9 / 3.2 | 4MB | DDR3-2133 | Radeon R7 Series | | | | | | | | | | | | | | | | | | | | | | | | | | | | | | | | | | | | | | | | | | | | | | | | | | | | | | | | | | | | | | | | | | | | | |
| A10 PRO-7800B | 4 | 3.9 / 3.5 | 4MB | DDR3-2133 | Radeon R7 Series | | | | | | | | | | | | | | | | | | | | | | | | | | | | | | | | | | | | | | | | | | | | | | | | | | | | | | | | | | | | | | | | | | | | | |
| PRO A10-8750B | 4 | 4.0 / 3.6 | 4MB | DDR3-2133 | Radeon R7 Series | | | | | | | | | | | | | | | | | | | | | | | | | | | | | | | | | | | | | | | | | | | | | | | | | | | | | | | | | | | | | | | | | | | | | |
| Memory | 32GB max, UDIMM, PC3-12800 1600MHz DDR3, four 240-pin DIMM sockets | | | | | | | | | | | | | | | | | | | | | | | | | | | | | | | | | | | | | | | | | | | | | | | | | | | | | | | | | | | | | | | | | | | | | | | | | |
| Disk | Some: SATA 6.0Gb/s, 3.5" Wide, 7200 rpm Some: hybrid hard disk / with 8GB MLC NAND flash memory, SATA 6.0Gb/s, 5400 rpm 2.5" wide or 7200 rpm 3.5" wide | | | | | | | | | | | | | | | | | | | | | | | | | | | | | | | | | | | | | | | | | | | | | | | | | | | | | | | | | | | | | | | | | | | | | | | | | |
| Optical | Some: Solid State Drive (SSD) / SATA 6.0Gb/s, 2.5" Wide Some: DVD-ROM SATA 1.5Gb/s Drive Some: Super Multi-Burner DVD±RW SATA 1.5Gb/s Drive | | | | | | | | | | | | | | | | | | | | | | | | | | | | | | | | | | | | | | | | | | | | | | | | | | | | | | | | | | | | | | | | | | | | | | | | | |
| Onboard SATA | SATA 6.0Gb/s controller, three connectors on planar, RAID 0/1 support (only applicable on dual SSD models) | | | | | | | | | | | | | | | | | | | | | | | | | | | | | | | | | | | | | | | | | | | | | | | | | | | | | | | | | | | | | | | | | | | | | | | | | |
| Media reader | Optional 7-in-1 single slot media card reader | | | | | | | | | | | | | | | | | | | | | | | | | | | | | | | | | | | | | | | | | | | | | | | | | | | | | | | | | | | | | | | | | | | | | | | | | |
| Graphics | AMD Radeon™ Graphics in processor, uses main memory, one VGA, one DisplayPort™, one optional DP, supports up to three independent displays, works along with optional discrete graphics to support up to five independent displays; <i>Maximum resolution: 1920x1200 (VGA) @60Hz; 2560x2048 (DisplayPort) @60Hz</i> Some: AMD Radeon HD 8570 , DirectX 11, 3D Hardware Acceleration, 2GB, PCI Express 3.0 x16 adapter (8x elec), one VGA, one HDMI, 40W; <i>Max resolution: 4096x2160 (HDMI) @24Hz; 2048x1536 (VGA) @85Hz</i> Some: NVIDIA[®] GeForce[®] GT 620 , DirectX 11, 3D Hardware Acceleration, 1GB, PCI Express 2.0 x16 adapter, one VGA, one DisplayPort, 30 watts; <i>Max resolution: 2560x1600 (DisplayPort) @60Hz; 2048x1536 (VGA) @85Hz</i> Some: AMD Radeon™ HD 7450 , DirectX 11, 3D Hardware Acceleration, 1GB, PCI Express 2.0 x16 adapter, one DVI-I (includes DVI-to-VGA dongle), one DisplayPort, 25 watts; <i>Max resolution: 2560x1600 (DisplayPort, DVI-I) @60Hz</i> | | | | | | | | | | | | | | | | | | | | | | | | | | | | | | | | | | | | | | | | | | | | | | | | | | | | | | | | | | | | | | | | | | | | | | | | | |
| DP cable | Optional DisplayPort to DVI-D monitor cable | | | | | | | | | | | | | | | | | | | | | | | | | | | | | | | | | | | | | | | | | | | | | | | | | | | | | | | | | | | | | | | | | | | | | | | | | |
| Chipset | AMD A78 FCH | | | | | | | | | | | | | | | | | | | | | | | | | | | | | | | | | | | | | | | | | | | | | | | | | | | | | | | | | | | | | | | | | | | | | | | | | |
| Front ports | Two USB 2.0, microphone (stereo, 3.5mm), headphone (stereo, 3.5mm) | | | | | | | | | | | | | | | | | | | | | | | | | | | | | | | | | | | | | | | | | | | | | | | | | | | | | | | | | | | | | | | | | | | | | | | | | |
| Rear ports | Up to six USB ports (2x USB 3.0 + 2x USB 2.0 + 2x optional USB 2.0), serial (9-pin), optional 2nd serial (9-pin), optional parallel (25-pin), ethernet (RJ-45), VGA, DisplayPort (1x standard + 1x optional), two PS/2 ports | | | | | | | | | | | | | | | | | | | | | | | | | | | | | | | | | | | | | | | | | | | | | | | | | | | | | | | | | | | | | | | | | | | | | | | | | |
| Rear audio ports | Line-in (stereo, 3.5mm), line-out (stereo, 3.5mm), microphone (stereo, 3.5mm) | | | | | | | | | | | | | | | | | | | | | | | | | | | | | | | | | | | | | | | | | | | | | | | | | | | | | | | | | | | | | | | | | | | | | | | | | |
| IEEE 1394 | Optional FireWire PCIe adapter, 1394a-2000, 400Mbps, two 6-pin ports on rear | | | | | | | | | | | | | | | | | | | | | | | | | | | | | | | | | | | | | | | | | | | | | | | | | | | | | | | | | | | | | | | | | | | | | | | | | |
| Audio support | High Definition (HD) Audio, Realtek ALC662 / internal speaker (1watt) | | | | | | | | | | | | | | | | | | | | | | | | | | | | | | | | | | | | | | | | | | | | | | | | | | | | | | | | | | | | | | | | | | | | | | | | | |
| WLAN ¹³ | Some: 11b/g/n wireless, Realtek RTL8723BE, Wi-Fi + BT 4.0 combo, 1x1 Some: 11b/g/n wireless, Realtek RTL8192EE, Wi-Fi + BT 4.0 combo, 2x2 Some: 11ac/b/g/n wireless, Broadcom BCM4352, 2.4/5GHz, Wi-Fi + BT 4.0, 2x2 | | | | | | | | | | | | | | | | | | | | | | | | | | | | | | | | | | | | | | | | | | | | | | | | | | | | | | | | | | | | | | | | | | | | | | | | | |
| Bluetooth™ | Some: Bluetooth 4.0 wireless, integrated in Wi-Fi + Bluetooth combo adapter | | | | | | | | | | | | | | | | | | | | | | | | | | | | | | | | | | | | | | | | | | | | | | | | | | | | | | | | | | | | | | | | | | | | | | | | | |
| Ethernet | One gigabit ethernet port, Realtek 8111EPV, Wake on LAN [®] | | | | | | | | | | | | | | | | | | | | | | | | | | | | | | | | | | | | | | | | | | | | | | | | | | | | | | | | | | | | | | | | | | | | | | | | | |
| Modem | None | | | | | | | | | | | | | | | | | | | | | | | | | | | | | | | | | | | | | | | | | | | | | | | | | | | | | | | | | | | | | | | | | | | | | | | | | |
| Manageability | Enhanced Manageability with DASH 1.1 | | | | | | | | | | | | | | | | | | | | | | | | | | | | | | | | | | | | | | | | | | | | | | | | | | | | | | | | | | | | | | | | | | | | | | | | | |
| Security chip | Trusted Platform Module, TCG 1.2-compliant | | | | | | | | | | | | | | | | | | | | | | | | | | | | | | | | | | | | | | | | | | | | | | | | | | | | | | | | | | | | | | | | | | | | | | | | | |
| Security features | <ul style="list-style-type: none"> • Padlock loop (in rear for opt padlock) • Security slot (in rear for optional Kensington[®] MicroSaver[®] cable) • Administrator password • Hard disk password • Boot sequence control | | | | | | | | | | | | | | | | | | | | | | | | | | | | | | | | | | | | | | | | | | | | | | | | | | | | | | | | | | | | | | | | | | | | | | | | | |
| Environment | ENERGY STAR [®] 6.0 (Need 85% PSU and Windows OS); EPEAT™ Gold rating (Need 85% PSU and Windows OS); GREENGUARD [®] ; RoHS-compliant; Cisco EnergyWise compatible; ErP Lot 3 | | | | | | | | | | | | | | | | | | | | | | | | | | | | | | | | | | | | | | | | | | | | | | | | | | | | | | | | | | | | | | | | | | | | | | | | | |
| Accessories | For compatible accessories, please go to TC-AQP sheet | | | | | | | | | | | | | | | | | | | | | | | | | | | | | | | | | | | | | | | | | | | | | | | | | | | | | | | | | | | | | | | | | | | | | | | | | |

See footnotes for more detailed information

(ALSK1-SFF) September 2015 © Lenovo

ThinkCentre M79 SFF - TopSeller - 10CV

Product Specifications Reference (PSREF)

| Model | Region | Processor | vPro | Graphics | Monitor Cable | Memory | Storage | Optical | Media Reader | WLAN + Bluetooth | Optional Rear Ports | Chassis Intrusion Switch | Cable Lock | Keyboard / Mouse | Stand | Power Supply | Operating System | Warranty | Ann Date (m/y) |
|------------|--------|---|------|-----------------|---------------|--------|--------------------------|---------|--------------|------------------|---------------------|--------------------------|------------|------------------|-------------|--------------|--------------------------|-------------------|----------------|
| 10CV0000US | US | AMD A6-6400B | No | AMD HD 8470D | None | 4GBx1 | 500GB 7200rpm 3.5" | DVD±RW | None | None | None | None | None | USB / USB | None | 180W | Win8.1 DG Win7 Pro 64 | 3-year, Onsite | 07/14 |
| 10CV0001US | US | AMD A8-6500B | No | AMD HD 8570D | None | 4GBx1 | 500GB 7200rpm 3.5" | DVD±RW | None | None | None | None | None | USB / USB | None | 180W | Win8.1 DG Win7 Pro 64 | 3-year, Onsite | 07/14 |
| 10CV0002US | US | AMD A8 PRO-7600B | No | AMD R7 Graphics | None | 4GBx1 | 500GB 7200rpm 3.5" | DVD±RW | None | None | None | None | None | USB / USB | None | 240W | Win8.1 DG Win7 Pro 64 | 3-year, Onsite | 07/14 |
| 10CV0003US | US | AMD A4-6300B | No | AMD HD 8370D | None | 4GBx1 | 500GB 7200rpm 3.5" | DVD | None | None | None | None | None | USB / USB | None | 180W | Win8.1 DG Win7 Pro 64 | 3-year, Onsite | 10/14 |
| 10CV000TUS | US | AMD A10 PRO-7800B (4C, 3.5 / 3.9GHz, 4MB) | No | AMD R7 Graphics | None | 4GBx1 | 500GB 7200rpm 3.5" | DVD±RW | 9-in-1 | None | None | None | None | USB / USB | Floor Stand | 180W | Win8.1 DG Win7 Pro 64 | 3-year, Onsite | 02/15 |
| 10CV000UUS | US | AMD A10 PRO-7800B (4C, 3.5 / 3.9GHz, 4MB) | No | AMD R7 Graphics | None | 8GBx1 | 500GB 7200rpm 3.5" | DVD±RW | 9-in-1 | None | None | None | None | USB / USB | Floor Stand | 180W | Win8.1 DG Win7 Pro 64 | 3-year, Onsite | 02/15 |
| 10CV000VUS | US | AMD A6-6400B | No | AMD R5 Graphics | None | 4GBx1 | 500GB 7200rpm 3.5" | DVD±RW | 9-in-1 | None | None | None | None | USB / USB | None | 180W | Win8.1 DG Win7 Pro 64 | 3-year, Onsite | 02/15 |
| 10CV000WUS | US | AMD A8 PRO-7600B | No | AMD R7 Graphics | None | 4GBx1 | 500GB 7200rpm 3.5" | DVD±RW | None | None | 2 Rear USB 2.0 | None | Cable Lock | USB / USB | Floor Stand | 180W | Win8.1 DG Win7 Pro 64 | 3-year, Onsite | 02/15 |
| 10CV000XUS | US | AMD A8 PRO-7600B | No | AMD R7 Graphics | None | 4GBx1 | 500GB 7200rpm 3.5" | DVD±RW | None | None | None | Switch | None | USB / USB | Floor Stand | 180W | Win8.1 DG Win7 Pro 64 | 3-year, Onsite | 07/15 |

ThinkCentre M79 SFF - TopSeller - 10JB

Product Specifications Reference (PSREF)

| Model | Region | Processor | vPro | Graphics | Monitor Cable | Memory | Storage | Optical | Media Reader | WLAN + Bluetooth | Optional Rear Ports | Chassis Intrusion Switch | Cable Lock | Keyboard / Mouse | Stand | Power Supply | Operating System | Warranty | Ann Date (m/y) |
|------------|--------|---|------|-----------------|---------------|--------|--------------------------|---------|--------------|------------------------------------|---------------------|--------------------------|---------------|------------------|-------|--------------|-------------------------|-------------------|----------------|
| 10JB0005US | US | AMD PRO A10-8750B | No | AMD R7 Graphics | None | 4GBx1 | 500GB 7200rpm 3.5" | DVD±RW | None | RTL8723BE b/g/n, 1x1 + BT4.0 | None | Switch | Cable Lock | USB / USB | None | 240W 85% | Win10 DG Win7 Pro 64 | 3-year, Onsite | 10/15 |
| 10JB0006US | US | AMD PRO A4-8350B | No | AMD R5 Graphics | None | 4GBx1 | 500GB 7200rpm 3.5" | DVD±RW | None | RTL8723BE b/g/n, 1x1 + BT4.0 | 2nd DP | Switch | Cable Lock | USB / USB | None | 240W 85% | Win10 DG Win7 Pro 64 | 3-year, Onsite | 10/15 |
| 10JB0007US | US | AMD PRO A8-9600 | No | AMD R7 Graphics | None | 4GBx1 | 500GB 7200rpm 3.5" | DVD±RW | None | RTL8723BE b/g/n, 1x1 + BT4.0 | 2nd DP + 1394 | Switch | Cable Lock | USB / USB | None | 240W 85% | Win10 DG Win7 Pro 64 | 3-year, Onsite | 10/15 |
| 10JB0008US | US | AMD PRO A6-8550B | No | AMD R5 Graphics | None | 4GBx1 | 500GB 7200rpm 3.5" | DVD±RW | None | RTL8723BE b/g/n, 1x1 + BT4.0 | 2nd DP | Switch | Cable Lock | USB / USB | None | 240W 85% | Win10 DG Win7 Pro 64 | 3-year, Onsite | 10/15 |
| 10JB0009US | US | AMD A4 PRO-7300B | No | AMD HD 8470D | DP to DVI | 4GBx1 | 500GB 7200rpm 3.5" | DVD±RW | None | RTL8723BE b/g/n, 1x1 + BT4.0 | None | None | None | USB / USB | None | 240W 85% | Win10 Pro 64 | 3-year, Onsite | 09/15 |
| 10JB000AUS | US | AMD A6-6400B | No | AMD R5 Graphics | DP to DVI | 4GBx1 | 500GB 7200rpm 3.5" | DVD±RW | None | RTL8723BE b/g/n, 1x1 + BT4.0 | None | None | None | USB / USB | None | 240W 85% | Win10 Pro 64 | 3-year, Onsite | 09/15 |
| 10JB000BUS | US | AMD A4 PRO-7300B | No | AMD HD 8470D | DP to DVI | 4GBx1 | 500GB 7200rpm 3.5" | DVD±RW | None | RTL8723BE b/g/n, 1x1 + BT4.0 | None | None | None | USB / USB | None | 240W 85% | Win10 DG Win7 Pro 64 | 3-year, Onsite | 10/15 |
| 10JB000CUS | US | AMD A6-6400B | No | AMD R5 Graphics | DP to DVI | 4GBx1 | 500GB 7200rpm 3.5" | DVD±RW | None | RTL8723BE b/g/n, 1x1 + BT4.0 | None | None | None | USB / USB | None | 240W 85% | Win10 DG Win7 Pro 64 | 3-year, Onsite | 10/15 |
| 10JB000DUS | US | AMD A10 PRO-7800B (4C, 3.5 / 3.9GHz, 4MB) | No | AMD R7 Graphics | DP to DVI | 4GBx1 | 500GB 7200rpm 3.5" | DVD±RW | None | RTL8723BE b/g/n, 1x1 + BT4.0 | None | None | None | USB / USB | None | 240W 85% | Win10 Pro 64 | 3-year, Onsite | 09/15 |
| 10JB000EUS | US | AMD A10 PRO-7800B (4C, 3.5 / 3.9GHz, 4MB) | No | AMD R7 Graphics | DP to DVI | 4GBx1 | 500GB 7200rpm 3.5" | DVD±RW | None | RTL8723BE b/g/n, 1x1 + BT4.0 | None | None | None | USB / USB | None | 240W 85% | Win10 DG Win7 Pro 64 | 3-year, Onsite | 10/15 |
| 10JB000FUS | US | AMD A8 PRO-7600B | No | AMD R7 Graphics | DP to DVI | 4GBx1 | 500GB 7200rpm 3.5" | DVD±RW | None | RTL8723BE b/g/n, 1x1 + BT4.0 | None | None | None | USB / USB | None | 240W 85% | Win10 Pro 64 | 3-year, Onsite | 09/15 |
| 10JB000GUS | US | AMD A8 PRO-7600B | No | AMD R7 Graphics | DP to DVI | 4GBx1 | 500GB 7200rpm 3.5" | DVD±RW | None | RTL8723BE b/g/n, 1x1 + BT4.0 | None | None | None | USB / USB | None | 240W 85% | Win10 DG Win7 Pro 64 | 3-year, Onsite | 10/15 |
| 10JB000HUS | US | AMD A10 PRO-7800B (4C, 3.5 / 3.9GHz, 4MB) | No | AMD R7 Graphics | None | 4GBx1 | 500GB 7200rpm 3.5" | DVD±RW | 9-in-1 | None | None | None | None | USB / USB | None | 240W 85% | Win10 DG Win7 Pro 64 | 3-year, Onsite | 12/15 |
| 10JB000JUS | US | AMD A8 PRO-7600B | No | AMD R7 Graphics | None | 4GBx1 | 500GB 7200rpm 3.5" | DVD±RW | 9-in-1 | None | None | None | None | USB / USB | None | 240W 85% | Win10 DG Win7 Pro 64 | 3-year, Onsite | 12/15 |
| 10JB000KUS | US | AMD A4 PRO-7300B | No | AMD HD 8470D | None | 4GBx1 | 500GB 7200rpm 3.5" | DVD±RW | 9-in-1 | None | None | None | None | USB / USB | None | 240W 85% | Win10 DG Win7 Pro 64 | 3-year, Onsite | 12/15 |
| 10JB000LUS | US | AMD A6-6400B | No | AMD R5 Graphics | None | 4GBx1 | 500GB 7200rpm 3.5" | DVD±RW | 9-in-1 | None | None | None | None | USB / USB | None | 240W 85% | Win10 DG Win7 Pro 64 | 3-year, Onsite | 12/15 |

| Model | Region | Processor | vPro | Graphics | Monitor Cable | Memory | Storage | Optical | Media Reader | WLAN + Bluetooth | Optional Rear Ports | Chassis Intrusion Switch | Cable Lock | Keyboard / Mouse | Stand | Power Supply | Operating System | Warranty | Ann Date (m/y) |
|------------|--------|------------------|------|-----------------|---------------|--------|--------------------------|---------|--------------|------------------------------------|---------------------|--------------------------|------------|------------------|-------|--------------|--------------------------|-------------------|----------------|
| 10CT0006US | US | AMD A4-6300B | No | AMD HD 8370D | None | 2GBx1 | 250GB 7200rpm 3.5" | DVD | None | None | None | Switch | None | USB / USB | None | 240W 85% | Win7 Pro 32 | 3-year, Onsite | 07/14 |
| 10CT0007US | US | AMD A6-6400B | No | AMD R5 Graphics | None | 2GBx1 | 500GB 7200rpm 3.5" | DVD±RW | None | None | None | Switch | None | USB / USB | None | 240W 85% | Win7 Pro 32 | 3-year, Onsite | 07/14 |
| 10CT0008US | US | AMD A6-6400B | No | AMD HD 8470D | None | 4GBx1 | 500GB 7200rpm 3.5" | DVD±RW | None | None | None | None | None | USB / USB | None | 240W 85% | Win8.1 DG Win7 Pro 64 | 3-year, Onsite | 08/14 |
| 10CT0009US | US | AMD A6-6400B | No | AMD HD 8470D | None | 4GBx1 | 500GB 7200rpm 3.5" | DVD±RW | None | RTL8723BE b/g/n, 1x1 + BT4.0 | None | None | None | USB / USB | None | 240W 85% | Win8.1 DG Win7 Pro 64 | 3-year, Onsite | 08/14 |
| 10CT000AUS | US | AMD A8 PRO-7600B | No | AMD R7 Graphics | None | 8GBx1 | 500GB 7200rpm 3.5" | DVD±RW | None | None | None | None | None | USB / USB | None | 240W 85% | Win8.1 DG Win7 Pro 64 | 3-year, Onsite | 08/14 |
| 10CT000BUS | US | AMD A8 PRO-7600B | No | GT 620 1GB | None | 8GBx1 | 500GB 7200rpm 3.5" | DVD±RW | None | RTL8723BE b/g/n, 1x1 + BT4.0 | None | None | None | USB / USB | None | 240W 85% | Win8.1 DG Win7 Pro 64 | 3-year, Onsite | 08/14 |

| Model | Region | Processor | vPro | Graphics | Monitor Cable | Memory | Storage | Optical | Media Reader | WLAN + Bluetooth | Optional Rear Ports | Chassis Intrusion Switch | Cable Lock | Keyboard / Mouse | Stand | Power Supply | Operating System | Warranty | Ann Date (m/y) |
|------------|--------|--------------|------|--------------|---------------|--------|--------------------------|---------|--------------|------------------|---------------------|--------------------------|------------|------------------|-------|--------------|--------------------------|-------------------|----------------|
| 10CW000BUS | US | AMD A4-6300B | No | AMD HD 8370D | None | 4GBx1 | 500GB 7200rpm 3.5" | DVD±RW | None | None | None | None | None | USB / USB | None | 180W | Win8.1 DG Win7 Pro 64 | 3-year, Onsite | 08/14 |

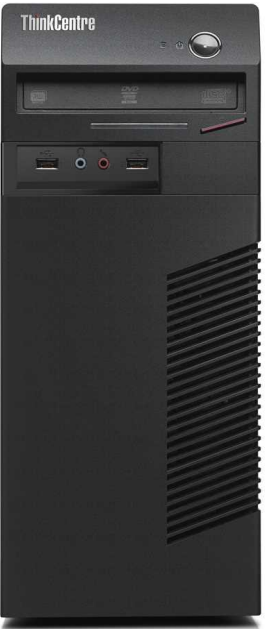

ThinkCentre M79 Tower Platform Specifications

Product Specifications Reference (PSREF)

| Processor | AMD A4, A6, A8, or A10 series APUs | <ul style="list-style-type: none"> • Cable lock to physically lock both keyboard and mouse (optional) • Power-on password • Boot without keyboard and mouse • Individual USB port disablement • Optional <i>Chassis intrusion switch</i> | | | | | | | | | | | | | | | | | | | | | | | | | | | | | | | | | | | | | | | | | | | | | | | | | | | | | | | | | | | | | | | | | | | | | | | | |
|---------------------------|--|---|----------|----------------------|---------------------|--------------|---------------------|----------|---|-----------|-----|-----------|----------|--------------|---|-----------|-----|-----------|----------|--------------|---|-----------|-----|-----------|------------------|----------|---|-----------|-----|-----------|----------|--------------|---|-----------|-----|-----------|------------------|--------------|---|-----------|-----|-----------|------------------|----------|---|-----------|-----|-----------|----------|--------------|---|-----------|-----|-----------|------------------|--------------|---|-----------|-----|-----------|------------------|---------------|---|-----------|-----|-----------|------------------|---------------|---|-----------|-----|-----------|------------------|---|
| | <table border="1"> <thead> <tr> <th>APU</th> <th>Cores</th> <th>Frequency (Max/Base)</th> <th>L2 Cache</th> <th>Memory Types</th> <th>Integrated Graphics</th> </tr> </thead> <tbody> <tr> <td>A4-6300B</td> <td>2</td> <td>3.9 / 3.7</td> <td>1MB</td> <td>DDR3-1600</td> <td>HD 8370D</td> </tr> <tr> <td>A4 PRO-7300B</td> <td>2</td> <td>4.0 / 3.8</td> <td>1MB</td> <td>DDR3-1600</td> <td>HD 8470D</td> </tr> <tr> <td>PRO A4-8350B</td> <td>2</td> <td>3.9 / 3.5</td> <td>1MB</td> <td>DDR3-1866</td> <td>Radeon R5 Series</td> </tr> <tr> <td>A6-6400B</td> <td>2</td> <td>4.1 / 3.9</td> <td>1MB</td> <td>DDR3-1866</td> <td>HD 8470D</td> </tr> <tr> <td>A6 PRO-7400B</td> <td>2</td> <td>3.9 / 3.5</td> <td>1MB</td> <td>DDR3-1866</td> <td>Radeon R5 Series</td> </tr> <tr> <td>PRO A6-8550B</td> <td>2</td> <td>4.0 / 3.7</td> <td>1MB</td> <td>DDR3-2133</td> <td>Radeon R5 Series</td> </tr> <tr> <td>A8-6500B</td> <td>4</td> <td>4.1 / 3.5</td> <td>4MB</td> <td>DDR3-1866</td> <td>HD 8570D</td> </tr> <tr> <td>A8 PRO-7600B</td> <td>4</td> <td>3.8 / 3.1</td> <td>4MB</td> <td>DDR3-2133</td> <td>Radeon R7 Series</td> </tr> <tr> <td>PRO A8-8650B</td> <td>4</td> <td>3.9 / 3.2</td> <td>4MB</td> <td>DDR3-2133</td> <td>Radeon R7 Series</td> </tr> <tr> <td>A10 PRO-7800B</td> <td>4</td> <td>3.9 / 3.5</td> <td>4MB</td> <td>DDR3-2133</td> <td>Radeon R7 Series</td> </tr> <tr> <td>PRO A10-8750B</td> <td>4</td> <td>4.0 / 3.6</td> <td>4MB</td> <td>DDR3-2133</td> <td>Radeon R7 Series</td> </tr> </tbody> </table> | APU | Cores | Frequency (Max/Base) | L2 Cache | Memory Types | Integrated Graphics | A4-6300B | 2 | 3.9 / 3.7 | 1MB | DDR3-1600 | HD 8370D | A4 PRO-7300B | 2 | 4.0 / 3.8 | 1MB | DDR3-1600 | HD 8470D | PRO A4-8350B | 2 | 3.9 / 3.5 | 1MB | DDR3-1866 | Radeon R5 Series | A6-6400B | 2 | 4.1 / 3.9 | 1MB | DDR3-1866 | HD 8470D | A6 PRO-7400B | 2 | 3.9 / 3.5 | 1MB | DDR3-1866 | Radeon R5 Series | PRO A6-8550B | 2 | 4.0 / 3.7 | 1MB | DDR3-2133 | Radeon R5 Series | A8-6500B | 4 | 4.1 / 3.5 | 4MB | DDR3-1866 | HD 8570D | A8 PRO-7600B | 4 | 3.8 / 3.1 | 4MB | DDR3-2133 | Radeon R7 Series | PRO A8-8650B | 4 | 3.9 / 3.2 | 4MB | DDR3-2133 | Radeon R7 Series | A10 PRO-7800B | 4 | 3.9 / 3.5 | 4MB | DDR3-2133 | Radeon R7 Series | PRO A10-8750B | 4 | 4.0 / 3.6 | 4MB | DDR3-2133 | Radeon R7 Series | <ul style="list-style-type: none"> • Keyboard • Mouse • Mechanical |
| APU | Cores | Frequency (Max/Base) | L2 Cache | Memory Types | Integrated Graphics | | | | | | | | | | | | | | | | | | | | | | | | | | | | | | | | | | | | | | | | | | | | | | | | | | | | | | | | | | | | | | | | | | | | | |
| A4-6300B | 2 | 3.9 / 3.7 | 1MB | DDR3-1600 | HD 8370D | | | | | | | | | | | | | | | | | | | | | | | | | | | | | | | | | | | | | | | | | | | | | | | | | | | | | | | | | | | | | | | | | | | | | |
| A4 PRO-7300B | 2 | 4.0 / 3.8 | 1MB | DDR3-1600 | HD 8470D | | | | | | | | | | | | | | | | | | | | | | | | | | | | | | | | | | | | | | | | | | | | | | | | | | | | | | | | | | | | | | | | | | | | | |
| PRO A4-8350B | 2 | 3.9 / 3.5 | 1MB | DDR3-1866 | Radeon R5 Series | | | | | | | | | | | | | | | | | | | | | | | | | | | | | | | | | | | | | | | | | | | | | | | | | | | | | | | | | | | | | | | | | | | | | |
| A6-6400B | 2 | 4.1 / 3.9 | 1MB | DDR3-1866 | HD 8470D | | | | | | | | | | | | | | | | | | | | | | | | | | | | | | | | | | | | | | | | | | | | | | | | | | | | | | | | | | | | | | | | | | | | | |
| A6 PRO-7400B | 2 | 3.9 / 3.5 | 1MB | DDR3-1866 | Radeon R5 Series | | | | | | | | | | | | | | | | | | | | | | | | | | | | | | | | | | | | | | | | | | | | | | | | | | | | | | | | | | | | | | | | | | | | | |
| PRO A6-8550B | 2 | 4.0 / 3.7 | 1MB | DDR3-2133 | Radeon R5 Series | | | | | | | | | | | | | | | | | | | | | | | | | | | | | | | | | | | | | | | | | | | | | | | | | | | | | | | | | | | | | | | | | | | | | |
| A8-6500B | 4 | 4.1 / 3.5 | 4MB | DDR3-1866 | HD 8570D | | | | | | | | | | | | | | | | | | | | | | | | | | | | | | | | | | | | | | | | | | | | | | | | | | | | | | | | | | | | | | | | | | | | | |
| A8 PRO-7600B | 4 | 3.8 / 3.1 | 4MB | DDR3-2133 | Radeon R7 Series | | | | | | | | | | | | | | | | | | | | | | | | | | | | | | | | | | | | | | | | | | | | | | | | | | | | | | | | | | | | | | | | | | | | | |
| PRO A8-8650B | 4 | 3.9 / 3.2 | 4MB | DDR3-2133 | Radeon R7 Series | | | | | | | | | | | | | | | | | | | | | | | | | | | | | | | | | | | | | | | | | | | | | | | | | | | | | | | | | | | | | | | | | | | | | |
| A10 PRO-7800B | 4 | 3.9 / 3.5 | 4MB | DDR3-2133 | Radeon R7 Series | | | | | | | | | | | | | | | | | | | | | | | | | | | | | | | | | | | | | | | | | | | | | | | | | | | | | | | | | | | | | | | | | | | | | |
| PRO A10-8750B | 4 | 4.0 / 3.6 | 4MB | DDR3-2133 | Radeon R7 Series | | | | | | | | | | | | | | | | | | | | | | | | | | | | | | | | | | | | | | | | | | | | | | | | | | | | | | | | | | | | | | | | | | | | | |
| Memory | 32GB max, UDIMM, PC3-12800 1600MHz DDR3, four 240-pin DIMM sockets | | | | | | | | | | | | | | | | | | | | | | | | | | | | | | | | | | | | | | | | | | | | | | | | | | | | | | | | | | | | | | | | | | | | | | | | | |
| Disk | <i>Some:</i> SATA 6.0Gb/s, 3.5" Wide, 7200 rpm <i>Some:</i> hybrid hard disk / with 8GB MLC NAND flash memory, SATA 6.0Gb/s, 5400 rpm 2.5" wide or 7200 rpm 3.5" wide <i>Some:</i> Solid State Drive (SSD) / SATA 6.0Gb/s, 2.5" Wide | | | | | | | | | | | | | | | | | | | | | | | | | | | | | | | | | | | | | | | | | | | | | | | | | | | | | | | | | | | | | | | | | | | | | | | | | |
| Optical | <i>Some:</i> DVD-ROM SATA 1.5Gb/s Drive <i>Some:</i> Super Multi-Burner DVD±RW SATA 1.5Gb/s Drive | <ul style="list-style-type: none"> • Power supply | | | | | | | | | | | | | | | | | | | | | | | | | | | | | | | | | | | | | | | | | | | | | | | | | | | | | | | | | | | | | | | | | | | | | | | | |
| Onboard SATA Media reader | SATA 6.0Gb/s controller, three connectors on planar, RAID 0/1 support Optional 7-in-1 single slot media card reader | <ul style="list-style-type: none"> • Limited warranty³ • Preload | | | | | | | | | | | | | | | | | | | | | | | | | | | | | | | | | | | | | | | | | | | | | | | | | | | | | | | | | | | | | | | | | | | | | | | | |
| Graphics | AMD Radeon™ Graphics in processor, uses main memory, one VGA, one DisplayPort™, one optional DP, supports up to three independent displays, works along with optional discrete graphics to support up to five independent displays; <i>Maximum resolution:</i> 1920x1200 (VGA)@60Hz; 2560x2048 (DisplayPort)@60Hz <i>Some:</i> AMD Radeon HD 8570 , DirectX 11, 3D Hardware Acceleration, 2GB, PCI Express 3.0 x16 adapter (8x elec), one VGA, one HDMI, 40W; <i>Max resolution:</i> 4096x2160 (HDMI)@24Hz; 2048x1536 (VGA)@85Hz <i>Some:</i> NVIDIA® GeForce® GT 620 , DirectX 11, 3D Hardware Acceleration, 1GB, PCI Express 2.0 x16 adapter, one VGA, one DisplayPort, 30 watts; <i>Max resolution:</i> 2560x1600 (DisplayPort)@60Hz; 2048x1536 (VGA)@85Hz <i>Some:</i> AMD Radeon™ HD 7450 , DirectX 11, 3D Hardware Acceleration, 1GB, PCI Express 2.0 x16 adapter, one DVI-I (includes DVI-to-VGA dongle), one DisplayPort, 25 watts; <i>Max resolution:</i> 2560x1600 (DisplayPort, DVI-I)@60Hz | <ul style="list-style-type: none"> • Power supply | | | | | | | | | | | | | | | | | | | | | | | | | | | | | | | | | | | | | | | | | | | | | | | | | | | | | | | | | | | | | | | | | | | | | | | | |
| DP cable | Optional DisplayPort to DVI-D monitor cable | <ul style="list-style-type: none"> • Limited warranty³ • Preload | | | | | | | | | | | | | | | | | | | | | | | | | | | | | | | | | | | | | | | | | | | | | | | | | | | | | | | | | | | | | | | | | | | | | | | | |
| Chipset | AMD A78 FCH | <ul style="list-style-type: none"> • Power supply | | | | | | | | | | | | | | | | | | | | | | | | | | | | | | | | | | | | | | | | | | | | | | | | | | | | | | | | | | | | | | | | | | | | | | | | |
| Front ports | Two USB 2.0, microphone (stereo, 3.5mm), headphone (stereo, 3.5mm) | <ul style="list-style-type: none"> • Limited warranty³ • Preload | | | | | | | | | | | | | | | | | | | | | | | | | | | | | | | | | | | | | | | | | | | | | | | | | | | | | | | | | | | | | | | | | | | | | | | | |
| Rear ports | Up to six USB ports (2x USB 3.0 + 2x USB 2.0 + 2x optional USB 2.0), serial (9-pin), optional 2nd serial (9-pin), optional parallel (25-pin), ethernet (RJ-45), VGA, DisplayPort (1x standard + 1x optional), two PS/2 ports | <ul style="list-style-type: none"> • Limited warranty³ • Preload | | | | | | | | | | | | | | | | | | | | | | | | | | | | | | | | | | | | | | | | | | | | | | | | | | | | | | | | | | | | | | | | | | | | | | | | |
| Rear audio ports | Line-in (stereo, 3.5mm), line-out (stereo, 3.5mm), microphone (stereo, 3.5mm) | <ul style="list-style-type: none"> • Limited warranty³ • Preload | | | | | | | | | | | | | | | | | | | | | | | | | | | | | | | | | | | | | | | | | | | | | | | | | | | | | | | | | | | | | | | | | | | | | | | | |
| IEEE 1394 | Optional FireWire PCIe adapter, 1394a-2000, 400Mbps, two 6-pin ports on rear | <ul style="list-style-type: none"> • Limited warranty³ • Preload | | | | | | | | | | | | | | | | | | | | | | | | | | | | | | | | | | | | | | | | | | | | | | | | | | | | | | | | | | | | | | | | | | | | | | | | |
| Audio support | High Definition (HD) Audio, Realtek ALC662 / internal speaker (1.5watt) | <ul style="list-style-type: none"> • Limited warranty³ • Preload | | | | | | | | | | | | | | | | | | | | | | | | | | | | | | | | | | | | | | | | | | | | | | | | | | | | | | | | | | | | | | | | | | | | | | | | |
| WLAN ¹³ | <i>Some:</i> 11b/g/n wireless, Realtek RTL8723BE, Wi-Fi + BT 4.0 combo, 1x1 <i>Some:</i> 11b/g/n wireless, Realtek RTL8192EE, Wi-Fi + BT 4.0 combo, 2x2 <i>Some:</i> 11ac/b/g/n wireless, Broadcom BCM4352, 2.4/5GHz, Wi-Fi + BT 4.0, 2x2 | <ul style="list-style-type: none"> • Limited warranty³ • Preload | | | | | | | | | | | | | | | | | | | | | | | | | | | | | | | | | | | | | | | | | | | | | | | | | | | | | | | | | | | | | | | | | | | | | | | | |
| Bluetooth™ | <i>Some:</i> Bluetooth 4.0 wireless, integrated in Wi-Fi + Bluetooth combo adapter | <ul style="list-style-type: none"> • Limited warranty³ • Preload | | | | | | | | | | | | | | | | | | | | | | | | | | | | | | | | | | | | | | | | | | | | | | | | | | | | | | | | | | | | | | | | | | | | | | | | |
| Ethernet | One gigabit ethernet port, Realtek 8111EPV, Wake on LAN® | <ul style="list-style-type: none"> • Limited warranty³ • Preload | | | | | | | | | | | | | | | | | | | | | | | | | | | | | | | | | | | | | | | | | | | | | | | | | | | | | | | | | | | | | | | | | | | | | | | | |
| Modem | None | <ul style="list-style-type: none"> • Limited warranty³ • Preload | | | | | | | | | | | | | | | | | | | | | | | | | | | | | | | | | | | | | | | | | | | | | | | | | | | | | | | | | | | | | | | | | | | | | | | | |
| Manageability | Enhanced Manageability with DASH 1.1 | <ul style="list-style-type: none"> • Limited warranty³ • Preload | | | | | | | | | | | | | | | | | | | | | | | | | | | | | | | | | | | | | | | | | | | | | | | | | | | | | | | | | | | | | | | | | | | | | | | | |
| Security chip | Trusted Platform Module, TCG 1.2-compliant | <ul style="list-style-type: none"> • Limited warranty³ • Preload | | | | | | | | | | | | | | | | | | | | | | | | | | | | | | | | | | | | | | | | | | | | | | | | | | | | | | | | | | | | | | | | | | | | | | | | |
| Security features | <ul style="list-style-type: none"> • Padlock loop (in rear for opt padlock) • Security slot (in rear for optional Kensington® MicroSaver® cable) • Administrator password • Hard disk password • Boot sequence control | <ul style="list-style-type: none"> • Limited warranty³ • Preload | | | | | | | | | | | | | | | | | | | | | | | | | | | | | | | | | | | | | | | | | | | | | | | | | | | | | | | | | | | | | | | | | | | | | | | | |
| Environment | ENERGY STAR® 6.0 (Need 85% PSU and Windows OS); EPEAT™ Gold rating (Need 85% PSU and Windows OS); GREENGUARD®; RoHS-compliant; Cisco EnergyWise compatible; ErP Lot 3 | <ul style="list-style-type: none"> • Limited warranty³ • Preload | | | | | | | | | | | | | | | | | | | | | | | | | | | | | | | | | | | | | | | | | | | | | | | | | | | | | | | | | | | | | | | | | | | | | | | | |
| Accessories | For compatible accessories, please go to TC-AQP sheet | <ul style="list-style-type: none"> • Limited warranty³ • Preload | | | | | | | | | | | | | | | | | | | | | | | | | | | | | | | | | | | | | | | | | | | | | | | | | | | | | | | | | | | | | | | | | | | | | | | | |

See footnotes for more detailed information

(ALSK1-TW) September 2015 © Lenovo

ThinkCentre M79 Tower - TopSeller - 10CN

Product Specifications Reference (PSREF)

| Model | Region | Processor | vPro | Graphics | Monitor Cable | Memory | Storage | Optical | Media Reader | WLAN + Bluetooth | Optional Rear Ports | Chassis Intrusion Switch | Cable Lock | Keyboard / Mouse | Power Supply | Operating System | Warranty | Ann Date (m/y) |
|------------|--------|---|------|-----------------|---------------|--------|--------------------------|---------|--------------|------------------|---------------------|--------------------------|------------|------------------|--------------|--------------------------|-------------------|----------------|
| 10CN0000US | US | AMD A4-6300B | No | AMD HD 8370D | None | 4GBx1 | 500GB 7200rpm 3.5" | DVD±RW | None | None | None | None | None | USB / USB | 180W | Win8.1 DG Win7 Pro 64 | 3-year, Onsite | 07/14 |
| 10CN0001US | US | AMD A8-6500B | No | AMD HD 8570D | None | 4GBx1 | 500GB 7200rpm 3.5" | DVD±RW | None | None | None | None | None | USB / USB | 180W | Win8.1 DG Win7 Pro 64 | 3-year, Onsite | 07/14 |
| 10CN0002US | US | AMD A8 PRO-7600B | No | AMD R7 Graphics | None | 4GBx1 | 500GB 7200rpm 3.5" | DVD±RW | None | None | None | None | None | USB / USB | 280W | Win8.1 DG Win7 Pro 64 | 3-year, Onsite | 07/14 |
| 10CN0003US | US | AMD A6-6400B | No | AMD HD 8470D | None | 4GBx1 | 500GB 7200rpm 3.5" | DVD±RW | None | None | None | None | None | USB / USB | 180W | Win8.1 DG Win7 Pro 64 | 3-year, Onsite | 07/14 |
| 10CN000VUS | US | AMD A10 PRO-7800B (4C, 3.5 / 3.9GHz, 4MB) | No | AMD R7 Graphics | None | 4GBx1 | 500GB 7200rpm 3.5" | DVD±RW | None | None | None | None | None | USB / USB | 280W | Win8.1 DG Win7 Pro 64 | 3-year, Onsite | 11/14 |
| 10CN000WUS | US | AMD A10 PRO-7800B (4C, 3.5 / 3.9GHz, 4MB) | No | AMD R7 Graphics | None | 8GBx1 | 500GB 7200rpm 3.5" | DVD±RW | None | None | None | None | None | USB / USB | 280W | Win8.1 DG Win7 Pro 64 | 3-year, Onsite | 11/14 |
| 10CN000XUS | US | AMD A6-6400B | No | AMD R5 Graphics | None | 4GBx1 | 500GB 7200rpm 3.5" | DVD±RW | None | None | None | None | None | USB / USB | 180W | Win8.1 DG Win7 Pro 64 | 3-year, Onsite | 02/15 |
| 10CN000YUS | US | AMD A8 PRO-7600B | No | AMD R7 Graphics | None | 4GBx1 | 500GB 7200rpm 3.5" | DVD±RW | 9-in-1 | None | None | None | None | USB / USB | 180W | Win8.1 DG Win7 Pro 64 | 3-year, Onsite | 07/15 |

| Model | Region | Processor | vPro | Graphics | Monitor Cable | Memory | Storage | Optical | Media Reader | WLAN + Bluetooth | Optional Rear Ports | Chassis Intrusion Switch | Cable Lock | Keyboard / Mouse | Power Supply | Operating System | Warranty | Ann Date (m/y) |
|------------|--------|---|------|-----------------|---------------|--------|--------------------------|---------|--------------|------------------------------------|---------------------|--------------------------|------------|------------------|--------------|-------------------------|-------------------|----------------|
| 10J70009US | US | AMD PRO A4-8350B | No | AMD R5 Graphics | None | 4GBx1 | 500GB 7200rpm 3.5" | DVD±RW | None | RTL8723BE b/g/n, 1x1 + BT4.0 | None | Switch | Cable Lock | USB / USB | 280W 85% | Win10 DG Win7 Pro 64 | 3-year, Onsite | 10/15 |
| 10J7000AUS | US | AMD PRO A8-9600 | No | AMD R7 Graphics | None | 4GBx1 | 500GB 7200rpm 3.5" | DVD±RW | None | RTL8723BE b/g/n, 1x1 + BT4.0 | None | Switch | Cable Lock | USB / USB | 280W 85% | Win10 DG Win7 Pro 64 | 3-year, Onsite | 10/15 |
| 10J7000BUS | US | AMD PRO A10-8750B | No | AMD R7 Graphics | None | 4GBx1 | 500GB 7200rpm 3.5" | DVD±RW | None | RTL8723BE b/g/n, 1x1 + BT4.0 | None | Switch | Cable Lock | USB / USB | 280W 85% | Win10 DG Win7 Pro 64 | 3-year, Onsite | 10/15 |
| 10J7000CUS | US | AMD PRO A6-8550B | No | AMD R5 Graphics | None | 4GBx1 | 500GB 7200rpm 3.5" | DVD±RW | None | RTL8723BE b/g/n, 1x1 + BT4.0 | None | Switch | Cable Lock | USB / USB | 280W 85% | Win10 DG Win7 Pro 64 | 3-year, Onsite | 10/15 |
| 10J7000DUS | US | AMD A4 PRO-7300B | No | AMD HD 8470D | DP to DVI | 4GBx1 | 500GB 7200rpm 3.5" | DVD±RW | None | RTL8723BE b/g/n, 1x1 + BT4.0 | None | None | None | USB / USB | 280W 85% | Win10 Pro 64 | 3-year, Onsite | 09/15 |
| 10J7000EUS | US | AMD A8 PRO-7600B | No | AMD R7 Graphics | DP to DVI | 4GBx1 | 500GB 7200rpm 3.5" | DVD±RW | None | RTL8723BE b/g/n, 1x1 + BT4.0 | None | None | None | USB / USB | 280W 85% | Win10 Pro 64 | 3-year, Onsite | 07/16 |
| 10J7000FUS | US | AMD A6-6400B | No | AMD R5 Graphics | DP to DVI | 4GBx1 | 500GB 7200rpm 3.5" | DVD±RW | None | RTL8723BE b/g/n, 1x1 + BT4.0 | None | None | None | USB / USB | 280W 85% | Win10 Pro 64 | 3-year, Onsite | 09/15 |
| 10J7000GUS | US | AMD A4 PRO-7300B | No | AMD HD 8470D | DP to DVI | 4GBx1 | 500GB 7200rpm 3.5" | DVD±RW | None | RTL8723BE b/g/n, 1x1 + BT4.0 | None | None | None | USB / USB | 280W 85% | Win10 DG Win7 Pro 64 | 3-year, Onsite | 10/15 |
| 10J7000HUS | US | AMD A10 PRO-7800B (4C, 3.5 / 3.9GHz, 4MB) | No | AMD R7 Graphics | DP to DVI | 4GBx1 | 500GB 7200rpm 3.5" | DVD±RW | None | RTL8723BE b/g/n, 1x1 + BT4.0 | None | None | None | USB / USB | 280W 85% | Win10 Pro 64 | 3-year, Onsite | 09/15 |
| 10J7000JUS | US | AMD A6-6400B | No | AMD R5 Graphics | DP to DVI | 4GBx1 | 500GB 7200rpm 3.5" | DVD±RW | None | RTL8723BE b/g/n, 1x1 + BT4.0 | None | None | None | USB / USB | 280W 85% | Win10 DG Win7 Pro 64 | 3-year, Onsite | 10/15 |
| 10J7000KUS | US | AMD A10 PRO-7800B (4C, 3.5 / 3.9GHz, 4MB) | No | AMD R7 Graphics | DP to DVI | 4GBx1 | 500GB 7200rpm 3.5" | DVD±RW | None | RTL8723BE b/g/n, 1x1 + BT4.0 | None | None | Cable Lock | USB / USB | 280W 85% | Win10 DG Win7 Pro 64 | 3-year, Onsite | 10/15 |
| 10J7000LUS | US | AMD A8 PRO-7600B | No | AMD R7 Graphics | DP to DVI | 4GBx1 | 500GB 7200rpm 3.5" | DVD±RW | None | RTL8723BE b/g/n, 1x1 + BT4.0 | None | None | None | USB / USB | 280W 85% | Win10 DG Win7 Pro 64 | 3-year, Onsite | 10/15 |

ThinkCentre M79 Tower - 10CQ

Product Specifications Reference (PSREF)

| Model | Region | Processor | vPro | Graphics | Monitor Cable | Memory | Storage | Optical | Media Reader | WLAN + Bluetooth | Optional Rear Ports | Chassis Intrusion Switch | Cable Lock | Keyboard / Mouse | Power Supply | Operating System | Warranty | Ann Date (m/y) |
|------------|--------|------------------|------|-----------------|---------------|--------|--------------------------|---------|--------------|------------------|---------------------|--------------------------|------------|------------------|--------------|------------------|------------------------|----------------|
| 10CQ0005US | US | AMD A4-6300B | No | AMD HD 8370D | None | 2GBx1 | 250GB 7200rpm 3.5" | DVD | None | None | None | Switch | None | USB / USB | 280W 85% | Win7 Pro 32 | 3-year, Onsite, OID | 07/14 |
| 10CQ0006US | US | AMD A6-6400B | No | AMD R5 Graphics | None | 2GBx1 | 500GB 7200rpm 3.5" | DVD±RW | None | None | None | Switch | None | USB / USB | 280W 85% | Win7 Pro 32 | 3-year, Onsite, OID | 07/14 |
| 10CQ0007US | US | AMD A8 PRO-7600B | No | AMD HD 8570 2GB | None | 4GBx1 | 1TB 7200rpm 3.5" | DVD±RW | 9-in-1 | None | Parallel | Switch | None | USB / USB | 280W 85% | Win7 Pro 64 | 3-year, Onsite, OID | 07/14 |

ThinkCentre M79 Tower - 10CS

Product Specifications Reference (PSREF)

| Model | Region | Processor | vPro | Graphics | Monitor Cable | Memory | Storage | Optical | Media Reader | WLAN + Bluetooth | Optional Rear Ports | Chassis Intrusion Switch | Cable Lock | Keyboard / Mouse | Power Supply | Operating System | Warranty | Ann Date (m/y) |
|------------|--------|--------------|------|--------------|---------------|--------|--------------------------|---------|--------------|------------------|---------------------|--------------------------|------------|------------------|--------------|--------------------------|----------------|----------------|
| 10CS0003US | US | AMD A4-6300B | No | AMD HD 8370D | None | 4GBx1 | 500GB 7200rpm 3.5" | DVD±RW | None | None | None | None | None | USB / USB | 180W | Win8.1 DG Win7 Pro 64 | 3-year, Onsite | 08/14 |



ThinkCentre M800 SFF Platform Specifications

Product Specifications Reference (PSREF)

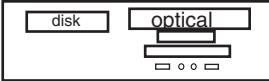
| | | | | | | | |
|-------------------------------|--|-----------------|---|-----------|--------------|---------------------|--|
| Processor | Intel® Celeron®, Intel Pentium®, or 6th Generation Intel Core™ i3 / i5 / i7 Processor | | | | | | Manageability Intel Standard Manageability Security chip Trusted Platform Module, TCG 1.2-compliant Security features <ul style="list-style-type: none"> One lock to secure both cover and entire system to fixed object: <ul style="list-style-type: none"> -Padlock loop (in rear for opt padlock) -Security slot (in rear for optional Kensington® MicroSaver® cable) Power-on password Administrator password Hard disk password Boot sequence control Boot without keyboard and mouse Individual USB port disablement Optional chassis intrusion switch |
| | Processor | Cores / Threads | Frequency Base/Max(GHz) | Cache | Memory Types | Integrated Graphics | |
| | Pentium G4400 | 2 / 2 | 3.3G | 3 MB | DDR4-2133 | HD 510 | |
| | Pentium G4500 | 2 / 2 | 3.5G | 3 MB | DDR4-2133 | HD 530 | |
| | Core i3-6100 | 2 / 4 | 3.7 G | 3 MB | DDR4-2133 | HD 530 | |
| | Core i3-6300 | 2 / 4 | 3.8 G | 4 MB | DDR4-2133 | HD 530 | |
| | Core i5-6400 | 4 / 4 | 2.7 G / 3.3 G | 6 MB | DDR4-2133 | HD 530 | |
| | Core i5-6500 | 4 / 4 | 3.2 G / 3.6 G | 6 MB | DDR4-2133 | HD 530 | |
| Core i5-6600 | 4 / 4 | 3.3 G / 3.9 G | 6 MB | DDR4-2133 | HD 530 | | |
| Core i7-6700 | 4 / 8 | 3.4 G / 4.0 G | 8 MB | DDR4-2133 | HD 530 | | |
| Memory | 64GB max, UDIMM, DDR4 2133, four 288-pin DIMM sockets, dual-channel capable | | | | | | |
| Disk | <i>Some:</i> Hard disk, SATA 6.0Gb/s, 2.5"/ 3.5" wide, 5400 / 7200 rpm <i>Some:</i> Solid State Hybrid Drive (SSHD), 500GB (5400 rpm, 2.5") / 1TB or 2TB (7200 rpm, 3.5"), with 8GB NAND flash memory, SATA 6.0Gb/s <i>Some:</i> Solid State Drive (SSD) / SATA 6.0Gb/s, 2.5" Wide <i>Some:</i> DVD-ROM SATA 1.5Gb/s Drive <i>Some:</i> Super Multi-Burner DVD±RW SATA 1.5Gb/s Drive | | | | | | |
| Optical | | | | | | | |
| Onboard SATA | Four onboard SATA 6.0Gb/s connectors, one is eSATA connector for optional rear eSATA port | | | | | | |
| Media reader | Optional 9-in-1 media reader | | | | | | |
| Graphics | Intel HD Graphics 510/530 in processor, uses main memory, DirectX® 12, one VGA, two DisplayPort™, supports three independent displays, works along with discrete graphics to support more displays; <i>Max resolution:</i> 4096x2304 (DP) @60Hz; 1920x1200 (VGA) @60Hz <i>Some:</i> NVIDIA® Quadro® K420 , DirectX 12, 2GB, PCIe 2.0 x16 adapter, one DVI-I, one DisplayPort, 41 watts; <i>Max resolution:</i> 3840x2160 (DisplayPort) @60Hz; 2560x1600 (DVI-I) @60Hz <i>Some:</i> NVIDIA GeForce® GT 720 , DirectX 12, 2GB, PCIe 2.0 x8 adapter, one VGA, one HDMI, 25 watts; <i>Max resolution:</i> 1920x1080 (HDMI) @60Hz; 2048x1536 (VGA) @85Hz <i>Some:</i> NVIDIA GeForce GT 720 , DirectX 12, 1GB, PCIe 2.0 x8 adapter, two DisplayPort, 25 watts; <i>Max resolution:</i> 3840x2160 (DisplayPort) @60Hz; | | | | | | |
| DP cable | Optional DP to VGA, DP to DVI-D (single link), or DP to HDMI 1.4 dongle | | | | | | |
| Chipset | Intel Q150 Chipset | | | | | | |
| Front ports | Two USB 3.0, two optional USB 2.0, microphone (3.5mm), headphone (3.5mm) | | | | | | |
| Rear ports | Four USB 3.0, two USB 2.0, two optional USB 2.0, serial (9-pin), optional 2nd serial (9-pin), optional parallel (25-pin), ethernet (RJ-45), one VGA, two DisplayPort, optional PS/2 ports (keyboard/mouse), one optional eSATA port additional VGA, DisplayPort, DVI-I or HDMI on optional graphics on some models | | | | | | |
| Rear audio ports | Line-in (3.5mm), line-out (3.5mm), microphone-in (3.5mm) | | | | | | |
| IEEE 1394 | None | | | | | | |
| Audio support | High Definition (HD) Audio, Realtek ALC662 / optional internal speaker (1.5 watt) | | | | | | |
| WLAN ¹³ | <i>Some:</i> 11ac wireless, M.2 Card, Qualcomm Atheros QCA9377 (dual band), Wi-Fi + Bluetooth 4.1 combo adapter, 1x1 <i>Some:</i> 11ac wireless, M.2 Card, Qualcomm Atheros QCA6174 (dual band), Wi-Fi + Bluetooth 4.1 combo adapter, 2x2 <i>Some:</i> 11ac wireless, M.2 Card, Intel Dual Band Wireless-AC 3165, Wi-Fi + Bluetooth 4.0 combo adapter, 1x1 <i>Some:</i> 11ac wireless, M.2 Card, Intel Dual Band Wireless-AC 8260, Wi-Fi + Bluetooth 4.1 combo adapter, 2x2 | | | | | | |
| Bluetooth™ | <i>Some:</i> Bluetooth 4.0 or 4.1 wireless, integrated in Wi-Fi + BT combo adapter | | | | | | |
| Ethernet | Gigabit ethernet, Intel Ethernet Connection I219-LM (Jacksonville), Wake on LAN® | | | | | | |
| Modem | None | | | | | | |
| Mechanical | <ul style="list-style-type: none"> SFF (9.7L), black color; metal case (WxDxH) 13.31" X 14.05" X 3.46"; 338mm X 357mm X 88mm 12.3 lb (5.6 kg) Toolless cover, disk, optical removal Toolless graphics, PCI adapter retention Optional dust filter Bay 1: N/A, 9.5mm high, external, std optical Bay 2: 3.5", 1" high, internal, std disk Bay 3: 2.5", N/A, internal, opt 2nd 2.5" disk (optional bay) Bay 4: N/A, N/A, external, opt reader Slot 1: Low Profile, PCI Express 3.0 x16 (45w max) Slot 2: Low Profile, PCIe 3.0 x1 Slot 3: Low Profile, PCIe 3.0 x16 (x4 elec, 45w max) Slot 4: Low Profile, optional 32-bit PCI 2.3 (via M.2 to PCI adaptor)  | | | | | | |
| Floor Stand | Optional system floor stand for vertical orientation | | | | | | |
| Power supply | 210 watts, autosensing, 85% PSU | | | | | | |
| Limited warranty ³ | <i>Some:</i> 1-year or 3-year, limited onsite service / service upgrades available <i>Some:</i> 3-year, limited onsite service, OID (Onsite International Delivery) / service upgrades available <i>For Lenovo service upgrade options, please go to S-TC sheet</i> | | | | | | |
| Preload | Preloaded operating system <i>Some:</i> Windows® 7 Professional 64 preinstalled through downgrade rights in Windows 10 Pro 64-bit <i>Some:</i> Windows 7 Professional 64 <i>Some:</i> Windows 10 Pro 64-bit <i>Some:</i> Windows 10 Home 64-bit | | Preloaded applications (only some listed) <ul style="list-style-type: none"> Desktop Power Manager Lenovo Solution Center Lenovo REACHit Lenovo SHAREit Lenovo Bluetooth Lock (for models with Wi-Fi/BT card) McAfee® LiveSafe™ (30-day trial) Microsoft Office preloaded; purchase a product key to activate PowerDVD Create (DVD±RW) Lenovo ThinkVantage Tools - Only for Window 10 Lenovo Companion Cyberlink PowerDVD (DVD, DVD±RW) Lenovo QuickOptimizer - Only for Window 7 Rescue and Recovery Password Manager ThinkVantage System Update Lenovo Message Center Plus Adobe® Reader® | | | | |
| Environment | ENERGY STAR® 6.1>(*Need 85% PSU and Windows OS); ErP Lot 3; GREENGUARD®; RoHS-compliant; TUV Green Mark | | | | | | |
| Accessories | For compatible accessories, please go to TC-AQP sheet | | | | | | |

See footnotes for more detailed information

| Model | Region | Processor | vPro | Graphics | Monitor Cable | Memory | Storage | Optical | Optional 2nd 2.5" Bay | Media Reader | WLAN + Bluetooth | Optional Front Ports | Optional Rear Ports | Chassis Intrusion Switch | Cable Lock | PCI Slot | Dust Filter | Keyboard / Mouse | Stand | Power Supply | Operating System | Warranty | Ann Date (m/y) |
|------------|--------|-----------|------|--------------|---------------|--------|--------------------|---------|-----------------------|--------------|------------------|----------------------|---------------------|--------------------------|------------|----------|-------------|------------------|-------------|--------------|----------------------|----------------|----------------|
| 10FY0004US | US | i7-6700 | No | Intel HD 530 | None | 8GBx1 | 192GB SSD | DVD±RW | None | None | None | None | PS/2 | None | None | None | None | USB / USB | Floor Stand | 210W 85% | Win10 DG Win7 Pro 64 | 3-year, Onsite | 11/15 |
| 10FY0005US | US | i5-6500 | No | Intel HD 530 | None | 4GBx1 | 192GB SSD | DVD±RW | None | None | None | None | PS/2 | None | None | None | None | USB / USB | Floor Stand | 210W 85% | Win10 DG Win7 Pro 64 | 3-year, Onsite | 11/15 |
| 10FY0006US | US | i5-6500 | No | Intel HD 530 | None | 4GBx1 | 500GB 7200rpm 3.5" | DVD±RW | None | None | None | None | PS/2 | None | None | None | None | USB / USB | Floor Stand | 210W 85% | Win10 DG Win7 Pro 64 | 3-year, Onsite | 11/15 |
| 10FY0007US | US | i7-6700 | No | Intel HD 530 | None | 4GBx1 | 500GB 7200rpm 3.5" | DVD±RW | None | None | None | None | PS/2 | None | None | None | None | USB / USB | Floor Stand | 210W 85% | Win10 DG Win7 Pro 64 | 3-year, Onsite | 11/15 |
| 10FY0008US | US | i7-6700 | No | GT 720 1GB | None | 8GBx1 | 1TB 7200rpm 3.5" | DVD±RW | None | None | None | None | PS/2 | None | None | None | None | USB / USB | Floor Stand | 210W 85% | Win10 DG Win7 Pro 64 | 3-year, Onsite | 11/15 |
| 10FY0009US | US | i5-6500 | No | Intel HD 530 | None | 4GBx1 | 1TB 7200rpm 3.5" | DVD±RW | None | None | None | None | PS/2 | None | None | None | None | USB / USB | Floor Stand | 210W 85% | Win10 DG Win7 Pro 64 | 3-year, Onsite | 11/15 |
| 10FY000AUS | US | i7-6700 | No | Intel HD 530 | None | 8GBx1 | 1TB 7200rpm 3.5" | DVD±RW | None | None | None | None | PS/2 | None | None | None | None | USB / USB | Floor Stand | 210W 85% | Win10 DG Win7 Pro 64 | 3-year, Onsite | 11/15 |
| 10FY000CUS | US | i7-6700 | No | Intel HD 530 | None | 8GBx1 | 1TB 7200rpm 3.5" | DVD±RW | None | None | None | None | PS/2 | None | None | None | None | USB / USB | Floor Stand | 210W 85% | Win10 Pro 64 | 3-year, Onsite | 11/15 |
| 10FY000DUS | US | i5-6400 | No | Intel HD 530 | None | 4GBx1 | 500GB 7200rpm 3.5" | DVD±RW | None | None | None | None | None | None | None | None | None | USB / USB | Floor Stand | 210W 85% | Win10 Pro 64 | 3-year, Onsite | 11/15 |
| 10FY000EUS | US | i7-6700 | No | GT 720 1GB | None | 8GBx1 | 1TB 7200rpm 3.5" | DVD±RW | None | None | None | None | None | None | None | None | None | USB / USB | Floor Stand | 210W 85% | Win10 Pro 64 | 3-year, Onsite | 11/15 |
| 10FY000FUS | US | i5-6500 | No | Intel HD 530 | None | 4GBx1 | 500GB 7200rpm 3.5" | DVD±RW | None | None | None | None | None | None | None | None | None | USB / USB | Floor Stand | 210W 85% | Win10 Pro 64 | 3-year, Onsite | 11/15 |
| 10FY000QUS | US | i3-6100 | No | Intel HD 530 | None | 4GBx1 | 500GB 7200rpm 3.5" | DVD±RW | Optional 2nd 2.5" Bay | None | None | None | None | None | None | None | None | USB / USB | Floor Stand | 210W 85% | Win10 DG Win7 Pro 64 | 3-year, Onsite | 12/15 |
| 10FY0012US | US | i3-6100 | No | Intel HD 530 | None | 4GBx1 | 500GB 7200rpm 3.5" | DVD±RW | None | None | None | None | None | None | None | None | None | USB / USB | Floor Stand | 210W 85% | Win10 DG Win7 Pro 64 | 3-year, Onsite | 12/15 |
| 10FY0013US | US | i5-6400 | No | Intel HD 530 | None | 4GBx1 | 500GB 7200rpm 3.5" | DVD±RW | Optional 2nd 2.5" Bay | None | None | None | None | None | None | None | None | USB / USB | Floor Stand | 210W 85% | Win10 DG Win7 Pro 64 | 3-year, Onsite | 12/15 |
| 10FY0014US | US | i5-6400 | No | Intel HD 530 | None | 8GBx1 | 180GB SSD Opal | DVD±RW | Optional 2nd 2.5" Bay | None | None | None | None | None | None | None | None | USB / USB | Floor Stand | 210W 85% | Win10 DG Win7 Pro 64 | 3-year, Onsite | 12/15 |
| 10FY0015US | US | i7-6700 | No | Intel HD 530 | None | 8GBx1 | 256GB SSD Opal | DVD±RW | Optional 2nd 2.5" Bay | None | None | None | None | None | None | None | None | USB / USB | Floor Stand | 210W 85% | Win10 DG Win7 Pro 64 | 3-year, Onsite | 12/15 |
| 10FY0016US | US | i7-6700 | No | GT 720 1GB | None | 8GBx1 | 1TB 7200rpm 3.5" | DVD±RW | Optional 2nd 2.5" Bay | None | None | None | None | None | None | None | None | USB / USB | Floor Stand | 210W 85% | Win10 DG Win7 Pro 64 | 3-year, Onsite | 12/15 |
| 10FY0017US | US | i7-6700 | No | Intel HD 530 | None | 8GBx1 | 1TB 7200rpm 3.5" | DVD±RW | Optional 2nd 2.5" Bay | None | None | None | None | None | None | None | None | USB / USB | Floor Stand | 210W 85% | Win10 DG Win7 Pro 64 | 3-year, Onsite | 12/15 |
| 10FY0018US | US | i5-6400 | No | Intel HD 530 | None | 8GBx1 | 1TB 7200rpm 3.5" | DVD±RW | Optional 2nd 2.5" Bay | None | None | None | None | None | None | None | None | USB / USB | Floor Stand | 210W 85% | Win10 DG Win7 Pro 64 | 3-year, Onsite | 12/15 |
| 10FY0019US | US | i7-6700 | No | Intel HD 530 | None | 8GBx1 | 1TB 7200rpm 3.5" | DVD±RW | Optional 2nd 2.5" Bay | None | None | None | None | None | None | None | None | USB / USB | Floor Stand | 210W 85% | Win10 Pro 64 | 3-year, Onsite | 12/15 |

| Model | Region | Processor | vPro | Graphics | Monitor Cable | Memory | Storage | Optical | Optional 2nd 2.5" Bay | Media Reader | WLAN + Bluetooth | Optional Front Ports | Optional Rear Ports | Chassis Intrusion Switch | Cable Lock | PCI Slot | Dust Filter | Keyboard / Mouse | Stand | Power Supply | Operating System | Warranty | Ann Date (m/y) |
|------------|--------|-----------|------|--------------|---------------|--------|--------------------|---------|-----------------------|--------------|----------------------|----------------------|---------------------|--------------------------|------------|----------|-------------|------------------|-------------|--------------|----------------------|----------------|----------------|
| 10FY001AUS | US | i7-6700 | No | Intel HD 530 | None | 8GBx1 | 128GB SSD | DVD±RW | Optional 2nd 2.5" Bay | None | None | None | None | None | None | None | None | USB / USB | Floor Stand | 210W 85% | Win10 DG Win7 Pro 64 | 3-year, Onsite | 12/15 |
| 10FY001BUS | US | i5-6400 | No | Intel HD 530 | None | 8GBx1 | 128GB SSD | DVD±RW | Optional 2nd 2.5" Bay | None | None | None | None | None | None | None | None | USB / USB | Floor Stand | 210W 85% | Win10 DG Win7 Pro 64 | 3-year, Onsite | 12/15 |
| 10FY001DUS | US | i5-6400 | No | Intel HD 530 | None | 8GBx1 | 256GB SSD Opal | DVD±RW | Optional 2nd 2.5" Bay | None | None | None | None | None | None | None | None | USB / USB | Floor Stand | 210W 85% | Win10 DG Win7 Pro 64 | 3-year, Onsite | 12/15 |
| 10FY001EUS | US | i7-6700 | No | GT 720 1GB | None | 8GBx1 | 1TB 7200rpm 3.5" | DVD±RW | Optional 2nd 2.5" Bay | None | None | None | None | None | None | None | None | USB / USB | Floor Stand | 210W 85% | Win10 Pro 64 | 3-year, Onsite | 12/15 |
| 10FY001FUS | US | i5-6400 | No | Intel HD 530 | None | 4GBx1 | 500GB 7200rpm 3.5" | DVD±RW | Optional 2nd 2.5" Bay | None | None | None | None | None | None | None | None | USB / USB | Floor Stand | 210W 85% | Win10 Pro 64 | 3-year, Onsite | 12/15 |
| 10FY001GUS | US | i7-6700 | No | GT 720 1GB | None | 8GBx2 | 1TB 7200rpm 3.5" | DVD±RW | Optional 2nd 2.5" Bay | None | None | None | None | None | None | None | None | USB / USB | Floor Stand | 210W 85% | Win10 DG Win7 Pro 64 | 3-year, Onsite | 12/15 |
| 10FY001HUS | US | i5-6400 | No | Intel HD 530 | None | 8GBx1 | 500GB 7200rpm 3.5" | DVD±RW | Optional 2nd 2.5" Bay | None | None | None | None | None | None | None | None | USB / USB | Floor Stand | 210W 85% | Win10 Pro 64 | 3-year, Onsite | 12/15 |
| 10FY001JUS | US | i7-6700 | No | GT 720 1GB | None | 8GBx2 | 1TB 7200rpm 3.5" | DVD±RW | Optional 2nd 2.5" Bay | None | None | None | None | None | None | None | None | USB / USB | Floor Stand | 210W 85% | Win10 Pro 64 | 3-year, Onsite | 12/15 |
| 10FY001KUS | US | i3-6100 | No | Intel HD 530 | None | 4GBx1 | 128GB SSD | DVD±RW | Optional 2nd 2.5" Bay | None | None | None | None | None | None | None | None | USB / USB | Floor Stand | 210W 85% | Win10 DG Win7 Pro 64 | 3-year, Onsite | 12/15 |
| 10FY001LUS | US | i3-6100 | No | Intel HD 530 | None | 4GBx1 | 128GB SSD | DVD±RW | Optional 2nd 2.5" Bay | None | 8260 ac, 2x2 + BT4.1 | None | None | None | None | None | None | USB / USB | Floor Stand | 210W 85% | Win10 Pro 64 | 3-year, Onsite | 12/15 |
| 10FY001MUS | US | i3-6100 | No | Intel HD 530 | None | 8GBx1 | 1TB 7200rpm 3.5" | DVD±RW | Optional 2nd 2.5" Bay | None | None | None | None | None | None | None | None | USB / USB | Floor Stand | 210W 85% | Win10 DG Win7 Pro 64 | 3-year, Onsite | 12/15 |
| 10FY001NUS | US | i3-6100 | No | Intel HD 530 | None | 4GBx1 | 500GB 7200rpm 3.5" | DVD±RW | Optional 2nd 2.5" Bay | None | 8260 ac, 2x2 + BT4.1 | None | None | None | None | None | None | USB / USB | Floor Stand | 210W 85% | Win10 DG Win7 Pro 64 | 3-year, Onsite | 12/15 |
| 10FY001PUS | US | i3-6100 | No | Intel HD 530 | None | 4GBx1 | 500GB 7200rpm 3.5" | DVD±RW | Optional 2nd 2.5" Bay | None | 8260 ac, 2x2 + BT4.1 | None | None | None | None | None | None | USB / USB | Floor Stand | 210W 85% | Win10 Pro 64 | 3-year, Onsite | 12/15 |
| 10FY0029US | US | i5-6400 | No | Intel HD 530 | None | 8GBx1 | 1TB 7200rpm 3.5" | DVD±RW | Optional 2nd 2.5" Bay | None | None | None | None | None | None | None | None | USB / USB | Floor Stand | 210W 85% | Win10 Pro 64 | 3-year, Onsite | 10/16 |
| 10FY002GUS | US | i3-6100 | No | Intel HD 530 | None | 4GBx1 | 500GB 7200rpm 2.5" | DVD±RW | Optional 2nd 2.5" Bay | None | None | None | None | None | None | None | None | USB / USB | Floor Stand | 210W 85% | Win10 Pro 64 | 3-year, Onsite | 07/16 |
| 10FY003BUS | US | i7-6700 | No | GT 720 1GB | None | 8GBx1 | 1TB 7200rpm 3.5" | DVD±RW | Optional 2nd 2.5" Bay | None | None | None | None | None | None | None | None | USB / USB | Floor Stand | 210W 85% | Win10 DG Win7 Pro 64 | 3-year, Onsite | 10/16 |
| 10FY003CUS | US | i7-6700 | No | GT 720 1GB | None | 8GBx2 | 1TB 7200rpm 3.5" | DVD±RW | Optional 2nd 2.5" Bay | None | None | None | None | None | None | None | None | USB / USB | Floor Stand | 210W 85% | Win10 DG Win7 Pro 64 | 3-year, Onsite | 10/16 |
| 10FY003DUS | US | i7-6700 | No | GT 720 1GB | None | 8GBx1 | 1TB 7200rpm 3.5" | DVD±RW | Optional 2nd 2.5" Bay | None | None | None | None | None | None | None | None | USB / USB | Floor Stand | 210W 85% | Win10 Pro 64 | 3-year, Onsite | 10/16 |
| 10FY003EUS | US | i7-6700 | No | GT 720 1GB | None | 8GBx2 | 1TB 7200rpm 3.5" | DVD±RW | Optional 2nd 2.5" Bay | None | None | None | None | None | None | None | None | USB / USB | Floor Stand | 210W 85% | Win10 Pro 64 | 3-year, Onsite | 10/16 |

| Model | Region | Processor | vPro | Graphics | Monitor Cable | Memory | Storage | Optical | Optional 2nd 2.5" Bay | Media Reader | WLAN + Bluetooth | Optional Front Ports | Optional Rear Ports | Chassis Intrusion Switch | Cable Lock | PCI Slot | Dust Filter | Keyboard / Mouse | Stand | Power Supply | Operating System | Warranty | Ann Date (m/y) |
|------------|--------|-----------|------|---------------|---------------|--------|--------------------------|---------|-----------------------|--------------|------------------|----------------------|---------------------|--------------------------|------------|----------|-------------|------------------|-------------|--------------|-------------------------|------------------------|----------------|
| 10FX0005US | US | i5-6500 | No | Intel HD 530 | None | 4GBx1 | 500GB 7200rpm 3.5" | DVD±RW | None | None | None | None | PS/2 | None | None | None | None | USB / USB | Floor Stand | 210W 85% | Win10 DG Win7 Pro 64 | 3-year, Onsite | 11/15 |
| 10FX0006US | US | i7-6700 | No | GT 720 1GB | None | 8GBx1 | 1TB 7200rpm 3.5" | DVD±RW | None | None | None | None | PS/2 | None | None | None | None | USB / USB | Floor Stand | 210W 85% | Win10 DG Win7 Pro 64 | 3-year, Onsite | 11/15 |
| 10FX0007US | US | i7-6700 | No | Intel HD 530 | None | 8GBx1 | 120GB SSD | DVD±RW | None | None | None | None | PS/2 | None | None | None | None | USB / USB | Floor Stand | 210W 85% | Win10 DG Win7 Pro 64 | 3-year, Onsite | 11/15 |
| 10FX0008US | US | i7-6700 | No | Intel HD 530 | None | 4GBx1 | 500GB 7200rpm 3.5" | DVD±RW | None | None | None | None | PS/2 | None | None | None | None | USB / USB | Floor Stand | 210W 85% | Win10 DG Win7 Pro 64 | 3-year, Onsite | 11/15 |
| 10FX0009US | US | i7-6700 | No | Intel HD 530 | None | 8GBx1 | 1TB 7200rpm 3.5" | DVD±RW | None | None | None | None | PS/2 | None | None | None | None | USB / USB | Floor Stand | 210W 85% | Win10 DG Win7 Pro 64 | 3-year, Onsite | 11/15 |
| 10FX000VUS | US | i5-6500 | No | Intel HD 530 | DP to HDMI | 4GBx1 | 500GB 7200rpm 3.5" | DVD±RW | None | None | None | None | None | None | None | None | None | USB / USB | None | 210W 85% | Win10 Pro 64 | 3-year, Onsite, OID | 11/15 |
| 10FX0011US | US | i5-6500 | No | GT 720 1GB | DP to VGA | 4GBx1 | 1TB 7200rpm 3.5" | DVD±RW | None | 9-in-1 | None | None | None | None | None | None | None | USB / USB | None | 210W 85% | Win10 Pro 64 | 3-year, Onsite, OID | 11/15 |
| 10FX0012US | US | i5-6500 | No | Intel HD 530 | None | 4GBx1 | 500GB 7200rpm 3.5" | DVD | None | None | None | None | None | None | None | None | None | USB / USB | None | 210W 85% | Win10 DG Win7 Pro 64 | 3-year, Onsite, OID | 11/15 |
| 10FX0013US | US | i5-6500 | No | GT 720 1GB | None | 4GBx1 | 1TB 7200rpm 3.5" | DVD±RW | None | 9-in-1 | None | None | None | None | None | None | Dust Filter | USB / USB | None | 210W 85% | Win10 DG Win7 Pro 64 | 3-year, Onsite, OID | 11/15 |
| 10FX0014US | US | i5-6500 | No | Intel HD 530 | None | 4GBx1 | 500GB 7200rpm 3.5" | DVD±RW | None | None | None | None | None | None | None | None | None | USB / USB | None | 210W 85% | Win10 DG Win7 Pro 64 | 3-year, Onsite, OID | 11/15 |



ThinkCentre M800 Tower Platform Specifications

Product Specifications Reference (PSREF)

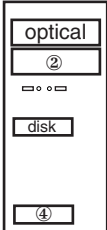
| | | | | | | | |
|-------------------------------|---|-----------------|---|-----------|--------------|---------------------|--|
| Processor | Intel® Celeron®, Intel Pentium®, or 6th Generation Intel Core™ i3 / i5 / i7 Processor | | | | | | Manageability Intel Standard Manageability Security chip Trusted Platform Module, TCG 1.2-compliant Security features <ul style="list-style-type: none"> One lock to secure both cover and entire system to fixed object: <ul style="list-style-type: none"> -Padlock loop (in rear for opt padlock) -Security slot (in rear for optional Kensington® MicroSaver® cable) Power-on password Administrator password Hard disk password Boot sequence control Boot without keyboard and mouse Individual USB port disablement Optional chassis intrusion switch |
| | Processor | Cores / Threads | Frequency Base/Max(GHz) | Cache | Memory Types | Integrated Graphics | |
| | Pentium G4400 | 2 / 2 | 3.3G | 3 MB | DDR4-2133 | HD 510 | |
| | Pentium G4500 | 2 / 2 | 3.5G | 3 MB | DDR4-2133 | HD 530 | |
| | Core i3-6100 | 2 / 4 | 3.7 G | 3 MB | DDR4-2133 | HD 530 | |
| | Core i3-6300 | 2 / 4 | 3.8 G | 4 MB | DDR4-2133 | HD 530 | |
| | Core i5-6400 | 4 / 4 | 2.7 G / 3.3 G | 6 MB | DDR4-2133 | HD 530 | |
| | Core i5-6500 | 4 / 4 | 3.2 G / 3.6 G | 6 MB | DDR4-2133 | HD 530 | |
| Core i5-6600 | 4 / 4 | 3.3 G / 3.9 G | 6 MB | DDR4-2133 | HD 530 | | |
| Core i7-6700 | 4 / 8 | 3.4 G / 4.0 G | 8 MB | DDR4-2133 | HD 530 | | |
| Memory | 64GB max, UDIMM, DDR4 2133, four 288-pin DIMM sockets, dual-channel capable | | | | | | |
| Disk | <i>Some:</i> Hard disk, SATA 6.0Gb/s, 2.5"/ 3.5" wide, 5400 / 7200 rpm <i>Some:</i> Solid State Hybrid Drive (SSHD), 500GB (5400 rpm, 2.5") / 1TB or 2TB (7200 rpm, 3.5"), with 8GB NAND flash memory, SATA 6.0Gb/s <i>Some:</i> Solid State Drive (SSD) / SATA 6.0Gb/s, 2.5" Wide <i>Some:</i> Front accessible and removable HDD, 3.5", lockable via physical key | | | | | | |
| Optical | <i>Some:</i> DVD-ROM SATA 1.5Gb/s Drive <i>Some:</i> Super Multi-Burner DVD±RW SATA 1.5Gb/s Drive | | | | | | |
| Onboard SATA | Four onboard SATA 6.0Gb/s connectors, one is eSATA connector for optional rear eSATA port | | | | | | |
| Media reader | Optional 29-in-1 media reader | | | | | | |
| Graphics | Intel HD Graphics 510/530 in processor, uses main memory, DirectX® 12, one VGA, two DisplayPort™, supports three independent displays, works along with discrete graphics to support more displays; <i>Max resolution:</i> 4096x2304 (DP)@60Hz; 1920x1200 (VGA)@60Hz <i>Some:</i> NVIDIA® Quadro® K420 , DirectX 12, 2GB, PCIe 2.0 x16 adapter, one DVI-I, one DisplayPort, 41 watts; <i>Max resolution:</i> 3840x2160 (DisplayPort)@60Hz; 2560x1600 (DVI-I)@60Hz <i>Some:</i> NVIDIA GeForce® GT 720 , DirectX 12, 2GB, PCIe 2.0 x8 adapter, one VGA, one HDMI, 25 watts; <i>Max resolution:</i> 1920x1080 (HDMI)@60Hz; 2048x1536 (VGA)@85Hz <i>Some:</i> NVIDIA GeForce GT 720 , DirectX 12, 1GB, PCIe 2.0 x8 adapter, two DisplayPort, 25 watts; <i>Max resolution:</i> 3840x2160 (DisplayPort)@60Hz; Optional DP to VGA, DP to DVI-D (single link), or DP to HDMI 1.4 dongle | | | | | | |
| DP cable | Optional DP to VGA, DP to DVI-D (single link), or DP to HDMI 1.4 dongle | | | | | | |
| Chipset | Intel Q150 Chipset | | | | | | |
| Front ports | Two USB 3.0, two optional USB 2.0, microphone (3.5mm), headphone (3.5mm) | | | | | | |
| Rear ports | Four USB 3.0, two USB 2.0, two optional USB 2.0, serial (9-pin), optional 2nd serial (9-pin), optional parallel (25-pin), ethernet (RJ-45), one VGA, two DisplayPort, optional PS/2 ports (keyboard/mouse), one optional eSATA port additional VGA, DisplayPort, DVI-I or HDMI on optional graphics on some models | | | | | | |
| Rear audio ports IEEE 1394 | Line-in (3.5mm), line-out (3.5mm), microphone-in (3.5mm) None | | | | | | |
| Audio support | High Definition (HD) Audio, Realtek ALC662 / optional internal speaker (1.5 watt) | | | | | | |
| WLAN ¹³ | <i>Some:</i> 11ac wireless, M.2 Card, Qualcomm Atheros QCA9377 (dual band), Wi-Fi + Bluetooth 4.1 combo adapter, 1x1 <i>Some:</i> 11ac wireless, M.2 Card, Qualcomm Atheros QCA6174 (dual band), Wi-Fi + Bluetooth 4.1 combo adapter, 2x2 <i>Some:</i> 11ac wireless, M.2 Card, Intel Dual Band Wireless-AC 3165, Wi-Fi + Bluetooth 4.0 combo adapter, 1x1 <i>Some:</i> 11ac wireless, M.2 Card, Intel Dual Band Wireless-AC 8260, Wi-Fi + Bluetooth 4.1 combo adapter, 2x2 | | | | | | |
| Bluetooth™ | <i>Some:</i> Bluetooth 4.0 or 4.1 wireless, integrated in Wi-Fi + BT combo adapter | | | | | | |
| Ethernet | Gigabit ethernet, Intel Ethernet Connection I219-LM (Jacksonville), Wake on LAN® | | | | | | |
| Modem | None | | | | | | |
| Mechanical | <ul style="list-style-type: none"> Tower (25L), black color, metal case (WxDxH) 6.89" X 16.26" X 15.98"; 175mm X 413mm X 406mm 27.56 lb (12.5 kg) Toolless cover, disk, optical removal Toolless graphics, PCI adapter retention Optional dust filter Bay 1: 5.25", 1.6" high, access, std optical Bay 2: 5.25", 1.6" high, access, opt media reader / front access HDD Bay 3: 3.5", 1" high, no access, std disk Bay 4: 3.5", 1" high, no access, opt disk (optional 2nd 3.5" disk tray) Slot 1: half-length, full-height, PCIe 3.0 x16 (75w max) Slot 2: half-length, full-height, PCIe 3.0 x1 Slot 3: half-length, full-height, PCIe 3.0 x16 (x4 elec, 75w max) Slot 4: half-length, full-height, optional 32-bit PCI 2.3 (via M.2 to PCI adaptor)  | | | | | | |
| Power supply | 250 watts, autosensing, 85% PSU | | | | | | |
| Limited warranty ³ | <i>Some:</i> 1-year or 3-year, limited onsite service / service upgrades available <i>Some:</i> 3-year, limited onsite service, OID (Onsite International Delivery) / service upgrades available For Lenovo service upgrade options, please go to S-TC sheet | | | | | | |
| Preload | Preloaded operating system <i>Some:</i> Windows® 7 Professional 64 preinstalled through downgrade rights in Windows 10 Pro 64-bit <i>Some:</i> Windows 7 Professional 64 <i>Some:</i> Windows 10 Pro 64-bit <i>Some:</i> Windows 10 Home 64-bit | | Preloaded applications (only some listed) <ul style="list-style-type: none"> Desktop Power Manager Lenovo Solution Center Lenovo REACHit Lenovo SHAREit Lenovo Bluetooth Lock (for models with Wi-Fi/BT card) McAfee® LiveSafe™ (30-day trial) Microsoft Office preloaded; purchase a product key to activate PowerDVD Create (DVD±RW) Lenovo ThinkVantage Tools - Only for Window 10 <ul style="list-style-type: none"> Lenovo Companion Cyberlink PowerDVD (DVD, DVD±RW) Lenovo QuickOptimizer - Only for Window 7 <ul style="list-style-type: none"> Rescue and Recovery Password Manager ThinkVantage System Update Lenovo Message Center Plus Adobe® Reader® | | | | |
| Environment | ENERGY STAR® 6.1*(Need 85% PSU and Windows OS); ErP Lot 3; GREENGUARD®; RoHS-compliant; TUV Green Mark | | | | | | |
| Accessories | For compatible accessories, please go to TC-AQP sheet | | | | | | |

See footnotes for more detailed information

| Model | Region | Processor | vPro | Graphics | Monitor Cable | Memory | Storage | Optical | Optional 2nd 3.5" Tray | Media Reader | WLAN + Bluetooth | Optional Front Ports | Optional Rear Ports | Chassis Intrusion Switch | Cable Lock | Front Access HDD | PCI Slot | Dust Filter | Keyboard / Mouse | Carry Handle | Power Supply | Operating System | Warranty | Ann Date (m/y) | |
|------------|--------|-----------|------|--------------|---------------|--------|--------------------|---------|------------------------|--------------|----------------------|----------------------|---------------------|--------------------------|------------|------------------|----------|-------------|------------------|--------------|--------------|------------------|----------------------|----------------|-------|
| 10FW0002US | US | i7-6700 | No | Intel HD 530 | None | 4GBx1 | 1TB 7200rpm 3.5" | DVD±RW | None | None | None | None | None | None | None | None | None | None | None | USB / USB | Carry Handle | 250W 85% | Win10 DG Win7 Pro 64 | 3-year, Onsite | 11/15 |
| 10FW0003US | US | i7-6700 | No | K420 2GB | None | 8GBx1 | 1TB 7200rpm 3.5" | DVD±RW | None | None | None | None | None | None | None | None | None | None | None | USB / USB | Carry Handle | 250W 85% | Win10 DG Win7 Pro 64 | 3-year, Onsite | 11/15 |
| 10FW0004US | US | i7-6700 | No | Intel HD 530 | None | 8GBx1 | 120GB SSD | DVD±RW | None | None | None | None | None | None | None | None | None | None | None | USB / USB | Carry Handle | 250W 85% | Win10 DG Win7 Pro 64 | 3-year, Onsite | 11/15 |
| 10FW0005US | US | i5-6500 | No | Intel HD 530 | None | 4GBx1 | 500GB 7200rpm 3.5" | DVD±RW | None | None | None | None | None | None | None | None | None | None | None | USB / USB | Carry Handle | 250W 85% | Win10 DG Win7 Pro 64 | 3-year, Onsite | 11/15 |
| 10FW0006US | US | i7-6700 | No | Intel HD 530 | None | 8GBx1 | 500GB 7200rpm 3.5" | DVD±RW | None | None | None | None | None | None | None | None | None | None | None | USB / USB | Carry Handle | 250W 85% | Win10 DG Win7 Pro 64 | 3-year, Onsite | 11/15 |
| 10FW0007US | US | i5-6500 | No | Intel HD 530 | None | 4GBx1 | 120GB SSD | DVD±RW | None | None | None | None | None | None | None | None | None | None | None | USB / USB | Carry Handle | 250W 85% | Win10 DG Win7 Pro 64 | 3-year, Onsite | 11/15 |
| 10FW000WUS | US | i5-6400 | No | Intel HD 530 | None | 4GBx1 | 500GB 7200rpm 3.5" | DVD±RW | None | None | None | None | None | None | None | None | None | None | None | USB / USB | Carry Handle | 250W 85% | Win10 Pro 64 | 3-year, Onsite | 11/15 |
| 10FW000XUS | US | i7-6700 | No | GT 720 1GB | None | 8GBx1 | 1TB 7200rpm 3.5" | DVD±RW | None | None | None | None | None | None | None | None | None | None | None | USB / USB | Carry Handle | 250W 85% | Win10 Pro 64 | 3-year, Onsite | 11/15 |
| 10FW000YUS | US | i7-6700 | No | Intel HD 530 | None | 8GBx1 | 1TB 7200rpm 3.5" | DVD±RW | None | None | None | None | None | None | None | None | None | None | None | USB / USB | Carry Handle | 250W 85% | Win10 Pro 64 | 3-year, Onsite | 11/15 |
| 10FW0010US | US | i5-6500 | No | Intel HD 530 | None | 4GBx1 | 500GB 7200rpm 3.5" | DVD±RW | None | None | None | None | None | None | None | None | None | None | None | USB / USB | Carry Handle | 250W 85% | Win10 Pro 64 | 3-year, Onsite | 11/15 |
| 10FW001NUS | US | i7-6700 | No | Intel HD 530 | None | 8GBx1 | 1TB 7200rpm 3.5" | DVD±RW | Optional 2nd 3.5" Tray | None | None | None | None | None | None | None | None | None | None | USB / USB | Carry Handle | 250W 85% | Win10 Pro 64 | 3-year, Onsite | 12/15 |
| 10FW001PUS | US | i5-6400 | No | Intel HD 530 | None | 8GBx1 | 500GB 7200rpm 3.5" | DVD±RW | Optional 2nd 3.5" Tray | None | None | None | None | None | None | None | None | None | None | USB / USB | Carry Handle | 250W 85% | Win10 Pro 64 | 3-year, Onsite | 12/15 |
| 10FW001QUS | US | i7-6700 | No | GT 720 1GB | None | 8GBx2 | 1TB 7200rpm 3.5" | DVD±RW | Optional 2nd 3.5" Tray | None | None | None | None | None | None | None | None | None | None | USB / USB | Carry Handle | 250W 85% | Win10 Pro 64 | 3-year, Onsite | 12/15 |
| 10FW001RUS | US | i7-6700 | No | GT 720 1GB | None | 8GBx1 | 1TB 7200rpm 3.5" | DVD±RW | Optional 2nd 3.5" Tray | None | None | None | None | None | None | None | None | None | None | USB / USB | Carry Handle | 250W 85% | Win10 Pro 64 | 3-year, Onsite | 12/15 |
| 10FW001SUS | US | i5-6400 | No | Intel HD 530 | None | 4GBx1 | 500GB 7200rpm 3.5" | DVD±RW | Optional 2nd 3.5" Tray | None | None | None | None | None | None | None | None | None | None | USB / USB | Carry Handle | 250W 85% | Win10 Pro 64 | 3-year, Onsite | 12/15 |
| 10FW001TUS | US | i3-6100 | No | Intel HD 530 | None | 4GBx1 | 500GB 7200rpm 3.5" | DVD±RW | Optional 2nd 3.5" Tray | None | 8260 ac, 2x2 + BT4.1 | None | None | None | None | None | None | None | None | USB / USB | Carry Handle | 250W 85% | Win10 Pro 64 | 3-year, Onsite | 12/15 |
| 10FW001UUS | US | i3-6100 | No | Intel HD 530 | None | 4GBx1 | 500GB 7200rpm 3.5" | DVD±RW | Optional 2nd 3.5" Tray | None | None | None | None | None | None | None | None | None | None | USB / USB | Carry Handle | 250W 85% | Win10 DG Win7 Pro 64 | 3-year, Onsite | 12/15 |
| 10FW001VUS | US | i3-6100 | No | Intel HD 530 | None | 4GBx1 | 128GB SSD | DVD±RW | Optional 2nd 3.5" Tray | None | 8260 ac, 2x2 + BT4.1 | None | None | None | None | None | None | None | None | USB / USB | Carry Handle | 250W 85% | Win10 Pro 64 | 3-year, Onsite | 12/15 |
| 10FW001WUS | US | i3-6100 | No | Intel HD 530 | None | 4GBx1 | 500GB 7200rpm 3.5" | DVD±RW | Optional 2nd 3.5" Tray | None | 8260 ac, 2x2 + BT4.1 | None | None | None | None | None | None | None | None | USB / USB | Carry Handle | 250W 85% | Win10 DG Win7 Pro 64 | 3-year, Onsite | 12/15 |
| 10FW001XUS | US | i3-6100 | No | Intel HD 530 | None | 8GBx1 | 1TB 7200rpm 3.5" | DVD±RW | Optional 2nd 3.5" Tray | None | None | None | None | None | None | None | None | None | None | USB / USB | Carry Handle | 250W 85% | Win10 DG Win7 Pro 64 | 3-year, Onsite | 12/15 |

| Model | Region | Processor | vPro | Graphics | Monitor Cable | Memory | Storage | Optical | Optional 2nd 3.5" Tray | Media Reader | WLAN + Bluetooth | Optional Front Ports | Optional Rear Ports | Chassis Intrusion Switch | Cable Lock | Front Access HDD | PCI Slot | Dust Filter | Keyboard / Mouse | Carry Handle | Power Supply | Operating System | Warranty | Ann Date (m/y) |
|------------|--------|-----------|------|--------------|---------------|--------|--------------------|---------|------------------------|--------------|------------------|----------------------|---------------------|--------------------------|------------|------------------|----------|-------------|------------------|--------------|--------------|----------------------|----------------|----------------|
| 10FW001YUS | US | i3-6100 | No | Intel HD 530 | None | 4GBx1 | 128GB SSD | DVD±RW | Optional 2nd 3.5" Tray | None | None | None | None | None | None | None | None | None | USB / USB | Carry Handle | 250W 85% | Win10 DG Win7 Pro 64 | 3-year, Onsite | 12/15 |
| 10FW002TUS | US | i3-6100 | No | Intel HD 530 | None | 4GBx1 | 500GB 7200rpm 3.5" | DVD±RW | Optional 2nd 3.5" Tray | None | None | None | None | None | None | None | None | None | USB / USB | Carry Handle | 250W 85% | Win10 Pro 64 | 3-year, Onsite | 07/16 |
| 10FW002UUS | US | i7-6700 | No | Intel HD 530 | None | 8GBx1 | 128GB SSD | DVD±RW | Optional 2nd 3.5" Tray | None | None | None | None | None | None | None | None | None | USB / USB | Carry Handle | 250W 85% | Win10 Pro 64 | 3-year, Onsite | 07/16 |
| 10FW003DUS | US | i7-6700 | No | GT 720 1GB | None | 8GBx2 | 1TB 7200rpm 3.5" | DVD±RW | Optional 2nd 3.5" Tray | None | None | None | None | None | None | None | None | None | USB / USB | Carry Handle | 250W 85% | Win10 Pro 64 | 3-year, Onsite | 10/16 |
| 10FW003EUS | US | i7-6700 | No | GT 720 1GB | None | 8GBx2 | 1TB 7200rpm 3.5" | DVD±RW | Optional 2nd 3.5" Tray | None | None | None | None | None | None | None | None | None | USB / USB | Carry Handle | 250W 85% | Win10 DG Win7 Pro 64 | 3-year, Onsite | 10/16 |
| 10FW003FUS | US | i7-6700 | No | GT 720 1GB | None | 8GBx1 | 1TB 7200rpm 3.5" | DVD±RW | Optional 2nd 3.5" Tray | None | None | None | None | None | None | None | None | None | USB / USB | Carry Handle | 250W 85% | Win10 DG Win7 Pro 64 | 3-year, Onsite | 10/16 |
| 10FW003GUS | US | i7-6700 | No | GT 720 1GB | None | 8GBx1 | 1TB 7200rpm 3.5" | DVD±RW | Optional 2nd 3.5" Tray | None | None | None | None | None | None | None | None | None | USB / USB | Carry Handle | 250W 85% | Win10 Pro 64 | 3-year, Onsite | 10/16 |

| Model | Region | Processor | vPro | Graphics | Monitor Cable | Memory | Storage | Optical | Optional 2nd 3.5" Tray | Media Reader | WLAN + Bluetooth | Optional Front Ports | Optional Rear Ports | Chassis Intrusion Switch | Cable Lock | Front Access HDD | PCI Slot | Dust Filter | Keyboard / Mouse | Carry Handle | Power Supply | Operating System | Warranty | Ann Date (m/y) |
|------------|--------|-----------|------|---------------|---------------|--------|--------------------------|---------|------------------------|--------------|------------------|----------------------|---------------------|--------------------------|------------|------------------|----------|----------------|------------------|--------------|--------------|----------------------------|---------------------------|----------------|
| 10FV0004US | US | i7-6700 | No | K420 2GB | None | 8GBx1 | 1TB 7200rpm 3.5" | DVD±RW | None | None | None | None | None | None | None | None | None | None | USB / USB | Carry Handle | 250W 85% | Win10 DG Win7 Pro 64 | 3-year, Onsite | 11/15 |
| 10FV0005US | US | i7-6700 | No | Intel HD 530 | None | 8GBx1 | 120GB SSD | DVD±RW | None | None | None | None | None | None | None | None | None | None | USB / USB | Carry Handle | 250W 85% | Win10 DG Win7 Pro 64 | 3-year, Onsite | 11/15 |
| 10FV0006US | US | i7-6700 | No | Intel HD 530 | None | 8GBx1 | 500GB 7200rpm 3.5" | DVD±RW | None | None | None | None | None | None | None | None | None | None | USB / USB | Carry Handle | 250W 85% | Win10 DG Win7 Pro 64 | 3-year, Onsite | 11/15 |
| 10FV0007US | US | i5-6500 | No | Intel HD 530 | None | 4GBx1 | 120GB SSD | DVD±RW | None | None | None | None | None | None | None | None | None | None | USB / USB | Carry Handle | 250W 85% | Win10 DG Win7 Pro 64 | 3-year, Onsite | 11/15 |
| 10FV0008US | US | i7-6700 | No | GT 720 1GB | None | 8GBx1 | 1TB 7200rpm 3.5" | DVD±RW | None | None | None | None | None | None | None | None | None | None | USB / USB | Carry Handle | 250W 85% | Win10 DG Win7 Pro 64 | 3-year, Onsite | 11/15 |
| 10FV0009US | US | i7-6700 | No | Intel HD 530 | None | 8GBx1 | 1TB 7200rpm 3.5" | DVD±RW | None | None | None | None | None | None | None | None | None | None | USB / USB | Carry Handle | 250W 85% | Win10 DG Win7 Pro 64 | 3-year, Onsite | 11/15 |
| 10FV000AUS | US | i5-6500 | No | Intel HD 530 | None | 4GBx1 | 1TB 7200rpm 3.5" | DVD±RW | None | None | None | None | None | None | None | None | None | None | USB / USB | Carry Handle | 250W 85% | Win10 DG Win7 Pro 64 | 3-year, Onsite | 11/15 |
| 10FV000BUS | US | i5-6500 | No | GT 720 1GB | None | 4GBx1 | 1TB 7200rpm 3.5" | DVD±RW | None | None | None | None | None | None | None | None | None | None | USB / USB | Carry Handle | 250W 85% | Win10 DG Win7 Pro 64 | 3-year, Onsite | 11/15 |
| 10FV000CUS | US | i5-6500 | No | Intel HD 530 | None | 4GBx1 | 500GB 7200rpm 3.5" | DVD±RW | None | None | None | None | None | None | None | None | None | None | USB / USB | Carry Handle | 250W 85% | Win10 DG Win7 Pro 64 | 3-year, Onsite | 11/15 |
| 10FV000MUS | US | i5-6500 | No | Intel HD 530 | None | 4GBx1 | 500GB 7200rpm 3.5" | DVD | None | None | None | None | None | None | None | None | None | None | USB / USB | None | 250W 85% | Win10 Pro 64 | 3-year, Onsite, OID | 11/15 |
| 10FV000NUS | US | i5-6500 | No | GT 720 1GB | DP to HDMI | 4GBx1 | 1TB 7200rpm 3.5" | DVD±RW | None | 29-in-1 | None | None | None | None | None | None | None | None | USB / USB | None | 250W 85% | Win10 Pro 64 | 3-year, Onsite, OID | 11/15 |
| 10FV000PUS | US | i5-6500 | No | Intel HD 530 | None | 4GBx1 | 500GB 7200rpm 3.5" | None | None | None | None | None | None | None | None | None | None | None | USB / USB | Carry Handle | 250W 85% | Win10 Pro 64 | 3-year, Onsite, OID | 11/15 |
| 10FV000QUS | US | i5-6500 | No | GT 720 1GB | None | 4GBx1 | 1TB 7200rpm 3.5" | DVD±RW | None | 29-in-1 | None | None | None | None | None | None | None | Dust Filter | USB / USB | Carry Handle | 250W 85% | Win10 DG Win7 Pro 64 | 3-year, Onsite, OID | 11/15 |
| 10FV000RUS | US | i5-6500 | No | Intel HD 530 | None | 4GBx1 | 500GB 7200rpm 3.5" | DVD±RW | None | None | None | None | None | None | None | None | None | None | USB / USB | None | 250W 85% | Win10 DG Win7 Pro 64 | 3-year, Onsite, OID | 11/15 |
| 10FV000SUS | US | i5-6500 | No | Intel HD 530 | None | 4GBx1 | 500GB 7200rpm 3.5" | DVD | None | None | None | None | None | None | None | None | None | None | USB / USB | None | 250W 85% | Win10 DG Win7 Pro 64 | 3-year, Onsite, OID | 11/15 |



ThinkCentre M900 SFF Platform Specifications

Product Specifications Reference (PSREF)

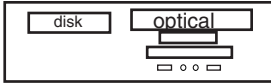
| | | | | | | | | |
|--------------------|---|-----------------|-------------------------|-----------|--------------|---------------------|------------|--|
| Processor | Intel® Celeron®, Intel Pentium®, or 6th Generation Intel Core™ i3 / i5 / i7 Processor | | | | | | | Manageability Intel Active Management Technology 11.0 (Intel AMT 11.0); Intel vPro technology on some models (require choosing a vPro-support Wi-Fi adapter to enable vPro function through wireless connection) |
| | Processor | Cores / Threads | Frequency Base/Max(GHz) | Cache | Memory Types | Integrated Graphics | Intel vPro | |
| | Pentium G4400 | 2 / 2 | 3.3G | 3 MB | DDR4-2133 | HD 510 | No | |
| | Pentium G4500 | 2 / 2 | 3.5G | 3 MB | DDR4-2133 | HD 530 | No | |
| | Core i3-6100 | 2 / 4 | 3.7 G | 3 MB | DDR4-2133 | HD 530 | No | |
| | Core i3-6300 | 2 / 4 | 3.8 G | 4 MB | DDR4-2133 | HD 530 | No | |
| | Core i5-6400 | 4 / 4 | 2.7 G / 3.3 G | 6 MB | DDR4-2133 | HD 530 | No | |
| | Core i5-6500 | 4 / 4 | 3.2 G / 3.6 G | 6 MB | DDR4-2133 | HD 530 | vPro | |
| Core i5-6600 | 4 / 4 | 3.3 G / 3.9 G | 6 MB | DDR4-2133 | HD 530 | vPro | | |
| Core i7-6700 | 4 / 8 | 3.4 G / 4.0 G | 8 MB | DDR4-2133 | HD 530 | vPro | | |
| Memory | 64GB max, UDIMM, DDR4 2133, four 288-pin DIMM sockets, dual-channel capable | | | | | | | Security chip Trusted Platform Module, TCG 1.2-compliant |
| Disk | <i>Some:</i> Hard disk, SATA 6.0Gb/s, 2.5"/ 3.5" wide, 5400 / 7200 rpm <i>Some:</i> Solid State Hybrid Drive (SSHD), 500GB (5400 rpm, 2.5") / 1TB or 2TB (7200 rpm, 3.5"), with 8GB NAND flash memory, SATA 6.0Gb/s <i>Some:</i> Solid State Drive (SSD) / SATA 6.0Gb/s, 2.5" Wide <i>Some:</i> M.2 SSD, PCIe NVMe, PCIe 3.0 x4, 32Gb/s <i>Some:</i> DVD-ROM SATA 1.5Gb/s Drive <i>Some:</i> Super Multi-Burner DVD±RW SATA 1.5Gb/s Drive | | | | | | | |
| Optical | Four onboard SATA 6.0Gb/s connectors, one is eSATA connector for optional rear eSATA port, RAID 0, 1 support | | | | | | | Security features <ul style="list-style-type: none"> • One lock to secure both cover and entire system to fixed object: <ul style="list-style-type: none"> -Padlock loop (in rear for opt padlock) -Security slot (in rear for optional Kensington® MicroSaver® cable) • Power-on password • Administrator password • Hard disk password • Boot sequence control • Boot without keyboard and mouse • Individual USB port disablement • Optional chassis intrusion switch |
| Onboard SATA | Optional 9-in-1 media reader | | | | | | | |
| Media reader | Optional 9-in-1 media reader | | | | | | | Keyboard <i>Some:</i> Preferred Pro USB Keyboard (USB connector), Lenovo logo <i>Some:</i> Lenovo USB Fingerprint Keyboard (USB connector) <i>Some:</i> Ultralim Plus Wireless Keyboard (2.4GHz via USB receiver), black <i>Some:</i> Enhanced Optical USB Mouse, black, Lenovo logo <i>Some:</i> Ultralim Plus Wireless Mouse (2.4GHz via USB receiver), black |
| Graphics | Intel HD Graphics 510/530 in processor, uses main memory, DirectX® 12, one VGA, two DisplayPort™, supports three independent displays, works along with discrete graphics to support more displays; <i>Max resolution:</i> 4096x2304 (DP)@60Hz; 1920x1200 (VGA)@60Hz <i>Some:</i> NVIDIA® Quadro® K420 , DirectX 12, 2GB, PCIe 2.0 x16 adapter, one DVI-I, one DisplayPort, 41 watts; <i>Max resolution:</i> 3840x2160 (DisplayPort)@60Hz; 2560x1600 (DVI-I)@60Hz <i>Some:</i> NVIDIA GeForce® GT 720 , DirectX 12, 2GB, PCIe 2.0 x8 adapter, one VGA, one HDMI, 25 watts; <i>Max resolution:</i> 1920x1080 (HDMI)@60Hz; 2048x1536 (VGA)@85Hz <i>Some:</i> NVIDIA GeForce GT 720 , DirectX 12, 1GB, PCIe 2.0 x8 adapter, two DisplayPort, 25 watts; <i>Max resolution:</i> 3840x2160 (DisplayPort)@60Hz; | | | | | | | |
| DP cable | Optional DP to VGA, DP to DVI-D (single link), or DP to HDMI 1.4 dongle | | | | | | | Mechanical <ul style="list-style-type: none"> • SFF (9.7L), black color; metal case • (WxDxH) 13.31" X 14.05" X 3.46"; 338mm X 357mm X 88mm • 12.3 lb (5.6 kg) • Toolless cover, disk, optical removal • Toolless graphics, PCI adapter retention • Optional dust filter  |
| Chipset | Intel Q170 Chipset | | | | | | | |
| Front ports | Two USB 3.0, two optional USB 2.0, microphone (3.5mm), headphone (3.5mm) | | | | | | | Floor Stand Optional system floor stand for vertical orientation |
| Rear ports | Six USB 3.0, two optional USB 2.0, serial (9-pin), optional 2nd serial (9-pin), optional parallel (25-pin), ethernet (RJ-45), one VGA, two DisplayPort, optional PS/2 ports (keyboard/mouse), one optional eSATA port additional VGA, DisplayPort, DVI-I or HDMI on optional graphics on some models | | | | | | | |
| Rear audio ports | Line-in (3.5mm), line-out (3.5mm), microphone-in (3.5mm) | | | | | | | Power supply 210 watts, autosensing, 85% PSU |
| IEEE 1394 | None | | | | | | | |
| Audio support | High Definition (HD) Audio, Realtek ALC662 / optional internal speaker (1.5 watt) | | | | | | | Limited warranty ³ <i>Some:</i> 1-year or 3-year, limited onsite service / service upgrades available <i>Some:</i> 3-year, limited onsite service, OID (Onsite International Delivery) / service upgrades available <i>For Lenovo service upgrade options, please go to S-TC sheet</i> |
| WLAN ¹³ | <i>Some:</i> 11ac wireless, M.2 Card, Qualcomm Atheros QCA9377 (dual band), Wi-Fi + Bluetooth 4.1 combo adapter, 1x1 <i>Some:</i> 11ac wireless, M.2 Card, Qualcomm Atheros QCA6174 (dual band), Wi-Fi + Bluetooth 4.1 combo adapter, 2x2 <i>Some:</i> 11ac wireless, M.2 Card, Intel Dual Band Wireless-AC 3165, Wi-Fi + Bluetooth 4.0 combo adapter, 1x1 <i>Some:</i> 11ac wireless, M.2 Card, Intel Dual Band Wireless-AC 8260, Wi-Fi + Bluetooth 4.1 combo adapter, 2x2 <i>Some:</i> 11ac wireless, M.2 Card, Intel Dual Band Wireless-AC 8260, Wi-Fi + Bluetooth 4.1 combo adapter, Intel vPro technology support, 2x2 | | | | | | | |
| Bluetooth™ | <i>Some:</i> Bluetooth 4.0 or 4.1 wireless, integrated in Wi-Fi + BT combo adapter | | | | | | | Preload Preloaded operating system <i>Some:</i> Windows® 7 Professional 64 preinstalled through downgrade rights in Windows 10 Pro 64-bit <i>Some:</i> Windows 7 Professional 64 <i>Some:</i> Windows 10 Pro 64-bit <i>Some:</i> Windows 10 Home 64-bit |
| Ethernet | Gigabit ethernet, Intel Ethernet Connection I219-LM (Jacksonville), Wake on LAN® | | | | | | | |
| Modem | None | | | | | | | Preloaded applications (only some listed) <ul style="list-style-type: none"> • Desktop Power Manager • Lenovo Solution Center • Lenovo REACHit • Lenovo SHAREit • Lenovo Bluetooth Lock (for models with Wi-Fi/BT card) • McAfee® LiveSafe™ (30-day trial) • Microsoft Office preloaded; purchase a product key to activate • PowerDVD Create (DVD±RW) • Lenovo ThinkVantage Tools • Intel Unite (vPro models only) - Only for Window 10 • Lenovo Companion • Cyberlink PowerDVD (DVD, DVD±RW) • Lenovo QuickOptimizer - Only for Window 7 • Rescue and Recovery • Password Manager • ThinkVantage System Update • Lenovo Message Center Plus • Adobe® Reader® |
| Environment | ENERGY STAR® 6.1*; EPEAT™ Gold rating*; (*Need 85% PSU and Windows OS); ErP Lot 3; GREENGUARD®; RoHS-compliant; TUV Green Mark, ULE Gold | | | | | | | |
| Accessories | For compatible accessories, please go to TC-AQP sheet | | | | | | | |

See footnotes for more detailed information

| Model | Region | Processor | vPro | Graphics | Monitor Cable | Memory | Storage(HDD/SSD) | Optical | Optional 2nd 2.5" Bay | Media Reader | WLAN + Bluetooth | Optional Front Ports | Optional Rear Ports | Chassis Intrusion Switch | Cable Lock | PCI Slot | Dust Filter | Keyboard / Mouse | Stand | Power Supply | Operating System | Warranty | Ann Date (m/y) |
|------------|--------|-----------|------|--------------|---------------|--------|--------------------|---------|-----------------------|--------------|----------------------------|----------------------|---------------------|--------------------------|------------|----------|-------------|------------------|-------------|--------------|----------------------|---------------------|----------------|
| 10FH000KUS | US | i5-6500 | vPro | Intel HD 530 | None | 4GBx1 | 500GB 7200rpm 3.5" | DVD±RW | None | None | None | None | None | None | None | None | None | USB / USB | Floor Stand | 210W 85% | Win10 DG Win7 Pro 64 | 3-year, Onsite, OID | 11/15 |
| 10FH000LUS | US | i7-6700 | vPro | GT 720 1GB | None | 8GBx1 | 1TB 7200rpm 3.5" | DVD±RW | None | None | 8260 ac, 2x2, vPro + BT4.1 | None | None | None | None | None | None | USB / USB | Floor Stand | 210W 85% | Win10 Pro 64 | 3-year, Onsite, OID | 11/15 |
| 10FH000MUS | US | i7-6700 | vPro | GT 720 1GB | None | 8GBx1 | 1TB 7200rpm 3.5" | DVD±RW | None | None | 8260 ac, 2x2, vPro + BT4.1 | None | None | None | None | None | None | USB / USB | Floor Stand | 210W 85% | Win10 DG Win7 Pro 64 | 3-year, Onsite, OID | 11/15 |
| 10FH000NUS | US | i5-6500 | vPro | Intel HD 530 | None | 4GBx1 | 500GB 7200rpm 3.5" | DVD±RW | None | None | None | None | None | None | None | None | None | USB / USB | Floor Stand | 210W 85% | Win10 Pro 64 | 3-year, Onsite, OID | 11/15 |
| 10FH001YUS | US | i5-6500 | vPro | GT 720 1GB | None | 4GBx1 | 500GB 7200rpm 3.5" | DVD±RW | Optional 2nd 2.5" Bay | None | None | None | None | None | None | None | None | USB / USB | Floor Stand | 210W 85% | Win10 DG Win7 Pro 64 | 3-year, Onsite | 12/15 |
| 10FH0020US | US | i7-6700 | vPro | GT 720 1GB | None | 8GBx1 | 1TB 7200rpm 3.5" | DVD±RW | Optional 2nd 2.5" Bay | None | None | None | None | None | None | None | None | USB / USB | Floor Stand | 210W 85% | Win10 Pro 64 | 3-year, Onsite | 12/15 |
| 10FH0021US | US | i5-6500 | vPro | Intel HD 530 | None | 4GBx1 | 180GB SSD Opal | DVD±RW | Optional 2nd 2.5" Bay | None | None | None | None | None | None | None | None | USB / USB | Floor Stand | 210W 85% | Win10 DG Win7 Pro 64 | 3-year, Onsite | 12/15 |
| 10FH0022US | US | i5-6500 | vPro | Intel HD 530 | None | 8GBx1 | 256GB SSD Opal | DVD±RW | Optional 2nd 2.5" Bay | None | None | None | None | None | None | None | None | USB / USB | Floor Stand | 210W 85% | Win10 DG Win7 Pro 64 | 3-year, Onsite | 12/15 |
| 10FH0023US | US | i5-6500 | vPro | Intel HD 530 | None | 8GBx1 | 192GB SSD | DVD±RW | Optional 2nd 2.5" Bay | None | None | None | None | None | None | None | None | USB / USB | Floor Stand | 210W 85% | Win10 Pro 64 | 3-year, Onsite | 12/15 |
| 10FH0024US | US | i5-6500 | vPro | Intel HD 530 | None | 8GBx1 | 1TB 7200rpm 3.5" | DVD±RW | Optional 2nd 2.5" Bay | None | 8260 ac, 2x2, vPro + BT4.1 | None | None | None | None | None | None | USB / USB | Floor Stand | 210W 85% | Win10 DG Win7 Pro 64 | 3-year, Onsite, OID | 12/15 |
| 10FH0025US | US | i7-6700 | vPro | GT 720 1GB | None | 8GBx1 | 256GB SSD Opal | DVD±RW | Optional 2nd 2.5" Bay | None | None | None | None | None | None | None | None | USB / USB | Floor Stand | 210W 85% | Win10 DG Win7 Pro 64 | 3-year, Onsite | 12/15 |
| 10FH0026US | US | i5-6500 | vPro | Intel HD 530 | None | 8GBx1 | 180GB SSD Opal | DVD±RW | Optional 2nd 2.5" Bay | None | None | None | None | None | None | None | None | USB / USB | Floor Stand | 210W 85% | Win10 Pro 64 | 3-year, Onsite | 12/15 |
| 10FH0027US | US | i7-6700 | vPro | Intel HD 530 | None | 8GBx1 | 256GB SSD Opal | DVD±RW | Optional 2nd 2.5" Bay | None | None | None | None | None | None | None | None | USB / USB | Floor Stand | 210W 85% | Win10 DG Win7 Pro 64 | 3-year, Onsite | 12/15 |
| 10FH0028US | US | i5-6500 | vPro | Intel HD 530 | None | 4GBx1 | 128GB SSD | DVD±RW | Optional 2nd 2.5" Bay | None | None | None | None | None | None | None | None | USB / USB | Floor Stand | 210W 85% | Win10 DG Win7 Pro 64 | 3-year, Onsite | 12/15 |
| 10FH0029US | US | i5-6500 | vPro | Intel HD 530 | None | 4GBx1 | 192GB SSD | DVD±RW | Optional 2nd 2.5" Bay | None | None | None | None | None | None | None | None | USB / USB | Floor Stand | 210W 85% | Win10 DG Win7 Pro 64 | 3-year, Onsite | 12/15 |
| 10FH002AUS | US | i7-6700 | vPro | Intel HD 530 | None | 8GBx1 | 256GB SSD Opal | DVD±RW | Optional 2nd 2.5" Bay | None | None | None | None | None | None | None | None | USB / USB | Floor Stand | 210W 85% | Win10 Pro 64 | 3-year, Onsite | 12/15 |
| 10FH002BUS | US | i5-6500 | vPro | Intel HD 530 | None | 4GBx1 | 500GB 7200rpm 3.5" | DVD±RW | Optional 2nd 2.5" Bay | None | None | None | None | None | None | None | None | USB / USB | Floor Stand | 210W 85% | Win10 DG Win7 Pro 64 | 3-year, Onsite, OID | 12/15 |
| 10FH002CUS | US | i5-6500 | vPro | Intel HD 530 | None | 8GBx1 | 500GB 7200rpm 3.5" | DVD±RW | Optional 2nd 2.5" Bay | None | None | None | None | None | None | None | None | USB / USB | Floor Stand | 210W 85% | Win10 DG Win7 Pro 64 | 3-year, Onsite, OID | 12/15 |
| 10FH002DUS | US | i7-6700 | vPro | GT 720 1GB | None | 8GBx1 | 1TB 7200rpm 3.5" | DVD±RW | Optional 2nd 2.5" Bay | None | None | None | None | None | None | None | None | USB / USB | Floor Stand | 210W 85% | Win10 DG Win7 Pro 64 | 3-year, Onsite | 12/15 |
| 10FH002EUS | US | i5-6500 | vPro | GT 720 1GB | None | 8GBx1 | 1TB 7200rpm 3.5" | DVD±RW | Optional 2nd 2.5" Bay | None | None | None | None | None | None | None | None | USB / USB | Floor Stand | 210W 85% | Win10 DG Win7 Pro 64 | 3-year, Onsite | 12/15 |

| Model | Region | Processor | vPro | Graphics | Monitor Cable | Memory | Storage(HDD/SSD) | Optical | Optional 2nd 2.5" Bay | Media Reader | WLAN + Bluetooth | Optional Front Ports | Optional Rear Ports | Chassis Intrusion Switch | Cable Lock | PCI Slot | Dust Filter | Keyboard / Mouse | Stand | Power Supply | Operating System | Warranty | Ann Date (m/y) |
|------------|--------|-----------|------|--------------|---------------|--------|--------------------|---------|-----------------------|--------------|----------------------------|----------------------|---------------------|--------------------------|------------|----------|-------------|------------------|-------------|--------------|----------------------|---------------------|----------------|
| 10FH002FUS | US | i5-6500 | vPro | Intel HD 530 | None | 8GBx1 | 1TB 7200rpm 3.5" | DVD±RW | Optional 2nd 2.5" Bay | None | None | None | None | None | None | None | None | USB / USB | Floor Stand | 210W 85% | Win10 DG Win7 Pro 64 | 3-year, Onsite, OID | 12/15 |
| 10FH002GUS | US | i5-6500 | vPro | GT 720 1GB | None | 8GBx1 | 1TB 7200rpm 3.5" | DVD±RW | Optional 2nd 2.5" Bay | None | None | None | None | None | None | None | None | USB / USB | Floor Stand | 210W 85% | Win10 Pro 64 | 3-year, Onsite | 12/15 |
| 10FH002HUS | US | i7-6700 | vPro | Intel HD 530 | None | 8GBx1 | 1TB 7200rpm 3.5" | DVD±RW | Optional 2nd 2.5" Bay | None | None | None | None | None | None | None | None | USB / USB | Floor Stand | 210W 85% | Win10 DG Win7 Pro 64 | 3-year, Onsite, OID | 12/15 |
| 10FH002JUS | US | i5-6500 | vPro | Intel HD 530 | None | 8GBx1 | 128GB SSD | DVD±RW | Optional 2nd 2.5" Bay | None | None | None | None | None | None | None | None | USB / USB | Floor Stand | 210W 85% | Win10 Pro 64 | 3-year, Onsite | 12/15 |
| 10FH002KUS | US | i5-6500 | vPro | Intel HD 530 | None | 4GBx1 | 500GB 7200rpm 3.5" | DVD±RW | Optional 2nd 2.5" Bay | None | 8260 ac, 2x2, vPro + BT4.1 | None | None | None | None | None | None | USB / USB | Floor Stand | 210W 85% | Win10 DG Win7 Pro 64 | 3-year, Onsite, OID | 12/15 |
| 10FH002LUS | US | i7-6700 | vPro | Intel HD 530 | None | 8GBx1 | 1TB 7200rpm 3.5" | DVD±RW | Optional 2nd 2.5" Bay | None | 8260 ac, 2x2, vPro + BT4.1 | None | None | None | None | None | None | USB / USB | Floor Stand | 210W 85% | Win10 DG Win7 Pro 64 | 3-year, Onsite, OID | 12/15 |
| 10FH003MUS | US | i5-6500 | vPro | Intel HD 530 | None | 8GBx1 | 128GB SSD | DVD±RW | Optional 2nd 2.5" Bay | None | None | None | None | None | None | None | None | USB / USB | Floor Stand | 210W 85% | Win10 DG Win7 Pro 64 | 3-year, Onsite | 03/16 |
| 10FH003NUS | US | i5-6500 | vPro | Intel HD 530 | None | 8GBx1 | 500GB 7200rpm 3.5" | DVD±RW | Optional 2nd 2.5" Bay | None | None | None | None | None | None | None | None | USB / USB | Floor Stand | 210W 85% | Win10 DG Win7 Pro 64 | 3-year, Onsite | 03/16 |
| 10FH004JUS | US | i5-6500 | vPro | Intel HD 530 | None | 4GBx1 | 500GB 7200rpm 3.5" | DVD±RW | Optional 2nd 2.5" Bay | None | None | None | None | None | None | None | None | USB / USB | Floor Stand | 210W 85% | Win10 Pro 64 | 3-year, Onsite | 07/16 |
| 10FH0054US | US | i7-6700 | vPro | GT 720 1GB | None | 8GBx1 | 1TB 7200rpm 3.5" | DVD±RW | Optional 2nd 2.5" Bay | None | 8260 ac, 2x2, vPro + BT4.1 | None | None | None | None | None | None | USB / USB | Floor Stand | 210W 85% | Win10 Pro 64 | 3-year, Onsite | 07/16 |
| 10FH005JUS | US | i7-6700 | vPro | GT 720 1GB | None | 8GBx1 | 1TB 7200rpm 3.5" | DVD±RW | Optional 2nd 2.5" Bay | None | None | None | None | None | None | None | None | USB / USB | Floor Stand | 210W 85% | Win10 DG Win7 Pro 64 | 3-year, Onsite | 10/16 |
| 10FH005KUS | US | i7-6700 | vPro | GT 720 1GB | None | 8GBx1 | 256GB SSD Opal | DVD±RW | Optional 2nd 2.5" Bay | None | None | None | None | None | None | None | None | USB / USB | Floor Stand | 210W 85% | Win10 DG Win7 Pro 64 | 3-year, Onsite | 10/16 |
| 10FH005LUS | US | i5-6500 | vPro | GT 720 1GB | None | 4GBx1 | 500GB 7200rpm 2.5" | DVD±RW | Optional 2nd 2.5" Bay | None | None | None | None | None | None | None | None | USB / USB | Floor Stand | 210W 85% | Win10 Pro 64 | 3-year, Onsite | 10/16 |
| 10FH005MUS | US | i5-6500 | vPro | GT 720 1GB | None | 8GBx1 | 1TB 7200rpm 3.5" | DVD±RW | Optional 2nd 2.5" Bay | None | None | None | None | None | None | None | None | USB / USB | Floor Stand | 210W 85% | Win10 DG Win7 Pro 64 | 3-year, Onsite | 10/16 |
| 10FH005NUS | US | i7-6700 | vPro | GT 720 1GB | None | 8GBx1 | 1TB 7200rpm 3.5" | DVD±RW | Optional 2nd 2.5" Bay | None | None | None | None | None | None | None | None | USB / USB | Floor Stand | 210W 85% | Win10 Pro 64 | 3-year, Onsite | 10/16 |
| 10FH005PUS | US | i5-6500 | vPro | GT 720 1GB | None | 4GBx1 | 500GB 7200rpm 2.5" | DVD±RW | Optional 2nd 2.5" Bay | None | None | None | None | None | None | None | None | USB / USB | Floor Stand | 210W 85% | Win10 DG Win7 Pro 64 | 3-year, Onsite | 10/16 |
| 10FH005QUS | US | i7-6700 | vPro | GT 720 1GB | None | 8GBx1 | 1TB 7200rpm 3.5" | DVD±RW | Optional 2nd 2.5" Bay | None | 8260 ac, 2x2, vPro + BT4.1 | None | None | None | None | None | None | USB / USB | Floor Stand | 210W 85% | Win10 DG Win7 Pro 64 | 3-year, Onsite | 10/16 |
| 10FH005RUS | US | i5-6500 | vPro | GT 720 1GB | None | 8GBx1 | 1TB 7200rpm 3.5" | DVD±RW | Optional 2nd 2.5" Bay | None | None | None | None | None | None | None | None | USB / USB | Floor Stand | 210W 85% | Win10 Pro 64 | 3-year, Onsite | 10/16 |
| 10FH005SUS | US | i7-6700 | vPro | GT 720 1GB | None | 8GBx1 | 1TB 7200rpm 3.5" | DVD±RW | Optional 2nd 2.5" Bay | None | 8260 ac, 2x2, vPro + BT4.1 | None | None | None | None | None | None | USB / USB | Floor Stand | 210W 85% | Win10 Pro 64 | 3-year, Onsite | 10/16 |
| 10FH005TUS | US | i7-6700 | vPro | GT 720 1GB | None | 8GBx1 | 256GB SSD Opal | DVD±RW | Optional 2nd 2.5" Bay | None | None | None | None | None | None | None | None | USB / USB | Floor Stand | 210W 85% | Win10 Pro 64 | 3-year, Onsite | 10/16 |

| Model | Region | Processor | vPro | Graphics | Monitor Cable | Memory | Storage(HDD/SSD) | Optical | Optional 2nd 2.5" Bay | Media Reader | WLAN + Bluetooth | Optional Front Ports | Optional Rear Ports | Chassis Intrusion Switch | Cable Lock | PCI Slot | Dust Filter | Keyboard / Mouse | Stand | Power Supply | Operating System | Warranty | Ann Date (m/y) |
|------------|--------|-----------|------|--------------|---------------|--------|--------------------|---------|-----------------------|--------------|----------------------------|----------------------|---------------------|--------------------------|------------|----------|-------------|------------------|-------------|--------------|----------------------|---------------------|----------------|
| 10FG0006US | US | i5-6500 | vPro | Intel HD 530 | None | 4GBx1 | 500GB 7200rpm 3.5" | DVD±RW | None | None | None | None | None | None | None | None | None | USB / USB | Floor Stand | 210W 85% | Win10 DG Win7 Pro 64 | 3-year, Onsite, OID | 11/15 |
| 10FG0007US | US | i7-6700 | vPro | GT 720 1GB | None | 8GBx1 | 1TB 7200rpm 3.5" | DVD±RW | None | None | 8260 ac, 2x2, vPro + BT4.1 | None | None | None | None | None | None | USB / USB | Floor Stand | 210W 85% | Win10 DG Win7 Pro 64 | 3-year, Onsite, OID | 11/15 |
| 10FG000XUS | US | i5-6500 | vPro | Intel HD 530 | None | 4GBx1 | 500GB 7200rpm 3.5" | DVD | None | None | None | None | None | None | None | None | None | USB / USB | None | 210W 85% | Win10 Pro 64 | 3-year, Onsite, OID | 11/15 |
| 10FG000YUS | US | i5-6600 | vPro | Intel HD 530 | None | 4GBx1 | 500GB 7200rpm 3.5" | DVD±RW | None | None | None | None | None | None | None | None | None | USB / USB | None | 210W 85% | Win10 Pro 64 | 3-year, Onsite, OID | 11/15 |
| 10FG0013US | US | i7-6700 | vPro | GT 720 1GB | None | 4GBx1 | 1TB 7200rpm 3.5" | DVD±RW | None | 9-in-1 | None | None | None | None | None | None | None | USB / USB | None | 210W 85% | Win10 Pro 64 | 3-year, Onsite, OID | 11/15 |
| 10FG0014US | US | i7-6700 | vPro | GT 720 1GB | None | 4GBx1 | 1TB 7200rpm 3.5" | DVD±RW | None | 9-in-1 | None | None | None | None | None | None | Dust Filter | USB / USB | None | 210W 85% | Win10 DG Win7 Pro 64 | 3-year, Onsite, OID | 11/15 |
| 10FG0015US | US | i5-6600 | vPro | Intel HD 530 | None | 4GBx1 | 500GB 7200rpm 3.5" | DVD±RW | None | None | None | None | None | None | None | None | None | USB / USB | None | 210W 85% | Win10 DG Win7 Pro 64 | 3-year, Onsite, OID | 11/15 |
| 10FG0016US | US | i5-6500 | vPro | Intel HD 530 | None | 4GBx1 | 500GB 7200rpm 3.5" | DVD | None | None | None | None | None | None | None | None | None | USB / USB | None | 210W 85% | Win10 DG Win7 Pro 64 | 3-year, Onsite, OID | 11/15 |



ThinkCentre M900 Tiny Platform Specifications

Product Specifications Reference (PSREF)

| | | | | | | | | |
|-------------------------------|---|-----------------|---|-----------|--------------|---------------------|------------|---|
| Processor | Intel® Celeron®, Intel Pentium®, or 6th Generation Intel Core™ i3 / i5 / i7 Processor | | | | | | | Security features <ul style="list-style-type: none"> • Security slot (in rear for optional Kensington® MicroSaver® cable) • Padlock loop • Smart USB protection, allows keyboard/mouse only, blocks all storage devices • Power-on password • Administrator password • Hard disk password • Boot sequence control • Boot without keyboard and mouse • Individual USB port disablement • Chassis intrusion switch |
| | Processor | Cores / Threads | Frequency Base/Max(GHz) | Cache | Memory Types | Integrated Graphics | Intel vPro | |
| | Pentium G4400T | 2 / 2 | 2.9 G | 3 MB | DDR4-2133 | HD 510 | No | |
| | Pentium G4500T | 2 / 2 | 3.0 G | 3 MB | DDR4-2133 | HD 530 | No | |
| | Core i3-6100T | 2 / 4 | 3.2 G | 3 MB | DDR4-2133 | HD 530 | No | |
| | Core i3-6300T | 2 / 4 | 3.3 G | 4 MB | DDR4-2133 | HD 530 | No | |
| | Core i5-6400T | 4 / 4 | 2.2 G / 2.8 G | 6 MB | DDR4-2133 | HD 530 | No | |
| | Core i5-6500T | 4 / 4 | 2.5 G / 3.1 G | 6 MB | DDR4-2133 | HD 530 | vPro | |
| | Core i5-6600T | 4 / 4 | 2.7 G / 3.5 G | 6 MB | DDR4-2133 | HD 530 | vPro | |
| Core i7-6700T | 4 / 8 | 2.8 G / 3.6 G | 8 MB | DDR4-2133 | HD 530 | vPro | | |
| Memory | 32GB max, DDR4 2133, two 260-pin SO-DIMM sockets, dual-channel capable | | | | | | | |
| Disk | <i>Some:</i> SATA 6.0Gb/s, 2.5" Wide, 5400 rpm or 7200 rpm <i>Some:</i> 500GB (5400 rpm) Solid State Hybrid Drive (SSHD) / with 8GB MLC NAND flash memory, SATA 6.0Gb/s, 2.5" wide <i>Some:</i> Solid State Drive (SSD) / SATA 6.0Gb/s, 2.5" Wide <i>Some:</i> M.2 SSD, PCIe or SATA interface | | | | | | | |
| Optical | <i>Some:</i> external ODD box with DVD-ROM, 9.5mm high, via USB <i>Some:</i> external ODD box with DVD±RW, 9.5mm high, via USB <i>Some:</i> external ODD box (for TIO) with DVD-ROM, 9.5mm high, via USB <i>Some:</i> external ODD box (for TIO) with DVD±RW, 9.5mm high, via USB | | | | | | | |
| Onboard SATA Media reader | One SATA cable (1-drop to device), one SATA 6.0Gb/s connector on planar None | | | | | | | |
| Graphics | Intel HD Graphics 510/530 in processor, uses main memory, DirectX® 12, two DisplayPort™, one optional HDMI, VGA, or 3rd DP, up to 3 independent displays; <i>Max resolution:</i> 4096x2304 (DP) @60Hz; 4096x2160 (HDMI) @24Hz; 1920x1200 (VGA) @60Hz | | | | | | | |
| DP cable | Optional DP to VGA, DP to DVI-D (single link), or DP to HDMI 1.4 dongle | | | | | | | |
| Chipset | Intel Q170 Chipset | | | | | | | |
| Front ports | Two USB 3.0 (one is Always On and fast charge), one microphone (stereo, 3.5mm), one headphone / microphone combo jack (stereo, 3.5mm) | | | | | | | |
| Rear ports | Four USB 3.0 (optional external optical box or external I/O box occupies one or two specific USB 3.0 on some models), ethernet (RJ-45), two DisplayPort, one optional port (VGA, 3rd DP, HDMI, or serial on some models), one headphone | | | | | | | |
| I/O box | Optional external I/O box, extends two USB 2.0, two USB 3.0, and one serial on rear, two USB 2.0 on front, via USB (occupy two specific USB 3.0 of M900 Tiny) | | | | | | | |
| Audio support | High Definition (HD) Audio, Realtek ALC223 / optional internal speaker (1 watt) | | | | | | | |
| WLAN ¹³ | <i>Some:</i> 11ac wireless, M.2 Card, Qualcomm Atheros QCA9377 (dual band), Wi-Fi + Bluetooth 4.1 combo adapter, 1x1 <i>Some:</i> 11ac wireless, M.2 Card, Qualcomm Atheros QCA6174 (dual band), Wi-Fi + Bluetooth 4.1 combo adapter, 2x2 <i>Some:</i> 11ac wireless, M.2 Card, Intel Dual Band Wireless-AC 3165, Wi-Fi + Bluetooth 4.0 combo adapter, 1x1 <i>Some:</i> 11ac wireless, M.2 Card, Intel Dual Band Wireless-AC 8260, Wi-Fi + Bluetooth 4.1 combo adapter, 2x2 <i>Some:</i> 11ac wireless, M.2 Card, Intel Dual Band Wireless-AC 8260, Wi-Fi + Bluetooth 4.1 combo adapter, Intel vPro technology support, 2x2 | | | | | | | |
| Bluetooth™ Ethernet Modem | <i>Some:</i> Bluetooth 4.0 or 4.1 wireless, integrated in Wi-Fi + BT combo adapter Gigabit ethernet, Intel Ethernet Connection I219-LM (Jacksonville), Wake on LAN® None | | | | | | | |
| Manageability | Intel Active Management Technology 11.0 (Intel AMT 11.0); Intel vPro technology on some models (require choosing a vPro-support Wi-Fi adapter to enable vPro function through wireless connection) | | | | | | | |
| Security chip | Trusted Platform Module, TCG 1.2-compliant | | | | | | | |
| Keyboard | <i>Some:</i> Preferred Pro USB Keyboard (USB connector), Lenovo logo <i>Some:</i> Lenovo USB Fingerprint Keyboard (USB connector) <i>Some:</i> Ultralim Plus Wireless Keyboard (2.4GHz via USB receiver), black <i>Some:</i> Enhanced Optical USB Mouse, black, Lenovo logo <i>Some:</i> Ultralim Plus Wireless Mouse (2.4GHz via USB receiver), black | | | | | | | |
| Mouse | <i>Some:</i> Preferred Pro USB Keyboard (USB connector), Lenovo logo <i>Some:</i> Lenovo USB Fingerprint Keyboard (USB connector) <i>Some:</i> Ultralim Plus Wireless Keyboard (2.4GHz via USB receiver), black <i>Some:</i> Enhanced Optical USB Mouse, black, Lenovo logo <i>Some:</i> Ultralim Plus Wireless Mouse (2.4GHz via USB receiver), black | | | | | | | |
| Mechanical | Tiny (1L), black color; metal case M900 Tiny only: 7.05" W X 7.20" D X 1.36" H 179mm W X 182.9mm D X 34.5mm H 2.9 lb (1.3 kg), weight may vary by configuration With VESA mount & ODD box: 7.42" W X 7.30" D X 2.48" H 188.4mm W X 185.38mm D X 63mm H 4.12 lb (1.87 kg), weight may vary by configuration With VESA mount & I/O box: 7.42" W X 7.30" D X 2.62" H 188.4mm W X 185.38mm D X 66.6mm H 3.53 lb (1.6 kg), weight may vary by configuration Optional VESA mount bracket kit, supports VESA 75mm and 100mm Optional system floor stand for vertical orientation | | | | | | | |
| VESA mount Floor Stand | Optional VESA mount bracket kit, supports VESA 75mm and 100mm Optional system floor stand for vertical orientation | | | | | | | |
| Power supply | 65 watts AC/DC adapter, autosensing, 88% PSU (not included for TIO models) 90 watts AC/DC adapter, autosensing, 88% PSU (only for models with I/O box) | | | | | | | |
| Limited warranty ³ | <i>Some:</i> 1-year or 3-year, depot service / service upgrades available <i>Some:</i> 1-year or 3-year, limited onsite service / service upgrades available <i>Some:</i> 3-year, limited onsite service, OID (Onsite International Delivery) / service upgrades available <i>For Lenovo service upgrade options, please go to S-TC sheet</i> | | | | | | | |
| Preload | Preloaded operating system <i>Some:</i> Windows® 7 Professional 64 preinstalled through downgrade rights in Windows 10 Pro 64-bit <i>Some:</i> Windows 7 Professional 64 <i>Some:</i> Windows 10 Pro 64-bit <i>Some:</i> Windows 10 Home 64-bit | | Preloaded applications (only some listed) <ul style="list-style-type: none"> • Desktop Power Manager • Lenovo Solution Center • Lenovo REACHit • Lenovo SHAREit • Lenovo Bluetooth Lock (for models with Wi-Fi/BT card) • McAfee® LiveSafe™ (30-day trial) • Microsoft Office preloaded; purchase a product key to activate • PowerDVD Create (DVD±RW) • Lenovo ThinkVantage Tools • Intel Unite (vPro models only) - Only for Window 10 • Lenovo Companion • Cyberlink PowerDVD (DVD, DVD±RW) • Lenovo QuickOptimizer - Only for Window 7 • Rescue and Recovery • Password Manager • ThinkVantage System Update • Lenovo Message Center Plus • Adobe® Reader® | | | | | |
| Environment | ENERGY STAR® 6.1*; EPEAT™ Gold rating*; (*Need 85% PSU and Windows OS); ErP Lot 3; GREENGUARD®; RoHS-compliant; TUV Green Mark, ULE Gold | | | | | | | |
| MIL-SPEC test | MIL-STD-810G military certification (Low Pressure [Altitude], High Temperature, Low Temperature, Temperature Shock, Humidity, Sand and Dust, Vibration, Shock) | | | | | | | |
| Accessories | For compatible accessories, please go to TC-AQP sheet | | | | | | | |

See footnotes for more detailed information

| Model | Region | Processor | vPro | Graphics | Monitor Cable | Memory | Storage(HDD/SSD) | External Optical / I/O Box | WLAN + Bluetooth | Optional Rear Ports | Chassis Intrusion Switch | Kensington Cable Lock | Speaker | Adapter Cage | Toolless Chassis Screw | Dust Filter | Keyboard / Mouse | VESA Mount | Stand | Power Supply | Operating System | Warranty | Ann Date (m/y) |
|------------|--------|-----------|------|--------------|---------------|--------|--------------------|----------------------------|----------------------------|---------------------|--------------------------|-----------------------|---------|--------------|------------------------|-------------|------------------|------------|-------------|-----------------|----------------------|----------------|----------------|
| 10FM0006US | US | i5-6500T | vPro | Intel HD 530 | None | 4GBx1 | 120GB SSD | None | 8260 ac, 2x2, vPro + BT4.1 | 3rd DP | Switch | None | 1Wx1 | None | None | None | USB / USB | None | Floor Stand | 65W Adapter 88% | Win10 DG Win7 Pro 64 | 3-year, Onsite | 11/15 |
| 10FM0007US | US | i5-6500T | vPro | Intel HD 530 | None | 4GBx1 | 500GB 7200rpm 2.5" | None | 8260 ac, 2x2, vPro + BT4.1 | 3rd DP | Switch | None | 1Wx1 | None | None | None | USB / USB | None | Floor Stand | 65W Adapter 88% | Win10 DG Win7 Pro 64 | 3-year, Onsite | 11/15 |
| 10FM0008US | US | i7-6700T | vPro | Intel HD 530 | None | 8GBx1 | 120GB SSD | DVD±RW | 8260 ac, 2x2, vPro + BT4.1 | HDMI | Switch | None | 1Wx1 | None | None | None | USB / USB | VESA Mount | None | 65W Adapter 88% | Win10 DG Win7 Pro 64 | 3-year, Onsite | 11/15 |
| 10FM0009US | US | i5-6500T | vPro | Intel HD 530 | None | 4GBx1 | 500GB 7200rpm 2.5" | None | 8260 ac, 2x2, vPro + BT4.1 | None | Switch | None | 1Wx1 | None | None | None | USB / USB | None | Floor Stand | 65W Adapter 88% | Win10 DG Win7 Pro 64 | 3-year, Onsite | 11/15 |
| 10FM000AUS | US | i5-6500T | vPro | Intel HD 530 | None | 4GBx1 | 120GB SSD | DVD±RW | 8260 ac, 2x2, vPro + BT4.1 | HDMI | Switch | None | 1Wx1 | None | None | None | USB / USB | VESA Mount | None | 65W Adapter 88% | Win10 DG Win7 Pro 64 | 3-year, Onsite | 11/15 |
| 10FM000BUS | US | i7-6700T | vPro | Intel HD 530 | None | 8GBx1 | 120GB SSD | None | 8260 ac, 2x2, vPro + BT4.1 | 3rd DP | Switch | None | 1Wx1 | None | None | None | USB / USB | None | Floor Stand | 65W Adapter 88% | Win10 DG Win7 Pro 64 | 3-year, Onsite | 11/15 |
| 10FM0014US | US | i5-6500T | vPro | Intel HD 530 | None | 8GBx1 | 128GB SSD | DVD±RW | 8260 ac, 2x2, vPro + BT4.1 | HDMI | Switch | None | 1Wx1 | None | None | None | USB / USB | VESA Mount | None | 65W Adapter 88% | Win10 DG Win7 Pro 64 | 3-year, Onsite | 12/15 |
| 10FM0017US | US | i5-6500T | vPro | Intel HD 530 | None | 4GBx1 | 128GB SSD | None | 8260 ac, 2x2, vPro + BT4.1 | HDMI | Switch | None | 1Wx1 | None | None | None | USB / USB | None | Floor Stand | 65W Adapter 88% | Win10 DG Win7 Pro 64 | 3-year, Onsite | 12/15 |
| 10FM0018US | US | i7-6700T | vPro | Intel HD 530 | None | 8GBx1 | 180GB SSD Opal | DVD±RW | 8260 ac, 2x2, vPro + BT4.1 | HDMI | Switch | None | 1Wx1 | None | None | None | USB / USB | VESA Mount | None | 65W Adapter 88% | Win10 DG Win7 Pro 64 | 3-year, Onsite | 12/15 |
| 10FM0019US | US | i7-6700T | vPro | Intel HD 530 | None | 8GBx1 | 256GB SSD Opal | DVD±RW | 8260 ac, 2x2, vPro + BT4.1 | Serial | Switch | None | 1Wx1 | None | None | None | USB / USB | VESA Mount | None | 65W Adapter 88% | Win10 DG Win7 Pro 64 | 3-year, Onsite | 12/15 |
| 10FM001AUS | US | i7-6700T | vPro | Intel HD 530 | None | 8GBx1 | 500GB 7200rpm 2.5" | DVD±RW | 8260 ac, 2x2, vPro + BT4.1 | None | Switch | None | 1Wx1 | None | None | None | USB / USB | VESA Mount | None | 65W Adapter 88% | Win10 DG Win7 Pro 64 | 3-year, Onsite | 12/15 |
| 10FM001BUS | US | i7-6700T | vPro | Intel HD 530 | None | 8GBx1 | 256GB SSD Opal | DVD±RW | 8260 ac, 2x2, vPro + BT4.1 | HDMI | Switch | None | 1Wx1 | None | None | None | USB / USB | VESA Mount | None | 65W Adapter 88% | Win10 DG Win7 Pro 64 | 3-year, Onsite | 12/15 |
| 10FM001CUS | US | i5-6500T | vPro | Intel HD 530 | None | 4GBx1 | 500GB 7200rpm 2.5" | DVD±RW | 8260 ac, 2x2, vPro + BT4.1 | None | Switch | None | 1Wx1 | None | None | None | USB / USB | VESA Mount | None | 65W Adapter 88% | Win10 DG Win7 Pro 64 | 3-year, Onsite | 12/15 |
| 10FM001DUS | US | i7-6700T | vPro | Intel HD 530 | None | 8GBx1 | 180GB SSD Opal | DVD±RW | 8260 ac, 2x2, vPro + BT4.1 | 3rd DP | Switch | None | 1Wx1 | None | None | None | USB / USB | VESA Mount | None | 65W Adapter 88% | Win10 DG Win7 Pro 64 | 3-year, Onsite | 12/15 |
| 10FM001EUS | US | i5-6500T | vPro | Intel HD 530 | None | 4GBx1 | 500GB 7200rpm 2.5" | DVD±RW | 8260 ac, 2x2, vPro + BT4.1 | 3rd DP | Switch | None | 1Wx1 | None | None | None | USB / USB | VESA Mount | None | 65W Adapter 88% | Win10 DG Win7 Pro 64 | 3-year, Onsite | 12/15 |
| 10FM001FUS | US | i5-6500T | vPro | Intel HD 530 | None | 8GBx1 | 256GB SSD Opal | DVD±RW | 8260 ac, 2x2, vPro + BT4.1 | HDMI | Switch | None | 1Wx1 | None | None | None | USB / USB | VESA Mount | None | 65W Adapter 88% | Win10 DG Win7 Pro 64 | 3-year, Onsite | 12/15 |
| 10FM001GUS | US | i7-6700T | vPro | Intel HD 530 | None | 8GBx1 | 128GB SSD | None | 8260 ac, 2x2, vPro + BT4.1 | HDMI | Switch | None | 1Wx1 | None | None | None | USB / USB | None | Floor Stand | 65W Adapter 88% | Win10 DG Win7 Pro 64 | 3-year, Onsite | 12/15 |
| 10FM001HUS | US | i5-6500T | vPro | Intel HD 530 | None | 8GBx1 | 192GB SSD | DVD±RW | 8260 ac, 2x2, vPro + BT4.1 | HDMI | Switch | None | 1Wx1 | None | None | None | USB / USB | VESA Mount | None | 65W Adapter 88% | Win10 DG Win7 Pro 64 | 3-year, Onsite | 12/15 |
| 10FM001JUS | US | i7-6700T | vPro | Intel HD 530 | None | 8GBx1 | 128GB SSD | DVD±RW | 8260 ac, 2x2, vPro + BT4.1 | 3rd DP | Switch | None | 1Wx1 | None | None | None | USB / USB | VESA Mount | None | 65W Adapter 88% | Win10 DG Win7 Pro 64 | 3-year, Onsite | 12/15 |
| 10FM001KUS | US | i7-6700T | vPro | Intel HD 530 | None | 8GBx1 | 192GB SSD | DVD±RW | 8260 ac, 2x2, vPro + BT4.1 | HDMI | Switch | None | 1Wx1 | None | None | None | USB / USB | VESA Mount | None | 65W Adapter 88% | Win10 DG Win7 Pro 64 | 3-year, Onsite | 12/15 |

| Model | Region | Processor | vPro | Graphics | Monitor Cable | Memory | Storage(HDD/SSD) | External Optical / I/O Box | WLAN + Bluetooth | Optional Rear Ports | Chassis Intrusion Switch | Kensington Cable Lock | Speaker | Adapter Cage | Toolless Chassis Screw | Dust Filter | Keyboard / Mouse | VESA Mount | Stand | Power Supply | Operating System | Warranty | Ann Date (m/y) |
|------------|--------|-----------|------|--------------|---------------|--------|--------------------|----------------------------|----------------------------|---------------------|--------------------------|-----------------------|---------|--------------|------------------------|-------------|------------------|------------|-------------|-----------------|----------------------|----------------|----------------|
| 10FM001LUS | US | i7-6700T | vPro | Intel HD 530 | None | 8GBx1 | 192GB SSD | DVD±RW | 8260 ac, 2x2, vPro + BT4.1 | 3rd DP | Switch | None | 1Wx1 | None | None | None | USB / USB | VESA Mount | None | 65W Adapter 88% | Win10 DG Win7 Pro 64 | 3-year, Onsite | 12/15 |
| 10FM001MUS | US | i5-6500T | vPro | Intel HD 530 | None | 4GBx1 | 128GB SSD | DVD±RW | 8260 ac, 2x2, vPro + BT4.1 | 3rd DP | Switch | None | 1Wx1 | None | None | None | USB / USB | VESA Mount | None | 65W Adapter 88% | Win10 DG Win7 Pro 64 | 3-year, Onsite | 12/15 |
| 10FM001NUS | US | i5-6500T | vPro | Intel HD 530 | None | 4GBx1 | 128GB SSD | None | 8260 ac, 2x2, vPro + BT4.1 | 3rd DP | Switch | None | 1Wx1 | None | None | None | USB / USB | None | Floor Stand | 65W Adapter 88% | Win10 DG Win7 Pro 64 | 3-year, Onsite | 12/15 |
| 10FM001PUS | US | i5-6500T | vPro | Intel HD 530 | None | 4GBx1 | 500GB 7200rpm 2.5" | None | 8260 ac, 2x2, vPro + BT4.1 | Serial | Switch | None | 1Wx1 | None | None | None | USB / USB | None | Floor Stand | 65W Adapter 88% | Win10 DG Win7 Pro 64 | 3-year, Onsite | 12/15 |
| 10FM001QUS | US | i5-6500T | vPro | Intel HD 530 | None | 4GBx1 | 128GB SSD | None | 8260 ac, 2x2, vPro + BT4.1 | None | Switch | None | 1Wx1 | None | None | None | USB / USB | None | Floor Stand | 65W Adapter 88% | Win10 DG Win7 Pro 64 | 3-year, Onsite | 12/15 |
| 10FM001RUS | US | i5-6500T | vPro | Intel HD 530 | None | 8GBx1 | 192GB SSD | None | 8260 ac, 2x2, vPro + BT4.1 | None | Switch | None | 1Wx1 | None | None | None | USB / USB | None | Floor Stand | 65W Adapter 88% | Win10 DG Win7 Pro 64 | 3-year, Onsite | 12/15 |
| 10FM001SUS | US | i5-6500T | vPro | Intel HD 530 | None | 8GBx1 | 180GB SSD Opal | None | 8260 ac, 2x2, vPro + BT4.1 | 3rd DP | Switch | None | 1Wx1 | None | None | None | USB / USB | None | Floor Stand | 65W Adapter 88% | Win10 DG Win7 Pro 64 | 3-year, Onsite | 12/15 |
| 10FM001TUS | US | i5-6500T | vPro | Intel HD 530 | None | 4GBx1 | 500GB 7200rpm 2.5" | None | 8260 ac, 2x2, vPro + BT4.1 | HDMI | Switch | None | 1Wx1 | None | None | None | USB / USB | None | Floor Stand | 65W Adapter 88% | Win10 DG Win7 Pro 64 | 3-year, Onsite | 12/15 |
| 10FM001UUS | US | i5-6500T | vPro | Intel HD 530 | None | 8GBx1 | 256GB SSD Opal | None | 8260 ac, 2x2, vPro + BT4.1 | 3rd DP | Switch | None | 1Wx1 | None | None | None | USB / USB | None | Floor Stand | 65W Adapter 88% | Win10 DG Win7 Pro 64 | 3-year, Onsite | 12/15 |
| 10FM001VUS | US | i7-6700T | vPro | Intel HD 530 | None | 8GBx1 | 128GB SSD | None | 8260 ac, 2x2, vPro + BT4.1 | 3rd DP | Switch | None | 1Wx1 | None | None | None | USB / USB | None | Floor Stand | 65W Adapter 88% | Win10 DG Win7 Pro 64 | 3-year, Onsite | 12/15 |
| 10FM001WUS | US | i7-6700T | vPro | Intel HD 530 | None | 8GBx1 | 192GB SSD | None | 8260 ac, 2x2, vPro + BT4.1 | 3rd DP | Switch | None | 1Wx1 | None | None | None | USB / USB | None | Floor Stand | 65W Adapter 88% | Win10 DG Win7 Pro 64 | 3-year, Onsite | 12/15 |
| 10FM001XUS | US | i7-6700T | vPro | Intel HD 530 | None | 8GBx1 | 500GB 7200rpm 2.5" | None | 8260 ac, 2x2, vPro + BT4.1 | None | Switch | None | 1Wx1 | None | None | None | USB / USB | None | Floor Stand | 65W Adapter 88% | Win10 DG Win7 Pro 64 | 3-year, Onsite | 12/15 |
| 10FM001YUS | US | i7-6700T | vPro | Intel HD 530 | None | 8GBx1 | 180GB SSD Opal | None | 8260 ac, 2x2, vPro + BT4.1 | 3rd DP | Switch | None | 1Wx1 | None | None | None | USB / USB | None | Floor Stand | 65W Adapter 88% | Win10 DG Win7 Pro 64 | 3-year, Onsite | 12/15 |
| 10FM0020US | US | i7-6700T | vPro | Intel HD 530 | None | 8GBx1 | 128GB SSD | None | 8260 ac, 2x2, vPro + BT4.1 | None | Switch | None | 1Wx1 | None | None | None | USB / USB | None | Floor Stand | 65W Adapter 88% | Win10 DG Win7 Pro 64 | 3-year, Onsite | 12/15 |
| 10FM0021US | US | i7-6700T | vPro | Intel HD 530 | None | 8GBx1 | 256GB SSD Opal | None | 8260 ac, 2x2, vPro + BT4.1 | 3rd DP | Switch | None | 1Wx1 | None | None | None | USB / USB | None | Floor Stand | 65W Adapter 88% | Win10 DG Win7 Pro 64 | 3-year, Onsite | 12/15 |
| 10FM0022US | US | i7-6700T | vPro | Intel HD 530 | None | 8GBx1 | 128GB SSD | None | 8260 ac, 2x2, vPro + BT4.1 | 3rd DP | Switch | None | 1Wx1 | None | None | None | USB / USB | None | Floor Stand | 65W Adapter 88% | Win10 Pro 64 | 3-year, Onsite | 12/15 |
| 10FM0023US | US | i5-6500T | vPro | Intel HD 530 | None | 4GBx1 | 500GB 7200rpm 2.5" | DVD±RW | 8260 ac, 2x2, vPro + BT4.1 | 3rd DP | Switch | None | 1Wx1 | None | None | None | USB / USB | VESA Mount | None | 65W Adapter 88% | Win10 Pro 64 | 3-year, Onsite | 12/15 |
| 10FM0024US | US | i5-6500T | vPro | Intel HD 530 | None | 8GBx1 | 128GB SSD | DVD±RW | 8260 ac, 2x2, vPro + BT4.1 | 3rd DP | Switch | None | 1Wx1 | None | None | None | USB / USB | VESA Mount | None | 65W Adapter 88% | Win10 Pro 64 | 3-year, Onsite | 12/15 |
| 10FM0025US | US | i7-6700T | vPro | Intel HD 530 | None | 8GBx1 | 128GB SSD | DVD±RW | 8260 ac, 2x2, vPro + BT4.1 | 3rd DP | Switch | None | 1Wx1 | None | None | None | USB / USB | VESA Mount | None | 65W Adapter 88% | Win10 Pro 64 | 3-year, Onsite | 12/15 |
| 10FM0026US | US | i5-6500T | vPro | Intel HD 530 | None | 8GBx1 | 128GB SSD | None | 8260 ac, 2x2, vPro + BT4.1 | 3rd DP | Switch | None | 1Wx1 | None | None | None | USB / USB | None | Floor Stand | 65W Adapter 88% | Win10 Pro 64 | 3-year, Onsite | 12/15 |

| Model | Region | Processor | vPro | Graphics | Monitor Cable | Memory | Storage(HDD/SSD) | External Optical / I/O Box | WLAN + Bluetooth | Optional Rear Ports | Chassis Intrusion Switch | Kensington Cable Lock | Speaker | Adapter Cage | Toolless Chassis Screw | Dust Filter | Keyboard / Mouse | VESA Mount | Stand | Power Supply | Operating System | Warranty | Ann Date (m/y) |
|------------|--------|-----------|------|--------------|---------------|--------|------------------------------------|----------------------------|----------------------------|---------------------|--------------------------|-----------------------|---------|--------------|------------------------|-------------|------------------|------------|-------------|-----------------|----------------------|----------------|----------------|
| 10FM0027US | US | i5-6500T | vPro | Intel HD 530 | None | 4GBx1 | 500GB 7200rpm 2.5" | None | 8260 ac, 2x2, vPro + BT4.1 | 3rd DP | Switch | None | 1Wx1 | None | None | None | USB / USB | None | Floor Stand | 65W Adapter 88% | Win10 Pro 64 | 3-year, Onsite | 12/15 |
| 10FM002TUS | US | i7-6700T | vPro | Intel HD 530 | None | 8GBx1 | 256GB SSD Opal | None | 8260 ac, 2x2, vPro + BT4.1 | VGA | Switch | None | 1Wx1 | None | None | None | USB / USB | None | Floor Stand | 65W Adapter 88% | Win10 DG Win7 Pro 64 | 3-year, Onsite | 02/16 |
| 10FM002UUS | US | i5-6500T | vPro | Intel HD 530 | None | 4GBx1 | 500GB 7200rpm 2.5" | DVD±RW | 8260 ac, 2x2, vPro + BT4.1 | VGA | Switch | None | 1Wx1 | None | None | None | USB / USB | VESA Mount | None | 65W Adapter 88% | Win10 DG Win7 Pro 64 | 3-year, Onsite | 02/16 |
| 10FM002VUS | US | i5-6500T | vPro | Intel HD 530 | None | 4GBx1 | 500GB 7200rpm 2.5" | DVD±RW | 8260 ac, 2x2, vPro + BT4.1 | VGA | Switch | None | 1Wx1 | None | None | None | None / USB | VESA Mount | None | 65W Adapter 88% | Win10 DG Win7 Pro 64 | 3-year, Onsite | 02/16 |
| 10FM0030US | US | i5-6600T | vPro | Intel HD 530 | None | 8GBx1 | 128GB SSD | None | 8260 ac, 2x2, vPro + BT4.1 | 3rd DP | Switch | None | 1Wx1 | None | None | None | USB / USB | None | Floor Stand | 65W Adapter 88% | Win10 DG Win7 Pro 64 | 3-year, Onsite | 03/16 |
| 10FM0031US | US | i5-6500T | vPro | Intel HD 530 | None | 8GBx1 | 128GB SSD | None | 8260 ac, 2x2, vPro + BT4.1 | VGA | Switch | None | 1Wx1 | None | None | None | USB / USB | None | Floor Stand | 65W Adapter 88% | Win10 DG Win7 Pro 64 | 3-year, Onsite | 03/16 |
| 10FM0032US | US | i5-6600T | vPro | Intel HD 530 | None | 8GBx1 | 500GB 7200rpm 2.5" | None | 8260 ac, 2x2, vPro + BT4.1 | 3rd DP | Switch | None | 1Wx1 | None | None | None | USB / USB | None | Floor Stand | 65W Adapter 88% | Win10 DG Win7 Pro 64 | 3-year, Onsite | 03/16 |
| 10FM0033US | US | i7-6700T | vPro | Intel HD 530 | None | 8GBx1 | 128GB SSD | None | 8260 ac, 2x2, vPro + BT4.1 | HDMI | Switch | None | 1Wx1 | None | None | None | USB / USB | None | Floor Stand | 65W Adapter 88% | Win10 Pro 64 | 3-year, Onsite | 04/16 |
| 10FM0034US | US | i5-6500T | vPro | Intel HD 530 | None | 8GBx1 | 256GB SSD Opal | None | 8260 ac, 2x2, vPro + BT4.1 | 3rd DP | Switch | None | 1Wx1 | None | None | None | USB / USB | None | Floor Stand | 65W Adapter 88% | Win10 Pro 64 | 3-year, Onsite | 04/16 |
| 10FM0039US | US | i5-6500T | vPro | Intel HD 530 | None | 8GBx1 | 500GB 7200rpm 2.5" + 128GB SSD M.2 | None | 8260 ac, 2x2, vPro + BT4.1 | HDMI | Switch | None | 1Wx1 | None | None | None | USB / USB | None | Floor Stand | 65W Adapter 88% | Win10 DG Win7 Pro 64 | 3-year, Onsite | 05/16 |
| 10FM003AUS | US | i7-6700T | vPro | Intel HD 530 | None | 8GBx1 | 128GB SSD + 128GB SSD M.2 PCIe | None | 8260 ac, 2x2, vPro + BT4.1 | HDMI | Switch | None | 1Wx1 | None | None | None | USB / USB | None | Floor Stand | 65W Adapter 88% | Win10 DG Win7 Pro 64 | 3-year, Onsite | 05/16 |
| 10FM003BUS | US | i7-6700T | vPro | Intel HD 530 | None | 4GBx1 | 500GB 7200rpm 2.5" | None | 8260 ac, 2x2, vPro + BT4.1 | 3rd DP | Switch | None | 1Wx1 | None | None | None | USB / USB | None | Floor Stand | 65W Adapter 88% | Win10 DG Win7 Pro 64 | 3-year, Onsite | 05/16 |
| 10FM003LUS | US | i5-6500T | vPro | Intel HD 530 | None | 4GBx1 | 500GB 7200rpm 2.5" | None | 8260 ac, 2x2, vPro + BT4.1 | Serial | Switch | None | 1Wx1 | None | None | None | USB / USB | None | Floor Stand | 65W Adapter 88% | Win10 Pro 64 | 3-year, Onsite | 07/16 |
| 10FM003YUS | US | i7-6700T | vPro | Intel HD 530 | None | 8GBx1 | 256GB SSD Opal | None | 8260 ac, 2x2, vPro + BT4.1 | HDMI | Switch | None | 1Wx1 | None | None | None | USB / USB | None | Floor Stand | 65W Adapter 88% | Win10 Pro 64 | 3-year, Onsite | 10/16 |

| Model | Region | Processor | vPro | Graphics | Monitor Cable | Memory | Storage(HDD/SSD) | External Optical / I/O Box | WLAN + Bluetooth | Optional Rear Ports | Chassis Intrusion Switch | Kensington Cable Lock | Speaker | Adapter Cage | Toolless Chassis Screw | Dust Filter | Keyboard / Mouse | VESA Mount | Stand | Power Supply | Operating System | Warranty | Ann Date (m/y) |
|------------|--------|-----------|------|--------------|---------------|--------|--------------------|----------------------------|----------------------------|---------------------|--------------------------|-----------------------|---------|--------------|------------------------|-------------|------------------|------------|-------------|-----------------|----------------------|----------------|----------------|
| 10NE0000US | US | i5-6500T | vPro | Intel HD 530 | None | 4GBx1 | 500GB 7200rpm 2.5" | None | 8260 ac, 2x2, vPro + BT4.1 | HDMI | Switch | None | 1Wx1 | None | None | None | USB / USB | None | Floor Stand | 65W Adapter 88% | Win10 Pro 64 | 3-year, Onsite | 07/16 |
| 10NE0001US | US | i5-6500T | vPro | Intel HD 530 | None | 4GBx1 | 500GB 7200rpm 2.5" | None | 8260 ac, 2x2, vPro + BT4.1 | 3rd DP | Switch | None | 1Wx1 | None | None | None | USB / USB | None | Floor Stand | 65W Adapter 88% | Win10 Pro 64 | 3-year, Onsite | 07/16 |
| 10NE0002US | US | i5-6500T | vPro | Intel HD 530 | None | 8GBx1 | 256GB SSD Opal | None | 8260 ac, 2x2, vPro + BT4.1 | 3rd DP | Switch | None | 1Wx1 | None | None | None | USB / USB | None | Floor Stand | 65W Adapter 88% | Win10 Pro 64 | 3-year, Onsite | 07/16 |
| 10NE0003US | US | i5-6500T | vPro | Intel HD 530 | None | 4GBx1 | 128GB SSD | None | 8260 ac, 2x2, vPro + BT4.1 | HDMI | Switch | None | 1Wx1 | None | None | None | USB / USB | None | Floor Stand | 65W Adapter 88% | Win10 Pro 64 | 3-year, Onsite | 07/16 |
| 10NE0004US | US | i7-6700T | vPro | Intel HD 530 | None | 8GBx1 | 128GB SSD | None | 8260 ac, 2x2, vPro + BT4.1 | HDMI | Switch | None | 1Wx1 | None | None | None | USB / USB | None | Floor Stand | 65W Adapter 88% | Win10 Pro 64 | 3-year, Onsite | 07/16 |
| 10NE0005US | US | i5-6500T | vPro | Intel HD 530 | None | 8GBx1 | 256GB SSD Opal | None | 8260 ac, 2x2, vPro + BT4.1 | HDMI | Switch | None | 1Wx1 | None | None | None | USB / USB | None | Floor Stand | 65W Adapter 88% | Win10 Pro 64 | 3-year, Onsite | 07/16 |
| 10NE000RUS | US | i7-6700T | vPro | Intel HD 530 | None | 8GBx1 | 256GB SSD Opal | None | 8260 ac, 2x2, vPro + BT4.1 | HDMI | Switch | None | 1Wx1 | None | None | None | USB / USB | None | Floor Stand | 65W Adapter 88% | Win10 Pro 64 | 3-year, Onsite | 10/16 |
| 10NE000SUS | US | i5-6500T | vPro | Intel HD 530 | None | 8GBx1 | 512GB SSD | None | 8260 ac, 2x2, vPro + BT4.1 | 3rd DP | Switch | None | 1Wx1 | None | None | None | USB / USB | None | Floor Stand | 65W Adapter 88% | Win10 DG Win7 Pro 64 | 3-year, Onsite | 11/16 |
| 10NE000TUS | US | i7-6700T | vPro | Intel HD 530 | None | 8GBx1 | 512GB SSD | None | 8260 ac, 2x2, vPro + BT4.1 | 3rd DP | Switch | None | 1Wx1 | None | None | None | USB / USB | None | Floor Stand | 65W Adapter 88% | Win10 DG Win7 Pro 64 | 3-year, Onsite | 11/16 |
| 10NE000UUS | US | i5-6500T | vPro | Intel HD 530 | None | 8GBx1 | 512GB SSD | None | 8260 ac, 2x2, vPro + BT4.1 | 3rd DP | Switch | None | 1Wx1 | None | None | None | USB / USB | None | Floor Stand | 65W Adapter 88% | Win10 Pro 64 | 3-year, Onsite | 11/16 |
| 10NE000VUS | US | i7-6700T | vPro | Intel HD 530 | None | 8GBx1 | 512GB SSD | None | 8260 ac, 2x2, vPro + BT4.1 | 3rd DP | Switch | None | 1Wx1 | None | None | None | USB / USB | None | Floor Stand | 65W Adapter 88% | Win10 Pro 64 | 3-year, Onsite | 11/16 |

| Model | Region | Processor | vPro | Graphics | Monitor Cable | Memory | Storage(HDD/SSD) | External Optical / I/O Box | WLAN + Bluetooth | Optional Rear Ports | Chassis Intrusion Switch | Kensington Cable Lock | Speaker | Adapter Cage | Toolless Chassis Screw | Dust Filter | Keyboard / Mouse | VESA Mount | Stand | Power Supply | Operating System | Warranty | Ann Date (m/y) |
|------------|--------|-----------|------|--------------|---------------|--------|--------------------|----------------------------|----------------------------|---------------------|--------------------------|-----------------------|---------|--------------|------------------------|-------------|------------------|------------|-------------|-----------------|----------------------|---------------------|----------------|
| 10FL0003US | US | i5-6500T | vPro | Intel HD 530 | None | 4GBx1 | 500GB 7200rpm 2.5" | None | 8260 ac, 2x2, vPro + BT4.1 | 3rd DP | Switch | None | 1Wx1 | None | None | None | USB / USB | None | Floor Stand | 65W Adapter 88% | Win10 DG Win7 Pro 64 | 3-year, Onsite, OID | 11/15 |
| 10FL0004US | US | i7-6700T | vPro | Intel HD 530 | None | 8GBx1 | 120GB SSD | None | 8260 ac, 2x2, vPro + BT4.1 | 3rd DP | Switch | None | 1Wx1 | None | None | None | USB / USB | None | Floor Stand | 65W Adapter 88% | Win10 DG Win7 Pro 64 | 3-year, Onsite, OID | 11/15 |
| 10FL0005US | US | i5-6500T | vPro | Intel HD 530 | None | 4GBx1 | 120GB SSD | None | 8260 ac, 2x2, vPro + BT4.1 | 3rd DP | Switch | None | 1Wx1 | None | None | None | USB / USB | None | Floor Stand | 65W Adapter 88% | Win10 DG Win7 Pro 64 | 3-year, Onsite, OID | 11/15 |
| 10FL0006US | US | i7-6700T | vPro | Intel HD 530 | None | 8GBx1 | 120GB SSD | DVD±RW | 8260 ac, 2x2, vPro + BT4.1 | HDMI | Switch | None | 1Wx1 | None | None | None | USB / USB | VESA Mount | None | 65W Adapter 88% | Win10 DG Win7 Pro 64 | 3-year, Onsite, OID | 11/15 |
| 10FL0007US | US | i5-6500T | vPro | Intel HD 530 | None | 4GBx1 | 500GB 7200rpm 2.5" | None | 8260 ac, 2x2, vPro + BT4.1 | None | Switch | None | 1Wx1 | None | None | None | USB / USB | None | Floor Stand | 65W Adapter 88% | Win10 DG Win7 Pro 64 | 3-year, Onsite, OID | 11/15 |
| 10FL0008US | US | i5-6500T | vPro | Intel HD 530 | None | 4GBx1 | 120GB SSD | DVD±RW | 8260 ac, 2x2, vPro + BT4.1 | HDMI | Switch | None | 1Wx1 | None | None | None | USB / USB | VESA Mount | None | 65W Adapter 88% | Win10 DG Win7 Pro 64 | 3-year, Onsite, OID | 11/15 |
| 10FL001RUS | US | i5-6600T | vPro | Intel HD 530 | VGA | 4GBx1 | 500GB 7200rpm 2.5" | None | 8260 ac, 2x2 + BT4.1 | VGA | Switch | None | 1Wx1 | None | None | None | USB / USB | None | Floor Stand | 65W Adapter 88% | Win10 Pro 64 | 3-year, Onsite, OID | 11/15 |
| 10FL001SUS | US | i5-6500T | vPro | Intel HD 530 | None | 4GBx1 | 500GB 7200rpm 2.5" | None | None | 3rd DP | Switch | None | 1Wx1 | None | None | None | USB / USB | None | None | 65W Adapter 88% | Win10 Pro 64 | 3-year, Onsite, OID | 11/15 |
| 10FL001WUS | US | i5-6500T | vPro | Intel HD 530 | None | 4GBx1 | 500GB 7200rpm 2.5" | None | None | None | Switch | None | 1Wx1 | None | None | None | USB / USB | None | None | 65W Adapter 88% | Win10 DG Win7 Pro 64 | 3-year, Onsite, OID | 11/15 |
| 10FL001XUS | US | i5-6600T | vPro | Intel HD 530 | None | 4GBx1 | 500GB 7200rpm 2.5" | None | 8260 ac, 2x2 + BT4.1 | None | Switch | None | 1Wx1 | None | None | None | USB / USB | None | None | 65W Adapter 88% | Win10 DG Win7 Pro 64 | 3-year, Onsite, OID | 11/15 |
| 10FL0024US | US | i7-6700T | vPro | Intel HD 530 | None | 4GBx1 | 1TB 5400rpm 2.5" | DVD±RW | 8260 ac, 2x2 + BT4.1 | None | Switch | None | 1Wx1 | None | None | None | USB / USB | VESA Mount | None | 65W Adapter 88% | Win10 Pro 64 | 3-year, Onsite, OID | 11/15 |



ThinkCentre M900 Mini Tower Platform Specifications

Product Specifications Reference (PSREF)

| | | | | | | | | |
|-------------------------------|---|-----------------|-------------------------|-----------|--------------|---------------------|------------|---|
| Processor | Intel® Celeron®, Intel Pentium®, or 6th Generation Intel Core™ i3 / i5 / i7 Processor | | | | | | | Manageability Intel Active Management Technology 11.0 (Intel AMT 11.0); Intel vPro technology on some models (require choosing a vPro-support Wi-Fi adapter to enable vPro function through wireless connection) |
| | Processor | Cores / Threads | Frequency Base/Max(GHz) | Cache | Memory Types | Integrated Graphics | Intel vPro | |
| | Pentium G4400 | 2 / 2 | 3.3G | 3 MB | DDR4-2133 | HD 510 | No | |
| | Pentium G4500 | 2 / 2 | 3.5G | 3 MB | DDR4-2133 | HD 530 | No | |
| | Core i3-6100 | 2 / 4 | 3.7 G | 3 MB | DDR4-2133 | HD 530 | No | |
| | Core i3-6300 | 2 / 4 | 3.8 G | 4 MB | DDR4-2133 | HD 530 | No | |
| | Core i5-6400 | 4 / 4 | 2.7 G / 3.3 G | 6 MB | DDR4-2133 | HD 530 | No | |
| | Core i5-6500 | 4 / 4 | 3.2 G / 3.6 G | 6 MB | DDR4-2133 | HD 530 | vPro | |
| | Core i5-6600 | 4 / 4 | 3.3 G / 3.9 G | 6 MB | DDR4-2133 | HD 530 | vPro | |
| Core i7-6700 | 4 / 8 | 3.4 G / 4.0 G | 8 MB | DDR4-2133 | HD 530 | vPro | | |
| Memory | 64GB max, UDIMM, DDR4 2133, four 288-pin DIMM sockets, dual-channel capable | | | | | | | Security chip Trusted Platform Module, TCG 1.2-compliant |
| Disk | <i>Some:</i> Hard disk, SATA 6.0Gb/s, 2.5"/ 3.5" wide, 5400 / 7200 rpm | | | | | | | |
| | <i>Some:</i> Solid State Hybrid Drive (SSHD), 500GB (5400 rpm, 2.5") / 1TB or 2TB (7200 rpm, 3.5"), with 8GB NAND flash memory, SATA 6.0Gb/s | | | | | | | |
| Optical | <i>Some:</i> Solid State Drive (SSD) / SATA 6.0Gb/s, 2.5" Wide | | | | | | | |
| | <i>Some:</i> M.2 SSD, PCIe NVMe, PCIe 3.0 x4, 32Gb/s | | | | | | | |
| Onboard SATA | <i>Some:</i> Front accessible and removable HDD, 3.5", lockable via physical key | | | | | | | |
| | <i>Some:</i> DVD-ROM SATA 1.5Gb/s Drive | | | | | | | |
| Media reader | <i>Some:</i> Super Multi-Burner DVD±RW SATA 1.5Gb/s Drive | | | | | | | |
| | Four onboard SATA 6.0Gb/s connectors, one is eSATA connector for optional rear eSATA port, RAID 0, 1 support | | | | | | | |
| Graphics | Optional 29-in-1 media reader | | | | | | | |
| | Intel HD Graphics 510/530 in processor, uses main memory, DirectX® 12, one VGA, two DisplayPort™, supports three independent displays, works along with discrete graphics to support more displays; | | | | | | | |
| Mechanical | <i>Max resolution:</i> 4096x2304 (DP) @60Hz; 1920x1200 (VGA) @60Hz | | | | | | | |
| | <i>Some:</i> NVIDIA® Quadro® K420, DirectX 12, 2GB, PCIe 2.0 x16 adapter, one DVI-I, one DisplayPort, 41 watts; | | | | | | | |
| Power supply | <i>Max resolution:</i> 3840x2160 (DisplayPort) @60Hz; 2560x1600 (DVI-I) @60Hz | | | | | | | |
| | <i>Some:</i> NVIDIA GeForce® GT 720, DirectX 12, 2GB, PCIe 2.0 x8 adapter, one VGA, one HDMI, 25 watts; | | | | | | | |
| Limited warranty ³ | <i>Max resolution:</i> 1920x1080 (HDMI) @60Hz; 2048x1536 (VGA) @85Hz | | | | | | | |
| | <i>Some:</i> NVIDIA GeForce GT 720, DirectX 12, 1GB, PCIe 2.0 x8 adapter, two DisplayPort, 25 watts; | | | | | | | |
| Preload | <i>Max resolution:</i> 3840x2160 (DisplayPort) @60Hz; | | | | | | | |
| | Optional DP to VGA, DP to DVI-D (single link), or DP to HDMI 1.4 dongle | | | | | | | |
| Preload | Intel Q170 Chipset | | | | | | | |
| | Preloaded operating system | | | | | | | |
| Front ports | Two USB 3.0, two optional USB 2.0, microphone (3.5mm), headphone (3.5mm) | | | | | | | |
| | preinstalled through downgrade rights in Windows 10 Pro 64-bit | | | | | | | |
| Rear ports | Six USB 3.0, two optional USB 2.0, serial (9-pin), optional 2nd serial (9-pin), optional parallel (25-pin), ethernet (RJ-45), one VGA, two DisplayPort, optional PS/2 ports (keyboard/mouse), one optional eSATA port | | | | | | | |
| | additional VGA, DisplayPort, DVI-I or HDMI on optional graphics on some models | | | | | | | |
| Rear audio ports | Line-in (3.5mm), line-out (3.5mm), microphone-in (3.5mm) | | | | | | | |
| | None | | | | | | | |
| Audio support | None | | | | | | | |
| | High Definition (HD) Audio, Realtek ALC662 / optional internal speaker (1.5 watt) | | | | | | | |
| WLAN ¹³ | None | | | | | | | |
| | Preloaded applications (only some listed) | | | | | | | |
| Bluetooth™ | <i>Some:</i> 11ac wireless, M.2 Card, Qualcomm Atheros QCA9377 (dual band), Wi-Fi + Bluetooth 4.1 combo adapter, 1x1 | | | | | | | |
| | Desktop Power Manager | | | | | | | |
| Ethernet | <i>Some:</i> 11ac wireless, M.2 Card, Qualcomm Atheros QCA6174 (dual band), Wi-Fi + Bluetooth 4.1 combo adapter, 2x2 | | | | | | | |
| | Lenovo Solution Center | | | | | | | |
| Modem | <i>Some:</i> 11ac wireless, M.2 Card, Intel Dual Band Wireless-AC 3165, Wi-Fi + Bluetooth 4.0 combo adapter, 1x1 | | | | | | | |
| | Lenovo REACHit | | | | | | | |
| Modem | <i>Some:</i> 11ac wireless, M.2 Card, Intel Dual Band Wireless-AC 8260, Wi-Fi + Bluetooth 4.1 combo adapter, 2x2 | | | | | | | |
| | Lenovo SHAREit | | | | | | | |
| Modem | <i>Some:</i> 11ac wireless, M.2 Card, Intel Dual Band Wireless-AC 8260, Wi-Fi + Bluetooth 4.1 combo adapter, Intel vPro technology support, 2x2 | | | | | | | |
| | Lenovo Bluetooth Lock (for models with Wi-Fi/BT card) | | | | | | | |
| Modem | None | | | | | | | |
| | McAfee® LiveSafe™ (30-day trial) | | | | | | | |
| Modem | None | | | | | | | |
| | Microsoft Office preloaded; purchase a product key to activate | | | | | | | |
| Modem | None | | | | | | | |
| | PowerDVD Create (DVD±RW) | | | | | | | |
| Modem | None | | | | | | | |
| | Lenovo ThinkVantage Tools | | | | | | | |
| Modem | None | | | | | | | |
| | Intel Unite (vPro models only) | | | | | | | |
| Modem | None | | | | | | | |
| | - Only for Window 10 | | | | | | | |
| Modem | None | | | | | | | |
| | • Lenovo Companion | | | | | | | |
| Modem | None | | | | | | | |
| | • Cyberlink PowerDVD (DVD, DVD±RW) | | | | | | | |
| Modem | None | | | | | | | |
| | • Lenovo QuickOptimizer | | | | | | | |
| Modem | None | | | | | | | |
| | - Only for Window 7 | | | | | | | |
| Modem | None | | | | | | | |
| | • Rescue and Recovery | | | | | | | |
| Modem | None | | | | | | | |
| | • Password Manager | | | | | | | |
| Modem | None | | | | | | | |
| | • ThinkVantage System Update | | | | | | | |
| Modem | None | | | | | | | |
| | • Lenovo Message Center Plus | | | | | | | |
| Modem | None | | | | | | | |
| | • Adobe® Reader® | | | | | | | |
| Modem | None | | | | | | | |
| | ENERGY STAR® 6.1*; EPEAT™ Gold rating*; (*Need 85% PSU and Windows OS); ErP Lot 3; GREENGUARD®; RoHS-compliant; TUV Green Mark, ULE Gold | | | | | | | |
| Modem | None | | | | | | | |
| | For compatible accessories, please go to TC-AQP sheet | | | | | | | |

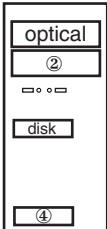

See footnotes for more detailed information

| Model | Region | Processor | vPro | Graphics | Monitor Cable | Memory | Storage(HDD/SSD) | Optical | Optional 2nd 3.5" Tray | Media Reader | WLAN + Bluetooth | Optional Front Ports | Optional Rear Ports | Chassis Intrusion Switch | Cable Lock | Front Access HDD | PCI Slot | Dust Filter | Keyboard / Mouse | Carry Handle | Power Supply | Operating System | Warranty | Ann Date (m/y) | |
|------------|--------|-----------|------|--------------|---------------|--------|--------------------|---------|------------------------|--------------|------------------|----------------------|---------------------|--------------------------|------------|------------------|----------|-------------|------------------|--------------|--------------|------------------|----------------------|---------------------|-------|
| 10FD0007US | US | i7-6700 | vPro | Intel HD 530 | None | 8GBx1 | 1TB 7200rpm 3.5" | DVD±RW | None | None | None | None | None | None | None | None | None | None | None | USB / USB | Carry Handle | 250W 85% | Win10 DG Win7 Pro 64 | 3-year, Onsite, OID | 11/15 |
| 10FD0008US | US | i5-6500 | vPro | Intel HD 530 | None | 4GBx1 | 500GB 7200rpm 3.5" | DVD±RW | None | None | None | None | None | None | None | None | None | None | None | USB / USB | Carry Handle | 250W 85% | Win10 DG Win7 Pro 64 | 3-year, Onsite, OID | 11/15 |
| 10FD001WUS | US | i7-6700 | vPro | Intel HD 530 | None | 8GBx1 | 1TB 7200rpm 3.5" | DVD±RW | Optional 2nd 3.5" Tray | None | None | None | None | None | None | None | None | None | None | USB / USB | Carry Handle | 250W 85% | Win10 Pro 64 | 3-year, Onsite | 11/15 |
| 10FD001XUS | US | i7-6700 | vPro | Intel HD 530 | None | 8GBx1 | 1TB 7200rpm 3.5" | DVD±RW | Optional 2nd 3.5" Tray | None | None | None | None | None | None | None | None | None | None | USB / USB | Carry Handle | 250W 85% | Win10 DG Win7 Pro 64 | 3-year, Onsite | 11/15 |
| 10FD001YUS | US | i5-6500 | vPro | Intel HD 530 | None | 4GBx1 | 500GB 7200rpm 3.5" | DVD±RW | Optional 2nd 3.5" Tray | None | None | None | None | None | None | None | None | None | None | USB / USB | Carry Handle | 250W 85% | Win10 DG Win7 Pro 64 | 3-year, Onsite | 11/15 |
| 10FD0020US | US | i5-6500 | vPro | Intel HD 530 | None | 4GBx1 | 500GB 7200rpm 3.5" | DVD±RW | Optional 2nd 3.5" Tray | None | None | None | None | None | None | None | None | None | None | USB / USB | Carry Handle | 250W 85% | Win10 Pro 64 | 3-year, Onsite | 11/15 |
| 10FD0021US | US | i5-6500 | vPro | Intel HD 530 | None | 8GBx1 | 500GB 7200rpm 3.5" | DVD±RW | Optional 2nd 3.5" Tray | None | None | None | None | None | None | None | None | None | None | USB / USB | Carry Handle | 250W 85% | Win10 Pro 64 | 3-year, Onsite | 11/15 |
| 10FD0022US | US | i5-6500 | vPro | Intel HD 530 | None | 8GBx1 | 500GB 7200rpm 3.5" | DVD±RW | Optional 2nd 3.5" Tray | None | None | None | None | None | None | None | None | None | None | USB / USB | Carry Handle | 250W 85% | Win10 DG Win7 Pro 64 | 3-year, Onsite | 11/15 |
| 10FD0024US | US | i5-6500 | vPro | Intel HD 530 | None | 4GBx1 | 128GB SSD | DVD±RW | Optional 2nd 3.5" Tray | None | None | None | None | None | None | None | None | None | None | USB / USB | Carry Handle | 250W 85% | Win10 Pro 64 | 3-year, Onsite | 12/15 |
| 10FD0025US | US | i5-6500 | vPro | Intel HD 530 | None | 8GBx1 | 256GB SSD Opal | DVD±RW | Optional 2nd 3.5" Tray | None | None | None | None | None | None | None | None | None | None | USB / USB | Carry Handle | 250W 85% | Win10 DG Win7 Pro 64 | 3-year, Onsite | 12/15 |
| 10FD0026US | US | i7-6700 | vPro | GT 720 1GB | None | 8GBx1 | 256GB SSD Opal | DVD±RW | Optional 2nd 3.5" Tray | None | None | None | None | None | None | None | None | None | None | USB / USB | Carry Handle | 250W 85% | Win10 DG Win7 Pro 64 | 3-year, Onsite | 12/15 |
| 10FD0027US | US | i7-6700 | vPro | GT 720 1GB | None | 8GBx1 | 1TB 7200rpm 3.5" | DVD±RW | Optional 2nd 3.5" Tray | None | None | None | None | None | None | None | None | None | None | USB / USB | Carry Handle | 250W 85% | Win10 Pro 64 | 3-year, Onsite | 12/15 |
| 10FD0028US | US | i7-6700 | vPro | Intel HD 530 | None | 8GBx1 | 256GB SSD Opal | DVD±RW | Optional 2nd 3.5" Tray | None | None | None | None | None | None | None | None | None | None | USB / USB | Carry Handle | 250W 85% | Win10 DG Win7 Pro 64 | 3-year, Onsite | 12/15 |
| 10FD0029US | US | i5-6500 | vPro | GT 720 1GB | None | 4GBx1 | 500GB 7200rpm 3.5" | DVD±RW | Optional 2nd 3.5" Tray | None | None | None | None | None | None | None | None | None | None | USB / USB | Carry Handle | 250W 85% | Win10 DG Win7 Pro 64 | 3-year, Onsite | 12/15 |
| 10FD002AUS | US | i5-6500 | vPro | Intel HD 530 | None | 4GBx1 | 180GB SSD Opal | DVD±RW | Optional 2nd 3.5" Tray | None | None | None | None | None | None | None | None | None | None | USB / USB | Carry Handle | 250W 85% | Win10 DG Win7 Pro 64 | 3-year, Onsite | 12/15 |
| 10FD002BUS | US | i7-6700 | vPro | GT 720 1GB | None | 8GBx1 | 1TB 7200rpm 3.5" | DVD±RW | Optional 2nd 3.5" Tray | None | None | None | None | None | None | None | None | None | None | USB / USB | Carry Handle | 250W 85% | Win10 DG Win7 Pro 64 | 3-year, Onsite | 12/15 |
| 10FD002CUS | US | i7-6700 | vPro | Intel HD 530 | None | 8GBx1 | 256GB SSD Opal | DVD±RW | Optional 2nd 3.5" Tray | None | None | None | None | None | None | None | None | None | None | USB / USB | Carry Handle | 250W 85% | Win10 Pro 64 | 3-year, Onsite | 12/15 |
| 10FD002DUS | US | i5-6500 | vPro | Intel HD 530 | None | 4GBx1 | 128GB SSD | DVD±RW | Optional 2nd 3.5" Tray | None | None | None | None | None | None | None | None | None | None | USB / USB | Carry Handle | 250W 85% | Win10 DG Win7 Pro 64 | 3-year, Onsite | 12/15 |
| 10FD002EUS | US | i5-6500 | vPro | Intel HD 530 | None | 8GBx1 | 180GB SSD Opal | DVD±RW | Optional 2nd 3.5" Tray | None | None | None | None | None | None | None | None | None | None | USB / USB | Carry Handle | 250W 85% | Win10 Pro 64 | 3-year, Onsite | 12/15 |
| 10FD002FUS | US | i5-6500 | vPro | GT 720 1GB | None | 8GBx1 | 1TB 7200rpm 3.5" | DVD±RW | Optional 2nd 3.5" Tray | None | None | None | None | None | None | None | None | None | None | USB / USB | Carry Handle | 250W 85% | Win10 DG Win7 Pro 64 | 3-year, Onsite | 12/15 |

| Model | Region | Processor | vPro | Graphics | Monitor Cable | Memory | Storage(HDD/SSD) | Optical | Optional 2nd 3.5" Tray | Media Reader | WLAN + Bluetooth | Optional Front Ports | Optional Rear Ports | Chassis Intrusion Switch | Cable Lock | Front Access HDD | PCI Slot | Dust Filter | Keyboard / Mouse | Carry Handle | Power Supply | Operating System | Warranty | Ann Date (m/y) | |
|------------|--------|-----------|------|--------------|---------------|--------|--------------------|---------|------------------------|--------------|------------------|----------------------|---------------------|--------------------------|------------|------------------|----------|-------------|------------------|--------------|--------------|------------------|----------------------|----------------|-------|
| 10FD002GUS | US | i5-6500 | vPro | Intel HD 530 | None | 4GBx1 | 192GB SSD | DVD±RW | Optional 2nd 3.5" Tray | None | None | None | None | None | None | None | None | None | None | USB / USB | Carry Handle | 250W 85% | Win10 DG Win7 Pro 64 | 3-year, Onsite | 12/15 |
| 10FD002HUS | US | i5-6500 | vPro | GT 720 1GB | None | 8GBx1 | 1TB 7200rpm 3.5" | DVD±RW | Optional 2nd 3.5" Tray | None | None | None | None | None | None | None | None | None | None | USB / USB | Carry Handle | 250W 85% | Win10 Pro 64 | 3-year, Onsite | 12/15 |
| 10FD003PUS | US | i7-6700 | vPro | GT 720 1GB | None | 8GBx1 | 256GB SSD Opal | DVD±RW | Optional 2nd 3.5" Tray | None | None | None | None | None | None | None | None | None | None | USB / USB | Carry Handle | 250W 85% | Win10 Pro 64 | 3-year, Onsite | 10/16 |
| 10FD003QUS | US | i7-6700 | vPro | GT 720 1GB | None | 8GBx1 | 1TB 7200rpm 3.5" | DVD±RW | Optional 2nd 3.5" Tray | None | None | None | None | None | None | None | None | None | None | USB / USB | Carry Handle | 250W 85% | Win10 DG Win7 Pro 64 | 3-year, Onsite | 10/16 |
| 10FD003RUS | US | i7-6700 | vPro | GT 720 1GB | None | 8GBx1 | 1TB 7200rpm 3.5" | DVD±RW | Optional 2nd 3.5" Tray | None | None | None | None | None | None | None | None | None | None | USB / USB | Carry Handle | 250W 85% | Win10 Pro 64 | 3-year, Onsite | 10/16 |
| 10FD003SUS | US | i5-6500 | vPro | GT 720 1GB | None | 4GBx1 | 500GB 7200rpm 3.5" | DVD±RW | Optional 2nd 3.5" Tray | None | None | None | None | None | None | None | None | None | None | USB / USB | Carry Handle | 250W 85% | Win10 Pro 64 | 3-year, Onsite | 10/16 |
| 10FD003TUS | US | i7-6700 | vPro | GT 720 1GB | None | 8GBx1 | 256GB SSD Opal | DVD±RW | Optional 2nd 3.5" Tray | None | None | None | None | None | None | None | None | None | None | USB / USB | Carry Handle | 250W 85% | Win10 DG Win7 Pro 64 | 3-year, Onsite | 10/16 |
| 10FD003UUS | US | i5-6500 | vPro | GT 720 1GB | None | 4GBx1 | 500GB 7200rpm 3.5" | DVD±RW | Optional 2nd 3.5" Tray | None | None | None | None | None | None | None | None | None | None | USB / USB | Carry Handle | 250W 85% | Win10 DG Win7 Pro 64 | 3-year, Onsite | 10/16 |
| 10FD003VUS | US | i5-6500 | vPro | GT 720 1GB | None | 8GBx1 | 1TB 7200rpm 3.5" | DVD±RW | Optional 2nd 3.5" Tray | None | None | None | None | None | None | None | None | None | None | USB / USB | Carry Handle | 250W 85% | Win10 Pro 64 | 3-year, Onsite | 10/16 |
| 10FD003WUS | US | i5-6500 | vPro | GT 720 1GB | None | 8GBx1 | 1TB 7200rpm 3.5" | DVD±RW | Optional 2nd 3.5" Tray | None | None | None | None | None | None | None | None | None | None | USB / USB | Carry Handle | 250W 85% | Win10 DG Win7 Pro 64 | 3-year, Onsite | 10/16 |

ThinkCentre M900 Tower - 10FC

| Model | Region | Processor | vPro | Graphics | Monitor Cable | Memory | Storage(HDD/SSD) | Optical | Optional 2nd 3.5" Tray | Media Reader | WLAN + Bluetooth | Optional Front Ports | Optional Rear Ports | Chassis Intrusion Switch | Cable Lock | Front Access HDD | PCI Slot | Dust Filter | Keyboard / Mouse | Carry Handle | Power Supply | Operating System | Warranty | Ann Date (m/y) |
|------------|--------|-----------|------|--------------|---------------|--------|--------------------|---------|------------------------|--------------|------------------|----------------------|---------------------|--------------------------|------------|------------------|----------|-------------|------------------|--------------|--------------|----------------------|---------------------|----------------|
| 10FC0003US | US | i5-6500 | vPro | Intel HD 530 | None | 4GBx1 | 500GB 7200rpm 3.5" | DVD±RW | None | None | None | None | None | None | None | None | None | None | USB / USB | None | 250W 85% | Win10 Pro 64 | 3-year, Onsite, OID | 11/15 |
| 10FC0004US | US | i5-6500 | vPro | Intel HD 530 | None | 4GBx1 | 500GB 7200rpm 3.5" | DVD±RW | None | None | None | None | None | None | None | None | None | None | USB / USB | None | 250W 85% | Win10 DG Win7 Pro 64 | 3-year, Onsite, OID | 11/15 |
| 10FC0005US | US | i7-6700 | vPro | Intel HD 530 | None | 8GBx1 | 1TB 7200rpm 3.5" | DVD±RW | None | None | None | None | None | None | None | None | None | None | USB / USB | None | 250W 85% | Win10 DG Win7 Pro 64 | 3-year, Onsite, OID | 11/15 |
| 10FC0006US | US | i7-6700 | vPro | Intel HD 530 | None | 8GBx1 | 1TB 7200rpm 3.5" | DVD±RW | None | None | None | None | None | None | None | None | None | None | USB / USB | None | 250W 85% | Win10 Pro 64 | 3-year, Onsite, OID | 11/15 |
| 10FC000BUS | US | i5-6600 | vPro | Intel HD 530 | None | 4GBx1 | 500GB 7200rpm 3.5" | DVD±RW | None | None | None | None | None | None | None | None | None | None | USB / USB | Carry Handle | 250W 85% | Win10 Pro 64 | 3-year, Onsite, OID | 11/15 |
| 10FC000GUS | US | i5-6500 | vPro | Intel HD 530 | None | 4GBx1 | 500GB 7200rpm 3.5" | DVD | None | None | None | None | None | None | None | None | None | None | USB / USB | Carry Handle | 250W 85% | Win10 Pro 64 | 3-year, Onsite, OID | 11/15 |
| 10FC000HUS | US | i7-6700 | vPro | GT 720 1GB | None | 4GBx1 | 1TB 7200rpm 3.5" | DVD±RW | None | 29-in-1 | None | None | None | None | None | None | None | None | USB / USB | Carry Handle | 250W 85% | Win10 Pro 64 | 3-year, Onsite, OID | 11/15 |
| 10FC000KUS | US | i5-6600 | vPro | Intel HD 530 | None | 4GBx1 | 500GB 7200rpm 3.5" | DVD±RW | None | None | None | None | None | None | None | None | None | None | USB / USB | None | 250W 85% | Win10 DG Win7 Pro 64 | 3-year, Onsite, OID | 11/15 |
| 10FC000LUS | US | i7-6700 | vPro | GT 720 1GB | None | 4GBx1 | 1TB 7200rpm 3.5" | DVD±RW | None | 29-in-1 | None | None | None | None | None | None | None | Dust Filter | USB / USB | Carry Handle | 250W 85% | Win10 DG Win7 Pro 64 | 3-year, Onsite, OID | 11/15 |
| 10FC000MUS | US | i5-6500 | vPro | Intel HD 530 | None | 4GBx1 | 500GB 7200rpm 3.5" | DVD | None | None | None | None | None | None | None | None | None | None | USB / USB | None | 250W 85% | Win10 DG Win7 Pro 64 | 3-year, Onsite, OID | 11/15 |



ThinkCentre M900x Tiny Platform Specifications

Product Specifications Reference (PSREF)

| Processor | Intel® Celeron®, Intel Pentium®, or 6th Generation Intel Core™ i3 / i5 / i7 Processor | Security features | <ul style="list-style-type: none"> Security slot (in rear for optional Kensington® MicroSaver® cable) Administrator password Padlock loop Hard disk password Smart USB protection, allows keyboard/mouse only, blocks all storage devices Boot sequence control Power-on password Boot without keyboard and mouse Individual USB port disablement Chassis intrusion switch | | | | | | | | | | | | | | | | | | | | | | | | | | | | | | | | | | | | | | | | | | | | | | | | | |
|---------------------------|---|-------------------------------|---|-------------------------|---------------------|--------------|---------------------|------------|--------------|-------|-------|------|-----------|--------|----|--------------|-------|-------|------|-----------|--------|----|--------------|-------|---------------|------|-----------|--------|----|--------------|-------|---------------|------|-----------|--------|------|--------------|-------|---------------|------|-----------|--------|------|--------------|-------|---------------|------|-----------|--------|------|----------|--|
| | <table border="1"> <thead> <tr> <th>Processor</th> <th>Cores / Threads</th> <th>Frequency Base/Max(GHz)</th> <th>Cache</th> <th>Memory Types</th> <th>Integrated Graphics</th> <th>Intel vPro</th> </tr> </thead> <tbody> <tr> <td>Core i3-6100</td> <td>2 / 4</td> <td>3.7 G</td> <td>3 MB</td> <td>DDR4-2133</td> <td>HD 530</td> <td>No</td> </tr> <tr> <td>Core i3-6300</td> <td>2 / 4</td> <td>3.8 G</td> <td>4 MB</td> <td>DDR4-2133</td> <td>HD 530</td> <td>No</td> </tr> <tr> <td>Core i5-6400</td> <td>4 / 4</td> <td>2.7 G / 3.3 G</td> <td>6 MB</td> <td>DDR4-2133</td> <td>HD 530</td> <td>No</td> </tr> <tr> <td>Core i5-6500</td> <td>4 / 4</td> <td>3.2 G / 3.6 G</td> <td>6 MB</td> <td>DDR4-2133</td> <td>HD 530</td> <td>vPro</td> </tr> <tr> <td>Core i5-6600</td> <td>4 / 4</td> <td>3.3 G / 3.9 G</td> <td>6 MB</td> <td>DDR4-2133</td> <td>HD 530</td> <td>vPro</td> </tr> <tr> <td>Core i7-6700</td> <td>4 / 8</td> <td>3.4 G / 4.0 G</td> <td>8 MB</td> <td>DDR4-2133</td> <td>HD 530</td> <td>vPro</td> </tr> </tbody> </table> | Processor | Cores / Threads | Frequency Base/Max(GHz) | Cache | Memory Types | Integrated Graphics | Intel vPro | Core i3-6100 | 2 / 4 | 3.7 G | 3 MB | DDR4-2133 | HD 530 | No | Core i3-6300 | 2 / 4 | 3.8 G | 4 MB | DDR4-2133 | HD 530 | No | Core i5-6400 | 4 / 4 | 2.7 G / 3.3 G | 6 MB | DDR4-2133 | HD 530 | No | Core i5-6500 | 4 / 4 | 3.2 G / 3.6 G | 6 MB | DDR4-2133 | HD 530 | vPro | Core i5-6600 | 4 / 4 | 3.3 G / 3.9 G | 6 MB | DDR4-2133 | HD 530 | vPro | Core i7-6700 | 4 / 8 | 3.4 G / 4.0 G | 8 MB | DDR4-2133 | HD 530 | vPro | Keyboard | <i>Some:</i> Preferred Pro USB Keyboard (USB connector), Lenovo logo <i>Some:</i> Lenovo USB Fingerprint Keyboard (USB connector) <i>Some:</i> Ultralim Plus Wireless Keyboard (2.4GHz via USB receiver), black <i>Some:</i> Enhanced Optical USB Mouse, black, Lenovo logo <i>Some:</i> Ultralim Plus Wireless Mouse (2.4GHz via USB receiver), black |
| Processor | Cores / Threads | Frequency Base/Max(GHz) | Cache | Memory Types | Integrated Graphics | Intel vPro | | | | | | | | | | | | | | | | | | | | | | | | | | | | | | | | | | | | | | | | | | | | | | |
| Core i3-6100 | 2 / 4 | 3.7 G | 3 MB | DDR4-2133 | HD 530 | No | | | | | | | | | | | | | | | | | | | | | | | | | | | | | | | | | | | | | | | | | | | | | | |
| Core i3-6300 | 2 / 4 | 3.8 G | 4 MB | DDR4-2133 | HD 530 | No | | | | | | | | | | | | | | | | | | | | | | | | | | | | | | | | | | | | | | | | | | | | | | |
| Core i5-6400 | 4 / 4 | 2.7 G / 3.3 G | 6 MB | DDR4-2133 | HD 530 | No | | | | | | | | | | | | | | | | | | | | | | | | | | | | | | | | | | | | | | | | | | | | | | |
| Core i5-6500 | 4 / 4 | 3.2 G / 3.6 G | 6 MB | DDR4-2133 | HD 530 | vPro | | | | | | | | | | | | | | | | | | | | | | | | | | | | | | | | | | | | | | | | | | | | | | |
| Core i5-6600 | 4 / 4 | 3.3 G / 3.9 G | 6 MB | DDR4-2133 | HD 530 | vPro | | | | | | | | | | | | | | | | | | | | | | | | | | | | | | | | | | | | | | | | | | | | | | |
| Core i7-6700 | 4 / 8 | 3.4 G / 4.0 G | 8 MB | DDR4-2133 | HD 530 | vPro | | | | | | | | | | | | | | | | | | | | | | | | | | | | | | | | | | | | | | | | | | | | | | |
| Memory | 32GB max, DDR4 2133, two 260-pin SO-DIMM sockets, dual-channel capable | Mouse | | | | | | | | | | | | | | | | | | | | | | | | | | | | | | | | | | | | | | | | | | | | | | | | | | |
| Disk | <i>Some:</i> SATA 6.0Gb/s, 2.5" Wide, 5400 rpm or 7200 rpm <i>Some:</i> 500GB (5400 rpm) Solid State Hybrid Drive (SSHD) / with 8GB MLC NAND flash memory, SATA 6.0Gb/s, 2.5" wide <i>Some:</i> Solid State Drive (SSD) / SATA 6.0Gb/s, 2.5" Wide <i>Some:</i> M.2 SSD, PCIe or SATA interface | Mechanical | Tiny (1L), black color; metal case M900x Tiny only: 7.05" W X 7.20" D X 1.36" H 179mm W X 182.9mm D X 34.5mm H 2.9 lb (1.3 kg), weight may vary by configuration With VESA mount & ODD box: 7.42" W X 7.30" D X 2.48" H 188.4mm W X 185.38mm D X 63mm H 4.12 lb (1.87 kg), weight may vary by configuration With VESA mount & I/O box: 7.42" W X 7.30" D X 2.62" H 188.4mm W X 185.38mm D X 66.6mm H 3.53 lb (1.6 kg), weight may vary by configuration Optional VESA mount bracket kit, supports VESA 75mm and 100mm Optional system floor stand for vertical orientation | | | | | | | | | | | | | | | | | | | | | | | | | | | | | | | | | | | | | | | | | | | | | | | | | |
| Optical | <i>Some:</i> external ODD box with DVD-ROM, 9.5mm high, via USB <i>Some:</i> external ODD box with DVD±RW, 9.5mm high, via USB <i>Some:</i> external ODD box (for TIO) with DVD-ROM, 9.5mm high, via USB <i>Some:</i> external ODD box (for TIO) with DVD±RW, 9.5mm high, via USB <i>One:</i> SATA cable (1-drop to device), one SATA 6.0Gb/s connector on planar | VESA mount | | | | | | | | | | | | | | | | | | | | | | | | | | | | | | | | | | | | | | | | | | | | | | | | | | |
| Onboard SATA Media reader | None | Floor Stand | | | | | | | | | | | | | | | | | | | | | | | | | | | | | | | | | | | | | | | | | | | | | | | | | | |
| Graphics | Intel HD Graphics 510/530 in processor, uses main memory, DirectX® 12, two DisplayPort™, one optional HDMI, VGA, or 3rd DP, up to 3 independent displays; <i>Max resolution:</i> 4096x2304 (DP) @60Hz; 4096x2160 (HDMI) @24Hz; 1920x1200 (VGA) @60Hz | Power supply | 135 watts AC/DC adapter, autosensing, 88% PSU | | | | | | | | | | | | | | | | | | | | | | | | | | | | | | | | | | | | | | | | | | | | | | | | | |
| DP cable | Optional DP to VGA, DP to DVI-D (single link), or DP to HDMI 1.4 dongle | Limited warranty ³ | <i>Some:</i> 1-year or 3-year, depot service / service upgrades available <i>Some:</i> 1-year or 3-year, limited onsite service / service upgrades available <i>Some:</i> 3-year, limited onsite service, OID (Onsite International Delivery) / service upgrades available <i>For Lenovo service upgrade options, please go to S-TC sheet</i> | | | | | | | | | | | | | | | | | | | | | | | | | | | | | | | | | | | | | | | | | | | | | | | | | |
| Chipset | Intel Q170 Chipset | Preload | Preloaded operating system <i>Some:</i> Windows® 7 Professional 64 preinstalled through downgrade rights in Windows 10 Pro 64-bit <i>Some:</i> Windows 7 Professional 64 <i>Some:</i> Windows 10 Pro 64-bit Preloaded applications (only some listed) <ul style="list-style-type: none"> Desktop Power Manager Lenovo Solution Center Lenovo REACHit Lenovo SHAREit Lenovo Bluetooth Lock (for models with Wi-Fi/BT card) McAfee® LiveSafe™ (30-day trial) Microsoft Office preloaded; purchase a product key to activate PowerDVD Create (DVD±RW) Lenovo ThinkVantage Tools Intel Unite (vPro models only) - Only for Window 10 Lenovo Companion Cyberlink PowerDVD (DVD, DVD±RW) Lenovo QuickOptimizer - Only for Window 7 Rescue and Recovery Password Manager ThinkVantage System Update Lenovo Message Center Plus Adobe® Reader® | | | | | | | | | | | | | | | | | | | | | | | | | | | | | | | | | | | | | | | | | | | | | | | | | |
| Front ports | Two USB 3.0 (one is Always On and fast charge), one microphone (stereo, 3.5mm), one headphone / microphone combo jack (stereo, 3.5mm) | Environment | ENERGY STAR® 6.1*; EPEAT™ Gold rating*; (*Need 85% PSU and Windows OS); ErP Lot 3; GREENGUARD®; RoHS-compliant | | | | | | | | | | | | | | | | | | | | | | | | | | | | | | | | | | | | | | | | | | | | | | | | | |
| Rear ports | Four USB 3.0 (optional external optical box or external I/O box occupies one or two specific USB 3.0 on some models), ethernet (RJ-45), two DisplayPort, one optional port (VGA, 3rd DP, HDMI, or serial on some models), one headphone | Accessories | For compatible accessories, please go to TC-AQP sheet | | | | | | | | | | | | | | | | | | | | | | | | | | | | | | | | | | | | | | | | | | | | | | | | | |
| I/O box | Optional external I/O box, extends two USB 2.0, two USB 3.0, and one serial on rear, two USB 2.0 on front, via USB (occupy two specific USB 3.0 of M900x Tiny) | | | | | | | | | | | | | | | | | | | | | | | | | | | | | | | | | | | | | | | | | | | | | | | | | | | |
| Audio support | High Definition (HD) Audio, Realtek ALC223 / optional internal speaker (1 watt) | | | | | | | | | | | | | | | | | | | | | | | | | | | | | | | | | | | | | | | | | | | | | | | | | | | |
| WLAN ¹³ | <i>Some:</i> 11ac wireless, M.2 Card, Qualcomm Atheros QCA9377 (dual band), Wi-Fi + Bluetooth 4.1 combo adapter, 1x1 <i>Some:</i> 11ac wireless, M.2 Card, Qualcomm Atheros QCA6174 (dual band), Wi-Fi + Bluetooth 4.1 combo adapter, 2x2 <i>Some:</i> 11ac wireless, M.2 Card, Intel Dual Band Wireless-AC 3165, Wi-Fi + Bluetooth 4.0 combo adapter, 1x1 <i>Some:</i> 11ac wireless, M.2 Card, Intel Dual Band Wireless-AC 8260, Wi-Fi + Bluetooth 4.1 combo adapter, 2x2 <i>Some:</i> 11ac wireless, M.2 Card, Intel Dual Band Wireless-AC 8260, Wi-Fi + Bluetooth 4.1 combo adapter, Intel vPro technology support, 2x2 | | | | | | | | | | | | | | | | | | | | | | | | | | | | | | | | | | | | | | | | | | | | | | | | | | | |
| Bluetooth™ | <i>Some:</i> Bluetooth 4.0 or 4.1 wireless, integrated in Wi-Fi + BT combo adapter | | | | | | | | | | | | | | | | | | | | | | | | | | | | | | | | | | | | | | | | | | | | | | | | | | | |
| Ethernet | Gigabit ethernet, Intel Ethernet Connection I219-LM (Jacksonville), Wake on LAN® | | | | | | | | | | | | | | | | | | | | | | | | | | | | | | | | | | | | | | | | | | | | | | | | | | | |
| Modem | None | | | | | | | | | | | | | | | | | | | | | | | | | | | | | | | | | | | | | | | | | | | | | | | | | | | |
| Manageability | Intel Active Management Technology 11.0 (Intel AMT 11.0); Intel vPro technology on some models (require choosing a vPro-support Wi-Fi adapter to enable vPro function through wireless connection) | | | | | | | | | | | | | | | | | | | | | | | | | | | | | | | | | | | | | | | | | | | | | | | | | | | |
| Security chip | Trusted Platform Module, TCG 1.2-compliant | | | | | | | | | | | | | | | | | | | | | | | | | | | | | | | | | | | | | | | | | | | | | | | | | | | |

See footnotes for more detailed information

ThinkCentre M900x Tiny - TopSeller - 10LX

Product Specifications Reference (PSREF)

| Model | Region | Processor | vPro | Graphics | Monitor Cable | Memory | Storage(HDD/SSD) | External Optical / I/O Box | WLAN + Bluetooth | Optional Rear Ports | Chassis Intrusion Switch | Kensington Cable Lock | Speaker | Adapter Cage | Toolless Chassis Screw | Dust Filter | Keyboard / Mouse | VESA Mount | Stand | Power Supply | Operating System | Warranty | Ann Date (mm/yy) |
|------------|--------|-----------|------|--------------|---------------|--------|--------------------|----------------------------|----------------------------|---------------------|--------------------------|-----------------------|---------|--------------|------------------------|-------------|------------------|------------|-------------|------------------|----------------------|----------------|------------------|
| 10LX0002US | US | i7-6700 | vPro | Intel HD 530 | None | 8GBx1 | 128GB SSD | None | 8260 ac, 2x2, vPro + BT4.1 | 3rd DP | Switch | None | 1Wx1 | None | None | None | USB / USB | None | Floor Stand | 135W Adapter 88% | Win10 Pro 64 | 3-year, Onsite | 07/16 |
| 10LX0003US | US | i5-6500 | vPro | Intel HD 530 | None | 4GBx1 | 500GB 7200rpm 2.5" | None | 8260 ac, 2x2, vPro + BT4.1 | VGA | Switch | None | 1Wx1 | None | None | None | USB / USB | None | Floor Stand | 135W Adapter 88% | Win10 Pro 64 | 3-year, Onsite | 07/16 |
| 10LX0004US | US | i5-6500 | vPro | Intel HD 530 | None | 4GBx1 | 500GB 7200rpm 2.5" | None | 8260 ac, 2x2, vPro + BT4.1 | 3rd DP | Switch | None | 1Wx1 | None | None | None | USB / USB | None | Floor Stand | 135W Adapter 88% | Win10 Pro 64 | 3-year, Onsite | 07/16 |
| 10LX0005US | US | i5-6500 | vPro | Intel HD 530 | None | 4GBx1 | 500GB 7200rpm 2.5" | None | 8260 ac, 2x2, vPro + BT4.1 | None | Switch | None | 1Wx1 | None | None | None | USB / USB | None | Floor Stand | 135W Adapter 88% | Win10 Pro 64 | 3-year, Onsite | 07/16 |
| 10LX0006US | US | i5-6500 | vPro | Intel HD 530 | None | 8GBx1 | 128GB SSD | None | 8260 ac, 2x2, vPro + BT4.1 | 3rd DP | Switch | None | 1Wx1 | None | None | None | USB / USB | None | Floor Stand | 135W Adapter 88% | Win10 Pro 64 | 3-year, Onsite | 07/16 |
| 10LX0007US | US | i7-6700 | vPro | Intel HD 530 | None | 8GBx1 | 256GB SSD Opal | None | 8260 ac, 2x2, vPro + BT4.1 | 3rd DP | Switch | None | 1Wx1 | None | None | None | USB / USB | None | Floor Stand | 135W Adapter 88% | Win10 DG Win7 Pro 64 | 3-year, Onsite | 09/16 |
| 10LX0008US | US | i5-6500 | vPro | Intel HD 530 | None | 8GBx1 | 256GB SSD Opal | None | 8260 ac, 2x2, vPro + BT4.1 | 3rd DP | Switch | None | 1Wx1 | None | None | None | USB / USB | None | Floor Stand | 135W Adapter 88% | Win10 DG Win7 Pro 64 | 3-year, Onsite | 09/16 |
| 10LX0009US | US | i5-6500 | vPro | Intel HD 530 | None | 4GBx1 | 500GB 7200rpm 2.5" | None | 8260 ac, 2x2, vPro + BT4.1 | VGA | Switch | None | 1Wx1 | None | None | None | USB / USB | None | Floor Stand | 135W Adapter 88% | Win10 DG Win7 Pro 64 | 3-year, Onsite | 09/16 |
| 10LX000AUS | US | i5-6500 | vPro | Intel HD 530 | None | 4GBx1 | 500GB 7200rpm 2.5" | None | 8260 ac, 2x2, vPro + BT4.1 | None | Switch | None | 1Wx1 | None | None | None | USB / USB | None | Floor Stand | 135W Adapter 88% | Win10 DG Win7 Pro 64 | 3-year, Onsite | 09/16 |
| 10LX000BUS | US | i5-6500 | vPro | Intel HD 530 | None | 4GBx1 | 500GB 7200rpm 2.5" | None | 8260 ac, 2x2, vPro + BT4.1 | 3rd DP | Switch | None | 1Wx1 | None | None | None | USB / USB | None | Floor Stand | 135W Adapter 88% | Win10 DG Win7 Pro 64 | 3-year, Onsite | 09/16 |
| 10LX000CUS | US | i5-6500 | vPro | Intel HD 530 | None | 8GBx1 | 128GB SSD | None | 8260 ac, 2x2, vPro + BT4.1 | 3rd DP | Switch | None | 1Wx1 | None | None | None | USB / USB | None | Floor Stand | 135W Adapter 88% | Win10 DG Win7 Pro 64 | 3-year, Onsite | 09/16 |
| 10LX000DUS | US | i7-6700 | vPro | Intel HD 530 | None | 8GBx1 | 128GB SSD | None | 8260 ac, 2x2, vPro + BT4.1 | 3rd DP | Switch | None | 1Wx1 | None | None | None | USB / USB | None | Floor Stand | 135W Adapter 88% | Win10 DG Win7 Pro 64 | 3-year, Onsite | 09/16 |

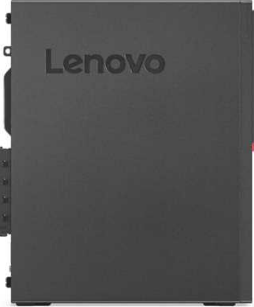

ThinkCentre M910 SFF Platform Specifications

Product Specifications Reference (PSREF)

| | | | | | | | |
|-------------------------------|---|-----------------|-------------------------|-----------|------------------------|---------------------|--|
| Processor | Intel® Celeron®, Intel Pentium®, or 6/7th Generation Intel Core™ i3 / i5 / i7 Processor | | | | | | Security features <ul style="list-style-type: none"> Security slot (in rear for optional Kensington® MicroSaver® cable) Padlock loop Smart USB protection, allows keyboard/mouse only, blocks all storage devices Optional cable lock to physically lock both keyboard and mouse Power-on password Administrator password Hard disk password Boot sequence control Boot without keyboard and mouse Individual USB port disablement Optional chassis intrusion switch |
| | Processor | Cores / Threads | Frequency Base/Max(GHz) | Cache | Memory Support (Up to) | Integrated Graphics | |
| | Core i5-6500 | 4 / 4 | 3.2G / 3.6G | 6 MB | DDR4-2133 | HD 530 | |
| | Core i7-6700 | 4 / 8 | 3.4G / 4.0G | 8 MB | DDR4-2133 | HD 530 | |
| | Core i5-7400 | 4 / 4 | 3.0G / 3.5G | 6 MB | DDR4-2400 | HD 630 | |
| | Core i5-7500 | 4 / 4 | 3.4G / 3.8G | 6 MB | DDR4-2400 | HD 630 | |
| | Core i5-7600 | 4 / 4 | 3.5G / 4.1G | 6 MB | DDR4-2400 | HD 630 | |
| Core i7-7700 | 4 / 8 | 3.6G / 4.2G | 8 MB | DDR4-2400 | HD 630 | | |
| Memory | 64GB max, UDIMM, DDR4-2400*, four 288-pin DIMM sockets, non-ECC, dual-channel capable * System automatically clocks down for the processors with lower memory controller | | | | | | |
| Storage | <i>Some:</i> Hard Drive / SATA 6.0Gb/s, 2.5" or 3.5", 5400 rpm or 7200 rpm <i>Some:</i> Solid State Drive (SSD) / SATA 6.0Gb/s, 2.5" <i>Some:</i> M.2 Solid State Drive (SSD) / PCIe NVMe, PCIe 3.0 x 4, 32Gb/s <i>Some:</i> Intel Optane™ Memory Ready (models with 7th gen Core processor), M.2 <i>Some:</i> DVD-ROM SATA 1.5Gb/s Drive, slim (9.0mm) <i>Some:</i> DVD Burner (DVD±RW), SATA 1.5Gb/s Drive, slim (9.0mm) | | | | | | |
| Optical | Four onboard SATA 6.0Gb/s connectors, RAID 0/1 support (RAID preset only available via special bid model) | | | | | | |
| Onboard SATA | Optional 7-in-1 media reader | | | | | | |
| Media reader | Intel HD Graphics 510/530/610/630 in processor, uses main memory, DirectX® 12, one VGA, two DisplayPort™, supports 3 independent displays, works along with discrete graphics to support more displays; <i>Max resolution:</i> 4096x2304 (DP) @60Hz; 2048x1536 (VGA) @50Hz <i>Some:</i> NVIDIA GeForce® GT 730 , DirectX 12, 2GB, PCIe 2.0 x8 adapter, two DisplayPort, 35 watts; <i>Max resolution:</i> 3840x2160 (DisplayPort) @60Hz; | | | | | | |
| Graphics | Optional DP to VGA, DP to DVI-D (single link), DP to dual DP, or DP to HDMI 1.4 | | | | | | |
| Monitor cable | Intel Q270 Chipset | | | | | | |
| Chipset | Four USB 3.1 Gen1, optional two USB 3.1 Type-C Gen 2 (only available via special bid), microphone (3.5mm), headphone (3.5mm) | | | | | | |
| Front ports | Four USB 3.1 Gen1, optional two USB 2.0, serial (9-pin), optional 2nd serial (9-pin), optional parallel (25-pin), ethernet (RJ-45), one VGA, two DisplayPort, optional two PS/2 ports (keyboard/mouse); additional DisplayPort on optional graphics on some models | | | | | | |
| Rear ports | Line-in (3.5mm), line-out (3.5mm), microphone-in (3.5mm) | | | | | | |
| Rear audio ports | None | | | | | | |
| IEEE 1394 | High Definition (HD) Audio, Realtek ALC662 / optional internal speaker (1.5 watt) | | | | | | |
| Audio support | <i>Some:</i> 11ac wireless, M.2 Card, Qualcomm Atheros QCA9377A (dual band), Wi-Fi + Bluetooth 4.1 combo adapter, 1x1 <i>Some:</i> 11ac wireless, M.2 Card, Qualcomm Atheros QCA6174A (dual band), Wi-Fi + Bluetooth 4.1 combo adapter, 2x2 <i>Some:</i> 11ac wireless, M.2 Card, Intel Dual Band Wireless-AC 3165, Wi-Fi + Bluetooth 4.1 combo adapter, 1x1 <i>Some:</i> 11ac wireless, M.2 Card, Intel Dual Band Wireless-AC 8265, Wi-Fi + Bluetooth 4.1 combo adapter, 2x2 <i>Some:</i> 11ac wireless, M.2 Card, Intel Dual Band Wireless-AC 8265, Wi-Fi + Bluetooth 4.1 combo adapter, Intel vPro technology support, 2x2 | | | | | | |
| WLAN ¹³ | <i>Some:</i> Bluetooth 4.1 wireless, integrated in Wi-Fi + BT combo adapter Gigabit ethernet, Intel Ethernet Connection I219-LM(Jacksonville), Wake on LAN® None | | | | | | |
| Bluetooth™ | ENERGY STAR® 6.1 , EPEAT™ Gold rating (North America), ErP Lot 3, GREENGUARD®, RoHS-compliant, TUV low noise verified (on some models) | | | | | | |
| Ethernet | For compatible accessories, please go to http://www.lenovoquickpick.com | | | | | | |
| Modem | For compatible accessories, please go to http://www.lenovoquickpick.com | | | | | | |
| Manageability | Intel Active Management Technology 11.0 (Intel AMT 11.0); Intel vPro technology on some models (require choosing a vPro-support Wi-Fi adapter to enable vPro function through wireless connection) | | | | | | |
| Security chip | TPM (Trusted Platform Module) 2.0, TCG Certified * Downgrade to TPM1.2 for the models with Win10 DG Win7 32 OS | | | | | | |
| Keyboard | <i>Some:</i> Lenovo Calliope Keyboard (USB connector), black <i>Some:</i> Lenovo Traditional Keyboard (USB connector), black <i>Some:</i> Lenovo Calliope Wireless Keyboard (2.4GHz via USB receiver), black <i>Some:</i> Lenovo Calliope Mouse (USB connector), black <i>Some:</i> Lenovo Calliope Wireless Mouse (2.4GHz via USB receiver), black | | | | | | |
| Mouse | Same as Keyboard | | | | | | |
| Mechanical | <ul style="list-style-type: none"> SFF (8.4L), black color, metal case (WxDxH) 3.6" X 11.4" X 13.5"; 92.5mm X 290.5mm X 343.5mm Approx. 11.92 lb (5.4 kg), weight may vary by configuration Toolless cover, disk, optical, graphic card removal Optional dust filter Bay 1: Slim external ODD bay Bay 2: 3.5", 1" high, internal, HDD/SSD Bay 3: 2.5", internal, HDD/SSD (optional bay) Slot 1: low-profile (length < 150mm, height < 68mm), PCIe 3.0 x16* Slot 2: low-profile (length < 150mm, height < 68mm), PCIe 3.0 x1* Slot 3: low-profile (length < 150mm, height < 68mm), PCIe 3.0 x16 (x4 signal)* Slot 4: no slot, only bracket for optional port extension* M.2 card slots: Two (one for WLAN, one for SSD/Optane) * Optional front USB3.1 Type-C x2 module occupies PCIe x16 (x4 signal) slot, optional rear 2x USB2.0 / parallel / 2nd serial / cable lock / Wi-Fi antenna occupies one expansion slot | | | | | | |
| Floor Stand | Optional system floor stand for vertical orientation | | | | | | |
| Power supply | <i>Some:</i> 180 watts, autosensing, 85% PSU <i>Some:</i> 210 watts, autosensing, 85% PSU <i>Some:</i> 210 watts, autosensing, 92% PSU (only available via special bid) | | | | | | |
| Limited warranty ³ | <i>Some:</i> 1-year or 3-year, depot service / service upgrades available <i>Some:</i> 1-year or 3-year, limited onsite service / service upgrades available | | | | | | |
| Preload | Preloaded operating system <i>Some:</i> Windows® 7 Professional 32/64 preinstalled through downgrade rights in Windows 10 Pro 64-bit (not available with 7th Gen Intel processor) <i>Some:</i> Windows 10 Pro 64-bit <i>Some:</i> Windows 10 Home 64-bit | | | | | | |
| Environment | Preloaded applications (only some listed) <ul style="list-style-type: none"> Microsoft Office preloaded; purchase a product key to activate Cyberlink PowerDVD Create (DVD±RW) Intel Unite (vPro models only) - Only for Window 10 Lenovo Companion Lenovo ID Cyberlink PowerDVD (DVD, DVD±RW) - Only for Window 7 Lenovo Solution Center Lenovo ThinkVantage Tools Create Recovery Media Adobe® Reader® | | | | | | |
| Accessories | For compatible accessories, please go to http://www.lenovoquickpick.com | | | | | | |

See footnotes for more detailed information

| Model | Region | Processor | vPro | Graphics | Monitor Cable | Memory | Storage(HDD/SSD) | Optical | Optional 2nd 2.5" Bay | Media Reader | WLAN + Bluetooth | Optional Front Ports | Optional Rear Ports | Chassis Intrusion Switch | Cable Lock | Front Access HDD | Speaker | Dust Filter | Keyboard / Mouse | Stand | Power Supply | Operating System | Warranty | End of Support | Ann Date (mm/yy) |
|------------|--------|-----------|------|--------------|---------------|--------|-------------------------|---------|-----------------------|--------------|----------------------------|----------------------|---------------------|--------------------------|------------|------------------|---------|-------------|------------------|-------------|--------------|----------------------|----------------|----------------|------------------|
| 10MK000AUS | US | i7-7700 | vPro | Intel HD 630 | None | 8GBx1 | 1TB 7200rpm 3.5" | DVD±RW | Optional 2nd 2.5" Bay | None | 8265 ac, 2x2, vPro + BT4.1 | None | None | None | None | None | 1.5Wx1 | None | USB / USB | Floor Stand | 210W 85% | Win10 Pro 64 | 3-year, Onsite | Mar 21, 2023 | 02/17 |
| 10MK000BUS | US | i7-7700 | vPro | Intel HD 630 | None | 8GBx1 | 256GB SSD M.2 PCIe NVMe | DVD±RW | Optional 2nd 2.5" Bay | None | 8265 ac, 2x2, vPro + BT4.1 | None | None | None | None | None | 1.5Wx1 | None | USB / USB | Floor Stand | 210W 85% | Win10 Pro 64 | 3-year, Onsite | Mar 21, 2023 | 02/17 |
| 10MK000CUS | US | i5-7500 | vPro | GT 730 2GB | None | 8GBx1 | 1TB 7200rpm 3.5" | DVD±RW | Optional 2nd 2.5" Bay | None | None | None | None | None | None | None | 1.5Wx1 | None | USB / USB | Floor Stand | 210W 85% | Win10 Pro 64 | 3-year, Onsite | Mar 21, 2023 | 02/17 |
| 10MK000DUS | US | i5-7500 | vPro | GT 730 2GB | None | 8GBx1 | 512GB SSD M.2 PCIe NVMe | DVD±RW | Optional 2nd 2.5" Bay | None | 8265 ac, 2x2, vPro + BT4.1 | None | None | None | None | None | 1.5Wx1 | None | USB / USB | Floor Stand | 210W 85% | Win10 Pro 64 | 3-year, Onsite | Mar 21, 2023 | 02/17 |
| 10MK000EUS | US | i7-7700 | vPro | GT 730 2GB | None | 8GBx1 | 256GB SSD M.2 PCIe NVMe | DVD±RW | Optional 2nd 2.5" Bay | None | None | None | None | None | None | None | 1.5Wx1 | None | USB / USB | Floor Stand | 210W 85% | Win10 Pro 64 | 3-year, Onsite | Mar 21, 2023 | 02/17 |
| 10MK000FUS | US | i7-7700 | vPro | GT 730 2GB | None | 8GBx1 | 512GB SSD M.2 PCIe NVMe | DVD±RW | Optional 2nd 2.5" Bay | None | 8265 ac, 2x2, vPro + BT4.1 | None | None | None | None | None | 1.5Wx1 | None | USB / USB | Floor Stand | 210W 85% | Win10 Pro 64 | 3-year, Onsite | Mar 21, 2023 | 02/17 |
| 10MK000GUS | US | i5-7500 | vPro | Intel HD 630 | None | 4GBx1 | 500GB 7200rpm 3.5" | DVD±RW | Optional 2nd 2.5" Bay | None | None | None | None | None | None | None | 1.5Wx1 | None | USB / USB | Floor Stand | 210W 85% | Win10 Pro 64 | 3-year, Onsite | Mar 21, 2023 | 02/17 |
| 10MK000HUS | US | i5-7500 | vPro | Intel HD 630 | None | 8GBx1 | 256GB SSD M.2 PCIe NVMe | DVD±RW | Optional 2nd 2.5" Bay | None | None | None | None | None | None | None | 1.5Wx1 | None | USB / USB | Floor Stand | 210W 85% | Win10 Pro 64 | 3-year, Onsite | Mar 21, 2023 | 02/17 |
| 10MK000KUS | US | i5-7500 | vPro | GT 730 2GB | None | 8GBx1 | 256GB SSD M.2 PCIe NVMe | DVD±RW | Optional 2nd 2.5" Bay | None | None | None | None | None | None | None | 1.5Wx1 | None | USB / USB | Floor Stand | 210W 85% | Win10 Pro 64 | 3-year, Onsite | Mar 21, 2023 | 02/17 |
| 10MK000LUS | US | i7-7700 | vPro | GT 730 2GB | None | 8GBx1 | 1TB 7200rpm 3.5" | DVD±RW | Optional 2nd 2.5" Bay | None | None | None | None | None | None | None | 1.5Wx1 | None | USB / USB | Floor Stand | 210W 85% | Win10 Pro 64 | 3-year, Onsite | Mar 21, 2023 | 02/17 |
| 10MK000MUS | US | i7-7700 | vPro | Intel HD 630 | None | 8GBx1 | 512GB SSD M.2 PCIe NVMe | DVD±RW | Optional 2nd 2.5" Bay | None | None | None | None | None | None | None | 1.5Wx1 | None | USB / USB | Floor Stand | 210W 85% | Win10 Pro 64 | 3-year, Onsite | Mar 21, 2023 | 02/17 |
| 10MK000NUS | US | i7-7700 | vPro | Intel HD 630 | None | 8GBx1 | 1TB 7200rpm 3.5" | DVD±RW | Optional 2nd 2.5" Bay | None | None | None | None | None | None | None | 1.5Wx1 | None | USB / USB | Floor Stand | 210W 85% | Win10 Pro 64 | 3-year, Onsite | Mar 21, 2023 | 02/17 |
| 10MK000PUS | US | i7-7700 | vPro | Intel HD 630 | None | 8GBx1 | 256GB SSD M.2 PCIe NVMe | DVD±RW | Optional 2nd 2.5" Bay | None | None | None | None | None | None | None | 1.5Wx1 | None | USB / USB | Floor Stand | 210W 85% | Win10 Pro 64 | 3-year, Onsite | Mar 21, 2023 | 02/17 |
| 10MK000QUS | US | i5-7500 | vPro | Intel HD 630 | None | 8GBx1 | 1TB 7200rpm 3.5" | DVD±RW | Optional 2nd 2.5" Bay | None | None | None | None | None | None | None | 1.5Wx1 | None | USB / USB | Floor Stand | 210W 85% | Win10 Pro 64 | 3-year, Onsite | Mar 21, 2023 | 02/17 |
| 10MK000RUS | US | i5-7500 | vPro | Intel HD 630 | None | 8GBx1 | 1TB 7200rpm 3.5" | DVD±RW | Optional 2nd 2.5" Bay | None | 8265 ac, 2x2, vPro + BT4.1 | None | None | None | None | None | 1.5Wx1 | None | USB / USB | Floor Stand | 210W 85% | Win10 Pro 64 | 3-year, Onsite | Mar 21, 2023 | 02/17 |
| 10MK000SUS | US | i5-7500 | vPro | Intel HD 630 | None | 8GBx1 | 512GB SSD M.2 PCIe NVMe | DVD±RW | Optional 2nd 2.5" Bay | None | None | None | None | None | None | None | 1.5Wx1 | None | USB / USB | Floor Stand | 210W 85% | Win10 Pro 64 | 3-year, Onsite | Mar 21, 2023 | 02/17 |
| 10MK000TUS | US | i5-7500 | vPro | Intel HD 630 | None | 8GBx1 | 256GB SSD M.2 PCIe NVMe | DVD±RW | Optional 2nd 2.5" Bay | None | 8265 ac, 2x2, vPro + BT4.1 | None | None | None | None | None | 1.5Wx1 | None | USB / USB | Floor Stand | 210W 85% | Win10 Pro 64 | 3-year, Onsite | Mar 21, 2023 | 02/17 |
| 10MK0035US | US | i5-6500 | vPro | GT 730 2GB | None | 8GBx1 | 512GB SSD M.2 PCIe NVMe | DVD±RW | Optional 2nd 2.5" Bay | None | 8265 ac, 2x2, vPro + BT4.1 | None | None | None | None | None | 1.5Wx1 | None | USB / USB | Floor Stand | 210W 85% | Win10 DG Win7 Pro 64 | 3-year, Onsite | Apr 28, 2023 | 03/17 |
| 10MK0036US | US | i5-6500 | vPro | Intel HD 530 | None | 4GBx1 | 128GB SSD M.2 PCIe NVMe | DVD±RW | Optional 2nd 2.5" Bay | None | None | None | None | None | None | None | 1.5Wx1 | None | USB / USB | Floor Stand | 210W 85% | Win10 DG Win7 Pro 64 | 3-year, Onsite | Apr 28, 2023 | 03/17 |
| 10MK0037US | US | i5-6500 | vPro | Intel HD 530 | None | 8GBx1 | 256GB SSD M.2 PCIe NVMe | DVD±RW | Optional 2nd 2.5" Bay | None | 8265 ac, 2x2, vPro + BT4.1 | None | None | None | None | None | 1.5Wx1 | None | USB / USB | Floor Stand | 210W 85% | Win10 DG Win7 Pro 64 | 3-year, Onsite | Apr 28, 2023 | 03/17 |

| Model | Region | Processor | vPro | Graphics | Monitor Cable | Memory | Storage(HDD/SSD) | Optical | Optional 2nd 2.5" Bay | Media Reader | WLAN + Bluetooth | Optional Front Ports | Optional Rear Ports | Chassis Intrusion Switch | Cable Lock | Front Access HDD | Speaker | Dust Filter | Keyboard / Mouse | Stand | Power Supply | Operating System | Warranty | End of Support | Ann Date (mm/yy) |
|------------|--------|-----------|------|--------------|---------------|--------|-------------------------|---------|-----------------------|--------------|----------------------------|----------------------|---------------------|--------------------------|------------|------------------|---------|-------------|------------------|-------------|--------------|----------------------|----------------|----------------|------------------|
| 10MK0038US | US | i7-6700 | vPro | Intel HD 530 | None | 8GBx1 | 256GB SSD M.2 PCIe NVMe | DVD±RW | Optional 2nd 2.5" Bay | None | None | None | None | None | None | None | 1.5Wx1 | None | USB / USB | Floor Stand | 210W 85% | Win10 DG Win7 Pro 64 | 3-year, Onsite | Apr 28, 2023 | 03/17 |
| 10MK0039US | US | i5-6500 | vPro | Intel HD 530 | None | 8GBx1 | 1TB 7200rpm 3.5" | DVD±RW | Optional 2nd 2.5" Bay | None | None | None | None | None | None | None | 1.5Wx1 | None | USB / USB | Floor Stand | 210W 85% | Win10 DG Win7 Pro 64 | 3-year, Onsite | Apr 28, 2023 | 03/17 |
| 10MK003AUS | US | i7-6700 | vPro | GT 730 2GB | None | 8GBx1 | 512GB SSD M.2 PCIe NVMe | DVD±RW | Optional 2nd 2.5" Bay | None | 8265 ac, 2x2, vPro + BT4.1 | None | None | None | None | None | 1.5Wx1 | None | USB / USB | Floor Stand | 210W 85% | Win10 DG Win7 Pro 64 | 3-year, Onsite | Apr 28, 2023 | 03/17 |
| 10MK003BUS | US | i7-6700 | vPro | Intel HD 530 | None | 8GBx1 | 1TB 7200rpm 3.5" | DVD±RW | Optional 2nd 2.5" Bay | None | None | None | None | None | None | None | 1.5Wx1 | None | USB / USB | Floor Stand | 210W 85% | Win10 DG Win7 Pro 64 | 3-year, Onsite | Apr 28, 2023 | 03/17 |
| 10MK003CUS | US | i5-6500 | vPro | GT 730 2GB | None | 8GBx1 | 1TB 7200rpm 3.5" | DVD±RW | Optional 2nd 2.5" Bay | None | None | None | None | None | None | None | 1.5Wx1 | None | USB / USB | Floor Stand | 210W 85% | Win10 DG Win7 Pro 64 | 3-year, Onsite | Apr 28, 2023 | 03/17 |
| 10MK003DUS | US | i5-6500 | vPro | Intel HD 530 | None | 8GBx1 | 1TB 7200rpm 3.5" | DVD±RW | Optional 2nd 2.5" Bay | None | 8265 ac, 2x2, vPro + BT4.1 | None | None | None | None | None | 1.5Wx1 | None | USB / USB | Floor Stand | 210W 85% | Win10 DG Win7 Pro 64 | 3-year, Onsite | Apr 28, 2023 | 03/17 |
| 10MK003EUS | US | i5-6500 | vPro | GT 730 2GB | None | 8GBx1 | 256GB SSD M.2 PCIe NVMe | DVD±RW | Optional 2nd 2.5" Bay | None | None | None | None | None | None | None | 1.5Wx1 | None | USB / USB | Floor Stand | 210W 85% | Win10 DG Win7 Pro 64 | 3-year, Onsite | Apr 28, 2023 | 03/17 |
| 10MK003FUS | US | i5-6500 | vPro | Intel HD 530 | None | 8GBx1 | 512GB SSD M.2 PCIe NVMe | DVD±RW | Optional 2nd 2.5" Bay | None | None | None | None | None | None | None | 1.5Wx1 | None | USB / USB | Floor Stand | 210W 85% | Win10 DG Win7 Pro 64 | 3-year, Onsite | Apr 28, 2023 | 03/17 |
| 10MK003GUS | US | i7-6700 | vPro | Intel HD 530 | None | 8GBx1 | 256GB SSD M.2 PCIe NVMe | DVD±RW | Optional 2nd 2.5" Bay | None | 8265 ac, 2x2, vPro + BT4.1 | None | None | None | None | None | 1.5Wx1 | None | USB / USB | Floor Stand | 210W 85% | Win10 DG Win7 Pro 64 | 3-year, Onsite | Apr 28, 2023 | 03/17 |
| 10MK003HUS | US | i7-6700 | vPro | GT 730 2GB | None | 8GBx1 | 1TB 7200rpm 3.5" | DVD±RW | Optional 2nd 2.5" Bay | None | None | None | None | None | None | None | 1.5Wx1 | None | USB / USB | Floor Stand | 210W 85% | Win10 DG Win7 Pro 64 | 3-year, Onsite | Apr 28, 2023 | 03/17 |
| 10MK003JUS | US | i5-6500 | vPro | Intel HD 530 | None | 4GBx1 | 500GB 7200rpm 3.5" | DVD±RW | Optional 2nd 2.5" Bay | None | None | None | None | None | None | None | 1.5Wx1 | None | USB / USB | Floor Stand | 210W 85% | Win10 DG Win7 Pro 64 | 3-year, Onsite | Apr 28, 2023 | 03/17 |
| 10MK003KUS | US | i5-6500 | vPro | Intel HD 530 | None | 8GBx1 | 256GB SSD M.2 PCIe NVMe | DVD±RW | Optional 2nd 2.5" Bay | None | None | None | None | None | None | None | 1.5Wx1 | None | USB / USB | Floor Stand | 210W 85% | Win10 DG Win7 Pro 64 | 3-year, Onsite | Apr 28, 2023 | 03/17 |
| 10MK003LUS | US | i7-6700 | vPro | GT 730 2GB | None | 8GBx1 | 256GB SSD M.2 PCIe NVMe | DVD±RW | Optional 2nd 2.5" Bay | None | None | None | None | None | None | None | 1.5Wx1 | None | USB / USB | Floor Stand | 210W 85% | Win10 DG Win7 Pro 64 | 3-year, Onsite | Apr 28, 2023 | 03/17 |
| 10MK003MUS | US | i5-7500 | vPro | Intel HD 630 | None | 4GBx1 | 128GB SSD M.2 PCIe NVMe | DVD±RW | Optional 2nd 2.5" Bay | None | None | None | None | None | None | None | 1.5Wx1 | None | USB / USB | Floor Stand | 210W 85% | Win10 Pro 64 | 3-year, Onsite | Apr 28, 2023 | 03/17 |
| 10MK003NUS | US | i7-6700 | vPro | Intel HD 530 | None | 8GBx1 | 512GB SSD M.2 PCIe NVMe | DVD±RW | Optional 2nd 2.5" Bay | None | None | None | None | None | None | None | 1.5Wx1 | None | USB / USB | Floor Stand | 210W 85% | Win10 DG Win7 Pro 64 | 3-year, Onsite | Apr 28, 2023 | 03/17 |
| 10MK003PUS | US | i7-6700 | vPro | Intel HD 530 | None | 8GBx1 | 1TB 7200rpm 3.5" | DVD±RW | Optional 2nd 2.5" Bay | None | 8265 ac, 2x2, vPro + BT4.1 | None | None | None | None | None | 1.5Wx1 | None | USB / USB | Floor Stand | 210W 85% | Win10 DG Win7 Pro 64 | 3-year, Onsite | Apr 28, 2023 | 03/17 |



ThinkCentre M910 Tiny Platform Specifications

Product Specifications Reference (PSREF)

| | | | | | | | |
|-------------------------------|--|-----------------|-------------------------|-----------|------------------------|---------------------|---|
| Processor | Intel® Celeron®, Intel Pentium®, or 6/7th Generation Intel Core™ i3 / i5 / i7 Processor | | | | | | Security features <ul style="list-style-type: none"> Security slot (in rear for optional Kensington® MicroSaver® cable) Smart USB protection, allows keyboard/mouse only, blocks all storage devices Power-on password Administrator password Hard disk password Boot sequence control Boot without keyboard and mouse Individual USB port disablement Chassis intrusion switch |
| | Processor | Cores / Threads | Frequency Base/Max(GHz) | Cache | Memory Support (Up to) | Integrated Graphics | |
| | Core i5-6500T | 4 / 4 | 2.5G / 3.1G | 6 MB | DDR4-2133 | HD 530 | |
| | Core i7-6700T | 4 / 8 | 2.8G / 3.6G | 8 MB | DDR4-2133 | HD 530 | |
| | Core i5-7500T | 4 / 4 | 2.7G / 3.3G | 6 MB | DDR4-2400 | HD 630 | |
| | Core i5-7600T | 4 / 4 | 2.8G / 3.7G | 6 MB | DDR4-2400 | HD 630 | |
| Core i7-7700T | 4 / 8 | 2.9G / 3.8G | 8 MB | DDR4-2400 | HD 630 | | |
| Memory | 32GB max, DDR4-2400*, two 260-pin SO-DIMM sockets, non-ECC, dual-channel capable * System automatically clocks down for the processors with lower memory controller | | | | | | |
| Storage | <i>Some:</i> Hard Drive / SATA 6.0Gb/s, 2.5", 5400 rpm or 7200 rpm, APS <i>Some:</i> Solid State Drive (SSD) / SATA 6.0Gb/s, 2.5" <i>Some:</i> M.2 Solid State Drive (SSD) / PCIe NVMe, PCIe 3.0 x 4, 32Gb/s <i>Some:</i> Intel Optane™ Memory Ready (models with 7th gen Core processor), M.2 <i>Some:</i> DVD-ROM, slim (9.0mm), via USB external ODD box <i>Some:</i> DVD Burner (DVD±RW), slim (9.0mm), via USB external ODD box | | | | | | |
| Optical | One onboard SATA 6.0Gb/s connector None | | | | | | |
| Onboard SATA Media reader | None | | | | | | |
| Graphics | Intel HD Graphics 510/530/610/630 in processor, uses main memory, DirectX® 12, two DisplayPort™, one optional video port (HDMI, VGA, 3rd DP, or USB 3.1 Type-C with DisplayPort Alternate Mode), up to 3 independent displays; <i>Max resolution:</i> 4096x2304 (DP) @60Hz; 4096x2304 (Type-C) @60Hz; 4096x2160 (HDMI) @24Hz; 1920x1200 (VGA) @60Hz | | | | | | |
| Monitor cable | Optional DP to VGA, DP to DVI-D (single link), DP to dual DP, or DP to HDMI 1.4 | | | | | | |
| Chipset | Intel Q270 Chipset | | | | | | |
| Front ports | Two USB 3.1 Gen1 (one is Always On and fast charge), one microphone (3.5mm), one headphone / microphone combo jack (3.5mm) | | | | | | |
| Rear ports | Four USB 3.1 Gen1 (optional external optical box or external I/O box occupies one or two specific USB 3.1 Gen1 on some models), ethernet (RJ-45), two DisplayPort, two optional ports (Port 1 for VGA / 3rd DP / HDMI / serial / USB 3.1 Type-C Gen 1 (with DisplayPort Alternate Mode), Port 2 for serial) | | | | | | |
| I/O box | Optional external I/O box, extends two USB 2.0, two USB 3.1 Gen1, and one serial on rear, two USB 2.0 on front, via USB cable (occupy two specific USB 3.1 Gen1 of Tiny) | | | | | | |
| Audio support | High Definition (HD) Audio, Realtek ALC294 / optional internal speaker (1w or 2w) | | | | | | |
| WLAN ¹³ | <i>Some:</i> 11ac wireless, M.2 Card, Qualcomm Atheros QCA9377A (dual band), Wi-Fi + Bluetooth 4.1 combo adapter, 1x1 <i>Some:</i> 11ac wireless, M.2 Card, Qualcomm Atheros QCA6174A (dual band), Wi-Fi + Bluetooth 4.1 combo adapter, 2x2 <i>Some:</i> 11ac wireless, M.2 Card, Intel Dual Band Wireless-AC 3165, Wi-Fi + Bluetooth 4.1 combo adapter, 1x1 <i>Some:</i> 11ac wireless, M.2 Card, Intel Dual Band Wireless-AC 8265, Wi-Fi + Bluetooth 4.1 combo adapter, 2x2 | | | | | | |
| Bluetooth™ | <i>Some:</i> 11ac wireless, M.2 Card, Intel Dual Band Wireless-AC 8265, Wi-Fi + Bluetooth 4.1 combo adapter, Intel vPro technology support, 2x2 <i>Some:</i> Bluetooth 4.1 wireless, integrated in Wi-Fi + BT combo adapter | | | | | | |
| Ethernet Modem | Gigabit ethernet, Intel Ethernet Connection I219-LM(Jacksonville), Wake on LAN® None | | | | | | |
| Manageability | Intel Active Management Technology 11.0 (Intel AMT 11.0); Intel vPro technology on some models (require choosing a vPro-support Wi-Fi adapter to enable vPro function through wireless connection) | | | | | | |
| Security chip | TPM (Trusted Platform Module) 2.0*, TCG Certified * Downgrade to TPM1.2 for the models with Win10 DG Win7 32 OS | | | | | | |
| VESA mount Floor Stand | Optional VESA mount bracket kit, supports VESA 75mm and 100mm Optional system floor stand for vertical orientation | | | | | | |
| Power supply | 65 watts AC/DC adapter, autosensing, 88% PSU (not included for TIO models) 90 watts AC/DC adapter, autosensing, 88% PSU (only for models with I/O box) | | | | | | |
| Limited warranty ³ | <i>Some:</i> 1-year or 3-year, depot service / service upgrades available <i>Some:</i> 1-year or 3-year, limited onsite service / service upgrades available | | | | | | |
| Preload | <i>Some:</i> Windows® 7 Professional 32/64 preinstalled through downgrade rights in Windows 10 Pro 64-bit (not available with 7th Gen Intel processor) <i>Some:</i> Windows 10 Pro 64-bit <i>Some:</i> Windows 10 Home 64-bit | | | | | | |
| Environment | ENERGY STAR® 6.1, EPEAT™ Gold rating (North America), ErP Lot 3, GREENGUARD®, RoHS-compliant, TUV low noise verified (on some models) | | | | | | |
| MIL-SPEC test | MIL-STD-810G military certification (Low Pressure [Altitude], High Temperature, Low Temperature, Temperature Shock, Humidity, Sand and Dust, Vibration, Shock, Fungus, Solar Radiation) | | | | | | |
| Accessories | For compatible accessories, please go to http://www.lenovoquickpick.com | | | | | | |

See footnotes for more detailed information

| Model | Region | Processor | vPro | Graphics | Monitor Cable | Memory | Storage(HDD/SSD) | External Optical / I/O Box | WLAN + Bluetooth | Optional Rear Ports | Chassis Intrusion Switch | Kensington Cable Lock | Speaker | Adapter Cage | Toolless Chassis Screw | Dust Filter | Keyboard / Mouse | VESA Mount | Stand | Power Supply | Operating System | Warranty | End of Support | Ann Date (mm/yy) |
|------------|--------|-----------|------|--------------|---------------|--------|-------------------------|----------------------------|----------------------------|---------------------|--------------------------|-----------------------|---------|--------------|------------------------|-------------|------------------|------------|-------------|-----------------|----------------------|----------------|----------------|------------------|
| 10MV000JUS | US | i5-7500T | vPro | Intel HD 630 | None | 4GBx1 | 128GB SSD M.2 PCIe NVMe | None | 8265 ac, 2x2, vPro + BT4.1 | 3rd DP | Switch | None | 1Wx1 | None | None | None | USB / USB | None | Floor Stand | 65W Adapter 88% | Win10 Pro 64 | 3-year, Onsite | Mar 21, 2023 | 02/17 |
| 10MV000KUS | US | i7-7700T | vPro | Intel HD 630 | None | 8GBx1 | 256GB SSD M.2 PCIe NVMe | DVD±RW | 8265 ac, 2x2, vPro + BT4.1 | HDMI | Switch | None | 1Wx1 | None | None | None | USB / USB | VESA Mount | None | 65W Adapter 88% | Win10 Pro 64 | 3-year, Onsite | Mar 21, 2023 | 02/17 |
| 10MV000LUS | US | i5-7500T | vPro | Intel HD 630 | None | 4GBx1 | 500GB 7200rpm 2.5" | None | 8265 ac, 2x2, vPro + BT4.1 | 3rd DP | Switch | None | 1Wx1 | None | None | None | USB / USB | None | Floor Stand | 65W Adapter 88% | Win10 Pro 64 | 3-year, Onsite | Mar 21, 2023 | 02/17 |
| 10MV000MUS | US | i5-7500T | vPro | Intel HD 630 | None | 8GBx1 | 500GB 7200rpm 2.5" | None | 8265 ac, 2x2, vPro + BT4.1 | HDMI | Switch | None | 1Wx1 | None | None | None | USB / USB | None | Floor Stand | 65W Adapter 88% | Win10 Pro 64 | 3-year, Onsite | Mar 21, 2023 | 02/17 |
| 10MV000NUS | US | i5-7500T | vPro | Intel HD 630 | None | 8GBx1 | 256GB SSD M.2 PCIe NVMe | None | 8265 ac, 2x2, vPro + BT4.1 | 3rd DP | Switch | None | 1Wx1 | None | None | None | USB / USB | None | Floor Stand | 65W Adapter 88% | Win10 Pro 64 | 3-year, Onsite | Mar 21, 2023 | 02/17 |
| 10MV000PUS | US | i5-7500T | vPro | Intel HD 630 | None | 8GBx1 | 500GB 7200rpm 2.5" | DVD±RW | 8265 ac, 2x2, vPro + BT4.1 | HDMI | Switch | None | 1Wx1 | None | None | None | USB / USB | VESA Mount | None | 65W Adapter 88% | Win10 Pro 64 | 3-year, Onsite | Mar 21, 2023 | 02/17 |
| 10MV000QUS | US | i5-7500T | vPro | Intel HD 630 | None | 8GBx1 | 256GB SSD M.2 PCIe NVMe | None | 8265 ac, 2x2, vPro + BT4.1 | HDMI | Switch | None | 1Wx1 | None | None | None | USB / USB | None | Floor Stand | 65W Adapter 88% | Win10 Pro 64 | 3-year, Onsite | Mar 21, 2023 | 02/17 |
| 10MV000RUS | US | i5-7500T | vPro | Intel HD 630 | None | 4GBx1 | 128GB SSD M.2 PCIe NVMe | None | 8265 ac, 2x2, vPro + BT4.1 | None | Switch | None | 1Wx1 | None | None | None | USB / USB | None | Floor Stand | 65W Adapter 88% | Win10 Pro 64 | 3-year, Onsite | Mar 21, 2023 | 02/17 |
| 10MV000SUS | US | i5-7500T | vPro | Intel HD 630 | None | 8GBx1 | 128GB SSD M.2 PCIe NVMe | None | 8265 ac, 2x2, vPro + BT4.1 | 3rd DP | Switch | None | 1Wx1 | None | None | None | USB / USB | None | Floor Stand | 65W Adapter 88% | Win10 Pro 64 | 3-year, Onsite | Mar 21, 2023 | 02/17 |
| 10MV000TUS | US | i5-7500T | vPro | Intel HD 630 | None | 8GBx1 | 500GB 7200rpm 2.5" | None | 8265 ac, 2x2, vPro + BT4.1 | 3rd DP | Switch | None | 1Wx1 | None | None | None | USB / USB | None | Floor Stand | 65W Adapter 88% | Win10 Pro 64 | 3-year, Onsite | Mar 21, 2023 | 02/17 |
| 10MV000UUS | US | i7-7700T | vPro | Intel HD 630 | None | 8GBx1 | 256GB SSD M.2 PCIe NVMe | None | 8265 ac, 2x2, vPro + BT4.1 | HDMI | Switch | None | 1Wx1 | None | None | None | USB / USB | None | Floor Stand | 65W Adapter 88% | Win10 Pro 64 | 3-year, Onsite | Mar 21, 2023 | 02/17 |
| 10MV000VUS | US | i5-7500T | vPro | Intel HD 630 | None | 4GBx1 | 500GB 7200rpm 2.5" | None | 8265 ac, 2x2, vPro + BT4.1 | Serial | Switch | None | 1Wx1 | None | None | None | USB / USB | None | Floor Stand | 65W Adapter 88% | Win10 Pro 64 | 3-year, Onsite | Mar 21, 2023 | 02/17 |
| 10MV000XUS | US | i5-7500T | vPro | Intel HD 630 | None | 4GBx1 | 500GB 7200rpm 2.5" | None | 8265 ac, 2x2, vPro + BT4.1 | None | Switch | None | 1Wx1 | None | None | None | USB / USB | None | Floor Stand | 65W Adapter 88% | Win10 Pro 64 | 3-year, Onsite | Mar 21, 2023 | 02/17 |
| 10MV000YUS | US | i7-7700T | vPro | Intel HD 630 | None | 8GBx1 | 128GB SSD M.2 PCIe NVMe | None | 8265 ac, 2x2, vPro + BT4.1 | HDMI | Switch | None | 1Wx1 | None | None | None | USB / USB | None | Floor Stand | 65W Adapter 88% | Win10 Pro 64 | 3-year, Onsite | Mar 21, 2023 | 02/17 |
| 10MV0010US | US | i7-7700T | vPro | Intel HD 630 | None | 8GBx1 | 500GB 7200rpm 2.5" | None | 8265 ac, 2x2, vPro + BT4.1 | HDMI | Switch | None | 1Wx1 | None | None | None | USB / USB | None | Floor Stand | 65W Adapter 88% | Win10 Pro 64 | 3-year, Onsite | Mar 21, 2023 | 02/17 |
| 10MV0011US | US | i5-7500T | vPro | Intel HD 630 | None | 4GBx1 | 256GB SSD M.2 PCIe NVMe | None | 8265 ac, 2x2, vPro + BT4.1 | 3rd DP | Switch | None | 1Wx1 | None | None | None | USB / USB | None | Floor Stand | 65W Adapter 88% | Win10 Pro 64 | 3-year, Onsite | Mar 21, 2023 | 02/17 |
| 10MV0012US | US | i5-7500T | vPro | Intel HD 630 | None | 8GBx1 | 512GB SSD M.2 PCIe NVMe | None | 8265 ac, 2x2, vPro + BT4.1 | HDMI | Switch | None | 1Wx1 | None | None | None | USB / USB | None | Floor Stand | 65W Adapter 88% | Win10 Pro 64 | 3-year, Onsite | Mar 21, 2023 | 02/17 |
| 10MV0013US | US | i7-7700T | vPro | Intel HD 630 | None | 8GBx1 | 512GB SSD M.2 PCIe NVMe | None | 8265 ac, 2x2, vPro + BT4.1 | HDMI | Switch | None | 1Wx1 | None | None | None | USB / USB | None | Floor Stand | 65W Adapter 88% | Win10 Pro 64 | 3-year, Onsite | Mar 21, 2023 | 02/17 |
| 10MV0014US | US | i5-7500T | vPro | Intel HD 630 | None | 8GBx1 | 256GB SSD M.2 PCIe NVMe | DVD±RW | 8265 ac, 2x2, vPro + BT4.1 | HDMI | Switch | None | 1Wx1 | None | None | None | USB / USB | VESA Mount | None | 65W Adapter 88% | Win10 Pro 64 | 3-year, Onsite | Mar 21, 2023 | 02/17 |
| 10MV002MUS | US | i7-6700T | vPro | Intel HD 530 | None | 8GBx1 | 512GB SSD M.2 PCIe NVMe | None | 8265 ac, 2x2, vPro + BT4.1 | HDMI | Switch | None | 1Wx1 | None | None | None | USB / USB | None | Floor Stand | 65W Adapter 88% | Win10 DG Win7 Pro 64 | 3-year, Onsite | Apr 21, 2023 | 03/17 |

| Model | Region | Processor | vPro | Graphics | Monitor Cable | Memory | Storage(HDD/SSD) | External Optical / I/O Box | WLAN + Bluetooth | Optional Rear Ports | Chassis Intrusion Switch | Kensington Cable Lock | Speaker | Adapter Cage | Toolless Chassis Screw | Dust Filter | Keyboard / Mouse | VESA Mount | Stand | Power Supply | Operating System | Warranty | End of Support | Ann Date (mm/yy) |
|------------|--------|-----------|------|--------------|---------------|--------|-------------------------|----------------------------|----------------------------|---------------------|--------------------------|-----------------------|---------|--------------|------------------------|-------------|------------------|------------|-------------|-----------------|----------------------|----------------|----------------|------------------|
| 10MV002NUS | US | i5-6500T | vPro | Intel HD 530 | None | 4GBx1 | 500GB 7200rpm 2.5" | None | 8265 ac, 2x2, vPro + BT4.1 | Serial | Switch | None | 1Wx1 | None | None | None | USB / USB | None | Floor Stand | 65W Adapter 88% | Win10 DG Win7 Pro 64 | 3-year, Onsite | Apr 21, 2023 | 03/17 |
| 10MV002PUS | US | i5-7500T | vPro | Intel HD 630 | None | 8GBx2 | 512GB SSD M.2 PCIe NVMe | None | 8265 ac, 2x2, vPro + BT4.1 | 3rd DP | Switch | None | 1Wx1 | None | None | None | USB / USB | None | Floor Stand | 65W Adapter 88% | Win10 Pro 64 | 3-year, Onsite | Apr 21, 2023 | 03/17 |
| 10MV002QUS | US | i7-7700T | vPro | Intel HD 630 | None | 8GBx2 | 512GB SSD M.2 PCIe NVMe | None | 8265 ac, 2x2, vPro + BT4.1 | 3rd DP | Switch | None | 1Wx1 | None | None | None | USB / USB | None | Floor Stand | 65W Adapter 88% | Win10 Pro 64 | 3-year, Onsite | Apr 21, 2023 | 03/17 |
| 10MV002RUS | US | i7-7700T | vPro | Intel HD 630 | None | 8GBx1 | 500GB 7200rpm 2.5" | None | 8265 ac, 2x2, vPro + BT4.1 | 3rd DP | Switch | None | 1Wx1 | None | None | None | USB / USB | None | Floor Stand | 65W Adapter 88% | Win10 Pro 64 | 3-year, Onsite | Apr 21, 2023 | 03/17 |
| 10MV002SUS | US | i5-6500T | vPro | Intel HD 530 | None | 8GBx1 | 512GB SSD M.2 PCIe NVMe | None | 8265 ac, 2x2, vPro + BT4.1 | 3rd DP | Switch | None | 1Wx1 | None | None | None | USB / USB | None | Floor Stand | 65W Adapter 88% | Win10 DG Win7 Pro 64 | 3-year, Onsite | Apr 21, 2023 | 03/17 |
| 10MV002TUS | US | i7-6700T | vPro | Intel HD 530 | None | 16GBx1 | 512GB SSD M.2 PCIe NVMe | None | 8265 ac, 2x2, vPro + BT4.1 | 3rd DP | Switch | None | 1Wx1 | None | None | None | USB / USB | None | Floor Stand | 65W Adapter 88% | Win10 DG Win7 Pro 64 | 3-year, Onsite | Apr 21, 2023 | 03/17 |
| 10MV002UUS | US | i7-6700T | vPro | Intel HD 530 | None | 8GBx1 | 500GB 7200rpm 2.5" | None | 8265 ac, 2x2, vPro + BT4.1 | 3rd DP | Switch | None | 1Wx1 | None | None | None | USB / USB | None | Floor Stand | 65W Adapter 88% | Win10 DG Win7 Pro 64 | 3-year, Onsite | Apr 21, 2023 | 03/17 |
| 10MV002VUS | US | i7-7700T | vPro | Intel HD 630 | None | 8GBx2 | 500GB 7200rpm 2.5" | None | 8265 ac, 2x2, vPro + BT4.1 | 3rd DP | Switch | None | 1Wx1 | None | None | None | USB / USB | None | Floor Stand | 65W Adapter 88% | Win10 Pro 64 | 3-year, Onsite | Apr 21, 2023 | 03/17 |
| 10MV002WUS | US | i7-6700T | vPro | Intel HD 530 | None | 8GBx1 | 256GB SSD M.2 PCIe NVMe | None | 8265 ac, 2x2, vPro + BT4.1 | HDMI | Switch | None | 1Wx1 | None | None | None | USB / USB | None | Floor Stand | 65W Adapter 88% | Win10 DG Win7 Pro 64 | 3-year, Onsite | Apr 21, 2023 | 03/17 |
| 10MV002XUS | US | i5-7500T | vPro | Intel HD 630 | None | 8GBx2 | 256GB SSD M.2 PCIe NVMe | None | 8265 ac, 2x2, vPro + BT4.1 | 3rd DP | Switch | None | 1Wx1 | None | None | None | USB / USB | None | Floor Stand | 65W Adapter 88% | Win10 Pro 64 | 3-year, Onsite | Apr 21, 2023 | 03/17 |
| 10MV002YUS | US | i5-6500T | vPro | Intel HD 530 | None | 8GBx2 | 512GB SSD M.2 PCIe NVMe | None | 8265 ac, 2x2, vPro + BT4.1 | 3rd DP | Switch | None | 1Wx1 | None | None | None | USB / USB | None | Floor Stand | 65W Adapter 88% | Win10 DG Win7 Pro 64 | 3-year, Onsite | Apr 21, 2023 | 03/17 |
| 10MV0030US | US | i5-6500T | vPro | Intel HD 530 | None | 4GBx1 | 500GB 7200rpm 2.5" | None | 8265 ac, 2x2, vPro + BT4.1 | None | Switch | None | 1Wx1 | None | None | None | USB / USB | None | Floor Stand | 65W Adapter 88% | Win10 DG Win7 Pro 64 | 3-year, Onsite | Apr 21, 2023 | 03/17 |
| 10MV0031US | US | i5-6500T | vPro | Intel HD 530 | None | 4GBx1 | 500GB 7200rpm 2.5" | None | 8265 ac, 2x2, vPro + BT4.1 | VGA | Switch | None | 1Wx1 | None | None | None | USB / USB | None | Floor Stand | 65W Adapter 88% | Win10 DG Win7 Pro 64 | 3-year, Onsite | Apr 21, 2023 | 03/17 |
| 10MV0032US | US | i5-6500T | vPro | Intel HD 530 | None | 8GBx1 | 256GB SSD M.2 PCIe NVMe | None | 8265 ac, 2x2, vPro + BT4.1 | 3rd DP | Switch | None | 1Wx1 | None | None | None | USB / USB | None | Floor Stand | 65W Adapter 88% | Win10 DG Win7 Pro 64 | 3-year, Onsite | Mar 21, 2022 | 03/17 |
| 10MV0033US | US | i7-6700T | vPro | Intel HD 530 | None | 8GBx1 | 512GB SSD M.2 PCIe NVMe | None | 8265 ac, 2x2, vPro + BT4.1 | 3rd DP | Switch | None | 1Wx1 | None | None | None | USB / USB | None | Floor Stand | 65W Adapter 88% | Win10 DG Win7 Pro 64 | 3-year, Onsite | Apr 21, 2023 | 03/17 |
| 10MV0034US | US | i5-6500T | vPro | Intel HD 530 | None | 8GBx1 | 128GB SSD M.2 PCIe NVMe | None | 8265 ac, 2x2, vPro + BT4.1 | 3rd DP | Switch | None | 1Wx1 | None | None | None | USB / USB | None | Floor Stand | 65W Adapter 88% | Win10 DG Win7 Pro 64 | 3-year, Onsite | Apr 21, 2023 | 03/17 |
| 10MV0035US | US | i7-7700T | vPro | Intel HD 630 | None | 8GBx2 | 256GB SSD M.2 PCIe NVMe | None | 8265 ac, 2x2, vPro + BT4.1 | 3rd DP | Switch | None | 1Wx1 | None | None | None | USB / USB | None | Floor Stand | 65W Adapter 88% | Win10 Pro 64 | 3-year, Onsite | Apr 21, 2023 | 03/17 |
| 10MV0036US | US | i5-6500T | vPro | Intel HD 530 | None | 8GBx1 | 500GB 7200rpm 2.5" | None | 8265 ac, 2x2, vPro + BT4.1 | 3rd DP | Switch | None | 1Wx1 | None | None | None | USB / USB | None | Floor Stand | 65W Adapter 88% | Win10 DG Win7 Pro 64 | 3-year, Onsite | Apr 21, 2023 | 03/17 |
| 10MV0037US | US | i5-6500T | vPro | Intel HD 530 | None | 8GBx2 | 256GB SSD M.2 PCIe NVMe | None | 8265 ac, 2x2, vPro + BT4.1 | 3rd DP | Switch | None | 1Wx1 | None | None | None | USB / USB | None | Floor Stand | 65W Adapter 88% | Win10 DG Win7 Pro 64 | 3-year, Onsite | Apr 21, 2023 | 03/17 |
| 10MV0038US | US | i5-6500T | vPro | Intel HD 530 | None | 4GBx1 | 500GB 7200rpm 2.5" | None | 8265 ac, 2x2, vPro + BT4.1 | 3rd DP | Switch | None | 1Wx1 | None | None | None | USB / USB | None | Floor Stand | 65W Adapter 88% | Win10 DG Win7 Pro 64 | 3-year, Onsite | Apr 21, 2023 | 03/17 |

| Model | Region | Processor | vPro | Graphics | Monitor Cable | Memory | Storage(HDD/SSD) | External Optical / I/O Box | WLAN + Bluetooth | Optional Rear Ports | Chassis Intrusion Switch | Kensington Cable Lock | Speaker | Adapter Cage | Toolless Chassis Screw | Dust Filter | Keyboard / Mouse | VESA Mount | Stand | Power Supply | Operating System | Warranty | End of Support | Ann Date (mm/yy) |
|------------|--------|-----------|------|--------------|---------------|--------|-------------------------|----------------------------|----------------------------|---------------------|--------------------------|-----------------------|---------|--------------|------------------------|-------------|------------------|------------|-------------|-----------------|----------------------|----------------|----------------|------------------|
| 10MV0039US | US | i7-6700T | vPro | Intel HD 530 | None | 8GBx1 | 256GB SSD M.2 PCIe NVMe | None | 8265 ac, 2x2, vPro + BT4.1 | 3rd DP | Switch | None | 1Wx1 | None | None | None | USB / USB | None | Floor Stand | 65W Adapter 88% | Win10 DG Win7 Pro 64 | 3-year, Onsite | Apr 21, 2023 | 03/17 |

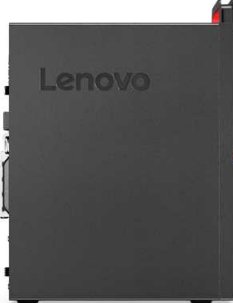

ThinkCentre M910 Tower Platform Specifications

Product Specifications Reference (PSREF)

| Processor | Intel® Celeron®, Intel Pentium®, or 6/7th Generation Intel Core™ i3 / i5 / i7 Processor | Manageability | Intel Active Management Technology 11.0 (Intel AMT 11.0); Intel vPro technology on some models (require choosing a vPro-support Wi-Fi adapter to enable vPro function through wireless connection) | | | | | | | | | | | | | | | | | | | | | | | | | | | | | | | | | | | | | | | | | | |
|------------------|--|-------------------------|---|-------------------------|---------------------|------------------------|---------------------|--------------|-------|-------------|------|-----------|--------|--------------|-------|-------------|------|-----------|--------|--------------|-------|-------------|------|-----------|--------|--------------|-------|-------------|------|-----------|--------|--------------|-------|-------------|------|-----------|--------|--------------|-------|-------------|------|-----------|--------|---------------|---|
| | <table border="1"> <thead> <tr> <th>Processor</th> <th>Cores / Threads</th> <th>Frequency Base/Max(GHz)</th> <th>Cache</th> <th>Memory Support (Up to)</th> <th>Integrated Graphics</th> </tr> </thead> <tbody> <tr> <td>Core i5-6500</td> <td>4 / 4</td> <td>3.2G / 3.6G</td> <td>6 MB</td> <td>DDR4-2133</td> <td>HD 530</td> </tr> <tr> <td>Core i7-6700</td> <td>4 / 8</td> <td>3.4G / 4.0G</td> <td>8 MB</td> <td>DDR4-2133</td> <td>HD 530</td> </tr> <tr> <td>Core i5-7400</td> <td>4 / 4</td> <td>3.0G / 3.5G</td> <td>6 MB</td> <td>DDR4-2400</td> <td>HD 630</td> </tr> <tr> <td>Core i5-7500</td> <td>4 / 4</td> <td>3.4G / 3.8G</td> <td>6 MB</td> <td>DDR4-2400</td> <td>HD 630</td> </tr> <tr> <td>Core i5-7600</td> <td>4 / 4</td> <td>3.5G / 4.1G</td> <td>6 MB</td> <td>DDR4-2400</td> <td>HD 630</td> </tr> <tr> <td>Core i7-7700</td> <td>4 / 8</td> <td>3.6G / 4.2G</td> <td>8 MB</td> <td>DDR4-2400</td> <td>HD 630</td> </tr> </tbody> </table> | Processor | Cores / Threads | Frequency Base/Max(GHz) | Cache | Memory Support (Up to) | Integrated Graphics | Core i5-6500 | 4 / 4 | 3.2G / 3.6G | 6 MB | DDR4-2133 | HD 530 | Core i7-6700 | 4 / 8 | 3.4G / 4.0G | 8 MB | DDR4-2133 | HD 530 | Core i5-7400 | 4 / 4 | 3.0G / 3.5G | 6 MB | DDR4-2400 | HD 630 | Core i5-7500 | 4 / 4 | 3.4G / 3.8G | 6 MB | DDR4-2400 | HD 630 | Core i5-7600 | 4 / 4 | 3.5G / 4.1G | 6 MB | DDR4-2400 | HD 630 | Core i7-7700 | 4 / 8 | 3.6G / 4.2G | 8 MB | DDR4-2400 | HD 630 | Security chip | TPM (Trusted Platform Module) 2.0, TCG Certified * Downgrade to TPM1.2 for the models with Win10 DG Win7 32 OS |
| Processor | Cores / Threads | Frequency Base/Max(GHz) | Cache | Memory Support (Up to) | Integrated Graphics | | | | | | | | | | | | | | | | | | | | | | | | | | | | | | | | | | | | | | | | |
| Core i5-6500 | 4 / 4 | 3.2G / 3.6G | 6 MB | DDR4-2133 | HD 530 | | | | | | | | | | | | | | | | | | | | | | | | | | | | | | | | | | | | | | | | |
| Core i7-6700 | 4 / 8 | 3.4G / 4.0G | 8 MB | DDR4-2133 | HD 530 | | | | | | | | | | | | | | | | | | | | | | | | | | | | | | | | | | | | | | | | |
| Core i5-7400 | 4 / 4 | 3.0G / 3.5G | 6 MB | DDR4-2400 | HD 630 | | | | | | | | | | | | | | | | | | | | | | | | | | | | | | | | | | | | | | | | |
| Core i5-7500 | 4 / 4 | 3.4G / 3.8G | 6 MB | DDR4-2400 | HD 630 | | | | | | | | | | | | | | | | | | | | | | | | | | | | | | | | | | | | | | | | |
| Core i5-7600 | 4 / 4 | 3.5G / 4.1G | 6 MB | DDR4-2400 | HD 630 | | | | | | | | | | | | | | | | | | | | | | | | | | | | | | | | | | | | | | | | |
| Core i7-7700 | 4 / 8 | 3.6G / 4.2G | 8 MB | DDR4-2400 | HD 630 | | | | | | | | | | | | | | | | | | | | | | | | | | | | | | | | | | | | | | | | |
| Memory | 64GB max, UDIMM, DDR4-2400*, four 288-pin DIMM sockets, non-ECC, dual-channel capable * System automatically clocks down for the processors with lower memory controller | Security features | <ul style="list-style-type: none"> Security slot (in rear for optional Kensington® MicroSaver® cable) Padlock loop Smart USB protection, allows keyboard/ mouse only, blocks all storage devices Optional cable lock to physically lock both keyboard and mouse Power-on password Administrator password Hard disk password Boot sequence control Boot without keyboard and mouse Individual USB port disablement Optional chassis intrusion switch | | | | | | | | | | | | | | | | | | | | | | | | | | | | | | | | | | | | | | | | | | |
| Storage | <i>Some:</i> Hard Drive / SATA 6.0Gb/s, 2.5" or 3.5", 5400 rpm or 7200 rpm <i>Some:</i> Solid State Drive (SSD) / SATA 6.0Gb/s, 2.5" <i>Some:</i> M.2 Solid State Drive (SSD) / PCIe NVMe, PCIe 3.0 x 4, 32Gb/s <i>Some:</i> Intel Optane™ Memory Ready (models with 7th gen Core processor), M.2 <i>Some:</i> Front accessible and removable HDD, 3.5", lockable via physical key <i>Some:</i> DVD-ROM, SATA 1.5Gb/s, 5.25" or slim (9.0mm) <i>Some:</i> DVD Burner (DVD±RW), SATA 1.5Gb/s, 5.25" or slim (9.0mm) | Keyboard | <i>Some:</i> Lenovo Calliope Keyboard (USB connector), black <i>Some:</i> Lenovo Traditional Keyboard (USB connector), black <i>Some:</i> Lenovo Calliope Wireless Keyboard (2.4GHz via USB receiver), black <i>Some:</i> Lenovo Calliope Mouse (USB connector), black <i>Some:</i> Lenovo Calliope Wireless Mouse (2.4GHz via USB receiver), black | | | | | | | | | | | | | | | | | | | | | | | | | | | | | | | | | | | | | | | | | | |
| Optical | Four onboard SATA 6.0Gb/s connectors (1x eSATA and 3x SATA), RAID 0/1 support (RAID preset only available via special bid model) | Mouse | <i>Some:</i> Lenovo Calliope Mouse (USB connector), black <i>Some:</i> Lenovo Calliope Wireless Mouse (2.4GHz via USB receiver), black | | | | | | | | | | | | | | | | | | | | | | | | | | | | | | | | | | | | | | | | | | |
| Onboard SATA | Optional 7-in-1 media reader | Mechanical | <ul style="list-style-type: none"> Tower (18L), black color, metal case (WxDxH) 6.5" X 12.65" X 16.15"; 165mm X 321.35mm X 410.25mm Approx. 15.45 lb (7 kg), weight may vary by configuration Toolless cover, disk, optical, graphic card removal Optional carry handle, dust filter Bay 1: Slim external ODD bay Bay 2: 5.25", 1.6" high, external, ODD / optional front access HDD Bay 3: 3.5", 1" high, internal, HDD/SSD Bay 4: 3.5", 1" high, internal, HDD/SSD (optional bay, bay 3 comes with disk) Bay 5: 2.5", internal, HDD/SSD (optional bay) Notes: M910 Tower supports up to 3 SATA devices (ODD/HDD/SSD) and 1 eSATA device (front access HDD) Slot 1: full-length full-height (length < 268mm, height < 112mm), PCIe 3.0 x16* Slot 2: full-length full-height (length < 268mm, height < 112mm), PCIe 3.0 x1* Slot 3: full-length full-height (length < 268mm, height < 112mm), PCIe 3.0 x16 (x4 signal)* Slot 4: no slot, only bracket for optional port extension* M.2 card slots: Two (one for WLAN, one for SSD/Optane) * Optional front USB3.1 Type-C x2 module occupies PCIe x16 (x4 signal) slot, optional rear 2x USB2.0 / parallel / 2nd serial occupies one expansion slot | | | | | | | | | | | | | | | | | | | | | | | | | | | | | | | | | | | | | | | | | | |
| Media reader | Optional 7-in-1 media reader | Power supply | <i>Some:</i> 180 watts, autosensing, 85% PSU <i>Some:</i> 250 watts, autosensing, 85% PSU <i>Some:</i> 400 watts, autosensing, 92% PSU (only available via special bid) | | | | | | | | | | | | | | | | | | | | | | | | | | | | | | | | | | | | | | | | | | |
| Graphics | Intel HD Graphics 510/530/610/630 in processor, uses main memory, DirectX® 12, one VGA, two DisplayPort™, supports 3 independent displays, works along with discrete graphics to support more displays; <i>Max resolution:</i> 4096x2304 (DP)@60Hz; 2048x1536 (VGA)@50Hz <i>Some:</i> NVIDIA GeForce® GT 730 , DirectX 12, 2GB, PCIe 2.0 x8 adapter, two DisplayPort, 35 watts; <i>Max resolution:</i> 3840x2160 (DisplayPort)@60Hz; <i>Some:</i> AMD Radeon™ R7 350 , DirectX 11, 2GB, PCIe 3.0 x8 adapter, one VGA, one HDMI, 75 watts, occupies two slots; <i>Max resolution:</i> 4096x2160 (HDMI)@24Hz; 2048x1536 (VGA)@85Hz <i>Some:</i> NVIDIA GeForce GTX™ 1080 (only available via special bid model), DirectX 12, 8GB, PCIe 3.0 x16 adapter, one DVI-D, one HDMI, three DisplayPort, 180 watts, occupies two slots; <i>Max resolution:</i> 2560x1600 (DVI-D)@60Hz; 4096x2160 (HDMI)@60Hz 7680x4320 (with Single DP)@60Hz | Limited warranty | <i>Some:</i> 1-year or 3-year, depot service / service upgrades available <i>Some:</i> 1-year or 3-year, limited onsite service / service upgrades available | | | | | | | | | | | | | | | | | | | | | | | | | | | | | | | | | | | | | | | | | | |
| Monitor Cable | Optional DP to VGA, DP to DVI-D (single link), DP to dual DP, or DP to HDMI 1.4 | Preload | Preloaded operating system <i>Some:</i> Windows® 7 Professional 32/64 preinstalled through downgrade rights in Windows 10 Pro 64-bit (not available with 7th Gen Intel processor) <i>Some:</i> Windows 10 Pro 64-bit <i>Some:</i> Windows 10 Home 64-bit Preloaded applications (only some listed) <ul style="list-style-type: none"> Microsoft Office preloaded; purchase a product key to activate Cyberlink PowerDVD Create (DVD±RW) Intel Unite (vPro models only) Only for Window 10 Lenovo Companion Lenovo ID Cyberlink PowerDVD (DVD, DVD±RW) Only for Window 7 Lenovo Solution Center Lenovo ThinkVantage Tools Create Recovery Media Adobe® Reader® | | | | | | | | | | | | | | | | | | | | | | | | | | | | | | | | | | | | | | | | | | |
| Chipset | Intel Q270 Chipset | Environment | ENERGY STAR® 6.1, EPEAT™ Gold rating (North America), ErP Lot 3, GREENGUARD®, RoHS-compliant, TUV low noise verified (on some models) | | | | | | | | | | | | | | | | | | | | | | | | | | | | | | | | | | | | | | | | | | |
| Front ports | Four USB 3.1 Gen1, optional two USB 3.1 Type-C Gen 2 (only available via special bid), microphone (3.5mm), headphone (3.5mm) | Accessories | For compatible accessories, please go to http://www.lenovoquickpick.com | | | | | | | | | | | | | | | | | | | | | | | | | | | | | | | | | | | | | | | | | | |
| Rear ports | Four USB 3.1 Gen1, optional two USB 2.0, serial (9-pin), optional 2nd serial (9-pin), optional parallel (25-pin), ethernet (RJ-45), one VGA, two DisplayPort, optional two PS/2 ports (keyboard/mouse); additional VGA, DisplayPort, DVI-D, or HDMI on optional graphics on some models | Bluetooth™ | <i>Some:</i> Bluetooth 4.1 wireless, integrated in Wi-Fi + BT combo adapter | | | | | | | | | | | | | | | | | | | | | | | | | | | | | | | | | | | | | | | | | | |
| Rear audio ports | Line-in (3.5mm), line-out (3.5mm), microphone-in (3.5mm) | Ethernet | Gigabit ethernet, Intel Ethernet Connection I219-LM(Jacksonville), Wake on LAN® | | | | | | | | | | | | | | | | | | | | | | | | | | | | | | | | | | | | | | | | | | |
| IEEE 1394 | None | Modem | None | | | | | | | | | | | | | | | | | | | | | | | | | | | | | | | | | | | | | | | | | | |
| Audio support | High Definition (HD) Audio, Realtek ALC662 / optional internal speaker (1.5 watt) | | | | | | | | | | | | | | | | | | | | | | | | | | | | | | | | | | | | | | | | | | | | |
| WLAN | <i>Some:</i> 11ac wireless, M.2 Card, Qualcomm Atheros QCA9377A (dual band), Wi-Fi + Bluetooth 4.1 combo adapter, 1x1 <i>Some:</i> 11ac wireless, M.2 Card, Qualcomm Atheros QCA6174A (dual band), Wi-Fi + Bluetooth 4.1 combo adapter, 2x2 <i>Some:</i> 11ac wireless, M.2 Card, Intel Dual Band Wireless-AC 3165, Wi-Fi + Bluetooth 4.1 combo adapter, 1x1 <i>Some:</i> 11ac wireless, M.2 Card, Intel Dual Band Wireless-AC 8265, Wi-Fi + Bluetooth 4.1 combo adapter, 2x2 <i>Some:</i> 11ac wireless, M.2 Card, Intel Dual Band Wireless-AC 8265, Wi-Fi + Bluetooth 4.1 combo adapter, Intel vPro technology support, 2x2 | | | | | | | | | | | | | | | | | | | | | | | | | | | | | | | | | | | | | | | | | | | | |

| Model | Region | Processor | vPro | Graphics | Monitor Cable | Memory | Storage(HDD/SSD) | Optical | Optional 2.5" Bay | Media Reader | WLAN + Bluetooth | Optional Front Ports | Optional Rear Ports | Chassis Intrusion Switch | Cable Lock | Front Access HDD | Speaker | Dust Filter | Keyboard / Mouse | Carry Handle | Power Supply | Operating System | Warranty | End of Support | Ann Date (mm/yy) |
|------------|--------|-----------|------|--------------|---------------|--------|-------------------------|---------|-------------------|--------------|----------------------------|----------------------|---------------------|--------------------------|------------|------------------|---------|-------------|------------------|--------------|--------------|----------------------|----------------|----------------|------------------|
| 10MM000AUS | US | i5-7500 | vPro | Intel HD 630 | None | 4GBx1 | 500GB 7200rpm 3.5" | DVD±RW | Optional 2.5" Bay | None | None | None | None | None | None | None | 1.5Wx1 | None | USB / USB | Carry Handle | 250W 85% | Win10 Pro 64 | 3-year, Onsite | Mar 21, 2023 | 02/17 |
| 10MM000BUS | US | i7-7700 | vPro | GT 730 2GB | None | 8GBx1 | 256GB SSD M.2 PCIe NVMe | DVD±RW | Optional 2.5" Bay | None | None | None | None | None | None | None | 1.5Wx1 | None | USB / USB | Carry Handle | 250W 85% | Win10 Pro 64 | 3-year, Onsite | Mar 21, 2023 | 02/17 |
| 10MM000CUS | US | i5-7500 | vPro | Intel HD 630 | None | 8GBx1 | 512GB SSD M.2 PCIe NVMe | DVD±RW | Optional 2.5" Bay | None | None | None | None | None | None | None | 1.5Wx1 | None | USB / USB | Carry Handle | 250W 85% | Win10 Pro 64 | 3-year, Onsite | Mar 21, 2023 | 02/17 |
| 10MM000DUS | US | i7-7700 | vPro | Intel HD 630 | None | 8GBx1 | 256GB SSD M.2 PCIe NVMe | DVD±RW | Optional 2.5" Bay | None | None | None | None | None | None | None | 1.5Wx1 | None | USB / USB | Carry Handle | 250W 85% | Win10 Pro 64 | 3-year, Onsite | Mar 21, 2023 | 02/17 |
| 10MM000EUS | US | i5-7500 | vPro | GT 730 2GB | None | 8GBx1 | 512GB SSD M.2 PCIe NVMe | DVD±RW | Optional 2.5" Bay | None | None | None | None | None | None | None | 1.5Wx1 | None | USB / USB | Carry Handle | 250W 85% | Win10 Pro 64 | 3-year, Onsite | Mar 21, 2023 | 02/17 |
| 10MM000FUS | US | i5-7500 | vPro | Intel HD 630 | None | 8GBx1 | 1TB 7200rpm 3.5" | DVD±RW | Optional 2.5" Bay | None | None | None | None | None | None | None | 1.5Wx1 | None | USB / USB | Carry Handle | 250W 85% | Win10 Pro 64 | 3-year, Onsite | Mar 21, 2023 | 02/17 |
| 10MM000GUS | US | i5-7500 | vPro | GT 730 2GB | None | 8GBx1 | 1TB 7200rpm 3.5" | DVD±RW | Optional 2.5" Bay | None | None | None | None | None | None | None | 1.5Wx1 | None | USB / USB | Carry Handle | 250W 85% | Win10 Pro 64 | 3-year, Onsite | Mar 21, 2023 | 02/17 |
| 10MM000HUS | US | i5-7500 | vPro | Intel HD 630 | None | 8GBx1 | 256GB SSD M.2 PCIe NVMe | DVD±RW | Optional 2.5" Bay | None | None | None | None | None | None | None | 1.5Wx1 | None | USB / USB | Carry Handle | 250W 85% | Win10 Pro 64 | 3-year, Onsite | Mar 21, 2023 | 02/17 |
| 10MM000JUS | US | i7-7700 | vPro | GT 730 2GB | None | 8GBx1 | 1TB 7200rpm 3.5" | DVD±RW | Optional 2.5" Bay | None | None | None | None | None | None | None | 1.5Wx1 | None | USB / USB | Carry Handle | 250W 85% | Win10 Pro 64 | 3-year, Onsite | Mar 21, 2023 | 02/17 |
| 10MM000KUS | US | i7-7700 | vPro | Intel HD 630 | None | 8GBx1 | 512GB SSD M.2 PCIe NVMe | DVD±RW | Optional 2.5" Bay | None | None | None | None | None | None | None | 1.5Wx1 | None | USB / USB | Carry Handle | 250W 85% | Win10 Pro 64 | 3-year, Onsite | Mar 21, 2023 | 02/17 |
| 10MM000LUS | US | i7-7700 | vPro | Intel HD 630 | None | 8GBx1 | 256GB SSD M.2 PCIe NVMe | DVD±RW | Optional 2.5" Bay | None | 8265 ac, 2x2, vPro + BT4.1 | None | None | None | None | None | 1.5Wx1 | None | USB / USB | Carry Handle | 250W 85% | Win10 Pro 64 | 3-year, Onsite | Mar 21, 2023 | 02/17 |
| 10MM000MUS | US | i7-7700 | vPro | GT 730 2GB | None | 8GBx1 | 512GB SSD M.2 PCIe NVMe | DVD±RW | Optional 2.5" Bay | None | None | None | None | None | None | None | 1.5Wx1 | None | USB / USB | Carry Handle | 250W 85% | Win10 Pro 64 | 3-year, Onsite | Mar 21, 2023 | 02/17 |
| 10MM000NUS | US | i5-7500 | vPro | Intel HD 630 | None | 8GBx1 | 256GB SSD M.2 PCIe NVMe | DVD±RW | Optional 2.5" Bay | None | 8265 ac, 2x2, vPro + BT4.1 | None | None | None | None | None | 1.5Wx1 | None | USB / USB | Carry Handle | 250W 85% | Win10 Pro 64 | 3-year, Onsite | Mar 21, 2023 | 02/17 |
| 10MM000PUS | US | i7-7700 | vPro | Intel HD 630 | None | 8GBx1 | 1TB 7200rpm 3.5" | DVD±RW | Optional 2.5" Bay | None | None | None | None | None | None | None | 1.5Wx1 | None | USB / USB | Carry Handle | 250W 85% | Win10 Pro 64 | 3-year, Onsite | Mar 21, 2023 | 02/17 |
| 10MM000QUS | US | i5-7500 | vPro | GT 730 2GB | None | 8GBx1 | 256GB SSD M.2 PCIe NVMe | DVD±RW | Optional 2.5" Bay | None | None | None | None | None | None | None | 1.5Wx1 | None | USB / USB | Carry Handle | 250W 85% | Win10 Pro 64 | 3-year, Onsite | Mar 21, 2023 | 02/17 |
| 10MM002JUS | US | i5-6500 | vPro | GT 730 2GB | None | 8GBx1 | 256GB SSD M.2 PCIe NVMe | DVD±RW | Optional 2.5" Bay | None | 8265 ac, 2x2, vPro + BT4.1 | None | None | None | None | None | 1.5Wx1 | None | USB / USB | Carry Handle | 250W 85% | Win10 DG Win7 Pro 64 | 3-year, Onsite | Apr 28, 2023 | 03/17 |
| 10MM002KUS | US | i5-6500 | vPro | GT 730 2GB | None | 8GBx1 | 512GB SSD M.2 PCIe NVMe | DVD±RW | Optional 2.5" Bay | None | None | None | None | None | None | None | 1.5Wx1 | None | USB / USB | Carry Handle | 250W 85% | Win10 DG Win7 Pro 64 | 3-year, Onsite | Apr 28, 2023 | 03/17 |
| 10MM002LUS | US | i5-6500 | vPro | Intel HD 530 | None | 8GBx1 | 256GB SSD M.2 PCIe NVMe | DVD±RW | Optional 2.5" Bay | None | None | None | None | None | None | None | 1.5Wx1 | None | USB / USB | Carry Handle | 250W 85% | Win10 DG Win7 Pro 64 | 3-year, Onsite | Apr 28, 2023 | 03/17 |
| 10MM002MUS | US | i5-6500 | vPro | Intel HD 530 | None | 4GBx1 | 128GB SSD M.2 PCIe NVMe | DVD±RW | Optional 2.5" Bay | None | None | None | None | None | None | None | 1.5Wx1 | None | USB / USB | Carry Handle | 250W 85% | Win10 DG Win7 Pro 64 | 3-year, Onsite | Apr 28, 2023 | 03/17 |
| 10MM002NUS | US | i7-6700 | vPro | GT 730 2GB | None | 8GBx1 | 512GB SSD M.2 PCIe NVMe | DVD±RW | Optional 2.5" Bay | None | None | None | None | None | None | None | 1.5Wx1 | None | USB / USB | Carry Handle | 250W 85% | Win10 DG Win7 Pro 64 | 3-year, Onsite | Apr 28, 2023 | 03/17 |

| Model | Region | Processor | vPro | Graphics | Monitor Cable | Memory | Storage(HDD/SSD) | Optical | Optional 2.5" Bay | Media Reader | WLAN + Bluetooth | Optional Front Ports | Optional Rear Ports | Chassis Intrusion Switch | Cable Lock | Front Access HDD | Speaker | Dust Filter | Keyboard / Mouse | Carry Handle | Power Supply | Operating System | Warranty | End of Support | Ann Date (mm/yy) |
|------------|--------|-----------|------|--------------|---------------|--------|-------------------------|---------|-------------------|--------------|----------------------------|----------------------|---------------------|--------------------------|------------|------------------|---------|-------------|------------------|--------------|--------------|----------------------|----------------|----------------|------------------|
| 10MM002PUS | US | i7-6700 | vPro | GT 730 2GB | None | 8GBx1 | 256GB SSD M.2 PCIe NVMe | DVD±RW | Optional 2.5" Bay | None | None | None | None | None | None | None | 1.5Wx1 | None | USB / USB | Carry Handle | 250W 85% | Win10 DG Win7 Pro 64 | 3-year, Onsite | Apr 28, 2023 | 03/17 |
| 10MM002QUS | US | i5-7500 | vPro | Intel HD 630 | None | 4GBx1 | 128GB SSD M.2 PCIe NVMe | DVD±RW | Optional 2.5" Bay | None | None | None | None | None | None | None | 1.5Wx1 | None | USB / USB | Carry Handle | 250W 85% | Win10 Pro 64 | 3-year, Onsite | Apr 28, 2023 | 03/17 |
| 10MM002RUS | US | i7-6700 | vPro | GT 730 2GB | None | 8GBx1 | 1TB 7200rpm 3.5" | DVD±RW | Optional 2.5" Bay | None | None | None | None | None | None | None | 1.5Wx1 | None | USB / USB | Carry Handle | 250W 85% | Win10 DG Win7 Pro 64 | 3-year, Onsite | Apr 28, 2023 | 03/17 |
| 10MM002SUS | US | i7-6700 | vPro | Intel HD 530 | None | 8GBx1 | 256GB SSD M.2 PCIe NVMe | DVD±RW | Optional 2.5" Bay | None | None | None | None | None | None | None | 1.5Wx1 | None | USB / USB | Carry Handle | 250W 85% | Win10 DG Win7 Pro 64 | 3-year, Onsite | Apr 28, 2023 | 03/17 |
| 10MM002TUS | US | i5-6500 | vPro | Intel HD 530 | None | 4GBx1 | 500GB 7200rpm 3.5" | DVD±RW | Optional 2.5" Bay | None | None | None | None | None | None | None | 1.5Wx1 | None | USB / USB | Carry Handle | 250W 85% | Win10 DG Win7 Pro 64 | 3-year, Onsite | Apr 28, 2023 | 03/17 |
| 10MM002UUS | US | i5-6500 | vPro | GT 730 2GB | None | 8GBx1 | 256GB SSD M.2 PCIe NVMe | DVD±RW | Optional 2.5" Bay | None | None | None | None | None | None | None | 1.5Wx1 | None | USB / USB | Carry Handle | 250W 85% | Win10 DG Win7 Pro 64 | 3-year, Onsite | Apr 28, 2023 | 03/17 |
| 10MM002VUS | US | i5-6500 | vPro | Intel HD 530 | None | 8GBx1 | 1TB 7200rpm 3.5" | DVD±RW | Optional 2.5" Bay | None | None | None | None | None | None | None | 1.5Wx1 | None | USB / USB | Carry Handle | 250W 85% | Win10 DG Win7 Pro 64 | 3-year, Onsite | Apr 28, 2023 | 03/17 |
| 10MM002WUS | US | i5-6500 | vPro | Intel HD 530 | None | 8GBx1 | 512GB SSD M.2 PCIe NVMe | DVD±RW | Optional 2.5" Bay | None | None | None | None | None | None | None | 1.5Wx1 | None | USB / USB | Carry Handle | 250W 85% | Win10 DG Win7 Pro 64 | 3-year, Onsite | Apr 28, 2023 | 03/17 |
| 10MM002XUS | US | i7-6700 | vPro | Intel HD 530 | None | 8GBx1 | 512GB SSD M.2 PCIe NVMe | DVD±RW | Optional 2.5" Bay | None | None | None | None | None | None | None | 1.5Wx1 | None | USB / USB | Carry Handle | 250W 85% | Win10 DG Win7 Pro 64 | 3-year, Onsite | Apr 28, 2023 | 03/17 |
| 10MM002YUS | US | i5-6500 | vPro | GT 730 2GB | None | 8GBx1 | 1TB 7200rpm 3.5" | DVD±RW | Optional 2.5" Bay | None | None | None | None | None | None | None | 1.5Wx1 | None | USB / USB | Carry Handle | 250W 85% | Win10 DG Win7 Pro 64 | 3-year, Onsite | Apr 28, 2023 | 03/17 |
| 10MM0030US | US | i7-6700 | vPro | Intel HD 530 | None | 8GBx1 | 1TB 7200rpm 3.5" | DVD±RW | Optional 2.5" Bay | None | None | None | None | None | None | None | 1.5Wx1 | None | USB / USB | Carry Handle | 250W 85% | Win10 DG Win7 Pro 64 | 3-year, Onsite | Apr 28, 2023 | 03/17 |
| 10MM0031US | US | i7-6700 | vPro | GT 730 2GB | None | 8GBx1 | 256GB SSD M.2 PCIe NVMe | DVD±RW | Optional 2.5" Bay | None | 8265 ac, 2x2, vPro + BT4.1 | None | None | None | None | None | 1.5Wx1 | None | USB / USB | Carry Handle | 250W 85% | Win10 DG Win7 Pro 64 | 3-year, Onsite | Apr 28, 2023 | 03/17 |
| 10MM003AUS | US | i5-6500 | vPro | Intel HD 530 | None | 8GBx1 | 256GB SSD M.2 PCIe NVMe | DVD±RW | Optional 2.5" Bay | None | 8265 ac, 2x2, vPro + BT4.1 | None | None | None | None | None | 1.5Wx1 | None | USB / USB | Carry Handle | 250W 85% | Win10 DG Win7 Pro 64 | 3-year, Onsite | Apr 28, 2023 | 03/17 |
| 10MM003BUS | US | i7-6700 | vPro | Intel HD 530 | None | 8GBx1 | 256GB SSD M.2 PCIe NVMe | DVD±RW | Optional 2.5" Bay | None | 8265 ac, 2x2, vPro + BT4.1 | None | None | None | None | None | 1.5Wx1 | None | USB / USB | Carry Handle | 250W 85% | Win10 DG Win7 Pro 64 | 3-year, Onsite | Apr 28, 2023 | 03/17 |



ThinkCentre M910x Tiny Platform Specifications

Product Specifications Reference (PSREF)

| Processor | Intel® Celeron®, Intel Pentium®, or 6/7th Generation Intel Core™ i3 / i5 / i7 Processor | | | | | | Manageability Intel Active Management Technology 11.0 (Intel AMT 11.0); Intel vPro technology on some models (require choosing a vPro-support Wi-Fi adapter to enable vPro function through wireless connection) Security chip TPM (Trusted Platform Module) 2.0*, TCG Certified * Downgrade to TPM1.2 for the models with Win10 DG Win7 32 OS Security features ● Security slot (in rear for optional Kensington® MicroSaver® cable) ● Smart USB protection, allows keyboard/mouse only, blocks all storage devices ● Power-on password ● Administrator password ● Hard disk password ● Boot sequence control ● Boot without keyboard and mouse ● Individual USB port disablement ● Chassis intrusion switch | | | | | | | | | | | | |
|---------------------------|---|-----------------------------------|-------------------------|-----------|------------------------|---------------------|--|--|--------------------|------------------|----------------|---|-----------------------------------|---------------------------|--|-----------------------------------|---------------------------|--|-----------------------------------|
| | Processor | Cores / Threads | Frequency Base/Max(GHz) | Cache | Memory Support (Up to) | Integrated Graphics | | | | | | | | | | | | | |
| | Core i5-6500T | 4 / 4 | 2.5G / 3.1G | 6 MB | DDR4-2133 | HD 530 | | | | | | | | | | | | | |
| | Core i7-6700T | 4 / 8 | 2.8G / 3.6G | 8 MB | DDR4-2133 | HD 530 | | | | | | | | | | | | | |
| | Core i5-7500T | 4 / 4 | 2.7G / 3.3G | 6 MB | DDR4-2400 | HD 630 | | | | | | | | | | | | | |
| | Core i5-7600T | 4 / 4 | 2.8G / 3.7G | 6 MB | DDR4-2400 | HD 630 | | | | | | | | | | | | | |
| | Core i7-7700T | 4 / 8 | 2.9G / 3.8G | 8 MB | DDR4-2400 | HD 630 | | | | | | | | | | | | | |
| | Core i5-6500 | 4 / 4 | 3.2G / 3.6G | 6 MB | DDR4-2133 | HD 530 | | | | | | | | | | | | | |
| | Core i7-6700 | 4 / 8 | 3.4G / 4.0G | 8 MB | DDR4-2133 | HD 530 | | | | | | | | | | | | | |
| | Core i5-7500 | 4 / 4 | 3.4G / 3.8G | 6 MB | DDR4-2400 | HD 630 | | | | | | | | | | | | | |
| Core i5-7600 | 4 / 4 | 3.5G / 4.1G | 6 MB | DDR4-2400 | HD 630 | | | | | | | | | | | | | | |
| Core i7-7700 | 4 / 8 | 3.6G / 4.2G | 8 MB | DDR4-2400 | HD 630 | | | | | | | | | | | | | | |
| Memory | 32GB max, DDR4-2400*, two 260-pin SO-DIMM sockets, non-ECC, dual-channel capable * System automatically clocks down for the processors with lower memory controller | | | | | | Keyboard <i>Some:</i> Lenovo Calliope Keyboard (USB connector), black <i>Some:</i> Lenovo Traditional Keyboard (USB connector), black <i>Some:</i> Lenovo Calliope Wireless Keyboard (2.4GHz via USB receiver), black Mouse <i>Some:</i> Lenovo Calliope Mouse (USB connector), black <i>Some:</i> Lenovo Calliope Wireless Mouse (2.4GHz via USB receiver), black Mechanical Tiny (1L), black color; metal case ● Toolless chassis open ● Toolless HDD, SSD, memory removal ● Optional toolless chassis screw ● Optional dust filter <table border="1" data-bbox="1228 641 1963 820"> <thead> <tr> <th></th> <th>Dimensions (WxDxH)</th> <th>Weight (Approx.)</th> </tr> </thead> <tbody> <tr> <td>M910 Tiny only</td> <td>7.05" X 7.20" X 1.36" 179mm X 182.9mm X 34.5mm</td> <td>2.91 lb (1.32 kg), vary by config</td> </tr> <tr> <td>With VESA mount & ODD box</td> <td>7.42" X 7.30" X 2.48" 188.4mm X 185.38mm X 63mm</td> <td>3.66 lb (1.66 kg), vary by config</td> </tr> <tr> <td>With VESA mount & I/O box</td> <td>7.42" X 7.30" X 2.62" 188.4mm X 185.38mm X 66.6mm</td> <td>3.66 lb (1.66 kg), vary by config</td> </tr> </tbody> </table> VESA mount Optional VESA mount bracket kit, supports VESA 75mm and 100mm Floor Stand Optional system floor stand for vertical orientation Power supply 135 watts AC/DC adapter, autosensing, 88% PSU Limited warranty ³ <i>Some:</i> 1-year or 3-year, depot service / service upgrades available <i>Some:</i> 1-year or 3-year, limited onsite service / service upgrades available Preload <i>Some:</i> Windows® 7 Professional 32/64 preinstalled through downgrade rights in Windows 10 Pro 64-bit (not available with 7th Gen Intel processor) <i>Some:</i> Windows 10 Pro 64-bit <i>Some:</i> Windows 10 Home 64-bit Preloaded applications (only some listed) ● Microsoft Office preloaded; purchase a product key to activate ● Cyberlink PowerDVD Create (DVD±RW) ● Intel Unite (vPro models only) - Only for Window 10 ● Lenovo Companion ● Lenovo ID ● Cyberlink PowerDVD (DVD, DVD±RW) - Only for Window 7 ● Lenovo Solution Center ● Lenovo ThinkVantage Tools ● Create Recovery Media ● Adobe® Reader® Environment ENERGY STAR® 6.1, EPEAT™ Gold rating (North America), ErP Lot 3, GREENGUARD®, RoHS-compliant, TUV low noise verified (on some models) MIL-SPEC test MIL-STD-810G military certification (Low Pressure [Altitude], High Temperature, Low Temperature, Temperature Shock, Humidity, Sand and Dust, Vibration, Shock, Fungus, Solar Radiation) Accessories For compatible accessories, please go to http://www.lenovoquickpick.com | | Dimensions (WxDxH) | Weight (Approx.) | M910 Tiny only | 7.05" X 7.20" X 1.36" 179mm X 182.9mm X 34.5mm | 2.91 lb (1.32 kg), vary by config | With VESA mount & ODD box | 7.42" X 7.30" X 2.48" 188.4mm X 185.38mm X 63mm | 3.66 lb (1.66 kg), vary by config | With VESA mount & I/O box | 7.42" X 7.30" X 2.62" 188.4mm X 185.38mm X 66.6mm | 3.66 lb (1.66 kg), vary by config |
| | Dimensions (WxDxH) | Weight (Approx.) | | | | | | | | | | | | | | | | | |
| M910 Tiny only | 7.05" X 7.20" X 1.36" 179mm X 182.9mm X 34.5mm | 2.91 lb (1.32 kg), vary by config | | | | | | | | | | | | | | | | | |
| With VESA mount & ODD box | 7.42" X 7.30" X 2.48" 188.4mm X 185.38mm X 63mm | 3.66 lb (1.66 kg), vary by config | | | | | | | | | | | | | | | | | |
| With VESA mount & I/O box | 7.42" X 7.30" X 2.62" 188.4mm X 185.38mm X 66.6mm | 3.66 lb (1.66 kg), vary by config | | | | | | | | | | | | | | | | | |
| Storage | <i>Some:</i> Hard Drive* / SATA 6.0Gb/s, 2.5", 5400 rpm or 7200 rpm, APS <i>Some:</i> Solid State Drive (SSD)* / SATA 6.0Gb/s, 2.5" (* 2.5" HDD/SSD and RX 460 graphics are mutually exclusive) <i>Some:</i> M.2 SSD (support up to two M.2 SSD) / PCIe NVMe, PCIe 3.0 x 4, 32Gb/s, RAID 0/1 support (RAID preset only available via special bid model) | | | | | | | | | | | | | | | | | | |
| Optical | <i>Some:</i> Intel Optane™ Memory Ready (models with 7th gen Core processor), M.2 <i>Some:</i> DVD-ROM, slim (9.0mm), via USB external ODD box <i>Some:</i> DVD Burner (DVD±RW), slim (9.0mm), via USB external ODD box | | | | | | | | | | | | | | | | | | |
| Onboard SATA Media reader | One onboard SATA 6.0Gb/s connector None | | | | | | | | | | | | | | | | | | |
| Graphics | Intel HD Graphics 510/530/610/630 in processor, uses main memory, DirectX® 12, two DisplayPort™, one optional video port (HDMI, VGA, 3rd DP, or USB 3.1 Type-C with DisplayPort Alternate Mode), up to 3 independent displays; <i>Max resolution:</i> 4096x2304 (DP) @60Hz; 4096x2304 (Type-C) @60Hz; 4096x2160 (HDMI) @24Hz; 1920x1200 (VGA) @60Hz <i>Some:</i> AMD Radeon™ RX 460 , DirectX 12, 4GB, PCIe 3.0 x8 adapter (low profile), four mini DisplayPort, 35 watts (TDP), up to 4 independent displays, works along with 2 onboard DisplayPort to support up to 6 independent displays; <i>Max resolution:</i> 5120x2880 @60Hz (up to 2 mini DisplayPort); 4096x2160 @60Hz (up to 4 mini DisplayPort) | | | | | | | | | | | | | | | | | | |
| Monitor cable | Optional DP to VGA, DP to DVI-D, DP to dual DP, mini DP to DP, or DP to HDMI 1.4 | | | | | | | | | | | | | | | | | | |
| Chipset | Intel Q270 Chipset | | | | | | | | | | | | | | | | | | |
| Front ports | Two USB 3.1 Gen1 (one is Always On and fast charge), one microphone (3.5mm), one headphone / microphone combo jack (3.5mm) | | | | | | | | | | | | | | | | | | |
| Rear ports | Four USB 3.1 Gen1 (optional optical box or I/O box occupies one or two specific USB 3.1 Gen1), ethernet (RJ-45), two DisplayPort, two optional ports (not available for the models with RX 460 graphics): Port 1 for [VGA / 3rd DP / HDMI / serial / USB 3.1 Type-C Gen 1 (with DisplayPort Alternate Mode)]; Port 2 for [serial] | | | | | | | | | | | | | | | | | | |
| I/O box | Optional external I/O box, extends two USB 2.0, two USB 3.1 Gen1, and one serial on rear, two USB 2.0 on front, via USB cable (occupy 2 specific USB 3.1 G1 of Tiny) | | | | | | | | | | | | | | | | | | |
| Audio support | High Definition (HD) Audio, Realtek ALC294 / optional internal speaker (1w or 2w) | | | | | | | | | | | | | | | | | | |
| WLAN ¹³ | <i>Some:</i> 11ac wireless, M.2 Card, Qualcomm Atheros QCA9377A (dual band), Wi-Fi + Bluetooth 4.1 combo adapter, 1x1 <i>Some:</i> 11ac wireless, M.2 Card, Qualcomm Atheros QCA6174A (dual band), Wi-Fi + Bluetooth 4.1 combo adapter, 2x2 <i>Some:</i> 11ac wireless, M.2 Card, Intel Dual Band Wireless-AC 3165, Wi-Fi + Bluetooth 4.1 combo adapter, 1x1 <i>Some:</i> 11ac wireless, M.2 Card, Intel Dual Band Wireless-AC 8265, Wi-Fi + Bluetooth 4.1 combo adapter, 2x2 | | | | | | | | | | | | | | | | | | |
| Bluetooth™ | <i>Some:</i> 11ac wireless, M.2 Card, Intel Dual Band Wireless-AC 8265, Wi-Fi + Bluetooth 4.1 combo adapter, Intel vPro technology support, 2x2 <i>Some:</i> Bluetooth 4.1 wireless, integrated in Wi-Fi + BT combo adapter | | | | | | | | | | | | | | | | | | |
| Ethernet Modem | Gigabit ethernet, Intel Ethernet Connection I219-LM(Jacksonville), Wake on LAN® None | | | | | | | | | | | | | | | | | | |

See footnotes for more detailed information

© Lenovo (M910x Tiny-Spec) May 2017

| Model | Region | Processor | vPro | Graphics | Monitor Cable | Memory | Storage(HDD/SSD) | External Optical / I/O Box | WLAN + Bluetooth | Optional Rear Ports | Chassis Intrusion Switch | Kensington Cable Lock | Speaker | Adapter Cage | Toolless Chassis Screw | Dust Filter | Keyboard / Mouse | VESA Mount | Stand | Power Supply | Operating System | Warranty | Ann Date (mm/yy) |
|------------|--------|-----------|------|---------------|---------------|--------|-------------------------|----------------------------|----------------------------|---------------------|--------------------------|-----------------------|---------|--------------|------------------------|-------------|------------------|------------|-------------|------------------|----------------------|----------------|------------------|
| 10N00007SS | US | i5-7600 | vPro | Intel HD 630 | None | 8GBx1 | 256GB SSD M.2 PCIe NVMe | None | 8265 ac, 2x2, vPro + BT4.1 | 3rd DP | Switch | None | 1Wx1 | None | None | None | USB / USB | None | Floor Stand | 135W Adapter 88% | Win10 Pro 64 | 3-year, Onsite | 04/17 |
| 10N00007US | US | i5-7600 | vPro | Intel HD 630 | None | 8GBx1 | 256GB SSD M.2 PCIe NVMe | None | 8265 ac, 2x2, vPro + BT4.1 | 3rd DP | Switch | None | 1Wx1 | None | None | None | USB / USB | None | Floor Stand | 135W Adapter 88% | Win10 Pro 64 | 3-year, Onsite | 04/17 |
| 10N00008SS | US | i5-7500 | vPro | Intel HD 630 | None | 4GBx1 | 500GB 7200rpm 2.5" | None | 8265 ac, 2x2, vPro + BT4.1 | 3rd DP | Switch | None | 1Wx1 | None | None | None | USB / USB | None | Floor Stand | 135W Adapter 88% | Win10 Pro 64 | 3-year, Onsite | 04/17 |
| 10N00008US | US | i5-7500 | vPro | Intel HD 630 | None | 4GBx1 | 500GB 7200rpm 2.5" | None | 8265 ac, 2x2, vPro + BT4.1 | 3rd DP | Switch | None | 1Wx1 | None | None | None | USB / USB | None | Floor Stand | 135W Adapter 88% | Win10 Pro 64 | 3-year, Onsite | 04/17 |
| 10N00009SS | US | i7-7700 | vPro | Intel HD 630 | None | 8GBx1 | 500GB 7200rpm 2.5" | None | 8265 ac, 2x2, vPro + BT4.1 | 3rd DP | Switch | None | 1Wx1 | None | None | None | USB / USB | None | Floor Stand | 135W Adapter 88% | Win10 Pro 64 | 3-year, Onsite | 04/17 |
| 10N00009US | US | i7-7700 | vPro | Intel HD 630 | None | 8GBx1 | 500GB 7200rpm 2.5" | None | 8265 ac, 2x2, vPro + BT4.1 | 3rd DP | Switch | None | 1Wx1 | None | None | None | USB / USB | None | Floor Stand | 135W Adapter 88% | Win10 Pro 64 | 3-year, Onsite | 04/17 |
| 10N0000ASS | US | i5-7500 | vPro | Intel HD 630 | None | 8GBx1 | 256GB SSD M.2 PCIe NVMe | None | 8265 ac, 2x2, vPro + BT4.1 | 3rd DP | Switch | None | 1Wx1 | None | None | None | USB / USB | None | Floor Stand | 135W Adapter 88% | Win10 Pro 64 | 3-year, Onsite | 04/17 |
| 10N0000AUS | US | i5-7500 | vPro | Intel HD 630 | None | 8GBx1 | 256GB SSD M.2 PCIe NVMe | None | 8265 ac, 2x2, vPro + BT4.1 | 3rd DP | Switch | None | 1Wx1 | None | None | None | USB / USB | None | Floor Stand | 135W Adapter 88% | Win10 Pro 64 | 3-year, Onsite | 04/17 |
| 10N0000BSS | US | i5-7500 | vPro | Intel HD 630 | None | 8GBx1 | 500GB 7200rpm 2.5" | None | 8265 ac, 2x2, vPro + BT4.1 | 3rd DP | Switch | None | 1Wx1 | None | None | None | USB / USB | None | Floor Stand | 135W Adapter 88% | Win10 Pro 64 | 3-year, Onsite | 04/17 |
| 10N0000BUS | US | i5-7500 | vPro | Intel HD 630 | None | 8GBx1 | 500GB 7200rpm 2.5" | None | 8265 ac, 2x2, vPro + BT4.1 | 3rd DP | Switch | None | 1Wx1 | None | None | None | USB / USB | None | Floor Stand | 135W Adapter 88% | Win10 Pro 64 | 3-year, Onsite | 04/17 |
| 10N00014US | US | i5-6500T | vPro | AMD RX460 4GB | None | 8GBx1 | 256GB SSD M.2 PCIe NVMe | None | 8265 ac, 2x2, vPro + BT4.1 | None | Switch | None | 1Wx1 | None | None | None | USB / USB | None | Floor Stand | 135W Adapter 88% | Win10 DG Win7 Pro 64 | 3-year, Onsite | 04/17 |
| 10N00015SS | US | i5-6500 | vPro | Intel HD 530 | None | 8GBx1 | 512GB SSD M.2 PCIe NVMe | None | 8265 ac, 2x2, vPro + BT4.1 | 3rd DP | Switch | None | 1Wx1 | None | None | None | USB / USB | None | Floor Stand | 135W Adapter 88% | Win10 DG Win7 Pro 64 | 3-year, Onsite | 04/17 |
| 10N00015US | US | i5-6500 | vPro | Intel HD 530 | None | 8GBx1 | 512GB SSD M.2 PCIe NVMe | None | 8265 ac, 2x2, vPro + BT4.1 | 3rd DP | Switch | None | 1Wx1 | None | None | None | USB / USB | None | Floor Stand | 135W Adapter 88% | Win10 DG Win7 Pro 64 | 3-year, Onsite | 04/17 |
| 10N00016SS | US | i7-6700 | vPro | Intel HD 530 | None | 8GBx1 | 256GB SSD M.2 PCIe NVMe | None | 8265 ac, 2x2, vPro + BT4.1 | 3rd DP | Switch | None | 1Wx1 | None | None | None | USB / USB | None | Floor Stand | 135W Adapter 88% | Win10 DG Win7 Pro 64 | 3-year, Onsite | 04/17 |
| 10N00016US | US | i7-6700 | vPro | Intel HD 530 | None | 8GBx1 | 256GB SSD M.2 PCIe NVMe | None | 8265 ac, 2x2, vPro + BT4.1 | 3rd DP | Switch | None | 1Wx1 | None | None | None | USB / USB | None | Floor Stand | 135W Adapter 88% | Win10 DG Win7 Pro 64 | 3-year, Onsite | 04/17 |
| 10N00017US | US | i7-6700T | vPro | AMD RX460 4GB | None | 8GBx1 | 256GB SSD M.2 PCIe NVMe | None | 8265 ac, 2x2, vPro + BT4.1 | None | Switch | None | 1Wx1 | None | None | None | USB / USB | None | Floor Stand | 135W Adapter 88% | Win10 DG Win7 Pro 64 | 3-year, Onsite | 04/17 |
| 10N00018SS | US | i5-7500T | vPro | AMD RX460 4GB | None | 8GBx1 | 256GB SSD M.2 PCIe NVMe | None | 8265 ac, 2x2, vPro + BT4.1 | None | Switch | None | 1Wx1 | None | None | None | USB / USB | None | Floor Stand | 135W Adapter 88% | Win10 Pro 64 | 3-year, Onsite | 04/17 |
| 10N00018US | US | i5-7500T | vPro | AMD RX460 4GB | None | 8GBx1 | 256GB SSD M.2 PCIe NVMe | None | 8265 ac, 2x2, vPro + BT4.1 | None | Switch | None | 1Wx1 | None | None | None | USB / USB | None | Floor Stand | 135W Adapter 88% | Win10 Pro 64 | 3-year, Onsite | 04/17 |
| 10N00019US | US | i5-6500T | vPro | AMD RX460 4GB | None | 8GBx1 | 512GB SSD M.2 PCIe NVMe | None | 8265 ac, 2x2, vPro + BT4.1 | None | Switch | None | 1Wx1 | None | None | None | USB / USB | None | Floor Stand | 135W Adapter 88% | Win10 DG Win7 Pro 64 | 3-year, Onsite | 04/17 |
| 10N0001ASS | US | i7-6700 | vPro | Intel HD 530 | None | 8GBx1 | 500GB 7200rpm 2.5" | None | 8265 ac, 2x2, vPro + BT4.1 | 3rd DP | Switch | None | 1Wx1 | None | None | None | USB / USB | None | Floor Stand | 135W Adapter 88% | Win10 DG Win7 Pro 64 | 3-year, Onsite | 04/17 |

| Model | Region | Processor | vPro | Graphics | Monitor Cable | Memory | Storage(HDD/SSD) | External Optical / I/O Box | WLAN + Bluetooth | Optional Rear Ports | Chassis Intrusion Switch | Kensington Cable Lock | Speaker | Adapter Cage | Toolless Chassis Screw | Dust Filter | Keyboard / Mouse | VESA Mount | Stand | Power Supply | Operating System | Warranty | Ann Date (mm/yy) |
|------------|--------|-----------|------|---------------|---------------|--------|-------------------------|----------------------------|----------------------------|---------------------|--------------------------|-----------------------|---------|--------------|------------------------|-------------|------------------|------------|-------------|------------------|----------------------|----------------|------------------|
| 10N0001AUS | US | i7-6700 | vPro | Intel HD 530 | None | 8GBx1 | 500GB 7200rpm 2.5" | None | 8265 ac, 2x2, vPro + BT4.1 | 3rd DP | Switch | None | 1Wx1 | None | None | None | USB / USB | None | Floor Stand | 135W Adapter 88% | Win10 DG Win7 Pro 64 | 3-year, Onsite | 04/17 |
| 10N0001BSS | US | i5-6500 | vPro | Intel HD 530 | None | 8GBx1 | 256GB SSD M.2 PCIe NVMe | None | 8265 ac, 2x2, vPro + BT4.1 | 3rd DP | Switch | None | 1Wx1 | None | None | None | USB / USB | None | Floor Stand | 135W Adapter 88% | Win10 DG Win7 Pro 64 | 3-year, Onsite | 04/17 |
| 10N0001BUS | US | i5-6500 | vPro | Intel HD 530 | None | 8GBx1 | 256GB SSD M.2 PCIe NVMe | None | 8265 ac, 2x2, vPro + BT4.1 | 3rd DP | Switch | None | 1Wx1 | None | None | None | USB / USB | None | Floor Stand | 135W Adapter 88% | Win10 DG Win7 Pro 64 | 3-year, Onsite | 04/17 |
| 10N0001CSS | US | i5-6500 | vPro | Intel HD 530 | None | 8GBx1 | 500GB 7200rpm 2.5" | None | 8265 ac, 2x2, vPro + BT4.1 | 3rd DP | Switch | None | 1Wx1 | None | None | None | USB / USB | None | Floor Stand | 135W Adapter 88% | Win10 DG Win7 Pro 64 | 3-year, Onsite | 04/17 |
| 10N0001CUS | US | i5-6500 | vPro | Intel HD 530 | None | 8GBx1 | 500GB 7200rpm 2.5" | None | 8265 ac, 2x2, vPro + BT4.1 | 3rd DP | Switch | None | 1Wx1 | None | None | None | USB / USB | None | Floor Stand | 135W Adapter 88% | Win10 DG Win7 Pro 64 | 3-year, Onsite | 04/17 |
| 10N0001DSS | US | i5-7500T | vPro | AMD RX460 4GB | None | 8GBx1 | 512GB SSD M.2 PCIe NVMe | None | 8265 ac, 2x2, vPro + BT4.1 | None | Switch | None | 1Wx1 | None | None | None | USB / USB | None | Floor Stand | 135W Adapter 88% | Win10 Pro 64 | 3-year, Onsite | 04/17 |
| 10N0001DUS | US | i5-7500T | vPro | AMD RX460 4GB | None | 8GBx1 | 512GB SSD M.2 PCIe NVMe | None | 8265 ac, 2x2, vPro + BT4.1 | None | Switch | None | 1Wx1 | None | None | None | USB / USB | None | Floor Stand | 135W Adapter 88% | Win10 Pro 64 | 3-year, Onsite | 04/17 |
| 10N0001ESS | US | i7-6700 | vPro | Intel HD 530 | None | 8GBx1 | 512GB SSD M.2 PCIe NVMe | None | 8265 ac, 2x2, vPro + BT4.1 | 3rd DP | Switch | None | 1Wx1 | None | None | None | USB / USB | None | Floor Stand | 135W Adapter 88% | Win10 DG Win7 Pro 64 | 3-year, Onsite | 04/17 |
| 10N0001EUS | US | i7-6700 | vPro | Intel HD 530 | None | 8GBx1 | 512GB SSD M.2 PCIe NVMe | None | 8265 ac, 2x2, vPro + BT4.1 | 3rd DP | Switch | None | 1Wx1 | None | None | None | USB / USB | None | Floor Stand | 135W Adapter 88% | Win10 DG Win7 Pro 64 | 3-year, Onsite | 04/17 |
| 10N0001FSS | US | i7-7700T | vPro | AMD RX460 4GB | None | 8GBx1 | 256GB SSD M.2 PCIe NVMe | None | 8265 ac, 2x2, vPro + BT4.1 | None | Switch | None | 1Wx1 | None | None | None | USB / USB | None | Floor Stand | 135W Adapter 88% | Win10 Pro 64 | 3-year, Onsite | 04/17 |
| 10N0001FUS | US | i7-7700T | vPro | AMD RX460 4GB | None | 8GBx1 | 256GB SSD M.2 PCIe NVMe | None | 8265 ac, 2x2, vPro + BT4.1 | None | Switch | None | 1Wx1 | None | None | None | USB / USB | None | Floor Stand | 135W Adapter 88% | Win10 Pro 64 | 3-year, Onsite | 04/17 |
| 10N0001GSS | US | i7-7700T | vPro | AMD RX460 4GB | None | 8GBx1 | 512GB SSD M.2 PCIe NVMe | None | 8265 ac, 2x2, vPro + BT4.1 | None | Switch | None | 1Wx1 | None | None | None | USB / USB | None | Floor Stand | 135W Adapter 88% | Win10 Pro 64 | 3-year, Onsite | 04/17 |
| 10N0001GUS | US | i7-7700T | vPro | AMD RX460 4GB | None | 8GBx1 | 512GB SSD M.2 PCIe NVMe | None | 8265 ac, 2x2, vPro + BT4.1 | None | Switch | None | 1Wx1 | None | None | None | USB / USB | None | Floor Stand | 135W Adapter 88% | Win10 Pro 64 | 3-year, Onsite | 04/17 |
| 10N0001HUS | US | i7-6700T | vPro | AMD RX460 4GB | None | 8GBx1 | 512GB SSD M.2 PCIe NVMe | None | 8265 ac, 2x2, vPro + BT4.1 | None | Switch | None | 1Wx1 | None | None | None | USB / USB | None | Floor Stand | 135W Adapter 88% | Win10 DG Win7 Pro 64 | 3-year, Onsite | 04/17 |



ThinkCentre Tiny-in-One (TIO) 22

Product Specifications Reference (PSREF)

| | | | |
|---|---|--------------------------------|----------------------------------|
| Model | 10LKPAR6++ / 10LKPAT6++ | | |
| Form factor | Tiny-in-One, offers a full All-In-One experience when optional Tiny slots into the back of TIO 22, clean cabling and effortless setup | | |
| Compatible Tiny: | M900 Tiny, M700 Tiny, M600 Tiny, M93/p Tiny*, M83 Tiny, M73 Tiny*, or M53 Tiny, Chromebox * Non-TIO models can't be turned on by pressing power button of TIO 22 | | |
| Panel | TFT-LCD, In-Plane Switching (IPS), White LED backlight | | |
| Viewable image size | 21.5" (546.1mm) diagonal | | |
| Max view area (W x H) | 18.74" x 10.54" / 476.06mm x 267.79mm | | |
| Bezel Width | Top / Side: 2mm, Bottom: 16.3mm | | |
| Optimum resolution | 1920x1080 | | |
| Aspect ratio | 16:9 | | |
| Pixel pitch (mm) | 0.24795mm | | |
| Dot/Pixel per Inch | 102.4 dpi | | |
| Brightness | 250 nits or cd/m ² (typical) | | |
| Contrast ratio | 1000:1 (typical) | | |
| Pixel response time | 7ms | | |
| Color gamut | 72% | | |
| Anti-reflective | Anti-glare | | |
| Viewing angle at 10:1 CR | 178° (+/- 89°) horizontal, 178° (+/- 89°) vertical | | |
| Preset resolutions | 640x350 @ 70Hz 640x480 @ 60Hz, 66Hz, 72Hz, 75Hz 720x400 @ 70Hz 800x600 @ 60Hz, 72Hz, 75Hz 1024x768 @ 60Hz, 70Hz, 75Hz 1152x864 @ 75Hz 1280x800 @ 60Hz 1280x1024 @ 60Hz, 72Hz, 75Hz 1366x768 @ 60Hz 1440x900 @ 60Hz, 75Hz 1600x1200 @ 60Hz, 70Hz, 75Hz 1680x1050 @ 60Hz 1920x1080 @ 60Hz | | |
| Presets / user settings | Presets: 25; user settings: 25 | | |
| On screen display | On screen display with digital user controls (8 languages) | | |
| Control features | Mode-switching (TIO mode / standalone monitor mode, switches video / audio / USB input sources) / Back button, Left shift button, Right shift / Brightness button, Selection button / Menu button, Power button | | |
| Tiny-in-One Power On | Pressing Alt + P on keyboard or pressing Power button positioned on TIO can turn on both TIO and Tiny (only some Tiny support, see compatible list) | | |
| Front ports | Two USB 3.0 or two USB 2.0 (when M73 or M53 installed or USB 2.0 connected via USB upstream port), one headphone / microphone combo jack (3.5mm) * The USB ports are only available when a Tiny is installed or a PC is connected via USB upstream port | | |
| Side ports | Side ports offered by installed Tiny (optional) | | |
| Rear ports | One DisplayPort 1.2 port, one USB upstream port, one power connector | | |
| 3-in-1 Cable | Undetachable 3-in-1 cable (Power connector, USB 3.0 [supports USB 3.0/USB 2.0], DisplayPort 1.2), only for connecting to Tiny installed (optional) | | |
| Internal Speaker | 1.5 watt x1 | | |
| Security | Security keyhole for attachment of optional cable lock (Kensington® lock compatible), locks optional Tiny with TIO 22 together, more security features offered by Tiny installed (optional) | | |
| Mechanical | Dimensions | TIO 22 without stand | TIO 22 with stand |
| | W x D x H (inch) | 19.25 x 2.65 x 12.47 | 19.25 x 9.90 x 14.02 - 18.35 |
| | W x D x H (mm) | 489.06 x 67.2 x 316.78 | 489.06 x 251.4 x 356.07 - 466.07 |
| | Weight (approximately) | 11.27 lb /5.11 kg (with stand) | |
| Mounting features | Wall or desk mounting using the extend arm or third-party accessories meeting the VESA FPMPMI® (100mm mount) <i>Tilt: 35° back, -5° forward; lift: 4.3" (110mm); swivel: +/-45°</i> | | |
| Adjustable stand | | | |
| Power supply | 90 watts AC/DC adapter, 88% PSU, universal | | |
| Power consumption | 15.57 watts typical, 35 watts maximum, <0.5 watts standby / suspend | | |
| Limited warranty ³ | 3-years , Customer Carry-In or Mail-In via Rapid Replacement Service | | |
| VESA-compliant ² | VESA DDC2B/CI, VESA DPMS-compliant | | |
| Ergonomics | ISO 9241-307 | | |
| Emission standards | FCC Class B | | |
| Environmental | TCO 7.0, TCO Edge 2.0, WEEE, RoHS, ENERGY STAR® 7.0 EPEAT™ Gold rating, ULE Gold, TUV, VOC | | |
| Windows certifications | Windows 7, Windows 8/8.1, and Windows 10 certified | | |
| Ship group | TIO 22 (Monitor), detachable stand, AC/DC power adapter, power cord, user's guide and driver CD, quick start and safety poster | | |
| Accessories | For compatible accessories, please go to http://www.lenovoquickpick.com | | |
| ThinkCentre Tiny-in-One 22 Compatible list | | | |
| Model | M900 Tiny, M700 Tiny, M600 Tiny, M83 Tiny, M53 Tiny | M93/p Tiny, M73 Tiny | Chromebox |
| Turn on TIO and Tiny together via Alt + P on USB KB | All models | All models | Not support |
| Turn on TIO and Tiny together via TIO Power Button | All models | TIO models | All models |

See footnotes for more detailed information

| Model | Region | Color | Display Size | Resolution | Aspect Ratio | Pixel Pitch | Dot / Pixel Per Inch | Brightness | Contrast Ratio | Pixel Response Time | Color Gamut | View Angle (H / V) | Stand | Power Consumption (Typical / Maximum) | Power Supply | Warranty | Ann Date (mm/yy) |
|------------|--------|-------|--------------|------------|--------------|-------------|----------------------|------------|----------------|---------------------|-------------|--------------------|------------------|---------------------------------------|-----------------|----------|------------------|
| 10LKPAR6US | US | Black | 21.5" | 1920x1080 | 16:9 | 0.24795mm | 102.4 dpi | 250 nits | 1000:1 | 7 ms | 72% | 178 / 178 | Adjustable Stand | 15.57W / 35W | 90W 88% Adapter | 3-year | 04/16 |
| 10LKPAT6US | US | Black | 21.5" | 1920x1080 | 16:9 | 0.24795mm | 102.4 dpi | 250 nits | 1000:1 | 7 ms | 72% | 178 / 178 | Adjustable Stand | 15.57W / 35W | 90W 88% Adapter | 3-year | 04/16 |



ThinkCentre Tiny-in-One (TIO) 22 Gen3

Product Specifications Reference (PSREF)

| Model | <i>Non-touch model:</i> 10R1PAR1++/10R1PAT1++; <i>Touch model:</i> 10R0PAR1++/10R0PAT1++ | | | Mounting features | Wall or desk mounting using the extend arm or third-party accessories meeting the VESA FPMPI® (100mm mount) | | | | | | | | | | | | | | | | |
|---|---|-------------------------------|-------------|--|--|---|------------------|----------------------|-------------------------------|----------------|--|-------------------------------|------------------|---|--------------------|------------|-------------|--|------------|------------|------------|
| Form factor | Tiny-in-One, offers a full All-In-One experience when optional Tiny slots into the back of TIO, clean cabling and effortless setup | | | Adjustable stand | <i>Tilt:</i> 30° back, -5° forward; <i>lift:</i> 4.3" (110mm); <i>swivel:</i> +/-45°; <i>Pivot:</i> clockwise 0° to 90° | | | | | | | | | | | | | | | | |
| Compatible Tiny: | M910 / M710 / M900 / M700 / M600 / M715 / M93/p* / M83 / M73* / M53 / Chromebox Tiny * Non-TIO models can't be turned on by pressing power button of TIO | | | Power supply | 90 watts AC/DC adapter, 88% PSU, universal | | | | | | | | | | | | | | | | |
| Panel | TFT-LCD, In-Plane Switching technology**, White LED backlight <i>Notes:</i> In-Plane Switching may refer to VA, PLS, and IPS panels | | | Power consumption | 19 watts typical, 32 watts maximum, <0.5 watts standby / suspend | | | | | | | | | | | | | | | | |
| Viewable image size | 21.5" (546.1mm) diagonal | | | Limited warranty | 3-years , Customer Carry-In or Mail-In via Rapid Replacement Service | | | | | | | | | | | | | | | | |
| Max view area (W x H) | 18.74" x 10.54" / 476.1mm x 267.8mm | | | VESA-compliant | VESA DDC2B/CI, VESA DPMS-compliant | | | | | | | | | | | | | | | | |
| Bezel Width | Top / Side: 2mm, Bottom: 22.1mm | | | Ergonomics | ISO 9241-307, TUV Eye Comfort certified | | | | | | | | | | | | | | | | |
| Native resolution | 1920x1080 | | | Emission standards | FCC Class B | | | | | | | | | | | | | | | | |
| Multi-touch | Optional 10-point multi-touch, supports Wake on Touch | | | Environmental | TCO 7.0, TCO Edge 2.0, WEEE, RoHS, ENERGY STAR® 7.0, EPEAT™ Gold rating, ULE Gold, TUV, VOC | | | | | | | | | | | | | | | | |
| Aspect ratio | 16:9 | | | Windows certifications | Windows 7 and Windows 10 certified | | | | | | | | | | | | | | | | |
| Pixel pitch (mm) | 0.24795mm | | | Ship group | TIO (Monitor), detachable stand, AC/DC power adapter, power cord, user's guide and driver CD, quick start and safety poster | | | | | | | | | | | | | | | | |
| Dot/Pixel per Inch | 102.4 dpi | | | Accessories | For compatible accessories, please go to http://www.lenovoquickpick.com | | | | | | | | | | | | | | | | |
| Brightness | 250 nits or cd/m² (typical) | | | <table border="1"> <thead> <tr> <th colspan="4">ThinkCentre Tiny-in-One 22 Gen3 Compatible list</th> </tr> <tr> <th>Model</th> <th>M910 / M710 / M900 / M700 / M600 / M715 / M83 / M53 Tiny</th> <th>M93/p Tiny, M73 Tiny</th> <th>Chromebox</th> </tr> </thead> <tbody> <tr> <td>Turn on TIO and Tiny together via Alt + P on USB KB</td> <td>All models</td> <td>All models</td> <td>Not support</td> </tr> <tr> <td>Turn on TIO and Tiny together via TIO Power Button</td> <td>All models</td> <td>TIO models</td> <td>All models</td> </tr> </tbody> </table> | | ThinkCentre Tiny-in-One 22 Gen3 Compatible list | | | | Model | M910 / M710 / M900 / M700 / M600 / M715 / M83 / M53 Tiny | M93/p Tiny, M73 Tiny | Chromebox | Turn on TIO and Tiny together via Alt + P on USB KB | All models | All models | Not support | Turn on TIO and Tiny together via TIO Power Button | All models | TIO models | All models |
| ThinkCentre Tiny-in-One 22 Gen3 Compatible list | | | | | | | | | | | | | | | | | | | | | |
| Model | M910 / M710 / M900 / M700 / M600 / M715 / M83 / M53 Tiny | M93/p Tiny, M73 Tiny | Chromebox | | | | | | | | | | | | | | | | | | |
| Turn on TIO and Tiny together via Alt + P on USB KB | All models | All models | Not support | | | | | | | | | | | | | | | | | | |
| Turn on TIO and Tiny together via TIO Power Button | All models | TIO models | All models | | | | | | | | | | | | | | | | | | |
| Contrast ratio | 1000:1 (typical) | | | | | | | | | | | | | | | | | | | | |
| Pixel response time | 14ms (default), over drive to 4ms, 6ms | | | | | | | | | | | | | | | | | | | | |
| Color gamut | 72% | | | | | | | | | | | | | | | | | | | | |
| Anti-reflective | Anti-glare | | | | | | | | | | | | | | | | | | | | |
| Viewing angle at 10:1 CR | 178° (+/- 89°) horizontal, 178° (+/- 89°) vertical | | | | | | | | | | | | | | | | | | | | |
| Preset resolutions | 640x350 @ 70Hz 640x480 @ 60Hz, 66Hz, 72Hz, 75Hz 720x400 @ 70Hz 800x600 @ 60Hz, 72Hz, 75Hz 1024x768 @ 60Hz, 70Hz, 75Hz 1152x864 @ 75Hz 1280x800 @ 60Hz 1280x1024 @ 60Hz, 72Hz, 75Hz 1366x768 @ 60Hz 1440x900 @ 60Hz, 75Hz 1600x1200 @ 60Hz, 70Hz, 75Hz 1680x1050 @ 60Hz 1920x1080 @ 60Hz | | | | | | | | | | | | | | | | | | | | |
| Presets / user settings | Presets: 25; user settings: 25 | | | | | | | | | | | | | | | | | | | | |
| On screen display | On screen display with digital user controls (8 languages) | | | | | | | | | | | | | | | | | | | | |
| Control features | <i>Font:</i> Exit button, Left / Mode-switching button (TIO / monitor mode), Right / Brightness button, Enter / Menu button, Power button <i>Bottom:</i> Volume up button, Volume down button | | | | | | | | | | | | | | | | | | | | |
| Tiny-in-One Power On | Pressing Alt + P on keyboard or pressing Power button positioned on TIO can turn on both TIO and Tiny (only some Tiny support, see compatible list) | | | | | | | | | | | | | | | | | | | | |
| Side ports (TIO) | One USB 3.1 Gen1 / USB 2.0 (when M73 or M53 installed or USB 2.0 connected via USB upstream port) <i>Notes:</i> The USB port is only available when a Tiny is installed or a PC is connected via USB upstream port | | | | | | | | | | | | | | | | | | | | |
| Side ports (Tiny) | Side ports offered by installed Tiny (optional) | | | | | | | | | | | | | | | | | | | | |
| Rear ports | One DisplayPort in port, one USB upstream port, one power connector | | | | | | | | | | | | | | | | | | | | |
| 3-in-1 Cable | Undetachable 3-in-1 cable (Power connector, USB [supports USB 3.1 Gen1 / USB 2.0], DisplayPort), only for connecting to Tiny installed (optional) | | | | | | | | | | | | | | | | | | | | |
| Camera | 720p camera with dual microphone for VOIP, LED indicator | | | | | | | | | | | | | | | | | | | | |
| Internal Speaker | 2 watt x2 | | | | | | | | | | | | | | | | | | | | |
| Security | Security keyhole for attachment of optional cable lock (Kensington® lock compatible), locks optional Tiny with TIO together, more security features offered by Tiny installed (optional) | | | | | | | | | | | | | | | | | | | | |
| Mechanical | <table border="1"> <thead> <tr> <th>Dimensions</th> <th>TIO without stand</th> <th>TIO with stand</th> </tr> </thead> <tbody> <tr> <td>W x D x H (inch)</td> <td>19.26 x 2.85 x 13.35</td> <td>19.26 x 10.76 x 14.59 - 18.93</td> </tr> <tr> <td>W x D x H (mm)</td> <td>489.3 x 72.5 x 339</td> <td>489.3 x 273.3 x 370.7 - 480.7</td> </tr> <tr> <td>Weight (Approx.)</td> <td>7.01 lb / 3.19 kg</td> <td>11.77 lb / 5.34 kg</td> </tr> </tbody> </table> | | | Dimensions | TIO without stand | TIO with stand | W x D x H (inch) | 19.26 x 2.85 x 13.35 | 19.26 x 10.76 x 14.59 - 18.93 | W x D x H (mm) | 489.3 x 72.5 x 339 | 489.3 x 273.3 x 370.7 - 480.7 | Weight (Approx.) | 7.01 lb / 3.19 kg | 11.77 lb / 5.34 kg | | | | | | |
| Dimensions | TIO without stand | TIO with stand | | | | | | | | | | | | | | | | | | | |
| W x D x H (inch) | 19.26 x 2.85 x 13.35 | 19.26 x 10.76 x 14.59 - 18.93 | | | | | | | | | | | | | | | | | | | |
| W x D x H (mm) | 489.3 x 72.5 x 339 | 489.3 x 273.3 x 370.7 - 480.7 | | | | | | | | | | | | | | | | | | | |
| Weight (Approx.) | 7.01 lb / 3.19 kg | 11.77 lb / 5.34 kg | | | | | | | | | | | | | | | | | | | |



ThinkCentre Tiny-in-One (TIO) 24

Product Specifications Reference (PSREF)

| Model | 10LLPAR6++ / 10LLPAT6++ | | | | | | | | | | | | | | |
|---|---|---------------------------------|-------------|------------|----------------------|-------------------|------------------|---------------------|------------------------------|----------------|-----------------------|---------------------------------|------------------------|--------------------------------|--|
| Form factor | Tiny-in-One, offers a full All-In-One experience when optional Tiny slots into the back of TIO 24, clean cabling and effortless setup | | | | | | | | | | | | | | |
| Compatible Tiny: | M900 Tiny, M700 Tiny, M600 Tiny, M93/p Tiny*, M83 Tiny, M73 Tiny*, or M53 Tiny, Chromebox * Non-TIO models can't be turned on by pressing power button of TIO 24 | | | | | | | | | | | | | | |
| Panel | TFT-LCD, In-Plane Switching (IPS), White LED backlight | | | | | | | | | | | | | | |
| Viewable image size | 23.8" (604.7mm) diagonal | | | | | | | | | | | | | | |
| Max view area (W x H) | 21.06" x 12.32" / 535.0mm x 313.0mm | | | | | | | | | | | | | | |
| Bezel Width | Top / Side: 2mm, Bottom: 16.3mm | | | | | | | | | | | | | | |
| Optimum resolution | 1920x1080 | | | | | | | | | | | | | | |
| Aspect ratio | 16:9 | | | | | | | | | | | | | | |
| Pixel pitch (mm) | 0.2745mm | | | | | | | | | | | | | | |
| Dot/Pixel per Inch | 92.6 dpi | | | | | | | | | | | | | | |
| Brightness | 250 nits or cd/m ² (typical) | | | | | | | | | | | | | | |
| Contrast ratio | 1000:1 (typical) | | | | | | | | | | | | | | |
| Pixel response time | 7ms | | | | | | | | | | | | | | |
| Color gamut | 72% | | | | | | | | | | | | | | |
| Anti-reflective | Anti-glare | | | | | | | | | | | | | | |
| Viewing angle at 10:1 CR | 178° (+/- 89°) horizontal, 178° (+/- 89°) vertical | | | | | | | | | | | | | | |
| Preset resolutions | 640x350 @ 70Hz 640x480 @ 60Hz, 66Hz, 72Hz, 75Hz 720x400 @ 70Hz 800x600 @ 60Hz, 72Hz, 75Hz 1024x768 @ 60Hz, 70Hz, 75Hz 1152x864 @ 75Hz 1280x800 @ 60Hz 1280x1024 @ 60Hz, 72Hz, 75Hz 1366x768 @ 60Hz 1440x900 @ 60Hz, 75Hz 1600x1200 @ 60Hz, 70Hz, 75Hz 1680x1050 @ 60Hz 1920x1080 @ 60Hz | | | | | | | | | | | | | | |
| Presets / user settings | Presets: 25; user settings: 25 | | | | | | | | | | | | | | |
| On screen display | On screen display with digital user controls (8 languages) | | | | | | | | | | | | | | |
| Control features | Mode-switching (TIO mode / standalone monitor mode, switches video / audio / USB input sources) / Back button, Left shift button, Right shift / Brightness button, Selection button / Menu button, Power button | | | | | | | | | | | | | | |
| Tiny-in-One Power On | Pressing Alt + P on keyboard or pressing Power button positioned on TIO can turn on both TIO and Tiny (only some Tiny support, see compatible list) | | | | | | | | | | | | | | |
| Front ports | Two USB 3.0 or two USB 2.0 (when M73 or M53 installed or USB 2.0 connected via USB upstream port), one headphone / microphone combo jack (3.5mm) * The USB ports are only available when a Tiny is installed or a PC is connected via USB upstream port | | | | | | | | | | | | | | |
| Side ports | Side ports offered by installed Tiny (optional) | | | | | | | | | | | | | | |
| Rear ports | One DisplayPort 1.2 port, one USB upstream port, one power connector | | | | | | | | | | | | | | |
| 3-in-1 Cable | Undetachable 3-in-1 cable (Power connector, USB 3.0 [supports USB 3.0/USB 2.0], DisplayPort 1.2), only for connecting to Tiny installed (optional) | | | | | | | | | | | | | | |
| Internal Speaker | 1.5 watt x1 | | | | | | | | | | | | | | |
| Security | Security keyhole for attachment of optional cable lock (Kensington® lock compatible), locks optional Tiny with TIO 24 together, more security features offered by Tiny installed (optional) | | | | | | | | | | | | | | |
| Mechanical | <table border="1"> <thead> <tr> <th>Dimensions</th> <th>TIO 24 without stand</th> <th>TIO 24 with stand</th> </tr> </thead> <tbody> <tr> <td>W x D x H (inch)</td> <td>21.24 x 2.7 x 13.64</td> <td>21.24 x 9.90 x 15.16 - 19.46</td> </tr> <tr> <td>W x D x H (mm)</td> <td>539.6 x 68.2 x 346.45</td> <td>539.6 x 251.4 x 385.08 - 495.08</td> </tr> <tr> <td>Weight (approximately)</td> <td colspan="2">12.25 lb /5.57 kg (with stand)</td> </tr> </tbody> </table> | | | Dimensions | TIO 24 without stand | TIO 24 with stand | W x D x H (inch) | 21.24 x 2.7 x 13.64 | 21.24 x 9.90 x 15.16 - 19.46 | W x D x H (mm) | 539.6 x 68.2 x 346.45 | 539.6 x 251.4 x 385.08 - 495.08 | Weight (approximately) | 12.25 lb /5.57 kg (with stand) | |
| Dimensions | TIO 24 without stand | TIO 24 with stand | | | | | | | | | | | | | |
| W x D x H (inch) | 21.24 x 2.7 x 13.64 | 21.24 x 9.90 x 15.16 - 19.46 | | | | | | | | | | | | | |
| W x D x H (mm) | 539.6 x 68.2 x 346.45 | 539.6 x 251.4 x 385.08 - 495.08 | | | | | | | | | | | | | |
| Weight (approximately) | 12.25 lb /5.57 kg (with stand) | | | | | | | | | | | | | | |
| Mounting features | Wall or desk mounting using the extend arm or third-party accessories meeting the VESA FPMPMI® (100mm mount) | | | | | | | | | | | | | | |
| Adjustable stand | Tilt: 35° back, -5° forward; lift: 4.3" (110mm); swivel: +/-45° | | | | | | | | | | | | | | |
| Power supply | 90 watts AC/DC adapter, 88% PSU, universal | | | | | | | | | | | | | | |
| Power consumption | 16.7 watts typical, 35 watts maximum, <0.5 watts standby / suspend | | | | | | | | | | | | | | |
| Limited warranty ³ | 3-years , Customer Carry-In or Mail-In via Rapid Replacement Service | | | | | | | | | | | | | | |
| VESA-compliant ² | VESA DDC2B/CI, VESA DPMS-compliant | | | | | | | | | | | | | | |
| Ergonomics | ISO 9241-307 | | | | | | | | | | | | | | |
| Emission standards | FCC Class B | | | | | | | | | | | | | | |
| Environmental | TCO 7.0, TCO Edge 2.0, WEEE, RoHS, ENERGY STAR® 7.0 | | | | | | | | | | | | | | |
| Windows certifications | EPEAT™ Gold rating, ULE Gold, TUV, VOC Windows 7, Windows 8/8.1, and Windows 10 certified | | | | | | | | | | | | | | |
| Ship group | TIO 24 (Monitor), detachable stand, AC/DC power adapter, power cord, user's guide and driver CD, quick start and safety poster | | | | | | | | | | | | | | |
| Accessories | For compatible accessories, please go to http://www.lenovoquickpick.com | | | | | | | | | | | | | | |
| ThinkCentre Tiny-in-One 24 Compatible list | | | | | | | | | | | | | | | |
| Model | M900 Tiny, M700 Tiny, M600 Tiny, M83 Tiny, M53 Tiny | M93/p Tiny, M73 Tiny | Chromebox | | | | | | | | | | | | |
| Turn on TIO and Tiny together via Alt + P on USB KB | All models | All models | Not support | | | | | | | | | | | | |
| Turn on TIO and Tiny together via TIO Power Button | All models | TIO models | All models | | | | | | | | | | | | |

See footnotes for more detailed information

ThinkCentre Tiny-In-One 24 - 10LL

Product Specifications Reference (PSREF)

| Model | Region | Color | Display Size | Resolution | Aspect Ratio | Pixel Pitch | Dot / Pixel Per Inch | Brightness | Contrast Ratio | Pixel Response Time | Color Gamut | View Angle (H / V) | Stand | Power Consumption (Typical / Maximum) | Power Supply | Warranty | Ann Date (mm/yy) |
|------------|--------|-------|--------------|------------|--------------|-------------|----------------------|------------|----------------|---------------------|-------------|--------------------|------------------|---------------------------------------|-----------------|----------|------------------|
| 10LLPAR6US | US | Black | 23.8" | 1920x1080 | 16:9 | 0.2745mm | 92.6 dpi | 250 nits | 1000:1 | 7 ms | 72% | 178 / 178 | Adjustable Stand | 16.7W / 35W | 90W 88% Adapter | 3-year | 05/16 |
| 10LLPAT6US | US | Black | 23.8" | 1920x1080 | 16:9 | 0.2745mm | 92.6 dpi | 250 nits | 1000:1 | 7 ms | 72% | 178 / 178 | Adjustable Stand | 16.7W / 35W | 90W 88% Adapter | 3-year | 05/16 |



ThinkCentre Tiny-in-One (TIO) 24 Gen3

Product Specifications Reference (PSREF)

| Model | <i>Non-touch model:</i> 10QYPAR1++/10QYPAT1++; <i>Touch model:</i> 10QXPAR1++/10QXPAT1++ | | | Mounting features | Wall or desk mounting using the extend arm or third-party accessories meeting the VESA FPMPI® (100mm mount) | | | | | | | | | | | | | | | | |
|---|---|-------------------------------|-------------|--|--|---|------------------|----------------------|-------------------------------|----------------|--|-------------------------------|------------------|---|-------------------|------------|-------------|--|------------|------------|------------|
| Form factor | Tiny-in-One, offers a full All-In-One experience when optional Tiny slots into the back of TIO, clean cabling and effortless setup | | | Adjustable stand | <i>Tilt:</i> 30° back, -5° forward; <i>lift:</i> 4.3" (110mm); <i>swivel:</i> +/-45°; <i>Pivot:</i> clockwise 0° to 90° | | | | | | | | | | | | | | | | |
| Compatible Tiny: | M910 / M710 / M900 / M700 / M600 / M715 / M93/p* / M83 / M73* / M53 / Chromebox Tiny * Non-TIO models can't be turned on by pressing power button of TIO | | | Power supply | 90 watts AC/DC adapter, 88% PSU, universal | | | | | | | | | | | | | | | | |
| Panel | TFT-LCD, In-Plane Switching technology**, White LED backlight <i>Notes:</i> In-Plane Switching may refer to VA, PLS, and IPS panels | | | Power consumption | 19 watts typical, 32 watts maximum, <0.5 watts standby / suspend | | | | | | | | | | | | | | | | |
| Viewable image size | 23.8" (604.7mm) diagonal | | | Limited warranty | 3-years , Customer Carry-In or Mail-In via Rapid Replacement Service | | | | | | | | | | | | | | | | |
| Max view area (W x H) | 21.06" x 12.32" / 535.0mm x 313.0mm | | | VESA-compliant | VESA DDC2B/CI, VESA DPMS-compliant | | | | | | | | | | | | | | | | |
| Bezel Width | Top / Side: 2mm, Bottom: 22.1mm | | | Ergonomics | ISO 9241-307, TUV Eye Comfort certified | | | | | | | | | | | | | | | | |
| Native resolution | 1920x1080 | | | Emission standards | FCC Class B | | | | | | | | | | | | | | | | |
| Multi-touch | Optional 10-point multi-touch, supports Wake on Touch | | | Environmental | TCO 7.0, TCO Edge 2.0, WEEE, RoHS, ENERGY STAR® 7.0, EPEAT™ Gold rating, ULE Gold, TUV, VOC | | | | | | | | | | | | | | | | |
| Aspect ratio | 16:9 | | | Windows certifications | Windows 7 and Windows 10 certified | | | | | | | | | | | | | | | | |
| Pixel pitch (mm) | 0.2745mm | | | Ship group | TIO 24 (Monitor), detachable stand, AC/DC power adapter, power cord, user's guide and driver CD, quick start and safety poster | | | | | | | | | | | | | | | | |
| Dot/Pixel per Inch | 92.6 dpi | | | Accessories | For compatible accessories, please go to http://www.lenovoquickpick.com | | | | | | | | | | | | | | | | |
| Brightness | 250 nits or cd/m² (typical) | | | <table border="1"> <thead> <tr> <th colspan="4">ThinkCentre Tiny-in-One 24 Gen3 Compatible list</th> </tr> </thead> <tbody> <tr> <td>Model</td> <td>M910 / M710 / M900 / M700 / M600 / M715 / M83 / M53 Tiny</td> <td>M93/p Tiny, M73 Tiny</td> <td>Chromebox</td> </tr> <tr> <td>Turn on TIO and Tiny together via Alt + P on USB KB</td> <td>All models</td> <td>All models</td> <td>Not support</td> </tr> <tr> <td>Turn on TIO and Tiny together via TIO Power Button</td> <td>All models</td> <td>TIO models</td> <td>All models</td> </tr> </tbody> </table> | | ThinkCentre Tiny-in-One 24 Gen3 Compatible list | | | | Model | M910 / M710 / M900 / M700 / M600 / M715 / M83 / M53 Tiny | M93/p Tiny, M73 Tiny | Chromebox | Turn on TIO and Tiny together via Alt + P on USB KB | All models | All models | Not support | Turn on TIO and Tiny together via TIO Power Button | All models | TIO models | All models |
| ThinkCentre Tiny-in-One 24 Gen3 Compatible list | | | | | | | | | | | | | | | | | | | | | |
| Model | M910 / M710 / M900 / M700 / M600 / M715 / M83 / M53 Tiny | M93/p Tiny, M73 Tiny | Chromebox | | | | | | | | | | | | | | | | | | |
| Turn on TIO and Tiny together via Alt + P on USB KB | All models | All models | Not support | | | | | | | | | | | | | | | | | | |
| Turn on TIO and Tiny together via TIO Power Button | All models | TIO models | All models | | | | | | | | | | | | | | | | | | |
| Contrast ratio | 1000:1 (typical) | | | | | | | | | | | | | | | | | | | | |
| Pixel response time | 14ms (default), over drive to 4ms, 6ms | | | | | | | | | | | | | | | | | | | | |
| Color gamut | 72% | | | | | | | | | | | | | | | | | | | | |
| Anti-reflective | Anti-glare | | | | | | | | | | | | | | | | | | | | |
| Viewing angle at 10:1 CR | 178° (+/- 89°) horizontal, 178° (+/- 89°) vertical | | | | | | | | | | | | | | | | | | | | |
| Preset resolutions | 640x350 @ 70Hz 640x480 @ 60Hz, 67Hz, 72Hz, 75Hz 720x400 @ 70Hz 800x600 @ 60Hz, 72Hz, 75Hz 1024x768 @ 60Hz, 70Hz, 75Hz 1152x864 @ 75Hz 1280x800 @ 60Hz 1280x1024 @ 60Hz, 72Hz, 75Hz 1366x768 @ 60Hz 1440x900 @ 60Hz, 75Hz 1600x1200 @ 60Hz, 70Hz, 75Hz 1680x1050 @ 60Hz 1920x1080 @ 60Hz | | | | | | | | | | | | | | | | | | | | |
| Presets / user settings | Presets: 25; user settings: 25 | | | | | | | | | | | | | | | | | | | | |
| On screen display | On screen display with digital user controls (8 languages) | | | | | | | | | | | | | | | | | | | | |
| Control features | Font: Exit button, Left / Mode-switching button (TIO / monitor mode), Right / Brightness button, Enter / Menu button, Power button Bottom: Volume up button, Volume down button | | | | | | | | | | | | | | | | | | | | |
| Tiny-in-One Power On | Pressing Alt + P on keyboard or pressing Power button positioned on TIO can turn on both TIO and Tiny (only some Tiny support, see compatible list) | | | | | | | | | | | | | | | | | | | | |
| Side ports (TIO) | One USB 3.1 Gen1 / USB 2.0 (when M73 or M53 installed or USB 2.0 connected via USB upstream port) <i>Notes:</i> The USB port is only available when a Tiny is installed or a PC is connected via USB upstream port | | | | | | | | | | | | | | | | | | | | |
| Side ports (Tiny) | Side ports offered by installed Tiny (optional) | | | | | | | | | | | | | | | | | | | | |
| Rear ports | One DisplayPort in port, one USB upstream port, one power connector | | | | | | | | | | | | | | | | | | | | |
| 3-in-1 Cable | Undetachable 3-in-1 cable (Power connector, USB [supports USB 3.1 Gen1 / USB 2.0], DisplayPort), only for connecting to Tiny installed (optional) | | | | | | | | | | | | | | | | | | | | |
| Camera | 1080p camera with dual microphone for VOIP, LED indicator | | | | | | | | | | | | | | | | | | | | |
| Internal Speaker | 2 watt x2 | | | | | | | | | | | | | | | | | | | | |
| Security | Security keyhole for attachment of optional cable lock (Kensington® lock compatible), locks optional Tiny with TIO together, more security features offered by Tiny installed (optional) | | | | | | | | | | | | | | | | | | | | |
| Mechanical | <table border="1"> <thead> <tr> <th>Dimensions</th> <th>TIO without stand</th> <th>TIO with stand</th> </tr> </thead> <tbody> <tr> <td>W x D x H (inch)</td> <td>21.25 x 2.85 x 14.47</td> <td>21.25 x 11.11 x 15.72 - 20.06</td> </tr> <tr> <td>W x D x H (mm)</td> <td>539.8 x 72.5 x 367.6</td> <td>539.8 x 282.3 x 399.4 - 509.4</td> </tr> <tr> <td>Weight (Approx.)</td> <td>7.96 lb /3.61 kg</td> <td>12.92 lb /5.86 kg</td> </tr> </tbody> </table> | | | Dimensions | TIO without stand | TIO with stand | W x D x H (inch) | 21.25 x 2.85 x 14.47 | 21.25 x 11.11 x 15.72 - 20.06 | W x D x H (mm) | 539.8 x 72.5 x 367.6 | 539.8 x 282.3 x 399.4 - 509.4 | Weight (Approx.) | 7.96 lb /3.61 kg | 12.92 lb /5.86 kg | | | | | | |
| Dimensions | TIO without stand | TIO with stand | | | | | | | | | | | | | | | | | | | |
| W x D x H (inch) | 21.25 x 2.85 x 14.47 | 21.25 x 11.11 x 15.72 - 20.06 | | | | | | | | | | | | | | | | | | | |
| W x D x H (mm) | 539.8 x 72.5 x 367.6 | 539.8 x 282.3 x 399.4 - 509.4 | | | | | | | | | | | | | | | | | | | |
| Weight (Approx.) | 7.96 lb /3.61 kg | 12.92 lb /5.86 kg | | | | | | | | | | | | | | | | | | | |



ThinkCentre X1 Platform Specifications

Product Specifications Reference (PSREF)

| Processor | Intel® 6th Generation Intel Core™ i3 / i5 / i7 Processor | Security features | <ul style="list-style-type: none"> Security slot (in rear for attachment of optional Kensington® MicroSaver® cable; Kensington lock also locks chassis) Smart USB protection, allows keyboard/mouse only, blocks all storage devices Power-on, admin, hard disk password Boot sequence control Boot without keyboard and mouse Individual USB port disablement Optional chassis intrusion switch | | | | | | | | | | | | | | | | | | | | | | | | | | | | | | | | | | | |
|-------------------------|--|-------------------------------|---|-------------------------|---------------------|----------------------|---------------------|----------------|--|---------|-------|-------------------------|---|----------|--------------------------------|---------------|-------|---------------|------|-----------|--------|----|---------------|-------|---------------|------|-----------|--------|------|---------------|-------|---------------|------|-----------|--------|------|----------|---|
| | <table border="1"> <thead> <tr> <th>Processor</th> <th>Cores / Threads</th> <th>Frequency Base/Max(GHz)</th> <th>Cache</th> <th>Memory Types</th> <th>Integrated Graphics</th> <th>Intel vPro</th> </tr> </thead> <tbody> <tr> <td>Core i3-6100U</td> <td>2 / 4</td> <td>2.3 G</td> <td>3 MB</td> <td>DDR4-2133</td> <td>HD 520</td> <td>No</td> </tr> <tr> <td>Core i5-6200U</td> <td>2 / 4</td> <td>2.3 G / 2.8 G</td> <td>3 MB</td> <td>DDR4-2133</td> <td>HD 520</td> <td>No</td> </tr> <tr> <td>Core i5-6300U</td> <td>2 / 4</td> <td>2.4 G / 3.0 G</td> <td>3 MB</td> <td>DDR4-2133</td> <td>HD 520</td> <td>vPro</td> </tr> <tr> <td>Core i7-6600U</td> <td>2 / 4</td> <td>2.6 G / 3.4 G</td> <td>4 MB</td> <td>DDR4-2133</td> <td>HD 520</td> <td>vPro</td> </tr> </tbody> </table> <p>Intel Architecture (IA) SoC that integrates Intel processor core, graphics, memory controller, and I/O interfaces into a single system-on-chip solution</p> | Processor | Cores / Threads | Frequency Base/Max(GHz) | Cache | Memory Types | Integrated Graphics | Intel vPro | Core i3-6100U | 2 / 4 | 2.3 G | 3 MB | DDR4-2133 | HD 520 | No | Core i5-6200U | 2 / 4 | 2.3 G / 2.8 G | 3 MB | DDR4-2133 | HD 520 | No | Core i5-6300U | 2 / 4 | 2.4 G / 3.0 G | 3 MB | DDR4-2133 | HD 520 | vPro | Core i7-6600U | 2 / 4 | 2.6 G / 3.4 G | 4 MB | DDR4-2133 | HD 520 | vPro | Keyboard | Some: Lenovo Slim USB Keyboard (USB connector), black Some: Ultralim Plus Wireless Keyboard (2.4GHz via USB receiver), black |
| Processor | Cores / Threads | Frequency Base/Max(GHz) | Cache | Memory Types | Integrated Graphics | Intel vPro | | | | | | | | | | | | | | | | | | | | | | | | | | | | | | | | |
| Core i3-6100U | 2 / 4 | 2.3 G | 3 MB | DDR4-2133 | HD 520 | No | | | | | | | | | | | | | | | | | | | | | | | | | | | | | | | | |
| Core i5-6200U | 2 / 4 | 2.3 G / 2.8 G | 3 MB | DDR4-2133 | HD 520 | No | | | | | | | | | | | | | | | | | | | | | | | | | | | | | | | | |
| Core i5-6300U | 2 / 4 | 2.4 G / 3.0 G | 3 MB | DDR4-2133 | HD 520 | vPro | | | | | | | | | | | | | | | | | | | | | | | | | | | | | | | | |
| Core i7-6600U | 2 / 4 | 2.6 G / 3.4 G | 4 MB | DDR4-2133 | HD 520 | vPro | | | | | | | | | | | | | | | | | | | | | | | | | | | | | | | | |
| Memory | 16GB max, DDR4 2133, one 260-pin SO-DIMM socket | Mouse | Some: Enhanced Optical USB Mouse, black, Lenovo logo Some: Ultralim Plus Wireless Mouse (2.4GHz via USB receiver), black | | | | | | | | | | | | | | | | | | | | | | | | | | | | | | | | | | | |
| Disk | Some: SATA 6.0Gb/s, 2.5" Wide, 5400 rpm or 7200 rpm Some: Solid State Hybrid Drive (SSHD) / with 8GB MLC NAND flash memory, SATA 6.0Gb/s, 2.5" Wide, 5400 rpm Some: Solid State Drive (SSD) / SATA 6.0Gb/s, 2.5" Wide | Mechanical | <ul style="list-style-type: none"> Business black color, Aluminum Alloy Toolless back cover and memory removal Optional VESA mount kit (100mm) <table border="1"> <thead> <tr> <th></th> <th>Dimensions (WxDxH)</th> <th>Max weight (lb / kg)</th> <th>Adjustments</th> </tr> </thead> <tbody> <tr> <td>Without stand:</td> <td>22.4 X 1.3 X 14.2 (inch); 570 X 33 X 360 (mm)</td> <td>8.8 / 4</td> <td>N/A</td> </tr> <tr> <td>With Orchid tilt stand:</td> <td>22.4 X 9.4 X 17.8 (inch); 570 X 240 X 451 (mm)</td> <td>11.0 / 5</td> <td>Tilt: 45° back, -5° forward</td> </tr> </tbody> </table> | | Dimensions (WxDxH) | Max weight (lb / kg) | Adjustments | Without stand: | 22.4 X 1.3 X 14.2 (inch); 570 X 33 X 360 (mm) | 8.8 / 4 | N/A | With Orchid tilt stand: | 22.4 X 9.4 X 17.8 (inch); 570 X 240 X 451 (mm) | 11.0 / 5 | Tilt: 45° back, -5° forward | | | | | | | | | | | | | | | | | | | | | | | |
| | Dimensions (WxDxH) | Max weight (lb / kg) | Adjustments | | | | | | | | | | | | | | | | | | | | | | | | | | | | | | | | | | | |
| Without stand: | 22.4 X 1.3 X 14.2 (inch); 570 X 33 X 360 (mm) | 8.8 / 4 | N/A | | | | | | | | | | | | | | | | | | | | | | | | | | | | | | | | | | | |
| With Orchid tilt stand: | 22.4 X 9.4 X 17.8 (inch); 570 X 240 X 451 (mm) | 11.0 / 5 | Tilt: 45° back, -5° forward | | | | | | | | | | | | | | | | | | | | | | | | | | | | | | | | | | | |
| Optical Media reader | None Optional 9-in-1 media card reader | Power supply | 90 watts adapter, autosensing, 88% PSU | | | | | | | | | | | | | | | | | | | | | | | | | | | | | | | | | | | |
| Graphics | Intel HD Graphics 520 in processor, uses main memory, DirectX® 12, external monitor support via DisplayPort™; Max resolution: 4096x2304 (DP)@60Hz | Limited warranty ³ | Some: 1-year or 3-year, limited onsite service Some: 3-years, limited onsite service, OID (Onsite International Delivery) / For <i>Lenovo service upgrade options, please go to S-TC sheet</i> | | | | | | | | | | | | | | | | | | | | | | | | | | | | | | | | | | | |
| DP Dongle Display | Optional DP to VGA, DP to DVI-D (single link), or DP to HDMI 1.4 dongle 23.8" (604.5mm) Full HD 1080p (1920x1080) TFT color , IPS panel, wide viewing angle (+/- 89°), LED backlight, 250 nits, 16:9 aspect ratio, 1000:1 contrast ratio, anti-glare, work as standalone monitor via DisplayPort (DP in / out combo) | Preload | Preloaded operating system Some: Windows® 7 Professional 32/64 preinstalled through downgrade rights in Windows 10 Pro 64-bit Some: Windows 7 Professional 64 Some: Windows 10 Pro 64-bit Some: Windows 10 Home 64-bit Preloaded applications (only some listed) <ul style="list-style-type: none"> Desktop Power Manager Lenovo Solution Center Lenovo REACHit Lenovo SHAREit Lenovo Bluetooth Lock (for models with Wi-Fi/BT card) McAfee® LiveSafe™ (30-day trial) Microsoft Office preloaded; purchase a product key to activate Lenovo ThinkVantage Tools <ul style="list-style-type: none"> Only for Window 10 Lenovo Companion Only for Window 7 Rescue and Recovery Password Manager ThinkVantage System Update Lenovo Message Center Plus Adobe® Reader® | | | | | | | | | | | | | | | | | | | | | | | | | | | | | | | | | | | |
| Light sensor | None | Environment | EPEAT™ Gold rating; ENERGY STAR® 6.1; TCO Certified Edge; TUV Green Mark; ULE Gold; ErP Lot 3; GREENGUARD® certified; RoHS-compliant | | | | | | | | | | | | | | | | | | | | | | | | | | | | | | | | | | | |
| Multi-touch | None | MIL-SPEC test | MIL-STD-810G military certification (Low Pressure [Altitude], High Temperature, Low Temperature, Temperature Shock, Humidity, Sand and Dust, Vibration, Shock) | | | | | | | | | | | | | | | | | | | | | | | | | | | | | | | | | | | |
| Camera | 2.0-megapixel camera, fixed focus, supports 1080p, with dual array digital microphone, LED indicator, physical switch on/off, Skype for Business certified | Accessories | For compatible accessories, please go to TC-AQP sheet | | | | | | | | | | | | | | | | | | | | | | | | | | | | | | | | | | | |
| Controls | Microphone mute, DP in / out switch, and power button | | | | | | | | | | | | | | | | | | | | | | | | | | | | | | | | | | | | | |
| Chipset | Intel System-on-Chip (SoC) platform | | | | | | | | | | | | | | | | | | | | | | | | | | | | | | | | | | | | | |
| Rear ports | Three USB 3.0, ethernet (RJ-45), DisplayPort in/out combo port, | | | | | | | | | | | | | | | | | | | | | | | | | | | | | | | | | | | | | |
| Side ports | Two USB 3.0 (one is Always On and fast charge), optional card reader, one headphone / microphone combo jack (3.5mm) | | | | | | | | | | | | | | | | | | | | | | | | | | | | | | | | | | | | | |
| M.2 card slot | One M.2 Card slot (for WLAN) | | | | | | | | | | | | | | | | | | | | | | | | | | | | | | | | | | | | | |
| Audio support | High Definition (HD) Audio, Realtek ALC233 / two internal speakers (5W x 2), Dolby® Audio™ certified, Skype for Business certified | | | | | | | | | | | | | | | | | | | | | | | | | | | | | | | | | | | | | |
| WLAN ¹³ | Some: 11ac wireless, M.2 Card, Qualcomm Atheros QCA6174 (dual band), Wi-Fi + Bluetooth 4.1 combo adapter, 2x2 Some: 11ac wireless, M.2 Card, Intel Dual Band Wireless-AC 8260, Wi-Fi + Bluetooth 4.1 combo adapter, 2x2 Some: 11ac wireless, M.2 Card, Intel Dual Band Wireless-AC 8260, Wi-Fi + Bluetooth 4.1 combo adapter, Intel vPro technology support, 2x2 | | | | | | | | | | | | | | | | | | | | | | | | | | | | | | | | | | | | | |
| Bluetooth™ Ethernet | Some: Bluetooth 4.0 or 4.1 wireless, integrated in Wi-Fi + Bluetooth combo adapter Gigabit ethernet, Intel Ethernet Connection I219-LM (Jacksonville), Wake on LAN® | | | | | | | | | | | | | | | | | | | | | | | | | | | | | | | | | | | | | |
| Manageability | Intel Active Management Technology 11.0 (Intel AMT 11.0) on some models; Intel vPro technology on some models (require choosing a vPro-support Wi-Fi adapter to enable vPro function through wireless connection) | | | | | | | | | | | | | | | | | | | | | | | | | | | | | | | | | | | | | |
| Security chip | Trusted Platform Module (TPM 1.2-compliant) | | | | | | | | | | | | | | | | | | | | | | | | | | | | | | | | | | | | | |

See footnotes for more detailed information

© Lenovo
(X1-Spec) July 2016

ThinkCentre X1 AIO - TopSeller - 10KE

Product Specifications Reference (PSREF)

| Model | Region | Processor | vPro | Graphics | Monitor Cable | Memory | Display | Multi-touch | Storage(HDD/SSD) | Media Reader | WLAN + Bluetooth | Camera | Chassis Intrusion Switch | Keyboard / Mouse | Stand | Power Supply | Operating System | Warranty | Global | Ann Date (mm/yy) |
|------------|--------|-----------|------|--------------|---------------|--------|--------------------------------------|-------------|--------------------|--------------|----------------------|--------|--------------------------|------------------|-------------------|-----------------|----------------------|----------------|--------|------------------|
| 10KE0007US | US | i5-6200U | No | Intel HD 520 | None | 8GBx1 | 23.8" FHD (1920x1080) IPS Anti-glare | None | 256GB SSD | 9-in-1 | 8260 ac, 2x2 + BT4.1 | 1080p | None | 2.4G / 2.4G | Orchid Tilt Stand | 90W 88% Adapter | Win10 DG Win7 Pro 64 | 3-year, Onsite | No | 01/16 |
| 10KE0008US | US | i5-6200U | No | Intel HD 520 | None | 4GBx1 | 23.8" FHD (1920x1080) IPS Anti-glare | None | 120GB SSD | 9-in-1 | 8260 ac, 2x2 + BT4.1 | 1080p | None | 2.4G / 2.4G | Orchid Tilt Stand | 90W 88% Adapter | Win10 DG Win7 Pro 64 | 3-year, Onsite | No | 01/16 |
| 10KE001CUS | US | i5-6200U | No | Intel HD 520 | None | 8GBx1 | 23.8" FHD (1920x1080) IPS Anti-glare | None | 256GB SSD | None | 8260 ac, 2x2 + BT4.1 | 1080p | None | USB (Slim) / USB | Orchid Tilt Stand | 90W 88% Adapter | Win10 Pro 64 | 3-year, Onsite | No | 08/16 |
| 10KE001DUS | US | i5-6200U | No | Intel HD 520 | None | 4GBx1 | 23.8" FHD (1920x1080) IPS Anti-glare | None | 128GB SSD | None | 8260 ac, 2x2 + BT4.1 | 1080p | None | USB (Slim) / USB | Orchid Tilt Stand | 90W 88% Adapter | Win10 Pro 64 | 3-year, Onsite | No | 08/16 |
| 10KE001EUS | US | i5-6200U | No | Intel HD 520 | None | 4GBx1 | 23.8" FHD (1920x1080) IPS Anti-glare | None | 128GB SSD | None | 8260 ac, 2x2 + BT4.1 | 1080p | None | 2.4G / 2.4G | Orchid Tilt Stand | 90W 88% Adapter | Win10 Pro 64 | 3-year, Onsite | No | 09/16 |
| 10KE001FUS | US | i5-6200U | No | Intel HD 520 | None | 8GBx1 | 23.8" FHD (1920x1080) IPS Anti-glare | None | 256GB SSD | None | 8260 ac, 2x2 + BT4.1 | 1080p | None | 2.4G / 2.4G | Orchid Tilt Stand | 90W 88% Adapter | Win10 Pro 64 | 3-year, Onsite | No | 09/16 |
| 10KE001GUS | US | i5-6200U | No | Intel HD 520 | None | 4GBx1 | 23.8" FHD (1920x1080) IPS Anti-glare | None | 500GB 7200rpm 2.5" | None | 8260 ac, 2x2 + BT4.1 | 1080p | None | 2.4G / 2.4G | Orchid Tilt Stand | 90W 88% Adapter | Win10 Pro 64 | 3-year, Onsite | No | 09/16 |
| 10KE001HUS | US | i5-6200U | No | Intel HD 520 | None | 4GBx1 | 23.8" FHD (1920x1080) IPS Anti-glare | None | 500GB 7200rpm 2.5" | None | 8260 ac, 2x2 + BT4.1 | 1080p | None | 2.4G / 2.4G | Orchid Tilt Stand | 90W 88% Adapter | Win10 DG Win7 Pro 64 | 3-year, Onsite | No | 09/16 |
| 10KE001JUS | US | i5-6200U | No | Intel HD 520 | None | 4GBx1 | 23.8" FHD (1920x1080) IPS Anti-glare | None | 128GB SSD | None | 8260 ac, 2x2 + BT4.1 | 1080p | None | 2.4G / 2.4G | Orchid Tilt Stand | 90W 88% Adapter | Win10 DG Win7 Pro 64 | 3-year, Onsite | No | 09/16 |
| 10KE001LUS | US | i5-6200U | No | Intel HD 520 | None | 8GBx1 | 23.8" FHD (1920x1080) IPS Anti-glare | None | 256GB SSD Opal | 9-in-1 | 8260 ac, 2x2 + BT4.1 | 1080p | None | 2.4G / 2.4G | Orchid Tilt Stand | 90W 88% Adapter | Win10 DG Win7 Pro 64 | 3-year, Onsite | No | 12/16 |
| 10KE001MUS | US | i5-6200U | No | Intel HD 520 | None | 8GBx1 | 23.8" FHD (1920x1080) IPS Anti-glare | None | 256GB SSD Opal | None | 8260 ac, 2x2 + BT4.1 | 1080p | None | 2.4G / 2.4G | Orchid Tilt Stand | 90W 88% Adapter | Win10 Pro 64 | 3-year, Onsite | No | 12/16 |
| 10KE001NUS | US | i5-6200U | No | Intel HD 520 | None | 8GBx1 | 23.8" FHD (1920x1080) IPS Anti-glare | None | 256GB SSD Opal | None | 8260 ac, 2x2 + BT4.1 | 1080p | None | USB (Slim) / USB | Orchid Tilt Stand | 90W 88% Adapter | Win10 Pro 64 | 3-year, Onsite | No | 12/16 |

This publication was developed for products and services offered in the United States and E.M.E.A countries. Lenovo may not offer the products, services or features discussed in this document in other countries. Lenovo may withdraw an offering at any time. Information is subject to change without notice. Consult your local representative for information on offerings available in your area.

Lenovo reserves the right to change specifications or other product information without notice. Lenovo is not responsible for photographic or typographical errors.

LENOVO PROVIDES THIS PUBLICATION "AS IS," WITHOUT WARRANTY OF ANY KIND, EITHER EXPRESS OR IMPLIED, INCLUDING THE IMPLIED WARRANTIES OF MERCHANTABILITY OR FITNESS FOR A PARTICULAR PURPOSE.

Some jurisdictions do not allow disclaimer of express or implied warranties in certain transactions, therefore this disclaimer may not apply to you.

Availability: All offers subject to availability. Lenovo reserves the right to alter product offerings and specifications at any time, without notice. Lenovo is not responsible for photographic or typographic errors.

General: Review key information provided by Microsoft that may apply to your system purchase, including details on Windows 10, Windows 8, Windows 7, and potential upgrades/downgrades. Lenovo makes no representation or warranty regarding third-party products or services.

Trademarks: Lenovo, ThinkPad, ThinkCentre, ThinkStation and the Lenovo logo are trademarks of Lenovo. Microsoft, Windows, Windows NT, and the Windows logo are trademarks of Microsoft Corporation. Ultrabook, Celeron, Celeron Inside, Core Inside, Intel, Intel Logo, Intel Atom, Intel Atom Inside, Intel Core, Intel Inside, Intel Inside Logo, Intel vPro, Itanium, Itanium Inside, Pentium, Pentium Inside, vPro Inside, Xeon, Xeon Phi, and Xeon Inside are trademarks of Intel Corporation in the U.S. and/or other countries. Other company, product or service names may be trademarks or service marks of others.

Warranty: For a copy of applicable warranties, write to: Lenovo Warranty Information, 1009 Think Place, Morrisville, NC, 27560. Lenovo makes no representation or warranty regarding third party products or services. The Lenovo Limited Warranty applies only to Lenovo hardware products purchased for your own use, and does not transfer upon resale.

Limited warranty: Support unrelated to a warranty issue may be subject to additional charges.

Lenovo Services:

Carry-in or Mail-in Service: Parts and labor repair coverage where the customer is responsible for shipping (including packaging) or delivery to authorized warranty provider or repair center.

Depot or Courier Service: Parts and labor repair coverage where shipping (including packaging) or delivery to the repair center is paid for by Lenovo.

Expedited Depot: Parts and labor coverage with expedited turnaround. Shipping (including packaging) or delivery to the repair center is paid for by Lenovo.

Onsite / In-home Service: Parts and labor repair coverage where labor is provided onsite at your place of business.

If Lenovo determines your product problem is covered by the product warranty and cannot be resolved over the telephone, a technician will be dispatched to arrive onsite, typically the next day.

International Warranty Service (IWS): PC repair coverage for customers who require a critical warranty repair while travelling internationally. Visit www.lenovo.com/internationalwarranty for details. Visit www.lenovo.com/warranty for Lenovo Warranty Services terms and conditions for complete details and restrictions.

Included software: may differ from its retail version (if available), and may not include user manuals or all program functionality. Software license agreements may apply.

Battery life: Battery life (and recharge times) will vary based on many factors including screen brightness, applications, features, power management, battery conditioning, and other customer preferences.

Visit <http://psref.lenovo.com/> for the latest version of Product Specifications Reference.

© Lenovo, 2017. All rights reserved.
Lenovo 1009 Think Place Morrisville, NC 27560 U.S.A.

Lenovo™ **ThinkStation.**

PSREF



Product Specifications Reference

Version 508, June 2017

U.S.

Visit <http://psref.lenovo.com> for the latest version

Contents

| | | | |
|---|----|---|-----------|
| Cover | 1 | ThinkStation P510 - TopSeller - 30B5 - 1 of 5 | 34 |
| Contents | 2 | ThinkStation P510 - TopSeller - 30B5 - 2 of 5 | 35 |
| Summary Of Change | 3 | ThinkStation P510 - TopSeller - 30B5 - 3 of 5 | 36 |
| P Series | 5 | ThinkStation P510 - TopSeller - 30B5 - 4 of 5 | 37 |
| ThinkStation P310 SFF | 5 | ThinkStation P510 - TopSeller - 30B5 - 5 of 5 | 38 |
| ThinkStation P310 SFF Platform Specifications | 6 | ThinkStation P700 | 39 |
| ThinkStation P310 SFF - TopSeller - 30AV - 1 of 2 | 7 | ThinkStation P700 Platform Specifications | 40 |
| ThinkStation P310 SFF - TopSeller - 30AV - 2 of 2 | 8 | ThinkStation P700 - TopSeller - 30A9 | 41 |
| ThinkStation P310 Tower | 9 | ThinkStation P700 - 30A8 | 42 |
| ThinkStation P310 Tower Platform Specifications | 10 | ThinkStation P710 | 43 |
| ThinkStation P310 Tower - TopSeller - 30AT - 1 of 3 | 11 | ThinkStation P710 Platform Specifications | 43 |
| ThinkStation P310 Tower - TopSeller - 30AT - 2 of 3 | 12 | ThinkStation P710 - TopSeller - 30B7 - 1 of 3 | 44 |
| ThinkStation P310 Tower - TopSeller - 30AT - 3 of 3 | 13 | ThinkStation P710 - TopSeller - 30B7 - 2 of 3 | 45 |
| ThinkStation P320 SFF | 14 | ThinkStation P710 - TopSeller - 30B7 - 3 of 3 | 46 |
| ThinkStation P320 SFF Platform Specifications | 15 | ThinkStation P910 | 47 |
| ThinkStation P320 SFF - TopSeller - 30BK - 1 of 3 | 16 | ThinkStation P910 Platform Specifications | 47 |
| ThinkStation P320 SFF - TopSeller - 30BK - 2 of 3 | 17 | ThinkStation P910 - TopSeller - 30B9 - 1 of 2 | 48 |
| ThinkStation P320 SFF - TopSeller - 30BK - 3 of 3 | 18 | ThinkStation P910 - TopSeller - 30B9 - 2 of 2 | 49 |
| ThinkStation P320 Tiny | 19 | Legal Information | 50 |
| ThinkStation P320 Tiny Platform Specifications | 20 | | |
| ThinkStation P320 Tiny - TopSeller - 30C2 | 21 | | |
| ThinkStation P320 Tower | 22 | | |
| ThinkStation P320 Tower Platform Specifications | 23 | | |
| ThinkStation P320 Tower - TopSeller - 30BH - 1 of 4 | 24 | | |
| ThinkStation P320 Tower - TopSeller - 30BH - 2 of 4 | 25 | | |
| ThinkStation P320 Tower - TopSeller - 30BH - 3 of 4 | 26 | | |
| ThinkStation P320 Tower - TopSeller - 30BH - 4 of 4 | 27 | | |
| ThinkStation P410 | 28 | | |
| ThinkStation P410 Platform Specifications | 28 | | |
| ThinkStation P410 - TopSeller - 30B3 - 1 of 4 | 29 | | |
| ThinkStation P410 - TopSeller - 30B3 - 2 of 4 | 30 | | |
| ThinkStation P410 - TopSeller - 30B3 - 3 of 4 | 31 | | |
| ThinkStation P410 - TopSeller - 30B3 - 4 of 4 | 32 | | |
| ThinkStation P510 | 33 | | |
| ThinkStation P510 Platform Specifications | 33 | | |

Summary of Changes

This section describes the changes made in this version of ThinkStation PSREF and in previous version. This edition might also include minor corrections and editorial changes which are not identified.

June 21, 2017 - Version 508

- ▶ New ThinkStation P320 Tiny announced on June 2017

May 26, 2017 - Version 507

- ▶ Add ThinkStation P410/P510/P710/P910 Refresh 3.0 Wave 1 models and update platform specifications

April 19, 2017 - Version 505

- ▶ New ThinkStation P320 Tower announced on April 2017
- ▶ New ThinkStation P320 SFF announced on April 2017

March 29, 2017 - Version 504

- ▶ Added ThinkStation P310 Tower and SFF models announced on March 2017
- ▶ Added ThinkStation P410 models announced on March 2017

January 25, 2017 - Version 501

- ▶ Update quantity of PCIe SSD adapter in ThinkStation P510/P910

January 4, 2017 - Version 500

- ▶ Added ThinkStation P310 models announced on December 2016

December 14, 2016 - Version 499

- ▶ Added ThinkStation P410/P510/P710/P910 EMEA models
- ▶ Added 1TB M.2 PCIe SSD, Quadro P5000, Quadro P6000 support on ThinkStation P510/P710/P910
- ▶ Added Quadro P5000 support on ThinkStation P410
- ▶ Added 6TB 7.2K SATA6Gbs HDD support on ThinkStation P410/P510/P710/P910
- ▶ Added ThinkStation P410/P510/P710/P910 models announced on December 2016

November 23, 2016 - Version 498

- ▶ Removed ThinkStation P500/P900 due to EOL
- ▶ Added ThinkStation P310 Tower and SFF models announced on November 2016

October 12, 2016 - Version 496

- ▶ Removed flash option on ThinkStation P510/P710/P910
- ▶ Added ThinkStation P310/P410/P510/P710/P910 models announced on September 2016

August 3, 2016 - Version 493

- ▶ Removed ThinkStation P500/P700/P900 Windows 7 DG from Win8.1 U.S. models
- ▶ Added keyboard and mouse features on all ThinkStation

July 13, 2016 - Version 492

- ▶ Added ThinkStation P500, P700, and P900 Windows 10 downgrade to Windows 7 models
- ▶ Updated Maximum configuration weight of ThinkStation P410
- ▶ Added ThinkStation P710 and P910 models announced on on July 2016
- ▶ Added "Maximum drives in 3.5" bay" feature on ThinkStation P500/P510/P700/P710/P900/P910

June 22, 2016 - Version 491

- ▶ Added new product ThinkStation P410/P510
- ▶ Added NVIDIA Quadro M2000 on ThinkStation P310 Tower
- ▶ Added keyboard and mouse information on ThinkStation P710/P910
- ▶ Added internal USB information on ThinkStation P710/P910

June 2, 2016 - Version 490

- ▶ Added ThinkStation P710/P910 US models
- ▶ Updated ThinkStation P710/P910 processor information

May 19, 2016 - Version 489

- ▶ Added NVIDIA Quadro M2000 on compatible product
- ▶ Updated maximum weight on ThinkStation P710
- ▶ Removed 30AT000BUS

April 27, 2016 - Version 488

- ▶ Added ThinkStation P710 and P910 models for EMEA, announced on April 2016
- ▶ Updated Energy star information on ThinkStation P500/P700/P710/P900/P910

April 6, 2016 - Version 487

- ▶ New ThinkStation P710 and P910, announced April 5, 2016 (specification only)

March 23, 2016 - Version 486

- ▶ Added processors specifications for P310/P500/P700/P900

February 24, 2016 - Version 485

- ▶ Added ThinkStation P310 and P700 models for US, announced on February 2016
- ▶ Added ThinkStation P700 and P900 models for EMEA, announced on February 2016

December 9, 2015 - Version 482

- ▶ New ThinkStation P310 Tower and SFF, announced November 24, 2015

November 18, 2015 - Version 481

- ▶ Combines ThinkStation PSREF United States version and Western Europe version.
- ▶ Extends the supported GEO into Europe, Middle East and Africa.
- ▶ Covers all TopSeller and Relationship models for US and all focus models for EMEA



ThinkStation P310 SFF Platform Specifications

Product Specifications Reference (PSREF)

| Components | Specification | | | | | | | | | | | | | | | | | | | | | | | | | | | | | | | | | | | |
|--------------------------------|---|---|---|----------------------|---|--------------|---|----|-----|-------|------|---------|----|-----|-------|-----------------|---------|-----|-----|-------|-----------|-------------|-----|-----|-----|-----------------|-------------|-----|-----|-----|-----------------|--------------|-----|-----|-----|----------|
| Chipset | Intel C236 Chipset | | | | | | | | | | | | | | | | | | | | | | | | | | | | | | | | | | | |
| Intel AMT | Intel Active Management Technology 11 supported on Xeon models | | | | | | | | | | | | | | | | | | | | | | | | | | | | | | | | | | | |
| Processor | One LGA1151 socket, supports one the following processors: | | | | | | | | | | | | | | | | | | | | | | | | | | | | | | | | | | | |
| | Xeon E3-1280 v5 | 4C/3.7GHz/8MB/80W/DDR4-2133 | | | | | | | | | | | | | | | | | | | | | | | | | | | | | | | | | | |
| | Xeon E3-1275 v5 | 4C/3.6GHz/8MB/80W/DDR4-2133 | | | | | | | | | | | | | | | | | | | | | | | | | | | | | | | | | | |
| | Xeon E3-1270 v5 | 4C/3.6GHz/8MB/80W/DDR4-2133 | | | | | | | | | | | | | | | | | | | | | | | | | | | | | | | | | | |
| | Xeon E3-1245 v5 | 4C/3.5GHz/8MB/80W/DDR4-2133 | | | | | | | | | | | | | | | | | | | | | | | | | | | | | | | | | | |
| | Xeon E3-1240 v5 | 4C/3.5GHz/8MB/80W/DDR4-2133 | | | | | | | | | | | | | | | | | | | | | | | | | | | | | | | | | | |
| | Xeon E3-1230 v5 | 4C/3.4GHz/8MB/80W/DDR4-2133 | | | | | | | | | | | | | | | | | | | | | | | | | | | | | | | | | | |
| | Xeon E3-1225 v5 | 4C/3.3GHz/8MB/80W/DDR4-2133 | | | | | | | | | | | | | | | | | | | | | | | | | | | | | | | | | | |
| | Xeon E3-1220 v5 | 4C/3GHz/8MB/80W/DDR4-2133 | | | | | | | | | | | | | | | | | | | | | | | | | | | | | | | | | | |
| | Core i7-6700 | 4C/3.4GHz/8MB/65W/DDR4-2133 | | | | | | | | | | | | | | | | | | | | | | | | | | | | | | | | | | |
| | Core i5-6600 | 4C/3.3GHz/6MB/65W/DDR4-2133 | | | | | | | | | | | | | | | | | | | | | | | | | | | | | | | | | | |
| | Core i5-6500 | 4C/3.2GHz/6MB/65W/DDR4-2133 | | | | | | | | | | | | | | | | | | | | | | | | | | | | | | | | | | |
| | Core i5-6400 | 4C/2.7GHz/6MB/65W/DDR4-2133 | | | | | | | | | | | | | | | | | | | | | | | | | | | | | | | | | | |
| | Core i3-6320 | 2C/3.9GHz/4MB/51W/DDR4-2133 | | | | | | | | | | | | | | | | | | | | | | | | | | | | | | | | | | |
| Core i3-6300 | 2C/3.8GHz/4MB/51W/DDR4-2133 | | | | | | | | | | | | | | | | | | | | | | | | | | | | | | | | | | | |
| Core i3-6100 | 2C/3.7GHz/3MB/51W/DDR4-2133 | | | | | | | | | | | | | | | | | | | | | | | | | | | | | | | | | | | |
| Memory DIMM slots | 4 DIMM slots, 2-channel (integrated memory controller in processor) | | | | | | | | | | | | | | | | | | | | | | | | | | | | | | | | | | | |
| Memory type/capacity | Up to 64GB ECC/non-ECC (4 x 16GB), DDR4-2133, UDIMM | | | | | | | | | | | | | | | | | | | | | | | | | | | | | | | | | | | |
| Intel HD Graphics in processor | Integrated Intel HD P530 in Xeon E3-12x5 v5 processors; or Intel HD 530 in Core i7, i5, or i3 processors. Works along with discrete graphics to support multi-display, enables three display connectors (2 DP, 1 VGA) on rear. Max Resolution: 4096 x 2304 | | | | | | | | | | | | | | | | | | | | | | | | | | | | | | | | | | | |
| Discrete graphics | Two PCI Express 3.0 x16 slots for graphics adapters. Up to two Quadro K1200. Supports the following NVIDIA graphics adapters: | | | | | | | | | | | | | | | | | | | | | | | | | | | | | | | | | | | |
| | <table border="1"> <thead> <tr> <th>Adapter</th> <th>Cores</th> <th>Memory</th> <th>Power</th> <th>Connector</th> </tr> </thead> <tbody> <tr> <td>NVS 310</td> <td>48</td> <td>1GB</td> <td>19.5W</td> <td>2xDP</td> </tr> <tr> <td>NVS 315</td> <td>48</td> <td>1GB</td> <td>19.5W</td> <td>2xDVI-I SL/2xDP</td> </tr> <tr> <td>NVS 510</td> <td>192</td> <td>2GB</td> <td>33.4W</td> <td>4xmini DP</td> </tr> <tr> <td>Quadro K420</td> <td>192</td> <td>2GB</td> <td>41W</td> <td>1xDVI-I DL+1xDP</td> </tr> <tr> <td>Quadro K620</td> <td>384</td> <td>2GB</td> <td>45W</td> <td>1xDVI-I DL+1xDP</td> </tr> <tr> <td>Quadro K1200</td> <td>512</td> <td>4GB</td> <td>45W</td> <td>4xminiDP</td> </tr> </tbody> </table> | Adapter | Cores | Memory | Power | Connector | NVS 310 | 48 | 1GB | 19.5W | 2xDP | NVS 315 | 48 | 1GB | 19.5W | 2xDVI-I SL/2xDP | NVS 510 | 192 | 2GB | 33.4W | 4xmini DP | Quadro K420 | 192 | 2GB | 41W | 1xDVI-I DL+1xDP | Quadro K620 | 384 | 2GB | 45W | 1xDVI-I DL+1xDP | Quadro K1200 | 512 | 4GB | 45W | 4xminiDP |
| | Adapter | Cores | Memory | Power | Connector | | | | | | | | | | | | | | | | | | | | | | | | | | | | | | | |
| | NVS 310 | 48 | 1GB | 19.5W | 2xDP | | | | | | | | | | | | | | | | | | | | | | | | | | | | | | | |
| | NVS 315 | 48 | 1GB | 19.5W | 2xDVI-I SL/2xDP | | | | | | | | | | | | | | | | | | | | | | | | | | | | | | | |
| | NVS 510 | 192 | 2GB | 33.4W | 4xmini DP | | | | | | | | | | | | | | | | | | | | | | | | | | | | | | | |
| | Quadro K420 | 192 | 2GB | 41W | 1xDVI-I DL+1xDP | | | | | | | | | | | | | | | | | | | | | | | | | | | | | | | |
| Quadro K620 | 384 | 2GB | 45W | 1xDVI-I DL+1xDP | | | | | | | | | | | | | | | | | | | | | | | | | | | | | | | | |
| Quadro K1200 | 512 | 4GB | 45W | 4xminiDP | | | | | | | | | | | | | | | | | | | | | | | | | | | | | | | | |
| | | | | | | | | | | | | | | | | | | | | | | | | | | | | | | | | | | | | |
| | | | | | | | | | | | | | | | | | | | | | | | | | | | | | | | | | | | | |
| | | | | | | | | | | | | | | | | | | | | | | | | | | | | | | | | | | | | |
| | | | | | | | | | | | | | | | | | | | | | | | | | | | | | | | | | | | | |
| Onboard drive controller | Five onboard SATA 6.0Gb/s connectors for optical and disk drives plus one SATA connector for optional eSATA. RAID 0, 1, 5* support * RAID 5 supports three 2.5" SSD drives only. | | | | | | | | | | | | | | | | | | | | | | | | | | | | | | | | | | | |
| Drive Bays | One external 5.25" bay, one internal 3.5" bay (see right). Up to one 9.5mm optical + 2 x 3.5" disk drive bays + 1 x 2.5" disk drive bay + one M.2 NVMe SSD | | | | | | | | | | | | | | | | | | | | | | | | | | | | | | | | | | | |
| Supporting disk drives | <table border="1"> <tbody> <tr> <td>3.5" SATA HDD (7.2K 6Gbs)</td> <td>500GB/1TB/2TB/3TB/4TB/6TB/1TB hybrid/2TB hybrid</td> </tr> <tr> <td>2.5" SATA SSD (6Gbs)</td> <td>128GB/180GB*/240GB*/256GB*/480GB*/512GB*/1TB*</td> </tr> <tr> <td>M.2 NVMe SSD</td> <td>256GB*/512GB*/1TB*, via PCIe 3.0 x4 adapter</td> </tr> </tbody> </table> | 3.5" SATA HDD (7.2K 6Gbs) | 500GB/1TB/2TB/3TB/4TB/6TB/1TB hybrid/2TB hybrid | 2.5" SATA SSD (6Gbs) | 128GB/180GB*/240GB*/256GB*/480GB*/512GB*/1TB* | M.2 NVMe SSD | 256GB*/512GB*/1TB*, via PCIe 3.0 x4 adapter | | | | | | | | | | | | | | | | | | | | | | | | | | | | | |
| | 3.5" SATA HDD (7.2K 6Gbs) | 500GB/1TB/2TB/3TB/4TB/6TB/1TB hybrid/2TB hybrid | | | | | | | | | | | | | | | | | | | | | | | | | | | | | | | | | | |
| | 2.5" SATA SSD (6Gbs) | 128GB/180GB*/240GB*/256GB*/480GB*/512GB*/1TB* | | | | | | | | | | | | | | | | | | | | | | | | | | | | | | | | | | |
| M.2 NVMe SSD | 256GB*/512GB*/1TB*, via PCIe 3.0 x4 adapter | | | | | | | | | | | | | | | | | | | | | | | | | | | | | | | | | | | |
| | ** Includes OPAL options | | | | | | | | | | | | | | | | | | | | | | | | | | | | | | | | | | | |
| | | | | | | | | | | | | | | | | | | | | | | | | | | | | | | | | | | | | |
| Max internal storage | 9TB (2 x 4TB 3.5" HDDs + 1 x 1TB 2.5" SSD) plus one 512GB M.2 NVMe SSD | | | | | | | | | | | | | | | | | | | | | | | | | | | | | | | | | | | |
| Media reader | 9-in-1 card reader. Optional 29-in-1 card reader on selected models | | | | | | | | | | | | | | | | | | | | | | | | | | | | | | | | | | | |
| Power supply | 210 watts with variable speed fan, autosensing, 85% PSU, Climate Savers Computing Bronze, 80 PLUS Bronze qualified | | | | | | | | | | | | | | | | | | | | | | | | | | | | | | | | | | | |
| Onboard Ethernet | One onboard gigabit ethernet, Intel I219LM, supports Wake-on-LAN | | | | | | | | | | | | | | | | | | | | | | | | | | | | | | | | | | | |
| HD Audio | Realtek ALC662 codec | | | | | | | | | | | | | | | | | | | | | | | | | | | | | | | | | | | |
| TPM | Standard, TCG 1.2-compliant | | | | | | | | | | | | | | | | | | | | | | | | | | | | | | | | | | | |
| Front ports | Two USB 3.0, microphone (3.5mm), headphone (3.5mm) | | | | | | | | | | | | | | | | | | | | | | | | | | | | | | | | | | | |
| Rear ports | 1 VGA and 2 DisplayPort (functional only on Intel HD Graphics models), two USB 2.0, four USB 3.0 (blue), one serial (9-pin), one ethernet (RJ-45), three analog audio ports (line-in, line-out, mic-in) | | | | | | | | | | | | | | | | | | | | | | | | | | | | | | | | | | | |
| Additional ports | Supports the following optional ports: • Two IEEE 1394 (one on rear and one on front flex module) via PCIe adapter, up to one adapter per system. Supports one of the following per system: • Two rear USB 3.0 per PCIe adapter. • One front eSATA (on flex module), or one rear eSATA via cable and PCIe slot bracket, up to one eSATA port per system. • One additional serial port via cable. • One parallel port via cable | | | | | | | | | | | | | | | | | | | | | | | | | | | | | | | | | | | |

| Components | Specification |
|------------------|---|
| Mechanical | <ul style="list-style-type: none"> Raven black color; metal case 4.02"W x 15.53"D x 13.31"H 102mm W x 394.5mm D x 338mm H 17.2 lb (7.9kg) max configuration 12.9-liter |
| | Environmental certifications |
| Limited warranty | 1 or 3-year limited onsite service with 9x5/NBD. Some parts are Customer Replaceable Units. |

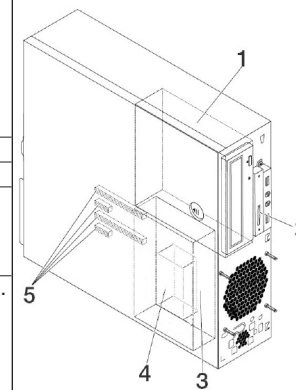

Drive Bays and PCIe Slots

| | |
|-----------|---|
| Bay 1 | 5.25", supports one of the following: HH optical/flex module***/9.5mm optical+3.5" HDD bay/ 3.5" HDD bay/Front Access Storage Enclosure *** Flex module supports one or more of the following: 9.5mm optical/ 29-in-1 reader/front IEEE 1394/front eSATA. Up to one flex module is supported per system. |
| Bay 2 | Optional 9-in-1 single slot reader |
| Bay 3 | Standard 3.5" HDD bay |
| Bay 4 | Optional 2.5" HDD bay (under Bay 3) |
| 5 - Slots | Four PCIe slots (top-down): Slot 1: Low Profile, PCIe 3.0 x16 (near CPU) Slot 2: Low Profile, PCIe 3.0 x1 Slot 3: Low Profile, PCIe 3.0 x16 (x4 elec) Slot 4: Low Profile, PCIe 3.0 x1 |

For the list of ISV certifications, please visit www.thinkworkstations.com/isv-certifications/
For a list of all supported options, please visit https://download.lenovo.com/pccbbs/options_iso/ocm_december_2016.xlsx sheet

| Model | Region | Processor | Graphics | Memory (Capacity/Type) | Storage (Capacity/Type/Interface) | Optical | Media Reader | Power Supply | Add-on Ports | Discrete Ethernet | Chassis Intrusion Switch | Keyboard / Mouse | Operating System | Warranty | Global | Ann Date (mm/yy) |
|------------|--------|--|--|----------------------------------|-----------------------------------|--------------|--------------|--------------|--------------|-------------------|--------------------------|----------------------|-------------------------|----------|--------|------------------|
| 30AV0007US | US | Core i5-6500 4C/3.2GHz/6MB/65W/DDR4-2133 | Intel HD 530 | 1x4GB UDIMM DDR4-2133 Non-ECC | 1x1TB HDD 7.2K 3.5" SATA6Gbs | HH DVD±RW | 9-in-1 | 210W 85% | None | None | Switch | USB / USB Optical | Win10 DG Win7 Pro 64 | 3-year | No | 11/15 |
| 30AV0008US | US | Core i3-6100 2C/3.7GHz/3MB/51W/DDR4-2133 | Intel HD 530 | 1x4GB UDIMM DDR4-2133 Non-ECC | 1x1TB HDD 7.2K 3.5" SATA6Gbs | HH DVD±RW | 9-in-1 | 210W 85% | None | None | Switch | USB / USB Optical | Win10 DG Win7 Pro 64 | 3-year | No | 11/15 |
| 30AV0009US | US | Core i3-6100 2C/3.7GHz/3MB/51W/DDR4-2133 | Intel HD 530 | 1x4GB UDIMM DDR4-2133 Non-ECC | 1x500GB HDD 7.2K 3.5" SATA6Gbs | HH DVD±RW | 9-in-1 | 210W 85% | None | None | Switch | USB / USB Optical | Win10 DG Win7 Pro 64 | 3-year | No | 11/15 |
| 30AV000AUS | US | Core i5-6600 4C/3.3GHz/6MB/65W/DDR4-2133 | Intel HD 530 | 1x8GB UDIMM DDR4-2133 Non-ECC | 1x1TB HDD 7.2K 3.5" SATA6Gbs | HH DVD±RW | 9-in-1 | 210W 85% | None | None | Switch | USB / USB Optical | Win10 DG Win7 Pro 64 | 3-year | No | 11/15 |
| 30AV000BUS | US | Core i7-6700 4C/3.4GHz/8MB/65W/DDR4-2133 | Intel HD 530 | 1x8GB UDIMM DDR4-2133 Non-ECC | 1x1TB HDD 7.2K 3.5" SATA6Gbs | HH DVD±RW | 9-in-1 | 210W 85% | None | None | Switch | USB / USB Optical | Win10 DG Win7 Pro 64 | 3-year | No | 11/15 |
| 30AV000CUS | US | Core i7-6700 4C/3.4GHz/8MB/65W/DDR4-2133 | Intel HD 530 | 1x8GB UDIMM DDR4-2133 Non-ECC | 1x256GB SSD 2.5" SATA6Gbs Opal | HH DVD±RW | 9-in-1 | 210W 85% | None | None | Switch | USB / USB Optical | Win10 DG Win7 Pro 64 | 3-year | No | 11/15 |
| 30AV000DUS | US | Xeon E3-1245 v5 4C/3.5GHz/8MB/80W/DDR4-2133 | Intel HD P530 | 1x8GB UDIMM DDR4-2133 Non-ECC | 1x256GB SSD 2.5" SATA6Gbs Opal | HH DVD±RW | 9-in-1 | 210W 85% | None | None | Switch | USB / USB Optical | Win10 DG Win7 Pro 64 | 3-year | No | 11/15 |
| 30AV000EUS | US | Xeon E3-1240 v5 4C/3.5GHz/8MB/80W/DDR4-2133 | NVIDIA Quadro K620 2GB | 1x8GB UDIMM DDR4-2133 Non-ECC | 1x256GB SSD 2.5" SATA6Gbs Opal | HH DVD±RW | 9-in-1 | 210W 85% | None | None | Switch | USB / USB Optical | Win10 DG Win7 Pro 64 | 3-year | No | 11/15 |
| 30AV000VUS | US | Core i5-6500 4C/3.2GHz/6MB/65W/DDR4-2133 | Intel HD 530+NVIDIA Quadro K620 2GB | 1x8GB UDIMM DDR4-2133 Non-ECC | 1x1TB HDD 7.2K 3.5" SATA6Gbs | HH DVD±RW | 9-in-1 | 210W 85% | None | None | Switch | USB / USB Optical | Win10 DG Win7 Pro 64 | 3-year | No | 02/16 |
| 30AV000WUS | US | Core i7-6700 4C/3.4GHz/8MB/65W/DDR4-2133 | Intel HD 530+NVIDIA Quadro K620 2GB | 2x8GB UDIMM DDR4-2133 Non-ECC | 1x256GB SSD 2.5" SATA6Gbs Opal | HH DVD±RW | 9-in-1 | 210W 85% | None | None | Switch | USB / USB Optical | Win10 DG Win7 Pro 64 | 3-year | No | 02/16 |
| 30AV000XUS | US | Xeon E3-1230 v5 4C/3.4GHz/8MB/80W/DDR4-2133 | NVIDIA Quadro K1200 4GB | 4x8GB UDIMM DDR4-2133 Non-ECC | 1x512GB SSD 2.5" SATA6Gbs | HH DVD±RW | 9-in-1 | 210W 85% | None | None | Switch | USB / USB Optical | Win10 DG Win7 Pro 64 | 3-year | No | 02/16 |
| 30AV0012US | US | Core i7-6700 4C/3.4GHz/8MB/65W/DDR4-2133 | Intel HD 530+NVIDIA Quadro K620 2GB | 1x8GB UDIMM DDR4-2133 Non-ECC | 1x1TB HDD 7.2K 3.5" SATA6Gbs | HH DVD±RW | 9-in-1 | 210W 85% | None | None | Switch | USB / USB Optical | Win10 Pro 64 | 3-year | No | 07/16 |
| 30AV001TUS | US | Core i7-6700 4C/3.4GHz/8MB/65W/DDR4-2133 | Intel HD 530 | 1x8GB UDIMM DDR4-2133 Non-ECC | 1x1TB HDD 7.2K 3.5" SATA6Gbs | HH DVD±RW | 9-in-1 | 210W 85% | None | None | Switch | USB / USB Optical | Win10 Pro 64 | 3-year | No | 07/16 |
| 30AV001UUS | US | Core i5-6500 4C/3.2GHz/6MB/65W/DDR4-2133 | Intel HD 530 | 1x8GB UDIMM DDR4-2133 Non-ECC | 1x1TB HDD 7.2K 3.5" SATA6Gbs | HH DVD±RW | 9-in-1 | 210W 85% | None | None | Switch | USB / USB Optical | Win10 Pro 64 | 3-year | No | 07/16 |
| 30AV001VUS | US | Xeon E3-1240 v5 4C/3.5GHz/8MB/80W/DDR4-2133 | NVIDIA Quadro K1200 4GB | 1x8GB UDIMM DDR4-2133 ECC | 1x256GB SSD 2.5" SATA6Gbs Opal | HH DVD±RW | 9-in-1 | 210W 85% | None | None | Switch | USB / USB Optical | Win10 Pro 64 | 3-year | No | 07/16 |

| Model | Region | Processor | Graphics | Memory (Capacity/Type) | Storage (Capacity/Type/Interface) | Optical | Media Reader | Power Supply | Add-on Ports | Discrete Ethernet | Chassis Intrusion Switch | Keyboard / Mouse | Operating System | Warranty | Global | Ann Date (mm/yy) |
|------------|--------|--|--|--------------------------------------|--------------------------------------|--------------|-----------------|-----------------|-----------------|----------------------|--------------------------------|----------------------|-------------------------|----------|--------|---------------------|
| 30AV001WUS | US | Xeon E3-1240 v5 4C/3.5GHz/8MB/80W/DDR4-2133 | NVIDIA Quadro K620 2GB | 1x8GB UDIMM DDR4-2133 ECC | 1x1TB HDD 7.2K 3.5" SATA6Gbs | HH DVD±RW | 9-in-1 | 210W 85% | None | None | Switch | USB / USB Optical | Win10 Pro 64 | 3-year | No | 07/16 |
| 30AV001XUS | US | Xeon E3-1245 v5 4C/3.5GHz/8MB/80W/DDR4-2133 | Intel HD P530 | 1x8GB UDIMM DDR4-2133 ECC | 1x1TB HDD 7.2K 3.5" SATA6Gbs | HH DVD±RW | 9-in-1 | 210W 85% | None | None | Switch | USB / USB Optical | Win10 Pro 64 | 3-year | No | 07/16 |
| 30AV001YUS | US | Core i3-6100 2C/3.7GHz/3MB/51W/DDR4-2133 | Intel HD 530 | 1x8GB UDIMM DDR4-2133 Non- ECC | 1x1TB HDD 7.2K 3.5" SATA6Gbs | HH DVD±RW | 9-in-1 | 210W 85% | None | None | Switch | USB / USB Optical | Win10 Pro 64 | 3-year | No | 07/16 |
| 30AV0020US | US | Xeon E3-1245 v5 4C/3.5GHz/8MB/80W/DDR4-2133 | Intel HD P530 | 1x8GB UDIMM DDR4-2133 ECC | 1x256GB SSD 2.5" SATA6Gbs Opal | HH DVD±RW | 9-in-1 | 210W 85% | None | None | Switch | USB / USB Optical | Win10 Pro 64 | 3-year | No | 07/16 |
| 30AV0021US | US | Xeon E3-1220 v5 4C/3GHz/8MB/80W/DDR4-2133 | NVIDIA Quadro K620 2GB | 1x8GB UDIMM DDR4-2133 ECC | 1x1TB HDD 7.2K 3.5" SATA6Gbs | HH DVD±RW | 9-in-1 | 210W 85% | None | None | Switch | USB / USB Optical | Win10 Pro 64 | 3-year | No | 07/16 |
| 30AV0022US | US | Xeon E3-1240 v5 4C/3.5GHz/8MB/80W/DDR4-2133 | NVIDIA Quadro K1200 4GB | 1x8GB UDIMM DDR4-2133 ECC | 1x1TB HDD 7.2K 3.5" SATA6Gbs | HH DVD±RW | 9-in-1 | 210W 85% | None | None | Switch | USB / USB Optical | Win10 Pro 64 | 3-year | No | 07/16 |
| 30AV0023US | US | Xeon E3-1240 v5 4C/3.5GHz/8MB/80W/DDR4-2133 | NVIDIA Quadro K620 2GB | 1x8GB UDIMM DDR4-2133 ECC | 1x256GB SSD 2.5" SATA6Gbs Opal | HH DVD±RW | 9-in-1 | 210W 85% | None | None | Switch | USB / USB Optical | Win10 Pro 64 | 3-year | No | 07/16 |
| 30AV002DUS | US | Core i7-6700 4C/3.4GHz/8MB/65W/DDR4-2133 | Intel HD 530+NVIDIA Quadro K620 2GB | 2x8GB UDIMM DDR4-2133 Non- ECC | 1x1TB HDD 7.2K 3.5" SATA6Gbs | HH DVD±RW | 9-in-1 | 210W 85% | None | None | Switch | USB / USB Optical | Win10 DG Win7 Pro 64 | 3-year | No | 12/16 |
| 30AV002EUS | US | Core i5-6500 4C/3.2GHz/6MB/65W/DDR4-2133 | Intel HD 530+NVIDIA Quadro K620 2GB | 1x8GB UDIMM DDR4-2133 Non- ECC | 1x256GB SSD 2.5" SATA6Gbs Opal | HH DVD±RW | 9-in-1 | 210W 85% | None | None | Switch | USB / USB Optical | Win10 DG Win7 Pro 64 | 3-year | No | 12/16 |

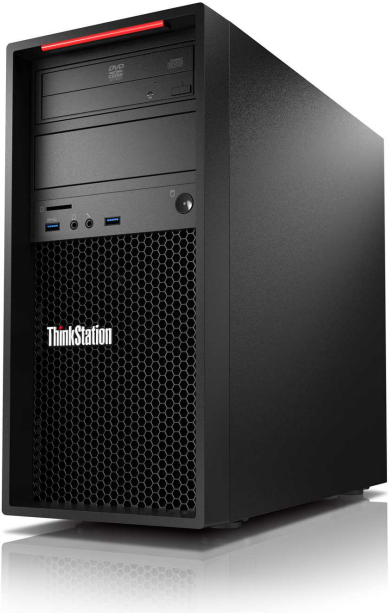

ThinkStation P310 Tower Platform Specifications

Product Specifications Reference (PSREF)

| Components | Specification | | | | | | | | | | | | | | | | | | | | | | | | | | | | | | | | | | | | | | | | | | | | | | | | | | |
|--------------------------------|--|---|--------|--------|-----------------|-----------|---------|----|-----|-------|------|---------|----|-----|-------|-----------------|---------|-----|-----|-------|-----------|-------------|-----|-----|-----|-----------------|-------------|-----|-----|-----|-----------------|--------------|-----|-----|-----|----------|--------------|-----|-----|-----|-----------------|--------------|-----|-----|-----|------|--------------|------|-----|------|------|
| Chipset | Intel C236 Chipset | | | | | | | | | | | | | | | | | | | | | | | | | | | | | | | | | | | | | | | | | | | | | | | | | | |
| Intel AMT | Intel Active Management Technology 11 supported on Xeon models | | | | | | | | | | | | | | | | | | | | | | | | | | | | | | | | | | | | | | | | | | | | | | | | | | |
| Processor | One LGA1151 socket, supports one the following processors: | | | | | | | | | | | | | | | | | | | | | | | | | | | | | | | | | | | | | | | | | | | | | | | | | | |
| | Xeon E3-1280 v5 | 4C/3.7GHz/8MB/80W/DDR4-2133 | | | | | | | | | | | | | | | | | | | | | | | | | | | | | | | | | | | | | | | | | | | | | | | | | |
| | Xeon E3-1275 v5 | 4C/3.6GHz/8MB/80W/DDR4-2133 | | | | | | | | | | | | | | | | | | | | | | | | | | | | | | | | | | | | | | | | | | | | | | | | | |
| | Xeon E3-1270 v5 | 4C/3.6GHz/8MB/80W/DDR4-2133 | | | | | | | | | | | | | | | | | | | | | | | | | | | | | | | | | | | | | | | | | | | | | | | | | |
| | Xeon E3-1245 v5 | 4C/3.5GHz/8MB/80W/DDR4-2133 | | | | | | | | | | | | | | | | | | | | | | | | | | | | | | | | | | | | | | | | | | | | | | | | | |
| | Xeon E3-1240 v5 | 4C/3.5GHz/8MB/80W/DDR4-2133 | | | | | | | | | | | | | | | | | | | | | | | | | | | | | | | | | | | | | | | | | | | | | | | | | |
| | Xeon E3-1230 v5 | 4C/3.4GHz/8MB/80W/DDR4-2133 | | | | | | | | | | | | | | | | | | | | | | | | | | | | | | | | | | | | | | | | | | | | | | | | | |
| | Xeon E3-1225 v5 | 4C/3.3GHz/8MB/80W/DDR4-2133 | | | | | | | | | | | | | | | | | | | | | | | | | | | | | | | | | | | | | | | | | | | | | | | | | |
| | Xeon E3-1220 v5 | 4C/3GHz/8MB/80W/DDR4-2133 | | | | | | | | | | | | | | | | | | | | | | | | | | | | | | | | | | | | | | | | | | | | | | | | | |
| | Core i7-6700 | 4C/3.4GHz/8MB/65W/DDR4-2133 | | | | | | | | | | | | | | | | | | | | | | | | | | | | | | | | | | | | | | | | | | | | | | | | | |
| | Core i5-6600 | 4C/3.3GHz/6MB/65W/DDR4-2133 | | | | | | | | | | | | | | | | | | | | | | | | | | | | | | | | | | | | | | | | | | | | | | | | | |
| | Core i5-6500 | 4C/3.2GHz/6MB/65W/DDR4-2133 | | | | | | | | | | | | | | | | | | | | | | | | | | | | | | | | | | | | | | | | | | | | | | | | | |
| | Core i5-6400 | 4C/2.7GHz/6MB/65W/DDR4-2133 | | | | | | | | | | | | | | | | | | | | | | | | | | | | | | | | | | | | | | | | | | | | | | | | | |
| | Core i3-6320 | 2C/3.9GHz/4MB/51W/DDR4-2133 | | | | | | | | | | | | | | | | | | | | | | | | | | | | | | | | | | | | | | | | | | | | | | | | | |
| Core i3-6300 | 2C/3.8GHz/4MB/51W/DDR4-2133 | | | | | | | | | | | | | | | | | | | | | | | | | | | | | | | | | | | | | | | | | | | | | | | | | | |
| Core i3-6100 | 2C/3.7GHz/3MB/51W/DDR4-2133 | | | | | | | | | | | | | | | | | | | | | | | | | | | | | | | | | | | | | | | | | | | | | | | | | | |
| Memory DIMM slots | 4 DIMM slots, 2-channel (integrated memory controller in processor) | | | | | | | | | | | | | | | | | | | | | | | | | | | | | | | | | | | | | | | | | | | | | | | | | | |
| Memory type/capacity | Up to 64GB ECC/non-ECC (4 x 16GB), DDR4-2133, UDIMM | | | | | | | | | | | | | | | | | | | | | | | | | | | | | | | | | | | | | | | | | | | | | | | | | | |
| Intel HD Graphics in processor | Integrated Intel HD P530 in Xeon E3-12x5 v5 processors; or Intel HD 530 in Core i7, i5, or i3 processors. Works along with discrete graphics to support multi-display, enables three display connectors (2 DP, 1 VGA) on rear. Max resolution: 4096 x 2304 | | | | | | | | | | | | | | | | | | | | | | | | | | | | | | | | | | | | | | | | | | | | | | | | | | |
| Discrete graphics | Two PCI Express 3.0 x16 slots for graphics adapters. Up to two Quadro K1200 on 250 watts models. Or up to two Quadro K2200, or up to one Quadro M4000 on 400 watts models. Supports the following NVIDIA graphics adapters: | | | | | | | | | | | | | | | | | | | | | | | | | | | | | | | | | | | | | | | | | | | | | | | | | | |
| | <table border="1"> <thead> <tr> <th>Adapter</th> <th>Cores</th> <th>Memory</th> <th>Power</th> <th>Connector</th> </tr> </thead> <tbody> <tr> <td>NVS 310</td> <td>48</td> <td>1GB</td> <td>19.5W</td> <td>2xDP</td> </tr> <tr> <td>NVS 315</td> <td>48</td> <td>1GB</td> <td>19.5W</td> <td>2xDVI-I SL/2xDP</td> </tr> <tr> <td>NVS 510</td> <td>192</td> <td>2GB</td> <td>33.4W</td> <td>4xmini DP</td> </tr> <tr> <td>Quadro K420</td> <td>192</td> <td>2GB</td> <td>41W</td> <td>1xDVI-I DL+1xDP</td> </tr> <tr> <td>Quadro K620</td> <td>384</td> <td>2GB</td> <td>45W</td> <td>1xDVI-I DL+1xDP</td> </tr> <tr> <td>Quadro K1200</td> <td>512</td> <td>4GB</td> <td>45W</td> <td>4xminiDP</td> </tr> <tr> <td>Quadro K2200</td> <td>640</td> <td>4GB</td> <td>68W</td> <td>1xDVI-I DL+2xDP</td> </tr> <tr> <td>Quadro M2000</td> <td>768</td> <td>4GB</td> <td>75W</td> <td>4xDP</td> </tr> <tr> <td>Quadro M4000</td> <td>1664</td> <td>8GB</td> <td>120W</td> <td>4xDP</td> </tr> </tbody> </table> | Adapter | Cores | Memory | Power | Connector | NVS 310 | 48 | 1GB | 19.5W | 2xDP | NVS 315 | 48 | 1GB | 19.5W | 2xDVI-I SL/2xDP | NVS 510 | 192 | 2GB | 33.4W | 4xmini DP | Quadro K420 | 192 | 2GB | 41W | 1xDVI-I DL+1xDP | Quadro K620 | 384 | 2GB | 45W | 1xDVI-I DL+1xDP | Quadro K1200 | 512 | 4GB | 45W | 4xminiDP | Quadro K2200 | 640 | 4GB | 68W | 1xDVI-I DL+2xDP | Quadro M2000 | 768 | 4GB | 75W | 4xDP | Quadro M4000 | 1664 | 8GB | 120W | 4xDP |
| | Adapter | Cores | Memory | Power | Connector | | | | | | | | | | | | | | | | | | | | | | | | | | | | | | | | | | | | | | | | | | | | | | |
| | NVS 310 | 48 | 1GB | 19.5W | 2xDP | | | | | | | | | | | | | | | | | | | | | | | | | | | | | | | | | | | | | | | | | | | | | | |
| | NVS 315 | 48 | 1GB | 19.5W | 2xDVI-I SL/2xDP | | | | | | | | | | | | | | | | | | | | | | | | | | | | | | | | | | | | | | | | | | | | | | |
| | NVS 510 | 192 | 2GB | 33.4W | 4xmini DP | | | | | | | | | | | | | | | | | | | | | | | | | | | | | | | | | | | | | | | | | | | | | | |
| | Quadro K420 | 192 | 2GB | 41W | 1xDVI-I DL+1xDP | | | | | | | | | | | | | | | | | | | | | | | | | | | | | | | | | | | | | | | | | | | | | | |
| | Quadro K620 | 384 | 2GB | 45W | 1xDVI-I DL+1xDP | | | | | | | | | | | | | | | | | | | | | | | | | | | | | | | | | | | | | | | | | | | | | | |
| | Quadro K1200 | 512 | 4GB | 45W | 4xminiDP | | | | | | | | | | | | | | | | | | | | | | | | | | | | | | | | | | | | | | | | | | | | | | |
| | Quadro K2200 | 640 | 4GB | 68W | 1xDVI-I DL+2xDP | | | | | | | | | | | | | | | | | | | | | | | | | | | | | | | | | | | | | | | | | | | | | | |
| Quadro M2000 | 768 | 4GB | 75W | 4xDP | | | | | | | | | | | | | | | | | | | | | | | | | | | | | | | | | | | | | | | | | | | | | | | |
| Quadro M4000 | 1664 | 8GB | 120W | 4xDP | | | | | | | | | | | | | | | | | | | | | | | | | | | | | | | | | | | | | | | | | | | | | | | |
| Onboard drive controller | Five onboard SATA 6.0Gb/s connectors for optical and disk drives plus one SATA connector for optional eSATA. RAID 0, 1, 5, 10 support | | | | | | | | | | | | | | | | | | | | | | | | | | | | | | | | | | | | | | | | | | | | | | | | | | |
| Drive Bays | Two external 5.25" bays, two internal 3.5" bays (see right). Up to one 9.5mm optical plus 4 x 3.5" disk drive bays plus one M.2 NVMe SSD | | | | | | | | | | | | | | | | | | | | | | | | | | | | | | | | | | | | | | | | | | | | | | | | | | |
| Supporting disk drives | 3.5" SATA HDD (7.2K 6Gbs) | 500GB/1TB/2TB/3TB/4TB/6TB/1TB hybrid/2TB hybrid | | | | | | | | | | | | | | | | | | | | | | | | | | | | | | | | | | | | | | | | | | | | | | | | | |
| | 2.5" SATA SSD (6Gbs) | 128GB/180GB*/240GB*/256GB*/480GB*/512GB*/1TB* | | | | | | | | | | | | | | | | | | | | | | | | | | | | | | | | | | | | | | | | | | | | | | | | | |
| | M.2 NVMe SSD | 256GB*/512GB*/1TB*, via PCIe 3.0 x4 adapter | | | | | | | | | | | | | | | | | | | | | | | | | | | | | | | | | | | | | | | | | | | | | | | | | |
| | ** Includes OPAL options | | | | | | | | | | | | | | | | | | | | | | | | | | | | | | | | | | | | | | | | | | | | | | | | | | |
| Max internal storage | 16TB (4 x 4TB 3.5" HDDs) plus 512GB M.2 NVMe SSD | | | | | | | | | | | | | | | | | | | | | | | | | | | | | | | | | | | | | | | | | | | | | | | | | | |
| Media reader | 9-in-1 card reader. Optional 29-in-1 card reader on selected models | | | | | | | | | | | | | | | | | | | | | | | | | | | | | | | | | | | | | | | | | | | | | | | | | | |
| Power supply | Supports one of the following: <ul style="list-style-type: none"> 250 watts with variable speed fan, autosensing, 85% PSU, Climate Savers Computing Bronze, 80 PLUS Bronze qualified 400 watts with variable speed fan, autosensing, 92% PSU, Climate Savers Computing Platinum, 80 PLUS Platinum qualified | | | | | | | | | | | | | | | | | | | | | | | | | | | | | | | | | | | | | | | | | | | | | | | | | | |
| Onboard Ethernet | One onboard gigabit ethernet, Intel I219LM, supports Wake-on-LAN | | | | | | | | | | | | | | | | | | | | | | | | | | | | | | | | | | | | | | | | | | | | | | | | | | |
| HD Audio | Realtek ALC662 codec | | | | | | | | | | | | | | | | | | | | | | | | | | | | | | | | | | | | | | | | | | | | | | | | | | |
| TPM | Standard, TCG 1.2-compliant | | | | | | | | | | | | | | | | | | | | | | | | | | | | | | | | | | | | | | | | | | | | | | | | | | |
| Front ports | Two USB 3.0, microphone (3.5mm), headphone (3.5mm) | | | | | | | | | | | | | | | | | | | | | | | | | | | | | | | | | | | | | | | | | | | | | | | | | | |
| Rear ports | 1 VGA and 2 DisplayPort (for Intel HD Graphics models only), two USB 2.0, four USB 3.0 (blue), one serial (9-pin), one ethernet (RJ-45), three analog audio ports (line-in, line-out, mic-in) | | | | | | | | | | | | | | | | | | | | | | | | | | | | | | | | | | | | | | | | | | | | | | | | | | |

| Components | Specification |
|------------------------------|---|
| Additional ports | Supports the following optional ports: <ul style="list-style-type: none"> Two IEEE 1394 (one on rear and one on front flex module) via PCIe adapter, up to one adapter per system. Supports one of the following per system: <ul style="list-style-type: none"> Two rear USB 3.0 per PCIe adapter. One rear Thunderbolt via PCIe adapter. One front eSATA (on flex module), or one rear eSATA via cable and PCIe slot bracket, up to one eSATA port per system. One additional serial port via cable. One parallel port via cable |
| | Mechanical |
| Environmental certifications | GREENGUARD certified/RoHS-compliant/EPEAT Gold rating/ENERGY STAR 6.1 qualified |
| Limited warranty | 3-year limited onsite service with 9x5/NBD. Some parts are Customer Replaceable Units. |

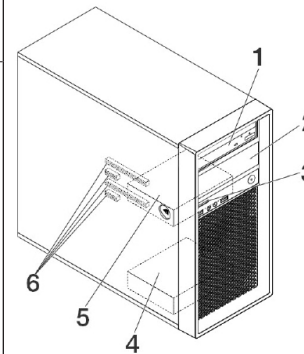

Drive Bays and PCIe Slots

| | |
|-----------------|---|
| Bay 1 and Bay 2 | 5.25", support one of the following: HH optical/flex module**/9.5mm optical+3.5" HDD bay/ 3.5" HDD bay/Front Access Storage Enclosure ** Flex module supports one or more of the following: 9.5mm optical/ 29-in-1 reader/front IEEE 1394/front eSATA Up to one flex module is supported per system. |
| Bay 3 | Optional 9-in-1 single slot reader |
| Bay 4 | Standard 3.5" HDD bay |
| Bay 5 | Standard 3.5" HDD bay |
| 6 -Slots | Four PCIe slots (top-down): Slot 1: Half length, full height, PCIe 3.0 x16 (near CPU) Slot 2: Half length, full height, PCIe 3.0 x1 Slot 3: Half length, full height, PCIe 3.0 x16 (x4 elec) Slot 4: Half length, full height, PCIe 3.0 x1 |

For the list of ISV certifications, please visit www.thinkworkstations.com/isv-certifications/
For a list of all supported options, please visit https://download.lenovo.com/pccbbs/options_iso/ocm_december_2016.xlsx sheet

| Model | Region | Processor | Graphics | Memory (Capacity/Type) | Storage (Capacity/Type/Interface) | Optical | Media Reader | Power Supply | Add-on Ports | Discrete Ethernet | Chassis Intrusion Switch | Keyboard / Mouse | Operating System | Warranty | Global | Ann Date (mm/yy) |
|------------|--------|--|---|----------------------------------|-----------------------------------|--------------|--------------|--------------|--------------|-------------------|--------------------------|----------------------|-------------------------|----------|--------|------------------|
| 30AT000BUS | US | Core i7-6700 4C/3.4GHz/8MB/65W/DDR4-2133 | Intel HD 530 | 1x8GB UDIMM DDR4-2133 ECC | 1x1TB HDD 7.2K 3.5" SATA6Gbs | HH DVD±RW | 9-in-1 | 250W 85% | None | None | Switch | USB / USB Optical | Win10 DG Win7 Pro 64 | 3-year | No | 11/15 |
| 30AT000CUS | US | Xeon E3-1245 v5 4C/3.5GHz/8MB/80W/DDR4-2133 | Intel HD P530 | 1x8GB UDIMM DDR4-2133 ECC | 1x1TB HDD 7.2K 3.5" SATA6Gbs | HH DVD±RW | 9-in-1 | 250W 85% | None | None | Switch | USB / USB Optical | Win10 DG Win7 Pro 64 | 3-year | No | 11/15 |
| 30AT000EUS | US | Core i7-6700 4C/3.4GHz/8MB/65W/DDR4-2133 | Intel HD 530 | 1x8GB UDIMM DDR4-2133 Non-ECC | 1x1TB HDD 7.2K 3.5" SATA6Gbs | HH DVD±RW | 9-in-1 | 250W 85% | None | None | Switch | USB / USB Optical | Win10 DG Win7 Pro 64 | 3-year | No | 11/15 |
| 30AT000FUS | US | Xeon E3-1245 v5 4C/3.5GHz/8MB/80W/DDR4-2133 | Intel HD P530 | 1x8GB UDIMM DDR4-2133 Non-ECC | 1x1TB HDD 7.2K 3.5" SATA6Gbs | HH DVD±RW | 9-in-1 | 250W 85% | None | None | Switch | USB / USB Optical | Win10 DG Win7 Pro 64 | 3-year | No | 11/15 |
| 30AT000GUS | US | Xeon E3-1245 v5 4C/3.5GHz/8MB/80W/DDR4-2133 | Intel HD P530 | 1x8GB UDIMM DDR4-2133 Non-ECC | 1x256GB SSD 2.5" SATA6Gbs Opal | HH DVD±RW | 9-in-1 | 250W 85% | None | None | Switch | USB / USB Optical | Win10 DG Win7 Pro 64 | 3-year | No | 11/15 |
| 30AT000HUS | US | Xeon E3-1240 v5 4C/3.5GHz/8MB/80W/DDR4-2133 | NVIDIA Quadro K620 2GB | 1x8GB UDIMM DDR4-2133 Non-ECC | 1x1TB HDD 7.2K 3.5" SATA6Gbs | HH DVD±RW | 9-in-1 | 250W 85% | None | None | Switch | USB / USB Optical | Win10 DG Win7 Pro 64 | 3-year | No | 11/15 |
| 30AT000JUS | US | Core i7-6700 4C/3.4GHz/8MB/65W/DDR4-2133 | Intel HD 530+NVIDIA Quadro K620 2GB | 1x8GB UDIMM DDR4-2133 Non-ECC | 1x1TB HDD 7.2K 3.5" SATA6Gbs | HH DVD±RW | 9-in-1 | 250W 85% | None | None | Switch | USB / USB Optical | Win10 DG Win7 Pro 64 | 3-year | No | 11/15 |
| 30AT000KUS | US | Core i7-6700 4C/3.4GHz/8MB/65W/DDR4-2133 | Intel HD 530+NVIDIA Quadro K2200 4GB | 1x8GB UDIMM DDR4-2133 Non-ECC | 1x1TB HDD 7.2K 3.5" SATA6Gbs | HH DVD±RW | 9-in-1 | 250W 85% | None | None | Switch | USB / USB Optical | Win10 DG Win7 Pro 64 | 3-year | No | 11/15 |
| 30AT000LUS | US | Core i7-6700 4C/3.4GHz/8MB/65W/DDR4-2133 | Intel HD 530+NVIDIA Quadro K2200 4GB | 2x8GB UDIMM DDR4-2133 Non-ECC | 1x256GB SSD 2.5" SATA6Gbs Opal | HH DVD±RW | 9-in-1 | 250W 85% | None | None | Switch | USB / USB Optical | Win10 DG Win7 Pro 64 | 3-year | No | 11/15 |
| 30AT000MUS | US | Core i7-6700 4C/3.4GHz/8MB/65W/DDR4-2133 | Intel HD 530 | 2x8GB UDIMM DDR4-2133 Non-ECC | 1x256GB SSD 2.5" SATA6Gbs Opal | HH DVD±RW | 9-in-1 | 250W 85% | None | None | Switch | USB / USB Optical | Win10 DG Win7 Pro 64 | 3-year | No | 11/15 |
| 30AT000NUS | US | Core i5-6500 4C/3.2GHz/6MB/65W/DDR4-2133 | Intel HD 530 | 1x8GB UDIMM DDR4-2133 Non-ECC | 1x1TB HDD 7.2K 3.5" SATA6Gbs | HH DVD±RW | 9-in-1 | 250W 85% | None | None | Switch | USB / USB Optical | Win10 DG Win7 Pro 64 | 3-year | No | 11/15 |
| 30AT000PUS | US | Xeon E3-1245 v5 4C/3.5GHz/8MB/80W/DDR4-2133 | Intel HD P530 | 2x8GB UDIMM DDR4-2133 Non-ECC | 1x256GB SSD M.2 PCIe Opal | HH DVD±RW | 9-in-1 | 400W 92% | None | None | Switch | USB / USB Optical | Win10 DG Win7 Pro 64 | 3-year | No | 11/15 |
| 30AT005CUS | US | Xeon E3-1240 v5 4C/3.5GHz/8MB/80W/DDR4-2133 | NVIDIA Quadro K620 2GB | 1x8GB UDIMM DDR4-2133 ECC | 1x256GB SSD M.2 PCIe Opal | HH DVD±RW | 9-in-1 | 250W 85% | None | None | Switch | USB / USB Optical | Win10 Pro 64 | 3-year | No | 07/16 |
| 30AT005DUS | US | Xeon E3-1220 v5 4C/3GHz/8MB/80W/DDR4-2133 | NVIDIA Quadro K620 2GB | 1x8GB UDIMM DDR4-2133 ECC | 1x1TB HDD 7.2K 3.5" SATA6Gbs | HH DVD±RW | 9-in-1 | 250W 85% | None | None | Switch | USB / USB Optical | Win10 Pro 64 | 3-year | No | 07/16 |
| 30AT005EUS | US | Xeon E3-1240 v5 4C/3.5GHz/8MB/80W/DDR4-2133 | NVIDIA Quadro M2000 4GB | 1x8GB UDIMM DDR4-2133 ECC | 1x256GB SSD M.2 PCIe Opal | HH DVD±RW | 9-in-1 | 250W 85% | None | None | Switch | USB / USB Optical | Win10 Pro 64 | 3-year | No | 07/16 |

| Model | Region | Processor | Graphics | Memory (Capacity/Type) | Storage (Capacity/Type/Interface) | Optical | Media Reader | Power Supply | Add-on Ports | Discrete Ethernet | Chassis Intrusion Switch | Keyboard / Mouse | Operating System | Warranty | Global | Ann Date (mm/yy) |
|------------|--------|--|---|--------------------------------------|-----------------------------------|--------------|--------------|--------------|--------------|-------------------|--------------------------|----------------------|-------------------------|----------|--------|------------------|
| 30AT005FUS | US | Xeon E3-1245 v5 4C/3.5GHz/8MB/80W/DDR4-2133 | Intel HD P530 | 1x8GB UDIMM DDR4-2133 ECC | 1x256GB SSD M.2 PCIe Opal | HH DVD±RW | 9-in-1 | 250W 85% | None | None | Switch | USB / USB Optical | Win10 Pro 64 | 3-year | No | 07/16 |
| 30AT005GUS | US | Core i7-6700 4C/3.4GHz/8MB/65W/DDR4-2133 | Intel HD 530+NVIDIA Quadro K620 2GB | 1x8GB UDIMM DDR4-2133 Non- ECC | 1x1TB HDD 7.2K 3.5" SATA6Gbs | HH DVD±RW | 9-in-1 | 250W 85% | None | None | Switch | USB / USB Optical | Win10 Pro 64 | 3-year | No | 07/16 |
| 30AT005HUS | US | Core i7-6700 4C/3.4GHz/8MB/65W/DDR4-2133 | Intel HD 530 | 1x8GB UDIMM DDR4-2133 Non- ECC | 1x1TB HDD 7.2K 3.5" SATA6Gbs | HH DVD±RW | 9-in-1 | 400W 92% | None | None | Switch | USB / USB Optical | Win10 Pro 64 | 3-year | No | 07/16 |
| 30AT005JUS | US | Xeon E3-1245 v5 4C/3.5GHz/8MB/80W/DDR4-2133 | Intel HD P530 | 1x8GB UDIMM DDR4-2133 ECC | 1x1TB HDD 7.2K 3.5" SATA6Gbs | HH DVD±RW | 9-in-1 | 400W 92% | None | None | Switch | USB / USB Optical | Win10 Pro 64 | 3-year | No | 07/16 |
| 30AT005KUS | US | Core i5-6500 4C/3.2GHz/6MB/65W/DDR4-2133 | Intel HD 530+NVIDIA Quadro K620 2GB | 1x8GB UDIMM DDR4-2133 Non- ECC | 1x1TB HDD 7.2K 3.5" SATA6Gbs | HH DVD±RW | 9-in-1 | 250W 85% | None | None | Switch | USB / USB Optical | Win10 Pro 64 | 3-year | No | 07/16 |
| 30AT005LUS | US | Core i3-6100 2C/3.7GHz/3MB/51W/DDR4-2133 | Intel HD 530 | 1x8GB UDIMM DDR4-2133 Non- ECC | 1x1TB HDD 7.2K 3.5" SATA6Gbs | HH DVD±RW | 9-in-1 | 250W 85% | None | None | Switch | USB / USB Optical | Win10 Pro 64 | 3-year | No | 07/16 |
| 30AT005MUS | US | Xeon E3-1245 v5 4C/3.5GHz/8MB/80W/DDR4-2133 | Intel HD P530 | 1x8GB UDIMM DDR4-2133 ECC | 1x1TB HDD 7.2K 3.5" SATA6Gbs | HH DVD±RW | 9-in-1 | 250W 85% | None | None | Switch | USB / USB Optical | Win10 Pro 64 | 3-year | No | 07/16 |
| 30AT005NUS | US | Xeon E3-1240 v5 4C/3.5GHz/8MB/80W/DDR4-2133 | NVIDIA Quadro K620 2GB | 1x8GB UDIMM DDR4-2133 ECC | 1x1TB HDD 7.2K 3.5" SATA6Gbs | HH DVD±RW | 9-in-1 | 250W 85% | None | None | Switch | USB / USB Optical | Win10 Pro 64 | 3-year | No | 07/16 |
| 30AT005PUS | US | Core i7-6700 4C/3.4GHz/8MB/65W/DDR4-2133 | Intel HD 530+NVIDIA Quadro M2000 4GB | 1x8GB UDIMM DDR4-2133 Non- ECC | 1x256GB SSD 2.5" SATA6Gbs Opal | HH DVD±RW | 9-in-1 | 250W 85% | None | None | Switch | USB / USB Optical | Win10 Pro 64 | 3-year | No | 07/16 |
| 30AT006PUS | US | Core i7-6700 4C/3.4GHz/8MB/65W/DDR4-2133 | Intel HD 530+NVIDIA Quadro K1200 4GB | 2x8GB UDIMM DDR4-2133 Non- ECC | 1x512GB SSD 2.5" SATA6Gbs | HH DVD±RW | 9-in-1 | 250W 85% | None | None | Switch | USB / USB Optical | Win10 DG Win7 Pro 64 | 3-year | No | 11/16 |
| 30AT006QUS | US | Core i7-6700 4C/3.4GHz/8MB/65W/DDR4-2133 | Intel HD 530+NVIDIA Quadro K620 2GB | 2x8GB UDIMM DDR4-2133 Non- ECC | 1x512GB SSD M.2 PCIe | HH DVD±RW | 9-in-1 | 250W 85% | None | None | Switch | USB / USB Optical | Win10 DG Win7 Pro 64 | 3-year | No | 11/16 |
| 30AT006RUS | US | Core i7-6700 4C/3.4GHz/8MB/65W/DDR4-2133 | Intel HD 530+NVIDIA Quadro K620 2GB | 2x8GB UDIMM DDR4-2133 Non- ECC | 1x256GB SSD M.2 PCIe Opal | HH DVD±RW | 9-in-1 | 250W 85% | None | None | Switch | USB / USB Optical | Win10 DG Win7 Pro 64 | 3-year | No | 11/16 |
| 30AT006SUS | US | Core i7-6700 4C/3.4GHz/8MB/65W/DDR4-2133 | Intel HD 530+NVIDIA NVS 510 2GB | 2x8GB UDIMM DDR4-2133 Non- ECC | 1x512GB SSD 2.5" SATA6Gbs | HH DVD±RW | 9-in-1 | 250W 85% | None | None | Switch | USB / USB Optical | Win10 DG Win7 Pro 64 | 3-year | No | 11/16 |
| 30AT006TUS | US | Core i7-6700 4C/3.4GHz/8MB/65W/DDR4-2133 | Intel HD 530+NVIDIA Quadro K1200 4GB | 2x8GB UDIMM DDR4-2133 Non- ECC | 1x512GB SSD M.2 PCIe | HH DVD±RW | 9-in-1 | 250W 85% | None | None | Switch | USB / USB Optical | Win10 DG Win7 Pro 64 | 3-year | No | 11/16 |
| 30AT006UUS | US | Core i7-6700 4C/3.4GHz/8MB/65W/DDR4-2133 | Intel HD 530+NVIDIA Quadro M2000 4GB | 2x8GB UDIMM DDR4-2133 Non- ECC | 1x512GB SSD M.2 PCIe | HH DVD±RW | 9-in-1 | 250W 85% | None | None | Switch | USB / USB Optical | Win10 DG Win7 Pro 64 | 3-year | No | 11/16 |

| Model | Region | Processor | Graphics | Memory (Capacity/Type) | Storage (Capacity/Type/Interface) | Optical | Media Reader | Power Supply | Add-on Ports | Discrete Ethernet | Chassis Intrusion Switch | Keyboard / Mouse | Operating System | Warranty | Global | Ann Date (mm/yy) |
|------------|--------|---|---|---------------------------------------|--------------------------------------|--------------|-----------------|-----------------|-----------------|----------------------|--------------------------------|----------------------|-------------------------|----------|--------|---------------------|
| 30AT006VUS | US | Core i7-6700 4C/3.4GHz/8MB/65W/DDR4-2133 | Intel HD 530+NVIDIA Quadro M2000 4GB | 1x16GB UDIMM DDR4-2133 Non- ECC | 1x256GB SSD 2.5" SATA6Gbs Opal | HH DVD±RW | 9-in-1 | 250W 85% | None | None | Switch | USB / USB Optical | Win10 DG Win7 Pro 64 | 3-year | No | 11/16 |
| 30ATA023US | US | Core i7-6700 4C/3.4GHz/8MB/65W/DDR4-2133 | Intel HD 530 | 2x8GB UDIMM DDR4-2133 Non- ECC | 1x512GB SSD 2.5" SATA6Gbs | HH DVD±RW | 9-in-1 | 250W 85% | None | None | Switch | USB / USB Optical | Win10 DG Win7 Pro 64 | 3-year | No | 11/16 |



ThinkStation P320 SFF Platform Specifications

Product Specifications Reference (PSREF)

| Components | Specification | | | | | | | | | | | | | | | | | | | | | | | | | | | | | | | | | | | |
|--------------------------------|--|--|-----------------------------|-----------------------------|-----------------------------|-----------------------------|-----------------------------|-----------------------------|-----------------------------|-----------------------------|-----------------------------|---------------------------|-----------------------------|-----------------------------|-----------------------------|-----------------------------|---------------------------|-----------------------------|-----------------------------|-----------------------------|-----------------------------|--------------|-----------------------------|--------------|---------------------------|--------------|---------------------------|--------------|-----------------------------|-----|----------|--------------|-----|-----|-----|----------|
| Chipset | Intel C236 Chipset | | | | | | | | | | | | | | | | | | | | | | | | | | | | | | | | | | | |
| Intel AMT | Intel Active Management Technology 11 on Xeon models, Intel Standard Manageability on other models | | | | | | | | | | | | | | | | | | | | | | | | | | | | | | | | | | | |
| Processor | One Intel "Kabylake" or "Skylake" processor as listed: "Kaby Lake" | | | | | | | | | | | | | | | | | | | | | | | | | | | | | | | | | | | |
| | <table border="1"> <tbody> <tr><td>Xeon E3-1280 v6</td><td>4C/3.9GHz/8MB/72W/DDR4-2400</td></tr> <tr><td>Xeon E3-1275 v6</td><td>4C/3.8GHz/8MB/73W/DDR4-2400</td></tr> <tr><td>Xeon E3-1270 v6</td><td>4C/3.8GHz/8MB/72W/DDR4-2400</td></tr> <tr><td>Xeon E3-1245 v6</td><td>4C/3.7GHz/8MB/73W/DDR4-2400</td></tr> <tr><td>Xeon E3-1240 v6</td><td>4C/3.7GHz/8MB/72W/DDR4-2400</td></tr> <tr><td>Xeon E3-1230 v6</td><td>4C/3.5GHz/8MB/72W/DDR4-2400</td></tr> <tr><td>Xeon E3-1225 v6</td><td>4C/3.3GHz/8MB/73W/DDR4-2400</td></tr> <tr><td>Xeon E3-1220 v6</td><td>4C/3GHz/8MB/72W/DDR4-2400</td></tr> <tr><td>Core i7-7700</td><td>4C/3.6GHz/8MB/65W/DDR4-2400</td></tr> <tr><td>Core i5-7600</td><td>4C/3.5GHz/6MB/65W/DDR4-2400</td></tr> <tr><td>Core i5-7500</td><td>4C/3.4GHz/6MB/65W/DDR4-2400</td></tr> <tr><td>Core i5-7400</td><td>4C/3GHz/6MB/65W/DDR4-2400</td></tr> <tr><td>Core i3-7300</td><td>2C/4GHz/4MB/51W/DDR4-2400</td></tr> <tr><td>Core i3-7100</td><td>2C/3.9GHz/3MB/51W/DDR4-2400</td></tr> </tbody> </table> | Xeon E3-1280 v6 | 4C/3.9GHz/8MB/72W/DDR4-2400 | Xeon E3-1275 v6 | 4C/3.8GHz/8MB/73W/DDR4-2400 | Xeon E3-1270 v6 | 4C/3.8GHz/8MB/72W/DDR4-2400 | Xeon E3-1245 v6 | 4C/3.7GHz/8MB/73W/DDR4-2400 | Xeon E3-1240 v6 | 4C/3.7GHz/8MB/72W/DDR4-2400 | Xeon E3-1230 v6 | 4C/3.5GHz/8MB/72W/DDR4-2400 | Xeon E3-1225 v6 | 4C/3.3GHz/8MB/73W/DDR4-2400 | Xeon E3-1220 v6 | 4C/3GHz/8MB/72W/DDR4-2400 | Core i7-7700 | 4C/3.6GHz/8MB/65W/DDR4-2400 | Core i5-7600 | 4C/3.5GHz/6MB/65W/DDR4-2400 | Core i5-7500 | 4C/3.4GHz/6MB/65W/DDR4-2400 | Core i5-7400 | 4C/3GHz/6MB/65W/DDR4-2400 | Core i3-7300 | 2C/4GHz/4MB/51W/DDR4-2400 | Core i3-7100 | 2C/3.9GHz/3MB/51W/DDR4-2400 | | | | | | | |
| | Xeon E3-1280 v6 | 4C/3.9GHz/8MB/72W/DDR4-2400 | | | | | | | | | | | | | | | | | | | | | | | | | | | | | | | | | | |
| | Xeon E3-1275 v6 | 4C/3.8GHz/8MB/73W/DDR4-2400 | | | | | | | | | | | | | | | | | | | | | | | | | | | | | | | | | | |
| | Xeon E3-1270 v6 | 4C/3.8GHz/8MB/72W/DDR4-2400 | | | | | | | | | | | | | | | | | | | | | | | | | | | | | | | | | | |
| | Xeon E3-1245 v6 | 4C/3.7GHz/8MB/73W/DDR4-2400 | | | | | | | | | | | | | | | | | | | | | | | | | | | | | | | | | | |
| | Xeon E3-1240 v6 | 4C/3.7GHz/8MB/72W/DDR4-2400 | | | | | | | | | | | | | | | | | | | | | | | | | | | | | | | | | | |
| | Xeon E3-1230 v6 | 4C/3.5GHz/8MB/72W/DDR4-2400 | | | | | | | | | | | | | | | | | | | | | | | | | | | | | | | | | | |
| | Xeon E3-1225 v6 | 4C/3.3GHz/8MB/73W/DDR4-2400 | | | | | | | | | | | | | | | | | | | | | | | | | | | | | | | | | | |
| | Xeon E3-1220 v6 | 4C/3GHz/8MB/72W/DDR4-2400 | | | | | | | | | | | | | | | | | | | | | | | | | | | | | | | | | | |
| | Core i7-7700 | 4C/3.6GHz/8MB/65W/DDR4-2400 | | | | | | | | | | | | | | | | | | | | | | | | | | | | | | | | | | |
| | Core i5-7600 | 4C/3.5GHz/6MB/65W/DDR4-2400 | | | | | | | | | | | | | | | | | | | | | | | | | | | | | | | | | | |
| | Core i5-7500 | 4C/3.4GHz/6MB/65W/DDR4-2400 | | | | | | | | | | | | | | | | | | | | | | | | | | | | | | | | | | |
| | Core i5-7400 | 4C/3GHz/6MB/65W/DDR4-2400 | | | | | | | | | | | | | | | | | | | | | | | | | | | | | | | | | | |
| | Core i3-7300 | 2C/4GHz/4MB/51W/DDR4-2400 | | | | | | | | | | | | | | | | | | | | | | | | | | | | | | | | | | |
| | Core i3-7100 | 2C/3.9GHz/3MB/51W/DDR4-2400 | | | | | | | | | | | | | | | | | | | | | | | | | | | | | | | | | | |
| | "Skylake" | | | | | | | | | | | | | | | | | | | | | | | | | | | | | | | | | | | |
| | | <table border="1"> <tbody> <tr><td>Xeon E3-1245 v5</td><td>4C/3.5GHz/8MB/80W/DDR4-2133</td></tr> <tr><td>Xeon E3-1240 v5</td><td>4C/3.5GHz/8MB/80W/DDR4-2133</td></tr> <tr><td>Xeon E3-1230 v5</td><td>4C/3.4GHz/8MB/80W/DDR4-2133</td></tr> <tr><td>Xeon E3-1225 v5</td><td>4C/3.3GHz/8MB/80W/DDR4-2133</td></tr> <tr><td>Xeon E3-1220 v5</td><td>4C/3GHz/8MB/80W/DDR4-2133</td></tr> <tr><td>Core i7-6700</td><td>4C/3.4GHz/8MB/65W/DDR4-2133</td></tr> <tr><td>Core i5-6500</td><td>4C/3.2GHz/6MB/65W/DDR4-2133</td></tr> <tr><td>Core i5-6400</td><td>4C/2.7GHz/6MB/65W/DDR4-2133</td></tr> <tr><td>Core i3-6100</td><td>2C/3.7GHz/3MB/51W/DDR4-2133</td></tr> </tbody> </table> | Xeon E3-1245 v5 | 4C/3.5GHz/8MB/80W/DDR4-2133 | Xeon E3-1240 v5 | 4C/3.5GHz/8MB/80W/DDR4-2133 | Xeon E3-1230 v5 | 4C/3.4GHz/8MB/80W/DDR4-2133 | Xeon E3-1225 v5 | 4C/3.3GHz/8MB/80W/DDR4-2133 | Xeon E3-1220 v5 | 4C/3GHz/8MB/80W/DDR4-2133 | Core i7-6700 | 4C/3.4GHz/8MB/65W/DDR4-2133 | Core i5-6500 | 4C/3.2GHz/6MB/65W/DDR4-2133 | Core i5-6400 | 4C/2.7GHz/6MB/65W/DDR4-2133 | Core i3-6100 | 2C/3.7GHz/3MB/51W/DDR4-2133 | | | | | | | | | | | | | | | | |
| | | Xeon E3-1245 v5 | 4C/3.5GHz/8MB/80W/DDR4-2133 | | | | | | | | | | | | | | | | | | | | | | | | | | | | | | | | | |
| | | Xeon E3-1240 v5 | 4C/3.5GHz/8MB/80W/DDR4-2133 | | | | | | | | | | | | | | | | | | | | | | | | | | | | | | | | | |
| Xeon E3-1230 v5 | | 4C/3.4GHz/8MB/80W/DDR4-2133 | | | | | | | | | | | | | | | | | | | | | | | | | | | | | | | | | | |
| Xeon E3-1225 v5 | | 4C/3.3GHz/8MB/80W/DDR4-2133 | | | | | | | | | | | | | | | | | | | | | | | | | | | | | | | | | | |
| Xeon E3-1220 v5 | | 4C/3GHz/8MB/80W/DDR4-2133 | | | | | | | | | | | | | | | | | | | | | | | | | | | | | | | | | | |
| Core i7-6700 | | 4C/3.4GHz/8MB/65W/DDR4-2133 | | | | | | | | | | | | | | | | | | | | | | | | | | | | | | | | | | |
| Core i5-6500 | | 4C/3.2GHz/6MB/65W/DDR4-2133 | | | | | | | | | | | | | | | | | | | | | | | | | | | | | | | | | | |
| Core i5-6400 | | 4C/2.7GHz/6MB/65W/DDR4-2133 | | | | | | | | | | | | | | | | | | | | | | | | | | | | | | | | | | |
| Core i3-6100 | 2C/3.7GHz/3MB/51W/DDR4-2133 | | | | | | | | | | | | | | | | | | | | | | | | | | | | | | | | | | | |
| Memory DIMM slots | 4 DIMM slots, 2-channel (integrated memory controller in processor) | | | | | | | | | | | | | | | | | | | | | | | | | | | | | | | | | | | |
| Memory type/capacity | Up to 64GB ECC/non-ECC (4 x 16GB), DDR4-2400. UDIMM. "Skylake" processor supports up to DDR4-2133. Core i7 and i5 processors cannot support ECC. | | | | | | | | | | | | | | | | | | | | | | | | | | | | | | | | | | | |
| Intel HD Graphics in processor | Integrated Intel HD P530 in Xeon E3-12x5 v5 processors; or Intel HD 530 in Core i7, i5, or i3 processors. Works along with discrete graphics to support multi-display, enables three display connectors (2 DP, 1 VGA) on rear. | | | | | | | | | | | | | | | | | | | | | | | | | | | | | | | | | | | |
| Discrete graphics | Two PCI Express 3.0 x16 slots for graphics adapters. Up to two NVIDIA Quadro P1000. Supports the following NVIDIA graphic adapters: | | | | | | | | | | | | | | | | | | | | | | | | | | | | | | | | | | | |
| | <table border="1"> <thead> <tr> <th>Adapter</th> <th>Cores</th> <th>Memory</th> <th>Power</th> <th>Connector</th> </tr> </thead> <tbody> <tr><td>NVS 310</td><td>48</td><td>1GB</td><td>19.5W</td><td>2xDP</td></tr> <tr><td>NVS 315</td><td>48</td><td>1GB</td><td>19.5W</td><td>2xDVI-I SL/2xDP</td></tr> <tr><td>NVS 510</td><td>192</td><td>2GB</td><td>33.4W</td><td>4xmini DP</td></tr> <tr><td>Quadro P400</td><td>256</td><td>2GB</td><td>30W</td><td>3xminiDP</td></tr> <tr><td>Quadro P600</td><td>384</td><td>2GB</td><td>40W</td><td>4xminiDP</td></tr> <tr><td>Quadro P1000</td><td>640</td><td>4GB</td><td>47W</td><td>4xminiDP</td></tr> </tbody> </table> | Adapter | Cores | Memory | Power | Connector | NVS 310 | 48 | 1GB | 19.5W | 2xDP | NVS 315 | 48 | 1GB | 19.5W | 2xDVI-I SL/2xDP | NVS 510 | 192 | 2GB | 33.4W | 4xmini DP | Quadro P400 | 256 | 2GB | 30W | 3xminiDP | Quadro P600 | 384 | 2GB | 40W | 4xminiDP | Quadro P1000 | 640 | 4GB | 47W | 4xminiDP |
| | Adapter | Cores | Memory | Power | Connector | | | | | | | | | | | | | | | | | | | | | | | | | | | | | | | |
| | NVS 310 | 48 | 1GB | 19.5W | 2xDP | | | | | | | | | | | | | | | | | | | | | | | | | | | | | | | |
| | NVS 315 | 48 | 1GB | 19.5W | 2xDVI-I SL/2xDP | | | | | | | | | | | | | | | | | | | | | | | | | | | | | | | |
| | NVS 510 | 192 | 2GB | 33.4W | 4xmini DP | | | | | | | | | | | | | | | | | | | | | | | | | | | | | | | |
| Quadro P400 | 256 | 2GB | 30W | 3xminiDP | | | | | | | | | | | | | | | | | | | | | | | | | | | | | | | | |
| Quadro P600 | 384 | 2GB | 40W | 4xminiDP | | | | | | | | | | | | | | | | | | | | | | | | | | | | | | | | |
| Quadro P1000 | 640 | 4GB | 47W | 4xminiDP | | | | | | | | | | | | | | | | | | | | | | | | | | | | | | | | |
| Onboard drive controller | Five onboard SATA 6.0Gb/s connectors for optical and disk drives plus one SATA connector for optional eSATA. RAID 0, 1, 5* support * RAID 5 needs three 2.5" SSD drives. | | | | | | | | | | | | | | | | | | | | | | | | | | | | | | | | | | | |
| Drive Bays | One external 5.25" bay, one internal 3.5" bay (see right). Up to one 9mm optical + 2 x 3.5" disk drive bays + 1 x 2.5" disk drive bay + two M.2 NVMe SSD | | | | | | | | | | | | | | | | | | | | | | | | | | | | | | | | | | | |
| Supporting disk drives | 3.5" SATA HDD (7.2K 6Gbs) | | | | | | | | | | | | | | | | | | | | | | | | | | | | | | | | | | | |
| | 2.5" SATA SSD (6Gbs) | | | | | | | | | | | | | | | | | | | | | | | | | | | | | | | | | | | |
| | M.2 NVMe SSD | | | | | | | | | | | | | | | | | | | | | | | | | | | | | | | | | | | |
| Max internal storage | 10TB (2 x 4TB 3.5" HDDs + 1 x 2TB 2.5" SSD) plus two 1TB M.2 NVMe SSD | | | | | | | | | | | | | | | | | | | | | | | | | | | | | | | | | | | |
| Media reader | 9-in-1 card reader. Optional 29-in-1 card reader on selected models | | | | | | | | | | | | | | | | | | | | | | | | | | | | | | | | | | | |
| Power supply | 210 watts with variable speed fan, autosensing, Climate Savers Computing Bronze, 80 PLUS Bronze qualified | | | | | | | | | | | | | | | | | | | | | | | | | | | | | | | | | | | |
| Onboard Ethernet | One onboard gigabit ethernet, Intel I219LM, supports Wake-on-LAN | | | | | | | | | | | | | | | | | | | | | | | | | | | | | | | | | | | |
| HD Audio | Realtek ALC662 codec | | | | | | | | | | | | | | | | | | | | | | | | | | | | | | | | | | | |
| TPM | Standard, TCG 2.0-compliant | | | | | | | | | | | | | | | | | | | | | | | | | | | | | | | | | | | |

| Components | Specification |
|------------------------------|---|
| Front ports | Two USB 3.0, microphone (3.5mm), headphone (3.5mm) |
| Rear ports | 1 VGA and 2 DisplayPort (for Intel HD Graphics models only), two USB 2.0, four USB 3.0, one serial (9-pin), one ethernet (RJ-45), three analog audio ports (line-in, line-out, mic-in) |
| Mechanical | <ul style="list-style-type: none"> Raven black color; metal case 4.02"W x 15.53"D x 13.31"H 102mm W x 394.5mm D x 338mm H 17.2 lb (7.9kg) max configuration 12.9-liter |
| Environmental certifications | GREENGUARD certified/RoHS-compliant/EPEAT Gold rating/ENERGY STAR 6.1 qualified |
| Limited warranty | 1 or 3-year limited onsite service with 9x5/NBD. Some parts are Customer Replaceable Units. |
| ISV certifications | Please visit www.thinkworkstations.com/isv-certifications/ |

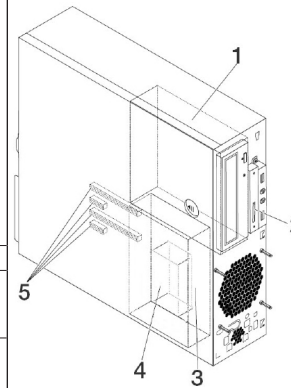

Drive Bays and PCIe Slots

| | |
|----------|---|
| Bay 1 | 5.25", supports one of the following: HH optical/flex module***/9mm optical+3.5" HDD bay/ 3.5" HDD bay/Front Access Storage Enclosure *** Flex module supports one or more of the following: 9mm optical/ 29-in-1 reader/front IEEE 1394/front eSATA. Up to one flex module is supported per system. |
| Bay 2 | Optional 9-in-1 single slot reader |
| Bay 3 | Standard 3.5" HDD bay |
| Bay 4 | Optional 2.5" HDD bay (under Bay 3) |
| 5 -Slots | Four PCIe slots (top-down): Slot 1: Low Profile, PCIe 3.0 x16 (near CPU) Slot 2: Low Profile, PCIe 3.0 x1 Slot 3: Low Profile, PCIe 3.0 x16 (x4 elec) Slot 4: Low Profile, PCIe 3.0 x1 |

| Model | Product | Region | Processor | Intel HD Graphics | Discrete Graphics | Memory | Internal Storage | M.2 PCIe SSD | Optical | Media Reader | Power Supply | Add-on Ports | Keyboard / Mouse | Operating System | Warranty | Global | Ann Date (mm/yy) |
|------------|----------|--------|---|-------------------|-------------------|-------------------------------|------------------------------|--------------|-----------|--------------|-------------------|--------------|------------------|-----------------------------|----------|--------|------------------|
| 30BK000LUS | P320 SFF | US | Core i5-6500 4C/3.2GHz/6MB/65W/DDR4-2133 | Intel HD 530 | Open | 1x8GB UDIMM DDR4-2400 Non-ECC | Open | 1x256GB Opal | HH DVD±RW | 9-in-1 | 210W Bronze Fixed | None | USB full/USB opt | Win7 Pro64 (Win10 Pro64 DG) | 3-year | No | 04/17 |
| 30BK000MUS | P320 SFF | US | Xeon E3-1240 v6 4C/3.7GHz/8MB/72W/DDR4-2400 | None | Quadro P600 2GB | 2x8GB UDIMM DDR4-2400 Non-ECC | 1x1TB HDD 7.2K 3.5" SATA6Gbs | None | HH DVD±RW | 9-in-1 | 210W Bronze Fixed | None | USB full/USB opt | Win10 Pro64 | 3-year | No | 04/17 |
| 30BK000NUS | P320 SFF | US | Core i7-7700 4C/3.6GHz/8MB/65W/DDR4-2400 | Intel HD 630 | Quadro P600 2GB | 1x8GB UDIMM DDR4-2400 Non-ECC | 1x1TB HDD 7.2K 3.5" SATA6Gbs | None | HH DVD±RW | 9-in-1 | 210W Bronze Fixed | None | USB full/USB opt | Win10 Pro64 | 3-year | No | 04/17 |
| 30BK000PUS | P320 SFF | US | Core i5-7500 4C/3.4GHz/6MB/65W/DDR4-2400 | Intel HD 630 | Quadro P400 2GB | 1x8GB UDIMM DDR4-2400 Non-ECC | 1x1TB HDD 7.2K 3.5" SATA6Gbs | None | HH DVD±RW | 9-in-1 | 210W Bronze Fixed | None | USB full/USB opt | Win10 Pro64 | 3-year | No | 04/17 |
| 30BK000QUS | P320 SFF | US | Core i7-6700 4C/3.4GHz/8MB/65W/DDR4-2133 | Intel HD 530 | Quadro P1000 4GB | 1x8GB UDIMM DDR4-2400 Non-ECC | 1x1TB HDD 7.2K 3.5" SATA6Gbs | None | HH DVD±RW | 9-in-1 | 210W Bronze Fixed | None | USB full/USB opt | Win7 Pro64 (Win10 Pro64 DG) | 3-year | No | 04/17 |
| 30BK000RUS | P320 SFF | US | Xeon E3-1245 v5 4C/3.5GHz/8MB/80W/DDR4-2133 | Intel HD P530 | Open | 1x8GB UDIMM DDR4-2400 Non-ECC | Open | 1x256GB Opal | HH DVD±RW | 9-in-1 | 210W Bronze Fixed | None | USB full/USB opt | Win7 Pro64 (Win10 Pro64 DG) | 3-year | No | 04/17 |
| 30BK000SUS | P320 SFF | US | Xeon E3-1240 v5 4C/3.5GHz/8MB/80W/DDR4-2133 | None | Quadro P600 2GB | 1x8GB UDIMM DDR4-2400 Non-ECC | 1x1TB HDD 7.2K 3.5" SATA6Gbs | None | HH DVD±RW | 9-in-1 | 210W Bronze Fixed | None | USB full/USB opt | Win7 Pro64 (Win10 Pro64 DG) | 3-year | No | 04/17 |
| 30BK000TUS | P320 SFF | US | Core i5-7600 4C/3.5GHz/6MB/65W/DDR4-2400 | Intel HD 630 | Open | 1x8GB UDIMM DDR4-2400 Non-ECC | 1x1TB HDD 7.2K 3.5" SATA6Gbs | None | HH DVD±RW | 9-in-1 | 210W Bronze Fixed | None | USB full/USB opt | Win10 Pro64 | 3-year | No | 04/17 |
| 30BK000UUS | P320 SFF | US | Core i7-6700 4C/3.4GHz/8MB/65W/DDR4-2133 | Intel HD 530 | Open | 1x8GB UDIMM DDR4-2400 Non-ECC | Open | 1x256GB Opal | HH DVD±RW | 9-in-1 | 210W Bronze Fixed | PS/2 | USB full/PS2 | Win7 Pro64 (Win10 Pro64 DG) | 3-year | No | 04/17 |
| 30BK000VUS | P320 SFF | US | Xeon E3-1245 v6 4C/3.7GHz/8MB/73W/DDR4-2400 | Intel HD P630 | Open | 2x8GB UDIMM DDR4-2400 Non-ECC | Open | 1x512GB Opal | HH DVD±RW | 9-in-1 | 210W Bronze Fixed | PS/2 | USB full/PS2 | Win10 Pro64 | 3-year | No | 04/17 |
| 30BK000WUS | P320 SFF | US | Core i7-6700 4C/3.4GHz/8MB/65W/DDR4-2133 | Intel HD 530 | Quadro P1000 4GB | 2x8GB UDIMM DDR4-2400 Non-ECC | Open | 1x512GB Opal | HH DVD±RW | 9-in-1 | 210W Bronze Fixed | None | USB full/USB opt | Win7 Pro64 (Win10 Pro64 DG) | 3-year | No | 04/17 |
| 30BK000XUS | P320 SFF | US | Xeon E3-1240 v6 4C/3.7GHz/8MB/72W/DDR4-2400 | None | Quadro P600 2GB | 2x8GB UDIMM DDR4-2400 Non-ECC | Open | 1x512GB Opal | HH DVD±RW | 9-in-1 | 210W Bronze Fixed | None | USB full/USB opt | Win10 Pro64 | 3-year | No | 04/17 |
| 30BK000YUS | P320 SFF | US | Core i7-7700 4C/3.6GHz/8MB/65W/DDR4-2400 | Intel HD 630 | Quadro P1000 4GB | 1x8GB UDIMM DDR4-2400 Non-ECC | 1x1TB HDD 7.2K 3.5" SATA6Gbs | None | HH DVD±RW | 9-in-1 | 210W Bronze Fixed | None | USB full/USB opt | Win10 Pro64 | 3-year | No | 04/17 |
| 30BK0010US | P320 SFF | US | Xeon E3-1240 v5 4C/3.5GHz/8MB/80W/DDR4-2133 | None | Quadro P1000 4GB | 1x8GB UDIMM DDR4-2400 Non-ECC | 1x1TB HDD 7.2K 3.5" SATA6Gbs | None | HH DVD±RW | 9-in-1 | 210W Bronze Fixed | None | USB full/USB opt | Win7 Pro64 (Win10 Pro64 DG) | 3-year | No | 04/17 |
| 30BK0011US | P320 SFF | US | Core i5-7500 4C/3.4GHz/6MB/65W/DDR4-2400 | Intel HD 630 | Open | 1x8GB UDIMM DDR4-2400 Non-ECC | Open | 1x256GB Opal | HH DVD±RW | 9-in-1 | 210W Bronze Fixed | None | USB full/USB opt | Win10 Pro64 | 3-year | No | 04/17 |

| Model | Product | Region | Processor | Intel HD Graphics | Discrete Graphics | Memory | Internal Storage | M.2 PCIe SSD | Optical | Media Reader | Power Supply | Add-on Ports | Keyboard / Mouse | Operating System | Warranty | Global | Ann Date (mm/yy) |
|------------|----------|--------|--|-------------------|-------------------|----------------------------------|---|-----------------|--------------|--------------|-------------------------|--------------|---------------------|-----------------------------------|----------|--------|------------------|
| 30BK0012US | P320 SFF | US | Core i7-7700 4C/3.6GHz/8MB/65W/DDR4-2400 | Intel HD 630 | Open | 1x8GB UDIMM DDR4-2400 Non-ECC | 1x1TB HDD 7.2K 3.5" SATA6Gbs | None | HH DVD±RW | 9-in-1 | 210W Bronze Fixed | None | USB full/USB opt | Win10 Pro64 | 3-year | No | 04/17 |
| 30BK0013US | P320 SFF | US | Core i3-6100 2C/3.7GHz/3MB/51W/DDR4-2133 | Intel HD 530 | Quadro P400 2GB | 1x8GB UDIMM DDR4-2400 Non-ECC | 1x1TB HDD 7.2K 3.5" SATA6Gbs | None | HH DVD±RW | 9-in-1 | 210W Bronze Fixed | None | USB full/USB opt | Win7 Pro64 (Win10 Pro64 DG) | 3-year | No | 04/17 |
| 30BK0014US | P320 SFF | US | Xeon E3-1240 v6 4C/3.7GHz/8MB/72W/DDR4-2400 | None | Quadro P1000 4GB | 1x8GB UDIMM DDR4-2400 Non-ECC | 1x1TB HDD 7.2K 3.5" SATA6Gbs | None | HH DVD±RW | 9-in-1 | 210W Bronze Fixed | None | USB full/USB opt | Win10 Pro64 | 3-year | No | 04/17 |
| 30BK0015US | P320 SFF | US | Core i5-6500 4C/3.2GHz/6MB/65W/DDR4-2133 | Intel HD 530 | Quadro P400 2GB | 1x8GB UDIMM DDR4-2400 Non-ECC | 1x512GB SSD 2.5" SATA6Gbs Opal | None | HH DVD±RW | 9-in-1 | 210W Bronze Fixed | None | USB full/USB opt | Win7 Pro64 (Win10 Pro64 DG) | 3-year | No | 04/17 |
| 30BK0016US | P320 SFF | US | Core i5-7500 4C/3.4GHz/6MB/65W/DDR4-2400 | Intel HD 630 | Quadro P400 2GB | 1x8GB UDIMM DDR4-2400 Non-ECC | 1x512GB SSD 2.5" SATA6Gbs Opal | None | HH DVD±RW | 9-in-1 | 210W Bronze Fixed | None | USB full/USB opt | Win10 Pro64 | 3-year | No | 04/17 |
| 30BK0017US | P320 SFF | US | Xeon E3-1225 v6 4C/3.3GHz/8MB/73W/DDR4-2400 | Intel HD P630 | Open | 1x8GB UDIMM DDR4-2400 Non-ECC | 1x1TB HDD 7.2K 3.5" SATA6Gbs | None | HH DVD±RW | 9-in-1 | 210W Bronze Fixed | None | USB full/USB opt | Win10 Pro64 | 3-year | No | 04/17 |
| 30BK0018US | P320 SFF | US | Core i3-6100 2C/3.7GHz/3MB/51W/DDR4-2133 | Intel HD 530 | Open | 1x8GB UDIMM DDR4-2400 Non-ECC | 1x1TB HDD 7.2K 3.5" SATA6Gbs | None | HH DVD±RW | 9-in-1 | 210W Bronze Fixed | None | USB full/USB opt | Win7 Pro64 (Win10 Pro64 DG) | 3-year | No | 04/17 |
| 30BK0019US | P320 SFF | US | Xeon E3-1245 v5 4C/3.5GHz/8MB/80W/DDR4-2133 | Intel HD P530 | Open | 1x8GB UDIMM DDR4-2400 Non-ECC | Open | 1x512GB Opal | HH DVD±RW | 9-in-1 | 210W Bronze Fixed | PS/2 | USB full/PS2 | Win7 Pro64 (Win10 Pro64 DG) | 3-year | No | 04/17 |
| 30BK001AUS | P320 SFF | US | Core i7-6700 4C/3.4GHz/8MB/65W/DDR4-2133 | Intel HD 530 | Quadro P600 2GB | 1x8GB UDIMM DDR4-2400 Non-ECC | 1x1TB HDD 7.2K 3.5" SATA6Gbs | None | HH DVD±RW | 9-in-1 | 210W Bronze Fixed | None | USB full/USB opt | Win7 Pro64 (Win10 Pro64 DG) | 3-year | No | 04/17 |
| 30BK001BUS | P320 SFF | US | Core i7-7700 4C/3.6GHz/8MB/65W/DDR4-2400 | Intel HD 630 | Open | 1x8GB UDIMM DDR4-2400 Non-ECC | Open | 1x256GB Opal | HH DVD±RW | 9-in-1 | 210W Bronze Fixed | PS/2 | USB full/PS2 | Win10 Pro64 | 3-year | No | 04/17 |
| 30BK001CUS | P320 SFF | US | Core i5-7500 4C/3.4GHz/6MB/65W/DDR4-2400 | Intel HD 630 | Open | 1x8GB UDIMM DDR4-2400 Non-ECC | 1x1TB HDD 7.2K 3.5" SATA6Gbs | None | HH DVD±RW | 9-in-1 | 210W Bronze Fixed | None | USB full/USB opt | Win10 Pro64 | 3-year | No | 04/17 |
| 30BK001DUS | P320 SFF | US | Core i7-6700 4C/3.4GHz/8MB/65W/DDR4-2133 | Intel HD 530 | Open | 1x8GB UDIMM DDR4-2400 Non-ECC | 1x1TB HDD 7.2K 3.5" SATA6Gbs | None | HH DVD±RW | 9-in-1 | 210W Bronze Fixed | None | USB full/USB opt | Win7 Pro64 (Win10 Pro64 DG) | 3-year | No | 04/17 |
| 30BK001EUS | P320 SFF | US | Xeon E3-1240 v5 4C/3.5GHz/8MB/80W/DDR4-2133 | None | Quadro P600 2GB | 2x8GB UDIMM DDR4-2400 Non-ECC | Open | 1x512GB Opal | HH DVD±RW | 9-in-1 | 210W Bronze Fixed | None | USB full/USB opt | Win7 Pro64 (Win10 Pro64 DG) | 3-year | No | 04/17 |
| 30BK001FUS | P320 SFF | US | Core i3-7100 2C/3.9GHz/3MB/51W/DDR4-2400 | Intel HD 630 | Quadro P400 2GB | 1x8GB UDIMM DDR4-2400 Non-ECC | 1x1TB HDD 7.2K 3.5" SATA6Gbs | None | HH DVD±RW | 9-in-1 | 210W Bronze Fixed | None | USB full/USB opt | Win10 Pro64 | 3-year | No | 04/17 |
| 30BK001GUS | P320 SFF | US | Xeon E3-1240 v5 4C/3.5GHz/8MB/80W/DDR4-2133 | None | Quadro P1000 4GB | 2x8GB UDIMM DDR4-2400 Non-ECC | Open | 1x512GB Opal | HH DVD±RW | 9-in-1 | 210W Bronze Fixed | PS/2 | USB full/PS2 | Win7 Pro64 (Win10 Pro64 DG) | 3-year | No | 04/17 |

| Model | Product | Region | Processor | Intel HD Graphics | Discrete Graphics | Memory | Internal Storage | M.2 PCIe SSD | Optical | Media Reader | Power Supply | Add-on Ports | Keyboard / Mouse | Operating System | Warranty | Global | Ann Date (mm/yy) |
|------------|----------|--------|---|-------------------|-------------------|-------------------------------|------------------------------|--------------|-----------|--------------|-------------------|--------------|------------------|-----------------------------|----------|--------|------------------|
| 30BK001HUS | P320 SFF | US | Core i5-6500 4C/3.2GHz/6MB/65W/DDR4-2133 | Intel HD 530 | Open | 1x8GB UDIMM DDR4-2400 Non-ECC | 1x1TB HDD 7.2K 3.5" SATA6Gbs | None | HH DVD±RW | 9-in-1 | 210W Bronze Fixed | None | USB full/USB opt | Win7 Pro64 (Win10 Pro64 DG) | 3-year | No | 04/17 |
| 30BK001JUS | P320 SFF | US | Core i3-7100 2C/3.9GHz/3MB/51W/DDR4-2400 | Intel HD 630 | Open | 1x8GB UDIMM DDR4-2400 Non-ECC | 1x1TB HDD 7.2K 3.5" SATA6Gbs | None | HH DVD±RW | 9-in-1 | 210W Bronze Fixed | None | USB full/USB opt | Win10 Pro64 | 3-year | No | 04/17 |
| 30BK001KUS | P320 SFF | US | Xeon E3-1245 v6 4C/3.7GHz/8MB/73W/DDR4-2400 | Intel HD P630 | Open | 1x8GB UDIMM DDR4-2400 Non-ECC | Open | 1x256GB Opal | HH DVD±RW | 9-in-1 | 210W Bronze Fixed | None | USB full/USB opt | Win10 Pro64 | 3-year | No | 04/17 |
| 30BK001LUS | P320 SFF | US | Core i7-7700 4C/3.6GHz/8MB/65W/DDR4-2400 | Intel HD 630 | Quadro P1000 4GB | 2x8GB UDIMM DDR4-2400 Non-ECC | Open | 1x512GB Opal | HH DVD±RW | 9-in-1 | 210W Bronze Fixed | None | USB full/USB opt | Win10 Pro64 | 3-year | No | 04/17 |
| 30BK001MUS | P320 SFF | US | Xeon E3-1225 v5 4C/3.3GHz/8MB/80W/DDR4-2133 | Intel HD P530 | Open | 1x8GB UDIMM DDR4-2400 Non-ECC | 1x1TB HDD 7.2K 3.5" SATA6Gbs | None | HH DVD±RW | 9-in-1 | 210W Bronze Fixed | None | USB full/USB opt | Win7 Pro64 (Win10 Pro64 DG) | 3-year | No | 04/17 |
| 30BK001NUS | P320 SFF | US | Core i5-6500 4C/3.2GHz/6MB/65W/DDR4-2133 | Intel HD 530 | Quadro P400 2GB | 1x8GB UDIMM DDR4-2400 Non-ECC | 1x1TB HDD 7.2K 3.5" SATA6Gbs | None | HH DVD±RW | 9-in-1 | 210W Bronze Fixed | None | USB full/USB opt | Win7 Pro64 (Win10 Pro64 DG) | 3-year | No | 04/17 |



ThinkStation P320 Tiny Platform Specifications

Product Specifications Reference (PSREF)

| Components | Specification | | | | | | | | | |
|--|---|--|-------|------------|-------|------------|-------------|-----|-----|-----|
| Chipset | Intel Q270 Chipset | | | | | | | | | |
| Intel AMT | Intel Active Management Technology 11 | | | | | | | | | |
| Processor | One Intel "Kaby Lake" or "Skylake" processor as listed: "Kaby Lake" | | | | | | | | | |
| | Core i7-7700T 4C/2.9GHz/8MB/35W/DDR4-2400/Intel HD 630 | | | | | | | | | |
| | Core i7-7700 4C/3.6GHz/8MB/65W/DDR4-2400/Intel HD 630 | | | | | | | | | |
| | Core i5-7600T 4C/2.8GHz/6MB/35W/DDR4-2400/Intel HD 630 | | | | | | | | | |
| | Core i5-7600 4C/3.5GHz/6MB/65W/DDR4-2400/Intel HD 630 | | | | | | | | | |
| | Core i5-7500T 4C/2.7GHz/6MB/35W/DDR4-2400/Intel HD 630 | | | | | | | | | |
| | Core i5-7500 4C/3.4GHz/6MB/65W/DDR4-2400/Intel HD 630 | | | | | | | | | |
| | Core i5-7400T 4C/2.4GHz/6MB/35W/DDR4-2400/Intel HD 630 | | | | | | | | | |
| | Core i5-7400 4C/3.0GHz/6MB/65W/DDR4-2400/Intel HD 630 | | | | | | | | | |
| | Core i3-7300T 2C/3.5GHz/4MB/35W/DDR4-2400/Intel HD 630 | | | | | | | | | |
| | Core i3-7300 2C/4.0GHz/4MB/51W/DDR4-2400/Intel HD 630 | | | | | | | | | |
| | Core i3-7100T 2C/3.4GHz/3MB/35W/DDR4-2400/Intel HD 630 | | | | | | | | | |
| Core i3-7100 2C/3.9GHz/3MB/51W/DDR4-2400/Intel HD 630 | | | | | | | | | | |
| Processor | "Skylake" | | | | | | | | | |
| | Core i7-6700T 4C/2.8GHz/8MB/35W/DDR4-2133/Intel HD 530 | | | | | | | | | |
| | Core i7-6700 4C/3.4GHz/8MB/65W/DDR4-2133/Intel HD 530 | | | | | | | | | |
| | Core i5-6500T 4C/2.5GHz/6MB/35W/DDR4-2133/Intel HD 530 | | | | | | | | | |
| | Core i5-6500 4C/3.2GHz/6MB/65W/DDR4-2133/Intel HD 530 | | | | | | | | | |
| | Core i3-6100T 2C/3.2GHz/3MB/35W/DDR4-2133/Intel HD 530 | | | | | | | | | |
| | Core i3-6100 2C/3.7GHz/3MB/51W/DDR4-2133/Intel HD 530 | | | | | | | | | |
| | "Kaby Lake" processors cannot support Windows 7 | | | | | | | | | |
| | Memory DIMM slots | 2 DIMM slots, 2-channel (integrated memory controller in processor) | | | | | | | | |
| | Memory type/capacity | Up to 32GB (2 x 16GB), non-ECC, DDR4-2400. SO-DIMM. "Skylake" processor supports up to DDR4-2133 | | | | | | | | |
| | Intel HD Graphics in processor | Integrated Intel HD 630 in "Kaby Lake" processors; or Intel HD 530 in "Skylake" processors. Works along with optional discrete graphics to support multi-display, enables two display connectors (2 DP) on rear. | | | | | | | | |
| | Discrete graphics | Up to one NVIDIA Quadro P600 on 35W processor models | | | | | | | | |
| <table border="1"> <thead> <tr> <th>Adapter</th> <th>Cores</th> <th>Memory</th> <th>Power</th> <th>Connectors</th> </tr> </thead> <tbody> <tr> <td>Quadro P600</td> <td>384</td> <td>2GB</td> <td>40W</td> <td>4xDP</td> </tr> </tbody> </table> | | Adapter | Cores | Memory | Power | Connectors | Quadro P600 | 384 | 2GB | 40W |
| Adapter | Cores | Memory | Power | Connectors | | | | | | |
| Quadro P600 | 384 | 2GB | 40W | 4xDP | | | | | | |
| Max simultaneous displays | Up to 6 displays (2 x DP plus 4 x mDP) with integrated Intel HD (2 x DP) and NVIDIA Quadro P600 (4 x mDP) | | | | | | | | | |
| Storage | Up to one 2.5" SATA6Gbs hard disk drive or SSD plus one M.2 NVMe SSD. 2.5" drive cannot work with Quadro P600 | | | | | | | | | |
| Supporting disk drives | 2.5" SATA6Gbs HDD 500GB 7.2K/1TB 5.4K | | | | | | | | | |
| | 2.5" SATA6Gbs SSD 128GB | | | | | | | | | |
| | M.2 NVMe SSD 128GB/256GB Opal/512GB Opal/1TB Opal | | | | | | | | | |
| Max internal storage | 1TB (1 x 1TB 2.5" HDD) plus 1TB (1 x 1TB) M.2 NVMe SSD | | | | | | | | | |
| Optical drive | Optional one 9.0mm optical drive via optical drive kit, DVD-ROM or DVD±RW. VESA mount is needed, consumes one USB 3.0 port | | | | | | | | | |
| Media reader | None | | | | | | | | | |
| Power supply | 135W AC/DC adapter, autosensing, 88% PSU | | | | | | | | | |
| Onboard Ethernet | One onboard gigabit ethernet. Intel I219LM. supports Wake-on-LAN | | | | | | | | | |
| WLAN/Bluetooth | Supports the following 11ac wireless, M.2 card: <ul style="list-style-type: none"> Qualcomm Atheros QCA9377A, dual band, Wi-Fi + Bluetooth 4.2, 1x1 (BT4.0 for Egypt models) Qualcomm Atheros QCA6174A, dual band, Wi-Fi + Bluetooth 4.2, 2x2 (BT4.0 for Egypt and US models) Intel Dual Band Wireless-AC 3165, Wi-Fi + Bluetooth 4.0, 1x1 Intel Dual Band Wireless-AC 8265, Wi-Fi + Bluetooth 4.2, 2x2 Intel Dual Band Wireless-AC 8265, Wi-Fi + Bluetooth 4.2, 2x2, vPro | | | | | | | | | |
| HD Audio | Realtek ALC294 codec | | | | | | | | | |
| TPM | Standard, TCG 2.0-compliant | | | | | | | | | |
| Front ports | Two USB 3.0 (one Always On), one microphone (3.5mm), one combo audio/microphone jack (3.5mm) | | | | | | | | | |
| Rear ports | 2 DisplayPort (for Intel HD Graphics), four USB 3.0, one ethernet (RJ-45). Optional 4 mDP for Quadro P600 | | | | | | | | | |

| Components | Specification |
|------------------------------|---|
| Mechanical | <ul style="list-style-type: none"> Raven black color; metal case 1.36"W x 7.05"D x 7.20"H 34.5mm W x 179mm D x 182.9mm H 2.9 lb (1.3kg) typical weight 1-liter |
| | VESA mount |
| I/O box | Optional I/O expansion box, extends additional two USB 2.0, two USB 3.0, and one serial on rear, two USB 2.0 on front. I/O box consumes two USB 3.0 ports. I/O box requires VESA mount |
| Floor stand | Optional system floor stand for vertical orientation |
| Environmental certifications | GREENGUARD certified/RoHS-compliant/EPEAT Gold rating/ENERGY STAR 6.1 qualified |
| Limited warranty | 1 or 3-year limited onsite service with 9x5/NBD. Some parts are Customer Replaceable Units. |
| ISV certifications | Please visit www.thinkworkstations.com/isv-certifications/ |

Popular and system-unique options:

| | |
|--|------------|
| Lenovo 4GB DDR4 2400MHz SoDIMM Memory | 4X70M60573 |
| Lenovo 8GB DDR4 2400MHz SoDIMM Memory | 4X70M60574 |
| Lenovo 16GB DDR4 2400MHz SoDIMM Memory | 4X70N24889 |
| Lenovo 256GB PCIe NVMe M.2 SSD | 4XB0M52449 |
| ThinkStation 256GB OPAL 2.5" Solid State Drive | 4XB0N67290 |
| 256GB M.2 TLC PCIe OPAL 2.0 SSD | 4XB0P01014 |
| Lenovo 128GB M.2 PCIe NVMe SSD | 4XB0N26469 |
| Tiny IV DVD Burner Kit (VESA Mount needed) | 4XA0N06917 |
| Tiny IV DVD ROM Kit (VESA Mount needed) | 4XA0N06918 |
| Tiny 4 IO Expansion Box (VESA Mount needed) | 4XH0N06919 |
| Tiny Under Desk Mount | 0B47097 |
| Tiny IV Vertical Stand | 4XF0N03160 |
| Tiny VESA Mount II | 4XF0N03161 |
| Tiny Power Cage II | 4XH0N23158 |
| Tiny Sandwich Kit II | 4XH0N04098 |
| Tiny Clamp Bracket Mounting Kit II (VESA Mount needed) | 4XF0N82412 |
| Tiny IV 1L Dust Shield | 4XH0N04885 |

ThinkStation P320 Tiny - TopSeller - 30C2

Product Specifications Reference (PSREF)

| Model | Product | Region | Processor | Intel HD Graphics | Discrete Graphics | Memory | 2.5" HDD/SSD | M.2 Storage | Optical | WLAN/Bluetooth | Stand | Cable lock | Keyboard / Mouse | Operating System | Warranty | Global | Ann Date (mm/yy) |
|------------|------------------------|--------|--|-------------------|-------------------|--------------------------------|--------------|--------------------------|---------|----------------------------------|-------|------------|------------------|-----------------------------------|----------|--------|------------------|
| 30C20015US | ThinkStation P320 Tiny | US | Core i5-6500T 4C/2.5GHz/6MB/35W/DDR4-2133 | Intel HD 530 | Quadro P600 2GB | 8GB SO-DIMM DDR4-2400 Non-ECC | None | 512GB M.2 PCIe NVMe Opal | None | Intel 8265 ac, 2x2, vPro + BT4.1 | Stand | None | USB/USB | Windows 10 DG Windows 7 Pro 64 | 3-year | No | 06/17 |
| 30C20016US | ThinkStation P320 Tiny | US | Core i7-6700T 4C/2.8GHz/8MB/35W/DDR4-2133 | Intel HD 530 | Quadro P600 2GB | 8GB SO-DIMM DDR4-2400 Non-ECC | None | 256GB M.2 PCIe NVMe Opal | None | Intel 8265 ac, 2x2, vPro + BT4.1 | Stand | None | USB/USB | Windows 10 DG Windows 7 Pro 64 | 3-year | No | 06/17 |
| 30C20018US | ThinkStation P320 Tiny | US | Core i5-6500T 4C/2.5GHz/6MB/35W/DDR4-2133 | Intel HD 530 | Quadro P600 2GB | 8GB SO-DIMM DDR4-2400 Non-ECC | None | 256GB M.2 PCIe NVMe Opal | None | Intel 8265 ac, 2x2, vPro + BT4.1 | Stand | None | USB/USB | Windows 10 DG Windows 7 Pro 64 | 3-year | No | 06/17 |
| 30C20019US | ThinkStation P320 Tiny | US | Core i3-6100T 2C/3.2GHz/3MB/35W/DDR4-2133 | Intel HD 530 | Quadro P600 2GB | 16GB SO-DIMM DDR4-2400 Non-ECC | None | 512GB M.2 PCIe NVMe Opal | None | Intel 3165 ac, 1x1, BT4.0 | Stand | None | USB/USB | Windows 10 DG Windows 7 Pro 64 | 3-year | No | 06/17 |
| 30C2001DUS | ThinkStation P320 Tiny | US | Core i7-6700T 4C/2.8GHz/8MB/35W/DDR4-2133 | Intel HD 530 | Quadro P600 2GB | 16GB SO-DIMM DDR4-2400 Non-ECC | None | 512GB M.2 PCIe NVMe Opal | None | Intel 8265 ac, 2x2, vPro + BT4.1 | Stand | None | USB/USB | Windows 10 DG Windows 7 Pro 64 | 3-year | No | 06/17 |
| 30C2001GUS | ThinkStation P320 Tiny | US | Core i3-6100T 2C/3.2GHz/3MB/35W/DDR4-2133 | Intel HD 530 | Quadro P600 2GB | 4GB SO-DIMM DDR4-2400 Non-ECC | None | 256GB M.2 PCIe NVMe Opal | None | Intel 3165 ac, 1x1, BT4.0 | Stand | None | USB/USB | Windows 10 DG Windows 7 Pro 64 | 3-year | No | 06/17 |
| 30C2001JUS | ThinkStation P320 Tiny | US | Core i5-6500T 4C/2.5GHz/6MB/35W/DDR4-2133 | Intel HD 530 | Quadro P600 2GB | 16GB SO-DIMM DDR4-2400 Non-ECC | None | 512GB M.2 PCIe NVMe Opal | None | Intel 8265 ac, 2x2, vPro + BT4.1 | Stand | None | USB/USB | Windows 10 DG Windows 7 Pro 64 | 3-year | No | 06/17 |
| 30C2001MUS | ThinkStation P320 Tiny | US | Core i3-6100T 2C/3.2GHz/3MB/35W/DDR4-2133 | Intel HD 530 | Quadro P600 2GB | 16GB SO-DIMM DDR4-2400 Non-ECC | None | 256GB M.2 PCIe NVMe Opal | None | Intel 3165 ac, 1x1, BT4.0 | Stand | None | USB/USB | Windows 10 DG Windows 7 Pro 64 | 3-year | No | 06/17 |
| 30C2001NUS | ThinkStation P320 Tiny | US | Core i7-6700T 4C/2.8GHz/8MB/35W/DDR4-2133 | Intel HD 530 | Quadro P600 2GB | 8GB SO-DIMM DDR4-2400 Non-ECC | None | 512GB M.2 PCIe NVMe Opal | None | Intel 8265 ac, 2x2, vPro + BT4.1 | Stand | None | USB/USB | Windows 10 DG Windows 7 Pro 64 | 3-year | No | 06/17 |
| 30C2001QUS | ThinkStation P320 Tiny | US | Core i7-6700T 4C/2.8GHz/8MB/35W/DDR4-2133 | Intel HD 530 | Quadro P600 2GB | 16GB SO-DIMM DDR4-2400 Non-ECC | None | 512GB M.2 PCIe NVMe Opal | None | Intel 8265 ac, 2x2, vPro + BT4.1 | Stand | None | USB/USB | Windows 10 DG Windows 7 Pro 64 | 3-year | No | 06/17 |
| 30C20025US | ThinkStation P320 Tiny | US | Core i5-7500T 4C/2.7GHz/6MB/35W/DDR4-2400 | Intel HD 630 | Quadro P600 2GB | 16GB SO-DIMM DDR4-2400 Non-ECC | None | 1TB M.2 PCIe NVMe Opal | None | Intel 8265 ac, 2x2, vPro + BT4.1 | Stand | None | USB/USB | Windows 10 Pro 64 | 3-year | No | 06/17 |
| 30C20026US | ThinkStation P320 Tiny | US | Core i7-7700T 4C/2.9GHz/8MB/35W/DDR4-2400 | Intel HD 630 | Quadro P600 2GB | 16GB SO-DIMM DDR4-2400 Non-ECC | None | 1TB M.2 PCIe NVMe Opal | None | Intel 8265 ac, 2x2, vPro + BT4.1 | Stand | None | USB/USB | Windows 10 Pro 64 | 3-year | No | 06/17 |
| 30C20027US | ThinkStation P320 Tiny | US | Core i7-6700T 4C/2.8GHz/8MB/35W/DDR4-2133 | Intel HD 530 | Quadro P600 2GB | 16GB SO-DIMM DDR4-2400 Non-ECC | None | 1TB M.2 PCIe NVMe Opal | None | Intel 8265 ac, 2x2, vPro + BT4.1 | Stand | None | USB/USB | Windows 10 DG Windows 7 Pro 64 | 3-year | No | 06/17 |
| 30C20028US | ThinkStation P320 Tiny | US | Core i5-6500T 4C/2.5GHz/6MB/35W/DDR4-2133 | Intel HD 530 | Quadro P600 2GB | 16GB SO-DIMM DDR4-2400 Non-ECC | None | 1TB M.2 PCIe NVMe Opal | None | Intel 8265 ac, 2x2, vPro + BT4.1 | Stand | None | USB/USB | Windows 10 DG Windows 7 Pro 64 | 3-year | No | 06/17 |



ThinkStation P320 Tower Platform Specifications

Product Specifications Reference (PSREF)

| Components | Specification | | | | | | | | | | | | | | | | | | | | | | | | | | | | | | | | | | | | | | | | | | | | | | | | | | |
|--------------------------------|--|--|-----------------------------|-----------------------------|-----------------------------|-----------------------------|-----------------------------|-----------------------------|-----------------------------|-----------------------------|-----------------------------|---------------------------|-----------------------------|-----------------------------|-----------------------------|-----------------------------|---------------------------|-----------------------------|-----------------------------|-----------------------------|-----------------------------|--------------|-----------------------------|--------------|-----------------------------|--------------|---------------------------|--------------|---------------------------|--------------|-----------------------------|-------------|-----|-----|-----|----------|--------------|-----|-----|-----|----------|--------------|------|-----|-----|------|--------------|------|-----|------|------|
| Chipset | Intel C236 Chipset | | | | | | | | | | | | | | | | | | | | | | | | | | | | | | | | | | | | | | | | | | | | | | | | | | |
| Intel AMT | Intel Active Management Technology 11 on Xeon models, Intel Standard Manageability on other models | | | | | | | | | | | | | | | | | | | | | | | | | | | | | | | | | | | | | | | | | | | | | | | | | | |
| Processor | One Intel "Kabylake" or "Skylake" processor as listed: "Kaby Lake" | | | | | | | | | | | | | | | | | | | | | | | | | | | | | | | | | | | | | | | | | | | | | | | | | | |
| | <table border="1"> <tbody> <tr><td>Xeon E3-1280 v6</td><td>4C/3.9GHz/8MB/72W/DDR4-2400</td></tr> <tr><td>Xeon E3-1275 v6</td><td>4C/3.8GHz/8MB/73W/DDR4-2400</td></tr> <tr><td>Xeon E3-1270 v6</td><td>4C/3.8GHz/8MB/72W/DDR4-2400</td></tr> <tr><td>Xeon E3-1245 v6</td><td>4C/3.7GHz/8MB/73W/DDR4-2400</td></tr> <tr><td>Xeon E3-1240 v6</td><td>4C/3.7GHz/8MB/72W/DDR4-2400</td></tr> <tr><td>Xeon E3-1230 v6</td><td>4C/3.5GHz/8MB/72W/DDR4-2400</td></tr> <tr><td>Xeon E3-1225 v6</td><td>4C/3.3GHz/8MB/73W/DDR4-2400</td></tr> <tr><td>Xeon E3-1220 v6</td><td>4C/3GHz/8MB/72W/DDR4-2400</td></tr> <tr><td>Core i7-7700K</td><td>4C/4.2GHz/8MB/91W/DDR4-2400</td></tr> <tr><td>Core i7-7700</td><td>4C/3.6GHz/8MB/65W/DDR4-2400</td></tr> <tr><td>Core i5-7600</td><td>4C/3.5GHz/6MB/65W/DDR4-2400</td></tr> <tr><td>Core i5-7500</td><td>4C/3.4GHz/6MB/65W/DDR4-2400</td></tr> <tr><td>Core i5-7400</td><td>4C/3GHz/6MB/65W/DDR4-2400</td></tr> <tr><td>Core i3-7300</td><td>2C/4GHz/4MB/51W/DDR4-2400</td></tr> <tr><td>Core i3-7100</td><td>2C/3.9GHz/3MB/51W/DDR4-2400</td></tr> </tbody> </table> | Xeon E3-1280 v6 | 4C/3.9GHz/8MB/72W/DDR4-2400 | Xeon E3-1275 v6 | 4C/3.8GHz/8MB/73W/DDR4-2400 | Xeon E3-1270 v6 | 4C/3.8GHz/8MB/72W/DDR4-2400 | Xeon E3-1245 v6 | 4C/3.7GHz/8MB/73W/DDR4-2400 | Xeon E3-1240 v6 | 4C/3.7GHz/8MB/72W/DDR4-2400 | Xeon E3-1230 v6 | 4C/3.5GHz/8MB/72W/DDR4-2400 | Xeon E3-1225 v6 | 4C/3.3GHz/8MB/73W/DDR4-2400 | Xeon E3-1220 v6 | 4C/3GHz/8MB/72W/DDR4-2400 | Core i7-7700K | 4C/4.2GHz/8MB/91W/DDR4-2400 | Core i7-7700 | 4C/3.6GHz/8MB/65W/DDR4-2400 | Core i5-7600 | 4C/3.5GHz/6MB/65W/DDR4-2400 | Core i5-7500 | 4C/3.4GHz/6MB/65W/DDR4-2400 | Core i5-7400 | 4C/3GHz/6MB/65W/DDR4-2400 | Core i3-7300 | 2C/4GHz/4MB/51W/DDR4-2400 | Core i3-7100 | 2C/3.9GHz/3MB/51W/DDR4-2400 | | | | | | | | | | | | | | | | | | | | |
| | Xeon E3-1280 v6 | 4C/3.9GHz/8MB/72W/DDR4-2400 | | | | | | | | | | | | | | | | | | | | | | | | | | | | | | | | | | | | | | | | | | | | | | | | | |
| | Xeon E3-1275 v6 | 4C/3.8GHz/8MB/73W/DDR4-2400 | | | | | | | | | | | | | | | | | | | | | | | | | | | | | | | | | | | | | | | | | | | | | | | | | |
| | Xeon E3-1270 v6 | 4C/3.8GHz/8MB/72W/DDR4-2400 | | | | | | | | | | | | | | | | | | | | | | | | | | | | | | | | | | | | | | | | | | | | | | | | | |
| | Xeon E3-1245 v6 | 4C/3.7GHz/8MB/73W/DDR4-2400 | | | | | | | | | | | | | | | | | | | | | | | | | | | | | | | | | | | | | | | | | | | | | | | | | |
| | Xeon E3-1240 v6 | 4C/3.7GHz/8MB/72W/DDR4-2400 | | | | | | | | | | | | | | | | | | | | | | | | | | | | | | | | | | | | | | | | | | | | | | | | | |
| | Xeon E3-1230 v6 | 4C/3.5GHz/8MB/72W/DDR4-2400 | | | | | | | | | | | | | | | | | | | | | | | | | | | | | | | | | | | | | | | | | | | | | | | | | |
| | Xeon E3-1225 v6 | 4C/3.3GHz/8MB/73W/DDR4-2400 | | | | | | | | | | | | | | | | | | | | | | | | | | | | | | | | | | | | | | | | | | | | | | | | | |
| | Xeon E3-1220 v6 | 4C/3GHz/8MB/72W/DDR4-2400 | | | | | | | | | | | | | | | | | | | | | | | | | | | | | | | | | | | | | | | | | | | | | | | | | |
| | Core i7-7700K | 4C/4.2GHz/8MB/91W/DDR4-2400 | | | | | | | | | | | | | | | | | | | | | | | | | | | | | | | | | | | | | | | | | | | | | | | | | |
| | Core i7-7700 | 4C/3.6GHz/8MB/65W/DDR4-2400 | | | | | | | | | | | | | | | | | | | | | | | | | | | | | | | | | | | | | | | | | | | | | | | | | |
| | Core i5-7600 | 4C/3.5GHz/6MB/65W/DDR4-2400 | | | | | | | | | | | | | | | | | | | | | | | | | | | | | | | | | | | | | | | | | | | | | | | | | |
| | Core i5-7500 | 4C/3.4GHz/6MB/65W/DDR4-2400 | | | | | | | | | | | | | | | | | | | | | | | | | | | | | | | | | | | | | | | | | | | | | | | | | |
| | Core i5-7400 | 4C/3GHz/6MB/65W/DDR4-2400 | | | | | | | | | | | | | | | | | | | | | | | | | | | | | | | | | | | | | | | | | | | | | | | | | |
| | Core i3-7300 | 2C/4GHz/4MB/51W/DDR4-2400 | | | | | | | | | | | | | | | | | | | | | | | | | | | | | | | | | | | | | | | | | | | | | | | | | |
| | Core i3-7100 | 2C/3.9GHz/3MB/51W/DDR4-2400 | | | | | | | | | | | | | | | | | | | | | | | | | | | | | | | | | | | | | | | | | | | | | | | | | |
| | | "Skylake" | | | | | | | | | | | | | | | | | | | | | | | | | | | | | | | | | | | | | | | | | | | | | | | | | |
| | | <table border="1"> <tbody> <tr><td>Xeon E3-1245 v5</td><td>4C/3.5GHz/8MB/80W/DDR4-2133</td></tr> <tr><td>Xeon E3-1240 v5</td><td>4C/3.5GHz/8MB/80W/DDR4-2133</td></tr> <tr><td>Xeon E3-1230 v5</td><td>4C/3.4GHz/8MB/80W/DDR4-2133</td></tr> <tr><td>Xeon E3-1225 v5</td><td>4C/3.3GHz/8MB/80W/DDR4-2133</td></tr> <tr><td>Xeon E3-1220 v5</td><td>4C/3GHz/8MB/80W/DDR4-2133</td></tr> <tr><td>Core i7-6700</td><td>4C/3.4GHz/8MB/65W/DDR4-2133</td></tr> <tr><td>Core i5-6500</td><td>4C/3.2GHz/6MB/65W/DDR4-2133</td></tr> <tr><td>Core i5-6400</td><td>4C/2.7GHz/6MB/65W/DDR4-2133</td></tr> <tr><td>Core i3-6100</td><td>2C/3.7GHz/3MB/51W/DDR4-2133</td></tr> </tbody> </table> | Xeon E3-1245 v5 | 4C/3.5GHz/8MB/80W/DDR4-2133 | Xeon E3-1240 v5 | 4C/3.5GHz/8MB/80W/DDR4-2133 | Xeon E3-1230 v5 | 4C/3.4GHz/8MB/80W/DDR4-2133 | Xeon E3-1225 v5 | 4C/3.3GHz/8MB/80W/DDR4-2133 | Xeon E3-1220 v5 | 4C/3GHz/8MB/80W/DDR4-2133 | Core i7-6700 | 4C/3.4GHz/8MB/65W/DDR4-2133 | Core i5-6500 | 4C/3.2GHz/6MB/65W/DDR4-2133 | Core i5-6400 | 4C/2.7GHz/6MB/65W/DDR4-2133 | Core i3-6100 | 2C/3.7GHz/3MB/51W/DDR4-2133 | | | | | | | | | | | | | | | | | | | | | | | | | | | | | | | |
| | Xeon E3-1245 v5 | 4C/3.5GHz/8MB/80W/DDR4-2133 | | | | | | | | | | | | | | | | | | | | | | | | | | | | | | | | | | | | | | | | | | | | | | | | | |
| Xeon E3-1240 v5 | 4C/3.5GHz/8MB/80W/DDR4-2133 | | | | | | | | | | | | | | | | | | | | | | | | | | | | | | | | | | | | | | | | | | | | | | | | | | |
| Xeon E3-1230 v5 | 4C/3.4GHz/8MB/80W/DDR4-2133 | | | | | | | | | | | | | | | | | | | | | | | | | | | | | | | | | | | | | | | | | | | | | | | | | | |
| Xeon E3-1225 v5 | 4C/3.3GHz/8MB/80W/DDR4-2133 | | | | | | | | | | | | | | | | | | | | | | | | | | | | | | | | | | | | | | | | | | | | | | | | | | |
| Xeon E3-1220 v5 | 4C/3GHz/8MB/80W/DDR4-2133 | | | | | | | | | | | | | | | | | | | | | | | | | | | | | | | | | | | | | | | | | | | | | | | | | | |
| Core i7-6700 | 4C/3.4GHz/8MB/65W/DDR4-2133 | | | | | | | | | | | | | | | | | | | | | | | | | | | | | | | | | | | | | | | | | | | | | | | | | | |
| Core i5-6500 | 4C/3.2GHz/6MB/65W/DDR4-2133 | | | | | | | | | | | | | | | | | | | | | | | | | | | | | | | | | | | | | | | | | | | | | | | | | | |
| Core i5-6400 | 4C/2.7GHz/6MB/65W/DDR4-2133 | | | | | | | | | | | | | | | | | | | | | | | | | | | | | | | | | | | | | | | | | | | | | | | | | | |
| Core i3-6100 | 2C/3.7GHz/3MB/51W/DDR4-2133 | | | | | | | | | | | | | | | | | | | | | | | | | | | | | | | | | | | | | | | | | | | | | | | | | | |
| Memory DIMM slots | 4 DIMM slots, 2-channel (integrated memory controller in processor) | | | | | | | | | | | | | | | | | | | | | | | | | | | | | | | | | | | | | | | | | | | | | | | | | | |
| Memory type/capacity | Up to 64GB ECC/non-ECC (4 x 16GB), DDR4-2400. UDIMM. "Skylake" processor supports up to DDR4-2133. Core i7 and i5 processors cannot support ECC. | | | | | | | | | | | | | | | | | | | | | | | | | | | | | | | | | | | | | | | | | | | | | | | | | | |
| Intel HD Graphics in processor | Integrated Intel HD P530 in Xeon E3-12x5 v5 processors; or Intel HD 530 in Core i7, i5, or i3 processors. Works along with discrete graphics to support multi-display, enables three display connectors (2 DP, 1 VGA) on rear. | | | | | | | | | | | | | | | | | | | | | | | | | | | | | | | | | | | | | | | | | | | | | | | | | | |
| Discrete graphics | Two PCI Express 3.0 x16 slots for graphics adapters. Up to two Quadro P1000 on 250 watts models. Or up to two Quadro P2000, or up to one Quadro P4000 on 400 watts models. Supports the following NVIDIA graphics adapters: | | | | | | | | | | | | | | | | | | | | | | | | | | | | | | | | | | | | | | | | | | | | | | | | | | |
| | <table border="1"> <thead> <tr> <th>Adapter</th> <th>Cores</th> <th>Memory</th> <th>Power</th> <th>Connector</th> </tr> </thead> <tbody> <tr><td>NVS 310</td><td>48</td><td>1GB</td><td>19.5W</td><td>2xDP</td></tr> <tr><td>NVS 315</td><td>48</td><td>1GB</td><td>19.5W</td><td>2xDVI-I SL/2xDP</td></tr> <tr><td>NVS 510</td><td>192</td><td>2GB</td><td>33.4W</td><td>4xmini DP</td></tr> <tr><td>NVS 810</td><td>1024</td><td>4GB</td><td>68W</td><td>8xmini DP</td></tr> <tr><td>Quadro P400</td><td>256</td><td>2GB</td><td>30W</td><td>3xminiDP</td></tr> <tr><td>Quadro P600</td><td>384</td><td>2GB</td><td>40W</td><td>4xminiDP</td></tr> <tr><td>Quadro P1000</td><td>640</td><td>4GB</td><td>47W</td><td>4xminiDP</td></tr> <tr><td>Quadro P2000</td><td>1024</td><td>5GB</td><td>75W</td><td>4xDP</td></tr> <tr><td>Quadro P4000</td><td>1792</td><td>8GB</td><td>105W</td><td>4xDP</td></tr> </tbody> </table> | Adapter | Cores | Memory | Power | Connector | NVS 310 | 48 | 1GB | 19.5W | 2xDP | NVS 315 | 48 | 1GB | 19.5W | 2xDVI-I SL/2xDP | NVS 510 | 192 | 2GB | 33.4W | 4xmini DP | NVS 810 | 1024 | 4GB | 68W | 8xmini DP | Quadro P400 | 256 | 2GB | 30W | 3xminiDP | Quadro P600 | 384 | 2GB | 40W | 4xminiDP | Quadro P1000 | 640 | 4GB | 47W | 4xminiDP | Quadro P2000 | 1024 | 5GB | 75W | 4xDP | Quadro P4000 | 1792 | 8GB | 105W | 4xDP |
| | Adapter | Cores | Memory | Power | Connector | | | | | | | | | | | | | | | | | | | | | | | | | | | | | | | | | | | | | | | | | | | | | | |
| | NVS 310 | 48 | 1GB | 19.5W | 2xDP | | | | | | | | | | | | | | | | | | | | | | | | | | | | | | | | | | | | | | | | | | | | | | |
| | NVS 315 | 48 | 1GB | 19.5W | 2xDVI-I SL/2xDP | | | | | | | | | | | | | | | | | | | | | | | | | | | | | | | | | | | | | | | | | | | | | | |
| | NVS 510 | 192 | 2GB | 33.4W | 4xmini DP | | | | | | | | | | | | | | | | | | | | | | | | | | | | | | | | | | | | | | | | | | | | | | |
| | NVS 810 | 1024 | 4GB | 68W | 8xmini DP | | | | | | | | | | | | | | | | | | | | | | | | | | | | | | | | | | | | | | | | | | | | | | |
| | Quadro P400 | 256 | 2GB | 30W | 3xminiDP | | | | | | | | | | | | | | | | | | | | | | | | | | | | | | | | | | | | | | | | | | | | | | |
| | Quadro P600 | 384 | 2GB | 40W | 4xminiDP | | | | | | | | | | | | | | | | | | | | | | | | | | | | | | | | | | | | | | | | | | | | | | |
| | Quadro P1000 | 640 | 4GB | 47W | 4xminiDP | | | | | | | | | | | | | | | | | | | | | | | | | | | | | | | | | | | | | | | | | | | | | | |
| Quadro P2000 | 1024 | 5GB | 75W | 4xDP | | | | | | | | | | | | | | | | | | | | | | | | | | | | | | | | | | | | | | | | | | | | | | | |
| Quadro P4000 | 1792 | 8GB | 105W | 4xDP | | | | | | | | | | | | | | | | | | | | | | | | | | | | | | | | | | | | | | | | | | | | | | | |
| Onboard drive controller | Five onboard SATA 6.0Gb/s connectors for optical and disk drives plus one SATA connector for optional eSATA. RAID 0, 1, 5, 10 support | | | | | | | | | | | | | | | | | | | | | | | | | | | | | | | | | | | | | | | | | | | | | | | | | | |
| Drive Bays | Two external 5.25" bays, two internal 3.5" bays (see right). Up to one 9mm optical plus 4 x 3.5" disk drive bays plus two M.2 NVMe SSD | | | | | | | | | | | | | | | | | | | | | | | | | | | | | | | | | | | | | | | | | | | | | | | | | | |
| Supporting disk drives | 3.5" SATA HDD (7.2K 6Gbs) | | | | | | | | | | | | | | | | | | | | | | | | | | | | | | | | | | | | | | | | | | | | | | | | | | |
| | 2.5" SATA SSD (6Gbs) | | | | | | | | | | | | | | | | | | | | | | | | | | | | | | | | | | | | | | | | | | | | | | | | | | |
| | M.2 NVMe SSD | | | | | | | | | | | | | | | | | | | | | | | | | | | | | | | | | | | | | | | | | | | | | | | | | | |
| Max internal storage | 16TB (4 x 4TB 3.5" HDDs) plus 2TB (2 x 1TB) M.2 NVMe SSD | | | | | | | | | | | | | | | | | | | | | | | | | | | | | | | | | | | | | | | | | | | | | | | | | | |
| Media reader | 9-in-1 card reader. Optional 29-in-1 card reader on selected models | | | | | | | | | | | | | | | | | | | | | | | | | | | | | | | | | | | | | | | | | | | | | | | | | | |
| Power supply | One 250 watts with variable speed fan, autosensing, Climate Savers Computing Bronze, 80 PLUS Bronze qualified. Or one 400 watts with variable speed fan, autosensing, Climate Savers Computing Platinum, 80 PLUS Platinum qualified. US models use 400 watts PSU | | | | | | | | | | | | | | | | | | | | | | | | | | | | | | | | | | | | | | | | | | | | | | | | | | |

| Components | Specification |
|------------------------------|--|
| Onboard Ethernet | One onboard gigabit ethernet, Intel I219LM, supports Wake-on-LAN |
| HD Audio | Realtek ALC662 codec |
| TPM | Standard, TCG 2.0-compliant |
| Front ports | Two USB 3.0, microphone (3.5mm), headphone (3.5mm) |
| Rear ports | 1 VGA and 2 DisplayPort (for Intel HD Graphics models only), two USB 2.0, four USB 3.0, one serial (9-pin), one ethernet (RJ-45), three analog audio ports (line-in, line-out, mic-in) |
| Mechanical | <ul style="list-style-type: none"> Raven black color; metal case 6.89"W x 16.77"D x 14.8"H 175mm W x 426mm D x 376mm H 28.66 lb (13kg) max configuration 25-liter |
| Environmental certifications | GREENGUARD certified/RoHS-compliant/EPEAT Gold rating/ENERGY STAR 6.1 qualified |
| Limited warranty | 1 or 3-year limited onsite service with 9x5/NBD. Some parts are Customer Replaceable Units. |
| ISV certifications | please visit www.thinkworkstations.com/isv-certifications/ |

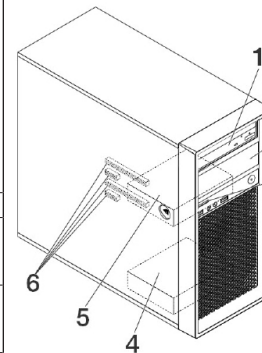

Drive Bays and PCIe Slots

| | |
|-----------------|--|
| Bay 1 and Bay 2 | 5.25", support one of the following: HH optical/flex module/9mm optical+3.5" HDD bay/ 3.5" HDD bay/Front Access Storage Enclosure (FASE) <i>Note:</i> 1. Flex module supports one or more of the following: 9mm optical/29-in-1 reader/front IEEE 1394/front eSATA. 2. Up to one flex module/FASE per system. |
| Bay 3 | Optional 9-in-1 single slot reader |
| Bay 4 | Standard 3.5" HDD bay |
| Bay 5 | Standard 3.5" HDD bay |
| 6 -Slots | Four PCIe slots (top-down): Slot 1: Half length, full height, PCIe 3.0 x16 (near CPU) Slot 2: Half length, full height, PCIe 3.0 x1 Slot 3: Half length, full height, PCIe 3.0 x16 (x4 elec) Slot 4: Half length, full height, PCIe 3.0 x1 <i>Note:</i> 1. Both discrete graphics adapter and M.2 NVMe SSD should be installed on slot 1 or slot 3, the maximum quantity of discrete graphics adapter and M.2 NVMe SSD is 2. 2. When two discrete graphics adapters are used, no other PCIe card can be used. |

ThinkStation P320 Tower - TopSeller - 30BH - 1 of 4

Product Specifications Reference (PSREF)

| Model | Product | Region | Processor | Intel HD Graphics | Discrete Graphics | Memory | Internal Storage | M.2 PCIe SSD | Optical | Media Reader | Power Supply | Add-on Ports | Keyboard / Mouse | Operating System | Warranty | Global | Ann Date (mm/yy) |
|------------|------------|--------|---|-------------------|-------------------|-------------------------------|------------------------------|--------------|-----------|--------------|-------------------|--------------|------------------|-----------------------------|----------|--------|------------------|
| 30BH0022US | P320 Tower | US | Core i7-7700 4C/3.6GHz/8MB/65W/DDR4-2400 | Intel HD 630 | Open | 1x8GB UDIMM DDR4-2400 Non-ECC | 1x1TB HDD 7.2K 3.5" SATA6Gbs | None | HH DVD±RW | 9-in-1 | 250W Bronze Fixed | None | USB full/USB opt | Win10 Pro64 | 3-year | No | 04/17 |
| 30BH0023US | P320 Tower | US | Xeon E3-1245 v5 4C/3.5GHz/8MB/80W/DDR4-2133 | Intel HD P530 | Open | 1x8GB UDIMM DDR4-2400 Non-ECC | Open | 1x512GB Opal | HH DVD±RW | 9-in-1 | 250W Bronze Fixed | None | USB full/USB opt | Win7 Pro64 (Win10 Pro64 DG) | 3-year | No | 04/17 |
| 30BH0024US | P320 Tower | US | Core i7-7700 4C/3.6GHz/8MB/65W/DDR4-2400 | Intel HD 630 | Open | 1x8GB UDIMM DDR4-2400 Non-ECC | Open | 1x512GB Opal | HH DVD±RW | 9-in-1 | 250W Bronze Fixed | None | USB full/USB opt | Win10 Pro64 | 3-year | No | 04/17 |
| 30BH0025US | P320 Tower | US | Core i7-6700 4C/3.4GHz/8MB/65W/DDR4-2133 | Intel HD 530 | Open | 1x8GB UDIMM DDR4-2400 Non-ECC | Open | 1x512GB Opal | HH DVD±RW | 9-in-1 | 250W Bronze Fixed | None | USB full/USB opt | Win7 Pro64 (Win10 Pro64 DG) | 3-year | No | 04/17 |
| 30BH0026US | P320 Tower | US | Xeon E3-1240 v6 4C/3.7GHz/8MB/72W/DDR4-2400 | None | Quadro P2000 5GB | 2x8GB UDIMM DDR4-2400 Non-ECC | 1x1TB HDD 7.2K 3.5" SATA6Gbs | None | HH DVD±RW | 9-in-1 | 250W Bronze Fixed | None | USB full/USB opt | Win10 Pro64 | 3-year | No | 04/17 |
| 30BH0027US | P320 Tower | US | Core i7-7700K 4C/4.2GHz/8MB/91W/DDR4-2400 | Intel HD 630 | Open | 2x8GB UDIMM DDR4-2400 Non-ECC | Open | 1x256GB Opal | HH DVD±RW | 9-in-1 | 250W Bronze Fixed | None | USB full/USB opt | Win10 Pro64 | 3-year | No | 04/17 |
| 30BH0028US | P320 Tower | US | Core i5-7500 4C/3.4GHz/6MB/65W/DDR4-2400 | Intel HD 630 | Open | 1x8GB UDIMM DDR4-2400 Non-ECC | 1x1TB HDD 7.2K 3.5" SATA6Gbs | None | HH DVD±RW | 9-in-1 | 250W Bronze Fixed | None | USB full/USB opt | Win10 Pro64 | 3-year | No | 04/17 |
| 30BH0029US | P320 Tower | US | Core i7-7700 4C/3.6GHz/8MB/65W/DDR4-2400 | Intel HD 630 | Open | 2x8GB UDIMM DDR4-2400 Non-ECC | Open | 1x512GB Opal | HH DVD±RW | 9-in-1 | 250W Bronze Fixed | None | USB full/USB opt | Win10 Pro64 | 3-year | No | 04/17 |
| 30BH002AUS | P320 Tower | US | Core i5-6500 4C/3.2GHz/6MB/65W/DDR4-2133 | Intel HD 530 | Open | 1x8GB UDIMM DDR4-2400 Non-ECC | 1x1TB HDD 7.2K 3.5" SATA6Gbs | None | HH DVD±RW | 9-in-1 | 250W Bronze Fixed | None | USB full/USB opt | Win7 Pro64 (Win10 Pro64 DG) | 3-year | No | 04/17 |
| 30BH002BUS | P320 Tower | US | Xeon E3-1240 v5 4C/3.5GHz/8MB/80W/DDR4-2133 | None | Quadro P600 2GB | 1x8GB UDIMM DDR4-2400 Non-ECC | 1x1TB HDD 7.2K 3.5" SATA6Gbs | None | HH DVD±RW | 9-in-1 | 250W Bronze Fixed | None | USB full/USB opt | Win7 Pro64 (Win10 Pro64 DG) | 3-year | No | 04/17 |
| 30BH002CUS | P320 Tower | US | Core i3-7100 2C/3.9GHz/3MB/51W/DDR4-2400 | Intel HD 630 | Open | 1x8GB UDIMM DDR4-2400 Non-ECC | 1x1TB HDD 7.2K 3.5" SATA6Gbs | None | HH DVD±RW | 9-in-1 | 250W Bronze Fixed | None | USB full/USB opt | Win10 Pro64 | 3-year | No | 04/17 |
| 30BH002DUS | P320 Tower | US | Core i7-7700K 4C/4.2GHz/8MB/91W/DDR4-2400 | Intel HD 630 | Open | 2x8GB UDIMM DDR4-2400 Non-ECC | 1x1TB HDD 7.2K 3.5" SATA6Gbs | None | HH DVD±RW | 9-in-1 | 250W Bronze Fixed | None | USB full/USB opt | Win10 Pro64 | 3-year | No | 04/17 |
| 30BH002EUS | P320 Tower | US | Core i7-7700 4C/3.6GHz/8MB/65W/DDR4-2400 | Intel HD 630 | Quadro P1000 4GB | 2x8GB UDIMM DDR4-2400 Non-ECC | 1x1TB HDD 7.2K 3.5" SATA6Gbs | None | HH DVD±RW | 9-in-1 | 250W Bronze Fixed | None | USB full/USB opt | Win10 Pro64 | 3-year | No | 04/17 |
| 30BH002FUS | P320 Tower | US | Core i3-6100 2C/3.7GHz/3MB/51W/DDR4-2133 | Intel HD 530 | Open | 1x8GB UDIMM DDR4-2400 Non-ECC | 1x1TB HDD 7.2K 3.5" SATA6Gbs | None | HH DVD±RW | 9-in-1 | 250W Bronze Fixed | None | USB full/USB opt | Win7 Pro64 (Win10 Pro64 DG) | 3-year | No | 04/17 |
| 30BH002GUS | P320 Tower | US | Core i5-6500 4C/3.2GHz/6MB/65W/DDR4-2133 | Intel HD 530 | Open | 1x8GB UDIMM DDR4-2400 Non-ECC | Open | 1x256GB Opal | HH DVD±RW | 9-in-1 | 250W Bronze Fixed | None | USB full/USB opt | Win7 Pro64 (Win10 Pro64 DG) | 3-year | No | 04/17 |

ThinkStation P320 Tower - TopSeller - 30BH - 2 of 4

Product Specifications Reference (PSREF)

| Model | Product | Region | Processor | Intel HD Graphics | Discrete Graphics | Memory | Internal Storage | M.2 PCIe SSD | Optical | Media Reader | Power Supply | Add-on Ports | Keyboard / Mouse | Operating System | Warranty | Global | Ann Date (mm/yy) |
|------------|------------|--------|--|-------------------|-------------------|--|------------------------------------|-----------------|--------------|--------------|-------------------------|--------------|---------------------|-----------------------------------|----------|--------|------------------|
| 30BH002HUS | P320 Tower | US | Xeon E3-1240 v6 4C/3.7GHz/8MB/72W/DDR4-2400 | None | Quadro P2000 5GB | 2x8GB UDIMM DDR4-2400 Non-ECC | Open | 1x512GB Opal | HH DVD±RW | 9-in-1 | 250W Bronze Fixed | None | USB full/USB opt | Win10 Pro64 | 3-year | No | 04/17 |
| 30BH002JUS | P320 Tower | US | Core i7-6700 4C/3.4GHz/8MB/65W/DDR4-2133 | Intel HD 530 | Quadro P1000 4GB | 2x8GB UDIMM DDR4-2400 Non-ECC | 1x1TB HDD 7.2K 3.5" SATA6Gbs | None | HH DVD±RW | 9-in-1 | 250W Bronze Fixed | None | USB full/USB opt | Win7 Pro64 (Win10 Pro64 DG) | 3-year | No | 04/17 |
| 30BH002KUS | P320 Tower | US | Core i7-7700 4C/3.6GHz/8MB/65W/DDR4-2400 | Intel HD 630 | Open | 2x8GB UDIMM DDR4-2400 Non-ECC | Open | 1x256GB Opal | HH DVD±RW | 9-in-1 | 250W Bronze Fixed | None | USB full/USB opt | Win10 Pro64 | 3-year | No | 04/17 |
| 30BH002LUS | P320 Tower | US | Core i7-7700 4C/3.6GHz/8MB/65W/DDR4-2400 | Intel HD 630 | Quadro P2000 5GB | 2x8GB UDIMM DDR4-2400 Non-ECC | Open | 1x512GB Opal | HH DVD±RW | 9-in-1 | 250W Bronze Fixed | None | USB full/USB opt | Win10 Pro64 | 3-year | No | 04/17 |
| 30BH002MUS | P320 Tower | US | Core i7-7700 4C/3.6GHz/8MB/65W/DDR4-2400 | Intel HD 630 | Quadro P2000 5GB | 2x8GB UDIMM DDR4-2400 Non-ECC | 1x2TB HDD 7.2K 3.5" SATA6Gbs | 1x512GB Opal | HH DVD±RW | 9-in-1 | 250W Bronze Fixed | None | USB full/USB opt | Win10 Pro64 | 3-year | No | 04/17 |
| 30BH002NUS | P320 Tower | US | Xeon E3-1230 v6 4C/3.5GHz/8MB/72W/DDR4-2400 | None | Quadro P400 2GB | 1x8GB UDIMM DDR4-2400 Non-ECC | 1x1TB HDD 7.2K 3.5" SATA6Gbs | None | HH DVD±RW | 9-in-1 | 250W Bronze Fixed | None | USB full/USB opt | Win10 Pro64 | 3-year | No | 04/17 |
| 30BH002PUS | P320 Tower | US | Core i7-7700 4C/3.6GHz/8MB/65W/DDR4-2400 | Intel HD 630 | Open | 2x8GB UDIMM DDR4-2400 Non-ECC | Open | 1x1TB Opal | HH DVD±RW | 9-in-1 | 250W Bronze Fixed | None | USB full/USB opt | Win10 Pro64 | 3-year | No | 04/17 |
| 30BH002QUS | P320 Tower | US | Core i7-6700 4C/3.4GHz/8MB/65W/DDR4-2133 | Intel HD 530 | Open | 2x8GB UDIMM DDR4-2400 Non-ECC | Open | 1x256GB Opal | HH DVD±RW | 9-in-1 | 250W Bronze Fixed | None | USB full/USB opt | Win7 Pro64 (Win10 Pro64 DG) | 3-year | No | 04/17 |
| 30BH002RUS | P320 Tower | US | Core i7-6700 4C/3.4GHz/8MB/65W/DDR4-2133 | Intel HD 530 | Open | 1x8GB UDIMM DDR4-2400 Non-ECC | 1x1TB HDD 7.2K 3.5" SATA6Gbs | None | HH DVD±RW | 9-in-1 | 250W Bronze Fixed | None | USB full/USB opt | Win7 Pro64 (Win10 Pro64 DG) | 3-year | No | 04/17 |
| 30BH002SUS | P320 Tower | US | Xeon E3-1245 v6 4C/3.7GHz/8MB/73W/DDR4-2400 | Intel HD P630 | Open | 2x8GB UDIMM DDR4-2400 Non-ECC | Open | 1x512GB Opal | HH DVD±RW | 9-in-1 | 250W Bronze Fixed | None | USB full/USB opt | Win10 Pro64 | 3-year | No | 04/17 |
| 30BH002TUS | P320 Tower | US | Core i5-7500 4C/3.4GHz/6MB/65W/DDR4-2400 | Intel HD 630 | Open | 1x8GB UDIMM DDR4-2400 Non-ECC | Open | 1x256GB Opal | HH DVD±RW | 9-in-1 | 250W Bronze Fixed | None | USB full/USB opt | Win10 Pro64 | 3-year | No | 04/17 |
| 30BH002UUS | P320 Tower | US | Core i7-6700 4C/3.4GHz/8MB/65W/DDR4-2133 | Intel HD 530 | Quadro P2000 5GB | 2x8GB UDIMM DDR4-2400 Non-ECC | Open | 1x512GB Opal | HH DVD±RW | 9-in-1 | 250W Bronze Fixed | None | USB full/USB opt | Win7 Pro64 (Win10 Pro64 DG) | 3-year | No | 04/17 |
| 30BH002VUS | P320 Tower | US | Xeon E3-1240 v5 4C/3.5GHz/8MB/80W/DDR4-2133 | None | Quadro P2000 5GB | 2x8GB UDIMM DDR4-2400 Non-ECC | 1x1TB HDD 7.2K 3.5" SATA6Gbs | None | HH DVD±RW | 9-in-1 | 250W Bronze Fixed | None | USB full/USB opt | Win7 Pro64 (Win10 Pro64 DG) | 3-year | No | 04/17 |
| 30BH002WUS | P320 Tower | US | Xeon E3-1245 v6 4C/3.7GHz/8MB/73W/DDR4-2400 | Intel HD P630 | Open | 1x8GB UDIMM DDR4-2400 Non-ECC | Open | 1x512GB Opal | HH DVD±RW | 9-in-1 | 250W Bronze Fixed | None | USB full/USB opt | Win10 Pro64 | 3-year | No | 04/17 |
| 30BH002XUS | P320 Tower | US | Xeon E3-1230 v5 4C/3.4GHz/8MB/80W/DDR4-2133 | None | Quadro P400 2GB | 1x8GB UDIMM DDR4-2400 Non-ECC | 1x1TB HDD 7.2K 3.5" SATA6Gbs | None | HH DVD±RW | 9-in-1 | 250W Bronze Fixed | None | USB full/USB opt | Win7 Pro64 (Win10 Pro64 DG) | 3-year | No | 04/17 |

ThinkStation P320 Tower - TopSeller - 30BH - 3 of 4

Product Specifications Reference (PSREF)

| Model | Product | Region | Processor | Intel HD Graphics | Discrete Graphics | Memory | Internal Storage | M.2 PCIe SSD | Optical | Media Reader | Power Supply | Add-on Ports | Keyboard / Mouse | Operating System | Warranty | Global | Ann Date (mm/yy) |
|------------|------------|--------|--|-------------------|-------------------|----------------------------------|--------------------------------|--------------|-----------|--------------|-------------------|--------------|------------------|-----------------------------|----------|--------|------------------|
| 30BH002YUS | P320 Tower | US | Xeon E3-1270 v6 4C/3.8GHz/8MB/72W/DDR4-2400 | None | Quadro P2000 5GB | 2x8GB UDIMM DDR4-2400 Non-ECC | Open | 1x512GB Opal | HH DVD±RW | 9-in-1 | 250W Bronze Fixed | None | USB full/USB opt | Win10 Pro64 | 3-year | No | 04/17 |
| 30BH0030US | P320 Tower | US | Xeon E3-1240 v5 4C/3.5GHz/8MB/80W/DDR4-2133 | None | Quadro P2000 5GB | 2x8GB UDIMM DDR4-2400 Non-ECC | Open | 1x512GB Opal | HH DVD±RW | 9-in-1 | 250W Bronze Fixed | None | USB full/USB opt | Win7 Pro64 (Win10 Pro64 DG) | 3-year | No | 04/17 |
| 30BH0031US | P320 Tower | US | Core i7-6700 4C/3.4GHz/8MB/65W/DDR4-2133 | Intel HD 530 | Quadro P2000 5GB | 2x8GB UDIMM DDR4-2400 Non-ECC | 1x2TB HDD 7.2K 3.5" SATA6Gbs | 1x512GB Opal | HH DVD±RW | 9-in-1 | 250W Bronze Fixed | None | USB full/USB opt | Win7 Pro64 (Win10 Pro64 DG) | 3-year | No | 04/17 |
| 30BH0032US | P320 Tower | US | Xeon E3-1240 v6 4C/3.7GHz/8MB/72W/DDR4-2400 | None | Quadro P600 2GB | 1x8GB UDIMM DDR4-2400 Non-ECC | 1x1TB HDD 7.2K 3.5" SATA6Gbs | None | HH DVD±RW | 9-in-1 | 250W Bronze Fixed | None | USB full/USB opt | Win10 Pro64 | 3-year | No | 04/17 |
| 30BH0033US | P320 Tower | US | Xeon E3-1245 v5 4C/3.5GHz/8MB/80W/DDR4-2133 | Intel HD P530 | Open | 2x8GB UDIMM DDR4-2400 Non-ECC | Open | 1x512GB Opal | HH DVD±RW | 9-in-1 | 250W Bronze Fixed | None | USB full/USB opt | Win7 Pro64 (Win10 Pro64 DG) | 3-year | No | 04/17 |
| 30BH0034US | P320 Tower | US | Core i7-6700 4C/3.4GHz/8MB/65W/DDR4-2133 | Intel HD 530 | Open | 2x8GB UDIMM DDR4-2400 Non-ECC | Open | 1x512GB Opal | HH DVD±RW | 9-in-1 | 250W Bronze Fixed | None | USB full/USB opt | Win7 Pro64 (Win10 Pro64 DG) | 3-year | No | 04/17 |
| 30BH0035US | P320 Tower | US | Core i7-7700K 4C/4.2GHz/8MB/91W/DDR4-2400 | Intel HD 630 | Quadro P1000 4GB | 1x8GB UDIMM DDR4-2400 Non-ECC | 1x1TB SSD 2.5" SATA6Gbs Opal | None | HH DVD±RW | 9-in-1 | 250W Bronze Fixed | None | USB full/USB opt | Win10 Pro64 | 3-year | No | 04/17 |
| 30BH0036US | P320 Tower | US | Xeon E3-1245 v6 4C/3.7GHz/8MB/73W/DDR4-2400 | Intel HD P630 | Open | 2x8GB UDIMM DDR4-2400 ECC | Open | 1x512GB Opal | HH DVD±RW | 9-in-1 | 250W Bronze Fixed | None | USB full/USB opt | Win10 Pro64 | 3-year | No | 04/17 |
| 30BH0037US | P320 Tower | US | Core i5-7500 4C/3.4GHz/6MB/65W/DDR4-2400 | Intel HD 630 | Quadro P600 2GB | 1x8GB UDIMM DDR4-2400 Non-ECC | 1x512GB SSD 2.5" SATA6Gbs Opal | None | HH DVD±RW | 9-in-1 | 250W Bronze Fixed | None | USB full/USB opt | Win10 Pro64 | 3-year | No | 04/17 |
| 30BH0038US | P320 Tower | US | Core i7-7700K 4C/4.2GHz/8MB/91W/DDR4-2400 | Intel HD 630 | Quadro P400 2GB | 1x8GB UDIMM DDR4-2400 Non-ECC | 1x1TB SSD 2.5" SATA6Gbs Opal | None | HH DVD±RW | 9-in-1 | 250W Bronze Fixed | None | USB full/USB opt | Win10 Pro64 | 3-year | No | 04/17 |
| 30BH0039US | P320 Tower | US | Core i3-7100 2C/3.9GHz/3MB/51W/DDR4-2400 | Intel HD 630 | Quadro P600 2GB | 1x8GB UDIMM DDR4-2400 Non-ECC | 1x1TB HDD 7.2K 3.5" SATA6Gbs | None | HH DVD±RW | 9-in-1 | 250W Bronze Fixed | None | USB full/USB opt | Win10 Pro64 | 3-year | No | 04/17 |
| 30BH003AUS | P320 Tower | US | Core i7-7700 4C/3.6GHz/8MB/65W/DDR4-2400 | Intel HD 630 | Quadro P600 2GB | 1x8GB UDIMM DDR4-2400 Non-ECC | 1x512GB SSD 2.5" SATA6Gbs Opal | None | HH DVD±RW | 9-in-1 | 250W Bronze Fixed | None | USB full/USB opt | Win10 Pro64 | 3-year | No | 04/17 |
| 30BH003BUS | P320 Tower | US | Core i7-7700K 4C/4.2GHz/8MB/91W/DDR4-2400 | Intel HD 630 | Quadro P600 2GB | 1x8GB UDIMM DDR4-2400 Non-ECC | 1x1TB SSD 2.5" SATA6Gbs Opal | None | HH DVD±RW | 9-in-1 | 250W Bronze Fixed | None | USB full/USB opt | Win10 Pro64 | 3-year | No | 04/17 |
| 30BH003CUS | P320 Tower | US | Core i7-7700 4C/3.6GHz/8MB/65W/DDR4-2400 | Intel HD 630 | Quadro P600 2GB | 1x8GB UDIMM DDR4-2400 Non-ECC | 1x1TB HDD 7.2K 3.5" SATA6Gbs | None | HH DVD±RW | 9-in-1 | 250W Bronze Fixed | None | USB full/USB opt | Win10 Pro64 | 3-year | No | 04/17 |
| 30BH003DUS | P320 Tower | US | Core i5-7500 4C/3.4GHz/6MB/65W/DDR4-2400 | Intel HD 630 | Quadro P600 2GB | 1x8GB UDIMM DDR4-2400 Non-ECC | 1x1TB HDD 7.2K 3.5" SATA6Gbs | None | HH DVD±RW | 9-in-1 | 250W Bronze Fixed | None | USB full/USB opt | Win10 Pro64 | 3-year | No | 04/17 |

| Model | Product | Region | Processor | Intel HD Graphics | Discrete Graphics | Memory | Internal Storage | M.2 PCIe SSD | Optical | Media Reader | Power Supply | Add-on Ports | Keyboard / Mouse | Operating System | Warranty | Global | Ann Date (mm/yy) |
|------------|------------|--------|--|-------------------|-------------------|-------------------------------|--------------------------------|--------------|-----------|--------------|-------------------|--------------|------------------|------------------|----------|--------|------------------|
| 30BH003EUS | P320 Tower | US | Core i3-7100 2C/3.9GHz/3MB/51W/DDR4-2400 | Intel HD 630 | Quadro P600 2GB | 1x8GB UDIMM DDR4-2400 Non-ECC | 1x512GB SSD 2.5" SATA6Gbs Opal | None | HH DVD±RW | 9-in-1 | 250W Bronze Fixed | None | USB full/USB opt | Win10 Pro64 | 3-year | No | 04/17 |

ThinkStation P410 Platform Specifications

Product Specifications Reference (PSREF)

| Components | Specification | | | | | | | | | | | | | | | | | | | | | | | | | | | | | | | | | | | | | | | | | | | | | | | | | | | | | | | | | | | | | | | | | | | | | | | | | | | | | | | | | | | | | | | | | | | | | | | | | | | | | | |
|---------------------------------------|--|---|--------|---------------|-----------------|--------------|-----|---------|----|-----|-------|------|--|---------|----|-----|-------|-----------------|--|---------|-----|-----|-----|-----------|--|---------|------|-----|-----|-----------|--|-------------|-----|-----|-----|-------------|--|-------------|-----|-----|-----|-------------|--|--------------|-----|-----|-----|-----------|--|--------------|-----|-----|-----|------|--|--------------|------|-----|------|------|--|--------------|------|-----|------|---------------|--|-------------|-----|-----|-----|----------|--|-------------|-----|-----|-----|----------|--|--------------|-----|-----|-----|----------|--|--------------|------|-----|-----|------|--|--------------|------|-----|------|------|-----|--------------|------|------|------|---------------|--|
| Chipset | Intel C612 Platform Controller Hub (PCH) | | | | | | | | | | | | | | | | | | | | | | | | | | | | | | | | | | | | | | | | | | | | | | | | | | | | | | | | | | | | | | | | | | | | | | | | | | | | | | | | | | | | | | | | | | | | | | | | | | | | | | |
| System mgmt | Intel Active Management Technology 9 | | | | | | | | | | | | | | | | | | | | | | | | | | | | | | | | | | | | | | | | | | | | | | | | | | | | | | | | | | | | | | | | | | | | | | | | | | | | | | | | | | | | | | | | | | | | | | | | | | | | | | |
| Processor | Up to one 140W Intel Xeon E5-1600 v4 family processors. Some Intel Xeon E5-2600 v4 processors are also available: | | | | | | | | | | | | | | | | | | | | | | | | | | | | | | | | | | | | | | | | | | | | | | | | | | | | | | | | | | | | | | | | | | | | | | | | | | | | | | | | | | | | | | | | | | | | | | | | | | | | | | |
| | E5-2637 v4 | 4C/3.5GHz/15MB/135W/DDR4-2400 | | | | | | | | | | | | | | | | | | | | | | | | | | | | | | | | | | | | | | | | | | | | | | | | | | | | | | | | | | | | | | | | | | | | | | | | | | | | | | | | | | | | | | | | | | | | | | | | | | | | | |
| | E5-2623 v4 | 4C/2.6GHz/10MB/85W/DDR4-2133 | | | | | | | | | | | | | | | | | | | | | | | | | | | | | | | | | | | | | | | | | | | | | | | | | | | | | | | | | | | | | | | | | | | | | | | | | | | | | | | | | | | | | | | | | | | | | | | | | | | | | |
| | E5-2620 v4 | 8C/2.1GHz/20MB/85W/DDR4-2133 | | | | | | | | | | | | | | | | | | | | | | | | | | | | | | | | | | | | | | | | | | | | | | | | | | | | | | | | | | | | | | | | | | | | | | | | | | | | | | | | | | | | | | | | | | | | | | | | | | | | | |
| | E5-1680 v4 | 8C/3.4GHz/20MB/140W/DDR4-2400 333 | | | | | | | | | | | | | | | | | | | | | | | | | | | | | | | | | | | | | | | | | | | | | | | | | | | | | | | | | | | | | | | | | | | | | | | | | | | | | | | | | | | | | | | | | | | | | | | | | | | | | |
| | E5-1660 v4 | 8C/3.2GHz/20MB/140W/DDR4-2400 | | | | | | | | | | | | | | | | | | | | | | | | | | | | | | | | | | | | | | | | | | | | | | | | | | | | | | | | | | | | | | | | | | | | | | | | | | | | | | | | | | | | | | | | | | | | | | | | | | | | | |
| | E5-1650 v4 | 6C/3.6GHz/15MB/140W/DDR4-2400 | | | | | | | | | | | | | | | | | | | | | | | | | | | | | | | | | | | | | | | | | | | | | | | | | | | | | | | | | | | | | | | | | | | | | | | | | | | | | | | | | | | | | | | | | | | | | | | | | | | | | |
| | E5-1630 v4 | 4C/3.7GHz/10MB/140W/DDR4-2400 | | | | | | | | | | | | | | | | | | | | | | | | | | | | | | | | | | | | | | | | | | | | | | | | | | | | | | | | | | | | | | | | | | | | | | | | | | | | | | | | | | | | | | | | | | | | | | | | | | | | | |
| | E5-1620 v4 | 4C/3.5GHz/10MB/140W/DDR4-2400 | | | | | | | | | | | | | | | | | | | | | | | | | | | | | | | | | | | | | | | | | | | | | | | | | | | | | | | | | | | | | | | | | | | | | | | | | | | | | | | | | | | | | | | | | | | | | | | | | | | | | |
| E5-1607 v4 | 4C/3.1GHz/10MB/140W/DDR4-2133 | | | | | | | | | | | | | | | | | | | | | | | | | | | | | | | | | | | | | | | | | | | | | | | | | | | | | | | | | | | | | | | | | | | | | | | | | | | | | | | | | | | | | | | | | | | | | | | | | | | | | | |
| E5-1603 v4 | 4C/2.8GHz/10MB/140W/DDR4-2133 | | | | | | | | | | | | | | | | | | | | | | | | | | | | | | | | | | | | | | | | | | | | | | | | | | | | | | | | | | | | | | | | | | | | | | | | | | | | | | | | | | | | | | | | | | | | | | | | | | | | | | |
| Coprocessor | None | | | | | | | | | | | | | | | | | | | | | | | | | | | | | | | | | | | | | | | | | | | | | | | | | | | | | | | | | | | | | | | | | | | | | | | | | | | | | | | | | | | | | | | | | | | | | | | | | | | | | | |
| Memory DIMM slots | 4 DIMM sockets. 4-channel capable. RDIMM. ECC. DDR4-2400 | | | | | | | | | | | | | | | | | | | | | | | | | | | | | | | | | | | | | | | | | | | | | | | | | | | | | | | | | | | | | | | | | | | | | | | | | | | | | | | | | | | | | | | | | | | | | | | | | | | | | | |
| Memory capacity | 128GB (32GB x 4) | | | | | | | | | | | | | | | | | | | | | | | | | | | | | | | | | | | | | | | | | | | | | | | | | | | | | | | | | | | | | | | | | | | | | | | | | | | | | | | | | | | | | | | | | | | | | | | | | | | | | | |
| Graphics | Two PCIe 3.0 x16 slots, up to two NVIDIA Quadro M4000, or up to one Quadro P5000 | | | | | | | | | | | | | | | | | | | | | | | | | | | | | | | | | | | | | | | | | | | | | | | | | | | | | | | | | | | | | | | | | | | | | | | | | | | | | | | | | | | | | | | | | | | | | | | | | | | | | | |
| Supporting Graphics and GPU computing | <table border="1"> <thead> <tr> <th>Adapter</th> <th>Cores</th> <th>Memory</th> <th>Power</th> <th>Connector***</th> <th>SLI</th> </tr> </thead> <tbody> <tr> <td>NVS 310</td> <td>48</td> <td>1GB</td> <td>19.5W</td> <td>2xDP</td> <td></td> </tr> <tr> <td>NVS 315</td> <td>48</td> <td>1GB</td> <td>19.5W</td> <td>2xDVI-I SL/2xDP</td> <td></td> </tr> <tr> <td>NVS 510</td> <td>192</td> <td>2GB</td> <td>35W</td> <td>4xmini DP</td> <td></td> </tr> <tr> <td>NVS 810</td> <td>1024</td> <td>4GB</td> <td>68W</td> <td>8xmini DP</td> <td></td> </tr> <tr> <td>Quadro K420</td> <td>192</td> <td>2GB</td> <td>41W</td> <td>DVI-I DL+DP</td> <td></td> </tr> <tr> <td>Quadro K620</td> <td>384</td> <td>2GB</td> <td>45W</td> <td>DVI-I DL+DP</td> <td></td> </tr> <tr> <td>Quadro K1200</td> <td>512</td> <td>4GB</td> <td>45W</td> <td>4xmini DP</td> <td></td> </tr> <tr> <td>Quadro M2000</td> <td>768</td> <td>4GB</td> <td>75W</td> <td>4xDP</td> <td></td> </tr> <tr> <td>Quadro M4000</td> <td>1664</td> <td>8GB</td> <td>120W</td> <td>4xDP</td> <td></td> </tr> <tr> <td>Quadro M5000</td> <td>2048</td> <td>8GB</td> <td>150W</td> <td>DVI-I DL+4xDP</td> <td></td> </tr> <tr> <td>Quadro P400</td> <td>256</td> <td>2GB</td> <td>30W</td> <td>3xminiDP</td> <td></td> </tr> <tr> <td>Quadro P600</td> <td>384</td> <td>2GB</td> <td>40W</td> <td>4xminiDP</td> <td></td> </tr> <tr> <td>Quadro P1000</td> <td>640</td> <td>4GB</td> <td>47W</td> <td>4xminiDP</td> <td></td> </tr> <tr> <td>Quadro P2000</td> <td>1024</td> <td>5GB</td> <td>75W</td> <td>4xDP</td> <td></td> </tr> <tr> <td>Quadro P4000</td> <td>1792</td> <td>8GB</td> <td>105W</td> <td>4xDP</td> <td>SLI</td> </tr> <tr> <td>Quadro P5000</td> <td>2560</td> <td>16GB</td> <td>180W</td> <td>DVI-D DL+4xDP</td> <td></td> </tr> </tbody> </table> | Adapter | Cores | Memory | Power | Connector*** | SLI | NVS 310 | 48 | 1GB | 19.5W | 2xDP | | NVS 315 | 48 | 1GB | 19.5W | 2xDVI-I SL/2xDP | | NVS 510 | 192 | 2GB | 35W | 4xmini DP | | NVS 810 | 1024 | 4GB | 68W | 8xmini DP | | Quadro K420 | 192 | 2GB | 41W | DVI-I DL+DP | | Quadro K620 | 384 | 2GB | 45W | DVI-I DL+DP | | Quadro K1200 | 512 | 4GB | 45W | 4xmini DP | | Quadro M2000 | 768 | 4GB | 75W | 4xDP | | Quadro M4000 | 1664 | 8GB | 120W | 4xDP | | Quadro M5000 | 2048 | 8GB | 150W | DVI-I DL+4xDP | | Quadro P400 | 256 | 2GB | 30W | 3xminiDP | | Quadro P600 | 384 | 2GB | 40W | 4xminiDP | | Quadro P1000 | 640 | 4GB | 47W | 4xminiDP | | Quadro P2000 | 1024 | 5GB | 75W | 4xDP | | Quadro P4000 | 1792 | 8GB | 105W | 4xDP | SLI | Quadro P5000 | 2560 | 16GB | 180W | DVI-D DL+4xDP | |
| | Adapter | Cores | Memory | Power | Connector*** | SLI | | | | | | | | | | | | | | | | | | | | | | | | | | | | | | | | | | | | | | | | | | | | | | | | | | | | | | | | | | | | | | | | | | | | | | | | | | | | | | | | | | | | | | | | | | | | | | | | | |
| | NVS 310 | 48 | 1GB | 19.5W | 2xDP | | | | | | | | | | | | | | | | | | | | | | | | | | | | | | | | | | | | | | | | | | | | | | | | | | | | | | | | | | | | | | | | | | | | | | | | | | | | | | | | | | | | | | | | | | | | | | | | | | |
| | NVS 315 | 48 | 1GB | 19.5W | 2xDVI-I SL/2xDP | | | | | | | | | | | | | | | | | | | | | | | | | | | | | | | | | | | | | | | | | | | | | | | | | | | | | | | | | | | | | | | | | | | | | | | | | | | | | | | | | | | | | | | | | | | | | | | | | | |
| | NVS 510 | 192 | 2GB | 35W | 4xmini DP | | | | | | | | | | | | | | | | | | | | | | | | | | | | | | | | | | | | | | | | | | | | | | | | | | | | | | | | | | | | | | | | | | | | | | | | | | | | | | | | | | | | | | | | | | | | | | | | | | |
| | NVS 810 | 1024 | 4GB | 68W | 8xmini DP | | | | | | | | | | | | | | | | | | | | | | | | | | | | | | | | | | | | | | | | | | | | | | | | | | | | | | | | | | | | | | | | | | | | | | | | | | | | | | | | | | | | | | | | | | | | | | | | | | |
| | Quadro K420 | 192 | 2GB | 41W | DVI-I DL+DP | | | | | | | | | | | | | | | | | | | | | | | | | | | | | | | | | | | | | | | | | | | | | | | | | | | | | | | | | | | | | | | | | | | | | | | | | | | | | | | | | | | | | | | | | | | | | | | | | | |
| | Quadro K620 | 384 | 2GB | 45W | DVI-I DL+DP | | | | | | | | | | | | | | | | | | | | | | | | | | | | | | | | | | | | | | | | | | | | | | | | | | | | | | | | | | | | | | | | | | | | | | | | | | | | | | | | | | | | | | | | | | | | | | | | | | |
| | Quadro K1200 | 512 | 4GB | 45W | 4xmini DP | | | | | | | | | | | | | | | | | | | | | | | | | | | | | | | | | | | | | | | | | | | | | | | | | | | | | | | | | | | | | | | | | | | | | | | | | | | | | | | | | | | | | | | | | | | | | | | | | | |
| | Quadro M2000 | 768 | 4GB | 75W | 4xDP | | | | | | | | | | | | | | | | | | | | | | | | | | | | | | | | | | | | | | | | | | | | | | | | | | | | | | | | | | | | | | | | | | | | | | | | | | | | | | | | | | | | | | | | | | | | | | | | | | |
| | Quadro M4000 | 1664 | 8GB | 120W | 4xDP | | | | | | | | | | | | | | | | | | | | | | | | | | | | | | | | | | | | | | | | | | | | | | | | | | | | | | | | | | | | | | | | | | | | | | | | | | | | | | | | | | | | | | | | | | | | | | | | | | |
| | Quadro M5000 | 2048 | 8GB | 150W | DVI-I DL+4xDP | | | | | | | | | | | | | | | | | | | | | | | | | | | | | | | | | | | | | | | | | | | | | | | | | | | | | | | | | | | | | | | | | | | | | | | | | | | | | | | | | | | | | | | | | | | | | | | | | | |
| | Quadro P400 | 256 | 2GB | 30W | 3xminiDP | | | | | | | | | | | | | | | | | | | | | | | | | | | | | | | | | | | | | | | | | | | | | | | | | | | | | | | | | | | | | | | | | | | | | | | | | | | | | | | | | | | | | | | | | | | | | | | | | | |
| | Quadro P600 | 384 | 2GB | 40W | 4xminiDP | | | | | | | | | | | | | | | | | | | | | | | | | | | | | | | | | | | | | | | | | | | | | | | | | | | | | | | | | | | | | | | | | | | | | | | | | | | | | | | | | | | | | | | | | | | | | | | | | | |
| | Quadro P1000 | 640 | 4GB | 47W | 4xminiDP | | | | | | | | | | | | | | | | | | | | | | | | | | | | | | | | | | | | | | | | | | | | | | | | | | | | | | | | | | | | | | | | | | | | | | | | | | | | | | | | | | | | | | | | | | | | | | | | | | |
| | Quadro P2000 | 1024 | 5GB | 75W | 4xDP | | | | | | | | | | | | | | | | | | | | | | | | | | | | | | | | | | | | | | | | | | | | | | | | | | | | | | | | | | | | | | | | | | | | | | | | | | | | | | | | | | | | | | | | | | | | | | | | | | |
| | Quadro P4000 | 1792 | 8GB | 105W | 4xDP | SLI | | | | | | | | | | | | | | | | | | | | | | | | | | | | | | | | | | | | | | | | | | | | | | | | | | | | | | | | | | | | | | | | | | | | | | | | | | | | | | | | | | | | | | | | | | | | | | | | | |
| Quadro P5000 | 2560 | 16GB | 180W | DVI-D DL+4xDP | | | | | | | | | | | | | | | | | | | | | | | | | | | | | | | | | | | | | | | | | | | | | | | | | | | | | | | | | | | | | | | | | | | | | | | | | | | | | | | | | | | | | | | | | | | | | | | | | | | |
| Disk drive controller | RAID 0, 1, 5, 10 with onboard SATA controller in chipset, SATA 6Gb/s. Optional RAID 0, 1, 10 with optional LSI 9340-8i PCIe adapter, 12Gb/s SAS and SATA, optional upgrade to RAID 5 is available | | | | | | | | | | | | | | | | | | | | | | | | | | | | | | | | | | | | | | | | | | | | | | | | | | | | | | | | | | | | | | | | | | | | | | | | | | | | | | | | | | | | | | | | | | | | | | | | | | | | | | |
| Drive Bays | Two external 5.25" flex bays, two internal 3.5" bays. Up to one 9.5mm optical plus four 3.5"/2.5" disk drives plus three M.2 PCIe SSD (see right) | | | | | | | | | | | | | | | | | | | | | | | | | | | | | | | | | | | | | | | | | | | | | | | | | | | | | | | | | | | | | | | | | | | | | | | | | | | | | | | | | | | | | | | | | | | | | | | | | | | | | | |
| Supporting storage | 3.5" HDD, 7.2K SATA6Gbs | 500GB/1TB/2TB/3TB/4TB/6TB, 1TB/2TB hybrid | | | | | | | | | | | | | | | | | | | | | | | | | | | | | | | | | | | | | | | | | | | | | | | | | | | | | | | | | | | | | | | | | | | | | | | | | | | | | | | | | | | | | | | | | | | | | | | | | | | | | |
| | 2.5" HDD, 10K SAS12Gbs | 300GB/600GB | | | | | | | | | | | | | | | | | | | | | | | | | | | | | | | | | | | | | | | | | | | | | | | | | | | | | | | | | | | | | | | | | | | | | | | | | | | | | | | | | | | | | | | | | | | | | | | | | | | | | |
| | 2.5" SSD, SATA6Gbs | 180GB/240GB/256GB/480GB/512GB with OPAL, 256GB/512GB/1TB without OPAL | | | | | | | | | | | | | | | | | | | | | | | | | | | | | | | | | | | | | | | | | | | | | | | | | | | | | | | | | | | | | | | | | | | | | | | | | | | | | | | | | | | | | | | | | | | | | | | | | | | | | |
| | PCIe SSD, M.2 via PCIe 3.0 x4 adapter | 256GB/512GB/1TB, NVMe | | | | | | | | | | | | | | | | | | | | | | | | | | | | | | | | | | | | | | | | | | | | | | | | | | | | | | | | | | | | | | | | | | | | | | | | | | | | | | | | | | | | | | | | | | | | | | | | | | | | | |
| Flex connector | None | | | | | | | | | | | | | | | | | | | | | | | | | | | | | | | | | | | | | | | | | | | | | | | | | | | | | | | | | | | | | | | | | | | | | | | | | | | | | | | | | | | | | | | | | | | | | | | | | | | | | | |
| Network interfaces | One onboard gigabit ethernet, Intel I218LM, supports Wake-on-LAN. Optional discrete ethernet adapters are available | | | | | | | | | | | | | | | | | | | | | | | | | | | | | | | | | | | | | | | | | | | | | | | | | | | | | | | | | | | | | | | | | | | | | | | | | | | | | | | | | | | | | | | | | | | | | | | | | | | | | | |
| HD Audio | Realtek ALC662 codec | | | | | | | | | | | | | | | | | | | | | | | | | | | | | | | | | | | | | | | | | | | | | | | | | | | | | | | | | | | | | | | | | | | | | | | | | | | | | | | | | | | | | | | | | | | | | | | | | | | | | | |
| TPM | TCG 1.2-compliant | | | | | | | | | | | | | | | | | | | | | | | | | | | | | | | | | | | | | | | | | | | | | | | | | | | | | | | | | | | | | | | | | | | | | | | | | | | | | | | | | | | | | | | | | | | | | | | | | | | | | | |
| Power supply | One fixed 450 watts, autosensing, 92%, 80 PLUS Platinum qualified | | | | | | | | | | | | | | | | | | | | | | | | | | | | | | | | | | | | | | | | | | | | | | | | | | | | | | | | | | | | | | | | | | | | | | | | | | | | | | | | | | | | | | | | | | | | | | | | | | | | | | |
| Front ports | Two USB 3.0, microphone (3.5mm), headphone (3.5mm) | | | | | | | | | | | | | | | | | | | | | | | | | | | | | | | | | | | | | | | | | | | | | | | | | | | | | | | | | | | | | | | | | | | | | | | | | | | | | | | | | | | | | | | | | | | | | | | | | | | | | | |
| Rear ports | Two USB 2.0, four USB 3.0, one ethernet (RJ-45), three analog audio ports (line-in, line-out, mic-in) | | | | | | | | | | | | | | | | | | | | | | | | | | | | | | | | | | | | | | | | | | | | | | | | | | | | | | | | | | | | | | | | | | | | | | | | | | | | | | | | | | | | | | | | | | | | | | | | | | | | | | |

| Components | Specification | |
|-----------------------------|--|--------------------------------------|
| Additional ports | Supports the following optional ports: Two IEEE 1394 (one on rear and one on front flex module) via PCIe adapter, up to one adapter per system. Two rear USB 3.0 per PCIe adapter, up to three adapters per system. One rear Thunderbolt via PCIe adapter, or two front Thunderbolt (on flex module) via PCIe adapter, front and rear Thunderbolt cannot be intermixed. One rear serial via cable, up to one per system. One front eSATA (on flex module), or one rear eSATA via cable and PCIe slot bracket, up to one eSATA port per system | |
| Media reader | 9-in-1 USB 2.0 card reader. Optional 29-in-1 USB 2.0 card reader on flex module | |
| Mechanical | <ul style="list-style-type: none"> 6.89"W x 16.77"D x 14.8"H 175mm W x 426mm D x 376mm H 30.86 lb (14kg) max configuration 25-liter | |
| Environmental specification | Temperature - operating | 50 °F to 95 °F (10 °C to 35 °C) |
| | Temperature - non operating (no package) | 14 °F to 140 °F (-10 °C to 60 °C) |
| | Temperature - non operating (with package) | -40 °F to 140 °F (-40 °C to 60 °C) |
| | Altitude - operating | (Unpressurized): 0-10000ft (0-3048m) |
| | Humidity - operating | 10%-80%, non-condensing |
| | Humidity - storage (with package) | 10%-90%, non-condensing |
| Base warranty | 1 or 3-year limited onsite service with 9x5/NBD | |
| ISV certifications | Please visit www.thinkworkstations.com/isv-certifications/ | |

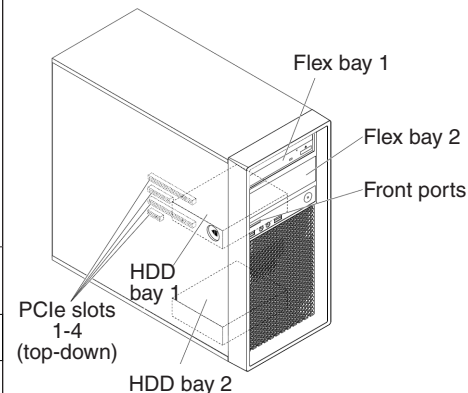

Expansion slots

| | |
|--------|--|
| Slot 1 | PCIe 3.0 x16, full length, full height |
| Slot 2 | PCIe 3.0 x8, full length, full height |
| Slot 3 | PCIe 3.0 x16, full length, full height |
| Slot 4 | PCIe 2.0 x4, half length, full height |

Drive Bays

| | |
|------------|---|
| HDD bay 1 | 3.5", for one 3.5"/2.5" drive |
| HDD bay 2 | 3.5", for one 3.5"/2.5" drive |
| Flex bay 1 | HH optical, or 3.5" HDD bay via optional conversion kit, or slim optical+3.5" HDD bay kit via optional conversion kit, or flex module |
| Flex bay 2 | HH optical, or 3.5" HDD bay via optional conversion kit, or slim optical+3.5" HDD bay kit via optional conversion kit, or flex module |

Note:

- HDD bay 2 is not available when one Quadro M5000, two Quadro M4000, or two NVS 810 are used.
- Flex module supports one or more of the following options: 9.5mm optical/29-in-1 USB 2.0 reader/one front IEEE 1394/one front eSATA/two front Thunderbolt. Up to one flex module is supported per system.
- Up to one slim optical+3.5" HDD bay kit is supported per system.

| Model | Region | Processor | Graphics | Memory (Capacity/Type) | RAID Controller | Storage (Capacity/Type/Interface) | Optical | Media Reader | Power Supply | Add-on Ports | Discrete Ethernet | Chassis Intrusion Switch | Keyboard / Mouse | Operating System | Warranty | Ann Date (mm/yy) |
|------------|--------|--|----------------------------------|------------------------------|--------------------|--------------------------------------|--------------|-----------------|-----------------|-----------------|----------------------|--------------------------------|----------------------|---|----------|---------------------|
| 30B3001PUS | US | Xeon E5-1620 v4 4C/3.5GHz/10MB/140W/DDR4-2400 | NVIDIA Quadro K620 2GB | 1x8GB RDIMM DDR4-2400 ECC | Onboard | 1x256GB SSD M.2 PCIe Opal | HH DVD±RW | 9-in-1 | 450W 92% | None | None | Switch | USB / USB Optical | Windows 10 Pro 64 | 3-year | 06/16 |
| 30B3001QUS | US | Xeon E5-1607 v4 4C/3.1GHz/10MB/140W/DDR4-2133 | Open | 1x8GB RDIMM DDR4-2400 ECC | Onboard | 1x1TB HDD 7.2K 3.5" SATA6Gbs | HH DVD±RW | 9-in-1 | 450W 92% | None | None | Switch | USB / USB Optical | Windows 10 Pro 64 | 3-year | 06/16 |
| 30B3001RUS | US | Xeon E5-1630 v4 4C/3.7GHz/10MB/140W/DDR4-2400 | NVIDIA Quadro K1200 4GB | 1x8GB RDIMM DDR4-2400 ECC | Onboard | 1x256GB SSD M.2 PCIe Opal | HH DVD±RW | 9-in-1 | 450W 92% | None | None | Switch | USB / USB Optical | Windows 10 Pro 64 | 3-year | 06/16 |
| 30B3001SUS | US | Xeon E5-1630 v4 4C/3.7GHz/10MB/140W/DDR4-2400 | NVIDIA Quadro M2000 4GB | 2x8GB RDIMM DDR4-2400 ECC | Onboard | 1x256GB SSD 2.5" SATA6Gbs Opal | HH DVD±RW | 9-in-1 | 450W 92% | None | None | Switch | USB / USB Optical | Windows 10 Pro 64 | 3-year | 06/16 |
| 30B3001TUS | US | Xeon E5-1620 v4 4C/3.5GHz/10MB/140W/DDR4-2400 | NVIDIA Quadro K620 2GB | 2x8GB RDIMM DDR4-2400 ECC | Onboard | 1x1TB SSD 2.5" SATA6Gbs | HH DVD±RW | 9-in-1 | 450W 92% | None | None | Switch | USB / USB Optical | Windows 10 Pro 64 | 3-year | 06/16 |
| 30B3001UUS | US | Xeon E5-1620 v4 4C/3.5GHz/10MB/140W/DDR4-2400 | Open | 1x8GB RDIMM DDR4-2400 ECC | Onboard | 1x1TB HDD 7.2K 3.5" SATA6Gbs | HH DVD±RW | 9-in-1 | 450W 92% | None | None | Switch | USB / USB Optical | Windows 10 Pro 64 | 3-year | 06/16 |
| 30B3001VUS | US | Xeon E5-1650 v4 6C/3.6GHz/15MB/140W/DDR4-2400 | NVIDIA Quadro M2000 4GB | 2x8GB RDIMM DDR4-2400 ECC | Onboard | 1x256GB SSD 2.5" SATA6Gbs Opal | HH DVD±RW | 9-in-1 | 450W 92% | None | None | Switch | USB / USB Optical | Windows 10 Pro 64 | 3-year | 06/16 |
| 30B3001WUS | US | Xeon E5-1620 v4 4C/3.5GHz/10MB/140W/DDR4-2400 | NVIDIA Quadro K620 2GB | 1x8GB RDIMM DDR4-2400 ECC | Onboard | 1x1TB HDD 7.2K 3.5" SATA6Gbs | HH DVD±RW | 9-in-1 | 450W 92% | None | None | Switch | USB / USB Optical | Windows 10 Pro 64 | 3-year | 06/16 |
| 30B3001XUS | US | Xeon E5-1630 v4 4C/3.7GHz/10MB/140W/DDR4-2400 | NVIDIA Quadro K620 2GB | 2x8GB RDIMM DDR4-2400 ECC | Onboard | 1x256GB SSD 2.5" SATA6Gbs Opal | HH DVD±RW | 9-in-1 | 450W 92% | None | None | Switch | USB / USB Optical | Windows 10 Pro 64 | 3-year | 06/16 |
| 30B3001YUS | US | Xeon E5-1650 v4 6C/3.6GHz/15MB/140W/DDR4-2400 | NVIDIA Quadro M4000 8GB | 2x8GB RDIMM DDR4-2400 ECC | Onboard | 1x1TB SSD 2.5" SATA6Gbs | HH DVD±RW | 9-in-1 | 450W 92% | None | None | Switch | USB / USB Optical | Windows 10 Pro 64 | 3-year | 06/16 |
| 30B30020US | US | Xeon E5-1650 v4 6C/3.6GHz/15MB/140W/DDR4-2400 | Open | 2x8GB RDIMM DDR4-2400 ECC | Onboard | 1x1TB HDD 7.2K 3.5" SATA6Gbs | HH DVD±RW | 9-in-1 | 450W 92% | None | None | Switch | USB / USB Optical | Windows 10 Pro 64 | 3-year | 06/16 |
| 30B30021US | US | Xeon E5-1620 v4 4C/3.5GHz/10MB/140W/DDR4-2400 | NVIDIA Quadro K1200 4GB | 1x8GB RDIMM DDR4-2400 ECC | Onboard | 1x256GB SSD M.2 PCIe Opal | HH DVD±RW | 9-in-1 | 450W 92% | None | None | Switch | USB / USB Optical | Windows 10 Pro 64 | 3-year | 06/16 |
| 30B30022US | US | Xeon E5-1650 v4 6C/3.6GHz/15MB/140W/DDR4-2400 | NVIDIA Quadro K1200 4GB | 2x8GB RDIMM DDR4-2400 ECC | Onboard | 1x512GB SSD M.2 PCIe | HH DVD±RW | 9-in-1 | 450W 92% | None | None | Switch | USB / CadMouse | Windows 10 Pro 64 | 3-year | 06/16 |
| 30B3002AUS | US | Xeon E5-1607 v4 4C/3.1GHz/10MB/140W/DDR4-2133 | Open | 1x8GB RDIMM DDR4-2400 ECC | Onboard | 1x1TB HDD 7.2K 3.5" SATA6Gbs | HH DVD±RW | 9-in-1 | 450W 92% | None | None | Switch | USB / USB Optical | Windows 10 DG Windows 7 Pro 64 | 3-year | 09/16 |
| 30B3002HUS | US | Xeon E5-1620 v4 4C/3.5GHz/10MB/140W/DDR4-2400 | Open | 1x8GB RDIMM DDR4-2400 ECC | Onboard | 1x1TB HDD 7.2K 3.5" SATA6Gbs | HH DVD±RW | 9-in-1 | 450W 92% | None | None | Switch | USB / USB Optical | Windows 10 DG Windows 7 Pro 64 | 3-year | 09/16 |

| Model | Region | Processor | Graphics | Memory (Capacity/Type) | RAID Controller | Storage (Capacity/Type/Interface) | Optical | Media Reader | Power Supply | Add-on Ports | Discrete Ethernet | Chassis Intrusion Switch | Keyboard / Mouse | Operating System | Warranty | Ann Date (mm/yy) |
|------------|--------|--|----------------------------------|-------------------------------|--------------------|---|--------------|-----------------|-----------------|-----------------|----------------------|--------------------------------|----------------------|---|----------|---------------------|
| 30B3003KUS | US | Xeon E5-1620 v4 4C/3.5GHz/10MB/140W/DDR4-2400 | NVIDIA Quadro K620 2GB | 1x8GB RDIMM DDR4-2400 ECC | Onboard | 1x256GB SSD M.2 PCIe Opal | HH DVD±RW | 9-in-1 | 450W 92% | None | None | Switch | USB / USB Optical | Windows 10 DG Windows 7 Pro 64 | 3-year | 09/16 |
| 30B3003LUS | US | Xeon E5-1620 v4 4C/3.5GHz/10MB/140W/DDR4-2400 | NVIDIA Quadro K620 2GB | 2x8GB RDIMM DDR4-2400 ECC | Onboard | 1x1TB SSD 2.5" SATA6Gbs | HH DVD±RW | 9-in-1 | 450W 92% | None | None | Switch | USB / USB Optical | Windows 10 DG Windows 7 Pro 64 | 3-year | 09/16 |
| 30B3003MUS | US | Xeon E5-1630 v4 4C/3.7GHz/10MB/140W/DDR4-2400 | NVIDIA Quadro K620 2GB | 2x8GB RDIMM DDR4-2400 ECC | Onboard | 1x256GB SSD 2.5" SATA6Gbs Opal | HH DVD±RW | 9-in-1 | 450W 92% | None | None | Switch | USB / USB Optical | Windows 10 DG Windows 7 Pro 64 | 3-year | 09/16 |
| 30B3003NUS | US | Xeon E5-1650 v4 6C/3.6GHz/15MB/140W/DDR4-2400 | NVIDIA Quadro M4000 8GB | 2x8GB RDIMM DDR4-2400 ECC | Onboard | 1x1TB SSD 2.5" SATA6Gbs | HH DVD±RW | 9-in-1 | 450W 92% | None | None | Switch | USB / USB Optical | Windows 10 DG Windows 7 Pro 64 | 3-year | 09/16 |
| 30B3003PUS | US | Xeon E5-1620 v4 4C/3.5GHz/10MB/140W/DDR4-2400 | NVIDIA Quadro K620 2GB | 1x8GB RDIMM DDR4-2400 ECC | Onboard | 1x1TB HDD 7.2K 3.5" SATA6Gbs | HH DVD±RW | 9-in-1 | 450W 92% | None | None | Switch | USB / USB Optical | Windows 10 DG Windows 7 Pro 64 | 3-year | 09/16 |
| 30B3003QUS | US | Xeon E5-1650 v4 6C/3.6GHz/15MB/140W/DDR4-2400 | NVIDIA Quadro K1200 4GB | 2x8GB RDIMM DDR4-2400 ECC | Onboard | 1x512GB SSD M.2 PCIe | HH DVD±RW | 9-in-1 | 450W 92% | None | None | Switch | USB / CadMouse | Windows 10 DG Windows 7 Pro 64 | 3-year | 09/16 |
| 30B3003RUS | US | Xeon E5-1650 v4 6C/3.6GHz/15MB/140W/DDR4-2400 | Open | 2x8GB RDIMM DDR4-2400 ECC | Onboard | 1x1TB HDD 7.2K 3.5" SATA6Gbs | HH DVD±RW | 9-in-1 | 450W 92% | None | None | Switch | USB / USB Optical | Windows 10 DG Windows 7 Pro 64 | 3-year | 09/16 |
| 30B3003SUS | US | Xeon E5-1630 v4 4C/3.7GHz/10MB/140W/DDR4-2400 | NVIDIA Quadro M2000 4GB | 2x8GB RDIMM DDR4-2400 ECC | Onboard | 1x256GB SSD 2.5" SATA6Gbs Opal | HH DVD±RW | 9-in-1 | 450W 92% | None | None | Switch | USB / USB Optical | Windows 10 DG Windows 7 Pro 64 | 3-year | 09/16 |
| 30B3003TUS | US | Xeon E5-1620 v4 4C/3.5GHz/10MB/140W/DDR4-2400 | NVIDIA Quadro K1200 4GB | 1x8GB RDIMM DDR4-2400 ECC | Onboard | 1x256GB SSD M.2 PCIe Opal | HH DVD±RW | 9-in-1 | 450W 92% | None | None | Switch | USB / USB Optical | Windows 10 DG Windows 7 Pro 64 | 3-year | 09/16 |
| 30B3003UUS | US | Xeon E5-1650 v4 6C/3.6GHz/15MB/140W/DDR4-2400 | NVIDIA Quadro M2000 4GB | 2x8GB RDIMM DDR4-2400 ECC | Onboard | 1x256GB SSD 2.5" SATA6Gbs Opal | HH DVD±RW | 9-in-1 | 450W 92% | None | None | Switch | USB / USB Optical | Windows 10 DG Windows 7 Pro 64 | 3-year | 09/16 |
| 30B3003VUS | US | Xeon E5-1630 v4 4C/3.7GHz/10MB/140W/DDR4-2400 | NVIDIA Quadro K1200 4GB | 1x8GB RDIMM DDR4-2400 ECC | Onboard | 1x256GB SSD M.2 PCIe Opal | HH DVD±RW | 9-in-1 | 450W 92% | None | None | Switch | USB / USB Optical | Windows 10 DG Windows 7 Pro 64 | 3-year | 09/16 |
| 30B3004JUS | US | Xeon E5-1630 v4 4C/3.7GHz/10MB/140W/DDR4-2400 | NVIDIA Quadro M2000 4GB | 2x16GB RDIMM DDR4-2400 ECC | Onboard | 1x512GB SSD 2.5" SATA6Gbs+1x256GB SSD M.2 PCIe Opal | None | None | 450W 92% | None | None | Switch | USB / USB Optical | Windows 10 DG Windows 7 Pro 64 | 3-year | 09/16 |
| 30B3004MUS | US | Xeon E5-1620 v4 4C/3.5GHz/10MB/140W/DDR4-2400 | NVIDIA Quadro K1200 4GB | 2x8GB RDIMM DDR4-2400 ECC | Onboard | 1x1TB SSD M.2 PCIe NVMe Opal | HH DVD±RW | 9-in-1 | 450W 92% | None | None | Switch | USB / USB Optical | Windows 10 DG Windows 7 Pro 64 | 3-year | 12/16 |
| 30B3004NUS | US | Xeon E5-1620 v4 4C/3.5GHz/10MB/140W/DDR4-2400 | Open | 2x8GB RDIMM DDR4-2400 ECC | Onboard | 1x1TB SSD M.2 PCIe NVMe Opal | HH DVD±RW | 9-in-1 | 450W 92% | None | None | Switch | USB / USB Optical | Windows 10 DG Windows 7 Pro 64 | 3-year | 12/16 |
| 30B3004PUS | US | Xeon E5-1620 v4 4C/3.5GHz/10MB/140W/DDR4-2400 | Open | 2x8GB RDIMM DDR4-2400 ECC | Onboard | 1x1TB HDD 7.2K 3.5" SATA6Gbs | HH DVD±RW | 9-in-1 | 450W 92% | None | None | Switch | USB / USB Optical | Windows 10 DG Windows 7 Pro 64 | 3-year | 12/16 |

| Model | Region | Processor | Graphics | Memory (Capacity/Type) | RAID Controller | Storage (Capacity/Type/Interface) | Optical | Media Reader | Power Supply | Add-on Ports | Discrete Ethernet | Chassis Intrusion Switch | Keyboard / Mouse | Operating System | Warranty | Ann Date (mm/yy) |
|------------|--------|--|-----------------------------------|------------------------------|--------------------|--------------------------------------|--------------|-----------------|-----------------|-----------------|----------------------|--------------------------------|----------------------|---|----------|---------------------|
| 30B3004QUS | US | Xeon E5-1630 v4 4C/3.7GHz/10MB/140W/DDR4-2400 | NVIDIA Quadro P5000 16GB | 2x8GB RDIMM DDR4-2400 ECC | Onboard | 1x1TB SSD M.2 PCIe NVMe Opal | HH DVD±RW | 9-in-1 | 450W 92% | None | None | Switch | USB / USB Optical | Windows 10 DG Windows 7 Pro 64 | 3-year | 12/16 |
| 30B3004RUS | US | Xeon E5-1620 v4 4C/3.5GHz/10MB/140W/DDR4-2400 | Open | 2x8GB RDIMM DDR4-2400 ECC | Onboard | 1x1TB HDD 7.2K 3.5" SATA6Gbs | None | 9-in-1 | 450W 92% | None | None | Switch | USB / USB Optical | Windows 10 DG Windows 7 Pro 64 | 3-year | 12/16 |
| 30B3004SUS | US | Xeon E5-1630 v4 4C/3.7GHz/10MB/140W/DDR4-2400 | Open | 2x8GB RDIMM DDR4-2400 ECC | Onboard | 1x1TB SSD M.2 PCIe NVMe Opal | HH DVD±RW | 9-in-1 | 450W 92% | None | None | Switch | USB / USB Optical | Windows 10 DG Windows 7 Pro 64 | 3-year | 12/16 |
| 30B3004TUS | US | Xeon E5-1650 v4 6C/3.6GHz/15MB/140W/DDR4-2400 | Open | 2x8GB RDIMM DDR4-2400 ECC | Onboard | 1x1TB SSD M.2 PCIe NVMe Opal | HH DVD±RW | 9-in-1 | 450W 92% | None | None | Switch | USB / USB Optical | Windows 10 DG Windows 7 Pro 64 | 3-year | 12/16 |
| 30B3004UUS | US | Xeon E5-1620 v4 4C/3.5GHz/10MB/140W/DDR4-2400 | Open | 2x8GB RDIMM DDR4-2400 ECC | 9340-8i PCIe | 1x256GB SSD M.2 PCIe Opal | HH DVD±RW | 9-in-1 | 450W 92% | None | None | Switch | USB / USB Optical | Windows 10 DG Windows 7 Pro 64 | 3-year | 12/16 |
| 30B3004VUS | US | Xeon E5-1607 v4 4C/3.1GHz/10MB/140W/DDR4-2133 | Open | 2x8GB RDIMM DDR4-2400 ECC | Onboard | 1x1TB SSD M.2 PCIe NVMe Opal | HH DVD±RW | 9-in-1 | 450W 92% | None | None | Switch | USB / USB Optical | Windows 10 DG Windows 7 Pro 64 | 3-year | 12/16 |
| 30B3005SUS | US | Xeon E5-1630 v4 4C/3.7GHz/10MB/140W/DDR4-2400 | Quadro P600 2GB | 2x8GB RDIMM DDR4-2400 ECC | Onboard | 1x256GB SSD 2.5" SATA6Gbs Opal | HH DVD±RW | 9-in-1 | 450W 92% | None | None | Switch | USB / USB Optical | Windows 10 DG Windows 7 Pro 64 | 3-year | 04/17 |
| 30B3005TUS | US | Xeon E5-1630 v4 4C/3.7GHz/10MB/140W/DDR4-2400 | Quadro P1000 4GB | 1x8GB RDIMM DDR4-2400 ECC | Onboard | 1x256GB SSD M.2 PCIe Opal | HH DVD±RW | 9-in-1 | 450W 92% | None | None | Switch | USB / USB Optical | Windows 10 DG Windows 7 Pro 64 | 3-year | 04/17 |
| 30B3005UUS | US | Xeon E5-1620 v4 4C/3.5GHz/10MB/140W/DDR4-2400 | Quadro P600 2GB | 2x8GB RDIMM DDR4-2400 ECC | Onboard | 1x1TB SSD 2.5" SATA6Gbs | HH DVD±RW | 9-in-1 | 450W 92% | None | None | Switch | USB / USB Optical | Windows 10 DG Windows 7 Pro 64 | 3-year | 04/17 |
| 30B3005VUS | US | Xeon E5-1620 v4 4C/3.5GHz/10MB/140W/DDR4-2400 | Quadro P600 2GB | 1x8GB RDIMM DDR4-2400 ECC | Onboard | 1x1TB HDD 7.2K 3.5" SATA6Gbs | HH DVD±RW | 9-in-1 | 450W 92% | None | None | Switch | USB / USB Optical | Windows 10 DG Windows 7 Pro 64 | 3-year | 04/17 |
| 30B3005WUS | US | Xeon E5-1630 v4 4C/3.7GHz/10MB/140W/DDR4-2400 | Quadro P2000 5GB | 2x8GB RDIMM DDR4-2400 ECC | Onboard | 1x256GB SSD 2.5" SATA6Gbs Opal | HH DVD±RW | 9-in-1 | 450W 92% | None | None | Switch | USB / USB Optical | Windows 10 DG Windows 7 Pro 64 | 3-year | 04/17 |
| 30B3005XUS | US | Xeon E5-1630 v4 4C/3.7GHz/10MB/140W/DDR4-2400 | Quadro P600 2GB | 2x8GB RDIMM DDR4-2400 ECC | Onboard | 1x256GB SSD 2.5" SATA6Gbs Opal | HH DVD±RW | 9-in-1 | 450W 92% | None | None | Switch | USB / USB Optical | Windows 10 DG Windows 7 Pro 64 | 3-year | 04/17 |
| 30B3005YUS | US | Xeon E5-1630 v4 4C/3.7GHz/10MB/140W/DDR4-2400 | Quadro P1000 4GB | 1x8GB RDIMM DDR4-2400 ECC | Onboard | 1x256GB SSD M.2 PCIe Opal | HH DVD±RW | 9-in-1 | 450W 92% | None | None | Switch | USB / USB Optical | Windows 10 DG Windows 7 Pro 64 | 3-year | 04/17 |
| 30B30060US | US | Xeon E5-1620 v4 4C/3.5GHz/10MB/140W/DDR4-2400 | Quadro P600 2GB | 1x8GB RDIMM DDR4-2400 ECC | Onboard | 1x1TB HDD 7.2K 3.5" SATA6Gbs | HH DVD±RW | 9-in-1 | 450W 92% | None | None | Switch | USB / USB Optical | Windows 10 DG Windows 7 Pro 64 | 3-year | 04/17 |
| 30B30061US | US | Xeon E5-1650 v4 6C/3.6GHz/15MB/140W/DDR4-2400 | Quadro P1000 4GB | 2x8GB RDIMM DDR4-2400 ECC | Onboard | 1x512GB SSD M.2 PCIe | HH DVD±RW | 9-in-1 | 450W 92% | None | None | Switch | USB / USB Optical | Windows 10 DG Windows 7 Pro 64 | 3-year | 04/17 |

| Model | Region | Processor | Graphics | Memory (Capacity/Type) | RAID Controller | Storage (Capacity/Type/Interface) | Optical | Media Reader | Power Supply | Add-on Ports | Discrete Ethernet | Chassis Intrusion Switch | Keyboard / Mouse | Operating System | Warranty | Ann Date (mm/yy) |
|------------|--------|--|------------------------|------------------------------|--------------------|--------------------------------------|--------------|-----------------|-----------------|-----------------|----------------------|--------------------------------|----------------------|---|----------|---------------------|
| 30B30062US | US | Xeon E5-1650 v4 6C/3.6GHz/15MB/140W/DDR4-2400 | Quadro P4000 8GB | 2x8GB RDIMM DDR4-2400 ECC | Onboard | 1x1TB SSD 2.5" SATA6Gbs | HH DVD±RW | 9-in-1 | 450W 92% | None | None | Switch | USB / USB Optical | Windows 10 Pro 64 | 3-year | 04/17 |
| 30B30063US | US | Xeon E5-1620 v4 4C/3.5GHz/10MB/140W/DDR4-2400 | Quadro P1000 4GB | 1x8GB RDIMM DDR4-2400 ECC | Onboard | 1x256GB SSD M.2 PCIe Opal | HH DVD±RW | 9-in-1 | 450W 92% | None | None | Switch | USB / USB Optical | Windows 10 DG Windows 7 Pro 64 | 3-year | 04/17 |
| 30B30064US | US | Xeon E5-1620 v4 4C/3.5GHz/10MB/140W/DDR4-2400 | Quadro P1000 4GB | 1x8GB RDIMM DDR4-2400 ECC | Onboard | 1x256GB SSD M.2 PCIe Opal | HH DVD±RW | 9-in-1 | 450W 92% | None | None | Switch | USB / USB Optical | Windows 10 Pro 64 | 3-year | 04/17 |
| 30B30065US | US | Xeon E5-1650 v4 6C/3.6GHz/15MB/140W/DDR4-2400 | Quadro P2000 5GB | 2x8GB RDIMM DDR4-2400 ECC | Onboard | 1x256GB SSD 2.5" SATA6Gbs Opal | HH DVD±RW | 9-in-1 | 450W 92% | None | None | Switch | USB / USB Optical | Windows 10 DG Windows 7 Pro 64 | 3-year | 04/17 |
| 30B30066US | US | Xeon E5-1650 v4 6C/3.6GHz/15MB/140W/DDR4-2400 | Quadro P2000 5GB | 2x8GB RDIMM DDR4-2400 ECC | Onboard | 1x256GB SSD 2.5" SATA6Gbs Opal | HH DVD±RW | 9-in-1 | 450W 92% | None | None | Switch | USB / USB Optical | Windows 10 Pro 64 | 3-year | 04/17 |
| 30B30067US | US | Xeon E5-1650 v4 6C/3.6GHz/15MB/140W/DDR4-2400 | Quadro P4000 8GB | 2x8GB RDIMM DDR4-2400 ECC | Onboard | 1x1TB SSD 2.5" SATA6Gbs | HH DVD±RW | 9-in-1 | 450W 92% | None | None | Switch | USB / USB Optical | Windows 10 DG Windows 7 Pro 64 | 3-year | 04/17 |
| 30B30068US | US | Xeon E5-1620 v4 4C/3.5GHz/10MB/140W/DDR4-2400 | Quadro P600 2GB | 1x8GB RDIMM DDR4-2400 ECC | Onboard | 1x256GB SSD M.2 PCIe Opal | HH DVD±RW | 9-in-1 | 450W 92% | None | None | Switch | USB / USB Optical | Windows 10 Pro 64 | 3-year | 04/17 |
| 30B30069US | US | Xeon E5-1630 v4 4C/3.7GHz/10MB/140W/DDR4-2400 | Quadro P2000 5GB | 2x8GB RDIMM DDR4-2400 ECC | Onboard | 1x256GB SSD 2.5" SATA6Gbs Opal | HH DVD±RW | 9-in-1 | 450W 92% | None | None | Switch | USB / USB Optical | Windows 10 Pro 64 | 3-year | 04/17 |
| 30B3006AUS | US | Xeon E5-1650 v4 6C/3.6GHz/15MB/140W/DDR4-2400 | Quadro P1000 4GB | 2x8GB RDIMM DDR4-2400 ECC | Onboard | 1x512GB SSD M.2 PCIe | HH DVD±RW | 9-in-1 | 450W 92% | None | None | Switch | USB / USB Optical | Windows 10 Pro 64 | 3-year | 04/17 |
| 30B3006BUS | US | Xeon E5-1620 v4 4C/3.5GHz/10MB/140W/DDR4-2400 | Quadro P600 2GB | 2x8GB RDIMM DDR4-2400 ECC | Onboard | 1x1TB SSD 2.5" SATA6Gbs | HH DVD±RW | 9-in-1 | 450W 92% | None | None | Switch | USB / USB Optical | Windows 10 DG Windows 7 Pro 64 | 3-year | 04/17 |

ThinkStation P510 Platform Specifications

| Components | Specification | | | | | | | | | | | | | | | | | | | | | | | | | | | | | | | | | | | | | | | | | | | | | | | | | | | | | | | | | | | | | | | | | | | | | | | | | | | | | | | | | | | | | | | | | | | | | | | | | | | | | | | | | | | | | | | | | | | | | | | | | | | | | | | | | | | | | | | | | | |
|---------------------------------------|---|---|--------|---------------|------------------------|--------------|-----|---------|----|-----|-------|------|--|---------|----|-----|-------|-----------------|--|---------|-----|-----|-----|-----------|--|---------|------|-----|-----|-----------|--|-------------|-----|-----|-----|-------------|--|-------------|-----|-----|-----|-------------|--|--------------|-----|-----|-----|-----------|--|--------------|-----|-----|-----|---------------|--|--------------|------|-----|------|---------------|--|--------------|------|-----|------|------------------------|-----|--------------|-----|-----|-----|------|--|--------------|------|-----|------|------|--|--------------|------|-----|------|---------------|-----|--------------|------|------|------|---------------|--|-------------|-----|-----|-----|----------|--|-------------|-----|-----|-----|----------|--|--------------|-----|-----|-----|----------|--|--------------|------|-----|-----|------|--|--------------|------|-----|------|------|-----|--------------|------|------|------|---------------|-----|--------------|------|------|------|---------------|--|-----------|------|------|------|--|--|
| Chipset | Intel C612 Platform Controller Hub (PCH) | | | | | | | | | | | | | | | | | | | | | | | | | | | | | | | | | | | | | | | | | | | | | | | | | | | | | | | | | | | | | | | | | | | | | | | | | | | | | | | | | | | | | | | | | | | | | | | | | | | | | | | | | | | | | | | | | | | | | | | | | | | | | | | | | | | | | | | | | | |
| System mgmt | Intel Active Management Technology 9 | | | | | | | | | | | | | | | | | | | | | | | | | | | | | | | | | | | | | | | | | | | | | | | | | | | | | | | | | | | | | | | | | | | | | | | | | | | | | | | | | | | | | | | | | | | | | | | | | | | | | | | | | | | | | | | | | | | | | | | | | | | | | | | | | | | | | | | | | | |
| Processor | Up to one 145W Intel Xeon E5-2600 v4 or E5-1600 v4 family processors. 22 cores up to 2.2GHz, 16 cores up to 2.6GHz, 14 cores up to 2.6GHz, 12 cores up to 2.2GHz, 10 cores up to 2.4GHz, 8 cores up to 3.4GHz, 6 cores up to 3.6GHz, 4 cores up to 3.7GHz Or up to one Intel Xeon E5-2600 v3 or E5-1600 v3 processors (not available in EMEA). | | | | | | | | | | | | | | | | | | | | | | | | | | | | | | | | | | | | | | | | | | | | | | | | | | | | | | | | | | | | | | | | | | | | | | | | | | | | | | | | | | | | | | | | | | | | | | | | | | | | | | | | | | | | | | | | | | | | | | | | | | | | | | | | | | | | | | | | | | |
| Coprocessor | None | | | | | | | | | | | | | | | | | | | | | | | | | | | | | | | | | | | | | | | | | | | | | | | | | | | | | | | | | | | | | | | | | | | | | | | | | | | | | | | | | | | | | | | | | | | | | | | | | | | | | | | | | | | | | | | | | | | | | | | | | | | | | | | | | | | | | | | | | | |
| Memory DIMM slots | 8 DIMM sockets, 4-channel capable. RDIMM, ECC, DDR4, 2400MHz | | | | | | | | | | | | | | | | | | | | | | | | | | | | | | | | | | | | | | | | | | | | | | | | | | | | | | | | | | | | | | | | | | | | | | | | | | | | | | | | | | | | | | | | | | | | | | | | | | | | | | | | | | | | | | | | | | | | | | | | | | | | | | | | | | | | | | | | | | |
| Memory capacity | 256GB | | | | | | | | | | | | | | | | | | | | | | | | | | | | | | | | | | | | | | | | | | | | | | | | | | | | | | | | | | | | | | | | | | | | | | | | | | | | | | | | | | | | | | | | | | | | | | | | | | | | | | | | | | | | | | | | | | | | | | | | | | | | | | | | | | | | | | | | | | |
| Graphics, GPU computing | Two PCIe 3.0 x16 slots for graphics and GPU computing adapters. Up to two NVIDIA Quadro M5000 SLI | | | | | | | | | | | | | | | | | | | | | | | | | | | | | | | | | | | | | | | | | | | | | | | | | | | | | | | | | | | | | | | | | | | | | | | | | | | | | | | | | | | | | | | | | | | | | | | | | | | | | | | | | | | | | | | | | | | | | | | | | | | | | | | | | | | | | | | | | | |
| Supporting Graphics and GPU computing | <table border="1"> <thead> <tr> <th>Adapter</th> <th>Cores</th> <th>Memory</th> <th>Power</th> <th>Connector***</th> <th>SLI</th> </tr> </thead> <tbody> <tr> <td>NVS 310</td> <td>48</td> <td>1GB</td> <td>19.5W</td> <td>2xDP</td> <td></td> </tr> <tr> <td>NVS 315</td> <td>48</td> <td>1GB</td> <td>19.5W</td> <td>2xDVI-I SL/2xDP</td> <td></td> </tr> <tr> <td>NVS 510</td> <td>192</td> <td>2GB</td> <td>35W</td> <td>4xmini DP</td> <td></td> </tr> <tr> <td>NVS 810</td> <td>1024</td> <td>4GB</td> <td>68W</td> <td>8xmini DP</td> <td></td> </tr> <tr> <td>Quadro K420</td> <td>192</td> <td>2GB</td> <td>41W</td> <td>DVI-I DL+DP</td> <td></td> </tr> <tr> <td>Quadro K620</td> <td>384</td> <td>2GB</td> <td>45W</td> <td>DVI-I DL+DP</td> <td></td> </tr> <tr> <td>Quadro K1200</td> <td>512</td> <td>4GB</td> <td>45W</td> <td>4xmini DP</td> <td></td> </tr> <tr> <td>Quadro K2200</td> <td>640</td> <td>4GB</td> <td>68W</td> <td>DVI-I DL+2xDP</td> <td></td> </tr> <tr> <td>Quadro K4200</td> <td>1344</td> <td>4GB</td> <td>108W</td> <td>DVI-I DL+2xDP</td> <td></td> </tr> <tr> <td>Quadro K5200</td> <td>2304</td> <td>8GB</td> <td>150W</td> <td>DVI-I DL+DVI-D DL+2xDP</td> <td>SLI</td> </tr> <tr> <td>Quadro M2000</td> <td>768</td> <td>4GB</td> <td>75W</td> <td>4xDP</td> <td></td> </tr> <tr> <td>Quadro M4000</td> <td>1664</td> <td>8GB</td> <td>120W</td> <td>4xDP</td> <td></td> </tr> <tr> <td>Quadro M5000</td> <td>2048</td> <td>8GB</td> <td>150W</td> <td>DVI-I DL+4xDP</td> <td>SLI</td> </tr> <tr> <td>Quadro M6000</td> <td>3072</td> <td>24GB</td> <td>250W</td> <td>DVI-I DL+4xDP</td> <td></td> </tr> <tr> <td>Quadro P400</td> <td>256</td> <td>2GB</td> <td>30W</td> <td>3xminiDP</td> <td></td> </tr> <tr> <td>Quadro P600</td> <td>384</td> <td>2GB</td> <td>40W</td> <td>4xminiDP</td> <td></td> </tr> <tr> <td>Quadro P1000</td> <td>640</td> <td>4GB</td> <td>47W</td> <td>4xminiDP</td> <td></td> </tr> <tr> <td>Quadro P2000</td> <td>1024</td> <td>5GB</td> <td>75W</td> <td>4xDP</td> <td></td> </tr> <tr> <td>Quadro P4000</td> <td>1792</td> <td>8GB</td> <td>105W</td> <td>4xDP</td> <td>SLI</td> </tr> <tr> <td>Quadro P5000</td> <td>2560</td> <td>16GB</td> <td>180W</td> <td>DVI-D DL+4xDP</td> <td>SLI</td> </tr> <tr> <td>Quadro P6000</td> <td>3840</td> <td>24GB</td> <td>250W</td> <td>DVI-D DL+4xDP</td> <td></td> </tr> <tr> <td>Tesla K40</td> <td>2880</td> <td>12GB</td> <td>235W</td> <td></td> <td></td> </tr> </tbody> </table> | Adapter | Cores | Memory | Power | Connector*** | SLI | NVS 310 | 48 | 1GB | 19.5W | 2xDP | | NVS 315 | 48 | 1GB | 19.5W | 2xDVI-I SL/2xDP | | NVS 510 | 192 | 2GB | 35W | 4xmini DP | | NVS 810 | 1024 | 4GB | 68W | 8xmini DP | | Quadro K420 | 192 | 2GB | 41W | DVI-I DL+DP | | Quadro K620 | 384 | 2GB | 45W | DVI-I DL+DP | | Quadro K1200 | 512 | 4GB | 45W | 4xmini DP | | Quadro K2200 | 640 | 4GB | 68W | DVI-I DL+2xDP | | Quadro K4200 | 1344 | 4GB | 108W | DVI-I DL+2xDP | | Quadro K5200 | 2304 | 8GB | 150W | DVI-I DL+DVI-D DL+2xDP | SLI | Quadro M2000 | 768 | 4GB | 75W | 4xDP | | Quadro M4000 | 1664 | 8GB | 120W | 4xDP | | Quadro M5000 | 2048 | 8GB | 150W | DVI-I DL+4xDP | SLI | Quadro M6000 | 3072 | 24GB | 250W | DVI-I DL+4xDP | | Quadro P400 | 256 | 2GB | 30W | 3xminiDP | | Quadro P600 | 384 | 2GB | 40W | 4xminiDP | | Quadro P1000 | 640 | 4GB | 47W | 4xminiDP | | Quadro P2000 | 1024 | 5GB | 75W | 4xDP | | Quadro P4000 | 1792 | 8GB | 105W | 4xDP | SLI | Quadro P5000 | 2560 | 16GB | 180W | DVI-D DL+4xDP | SLI | Quadro P6000 | 3840 | 24GB | 250W | DVI-D DL+4xDP | | Tesla K40 | 2880 | 12GB | 235W | | |
| | Adapter | Cores | Memory | Power | Connector*** | SLI | | | | | | | | | | | | | | | | | | | | | | | | | | | | | | | | | | | | | | | | | | | | | | | | | | | | | | | | | | | | | | | | | | | | | | | | | | | | | | | | | | | | | | | | | | | | | | | | | | | | | | | | | | | | | | | | | | | | | | | | | | | | | | | | | | | | | |
| | NVS 310 | 48 | 1GB | 19.5W | 2xDP | | | | | | | | | | | | | | | | | | | | | | | | | | | | | | | | | | | | | | | | | | | | | | | | | | | | | | | | | | | | | | | | | | | | | | | | | | | | | | | | | | | | | | | | | | | | | | | | | | | | | | | | | | | | | | | | | | | | | | | | | | | | | | | | | | | | | | |
| | NVS 315 | 48 | 1GB | 19.5W | 2xDVI-I SL/2xDP | | | | | | | | | | | | | | | | | | | | | | | | | | | | | | | | | | | | | | | | | | | | | | | | | | | | | | | | | | | | | | | | | | | | | | | | | | | | | | | | | | | | | | | | | | | | | | | | | | | | | | | | | | | | | | | | | | | | | | | | | | | | | | | | | | | | | | |
| | NVS 510 | 192 | 2GB | 35W | 4xmini DP | | | | | | | | | | | | | | | | | | | | | | | | | | | | | | | | | | | | | | | | | | | | | | | | | | | | | | | | | | | | | | | | | | | | | | | | | | | | | | | | | | | | | | | | | | | | | | | | | | | | | | | | | | | | | | | | | | | | | | | | | | | | | | | | | | | | | | |
| | NVS 810 | 1024 | 4GB | 68W | 8xmini DP | | | | | | | | | | | | | | | | | | | | | | | | | | | | | | | | | | | | | | | | | | | | | | | | | | | | | | | | | | | | | | | | | | | | | | | | | | | | | | | | | | | | | | | | | | | | | | | | | | | | | | | | | | | | | | | | | | | | | | | | | | | | | | | | | | | | | | |
| | Quadro K420 | 192 | 2GB | 41W | DVI-I DL+DP | | | | | | | | | | | | | | | | | | | | | | | | | | | | | | | | | | | | | | | | | | | | | | | | | | | | | | | | | | | | | | | | | | | | | | | | | | | | | | | | | | | | | | | | | | | | | | | | | | | | | | | | | | | | | | | | | | | | | | | | | | | | | | | | | | | | | | |
| | Quadro K620 | 384 | 2GB | 45W | DVI-I DL+DP | | | | | | | | | | | | | | | | | | | | | | | | | | | | | | | | | | | | | | | | | | | | | | | | | | | | | | | | | | | | | | | | | | | | | | | | | | | | | | | | | | | | | | | | | | | | | | | | | | | | | | | | | | | | | | | | | | | | | | | | | | | | | | | | | | | | | | |
| | Quadro K1200 | 512 | 4GB | 45W | 4xmini DP | | | | | | | | | | | | | | | | | | | | | | | | | | | | | | | | | | | | | | | | | | | | | | | | | | | | | | | | | | | | | | | | | | | | | | | | | | | | | | | | | | | | | | | | | | | | | | | | | | | | | | | | | | | | | | | | | | | | | | | | | | | | | | | | | | | | | | |
| | Quadro K2200 | 640 | 4GB | 68W | DVI-I DL+2xDP | | | | | | | | | | | | | | | | | | | | | | | | | | | | | | | | | | | | | | | | | | | | | | | | | | | | | | | | | | | | | | | | | | | | | | | | | | | | | | | | | | | | | | | | | | | | | | | | | | | | | | | | | | | | | | | | | | | | | | | | | | | | | | | | | | | | | | |
| | Quadro K4200 | 1344 | 4GB | 108W | DVI-I DL+2xDP | | | | | | | | | | | | | | | | | | | | | | | | | | | | | | | | | | | | | | | | | | | | | | | | | | | | | | | | | | | | | | | | | | | | | | | | | | | | | | | | | | | | | | | | | | | | | | | | | | | | | | | | | | | | | | | | | | | | | | | | | | | | | | | | | | | | | | |
| | Quadro K5200 | 2304 | 8GB | 150W | DVI-I DL+DVI-D DL+2xDP | SLI | | | | | | | | | | | | | | | | | | | | | | | | | | | | | | | | | | | | | | | | | | | | | | | | | | | | | | | | | | | | | | | | | | | | | | | | | | | | | | | | | | | | | | | | | | | | | | | | | | | | | | | | | | | | | | | | | | | | | | | | | | | | | | | | | | | | | |
| | Quadro M2000 | 768 | 4GB | 75W | 4xDP | | | | | | | | | | | | | | | | | | | | | | | | | | | | | | | | | | | | | | | | | | | | | | | | | | | | | | | | | | | | | | | | | | | | | | | | | | | | | | | | | | | | | | | | | | | | | | | | | | | | | | | | | | | | | | | | | | | | | | | | | | | | | | | | | | | | | | |
| | Quadro M4000 | 1664 | 8GB | 120W | 4xDP | | | | | | | | | | | | | | | | | | | | | | | | | | | | | | | | | | | | | | | | | | | | | | | | | | | | | | | | | | | | | | | | | | | | | | | | | | | | | | | | | | | | | | | | | | | | | | | | | | | | | | | | | | | | | | | | | | | | | | | | | | | | | | | | | | | | | | |
| | Quadro M5000 | 2048 | 8GB | 150W | DVI-I DL+4xDP | SLI | | | | | | | | | | | | | | | | | | | | | | | | | | | | | | | | | | | | | | | | | | | | | | | | | | | | | | | | | | | | | | | | | | | | | | | | | | | | | | | | | | | | | | | | | | | | | | | | | | | | | | | | | | | | | | | | | | | | | | | | | | | | | | | | | | | | | |
| | Quadro M6000 | 3072 | 24GB | 250W | DVI-I DL+4xDP | | | | | | | | | | | | | | | | | | | | | | | | | | | | | | | | | | | | | | | | | | | | | | | | | | | | | | | | | | | | | | | | | | | | | | | | | | | | | | | | | | | | | | | | | | | | | | | | | | | | | | | | | | | | | | | | | | | | | | | | | | | | | | | | | | | | | | |
| | Quadro P400 | 256 | 2GB | 30W | 3xminiDP | | | | | | | | | | | | | | | | | | | | | | | | | | | | | | | | | | | | | | | | | | | | | | | | | | | | | | | | | | | | | | | | | | | | | | | | | | | | | | | | | | | | | | | | | | | | | | | | | | | | | | | | | | | | | | | | | | | | | | | | | | | | | | | | | | | | | | |
| | Quadro P600 | 384 | 2GB | 40W | 4xminiDP | | | | | | | | | | | | | | | | | | | | | | | | | | | | | | | | | | | | | | | | | | | | | | | | | | | | | | | | | | | | | | | | | | | | | | | | | | | | | | | | | | | | | | | | | | | | | | | | | | | | | | | | | | | | | | | | | | | | | | | | | | | | | | | | | | | | | | |
| | Quadro P1000 | 640 | 4GB | 47W | 4xminiDP | | | | | | | | | | | | | | | | | | | | | | | | | | | | | | | | | | | | | | | | | | | | | | | | | | | | | | | | | | | | | | | | | | | | | | | | | | | | | | | | | | | | | | | | | | | | | | | | | | | | | | | | | | | | | | | | | | | | | | | | | | | | | | | | | | | | | | |
| | Quadro P2000 | 1024 | 5GB | 75W | 4xDP | | | | | | | | | | | | | | | | | | | | | | | | | | | | | | | | | | | | | | | | | | | | | | | | | | | | | | | | | | | | | | | | | | | | | | | | | | | | | | | | | | | | | | | | | | | | | | | | | | | | | | | | | | | | | | | | | | | | | | | | | | | | | | | | | | | | | | |
| Quadro P4000 | 1792 | 8GB | 105W | 4xDP | SLI | | | | | | | | | | | | | | | | | | | | | | | | | | | | | | | | | | | | | | | | | | | | | | | | | | | | | | | | | | | | | | | | | | | | | | | | | | | | | | | | | | | | | | | | | | | | | | | | | | | | | | | | | | | | | | | | | | | | | | | | | | | | | | | | | | | | | | |
| Quadro P5000 | 2560 | 16GB | 180W | DVI-D DL+4xDP | SLI | | | | | | | | | | | | | | | | | | | | | | | | | | | | | | | | | | | | | | | | | | | | | | | | | | | | | | | | | | | | | | | | | | | | | | | | | | | | | | | | | | | | | | | | | | | | | | | | | | | | | | | | | | | | | | | | | | | | | | | | | | | | | | | | | | | | | | |
| Quadro P6000 | 3840 | 24GB | 250W | DVI-D DL+4xDP | | | | | | | | | | | | | | | | | | | | | | | | | | | | | | | | | | | | | | | | | | | | | | | | | | | | | | | | | | | | | | | | | | | | | | | | | | | | | | | | | | | | | | | | | | | | | | | | | | | | | | | | | | | | | | | | | | | | | | | | | | | | | | | | | | | | | | | |
| Tesla K40 | 2880 | 12GB | 235W | | | | | | | | | | | | | | | | | | | | | | | | | | | | | | | | | | | | | | | | | | | | | | | | | | | | | | | | | | | | | | | | | | | | | | | | | | | | | | | | | | | | | | | | | | | | | | | | | | | | | | | | | | | | | | | | | | | | | | | | | | | | | | | | | | | | | | | | |
| RAID controller | Supports one of the following: RAID 0, 1, 5, 10 with onboard SATA controller in chipset, SATA 6Gb/s. RAID 0, 1, 5, 10 with optional LSI RAID flex adapter, 12Gb/s SAS and SATA. RAID 0, 1, 5, 6, 10 with optional LSI 9364-8i PCIe adapter, 1GB memory, 12Gb/s SAS and SATA | | | | | | | | | | | | | | | | | | | | | | | | | | | | | | | | | | | | | | | | | | | | | | | | | | | | | | | | | | | | | | | | | | | | | | | | | | | | | | | | | | | | | | | | | | | | | | | | | | | | | | | | | | | | | | | | | | | | | | | | | | | | | | | | | | | | | | | | | | |
| Drive Bays | Two external 5.25" flex bays for flex module, optical drives, or optional disk drives. Four 3.5" internal bays. Each 3.5" bay can support dual drives on selected models (see right). | | | | | | | | | | | | | | | | | | | | | | | | | | | | | | | | | | | | | | | | | | | | | | | | | | | | | | | | | | | | | | | | | | | | | | | | | | | | | | | | | | | | | | | | | | | | | | | | | | | | | | | | | | | | | | | | | | | | | | | | | | | | | | | | | | | | | | | | | | |
| Flex bay | Two 5.25" flex bays for optical drives, Front Access Storage Enclosure drives, Flex Bay Storage Enclosure drives, or flex module. • Up to two half-height optical drives or up to one 9.5mm optical drive, DVD-ROM, DVD±RW, or Blu-Ray burner • Up to one Front Access Storage Enclosure for one 3.5" or 2.5" SATA drive. • Up to two Flex Bay Storage Enclosure for two 3.5" or 2.5" SATA drives. | | | | | | | | | | | | | | | | | | | | | | | | | | | | | | | | | | | | | | | | | | | | | | | | | | | | | | | | | | | | | | | | | | | | | | | | | | | | | | | | | | | | | | | | | | | | | | | | | | | | | | | | | | | | | | | | | | | | | | | | | | | | | | | | | | | | | | | | | | |
| Supporting storage | 3.5" HDD, 7.2K SATA6Gbs | 500GB/1TB/2TB/3TB/4TB/6TB/1TB hybrid/2TB hybrid | | | | | | | | | | | | | | | | | | | | | | | | | | | | | | | | | | | | | | | | | | | | | | | | | | | | | | | | | | | | | | | | | | | | | | | | | | | | | | | | | | | | | | | | | | | | | | | | | | | | | | | | | | | | | | | | | | | | | | | | | | | | | | | | | | | | | | | | | |
| | 2.5" HDD, 15K SAS12Gbs | 300GB/600GB | | | | | | | | | | | | | | | | | | | | | | | | | | | | | | | | | | | | | | | | | | | | | | | | | | | | | | | | | | | | | | | | | | | | | | | | | | | | | | | | | | | | | | | | | | | | | | | | | | | | | | | | | | | | | | | | | | | | | | | | | | | | | | | | | | | | | | | | | |
| | 2.5" SSD, SAS12Gbs | 200GB/400GB/800GB | | | | | | | | | | | | | | | | | | | | | | | | | | | | | | | | | | | | | | | | | | | | | | | | | | | | | | | | | | | | | | | | | | | | | | | | | | | | | | | | | | | | | | | | | | | | | | | | | | | | | | | | | | | | | | | | | | | | | | | | | | | | | | | | | | | | | | | | | |
| | 2.5" SAS HDD, 10K 12Gbs | 300GB | | | | | | | | | | | | | | | | | | | | | | | | | | | | | | | | | | | | | | | | | | | | | | | | | | | | | | | | | | | | | | | | | | | | | | | | | | | | | | | | | | | | | | | | | | | | | | | | | | | | | | | | | | | | | | | | | | | | | | | | | | | | | | | | | | | | | | | | | |
| | 2.5" SSD, SATA6Gbs | 180GB/240GB/256GB/480GB/512GB with OPAL, 256GB/512GB/1TB without OPAL | | | | | | | | | | | | | | | | | | | | | | | | | | | | | | | | | | | | | | | | | | | | | | | | | | | | | | | | | | | | | | | | | | | | | | | | | | | | | | | | | | | | | | | | | | | | | | | | | | | | | | | | | | | | | | | | | | | | | | | | | | | | | | | | | | | | | | | | | |
| | PCIe SSD, U.2 | 400GB | | | | | | | | | | | | | | | | | | | | | | | | | | | | | | | | | | | | | | | | | | | | | | | | | | | | | | | | | | | | | | | | | | | | | | | | | | | | | | | | | | | | | | | | | | | | | | | | | | | | | | | | | | | | | | | | | | | | | | | | | | | | | | | | | | | | | | | | | |
| PCIe SSD, M.2 | 256 GB/512GB/1TB | | | | | | | | | | | | | | | | | | | | | | | | | | | | | | | | | | | | | | | | | | | | | | | | | | | | | | | | | | | | | | | | | | | | | | | | | | | | | | | | | | | | | | | | | | | | | | | | | | | | | | | | | | | | | | | | | | | | | | | | | | | | | | | | | | | | | | | | | | |
| PCIe SSD adapter | 400GB (up to 3 per system) | | | | | | | | | | | | | | | | | | | | | | | | | | | | | | | | | | | | | | | | | | | | | | | | | | | | | | | | | | | | | | | | | | | | | | | | | | | | | | | | | | | | | | | | | | | | | | | | | | | | | | | | | | | | | | | | | | | | | | | | | | | | | | | | | | | | | | | | | | |
| Flex connector | One flex connector, supports one of the following: • Up to one LSI RAID flex adapter for SATA/SAS RAID • Up to one Multi-I/O flex adapters for one 2.5" PCIe SSD • Up to one M.2 flex adapters for one M.2 PCIe SSD | | | | | | | | | | | | | | | | | | | | | | | | | | | | | | | | | | | | | | | | | | | | | | | | | | | | | | | | | | | | | | | | | | | | | | | | | | | | | | | | | | | | | | | | | | | | | | | | | | | | | | | | | | | | | | | | | | | | | | | | | | | | | | | | | | | | | | | | | | |

| Components | Specification | |
|--|--|--------------------------------------|
| Network interfaces | Integrated one Gigabit Ethernet (Intel i218LM), supports Wake-on-LAN. Optional discrete Ethernet is available | |
| HD Audio | Realtek ALC662 codec | |
| TPM | TCG 1.2-compliant | |
| Power supply | One fixed 490 watts, autosensing, 90%, 80 PLUS Gold qualified. Or one fixed 650 watts, autosensing, 92%, 80 PLUS Platinum qualified | |
| Front ports | Four USB 3.0 (one Diagnostic, one Always On), one combo audio/microphone jack (3.5mm) | |
| Rear ports | Four USB 2.0, four USB 3.0, one serial (9-pin), one ethernet (RJ-45), three analog audio ports (line-in, line-out, mic-in), two PS/2 | |
| Add-on ports | Supports the following optional ports: Two IEEE 1394 (one on rear and one on front flex module) via PCIe adapter, up to one adapter per system. Two rear USB 3.0 per PCIe adapter, up to three adapters per system. One rear Thunderbolt via PCIe adapter. One front eSATA (on flex module), or one rear eSATA via cable (also needs one PCIe slot), up to one eSATA port per system. One internal USB 3.0 port via cable, cannot be intermixed with 29-in-1 reader | |
| Media reader | 9-in-1 USB 2.0 or 29-in-1 USB 3.0 card reader | |
| Mechanical | <ul style="list-style-type: none"> 36-liter: 175mm/6.89" W x 470mm/18.5" D x 440mm/17.32" H (with feet) Tool-less parts: all except CPU fansink 48.94 lb (22.2kg) max configuration | |
| Environmental specification | Temperature - operating | 50 °F to 95 °F (10 °C to 35 °C) |
| | Temperature - non operating (no package) | 14 °F to 140 °F (-10 °C to 60 °C) |
| | Temperature - non operating (with package) | -40 °F to 140 °F (-40 °C to 60 °C) |
| | Altitude - operating | (Unpressurized): 0-10000ft (0-3048m) |
| Humidity - operating | Humidity - operating | 10%-80%, non-condensing |
| | Humidity - storage (with package) | 10%-90%, non-condensing |
| RoHS-compliant, GREENGUARD on all models. EPEAT Gold rating, ENERGY STAR 6.1 qualified on selected models. | | |
| Base warranty | 3-year limited onsite service with 9x5/NBD | |
| ISV certifications | Please visit www.thinkworkstations.com/isv-certifications/ | |

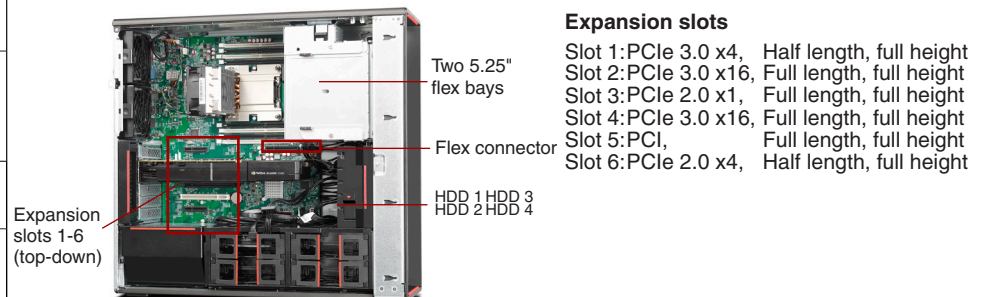

Expansion slots
Slot 1: PCIe 3.0 x4, Half length, full height
Slot 2: PCIe 3.0 x16, Full length, full height
Slot 3: PCIe 2.0 x1, Full length, full height
Slot 4: PCIe 3.0 x16, Full length, full height
Slot 5: PCI, Full length, full height
Slot 6: PCIe 2.0 x4, Half length, full height

Drive Bays
HDD 1-4: Standard 3.5" HDD bay, up to four 3.5" or 2.5" disk drives.
On selected models, each 3.5" bay can supports 2.5" (9mm or less) drive plus 3.5" drive, or two 2.5" (15mm or less) drives.
Flex bay: Two 5.25" flex bays, for HH optical drives.
Or up to one optional flex module (Flex module supports one or more of the following options: 9.5mm optical/29-in-1 USB 3.0 reader/front IEEE 1394/front eSATA).
Or up to two HDD bays for two drives, 3.5" or 2.5" each, SATA only.

| Model | Region | Processor | Graphics | Memory (Capacity/Type) | RAID Controller | Max Drives in 3.5" Bays | Storage (Capacity/Type/Interface) | Optical | Media Reader | Power Supply | Add-on Ports | Discrete Ethernet | Keyboard / Mouse | Operating System | Warranty | Ann Date (mm/yy) |
|------------|--------|---|-------------------------------|------------------------------|--------------------|----------------------------------|--------------------------------------|--------------|-----------------|-----------------|-----------------|----------------------|----------------------|--------------------------------------|----------|---------------------|
| 30B5000VUS | US | Xeon E5-1650 v4 6C/3.6GHz/ 15MB/140W/DDR4-2400 | Open | 1x8GB RDIMM DDR4-2400 ECC | Onboard | 4 | 1x1TB HDD 7.2K 3.5" SATA6Gbs | HH DVD±RW | 9-in-1 | 650W 92% | None | None | USB / USB Optical | Windows 10 Pro 64 | 3-year | 06/16 |
| 30B50019US | US | Xeon E5-1630 v4 4C/3.7GHz/ 10MB/140W/DDR4-2400 | Open | 2x8GB RDIMM DDR4-2400 ECC | Onboard | 4 | 1x256GB SSD 2.5" SATA6Gbs Opal | HH DVD±RW | 9-in-1 | 650W 92% | None | None | USB / USB Optical | Windows 10 Pro 64 | 3-year | 06/16 |
| 30B5001GUS | US | Xeon E5-1620 v4 4C/3.5GHz/ 10MB/140W/DDR4-2400 | NVIDIA Quadro M2000 4GB | 1x8GB RDIMM DDR4-2400 ECC | Onboard | 4 | 1x1TB HDD 7.2K 3.5" SATA6Gbs | HH DVD±RW | 9-in-1 | 490W 90% | None | None | USB / USB Optical | Windows 10 Pro 64 | 3-year | 06/16 |
| 30B5001HUS | US | Xeon E5-1620 v4 4C/3.5GHz/ 10MB/140W/DDR4-2400 | Open | 1x8GB RDIMM DDR4-2400 ECC | Onboard | 4 | 1x1TB HDD 7.2K 3.5" SATA6Gbs | HH DVD±RW | 9-in-1 | 650W 92% | None | None | USB / USB Optical | Windows 10 Pro 64 | 3-year | 06/16 |
| 30B5001JUS | US | Xeon E5-1620 v4 4C/3.5GHz/ 10MB/140W/DDR4-2400 | NVIDIA Quadro M2000 4GB | 2x8GB RDIMM DDR4-2400 ECC | Onboard | 4 | 1x512GB SSD 2.5" SATA6Gbs | HH DVD±RW | 9-in-1 | 490W 90% | None | None | USB / USB Optical | Windows 10 Pro 64 | 3-year | 06/16 |
| 30B5001KUS | US | Xeon E5-1620 v4 4C/3.5GHz/ 10MB/140W/DDR4-2400 | Open | 1x8GB RDIMM DDR4-2400 ECC | Onboard | 4 | 1x1TB HDD 7.2K 3.5" SATA6Gbs | HH DVD±RW | 9-in-1 | 490W 90% | None | None | USB / USB Optical | Windows 10 Pro 64 | 3-year | 06/16 |
| 30B5001LUS | US | Xeon E5-1607 v4 4C/3.1GHz/ 10MB/140W/DDR4-2133 | NVIDIA Quadro K620 2GB | 1x8GB RDIMM DDR4-2400 ECC | Onboard | 4 | 1x1TB HDD 7.2K 3.5" SATA6Gbs | HH DVD±RW | 9-in-1 | 490W 90% | None | None | USB / USB Optical | Windows 10 Pro 64 | 3-year | 06/16 |
| 30B5001MUS | US | Xeon E5-1607 v4 4C/3.1GHz/ 10MB/140W/DDR4-2133 | NVIDIA Quadro K620 2GB | 1x8GB RDIMM DDR4-2400 ECC | Onboard | 4 | 1x500GB HDD 7.2K 3.5" SATA6Gbs | HH DVD±RW | 9-in-1 | 490W 90% | None | None | USB / USB Optical | Windows 10 Pro 64 | 3-year | 06/16 |
| 30B5001NUS | US | Xeon E5-1630 v4 4C/3.7GHz/ 10MB/140W/DDR4-2400 | NVIDIA Quadro M4000 8GB | 2x8GB RDIMM DDR4-2400 ECC | Onboard | 4 | 1x512GB SSD 2.5" SATA6Gbs | HH DVD±RW | 9-in-1 | 650W 92% | None | None | USB / USB Optical | Windows 10 Pro 64 | 3-year | 06/16 |
| 30B5001PUS | US | Xeon E5-1607 v4 4C/3.1GHz/ 10MB/140W/DDR4-2133 | Open | 1x8GB RDIMM DDR4-2400 ECC | Onboard | 4 | 1x1TB HDD 7.2K 3.5" SATA6Gbs | HH DVD±RW | 9-in-1 | 490W 90% | None | None | USB / USB Optical | Windows 10 Pro 64 | 3-year | 06/16 |
| 30B5001QUS | US | Xeon E5-1630 v4 4C/3.7GHz/ 10MB/140W/DDR4-2400 | NVIDIA Quadro M4000 8GB | 2x8GB RDIMM DDR4-2400 ECC | Onboard | 4 | 1x1TB HDD 7.2K 3.5" SATA6Gbs | HH DVD±RW | 9-in-1 | 650W 92% | None | None | USB / USB Optical | Windows 10 Pro 64 | 3-year | 06/16 |
| 30B50022US | US | Xeon E5-1650 v4 6C/3.6GHz/ 15MB/140W/DDR4-2400 | Open | 1x8GB RDIMM DDR4-2400 ECC | Onboard | 4 | 1x1TB HDD 7.2K 3.5" SATA6Gbs | HH DVD±RW | 9-in-1 | 650W 92% | None | None | USB / USB Optical | Windows 10 DG Windows 7 Pro 64 | 3-year | 09/16 |
| 30B5002EUS | US | Xeon E5-1630 v4 4C/3.7GHz/ 10MB/140W/DDR4-2400 | Open | 2x8GB RDIMM DDR4-2400 ECC | Onboard | 4 | 1x256GB SSD 2.5" SATA6Gbs Opal | HH DVD±RW | 9-in-1 | 650W 92% | None | None | USB / USB Optical | Windows 10 DG Windows 7 Pro 64 | 3-year | 09/16 |
| 30B5002TUS | US | Xeon E5-1620 v4 4C/3.5GHz/ 10MB/140W/DDR4-2400 | NVIDIA Quadro K620 2GB | 1x8GB RDIMM DDR4-2400 ECC | Onboard | 4 | 1x1TB HDD 7.2K 3.5" SATA6Gbs | HH DVD±RW | 9-in-1 | 490W 90% | None | None | USB / USB Optical | Windows 10 Pro 64 | 3-year | 06/16 |
| 30B5002UUS | US | Xeon E5-1630 v4 4C/3.7GHz/ 10MB/140W/DDR4-2400 | Open | 1x8GB RDIMM DDR4-2400 ECC | Onboard | 4 | 1x256GB SSD 2.5" SATA6Gbs Opal | HH DVD±RW | 9-in-1 | 490W 90% | None | None | USB / USB Optical | Windows 10 Pro 64 | 3-year | 06/16 |

| Model | Region | Processor | Graphics | Memory (Capacity/Type) | RAID Controller | Max Drives in 3.5" Bays | Storage (Capacity/Type/Interface) | Optical | Media Reader | Power Supply | Add-on Ports | Discrete Ethernet | Keyboard / Mouse | Operating System | Warranty | Ann Date (mm/yy) |
|------------|--------|---|-------------------------------|------------------------------|--------------------|----------------------------------|--------------------------------------|--------------|-----------------|-----------------|-----------------|----------------------|----------------------|--------------------------------------|----------|---------------------|
| 30B5002VUS | US | Xeon E5-1630 v4 4C/3.7GHz/ 10MB/140W/DDR4-2400 | NVIDIA Quadro K1200 4GB | 1x8GB RDIMM DDR4-2400 ECC | Onboard | 4 | 1x256GB SSD 2.5" SATA6Gbs Opal | HH DVD±RW | 9-in-1 | 490W 90% | None | None | USB / USB Optical | Windows 10 Pro 64 | 3-year | 06/16 |
| 30B5002WUS | US | Xeon E5-1630 v4 4C/3.7GHz/ 10MB/140W/DDR4-2400 | NVIDIA Quadro M2000 4GB | 1x8GB RDIMM DDR4-2400 ECC | Onboard | 4 | 1x256GB SSD 2.5" SATA6Gbs Opal | HH DVD±RW | 9-in-1 | 490W 90% | None | None | USB / USB Optical | Windows 10 Pro 64 | 3-year | 06/16 |
| 30B5002XUS | US | Xeon E5-1630 v4 4C/3.7GHz/ 10MB/140W/DDR4-2400 | NVIDIA Quadro K1200 4GB | 1x8GB RDIMM DDR4-2400 ECC | Onboard | 4 | 1x1TB HDD 7.2K 3.5" SATA6Gbs | HH DVD±RW | 9-in-1 | 490W 90% | None | None | USB / USB Optical | Windows 10 Pro 64 | 3-year | 06/16 |
| 30B5002YUS | US | Xeon E5-1620 v4 4C/3.5GHz/ 10MB/140W/DDR4-2400 | NVIDIA Quadro M4000 8GB | 2x8GB RDIMM DDR4-2400 ECC | Onboard | 4 | 1x1TB HDD 7.2K 3.5" SATA6Gbs | HH DVD±RW | 9-in-1 | 650W 92% | None | None | USB / USB Optical | Windows 10 Pro 64 | 3-year | 06/16 |
| 30B50030US | US | Xeon E5-1630 v4 4C/3.7GHz/ 10MB/140W/DDR4-2400 | Open | 1x8GB RDIMM DDR4-2400 ECC | Onboard | 4 | 1x256GB SSD 2.5" SATA6Gbs Opal | HH DVD±RW | 9-in-1 | 650W 92% | None | None | USB / USB Optical | Windows 10 Pro 64 | 3-year | 06/16 |
| 30B50031US | US | Xeon E5-1630 v4 4C/3.7GHz/ 10MB/140W/DDR4-2400 | NVIDIA Quadro M2000 4GB | 1x8GB RDIMM DDR4-2400 ECC | Onboard | 4 | 1x256GB SSD 2.5" SATA6Gbs Opal | HH DVD±RW | 9-in-1 | 650W 92% | None | None | USB / USB Optical | Windows 10 Pro 64 | 3-year | 06/16 |
| 30B50032US | US | Xeon E5-1650 v4 6C/3.6GHz/ 15MB/140W/DDR4-2400 | Open | 2x8GB RDIMM DDR4-2400 ECC | Onboard | 4 | 1x256GB SSD 2.5" SATA6Gbs Opal | HH DVD±RW | 9-in-1 | 650W 92% | None | None | USB / USB Optical | Windows 10 Pro 64 | 3-year | 06/16 |
| 30B50033US | US | Xeon E5-1650 v4 6C/3.6GHz/ 15MB/140W/DDR4-2400 | NVIDIA Quadro M2000 4GB | 2x8GB RDIMM DDR4-2400 ECC | Onboard | 4 | 1x1TB HDD 7.2K 3.5" SATA6Gbs | HH DVD±RW | 9-in-1 | 650W 92% | None | None | USB / USB Optical | Windows 10 Pro 64 | 3-year | 06/16 |
| 30B50034US | US | Xeon E5-1650 v4 6C/3.6GHz/ 15MB/140W/DDR4-2400 | NVIDIA Quadro M4000 8GB | 2x8GB RDIMM DDR4-2400 ECC | Onboard | 4 | 1x1TB HDD 7.2K 3.5" SATA6Gbs | HH DVD±RW | 9-in-1 | 650W 92% | None | None | USB / USB Optical | Windows 10 Pro 64 | 3-year | 06/16 |
| 30B50035US | US | Xeon E5-1650 v4 6C/3.6GHz/ 15MB/140W/DDR4-2400 | NVIDIA Quadro M4000 8GB | 2x8GB RDIMM DDR4-2400 ECC | Onboard | 4 | 1x512GB SSD 2.5" SATA6Gbs | HH DVD±RW | 9-in-1 | 650W 92% | None | None | USB / USB Optical | Windows 10 Pro 64 | 3-year | 06/16 |
| 30B50036US | US | Xeon E5-1650 v4 6C/3.6GHz/ 15MB/140W/DDR4-2400 | NVIDIA Quadro M5000 8GB | 2x8GB RDIMM DDR4-2400 ECC | Onboard | 4 | 1x512GB SSD 2.5" SATA6Gbs | HH DVD±RW | 9-in-1 | 650W 92% | None | None | USB / USB Optical | Windows 10 Pro 64 | 3-year | 06/16 |
| 30B5003KUS | US | Xeon E5-1607 v4 4C/3.1GHz/ 10MB/140W/DDR4-2133 | Open | 1x8GB RDIMM DDR4-2400 ECC | Onboard | 4 | 1x1TB HDD 7.2K 3.5" SATA6Gbs | HH DVD±RW | 9-in-1 | 490W 90% | None | None | USB / USB Optical | Windows 10 DG Windows 7 Pro 64 | 3-year | 09/16 |
| 30B5003NUS | US | Xeon E5-1620 v4 4C/3.5GHz/ 10MB/140W/DDR4-2400 | NVIDIA Quadro M4000 8GB | 2x8GB RDIMM DDR4-2400 ECC | Onboard | 4 | 1x1TB HDD 7.2K 3.5" SATA6Gbs | HH DVD±RW | 9-in-1 | 650W 92% | None | None | USB / USB Optical | Windows 10 DG Windows 7 Pro 64 | 3-year | 09/16 |
| 30B5003UUS | US | Xeon E5-1620 v4 4C/3.5GHz/ 10MB/140W/DDR4-2400 | Open | 1x8GB RDIMM DDR4-2400 ECC | Onboard | 4 | 1x1TB HDD 7.2K 3.5" SATA6Gbs | HH DVD±RW | 9-in-1 | 490W 90% | None | None | USB / USB Optical | Windows 10 DG Windows 7 Pro 64 | 3-year | 09/16 |
| 30B5004YUS | US | Xeon E5-1630 v4 4C/3.7GHz/ 10MB/140W/DDR4-2400 | NVIDIA Quadro M4000 8GB | 2x8GB RDIMM DDR4-2400 ECC | Onboard | 4 | 1x1TB HDD 7.2K 3.5" SATA6Gbs | HH DVD±RW | 9-in-1 | 650W 92% | None | None | USB / USB Optical | Windows 10 DG Windows 7 Pro 64 | 3-year | 09/16 |

| Model | Region | Processor | Graphics | Memory (Capacity/Type) | RAID Controller | Max Drives in 3.5" Bays | Storage (Capacity/Type/Interface) | Optical | Media Reader | Power Supply | Add-on Ports | Discrete Ethernet | Keyboard / Mouse | Operating System | Warranty | Ann Date (mm/yy) |
|------------|--------|---|-------------------------|---------------------------|-----------------|-------------------------|-----------------------------------|-----------|--------------|--------------|--------------|-------------------|-------------------|--------------------------------|----------|------------------|
| 30B50050US | US | Xeon E5-1630 v4 4C/3.7GHz/10MB/140W/DDR4-2400 | NVIDIA Quadro M4000 8GB | 2x8GB RDIMM DDR4-2400 ECC | Onboard | 4 | 1x512GB SSD 2.5" SATA6Gbs | HH DVD±RW | 9-in-1 | 650W 92% | None | None | USB / USB Optical | Windows 10 DG Windows 7 Pro 64 | 3-year | 09/16 |
| 30B50051US | US | Xeon E5-1620 v4 4C/3.5GHz/10MB/140W/DDR4-2400 | NVIDIA Quadro M2000 4GB | 2x8GB RDIMM DDR4-2400 ECC | Onboard | 4 | 1x512GB SSD 2.5" SATA6Gbs | HH DVD±RW | 9-in-1 | 490W 90% | None | None | USB / USB Optical | Windows 10 DG Windows 7 Pro 64 | 3-year | 09/16 |
| 30B50052US | US | Xeon E5-1607 v4 4C/3.1GHz/10MB/140W/DDR4-2133 | NVIDIA Quadro K620 2GB | 1x8GB RDIMM DDR4-2400 ECC | Onboard | 4 | 1x500GB HDD 7.2K 3.5" SATA6Gbs | HH DVD±RW | 9-in-1 | 490W 90% | None | None | USB / USB Optical | Windows 10 DG Windows 7 Pro 64 | 3-year | 09/16 |
| 30B50053US | US | Xeon E5-1620 v4 4C/3.5GHz/10MB/140W/DDR4-2400 | Open | 1x8GB RDIMM DDR4-2400 ECC | Onboard | 4 | 1x1TB HDD 7.2K 3.5" SATA6Gbs | HH DVD±RW | 9-in-1 | 650W 92% | None | None | USB / USB Optical | Windows 10 DG Windows 7 Pro 64 | 3-year | 09/16 |
| 30B50054US | US | Xeon E5-1607 v4 4C/3.1GHz/10MB/140W/DDR4-2133 | NVIDIA Quadro K620 2GB | 1x8GB RDIMM DDR4-2400 ECC | Onboard | 4 | 1x1TB HDD 7.2K 3.5" SATA6Gbs | HH DVD±RW | 9-in-1 | 490W 90% | None | None | USB / USB Optical | Windows 10 DG Windows 7 Pro 64 | 3-year | 09/16 |
| 30B50055US | US | Xeon E5-1620 v4 4C/3.5GHz/10MB/140W/DDR4-2400 | NVIDIA Quadro M2000 4GB | 1x8GB RDIMM DDR4-2400 ECC | Onboard | 4 | 1x1TB HDD 7.2K 3.5" SATA6Gbs | HH DVD±RW | 9-in-1 | 490W 90% | None | None | USB / USB Optical | Windows 10 DG Windows 7 Pro 64 | 3-year | 09/16 |
| 30B50056US | US | Xeon E5-1650 v4 6C/3.6GHz/15MB/140W/DDR4-2400 | NVIDIA Quadro M4000 8GB | 2x8GB RDIMM DDR4-2400 ECC | Onboard | 4 | 1x1TB HDD 7.2K 3.5" SATA6Gbs | HH DVD±RW | 9-in-1 | 650W 92% | None | None | USB / USB Optical | Windows 10 DG Windows 7 Pro 64 | 3-year | 09/16 |
| 30B50057US | US | Xeon E5-1630 v4 4C/3.7GHz/10MB/140W/DDR4-2400 | NVIDIA Quadro K1200 4GB | 1x8GB RDIMM DDR4-2400 ECC | Onboard | 4 | 1x1TB HDD 7.2K 3.5" SATA6Gbs | HH DVD±RW | 9-in-1 | 490W 90% | None | None | USB / USB Optical | Windows 10 DG Windows 7 Pro 64 | 3-year | 09/16 |
| 30B50058US | US | Xeon E5-1630 v4 4C/3.7GHz/10MB/140W/DDR4-2400 | Open | 1x8GB RDIMM DDR4-2400 ECC | Onboard | 4 | 1x256GB SSD 2.5" SATA6Gbs Opal | HH DVD±RW | 9-in-1 | 490W 90% | None | None | USB / USB Optical | Windows 10 DG Windows 7 Pro 64 | 3-year | 09/16 |
| 30B50059US | US | Xeon E5-1630 v4 4C/3.7GHz/10MB/140W/DDR4-2400 | NVIDIA Quadro M2000 4GB | 1x8GB RDIMM DDR4-2400 ECC | Onboard | 4 | 1x256GB SSD 2.5" SATA6Gbs Opal | HH DVD±RW | 9-in-1 | 490W 90% | None | None | USB / USB Optical | Windows 10 DG Windows 7 Pro 64 | 3-year | 09/16 |
| 30B5005AUS | US | Xeon E5-1650 v4 6C/3.6GHz/15MB/140W/DDR4-2400 | NVIDIA Quadro M5000 8GB | 2x8GB RDIMM DDR4-2400 ECC | Onboard | 4 | 1x512GB SSD 2.5" SATA6Gbs | HH DVD±RW | 9-in-1 | 650W 92% | None | None | USB / USB Optical | Windows 10 DG Windows 7 Pro 64 | 3-year | 09/16 |
| 30B5005BUS | US | Xeon E5-1630 v4 4C/3.7GHz/10MB/140W/DDR4-2400 | NVIDIA Quadro K1200 4GB | 1x8GB RDIMM DDR4-2400 ECC | Onboard | 4 | 1x256GB SSD 2.5" SATA6Gbs Opal | HH DVD±RW | 9-in-1 | 490W 90% | None | None | USB / USB Optical | Windows 10 DG Windows 7 Pro 64 | 3-year | 09/16 |
| 30B5005CUS | US | Xeon E5-1650 v4 6C/3.6GHz/15MB/140W/DDR4-2400 | NVIDIA Quadro M2000 4GB | 2x8GB RDIMM DDR4-2400 ECC | Onboard | 4 | 1x1TB HDD 7.2K 3.5" SATA6Gbs | HH DVD±RW | 9-in-1 | 650W 92% | None | None | USB / USB Optical | Windows 10 DG Windows 7 Pro 64 | 3-year | 09/16 |
| 30B5005DUS | US | Xeon E5-1630 v4 4C/3.7GHz/10MB/140W/DDR4-2400 | Open | 1x8GB RDIMM DDR4-2400 ECC | Onboard | 4 | 1x256GB SSD 2.5" SATA6Gbs Opal | HH DVD±RW | 9-in-1 | 650W 92% | None | None | USB / USB Optical | Windows 10 DG Windows 7 Pro 64 | 3-year | 09/16 |
| 30B5005EUS | US | Xeon E5-1650 v4 6C/3.6GHz/15MB/140W/DDR4-2400 | Open | 2x8GB RDIMM DDR4-2400 ECC | Onboard | 4 | 1x256GB SSD 2.5" SATA6Gbs Opal | HH DVD±RW | 9-in-1 | 650W 92% | None | None | USB / USB Optical | Windows 10 DG Windows 7 Pro 64 | 3-year | 09/16 |

| Model | Region | Processor | Graphics | Memory (Capacity/Type) | RAID Controller | Max Drives in 3.5" Bays | Storage (Capacity/Type/Interface) | Optical | Media Reader | Power Supply | Add-on Ports | Discrete Ethernet | Keyboard / Mouse | Operating System | Warranty | Ann Date (mm/yy) |
|------------|--------|---|--------------------------|---------------------------|-----------------|-------------------------|-----------------------------------|-----------|--------------|--------------|--------------|-------------------|-------------------|--------------------------------|----------|------------------|
| 30B5005FUS | US | Xeon E5-1650 v4 6C/3.6GHz/15MB/140W/DDR4-2400 | NVIDIA Quadro M4000 8GB | 2x8GB RDIMM DDR4-2400 ECC | Onboard | 4 | 1x512GB SSD 2.5" SATA6Gbs | HH DVD±RW | 9-in-1 | 650W 92% | None | None | USB / USB Optical | Windows 10 DG Windows 7 Pro 64 | 3-year | 09/16 |
| 30B5005GUS | US | Xeon E5-1620 v4 4C/3.5GHz/10MB/140W/DDR4-2400 | NVIDIA Quadro K620 2GB | 1x8GB RDIMM DDR4-2400 ECC | Onboard | 4 | 1x1TB HDD 7.2K 3.5" SATA6Gbs | HH DVD±RW | 9-in-1 | 490W 90% | None | None | USB / USB Optical | Windows 10 DG Windows 7 Pro 64 | 3-year | 09/16 |
| 30B5005HUS | US | Xeon E5-1630 v4 4C/3.7GHz/10MB/140W/DDR4-2400 | NVIDIA Quadro M2000 4GB | 1x8GB RDIMM DDR4-2400 ECC | Onboard | 4 | 1x256GB SSD 2.5" SATA6Gbs Opal | HH DVD±RW | 9-in-1 | 650W 92% | None | None | USB / USB Optical | Windows 10 DG Windows 7 Pro 64 | 3-year | 09/16 |
| 30B5005KUS | US | Xeon E5-1620 v4 4C/3.5GHz/10MB/140W/DDR4-2400 | Open | 2x8GB RDIMM DDR4-2400 ECC | 9364-8i PCIe | 4 | 1x1TB SSD M.2 PCIe NVMe Opal | HH DVD±RW | 9-in-1 | 650W 92% | None | None | USB / USB Optical | Windows 10 DG Windows 7 Pro 64 | 3-year | 12/16 |
| 30B5005LUS | US | Xeon E5-1650 v4 6C/3.6GHz/15MB/140W/DDR4-2400 | Open | 2x8GB RDIMM DDR4-2400 ECC | Onboard | 4 | 1x1TB SSD M.2 PCIe NVMe Opal | HH DVD±RW | 9-in-1 | 650W 92% | None | None | USB / USB Optical | Windows 10 DG Windows 7 Pro 64 | 3-year | 12/16 |
| 30B5005MUS | US | Xeon E5-1620 v4 4C/3.5GHz/10MB/140W/DDR4-2400 | Open | 2x8GB RDIMM DDR4-2400 ECC | Onboard | 4 | 1x1TB SSD M.2 PCIe NVMe Opal | HH DVD±RW | 9-in-1 | 650W 92% | None | None | USB / USB Optical | Windows 10 DG Windows 7 Pro 64 | 3-year | 12/16 |
| 30B5005NUS | US | Xeon E5-1607 v4 4C/3.1GHz/10MB/140W/DDR4-2133 | Open | 2x8GB RDIMM DDR4-2400 ECC | Onboard | 4 | 1x1TB SSD M.2 PCIe NVMe Opal | HH DVD±RW | 9-in-1 | 650W 92% | None | None | USB / USB Optical | Windows 10 DG Windows 7 Pro 64 | 3-year | 12/16 |
| 30B5005PUS | US | Xeon E5-1607 v4 4C/3.1GHz/10MB/140W/DDR4-2133 | NVIDIA Quadro P5000 16GB | 2x8GB RDIMM DDR4-2400 ECC | Onboard | 4 | 1x1TB SSD M.2 PCIe NVMe Opal | HH DVD±RW | 9-in-1 | 650W 92% | None | None | USB / USB Optical | Windows 10 DG Windows 7 Pro 64 | 3-year | 12/16 |
| 30B5005QUS | US | Xeon E5-1650 v4 6C/3.6GHz/15MB/140W/DDR4-2400 | NVIDIA Quadro P5000 16GB | 2x8GB RDIMM DDR4-2400 ECC | Onboard | 4 | 1x1TB SSD M.2 PCIe NVMe Opal | HH DVD±RW | 9-in-1 | 650W 92% | None | None | USB / USB Optical | Windows 10 DG Windows 7 Pro 64 | 3-year | 12/16 |
| 30B5005RUS | US | Xeon E5-1630 v4 4C/3.7GHz/10MB/140W/DDR4-2400 | Open | 2x8GB RDIMM DDR4-2400 ECC | Onboard | 4 | 1x1TB SSD M.2 PCIe NVMe Opal | HH DVD±RW | 9-in-1 | 650W 92% | None | None | USB / USB Optical | Windows 10 DG Windows 7 Pro 64 | 3-year | 12/16 |
| 30B5005SUS | US | Xeon E5-1620 v4 4C/3.5GHz/10MB/140W/DDR4-2400 | Open | 2x8GB RDIMM DDR4-2400 ECC | Onboard | 4 | 1x1TB SSD M.2 PCIe NVMe Opal | HH DVD±RW | 9-in-1 | 650W 92% | None | None | USB / USB Optical | Windows 10 DG Windows 7 Pro 64 | 3-year | 12/16 |
| 30B5005VUS | US | Xeon E5-1620 v4 4C/3.5GHz/10MB/140W/DDR4-2400 | Quadro P600 2GB | 1x8GB RDIMM DDR4-2400 ECC | Onboard | 4 | 1x1TB HDD 7.2K 3.5" SATA6Gbs | HH DVD±RW | 9-in-1 | 490W 90% | None | None | USB / USB Optical | Windows 10 DG Windows 7 Pro 64 | 3-year | 04/17 |
| 30B5005WUS | US | Xeon E5-1620 v4 4C/3.5GHz/10MB/140W/DDR4-2400 | Quadro P2000 5GB | 2x8GB RDIMM DDR4-2400 ECC | Onboard | 4 | 1x512GB SSD 2.5" SATA6Gbs | HH DVD±RW | 9-in-1 | 490W 90% | None | None | USB / USB Optical | Windows 10 DG Windows 7 Pro 64 | 3-year | 04/17 |
| 30B5005XUS | US | Xeon E5-1650 v4 6C/3.6GHz/15MB/140W/DDR4-2400 | Quadro P2000 5GB | 2x8GB RDIMM DDR4-2400 ECC | Onboard | 4 | 1x1TB HDD 7.2K 3.5" SATA6Gbs | HH DVD±RW | 9-in-1 | 650W 92% | None | None | USB / USB Optical | Windows 10 DG Windows 7 Pro 64 | 3-year | 04/17 |
| 30B5005YUS | US | Xeon E5-1620 v4 4C/3.5GHz/10MB/140W/DDR4-2400 | Quadro P4000 8GB | 2x8GB RDIMM DDR4-2400 ECC | Onboard | 4 | 1x1TB HDD 7.2K 3.5" SATA6Gbs | HH DVD±RW | 9-in-1 | 650W 92% | None | None | USB / USB Optical | Windows 10 DG Windows 7 Pro 64 | 3-year | 04/17 |

| Model | Region | Processor | Graphics | Memory (Capacity/Type) | RAID Controller | Max Drives in 3.5" Bays | Storage (Capacity/Type/Interface) | Optical | Media Reader | Power Supply | Add-on Ports | Discrete Ethernet | Keyboard / Mouse | Operating System | Warranty | Ann Date (mm/yy) |
|------------|--------|---|---------------------|------------------------------|--------------------|----------------------------------|--------------------------------------|--------------|-----------------|-----------------|-----------------|----------------------|----------------------|--------------------------------------|----------|---------------------|
| 30B50060US | US | Xeon E5-1650 v4 6C/3.6GHz/ 15MB/140W/DDR4-2400 | Quadro P4000 8GB | 2x8GB RDIMM DDR4-2400 ECC | Onboard | 4 | 1x1TB HDD 7.2K 3.5" SATA6Gbs | HH DVD±RW | 9-in-1 | 650W 92% | None | None | USB / USB Optical | Windows 10 DG Windows 7 Pro 64 | 3-year | 04/17 |
| 30B50061US | US | Xeon E5-1650 v4 6C/3.6GHz/ 15MB/140W/DDR4-2400 | Quadro P2000 5GB | 2x8GB RDIMM DDR4-2400 ECC | Onboard | 4 | 1x1TB HDD 7.2K 3.5" SATA6Gbs | HH DVD±RW | 9-in-1 | 490W 90% | None | None | USB / USB Optical | Windows 10 DG Windows 7 Pro 64 | 3-year | 04/17 |
| 30B50062US | US | Xeon E5-1630 v4 4C/3.7GHz/ 10MB/140W/DDR4-2400 | Quadro P4000 8GB | 2x8GB RDIMM DDR4-2400 ECC | Onboard | 4 | 1x512GB SSD 2.5" SATA6Gbs | HH DVD±RW | 9-in-1 | 650W 92% | None | None | USB / USB Optical | Windows 10 DG Windows 7 Pro 64 | 3-year | 04/17 |
| 30B50063US | US | Xeon E5-1650 v4 6C/3.6GHz/ 15MB/140W/DDR4-2400 | Quadro P2000 5GB | 1x8GB RDIMM DDR4-2400 ECC | Onboard | 4 | 1x1TB HDD 7.2K 3.5" SATA6Gbs | HH DVD±RW | 9-in-1 | 490W 90% | None | None | USB / USB Optical | Windows 10 DG Windows 7 Pro 64 | 3-year | 04/17 |
| 30B50064US | US | Xeon E5-1630 v4 4C/3.7GHz/ 10MB/140W/DDR4-2400 | Quadro P2000 5GB | 1x8GB RDIMM DDR4-2400 ECC | Onboard | 4 | 1x256GB SSD 2.5" SATA6Gbs Opal | HH DVD±RW | 9-in-1 | 490W 90% | None | None | USB / USB Optical | Windows 10 DG Windows 7 Pro 64 | 3-year | 04/17 |
| 30B50065US | US | Xeon E5-1630 v4 4C/3.7GHz/ 10MB/140W/DDR4-2400 | Quadro P1000 4GB | 1x8GB RDIMM DDR4-2400 ECC | Onboard | 4 | 1x256GB SSD 2.5" SATA6Gbs Opal | HH DVD±RW | 9-in-1 | 490W 90% | None | None | USB / USB Optical | Windows 10 DG Windows 7 Pro 64 | 3-year | 04/17 |
| 30B50066US | US | Xeon E5-1630 v4 4C/3.7GHz/ 10MB/140W/DDR4-2400 | Quadro P2000 5GB | 1x8GB RDIMM DDR4-2400 ECC | Onboard | 4 | 1x256GB SSD 2.5" SATA6Gbs Opal | HH DVD±RW | 9-in-1 | 650W 92% | None | None | USB / USB Optical | Windows 10 DG Windows 7 Pro 64 | 3-year | 04/17 |
| 30B50067US | US | Xeon E5-1630 v4 4C/3.7GHz/ 10MB/140W/DDR4-2400 | Quadro P1000 4GB | 1x8GB RDIMM DDR4-2400 ECC | Onboard | 4 | 1x1TB HDD 7.2K 3.5" SATA6Gbs | HH DVD±RW | 9-in-1 | 490W 90% | None | None | USB / USB Optical | Windows 10 DG Windows 7 Pro 64 | 3-year | 04/17 |
| 30B50068US | US | Xeon E5-1650 v4 6C/3.6GHz/ 15MB/140W/DDR4-2400 | Quadro P4000 8GB | 2x8GB RDIMM DDR4-2400 ECC | Onboard | 4 | 1x512GB SSD 2.5" SATA6Gbs | HH DVD±RW | 9-in-1 | 650W 92% | None | None | USB / USB Optical | Windows 10 DG Windows 7 Pro 64 | 3-year | 04/17 |
| 30B50069US | US | Xeon E5-1607 v4 4C/3.1GHz/ 10MB/140W/DDR4-2133 | Quadro P600 2GB | 1x8GB RDIMM DDR4-2400 ECC | Onboard | 4 | 1x1TB HDD 7.2K 3.5" SATA6Gbs | HH DVD±RW | 9-in-1 | 490W 90% | None | None | USB / USB Optical | Windows 10 DG Windows 7 Pro 64 | 3-year | 04/17 |
| 30B5006AUS | US | Xeon E5-1630 v4 4C/3.7GHz/ 10MB/140W/DDR4-2400 | Quadro P600 2GB | 1x8GB RDIMM DDR4-2400 ECC | Onboard | 4 | 1x1TB HDD 7.2K 3.5" SATA6Gbs | HH DVD±RW | 9-in-1 | 490W 90% | None | None | USB / USB Optical | Windows 10 DG Windows 7 Pro 64 | 3-year | 04/17 |
| 30B5006BUS | US | Xeon E5-1630 v4 4C/3.7GHz/ 10MB/140W/DDR4-2400 | Quadro P600 2GB | 1x8GB RDIMM DDR4-2400 ECC | Onboard | 4 | 1x256GB SSD 2.5" SATA6Gbs Opal | HH DVD±RW | 9-in-1 | 490W 90% | None | None | USB / USB Optical | Windows 10 DG Windows 7 Pro 64 | 3-year | 04/17 |
| 30B5006CUS | US | Xeon E5-1630 v4 4C/3.7GHz/ 10MB/140W/DDR4-2400 | Quadro P4000 8GB | 2x8GB RDIMM DDR4-2400 ECC | Onboard | 4 | 1x1TB HDD 7.2K 3.5" SATA6Gbs | HH DVD±RW | 9-in-1 | 650W 92% | None | None | USB / USB Optical | Windows 10 DG Windows 7 Pro 64 | 3-year | 04/17 |

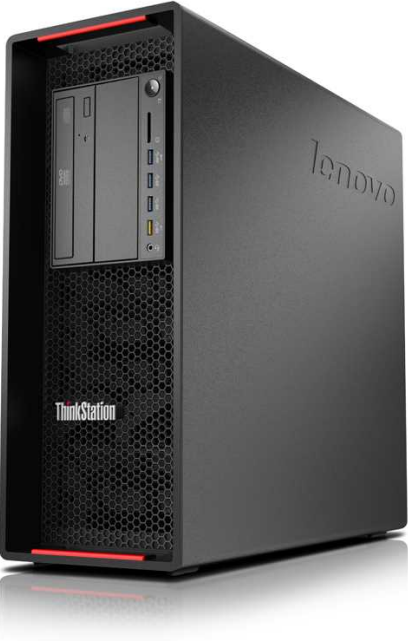

ThinkStation P700 Platform Specifications

| Components | Specification |
|--|--|
| Chipset | Intel C612 Platform Controller Hub (PCH) |
| System mgmt | Intel Active Management Technology 9 |
| Processor | Up to two 145W Intel Xeon E5-2600 v3 family processors, Or up to one 140W Intel Xeon E5-1600 v3 family processor: |
| | E5-2699 v3 18C/2.3GHz/45MB/145W/DDR4-2133 |
| | E5-2698 v3 16C/2.3GHz/40MB/135W/DDR4-2133 |
| | E5-2697 v3 14C/2.6GHz/35MB/145W/DDR4-2133 |
| | E5-2695 v3 14C/2.3GHz/35MB/120W/DDR4-2133 |
| | E5-2690 v3 12C/2.6GHz/30MB/135W/DDR4-2133 |
| | E5-2685 v3 12C/2.6GHz/30MB/120W/DDR4-2133 |
| | E5-2683 v3 14C/2GHz/35MB/120W/DDR4-2133 |
| | E5-2680 v3 12C/2.5GHz/30MB/120W/DDR4-2133 |
| | E5-2670 v3 12C/2.3GHz/30MB/120W/DDR4-2133 |
| | E5-2667 v3 8C/3.2GHz/20MB/135W/DDR4-2133 |
| | E5-2660 v3 10C/2.6GHz/25MB/105W/DDR4-2133 |
| | E5-2650L v3 12C/1.8GHz/30MB/65W/DDR4-2133 |
| | E5-2650 v3 10C/2.3GHz/25MB/105W/DDR4-2133 |
| | E5-2643 v3 6C/3.4GHz/20MB/135W/DDR4-2133 |
| | E5-2640 v3 8C/2.6GHz/20MB/90W/DDR4-1866 |
| | E5-2637 v3 4C/3.5GHz/15MB/135W/DDR4-2133 |
| | E5-2630L v3 8C/1.8GHz/20MB/55W/DDR4-1866 |
| | E5-2630 v3 8C/2.4GHz/20MB/85W/DDR4-1866 |
| | E5-2623 v3 4C/3GHz/10MB/105W/DDR4-1866 |
| | E5-2620 v3 6C/2.4GHz/15MB/85W/DDR4-1866 |
| | E5-2609 v3 6C/1.9GHz/15MB/85W/DDR4-1600 |
| | E5-2603 v3 6C/1.6GHz/15MB/85W/DDR4-1600 |
| | E5-1680 v3 8C/3.2GHz/20MB/140W/DDR4-2133 |
| E5-1660 v3 8C/3GHz/20MB/140W/DDR4-2133 | |
| E5-1650 v3 6C/3.5GHz/15MB/140W/DDR4-2133 | |
| E5-1630 v3 4C/3.7GHz/10MB/140W/DDR4-2133 | |
| E5-1620 v3 4C/3.5GHz/10MB/140W/DDR4-2133 | |
| E5-1607 v3 4C/3.1GHz/10MB/140W/DDR4-1866 | |
| E5-1603 v3 4C/2.8GHz/10MB/140W/DDR4-1866 | |
| Coprocessor | None |
| Memory DIMM slots | 12 DIMM sockets (6 DIMMs per processor), 8-channel capable (4-channel per processor). Supports RDIMM and LRDIMM (cannot be intermixed), ECC, DDR4-2133. |
| Memory capacity | 768GB (LRDIMM)/384GB, 2nd CPU is needed |
| Graphics, GPU computing, coprocessors | Three PCIe 3.0 x16 slots, two via CPU1, one via CPU2 Up to 3 graphics, GPU computing adapters per system, 2nd CPU is needed |
| | PSU Maximum quantity of PCIe x16 adapters per system (by power) 650W/1x150W+2x75W (supports onboard SATA controller and up to 85W CPU) 850W/1x225W+2x75W, or 2x150W+1x75W |
| Disk drive controller | RAID 0, 1, 5, 10 with onboard SATA controller in chipset, SATA 6Gb/s. RAID 0, 1, 5, 10 with optional LSI RAID flex adapter, 12Gb/s SAS and SATA. RAID 0, 1, 5, 6, 10 with optional LSI 9364-8i PCIe adapter, 1GB memory, optional 1GB flash with super capacitor, 12Gb/s SAS and SATA |
| Drive Bays | Two external 5.25" bays, four internal 3.5" bays (see right) |
| Flex connector | One flex connectors (see right), supports one of the following: • Up to one LSI RAID flex adapter for SATA/SAS RAID • Up to one Multi-I/O flex adapters for two PCIe SSD • Up to one M.2 flex adapters for two M.2 SSD |
| Network interfaces | Integrated two Gigabit Ethernet ports, supports Wake-on-LAN. Optional discrete Ethernet is available |
| HD Audio | Realtek ALC662 codec |
| TPM | TCG 1.2-compliant |
| Power supply | One fixed 650 watts or 850 watts, autosensing, 92%, 80 PLUS Platinum qualified |
| Front ports | Four USB 3.0 (one Diagnostic, one Always On), one combo audio/microphone jack (3.5mm) |
| Rear ports | Four USB 2.0, four USB 3.0 (blue), one serial (9-pin), two ethernet (RJ-45), three analog audio ports (line-in, line-out, mic-in), two PS/2 |
| IEEE 1394 | Up to one 6-pin port on rear, one 6-pin port on front, 1394a-2000, 400Mbps |
| Thunderbolt | 1 Thunderbolt via optional PCIe adapter. Uses slot 6. |
| Mechanical | • 36-liter: 175mm/6.89" W x 470mm/18.5" D x 440mm/17.32" H (with feet) • Tool-less parts: power supply, disk drive, fans, adapter retention • 52.25 lb (23.7kg) max configuration |
| Base warranty | 3-year limited onsite service with 9x5/NBD |

Drive Bays and Expansion slots



2 x 5.25", for half-height optical, or up to one optional flex module (Flex module supports one or more of the following options: 9.5mm optical/29-in-1 USB 3.0 reader/front IEEE 1394/front eSATA), or up to two optional front HDD bays



CPU 2
CPU 1

Expansion slots 1-6 (top-down)

Flex connector

HDD 1HDD 3
HDD 2HDD 4

Slot 1: PCIe 3.0 x16, Half length, full height, by CPU2
Slot 2: PCIe 3.0 x16, Full length, full height, by CPU1
Slot 3: PCIe 3.0 x8, Full length, full height, by CPU2
Slot 4: PCIe 3.0 x16, Full length, full height, by CPU1
Slot 5: PCI, Full length, full height, by PCH
Slot 6: PCIe 2.0 x4, Half length, full height, by PCH

Note:

- When LSI RAID flex adapter or 9364-8i adapter is installed, each HDD bay (HDD 1 - 4) can support 2 disk drives (1 x 3.5" drives + 2.5" SATA/SAS SSD, or 2 x 2.5" SATA/SAS SSD).
- More than 4 drives requires LSI RAID flex adapter or 9364-8i adapter.

Supporting NVIDIA graphics and GPU computing list

| Adapter | Cores | Memory | Power | SLI | Connector*** |
|---------------|-------|--------|-------|-----|---------------------------|
| NVS 310 | 48 | 1GB | 19.5W | | 2xDP |
| NVS 315 | 48 | 1024MB | 19.5W | | 2xDVI-I SL/2xDP |
| NVS 510 | 192 | 2048MB | 33.4W | | 4xmini DP |
| Quadro 410 | 192 | 512MB | 36.7W | | DVI-I DL+DP |
| Quadro K600 | 192 | 1GB | 41W | | DVI-I DL+DP |
| Quadro K2000 | 384 | 2GB | 51.1W | | DVI-I DL+2xDP |
| Quadro K2000D | 384 | 2GB | 51.1W | | DVI-I DL+DVI-D DL+mini DP |
| Quadro K4000 | 768 | 3GB | 80W | | DVI-I DL+2xDP |
| Quadro K5000 | 1536 | 4GB | 122W | | DVI-I DL+DVI-D DL+2xDP |
| Quadro K6000 | 2880 | 12GB | 225W | | DVI-I DL+DVI-D DL+2xDP |
| Quadro K420 | 192 | 2GB | 41W | | DVI-I DL+DP |
| Quadro K620 | 384 | 2GB | 45W | | DVI-I DL+DP |
| Quadro K2200 | 640 | 4GB | 68W | | DVI-I DL+2xDP |
| Quadro K4200 | 1344 | 4GB | 108W | | DVI-I DL+2xDP |
| Quadro K5200 | 2304 | 8GB | 150W | SLI | DVI-I DL+DVI-D DL+2xDP |
| Quadro M4000 | 1664 | 8GB | 120W | | 4xDP |
| Quadro M5000 | 2048 | 8GB | 150W | | DVI-I DL+4xDP |
| Quadro M6000 | 3072 | 12GB | 250W | | DVI-I DL+4xDP |
| Tesla K20 | 2496 | 5GB | 225W | | |
| GRID K2 | 3072 | 8GB | 225W | | |

** DL = Dual link, SL = Single Link, DP = DisplayPort 1.2

Supporting storage list

(SAS drive needs LSI RAID flex adapter or 9364-8i adapter)

| | |
|---------------------------|---|
| 3.5" SATA (7.2K 6Gbs HDD) | 500GB/1TB/2TB/3TB/4TB/1TB hybrid/2TB hybrid |
| 2.5" SAS (15K 12Gbs HDD) | 300GB/450GB/600GB |
| 2.5" SAS SSD (12Gbs) | 200GB/400GB/800GB |
| 2.5" SATA SSD (6Gbs) | 128GB/180GB/240GB/256GB/480GB/512GB/1TB (Optional OPAL) |
| M.2 SSD | 256 GB/512GB (Optional NVMe) |
| PCIe SSD adapter | 410GB/1.6TB |

Environment specification and certifications

| Temperature | |
|-------------|--|
| Operating: | 50 °F to 95 °F (10 °C to 35 °C) |
| Storage: | -10 °C to 60 °C, no package -40 °C to 60 °C, with package |
| Altitude | |
| Operating: | -50~10000ft (-15.2~3048m) |
| Humidity | |
| Operating: | 10%~80%, non-condensing |
| Storage: | 10%~90%, non-condensing |

RoHS-compliant/EPEAT Gold rating on all model, ENERGY STAR 6.1 qualified on selected models.

For the latest list of ISV certifications, please visit www.lenovo.com/support/ISV
For a list of all supported options, please visit https://download.lenovo.com/pccbbs/options_iso/ocm_april_2016.xlsx sheet

| Model | Region | Processor | Graphics | Memory (Capacity/Type) | RAID Controller | Max Drives in 3.5" Bays | Storage | Optical | Media Reader | Power Supply | Add-on Ports | Keyboard / Mouse | Operating System | Warranty | Global | Ann Date (mm/yy) |
|------------|--------|--|-------------------------|---------------------------|-----------------|-------------------------|-------------------------------------|-----------|--------------|--------------|--------------|-------------------|--------------------------------|----------|--------|------------------|
| 30A9001CUS | US | 1xE5-2609 v3 6C/1.9GHz/15MB/85W/DDR4-1600 | Open | 1x4GB RDIMM DDR4-2133 ECC | Onboard | 4 | 1x1TB HDD 7.2K 3.5" SATA6Gbs | HH DVD±RW | 9-in-1 | 650W 92% | None | USB / USB Optical | Windows 8.1 Pro 64-bit | 3-year | No | 10/14 |
| 30A9001DUS | US | 1xE5-2620 v3 6C/2.4GHz/15MB/85W/DDR4-1866 | Open | 2x4GB RDIMM DDR4-2133 ECC | Onboard | 4 | 1x180GB SSD 2.5" SATA6Gbs | HH DVD±RW | 9-in-1 | 650W 92% | None | USB / USB Optical | Windows 8.1 Pro 64-bit | 3-year | No | 10/14 |
| 30A9001EUS | US | 1xE5-2640 v3 8C/2.6GHz/20MB/90W/DDR4-1866 | Open | 2x4GB RDIMM DDR4-2133 ECC | Onboard | 4 | 1x256GB SSD M.2 PCIe | HH DVD±RW | 9-in-1 | 850W 92% | None | USB / USB Optical | Windows 8.1 Pro 64-bit | 3-year | No | 10/14 |
| 30A9002EUS | US | 1xE5-2609 v3 6C/1.9GHz/15MB/85W/DDR4-1600 | Open | 1x8GB RDIMM DDR4-2133 ECC | Onboard | 4 | 1x1TB Hybrid HDD 7.2K 3.5" SATA6Gbs | HH DVD±RW | 9-in-1 | 850W 92% | None | USB / USB Optical | Windows 10 DG Windows 7 Pro 64 | 3-year | No | 09/15 |
| 30A9002FUS | US | 1xE5-2620 v3 6C/2.4GHz/15MB/85W/DDR4-1866 | Open | 1x8GB RDIMM DDR4-2133 ECC | Onboard | 4 | 1x256GB SSD M.2 PCIe Opal | HH DVD±RW | 9-in-1 | 850W 92% | None | USB / USB Optical | Windows 10 DG Windows 7 Pro 64 | 3-year | No | 09/15 |
| 30A9002GUS | US | 1xE5-2643 v3 6C/3.4GHz/20MB/135W/DDR4-2133 | Open | 1x8GB RDIMM DDR4-2133 ECC | Onboard | 4 | 1x256GB SSD M.2 PCIe Opal | HH DVD±RW | 9-in-1 | 850W 92% | None | USB / USB Optical | Windows 10 DG Windows 7 Pro 64 | 3-year | No | 09/15 |
| 30A9002HUS | US | 2xE5-2667 v3 8C/3.2GHz/20MB/135W/DDR4-2133 | Open | 2x8GB RDIMM DDR4-2133 ECC | Onboard | 4 | 1x256GB SSD M.2 PCIe Opal | HH DVD±RW | 9-in-1 | 850W 92% | None | USB / USB Optical | Windows 10 DG Windows 7 Pro 64 | 3-year | No | 09/15 |
| 30A9002PUS | US | 2xE5-2630 v3 8C/2.4GHz/20MB/85W/DDR4-1866 | NVIDIA Quadro K2200 4GB | 4x8GB RDIMM DDR4-2133 ECC | Onboard | 4 | 1x512GB SSD 7.2K 3.5" SATA6Gbs | HH DVD±RW | 9-in-1 | 650W 92% | None | USB / USB Optical | Windows 10 DG Windows 7 Pro 64 | 3-year | No | 02/16 |
| 30A9002UUS | US | 1xE5-2609 v3 6C/1.9GHz/15MB/85W/DDR4-1600 | Open | 1x4GB RDIMM DDR4-2133 ECC | Onboard | 4 | 1x1TB HDD 7.2K 3.5" SATA6Gbs | HH DVD±RW | 9-in-1 | 650W 92% | None | USB / USB Optical | Windows 10 DG Windows 7 Pro 64 | 3-year | No | 03/16 |
| 30A9002VUS | US | 1xE5-2637 v3 4C/3.5GHz/15MB/135W/DDR4-2133 | Open | 2x8GB RDIMM DDR4-2133 ECC | Onboard | 4 | 1x256GB SSD M.2 PCIe Opal | HH DVD±RW | 9-in-1 | 850W 92% | None | USB / USB Optical | Windows 10 DG Windows 7 Pro 64 | 3-year | No | 03/16 |
| 30A9002WUS | US | 2xXeon E5-2650L v3 12C/1.8GHz/30MB/65W/DDR4-2133 | Open | 2x8GB RDIMM DDR4-2133 ECC | LSI Flex | 8 | 1x1TB HDD 7.2K 3.5" SATA6Gbs | HH DVD±RW | 9-in-1 | 850W 92% | None | USB / USB Optical | Windows 10 DG Windows 7 Pro 64 | 3-year | No | 03/16 |
| 30A9002XUS | US | 1xE5-2620 v3 6C/2.4GHz/15MB/85W/DDR4-1866 | Open | 1x8GB RDIMM DDR4-2133 ECC | Onboard | 4 | 1x180GB SSD 2.5" SATA6Gbs Opal | HH DVD±RW | 9-in-1 | 650W 92% | None | USB / USB Optical | Windows 10 DG Windows 7 Pro 64 | 3-year | No | 03/16 |
| 30A9002YUS | US | 1xE5-2620 v3 6C/2.4GHz/15MB/85W/DDR4-1866 | NVIDIA Quadro K4200 4GB | 1x8GB RDIMM DDR4-2133 ECC | Onboard | 4 | 1x1TB HDD 7.2K 3.5" SATA6Gbs | HH DVD±RW | 9-in-1 | 850W 92% | None | USB / USB Optical | Windows 10 DG Windows 7 Pro 64 | 3-year | No | 03/16 |
| 30A90030US | US | 1xE5-2630 v3 8C/2.4GHz/20MB/85W/DDR4-1866 | NVIDIA Quadro K4200 4GB | 1x8GB RDIMM DDR4-2133 ECC | Onboard | 4 | 1x2TB HDD 7.2K 3.5" SATA6Gbs | HH DVD±RW | 9-in-1 | 850W 92% | None | USB / USB Optical | Windows 10 DG Windows 7 Pro 64 | 3-year | No | 03/16 |

| Model | Region | Processor | Graphics | Memory (Capacity/Type) | RAID Controller | Max Drives in 3.5" Bays | Storage | Optical | Media Reader | Power Supply | Add-on Ports | Keyboard / Mouse | Operating System | Warranty | Global | Ann Date (mm/yy) |
|------------|--------|---|-------------------------|---------------------------|--------------------|----------------------------------|--------------------------------|-----------|-----------------|-----------------|-----------------|---------------------|------------------------|----------|--------|---------------------|
| 30A8000LUS | US | 2xE5-2620 v3 6C/2.4GHz/15MB/85W/DDR4-1866 | NVIDIA Quadro K2200 4GB | 2x8GB RDIMM DDR4-2133 ECC | Onboard | 4 | 2x500GB HDD 7.2K 3.5" SATA6Gbs | HH DVD±RW | None | 850W 92% | None | USB / USB Optical | Windows 8.1 Pro 64-bit | 3-year | No | 10/14 |
| 30A8000MUS | US | 2xE5-2623 v3 4C/3GHz/10MB/105W/DDR4-1866 | NVIDIA Quadro K4200 4GB | 2x8GB RDIMM DDR4-2133 ECC | Onboard | 4 | 2x180GB SSD 2.5" SATA6Gbs | HH DVD±RW | None | 850W 92% | None | USB / USB Optical | Windows 8.1 Pro 64-bit | 3-year | No | 10/14 |
| 30A8003AUS | US | 1xE5-2609 v3 6C/1.9GHz/15MB/85W/DDR4-1600 | Open | 2x4GB RDIMM DDR4-2133 ECC | Onboard | 4 | 1x1TB HDD 7.2K 3.5" SATA6Gbs | HH DVD±RW | 9-in-1 | 650W 92% | None | USB / USB Optical | Windows 8.1 Pro 64-bit | 3-year | No | 10/14 |
| 30A8003BUS | US | 1xE5-2620 v3 6C/2.4GHz/15MB/85W/DDR4-1866 | NVIDIA Quadro K620 2GB | 2x4GB RDIMM DDR4-2133 ECC | Onboard | 4 | 1x1TB HDD 7.2K 3.5" SATA6Gbs | HH DVD±RW | 9-in-1 | 650W 92% | None | USB / USB Optical | Windows 8.1 Pro 64-bit | 3-year | No | 10/14 |
| 30A8003CUS | US | 1xE5-2630 v3 8C/2.4GHz/20MB/85W/DDR4-1866 | NVIDIA Quadro K2200 4GB | 2x4GB RDIMM DDR4-2133 ECC | Onboard | 4 | 1x180GB SSD 2.5" SATA6Gbs | HH DVD±RW | 9-in-1 | 650W 92% | None | USB / USB Optical | Windows 8.1 Pro 64-bit | 3-year | No | 10/14 |

ThinkStation P710 Platform Specifications

| Components | Specification | | | | | | | | | | | | | | | | | | | | | | | | | | | | | | | | | | | | | | | | | | | | | | | | | | | | | | | | | | | | | | | | | | | | | | | | | | | | | | | | | | | | | | | | | | | | | | | | | | | | | | | | | | | | | | | | | | | | | | | | | | | | | | | | | | | | | | | | | | |
|--|---|---|---|--|------------------------|--|--------------|---------|----|-----|-------|------|--|---------|----|-----|-------|-----------------|--|---------|-----|-----|-----|-----------|--|---------|------|-----|-----|-----------|--|-------------|-----|-----|-----|-------------|--|-------------|-----|-----|-----|-------------|--|--------------|-----|-----|-----|-----------|--|--------------|-----|-----|-----|---------------|--|--------------|------|-----|------|---------------|--|--------------|------|-----|------|------------------------|-----|--------------|-----|-----|-----|------|--|--------------|------|-----|------|------|--|--------------|------|-----|------|---------------|-----|--------------|------|------|------|---------------|-----|-------------|-----|-----|-----|----------|--|-------------|-----|-----|-----|----------|--|--------------|-----|-----|-----|----------|--|--------------|------|-----|-----|------|--|--------------|------|-----|------|------|-----|--------------|------|------|------|---------------|-----|--------------|------|------|------|---------------|-----|-----------|------|------|------|--|--|
| Chipset | Intel C612 Platform Controller Hub (PCH) | | | | | | | | | | | | | | | | | | | | | | | | | | | | | | | | | | | | | | | | | | | | | | | | | | | | | | | | | | | | | | | | | | | | | | | | | | | | | | | | | | | | | | | | | | | | | | | | | | | | | | | | | | | | | | | | | | | | | | | | | | | | | | | | | | | | | | | | | | |
| System mgmt | Intel Active Management Technology 9 | | | | | | | | | | | | | | | | | | | | | | | | | | | | | | | | | | | | | | | | | | | | | | | | | | | | | | | | | | | | | | | | | | | | | | | | | | | | | | | | | | | | | | | | | | | | | | | | | | | | | | | | | | | | | | | | | | | | | | | | | | | | | | | | | | | | | | | | | | |
| Processor | Up to two 145W Intel Xeon E5-2600 v4 family processors. Each processor supports up to 22 cores up to 2.2GHz, 16 cores up to 2.6GHz, 14 cores up to 2.6GHz, 12 cores up to 2.2GHz, 10 cores up to 2.4GHz, 8 cores up to 3.2GHz, 6 cores up to 3.4GHz, 4 cores up to 3.5GHz. Or up to two Intel Xeon E5-2620 v3 or E5-2609 v3 processors (not available in EMEA) | | | | | | | | | | | | | | | | | | | | | | | | | | | | | | | | | | | | | | | | | | | | | | | | | | | | | | | | | | | | | | | | | | | | | | | | | | | | | | | | | | | | | | | | | | | | | | | | | | | | | | | | | | | | | | | | | | | | | | | | | | | | | | | | | | | | | | | | | | |
| Coprocessor | None | | | | | | | | | | | | | | | | | | | | | | | | | | | | | | | | | | | | | | | | | | | | | | | | | | | | | | | | | | | | | | | | | | | | | | | | | | | | | | | | | | | | | | | | | | | | | | | | | | | | | | | | | | | | | | | | | | | | | | | | | | | | | | | | | | | | | | | | | | |
| Memory DIMM slots | 12 DIMM sockets (6 DIMMs per processor), 8-channel capable (4-channel per processor). RDIMM, ECC, DDR4-2400 | | | | | | | | | | | | | | | | | | | | | | | | | | | | | | | | | | | | | | | | | | | | | | | | | | | | | | | | | | | | | | | | | | | | | | | | | | | | | | | | | | | | | | | | | | | | | | | | | | | | | | | | | | | | | | | | | | | | | | | | | | | | | | | | | | | | | | | | | | |
| Memory capacity | 384GB, 2nd CPU is needed | | | | | | | | | | | | | | | | | | | | | | | | | | | | | | | | | | | | | | | | | | | | | | | | | | | | | | | | | | | | | | | | | | | | | | | | | | | | | | | | | | | | | | | | | | | | | | | | | | | | | | | | | | | | | | | | | | | | | | | | | | | | | | | | | | | | | | | | | | |
| Graphics, GPU computing | Three PCIe 3.0 x16 slots, two via CPU1, one via CPU2. Up to three graphics and GPU computing adapters, 2nd CPU is needed | | | | | | | | | | | | | | | | | | | | | | | | | | | | | | | | | | | | | | | | | | | | | | | | | | | | | | | | | | | | | | | | | | | | | | | | | | | | | | | | | | | | | | | | | | | | | | | | | | | | | | | | | | | | | | | | | | | | | | | | | | | | | | | | | | | | | | | | | | |
| | <table border="1"> <thead> <tr> <th>PSU</th> <th>Maximum quantity of PCIe x16 adapters per system (by power)</th> </tr> </thead> <tbody> <tr> <td>650W 1x150W+2x75W with onboard SATA controller and up to two 120W CPU each</td> <td>1x150W+2x75W</td> </tr> <tr> <td>850W 1x300W+2x75W (up to two 120W CPU each), or 2x150W+1x75W</td> <td>1x300W+2x75W</td> </tr> </tbody> </table> | PSU | Maximum quantity of PCIe x16 adapters per system (by power) | 650W 1x150W+2x75W with onboard SATA controller and up to two 120W CPU each | 1x150W+2x75W | 850W 1x300W+2x75W (up to two 120W CPU each), or 2x150W+1x75W | 1x300W+2x75W | | | | | | | | | | | | | | | | | | | | | | | | | | | | | | | | | | | | | | | | | | | | | | | | | | | | | | | | | | | | | | | | | | | | | | | | | | | | | | | | | | | | | | | | | | | | | | | | | | | | | | | | | | | | | | | | | | | | | | | | | | | | | | | | | | | | |
| PSU | Maximum quantity of PCIe x16 adapters per system (by power) | | | | | | | | | | | | | | | | | | | | | | | | | | | | | | | | | | | | | | | | | | | | | | | | | | | | | | | | | | | | | | | | | | | | | | | | | | | | | | | | | | | | | | | | | | | | | | | | | | | | | | | | | | | | | | | | | | | | | | | | | | | | | | | | | | | | | | | | | | |
| 650W 1x150W+2x75W with onboard SATA controller and up to two 120W CPU each | 1x150W+2x75W | | | | | | | | | | | | | | | | | | | | | | | | | | | | | | | | | | | | | | | | | | | | | | | | | | | | | | | | | | | | | | | | | | | | | | | | | | | | | | | | | | | | | | | | | | | | | | | | | | | | | | | | | | | | | | | | | | | | | | | | | | | | | | | | | | | | | | | | | | |
| 850W 1x300W+2x75W (up to two 120W CPU each), or 2x150W+1x75W | 1x300W+2x75W | | | | | | | | | | | | | | | | | | | | | | | | | | | | | | | | | | | | | | | | | | | | | | | | | | | | | | | | | | | | | | | | | | | | | | | | | | | | | | | | | | | | | | | | | | | | | | | | | | | | | | | | | | | | | | | | | | | | | | | | | | | | | | | | | | | | | | | | | | |
| Supporting Graphics and GPU computing | <table border="1"> <thead> <tr> <th>Adapter</th> <th>Cores</th> <th>Memory</th> <th>Power</th> <th>Connector***</th> <th>SLI</th> </tr> </thead> <tbody> <tr><td>NVS 310</td><td>48</td><td>1GB</td><td>19.5W</td><td>2xDP</td><td></td></tr> <tr><td>NVS 315</td><td>48</td><td>1GB</td><td>19.5W</td><td>2xDVI-I SL/2xDP</td><td></td></tr> <tr><td>NVS 510</td><td>192</td><td>2GB</td><td>35W</td><td>4xmini DP</td><td></td></tr> <tr><td>NVS 810</td><td>1024</td><td>4GB</td><td>68W</td><td>8xmini DP</td><td></td></tr> <tr><td>Quadro K420</td><td>192</td><td>2GB</td><td>41W</td><td>DVI-I DL+DP</td><td></td></tr> <tr><td>Quadro K620</td><td>384</td><td>2GB</td><td>45W</td><td>DVI-I DL+DP</td><td></td></tr> <tr><td>Quadro K1200</td><td>512</td><td>4GB</td><td>45W</td><td>4xmini DP</td><td></td></tr> <tr><td>Quadro K2200</td><td>640</td><td>4GB</td><td>68W</td><td>DVI-I DL+2xDP</td><td></td></tr> <tr><td>Quadro K4200</td><td>1344</td><td>4GB</td><td>108W</td><td>DVI-I DL+2xDP</td><td></td></tr> <tr><td>Quadro K5200</td><td>2304</td><td>8GB</td><td>150W</td><td>DVI-I DL+DVI-D DL+2xDP</td><td>SLI</td></tr> <tr><td>Quadro M2000</td><td>768</td><td>4GB</td><td>75W</td><td>4xDP</td><td></td></tr> <tr><td>Quadro M4000</td><td>1664</td><td>8GB</td><td>120W</td><td>4xDP</td><td></td></tr> <tr><td>Quadro M5000</td><td>2048</td><td>8GB</td><td>150W</td><td>DVI-I DL+4xDP</td><td>SLI</td></tr> <tr><td>Quadro M6000</td><td>3072</td><td>24GB</td><td>250W</td><td>DVI-I DL+4xDP</td><td>SLI</td></tr> <tr><td>Quadro P400</td><td>256</td><td>2GB</td><td>30W</td><td>3xminiDP</td><td></td></tr> <tr><td>Quadro P600</td><td>384</td><td>2GB</td><td>40W</td><td>4xminiDP</td><td></td></tr> <tr><td>Quadro P1000</td><td>640</td><td>4GB</td><td>47W</td><td>4xminiDP</td><td></td></tr> <tr><td>Quadro P2000</td><td>1024</td><td>5GB</td><td>75W</td><td>4xDP</td><td></td></tr> <tr><td>Quadro P4000</td><td>1792</td><td>8GB</td><td>105W</td><td>4xDP</td><td>SLI</td></tr> <tr><td>Quadro P5000</td><td>2560</td><td>16GB</td><td>180W</td><td>DVI-D DL+4xDP</td><td>SLI</td></tr> <tr><td>Quadro P6000</td><td>3840</td><td>24GB</td><td>250W</td><td>DVI-D DL+4xDP</td><td>SLI</td></tr> <tr><td>Tesla K40</td><td>2880</td><td>12GB</td><td>235W</td><td></td><td></td></tr> </tbody> </table> | Adapter | Cores | Memory | Power | Connector*** | SLI | NVS 310 | 48 | 1GB | 19.5W | 2xDP | | NVS 315 | 48 | 1GB | 19.5W | 2xDVI-I SL/2xDP | | NVS 510 | 192 | 2GB | 35W | 4xmini DP | | NVS 810 | 1024 | 4GB | 68W | 8xmini DP | | Quadro K420 | 192 | 2GB | 41W | DVI-I DL+DP | | Quadro K620 | 384 | 2GB | 45W | DVI-I DL+DP | | Quadro K1200 | 512 | 4GB | 45W | 4xmini DP | | Quadro K2200 | 640 | 4GB | 68W | DVI-I DL+2xDP | | Quadro K4200 | 1344 | 4GB | 108W | DVI-I DL+2xDP | | Quadro K5200 | 2304 | 8GB | 150W | DVI-I DL+DVI-D DL+2xDP | SLI | Quadro M2000 | 768 | 4GB | 75W | 4xDP | | Quadro M4000 | 1664 | 8GB | 120W | 4xDP | | Quadro M5000 | 2048 | 8GB | 150W | DVI-I DL+4xDP | SLI | Quadro M6000 | 3072 | 24GB | 250W | DVI-I DL+4xDP | SLI | Quadro P400 | 256 | 2GB | 30W | 3xminiDP | | Quadro P600 | 384 | 2GB | 40W | 4xminiDP | | Quadro P1000 | 640 | 4GB | 47W | 4xminiDP | | Quadro P2000 | 1024 | 5GB | 75W | 4xDP | | Quadro P4000 | 1792 | 8GB | 105W | 4xDP | SLI | Quadro P5000 | 2560 | 16GB | 180W | DVI-D DL+4xDP | SLI | Quadro P6000 | 3840 | 24GB | 250W | DVI-D DL+4xDP | SLI | Tesla K40 | 2880 | 12GB | 235W | | |
| | Adapter | Cores | Memory | Power | Connector*** | SLI | | | | | | | | | | | | | | | | | | | | | | | | | | | | | | | | | | | | | | | | | | | | | | | | | | | | | | | | | | | | | | | | | | | | | | | | | | | | | | | | | | | | | | | | | | | | | | | | | | | | | | | | | | | | | | | | | | | | | | | | | | | | | | | | | | | | | |
| | NVS 310 | 48 | 1GB | 19.5W | 2xDP | | | | | | | | | | | | | | | | | | | | | | | | | | | | | | | | | | | | | | | | | | | | | | | | | | | | | | | | | | | | | | | | | | | | | | | | | | | | | | | | | | | | | | | | | | | | | | | | | | | | | | | | | | | | | | | | | | | | | | | | | | | | | | | | | | | | | | |
| | NVS 315 | 48 | 1GB | 19.5W | 2xDVI-I SL/2xDP | | | | | | | | | | | | | | | | | | | | | | | | | | | | | | | | | | | | | | | | | | | | | | | | | | | | | | | | | | | | | | | | | | | | | | | | | | | | | | | | | | | | | | | | | | | | | | | | | | | | | | | | | | | | | | | | | | | | | | | | | | | | | | | | | | | | | | |
| | NVS 510 | 192 | 2GB | 35W | 4xmini DP | | | | | | | | | | | | | | | | | | | | | | | | | | | | | | | | | | | | | | | | | | | | | | | | | | | | | | | | | | | | | | | | | | | | | | | | | | | | | | | | | | | | | | | | | | | | | | | | | | | | | | | | | | | | | | | | | | | | | | | | | | | | | | | | | | | | | | |
| | NVS 810 | 1024 | 4GB | 68W | 8xmini DP | | | | | | | | | | | | | | | | | | | | | | | | | | | | | | | | | | | | | | | | | | | | | | | | | | | | | | | | | | | | | | | | | | | | | | | | | | | | | | | | | | | | | | | | | | | | | | | | | | | | | | | | | | | | | | | | | | | | | | | | | | | | | | | | | | | | | | |
| | Quadro K420 | 192 | 2GB | 41W | DVI-I DL+DP | | | | | | | | | | | | | | | | | | | | | | | | | | | | | | | | | | | | | | | | | | | | | | | | | | | | | | | | | | | | | | | | | | | | | | | | | | | | | | | | | | | | | | | | | | | | | | | | | | | | | | | | | | | | | | | | | | | | | | | | | | | | | | | | | | | | | | |
| | Quadro K620 | 384 | 2GB | 45W | DVI-I DL+DP | | | | | | | | | | | | | | | | | | | | | | | | | | | | | | | | | | | | | | | | | | | | | | | | | | | | | | | | | | | | | | | | | | | | | | | | | | | | | | | | | | | | | | | | | | | | | | | | | | | | | | | | | | | | | | | | | | | | | | | | | | | | | | | | | | | | | | |
| | Quadro K1200 | 512 | 4GB | 45W | 4xmini DP | | | | | | | | | | | | | | | | | | | | | | | | | | | | | | | | | | | | | | | | | | | | | | | | | | | | | | | | | | | | | | | | | | | | | | | | | | | | | | | | | | | | | | | | | | | | | | | | | | | | | | | | | | | | | | | | | | | | | | | | | | | | | | | | | | | | | | |
| | Quadro K2200 | 640 | 4GB | 68W | DVI-I DL+2xDP | | | | | | | | | | | | | | | | | | | | | | | | | | | | | | | | | | | | | | | | | | | | | | | | | | | | | | | | | | | | | | | | | | | | | | | | | | | | | | | | | | | | | | | | | | | | | | | | | | | | | | | | | | | | | | | | | | | | | | | | | | | | | | | | | | | | | | |
| | Quadro K4200 | 1344 | 4GB | 108W | DVI-I DL+2xDP | | | | | | | | | | | | | | | | | | | | | | | | | | | | | | | | | | | | | | | | | | | | | | | | | | | | | | | | | | | | | | | | | | | | | | | | | | | | | | | | | | | | | | | | | | | | | | | | | | | | | | | | | | | | | | | | | | | | | | | | | | | | | | | | | | | | | | |
| | Quadro K5200 | 2304 | 8GB | 150W | DVI-I DL+DVI-D DL+2xDP | SLI | | | | | | | | | | | | | | | | | | | | | | | | | | | | | | | | | | | | | | | | | | | | | | | | | | | | | | | | | | | | | | | | | | | | | | | | | | | | | | | | | | | | | | | | | | | | | | | | | | | | | | | | | | | | | | | | | | | | | | | | | | | | | | | | | | | | | |
| | Quadro M2000 | 768 | 4GB | 75W | 4xDP | | | | | | | | | | | | | | | | | | | | | | | | | | | | | | | | | | | | | | | | | | | | | | | | | | | | | | | | | | | | | | | | | | | | | | | | | | | | | | | | | | | | | | | | | | | | | | | | | | | | | | | | | | | | | | | | | | | | | | | | | | | | | | | | | | | | | | |
| | Quadro M4000 | 1664 | 8GB | 120W | 4xDP | | | | | | | | | | | | | | | | | | | | | | | | | | | | | | | | | | | | | | | | | | | | | | | | | | | | | | | | | | | | | | | | | | | | | | | | | | | | | | | | | | | | | | | | | | | | | | | | | | | | | | | | | | | | | | | | | | | | | | | | | | | | | | | | | | | | | | |
| | Quadro M5000 | 2048 | 8GB | 150W | DVI-I DL+4xDP | SLI | | | | | | | | | | | | | | | | | | | | | | | | | | | | | | | | | | | | | | | | | | | | | | | | | | | | | | | | | | | | | | | | | | | | | | | | | | | | | | | | | | | | | | | | | | | | | | | | | | | | | | | | | | | | | | | | | | | | | | | | | | | | | | | | | | | | | |
| | Quadro M6000 | 3072 | 24GB | 250W | DVI-I DL+4xDP | SLI | | | | | | | | | | | | | | | | | | | | | | | | | | | | | | | | | | | | | | | | | | | | | | | | | | | | | | | | | | | | | | | | | | | | | | | | | | | | | | | | | | | | | | | | | | | | | | | | | | | | | | | | | | | | | | | | | | | | | | | | | | | | | | | | | | | | | |
| | Quadro P400 | 256 | 2GB | 30W | 3xminiDP | | | | | | | | | | | | | | | | | | | | | | | | | | | | | | | | | | | | | | | | | | | | | | | | | | | | | | | | | | | | | | | | | | | | | | | | | | | | | | | | | | | | | | | | | | | | | | | | | | | | | | | | | | | | | | | | | | | | | | | | | | | | | | | | | | | | | | |
| | Quadro P600 | 384 | 2GB | 40W | 4xminiDP | | | | | | | | | | | | | | | | | | | | | | | | | | | | | | | | | | | | | | | | | | | | | | | | | | | | | | | | | | | | | | | | | | | | | | | | | | | | | | | | | | | | | | | | | | | | | | | | | | | | | | | | | | | | | | | | | | | | | | | | | | | | | | | | | | | | | | |
| | Quadro P1000 | 640 | 4GB | 47W | 4xminiDP | | | | | | | | | | | | | | | | | | | | | | | | | | | | | | | | | | | | | | | | | | | | | | | | | | | | | | | | | | | | | | | | | | | | | | | | | | | | | | | | | | | | | | | | | | | | | | | | | | | | | | | | | | | | | | | | | | | | | | | | | | | | | | | | | | | | | | |
| | Quadro P2000 | 1024 | 5GB | 75W | 4xDP | | | | | | | | | | | | | | | | | | | | | | | | | | | | | | | | | | | | | | | | | | | | | | | | | | | | | | | | | | | | | | | | | | | | | | | | | | | | | | | | | | | | | | | | | | | | | | | | | | | | | | | | | | | | | | | | | | | | | | | | | | | | | | | | | | | | | | |
| Quadro P4000 | 1792 | 8GB | 105W | 4xDP | SLI | | | | | | | | | | | | | | | | | | | | | | | | | | | | | | | | | | | | | | | | | | | | | | | | | | | | | | | | | | | | | | | | | | | | | | | | | | | | | | | | | | | | | | | | | | | | | | | | | | | | | | | | | | | | | | | | | | | | | | | | | | | | | | | | | | | | | | |
| Quadro P5000 | 2560 | 16GB | 180W | DVI-D DL+4xDP | SLI | | | | | | | | | | | | | | | | | | | | | | | | | | | | | | | | | | | | | | | | | | | | | | | | | | | | | | | | | | | | | | | | | | | | | | | | | | | | | | | | | | | | | | | | | | | | | | | | | | | | | | | | | | | | | | | | | | | | | | | | | | | | | | | | | | | | | | |
| Quadro P6000 | 3840 | 24GB | 250W | DVI-D DL+4xDP | SLI | | | | | | | | | | | | | | | | | | | | | | | | | | | | | | | | | | | | | | | | | | | | | | | | | | | | | | | | | | | | | | | | | | | | | | | | | | | | | | | | | | | | | | | | | | | | | | | | | | | | | | | | | | | | | | | | | | | | | | | | | | | | | | | | | | | | | | |
| Tesla K40 | 2880 | 12GB | 235W | | | | | | | | | | | | | | | | | | | | | | | | | | | | | | | | | | | | | | | | | | | | | | | | | | | | | | | | | | | | | | | | | | | | | | | | | | | | | | | | | | | | | | | | | | | | | | | | | | | | | | | | | | | | | | | | | | | | | | | | | | | | | | | | | | | | | | | | |
| Disk drive controller | RAID 0, 1, 5, 10 with onboard SATA controller in chipset, SATA 6Gb/s. RAID 0, 1, 5, 10 with optional LSI RAID flex adapter, 12Gb/s SAS and SATA. RAID 0, 1, 5, 6, 10 with optional LSI 9364-8i PCIe adapter, 1GB memory, 12Gb/s SAS and SATA | | | | | | | | | | | | | | | | | | | | | | | | | | | | | | | | | | | | | | | | | | | | | | | | | | | | | | | | | | | | | | | | | | | | | | | | | | | | | | | | | | | | | | | | | | | | | | | | | | | | | | | | | | | | | | | | | | | | | | | | | | | | | | | | | | | | | | | | | | |
| Drive Bays | Two external 5.25" flex bays, four 3.5" internal bays. Each 3.5" bay can support dual drives on selected models (see right) | | | | | | | | | | | | | | | | | | | | | | | | | | | | | | | | | | | | | | | | | | | | | | | | | | | | | | | | | | | | | | | | | | | | | | | | | | | | | | | | | | | | | | | | | | | | | | | | | | | | | | | | | | | | | | | | | | | | | | | | | | | | | | | | | | | | | | | | | | |
| Flex bay | Two 5.25" flex bays for optical drives, Front Access Storage Enclosure drives, Flex Bay Storage Enclosure drives, or flex module. • Up to two half-height optical drives or up to one 9.5mm optical drive, DVD-ROM, DVD±RW, or Blu-Ray burner • Up to one Front Access Storage Enclosure for one 3.5" or 2.5" SATA drive. • Up to two Flex Bay Storage Enclosure for two 3.5" or 2.5" SATA drives. | | | | | | | | | | | | | | | | | | | | | | | | | | | | | | | | | | | | | | | | | | | | | | | | | | | | | | | | | | | | | | | | | | | | | | | | | | | | | | | | | | | | | | | | | | | | | | | | | | | | | | | | | | | | | | | | | | | | | | | | | | | | | | | | | | | | | | | | | | |
| Supporting storage | 3.5" SATA HDD, 7.2K 6Gbs | 500GB/1TB/2TB/3TB/4TB/6TB/1TB hybrid/2TB hybrid | | | | | | | | | | | | | | | | | | | | | | | | | | | | | | | | | | | | | | | | | | | | | | | | | | | | | | | | | | | | | | | | | | | | | | | | | | | | | | | | | | | | | | | | | | | | | | | | | | | | | | | | | | | | | | | | | | | | | | | | | | | | | | | | | | | | | | | | | |
| | 2.5" SAS HDD, 15K 12Gbs | 300GB/600GB | | | | | | | | | | | | | | | | | | | | | | | | | | | | | | | | | | | | | | | | | | | | | | | | | | | | | | | | | | | | | | | | | | | | | | | | | | | | | | | | | | | | | | | | | | | | | | | | | | | | | | | | | | | | | | | | | | | | | | | | | | | | | | | | | | | | | | | | | |
| | 2.5" SAS SSD, 12Gbs | 200GB/400GB/800GB | | | | | | | | | | | | | | | | | | | | | | | | | | | | | | | | | | | | | | | | | | | | | | | | | | | | | | | | | | | | | | | | | | | | | | | | | | | | | | | | | | | | | | | | | | | | | | | | | | | | | | | | | | | | | | | | | | | | | | | | | | | | | | | | | | | | | | | | | |
| | 2.5" SAS HDD, 10K 12Gbs | 300GB | | | | | | | | | | | | | | | | | | | | | | | | | | | | | | | | | | | | | | | | | | | | | | | | | | | | | | | | | | | | | | | | | | | | | | | | | | | | | | | | | | | | | | | | | | | | | | | | | | | | | | | | | | | | | | | | | | | | | | | | | | | | | | | | | | | | | | | | | |
| | 2.5" SSD, SATA6Gbs | 180GB/240GB/256GB/480GB/512GB with OPAL, 256GB/512GB/1TB without OPAL | | | | | | | | | | | | | | | | | | | | | | | | | | | | | | | | | | | | | | | | | | | | | | | | | | | | | | | | | | | | | | | | | | | | | | | | | | | | | | | | | | | | | | | | | | | | | | | | | | | | | | | | | | | | | | | | | | | | | | | | | | | | | | | | | | | | | | | | | |
| | PCIe SSD, 2.5" | 400GB | | | | | | | | | | | | | | | | | | | | | | | | | | | | | | | | | | | | | | | | | | | | | | | | | | | | | | | | | | | | | | | | | | | | | | | | | | | | | | | | | | | | | | | | | | | | | | | | | | | | | | | | | | | | | | | | | | | | | | | | | | | | | | | | | | | | | | | | | |
| | PCIe SSD, M.2 | 256 GB/512GB/1TB | | | | | | | | | | | | | | | | | | | | | | | | | | | | | | | | | | | | | | | | | | | | | | | | | | | | | | | | | | | | | | | | | | | | | | | | | | | | | | | | | | | | | | | | | | | | | | | | | | | | | | | | | | | | | | | | | | | | | | | | | | | | | | | | | | | | | | | | | |
| PCIe SSD adapter | 400GB (up to 4 per system, 2nd CPU is needed) | | | | | | | | | | | | | | | | | | | | | | | | | | | | | | | | | | | | | | | | | | | | | | | | | | | | | | | | | | | | | | | | | | | | | | | | | | | | | | | | | | | | | | | | | | | | | | | | | | | | | | | | | | | | | | | | | | | | | | | | | | | | | | | | | | | | | | | | | | |

| Components | Specification | |
|-----------------------------|--|--------------------------------------|
| Flex connector | One flex connectors (see right), supports one of the following: • Up to one LSI RAID flex adapter for SATA/SAS RAID • Up to one Multi-I/O flex adapters for two PCIe SSD • Up to one M.2 flex adapters for two M.2 PCIe SSD | |
| Network interfaces | Integrated two-port gigabit ethernet (Intel i218LM and i210AT), supports Wake-on-LAN. Optional discrete ethernet adapters are available | |
| HD Audio | Realtek ALC662 codec | |
| TPM | TCG 1.2-compliant | |
| Power supply | One fixed 650 watts or 850 watts, autosensing, 92%, 80 PLUS Platinum qualified | |
| Front ports | Four USB 3.0 (one Diagnostic, one Always On), one combo audio/microphone jack (3.5mm) | |
| Rear ports | Four USB 2.0, four USB 3.0 (blue), one serial (9-pin), two ethernet (RJ-45), three analog audio ports (line-in, line-out, mic-in), two PS/2 | |
| Add-on ports | Supports the following optional ports: Two IEEE 1394 (one on rear and one on front flex module) via PCIe adapter, up to one adapter per system. Two rear USB 3.0 per PCIe adapter, up to three adapters per system. One rear Thunderbolt via PCIe adapter. One front eSATA (on flex module), or one rear eSATA via cable (also needs one PCIe slot), up to one eSATA port per system. One internal USB 3.0 port via cable, cannot be intermixed with 29-in-1 reader | |
| Media reader | 9-in-1 USB 2.0 card reader. Optional 29-in-1 USB 3.0 card reader on flex module | |
| Mechanical | • 36-liter: 175mm/6.89" W x 485mm/19.1" D x 446mm/17.6" H (with feet) • Tool-less parts: all except CPU fansink • 52.25 lb (23.7kg) max configuration | |
| Environmental specification | Temperature - operating | 50 °F to 95 °F (10 °C to 35 °C) |
| | Temperature - non operating (no package) | 14 °F to 140 °F (-10 °C to 60 °C) |
| | Temperature - non operating (with package) | -40 °F to 140 °F (-40 °C to 60 °C) |
| | Altitude - operating | (Unpressurized): 0-10000ft (0-3048m) |
| | Humidity - operating | 10%-80%, non-condensing |
| | Humidity - storage (with package) | 10%-90%, non-condensing |
| | RoHS-compliant, GREENGUARD on all models. EPEAT Gold rating, ENERGY STAR 6.1 qualified on selected models. | |
| Base warranty | 3-year limited onsite service with 9x5/NBD | |
| ISV certifications | Please visit www.thinkworkstations.com/isv-certifications/ | |

Expansion slots
Slot 1: PCIe 3.0 x16, half length, full height, CPU2 needed (full length, full height if no flex adapter)
Slot 2: PCIe 3.0 x16, full length, full height
Slot 3: PCIe 3.0 x8, full length, full height, CPU2 needed
Slot 4: PCIe 3.0 x16, full length, full height
Slot 5: PCI, full length, full height
Slot 6: PCIe 2.0 x4, half length, full height
Also supports one flex connector

Two 5.25" flex bays
Flex connector
HDD 1 HDD 3
HDD 2 HDD 4

Expansion slots 1-6 (top-down)

Drive Bays
HDD 1-4: Standard 3.5" HDD bay, up to four 3.5" or 2.5" disk drives.
On selected models, each 3.5" bay can supports 2.5" (9mm or less) drive plus 3.5" drive, or two 2.5" (15mm or less) drives.
Flex bay: Two 5.25" flex bays, for HH optical drives.
Or up to one optional flex module (Flex module supports one or more of the following options: 9.5mm optical/29-in-1 USB 3.0 reader/front IEEE 1394/front eSATA).
Or up to two HDD bays for two drives, 3.5" or 2.5" each, SATA only.

| Model | Region | Processor | Graphics | Memory (Capacity/Type) | RAID Controller | Max Drives in 3.5" Bays | Storage (Capacity/Type/Interface) | Optical | Media Reader | Power Supply | Add-on Ports | Discrete ethernet | Keyboard / Mouse | Operating System | Warranty | Ann Date (mm/yy) |
|------------|--------|---|-----------------------------------|------------------------------|--------------------|----------------------------------|---|--------------|-----------------|-----------------|-----------------|----------------------|----------------------|---|----------|---------------------|
| 30B7000RUS | US | 2xXeon E5-2623 v4 4C/2.6GHz/10MB/85W/DDR4-2133 | Open | 2x8GB RDIMM DDR4-2400 ECC | Onboard | 4 | 1x256GB SSD 2.5" SATA6Gbs Opal | HH DVD±RW | 9-in-1 | 650W 92% | None | None | USB / USB Optical | Windows 10 Pro 64 | 3-year | 04/16 |
| 30B7000SUS | US | 1xXeon E5-2623 v4 4C/2.6GHz/10MB/85W/DDR4-2133 | Open | 2x8GB RDIMM DDR4-2400 ECC | Onboard | 4 | 1x256GB SSD 2.5" SATA6Gbs Opal | HH DVD±RW | 9-in-1 | 650W 92% | None | None | USB / USB Optical | Windows 10 Pro 64 | 3-year | 04/16 |
| 30B7000TUS | US | 2xXeon E5-2620 v4 8C/2.1GHz/20MB/85W/DDR4-2133 | Open | 2x8GB RDIMM DDR4-2400 ECC | Onboard | 4 | 1x1TB HDD 7.2K 3.5" SATA6Gbs | HH DVD±RW | 9-in-1 | 850W 92% | None | None | USB / USB Optical | Windows 10 Pro 64 | 3-year | 04/16 |
| 30B7000UUS | US | 2xXeon E5-2637 v4 4C/3.5GHz/15MB/135W/DDR4-2400 | Open | 2x8GB RDIMM DDR4-2400 ECC | Onboard | 4 | 1x256GB SSD 2.5" SATA6Gbs Opal | HH DVD±RW | 9-in-1 | 850W 92% | None | None | USB / USB Optical | Windows 10 Pro 64 | 3-year | 04/16 |
| 30B7000VUS | US | 1xXeon E5-2637 v4 4C/3.5GHz/15MB/135W/DDR4-2400 | Open | 2x8GB RDIMM DDR4-2400 ECC | Onboard | 4 | 1x256GB SSD 2.5" SATA6Gbs Opal | HH DVD±RW | 9-in-1 | 850W 92% | None | None | USB / USB Optical | Windows 10 Pro 64 | 3-year | 04/16 |
| 30B7000WUS | US | 2xXeon E5-2643 v4 6C/3.4GHz/20MB/135W/DDR4-2400 | NVIDIA Quadro M4000 8GB | 4x8GB RDIMM DDR4-2400 ECC | Onboard | 4 | 1x1TB SSD 2.5" SATA6Gbs | HH DVD±RW | 9-in-1 | 850W 92% | None | None | USB / USB Optical | Windows 10 Pro 64 | 3-year | 04/16 |
| 30B7000XUS | US | 2xXeon E5-2623 v4 4C/2.6GHz/10MB/85W/DDR4-2133 | NVIDIA Quadro M2000 4GB | 2x8GB RDIMM DDR4-2400 ECC | Onboard | 4 | 1x256GB SSD 2.5" SATA6Gbs Opal | HH DVD±RW | 9-in-1 | 650W 92% | None | None | USB / USB Optical | Windows 10 Pro 64 | 3-year | 04/16 |
| 30B7000YUS | US | 1xXeon E5-2620 v4 8C/2.1GHz/20MB/85W/DDR4-2133 | Open | 2x8GB RDIMM DDR4-2400 ECC | Onboard | 4 | 1x1TB HDD 7.2K 3.5" SATA6Gbs | HH DVD±RW | 9-in-1 | 850W 92% | None | None | USB / USB Optical | Windows 10 Pro 64 | 3-year | 04/16 |
| 30B7001MUS | US | 1xXeon E5-2650 v4 12C/2.2GHz/30MB/105W/DDR4-2400 | NVIDIA Quadro M4000 8GB | 2x8GB RDIMM DDR4-2400 ECC | Onboard | 4 | 1x1TB HDD 7.2K 3.5" SATA6Gbs+1x256GB SSD M.2 PCIe | HH DVD±RW | 9-in-1 | 850W 92% | None | None | USB / USB Optical | Windows 10 Pro 64 | 3-year | 07/16 |
| 30B7001NUS | US | 2xXeon E5-2620 v4 8C/2.1GHz/20MB/85W/DDR4-2133 | Open | 2x8GB RDIMM DDR4-2400 ECC | Onboard | 4 | 1x1TB HDD 7.2K 3.5" SATA6Gbs+1x256GB SSD M.2 PCIe | HH DVD±RW | 9-in-1 | 850W 92% | None | None | USB / USB Optical | Windows 10 Pro 64 | 3-year | 07/16 |
| 30B7001PUS | US | 2xXeon E5-2620 v4 8C/2.1GHz/20MB/85W/DDR4-2133 | NVIDIA Quadro M2000 4GB | 2x8GB RDIMM DDR4-2400 ECC | Onboard | 4 | 1x1TB HDD 7.2K 3.5" SATA6Gbs+1x256GB SSD M.2 PCIe | HH DVD±RW | 9-in-1 | 850W 92% | None | None | USB / USB Optical | Windows 10 Pro 64 | 3-year | 07/16 |
| 30B70023US | US | 2xXeon E5-2620 v4 8C/2.1GHz/20MB/85W/DDR4-2133 | Open | 2x8GB RDIMM DDR4-2400 ECC | Onboard | 4 | 1x1TB HDD 7.2K 3.5" SATA6Gbs+1x256GB SSD M.2 PCIe | HH DVD±RW | 9-in-1 | 850W 92% | None | None | USB / USB Optical | Windows 10 DG Windows 7 Pro 64 | 3-year | 09/16 |
| 30B70024US | US | 1xXeon E5-2650 v4 12C/2.2GHz/30MB/105W/DDR4-2400 | NVIDIA Quadro M4000 8GB | 2x8GB RDIMM DDR4-2400 ECC | Onboard | 4 | 1x1TB HDD 7.2K 3.5" SATA6Gbs+1x256GB SSD M.2 PCIe | HH DVD±RW | 9-in-1 | 850W 92% | None | None | USB / USB Optical | Windows 10 DG Windows 7 Pro 64 | 3-year | 09/16 |
| 30B70025US | US | 2xXeon E5-2620 v4 8C/2.1GHz/20MB/85W/DDR4-2133 | NVIDIA Quadro M2000 4GB | 2x8GB RDIMM DDR4-2400 ECC | Onboard | 4 | 1x1TB HDD 7.2K 3.5" SATA6Gbs+1x256GB SSD M.2 PCIe | HH DVD±RW | 9-in-1 | 850W 92% | None | None | USB / USB Optical | Windows 10 DG Windows 7 Pro 64 | 3-year | 09/16 |
| 30B70029US | US | 2xXeon E5-2623 v4 4C/2.6GHz/10MB/85W/DDR4-2133 | NVIDIA Quadro P5000 16GB | 2x8GB RDIMM DDR4-2400 ECC | Onboard | 4 | 1x1TB SSD M.2 PCIe NVMe Opal | HH DVD±RW | 9-in-1 | 850W 92% | 1xeSATA Rear | None | USB / USB Optical | Windows 10 DG Windows 7 Pro 64 | 3-year | 12/16 |

| Model | Region | Processor | Graphics | Memory (Capacity/Type) | RAID Controller | Max Drives in 3.5" Bays | Storage (Capacity/Type/Interface) | Optical | Media Reader | Power Supply | Add-on Ports | Discrete ethernet | Keyboard / Mouse | Operating System | Warranty | Ann Date (mm/yy) |
|------------|--------|---|--------------------------|----------------------------|-----------------|-------------------------|---|-----------|--------------|--------------|--------------|-------------------|-------------------|-----------------------------------|----------|------------------|
| 30B7002AUS | US | 1xXeon E5-2623 v4 4C/2.6GHz/10MB/85W/DDR4-2133 | NVIDIA Quadro M2000 4GB | 2x8GB RDIMM DDR4-2400 ECC | Onboard | 4 | 1x512GB SSD 2.5" SATA6Gbs | HH DVD±RW | 9-in-1 | 850W 92% | None | None | USB / USB Optical | Windows 10 DG Windows 7 Pro 64 | 3-year | 12/16 |
| 30B7002BUS | US | 1xXeon E5-2623 v4 4C/2.6GHz/10MB/85W/DDR4-2133 | NVIDIA Quadro P5000 16GB | 2x8GB RDIMM DDR4-2400 ECC | Onboard | 4 | 1x1TB SSD M.2 PCIe NVMe Opal | HH DVD±RW | 9-in-1 | 850W 92% | 1xeSATA Rear | None | USB / USB Optical | Windows 10 DG Windows 7 Pro 64 | 3-year | 12/16 |
| 30B7002CUS | US | 1xXeon E5-2623 v4 4C/2.6GHz/10MB/85W/DDR4-2133 | NVIDIA Quadro M2000 4GB | 2x8GB RDIMM DDR4-2400 ECC | Onboard | 4 | 1x256GB SSD 2.5" SATA6Gbs Opal | HH DVD±RW | 9-in-1 | 650W 92% | None | None | USB / USB Optical | Windows 10 DG Windows 7 Pro 64 | 3-year | 12/16 |
| 30B7002DUS | US | 2xXeon E5-2637 v4 4C/3.5GHz/15MB/135W/DDR4-2400 | NVIDIA Quadro P5000 16GB | 2x16GB RDIMM DDR4-2400 ECC | Onboard | 4 | 1x1TB SSD M.2 PCIe NVMe Opal | HH DVD±RW | 9-in-1 | 850W 92% | 1xeSATA Rear | None | USB / USB Optical | Windows 10 DG Windows 7 Pro 64 | 3-year | 12/16 |
| 30B7002EUS | US | 1xXeon E5-2623 v4 4C/2.6GHz/10MB/85W/DDR4-2133 | NVIDIA Quadro M2000 4GB | 2x8GB RDIMM DDR4-2400 ECC | Onboard | 4 | 1x256GB SSD 2.5" SATA6Gbs Opal | HH DVD±RW | 9-in-1 | 850W 92% | None | None | USB / USB Optical | Windows 10 DG Windows 7 Pro 64 | 3-year | 12/16 |
| 30B7002FUS | US | 2xXeon E5-2643 v4 6C/3.4GHz/20MB/135W/DDR4-2400 | NVIDIA Quadro M4000 8GB | 4x8GB RDIMM DDR4-2400 ECC | Onboard | 4 | 1x1TB HDD 7.2K 3.5" SATA6Gbs | HH DVD±RW | 9-in-1 | 850W 92% | None | None | USB / USB Optical | Windows 10 DG Windows 7 Pro 64 | 3-year | 12/16 |
| 30B7002GUS | US | 1xXeon E5-2623 v4 4C/2.6GHz/10MB/85W/DDR4-2133 | Open | 2x8GB RDIMM DDR4-2400 ECC | Onboard | 4 | 1x1TB SSD M.2 PCIe NVMe Opal | HH DVD±RW | 9-in-1 | 850W 92% | 1xeSATA Rear | None | USB / USB Optical | Windows 10 DG Windows 7 Pro 64 | 3-year | 12/16 |
| 30B7002MUS | US | 2xXeon E5-2623 v4 4C/2.6GHz/10MB/85W/DDR4-2133 | Quadro P2000 5GB | 2x8GB RDIMM DDR4-2400 ECC | Onboard | 4 | 1x256GB SSD 2.5" SATA6Gbs Opal | HH DVD±RW | 9-in-1 | 850W 92% | None | None | USB / USB Optical | Windows 10 DG Windows 7 Pro 64 | 3-year | 04/17 |
| 30B7002NUS | US | 1xXeon E5-2650 v4 12C/2.2GHz/30MB/105W/DDR4-2400 | Quadro P4000 8GB | 2x8GB RDIMM DDR4-2400 ECC | Onboard | 4 | 1x1TB HDD 7.2K 3.5" SATA6Gbs+1x256GB SSD M.2 PCIe | HH DVD±RW | 9-in-1 | 850W 92% | None | None | USB / USB Optical | Windows 10 DG Windows 7 Pro 64 | 3-year | 04/17 |
| 30B7002PUS | US | 1xXeon E5-2623 v4 4C/2.6GHz/10MB/85W/DDR4-2133 | Quadro P2000 5GB | 2x8GB RDIMM DDR4-2400 ECC | Onboard | 4 | 1x512GB SSD 2.5" SATA6Gbs | HH DVD±RW | 9-in-1 | 850W 92% | None | None | USB / USB Optical | Windows 10 DG Windows 7 Pro 64 | 3-year | 04/17 |
| 30B7002QUS | US | 2xXeon E5-2623 v4 4C/2.6GHz/10MB/85W/DDR4-2133 | Quadro P2000 5GB | 2x8GB RDIMM DDR4-2400 ECC | Onboard | 4 | 1x256GB SSD 2.5" SATA6Gbs Opal | HH DVD±RW | 9-in-1 | 650W 92% | None | None | USB / USB Optical | Windows 10 DG Windows 7 Pro 64 | 3-year | 04/17 |
| 30B7002RUS | US | 1xXeon E5-2620 v4 8C/2.1GHz/20MB/85W/DDR4-2133 | Quadro P2000 5GB | 2x8GB RDIMM DDR4-2400 ECC | Onboard | 4 | 1x1TB HDD 7.2K 3.5" SATA6Gbs | HH DVD±RW | 9-in-1 | 850W 92% | None | None | USB / USB Optical | Windows 10 DG Windows 7 Pro 64 | 3-year | 04/17 |
| 30B7002SUS | US | 2xXeon E5-2643 v4 6C/3.4GHz/20MB/135W/DDR4-2400 | Quadro P4000 8GB | 4x8GB RDIMM DDR4-2400 ECC | Onboard | 4 | 1x1TB HDD 7.2K 3.5" SATA6Gbs | HH DVD±RW | 9-in-1 | 850W 92% | None | None | USB / USB Optical | Windows 10 Pro 64 | 3-year | 04/17 |
| 30B7002TUS | US | 2xXeon E5-2643 v4 6C/3.4GHz/20MB/135W/DDR4-2400 | Quadro P4000 8GB | 4x8GB RDIMM DDR4-2400 ECC | Onboard | 4 | 1x1TB HDD 7.2K 3.5" SATA6Gbs | HH DVD±RW | 9-in-1 | 850W 92% | None | None | USB / USB Optical | Windows 10 DG Windows 7 Pro 64 | 3-year | 04/17 |
| 30B7002UUS | US | 2xXeon E5-2623 v4 4C/2.6GHz/10MB/85W/DDR4-2133 | Quadro P2000 5GB | 2x8GB RDIMM DDR4-2400 ECC | Onboard | 4 | 1x512GB SSD 2.5" SATA6Gbs | HH DVD±RW | 9-in-1 | 850W 92% | None | None | USB / USB Optical | Windows 10 DG Windows 7 Pro 64 | 3-year | 04/17 |

| Model | Region | Processor | Graphics | Memory (Capacity/Type) | RAID Controller | Max Drives in 3.5" Bays | Storage (Capacity/Type/Interface) | Optical | Media Reader | Power Supply | Add-on Ports | Discrete ethernet | Keyboard / Mouse | Operating System | Warranty | Ann Date (mm/yy) |
|------------|--------|---|------------------------|------------------------------|--------------------|----------------------------------|---|--------------|-----------------|-----------------|-----------------|----------------------|----------------------|---|----------|---------------------|
| 30B7002VUS | US | 1xXeon E5-2620 v4 8C/2.1GHz/20MB/85W/DDR4-2133 | Quadro P2000 5GB | 2x8GB RDIMM DDR4-2400 ECC | Onboard | 4 | 1x1TB HDD 7.2K 3.5" SATA6Gbs+1x256GB SSD M.2 PCIe | HH DVD±RW | 9-in-1 | 850W 92% | None | None | USB / USB Optical | Windows 10 DG Windows 7 Pro 64 | 3-year | 04/17 |
| 30B7002WUS | US | 1xXeon E5-2650 v4 12C/2.2GHz/30MB/105W/DDR4-2400 | Quadro P4000 8GB | 2x8GB RDIMM DDR4-2400 ECC | Onboard | 4 | 1x1TB HDD 7.2K 3.5" SATA6Gbs+1x256GB SSD M.2 PCIe | HH DVD±RW | 9-in-1 | 850W 92% | None | None | USB / USB Optical | Windows 10 Pro 64 | 3-year | 04/17 |

ThinkStation P910 Platform Specifications

Product Specifications Reference (PSREF)

| Components | Specification | | | | | | | | | | | | | | | | | | | | | | | | | | | | | | | | | | | | | | | | | | | | | | | | | | | | | | | | | | | | | | | | | | | | | | | | | | | | | | | | | | | | | | | | | | | | | | | | | | | | | | | | | | | | | | | | | | | | | | | | | | | | | | | | | | | | | | | | | | |
|---------------------------------------|---|--------------------------|---|-------------------------|------------------------|-------------------------|---|---------------------|-------------------|--------------------|---|----------------|-------|---------------|------------------|------------------|---|-----------------|--|---------|-----|-----|-----|-----------|--|---------|------|-----|-----|-----------|--|-------------|-----|-----|-----|-------------|--|-------------|-----|-----|-----|-------------|--|--------------|-----|-----|-----|-----------|--|--------------|-----|-----|-----|---------------|--|--------------|------|-----|------|---------------|--|--------------|------|-----|------|------------------------|-----|--------------|-----|-----|-----|------|--|--------------|------|-----|------|------|--|--------------|------|-----|------|---------------|-----|--------------|------|------|------|---------------|-----|-------------|-----|-----|-----|----------|--|-------------|-----|-----|-----|----------|--|--------------|-----|-----|-----|----------|--|--------------|------|-----|-----|------|--|--------------|------|-----|------|------|-----|--------------|------|------|------|---------------|-----|--------------|------|------|------|---------------|-----|-----------|------|------|------|--|--|
| Chipset | Intel C612 Platform Controller Hub (PCH) | | | | | | | | | | | | | | | | | | | | | | | | | | | | | | | | | | | | | | | | | | | | | | | | | | | | | | | | | | | | | | | | | | | | | | | | | | | | | | | | | | | | | | | | | | | | | | | | | | | | | | | | | | | | | | | | | | | | | | | | | | | | | | | | | | | | | | | | | | |
| System mgmt | Intel Active Management Technology 9 | | | | | | | | | | | | | | | | | | | | | | | | | | | | | | | | | | | | | | | | | | | | | | | | | | | | | | | | | | | | | | | | | | | | | | | | | | | | | | | | | | | | | | | | | | | | | | | | | | | | | | | | | | | | | | | | | | | | | | | | | | | | | | | | | | | | | | | | | | |
| Processor | Up to two 160W Intel Xeon E5-2600 v4 family processors. Each processor supports up to 22 cores up to 2.2GHz, 16 cores up to 2.6GHz, 14 cores up to 2.6GHz, 12 cores up to 3GHz, 10 cores up to 2.4GHz, 8 cores up to 3.2GHz, 6 cores up to 3.4GHz, 4 cores up to 3.5GHz. Or up to two Intel Xeon E5-2620 v3 or E5-2609 v3 processors (not available in EMEA) | | | | | | | | | | | | | | | | | | | | | | | | | | | | | | | | | | | | | | | | | | | | | | | | | | | | | | | | | | | | | | | | | | | | | | | | | | | | | | | | | | | | | | | | | | | | | | | | | | | | | | | | | | | | | | | | | | | | | | | | | | | | | | | | | | | | | | | | | | |
| Coprocessor | Optional. Up to one Intel Xeon Phi Coprocessor 3120A, PCIe 2.0 x16 adapter, 57 cores, 1.1GHz, 28.5MB L2 cache, 6GB memory, 300W | | | | | | | | | | | | | | | | | | | | | | | | | | | | | | | | | | | | | | | | | | | | | | | | | | | | | | | | | | | | | | | | | | | | | | | | | | | | | | | | | | | | | | | | | | | | | | | | | | | | | | | | | | | | | | | | | | | | | | | | | | | | | | | | | | | | | | | | | | |
| Memory DIMM slots | 16 DIMM sockets (8 DIMMs per processor), 8-channel capable (4-channel per processor). RDIMM or LRDIMM (cannot be intermixed), ECC, DDR4, 2400MHz | | | | | | | | | | | | | | | | | | | | | | | | | | | | | | | | | | | | | | | | | | | | | | | | | | | | | | | | | | | | | | | | | | | | | | | | | | | | | | | | | | | | | | | | | | | | | | | | | | | | | | | | | | | | | | | | | | | | | | | | | | | | | | | | | | | | | | | | | | |
| Memory capacity | 896GB (LRDIMM, 14x64GB)/512GB (RDIMM, 16x32GB), 2nd CPU is needed | | | | | | | | | | | | | | | | | | | | | | | | | | | | | | | | | | | | | | | | | | | | | | | | | | | | | | | | | | | | | | | | | | | | | | | | | | | | | | | | | | | | | | | | | | | | | | | | | | | | | | | | | | | | | | | | | | | | | | | | | | | | | | | | | | | | | | | | | | |
| Graphics and GPU computing | Four PCIe 3.0 x16 slots for graphics and GPU computing cards, two slots per processor <table border="1"> <thead> <tr> <th>Installed CPU</th> <th>Maximum quantity of PCIe x16 adapters per system (by power)</th> </tr> </thead> <tbody> <tr> <td>1</td> <td>1x300W+1x75W or 2x150W</td> </tr> <tr> <td>2</td> <td>2x300W+2x75W, or 1x300W+2x150W+1x75W, or 4x150W</td> </tr> </tbody> </table> | Installed CPU | Maximum quantity of PCIe x16 adapters per system (by power) | 1 | 1x300W+1x75W or 2x150W | 2 | 2x300W+2x75W, or 1x300W+2x150W+1x75W, or 4x150W | | | | | | | | | | | | | | | | | | | | | | | | | | | | | | | | | | | | | | | | | | | | | | | | | | | | | | | | | | | | | | | | | | | | | | | | | | | | | | | | | | | | | | | | | | | | | | | | | | | | | | | | | | | | | | | | | | | | | | | | | | | | | | | | | | | | |
| Installed CPU | Maximum quantity of PCIe x16 adapters per system (by power) | | | | | | | | | | | | | | | | | | | | | | | | | | | | | | | | | | | | | | | | | | | | | | | | | | | | | | | | | | | | | | | | | | | | | | | | | | | | | | | | | | | | | | | | | | | | | | | | | | | | | | | | | | | | | | | | | | | | | | | | | | | | | | | | | | | | | | | | | | |
| 1 | 1x300W+1x75W or 2x150W | | | | | | | | | | | | | | | | | | | | | | | | | | | | | | | | | | | | | | | | | | | | | | | | | | | | | | | | | | | | | | | | | | | | | | | | | | | | | | | | | | | | | | | | | | | | | | | | | | | | | | | | | | | | | | | | | | | | | | | | | | | | | | | | | | | | | | | | | | |
| 2 | 2x300W+2x75W, or 1x300W+2x150W+1x75W, or 4x150W | | | | | | | | | | | | | | | | | | | | | | | | | | | | | | | | | | | | | | | | | | | | | | | | | | | | | | | | | | | | | | | | | | | | | | | | | | | | | | | | | | | | | | | | | | | | | | | | | | | | | | | | | | | | | | | | | | | | | | | | | | | | | | | | | | | | | | | | | | |
| Supporting Graphics and GPU computing | <table border="1"> <thead> <tr> <th>Adapter</th> <th>Cores</th> <th>Memory</th> <th>Power</th> <th>Connector***</th> <th>SLI</th> </tr> </thead> <tbody> <tr><td>NVS 310</td><td>48</td><td>1GB</td><td>19.5W</td><td>2xDP</td><td></td></tr> <tr><td>NVS 315</td><td>48</td><td>1GB</td><td>19.5W</td><td>2xDVI-I SL/2xDP</td><td></td></tr> <tr><td>NVS 510</td><td>192</td><td>2GB</td><td>35W</td><td>4xmini DP</td><td></td></tr> <tr><td>NVS 810</td><td>1024</td><td>4GB</td><td>68W</td><td>8xmini DP</td><td></td></tr> <tr><td>Quadro K420</td><td>192</td><td>2GB</td><td>41W</td><td>DVI-I DL+DP</td><td></td></tr> <tr><td>Quadro K620</td><td>384</td><td>2GB</td><td>45W</td><td>DVI-I DL+DP</td><td></td></tr> <tr><td>Quadro K1200</td><td>512</td><td>4GB</td><td>45W</td><td>4xmini DP</td><td></td></tr> <tr><td>Quadro K2200</td><td>640</td><td>4GB</td><td>68W</td><td>DVI-I DL+2xDP</td><td></td></tr> <tr><td>Quadro K4200</td><td>1344</td><td>4GB</td><td>108W</td><td>DVI-I DL+2xDP</td><td></td></tr> <tr><td>Quadro K5200</td><td>2304</td><td>8GB</td><td>150W</td><td>DVI-I DL+DVI-D DL+2xDP</td><td>SLI</td></tr> <tr><td>Quadro M2000</td><td>768</td><td>4GB</td><td>75W</td><td>4xDP</td><td></td></tr> <tr><td>Quadro M4000</td><td>1664</td><td>8GB</td><td>120W</td><td>4xDP</td><td></td></tr> <tr><td>Quadro M5000</td><td>2048</td><td>8GB</td><td>150W</td><td>DVI-I DL+4xDP</td><td>SLI</td></tr> <tr><td>Quadro M6000</td><td>3072</td><td>24GB</td><td>250W</td><td>DVI-I DL+4xDP</td><td>SLI</td></tr> <tr><td>Quadro P400</td><td>256</td><td>2GB</td><td>30W</td><td>3xminiDP</td><td></td></tr> <tr><td>Quadro P600</td><td>384</td><td>2GB</td><td>40W</td><td>4xminiDP</td><td></td></tr> <tr><td>Quadro P1000</td><td>640</td><td>4GB</td><td>47W</td><td>4xminiDP</td><td></td></tr> <tr><td>Quadro P2000</td><td>1024</td><td>5GB</td><td>75W</td><td>4xDP</td><td></td></tr> <tr><td>Quadro P4000</td><td>1792</td><td>8GB</td><td>105W</td><td>4xDP</td><td>SLI</td></tr> <tr><td>Quadro P5000</td><td>2560</td><td>16GB</td><td>180W</td><td>DVI-D DL+4xDP</td><td>SLI</td></tr> <tr><td>Quadro P6000</td><td>3840</td><td>24GB</td><td>250W</td><td>DVI-D DL+4xDP</td><td>SLI</td></tr> <tr><td>Tesla K40</td><td>2880</td><td>12GB</td><td>235W</td><td></td><td></td></tr> </tbody> </table> | Adapter | Cores | Memory | Power | Connector*** | SLI | NVS 310 | 48 | 1GB | 19.5W | 2xDP | | NVS 315 | 48 | 1GB | 19.5W | 2xDVI-I SL/2xDP | | NVS 510 | 192 | 2GB | 35W | 4xmini DP | | NVS 810 | 1024 | 4GB | 68W | 8xmini DP | | Quadro K420 | 192 | 2GB | 41W | DVI-I DL+DP | | Quadro K620 | 384 | 2GB | 45W | DVI-I DL+DP | | Quadro K1200 | 512 | 4GB | 45W | 4xmini DP | | Quadro K2200 | 640 | 4GB | 68W | DVI-I DL+2xDP | | Quadro K4200 | 1344 | 4GB | 108W | DVI-I DL+2xDP | | Quadro K5200 | 2304 | 8GB | 150W | DVI-I DL+DVI-D DL+2xDP | SLI | Quadro M2000 | 768 | 4GB | 75W | 4xDP | | Quadro M4000 | 1664 | 8GB | 120W | 4xDP | | Quadro M5000 | 2048 | 8GB | 150W | DVI-I DL+4xDP | SLI | Quadro M6000 | 3072 | 24GB | 250W | DVI-I DL+4xDP | SLI | Quadro P400 | 256 | 2GB | 30W | 3xminiDP | | Quadro P600 | 384 | 2GB | 40W | 4xminiDP | | Quadro P1000 | 640 | 4GB | 47W | 4xminiDP | | Quadro P2000 | 1024 | 5GB | 75W | 4xDP | | Quadro P4000 | 1792 | 8GB | 105W | 4xDP | SLI | Quadro P5000 | 2560 | 16GB | 180W | DVI-D DL+4xDP | SLI | Quadro P6000 | 3840 | 24GB | 250W | DVI-D DL+4xDP | SLI | Tesla K40 | 2880 | 12GB | 235W | | |
| Adapter | Cores | Memory | Power | Connector*** | SLI | | | | | | | | | | | | | | | | | | | | | | | | | | | | | | | | | | | | | | | | | | | | | | | | | | | | | | | | | | | | | | | | | | | | | | | | | | | | | | | | | | | | | | | | | | | | | | | | | | | | | | | | | | | | | | | | | | | | | | | | | | | | | | | | | | | | | | |
| NVS 310 | 48 | 1GB | 19.5W | 2xDP | | | | | | | | | | | | | | | | | | | | | | | | | | | | | | | | | | | | | | | | | | | | | | | | | | | | | | | | | | | | | | | | | | | | | | | | | | | | | | | | | | | | | | | | | | | | | | | | | | | | | | | | | | | | | | | | | | | | | | | | | | | | | | | | | | | | | | | |
| NVS 315 | 48 | 1GB | 19.5W | 2xDVI-I SL/2xDP | | | | | | | | | | | | | | | | | | | | | | | | | | | | | | | | | | | | | | | | | | | | | | | | | | | | | | | | | | | | | | | | | | | | | | | | | | | | | | | | | | | | | | | | | | | | | | | | | | | | | | | | | | | | | | | | | | | | | | | | | | | | | | | | | | | | | | | |
| NVS 510 | 192 | 2GB | 35W | 4xmini DP | | | | | | | | | | | | | | | | | | | | | | | | | | | | | | | | | | | | | | | | | | | | | | | | | | | | | | | | | | | | | | | | | | | | | | | | | | | | | | | | | | | | | | | | | | | | | | | | | | | | | | | | | | | | | | | | | | | | | | | | | | | | | | | | | | | | | | | |
| NVS 810 | 1024 | 4GB | 68W | 8xmini DP | | | | | | | | | | | | | | | | | | | | | | | | | | | | | | | | | | | | | | | | | | | | | | | | | | | | | | | | | | | | | | | | | | | | | | | | | | | | | | | | | | | | | | | | | | | | | | | | | | | | | | | | | | | | | | | | | | | | | | | | | | | | | | | | | | | | | | | |
| Quadro K420 | 192 | 2GB | 41W | DVI-I DL+DP | | | | | | | | | | | | | | | | | | | | | | | | | | | | | | | | | | | | | | | | | | | | | | | | | | | | | | | | | | | | | | | | | | | | | | | | | | | | | | | | | | | | | | | | | | | | | | | | | | | | | | | | | | | | | | | | | | | | | | | | | | | | | | | | | | | | | | | |
| Quadro K620 | 384 | 2GB | 45W | DVI-I DL+DP | | | | | | | | | | | | | | | | | | | | | | | | | | | | | | | | | | | | | | | | | | | | | | | | | | | | | | | | | | | | | | | | | | | | | | | | | | | | | | | | | | | | | | | | | | | | | | | | | | | | | | | | | | | | | | | | | | | | | | | | | | | | | | | | | | | | | | | |
| Quadro K1200 | 512 | 4GB | 45W | 4xmini DP | | | | | | | | | | | | | | | | | | | | | | | | | | | | | | | | | | | | | | | | | | | | | | | | | | | | | | | | | | | | | | | | | | | | | | | | | | | | | | | | | | | | | | | | | | | | | | | | | | | | | | | | | | | | | | | | | | | | | | | | | | | | | | | | | | | | | | | |
| Quadro K2200 | 640 | 4GB | 68W | DVI-I DL+2xDP | | | | | | | | | | | | | | | | | | | | | | | | | | | | | | | | | | | | | | | | | | | | | | | | | | | | | | | | | | | | | | | | | | | | | | | | | | | | | | | | | | | | | | | | | | | | | | | | | | | | | | | | | | | | | | | | | | | | | | | | | | | | | | | | | | | | | | | |
| Quadro K4200 | 1344 | 4GB | 108W | DVI-I DL+2xDP | | | | | | | | | | | | | | | | | | | | | | | | | | | | | | | | | | | | | | | | | | | | | | | | | | | | | | | | | | | | | | | | | | | | | | | | | | | | | | | | | | | | | | | | | | | | | | | | | | | | | | | | | | | | | | | | | | | | | | | | | | | | | | | | | | | | | | | |
| Quadro K5200 | 2304 | 8GB | 150W | DVI-I DL+DVI-D DL+2xDP | SLI | | | | | | | | | | | | | | | | | | | | | | | | | | | | | | | | | | | | | | | | | | | | | | | | | | | | | | | | | | | | | | | | | | | | | | | | | | | | | | | | | | | | | | | | | | | | | | | | | | | | | | | | | | | | | | | | | | | | | | | | | | | | | | | | | | | | | | |
| Quadro M2000 | 768 | 4GB | 75W | 4xDP | | | | | | | | | | | | | | | | | | | | | | | | | | | | | | | | | | | | | | | | | | | | | | | | | | | | | | | | | | | | | | | | | | | | | | | | | | | | | | | | | | | | | | | | | | | | | | | | | | | | | | | | | | | | | | | | | | | | | | | | | | | | | | | | | | | | | | | |
| Quadro M4000 | 1664 | 8GB | 120W | 4xDP | | | | | | | | | | | | | | | | | | | | | | | | | | | | | | | | | | | | | | | | | | | | | | | | | | | | | | | | | | | | | | | | | | | | | | | | | | | | | | | | | | | | | | | | | | | | | | | | | | | | | | | | | | | | | | | | | | | | | | | | | | | | | | | | | | | | | | | |
| Quadro M5000 | 2048 | 8GB | 150W | DVI-I DL+4xDP | SLI | | | | | | | | | | | | | | | | | | | | | | | | | | | | | | | | | | | | | | | | | | | | | | | | | | | | | | | | | | | | | | | | | | | | | | | | | | | | | | | | | | | | | | | | | | | | | | | | | | | | | | | | | | | | | | | | | | | | | | | | | | | | | | | | | | | | | | |
| Quadro M6000 | 3072 | 24GB | 250W | DVI-I DL+4xDP | SLI | | | | | | | | | | | | | | | | | | | | | | | | | | | | | | | | | | | | | | | | | | | | | | | | | | | | | | | | | | | | | | | | | | | | | | | | | | | | | | | | | | | | | | | | | | | | | | | | | | | | | | | | | | | | | | | | | | | | | | | | | | | | | | | | | | | | | | |
| Quadro P400 | 256 | 2GB | 30W | 3xminiDP | | | | | | | | | | | | | | | | | | | | | | | | | | | | | | | | | | | | | | | | | | | | | | | | | | | | | | | | | | | | | | | | | | | | | | | | | | | | | | | | | | | | | | | | | | | | | | | | | | | | | | | | | | | | | | | | | | | | | | | | | | | | | | | | | | | | | | | |
| Quadro P600 | 384 | 2GB | 40W | 4xminiDP | | | | | | | | | | | | | | | | | | | | | | | | | | | | | | | | | | | | | | | | | | | | | | | | | | | | | | | | | | | | | | | | | | | | | | | | | | | | | | | | | | | | | | | | | | | | | | | | | | | | | | | | | | | | | | | | | | | | | | | | | | | | | | | | | | | | | | | |
| Quadro P1000 | 640 | 4GB | 47W | 4xminiDP | | | | | | | | | | | | | | | | | | | | | | | | | | | | | | | | | | | | | | | | | | | | | | | | | | | | | | | | | | | | | | | | | | | | | | | | | | | | | | | | | | | | | | | | | | | | | | | | | | | | | | | | | | | | | | | | | | | | | | | | | | | | | | | | | | | | | | | |
| Quadro P2000 | 1024 | 5GB | 75W | 4xDP | | | | | | | | | | | | | | | | | | | | | | | | | | | | | | | | | | | | | | | | | | | | | | | | | | | | | | | | | | | | | | | | | | | | | | | | | | | | | | | | | | | | | | | | | | | | | | | | | | | | | | | | | | | | | | | | | | | | | | | | | | | | | | | | | | | | | | | |
| Quadro P4000 | 1792 | 8GB | 105W | 4xDP | SLI | | | | | | | | | | | | | | | | | | | | | | | | | | | | | | | | | | | | | | | | | | | | | | | | | | | | | | | | | | | | | | | | | | | | | | | | | | | | | | | | | | | | | | | | | | | | | | | | | | | | | | | | | | | | | | | | | | | | | | | | | | | | | | | | | | | | | | |
| Quadro P5000 | 2560 | 16GB | 180W | DVI-D DL+4xDP | SLI | | | | | | | | | | | | | | | | | | | | | | | | | | | | | | | | | | | | | | | | | | | | | | | | | | | | | | | | | | | | | | | | | | | | | | | | | | | | | | | | | | | | | | | | | | | | | | | | | | | | | | | | | | | | | | | | | | | | | | | | | | | | | | | | | | | | | | |
| Quadro P6000 | 3840 | 24GB | 250W | DVI-D DL+4xDP | SLI | | | | | | | | | | | | | | | | | | | | | | | | | | | | | | | | | | | | | | | | | | | | | | | | | | | | | | | | | | | | | | | | | | | | | | | | | | | | | | | | | | | | | | | | | | | | | | | | | | | | | | | | | | | | | | | | | | | | | | | | | | | | | | | | | | | | | | |
| Tesla K40 | 2880 | 12GB | 235W | | | | | | | | | | | | | | | | | | | | | | | | | | | | | | | | | | | | | | | | | | | | | | | | | | | | | | | | | | | | | | | | | | | | | | | | | | | | | | | | | | | | | | | | | | | | | | | | | | | | | | | | | | | | | | | | | | | | | | | | | | | | | | | | | | | | | | | | |
| Disk drive controller | RAID 0, 1, 5, 10 with onboard SATA controller in chipset, 6Gb/s SATA. RAID 0, 1, 5, 10 with optional LSI RAID flex adapter, 12Gb/s SAS and SATA. RAID 0, 1, 5, 6, 10 with optional LSI 9364-8i PCIe adapter, 1GB memory, 12Gb/s SAS and SATA | | | | | | | | | | | | | | | | | | | | | | | | | | | | | | | | | | | | | | | | | | | | | | | | | | | | | | | | | | | | | | | | | | | | | | | | | | | | | | | | | | | | | | | | | | | | | | | | | | | | | | | | | | | | | | | | | | | | | | | | | | | | | | | | | | | | | | | | | | |
| Drive Bays | Three external 5.25" bays, four internal 3.5" dual drives bays (see right) | | | | | | | | | | | | | | | | | | | | | | | | | | | | | | | | | | | | | | | | | | | | | | | | | | | | | | | | | | | | | | | | | | | | | | | | | | | | | | | | | | | | | | | | | | | | | | | | | | | | | | | | | | | | | | | | | | | | | | | | | | | | | | | | | | | | | | | | | | |
| Flex bay | Three 5.25" flex bays for optical drives, Front Access Storage Enclosure drives, Flex Bay Storage Enclosure drives, or flex module. <ul style="list-style-type: none"> Up to three half-height optical drives or up to one 9.5mm optical drive, DVD-ROM, DVD±RW, or Blu-Ray burner Up to one Front Access Storage Enclosure for one 3.5" or 2.5" SATA drive. Up to two Flex Bay Storage Enclosure for two 3.5" or 2.5" SATA drives. | | | | | | | | | | | | | | | | | | | | | | | | | | | | | | | | | | | | | | | | | | | | | | | | | | | | | | | | | | | | | | | | | | | | | | | | | | | | | | | | | | | | | | | | | | | | | | | | | | | | | | | | | | | | | | | | | | | | | | | | | | | | | | | | | | | | | | | | | | |
| Supporting storage | <table border="1"> <tbody> <tr> <td>3.5" SATA HDD, 7.2K 6Gbs</td> <td>500GB/1TB/2TB/3TB/4TB/6TB/1TB hybrid/2TB hybrid</td> </tr> <tr> <td>2.5" SAS HDD, 15K 12Gbs</td> <td>300GB/600GB</td> </tr> <tr> <td>2.5" SAS HDD, 10K 12Gbs</td> <td>300GB</td> </tr> <tr> <td>2.5" SAS SSD, 12Gbs</td> <td>200GB/400GB/800GB</td> </tr> <tr> <td>2.5" SSD, SATA6Gbs</td> <td>180GB/240GB/256GB/480GB/512GB with OPAL, 256GB/512GB/1TB without OPAL</td> </tr> <tr> <td>PCIe SSD, 2.5"</td> <td>400GB</td> </tr> <tr> <td>PCIe SSD, M.2</td> <td>256 GB/512GB/1TB</td> </tr> <tr> <td>PCIe SSD adapter</td> <td>400GB (up to 4 per system, 2nd CPU is needed)</td> </tr> </tbody> </table> | 3.5" SATA HDD, 7.2K 6Gbs | 500GB/1TB/2TB/3TB/4TB/6TB/1TB hybrid/2TB hybrid | 2.5" SAS HDD, 15K 12Gbs | 300GB/600GB | 2.5" SAS HDD, 10K 12Gbs | 300GB | 2.5" SAS SSD, 12Gbs | 200GB/400GB/800GB | 2.5" SSD, SATA6Gbs | 180GB/240GB/256GB/480GB/512GB with OPAL, 256GB/512GB/1TB without OPAL | PCIe SSD, 2.5" | 400GB | PCIe SSD, M.2 | 256 GB/512GB/1TB | PCIe SSD adapter | 400GB (up to 4 per system, 2nd CPU is needed) | | | | | | | | | | | | | | | | | | | | | | | | | | | | | | | | | | | | | | | | | | | | | | | | | | | | | | | | | | | | | | | | | | | | | | | | | | | | | | | | | | | | | | | | | | | | | | | | | | | | | | | | | | | | | | | | | | | | | | | | | | |
| 3.5" SATA HDD, 7.2K 6Gbs | 500GB/1TB/2TB/3TB/4TB/6TB/1TB hybrid/2TB hybrid | | | | | | | | | | | | | | | | | | | | | | | | | | | | | | | | | | | | | | | | | | | | | | | | | | | | | | | | | | | | | | | | | | | | | | | | | | | | | | | | | | | | | | | | | | | | | | | | | | | | | | | | | | | | | | | | | | | | | | | | | | | | | | | | | | | | | | | | | | |
| 2.5" SAS HDD, 15K 12Gbs | 300GB/600GB | | | | | | | | | | | | | | | | | | | | | | | | | | | | | | | | | | | | | | | | | | | | | | | | | | | | | | | | | | | | | | | | | | | | | | | | | | | | | | | | | | | | | | | | | | | | | | | | | | | | | | | | | | | | | | | | | | | | | | | | | | | | | | | | | | | | | | | | | | |
| 2.5" SAS HDD, 10K 12Gbs | 300GB | | | | | | | | | | | | | | | | | | | | | | | | | | | | | | | | | | | | | | | | | | | | | | | | | | | | | | | | | | | | | | | | | | | | | | | | | | | | | | | | | | | | | | | | | | | | | | | | | | | | | | | | | | | | | | | | | | | | | | | | | | | | | | | | | | | | | | | | | | |
| 2.5" SAS SSD, 12Gbs | 200GB/400GB/800GB | | | | | | | | | | | | | | | | | | | | | | | | | | | | | | | | | | | | | | | | | | | | | | | | | | | | | | | | | | | | | | | | | | | | | | | | | | | | | | | | | | | | | | | | | | | | | | | | | | | | | | | | | | | | | | | | | | | | | | | | | | | | | | | | | | | | | | | | | | |
| 2.5" SSD, SATA6Gbs | 180GB/240GB/256GB/480GB/512GB with OPAL, 256GB/512GB/1TB without OPAL | | | | | | | | | | | | | | | | | | | | | | | | | | | | | | | | | | | | | | | | | | | | | | | | | | | | | | | | | | | | | | | | | | | | | | | | | | | | | | | | | | | | | | | | | | | | | | | | | | | | | | | | | | | | | | | | | | | | | | | | | | | | | | | | | | | | | | | | | | |
| PCIe SSD, 2.5" | 400GB | | | | | | | | | | | | | | | | | | | | | | | | | | | | | | | | | | | | | | | | | | | | | | | | | | | | | | | | | | | | | | | | | | | | | | | | | | | | | | | | | | | | | | | | | | | | | | | | | | | | | | | | | | | | | | | | | | | | | | | | | | | | | | | | | | | | | | | | | | |
| PCIe SSD, M.2 | 256 GB/512GB/1TB | | | | | | | | | | | | | | | | | | | | | | | | | | | | | | | | | | | | | | | | | | | | | | | | | | | | | | | | | | | | | | | | | | | | | | | | | | | | | | | | | | | | | | | | | | | | | | | | | | | | | | | | | | | | | | | | | | | | | | | | | | | | | | | | | | | | | | | | | | |
| PCIe SSD adapter | 400GB (up to 4 per system, 2nd CPU is needed) | | | | | | | | | | | | | | | | | | | | | | | | | | | | | | | | | | | | | | | | | | | | | | | | | | | | | | | | | | | | | | | | | | | | | | | | | | | | | | | | | | | | | | | | | | | | | | | | | | | | | | | | | | | | | | | | | | | | | | | | | | | | | | | | | | | | | | | | | | |

| Components | Specification | | | | | | | | | | | | |
|--|--|-------------------------|---------------------------------|--|-----------------------------------|--|------------------------------------|----------------------|--------------------------------------|----------------------|-------------------------|-----------------------------------|-------------------------|
| Flex connector | Two flex connectors (see right), one per processor. Supports one of the following: <ul style="list-style-type: none"> Up to one LSI RAID flex adapter for SATA/SAS RAID. Up to two Multi-I/O adapters for four PCIe SSD (two PCIe SSD per adapter). Up to two M.2 flex adapters for four M.2 PCIe SSD (two M.2 PCIe SSD per adapter) | | | | | | | | | | | | |
| Network interfaces | Integrated two-port gigabit ethernet (Intel i218LM and i210AT), supports Wake-on-LAN. Optional discrete ethernet adapters are available | | | | | | | | | | | | |
| HD Audio | Realtek ALC662 codec | | | | | | | | | | | | |
| TPM | TCG 1.2-compliant | | | | | | | | | | | | |
| Power supply | One fixed 1300 watts, autosensing, 92% PSU, 80 PLUS Platinum qualified <i>Note: PSU will automatically operate in 1120W (restricted mode) if the system line input is 100-110V. For other supported system line input voltages, the PSU will operate at the full 1300W.</i> | | | | | | | | | | | | |
| Front ports | Four USB 3.0 (one Diagnostic, one Always On), one combo audio/microphone jack (3.5mm) | | | | | | | | | | | | |
| Rear ports | Four USB 2.0, four USB 3.0 (blue), one serial (9-pin), two ethernet (RJ-45), three analog audio ports (line-in, line-out, mic-in), two PS/2 | | | | | | | | | | | | |
| Add-on ports | Supports the following optional ports: Two IEEE 1394 (one on rear and one on front flex module) via PCIe adapter, up to one adapter per system. Two rear USB 3.0 per USB add-on PCIe adapter, up to 3 adapters per system. One rear Thunderbolt via PCIe adapter. One front eSATA (on flex module), or one rear eSATA via cable (also needs one PCIe slot), up to one eSATA port per system. One internal USB 3.0 port via cable, cannot be intermixed with 29-in-1 reader | | | | | | | | | | | | |
| Media reader | 9-in-1 USB 2.0 card reader. Optional 29-in-1 USB 3.0 card reader on flex module | | | | | | | | | | | | |
| Mechanical | <ul style="list-style-type: none"> 55-liter: 200mm/7.87" W x 620mm/24.4" D x 446mm/17.56" H (with feet) Tool-less parts: all except CPU fansink 71.3 lb (32.3kg) max configuration | | | | | | | | | | | | |
| Environmental specification | <table border="1"> <tbody> <tr> <td>Temperature - operating</td> <td>50 °F to 95 °F (10 °C to 35 °C)</td> </tr> <tr> <td>Temperature - non operating (no package)</td> <td>14 °F to 140 °F (-10 °C to 60 °C)</td> </tr> <tr> <td>Temperature - non operating (with package)</td> <td>-40 °F to 140 °F (-40 °C to 60 °C)</td> </tr> <tr> <td>Altitude - operating</td> <td>(Unpressurized): 0-10000ft (0-3048m)</td> </tr> <tr> <td>Humidity - operating</td> <td>10%-80%, non-condensing</td> </tr> <tr> <td>Humidity - storage (with package)</td> <td>10%-90%, non-condensing</td> </tr> </tbody> </table> <p>RoHS-compliant, GREENGUARD on all models. EPEAT Gold rating, ENERGY STAR 6.1 qualified on selected models.</p> | Temperature - operating | 50 °F to 95 °F (10 °C to 35 °C) | Temperature - non operating (no package) | 14 °F to 140 °F (-10 °C to 60 °C) | Temperature - non operating (with package) | -40 °F to 140 °F (-40 °C to 60 °C) | Altitude - operating | (Unpressurized): 0-10000ft (0-3048m) | Humidity - operating | 10%-80%, non-condensing | Humidity - storage (with package) | 10%-90%, non-condensing |
| Temperature - operating | 50 °F to 95 °F (10 °C to 35 °C) | | | | | | | | | | | | |
| Temperature - non operating (no package) | 14 °F to 140 °F (-10 °C to 60 °C) | | | | | | | | | | | | |
| Temperature - non operating (with package) | -40 °F to 140 °F (-40 °C to 60 °C) | | | | | | | | | | | | |
| Altitude - operating | (Unpressurized): 0-10000ft (0-3048m) | | | | | | | | | | | | |
| Humidity - operating | 10%-80%, non-condensing | | | | | | | | | | | | |
| Humidity - storage (with package) | 10%-90%, non-condensing | | | | | | | | | | | | |
| Base warranty | 3-year limited onsite service with 9x5/NBD | | | | | | | | | | | | |
| ISV certifications | Please visit www.thinkworkstations.com/isv-certifications/ | | | | | | | | | | | | |

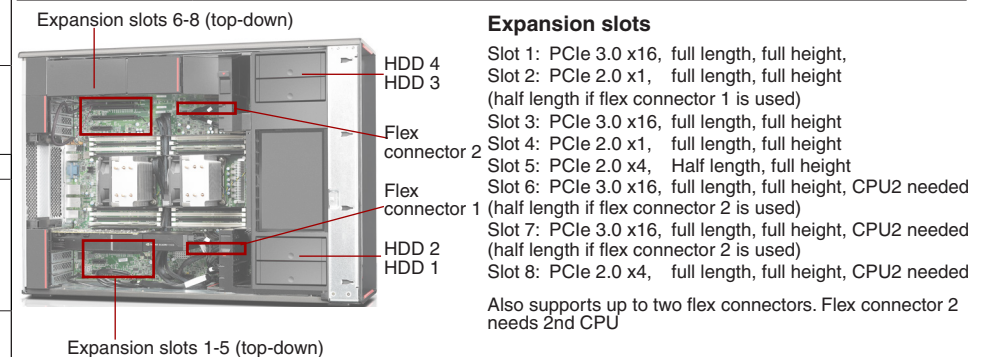

Expansion slots

Slot 1: PCIe 3.0 x16, full length, full height,
Slot 2: PCIe 2.0 x1, full length, full height (half length if flex connector 1 is used)
Slot 3: PCIe 3.0 x16, full length, full height
Slot 4: PCIe 2.0 x1, full length, full height
Slot 5: PCIe 2.0 x4, Half length, full height
Slot 6: PCIe 3.0 x16, full length, full height, CPU2 needed (half length if flex connector 2 is used)
Slot 7: PCIe 3.0 x16, full length, full height, CPU2 needed (half length if flex connector 2 is used)
Slot 8: PCIe 2.0 x4, full length, full height, CPU2 needed

Also supports up to two flex connectors. Flex connector 2 needs 2nd CPU

Drive bays

HDD 1-4: Standard 3.5" HDD bay, up to four 3.5" or 2.5" disk drives.
Each 3.5" bay supports 2.5" (9mm or less) drive plus 3.5" drive, or two 2.5" (15mm or less) drives. More than 4 drives requires LSI RAID flex adapter or 9364-8i adapter,
Flex bay: Three 5.25" flex bays, for HH optical drives.
Or up to one optional flex module (Flex module supports one or more of the following options: 9.5mm optical/29-in-1 USB 3.0 reader/front IEEE 1394/front eSATA).
Or up to two HDD bays for two drives, 3.5" or 2.5" each, SATA only.

| Model | Region | Processor | Graphics | Memory (Capacity/Type) | RAID Controller | Max Drives in 3.5" Bays | Storage (Capacity/Type/Interface) | Optical | Media Reader | Power Supply | Add-on Ports | Discrete Ethernet | Keyboard / Mouse | Operating System | Warranty | Ann Date (mm/yy) |
|------------|--------|---|-----------------------------------|-------------------------------|-----------------|-------------------------|---|--------------|--------------|--------------|--------------|-------------------|----------------------|---|----------|------------------|
| 30B9000EUS | US | 1xXeon E5-2643 v4 6C/3.4GHz/20MB/135W/DDR4-2400 | Open | 2x8GB RDIMM DDR4-2400 ECC | Onboard | 4 | 1x512GB SSD 2.5" SATA6Gbs | HH DVD±RW | 9-in-1 | 1300W 92% | None | None | USB / None | Windows 10 Pro 64 | 3-year | 04/16 |
| 30B9000FUS | US | 2xXeon E5-2650 v4 12C/2.2GHz/30MB/105W/DDR4-2400 | NVIDIA Quadro M5000 8GB | 4x8GB RDIMM DDR4-2400 ECC | Onboard | 4 | 1x1TB SSD 2.5" SATA6Gbs | HH DVD±RW | 9-in-1 | 1300W 92% | None | None | USB / None | Windows 10 Pro 64 | 3-year | 04/16 |
| 30B9000GUS | US | 2xXeon E5-2643 v4 6C/3.4GHz/20MB/135W/DDR4-2400 | Open | 4x8GB RDIMM DDR4-2400 ECC | Onboard | 4 | 1x1TB SSD 2.5" SATA6Gbs | HH DVD±RW | 9-in-1 | 1300W 92% | None | None | USB / None | Windows 10 Pro 64 | 3-year | 04/16 |
| 30B9000HUS | US | 1xXeon E5-2623 v4 4C/2.6GHz/10MB/85W/DDR4-2133 | Open | 2x8GB RDIMM DDR4-2400 ECC | Onboard | 4 | 1x512GB SSD 2.5" SATA6Gbs | HH DVD±RW | 9-in-1 | 1300W 92% | None | None | USB / None | Windows 10 Pro 64 | 3-year | 04/16 |
| 30B9001NUS | US | 2xXeon E5-2650 v4 12C/2.2GHz/30MB/105W/DDR4-2400 | NVIDIA Quadro M4000 8GB | 4x8GB RDIMM DDR4-2400 ECC | Onboard | 4 | 1x1TB HDD 7.2K 3.5" SATA6Gbs+1x512GB SSD M.2 PCIe | HH DVD±RW | 9-in-1 | 1300W 92% | None | None | USB / USB Optical | Windows 10 Pro 64 | 3-year | 07/16 |
| 30B9001PUS | US | 2xXeon E5-2650 v4 12C/2.2GHz/30MB/105W/DDR4-2400 | Open | 4x8GB RDIMM DDR4-2400 ECC | Onboard | 4 | 1x1TB HDD 7.2K 3.5" SATA6Gbs+1x512GB SSD M.2 PCIe | HH DVD±RW | 9-in-1 | 1300W 92% | None | None | USB / USB Optical | Windows 10 Pro 64 | 3-year | 07/16 |
| 30B9001UUS | US | 2xXeon E5-2650 v4 12C/2.2GHz/30MB/105W/DDR4-2400 | NVIDIA Quadro M4000 8GB | 4x8GB RDIMM DDR4-2400 ECC | Onboard | 4 | 1x1TB HDD 7.2K 3.5" SATA6Gbs+1x512GB SSD M.2 PCIe | HH DVD±RW | 9-in-1 | 1300W 92% | None | None | USB / USB Optical | Windows 10 DG Windows 7 Pro 64 | 3-year | 09/16 |
| 30B9001VUS | US | 2xXeon E5-2650 v4 12C/2.2GHz/30MB/105W/DDR4-2400 | Open | 4x8GB RDIMM DDR4-2400 ECC | Onboard | 4 | 1x1TB HDD 7.2K 3.5" SATA6Gbs+1x512GB SSD M.2 PCIe | HH DVD±RW | 9-in-1 | 1300W 92% | None | None | USB / USB Optical | Windows 10 DG Windows 7 Pro 64 | 3-year | 09/16 |
| 30B9001WUS | US | 1xXeon E5-2643 v4 6C/3.4GHz/20MB/135W/DDR4-2400 | Open | 2x8GB RDIMM DDR4-2400 ECC | Onboard | 4 | 1x512GB SSD 2.5" SATA6Gbs | HH DVD±RW | 9-in-1 | 1300W 92% | None | None | USB / None | Windows 10 DG Windows 7 Pro 64 | 3-year | 09/16 |
| 30B9001XUS | US | 2xXeon E5-2650 v4 12C/2.2GHz/30MB/105W/DDR4-2400 | NVIDIA Quadro M5000 8GB | 4x8GB RDIMM DDR4-2400 ECC | Onboard | 4 | 1x1TB SSD 2.5" SATA6Gbs | HH DVD±RW | 9-in-1 | 1300W 92% | None | None | USB / None | Windows 10 DG Windows 7 Pro 64 | 3-year | 09/16 |
| 30B9001YUS | US | 2xXeon E5-2643 v4 6C/3.4GHz/20MB/135W/DDR4-2400 | Open | 4x8GB RDIMM DDR4-2400 ECC | Onboard | 4 | 1x1TB SSD 2.5" SATA6Gbs | HH DVD±RW | 9-in-1 | 1300W 92% | None | None | USB / None | Windows 10 DG Windows 7 Pro 64 | 3-year | 09/16 |
| 30B90020US | US | 1xXeon E5-2623 v4 4C/2.6GHz/10MB/85W/DDR4-2133 | Open | 2x8GB RDIMM DDR4-2400 ECC | Onboard | 4 | 1x512GB SSD 2.5" SATA6Gbs | HH DVD±RW | 9-in-1 | 1300W 92% | None | None | USB / None | Windows 10 DG Windows 7 Pro 64 | 3-year | 09/16 |
| 30B9002DUS | US | 2xXeon E5-2620 v4 8C/2.1GHz/20MB/85W/DDR4-2133 | Open | 2x16GB RDIMM DDR4-2400 ECC | Onboard | 4 | 1x1TB SSD M.2 PCIe NVMe Opal | HH DVD±RW | 9-in-1 | 1300W 92% | None | None | USB / USB Optical | Windows 10 DG Windows 7 Pro 64 | 3-year | 12/16 |
| 30B9002EUS | US | 2xXeon E5-2620 v4 8C/2.1GHz/20MB/85W/DDR4-2133 | NVIDIA Quadro P5000 16GB | 2x16GB RDIMM DDR4-2400 ECC | Onboard | 4 | 1x1TB SSD M.2 PCIe NVMe Opal | HH DVD±RW | 9-in-1 | 1300W 92% | None | None | USB / USB Optical | Windows 10 DG Windows 7 Pro 64 | 3-year | 12/16 |
| 30B9002FUS | US | 2xXeon E5-2620 v4 8C/2.1GHz/20MB/85W/DDR4-2133 | NVIDIA Quadro P6000 24GB | 2x16GB RDIMM DDR4-2400 ECC | Onboard | 4 | 1x1TB SSD M.2 PCIe NVMe Opal | HH DVD±RW | 9-in-1 | 1300W 92% | None | None | USB / USB Optical | Windows 10 DG Windows 7 Pro 64 | 3-year | 12/16 |

| Model | Region | Processor | Graphics | Memory (Capacity/Type) | RAID Controller | Max Drives in 3.5" Bays | Storage (Capacity/Type/Interface) | Optical | Media Reader | Power Supply | Add-on Ports | Discrete Ethernet | Keyboard / Mouse | Operating System | Warranty | Ann Date (mm/yy) |
|------------|--------|---|------------------------|------------------------------|--------------------|----------------------------------|---|--------------|-----------------|-----------------|-----------------|----------------------|----------------------|---|----------|---------------------|
| 30B9002XCA | US | 1xXeon E5-2650 v4 12C/2.2GHz/30MB/105W/DDR4-2400 | Quadro P4000 8GB | 4x8GB RDIMM DDR4-2400 ECC | Onboard | 4 | 1x1TB HDD 7.2K 3.5" SATA6Gbs+1x512GB SSD M.2 PCIe | HH DVD±RW | 9-in-1 | 1300W 92% | None | None | USB / USB Optical | Windows 10 Pro 64 | 3-year | 04/17 |
| 30B9002XCC | US | 1xXeon E5-2650 v4 12C/2.2GHz/30MB/105W/DDR4-2400 | Quadro P4000 8GB | 4x8GB RDIMM DDR4-2400 ECC | Onboard | 4 | 1x1TB HDD 7.2K 3.5" SATA6Gbs+1x512GB SSD M.2 PCIe | HH DVD±RW | 9-in-1 | 1300W 92% | None | None | USB / USB Optical | Windows 10 Pro 64 | 3-year | 04/17 |
| 30B9002XSS | US | 1xXeon E5-2650 v4 12C/2.2GHz/30MB/105W/DDR4-2400 | Quadro P4000 8GB | 4x8GB RDIMM DDR4-2400 ECC | Onboard | 4 | 1x1TB HDD 7.2K 3.5" SATA6Gbs+1x512GB SSD M.2 PCIe | HH DVD±RW | 9-in-1 | 1300W 92% | None | None | USB / USB Optical | Windows 10 Pro 64 | 3-year | 04/17 |
| 30B9002XUS | US | 1xXeon E5-2650 v4 12C/2.2GHz/30MB/105W/DDR4-2400 | Quadro P4000 8GB | 4x8GB RDIMM DDR4-2400 ECC | Onboard | 4 | 1x1TB HDD 7.2K 3.5" SATA6Gbs+1x512GB SSD M.2 PCIe | HH DVD±RW | 9-in-1 | 1300W 92% | None | None | USB / USB Optical | Windows 10 Pro 64 | 3-year | 04/17 |
| 30B9002YCA | US | 1xXeon E5-2650 v4 12C/2.2GHz/30MB/105W/DDR4-2400 | Quadro P4000 8GB | 4x8GB RDIMM DDR4-2400 ECC | Onboard | 4 | 1x1TB HDD 7.2K 3.5" SATA6Gbs+1x512GB SSD M.2 PCIe | HH DVD±RW | 9-in-1 | 1300W 92% | None | None | USB / USB Optical | Windows 10 DG Windows 7 Pro 64 | 3-year | 04/17 |
| 30B9002YCC | US | 1xXeon E5-2650 v4 12C/2.2GHz/30MB/105W/DDR4-2400 | Quadro P4000 8GB | 4x8GB RDIMM DDR4-2400 ECC | Onboard | 4 | 1x1TB HDD 7.2K 3.5" SATA6Gbs+1x512GB SSD M.2 PCIe | HH DVD±RW | 9-in-1 | 1300W 92% | None | None | USB / USB Optical | Windows 10 DG Windows 7 Pro 64 | 3-year | 04/17 |
| 30B9002YSS | US | 1xXeon E5-2650 v4 12C/2.2GHz/30MB/105W/DDR4-2400 | Quadro P4000 8GB | 4x8GB RDIMM DDR4-2400 ECC | Onboard | 4 | 1x1TB HDD 7.2K 3.5" SATA6Gbs+1x512GB SSD M.2 PCIe | HH DVD±RW | 9-in-1 | 1300W 92% | None | None | USB / USB Optical | Windows 10 DG Windows 7 Pro 64 | 3-year | 04/17 |
| 30B9002YUS | US | 1xXeon E5-2650 v4 12C/2.2GHz/30MB/105W/DDR4-2400 | Quadro P4000 8GB | 4x8GB RDIMM DDR4-2400 ECC | Onboard | 4 | 1x1TB HDD 7.2K 3.5" SATA6Gbs+1x512GB SSD M.2 PCIe | HH DVD±RW | 9-in-1 | 1300W 92% | None | None | USB / USB Optical | Windows 10 DG Windows 7 Pro 64 | 3-year | 04/17 |

This publication was developed for products and services offered in the United States and E.M.E.A countries. Lenovo may not offer the products, services or features discussed in this document in other countries. Lenovo may withdraw an offering at any time. Information is subject to change without notice. Consult your local representative for information on offerings available in your area.

Lenovo reserves the right to change specifications or other product information without notice. Lenovo is not responsible for photographic or typographical errors.

LENOVO PROVIDES THIS PUBLICATION "AS IS," WITHOUT WARRANTY OF ANY KIND, EITHER EXPRESS OR IMPLIED, INCLUDING THE IMPLIED WARRANTIES OF MERCHANTABILITY OR FITNESS FOR A PARTICULAR PURPOSE.

Some jurisdictions do not allow disclaimer of express or implied warranties in certain transactions, therefore this disclaimer may not apply to you.

Availability: All offers subject to availability. Lenovo reserves the right to alter product offerings and specifications at any time, without notice. Lenovo is not responsible for photographic or typographic errors.

General: Review key information provided by Microsoft that may apply to your system purchase, including details on Windows 10, Windows 8, Windows 7, and potential upgrades/downgrades. Lenovo makes no representation or warranty regarding third-party products or services.

Trademarks: Lenovo, ThinkPad, ThinkCentre, ThinkStation and the Lenovo logo are trademarks of Lenovo. Microsoft, Windows, Windows NT, and the Windows logo are trademarks of Microsoft Corporation. Ultrabook, Celeron, Celeron Inside, Core Inside, Intel, Intel Logo, Intel Atom, Intel Atom Inside, Intel Core, Intel Inside, Intel Inside Logo, Intel vPro, Itanium, Itanium Inside, Pentium, Pentium Inside, vPro Inside, Xeon, Xeon Phi, and Xeon Inside are trademarks of Intel Corporation in the U.S. and/or other countries. Other company, product or service names may be trademarks or service marks of others.

Warranty: For a copy of applicable warranties, write to: Lenovo Warranty Information, 1009 Think Place, Morrisville, NC, 27560. Lenovo makes no representation or warranty regarding third party products or services. The Lenovo Limited Warranty applies only to Lenovo hardware products purchased for your own use, and does not transfer upon resale.

Limited warranty: Support unrelated to a warranty issue may be subject to additional charges.

Lenovo Services:

Carry-in or Mail-in Service: Parts and labor repair coverage where the customer is responsible for shipping (including packaging) or delivery to authorized warranty provider or repair center.

Depot or Courier Service: Parts and labor repair coverage where shipping (including packaging) or delivery to the repair center is paid for by Lenovo.

Expedited Depot: Parts and labor coverage with expedited turnaround. Shipping (including packaging) or delivery to the repair center is paid for by Lenovo.

Onsite / In-home Service: Parts and labor repair coverage where labor is provided onsite at your place of business.

If Lenovo determines your product problem is covered by the product warranty and cannot be resolved over the telephone, a technician will be dispatched to arrive onsite, typically the next day.

International Warranty Service (IWS): PC repair coverage for customers who require a critical warranty repair while travelling internationally. Visit www.lenovo.com/internationalwarranty for details. Visit www.lenovo.com/warranty for Lenovo Warranty Services terms and conditions for complete details and restrictions.

Included software: may differ from its retail version (if available), and may not include user manuals or all program functionality. Software license agreements may apply.

Battery life: Battery life (and recharge times) will vary based on many factors including screen brightness, applications, features, power management, battery conditioning, and other customer preferences.

Visit <http://psref.lenovo.com/> for the latest version of Product Specifications Reference.

© Lenovo, 2017. All rights reserved.
Lenovo 1009 Think Place Morrisville, NC 27560 U.S.A.

Lenovo **ThinkServer**

PSREF



Product Specifications Reference

Version 508, June 2017

U.S.

Visit <http://psref.lenovo.com> for the latest version

Contents

| | | |
|---|---|-----------|
| Cover | | |
| Contents | | |
| Summary Of Change | | |
| Racks | | |
| ThinkServer RD350 | | |
| ThinkServer RD350 Platform Specifications | | |
| ThinkServer RD350 - TopSeller - 70D6 | | |
| ThinkServer RD350 - TopSeller - 70D8 | | |
| ThinkServer RD350 - TopSeller - 70QK | | |
| ThinkServer RD350 - TopSeller - 70QM | | |
| ThinkServer RD450 | | |
| ThinkServer RD450 Platform Specifications | | |
| ThinkServer RD450 - TopSeller - 70DA | | |
| ThinkServer RD450 - TopSeller - 70DC | | |
| ThinkServer RD450 - TopSeller - 70DE | | |
| ThinkServer RD450 - TopSeller - 70DV | | |
| ThinkServer RD450 - TopSeller - 70Q9 | | |
| ThinkServer RD450 - TopSeller - 70QQ | | |
| ThinkServer RD450 - TopSeller - 70QS | | |
| ThinkServer RD450 - TopSeller - 70QW | | |
| ThinkServer RD550 | | |
| ThinkServer RD550 Platform Specifications | | |
| ThinkServer RD550 - TopSeller - 70CV | | |
| ThinkServer RD550 - TopSeller - 70CX | | |
| ThinkServer RD650 | | |
| ThinkServer RD650 Platform Specifications | | |
| ThinkServer RD650 - TopSeller - 70D0 | | |
| ThinkServer RD650 - TopSeller - 70D2 | | |
| ThinkServer RD650 - TopSeller - 70D4 | | |
| ThinkServer RD650 - TopSeller - 70DR | | |
| ThinkServer RD650 - TopSeller - 70DT | | |
| ThinkServer RS140 | | |
| ThinkServer RS140 Platform Specifications | | |
| ThinkServer RS140 - TopSeller - 70F3 | | |
| ThinkServer RS140 - TopSeller - 70F9 | | |
| 1 | ThinkServer RS140 - 70F2 | 36 |
| 2 | ThinkServer RS140 - 70F8 | 37 |
| 3 | ThinkServer RS160 | 38 |
| 5 | ThinkServer RS160 Platform Specifications | 39 |
| 5 | ThinkServer RS160 - TopSeller - 70TE | 40 |
| 6 | ThinkServer RS160 - TopSeller - 70TG | 41 |
| 7 | Towers | 42 |
| 8 | ThinkServer TD340 | 42 |
| 9 | ThinkServer TD340 Platform Specifications | 43 |
| 10 | ThinkServer TD340 - TopSeller - 70B5 | 44 |
| 11 | ThinkServer TD340 - TopSeller - 70B7 - 1 of 2 | 45 |
| 12 | ThinkServer TD340 - TopSeller - 70B7 - 2 of 2 | 46 |
| 13 | ThinkServer TD340 - 70B6 | 47 |
| 14 | ThinkServer TD350 | 48 |
| 15 | ThinkServer TD350 Platform Specifications | 49 |
| 16 | ThinkServer TD350 - TopSeller - 70DG | 50 |
| 17 | ThinkServer TD350 - TopSeller - 70DJ | 51 |
| 18 | ThinkServer TS150 | 52 |
| 19 | ThinkServer TS150 Platform Specifications | 52 |
| 20 | ThinkServer TS150 - TopSeller - 70LV | 53 |
| 21 | ThinkServer TS150 - TopSeller - 70LX | 54 |
| 22 | ThinkServer TS150 - TopSeller - 70UB | 55 |
| 23 | ThinkServer TS440 | 56 |
| 24 | ThinkServer TS440 Platform Specifications | 57 |
| 25 | ThinkServer TS440 - TopSeller - 70AN | 58 |
| 26 | ThinkServer TS440 - TopSeller - 70AQ - 1 of 2 | 59 |
| 27 | ThinkServer TS440 - TopSeller - 70AQ - 2 of 2 | 60 |
| 28 | ThinkServer TS440 - 70AL | 61 |
| 29 | ThinkServer TS440 - 70AM | 62 |
| 30 | ThinkServer TS460 | 63 |
| 31 | ThinkServer TS460 Platform Specifications | 64 |
| 32 | ThinkServer TS460 - TopSeller - 70TR - 1 of 2 | 65 |
| 33 | ThinkServer TS460 - TopSeller - 70TR - 2 of 2 | 66 |
| 34 | ThinkServer TS460 - TopSeller - 70TT | 67 |
| 35 | Legal Information | 68 |

Summary of Changes

This section describes the changes made in this version of ThinkServer PSREF and in previous version
This edition might also include minor corrections and editorial changes which are not identified

June 21, 2017 - Version 508

Additions in this update

- ▶ Add ThinkServer TS460 models announced June 2017
- ▶ Add ThinkServer RS160 models announced June 2017
- ▶ Update ThinkServer TS460 platform specifications, add new SBB support: Kaby Lake Xeon, Core i3, and Pentium processors. DDR4-2400 memory. 10TB 7.2K SATA6Gbs HDD, 10TB 7.2K SAS12Gbs HDD, 300GB/600GB 15K 2.5" SAS. Red Hat Enterprise Linux 7.3. SUSE Linux Enterprise Server 12 SP2/11 SP4
- ▶ Update ThinkServer RS160 platform specifications, add new SBB support: Kaby Lake Xeon, Core i3, Pentium, and Celeron processors. DDR4-2400 memory. 10TB 7.2K SATA6Gbs HDD, 10TB 7.2K SAS12Gbs HDD, 900GB 15K 2.5" SAS

May 26, 2017 - Version 507

Additions in this update

- ▶ Update ThinkServer RD650/RD550 platform specifications, add DDR4-2400 RDIMM memory, up to 1.92TB easy-swap NVMe SSD, and up to 3.84TB NVMe flash adapter

April 19, 2017 - Version 505

Additions in this update

- ▶ Add ThinkServer TS460 models announced April 2017
- ▶ Add ThinkServer TD350 models announced April 2017
- ▶ Add ThinkServer TS150 models announced April 2017
- ▶ Update ThinkServer TS150 platform specifications, add new Kaby Lake processors, DDR4-2400 memory, 10TB hard drive supports

February 15, 2017 - Version 502

Additions in this update

- ▶ Add ThinkServer RS160 models announced September 2016

Withdrawals in this update

- ▶ ThinkServer TS140 had been end of life

October 12, 2016 - Version 496

Additions in this update

- ▶ New ThinkServer RS160 product announced September 2016
- ▶ New ThinkServer TS150 models announced August and October 2016

September 14, 2016 - Version 495

Additions in this update

- ▶ New ThinkServer RS160 product announced September 2016
- ▶ New ThinkServer TS140 models announced September 2016

April 6, 2016 - Version 487

Additions in this update

- ▶ New ThinkServer TD350, RD350, and RD450 models announced April 2016
- ▶ Add Intel Xeon E5-2600 v4 processors

March 23, 2016 - Version 486

Additions in this update

- ▶ New ThinkServer TS140 models announced March 2016

February 24, 2016 - Version 485

Additions in this update

- ▶ Add 8TB SATA and SAS 72K 6Gbs hard drive on ThinkServer RD350/RD450/RD550/RD650/TD350

December 30, 2015 - Version 483

Additions in this update

- ▶ Updates ThinkServer RS140, TD340 specifications
- ▶ Updates the most recent ThinkServer RS140, TD340 models

December 9, 2015 - Version 482

Additions in this update

- ▶ Updates ThinkServer TS140, TS440 specifications
- ▶ Updates the most recent ThinkServer TS140, TS440, RD350, RD450, RD550, RD650 models

October 28, 2015 - Version 480

Additions in this update

- ▶ New ThinkServer TS140 models announced October 2015

July 30, 2015 - Version 476

Additions in this update

- ▶ New ThinkServer TD350, RD550, and RD650 models announced July 2015

May 6, 2015 - Version 473

Additions in this update

- ▶ Add 95mm optical support on TD350
- ▶ Add Red Hat Enterprise Linux 7 support on RD350/RD450/RD550/RD650/TD350
- ▶ Add 32 x 25" bay support on TD350
- ▶ Add AnyBay and 25" PCIe SSD support on RD550/RD650

April 15, 2015 - Version 471

Additions in this update

- ▶ New ThinkServer TD350 models announced March 2015

March 25, 2015 - Version 470

Additions in this update

- ▶ New ThinkServer TS140 and TS440 models announced March 2015



ThinkServer RD350 Platform Specifications

Product Specifications Reference (PSREF)

| Components | Specification | | | | | | | | | | | | | | | | | | | | | | | | | | | | | | | | | | | | | | | | |
|--------------------------|--|---------------------------------------|--------------------------------|-------------------------|--------------------------------|------------------|-------------------------------|-----------------------------|-------------------------------|--------------|------------------------------|--------------------------------|------------------------------|---------------|------------------------------|--------------------------------|------------------------------|---------------------------|-------------------------------|------------------|-------------------------------|---------------|--------------------------------|---------------------------------------|--------------------------------|------------|------------------------------|------------|------------------------------|------------|-----------------------------|------------|------------------------------|------------|------------------------------|------------|------------------------------|-------------|-------------------------------|-------------|------------------------------|
| Dimensions | 1U rack. Height: 43 mm (1.7 in), width: 482 mm (19 in), depth: 781.5 mm (30.77 in) | | | | | | | | | | | | | | | | | | | | | | | | | | | | | | | | | | | | | | | | |
| Weight | Minimum configuration: 13 kg (28.66 lb), maximum: 19.1 kg (42.11 lb) | | | | | | | | | | | | | | | | | | | | | | | | | | | | | | | | | | | | | | | | |
| Processor | Up to two 105W Intel Xeon E5-2600 v4 or E5-2600 v3 family processors. | | | | | | | | | | | | | | | | | | | | | | | | | | | | | | | | | | | | | | | | |
| | <table border="1"> <tbody> <tr><td>E5-2660 v4</td><td>14C/2GHz/35MB/105W/DDR4-2400</td></tr> <tr><td>E5-2650 v4</td><td>12C/2.2GHz/30MB/105W/DDR4-2400</td></tr> <tr><td>E5-2640 v4</td><td>10C/2.4GHz/25MB/90W/DDR4-2133</td></tr> <tr><td>E5-2630 v4</td><td>10C/2.2GHz/20MB/85W/DDR4-2133</td></tr> <tr><td>E5-2623 v4</td><td>4C/2.6GHz/10MB/85W/DDR4-2133</td></tr> <tr><td>E5-2620 v4</td><td>8C/2.1GHz/20MB/85W/DDR4-2133</td></tr> <tr><td>E5-2609 v4</td><td>8C/1.7GHz/20MB/85W/DDR4-1866</td></tr> <tr><td>E5-2603 v4</td><td>6C/1.7GHz/15MB/85W/DDR4-1866</td></tr> <tr><td>E5-2650L v4</td><td>14C/1.7GHz/35MB/65W/DDR4-2400</td></tr> <tr><td>E5-2630L v4</td><td>10C/1.8GHz/25MB/55W/DDR4-2133</td></tr> <tr><td>E5-2660 v3</td><td>10C/2.6GHz/25MB/105W/DDR4-2133</td></tr> <tr><td>E5-2650 v3</td><td>10C/2.3GHz/25MB/105W/DDR4-2133</td></tr> <tr><td>E5-2640 v3</td><td>8C/2.6GHz/20MB/90W/DDR4-1866</td></tr> <tr><td>E5-2630 v3</td><td>8C/2.4GHz/20MB/85W/DDR4-1866</td></tr> <tr><td>E5-2623 v3</td><td>4C/3GHz/10MB/105W/DDR4-1866</td></tr> <tr><td>E5-2620 v3</td><td>6C/2.4GHz/15MB/85W/DDR4-1866</td></tr> <tr><td>E5-2609 v3</td><td>6C/1.9GHz/15MB/85W/DDR4-1600</td></tr> <tr><td>E5-2603 v3</td><td>6C/1.6GHz/15MB/85W/DDR4-1600</td></tr> <tr><td>E5-2650L v3</td><td>12C/1.8GHz/30MB/65W/DDR4-2133</td></tr> <tr><td>E5-2630L v3</td><td>8C/1.8GHz/20MB/55W/DDR4-1866</td></tr> </tbody> </table> | E5-2660 v4 | 14C/2GHz/35MB/105W/DDR4-2400 | E5-2650 v4 | 12C/2.2GHz/30MB/105W/DDR4-2400 | E5-2640 v4 | 10C/2.4GHz/25MB/90W/DDR4-2133 | E5-2630 v4 | 10C/2.2GHz/20MB/85W/DDR4-2133 | E5-2623 v4 | 4C/2.6GHz/10MB/85W/DDR4-2133 | E5-2620 v4 | 8C/2.1GHz/20MB/85W/DDR4-2133 | E5-2609 v4 | 8C/1.7GHz/20MB/85W/DDR4-1866 | E5-2603 v4 | 6C/1.7GHz/15MB/85W/DDR4-1866 | E5-2650L v4 | 14C/1.7GHz/35MB/65W/DDR4-2400 | E5-2630L v4 | 10C/1.8GHz/25MB/55W/DDR4-2133 | E5-2660 v3 | 10C/2.6GHz/25MB/105W/DDR4-2133 | E5-2650 v3 | 10C/2.3GHz/25MB/105W/DDR4-2133 | E5-2640 v3 | 8C/2.6GHz/20MB/90W/DDR4-1866 | E5-2630 v3 | 8C/2.4GHz/20MB/85W/DDR4-1866 | E5-2623 v3 | 4C/3GHz/10MB/105W/DDR4-1866 | E5-2620 v3 | 6C/2.4GHz/15MB/85W/DDR4-1866 | E5-2609 v3 | 6C/1.9GHz/15MB/85W/DDR4-1600 | E5-2603 v3 | 6C/1.6GHz/15MB/85W/DDR4-1600 | E5-2650L v3 | 12C/1.8GHz/30MB/65W/DDR4-2133 | E5-2630L v3 | 8C/1.8GHz/20MB/55W/DDR4-1866 |
| | E5-2660 v4 | 14C/2GHz/35MB/105W/DDR4-2400 | | | | | | | | | | | | | | | | | | | | | | | | | | | | | | | | | | | | | | | |
| | E5-2650 v4 | 12C/2.2GHz/30MB/105W/DDR4-2400 | | | | | | | | | | | | | | | | | | | | | | | | | | | | | | | | | | | | | | | |
| | E5-2640 v4 | 10C/2.4GHz/25MB/90W/DDR4-2133 | | | | | | | | | | | | | | | | | | | | | | | | | | | | | | | | | | | | | | | |
| | E5-2630 v4 | 10C/2.2GHz/20MB/85W/DDR4-2133 | | | | | | | | | | | | | | | | | | | | | | | | | | | | | | | | | | | | | | | |
| | E5-2623 v4 | 4C/2.6GHz/10MB/85W/DDR4-2133 | | | | | | | | | | | | | | | | | | | | | | | | | | | | | | | | | | | | | | | |
| | E5-2620 v4 | 8C/2.1GHz/20MB/85W/DDR4-2133 | | | | | | | | | | | | | | | | | | | | | | | | | | | | | | | | | | | | | | | |
| | E5-2609 v4 | 8C/1.7GHz/20MB/85W/DDR4-1866 | | | | | | | | | | | | | | | | | | | | | | | | | | | | | | | | | | | | | | | |
| | E5-2603 v4 | 6C/1.7GHz/15MB/85W/DDR4-1866 | | | | | | | | | | | | | | | | | | | | | | | | | | | | | | | | | | | | | | | |
| | E5-2650L v4 | 14C/1.7GHz/35MB/65W/DDR4-2400 | | | | | | | | | | | | | | | | | | | | | | | | | | | | | | | | | | | | | | | |
| | E5-2630L v4 | 10C/1.8GHz/25MB/55W/DDR4-2133 | | | | | | | | | | | | | | | | | | | | | | | | | | | | | | | | | | | | | | | |
| | E5-2660 v3 | 10C/2.6GHz/25MB/105W/DDR4-2133 | | | | | | | | | | | | | | | | | | | | | | | | | | | | | | | | | | | | | | | |
| | E5-2650 v3 | 10C/2.3GHz/25MB/105W/DDR4-2133 | | | | | | | | | | | | | | | | | | | | | | | | | | | | | | | | | | | | | | | |
| | E5-2640 v3 | 8C/2.6GHz/20MB/90W/DDR4-1866 | | | | | | | | | | | | | | | | | | | | | | | | | | | | | | | | | | | | | | | |
| | E5-2630 v3 | 8C/2.4GHz/20MB/85W/DDR4-1866 | | | | | | | | | | | | | | | | | | | | | | | | | | | | | | | | | | | | | | | |
| | E5-2623 v3 | 4C/3GHz/10MB/105W/DDR4-1866 | | | | | | | | | | | | | | | | | | | | | | | | | | | | | | | | | | | | | | | |
| | E5-2620 v3 | 6C/2.4GHz/15MB/85W/DDR4-1866 | | | | | | | | | | | | | | | | | | | | | | | | | | | | | | | | | | | | | | | |
| | E5-2609 v3 | 6C/1.9GHz/15MB/85W/DDR4-1600 | | | | | | | | | | | | | | | | | | | | | | | | | | | | | | | | | | | | | | | |
| | E5-2603 v3 | 6C/1.6GHz/15MB/85W/DDR4-1600 | | | | | | | | | | | | | | | | | | | | | | | | | | | | | | | | | | | | | | | |
| E5-2650L v3 | 12C/1.8GHz/30MB/65W/DDR4-2133 | | | | | | | | | | | | | | | | | | | | | | | | | | | | | | | | | | | | | | | | |
| E5-2630L v3 | 8C/1.8GHz/20MB/55W/DDR4-1866 | | | | | | | | | | | | | | | | | | | | | | | | | | | | | | | | | | | | | | | | |
| Chipset | Intel C610 Series Chipset | | | | | | | | | | | | | | | | | | | | | | | | | | | | | | | | | | | | | | | | |
| Memory DIMMs | 16 DIMM sockets. 4 channels per processor, 2 DIMMs per channel. RDIMM or LRDIMM (cannot be intermixed), DDR4-2133 or DDR4-2400 | | | | | | | | | | | | | | | | | | | | | | | | | | | | | | | | | | | | | | | | |
| Memory capacity | 512GB (RDIMM, 32GB x 16)/1024GB (LRDIMM, 64GB x 16), 2nd CPU is needed | | | | | | | | | | | | | | | | | | | | | | | | | | | | | | | | | | | | | | | | |
| Memory protection | ECC, memory mirroring, lockstep, and memory sparing | | | | | | | | | | | | | | | | | | | | | | | | | | | | | | | | | | | | | | | | |
| RAID controller | <table border="1"> <thead> <tr> <th>RAID controller</th> <th>Drive type</th> <th>RAID support</th> <th>Compatible models</th> </tr> </thead> <tbody> <tr> <td>Onboard RAID110i</td> <td>6Gbs SATA</td> <td>0/1/10, 5 with optional key</td> <td>4x3.5" HS/ES, 8x2.5" HS</td> </tr> <tr> <td>RAID500 PCIe</td> <td>6Gbs SAS/SATA</td> <td>0/1/10, 5/50 with optional key</td> <td>4x3.5" HS, 8x2.5" HS</td> </tr> <tr> <td>RAID520i PCIe</td> <td>12Gbs SAS/SATA</td> <td>0/1/10, 5/50 with optional key</td> <td>4x3.5" HS/ES, 8x2.5" HS</td> </tr> <tr> <td>RAID710 PCIe (1GB memory)</td> <td>6Gbs SAS/SATA</td> <td>0/1/10/5/50/6/60</td> <td>4x3.5" HS, 8x2.5" HS</td> </tr> <tr> <td>RAID720i PCIe</td> <td>12Gbs SAS/SATA</td> <td>0/1/10/5/50, 6/60 with optional cache</td> <td>4x3.5" HS/ES, 8x2.5" HS</td> </tr> </tbody> </table> | RAID controller | Drive type | RAID support | Compatible models | Onboard RAID110i | 6Gbs SATA | 0/1/10, 5 with optional key | 4x3.5" HS/ES, 8x2.5" HS | RAID500 PCIe | 6Gbs SAS/SATA | 0/1/10, 5/50 with optional key | 4x3.5" HS, 8x2.5" HS | RAID520i PCIe | 12Gbs SAS/SATA | 0/1/10, 5/50 with optional key | 4x3.5" HS/ES, 8x2.5" HS | RAID710 PCIe (1GB memory) | 6Gbs SAS/SATA | 0/1/10/5/50/6/60 | 4x3.5" HS, 8x2.5" HS | RAID720i PCIe | 12Gbs SAS/SATA | 0/1/10/5/50, 6/60 with optional cache | 4x3.5" HS/ES, 8x2.5" HS | | | | | | | | | | | | | | | | |
| | RAID controller | Drive type | RAID support | Compatible models | | | | | | | | | | | | | | | | | | | | | | | | | | | | | | | | | | | | | |
| | Onboard RAID110i | 6Gbs SATA | 0/1/10, 5 with optional key | 4x3.5" HS/ES, 8x2.5" HS | | | | | | | | | | | | | | | | | | | | | | | | | | | | | | | | | | | | | |
| | RAID500 PCIe | 6Gbs SAS/SATA | 0/1/10, 5/50 with optional key | 4x3.5" HS, 8x2.5" HS | | | | | | | | | | | | | | | | | | | | | | | | | | | | | | | | | | | | | |
| | RAID520i PCIe | 12Gbs SAS/SATA | 0/1/10, 5/50 with optional key | 4x3.5" HS/ES, 8x2.5" HS | | | | | | | | | | | | | | | | | | | | | | | | | | | | | | | | | | | | | |
| | RAID710 PCIe (1GB memory) | 6Gbs SAS/SATA | 0/1/10/5/50/6/60 | 4x3.5" HS, 8x2.5" HS | | | | | | | | | | | | | | | | | | | | | | | | | | | | | | | | | | | | | |
| RAID720i PCIe | 12Gbs SAS/SATA | 0/1/10/5/50, 6/60 with optional cache | 4x3.5" HS/ES, 8x2.5" HS | | | | | | | | | | | | | | | | | | | | | | | | | | | | | | | | | | | | | | |
| | Optional cache for RAID 710: CacheVault flash cache with super capacitor, CacheCade Pro, or FastPath. | | | | | | | | | | | | | | | | | | | | | | | | | | | | | | | | | | | | | | | | |
| | Optional cache for RAID 720/AnyRAID 720i and 720ix: 1GB read-only memory or 1GB/2GB/4GB flash with super capacitor. Flash options include CacheVault, CacheCade Pro, and FastPath. 720ix must have cache. | | | | | | | | | | | | | | | | | | | | | | | | | | | | | | | | | | | | | | | | |
| | <i>Note: RAID 50 and 60 are available on 8 x 2.5" models only.</i> | | | | | | | | | | | | | | | | | | | | | | | | | | | | | | | | | | | | | | | | |
| Disk drive bays | Up to 4x3.5" hot-swap, 4x3.5" easy-swap, or 8x2.5" hot-swap disk bays on front. Supports external RDX tape drive via USB. | | | | | | | | | | | | | | | | | | | | | | | | | | | | | | | | | | | | | | | | |
| Maximum internal storage | 3.5" model: up to 32TB with 7.2K SATA or SAS HDD, up to 7.2TB with 10K SAS HDD, up to 2.4TB with 15K SAS HDD, or up to 6.4TB with SATA SSD. 3.5" ES model: up to 12TB with 7.2K SATA, up to 24TB with 7.2K SAS. 2.5" model: up to 16TB with 7.2K SATA HDD, up to 14.4TB with 10K SAS HDD, up to 4.8TB with 15K SAS HDD, or up to 12.8TB with SATA or SAS SSD | | | | | | | | | | | | | | | | | | | | | | | | | | | | | | | | | | | | | | | | |
| SD module | Up to 2 SDHC flash cards via optional SD module, 8GB or 32GB each | | | | | | | | | | | | | | | | | | | | | | | | | | | | | | | | | | | | | | | | |
| Optical drive | Optional one 9.5mm optical, DVD-ROM or DVD±RW. | | | | | | | | | | | | | | | | | | | | | | | | | | | | | | | | | | | | | | | | |
| Network interfaces | One dedicated management port, two Gigabit Ethernet ports (RJ-45). Supports optional discrete network adapters via PCIe slots | | | | | | | | | | | | | | | | | | | | | | | | | | | | | | | | | | | | | | | | |
| Security features | Power-on and administrator password. Optional TPM (TCG 1.2-compliant) Supports ThinkServer System Manager (TSM), optional TSM Premium. UEFI. Onboard Aspeed AST2400 graphics/management processor, IPMI 2.0-compliant baseboard management controller (BMC). | | | | | | | | | | | | | | | | | | | | | | | | | | | | | | | | | | | | | | | | |
| Systems management | Control Panel LEDs shows the status of power, ID, network, system. Supports ThinkServer management software: Diagnostics, Deployment Manager, Energy Manager, System Manager, Partner Pack for VMware vCenter and Microsoft System Center Operations Manager, Power Planner | | | | | | | | | | | | | | | | | | | | | | | | | | | | | | | | | | | | | | | | |

| Components | Specification | | | | | | | | | | | | | | |
|-----------------------------|---|--------------------------------------|------------------|--|--|------|------|------|--------|---|---|---|--------|---|---|
| Operating systems supported | Microsoft Windows Server 2016/2012 R2/2012/2008 R2. Windows Small Business Server 2011. Red Hat Enterprise Linux 6.5/6.6/7. SUSE Linux Enterprise Server 11. VMware vSphere (ESXi) 5.1 P5/5.5 U2/6.0 | | | | | | | | | | | | | | |
| Base warranty | 1 or 3-year limited onsite service with 9x5/NBD | | | | | | | | | | | | | | |
| Power supply | Up to two redundant hot-swap 450W/550W/750W power supplies. 450 W is 80 PLUS Gold qualified. 550W is 80 PLUS Platinum qualified. 750W is 80 PLUS Platinum or Titanium qualified. 750W Titanium is 200V - 240V, others are 110V - 240V. | | | | | | | | | | | | | | |
| | <table border="1"> <thead> <tr> <th rowspan="2">Disk bay configuration</th> <th colspan="3">PSU requirements</th> </tr> <tr> <th>450W</th> <th>550W</th> <th>750W</th> </tr> </thead> <tbody> <tr> <td>4x3.5"</td> <td>•</td> <td>•</td> <td>•</td> </tr> <tr> <td>8x2.5"</td> <td>•</td> <td>•</td> <td>•</td> </tr> </tbody> </table> | Disk bay configuration | PSU requirements | | | 450W | 550W | 750W | 4x3.5" | • | • | • | 8x2.5" | • | • |
| Disk bay configuration | PSU requirements | | | | | | | | | | | | | | |
| | 450W | 550W | 750W | | | | | | | | | | | | |
| 4x3.5" | • | • | • | | | | | | | | | | | | |
| 8x2.5" | • | • | • | | | | | | | | | | | | |
| Graphics | Onboard Aspeed AST2400 with 16MB memory, one DisplayPort on front, one VGA on rear. | | | | | | | | | | | | | | |
| Front ports | Two USB 2.0. One DisplayPort (one VGA on E5-2600 v4 models instead) | | | | | | | | | | | | | | |
| Rear ports | One VGA, two USB 3.0, one RJ-45 (dedicated mgmt), two ethernet, one serial (9-pin) | | | | | | | | | | | | | | |
| Cooling | 6 (5+1, dual processors) or 4 (3+1, single processor) fans, non-hot swap | | | | | | | | | | | | | | |
| Noise emissions | Operating: < 6.5 Bels. Idle: < 5.4 Bels (Maximum configuration) | | | | | | | | | | | | | | |
| Environmental specification | Temperature - operating | 50 °F to 95 °F (10 °C to 35 °C) | | | | | | | | | | | | | |
| | Temperature - non operating (no package) | -10 °C to 60 °C | | | | | | | | | | | | | |
| | Temperature - non operating (with package) | -40 °C to 70 °C | | | | | | | | | | | | | |
| | Altitude - operating | (Unpressurized): 0-10000ft (0-3048m) | | | | | | | | | | | | | |
| | Humidity - operating | 8%-90%, non-condensing | | | | | | | | | | | | | |
| | Humidity - storage (with package) | 8%-90%, non-condensing | | | | | | | | | | | | | |

Expansion slots

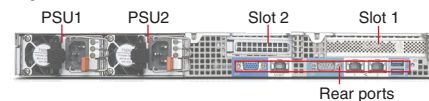

Up to two PCIe 3.0 x 16 slots:

| | |
|-----------------------------------|--|
| Slot 1 | PCIe 3.0 x16, half length, full height, by CPU1 |
| Slot 2 for dual processors model | PCIe 3.0 x16, low-profile, half length, requires 2nd riser card and 2nd CPU |
| Slot 2 for single processor model | PCIe 3.0 x16 (x8 electrical), low-profile, half length, by CPU1, requires 2nd riser card |

For a list of all supported options, please see https://download.lenovo.com/pccbbs/options_iso/ocm_september_2016_thinkserver.xlsx sheet

| Model | Region | Processor | 2nd CPU | Memory | RAID Controller | Disk Bays | Storage | Slots | Optical | Add-on NIC | TPM | System Mgmt | OS | Warranty | Power Supply | Ann Date (m/y) |
|------------|--------|---|------------|----------------------------|-----------------|-----------|------------------------------|--------------------|--------------|------------|-----|-------------|------|----------|-----------------|----------------|
| 70D6001YUX | US | 1xE5-2603 v3 6C/1.6GHz/15MB/85W/DDR4-1600 | 4XG0F28848 | 1x4GB RDIMM DDR4-2133 ECC | RAID 110i | 4x3.5" HS | Open | None | 9.5mm DVD±RW | None | TPM | TSM | None | 3-year | 550Wx1 Platinum | 12/14 |
| 70D60020UX | US | 1xE5-2609 v3 6C/1.9GHz/15MB/85W/DDR4-1600 | 4XG0F28847 | 1x8GB RDIMM DDR4-2133 ECC | RAID 110i | 4x3.5" HS | Open | 1xFHHL | 9.5mm DVD±RW | None | TPM | TSM | None | 3-year | 550Wx1 Platinum | 12/14 |
| 70D60021UX | US | 1xE5-2620 v3 6C/2.4GHz/15MB/85W/DDR4-1866 | 4XG0F28846 | 1x8GB RDIMM DDR4-2133 ECC | RAID 110i | 4x3.5" HS | Open | 1xFHHL | 9.5mm DVD±RW | None | TPM | TSM | None | 3-year | 550Wx1 Platinum | 12/14 |
| 70D60022UX | US | 2xE5-2640 v3 8C/2.6GHz/20MB/90W/DDR4-1866 | - | 2x8GB RDIMM DDR4-2133 ECC | RAID 110i | 4x3.5" HS | Open | 1xFHHL+1xLP (2x16) | 9.5mm DVD±RW | None | TPM | TSM | None | 3-year | 550Wx1 Platinum | 12/14 |
| 70D60023UX | US | 1xE5-2650 v3 10C/2.3GHz/25MB/105W/DDR4-2133 | 4XG0F28843 | 1x8GB RDIMM DDR4-2133 ECC | RAID 110i | 4x3.5" HS | Open | 1xFHHL | 9.5mm DVD±RW | None | TPM | TSM | None | 3-year | 550Wx1 Platinum | 12/14 |
| 70D60024UX | US | 1xE5-2660 v3 10C/2.6GHz/25MB/105W/DDR4-2133 | 4XG0F28842 | 1x8GB RDIMM DDR4-2133 ECC | RAID 110i | 4x3.5" HS | Open | 1xFHHL | 9.5mm DVD±RW | None | TPM | TSM | None | 3-year | 550Wx1 Platinum | 12/14 |
| 70D60025UX | US | 1xE5-2603 v3 6C/1.6GHz/15MB/85W/DDR4-1600 | 4XG0F28848 | 1x8GB RDIMM DDR4-2133 ECC | RAID 110i | 4x3.5" HS | Open | 1xFHHL | 9.5mm DVD±RW | None | TPM | TSM | None | 3-year | 550Wx1 Platinum | 12/14 |
| 70D60026UX | US | 1xE5-2630 v3 8C/2.4GHz/20MB/85W/DDR4-1866 | 4XG0F28845 | 1x8GB RDIMM DDR4-2133 ECC | RAID 110i | 4x3.5" HS | Open | 1xFHHL | 9.5mm DVD±RW | None | TPM | TSM | None | 3-year | 550Wx1 Platinum | 12/14 |
| 70D60035UX | US | 1xE5-2620 v3 6C/2.4GHz/15MB/85W/DDR4-1866 | 4XG0F28846 | 2x8GB RDIMM DDR4-2133 ECC | RAID 110i | 4x3.5" HS | 2x1TB HDD 7.2K 3.5" SATA6Gbs | 1xFHHL | 9.5mm DVD±RW | None | TPM | TSM Premium | None | 3-year | 750Wx2 Platinum | 02/15 |
| 70D6003DUX | US | 2xE5-2620 v3 6C/2.4GHz/15MB/85W/DDR4-1866 | - | 2x16GB RDIMM DDR4-2133 ECC | RAID 110i | 4x3.5" HS | Open | 1xFHHL+1xLP (2x16) | 9.5mm DVD±RW | None | TPM | TSM | None | 3-year | 550Wx2 Platinum | 09/15 |
| 70D6003PUX | US | 1xE5-2609 v3 6C/1.9GHz/15MB/85W/DDR4-1600 | 4XG0F28847 | 4x16GB RDIMM DDR4-2133 ECC | RAID 110i | 4x3.5" HS | 4x1TB HDD 7.2K 3.5" SATA6Gbs | None | None | None | TPM | TSM Premium | None | 3-year | 550Wx2 Platinum | 11/15 |

| Model | Region | Processor | 2nd CPU | Memory | RAID Controller | Disk Bays | Storage | Slots | Optical | Add-on NIC | TPM | System Mgmt | OS | Warranty | Power Supply | Ann Date (m/y) |
|------------|--------|---|------------|---------------------------|-----------------|-----------|---------|--------|--------------|------------|-----|-------------|------|----------|-----------------|----------------|
| 70D8001TUX | US | 1xE5-2603 v3 6C/1.6GHz/15MB/85W/DDR4-1600 | 4XG0F28848 | 1x4GB RDIMM DDR4-2133 ECC | RAID 110i | 8x2.5" HS | Open | None | 9.5mm DVD±RW | None | TPM | TSM | None | 3-year | 550Wx1 Platinum | 12/14 |
| 70D8001UUX | US | 1xE5-2609 v3 6C/1.9GHz/15MB/85W/DDR4-1600 | 4XG0F28847 | 1x8GB RDIMM DDR4-2133 ECC | RAID 110i | 8x2.5" HS | Open | 1xFHHL | 9.5mm DVD±RW | None | TPM | TSM | None | 3-year | 550Wx1 Platinum | 12/14 |
| 70D8001VUX | US | 1xE5-2620 v3 6C/2.4GHz/15MB/85W/DDR4-1866 | 4XG0F28846 | 1x8GB RDIMM DDR4-2133 ECC | RAID 110i | 8x2.5" HS | Open | 1xFHHL | 9.5mm DVD±RW | None | TPM | TSM | None | 3-year | 550Wx1 Platinum | 12/14 |
| 70D8001WUX | US | 1xE5-2640 v3 8C/2.6GHz/20MB/90W/DDR4-1866 | 4XG0F28844 | 1x8GB RDIMM DDR4-2133 ECC | RAID 110i | 8x2.5" HS | Open | 1xFHHL | 9.5mm DVD±RW | None | TPM | TSM | None | 3-year | 550Wx1 Platinum | 12/14 |
| 70D8001XUX | US | 1xE5-2650 v3 10C/2.3GHz/25MB/105W/DDR4-2133 | 4XG0F28843 | 1x8GB RDIMM DDR4-2133 ECC | RAID 110i | 8x2.5" HS | Open | 1xFHHL | 9.5mm DVD±RW | None | TPM | TSM | None | 3-year | 550Wx1 Platinum | 12/14 |
| 70D8001YUX | US | 1xE5-2660 v3 10C/2.6GHz/25MB/105W/DDR4-2133 | 4XG0F28842 | 1x8GB RDIMM DDR4-2133 ECC | RAID 110i | 8x2.5" HS | Open | 1xFHHL | 9.5mm DVD±RW | None | TPM | TSM | None | 3-year | 550Wx1 Platinum | 12/14 |
| 70D80020UX | US | 1xE5-2603 v3 6C/1.6GHz/15MB/85W/DDR4-1600 | 4XG0F28848 | 1x8GB RDIMM DDR4-2133 ECC | RAID 110i | 8x2.5" HS | Open | 1xFHHL | 9.5mm DVD±RW | None | TPM | TSM | None | 3-year | 550Wx1 Platinum | 12/14 |
| 70D80021UX | US | 1xE5-2630 v3 8C/2.4GHz/20MB/85W/DDR4-1866 | 4XG0F28845 | 1x8GB RDIMM DDR4-2133 ECC | RAID 110i | 8x2.5" HS | Open | 1xFHHL | 9.5mm DVD±RW | None | TPM | TSM | None | 3-year | 550Wx1 Platinum | 12/14 |

| Model | Region | Processor | 2nd CPU | Memory | RAID Controller | Disk Bays | Storage | Slots | Optical | Add-on NIC | TPM | System Mgmt | OS | Warranty | Power Supply | Ann Date (m/y) |
|------------|--------|---|------------|-------------------------------|-----------------|-----------|---------------------------------|-----------------------|---------|------------|-----|-------------|------|----------|-----------------|----------------|
| 70QK000VUX | US | 1xE5-2603 v4 6C/1.7GHz/15MB/85W/DDR4-1866 | 4XG0G89089 | 1x16GB RDIMM DDR4-2400 ECC | RAID 110i | 4x3.5" HS | Open | 1xFHHL | None | None | TPM | TSM | None | 3-year | 750Wx1 Platinum | 04/16 |
| 70QK000WUX | US | 1xE5-2609 v4 8C/1.7GHz/20MB/85W/DDR4-1866 | 4XG0G89084 | 1x16GB RDIMM DDR4-2400 ECC | RAID 110i | 4x3.5" HS | Open | 1xFHHL | None | None | TPM | TSM | None | 3-year | 750Wx1 Platinum | 04/16 |
| 70QK000XUX | US | 1xE5-2620 v4 8C/2.1GHz/20MB/85W/DDR4-2133 | 4XG0G89079 | 1x16GB RDIMM DDR4-2400 ECC | RAID 110i | 4x3.5" HS | Open | 1xFHHL | None | None | TPM | TSM | None | 3-year | 750Wx1 Platinum | 04/16 |
| 70QK000YUX | US | 1xE5-2630 v4 10C/2.2GHz/20MB/85W/DDR4-2133 | 4XG0G89074 | 1x16GB RDIMM DDR4-2400 ECC | RAID 110i | 4x3.5" HS | Open | 1xFHHL | None | None | TPM | TSM | None | 3-year | 750Wx1 Platinum | 04/16 |
| 70QK0010UX | US | 1xE5-2640 v4 10C/2.4GHz/25MB/90W/DDR4-2133 | 4XG0G89069 | 1x16GB RDIMM DDR4-2400 ECC | RAID 110i | 4x3.5" HS | Open | 1xFHHL | None | None | TPM | TSM | None | 3-year | 750Wx1 Platinum | 04/16 |
| 70QK0011UX | US | 1xE5-2650 v4 12C/2.2GHz/30MB/105W/DDR4-2400 | 4XG0G89064 | 1x16GB RDIMM DDR4-2400 ECC | RAID 110i | 4x3.5" HS | Open | 1xFHHL | None | None | TPM | TSM | None | 3-year | 750Wx1 Platinum | 04/16 |
| 70QK0012UX | US | 1xE5-2660 v4 14C/2GHz/35MB/105W/DDR4-2400 | 4XG0G89059 | 1x16GB RDIMM DDR4-2400 ECC | RAID 110i | 4x3.5" HS | Open | 1xFHHL | None | None | TPM | TSM | None | 3-year | 750Wx1 Platinum | 04/16 |
| 70QK0013UX | US | 1xE5-2609 v4 8C/1.7GHz/20MB/85W/DDR4-1866 | 4XG0G89084 | 4x16GB RDIMM DDR4-2400 ECC | RAID 110i | 4x3.5" HS | 4x1TB HDD 7.2K 3.5" SATA6Gbs | 1xFHHL | None | None | TPM | TSM Premium | None | 3-year | 750Wx2 Platinum | 04/16 |
| 70QK0014UX | US | 2xE5-2620 v4 8C/2.1GHz/20MB/85W/DDR4-2133 | - | 2x16GB RDIMM DDR4-2400 ECC | RAID 110i | 4x3.5" HS | Open | 1xFHHL+1xLP (2x16) | None | None | TPM | TSM Premium | None | 3-year | 750Wx2 Platinum | 04/16 |

| Model | Region | Processor | 2nd CPU | Memory | RAID Controller | Disk Bays | Storage | Slots | Optical | Add-on NIC | TPM | System Mgmt | OS | Warranty | Power Supply | Ann Date (m/y) |
|------------|--------|---|------------|----------------------------------|-----------------|--------------|---------|--------|---------|------------|-----|-------------|------|----------|--------------------|----------------|
| 70QM0010UX | US | 1xE5-2603 v4 6C/1.7GHz/15MB/85W/DDR4-1866 | 4XG0G89089 | 1x16GB RDIMM DDR4-2400 ECC | RAID 110i | 8x2.5" HS | Open | 1xFHHL | None | None | TPM | TSM | None | 3-year | 750Wx1 Platinum | 04/16 |
| 70QM0011UX | US | 1xE5-2609 v4 8C/1.7GHz/20MB/85W/DDR4-1866 | 4XG0G89084 | 1x16GB RDIMM DDR4-2400 ECC | RAID 110i | 8x2.5" HS | Open | 1xFHHL | None | None | TPM | TSM | None | 3-year | 750Wx1 Platinum | 04/16 |
| 70QM0012UX | US | 1xE5-2620 v4 8C/2.1GHz/20MB/85W/DDR4-2133 | 4XG0G89079 | 1x16GB RDIMM DDR4-2400 ECC | RAID 110i | 8x2.5" HS | Open | 1xFHHL | None | None | TPM | TSM | None | 3-year | 750Wx1 Platinum | 04/16 |
| 70QM0013UX | US | 1xE5-2630L v4 10C/1.8GHz/25MB/55W/DDR4-2133 | 4XG0G89104 | 1x16GB RDIMM DDR4-2400 ECC | RAID 110i | 8x2.5" HS | Open | 1xFHHL | None | None | TPM | TSM | None | 3-year | 750Wx1 Platinum | 04/16 |
| 70QM0014UX | US | 1xE5-2630 v4 10C/2.2GHz/20MB/85W/DDR4-2133 | 4XG0G89074 | 1x16GB RDIMM DDR4-2400 ECC | RAID 110i | 8x2.5" HS | Open | 1xFHHL | None | None | TPM | TSM | None | 3-year | 750Wx1 Platinum | 04/16 |
| 70QM0015UX | US | 1xE5-2640 v4 10C/2.4GHz/25MB/90W/DDR4-2133 | 4XG0G89069 | 1x16GB RDIMM DDR4-2400 ECC | RAID 110i | 8x2.5" HS | Open | 1xFHHL | None | None | TPM | TSM | None | 3-year | 750Wx1 Platinum | 04/16 |
| 70QM0016UX | US | 1xE5-2650 v4 12C/2.2GHz/30MB/105W/DDR4-2400 | 4XG0G89064 | 1x16GB RDIMM DDR4-2400 ECC | RAID 110i | 8x2.5" HS | Open | 1xFHHL | None | None | TPM | TSM | None | 3-year | 750Wx1 Platinum | 04/16 |
| 70QM0017UX | US | 1xE5-2660 v4 14C/2GHz/35MB/105W/DDR4-2400 | 4XG0G89059 | 1x16GB RDIMM DDR4-2400 ECC | RAID 110i | 8x2.5" HS | Open | 1xFHHL | None | None | TPM | TSM | None | 3-year | 750Wx1 Platinum | 04/16 |



ThinkServer RD450 Platform Specifications

Product Specifications Reference (PSREF)

| Components | Specification | | | | | | | | | | | | | | | | | | | | | | | | | | | | | | | | | | | | | | | | |
|---|--|--------------------------------|--|-------------------------|-------------------|------------------|-----------|-----------------------------|-------------------------|--------------|---------------|--------------------------------|-----------|---------------|----------------|--------------------------------|-------------------------|---------------------------|---------------|------------------|-----------|---------------|----------------|---------------------------------------|-------------------------|--------------|-----------|-----------------------------|-----------|--------------|---------------|--------------------------------|-----------|--------------|----------------|---------------------------------------|-----------|---------------|----------------|------------------|--|
| Dimensions | 2U rack. Height: 87 mm (3.4 in), width: 482 mm (19 in), depth: 764 mm (30 in) | | | | | | | | | | | | | | | | | | | | | | | | | | | | | | | | | | | | | | | | |
| Weight | Minimum configuration: 16 kg (35.3 lb), maximum: 27 kg (59.52 lb) | | | | | | | | | | | | | | | | | | | | | | | | | | | | | | | | | | | | | | | | |
| Processor | Up to two 105W Intel Xeon E5-2600 v4 or E5-2600 v3 family processors. | | | | | | | | | | | | | | | | | | | | | | | | | | | | | | | | | | | | | | | | |
| | E5-2660 v4 | 14C/2GHz/35MB/105W/DDR4-2400 | | | | | | | | | | | | | | | | | | | | | | | | | | | | | | | | | | | | | | | |
| | E5-2650 v4 | 12C/2.2GHz/30MB/105W/DDR4-2400 | | | | | | | | | | | | | | | | | | | | | | | | | | | | | | | | | | | | | | | |
| | E5-2640 v4 | 10C/2.4GHz/25MB/90W/DDR4-2133 | | | | | | | | | | | | | | | | | | | | | | | | | | | | | | | | | | | | | | | |
| | E5-2630 v4 | 10C/2.2GHz/20MB/85W/DDR4-2133 | | | | | | | | | | | | | | | | | | | | | | | | | | | | | | | | | | | | | | | |
| | E5-2623 v4 | 4C/2.6GHz/10MB/85W/DDR4-2133 | | | | | | | | | | | | | | | | | | | | | | | | | | | | | | | | | | | | | | | |
| | E5-2620 v4 | 8C/2.1GHz/20MB/85W/DDR4-2133 | | | | | | | | | | | | | | | | | | | | | | | | | | | | | | | | | | | | | | | |
| | E5-2609 v4 | 8C/1.7GHz/20MB/85W/DDR4-1866 | | | | | | | | | | | | | | | | | | | | | | | | | | | | | | | | | | | | | | | |
| | E5-2603 v4 | 6C/1.7GHz/15MB/85W/DDR4-1866 | | | | | | | | | | | | | | | | | | | | | | | | | | | | | | | | | | | | | | | |
| | E5-2650L v4 | 14C/1.7GHz/35MB/65W/DDR4-2400 | | | | | | | | | | | | | | | | | | | | | | | | | | | | | | | | | | | | | | | |
| | E5-2630L v4 | 10C/1.8GHz/25MB/55W/DDR4-2133 | | | | | | | | | | | | | | | | | | | | | | | | | | | | | | | | | | | | | | | |
| | E5-2660 v3 | 10C/2.6GHz/25MB/105W/DDR4-2133 | | | | | | | | | | | | | | | | | | | | | | | | | | | | | | | | | | | | | | | |
| | E5-2650 v3 | 10C/2.3GHz/25MB/105W/DDR4-2133 | | | | | | | | | | | | | | | | | | | | | | | | | | | | | | | | | | | | | | | |
| | E5-2640 v3 | 8C/2.6GHz/20MB/90W/DDR4-1866 | | | | | | | | | | | | | | | | | | | | | | | | | | | | | | | | | | | | | | | |
| | E5-2630 v3 | 8C/2.4GHz/20MB/85W/DDR4-1866 | | | | | | | | | | | | | | | | | | | | | | | | | | | | | | | | | | | | | | | |
| | E5-2623 v3 | 4C/3GHz/10MB/105W/DDR4-1866 | | | | | | | | | | | | | | | | | | | | | | | | | | | | | | | | | | | | | | | |
| | E5-2620 v3 | 6C/2.4GHz/15MB/85W/DDR4-1866 | | | | | | | | | | | | | | | | | | | | | | | | | | | | | | | | | | | | | | | |
| E5-2609 v3 | 6C/1.9GHz/15MB/85W/DDR4-1600 | | | | | | | | | | | | | | | | | | | | | | | | | | | | | | | | | | | | | | | | |
| E5-2603 v3 | 6C/1.6GHz/15MB/85W/DDR4-1600 | | | | | | | | | | | | | | | | | | | | | | | | | | | | | | | | | | | | | | | | |
| E5-2650L v3 | 12C/1.8GHz/30MB/65W/DDR4-2133 | | | | | | | | | | | | | | | | | | | | | | | | | | | | | | | | | | | | | | | | |
| E5-2630L v3 | 8C/1.8GHz/20MB/55W/DDR4-1866 | | | | | | | | | | | | | | | | | | | | | | | | | | | | | | | | | | | | | | | | |
| Chipset | Intel C610 Series Chipset | | | | | | | | | | | | | | | | | | | | | | | | | | | | | | | | | | | | | | | | |
| Memory DIMMs | 16 DIMM sockets with 8 channels. 4 channels per processor, 2 DIMMs per channel. RDIMM or LRDIMM (cannot be intermixed), DDR4, DDR4-2133 or DDR4-2400 | | | | | | | | | | | | | | | | | | | | | | | | | | | | | | | | | | | | | | | | |
| Memory capacity | 512GB (RDIMM, 32GB x 16)/1024GB (LRDIMM, 64GB x 16), 2nd CPU is needed | | | | | | | | | | | | | | | | | | | | | | | | | | | | | | | | | | | | | | | | |
| Memory protection | ECC, memory mirroring, lockstep, and memory sparing | | | | | | | | | | | | | | | | | | | | | | | | | | | | | | | | | | | | | | | | |
| RAID controller | <table border="1"> <thead> <tr> <th>RAID controller</th> <th>Drive type</th> <th>RAID support</th> <th>Compatible models</th> </tr> </thead> <tbody> <tr> <td>Onboard RAID110i</td> <td>6Gbs SATA</td> <td>0/1/10, 5 with optional key</td> <td>8x3.5" HS/ES, 8x2.5" HS</td> </tr> <tr> <td>RAID500 PCIe</td> <td>6Gbs SAS/SATA</td> <td>0/1/10, 5/50 with optional key</td> <td>8x3.5" HS</td> </tr> <tr> <td>RAID520i PCIe</td> <td>12Gbs SAS/SATA</td> <td>0/1/10, 5/50 with optional key</td> <td>8x3.5" HS/ES, 8x2.5" HS</td> </tr> <tr> <td>RAID710 PCIe (1GB memory)</td> <td>6Gbs SAS/SATA</td> <td>0/1/10/5/50/6/60</td> <td>8x3.5" HS</td> </tr> <tr> <td>RAID720i PCIe</td> <td>12Gbs SAS/SATA</td> <td>0/1/10/5/50, 6/60 with optional cache</td> <td>8x3.5" HS/ES, 8x2.5" HS</td> </tr> <tr> <td>AnyRAID 110i</td> <td>6Gbs SATA</td> <td>0/1/10, 5 with optional key</td> <td>8x2.5" HS</td> </tr> <tr> <td>AnyRAID 510i</td> <td>6Gbs SAS/SATA</td> <td>0/1/10, 5/50 with optional key</td> <td>8x2.5" HS</td> </tr> <tr> <td>AnyRAID 720i</td> <td>12Gbs SAS/SATA</td> <td>0/1/10/5/50, 6/60 with optional cache</td> <td>8x2.5" HS</td> </tr> <tr> <td>AnyRAID 720ix</td> <td>12Gbs SAS/SATA</td> <td>0/1/10/5/50/6/60</td> <td>16/24x2.5" HS, 8x2.5" HS+optional tape</td> </tr> </tbody> </table> | RAID controller | Drive type | RAID support | Compatible models | Onboard RAID110i | 6Gbs SATA | 0/1/10, 5 with optional key | 8x3.5" HS/ES, 8x2.5" HS | RAID500 PCIe | 6Gbs SAS/SATA | 0/1/10, 5/50 with optional key | 8x3.5" HS | RAID520i PCIe | 12Gbs SAS/SATA | 0/1/10, 5/50 with optional key | 8x3.5" HS/ES, 8x2.5" HS | RAID710 PCIe (1GB memory) | 6Gbs SAS/SATA | 0/1/10/5/50/6/60 | 8x3.5" HS | RAID720i PCIe | 12Gbs SAS/SATA | 0/1/10/5/50, 6/60 with optional cache | 8x3.5" HS/ES, 8x2.5" HS | AnyRAID 110i | 6Gbs SATA | 0/1/10, 5 with optional key | 8x2.5" HS | AnyRAID 510i | 6Gbs SAS/SATA | 0/1/10, 5/50 with optional key | 8x2.5" HS | AnyRAID 720i | 12Gbs SAS/SATA | 0/1/10/5/50, 6/60 with optional cache | 8x2.5" HS | AnyRAID 720ix | 12Gbs SAS/SATA | 0/1/10/5/50/6/60 | 16/24x2.5" HS, 8x2.5" HS+optional tape |
| | RAID controller | Drive type | RAID support | Compatible models | | | | | | | | | | | | | | | | | | | | | | | | | | | | | | | | | | | | | |
| | Onboard RAID110i | 6Gbs SATA | 0/1/10, 5 with optional key | 8x3.5" HS/ES, 8x2.5" HS | | | | | | | | | | | | | | | | | | | | | | | | | | | | | | | | | | | | | |
| | RAID500 PCIe | 6Gbs SAS/SATA | 0/1/10, 5/50 with optional key | 8x3.5" HS | | | | | | | | | | | | | | | | | | | | | | | | | | | | | | | | | | | | | |
| | RAID520i PCIe | 12Gbs SAS/SATA | 0/1/10, 5/50 with optional key | 8x3.5" HS/ES, 8x2.5" HS | | | | | | | | | | | | | | | | | | | | | | | | | | | | | | | | | | | | | |
| | RAID710 PCIe (1GB memory) | 6Gbs SAS/SATA | 0/1/10/5/50/6/60 | 8x3.5" HS | | | | | | | | | | | | | | | | | | | | | | | | | | | | | | | | | | | | | |
| | RAID720i PCIe | 12Gbs SAS/SATA | 0/1/10/5/50, 6/60 with optional cache | 8x3.5" HS/ES, 8x2.5" HS | | | | | | | | | | | | | | | | | | | | | | | | | | | | | | | | | | | | | |
| | AnyRAID 110i | 6Gbs SATA | 0/1/10, 5 with optional key | 8x2.5" HS | | | | | | | | | | | | | | | | | | | | | | | | | | | | | | | | | | | | | |
| | AnyRAID 510i | 6Gbs SAS/SATA | 0/1/10, 5/50 with optional key | 8x2.5" HS | | | | | | | | | | | | | | | | | | | | | | | | | | | | | | | | | | | | | |
| | AnyRAID 720i | 12Gbs SAS/SATA | 0/1/10/5/50, 6/60 with optional cache | 8x2.5" HS | | | | | | | | | | | | | | | | | | | | | | | | | | | | | | | | | | | | | |
| AnyRAID 720ix | 12Gbs SAS/SATA | 0/1/10/5/50/6/60 | 16/24x2.5" HS, 8x2.5" HS+optional tape | | | | | | | | | | | | | | | | | | | | | | | | | | | | | | | | | | | | | | |
| Optional cache for RAID 710: CacheVault flash cache with super capacitor, CacheCade Pro, or FastPath. | | | | | | | | | | | | | | | | | | | | | | | | | | | | | | | | | | | | | | | | | |
| Optional cache for RAID 720/AnyRAID 720i and 720ix: 1GB read-only memory or 1GB/2GB/4GB flash with super capacitor. Flash options include CacheVault, CacheCade Pro, and FastPath. 720ix must have cache. | | | | | | | | | | | | | | | | | | | | | | | | | | | | | | | | | | | | | | | | | |
| Disk drive bays | Up to 8x3.5" hot-swap, 8x3.5" easy-swap, or 24x2.5" hot-swap disk bays on front. Up to one internal LTO-6 SAS tape drive on 8x2.5" and 720ix model, or external RDX tape drive via USB. | | | | | | | | | | | | | | | | | | | | | | | | | | | | | | | | | | | | | | | | |
| Maximum internal storage | 3.5" HS model: up to 64TB with 7.2K SATA or SAS HDD, up to 14.4TB with 10K SAS HDD, up to 4.8TB with 15K SAS HDD, or up to 12.8TB with SATA SSD. 3.5" ES model: up to 24TB with 7.2K SATA, up to 48TB with 7.2K SAS. 2.5" HS model: up to 48TB with 7.2K SATA HDD, up to 43.2TB with 10K SAS HDD, up to 14.4TB with 15K SAS HDD, or up to 38.4TB with SATA or SAS SSD | | | | | | | | | | | | | | | | | | | | | | | | | | | | | | | | | | | | | | | | |
| SD module | Up to 2 SDHC flash cards via optional SD module, 8GB or 32GB each | | | | | | | | | | | | | | | | | | | | | | | | | | | | | | | | | | | | | | | | |
| PCIe SSD adapter | Supports 1.6TB or 3.2TB SSD via PCIe adapter | | | | | | | | | | | | | | | | | | | | | | | | | | | | | | | | | | | | | | | | |
| Optical drive | Optional one 9.5mm optical on 3.5" or 8/16 x 2.5" models, DVD-ROM or DVD±RW. | | | | | | | | | | | | | | | | | | | | | | | | | | | | | | | | | | | | | | | | |

| Components | Specification | | | | | | | | | | | | | | | | | | | | | | | | | | | | | | | | | | | | | |
|-----------------------------------|---|--------------------------------------|------|------|-------------------------|---------------------------------|--|--|--|-----------------|------|------|--|-----------------|---|---|----------------------|--------------------------------------|--------|---|----------------------|------------------------|---|---------------|-----------------------------------|------------------------|---|---|---------|---|---|---|---|---------|---|---|---|---|
| Network interfaces | One dedicated management port, two Gigabit Ethernet ports. Supports optional discrete network adapters via PCIe slots | | | | | | | | | | | | | | | | | | | | | | | | | | | | | | | | | | | | | |
| Security features | Power-on and administrator password. Optional TPM (TCG 1.2-compliant) | | | | | | | | | | | | | | | | | | | | | | | | | | | | | | | | | | | | | |
| Systems management | Supports ThinkServer System Manager (TSM), optional TSM Premium. UEFI. Onboard Aspeed AST2400 graphics/management processor, IPMI 2.0-compliant baseboard management controller (BMC). Control Panel LEDs shows the status of power, ID, network, system. Supports ThinkServer management software: Diagnostics, Deployment Manager, Energy Manager, System Manager, Partner Pack for VMware vCenter and Microsoft System Center Operations Manager, Power Planner | | | | | | | | | | | | | | | | | | | | | | | | | | | | | | | | | | | | | |
| Operating systems supported | Microsoft Windows Server 2016/2012 R2/2012/2008 R2. Windows Small Business Server 2011. Red Hat Enterprise Linux 6.5/6.6/7. SUSE Linux Enterprise Server 11. VMware vSphere (ESXi) 5.1 P5/5.5 U2/6.0 | | | | | | | | | | | | | | | | | | | | | | | | | | | | | | | | | | | | | |
| Base warranty | 1 or 3-year limited onsite service with 9x5/NBD | | | | | | | | | | | | | | | | | | | | | | | | | | | | | | | | | | | | | |
| Power supply | Up to two redundant hot-swap 450W/550W/750W/1100W power supplies. 450 W is 80 PLUS Gold qualified. 550W and 1100W are 80 PLUS Platinum qualified. 750W is 80 PLUS Platinum or Titanium qualified. 750W Titanium is 200V - 240V, others are 110V - 240V. | | | | | | | | | | | | | | | | | | | | | | | | | | | | | | | | | | | | | |
| | <table border="1"> <thead> <tr> <th rowspan="2">Disk bay configuration</th> <th colspan="4">PSU requirements</th> </tr> <tr> <th>450W</th> <th>550W</th> <th>750W</th> <th>1100W</th> </tr> </thead> <tbody> <tr> <td>8x3.5"</td> <td>•</td> <td>•</td> <td>•</td> <td>•</td> </tr> <tr> <td>8x2.5"</td> <td>•</td> <td>•</td> <td>•</td> <td>•</td> </tr> <tr> <td>8x2.5" + Tape</td> <td>•</td> <td>•</td> <td>•</td> <td>•</td> </tr> <tr> <td>16x2.5"</td> <td>•</td> <td>•</td> <td>•</td> <td>•</td> </tr> <tr> <td>24x2.5"</td> <td>•</td> <td>•</td> <td>•</td> <td>•</td> </tr> </tbody> </table> | | | | Disk bay configuration | PSU requirements | | | | 450W | 550W | 750W | 1100W | 8x3.5" | • | • | • | • | 8x2.5" | • | • | • | • | 8x2.5" + Tape | • | • | • | • | 16x2.5" | • | • | • | • | 24x2.5" | • | • | • | • |
| | Disk bay configuration | PSU requirements | | | | | | | | | | | | | | | | | | | | | | | | | | | | | | | | | | | | |
| | | 450W | 550W | 750W | 1100W | | | | | | | | | | | | | | | | | | | | | | | | | | | | | | | | | |
| | 8x3.5" | • | • | • | • | | | | | | | | | | | | | | | | | | | | | | | | | | | | | | | | | |
| 8x2.5" | • | • | • | • | | | | | | | | | | | | | | | | | | | | | | | | | | | | | | | | | | |
| 8x2.5" + Tape | • | • | • | • | | | | | | | | | | | | | | | | | | | | | | | | | | | | | | | | | | |
| 16x2.5" | • | • | • | • | | | | | | | | | | | | | | | | | | | | | | | | | | | | | | | | | | |
| 24x2.5" | • | • | • | • | | | | | | | | | | | | | | | | | | | | | | | | | | | | | | | | | | |
| Graphics | Onboard Aspeed AST2400 with 16MB memory | | | | | | | | | | | | | | | | | | | | | | | | | | | | | | | | | | | | | |
| Front ports | Two USB 2.0. One DisplayPort (one VGA on E5-2600 v4 models instead) | | | | | | | | | | | | | | | | | | | | | | | | | | | | | | | | | | | | | |
| Rear ports | One VGA, two USB 3.0, one RJ-45 (dedicated mgmt), two ethernet, one serial (9-pin) | | | | | | | | | | | | | | | | | | | | | | | | | | | | | | | | | | | | | |
| Cooling | 4 (3+1, dual processors) or 3 (2+1, single processor) fans, non-hot swap | | | | | | | | | | | | | | | | | | | | | | | | | | | | | | | | | | | | | |
| Noise emissions | Operating: < 6.5 Bels. Idle: < 5.6 Bels (Maximum configuration) | | | | | | | | | | | | | | | | | | | | | | | | | | | | | | | | | | | | | |
| Environmental specification | <table border="1"> <tbody> <tr> <td>Temperature - operating</td> <td colspan="3">50 °F to 95 °F (10 °C to 35 °C)</td> </tr> <tr> <td>Temperature - non operating (no package)</td> <td colspan="3">-10 °C to 60 °C</td> </tr> <tr> <td>Temperature - non operating (with package)</td> <td colspan="3">-40 °C to 70 °C</td> </tr> <tr> <td>Altitude - operating</td> <td colspan="3">(Unpressurized): 0-10000ft (0-3048m)</td> </tr> <tr> <td>Humidity - operating</td> <td colspan="3">8%-90%, non-condensing</td> </tr> <tr> <td>Humidity - storage (with package)</td> <td colspan="3">8%-90%, non-condensing</td> </tr> </tbody> </table> | | | | Temperature - operating | 50 °F to 95 °F (10 °C to 35 °C) | | | Temperature - non operating (no package) | -10 °C to 60 °C | | | Temperature - non operating (with package) | -40 °C to 70 °C | | | Altitude - operating | (Unpressurized): 0-10000ft (0-3048m) | | | Humidity - operating | 8%-90%, non-condensing | | | Humidity - storage (with package) | 8%-90%, non-condensing | | | | | | | | | | | | |
| | Temperature - operating | 50 °F to 95 °F (10 °C to 35 °C) | | | | | | | | | | | | | | | | | | | | | | | | | | | | | | | | | | | | |
| | Temperature - non operating (no package) | -10 °C to 60 °C | | | | | | | | | | | | | | | | | | | | | | | | | | | | | | | | | | | | |
| | Temperature - non operating (with package) | -40 °C to 70 °C | | | | | | | | | | | | | | | | | | | | | | | | | | | | | | | | | | | | |
| | Altitude - operating | (Unpressurized): 0-10000ft (0-3048m) | | | | | | | | | | | | | | | | | | | | | | | | | | | | | | | | | | | | |
| Humidity - operating | 8%-90%, non-condensing | | | | | | | | | | | | | | | | | | | | | | | | | | | | | | | | | | | | | |
| Humidity - storage (with package) | 8%-90%, non-condensing | | | | | | | | | | | | | | | | | | | | | | | | | | | | | | | | | | | | | |

Expansion slots



| | |
|-----------------------|--|
| Slot 1 (riser card 1) | PCIe 3.0 x8, half length, full height, CPU1 |
| Slot 2 (riser card 1) | PCIe 3.0 x8, half length, full height, CPU1 |
| Slot 3 (riser card 2) | PCIe 3.0 x8, low-profile, half length, CPU2, requires 2nd riser card and 2nd CPU |
| Slot 4 (riser card 2) | PCIe 3.0 x8, low-profile, half length, CPU2, requires 2nd riser card and 2nd CPU |
| Slot 5 (riser card 2) | PCIe 3.0 x8, low-profile, half length, CPU1, requires 2nd riser card |
| Slot 6 (onboard) | PCIe 3.0 x16 (x8 elec), low-profile, half length, requires 2nd CPU |

For a list of all supported options, please see https://download.lenovo.com/pccbbs/options_iso/ocm_september_2016_thinkserver.xlsx sheet

| Model | Region | Processor | 2nd CPU | Memory | RAID Controller | Disk Bays | Storage | Slots | Optical | Add-on NIC | TPM | System Mgmt | OS | Warranty | Power Supply | Ann Date (m/y) |
|------------|--------|---|------------|---------------------------------|-------------------|--------------|---------|------------|-----------------|------------|-----|-------------|------|----------|--------------------|----------------|
| 70DA000XUX | US | 1xE5-2603 v3 6C/1.6GHz/15MB/85W/DDR4-1600 | 4XG0F28860 | 1x4GB RDIMM DDR4-2133 ECC | 110i (AnyRAID) | 8x2.5" HS | Open | None | 9.5mm DVD±RW | None | TPM | TSM | None | 3-year | 550Wx1 Platinum | 12/14 |
| 70DA000YUX | US | 1xE5-2609 v3 6C/1.9GHz/15MB/85W/DDR4-1600 | 4XG0F28859 | 1x8GB RDIMM DDR4-2133 ECC | 110i (AnyRAID) | 8x2.5" HS | Open | 2xFH HL | 9.5mm DVD±RW | None | TPM | TSM | None | 3-year | 550Wx1 Platinum | 12/14 |
| 70DA0010UX | US | 1xE5-2620 v3 6C/2.4GHz/15MB/85W/DDR4-1866 | 4XG0F28858 | 1x8GB RDIMM DDR4-2133 ECC | 110i (AnyRAID) | 8x2.5" HS | Open | 2xFH HL | 9.5mm DVD±RW | None | TPM | TSM | None | 3-year | 550Wx1 Platinum | 12/14 |
| 70DA0011UX | US | 1xE5-2630 v3 8C/2.4GHz/20MB/85W/DDR4-1866 | 4XG0F28857 | 1x8GB RDIMM DDR4-2133 ECC | 110i (AnyRAID) | 8x2.5" HS | Open | 2xFH HL | 9.5mm DVD±RW | None | TPM | TSM | None | 3-year | 550Wx1 Platinum | 12/14 |
| 70DA0012UX | US | 1xE5-2640 v3 8C/2.6GHz/20MB/90W/DDR4-1866 | 4XG0F28856 | 1x8GB RDIMM DDR4-2133 ECC | 110i (AnyRAID) | 8x2.5" HS | Open | 2xFH HL | 9.5mm DVD±RW | None | TPM | TSM | None | 3-year | 550Wx1 Platinum | 12/14 |
| 70DA0013UX | US | 1xE5-2660 v3 10C/2.6GHz/25MB/105W/DDR4-2133 | 4XG0F28854 | 1x8GB RDIMM DDR4-2133 ECC | 110i (AnyRAID) | 8x2.5" HS | Open | 2xFH HL | 9.5mm DVD±RW | None | TPM | TSM | None | 3-year | 550Wx1 Platinum | 12/14 |
| 70DA0014UX | US | 1xE5-2603 v3 6C/1.6GHz/15MB/85W/DDR4-1600 | 4XG0F28860 | 1x8GB RDIMM DDR4-2133 ECC | 110i (AnyRAID) | 8x2.5" HS | Open | 2xFH HL | None | None | TPM | TSM | None | 3-year | 550Wx1 Platinum | 12/14 |

| Model | Region | Processor | 2nd CPU | Memory | RAID Controller | Disk Bays | Storage | Slots | Optical | Add-on NIC | TPM | System Mgmt | OS | Warranty | Power Supply | Ann Date (m/y) |
|------------|--------|---|------------|----------------------------|---------------------|-----------|------------------------------|-----------------|--------------|------------|-----|-------------|------|----------|-----------------|----------------|
| 70DC001CUX | US | 1xE5-2603 v3 6C/1.6GHz/15MB/85W/DDR4-1600 | 4XG0F28860 | 1x4GB RDIMM DDR4-2133 ECC | Onboard 110i (PCIe) | 8x3.5" HS | Open | None | 9.5mm DVD±RW | None | TPM | TSM | None | 3-year | 550Wx1 Platinum | 12/14 |
| 70DC001DUX | US | 1xE5-2609 v3 6C/1.9GHz/15MB/85W/DDR4-1600 | 4XG0F28859 | 1x8GB RDIMM DDR4-2133 ECC | Onboard 110i (PCIe) | 8x3.5" HS | Open | 2xFH HL | 9.5mm DVD±RW | None | TPM | TSM | None | 3-year | 550Wx1 Platinum | 12/14 |
| 70DC001EUX | US | 1xE5-2620 v3 6C/2.4GHz/15MB/85W/DDR4-1866 | 4XG0F28858 | 1x8GB RDIMM DDR4-2133 ECC | Onboard 110i (PCIe) | 8x3.5" HS | Open | 2xFH HL | 9.5mm DVD±RW | None | TPM | TSM | None | 3-year | 550Wx1 Platinum | 12/14 |
| 70DC001FUX | US | 1xE5-2630 v3 8C/2.4GHz/20MB/85W/DDR4-1866 | 4XG0F28857 | 1x8GB RDIMM DDR4-2133 ECC | Onboard 110i (PCIe) | 8x3.5" HS | Open | 2xFH HL | 9.5mm DVD±RW | None | TPM | TSM | None | 3-year | 550Wx1 Platinum | 12/14 |
| 70DC001GUX | US | 1xE5-2640 v3 8C/2.6GHz/20MB/90W/DDR4-1866 | 4XG0F28856 | 1x8GB RDIMM DDR4-2133 ECC | Onboard 110i (PCIe) | 8x3.5" HS | Open | 2xFH HL | 9.5mm DVD±RW | None | TPM | TSM | None | 3-year | 550Wx1 Platinum | 12/14 |
| 70DC001HUX | US | 1xE5-2650 v3 10C/2.3GHz/25MB/105W/DDR4-2133 | 4XG0F28855 | 1x8GB RDIMM DDR4-2133 ECC | Onboard 110i (PCIe) | 8x3.5" HS | Open | 2xFH HL | 9.5mm DVD±RW | None | TPM | TSM | None | 3-year | 550Wx1 Platinum | 12/14 |
| 70DC001JUX | US | 1xE5-2660 v3 10C/2.6GHz/25MB/105W/DDR4-2133 | 4XG0F28854 | 1x8GB RDIMM DDR4-2133 ECC | Onboard 110i (PCIe) | 8x3.5" HS | Open | 2xFH HL | 9.5mm DVD±RW | None | TPM | TSM | None | 3-year | 550Wx1 Platinum | 12/14 |
| 70DC001KUX | US | 1xE5-2603 v3 6C/1.6GHz/15MB/85W/DDR4-1600 | 4XG0F28860 | 1x8GB RDIMM DDR4-2133 ECC | Onboard 110i (PCIe) | 8x3.5" HS | Open | 2xFH HL | 9.5mm DVD±RW | None | TPM | TSM | None | 3-year | 550Wx1 Platinum | 12/14 |
| 70DC002EUX | US | 1xE5-2620 v3 6C/2.4GHz/15MB/85W/DDR4-1866 | 4XG0F28858 | 2x8GB RDIMM DDR4-2133 ECC | Onboard 110i (PCIe) | 8x3.5" HS | 2x1TB HDD 7.2K 3.5" SATA6Gbs | 2xFH HL | 9.5mm DVD±RW | None | TPM | TSM Premium | None | 3-year | 750Wx2 Platinum | 02/15 |
| 70DC002GUX | US | 2xE5-2620 v3 6C/2.4GHz/15MB/85W/1866MH | - | 2x16GB RDIMM DDR4-2133 ECC | Onboard 110i (PCIe) | 8x3.5" HS | Open | 2xFH HL+4xLP HL | 9.5mm DVD±RW | None | TPM | TSM Premium | None | 3-year | 750Wx2 Platinum | 09/15 |
| 70DC002UUX | US | 1xE5-2630 v3 8C/2.4GHz/20MB/85W/DDR4-1866 | 4XG0F28857 | 4x16GB RDIMM DDR4-2133 ECC | Onboard 110i (PCIe) | 8x3.5" HS | 4x1TB HDD 7.2K 3.5" SATA6Gbs | None | None | None | TPM | TSM Premium | None | 3-year | 550Wx2 Platinum | 11/15 |

| Model | Region | Processor | 2nd CPU | Memory | RAID Controller | Disk Bays | Storage | Slots | Optical | Add-on NIC | TPM | System Mgmt | OS | Warranty | Power Supply | Ann Date (m/y) |
|------------|--------|---|------------|----------------------------|-------------------------|------------|------------------------------|-----------------|---------|------------|-----|-------------|------|----------|-----------------|----------------|
| 70DE000BUX | US | 1xE5-2650 v3 10C/2.3GHz/25MB/105W/DDR4-2133 | 4XG0F28855 | 1x16GB RDIMM DDR4-2133 ECC | 720ix+1GB RAM (AnyRAID) | 24x2.5" HS | Open | 2xFH HL | None | None | TPM | TSM Premium | None | 3-year | 750Wx1 Platinum | 12/14 |
| 70DE000CUX | US | 2xE5-2620 v3 6C/2.4GHz/15MB/85W/1866MH | - | 8x16GB RDIMM DDR4-2133 ECC | 720ix+1GB RAM (AnyRAID) | 24x2.5" HS | 8x300GB HDD 10K 2.5" SAS6Gbs | 2xFH HL+4xLP HL | None | None | TPM | TSM Premium | None | 3-year | 750Wx2 Platinum | 12/14 |
| 70DE000HUX | US | 1xE5-2609 v3 6C/1.9GHz/15MB/85W/DDR4-1600 | 4XG0F28859 | 1x4GB RDIMM DDR4-2133 ECC | 720ix+1GB RAM (AnyRAID) | 24x2.5" HS | Open | None | None | None | TPM | TSM | None | 3-year | 750Wx1 Platinum | 12/14 |
| 70DE000JUX | US | 1xE5-2620 v3 6C/2.4GHz/15MB/85W/DDR4-1866 | 4XG0F28858 | 1x8GB RDIMM DDR4-2133 ECC | 720ix+1GB RAM (AnyRAID) | 24x2.5" HS | Open | 2xFH HL | None | None | TPM | TSM | None | 3-year | 750Wx1 Platinum | 12/14 |
| 70DE000KUX | US | 1xE5-2640 v3 8C/2.6GHz/20MB/90W/DDR4-1866 | 4XG0F28856 | 1x8GB RDIMM DDR4-2133 ECC | 720ix+1GB RAM (AnyRAID) | 24x2.5" HS | Open | 2xFH HL | None | None | TPM | TSM | None | 3-year | 750Wx1 Platinum | 12/14 |

| Model | Region | Processor | 2nd CPU | Memory | RAID Controller | Disk Bays | Storage | Slots | Optical | Add-on NIC | TPM | System Mgmt | OS | Warranty | Power Supply | Ann Date (m/y) |
|------------|--------|---|------------|---------------------------|-------------------------|------------|---------|---------|---------|------------|-----|-------------|------|----------|-----------------|----------------|
| 70DV0008UX | US | 1xE5-2603 v3 6C/1.6GHz/15MB/85W/DDR4-1600 | 4XG0F28860 | 1x4GB RDIMM DDR4-2133 ECC | 720ix+1GB RAM (AnyRAID) | 16x2.5" HS | Open | None | None | None | TPM | TSM | None | 3-year | 750Wx1 Platinum | 12/14 |
| 70DV0009UX | US | 1xE5-2620 v3 6C/2.4GHz/15MB/85W/DDR4-1866 | 4XG0F28858 | 1x8GB RDIMM DDR4-2133 ECC | 720ix+1GB RAM (AnyRAID) | 16x2.5" HS | Open | 2xFH HL | None | None | TPM | TSM | None | 3-year | 750Wx1 Platinum | 12/14 |
| 70DV000AUX | US | 1xE5-2640 v3 8C/2.6GHz/20MB/90W/DDR4-1866 | 4XG0F28856 | 1x8GB RDIMM DDR4-2133 ECC | 720ix+1GB RAM (AnyRAID) | 16x2.5" HS | Open | 2xFH HL | None | None | TPM | TSM | None | 3-year | 750Wx1 Platinum | 12/14 |

| Model | Region | Processor | 2nd CPU | Memory | RAID Controller | Disk Bays | Storage | Slots | Optical | Add-on NIC | TPM | System Mgmt | OS | Warranty | Power Supply | Ann Date (m/y) |
|------------|--------|---|------------|----------------------------------|-----------------|--------------|---------|------------|---------|------------|-----|-------------|------|----------|--------------------|----------------|
| 70Q9001DUX | US | 1xE5-2603 v4 6C/1.7GHz/15MB/85W/DDR4-1866 | 4XG0G89090 | 1x16GB RDIMM DDR4-2400 ECC | 110i (PCIe) | 8x2.5" HS | Open | 2xFH HL | None | None | TPM | TSM | None | 3-year | 750Wx1 Platinum | 03/16 |
| 70Q9001EUX | US | 1xE5-2609 v4 8C/1.7GHz/20MB/85W/DDR4-1866 | 4XG0G89085 | 1x16GB RDIMM DDR4-2400 ECC | 110i (PCIe) | 8x2.5" HS | Open | 2xFH HL | None | None | TPM | TSM | None | 3-year | 750Wx1 Platinum | 03/16 |
| 70Q9001FUX | US | 1xE5-2620 v4 8C/2.1GHz/20MB/85W/DDR4-2133 | 4XG0G89080 | 1x16GB RDIMM DDR4-2400 ECC | 110i (PCIe) | 8x2.5" HS | Open | 2xFH HL | None | None | TPM | TSM | None | 3-year | 750Wx1 Platinum | 03/16 |
| 70Q9001GUX | US | 1xE5-2630 v4 10C/2.2GHz/20MB/85W/DDR4-2133 | 4XG0G89075 | 1x16GB RDIMM DDR4-2400 ECC | 110i (PCIe) | 8x2.5" HS | Open | 2xFH HL | None | None | TPM | TSM | None | 3-year | 750Wx1 Platinum | 03/16 |
| 70Q9001HUX | US | 1xE5-2640 v4 10C/2.4GHz/25MB/90W/DDR4-2133 | 4XG0G89070 | 1x16GB RDIMM DDR4-2400 ECC | 110i (PCIe) | 8x2.5" HS | Open | 2xFH HL | None | None | TPM | TSM | None | 3-year | 750Wx1 Platinum | 03/16 |
| 70Q9001JUX | US | 1xE5-2650 v4 12C/2.2GHz/30MB/105W/DDR4-2400 | 4XG0G89065 | 1x16GB RDIMM DDR4-2400 ECC | 110i (PCIe) | 8x2.5" HS | Open | 2xFH HL | None | None | TPM | TSM | None | 3-year | 750Wx1 Platinum | 03/16 |
| 70Q9001KUX | US | 1xE5-2660 v4 14C/2GHz/35MB/105W/DDR4-2400 | 4XG0G89060 | 1x16GB RDIMM DDR4-2400 ECC | 110i (PCIe) | 8x2.5" HS | Open | 2xFH HL | None | None | TPM | TSM | None | 3-year | 750Wx1 Platinum | 03/16 |

| Model | Region | Processor | 2nd CPU | Memory | RAID Controller | Disk Bays | Storage | Slots | Optical | Add-on NIC | TPM | System Mgmt | OS | Warranty | Power Supply | Ann Date (m/y) |
|------------|--------|---|------------|-------------------------------|-----------------|-----------|---------------------------------|-----------------|---------|------------|-----|-------------|------|----------|-----------------|----------------|
| 70QQ0013UX | US | 1xE5-2603 v4 6C/1.7GHz/15MB/85W/DDR4-1866 | 4XG0G89090 | 1x16GB RDIMM DDR4-2400 ECC | 110i (PCIe) | 8x3.5" HS | Open | 2xFH HL | None | None | TPM | TSM | None | 3-year | 750Wx1 Platinum | 03/16 |
| 70QQ0014UX | US | 1xE5-2609 v4 8C/1.7GHz/20MB/85W/DDR4-1866 | 4XG0G89085 | 1x16GB RDIMM DDR4-2400 ECC | 110i (PCIe) | 8x3.5" HS | Open | 2xFH HL | None | None | TPM | TSM | None | 3-year | 750Wx1 Platinum | 03/16 |
| 70QQ0015UX | US | 1xE5-2620 v4 8C/2.1GHz/20MB/85W/DDR4-2133 | 4XG0G89080 | 1x16GB RDIMM DDR4-2400 ECC | 110i (PCIe) | 8x3.5" HS | Open | 2xFH HL | None | None | TPM | TSM | None | 3-year | 750Wx1 Platinum | 03/16 |
| 70QQ0016UX | US | 1xE5-2630 v4 10C/2.2GHz/20MB/85W/DDR4-2133 | 4XG0G89075 | 1x16GB RDIMM DDR4-2400 ECC | 110i (PCIe) | 8x3.5" HS | Open | 2xFH HL | None | None | TPM | TSM | None | 3-year | 750Wx1 Platinum | 03/16 |
| 70QQ0017UX | US | 1xE5-2640 v4 10C/2.4GHz/25MB/90W/DDR4-2133 | 4XG0G89070 | 1x16GB RDIMM DDR4-2400 ECC | 110i (PCIe) | 8x3.5" HS | Open | 2xFH HL | None | None | TPM | TSM | None | 3-year | 750Wx1 Platinum | 03/16 |
| 70QQ0018UX | US | 1xE5-2650 v4 12C/2.2GHz/30MB/105W/DDR4-2400 | 4XG0G89065 | 1x16GB RDIMM DDR4-2400 ECC | 110i (PCIe) | 8x3.5" HS | Open | 2xFH HL | None | None | TPM | TSM | None | 3-year | 750Wx1 Platinum | 03/16 |
| 70QQ0019UX | US | 1xE5-2660 v4 14C/2GHz/35MB/105W/DDR4-2400 | 4XG0G89060 | 1x16GB RDIMM DDR4-2400 ECC | 110i (PCIe) | 8x3.5" HS | Open | 2xFH HL | None | None | TPM | TSM | None | 3-year | 750Wx1 Platinum | 03/16 |
| 70QQ001AUX | US | 1xE5-2630 v4 10C/2.2GHz/20MB/85W/DDR4-2133 | 4XG0G89075 | 4x16GB RDIMM DDR4-2400 ECC | 110i (PCIe) | 8x3.5" HS | 4x1TB HDD 7.2K 3.5" SATA6Gbs | 2xFH HL | None | None | TPM | TSM Premium | None | 3-year | 750Wx2 Platinum | 03/16 |
| 70QQ001BUX | US | 2xE5-2620 v4 8C/2.1GHz/20MB/85W/DDR4-2133 | - | 2x16GB RDIMM DDR4-2400 ECC | 110i (PCIe) | 8x3.5" HS | Open | 2xFH HL+4xLP HL | None | None | TPM | TSM Premium | None | 3-year | 750Wx2 Platinum | 03/16 |

| Model | Region | Processor | 2nd CPU | Memory | RAID Controller | Disk Bays | Storage | Slots | Optical | Add-on NIC | TPM | System Mgmt | OS | Warranty | Power Supply | Ann Date (m/y) |
|------------|--------|---|------------|----------------------------------|---------------------------------|---------------|---------|------------|---------|------------|-----|-------------|------|----------|--------------------|----------------|
| 70QS0000UX | US | 1xE5-2603 v4 6C/1.7GHz/15MB/85W/DDR4-1866 | 4XG0G89090 | 1x16GB RDIMM DDR4-2400 ECC | 720ix+1GB Flash (AnyRAID) | 24x2.5" HS | Open | 2xFH HL | None | None | TPM | TSM | None | 3-year | 750Wx1 Platinum | 03/16 |
| 70QS0001UX | US | 1xE5-2609 v4 8C/1.7GHz/20MB/85W/DDR4-1866 | 4XG0G89085 | 1x16GB RDIMM DDR4-2400 ECC | 720ix+1GB Flash (AnyRAID) | 24x2.5" HS | Open | 2xFH HL | None | None | TPM | TSM | None | 3-year | 750Wx1 Platinum | 03/16 |
| 70QS0002UX | US | 1xE5-2620 v4 8C/2.1GHz/20MB/85W/DDR4-2133 | 4XG0G89080 | 1x16GB RDIMM DDR4-2400 ECC | 720ix+1GB Flash (AnyRAID) | 24x2.5" HS | Open | 2xFH HL | None | None | TPM | TSM | None | 3-year | 750Wx1 Platinum | 03/16 |
| 70QS0003UX | US | 1xE5-2630 v4 10C/2.2GHz/20MB/85W/DDR4-2133 | 4XG0G89075 | 1x16GB RDIMM DDR4-2400 ECC | 720ix+1GB Flash (AnyRAID) | 24x2.5" HS | Open | 2xFH HL | None | None | TPM | TSM | None | 3-year | 750Wx1 Platinum | 03/16 |
| 70QS0004UX | US | 1xE5-2640 v4 10C/2.4GHz/25MB/90W/DDR4-2133 | 4XG0G89070 | 1x16GB RDIMM DDR4-2400 ECC | 720ix+1GB Flash (AnyRAID) | 24x2.5" HS | Open | 2xFH HL | None | None | TPM | TSM | None | 3-year | 750Wx1 Platinum | 03/16 |
| 70QS0005UX | US | 1xE5-2650 v4 12C/2.2GHz/30MB/105W/DDR4-2400 | 4XG0G89065 | 1x16GB RDIMM DDR4-2400 ECC | 720ix+1GB Flash (AnyRAID) | 24x2.5" HS | Open | 2xFH HL | None | None | TPM | TSM | None | 3-year | 750Wx1 Platinum | 03/16 |
| 70QS0006UX | US | 1xE5-2660 v4 14C/2GHz/35MB/105W/DDR4-2400 | 4XG0G89060 | 1x16GB RDIMM DDR4-2400 ECC | 720ix+1GB Flash (AnyRAID) | 24x2.5" HS | Open | 2xFH HL | None | None | TPM | TSM | None | 3-year | 750Wx1 Platinum | 03/16 |

| Model | Region | Processor | 2nd CPU | Memory | RAID Controller | Disk Bays | Storage | Slots | Optical | Add-on NIC | TPM | System Mgmt | OS | Warranty | Power Supply | Ann Date (m/y) |
|------------|--------|---|------------|----------------------------|---------------------------|------------|---------|---------|---------|------------|-----|-------------|------|----------|-----------------|----------------|
| 70QW0004UX | US | 1xE5-2603 v4 6C/1.7GHz/15MB/85W/DDR4-1866 | 4XG0G89090 | 1x16GB RDIMM DDR4-2400 ECC | 720ix+1GB Flash (AnyRAID) | 16x2.5" HS | Open | 2xFH HL | None | None | TPM | TSM | None | 3-year | 750Wx1 Platinum | 03/16 |
| 70QW0005UX | US | 1xE5-2609 v4 8C/1.7GHz/20MB/85W/DDR4-1866 | 4XG0G89085 | 1x16GB RDIMM DDR4-2400 ECC | 720ix+1GB Flash (AnyRAID) | 16x2.5" HS | Open | 2xFH HL | None | None | TPM | TSM | None | 3-year | 750Wx1 Platinum | 03/16 |
| 70QW0006UX | US | 1xE5-2620 v4 8C/2.1GHz/20MB/85W/DDR4-2133 | 4XG0G89080 | 1x16GB RDIMM DDR4-2400 ECC | 720ix+1GB Flash (AnyRAID) | 16x2.5" HS | Open | 2xFH HL | None | None | TPM | TSM | None | 3-year | 750Wx1 Platinum | 03/16 |
| 70QW0007UX | US | 1xE5-2630 v4 10C/2.2GHz/20MB/85W/DDR4-2133 | 4XG0G89075 | 1x16GB RDIMM DDR4-2400 ECC | 720ix+1GB Flash (AnyRAID) | 16x2.5" HS | Open | 2xFH HL | None | None | TPM | TSM | None | 3-year | 750Wx1 Platinum | 03/16 |
| 70QW0008UX | US | 1xE5-2640 v4 10C/2.4GHz/25MB/90W/DDR4-2133 | 4XG0G89070 | 1x16GB RDIMM DDR4-2400 ECC | 720ix+1GB Flash (AnyRAID) | 16x2.5" HS | Open | 2xFH HL | None | None | TPM | TSM | None | 3-year | 750Wx1 Platinum | 03/16 |
| 70QW0009UX | US | 1xE5-2650 v4 12C/2.2GHz/30MB/105W/DDR4-2400 | 4XG0G89065 | 1x16GB RDIMM DDR4-2400 ECC | 720ix+1GB Flash (AnyRAID) | 16x2.5" HS | Open | 2xFH HL | None | None | TPM | TSM | None | 3-year | 750Wx1 Platinum | 03/16 |
| 70QW000AUX | US | 1xE5-2660 v4 14C/2GHz/35MB/105W/DDR4-2400 | 4XG0G89060 | 1x16GB RDIMM DDR4-2400 ECC | 720ix+1GB Flash (AnyRAID) | 16x2.5" HS | Open | 2xFH HL | None | None | TPM | TSM | None | 3-year | 750Wx1 Platinum | 03/16 |





ThinkServer RD550 Platform Specifications

Product Specifications Reference (PSREF)

| Components | Specification | | | | | | | | | | | | | | | | | | | | | | | | | |
|------------------------|--|---------------------------|--|-------------------------|--|--|--|----------|----------|----------|-----------|--------|---------------------------|---------------------------|---------------------------|--|--------|---|---|---|--|---------|--|--|--|-------------------------|
| Dimensions | 1U rack. Height: 43 mm (1.7 in), width: 482 mm (19 in), depth: 780 mm (30.7 in) | | | | | | | | | | | | | | | | | | | | | | | | | |
| Weight | Minimum configuration: 13.5 kg (29.76 lb), maximum: 21 kg (46.3 lb) | | | | | | | | | | | | | | | | | | | | | | | | | |
| Processor | Up to two 145W Intel Xeon E5-2600 v3 family (code name: Haswell) processors with 18 cores up to 2.3GHz, 16 cores up to 2.3GHz, 14 cores up to 2.6GHz, 12 cores up to 2.6GHz, 10 cores up to 2.6GHz, 8 cores up to 3.2GHz, 6 cores up to 3.4GHz, 4 cores up to 3.5GHz. Two QPI link up to 9.6 GT/s. Up to 2133MHz memory speed. Up to 45MB cache | | | | | | | | | | | | | | | | | | | | | | | | | |
| Chipset | Intel C610 Series Chipset | | | | | | | | | | | | | | | | | | | | | | | | | |
| Memory DIMMs | 24 DIMM sockets (12 DIMMs per processor), 8-channel capable (4-channel per processor). RDIMM and LRDIMM (cannot be intermixed), DDR4, LRDIMM up to DDR4-2133, RDIMM up to DDR4-2400 | | | | | | | | | | | | | | | | | | | | | | | | | |
| Memory capacity | 384GB (RDIMM, 16GB x 24)/768GB (LRDIMM, 32GB x 24) | | | | | | | | | | | | | | | | | | | | | | | | | |
| Memory protection | ECC, memory mirroring, lockstep, and memory sparing | | | | | | | | | | | | | | | | | | | | | | | | | |
| AnyRAID support | RAID 0, 1, 10 with AnyRAID 110i. 6Gb/s SATA, optional key for RAID 5. RAID 0, 1, 10 with AnyRAID 510i, 6Gb/s SAS/SATA, optional key for RAID 5/50. RAID 0, 1, 10, 5, 50, 6, 60 with AnyRAID 720i/720ix. 12Gb/s SAS/SATA. 720i needs cache for RAID 6/60 support. 720ix must have cache. Optional cache for 720i/720ix: 1GB read-only memory. 1GB/2GB/4GB flash with super capacitor. Flash options include CacheVault, CacheCade Pro, and FastPath <i>Note: At least 6 disk drives is required for RAID 50 and 60.</i> | | | | | | | | | | | | | | | | | | | | | | | | | |
| Disk drive bays | Up to 4 3.5" or 12 2.5" hot-swap disk bays on front. Up to 2 of 12 2.5" bays can support easy-swap PCIe SSD via optional Anybay kit (consumes one PCIe slot). Up to 2 2.5" rear mounted hot-swap disk bays on 3.5" models, optional. Up to 2 M.2 SSD drives via optional M.2 module. Supports external RDX tape drive via USB. <table border="1"> <thead> <tr> <th>Disk bay configuration</th> <th colspan="4">AnyRAID requirements and optional drives supported</th> </tr> <tr> <th></th> <th>RAID110i</th> <th>RAID510i</th> <th>RAID720i</th> <th>RAID720ix</th> </tr> </thead> <tbody> <tr> <td>4x3.5"</td> <td>• (optional rear bay/M.2)</td> <td>• (optional rear bay/M.2)</td> <td>• (optional rear bay/M.2)</td> <td></td> </tr> <tr> <td>8x2.5"</td> <td>•</td> <td>•</td> <td>•</td> <td></td> </tr> <tr> <td>12x2.5"</td> <td></td> <td></td> <td></td> <td>• (optional Anybay/M.2)</td> </tr> </tbody> </table> <i>Note: 1. Rear disk drive and M.2 SSD can not be supported simultaneously. Only one can be selected per system. 2. On AnyRAID 110i and 8x2.5" model, 6 of 8 drives can be configured as RAID</i> | Disk bay configuration | AnyRAID requirements and optional drives supported | | | | | RAID110i | RAID510i | RAID720i | RAID720ix | 4x3.5" | • (optional rear bay/M.2) | • (optional rear bay/M.2) | • (optional rear bay/M.2) | | 8x2.5" | • | • | • | | 12x2.5" | | | | • (optional Anybay/M.2) |
| Disk bay configuration | AnyRAID requirements and optional drives supported | | | | | | | | | | | | | | | | | | | | | | | | | |
| | RAID110i | RAID510i | RAID720i | RAID720ix | | | | | | | | | | | | | | | | | | | | | | |
| 4x3.5" | • (optional rear bay/M.2) | • (optional rear bay/M.2) | • (optional rear bay/M.2) | | | | | | | | | | | | | | | | | | | | | | | |
| 8x2.5" | • | • | • | | | | | | | | | | | | | | | | | | | | | | | |
| 12x2.5" | | | | • (optional Anybay/M.2) | | | | | | | | | | | | | | | | | | | | | | |
| Internal disk drive | 3.5" HDD up to 8TB (SATA/SAS). 2.5" HDD up to 1.8TB (SAS)/2TB (SATA). 2.5" SSD up to 1.6TB (SATA/SAS). Easy-swap PCIe SSD up to 1.92TB. PCIe SSD adapter up to 3.84TB. M.2 SSD up to 120GB. 2.5" SSD and HDD are compatible with 3.5" bay | | | | | | | | | | | | | | | | | | | | | | | | | |
| SD module | Up to 2 SDHC flash cards via optional SD module, 8GB or 32GB each | | | | | | | | | | | | | | | | | | | | | | | | | |
| Optical drive | Optional one 9.5mm optical drive on 3.5" model. DVD-ROM or DVD±RW | | | | | | | | | | | | | | | | | | | | | | | | | |
| Network interfaces | One dedicated management port. One (3.5" model) or two (2.5" model) AnyFabric slots for customized LOM. Optional discrete network adapters via PCIe slots | | | | | | | | | | | | | | | | | | | | | | | | | |
| Security features | Power-on and administrator password. Optional TPM (TCG 1.2-compliant) | | | | | | | | | | | | | | | | | | | | | | | | | |
| Systems management | Supports ThinkServer System Manager (TSM), optional TSM Premium. UEFI. Onboard Aspeed AST2400 graphics/management processor, IPMI 2.0-compliant baseboard management controller (BMC). Control Panel LEDs shows the status of power, ID, network, system. Supports ThinkServer management software: Diagnostics, Deployment Manager, Energy Manager, System Manager, Partner Pack for VMware vCenter and Microsoft System Center Operations Manager, Power Planner | | | | | | | | | | | | | | | | | | | | | | | | | |

| Components | Specification | | | | | | | | | | | | | | | |
|--|---|-------------------------|---------------------------------|--|-----------------|--|-----------------|----------------------|--------------------------------------|----------------------|------------------------|-----------------------------------|------------------------|---|---|---|
| Operating systems supported | Microsoft Windows Server 2016/2012 R2/2012/2008 R2. Windows Small Business Server 2011. Red Hat Enterprise Linux 6.5/6.6/7. SUSE Linux Enterprise Server 11. VMware vSphere (ESXi) 5.1 P5/5.5 U2/6.0 | | | | | | | | | | | | | | | |
| Base warranty | 3-year limited onsite service with 9x5/NBD. Some parts are Customer Replaceable Units | | | | | | | | | | | | | | | |
| Power supply | Up to two redundant hot-swap 550W/750W/1100W power supplies. 550W and 1100W are 80 PLUS Platinum qualified. 750W is 80 PLUS Platinum or Titanium qualified. <table border="1"> <thead> <tr> <th rowspan="2">Disk bay configuration</th> <th colspan="3">PSU requirements</th> </tr> <tr> <th>550W</th> <th>750W</th> <th>1100W</th> </tr> </thead> <tbody> <tr> <td>4x3.5"</td> <td>•</td> <td>•</td> <td>•</td> </tr> <tr> <td>12x2.5"</td> <td>•</td> <td>•</td> <td>•</td> </tr> </tbody> </table> <i>Note: 750W Titanium is 200V - 240V, others are 110V - 240V.</i> | Disk bay configuration | PSU requirements | | | 550W | 750W | 1100W | 4x3.5" | • | • | • | 12x2.5" | • | • | • |
| Disk bay configuration | PSU requirements | | | | | | | | | | | | | | | |
| | 550W | 750W | 1100W | | | | | | | | | | | | | |
| 4x3.5" | • | • | • | | | | | | | | | | | | | |
| 12x2.5" | • | • | • | | | | | | | | | | | | | |
| Graphics | Onboard Aspeed AST2400 with 16MB memory, one DisplayPort on front, one DisplayPort on rear. Maximum resolution: 1920x1200@60Hz | | | | | | | | | | | | | | | |
| Front ports | (Only 3.5" model) Two USB 2.0, one DisplayPort | | | | | | | | | | | | | | | |
| Rear ports | One DisplayPort, two USB 3.0, one RJ-45 (dedicate mgmt), one serial (9-pin) | | | | | | | | | | | | | | | |
| Cooling | 8 (7+1, dual processors) or 6 (5+1, single processor), hot-swap | | | | | | | | | | | | | | | |
| Noise emissions | Operating: < 6.5 Bels. Idle: < 6 Bels (Maximum configuration) | | | | | | | | | | | | | | | |
| Environmental specification | <table border="1"> <tbody> <tr> <td>Temperature - operating</td> <td>41 °F to 113 °F (5 °C to 45 °C)</td> </tr> <tr> <td>Temperature - non operating (no package)</td> <td>-10 °C to 60 °C</td> </tr> <tr> <td>Temperature - non operating (with package)</td> <td>-40 °C to 60 °C</td> </tr> <tr> <td>Altitude - operating</td> <td>(Unpressurized): 0-10000ft (0-3048m)</td> </tr> <tr> <td>Humidity - operating</td> <td>8%-90%, non-condensing</td> </tr> <tr> <td>Humidity - storage (with package)</td> <td>8%-90%, non-condensing</td> </tr> </tbody> </table> <i>Note: 45 °C continuous operation configuration limitation: no 145W CPU/no 135W 4, 6, or 8 cores CPU/no GPU card/redundant PSU/no FLFH card/no PCIe SSD adapter/no 1100W PSU.</i> | Temperature - operating | 41 °F to 113 °F (5 °C to 45 °C) | Temperature - non operating (no package) | -10 °C to 60 °C | Temperature - non operating (with package) | -40 °C to 60 °C | Altitude - operating | (Unpressurized): 0-10000ft (0-3048m) | Humidity - operating | 8%-90%, non-condensing | Humidity - storage (with package) | 8%-90%, non-condensing | | | |
| Temperature - operating | 41 °F to 113 °F (5 °C to 45 °C) | | | | | | | | | | | | | | | |
| Temperature - non operating (no package) | -10 °C to 60 °C | | | | | | | | | | | | | | | |
| Temperature - non operating (with package) | -40 °C to 60 °C | | | | | | | | | | | | | | | |
| Altitude - operating | (Unpressurized): 0-10000ft (0-3048m) | | | | | | | | | | | | | | | |
| Humidity - operating | 8%-90%, non-condensing | | | | | | | | | | | | | | | |
| Humidity - storage (with package) | 8%-90%, non-condensing | | | | | | | | | | | | | | | |

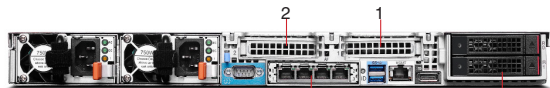
Expansion slots

| | |
|--|---|
| 3.5" model  <p>AnyFabric slot 1 (Network adapter is optional) Optional 2 x 2.5" rear bays</p> | Slot 1 (riser card 1) PCIe 3.0 x 16, low-profile, half length Slot 2 (riser card 2) PCIe 3.0 x 16, low-profile, half length, requires 2nd riser card and 2nd CPU |
| 2.5" model  <p>AnyFabric slot 1 (Network adapter is optional) AnyFabric slot 2 (Network adapter is optional)</p> | Slot 1 (riser card 1) PCIe 3.0 x 16 (x8 wired), low-profile, half length Slot 2 (riser card 1) PCIe 3.0 x 16 (x8 wired), low-profile, half length Slot 3 (riser card 2) PCIe 3.0 x 16, low-profile, half length, requires 2nd riser card and 2nd CPU |

| Model | Region | Processor | 2nd CPU | Memory | RAID Controller | Disk Bays | Storage | Slots | Optical | Add-on NIC | TPM | System Mgmt | OS | Warranty | Power Supply | Ann Date (m/y) |
|------------|--------|--|------------|----------------------------|----------------------|-----------|------------------------------|---------|--------------|-----------------------|-----|-------------|------|----------|-----------------|----------------|
| 70CV001CUX | US | 1xXeon E5-2609 v3 6C/1.9GHz/15MB/85W/DDR4-1600 | 4XG0F28803 | 1x8GB RDIMM DDR4-2133 ECC | AnyRAID 110i | 4x3.5" HS | Open | 1xLP HL | 9.5mm DVD±RW | None | TPM | TSM | None | 3-year | 750Wx1 Platinum | 09/14 |
| 70CV001DUX | US | 1xXeon E5-2620 v3 6C/2.4GHz/15MB/85W/DDR4-1866 | 4XG0F28802 | 1x8GB RDIMM DDR4-2133 ECC | AnyRAID 110i | 4x3.5" HS | Open | 1xLP HL | 9.5mm DVD±RW | None | TPM | TSM | None | 3-year | 750Wx1 Platinum | 09/14 |
| 70CV001EUX | US | 1xXeon E5-2640 v3 8C/2.6GHz/20MB/90W/DDR4-1866 | 4XG0F28800 | 1x8GB RDIMM DDR4-2133 ECC | AnyRAID 510i | 4x3.5" HS | Open | 1xLP HL | 9.5mm DVD±RW | None | TPM | TSM | None | 3-year | 750Wx1 Platinum | 09/14 |
| 70CV001FUX | US | 1xXeon E5-2650 v3 10C/2.3GHz/25MB/105W/DDR4-2133 | 4XG0F28799 | 1x8GB RDIMM DDR4-2133 ECC | AnyRAID 510i | 4x3.5" HS | Open | 1xLP HL | 9.5mm DVD±RW | None | TPM | TSM | None | 3-year | 750Wx1 Platinum | 09/14 |
| 70CV001GUX | US | 1xXeon E5-2670 v3 12C/2.3GHz/30MB/120W/DDR4-2133 | 4XG0F28797 | 1x8GB RDIMM DDR4-2133 ECC | AnyRAID 720i+1GB RAM | 4x3.5" HS | Open | 1xLP HL | 9.5mm DVD±RW | None | TPM | TSM | None | 3-year | 750Wx1 Platinum | 09/14 |
| 70CV001JUX | US | 1xXeon E5-2609 v3 6C/1.9GHz/15MB/85W/DDR4-1600 | 4XG0F28803 | 1x8GB RDIMM DDR4-2133 ECC | AnyRAID 510i | 4x3.5" HS | Open | 1xLP HL | 9.5mm DVD±RW | None | TPM | TSM | None | 3-year | 750Wx1 Platinum | 10/14 |
| 70CV001KUX | US | 1xXeon E5-2620 v3 6C/2.4GHz/15MB/85W/DDR4-1866 | 4XG0F28802 | 1x8GB RDIMM DDR4-2133 ECC | AnyRAID 510i | 4x3.5" HS | Open | 1xLP HL | 9.5mm DVD±RW | None | TPM | TSM | None | 3-year | 750Wx1 Platinum | 10/14 |
| 70CV001LUX | US | 1xXeon E5-2630 v3 8C/2.4GHz/20MB/85W/DDR4-1866 | 4XG0F28801 | 1x8GB RDIMM DDR4-2133 ECC | AnyRAID 510i | 4x3.5" HS | Open | 1xLP HL | 9.5mm DVD±RW | None | TPM | TSM | None | 3-year | 750Wx1 Platinum | 10/14 |
| 70CV001MUX | US | 2xXeon E5-2630 v3 8C/2.4GHz/20MB/85W/DDR4-1866 | - | 2x8GB RDIMM DDR4-2133 ECC | AnyRAID 510i | 4x3.5" HS | Open | 2xLP HL | 9.5mm DVD±RW | None | TPM | TSM | None | 3-year | 750Wx1 Platinum | 10/14 |
| 70CV001NUX | US | 1xXeon E5-2603 v3 6C/1.6GHz/15MB/85W/DDR4-1600 | 4XG0F28804 | 1x8GB RDIMM DDR4-2133 ECC | AnyRAID 110i | 4x3.5" HS | Open | No | None | None | TPM | TSM | None | 3-year | 550Wx1 Platinum | 10/14 |
| 70CV001SUX | US | 1xXeon E5-2630 v3 8C/2.4GHz/20MB/85W/DDR4-1866 | 4XG0F28801 | 2x8GB RDIMM DDR4-2133 ECC | AnyRAID 110i | 4x3.5" HS | 2x1TB HDD 7.2K 3.5" SATA6Gbs | 1xLP HL | 9.5mm DVD±RW | GbEx4 RJ-45 AnyFabric | TPM | TSM Premium | None | 3-year | 750Wx2 Platinum | 02/15 |
| 70CV001TUX | US | 2xXeon E5-2620 v3 6C/2.4GHz/15MB/85W/DDR4-1866 | - | 2x16GB RDIMM DDR4-2133 ECC | AnyRAID 110i | 4x3.5" HS | Open | 2xLP HL | 9.5mm DVD±RW | GbEx4 RJ-45 AnyFabric | TPM | TSM Premium | None | 3-year | 750Wx2 Platinum | 09/15 |

| Model | Region | Processor | 2nd CPU | Memory | RAID Controller | Disk Bays | Storage | Slots | Optical | Add-on NIC | TPM | System Mgmt | OS | Warranty | Power Supply | Ann Date (m/y) |
|------------|--------|--|------------|----------------------------|-----------------------|------------|-------------------------------|---------|---------|-----------------------|-----|-------------|------|----------|-----------------|----------------|
| 70CX001XUX | US | 1xXeon E5-2620 v3 6C/2.4GHz/15MB/85W/DDR4-1866 | 4XG0F28802 | 1x8GB RDIMM DDR4-2133 ECC | AnyRAID 510i+Key | 8x2.5" HS | Open | 2xLP HL | None | None | TPM | TSM | None | 3-year | 750Wx1 Platinum | 09/14 |
| 70CX001YUX | US | 1xXeon E5-2640 v3 8C/2.6GHz/20MB/90W/DDR4-1866 | 4XG0F28800 | 1x8GB RDIMM DDR4-2133 ECC | AnyRAID 510i+Key | 8x2.5" HS | Open | 2xLP HL | None | None | TPM | TSM | None | 3-year | 750Wx1 Platinum | 09/14 |
| 70CX0020UX | US | 1xXeon E5-2650 v3 10C/2.3GHz/25MB/105W/DDR4-2133 | 4XG0F28799 | 1x8GB RDIMM DDR4-2133 ECC | AnyRAID 720ix+1GB RAM | 12x2.5" HS | Open | 2xLP HL | None | None | TPM | TSM | None | 3-year | 750Wx1 Platinum | 09/14 |
| 70CX0021UX | US | 1xXeon E5-2670 v3 12C/2.3GHz/30MB/120W/DDR4-2133 | 4XG0F28797 | 1x8GB RDIMM DDR4-2133 ECC | AnyRAID 720ix+1GB RAM | 12x2.5" HS | Open | 2xLP HL | None | None | TPM | TSM | None | 3-year | 750Wx1 Platinum | 09/14 |
| 70CX0023UX | US | 1xXeon E5-2620 v3 6C/2.4GHz/15MB/85W/DDR4-1866 | 4XG0F28802 | 1x8GB RDIMM DDR4-2133 ECC | AnyRAID 720ix+1GB RAM | 12x2.5" HS | Open | 2xLP HL | None | None | TPM | TSM | None | 3-year | 750Wx1 Platinum | 10/14 |
| 70CX0024UX | US | 1xXeon E5-2630 v3 8C/2.4GHz/20MB/85W/DDR4-1866 | 4XG0F28801 | 1x8GB RDIMM DDR4-2133 ECC | AnyRAID 720ix+1GB RAM | 12x2.5" HS | Open | 2xLP HL | None | None | TPM | TSM | None | 3-year | 750Wx1 Platinum | 10/14 |
| 70CX0025UX | US | 1xXeon E5-2630 v3 8C/2.4GHz/20MB/85W/DDR4-1866 | 4XG0F28801 | 1x8GB RDIMM DDR4-2133 ECC | AnyRAID 510i | 8x2.5" HS | Open | 2xLP HL | None | None | TPM | TSM | None | 3-year | 750Wx1 Platinum | 10/14 |
| 70CX0027UX | US | 1xXeon E5-2603 v3 6C/1.6GHz/15MB/85W/DDR4-1600 | 4XG0F28804 | 1x8GB RDIMM DDR4-2133 ECC | AnyRAID 110i | 8x2.5" HS | Open | No | None | None | TPM | TSM | None | 3-year | 750Wx1 Platinum | 10/14 |
| 70CX002VUX | US | 1xXeon E5-2620 v3 6C/2.4GHz/15MB/85W/DDR4-1866 | 4XG0F28802 | 2x16GB RDIMM DDR4-2133 ECC | AnyRAID 510i+Key | 8x2.5" HS | 2x300GB HDD 15K 2.5" SAS12Gbs | No | None | GbEx4 RJ-45 AnyFabric | TPM | TSM Premium | None | 3-year | 750Wx2 Platinum | 02/16 |

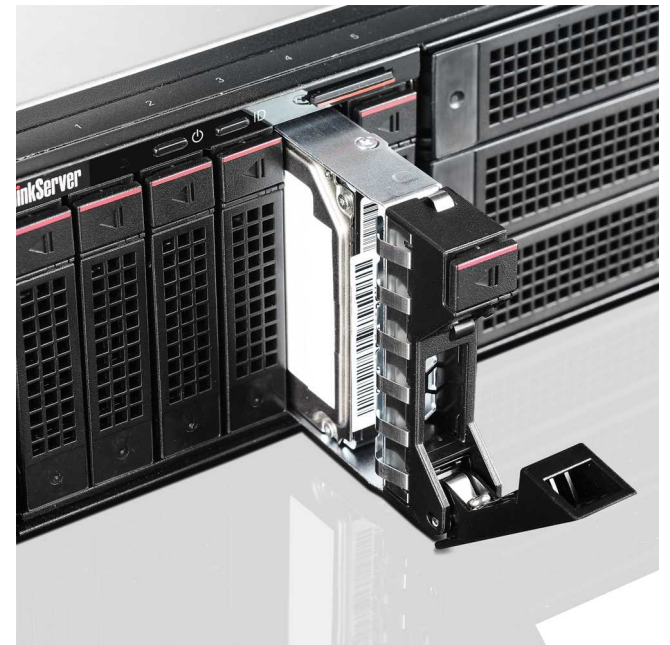

ThinkServer RD650 Platform Specifications

| Components | Specification | | | | | | | | | | | | | | | | | | | | | | | | | | | | | | | | | | | | | | | |
|------------------------|---|------------------------|--|----------------------------------|--|--|----------|----------|----------|-----------|--------|---|---|---|--|---------|--|--|--|---------------------------|--------|--|---|---|--------------------------------|---------|--|--|--|---------------------------|---------|--|--|--|----------------------------------|---------------|--|--|--|----------------------------------|
| Dimensions | 2U rack. Height: 87 mm (3.4 in), width: 482 mm (19 in), depth: 764 mm (30 in) | | | | | | | | | | | | | | | | | | | | | | | | | | | | | | | | | | | | | | | |
| Weight | Minimum configuration: 16 kg (35.3 lb), maximum: 32 kg (70.5 lb) | | | | | | | | | | | | | | | | | | | | | | | | | | | | | | | | | | | | | | | |
| Processor | Up to two 145W Intel Xeon E5-2600 v3 family (code name: Haswell) processors with 18 cores up to 2.3GHz, 16 cores up to 2.3GHz, 14 cores up to 2.6GHz, 12 cores up to 2.6GHz, 10 cores up to 2.6GHz, 8 cores up to 3.2GHz, 6 cores up to 3.4GHz, 4 cores up to 3.5GHz. Two QPI link up to 9.6 GT/s. Up to 2133MHz memory speed. Up to 45MB cache | | | | | | | | | | | | | | | | | | | | | | | | | | | | | | | | | | | | | | | |
| Chipset | Intel C610 Series Chipset | | | | | | | | | | | | | | | | | | | | | | | | | | | | | | | | | | | | | | | |
| Memory DIMMs | 24 DIMM sockets (12 DIMMs per processor), 8-channel capable (4-channel per processor). RDIMM and LRDIMM (cannot be intermixed), DDR4, LRDIMM up to DDR4-2133, RDIMM up to DDR4-2400 | | | | | | | | | | | | | | | | | | | | | | | | | | | | | | | | | | | | | | | |
| Memory capacity | 384GB (RDIMM, 16GB x 24)/768GB (LRDIMM, 32GB x 24) | | | | | | | | | | | | | | | | | | | | | | | | | | | | | | | | | | | | | | | |
| Memory protection | ECC, memory mirroring, lockstep, and memory sparing | | | | | | | | | | | | | | | | | | | | | | | | | | | | | | | | | | | | | | | |
| AnyRAID support | RAID 0, 1, 10 with AnyRAID 110i. 6Gb/s SATA, optional key for RAID 5. RAID 0, 1, 10 with AnyRAID 510i. 6Gb/s SAS/SATA, optional key for RAID 5/50. RAID 0, 1, 10, 5, 50, 6, 60 with AnyRAID 720i/720ix. 12Gb/s SAS/SATA. 720i needs cache for RAID 6/60 support. 720ix must have cache. Optional cache for 720i/720ix: 1GB read-only memory. 1GB/2GB/4GB flash with super capacitor. Flash options include CacheVault, CacheCade Pro, and FastPath | | | | | | | | | | | | | | | | | | | | | | | | | | | | | | | | | | | | | | | |
| Disk drive bays | Up to 12 3.5", 24 2.5", or 6 2.5" plus 9 3.5" hot-swap disk bays on front. Up to 4 2.5" bays on 24 2.5" or 2.5" + 3.5" models can support easy-swap PCIe SSD via optional Anybay kit (consumes two PCIe slots). Up to 2 2.5" rear mounted hot-swap disk bays, optional. Up to 2 M.2 SSD drives via optional M.2 module. Up to one internal LTO-6 SAS tape drive on 8 x 2.5" and 720ix model, or external RDX tape drive via USB. | | | | | | | | | | | | | | | | | | | | | | | | | | | | | | | | | | | | | | | |
| | <table border="1"> <thead> <tr> <th rowspan="2">Disk bay configuration</th> <th colspan="4">AnyRAID requirements and optional drives supported</th> </tr> <tr> <th>RAID110i</th> <th>RAID510i</th> <th>RAID720i</th> <th>RAID720ix</th> </tr> </thead> <tbody> <tr> <td>6x3.5"</td> <td>•</td> <td>•</td> <td>•</td> <td></td> </tr> <tr> <td>12x3.5"</td> <td></td> <td></td> <td></td> <td>• (optional rear bay/M.2)</td> </tr> <tr> <td>8x2.5"</td> <td></td> <td>•</td> <td>•</td> <td>• (optional tape/rear bay/M.2)</td> </tr> <tr> <td>16x2.5"</td> <td></td> <td></td> <td></td> <td>• (optional rear bay/M.2)</td> </tr> <tr> <td>24x2.5"</td> <td></td> <td></td> <td></td> <td>• (optional Anybay/rear bay/M.2)</td> </tr> <tr> <td>6x2.5"+9x3.5"</td> <td></td> <td></td> <td></td> <td>• (optional Anybay/rear bay/M.2)</td> </tr> </tbody> </table> | Disk bay configuration | AnyRAID requirements and optional drives supported | | | | RAID110i | RAID510i | RAID720i | RAID720ix | 6x3.5" | • | • | • | | 12x3.5" | | | | • (optional rear bay/M.2) | 8x2.5" | | • | • | • (optional tape/rear bay/M.2) | 16x2.5" | | | | • (optional rear bay/M.2) | 24x2.5" | | | | • (optional Anybay/rear bay/M.2) | 6x2.5"+9x3.5" | | | | • (optional Anybay/rear bay/M.2) |
| Disk bay configuration | AnyRAID requirements and optional drives supported | | | | | | | | | | | | | | | | | | | | | | | | | | | | | | | | | | | | | | | |
| | RAID110i | RAID510i | RAID720i | RAID720ix | | | | | | | | | | | | | | | | | | | | | | | | | | | | | | | | | | | | |
| 6x3.5" | • | • | • | | | | | | | | | | | | | | | | | | | | | | | | | | | | | | | | | | | | | |
| 12x3.5" | | | | • (optional rear bay/M.2) | | | | | | | | | | | | | | | | | | | | | | | | | | | | | | | | | | | | |
| 8x2.5" | | • | • | • (optional tape/rear bay/M.2) | | | | | | | | | | | | | | | | | | | | | | | | | | | | | | | | | | | | |
| 16x2.5" | | | | • (optional rear bay/M.2) | | | | | | | | | | | | | | | | | | | | | | | | | | | | | | | | | | | | |
| 24x2.5" | | | | • (optional Anybay/rear bay/M.2) | | | | | | | | | | | | | | | | | | | | | | | | | | | | | | | | | | | | |
| 6x2.5"+9x3.5" | | | | • (optional Anybay/rear bay/M.2) | | | | | | | | | | | | | | | | | | | | | | | | | | | | | | | | | | | | |
| Internal disk drive | 3.5" HDD up to 8TB (SATA/SAS). 2.5" HDD up to 1.8TB (SAS)/2TB (SATA). 2.5" SSD up to 1.6TB (SATA/SAS). Easy-swap PCIe SSD up to 1.92TB. PCIe SSD adapter up to 3.84TB. M.2 SSD up to 120GB. 2.5" SSD and HDD are compatible with 3.5" bay | | | | | | | | | | | | | | | | | | | | | | | | | | | | | | | | | | | | | | | |
| SD module | Up to 2 SDHC flash cards via optional SD module, 8GB or 32GB each | | | | | | | | | | | | | | | | | | | | | | | | | | | | | | | | | | | | | | | |
| Optical drive | Optional one 9.5mm optical drive on 8 or 16 x 2.5" model, DVD-ROM or DVD±RW | | | | | | | | | | | | | | | | | | | | | | | | | | | | | | | | | | | | | | | |
| Network interfaces | One dedicated management port, one AnyFabric slot for customized LOM. Discrete network options is also available via PCIe slots | | | | | | | | | | | | | | | | | | | | | | | | | | | | | | | | | | | | | | | |
| Security features | Power-on and administrator password. Optional TPM (TCG 1.2-compliant) Supports ThinkServer System Manager (TSM), optional TSM Premium. UEFI. Onboard Aspeed AST2400 graphics/management processor, IPMI 2.0-compliant baseboard management controller (BMC). Control Panel LEDs shows the status of power, ID, network, system. | | | | | | | | | | | | | | | | | | | | | | | | | | | | | | | | | | | | | | | |
| Systems management | Supports ThinkServer management software: Diagnostics, Deployment Manager, Energy Manager, System Manager, Partner Pack for VMware vCenter and Microsoft System Center Operations Manager, Power Planner | | | | | | | | | | | | | | | | | | | | | | | | | | | | | | | | | | | | | | | |

| Components | Specification | | | | | | | | | | | | | | | | | | | | | | | | | | | | | | | | | | | | | | |
|--|--|-------------------------|---------------------------------|--|-----------------|--|-----------------|----------------------|--------------------------------------|----------------------|------------------------|-----------------------------------|------------------------|---|---|---------|--------------------|--|--|--|--------|---|---|---|---|---------|--|--|--|--|---------|---|---|---|---|-----------|---|---|---|
| Operating systems supported | Microsoft Windows Server 2016/2012 R2/2012/2008 R2. Windows Small Business Server 2011. Red Hat Enterprise Linux 6.5/6.6/7. SUSE Linux Enterprise Server 11. VMware vSphere (ESXi) 5.1 P5/5.5 U2/6.0 | | | | | | | | | | | | | | | | | | | | | | | | | | | | | | | | | | | | | | |
| Base warranty | 3-year limited onsite service with 9x5/NBD. | | | | | | | | | | | | | | | | | | | | | | | | | | | | | | | | | | | | | | |
| Power supply | Up to two redundant hot-swap 550W/750W/1100W/1600W power supplies. 550W, 1100W, and 1600W are 80 PLUS Platinum qualified. 750W is 80 PLUS Platinum or Titanium qualified. | | | | | | | | | | | | | | | | | | | | | | | | | | | | | | | | | | | | | | |
| | <table border="1"> <thead> <tr> <th rowspan="2">Disk bay configuration</th> <th colspan="4">PSU requirements</th> </tr> <tr> <th>550W</th> <th>750W</th> <th>1100W</th> <th>1600W</th> </tr> </thead> <tbody> <tr> <td>6x3.5"</td> <td>•</td> <td>•</td> <td>•</td> <td>•</td> </tr> <tr> <td>12x3.5"</td> <td colspan="4">• (up to 135W CPU)</td> </tr> <tr> <td>8x2.5"</td> <td>•</td> <td>•</td> <td>•</td> <td>•</td> </tr> <tr> <td>16x2.5"</td> <td colspan="4">• (up to 105W CPU+24 DIMMs or 135W+16 DIMMs)</td> </tr> <tr> <td>24x2.5"</td> <td>•</td> <td>•</td> <td>•</td> <td>•</td> </tr> <tr> <td>2.5"+3.5"</td> <td>•</td> <td>•</td> <td>•</td> <td>•</td> </tr> </tbody> </table> <p>Note: 1. 750W Titanium is 200V - 240V, others are 110V - 240V. 2. 1600W will automatically operate in 1100W if the system line input is 100-127V.</p> | Disk bay configuration | PSU requirements | | | | 550W | 750W | 1100W | 1600W | 6x3.5" | • | • | • | • | 12x3.5" | • (up to 135W CPU) | | | | 8x2.5" | • | • | • | • | 16x2.5" | • (up to 105W CPU+24 DIMMs or 135W+16 DIMMs) | | | | 24x2.5" | • | • | • | • | 2.5"+3.5" | • | • | • |
| Disk bay configuration | PSU requirements | | | | | | | | | | | | | | | | | | | | | | | | | | | | | | | | | | | | | | |
| | 550W | 750W | 1100W | 1600W | | | | | | | | | | | | | | | | | | | | | | | | | | | | | | | | | | | |
| 6x3.5" | • | • | • | • | | | | | | | | | | | | | | | | | | | | | | | | | | | | | | | | | | | |
| 12x3.5" | • (up to 135W CPU) | | | | | | | | | | | | | | | | | | | | | | | | | | | | | | | | | | | | | | |
| 8x2.5" | • | • | • | • | | | | | | | | | | | | | | | | | | | | | | | | | | | | | | | | | | | |
| 16x2.5" | • (up to 105W CPU+24 DIMMs or 135W+16 DIMMs) | | | | | | | | | | | | | | | | | | | | | | | | | | | | | | | | | | | | | | |
| 24x2.5" | • | • | • | • | | | | | | | | | | | | | | | | | | | | | | | | | | | | | | | | | | | |
| 2.5"+3.5" | • | • | • | • | | | | | | | | | | | | | | | | | | | | | | | | | | | | | | | | | | | |
| Graphics | Onboard Aspeed AST2400 with 16MB memory, one DisplayPort on rear | | | | | | | | | | | | | | | | | | | | | | | | | | | | | | | | | | | | | | |
| Front ports | (Only 2.5" bay models) Two USB 2.0, one DisplayPort | | | | | | | | | | | | | | | | | | | | | | | | | | | | | | | | | | | | | | |
| Rear ports | One DisplayPort, two USB 3.0, one RJ-45 (dedicate mgmt), one serial (9-pin) | | | | | | | | | | | | | | | | | | | | | | | | | | | | | | | | | | | | | | |
| Cooling | Six (5+1, dual processors) or four (3+1, single processor), hot-swap | | | | | | | | | | | | | | | | | | | | | | | | | | | | | | | | | | | | | | |
| Noise emissions | Operating: < 6.5 Bels. Idle: < 6 Bels (Maximum configuration) | | | | | | | | | | | | | | | | | | | | | | | | | | | | | | | | | | | | | | |
| Environmental specification | <table border="1"> <tbody> <tr> <td>Temperature - operating</td> <td>41 °F to 113 °F (5 °C to 45 °C)</td> </tr> <tr> <td>Temperature - non operating (no package)</td> <td>-10 °C to 60 °C</td> </tr> <tr> <td>Temperature - non operating (with package)</td> <td>-40 °C to 60 °C</td> </tr> <tr> <td>Altitude - operating</td> <td>(Unpressurized): 0-10000ft (0-3048m)</td> </tr> <tr> <td>Humidity - operating</td> <td>8%-90%, non-condensing</td> </tr> <tr> <td>Humidity - storage (with package)</td> <td>8%-90%, non-condensing</td> </tr> </tbody> </table> <p>Note: 45 °C continuous operation configuration limitation: no 135W or 145W CPU/no GPU card/redundant PSU/no FLFH card/no PCIe SSD adapter.</p> | Temperature - operating | 41 °F to 113 °F (5 °C to 45 °C) | Temperature - non operating (no package) | -10 °C to 60 °C | Temperature - non operating (with package) | -40 °C to 60 °C | Altitude - operating | (Unpressurized): 0-10000ft (0-3048m) | Humidity - operating | 8%-90%, non-condensing | Humidity - storage (with package) | 8%-90%, non-condensing | | | | | | | | | | | | | | | | | | | | | | | | | | |
| Temperature - operating | 41 °F to 113 °F (5 °C to 45 °C) | | | | | | | | | | | | | | | | | | | | | | | | | | | | | | | | | | | | | | |
| Temperature - non operating (no package) | -10 °C to 60 °C | | | | | | | | | | | | | | | | | | | | | | | | | | | | | | | | | | | | | | |
| Temperature - non operating (with package) | -40 °C to 60 °C | | | | | | | | | | | | | | | | | | | | | | | | | | | | | | | | | | | | | | |
| Altitude - operating | (Unpressurized): 0-10000ft (0-3048m) | | | | | | | | | | | | | | | | | | | | | | | | | | | | | | | | | | | | | | |
| Humidity - operating | 8%-90%, non-condensing | | | | | | | | | | | | | | | | | | | | | | | | | | | | | | | | | | | | | | |
| Humidity - storage (with package) | 8%-90%, non-condensing | | | | | | | | | | | | | | | | | | | | | | | | | | | | | | | | | | | | | | |

Expansion slots

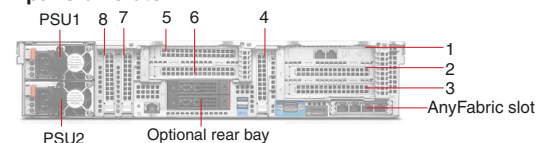

| | |
|-----------------------|--|
| Slot 1 (riser card 1) | PCIe 3.0 x 16, half length, full height |
| Slot 2 (riser card 1) | PCIe 3.0 x 16, half length, full height |
| Slot 3 (riser card 1) | PCIe 3.0 x 16, half length, full height |
| Slot 4 (onboard) | PCIe 3.0 x 16, low-profile, half length, requires 2nd CPU |
| Slot 5 (riser card 2) | PCIe 3.0 x 16, half length, full height, requires 2nd riser card and 2nd CPU |
| Slot 6 (riser card 2) | PCIe 3.0 x 16, half length, full height, requires 2nd riser card and 2nd CPU |
| Slot 7 (onboard) | PCIe 3.0 x 16, low-profile, half length, requires 2nd CPU |
| Slot 8 (onboard) | PCIe 3.0 x 16, low-profile, half length, requires 2nd CPU |

Notes:
On 2.5" disk bay models, slots 1 and 2 can be replaced with one PCIe 3.0 x 16 slot, double wide, full length, full height. Slots 5 and 6 can be replaced with one PCIe 3.0 x 16 slot, double wide, full length, full height.

| Model | Region | Processor | 2nd CPU | Memory | RAID Controller | Disk Bays | Storage | Slots | Optical | Add-on NIC | TPM | System Mgmt | OS | Warranty | Power Supply | Ann Date (m/y) |
|------------|--------|---|------------|---------------------------------|-----------------------------|---------------|---------|------------|---------|------------|-----|-------------|------|----------|---------------------|----------------|
| 70D0000FUX | US | 1xE5-2609 v3 6C/1.9GHz/15MB/85W/DDR4-1600 | 4XG0F28820 | 1x8GB RDIMM DDR4-2133 ECC | AnyRAID 720ix+1GB RAM | 12x3.5" HS | Open | 3xFH HL | None | None | TPM | TSM | None | 3-year | 1100Wx1 Platinum | 09/14 |
| 70D0000GUX | US | 1xE5-2620 v3 6C/2.4GHz/15MB/85W/DDR4-1866 | 4XG0F28819 | 1x8GB RDIMM DDR4-2133 ECC | AnyRAID 720ix+1GB RAM | 12x3.5" HS | Open | 3xFH HL | None | None | TPM | TSM | None | 3-year | 1100Wx1 Platinum | 09/14 |
| 70D0000HUX | US | 1xE5-2640 v3 8C/2.6GHz/20MB/90W/DDR4-1866 | 4XG0F28817 | 1x8GB RDIMM DDR4-2133 ECC | AnyRAID 720ix+1GB RAM | 12x3.5" HS | Open | 3xFH HL | None | None | TPM | TSM | None | 3-year | 1100Wx1 Platinum | 09/14 |
| 70D0000JUX | US | 1xE5-2650 v3 10C/2.3GHz/25MB/105W/DDR4-2133 | 4XG0F28816 | 1x8GB RDIMM DDR4-2133 ECC | AnyRAID 720ix+1GB RAM | 12x3.5" HS | Open | 3xFH HL | None | None | TPM | TSM | None | 3-year | 1100Wx1 Platinum | 09/14 |
| 70D0000KUX | US | 1xE5-2690 v3 12C/2.6GHz/30MB/135W/DDR4-2133 | 4XG0F28811 | 1x8GB RDIMM DDR4-2133 ECC | AnyRAID 720ix+1GB RAM | 12x3.5" HS | Open | 3xFH HL | None | None | TPM | TSM | None | 3-year | 1100Wx1 Platinum | 09/14 |
| 70D00025UX | US | 1xE5-2630 v3 8C/2.4GHz/20MB/85W/DDR4-1866 | 4XG0F28818 | 1x8GB RDIMM DDR4-2133 ECC | AnyRAID 720ix+1GB RAM | 12x3.5" HS | Open | 3xFH HL | None | None | TPM | TSM | None | 3-year | 1100Wx1 Platinum | 10/14 |
| 70D00026UX | US | 1xE5-2603 v3 6C/1.6GHz/15MB/85W/DDR4-1600 | 4XG0F28821 | 1x8GB RDIMM DDR4-2133 ECC | AnyRAID 110i | 6x3.5" HS | Open | No | None | None | TPM | TSM | None | 3-year | 550Wx1 Platinum | 10/14 |
| 70D0002BUX | US | 1xE5-2630 v3 8C/2.4GHz/20MB/85W/DDR4-1866 | 4XG0F28818 | 1x8GB RDIMM DDR4-2133 ECC | AnyRAID 720ix+1GB RAM | 12x3.5" HS | Open | 3xFH HL | None | None | TPM | TSM | None | 3-year | 750Wx1 Platinum | 02/15 |

| Model | Region | Processor | 2nd CPU | Memory | RAID Controller | Disk Bays | Storage | Slots | Optical | Add-on NIC | TPM | System Mgmt | OS | Warranty | Power Supply | Ann Date (m/y) |
|------------|--------|---|------------|---------------------------------|-----------------------------|---------------|---------|-------|---------|------------|-----|-------------|------|----------|--------------------|----------------|
| 70D20024UX | US | 1xE5-2603 v3 6C/1.6GHz/15MB/85W/DDR4-1600 | 4XG0F28821 | 1x8GB RDIMM DDR4-2133 ECC | AnyRAID 720ix+1GB RAM | 24x2.5" HS | Open | No | None | None | TPM | TSM | None | 3-year | 750Wx1 Platinum | 10/14 |

| Model | Region | Processor | 2nd CPU | Memory | RAID Controller | Disk Bays | Storage | Slots | Optical | Add-on NIC | TPM | System Mgmt | OS | Warranty | Power Supply | Ann Date (m/y) |
|------------|--------|---|------------|----------------------------|-------------------------|-----------------|--|-----------------|---------|-------------------------|-----|-------------|------|----------|------------------|----------------|
| 70D4000CUX | US | 1xE5-2620 v3 6C/2.4GHz/15MB/85W/DDR4-1866 | 4XG0F28819 | 1x8GB RDIMM DDR4-2133 ECC | AnyRAID 720ix+1GB RAM | 6+9 HS | Open | 3xFH HL | None | None | TPM | TSM | None | 3-year | 1100Wx1 Platinum | 09/14 |
| 70D4000DUX | US | 1xE5-2640 v3 8C/2.6GHz/20MB/90W/DDR4-1866 | 4XG0F28817 | 1x8GB RDIMM DDR4-2133 ECC | AnyRAID 720ix+1GB RAM | 6+9 HS | Open | 3xFH HL | None | None | TPM | TSM | None | 3-year | 1100Wx1 Platinum | 09/14 |
| 70D4000EUX | US | 1xE5-2650 v3 10C/2.3GHz/25MB/105W/DDR4-2133 | 4XG0F28816 | 1x8GB RDIMM DDR4-2133 ECC | AnyRAID 720ix+1GB RAM | 6+9 HS | Open | 3xFH HL | None | None | TPM | TSM | None | 3-year | 1100Wx1 Platinum | 09/14 |
| 70D4000FUX | US | 1xE5-2690 v3 12C/2.6GHz/30MB/135W/DDR4-2133 | 4XG0F28811 | 1x8GB RDIMM DDR4-2133 ECC | AnyRAID 720ix+1GB RAM | 6+9 HS | Open | 3xFH HL | None | None | TPM | TSM | None | 3-year | 1100Wx1 Platinum | 09/14 |
| 70D4001RUX | US | 1xE5-2603 v3 6C/1.6GHz/15MB/85W/DDR4-1600 | 4XG0F28821 | 1x8GB RDIMM DDR4-2133 ECC | AnyRAID 720ix+1GB RAM | 6+9 HS | Open | No | None | None | TPM | TSM | None | 3-year | 750Wx1 Platinum | 10/14 |
| 70D4001UUX | US | 1xE5-2650 v3 10C/2.3GHz/25MB/105W/DDR4-2133 | 4XG0F28816 | 1x8GB RDIMM DDR4-2133 ECC | AnyRAID 720ix+1GB RAM | 6+9 HS | Open | 3xFH HL | None | None | TPM | TSM | None | 3-year | 750Wx1 Platinum | 02/15 |
| 70D40025UX | US | 2xE5-2620 v3 6C/2.4GHz/15MB/85W/DDR4-1866 | - | 2x16GB RDIMM DDR4-2133 ECC | AnyRAID 720ix+1GB Flash | 6+9 HS | Open | 5xFH HL+3xLP HL | None | 10GbEx2 RJ-45 AnyFabric | TPM | TSM Premium | None | 3-year | 750Wx2 Platinum | 09/15 |
| 70D40026UX | US | 2xE5-2690 v3 12C/2.6GHz/30MB/135W/DDR4-2133 | - | 8x16GB RDIMM DDR4-2133 ECC | AnyRAID 720ix+1GB RAM | 6+9 HS | 4x600GB HDD 10K 2.5" SAS12Gbs | 3xLP HL | None | GbEx4 RJ-45 AnyFabric | TPM | TSM Premium | None | 3-year | 1100Wx2 Platinum | 02/16 |
| 70D40027UX | US | 1xE5-2650 v3 10C/2.3GHz/25MB/105W/DDR4-2133 | 4XG0F28816 | 4x16GB RDIMM DDR4-2133 ECC | AnyRAID 720ix+1GB RAM | 6+9 HS | 2x300GB HDD 15K 2.5" SAS12Gbs+2x2TB HDD 7.2K 3.5" SATA6Gbs | No | None | GbEx4 RJ-45 AnyFabric | TPM | TSM Premium | None | 3-year | 1100Wx2 Platinum | 02/16 |
| 70D40028UX | US | 2xE5-2650 v3 10C/2.3GHz/25MB/105W/DDR4-2133 | - | 8x16GB RDIMM DDR4-2133 ECC | AnyRAID 720ix+1GB RAM | 6+9 HS (AnyBay) | 2x120GB 2.5" SSD SATA6Gbs | 3xFH HL+3xLP HL | None | GbEx4 RJ-45 AnyFabric | TPM | TSM Premium | None | 3-year | 750Wx2 Platinum | 11/15 |
| 70D40029UX | US | 2xE5-2690 v3 12C/2.6GHz/30MB/135W/DDR4-2133 | - | 8x16GB RDIMM DDR4-2133 ECC | AnyRAID 720ix+1GB RAM | 6+9 HS (AnyBay) | 2x120GB 2.5" SSD SATA6Gbs | 3xFH HL+3xLP HL | None | GbEx4 RJ-45 AnyFabric | TPM | TSM Premium | None | 3-year | 750Wx2 Platinum | 11/15 |

| Model | Region | Processor | 2nd CPU | Memory | RAID Controller | Disk Bays | Storage | Slots | Optical | Add-on NIC | TPM | System Mgmt | OS | Warranty | Power Supply | Ann Date (m/y) |
|------------|--------|---|------------|---------------------------------|----------------------------|--------------|---------------------------------------|-----------------------|-----------------|--------------------------|-----|----------------|------|----------|---------------------|----------------|
| 70DR000QUX | US | 1xE5-2609 v3 6C/1.9GHz/15MB/85W/DDR4-1600 | 4XG0F28820 | 1x8GB RDIMM DDR4-2133 ECC | AnyRAID 510i | 8x2.5" HS | Open | 3xFH HL | 9.5mm DVD±RW | None | TPM | TSM | None | 3-year | 1100Wx1 Platinum | 09/14 |
| 70DR000RUX | US | 1xE5-2620 v3 6C/2.4GHz/15MB/85W/DDR4-1866 | 4XG0F28819 | 1x8GB RDIMM DDR4-2133 ECC | AnyRAID 510i | 8x2.5" HS | Open | 3xFH HL | 9.5mm DVD±RW | None | TPM | TSM | None | 3-year | 1100Wx1 Platinum | 09/14 |
| 70DR000SUX | US | 1xE5-2640 v3 8C/2.6GHz/20MB/90W/DDR4-1866 | 4XG0F28817 | 1x8GB RDIMM DDR4-2133 ECC | AnyRAID 510i | 8x2.5" HS | Open | 3xFH HL | 9.5mm DVD±RW | None | TPM | TSM | None | 3-year | 1100Wx1 Platinum | 09/14 |
| 70DR000TUX | US | 1xE5-2650 v3 10C/2.3GHz/25MB/105W/DDR4-2133 | 4XG0F28816 | 1x8GB RDIMM DDR4-2133 ECC | AnyRAID 510i | 8x2.5" HS | Open | 3xFH HL | 9.5mm DVD±RW | None | TPM | TSM | None | 3-year | 1100Wx1 Platinum | 09/14 |
| 70DR002KUX | US | 1xE5-2630 v3 8C/2.4GHz/20MB/85W/DDR4-1866 | 4XG0F28818 | 1x8GB RDIMM DDR4-2133 ECC | AnyRAID 510i | 8x2.5" HS | Open | 3xFH HL | None | None | TPM | TSM | None | 3-year | 1100Wx1 Platinum | 10/14 |
| 70DR002LUX | US | 2xE5-2630 v3 8C/2.4GHz/20MB/85W/DDR4-1866 | - | 2x8GB RDIMM DDR4-2133 ECC | AnyRAID 510i | 8x2.5" HS | Open | 3xFH HL+3xLP HL | None | None | TPM | TSM | None | 3-year | 1100Wx1 Platinum | 10/14 |
| 70DR002MUX | US | 1xE5-2603 v3 6C/1.6GHz/15MB/85W/DDR4-1600 | 4XG0F28821 | 1x8GB RDIMM DDR4-2133 ECC | AnyRAID 510i | 8x2.5" HS | Open | 3xFH HL | None | None | TPM | TSM | None | 3-year | 750Wx1 Platinum | 10/14 |
| 70DR002RUX | US | 1xE5-2620 v3 6C/2.4GHz/15MB/85W/DDR4-1866 | 4XG0F28819 | 2x8GB RDIMM DDR4-2133 ECC | AnyRAID 720i+1GB RAM | 8x2.5" HS | 2x300GB HDD 10K 2.5" SAS6Gbs | 3xFH HL | None | GbEx4 RJ-45 AnyFabric | TPM | TSM Premium | None | 3-year | 750Wx2 Platinum | 02/15 |
| 70DR002SUX | US | 1xE5-2620 v3 6C/2.4GHz/15MB/85W/DDR4-1866 | 4XG0F28819 | 1x8GB RDIMM DDR4-2133 ECC | AnyRAID 510i | 8x2.5" HS | Open | 3xFH HL | None | None | TPM | TSM | None | 3-year | 750Wx1 Platinum | 02/15 |

| Model | Region | Processor | 2nd CPU | Memory | RAID Controller | Disk Bays | Storage | Slots | Optical | Add-on NIC | TPM | System Mgmt | OS | Warranty | Power Supply | Ann Date (m/y) |
|------------|--------|---|------------|---------------------------------|-------------------------------|---------------|---------|-------|---------|------------|-----|-------------|------|----------|--------------------|----------------|
| 70DT000CUX | US | 1xE5-2603 v3 6C/1.6GHz/15MB/85W/DDR4-1600 | 4XG0F28821 | 1x8GB RDIMM DDR4-2133 ECC | AnyRAID 720ix+1GB Flash | 16x2.5" HS | Open | No | None | None | TPM | TSM | None | 3-year | 750Wx1 Platinum | 10/14 |



ThinkServer RS140 Platform Specifications

Product Specifications Reference (PSREF)

| Components | Specification | | | | | | | | | | | | |
|-----------------------------|---|--|--------------------------------------|--------------------------------------|--------------|----------------------------|--------------|---------------|----------------------|--------------|--|---------------|-------------------------------------|
| Dimensions | 1U rack. Height: 43.5 mm (1.71 in), width: 430 mm (16.9 in), depth: 411 mm (16.2 in) | | | | | | | | | | | | |
| Weight | Maximum configuration: 16.2 lb (7.36kg) | | | | | | | | | | | | |
| Processor | Supports one of the following Intel processors (code name: Haswell): <ul style="list-style-type: none"> Xeon E3-1200 v3: up to 4C/3.7GHz/8MB/84W/1600MHz Core i3: up to 2C/3.7GHz/4MB/54W/1600MHz Pentium: up to 2C/3.4GHz/3MB/53W/1600MHz Celeron: up to 2C/2.9GHz/2MB/53W/1333MHz <i>Note: Supports processors with integrated graphics only.</i> | | | | | | | | | | | | |
| Chipset | Intel C226 Platform Controller Hub (PCH) | | | | | | | | | | | | |
| Memory DIMMs | 4 DIMM sockets, 2-channel capable. UDIMM, DDR3 | | | | | | | | | | | | |
| Memory capacity | 32GB (4 x 8GB) | | | | | | | | | | | | |
| Memory protection | ECC | | | | | | | | | | | | |
| RAID controller | RAID 0, 1, 5, 10 with onboard RAID 100, 6Gb/s SATA. RAID 0, 1, 10 with RAID 500, PCIe adapter, 6Gb/s SAS/SATA, optional key for RAID5. RAID 0, 1, 10, 5, 6 with RAID 700, PCIe adapter, 6Gb/s SAS/SATA, optional Intelligent Battery Backup Unit (iBBU08) <i>Note: RAID 5, 6, and 10 needs 4 x 2.5" bays.</i> | | | | | | | | | | | | |
| Disk drive bays | Up to 2 3.5" disk bays or up to 4 2.5" disk bays. Direct cabled, non-hot swap. Supports optional external USB RDX tape drive | | | | | | | | | | | | |
| Supporting disk drives | <table border="1"> <tbody> <tr> <td rowspan="2">For 3.5" bay</td> <td>3.5" SATA HDD</td> <td>7.2K 6Gbs: 500GB/1TB/2TB/3TB/4TB/6TB</td> </tr> <tr> <td>3.5" SAS HDD</td> <td>7.2K 6Gbs: 1TB/2TB/3TB/4TB</td> </tr> <tr> <td rowspan="3">For 2.5" bay</td> <td>2.5" SATA HDD</td> <td>7.2K 6Gbs: 500GB/1TB</td> </tr> <tr> <td>2.5" SAS HDD</td> <td>10K 6Gbs: 300GB/600GB/900GB. 15K 6Gbs: 146GB/300GB</td> </tr> <tr> <td>2.5" SATA SSD</td> <td>6Gbs: 120GB/240GB/300GB/480GB/600GB</td> </tr> </tbody> </table> | For 3.5" bay | 3.5" SATA HDD | 7.2K 6Gbs: 500GB/1TB/2TB/3TB/4TB/6TB | 3.5" SAS HDD | 7.2K 6Gbs: 1TB/2TB/3TB/4TB | For 2.5" bay | 2.5" SATA HDD | 7.2K 6Gbs: 500GB/1TB | 2.5" SAS HDD | 10K 6Gbs: 300GB/600GB/900GB. 15K 6Gbs: 146GB/300GB | 2.5" SATA SSD | 6Gbs: 120GB/240GB/300GB/480GB/600GB |
| For 3.5" bay | 3.5" SATA HDD | | 7.2K 6Gbs: 500GB/1TB/2TB/3TB/4TB/6TB | | | | | | | | | | |
| | 3.5" SAS HDD | 7.2K 6Gbs: 1TB/2TB/3TB/4TB | | | | | | | | | | | |
| For 2.5" bay | 2.5" SATA HDD | 7.2K 6Gbs: 500GB/1TB | | | | | | | | | | | |
| | 2.5" SAS HDD | 10K 6Gbs: 300GB/600GB/900GB. 15K 6Gbs: 146GB/300GB | | | | | | | | | | | |
| | 2.5" SATA SSD | 6Gbs: 120GB/240GB/300GB/480GB/600GB | | | | | | | | | | | |
| Optical drive | Up to one 9.5mm optical. DVD-ROM or DVD±RW | | | | | | | | | | | | |
| Network interfaces | Two Gigabit Ethernet ports by Intel I210, on riser card. One Gigabit Ethernet port by Intel I217, dedicate/share management | | | | | | | | | | | | |
| Security features | Power-on and administrator password. TPM (TCG 1.2-compliant). | | | | | | | | | | | | |
| Systems management | Intel Active Management Technology 9 on models with Xeon processor. Remote presence is supported on models with Xeon processors. Supports ThinkServer EasyStartup/EasyUpdate | | | | | | | | | | | | |
| Operating systems supported | Microsoft Windows Server 2016/2012 R2/2012/2008 R2. Windows Small Business Server 2011. Red Hat Enterprise Linux 6.5. SUSE Linux Enterprise Server 11 SP3. VMware vSphere (ESXi) 5.5 <i>Note: VMware requires add-on network adapter.</i> | | | | | | | | | | | | |

| Components | Specification | |
|-----------------------------|---|---|
| Base warranty | 1 or 3-year limited onsite service with 9x5/NBD. | |
| Power supply | One fixed 300 watts power supply, 80 PLUS Gold qualified | |
| Graphics | Integrated Intel HD Graphics in processor | |
| Front ports | Two USB 2.0 | |
| Rear ports | Four USB 3.0, two USB 2.0, one serial (9-pin), two ethernet (RJ-45), one RJ-45 (dedicate/share mgmt), one VGA, one DisplayPort. Optional two serial ports via PCIe adapter | |
| Noise emissions | Operating: < 5.2 Bels. Idle: < 5.0 Bels (Mainstream configuration) | |
| Environmental specification | RoHS-compliant. | |
| | Temperature - operating | 50 °F to 95 °F (10 °C to 35 °C) |
| | Temperature - storage (with package) | -40 °C to 70 °C |
| | Altitude - operating | Supported Altitude (unpressurized): 0-10000ft (0-3048m) |
| | Humidity - operating | 10%-80%, non-condensing |
| | Humidity - storage (with package) | 10%-90%, non-condensing |

Expansion slots and disk bays

Supports one PCI-Express slot via riser card, half-length, full-height, PCIe 3.0 x8

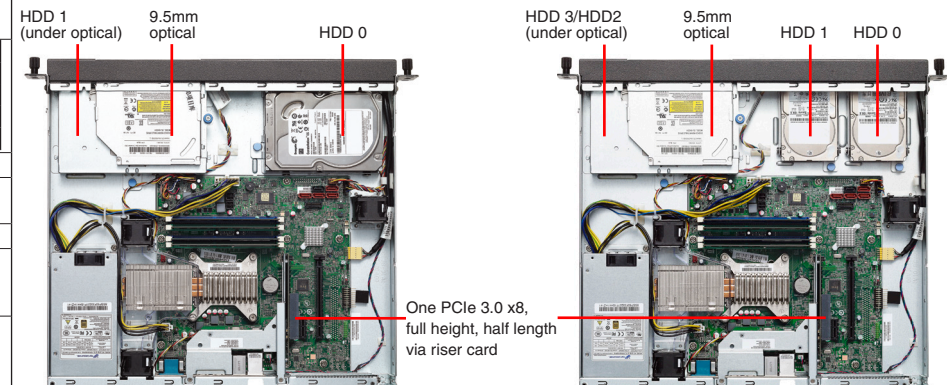

| Model | Region | Processor | Memory | RAID Controller | Disk Bays | Storage | Optical | Add-on NIC | Add-on Ports | System Mgmt | OS | Warranty | Power Supply | Ann Date (m/y) |
|------------|--------|---|---------------------------|-----------------|-----------|--------------------------------|--------------|------------|--------------|-------------|---------------------|----------|-----------------|----------------|
| 70F30006UX | US | Core i3-4130 2C/3.4GHz/3MB/54W/DDR3-1600 | 1x4GB UDIMM DDR3-1600 ECC | RAID 100 | 4x2.5" DC | Open | 9.5mm DVD±RW | None | None | AMT9 | None | 1-year | 300W Gold Fixed | 06/14 |
| 70F30007UX | US | Xeon E3-1225 v3 4C/3.2GHz/8MB/84W/DDR3-1600 | 1x4GB UDIMM DDR3-1600 ECC | RAID 100 | 4x2.5" DC | Open | 9.5mm DVD±RW | None | None | AMT9 | None | 1-year | 300W Gold Fixed | 06/14 |
| 70F30008UX | US | Xeon E3-1245 v3 4C/3.4GHz/8MB/84W/DDR3-1600 | 1x4GB UDIMM DDR3-1600 ECC | RAID 100 | 4x2.5" DC | Open | 9.5mm DVD±RW | None | None | AMT9 | None | 1-year | 300W Gold Fixed | 06/14 |
| 70F30009UX | US | Xeon E3-1225 v3 4C/3.2GHz/8MB/84W/DDR3-1600 | 1x4GB UDIMM DDR3-1600 ECC | RAID 500 | 4x2.5" DC | Open | 9.5mm DVD±RW | None | None | AMT9 | None | 1-year | 300W Gold Fixed | 06/14 |
| 70F3000AUX | US | Xeon E3-1245 v3 4C/3.4GHz/8MB/84W/DDR3-1600 | 1x4GB UDIMM DDR3-1600 ECC | RAID 500 | 4x2.5" DC | Open | 9.5mm DVD±RW | None | None | AMT9 | None | 1-year | 300W Gold Fixed | 06/14 |
| 70F3000BUX | US | Xeon E3-1245 v3 4C/3.4GHz/8MB/84W/DDR3-1600 | 1x8GB UDIMM DDR3-1600 ECC | RAID 500+Key | 4x2.5" DC | Open | 9.5mm DVD±RW | None | None | AMT9 | None | 1-year | 300W Gold Fixed | 06/14 |
| 70F3000CUX | US | Xeon E3-1245 v3 4C/3.4GHz/8MB/84W/DDR3-1600 | 1x8GB UDIMM DDR3-1600 ECC | RAID 700 | 4x2.5" DC | Open | 9.5mm DVD±RW | None | None | AMT9 | None | 1-year | 300W Gold Fixed | 06/14 |
| 70F3000DUS | US | Xeon E3-1225 v3 4C/3.2GHz/8MB/84W/DDR3-1600 | 2x4GB UDIMM DDR3-1600 ECC | RAID 500+Key | 4x2.5" DC | 2x500GB HDD 7.2K 2.5" SATA6Gbs | 9.5mm DVD±RW | None | None | AMT9 | 2012 R2 Standard | 1-year | 300W Gold Fixed | 06/14 |
| 70F3000EUS | US | Xeon E3-1245 v3 4C/3.4GHz/8MB/84W/DDR3-1600 | 2x8GB UDIMM DDR3-1600 ECC | RAID 700 | 4x2.5" DC | 4x500GB HDD 7.2K 2.5" SATA6Gbs | 9.5mm DVD±RW | None | None | AMT9 | 2012 R2 Standard | 1-year | 300W Gold Fixed | 06/14 |
| 70F30017UX | US | Core i3-4150 2C/3.5GHz/3MB/54W/DDR3-1600 | 1x4GB UDIMM DDR3-1600 ECC | RAID 100 | 4x2.5" DC | Open | 9.5mm DVD±RW | None | None | AMT9 | None | 1-year | 300W Gold Fixed | 09/14 |
| 70F30018UX | US | Xeon E3-1226 v3 4C/3.3GHz/8MB/84W/DDR3-1600 | 1x4GB UDIMM DDR3-1600 ECC | RAID 100 | 4x2.5" DC | Open | 9.5mm DVD±RW | None | None | AMT9 | None | 1-year | 300W Gold Fixed | 09/14 |
| 70F30019UX | US | Xeon E3-1246 v3 4C/3.5GHz/8MB/84W/DDR3-1600 | 1x4GB UDIMM DDR3-1600 ECC | RAID 100 | 4x2.5" DC | Open | 9.5mm DVD±RW | None | None | AMT9 | None | 1-year | 300W Gold Fixed | 09/14 |
| 70F3001AUX | US | Xeon E3-1226 v3 4C/3.3GHz/8MB/84W/DDR3-1600 | 1x4GB UDIMM DDR3-1600 ECC | RAID 500 | 4x2.5" DC | Open | 9.5mm DVD±RW | None | None | AMT9 | None | 1-year | 300W Gold Fixed | 09/14 |
| 70F3001BUX | US | Xeon E3-1246 v3 4C/3.5GHz/8MB/84W/DDR3-1600 | 1x4GB UDIMM DDR3-1600 ECC | RAID 500 | 4x2.5" DC | Open | 9.5mm DVD±RW | None | None | AMT9 | None | 1-year | 300W Gold Fixed | 09/14 |
| 70F3001EUS | US | Xeon E3-1226 v3 4C/3.3GHz/8MB/84W/DDR3-1600 | 1x4GB UDIMM DDR3-1600 ECC | RAID 100 | 4x2.5" DC | 2x500GB HDD 7.2K 2.5" SATA6Gbs | 9.5mm DVD±RW | None | None | AMT9 | 2012 R2 Foundations | 1-year | 300W Gold Fixed | 09/14 |
| 70F3001FUS | US | Xeon E3-1226 v3 4C/3.3GHz/8MB/84W/DDR3-1600 | 1x4GB UDIMM DDR3-1600 ECC | RAID 100 | 4x2.5" DC | 2x500GB HDD 7.2K 2.5" SATA6Gbs | 9.5mm DVD±RW | None | None | AMT9 | 2012 R2 Essentials | 1-year | 300W Gold Fixed | 09/14 |
| 70F3001GUS | US | Xeon E3-1226 v3 4C/3.3GHz/8MB/84W/DDR3-1600 | 1x4GB UDIMM DDR3-1600 ECC | RAID 100 | 4x2.5" DC | 2x120GB SSD 2.5" SATA6Gbs | 9.5mm DVD±RW | None | None | AMT9 | 2012 R2 Foundations | 1-year | 300W Gold Fixed | 09/14 |
| 70F3001HUS | US | Xeon E3-1226 v3 4C/3.3GHz/8MB/84W/DDR3-1600 | 1x4GB UDIMM DDR3-1600 ECC | RAID 100 | 4x2.5" DC | 2x120GB SSD 2.5" SATA6Gbs | 9.5mm DVD±RW | None | None | AMT9 | 2012 R2 Essentials | 1-year | 300W Gold Fixed | 09/14 |

| Model | Region | Processor | Memory | RAID Controller | Disk Bays | Storage | Optical | Add-on NIC | Add-on Ports | System Mgmt | OS | Warranty | Power Supply | Ann Date (m/y) |
|------------|--------|---|---------------------------|-----------------|-----------|--------------------------------|--------------|------------|--------------|-------------|---------------------|----------|-----------------|----------------|
| 70F90007UX | US | Core i3-4130 2C/3.4GHz/3MB/54W/DDR3-1600 | 1x4GB UDIMM DDR3-1600 ECC | RAID 100 | 2x3.5" DC | Open | 9.5mm DVD±RW | None | None | AMT9 | None | 1-year | 300W Gold Fixed | 06/14 |
| 70F90008UX | US | Xeon E3-1225 v3 4C/3.2GHz/8MB/84W/DDR3-1600 | 1x4GB UDIMM DDR3-1600 ECC | RAID 100 | 2x3.5" DC | Open | 9.5mm DVD±RW | None | None | AMT9 | None | 1-year | 300W Gold Fixed | 06/14 |
| 70F90009UX | US | Xeon E3-1245 v3 4C/3.4GHz/8MB/84W/DDR3-1600 | 1x4GB UDIMM DDR3-1600 ECC | RAID 100 | 2x3.5" DC | Open | 9.5mm DVD±RW | None | None | AMT9 | None | 1-year | 300W Gold Fixed | 06/14 |
| 70F9000AUX | US | Core i3-4130 2C/3.4GHz/3MB/54W/DDR3-1600 | 1x4GB UDIMM DDR3-1600 ECC | RAID 500 | 2x3.5" DC | Open | 9.5mm DVD±RW | None | None | AMT9 | None | 1-year | 300W Gold Fixed | 06/14 |
| 70F9000BUX | US | Xeon E3-1225 v3 4C/3.2GHz/8MB/84W/DDR3-1600 | 1x4GB UDIMM DDR3-1600 ECC | RAID 500 | 2x3.5" DC | Open | 9.5mm DVD±RW | None | None | AMT9 | None | 1-year | 300W Gold Fixed | 06/14 |
| 70F9000CUX | US | Xeon E3-1245 v3 4C/3.4GHz/8MB/84W/DDR3-1600 | 1x4GB UDIMM DDR3-1600 ECC | RAID 500 | 2x3.5" DC | Open | 9.5mm DVD±RW | None | None | AMT9 | None | 1-year | 300W Gold Fixed | 06/14 |
| 70F9000DUX | US | Xeon E3-1225 v3 4C/3.2GHz/8MB/84W/DDR3-1600 | 2x4GB UDIMM DDR3-1600 ECC | RAID 500 | 2x3.5" DC | Open | 9.5mm DVD±RW | None | None | AMT9 | None | 1-year | 300W Gold Fixed | 06/14 |
| 70F9000EUX | US | Xeon E3-1245 v3 4C/3.4GHz/8MB/84W/DDR3-1600 | 2x8GB UDIMM DDR3-1600 ECC | RAID 500 | 2x3.5" DC | Open | 9.5mm DVD±RW | None | None | AMT9 | None | 1-year | 300W Gold Fixed | 06/14 |
| 70F9000FUS | US | Xeon E3-1225 v3 4C/3.2GHz/8MB/84W/DDR3-1600 | 2x4GB UDIMM DDR3-1600 ECC | RAID 500 | 2x3.5" DC | 2x500GB HDD 7.2K 3.5" SATA6Gbs | 9.5mm DVD±RW | None | None | AMT9 | 2012 R2 Standard | 1-year | 300W Gold Fixed | 06/14 |
| 70F9000GUS | US | Xeon E3-1245 v3 4C/3.4GHz/8MB/84W/DDR3-1600 | 2x8GB UDIMM DDR3-1600 ECC | RAID 500 | 2x3.5" DC | 2x500GB HDD 7.2K 3.5" SATA6Gbs | 9.5mm DVD±RW | None | None | AMT9 | 2012 R2 Standard | 1-year | 300W Gold Fixed | 06/14 |
| 70F9000HUS | US | Xeon E3-1225 v3 4C/3.2GHz/8MB/84W/DDR3-1600 | 2x4GB UDIMM DDR3-1600 ECC | RAID 500 | 2x3.5" DC | 2x500GB HDD 7.2K 3.5" SATA6Gbs | 9.5mm DVD±RW | None | None | AMT9 | 2012 R2 Essentials | 1-year | 300W Gold Fixed | 06/14 |
| 70F9001MUX | US | Core i3-4150 2C/3.5GHz/3MB/54W/DDR3-1600 | 1x4GB UDIMM DDR3-1600 ECC | RAID 100 | 2x3.5" DC | Open | 9.5mm DVD±RW | None | None | AMT9 | None | 1-year | 300W Gold Fixed | 09/14 |
| 70F9001NUX | US | Xeon E3-1226 v3 4C/3.3GHz/8MB/84W/DDR3-1600 | 1x4GB UDIMM DDR3-1600 ECC | RAID 100 | 2x3.5" DC | Open | 9.5mm DVD±RW | None | None | AMT9 | None | 1-year | 300W Gold Fixed | 09/14 |
| 70F9001PUX | US | Xeon E3-1246 v3 4C/3.5GHz/8MB/84W/DDR3-1600 | 1x4GB UDIMM DDR3-1600 ECC | RAID 100 | 2x3.5" DC | Open | 9.5mm DVD±RW | None | None | AMT9 | None | 1-year | 300W Gold Fixed | 09/14 |
| 70F9001QUX | US | Xeon E3-1226 v3 4C/3.3GHz/8MB/84W/DDR3-1600 | 1x4GB UDIMM DDR3-1600 ECC | RAID 500 | 2x3.5" DC | Open | 9.5mm DVD±RW | None | None | AMT9 | None | 1-year | 300W Gold Fixed | 09/14 |
| 70F9001RUX | US | Xeon E3-1246 v3 4C/3.5GHz/8MB/84W/DDR3-1600 | 1x4GB UDIMM DDR3-1600 ECC | RAID 500 | 2x3.5" DC | Open | 9.5mm DVD±RW | None | None | AMT9 | None | 1-year | 300W Gold Fixed | 09/14 |
| 70F9001UUS | US | Xeon E3-1226 v3 4C/3.3GHz/8MB/84W/DDR3-1600 | 1x4GB UDIMM DDR3-1600 ECC | RAID 100 | 2x3.5" DC | 2x500GB HDD 7.2K 3.5" SATA6Gbs | 9.5mm DVD±RW | None | None | AMT9 | 2012 R2 Foundations | 1-year | 300W Gold Fixed | 09/14 |
| 70F9001VUS | US | Xeon E3-1226 v3 4C/3.3GHz/8MB/84W/DDR3-1600 | 1x4GB UDIMM DDR3-1600 ECC | RAID 100 | 2x3.5" DC | 2x500GB HDD 7.2K 3.5" SATA6Gbs | 9.5mm DVD±RW | None | None | AMT9 | 2012 R2 Essentials | 1-year | 300W Gold Fixed | 09/14 |

ThinkServer RS140 - 70F2

Product Specifications Reference (PSREF)

| Model | Region | Processor | Memory | RAID Controller | Disk Bays | Storage | Optical | Add-on NIC | Add-on Ports | System Mgmt | OS | Warranty | Power Supply | Ann Date (m/y) |
|------------|--------|---|------------------------------|-----------------|--------------|---------|---------|------------|--------------|-------------|------|----------|--------------------|----------------|
| 70F20001UX | US | Xeon E3-1225 v3 4C/3.2GHz/8MB/84W/DDR3-1600 | 2x4GB UDIMM DDR3-1600 ECC | RAID 100 | 4x2.5" DC | Open | None | None | None | AMT9 | None | 3-year | 300W Gold Fixed | 06/14 |
| 70F20002UX | US | Xeon E3-1245 v3 4C/3.4GHz/8MB/84W/DDR3-1600 | 2x8GB UDIMM DDR3-1600 ECC | RAID 700 | 4x2.5" DC | Open | None | None | None | AMT9 | None | 3-year | 300W Gold Fixed | 06/14 |

ThinkServer RS140 - 70F8

Product Specifications Reference (PSREF)

| Model | Region | Processor | Memory | RAID Controller | Disk Bays | Storage | Optical | Add-on NIC | Add-on Ports | System Mgmt | OS | Warranty | Power Supply | Ann Date (m/y) |
|------------|--------|---|------------------------------|-----------------|--------------|---------|-----------------|------------|--------------|-------------|------|----------|--------------------|----------------|
| 70F80000UX | US | Xeon E3-1225 v3 4C/3.2GHz/8MB/84W/DDR3-1600 | 2x4GB UDIMM DDR3-1600 ECC | RAID 100 | 2x3.5" DC | Open | 9.5mm DVD±RW | None | None | AMT9 | None | 3-year | 300W Gold Fixed | 06/14 |
| 70F80001UX | US | Xeon E3-1245 v3 4C/3.4GHz/8MB/84W/DDR3-1600 | 2x8GB UDIMM DDR3-1600 ECC | RAID 500 | 2x3.5" DC | Open | 9.5mm DVD±RW | None | None | AMT9 | None | 3-year | 300W Gold Fixed | 06/14 |



ThinkServer RS160 Platform Specifications

| Components | Specification | | | | | | | | | | | | | | | | | | | | | | | | | | | | | | | | | | | | | | |
|---|--|--|-----------------------------|-----------------------------|-----------------------------|-----------------------------|-----------------------------|-----------------------------|-----------------------------|-----------------------------|-----------------------------|---------------------------|-----------------------------|-----------------------------|-----------------------------|-----------------------------|---------------------------------|-----------------------------|-----------------------------|-----------------------------|-----------------------------|-----------------------------|-----------------------------|-----------------------------|-----------------------------|-----------------------------|-----------------------------|-----------------------------|---------------------------|-----------------------------|-----------------------------|-----------------------------|-----------------------------|-----------------------------|---------------------------|-----------------------------|-----------------------------|----------------|-----------------------------|
| Dimensions | 1U rack. Height: 43.2 mm (1.7 in), width: 438.5 mm (17.26 in), depth: 393.7 mm (15.5 in) | | | | | | | | | | | | | | | | | | | | | | | | | | | | | | | | | | | | | | |
| Weight | Minimum configuration: 6.2 kg (13.67 lb), maximum: 7.6 kg (16.76 lb) | | | | | | | | | | | | | | | | | | | | | | | | | | | | | | | | | | | | | | |
| Processor | Supports one of the following Intel "Kaby Lake" processors: | | | | | | | | | | | | | | | | | | | | | | | | | | | | | | | | | | | | | | |
| | <table border="1"> <tbody> <tr><td>Xeon E3-1280 v6</td><td>4C/3.9GHz/8MB/72W/DDR4-2400</td></tr> <tr><td>Xeon E3-1270 v6</td><td>4C/3.8GHz/8MB/72W/DDR4-2400</td></tr> <tr><td>Xeon E3-1240 v6</td><td>4C/3.7GHz/8MB/72W/DDR4-2400</td></tr> <tr><td>Xeon E3-1230 v6</td><td>4C/3.5GHz/8MB/72W/DDR4-2400</td></tr> <tr><td>Xeon E3-1225 v6</td><td>4C/3.3GHz/8MB/73W/DDR4-2400</td></tr> <tr><td>Xeon E3-1220 v6</td><td>4C/3GHz/8MB/72W/DDR4-2400</td></tr> <tr><td>Core i3-7320</td><td>2C/4.1GHz/4MB/51W/DDR4-2400</td></tr> <tr><td>Core i3-7300</td><td>2C/4GHz/4MB/51W/DDR4-2400</td></tr> <tr><td>Core i3-7300T</td><td>2C/3.5GHz/4MB/35W/DDR4-2400</td></tr> <tr><td>Core i3-7100</td><td>2C/3.9GHz/3MB/51W/DDR4-2400</td></tr> <tr><td>Core i3-7100T</td><td>2C/3.4GHz/3MB/35W/DDR4-2400</td></tr> <tr><td>Pentium G4620</td><td>2C/3.7GHz/3MB/51W/DDR4-2400</td></tr> <tr><td>Pentium G4600</td><td>2C/3.6GHz/3MB/51W/DDR4-2400</td></tr> <tr><td>Pentium G4600T</td><td>2C/3GHz/3MB/35W/DDR4-2400</td></tr> <tr><td>Pentium G4560</td><td>2C/3.5GHz/3MB/54W/DDR4-2400</td></tr> <tr><td>Pentium G4560T</td><td>2C/2.9GHz/3MB/35W/DDR4-2400</td></tr> <tr><td>Celeron G3950</td><td>2C/3GHz/2MB/51W/DDR4-2133</td></tr> <tr><td>Celeron G3930</td><td>2C/2.9GHz/2MB/51W/DDR4-2133</td></tr> <tr><td>Celeron G3930T</td><td>2C/2.7GHz/2MB/35W/DDR4-2133</td></tr> </tbody> </table> | Xeon E3-1280 v6 | 4C/3.9GHz/8MB/72W/DDR4-2400 | Xeon E3-1270 v6 | 4C/3.8GHz/8MB/72W/DDR4-2400 | Xeon E3-1240 v6 | 4C/3.7GHz/8MB/72W/DDR4-2400 | Xeon E3-1230 v6 | 4C/3.5GHz/8MB/72W/DDR4-2400 | Xeon E3-1225 v6 | 4C/3.3GHz/8MB/73W/DDR4-2400 | Xeon E3-1220 v6 | 4C/3GHz/8MB/72W/DDR4-2400 | Core i3-7320 | 2C/4.1GHz/4MB/51W/DDR4-2400 | Core i3-7300 | 2C/4GHz/4MB/51W/DDR4-2400 | Core i3-7300T | 2C/3.5GHz/4MB/35W/DDR4-2400 | Core i3-7100 | 2C/3.9GHz/3MB/51W/DDR4-2400 | Core i3-7100T | 2C/3.4GHz/3MB/35W/DDR4-2400 | Pentium G4620 | 2C/3.7GHz/3MB/51W/DDR4-2400 | Pentium G4600 | 2C/3.6GHz/3MB/51W/DDR4-2400 | Pentium G4600T | 2C/3GHz/3MB/35W/DDR4-2400 | Pentium G4560 | 2C/3.5GHz/3MB/54W/DDR4-2400 | Pentium G4560T | 2C/2.9GHz/3MB/35W/DDR4-2400 | Celeron G3950 | 2C/3GHz/2MB/51W/DDR4-2133 | Celeron G3930 | 2C/2.9GHz/2MB/51W/DDR4-2133 | Celeron G3930T | 2C/2.7GHz/2MB/35W/DDR4-2133 |
| | Xeon E3-1280 v6 | 4C/3.9GHz/8MB/72W/DDR4-2400 | | | | | | | | | | | | | | | | | | | | | | | | | | | | | | | | | | | | | |
| | Xeon E3-1270 v6 | 4C/3.8GHz/8MB/72W/DDR4-2400 | | | | | | | | | | | | | | | | | | | | | | | | | | | | | | | | | | | | | |
| | Xeon E3-1240 v6 | 4C/3.7GHz/8MB/72W/DDR4-2400 | | | | | | | | | | | | | | | | | | | | | | | | | | | | | | | | | | | | | |
| | Xeon E3-1230 v6 | 4C/3.5GHz/8MB/72W/DDR4-2400 | | | | | | | | | | | | | | | | | | | | | | | | | | | | | | | | | | | | | |
| | Xeon E3-1225 v6 | 4C/3.3GHz/8MB/73W/DDR4-2400 | | | | | | | | | | | | | | | | | | | | | | | | | | | | | | | | | | | | | |
| | Xeon E3-1220 v6 | 4C/3GHz/8MB/72W/DDR4-2400 | | | | | | | | | | | | | | | | | | | | | | | | | | | | | | | | | | | | | |
| | Core i3-7320 | 2C/4.1GHz/4MB/51W/DDR4-2400 | | | | | | | | | | | | | | | | | | | | | | | | | | | | | | | | | | | | | |
| | Core i3-7300 | 2C/4GHz/4MB/51W/DDR4-2400 | | | | | | | | | | | | | | | | | | | | | | | | | | | | | | | | | | | | | |
| | Core i3-7300T | 2C/3.5GHz/4MB/35W/DDR4-2400 | | | | | | | | | | | | | | | | | | | | | | | | | | | | | | | | | | | | | |
| | Core i3-7100 | 2C/3.9GHz/3MB/51W/DDR4-2400 | | | | | | | | | | | | | | | | | | | | | | | | | | | | | | | | | | | | | |
| | Core i3-7100T | 2C/3.4GHz/3MB/35W/DDR4-2400 | | | | | | | | | | | | | | | | | | | | | | | | | | | | | | | | | | | | | |
| | Pentium G4620 | 2C/3.7GHz/3MB/51W/DDR4-2400 | | | | | | | | | | | | | | | | | | | | | | | | | | | | | | | | | | | | | |
| | Pentium G4600 | 2C/3.6GHz/3MB/51W/DDR4-2400 | | | | | | | | | | | | | | | | | | | | | | | | | | | | | | | | | | | | | |
| | Pentium G4600T | 2C/3GHz/3MB/35W/DDR4-2400 | | | | | | | | | | | | | | | | | | | | | | | | | | | | | | | | | | | | | |
| | Pentium G4560 | 2C/3.5GHz/3MB/54W/DDR4-2400 | | | | | | | | | | | | | | | | | | | | | | | | | | | | | | | | | | | | | |
| | Pentium G4560T | 2C/2.9GHz/3MB/35W/DDR4-2400 | | | | | | | | | | | | | | | | | | | | | | | | | | | | | | | | | | | | | |
| | Celeron G3950 | 2C/3GHz/2MB/51W/DDR4-2133 | | | | | | | | | | | | | | | | | | | | | | | | | | | | | | | | | | | | | |
| | Celeron G3930 | 2C/2.9GHz/2MB/51W/DDR4-2133 | | | | | | | | | | | | | | | | | | | | | | | | | | | | | | | | | | | | | |
| | Celeron G3930T | 2C/2.7GHz/2MB/35W/DDR4-2133 | | | | | | | | | | | | | | | | | | | | | | | | | | | | | | | | | | | | | |
| | Processor | Supports one of the following Intel "Skylake" processors: | | | | | | | | | | | | | | | | | | | | | | | | | | | | | | | | | | | | | |
| | | <table border="1"> <tbody> <tr><td>Xeon E3-1280 v5</td><td>4C/3.7GHz/8MB/80W/DDR4-2133</td></tr> <tr><td>Xeon E3-1270 v5</td><td>4C/3.6GHz/8MB/80W/DDR4-2133</td></tr> <tr><td>Xeon E3-1240 v5</td><td>4C/3.5GHz/8MB/80W/DDR4-2133</td></tr> <tr><td>Xeon E3-1230 v5</td><td>4C/3.4GHz/8MB/80W/DDR4-2133</td></tr> <tr><td>Xeon E3-1220 v5</td><td>4C/3GHz/8MB/80W/DDR4-2133</td></tr> <tr><td>Xeon E3-1260L v5</td><td>4C/2.9GHz/8MB/45W/DDR4-2133</td></tr> <tr><td>Xeon E3-1240L v5</td><td>4C/2.1GHz/8MB/25W/DDR4-2133</td></tr> <tr><td>Xeon E3-1225 v5</td><td>4C/3.3GHz/8MB/80W/DDR4-2133</td></tr> <tr><td>Core i3-6320</td><td>2C/3.9GHz/4MB/51W/DDR4-2133</td></tr> <tr><td>Core i3-6300</td><td>2C/3.8GHz/4MB/51W/DDR4-2133</td></tr> <tr><td>Core i3-6100</td><td>2C/3.7GHz/3MB/51W/DDR4-2133</td></tr> <tr><td>Pentium G4520</td><td>2C/3.6GHz/3MB/51W/DDR4-2133</td></tr> <tr><td>Pentium G4500</td><td>2C/3.5GHz/3MB/51W/DDR4-2133</td></tr> <tr><td>Pentium G4400</td><td>2C/3.3GHz/3MB/54W/DDR4-2133</td></tr> <tr><td>Celeron G3920</td><td>2C/2.9GHz/2MB/51W/DDR4-2133</td></tr> <tr><td>Celeron G3900</td><td>2C/2.8GHz/2MB/51W/DDR4-2133</td></tr> <tr><td>Celeron G3900T</td><td>2C/2.6GHz/2MB/35W/DDR4-2133</td></tr> </tbody> </table> | Xeon E3-1280 v5 | 4C/3.7GHz/8MB/80W/DDR4-2133 | Xeon E3-1270 v5 | 4C/3.6GHz/8MB/80W/DDR4-2133 | Xeon E3-1240 v5 | 4C/3.5GHz/8MB/80W/DDR4-2133 | Xeon E3-1230 v5 | 4C/3.4GHz/8MB/80W/DDR4-2133 | Xeon E3-1220 v5 | 4C/3GHz/8MB/80W/DDR4-2133 | Xeon E3-1260L v5 | 4C/2.9GHz/8MB/45W/DDR4-2133 | Xeon E3-1240L v5 | 4C/2.1GHz/8MB/25W/DDR4-2133 | Xeon E3-1225 v5 | 4C/3.3GHz/8MB/80W/DDR4-2133 | Core i3-6320 | 2C/3.9GHz/4MB/51W/DDR4-2133 | Core i3-6300 | 2C/3.8GHz/4MB/51W/DDR4-2133 | Core i3-6100 | 2C/3.7GHz/3MB/51W/DDR4-2133 | Pentium G4520 | 2C/3.6GHz/3MB/51W/DDR4-2133 | Pentium G4500 | 2C/3.5GHz/3MB/51W/DDR4-2133 | Pentium G4400 | 2C/3.3GHz/3MB/54W/DDR4-2133 | Celeron G3920 | 2C/2.9GHz/2MB/51W/DDR4-2133 | Celeron G3900 | 2C/2.8GHz/2MB/51W/DDR4-2133 | Celeron G3900T | 2C/2.6GHz/2MB/35W/DDR4-2133 | | | |
| | | Xeon E3-1280 v5 | 4C/3.7GHz/8MB/80W/DDR4-2133 | | | | | | | | | | | | | | | | | | | | | | | | | | | | | | | | | | | | |
| | | Xeon E3-1270 v5 | 4C/3.6GHz/8MB/80W/DDR4-2133 | | | | | | | | | | | | | | | | | | | | | | | | | | | | | | | | | | | | |
| | | Xeon E3-1240 v5 | 4C/3.5GHz/8MB/80W/DDR4-2133 | | | | | | | | | | | | | | | | | | | | | | | | | | | | | | | | | | | | |
| | | Xeon E3-1230 v5 | 4C/3.4GHz/8MB/80W/DDR4-2133 | | | | | | | | | | | | | | | | | | | | | | | | | | | | | | | | | | | | |
| Xeon E3-1220 v5 | | 4C/3GHz/8MB/80W/DDR4-2133 | | | | | | | | | | | | | | | | | | | | | | | | | | | | | | | | | | | | | |
| Xeon E3-1260L v5 | | 4C/2.9GHz/8MB/45W/DDR4-2133 | | | | | | | | | | | | | | | | | | | | | | | | | | | | | | | | | | | | | |
| Xeon E3-1240L v5 | | 4C/2.1GHz/8MB/25W/DDR4-2133 | | | | | | | | | | | | | | | | | | | | | | | | | | | | | | | | | | | | | |
| Xeon E3-1225 v5 | | 4C/3.3GHz/8MB/80W/DDR4-2133 | | | | | | | | | | | | | | | | | | | | | | | | | | | | | | | | | | | | | |
| Core i3-6320 | | 2C/3.9GHz/4MB/51W/DDR4-2133 | | | | | | | | | | | | | | | | | | | | | | | | | | | | | | | | | | | | | |
| Core i3-6300 | | 2C/3.8GHz/4MB/51W/DDR4-2133 | | | | | | | | | | | | | | | | | | | | | | | | | | | | | | | | | | | | | |
| Core i3-6100 | | 2C/3.7GHz/3MB/51W/DDR4-2133 | | | | | | | | | | | | | | | | | | | | | | | | | | | | | | | | | | | | | |
| Pentium G4520 | | 2C/3.6GHz/3MB/51W/DDR4-2133 | | | | | | | | | | | | | | | | | | | | | | | | | | | | | | | | | | | | | |
| Pentium G4500 | | 2C/3.5GHz/3MB/51W/DDR4-2133 | | | | | | | | | | | | | | | | | | | | | | | | | | | | | | | | | | | | | |
| Pentium G4400 | | 2C/3.3GHz/3MB/54W/DDR4-2133 | | | | | | | | | | | | | | | | | | | | | | | | | | | | | | | | | | | | | |
| Celeron G3920 | | 2C/2.9GHz/2MB/51W/DDR4-2133 | | | | | | | | | | | | | | | | | | | | | | | | | | | | | | | | | | | | | |
| Celeron G3900 | | 2C/2.8GHz/2MB/51W/DDR4-2133 | | | | | | | | | | | | | | | | | | | | | | | | | | | | | | | | | | | | | |
| Celeron G3900T | | 2C/2.6GHz/2MB/35W/DDR4-2133 | | | | | | | | | | | | | | | | | | | | | | | | | | | | | | | | | | | | | |
| Chipset | | Intel C232 Platform Controller Hub (PCH) | | | | | | | | | | | | | | | | | | | | | | | | | | | | | | | | | | | | | |
| Memory DIMMs | | 4 DIMM sockets with 2-channels. UDIMM. DDR4-2133 or DDR4-2400 | | | | | | | | | | | | | | | | | | | | | | | | | | | | | | | | | | | | | |
| Memory capacity | | 64GB (16GB x 4) | | | | | | | | | | | | | | | | | | | | | | | | | | | | | | | | | | | | | |
| Memory protection | | ECC | | | | | | | | | | | | | | | | | | | | | | | | | | | | | | | | | | | | | |
| RAID controller | | <table border="1"> <thead> <tr> <th>RAID controller</th> <th>Drive type</th> <th>RAID support</th> <th>Compatible models</th> </tr> </thead> <tbody> <tr> <td>Onboard RAID121i</td> <td>6Gbs SATA</td> <td>0/1/5/10</td> <td>2x3.5", 4x2.5"</td> </tr> <tr> <td>RAID520i PCIe</td> <td>12Gbs SAS/SATA</td> <td>0/1/10, 5 with optional key</td> <td>2x3.5", 4x2.5"</td> </tr> <tr> <td>RAID720i PCIe</td> <td>12Gbs SAS/SATA</td> <td>0/1/10/5, 6 with optional cache</td> <td>2x3.5", 4x2.5"</td> </tr> </tbody> </table> | RAID controller | Drive type | RAID support | Compatible models | Onboard RAID121i | 6Gbs SATA | 0/1/5/10 | 2x3.5", 4x2.5" | RAID520i PCIe | 12Gbs SAS/SATA | 0/1/10, 5 with optional key | 2x3.5", 4x2.5" | RAID720i PCIe | 12Gbs SAS/SATA | 0/1/10/5, 6 with optional cache | 2x3.5", 4x2.5" | | | | | | | | | | | | | | | | | | | | | |
| | | RAID controller | Drive type | RAID support | Compatible models | | | | | | | | | | | | | | | | | | | | | | | | | | | | | | | | | | |
| | | Onboard RAID121i | 6Gbs SATA | 0/1/5/10 | 2x3.5", 4x2.5" | | | | | | | | | | | | | | | | | | | | | | | | | | | | | | | | | | |
| RAID520i PCIe | | 12Gbs SAS/SATA | 0/1/10, 5 with optional key | 2x3.5", 4x2.5" | | | | | | | | | | | | | | | | | | | | | | | | | | | | | | | | | | | |
| RAID720i PCIe | 12Gbs SAS/SATA | 0/1/10/5, 6 with optional cache | 2x3.5", 4x2.5" | | | | | | | | | | | | | | | | | | | | | | | | | | | | | | | | | | | | |
| Optional cache for RAID720i: 1GB memory. 1GB, 2GB, or 4GB flash with super capacitor. | | | | | | | | | | | | | | | | | | | | | | | | | | | | | | | | | | | | | | | |
| Disk drive bays | Supports two 3.5" or four 2.5" disk drive bays. Non-hot swap. Cables are connected to onboard SATA connectors or PCIe RAID controller. Also supports one M.2 SATA SSD | | | | | | | | | | | | | | | | | | | | | | | | | | | | | | | | | | | | | | |
| Supporting storage | 3.5" HDD, 7.2K SATA6Gbs | | 1TB/2TB/4TB/6TB/8TB/10TB | | | | | | | | | | | | | | | | | | | | | | | | | | | | | | | | | | | | |
| | 3.5" HDD, 7.2K SAS12Gbs | | 1TB/2TB/4TB/6TB/8TB/10TB | | | | | | | | | | | | | | | | | | | | | | | | | | | | | | | | | | | | |
| | 3.5" SSD, SATA6Gbs (2.5" SSD with 3.5" tray) | | 240GB/480GB/960GB | | | | | | | | | | | | | | | | | | | | | | | | | | | | | | | | | | | | |
| | 2.5" HDD, 7.2K SATA6Gbs | | 1TB/2TB | | | | | | | | | | | | | | | | | | | | | | | | | | | | | | | | | | | | |
| | 2.5" HDD, 10K SAS12Gbs | | 300GB/600GB/900GB/1.2TB | | | | | | | | | | | | | | | | | | | | | | | | | | | | | | | | | | | | |
| | 2.5" HDD, 15K SAS12Gbs | | 900GB | | | | | | | | | | | | | | | | | | | | | | | | | | | | | | | | | | | | |
| | 2.5" SSD, SATA6Gbs | | 120GB/240GB/480GB/960GB | | | | | | | | | | | | | | | | | | | | | | | | | | | | | | | | | | | | |
| M.2 SATA SSD | | 32GB/128GB | | | | | | | | | | | | | | | | | | | | | | | | | | | | | | | | | | | | | |

| Components | Specification | |
|-----------------------------|---|--------------------------------------|
| Optical drive | Optional one 9.5mm optical. DVD-ROM or DVD±RW | |
| Network interfaces | One dedicated management port, two Gigabit Ethernet ports. Supports optional discrete network adapters via riser card | |
| Security features | Power-on and administrator password. Optional TPM, TCG 1.2 or 2.0 compliant. | |
| Systems management | UEFI. Onboard Aspeed AST2400 graphics/management processor, IPMI 2.0-compliant baseboard management controller (BMC). Control Panel LEDs shows the status of power, ID, disk drives, network, system. Supports the following management software: EasyStartup, Power Planner. On November 2016, EasyUpdate, Lenovo ThinkServer Diagnostics Standalone, ToolsCenter Suite CLI inventory module on ThinkServer, and Lenovo xClarity Administrator will be available | |
| Operating systems | Microsoft Windows Server 2016 (Standard and Essentials)/2012 R2/2012. Windows 10 Pro. Red Hat Enterprise Linux 6.7/6.8/7.2. SUSE Linux Enterprise Server 11/12. VMware vSphere (ESXi) 6.0U0/U2 | |
| Base warranty | 1 or 3-year limited onsite service with 9x5/NBD | |
| Power supply | One fixed 300 watts power supply, Non-hot swap. 80 PLUS Gold qualified | |
| Graphics | Onboard Aspeed AST2400 | |
| Front ports | Two USB 2.0 | |
| Rear ports | One VGA, four USB 3.0, one RJ-45 (dedicated mgmt), two ethernet, one serial (9-pin) | |
| Cooling | 3 fans for processor, PCIe slot, and disk drives | |
| Noise emissions | Operating: < 5.9 Bels. Idle: < 5.2 Bels (Maximum configuration) | |
| Environmental specification | Temperature - operating | 50 °F to 95 °F (10 °C to 35 °C) |
| | Temperature - non operating (with package) | -40 °C to 60 °C |
| | Altitude - operating | (Unpressurized): 0-10000ft (0-3048m) |
| | Humidity - operating | 8%~80%, non-condensing |
| | Humidity - storage (with package) | 10%~90%, non-condensing |

Expansion slots and disk bays

Supports one PCIe slot via optional riser card, PCIe 3.0 x16, half length, half height

Core options for ThinkServer RS160 (partial)

| | |
|--|------------|
| ThinkServer 8GB 2RX8 PC4-2133-E CL15 DDR4-2133 ECC-UDIMM | 4X70G88316 |
| ThinkServer 16GB 2RX8 PC4-2133-E CL15 DDR4-2133 ECC-UDIMM | 4X70G88317 |
| ThinkServer 3.5" 8TB 7.2K Enterprise SATA 6Gbps 512e Hard Drive for RS-Series | 4XB0K12297 |
| ThinkServer 2.5" 1.2TB 10K Enterprise SAS 12Gbps Hard Drive for RS-Series | 4XB0K12306 |
| ThinkServer 2.5" 2TB 7.2K Enterprise SATA 6Gbps Hard Drive for RS-Series | 4XB0K12302 |
| ThinkServer 2.5" 480GB S3510 Enterprise Entry SATA 6Gbps SSD for RS-Series | 4XB0K12321 |
| ThinkServer M.2 32GB Value Read-Optimized SATA 6Gbps Solid State Drive | 4XB0K12310 |
| ThinkServer RAID 520i RAID 5 Upgrade | 4XC0G88841 |
| ThinkServer RS160 Slim SATA DVD-RW Optical Disk Drive | 4XA0G88613 |
| Lenovo ThinkServer Gen 5 Trusted Platform Module v1.2 (Worldwide except China) | 4XF0G45868 |

| Model | Region | Processor | Memory | RAID Controller | Disk Bays | Storage(HDD/SSD) | Optical | Add-on NIC | Slots | TPM | OS | Warranty | Power Supply | Ann Date (m/y) |
|------------|--------|---|---------------------------|-----------------|------------|------------------|---------|------------|--------|--------|------|----------|----------------|----------------|
| 70TE000DUX | US | Xeon E3-1220 v5 4C/3GHz/8MB/80W/DDR4-2133 | 1x8GB UDIMM DDR4-2133 ECC | RAID 121i | 4x2.5" NHS | Open | None | None | None | TPM | None | 1-year | 300W 85% Fixed | 09/16 |
| 70TE000EUX | US | Xeon E3-1230 v5 4C/3.4GHz/8MB/80W/DDR4-2133 | 1x8GB UDIMM DDR4-2133 ECC | RAID 121i | 4x2.5" NHS | Open | None | None | None | TPM | None | 1-year | 300W 85% Fixed | 09/16 |
| 70TE000FUX | US | Xeon E3-1240 v5 4C/3.5GHz/8MB/80W/DDR4-2133 | 1x8GB UDIMM DDR4-2133 ECC | RAID 121i | 4x2.5" NHS | Open | None | None | None | TPM | None | 1-year | 300W 85% Fixed | 09/16 |
| 70TE000GUX | US | Xeon E3-1270 v5 4C/3.6GHz/8MB/80W/DDR4-2133 | 1x8GB UDIMM DDR4-2133 ECC | RAID 121i | 4x2.5" NHS | Open | None | None | None | TPM | None | 1-year | 300W 85% Fixed | 09/16 |
| 70TE000HUX | US | Xeon E3-1280 v5 4C/3.7GHz/8MB/80W/DDR4-2133 | 1x8GB UDIMM DDR4-2133 ECC | RAID 121i | 4x2.5" NHS | Open | None | None | None | TPM | None | 1-year | 300W 85% Fixed | 09/16 |
| 70TE000YUX | US | Xeon E3-1220 v6 4C/3GHz/8MB/72W/DDR4-2400 | 1x8GB UDIMM DDR4-2400 ECC | RAID121i | 4x2.5" NHS | Open | None | None | None | TPM2.0 | None | 1-year | 300W 85% Fixed | 06/17 |
| 70TE0010UX | US | Xeon E3-1230 v6 4C/3.5GHz/8MB/72W/DDR4-2400 | 1x8GB UDIMM DDR4-2400 ECC | RAID121i | 4x2.5" NHS | Open | None | None | None | TPM2.0 | None | 1-year | 300W 85% Fixed | 06/17 |
| 70TE0011UX | US | Xeon E3-1240 v6 4C/3.7GHz/8MB/72W/DDR4-2400 | 1x8GB UDIMM DDR4-2400 ECC | RAID121i | 4x2.5" NHS | Open | None | None | None | TPM2.0 | None | 1-year | 300W 85% Fixed | 06/17 |
| 70TE0012UX | US | Xeon E3-1270 v6 4C/3.8GHz/8MB/72W/DDR4-2400 | 1x8GB UDIMM DDR4-2400 ECC | RAID121i | 4x2.5" NHS | Open | None | None | None | TPM2.0 | None | 1-year | 300W 85% Fixed | 06/17 |
| 70TE0013UX | US | Xeon E3-1280 v6 4C/3.9GHz/8MB/72W/DDR4-2400 | 1x8GB UDIMM DDR4-2400 ECC | RAID121i | 4x2.5" NHS | Open | None | None | None | TPM2.0 | None | 1-year | 300W 85% Fixed | 06/17 |
| 70TER001UX | US | Xeon E3-1220 v5 4C/3GHz/8MB/80W/DDR4-2133 | 1x8GB UDIMM DDR4-2133 ECC | RAID 121i | 4x2.5" NHS | Open | None | None | 1xHHHL | TPM | None | 1-year | 300W 85% Fixed | 09/16 |
| 70TER002UX | US | Xeon E3-1230 v5 4C/3.4GHz/8MB/80W/DDR4-2133 | 1x8GB UDIMM DDR4-2133 ECC | RAID 121i | 4x2.5" NHS | Open | None | None | 1xHHHL | TPM | None | 1-year | 300W 85% Fixed | 09/16 |
| 70TER003UX | US | Xeon E3-1270 v5 4C/3.6GHz/8MB/80W/DDR4-2133 | 1x8GB UDIMM DDR4-2133 ECC | RAID 121i | 4x2.5" NHS | Open | None | None | 1xHHHL | TPM | None | 1-year | 300W 85% Fixed | 09/16 |

| Model | Region | Processor | Memory | RAID Controller | Disk Bays | Storage(HDD/SSD) | Optical | Add-on NIC | Slots | TPM | OS | Warranty | Power Supply | Ann Date (m/y) |
|------------|--------|---|------------------------------|-----------------|---------------|------------------|---------|------------|--------|--------|------|----------|-------------------|----------------|
| 70TG000JUX | US | Pentium G4400 2C/3.3GHz/3MB/54W/DDR4-2133 | 1x8GB UDIMM DDR4-2133 ECC | RAID 121i | 2x3.5" NHS | Open | None | None | None | TPM | None | 1-year | 300W 85% Fixed | 09/16 |
| 70TG000KUX | US | Xeon E3-1220 v5 4C/3GHz/8MB/80W/DDR4-2133 | 1x8GB UDIMM DDR4-2133 ECC | RAID 121i | 2x3.5" NHS | Open | None | None | None | TPM | None | 1-year | 300W 85% Fixed | 09/16 |
| 70TG000LUX | US | Xeon E3-1230 v5 4C/3.4GHz/8MB/80W/DDR4-2133 | 1x8GB UDIMM DDR4-2133 ECC | RAID 121i | 2x3.5" NHS | Open | None | None | None | TPM | None | 1-year | 300W 85% Fixed | 09/16 |
| 70TG000MUX | US | Xeon E3-1240 v5 4C/3.5GHz/8MB/80W/DDR4-2133 | 1x8GB UDIMM DDR4-2133 ECC | RAID 121i | 2x3.5" NHS | Open | None | None | None | TPM | None | 1-year | 300W 85% Fixed | 09/16 |
| 70TG000NUX | US | Xeon E3-1270 v5 4C/3.6GHz/8MB/80W/DDR4-2133 | 1x8GB UDIMM DDR4-2133 ECC | RAID 121i | 2x3.5" NHS | Open | None | None | None | TPM | None | 1-year | 300W 85% Fixed | 09/16 |
| 70TG000PUX | US | Xeon E3-1280 v5 4C/3.7GHz/8MB/80W/DDR4-2133 | 1x8GB UDIMM DDR4-2133 ECC | RAID 121i | 2x3.5" NHS | Open | None | None | None | TPM | None | 1-year | 300W 85% Fixed | 09/16 |
| 70TG001RUX | US | Xeon E3-1220 v6 4C/3GHz/8MB/72W/DDR4-2400 | 1x8GB UDIMM DDR4-2400 ECC | RAID121i | 2x3.5" NHS | Open | None | None | None | TPM2.0 | None | 1-year | 300W 85% Fixed | 06/17 |
| 70TG001SUX | US | Xeon E3-1230 v6 4C/3.5GHz/8MB/72W/DDR4-2400 | 1x8GB UDIMM DDR4-2400 ECC | RAID121i | 2x3.5" NHS | Open | None | None | None | TPM2.0 | None | 1-year | 300W 85% Fixed | 06/17 |
| 70TG001TUX | US | Xeon E3-1240 v6 4C/3.7GHz/8MB/72W/DDR4-2400 | 1x8GB UDIMM DDR4-2400 ECC | RAID121i | 2x3.5" NHS | Open | None | None | None | TPM2.0 | None | 1-year | 300W 85% Fixed | 06/17 |
| 70TG001UUX | US | Xeon E3-1270 v6 4C/3.8GHz/8MB/72W/DDR4-2400 | 1x8GB UDIMM DDR4-2400 ECC | RAID121i | 2x3.5" NHS | Open | None | None | None | TPM2.0 | None | 1-year | 300W 85% Fixed | 06/17 |
| 70TG001VUX | US | Xeon E3-1280 v6 4C/3.9GHz/8MB/72W/DDR4-2400 | 1x8GB UDIMM DDR4-2400 ECC | RAID121i | 2x3.5" NHS | Open | None | None | None | TPM2.0 | None | 1-year | 300W 85% Fixed | 06/17 |
| 70TGR001UX | US | Pentium G4400 2C/3.3GHz/3MB/54W/DDR4-2133 | 1x8GB UDIMM DDR4-2133 ECC | RAID 121i | 2x3.5" NHS | Open | None | None | 1xHHHL | TPM | None | 1-year | 300W 85% Fixed | 09/16 |
| 70TGR002UX | US | Xeon E3-1220 v5 4C/3GHz/8MB/80W/DDR4-2133 | 1x8GB UDIMM DDR4-2133 ECC | RAID 121i | 2x3.5" NHS | Open | None | None | 1xHHHL | TPM | None | 1-year | 300W 85% Fixed | 09/16 |
| 70TGR003UX | US | Xeon E3-1230 v5 4C/3.4GHz/8MB/80W/DDR4-2133 | 1x8GB UDIMM DDR4-2133 ECC | RAID 121i | 2x3.5" NHS | Open | None | None | 1xHHHL | TPM | None | 1-year | 300W 85% Fixed | 09/16 |

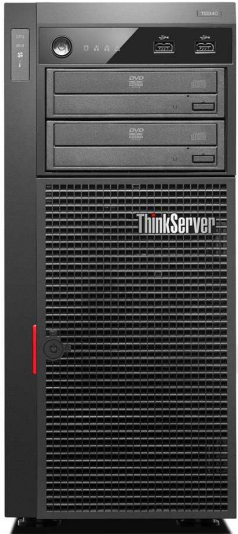

ThinkServer TD340 Platform Specifications

| Components | Specification | | | | | | | | | | | | | | | | | | | | | | | | | | | | | | | | | | | | | | | | | |
|---|---|---------------------------------|---|-------------------|---|--------------------|---|-------------------|-----------------------------|---|-------------------------------------|--|--------------------------|----------|--------------------------------|--|--|--|-----------|---|---|---|---|---|-----------|--|---|---|---|---|-----------|--|---|---|---|---|------------|--|--|---|---|---|
| Dimensions | Tower or 5U rack. Height: 430 mm (16.9 in), width: 195 mm (7.68 in), depth: 595 mm (23.4 in) | | | | | | | | | | | | | | | | | | | | | | | | | | | | | | | | | | | | | | | | | |
| Weight | Maximum: 26 kg (57.3 lb) | | | | | | | | | | | | | | | | | | | | | | | | | | | | | | | | | | | | | | | | | |
| Processor | Up to two 95W Intel Xeon E5-2400 v2 family (code name: Ivy Bridge EN) processors with 10 cores up to 2.4GHz, 8 cores up to 2.5GHz, 6 cores up to 2.5GHz, 4 cores up to 2.4GHz. One QPI link up to 8.0 GT/s. Up to 1600MHz memory speed. Up to 25MB cache. Or up to two Intel Xeon E5-2420 (code name: Sandy Bridge EN) processors with 6 cores, 1.9GHz, 15MB cache, 95W, up to 1333MHz memory speed, one 7.2GT/s QPI link | | | | | | | | | | | | | | | | | | | | | | | | | | | | | | | | | | | | | | | | | |
| Chipset | Intel C606 Platform Controller Hub (PCH) | | | | | | | | | | | | | | | | | | | | | | | | | | | | | | | | | | | | | | | | | |
| Memory DIMMs | 12 DIMM sockets (6 DIMMs per processor). 6-channel capable (3-channel per processor). RDIMM, LV RDIMM and LV UDIMM (cannot be intermixed). DDR3. Up to 1866MHz (RDIMM), 1600MHz (LV RDIMM) or 1600MHz (LV UDIMM) | | | | | | | | | | | | | | | | | | | | | | | | | | | | | | | | | | | | | | | | | |
| Memory capacity | 192GB (RDIMM and LV RDIMM), 16GB x 12/48GB (LV UDIMM, 4GB x 12) | | | | | | | | | | | | | | | | | | | | | | | | | | | | | | | | | | | | | | | | | |
| Memory protection | ECC, memory mirroring, memory sparing | | | | | | | | | | | | | | | | | | | | | | | | | | | | | | | | | | | | | | | | | |
| AnyRAID support | Supports one of the following: RAID 0, 1, 10 with onboard RAID 100, 6Gb/s SATA, optional key for RAID 5. RAID 0, 1, 10 with onboard RAID 300, 6Gb/s SAS/SATA, optional key for RAID 5. RAID 0, 1, 10 with RAID 500, PCIe adapter, 6Gb/s SAS/SATA, optional key for RAID 5, 50. RAID 0, 1, 10, 5, 50, 6, 60 with RAID 700, PCIe adapter, 512MB cache, optional intelligent Battery Backup Unit (iBBU08). RAID 0, 1, 10, 5, 50, 6, 60 with RAID 710, PCIe adapter, 1GB cache, optional CacheVault flash cache with super capacitor/CacheCade Pro 2.0/FastPath key <i>Note: At least 6 disk drives is required for RAID 50 and 60.</i> | | | | | | | | | | | | | | | | | | | | | | | | | | | | | | | | | | | | | | | | | |
| Disk drive bays | Up to 8 3.5" hot-swap bays, or up to 16 2.5" hot-swap bays, or up to 4 3.5" non-hot swap bays. On front. Supports internal RDX tape drive, consumes 5.25" bay, also supports optional external SAS tape drive, additional SAS HBA card is needed. <table border="1"> <thead> <tr> <th rowspan="2">Disk bay configuration</th> <th colspan="5">RAID controller requirements</th> </tr> <tr> <th>RAID100</th> <th>RAID300</th> <th>RAID500</th> <th>RAID700</th> <th>RAID710</th> </tr> </thead> <tbody> <tr> <td>4x3.5" non-hot swap</td> <td>•</td> <td></td> <td></td> <td></td> <td></td> </tr> <tr> <td>4x3.5" HS</td> <td>•</td> <td>•</td> <td>•</td> <td>•</td> <td>•</td> </tr> <tr> <td>8x3.5" HS</td> <td></td> <td>•</td> <td>•</td> <td>•</td> <td>•</td> </tr> <tr> <td>8x2.5" HS</td> <td></td> <td>•</td> <td>•</td> <td>•</td> <td>•</td> </tr> <tr> <td>16x2.5" HS</td> <td></td> <td></td> <td>•</td> <td>•</td> <td>•</td> </tr> </tbody> </table> | Disk bay configuration | RAID controller requirements | | | | | RAID100 | RAID300 | RAID500 | RAID700 | RAID710 | 4x3.5" non-hot swap | • | | | | | 4x3.5" HS | • | • | • | • | • | 8x3.5" HS | | • | • | • | • | 8x2.5" HS | | • | • | • | • | 16x2.5" HS | | | • | • | • |
| Disk bay configuration | RAID controller requirements | | | | | | | | | | | | | | | | | | | | | | | | | | | | | | | | | | | | | | | | | |
| | RAID100 | RAID300 | RAID500 | RAID700 | RAID710 | | | | | | | | | | | | | | | | | | | | | | | | | | | | | | | | | | | | | |
| 4x3.5" non-hot swap | • | | | | | | | | | | | | | | | | | | | | | | | | | | | | | | | | | | | | | | | | | |
| 4x3.5" HS | • | • | • | • | • | | | | | | | | | | | | | | | | | | | | | | | | | | | | | | | | | | | | | |
| 8x3.5" HS | | • | • | • | • | | | | | | | | | | | | | | | | | | | | | | | | | | | | | | | | | | | | | |
| 8x2.5" HS | | • | • | • | • | | | | | | | | | | | | | | | | | | | | | | | | | | | | | | | | | | | | | |
| 16x2.5" HS | | | • | • | • | | | | | | | | | | | | | | | | | | | | | | | | | | | | | | | | | | | | | |
| Supporting disk drives | <table border="1"> <tbody> <tr> <td>3.5" SATA HDD (both HS and NHS)</td> <td>7.2K 6Gbs: 7.2K 6Gbs: 500GB/1TB/2TB/3TB/4TB</td> </tr> <tr> <td>3.5" SAS HDD (HS)</td> <td>7.2K 6Gbs: 1TB/2TB/3TB/4TB. 15K 6Gbs: 300GB/600GB</td> </tr> <tr> <td>2.5" SATA HDD (HS)</td> <td>7.2K 6Gbs: 500GB/1TB. 10K 6Gbs: 300GB/600GB/900GB</td> </tr> <tr> <td>2.5" SAS HDD (HS)</td> <td>15K 6Gbs: 146GB/300GB/600GB</td> </tr> <tr> <td>2.5" SATA SSD (HS, also supports 3.5" HS bay)</td> <td>6Gbs: 120GB/240GB/300GB/480GB/600GB</td> </tr> <tr> <td>2.5" SAS SSD (HS, also supports 3.5" HS bay)</td> <td>12Gbs: 200GB/400GB/800GB</td> </tr> <tr> <td>PCIe SSD</td> <td>1.4TB, via PCIe 2.0 x8 adapter</td> </tr> </tbody> </table> <p><i>Note: Supports up to 2 SSD drives on 8 x 3.5" HS model, up to 4 SSD drives on 16 x 2.5" HS model.</i></p> | 3.5" SATA HDD (both HS and NHS) | 7.2K 6Gbs: 7.2K 6Gbs: 500GB/1TB/2TB/3TB/4TB | 3.5" SAS HDD (HS) | 7.2K 6Gbs: 1TB/2TB/3TB/4TB. 15K 6Gbs: 300GB/600GB | 2.5" SATA HDD (HS) | 7.2K 6Gbs: 500GB/1TB. 10K 6Gbs: 300GB/600GB/900GB | 2.5" SAS HDD (HS) | 15K 6Gbs: 146GB/300GB/600GB | 2.5" SATA SSD (HS, also supports 3.5" HS bay) | 6Gbs: 120GB/240GB/300GB/480GB/600GB | 2.5" SAS SSD (HS, also supports 3.5" HS bay) | 12Gbs: 200GB/400GB/800GB | PCIe SSD | 1.4TB, via PCIe 2.0 x8 adapter | | | | | | | | | | | | | | | | | | | | | | | | | | | |
| 3.5" SATA HDD (both HS and NHS) | 7.2K 6Gbs: 7.2K 6Gbs: 500GB/1TB/2TB/3TB/4TB | | | | | | | | | | | | | | | | | | | | | | | | | | | | | | | | | | | | | | | | | |
| 3.5" SAS HDD (HS) | 7.2K 6Gbs: 1TB/2TB/3TB/4TB. 15K 6Gbs: 300GB/600GB | | | | | | | | | | | | | | | | | | | | | | | | | | | | | | | | | | | | | | | | | |
| 2.5" SATA HDD (HS) | 7.2K 6Gbs: 500GB/1TB. 10K 6Gbs: 300GB/600GB/900GB | | | | | | | | | | | | | | | | | | | | | | | | | | | | | | | | | | | | | | | | | |
| 2.5" SAS HDD (HS) | 15K 6Gbs: 146GB/300GB/600GB | | | | | | | | | | | | | | | | | | | | | | | | | | | | | | | | | | | | | | | | | |
| 2.5" SATA SSD (HS, also supports 3.5" HS bay) | 6Gbs: 120GB/240GB/300GB/480GB/600GB | | | | | | | | | | | | | | | | | | | | | | | | | | | | | | | | | | | | | | | | | |
| 2.5" SAS SSD (HS, also supports 3.5" HS bay) | 12Gbs: 200GB/400GB/800GB | | | | | | | | | | | | | | | | | | | | | | | | | | | | | | | | | | | | | | | | | |
| PCIe SSD | 1.4TB, via PCIe 2.0 x8 adapter | | | | | | | | | | | | | | | | | | | | | | | | | | | | | | | | | | | | | | | | | |
| Optical drive | Two 5.25" bays for optical drive. DVD-ROM or DVD±RW. Half-height | | | | | | | | | | | | | | | | | | | | | | | | | | | | | | | | | | | | | | | | | |
| Network interfaces | Two Gigabit Ethernet port via two Intel 82574L. One port is shared with ThinkServer Management Module. Supports optional discrete network adapters via PCIe slots | | | | | | | | | | | | | | | | | | | | | | | | | | | | | | | | | | | | | | | | | |

| Components | Specification | |
|--------------------------------------|---|---|
| Security features | Power-on and administrator password. Optional TPM (TCG 1.2-compliant) | |
| Intelligent Diagnostics Module (IDM) | Supports IDM or IDM Premium on selected models, IDM LED lights indicate failing component category, IDM Premium LED lights indicate individual failing part | |
| Systems management | Supports ThinkServer Management Module (TMM), optional TMM Premium for remote presence. Onboard Aspeed AST2300 graphics/management processor, IPMI 2.0-compliant baseboard management controller (BMC). Front control panel LEDs shows the status of power, hard drive activity, network, system. Supports EasyStartup, EasyManage, EasyUpdate. | |
| Operating systems supported | Microsoft Windows Server 2012 R2/2012/2008 R2/2008. Windows Small Business Server 2011. Red Hat Enterprise Linux 7.1/7/6.7/6.5/6.4/5.10/5.9. SUSE Linux Enterprise Server 11/10. VMware vSphere (ESXi) 5.5/5.1 | |
| Base warranty | 1 or 3-year limited onsite service with 9x5/NBD. | |
| Power supply | One fixed 625 watts, universal, 80 PLUS Bronze qualified. Or up to two redundant 800 watts, two maximum, rear access, hot-swap, 80 PLUS Gold qualified, redundant with two power supplies | |
| Graphics | Onboard Aspeed AST2300 graphics/management processor | |
| Front ports | Two USB 2.0 | |
| Rear ports | Four USB 2.0, one serial (9-pin), two ethernet (RJ-45, one for dedicate/share mgmt), one analog VGA DB-15 connector | |
| Noise emissions | Operating: < 42 dB(A). Idle: < 38 dB(A) (Maximum configuration) | |
| Environmental specification | Energy Star Server 1.1 qualified for 625W models, Energy Star Server 2.0 qualified for 800W models. RoHS-compliant. | |
| | Temperature - operating | 50 °F to 95 °F (10 °C to 35 °C) |
| | Temperature - storage (with package) | -40 °C to 60 °C |
| | Altitude - operating | Supported Altitude (unpressurized): 0-10000ft (0-3048m) |
| | Humidity - operating | 10%~80%, non-condensing |
| Humidity - storage (with package) | 8%~90%, non-condensing | |



Expansion slots

| | |
|---------------|---|
| Slot 1 (PCH) | 32-bit PCI 2.3, half-length, full-height |
| Slot 2 (CPU1) | PCIe 3.0 x8 (x4 elec), half-length, full-height |
| Slot 3 (CPU2) | PCIe 3.0 x8, half-length, full-height |
| Slot 4 (CPU2) | PCIe 3.0 x8, half-length, full-height |
| Slot 5 (CPU1) | PCIe 3.0 x16, half-length, full-height |
| Slot 6 (CPU2) | PCIe 3.0 x8, half-length, full-height |

ThinkServer TD340 - TopSeller - 70B5

Product Specifications Reference (PSREF)

| Model | Region | Processor | Memory | RAID Controller | Disk Bays | Storage | Optical | Add-on NIC | TPM | Diagnostics | System Mgmt | OS | Warranty | Power Supply | Ann Date (m/y) |
|------------|--------|---|------------------------------|-----------------|--------------|---------|-----------|------------|-----|-------------|-------------|------|----------|-------------------------|----------------|
| 70B5001TUX | US | 1xE5-2403 v2 4C/1.8GHz/10MB/80W/DDR3-1333 | 1x8GB RDIMM DDR3-1600 ECC | RAID 300 | 4x3.5" HS | Open | HH DVD±RW | None | TPM | IDM Premium | TMM | None | 1-year | 625W Bronze Fixed | 05/14 |

| Model | Region | Processor | Memory | RAID Controller | Disk Bays | Storage | Optical | Add-on NIC | TPM | Diagnostics | System Mgmt | OS | Warranty | Power Supply | Ann Date (m/y) |
|------------|--------|--|------------------------------|-----------------|--------------|---------|-----------|------------|-----|-------------|-------------|------|----------|----------------|----------------|
| 70B7002GUX | US | 1xE5-2403 v2 4C/1.8GHz/10MB/80W/DDR3-1333 | 1x8GB RDIMM DDR3-1600 ECC | RAID 300 | 4x3.5" HS | Open | HH DVD±RW | None | TPM | IDM | TMM | None | 1-year | 800Wx1 Gold | 01/14 |
| 70B7002HUX | US | 1xE5-2407 v2 4C/2.4GHz/10MB/80W/DDR3-1333 | 1x8GB RDIMM DDR3-1600 ECC | RAID 300 | 4x3.5" HS | Open | HH DVD±RW | None | TPM | IDM | TMM | None | 1-year | 800Wx1 Gold | 01/14 |
| 70B7002JUX | US | 1xE5-2403 v2 4C/1.8GHz/10MB/80W/DDR3-1333 | 1x8GB RDIMM DDR3-1600 ECC | RAID 300 | 4x3.5" HS | Open | HH DVD±RW | None | TPM | IDM Premium | TMM | None | 3-year | 800Wx1 Gold | 01/14 |
| 70B7002KUX | US | 1xE5-2407 v2 4C/2.4GHz/10MB/80W/DDR3-1333 | 1x8GB RDIMM DDR3-1600 ECC | RAID 300 | 4x3.5" HS | Open | HH DVD±RW | None | TPM | IDM Premium | TMM | None | 3-year | 800Wx1 Gold | 01/14 |
| 70B7002LUX | US | 1xE5-2420 v2 6C/2.2GHz/15MB/80W/DDR3-1600 | 1x8GB RDIMM DDR3-1600 ECC | RAID 300 | 4x3.5" HS | Open | HH DVD±RW | None | TPM | IDM Premium | TMM | None | 3-year | 800Wx1 Gold | 01/14 |
| 70B7002MUX | US | 1xE5-2430 v2 6C/2.5GHz/15MB/80W/DDR3-1600 | 1x8GB RDIMM DDR3-1600 ECC | RAID 300 | 4x3.5" HS | Open | HH DVD±RW | None | TPM | IDM Premium | TMM | None | 3-year | 800Wx1 Gold | 01/14 |
| 70B7002NUX | US | 1xE5-2440 v2 8C/1.9GHz/20MB/95W/DDR3-1600 | 1x8GB RDIMM DDR3-1600 ECC | RAID 300 | 4x3.5" HS | Open | HH DVD±RW | None | TPM | IDM Premium | TMM | None | 3-year | 800Wx1 Gold | 01/14 |
| 70B7002PUX | US | 1xE5-2450 v2 8C/2.5GHz/20MB/95W/DDR3-1600 | 1x8GB RDIMM DDR3-1600 ECC | RAID 300 | 4x3.5" HS | Open | HH DVD±RW | None | TPM | IDM Premium | TMM | None | 3-year | 800Wx1 Gold | 01/14 |
| 70B7002QUX | US | 1xE5-2470 v2 10C/2.4GHz/25MB/95W/DDR3-1600 | 1x8GB RDIMM DDR3-1600 ECC | RAID 300 | 4x3.5" HS | Open | HH DVD±RW | None | TPM | IDM Premium | TMM | None | 3-year | 800Wx1 Gold | 01/14 |
| 70B7002RUX | US | 1xE5-2420 v2 6C/2.2GHz/15MB/80W/DDR3-1600 | 1x8GB RDIMM DDR3-1600 ECC | RAID 300 | 8x3.5" HS | Open | HH DVD±RW | None | TPM | IDM Premium | TMM | None | 3-year | 800Wx1 Gold | 01/14 |
| 70B7002SUX | US | 1xE5-2430 v2 6C/2.5GHz/15MB/80W/DDR3-1600 | 1x8GB RDIMM DDR3-1600 ECC | RAID 300 | 8x3.5" HS | Open | HH DVD±RW | None | TPM | IDM Premium | TMM | None | 3-year | 800Wx1 Gold | 01/14 |
| 70B7002TUX | US | 1xE5-2440 v2 8C/1.9GHz/20MB/95W/DDR3-1600 | 1x8GB RDIMM DDR3-1600 ECC | RAID 300 | 8x3.5" HS | Open | HH DVD±RW | None | TPM | IDM Premium | TMM | None | 3-year | 800Wx1 Gold | 01/14 |
| 70B7002UUX | US | 1xE5-2450 v2 8C/2.5GHz/20MB/95W/DDR3-1600 | 1x8GB RDIMM DDR3-1600 ECC | RAID 300 | 8x3.5" HS | Open | HH DVD±RW | None | TPM | IDM Premium | TMM | None | 3-year | 800Wx1 Gold | 01/14 |
| 70B7002VUX | US | 1xE5-2470 v2 10C/2.4GHz/25MB/95W/DDR3-1600 | 1x8GB RDIMM DDR3-1600 ECC | RAID 300 | 8x3.5" HS | Open | HH DVD±RW | None | TPM | IDM Premium | TMM | None | 3-year | 800Wx1 Gold | 01/14 |
| 70B7002WUX | US | 1xE5-2420 v2 6C/2.2GHz/15MB/80W/DDR3-1600 | 1x8GB RDIMM DDR3-1600 ECC | RAID 300 | 8x2.5" HS | Open | HH DVD±RW | None | TPM | IDM Premium | TMM | None | 3-year | 800Wx1 Gold | 01/14 |
| 70B7002XUX | US | 1xE5-2430 v2 6C/2.5GHz/15MB/80W/DDR3-1600 | 1x8GB RDIMM DDR3-1600 ECC | RAID 300 | 8x2.5" HS | Open | HH DVD±RW | None | TPM | IDM Premium | TMM | None | 3-year | 800Wx1 Gold | 01/14 |
| 70B7002YUX | US | 1xE5-2440 v2 8C/1.9GHz/20MB/95W/DDR3-1600 | 1x8GB RDIMM DDR3-1600 ECC | RAID 300 | 8x2.5" HS | Open | HH DVD±RW | None | TPM | IDM Premium | TMM | None | 3-year | 800Wx1 Gold | 01/14 |

| Model | Region | Processor | Memory | RAID Controller | Disk Bays | Storage | Optical | Add-on NIC | TPM | Diagnostics | System Mgmt | OS | Warranty | Power Supply | Ann Date (m/y) |
|------------|--------|--|-------------------------------|-----------------|---------------|---------|-----------|------------|-----|-------------|----------------|------|----------|----------------|----------------|
| 70B70030UX | US | 1xE5-2450 v2 8C/2.5GHz/20MB/95W/DDR3-1600 | 1x8GB RDIMM DDR3-1600 ECC | RAID 300 | 8x2.5" HS | Open | HH DVD±RW | None | TPM | IDM Premium | TMM | None | 3-year | 800Wx1 Gold | 01/14 |
| 70B70031UX | US | 1xE5-2470 v2 10C/2.4GHz/25MB/95W/DDR3-1600 | 1x8GB RDIMM DDR3-1600 ECC | RAID 300 | 8x2.5" HS | Open | HH DVD±RW | None | TPM | IDM Premium | TMM | None | 3-year | 800Wx1 Gold | 01/14 |
| 70B70032UX | US | 1xE5-2420 v2 6C/2.2GHz/15MB/80W/DDR3-1600 | 1x8GB RDIMM DDR3-1600 ECC | RAID 700 | 16x2.5" HS | Open | HH DVD±RW | None | TPM | IDM Premium | TMM | None | 3-year | 800Wx1 Gold | 01/14 |
| 70B70033UX | US | 1xE5-2430 v2 6C/2.5GHz/15MB/80W/DDR3-1600 | 1x8GB RDIMM DDR3-1600 ECC | RAID 700 | 16x2.5" HS | Open | HH DVD±RW | None | TPM | IDM Premium | TMM | None | 3-year | 800Wx1 Gold | 01/14 |
| 70B70034UX | US | 1xE5-2440 v2 8C/1.9GHz/20MB/95W/DDR3-1600 | 1x8GB RDIMM DDR3-1600 ECC | RAID 700 | 16x2.5" HS | Open | HH DVD±RW | None | TPM | IDM Premium | TMM | None | 3-year | 800Wx1 Gold | 01/14 |
| 70B70035UX | US | 1xE5-2450 v2 8C/2.5GHz/20MB/95W/DDR3-1600 | 1x8GB RDIMM DDR3-1600 ECC | RAID 710 | 16x2.5" HS | Open | HH DVD±RW | None | TPM | IDM Premium | TMM | None | 3-year | 800Wx1 Gold | 01/14 |
| 70B70036UX | US | 1xE5-2470 v2 10C/2.4GHz/25MB/95W/DDR3-1600 | 1x8GB RDIMM DDR3-1600 ECC | RAID 710 | 16x2.5" HS | Open | HH DVD±RW | None | TPM | IDM Premium | TMM | None | 3-year | 800Wx1 Gold | 01/14 |
| 70B7004DUX | US | 2xE5-2420 v2 6C/2.2GHz/15MB/80W/DDR3-1600 | 2x16GB RDIMM DDR3-1866 ECC | RAID 300 | 8x3.5" HS | Open | HH DVD±RW | None | TPM | IDM Premium | TMM Premium | None | 3-year | 800Wx2 Gold | 09/15 |

| Model | Region | Processor | Memory | RAID Controller | Disk Bays | Storage | Optical | Add-on NIC | TPM | Diagnostics | System Mgmt | OS | Warranty | Power Supply | Ann Date (m/y) |
|------------|--------|---|----------------------------|---------------------|------------|------------------------------|-----------|------------|-----|-------------|-------------|------|----------|--------------|----------------|
| 70B60002UX | US | 1xE5-2420 v2 6C/2.2GHz/15MB/80W/DDR3-1600 | 4x8GB RDIMM DDR3-1600 ECC | RAID 500+Key | 4x3.5" HS | 4x2TB HDD 7.2K 3.5" SATA6Gbs | HH DVD±RW | 2xGbE | TPM | IDM Premium | TMM Premium | None | 3-year | 800Wx2 Gold | 01/14 |
| 70B60003UX | US | 2xE5-2440 v2 8C/1.9GHz/20MB/95W/DDR3-1600 | 8x8GB RDIMM DDR3-1600 ECC | RAID 700 | 8x3.5" HS | 8x2TB 3.5" SAS6Gbs 7.2K | HH DVD±RW | 2xGbE | TPM | IDM Premium | TMM Premium | None | 3-year | 800Wx2 Gold | 01/14 |
| 70B60004UX | US | 2xE5-2450 v2 8C/2.5GHz/20MB/95W/DDR3-1600 | 12x8GB RDIMM DDR3-1600 ECC | RAID 710+CacheVault | 16x2.5" HS | 8x300GB HDD 15K 2.5" SAS6Gbs | HH DVD±RW | 4xGbE | TPM | IDM Premium | TMM Premium | None | 3-year | 800Wx2 Gold | 01/14 |
| 70B60005UX | US | 1xE5-2407 v2 4C/2.4GHz/10MB/80W/DDR3-1333 | 1x8GB RDIMM DDR3-1600 ECC | RAID 300+Key | 4x3.5" HS | Open | HH DVD±RW | None | TPM | IDM Premium | TMM | None | 3-year | 800Wx1 Gold | 04/14 |
| 70B60006UX | US | 1xE5-2420 v2 6C/2.2GHz/15MB/80W/DDR3-1600 | 1x8GB RDIMM DDR3-1600 ECC | RAID 500 | 8x3.5" HS | Open | HH DVD±RW | None | TPM | IDM Premium | TMM | None | 3-year | 800Wx1 Gold | 04/14 |
| 70B60007UX | US | 1xE5-2420 v2 6C/2.2GHz/15MB/80W/DDR3-1600 | 1x8GB RDIMM DDR3-1600 ECC | RAID 700 | 8x3.5" HS | Open | HH DVD±RW | None | TPM | IDM Premium | TMM Premium | None | 3-year | 800Wx2 Gold | 04/14 |
| 70B60008UX | US | 1xE5-2440 v2 8C/1.9GHz/20MB/95W/DDR3-1600 | 1x8GB RDIMM DDR3-1600 ECC | RAID 700 | 8x2.5" HS | Open | HH DVD±RW | None | TPM | IDM Premium | TMM | None | 3-year | 800Wx1 Gold | 04/14 |
| 70B60009UX | US | 1xE5-2450 v2 8C/2.5GHz/20MB/95W/DDR3-1600 | 1x16GB RDIMM DDR3-1600 ECC | RAID 710 | 16x2.5" HS | Open | HH DVD±RW | None | TPM | IDM Premium | TMM Premium | None | 3-year | 800Wx2 Gold | 04/14 |



ThinkServer TD350 Platform Specifications

Product Specifications Reference (PSREF)

| Components | Specification | | | | | | | | | | | | | | | | | | | | | | | | | | | | |
|--|---|------------------|--------------------------------------|-------------------------|-------------------|------------------|-----------|----------------------------|-------------------------|---------------|----------------|-------------------------------|----------------------|---------------|----------------|--------------------------------------|----------------------|--------------|---------------|-------------------------------|----------------------|--------------|----------------|--------------------------------------|----------------------|---------------|----------------|------------------|---------------------------|
| Dimensions | Tower or 4U rack. Tower: Height: 459 mm (18.1 in), width: 251 mm (9.9 in), depth: 686 mm (27 in) Rack: height: 173 mm (6.8 in), width: 482 mm (19 in), depth: 686 mm (27 in) | | | | | | | | | | | | | | | | | | | | | | | | | | | | |
| Weight | Minimum configuration: 22 kg (48.5 lb), maximum: 41.4 kg (91.27 lb) | | | | | | | | | | | | | | | | | | | | | | | | | | | | |
| Processor | Up to two 135W Intel Xeon E5-2600 v4 or E5-2600 v3 family processors. | | | | | | | | | | | | | | | | | | | | | | | | | | | | |
| | E5-2698 v4 20C/2.2GHz/50MB/135W/DDR4-2400 | | | | | | | | | | | | | | | | | | | | | | | | | | | | |
| | E5-2695 v4 18C/2.1GHz/45MB/120W/DDR4-2400 | | | | | | | | | | | | | | | | | | | | | | | | | | | | |
| | E5-2690 v4 14C/2.6GHz/35MB/135W/DDR4-2400 | | | | | | | | | | | | | | | | | | | | | | | | | | | | |
| | E5-2683 v4 16C/2.1GHz/40MB/120W/DDR4-2400 | | | | | | | | | | | | | | | | | | | | | | | | | | | | |
| | E5-2680 v4 14C/2.4GHz/35MB/120W/DDR4-2400 | | | | | | | | | | | | | | | | | | | | | | | | | | | | |
| | E5-2667 v4 8C/3.2GHz/25MB/135W/DDR4-2400 | | | | | | | | | | | | | | | | | | | | | | | | | | | | |
| | E5-2660 v4 14C/2GHz/35MB/105W/DDR4-2400 | | | | | | | | | | | | | | | | | | | | | | | | | | | | |
| | E5-2650L v4 14C/1.7GHz/35MB/65W/DDR4-2400 | | | | | | | | | | | | | | | | | | | | | | | | | | | | |
| | E5-2650 v4 12C/2.2GHz/30MB/105W/DDR4-2400 | | | | | | | | | | | | | | | | | | | | | | | | | | | | |
| | E5-2643 v4 6C/3.4GHz/20MB/135W/DDR4-2400 | | | | | | | | | | | | | | | | | | | | | | | | | | | | |
| | E5-2640 v4 10C/2.4GHz/25MB/90W/DDR4-2133 | | | | | | | | | | | | | | | | | | | | | | | | | | | | |
| | E5-2637 v4 4C/3.5GHz/15MB/135W/DDR4-2400 | | | | | | | | | | | | | | | | | | | | | | | | | | | | |
| | E5-2630L v4 10C/1.8GHz/25MB/55W/DDR4-2133 | | | | | | | | | | | | | | | | | | | | | | | | | | | | |
| | E5-2630 v4 10C/2.2GHz/20MB/85W/DDR4-2133 | | | | | | | | | | | | | | | | | | | | | | | | | | | | |
| | E5-2623 v4 4C/2.6GHz/10MB/85W/DDR4-2133 | | | | | | | | | | | | | | | | | | | | | | | | | | | | |
| | E5-2620 v4 8C/2.1GHz/20MB/85W/DDR4-2133 | | | | | | | | | | | | | | | | | | | | | | | | | | | | |
| | E5-2609 v4 8C/1.7GHz/20MB/85W/DDR4-1866 | | | | | | | | | | | | | | | | | | | | | | | | | | | | |
| | E5-2603 v4 6C/1.7GHz/15MB/85W/DDR4-1866 | | | | | | | | | | | | | | | | | | | | | | | | | | | | |
| | E5-2698 v3 16C/2.3GHz/40MB/135W/DDR4-2133 | | | | | | | | | | | | | | | | | | | | | | | | | | | | |
| | E5-2695 v3 14C/2.3GHz/35MB/120W/DDR4-2133 | | | | | | | | | | | | | | | | | | | | | | | | | | | | |
| | E5-2690 v3 12C/2.6GHz/30MB/135W/DDR4-2133 | | | | | | | | | | | | | | | | | | | | | | | | | | | | |
| | E5-2685 v3 12C/2.6GHz/30MB/120W/DDR4-2133 | | | | | | | | | | | | | | | | | | | | | | | | | | | | |
| | E5-2683 v3 14C/2GHz/35MB/120W/DDR4-2133 | | | | | | | | | | | | | | | | | | | | | | | | | | | | |
| | E5-2680 v3 12C/2.5GHz/30MB/120W/DDR4-2133 | | | | | | | | | | | | | | | | | | | | | | | | | | | | |
| | E5-2670 v3 12C/2.3GHz/30MB/120W/DDR4-2133 | | | | | | | | | | | | | | | | | | | | | | | | | | | | |
| | E5-2667 v3 8C/3.2GHz/20MB/135W/DDR4-2133 | | | | | | | | | | | | | | | | | | | | | | | | | | | | |
| | E5-2660 v3 10C/2.6GHz/25MB/105W/DDR4-2133 | | | | | | | | | | | | | | | | | | | | | | | | | | | | |
| | E5-2650L v3 12C/1.8GHz/30MB/65W/DDR4-2133 | | | | | | | | | | | | | | | | | | | | | | | | | | | | |
| | E5-2650 v3 10C/2.3GHz/25MB/105W/DDR4-2133 | | | | | | | | | | | | | | | | | | | | | | | | | | | | |
| | E5-2643 v3 6C/3.4GHz/20MB/135W/DDR4-2133 | | | | | | | | | | | | | | | | | | | | | | | | | | | | |
| | E5-2640 v3 8C/2.6GHz/20MB/90W/DDR4-1866 | | | | | | | | | | | | | | | | | | | | | | | | | | | | |
| | E5-2637 v3 4C/3.5GHz/15MB/135W/DDR4-2133 | | | | | | | | | | | | | | | | | | | | | | | | | | | | |
| E5-2630L v3 8C/1.8GHz/20MB/55W/DDR4-1866 | | | | | | | | | | | | | | | | | | | | | | | | | | | | | |
| E5-2630 v3 8C/2.4GHz/20MB/85W/DDR4-1866 | | | | | | | | | | | | | | | | | | | | | | | | | | | | | |
| E5-2623 v3 4C/3GHz/10MB/105W/DDR4-1866 | | | | | | | | | | | | | | | | | | | | | | | | | | | | | |
| E5-2620 v3 6C/2.4GHz/15MB/85W/DDR4-1866 | | | | | | | | | | | | | | | | | | | | | | | | | | | | | |
| E5-2609 v3 6C/1.9GHz/15MB/85W/DDR4-1600 | | | | | | | | | | | | | | | | | | | | | | | | | | | | | |
| E5-2603 v3 6C/1.6GHz/15MB/85W/DDR4-1600 | | | | | | | | | | | | | | | | | | | | | | | | | | | | | |
| Chipset | Intel C610 Series Chipset | | | | | | | | | | | | | | | | | | | | | | | | | | | | |
| Memory DIMMs | 16 DIMM sockets (8 DIMMs per processor), 8-channel capable (4-channel per processor). RDIMM and LRDIMM (cannot be intermixed), DDR4, up to 2400MHz | | | | | | | | | | | | | | | | | | | | | | | | | | | | |
| Memory capacity | 512GB (RDIMM, 32GB x 16)/1024GB (LRDIMM, 64GB x 16), 2nd CPU is needed | | | | | | | | | | | | | | | | | | | | | | | | | | | | |
| Memory protection | ECC, memory mirroring, lockstep, and memory sparing | | | | | | | | | | | | | | | | | | | | | | | | | | | | |
| RAID controller | <table border="1"> <thead> <tr> <th>RAID controller</th> <th>Drive type</th> <th>RAID support</th> <th>Compatible models</th> </tr> </thead> <tbody> <tr> <td>Onboard RAID110i</td> <td>6Gbs SATA</td> <td>0/1/10,5 with optional key</td> <td>5x3.5" HS/ES, 8x2.5" HS</td> </tr> <tr> <td>RAID520i PCIe</td> <td>12Gbs SAS/SATA</td> <td>0/1/10,5/50 with optional key</td> <td>5x3.5" HS, 8x2.5" HS</td> </tr> <tr> <td>RAID720i PCIe</td> <td>12Gbs SAS/SATA</td> <td>0/1/10/5/50,6/60 with optional cache</td> <td>5x3.5" HS, 8x2.5" HS</td> </tr> <tr> <td>AnyRAID 510i</td> <td>6Gbs SAS/SATA</td> <td>0/1/10,5/50 with optional key</td> <td>5x3.5" HS, 8x2.5" HS</td> </tr> <tr> <td>AnyRAID 720i</td> <td>12Gbs SAS/SATA</td> <td>0/1/10/5/50,6/60 with optional cache</td> <td>5x3.5" HS, 8x2.5" HS</td> </tr> <tr> <td>AnyRAID 720ix</td> <td>12Gbs SAS/SATA</td> <td>0/1/10/5/50/6/60</td> <td>15x3.5" HS, 16/32x2.5" HS</td> </tr> </tbody> </table> | RAID controller | Drive type | RAID support | Compatible models | Onboard RAID110i | 6Gbs SATA | 0/1/10,5 with optional key | 5x3.5" HS/ES, 8x2.5" HS | RAID520i PCIe | 12Gbs SAS/SATA | 0/1/10,5/50 with optional key | 5x3.5" HS, 8x2.5" HS | RAID720i PCIe | 12Gbs SAS/SATA | 0/1/10/5/50,6/60 with optional cache | 5x3.5" HS, 8x2.5" HS | AnyRAID 510i | 6Gbs SAS/SATA | 0/1/10,5/50 with optional key | 5x3.5" HS, 8x2.5" HS | AnyRAID 720i | 12Gbs SAS/SATA | 0/1/10/5/50,6/60 with optional cache | 5x3.5" HS, 8x2.5" HS | AnyRAID 720ix | 12Gbs SAS/SATA | 0/1/10/5/50/6/60 | 15x3.5" HS, 16/32x2.5" HS |
| | RAID controller | Drive type | RAID support | Compatible models | | | | | | | | | | | | | | | | | | | | | | | | | |
| | Onboard RAID110i | 6Gbs SATA | 0/1/10,5 with optional key | 5x3.5" HS/ES, 8x2.5" HS | | | | | | | | | | | | | | | | | | | | | | | | | |
| | RAID520i PCIe | 12Gbs SAS/SATA | 0/1/10,5/50 with optional key | 5x3.5" HS, 8x2.5" HS | | | | | | | | | | | | | | | | | | | | | | | | | |
| | RAID720i PCIe | 12Gbs SAS/SATA | 0/1/10/5/50,6/60 with optional cache | 5x3.5" HS, 8x2.5" HS | | | | | | | | | | | | | | | | | | | | | | | | | |
| | AnyRAID 510i | 6Gbs SAS/SATA | 0/1/10,5/50 with optional key | 5x3.5" HS, 8x2.5" HS | | | | | | | | | | | | | | | | | | | | | | | | | |
| | AnyRAID 720i | 12Gbs SAS/SATA | 0/1/10/5/50,6/60 with optional cache | 5x3.5" HS, 8x2.5" HS | | | | | | | | | | | | | | | | | | | | | | | | | |
| AnyRAID 720ix | 12Gbs SAS/SATA | 0/1/10/5/50/6/60 | 15x3.5" HS, 16/32x2.5" HS | | | | | | | | | | | | | | | | | | | | | | | | | | |
| | Optional cache for RAID 720/AnyRAID 720i and 720ix: 1GB read-only memory or 1GB/2GB/4GB flash with super capacitor. Flash options include CacheVault, Cache-Cade Pro, and FastPath. 720ix must have cache. | | | | | | | | | | | | | | | | | | | | | | | | | | | | |
| Disk drive bays | Up to 15 3.5" or 32 2.5" hot-swap bays, or up to 5 3.5" easy-swap bays, on front. Up to 2 M.2 SSD drives via optional M.2 module. Up to one internal LTO-6 SAS tape drive on 720ix model, or external RDX tape drive via USB. | | | | | | | | | | | | | | | | | | | | | | | | | | | | |

| Components | Specification | | | | | | | | | | | | | | | | | | | | | | | | | | | | | | | | | | | | | | |
|---------------------------------------|---|--------------------------------------|---|---------------------------------|--|-------------------------|--|---------------------------------|--|--------------------------------------|--|-----------------|--|----------------------|--|-----------|-----------------|---------------------------------------|--------|--------|------------|-----------------------------------|------------------------|---|---|-----------|-----------------|---|---|---|------------|-----------------|---|---|---|------------|---|---|---|
| Maximum internal storage | 3.5" model: up to 120TB with 7.2K SATA or SAS HDD, up to 27TB with 10K SAS HDD, up to 9TB with 15K SAS HDD, or up to 24TB with SATA or SAS SSD. 2.5" model: up to 64TB with 7.2K SATA HDD, up to 57.6TB with 10K SAS HDD, up to 19.2TB with 15K SAS HDD, or up to 51.2TB with SATA or SAS SSD | | | | | | | | | | | | | | | | | | | | | | | | | | | | | | | | | | | | | | |
| SD module | Up to 2 SDHC flash cards via optional SD module, 8GB or 32GB each | | | | | | | | | | | | | | | | | | | | | | | | | | | | | | | | | | | | | | |
| Optical drive | Two 5.25" bays for optical drive. DVD-ROM or DVD±RW. Half-height or 9.5mm | | | | | | | | | | | | | | | | | | | | | | | | | | | | | | | | | | | | | | |
| Network interfaces | One dedicate management port, two gigabit ethernet ports. Supports optional discrete network adapters via PCIe slots | | | | | | | | | | | | | | | | | | | | | | | | | | | | | | | | | | | | | | |
| Security features | Power-on and administrator password. Optional TPM (TCG 1.2 or 2.0-compliant) | | | | | | | | | | | | | | | | | | | | | | | | | | | | | | | | | | | | | | |
| Systems management | Supports ThinkServer System Manager (TSM), optional TSM Premium for remote presence. UEFI. Onboard Aspeed AST2400 graphics/management processor, IPMI 2.0-compliant baseboard management controller (BMC). Control Panel LEDs shows the status of power, ID, network, system. Supports ThinkServer Diagnostics, ThinkServer Deployment Manager, ThinkServer Energy Manager, ThinkServer System Manager CLI, Lenovo ThinkServer Partner Pack for VMware vCenter and Microsoft System Center Operations Manager, ThinkServer Power Planner. | | | | | | | | | | | | | | | | | | | | | | | | | | | | | | | | | | | | | | |
| Operating systems supported | Microsoft Windows Server 2016/2012 R2/2012/2008 R2. Windows Small Business Server 2011. Red Hat Enterprise Linux 6.5/6.6/7. SUSE Linux Enterprise Server 11. VMware vSphere (ESXi) 5.1 P5/5.5 U2/6.0 | | | | | | | | | | | | | | | | | | | | | | | | | | | | | | | | | | | | | | |
| Base warranty | 1 or 3-year limited onsite service with 9x5/NBD. | | | | | | | | | | | | | | | | | | | | | | | | | | | | | | | | | | | | | | |
| Power supply | Up to two redundant hot-swap 450W/550W/750W/1100W power supplies. 450 W is 80 PLUS Gold qualified. 550W and 1100W are 80 PLUS Platinum qualified. 750W is 80 PLUS Platinum or Titanium qualified. 750W Titanium is 200V - 240V, others are 110V - 240V. | | | | | | | | | | | | | | | | | | | | | | | | | | | | | | | | | | | | | | |
| | <table border="1"> <thead> <tr> <th rowspan="2">Disk bay configuration</th> <th colspan="4">PSU requirements</th> </tr> <tr> <th>450W</th> <th>550W</th> <th>750W</th> <th>1100W</th> </tr> </thead> <tbody> <tr> <td>5x3.5" ES</td> <td>• (up to 1 CPU)</td> <td>•</td> <td>•</td> <td>•</td> </tr> <tr> <td>5x3.5" HS</td> <td>• (up to 1 CPU)</td> <td>•</td> <td>•</td> <td>•</td> </tr> <tr> <td>15x3.5" HS</td> <td>•</td> <td>•</td> <td>•</td> <td>•</td> </tr> <tr> <td>8x2.5" HS</td> <td>• (up to 1 CPU)</td> <td>•</td> <td>•</td> <td>•</td> </tr> <tr> <td>16x2.5" HS</td> <td>• (up to 1 CPU)</td> <td>•</td> <td>•</td> <td>•</td> </tr> <tr> <td>32x2.5" HS</td> <td>•</td> <td>•</td> <td>•</td> <td>•</td> </tr> </tbody> </table> | Disk bay configuration | PSU requirements | | | | 450W | 550W | 750W | 1100W | 5x3.5" ES | • (up to 1 CPU) | • | • | • | 5x3.5" HS | • (up to 1 CPU) | • | • | • | 15x3.5" HS | • | • | • | • | 8x2.5" HS | • (up to 1 CPU) | • | • | • | 16x2.5" HS | • (up to 1 CPU) | • | • | • | 32x2.5" HS | • | • | • |
| Disk bay configuration | PSU requirements | | | | | | | | | | | | | | | | | | | | | | | | | | | | | | | | | | | | | | |
| | 450W | 550W | 750W | 1100W | | | | | | | | | | | | | | | | | | | | | | | | | | | | | | | | | | | |
| 5x3.5" ES | • (up to 1 CPU) | • | • | • | | | | | | | | | | | | | | | | | | | | | | | | | | | | | | | | | | | |
| 5x3.5" HS | • (up to 1 CPU) | • | • | • | | | | | | | | | | | | | | | | | | | | | | | | | | | | | | | | | | | |
| 15x3.5" HS | • | • | • | • | | | | | | | | | | | | | | | | | | | | | | | | | | | | | | | | | | | |
| 8x2.5" HS | • (up to 1 CPU) | • | • | • | | | | | | | | | | | | | | | | | | | | | | | | | | | | | | | | | | | |
| 16x2.5" HS | • (up to 1 CPU) | • | • | • | | | | | | | | | | | | | | | | | | | | | | | | | | | | | | | | | | | |
| 32x2.5" HS | • | • | • | • | | | | | | | | | | | | | | | | | | | | | | | | | | | | | | | | | | | |
| Graphics | Onboard Aspeed AST2400 with 16MB memory, one VGA on rear | | | | | | | | | | | | | | | | | | | | | | | | | | | | | | | | | | | | | | |
| Front ports | Two USB 2.0 | | | | | | | | | | | | | | | | | | | | | | | | | | | | | | | | | | | | | | |
| Rear ports | One VGA, four USB 3.0, one RJ-45 (dedicate/share mgmt), two ethernet (RJ-45), one serial (9-pin) | | | | | | | | | | | | | | | | | | | | | | | | | | | | | | | | | | | | | | |
| Cooling | 4 (3+1), hot-swap | | | | | | | | | | | | | | | | | | | | | | | | | | | | | | | | | | | | | | |
| Noise emissions | Operating: < 6.5 Bels. Idle: < 6 Bels (Maximum configuration) | | | | | | | | | | | | | | | | | | | | | | | | | | | | | | | | | | | | | | |
| Environmental specification | <table border="1"> <thead> <tr> <th>ASHRAE Class</th> <th>A4</th> <th>A3</th> <th>A2</th> </tr> </thead> <tbody> <tr> <td>Temperature - operating</td> <td>41 °F to 113 °F (5 °C to 45 °C)</td> <td>41 °F to 104 °F (5 °C to 40 °C)</td> <td>50 °F to 95 °F (10 °C to 35 °C)</td> </tr> <tr> <td>Temperature - storage (with package)</td> <td colspan="3">-40 °C to 60 °C</td> </tr> <tr> <td>Altitude - operating</td> <td colspan="3">(Unpressurized): 0-10000ft (0-3048m)</td> </tr> <tr> <td>Humidity - operating (non-condensing)</td> <td>8%~90%</td> <td>8%~85%</td> <td>20%~80%</td> </tr> <tr> <td>Humidity - storage (with package)</td> <td colspan="3">8%~90%, non-condensing</td> </tr> </tbody> </table> | ASHRAE Class | A4 | A3 | A2 | Temperature - operating | 41 °F to 113 °F (5 °C to 45 °C) | 41 °F to 104 °F (5 °C to 40 °C) | 50 °F to 95 °F (10 °C to 35 °C) | Temperature - storage (with package) | -40 °C to 60 °C | | | Altitude - operating | (Unpressurized): 0-10000ft (0-3048m) | | | Humidity - operating (non-condensing) | 8%~90% | 8%~85% | 20%~80% | Humidity - storage (with package) | 8%~90%, non-condensing | | | | | | | | | | | | | | | | |
| | ASHRAE Class | A4 | A3 | A2 | | | | | | | | | | | | | | | | | | | | | | | | | | | | | | | | | | | |
| | Temperature - operating | 41 °F to 113 °F (5 °C to 45 °C) | 41 °F to 104 °F (5 °C to 40 °C) | 50 °F to 95 °F (10 °C to 35 °C) | | | | | | | | | | | | | | | | | | | | | | | | | | | | | | | | | | | |
| | Temperature - storage (with package) | -40 °C to 60 °C | | | | | | | | | | | | | | | | | | | | | | | | | | | | | | | | | | | | | |
| | Altitude - operating | (Unpressurized): 0-10000ft (0-3048m) | | | | | | | | | | | | | | | | | | | | | | | | | | | | | | | | | | | | | |
| Humidity - operating (non-condensing) | 8%~90% | 8%~85% | 20%~80% | | | | | | | | | | | | | | | | | | | | | | | | | | | | | | | | | | | | |
| Humidity - storage (with package) | 8%~90%, non-condensing | | | | | | | | | | | | | | | | | | | | | | | | | | | | | | | | | | | | | | |
| | ASHRAE Class A4: ES or 8x2.5" HS bays/Lenovo-qualified CPU; maximum of 120W thermal design power; not low-power type (no L-suffix in the CPU name)/No internal tape/Two PSU installed for redundancy/Lenovo-qualified PCIe card; power consumption of each PCIe card does not exceed 15W. 32 x 2.5" models support ASHRAE Class A2, the other models support ASHRAE Class A3. | | | | | | | | | | | | | | | | | | | | | | | | | | | | | | | | | | | | | | |
| | Expansion slots | | | | | | | | | | | | | | | | | | | | | | | | | | | | | | | | | | | | | | |
| | <table border="1"> <tbody> <tr> <td>Slot 1 (CPU1)</td> <td>PCIe 3.0 x16, full height, full length, double-wide</td> </tr> <tr> <td>Slot 2 (CPU1)</td> <td>PCIe 3.0 x16 (x8 elec), full height, full length</td> </tr> <tr> <td>Slot 3 (CPU1)</td> <td>PCIe 3.0 x16 (x8 elec), full height, full length</td> </tr> <tr> <td>Slot 4 (CPU2)</td> <td>PCIe 3.0 x16 (x8 elec), full height, full length</td> </tr> <tr> <td>Slot 5 (CPU2)</td> <td>PCIe 3.0 x16, full height, full length</td> </tr> <tr> <td>Slot 6 (CPU2)</td> <td>PCIe 3.0 x16 (x8 elec), full height, full length</td> </tr> <tr> <td>Slot 7 (CPU2)</td> <td>PCIe 3.0 x16 (x8 elec), full height, full length</td> </tr> </tbody> </table> | Slot 1 (CPU1) | PCIe 3.0 x16, full height, full length, double-wide | Slot 2 (CPU1) | PCIe 3.0 x16 (x8 elec), full height, full length | Slot 3 (CPU1) | PCIe 3.0 x16 (x8 elec), full height, full length | Slot 4 (CPU2) | PCIe 3.0 x16 (x8 elec), full height, full length | Slot 5 (CPU2) | PCIe 3.0 x16, full height, full length | Slot 6 (CPU2) | PCIe 3.0 x16 (x8 elec), full height, full length | Slot 7 (CPU2) | PCIe 3.0 x16 (x8 elec), full height, full length | | | | | | | | | | | | | | | | | | | | | | | | |
| Slot 1 (CPU1) | PCIe 3.0 x16, full height, full length, double-wide | | | | | | | | | | | | | | | | | | | | | | | | | | | | | | | | | | | | | | |
| Slot 2 (CPU1) | PCIe 3.0 x16 (x8 elec), full height, full length | | | | | | | | | | | | | | | | | | | | | | | | | | | | | | | | | | | | | | |
| Slot 3 (CPU1) | PCIe 3.0 x16 (x8 elec), full height, full length | | | | | | | | | | | | | | | | | | | | | | | | | | | | | | | | | | | | | | |
| Slot 4 (CPU2) | PCIe 3.0 x16 (x8 elec), full height, full length | | | | | | | | | | | | | | | | | | | | | | | | | | | | | | | | | | | | | | |
| Slot 5 (CPU2) | PCIe 3.0 x16, full height, full length | | | | | | | | | | | | | | | | | | | | | | | | | | | | | | | | | | | | | | |
| Slot 6 (CPU2) | PCIe 3.0 x16 (x8 elec), full height, full length | | | | | | | | | | | | | | | | | | | | | | | | | | | | | | | | | | | | | | |
| Slot 7 (CPU2) | PCIe 3.0 x16 (x8 elec), full height, full length | | | | | | | | | | | | | | | | | | | | | | | | | | | | | | | | | | | | | | |
| | | | | | | | | | | | | | | | | | | | | | | | | | | | | | | | | | | | | | | | |

For a list of all supported options, please see https://download.lenovo.com/pcbbbs/options_iso/ocm_september_2016_thinkserver.xlsx sheet

| Model | Region | Processor | 2nd CPU | Memory | RAID Controller | Disk Bays | Storage | Optical | Add-on NIC | Add-on Ports | TPM | System Mgmt | OS | Warranty | Power Supply | Ann Date (m/y) |
|------------|--------|---|------------|----------------------------|-------------------------|------------|---------|-----------|------------|--------------|---------|-------------|------|----------|-----------------|----------------|
| 70DG0003UX | US | 2xE5-2620 v3 6C/2.4GHz/15MB/85W/DDR4-1866 | - | 4x8GB RDIMM DDR4-2133 ECC | AnyRAID 110i+Key | 5x3.5" HS | Open | HH DVD±RW | None | None | TPM 1.2 | TSM | None | 3-year | 750Wx1 Platinum | 09/14 |
| 70DG0007UX | US | 1xE5-2603 v3 6C/1.6GHz/15MB/85W/DDR4-1600 | 4XG0F28787 | 1x8GB RDIMM DDR4-2133 ECC | AnyRAID 110i+Key | 5x3.5" HS | Open | HH DVD±RW | None | None | TPM 1.2 | TSM | None | 3-year | 550Wx1 Platinum | 09/14 |
| 70DG0008UX | US | 1xE5-2609 v3 6C/1.9GHz/15MB/85W/DDR4-1600 | 4XG0F28786 | 1x8GB RDIMM DDR4-2133 ECC | AnyRAID 110i+Key | 5x3.5" HS | Open | HH DVD±RW | None | None | TPM 1.2 | TSM | None | 3-year | 550Wx1 Platinum | 09/14 |
| 70DG0009UX | US | 1xE5-2620 v3 6C/2.4GHz/15MB/85W/DDR4-1866 | 4XG0F28785 | 1x8GB RDIMM DDR4-2133 ECC | AnyRAID 720ix+1GB RAM | 15x3.5" HS | Open | HH DVD±RW | None | None | TPM 1.2 | TSM | None | 3-year | 750Wx1 Platinum | 09/14 |
| 70DG000AUX | US | 1xE5-2640 v3 8C/2.6GHz/20MB/90W/DDR4-1866 | 4XG0F28783 | 1x8GB RDIMM DDR4-2133 ECC | AnyRAID 720ix+1GB RAM | 15x3.5" HS | Open | HH DVD±RW | None | None | TPM 1.2 | TSM | None | 3-year | 750Wx1 Platinum | 09/14 |
| 70DG000BUX | US | 1xE5-2650 v3 10C/2.3GHz/25MB/105W/DDR4-2133 | 4XG0F28782 | 1x8GB RDIMM DDR4-2133 ECC | AnyRAID 720ix+1GB RAM | 15x3.5" HS | Open | HH DVD±RW | None | None | TPM 1.2 | TSM | None | 3-year | 750Wx1 Platinum | 09/14 |
| 70DG000CUX | US | 1xE5-2670 v3 12C/2.3GHz/30MB/120W/DDR4-2133 | 4XG0F28780 | 1x8GB RDIMM DDR4-2133 ECC | AnyRAID 720ix+1GB RAM | 15x3.5" HS | Open | HH DVD±RW | None | None | TPM 1.2 | TSM | None | 3-year | 750Wx1 Platinum | 09/14 |
| 70DG006NUX | US | 1xE5-2603 v4 6C/1.7GHz/15MB/85W/DDR4-1866 | 4XG0G89088 | 1x16GB RDIMM DDR4-2400 ECC | Onboard 110i | 5x3.5" HS | Open | None | None | None | TPM 1.2 | TSM | None | 3-year | 750Wx1 Platinum | 04/16 |
| 70DG006PUX | US | 1xE5-2609 v4 8C/1.7GHz/20MB/85W/DDR4-1866 | 4XG0G89083 | 1x16GB RDIMM DDR4-2400 ECC | Onboard 110i | 5x3.5" HS | Open | None | None | None | TPM 1.2 | TSM | None | 3-year | 750Wx1 Platinum | 04/16 |
| 70DG006QUX | US | 1xE5-2620 v4 8C/2.1GHz/20MB/85W/DDR4-2133 | 4XG0G89078 | 1x16GB RDIMM DDR4-2400 ECC | Onboard 110i | 5x3.5" HS | Open | None | None | None | TPM 1.2 | TSM | None | 3-year | 750Wx1 Platinum | 04/16 |
| 70DG006RUX | US | 1xE5-2630 v4 10C/2.2GHz/20MB/85W/DDR4-2133 | 4XG0G89073 | 1x16GB RDIMM DDR4-2400 ECC | AnyRAID 720ix+1GB Flash | 15x3.5" HS | Open | None | None | None | TPM 1.2 | TSM | None | 3-year | 750Wx1 Platinum | 04/16 |
| 70DG006SUX | US | 1xE5-2640 v4 10C/2.4GHz/25MB/90W/DDR4-2133 | 4XG0G89068 | 1x16GB RDIMM DDR4-2400 ECC | AnyRAID 720ix+1GB Flash | 15x3.5" HS | Open | None | None | None | TPM 1.2 | TSM | None | 3-year | 750Wx1 Platinum | 04/16 |
| 70DG006TUX | US | 1xE5-2650 v4 12C/2.2GHz/30MB/105W/DDR4-2400 | 4XG0G89063 | 1x16GB RDIMM DDR4-2400 ECC | AnyRAID 720ix+1GB Flash | 15x3.5" HS | Open | None | None | None | TPM 1.2 | TSM | None | 3-year | 750Wx1 Platinum | 04/16 |
| 70DG006UUX | US | 1xE5-2660 v4 14C/2GHz/35MB/105W/DDR4-2400 | 4XG0G89058 | 1x16GB RDIMM DDR4-2400 ECC | AnyRAID 720ix+1GB Flash | 15x3.5" HS | Open | None | None | None | TPM 1.2 | TSM | None | 3-year | 750Wx1 Platinum | 04/16 |
| 70DG006VUX | US | 1xE5-2680 v4 14C/2.4GHz/35MB/120W/DDR4-2400 | 4XG0G89055 | 1x16GB RDIMM DDR4-2400 ECC | AnyRAID 720ix+1GB Flash | 15x3.5" HS | Open | None | None | None | TPM 1.2 | TSM | None | 3-year | 750Wx1 Platinum | 04/16 |
| 70DG006WUX | US | 2xE5-2620 v4 8C/2.1GHz/20MB/85W/DDR4-2133 | - | 2x16GB RDIMM DDR4-2400 ECC | AnyRAID 110i | 5x3.5" HS | Open | None | None | None | TPM 1.2 | TSM Premium | None | 3-year | 750Wx2 Platinum | 04/16 |
| 70DG007QUX | US | 1xE5-2620 v4 8C/2.1GHz/20MB/85W/DDR4-2133 | 4XG0G89078 | 1x16GB RDIMM DDR4-2400 ECC | AnyRAID 720ix+1GB RAM | 15x3.5" HS | Open | None | None | None | TPM 1.2 | TSM | None | 3-year | 750Wx1 Platinum | 06/16 |

| Model | Region | Processor | 2nd CPU | Memory | RAID Controller | Disk Bays | Storage | Optical | Add-on NIC | Add-on Ports | TPM | System Mgmt | OS | Warranty | Power Supply | Ann Date (m/y) |
|------------|--------|--|------------|----------------------------------|----------------------------|--------------|---------|---------|------------|--------------|------------|-------------|------|----------|--------------------|----------------|
| 70DJ006NUX | US | 1xE5-2640 v4 10C/2.4GHz/25MB/90W/DDR4-2133 | 4XG0G89068 | 1x16GB RDIMM DDR4-2400 ECC | AnyRAID 720i+1GB RAM | 8x2.5" HS | Open | None | None | None | TPM 2.0 | TSM | None | 3-year | 750Wx1 Platinum | 04/16 |

ThinkServer TS150 Platform Specifications

Product Specifications Reference (PSREF)

| Components | Specification |
|--|---|
| Dimensions | Tower or 4U rack. Height: 375 mm (14.76 in), width: 175 mm (6.89 in), depth: 431 mm (16.97 in) |
| Weight | Maximum configuration: 27.6 lb (12.5kg) |
| Processor | One Intel "Kaby Lake" or "Skylake" processor as listed: "Kaby Lake" processors: |
| | Xeon E3-1280 v6 4C/3.9GHz/8MB/72W/DDR4-2400 |
| | Xeon E3-1275 v6 4C/3.8GHz/8MB/73W/DDR4-2400 |
| | Xeon E3-1270 v6 4C/3.8GHz/8MB/72W/DDR4-2400 |
| | Xeon E3-1245 v6 4C/3.7GHz/8MB/73W/DDR4-2400 |
| | Xeon E3-1240 v6 4C/3.7GHz/8MB/72W/DDR4-2400 |
| | Xeon E3-1230 v6 4C/3.5GHz/8MB/72W/DDR4-2400 |
| | Xeon E3-1225 v6 4C/3.3GHz/8MB/73W/DDR4-2400 |
| | Xeon E3-1220 v6 4C/3GHz/8MB/72W/DDR4-2400 |
| | Core i3-7320 2C/4.1GHz/4MB/51W/DDR4-2400 |
| | Core i3-7300T 2C/3.5GHz/4MB/35W/DDR4-2400 |
| | Core i3-7300 2C/4GHz/4MB/51W/DDR4-2400 |
| | Core i3-7100T 2C/3.4GHz/3MB/35W/DDR4-2400 |
| | Core i3-7100 2C/3.9GHz/3MB/51W/DDR4-2400 |
| | Pentium G4620 2C/3.7GHz/3MB/51W/DDR4-2400 |
| | Pentium G4600T 2C/3GHz/3MB/35W/DDR4-2400 |
| | Pentium G4600 2C/3.6GHz/3MB/51W/DDR4-2400 |
| | Pentium G4560T 2C/2.9GHz/3MB/35W/DDR4-2400 |
| | Pentium G4560 2C/3.5GHz/3MB/54W/DDR4-2400 |
| | Celeron G3950 2C/3GHz/2MB/51W/DDR4-2133 |
| | Celeron G3930T 2C/2.7GHz/2MB/35W/DDR4-2133 |
| | Celeron G3930 2C/2.9GHz/2MB/51W/DDR4-2133 |
| | "Skylake" processors: |
| | Xeon E3-1280 v5 4C/3.7GHz/8MB/80W/DDR4-2133 |
| | Xeon E3-1270 v5 4C/3.6GHz/8MB/80W/DDR4-2133 |
| | Xeon E3-1240 v5 4C/3.5GHz/8MB/80W/DDR4-2133 |
| | Xeon E3-1230 v5 4C/3.4GHz/8MB/80W/DDR4-2133 |
| | Xeon E3-1220 v5 4C/3GHz/8MB/80W/DDR4-2133 |
| | Xeon E3-1275 v5 4C/3.6GHz/8MB/80W/DDR4-2133 |
| | Xeon E3-1245 v5 4C/3.5GHz/8MB/80W/DDR4-2133 |
| | Xeon E3-1225 v5 4C/3.3GHz/8MB/80W/DDR4-2133 |
| | Core i3-6320 2C/3.9GHz/4MB/51W/DDR4-2133 |
| | Core i3-6300 2C/3.8GHz/4MB/51W/DDR4-2133 |
| | Core i3-6300T 2C/3.3GHz/4MB/35W/DDR4-2133 |
| | Core i3-6100 2C/3.7GHz/3MB/51W/DDR4-2133 |
| | Core i3-6100T 2C/3.2GHz/3MB/35W/DDR4-2133 |
| | Pentium G4520 2C/3.6GHz/3MB/51W/DDR4-2133 |
| | Pentium G4500 2C/3.5GHz/3MB/51W/DDR4-2133 |
| | Pentium G4500T 2C/3GHz/3MB/35W/DDR4-2133 |
| | Pentium G4400 2C/3.3GHz/3MB/54W/DDR4-2133 |
| Pentium G4400T 2C/2.9GHz/3MB/35W/DDR4-2133 | |
| Celeron G3920 2C/2.9GHz/2MB/51W/DDR4-2133 | |
| Celeron G3900 2C/2.8GHz/2MB/51W/DDR4-2133 | |
| Celeron G3900T 2C/2.6GHz/2MB/35W/DDR4-2133 | |
| Chipset | Intel C236 Platform Controller Hub (PCH) |
| Memory DIMMs | 4 DIMM sockets with 2 channels, 2 DIMMs per channel. UDIMM. Up to DDR4-2400 |
| Memory capacity | 64GB (16GB x 4) |
| Memory protection | ECC |
| RAID controller | RAID controller |
| | Drive type |
| RAID controller | Onboard RAID121i 6Gbs SATA 0/1/5/10 |
| | RAID520i PCIe 12Gbs SAS/SATA 0/1/10, 5 with optional key |
| Disk bays | Supports up to four 3.5" or hybrid 3.5" + 2.5" disk drives, or up to five 2.5" disk drives, one 9.5mm optical (see right). Non-hot swap. Cables are connected to onboard SATA connectors or PCIe RAID controller. Supports one optional internal USB RDX Tape drive |
| Supporting storage | 3.5" HDD, 7.2K SATA6Gbs 500GB/1TB/2TB/3TB/4TB/5TB/6TB/10TB |
| | 2.5" HDD, 7.2K SATA6Gbs 500GB/1TB/2TB |
| | 2.5" SSD, SATA6Gbs 120GB/240GB/480GB/600GB/800GB/960GB |

| Components | Specification |
|-----------------------------|---|
| SD module | Optional. Up to 2 SDHC flash cards via SD module, 8GB each |
| Optical drive | Up to two half-height optical drives or one 9.5mm optical. DVD-ROM or DVD±RW |
| Network interfaces | One Gigabit Ethernet port, Intel i219LM. Supports optional discrete network adapters via PCIe slots |
| Security features | Power-on and administrator password. TPM (TCG 1.2-compliant) |
| Systems management | UEFI, system LEDs, EasyStartup, EasyUpdate, Power Planner, and Diagnostics. Intel Active Management Technology 11 on models with Xeon processors. Intel Standard Manageability on models with Core i3, Pentium, or Celeron processors. KVM is supported on models with Xeon E3-12x5 v5 processors |
| Operating systems | Microsoft Windows Server 2016/2012 R2/2012, Windows MultiPoint Server 2012, Windows 10 Pro. Red Hat Enterprise Linux 6.7/7.2. SUSE Linux Enterprise Server 11/12. VMware vSphere (ESXi) 5.5U3/6.0U2 |
| Base warranty | 1 or 3-year limited onsite service with 9x5/NBD |
| Power supply | Supports one of the following: • One fixed 250 watts, autosensing, 85%, 80 PLUS Bronze qualified • One fixed 400 watts, autosensing, 92%, 80 PLUS Platinum qualified |
| Graphics | Integrated Intel HD Graphics on Xeon E3-12x5 v5, Core i3, Pentium, and Celeron processors. Uses main memory, works along with discrete graphics to support multi-display, enables two display connectors (1 DP, 1 VGA) on rear ports. Also supports the following discrete graphics adapter options: • NVIDIA Quadro NVS 315, 1GB • NVIDIA Quadro K620, 2GB |
| HD Audio | Realtek ALC662 codec |
| Front ports | Two USB 3.0 |
| Rear ports | One VGA, one DisplayPort, six USB 3.0, one RJ-45, one serial (9-pin), three analog audio ports (line-in, line-out, mic-in). Optional parallel or serial ports via PCIe adapters |
| Noise emissions | Operating: < 35 dB(A). Idle: < 34 dB(A) (Maximum configuration) |
| Environmental specification | Temperature - operating 50 °F to 95 °F (10 °C to 35 °C) |
| | Temperature - non operating (with package) -40 °C to 60 °C |
| | Altitude - operating (Unpressurized): 0-10000ft (0-3048m) |
| | Humidity - operating 8%-80%, non-condensing |
| | Humidity - storage (with package) 10%-90%, non-condensing |

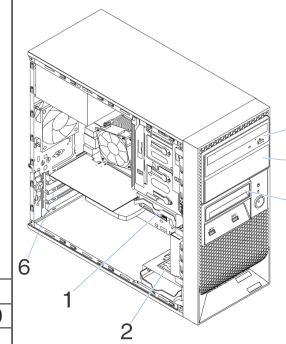

Note:
1. PCIe cards are optional.
2. Disk tray comes with the disk drive.

| | 4 x 3.5" | 5 x 2.5" | 4 x hybrid 3.5" + 2.5" |
|-------|--|--|---|
| Bay 1 | 1st HDD bay | 1st HDD bay | 1st HDD bay, 3.5"/2.5" |
| Bay 2 | 2nd HDD bay | 2nd HDD bay | 2nd HDD bay, 3.5"/2.5" |
| Bay 3 | Not supported | 3rd HDD bay | Not supported on standard models. Supports one 2.5" disk drive for special bid only |
| Bay 4 | 2nd half-height optical, or RDX tape drive, or 3rd HDD bay | 2nd half-height optical, or RDX tape drive, or 4th HDD bay | 2nd half-height optical, or RDX tape drive, or 3rd HDD bay (3.5"/2.5") |
| Bay 5 | 1st half-height optical, or 9.5mm optical + 4th HDD bay | 1st half-height optical, or 9.5mm optical + 5th HDD bay | 1st half-height optical, or 9.5mm optical + 4th HDD bay (3.5"/2.5") |
| 6 | Four PCIe slots (top-down): Slot 1: PCIe 3.0 x16, full height, half length (near CPU) Slot 2: PCIe 3.0 x1, full height, half length Slot 3: PCIe 3.0 x16 (x4 elec), full height, half length Slot 4: PCIe 3.0 x1, full height, half length | | |

ThinkServer TS150 - TopSeller - 70LV

Product Specifications Reference (PSREF)

| Model | Region | Processor | Memory | RAID Controller | Disk Bays | Storage | Optical | Add-on NIC | Add-on Ports | System Mgmt | OS | Warranty | Power Supply | Ann Date (m/y) |
|------------|--------|---|---------------------------|-----------------|-----------------------------|---------|--------------|------------|--------------|-------------|------|----------|-------------------|----------------|
| 70LV002XUX | US | Xeon E3-1225 v5 4C/3.3GHz/8MB/80W/DDR4-2133 | 1x8GB UDIMM DDR4-2133 ECC | RAID 121i | Up to 5x2.5" DC | Open | None | None | None | AMT | None | 1-year | Fixed 250W Bronze | 08/16 |
| 70LV002YUX | US | Xeon E3-1245 v5 4C/3.5GHz/8MB/80W/DDR4-2133 | 1x8GB UDIMM DDR4-2133 ECC | RAID 121i | Up to 5x2.5" DC | Open | None | None | None | AMT | None | 1-year | Fixed 250W Bronze | 08/16 |
| 70LV0030UX | US | Xeon E3-1275 v5 4C/3.6GHz/8MB/80W/DDR4-2133 | 1x8GB UDIMM DDR4-2133 ECC | RAID 121i | Up to 5x2.5" DC | Open | None | None | None | AMT | None | 1-year | Fixed 250W Bronze | 08/16 |
| 70LV0031UX | US | Xeon E3-1225 v5 4C/3.3GHz/8MB/80W/DDR4-2133 | 1x8GB UDIMM DDR4-2133 ECC | RAID 121i | Up to 4x3.5" DC | Open | None | None | None | AMT | None | 1-year | Fixed 250W Bronze | 08/16 |
| 70LV0032UX | US | Xeon E3-1245 v5 4C/3.5GHz/8MB/80W/DDR4-2133 | 1x8GB UDIMM DDR4-2133 ECC | RAID 121i | Up to 4x3.5" DC | Open | None | None | None | AMT | None | 1-year | Fixed 250W Bronze | 08/16 |
| 70LV0033UX | US | Xeon E3-1275 v5 4C/3.6GHz/8MB/80W/DDR4-2133 | 1x8GB UDIMM DDR4-2133 ECC | RAID 121i | Up to 4x3.5" DC | Open | None | None | None | AMT | None | 1-year | Fixed 250W Bronze | 08/16 |
| 70LV0034UX | US | Core i3-6100T 2C/3.2GHz/3MB/35W/DDR4-2133 | 1x8GB UDIMM DDR4-2133 ECC | RAID 121i | Up to 4x3.5" DC/3 available | Open | HH DVD±RW | None | None | ISM | None | 1-year | Fixed 250W Bronze | 08/16 |
| 70LV0035UX | US | Core i3-6100T 2C/3.2GHz/3MB/35W/DDR4-2133 | 1x8GB UDIMM DDR4-2133 ECC | RAID 121i | Up to 4x3.5" DC | Open | None | None | None | ISM | None | 1-year | Fixed 250W Bronze | 08/16 |
| 70LV0036UX | US | Xeon E3-1225 v5 4C/3.3GHz/8MB/80W/DDR4-2133 | 1x8GB UDIMM DDR4-2133 ECC | RAID 121i | Up to 4x3.5" DC | Open | 9.5mm DVD±RW | None | None | AMT | None | 1-year | Fixed 250W Bronze | 08/16 |
| 70LV0037UX | US | Xeon E3-1245 v5 4C/3.5GHz/8MB/80W/DDR4-2133 | 1x8GB UDIMM DDR4-2133 ECC | RAID 121i | Up to 4x3.5" DC | Open | 9.5mm DVD±RW | None | None | AMT | None | 1-year | Fixed 250W Bronze | 08/16 |
| 70LV0038UX | US | Xeon E3-1275 v5 4C/3.6GHz/8MB/80W/DDR4-2133 | 1x8GB UDIMM DDR4-2133 ECC | RAID 121i | Up to 4x3.5" DC | Open | 9.5mm DVD±RW | None | None | AMT | None | 1-year | Fixed 250W Bronze | 08/16 |
| 70LV0039UX | US | Xeon E3-1225 v5 4C/3.3GHz/8MB/80W/DDR4-2133 | 1x8GB UDIMM DDR4-2133 ECC | RAID 121i | Up to 5x2.5" DC | Open | 9.5mm DVD±RW | None | None | AMT | None | 1-year | Fixed 250W Bronze | 08/16 |
| 70LV003AUX | US | Xeon E3-1245 v5 4C/3.5GHz/8MB/80W/DDR4-2133 | 1x8GB UDIMM DDR4-2133 ECC | RAID 121i | Up to 5x2.5" DC | Open | 9.5mm DVD±RW | None | None | AMT | None | 1-year | Fixed 250W Bronze | 08/16 |
| 70LV003BUX | US | Xeon E3-1275 v5 4C/3.6GHz/8MB/80W/DDR4-2133 | 1x8GB UDIMM DDR4-2133 ECC | RAID 121i | Up to 5x2.5" DC | Open | 9.5mm DVD±RW | None | None | AMT | None | 1-year | Fixed 250W Bronze | 08/16 |

ThinkServer TS150 - TopSeller - 70LX

Product Specifications Reference (PSREF)

| Model | Region | Processor | Memory | RAID Controller | Disk Bays | Storage | Optical | Add-on NIC | Add-on Ports | System Mgmt | OS | Warranty | Power Supply | Ann Date (m/y) |
|------------|--------|---|------------------------------|-----------------|-----------------------|---------|---------|------------|--------------|-------------|------|----------|------------------------|----------------|
| 70LX0017UX | US | Xeon E3-1275 v5 4C/3.6GHz/8MB/80W/DDR4-2133 | 1x8GB UDIMM DDR4-2133 ECC | RAID 121i | Up to 4x3.5" DC | Open | None | None | None | AMT | None | 1-year | Fixed 400W Platinum | 08/16 |
| 70LX0018UX | US | Xeon E3-1275 v5 4C/3.6GHz/8MB/80W/DDR4-2133 | 1x8GB UDIMM DDR4-2133 ECC | RAID 121i | Up to 5x2.5" DC | Open | None | None | None | AMT | None | 1-year | Fixed 400W Platinum | 08/16 |

ThinkServer TS150 - TopSeller - 70UB

Product Specifications Reference (PSREF)

| Model | Region | Processor | Memory | RAID Controller | Disk Bays | Storage | Optical | Add-on NIC | Add-on Ports | System Mgmt | OS | Warranty | Power Supply | Ann Date (m/y) |
|------------|--------|---|---------------------------|-----------------|-----------------------------|---------|--------------|------------|--------------|-------------|------|----------|-------------------|----------------|
| 70UB0009UX | US | Xeon E3-1225 v6 4C/3.3GHz/8MB/73W/DDR4-2400 | 1x8GB UDIMM DDR4-2400 ECC | RAID 121i | Up to 4x3.5" DC | Open | None | None | None | AMT | None | 1-year | Fixed 250W Bronze | 04/17 |
| 70UB000AUX | US | Xeon E3-1225 v6 4C/3.3GHz/8MB/73W/DDR4-2400 | 1x8GB UDIMM DDR4-2400 ECC | RAID 121i | Up to 4x3.5" DC | Open | 9.5mm DVD±RW | None | None | AMT | None | 1-year | Fixed 250W Bronze | 04/17 |
| 70UB000BUX | US | Xeon E3-1245 v6 4C/3.7GHz/8MB/73W/DDR4-2400 | 1x8GB UDIMM DDR4-2400 ECC | RAID 121i | Up to 4x3.5" DC | Open | 9.5mm DVD±RW | None | None | AMT | None | 1-year | Fixed 250W Bronze | 04/17 |
| 70UB000CUX | US | Xeon E3-1245 v6 4C/3.7GHz/8MB/73W/DDR4-2400 | 1x8GB UDIMM DDR4-2400 ECC | RAID 121i | Up to 4x3.5" DC | Open | None | None | None | AMT | None | 1-year | Fixed 250W Bronze | 04/17 |
| 70UB000DUX | US | Xeon E3-1275 v6 4C/3.8GHz/8MB/73W/DDR4-2400 | 1x8GB UDIMM DDR4-2400 ECC | RAID 121i | Up to 4x3.5" DC | Open | None | None | None | AMT | None | 1-year | Fixed 250W Bronze | 04/17 |
| 70UB000EUX | US | Xeon E3-1275 v6 4C/3.8GHz/8MB/73W/DDR4-2400 | 1x8GB UDIMM DDR4-2400 ECC | RAID 121i | Up to 4x3.5" DC | Open | 9.5mm DVD±RW | None | None | AMT | None | 1-year | Fixed 250W Bronze | 04/17 |
| 70UB001WUX | US | Core i3-6100T 2C/3.2GHz/3MB/35W/DDR4-2133 | 1x8GB UDIMM DDR4-2400 ECC | RAID 121i | Up to 4x3.5" DC/3 available | Open | HH DVD±RW | None | None | ISM | None | 1-year | Fixed 250W Bronze | 04/17 |
| 70UB001XUX | US | Core i3-6100T 2C/3.2GHz/3MB/35W/DDR4-2133 | 1x8GB UDIMM DDR4-2400 ECC | RAID 121i | Up to 4x3.5" DC | Open | None | None | None | ISM | None | 1-year | Fixed 250W Bronze | 04/17 |



ThinkServer TS440 Platform Specifications

| Components | Specification | | | | | | | | | | | | | | | | | | | | | | | |
|-----------------------------|--|------------------------|--|--|--|---------|---------|---------|---------------------|---|--|--|-----------|---|---|---|-----------|--|---|---|-----------|--|---|---|
| Dimensions | Tower or 5U rack. Height: 430 mm (16.9 in), width: 195 mm (7.68 in), depth: 595 mm (23.4 in) | | | | | | | | | | | | | | | | | | | | | | | |
| Weight | Maximum configuration: 61.7 lb (28kg) | | | | | | | | | | | | | | | | | | | | | | | |
| Processor | Supports one of the following Intel processors (code name: Haswell): • Xeon E3-1200 v3: up to 4C/3.7GHz/8MB/84W/1600MHz | | | | | | | | | | | | | | | | | | | | | | | |
| Chipset | Intel C226 Platform Controller Hub (PCH) | | | | | | | | | | | | | | | | | | | | | | | |
| Memory DIMMs | 4 DIMM sockets, 2-channel capable. UDIMM, DDR3, up to 1600MHz | | | | | | | | | | | | | | | | | | | | | | | |
| Memory capacity | 32GB | | | | | | | | | | | | | | | | | | | | | | | |
| Memory protection | ECC | | | | | | | | | | | | | | | | | | | | | | | |
| RAID controller | Supports one of the following onboard or PCIe RAID adapters: • RAID 0, 1, 5, 10 with onboard RAID 100, 6Gb/s SATA. • RAID 0, 1, 10 with RAID 500, PCIe adapter, 6Gb/s SAS/SATA, optional key for RAID5/50. • RAID 0, 1, 5, 6, 10, 50, 60 with RAID 700, PCIe adapter, 6Gb/s SAS/SATA, optional Intelligent Battery Backup Unit (iBBU08). <i>Note: RAID 50 and 60 are supported on 8 hard drive bays models only.</i> | | | | | | | | | | | | | | | | | | | | | | | |
| Disk drive bays | Up to 4 3.5" disk bays, non-hot swap, direct cable. Or up to 8 3.5" disk bays, hot-swap. Or up to 8 2.5" disk bays, hot-swap. On front. Supports internal RDX tape drive, consumes 5.25" bay, also supports optional external USB RDX tape drive. <table border="1" data-bbox="283 581 919 695"> <thead> <tr> <th rowspan="2">Disk bay configuration</th> <th colspan="3">RAID controller requirements and optional drives supported</th> </tr> <tr> <th>RAID100</th> <th>RAID500</th> <th>RAID700</th> </tr> </thead> <tbody> <tr> <td>4x3.5" non-hot swap</td> <td>•</td> <td></td> <td></td> </tr> <tr> <td>4x3.5" HS</td> <td>•</td> <td>•</td> <td>•</td> </tr> <tr> <td>8x3.5" HS</td> <td></td> <td>•</td> <td>•</td> </tr> <tr> <td>8x2.5" HS</td> <td></td> <td>•</td> <td>•</td> </tr> </tbody> </table> | Disk bay configuration | RAID controller requirements and optional drives supported | | | RAID100 | RAID500 | RAID700 | 4x3.5" non-hot swap | • | | | 4x3.5" HS | • | • | • | 8x3.5" HS | | • | • | 8x2.5" HS | | • | • |
| Disk bay configuration | RAID controller requirements and optional drives supported | | | | | | | | | | | | | | | | | | | | | | | |
| | RAID100 | RAID500 | RAID700 | | | | | | | | | | | | | | | | | | | | | |
| 4x3.5" non-hot swap | • | | | | | | | | | | | | | | | | | | | | | | | |
| 4x3.5" HS | • | • | • | | | | | | | | | | | | | | | | | | | | | |
| 8x3.5" HS | | • | • | | | | | | | | | | | | | | | | | | | | | |
| 8x2.5" HS | | • | • | | | | | | | | | | | | | | | | | | | | | |
| Maximum internal storage | 3.5" non-hot swap model: up to 24TB with 7.2K SATA HDD. 3.5" hot swap model: up to 48TB with 7.2K SATA HDD, up to 32TB with 7.2K SAS HDD, up to 4.8TB with 15K SAS HDD, up to 2.4TB with SATA SSD 2.5" hot swap model: up to 8TB with 7.2K SATA HDD, up to 7.2TB with 10K SAS HDD, up to 4.8TB with 15K SAS HDD, up to 2.4TB with SATA SSD <i>Note: Supports up to 4 SSD drives.</i> | | | | | | | | | | | | | | | | | | | | | | | |
| Optical drive | Two 5.25" bays for optical. DVD-ROM or DVD±RW. Half-height | | | | | | | | | | | | | | | | | | | | | | | |
| Network interfaces | One onboard gigabit ethernet, Intel I217, shared with AMT. Supports optional discrete network adapters via PCIe slots | | | | | | | | | | | | | | | | | | | | | | | |
| Security features | Power-on and administrator password. TPM (TCG 1.2-compliant). Optional padlock loop, Kensington cable lock | | | | | | | | | | | | | | | | | | | | | | | |
| Systems management | Intel Active Management Technology 9 on models with Xeon processor. Remote presence is supported on models with Xeon E3-12x5 v3 or E3-12x6 v3 processor | | | | | | | | | | | | | | | | | | | | | | | |
| Operating systems supported | Microsoft Windows Server 2016/2012 R2/2012/2008 R2. Windows Small Business Server 2011. Windows 8.1/8/7(except Home edition). Red Hat Enterprise Linux 6.4/6.5/6.7/7/7.1. SUSE Linux Enterprise Server 11/12. VMware vSphere (ESXi) 5.1 U1/5.1 U2/5.5/5.5 U1/5.5 U2/5.5 U3, Citrix Xen server 6.2 <i>Note: VMware requires processors with Intel HD, add-on network adapters, and PCIe RAID adapters.</i> | | | | | | | | | | | | | | | | | | | | | | | |

| Components | Specification | |
|-----------------------------|---|---|
| Base warranty | 1 or 3-year limited onsite service with 9x5/NBD. | |
| Power supply | Supports one of the following, depending on models: • One fixed 450 watts, universal, 80 PLUS Platinum qualified. • Up to two redundant 450 watts, two maximum, rear access, hot-swap, 80 PLUS Gold qualified, redundant with two power supplies | |
| Graphics | Integrated Intel HD Graphics on Xeon E3-12x6 v3, Xeon E3-12x5 v3 processors. Uses main memory, works along with discrete graphics to support multi-display, enables one VGA connector on rear. Also supports the following optional discrete graphics adapters: • NVIDIA Quadro NVS 300, PCIe adapter, 512MB • NVIDIA Quadro NVS 315, PCIe adapter, 1GB | |
| Front ports | Two USB 3.0 (blue) | |
| Rear ports | One VGA for models with Intel HD Graphics, two USB 2.0, four USB 3.0 (blue), one serial (9-pin), one ethernet (RJ-45). Optional parallel or serial ports via PCI or PCIe adapters | |
| Noise emissions | Operating: < 42 dB(A). Idle: < 38 dB(A) (Maximum configuration) | |
| Environmental specification | GREENGUARD certified, Energy Star Server 1.1 qualified, RoHS-compliant | |
| | Temperature - operating | 50 °F to 95 °F (10 °C to 35 °C) |
| | Temperature - storage (with package) | -40 °C to 70 °C |
| | Altitude - operating | Supported Altitude (unpressurized): 0-10000ft (0-3048m) |
| | Humidity - operating | 10%-80%, non-condensing |
| | Humidity - storage (with package) | 10%-90%, non-condensing |

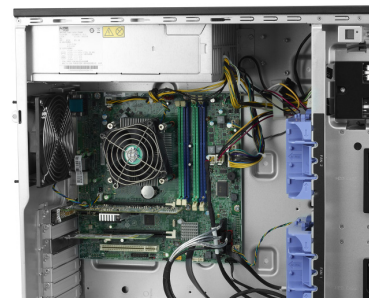

Expansion slots

- Four PCIe slots (top-down):
Slot 1: PCIe 3.0 x16, full height, half length (near CPU)
Slot 2: PCIe 3.0 x1, full height, half length
Slot 3: PCIe 2.0 x16 (x4 elec), full height, half length
Slot 4: PCI 2.3, full height, half length
Note: All PCI/PCIe adapters are optional.

ThinkServer TS440 - TopSeller - 70AN

Product Specifications Reference (PSREF)

| Model | Region | Processor | Memory | RAID Controller | Disk Bays | Storage | Optical | Add-on NIC | System Mgmt | OS | Warranty | Power Supply | Ann Date (m/y) |
|------------|--------|---|------------------------------|-----------------|--------------|---------|---------|------------|-------------|------|----------|---------------------|----------------|
| 70AN0001UX | US | Xeon E3-1225 v3 4C/3.2GHz/8MB/84W/DDR3-1600 | 1x4GB UDIMM DDR3-1600 ECC | RAID 100 | 4x3.5" HS | Open | HH DVD | None | AMT9 | None | 1-year | 450W Platinum Fixed | 09/13 |
| 70AN0002UX | US | Xeon E3-1225 v3 4C/3.2GHz/8MB/84W/DDR3-1600 | 1x4GB UDIMM DDR3-1600 ECC | RAID 100 | 4x3.5" HS | Open | HH DVD | None | AMT9 | None | 3-year | 450W Platinum Fixed | 09/13 |
| 70AN000KUX | US | Xeon E3-1226 v3 4C/3.3GHz/8MB/84W/DDR3-1600 | 1x4GB UDIMM DDR3-1600 ECC | RAID 100 | 4x3.5" HS | Open | HH DVD | None | AMT9 | None | 1-year | 450W Platinum Fixed | 09/14 |

| Model | Region | Processor | Memory | RAID Controller | Disk Bays | Storage | Optical | Add-on NIC | System Mgmt | OS | Warranty | Power Supply | Ann Date (m/y) |
|------------|--------|---|---------------------------|-----------------|-----------|--------------------------------|-----------|------------|-------------|------------------|----------|--------------|----------------|
| 70AQ0005US | US | Xeon E3-1225 v3 4C/3.2GHz/8MB/84W/DDR3-1600 | 1x4GB UDIMM DDR3-1600 ECC | RAID 100 | 4x3.5" HS | 2x500GB HDD 7.2K 3.5" SATA6Gbs | HH DVD±RW | None | AMT9 | 2012 Foundations | 3-year | 450Wx1 Gold | 09/13 |
| 70AQ0006US | US | Xeon E3-1225 v3 4C/3.2GHz/8MB/84W/DDR3-1600 | 1x4GB UDIMM DDR3-1600 ECC | RAID 100 | 4x3.5" HS | 2x500GB HDD 7.2K 3.5" SATA6Gbs | HH DVD±RW | None | AMT9 | 2012 Essentials | 3-year | 450Wx1 Gold | 09/13 |
| 70AQ0007US | US | Xeon E3-1225 v3 4C/3.2GHz/8MB/84W/DDR3-1600 | 1x4GB UDIMM DDR3-1600 ECC | RAID 100 | 4x3.5" HS | 2x500GB HDD 7.2K 3.5" SATA6Gbs | HH DVD±RW | None | AMT9 | 2012 Standard | 3-year | 450Wx1 Gold | 09/13 |
| 70AQ0009UX | US | Xeon E3-1225 v3 4C/3.2GHz/8MB/84W/DDR3-1600 | 1x4GB UDIMM DDR3-1600 ECC | RAID 100 | 4x3.5" HS | Open | HH DVD±RW | None | AMT9 | None | 1-year | 450Wx1 Gold | 09/13 |
| 70AQ000AUX | US | Xeon E3-1225 v3 4C/3.2GHz/8MB/84W/DDR3-1600 | 1x4GB UDIMM DDR3-1600 ECC | RAID 100 | 4x3.5" HS | Open | HH DVD±RW | None | AMT9 | None | 3-year | 450Wx1 Gold | 09/13 |
| 70AQ000BUX | US | Xeon E3-1245 v3 4C/3.4GHz/8MB/84W/DDR3-1600 | 1x4GB UDIMM DDR3-1600 ECC | RAID 100 | 4x3.5" HS | Open | HH DVD±RW | None | AMT9 | None | 3-year | 450Wx1 Gold | 09/13 |
| 70AQ000CUX | US | Xeon E3-1245 v3 4C/3.4GHz/8MB/84W/DDR3-1600 | 1x4GB UDIMM DDR3-1600 ECC | RAID 500 | 8x3.5" HS | Open | HH DVD±RW | None | AMT9 | None | 3-year | 450Wx1 Gold | 09/13 |
| 70AQ000DUX | US | Xeon E3-1225 v3 4C/3.2GHz/8MB/84W/DDR3-1600 | 1x4GB UDIMM DDR3-1600 ECC | RAID 500 | 8x3.5" HS | Open | HH DVD±RW | None | AMT9 | None | 3-year | 450Wx1 Gold | 09/13 |
| 70AQ000EUX | US | Xeon E3-1225 v3 4C/3.2GHz/8MB/84W/DDR3-1600 | 1x4GB UDIMM DDR3-1600 ECC | RAID 500 | 8x2.5" HS | Open | HH DVD±RW | None | AMT9 | None | 3-year | 450Wx1 Gold | 09/13 |
| 70AQ000FUX | US | Xeon E3-1245 v3 4C/3.4GHz/8MB/84W/DDR3-1600 | 1x4GB UDIMM DDR3-1600 ECC | RAID 500 | 8x2.5" HS | Open | HH DVD±RW | None | AMT9 | None | 3-year | 450Wx1 Gold | 09/13 |
| 70AQ000GUX | US | Xeon E3-1275 v3 4C/3.5GHz/8MB/84W/DDR3-1600 | 1x4GB UDIMM DDR3-1600 ECC | RAID 100 | 4x3.5" HS | Open | HH DVD±RW | None | AMT9 | None | 3-year | 450Wx1 Gold | 09/13 |
| 70AQ000HUX | US | Xeon E3-1225 v3 4C/3.2GHz/8MB/84W/DDR3-1600 | 1x4GB UDIMM DDR3-1600 ECC | RAID 700 | 8x3.5" HS | Open | HH DVD±RW | None | AMT9 | None | 3-year | 450Wx1 Gold | 09/13 |
| 70AQ000NUX | US | Xeon E3-1225 v3 4C/3.2GHz/8MB/84W/DDR3-1600 | 1x4GB UDIMM DDR3-1600 ECC | RAID 500 | 4x3.5" HS | Open | HH DVD | None | AMT9 | None | 1-year | 450Wx1 Gold | 09/13 |
| 70AQ000PUX | US | Xeon E3-1225 v3 4C/3.2GHz/8MB/84W/DDR3-1600 | 1x4GB UDIMM DDR3-1600 ECC | RAID 500 | 4x3.5" HS | Open | HH DVD | None | AMT9 | None | 3-year | 450Wx1 Gold | 09/13 |
| 70AQ000XUX | US | Xeon E3-1225 v3 4C/3.2GHz/8MB/84W/DDR3-1600 | 1x4GB UDIMM DDR3-1600 ECC | RAID 500 | 8x3.5" HS | Open | HH DVD±RW | None | AMT9 | None | 1-year | 450Wx1 Gold | 05/14 |
| 70AQ000YUX | US | Xeon E3-1245 v3 4C/3.4GHz/8MB/84W/DDR3-1600 | 1x4GB UDIMM DDR3-1600 ECC | RAID 500 | 8x3.5" HS | Open | HH DVD±RW | None | AMT9 | None | 1-year | 450Wx1 Gold | 05/14 |
| 70AQ001JUX | US | Xeon E3-1226 v3 4C/3.3GHz/8MB/84W/DDR3-1600 | 1x4GB UDIMM DDR3-1600 ECC | RAID 100 | 4x3.5" HS | Open | HH DVD±RW | None | AMT9 | None | 1-year | 450Wx1 Gold | 09/14 |

| Model | Region | Processor | Memory | RAID Controller | Disk Bays | Storage | Optical | Add-on NIC | System Mgmt | OS | Warranty | Power Supply | Ann Date (m/y) |
|------------|--------|---|------------------------------|-----------------|--------------|--------------------------------------|-----------|------------|-------------|------------------------|----------|----------------|----------------|
| 70AQ001KUX | US | Xeon E3-1226 v3 4C/3.3GHz/8MB/84W/DDR3-1600 | 1x4GB UDIMM DDR3-1600 ECC | RAID 500 | 8x3.5" HS | Open | HH DVD±RW | None | AMT9 | None | 1-year | 450Wx1 Gold | 09/14 |
| 70AQ001LUX | US | Xeon E3-1226 v3 4C/3.3GHz/8MB/84W/DDR3-1600 | 1x4GB UDIMM DDR3-1600 ECC | RAID 100 | 4x3.5" HS | Open | HH DVD | None | AMT9 | None | 1-year | 450Wx1 Gold | 09/14 |
| 70AQ001MUS | US | Xeon E3-1226 v3 4C/3.3GHz/8MB/84W/DDR3-1600 | 1x4GB UDIMM DDR3-1600 ECC | RAID 100 | 4x3.5" HS | 2x500GB HDD 7.2K 3.5" SATA6Gbs | HH DVD±RW | None | AMT9 | 2012 R2 Foundations | 1-year | 450Wx1 Gold | 09/14 |
| 70AQ001NUS | US | Xeon E3-1226 v3 4C/3.3GHz/8MB/84W/DDR3-1600 | 1x4GB UDIMM DDR3-1600 ECC | RAID 100 | 4x3.5" HS | 2x500GB HDD 7.2K 3.5" SATA6Gbs | HH DVD±RW | None | AMT9 | 2012 R2 Essentials | 1-year | 450Wx1 Gold | 09/14 |
| 70AQ001PUS | US | Xeon E3-1226 v3 4C/3.3GHz/8MB/84W/DDR3-1600 | 1x4GB UDIMM DDR3-1600 ECC | RAID 100 | 4x3.5" HS | 2x500GB HDD 7.2K 3.5" SATA6Gbs | HH DVD±RW | None | AMT9 | 2012 R2 Standard | 1-year | 450Wx1 Gold | 09/14 |
| 70AQ001QUX | US | Xeon E3-1246 v3 4C/3.5GHz/8MB/84W/DDR3-1600 | 1x4GB UDIMM DDR3-1600 ECC | RAID 100 | 4x3.5" HS | Open | HH DVD±RW | None | AMT9 | None | 1-year | 450Wx1 Gold | 09/14 |
| 70AQ001RUX | US | Xeon E3-1246 v3 4C/3.5GHz/8MB/84W/DDR3-1600 | 1x4GB UDIMM DDR3-1600 ECC | RAID 500 | 8x3.5" HS | Open | HH DVD±RW | None | AMT9 | None | 1-year | 450Wx1 Gold | 09/14 |
| 70AQ001SUX | US | Xeon E3-1246 v3 4C/3.5GHz/8MB/84W/DDR3-1600 | 1x4GB UDIMM DDR3-1600 ECC | RAID 500 | 8x2.5" HS | Open | HH DVD±RW | None | AMT9 | None | 1-year | 450Wx1 Gold | 09/14 |
| 70AQ001TUX | US | Xeon E3-1276 v3 4C/3.6GHz/8MB/84W/DDR3-1600 | 1x4GB UDIMM DDR3-1600 ECC | RAID 700 | 8x3.5" HS | Open | HH DVD±RW | None | AMT9 | None | 1-year | 450Wx1 Gold | 09/14 |
| 70AQ001UUX | US | Xeon E3-1276 v3 4C/3.6GHz/8MB/84W/DDR3-1600 | 1x4GB UDIMM DDR3-1600 ECC | RAID 700 | 8x2.5" HS | Open | HH DVD±RW | None | AMT9 | None | 1-year | 450Wx1 Gold | 09/14 |

| Model | Region | Processor | Memory | RAID Controller | Disk Bays | Storage | Optical | Add-on NIC | System Mgmt | OS | Warranty | Power Supply | Ann Date (m/y) |
|------------|--------|---|---------------------------|-----------------|-----------|--------------------------------|-------------|------------|-------------|------------------|----------|---------------------|----------------|
| 70AL0000US | US | Xeon E3-1225 v3 4C/3.2GHz/8MB/84W/DDR3-1600 | 3x8GB UDIMM DDR3-1600 ECC | RAID 100 | 4x3.5" HS | 3x3TB HDD 7.2K 3.5" SATA6Gbs | HH DVD±RW | 2xGbE | AMT9 | 2012 Foundations | 1-year | 450W Platinum Fixed | 09/13 |
| 70AL0001US | US | Xeon E3-1245 v3 4C/3.4GHz/8MB/84W/DDR3-1600 | 1x4GB UDIMM DDR3-1600 ECC | RAID 500 | 8x2.5" HS | 1x500GB HDD 7.2K 2.5" SATA6Gbs | 2xHH DVD±RW | 4xGbE | AMT9 | 2012 Foundations | 1-year | 450W Platinum Fixed | 09/13 |
| 70AL0002UX | US | Xeon E3-1225 v3 4C/3.2GHz/8MB/84W/DDR3-1600 | 1x4GB UDIMM DDR3-1600 ECC | RAID 100 | 4x3.5" HS | 1x500GB HDD 7.2K 3.5" SATA6Gbs | HH DVD | None | AMT9 | None | 3-year | 450W Platinum Fixed | 09/13 |
| 70AL0003UX | US | Xeon E3-1225 v3 4C/3.2GHz/8MB/84W/DDR3-1600 | 1x4GB UDIMM DDR3-1600 ECC | RAID 100 | 4x3.5" HS | Open | HH DVD | None | AMT9 | None | 3-year | 450W Platinum Fixed | 09/13 |

| Model | Region | Processor | Memory | RAID Controller | Disk Bays | Storage | Optical | Add-on NIC | System Mgmt | OS | Warranty | Power Supply | Ann Date (m/y) |
|------------|--------|---|---------------------------|-----------------|-----------|--------------------------------|-------------|------------|-------------|------------------|----------|--------------|----------------|
| 70AM0000US | US | Xeon E3-1225 v3 4C/3.2GHz/8MB/84W/DDR3-1600 | 2x2GB UDIMM DDR3-1600 ECC | RAID 100 | 4x3.5" DC | 2x500GB HDD 7.2K 3.5" SATA6Gbs | HH DVD | 1xGbE | AMT9 | 2012 Foundations | 1-year | 450Wx1 Gold | 09/13 |
| 70AM0001US | US | Xeon E3-1275 v3 4C/3.5GHz/8MB/84W/DDR3-1600 | 4x2GB UDIMM DDR3-1600 ECC | RAID 500+Key | 8x3.5" HS | 8x2TB HDD 7.2K 3.5" SATA6Gbs | 2xHH DVD±RW | 1xGbE | AMT9 | 2012 Foundations | 1-year | 450Wx2 Gold | 09/13 |
| 70AM0002UX | US | Xeon E3-1280 v3 4C/3.6GHz/8MB/82W/DDR3-1600 | 3x4GB UDIMM DDR3-1600 ECC | RAID 700 | 8x2.5" HS | 3x600GB HDD 10K 2.5" SAS6Gbs | HH DVD | 4xGbE | AMT9 | None | 1-year | 450Wx1 Gold | 09/13 |
| 70AM0003US | US | Xeon E3-1285 v3 4C/3.6GHz/8MB/84W/DDR3-1600 | 4x8GB UDIMM DDR3-1600 ECC | RAID 700 | 8x2.5" HS | 8x900GB HDD 10K 2.5" SAS6Gbs | HH DVD±RW | 2xGbE | AMT9 | 2012 Foundations | 1-year | 450Wx2 Gold | 09/13 |
| 70AM0004UX | US | Xeon E3-1225 v3 4C/3.2GHz/8MB/84W/DDR3-1600 | 1x4GB UDIMM DDR3-1600 ECC | RAID 100 | 4x3.5" HS | Open | HH DVD | None | AMT9 | None | 3-year | 450Wx1 Gold | 09/13 |

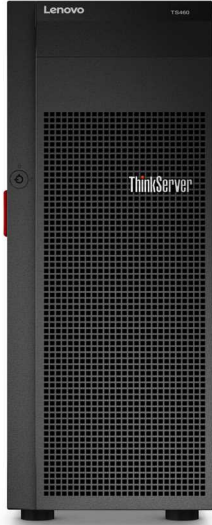

ThinkServer TS460 Platform Specifications

| Components | Specification | | | | |
|------------------------|--|---------------------------------------|-----------------------------|------------|--------------------|
| Dimensions | 42L tower or 4U rack. Height: 443.5 mm (17.46 in) with foot stands. Width: 173 mm (6.81 in). Depth: 593 mm (23.35 in) including front door and handle of hot-swap power supply | | | | |
| Weight | Maximum configuration: 57.32 lb (26.5 kg) | | | | |
| Processor | Supports one of the following Intel "Kaby Lake" processors: | | | | |
| | Xeon E3-1280 v6 | 4C/3.9GHz/8MB/72W/DDR4-2400 | | | |
| | Xeon E3-1270 v6 | 4C/3.8GHz/8MB/72W/DDR4-2400 | | | |
| | Xeon E3-1240 v6 | 4C/3.7GHz/8MB/72W/DDR4-2400 | | | |
| | Xeon E3-1230 v6 | 4C/3.5GHz/8MB/72W/DDR4-2400 | | | |
| | Xeon E3-1220 v6 | 4C/3GHz/8MB/72W/DDR4-2400 | | | |
| | Core i3-7320 | 2C/4.1GHz/4MB/51W/DDR4-2400 | | | |
| | Core i3-7300 | 2C/4GHz/4MB/51W/DDR4-2400 | | | |
| | Core i3-7300T | 2C/3.5GHz/4MB/35W/DDR4-2400 | | | |
| | Core i3-7100 | 2C/3.9GHz/3MB/51W/DDR4-2400 | | | |
| | Core i3-7100T | 2C/3.4GHz/3MB/35W/DDR4-2400 | | | |
| | Pentium G4620 | 2C/3.7GHz/3MB/51W/DDR4-2400 | | | |
| | Pentium G4600 | 2C/3.6GHz/3MB/51W/DDR4-2400 | | | |
| | Pentium G4600T | 2C/3GHz/3MB/35W/DDR4-2400 | | | |
| | Pentium G4560 | 2C/3.5GHz/3MB/54W/DDR4-2400 | | | |
| Pentium G4560T | 2C/2.9GHz/3MB/35W/DDR4-2400 | | | | |
| Processor | Supports one of the following Intel "Skylake" processors: | | | | |
| | Xeon E3-1280 v5 | 4C/3.7GHz/8MB/80W/DDR4-2133 | | | |
| | Xeon E3-1270 v5 | 4C/3.6GHz/8MB/80W/DDR4-2133 | | | |
| | Xeon E3-1240 v5 | 4C/3.5GHz/8MB/80W/DDR4-2133 | | | |
| | Xeon E3-1230 v5 | 4C/3.4GHz/8MB/80W/DDR4-2133 | | | |
| | Xeon E3-1220 v5 | 4C/3GHz/8MB/80W/DDR4-2133 | | | |
| | Core i3-6320 | 2C/3.9GHz/4MB/51W/DDR4-2133 | | | |
| | Core i3-6300T | 2C/3.3GHz/4MB/35W/DDR4-2133 | | | |
| | Core i3-6300 | 2C/3.8GHz/4MB/51W/DDR4-2133 | | | |
| | Core i3-6100T | 2C/3.2GHz/3MB/35W/DDR4-2133 | | | |
| | Core i3-6100 | 2C/3.7GHz/3MB/51W/DDR4-2133 | | | |
| | Pentium G4520 | 2C/3.6GHz/3MB/51W/DDR4-2133 | | | |
| | Pentium G4500T | 2C/3GHz/3MB/35W/DDR4-2133 | | | |
| | Pentium G4500 | 2C/3.5GHz/3MB/51W/DDR4-2133 | | | |
| | Pentium G4400T | 2C/2.9GHz/3MB/35W/DDR4-2133 | | | |
| Pentium G4400 | 2C/3.3GHz/3MB/54W/DDR4-2133 | | | | |
| Chipset | Intel C232 Platform Controller Hub (PCH) | | | | |
| Memory DIMMs | 4 DIMM sockets with 2-channels. UDIMM. DDR4-2133 or DDR4-2400 | | | | |
| Memory capacity | Up to 64GB (16GB x 4) | | | | |
| Memory protection | ECC | | | | |
| RAID controller | RAID controller | | | | |
| | Onboard RAID121i | 6Gbs SATA | 0/1/5/10 | | |
| | RAID520i PCIe | 12Gbs SAS/SATA | 0/1/10, 5 with optional key | | |
| RAID720i PCIe | 12Gbs SAS/SATA | 0/1/10/5/50, 6/60 with optional cache | | | |
| | Optional cache for RAID720i: 1GB memory, or 1GB, 2GB, 4GB flash with super capacitor. | | | | |
| Disk drive bays | Supports one of the following configurations: | | | | |
| | Disk bays configuration | RAID controller | Optical | Tape drive | |
| | 4x3.5" SATA non-hot swap | 121i | up to 2 | RDX | LTO |
| | 4x3.5" SATA hot-swap | 121i | up to 2 | up to 1 | - |
| | 4x3.5" SATA/SAS hot-swap | 520i or 720i | up to 2 | up to 1 | up to 1, 520i only |
| | 8x3.5" SATA/SAS hot-swap | 520i or 720i | up to 2 | up to 1 | - |
| | 8x2.5" SATA/SAS hot-swap | 520i or 720i | up to 2 | up to 1 | - |
| | 16x2.5" SATA/SAS hot-swap | 520i or 720i | up to 2 | up to 1 | - |
| | 4x3.5" + 8x2.5" SATA/SAS hot-swap | 520i or 720i | up to 2 | up to 1 | - |
| | 4 x 3.5" HS can be upgraded to 8 x 3.5" HS or 4 x 3.5" + 8 x 2.5" HS, 8 x 2.5" HS can be upgraded to 16 x 2.5" HS or 4 x 3.5" + 8 x 2.5" HS, redundant PSU models only, RAID520i/RAID720i and expansion kit is needed, more that 8 disk bays needs expander card. Also supports one M.2 SATA SSD, 32GB or 128GB. | | | | |
| Supporting disk drives | 3.5" SATA HDD, 7.2K 6Gbs, HS or NHS | 1TB/2TB/3TB/4TB/6TB/8TB/10TB | | | |
| | 3.5" SAS HDD, 7.2K 12Gbs, HS | 1TB/2TB/3TB/4TB/6TB/8TB/10TB | | | |
| | 2.5" SAS HDD, 10K 12Gbs, HS, 2.5" or 3.5" bay | 300GB/600GB/900GB/1.2TB/1.8TB | | | |
| | 2.5" SAS HDD, 15K 12Gbs, HS, 2.5" or 3.5" bay | 300GB/600GB | | | |
| | 2.5" SATA SSD, 6Gbs, HS, 2.5" or 3.5" bay | 120GB/240GB/480GB/800GB/960GB | | | |
| | 2.5" SATA HDD, 7.2K 6Gbs, HS | 1TB/2TB | | | |
| M.2 SATA SSD | 32GB/128GB | | | | |

| Components | Specification | | | |
|-----------------------------|--|--|--------------------------------|--------------------------------|
| Maximum internal storage | Up to 64TB with 8TB 3.5" SAS or SATA HDDs, 8 x 3.5" HS bay | | | |
| Optical drive | Two 5.25" bays. Up to 2 optical drives. DVD-ROM or DVD±RW. Half-height. 2nd optical drive will be disable if M.2 SATA SSD is used | | | |
| Tape drive | Supports one tape drive in 5.25" bay. RDX or LTO. LTO Tape drive needs RAID520i | | | |
| Network interfaces | Two integrated Gigabit Ethernet 1000BASE-T ports (RJ-45) with Intel i210. One dedicate management port with Realtek RTL8211E | | | |
| Systems management | UEFI. Onboard Aspeed AST2400 graphics/management processor, IPMI 2.0-compliant baseboard management controller (BMC). Control Panel LEDs shows the status of power, disk drives, network, system. On rear system ID. Supports EasyStartup, Power Planner, Lenovo ThinkServer Diagnostics Standalone, ToolsCenter Suite CLI inventory module on ThinkServ-er, Lenovo xClarity Administrator | | | |
| Security features | Power-on and administrator password. Optional TPM, TCG 1.2 or 2.0 compliant. | | | |
| Operating systems | Microsoft Windows Server 2016/2012 R2. Red Hat Enterprise Linux 6.8. VMware vSphere (ESXi) 6.0U2/6.5 | | | |
| Base warranty | 1 or 3-year limited onsite service with 9x5/NBD. | | | |
| Power supply | Supports one of the following, depending on models: • One fixed 300 watts, universal, 80 PLUS Bronze qualified. • Up to two redundant 450 watts, two maximum, rear access, hot-swap, 80 PLUS Gold qualified, universal, redundant with two power supplies | | | |
| Graphics | Integrated in onboard Aspeed AST2400 graphics/management processor. Optional NVIDIA Quadro K420 | | | |
| Front ports | Two USB 3.0 (blue) | | | |
| Rear ports | One VGA, four USB 3.0, one RJ-45 (dedicated mgmt), two ethernet, one serial (9-pin). Add-on parallel or serial ports via optional PCIe adapters | | | |
| Noise emissions | Operating: < 43.6 dB(A). Idle: < 33 dB(A) (Maximum configuration) | | | |
| Environmental specification | All models supports ASHARE B. Models with the following configuration supports ASHARE A3: Xeon E3-1230 v5/8GbX2/DVD±RW/1TB SATAx4/RAID520i/450Wx2/TPM | | | |
| | | ASHRAE A2 | ASHRAE A3 | ASHRAE B |
| | Temperature - operating | 10°C to 35°C (50°F to 95°F) | 5°C to 40°C (41°F to 104°F) | 5°C to 35°C (41°F to 95°F) |
| | Temperature - storage (with package) | -40°C to 60°C (-40°F to 140°F) | -40°C to 60°C (-40°F to 140°F) | -40°C to 60°C (-40°F to 140°F) |
| | Altitude - operating | 20% to 80% (non-condensing) | 8% to 85% (non-condensing) | 8% to 80% (non-condensing) |
| | Humidity - storage (with package) | 10% to 90% (non-condensing) | 10% to 90% (non-condensing) | 10% to 90% (non-condensing) |
| | Altitude - operating | 0 m to 3048 m (0 ft to 10 000 ft) in an unpressurized environment | | |
| | | GREENGUARD certified, RoHS-compliant, Energy Star Server 2.1 qualified on redundant PSU models | | |

Expansion slots
4 PCIe 3.0 slots (top-down):
Slot 1: PCIe 3.0 x4, full height, full length, open-end, from PCH
Slot 2: PCIe 3.0 x16, full height, full length, from CPU
Slot 3: PCIe 3.0 x1, full height, half length, from PCH
Slot 4: PCIe 3.0 x8, full height, half length, open-end, from CPU

Note:
1. If a PCIe card is connected to slot 4, both slot 2 and slot 4 will work at PCIe x8.
2. If a discrete graphics card is used, slot 2 will work at PCIe x16 and slot 4 will be disable.

| Model | Region | Processor | Memory | RAID Controller | Disk Bays | Storage | Optical | Add-on NIC | Add-on Ports | System Management | Operating System | Warranty | Power Supply | Ann Date (mm/yy) |
|------------|--------|---|---------------------------|-----------------|------------|---------|---------|------------|--------------|-------------------|------------------|----------|-------------------|------------------|
| 70TR000LUX | US | Xeon E3-1220 v5 4C/3GHz/8MB/80W/DDR4-2133 | 1x8GB UDIMM DDR4-2133 ECC | RAID121i | 4x3.5" HS | Open | Open | None | None | TPM2.0 | None | 1-year | Fixed 300W Bronze | 02/17 |
| 70TR000MUX | US | Xeon E3-1230 v5 4C/3.4GHz/8MB/80W/DDR4-2133 | 1x8GB UDIMM DDR4-2133 ECC | RAID121i | 4x3.5" HS | Open | Open | None | None | TPM2.0 | None | 1-year | Fixed 300W Bronze | 02/17 |
| 70TR000NUX | US | Xeon E3-1240 v5 4C/3.5GHz/8MB/80W/DDR4-2133 | 1x8GB UDIMM DDR4-2133 ECC | RAID121i | 4x3.5" HS | Open | Open | None | None | TPM2.0 | None | 1-year | Fixed 300W Bronze | 02/17 |
| 70TR000PUX | US | Xeon E3-1270 v5 4C/3.6GHz/8MB/80W/DDR4-2133 | 1x8GB UDIMM DDR4-2133 ECC | RAID121i | 4x3.5" HS | Open | Open | None | None | TPM2.0 | None | 1-year | Fixed 300W Bronze | 02/17 |
| 70TR000QUX | US | Xeon E3-1220 v5 4C/3GHz/8MB/80W/DDR4-2133 | 1x8GB UDIMM DDR4-2133 ECC | RAID520i | 8x2.5" HS | Open | Open | None | None | TPM2.0 | None | 1-year | Fixed 300W Bronze | 02/17 |
| 70TR000RUX | US | Xeon E3-1230 v5 4C/3.4GHz/8MB/80W/DDR4-2133 | 1x8GB UDIMM DDR4-2133 ECC | RAID520i | 8x2.5" HS | Open | Open | None | None | TPM2.0 | None | 1-year | Fixed 300W Bronze | 02/17 |
| 70TR000SUX | US | Xeon E3-1240 v5 4C/3.5GHz/8MB/80W/DDR4-2133 | 1x8GB UDIMM DDR4-2133 ECC | RAID520i | 8x2.5" HS | Open | Open | None | None | TPM2.0 | None | 1-year | Fixed 300W Bronze | 02/17 |
| 70TR000TUX | US | Xeon E3-1270 v5 4C/3.6GHz/8MB/80W/DDR4-2133 | 1x8GB UDIMM DDR4-2133 ECC | RAID520i | 8x2.5" HS | Open | Open | None | None | TPM2.0 | None | 1-year | Fixed 300W Bronze | 02/17 |
| 70TR000UUX | US | Xeon E3-1220 v5 4C/3GHz/8MB/80W/DDR4-2133 | 1x8GB UDIMM DDR4-2133 ECC | RAID121i | 4x3.5" NHS | Open | Open | None | None | TPM2.0 | None | 1-year | Fixed 300W Bronze | 02/17 |
| 70TR000VUX | US | Xeon E3-1230 v5 4C/3.4GHz/8MB/80W/DDR4-2133 | 1x8GB UDIMM DDR4-2133 ECC | RAID121i | 4x3.5" NHS | Open | Open | None | None | TPM2.0 | None | 1-year | Fixed 300W Bronze | 02/17 |
| 70TR000WUX | US | Xeon E3-1240 v5 4C/3.5GHz/8MB/80W/DDR4-2133 | 1x8GB UDIMM DDR4-2133 ECC | RAID121i | 4x3.5" NHS | Open | Open | None | None | TPM2.0 | None | 1-year | Fixed 300W Bronze | 02/17 |
| 70TR000XUX | US | Xeon E3-1270 v5 4C/3.6GHz/8MB/80W/DDR4-2133 | 1x8GB UDIMM DDR4-2133 ECC | RAID121i | 4x3.5" NHS | Open | Open | None | None | TPM2.0 | None | 1-year | Fixed 300W Bronze | 02/17 |
| 70TR000YUX | US | Pentium G4400 2C/3.3GHz/3MB/54W/DDR4-2133 | 1x8GB UDIMM DDR4-2133 ECC | RAID121i | 4x3.5" NHS | Open | Open | None | None | TPM2.0 | None | 1-year | Fixed 300W Bronze | 02/17 |
| 70TR0016UX | US | Xeon E3-1220 v6 4C/3GHz/8MB/72W/DDR4-2400 | 1x8GB UDIMM DDR4-2400 ECC | RAID121i | 4x3.5" HS | Open | Open | None | None | TPM2.0 | None | 1-year | Fixed 300W Bronze | 06/17 |
| 70TR0017UX | US | Xeon E3-1230 v6 4C/3.5GHz/8MB/72W/DDR4-2400 | 1x8GB UDIMM DDR4-2400 ECC | RAID121i | 4x3.5" HS | Open | Open | None | None | TPM2.0 | None | 1-year | Fixed 300W Bronze | 06/17 |
| 70TR0018UX | US | Xeon E3-1240 v6 4C/3.7GHz/8MB/72W/DDR4-2400 | 1x8GB UDIMM DDR4-2400 ECC | RAID121i | 4x3.5" HS | Open | Open | None | None | TPM2.0 | None | 1-year | Fixed 300W Bronze | 06/17 |
| 70TR0019UX | US | Xeon E3-1270 v6 4C/3.8GHz/8MB/72W/DDR4-2400 | 1x8GB UDIMM DDR4-2400 ECC | RAID121i | 4x3.5" HS | Open | Open | None | None | TPM2.0 | None | 1-year | Fixed 300W Bronze | 06/17 |

| Model | Region | Processor | Memory | RAID Controller | Disk Bays | Storage | Optical | Add-on NIC | Add-on Ports | System Management | Operating System | Warranty | Power Supply | Ann Date (mm/yy) |
|------------|--------|---|---------------------------|-----------------|-----------|---------|---------|------------|--------------|-------------------|------------------|----------|-------------------|------------------|
| 70TR001AUX | US | Xeon E3-1220 v6 4C/3GHz/8MB/72W/DDR4-2400 | 1x8GB UDIMM DDR4-2400 ECC | RAID520i | 8x2.5" HS | Open | Open | None | None | TPM2.0 | None | 1-year | Fixed 300W Bronze | 06/17 |
| 70TR001BUX | US | Xeon E3-1230 v6 4C/3.5GHz/8MB/72W/DDR4-2400 | 1x8GB UDIMM DDR4-2400 ECC | RAID520i | 8x2.5" HS | Open | Open | None | None | TPM2.0 | None | 1-year | Fixed 300W Bronze | 06/17 |
| 70TR001CUX | US | Xeon E3-1240 v6 4C/3.7GHz/8MB/72W/DDR4-2400 | 1x8GB UDIMM DDR4-2400 ECC | RAID520i | 8x2.5" HS | Open | Open | None | None | TPM2.0 | None | 1-year | Fixed 300W Bronze | 06/17 |
| 70TR001DUX | US | Xeon E3-1270 v6 4C/3.8GHz/8MB/72W/DDR4-2400 | 1x8GB UDIMM DDR4-2400 ECC | RAID520i | 8x2.5" HS | Open | Open | None | None | TPM2.0 | None | 1-year | Fixed 300W Bronze | 06/17 |

| Model | Region | Processor | Memory | RAID Controller | Disk Bays | Storage | Optical | Add-on NIC | Add-on Ports | System Management | Operating System | Warranty | Power Supply | Ann Date (mm/yy) |
|------------|--------|---|---------------------------|-----------------|-----------|---------|---------|------------|--------------|-------------------|------------------|----------|--------------|------------------|
| 70TT000JUX | US | Xeon E3-1220 v5 4C/3GHz/8MB/80W/DDR4-2133 | 1x8GB UDIMM DDR4-2133 ECC | RAID121i | 4x3.5" HS | Open | Open | None | None | TPM2.0 | None | 1-year | 1x450W Gold | 02/17 |
| 70TT000KUX | US | Xeon E3-1230 v5 4C/3.4GHz/8MB/80W/DDR4-2133 | 1x8GB UDIMM DDR4-2133 ECC | RAID121i | 4x3.5" HS | Open | Open | None | None | TPM2.0 | None | 1-year | 1x450W Gold | 02/17 |
| 70TT000LUX | US | Xeon E3-1240 v5 4C/3.5GHz/8MB/80W/DDR4-2133 | 1x8GB UDIMM DDR4-2133 ECC | RAID121i | 4x3.5" HS | Open | Open | None | None | TPM2.0 | None | 1-year | 1x450W Gold | 02/17 |
| 70TT000MUX | US | Xeon E3-1270 v5 4C/3.6GHz/8MB/80W/DDR4-2133 | 1x8GB UDIMM DDR4-2133 ECC | RAID121i | 4x3.5" HS | Open | Open | None | None | TPM2.0 | None | 1-year | 1x450W Gold | 02/17 |
| 70TT000NUX | US | Xeon E3-1220 v5 4C/3GHz/8MB/80W/DDR4-2133 | 1x8GB UDIMM DDR4-2133 ECC | RAID520i | 8x2.5" HS | Open | Open | None | None | TPM2.0 | None | 1-year | 1x450W Gold | 02/17 |
| 70TT000PUX | US | Xeon E3-1230 v5 4C/3.4GHz/8MB/80W/DDR4-2133 | 1x8GB UDIMM DDR4-2133 ECC | RAID520i | 8x2.5" HS | Open | Open | None | None | TPM2.0 | None | 1-year | 1x450W Gold | 02/17 |
| 70TT000QUX | US | Xeon E3-1240 v5 4C/3.5GHz/8MB/80W/DDR4-2133 | 1x8GB UDIMM DDR4-2133 ECC | RAID520i | 8x2.5" HS | Open | Open | None | None | TPM2.0 | None | 1-year | 1x450W Gold | 02/17 |
| 70TT000RUX | US | Xeon E3-1270 v5 4C/3.6GHz/8MB/80W/DDR4-2133 | 1x8GB UDIMM DDR4-2133 ECC | RAID520i | 8x2.5" HS | Open | Open | None | None | TPM2.0 | None | 1-year | 1x450W Gold | 02/17 |
| 70TT001YUX | US | Xeon E3-1220 v6 4C/3GHz/8MB/72W/DDR4-2400 | 1x8GB UDIMM DDR4-2400 ECC | RAID121i | 4x3.5" HS | Open | Open | None | None | TPM2.0 | None | 1-year | 1x450W Gold | 06/17 |
| 70TT0020UX | US | Xeon E3-1230 v6 4C/3.5GHz/8MB/72W/DDR4-2400 | 1x8GB UDIMM DDR4-2400 ECC | RAID121i | 4x3.5" HS | Open | Open | None | None | TPM2.0 | None | 1-year | 1x450W Gold | 06/17 |
| 70TT0021UX | US | Xeon E3-1240 v6 4C/3.7GHz/8MB/72W/DDR4-2400 | 1x8GB UDIMM DDR4-2400 ECC | RAID121i | 4x3.5" HS | Open | Open | None | None | TPM2.0 | None | 1-year | 1x450W Gold | 06/17 |
| 70TT0022UX | US | Xeon E3-1270 v6 4C/3.8GHz/8MB/72W/DDR4-2400 | 1x8GB UDIMM DDR4-2400 ECC | RAID121i | 4x3.5" HS | Open | Open | None | None | TPM2.0 | None | 1-year | 1x450W Gold | 06/17 |
| 70TT0023UX | US | Xeon E3-1220 v6 4C/3GHz/8MB/72W/DDR4-2400 | 1x8GB UDIMM DDR4-2400 ECC | RAID520i | 8x2.5" HS | Open | Open | None | None | TPM2.0 | None | 1-year | 1x450W Gold | 06/17 |
| 70TT0024UX | US | Xeon E3-1230 v6 4C/3.5GHz/8MB/72W/DDR4-2400 | 1x8GB UDIMM DDR4-2400 ECC | RAID520i | 8x2.5" HS | Open | Open | None | None | TPM2.0 | None | 1-year | 1x450W Gold | 06/17 |
| 70TT0025UX | US | Xeon E3-1240 v6 4C/3.7GHz/8MB/72W/DDR4-2400 | 1x8GB UDIMM DDR4-2400 ECC | RAID520i | 8x2.5" HS | Open | Open | None | None | TPM2.0 | None | 1-year | 1x450W Gold | 06/17 |
| 70TT0026UX | US | Xeon E3-1270 v6 4C/3.8GHz/8MB/72W/DDR4-2400 | 1x8GB UDIMM DDR4-2400 ECC | RAID520i | 8x2.5" HS | Open | Open | None | None | TPM2.0 | None | 1-year | 1x450W Gold | 06/17 |

This publication was developed for products and services offered in the United States and E.M.E.A countries. Lenovo may not offer the products, services or features discussed in this document in other countries. Lenovo may withdraw an offering at any time. Information is subject to change without notice. Consult your local representative for information on offerings available in your area.

Lenovo reserves the right to change specifications or other product information without notice. Lenovo is not responsible for photographic or typographical errors.

LENOVO PROVIDES THIS PUBLICATION "AS IS," WITHOUT WARRANTY OF ANY KIND, EITHER EXPRESS OR IMPLIED, INCLUDING THE IMPLIED WARRANTIES OF MERCHANTABILITY OR FITNESS FOR A PARTICULAR PURPOSE.

Some jurisdictions do not allow disclaimer of express or implied warranties in certain transactions, therefore this disclaimer may not apply to you.

Availability: All offers subject to availability. Lenovo reserves the right to alter product offerings and specifications at any time, without notice. Lenovo is not responsible for photographic or typographic errors.

General: Review key information provided by Microsoft that may apply to your system purchase, including details on Windows 10, Windows 8, Windows 7, and potential upgrades/downgrades. Lenovo makes no representation or warranty regarding third-party products or services.

Trademarks: Lenovo, ThinkPad, ThinkCentre, ThinkStation and the Lenovo logo are trademarks of Lenovo. Microsoft, Windows, Windows NT, and the Windows logo are trademarks of Microsoft Corporation. Ultrabook, Celeron, Celeron Inside, Core Inside, Intel, Intel Logo, Intel Atom, Intel Atom Inside, Intel Core, Intel Inside, Intel Inside Logo, Intel vPro, Itanium, Itanium Inside, Pentium, Pentium Inside, vPro Inside, Xeon, Xeon Phi, and Xeon Inside are trademarks of Intel Corporation in the U.S. and/or other countries. Other company, product or service names may be trademarks or service marks of others.

Warranty: For a copy of applicable warranties, write to: Lenovo Warranty Information, 1009 Think Place, Morrisville, NC, 27560. Lenovo makes no representation or warranty regarding third party products or services. The Lenovo Limited Warranty applies only to Lenovo hardware products purchased for your own use, and does not transfer upon resale.

Limited warranty: Support unrelated to a warranty issue may be subject to additional charges.

Lenovo Services:

Carry-in or Mail-in Service: Parts and labor repair coverage where the customer is responsible for shipping (including packaging) or delivery to authorized warranty provider or repair center.

Depot or Courier Service: Parts and labor repair coverage where shipping (including packaging) or delivery to the repair center is paid for by Lenovo.

Expedited Depot: Parts and labor coverage with expedited turnaround. Shipping (including packaging) or delivery to the repair center is paid for by Lenovo.

Onsite / In-home Service: Parts and labor repair coverage where labor is provided onsite at your place of business.

If Lenovo determines your product problem is covered by the product warranty and cannot be resolved over the telephone, a technician will be dispatched to arrive onsite, typically the next day.

International Warranty Service (IWS): PC repair coverage for customers who require a critical warranty repair while travelling internationally. Visit www.lenovo.com/internationalwarranty for details. Visit www.lenovo.com/warranty for Lenovo Warranty Services terms and conditions for complete details and restrictions.

Included software: may differ from its retail version (if available), and may not include user manuals or all program functionality. Software license agreements may apply.

Battery life: Battery life (and recharge times) will vary based on many factors including screen brightness, applications, features, power management, battery conditioning, and other customer preferences.

Visit <http://psref.lenovo.com/> for the latest version of Product Specifications Reference.

© Lenovo, 2017. All rights reserved.
Lenovo 1009 Think Place Morrisville, NC 27560 U.S.A.

Lenovo ThinkSystem

PSREF



Product Specifications Reference

Version 509, July 2017

Visit <http://psref.lenovo.com> for the latest version

Summary of Changes

This section describes the changes made in this version of ThinkSystem PSREF and in previous version
This edition might also include minor corrections and editorial changes which are not identified

June 21, 2017 - Version 509

Additions in this update

- ▶ Initial version, includes ThinkSystem rack servers SR650/SR630/SR550/SR530, tower server ST550, and mission-critical servers SR850 and SR950.



ThinkSystem SR530 Platform Specifications

Product Specifications Reference (PSREF)

| Components | Specification | | | | | | | | | | | | | | | | | | | | | | | | | | | | | | | | | | | | | | | | | | | | | | | | | | | | | | | | | | | | | | | | | | | | | | | | | | | | | | | | | | | | |
|---|---|--------------------------|-------------------------------|--------------------------|--|--------------------------|--------------------------|--------------------------|----------------------|--------------|-------------------------|-------------|--------------------|-------------|--------------------------|----------|--------------------------|---------|-------------------------|-------------------------------|-------------------------|-------------|--------------------|--------------------|--------------------|-------------|--------------|------------|-----|---|--------|------------|----------|-------------|-----|-----|------|----|---|-------------|--------|------------|----------|------------------|-----|-----|--------------|-----|---|--------|------------|----------|---|-----|------|------|---|---|--------|------------|----------|---|-----|------|------|---|---|---------|------------|----------|---|-----|------|------|---|---|--------|------------|----------|------------------|-----|-----|--------------|-----|---|
| Form factor | 1U rack | | | | | | | | | | | | | | | | | | | | | | | | | | | | | | | | | | | | | | | | | | | | | | | | | | | | | | | | | | | | | | | | | | | | | | | | | | | | | | | | | | | | |
| Dimensions | Height: 43 mm (1.7 in). Width: 482 mm (19.0 in) with rack latches. Depth: 778.3 mm (30.64 in) | | | | | | | | | | | | | | | | | | | | | | | | | | | | | | | | | | | | | | | | | | | | | | | | | | | | | | | | | | | | | | | | | | | | | | | | | | | | | | | | | | | | |
| Weight | Maximum configuration: 35.27 lb (16 kg) | | | | | | | | | | | | | | | | | | | | | | | | | | | | | | | | | | | | | | | | | | | | | | | | | | | | | | | | | | | | | | | | | | | | | | | | | | | | | | | | | | | | |
| Processor | Up to two 125W Intel Xeon Scalable family processors, Bronze, Silver, Gold, or Platinum. Up to 20 cores at 2.0GHz, up to 3.6GHz with 4 cores. Two processors are connected with two UPI (Ultra Path Interconnect) links up to 10.4GT/s | | | | | | | | | | | | | | | | | | | | | | | | | | | | | | | | | | | | | | | | | | | | | | | | | | | | | | | | | | | | | | | | | | | | | | | | | | | | | | | | | | | | |
| Chipset | Intel C622 Platform Controller Hub | | | | | | | | | | | | | | | | | | | | | | | | | | | | | | | | | | | | | | | | | | | | | | | | | | | | | | | | | | | | | | | | | | | | | | | | | | | | | | | | | | | | |
| Memory | Up to 12 DIMM sockets. Each processor supports up to 6 DIMM sockets with 6 channels. DDR4-2666. RDIMMs and LRDIMMs are supported, but memory types cannot be intermixed | | | | | | | | | | | | | | | | | | | | | | | | | | | | | | | | | | | | | | | | | | | | | | | | | | | | | | | | | | | | | | | | | | | | | | | | | | | | | | | | | | | | |
| Memory capacity | With RDIMMs: Up to 384GB with 12 x 32 GB RDIMMs and two processors With LRDIMMs: Up to 768GB with 12 x 64 GB LRDIMMs and two processors | | | | | | | | | | | | | | | | | | | | | | | | | | | | | | | | | | | | | | | | | | | | | | | | | | | | | | | | | | | | | | | | | | | | | | | | | | | | | | | | | | | | |
| Memory protection | ECC, memory mirroring, and memory sparing | | | | | | | | | | | | | | | | | | | | | | | | | | | | | | | | | | | | | | | | | | | | | | | | | | | | | | | | | | | | | | | | | | | | | | | | | | | | | | | | | | | | |
| Storage controllers | Supports the following RAID/HBA adapters: | | | | | | | | | | | | | | | | | | | | | | | | | | | | | | | | | | | | | | | | | | | | | | | | | | | | | | | | | | | | | | | | | | | | | | | | | | | | | | | | | | | | |
| | <table border="1"> <thead> <tr> <th></th> <th>RAID adapter</th> <th>Interface</th> <th>Drive type</th> <th>RAID levels</th> <th>JBOD</th> <th>Cache</th> <th>Cache protection</th> <th>FastPath</th> <th>Max qty</th> </tr> </thead> <tbody> <tr> <td rowspan="3">For SS bays</td> <td>Onboard SATA</td> <td>6Gbps SATA</td> <td>SATA</td> <td>0/1/10/5</td> <td>Yes</td> <td>None</td> <td>None</td> <td>No</td> <td>-</td> </tr> <tr> <td>530-8i</td> <td>12Gbps SAS</td> <td>SATA/SAS</td> <td>0/1/10/5/50</td> <td>Yes</td> <td>None</td> <td>None</td> <td>Yes</td> <td>1</td> </tr> <tr> <td>730-8i</td> <td>12Gbps SAS</td> <td>SATA/SAS</td> <td>0/1/10/5/50</td> <td>Yes</td> <td>1GB</td> <td>None</td> <td>No</td> <td>1</td> </tr> <tr> <td rowspan="5">For HS bays</td> <td>930-8i</td> <td>12Gbps SAS</td> <td>SATA/SAS</td> <td>0/1/10/5/50/6/60</td> <td>Yes</td> <td>2GB</td> <td>Flash backup</td> <td>Yes</td> <td>1</td> </tr> <tr> <td>430-8i</td> <td>12Gbps SAS</td> <td>SATA/SAS</td> <td>-</td> <td>Yes</td> <td>None</td> <td>None</td> <td>-</td> <td>1</td> </tr> <tr> <td>430-8e</td> <td>12Gbps SAS</td> <td>SATA/SAS</td> <td>-</td> <td>Yes</td> <td>None</td> <td>None</td> <td>-</td> <td>2</td> </tr> <tr> <td>430-16e</td> <td>12Gbps SAS</td> <td>SATA/SAS</td> <td>-</td> <td>Yes</td> <td>None</td> <td>None</td> <td>-</td> <td>2</td> </tr> <tr> <td>930-8e</td> <td>12Gbps SAS</td> <td>SATA/SAS</td> <td>0/1/10/5/50/6/60</td> <td>Yes</td> <td>4GB</td> <td>Flash backup</td> <td>Yes</td> <td>2</td> </tr> </tbody> </table> | | RAID adapter | Interface | Drive type | RAID levels | JBOD | Cache | Cache protection | FastPath | Max qty | For SS bays | Onboard SATA | 6Gbps SATA | SATA | 0/1/10/5 | Yes | None | None | No | - | 530-8i | 12Gbps SAS | SATA/SAS | 0/1/10/5/50 | Yes | None | None | Yes | 1 | 730-8i | 12Gbps SAS | SATA/SAS | 0/1/10/5/50 | Yes | 1GB | None | No | 1 | For HS bays | 930-8i | 12Gbps SAS | SATA/SAS | 0/1/10/5/50/6/60 | Yes | 2GB | Flash backup | Yes | 1 | 430-8i | 12Gbps SAS | SATA/SAS | - | Yes | None | None | - | 1 | 430-8e | 12Gbps SAS | SATA/SAS | - | Yes | None | None | - | 2 | 430-16e | 12Gbps SAS | SATA/SAS | - | Yes | None | None | - | 2 | 930-8e | 12Gbps SAS | SATA/SAS | 0/1/10/5/50/6/60 | Yes | 4GB | Flash backup | Yes | 2 |
| | | RAID adapter | Interface | Drive type | RAID levels | JBOD | Cache | Cache protection | FastPath | Max qty | | | | | | | | | | | | | | | | | | | | | | | | | | | | | | | | | | | | | | | | | | | | | | | | | | | | | | | | | | | | | | | | | | | | | | | | | | | |
| | For SS bays | Onboard SATA | 6Gbps SATA | SATA | 0/1/10/5 | Yes | None | None | No | - | | | | | | | | | | | | | | | | | | | | | | | | | | | | | | | | | | | | | | | | | | | | | | | | | | | | | | | | | | | | | | | | | | | | | | | | | | | |
| | | 530-8i | 12Gbps SAS | SATA/SAS | 0/1/10/5/50 | Yes | None | None | Yes | 1 | | | | | | | | | | | | | | | | | | | | | | | | | | | | | | | | | | | | | | | | | | | | | | | | | | | | | | | | | | | | | | | | | | | | | | | | | | | |
| | | 730-8i | 12Gbps SAS | SATA/SAS | 0/1/10/5/50 | Yes | 1GB | None | No | 1 | | | | | | | | | | | | | | | | | | | | | | | | | | | | | | | | | | | | | | | | | | | | | | | | | | | | | | | | | | | | | | | | | | | | | | | | | | | |
| | For HS bays | 930-8i | 12Gbps SAS | SATA/SAS | 0/1/10/5/50/6/60 | Yes | 2GB | Flash backup | Yes | 1 | | | | | | | | | | | | | | | | | | | | | | | | | | | | | | | | | | | | | | | | | | | | | | | | | | | | | | | | | | | | | | | | | | | | | | | | | | | |
| | | 430-8i | 12Gbps SAS | SATA/SAS | - | Yes | None | None | - | 1 | | | | | | | | | | | | | | | | | | | | | | | | | | | | | | | | | | | | | | | | | | | | | | | | | | | | | | | | | | | | | | | | | | | | | | | | | | | |
| | | 430-8e | 12Gbps SAS | SATA/SAS | - | Yes | None | None | - | 2 | | | | | | | | | | | | | | | | | | | | | | | | | | | | | | | | | | | | | | | | | | | | | | | | | | | | | | | | | | | | | | | | | | | | | | | | | | | |
| | | 430-16e | 12Gbps SAS | SATA/SAS | - | Yes | None | None | - | 2 | | | | | | | | | | | | | | | | | | | | | | | | | | | | | | | | | | | | | | | | | | | | | | | | | | | | | | | | | | | | | | | | | | | | | | | | | | | |
| 930-8e | | 12Gbps SAS | SATA/SAS | 0/1/10/5/50/6/60 | Yes | 4GB | Flash backup | Yes | 2 | | | | | | | | | | | | | | | | | | | | | | | | | | | | | | | | | | | | | | | | | | | | | | | | | | | | | | | | | | | | | | | | | | | | | | | | | | | | |
| <i>Note: 730-8i is available in China only. All RAID/HBA adapters should be placed in slot 1 firstly.</i> | | | | | | | | | | | | | | | | | | | | | | | | | | | | | | | | | | | | | | | | | | | | | | | | | | | | | | | | | | | | | | | | | | | | | | | | | | | | | | | | | | | | | |
| Disk drive bays | Support 4 front 3.5" SATA simple-swap bays, or 4 front 3.5" SATA/SAS HS bays, or 8 front 2.5" SATA/SAS HS bays. Optional one or two internal M.2 SSD for boot, dual M.2 SSD supports mirroring | | | | | | | | | | | | | | | | | | | | | | | | | | | | | | | | | | | | | | | | | | | | | | | | | | | | | | | | | | | | | | | | | | | | | | | | | | | | | | | | | | | | |
| Internal storage | <table border="1"> <thead> <tr> <th>For 3.5" SS bay</th> <th>3.5" HDD, SATA6Gbs, 7.2K</th> <th>1TB/2TB/4TB/6TB/8TB/10TB</th> </tr> </thead> <tbody> <tr> <td rowspan="2">For 3.5" bay (3.5" disks or 2.5" disks with 3.5" tray)</td> <td>3.5" HDD, SATA6Gbs, 7.2K</td> <td>1TB/2TB/4TB/6TB/8TB/10TB</td> </tr> <tr> <td>3.5" HDD, SAS12Gbs, 7.2K</td> <td>1TB/2TB/4TB/6TB/10TB</td> </tr> <tr> <td rowspan="8">For 2.5" bay</td> <td>2.5" HDD, SAS12Gbs, 15K</td> <td>300GB/600GB</td> </tr> <tr> <td>2.5" SSD, SATA6Gbs</td> <td>240GB/480GB</td> </tr> <tr> <td>2.5" HDD, SATA6Gbs, 7.2K</td> <td>1TB/2TB</td> </tr> <tr> <td>2.5" HDD, SAS12Gbs, 7.2K</td> <td>1TB/2TB</td> </tr> <tr> <td>2.5" HDD, SAS12Gbs, 10K</td> <td>300GB/600GB/900GB/1.2TB/1.8TB</td> </tr> <tr> <td>2.5" HDD, SAS12Gbs, 15K</td> <td>300GB/600GB</td> </tr> <tr> <td>2.5" SSD, SAS12Gbs</td> <td>400GB/800GB/3.84TB</td> </tr> <tr> <td>2.5" SSD, SATA6Gbs</td> <td>240GB/480GB</td> </tr> <tr> <td>M.2 SATA SSD</td> <td>32GB/128GB</td> <td></td> </tr> </tbody> </table> | For 3.5" SS bay | 3.5" HDD, SATA6Gbs, 7.2K | 1TB/2TB/4TB/6TB/8TB/10TB | For 3.5" bay (3.5" disks or 2.5" disks with 3.5" tray) | 3.5" HDD, SATA6Gbs, 7.2K | 1TB/2TB/4TB/6TB/8TB/10TB | 3.5" HDD, SAS12Gbs, 7.2K | 1TB/2TB/4TB/6TB/10TB | For 2.5" bay | 2.5" HDD, SAS12Gbs, 15K | 300GB/600GB | 2.5" SSD, SATA6Gbs | 240GB/480GB | 2.5" HDD, SATA6Gbs, 7.2K | 1TB/2TB | 2.5" HDD, SAS12Gbs, 7.2K | 1TB/2TB | 2.5" HDD, SAS12Gbs, 10K | 300GB/600GB/900GB/1.2TB/1.8TB | 2.5" HDD, SAS12Gbs, 15K | 300GB/600GB | 2.5" SSD, SAS12Gbs | 400GB/800GB/3.84TB | 2.5" SSD, SATA6Gbs | 240GB/480GB | M.2 SATA SSD | 32GB/128GB | | | | | | | | | | | | | | | | | | | | | | | | | | | | | | | | | | | | | | | | | | | | | | | | | | | | | | | | | |
| | For 3.5" SS bay | 3.5" HDD, SATA6Gbs, 7.2K | 1TB/2TB/4TB/6TB/8TB/10TB | | | | | | | | | | | | | | | | | | | | | | | | | | | | | | | | | | | | | | | | | | | | | | | | | | | | | | | | | | | | | | | | | | | | | | | | | | | | | | | | | | |
| | For 3.5" bay (3.5" disks or 2.5" disks with 3.5" tray) | 3.5" HDD, SATA6Gbs, 7.2K | 1TB/2TB/4TB/6TB/8TB/10TB | | | | | | | | | | | | | | | | | | | | | | | | | | | | | | | | | | | | | | | | | | | | | | | | | | | | | | | | | | | | | | | | | | | | | | | | | | | | | | | | | | |
| | | 3.5" HDD, SAS12Gbs, 7.2K | 1TB/2TB/4TB/6TB/10TB | | | | | | | | | | | | | | | | | | | | | | | | | | | | | | | | | | | | | | | | | | | | | | | | | | | | | | | | | | | | | | | | | | | | | | | | | | | | | | | | | | |
| | For 2.5" bay | 2.5" HDD, SAS12Gbs, 15K | 300GB/600GB | | | | | | | | | | | | | | | | | | | | | | | | | | | | | | | | | | | | | | | | | | | | | | | | | | | | | | | | | | | | | | | | | | | | | | | | | | | | | | | | | | |
| | | 2.5" SSD, SATA6Gbs | 240GB/480GB | | | | | | | | | | | | | | | | | | | | | | | | | | | | | | | | | | | | | | | | | | | | | | | | | | | | | | | | | | | | | | | | | | | | | | | | | | | | | | | | | | |
| | | 2.5" HDD, SATA6Gbs, 7.2K | 1TB/2TB | | | | | | | | | | | | | | | | | | | | | | | | | | | | | | | | | | | | | | | | | | | | | | | | | | | | | | | | | | | | | | | | | | | | | | | | | | | | | | | | | | |
| | | 2.5" HDD, SAS12Gbs, 7.2K | 1TB/2TB | | | | | | | | | | | | | | | | | | | | | | | | | | | | | | | | | | | | | | | | | | | | | | | | | | | | | | | | | | | | | | | | | | | | | | | | | | | | | | | | | | |
| | | 2.5" HDD, SAS12Gbs, 10K | 300GB/600GB/900GB/1.2TB/1.8TB | | | | | | | | | | | | | | | | | | | | | | | | | | | | | | | | | | | | | | | | | | | | | | | | | | | | | | | | | | | | | | | | | | | | | | | | | | | | | | | | | | |
| | | 2.5" HDD, SAS12Gbs, 15K | 300GB/600GB | | | | | | | | | | | | | | | | | | | | | | | | | | | | | | | | | | | | | | | | | | | | | | | | | | | | | | | | | | | | | | | | | | | | | | | | | | | | | | | | | | |
| 2.5" SSD, SAS12Gbs | | 400GB/800GB/3.84TB | | | | | | | | | | | | | | | | | | | | | | | | | | | | | | | | | | | | | | | | | | | | | | | | | | | | | | | | | | | | | | | | | | | | | | | | | | | | | | | | | | | |
| 2.5" SSD, SATA6Gbs | | 240GB/480GB | | | | | | | | | | | | | | | | | | | | | | | | | | | | | | | | | | | | | | | | | | | | | | | | | | | | | | | | | | | | | | | | | | | | | | | | | | | | | | | | | | | |
| M.2 SATA SSD | 32GB/128GB | | | | | | | | | | | | | | | | | | | | | | | | | | | | | | | | | | | | | | | | | | | | | | | | | | | | | | | | | | | | | | | | | | | | | | | | | | | | | | | | | | | | |
| Optical | No internal optical bay. Optional USB DVD±RW optical drive | | | | | | | | | | | | | | | | | | | | | | | | | | | | | | | | | | | | | | | | | | | | | | | | | | | | | | | | | | | | | | | | | | | | | | | | | | | | | | | | | | | | |
| Network interfaces | Integrated one dedicated management port plus two GbE ports. One LOM slot for customized LOM with two RJ-45 or SFP+ ports, up to 10GbE. Optional ML2 or PCIe adapters are supported. ML2 adapter requires riser card with ML2 slot. Up to two ports supports Wake-on-LAN and NC-SI (see right) | | | | | | | | | | | | | | | | | | | | | | | | | | | | | | | | | | | | | | | | | | | | | | | | | | | | | | | | | | | | | | | | | | | | | | | | | | | | | | | | | | | | |
| Security features | Power-on and admin password. Trusted Platform Module, TCG 1.2 compliant, upgrade to 2.0 via UEFI setting. Optional TCM in China only. Optional lockable security bezel | | | | | | | | | | | | | | | | | | | | | | | | | | | | | | | | | | | | | | | | | | | | | | | | | | | | | | | | | | | | | | | | | | | | | | | | | | | | | | | | | | | | |
| Operating systems supported | Microsoft Windows Server 2016/2012 R2. Red Hat Enterprise Linux 7.3/6.9. SUSE Linux Enterprise Server 12 SP2/11 SP4. VMware vSphere (ESXi) 6.5/6.0 U3 | | | | | | | | | | | | | | | | | | | | | | | | | | | | | | | | | | | | | | | | | | | | | | | | | | | | | | | | | | | | | | | | | | | | | | | | | | | | | | | | | | | | |
| Systems management | XClarity Controller Standard, optional upgrades to Advanced or Enterprise are available. Energy Manager. XClarity Administrator. Lenovo Capacity Planner. Provisioning Manager. Essentials. Light Path Diagnostics | | | | | | | | | | | | | | | | | | | | | | | | | | | | | | | | | | | | | | | | | | | | | | | | | | | | | | | | | | | | | | | | | | | | | | | | | | | | | | | | | | | | |
| GPU support | None | | | | | | | | | | | | | | | | | | | | | | | | | | | | | | | | | | | | | | | | | | | | | | | | | | | | | | | | | | | | | | | | | | | | | | | | | | | | | | | | | | | | |

| Components | Specification | | | | | | | | | | | | |
|--|---|---|---|--|-------------------------------|--|--------------------------------|----------------------|--------------------------------------|--------------------------------------|-----------------------------------|---|--------|
| Base warranty | MT 7X07: 1-year limited onsite service with 9x5/NBD MT 7X08: 3-year limited onsite service with 9x5/NBD | | | | | | | | | | | | |
| Power supply | Up to two redundant hot-swap 550W and 750W 80 PLUS Platinum qualified AC power supplies. Or up to two redundant hot-swap 750W Titanium qualified AC power supplies. 750W Titanium is 200V - 240V, others are 100V - 240V | | | | | | | | | | | | |
| Video | Integrated Matrox G200 in XClarity Controller | | | | | | | | | | | | |
| Cooling | Four fans (3+1) for single processor model, six fans (5+1) for dual processor model | | | | | | | | | | | | |
| Front ports | One XClarity Controller USB, one USB 3.0, one optional VGA | | | | | | | | | | | | |
| Rear ports | One VGA, two USB 3.0, two ethernet (RJ-45), one XClarity Controller connector. Optional COM port | | | | | | | | | | | | |
| Environmental specification | Supports ASHRAE A4 with limitations. | | | | | | | | | | | | |
| | <table border="1"> <tbody> <tr> <td>Temperature - operating</td> <td>A4: 5°C to 45°C (41°F to 113°F) A3: 5°C to 40°C (41°F to 104°F) A2: 10°C to 35°C (50°F to 95°F)</td> </tr> <tr> <td>Temperature - non operating (no package)</td> <td>-10°C to 60°C (14°F to 140°F)</td> </tr> <tr> <td>Temperature - non operating (with package)</td> <td>-40°C to 70°C (-40°F to 158°F)</td> </tr> <tr> <td>Altitude - operating</td> <td>(Unpressurized): 0-10000ft (0-3048m)</td> </tr> <tr> <td>Humidity - operating, non-condensing</td> <td>A4: 8%-90%. A3:8%-85%. A2:20%-80%</td> </tr> <tr> <td>Humidity - storage (with package), non-condensing</td> <td>8%-90%</td> </tr> </tbody> </table> | Temperature - operating | A4: 5°C to 45°C (41°F to 113°F) A3: 5°C to 40°C (41°F to 104°F) A2: 10°C to 35°C (50°F to 95°F) | Temperature - non operating (no package) | -10°C to 60°C (14°F to 140°F) | Temperature - non operating (with package) | -40°C to 70°C (-40°F to 158°F) | Altitude - operating | (Unpressurized): 0-10000ft (0-3048m) | Humidity - operating, non-condensing | A4: 8%-90%. A3:8%-85%. A2:20%-80% | Humidity - storage (with package), non-condensing | 8%-90% |
| | Temperature - operating | A4: 5°C to 45°C (41°F to 113°F) A3: 5°C to 40°C (41°F to 104°F) A2: 10°C to 35°C (50°F to 95°F) | | | | | | | | | | | |
| | Temperature - non operating (no package) | -10°C to 60°C (14°F to 140°F) | | | | | | | | | | | |
| | Temperature - non operating (with package) | -40°C to 70°C (-40°F to 158°F) | | | | | | | | | | | |
| Altitude - operating | (Unpressurized): 0-10000ft (0-3048m) | | | | | | | | | | | | |
| Humidity - operating, non-condensing | A4: 8%-90%. A3:8%-85%. A2:20%-80% | | | | | | | | | | | | |
| Humidity - storage (with package), non-condensing | 8%-90% | | | | | | | | | | | | |
| <i>Models should meet the following requirements to support A3 and A4:</i> | | | | | | | | | | | | | |
| • Redundant power supplies required | | | | | | | | | | | | | |
| • No system fan fails | | | | | | | | | | | | | |
| Environmental certification | Energy Star Server 2.1 certified. More environmental information please see: www.lenovo.com/social_responsibility/us/en/environment/ | | | | | | | | | | | | |

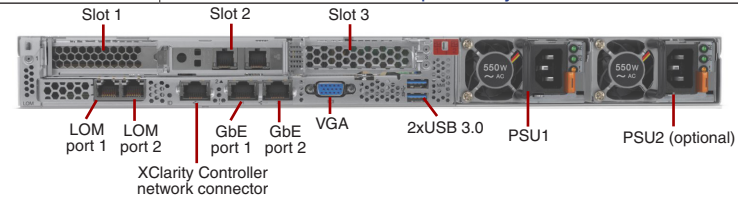

Note: GbE port 1 and LOM port 1 support Wake-on-LAN and NC-SI. Riser cards, expansion cards, and LOM adapters are optional.

| Expansion slots | |
|-------------------------|---|
| Slot 1-2 (riser card 1) | Supports one of the following for riser card 1: Option 1: PCIe 3.0 x8/x16 (slot 1-2). Low profile for x8, low profile or full height half length for x16 Option 2: PCIe 3.0 x8/x8 ML2 (slot 1-2). Low profile |
| Slot 3 (riser card 2) | Option 1: PCIe 3.0 x 8, low profile, for single processor model Option 2: PCIe 3.0 x 16, low profile, for dual processor model When slot 2 is full height, slot 3 cannot be used |

| System unique options | |
|-----------------------|---|
| Option | Description |
| 7XH7A05892 | ThinkSystem SR530/SR570 x8/x8ML2 PCIe LP+LP Riser 1 kit |
| 7XH7A02682 | ThinkSystem SR530/SR570/SR630 x8/x16 PCIe LP+LP Riser 1 Kit |
| 7XH7A05893 | ThinkSystem SR530/SR570/SR630 x8/x16 PCIe LP+FH Riser 1 Kit |
| 7XH7A05891 | ThinkSystem SR530/SR570 x8 PCIe LP Riser 2 kit |
| 7XH7A02685 | ThinkSystem SR530/SR570/SR630 x16 PCIe LP Riser 2 Kit |
| 7Z17A02579 | ThinkSystem SR530/SR570/SR630 Front VGA Connector Upgrade Kit |
| 7Z17A02581 | ThinkSystem 1U Security Bezel |
| 7Z17A02577 | ThinkSystem COM Port Upgrade Kit |
| 7XH7A05896 | ThinkSystem SR530/SR630 2.5" SATA/SAS 8-Bay Backplane Kit |

ThinkSystem SR530 Models for USA and Canada - TopSeller

Product Specifications Reference (PSREF)

| Model | Processor | Memory | RAID/HBA Adapter | Chassis | Disk Bays | Disks | Networking (LOM/ML2/PCIe) | M.2 Boot Drive | Riser Card 1 for Slot 1-2 | Riser Card 2 for Slot 3 | Front VGA | Security | System Management | Power Supply | Base Warranty | Ann Date (mm/yy) |
|------------|---|---------------------------|------------------|---------|------------------------|-------|---------------------------|----------------|---------------------------|-------------------------|--------------|----------|------------------------|--------------------|---------------|------------------|
| 7X08A03SNA | 1xXeon Silver 4110 8C/2.1GHz/ 11MB/85W/DDR4-2400 | 1x16GB RDIMM DDR4-2666 | 1x530-8i | 4x3.5" | 4x3.5" SATA/ SAS HS | Open | None | None | x8 LP / x16 FH | None | Front VGA | TPM 1.2 | XClarity Enterprise | 1x750W Platinum | 3-year | 07/17 |
| 7X08A045NA | 1xXeon Silver 4116 12C/2.1GHz/ 16.5MB/85W/DDR4-2400 | 1x32GB RDIMM DDR4-2666 | 1x530-8i | 4x3.5" | 4x3.5" SATA/ SAS HS | Open | None | None | x8 LP / x16 FH | None | Front VGA | TPM 1.2 | XClarity Enterprise | 1x750W Platinum | 3-year | 07/17 |
| 7X08A04FNA | 1xXeon Bronze 3106 8C/1.7GHz/ 11MB/85W/DDR4-2133 | 1x16GB RDIMM DDR4-2666 | 1x530-8i | 4x3.5" | 4x3.5" SATA/ SAS HS | Open | None | None | x8 LP / x16 FH | None | Front VGA | TPM 1.2 | XClarity Enterprise | 1x750W Platinum | 3-year | 07/17 |

ThinkSystem SR530 Models for USA and Canada - Non TopSeller

Product Specifications Reference (PSREF)

| Model | Processor | Memory | RAID/HBA Adapter | Chassis | Disk Bays | Disks | Networking (LOM/ML2/PCIe) | M.2 Boot Drive | Riser Card 1 for Slot 1-3 | Riser Card 2 for Slot 5-6 | Front VGA | Security | System Management | Power Supply | Base Warranty | Ann Date (mm/yy) |
|------------|--|---------------------------|-----------------------|---------|------------------------|-------|---------------------------|----------------|---------------------------|---------------------------|-----------|----------|----------------------|--------------------|---------------|------------------|
| 7X08A052NA | 1xXeon Gold 6138 20C/2.0GHz/ 27.5MB/125W/DDR4-2666 | 1x32GB RDIMM DDR4-2666 | 1x930-8i 2GB flash | 8x2.5" | 8x2.5" SATA/ SAS HS | Open | None | None | x8 / x16, LP | None | None | TPM 1.2 | XClarity Standard | 1x750W Platinum | 3-year | 07/17 |
| 7X08A055NA | 1xXeon Silver 4110 8C/2.1GHz/ 11MB/85W/DDR4-2400 | 1x16GB RDIMM DDR4-2666 | 1x930-8i 2GB flash | 8x2.5" | 8x2.5" SATA/ SAS HS | Open | None | None | x8 / x16, LP | None | None | TPM 1.2 | XClarity Standard | 1x750W Platinum | 3-year | 07/17 |
| 7X08A056NA | 1xXeon Bronze 3104 6C/1.7GHz/ 8.25MB/85W/DDR4-2133 | 1x16GB RDIMM DDR4-2666 | 1x530-8i | 8x2.5" | 8x2.5" SATA/ SAS HS | Open | None | None | x8 / x16, LP | None | None | TPM 1.2 | XClarity Standard | 1x750W Platinum | 3-year | 07/17 |
| 7X08A057NA | 1xXeon Silver 4110 8C/2.1GHz/ 11MB/85W/DDR4-2400 | 1x16GB RDIMM DDR4-2666 | 1x530-8i | 8x2.5" | 8x2.5" SATA/ SAS HS | Open | None | None | x8 / x16, LP | None | None | TPM 1.2 | XClarity Standard | 1x750W Platinum | 3-year | 07/17 |
| 7X08A058NA | 1xXeon Gold 5118 12C/2.3GHz/ 16.5MB/105W/DDR4-2400 | 1x32GB RDIMM DDR4-2666 | 1x930-8i 2GB flash | 8x2.5" | 8x2.5" SATA/ SAS HS | Open | None | None | x8 / x16, LP | None | None | TPM 1.2 | XClarity Standard | 1x750W Platinum | 3-year | 07/17 |
| 7X08A05ENA | 1xXeon Gold 5115 10C/2.4GHz/ 13.75MB/85W/DDR4-2400 | 1x16GB RDIMM DDR4-2666 | 1x930-8i 2GB flash | 8x2.5" | 8x2.5" SATA/ SAS HS | Open | None | None | x8 / x16, LP | None | None | TPM 1.2 | XClarity Standard | 1x750W Platinum | 3-year | 07/17 |
| 7X08A05KNA | 1xXeon Silver 4116 12C/2.1GHz/ 16.5MB/85W/DDR4-2400 | 1x16GB RDIMM DDR4-2666 | 1x930-8i 2GB flash | 8x2.5" | 8x2.5" SATA/ SAS HS | Open | None | None | x8 / x16, LP | None | None | TPM 1.2 | XClarity Standard | 1x750W Platinum | 3-year | 07/17 |
| 7X08A05MNA | 1xXeon Silver 4114 10C/2.2GHz/ 13.75MB/85W/DDR4-2400 | 1x16GB RDIMM DDR4-2666 | 1x930-8i 2GB flash | 8x2.5" | 8x2.5" SATA/ SAS HS | Open | None | None | x8 / x16, LP | None | None | TPM 1.2 | XClarity Standard | 1x750W Platinum | 3-year | 07/17 |
| 7X08A05PNA | 1xXeon Gold 6126 12C/2.6GHz/ 19.25MB/125W/DDR4-2666 | 1x16GB RDIMM DDR4-2666 | 1x930-8i 2GB flash | 8x2.5" | 8x2.5" SATA/ SAS HS | Open | None | None | x8 / x16, LP | None | None | TPM 1.2 | XClarity Standard | 1x750W Platinum | 3-year | 07/17 |
| 7X08A05RNA | 1xXeon Gold 5120 14C/2.2GHz/ 19.25MB/105W/DDR4-2400 | 1x16GB RDIMM DDR4-2666 | 1x930-8i 2GB flash | 8x2.5" | 8x2.5" SATA/ SAS HS | Open | None | None | x8 / x16, LP | None | None | TPM 1.2 | XClarity Standard | 1x750W Platinum | 3-year | 07/17 |
| 7X08A05SNA | 1xXeon Gold 5118 12C/2.3GHz/ 16.5MB/105W/DDR4-2400 | 1x16GB RDIMM DDR4-2666 | 1x930-8i 2GB flash | 8x2.5" | 8x2.5" SATA/ SAS HS | Open | None | None | x8 / x16, LP | None | None | TPM 1.2 | XClarity Standard | 1x750W Platinum | 3-year | 07/17 |
| 7X08A05TNA | 1xXeon Silver 4108 8C/1.8GHz/ 11MB/85W/DDR4-2400 | 1x16GB RDIMM DDR4-2666 | 1x530-8i | 4x3.5" | 4x3.5" SATA/ SAS HS | Open | None | None | x8 / x16, LP | None | None | TPM 1.2 | XClarity Standard | 1x750W Platinum | 3-year | 07/17 |
| 7X08A05WNA | 1xXeon Bronze 3106 8C/1.7GHz/ 11MB/85W/DDR4-2133 | 1x16GB RDIMM DDR4-2666 | 1x530-8i | 8x2.5" | 8x2.5" SATA/ SAS HS | Open | None | None | x8 / x16, LP | None | None | TPM 1.2 | XClarity Standard | 1x750W Platinum | 3-year | 07/17 |
| 7X08A05XNA | 1xXeon Silver 4108 8C/1.8GHz/ 11MB/85W/DDR4-2400 | 1x16GB RDIMM DDR4-2666 | 1x530-8i | 8x2.5" | 8x2.5" SATA/ SAS HS | Open | None | None | x8 / x16, LP | None | None | TPM 1.2 | XClarity Standard | 1x750W Platinum | 3-year | 07/17 |

ThinkSystem SR530 Models for EMEA - TopSeller

Product Specifications Reference (PSREF)

| Model | Processor | Memory | RAID/HBA Adapter | Chassis | Disk Bays | Disks | Networking (LOM/ML2/PCIe) | M.2 Boot Drive | Riser Card 1 for Slot 1-3 | Riser Card 2 for Slot 5-6 | Front VGA | Security | System Management | Power Supply | Base Warranty | Ann Date (mm/yy) |
|------------|--|---------------------------|-----------------------|---------|------------------------|--|---------------------------|----------------|---------------------------|---------------------------|--------------|----------|------------------------|--------------------|---------------|------------------|
| 7X08A009EA | 1xXeon Gold 5118 12C/2.3GHz/ 16.5MB/105W/DDR4-2400 | 1x16GB RDIMM DDR4-2666 | 1x930-8i 2GB flash | 8x2.5" | 8x2.5" SATA/ SAS HS | Open | None | None | x8 / x16, LP | None | None | TPM 1.2 | XClarity Enterprise | 1x750W Platinum | 3-year | 07/17 |
| 7X08A00XEA | 1xXeon Gold 6138 20C/2.0GHz/ 27.5MB/125W/DDR4-2666 | 1x32GB RDIMM DDR4-2666 | 1x930-8i 2GB flash | 8x2.5" | 8x2.5" SATA/ SAS HS | Open | None | None | x8 / x16, LP | None | None | TPM 1.2 | XClarity Standard | 1x750W Platinum | 3-year | 07/17 |
| 7X08A01HEA | 1xXeon Gold 6130 16C/2.1GHz/ 22MB/125W/DDR4-2666 | 1x32GB RDIMM DDR4-2666 | 1x930-8i 2GB flash | 8x2.5" | 8x2.5" SATA/ SAS HS | Open | None | None | x8 / x16, LP | None | None | TPM 1.2 | XClarity Standard | 1x750W Platinum | 3-year | 07/17 |
| 7X08A01UEA | 1xXeon Silver 4108 8C/1.8GHz/ 11MB/85W/DDR4-2400 | 1x16GB RDIMM DDR4-2666 | 1x930-8i 2GB flash | 8x2.5" | 8x2.5" SATA/ SAS HS | Open | None | None | x8 / x16, LP | None | None | TPM 1.2 | XClarity Advanced | 1x750W Platinum | 3-year | 07/17 |
| 7X08A01VEA | 1xXeon Silver 4110 8C/2.1GHz/ 11MB/85W/DDR4-2400 | 1x16GB RDIMM DDR4-2666 | 1x930-8i 2GB flash | 4x3.5" | 4x3.5" SATA/ SAS HS | Open | None | None | x8 / x16, LP | None | Front VGA | TPM 1.2 | XClarity Advanced | 1x750W Platinum | 3-year | 07/17 |
| 7X08A01XEA | 1xXeon Silver 4116 12C/2.1GHz/ 16.5MB/85W/DDR4-2400 | 1x16GB RDIMM DDR4-2666 | 1x930-8i 2GB flash | 8x2.5" | 8x2.5" SATA/ SAS HS | Open | None | None | x8 / x16, LP | None | None | TPM 1.2 | XClarity Advanced | 1x750W Platinum | 3-year | 07/17 |
| 7X08A020EA | 1xXeon Silver 4108 8C/1.8GHz/ 11MB/85W/DDR4-2400 | 1x16GB RDIMM DDR4-2666 | 1x530-8i | 8x2.5" | 8x2.5" SATA/ SAS HS | Open | None | None | x8 / x16, LP | None | None | TPM 1.2 | XClarity Advanced | 1x750W Platinum | 3-year | 07/17 |
| 7X08A022EA | 1xXeon Bronze 3104 6C/1.7GHz/ 8.25MB/85W/DDR4-2133 | 1x16GB RDIMM DDR4-2666 | Onboard SATA | 4x3.5" | 4x3.5" SATA SS | Open | None | None | None | None | Front VGA | TPM 1.2 | XClarity Standard | 1x550W Platinum | 3-year | 07/17 |
| 7X08A024EA | 1xXeon Silver 4114 10C/2.2GHz/ 13.75MB/85W/DDR4-2400 | 1x16GB RDIMM DDR4-2666 | 1x930-8i 2GB flash | 8x2.5" | 8x2.5" SATA/ SAS HS | Open | None | None | x8 / x16, LP | None | None | TPM 1.2 | XClarity Advanced | 1x750W Platinum | 3-year | 07/17 |
| 7X08A025EA | 1xXeon Bronze 3104 6C/1.7GHz/ 8.25MB/85W/DDR4-2133 | 1x16GB RDIMM DDR4-2666 | 1x530-8i | 8x2.5" | 8x2.5" SATA/ SAS HS | Open | None | None | x8 / x16, LP | None | None | TPM 1.2 | XClarity Advanced | 1x750W Platinum | 3-year | 07/17 |
| 7X08A027EA | 1xXeon Silver 4110 8C/2.1GHz/ 11MB/85W/DDR4-2400 | 2x32GB RDIMM DDR4-2666 | 1x930-8i 2GB flash | 8x2.5" | 8x2.5" SATA/ SAS HS | 2x600GB HDD 10K 2.5" SAS- 12Gbps | None | None | x8 / x16, LP | None | None | TPM 1.2 | XClarity Advanced | 2x750W Platinum | 3-year | 07/17 |
| 7X08A028EA | 1xXeon Bronze 3104 6C/1.7GHz/ 8.25MB/85W/DDR4-2133 | 1x16GB RDIMM DDR4-2666 | 1x530-8i | 4x3.5" | 4x3.5" SATA/ SAS HS | Open | None | None | x8 / x16, LP | None | Front VGA | TPM 1.2 | XClarity Standard | 1x550W Platinum | 3-year | 07/17 |
| 7X08A029EA | 1xXeon Silver 4110 8C/2.1GHz/ 11MB/85W/DDR4-2400 | 1x16GB RDIMM DDR4-2666 | 1x930-8i 2GB flash | 8x2.5" | 8x2.5" SATA/ SAS HS | Open | None | None | x8 / x16, LP | None | None | TPM 1.2 | XClarity Advanced | 1x750W Platinum | 3-year | 07/17 |
| 7X08A02BEA | 1xXeon Silver 4114 10C/2.2GHz/ 13.75MB/85W/DDR4-2400 | 1x16GB RDIMM DDR4-2666 | 1x930-8i 2GB flash | 8x2.5" | 8x2.5" SATA/ SAS HS | 2x300GB HDD 10K 2.5" SAS- 12Gbps | None | None | x8 / x16, LP | None | None | TPM 1.2 | XClarity Advanced | 2x750W Platinum | 3-year | 07/17 |
| 7X08A04GEA | 1xXeon Silver 4110 8C/2.1GHz/ 11MB/85W/DDR4-2400 | 4x32GB RDIMM DDR4-2666 | 1x930-8i 2GB flash | 8x2.5" | 8x2.5" SATA/ SAS HS | 3x600GB HDD 10K 2.5" SAS- 12Gbps | None | None | x8 / x16, LP | None | None | TPM 1.2 | XClarity Enterprise | 2x750W Platinum | 3-year | 07/17 |
| 7X08A04TEA | 1xXeon Gold 5115 10C/2.4GHz/ 13.75MB/85W/DDR4-2400 | 1x16GB RDIMM DDR4-2666 | 1x930-8i 2GB flash | 8x2.5" | 8x2.5" SATA/ SAS HS | Open | None | None | x8 / x16, LP | None | None | TPM 1.2 | XClarity Enterprise | 1x750W Platinum | 3-year | 07/17 |

ThinkSystem SR530 Models for EMEA - Non TopSeller

Product Specifications Reference (PSREF)

| Model | Processor | Memory | RAID/HBA Adapter | Chassis | Disk Bays | Disks | Networking (LOM/ML2/PCIe) | M.2 Boot Drive | Riser Card 1 for Slot 1-3 | Riser Card 2 for Slot 5-6 | Front VGA | Security | System Management | Power Supply | Base Warranty | Ann Date (mm/yy) |
|------------|--|---------------------------|-----------------------|---------|------------------------|-------|---------------------------|----------------|---------------------------|---------------------------|-----------|----------|----------------------|--------------------|---------------|------------------|
| 7X08A003EA | 1xXeon Gold 5118 12C/2.3GHz/ 16.5MB/105W/DDR4-2400 | 1x16GB RDIMM DDR4-2666 | 1x930-8i 2GB flash | 8x2.5" | 8x2.5" SATA/ SAS HS | Open | None | None | x8 / x16, LP | None | None | TPM 1.2 | XClarity Standard | 1x750W Platinum | 3-year | 07/17 |
| 7X08A00JEA | 1xXeon Gold 5120 14C/2.2GHz/ 19.25MB/105W/DDR4-2400 | 1x16GB RDIMM DDR4-2666 | 1x930-8i 2GB flash | 8x2.5" | 8x2.5" SATA/ SAS HS | Open | None | None | x8 / x16, LP | None | None | TPM 1.2 | XClarity Standard | 1x750W Platinum | 3-year | 07/17 |
| 7X08A00NEA | 1xXeon Gold 6126 12C/2.6GHz/ 19.25MB/125W/DDR4-2666 | 1x16GB RDIMM DDR4-2666 | 1x930-8i 2GB flash | 8x2.5" | 8x2.5" SATA/ SAS HS | Open | None | None | x8 / x16, LP | None | None | TPM 1.2 | XClarity Standard | 1x750W Platinum | 3-year | 07/17 |
| 7X08A00PEA | 1xXeon Gold 5118 12C/2.3GHz/ 16.5MB/105W/DDR4-2400 | 1x32GB RDIMM DDR4-2666 | 1x930-8i 2GB flash | 8x2.5" | 8x2.5" SATA/ SAS HS | Open | None | None | x8 / x16, LP | None | None | TPM 1.2 | XClarity Standard | 1x750W Platinum | 3-year | 07/17 |
| 7X08A018EA | 1xXeon Gold 6138 20C/2.0GHz/ 27.5MB/125W/DDR4-2666 | 1x32GB RDIMM DDR4-2666 | 1x930-8i 2GB flash | 8x2.5" | 8x2.5" SATA/ SAS HS | Open | None | None | x8 / x16, LP | None | None | TPM 1.2 | XClarity Standard | 1x750W Platinum | 3-year | 07/17 |
| 7X08A01TEA | 1xXeon Bronze 3106 8C/1.7GHz/ 11MB/85W/DDR4-2133 | 1x16GB RDIMM DDR4-2666 | 1x530-8i | 8x2.5" | 8x2.5" SATA/ SAS HS | Open | None | None | x8 / x16, LP | None | None | TPM 1.2 | XClarity Standard | 1x750W Platinum | 3-year | 07/17 |
| 7X08A01WEA | 1xXeon Silver 4108 8C/1.8GHz/ 11MB/85W/DDR4-2400 | 1x16GB RDIMM DDR4-2666 | 1x530-8i | 8x2.5" | 8x2.5" SATA/ SAS HS | Open | None | None | x8 / x16, LP | None | None | TPM 1.2 | XClarity Standard | 1x750W Platinum | 3-year | 07/17 |
| 7X08A01YEA | 1xXeon Silver 4114 10C/2.2GHz/ 13.75MB/85W/DDR4-2400 | 1x16GB RDIMM DDR4-2666 | 1x930-8i 2GB flash | 8x2.5" | 8x2.5" SATA/ SAS HS | Open | None | None | x8 / x16, LP | None | None | TPM 1.2 | XClarity Standard | 1x750W Platinum | 3-year | 07/17 |
| 7X08A01ZEA | 1xXeon Silver 4108 8C/1.8GHz/ 11MB/85W/DDR4-2400 | 1x16GB RDIMM DDR4-2666 | 1x530-8i | 4x3.5" | 4x3.5" SATA/ SAS HS | Open | None | None | x8 / x16, LP | None | None | TPM 1.2 | XClarity Standard | 1x750W Platinum | 3-year | 07/17 |
| 7X08A021EA | 1xXeon Silver 4116 12C/2.1GHz/ 16.5MB/85W/DDR4-2400 | 1x16GB RDIMM DDR4-2666 | 1x930-8i 2GB flash | 8x2.5" | 8x2.5" SATA/ SAS HS | Open | None | None | x8 / x16, LP | None | None | TPM 1.2 | XClarity Standard | 1x750W Platinum | 3-year | 07/17 |
| 7X08A023EA | 1xXeon Silver 4110 8C/2.1GHz/ 11MB/85W/DDR4-2400 | 1x16GB RDIMM DDR4-2666 | 1x930-8i 2GB flash | 8x2.5" | 8x2.5" SATA/ SAS HS | Open | None | None | x8 / x16, LP | None | None | TPM 1.2 | XClarity Standard | 1x750W Platinum | 3-year | 07/17 |
| 7X08A026EA | 1xXeon Bronze 3104 6C/1.7GHz/ 8.25MB/85W/DDR4-2133 | 1x16GB RDIMM DDR4-2666 | 1x530-8i | 8x2.5" | 8x2.5" SATA/ SAS HS | Open | None | None | x8 / x16, LP | None | None | TPM 1.2 | XClarity Standard | 1x750W Platinum | 3-year | 07/17 |
| 7X08A02AEA | 1xXeon Silver 4110 8C/2.1GHz/ 11MB/85W/DDR4-2400 | 1x16GB RDIMM DDR4-2666 | 1x530-8i | 8x2.5" | 8x2.5" SATA/ SAS HS | Open | None | None | x8 / x16, LP | None | None | TPM 1.2 | XClarity Standard | 1x750W Platinum | 3-year | 07/17 |
| 7X08A04SEA | 1xXeon Gold 5115 10C/2.4GHz/ 13.75MB/85W/DDR4-2400 | 1x16GB RDIMM DDR4-2666 | 1x930-8i 2GB flash | 8x2.5" | 8x2.5" SATA/ SAS HS | Open | None | None | x8 / x16, LP | None | None | TPM 1.2 | XClarity Standard | 1x750W Platinum | 3-year | 07/17 |

ThinkSystem SR530 Models for Australia and New Zealand - TopSeller

Product Specifications Reference (PSREF)

| Model | Processor | Memory | RAID/HBA Adapter | Chassis | Disk Bays | Disks | Networking (LOM/ML2/PCIe) | M.2 Boot Drive | Riser Card 1 for Slot 1-3 | Riser Card 2 for Slot 5-6 | Front VGA | Security | System Management | Power Supply | Base Warranty | Ann Date (mm/yy) |
|------------|--|---------------------------|-----------------------|---------|------------------------|--|---------------------------|----------------|---------------------------|---------------------------|--------------|----------|------------------------|--------------------|---------------|------------------|
| 7X08A02RAU | 1xXeon Silver 4110 8C/2.1GHz/11MB/85W/ DDR4-2400 | 1x16GB RDIMM DDR4-2666 | 1x930-8i 2GB flash | 8x2.5" | 8x2.5" SATA/ SAS HS | Open | None | None | x8 / x16, LP | None | None | TPM 1.2 | XClarity Advanced | 1x750W Platinum | 3-year | 07/17 |
| 7X08A030AU | 1xXeon Bronze 3104 6C/1.7GHz/8.25MB/85W/ DDR4-2133 | 1x16GB RDIMM DDR4-2666 | Onboard SATA | 4x3.5" | 4x3.5" SATA SS | Open | None | None | None | None | Front VGA | TPM 1.2 | XClarity Standard | 1x550W Platinum | 3-year | 07/17 |
| 7X08A032AU | 1xXeon Silver 4110 8C/2.1GHz/11MB/85W/ DDR4-2400 | 1x16GB RDIMM DDR4-2666 | 1x930-8i 2GB flash | 4x3.5" | 4x3.5" SATA/ SAS HS | Open | None | None | x8 / x16, LP | None | Front VGA | TPM 1.2 | XClarity Advanced | 1x750W Platinum | 3-year | 07/17 |
| 7X08A034AU | 1xXeon Silver 4110 8C/2.1GHz/11MB/85W/ DDR4-2400 | 2x32GB RDIMM DDR4-2666 | 1x930-8i 2GB flash | 8x2.5" | 8x2.5" SATA/ SAS HS | 2x600GB HDD 10K 2.5" SAS- 12Gbps | None | None | x8 / x16, LP | None | None | TPM 1.2 | XClarity Advanced | 2x750W Platinum | 3-year | 07/17 |
| 7X08A035AU | 1xXeon Silver 4114 10C/2.2GHz/13.75MB/85W/ DDR4-2400 | 1x16GB RDIMM DDR4-2666 | 1x930-8i 2GB flash | 8x2.5" | 8x2.5" SATA/ SAS HS | 2x300GB HDD 10K 2.5" SAS- 12Gbps | None | None | x8 / x16, LP | None | None | TPM 1.2 | XClarity Advanced | 2x750W Platinum | 3-year | 07/17 |
| 7X08A038AU | 1xXeon Silver 4108 8C/1.8GHz/11MB/85W/ DDR4-2400 | 1x16GB RDIMM DDR4-2666 | 1x930-8i 2GB flash | 8x2.5" | 8x2.5" SATA/ SAS HS | Open | None | None | x8 / x16, LP | None | None | TPM 1.2 | XClarity Advanced | 1x750W Platinum | 3-year | 07/17 |
| 7X08A03AAU | 1xXeon Silver 4108 8C/1.8GHz/11MB/85W/ DDR4-2400 | 1x16GB RDIMM DDR4-2666 | 1x530-8i | 8x2.5" | 8x2.5" SATA/ SAS HS | Open | None | None | x8 / x16, LP | None | None | TPM 1.2 | XClarity Advanced | 1x750W Platinum | 3-year | 07/17 |
| 7X08A03JAU | 1xXeon Silver 4116 12C/2.1GHz/16.5MB/85W/ DDR4-2400 | 1x16GB RDIMM DDR4-2666 | 1x930-8i 2GB flash | 8x2.5" | 8x2.5" SATA/ SAS HS | Open | None | None | x8 / x16, LP | None | None | TPM 1.2 | XClarity Advanced | 1x750W Platinum | 3-year | 07/17 |
| 7X08A03MAU | 1xXeon Bronze 3104 6C/1.7GHz/8.25MB/85W/ DDR4-2133 | 1x16GB RDIMM DDR4-2666 | 1x530-8i | 4x3.5" | 4x3.5" SATA/ SAS HS | Open | None | None | x8 / x16, LP | None | Front VGA | TPM 1.2 | XClarity Standard | 1x550W Platinum | 3-year | 07/17 |
| 7X08A03QAU | 1xXeon Bronze 3104 6C/1.7GHz/8.25MB/85W/ DDR4-2133 | 1x16GB RDIMM DDR4-2666 | 1x530-8i | 8x2.5" | 8x2.5" SATA/ SAS HS | Open | None | None | x8 / x16, LP | None | None | TPM 1.2 | XClarity Advanced | 1x750W Platinum | 3-year | 07/17 |
| 7X08A03RAU | 1xXeon Silver 4114 10C/2.2GHz/13.75MB/85W/ DDR4-2400 | 1x16GB RDIMM DDR4-2666 | 1x930-8i 2GB flash | 8x2.5" | 8x2.5" SATA/ SAS HS | Open | None | None | x8 / x16, LP | None | None | TPM 1.2 | XClarity Advanced | 1x750W Platinum | 3-year | 07/17 |
| 7X08A03TAU | 1xXeon Gold 5118 12C/2.3GHz/16.5MB/105W/ DDR4-2400 | 1x16GB RDIMM DDR4-2666 | 1x930-8i 2GB flash | 8x2.5" | 8x2.5" SATA/ SAS HS | Open | None | None | x8 / x16, LP | None | None | TPM 1.2 | XClarity Enterprise | 1x750W Platinum | 3-year | 07/17 |
| 7X08A03ZAU | 1xXeon Gold 6130 16C/2.1GHz/22MB/125W/ DDR4-2666 | 1x32GB RDIMM DDR4-2666 | 1x930-8i 2GB flash | 8x2.5" | 8x2.5" SATA/ SAS HS | Open | None | None | x8 / x16, LP | None | None | TPM 1.2 | XClarity Standard | 1x750W Platinum | 3-year | 07/17 |

ThinkSystem SR530 Models for Australia and New Zealand - Non TopSeller

Product Specifications Reference (PSREF)

| Model | Processor | Memory | RAID/HBA Adapter | Chassis | Disk Bays | Disks | Networking (LOM/ML2/PCIe) | M.2 Boot Drive | Riser Card 1 for Slot 1-3 | Riser Card 2 for Slot 5-6 | Front VGA | Security | System Management | Power Supply | Base Warranty | Ann Date (mm/yy) |
|-------------|---|------------------------|--------------------|---------|--------------------|-------|---------------------------|----------------|---------------------------|---------------------------|-----------|----------|-------------------|-----------------|---------------|------------------|
| 7X08A006AU | 1xXeon Gold 5120 14C/2.2GHz/19.25MB/105W/DDR4-2400 | 1x8GB RDIMM DDR4-2666 | 1x530-8i | 8x2.5" | 8x2.5" SATA/SAS HS | Open | None | None | x8 / x8 ML2, LP | None | None | TPM 1.2 | XClarity Standard | 1x550W Platinum | 3-year | 07/17 |
| 7X08A00DAU | 1xXeon Gold 5120 14C/2.2GHz/19.25MB/105W/DDR4-2400 | 1x8GB RDIMM DDR4-2666 | 1x530-8i | 4x3.5" | 4x3.5" SATA/SAS HS | Open | None | None | x8 / x8 ML2, LP | None | Front VGA | TPM 1.2 | XClarity Standard | 1x550W Platinum | 3-year | 07/17 |
| 7X08A00YAU | 1xXeon Gold 5120 14C/2.2GHz/19.25MB/105W/DDR4-2400 | 1x16GB RDIMM DDR4-2666 | 1x930-8i 2GB flash | 8x2.5" | 8x2.5" SATA/SAS HS | Open | None | None | x8 / x16, LP | None | None | TPM 1.2 | XClarity Standard | 1x550W Platinum | 3-year | 07/17 |
| 7X08A010AU | 1xXeon Gold 6126 12C/2.6GHz/19.25MB/125W/DDR4-2666 | 1x16GB RDIMM DDR4-2666 | 1x930-8i 2GB flash | 8x2.5" | 8x2.5" SATA/SAS HS | Open | None | None | x8 / x16, LP | None | None | TPM 1.2 | XClarity Standard | 1x750W Platinum | 3-year | 07/17 |
| 7X08A01EAU | 1xXeon Gold 5118 12C/2.3GHz/16.5MB/105W/DDR4-2400 | 1x16GB RDIMM DDR4-2666 | 1x930-8i 2GB flash | 8x2.5" | 8x2.5" SATA/SAS HS | Open | None | None | x8 / x8 ML2, LP | None | None | TPM 1.2 | XClarity Standard | 1x550W Platinum | 3-year | 07/17 |
| 7X08A01JAU | 1xXeon Gold 5118 12C/2.3GHz/16.5MB/105W/DDR4-2400 | 1x8GB RDIMM DDR4-2666 | 1x530-8i | 4x3.5" | 4x3.5" SATA/SAS HS | Open | None | None | x8 / x8 ML2, LP | None | Front VGA | TPM 1.2 | XClarity Standard | 1x550W Platinum | 3-year | 07/17 |
| 7X08A01KAU | 1xXeon Gold 5118 12C/2.3GHz/16.5MB/105W/DDR4-2400 | 1x16GB RDIMM DDR4-2666 | 1x530-8i | 8x2.5" | 8x2.5" SATA/SAS HS | Open | None | None | x8 / x8 ML2, LP | None | None | TPM 1.2 | XClarity Standard | 1x550W Platinum | 3-year | 07/17 |
| 7X08A01NAU | 1xXeon Gold 5118 12C/2.3GHz/16.5MB/105W/DDR4-2400 | 1x8GB RDIMM DDR4-2666 | Onboard SATA | 4x3.5" | 4x3.5" SATA SS | Open | None | None | None | None | Front VGA | TPM 1.2 | XClarity Standard | 1x550W Platinum | 3-year | 07/17 |
| 7X08A01PAU | 1xXeon Gold 5118 12C/2.3GHz/16.5MB/105W/DDR4-2400 | 1x8GB RDIMM DDR4-2666 | 1x530-8i | 8x2.5" | 8x2.5" SATA/SAS HS | Open | None | None | x8 / x8 ML2, LP | None | None | TPM 1.2 | XClarity Standard | 1x550W Platinum | 3-year | 07/17 |
| 7X08A01QAU | 1xXeon Gold 6138 20C/2.0GHz/27.5MB/125W/DDR4-2666 | 1x16GB RDIMM DDR4-2666 | 1x930-8i 2GB flash | 8x2.5" | 8x2.5" SATA/SAS HS | Open | None | None | x8 / x16, LP | None | None | TPM 1.2 | XClarity Standard | 1x750W Platinum | 3-year | 07/17 |
| 7X08A01RAU | 1xXeon Gold 6126 12C/2.6GHz/19.25MB/125W/DDR4-2666 | 1x16GB RDIMM DDR4-2666 | 1x530-8i | 8x2.5" | 8x2.5" SATA/SAS HS | Open | None | None | x8 / x8 ML2, LP | None | None | TPM 1.2 | XClarity Standard | 1x750W Platinum | 3-year | 07/17 |
| 7X08A01SAU | 1xXeon Gold 6130 16C/2.1GHz/22MB/125W/DDR4-2666 | 1x16GB RDIMM DDR4-2666 | 1x930-8i 2GB flash | 8x2.5" | 8x2.5" SATA/SAS HS | Open | None | None | x8 / x16, LP | None | None | TPM 1.2 | XClarity Standard | 1x750W Platinum | 3-year | 07/17 |
| 7X08A02SAU | 1xXeon Silver 4110 8C/2.1GHz/11MB/85W/DDR4-2400 | 1x16GB RDIMM DDR4-2666 | 1x530-8i | 8x2.5" | 8x2.5" SATA/SAS HS | Open | None | None | x8 / x16, LP | None | None | TPM 1.2 | XClarity Standard | 1x750W Platinum | 3-year | 07/17 |
| 7X08A02XAU | 1xXeon Silver 4110 8C/2.1GHz/11MB/85W/DDR4-2400 | 1x16GB RDIMM DDR4-2666 | 1x930-8i 2GB flash | 8x2.5" | 8x2.5" SATA/SAS HS | Open | None | None | x8 / x16, LP | None | None | TPM 1.2 | XClarity Standard | 1x750W Platinum | 3-year | 07/17 |
| 7X08A033AU | 1xXeon Silver 4114 10C/2.2GHz/13.75MB/85W/DDR4-2400 | 1x16GB RDIMM DDR4-2666 | 1x930-8i 2GB flash | 8x2.5" | 8x2.5" SATA/SAS HS | Open | None | None | x8 / x16, LP | None | None | TPM 1.2 | XClarity Standard | 1x750W Platinum | 3-year | 07/17 |
| 7X08A037AU | 1xXeon Bronze 3106 8C/1.7GHz/11MB/85W/DDR4-2133 | 1x16GB RDIMM DDR4-2666 | 1x530-8i | 8x2.5" | 8x2.5" SATA/SAS HS | Open | None | None | x8 / x16, LP | None | None | TPM 1.2 | XClarity Standard | 1x750W Platinum | 3-year | 07/17 |
| 7X08A03FAU | 1xXeon Silver 4108 8C/1.8GHz/11MB/85W/DDR4-2400 | 1x16GB RDIMM DDR4-2666 | 1x530-8i | 8x2.5" | 8x2.5" SATA/SAS HS | Open | None | None | x8 / x16, LP | None | None | TPM 1.2 | XClarity Standard | 1x750W Platinum | 3-year | 07/17 |
| 7X08A03HAU | 1xXeon Silver 4108 8C/1.8GHz/11MB/85W/DDR4-2400 | 1x16GB RDIMM DDR4-2666 | 1x530-8i | 4x3.5" | 4x3.5" SATA/SAS HS | Open | None | None | x8 / x16, LP | None | None | TPM 1.2 | XClarity Standard | 1x750W Platinum | 3-year | 07/17 |
| 7X08A03LAU | 1xXeon Silver 4116 12C/2.1GHz/16.5MB/85W/DDR4-2400 | 1x16GB RDIMM DDR4-2666 | 1x930-8i 2GB flash | 8x2.5" | 8x2.5" SATA/SAS HS | Open | None | None | x8 / x16, LP | None | None | TPM 1.2 | XClarity Standard | 1x750W Platinum | 3-year | 07/17 |
| 7X08A03NAU | 1xXeon Bronze 3104 6C/1.7GHz/8.25MB/85W/DDR4-2133 | 1x16GB RDIMM DDR4-2666 | 1x530-8i | 8x2.5" | 8x2.5" SATA/SAS HS | Open | None | None | x8 / x16, LP | None | None | TPM 1.2 | XClarity Standard | 1x750W Platinum | 3-year | 07/17 |
| 7X08A03UUAU | 1xXeon Gold 6138 20C/2.0GHz/27.5MB/125W/DDR4-2666 | 1x32GB RDIMM DDR4-2666 | 1x930-8i 2GB flash | 8x2.5" | 8x2.5" SATA/SAS HS | Open | None | None | x8 / x16, LP | None | None | TPM 1.2 | XClarity Standard | 1x750W Platinum | 3-year | 07/17 |
| 7X08A03VAU | 1xXeon Gold 5118 12C/2.3GHz/16.5MB/105W/DDR4-2400 | 1x32GB RDIMM DDR4-2666 | 1x930-8i 2GB flash | 8x2.5" | 8x2.5" SATA/SAS HS | Open | None | None | x8 / x16, LP | None | None | TPM 1.2 | XClarity Standard | 1x750W Platinum | 3-year | 07/17 |
| 7X08A041AU | 1xXeon Gold 5120 14C/2.2GHz/19.25MB/105W/DDR4-2400 | 1x16GB RDIMM DDR4-2666 | 1x930-8i 2GB flash | 8x2.5" | 8x2.5" SATA/SAS HS | Open | None | None | x8 / x16, LP | None | None | TPM 1.2 | XClarity Standard | 1x750W Platinum | 3-year | 07/17 |
| 7X08A04MAU | 1xXeon Gold 5118 12C/2.3GHz/16.5MB/105W/DDR4-2400 | 1x16GB RDIMM DDR4-2666 | 1x930-8i 2GB flash | 8x2.5" | 8x2.5" SATA/SAS HS | Open | None | None | x8 / x16, LP | None | None | TPM 1.2 | XClarity Standard | 1x750W Platinum | 3-year | 07/17 |

ThinkSystem SR530 Models for South East Asian (ASEAN) - Non TopSeller
Product Specifications Reference (PSREF)

| Model | Processor | Memory | RAID/HBA Adapter | Chassis | Disk Bays | Disks | Networking (LOM/ML2/PCIe) | M.2 Boot Drive | Riser Card 1 for Slot 1-3 | Riser Card 2 for Slot 5-6 | Front VGA | Security | System Management | Power Supply | Base Warranty | Ann Date (mm/yy) |
|------------|--|--------------------------|------------------|---------|------------------------|-------|---------------------------|----------------|---------------------------|---------------------------|--------------|----------|----------------------|--------------------|---------------|------------------|
| 7X08A02CSG | 1xXeon Gold 5118 12C/2.3GHz/ 16.5MB/105W/DDR4-2400 | 1x8GB RDIMM DDR4-2666 | 1x530-8i | 8x2.5" | 8x2.5" SATA/ SAS HS | Open | 2xGbE RJ- 45 LOM | None | x8 / x16, LP | None | None | TPM 1.2 | XClarity Standard | 1x550W Platinum | 3-year | 07/17 |
| 7X08A02DSG | 1xXeon Gold 5120 14C/2.2GHz/ 19.25MB/105W/DDR4-2400 | 1x8GB RDIMM DDR4-2666 | 1x530-8i | 8x2.5" | 8x2.5" SATA/ SAS HS | Open | 2xGbE RJ- 45 LOM | None | x8 / x16, LP | None | None | TPM 1.2 | XClarity Standard | 1x550W Platinum | 3-year | 07/17 |
| 7X08A02ESG | 1xXeon Gold 5122 4C/3.6GHz/ 16.5MB/105W/DDR4-2400 | 1x8GB RDIMM DDR4-2666 | 1x530-8i | 8x2.5" | 8x2.5" SATA/ SAS HS | Open | 2xGbE RJ- 45 LOM | None | x8 / x16, LP | None | None | TPM 1.2 | XClarity Standard | 1x550W Platinum | 3-year | 07/17 |
| 7X08A02FSG | 1xXeon Gold 6130 16C/2.1GHz/ 22MB/125W/DDR4-2666 | 1x8GB RDIMM DDR4-2666 | 1x530-8i | 8x2.5" | 8x2.5" SATA/ SAS HS | Open | 2xGbE RJ- 45 LOM | None | x8 / x16, LP | None | None | TPM 1.2 | XClarity Standard | 1x550W Platinum | 3-year | 07/17 |
| 7X08A02GSG | 1xXeon Gold 6138 20C/2.0GHz/ 27.5MB/125W/DDR4-2666 | 1x8GB RDIMM DDR4-2666 | 1x530-8i | 8x2.5" | 8x2.5" SATA/ SAS HS | Open | 2xGbE RJ- 45 LOM | None | x8 / x16, LP | None | None | TPM 1.2 | XClarity Standard | 1x550W Platinum | 3-year | 07/17 |
| 7X08A02HSG | 1xXeon Gold 5122 4C/3.6GHz/ 16.5MB/105W/DDR4-2400 | 1x8GB RDIMM DDR4-2666 | 1x530-8i | 4x3.5" | 4x3.5" SATA/ SAS HS | Open | 2xGbE RJ- 45 LOM | None | x8 / x16, LP | None | Front VGA | TPM 1.2 | XClarity Standard | 1x550W Platinum | 3-year | 07/17 |
| 7X08A02JSG | 1xXeon Silver 4110 8C/2.1GHz/ 11MB/85W/DDR4-2400 | 1x8GB RDIMM DDR4-2666 | 1x530-8i | 8x2.5" | 8x2.5" SATA/ SAS HS | Open | None | None | x8 / x16, LP | None | None | TPM 1.2 | XClarity Standard | 1x550W Platinum | 3-year | 07/17 |
| 7X08A02KSG | 1xXeon Silver 4112 4C/2.6GHz/ 8.25MB/85W/DDR4-2400 | 1x8GB RDIMM DDR4-2666 | 1x530-8i | 8x2.5" | 8x2.5" SATA/ SAS HS | Open | None | None | x8 / x16, LP | None | None | TPM 1.2 | XClarity Standard | 1x550W Platinum | 3-year | 07/17 |
| 7X08A02LSG | 1xXeon Bronze 3104 6C/1.7GHz/ 8.25MB/85W/DDR4-2133 | 1x8GB RDIMM DDR4-2666 | 1x530-8i | 8x2.5" | 8x2.5" SATA/ SAS HS | Open | None | None | x8 / x16, LP | None | None | TPM 1.2 | XClarity Standard | 1x550W Platinum | 3-year | 07/17 |
| 7X08A02MSG | 1xXeon Bronze 3106 8C/1.7GHz/ 11MB/85W/DDR4-2133 | 1x8GB RDIMM DDR4-2666 | 1x530-8i | 8x2.5" | 8x2.5" SATA/ SAS HS | Open | None | None | x8 / x16, LP | None | None | TPM 1.2 | XClarity Standard | 1x550W Platinum | 3-year | 07/17 |
| 7X08A02NSG | 1xXeon Silver 4114 10C/2.2GHz/ 13.75MB/85W/DDR4-2400 | 1x8GB RDIMM DDR4-2666 | 1x530-8i | 8x2.5" | 8x2.5" SATA/ SAS HS | Open | None | None | x8 / x16, LP | None | None | TPM 1.2 | XClarity Standard | 1x550W Platinum | 3-year | 07/17 |
| 7X08A02PSG | 1xXeon Silver 4116 12C/2.1GHz/ 16.5MB/85W/DDR4-2400 | 1x8GB RDIMM DDR4-2666 | 1x530-8i | 8x2.5" | 8x2.5" SATA/ SAS HS | Open | None | None | x8 / x16, LP | None | None | TPM 1.2 | XClarity Standard | 1x550W Platinum | 3-year | 07/17 |
| 7X08A02QSG | 1xXeon Silver 4112 4C/2.6GHz/ 8.25MB/85W/DDR4-2400 | 1x8GB RDIMM DDR4-2666 | 1x530-8i | 4x3.5" | 4x3.5" SATA/ SAS HS | Open | None | None | x8 / x16, LP | None | None | TPM 1.2 | XClarity Standard | 1x550W Platinum | 3-year | 07/17 |

ThinkSystem SR530 Models for Hong Kong, Taiwan, Korea (HTK) - Non TopSeller

Product Specifications Reference (PSREF)

| Model | Processor | Memory | RAID/HBA Adapter | Chassis | Disk Bays | Disks | Networking (LOM/ML2/PCIe) | M.2 Boot Drive | Riser Card for Slot 1-3 | Riser Card for Slot 5-6 | Front VGA | Security | System Management | Power Supply | Base Warranty | Ann Date (mm/yy) |
|------------|---|---------------------------|-----------------------|---------|------------------------|-------|---------------------------|----------------|-------------------------|-------------------------|-----------|----------|----------------------|--------------------|---------------|------------------|
| 7X08A00SCN | 1xXeon Gold 6130 16C/2.1GHz/22MB/125W/DDR4-2666 | 1x16GB RDIMM DDR4-2666 | 1x930-8i 2GB flash | 4x3.5" | 4x3.5" SATA/ SAS HS | Open | 2xGbE RJ- 45 LOM | None | x8 LP / x16 FH | None | None | TPM 1.2 | XClarity Standard | 1x750W Platinum | 3-year | 07/17 |
| 7X08A00TCN | 1xXeon Gold 6126 12C/2.6GHz/19.25MB/125W/DDR4- 2666 | 1x16GB RDIMM DDR4-2666 | 1x930-8i 2GB flash | 4x3.5" | 4x3.5" SATA/ SAS HS | Open | 2xGbE RJ- 45 LOM | None | x8 LP / x16 FH | None | None | TPM 1.2 | XClarity Standard | 1x750W Platinum | 3-year | 07/17 |
| 7X08A00UCN | 1xXeon Gold 5122 4C/3.6GHz/16.5MB/105W/DDR4-2400 | 1x16GB RDIMM DDR4-2666 | 1x930-8i 2GB flash | 4x3.5" | 4x3.5" SATA/ SAS HS | Open | 2xGbE RJ- 45 LOM | None | x8 LP / x16 FH | None | None | TPM 1.2 | XClarity Standard | 1x750W Platinum | 3-year | 07/17 |
| 7X08A00WCN | 1xXeon Gold 5120 14C/2.2GHz/19.25MB/105W/DDR4- 2400 | 1x16GB RDIMM DDR4-2666 | 1x930-8i 2GB flash | 4x3.5" | 4x3.5" SATA/ SAS HS | Open | 2xGbE RJ- 45 LOM | None | x8 LP / x16 FH | None | None | TPM 1.2 | XClarity Standard | 1x750W Platinum | 3-year | 07/17 |
| 7X08A00ZCN | 1xXeon Gold 5118 12C/2.3GHz/16.5MB/105W/DDR4-2400 | 1x16GB RDIMM DDR4-2666 | 1x930-8i 2GB flash | 4x3.5" | 4x3.5" SATA/ SAS HS | Open | 2xGbE RJ- 45 LOM | None | x8 LP / x16 FH | None | None | TPM 1.2 | XClarity Standard | 1x750W Platinum | 3-year | 07/17 |
| 7X08A014CN | 1xXeon Gold 5122 4C/3.6GHz/16.5MB/105W/DDR4-2400 | 1x16GB RDIMM DDR4-2666 | 1x930-8i 2GB flash | 8x2.5" | 8x2.5" SATA/ SAS HS | Open | 2xGbE RJ- 45 LOM | None | x8 LP / x16 FH | None | None | TPM 1.2 | XClarity Standard | 1x750W Platinum | 3-year | 07/17 |
| 7X08A016CN | 1xXeon Gold 6126 12C/2.6GHz/19.25MB/125W/DDR4- 2666 | 1x16GB RDIMM DDR4-2666 | 1x930-8i 2GB flash | 8x2.5" | 8x2.5" SATA/ SAS HS | Open | 2xGbE RJ- 45 LOM | None | x8 LP / x16 FH | None | None | TPM 1.2 | XClarity Standard | 1x750W Platinum | 3-year | 07/17 |
| 7X08A01DCN | 1xXeon Gold 6130 16C/2.1GHz/22MB/125W/DDR4-2666 | 1x16GB RDIMM DDR4-2666 | 1x930-8i 2GB flash | 8x2.5" | 8x2.5" SATA/ SAS HS | Open | 2xGbE RJ- 45 LOM | None | x8 LP / x16 FH | None | None | TPM 1.2 | XClarity Standard | 1x750W Platinum | 3-year | 07/17 |
| 7X08A01GCN | 1xXeon Gold 5120 14C/2.2GHz/19.25MB/105W/DDR4- 2400 | 1x16GB RDIMM DDR4-2666 | 1x930-8i 2GB flash | 8x2.5" | 8x2.5" SATA/ SAS HS | Open | 2xGbE RJ- 45 LOM | None | x8 LP / x16 FH | None | None | TPM 1.2 | XClarity Standard | 1x750W Platinum | 3-year | 07/17 |
| 7X08A01LCN | 1xXeon Gold 5118 12C/2.3GHz/16.5MB/105W/DDR4-2400 | 1x16GB RDIMM DDR4-2666 | 1x930-8i 2GB flash | 8x2.5" | 8x2.5" SATA/ SAS HS | Open | 2xGbE RJ- 45 LOM | None | x8 LP / x16 FH | None | None | TPM 1.2 | XClarity Standard | 1x750W Platinum | 3-year | 07/17 |
| 7X08A02TCN | 1xXeon Bronze 3106 8C/1.7GHz/11MB/85W/DDR4-2133 | 1x16GB RDIMM DDR4-2666 | 1x930-8i 2GB flash | 8x2.5" | 8x2.5" SATA/ SAS HS | Open | 2xGbE RJ- 45 LOM | None | x8 / x16, LP | None | None | TPM 1.2 | XClarity Standard | 1x750W Platinum | 3-year | 07/17 |
| 7X08A02UCN | 1xXeon Silver 4114 10C/2.2GHz/13.75MB/85W/DDR4-2400 | 1x16GB RDIMM DDR4-2666 | 1x930-8i 2GB flash | 8x2.5" | 8x2.5" SATA/ SAS HS | Open | 2xGbE RJ- 45 LOM | None | x8 / x16, LP | None | None | TPM 1.2 | XClarity Standard | 1x750W Platinum | 3-year | 07/17 |
| 7X08A02VCN | 1xXeon Gold 5115 10C/2.4GHz/13.75MB/85W/DDR4-2400 | 1x16GB RDIMM DDR4-2666 | 1x930-8i 2GB flash | 4x3.5" | 4x3.5" SATA/ SAS HS | Open | 2xGbE RJ- 45 LOM | None | x8 / x16, LP | None | None | TPM 1.2 | XClarity Standard | 1x750W Platinum | 3-year | 07/17 |
| 7X08A02WCN | 1xXeon Silver 4116 12C/2.1GHz/16.5MB/85W/DDR4-2400 | 1x16GB RDIMM DDR4-2666 | 1x930-8i 2GB flash | 4x3.5" | 4x3.5" SATA/ SAS HS | Open | 2xGbE RJ- 45 LOM | None | x8 / x16, LP | None | None | TPM 1.2 | XClarity Standard | 1x750W Platinum | 3-year | 07/17 |
| 7X08A02YCN | 1xXeon Silver 4116 12C/2.1GHz/16.5MB/85W/DDR4-2400 | 1x16GB RDIMM DDR4-2666 | 1x930-8i 2GB flash | 8x2.5" | 8x2.5" SATA/ SAS HS | Open | 2xGbE RJ- 45 LOM | None | x8 / x16, LP | None | None | TPM 1.2 | XClarity Standard | 1x750W Platinum | 3-year | 07/17 |
| 7X08A02ZCN | 1xXeon Bronze 3104 6C/1.7GHz/8.25MB/85W/DDR4-2133 | 1x16GB RDIMM DDR4-2666 | 1x930-8i 2GB flash | 4x3.5" | 4x3.5" SATA/ SAS HS | Open | 2xGbE RJ- 45 LOM | None | x8 / x16, LP | None | None | TPM 1.2 | XClarity Standard | 1x750W Platinum | 3-year | 07/17 |
| 7X08A031CN | 1xXeon Bronze 3106 8C/1.7GHz/11MB/85W/DDR4-2133 | 1x16GB RDIMM DDR4-2666 | 1x930-8i 2GB flash | 4x3.5" | 4x3.5" SATA/ SAS HS | Open | 2xGbE RJ- 45 LOM | None | x8 / x16, LP | None | None | TPM 1.2 | XClarity Standard | 1x750W Platinum | 3-year | 07/17 |
| 7X08A036CN | 1xXeon Silver 4114 10C/2.2GHz/13.75MB/85W/DDR4-2400 | 1x16GB RDIMM DDR4-2666 | 1x930-8i 2GB flash | 4x3.5" | 4x3.5" SATA/ SAS HS | Open | 2xGbE RJ- 45 LOM | None | x8 / x16, LP | None | None | TPM 1.2 | XClarity Standard | 1x750W Platinum | 3-year | 07/17 |
| 7X08A039CN | 1xXeon Silver 4108 8C/1.8GHz/11MB/85W/DDR4-2400 | 1x16GB RDIMM DDR4-2666 | 1x930-8i 2GB flash | 8x2.5" | 8x2.5" SATA/ SAS HS | Open | 2xGbE RJ- 45 LOM | None | x8 / x16, LP | None | None | TPM 1.2 | XClarity Standard | 1x750W Platinum | 3-year | 07/17 |
| 7X08A03BCN | 1xXeon Bronze 3104 6C/1.7GHz/8.25MB/85W/DDR4-2133 | 1x16GB RDIMM DDR4-2666 | 1x930-8i 2GB flash | 8x2.5" | 8x2.5" SATA/ SAS HS | Open | 2xGbE RJ- 45 LOM | None | x8 / x16, LP | None | None | TPM 1.2 | XClarity Standard | 1x750W Platinum | 3-year | 07/17 |
| 7X08A03CCN | 1xXeon Silver 4112 4C/2.6GHz/8.25MB/85W/DDR4-2400 | 1x16GB RDIMM DDR4-2666 | 1x930-8i 2GB flash | 4x3.5" | 4x3.5" SATA/ SAS HS | Open | 2xGbE RJ- 45 LOM | None | x8 / x16, LP | None | None | TPM 1.2 | XClarity Standard | 1x750W Platinum | 3-year | 07/17 |
| 7X08A03DCN | 1xXeon Silver 4112 4C/2.6GHz/8.25MB/85W/DDR4-2400 | 1x16GB RDIMM DDR4-2666 | 1x930-8i 2GB flash | 8x2.5" | 8x2.5" SATA/ SAS HS | Open | 2xGbE RJ- 45 LOM | None | x8 / x16, LP | None | None | TPM 1.2 | XClarity Standard | 1x750W Platinum | 3-year | 07/17 |
| 7X08A03ECN | 1xXeon Gold 5115 10C/2.4GHz/13.75MB/85W/DDR4-2400 | 1x16GB RDIMM DDR4-2666 | 1x930-8i 2GB flash | 8x2.5" | 8x2.5" SATA/ SAS HS | Open | 2xGbE RJ- 45 LOM | None | x8 / x16, LP | None | None | TPM 1.2 | XClarity Standard | 1x750W Platinum | 3-year | 07/17 |
| 7X08A03GCN | 1xXeon Silver 4110 8C/2.1GHz/11MB/85W/DDR4-2400 | 1x16GB RDIMM DDR4-2666 | 1x930-8i 2GB flash | 4x3.5" | 4x3.5" SATA/ SAS HS | Open | 2xGbE RJ- 45 LOM | None | x8 / x16, LP | None | None | TPM 1.2 | XClarity Standard | 1x750W Platinum | 3-year | 07/17 |
| 7X08A03KCN | 1xXeon Silver 4108 8C/1.8GHz/11MB/85W/DDR4-2400 | 1x16GB RDIMM DDR4-2666 | 1x930-8i 2GB flash | 4x3.5" | 4x3.5" SATA/ SAS HS | Open | 2xGbE RJ- 45 LOM | None | x8 / x16, LP | None | None | TPM 1.2 | XClarity Standard | 1x750W Platinum | 3-year | 07/17 |
| 7X08A03PCN | 1xXeon Silver 4110 8C/2.1GHz/11MB/85W/DDR4-2400 | 1x16GB RDIMM DDR4-2666 | 1x930-8i 2GB flash | 8x2.5" | 8x2.5" SATA/ SAS HS | Open | 2xGbE RJ- 45 LOM | None | x8 / x16, LP | None | None | TPM 1.2 | XClarity Standard | 1x750W Platinum | 3-year | 07/17 |

ThinkSystem SR530 Models for India - Non TopSeller

Product Specifications Reference (PSREF)

| Model | Processor | Memory | RAID/HBA Adapter | Chassis | Disk Bays | Disks | Networking (LOM/ML2/PCIe) | M.2 Boot Drive | Riser Card 1 for Slot 1-3 | Riser Card 2 for Slot 5-6 | Front VGA | Security | System Management | Power Supply | Base Warranty | Ann Date (mm/yy) |
|------------|---|---------------------------|-----------------------|---------|------------------------|-------|---------------------------|----------------|---------------------------|---------------------------|--------------|----------|----------------------|--------------------|---------------|------------------|
| 7X08A004SG | 1xXeon Gold 5118 12C/2.3GHz/ 16.5MB/105W/DDR4-2400 | 1x8GB RDIMM DDR4-2666 | 1x530-8i | 4x3.5" | 4x3.5" SATA/ SAS HS | Open | 2xGbE RJ- 45 LOM | None | x8 / x8 ML2, LP | None | Front VGA | TPM 1.2 | XClarity Standard | 1x550W Platinum | 3-year | 07/17 |
| 7X08A007SG | 1xXeon Gold 5118 12C/2.3GHz/ 16.5MB/105W/DDR4-2400 | 1x8GB RDIMM DDR4-2666 | Onboard SATA | 4x3.5" | 4x3.5" SATA SS | Open | 2xGbE RJ- 45 LOM | None | None | None | Front VGA | TPM 1.2 | XClarity Standard | 1x550W Platinum | 3-year | 07/17 |
| 7X08A008SG | 1xXeon Gold 5118 12C/2.3GHz/ 16.5MB/105W/DDR4-2400 | 1x16GB RDIMM DDR4-2666 | 1x530-8i | 8x2.5" | 8x2.5" SATA/ SAS HS | Open | 2xGbE RJ- 45 LOM | None | x8 / x8 ML2, LP | None | None | TPM 1.2 | XClarity Standard | 1x550W Platinum | 3-year | 07/17 |
| 7X08A00ASG | 1xXeon Gold 5118 12C/2.3GHz/ 16.5MB/105W/DDR4-2400 | 1x8GB RDIMM DDR4-2666 | 1x530-8i | 8x2.5" | 8x2.5" SATA/ SAS HS | Open | 2xGbE RJ- 45 LOM | None | x8 / x8 ML2, LP | None | None | TPM 1.2 | XClarity Standard | 1x550W Platinum | 3-year | 07/17 |
| 7X08A00BSG | 1xXeon Gold 5120 14C/2.2GHz/ 19.25MB/105W/DDR4-2400 | 1x8GB RDIMM DDR4-2666 | 1x530-8i | 8x2.5" | 8x2.5" SATA/ SAS HS | Open | 2xGbE RJ- 45 LOM | None | x8 / x8 ML2, LP | None | None | TPM 1.2 | XClarity Standard | 1x550W Platinum | 3-year | 07/17 |
| 7X08A00CSG | 1xXeon Gold 5118 12C/2.3GHz/ 16.5MB/105W/DDR4-2400 | 1x16GB RDIMM DDR4-2666 | 1x930-8i 2GB flash | 8x2.5" | 8x2.5" SATA/ SAS HS | Open | 2xGbE RJ- 45 LOM | None | x8 / x8 ML2, LP | None | None | TPM 1.2 | XClarity Standard | 1x550W Platinum | 3-year | 07/17 |
| 7X08A00FSG | 1xXeon Gold 5120 14C/2.2GHz/ 19.25MB/105W/DDR4-2400 | 1x8GB RDIMM DDR4-2666 | 1x530-8i | 4x3.5" | 4x3.5" SATA/ SAS HS | Open | 2xGbE RJ- 45 LOM | None | x8 / x8 ML2, LP | None | Front VGA | TPM 1.2 | XClarity Standard | 1x550W Platinum | 3-year | 07/17 |
| 7X08A00GSG | 1xXeon Gold 5120 14C/2.2GHz/ 19.25MB/105W/DDR4-2400 | 1x8GB RDIMM DDR4-2666 | 1x930-8i 2GB flash | 8x2.5" | 8x2.5" SATA/ SAS HS | Open | 2xGbE RJ- 45 LOM | None | x8 / x8 ML2, LP | None | None | TPM 1.2 | XClarity Standard | 1x550W Platinum | 3-year | 07/17 |
| 7X08A011SG | 1xXeon Gold 6126 12C/2.6GHz/ 19.25MB/125W/DDR4-2666 | 1x16GB RDIMM DDR4-2666 | 1x930-8i 2GB flash | 8x2.5" | 8x2.5" SATA/ SAS HS | Open | 2xGbE RJ- 45 LOM | None | x8 / x8 ML2, LP | None | None | TPM 1.2 | XClarity Standard | 1x750W Platinum | 3-year | 07/17 |
| 7X08A013SG | 1xXeon Gold 6126 12C/2.6GHz/ 19.25MB/125W/DDR4-2666 | 1x16GB RDIMM DDR4-2666 | 1x530-8i | 8x2.5" | 8x2.5" SATA/ SAS HS | Open | 2xGbE RJ- 45 LOM | None | x8 / x8 ML2, LP | None | None | TPM 1.2 | XClarity Standard | 1x750W Platinum | 3-year | 07/17 |
| 7X08A015SG | 1xXeon Gold 6130 16C/2.1GHz/ 22MB/125W/DDR4-2666 | 1x16GB RDIMM DDR4-2666 | 1x930-8i 2GB flash | 8x2.5" | 8x2.5" SATA/ SAS HS | Open | 2xGbE RJ- 45 LOM | None | x8 / x8 ML2, LP | None | None | TPM 1.2 | XClarity Standard | 1x750W Platinum | 3-year | 07/17 |
| 7X08A01BSG | 1xXeon Gold 6138 20C/2.0GHz/ 27.5MB/125W/DDR4-2666 | 1x16GB RDIMM DDR4-2666 | 1x930-8i 2GB flash | 8x2.5" | 8x2.5" SATA/ SAS HS | Open | 2xGbE RJ- 45 LOM | None | x8 / x8 ML2, LP | None | None | TPM 1.2 | XClarity Standard | 1x750W Platinum | 3-year | 07/17 |

ThinkSystem SR530 Models for Japan - TopSeller

Product Specifications Reference (PSREF)

| Model | Processor | Memory | RAID/HBA Adapter | Chassis | Disk Bays | Disks | Networking (LOM/ML2/PCIe) | M.2 Boot Drive | Riser Card 1 for Slot 1-3 | Riser Card 2 for Slot 5-6 | Front VGA | Security | System Management | Power Supply | Base Warranty | Ann Date (mm/yy) |
|------------|--|--------------------------|-----------------------|---------|------------------------|-------|---------------------------|----------------|---------------------------|---------------------------|-----------|----------|----------------------|--------------------|---------------|------------------|
| 7X08A04UJP | 1xXeon Silver 4110 8C/2.1GHz/ 11MB/85W/DDR4-2400 | 1x8GB RDIMM DDR4-2666 | 1x930-8i 2GB flash | 8x2.5" | 8x2.5" SATA/ SAS HS | Open | None | None | x8 / x16, LP | None | None | TPM 1.2 | XClarity Advanced | 1x550W Platinum | 3-year | 07/17 |
| 7X08A04VJP | 1xXeon Bronze 3104 6C/1.7GHz/ 8.25MB/85W/DDR4-2133 | 1x8GB RDIMM DDR4-2666 | 1x930-8i 2GB flash | 8x2.5" | 8x2.5" SATA/ SAS HS | Open | None | None | x8 / x16, LP | None | None | TPM 1.2 | XClarity Advanced | 1x550W Platinum | 3-year | 07/17 |
| 7X08A04YJP | 1xXeon Silver 4112 4C/2.6GHz/ 8.25MB/85W/DDR4-2400 | 1x8GB RDIMM DDR4-2666 | 1x930-8i 2GB flash | 8x2.5" | 8x2.5" SATA/ SAS HS | Open | None | None | x8 / x16, LP | None | None | TPM 1.2 | XClarity Advanced | 1x550W Platinum | 3-year | 07/17 |
| 7X08A04ZJP | 1xXeon Bronze 3104 6C/1.7GHz/ 8.25MB/85W/DDR4-2133 | 1x8GB RDIMM DDR4-2666 | 1x530-8i | 4x3.5" | 4x3.5" SATA/ SAS HS | Open | None | None | x8 / x16, LP | None | None | TPM 1.2 | XClarity Advanced | 1x550W Platinum | 3-year | 07/17 |
| 7X08A050JP | 1xXeon Bronze 3106 8C/1.7GHz/ 11MB/85W/DDR4-2133 | 1x8GB RDIMM DDR4-2666 | 1x930-8i 2GB flash | 8x2.5" | 8x2.5" SATA/ SAS HS | Open | None | None | x8 / x16, LP | None | None | TPM 1.2 | XClarity Advanced | 1x550W Platinum | 3-year | 07/17 |

ThinkSystem SR530 Models for Japan - Non TopSeller

Product Specifications Reference (PSREF)

| Model | Processor | Memory | RAID/HBA Adapter | Chassis | Disk Bays | Disks | Networking (LOM/ML2/PCIe) | M.2 Boot Drive | Riser Card 1 for Slot 1-3 | Riser Card 2 for Slot 5-6 | Front VGA | Security | System Management | Power Supply | Base Warranty | Ann Date (mm/yy) |
|------------|--|--------------------------|-----------------------|---------|------------------------|-------|---------------------------|----------------|---------------------------|---------------------------|-----------|----------|----------------------|--------------------|---------------|------------------|
| 7X08A04WJP | 1xXeon Gold 6138 20C/2.0GHz/ 27.5MB/125W/DDR4-2666 | 1x8GB RDIMM DDR4-2666 | 1x930-8i 2GB flash | 8x2.5" | 8x2.5" SATA/ SAS HS | Open | None | None | x8 / x16, LP | None | None | TPM 1.2 | XClarity Advanced | 1x550W Platinum | 3-year | 07/17 |
| 7X08A04XJP | 1xXeon Gold 5122 4C/3.6GHz/ 16.5MB/105W/DDR4-2400 | 1x8GB RDIMM DDR4-2666 | 1x930-8i 2GB flash | 8x2.5" | 8x2.5" SATA/ SAS HS | Open | None | None | x8 / x16, LP | None | None | TPM 1.2 | XClarity Advanced | 1x550W Platinum | 3-year | 07/17 |

ThinkSystem SR530 Models for Latin America - TopSeller

Product Specifications Reference (PSREF)

| Model | Processor | Memory | RAID/HBA Adapter | Chassis | Disk Bays | Disks | Networking (LOM/ML2/PCIe) | M.2 Boot Drive | Riser Card 1 for Slot 1-3 | Riser Card 2 for Slot 5-6 | Front VGA | Security | System Management | Power Supply | Base Warranty | Ann Date (mm/yy) |
|------------|--|---------------------------|------------------|---------|------------------------|--|---------------------------|----------------|---------------------------|---------------------------|--------------|----------|----------------------|--------------------|---------------|------------------|
| 7X08A051LA | 1xXeon Bronze 3104 6C/1.7GHz/ 8.25MB/85W/DDR4-2133 | 1x8GB RDIMM DDR4-2666 | 1x530-8i | 4x3.5" | 4x3.5" SATA/ SAS HS | Open | None | None | x8 / x16, LP | None | Front VGA | TPM 1.2 | XClarity Standard | 1x550W Platinum | 3-year | 07/17 |
| 7X08A053LA | 1xXeon Silver 4108 8C/1.8GHz/ 11MB/85W/DDR4-2400 | 1x16GB RDIMM DDR4-2666 | 1x530-8i | 4x3.5" | 4x3.5" SATA/ SAS HS | 2x600GB HDD 15K 3.5" SAS12G- bps | None | None | x8 / x16, LP | None | Front VGA | TPM 1.2 | XClarity Advanced | 2x750W Platinum | 3-year | 07/17 |
| 7X08A054LA | 1xXeon Bronze 3104 6C/1.7GHz/ 8.25MB/85W/DDR4-2133 | 1x8GB RDIMM DDR4-2666 | 1x530-8i | 8x2.5" | 8x2.5" SATA/ SAS HS | Open | None | None | x8 / x16, LP | None | None | TPM 1.2 | XClarity Standard | 1x550W Platinum | 3-year | 07/17 |
| 7X08A059LA | 1xXeon Silver 4108 8C/1.8GHz/ 11MB/85W/DDR4-2400 | 1x16GB RDIMM DDR4-2666 | 1x530-8i | 4x3.5" | 4x3.5" SATA/ SAS HS | 2x2TB HDD 7.2K 3.5" SAS12Gbps | None | None | x8 / x16, LP | None | Front VGA | TPM 1.2 | XClarity Advanced | 2x750W Platinum | 3-year | 07/17 |
| 7X08A05ALA | 1xXeon Silver 4108 8C/1.8GHz/ 11MB/85W/DDR4-2400 | 1x16GB RDIMM DDR4-2666 | 1x530-8i | 4x3.5" | 4x3.5" SATA/ SAS HS | 2x2TB HDD 7.2K 3.5" SAS12Gbps | None | None | x8 / x16, LP | None | Front VGA | TPM 1.2 | XClarity Advanced | 2x750W Platinum | 3-year | 07/17 |
| 7X08A05CLA | 1xXeon Silver 4110 8C/2.1GHz/ 11MB/85W/DDR4-2400 | 1x8GB RDIMM DDR4-2666 | 1x530-8i | 8x2.5" | 8x2.5" SATA/ SAS HS | Open | None | None | x8 / x16, LP | None | None | TPM 1.2 | XClarity Standard | 1x550W Platinum | 3-year | 07/17 |
| 7X08A05FLA | 1xXeon Bronze 3106 8C/1.7GHz/ 11MB/85W/DDR4-2133 | 1x8GB RDIMM DDR4-2666 | 1x530-8i | 8x2.5" | 8x2.5" SATA/ SAS HS | Open | None | None | x8 / x16, LP | None | None | TPM 1.2 | XClarity Standard | 1x550W Platinum | 3-year | 07/17 |
| 7X08A05GLA | 1xXeon Silver 4108 8C/1.8GHz/ 11MB/85W/DDR4-2400 | 1x8GB RDIMM DDR4-2666 | 1x530-8i | 4x3.5" | 4x3.5" SATA/ SAS HS | Open | None | None | x8 / x16, LP | None | Front VGA | TPM 1.2 | XClarity Standard | 1x550W Platinum | 3-year | 07/17 |
| 7X08A05HLA | 1xXeon Silver 4108 8C/1.8GHz/ 11MB/85W/DDR4-2400 | 1x8GB RDIMM DDR4-2666 | 1x530-8i | 8x2.5" | 8x2.5" SATA/ SAS HS | Open | None | None | x8 / x16, LP | None | None | TPM 1.2 | XClarity Standard | 1x550W Platinum | 3-year | 07/17 |
| 7X08A05JLA | 1xXeon Silver 4114 10C/2.2GHz/ 13.75MB/85W/DDR4-2400 | 1x8GB RDIMM DDR4-2666 | 1x530-8i | 4x3.5" | 4x3.5" SATA/ SAS HS | Open | None | None | x8 / x16, LP | None | Front VGA | TPM 1.2 | XClarity Standard | 1x550W Platinum | 3-year | 07/17 |
| 7X08A05LLA | 1xXeon Silver 4114 10C/2.2GHz/ 13.75MB/85W/DDR4-2400 | 2x16GB RDIMM DDR4-2666 | 1x530-8i | 4x3.5" | 4x3.5" SATA/ SAS HS | 3x600GB HDD 15K 3.5" SAS12G- bps | None | None | x8 / x16, LP | None | Front VGA | TPM 1.2 | XClarity Advanced | 2x750W Platinum | 3-year | 07/17 |
| 7X08A05QLA | 1xXeon Silver 4110 8C/2.1GHz/ 11MB/85W/DDR4-2400 | 2x16GB RDIMM DDR4-2666 | 1x530-8i | 4x3.5" | 4x3.5" SATA/ SAS HS | 2x2TB HDD 7.2K 3.5" SAS12Gbps | None | None | x8 / x16, LP | None | Front VGA | TPM 1.2 | XClarity Advanced | 2x750W Platinum | 3-year | 07/17 |
| 7X08A05ULA | 1xXeon Silver 4114 10C/2.2GHz/ 13.75MB/85W/DDR4-2400 | 1x8GB RDIMM DDR4-2666 | 1x530-8i | 8x2.5" | 8x2.5" SATA/ SAS HS | Open | None | None | x8 / x16, LP | None | None | TPM 1.2 | XClarity Standard | 1x550W Platinum | 3-year | 07/17 |
| 7X08A05VLA | 1xXeon Silver 4110 8C/2.1GHz/ 11MB/85W/DDR4-2400 | 1x8GB RDIMM DDR4-2666 | 1x530-8i | 4x3.5" | 4x3.5" SATA/ SAS HS | Open | None | None | x8 / x16, LP | None | Front VGA | TPM 1.2 | XClarity Standard | 1x550W Platinum | 3-year | 07/17 |
| 7X08A05YLA | 1xXeon Bronze 3106 8C/1.7GHz/ 11MB/85W/DDR4-2133 | 1x8GB RDIMM DDR4-2666 | 1x530-8i | 4x3.5" | 4x3.5" SATA/ SAS HS | Open | None | None | x8 / x16, LP | None | Front VGA | TPM 1.2 | XClarity Standard | 1x550W Platinum | 3-year | 07/17 |

ThinkSystem SR530 Models for Latin America - Non TopSeller

Product Specifications Reference (PSREF)

| Model | Processor | Memory | RAID/HBA Adapter | Chassis | Disk Bays | Disks | Networking (LOM/ML2/PCIe) | M.2 Boot Drive | Riser Card 1 for Slot 1-3 | Riser Card 2 for Slot 5-6 | Front VGA | Security | System Management | Power Supply | Base Warranty | Ann Date (mm/yy) |
|------------|---|--------------------------|------------------|---------|------------------------|-------|---------------------------|----------------|---------------------------|---------------------------|--------------|----------|-------------------|--------------------|---------------|------------------|
| 7X08A00HLA | 1xXeon Gold 6130 16C/2.1GHz/ 22MB/125W/DDR4-2666 | 1x8GB RDIMM DDR4-2666 | 1x530-8i | 8x2.5" | 8x2.5" SATA/ SAS HS | Open | None | None | x8 / x16, LP | None | None | TPM 1.2 | XClarity Standard | 1x750W Platinum | 3-year | 07/17 |
| 7X08A00KLA | 1xXeon Gold 5120 14C/2.2GHz/ 19.25MB/105W/DDR4-2400 | 1x8GB RDIMM DDR4-2666 | 1x530-8i | 8x2.5" | 8x2.5" SATA/ SAS HS | Open | None | None | x8 / x16, LP | None | None | TPM 1.2 | XClarity Standard | 1x750W Platinum | 3-year | 07/17 |
| 7X08A00MLA | 1xXeon Gold 5118 12C/2.3GHz/ 16.5MB/105W/DDR4-2400 | 1x8GB RDIMM DDR4-2666 | 1x530-8i | 8x2.5" | 8x2.5" SATA/ SAS HS | Open | None | None | x8 / x16, LP | None | None | TPM 1.2 | XClarity Standard | 1x750W Platinum | 3-year | 07/17 |
| 7X08A017LA | 1xXeon Gold 5118 12C/2.3GHz/ 16.5MB/105W/DDR4-2400 | 1x8GB RDIMM DDR4-2666 | 1x530-8i | 4x3.5" | 4x3.5" SATA/ SAS HS | Open | None | None | x8 / x16, LP | None | Front VGA | TPM 1.2 | XClarity Standard | 1x750W Platinum | 3-year | 07/17 |
| 7X08A019LA | 1xXeon Gold 5120 14C/2.2GHz/ 19.25MB/105W/DDR4-2400 | 1x8GB RDIMM DDR4-2666 | 1x530-8i | 4x3.5" | 4x3.5" SATA/ SAS HS | Open | None | None | x8 / x16, LP | None | Front VGA | TPM 1.2 | XClarity Standard | 1x750W Platinum | 3-year | 07/17 |
| 7X08A01CLA | 1xXeon Gold 6130 16C/2.1GHz/ 22MB/125W/DDR4-2666 | 1x8GB RDIMM DDR4-2666 | 1x530-8i | 4x3.5" | 4x3.5" SATA/ SAS HS | Open | None | None | x8 / x16, LP | None | Front VGA | TPM 1.2 | XClarity Standard | 1x750W Platinum | 3-year | 07/17 |
| 7X08A05DLA | 1xXeon Gold 5115 10C/2.4GHz/ 13.75MB/85W/DDR4-2400 | 1x8GB RDIMM DDR4-2666 | 1x530-8i | 4x3.5" | 4x3.5" SATA/ SAS HS | Open | None | None | x8 / x16, LP | None | Front VGA | TPM 1.2 | XClarity Standard | 1x550W Platinum | 3-year | 07/17 |
| 7X08A05NLA | 1xXeon Gold 5115 10C/2.4GHz/ 13.75MB/85W/DDR4-2400 | 1x8GB RDIMM DDR4-2666 | 1x530-8i | 8x2.5" | 8x2.5" SATA/ SAS HS | Open | None | None | x8 / x16, LP | None | None | TPM 1.2 | XClarity Standard | 1x550W Platinum | 3-year | 07/17 |

ThinkSystem SR530 Models for Brazil - Non TopSeller - 1 of 2

Product Specifications Reference (PSREF)

| Model | Processor | Memory | RAID/HBA Adapter | Chassis | Disk Bays | Disks | Networking (LOM/ML2/PCIe) | M.2 Boot Drive | Riser Card 1 for Slot 1-3 | Riser Card 2 for Slot 5-6 | Front VGA | Security | System Management | Power Supply | Base Warranty | Ann Date (mm/yy) |
|------------|---|--------------------------------|------------------|---------|------------------------|--|---------------------------|----------------|---------------------------|---------------------------|-----------|----------|----------------------|--------------------|---------------|------------------|
| 7X08A03WBR | 1xXeon Gold 5120 14C/2.2GHz/19.25MB/105W/ DDR4-2400 | 1x32GB RDIMM DDR4-2666 | 1x530-8i | 8x2.5" | 8x2.5" SATA/ SAS HS | Open | None | None | x8 / x16, LP | None | None | TPM 1.2 | XClarity Standard | 1x750W Platinum | 3-year | 07/17 |
| 7X08A03XBR | 1xXeon Gold 6130 16C/2.1GHz/22MB/125W/DDR4- 2666 | 1x16GB RDIMM DDR4-2666 | 1x530-8i | 8x2.5" | 8x2.5" SATA/ SAS HS | Open | None | None | x8 / x16, LP | None | None | TPM 1.2 | XClarity Standard | 1x750W Platinum | 3-year | 07/17 |
| 7X08A03YBR | 1xXeon Gold 5120 14C/2.2GHz/19.25MB/105W/ DDR4-2400 | 1x32GB RDIMM DDR4-2666 | 1x530-8i | 8x2.5" | 8x2.5" SATA/ SAS HS | 1x600GB HDD 10K 2.5" SAS- 12Gbps | None | None | x8 / x16, LP | None | None | TPM 1.2 | XClarity Standard | 1x750W Platinum | 3-year | 07/17 |
| 7X08A040BR | 1xXeon Gold 5118 12C/2.3GHz/16.5MB/105W/DDR4- 2400 | 1x64GB LRDIMM DDR4- 2666 | 1x530-8i | 8x2.5" | 8x2.5" SATA/ SAS HS | Open | None | None | x8 / x16, LP | None | None | TPM 1.2 | XClarity Standard | 1x750W Platinum | 3-year | 07/17 |
| 7X08A042BR | 1xXeon Gold 5118 12C/2.3GHz/16.5MB/105W/DDR4- 2400 | 1x16GB RDIMM DDR4-2666 | 1x530-8i | 8x2.5" | 8x2.5" SATA/ SAS HS | 1x600GB HDD 10K 2.5" SAS- 12Gbps | None | None | x8 / x16, LP | None | None | TPM 1.2 | XClarity Standard | 1x750W Platinum | 3-year | 07/17 |
| 7X08A043BR | 1xXeon Gold 5118 12C/2.3GHz/16.5MB/105W/DDR4- 2400 | 1x8GB RDIMM DDR4-2666 | 1x530-8i | 8x2.5" | 8x2.5" SATA/ SAS HS | Open | None | None | x8 / x16, LP | None | None | TPM 1.2 | XClarity Standard | 1x750W Platinum | 3-year | 07/17 |
| 7X08A044BR | 1xXeon Gold 5118 12C/2.3GHz/16.5MB/105W/DDR4- 2400 | 1x32GB RDIMM DDR4-2666 | 1x530-8i | 8x2.5" | 8x2.5" SATA/ SAS HS | 1x600GB HDD 10K 2.5" SAS- 12Gbps | None | None | x8 / x16, LP | None | None | TPM 1.2 | XClarity Standard | 1x750W Platinum | 3-year | 07/17 |
| 7X08A046BR | 1xXeon Gold 6130 16C/2.1GHz/22MB/125W/DDR4- 2666 | 1x8GB RDIMM DDR4-2666 | 1x530-8i | 8x2.5" | 8x2.5" SATA/ SAS HS | Open | None | None | x8 / x16, LP | None | None | TPM 1.2 | XClarity Standard | 1x750W Platinum | 3-year | 07/17 |
| 7X08A047BR | 1xXeon Gold 5120 14C/2.2GHz/19.25MB/105W/ DDR4-2400 | 1x64GB LRDIMM DDR4- 2666 | 1x530-8i | 8x2.5" | 8x2.5" SATA/ SAS HS | 1x600GB HDD 10K 2.5" SAS- 12Gbps | None | None | x8 / x16, LP | None | None | TPM 1.2 | XClarity Standard | 1x750W Platinum | 3-year | 07/17 |
| 7X08A048BR | 1xXeon Gold 5120 14C/2.2GHz/19.25MB/105W/ DDR4-2400 | 1x16GB RDIMM DDR4-2666 | 1x530-8i | 8x2.5" | 8x2.5" SATA/ SAS HS | Open | None | None | x8 / x16, LP | None | None | TPM 1.2 | XClarity Standard | 1x750W Platinum | 3-year | 07/17 |
| 7X08A049BR | 1xXeon Gold 5120 14C/2.2GHz/19.25MB/105W/ DDR4-2400 | 1x8GB RDIMM DDR4-2666 | 1x530-8i | 8x2.5" | 8x2.5" SATA/ SAS HS | Open | None | None | x8 / x16, LP | None | None | TPM 1.2 | XClarity Standard | 1x750W Platinum | 3-year | 07/17 |
| 7X08A04ABR | 1xXeon Gold 5120 14C/2.2GHz/19.25MB/105W/ DDR4-2400 | 1x64GB LRDIMM DDR4- 2666 | 1x530-8i | 8x2.5" | 8x2.5" SATA/ SAS HS | Open | None | None | x8 / x16, LP | None | None | TPM 1.2 | XClarity Standard | 1x750W Platinum | 3-year | 07/17 |
| 7X08A04BBR | 1xXeon Gold 6130 16C/2.1GHz/22MB/125W/DDR4- 2666 | 1x32GB RDIMM DDR4-2666 | 1x530-8i | 8x2.5" | 8x2.5" SATA/ SAS HS | Open | None | None | x8 / x16, LP | None | None | TPM 1.2 | XClarity Standard | 1x750W Platinum | 3-year | 07/17 |
| 7X08A04CBR | 1xXeon Gold 6130 16C/2.1GHz/22MB/125W/DDR4- 2666 | 1x32GB RDIMM DDR4-2666 | 1x530-8i | 8x2.5" | 8x2.5" SATA/ SAS HS | 1x600GB HDD 10K 2.5" SAS- 12Gbps | None | None | x8 / x16, LP | None | None | TPM 1.2 | XClarity Standard | 1x750W Platinum | 3-year | 07/17 |
| 7X08A04DBR | 1xXeon Gold 6130 16C/2.1GHz/22MB/125W/DDR4- 2666 | 1x8GB RDIMM DDR4-2666 | 1x530-8i | 8x2.5" | 8x2.5" SATA/ SAS HS | 1x600GB HDD 10K 2.5" SAS- 12Gbps | None | None | x8 / x16, LP | None | None | TPM 1.2 | XClarity Standard | 1x750W Platinum | 3-year | 07/17 |
| 7X08A04EBR | 1xXeon Gold 6130 16C/2.1GHz/22MB/125W/DDR4- 2666 | 1x64GB LRDIMM DDR4- 2666 | 1x530-8i | 8x2.5" | 8x2.5" SATA/ SAS HS | 1x600GB HDD 10K 2.5" SAS- 12Gbps | None | None | x8 / x16, LP | None | None | TPM 1.2 | XClarity Standard | 1x750W Platinum | 3-year | 07/17 |
| 7X08A04HBR | 1xXeon Gold 5118 12C/2.3GHz/16.5MB/105W/DDR4- 2400 | 1x64GB LRDIMM DDR4- 2666 | 1x530-8i | 8x2.5" | 8x2.5" SATA/ SAS HS | 1x600GB HDD 10K 2.5" SAS- 12Gbps | None | None | x8 / x16, LP | None | None | TPM 1.2 | XClarity Standard | 1x750W Platinum | 3-year | 07/17 |
| 7X08A04JBR | 1xXeon Gold 5118 12C/2.3GHz/16.5MB/105W/DDR4- 2400 | 1x16GB RDIMM DDR4-2666 | 1x530-8i | 8x2.5" | 8x2.5" SATA/ SAS HS | Open | None | None | x8 / x16, LP | None | None | TPM 1.2 | XClarity Standard | 1x750W Platinum | 3-year | 07/17 |
| 7X08A04KBR | 1xXeon Gold 6130 16C/2.1GHz/22MB/125W/DDR4- 2666 | 1x64GB LRDIMM DDR4- 2666 | 1x530-8i | 8x2.5" | 8x2.5" SATA/ SAS HS | Open | None | None | x8 / x16, LP | None | None | TPM 1.2 | XClarity Standard | 1x750W Platinum | 3-year | 07/17 |
| 7X08A04LBR | 1xXeon Gold 5118 12C/2.3GHz/16.5MB/105W/DDR4- 2400 | 1x8GB RDIMM DDR4-2666 | 1x530-8i | 8x2.5" | 8x2.5" SATA/ SAS HS | 1x600GB HDD 10K 2.5" SAS- 12Gbps | None | None | x8 / x16, LP | None | None | TPM 1.2 | XClarity Standard | 1x750W Platinum | 3-year | 07/17 |
| 7X08A04NBR | 1xXeon Gold 6130 16C/2.1GHz/22MB/125W/DDR4- 2666 | 1x16GB RDIMM DDR4-2666 | 1x530-8i | 8x2.5" | 8x2.5" SATA/ SAS HS | 1x600GB HDD 10K 2.5" SAS- 12Gbps | None | None | x8 / x16, LP | None | None | TPM 1.2 | XClarity Standard | 1x750W Platinum | 3-year | 07/17 |

ThinkSystem SR530 Models for Brazil - Non TopSeller - 2 of 2

Product Specifications Reference (PSREF)

| Model | Processor | Memory | RAID/HBA Adapter | Chassis | Disk Bays | Disks | Networking (LOM/ML2/PCIe) | M.2 Boot Drive | Riser Card 1 for Slot 1-3 | Riser Card 2 for Slot 5-6 | Front VGA | Security | System Management | Power Supply | Base Warranty | Ann Date (mm/yy) |
|------------|---|---------------------------|------------------|---------|------------------------|--|---------------------------|----------------|---------------------------|---------------------------|-----------|----------|----------------------|--------------------|---------------|------------------|
| 7X08A04PBR | 1xXeon Gold 5120 14C/2.2GHz/19.25MB/105W/ DDR4-2400 | 1x8GB RDIMM DDR4-2666 | 1x530-8i | 8x2.5" | 8x2.5" SATA/ SAS HS | 1x600GB HDD 10K 2.5" SAS- 12Gbps | None | None | x8 / x16, LP | None | None | TPM 1.2 | XClarity Standard | 1x750W Platinum | 3-year | 07/17 |
| 7X08A04QBR | 1xXeon Gold 5118 12C/2.3GHz/16.5MB/105W/DDR4- 2400 | 1x32GB RDIMM DDR4-2666 | 1x530-8i | 8x2.5" | 8x2.5" SATA/ SAS HS | Open | None | None | x8 / x16, LP | None | None | TPM 1.2 | XClarity Standard | 1x750W Platinum | 3-year | 07/17 |
| 7X08A04RBR | 1xXeon Gold 5120 14C/2.2GHz/19.25MB/105W/ DDR4-2400 | 1x16GB RDIMM DDR4-2666 | 1x530-8i | 8x2.5" | 8x2.5" SATA/ SAS HS | 1x600GB HDD 10K 2.5" SAS- 12Gbps | None | None | x8 / x16, LP | None | None | TPM 1.2 | XClarity Standard | 1x750W Platinum | 3-year | 07/17 |



ThinkSystem SR550 Platform Specifications

Product Specifications Reference (PSREF)

| Components | Specification | | | | | | | | | | | | | | | | | | | | | | | | | | | | | | | | | | | | | | | | | | | | | | | | | | | | | | | | | | | | | | | | | | | | | | | | | | | | | | | | | | | | | | | | | | | | | | | | | | | | | | |
|--|--|-----------|--------------|------------------|------------|-------------|------------------|----------|------------------|----------|---------|-------------|--------------|----------|------|----------|-----|------|------|----|---|--------|-----------|----------|-------------|-----|------|------|-----|---|--------|-----------|----------|-------------|-----|-----|------|----|---|-------------|--------|-----------|----------|------------------|-----|-----|--------------|-----|---|---------|-----------|----------|------------------|-----|-----|--------------|-----|---|--------|-----------|----------|---|-----|------|------|---|---|---------|-----------|----------|---|-----|------|------|---|---|--------|-----------|----------|---|-----|------|------|---|---|---------|-----------|----------|---|-----|------|------|---|---|--------|-----------|----------|------------------|-----|-----|--------------|-----|---|
| Form factor | 2U rack | | | | | | | | | | | | | | | | | | | | | | | | | | | | | | | | | | | | | | | | | | | | | | | | | | | | | | | | | | | | | | | | | | | | | | | | | | | | | | | | | | | | | | | | | | | | | | | | | | | | | | |
| Dimensions | Height: 86.5 mm (3.4 in). Width: 482 mm (19.0 in) with rack latches. Depth: 763.7 mm (30.1 in) | | | | | | | | | | | | | | | | | | | | | | | | | | | | | | | | | | | | | | | | | | | | | | | | | | | | | | | | | | | | | | | | | | | | | | | | | | | | | | | | | | | | | | | | | | | | | | | | | | | | | | |
| Weight | Maximum configuration: 57.32 lb (26 kg) | | | | | | | | | | | | | | | | | | | | | | | | | | | | | | | | | | | | | | | | | | | | | | | | | | | | | | | | | | | | | | | | | | | | | | | | | | | | | | | | | | | | | | | | | | | | | | | | | | | | | | |
| Processor | Up to two 125W Intel Xeon Scalable family processors, Bronze, Silver, Gold, or Platinum. Up to 20 cores at 2.0GHz, up to 3.6GHz with 4 cores. Two processors are connected with two UPI (Ultra Path Interconnect) links up to 10.4GT/s | | | | | | | | | | | | | | | | | | | | | | | | | | | | | | | | | | | | | | | | | | | | | | | | | | | | | | | | | | | | | | | | | | | | | | | | | | | | | | | | | | | | | | | | | | | | | | | | | | | | | | |
| Chipset | Intel C622 Platform Controller Hub | | | | | | | | | | | | | | | | | | | | | | | | | | | | | | | | | | | | | | | | | | | | | | | | | | | | | | | | | | | | | | | | | | | | | | | | | | | | | | | | | | | | | | | | | | | | | | | | | | | | | | |
| Memory | Up to 12 DIMM sockets. Each processor supports up to 6 DIMM sockets with 6 channels. DDR4-2666. RDIMMs and LRDIMMs are supported, but memory types cannot be intermixed | | | | | | | | | | | | | | | | | | | | | | | | | | | | | | | | | | | | | | | | | | | | | | | | | | | | | | | | | | | | | | | | | | | | | | | | | | | | | | | | | | | | | | | | | | | | | | | | | | | | | | |
| Memory capacity | With RDIMMs: Up to 384GB with 12 x 32 GB RDIMMs and two processors With LRDIMMs: Up to 768GB with 12 x 64 GB LRDIMMs and two processors | | | | | | | | | | | | | | | | | | | | | | | | | | | | | | | | | | | | | | | | | | | | | | | | | | | | | | | | | | | | | | | | | | | | | | | | | | | | | | | | | | | | | | | | | | | | | | | | | | | | | | |
| Memory protection | ECC, memory mirroring, and memory sparing | | | | | | | | | | | | | | | | | | | | | | | | | | | | | | | | | | | | | | | | | | | | | | | | | | | | | | | | | | | | | | | | | | | | | | | | | | | | | | | | | | | | | | | | | | | | | | | | | | | | | | |
| Storage controllers | Supports the following RAID/HBA adapters: | | | | | | | | | | | | | | | | | | | | | | | | | | | | | | | | | | | | | | | | | | | | | | | | | | | | | | | | | | | | | | | | | | | | | | | | | | | | | | | | | | | | | | | | | | | | | | | | | | | | | | |
| | | | | | | | | | | | | | | | | | | | | | | | | | | | | | | | | | | | | | | | | | | | | | | | | | | | | | | | | | | | | | | | | | | | | | | | | | | | | | | | | | | | | | | | | | | | | | | | | | | | | | | | |
| | | | | | | | | | | | | | | | | | | | | | | | | | | | | | | | | | | | | | | | | | | | | | | | | | | | | | | | | | | | | | | | | | | | | | | | | | | | | | | | | | | | | | | | | | | | | | | | | | | | | | | | |
| | | | | | | | | | | | | | | | | | | | | | | | | | | | | | | | | | | | | | | | | | | | | | | | | | | | | | | | | | | | | | | | | | | | | | | | | | | | | | | | | | | | | | | | | | | | | | | | | | | | | | | | |
| | | | | | | | | | | | | | | | | | | | | | | | | | | | | | | | | | | | | | | | | | | | | | | | | | | | | | | | | | | | | | | | | | | | | | | | | | | | | | | | | | | | | | | | | | | | | | | | | | | | | | | | |
| | | | | | | | | | | | | | | | | | | | | | | | | | | | | | | | | | | | | | | | | | | | | | | | | | | | | | | | | | | | | | | | | | | | | | | | | | | | | | | | | | | | | | | | | | | | | | | | | | | | | | | | |
| | | | | | | | | | | | | | | | | | | | | | | | | | | | | | | | | | | | | | | | | | | | | | | | | | | | | | | | | | | | | | | | | | | | | | | | | | | | | | | | | | | | | | | | | | | | | | | | | | | | | | | | |
| | | | | | | | | | | | | | | | | | | | | | | | | | | | | | | | | | | | | | | | | | | | | | | | | | | | | | | | | | | | | | | | | | | | | | | | | | | | | | | | | | | | | | | | | | | | | | | | | | | | | | | | |
| | | | | | | | | | | | | | | | | | | | | | | | | | | | | | | | | | | | | | | | | | | | | | | | | | | | | | | | | | | | | | | | | | | | | | | | | | | | | | | | | | | | | | | | | | | | | | | | | | | | | | | | |
| | | | | | | | | | | | | | | | | | | | | | | | | | | | | | | | | | | | | | | | | | | | | | | | | | | | | | | | | | | | | | | | | | | | | | | | | | | | | | | | | | | | | | | | | | | | | | | | | | | | | | | | |
| <table border="1"> <thead> <tr> <th></th> <th>RAID adapter</th> <th>Interface</th> <th>Drive type</th> <th>RAID levels</th> <th>JBOD</th> <th>Cache</th> <th>Cache protection</th> <th>FastPath</th> <th>Max qty</th> </tr> </thead> <tbody> <tr> <td rowspan="3">For SS bays</td> <td>Onboard SATA</td> <td>6Gb SATA</td> <td>SATA</td> <td>0/1/10/5</td> <td>Yes</td> <td>None</td> <td>None</td> <td>No</td> <td>-</td> </tr> <tr> <td>530-8i</td> <td>12Gbs SAS</td> <td>SATA/SAS</td> <td>0/1/10/5/50</td> <td>Yes</td> <td>None</td> <td>None</td> <td>Yes</td> <td>2</td> </tr> <tr> <td>730-8i</td> <td>12Gbs SAS</td> <td>SATA/SAS</td> <td>0/1/10/5/50</td> <td>Yes</td> <td>1GB</td> <td>None</td> <td>No</td> <td>2</td> </tr> <tr> <td rowspan="7">For HS bays</td> <td>930-8i</td> <td>12Gbs SAS</td> <td>SATA/SAS</td> <td>0/1/10/5/50/6/60</td> <td>Yes</td> <td>2GB</td> <td>Flash backup</td> <td>Yes</td> <td>2</td> </tr> <tr> <td>930-16i</td> <td>12Gbs SAS</td> <td>SATA/SAS</td> <td>0/1/10/5/50/6/60</td> <td>Yes</td> <td>4GB</td> <td>Flash backup</td> <td>Yes</td> <td>1</td> </tr> <tr> <td>430-8i</td> <td>12Gbs SAS</td> <td>SATA/SAS</td> <td>-</td> <td>Yes</td> <td>None</td> <td>None</td> <td>-</td> <td>2</td> </tr> <tr> <td>430-16i</td> <td>12Gbs SAS</td> <td>SATA/SAS</td> <td>-</td> <td>Yes</td> <td>None</td> <td>None</td> <td>-</td> <td>1</td> </tr> <tr> <td>430-8e</td> <td>12Gbs SAS</td> <td>SATA/SAS</td> <td>-</td> <td>Yes</td> <td>None</td> <td>None</td> <td>-</td> <td>6</td> </tr> <tr> <td>430-16e</td> <td>12Gbs SAS</td> <td>SATA/SAS</td> <td>-</td> <td>Yes</td> <td>None</td> <td>None</td> <td>-</td> <td>6</td> </tr> <tr> <td>930-8e</td> <td>12Gbs SAS</td> <td>SATA/SAS</td> <td>0/1/10/5/50/6/60</td> <td>Yes</td> <td>4GB</td> <td>Flash backup</td> <td>Yes</td> <td>6</td> </tr> </tbody> </table> | | | RAID adapter | Interface | Drive type | RAID levels | JBOD | Cache | Cache protection | FastPath | Max qty | For SS bays | Onboard SATA | 6Gb SATA | SATA | 0/1/10/5 | Yes | None | None | No | - | 530-8i | 12Gbs SAS | SATA/SAS | 0/1/10/5/50 | Yes | None | None | Yes | 2 | 730-8i | 12Gbs SAS | SATA/SAS | 0/1/10/5/50 | Yes | 1GB | None | No | 2 | For HS bays | 930-8i | 12Gbs SAS | SATA/SAS | 0/1/10/5/50/6/60 | Yes | 2GB | Flash backup | Yes | 2 | 930-16i | 12Gbs SAS | SATA/SAS | 0/1/10/5/50/6/60 | Yes | 4GB | Flash backup | Yes | 1 | 430-8i | 12Gbs SAS | SATA/SAS | - | Yes | None | None | - | 2 | 430-16i | 12Gbs SAS | SATA/SAS | - | Yes | None | None | - | 1 | 430-8e | 12Gbs SAS | SATA/SAS | - | Yes | None | None | - | 6 | 430-16e | 12Gbs SAS | SATA/SAS | - | Yes | None | None | - | 6 | 930-8e | 12Gbs SAS | SATA/SAS | 0/1/10/5/50/6/60 | Yes | 4GB | Flash backup | Yes | 6 |
| | RAID adapter | Interface | Drive type | RAID levels | JBOD | Cache | Cache protection | FastPath | Max qty | | | | | | | | | | | | | | | | | | | | | | | | | | | | | | | | | | | | | | | | | | | | | | | | | | | | | | | | | | | | | | | | | | | | | | | | | | | | | | | | | | | | | | | | | | | | | | |
| For SS bays | Onboard SATA | 6Gb SATA | SATA | 0/1/10/5 | Yes | None | None | No | - | | | | | | | | | | | | | | | | | | | | | | | | | | | | | | | | | | | | | | | | | | | | | | | | | | | | | | | | | | | | | | | | | | | | | | | | | | | | | | | | | | | | | | | | | | | | | | |
| | 530-8i | 12Gbs SAS | SATA/SAS | 0/1/10/5/50 | Yes | None | None | Yes | 2 | | | | | | | | | | | | | | | | | | | | | | | | | | | | | | | | | | | | | | | | | | | | | | | | | | | | | | | | | | | | | | | | | | | | | | | | | | | | | | | | | | | | | | | | | | | | | | |
| | 730-8i | 12Gbs SAS | SATA/SAS | 0/1/10/5/50 | Yes | 1GB | None | No | 2 | | | | | | | | | | | | | | | | | | | | | | | | | | | | | | | | | | | | | | | | | | | | | | | | | | | | | | | | | | | | | | | | | | | | | | | | | | | | | | | | | | | | | | | | | | | | | | |
| For HS bays | 930-8i | 12Gbs SAS | SATA/SAS | 0/1/10/5/50/6/60 | Yes | 2GB | Flash backup | Yes | 2 | | | | | | | | | | | | | | | | | | | | | | | | | | | | | | | | | | | | | | | | | | | | | | | | | | | | | | | | | | | | | | | | | | | | | | | | | | | | | | | | | | | | | | | | | | | | | | |
| | 930-16i | 12Gbs SAS | SATA/SAS | 0/1/10/5/50/6/60 | Yes | 4GB | Flash backup | Yes | 1 | | | | | | | | | | | | | | | | | | | | | | | | | | | | | | | | | | | | | | | | | | | | | | | | | | | | | | | | | | | | | | | | | | | | | | | | | | | | | | | | | | | | | | | | | | | | | | |
| | 430-8i | 12Gbs SAS | SATA/SAS | - | Yes | None | None | - | 2 | | | | | | | | | | | | | | | | | | | | | | | | | | | | | | | | | | | | | | | | | | | | | | | | | | | | | | | | | | | | | | | | | | | | | | | | | | | | | | | | | | | | | | | | | | | | | | |
| | 430-16i | 12Gbs SAS | SATA/SAS | - | Yes | None | None | - | 1 | | | | | | | | | | | | | | | | | | | | | | | | | | | | | | | | | | | | | | | | | | | | | | | | | | | | | | | | | | | | | | | | | | | | | | | | | | | | | | | | | | | | | | | | | | | | | | |
| | 430-8e | 12Gbs SAS | SATA/SAS | - | Yes | None | None | - | 6 | | | | | | | | | | | | | | | | | | | | | | | | | | | | | | | | | | | | | | | | | | | | | | | | | | | | | | | | | | | | | | | | | | | | | | | | | | | | | | | | | | | | | | | | | | | | | | |
| | 430-16e | 12Gbs SAS | SATA/SAS | - | Yes | None | None | - | 6 | | | | | | | | | | | | | | | | | | | | | | | | | | | | | | | | | | | | | | | | | | | | | | | | | | | | | | | | | | | | | | | | | | | | | | | | | | | | | | | | | | | | | | | | | | | | | | |
| | 930-8e | 12Gbs SAS | SATA/SAS | 0/1/10/5/50/6/60 | Yes | 4GB | Flash backup | Yes | 6 | | | | | | | | | | | | | | | | | | | | | | | | | | | | | | | | | | | | | | | | | | | | | | | | | | | | | | | | | | | | | | | | | | | | | | | | | | | | | | | | | | | | | | | | | | | | | | |
| <p>Note: 730-8i is available in China only. All RAID/HBA adapters should be placed in slot 4 firstly.</p> | | | | | | | | | | | | | | | | | | | | | | | | | | | | | | | | | | | | | | | | | | | | | | | | | | | | | | | | | | | | | | | | | | | | | | | | | | | | | | | | | | | | | | | | | | | | | | | | | | | | | | | |
| Disk drive bays | Support 8 front 3.5" SATA simple-swap bays, or 8 front 3.5" SATA/SAS HS bays, or 12 front 3.5" SATA/SAS HS bays, or 8 front 2.5" SATA/SAS HS bays, or 16 front 2.5" SATA/SAS HS bays. Optional one or two internal M.2 SSD for boot, dual M.2 SSD supports mirroring | | | | | | | | | | | | | | | | | | | | | | | | | | | | | | | | | | | | | | | | | | | | | | | | | | | | | | | | | | | | | | | | | | | | | | | | | | | | | | | | | | | | | | | | | | | | | | | | | | | | | | |
| Internal storage | For 3.5" SS bay | | | | | | | | | | | | | | | | | | | | | | | | | | | | | | | | | | | | | | | | | | | | | | | | | | | | | | | | | | | | | | | | | | | | | | | | | | | | | | | | | | | | | | | | | | | | | | | | | | | | | | |
| | | | | | | | | | | | | | | | | | | | | | | | | | | | | | | | | | | | | | | | | | | | | | | | | | | | | | | | | | | | | | | | | | | | | | | | | | | | | | | | | | | | | | | | | | | | | | | | | | | | | | | | |
| | | | | | | | | | | | | | | | | | | | | | | | | | | | | | | | | | | | | | | | | | | | | | | | | | | | | | | | | | | | | | | | | | | | | | | | | | | | | | | | | | | | | | | | | | | | | | | | | | | | | | | | |
| | | | | | | | | | | | | | | | | | | | | | | | | | | | | | | | | | | | | | | | | | | | | | | | | | | | | | | | | | | | | | | | | | | | | | | | | | | | | | | | | | | | | | | | | | | | | | | | | | | | | | | | |
| | | | | | | | | | | | | | | | | | | | | | | | | | | | | | | | | | | | | | | | | | | | | | | | | | | | | | | | | | | | | | | | | | | | | | | | | | | | | | | | | | | | | | | | | | | | | | | | | | | | | | | | |
| | | | | | | | | | | | | | | | | | | | | | | | | | | | | | | | | | | | | | | | | | | | | | | | | | | | | | | | | | | | | | | | | | | | | | | | | | | | | | | | | | | | | | | | | | | | | | | | | | | | | | | | |
| | | | | | | | | | | | | | | | | | | | | | | | | | | | | | | | | | | | | | | | | | | | | | | | | | | | | | | | | | | | | | | | | | | | | | | | | | | | | | | | | | | | | | | | | | | | | | | | | | | | | | | | |
| | | | | | | | | | | | | | | | | | | | | | | | | | | | | | | | | | | | | | | | | | | | | | | | | | | | | | | | | | | | | | | | | | | | | | | | | | | | | | | | | | | | | | | | | | | | | | | | | | | | | | | | |
| | | | | | | | | | | | | | | | | | | | | | | | | | | | | | | | | | | | | | | | | | | | | | | | | | | | | | | | | | | | | | | | | | | | | | | | | | | | | | | | | | | | | | | | | | | | | | | | | | | | | | | | |
| | | | | | | | | | | | | | | | | | | | | | | | | | | | | | | | | | | | | | | | | | | | | | | | | | | | | | | | | | | | | | | | | | | | | | | | | | | | | | | | | | | | | | | | | | | | | | | | | | | | | | | | |
| Optical | No internal optical bay. Optional USB DVD±RW optical drive | | | | | | | | | | | | | | | | | | | | | | | | | | | | | | | | | | | | | | | | | | | | | | | | | | | | | | | | | | | | | | | | | | | | | | | | | | | | | | | | | | | | | | | | | | | | | | | | | | | | | | |
| | | | | | | | | | | | | | | | | | | | | | | | | | | | | | | | | | | | | | | | | | | | | | | | | | | | | | | | | | | | | | | | | | | | | | | | | | | | | | | | | | | | | | | | | | | | | | | | | | | | | | | | |
| | | | | | | | | | | | | | | | | | | | | | | | | | | | | | | | | | | | | | | | | | | | | | | | | | | | | | | | | | | | | | | | | | | | | | | | | | | | | | | | | | | | | | | | | | | | | | | | | | | | | | | | |
| | | | | | | | | | | | | | | | | | | | | | | | | | | | | | | | | | | | | | | | | | | | | | | | | | | | | | | | | | | | | | | | | | | | | | | | | | | | | | | | | | | | | | | | | | | | | | | | | | | | | | | | |
| | | | | | | | | | | | | | | | | | | | | | | | | | | | | | | | | | | | | | | | | | | | | | | | | | | | | | | | | | | | | | | | | | | | | | | | | | | | | | | | | | | | | | | | | | | | | | | | | | | | | | | | |
| | | | | | | | | | | | | | | | | | | | | | | | | | | | | | | | | | | | | | | | | | | | | | | | | | | | | | | | | | | | | | | | | | | | | | | | | | | | | | | | | | | | | | | | | | | | | | | | | | | | | | | | |
| | | | | | | | | | | | | | | | | | | | | | | | | | | | | | | | | | | | | | | | | | | | | | | | | | | | | | | | | | | | | | | | | | | | | | | | | | | | | | | | | | | | | | | | | | | | | | | | | | | | | | | | |
| | | | | | | | | | | | | | | | | | | | | | | | | | | | | | | | | | | | | | | | | | | | | | | | | | | | | | | | | | | | | | | | | | | | | | | | | | | | | | | | | | | | | | | | | | | | | | | | | | | | | | | | |
| | | | | | | | | | | | | | | | | | | | | | | | | | | | | | | | | | | | | | | | | | | | | | | | | | | | | | | | | | | | | | | | | | | | | | | | | | | | | | | | | | | | | | | | | | | | | | | | | | | | | | | | |
| | | | | | | | | | | | | | | | | | | | | | | | | | | | | | | | | | | | | | | | | | | | | | | | | | | | | | | | | | | | | | | | | | | | | | | | | | | | | | | | | | | | | | | | | | | | | | | | | | | | | | | | |
| Network interfaces | Integrated one dedicated management port plus two GbE ports. One LOM slot for customized LOM with two RJ-45 or SFP+ ports, up to 10GbE. Optional ML2 or PCIe adapters are supported. ML2 adapter requires riser card with ML2 slot. Up to two ports supports Wake-on-LAN and NC-SI (see right) | | | | | | | | | | | | | | | | | | | | | | | | | | | | | | | | | | | | | | | | | | | | | | | | | | | | | | | | | | | | | | | | | | | | | | | | | | | | | | | | | | | | | | | | | | | | | | | | | | | | | | |
| Security features | Power-on and admin password. Trusted Platform Module, TCG 1.2 compliant, upgrade to 2.0 via UEFI setting. Optional TCM in China only. Optional lockable security bezel | | | | | | | | | | | | | | | | | | | | | | | | | | | | | | | | | | | | | | | | | | | | | | | | | | | | | | | | | | | | | | | | | | | | | | | | | | | | | | | | | | | | | | | | | | | | | | | | | | | | | | |
| Operating systems supported | Microsoft Windows Server 2016/2012 R2. Red Hat Enterprise Linux 7.3/6.9. SUSE Linux Enterprise Server 12 SP2/11 SP4. VMware vSphere (ESXi) 6.5/6.0 U3 | | | | | | | | | | | | | | | | | | | | | | | | | | | | | | | | | | | | | | | | | | | | | | | | | | | | | | | | | | | | | | | | | | | | | | | | | | | | | | | | | | | | | | | | | | | | | | | | | | | | | | |
| Systems management | XClarity Controller Standard, optional upgrades to Advanced or Enterprise are available. Energy Manager. XClarity Administrator. Lenovo Capacity Planner. Provisioning Manager. Essentials. Light Path Diagnostics | | | | | | | | | | | | | | | | | | | | | | | | | | | | | | | | | | | | | | | | | | | | | | | | | | | | | | | | | | | | | | | | | | | | | | | | | | | | | | | | | | | | | | | | | | | | | | | | | | | | | | |
| GPU support | None | | | | | | | | | | | | | | | | | | | | | | | | | | | | | | | | | | | | | | | | | | | | | | | | | | | | | | | | | | | | | | | | | | | | | | | | | | | | | | | | | | | | | | | | | | | | | | | | | | | | | | |

| Components | Specification |
|-----------------------------|--|
| Base warranty | MT 7X03: 1-year limited onsite service with 9x5/NBD MT 7X04: 3-year limited onsite service with 9x5/NBD |
| Power supply | Up to two redundant hot-swap 550W and 750W 80 PLUS Platinum qualified AC power supplies. Or up to two redundant hot-swap 750W Titanium qualified AC power supplies. 750W Titanium is 200V - 240V, others are 100V - 240V |
| Video | Integrated Matrox G200 in XClarity Controller |
| Cooling | Three fans (2+1) for single processor model, four fans (3+1) for dual processor model |
| Front ports | One XClarity Controller USB, one USB 3.0, one optional VGA |
| Rear ports | One VGA, two USB 3.0, two ethernet (RJ-45) one XClarity Controller connector. Optional COM port |
| Environmental specification | Supports ASHRAE A4 with limitations. |
| | |
| | |
| | |
| | |
| Environmental certification | Energy Star Server 2.1 certified. More environmental information please see: www.lenovo.com/social_responsibility/us/en/environment/ |

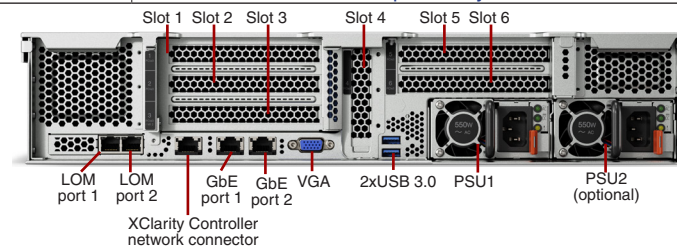

Note: GbE port 1 and LOM port 1 support Wake-on-LAN and NC-SI. Riser cards, expansion cards, and LOM adapters are optional.

| Expansion slots | Specification |
|-------------------------|--|
| Slot 1-3 (riser card 1) | Supports one of the following for riser card 1: Option 1: PCIe 3.0 x8/x8/x8 (slot 1-3). Full height, half length. Option 2: PCIe 3.0 x16/x8 (slot 1 and 3). Full height, half length Option 3: PCIe 3.0 x8/x8/x8 ML2 (slot 1-3). Full height, half length |
| Slot 4 (onboard) | PCIe 3.0 x8, low profile |
| Slot 5 (riser card 2) | PCIe 3.0 x16, full height, half length, requires 2nd CPU |
| Slot 6 (riser card 2) | PCIe 3.0 x8, full height, half length |

| System unique options | Specification |
|-----------------------|---|
| 7XH7A02680 | Lenovo SR550/SR590/SR650 x8/x8/x8ML2 PCIe FH Riser 1 Kit |
| 7XH7A02679 | Lenovo SR550/SR590/SR650 (x16/x8)/(x16/x16) PCIe FH Riser 2 Kit |
| 7XH7A02678 | Lenovo SR550/SR590/SR650 x16/x8 PCIe FH Riser 1 Kit |
| 7XH7A02677 | Lenovo SR550/SR590/SR650 x8/x8/x8 PCIe FH Riser 1 Kit |
| 7Z17A02578 | Lenovo SR550/SR590/SR650 EIA Latch w/VGA Upgrade Kit |
| 7XH7A06254 | Lenovo SR550/SR650 2.5" SATA/SAS 8-Bay Backplane Kit |
| 7Z17A02580 | Lenovo 2U Security Bezel |
| 7Z17A02577 | Lenovo COM Port Upgrade Kit |

ThinkSystem SR550 Models for USA and Canada - TopSeller

Product Specifications Reference (PSREF)

| Model | Processor | Memory | RAID/HBA Adapter | Chassis | Disk Bays | Disks | Networking (LOM/ML2/PCIe) | M.2 Boot Drive | Riser Card 1 for Slot 1-3 | Riser Card 2 for Slot 5-6 | Front VGA | Security | System Management | Power Supply | Base Warranty | Ann Date (mm/yy) |
|------------|---|---------------------------|------------------------|---------|-------------------------|-------|---------------------------|----------------|---------------------------|---------------------------|-----------|----------|------------------------|--------------------|---------------|------------------|
| 7X04A02KNA | 1xXeon Silver 4110 8C/2.1GHz/ 11MB/85W/DDR4-2400 | 1x16GB RDIMM DDR4-2666 | 1x930-16i 4GB flash | 12x3.5" | 12x3.5" SATA/ SAS HS | Open | None | None | None | None | None | TPM 1.2 | XClarity Enterprise | 1x750W Platinum | 3-year | 07/17 |
| 7X04A02QNA | 1xXeon Bronze 3106 8C/1.7GHz/ 11MB/85W/DDR4-2133 | 1x16GB RDIMM DDR4-2666 | 1x530-8i | 12x3.5" | 8x3.5" SATA/ SAS HS | Open | None | None | None | None | None | TPM 1.2 | XClarity Enterprise | 1x750W Platinum | 3-year | 07/17 |
| 7X04A02TNA | 1xXeon Silver 4116 12C/2.1GHz/ 16.5MB/85W/DDR4-2400 | 1x32GB RDIMM DDR4-2666 | 1x530-8i | 16x2.5" | 8x2.5" SATA/ SAS HS | Open | None | None | None | None | None | TPM 1.2 | XClarity Enterprise | 1x750W Platinum | 3-year | 07/17 |

ThinkSystem SR550 Models for USA and Canada - Non TopSeller

Product Specifications Reference (PSREF)

| Model | Processor | Memory | RAID/HBA Adapter | Chassis | Disk Bays | Disks | Networking (LOM/ML2/PCIe) | M.2 Boot Drive | Riser Card 1 for Slot 1-3 | Riser Card 2 for Slot 5-6 | Front VGA | Security | System Management | Power Supply | Base Warranty | Ann Date (mm/yy) |
|------------|--|---------------------------|------------------------|---------|-------------------------|-------|---------------------------|----------------|---------------------------|---------------------------|--------------|----------|----------------------|--------------------|---------------|------------------|
| 7X04A04NNA | 1xXeon Gold 6138 20C/2.0GHz/ 27.5MB/125W/DDR4-2666 | 1x32GB RDIMM DDR4-2666 | 1x930-8i 2GB flash | 16x2.5" | 8x2.5" SATA/ SAS HS | Open | None | None | x8 / x8 / x8, FHHL | None | Front VGA | TPM 1.2 | XClarity Standard | 1x750W Platinum | 3-year | 07/17 |
| 7X04A04PNA | 1xXeon Gold 6126 12C/2.6GHz/ 19.25MB/125W/DDR4-2666 | 1x32GB RDIMM DDR4-2666 | 1x930-8i 2GB flash | 16x2.5" | 8x2.5" SATA/ SAS HS | Open | None | None | x8 / x8 / x8, FHHL | None | Front VGA | TPM 1.2 | XClarity Standard | 1x750W Platinum | 3-year | 07/17 |
| 7X04A04UNA | 1xXeon Gold 6130 16C/2.1GHz/ 22MB/125W/DDR4-2666 | 1x32GB RDIMM DDR4-2666 | 1x930-8i 2GB flash | 16x2.5" | 8x2.5" SATA/ SAS HS | Open | None | None | x8 / x8 / x8, FHHL | None | Front VGA | TPM 1.2 | XClarity Standard | 1x750W Platinum | 3-year | 07/17 |
| 7X04A04VNA | 1xXeon Gold 5120 14C/2.2GHz/ 19.25MB/105W/DDR4-2400 | 1x16GB RDIMM DDR4-2666 | 1x930-8i 2GB flash | 16x2.5" | 8x2.5" SATA/ SAS HS | Open | None | None | x8 / x8 / x8, FHHL | None | Front VGA | TPM 1.2 | XClarity Standard | 1x750W Platinum | 3-year | 07/17 |
| 7X04A04YNA | 1xXeon Silver 4110 8C/2.1GHz/ 11MB/85W/DDR4-2400 | 1x16GB RDIMM DDR4-2666 | 1x530-8i | 16x2.5" | 8x2.5" SATA/ SAS HS | Open | None | None | None | None | None | TPM 1.2 | XClarity Standard | 1x750W Platinum | 3-year | 07/17 |
| 7X04A04ZNA | 1xXeon Silver 4108 8C/1.8GHz/ 11MB/85W/DDR4-2400 | 1x16GB RDIMM DDR4-2666 | 1x530-8i | 16x2.5" | 8x2.5" SATA/ SAS HS | Open | None | None | None | None | None | TPM 1.2 | XClarity Standard | 1x750W Platinum | 3-year | 07/17 |
| 7X04A051NA | 1xXeon Bronze 3104 6C/1.7GHz/ 8.25MB/85W/DDR4-2133 | 1x16GB RDIMM DDR4-2666 | 1x530-8i | 16x2.5" | 8x2.5" SATA/ SAS HS | Open | None | None | None | None | None | TPM 1.2 | XClarity Standard | 1x750W Platinum | 3-year | 07/17 |
| 7X04A053NA | 1xXeon Silver 4114 10C/2.2GHz/ 13.75MB/85W/DDR4-2400 | 1x16GB RDIMM DDR4-2666 | 1x930-8i 2GB flash | 16x2.5" | 8x2.5" SATA/ SAS HS | Open | None | None | None | None | None | TPM 1.2 | XClarity Standard | 1x750W Platinum | 3-year | 07/17 |
| 7X04A055NA | 1xXeon Silver 4116 12C/2.1GHz/ 16.5MB/85W/DDR4-2400 | 1x16GB RDIMM DDR4-2666 | 1x930-8i 2GB flash | 16x2.5" | 8x2.5" SATA/ SAS HS | Open | None | None | None | None | None | TPM 1.2 | XClarity Standard | 1x750W Platinum | 3-year | 07/17 |
| 7X04A056NA | 1xXeon Silver 4108 8C/1.8GHz/ 11MB/85W/DDR4-2400 | 1x16GB RDIMM DDR4-2666 | 1x930-8i 2GB flash | 16x2.5" | 8x2.5" SATA/ SAS HS | Open | None | None | None | None | None | TPM 1.2 | XClarity Standard | 1x750W Platinum | 3-year | 07/17 |
| 7X04A057NA | 1xXeon Silver 4110 8C/2.1GHz/ 11MB/85W/DDR4-2400 | 1x16GB RDIMM DDR4-2666 | 1x930-8i 2GB flash | 16x2.5" | 8x2.5" SATA/ SAS HS | Open | None | None | None | None | None | TPM 1.2 | XClarity Standard | 1x750W Platinum | 3-year | 07/17 |
| 7X04A05ANA | 1xXeon Silver 4114 10C/2.2GHz/ 13.75MB/85W/DDR4-2400 | 1x16GB RDIMM DDR4-2666 | 1x930-16i 4GB flash | 12x3.5" | 12x3.5" SATA/ SAS HS | Open | None | None | None | None | None | TPM 1.2 | XClarity Standard | 1x750W Platinum | 3-year | 07/17 |
| 7X04A05BNA | 1xXeon Gold 5115 10C/2.4GHz/ 13.75MB/85W/DDR4-2400 | 1x16GB RDIMM DDR4-2666 | 1x930-8i 2GB flash | 16x2.5" | 8x2.5" SATA/ SAS HS | Open | None | None | None | None | None | TPM 1.2 | XClarity Standard | 1x750W Platinum | 3-year | 07/17 |
| 7X04A05JNA | 1xXeon Gold 5118 12C/2.3GHz/ 16.5MB/105W/DDR4-2400 | 1x16GB RDIMM DDR4-2666 | 1x930-8i 2GB flash | 16x2.5" | 8x2.5" SATA/ SAS HS | Open | None | None | x8 / x8 / x8, FHHL | None | Front VGA | TPM 1.2 | XClarity Standard | 1x750W Platinum | 3-year | 07/17 |

ThinkSystem SR550 Models for EMEA - TopSeller

Product Specifications Reference (PSREF)

| Model | Processor | Memory | RAID/HBA Adapter | Chassis | Disk Bays | Disks | Networking (LOM/ML2/PCIe) | M.2 Boot Drive | Riser Card 1 for Slot 1-3 | Riser Card 2 for Slot 5-6 | Front VGA | Security | System Management | Power Supply | Base Warranty | Ann Date (mm/yy) |
|------------|--|---------------------------|-----------------------|---------|------------------------|-------|---------------------------|----------------|---------------------------|---------------------------|--------------|----------|------------------------|--------------------|---------------|------------------|
| 7X04A002EA | 1xXeon Silver 4110 8C/2.1GHz/ 11MB/85W/DDR4-2400 | 1x16GB RDIMM DDR4-2666 | 1x930-8i 2GB flash | 16x2.5" | 8x2.5" SATA/ SAS HS | Open | None | None | None | None | Front VGA | TPM 1.2 | XClarity Advanced | 1x750W Platinum | 3-year | 07/17 |
| 7X04A003EA | 1xXeon Silver 4116 12C/2.1GHz/ 16.5MB/85W/DDR4-2400 | 1x16GB RDIMM DDR4-2666 | 1x930-8i 2GB flash | 16x2.5" | 8x2.5" SATA/ SAS HS | Open | None | None | None | None | Front VGA | TPM 1.2 | XClarity Advanced | 1x750W Platinum | 3-year | 07/17 |
| 7X04A007EA | 1xXeon Silver 4110 8C/2.1GHz/ 11MB/85W/DDR4-2400 | 1x16GB RDIMM DDR4-2666 | 1x930-8i 2GB flash | 16x2.5" | 8x2.5" SATA/ SAS HS | Open | None | None | None | None | Front VGA | TPM 1.2 | XClarity Advanced | 2x750W Platinum | 3-year | 07/17 |
| 7X04A00AEA | 1xXeon Silver 4114 10C/2.2GHz/ 13.75MB/85W/DDR4-2400 | 1x16GB RDIMM DDR4-2666 | 1x930-8i 2GB flash | 16x2.5" | 8x2.5" SATA/ SAS HS | Open | None | None | None | None | Front VGA | TPM 1.2 | XClarity Advanced | 1x750W Platinum | 3-year | 07/17 |
| 7X04A00CEA | 1xXeon Bronze 3106 8C/1.7GHz/ 11MB/85W/DDR4-2133 | 1x16GB RDIMM DDR4-2666 | 1x530-8i | 16x2.5" | 8x2.5" SATA/ SAS HS | Open | None | None | None | None | Front VGA | TPM 1.2 | XClarity Advanced | 1x750W Platinum | 3-year | 07/17 |
| 7X04A00DEA | 1xXeon Bronze 3104 6C/1.7GHz/ 8.25MB/85W/DDR4-2133 | 1x16GB RDIMM DDR4-2666 | 1x530-8i | 16x2.5" | 8x2.5" SATA/ SAS HS | Open | None | None | None | None | Front VGA | TPM 1.2 | XClarity Advanced | 1x750W Platinum | 3-year | 07/17 |
| 7X04A00FEA | 1xXeon Silver 4110 8C/2.1GHz/ 11MB/85W/DDR4-2400 | 1x16GB RDIMM DDR4-2666 | 1x930-8i 2GB flash | 12x3.5" | 8x3.5" SATA/ SAS HS | Open | None | None | None | None | Front VGA | TPM 1.2 | XClarity Advanced | 1x750W Platinum | 3-year | 07/17 |
| 7X04A00HEA | 1xXeon Silver 4108 8C/1.8GHz/ 11MB/85W/DDR4-2400 | 1x16GB RDIMM DDR4-2666 | 1x930-8i 2GB flash | 16x2.5" | 8x2.5" SATA/ SAS HS | Open | None | None | None | None | Front VGA | TPM 1.2 | XClarity Advanced | 2x750W Platinum | 3-year | 07/17 |
| 7X04A00MEA | 1xXeon Bronze 3104 6C/1.7GHz/ 8.25MB/85W/DDR4-2133 | 1x16GB RDIMM DDR4-2666 | Onboard SATA | 12x3.5" | 8x3.5" SATA SS | Open | None | None | None | None | Front VGA | TPM 1.2 | XClarity Standard | 1x750W Platinum | 3-year | 07/17 |
| 7X04A00NEA | 1xXeon Silver 4108 8C/1.8GHz/ 11MB/85W/DDR4-2400 | 1x16GB RDIMM DDR4-2666 | 1x930-8i 2GB flash | 12x3.5" | 8x3.5" SATA/ SAS HS | Open | None | None | None | None | Front VGA | TPM 1.2 | XClarity Advanced | 1x750W Platinum | 3-year | 07/17 |
| 7X04A00QEA | 1xXeon Silver 4108 8C/1.8GHz/ 11MB/85W/DDR4-2400 | 1x16GB RDIMM DDR4-2666 | 1x930-8i 2GB flash | 16x2.5" | 8x2.5" SATA/ SAS HS | Open | None | None | None | None | Front VGA | TPM 1.2 | XClarity Advanced | 1x750W Platinum | 3-year | 07/17 |
| 7X04A01YEA | 1xXeon Gold 5122 4C/3.6GHz/ 16.5MB/105W/DDR4-2400 | 1x16GB RDIMM DDR4-2666 | 1x930-8i 2GB flash | 16x2.5" | 8x2.5" SATA/ SAS HS | Open | None | None | None | None | Front VGA | TPM 1.2 | XClarity Advanced | 1x750W Platinum | 3-year | 07/17 |
| 7X04A01ZEA | 1xXeon Gold 5120 14C/2.2GHz/ 19.25MB/105W/DDR4-2400 | 1x16GB RDIMM DDR4-2666 | 1x930-8i 2GB flash | 16x2.5" | 8x2.5" SATA/ SAS HS | Open | None | None | None | None | Front VGA | TPM 1.2 | XClarity Advanced | 1x750W Platinum | 3-year | 07/17 |
| 7X04A020EA | 1xXeon Gold 5118 12C/2.3GHz/ 16.5MB/105W/DDR4-2400 | 1x16GB RDIMM DDR4-2666 | 1x930-8i 2GB flash | 16x2.5" | 8x2.5" SATA/ SAS HS | Open | None | None | None | None | Front VGA | TPM 1.2 | XClarity Advanced | 1x750W Platinum | 3-year | 07/17 |
| 7X04A023EA | 1xXeon Gold 6138 20C/2.0GHz/ 27.5MB/125W/DDR4-2666 | 1x32GB RDIMM DDR4-2666 | 1x930-8i 2GB flash | 16x2.5" | 8x2.5" SATA/ SAS HS | Open | None | None | None | None | Front VGA | TPM 1.2 | XClarity Advanced | 1x750W Platinum | 3-year | 07/17 |
| 7X04A024EA | 1xXeon Gold 6130 16C/2.1GHz/ 22MB/125W/DDR4-2666 | 1x32GB RDIMM DDR4-2666 | 1x930-8i 2GB flash | 16x2.5" | 8x2.5" SATA/ SAS HS | Open | None | None | None | None | Front VGA | TPM 1.2 | XClarity Advanced | 1x750W Platinum | 3-year | 07/17 |
| 7X04A028EA | 1xXeon Gold 6126 12C/2.6GHz/ 19.25MB/125W/DDR4-2666 | 1x32GB RDIMM DDR4-2666 | 1x930-8i 2GB flash | 16x2.5" | 8x2.5" SATA/ SAS HS | Open | None | None | x8 / x8 / x8, FHHL | None | Front VGA | TPM 1.2 | XClarity Advanced | 1x750W Platinum | 3-year | 07/17 |
| 7X04A04BEA | 1xXeon Gold 5115 10C/2.4GHz/ 13.75MB/85W/DDR4-2400 | 1x16GB RDIMM DDR4-2666 | 1x930-8i 2GB flash | 16x2.5" | 8x2.5" SATA/ SAS HS | Open | None | None | None | None | Front VGA | TPM 1.2 | XClarity Enterprise | 1x750W Platinum | 3-year | 07/17 |

ThinkSystem SR550 Models for EMEA - Non TopSeller

Product Specifications Reference (PSREF)

| Model | Processor | Memory | RAID/HBA Adapter | Chassis | Disk Bays | Disks | Networking (LOM/ML2/PCIe) | M.2 Boot Drive | Riser Card 1 for Slot 1-3 | Riser Card 2 for Slot 5-6 | Front VGA | Security | System Management | Power Supply | Base Warranty | Ann Date (mm/yy) |
|------------|--|---------------------------|------------------------|---------|-------------------------|-------|---------------------------|----------------|---------------------------|---------------------------|--------------|----------|----------------------|--------------------|---------------|------------------|
| 7X04A001EA | 1xXeon Silver 4110 8C/2.1GHz/ 11MB/85W/DDR4-2400 | 1x16GB RDIMM DDR4-2666 | 1x930-8i 2GB flash | 16x2.5" | 8x2.5" SATA/ SAS HS | Open | None | None | None | None | None | TPM 1.2 | XClarity Standard | 1x750W Platinum | 3-year | 07/17 |
| 7X04A004EA | 1xXeon Silver 4108 8C/1.8GHz/ 11MB/85W/DDR4-2400 | 1x16GB RDIMM DDR4-2666 | 1x930-8i 2GB flash | 16x2.5" | 8x2.5" SATA/ SAS HS | Open | None | None | None | None | None | TPM 1.2 | XClarity Standard | 1x750W Platinum | 3-year | 07/17 |
| 7X04A005EA | 1xXeon Silver 4108 8C/1.8GHz/ 11MB/85W/DDR4-2400 | 1x16GB RDIMM DDR4-2666 | 1x530-8i | 16x2.5" | 8x2.5" SATA/ SAS HS | Open | None | None | None | None | None | TPM 1.2 | XClarity Standard | 1x750W Platinum | 3-year | 07/17 |
| 7X04A009EA | 1xXeon Silver 4110 8C/2.1GHz/ 11MB/85W/DDR4-2400 | 1x16GB RDIMM DDR4-2666 | 1x530-8i | 16x2.5" | 8x2.5" SATA/ SAS HS | Open | None | None | None | None | None | TPM 1.2 | XClarity Standard | 1x750W Platinum | 3-year | 07/17 |
| 7X04A00EEA | 1xXeon Silver 4114 10C/2.2GHz/ 13.75MB/85W/DDR4-2400 | 1x16GB RDIMM DDR4-2666 | 1x930-8i 2GB flash | 16x2.5" | 8x2.5" SATA/ SAS HS | Open | None | None | None | None | None | TPM 1.2 | XClarity Standard | 1x750W Platinum | 3-year | 07/17 |
| 7X04A00JEA | 1xXeon Silver 4114 10C/2.2GHz/ 13.75MB/85W/DDR4-2400 | 1x16GB RDIMM DDR4-2666 | 1x930-16i 4GB flash | 12x3.5" | 12x3.5" SATA/ SAS HS | Open | None | None | None | None | None | TPM 1.2 | XClarity Standard | 1x750W Platinum | 3-year | 07/17 |
| 7X04A00LEA | 1xXeon Silver 4116 12C/2.1GHz/ 16.5MB/85W/DDR4-2400 | 1x16GB RDIMM DDR4-2666 | 1x930-8i 2GB flash | 16x2.5" | 8x2.5" SATA/ SAS HS | Open | None | None | None | None | None | TPM 1.2 | XClarity Standard | 1x750W Platinum | 3-year | 07/17 |
| 7X04A00PEA | 1xXeon Bronze 3104 6C/1.7GHz/ 8.25MB/85W/DDR4-2133 | 1x16GB RDIMM DDR4-2666 | 1x530-8i | 16x2.5" | 8x2.5" SATA/ SAS HS | Open | None | None | None | None | None | TPM 1.2 | XClarity Standard | 1x750W Platinum | 3-year | 07/17 |
| 7X04A021EA | 1xXeon Gold 5120 14C/2.2GHz/ 19.25MB/105W/DDR4-2400 | 1x16GB RDIMM DDR4-2666 | 1x930-8i 2GB flash | 16x2.5" | 8x2.5" SATA/ SAS HS | Open | None | None | None | None | None | TPM 1.2 | XClarity Standard | 1x750W Platinum | 3-year | 07/17 |
| 7X04A022EA | 1xXeon Gold 6138 20C/2.0GHz/ 27.5MB/125W/DDR4-2666 | 1x32GB RDIMM DDR4-2666 | 1x930-8i 2GB flash | 16x2.5" | 8x2.5" SATA/ SAS HS | Open | None | None | None | None | None | TPM 1.2 | XClarity Standard | 1x750W Platinum | 3-year | 07/17 |
| 7X04A025EA | 1xXeon Gold 5118 12C/2.3GHz/ 16.5MB/105W/DDR4-2400 | 1x16GB RDIMM DDR4-2666 | 1x930-8i 2GB flash | 16x2.5" | 8x2.5" SATA/ SAS HS | Open | None | None | None | None | None | TPM 1.2 | XClarity Standard | 1x750W Platinum | 3-year | 07/17 |
| 7X04A026EA | 1xXeon Gold 6126 12C/2.6GHz/ 19.25MB/125W/DDR4-2666 | 1x32GB RDIMM DDR4-2666 | 1x930-8i 2GB flash | 16x2.5" | 8x2.5" SATA/ SAS HS | Open | None | None | None | None | None | TPM 1.2 | XClarity Standard | 1x750W Platinum | 3-year | 07/17 |
| 7X04A027EA | 1xXeon Gold 6130 16C/2.1GHz/ 22MB/125W/DDR4-2666 | 1x32GB RDIMM DDR4-2666 | 1x930-8i 2GB flash | 16x2.5" | 8x2.5" SATA/ SAS HS | Open | None | None | x8 / x8 / x8, FHHL | None | Front VGA | TPM 1.2 | XClarity Standard | 1x750W Platinum | 3-year | 07/17 |
| 7X04A04AEA | 1xXeon Gold 5115 10C/2.4GHz/ 13.75MB/85W/DDR4-2400 | 1x16GB RDIMM DDR4-2666 | 1x930-8i 2GB flash | 16x2.5" | 8x2.5" SATA/ SAS HS | Open | None | None | None | None | None | TPM 1.2 | XClarity Standard | 1x750W Platinum | 3-year | 07/17 |

ThinkSystem SR550 Models for Australia and New Zealand - TopSeller

Product Specifications Reference (PSREF)

| Model | Processor | Memory | RAID/HBA Adapter | Chassis | Disk Bays | Disks | Networking (LOM/ML2/PCIe) | M.2 Boot Drive | Riser Card 1 for Slot 1-3 | Riser Card 2 for Slot 5-6 | Front VGA | Security | System Management | Power Supply | Base Warranty | Ann Date (mm/yy) |
|------------|---|------------------------|--------------------|---------|--------------------|---------------------------------|---------------------------|----------------|---------------------------|---------------------------|-----------|----------|---------------------|-----------------|---------------|------------------|
| 7X04A02AAU | 1xXeon Silver 4108 8C/1.8GHz/11MB/85W/DDR4-2400 | 1x16GB RDIMM DDR4-2666 | 1x930-8i 2GB flash | 16x2.5" | 8x2.5" SATA/SAS HS | Open | None | None | None | None | Front VGA | TPM 1.2 | XClarity Advanced | 1x750W Platinum | 3-year | 07/17 |
| 7X04A02BAU | 1xXeon Silver 4108 8C/1.8GHz/11MB/85W/DDR4-2400 | 1x16GB RDIMM DDR4-2666 | 1x930-8i 2GB flash | 16x2.5" | 8x2.5" SATA/SAS HS | 2x300GB HDD 10K 2.5" SAS-12Gbps | None | None | None | None | Front VGA | TPM 1.2 | XClarity Advanced | 2x750W Platinum | 3-year | 07/17 |
| 7X04A02GAU | 1xXeon Bronze 3104 6C/1.7GHz/8.25MB/85W/DDR4-2133 | 1x16GB RDIMM DDR4-2666 | Onboard SATA | 12x3.5" | 8x3.5" SATA SS | Open | None | None | None | None | Front VGA | TPM 1.2 | XClarity Standard | 1x750W Platinum | 3-year | 07/17 |
| 7X04A02JAU | 1xXeon Silver 4110 8C/2.1GHz/11MB/85W/DDR4-2400 | 1x16GB RDIMM DDR4-2666 | 1x930-8i 2GB flash | 12x3.5" | 8x3.5" SATA/SAS HS | Open | None | None | None | None | Front VGA | TPM 1.2 | XClarity Advanced | 1x750W Platinum | 3-year | 07/17 |
| 7X04A02RAU | 1xXeon Gold 6126 12C/2.6GHz/19.25MB/125W/DDR4-2666 | 1x32GB RDIMM DDR4-2666 | 1x930-8i 2GB flash | 16x2.5" | 8x2.5" SATA/SAS HS | Open | None | None | x8 / x8 / x8, FHHL | None | Front VGA | TPM 1.2 | XClarity Advanced | 1x750W Platinum | 3-year | 07/17 |
| 7X04A02VAU | 1xXeon Silver 4116 12C/2.1GHz/16.5MB/85W/DDR4-2400 | 1x16GB RDIMM DDR4-2666 | 1x930-8i 2GB flash | 16x2.5" | 8x2.5" SATA/SAS HS | Open | None | None | None | None | Front VGA | TPM 1.2 | XClarity Advanced | 1x750W Platinum | 3-year | 07/17 |
| 7X04A02WAU | 1xXeon Silver 4110 8C/2.1GHz/11MB/85W/DDR4-2400 | 1x16GB RDIMM DDR4-2666 | 1x930-8i 2GB flash | 16x2.5" | 8x2.5" SATA/SAS HS | Open | None | None | None | None | Front VGA | TPM 1.2 | XClarity Advanced | 1x750W Platinum | 3-year | 07/17 |
| 7X04A02YAU | 1xXeon Bronze 3106 8C/1.7GHz/11MB/85W/DDR4-2133 | 1x16GB RDIMM DDR4-2666 | 1x530-8i | 16x2.5" | 8x2.5" SATA/SAS HS | Open | None | None | None | None | Front VGA | TPM 1.2 | XClarity Advanced | 1x750W Platinum | 3-year | 07/17 |
| 7X04A034AU | 1xXeon Gold 6138 20C/2.0GHz/27.5MB/125W/DDR4-2666 | 1x32GB RDIMM DDR4-2666 | 1x930-8i 2GB flash | 16x2.5" | 8x2.5" SATA/SAS HS | Open | None | None | x8 / x8 / x8, FHHL | None | Front VGA | TPM 1.2 | XClarity Advanced | 1x750W Platinum | 3-year | 07/17 |
| 7X04A035AU | 1xXeon Gold 6130 16C/2.1GHz/22MB/125W/DDR4-2666 | 1x32GB RDIMM DDR4-2666 | 1x930-8i 2GB flash | 16x2.5" | 8x2.5" SATA/SAS HS | Open | None | None | x8 / x8 / x8, FHHL | None | Front VGA | TPM 1.2 | XClarity Advanced | 1x750W Platinum | 3-year | 07/17 |
| 7X04A039AU | 1xXeon Gold 5118 12C/2.3GHz/16.5MB/105W/DDR4-2400 | 1x16GB RDIMM DDR4-2666 | 1x930-8i 2GB flash | 16x2.5" | 8x2.5" SATA/SAS HS | Open | None | None | x8 / x8 / x8, FHHL | None | Front VGA | TPM 1.2 | XClarity Advanced | 1x750W Platinum | 3-year | 07/17 |
| 7X04A03EAU | 1xXeon Gold 5122 4C/3.6GHz/16.5MB/105W/DDR4-2400 | 1x16GB RDIMM DDR4-2666 | 1x930-8i 2GB flash | 16x2.5" | 8x2.5" SATA/SAS HS | Open | None | None | x8 / x8 / x8, FHHL | None | Front VGA | TPM 1.2 | XClarity Advanced | 1x750W Platinum | 3-year | 07/17 |
| 7X04A03KAU | 1xXeon Silver 4110 8C/2.1GHz/11MB/85W/DDR4-2400 | 1x16GB RDIMM DDR4-2666 | 1x930-8i 2GB flash | 16x2.5" | 8x2.5" SATA/SAS HS | 2x300GB HDD 10K 2.5" SAS-12Gbps | None | None | None | None | Front VGA | TPM 1.2 | XClarity Advanced | 2x750W Platinum | 3-year | 07/17 |
| 7X04A03SAU | 1xXeon Gold 5120 14C/2.2GHz/19.25MB/105W/DDR4-2400 | 1x16GB RDIMM DDR4-2666 | 1x930-8i 2GB flash | 16x2.5" | 8x2.5" SATA/SAS HS | Open | None | None | x8 / x8 / x8, FHHL | None | Front VGA | TPM 1.2 | XClarity Advanced | 1x750W Platinum | 3-year | 07/17 |
| 7X04A03TAU | 1xXeon Bronze 3104 6C/1.7GHz/8.25MB/85W/DDR4-2133 | 1x16GB RDIMM DDR4-2666 | 1x530-8i | 16x2.5" | 8x2.5" SATA/SAS HS | Open | None | None | None | None | Front VGA | TPM 1.2 | XClarity Advanced | 1x750W Platinum | 3-year | 07/17 |
| 7X04A03VAU | 1xXeon Silver 4114 10C/2.2GHz/13.75MB/85W/DDR4-2400 | 1x16GB RDIMM DDR4-2666 | 1x930-8i 2GB flash | 16x2.5" | 8x2.5" SATA/SAS HS | Open | None | None | None | None | Front VGA | TPM 1.2 | XClarity Advanced | 1x750W Platinum | 3-year | 07/17 |
| 7X04A03WAU | 1xXeon Silver 4108 8C/1.8GHz/11MB/85W/DDR4-2400 | 1x16GB RDIMM DDR4-2666 | 1x930-8i 2GB flash | 12x3.5" | 8x3.5" SATA/SAS HS | Open | None | None | None | None | Front VGA | TPM 1.2 | XClarity Advanced | 1x750W Platinum | 3-year | 07/17 |
| 7X04A03ZAU | 1xXeon Gold 6126T 12C/2.6GHz/19.25MB/125W/DDR4-2666 | 1x32GB RDIMM DDR4-2666 | 1x930-8i 2GB flash | 16x2.5" | 8x2.5" SATA/SAS HS | Open | None | None | x8 / x8 / x8, FHHL | None | None | TPM 1.2 | XClarity Enterprise | 1x750W Platinum | 3-year | 07/17 |
| 7X04A040AU | 1xXeon Gold 5120 14C/2.2GHz/19.25MB/105W/DDR4-2400 | 1x16GB RDIMM DDR4-2666 | 1x930-8i 2GB flash | 16x2.5" | 8x2.5" SATA/SAS HS | Open | None | None | x8 / x8 / x8, FHHL | None | None | TPM 1.2 | XClarity Enterprise | 1x750W Platinum | 3-year | 07/17 |
| 7X04A045AU | 1xXeon Gold 5118 12C/2.3GHz/16.5MB/105W/DDR4-2400 | 1x16GB RDIMM DDR4-2666 | 1x930-8i 2GB flash | 16x2.5" | 8x2.5" SATA/SAS HS | Open | None | None | x8 / x8 / x8, FHHL | None | None | TPM 1.2 | XClarity Enterprise | 1x750W Platinum | 3-year | 07/17 |
| 7X04A046AU | 1xXeon Gold 6130 16C/2.1GHz/22MB/125W/DDR4-2666 | 1x32GB RDIMM DDR4-2666 | 1x930-8i 2GB flash | 16x2.5" | 8x2.5" SATA/SAS HS | Open | None | None | x8 / x8 / x8, FHHL | None | None | TPM 1.2 | XClarity Enterprise | 1x750W Platinum | 3-year | 07/17 |
| 7X04A047AU | 1xXeon Gold 6138 20C/2.0GHz/27.5MB/125W/DDR4-2666 | 1x16GB RDIMM DDR4-2666 | 1x930-8i 2GB flash | 16x2.5" | 8x2.5" SATA/SAS HS | Open | None | None | x8 / x8 / x8, FHHL | None | None | TPM 1.2 | XClarity Enterprise | 1x750W Platinum | 3-year | 07/17 |
| 7X04A048AU | 1xXeon Gold 5122 4C/3.6GHz/16.5MB/105W/DDR4-2400 | 1x16GB RDIMM DDR4-2666 | 1x930-8i 2GB flash | 16x2.5" | 8x2.5" SATA/SAS HS | Open | None | None | x8 / x8 / x8, FHHL | None | None | TPM 1.2 | XClarity Enterprise | 1x750W Platinum | 3-year | 07/17 |

ThinkSystem SR550 Models for Australia and New Zealand - Non TopSeller

Product Specifications Reference (PSREF)

| Model | Processor | Memory | RAID/HBA Adapter | Chassis | Disk Bays | Disks | Networking (LOM/ML2/PCIe) | M.2 Boot Drive | Riser Card for Slot 1-3 | Riser Card 2 for Slot 5-6 | Front VGA | Security | System Management | Power Supply | Base Warranty | Ann Date (mm/yy) |
|------------|--|---------------------------|------------------------|---------|-------------------------|-------|---------------------------|----------------|-------------------------|---------------------------|--------------|----------|----------------------|--------------------|---------------|------------------|
| 7X04A029AU | 1xXeon Gold 6138 20C/2.0GHz/ 27.5MB/125W/DDR4-2666 | 1x32GB RDIMM DDR4-2666 | 1x930-8i 2GB flash | 16x2.5" | 8x2.5" SATA/ SAS HS | Open | None | None | x8 / x8 / x8, FHHL | None | Front VGA | TPM 1.2 | XClarity Standard | 1x750W Platinum | 3-year | 07/17 |
| 7X04A02HAU | 1xXeon Silver 4116 12C/2.1GHz/ 16.5MB/85W/DDR4-2400 | 1x16GB RDIMM DDR4-2666 | 1x930-8i 2GB flash | 16x2.5" | 8x2.5" SATA/ SAS HS | Open | None | None | None | None | None | TPM 1.2 | XClarity Standard | 1x750W Platinum | 3-year | 07/17 |
| 7X04A02SAU | 1xXeon Silver 4110 8C/2.1GHz/ 11MB/85W/DDR4-2400 | 1x16GB RDIMM DDR4-2666 | 1x930-8i 2GB flash | 16x2.5" | 8x2.5" SATA/ SAS HS | Open | None | None | None | None | None | TPM 1.2 | XClarity Standard | 1x750W Platinum | 3-year | 07/17 |
| 7X04A02XAU | 1xXeon Gold 6130 16C/2.1GHz/ 22MB/125W/DDR4-2666 | 1x32GB RDIMM DDR4-2666 | 1x930-8i 2GB flash | 16x2.5" | 8x2.5" SATA/ SAS HS | Open | None | None | x8 / x8 / x8, FHHL | None | Front VGA | TPM 1.2 | XClarity Standard | 1x750W Platinum | 3-year | 07/17 |
| 7X04A031AU | 1xXeon Gold 5118 12C/2.3GHz/ 16.5MB/105W/DDR4-2400 | 1x16GB RDIMM DDR4-2666 | 1x930-8i 2GB flash | 16x2.5" | 8x2.5" SATA/ SAS HS | Open | None | None | x8 / x8 / x8, FHHL | None | Front VGA | TPM 1.2 | XClarity Standard | 1x750W Platinum | 3-year | 07/17 |
| 7X04A033AU | 1xXeon Silver 4108 8C/1.8GHz/ 11MB/85W/DDR4-2400 | 1x16GB RDIMM DDR4-2666 | 1x930-8i 2GB flash | 16x2.5" | 8x2.5" SATA/ SAS HS | Open | None | None | None | None | None | TPM 1.2 | XClarity Standard | 1x750W Platinum | 3-year | 07/17 |
| 7X04A037AU | 1xXeon Gold 5120 14C/2.2GHz/ 19.25MB/105W/DDR4-2400 | 1x16GB RDIMM DDR4-2666 | 1x930-8i 2GB flash | 16x2.5" | 8x2.5" SATA/ SAS HS | Open | None | None | x8 / x8 / x8, FHHL | None | Front VGA | TPM 1.2 | XClarity Standard | 1x750W Platinum | 3-year | 07/17 |
| 7X04A03AAU | 1xXeon Bronze 3104 6C/1.7GHz/ 8.25MB/85W/DDR4-2133 | 1x16GB RDIMM DDR4-2666 | 1x530-8i | 16x2.5" | 8x2.5" SATA/ SAS HS | Open | None | None | None | None | None | TPM 1.2 | XClarity Standard | 1x750W Platinum | 3-year | 07/17 |
| 7X04A03CAU | 1xXeon Silver 4108 8C/1.8GHz/ 11MB/85W/DDR4-2400 | 1x16GB RDIMM DDR4-2666 | 1x530-8i | 16x2.5" | 8x2.5" SATA/ SAS HS | Open | None | None | None | None | None | TPM 1.2 | XClarity Standard | 1x750W Platinum | 3-year | 07/17 |
| 7X04A03GAU | 1xXeon Silver 4114 10C/2.2GHz/ 13.75MB/85W/DDR4-2400 | 1x16GB RDIMM DDR4-2666 | 1x930-8i 2GB flash | 16x2.5" | 8x2.5" SATA/ SAS HS | Open | None | None | None | None | None | TPM 1.2 | XClarity Standard | 1x750W Platinum | 3-year | 07/17 |
| 7X04A03HAU | 1xXeon Gold 6126 12C/2.6GHz/ 19.25MB/125W/DDR4-2666 | 1x32GB RDIMM DDR4-2666 | 1x930-8i 2GB flash | 16x2.5" | 8x2.5" SATA/ SAS HS | Open | None | None | x8 / x8 / x8, FHHL | None | Front VGA | TPM 1.2 | XClarity Standard | 1x750W Platinum | 3-year | 07/17 |
| 7X04A03QAU | 1xXeon Silver 4110 8C/2.1GHz/ 11MB/85W/DDR4-2400 | 1x16GB RDIMM DDR4-2666 | 1x530-8i | 16x2.5" | 8x2.5" SATA/ SAS HS | Open | None | None | None | None | None | TPM 1.2 | XClarity Standard | 1x750W Platinum | 3-year | 07/17 |
| 7X04A03RAU | 1xXeon Silver 4114 10C/2.2GHz/ 13.75MB/85W/DDR4-2400 | 1x16GB RDIMM DDR4-2666 | 1x930-16i 4GB flash | 12x3.5" | 12x3.5" SATA/ SAS HS | Open | None | None | None | None | None | TPM 1.2 | XClarity Standard | 1x750W Platinum | 3-year | 07/17 |
| 7X04A041AU | 1xXeon Gold 6130 16C/2.1GHz/ 22MB/125W/DDR4-2666 | 1x32GB RDIMM DDR4-2666 | 1x930-8i 2GB flash | 16x2.5" | 8x2.5" SATA/ SAS HS | Open | None | None | x8 / x8 / x8, FHHL | None | None | TPM 1.2 | XClarity Standard | 1x750W Platinum | 3-year | 07/17 |
| 7X04A042AU | 1xXeon Gold 6138 20C/2.0GHz/ 27.5MB/125W/DDR4-2666 | 1x32GB RDIMM DDR4-2666 | 1x930-8i 2GB flash | 16x2.5" | 8x2.5" SATA/ SAS HS | Open | None | None | x8 / x8 / x8, FHHL | None | None | TPM 1.2 | XClarity Standard | 1x750W Platinum | 3-year | 07/17 |
| 7X04A043AU | 1xXeon Gold 5120 14C/2.2GHz/ 19.25MB/105W/DDR4-2400 | 1x16GB RDIMM DDR4-2666 | 1x930-8i 2GB flash | 16x2.5" | 8x2.5" SATA/ SAS HS | Open | None | None | x8 / x8 / x8, FHHL | None | None | TPM 1.2 | XClarity Standard | 1x750W Platinum | 3-year | 07/17 |
| 7X04A044AU | 1xXeon Gold 5118 12C/2.3GHz/ 16.5MB/105W/DDR4-2400 | 1x16GB RDIMM DDR4-2666 | 1x930-8i 2GB flash | 16x2.5" | 8x2.5" SATA/ SAS HS | Open | None | None | x8 / x8 / x8, FHHL | None | None | TPM 1.2 | XClarity Standard | 1x750W Platinum | 3-year | 07/17 |
| 7X04A049AU | 1xXeon Gold 6126T 12C/2.6GHz/ 19.25MB/125W/DDR4-2666 | 1x32GB RDIMM DDR4-2666 | 1x930-8i 2GB flash | 16x2.5" | 8x2.5" SATA/ SAS HS | Open | None | None | x8 / x8 / x8, FHHL | None | None | TPM 1.2 | XClarity Standard | 1x750W Platinum | 3-year | 07/17 |
| 7X04A04KAU | 1xXeon Gold 6138 20C/2.0GHz/ 27.5MB/125W/DDR4-2666 | 1x32GB RDIMM DDR4-2666 | 1x930-8i 2GB flash | 16x2.5" | 8x2.5" SATA/ SAS HS | Open | None | None | x8 / x8 / x8, FHHL | None | Front VGA | TPM 1.2 | XClarity Standard | 1x750W Platinum | 3-year | 07/17 |

ThinkSystem SR550 Models for South East Asian (ASEAN) - Non TopSeller

Product Specifications Reference (PSREF)

| Model | Processor | Memory | RAID/HBA Adapter | Chassis | Disk Bays | Disks | Networking (LOM/ML2/PCIe) | M.2 Boot Drive | Riser Card 1 for Slot 1-3 | Riser Card 2 for Slot 5-6 | Front VGA | Security | System Management | Power Supply | Base Warranty | Ann Date (mm/yy) |
|------------|--|--------------------------|------------------------|---------|-------------------------|-------|---------------------------|----------------|---------------------------|---------------------------|-----------|----------|----------------------|--------------------|---------------|------------------|
| 7X04A006SG | 1xXeon Silver 4112 4C/2.6GHz/ 8.25MB/85W/DDR4-2400 | 1x8GB RDIMM DDR4-2666 | 1x930-16i 4GB flash | 12x3.5" | 12x3.5" SATA/ SAS HS | Open | None | None | None | None | None | TPM 1.2 | XClarity Standard | 1x750W Platinum | 3-year | 07/17 |
| 7X04A008SG | 1xXeon Silver 4114 10C/2.2GHz/ 13.75MB/85W/DDR4-2400 | 1x8GB RDIMM DDR4-2666 | 1x530-8i | 16x2.5" | 8x2.5" SATA/ SAS HS | Open | None | None | None | None | None | TPM 1.2 | XClarity Standard | 1x750W Platinum | 3-year | 07/17 |
| 7X04A00BSG | 1xXeon Silver 4116 12C/2.1GHz/ 16.5MB/85W/DDR4-2400 | 1x8GB RDIMM DDR4-2666 | 1x530-8i | 16x2.5" | 8x2.5" SATA/ SAS HS | Open | None | None | None | None | None | TPM 1.2 | XClarity Standard | 1x750W Platinum | 3-year | 07/17 |
| 7X04A00GSG | 1xXeon Silver 4110 8C/2.1GHz/ 11MB/85W/DDR4-2400 | 1x8GB RDIMM DDR4-2666 | 1x530-8i | 16x2.5" | 8x2.5" SATA/ SAS HS | Open | None | None | None | None | None | TPM 1.2 | XClarity Standard | 1x750W Platinum | 3-year | 07/17 |
| 7X04A00KSG | 1xXeon Silver 4112 4C/2.6GHz/ 8.25MB/85W/DDR4-2400 | 1x8GB RDIMM DDR4-2666 | 1x530-8i | 16x2.5" | 8x2.5" SATA/ SAS HS | Open | None | None | None | None | None | TPM 1.2 | XClarity Standard | 1x750W Platinum | 3-year | 07/17 |
| 7X04A00RSG | 1xXeon Bronze 3104 6C/1.7GHz/ 8.25MB/85W/DDR4-2133 | 1x8GB RDIMM DDR4-2666 | 1x530-8i | 16x2.5" | 8x2.5" SATA/ SAS HS | Open | None | None | None | None | None | TPM 1.2 | XClarity Standard | 1x750W Platinum | 3-year | 07/17 |
| 7X04A00SSG | 1xXeon Bronze 3106 8C/1.7GHz/ 11MB/85W/DDR4-2133 | 1x8GB RDIMM DDR4-2666 | 1x530-8i | 16x2.5" | 8x2.5" SATA/ SAS HS | Open | None | None | None | None | None | TPM 1.2 | XClarity Standard | 1x750W Platinum | 3-year | 07/17 |
| 7X04A00VSG | 1xXeon Gold 5122 4C/3.6GHz/ 16.5MB/105W/DDR4-2400 | 1x8GB RDIMM DDR4-2666 | 1x530-8i | 16x2.5" | 8x2.5" SATA/ SAS HS | Open | 2xGbE RJ- 45 LOM | None | None | None | None | TPM 1.2 | XClarity Standard | 1x750W Platinum | 3-year | 07/17 |
| 7X04A00XSG | 1xXeon Gold 5122 4C/3.6GHz/ 16.5MB/105W/DDR4-2400 | 1x8GB RDIMM DDR4-2666 | 1x930-16i 4GB flash | 12x3.5" | 12x3.5" SATA/ SAS HS | Open | 2xGbE RJ- 45 LOM | None | None | None | None | TPM 1.2 | XClarity Standard | 1x750W Platinum | 3-year | 07/17 |
| 7X04A017SG | 1xXeon Gold 5120 14C/2.2GHz/ 19.25MB/105W/DDR4-2400 | 1x8GB RDIMM DDR4-2666 | 1x530-8i | 16x2.5" | 8x2.5" SATA/ SAS HS | Open | 2xGbE RJ- 45 LOM | None | None | None | None | TPM 1.2 | XClarity Standard | 1x750W Platinum | 3-year | 07/17 |
| 7X04A01ASG | 1xXeon Gold 6130 16C/2.1GHz/ 22MB/125W/DDR4-2666 | 1x8GB RDIMM DDR4-2666 | 1x530-8i | 16x2.5" | 8x2.5" SATA/ SAS HS | Open | 2xGbE RJ- 45 LOM | None | None | None | None | TPM 1.2 | XClarity Standard | 1x750W Platinum | 3-year | 07/17 |
| 7X04A01ESG | 1xXeon Gold 5118 12C/2.3GHz/ 16.5MB/105W/DDR4-2400 | 1x8GB RDIMM DDR4-2666 | 1x530-8i | 16x2.5" | 8x2.5" SATA/ SAS HS | Open | 2xGbE RJ- 45 LOM | None | None | None | None | TPM 1.2 | XClarity Standard | 1x750W Platinum | 3-year | 07/17 |
| 7X04A01XSG | 1xXeon Gold 6138 20C/2.0GHz/ 27.5MB/125W/DDR4-2666 | 1x8GB RDIMM DDR4-2666 | 1x530-8i | 16x2.5" | 8x2.5" SATA/ SAS HS | Open | 2xGbE RJ- 45 LOM | None | None | None | None | TPM 1.2 | XClarity Standard | 1x750W Platinum | 3-year | 07/17 |
| 7X04A04TSG | 1xXeon Gold 5118 12C/2.3GHz/ 16.5MB/105W/DDR4-2400 | 1x8GB RDIMM DDR4-2666 | 1x530-8i | 16x2.5" | 8x2.5" SATA/ SAS HS | Open | 2xGbE RJ- 45 LOM | None | None | None | None | TPM 1.2 | XClarity Standard | 1x750W Platinum | 3-year | 07/17 |

ThinkSystem SR550 Models for Hong Kong, Taiwan, Korea (HTK) - Non TopSeller

Product Specifications Reference (PSREF)

| Model | Processor | Memory | RAID/HBA Adapter | Chassis | Disk Bays | Disks | Networking (LOM/ML2/PCIe) | M.2 Boot Drive | Riser Card 1 for Slot 1-3 | Riser Card 2 for Slot 5-6 | Front VGA | Security | System Management | Power Supply | Base Warranty | Ann Date (mm/yy) |
|------------|---|------------------------|---------------------|---------|---------------------|-------|---------------------------|----------------|---------------------------|---------------------------|-----------|----------|-------------------|-----------------|---------------|------------------|
| 7X04A00TCN | 1xXeon Gold 5120 14C/2.2GHz/19.25MB/105W/DDR4-2400 | 1x16GB RDIMM DDR4-2666 | 1x930-8i 2GB flash | 16x2.5" | 8x2.5" SATA/SAS HS | Open | 2xGbE RJ-45 LOM | None | x8 / x8 / x8, FHHL | None | None | TPM 1.2 | XClarity Standard | 1x750W Platinum | 3-year | 07/17 |
| 7X04A00WCN | 1xXeon Gold 5118 12C/2.3GHz/16.5MB/105W/DDR4-2400 | 1x16GB RDIMM DDR4-2666 | 1x930-8i 2GB flash | 16x2.5" | 8x2.5" SATA/SAS HS | Open | 2xGbE RJ-45 LOM | None | x8 / x8 / x8, FHHL | None | None | TPM 1.2 | XClarity Standard | 1x750W Platinum | 3-year | 07/17 |
| 7X04A016CN | 1xXeon Gold 6138 20C/2.0GHz/27.5MB/125W/DDR4-2666 | 1x16GB RDIMM DDR4-2666 | 1x930-8i 2GB flash | 16x2.5" | 8x2.5" SATA/SAS HS | Open | 2xGbE RJ-45 LOM | None | x8 / x8 / x8, FHHL | None | None | TPM 1.2 | XClarity Standard | 1x750W Platinum | 3-year | 07/17 |
| 7X04A01CCN | 1xXeon Gold 6130 16C/2.1GHz/22MB/125W/DDR4-2666 | 1x16GB RDIMM DDR4-2666 | 1x930-8i 2GB flash | 16x2.5" | 8x2.5" SATA/SAS HS | Open | 2xGbE RJ-45 LOM | None | x8 / x8 / x8, FHHL | None | None | TPM 1.2 | XClarity Standard | 1x750W Platinum | 3-year | 07/17 |
| 7X04A01DCN | 1xXeon Gold 5122 4C/3.6GHz/16.5MB/105W/DDR4-2400 | 1x16GB RDIMM DDR4-2666 | 1x930-8i 2GB flash | 16x2.5" | 8x2.5" SATA/SAS HS | Open | 2xGbE RJ-45 LOM | None | x8 / x8 / x8, FHHL | None | None | TPM 1.2 | XClarity Standard | 1x750W Platinum | 3-year | 07/17 |
| 7X04A01FCN | 1xXeon Gold 6138 20C/2.0GHz/27.5MB/125W/DDR4-2666 | 1x16GB RDIMM DDR4-2666 | 1x930-16i 4GB flash | 12x3.5" | 12x3.5" SATA/SAS HS | Open | 2xGbE RJ-45 LOM | None | x8 / x8 / x8, FHHL | None | None | TPM 1.2 | XClarity Standard | 1x750W Platinum | 3-year | 07/17 |
| 7X04A01GCN | 1xXeon Gold 6130 16C/2.1GHz/22MB/125W/DDR4-2666 | 1x16GB RDIMM DDR4-2666 | 1x930-16i 4GB flash | 12x3.5" | 12x3.5" SATA/SAS HS | Open | 2xGbE RJ-45 LOM | None | x8 / x8 / x8, FHHL | None | None | TPM 1.2 | XClarity Standard | 1x750W Platinum | 3-year | 07/17 |
| 7X04A01JCN | 1xXeon Gold 5122 4C/3.6GHz/16.5MB/105W/DDR4-2400 | 1x16GB RDIMM DDR4-2666 | 1x930-16i 4GB flash | 12x3.5" | 12x3.5" SATA/SAS HS | Open | 2xGbE RJ-45 LOM | None | x8 / x8 / x8, FHHL | None | None | TPM 1.2 | XClarity Standard | 1x750W Platinum | 3-year | 07/17 |
| 7X04A01MCN | 1xXeon Gold 5120 14C/2.2GHz/19.25MB/105W/DDR4-2400 | 1x16GB RDIMM DDR4-2666 | 1x930-16i 4GB flash | 12x3.5" | 12x3.5" SATA/SAS HS | Open | 2xGbE RJ-45 LOM | None | x8 / x8 / x8, FHHL | None | None | TPM 1.2 | XClarity Standard | 1x750W Platinum | 3-year | 07/17 |
| 7X04A01PCN | 1xXeon Gold 5118 12C/2.3GHz/16.5MB/105W/DDR4-2400 | 1x16GB RDIMM DDR4-2666 | 1x930-16i 4GB flash | 12x3.5" | 12x3.5" SATA/SAS HS | Open | 2xGbE RJ-45 LOM | None | x8 / x8 / x8, FHHL | None | None | TPM 1.2 | XClarity Standard | 1x750W Platinum | 3-year | 07/17 |
| 7X04A02DCN | 1xXeon Bronze 3104 6C/1.7GHz/8.25MB/85W/DDR4-2133 | 1x16GB RDIMM DDR4-2666 | 1x930-16i 4GB flash | 12x3.5" | 12x3.5" SATA/SAS HS | Open | 2xGbE RJ-45 LOM | None | x8 / x8 / x8, FHHL | None | None | TPM 1.2 | XClarity Standard | 1x750W Platinum | 3-year | 07/17 |
| 7X04A02ECN | 1xXeon Silver 4110 8C/2.1GHz/11MB/85W/DDR4-2400 | 1x16GB RDIMM DDR4-2666 | 1x930-8i 2GB flash | 16x2.5" | 8x2.5" SATA/SAS HS | Open | 2xGbE RJ-45 LOM | None | x8 / x8 / x8, FHHL | None | None | TPM 1.2 | XClarity Standard | 1x750W Platinum | 3-year | 07/17 |
| 7X04A02FCN | 1xXeon Silver 4110 8C/2.1GHz/11MB/85W/DDR4-2400 | 1x16GB RDIMM DDR4-2666 | 1x930-16i 4GB flash | 12x3.5" | 12x3.5" SATA/SAS HS | Open | 2xGbE RJ-45 LOM | None | x8 / x8 / x8, FHHL | None | None | TPM 1.2 | XClarity Standard | 1x750W Platinum | 3-year | 07/17 |
| 7X04A02MCN | 1xXeon Silver 4112 4C/2.6GHz/8.25MB/85W/DDR4-2400 | 1x16GB RDIMM DDR4-2666 | 1x930-16i 4GB flash | 12x3.5" | 12x3.5" SATA/SAS HS | Open | 2xGbE RJ-45 LOM | None | x8 / x8 / x8, FHHL | None | None | TPM 1.2 | XClarity Standard | 1x750W Platinum | 3-year | 07/17 |
| 7X04A02NCN | 1xXeon Silver 4114 10C/2.2GHz/13.75MB/85W/DDR4-2400 | 1x16GB RDIMM DDR4-2666 | 1x930-16i 4GB flash | 12x3.5" | 12x3.5" SATA/SAS HS | Open | 2xGbE RJ-45 LOM | None | x8 / x8 / x8, FHHL | None | None | TPM 1.2 | XClarity Standard | 1x750W Platinum | 3-year | 07/17 |
| 7X04A02UCN | 1xXeon Bronze 3106 8C/1.7GHz/11MB/85W/DDR4-2133 | 1x16GB RDIMM DDR4-2666 | 1x930-16i 4GB flash | 12x3.5" | 12x3.5" SATA/SAS HS | Open | 2xGbE RJ-45 LOM | None | x8 / x8 / x8, FHHL | None | None | TPM 1.2 | XClarity Standard | 1x750W Platinum | 3-year | 07/17 |
| 7X04A02ZCN | 1xXeon Silver 4114 10C/2.2GHz/13.75MB/85W/DDR4-2400 | 1x16GB RDIMM DDR4-2666 | 1x930-8i 2GB flash | 16x2.5" | 8x2.5" SATA/SAS HS | Open | 2xGbE RJ-45 LOM | None | x8 / x8 / x8, FHHL | None | None | TPM 1.2 | XClarity Standard | 1x750W Platinum | 3-year | 07/17 |
| 7X04A030CN | 1xXeon Gold 5115 10C/2.4GHz/13.75MB/85W/DDR4-2400 | 1x16GB RDIMM DDR4-2666 | 1x930-16i 4GB flash | 12x3.5" | 12x3.5" SATA/SAS HS | Open | 2xGbE RJ-45 LOM | None | x8 / x8 / x8, FHHL | None | None | TPM 1.2 | XClarity Standard | 1x750W Platinum | 3-year | 07/17 |
| 7X04A032CN | 1xXeon Silver 4108 8C/1.8GHz/11MB/85W/DDR4-2400 | 1x16GB RDIMM DDR4-2666 | 1x930-16i 4GB flash | 12x3.5" | 12x3.5" SATA/SAS HS | Open | 2xGbE RJ-45 LOM | None | x8 / x8 / x8, FHHL | None | None | TPM 1.2 | XClarity Standard | 1x750W Platinum | 3-year | 07/17 |
| 7X04A038CN | 1xXeon Gold 5115 10C/2.4GHz/13.75MB/85W/DDR4-2400 | 1x16GB RDIMM DDR4-2666 | 1x930-8i 2GB flash | 16x2.5" | 8x2.5" SATA/SAS HS | Open | 2xGbE RJ-45 LOM | None | x8 / x8 / x8, FHHL | None | None | TPM 1.2 | XClarity Standard | 1x750W Platinum | 3-year | 07/17 |
| 7X04A03BCN | 1xXeon Bronze 3104 6C/1.7GHz/8.25MB/85W/DDR4-2133 | 1x16GB RDIMM DDR4-2666 | 1x930-8i 2GB flash | 16x2.5" | 8x2.5" SATA/SAS HS | Open | 2xGbE RJ-45 LOM | None | x8 / x8 / x8, FHHL | None | None | TPM 1.2 | XClarity Standard | 1x750W Platinum | 3-year | 07/17 |
| 7X04A03DCN | 1xXeon Silver 4112 4C/2.6GHz/8.25MB/85W/DDR4-2400 | 1x16GB RDIMM DDR4-2666 | 1x930-8i 2GB flash | 16x2.5" | 8x2.5" SATA/SAS HS | Open | 2xGbE RJ-45 LOM | None | x8 / x8 / x8, FHHL | None | None | TPM 1.2 | XClarity Standard | 1x750W Platinum | 3-year | 07/17 |
| 7X04A03FCN | 1xXeon Bronze 3106 8C/1.7GHz/11MB/85W/DDR4-2133 | 1x16GB RDIMM DDR4-2666 | 1x930-8i 2GB flash | 16x2.5" | 8x2.5" SATA/SAS HS | Open | 2xGbE RJ-45 LOM | None | x8 / x8 / x8, FHHL | None | None | TPM 1.2 | XClarity Standard | 1x750W Platinum | 3-year | 07/17 |
| 7X04A03JCN | 1xXeon Silver 4108 8C/1.8GHz/11MB/85W/DDR4-2400 | 1x16GB RDIMM DDR4-2666 | 1x930-8i 2GB flash | 16x2.5" | 8x2.5" SATA/SAS HS | Open | 2xGbE RJ-45 LOM | None | x8 / x8 / x8, FHHL | None | None | TPM 1.2 | XClarity Standard | 1x750W Platinum | 3-year | 07/17 |
| 7X04A03PCN | 1xXeon Silver 4116 12C/2.1GHz/16.5MB/85W/DDR4-2400 | 1x16GB RDIMM DDR4-2666 | 1x930-16i 4GB flash | 12x3.5" | 12x3.5" SATA/SAS HS | Open | 2xGbE RJ-45 LOM | None | x8 / x8 / x8, FHHL | None | None | TPM 1.2 | XClarity Standard | 1x750W Platinum | 3-year | 07/17 |
| 7X04A03UCN | 1xXeon Silver 4116 12C/2.1GHz/16.5MB/85W/DDR4-2400 | 1x16GB RDIMM DDR4-2666 | 1x930-8i 2GB flash | 16x2.5" | 8x2.5" SATA/SAS HS | Open | 2xGbE RJ-45 LOM | None | x8 / x8 / x8, FHHL | None | None | TPM 1.2 | XClarity Standard | 1x750W Platinum | 3-year | 07/17 |

ThinkSystem SR550 Models for India - Non TopSeller

Product Specifications Reference (PSREF)

| Model | Processor | Memory | RAID/HBA Adapter | Chassis | Disk Bays | Disks | Networking (LOM/ML2/PCIe) | M.2 Boot Drive | Riser Card 1 for Slot 1-3 | Riser Card 2 for Slot 5-6 | Front VGA | Security | System Management | Power Supply | Base Warranty | Ann Date (mm/yy) |
|------------|---|---------------------------|------------------------|---------|-------------------------|-------|---------------------------|----------------|---------------------------|---------------------------|-----------|----------|-------------------|-----------------|---------------|------------------|
| 7X04A00USG | 1xXeon Gold 5118 12C/2.3GHz/ 16.5MB/105W/DDR4-2400 | 1x8GB RDIMM DDR4-2666 | Onboard SATA | 12x3.5" | 8x3.5" SATA SS | Open | 2xGbE RJ-45 LOM | None | None | None | None | TPM 1.2 | XClarity Standard | 1x550W Platinum | 3-year | 07/17 |
| 7X04A00YSG | 1xXeon Gold 5118 12C/2.3GHz/ 16.5MB/105W/DDR4-2400 | 1x8GB RDIMM DDR4-2666 | 1x530-8i | 16x2.5" | 8x2.5" SATA/ SAS HS | Open | 2xGbE RJ-45 LOM | None | None | None | None | TPM 1.2 | XClarity Standard | 1x550W Platinum | 3-year | 07/17 |
| 7X04A00ZSG | 1xXeon Gold 6130 16C/2.1GHz/ 22MB/125W/DDR4-2666 | 1x16GB RDIMM DDR4-2666 | 1x930-8i 2GB flash | 16x2.5" | 8x2.5" SATA/ SAS HS | Open | 2xGbE RJ-45 LOM | None | None | None | None | TPM 1.2 | XClarity Standard | 1x750W Platinum | 3-year | 07/17 |
| 7X04A010SG | 1xXeon Gold 5118 12C/2.3GHz/ 16.5MB/105W/DDR4-2400 | 1x16GB RDIMM DDR4-2666 | 1x530-8i | 12x3.5" | 8x3.5" SATA/ SAS HS | Open | 2xGbE RJ-45 LOM | None | None | None | None | TPM 1.2 | XClarity Standard | 1x550W Platinum | 3-year | 07/17 |
| 7X04A011SG | 1xXeon Gold 5118 12C/2.3GHz/ 16.5MB/105W/DDR4-2400 | 1x8GB RDIMM DDR4-2666 | 1x530-8i | 12x3.5" | 8x3.5" SATA/ SAS HS | Open | 2xGbE RJ-45 LOM | None | None | None | None | TPM 1.2 | XClarity Standard | 1x550W Platinum | 3-year | 07/17 |
| 7X04A012SG | 1xXeon Gold 5118 12C/2.3GHz/ 16.5MB/105W/DDR4-2400 | 1x8GB RDIMM DDR4-2666 | 1x930-8i 2GB flash | 12x3.5" | 8x3.5" SATA/ SAS HS | Open | 2xGbE RJ-45 LOM | None | None | None | None | TPM 1.2 | XClarity Standard | 1x550W Platinum | 3-year | 07/17 |
| 7X04A013SG | 1xXeon Gold 5120 14C/2.2GHz/ 19.25MB/105W/DDR4-2400 | 1x16GB RDIMM DDR4-2666 | 1x530-8i | 16x2.5" | 8x2.5" SATA/ SAS HS | Open | 2xGbE RJ-45 LOM | None | None | None | None | TPM 1.2 | XClarity Standard | 1x550W Platinum | 3-year | 07/17 |
| 7X04A014SG | 1xXeon Gold 5118 12C/2.3GHz/ 16.5MB/105W/DDR4-2400 | 1x8GB RDIMM DDR4-2666 | 1x930-16i 4GB flash | 12x3.5" | 12x3.5" SATA/ SAS HS | Open | 2xGbE RJ-45 LOM | None | None | None | None | TPM 1.2 | XClarity Standard | 1x550W Platinum | 3-year | 07/17 |
| 7X04A015SG | 1xXeon Gold 6138 20C/2.0GHz/ 27.5MB/125W/DDR4-2666 | 1x16GB RDIMM DDR4-2666 | 1x930-8i 2GB flash | 16x2.5" | 8x2.5" SATA/ SAS HS | Open | 2xGbE RJ-45 LOM | None | None | None | None | TPM 1.2 | XClarity Standard | 1x750W Platinum | 3-year | 07/17 |
| 7X04A01KSG | 1xXeon Gold 6138 20C/2.0GHz/ 27.5MB/125W/DDR4-2666 | 1x16GB RDIMM DDR4-2666 | 1x930-8i 2GB flash | 16x2.5" | 8x2.5" SATA/ SAS HS | Open | 2xGbE RJ-45 LOM | None | None | None | None | TPM 1.2 | XClarity Standard | 1x550W Platinum | 3-year | 07/17 |
| 7X04A01NSG | 1xXeon Gold 5122 4C/3.6GHz/ 16.5MB/105W/DDR4-2400 | 1x16GB RDIMM DDR4-2666 | 1x930-8i 2GB flash | 16x2.5" | 8x2.5" SATA/ SAS HS | Open | 2xGbE RJ-45 LOM | None | None | None | None | TPM 1.2 | XClarity Standard | 1x750W Platinum | 3-year | 07/17 |
| 7X04A01QSG | 1xXeon Gold 5120 14C/2.2GHz/ 19.25MB/105W/DDR4-2400 | 1x16GB RDIMM DDR4-2666 | 1x930-8i 2GB flash | 16x2.5" | 8x2.5" SATA/ SAS HS | Open | 2xGbE RJ-45 LOM | None | None | None | None | TPM 1.2 | XClarity Standard | 1x750W Platinum | 3-year | 07/17 |
| 7X04A01RSG | 1xXeon Gold 6126 12C/2.6GHz/ 19.25MB/125W/DDR4-2666 | 1x16GB RDIMM DDR4-2666 | 1x930-8i 2GB flash | 16x2.5" | 8x2.5" SATA/ SAS HS | Open | 2xGbE RJ-45 LOM | None | None | None | None | TPM 1.2 | XClarity Standard | 1x750W Platinum | 3-year | 07/17 |
| 7X04A01SSG | 1xXeon Gold 5120 14C/2.2GHz/ 19.25MB/105W/DDR4-2400 | 1x16GB RDIMM DDR4-2666 | 1x930-8i 2GB flash | 16x2.5" | 8x2.5" SATA/ SAS HS | Open | 2xGbE RJ-45 LOM | None | None | None | None | TPM 1.2 | XClarity Standard | 1x550W Platinum | 3-year | 07/17 |
| 7X04A01TSG | 1xXeon Gold 5122 4C/3.6GHz/ 16.5MB/105W/DDR4-2400 | 1x16GB RDIMM DDR4-2666 | 1x930-8i 2GB flash | 16x2.5" | 8x2.5" SATA/ SAS HS | Open | 2xGbE RJ-45 LOM | None | None | None | None | TPM 1.2 | XClarity Standard | 1x550W Platinum | 3-year | 07/17 |
| 7X04A01USG | 1xXeon Gold 6126 12C/2.6GHz/ 19.25MB/125W/DDR4-2666 | 1x16GB RDIMM DDR4-2666 | 1x930-8i 2GB flash | 16x2.5" | 8x2.5" SATA/ SAS HS | Open | 2xGbE RJ-45 LOM | None | None | None | None | TPM 1.2 | XClarity Standard | 1x550W Platinum | 3-year | 07/17 |
| 7X04A01VSG | 1xXeon Gold 6130 16C/2.1GHz/ 22MB/125W/DDR4-2666 | 1x16GB RDIMM DDR4-2666 | 1x930-8i 2GB flash | 16x2.5" | 8x2.5" SATA/ SAS HS | Open | 2xGbE RJ-45 LOM | None | None | None | None | TPM 1.2 | XClarity Standard | 1x550W Platinum | 3-year | 07/17 |

ThinkSystem SR550 Models for Japan - TopSeller

Product Specifications Reference (PSREF)

| Model | Processor | Memory | RAID/HBA Adapter | Chassis | Disk Bays | Disks | Networking (LOM/ML2/PCIe) | M.2 Boot Drive | Riser Card 1 for Slot 1-3 | Riser Card 2 for Slot 5-6 | Front VGA | Security | System Management | Power Supply | Base Warranty | Ann Date (mm/yy) |
|------------|--|--------------------------|-----------------------|---------|------------------------|-------|---------------------------|----------------|---------------------------|---------------------------|-----------|----------|----------------------|--------------------|---------------|------------------|
| 7X04A04EJP | 1xXeon Silver 4112 4C/2.6GHz/ 8.25MB/85W/DDR4-2400 | 1x8GB RDIMM DDR4-2666 | 1x930-8i 2GB flash | 16x2.5" | 8x2.5" SATA/ SAS HS | Open | None | None | x8 / x8 / x8, FHHL | None | None | TPM 1.2 | XClarity Advanced | 1x550W Platinum | 3-year | 07/17 |
| 7X04A04FJP | 1xXeon Silver 4110 8C/2.1GHz/ 11MB/85W/DDR4-2400 | 1x8GB RDIMM DDR4-2666 | 1x930-8i 2GB flash | 16x2.5" | 8x2.5" SATA/ SAS HS | Open | None | None | x8 / x8 / x8, FHHL | None | None | TPM 1.2 | XClarity Advanced | 1x550W Platinum | 3-year | 07/17 |
| 7X04A04GJP | 1xXeon Bronze 3106 8C/1.7GHz/ 11MB/85W/DDR4-2133 | 1x8GB RDIMM DDR4-2666 | 1x930-8i 2GB flash | 16x2.5" | 8x2.5" SATA/ SAS HS | Open | None | None | x8 / x8 / x8, FHHL | None | None | TPM 1.2 | XClarity Advanced | 1x550W Platinum | 3-year | 07/17 |
| 7X04A04HJP | 1xXeon Bronze 3104 6C/1.7GHz/ 8.25MB/85W/DDR4-2133 | 1x8GB RDIMM DDR4-2666 | 1x930-8i 2GB flash | 12x3.5" | 8x3.5" SATA/ SAS HS | Open | None | None | x8 / x8 / x8, FHHL | None | None | TPM 1.2 | XClarity Advanced | 1x550W Platinum | 3-year | 07/17 |
| 7X04A04JJP | 1xXeon Bronze 3104 6C/1.7GHz/ 8.25MB/85W/DDR4-2133 | 1x8GB RDIMM DDR4-2666 | 1x930-8i 2GB flash | 16x2.5" | 8x2.5" SATA/ SAS HS | Open | None | None | x8 / x8 / x8, FHHL | None | None | TPM 1.2 | XClarity Advanced | 1x550W Platinum | 3-year | 07/17 |

ThinkSystem SR550 Models for Japan - Non TopSeller

Product Specifications Reference (PSREF)

| Model | Processor | Memory | RAID/HBA Adapter | Chassis | Disk Bays | Disks | Networking (LOM/ML2/PCIe) | M.2 Boot Drive | Riser Card 1 for Slot 1-3 | Riser Card 2 for Slot 5-6 | Front VGA | Security | System Management | Power Supply | Base Warranty | Ann Date (mm/yy) |
|------------|--|--------------------------|-----------------------|---------|------------------------|-------|---------------------------|----------------|---------------------------|---------------------------|-----------|----------|----------------------|--------------------|---------------|------------------|
| 7X04A04CJP | 1xXeon Gold 5122 4C/3.6GHz/ 16.5MB/105W/DDR4-2400 | 1x8GB RDIMM DDR4-2666 | 1x930-8i 2GB flash | 16x2.5" | 8x2.5" SATA/ SAS HS | Open | None | None | x8 / x8 / x8, FHHL | None | None | TPM 1.2 | XClarity Advanced | 1x750W Platinum | 3-year | 07/17 |
| 7X04A04DJP | 1xXeon Gold 6138 20C/2.0GHz/ 27.5MB/125W/DDR4-2666 | 1x8GB RDIMM DDR4-2666 | 1x930-8i 2GB flash | 16x2.5" | 8x2.5" SATA/ SAS HS | Open | None | None | x8 / x8 / x8, FHHL | None | None | TPM 1.2 | XClarity Advanced | 1x750W Platinum | 3-year | 07/17 |

ThinkSystem SR550 Models for Latin America - TopSeller

Product Specifications Reference (PSREF)

| Model | Processor | Memory | RAID/HBA Adapter | Chassis | Disk Bays | Disks | Networking (LOM/ML2/PCIe) | M.2 Boot Drive | Riser Card 1 for Slot 1-3 | Riser Card 2 for Slot 5-6 | Front VGA | Security | System Management | Power Supply | Base Warranty | Ann Date (mm/yy) |
|------------|--|---------------------------|------------------|---------|------------------------|----------------------------------|---------------------------|----------------|---------------------------|---------------------------|--------------|----------|----------------------|--------------------|---------------|------------------|
| 7X04A04LLA | 1xXeon Silver 4110 8C/2.1GHz/ 11MB/85W/DDR4-2400 | 2x16GB RDIMM DDR4-2666 | 1x530-8i | 12x3.5" | 8x3.5" SATA/ SAS HS | Open | None | None | x8 / x8 / x8, FHHL | None | Front VGA | TPM 1.2 | XClarity Advanced | 2x750W Platinum | 3-year | 07/17 |
| 7X04A04MLA | 1xXeon Silver 4108 8C/1.8GHz/ 11MB/85W/DDR4-2400 | 2x16GB RDIMM DDR4-2666 | 1x530-8i | 12x3.5" | 8x3.5" SATA/ SAS HS | Open | None | None | x8 / x8 / x8, FHHL | None | Front VGA | TPM 1.2 | XClarity Advanced | 2x750W Platinum | 3-year | 07/17 |
| 7X04A04QLA | 1xXeon Silver 4108 8C/1.8GHz/ 11MB/85W/DDR4-2400 | 2x16GB RDIMM DDR4-2666 | 1x530-8i | 12x3.5" | 8x3.5" SATA/ SAS HS | Open | None | None | x8 / x8 / x8, FHHL | None | Front VGA | TPM 1.2 | XClarity Advanced | 2x750W Platinum | 3-year | 07/17 |
| 7X04A04WLA | 1xXeon Silver 4108 8C/1.8GHz/ 11MB/85W/DDR4-2400 | 2x16GB RDIMM DDR4-2666 | 1x530-8i | 12x3.5" | 8x3.5" SATA/ SAS HS | Open | None | None | x8 / x8 / x8, FHHL | None | Front VGA | TPM 1.2 | XClarity Advanced | 2x750W Platinum | 3-year | 07/17 |
| 7X04A04XLA | 1xXeon Silver 4110 8C/2.1GHz/ 11MB/85W/DDR4-2400 | 1x16GB RDIMM DDR4-2666 | 1x530-8i | 12x3.5" | 8x3.5" SATA/ SAS HS | 2x2TB HDD 7.2K 3.5" SAS12Gbps | None | None | x8 / x8 / x8, FHHL | None | Front VGA | TPM 1.2 | XClarity Advanced | 2x750W Platinum | 3-year | 07/17 |
| 7X04A050LA | 1xXeon Bronze 3104 6C/1.7GHz/ 8.25MB/85W/DDR4-2133 | 1x8GB RDIMM DDR4-2666 | 1x530-8i | 16x2.5" | 8x2.5" SATA/ SAS HS | Open | None | None | x8 / x8 / x8, FHHL | None | Front VGA | TPM 1.2 | XClarity Standard | 1x750W Platinum | 3-year | 07/17 |
| 7X04A052LA | 1xXeon Bronze 3106 8C/1.7GHz/ 11MB/85W/DDR4-2133 | 1x8GB RDIMM DDR4-2666 | 1x530-8i | 16x2.5" | 8x2.5" SATA/ SAS HS | Open | None | None | x8 / x8 / x8, FHHL | None | Front VGA | TPM 1.2 | XClarity Standard | 1x750W Platinum | 3-year | 07/17 |
| 7X04A058LA | 1xXeon Gold 5115 10C/2.4GHz/ 13.75MB/85W/DDR4-2400 | 1x16GB RDIMM DDR4-2666 | 1x530-8i | 12x3.5" | 8x3.5" SATA/ SAS HS | 2x2TB HDD 7.2K 3.5" SAS12Gbps | None | None | x8 / x8 / x8, FHHL | None | Front VGA | TPM 1.2 | XClarity Advanced | 2x750W Platinum | 3-year | 07/17 |
| 7X04A059LA | 1xXeon Silver 4110 8C/2.1GHz/ 11MB/85W/DDR4-2400 | 1x16GB RDIMM DDR4-2666 | 1x530-8i | 12x3.5" | 8x3.5" SATA/ SAS HS | Open | None | None | x8 / x8 / x8, FHHL | None | Front VGA | TPM 1.2 | XClarity Advanced | 2x750W Platinum | 3-year | 07/17 |
| 7X04A05DLA | 1xXeon Bronze 3106 8C/1.7GHz/ 11MB/85W/DDR4-2133 | 1x8GB RDIMM DDR4-2666 | 1x530-8i | 12x3.5" | 8x3.5" SATA/ SAS HS | Open | None | None | x8 / x8 / x8, FHHL | None | Front VGA | TPM 1.2 | XClarity Standard | 1x750W Platinum | 3-year | 07/17 |
| 7X04A05FLA | 1xXeon Bronze 3104 6C/1.7GHz/ 8.25MB/85W/DDR4-2133 | 1x8GB RDIMM DDR4-2666 | 1x530-8i | 12x3.5" | 8x3.5" SATA/ SAS HS | Open | None | None | x8 / x8 / x8, FHHL | None | Front VGA | TPM 1.2 | XClarity Standard | 1x750W Platinum | 3-year | 07/17 |

ThinkSystem SR550 Models for Latin America - Non TopSeller

Product Specifications Reference (PSREF)

| Model | Processor | Memory | RAID/HBA Adapter | Chassis | Disk Bays | Disks | Networking (LOM/ML2/PCIe) | M.2 Boot Drive | Riser Card 1 for Slot 1-3 | Riser Card 2 for Slot 5-6 | Front VGA | Security | System Management | Power Supply | Base Warranty | Ann Date (mm/yy) |
|------------|--|--------------------------|-----------------------|---------|------------------------|-------|---------------------------|----------------|---------------------------|---------------------------|--------------|----------|----------------------|--------------------|---------------|------------------|
| 7X04A02CLA | 1xXeon Gold 5118 12C/2.3GHz/ 16.5MB/105W/DDR4-2400 | 1x8GB RDIMM DDR4-2666 | 1x930-8i 2GB flash | 16x2.5" | 8x2.5" SATA/ SAS HS | Open | None | None | x8 / x8 / x8, FHHL | None | Front VGA | TPM 1.2 | XClarity Standard | 1x750W Platinum | 3-year | 07/17 |
| 7X04A02LLA | 1xXeon Gold 6130 16C/2.1GHz/ 22MB/125W/DDR4-2666 | 1x8GB RDIMM DDR4-2666 | 1x930-8i 2GB flash | 12x3.5" | 8x3.5" SATA/ SAS HS | Open | None | None | x8 / x8 / x8, FHHL | None | Front VGA | TPM 1.2 | XClarity Standard | 1x750W Platinum | 3-year | 07/17 |
| 7X04A02PLA | 1xXeon Gold 5118 12C/2.3GHz/ 16.5MB/105W/DDR4-2400 | 1x8GB RDIMM DDR4-2666 | 1x530-8i | 16x2.5" | 8x2.5" SATA/ SAS HS | Open | None | None | x8 / x8 / x8, FHHL | None | Front VGA | TPM 1.2 | XClarity Standard | 1x750W Platinum | 3-year | 07/17 |
| 7X04A036LA | 1xXeon Gold 6130 16C/2.1GHz/ 22MB/125W/DDR4-2666 | 1x8GB RDIMM DDR4-2666 | 1x930-8i 2GB flash | 16x2.5" | 8x2.5" SATA/ SAS HS | Open | None | None | x8 / x8 / x8, FHHL | None | Front VGA | TPM 1.2 | XClarity Standard | 1x750W Platinum | 3-year | 07/17 |
| 7X04A03LLA | 1xXeon Gold 6130 16C/2.1GHz/ 22MB/125W/DDR4-2666 | 1x8GB RDIMM DDR4-2666 | 1x530-8i | 16x2.5" | 8x2.5" SATA/ SAS HS | Open | None | None | x8 / x8 / x8, FHHL | None | Front VGA | TPM 1.2 | XClarity Standard | 1x750W Platinum | 3-year | 07/17 |
| 7X04A03MLA | 1xXeon Gold 5118 12C/2.3GHz/ 16.5MB/105W/DDR4-2400 | 1x8GB RDIMM DDR4-2666 | 1x930-8i 2GB flash | 12x3.5" | 8x3.5" SATA/ SAS HS | Open | None | None | x8 / x8 / x8, FHHL | None | Front VGA | TPM 1.2 | XClarity Standard | 1x750W Platinum | 3-year | 07/17 |
| 7X04A03NLA | 1xXeon Gold 5120 14C/2.2GHz/ 19.25MB/105W/DDR4-2400 | 1x8GB RDIMM DDR4-2666 | 1x930-8i 2GB flash | 16x2.5" | 8x2.5" SATA/ SAS HS | Open | None | None | x8 / x8 / x8, FHHL | None | Front VGA | TPM 1.2 | XClarity Standard | 1x750W Platinum | 3-year | 07/17 |
| 7X04A03XLA | 1xXeon Gold 5120 14C/2.2GHz/ 19.25MB/105W/DDR4-2400 | 1x8GB RDIMM DDR4-2666 | 1x530-8i | 16x2.5" | 8x2.5" SATA/ SAS HS | Open | None | None | x8 / x8 / x8, FHHL | None | Front VGA | TPM 1.2 | XClarity Standard | 1x750W Platinum | 3-year | 07/17 |
| 7X04A03YLA | 1xXeon Gold 5120 14C/2.2GHz/ 19.25MB/105W/DDR4-2400 | 1x8GB RDIMM DDR4-2666 | 1x930-8i 2GB flash | 12x3.5" | 8x3.5" SATA/ SAS HS | Open | None | None | x8 / x8 / x8, FHHL | None | Front VGA | TPM 1.2 | XClarity Standard | 1x750W Platinum | 3-year | 07/17 |
| 7X04A054LA | 1xXeon Silver 4108 8C/1.8GHz/ 11MB/85W/DDR4-2400 | 1x8GB RDIMM DDR4-2666 | 1x930-8i 2GB flash | 16x2.5" | 8x2.5" SATA/ SAS HS | Open | None | None | x8 / x8 / x8, FHHL | None | Front VGA | TPM 1.2 | XClarity Standard | 1x750W Platinum | 3-year | 07/17 |
| 7X04A05CLA | 1xXeon Silver 4116 12C/2.1GHz/ 16.5MB/85W/DDR4-2400 | 1x8GB RDIMM DDR4-2666 | 1x930-8i 2GB flash | 16x2.5" | 8x2.5" SATA/ SAS HS | Open | None | None | x8 / x8 / x8, FHHL | None | Front VGA | TPM 1.2 | XClarity Standard | 1x750W Platinum | 3-year | 07/17 |
| 7X04A05ELA | 1xXeon Gold 5115 10C/2.4GHz/ 13.75MB/85W/DDR4-2400 | 1x8GB RDIMM DDR4-2666 | 1x930-8i 2GB flash | 16x2.5" | 8x2.5" SATA/ SAS HS | Open | None | None | x8 / x8 / x8, FHHL | None | Front VGA | TPM 1.2 | XClarity Standard | 1x750W Platinum | 3-year | 07/17 |
| 7X04A05GLA | 1xXeon Silver 4110 8C/2.1GHz/ 11MB/85W/DDR4-2400 | 1x8GB RDIMM DDR4-2666 | 1x930-8i 2GB flash | 16x2.5" | 8x2.5" SATA/ SAS HS | Open | None | None | x8 / x8 / x8, FHHL | None | Front VGA | TPM 1.2 | XClarity Standard | 1x750W Platinum | 3-year | 07/17 |
| 7X04A05HLA | 1xXeon Silver 4114 10C/2.2GHz/ 13.75MB/85W/DDR4-2400 | 1x8GB RDIMM DDR4-2666 | 1x930-8i 2GB flash | 16x2.5" | 8x2.5" SATA/ SAS HS | Open | None | None | x8 / x8 / x8, FHHL | None | Front VGA | TPM 1.2 | XClarity Standard | 1x750W Platinum | 3-year | 07/17 |

ThinkSystem SR550 Models for Brazil - Non TopSeller

Product Specifications Reference (PSREF)

| Model | Processor | Memory | RAID/HBA Adapter | Chassis | Disk Bays | Disks | Networking (LOM/ML2/PCIe) | M.2 Boot Drive | Riser Card 1 for Slot 1-3 | Riser Card 2 for Slot 5-6 | Front VGA | Security | System Management | Power Supply | Base Warranty | Ann Date (mm/yy) |
|------------|---|---------------------------|------------------|---------|------------------------|-------|---------------------------|----------------|---------------------------|---------------------------|--------------|----------|----------------------|--------------------|---------------|------------------|
| 7X04A063BR | 1xXeon Gold 5118 12C/2.3GHz/ 16.5MB/105W/DDR4-2400 | 1x16GB RDIMM DDR4-2666 | 1x530-8i | 16x2.5" | 8x2.5" SATA/ SAS HS | Open | None | None | x8 / x8 / x8, FHHL | None | Front VGA | TPM 1.2 | XClarity Standard | 1x750W Platinum | 3-year | 07/17 |
| 7X04A064BR | 1xXeon Gold 5120 14C/2.2GHz/ 19.25MB/105W/DDR4-2400 | 1x16GB RDIMM DDR4-2666 | 1x530-8i | 16x2.5" | 8x2.5" SATA/ SAS HS | Open | None | None | x8 / x8 / x8, FHHL | None | Front VGA | TPM 1.2 | XClarity Standard | 1x750W Platinum | 3-year | 07/17 |
| 7X04A065BR | 1xXeon Gold 6130 16C/2.1GHz/ 22MB/125W/DDR4-2666 | 1x16GB RDIMM DDR4-2666 | 1x530-8i | 16x2.5" | 8x2.5" SATA/ SAS HS | Open | None | None | x8 / x8 / x8, FHHL | None | Front VGA | TPM 1.2 | XClarity Standard | 1x750W Platinum | 3-year | 07/17 |
| 7X04A066BR | 1xXeon Gold 5118 12C/2.3GHz/ 16.5MB/105W/DDR4-2400 | 1x16GB RDIMM DDR4-2666 | 1x530-8i | 16x2.5" | 8x2.5" SATA/ SAS HS | Open | None | None | x8 / x8 / x8, FHHL | None | Front VGA | TPM 1.2 | XClarity Standard | 1x750W Platinum | 3-year | 07/17 |
| 7X04A067BR | 1xXeon Gold 5120 14C/2.2GHz/ 19.25MB/105W/DDR4-2400 | 1x16GB RDIMM DDR4-2666 | 1x530-8i | 16x2.5" | 8x2.5" SATA/ SAS HS | Open | None | None | x8 / x8 / x8, FHHL | None | Front VGA | TPM 1.2 | XClarity Standard | 1x750W Platinum | 3-year | 07/17 |
| 7X04A068BR | 1xXeon Gold 6130 16C/2.1GHz/ 22MB/125W/DDR4-2666 | 1x16GB RDIMM DDR4-2666 | 1x530-8i | 16x2.5" | 8x2.5" SATA/ SAS HS | Open | None | None | x8 / x8 / x8, FHHL | None | Front VGA | TPM 1.2 | XClarity Standard | 1x750W Platinum | 3-year | 07/17 |
| 7X04A069BR | 1xXeon Gold 5118 12C/2.3GHz/ 16.5MB/105W/DDR4-2400 | 1x16GB RDIMM DDR4-2666 | 1x530-8i | 12x3.5" | 8x3.5" SATA/ SAS HS | Open | None | None | x8 / x8 / x8, FHHL | None | Front VGA | TPM 1.2 | XClarity Standard | 1x750W Platinum | 3-year | 07/17 |
| 7X04A06ABR | 1xXeon Gold 5120 14C/2.2GHz/ 19.25MB/105W/DDR4-2400 | 1x16GB RDIMM DDR4-2666 | 1x530-8i | 12x3.5" | 8x3.5" SATA/ SAS HS | Open | None | None | x8 / x8 / x8, FHHL | None | Front VGA | TPM 1.2 | XClarity Standard | 1x750W Platinum | 3-year | 07/17 |
| 7X04A06BBR | 1xXeon Gold 6130 16C/2.1GHz/ 22MB/125W/DDR4-2666 | 1x16GB RDIMM DDR4-2666 | 1x530-8i | 12x3.5" | 8x3.5" SATA/ SAS HS | Open | None | None | x8 / x8 / x8, FHHL | None | Front VGA | TPM 1.2 | XClarity Standard | 1x750W Platinum | 3-year | 07/17 |
| 7X04A06CBR | 1xXeon Gold 5118 12C/2.3GHz/ 16.5MB/105W/DDR4-2400 | 1x32GB RDIMM DDR4-2666 | 1x530-8i | 12x3.5" | 8x3.5" SATA/ SAS HS | Open | None | None | x8 / x8 / x8, FHHL | None | Front VGA | TPM 1.2 | XClarity Standard | 1x750W Platinum | 3-year | 07/17 |
| 7X04A06DBR | 1xXeon Gold 5120 14C/2.2GHz/ 19.25MB/105W/DDR4-2400 | 1x32GB RDIMM DDR4-2666 | 1x530-8i | 12x3.5" | 8x3.5" SATA/ SAS HS | Open | None | None | x8 / x8 / x8, FHHL | None | Front VGA | TPM 1.2 | XClarity Standard | 1x750W Platinum | 3-year | 07/17 |
| 7X04A06EBR | 1xXeon Gold 6130 16C/2.1GHz/ 22MB/125W/DDR4-2666 | 1x32GB RDIMM DDR4-2666 | 1x530-8i | 12x3.5" | 8x3.5" SATA/ SAS HS | Open | None | None | x8 / x8 / x8, FHHL | None | Front VGA | TPM 1.2 | XClarity Standard | 1x750W Platinum | 3-year | 07/17 |



ThinkSystem SR630 Platform Specifications

Product Specifications Reference (PSREF)

| Components | Specification | | | | | | | | | | | | | | | | | | | | | | | | | | | | | | | | | | | | | | | | | | | | | | | | | | | | | | | | | | | | | | | | | | | | | | | | | | | | | | | | | | | | | | | | | | |
|---|---|---|-----------------------------------|------------------|-------------|-------|------------------|------------------|----------|---------|--------|------------|----------|-------------|-----|------|------|-----|---|--------|------------|----------|-------------|-----|-----|------|----|---|--------|------------|----------|------------------|-----|-----|--------------|-----|---|---------|------------|----------|------------------|-----|-----|--------------|-----|---|--------|------------|----------|---|-----|------|------|---|---|---------|------------|----------|---|-----|------|------|---|---|--------|------------|----------|------------------|-----|-----|--------------|-----|---|--------|------------|----------|---|-----|------|------|---|---|---------|------------|----------|---|-----|------|------|---|---|
| Form factor | 1U rack | | | | | | | | | | | | | | | | | | | | | | | | | | | | | | | | | | | | | | | | | | | | | | | | | | | | | | | | | | | | | | | | | | | | | | | | | | | | | | | | | | | | | | | | | | |
| Dimensions | Height: 43 mm (1.7 in). Width: 482 mm (19.0 in) with rack latches. Depth: 778.3 mm (30.64 in) | | | | | | | | | | | | | | | | | | | | | | | | | | | | | | | | | | | | | | | | | | | | | | | | | | | | | | | | | | | | | | | | | | | | | | | | | | | | | | | | | | | | | | | | | | |
| Weight | Maximum configuration: 41.9 lb (19 kg) | | | | | | | | | | | | | | | | | | | | | | | | | | | | | | | | | | | | | | | | | | | | | | | | | | | | | | | | | | | | | | | | | | | | | | | | | | | | | | | | | | | | | | | | | | |
| Processor | Up to two 205W Intel Xeon Scalable family processors, Bronze, Silver, Gold, or Platinum. Up to 28 cores at 2.5GHz, up to 3.6GHz with 4 cores. Two processors are connected with two UPI (Ultra Path Interconnect) links up to 10.4GT/s | | | | | | | | | | | | | | | | | | | | | | | | | | | | | | | | | | | | | | | | | | | | | | | | | | | | | | | | | | | | | | | | | | | | | | | | | | | | | | | | | | | | | | | | | | |
| Chipset | Intel C624 Platform Controller Hub | | | | | | | | | | | | | | | | | | | | | | | | | | | | | | | | | | | | | | | | | | | | | | | | | | | | | | | | | | | | | | | | | | | | | | | | | | | | | | | | | | | | | | | | | | |
| Memory | Up to 24 DIMM sockets. Each processor supports up to 12 DIMM sockets with 6 channels. DDR4-2666. RDIMMs, LRDIMMs, 3DS RDIMMs are supported, but memory types cannot be intermixed. 3DS RDIMM is planned to available later | | | | | | | | | | | | | | | | | | | | | | | | | | | | | | | | | | | | | | | | | | | | | | | | | | | | | | | | | | | | | | | | | | | | | | | | | | | | | | | | | | | | | | | | | | |
| Memory capacity | Up to 768GB with 24 x 32 GB RDIMMs and two processors. Or up to 1.5TB with 24 x 64 GB LRDIMMs and two processors. Or up to 3TB with 24 x 128 GB 3DS LRDIMMs and two -M suffix processors. -M suffix processor supports 1.5TB memory per socket, non -M suffix processor supports 768GB memory per socket | | | | | | | | | | | | | | | | | | | | | | | | | | | | | | | | | | | | | | | | | | | | | | | | | | | | | | | | | | | | | | | | | | | | | | | | | | | | | | | | | | | | | | | | | | |
| Memory protection | ECC, memory mirroring, and memory sparing | | | | | | | | | | | | | | | | | | | | | | | | | | | | | | | | | | | | | | | | | | | | | | | | | | | | | | | | | | | | | | | | | | | | | | | | | | | | | | | | | | | | | | | | | | |
| Storage controllers | One dedicated internal RAID slot for most RAID/HBA adapters. Supports the following RAID/HBA adapters: | | | | | | | | | | | | | | | | | | | | | | | | | | | | | | | | | | | | | | | | | | | | | | | | | | | | | | | | | | | | | | | | | | | | | | | | | | | | | | | | | | | | | | | | | | |
| | <table border="1"> <thead> <tr> <th>Feature</th> <th>Interface</th> <th>Drive type</th> <th>RAID levels</th> <th>JBOD</th> <th>Cache</th> <th>Cache protection</th> <th>FastPath</th> <th>Max qty</th> </tr> </thead> <tbody> <tr> <td>530-8i</td> <td>12Gbps SAS</td> <td>SATA/SAS</td> <td>0/1/10/5/50</td> <td>Yes</td> <td>None</td> <td>None</td> <td>Yes</td> <td>1</td> </tr> <tr> <td>730-8i</td> <td>12Gbps SAS</td> <td>SATA/SAS</td> <td>0/1/10/5/50</td> <td>Yes</td> <td>1GB</td> <td>None</td> <td>No</td> <td>1</td> </tr> <tr> <td>930-8i</td> <td>12Gbps SAS</td> <td>SATA/SAS</td> <td>0/1/10/5/50/6/60</td> <td>Yes</td> <td>2GB</td> <td>Flash backup</td> <td>Yes</td> <td>1</td> </tr> <tr> <td>930-16i</td> <td>12Gbps SAS</td> <td>SATA/SAS</td> <td>0/1/10/5/50/6/60</td> <td>Yes</td> <td>4GB</td> <td>Flash backup</td> <td>Yes</td> <td>1</td> </tr> <tr> <td>430-8i</td> <td>12Gbps SAS</td> <td>SATA/SAS</td> <td>-</td> <td>Yes</td> <td>None</td> <td>None</td> <td>-</td> <td>1</td> </tr> <tr> <td>430-16i</td> <td>12Gbps SAS</td> <td>SATA/SAS</td> <td>-</td> <td>Yes</td> <td>None</td> <td>None</td> <td>-</td> <td>1</td> </tr> <tr> <td>930-8e</td> <td>12Gbps SAS</td> <td>SATA/SAS</td> <td>0/1/10/5/50/6/60</td> <td>Yes</td> <td>4GB</td> <td>Flash backup</td> <td>Yes</td> <td>2</td> </tr> <tr> <td>430-8e</td> <td>12Gbps SAS</td> <td>SATA/SAS</td> <td>-</td> <td>Yes</td> <td>None</td> <td>None</td> <td>-</td> <td>2</td> </tr> <tr> <td>430-16e</td> <td>12Gbps SAS</td> <td>SATA/SAS</td> <td>-</td> <td>Yes</td> <td>None</td> <td>None</td> <td>-</td> <td>2</td> </tr> </tbody> </table> | Feature | Interface | Drive type | RAID levels | JBOD | Cache | Cache protection | FastPath | Max qty | 530-8i | 12Gbps SAS | SATA/SAS | 0/1/10/5/50 | Yes | None | None | Yes | 1 | 730-8i | 12Gbps SAS | SATA/SAS | 0/1/10/5/50 | Yes | 1GB | None | No | 1 | 930-8i | 12Gbps SAS | SATA/SAS | 0/1/10/5/50/6/60 | Yes | 2GB | Flash backup | Yes | 1 | 930-16i | 12Gbps SAS | SATA/SAS | 0/1/10/5/50/6/60 | Yes | 4GB | Flash backup | Yes | 1 | 430-8i | 12Gbps SAS | SATA/SAS | - | Yes | None | None | - | 1 | 430-16i | 12Gbps SAS | SATA/SAS | - | Yes | None | None | - | 1 | 930-8e | 12Gbps SAS | SATA/SAS | 0/1/10/5/50/6/60 | Yes | 4GB | Flash backup | Yes | 2 | 430-8e | 12Gbps SAS | SATA/SAS | - | Yes | None | None | - | 2 | 430-16e | 12Gbps SAS | SATA/SAS | - | Yes | None | None | - | 2 |
| | Feature | Interface | Drive type | RAID levels | JBOD | Cache | Cache protection | FastPath | Max qty | | | | | | | | | | | | | | | | | | | | | | | | | | | | | | | | | | | | | | | | | | | | | | | | | | | | | | | | | | | | | | | | | | | | | | | | | | | | | | | | | | |
| | 530-8i | 12Gbps SAS | SATA/SAS | 0/1/10/5/50 | Yes | None | None | Yes | 1 | | | | | | | | | | | | | | | | | | | | | | | | | | | | | | | | | | | | | | | | | | | | | | | | | | | | | | | | | | | | | | | | | | | | | | | | | | | | | | | | | | |
| | 730-8i | 12Gbps SAS | SATA/SAS | 0/1/10/5/50 | Yes | 1GB | None | No | 1 | | | | | | | | | | | | | | | | | | | | | | | | | | | | | | | | | | | | | | | | | | | | | | | | | | | | | | | | | | | | | | | | | | | | | | | | | | | | | | | | | | |
| | 930-8i | 12Gbps SAS | SATA/SAS | 0/1/10/5/50/6/60 | Yes | 2GB | Flash backup | Yes | 1 | | | | | | | | | | | | | | | | | | | | | | | | | | | | | | | | | | | | | | | | | | | | | | | | | | | | | | | | | | | | | | | | | | | | | | | | | | | | | | | | | | |
| | 930-16i | 12Gbps SAS | SATA/SAS | 0/1/10/5/50/6/60 | Yes | 4GB | Flash backup | Yes | 1 | | | | | | | | | | | | | | | | | | | | | | | | | | | | | | | | | | | | | | | | | | | | | | | | | | | | | | | | | | | | | | | | | | | | | | | | | | | | | | | | | | |
| | 430-8i | 12Gbps SAS | SATA/SAS | - | Yes | None | None | - | 1 | | | | | | | | | | | | | | | | | | | | | | | | | | | | | | | | | | | | | | | | | | | | | | | | | | | | | | | | | | | | | | | | | | | | | | | | | | | | | | | | | | |
| | 430-16i | 12Gbps SAS | SATA/SAS | - | Yes | None | None | - | 1 | | | | | | | | | | | | | | | | | | | | | | | | | | | | | | | | | | | | | | | | | | | | | | | | | | | | | | | | | | | | | | | | | | | | | | | | | | | | | | | | | | |
| | 930-8e | 12Gbps SAS | SATA/SAS | 0/1/10/5/50/6/60 | Yes | 4GB | Flash backup | Yes | 2 | | | | | | | | | | | | | | | | | | | | | | | | | | | | | | | | | | | | | | | | | | | | | | | | | | | | | | | | | | | | | | | | | | | | | | | | | | | | | | | | | | |
| 430-8e | 12Gbps SAS | SATA/SAS | - | Yes | None | None | - | 2 | | | | | | | | | | | | | | | | | | | | | | | | | | | | | | | | | | | | | | | | | | | | | | | | | | | | | | | | | | | | | | | | | | | | | | | | | | | | | | | | | | | |
| 430-16e | 12Gbps SAS | SATA/SAS | - | Yes | None | None | - | 2 | | | | | | | | | | | | | | | | | | | | | | | | | | | | | | | | | | | | | | | | | | | | | | | | | | | | | | | | | | | | | | | | | | | | | | | | | | | | | | | | | | | |
| <i>Note: 730-8i is available in China only. 930-8e, 430-8e, and 430-16e will be placed in slot 2 firstly.</i> | | | | | | | | | | | | | | | | | | | | | | | | | | | | | | | | | | | | | | | | | | | | | | | | | | | | | | | | | | | | | | | | | | | | | | | | | | | | | | | | | | | | | | | | | | | |
| Disk drive bays | Supports 4 front 3.5" SATA/SAS HS bays, or 8 front 2.5" SATA/SAS HS bays, or 10 front 2.5" SATA/SAS HS bays with 4 AnyBay support. 10 front 2.5" AnyBay will be available later. Optional 2 rear 2.5" HS bays are supported on 10 x 2.5" model, takes place in riser card 1 location. Optional one or two internal M.2 SSD for boot, dual M.2 SSD supports mirroring | | | | | | | | | | | | | | | | | | | | | | | | | | | | | | | | | | | | | | | | | | | | | | | | | | | | | | | | | | | | | | | | | | | | | | | | | | | | | | | | | | | | | | | | | | |
| Internal storage | For 3.5" bay | | | | | | | | | | | | | | | | | | | | | | | | | | | | | | | | | | | | | | | | | | | | | | | | | | | | | | | | | | | | | | | | | | | | | | | | | | | | | | | | | | | | | | | | | | |
| | 3.5" HDD, SATA6Gbps, 7.2K | 1TB/2TB/4TB/6TB/8TB/10TB | | | | | | | | | | | | | | | | | | | | | | | | | | | | | | | | | | | | | | | | | | | | | | | | | | | | | | | | | | | | | | | | | | | | | | | | | | | | | | | | | | | | | | | | | |
| | (3.5" disks or 2.5" disks with 3.5" tray) | 3.5" HDD, SAS12Gbps, 7.2K | 1TB/2TB/4TB/6TB SED FIPS/6TB/10TB | | | | | | | | | | | | | | | | | | | | | | | | | | | | | | | | | | | | | | | | | | | | | | | | | | | | | | | | | | | | | | | | | | | | | | | | | | | | | | | | | | | | | | | | |
| | 2.5" HDD, SAS12Gbps, 15K | 300GB/600GB | | | | | | | | | | | | | | | | | | | | | | | | | | | | | | | | | | | | | | | | | | | | | | | | | | | | | | | | | | | | | | | | | | | | | | | | | | | | | | | | | | | | | | | | | |
| | 2.5" SSD, SATA6Gbps | 240GB/480GB | | | | | | | | | | | | | | | | | | | | | | | | | | | | | | | | | | | | | | | | | | | | | | | | | | | | | | | | | | | | | | | | | | | | | | | | | | | | | | | | | | | | | | | | | |
| | 2.5" HDD, SATA6Gbps, 7.2K | 1TB/2TB | | | | | | | | | | | | | | | | | | | | | | | | | | | | | | | | | | | | | | | | | | | | | | | | | | | | | | | | | | | | | | | | | | | | | | | | | | | | | | | | | | | | | | | | | |
| | 2.5" HDD, SAS12Gbps, 7.2K | 1TB/2TB | | | | | | | | | | | | | | | | | | | | | | | | | | | | | | | | | | | | | | | | | | | | | | | | | | | | | | | | | | | | | | | | | | | | | | | | | | | | | | | | | | | | | | | | | |
| | 2.5" HDD, SAS12Gbps, 10K | 300GB/300GB SED/600GB/600GB SED/900GB/1.2TB/1.8TB | | | | | | | | | | | | | | | | | | | | | | | | | | | | | | | | | | | | | | | | | | | | | | | | | | | | | | | | | | | | | | | | | | | | | | | | | | | | | | | | | | | | | | | | | |
| | For 2.5" bay | 2.5" HDD, SAS12Gbps, 15K | 300GB/600GB/900GB | | | | | | | | | | | | | | | | | | | | | | | | | | | | | | | | | | | | | | | | | | | | | | | | | | | | | | | | | | | | | | | | | | | | | | | | | | | | | | | | | | | | | | | | |
| | 2.5" SSD, SAS12Gbps | 400GB/800GB/3.84TB/7.68TB | | | | | | | | | | | | | | | | | | | | | | | | | | | | | | | | | | | | | | | | | | | | | | | | | | | | | | | | | | | | | | | | | | | | | | | | | | | | | | | | | | | | | | | | | |
| 2.5" SSD, SATA6Gbps | 240GB/480GB | | | | | | | | | | | | | | | | | | | | | | | | | | | | | | | | | | | | | | | | | | | | | | | | | | | | | | | | | | | | | | | | | | | | | | | | | | | | | | | | | | | | | | | | | | |
| 2.5" NVMe SSD, AnyBay | 800GB/960GB/1.6TB/1.92TB/3.84TB | | | | | | | | | | | | | | | | | | | | | | | | | | | | | | | | | | | | | | | | | | | | | | | | | | | | | | | | | | | | | | | | | | | | | | | | | | | | | | | | | | | | | | | | | | |
| PCIe 3.0 x4, HHHL adapter | NVMe SSD | 1.6TB/1.92TB/3.2TB/3.84TB | | | | | | | | | | | | | | | | | | | | | | | | | | | | | | | | | | | | | | | | | | | | | | | | | | | | | | | | | | | | | | | | | | | | | | | | | | | | | | | | | | | | | | | | | |
| M.2 boot drive | M.2 SATA SSD | 32GB/128GB | | | | | | | | | | | | | | | | | | | | | | | | | | | | | | | | | | | | | | | | | | | | | | | | | | | | | | | | | | | | | | | | | | | | | | | | | | | | | | | | | | | | | | | | | |
| Optical | No internal optical bay. Optional USB DVD±RW optical drive | | | | | | | | | | | | | | | | | | | | | | | | | | | | | | | | | | | | | | | | | | | | | | | | | | | | | | | | | | | | | | | | | | | | | | | | | | | | | | | | | | | | | | | | | | |
| Network interfaces | One dedicated management port. One LOM slot for customized LOM with up to four RJ-45 or SFP+ ports, up to 10GbE. Wake-on-LAN and NC-SI are available on Port 0 of LOM. Optional ML2 or PCIe adapters are supported. ML2 adapter requires riser card with ML2 slot. | | | | | | | | | | | | | | | | | | | | | | | | | | | | | | | | | | | | | | | | | | | | | | | | | | | | | | | | | | | | | | | | | | | | | | | | | | | | | | | | | | | | | | | | | | |
| Security features | Power-on and admin password. Trusted Platform Module, TCG 1.2 compliant, upgrade to 2.0 via UEFI setting. Optional TCM in China only. Optional lockable security bezel | | | | | | | | | | | | | | | | | | | | | | | | | | | | | | | | | | | | | | | | | | | | | | | | | | | | | | | | | | | | | | | | | | | | | | | | | | | | | | | | | | | | | | | | | | |
| Operating systems supported | Microsoft Windows Server 2016/2012 R2. Red Hat Enterprise Linux 7.3/6.9. SUSE Linux Enterprise Server 12 SP2/11 SP4. VMware vSphere (ESXi) 6.5/6.0 U3 | | | | | | | | | | | | | | | | | | | | | | | | | | | | | | | | | | | | | | | | | | | | | | | | | | | | | | | | | | | | | | | | | | | | | | | | | | | | | | | | | | | | | | | | | | |
| Systems management | XClarity Controller Standard, optional upgrades to Advanced or Enterprise are available. Energy Manager. XClarity Administrator. Lenovo Capacity Planner. Provisioning Manager. Essentials. Light Path Diagnostics | | | | | | | | | | | | | | | | | | | | | | | | | | | | | | | | | | | | | | | | | | | | | | | | | | | | | | | | | | | | | | | | | | | | | | | | | | | | | | | | | | | | | | | | | | |

| Components | Specification | |
|-----------------------------|--|---|
| GPU support | Up to one optional GPU, requires riser card with PCIe x16 full height slot. Supports NVIDIA Quadro P2000 | |
| Base warranty | MT 7X01: 1-year limited onsite service with 9x5/NBD MT 7X02: 3-year limited onsite service with 9x5/NBD | |
| Power supply | Up to two redundant hot-swap 550W/750W/1100W 80 PLUS Platinum qualified power supplies. Or up to two redundant hot-swap 750W Titanium qualified power supplies. 750W Titanium is 200V - 240V, others are 100V - 240V | |
| Video | Integrated Matrox G200 in XClarity Controller | |
| Cooling | Five fans (4+1) for single processor model, seven fans (6+1) for dual processor model | |
| Front ports | One XClarity Controller USB connector, one USB 3.0, one optional VGA | |
| Rear ports | One VGA, two USB 3.0, one XClarity Controller network connector. Optional COM port | |
| Environmental specification | Supports ASHRAE A4 with limitations. | |
| | Temperature - operating | A4: 5°C to 45°C (41°F to 113°F) A3: 5°C to 40°C (41°F to 104°F) A2: 10°C to 35°C (50°F to 95°F) |
| | Temperature - non operating (no package) | -10°C to 60°C (14°F to 140°F) |
| | Temperature - non operating (with package) | -40°C to 70°C (-40°F to 158°F) |
| | Altitude - operating | (Unpressurized): 0-10000ft (0-3048m) |
| | Humidity - operating, non-condensing | A4: 8%-90%. A3: 8%-85%. A2: 20%-80% |
| | Humidity - storage (with package), non-condensing | 8%-90% |
| | <i>Models should meet the following requirements to support A3 and A4:</i> | |
| | <ul style="list-style-type: none"> Processors with TDP higher than or equal to 150-Watt and Xeon A112, 5122, 6126, 6128, 6132, 6134, 6134M, and 8156 processors not installed Both NVMe 2.5" SSD and NVMe PCIe adapter not installed GPU not installed Must have redundant PSU RAID super capacitor module cannot be installed on the bottom of the air baffle, but only can be installed on the chassis. | |
| | Environmental certification | Energy Star Server 2.1 certified. More environmental information please see: www.lenovo.com/social_responsibility/us/en/environment/ |

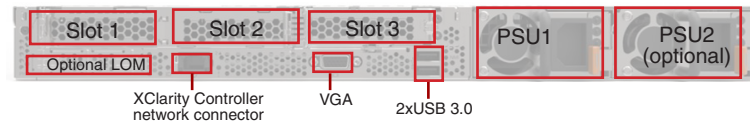

| Expansion slots | Specification |
|-------------------------|--|
| Slot 1-2 (riser card 1) | Supports one of the following for riser card 1: Option 1: PCIe 3.0 x8/x16 (slot 1-2). Low profile for x8, low profile or full height half length for x16 Option 2: PCIe 3.0 x8 ML2/x16 (slot 1-2). Low profile for x8 ML2, low profile or full height half length for x16 Option 3: PCIe 3.0 x16 ML2/x8 (slot 1-2). Low profile for x16 ML2, low profile or full height half length for x8 Option 4: 2x 2.5" drive bay, for 10 x 2.5" model only |
| Slot 3 (riser card 2) | PCIe 3.0 x 16, low profile, requires 2nd CPU. When slot 2 is full height, slot 3 cannot be used |

| System unique options | Specification |
|-----------------------|--|
| 7XH7A05896 | Lenovo SR530/SR570/SR630 2.5" SATA/SAS 8-Bay Backplane Kit |
| 7XH7A05893 | Lenovo SR530/SR570/SR630 x8/x16 PCIe LP+FH Riser 1 Kit |
| 7XH7A05895 | Lenovo SR630 x16ML2/x8 PCIe LP+FH Riser 1 Kit |
| 7XH7A05894 | Lenovo SR630 x8ML2/x16 PCIe LP+FH Riser 1 Kit |
| 7XH7A02682 | Lenovo SR530/SR570/SR630 x8/x16 PCIe LP+LP Riser 1 Kit |
| 7XH7A02683 | Lenovo SR630 x8ML2/x16 PCIe LP+LP Riser 1 Kit |
| 7XH7A02684 | Lenovo SR630 x16ML2/x8 PCIe LP+LP Riser 1 Kit |
| 7XH7A02685 | Lenovo SR530/SR570/SR630 x16 PCIe LP Riser 2 Kit |
| 7XH7A06252 | Lenovo SR630 Rear HDD Kit |
| 7Z17A02577 | Lenovo COM Port Upgrade Kit |
| 7Z17A02579 | Lenovo SR530/SR570/SR630 Front VGA Connector Upgrade Kit |
| 7Z17A02581 | Lenovo 1U Security Bezel |

ThinkSystem SR630 Models for USA and Canada - TopSeller

Product Specifications Reference (PSREF)

| Model | Processor | Memory | RAID/HBA Adapter | Chassis | Disk Bays | Disks | GPU | Networking (LOM/ML2/PCIe) | M.2 Boot Drive | Riser Card 1 for Slot 1-2 | Riser Card 2 for Slot 3 | Front VGA | Security | System Management | Power Supply | Base Warranty | Ann Date (mm/yy) |
|------------|---|------------------------------|------------------|---------|-----------|-------|------|---------------------------|----------------|---------------------------|-------------------------|--------------|----------|------------------------|--------------------|---------------|------------------|
| 7X02A03UNA | 1xXeon Silver 4110 8C/2.1GHz/ 11MB/85W/DDR4-2400 | 1x16GB RDIMM DDR4-2666 | None | 8x2.5" | None | None | None | None | None | None | None | Front VGA | TPM 1.2 | XClarity Enterprise | 1x750W Platinum | 3-year | 07/17 |
| 7X02A04JNA | 1xXeon Silver 4116 12C/2.1GHz/ 16.5MB/85W/DDR4-2400 | 1x32GB RDIMM DDR4-2666 | None | 8x2.5" | None | None | None | None | None | None | None | Front VGA | TPM 1.2 | XClarity Enterprise | 1x750W Platinum | 3-year | 07/17 |
| 7X02A04YNA | 1xXeon Gold 5118 12C/2.3GHz/ 16.5MB/105W/DDR4-2400 | 1x32GB RDIMM DDR4-2666 | None | 8x2.5" | None | None | None | None | None | None | None | Front VGA | TPM 1.2 | XClarity Enterprise | 1x750W Platinum | 3-year | 07/17 |

ThinkSystem SR630 Models for USA and Canada - Non TopSeller

Product Specifications Reference (PSREF)

| Model | Processor | Memory | RAID/HBA Adapter | Chassis | Disk Bays | Disks | GPU | Networking (LOM/ML2/PCIe) | M.2 Boot Drive | Riser Card 1 for Slot 1-2 | Riser Card 2 for Slot 3 | Front VGA | Security | System Management | Power Supply | Base Warranty | Ann Date (mm/yy) |
|------------|--|------------------------------|------------------------|---------|---|-------|------|---------------------------|----------------|---------------------------|-------------------------|--------------|----------|----------------------|--------------------|---------------|------------------|
| 7X02A01ANA | 1xXeon Gold 6140 18C/2.3GHz/ 24.75MB/140W/DDR4-2666 | 1x32GB RDIMM DDR4-2666 | 1x930-8i 2GB flash | 8x2.5" | 8x2.5" SATA/ SAS HS | Open | None | None | None | x8 / x16, LP | None | Front VGA | TPM 1.2 | XClarity Standard | 1x750W Platinum | 3-year | 07/17 |
| 7X02A01LNA | 1xXeon Gold 5115 10C/2.4GHz/ 13.75MB/85W/DDR4-2400 | 1x16GB RDIMM DDR4-2666 | 1x930-8i 2GB flash | 8x2.5" | 8x2.5" SATA/ SAS HS | Open | None | None | None | x8 / x16, LP | None | Front VGA | TPM 1.2 | XClarity Standard | 1x750W Platinum | 3-year | 07/17 |
| 7X02A01MNA | 1xXeon Gold 5118 12C/2.3GHz/ 16.5MB/105W/DDR4-2400 | 1x16GB RDIMM DDR4-2666 | 1x930-8i 2GB flash | 8x2.5" | 8x2.5" SATA/ SAS HS | Open | None | None | None | x8 / x16, LP | None | Front VGA | TPM 1.2 | XClarity Standard | 1x750W Platinum | 3-year | 07/17 |
| 7X02A01PNA | 1xXeon Gold 5118 12C/2.3GHz/ 16.5MB/105W/DDR4-2400 | 1x16GB RDIMM DDR4-2666 | 1x930-16i 4GB flash | 10x2.5" | 10x2.5" (6 SATA/SAS, 4 AnyBay) HS | Open | None | None | None | x8 / x16, LP | None | Front VGA | TPM 1.2 | XClarity Standard | 1x750W Platinum | 3-year | 07/17 |
| 7X02A01VNA | 1xXeon Gold 6148 20C/2.4GHz/ 27.5MB/150W/DDR4-2666 | 1x32GB RDIMM DDR4-2666 | 1x930-8i 2GB flash | 8x2.5" | 8x2.5" SATA/ SAS HS | Open | None | None | None | x8 / x16, LP | None | Front VGA | TPM 1.2 | XClarity Standard | 1x750W Platinum | 3-year | 07/17 |
| 7X02A01ZNA | 1xXeon Gold 6142 16C/2.6GHz/ 22MB/150W/DDR4-2666 | 1x32GB RDIMM DDR4-2666 | 1x930-8i 2GB flash | 8x2.5" | 8x2.5" SATA/ SAS HS | Open | None | None | None | x8 / x16, LP | None | Front VGA | TPM 1.2 | XClarity Standard | 1x750W Platinum | 3-year | 07/17 |
| 7X02A029NA | 2xXeon Gold 5118 12C/2.3GHz/ 16.5MB/105W/DDR4-2400 | 2x32GB RDIMM DDR4-2666 | 1x430-16i | 10x2.5" | 10x2.5" (6 SATA/SAS, 4 AnyBay) HS | Open | None | None | None | x8 / x16, LP | x16 LP | Front VGA | TPM 1.2 | XClarity Standard | 1x750W Platinum | 3-year | 07/17 |
| 7X02A02DNA | 1xXeon Gold 6126T 12C/2.6GHz/ 19.25MB/125W/DDR4-2666 | 1x32GB RDIMM DDR4-2666 | 1x930-8i 2GB flash | 8x2.5" | 8x2.5" SATA/ SAS HS | Open | None | None | None | x8 / x16, LP | None | Front VGA | TPM 1.2 | XClarity Standard | 1x750W Platinum | 3-year | 07/17 |
| 7X02A02HNA | 1xXeon Gold 5120 14C/2.2GHz/ 19.25MB/105W/DDR4-2400 | 1x16GB RDIMM DDR4-2666 | 1x930-8i 2GB flash | 8x2.5" | 8x2.5" SATA/ SAS HS | Open | None | None | None | x8 / x16, LP | None | Front VGA | TPM 1.2 | XClarity Standard | 1x750W Platinum | 3-year | 07/17 |
| 7X02A02XNA | 1xXeon Gold 6150 18C/2.7GHz/ 24.75MB/165W/DDR4-2666 | 1x32GB RDIMM DDR4-2666 | 1x930-8i 2GB flash | 8x2.5" | 8x2.5" SATA/ SAS HS | Open | None | None | None | x8 / x16, LP | None | Front VGA | TPM 1.2 | XClarity Standard | 1x750W Platinum | 3-year | 07/17 |
| 7X02A039NA | 1xXeon Gold 6152 22C/2.1GHz/ 30.25MB/140W/DDR4-2666 | 1x32GB RDIMM DDR4-2666 | 1x930-8i 2GB flash | 8x2.5" | 8x2.5" SATA/ SAS HS | Open | None | None | None | x8 / x16, LP | None | Front VGA | TPM 1.2 | XClarity Standard | 1x750W Platinum | 3-year | 07/17 |
| 7X02A03BNA | 1xXeon Platinum 8160 24C/2.1GHz/ 33MB/150W/DDR4-2666 | 1x32GB RDIMM DDR4-2666 | 1x930-8i 2GB flash | 8x2.5" | 8x2.5" SATA/ SAS HS | Open | None | None | None | x8 / x16, LP | None | Front VGA | TPM 1.2 | XClarity Standard | 1x750W Platinum | 3-year | 07/17 |
| 7X02A03CNA | 1xXeon Gold 6134 8C/3.2GHz/ 24.75MB/130W/DDR4-2666 | 1x32GB RDIMM DDR4-2666 | 1x930-8i 2GB flash | 8x2.5" | 8x2.5" SATA/ SAS HS | Open | None | None | None | x8 / x16, LP | None | Front VGA | TPM 1.2 | XClarity Standard | 1x750W Platinum | 3-year | 07/17 |

ThinkSystem SR630 Models for EMEA - TopSeller

Product Specifications Reference (PSREF)

| Model | Processor | Memory | RAID/HBA Adapter | Chassis | Disk Bays | Disks | GPU | Networking (LOM/ML2/PCIe) | M.2 Boot Drive | Riser Card for Slot 1-2 | Riser Card for Slot 3 | Front VGA | Security | System Management | Power Supply | Base Warranty | Ann Date (mm/yy) |
|------------|--|------------------------------|------------------------|---------|---|--|------|---------------------------|----------------|-------------------------|-----------------------|--------------|----------|------------------------|--------------------|---------------|------------------|
| 7X02A006EA | 1xXeon Gold 6130 16C/2.1GHz/ 22MB/125W/DDR4-2666 | 1x32GB RDIMM DDR4-2666 | 1x930-8i 2GB flash | 8x2.5" | 8x2.5" SATA/ SAS HS | Open | None | None | None | x8 / x16, LP | None | Front VGA | TPM 1.2 | XClarity Enterprise | 1x750W Platinum | 3-year | 07/17 |
| 7X02A008EA | 1xXeon Gold 5118 12C/2.3GHz/ 16.5MB/105W/DDR4-2400 | 1x16GB RDIMM DDR4-2666 | 1x930-8i 2GB flash | 8x2.5" | 8x2.5" SATA/ SAS HS | Open | None | None | None | x8 / x16, LP | None | Front VGA | TPM 1.2 | XClarity Enterprise | 1x750W Platinum | 3-year | 07/17 |
| 7X02A00HEA | 1xXeon Gold 5115 10C/2.4GHz/ 13.75MB/85W/DDR4-2400 | 1x16GB RDIMM DDR4-2666 | 1x930-8i 2GB flash | 8x2.5" | 8x2.5" SATA/ SAS HS | Open | None | None | None | x8 / x16, LP | None | Front VGA | TPM 1.2 | XClarity Enterprise | 1x750W Platinum | 3-year | 07/17 |
| 7X02A00QEA | 1xXeon Gold 5118 12C/2.3GHz/ 16.5MB/105W/DDR4-2400 | 1x16GB RDIMM DDR4-2666 | 1x930-16i 4GB flash | 10x2.5" | 10x2.5" (6 SATA/SAS, 4 AnyBay) HS | Open | None | None | None | x8 / x16, LP | None | Front VGA | TPM 1.2 | XClarity Enterprise | 1x750W Platinum | 3-year | 07/17 |
| 7X02A01QEA | 2xXeon Gold 5118 12C/2.3GHz/ 16.5MB/105W/DDR4-2400 | 4x32GB RDIMM DDR4-2666 | 1x430-8i | 8x2.5" | 8x2.5" SATA/ SAS HS | Open | None | None | 2x32GB | x8 / x16, LP | x16 LP | Front VGA | TPM 1.2 | XClarity Enterprise | 2x750W Platinum | 3-year | 07/17 |
| 7X02A02VEA | 2xXeon Gold 5118 12C/2.3GHz/ 16.5MB/105W/DDR4-2400 | 4x32GB RDIMM DDR4-2666 | 1x430-8i | 8x2.5" | 8x2.5" SATA/ SAS HS | Open | None | None | 2x32GB | x8 / x16, LP | x16 LP | None | TPM 1.2 | XClarity Enterprise | 2x750W Platinum | 3-year | 07/17 |
| 7X02A03TEA | 1xXeon Silver 4114 10C/2.2GHz/ 13.75MB/85W/DDR4-2400 | 1x16GB RDIMM DDR4-2666 | 1x930-8i 2GB flash | 8x2.5" | 8x2.5" SATA/ SAS HS | 3x300GB HDD 10K 2.5" SAS- 12Gbps | None | None | None | x8 / x16, LP | None | Front VGA | TPM 1.2 | XClarity Enterprise | 2x750W Platinum | 3-year | 07/17 |
| 7X02A03VEA | 1xXeon Silver 4108 8C/2.1GHz/ 11MB/85W/DDR4-2400 | 1x16GB RDIMM DDR4-2666 | 1x530-8i | 8x2.5" | 8x2.5" SATA/ SAS HS | Open | None | None | None | x8 / x16, LP | None | Front VGA | TPM 1.2 | XClarity Enterprise | 1x750W Platinum | 3-year | 07/17 |
| 7X02A042EA | 1xXeon Silver 4110 8C/2.1GHz/ 11MB/85W/DDR4-2400 | 1x16GB RDIMM DDR4-2666 | 1x930-8i 2GB flash | 8x2.5" | 8x2.5" SATA/ SAS HS | Open | None | None | None | x8 / x16, LP | None | Front VGA | TPM 1.2 | XClarity Enterprise | 1x750W Platinum | 3-year | 07/17 |
| 7X02A048EA | 1xXeon Silver 4114 10C/2.2GHz/ 13.75MB/85W/DDR4-2400 | 1x32GB RDIMM DDR4-2666 | 1x930-8i 2GB flash | 8x2.5" | 8x2.5" SATA/ SAS HS | Open | None | None | None | None | None | Front VGA | TPM 1.2 | XClarity Enterprise | 2x750W Platinum | 3-year | 07/17 |
| 7X02A049EA | 1xXeon Silver 4110 8C/2.1GHz/ 11MB/85W/DDR4-2400 | 1x32GB RDIMM DDR4-2666 | 1x930-8i 2GB flash | 8x2.5" | 8x2.5" SATA/ SAS HS | Open | None | None | None | x8 / x16, LP | None | Front VGA | TPM 1.2 | XClarity Enterprise | 2x750W Platinum | 3-year | 07/17 |
| 7X02A04DEA | 1xXeon Bronze 3104 6C/1.7GHz/ 8.25MB/85W/DDR4-2133 | 1x8GB RDIMM DDR4-2666 | 1x530-8i | 8x2.5" | 8x2.5" SATA/ SAS HS | Open | None | None | None | x8 / x16, LP | None | Front VGA | TPM 1.2 | XClarity Enterprise | 1x750W Platinum | 3-year | 07/17 |
| 7X02A04GEA | 1xXeon Silver 4116 12C/2.1GHz/ 16.5MB/85W/DDR4-2400 | 1x16GB RDIMM DDR4-2666 | 1x930-8i 2GB flash | 8x2.5" | 8x2.5" SATA/ SAS HS | Open | None | None | None | x8 / x16, LP | None | Front VGA | TPM 1.2 | XClarity Enterprise | 1x750W Platinum | 3-year | 07/17 |
| 7X02A04KEA | 1xXeon Silver 4108 8C/2.1GHz/ 11MB/85W/DDR4-2400 | 1x16GB RDIMM DDR4-2666 | 1x930-8i 2GB flash | 8x2.5" | 8x2.5" SATA/ SAS HS | Open | None | None | None | x8 / x16, LP | None | Front VGA | TPM 1.2 | XClarity Enterprise | 1x750W Platinum | 3-year | 07/17 |
| 7X02A04WEA | 1xXeon Silver 4110 8C/2.1GHz/ 11MB/85W/DDR4-2400 | 1x16GB RDIMM DDR4-2666 | 1x530-8i | 8x2.5" | 8x2.5" SATA/ SAS HS | Open | None | None | None | x8 / x16, LP | None | Front VGA | TPM 1.2 | XClarity Enterprise | 1x750W Platinum | 3-year | 07/17 |
| 7X02A051EA | 1xXeon Gold 5118 12C/2.3GHz/ 16.5MB/105W/DDR4-2400 | 4x32GB RDIMM DDR4-2666 | 1x930-8i 2GB flash | 8x2.5" | 8x2.5" SATA/ SAS HS | Open | None | None | 2x32GB | x8 / x16, LP | None | Front VGA | TPM 1.2 | XClarity Enterprise | 2x750W Platinum | 3-year | 07/17 |
| 7X02A054EA | 1xXeon Silver 4114 10C/2.2GHz/ 13.75MB/85W/DDR4-2400 | 1x16GB RDIMM DDR4-2666 | 1x930-8i 2GB flash | 8x2.5" | 8x2.5" SATA/ SAS HS | 2x300GB HDD 10K 2.5" SAS- 12Gbps | None | None | None | x8 / x16, LP | None | Front VGA | TPM 1.2 | XClarity Enterprise | 2x750W Platinum | 3-year | 07/17 |
| 7X02A056EA | 1xXeon Silver 4114 10C/2.2GHz/ 13.75MB/85W/DDR4-2400 | 1x16GB RDIMM DDR4-2666 | 1x930-8i 2GB flash | 8x2.5" | 8x2.5" SATA/ SAS HS | Open | None | None | None | x8 / x16, LP | None | Front VGA | TPM 1.2 | XClarity Enterprise | 1x750W Platinum | 3-year | 07/17 |
| 7X02A057EA | 1xXeon Silver 4110 8C/2.1GHz/ 11MB/85W/DDR4-2400 | 1x16GB RDIMM DDR4-2666 | 1x930-16i 4GB flash | 10x2.5" | 10x2.5" (6 SATA/SAS, 4 AnyBay) HS | Open | None | None | None | x8 / x16, LP | None | Front VGA | TPM 1.2 | XClarity Enterprise | 1x750W Platinum | 3-year | 07/17 |
| 7X02A05AEA | 1xXeon Silver 4110 8C/2.1GHz/ 11MB/85W/DDR4-2400 | 4x32GB RDIMM DDR4-2666 | 1x930-8i 2GB flash | 8x2.5" | 8x2.5" SATA/ SAS HS | 3x1.2TB HDD 10K 2.5" SAS- 12Gbps | None | None | None | x8 / x16, LP | None | Front VGA | TPM 1.2 | XClarity Enterprise | 2x750W Platinum | 3-year | 07/17 |

ThinkSystem SR630 Models for EMEA - Non TopSeller

Product Specifications Reference (PSREF)

| Model | Processor | Memory | RAID/HBA Adapter | Chassis | Disk Bays | Disks | GPU | Networking (LOM/ML2/PCIe) | M.2 Boot Drive | Riser Card for Slot 1-2 | Riser Card for Slot 3 | Front VGA | Security | System Management | Power Supply | Base Warranty | Ann Date (mm/yy) |
|------------|---|------------------------|---------------------|---------|-----------------------------------|-------|------|---------------------------|----------------|-------------------------|-----------------------|-----------|----------|-------------------|-----------------|---------------|------------------|
| 7X02A002EA | 1xXeon Gold 5118 12C/2.3GHz/16.5MB/105W/DDR4-2400 | 1x16GB RDIMM DDR4-2666 | 1x930-16i 4GB flash | 10x2.5" | 10x2.5" (6 SATA/SAS, 4 AnyBay) HS | Open | None | None | None | x8 / x16, LP | None | None | TPM 1.2 | XClarity Standard | 1x750W Platinum | 3-year | 07/17 |
| 7X02A003EA | 1xXeon Gold 5118 12C/2.3GHz/16.5MB/105W/DDR4-2400 | 1x16GB RDIMM DDR4-2666 | 1x930-8i 2GB flash | 8x2.5" | 8x2.5" SATA/SAS HS | Open | None | None | None | x8 / x16, LP | None | None | TPM 1.2 | XClarity Standard | 1x750W Platinum | 3-year | 07/17 |
| 7X02A004EA | 1xXeon Gold 5115 10C/2.4GHz/13.75MB/85W/DDR4-2400 | 1x16GB RDIMM DDR4-2666 | 1x930-8i 2GB flash | 8x2.5" | 8x2.5" SATA/SAS HS | Open | None | None | None | x8 / x16, LP | None | None | TPM 1.2 | XClarity Standard | 1x750W Platinum | 3-year | 07/17 |
| 7X02A005EA | 1xXeon Platinum 8160 24C/2.1GHz/33MB/150W/DDR4-2666 | 1x32GB RDIMM DDR4-2666 | 1x930-8i 2GB flash | 8x2.5" | 8x2.5" SATA/SAS HS | Open | None | None | None | x8 / x16, LP | None | Front VGA | TPM 1.2 | XClarity Standard | 1x750W Platinum | 3-year | 07/17 |
| 7X02A007EA | 1xXeon Gold 6152 22C/2.1GHz/30.25MB/140W/DDR4-2666 | 1x32GB RDIMM DDR4-2666 | 1x930-8i 2GB flash | 8x2.5" | 8x2.5" SATA/SAS HS | Open | None | None | None | x8 / x16, LP | None | None | TPM 1.2 | XClarity Standard | 1x750W Platinum | 3-year | 07/17 |
| 7X02A009EA | 1xXeon Gold 6150 18C/2.7GHz/24.75MB/165W/DDR4-2666 | 1x32GB RDIMM DDR4-2666 | 1x930-8i 2GB flash | 8x2.5" | 8x2.5" SATA/SAS HS | Open | None | None | None | x8 / x16, LP | None | None | TPM 1.2 | XClarity Standard | 1x750W Platinum | 3-year | 07/17 |
| 7X02A00AEA | 2xXeon Gold 5118 12C/2.3GHz/16.5MB/105W/DDR4-2400 | 2x32GB RDIMM DDR4-2666 | 1x430-16i | 10x2.5" | 10x2.5" (6 SATA/SAS, 4 AnyBay) HS | Open | None | None | None | x8 / x16, LP | x16 LP | None | TPM 1.2 | XClarity Standard | 1x750W Platinum | 3-year | 07/17 |
| 7X02A00CEA | 1xXeon Gold 6134 8C/3.2GHz/24.75MB/130W/DDR4-2666 | 1x32GB RDIMM DDR4-2666 | 1x930-8i 2GB flash | 8x2.5" | 8x2.5" SATA/SAS HS | Open | None | None | None | x8 / x16, LP | None | None | TPM 1.2 | XClarity Standard | 1x750W Platinum | 3-year | 07/17 |
| 7X02A00EEA | 1xXeon Gold 5120 14C/2.2GHz/19.25MB/105W/DDR4-2400 | 1x16GB RDIMM DDR4-2666 | 1x930-8i 2GB flash | 8x2.5" | 8x2.5" SATA/SAS HS | Open | None | None | None | x8 / x16, LP | None | None | TPM 1.2 | XClarity Standard | 1x750W Platinum | 3-year | 07/17 |
| 7X02A00GEA | 1xXeon Gold 6148 20C/2.4GHz/27.5MB/150W/DDR4-2666 | 1x32GB RDIMM DDR4-2666 | 1x930-8i 2GB flash | 8x2.5" | 8x2.5" SATA/SAS HS | Open | None | None | None | x8 / x16, LP | None | None | TPM 1.2 | XClarity Standard | 1x750W Platinum | 3-year | 07/17 |
| 7X02A00JEA | 1xXeon Gold 6126 12C/2.6GHz/19.25MB/125W/DDR4-2666 | 1x32GB RDIMM DDR4-2666 | 1x930-8i 2GB flash | 8x2.5" | 8x2.5" SATA/SAS HS | Open | None | None | None | x8 / x16, LP | None | None | TPM 1.2 | XClarity Standard | 1x750W Platinum | 3-year | 07/17 |
| 7X02A00PEA | 1xXeon Gold 6142 16C/2.6GHz/22MB/150W/DDR4-2666 | 1x32GB RDIMM DDR4-2666 | 1x930-8i 2GB flash | 8x2.5" | 8x2.5" SATA/SAS HS | Open | None | None | None | x8 / x16, LP | None | None | TPM 1.2 | XClarity Standard | 1x750W Platinum | 3-year | 07/17 |
| 7X02A00REA | 1xXeon Gold 6140 18C/2.3GHz/24.75MB/140W/DDR4-2666 | 1x32GB RDIMM DDR4-2666 | 1x930-8i 2GB flash | 8x2.5" | 8x2.5" SATA/SAS HS | Open | None | None | None | x8 / x16, LP | None | None | TPM 1.2 | XClarity Standard | 1x750W Platinum | 3-year | 07/17 |
| 7X02A03WEA | 1xXeon Silver 4108 8C/1.8GHz/11MB/85W/DDR4-2400 | 1x16GB RDIMM DDR4-2666 | 1x530-8i | 4x3.5" | 4x3.5" SATA/SAS HS | Open | None | None | None | x8 / x16, LP | None | None | TPM 1.2 | XClarity Standard | 1x750W Platinum | 3-year | 07/17 |
| 7X02A03ZEA | 1xXeon Bronze 3106 8C/1.7GHz/11MB/85W/DDR4-2133 | 1x8GB RDIMM DDR4-2666 | 1x530-8i | 8x2.5" | 8x2.5" SATA/SAS HS | Open | None | None | None | x8 / x16, LP | None | None | TPM 1.2 | XClarity Standard | 1x750W Platinum | 3-year | 07/17 |
| 7X02A043EA | 2xXeon Silver 4110 8C/2.1GHz/11MB/85W/DDR4-2400 | 2x32GB RDIMM DDR4-2666 | 1x430-16i | 10x2.5" | 10x2.5" (6 SATA/SAS, 4 AnyBay) HS | Open | None | None | None | x8 / x16, LP | None | None | TPM 1.2 | XClarity Standard | 1x750W Platinum | 3-year | 07/17 |
| 7X02A044EA | 1xXeon Bronze 3104 6C/1.7GHz/8.25MB/85W/DDR4-2133 | 1x8GB RDIMM DDR4-2666 | 1x530-8i | 8x2.5" | 8x2.5" SATA/SAS HS | Open | None | None | None | x8 / x16, LP | None | None | TPM 1.2 | XClarity Standard | 1x750W Platinum | 3-year | 07/17 |
| 7X02A045EA | 1xXeon Silver 4108 8C/1.8GHz/11MB/85W/DDR4-2400 | 1x16GB RDIMM DDR4-2666 | 1x530-8i | 8x2.5" | 8x2.5" SATA/SAS HS | Open | None | None | None | x8 / x16, LP | None | None | TPM 1.2 | XClarity Standard | 1x750W Platinum | 3-year | 07/17 |
| 7X02A046EA | 1xXeon Silver 4114 10C/2.2GHz/13.75MB/85W/DDR4-2400 | 1x16GB RDIMM DDR4-2666 | 1x930-8i 2GB flash | 8x2.5" | 8x2.5" SATA/SAS HS | Open | None | None | None | x8 / x16, LP | None | None | TPM 1.2 | XClarity Standard | 1x750W Platinum | 3-year | 07/17 |
| 7X02A04BEA | 1xXeon Silver 4110 8C/2.1GHz/11MB/85W/DDR4-2400 | 1x16GB RDIMM DDR4-2666 | 1x930-16i 4GB flash | 10x2.5" | 10x2.5" (6 SATA/SAS, 4 AnyBay) HS | Open | None | None | None | x8 / x16, LP | None | None | TPM 1.2 | XClarity Standard | 1x750W Platinum | 3-year | 07/17 |
| 7X02A04TEA | 1xXeon Silver 4110 8C/2.1GHz/11MB/85W/DDR4-2400 | 1x16GB RDIMM DDR4-2666 | 1x930-8i 2GB flash | 8x2.5" | 8x2.5" SATA/SAS HS | Open | None | None | None | x8 / x16, LP | None | None | TPM 1.2 | XClarity Standard | 1x750W Platinum | 3-year | 07/17 |
| 7X02A04VEA | 1xXeon Silver 4110 8C/2.1GHz/11MB/85W/DDR4-2400 | 1x16GB RDIMM DDR4-2666 | 1x530-8i | 8x2.5" | 8x2.5" SATA/SAS HS | Open | None | None | None | x8 / x16, LP | None | None | TPM 1.2 | XClarity Standard | 1x750W Platinum | 3-year | 07/17 |
| 7X02A052EA | 1xXeon Silver 4116 12C/2.1GHz/16.5MB/85W/DDR4-2400 | 1x16GB RDIMM DDR4-2666 | 1x930-8i 2GB flash | 8x2.5" | 8x2.5" SATA/SAS HS | Open | None | None | None | x8 / x16, LP | None | None | TPM 1.2 | XClarity Standard | 1x750W Platinum | 3-year | 07/17 |

ThinkSystem SR630 Models for Australia and New Zealand - TopSeller

Product Specifications Reference (PSREF)

| Model | Processor | Memory | RAID/HBA Adapter | Chassis | Disk Bays | Disks | GPU | Networking (LOM/ML2/PCIe) | M.2 Boot Drive | Riser Card 1 for Slot 1-2 | Riser Card 2 for Slot 3 | Front VGA | Security | System Management | Power Supply | Base Warranty | Ann Date (mm/yy) |
|------------|--|------------------------------|------------------------|---------|--|--|------|---------------------------|----------------|---------------------------|-------------------------|--------------|----------|------------------------|--------------------|---------------|------------------|
| 7X02A03TAU | 1xXeon Silver 4114 10C/2.2GHz/ 13.75MB/85W/DDR4-2400 | 1x16GB RDIMM DDR4-2666 | 1x930-8i 2GB flash | 8x2.5" | 8x2.5" | 3x300GB HDD 10K 2.5" SAS- 12Gbps | None | None | None | x8 / x16, LP | None | Front VGA | TPM 1.2 | XClarity Enterprise | 2x750W Platinum | 3-year | 07/17 |
| 7X02A03VAU | 1xXeon Silver 4108 8C/1.8GHz/ 11MB/85W/DDR4-2400 | 1x16GB RDIMM DDR4-2666 | 1x530-8i | 8x2.5" | 8x2.5" | SATA/SAS HS | None | None | None | x8 / x16, LP | None | Front VGA | TPM 1.2 | XClarity Enterprise | 1x750W Platinum | 3-year | 07/17 |
| 7X02A041AU | 1xXeon Gold 6130 16C/2.1GHz/ 22MB/125W/DDR4-2666 | 1x32GB RDIMM DDR4-2666 | 1x930-8i 2GB flash | 8x2.5" | 8x2.5" | SATA/SAS HS | None | None | None | x8 / x16, LP | None | Front VGA | TPM 1.2 | XClarity Enterprise | 1x750W Platinum | 3-year | 07/17 |
| 7X02A042AU | 1xXeon Silver 4110 8C/2.1GHz/ 11MB/85W/DDR4-2400 | 1x16GB RDIMM DDR4-2666 | 1x930-8i 2GB flash | 8x2.5" | 8x2.5" | SATA/SAS HS | None | None | None | x8 / x16, LP | None | Front VGA | TPM 1.2 | XClarity Enterprise | 1x750W Platinum | 3-year | 07/17 |
| 7X02A048AU | 1xXeon Silver 4114 10C/2.2GHz/ 13.75MB/85W/DDR4-2400 | 1x32GB RDIMM DDR4-2666 | 1x930-8i 2GB flash | 8x2.5" | 8x2.5" | SATA/SAS HS | None | None | None | None | None | Front VGA | TPM 1.2 | XClarity Enterprise | 2x750W Platinum | 3-year | 07/17 |
| 7X02A049AU | 1xXeon Silver 4110 8C/2.1GHz/ 11MB/85W/DDR4-2400 | 1x32GB RDIMM DDR4-2666 | 1x930-8i 2GB flash | 8x2.5" | 8x2.5" | SATA/SAS HS | None | None | None | None | None | Front VGA | TPM 1.2 | XClarity Enterprise | 2x750W Platinum | 3-year | 07/17 |
| 7X02A04DAU | 1xXeon Bronze 3104 6C/1.7GHz/ 8.25MB/85W/DDR4-2133 | 1x8GB RDIMM DDR4-2666 | 1x530-8i | 8x2.5" | 8x2.5" | SATA/SAS HS | None | None | None | x8 / x16, LP | None | Front VGA | TPM 1.2 | XClarity Enterprise | 1x750W Platinum | 3-year | 07/17 |
| 7X02A04GAU | 1xXeon Silver 4116 12C/2.1GHz/ 16.5MB/85W/DDR4-2400 | 1x16GB RDIMM DDR4-2666 | 1x930-8i 2GB flash | 8x2.5" | 8x2.5" | SATA/SAS HS | None | None | None | x8 / x16, LP | None | Front VGA | TPM 1.2 | XClarity Enterprise | 1x750W Platinum | 3-year | 07/17 |
| 7X02A04KAU | 1xXeon Silver 4108 8C/1.8GHz/ 11MB/85W/DDR4-2400 | 1x16GB RDIMM DDR4-2666 | 1x930-8i 2GB flash | 8x2.5" | 8x2.5" | SATA/SAS HS | None | None | None | x8 / x16, LP | None | Front VGA | TPM 1.2 | XClarity Enterprise | 1x750W Platinum | 3-year | 07/17 |
| 7X02A04RAU | 1xXeon Gold 5115 10C/2.4GHz/ 13.75MB/85W/DDR4-2400 | 1x16GB RDIMM DDR4-2666 | 1x930-8i 2GB flash | 8x2.5" | 8x2.5" | SATA/SAS HS | None | None | None | x8 / x16, LP | None | Front VGA | TPM 1.2 | XClarity Enterprise | 1x750W Platinum | 3-year | 07/17 |
| 7X02A04WAU | 1xXeon Silver 4110 8C/2.1GHz/ 11MB/85W/DDR4-2400 | 1x16GB RDIMM DDR4-2666 | 1x530-8i | 8x2.5" | 8x2.5" | SATA/SAS HS | None | None | None | x8 / x16, LP | None | Front VGA | TPM 1.2 | XClarity Enterprise | 1x750W Platinum | 3-year | 07/17 |
| 7X02A051AU | 1xXeon Gold 5118 12C/2.3GHz/ 16.5MB/105W/DDR4-2400 | 4x32GB RDIMM DDR4-2666 | 1x930-8i 2GB flash | 8x2.5" | 8x2.5" | SATA/SAS HS | None | None | 2x32GB | x8 / x16, LP | None | Front VGA | TPM 1.2 | XClarity Enterprise | 2x750W Platinum | 3-year | 07/17 |
| 7X02A054AU | 1xXeon Silver 4114 10C/2.2GHz/ 13.75MB/85W/DDR4-2400 | 1x16GB RDIMM DDR4-2666 | 1x930-8i 2GB flash | 8x2.5" | 8x2.5" | 2x300GB HDD 10K 2.5" SAS- 12Gbps | None | None | None | x8 / x16, LP | None | Front VGA | TPM 1.2 | XClarity Enterprise | 2x750W Platinum | 3-year | 07/17 |
| 7X02A055AU | 1xXeon Gold 5118 12C/2.3GHz/ 16.5MB/105W/DDR4-2400 | 1x16GB RDIMM DDR4-2666 | 1x930-16i 4GB flash | 10x2.5" | 10x2.5" (6 SATA/SAS, 4 AnyBay) HS | Open | None | None | None | x8 / x16, LP | None | Front VGA | TPM 1.2 | XClarity Enterprise | 1x750W Platinum | 3-year | 07/17 |
| 7X02A056AU | 1xXeon Silver 4114 10C/2.2GHz/ 13.75MB/85W/DDR4-2400 | 1x16GB RDIMM DDR4-2666 | 1x930-8i 2GB flash | 8x2.5" | 8x2.5" | SATA/SAS HS | None | None | None | x8 / x16, LP | None | Front VGA | TPM 1.2 | XClarity Enterprise | 1x750W Platinum | 3-year | 07/17 |
| 7X02A057AU | 1xXeon Silver 4110 8C/2.1GHz/ 11MB/85W/DDR4-2400 | 1x16GB RDIMM DDR4-2666 | 1x930-16i 4GB flash | 10x2.5" | 10x2.5" (6 SATA/SAS, 4 AnyBay) HS | Open | None | None | None | x8 / x16, LP | None | Front VGA | TPM 1.2 | XClarity Enterprise | 1x750W Platinum | 3-year | 07/17 |
| 7X02A059AU | 1xXeon Gold 5118 12C/2.3GHz/ 16.5MB/105W/DDR4-2400 | 1x16GB RDIMM DDR4-2666 | 1x930-8i 2GB flash | 8x2.5" | 8x2.5" | SATA/SAS HS | None | None | None | x8 / x16, LP | None | Front VGA | TPM 1.2 | XClarity Enterprise | 1x750W Platinum | 3-year | 07/17 |

ThinkSystem SR630 Models for Australia and New Zealand - Non TopSeller - 1 of 2

Product Specifications Reference (PSREF)

| Model | Processor | Memory | RAID/HBA Adapter | Chassis | Disk Bays | Disks | GPU | Networking (LOM/ML2/PCIe) | M.2 Boot Drive | Riser Card 1 for Slot 1-2 | Riser Card 2 for Slot 3 | Front VGA | Security | System Management | Power Supply | Base Warranty | Ann Date (mm/yy) |
|-------------|---|------------------------------|---------------------|---------|--|-------|------|---------------------------|----------------|---------------------------|-------------------------|-----------|----------|-------------------|-----------------|---------------|------------------|
| 7X02A00ZAU | 1xXeon Gold 5115 10C/2.4GHz/ 13.75MB/85W/DDR4-2400 | 1x8GB RDIMM DDR4-2666 | 1x530-8i | 8x2.5" | 8x2.5" SATA/SAS HS | Open | None | 4xGbE RJ-45 LOM | None | x8 / x16, LP | None | Front VGA | TPM 1.2 | XClarity Standard | 1x550W Platinum | 3-year | 07/17 |
| 7X02A01SAU | 1xXeon Gold 5118 12C/2.3GHz/ 16.5MB/105W/DDR4-2400 | 1x16GB RDIMM DDR4-2666 | 1x930-8i 2GB flash | 8x2.5" | 8x2.5" SATA/SAS HS | Open | None | None | None | x8 / x16, LP | None | Front VGA | TPM 1.2 | XClarity Standard | 1x750W Platinum | 3-year | 07/17 |
| 7X02A01UUAU | 1xXeon Gold 6130 16C/2.1GHz/ 22MB/125W/DDR4-2666 | 1x32GB RDIMM DDR4-2666 | 1x930-8i 2GB flash | 8x2.5" | 8x2.5" SATA/SAS HS | Open | None | None | None | x8 / x16, LP | None | Front VGA | TPM 1.2 | XClarity Standard | 1x750W Platinum | 3-year | 07/17 |
| 7X02A01XAU | 1xXeon Gold 6130 16C/2.1GHz/ 22MB/125W/DDR4-2666 | 1x16GB RDIMM DDR4-2666 | 1x930-8i 2GB flash | 8x2.5" | 8x2.5" SATA/SAS HS | Open | None | 4xGbE RJ-45 LOM | None | x8 / x16, LP | None | Front VGA | TPM 1.2 | XClarity Standard | 1x550W Platinum | 3-year | 07/17 |
| 7X02A020AU | 1xXeon Gold 5120 14C/2.2GHz/ 19.25MB/105W/DDR4-2400 | 1x16GB RDIMM DDR4-2666 | 1x530-8i | 8x2.5" | 8x2.5" SATA/SAS HS | Open | None | 4xGbE RJ-45 LOM | None | x8 / x16, LP | None | Front VGA | TPM 1.2 | XClarity Standard | 1x550W Platinum | 3-year | 07/17 |
| 7X02A022AU | 1xXeon Gold 5122 4C/3.6GHz/ 16.5MB/105W/DDR4-2400 | 1x16GB RDIMM DDR4-2666 | 1x930-8i 2GB flash | 8x2.5" | 8x2.5" SATA/SAS HS | Open | None | 4xGbE RJ-45 LOM | None | x8 / x16, LP | None | Front VGA | TPM 1.2 | XClarity Standard | 1x550W Platinum | 3-year | 07/17 |
| 7X02A023AU | 1xXeon Gold 5118 12C/2.3GHz/ 16.5MB/105W/DDR4-2400 | 1x16GB RDIMM DDR4-2666 | 1x930-16i 4GB flash | 10x2.5" | 10x2.5" (6 SATA/SAS, 4 AnyBay) HS | Open | None | None | None | x8 / x16, LP | None | Front VGA | TPM 1.2 | XClarity Standard | 1x750W Platinum | 3-year | 07/17 |
| 7X02A026AU | 1xXeon Gold 5115 10C/2.4GHz/ 13.75MB/85W/DDR4-2400 | 1x8GB RDIMM DDR4-2666 | 1x530-8i | 4x3.5" | 4x3.5" SATA/SAS HS | Open | None | 4xGbE RJ-45 LOM | None | x8 / x16, LP | None | Front VGA | TPM 1.2 | XClarity Standard | 1x550W Platinum | 3-year | 07/17 |
| 7X02A02MAU | 1xXeon Gold 6126 12C/2.6GHz/ 19.25MB/125W/DDR4-2666 | 1x16GB RDIMM DDR4-2666 | 1x930-8i 2GB flash | 8x2.5" | 8x2.5" SATA/SAS HS | Open | None | 4xGbE RJ-45 LOM | None | x8 / x16, LP | None | Front VGA | TPM 1.2 | XClarity Standard | 1x550W Platinum | 3-year | 07/17 |
| 7X02A02PAU | 1xXeon Gold 5118 12C/2.3GHz/ 16.5MB/105W/DDR4-2400 | 1x16GB RDIMM DDR4-2666 | 1x930-8i 2GB flash | 8x2.5" | 8x2.5" SATA/SAS HS | Open | None | 4xGbE RJ-45 LOM | None | x8 / x16, LP | None | Front VGA | TPM 1.2 | XClarity Standard | 1x550W Platinum | 3-year | 07/17 |
| 7X02A030AU | 1xXeon Gold 5118 12C/2.3GHz/ 16.5MB/105W/DDR4-2400 | 1x16GB RDIMM DDR4-2666 | 1x530-8i | 8x2.5" | 8x2.5" SATA/SAS HS | Open | None | 4xGbE RJ-45 LOM | None | x8 / x16, LP | None | Front VGA | TPM 1.2 | XClarity Standard | 1x550W Platinum | 3-year | 07/17 |
| 7X02A032AU | 1xXeon Gold 5118 12C/2.3GHz/ 16.5MB/105W/DDR4-2400 | 1x8GB RDIMM DDR4-2666 | 1x530-8i | 8x2.5" | 8x2.5" SATA/SAS HS | Open | None | 4xGbE RJ-45 LOM | None | x8 / x16, LP | None | Front VGA | TPM 1.2 | XClarity Standard | 1x550W Platinum | 3-year | 07/17 |
| 7X02A033AU | 1xXeon Gold 6142 16C/2.6GHz/ 22MB/150W/DDR4-2666 | 1x16GB RDIMM DDR4-2666 | 1x930-8i 2GB flash | 8x2.5" | 8x2.5" SATA/SAS HS | Open | None | 4xGbE RJ-45 LOM | None | x8 / x16, LP | None | Front VGA | TPM 1.2 | XClarity Standard | 1x550W Platinum | 3-year | 07/17 |
| 7X02A034AU | 1xXeon Gold 5120 14C/2.2GHz/ 19.25MB/105W/DDR4-2400 | 1x16GB RDIMM DDR4-2666 | 1x930-8i 2GB flash | 8x2.5" | 8x2.5" SATA/SAS HS | Open | None | 4xGbE RJ-45 LOM | None | x8 / x16, LP | None | Front VGA | TPM 1.2 | XClarity Standard | 1x550W Platinum | 3-year | 07/17 |
| 7X02A035AU | 1xXeon Gold 5115 10C/2.4GHz/ 13.75MB/85W/DDR4-2400 | 1x16GB RDIMM DDR4-2666 | 1x930-8i 2GB flash | 8x2.5" | 8x2.5" SATA/SAS HS | Open | None | None | None | x8 / x16, LP | None | Front VGA | TPM 1.2 | XClarity Standard | 1x750W Platinum | 3-year | 07/17 |
| 7X02A03DAU | 1xXeon Gold 6154 18C/3.0GHz/ 24.75MB/200W/DDR4-2666 | 1x16GB RDIMM DDR4-2666 | 1x930-8i 2GB flash | 8x2.5" | 8x2.5" SATA/SAS HS | Open | None | 4xGbE RJ-45 LOM | None | x8 / x16, LP | None | Front VGA | TPM 1.2 | XClarity Standard | 1x550W Platinum | 3-year | 07/17 |
| 7X02A03EAU | 1xXeon Gold 6148 20C/2.4GHz/ 27.5MB/150W/DDR4-2666 | 1x32GB RDIMM DDR4-2666 | 1x930-8i 2GB flash | 8x2.5" | 8x2.5" SATA/SAS HS | Open | None | None | None | x8 / x16, LP | None | Front VGA | TPM 1.2 | XClarity Standard | 1x750W Platinum | 3-year | 07/17 |
| 7X02A03FAU | 1xXeon Gold 6140 18C/2.3GHz/ 24.75MB/140W/DDR4-2666 | 1x32GB RDIMM DDR4-2666 | 1x930-8i 2GB flash | 8x2.5" | 8x2.5" SATA/SAS HS | Open | None | None | None | x8 / x16, LP | None | Front VGA | TPM 1.2 | XClarity Standard | 1x750W Platinum | 3-year | 07/17 |

ThinkSystem SR630 Models for Australia and New Zealand - Non TopSeller - 2 of 2

Product Specifications Reference (PSREF)

| Model | Processor | Memory | RAID/HBA Adapter | Chassis | Disk Bays | Disks | GPU | Networking (LOM/ML2/PCIe) | M.2 Boot Drive | Riser Card 1 for Slot 1-2 | Riser Card 2 for Slot 3 | Front VGA | Security | System Management | Power Supply | Base Warranty | Ann Date (mm/yy) |
|------------|--|------------------------------|------------------------|---------|--|-------|------|---------------------------|----------------|---------------------------|-------------------------|--------------|----------|----------------------|--------------------|---------------|------------------|
| 7X02A03GAU | 1xXeon Gold 6152 22C/2.1GHz/ 30.25MB/140W/DDR4-2666 | 1x32GB RDIMM DDR4-2666 | 1x930-8i 2GB flash | 8x2.5" | 8x2.5" SATA/SAS HS | Open | None | None | None | x8 / x16, LP | None | Front VGA | TPM 1.2 | XClarity Standard | 1x750W Platinum | 3-year | 07/17 |
| 7X02A03HAU | 1xXeon Gold 6134 8C/3.2GHz/ 24.75MB/130W/DDR4-2666 | 1x32GB RDIMM DDR4-2666 | 1x930-8i 2GB flash | 8x2.5" | 8x2.5" SATA/SAS HS | Open | None | None | None | x8 / x16, LP | None | Front VGA | TPM 1.2 | XClarity Standard | 1x750W Platinum | 3-year | 07/17 |
| 7X02A03JAU | 1xXeon Platinum 8160 24C/2.1GHz/ 33MB/150W/DDR4-2666 | 1x32GB RDIMM DDR4-2666 | 1x930-8i 2GB flash | 8x2.5" | 8x2.5" SATA/SAS HS | Open | None | None | None | x8 / x16, LP | None | Front VGA | TPM 1.2 | XClarity Standard | 1x750W Platinum | 3-year | 07/17 |
| 7X02A03KAU | 2xXeon Gold 5118 12C/2.3GHz/ 16.5MB/105W/DDR4-2400 | 2x32GB RDIMM DDR4-2666 | 1x430-16i | 10x2.5" | 10x2.5" (6 SATA/SAS, 4 AnyBay) HS | Open | None | None | None | x8 / x16, LP | x16 LP | Front VGA | TPM 1.2 | XClarity Standard | 1x750W Platinum | 3-year | 07/17 |
| 7X02A03LAU | 1xXeon Gold 6142 16C/2.6GHz/ 22MB/150W/DDR4-2666 | 1x32GB RDIMM DDR4-2666 | 1x930-8i 2GB flash | 8x2.5" | 8x2.5" SATA/SAS HS | Open | None | None | None | x8 / x16, LP | None | Front VGA | TPM 1.2 | XClarity Standard | 1x750W Platinum | 3-year | 07/17 |
| 7X02A03MAU | 1xXeon Gold 5120 14C/2.2GHz/ 19.25MB/105W/DDR4-2400 | 1x16GB RDIMM DDR4-2666 | 1x930-8i 2GB flash | 8x2.5" | 8x2.5" SATA/SAS HS | Open | None | None | None | x8 / x16, LP | None | Front VGA | TPM 1.2 | XClarity Standard | 1x750W Platinum | 3-year | 07/17 |
| 7X02A03NAU | 1xXeon Gold 6126T 12C/2.6GHz/ 19.25MB/125W/DDR4-2666 | 1x32GB RDIMM DDR4-2666 | 1x930-8i 2GB flash | 8x2.5" | 8x2.5" SATA/SAS HS | Open | None | None | None | x8 / x16, LP | None | Front VGA | TPM 1.2 | XClarity Standard | 1x750W Platinum | 3-year | 07/17 |
| 7X02A03PAU | 1xXeon Gold 6150 18C/2.7GHz/ 24.75MB/165W/DDR4-2666 | 1x32GB RDIMM DDR4-2666 | 1x930-8i 2GB flash | 8x2.5" | 8x2.5" SATA/SAS HS | Open | None | None | None | x8 / x16, LP | None | Front VGA | TPM 1.2 | XClarity Standard | 1x750W Platinum | 3-year | 07/17 |
| 7X02A03SAU | 1xXeon Silver 4114 10C/2.2GHz/ 13.75MB/85W/DDR4-2400 | 1x16GB RDIMM DDR4-2666 | 1x930-8i 2GB flash | 8x2.5" | 8x2.5" SATA/SAS HS | Open | None | None | None | x8 / x16, LP | None | None | TPM 1.2 | XClarity Standard | 1x750W Platinum | 3-year | 07/17 |
| 7X02A040AU | 2xXeon Silver 4110 8C/2.1GHz/ 11MB/85W/DDR4-2400 | 2x32GB RDIMM DDR4-2666 | 1x430-16i | 10x2.5" | 10x2.5" (6 SATA/SAS, 4 AnyBay) HS | Open | None | None | None | x8 / x16, LP | None | None | TPM 1.2 | XClarity Standard | 1x750W Platinum | 3-year | 07/17 |
| 7X02A04AAU | 1xXeon Silver 4110 8C/2.1GHz/ 11MB/85W/DDR4-2400 | 1x16GB RDIMM DDR4-2666 | 1x930-8i 2GB flash | 8x2.5" | 8x2.5" SATA/SAS HS | Open | None | None | None | x8 / x16, LP | None | None | TPM 1.2 | XClarity Standard | 1x750W Platinum | 3-year | 07/17 |
| 7X02A04FAU | 1xXeon Silver 4108 8C/1.8GHz/ 11MB/85W/DDR4-2400 | 1x16GB RDIMM DDR4-2666 | 1x530-8i | 8x2.5" | 8x2.5" SATA/SAS HS | Open | None | None | None | x8 / x16, LP | None | None | TPM 1.2 | XClarity Standard | 1x750W Platinum | 3-year | 07/17 |
| 7X02A04HAU | 1xXeon Silver 4110 8C/2.1GHz/ 11MB/85W/DDR4-2400 | 1x16GB RDIMM DDR4-2666 | 1x930-16i 4GB flash | 10x2.5" | 10x2.5" (6 SATA/SAS, 4 AnyBay) HS | Open | None | None | None | x8 / x16, LP | None | None | TPM 1.2 | XClarity Standard | 1x750W Platinum | 3-year | 07/17 |
| 7X02A04LAU | 1xXeon Bronze 3106 8C/1.7GHz/ 11MB/85W/DDR4-2133 | 1x8GB RDIMM DDR4-2666 | 1x530-8i | 8x2.5" | 8x2.5" SATA/SAS HS | Open | None | None | None | x8 / x16, LP | None | None | TPM 1.2 | XClarity Standard | 1x750W Platinum | 3-year | 07/17 |
| 7X02A04UAU | 1xXeon Silver 4108 8C/1.8GHz/ 11MB/85W/DDR4-2400 | 1x16GB RDIMM DDR4-2666 | 1x530-8i | 4x3.5" | 4x3.5" SATA/SAS HS | Open | None | None | None | x8 / x16, LP | None | None | TPM 1.2 | XClarity Standard | 1x750W Platinum | 3-year | 07/17 |
| 7X02A04XAU | 1xXeon Silver 4110 8C/2.1GHz/ 11MB/85W/DDR4-2400 | 1x16GB RDIMM DDR4-2666 | 1x530-8i | 8x2.5" | 8x2.5" SATA/SAS HS | Open | None | None | None | x8 / x16, LP | None | None | TPM 1.2 | XClarity Standard | 1x750W Platinum | 3-year | 07/17 |
| 7X02A050AU | 1xXeon Silver 4116 12C/2.1GHz/ 16.5MB/85W/DDR4-2400 | 1x16GB RDIMM DDR4-2666 | 1x930-8i 2GB flash | 8x2.5" | 8x2.5" SATA/SAS HS | Open | None | None | None | x8 / x16, LP | None | None | TPM 1.2 | XClarity Standard | 1x750W Platinum | 3-year | 07/17 |
| 7X02A058AU | 1xXeon Bronze 3104 6C/1.7GHz/ 8.25MB/85W/DDR4-2133 | 1x8GB RDIMM DDR4-2666 | 1x530-8i | 8x2.5" | 8x2.5" SATA/SAS HS | Open | None | None | None | x8 / x16, LP | None | None | TPM 1.2 | XClarity Standard | 1x750W Platinum | 3-year | 07/17 |

ThinkSystem SR630 Models for South East Asian (ASEAN) - Non TopSeller

Product Specifications Reference (PSREF)

| Model | Processor | Memory | RAID/HBA Adapter | Chassis | Disk Bays | Disks | GPU | Networking (LOM/ML2/PCIe) | M.2 Boot Drive | Riser Card 1 for Slot 1-2 | Riser Card 2 for Slot 3 | Front VGA | Security | System Management | Power Supply | Base Warranty | Ann Date (mm/yy) |
|------------|---|------------------------------|-----------------------|---------|-----------------------|-------|------|---------------------------|----------------|---------------------------|-------------------------|--------------|----------|----------------------|---------------------|---------------|------------------|
| 7X02A001SG | 1xXeon Gold 5115 10C/2.4GHz/ 13.75MB/85W/DDR4-2400 | 1x16GB RDIMM DDR4-2666 | 1x930-8i 2GB flash | 8x2.5" | 8x2.5" SATA/SAS HS | Open | None | 4x10GbE RJ-45 LOM | None | x8 / x16, LP | None | Front VGA | TPM 1.2 | XClarity Advanced | 1x750W Platinum | 3-year | 07/17 |
| 7X02A00BSG | 1xXeon Gold 6130 16C/2.1GHz/ 22MB/125W/DDR4-2666 | 1x16GB RDIMM DDR4-2666 | 1x930-8i 2GB flash | 8x2.5" | 8x2.5" SATA/SAS HS | Open | None | 4x10GbE RJ-45 LOM | None | x8 / x16, LP | None | Front VGA | TPM 1.2 | XClarity Advanced | 1x1100W Platinum | 3-year | 07/17 |
| 7X02A00DSG | 1xXeon Gold 6134 8C/3.2GHz/ 24.75MB/130W/DDR4-2666 | 1x16GB RDIMM DDR4-2666 | 1x930-8i 2GB flash | 8x2.5" | 8x2.5" SATA/SAS HS | Open | None | 4x10GbE RJ-45 LOM | None | x8 / x16, LP | None | Front VGA | TPM 1.2 | XClarity Advanced | 1x1100W Platinum | 3-year | 07/17 |
| 7X02A00FSG | 1xXeon Gold 5120 14C/2.2GHz/ 19.25MB/105W/DDR4-2400 | 1x16GB RDIMM DDR4-2666 | 1x930-8i 2GB flash | 8x2.5" | 8x2.5" SATA/SAS HS | Open | None | 4x10GbE RJ-45 LOM | None | x8 / x16, LP | None | Front VGA | TPM 1.2 | XClarity Advanced | 1x750W Platinum | 3-year | 07/17 |
| 7X02A00KSG | 1xXeon Gold 5118 12C/2.3GHz/ 16.5MB/105W/DDR4-2400 | 1x16GB RDIMM DDR4-2666 | 1x930-8i 2GB flash | 8x2.5" | 8x2.5" SATA/SAS HS | Open | None | 4x10GbE RJ-45 LOM | None | x8 / x16, LP | None | Front VGA | TPM 1.2 | XClarity Advanced | 1x750W Platinum | 3-year | 07/17 |
| 7X02A00LSG | 1xXeon Gold 5115 10C/2.4GHz/ 13.75MB/85W/DDR4-2400 | 1x16GB RDIMM DDR4-2666 | 1x930-8i 2GB flash | 4x3.5" | 4x3.5" SATA/SAS HS | Open | None | 4x10GbE RJ-45 LOM | None | x8 / x16, LP | None | Front VGA | TPM 1.2 | XClarity Advanced | 1x1100W Platinum | 3-year | 07/17 |
| 7X02A00MSG | 1xXeon Gold 6152 22C/2.1GHz/ 30.25MB/140W/DDR4-2666 | 1x32GB RDIMM DDR4-2666 | 1x930-8i 2GB flash | 8x2.5" | 8x2.5" SATA/SAS HS | Open | None | 4x10GbE RJ-45 LOM | None | x8 / x16, LP | None | Front VGA | TPM 1.2 | XClarity Advanced | 1x1100W Platinum | 3-year | 07/17 |
| 7X02A00NSG | 1xXeon Gold 6148 20C/2.4GHz/ 27.5MB/150W/DDR4-2666 | 1x32GB RDIMM DDR4-2666 | 1x930-8i 2GB flash | 8x2.5" | 8x2.5" SATA/SAS HS | Open | None | 4x10GbE RJ-45 LOM | None | x8 / x16, LP | None | Front VGA | TPM 1.2 | XClarity Advanced | 1x1100W Platinum | 3-year | 07/17 |
| 7X02A00SSG | 1xXeon Gold 6140 18C/2.3GHz/ 24.75MB/140W/DDR4-2666 | 1x16GB RDIMM DDR4-2666 | 1x930-8i 2GB flash | 8x2.5" | 8x2.5" SATA/SAS HS | Open | None | 4x10GbE RJ-45 LOM | None | x8 / x16, LP | None | Front VGA | TPM 1.2 | XClarity Advanced | 1x1100W Platinum | 3-year | 07/17 |

ThinkSystem SR630 Models for Hong Kong, Taiwan, Korea (HTK) - Non TopSeller - 1 of 2

Product Specifications Reference (PSREF)

| Model | Processor | Memory | RAID/HBA Adapter | Chassis | Disk Bays | Disks | GPU | Networking (LOM/ML2/PCIe) | M.2 Boot Drive | Riser Card 1 for Slot 1-2 | Riser Card 2 for Slot 3 | Front VGA | Security | System Management | Power Supply | Base Warranty | Ann Date (mm/yy) |
|------------|---|------------------------------|-----------------------|---------|------------------------|-------|-----------------|---------------------------|----------------|---------------------------|-------------------------|--------------|----------|----------------------|--------------------|---------------|------------------|
| 7X02A00TCN | 1xXeon Gold 6150 18C/2.7GHz/ 24.75MB/165W/DDR4-2666 | 1x16GB RDIMM DDR4-2666 | 1x930-8i 2GB flash | 8x2.5" | 8x2.5" SATA/ SAS HS | Open | Quadro P2000 | 4xGbE RJ- 45 LOM | None | x8 LP / x16 FH | None | Front VGA | TPM 1.2 | XClarity Standard | 1x750W Platinum | 3-year | 07/17 |
| 7X02A00VCN | 1xXeon Gold 5118 12C/2.3GHz/ 16.5MB/105W/DDR4-2400 | 1x16GB RDIMM DDR4-2666 | None | 8x2.5" | None | None | None | 4xGbE RJ- 45 LOM | None | x8 / x16, LP | None | Front VGA | TPM 1.2 | XClarity Standard | 1x750W Platinum | 3-year | 07/17 |
| 7X02A00XCN | 1xXeon Gold 6140 18C/2.3GHz/ 24.75MB/140W/DDR4-2666 | 1x16GB RDIMM DDR4-2666 | 1x930-8i 2GB flash | 8x2.5" | 8x2.5" SATA/ SAS HS | Open | Quadro P2000 | 4xGbE RJ- 45 LOM | None | x8 LP / x16 FH | None | Front VGA | TPM 1.2 | XClarity Standard | 1x750W Platinum | 3-year | 07/17 |
| 7X02A00YCN | 1xXeon Gold 6142 16C/2.6GHz/ 22MB/150W/DDR4-2666 | 1x16GB RDIMM DDR4-2666 | 1x930-8i 2GB flash | 8x2.5" | 8x2.5" SATA/ SAS HS | Open | Quadro P2000 | 4xGbE RJ- 45 LOM | None | x8 LP / x16 FH | None | Front VGA | TPM 1.2 | XClarity Standard | 1x750W Platinum | 3-year | 07/17 |
| 7X02A010CN | 1xXeon Gold 5115 10C/2.4GHz/ 13.75MB/85W/DDR4-2400 | 1x16GB RDIMM DDR4-2666 | 1x930-8i 2GB flash | 4x3.5" | 4x3.5" SATA/ SAS HS | Open | None | 4xGbE RJ- 45 LOM | None | x8 / x16, LP | None | None | TPM 1.2 | XClarity Standard | 1x750W Platinum | 3-year | 07/17 |
| 7X02A011CN | 1xXeon Gold 5118 12C/2.3GHz/ 16.5MB/105W/DDR4-2400 | 1x16GB RDIMM DDR4-2666 | 1x930-8i 2GB flash | 4x3.5" | 4x3.5" SATA/ SAS HS | Open | None | 4xGbE RJ- 45 LOM | None | x8 / x16, LP | None | None | TPM 1.2 | XClarity Standard | 1x750W Platinum | 3-year | 07/17 |
| 7X02A013CN | 1xXeon Gold 5115 10C/2.4GHz/ 13.75MB/85W/DDR4-2400 | 1x16GB RDIMM DDR4-2666 | 1x930-8i 2GB flash | 8x2.5" | 8x2.5" SATA/ SAS HS | Open | Quadro P2000 | 4xGbE RJ- 45 LOM | None | x8 LP / x16 FH | None | Front VGA | TPM 1.2 | XClarity Standard | 1x750W Platinum | 3-year | 07/17 |
| 7X02A014CN | 1xXeon Gold 6126 12C/2.6GHz/ 19.25MB/125W/DDR4-2666 | 1x16GB RDIMM DDR4-2666 | 1x930-8i 2GB flash | 8x2.5" | 8x2.5" SATA/ SAS HS | Open | Quadro P2000 | 4xGbE RJ- 45 LOM | None | x8 LP / x16 FH | None | Front VGA | TPM 1.2 | XClarity Standard | 1x750W Platinum | 3-year | 07/17 |
| 7X02A015CN | 1xXeon Gold 5120 14C/2.2GHz/ 19.25MB/105W/DDR4-2400 | 1x16GB RDIMM DDR4-2666 | 1x930-8i 2GB flash | 8x2.5" | 8x2.5" SATA/ SAS HS | Open | Quadro P2000 | 4xGbE RJ- 45 LOM | None | x8 LP / x16 FH | None | Front VGA | TPM 1.2 | XClarity Standard | 1x750W Platinum | 3-year | 07/17 |
| 7X02A016CN | 1xXeon Gold 5122 4C/3.6GHz/ 16.5MB/105W/DDR4-2400 | 1x16GB RDIMM DDR4-2666 | 1x930-8i 2GB flash | 8x2.5" | 8x2.5" SATA/ SAS HS | Open | Quadro P2000 | 4xGbE RJ- 45 LOM | None | x8 LP / x16 FH | None | Front VGA | TPM 1.2 | XClarity Standard | 1x750W Platinum | 3-year | 07/17 |
| 7X02A018CN | 1xXeon Gold 6136 12C/3.0GHz/ 24.75MB/150W/DDR4-2666 | 1x16GB RDIMM DDR4-2666 | 1x930-8i 2GB flash | 8x2.5" | 8x2.5" SATA/ SAS HS | Open | Quadro P2000 | 4xGbE RJ- 45 LOM | None | x8 LP / x16 FH | None | Front VGA | TPM 1.2 | XClarity Standard | 1x750W Platinum | 3-year | 07/17 |
| 7X02A019CN | 1xXeon Gold 6134 8C/3.2GHz/ 24.75MB/130W/DDR4-2666 | 1x16GB RDIMM DDR4-2666 | 1x930-8i 2GB flash | 8x2.5" | 8x2.5" SATA/ SAS HS | Open | Quadro P2000 | 4xGbE RJ- 45 LOM | None | x8 LP / x16 FH | None | None | TPM 1.2 | XClarity Standard | 1x750W Platinum | 3-year | 07/17 |
| 7X02A01BCN | 1xXeon Gold 6138T 20C/2.0GHz/ 27.5MB/125W/DDR4-2666 | 1x16GB RDIMM DDR4-2666 | 1x930-8i 2GB flash | 8x2.5" | 8x2.5" SATA/ SAS HS | Open | Quadro P2000 | 4xGbE RJ- 45 LOM | None | x8 LP / x16 FH | None | Front VGA | TPM 1.2 | XClarity Standard | 1x750W Platinum | 3-year | 07/17 |
| 7X02A01DCN | 1xXeon Gold 6130 16C/2.1GHz/ 22MB/125W/DDR4-2666 | 1x16GB RDIMM DDR4-2666 | 1x930-8i 2GB flash | 8x2.5" | 8x2.5" SATA/ SAS HS | Open | Quadro P2000 | 4xGbE RJ- 45 LOM | None | x8 LP / x16 FH | None | Front VGA | TPM 1.2 | XClarity Standard | 1x750W Platinum | 3-year | 07/17 |
| 7X02A01ECN | 1xXeon Gold 6134 8C/3.2GHz/ 24.75MB/130W/DDR4-2666 | 1x16GB RDIMM DDR4-2666 | 1x930-8i 2GB flash | 8x2.5" | 8x2.5" SATA/ SAS HS | Open | Quadro P2000 | 4xGbE RJ- 45 LOM | None | x8 LP / x16 FH | None | Front VGA | TPM 1.2 | XClarity Standard | 1x750W Platinum | 3-year | 07/17 |
| 7X02A01RCN | 1xXeon Gold 6130 16C/2.1GHz/ 22MB/125W/DDR4-2666 | 1x16GB RDIMM DDR4-2666 | 1x930-8i 2GB flash | 4x3.5" | 4x3.5" SATA/ SAS HS | Open | None | 4xGbE RJ- 45 LOM | None | x8 / x16, LP | None | None | TPM 1.2 | XClarity Standard | 1x750W Platinum | 3-year | 07/17 |
| 7X02A01TCN | 1xXeon Gold 6134 8C/3.2GHz/ 24.75MB/130W/DDR4-2666 | 1x16GB RDIMM DDR4-2666 | 1x930-8i 2GB flash | 4x3.5" | 4x3.5" SATA/ SAS HS | Open | None | 4xGbE RJ- 45 LOM | None | x8 / x16, LP | None | None | TPM 1.2 | XClarity Standard | 1x750W Platinum | 3-year | 07/17 |
| 7X02A01YCN | 1xXeon Gold 5122 4C/3.6GHz/ 16.5MB/105W/DDR4-2400 | 1x16GB RDIMM DDR4-2666 | 1x930-8i 2GB flash | 4x3.5" | 4x3.5" SATA/ SAS HS | Open | None | 4xGbE RJ- 45 LOM | None | x8 / x16, LP | None | None | TPM 1.2 | XClarity Standard | 1x750W Platinum | 3-year | 07/17 |
| 7X02A028CN | 1xXeon Gold 5120 14C/2.2GHz/ 19.25MB/105W/DDR4-2400 | 1x16GB RDIMM DDR4-2666 | 1x930-8i 2GB flash | 4x3.5" | 4x3.5" SATA/ SAS HS | Open | None | 4xGbE RJ- 45 LOM | None | x8 / x16, LP | None | None | TPM 1.2 | XClarity Standard | 1x750W Platinum | 3-year | 07/17 |
| 7X02A02ACN | 1xXeon Gold 5118 12C/2.3GHz/ 16.5MB/105W/DDR4-2400 | 1x16GB RDIMM DDR4-2666 | 1x930-8i 2GB flash | 8x2.5" | 8x2.5" SATA/ SAS HS | Open | Quadro P2000 | 4xGbE RJ- 45 LOM | None | x8 LP / x16 FH | None | None | TPM 1.2 | XClarity Standard | 1x750W Platinum | 3-year | 07/17 |

ThinkSystem SR630 Models for Hong Kong, Taiwan, Korea (HTK) - Non TopSeller - 2 of 2

Product Specifications Reference (PSREF)

| Model | Processor | Memory | RAID/HBA Adapter | Chassis | Disk Bays | Disks | GPU | Networking (LOM/ML2/PCIe) | M.2 Boot Drive | Riser Card 1 for Slot 1-2 | Riser Card 2 for Slot 3 | Front VGA | Security | System Management | Power Supply | Base Warranty | Ann Date (mm/yy) |
|------------|--|------------------------------|-----------------------|---------|------------------------|-------|-----------------|---------------------------|----------------|---------------------------|-------------------------|--------------|----------|----------------------|--------------------|---------------|------------------|
| 7X02A02BCN | 1xXeon Gold 5115 10C/2.4GHz/ 13.75MB/85W/DDR4-2400 | 1x16GB RDIMM DDR4-2666 | 1x930-8i 2GB flash | 8x2.5" | 8x2.5" SATA/ SAS HS | Open | Quadro P2000 | 4xGbE RJ- 45 LOM | None | x8 LP / x16 FH | None | None | TPM 1.2 | XClarity Standard | 1x750W Platinum | 3-year | 07/17 |
| 7X02A02KCN | 1xXeon Silver 4110 8C/2.1GHz/ 11MB/85W/DDR4-2400 | 1x16GB RDIMM DDR4-2666 | 1x930-8i 2GB flash | 8x2.5" | 8x2.5" SATA/ SAS HS | Open | None | 4xGbE RJ- 45 LOM | None | x8 / x16, LP | None | None | TPM 1.2 | XClarity Standard | 1x750W Platinum | 3-year | 07/17 |
| 7X02A02QCN | 1xXeon Gold 6152 22C/2.1GHz/ 30.25MB/140W/DDR4-2666 | 1x16GB RDIMM DDR4-2666 | 1x930-8i 2GB flash | 8x2.5" | 8x2.5" SATA/ SAS HS | Open | Quadro P2000 | 4xGbE RJ- 45 LOM | None | x8 LP / x16 FH | None | Front VGA | TPM 1.2 | XClarity Standard | 1x750W Platinum | 3-year | 07/17 |
| 7X02A036CN | 1xXeon Gold 6130 16C/2.1GHz/ 22MB/125W/DDR4-2666 | 1x16GB RDIMM DDR4-2666 | 1x930-8i 2GB flash | 8x2.5" | 8x2.5" SATA/ SAS HS | Open | Quadro P2000 | 4xGbE RJ- 45 LOM | None | x8 LP / x16 FH | None | None | TPM 1.2 | XClarity Standard | 1x750W Platinum | 3-year | 07/17 |
| 7X02A037CN | 1xXeon Gold 5120 14C/2.2GHz/ 19.25MB/105W/DDR4-2400 | 1x16GB RDIMM DDR4-2666 | 1x930-8i 2GB flash | 8x2.5" | 8x2.5" SATA/ SAS HS | Open | Quadro P2000 | 4xGbE RJ- 45 LOM | None | x8 LP / x16 FH | None | None | TPM 1.2 | XClarity Standard | 1x750W Platinum | 3-year | 07/17 |
| 7X02A03ACN | 1xXeon Gold 5122 4C/3.6GHz/ 16.5MB/105W/DDR4-2400 | 1x16GB RDIMM DDR4-2666 | 1x930-8i 2GB flash | 8x2.5" | 8x2.5" SATA/ SAS HS | Open | Quadro P2000 | 4xGbE RJ- 45 LOM | None | x8 LP / x16 FH | None | None | TPM 1.2 | XClarity Standard | 1x750W Platinum | 3-year | 07/17 |
| 7X02A03QCN | 1xXeon Silver 4112 4C/2.6GHz/ 8.25MB/85W/DDR4-2400 | 1x16GB RDIMM DDR4-2666 | 1x930-8i 2GB flash | 4x3.5" | 4x3.5" SATA/ SAS HS | Open | None | 4xGbE RJ- 45 LOM | None | x8 / x16, LP | None | None | TPM 1.2 | XClarity Standard | 1x750W Platinum | 3-year | 07/17 |
| 7X02A03RCN | 1xXeon Silver 4114 10C/2.2GHz/ 13.75MB/85W/DDR4-2400 | 1x16GB RDIMM DDR4-2666 | 1x930-8i 2GB flash | 4x3.5" | 4x3.5" SATA/ SAS HS | Open | None | 4xGbE RJ- 45 LOM | None | x8 / x16, LP | None | None | TPM 1.2 | XClarity Standard | 1x750W Platinum | 3-year | 07/17 |
| 7X02A03XCN | 1xXeon Silver 4110 8C/2.1GHz/ 11MB/85W/DDR4-2400 | 1x16GB RDIMM DDR4-2666 | 1x930-8i 2GB flash | 4x3.5" | 4x3.5" SATA/ SAS HS | Open | None | 4xGbE RJ- 45 LOM | None | x8 / x16, LP | None | None | TPM 1.2 | XClarity Standard | 1x750W Platinum | 3-year | 07/17 |
| 7X02A03YCN | 1xXeon Silver 4108 8C/1.8GHz/ 11MB/85W/DDR4-2400 | 1x16GB RDIMM DDR4-2666 | 1x930-8i 2GB flash | 4x3.5" | 4x3.5" SATA/ SAS HS | Open | None | 4xGbE RJ- 45 LOM | None | x8 / x16, LP | None | None | TPM 1.2 | XClarity Standard | 1x750W Platinum | 3-year | 07/17 |
| 7X02A047CN | 1xXeon Silver 4116 12C/2.1GHz/ 16.5MB/85W/DDR4-2400 | 1x16GB RDIMM DDR4-2666 | 1x930-8i 2GB flash | 4x3.5" | 4x3.5" SATA/ SAS HS | Open | None | 4xGbE RJ- 45 LOM | None | x8 / x16, LP | None | None | TPM 1.2 | XClarity Standard | 1x750W Platinum | 3-year | 07/17 |
| 7X02A04CCN | 1xXeon Silver 4114 10C/2.2GHz/ 13.75MB/85W/DDR4-2400 | 1x16GB RDIMM DDR4-2666 | 1x930-8i 2GB flash | 8x2.5" | 8x2.5" SATA/ SAS HS | Open | None | 4xGbE RJ- 45 LOM | None | x8 / x16, LP | None | None | TPM 1.2 | XClarity Standard | 1x750W Platinum | 3-year | 07/17 |
| 7X02A04ECN | 1xXeon Silver 4112 4C/2.6GHz/ 8.25MB/85W/DDR4-2400 | 1x16GB RDIMM DDR4-2666 | 1x930-8i 2GB flash | 8x2.5" | 8x2.5" SATA/ SAS HS | Open | None | 4xGbE RJ- 45 LOM | None | x8 / x16, LP | None | None | TPM 1.2 | XClarity Standard | 1x750W Platinum | 3-year | 07/17 |
| 7X02A04MCN | 1xXeon Silver 4108 8C/1.8GHz/ 11MB/85W/DDR4-2400 | 1x16GB RDIMM DDR4-2666 | 1x930-8i 2GB flash | 8x2.5" | 8x2.5" SATA/ SAS HS | Open | None | 4xGbE RJ- 45 LOM | None | x8 / x16, LP | None | None | TPM 1.2 | XClarity Standard | 1x750W Platinum | 3-year | 07/17 |
| 7X02A04NCN | 1xXeon Bronze 3104 6C/1.7GHz/ 8.25MB/85W/DDR4-2133 | 1x16GB RDIMM DDR4-2666 | 1x930-8i 2GB flash | 8x2.5" | 8x2.5" SATA/ SAS HS | Open | None | 4xGbE RJ- 45 LOM | None | x8 / x16, LP | None | None | TPM 1.2 | XClarity Standard | 1x750W Platinum | 3-year | 07/17 |
| 7X02A04PCN | 1xXeon Bronze 3106 8C/1.7GHz/ 11MB/85W/DDR4-2133 | 1x16GB RDIMM DDR4-2666 | 1x930-8i 2GB flash | 8x2.5" | 8x2.5" SATA/ SAS HS | Open | None | 4xGbE RJ- 45 LOM | None | x8 / x16, LP | None | None | TPM 1.2 | XClarity Standard | 1x750W Platinum | 3-year | 07/17 |
| 7X02A04QCN | 1xXeon Silver 4116 12C/2.1GHz/ 16.5MB/85W/DDR4-2400 | 1x16GB RDIMM DDR4-2666 | 1x930-8i 2GB flash | 8x2.5" | 8x2.5" SATA/ SAS HS | Open | None | 4xGbE RJ- 45 LOM | None | x8 / x16, LP | None | None | TPM 1.2 | XClarity Standard | 1x750W Platinum | 3-year | 07/17 |
| 7X02A04SCN | 1xXeon Bronze 3104 6C/1.7GHz/ 8.25MB/85W/DDR4-2133 | 1x16GB RDIMM DDR4-2666 | 1x930-8i 2GB flash | 4x3.5" | 4x3.5" SATA/ SAS HS | Open | None | 4xGbE RJ- 45 LOM | None | x8 / x16, LP | None | None | TPM 1.2 | XClarity Standard | 1x750W Platinum | 3-year | 07/17 |
| 7X02A04ZCN | 1xXeon Bronze 3106 8C/1.7GHz/ 11MB/85W/DDR4-2133 | 1x16GB RDIMM DDR4-2666 | 1x930-8i 2GB flash | 4x3.5" | 4x3.5" SATA/ SAS HS | Open | None | 4xGbE RJ- 45 LOM | None | x8 / x16, LP | None | None | TPM 1.2 | XClarity Standard | 1x750W Platinum | 3-year | 07/17 |
| 7X02A053CN | 1xXeon Gold 5115 10C/2.4GHz/ 13.75MB/85W/DDR4-2400 | 1x16GB RDIMM DDR4-2666 | 1x930-8i 2GB flash | 8x2.5" | 8x2.5" SATA/ SAS HS | Open | None | 4xGbE RJ- 45 LOM | None | x8 / x16, LP | None | None | TPM 1.2 | XClarity Standard | 1x750W Platinum | 3-year | 07/17 |

ThinkSystem SR630 Models for India - Non TopSeller

Product Specifications Reference (PSREF)

| Model | Processor | Memory | RAID/HBA Adapter | Chassis | Disk Bays | Disks | GPU | Networking (LOM/ML2/PCIe) | M.2 Boot Drive | Riser Card 1 for Slot 1-2 | Riser Card 2 for Slot 3 | Front VGA | Security | System Management | Power Supply | Base Warranty | Ann Date (mm/yy) |
|------------|---|------------------------------|-----------------------|---------|------------------------|-------|------|---------------------------|----------------|---------------------------|-------------------------|--------------|----------|----------------------|--------------------|---------------|------------------|
| 7X02A00USG | 1xXeon Gold 5118 12C/2.3GHz/ 16.5MB/105W/DDR4-2400 | 1x16GB RDIMM DDR4-2666 | 1x930-8i 2GB flash | 8x2.5" | 8x2.5" SATA/ SAS HS | Open | None | 4xGbE RJ- 45 LOM | None | None | None | Front VGA | TPM 1.2 | XClarity Standard | 1x550W Platinum | 3-year | 07/17 |
| 7X02A00WSG | 1xXeon Gold 5118 12C/2.3GHz/ 16.5MB/105W/DDR4-2400 | 1x16GB RDIMM DDR4-2666 | 1x530-8i | 8x2.5" | 8x2.5" SATA/ SAS HS | Open | None | 4xGbE RJ- 45 LOM | None | None | None | Front VGA | TPM 1.2 | XClarity Standard | 1x550W Platinum | 3-year | 07/17 |
| 7X02A017SG | 1xXeon Gold 5115 10C/2.4GHz/ 13.75MB/85W/DDR4-2400 | 1x8GB RDIMM DDR4-2666 | 1x530-8i | 4x3.5" | 4x3.5" SATA/ SAS HS | Open | None | 4xGbE RJ- 45 LOM | None | None | None | Front VGA | TPM 1.2 | XClarity Standard | 1x550W Platinum | 3-year | 07/17 |
| 7X02A01CSG | 1xXeon Gold 5118 12C/2.3GHz/ 16.5MB/105W/DDR4-2400 | 1x8GB RDIMM DDR4-2666 | 1x530-8i | 8x2.5" | 8x2.5" SATA/ SAS HS | Open | None | 4xGbE RJ- 45 LOM | None | None | None | Front VGA | TPM 1.2 | XClarity Standard | 1x550W Platinum | 3-year | 07/17 |
| 7X02A01FSG | 1xXeon Gold 5120 14C/2.2GHz/ 19.25MB/105W/DDR4-2400 | 1x16GB RDIMM DDR4-2666 | 1x530-8i | 8x2.5" | 8x2.5" SATA/ SAS HS | Open | None | 4xGbE RJ- 45 LOM | None | None | None | Front VGA | TPM 1.2 | XClarity Standard | 1x550W Platinum | 3-year | 07/17 |
| 7X02A01GSG | 1xXeon Gold 5122 4C/3.6GHz/ 16.5MB/105W/DDR4-2400 | 1x16GB RDIMM DDR4-2666 | 1x930-8i 2GB flash | 8x2.5" | 8x2.5" SATA/ SAS HS | Open | None | 4xGbE RJ- 45 LOM | None | None | None | Front VGA | TPM 1.2 | XClarity Standard | 1x550W Platinum | 3-year | 07/17 |
| 7X02A01HSG | 1xXeon Gold 5120 14C/2.2GHz/ 19.25MB/105W/DDR4-2400 | 1x16GB RDIMM DDR4-2666 | 1x930-8i 2GB flash | 8x2.5" | 8x2.5" SATA/ SAS HS | Open | None | 4xGbE RJ- 45 LOM | None | None | None | Front VGA | TPM 1.2 | XClarity Standard | 1x550W Platinum | 3-year | 07/17 |
| 7X02A01JSG | 1xXeon Gold 6126 12C/2.6GHz/ 19.25MB/125W/DDR4-2666 | 1x16GB RDIMM DDR4-2666 | 1x930-8i 2GB flash | 8x2.5" | 8x2.5" SATA/ SAS HS | Open | None | 4xGbE RJ- 45 LOM | None | None | None | Front VGA | TPM 1.2 | XClarity Standard | 1x550W Platinum | 3-year | 07/17 |
| 7X02A027SG | 1xXeon Gold 5115 10C/2.4GHz/ 13.75MB/85W/DDR4-2400 | 1x8GB RDIMM DDR4-2666 | 1x530-8i | 8x2.5" | 8x2.5" SATA/ SAS HS | Open | None | 4xGbE RJ- 45 LOM | None | None | None | Front VGA | TPM 1.2 | XClarity Standard | 1x550W Platinum | 3-year | 07/17 |
| 7X02A02USG | 1xXeon Gold 6154 18C/3.0GHz/ 24.75MB/200W/DDR4-2666 | 1x16GB RDIMM DDR4-2666 | 1x930-8i 2GB flash | 8x2.5" | 8x2.5" SATA/ SAS HS | Open | None | 4xGbE RJ- 45 LOM | None | None | None | Front VGA | TPM 1.2 | XClarity Standard | 1x550W Platinum | 3-year | 07/17 |
| 7X02A02WSG | 1xXeon Gold 6142 16C/2.6GHz/ 22MB/150W/DDR4-2666 | 1x16GB RDIMM DDR4-2666 | 1x930-8i 2GB flash | 8x2.5" | 8x2.5" SATA/ SAS HS | Open | None | 4xGbE RJ- 45 LOM | None | None | None | Front VGA | TPM 1.2 | XClarity Standard | 1x550W Platinum | 3-year | 07/17 |
| 7X02A02ZSG | 1xXeon Gold 6130 16C/2.1GHz/ 22MB/125W/DDR4-2666 | 1x16GB RDIMM DDR4-2666 | 1x930-8i 2GB flash | 8x2.5" | 8x2.5" SATA/ SAS HS | Open | None | 4xGbE RJ- 45 LOM | None | None | None | Front VGA | TPM 1.2 | XClarity Standard | 1x550W Platinum | 3-year | 07/17 |

ThinkSystem SR630 Models for Japan - TopSeller

Product Specifications Reference (PSREF)

| Model | Processor | Memory | RAID/HBA Adapter | Chassis | Disk Bays | Disks | GPU | Networking (LOM/ML2/PCIe) | M.2 Boot Drive | Riser Card 1 for Slot 1-2 | Riser Card 2 for Slot 3 | Front VGA | Security | System Management | Power Supply | Base Warranty | Ann Date (mm/yy) |
|------------|--|------------------------------|-----------------------|---------|------------------------|-------|------|---------------------------|----------------|---------------------------|-------------------------|-----------|----------|-------------------|-----------------|---------------|------------------|
| 7X02A01WJP | 1xXeon Bronze 3104 6C/1.7GHz/ 8.25MB/85W/DDR4-2133 | 1x16GB RDIMM DDR4-2666 | 1x530-8i | 4x3.5" | 4x3.5" SATA/ SAS HS | Open | None | 4xGbE RJ-45 LOM | None | x8 / x16, LP | None | None | TPM 1.2 | XClarity Advanced | 1x550W Platinum | 3-year | 07/17 |
| 7X02A02CJP | 1xXeon Bronze 3104 6C/1.7GHz/ 8.25MB/85W/DDR4-2133 | 1x16GB RDIMM DDR4-2666 | 1x930-8i 2GB flash | 8x2.5" | 8x2.5" SATA/ SAS HS | Open | None | 4xGbE RJ-45 LOM | None | x8 / x16, LP | None | None | TPM 1.2 | XClarity Advanced | 1x550W Platinum | 3-year | 07/17 |
| 7X02A02RJP | 1xXeon Bronze 3106 8C/1.7GHz/ 11MB/85W/DDR4-2133 | 1x16GB RDIMM DDR4-2666 | 1x930-8i 2GB flash | 8x2.5" | 8x2.5" SATA/ SAS HS | Open | None | 4xGbE RJ-45 LOM | None | x8 / x16, LP | None | None | TPM 1.2 | XClarity Advanced | 1x550W Platinum | 3-year | 07/17 |
| 7X02A02SJP | 1xXeon Silver 4110 8C/2.1GHz/ 11MB/85W/DDR4-2400 | 1x16GB RDIMM DDR4-2666 | 1x930-8i 2GB flash | 8x2.5" | 8x2.5" SATA/ SAS HS | Open | None | 4xGbE RJ-45 LOM | None | x8 / x16, LP | None | None | TPM 1.2 | XClarity Advanced | 1x550W Platinum | 3-year | 07/17 |
| 7X02A02TJP | 1xXeon Silver 4112 4C/2.6GHz/ 8.25MB/85W/DDR4-2400 | 1x16GB RDIMM DDR4-2666 | 1x930-8i 2GB flash | 8x2.5" | 8x2.5" SATA/ SAS HS | Open | None | 4xGbE RJ-45 LOM | None | x8 / x16, LP | None | None | TPM 1.2 | XClarity Advanced | 1x550W Platinum | 3-year | 07/17 |

ThinkSystem SR630 Models for Japan - Non TopSeller

Product Specifications Reference (PSREF)

| Model | Processor | Memory | RAID/HBA Adapter | Chassis | Disk Bays | Disks | GPU | Networking (LOM/ML2/PCIe) | M.2 Boot Drive | Riser Card 1 for Slot 1-2 | Riser Card 2 for Slot 3 | Front VGA | Security | System Management | Power Supply | Base Warranty | Ann Date (mm/yy) |
|------------|--|------------------------------|------------------------|---------|---|-------|------|---------------------------|----------------|---------------------------|-------------------------|--------------|----------|----------------------|---------------------|---------------|------------------|
| 7X02A012JP | 1xXeon Gold 6134 8C/3.2GHz/ 24.75MB/130W/DDR4-2666 | 1x16GB RDIMM DDR4-2666 | 1x930-8i 2GB flash | 8x2.5" | 8x2.5" SATA/ SAS HS | Open | None | 4x10GbE RJ-45 LOM | None | x8 / x16, LP | None | None | TPM 1.2 | XClarity Advanced | 1x750W Platinum | 3-year | 07/17 |
| 7X02A024JP | 1xXeon Platinum 8160 24C/2.1GHz/ 33MB/150W/DDR4-2666 | 1x16GB RDIMM DDR4-2666 | 1x930-16i 4GB flash | 10x2.5" | 10x2.5" (6 SATA/SAS, 4 AnyBay) HS | Open | None | 4x10GbE RJ-45 LOM | None | x8 / x16, LP | None | Front VGA | TPM 1.2 | XClarity Advanced | 1x1100W Platinum | 3-year | 07/17 |
| 7X02A02NJP | 1xXeon Gold 5122 4C/3.6GHz/ 16.5MB/105W/DDR4-2400 | 1x16GB RDIMM DDR4-2666 | 1x930-8i 2GB flash | 8x2.5" | 8x2.5" SATA/ SAS HS | Open | None | 4x10GbE RJ-45 LOM | None | x8 / x16, LP | None | None | TPM 1.2 | XClarity Advanced | 1x750W Platinum | 3-year | 07/17 |
| 7X02A05DJP | 2xXeon Gold 6154 18C/3.0GHz/ 24.75MB/200W/DDR4-2666 | 2x16GB RDIMM DDR4-2666 | None | 8x2.5" | None | None | None | 4xGbE RJ- 45 LOM | None | x8 / x16, LP | None | None | TPM 1.2 | XClarity Advanced | 1x750W Platinum | 3-year | 07/17 |
| 7X02A05EJP | 1xXeon Platinum 8160 24C/2.1GHz/ 33MB/150W/DDR4-2666 | 1x16GB RDIMM DDR4-2666 | None | 8x2.5" | None | None | None | 4xGbE RJ- 45 LOM | None | x8 / x16, LP | None | None | TPM 1.2 | XClarity Advanced | 1x750W Platinum | 3-year | 07/17 |
| 7X02A05KJP | 1xXeon Gold 6148 20C/2.4GHz/ 27.5MB/150W/DDR4-2666 | 1x16GB RDIMM DDR4-2666 | None | 8x2.5" | None | None | None | 4xGbE RJ- 45 LOM | None | x8 / x16, LP | None | None | TPM 1.2 | XClarity Advanced | 1x750W Platinum | 3-year | 07/17 |

ThinkSystem SR630 Models for Latin America - TopSeller

Product Specifications Reference (PSREF)

| Model | Processor | Memory | RAID/HBA Adapter | Chassis | Disk Bays | Disks | GPU | Networking (LOM/ML2/PCIe) | M.2 Boot Drive | Riser Card 1 for Slot 1-2 | Riser Card 2 for Slot 3 | Front VGA | Security | System Management | Power Supply | Base Warranty | Ann Date (mm/yy) |
|------------|--|------------------------------|-----------------------|---------|------------------------|-------|------|---------------------------|----------------|---------------------------|-------------------------|--------------|----------|----------------------|--------------------|---------------|------------------|
| 7X02A02LLA | 1xXeon Gold 5118 12C/2.3GHz/ 16.5MB/105W/DDR4-2400 | 1x16GB RDIMM DDR4-2666 | 1x930-8i 2GB flash | 8x2.5" | 8x2.5" SATA/ SAS HS | Open | None | None | None | x8 / x16, LP | None | Front VGA | TPM 1.2 | XClarity Standard | 1x750W Platinum | 3-year | 07/17 |
| 7X02A038LA | 1xXeon Gold 5115 10C/2.4GHz/ 13.75MB/85W/DDR4-2400 | 1x16GB RDIMM DDR4-2666 | 1x930-8i 2GB flash | 8x2.5" | 8x2.5" SATA/ SAS HS | Open | None | None | None | x8 / x16, LP | None | Front VGA | TPM 1.2 | XClarity Standard | 1x750W Platinum | 3-year | 07/17 |

ThinkSystem SR630 Models for Latin America - Non TopSeller

Product Specifications Reference (PSREF)

| Model | Processor | Memory | RAID/HBA Adapter | Chassis | Disk Bays | Disks | GPU | Networking (LOM/ML2/PCIe) | M.2 Boot Drive | Riser Card 1 for Slot 1-2 | Riser Card 2 for Slot 3 | Front VGA | Security | System Management | Power Supply | Base Warranty | Ann Date (mm/yy) |
|------------|--|------------------------------|-----------------------|---------|------------------------|-------|------|---------------------------|----------------|---------------------------|-------------------------|--------------|----------|----------------------|---------------------|---------------|------------------|
| 7X02A01KLA | 1xXeon Platinum 8160 24C/2.1GHz/ 33MB/150W/DDR4-2666 | 1x16GB RDIMM DDR4-2666 | 1x930-8i 2GB flash | 8x2.5" | 8x2.5" SATA/ SAS HS | Open | None | None | None | x8 / x16, LP | None | Front VGA | TPM 1.2 | XClarity Standard | 1x1100W Platinum | 3-year | 07/17 |
| 7X02A02ELA | 1xXeon Gold 6148 20C/2.4GHz/ 27.5MB/150W/DDR4-2666 | 1x16GB RDIMM DDR4-2666 | 1x930-8i 2GB flash | 8x2.5" | 8x2.5" SATA/ SAS HS | Open | None | None | None | x8 / x16, LP | None | Front VGA | TPM 1.2 | XClarity Standard | 1x1100W Platinum | 3-year | 07/17 |
| 7X02A02FLA | 1xXeon Gold 6140 18C/2.3GHz/ 24.75MB/140W/DDR4-2666 | 1x16GB RDIMM DDR4-2666 | 1x930-8i 2GB flash | 8x2.5" | 8x2.5" SATA/ SAS HS | Open | None | None | None | x8 / x16, LP | None | Front VGA | TPM 1.2 | XClarity Standard | 1x1100W Platinum | 3-year | 07/17 |
| 7X02A02GLA | 1xXeon Gold 6130 16C/2.1GHz/ 22MB/125W/DDR4-2666 | 1x32GB RDIMM DDR4-2666 | 1x930-8i 2GB flash | 8x2.5" | 8x2.5" SATA/ SAS HS | Open | None | None | None | x8 / x16, LP | None | Front VGA | TPM 1.2 | XClarity Standard | 1x1100W Platinum | 3-year | 07/17 |
| 7X02A02JLA | 1xXeon Gold 5120 14C/2.2GHz/ 19.25MB/105W/DDR4-2400 | 1x16GB RDIMM DDR4-2666 | 1x930-8i 2GB flash | 8x2.5" | 8x2.5" SATA/ SAS HS | Open | None | None | None | x8 / x16, LP | None | Front VGA | TPM 1.2 | XClarity Standard | 1x1100W Platinum | 3-year | 07/17 |
| 7X02A05CLA | 1xXeon Silver 4116 12C/2.1GHz/ 16.5MB/85W/DDR4-2400 | 1x16GB RDIMM DDR4-2666 | 1x930-8i 2GB flash | 8x2.5" | 8x2.5" SATA/ SAS HS | Open | None | None | None | x8 / x16, LP | None | Front VGA | TPM 1.2 | XClarity Standard | 1x750W Platinum | 3-year | 07/17 |
| 7X02A05MLA | 1xXeon Silver 4110 8C/2.1GHz/ 11MB/85W/DDR4-2400 | 1x16GB RDIMM DDR4-2666 | 1x930-8i 2GB flash | 8x2.5" | 8x2.5" SATA/ SAS HS | Open | None | None | None | x8 / x16, LP | None | Front VGA | TPM 1.2 | XClarity Standard | 1x750W Platinum | 3-year | 07/17 |



ThinkSystem SR650 Platform Specifications

Product Specifications Reference (PSREF)

| Components | Specification | | | | | | | | | | | | | | | | | | | | | | | | | | | | | | | | | | | | | | | | | | | | | | | | | | | | | | | | | | | | | | | | | | | | | | | | | | | | | | | | | | | | | | | | | | | | | | | | | | | |
|---|---|--|---|------------------|-------------|--------------|------------------|------------------|----------|---------|--------|------------|----------|-------------|-----|------|------|-----|---|--------|------------|----------|-------------|-----|-----|------|----|---|--------|------------|----------|------------------|-----|-----|--------------|-----|---|---------|------------|----------|------------------|-----|-----|--------------|-----|---|---------|------------|----------|------------------|-----|-----|--------------|-----|---|--------|------------|----------|---|-----|------|------|---|---|---------|------------|----------|---|-----|------|------|---|---|--------|------------|----------|------------------|-----|-----|--------------|-----|---|--------|------------|----------|---|-----|------|------|---|---|---------|------------|----------|---|-----|------|------|---|---|
| Form factor | 2U rack | | | | | | | | | | | | | | | | | | | | | | | | | | | | | | | | | | | | | | | | | | | | | | | | | | | | | | | | | | | | | | | | | | | | | | | | | | | | | | | | | | | | | | | | | | | | | | | | | | | |
| Dimensions | Height: 86.5 mm (3.4 in). Width: 482 mm (19.0 in) with rack latches. Depth: 763.7 mm (30.1 in) | | | | | | | | | | | | | | | | | | | | | | | | | | | | | | | | | | | | | | | | | | | | | | | | | | | | | | | | | | | | | | | | | | | | | | | | | | | | | | | | | | | | | | | | | | | | | | | | | | | |
| Weight | Maximum configuration: 70.54 lb (32 kg) | | | | | | | | | | | | | | | | | | | | | | | | | | | | | | | | | | | | | | | | | | | | | | | | | | | | | | | | | | | | | | | | | | | | | | | | | | | | | | | | | | | | | | | | | | | | | | | | | | | |
| Processor | Up to two 205W Intel Xeon Scalable family processors, Bronze, Silver, Gold, or Platinum. Up to 28 cores at 2.5GHz, up to 3.6GHz with 4 cores. Two processors are connected with two UPI (Ultra Path Interconnect) links up to 10.4GT/s | | | | | | | | | | | | | | | | | | | | | | | | | | | | | | | | | | | | | | | | | | | | | | | | | | | | | | | | | | | | | | | | | | | | | | | | | | | | | | | | | | | | | | | | | | | | | | | | | | | |
| Chipset | Intel C624 Platform Controller Hub | | | | | | | | | | | | | | | | | | | | | | | | | | | | | | | | | | | | | | | | | | | | | | | | | | | | | | | | | | | | | | | | | | | | | | | | | | | | | | | | | | | | | | | | | | | | | | | | | | | |
| Memory | Up to 24 DIMM sockets. Each processor supports up to 12 DIMM sockets with 6 channels. DDR4-2666. RDIMMs, LRDIMMs, 3DS RDIMMs are supported, but memory types cannot be intermixed. 3DS RDIMM is planned to available later | | | | | | | | | | | | | | | | | | | | | | | | | | | | | | | | | | | | | | | | | | | | | | | | | | | | | | | | | | | | | | | | | | | | | | | | | | | | | | | | | | | | | | | | | | | | | | | | | | | |
| Memory capacity | Up to 768GB with 24 x 32 GB RDIMMs and two processors. Or up to 1.5TB with 24 x 64 GB LRDIMMs and two processors. Or up to 3TB with 24 x 128 GB 3DS LRDIMMs and two -M suffix processors. -M suffix processor supports 1.5TB memory per socket, non -M suffix processor supports 768GB memory per socket | | | | | | | | | | | | | | | | | | | | | | | | | | | | | | | | | | | | | | | | | | | | | | | | | | | | | | | | | | | | | | | | | | | | | | | | | | | | | | | | | | | | | | | | | | | | | | | | | | | |
| Memory protection | ECC, memory mirroring, and memory sparing | | | | | | | | | | | | | | | | | | | | | | | | | | | | | | | | | | | | | | | | | | | | | | | | | | | | | | | | | | | | | | | | | | | | | | | | | | | | | | | | | | | | | | | | | | | | | | | | | | | |
| Storage controllers | One dedicated internal RAID slot for most RAID/HBA adapters. | | | | | | | | | | | | | | | | | | | | | | | | | | | | | | | | | | | | | | | | | | | | | | | | | | | | | | | | | | | | | | | | | | | | | | | | | | | | | | | | | | | | | | | | | | | | | | | | | | | |
| | <table border="1"> <thead> <tr> <th>Feature</th> <th>Interface</th> <th>Drive type</th> <th>RAID levels</th> <th>JBOD</th> <th>Cache</th> <th>Cache protection</th> <th>FastPath</th> <th>Max qty</th> </tr> </thead> <tbody> <tr> <td>530-8i</td> <td>12Gbps SAS</td> <td>SATA/SAS</td> <td>0/1/10/5/50</td> <td>Yes</td> <td>None</td> <td>None</td> <td>Yes</td> <td>2</td> </tr> <tr> <td>730-8i</td> <td>12Gbps SAS</td> <td>SATA/SAS</td> <td>0/1/10/5/50</td> <td>Yes</td> <td>1GB</td> <td>None</td> <td>No</td> <td>3</td> </tr> <tr> <td>930-8i</td> <td>12Gbps SAS</td> <td>SATA/SAS</td> <td>0/1/10/5/50/6/60</td> <td>Yes</td> <td>2GB</td> <td>Flash backup</td> <td>Yes</td> <td>3</td> </tr> <tr> <td>930-16i</td> <td>12Gbps SAS</td> <td>SATA/SAS</td> <td>0/1/10/5/50/6/60</td> <td>Yes</td> <td>4GB</td> <td>Flash backup</td> <td>Yes</td> <td>1</td> </tr> <tr> <td>930-24i</td> <td>12Gbps SAS</td> <td>SATA/SAS</td> <td>0/1/10/5/50/6/60</td> <td>Yes</td> <td>4GB</td> <td>Flash backup</td> <td>Yes</td> <td>1</td> </tr> <tr> <td>430-8i</td> <td>12Gbps SAS</td> <td>SATA/SAS</td> <td>-</td> <td>Yes</td> <td>None</td> <td>None</td> <td>-</td> <td>3</td> </tr> <tr> <td>430-16i</td> <td>12Gbps SAS</td> <td>SATA/SAS</td> <td>-</td> <td>Yes</td> <td>None</td> <td>None</td> <td>-</td> <td>1</td> </tr> <tr> <td>930-8e</td> <td>12Gbps SAS</td> <td>SATA/SAS</td> <td>0/1/10/5/50/6/60</td> <td>Yes</td> <td>4GB</td> <td>Flash backup</td> <td>Yes</td> <td>5</td> </tr> <tr> <td>430-8e</td> <td>12Gbps SAS</td> <td>SATA/SAS</td> <td>-</td> <td>Yes</td> <td>None</td> <td>None</td> <td>-</td> <td>5</td> </tr> <tr> <td>430-16e</td> <td>12Gbps SAS</td> <td>SATA/SAS</td> <td>-</td> <td>Yes</td> <td>None</td> <td>None</td> <td>-</td> <td>5</td> </tr> </tbody> </table> | Feature | Interface | Drive type | RAID levels | JBOD | Cache | Cache protection | FastPath | Max qty | 530-8i | 12Gbps SAS | SATA/SAS | 0/1/10/5/50 | Yes | None | None | Yes | 2 | 730-8i | 12Gbps SAS | SATA/SAS | 0/1/10/5/50 | Yes | 1GB | None | No | 3 | 930-8i | 12Gbps SAS | SATA/SAS | 0/1/10/5/50/6/60 | Yes | 2GB | Flash backup | Yes | 3 | 930-16i | 12Gbps SAS | SATA/SAS | 0/1/10/5/50/6/60 | Yes | 4GB | Flash backup | Yes | 1 | 930-24i | 12Gbps SAS | SATA/SAS | 0/1/10/5/50/6/60 | Yes | 4GB | Flash backup | Yes | 1 | 430-8i | 12Gbps SAS | SATA/SAS | - | Yes | None | None | - | 3 | 430-16i | 12Gbps SAS | SATA/SAS | - | Yes | None | None | - | 1 | 930-8e | 12Gbps SAS | SATA/SAS | 0/1/10/5/50/6/60 | Yes | 4GB | Flash backup | Yes | 5 | 430-8e | 12Gbps SAS | SATA/SAS | - | Yes | None | None | - | 5 | 430-16e | 12Gbps SAS | SATA/SAS | - | Yes | None | None | - | 5 |
| | Feature | Interface | Drive type | RAID levels | JBOD | Cache | Cache protection | FastPath | Max qty | | | | | | | | | | | | | | | | | | | | | | | | | | | | | | | | | | | | | | | | | | | | | | | | | | | | | | | | | | | | | | | | | | | | | | | | | | | | | | | | | | | | | | | | | | | |
| | 530-8i | 12Gbps SAS | SATA/SAS | 0/1/10/5/50 | Yes | None | None | Yes | 2 | | | | | | | | | | | | | | | | | | | | | | | | | | | | | | | | | | | | | | | | | | | | | | | | | | | | | | | | | | | | | | | | | | | | | | | | | | | | | | | | | | | | | | | | | | | |
| | 730-8i | 12Gbps SAS | SATA/SAS | 0/1/10/5/50 | Yes | 1GB | None | No | 3 | | | | | | | | | | | | | | | | | | | | | | | | | | | | | | | | | | | | | | | | | | | | | | | | | | | | | | | | | | | | | | | | | | | | | | | | | | | | | | | | | | | | | | | | | | | |
| | 930-8i | 12Gbps SAS | SATA/SAS | 0/1/10/5/50/6/60 | Yes | 2GB | Flash backup | Yes | 3 | | | | | | | | | | | | | | | | | | | | | | | | | | | | | | | | | | | | | | | | | | | | | | | | | | | | | | | | | | | | | | | | | | | | | | | | | | | | | | | | | | | | | | | | | | | |
| | 930-16i | 12Gbps SAS | SATA/SAS | 0/1/10/5/50/6/60 | Yes | 4GB | Flash backup | Yes | 1 | | | | | | | | | | | | | | | | | | | | | | | | | | | | | | | | | | | | | | | | | | | | | | | | | | | | | | | | | | | | | | | | | | | | | | | | | | | | | | | | | | | | | | | | | | | |
| | 930-24i | 12Gbps SAS | SATA/SAS | 0/1/10/5/50/6/60 | Yes | 4GB | Flash backup | Yes | 1 | | | | | | | | | | | | | | | | | | | | | | | | | | | | | | | | | | | | | | | | | | | | | | | | | | | | | | | | | | | | | | | | | | | | | | | | | | | | | | | | | | | | | | | | | | | |
| | 430-8i | 12Gbps SAS | SATA/SAS | - | Yes | None | None | - | 3 | | | | | | | | | | | | | | | | | | | | | | | | | | | | | | | | | | | | | | | | | | | | | | | | | | | | | | | | | | | | | | | | | | | | | | | | | | | | | | | | | | | | | | | | | | | |
| | 430-16i | 12Gbps SAS | SATA/SAS | - | Yes | None | None | - | 1 | | | | | | | | | | | | | | | | | | | | | | | | | | | | | | | | | | | | | | | | | | | | | | | | | | | | | | | | | | | | | | | | | | | | | | | | | | | | | | | | | | | | | | | | | | | |
| 930-8e | 12Gbps SAS | SATA/SAS | 0/1/10/5/50/6/60 | Yes | 4GB | Flash backup | Yes | 5 | | | | | | | | | | | | | | | | | | | | | | | | | | | | | | | | | | | | | | | | | | | | | | | | | | | | | | | | | | | | | | | | | | | | | | | | | | | | | | | | | | | | | | | | | | | | |
| 430-8e | 12Gbps SAS | SATA/SAS | - | Yes | None | None | - | 5 | | | | | | | | | | | | | | | | | | | | | | | | | | | | | | | | | | | | | | | | | | | | | | | | | | | | | | | | | | | | | | | | | | | | | | | | | | | | | | | | | | | | | | | | | | | | |
| 430-16e | 12Gbps SAS | SATA/SAS | - | Yes | None | None | - | 5 | | | | | | | | | | | | | | | | | | | | | | | | | | | | | | | | | | | | | | | | | | | | | | | | | | | | | | | | | | | | | | | | | | | | | | | | | | | | | | | | | | | | | | | | | | | | |
| <i>Note: 730-8i is available in China only. 930-8e, 430-8e, and 430-16e will be placed in slot 4 firstly. 930-24i will be placed in slot 1 firstly.</i> | | | | | | | | | | | | | | | | | | | | | | | | | | | | | | | | | | | | | | | | | | | | | | | | | | | | | | | | | | | | | | | | | | | | | | | | | | | | | | | | | | | | | | | | | | | | | | | | | | | | |
| Disk drive bays | Supports 8 front 3.5" SATA/SAS HS bays, or 12 front 3.5" SATA/SAS HS bays with maximum 4 AnyBay, or 8 front 2.5" SATA/SAS HS bays with maximum 4 AnyBay, or 16 front 2.5" SATA/SAS HS bays with maximum 8 AnyBay, or 24 front 2.5" SATA/SAS HS bays with maximum 4 AnyBay. Optional 2 rear 3.5" HS bays are supported on 12 x 3.5" model, takes place in riser card 1 location. Optional one or two internal M.2 SSD for boot, dual M.2 SSD supports mirroring | | | | | | | | | | | | | | | | | | | | | | | | | | | | | | | | | | | | | | | | | | | | | | | | | | | | | | | | | | | | | | | | | | | | | | | | | | | | | | | | | | | | | | | | | | | | | | | | | | | |
| Internal storage | For 3.5" bay | 3.5" HDD, SATA6Gbps, 7.2K 3.5" HDD, SAS12Gbps, 7.2K | 1TB/2TB/4TB/6TB/8TB/10TB 1TB/2TB/4TB/4TB SED FIPS/6TB/10TB | | | | | | | | | | | | | | | | | | | | | | | | | | | | | | | | | | | | | | | | | | | | | | | | | | | | | | | | | | | | | | | | | | | | | | | | | | | | | | | | | | | | | | | | | | | | | | | | | |
| | (3.5" disks or 2.5" disks with 3.5" tray) | 2.5" HDD, SAS12Gbps, 15K 2.5" SSD, SATA6Gbps | 300GB/600GB 240GB/480GB | | | | | | | | | | | | | | | | | | | | | | | | | | | | | | | | | | | | | | | | | | | | | | | | | | | | | | | | | | | | | | | | | | | | | | | | | | | | | | | | | | | | | | | | | | | | | | | | | |
| | | 2.5" NVMe SSD, AnyBay | 960GB/1.92TB/3.84TB | | | | | | | | | | | | | | | | | | | | | | | | | | | | | | | | | | | | | | | | | | | | | | | | | | | | | | | | | | | | | | | | | | | | | | | | | | | | | | | | | | | | | | | | | | | | | | | | | |
| | For 2.5" bay | 2.5" HDD, SATA6Gbps, 7.2K 2.5" HDD, SAS12Gbps, 7.2K | 1TB/2TB 1TB/2TB | | | | | | | | | | | | | | | | | | | | | | | | | | | | | | | | | | | | | | | | | | | | | | | | | | | | | | | | | | | | | | | | | | | | | | | | | | | | | | | | | | | | | | | | | | | | | | | | | |
| | | 2.5" HDD, SAS12Gbps, 10K | 300GB/300GB SED/600GB/600GB SED/900GB/1.2TB/1.8TB | | | | | | | | | | | | | | | | | | | | | | | | | | | | | | | | | | | | | | | | | | | | | | | | | | | | | | | | | | | | | | | | | | | | | | | | | | | | | | | | | | | | | | | | | | | | | | | | | |
| | | 2.5" HDD, SAS12Gbps, 15K | 300GB/600GB/900GB | | | | | | | | | | | | | | | | | | | | | | | | | | | | | | | | | | | | | | | | | | | | | | | | | | | | | | | | | | | | | | | | | | | | | | | | | | | | | | | | | | | | | | | | | | | | | | | | | |
| 2.5" SSD, SAS12Gbps | | 400GB/800GB/3.84TB/7.68TB | | | | | | | | | | | | | | | | | | | | | | | | | | | | | | | | | | | | | | | | | | | | | | | | | | | | | | | | | | | | | | | | | | | | | | | | | | | | | | | | | | | | | | | | | | | | | | | | | | |
| 2.5" SSD, SATA6Gbps | | 240GB/480GB | | | | | | | | | | | | | | | | | | | | | | | | | | | | | | | | | | | | | | | | | | | | | | | | | | | | | | | | | | | | | | | | | | | | | | | | | | | | | | | | | | | | | | | | | | | | | | | | | | |
| 2.5" NVMe SSD, AnyBay | | 800GB/960GB/1.6TB/1.92TB/3.84TB | | | | | | | | | | | | | | | | | | | | | | | | | | | | | | | | | | | | | | | | | | | | | | | | | | | | | | | | | | | | | | | | | | | | | | | | | | | | | | | | | | | | | | | | | | | | | | | | | | |
| Optical | No internal optical bay. Optional USB DVD±RW optical drive | | | | | | | | | | | | | | | | | | | | | | | | | | | | | | | | | | | | | | | | | | | | | | | | | | | | | | | | | | | | | | | | | | | | | | | | | | | | | | | | | | | | | | | | | | | | | | | | | | | |
| Network interfaces | One dedicated management port. One LOM slot for customized LOM with up to four RJ-45 or SFP+ ports, up to 10GbE. Wake-on-LAN and NC-SI are available on Port 0 of LOM. Optional ML2 or PCIe adapters are supported. ML2 adapter requires riser card with ML2 slot. | | | | | | | | | | | | | | | | | | | | | | | | | | | | | | | | | | | | | | | | | | | | | | | | | | | | | | | | | | | | | | | | | | | | | | | | | | | | | | | | | | | | | | | | | | | | | | | | | | | |
| Security features | Power-on and admin password. Trusted Platform Module, TCG 1.2 compliant, upgrade to 2.0 via UEFI setting. Optional TCM in China only. Optional lockable security bezel | | | | | | | | | | | | | | | | | | | | | | | | | | | | | | | | | | | | | | | | | | | | | | | | | | | | | | | | | | | | | | | | | | | | | | | | | | | | | | | | | | | | | | | | | | | | | | | | | | | |
| Operating systems supported | Microsoft Windows Server 2016/2012 R2. Red Hat Enterprise Linux 7.3/6.9. SUSE Linux Enterprise Server 12 SP2/11 SP4. VMware vSphere (ESXi) 6.5/6.0 U3 | | | | | | | | | | | | | | | | | | | | | | | | | | | | | | | | | | | | | | | | | | | | | | | | | | | | | | | | | | | | | | | | | | | | | | | | | | | | | | | | | | | | | | | | | | | | | | | | | | | |
| Systems management | XClarity Controller Standard, optional upgrades to Advanced or Enterprise are available. Energy Manager. XClarity Administrator. Lenovo Capacity Planner. Provisioning Manager. Essentials. Light Path Diagnostics | | | | | | | | | | | | | | | | | | | | | | | | | | | | | | | | | | | | | | | | | | | | | | | | | | | | | | | | | | | | | | | | | | | | | | | | | | | | | | | | | | | | | | | | | | | | | | | | | | | |
| GPU support | Up to two optional GPU, requires riser card with PCIe x16 slot. 2nd GPU requires 2nd CPU. Supports Intel Xeon Phi 7240P, NVIDIA Quadro M60, or Quadro P100 | | | | | | | | | | | | | | | | | | | | | | | | | | | | | | | | | | | | | | | | | | | | | | | | | | | | | | | | | | | | | | | | | | | | | | | | | | | | | | | | | | | | | | | | | | | | | | | | | | | |

| Components | Specification | |
|-----------------------------|--|---|
| Base warranty | MT 7X05: 1-year limited onsite service with 9x5/NBD MT 7X06: 3-year limited onsite service with 9x5/NBD | |
| Power supply | Up to two redundant hot-swap 550W/750W/1100W/1600W 80 PLUS Platinum qualified AC power supplies. Or up to two redundant hot-swap 750W Titanium qualified AC power supplies. 750W Titanium and 1600W Platinum are 200V - 240V, others are 100V - 240V | |
| Video | Integrated Matrox G200 in XClarity Controller | |
| Cooling | Five fans (4+1) for single processor model, six fans (5+1) for dual processor model | |
| Front ports | One XClarity Controller USB connector, one USB 3.0, one optional VGA | |
| Rear ports | One VGA, two USB 3.0, one XClarity Controller network connector. Optional COM port | |
| Environmental specification | Supports ASHRAE A4 with limitations. | |
| | Temperature - operating | A4: 5°C to 45°C (41°F to 113°F) A3: 5°C to 40°C (41°F to 104°F) A2: 10°C to 35°C (50°F to 95°F) |
| | Temperature - non operating (no package) | -10°C to 60°C (14°F to 140°F) |
| | Temperature - non operating (with package) | -40°C to 70°C (-40°F to 158°F) |
| | Altitude - operating | (Unpressurized): 0-10000ft (0-3048m) |
| | Humidity - operating, non-condensing | A4: 8%-90%. A3:8%-85%. A2:20%~80% |
| | Humidity - storage (with package), non-condensing | 8%~90% |
| | <i>Models should meet the following requirements to support A3 and A4:</i> | |
| | <ul style="list-style-type: none"> NVMe drives not installed PCIe flash adapter not installed Graphic processing unit (GPU) not installed Must have redundant PSU Certain processors not installed: <ul style="list-style-type: none"> Processors with TDP more than or equal to 150-watt not installed On 16 x 2.5", 24 x 2.5", and 12 x 3.5" models, the following processors not installed: Intel Xeon 4112, 5122, 6126, 6128*, 6132*, 6134, 6134M*, and 8156 processors (Processors marked with * will be available later) | |
| | Environmental certification | Energy Star Server 2.1 certified. More environmental information please see: www.lenovo.com/social_responsibility/us/en/environment/ |

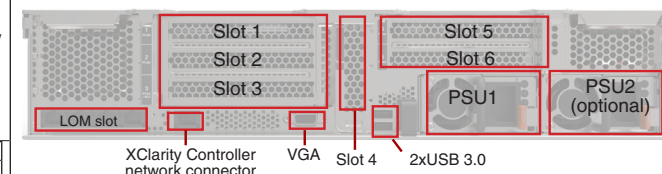

| Expansion slots | Supports one of the following for riser card 1: |
|-------------------------|--|
| Slot 1-3 (riser card 1) | Option 1: PCIe 3.0 x8/x8/x8 (slot 1-3). Full height, half length. Option 2: PCIe 3.0 x16/x8 (slot 1 and 3). Full height, full length for x16. Full height, half length for x8 Option 3: PCIe 3.0 x8/x8/x8 ML2 (slot 1-3). Full height, half length Option 4: PCIe 3.0 x8/x16 ML2 (slot 1 and 3). Full height, half length Option 5: Two rear 3.5" disk bays, 12 x 3.5" models only |
| Slot 4 (onboard) | PCIe 3.0 x8, low profile |
| Slot 5 (riser card 2) | PCIe 3.0 x16, full height, full length, requires 2nd CPU |
| Slot 6 (riser card 2) | PCIe 3.0 x16, full height, half length, requires 2nd CPU |

| System unique options | |
|-----------------------|---|
| 7XH7A06253 | ThinkSystem SR590/SR650 Rear HDD Kit |
| 7XH7A02681 | ThinkSystem SR650 x8/x16ML2 PCIe FH Riser 1 Kit |
| 7XH7A02680 | ThinkSystem SR550/SR590/SR650 x8/x8x8ML2 PCIe FH Riser 1 Kit |
| 7XH7A02678 | ThinkSystem SR550/SR590/SR650 x16/x8 PCIe FH Riser 1 Kit |
| 7XH7A02677 | ThinkSystem SR550/SR590/SR650 x8/x8/x8 PCIe FH Riser 1 Kit |
| 7XH7A02679 | ThinkSystem SR550/SR590/SR650 x16/x8 (or x16) PCIe FH Riser 2 Kit |
| 7XH7A06251 | ThinkSystem SR650 2.5" AnyBay 8-Bay Backplane Kit |
| 7XH7A06254 | ThinkSystem SR550/SR650 2.5" SATA/SAS 8-Bay Backplane Kit |
| 7Z17A02578 | ThinkSystem SR550/SR590/SR650 EIA Latch w/ VGA Upgrade Kit |
| 7Z17A02580 | ThinkSystem 2U Security Bezel |
| 7Z17A02577 | ThinkSystem COM Port Upgrade Kit |
| 7XH7A05899 | ThinkSystem SR650 2nd GPU Upgrade Kit |
| 7XH7A05897 | ThinkSystem SR650 GPU Thermal Kit |
| 7XH7A05898 | ThinkSystem SR650(GPU) 1U Heatsink Option Kit |

ThinkSystem SR650 Models for USA and Canada - TopSeller

Product Specifications Reference (PSREF)

| Model | Processor | Memory | RAID/HBA Adapter | Chassis | Disk Bays | Disks | GPU | Networking (LOM/ML2/PCIe) | M.2 Boot Drive | Riser Card 1 for Slot 1-3 | Riser Card 2 for Slot 5-6 | Front VGA | Security | System Management | Power Supply | Base Warranty | Ann Date (mm/yy) |
|------------|---|------------------------------|------------------|---------|------------------------|-------|------|---------------------------|----------------|---------------------------|---------------------------|--------------|----------|------------------------|--------------------|---------------|------------------|
| 7X06A04ZNA | 1xXeon Silver 4116 12C/2.1GHz/ 16.5MB/85W/DDR4-2400 | 1x32GB RDIMM DDR4-2666 | 1x530-8i | 16x2.5" | 8x2.5" SATA/ SAS HS | Open | None | None | None | None | None | Front VGA | None | XClarity Enterprise | 1x750W Platinum | 3-year | 07/17 |
| 7X06A057NA | 1xXeon Silver 4110 8C/2.1GHz/ 11MB/85W/DDR4-2400 | 1x16GB RDIMM DDR4-2666 | 1x530-8i | 16x2.5" | 8x2.5" SATA/ SAS HS | Open | None | None | None | None | None | Front VGA | None | XClarity Enterprise | 1x750W Platinum | 3-year | 07/17 |
| 7X06A05XNA | 1xXeon Gold 5118 12C/2.3GHz/ 16.5MB/105W/DDR4-2400 | 1x32GB RDIMM DDR4-2666 | 1x530-8i | 16x2.5" | 8x2.5" SATA/ SAS HS | Open | None | None | None | None | None | Front VGA | None | XClarity Enterprise | 1x750W Platinum | 3-year | 07/17 |

ThinkSystem SR650 Models for USA and Canada - Non TopSeller

Product Specifications Reference (PSREF)

| Model | Processor | Memory | RAID/HBA Adapter | Chassis | Disk Bays | Disks | GPU | Networking (LOM/ML2/PCIe) | M.2 Boot Drive | Riser Card 1 for Slot 1-3 | Riser Card 2 for Slot 5-6 | Front VGA | Security | System Management | Power Supply | Base Warranty | Ann Date (mm/yy) |
|------------|---|------------------------------|-----------------------|---------|--|-------|------|---------------------------|----------------|---------------------------|---------------------------|--------------|----------|------------------------|---------------------|---------------|------------------|
| 7X06A02CNA | 1xXeon Gold 6126 12C/2.6GHz/ 19.25MB/125W/DDR4-2666 | 1x32GB RDIMM DDR4-2666 | None | 24x2.5" | None | None | None | None | None | None | None | Front VGA | TPM 1.2 | XClarity Standard | 1x750W Platinum | 3-year | 07/17 |
| 7X06A02TNA | 1xXeon Gold 6134 8C/3.2GHz/ 24.75MB/130W/DDR4-2666 | 1x32GB RDIMM DDR4-2666 | 1x930-8i 2GB flash | 24x2.5" | 8x2.5" SATA/ SAS HS | Open | None | None | None | None | None | None | TPM 1.2 | XClarity Standard | 1x750W Platinum | 3-year | 07/17 |
| 7X06A02UNA | 1xXeon Gold 6150 18C/2.7GHz/ 24.75MB/165W/DDR4-2666 | 1x32GB RDIMM DDR4-2666 | 1x930-8i 2GB flash | 24x2.5" | 8x2.5" SATA/ SAS HS | Open | None | None | None | None | None | None | TPM 1.2 | XClarity Standard | 1x1100W Platinum | 3-year | 07/17 |
| 7X06A02VNA | 1xXeon Gold 6140 18C/2.3GHz/ 24.75MB/140W/DDR4-2666 | 1x32GB RDIMM DDR4-2666 | 1x930-8i 2GB flash | 24x2.5" | 8x2.5" SATA/ SAS HS | Open | None | None | None | None | None | None | TPM 1.2 | XClarity Standard | 1x1100W Platinum | 3-year | 07/17 |
| 7X06A02ZNA | 1xXeon Gold 6152 22C/2.1GHz/ 30.25MB/140W/DDR4-2666 | 1x32GB RDIMM DDR4-2666 | 1x930-8i 2GB flash | 24x2.5" | 8x2.5" SATA/ SAS HS | Open | None | None | None | None | None | None | TPM 1.2 | XClarity Standard | 1x1100W Platinum | 3-year | 07/17 |
| 7X06A030NA | 1xXeon Gold 5120 14C/2.2GHz/ 19.25MB/105W/DDR4-2400 | 1x16GB RDIMM DDR4-2666 | 1x930-8i 2GB flash | 24x2.5" | 8x2.5" SATA/ SAS HS | Open | None | None | None | None | None | None | TPM 1.2 | XClarity Standard | 1x750W Platinum | 3-year | 07/17 |
| 7X06A031NA | 1xXeon Platinum 8160 24C/2.1GHz/ 33MB/150W/DDR4-2666 | 1x32GB RDIMM DDR4-2666 | 1x930-8i 2GB flash | 24x2.5" | 8x2.5" SATA/ SAS HS | Open | None | None | None | None | None | None | TPM 1.2 | XClarity Standard | 1x1100W Platinum | 3-year | 07/17 |
| 7X06A032NA | 1xXeon Gold 6142 16C/2.6GHz/ 22MB/150W/DDR4-2666 | 1x32GB RDIMM DDR4-2666 | 1x930-8i 2GB flash | 24x2.5" | 8x2.5" SATA/ SAS HS | Open | None | None | None | None | None | None | TPM 1.2 | XClarity Standard | 1x1100W Platinum | 3-year | 07/17 |
| 7X06A039NA | 1xXeon Gold 6130 16C/2.1GHz/ 22MB/125W/DDR4-2666 | 1x32GB RDIMM DDR4-2666 | 1x930-8i 2GB flash | 24x2.5" | 8x2.5" SATA/ SAS HS | Open | None | None | None | None | None | None | TPM 1.2 | XClarity Standard | 1x750W Platinum | 3-year | 07/17 |
| 7X06A03DNA | 1xXeon Platinum 8164 26C/2.0GHz/ 35.75MB/150W/DDR4-2666 | 1x32GB RDIMM DDR4-2666 | 1x930-8i 2GB flash | 24x2.5" | 8x2.5" SATA/ SAS HS | Open | None | None | None | None | None | None | TPM 1.2 | XClarity Standard | 1x1100W Platinum | 3-year | 07/17 |
| 7X06A03GNA | 1xXeon Gold 5115 10C/2.4GHz/ 13.75MB/85W/DDR4-2400 | 1x16GB RDIMM DDR4-2666 | 1x930-8i 2GB flash | 24x2.5" | 8x2.5" SATA/ SAS HS | Open | None | None | None | None | None | None | TPM 1.2 | XClarity Standard | 1x750W Platinum | 3-year | 07/17 |
| 7X06A03KNA | 1xXeon Gold 6148 20C/2.4GHz/ 27.5MB/150W/DDR4-2666 | 1x32GB RDIMM DDR4-2666 | 1x930-8i 2GB flash | 24x2.5" | 8x2.5" SATA/ SAS HS | Open | None | None | None | None | None | None | TPM 1.2 | XClarity Standard | 1x1100W Platinum | 3-year | 07/17 |
| 7X06A03ZNA | 1xXeon Gold 5118 12C/2.3GHz/ 16.5MB/105W/DDR4-2400 | 1x16GB RDIMM DDR4-2666 | 1x930-8i 2GB flash | 24x2.5" | 8x2.5" SATA/ SAS HS | Open | None | None | None | None | None | None | TPM 1.2 | XClarity Standard | 1x750W Platinum | 3-year | 07/17 |
| 7X06A040NA | 1xXeon Gold 6134 8C/3.2GHz/ 24.75MB/130W/DDR4-2666 | 1x32GB RDIMM DDR4-2666 | 1x930-8i 2GB flash | 24x2.5" | 8x2.5" SATA/ SAS HS | Open | None | None | None | None | None | None | TPM 1.2 | XClarity Standard | 1x1100W Platinum | 3-year | 07/17 |
| 7X06A043NA | 2xXeon Gold 5120 14C/2.2GHz/ 19.25MB/105W/DDR4-2400 | 2x32GB RDIMM DDR4-2666 | 1x430-16i | 24x2.5" | 16x2.5" (12 SATA/SAS, 4 AnyBay) HS | Open | None | None | None | x8 / x8 / x8, FHHL | x16 FHFL / x16 FHHL | None | TPM 1.2 | XClarity Enterprise | 2x1100W Platinum | 3-year | 07/17 |
| 7X06A046NA | 1xXeon Gold 6126 12C/2.6GHz/ 19.25MB/125W/DDR4-2666 | 1x32GB RDIMM DDR4-2666 | 1x930-8i 2GB flash | 24x2.5" | 8x2.5" SATA/ SAS HS | Open | None | None | None | None | None | None | TPM 1.2 | XClarity Standard | 1x750W Platinum | 3-year | 07/17 |

ThinkSystem SR650 Models for EMEA - TopSeller - 1 of 2

Product Specifications Reference (PSREF)

| Model | Processor | Memory | RAID/HBA Adapter | Chassis | Disk Bays | Disks | GPU | Networking (LOM/ML2/PCIe) | M.2 Boot Drive | Riser Card 1 for Slot 1-3 | Riser Card 2 for Slot 5-6 | Front VGA | Security | System Management | Power Supply | Base Warranty | Ann Date (mm/yy) |
|------------|--|------------------------------|------------------------|---------|-------------------------|--|------|---------------------------|----------------|---------------------------|---------------------------|--------------|----------|------------------------|---------------------|---------------|------------------|
| 7X06A00KEA | 1xXeon Gold 5118 12C/2.3GHz/ 16.5MB/105W/DDR4-2400 | 1x16GB RDIMM DDR4-2666 | 1x930-8i 2GB flash | 24x2.5" | 8x2.5" SATA/ SAS HS | Open | None | None | None | None | None | Front VGA | TPM 1.2 | XClarity Enterprise | 1x750W Platinum | 3-year | 07/17 |
| 7X06A00LEA | 1xXeon Gold 5115 10C/2.4GHz/ 13.75MB/85W/DDR4-2400 | 1x16GB RDIMM DDR4-2666 | 1x930-8i 2GB flash | 24x2.5" | 8x2.5" SATA/ SAS HS | Open | None | None | None | None | None | Front VGA | TPM 1.2 | XClarity Enterprise | 1x750W Platinum | 3-year | 07/17 |
| 7X06A00NEA | 1xXeon Gold 6140 18C/2.3GHz/ 24.75MB/140W/DDR4-2666 | 1x32GB RDIMM DDR4-2666 | 1x930-8i 2GB flash | 24x2.5" | 8x2.5" SATA/ SAS HS | Open | None | None | None | None | None | Front VGA | TPM 1.2 | XClarity Enterprise | 1x1100W Platinum | 3-year | 07/17 |
| 7X06A00PEA | 1xXeon Gold 6130 16C/2.1GHz/ 22MB/125W/DDR4-2666 | 1x32GB RDIMM DDR4-2666 | 1x930-8i 2GB flash | 24x2.5" | 8x2.5" SATA/ SAS HS | Open | None | None | None | None | None | Front VGA | TPM 1.2 | XClarity Enterprise | 1x1100W Platinum | 3-year | 07/17 |
| 7X06A010EA | 1xXeon Gold 6152 22C/2.1GHz/ 30.25MB/140W/DDR4-2666 | 1x32GB RDIMM DDR4-2666 | 1x930-8i 2GB flash | 24x2.5" | 8x2.5" SATA/ SAS HS | Open | None | None | None | None | None | Front VGA | TPM 1.2 | XClarity Enterprise | 1x1100W Platinum | 3-year | 07/17 |
| 7X06A011EA | 1xXeon Gold 5115 10C/2.4GHz/ 13.75MB/85W/DDR4-2400 | 1x16GB RDIMM DDR4-2666 | 1x930-8i 2GB flash | 24x2.5" | 8x2.5" SATA/ SAS HS | Open | None | None | None | None | None | Front VGA | TPM 1.2 | XClarity Enterprise | 1x1100W Platinum | 3-year | 07/17 |
| 7X06A013EA | 1xXeon Platinum 8160 24C/2.1GHz/ 33MB/150W/DDR4-2666 | 1x32GB RDIMM DDR4-2666 | 1x930-8i 2GB flash | 24x2.5" | 8x2.5" SATA/ SAS HS | Open | None | None | None | None | None | Front VGA | TPM 1.2 | XClarity Enterprise | 1x1100W Platinum | 3-year | 07/17 |
| 7X06A014EA | 1xXeon Gold 5120 14C/2.2GHz/ 19.25MB/105W/DDR4-2400 | 1x16GB RDIMM DDR4-2666 | 1x930-8i 2GB flash | 24x2.5" | 8x2.5" SATA/ SAS HS | Open | None | None | None | None | None | Front VGA | TPM 1.2 | XClarity Enterprise | 1x1100W Platinum | 3-year | 07/17 |
| 7X06A01AEA | 1xXeon Gold 6140 18C/2.3GHz/ 24.75MB/140W/DDR4-2666 | 1x32GB RDIMM DDR4-2666 | 1x930-8i 2GB flash | 24x2.5" | 8x2.5" SATA/ SAS HS | Open | None | None | None | None | None | Front VGA | TPM 1.2 | XClarity Enterprise | 1x1100W Platinum | 3-year | 07/17 |
| 7X06A01BEA | 1xXeon Gold 5122 4C/3.6GHz/ 16.5MB/105W/DDR4-2400 | 1x32GB RDIMM DDR4-2666 | 1x930-8i 2GB flash | 24x2.5" | 8x2.5" SATA/ SAS HS | Open | None | None | None | None | None | Front VGA | TPM 1.2 | XClarity Enterprise | 1x1600W Platinum | 3-year | 07/17 |
| 7X06A01HEA | 1xXeon Gold 5118 12C/2.3GHz/ 16.5MB/105W/DDR4-2400 | 1x16GB RDIMM DDR4-2666 | 1x930-8i 2GB flash | 24x2.5" | 8x2.5" SATA/ SAS HS | Open | None | None | None | None | None | Front VGA | TPM 1.2 | XClarity Enterprise | 1x1100W Platinum | 3-year | 07/17 |
| 7X06A01NEA | 1xXeon Gold 6130 16C/2.1GHz/ 22MB/125W/DDR4-2666 | 1x32GB RDIMM DDR4-2666 | 1x930-8i 2GB flash | 24x2.5" | 8x2.5" SATA/ SAS HS | Open | None | None | None | None | None | Front VGA | TPM 1.2 | XClarity Enterprise | 1x750W Platinum | 3-year | 07/17 |
| 7X06A01REA | 1xXeon Gold 6126 12C/2.6GHz/ 19.25MB/125W/DDR4-2666 | 1x32GB RDIMM DDR4-2666 | 1x930-8i 2GB flash | 24x2.5" | 8x2.5" SATA/ SAS HS | Open | None | None | None | None | None | Front VGA | TPM 1.2 | XClarity Enterprise | 1x750W Platinum | 3-year | 07/17 |
| 7X06A01SEA | 1xXeon Gold 5120 14C/2.2GHz/ 19.25MB/105W/DDR4-2400 | 1x16GB RDIMM DDR4-2666 | 1x930-8i 2GB flash | 24x2.5" | 8x2.5" SATA/ SAS HS | Open | None | None | None | None | None | Front VGA | TPM 1.2 | XClarity Enterprise | 1x750W Platinum | 3-year | 07/17 |
| 7X06A047EA | 1xXeon Silver 4108 8C/1.8GHz/ 11MB/85W/DDR4-2400 | 1x16GB RDIMM DDR4-2666 | 1x930-8i 2GB flash | 24x2.5" | 8x2.5" SATA/ SAS HS | 2x300GB HDD 10K 2.5" SAS- 12Gbps | None | None | None | None | None | Front VGA | TPM 1.2 | XClarity Enterprise | 2x750W Platinum | 3-year | 07/17 |
| 7X06A048EA | 1xXeon Silver 4114 10C/2.2GHz/ 13.75MB/85W/DDR4-2400 | 1x16GB RDIMM DDR4-2666 | 1x930-16i 4GB flash | 24x2.5" | 16x2.5" SATA/ SAS HS | Open | None | None | None | None | None | Front VGA | TPM 1.2 | XClarity Enterprise | 2x750W Platinum | 3-year | 07/17 |
| 7X06A049EA | 1xXeon Silver 4110 8C/2.1GHz/ 11MB/85W/DDR4-2400 | 1x32GB RDIMM DDR4-2666 | 1x930-8i 2GB flash | 24x2.5" | 8x2.5" SATA/ SAS HS | 3x300GB HDD 10K 2.5" SAS- 12Gbps | None | None | None | None | None | Front VGA | TPM 1.2 | XClarity Enterprise | 2x750W Platinum | 3-year | 07/17 |
| 7X06A04AEA | 1xXeon Silver 4114 10C/2.2GHz/ 13.75MB/85W/DDR4-2400 | 1x32GB RDIMM DDR4-2666 | 1x930-8i 2GB flash | 24x2.5" | 8x2.5" SATA/ SAS HS | 3x300GB HDD 10K 2.5" SAS- 12Gbps | None | None | None | None | None | Front VGA | TPM 1.2 | XClarity Enterprise | 2x750W Platinum | 3-year | 07/17 |
| 7X06A04BEA | 1xXeon Silver 4110 8C/2.1GHz/ 11MB/85W/DDR4-2400 | 1x16GB RDIMM DDR4-2666 | 1x930-8i 2GB flash | 24x2.5" | 8x2.5" SATA/ SAS HS | 3x300GB HDD 10K 2.5" SAS- 12Gbps | None | None | None | None | None | Front VGA | TPM 1.2 | XClarity Enterprise | 2x750W Platinum | 3-year | 07/17 |
| 7X06A04CEA | 1xXeon Silver 4108 8C/1.8GHz/ 11MB/85W/DDR4-2400 | 1x16GB RDIMM DDR4-2666 | 1x930-8i 2GB flash | 24x2.5" | 8x2.5" SATA/ SAS HS | Open | None | None | None | None | None | Front VGA | TPM 1.2 | XClarity Enterprise | 1x750W Platinum | 3-year | 07/17 |
| 7X06A04DEA | 1xXeon Silver 4116 12C/2.1GHz/ 16.5MB/85W/DDR4-2400 | 1x16GB RDIMM DDR4-2666 | 1x930-8i 2GB flash | 24x2.5" | 8x2.5" SATA/ SAS HS | Open | None | None | None | None | None | Front VGA | TPM 1.2 | XClarity Enterprise | 1x750W Platinum | 3-year | 07/17 |
| 7X06A04EEA | 1xXeon Silver 4110 8C/2.1GHz/ 11MB/85W/DDR4-2400 | 1x16GB RDIMM DDR4-2666 | 1x930-8i 2GB flash | 24x2.5" | 8x2.5" SATA/ SAS HS | Open | None | None | None | None | None | Front VGA | TPM 1.2 | XClarity Enterprise | 1x1100W Platinum | 3-year | 07/17 |

ThinkSystem SR650 Models for EMEA - TopSeller - 2 of 2

| Model | Processor | Memory | RAID/HBA Adapter | Chassis | Disk Bays | Disks | GPU | Networking (LOM/ML2/PCIe) | M.2 Boot Drive | Riser Card 1 for Slot 1-3 | Riser Card 2 for Slot 5-6 | Front VGA | Security | System Management | Power Supply | Base Warranty | Ann Date (mm/yy) |
|------------|--|------------------------------|-----------------------|---------|------------------------|--|------|---------------------------|----------------|---------------------------|---------------------------|--------------|----------|------------------------|---------------------|---------------|------------------|
| 7X06A04FEA | 1xXeon Bronze 3106 8C/1.7GHz/ 11MB/85W/DDR4-2133 | 1x8GB RDIMM DDR4-2666 | 1x530-8i | 24x2.5" | 8x2.5" SATA/ SAS HS | Open | None | None | None | None | None | Front VGA | TPM 1.2 | XClarity Enterprise | 1x750W Platinum | 3-year | 07/17 |
| 7X06A04GEA | 1xXeon Silver 4110 8C/2.1GHz/ 11MB/85W/DDR4-2400 | 1x16GB RDIMM DDR4-2666 | 1x930-8i 2GB flash | 24x2.5" | 8x2.5" SATA/ SAS HS | 2x300GB HDD 10K 2.5" SAS- 12Gbps | None | None | None | None | None | Front VGA | TPM 1.2 | XClarity Enterprise | 2x750W Platinum | 3-year | 07/17 |
| 7X06A04HEA | 1xXeon Silver 4110 8C/2.1GHz/ 11MB/85W/DDR4-2400 | 1x8GB RDIMM DDR4-2666 | 1x930-8i 2GB flash | 12x3.5" | 8x3.5" SATA/ SAS HS | Open | None | None | None | None | None | Front VGA | TPM 1.2 | XClarity Enterprise | 1x750W Platinum | 3-year | 07/17 |
| 7X06A04JEA | 1xXeon Bronze 3104 6C/1.7GHz/ 8.25MB/85W/DDR4-2133 | 1x8GB RDIMM DDR4-2666 | 1x530-8i | 24x2.5" | 8x2.5" SATA/ SAS HS | Open | None | None | None | None | None | Front VGA | TPM 1.2 | XClarity Enterprise | 1x750W Platinum | 3-year | 07/17 |
| 7X06A04KEA | 1xXeon Silver 4108 8C/1.8GHz/ 11MB/85W/DDR4-2400 | 1x16GB RDIMM DDR4-2666 | 1x930-8i 2GB flash | 24x2.5" | 8x2.5" SATA/ SAS HS | Open | None | None | None | None | None | Front VGA | TPM 1.2 | XClarity Enterprise | 1x1100W Platinum | 3-year | 07/17 |
| 7X06A04LEA | 1xXeon Silver 4110 8C/2.1GHz/ 11MB/85W/DDR4-2400 | 1x16GB RDIMM DDR4-2666 | 1x930-8i 2GB flash | 24x2.5" | 8x2.5" SATA/ SAS HS | Open | None | None | None | None | None | Front VGA | TPM 1.2 | XClarity Enterprise | 1x750W Platinum | 3-year | 07/17 |
| 7X06A04MEA | 1xXeon Silver 4110 8C/2.1GHz/ 11MB/85W/DDR4-2400 | 1x16GB RDIMM DDR4-2666 | 1x530-8i | 24x2.5" | 8x2.5" SATA/ SAS HS | Open | None | None | None | None | None | Front VGA | TPM 1.2 | XClarity Enterprise | 1x750W Platinum | 3-year | 07/17 |
| 7X06A04NEA | 1xXeon Silver 4108 8C/1.8GHz/ 11MB/85W/DDR4-2400 | 1x16GB RDIMM DDR4-2666 | 1x930-8i 2GB flash | 24x2.5" | 8x2.5" SATA/ SAS HS | 3x300GB HDD 10K 2.5" SAS- 12Gbps | None | None | None | None | None | Front VGA | TPM 1.2 | XClarity Enterprise | 2x750W Platinum | 3-year | 07/17 |
| 7X06A04PEA | 1xXeon Silver 4110 8C/2.1GHz/ 11MB/85W/DDR4-2400 | 1x16GB RDIMM DDR4-2666 | 1x930-8i 2GB flash | 24x2.5" | 8x2.5" SATA/ SAS HS | Open | None | None | None | None | None | Front VGA | TPM 1.2 | XClarity Enterprise | 1x750W Platinum | 3-year | 07/17 |
| 7X06A04QEA | 1xXeon Silver 4114 10C/2.2GHz/ 13.75MB/85W/DDR4-2400 | 1x16GB RDIMM DDR4-2666 | 1x930-8i 2GB flash | 24x2.5" | 8x2.5" SATA/ SAS HS | Open | None | None | None | None | None | Front VGA | TPM 1.2 | XClarity Enterprise | 1x750W Platinum | 3-year | 07/17 |
| 7X06A04REA | 1xXeon Silver 4114 10C/2.2GHz/ 13.75MB/85W/DDR4-2400 | 1x16GB RDIMM DDR4-2666 | 1x930-8i 2GB flash | 24x2.5" | 8x2.5" SATA/ SAS HS | Open | None | None | None | None | None | Front VGA | TPM 1.2 | XClarity Enterprise | 1x1100W Platinum | 3-year | 07/17 |
| 7X06A04SEA | 1xXeon Silver 4116 12C/2.1GHz/ 16.5MB/85W/DDR4-2400 | 1x16GB RDIMM DDR4-2666 | 1x930-8i 2GB flash | 24x2.5" | 8x2.5" SATA/ SAS HS | Open | None | None | None | None | None | Front VGA | TPM 1.2 | XClarity Enterprise | 1x1100W Platinum | 3-year | 07/17 |
| 7X06A04TEA | 1xXeon Silver 4108 8C/1.8GHz/ 11MB/85W/DDR4-2400 | 1x16GB RDIMM DDR4-2666 | 1x530-8i | 24x2.5" | 8x2.5" SATA/ SAS HS | Open | None | None | None | None | None | Front VGA | TPM 1.2 | XClarity Enterprise | 1x750W Platinum | 3-year | 07/17 |
| 7X06A04UEA | 1xXeon Silver 4108 8C/1.8GHz/ 11MB/85W/DDR4-2400 | 1x8GB RDIMM DDR4-2666 | 1x930-8i 2GB flash | 12x3.5" | 8x3.5" SATA/ SAS HS | Open | None | None | None | None | None | Front VGA | TPM 1.2 | XClarity Enterprise | 1x750W Platinum | 3-year | 07/17 |

ThinkSystem SR650 Models for EMEA - Non TopSeller - 1 of 2

| Model | Processor | Memory | RAID/HBA Adapter | Chassis | Disk Bays | Disks | GPU | Networking (LOM/ML2/PCIe) | M.2 Boot Drive | Riser Card 1 for Slot 1-3 | Riser Card 2 for Slot 5-6 | Front VGA | Security | System Management | Power Supply | Base Warranty | Ann Date (mm/yy) |
|------------|--|------------------------|---------------------|---------|----------------------------------|-------|------|---------------------------|----------------|---------------------------|---------------------------|-----------|----------|---------------------|------------------|---------------|------------------|
| 7X06A02SEA | 1xXeon Gold 6134 8C/3.2GHz/24.75MB/130W/DDR4-2666 | 1x32GB RDIMM DDR4-2666 | 1x930-8i 2GB flash | 24x2.5" | 8x2.5" SATA/SAS HS | Open | None | None | None | None | None | None | TPM 1.2 | XClarity Standard | 1x1100W Platinum | 3-year | 07/17 |
| 7X06A02WEA | 1xXeon Silver 4114 10C/2.2GHz/13.75MB/85W/DDR4-2400 | 1x16GB RDIMM DDR4-2666 | 1x930-8i 2GB flash | 24x2.5" | 8x2.5" SATA/SAS HS | Open | None | None | None | None | None | None | TPM 1.2 | XClarity Standard | 1x750W Platinum | 3-year | 07/17 |
| 7X06A02XEA | 1xXeon Gold 6134 8C/3.2GHz/24.75MB/130W/DDR4-2666 | 1x32GB RDIMM DDR4-2666 | 1x930-8i 2GB flash | 24x2.5" | 8x2.5" SATA/SAS HS | Open | None | None | None | None | None | None | TPM 1.2 | XClarity Standard | 1x750W Platinum | 3-year | 07/17 |
| 7X06A02YEA | 1xXeon Gold 6140 18C/2.3GHz/24.75MB/140W/DDR4-2666 | 1x32GB RDIMM DDR4-2666 | 1x930-8i 2GB flash | 24x2.5" | 8x2.5" SATA/SAS HS | Open | None | None | None | None | None | None | TPM 1.2 | XClarity Standard | 1x1100W Platinum | 3-year | 07/17 |
| 7X06A033EA | 2xXeon Gold 5120 14C/2.2GHz/19.25MB/105W/DDR4-2400 | 2x32GB RDIMM DDR4-2666 | 1x430-16i | 24x2.5" | 8x2.5" (4 SATA/SAS, 4 AnyBay) HS | Open | None | None | None | None | x16 FHFL / x16 FHHL | None | TPM 1.2 | XClarity Enterprise | 1x1100W Platinum | 3-year | 07/17 |
| 7X06A035EA | 1xXeon Bronze 3104 6C/1.7GHz/8.25MB/85W/DDR4-2133 | 1x8GB RDIMM DDR4-2666 | 1x530-8i | 24x2.5" | 8x2.5" SATA/SAS HS | Open | None | None | None | None | None | None | TPM 1.2 | XClarity Standard | 1x550W Platinum | 3-year | 07/17 |
| 7X06A036EA | 1xXeon Gold 5118 12C/2.3GHz/16.5MB/105W/DDR4-2400 | 1x16GB RDIMM DDR4-2666 | 1x930-8i 2GB flash | 24x2.5" | 8x2.5" SATA/SAS HS | Open | None | None | None | None | None | None | TPM 1.2 | XClarity Standard | 1x750W Platinum | 3-year | 07/17 |
| 7X06A037EA | 1xXeon Silver 4108 8C/1.8GHz/11MB/85W/DDR4-2400 | 1x16GB RDIMM DDR4-2666 | 1x530-8i | 24x2.5" | 8x2.5" SATA/SAS HS | Open | None | None | None | None | None | None | TPM 1.2 | XClarity Standard | 1x750W Platinum | 3-year | 07/17 |
| 7X06A038EA | 2xXeon Silver 4110 8C/2.1GHz/11MB/85W/DDR4-2400 | 2x32GB RDIMM DDR4-2666 | 1x430-16i | 24x2.5" | 8x2.5" (4 SATA/SAS, 4 AnyBay) HS | Open | None | None | None | None | None | None | TPM 1.2 | XClarity Enterprise | 1x1100W Platinum | 3-year | 07/17 |
| 7X06A03AEA | 1xXeon Gold 5115 10C/2.4GHz/13.75MB/85W/DDR4-2400 | 1x16GB RDIMM DDR4-2666 | 1x930-8i 2GB flash | 24x2.5" | 8x2.5" SATA/SAS HS | Open | None | None | None | None | None | None | TPM 1.2 | XClarity Standard | 1x750W Platinum | 3-year | 07/17 |
| 7X06A03BEA | 1xXeon Silver 4116 12C/2.1GHz/16.5MB/85W/DDR4-2400 | 1x16GB RDIMM DDR4-2666 | 1x930-8i 2GB flash | 24x2.5" | 8x2.5" SATA/SAS HS | Open | None | None | None | None | None | None | TPM 1.2 | XClarity Standard | 1x750W Platinum | 3-year | 07/17 |
| 7X06A03CEA | 1xXeon Silver 4110 8C/2.1GHz/11MB/85W/DDR4-2400 | 1x16GB RDIMM DDR4-2666 | 1x930-8i 2GB flash | 24x2.5" | 8x2.5" SATA/SAS HS | Open | None | None | None | None | None | None | TPM 1.2 | XClarity Standard | 1x750W Platinum | 3-year | 07/17 |
| 7X06A03EEA | 1xXeon Gold 6142 16C/2.6GHz/22MB/150W/DDR4-2666 | 1x32GB RDIMM DDR4-2666 | 1x930-8i 2GB flash | 24x2.5" | 8x2.5" SATA/SAS HS | Open | None | None | None | None | None | None | TPM 1.2 | XClarity Standard | 1x1100W Platinum | 3-year | 07/17 |
| 7X06A03HEA | 1xXeon Gold 6148 20C/2.4GHz/27.5MB/150W/DDR4-2666 | 1x32GB RDIMM DDR4-2666 | 1x930-8i 2GB flash | 24x2.5" | 8x2.5" SATA/SAS HS | Open | None | None | None | None | None | None | TPM 1.2 | XClarity Standard | 1x1100W Platinum | 3-year | 07/17 |
| 7X06A03LEA | 1xXeon Platinum 8160 24C/2.1GHz/33MB/150W/DDR4-2666 | 1x32GB RDIMM DDR4-2666 | 1x930-8i 2GB flash | 24x2.5" | 8x2.5" SATA/SAS HS | Open | None | None | None | None | None | None | TPM 1.2 | XClarity Standard | 1x1100W Platinum | 3-year | 07/17 |
| 7X06A03MEA | 1xXeon Platinum 8164 26C/2.0GHz/35.75MB/150W/DDR4-2666 | 1x32GB RDIMM DDR4-2666 | 1x930-8i 2GB flash | 24x2.5" | 8x2.5" SATA/SAS HS | Open | None | None | None | None | None | None | TPM 1.2 | XClarity Standard | 1x1100W Platinum | 3-year | 07/17 |
| 7X06A03NEA | 1xXeon Gold 6152 22C/2.1GHz/30.25MB/140W/DDR4-2666 | 1x32GB RDIMM DDR4-2666 | 1x930-8i 2GB flash | 24x2.5" | 8x2.5" SATA/SAS HS | Open | None | None | None | None | None | None | TPM 1.2 | XClarity Standard | 1x1100W Platinum | 3-year | 07/17 |
| 7X06A03PEA | 1xXeon Gold 6130 16C/2.1GHz/22MB/125W/DDR4-2666 | 1x32GB RDIMM DDR4-2666 | 1x930-8i 2GB flash | 24x2.5" | 8x2.5" SATA/SAS HS | Open | None | None | None | None | None | None | TPM 1.2 | XClarity Standard | 1x750W Platinum | 3-year | 07/17 |
| 7X06A03QEA | 1xXeon Gold 6150 18C/2.7GHz/24.75MB/165W/DDR4-2666 | 1x32GB RDIMM DDR4-2666 | 1x930-8i 2GB flash | 24x2.5" | 8x2.5" SATA/SAS HS | Open | None | None | None | None | None | None | TPM 1.2 | XClarity Standard | 1x1100W Platinum | 3-year | 07/17 |
| 7X06A03SEA | 1xXeon Silver 4108 8C/1.8GHz/11MB/85W/DDR4-2400 | 1x16GB RDIMM DDR4-2666 | 1x930-8i 2GB flash | 24x2.5" | 8x2.5" SATA/SAS HS | Open | None | None | None | None | None | None | TPM 1.2 | XClarity Standard | 1x750W Platinum | 3-year | 07/17 |
| 7X06A03WEA | 1xXeon Silver 4114 10C/2.2GHz/13.75MB/85W/DDR4-2400 | 1x16GB RDIMM DDR4-2666 | 1x930-16i 4GB flash | 12x3.5" | 12x3.5" SATA/SAS HS | Open | None | None | None | None | None | None | TPM 1.2 | XClarity Standard | 1x750W Platinum | 3-year | 07/17 |
| 7X06A041EA | 1xXeon Gold 5120 14C/2.2GHz/19.25MB/105W/DDR4-2400 | 1x16GB RDIMM DDR4-2666 | 1x930-8i 2GB flash | 24x2.5" | 8x2.5" SATA/SAS HS | Open | None | None | None | None | None | None | TPM 1.2 | XClarity Standard | 1x750W Platinum | 3-year | 07/17 |

ThinkSystem SR650 Models for EMEA - Non TopSeller - 2 of 2

Product Specifications Reference (PSREF)

| Model | Processor | Memory | RAID/HBA Adapter | Chassis | Disk Bays | Disks | GPU | Networking (LOM/ML2/PCIe) | M.2 Boot Drive | Riser Card 1 for Slot 1-3 | Riser Card 2 for Slot 5-6 | Front VGA | Security | System Management | Power Supply | Base Warranty | Ann Date (mm/yy) |
|------------|---|------------------------------|-----------------------|---------|------------------------|-------|------|---------------------------|----------------|---------------------------|---------------------------|-----------|----------|----------------------|--------------------|---------------|------------------|
| 7X06A044EA | 1xXeon Gold 6126 12C/2.6GHz/ 19.25MB/125W/DDR4-2666 | 1x32GB RDIMM DDR4-2666 | 1x930-8i 2GB flash | 24x2.5" | 8x2.5" SATA/ SAS HS | Open | None | None | None | None | None | None | TPM 1.2 | XClarity Standard | 1x750W Platinum | 3-year | 07/17 |
| 7X06A045EA | 1xXeon Silver 4110 8C/2.1GHz/ 11MB/85W/DDR4-2400 | 1x16GB RDIMM DDR4-2666 | 1x530-8i | 24x2.5" | 8x2.5" SATA/ SAS HS | Open | None | None | None | None | None | None | TPM 1.2 | XClarity Standard | 1x750W Platinum | 3-year | 07/17 |

ThinkSystem SR650 Models for Australia and New Zealand - TopSeller

Product Specifications Reference (PSREF)

| Model | Processor | Memory | RAID/HBA Adapter | Chassis | Disk Bays | Disks | GPU | Networking (LOM/ML2/PCIe) | M.2 Boot Drive | Riser Card 1 for Slot 1-3 | Riser Card 2 for Slot 5-6 | Front VGA | Security | System Management | Power Supply | Base Warranty | Ann Date (mm/yy) |
|------------|--|------------------------------|-----------------------|---------|--------------------------|-------|------|---------------------------|----------------|---------------------------|---------------------------|--------------|----------|------------------------|---------------------|---------------|------------------|
| 7X06A05ZAU | 1xXeon Gold 6130 16C/2.1GHz/ 22MB/125W/DDR4-2666 | 1x32GB RDIMM DDR4-2666 | 1x930-8i 2GB flash | 24x2.5" | 8x2.5" SATA/SAS HS | Open | None | None | None | None | None | Front VGA | TPM 1.2 | XClarity Enterprise | 1x1100W Platinum | 3-year | 07/17 |
| 7X06A060AU | 1xXeon Gold 5118 12C/2.3GHz/ 16.5MB/105W/DDR4-2400 | 1x16GB RDIMM DDR4-2666 | 1x930-8i 2GB flash | 24x2.5" | 8x2.5" SATA/SAS HS | Open | None | None | None | None | None | Front VGA | TPM 1.2 | XClarity Enterprise | 1x1100W Platinum | 3-year | 07/17 |
| 7X06A061AU | 1xXeon Gold 5120 14C/2.2GHz/ 19.25MB/105W/DDR4-2400 | 1x16GB RDIMM DDR4-2666 | 1x930-8i 2GB flash | 24x2.5" | 8x2.5" SATA/SAS HS | Open | None | None | None | None | None | Front VGA | TPM 1.2 | XClarity Enterprise | 1x1100W Platinum | 3-year | 07/17 |
| 7X06A062AU | 1xXeon Gold 6126 12C/2.6GHz/ 19.25MB/125W/DDR4-2666 | 1x32GB RDIMM DDR4-2666 | 1x930-8i 2GB flash | 24x2.5" | 8x2.5" SATA/SAS HS | Open | None | None | None | None | None | Front VGA | TPM 1.2 | XClarity Enterprise | 1x750W Platinum | 3-year | 07/17 |
| 7X06A063AU | 1xXeon Gold 5118 12C/2.3GHz/ 16.5MB/105W/DDR4-2400 | 1x16GB RDIMM DDR4-2666 | 1x930-8i 2GB flash | 24x2.5" | 8x2.5" SATA/SAS HS | Open | None | None | None | None | None | Front VGA | TPM 1.2 | XClarity Enterprise | 1x750W Platinum | 3-year | 07/17 |
| 7X06A064AU | 1xXeon Gold 6140 18C/2.3GHz/ 24.75MB/140W/DDR4-2666 | 1x32GB RDIMM DDR4-2666 | 1x930-8i 2GB flash | 24x2.5" | 8x2.5" SATA/SAS HS | Open | None | None | None | None | None | Front VGA | TPM 1.2 | XClarity Enterprise | 1x1100W Platinum | 3-year | 07/17 |
| 7X06A065AU | 1xXeon Gold 5115 10C/2.4GHz/ 13.75MB/85W/DDR4-2400 | 1x16GB RDIMM DDR4-2666 | 1x930-8i 2GB flash | 24x2.5" | 8x2.5" SATA/SAS HS | Open | None | None | None | None | None | Front VGA | TPM 1.2 | XClarity Enterprise | 1x1100W Platinum | 3-year | 07/17 |
| 7X06A066AU | 1xXeon Gold 5122 4C/3.6GHz/ 16.5MB/105W/DDR4-2400 | 1x32GB RDIMM DDR4-2666 | 1x930-8i 2GB flash | 24x2.5" | 8x2.5" SATA/SAS HS | Open | None | None | None | None | None | Front VGA | TPM 1.2 | XClarity Enterprise | 1x1600W Platinum | 3-year | 07/17 |
| 7X06A067AU | 1xXeon Gold 5120 14C/2.2GHz/ 19.25MB/105W/DDR4-2400 | 1x16GB RDIMM DDR4-2666 | 1x930-8i 2GB flash | 24x2.5" | 8x2.5" SATA/SAS HS | Open | None | None | None | None | None | Front VGA | TPM 1.2 | XClarity Enterprise | 1x750W Platinum | 3-year | 07/17 |
| 7X06A069AU | 1xXeon Platinum 8160 24C/2.1GHz/ 33MB/150W/DDR4-2666 | 1x32GB RDIMM DDR4-2666 | 1x930-8i 2GB flash | 24x2.5" | 8x2.5" SATA/SAS HS | Open | None | None | None | None | None | Front VGA | TPM 1.2 | XClarity Enterprise | 1x1100W Platinum | 3-year | 07/17 |
| 7X06A06AAU | 1xXeon Gold 6152 22C/2.1GHz/ 30.25MB/140W/DDR4-2666 | 1x32GB RDIMM DDR4-2666 | 1x930-8i 2GB flash | 24x2.5" | 8x2.5" SATA/SAS HS | Open | None | None | None | None | None | Front VGA | TPM 1.2 | XClarity Enterprise | 1x1100W Platinum | 3-year | 07/17 |
| 7X06A06BAU | 1xXeon Gold 6130 16C/2.1GHz/ 22MB/125W/DDR4-2666 | 1x32GB RDIMM DDR4-2666 | 1x930-8i 2GB flash | 24x2.5" | 8x2.5" SATA/SAS HS | Open | None | None | None | None | None | Front VGA | TPM 1.2 | XClarity Enterprise | 1x750W Platinum | 3-year | 07/17 |
| 7X06A06CAU | 1xXeon Gold 6126 12C/2.6GHz/ 19.25MB/125W/DDR4-2666 | 1x32GB RDIMM DDR4-2666 | 1x930-8i 2GB flash | 24x2.5" | 8x2.5" SATA/SAS HS | Open | None | None | None | None | None | Front VGA | TPM 1.2 | XClarity Enterprise | 1x1100W Platinum | 3-year | 07/17 |
| 7X06A06DAU | 1xXeon Gold 5115 10C/2.4GHz/ 13.75MB/85W/DDR4-2400 | 1x16GB RDIMM DDR4-2666 | 1x930-8i 2GB flash | 24x2.5" | 8x2.5" SATA/SAS HS | Open | None | None | None | None | None | Front VGA | TPM 1.2 | XClarity Enterprise | 1x750W Platinum | 3-year | 07/17 |

ThinkSystem SR650 Models for Australia and New Zealand - Non TopSeller - 1 of 2

Product Specifications Reference (PSREF)

| Model | Processor | Memory | RAID/ HBA Adapter | Chassis | Disk Bays | Disks | GPU | Networking (LOM/ML2/ PCIe) | M.2 Boot Drive | Riser Card 1 for Slot 1-3 | Riser Card 2 for Slot 5-6 | Front VGA | Security | System Manage- ment | Power Supply | Base Warranty | Ann Date (mm/yy) |
|------------|---|---------------------------|-------------------------|---------|--|-------|------|----------------------------------|----------------------|------------------------------|------------------------------|--------------|----------|---------------------------|---------------------|------------------|------------------------|
| 7X06A04WAU | 1xXeon Gold 5115 10C/2.4GHz/ 13.75MB/85W/DDR4-2400 | 1x16GB RDIMM DDR4-2666 | 1x930-8i 2GB flash | 24x2.5" | 8x2.5" SATA/ SAS HS | Open | None | None | None | None | None | None | TPM 1.2 | XClarity Standard | 1x750W Platinum | 3-year | 07/17 |
| 7X06A04YAU | 1xXeon Platinum 8160 24C/2.1GHz/ 33MB/150W/DDR4-2666 | 1x32GB RDIMM DDR4-2666 | 1x930-8i 2GB flash | 24x2.5" | 8x2.5" SATA/ SAS HS | Open | None | None | None | None | None | None | TPM 1.2 | XClarity Standard | 1x1100W Platinum | 3-year | 07/17 |
| 7X06A050AU | 1xXeon Gold 6148 20C/2.4GHz/ 27.5MB/150W/DDR4-2666 | 1x32GB RDIMM DDR4-2666 | 1x930-8i 2GB flash | 24x2.5" | 8x2.5" SATA/ SAS HS | Open | None | None | None | None | None | None | TPM 1.2 | XClarity Standard | 1x1100W Platinum | 3-year | 07/17 |
| 7X06A051AU | 1xXeon Gold 6152 22C/2.1GHz/ 30.25MB/140W/DDR4-2666 | 1x32GB RDIMM DDR4-2666 | 1x930-8i 2GB flash | 24x2.5" | 8x2.5" SATA/ SAS HS | Open | None | None | None | None | None | None | TPM 1.2 | XClarity Standard | 1x1100W Platinum | 3-year | 07/17 |
| 7X06A052AU | 1xXeon Gold 6140 18C/2.3GHz/ 24.75MB/140W/DDR4-2666 | 1x32GB RDIMM DDR4-2666 | 1x930-8i 2GB flash | 24x2.5" | 8x2.5" SATA/ SAS HS | Open | None | None | None | None | None | None | TPM 1.2 | XClarity Standard | 1x1100W Platinum | 3-year | 07/17 |
| 7X06A054AU | 1xXeon Gold 6130 16C/2.1GHz/ 22MB/125W/DDR4-2666 | 1x32GB RDIMM DDR4-2666 | 1x930-8i 2GB flash | 24x2.5" | 8x2.5" SATA/ SAS HS | Open | None | None | None | None | None | None | TPM 1.2 | XClarity Standard | 1x750W Platinum | 3-year | 07/17 |
| 7X06A059AU | 1xXeon Platinum 8164 26C/2.0GHz/ 35.75MB/150W/DDR4-2666 | 1x32GB RDIMM DDR4-2666 | 1x930-8i 2GB flash | 24x2.5" | 8x2.5" SATA/ SAS HS | Open | None | None | None | None | None | None | TPM 1.2 | XClarity Standard | 1x1100W Platinum | 3-year | 07/17 |
| 7X06A05CAU | 2xXeon Gold 5120 14C/2.2GHz/ 19.25MB/105W/DDR4-2400 | 2x32GB RDIMM DDR4-2666 | 1x430-16i | 24x2.5" | 16x2.5" (12 SATA/SAS, 4 AnyBay) HS | Open | None | None | None | x8 / x8 / x8, FHHL | x16 FHFL / x16 FHHL | None | TPM 1.2 | XClarity Enterprise | 1x1100W Platinum | 3-year | 07/17 |
| 7X06A05DAU | 1xXeon Gold 5120 14C/2.2GHz/ 19.25MB/105W/DDR4-2400 | 1x16GB RDIMM DDR4-2666 | 1x930-8i 2GB flash | 24x2.5" | 8x2.5" SATA/ SAS HS | Open | None | None | None | None | None | None | TPM 1.2 | XClarity Standard | 1x750W Platinum | 3-year | 07/17 |
| 7X06A05GAU | 1xXeon Gold 6150 18C/2.7GHz/ 24.75MB/165W/DDR4-2666 | 1x32GB RDIMM DDR4-2666 | 1x930-8i 2GB flash | 24x2.5" | 8x2.5" SATA/ SAS HS | Open | None | None | None | None | None | None | TPM 1.2 | XClarity Standard | 1x1100W Platinum | 3-year | 07/17 |
| 7X06A05HAU | 1xXeon Gold 6126 12C/2.6GHz/ 19.25MB/125W/DDR4-2666 | 1x32GB RDIMM DDR4-2666 | 1x930-8i 2GB flash | 24x2.5" | 8x2.5" SATA/ SAS HS | Open | None | None | None | None | None | None | TPM 1.2 | XClarity Standard | 1x750W Platinum | 3-year | 07/17 |
| 7X06A05NAU | 1xXeon Gold 5118 12C/2.3GHz/ 16.5MB/105W/DDR4-2400 | 1x16GB RDIMM DDR4-2666 | 1x930-8i 2GB flash | 24x2.5" | 8x2.5" SATA/ SAS HS | Open | None | None | None | None | None | None | TPM 1.2 | XClarity Standard | 1x750W Platinum | 3-year | 07/17 |
| 7X06A05PAU | 1xXeon Gold 6134 8C/3.2GHz/ 24.75MB/130W/DDR4-2666 | 1x32GB RDIMM DDR4-2666 | 1x930-8i 2GB flash | 24x2.5" | 8x2.5" SATA/ SAS HS | Open | None | None | None | None | None | None | TPM 1.2 | XClarity Standard | 1x1100W Platinum | 3-year | 07/17 |
| 7X06A05RAU | 1xXeon Gold 6142 16C/2.6GHz/ 22MB/150W/DDR4-2666 | 1x32GB RDIMM DDR4-2666 | 1x930-8i 2GB flash | 24x2.5" | 8x2.5" SATA/ SAS HS | Open | None | None | None | None | None | None | TPM 1.2 | XClarity Standard | 1x1100W Platinum | 3-year | 07/17 |
| 7X06A05SAU | 1xXeon Gold 6134 8C/3.2GHz/ 24.75MB/130W/DDR4-2666 | 1x32GB RDIMM DDR4-2666 | 1x930-8i 2GB flash | 24x2.5" | 8x2.5" SATA/ SAS HS | Open | None | None | None | None | None | None | TPM 1.2 | XClarity Standard | 1x750W Platinum | 3-year | 07/17 |
| 7X06A068AU | 1xXeon Gold 6126T 12C/2.6GHz/ 19.25MB/125W/DDR4-2666 | 1x32GB RDIMM DDR4-2666 | 1x930-8i 2GB flash | 24x2.5" | 8x2.5" SATA/ SAS HS | Open | None | None | None | None | None | None | TPM 1.2 | XClarity Standard | 1x750W Platinum | 3-year | 07/17 |
| 7X06A06FAU | 1xXeon Gold 6152 22C/2.1GHz/ 30.25MB/140W/DDR4-2666 | 1x32GB RDIMM DDR4-2666 | 1x930-8i 2GB flash | 24x2.5" | 8x2.5" SATA/ SAS HS | Open | None | None | None | None | None | None | TPM 1.2 | XClarity Standard | 1x1100W Platinum | 3-year | 07/17 |
| 7X06A06GAU | 1xXeon Gold 6134 8C/3.2GHz/ 24.75MB/130W/DDR4-2666 | 1x32GB RDIMM DDR4-2666 | 1x930-8i 2GB flash | 24x2.5" | 8x2.5" SATA/ SAS HS | Open | None | None | None | None | None | None | TPM 1.2 | XClarity Standard | 1x1100W Platinum | 3-year | 07/17 |
| 7X06A06HAU | 1xXeon Gold 6140 18C/2.3GHz/ 24.75MB/140W/DDR4-2666 | 1x16GB RDIMM DDR4-2666 | 1x930-8i 2GB flash | 16x2.5" | 8x2.5" SATA/ SAS HS | Open | None | 4xGbE RJ- 45 LOM | None | None | None | None | TPM 1.2 | XClarity Standard | 1x1100W Platinum | 3-year | 07/17 |
| 7X06A06JAU | 1xXeon Gold 5115 10C/2.4GHz/ 13.75MB/85W/DDR4-2400 | 1x16GB RDIMM DDR4-2666 | 1x530-8i | 16x2.5" | 8x2.5" SATA/ SAS HS | Open | None | 4xGbE RJ- 45 LOM | None | None | None | None | TPM 1.2 | XClarity Standard | 1x550W Platinum | 3-year | 07/17 |
| 7X06A06KAU | 1xXeon Gold 6148 20C/2.4GHz/ 27.5MB/150W/DDR4-2666 | 1x32GB RDIMM DDR4-2666 | 1x930-8i 2GB flash | 24x2.5" | 8x2.5" SATA/ SAS HS | Open | None | None | None | None | None | None | TPM 1.2 | XClarity Standard | 1x1100W Platinum | 3-year | 07/17 |
| 7X06A06LAU | 1xXeon Gold 6140 18C/2.3GHz/ 24.75MB/140W/DDR4-2666 | 1x32GB RDIMM DDR4-2666 | 1x930-8i 2GB flash | 24x2.5" | 8x2.5" SATA/ SAS HS | Open | None | None | None | None | None | None | TPM 1.2 | XClarity Standard | 1x1100W Platinum | 3-year | 07/17 |

ThinkSystem SR650 Models for Australia and New Zealand - Non TopSeller -2 of 2

Product Specifications Reference (PSREF)

| Model | Processor | Memory | RAID/HBA Adapter | Chassis | Disk Bays | Disks | GPU | Networking (LOM/ML2/PCIe) | M.2 Boot Drive | Riser Card 1 for Slot 1-3 | Riser Card 2 for Slot 5-6 | Front VGA | Security | System Management | Power Supply | Base Warranty | Ann Date (mm/yy) |
|-------------|---|------------------------------|------------------------|---------|-------------------------|-------|------|---------------------------|----------------|---------------------------|---------------------------|-----------|----------|----------------------|---------------------|---------------|------------------|
| 7X06A06MAU | 1xXeon Platinum 8160 24C/2.1GHz/ 33MB/150W/DDR4-2666 | 1x32GB RDIMM DDR4-2666 | 1x930-8i 2GB flash | 24x2.5" | 8x2.5" SATA/SAS HS | Open | None | None | None | None | None | None | TPM 1.2 | XClarity Standard | 1x1100W Platinum | 3-year | 07/17 |
| 7X06A06PAU | 1xXeon Gold 5115 10C/2.4GHz/ 13.75MB/85W/DDR4-2400 | 1x8GB RDIMM DDR4-2666 | 1x530-8i | 16x2.5" | 8x2.5" SATA/SAS HS | Open | None | 4xGbE RJ- 45 LOM | None | None | None | None | TPM 1.2 | XClarity Standard | 1x550W Platinum | 3-year | 07/17 |
| 7X06A06QAU | 1xXeon Gold 5118 12C/2.3GHz/ 16.5MB/105W/DDR4-2400 | 1x16GB RDIMM DDR4-2666 | 1x930-8i 2GB flash | 16x2.5" | 8x2.5" SATA/SAS HS | Open | None | 4xGbE RJ- 45 LOM | None | None | None | None | TPM 1.2 | XClarity Standard | 1x750W Platinum | 3-year | 07/17 |
| 7X06A06RAU | 1xXeon Gold 5150 18C/2.7GHz/ 24.75MB/165W/DDR4-2666 | 1x32GB RDIMM DDR4-2666 | 1x930-8i 2GB flash | 24x2.5" | 8x2.5" SATA/SAS HS | Open | None | None | None | None | None | None | TPM 1.2 | XClarity Standard | 1x1100W Platinum | 3-year | 07/17 |
| 7X06A06SAU | 1xXeon Gold 5120 14C/2.2GHz/ 19.25MB/105W/DDR4-2400 | 1x16GB RDIMM DDR4-2666 | 1x930-8i 2GB flash | 16x2.5" | 8x2.5" SATA/SAS HS | Open | None | 4xGbE RJ- 45 LOM | None | None | None | None | TPM 1.2 | XClarity Standard | 1x750W Platinum | 3-year | 07/17 |
| 7X06A06TAU | 1xXeon Gold 5118 12C/2.3GHz/ 16.5MB/105W/DDR4-2400 | 1x16GB RDIMM DDR4-2666 | 1x930-16i 4GB flash | 12x3.5" | 12x3.5" SATA/ SAS HS | Open | None | 4xGbE RJ- 45 LOM | None | None | None | None | TPM 1.2 | XClarity Standard | 1x750W Platinum | 3-year | 07/17 |
| 7X06A06UUAU | 1xXeon Gold 6142 16C/2.6GHz/ 22MB/150W/DDR4-2666 | 1x32GB RDIMM DDR4-2666 | 1x930-8i 2GB flash | 24x2.5" | 8x2.5" SATA/SAS HS | Open | None | None | None | None | None | None | TPM 1.2 | XClarity Standard | 1x1100W Platinum | 3-year | 07/17 |
| 7X06A06VAU | 1xXeon Gold 5120 14C/2.2GHz/ 19.25MB/105W/DDR4-2400 | 1x16GB RDIMM DDR4-2666 | 1x930-16i 4GB flash | 16x2.5" | 16x2.5" SATA/ SAS HS | Open | None | 4xGbE RJ- 45 LOM | None | None | None | None | TPM 1.2 | XClarity Standard | 1x750W Platinum | 3-year | 07/17 |
| 7X06A06WAU | 1xXeon Gold 5118 12C/2.3GHz/ 16.5MB/105W/DDR4-2400 | 1x16GB RDIMM DDR4-2666 | 1x930-8i 2GB flash | 12x3.5" | 8x3.5" SATA/SAS HS | Open | None | 4xGbE RJ- 45 LOM | None | None | None | None | TPM 1.2 | XClarity Standard | 1x750W Platinum | 3-year | 07/17 |
| 7X06A06XAU | 1xXeon Platinum 8164 26C/2.0GHz/ 35.75MB/150W/DDR4-2666 | 1x32GB RDIMM DDR4-2666 | 1x930-8i 2GB flash | 24x2.5" | 8x2.5" SATA/SAS HS | Open | None | None | None | None | None | None | TPM 1.2 | XClarity Standard | 1x1100W Platinum | 3-year | 07/17 |
| 7X06A06YAU | 1xXeon Platinum 8160 24C/2.1GHz/ 33MB/150W/DDR4-2666 | 1x16GB RDIMM DDR4-2666 | 1x930-16i 4GB flash | 16x2.5" | 16x2.5" SATA/ SAS HS | Open | None | 4xGbE RJ- 45 LOM | None | None | None | None | TPM 1.2 | XClarity Standard | 1x1100W Platinum | 3-year | 07/17 |
| 7X06A06ZAU | 1xXeon Gold 6130 16C/2.1GHz/ 22MB/125W/DDR4-2666 | 1x16GB RDIMM DDR4-2666 | 1x930-8i 2GB flash | 16x2.5" | 8x2.5" SATA/SAS HS | Open | None | 4xGbE RJ- 45 LOM | None | None | None | None | TPM 1.2 | XClarity Standard | 1x750W Platinum | 3-year | 07/17 |

ThinkSystem SR650 Models for South East Asian (ASEAN) - Non TopSeller

Product Specifications Reference (PSREF)

| Model | Processor | Memory | RAID/HBA Adapter | Chassis | Disk Bays | Disks | GPU | Networking (LOM/ML2/PCIe) | M.2 Boot Drive | Riser Card 1 for Slot 1-3 | Riser Card 2 for Slot 5-6 | Front VGA | Security | System Management | Power Supply | Base Warranty | Ann Date (mm/yy) |
|------------|---|------------------------------|------------------------|---------|-------------------------|-------|------|---------------------------|----------------|---------------------------|---------------------------|-----------|----------|----------------------|---------------------|---------------|------------------|
| 7X06A034SG | 1xXeon Gold 5120 14C/2.2GHz/ 19.25MB/105W/DDR4-2400 | 1x16GB RDIMM DDR4-2666 | 1x530-8i | 24x2.5" | 8x2.5" SATA/SAS HS | Open | None | 4x10GbE RJ-45 LOM | None | None | None | None | TPM 1.2 | XClarity Advanced | 1x750W Platinum | 3-year | 07/17 |
| 7X06A03FSG | 1xXeon Gold 5115 10C/2.4GHz/ 13.75MB/85W/DDR4-2400 | 1x16GB RDIMM DDR4-2666 | 1x530-8i | 24x2.5" | 8x2.5" SATA/SAS HS | Open | None | 4x10GbE RJ-45 LOM | None | None | None | None | TPM 1.2 | XClarity Advanced | 1x750W Platinum | 3-year | 07/17 |
| 7X06A03JSG | 1xXeon Gold 5118 12C/2.3GHz/ 16.5MB/105W/DDR4-2400 | 1x16GB RDIMM DDR4-2666 | 1x530-8i | 24x2.5" | 8x2.5" SATA/SAS HS | Open | None | 4x10GbE RJ-45 LOM | None | None | None | None | TPM 1.2 | XClarity Advanced | 1x750W Platinum | 3-year | 07/17 |
| 7X06A03RSG | 1xXeon Gold 5115 10C/2.4GHz/ 13.75MB/85W/DDR4-2400 | 1x16GB RDIMM DDR4-2666 | 1x930-16i 4GB flash | 12x3.5" | 12x3.5" SATA/ SAS HS | Open | None | 4x10GbE RJ-45 LOM | None | None | None | None | TPM 1.2 | XClarity Advanced | 1x1100W Platinum | 3-year | 07/17 |
| 7X06A03TSG | 1xXeon Gold 6148 20C/2.4GHz/ 27.5MB/150W/DDR4-2666 | 1x32GB RDIMM DDR4-2666 | 1x530-8i | 24x2.5" | 8x2.5" SATA/SAS HS | Open | None | 4x10GbE RJ-45 LOM | None | None | None | None | TPM 1.2 | XClarity Advanced | 1x1100W Platinum | 3-year | 07/17 |
| 7X06A03USG | 1xXeon Gold 6140 18C/2.3GHz/ 24.75MB/140W/DDR4-2666 | 1x16GB RDIMM DDR4-2666 | 1x530-8i | 24x2.5" | 8x2.5" SATA/SAS HS | Open | None | 4x10GbE RJ-45 LOM | None | None | None | None | TPM 1.2 | XClarity Advanced | 1x1100W Platinum | 3-year | 07/17 |
| 7X06A03VSG | 1xXeon Gold 6152 22C/2.1GHz/ 30.25MB/140W/DDR4-2666 | 1x32GB RDIMM DDR4-2666 | 1x530-8i | 24x2.5" | 8x2.5" SATA/SAS HS | Open | None | 4x10GbE RJ-45 LOM | None | None | None | None | TPM 1.2 | XClarity Advanced | 1x1100W Platinum | 3-year | 07/17 |
| 7X06A03XSG | 1xXeon Gold 6130 16C/2.1GHz/ 22MB/125W/DDR4-2666 | 1x16GB RDIMM DDR4-2666 | 1x530-8i | 24x2.5" | 8x2.5" SATA/SAS HS | Open | None | 4x10GbE RJ-45 LOM | None | None | None | None | TPM 1.2 | XClarity Advanced | 1x1100W Platinum | 3-year | 07/17 |
| 7X06A042SG | 1xXeon Gold 6134 8C/3.2GHz/ 24.75MB/130W/DDR4-2666 | 1x16GB RDIMM DDR4-2666 | 1x530-8i | 24x2.5" | 8x2.5" SATA/SAS HS | Open | None | 4x10GbE RJ-45 LOM | None | None | None | None | TPM 1.2 | XClarity Advanced | 1x1100W Platinum | 3-year | 07/17 |

ThinkSystem SR650 Models for Hong Kong, Taiwan, Korea (HTK) - TopSeller

Product Specifications Reference (PSREF)

| Model | Processor | Memory | RAID/HBA Adapter | Chassis | Disk Bays | Disks | GPU | Networking (LOM/ML2/PCIe) | M.2 Boot Drive | Riser Card 1 for Slot 1-3 | Riser Card 2 for Slot 5-6 | Front VGA | Security | System Management | Power Supply | Base Warranty | Ann Date (mm/yy) |
|------------|--|------------------------------|------------------------|---------|-------------------------|-------|------|---------------------------|----------------|---------------------------|---------------------------|-----------|----------|-------------------|--------------------|---------------|------------------|
| 7X06A009CN | 1xXeon Gold 5120 14C/2.2GHz/ 19.25MB/105W/DDR4-2400 | 1x16GB RDIMM DDR4-2666 | 1x930-16i 4GB flash | 16x2.5" | 16x2.5" SATA/ SAS HS | Open | None | 4xGbE RJ-45 LOM | None | x8 / x8 / x8, FHHL | None | None | TPM 1.2 | XClarity Standard | 1x750W Platinum | 3-year | 07/17 |
| 7X06A01DCN | 1xXeon Gold 5120T 14C/2.2GHz/ 19.25MB/105W/DDR4-2400 | 1x16GB RDIMM DDR4-2666 | 1x930-16i 4GB flash | 16x2.5" | 16x2.5" SATA/ SAS HS | Open | None | 4xGbE RJ-45 LOM | None | x8 / x8 / x8, FHHL | None | None | TPM 1.2 | XClarity Standard | 1x750W Platinum | 3-year | 07/17 |
| 7X06A01KCN | 1xXeon Gold 5122 4C/3.6GHz/ 16.5MB/105W/DDR4-2400 | 1x16GB RDIMM DDR4-2666 | 1x930-16i 4GB flash | 16x2.5" | 16x2.5" SATA/ SAS HS | Open | None | 4xGbE RJ-45 LOM | None | x8 / x8 / x8, FHHL | None | None | TPM 1.2 | XClarity Standard | 1x750W Platinum | 3-year | 07/17 |
| 7X06A01LCN | 1xXeon Gold 5118 12C/2.3GHz/ 16.5MB/105W/DDR4-2400 | 1x16GB RDIMM DDR4-2666 | 1x930-16i 4GB flash | 16x2.5" | 16x2.5" SATA/ SAS HS | Open | None | 4xGbE RJ-45 LOM | None | x8 / x8 / x8, FHHL | None | None | TPM 1.2 | XClarity Standard | 1x750W Platinum | 3-year | 07/17 |
| 7X06A027CN | 1xXeon Gold 5115 10C/2.4GHz/ 13.75MB/85W/DDR4-2400 | 1x16GB RDIMM DDR4-2666 | 1x930-16i 4GB flash | 16x2.5" | 16x2.5" SATA/ SAS HS | Open | None | 4xGbE RJ-45 LOM | None | x8 / x8 / x8, FHHL | None | None | TPM 1.2 | XClarity Standard | 1x750W Platinum | 3-year | 07/17 |

ThinkSystem SR650 Models for Hong Kong, Taiwan, Korea (HTK) - Non TopSeller - 1 of 2

Product Specifications Reference (PSREF)

| Model | Processor | Memory | RAID/HBA Adapter | Chassis | Disk Bays | Disks | GPU | Networking (LOM/ML2/PCIe) | M.2 Boot Drive | Riser Card 1 for Slot 1-3 | Riser Card 2 for Slot 5-6 | Front VGA | Security | System Management | Power Supply | Base Warranty | Ann Date (mm/yy) |
|------------|---|------------------------|---------------------|---------|---------------------|-------|------|---------------------------|----------------|---------------------------|---------------------------|-----------|----------|-------------------|-----------------|---------------|------------------|
| 7X06A003CN | 1xXeon Gold 5118 12C/2.3GHz/16.5MB/105W/DDR4-2400 | 1x16GB RDIMM DDR4-2666 | 1x930-8i 2GB flash | 16x2.5" | 8x2.5" SATA/SAS HS | Open | None | 4xGbE RJ-45 LOM | None | x8 / x8 / x8, FHHL | None | None | TPM 1.2 | XClarity Standard | 1x750W Platinum | 3-year | 07/17 |
| 7X06A005CN | 1xXeon Gold 5120 14C/2.2GHz/19.25MB/105W/DDR4-2400 | 1x16GB RDIMM DDR4-2666 | 1x930-8i 2GB flash | 16x2.5" | 8x2.5" SATA/SAS HS | Open | None | 4xGbE RJ-45 LOM | None | x8 / x8 / x8, FHHL | None | None | TPM 1.2 | XClarity Standard | 1x750W Platinum | 3-year | 07/17 |
| 7X06A007CN | 1xXeon Gold 5122 4C/3.6GHz/16.5MB/105W/DDR4-2400 | 1x16GB RDIMM DDR4-2666 | 1x930-8i 2GB flash | 16x2.5" | 8x2.5" SATA/SAS HS | Open | None | 4xGbE RJ-45 LOM | None | x8 / x8 / x8, FHHL | None | None | TPM 1.2 | XClarity Standard | 1x750W Platinum | 3-year | 07/17 |
| 7X06A00ECN | 1xXeon Gold 5115 10C/2.4GHz/13.75MB/85W/DDR4-2400 | 1x16GB RDIMM DDR4-2666 | 1x930-8i 2GB flash | 16x2.5" | 8x2.5" SATA/SAS HS | Open | None | 4xGbE RJ-45 LOM | None | x8 / x8 / x8, FHHL | None | None | TPM 1.2 | XClarity Standard | 1x750W Platinum | 3-year | 07/17 |
| 7X06A00GCN | 1xXeon Gold 6134 8C/3.2GHz/24.75MB/130W/DDR4-2666 | 1x16GB RDIMM DDR4-2666 | 1x930-8i 2GB flash | 16x2.5" | 8x2.5" SATA/SAS HS | Open | None | 4xGbE RJ-45 LOM | None | x8 / x8 / x8, FHHL | None | None | TPM 1.2 | XClarity Standard | 1x750W Platinum | 3-year | 07/17 |
| 7X06A00MCN | 1xXeon Gold 6130 16C/2.1GHz/22MB/125W/DDR4-2666 | 1x16GB RDIMM DDR4-2666 | 1x930-8i 2GB flash | 16x2.5" | 8x2.5" SATA/SAS HS | Open | None | 4xGbE RJ-45 LOM | None | x8 / x8 / x8, FHHL | None | None | TPM 1.2 | XClarity Standard | 1x750W Platinum | 3-year | 07/17 |
| 7X06A00QCN | 1xXeon Gold 6140 18C/2.3GHz/24.75MB/140W/DDR4-2666 | 1x16GB RDIMM DDR4-2666 | 1x930-8i 2GB flash | 16x2.5" | 8x2.5" SATA/SAS HS | Open | None | 4xGbE RJ-45 LOM | None | x8 / x8 / x8, FHHL | None | None | TPM 1.2 | XClarity Standard | 1x750W Platinum | 3-year | 07/17 |
| 7X06A00UCN | 1xXeon Gold 6148 20C/2.4GHz/27.5MB/150W/DDR4-2666 | 1x16GB RDIMM DDR4-2666 | 1x930-8i 2GB flash | 16x2.5" | 8x2.5" SATA/SAS HS | Open | None | 4xGbE RJ-45 LOM | None | x8 / x8 / x8, FHHL | None | None | TPM 1.2 | XClarity Standard | 1x750W Platinum | 3-year | 07/17 |
| 7X06A00ZCN | 1xXeon Gold 6136 12C/3.0GHz/24.75MB/150W/DDR4-2666 | 1x16GB RDIMM DDR4-2666 | 1x930-8i 2GB flash | 16x2.5" | 8x2.5" SATA/SAS HS | Open | None | 4xGbE RJ-45 LOM | None | x8 / x8 / x8, FHHL | None | None | TPM 1.2 | XClarity Standard | 1x750W Platinum | 3-year | 07/17 |
| 7X06A01QCN | 1xXeon Gold 6134 8C/3.2GHz/24.75MB/130W/DDR4-2666 | 1x16GB RDIMM DDR4-2666 | 1x930-16i 4GB flash | 12x3.5" | 12x3.5" SATA/SAS HS | Open | None | 4xGbE RJ-45 LOM | None | x8 / x8 / x8, FHHL | None | None | TPM 1.2 | XClarity Standard | 1x750W Platinum | 3-year | 07/17 |
| 7X06A01TCN | 1xXeon Gold 6136 12C/3.0GHz/24.75MB/150W/DDR4-2666 | 1x16GB RDIMM DDR4-2666 | 1x930-16i 4GB flash | 12x3.5" | 12x3.5" SATA/SAS HS | Open | None | 4xGbE RJ-45 LOM | None | x8 / x8 / x8, FHHL | None | None | TPM 1.2 | XClarity Standard | 1x750W Platinum | 3-year | 07/17 |
| 7X06A01UCN | 1xXeon Gold 5118 12C/2.3GHz/16.5MB/105W/DDR4-2400 | 1x16GB RDIMM DDR4-2666 | 1x930-16i 4GB flash | 12x3.5" | 12x3.5" SATA/SAS HS | Open | None | 4xGbE RJ-45 LOM | None | x8 / x8 / x8, FHHL | None | None | TPM 1.2 | XClarity Standard | 1x750W Platinum | 3-year | 07/17 |
| 7X06A01VCN | 1xXeon Gold 5120 14C/2.2GHz/19.25MB/105W/DDR4-2400 | 1x16GB RDIMM DDR4-2666 | 1x930-16i 4GB flash | 12x3.5" | 12x3.5" SATA/SAS HS | Open | None | 4xGbE RJ-45 LOM | None | x8 / x8 / x8, FHHL | None | None | TPM 1.2 | XClarity Standard | 1x750W Platinum | 3-year | 07/17 |
| 7X06A01YCN | 1xXeon Gold 5122 4C/3.6GHz/16.5MB/105W/DDR4-2400 | 1x16GB RDIMM DDR4-2666 | 1x930-16i 4GB flash | 12x3.5" | 12x3.5" SATA/SAS HS | Open | None | 4xGbE RJ-45 LOM | None | x8 / x8 / x8, FHHL | None | None | TPM 1.2 | XClarity Standard | 1x750W Platinum | 3-year | 07/17 |
| 7X06A020CN | 1xXeon Gold 6130 16C/2.1GHz/22MB/125W/DDR4-2666 | 1x16GB RDIMM DDR4-2666 | 1x930-16i 4GB flash | 12x3.5" | 12x3.5" SATA/SAS HS | Open | None | 4xGbE RJ-45 LOM | None | x8 / x8 / x8, FHHL | None | None | TPM 1.2 | XClarity Standard | 1x750W Platinum | 3-year | 07/17 |
| 7X06A021CN | 1xXeon Silver 4114 10C/2.2GHz/13.75MB/85W/DDR4-2400 | 1x16GB RDIMM DDR4-2666 | 1x930-8i 2GB flash | 16x2.5" | 8x2.5" SATA/SAS HS | Open | None | 4xGbE RJ-45 LOM | None | x8 / x8 / x8, FHHL | None | None | TPM 1.2 | XClarity Standard | 1x750W Platinum | 3-year | 07/17 |
| 7X06A02FCN | 1xXeon Gold 6152 22C/2.1GHz/30.25MB/140W/DDR4-2666 | 1x16GB RDIMM DDR4-2666 | 1x930-8i 2GB flash | 16x2.5" | 8x2.5" SATA/SAS HS | Open | None | 4xGbE RJ-45 LOM | None | x8 / x8 / x8, FHHL | None | None | TPM 1.2 | XClarity Standard | 1x750W Platinum | 3-year | 07/17 |
| 7X06A02HCN | 1xXeon Gold 5115 10C/2.4GHz/13.75MB/85W/DDR4-2400 | 1x16GB RDIMM DDR4-2666 | 1x930-16i 4GB flash | 16x2.5" | 16x2.5" SATA/SAS HS | Open | None | 4xGbE RJ-45 LOM | None | x8 / x8 / x8, FHHL | None | None | TPM 1.2 | XClarity Standard | 1x750W Platinum | 3-year | 07/17 |
| 7X06A02JCN | 1xXeon Gold 6148 20C/2.4GHz/13.75MB/85W/DDR4-2400 | 1x16GB RDIMM DDR4-2666 | 1x930-16i 4GB flash | 12x3.5" | 12x3.5" SATA/SAS HS | Open | None | 4xGbE RJ-45 LOM | None | x8 / x8 / x8, FHHL | None | None | TPM 1.2 | XClarity Standard | 1x750W Platinum | 3-year | 07/17 |
| 7X06A02KCN | 1xXeon Gold 6140 18C/2.3GHz/24.75MB/140W/DDR4-2666 | 1x16GB RDIMM DDR4-2666 | 1x930-16i 4GB flash | 12x3.5" | 12x3.5" SATA/SAS HS | Open | None | 4xGbE RJ-45 LOM | None | x8 / x8 / x8, FHHL | None | None | TPM 1.2 | XClarity Standard | 1x750W Platinum | 3-year | 07/17 |
| 7X06A02LCN | 1xXeon Gold 6148 20C/2.4GHz/27.5MB/150W/DDR4-2666 | 1x16GB RDIMM DDR4-2666 | 1x930-16i 4GB flash | 12x3.5" | 12x3.5" SATA/SAS HS | Open | None | 4xGbE RJ-45 LOM | None | x8 / x8 / x8, FHHL | None | None | TPM 1.2 | XClarity Standard | 1x750W Platinum | 3-year | 07/17 |
| 7X06A02QCN | 1xXeon Gold 6152 22C/2.1GHz/30.25MB/140W/DDR4-2666 | 1x16GB RDIMM DDR4-2666 | 1x930-16i 4GB flash | 12x3.5" | 12x3.5" SATA/SAS HS | Open | None | 4xGbE RJ-45 LOM | None | x8 / x8 / x8, FHHL | None | None | TPM 1.2 | XClarity Standard | 1x750W Platinum | 3-year | 07/17 |

ThinkSystem SR650 Models for Hong Kong, Taiwan, Korea (HTK) - Non TopSeller - 2 of 2

Product Specifications Reference (PSREF)

| Model | Processor | Memory | RAID/HBA Adapter | Chassis | Disk Bays | Disks | GPU | Networking (LOM/ML2/PCIe) | M.2 Boot Drive | Riser Card 1 for Slot 1-3 | Riser Card 2 for Slot 5-6 | Front VGA | Security | System Management | Power Supply | Base Warranty | Ann Date (mm/yy) |
|------------|--|------------------------------|------------------------|---------|-------------------------|-------|------|---------------------------|----------------|---------------------------|---------------------------|-----------|----------|----------------------|--------------------|---------------|------------------|
| 7X06A04VCN | 1xXeon Silver 4112 4C/2.6GHz/ 8.25MB/85W/DDR4-2400 | 1x16GB RDIMM DDR4-2666 | 1x930-8i 2GB flash | 16x2.5" | 8x2.5" SATA/ SAS HS | Open | None | 4xGbE RJ- 45 LOM | None | x8 / x8 / x8, FHHL | None | None | TPM 1.2 | XClarity Standard | 1x750W Platinum | 3-year | 07/17 |
| 7X06A04XCN | 1xXeon Silver 4110 8C/2.1GHz/ 11MB/85W/DDR4-2400 | 1x16GB RDIMM DDR4-2666 | 1x930-8i 2GB flash | 16x2.5" | 8x2.5" SATA/ SAS HS | Open | None | 4xGbE RJ- 45 LOM | None | x8 / x8 / x8, FHHL | None | None | TPM 1.2 | XClarity Standard | 1x750W Platinum | 3-year | 07/17 |
| 7X06A053CN | 1xXeon Bronze 3106 8C/1.7GHz/ 11MB/85W/DDR4-2133 | 1x16GB RDIMM DDR4-2666 | 1x930-16i 4GB flash | 12x3.5" | 12x3.5" SATA/ SAS HS | Open | None | 4xGbE RJ- 45 LOM | None | x8 / x8 / x8, FHHL | None | None | TPM 1.2 | XClarity Standard | 1x750W Platinum | 3-year | 07/17 |
| 7X06A055CN | 1xXeon Silver 4114 10C/2.2GHz/ 13.75MB/85W/DDR4-2400 | 1x16GB RDIMM DDR4-2666 | 1x930-8i 2GB flash | 16x2.5" | 8x2.5" SATA/ SAS HS | Open | None | 4xGbE RJ- 45 LOM | None | x8 / x8 / x8, FHHL | None | None | TPM 1.2 | XClarity Standard | 1x750W Platinum | 3-year | 07/17 |
| 7X06A05ECN | 1xXeon Bronze 3104 6C/1.7GHz/ 8.25MB/85W/DDR4-2133 | 1x16GB RDIMM DDR4-2666 | 1x930-8i 2GB flash | 16x2.5" | 8x2.5" SATA/ SAS HS | Open | None | 4xGbE RJ- 45 LOM | None | x8 / x8 / x8, FHHL | None | None | TPM 1.2 | XClarity Standard | 1x750W Platinum | 3-year | 07/17 |
| 7X06A05FCN | 1xXeon Silver 4108 8C/1.8GHz/ 11MB/85W/DDR4-2400 | 1x16GB RDIMM DDR4-2666 | 1x930-16i 4GB flash | 12x3.5" | 12x3.5" SATA/ SAS HS | Open | None | 4xGbE RJ- 45 LOM | None | x8 / x8 / x8, FHHL | None | None | TPM 1.2 | XClarity Standard | 1x750W Platinum | 3-year | 07/17 |
| 7X06A05KCN | 1xXeon Silver 4112 4C/2.6GHz/ 8.25MB/85W/DDR4-2400 | 1x16GB RDIMM DDR4-2666 | 1x930-16i 4GB flash | 12x3.5" | 12x3.5" SATA/ SAS HS | Open | None | 4xGbE RJ- 45 LOM | None | x8 / x8 / x8, FHHL | None | None | TPM 1.2 | XClarity Standard | 1x750W Platinum | 3-year | 07/17 |
| 7X06A05LCN | 1xXeon Silver 4108 8C/1.8GHz/ 11MB/85W/DDR4-2400 | 1x16GB RDIMM DDR4-2666 | 1x930-8i 2GB flash | 16x2.5" | 8x2.5" SATA/ SAS HS | Open | None | 4xGbE RJ- 45 LOM | None | x8 / x8 / x8, FHHL | None | None | TPM 1.2 | XClarity Standard | 1x750W Platinum | 3-year | 07/17 |
| 7X06A05MCN | 1xXeon Bronze 3104 6C/1.7GHz/ 8.25MB/85W/DDR4-2133 | 1x16GB RDIMM DDR4-2666 | 1x930-16i 4GB flash | 12x3.5" | 12x3.5" SATA/ SAS HS | Open | None | 4xGbE RJ- 45 LOM | None | x8 / x8 / x8, FHHL | None | None | TPM 1.2 | XClarity Standard | 1x750W Platinum | 3-year | 07/17 |
| 7X06A05QCN | 1xXeon Silver 4110 8C/2.1GHz/ 11MB/85W/DDR4-2400 | 1x16GB RDIMM DDR4-2666 | 1x930-16i 4GB flash | 12x3.5" | 12x3.5" SATA/ SAS HS | Open | None | 4xGbE RJ- 45 LOM | None | x8 / x8 / x8, FHHL | None | None | TPM 1.2 | XClarity Standard | 1x750W Platinum | 3-year | 07/17 |
| 7X06A05TCN | 1xXeon Silver 4116 12C/2.1GHz/ 16.5MB/85W/DDR4-2400 | 1x16GB RDIMM DDR4-2666 | 1x930-16i 4GB flash | 12x3.5" | 12x3.5" SATA/ SAS HS | Open | None | 4xGbE RJ- 45 LOM | None | x8 / x8 / x8, FHHL | None | None | TPM 1.2 | XClarity Standard | 1x750W Platinum | 3-year | 07/17 |
| 7X06A05UCN | 1xXeon Silver 4116 12C/2.1GHz/ 16.5MB/85W/DDR4-2400 | 1x16GB RDIMM DDR4-2666 | 1x930-8i 2GB flash | 16x2.5" | 8x2.5" SATA/ SAS HS | Open | None | 4xGbE RJ- 45 LOM | None | x8 / x8 / x8, FHHL | None | None | TPM 1.2 | XClarity Standard | 1x750W Platinum | 3-year | 07/17 |
| 7X06A05VCN | 1xXeon Silver 4114 10C/2.2GHz/ 13.75MB/85W/DDR4-2400 | 1x16GB RDIMM DDR4-2666 | 1x930-16i 4GB flash | 12x3.5" | 12x3.5" SATA/ SAS HS | Open | None | 4xGbE RJ- 45 LOM | None | x8 / x8 / x8, FHHL | None | None | TPM 1.2 | XClarity Standard | 1x750W Platinum | 3-year | 07/17 |
| 7X06A05WCN | 1xXeon Bronze 3106 8C/1.7GHz/ 11MB/85W/DDR4-2133 | 1x16GB RDIMM DDR4-2666 | 1x930-8i 2GB flash | 16x2.5" | 8x2.5" SATA/ SAS HS | Open | None | 4xGbE RJ- 45 LOM | None | x8 / x8 / x8, FHHL | None | None | TPM 1.2 | XClarity Standard | 1x750W Platinum | 3-year | 07/17 |

ThinkSystem SR650 Models for India - Non TopSeller

Product Specifications Reference (PSREF)

| Model | Processor | Memory | RAID/HBA Adapter | Chassis | Disk Bays | Disks | GPU | Networking (LOM/ML2/PCIe) | M.2 Boot Drive | Riser Card 1 for Slot 1-3 | Riser Card 2 for Slot 5-6 | Front VGA | Security | System Management | Power Supply | Base Warranty | Ann Date (mm/yy) |
|------------|--|------------------------------|------------------------|---------|-------------------------|-------|------|---------------------------|----------------|---------------------------|---------------------------|-----------|----------|----------------------|---------------------|---------------|------------------|
| 7X06A00ASG | 1xXeon Gold 5118 12C/2.3GHz/ 16.5MB/105W/DDR4-2400 | 1x16GB RDIMM DDR4-2666 | 1x930-8i 2GB flash | 16x2.5" | 8x2.5" SATA/ SAS HS | Open | None | 4xGbE RJ- 45 LOM | None | None | None | None | TPM 1.2 | XClarity Standard | 1x750W Platinum | 3-year | 07/17 |
| 7X06A00CSG | 1xXeon Gold 5118 12C/2.3GHz/ 16.5MB/105W/DDR4-2400 | 1x16GB RDIMM DDR4-2666 | 1x930-8i 2GB flash | 12x3.5" | 8x3.5" SATA/ SAS HS | Open | None | 4xGbE RJ- 45 LOM | None | None | None | None | TPM 1.2 | XClarity Standard | 1x750W Platinum | 3-year | 07/17 |
| 7X06A00FSG | 1xXeon Gold 5115 10C/2.4GHz/ 13.75MB/85W/DDR4-2400 | 1x16GB RDIMM DDR4-2666 | 1x530-8i | 16x2.5" | 8x2.5" SATA/ SAS HS | Open | None | 4xGbE RJ- 45 LOM | None | None | None | None | TPM 1.2 | XClarity Standard | 1x550W Platinum | 3-year | 07/17 |
| 7X06A00JSG | 1xXeon Gold 5115 10C/2.4GHz/ 13.75MB/85W/DDR4-2400 | 1x8GB RDIMM DDR4-2666 | 1x530-8i | 16x2.5" | 8x2.5" SATA/ SAS HS | Open | None | 4xGbE RJ- 45 LOM | None | None | None | None | TPM 1.2 | XClarity Standard | 1x550W Platinum | 3-year | 07/17 |
| 7X06A00RSG | 1xXeon Gold 5120 14C/2.2GHz/ 19.25MB/105W/DDR4-2400 | 1x16GB RDIMM DDR4-2666 | 1x930-16i 4GB flash | 16x2.5" | 16x2.5" SATA/ SAS HS | Open | None | 4xGbE RJ- 45 LOM | None | None | None | None | TPM 1.2 | XClarity Standard | 1x750W Platinum | 3-year | 07/17 |
| 7X06A00SSG | 1xXeon Gold 5120 14C/2.2GHz/ 19.25MB/105W/DDR4-2400 | 1x16GB RDIMM DDR4-2666 | 1x930-8i 2GB flash | 16x2.5" | 8x2.5" SATA/ SAS HS | Open | None | 4xGbE RJ- 45 LOM | None | None | None | None | TPM 1.2 | XClarity Standard | 1x750W Platinum | 3-year | 07/17 |
| 7X06A00TSG | 1xXeon Gold 5118 12C/2.3GHz/ 16.5MB/105W/DDR4-2400 | 1x16GB RDIMM DDR4-2666 | 1x930-16i 4GB flash | 12x3.5" | 12x3.5" SATA/ SAS HS | Open | None | 4xGbE RJ- 45 LOM | None | None | None | None | TPM 1.2 | XClarity Standard | 1x750W Platinum | 3-year | 07/17 |
| 7X06A00WSG | 1xXeon Platinum 8160 24C/2.1GHz/ 33MB/150W/DDR4-2666 | 1x16GB RDIMM DDR4-2666 | 1x930-16i 4GB flash | 16x2.5" | 16x2.5" SATA/ SAS HS | Open | None | 4xGbE RJ- 45 LOM | None | None | None | None | TPM 1.2 | XClarity Standard | 1x1100W Platinum | 3-year | 07/17 |
| 7X06A00XSG | 1xXeon Gold 6140 18C/2.3GHz/ 24.75MB/140W/DDR4-2666 | 1x16GB RDIMM DDR4-2666 | 1x930-8i 2GB flash | 16x2.5" | 8x2.5" SATA/ SAS HS | Open | None | 4xGbE RJ- 45 LOM | None | None | None | None | TPM 1.2 | XClarity Standard | 1x1100W Platinum | 3-year | 07/17 |
| 7X06A00YSG | 1xXeon Gold 6130 16C/2.1GHz/ 22MB/125W/DDR4-2666 | 1x16GB RDIMM DDR4-2666 | 1x930-8i 2GB flash | 16x2.5" | 8x2.5" SATA/ SAS HS | Open | None | 4xGbE RJ- 45 LOM | None | None | None | None | TPM 1.2 | XClarity Standard | 1x750W Platinum | 3-year | 07/17 |

ThinkSystem SR650 Models for Japan - TopSeller

Product Specifications Reference (PSREF)

| Model | Processor | Memory | RAID/HBA Adapter | Chassis | Disk Bays | Disks | GPU | Networking (LOM/ML2/PCIe) | M.2 Boot Drive | Riser Card 1 for Slot 1-3 | Riser Card 2 for Slot 5-6 | Front VGA | Security | System Management | Power Supply | Base Warranty | Ann Date (mm/yy) |
|------------|--|------------------------------|-----------------------|---------|------------------------|-------|------|---------------------------|----------------|---------------------------|---------------------------|-----------|----------|----------------------|--------------------|---------------|------------------|
| 7X06A01MJP | 1xXeon Bronze 3104 6C/1.7GHz/ 8.25MB/85W/DDR4-2133 | 1x16GB RDIMM DDR4-2666 | 1x930-8i 2GB flash | 12x3.5" | 8x3.5" SATA/ SAS HS | Open | None | 4xGbE RJ- 45 LOM | None | x8 / x8 / x8, FHHL | None | None | TPM 1.2 | XClarity Advanced | 1x550W Platinum | 3-year | 07/17 |
| 7X06A02BJP | 1xXeon Silver 4112 4C/2.6GHz/ 8.25MB/85W/DDR4-2400 | 1x16GB RDIMM DDR4-2666 | 1x930-8i 2GB flash | 24x2.5" | 8x2.5" SATA/ SAS HS | Open | None | 4xGbE RJ- 45 LOM | None | x8 / x8 / x8, FHHL | None | None | TPM 1.2 | XClarity Advanced | 1x550W Platinum | 3-year | 07/17 |
| 7X06A05AJP | 1xXeon Bronze 3106 8C/1.7GHz/ 11MB/85W/DDR4-2133 | 1x16GB RDIMM DDR4-2666 | 1x930-8i 2GB flash | 24x2.5" | 8x2.5" SATA/ SAS HS | Open | None | 4xGbE RJ- 45 LOM | None | x8 / x8 / x8, FHHL | None | None | TPM 1.2 | XClarity Advanced | 1x550W Platinum | 3-year | 07/17 |
| 7X06A05BJP | 1xXeon Silver 4110 8C/2.1GHz/ 11MB/85W/DDR4-2400 | 1x16GB RDIMM DDR4-2666 | 1x930-8i 2GB flash | 24x2.5" | 8x2.5" SATA/ SAS HS | Open | None | 4xGbE RJ- 45 LOM | None | x8 / x8 / x8, FHHL | None | None | TPM 1.2 | XClarity Advanced | 1x550W Platinum | 3-year | 07/17 |

ThinkSystem SR650 Models for Japan - Non TopSeller

Product Specifications Reference (PSREF)

| Model | Processor | Memory | RAID/HBA Adapter | Chassis | Disk Bays | Disks | GPU | Networking (LOM/ML2/PCIe) | M.2 Boot Drive | Riser Card 1 for Slot 1-3 | Riser Card 2 for Slot 5-6 | Front VGA | Security | System Management | Power Supply | Base Warranty | Ann Date (mm/yy) |
|------------|--|------------------------------|------------------------|---------|---|-------|------|---------------------------|----------------|---------------------------|---------------------------|--------------|----------|----------------------|---------------------|---------------|------------------|
| 7X06A01JJP | 1xXeon Bronze 3104 6C/1.7GHz/ 8.25MB/85W/DDR4-2133 | 1x16GB RDIMM DDR4-2666 | 1x930-8i 2GB flash | 24x2.5" | 8x2.5" SATA/ SAS HS | Open | None | 4xGbE RJ-45 LOM | None | x8 / x8 / x8, FHHL | None | None | TPM 1.2 | XClarity Advanced | 1x550W Platinum | 3-year | 07/17 |
| 7X06A056JP | 1xXeon Gold 6134 8C/3.2GHz/ 24.75MB/130W/DDR4-2666 | 1x16GB RDIMM DDR4-2666 | 1x930-24i 4GB flash | 24x2.5" | 24x2.5" (20 SATA/SAS,4 AnyBay) HS | Open | None | 4x10GbE RJ-45 LOM | None | x8 / x8 / x8, FHHL | None | Front VGA | TPM 1.2 | XClarity Advanced | 1x1100W Platinum | 3-year | 07/17 |
| 7X06A058JP | 1xXeon Gold 5122 4C/3.6GHz/ 16.5MB/105W/DDR4-2400 | 1x16GB RDIMM DDR4-2666 | 1x930-8i 2GB flash | 24x2.5" | 8x2.5" SATA/ SAS HS | Open | None | 4x10GbE RJ-45 LOM | None | x8 / x8 / x8, FHHL | None | Front VGA | TPM 1.2 | XClarity Advanced | 1x750W Platinum | 3-year | 07/17 |
| 7X06A05JJP | 1xXeon Platinum 8160 24C/2.1GHz/ 33MB/150W/DDR4-2666 | 1x16GB RDIMM DDR4-2666 | 1x930-24i 4GB flash | 24x2.5" | 24x2.5" (20 SATA/SAS,4 AnyBay) HS | Open | None | 4x10GbE RJ-45 LOM | None | x8 / x8 / x8, FHHL | None | Front VGA | TPM 1.2 | XClarity Advanced | 1x1600W Platinum | 3-year | 07/17 |
| 7X06A05YJP | 1xXeon Platinum 8180 28C/2.5GHz/ 38.5MB/205W/DDR4-2666 | 1x16GB RDIMM DDR4-2666 | 1x930-8i 2GB flash | 24x2.5" | 8x2.5" SATA/ SAS HS | Open | None | 4x10GbE RJ-45 LOM | None | x8 / x8 / x8, FHHL | None | Front VGA | TPM 1.2 | XClarity Advanced | 1x1100W Platinum | 3-year | 07/17 |

ThinkSystem SR650 Models for Latin America - Non TopSeller

Product Specifications Reference (PSREF)

| Model | Processor | Memory | RAID/HBA Adapter | Chassis | Disk Bays | Disks | GPU | Networking (LOM/ML2/PCIe) | M.2 Boot Drive | Riser Card 1 for Slot 1-3 | Riser Card 2 for Slot 5-6 | Front VGA | Security | System Management | Power Supply | Base Warranty | Ann Date (mm/yy) |
|------------|--|------------------------------|-----------------------|---------|------------------------|-------|------|---------------------------|----------------|---------------------------|---------------------------|--------------|----------|----------------------|---------------------|---------------|------------------|
| 7X06A006LA | 1xXeon Gold 5120 14C/2.2GHz/ 19.25MB/105W/DDR4-2400 | 1x16GB RDIMM DDR4-2666 | 1x930-8i 2GB flash | 16x2.5" | 8x2.5" SATA/ SAS HS | Open | None | None | None | x8 / x8 / x8, FHHL | None | Front VGA | TPM 1.2 | XClarity Standard | 1x750W Platinum | 3-year | 07/17 |
| 7X06A008LA | 1xXeon Gold 6140 18C/2.3GHz/ 24.75MB/140W/DDR4-2666 | 1x16GB RDIMM DDR4-2666 | 1x930-8i 2GB flash | 16x2.5" | 8x2.5" SATA/ SAS HS | Open | None | None | None | x8 / x8 / x8, FHHL | None | Front VGA | TPM 1.2 | XClarity Standard | 1x1100W Platinum | 3-year | 07/17 |
| 7X06A00VLA | 1xXeon Gold 6140 18C/2.3GHz/ 24.75MB/140W/DDR4-2666 | 1x16GB RDIMM DDR4-2666 | 1x930-8i 2GB flash | 16x2.5" | 8x2.5" SATA/ SAS HS | Open | None | None | None | x8 / x8 / x8, FHHL | None | Front VGA | TPM 1.2 | XClarity Standard | 1x1100W Platinum | 3-year | 07/17 |
| 7X06A016LA | 1xXeon Platinum 8160 24C/2.1GHz/ 33MB/150W/DDR4-2666 | 1x16GB RDIMM DDR4-2666 | 1x930-8i 2GB flash | 16x2.5" | 8x2.5" SATA/ SAS HS | Open | None | None | None | x8 / x8 / x8, FHHL | None | Front VGA | TPM 1.2 | XClarity Standard | 1x1100W Platinum | 3-year | 07/17 |
| 7X06A01CLA | 1xXeon Gold 6148 20C/2.4GHz/ 27.5MB/150W/DDR4-2666 | 1x16GB RDIMM DDR4-2666 | 1x930-8i 2GB flash | 16x2.5" | 8x2.5" SATA/ SAS HS | Open | None | None | None | x8 / x8 / x8, FHHL | None | Front VGA | TPM 1.2 | XClarity Standard | 1x1100W Platinum | 3-year | 07/17 |
| 7X06A01WLA | 1xXeon Platinum 8160 24C/2.1GHz/ 33MB/150W/DDR4-2666 | 1x16GB RDIMM DDR4-2666 | 1x930-8i 2GB flash | 16x2.5" | 8x2.5" SATA/ SAS HS | Open | None | None | None | x8 / x8 / x8, FHHL | None | Front VGA | TPM 1.2 | XClarity Standard | 1x1100W Platinum | 3-year | 07/17 |
| 7X06A023LA | 1xXeon Gold 6130 16C/2.1GHz/ 22MB/125W/DDR4-2666 | 1x16GB RDIMM DDR4-2666 | 1x930-8i 2GB flash | 16x2.5" | 8x2.5" SATA/ SAS HS | Open | None | None | None | x8 / x8 / x8, FHHL | None | Front VGA | TPM 1.2 | XClarity Standard | 1x1100W Platinum | 3-year | 07/17 |
| 7X06A026LA | 1xXeon Gold 6148 20C/2.4GHz/ 27.5MB/150W/DDR4-2666 | 1x16GB RDIMM DDR4-2666 | 1x930-8i 2GB flash | 16x2.5" | 8x2.5" SATA/ SAS HS | Open | None | None | None | x8 / x8 / x8, FHHL | None | Front VGA | TPM 1.2 | XClarity Standard | 1x1100W Platinum | 3-year | 07/17 |
| 7X06A02ALA | 1xXeon Gold 5120 14C/2.2GHz/ 19.25MB/105W/DDR4-2400 | 1x16GB RDIMM DDR4-2666 | 1x930-8i 2GB flash | 16x2.5" | 8x2.5" SATA/ SAS HS | Open | None | None | None | x8 / x8 / x8, FHHL | None | Front VGA | TPM 1.2 | XClarity Standard | 1x750W Platinum | 3-year | 07/17 |
| 7X06A02NLA | 1xXeon Gold 6130 16C/2.1GHz/ 22MB/125W/DDR4-2666 | 1x16GB RDIMM DDR4-2666 | 1x930-8i 2GB flash | 16x2.5" | 8x2.5" SATA/ SAS HS | Open | None | None | None | x8 / x8 / x8, FHHL | None | Front VGA | TPM 1.2 | XClarity Standard | 1x1100W Platinum | 3-year | 07/17 |



ThinkSystem ST550 Platform Specifications

Product Specifications Reference (PSREF)

| Components | Specification | |
|---|---|--|
| Form factor | Tower or 4U rack | |
| Dimensions | Without foot stands and security door: Height: 425.5 mm (16.8 in). Width: 175.8 mm (6.92 in). Depth: 666.4 mm (26.24 in) | |
| Weight | Maximum configuration: 81.35 lb (36.9 kg) | |
| Processor | Up to two 125W Intel Xeon Scalable family processors, Bronze, Silver, Gold, or Platinum. Up to 20 cores at 2.0GHz, up to 3.6GHz with 4 cores. Two processors are connected with two UPI (Ultra Path Interconnect) links up to 10.4GT/s | |
| Chipset | Intel C621 Platform Controller Hub | |
| Memory | Up to 12 DIMM sockets. Each processor supports up to 6 DIMM sockets with 6 channels. DDR4-2666. RDIMMs and LRDIMMs are supported, but memory types cannot be intermixed | |
| Memory capacity | With RDIMMs: Up to 384GB with 12 x 32 GB RDIMMs and two processors With LRDIMMs: Up to 768GB with 12 x 64 GB LRDIMMs and two processors | |
| Memory protection | ECC, memory mirroring, and memory sparing | |
| Storage controllers | Supports the following RAID/HBA adapters: | |
| | | |
| | | |
| | | |
| | | |
| | | |
| | | |
| | | |
| | | |
| | | |
| <i>Note: 730-8i is available in China only. All RAID/HBA adapters should be placed in slot 1 firstly.</i> | | |
| Disk drive bays | Supports 4 or 8 front 3.5" SATA simple-swap bays. Or 4 or 8 front 3.5" SATA/SAS HS bays. Or 8 or 16 front 2.5" SATA/SAS HS bays with maximum 4 AnyBay. Optional 4 front 2.5" HS bays are supported on hot-swap models, takes place in two 5.25" bays location Optional one or two internal M.2 SSD for boot, dual M.2 SSD supports mirroring | |
| Internal storage | For 3.5" SS bay | |
| | For 3.5" bay | |
| | (3.5" disks or 2.5" disks with 3.5" tray) | |
| | | |
| | For 2.5" bay | |
| | | |
| | | |
| | | |
| | | |
| | | |
| | | |
| | | |
| Optical | Two 5.25" bays for optical and tape drive. Supports DVD-ROM or DVD±RW drives, half-height. Supports LTO-6 SAS, LTO-7 SAS, and RDX USB 3.0 tape drives | |
| Network interfaces | Integrated one dedicated management port plus two GbE ports. Optional PCIe adapters are supported. NC-SI and Wake-on-LAN are available on GbE port 1 (See right) | |
| Security features | Power-on and admin password. Trusted Platform Module, TCG 1.2 compliant, upgrade to 2.0 via UEFI setting. Optional TCM in China only. Optional lockable security bezel. Optional chassis intrusion switch | |
| Operating systems supported | Microsoft Windows Server 2016/2012 R2. Red Hat Enterprise Linux 7.3/6.9. SUSE Linux Enterprise Server 12 SP2/11 SP4. VMware vSphere (ESXi) 6.5/6.0 U3 | |
| Systems management | XClarity Controller Standard, optional upgrades to Advanced or Enterprise are available. Energy Manager. XClarity Administrator. Provisioning Manager. Essentials. LEDs on front panel show the status of power, ID, network, simple-swap disks, and system error | |
| GPU support | Up to two optional NVIDIA Quadro P2000 or Quadro P6000 | |

| Components | Specification |
|-----------------------------|---|
| Base warranty | MT 7X09: 1-year limited onsite service with 9x5/NBD MT 7X10: 3-year limited onsite service with 9x5/NBD |
| Power supply | Supports one fixed 450W 80 PLUS Gold qualified AC power supply, non-hot-swap, no redundant. Or up to two redundant hot-swap 550W/750W/1100W 80 PLUS Platinum qualified AC power supplies. Or up to two redundant hot-swap 750W Titanium qualified AC power supplies. 750W Titanium is 200V - 240V, others are 100V - 240V |
| Video | Integrated Matrox G200 in XClarity Controller |
| Cooling | Up to four fans with one for redundant. Two fans for single processor, three fans for dual processor or single processor with 4 x 2.5" HS bay installed. 4th fan is N + 1 redundant or GPU installed |
| Front ports | One XClarity Controller USB connector, one USB 3.0 |
| Rear ports | One VGA, two USB 3.0, four USB 2.0, two ethernet (RJ-45), one XClarity Controller network connector. Optional COM port |
| Environmental specification | Supports ASHRAE A4 with limitations. |
| | |
| | |
| | |
| | |
| | |
| | |
| | |
| | |
| | |
| Environmental certification | Energy Star Server 2.1 certified. More environmental information please see: www.lenovo.com/social_responsibility/us/en/environment/ |

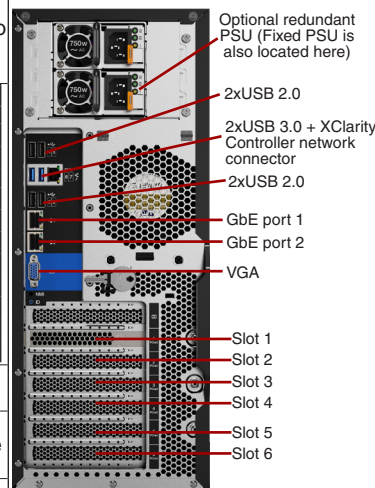

| Expansion slots | |
|-----------------|--|
| Slot 1 (CPU1) | PCIe 3.0 x8, full height, half length |
| Slot 2 (CPU1) | PCIe 3.0 x16, full height, half length |
| Slot 3 (CPU1) | PCIe 3.0 x16, full height, full length, double-width |
| Slot 4 (CPU2) | PCIe 3.0 x16 (x8 elec), full height, full length |
| Slot 5 (CPU2) | PCIe 3.0 x16, full height, full length, double-width |
| Slot 6 (CPU1) | PCIe 3.0 x8 (x4 elec), full height, full length |

Note: All expansion cards and redundant PSU are optional.

| System unique options | |
|-----------------------|--|
| 7X77A03475 | ThinkSystem ST550 2.5" SATA/SAS 4-Bay Backplane Kit |
| 7X77A03476 | ThinkSystem ST550 2.5" Anybay 8-Bay Backplane Kit |
| 7TP7A04369 | ThinkSystem ST550 2.5" 8-Bay Backplane Kit |
| 7TP7A04370 | ThinkSystem ST550 3.5" SATA/SAS 4-Bay Backplane kit |
| 7X77A03481 | ThinkSystem ST550 3.5" Simple Swap Bracket Plate |
| 7X77A03484 | ThinkSystem ST550 4U Security Bezel |
| 7X77A03485 | ThinkSystem ST550 CMA kit |
| 7X77A03488 | ThinkSystem ST550 4U Tower to Rack Conversion Kit |
| 7Z17A02577 | ThinkSystem ST550 COM Port Upgrade Kit |
| 7XH7A06781 | ThinkSystem ST550 Front Mid FAN Module for 4x2.5" ODD conversion |
| 7TP7A04371 | ThinkSystem ST550 Rear FAN Module for RDN FAN |

ThinkSystem ST550 Models for USA and Canada - TopSeller

Product Specifications Reference (PSREF)

| Model | Processor | Memory | RAID/HBA Adapter | Chassis | Disk Bays | Disks | Optical | GPU | Networking (PCIe) | M.2 Boot Drive | Security | System Management | Power Supply | Base Warranty | Ann Date (mm/yy) |
|------------|--|------------------------|--------------------|---------|--------------------|-------|---------|------|-------------------|----------------|----------------------------------|---------------------|-----------------|---------------|------------------|
| 7X10A028NA | 1xXeon Silver 4110 8C/2.1GHz/11MB/85W/DDR4-2400 | 1x16GB RDIMM DDR4-2666 | 1x530-8i | 8x3.5" | 8x3.5" SATA/SAS HS | Open | None | None | None | None | Chassis Intrusion Switch/TPM 1.2 | XClarity Enterprise | 1x750W Platinum | 3-year | 07/17 |
| 7X10A02PNA | 1xXeon Silver 4116 12C/2.1GHz/16.5MB/85W/DDR4-2400 | 1x32GB RDIMM DDR4-2666 | 1x930-8i 2GB flash | 8x3.5" | 8x3.5" SATA/SAS HS | Open | None | None | None | None | Chassis Intrusion Switch/TPM 1.2 | XClarity Enterprise | 1x750W Platinum | 3-year | 07/17 |
| 7X10A03PNA | 1xXeon Bronze 3106 8C/1.7GHz/11MB/85W/DDR4-2133 | 1x16GB RDIMM DDR4-2666 | 1x530-8i | 8x3.5" | 4x3.5" SATA/SAS HS | Open | None | None | None | None | Chassis Intrusion Switch/TPM 1.2 | XClarity Enterprise | 1x750W Platinum | 3-year | 07/17 |

ThinkSystem ST550 Models for USA and Canada - Non TopSeller

Product Specifications Reference (PSREF)

| Model | Processor | Memory | RAID/HBA Adapter | Chassis | Disk Bays | Disks | Optical | GPU | Networking (PCIe) | M.2 Boot Drive | Security | System Management | Power Supply | Base Warranty | Ann Date (mm/yy) |
|------------|---|------------------------|--------------------|---------|--------------------|-------|-----------|------|-------------------|----------------|---|-------------------|-----------------|---------------|------------------|
| 7X10A04DNA | 1xXeon Silver 4108 8C/1.8GHz/11MB/85W/DDR4-2400 | 1x16GB RDIMM DDR4-2666 | 1x530-8i | 16x2.5" | 8x2.5" SATA/SAS HS | Open | DVD HH | None | None | None | Security Bezel/Chassis Intrusion Switch/TPM 1.2 | XClarity Standard | 1x750W Platinum | 3-year | 07/17 |
| 7X10A04FNA | 1xXeon Silver 4110 8C/2.1GHz/11MB/85W/DDR4-2400 | 1x16GB RDIMM DDR4-2666 | 1x530-8i | 16x2.5" | 8x2.5" SATA/SAS HS | Open | DVD HH | None | None | None | Security Bezel/Chassis Intrusion Switch/TPM 1.2 | XClarity Standard | 1x750W Platinum | 3-year | 07/17 |
| 7X10A04HNA | 1xXeon Silver 4114 10C/2.2GHz/13.75MB/85W/DDR4-2400 | 1x16GB RDIMM DDR4-2666 | 1x530-8i | 16x2.5" | 8x2.5" SATA/SAS HS | Open | DVD HH | None | None | None | Security Bezel/Chassis Intrusion Switch/TPM 1.2 | XClarity Standard | 1x750W Platinum | 3-year | 07/17 |
| 7X10A04NNA | 1xXeon Bronze 3104 6C/1.7GHz/8.25MB/85W/DDR4-2133 | 1x16GB RDIMM DDR4-2666 | 1x530-8i | 16x2.5" | 8x2.5" SATA/SAS HS | Open | DVD HH | None | None | None | Security Bezel/Chassis Intrusion Switch/TPM 1.2 | XClarity Standard | 1x750W Platinum | 3-year | 07/17 |
| 7X10A04PNA | 1xXeon Bronze 3106 8C/1.7GHz/11MB/85W/DDR4-2133 | 1x16GB RDIMM DDR4-2666 | 1x530-8i | 16x2.5" | 8x2.5" SATA/SAS HS | Open | DVD HH | None | None | None | Security Bezel/Chassis Intrusion Switch/TPM 1.2 | XClarity Standard | 1x750W Platinum | 3-year | 07/17 |
| 7X10A04TNA | 1xXeon Silver 4116 12C/2.1GHz/16.5MB/85W/DDR4-2400 | 1x16GB RDIMM DDR4-2666 | 1x530-8i | 16x2.5" | 8x2.5" SATA/SAS HS | Open | DVD HH | None | None | None | Security Bezel/Chassis Intrusion Switch/TPM 1.2 | XClarity Standard | 1x750W Platinum | 3-year | 07/17 |
| 7X10A04UNA | 1xXeon Bronze 3104 6C/1.7GHz/8.25MB/85W/DDR4-2133 | 1x16GB RDIMM DDR4-2666 | Onboard SATA | 8x3.5" | 8x3.5" SATA SS | Open | DVD±RW HH | None | None | None | Security Bezel/Chassis Intrusion Switch/TPM 1.2 | XClarity Standard | 1x750W Platinum | 3-year | 07/17 |
| 7X10A04VNA | 1xXeon Silver 4108 8C/1.8GHz/11MB/85W/DDR4-2400 | 1x16GB RDIMM DDR4-2666 | Onboard SATA | 8x3.5" | 8x3.5" SATA SS | Open | DVD±RW HH | None | None | None | Security Bezel/Chassis Intrusion Switch/TPM 1.2 | XClarity Standard | 1x750W Platinum | 3-year | 07/17 |
| 7X10A04YNA | 1xXeon Gold 5118 12C/2.3GHz/16.5MB/105W/DDR4-2400 | 1x16GB RDIMM DDR4-2666 | 1x930-8i 2GB flash | 16x2.5" | 8x2.5" SATA/SAS HS | Open | DVD HH | None | None | None | Security Bezel/Chassis Intrusion Switch/TPM 1.2 | XClarity Standard | 1x750W Platinum | 3-year | 07/17 |
| 7X10A04ZNA | 1xXeon Gold 5120 14C/2.2GHz/19.25MB/105W/DDR4-2400 | 1x16GB RDIMM DDR4-2666 | 1x930-8i 2GB flash | 16x2.5" | 8x2.5" SATA/SAS HS | Open | DVD HH | None | None | None | Security Bezel/Chassis Intrusion Switch/TPM 1.2 | XClarity Standard | 1x750W Platinum | 3-year | 07/17 |

ThinkSystem ST550 Models for EMEA - TopSeller - 1 of 2

Product Specifications Reference (PSREF)

| Model | Processor | Memory | RAID/HBA Adapter | Chassis | Disk Bays | Disks | Optical | GPU | Networking (PCIe) | M.2 Boot Drive | Security | System Management | Power Supply | Base Warranty | Ann Date (mm/yy) |
|------------|---|------------------------|--------------------|---------|--------------------|--------------------------------|-----------|------|-------------------|----------------|---|-------------------|-----------------|---------------|------------------|
| 7X10A006EA | 1xXeon Gold 5122 4C/3.6GHz/16.5MB/105W/DDR4-2400 | 1x16GB RDIMM DDR4-2666 | 1x930-8i 2GB flash | 16x2.5" | 8x2.5" SATA/SAS HS | Open | DVD±RW HH | None | None | None | Security Bezel/Chassis Intrusion Switch/TPM 1.2 | XClarity Standard | 1x750W Platinum | 3-year | 07/17 |
| 7X10A00HEA | 1xXeon Gold 5115 10C/2.4GHz/13.75MB/85W/DDR4-2400 | 1x16GB RDIMM DDR4-2666 | 1x930-8i 2GB flash | 16x2.5" | 8x2.5" SATA/SAS HS | Open | DVD±RW HH | None | None | None | Security Bezel/Chassis Intrusion Switch/TPM 1.2 | XClarity Standard | 2x750W Platinum | 3-year | 07/17 |
| 7X10A013EA | 1xXeon Gold 5115 10C/2.4GHz/13.75MB/85W/DDR4-2400 | 1x16GB RDIMM DDR4-2666 | 1x930-8i 2GB flash | 16x2.5" | 8x2.5" SATA/SAS HS | Open | None | None | None | None | Security Bezel/Chassis Intrusion Switch/TPM 1.2 | XClarity Standard | 1x750W Platinum | 3-year | 07/17 |
| 7X10A017EA | 1xXeon Silver 4110 8C/2.1GHz/11MB/85W/DDR4-2400 | 1x16GB RDIMM DDR4-2666 | 1x930-8i 2GB flash | 16x2.5" | 8x2.5" SATA/SAS HS | Open | DVD±RW HH | None | None | None | Security Bezel/Chassis Intrusion Switch/TPM 1.2 | XClarity Standard | 1x750W Platinum | 3-year | 07/17 |
| 7X10A018EA | 1xXeon Silver 4108 8C/1.8GHz/11MB/85W/DDR4-2400 | 1x16GB RDIMM DDR4-2666 | 1x930-8i 2GB flash | 16x2.5" | 8x2.5" SATA/SAS HS | Open | DVD±RW HH | None | None | None | Security Bezel/Chassis Intrusion Switch/TPM 1.2 | XClarity Standard | 1x750W Platinum | 3-year | 07/17 |
| 7X10A019EA | 1xXeon Silver 4108 8C/1.8GHz/11MB/85W/DDR4-2400 | 1x16GB RDIMM DDR4-2666 | 1x930-8i 2GB flash | 16x2.5" | 8x2.5" SATA/SAS HS | 3x300GB HDD 10K 2.5" SAS12Gbps | DVD±RW HH | None | None | None | Security Bezel/Chassis Intrusion Switch/TPM 1.2 | XClarity Standard | 2x750W Platinum | 3-year | 07/17 |
| 7X10A01AEA | 1xXeon Silver 4110 8C/2.1GHz/11MB/85W/DDR4-2400 | 1x16GB RDIMM DDR4-2666 | 1x930-8i 2GB flash | 16x2.5" | 8x2.5" SATA/SAS HS | 3x300GB HDD 10K 2.5" SAS12Gbps | DVD±RW HH | None | None | None | Security Bezel/Chassis Intrusion Switch/TPM 1.2 | XClarity Standard | 2x750W Platinum | 3-year | 07/17 |
| 7X10A01BEA | 1xXeon Silver 4116 12C/2.1GHz/16.5MB/85W/DDR4-2400 | 1x16GB RDIMM DDR4-2666 | 1x930-8i 2GB flash | 16x2.5" | 8x2.5" SATA/SAS HS | Open | None | None | None | None | Security Bezel/Chassis Intrusion Switch/TPM 1.2 | XClarity Standard | 1x750W Platinum | 3-year | 07/17 |
| 7X10A01CEA | 1xXeon Silver 4108 8C/1.8GHz/11MB/85W/DDR4-2400 | 1x16GB RDIMM DDR4-2666 | 1x930-8i 2GB flash | 16x2.5" | 8x2.5" SATA/SAS HS | Open | DVD±RW HH | None | None | None | Security Bezel/Chassis Intrusion Switch/TPM 1.2 | XClarity Standard | 2x750W Platinum | 3-year | 07/17 |
| 7X10A01DEA | 1xXeon Bronze 3106 8C/1.7GHz/11MB/85W/DDR4-2133 | 1x16GB RDIMM DDR4-2666 | 1x530-8i | 16x2.5" | 8x2.5" SATA/SAS HS | Open | DVD±RW HH | None | None | None | Security Bezel/Chassis Intrusion Switch/TPM 1.2 | XClarity Standard | 1x750W Platinum | 3-year | 07/17 |
| 7X10A01EEA | 1xXeon Silver 4110 8C/2.1GHz/11MB/85W/DDR4-2400 | 1x16GB RDIMM DDR4-2666 | 1x930-8i 2GB flash | 16x2.5" | 8x2.5" SATA/SAS HS | Open | None | None | None | None | Security Bezel/Chassis Intrusion Switch/TPM 1.2 | XClarity Standard | 1x750W Platinum | 3-year | 07/17 |
| 7X10A01FEA | 1xXeon Bronze 3106 8C/1.7GHz/11MB/85W/DDR4-2133 | 1x16GB RDIMM DDR4-2666 | 1x530-8i | 8x3.5" | 8x3.5" SATA/SAS HS | Open | DVD±RW HH | None | None | None | Security Bezel/Chassis Intrusion Switch/TPM 1.2 | XClarity Standard | 1x750W Platinum | 3-year | 07/17 |
| 7X10A01GEA | 1xXeon Silver 4116 12C/2.1GHz/16.5MB/85W/DDR4-2400 | 1x16GB RDIMM DDR4-2666 | 1x930-8i 2GB flash | 16x2.5" | 8x2.5" SATA/SAS HS | Open | DVD±RW HH | None | None | None | Security Bezel/Chassis Intrusion Switch/TPM 1.2 | XClarity Standard | 1x750W Platinum | 3-year | 07/17 |
| 7X10A01HEA | 1xXeon Bronze 3104 6C/1.7GHz/8.25MB/85W/DDR4-2133 | 1x16GB RDIMM DDR4-2666 | 1x530-8i | 8x3.5" | 8x3.5" SATA/SAS HS | Open | DVD±RW HH | None | None | None | Security Bezel/Chassis Intrusion Switch/TPM 1.2 | XClarity Standard | 1x750W Platinum | 3-year | 07/17 |
| 7X10A01JEA | 1xXeon Silver 4110 8C/2.1GHz/11MB/85W/DDR4-2400 | 1x16GB RDIMM DDR4-2666 | 1x930-8i 2GB flash | 8x3.5" | 8x3.5" SATA/SAS HS | Open | None | None | None | None | Security Bezel/Chassis Intrusion Switch/TPM 1.2 | XClarity Standard | 1x750W Platinum | 3-year | 07/17 |
| 7X10A01KEA | 1xXeon Silver 4110 8C/2.1GHz/11MB/85W/DDR4-2400 | 4x16GB RDIMM DDR4-2666 | 1x930-8i 2GB flash | 16x2.5" | 8x2.5" SATA/SAS HS | 2x600GB HDD 10K 2.5" SAS12Gbps | DVD±RW HH | None | None | None | Security Bezel/Chassis Intrusion Switch/TPM 1.2 | XClarity Standard | 2x750W Platinum | 3-year | 07/17 |
| 7X10A01LEA | 1xXeon Silver 4108 8C/1.8GHz/11MB/85W/DDR4-2400 | 1x16GB RDIMM DDR4-2666 | 1x930-8i 2GB flash | 16x2.5" | 8x2.5" SATA/SAS HS | Open | None | None | None | None | Security Bezel/Chassis Intrusion Switch/TPM 1.2 | XClarity Standard | 1x750W Platinum | 3-year | 07/17 |
| 7X10A01MEA | 1xXeon Silver 4114 10C/2.2GHz/13.75MB/85W/DDR4-2400 | 1x16GB RDIMM DDR4-2666 | 1x930-8i 2GB flash | 8x3.5" | 8x3.5" SATA/SAS HS | Open | None | None | None | None | Security Bezel/Chassis Intrusion Switch/TPM 1.2 | XClarity Standard | 1x750W Platinum | 3-year | 07/17 |
| 7X10A01NEA | 1xXeon Bronze 3104 6C/1.7GHz/8.25MB/85W/DDR4-2133 | 1x16GB RDIMM DDR4-2666 | 1x530-8i | 16x2.5" | 8x2.5" SATA/SAS HS | Open | DVD±RW HH | None | None | None | Security Bezel/Chassis Intrusion Switch/TPM 1.2 | XClarity Standard | 1x750W Platinum | 3-year | 07/17 |
| 7X10A01PEA | 1xXeon Silver 4114 10C/2.2GHz/13.75MB/85W/DDR4-2400 | 1x16GB RDIMM DDR4-2666 | 1x930-8i 2GB flash | 16x2.5" | 8x2.5" SATA/SAS HS | Open | None | None | None | None | Security Bezel/Chassis Intrusion Switch/TPM 1.2 | XClarity Standard | 1x750W Platinum | 3-year | 07/17 |
| 7X10A01QEA | 1xXeon Bronze 3104 6C/1.7GHz/8.25MB/85W/DDR4-2133 | 1x16GB RDIMM DDR4-2666 | 1x930-8i 2GB flash | 16x2.5" | 8x2.5" SATA/SAS HS | Open | None | None | None | None | Security Bezel/Chassis Intrusion Switch/TPM 1.2 | XClarity Standard | 1x750W Platinum | 3-year | 07/17 |
| 7X10A02HEA | 1xXeon Gold 5118 12C/2.3GHz/16.5MB/105W/DDR4-2400 | 1x16GB RDIMM DDR4-2666 | 1x930-8i 2GB flash | 16x2.5" | 8x2.5" SATA/SAS HS | Open | None | None | None | None | Security Bezel/Chassis Intrusion Switch/TPM 1.2 | XClarity Standard | 1x750W Platinum | 3-year | 07/17 |

ThinkSystem ST550 Models for EMEA - TopSeller - 2 of 2

Product Specifications Reference (PSREF)

| Model | Processor | Memory | RAID/HBA Adapter | Chassis | Disk Bays | Disks | Optical | GPU | Networking (PCIe) | M.2 Boot Drive | Security | System Management | Power Supply | Base Warranty | Ann Date (mm/yy) |
|------------|--|---------------------------|-----------------------|---------|-----------------------|-----------------------------------|--------------|------|-------------------|----------------|--|----------------------|--------------------|---------------|------------------|
| 7X10A02YEA | 1xXeon Silver 4110 8C/2.1GHz/11MB/85W/DDR4-2400 | 1x16GB RDIMM DDR4-2666 | 1x930-8i 2GB flash | 16x2.5" | 8x2.5" SATA/SAS HS | Open | DVD±RW HH | None | None | None | Security Bezel/Chassis Intrusion Switch/ TPM 1.2 | XClarity Standard | 1x550W Platinum | 3-year | 07/17 |
| 7X10A035EA | 1xXeon Gold 5115 10C/2.4GHz/13.75MB/85W/ DDR4-2400 | 1x16GB RDIMM DDR4-2666 | 1x930-8i 2GB flash | 16x2.5" | 8x2.5" SATA/SAS HS | Open | DVD±RW HH | None | None | None | Security Bezel/Chassis Intrusion Switch/ TPM 1.2 | XClarity Standard | 2x750W Platinum | 3-year | 07/17 |
| 7X10A039EA | 1xXeon Bronze 3106 8C/1.7GHz/11MB/85W/DDR4- 2133 | 1x16GB RDIMM DDR4-2666 | 1x530-8i | 8x3.5" | 8x3.5" SATA/SAS HS | 2x1TB HDD 7.2K 3.5" SATA6Gbps | None | None | None | None | Security Bezel/Chassis Intrusion Switch/ TPM 1.2 | XClarity Standard | 1x550W Platinum | 3-year | 07/17 |
| 7X10A03KEA | 1xXeon Bronze 3106 8C/1.7GHz/11MB/85W/DDR4- 2133 | 1x16GB RDIMM DDR4-2666 | 1x530-8i | 8x3.5" | 4x3.5" SATA/SAS HS | Open | DVD±RW HH | None | None | None | Security Bezel/Chassis Intrusion Switch/ TPM 1.2 | XClarity Standard | 1x550W Platinum | 3-year | 07/17 |
| 7X10A03VEA | 1xXeon Silver 4110 8C/2.1GHz/11MB/85W/DDR4- 2400 | 1x16GB RDIMM DDR4-2666 | 1x930-8i 2GB flash | 16x2.5" | 8x2.5" SATA/SAS HS | 2x300GB HDD 10K 2.5" SAS12Gbps | DVD±RW HH | None | None | None | Security Bezel/Chassis Intrusion Switch/ TPM 1.2 | XClarity Standard | 2x550W Platinum | 3-year | 07/17 |
| 7X10A03ZEA | 1xXeon Silver 4110 8C/2.1GHz/11MB/85W/DDR4- 2400 | 4x32GB RDIMM DDR4-2666 | 1x930-8i 2GB flash | 16x2.5" | 8x2.5" SATA/SAS HS | 3x900GB HDD 10K 2.5" SAS12Gbps | DVD±RW HH | None | None | None | Security Bezel/Chassis Intrusion Switch/ TPM 1.2 | XClarity Standard | 2x750W Platinum | 3-year | 07/17 |

ThinkSystem ST550 Models for EMEA - Non TopSeller

Product Specifications Reference (PSREF)

| Model | Processor | Memory | RAID/HBA Adapter | Chassis | Disk Bays | Disks | Optical | GPU | Networking (PCIe) | M.2 Boot Drive | Security | System Management | Power Supply | Base Warranty | Ann Date (mm/yy) |
|------------|--|---------------------------|-----------------------|---------|-----------------------|-------|--------------|------|-------------------|----------------|--|----------------------|--------------------|---------------|------------------|
| 7X10A00VEA | 1xXeon Gold 5120 14C/2.2GHz/19.25MB/105W/ DDR4-2400 | 1x16GB RDIMM DDR4-2666 | 1x930-8i 2GB flash | 16x2.5" | 8x2.5" SATA/SAS HS | Open | DVD HH | None | None | None | Security Bezel/Chassis Intrusion Switch/ TPM 1.2 | XClarity Standard | 1x750W Platinum | 3-year | 07/17 |
| 7X10A01REA | 1xXeon Bronze 3106 8C/1.7GHz/11MB/85W/DDR4- 2133 | 1x16GB RDIMM DDR4-2666 | 1x530-8i | 16x2.5" | 8x2.5" SATA/SAS HS | Open | DVD HH | None | None | None | Security Bezel/Chassis Intrusion Switch/ TPM 1.2 | XClarity Standard | 1x750W Platinum | 3-year | 07/17 |
| 7X10A01SEA | 1xXeon Silver 4116 12C/2.1GHz/16.5MB/85W/DDR4- 2400 | 1x16GB RDIMM DDR4-2666 | 1x530-8i | 16x2.5" | 8x2.5" SATA/SAS HS | Open | DVD HH | None | None | None | Security Bezel/Chassis Intrusion Switch/ TPM 1.2 | XClarity Standard | 1x750W Platinum | 3-year | 07/17 |
| 7X10A01TEA | 1xXeon Silver 4108 8C/1.8GHz/11MB/85W/DDR4- 2400 | 1x16GB RDIMM DDR4-2666 | Onboard SATA | 8x3.5" | 8x3.5" SATA SS | Open | DVD±RW HH | None | None | None | Security Bezel/Chassis Intrusion Switch/ TPM 1.2 | XClarity Standard | 1x750W Platinum | 3-year | 07/17 |
| 7X10A01UEA | 1xXeon Bronze 3104 6C/1.7GHz/8.25MB/85W/DDR4- 2133 | 1x16GB RDIMM DDR4-2666 | Onboard SATA | 8x3.5" | 8x3.5" SATA SS | Open | DVD±RW HH | None | None | None | Security Bezel/Chassis Intrusion Switch/ TPM 1.2 | XClarity Standard | 1x750W Platinum | 3-year | 07/17 |
| 7X10A01VEA | 1xXeon Silver 4108 8C/1.8GHz/11MB/85W/DDR4- 2400 | 1x16GB RDIMM DDR4-2666 | 1x530-8i | 16x2.5" | 8x2.5" SATA/SAS HS | Open | DVD HH | None | None | None | Security Bezel/Chassis Intrusion Switch/ TPM 1.2 | XClarity Standard | 1x750W Platinum | 3-year | 07/17 |
| 7X10A01WEA | 1xXeon Silver 4114 10C/2.2GHz/13.75MB/85W/ DDR4-2400 | 1x16GB RDIMM DDR4-2666 | 1x530-8i | 16x2.5" | 8x2.5" SATA/SAS HS | Open | DVD HH | None | None | None | Security Bezel/Chassis Intrusion Switch/ TPM 1.2 | XClarity Standard | 1x750W Platinum | 3-year | 07/17 |
| 7X10A01XEA | 1xXeon Bronze 3104 6C/1.7GHz/8.25MB/85W/DDR4- 2133 | 1x16GB RDIMM DDR4-2666 | 1x530-8i | 16x2.5" | 8x2.5" SATA/SAS HS | Open | DVD HH | None | None | None | Security Bezel/Chassis Intrusion Switch/ TPM 1.2 | XClarity Standard | 1x750W Platinum | 3-year | 07/17 |
| 7X10A01YEA | 1xXeon Silver 4110 8C/2.1GHz/11MB/85W/DDR4- 2400 | 1x16GB RDIMM DDR4-2666 | 1x530-8i | 16x2.5" | 8x2.5" SATA/SAS HS | Open | DVD HH | None | None | None | Security Bezel/Chassis Intrusion Switch/ TPM 1.2 | XClarity Standard | 1x750W Platinum | 3-year | 07/17 |
| 7X10A02UEA | 1xXeon Gold 5118 12C/2.3GHz/16.5MB/105W/ DDR4-2400 | 1x16GB RDIMM DDR4-2666 | 1x930-8i 2GB flash | 16x2.5" | 8x2.5" SATA/SAS HS | Open | DVD HH | None | None | None | Security Bezel/Chassis Intrusion Switch/ TPM 1.2 | XClarity Standard | 1x750W Platinum | 3-year | 07/17 |
| 7X10A03JEA | 1xXeon Gold 5120 14C/2.2GHz/19.25MB/105W/ DDR4-2400 | 1x16GB RDIMM DDR4-2666 | 1x930-8i 2GB flash | 16x2.5" | 8x2.5" SATA/SAS HS | Open | DVD HH | None | None | None | Security Bezel/Chassis Intrusion Switch/ TPM 1.2 | XClarity Standard | 1x750W Platinum | 3-year | 07/17 |

ThinkSystem ST550 Models for Australia and New Zealand - TopSeller

Product Specifications Reference (PSREF)

| Model | Processor | Memory | RAID/HBA Adapter | Chassis | Disk Bays | Disks | Optical | GPU | Networking (PCIe) | M.2 Boot Drive | Security | System Management | Power Supply | Base Warranty | Ann Date (mm/yy) |
|------------|---|------------------------|--------------------|---------|--------------------|--------------------------------|-----------|------|-------------------|----------------|---|-------------------|-----------------|---------------|------------------|
| 7X10A029AU | 1xXeon Bronze 3106 8C/1.7GHz/11MB/85W/DDR4-2133 | 1x16GB RDIMM DDR4-2666 | 1x530-8i | 16x2.5" | 8x2.5" SATA/SAS HS | Open | DVD±RW HH | None | None | None | Security Bezel/Chassis Intrusion Switch/TPM 1.2 | XClarity Standard | 1x750W Platinum | 3-year | 07/17 |
| 7X10A02BAU | 1xXeon Gold 5115 10C/2.4GHz/13.75MB/85W/DDR4-2400 | 1x16GB RDIMM DDR4-2666 | 1x930-8i 2GB flash | 16x2.5" | 8x2.5" SATA/SAS HS | Open | DVD±RW HH | None | None | None | Security Bezel/Chassis Intrusion Switch/TPM 1.2 | XClarity Standard | 2x750W Platinum | 3-year | 07/17 |
| 7X10A02DAU | 1xXeon Silver 4110 8C/2.1GHz/11MB/85W/DDR4-2400 | 4x16GB RDIMM DDR4-2666 | 1x930-8i 2GB flash | 16x2.5" | 8x2.5" SATA/SAS HS | 2x600GB HDD 10K 2.5" SAS12Gbps | DVD±RW HH | None | None | None | Security Bezel/Chassis Intrusion Switch/TPM 1.2 | XClarity Standard | 2x750W Platinum | 3-year | 07/17 |
| 7X10A02EAU | 1xXeon Silver 4114 10C/2.2GHz/13.75MB/85W/DDR4-2400 | 1x16GB RDIMM DDR4-2666 | 1x930-8i 2GB flash | 8x3.5" | 8x3.5" SATA/SAS HS | Open | None | None | None | None | Security Bezel/Chassis Intrusion Switch/TPM 1.2 | XClarity Standard | 1x750W Platinum | 3-year | 07/17 |
| 7X10A02GAU | 1xXeon Silver 4110 8C/2.1GHz/11MB/85W/DDR4-2133 | 1x16GB RDIMM DDR4-2666 | 1x930-8i 2GB flash | 16x2.5" | 8x2.5" SATA/SAS HS | 3x300GB HDD 10K 2.5" SAS12Gbps | DVD±RW HH | None | None | None | Security Bezel/Chassis Intrusion Switch/TPM 1.2 | XClarity Standard | 2x750W Platinum | 3-year | 07/17 |
| 7X10A02JAU | 1xXeon Silver 4114 10C/2.2GHz/13.75MB/85W/DDR4-2400 | 1x16GB RDIMM DDR4-2666 | 1x930-8i 2GB flash | 16x2.5" | 8x2.5" SATA/SAS HS | Open | None | None | None | None | Security Bezel/Chassis Intrusion Switch/TPM 1.2 | XClarity Standard | 1x750W Platinum | 3-year | 07/17 |
| 7X10A02TAU | 1xXeon Bronze 3104 6C/1.7GHz/8.25MB/85W/DDR4-2133 | 1x16GB RDIMM DDR4-2666 | 1x530-8i | 16x2.5" | 8x2.5" SATA/SAS HS | Open | DVD±RW HH | None | None | None | Security Bezel/Chassis Intrusion Switch/TPM 1.2 | XClarity Standard | 1x750W Platinum | 3-year | 07/17 |
| 7X10A02VAU | 1xXeon Silver 4108 8C/1.8GHz/11MB/85W/DDR4-2400 | 1x16GB RDIMM DDR4-2666 | 1x930-8i 2GB flash | 16x2.5" | 8x2.5" SATA/SAS HS | Open | DVD±RW HH | None | None | None | Security Bezel/Chassis Intrusion Switch/TPM 1.2 | XClarity Standard | 1x750W Platinum | 3-year | 07/17 |
| 7X10A032AU | 1xXeon Silver 4108 8C/1.8GHz/11MB/85W/DDR4-2400 | 1x16GB RDIMM DDR4-2666 | 1x930-8i 2GB flash | 16x2.5" | 8x2.5" SATA/SAS HS | 3x300GB HDD 10K 2.5" SAS12Gbps | DVD±RW HH | None | None | None | Security Bezel/Chassis Intrusion Switch/TPM 1.2 | XClarity Standard | 2x750W Platinum | 3-year | 07/17 |
| 7X10A036AU | 1xXeon Silver 4110 8C/2.1GHz/11MB/85W/DDR4-2400 | 1x16GB RDIMM DDR4-2666 | 1x930-8i 2GB flash | 16x2.5" | 8x2.5" SATA/SAS HS | Open | None | None | None | None | Security Bezel/Chassis Intrusion Switch/TPM 1.2 | XClarity Standard | 1x750W Platinum | 3-year | 07/17 |
| 7X10A038AU | 1xXeon Silver 4116 12C/2.1GHz/16.5MB/85W/DDR4-2400 | 1x16GB RDIMM DDR4-2666 | 1x930-8i 2GB flash | 16x2.5" | 8x2.5" SATA/SAS HS | Open | None | None | None | None | Security Bezel/Chassis Intrusion Switch/TPM 1.2 | XClarity Standard | 1x750W Platinum | 3-year | 07/17 |
| 7X10A03AAU | 1xXeon Silver 4116 12C/2.1GHz/16.5MB/85W/DDR4-2400 | 1x16GB RDIMM DDR4-2666 | 1x930-8i 2GB flash | 16x2.5" | 8x2.5" SATA/SAS HS | Open | DVD±RW HH | None | None | None | Security Bezel/Chassis Intrusion Switch/TPM 1.2 | XClarity Standard | 1x750W Platinum | 3-year | 07/17 |
| 7X10A03EAU | 1xXeon Bronze 3104 6C/1.7GHz/8.25MB/85W/DDR4-2133 | 1x16GB RDIMM DDR4-2666 | 1x530-8i | 8x3.5" | 8x3.5" SATA/SAS HS | Open | DVD±RW HH | None | None | None | Security Bezel/Chassis Intrusion Switch/TPM 1.2 | XClarity Standard | 1x750W Platinum | 3-year | 07/17 |
| 7X10A03FAU | 1xXeon Silver 4110 8C/2.1GHz/11MB/85W/DDR4-2400 | 1x16GB RDIMM DDR4-2666 | 1x930-8i 2GB flash | 8x3.5" | 8x3.5" SATA/SAS HS | Open | None | None | None | None | Security Bezel/Chassis Intrusion Switch/TPM 1.2 | XClarity Standard | 1x750W Platinum | 3-year | 07/17 |
| 7X10A03GAU | 1xXeon Bronze 3106 8C/1.7GHz/11MB/85W/DDR4-2133 | 1x16GB RDIMM DDR4-2666 | 1x530-8i | 8x3.5" | 8x3.5" SATA/SAS HS | Open | DVD±RW HH | None | None | None | Security Bezel/Chassis Intrusion Switch/TPM 1.2 | XClarity Standard | 1x750W Platinum | 3-year | 07/17 |
| 7X10A03HAU | 1xXeon Silver 4108 8C/1.8GHz/11MB/85W/DDR4-2400 | 1x16GB RDIMM DDR4-2666 | 1x930-8i 2GB flash | 16x2.5" | 8x2.5" SATA/SAS HS | Open | None | None | None | None | Security Bezel/Chassis Intrusion Switch/TPM 1.2 | XClarity Standard | 1x750W Platinum | 3-year | 07/17 |
| 7X10A03MAU | 1xXeon Bronze 3104 6C/1.7GHz/8.25MB/85W/DDR4-2133 | 1x16GB RDIMM DDR4-2666 | 1x930-8i 2GB flash | 16x2.5" | 8x2.5" SATA/SAS HS | Open | None | None | None | None | Security Bezel/Chassis Intrusion Switch/TPM 1.2 | XClarity Standard | 1x750W Platinum | 3-year | 07/17 |
| 7X10A03NAU | 1xXeon Silver 4108 8C/1.8GHz/11MB/85W/DDR4-2400 | 1x16GB RDIMM DDR4-2666 | 1x930-8i 2GB flash | 16x2.5" | 8x2.5" SATA/SAS HS | Open | DVD±RW HH | None | None | None | Security Bezel/Chassis Intrusion Switch/TPM 1.2 | XClarity Standard | 2x750W Platinum | 3-year | 07/17 |
| 7X10A03QAU | 1xXeon Silver 4110 8C/2.1GHz/11MB/85W/DDR4-2400 | 1x16GB RDIMM DDR4-2666 | 1x930-8i 2GB flash | 16x2.5" | 8x2.5" SATA/SAS HS | Open | DVD±RW HH | None | None | None | Security Bezel/Chassis Intrusion Switch/TPM 1.2 | XClarity Standard | 1x750W Platinum | 3-year | 07/17 |
| 7X10A03UAU | 1xXeon Gold 5118 12C/2.3GHz/16.5MB/105W/DDR4-2400 | 1x16GB RDIMM DDR4-2666 | 1x930-8i 2GB flash | 16x2.5" | 8x2.5" SATA/SAS HS | Open | None | None | None | None | Security Bezel/Chassis Intrusion Switch/TPM 1.2 | XClarity Standard | 1x750W Platinum | 3-year | 07/17 |

ThinkSystem ST550 Models for Australia and New Zealand - Non TopSeller

Product Specifications Reference (PSREF)

| Model | Processor | Memory | RAID/HBA Adapter | Chassis | Disk Bays | Disks | Optical | GPU | Networking (PCIe) | M.2 Boot Drive | Security | System Management | Power Supply | Base Warranty | Ann Date (mm/yy) |
|------------|---|------------------------|--------------------|---------|--------------------|-------|-----------|------|-------------------|----------------|---|-------------------|-----------------|---------------|------------------|
| 7X10A005AU | 1xXeon Gold 5115 10C/2.4GHz/13.75MB/85W/DDR4-2400 | 1x16GB RDIMM DDR4-2666 | Onboard SATA | 8x3.5" | 4x3.5" SATA SS | Open | None | None | None | None | Security Bezel/Chassis Intrusion Switch/TPM 1.2 | XClarity Standard | 1x550W Platinum | 3-year | 07/17 |
| 7X10A00AAU | 1xXeon Gold 5115 10C/2.4GHz/13.75MB/85W/DDR4-2400 | 1x16GB RDIMM DDR4-2666 | 1x930-8i 2GB flash | 16x2.5" | 8x2.5" SATA/SAS HS | Open | None | None | None | None | Security Bezel/Chassis Intrusion Switch/TPM 1.2 | XClarity Standard | 2x750W Platinum | 3-year | 07/17 |
| 7X10A00KAU | 1xXeon Gold 5120 14C/2.2GHz/19.25MB/105W/DDR4-2400 | 1x16GB RDIMM DDR4-2666 | 1x930-8i 2GB flash | 16x2.5" | 8x2.5" SATA/SAS HS | Open | None | None | None | None | Security Bezel/Chassis Intrusion Switch/TPM 1.2 | XClarity Standard | 1x750W Platinum | 3-year | 07/17 |
| 7X10A00MAU | 1xXeon Gold 6126T 12C/2.6GHz/19.25MB/125W/DDR4-2666 | 1x32GB RDIMM DDR4-2666 | 1x930-8i 2GB flash | 16x2.5" | 8x2.5" SATA/SAS HS | Open | None | None | None | None | Security Bezel/Chassis Intrusion Switch/TPM 1.2 | XClarity Standard | 1x750W Platinum | 3-year | 07/17 |
| 7X10A00TAU | 1xXeon Gold 5115 10C/2.4GHz/13.75MB/85W/DDR4-2400 | 1x16GB RDIMM DDR4-2666 | 1x530-8i | 8x3.5" | 4x3.5" SATA/SAS HS | Open | None | None | None | None | Security Bezel/Chassis Intrusion Switch/TPM 1.2 | XClarity Standard | 1x550W Platinum | 3-year | 07/17 |
| 7X10A011AU | 1xXeon Gold 6130T 16C/2.1GHz/22MB/125W/DDR4-2666 | 1x32GB RDIMM DDR4-2666 | 1x930-8i 2GB flash | 16x2.5" | 8x2.5" SATA/SAS HS | Open | None | None | None | None | Security Bezel/Chassis Intrusion Switch/TPM 1.2 | XClarity Standard | 1x750W Platinum | 3-year | 07/17 |
| 7X10A02AAU | 1xXeon Bronze 3104 6C/1.7GHz/8.25MB/85W/DDR4-2133 | 1x16GB RDIMM DDR4-2666 | Onboard SATA | 8x3.5" | 8x3.5" SATA SS | Open | DVD±RW HH | None | None | None | Security Bezel/Chassis Intrusion Switch/TPM 1.2 | XClarity Standard | 1x750W Platinum | 3-year | 07/17 |
| 7X10A02FAU | 1xXeon Bronze 3104 6C/1.7GHz/8.25MB/85W/DDR4-2133 | 1x16GB RDIMM DDR4-2666 | 1x530-8i | 16x2.5" | 8x2.5" SATA/SAS HS | Open | DVD HH | None | None | None | Security Bezel/Chassis Intrusion Switch/TPM 1.2 | XClarity Standard | 1x750W Platinum | 3-year | 07/17 |
| 7X10A02LAU | 1xXeon Silver 4110 8C/2.1GHz/11MB/85W/DDR4-2400 | 1x16GB RDIMM DDR4-2666 | 1x530-8i | 16x2.5" | 8x2.5" SATA/SAS HS | Open | DVD HH | None | None | None | Security Bezel/Chassis Intrusion Switch/TPM 1.2 | XClarity Standard | 1x750W Platinum | 3-year | 07/17 |
| 7X10A02MAU | 1xXeon Bronze 3106 8C/1.7GHz/11MB/85W/DDR4-2133 | 1x16GB RDIMM DDR4-2666 | 1x530-8i | 16x2.5" | 8x2.5" SATA/SAS HS | Open | DVD HH | None | None | None | Security Bezel/Chassis Intrusion Switch/TPM 1.2 | XClarity Standard | 1x750W Platinum | 3-year | 07/17 |
| 7X10A02NAU | 1xXeon Silver 4108 8C/1.8GHz/11MB/85W/DDR4-2400 | 1x16GB RDIMM DDR4-2666 | 1x530-8i | 16x2.5" | 8x2.5" SATA/SAS HS | Open | DVD HH | None | None | None | Security Bezel/Chassis Intrusion Switch/TPM 1.2 | XClarity Standard | 1x750W Platinum | 3-year | 07/17 |
| 7X10A02RAU | 1xXeon Gold 5118 12C/2.3GHz/16.5MB/105W/DDR4-2400 | 1x16GB RDIMM DDR4-2666 | 1x930-8i 2GB flash | 16x2.5" | 8x2.5" SATA/SAS HS | Open | DVD HH | None | None | None | Security Bezel/Chassis Intrusion Switch/TPM 1.2 | XClarity Standard | 1x750W Platinum | 3-year | 07/17 |
| 7X10A02ZAU | 1xXeon Silver 4116 12C/2.1GHz/16.5MB/85W/DDR4-2400 | 1x16GB RDIMM DDR4-2666 | 1x530-8i | 16x2.5" | 8x2.5" SATA/SAS HS | Open | DVD HH | None | None | None | Security Bezel/Chassis Intrusion Switch/TPM 1.2 | XClarity Standard | 1x750W Platinum | 3-year | 07/17 |
| 7X10A03DAU | 1xXeon Silver 4108 8C/1.8GHz/11MB/85W/DDR4-2400 | 1x16GB RDIMM DDR4-2666 | Onboard SATA | 8x3.5" | 8x3.5" SATA SS | Open | DVD±RW HH | None | None | None | Security Bezel/Chassis Intrusion Switch/TPM 1.2 | XClarity Standard | 1x750W Platinum | 3-year | 07/17 |
| 7X10A03LAU | 1xXeon Gold 5120 14C/2.2GHz/19.25MB/105W/DDR4-2400 | 1x16GB RDIMM DDR4-2666 | 1x930-8i 2GB flash | 16x2.5" | 8x2.5" SATA/SAS HS | Open | DVD HH | None | None | None | Security Bezel/Chassis Intrusion Switch/TPM 1.2 | XClarity Standard | 1x750W Platinum | 3-year | 07/17 |
| 7X10A03RAU | 1xXeon Silver 4114 10C/2.2GHz/13.75MB/85W/DDR4-2400 | 1x16GB RDIMM DDR4-2666 | 1x530-8i | 16x2.5" | 8x2.5" SATA/SAS HS | Open | DVD HH | None | None | None | Security Bezel/Chassis Intrusion Switch/TPM 1.2 | XClarity Standard | 1x750W Platinum | 3-year | 07/17 |

ThinkSystem ST550 Models for South East Asian (ASEAN) - Non TopSeller

Product Specifications Reference (PSREF)

| Model | Processor | Memory | RAID/HBA Adapter | Chassis | Disk Bays | Disks | Optical | GPU | Networking (PCIe) | M.2 Boot Drive | Security | System Management | Power Supply | Base Warranty | Ann Date (mm/yy) |
|------------|---|-----------------------|------------------|---------|--------------------|-------|---------|------|-------------------|----------------|----------------------------------|-------------------|-----------------|---------------|------------------|
| 7X10A003SG | 1xXeon Gold 5115 10C/2.4GHz/13.75MB/85W/DDR4-2400 | 1x8GB RDIMM DDR4-2666 | 1x530-8i | 8x3.5" | 4x3.5" SATA/SAS HS | Open | None | None | None | None | Chassis Intrusion Switch/TPM 1.2 | XClarity Standard | 1x750W Platinum | 3-year | 07/17 |
| 7X10A004SG | 1xXeon Gold 5118 12C/2.3GHz/16.5MB/105W/DDR4-2400 | 1x8GB RDIMM DDR4-2666 | 1x530-8i | 8x3.5" | 4x3.5" SATA/SAS HS | Open | None | None | None | None | Chassis Intrusion Switch/TPM 1.2 | XClarity Standard | 1x750W Platinum | 3-year | 07/17 |
| 7X10A00BSG | 1xXeon Gold 6130 16C/2.1GHz/22MB/125W/DDR4-2666 | 1x8GB RDIMM DDR4-2666 | 1x530-8i | 16x2.5" | 8x2.5" SATA/SAS HS | Open | None | None | None | None | Chassis Intrusion Switch/TPM 1.2 | XClarity Standard | 1x750W Platinum | 3-year | 07/17 |
| 7X10A00DSG | 1xXeon Gold 5120 14C/2.2GHz/19.25MB/105W/DDR4-2400 | 1x8GB RDIMM DDR4-2666 | 1x530-8i | 16x2.5" | 8x2.5" SATA/SAS HS | Open | None | None | None | None | Chassis Intrusion Switch/TPM 1.2 | XClarity Standard | 1x750W Platinum | 3-year | 07/17 |
| 7X10A00ESG | 1xXeon Gold 5118 12C/2.3GHz/16.5MB/105W/DDR4-2400 | 1x8GB RDIMM DDR4-2666 | 1x530-8i | 16x2.5" | 8x2.5" SATA/SAS HS | Open | None | None | None | None | Chassis Intrusion Switch/TPM 1.2 | XClarity Standard | 1x750W Platinum | 3-year | 07/17 |
| 7X10A00GSG | 1xXeon Gold 5122 4C/3.6GHz/16.5MB/105W/DDR4-2400 | 1x8GB RDIMM DDR4-2666 | 1x530-8i | 8x3.5" | 4x3.5" SATA/SAS HS | Open | None | None | None | None | Chassis Intrusion Switch/TPM 1.2 | XClarity Standard | 1x750W Platinum | 3-year | 07/17 |
| 7X10A01ZSG | 1xXeon Bronze 3104 6C/1.7GHz/8.25MB/85W/DDR4-2133 | 1x8GB RDIMM DDR4-2666 | 1x530-8i | 8x3.5" | 4x3.5" SATA/SAS HS | Open | None | None | None | None | Chassis Intrusion Switch/TPM 1.2 | XClarity Standard | 1x550W Platinum | 3-year | 07/17 |
| 7X10A020SG | 1xXeon Silver 4110 8C/2.1GHz/11MB/85W/DDR4-2400 | 1x8GB RDIMM DDR4-2666 | 1x530-8i | 8x3.5" | 4x3.5" SATA/SAS HS | Open | None | None | None | None | Chassis Intrusion Switch/TPM 1.2 | XClarity Standard | 1x550W Platinum | 3-year | 07/17 |
| 7X10A021SG | 1xXeon Bronze 3106 8C/1.7GHz/11MB/85W/DDR4-2133 | 1x8GB RDIMM DDR4-2666 | 1x530-8i | 8x3.5" | 4x3.5" SATA/SAS HS | Open | None | None | None | None | Chassis Intrusion Switch/TPM 1.2 | XClarity Standard | 1x550W Platinum | 3-year | 07/17 |
| 7X10A022SG | 1xXeon Silver 4114 10C/2.2GHz/13.75MB/85W/DDR4-2400 | 1x8GB RDIMM DDR4-2666 | 1x530-8i | 8x3.5" | 4x3.5" SATA/SAS HS | Open | None | None | None | None | Chassis Intrusion Switch/TPM 1.2 | XClarity Standard | 1x550W Platinum | 3-year | 07/17 |
| 7X10A023SG | 1xXeon Silver 4114 10C/2.2GHz/13.75MB/85W/DDR4-2400 | 1x8GB RDIMM DDR4-2666 | 1x530-8i | 16x2.5" | 8x2.5" SATA/SAS HS | Open | None | None | None | None | Chassis Intrusion Switch/TPM 1.2 | XClarity Standard | 1x750W Platinum | 3-year | 07/17 |
| 7X10A024SG | 1xXeon Silver 4116 12C/2.1GHz/16.5MB/85W/DDR4-2400 | 1x8GB RDIMM DDR4-2666 | 1x530-8i | 16x2.5" | 8x2.5" SATA/SAS HS | Open | None | None | None | None | Chassis Intrusion Switch/TPM 1.2 | XClarity Standard | 1x750W Platinum | 3-year | 07/17 |
| 7X10A025SG | 1xXeon Silver 4116 12C/2.1GHz/16.5MB/85W/DDR4-2400 | 1x8GB RDIMM DDR4-2666 | 1x530-8i | 8x3.5" | 4x3.5" SATA/SAS HS | Open | None | None | None | None | Chassis Intrusion Switch/TPM 1.2 | XClarity Standard | 1x550W Platinum | 3-year | 07/17 |
| 7X10A026SG | 1xXeon Silver 4112 4C/2.6GHz/8.25MB/85W/DDR4-2400 | 1x8GB RDIMM DDR4-2666 | 1x530-8i | 8x3.5" | 4x3.5" SATA/SAS HS | Open | None | None | None | None | Chassis Intrusion Switch/TPM 1.2 | XClarity Standard | 1x550W Platinum | 3-year | 07/17 |

ThinkSystem ST550 Models for Hong Kong, Taiwan, Korea (HTK) - Non TopSeller

Product Specifications Reference (PSREF)

| Model | Processor | Memory | RAID/HBA Adapter | Chassis | Disk Bays | Disks | Optical | GPU | Networking (PCIe) | M.2 Boot Drive | Security | System Management | Power Supply | Base Warranty | Ann Date (mm/yy) |
|------------|--|------------------------|--------------------|---------|--------------------|-------|---------|------|-------------------|----------------|----------------------------------|-------------------|-----------------|---------------|------------------|
| 7X10A00PCN | 1xXeon Gold 6130 16C/2.1GHz/22MB/125W/DDR4-2666 | 1x16GB RDIMM DDR4-2666 | 1x930-8i 2GB flash | 8x3.5" | 4x3.5" SATA/SAS HS | Open | None | None | None | None | Chassis Intrusion Switch/TPM 1.2 | XClarity Standard | 1x750W Platinum | 3-year | 07/17 |
| 7X10A00QCN | 1xXeon Gold 6126 12C/2.6GHz/19.25MB/125W/DDR4-2666 | 1x16GB RDIMM DDR4-2666 | 1x930-8i 2GB flash | 8x3.5" | 4x3.5" SATA/SAS HS | Open | None | None | None | None | Chassis Intrusion Switch/TPM 1.2 | XClarity Standard | 1x750W Platinum | 3-year | 07/17 |
| 7X10A00RCN | 1xXeon Gold 5120 14C/2.2GHz/19.25MB/105W/DDR4-2400 | 1x16GB RDIMM DDR4-2666 | 1x930-8i 2GB flash | 8x3.5" | 4x3.5" SATA/SAS HS | Open | None | None | None | None | Chassis Intrusion Switch/TPM 1.2 | XClarity Standard | 1x750W Platinum | 3-year | 07/17 |
| 7X10A00SCN | 1xXeon Gold 5122 4C/3.6GHz/16.5MB/105W/DDR4-2400 | 1x16GB RDIMM DDR4-2666 | 1x930-8i 2GB flash | 8x3.5" | 4x3.5" SATA/SAS HS | Open | None | None | None | None | Chassis Intrusion Switch/TPM 1.2 | XClarity Standard | 1x750W Platinum | 3-year | 07/17 |
| 7X10A00WCN | 1xXeon Gold 5120 14C/2.2GHz/19.25MB/105W/DDR4-2400 | 1x16GB RDIMM DDR4-2666 | 1x930-8i 2GB flash | 16x2.5" | 8x2.5" SATA/SAS HS | Open | None | None | None | None | Chassis Intrusion Switch/TPM 1.2 | XClarity Standard | 1x750W Platinum | 3-year | 07/17 |
| 7X10A00XCN | 1xXeon Gold 6130 16C/2.1GHz/22MB/125W/DDR4-2666 | 1x16GB RDIMM DDR4-2666 | 1x930-8i 2GB flash | 16x2.5" | 8x2.5" SATA/SAS HS | Open | None | None | None | None | Chassis Intrusion Switch/TPM 1.2 | XClarity Standard | 1x750W Platinum | 3-year | 07/17 |
| 7X10A00YCN | 1xXeon Gold 5118 12C/2.3GHz/16.5MB/105W/DDR4-2400 | 1x16GB RDIMM DDR4-2666 | 1x930-8i 2GB flash | 16x2.5" | 8x2.5" SATA/SAS HS | Open | None | None | None | None | Chassis Intrusion Switch/TPM 1.2 | XClarity Standard | 1x750W Platinum | 3-year | 07/17 |
| 7X10A00ZCN | 1xXeon Gold 6126 12C/2.6GHz/19.25MB/125W/DDR4-2666 | 1x16GB RDIMM DDR4-2666 | 1x930-8i 2GB flash | 16x2.5" | 8x2.5" SATA/SAS HS | Open | None | None | None | None | Chassis Intrusion Switch/TPM 1.2 | XClarity Standard | 1x750W Platinum | 3-year | 07/17 |
| 7X10A010CN | 1xXeon Gold 5115 10C/2.4GHz/13.75MB/85W/DDR4-2400 | 1x16GB RDIMM DDR4-2666 | 1x930-8i 2GB flash | 16x2.5" | 8x2.5" SATA/SAS HS | Open | None | None | None | None | Chassis Intrusion Switch/TPM 1.2 | XClarity Standard | 1x750W Platinum | 3-year | 07/17 |
| 7X10A012CN | 1xXeon Gold 6126 12C/2.6GHz/19.25MB/125W/DDR4-2666 | 1x8GB RDIMM DDR4-2666 | 1x530-8i | 8x3.5" | 4x3.5" SATA/SAS HS | Open | None | None | None | None | Chassis Intrusion Switch/TPM 1.2 | XClarity Standard | 1x750W Platinum | 3-year | 07/17 |
| 7X10A014CN | 1xXeon Gold 5122 4C/3.6GHz/16.5MB/105W/DDR4-2400 | 1x16GB RDIMM DDR4-2666 | 1x930-8i 2GB flash | 16x2.5" | 8x2.5" SATA/SAS HS | Open | None | None | None | None | Chassis Intrusion Switch/TPM 1.2 | XClarity Standard | 1x750W Platinum | 3-year | 07/17 |

ThinkSystem ST550 Models for India - Non TopSeller

Product Specifications Reference (PSREF)

| Model | Processor | Memory | RAID/HBA Adapter | Chassis | Disk Bays | Disks | Optical | GPU | Networking (PCIe) | M.2 Boot Drive | Security | System Management | Power Supply | Base Warranty | Ann Date (mm/yy) |
|------------|---|------------------------|---------------------|---------|---------------------|-------|-----------|------|-------------------|----------------|----------------------------------|-------------------|-----------------|---------------|------------------|
| 7X10A001SG | 1xXeon Gold 5115 10C/2.4GHz/13.75MB/85W/DDR4-2400 | 1x8GB RDIMM DDR4-2666 | 1x530-8i | 8x3.5" | 4x3.5" SATA/SAS HS | Open | DVD±RW HH | None | None | None | Chassis Intrusion Switch/TPM 1.2 | XClarity Standard | 1x550W Platinum | 3-year | 07/17 |
| 7X10A002SG | 1xXeon Gold 6130 16C/2.1GHz/22MB/125W/DDR4-2666 | 1x16GB RDIMM DDR4-2666 | 1x930-16i 4GB flash | 16x2.5" | 16x2.5" SATA/SAS HS | Open | DVD±RW HH | None | None | None | Chassis Intrusion Switch/TPM 1.2 | XClarity Standard | 1x750W Platinum | 3-year | 07/17 |
| 7X10A007SG | 1xXeon Gold 6126 12C/2.6GHz/19.25MB/125W/DDR4-2666 | 1x16GB RDIMM DDR4-2666 | 1x930-16i 4GB flash | 16x2.5" | 16x2.5" SATA/SAS HS | Open | DVD±RW HH | None | None | None | Chassis Intrusion Switch/TPM 1.2 | XClarity Standard | 1x750W Platinum | 3-year | 07/17 |
| 7X10A008SG | 1xXeon Gold 5120 14C/2.2GHz/19.25MB/105W/DDR4-2400 | 1x16GB RDIMM DDR4-2666 | 1x530-8i | 16x2.5" | 8x2.5" SATA/SAS HS | Open | DVD±RW HH | None | None | None | Chassis Intrusion Switch/TPM 1.2 | XClarity Standard | 1x550W Platinum | 3-year | 07/17 |
| 7X10A00FSG | 1xXeon Gold 5115 10C/2.4GHz/13.75MB/85W/DDR4-2666 | 1x8GB RDIMM DDR4-2666 | Onboard SATA | 8x3.5" | 4x3.5" SATA SS | Open | DVD±RW HH | None | None | None | Chassis Intrusion Switch/TPM 1.2 | XClarity Standard | 1x550W Platinum | 3-year | 07/17 |
| 7X10A00LSG | 1xXeon Gold 5118 12C/2.3GHz/16.5MB/105W/DDR4-2400 | 1x16GB RDIMM DDR4-2666 | 1x530-8i | 16x2.5" | 8x2.5" SATA/SAS HS | Open | DVD±RW HH | None | None | None | Chassis Intrusion Switch/TPM 1.2 | XClarity Standard | 1x550W Platinum | 3-year | 07/17 |
| 7X10A00NSG | 1xXeon Gold 6130 16C/2.1GHz/22MB/125W/DDR4-2666 | 1x16GB RDIMM DDR4-2666 | 1x930-8i 2GB flash | 16x2.5" | 8x2.5" SATA/SAS HS | Open | DVD±RW HH | None | None | None | Chassis Intrusion Switch/TPM 1.2 | XClarity Standard | 1x750W Platinum | 3-year | 07/17 |
| 7X10A00USG | 1xXeon Gold 5120 14C/2.2GHz/19.25MB/105W/DDR4-2400 | 1x16GB RDIMM DDR4-2666 | 1x930-8i 2GB flash | 16x2.5" | 8x2.5" SATA/SAS HS | Open | DVD±RW HH | None | None | None | Chassis Intrusion Switch/TPM 1.2 | XClarity Standard | 1x750W Platinum | 3-year | 07/17 |
| 7X10A015SG | 1xXeon Gold 5115 10C/2.4GHz/13.75MB/85W/DDR4-2400 | 1x16GB RDIMM DDR4-2666 | 1x530-8i | 8x3.5" | 4x3.5" SATA/SAS HS | Open | DVD±RW HH | None | None | None | Chassis Intrusion Switch/TPM 1.2 | XClarity Standard | 1x550W Platinum | 3-year | 07/17 |
| 7X10A016SG | 1xXeon Gold 5115 10C/2.4GHz/13.75MB/85W/DDR4-2400 | 1x16GB RDIMM DDR4-2666 | 1x530-8i | 16x2.5" | 8x2.5" SATA/SAS HS | Open | DVD±RW HH | None | None | None | Chassis Intrusion Switch/TPM 1.2 | XClarity Standard | 1x550W Platinum | 3-year | 07/17 |
| 7X10A027SG | 1xXeon Silver 4108 8C/1.8GHz/11MB/85W/DDR4-2400 | 1x16GB RDIMM DDR4-2666 | 1x530-8i | 16x2.5" | 8x2.5" SATA/SAS HS | Open | DVD±RW HH | None | None | None | Chassis Intrusion Switch/TPM 1.2 | XClarity Standard | 1x550W Platinum | 3-year | 07/17 |
| 7X10A02CSG | 1xXeon Bronze 3106 8C/1.7GHz/11MB/85W/DDR4-2133 | 1x8GB RDIMM DDR4-2666 | 1x530-8i | 16x2.5" | 8x2.5" SATA/SAS HS | Open | DVD±RW HH | None | None | None | Chassis Intrusion Switch/TPM 1.2 | XClarity Standard | 1x550W Platinum | 3-year | 07/17 |
| 7X10A02KSG | 1xXeon Silver 4116 12C/2.1GHz/16.5MB/85W/DDR4-2400 | 1x16GB RDIMM DDR4-2666 | 1x930-16i 4GB flash | 16x2.5" | 16x2.5" SATA/SAS HS | Open | DVD±RW HH | None | None | None | Chassis Intrusion Switch/TPM 1.2 | XClarity Standard | 1x750W Platinum | 3-year | 07/17 |
| 7X10A02QSG | 1xXeon Silver 4114 10C/2.2GHz/13.75MB/85W/DDR4-2400 | 1x16GB RDIMM DDR4-2666 | 1x530-8i | 16x2.5" | 8x2.5" SATA/SAS HS | Open | DVD±RW HH | None | None | None | Chassis Intrusion Switch/TPM 1.2 | XClarity Standard | 1x550W Platinum | 3-year | 07/17 |
| 7X10A02SSG | 1xXeon Bronze 3106 8C/1.7GHz/11MB/85W/DDR4-2133 | 1x8GB RDIMM DDR4-2666 | Onboard SATA | 8x3.5" | 4x3.5" SATA SS | Open | DVD±RW HH | None | None | None | Chassis Intrusion Switch/TPM 1.2 | XClarity Standard | 1x550W Platinum | 3-year | 07/17 |
| 7X10A02WSG | 1xXeon Silver 4114 10C/2.2GHz/13.75MB/85W/DDR4-2400 | 1x16GB RDIMM DDR4-2666 | 1x530-8i | 8x3.5" | 4x3.5" SATA/SAS HS | Open | DVD±RW HH | None | None | None | Chassis Intrusion Switch/TPM 1.2 | XClarity Standard | 1x550W Platinum | 3-year | 07/17 |
| 7X10A02XSG | 1xXeon Silver 4116 12C/2.1GHz/16.5MB/85W/DDR4-2400 | 1x8GB RDIMM DDR4-2666 | 1x530-8i | 16x2.5" | 8x2.5" SATA/SAS HS | Open | DVD±RW HH | None | None | None | Chassis Intrusion Switch/TPM 1.2 | XClarity Standard | 1x550W Platinum | 3-year | 07/17 |
| 7X10A030SG | 1xXeon Silver 4116 12C/2.1GHz/16.5MB/85W/DDR4-2400 | 1x16GB RDIMM DDR4-2666 | 1x930-8i 2GB flash | 16x2.5" | 8x2.5" SATA/SAS HS | Open | DVD±RW HH | None | None | None | Chassis Intrusion Switch/TPM 1.2 | XClarity Standard | 1x550W Platinum | 3-year | 07/17 |
| 7X10A033SG | 1xXeon Bronze 3106 8C/1.7GHz/11MB/85W/DDR4-2133 | 1x8GB RDIMM DDR4-2666 | 1x530-8i | 8x3.5" | 4x3.5" SATA/SAS HS | Open | DVD±RW HH | None | None | None | Chassis Intrusion Switch/TPM 1.2 | XClarity Standard | 1x550W Platinum | 3-year | 07/17 |
| 7X10A034SG | 1xXeon Silver 4108 8C/1.8GHz/11MB/85W/DDR4-2400 | 1x8GB RDIMM DDR4-2666 | 1x530-8i | 8x3.5" | 4x3.5" SATA/SAS HS | Open | DVD±RW HH | None | None | None | Chassis Intrusion Switch/TPM 1.2 | XClarity Standard | 1x550W Platinum | 3-year | 07/17 |
| 7X10A037SG | 1xXeon Silver 4110 8C/2.1GHz/11MB/85W/DDR4-2400 | 1x8GB RDIMM DDR4-2666 | 1x530-8i | 8x3.5" | 4x3.5" SATA/SAS HS | Open | DVD±RW HH | None | None | None | Chassis Intrusion Switch/TPM 1.2 | XClarity Standard | 1x550W Platinum | 3-year | 07/17 |
| 7X10A03BSG | 1xXeon Bronze 3106 8C/1.7GHz/11MB/85W/DDR4-2133 | 1x16GB RDIMM DDR4-2666 | 1x530-8i | 8x3.5" | 4x3.5" SATA/SAS HS | Open | DVD±RW HH | None | None | None | Chassis Intrusion Switch/TPM 1.2 | XClarity Standard | 1x550W Platinum | 3-year | 07/17 |
| 7X10A03CSG | 1xXeon Silver 4114 10C/2.2GHz/13.75MB/85W/DDR4-2400 | 1x16GB RDIMM DDR4-2666 | 1x930-8i 2GB flash | 16x2.5" | 8x2.5" SATA/SAS HS | Open | DVD±RW HH | None | None | None | Chassis Intrusion Switch/TPM 1.2 | XClarity Standard | 1x550W Platinum | 3-year | 07/17 |
| 7X10A03SSG | 1xXeon Bronze 3104 6C/1.7GHz/8.25MB/85W/DDR4-2133 | 1x8GB RDIMM DDR4-2666 | Onboard SATA | 8x3.5" | 4x3.5" SATA SS | Open | DVD±RW HH | None | None | None | Chassis Intrusion Switch/TPM 1.2 | XClarity Standard | 1x550W Platinum | 3-year | 07/17 |
| 7X10A03TSG | 1xXeon Bronze 3106 8C/1.7GHz/11MB/85W/DDR4-2133 | 1x16GB RDIMM DDR4-2666 | 1x930-8i 2GB flash | 16x2.5" | 8x2.5" SATA/SAS HS | Open | DVD±RW HH | None | None | None | Chassis Intrusion Switch/TPM 1.2 | XClarity Standard | 1x550W Platinum | 3-year | 07/17 |
| 7X10A03WSG | 1xXeon Silver 4108 8C/1.8GHz/11MB/85W/DDR4-2400 | 1x16GB RDIMM DDR4-2666 | 1x930-8i 2GB flash | 16x2.5" | 8x2.5" SATA/SAS HS | Open | DVD±RW HH | None | None | None | Chassis Intrusion Switch/TPM 1.2 | XClarity Standard | 1x550W Platinum | 3-year | 07/17 |
| 7X10A03XSG | 1xXeon Silver 4116 12C/2.1GHz/16.5MB/85W/DDR4-2400 | 1x16GB RDIMM DDR4-2666 | 1x530-8i | 8x3.5" | 4x3.5" SATA/SAS HS | Open | DVD±RW HH | None | None | None | Chassis Intrusion Switch/TPM 1.2 | XClarity Standard | 1x550W Platinum | 3-year | 07/17 |

ThinkSystem ST550 Models for Japan - Non TopSeller

Product Specifications Reference (PSREF)

| Model | Processor | Memory | RAID/HBA Adapter | Chassis | Disk Bays | Disks | Optical | GPU | Networking (PCIe) | M.2 Boot Drive | Security | System Management | Power Supply | Base Warranty | Ann Date (mm/yy) |
|------------|---|------------------------|---------------------|---------|----------------------------|-------|---------|------|-------------------|----------------|---|-------------------|------------------|---------------|------------------|
| 7X10A009JP | 1xXeon Gold 6130 16C/2.1GHz/22MB/125W/DDR4-2666 | 2x16GB RDIMM DDR4-2666 | 1x930-16i 4GB flash | 16x2.5" | 16x2.5" SATA/SAS HS | Open | DVD HH | None | None | None | Security Bezel/Chassis Intrusion Switch/TPM 1.2 | XClarity Advanced | 1x1100W Platinum | 3-year | 07/17 |
| 7X10A043JP | 1xXeon Silver 4110 8C/2.1GHz/11MB/85W/DDR4-2400 | 2x16GB RDIMM DDR4-2666 | 1x930-16i 4GB flash | 16x2.5" | 16x2.5" SATA/SAS HS | Open | DVD HH | None | None | None | Security Bezel/Chassis Intrusion Switch/TPM 1.2 | XClarity Advanced | 1x1100W Platinum | 3-year | 07/17 |
| 7X10A044JP | 1xXeon Bronze 3104 6C/1.7GHz/8.25MB/85W/DDR4-2133 | 2x16GB RDIMM DDR4-2666 | 1x930-8i 2GB flash | 8x3.5" | 8x3.5" SATA/SAS HS | Open | DVD HH | None | None | None | Security Bezel/Chassis Intrusion Switch/TPM 1.2 | XClarity Advanced | 1x550W Platinum | 3-year | 07/17 |
| 7X10A045JP | 1xXeon Bronze 3106 8C/1.7GHz/11MB/85W/DDR4-2133 | 2x16GB RDIMM DDR4-2666 | 1x930-16i 4GB flash | 16x2.5" | 16x2.5" SATA/SAS HS | Open | DVD HH | None | None | None | Security Bezel/Chassis Intrusion Switch/TPM 1.2 | XClarity Advanced | 1x750W Platinum | 3-year | 07/17 |
| 7X10A046JP | 1xXeon Silver 4110 8C/2.1GHz/11MB/85W/DDR4-2400 | 2x16GB RDIMM DDR4-2666 | 1x930-8i 2GB flash | 8x3.5" | 8x3.5" SATA/SAS HS | Open | DVD HH | None | None | None | Security Bezel/Chassis Intrusion Switch/TPM 1.2 | XClarity Advanced | 1x1100W Platinum | 3-year | 07/17 |
| 7X10A047JP | 1xXeon Silver 4114 10C/2.2GHz/13.75MB/85W/DDR4-2400 | 2x16GB RDIMM DDR4-2666 | 1x930-8i 2GB flash | 8x3.5" | 8x3.5" SATA/SAS HS | Open | DVD HH | None | None | None | Security Bezel/Chassis Intrusion Switch/TPM 1.2 | XClarity Advanced | 1x750W Platinum | 3-year | 07/17 |
| 7X10A048JP | 1xXeon Gold 6130 16C/2.1GHz/22MB/125W/DDR4-2666 | 2x16GB RDIMM DDR4-2666 | 1x930-24i 4GB flash | 16x2.5" | 20x2.5" (16+4) SATA/SAS HS | Open | None | None | None | None | Security Bezel/Chassis Intrusion Switch/TPM 1.2 | XClarity Advanced | 1x1100W Platinum | 3-year | 07/17 |
| 7X10A049JP | 1xXeon Gold 6130 16C/2.1GHz/22MB/125W/DDR4-2666 | 2x16GB RDIMM DDR4-2666 | 1x930-16i 4GB flash | 16x2.5" | 16x2.5" SATA/SAS HS | Open | DVD HH | None | None | None | Security Bezel/Chassis Intrusion Switch/TPM 1.2 | XClarity Advanced | 1x1100W Platinum | 3-year | 07/17 |

ThinkSystem ST550 Models for Latin America - TopSeller

Product Specifications Reference (PSREF)

| Model | Processor | Memory | RAID/HBA Adapter | Chassis | Disk Bays | Disks | Optical | GPU | Networking (PCIe) | M.2 Boot Drive | Security | System Management | Power Supply | Base Warranty | Ann Date (mm/yy) |
|------------|---|------------------------|--------------------|---------|--------------------|--------------------------------|-----------|------|-------------------|----------------|----------------------------------|-------------------|-----------------|---------------|------------------|
| 7X10A04ELA | 1xXeon Silver 4110 8C/2.1GHz/11MB/85W/DDR4-2400 | 1x8GB RDIMM DDR4-2666 | 1x530-8i | 8x3.5" | 4x3.5" SATA/SAS HS | Open | DVD±RW HH | None | None | None | Chassis Intrusion Switch/TPM 1.2 | XClarity Standard | 1x750W Platinum | 3-year | 07/17 |
| 7X10A04GLA | 1xXeon Silver 4108 8C/1.8GHz/11MB/85W/DDR4-2400 | 1x16GB RDIMM DDR4-2666 | 1x930-8i 2GB flash | 8x3.5" | 8x3.5" SATA/SAS HS | 2x2TB HDD 7.2K 3.5" SAS12Gbps | DVD±RW HH | None | None | None | Chassis Intrusion Switch/TPM 1.2 | XClarity Advanced | 2x750W Platinum | 3-year | 07/17 |
| 7X10A04JLA | 1xXeon Silver 4108 8C/1.8GHz/11MB/85W/DDR4-2400 | 1x16GB RDIMM DDR4-2666 | 1x930-8i 2GB flash | 8x3.5" | 8x3.5" SATA/SAS HS | 2x600GB HDD 15K 3.5" SAS12Gbps | DVD±RW HH | None | None | None | Chassis Intrusion Switch/TPM 1.2 | XClarity Advanced | 2x750W Platinum | 3-year | 07/17 |
| 7X10A04LLA | 1xXeon Silver 4110 8C/2.1GHz/11MB/85W/DDR4-2400 | 1x16GB RDIMM DDR4-2666 | 1x930-8i 2GB flash | 16x2.5" | 8x2.5" SATA/SAS HS | 2x900GB HDD 10K 2.5" SAS12Gbps | DVD±RW HH | None | None | None | Chassis Intrusion Switch/TPM 1.2 | XClarity Advanced | 2x750W Platinum | 3-year | 07/17 |
| 7X10A04QLA | 1xXeon Silver 4110 8C/2.1GHz/11MB/85W/DDR4-2400 | 1x16GB RDIMM DDR4-2666 | 1x930-8i 2GB flash | 8x3.5" | 8x3.5" SATA/SAS HS | 2x2TB HDD 7.2K 3.5" SAS12Gbps | DVD±RW HH | None | None | None | Chassis Intrusion Switch/TPM 1.2 | XClarity Advanced | 2x750W Platinum | 3-year | 07/17 |
| 7X10A04SLA | 1xXeon Bronze 3106 8C/1.7GHz/11MB/85W/DDR4-2133 | 1x8GB RDIMM DDR4-2666 | 1x530-8i | 8x3.5" | 4x3.5" SATA/SAS HS | Open | DVD±RW HH | None | None | None | Chassis Intrusion Switch/TPM 1.2 | XClarity Standard | 1x750W Platinum | 3-year | 07/17 |
| 7X10A04WLA | 1xXeon Silver 4108 8C/1.8GHz/11MB/85W/DDR4-2400 | 1x8GB RDIMM DDR4-2666 | 1x530-8i | 8x3.5" | 4x3.5" SATA/SAS HS | Open | DVD±RW HH | None | None | None | Chassis Intrusion Switch/TPM 1.2 | XClarity Standard | 1x750W Platinum | 3-year | 07/17 |
| 7X10A051LA | 1xXeon Silver 4108 8C/1.8GHz/11MB/85W/DDR4-2400 | 1x16GB RDIMM DDR4-2666 | 1x930-8i 2GB flash | 8x3.5" | 8x3.5" SATA/SAS HS | 2x2TB HDD 7.2K 3.5" SAS12Gbps | DVD±RW HH | None | None | None | Chassis Intrusion Switch/TPM 1.2 | XClarity Advanced | 2x750W Platinum | 3-year | 07/17 |
| 7X10A052LA | 1xXeon Silver 4108 8C/1.8GHz/11MB/85W/DDR4-2400 | 1x8GB RDIMM DDR4-2666 | 1x530-8i | 16x2.5" | 8x2.5" SATA/SAS HS | Open | DVD±RW HH | None | None | None | Chassis Intrusion Switch/TPM 1.2 | XClarity Standard | 1x750W Platinum | 3-year | 07/17 |
| 7X10A053LA | 1xXeon Silver 4108 8C/1.8GHz/11MB/85W/DDR4-2400 | 1x16GB RDIMM DDR4-2666 | 1x930-8i 2GB flash | 8x3.5" | 8x3.5" SATA/SAS HS | 2x600GB HDD 15K 3.5" SAS12Gbps | DVD±RW HH | None | None | None | Chassis Intrusion Switch/TPM 1.2 | XClarity Advanced | 2x750W Platinum | 3-year | 07/17 |
| 7X10A055LA | 1xXeon Bronze 3106 8C/1.7GHz/11MB/85W/DDR4-2133 | 1x8GB RDIMM DDR4-2666 | 1x530-8i | 16x2.5" | 8x2.5" SATA/SAS HS | Open | DVD±RW HH | None | None | None | Chassis Intrusion Switch/TPM 1.2 | XClarity Standard | 1x750W Platinum | 3-year | 07/17 |
| 7X10A057LA | 1xXeon Bronze 3104 6C/1.7GHz/8.25MB/85W/DDR4-2133 | 1x8GB RDIMM DDR4-2666 | 1x530-8i | 8x3.5" | 4x3.5" SATA/SAS HS | Open | DVD±RW HH | None | None | None | Chassis Intrusion Switch/TPM 1.2 | XClarity Standard | 1x750W Platinum | 3-year | 07/17 |
| 7X10A058LA | 1xXeon Silver 4110 8C/2.1GHz/11MB/85W/DDR4-2400 | 2x16GB RDIMM DDR4-2666 | 1x930-8i 2GB flash | 8x3.5" | 8x3.5" SATA/SAS HS | 3x4TB HDD 7.2K 3.5" SAS12Gbps | DVD±RW HH | None | None | None | Chassis Intrusion Switch/TPM 1.2 | XClarity Advanced | 2x750W Platinum | 3-year | 07/17 |
| 7X10A05BLA | 1xXeon Silver 4108 8C/1.8GHz/11MB/85W/DDR4-2400 | 1x16GB RDIMM DDR4-2666 | 1x930-8i 2GB flash | 8x3.5" | 8x3.5" SATA/SAS HS | 2x4TB HDD 7.2K 3.5" SAS12Gbps | DVD±RW HH | None | None | None | Chassis Intrusion Switch/TPM 1.2 | XClarity Advanced | 2x750W Platinum | 3-year | 07/17 |
| 7X10A05CLA | 1xXeon Bronze 3104 6C/1.7GHz/8.25MB/85W/DDR4-2133 | 1x8GB RDIMM DDR4-2666 | 1x530-8i | 16x2.5" | 8x2.5" SATA/SAS HS | Open | DVD±RW HH | None | None | None | Chassis Intrusion Switch/TPM 1.2 | XClarity Standard | 1x750W Platinum | 3-year | 07/17 |
| 7X10A05DLA | 1xXeon Silver 4114 10C/2.2GHz/13.75MB/85W/DDR4-2400 | 2x16GB RDIMM DDR4-2666 | 1x930-8i 2GB flash | 8x3.5" | 8x3.5" SATA/SAS HS | 3x600GB HDD 15K 3.5" SAS12Gbps | DVD±RW HH | None | None | None | Chassis Intrusion Switch/TPM 1.2 | XClarity Advanced | 2x750W Platinum | 3-year | 07/17 |
| 7X10A05ELA | 1xXeon Silver 4110 8C/2.1GHz/11MB/85W/DDR4-2400 | 2x16GB RDIMM DDR4-2666 | 1x930-8i 2GB flash | 16x2.5" | 8x2.5" SATA/SAS HS | 3x900GB HDD 10K 2.5" SAS12Gbps | DVD±RW HH | None | None | None | Chassis Intrusion Switch/TPM 1.2 | XClarity Advanced | 2x750W Platinum | 3-year | 07/17 |
| 7X10A05JLA | 1xXeon Silver 4110 8C/2.1GHz/11MB/85W/DDR4-2400 | 1x8GB RDIMM DDR4-2666 | 1x530-8i | 16x2.5" | 8x2.5" SATA/SAS HS | Open | DVD±RW HH | None | None | None | Chassis Intrusion Switch/TPM 1.2 | XClarity Standard | 1x750W Platinum | 3-year | 07/17 |

ThinkSystem ST550 Models for Latin America - Non TopSeller

Product Specifications Reference (PSREF)

| Model | Processor | Memory | RAID/HBA Adapter | Chassis | Disk Bays | Disks | Optical | GPU | Networking (PCIe) | M.2 Boot Drive | Security | System Management | Power Supply | Base Warranty | Ann Date (mm/yy) |
|------------|---|------------------------|--------------------|---------|--------------------|-------|-----------|------|-------------------|----------------|----------------------------------|-------------------|-----------------|---------------|------------------|
| 7X10A04KLA | 1xXeon Gold 6130 16C/2.1GHz/22MB/125W/DDR4-2666 | 1x16GB RDIMM DDR4-2666 | 1x930-8i 2GB flash | 8x3.5" | 4x3.5" SATA/SAS HS | Open | DVD±RW HH | None | None | None | Chassis Intrusion Switch/TPM 1.2 | XClarity Standard | 1x750W Platinum | 3-year | 07/17 |
| 7X10A04RLA | 1xXeon Gold 5115 10C/2.4GHz/13.75MB/85W/DDR4-2400 | 1x16GB RDIMM DDR4-2666 | 1x930-8i 2GB flash | 8x3.5" | 4x3.5" SATA/SAS HS | Open | DVD±RW HH | None | None | None | Chassis Intrusion Switch/TPM 1.2 | XClarity Standard | 1x750W Platinum | 3-year | 07/17 |
| 7X10A04XLA | 1xXeon Gold 5118 12C/2.3GHz/16.5MB/105W/DDR4-2400 | 1x16GB RDIMM DDR4-2666 | 1x930-8i 2GB flash | 8x3.5" | 4x3.5" SATA/SAS HS | Open | DVD±RW HH | None | None | None | Chassis Intrusion Switch/TPM 1.2 | XClarity Standard | 1x750W Platinum | 3-year | 07/17 |
| 7X10A054LA | 1xXeon Gold 6138 20C/2.0GHz/27.5MB/125W/DDR4-2666 | 1x16GB RDIMM DDR4-2666 | 1x930-8i 2GB flash | 16x2.5" | 8x2.5" SATA/SAS HS | Open | DVD±RW HH | None | None | None | Chassis Intrusion Switch/TPM 1.2 | XClarity Standard | 1x750W Platinum | 3-year | 07/17 |
| 7X10A056LA | 1xXeon Gold 6130 16C/2.1GHz/22MB/125W/DDR4-2666 | 1x16GB RDIMM DDR4-2666 | 1x930-8i 2GB flash | 16x2.5" | 8x2.5" SATA/SAS HS | Open | DVD±RW HH | None | None | None | Chassis Intrusion Switch/TPM 1.2 | XClarity Standard | 1x750W Platinum | 3-year | 07/17 |
| 7X10A059LA | 1xXeon Gold 6138 20C/2.0GHz/27.5MB/125W/DDR4-2666 | 1x16GB RDIMM DDR4-2666 | 1x930-8i 2GB flash | 8x3.5" | 4x3.5" SATA/SAS HS | Open | DVD±RW HH | None | None | None | Chassis Intrusion Switch/TPM 1.2 | XClarity Standard | 1x750W Platinum | 3-year | 07/17 |
| 7X10A05ALA | 1xXeon Gold 5118 12C/2.3GHz/16.5MB/105W/DDR4-2400 | 1x16GB RDIMM DDR4-2666 | 1x930-8i 2GB flash | 16x2.5" | 8x2.5" SATA/SAS HS | Open | DVD±RW HH | None | None | None | Chassis Intrusion Switch/TPM 1.2 | XClarity Standard | 1x750W Platinum | 3-year | 07/17 |
| 7X10A05FLA | 1xXeon Gold 5115 10C/2.4GHz/13.75MB/85W/DDR4-2400 | 1x16GB RDIMM DDR4-2666 | 1x930-8i 2GB flash | 16x2.5" | 8x2.5" SATA/SAS HS | Open | DVD±RW HH | None | None | None | Chassis Intrusion Switch/TPM 1.2 | XClarity Standard | 1x750W Platinum | 3-year | 07/17 |
| 7X10A05GLA | 1xXeon Gold 5120 14C/2.2GHz/19.25MB/105W/DDR4-2400 | 1x16GB RDIMM DDR4-2666 | 1x930-8i 2GB flash | 8x3.5" | 4x3.5" SATA/SAS HS | Open | DVD±RW HH | None | None | None | Chassis Intrusion Switch/TPM 1.2 | XClarity Standard | 1x750W Platinum | 3-year | 07/17 |
| 7X10A05HLA | 1xXeon Silver 4114 10C/2.2GHz/13.75MB/85W/DDR4-2400 | 1x8GB RDIMM DDR4-2666 | 1x530-8i | 16x2.5" | 8x2.5" SATA/SAS HS | Open | DVD±RW HH | None | None | None | Chassis Intrusion Switch/TPM 1.2 | XClarity Standard | 1x750W Platinum | 3-year | 07/17 |
| 7X10A05KLA | 1xXeon Gold 5120 14C/2.2GHz/19.25MB/105W/DDR4-2400 | 1x16GB RDIMM DDR4-2666 | 1x930-8i 2GB flash | 16x2.5" | 8x2.5" SATA/SAS HS | Open | DVD±RW HH | None | None | None | Chassis Intrusion Switch/TPM 1.2 | XClarity Standard | 1x750W Platinum | 3-year | 07/17 |
| 7X10A05LLA | 1xXeon Silver 4114 10C/2.2GHz/13.75MB/85W/DDR4-2400 | 1x8GB RDIMM DDR4-2666 | 1x530-8i | 8x3.5" | 4x3.5" SATA/SAS HS | Open | DVD±RW HH | None | None | None | Chassis Intrusion Switch/TPM 1.2 | XClarity Standard | 1x750W Platinum | 3-year | 07/17 |

ThinkSystem ST550 Models for Brazil - Non TopSeller

Product Specifications Reference (PSREF)

| Model | Processor | Memory | RAID/HBA Adapter | Chassis | Disk Bays | Disks | Optical | GPU | Networking (PCIe) | M.2 Boot Drive | Security | System Management | Power Supply | Base Warranty | Ann Date (mm/yy) |
|------------|--|------------------------|--------------------|---------|--------------------|-------|-----------|------|-------------------|----------------|---|-------------------|-----------------|---------------|------------------|
| 7X10A03YBR | 1xXeon Gold 5120 14C/2.2GHz/19.25MB/105W/DDR4-2400 | 1x16GB RDIMM DDR4-2666 | 1x930-8i 2GB flash | 16x2.5" | 8x2.5" SATA/SAS HS | Open | DVD HH | None | None | None | Security Bezel/Chassis Intrusion Switch/TPM 1.2 | XClarity Standard | 1x750W Platinum | 3-year | 07/17 |
| 7X10A040BR | 1xXeon Gold 5115 10C/2.4GHz/13.75MB/85W/DDR4-2400 | 1x16GB RDIMM DDR4-2666 | 1x930-8i 2GB flash | 16x2.5" | 8x2.5" SATA/SAS HS | Open | DVD±RW HH | None | None | None | Security Bezel/Chassis Intrusion Switch/TPM 1.2 | XClarity Standard | 2x750W Platinum | 3-year | 07/17 |
| 7X10A041BR | 1xXeon Gold 5118 12C/2.3GHz/16.5MB/105W/DDR4-2400 | 1x16GB RDIMM DDR4-2666 | 1x930-8i 2GB flash | 16x2.5" | 8x2.5" SATA/SAS HS | Open | None | None | None | None | Security Bezel/Chassis Intrusion Switch/TPM 1.2 | XClarity Standard | 1x750W Platinum | 3-year | 07/17 |
| 7X10A042BR | 1xXeon Gold 5118 12C/2.3GHz/16.5MB/105W/DDR4-2400 | 1x16GB RDIMM DDR4-2666 | 1x930-8i 2GB flash | 16x2.5" | 8x2.5" SATA/SAS HS | Open | DVD HH | None | None | None | Security Bezel/Chassis Intrusion Switch/TPM 1.2 | XClarity Standard | 1x750W Platinum | 3-year | 07/17 |



ThinkSystem SR850 Platform Specifications

| Components | Specification | | | | | | | | | | | | | | | | | | | | | | | | | | | | | | | | | | | | | | | | | | | | | | | | | | | | | | | | | | | | | | | | | | | | | | | | | | | | | | | | | | | | | | | | | | |
|-----------------------------|---|------------|------------|------------------|-------------|-------|------------------|------------------|----------|---------|--------|------------|----------|-------------|-----|------|------|-----|---|--------|------------|----------|-------------|-----|-----|------|----|---|--------|------------|----------|------------------|-----|-----|--------------|-----|---|---------|------------|----------|------------------|-----|-----|--------------|-----|---|--------|------------|----------|---|-----|------|------|---|---|---------|------------|----------|---|-----|------|------|---|---|--------|------------|----------|------------------|-----|-----|--------------|-----|---|--------|------------|----------|---|-----|------|------|---|---|---------|------------|----------|---|-----|------|------|---|---|
| Form factor | 2U rack | | | | | | | | | | | | | | | | | | | | | | | | | | | | | | | | | | | | | | | | | | | | | | | | | | | | | | | | | | | | | | | | | | | | | | | | | | | | | | | | | | | | | | | | | | |
| Dimensions | Height: 86.5 mm (3.4 in). Width: 482 mm (19.0 in) with rack latches. Depth: 763.7 mm (30.1 in) without security bezel | | | | | | | | | | | | | | | | | | | | | | | | | | | | | | | | | | | | | | | | | | | | | | | | | | | | | | | | | | | | | | | | | | | | | | | | | | | | | | | | | | | | | | | | | | |
| Weight | Maximum configuration: 59.52 lb (27 kg) | | | | | | | | | | | | | | | | | | | | | | | | | | | | | | | | | | | | | | | | | | | | | | | | | | | | | | | | | | | | | | | | | | | | | | | | | | | | | | | | | | | | | | | | | | |
| Processor | Supports up to four 165W Intel Xeon Scalable family processors, Gold or Platinum. 2 processor sockets on system board, 2 processor sockets on optional processor and memory expansion tray. Up to 28 cores at 2.1GHz, up to 3.6GHz with 4 cores. Four processors are connected in ring topology with two 10.4GT/s UPI (Ultra Path Interconnect) | | | | | | | | | | | | | | | | | | | | | | | | | | | | | | | | | | | | | | | | | | | | | | | | | | | | | | | | | | | | | | | | | | | | | | | | | | | | | | | | | | | | | | | | | | |
| Chipset | Intel C624 Platform Controller Hub | | | | | | | | | | | | | | | | | | | | | | | | | | | | | | | | | | | | | | | | | | | | | | | | | | | | | | | | | | | | | | | | | | | | | | | | | | | | | | | | | | | | | | | | | | |
| Memory | Up to 48 DIMM sockets. 24 DIMM sockets on system main board, 24 DIMM sockets on optional processor and memory expansion tray. Each processor supports up to 12 DIMM sockets with 6 channels. DDR4-2666. RDIMMs, LRDIMMs, 3DS RDIMMs are supported, but memory types cannot be intermixed. 3DS RDIMM is planned to available later | | | | | | | | | | | | | | | | | | | | | | | | | | | | | | | | | | | | | | | | | | | | | | | | | | | | | | | | | | | | | | | | | | | | | | | | | | | | | | | | | | | | | | | | | | |
| Memory capacity | Up to 1.5TB with 48 x 32GB RDIMMs and four processors. Or up to 3TB with 48 x 64GB LRDIMMs and four processors. Or up to 6TB with 48 x 128GB 3DS RDIMMs and four -M suffix processors. -M suffix processor supports 1.5TB memory per socket, non -M suffix processor supports 768GB memory per socket | | | | | | | | | | | | | | | | | | | | | | | | | | | | | | | | | | | | | | | | | | | | | | | | | | | | | | | | | | | | | | | | | | | | | | | | | | | | | | | | | | | | | | | | | | |
| Memory protection | ECC, memory mirroring, and memory sparing | | | | | | | | | | | | | | | | | | | | | | | | | | | | | | | | | | | | | | | | | | | | | | | | | | | | | | | | | | | | | | | | | | | | | | | | | | | | | | | | | | | | | | | | | | |
| Storage controllers | Supports the following RAID/HBA adapters: | | | | | | | | | | | | | | | | | | | | | | | | | | | | | | | | | | | | | | | | | | | | | | | | | | | | | | | | | | | | | | | | | | | | | | | | | | | | | | | | | | | | | | | | | | |
| | <table border="1"> <thead> <tr> <th>Feature</th> <th>Interface</th> <th>Drive type</th> <th>RAID levels</th> <th>JBOD</th> <th>Cache</th> <th>Cache protection</th> <th>FastPath</th> <th>Max qty</th> </tr> </thead> <tbody> <tr> <td>530-8i</td> <td>12Gbps SAS</td> <td>SATA/SAS</td> <td>0/1/10/5/50</td> <td>Yes</td> <td>None</td> <td>None</td> <td>Yes</td> <td>2</td> </tr> <tr> <td>730-8i</td> <td>12Gbps SAS</td> <td>SATA/SAS</td> <td>0/1/10/5/50</td> <td>Yes</td> <td>1GB</td> <td>None</td> <td>No</td> <td>2</td> </tr> <tr> <td>930-8i</td> <td>12Gbps SAS</td> <td>SATA/SAS</td> <td>0/1/10/5/50/6/60</td> <td>Yes</td> <td>2GB</td> <td>Flash backup</td> <td>Yes</td> <td>2</td> </tr> <tr> <td>930-16i</td> <td>12Gbps SAS</td> <td>SATA/SAS</td> <td>0/1/10/5/50/6/60</td> <td>Yes</td> <td>4GB</td> <td>Flash backup</td> <td>Yes</td> <td>1</td> </tr> <tr> <td>430-8i</td> <td>12Gbps SAS</td> <td>SATA/SAS</td> <td>-</td> <td>Yes</td> <td>None</td> <td>None</td> <td>-</td> <td>2</td> </tr> <tr> <td>430-16i</td> <td>12Gbps SAS</td> <td>SATA/SAS</td> <td>-</td> <td>Yes</td> <td>None</td> <td>None</td> <td>-</td> <td>1</td> </tr> <tr> <td>930-8e</td> <td>12Gbps SAS</td> <td>SATA/SAS</td> <td>0/1/10/5/50/6/60</td> <td>Yes</td> <td>4GB</td> <td>Flash backup</td> <td>Yes</td> <td>4</td> </tr> <tr> <td>430-8e</td> <td>12Gbps SAS</td> <td>SATA/SAS</td> <td>-</td> <td>Yes</td> <td>None</td> <td>None</td> <td>-</td> <td>8</td> </tr> <tr> <td>430-16e</td> <td>12Gbps SAS</td> <td>SATA/SAS</td> <td>-</td> <td>Yes</td> <td>None</td> <td>None</td> <td>-</td> <td>8</td> </tr> </tbody> </table> | Feature | Interface | Drive type | RAID levels | JBOD | Cache | Cache protection | FastPath | Max qty | 530-8i | 12Gbps SAS | SATA/SAS | 0/1/10/5/50 | Yes | None | None | Yes | 2 | 730-8i | 12Gbps SAS | SATA/SAS | 0/1/10/5/50 | Yes | 1GB | None | No | 2 | 930-8i | 12Gbps SAS | SATA/SAS | 0/1/10/5/50/6/60 | Yes | 2GB | Flash backup | Yes | 2 | 930-16i | 12Gbps SAS | SATA/SAS | 0/1/10/5/50/6/60 | Yes | 4GB | Flash backup | Yes | 1 | 430-8i | 12Gbps SAS | SATA/SAS | - | Yes | None | None | - | 2 | 430-16i | 12Gbps SAS | SATA/SAS | - | Yes | None | None | - | 1 | 930-8e | 12Gbps SAS | SATA/SAS | 0/1/10/5/50/6/60 | Yes | 4GB | Flash backup | Yes | 4 | 430-8e | 12Gbps SAS | SATA/SAS | - | Yes | None | None | - | 8 | 430-16e | 12Gbps SAS | SATA/SAS | - | Yes | None | None | - | 8 |
| | Feature | Interface | Drive type | RAID levels | JBOD | Cache | Cache protection | FastPath | Max qty | | | | | | | | | | | | | | | | | | | | | | | | | | | | | | | | | | | | | | | | | | | | | | | | | | | | | | | | | | | | | | | | | | | | | | | | | | | | | | | | | | |
| | 530-8i | 12Gbps SAS | SATA/SAS | 0/1/10/5/50 | Yes | None | None | Yes | 2 | | | | | | | | | | | | | | | | | | | | | | | | | | | | | | | | | | | | | | | | | | | | | | | | | | | | | | | | | | | | | | | | | | | | | | | | | | | | | | | | | | |
| | 730-8i | 12Gbps SAS | SATA/SAS | 0/1/10/5/50 | Yes | 1GB | None | No | 2 | | | | | | | | | | | | | | | | | | | | | | | | | | | | | | | | | | | | | | | | | | | | | | | | | | | | | | | | | | | | | | | | | | | | | | | | | | | | | | | | | | |
| | 930-8i | 12Gbps SAS | SATA/SAS | 0/1/10/5/50/6/60 | Yes | 2GB | Flash backup | Yes | 2 | | | | | | | | | | | | | | | | | | | | | | | | | | | | | | | | | | | | | | | | | | | | | | | | | | | | | | | | | | | | | | | | | | | | | | | | | | | | | | | | | | |
| | 930-16i | 12Gbps SAS | SATA/SAS | 0/1/10/5/50/6/60 | Yes | 4GB | Flash backup | Yes | 1 | | | | | | | | | | | | | | | | | | | | | | | | | | | | | | | | | | | | | | | | | | | | | | | | | | | | | | | | | | | | | | | | | | | | | | | | | | | | | | | | | | |
| | 430-8i | 12Gbps SAS | SATA/SAS | - | Yes | None | None | - | 2 | | | | | | | | | | | | | | | | | | | | | | | | | | | | | | | | | | | | | | | | | | | | | | | | | | | | | | | | | | | | | | | | | | | | | | | | | | | | | | | | | | |
| | 430-16i | 12Gbps SAS | SATA/SAS | - | Yes | None | None | - | 1 | | | | | | | | | | | | | | | | | | | | | | | | | | | | | | | | | | | | | | | | | | | | | | | | | | | | | | | | | | | | | | | | | | | | | | | | | | | | | | | | | | |
| | 930-8e | 12Gbps SAS | SATA/SAS | 0/1/10/5/50/6/60 | Yes | 4GB | Flash backup | Yes | 4 | | | | | | | | | | | | | | | | | | | | | | | | | | | | | | | | | | | | | | | | | | | | | | | | | | | | | | | | | | | | | | | | | | | | | | | | | | | | | | | | | | |
| 430-8e | 12Gbps SAS | SATA/SAS | - | Yes | None | None | - | 8 | | | | | | | | | | | | | | | | | | | | | | | | | | | | | | | | | | | | | | | | | | | | | | | | | | | | | | | | | | | | | | | | | | | | | | | | | | | | | | | | | | | |
| 430-16e | 12Gbps SAS | SATA/SAS | - | Yes | None | None | - | 8 | | | | | | | | | | | | | | | | | | | | | | | | | | | | | | | | | | | | | | | | | | | | | | | | | | | | | | | | | | | | | | | | | | | | | | | | | | | | | | | | | | | |
| | <i>Note: 730-8i is available in China only</i> | | | | | | | | | | | | | | | | | | | | | | | | | | | | | | | | | | | | | | | | | | | | | | | | | | | | | | | | | | | | | | | | | | | | | | | | | | | | | | | | | | | | | | | | | | |
| Disk drive bays | Supports 8 front 2.5" SATA/SAS HS bays with maximum 4 AnyBay, or 16 front 2.5" SATA/SAS HS bays with maximum 8 AnyBay Optional one or two internal M.2 SSD for boot, dual M.2 SSD supports mirroring | | | | | | | | | | | | | | | | | | | | | | | | | | | | | | | | | | | | | | | | | | | | | | | | | | | | | | | | | | | | | | | | | | | | | | | | | | | | | | | | | | | | | | | | | | |
| Internal storage | 2.5" HDD, SAS12Gbps, 7.2K | | | | | | | | | | | | | | | | | | | | | | | | | | | | | | | | | | | | | | | | | | | | | | | | | | | | | | | | | | | | | | | | | | | | | | | | | | | | | | | | | | | | | | | | | | |
| | 2.5" HDD, SAS12Gbps, 10K | | | | | | | | | | | | | | | | | | | | | | | | | | | | | | | | | | | | | | | | | | | | | | | | | | | | | | | | | | | | | | | | | | | | | | | | | | | | | | | | | | | | | | | | | | |
| | 2.5" HDD, SAS12Gbps, 15K | | | | | | | | | | | | | | | | | | | | | | | | | | | | | | | | | | | | | | | | | | | | | | | | | | | | | | | | | | | | | | | | | | | | | | | | | | | | | | | | | | | | | | | | | | |
| | 2.5" SSD, SAS12Gbps | | | | | | | | | | | | | | | | | | | | | | | | | | | | | | | | | | | | | | | | | | | | | | | | | | | | | | | | | | | | | | | | | | | | | | | | | | | | | | | | | | | | | | | | | | |
| | 2.5" SSD, SATA6Gbps | | | | | | | | | | | | | | | | | | | | | | | | | | | | | | | | | | | | | | | | | | | | | | | | | | | | | | | | | | | | | | | | | | | | | | | | | | | | | | | | | | | | | | | | | | |
| | 2.5" NVMe SSD, AnyBay | | | | | | | | | | | | | | | | | | | | | | | | | | | | | | | | | | | | | | | | | | | | | | | | | | | | | | | | | | | | | | | | | | | | | | | | | | | | | | | | | | | | | | | | | | |
| | NVMe SSD, PCIe 3.0 x4, HHHL adapter | | | | | | | | | | | | | | | | | | | | | | | | | | | | | | | | | | | | | | | | | | | | | | | | | | | | | | | | | | | | | | | | | | | | | | | | | | | | | | | | | | | | | | | | | | |
| M.2 SATA SSD for boot | | | | | | | | | | | | | | | | | | | | | | | | | | | | | | | | | | | | | | | | | | | | | | | | | | | | | | | | | | | | | | | | | | | | | | | | | | | | | | | | | | | | | | | | | | | |
| Optical | No internal optical bay. Optional USB DVD±RW optical drive | | | | | | | | | | | | | | | | | | | | | | | | | | | | | | | | | | | | | | | | | | | | | | | | | | | | | | | | | | | | | | | | | | | | | | | | | | | | | | | | | | | | | | | | | | |
| Network interfaces | One dedicated management port. One LOM slot for customized LOM with up to four RJ-45 or SFP+ ports, up to 10GbE. Wake-on-LAN and NC-SI are available on one port of LOM. Optional ML2 or PCIe adapters are supported. ML2 adapter requires riser card with ML2 slot. | | | | | | | | | | | | | | | | | | | | | | | | | | | | | | | | | | | | | | | | | | | | | | | | | | | | | | | | | | | | | | | | | | | | | | | | | | | | | | | | | | | | | | | | | | |
| Security features | Power-on and admin password. Trusted Platform Module, TCG 1.2 compliant, upgrade to 2.0 via UEFI setting. Optional TCM in China only. Optional lockable security bezel | | | | | | | | | | | | | | | | | | | | | | | | | | | | | | | | | | | | | | | | | | | | | | | | | | | | | | | | | | | | | | | | | | | | | | | | | | | | | | | | | | | | | | | | | | |
| Operating systems supported | Microsoft Windows Server 2016/2012 R2. Red Hat Enterprise Linux 7.3/6.9. SUSE Linux Enterprise Server 12 SP2/11 SP4. VMware vSphere (ESXi) 6.5/6.0 U3 | | | | | | | | | | | | | | | | | | | | | | | | | | | | | | | | | | | | | | | | | | | | | | | | | | | | | | | | | | | | | | | | | | | | | | | | | | | | | | | | | | | | | | | | | | |
| Systems management | XClarity Controller Advanced, optional upgrades to Enterprise is available. Energy Manager. XClarity Administrator. Lenovo Capacity Planner. Light Path Diagnostics with optional LCD diagnostic pull-out panel | | | | | | | | | | | | | | | | | | | | | | | | | | | | | | | | | | | | | | | | | | | | | | | | | | | | | | | | | | | | | | | | | | | | | | | | | | | | | | | | | | | | | | | | | | |
| GPU support | None | | | | | | | | | | | | | | | | | | | | | | | | | | | | | | | | | | | | | | | | | | | | | | | | | | | | | | | | | | | | | | | | | | | | | | | | | | | | | | | | | | | | | | | | | | |
| Base warranty | MT 7X18: 1-year limited onsite service with 9x5/NBD MT 7X19: 3-year limited onsite service with 9x5/NBD | | | | | | | | | | | | | | | | | | | | | | | | | | | | | | | | | | | | | | | | | | | | | | | | | | | | | | | | | | | | | | | | | | | | | | | | | | | | | | | | | | | | | | | | | | |
| Power supply | Up to two redundant hot-swap 750W/100W/1600W 80 PLUS Platinum qualified AC power supplies. 1600W Platinum are 200V - 240V, others are 100V - 240V | | | | | | | | | | | | | | | | | | | | | | | | | | | | | | | | | | | | | | | | | | | | | | | | | | | | | | | | | | | | | | | | | | | | | | | | | | | | | | | | | | | | | | | | | | |

| Components | Specification | |
|---|---|---|
| Video | Integrated Matrox G200 in XClarity Controller | |
| Cooling | Six hot-swap fans, N + 1 redundancy | |
| Front ports | One XClarity Controller USB connector, one USB 2.0 or USB 3.0 (model dependent), one optional VGA | |
| Rear ports | One VGA, two USB 3.0, one serial, one XClarity Controller network connector | |
| Environmental specification | Supports ASHRAE A4 with limitations. | |
| | Temperature - operating | A4: 5°C to 45°C (41°F to 113°F) A3: 5°C to 40°C (41°F to 104°F) A2: 10°C to 35°C (50°F to 95°F) |
| | Temperature - non operating (no package) | -10°C to 60°C (14°F to 140°F) |
| | Temperature - non operating (with package) | -40°C to 70°C (-40°F to 158°F) |
| | Altitude - operating | (Unpressurized): 0-10000ft (0-3048m) |
| | Humidity - operating, non-condensing | A4: 8%-90%. A3:8%-85%. A2:20%-80% |
| Humidity - storage (with package), non-condensing | 8%-90% | |
| | <i>Models should meet the following requirements to support A3 and A4:</i> | |
| | <ul style="list-style-type: none"> • NVMe drives not installed • PCIe flash adapter not installed • M.2 SSD not installed | |
| Environmental certification | Energy Star Server 2.1 certified. More environmental information please see: www.lenovo.com/social_responsibility/us/en/environment/ | |

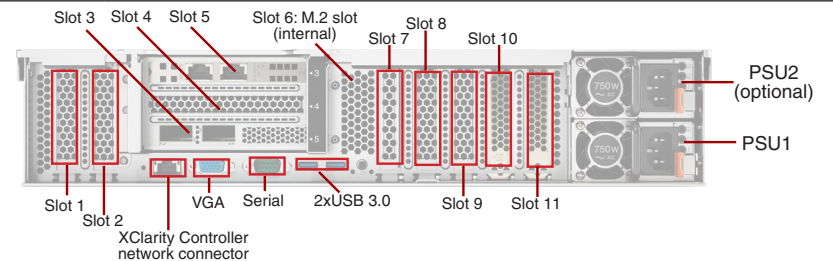

Note: All riser cards, expansion cards, and LOM adapters are optional. Slots are labelled as 1, 2, 3, 4, 5, 7, 8, 9, 10, 11. Slot 6 is internal M.2 slot for optional M.2 enablement kit

Expansion slots

| | |
|-----------------------|---|
| Slot 1 (onboard) | PCIe 3.0 x16, low profile, requires 2nd CPU |
| Slot 2 (onboard) | PCIe 3.0 x8, low profile, requires 2nd CPU |
| Slot 3-5 (riser card) | Supports one of the following for riser card: Option 1: PCIe 3.0 x8/x8/x8 (slot 3-5). Full height, half length. Option 2: PCIe 3.0 x8/x8/x8 ML2 (slot 3-5). Full height, half length Option 4: PCIe 3.0 x8/x16 ML2 (slot 3 and 5). Full height, half length Slot 3 - 5 requires 2nd CPU |
| Slot 7 (onboard) | LOM, low profile |
| Slot 8 (onboard) | PCIe 3.0 x8, low profile |
| Slot 9 (onboard) | PCIe 3.0 x8, low profile |
| Slot 10 (onboard) | PCIe 3.0 x8, low profile |
| Slot 11 (onboard) | PCIe 3.0 x16, low profile |

System unique options for ThinkSystem SR850

| | |
|------------|---|
| 7B27A03953 | ThinkSystem SR850/SR860 Processor and Memory Expansion Tray |
| 7C57A03999 | ThinkSystem SR850/SR860 2.5" Anybay 8-Bay BP Kit |
| 7C57A03998 | ThinkSystem SR850/SR860 2.5" SATA/SAS 8-Bay BP Kit |
| 7X97A03954 | ThinkSystem SR850 Front VGA Connector Upgrade Kit |
| 7C57A03950 | ThinkSystem SR850/SR860 x8/x8/x8 PCIe FH Riser Kit |
| 7C57A03951 | ThinkSystem SR850/SR860 x8/x8/x8ML2 PCIe FH Riser Kit |
| 7C57A03952 | ThinkSystem SR850/SR860 x8/x16ML2 PCIe FH Riser Kit |

ThinkSystem SR850 Models for USA and Canada - Non TopSeller

Product Specifications Reference (PSREF)

| Model | Processor | Memory | RAID/HBA Adapter | Disk Bays | Disks | Networking (LOM/ML2/PCIe) | M.2 Boot Drive | Riser Card for Slot 3-5 | Front VGA | Front Panel | Front USB | Security | System Management | Power Supply | Base Warranty | Ann Date (mm/yy) |
|------------|---|------------------------------|-----------------------|---|-------|---------------------------|----------------|-------------------------|--------------|--------------|-----------|----------|----------------------|---------------------|---------------|------------------|
| 7X19A008NA | 4xXeon Gold 5115 10C/2.4GHz/ 13.75MB/85W/DDR4-2400 | 4x32GB RDIMM DDR4-2666 | 1x930-8i 2GB flash | 8x2.5" (4 SATA/ SAS, 4 AnyBay) HS | Open | None | None | x8 / x8 / x8, FHHL | Front VGA | Pull-out LCD | USB 2.0 | TPM 1.2 | XClarity Advanced | 2x1100W Platinum | 3-year | 07/17 |
| 7X19A00JNA | 4xXeon Platinum 8170 26C/2.1GHz/ 35.75MB/165W/DDR4-2666 | 4x32GB RDIMM DDR4-2666 | 1x930-8i 2GB flash | 8x2.5" (4 SATA/ SAS, 4 AnyBay) HS | Open | None | None | x8 / x8 / x8, FHHL | Front VGA | Pull-out LCD | USB 2.0 | TPM 1.2 | XClarity Advanced | 2x1600W Platinum | 3-year | 07/17 |
| 7X19A00SNA | 4xXeon Gold 6130 16C/2.1GHz/ 22MB/125W/DDR4-2666 | 4x32GB RDIMM DDR4-2666 | 1x930-8i 2GB flash | 8x2.5" (4 SATA/ SAS, 4 AnyBay) HS | Open | None | None | x8 / x8 / x8, FHHL | Front VGA | Pull-out LCD | USB 2.0 | TPM 1.2 | XClarity Advanced | 2x1100W Platinum | 3-year | 07/17 |
| 7X19A00TNA | 4xXeon Platinum 8176 28C/2.1GHz/ 38.5MB/165W/DDR4-2666 | 4x32GB RDIMM DDR4-2666 | 1x930-8i 2GB flash | 8x2.5" (4 SATA/ SAS, 4 AnyBay) HS | Open | None | None | x8 / x8 / x8, FHHL | Front VGA | Pull-out LCD | USB 2.0 | TPM 1.2 | XClarity Advanced | 2x1600W Platinum | 3-year | 07/17 |
| 7X19A00UNA | 4xXeon Gold 6138 20C/2.0GHz/ 27.5MB/125W/DDR4-2666 | 4x32GB RDIMM DDR4-2666 | 1x930-8i 2GB flash | 8x2.5" (4 SATA/ SAS, 4 AnyBay) HS | Open | None | None | x8 / x8 / x8, FHHL | Front VGA | Pull-out LCD | USB 2.0 | TPM 1.2 | XClarity Advanced | 2x1100W Platinum | 3-year | 07/17 |
| 7X19A00YNA | 4xXeon Gold 6148 20C/2.4GHz/ 27.5MB/150W/DDR4-2666 | 4x32GB RDIMM DDR4-2666 | 1x930-8i 2GB flash | 8x2.5" (4 SATA/ SAS, 4 AnyBay) HS | Open | None | None | x8 / x8 / x8, FHHL | Front VGA | Pull-out LCD | USB 2.0 | TPM 1.2 | XClarity Advanced | 2x1600W Platinum | 3-year | 07/17 |
| 7X19A014NA | 4xXeon Gold 6150 18C/2.7GHz/ 24.75MB/165W/DDR4-2666 | 4x32GB RDIMM DDR4-2666 | 1x930-8i 2GB flash | 8x2.5" (4 SATA/ SAS, 4 AnyBay) HS | Open | None | None | x8 / x8 / x8, FHHL | Front VGA | Pull-out LCD | USB 2.0 | TPM 1.2 | XClarity Advanced | 2x1600W Platinum | 3-year | 07/17 |
| 7X19A015NA | 4xXeon Gold 6152 22C/2.1GHz/ 30.25MB/140W/DDR4-2666 | 4x32GB RDIMM DDR4-2666 | 1x930-8i 2GB flash | 8x2.5" (4 SATA/ SAS, 4 AnyBay) HS | Open | None | None | x8 / x8 / x8, FHHL | Front VGA | Pull-out LCD | USB 2.0 | TPM 1.2 | XClarity Advanced | 2x1600W Platinum | 3-year | 07/17 |
| 7X19A018NA | 4xXeon Gold 5118 12C/2.3GHz/ 16.5MB/105W/DDR4-2400 | 4x32GB RDIMM DDR4-2666 | 1x930-8i 2GB flash | 8x2.5" (4 SATA/ SAS, 4 AnyBay) HS | Open | None | None | x8 / x8 / x8, FHHL | Front VGA | Pull-out LCD | USB 2.0 | TPM 1.2 | XClarity Advanced | 2x1100W Platinum | 3-year | 07/17 |
| 7X19A019NA | 4xXeon Gold 5120 14C/2.2GHz/ 19.25MB/105W/DDR4-2400 | 4x32GB RDIMM DDR4-2666 | 1x930-8i 2GB flash | 8x2.5" (4 SATA/ SAS, 4 AnyBay) HS | Open | None | None | x8 / x8 / x8, FHHL | Front VGA | Pull-out LCD | USB 2.0 | TPM 1.2 | XClarity Advanced | 2x1100W Platinum | 3-year | 07/17 |
| 7X19A01CNA | 4xXeon Gold 6126 12C/2.6GHz/ 19.25MB/125W/DDR4-2666 | 4x32GB RDIMM DDR4-2666 | 1x930-8i 2GB flash | 8x2.5" (4 SATA/ SAS, 4 AnyBay) HS | Open | None | None | x8 / x8 / x8, FHHL | Front VGA | Pull-out LCD | USB 2.0 | TPM 1.2 | XClarity Advanced | 2x1100W Platinum | 3-year | 07/17 |
| 7X19A01LNA | 4xXeon Platinum 8160 24C/2.1GHz/ 33MB/150W/DDR4-2666 | 4x32GB RDIMM DDR4-2666 | 1x930-8i 2GB flash | 8x2.5" (4 SATA/ SAS, 4 AnyBay) HS | Open | None | None | x8 / x8 / x8, FHHL | Front VGA | Pull-out LCD | USB 2.0 | TPM 1.2 | XClarity Advanced | 2x1600W Platinum | 3-year | 07/17 |
| 7X19A01YNA | 4xXeon Platinum 8164 26C/2.0GHz/ 35.75MB/150W/DDR4-2666 | 4x32GB RDIMM DDR4-2666 | 1x930-8i 2GB flash | 8x2.5" (4 SATA/ SAS, 4 AnyBay) HS | Open | None | None | x8 / x8 / x8, FHHL | Front VGA | Pull-out LCD | USB 2.0 | TPM 1.2 | XClarity Advanced | 2x1600W Platinum | 3-year | 07/17 |

ThinkSystem SR850 Models for EMEA - Non TopSeller

Product Specifications Reference (PSREF)

| Model | Processor | Memory | RAID/HBA Adapter | Disk Bays | Disks | Networking (LOM/ML2/PCIe) | M.2 Boot Drive | Riser Card for Slot 3-5 | Front VGA | Front Panel | Front USB | Security | System Management | Power Supply | Base Warranty | Ann Date (mm/yy) |
|------------|---|------------------------------|-----------------------|---|-------|---------------------------|----------------|-------------------------|--------------|--------------|-----------|----------|----------------------|---------------------|---------------|------------------|
| 7X19A02GEA | 4xXeon Gold 5115 10C/2.4GHz/ 13.75MB/85W/DDR4-2400 | 4x32GB RDIMM DDR4-2666 | 1x930-8i 2GB flash | 8x2.5" (4 SATA/ SAS, 4 AnyBay) HS | Open | None | None | x8 / x8 / x8, FHHL | Front VGA | Pull-out LCD | USB 3.0 | TPM 1.2 | XClarity Advanced | 2x1100W Platinum | 3-year | 07/17 |
| 7X19A02HEA | 4xXeon Gold 5118 12C/2.3GHz/ 16.5MB/105W/DDR4-2400 | 4x32GB RDIMM DDR4-2666 | 1x930-8i 2GB flash | 8x2.5" (4 SATA/ SAS, 4 AnyBay) HS | Open | None | None | x8 / x8 / x8, FHHL | Front VGA | Pull-out LCD | USB 3.0 | TPM 1.2 | XClarity Advanced | 2x1100W Platinum | 3-year | 07/17 |
| 7X19A02JEA | 4xXeon Gold 5120 14C/2.2GHz/ 19.25MB/105W/DDR4-2400 | 4x32GB RDIMM DDR4-2666 | 1x930-8i 2GB flash | 8x2.5" (4 SATA/ SAS, 4 AnyBay) HS | Open | None | None | x8 / x8 / x8, FHHL | Front VGA | Pull-out LCD | USB 3.0 | TPM 1.2 | XClarity Advanced | 2x1100W Platinum | 3-year | 07/17 |
| 7X19A02KEA | 4xXeon Gold 6126 12C/2.6GHz/ 19.25MB/125W/DDR4-2666 | 4x32GB RDIMM DDR4-2666 | 1x930-8i 2GB flash | 8x2.5" (4 SATA/ SAS, 4 AnyBay) HS | Open | None | None | x8 / x8 / x8, FHHL | Front VGA | Pull-out LCD | USB 3.0 | TPM 1.2 | XClarity Advanced | 2x1100W Platinum | 3-year | 07/17 |
| 7X19A02LEA | 4xXeon Gold 6130 16C/2.1GHz/ 22MB/125W/DDR4-2666 | 4x32GB RDIMM DDR4-2666 | 1x930-8i 2GB flash | 8x2.5" (4 SATA/ SAS, 4 AnyBay) HS | Open | None | None | x8 / x8 / x8, FHHL | Front VGA | Pull-out LCD | USB 3.0 | TPM 1.2 | XClarity Advanced | 2x1100W Platinum | 3-year | 07/17 |
| 7X19A02MEA | 4xXeon Gold 6138 20C/2.0GHz/ 27.5MB/125W/DDR4-2666 | 4x32GB RDIMM DDR4-2666 | 1x930-8i 2GB flash | 8x2.5" (4 SATA/ SAS, 4 AnyBay) HS | Open | None | None | x8 / x8 / x8, FHHL | Front VGA | Pull-out LCD | USB 3.0 | TPM 1.2 | XClarity Advanced | 2x1100W Platinum | 3-year | 07/17 |
| 7X19A02NEA | 4xXeon Gold 6148 20C/2.4GHz/ 27.5MB/150W/DDR4-2666 | 4x32GB RDIMM DDR4-2666 | 1x930-8i 2GB flash | 8x2.5" (4 SATA/ SAS, 4 AnyBay) HS | Open | None | None | x8 / x8 / x8, FHHL | Front VGA | Pull-out LCD | USB 3.0 | TPM 1.2 | XClarity Advanced | 2x1600W Platinum | 3-year | 07/17 |
| 7X19A02PEA | 4xXeon Gold 6150 18C/2.7GHz/ 24.75MB/165W/DDR4-2666 | 4x32GB RDIMM DDR4-2666 | 1x930-8i 2GB flash | 8x2.5" (4 SATA/ SAS, 4 AnyBay) HS | Open | None | None | x8 / x8 / x8, FHHL | Front VGA | Pull-out LCD | USB 3.0 | TPM 1.2 | XClarity Advanced | 2x1600W Platinum | 3-year | 07/17 |
| 7X19A02QEA | 4xXeon Gold 6152 22C/2.1GHz/ 30.25MB/140W/DDR4-2666 | 4x32GB RDIMM DDR4-2666 | 1x930-8i 2GB flash | 8x2.5" (4 SATA/ SAS, 4 AnyBay) HS | Open | None | None | x8 / x8 / x8, FHHL | Front VGA | Pull-out LCD | USB 3.0 | TPM 1.2 | XClarity Advanced | 2x1600W Platinum | 3-year | 07/17 |
| 7X19A02REA | 4xXeon Platinum 8160 24C/2.1GHz/ 33MB/150W/DDR4-2666 | 4x32GB RDIMM DDR4-2666 | 1x930-8i 2GB flash | 8x2.5" (4 SATA/ SAS, 4 AnyBay) HS | Open | None | None | x8 / x8 / x8, FHHL | Front VGA | Pull-out LCD | USB 3.0 | TPM 1.2 | XClarity Advanced | 2x1600W Platinum | 3-year | 07/17 |
| 7X19A02SEA | 4xXeon Platinum 8164 26C/2.0GHz/ 35.75MB/150W/DDR4-2666 | 4x32GB RDIMM DDR4-2666 | 1x930-8i 2GB flash | 8x2.5" (4 SATA/ SAS, 4 AnyBay) HS | Open | None | None | x8 / x8 / x8, FHHL | Front VGA | Pull-out LCD | USB 3.0 | TPM 1.2 | XClarity Advanced | 2x1600W Platinum | 3-year | 07/17 |
| 7X19A02TEA | 4xXeon Platinum 8170 26C/2.1GHz/ 35.75MB/165W/DDR4-2666 | 4x32GB RDIMM DDR4-2666 | 1x930-8i 2GB flash | 8x2.5" (4 SATA/ SAS, 4 AnyBay) HS | Open | None | None | x8 / x8 / x8, FHHL | Front VGA | Pull-out LCD | USB 3.0 | TPM 1.2 | XClarity Advanced | 2x1600W Platinum | 3-year | 07/17 |
| 7X19A02UEA | 4xXeon Platinum 8176 28C/2.1GHz/ 38.5MB/165W/DDR4-2666 | 4x32GB RDIMM DDR4-2666 | 1x930-8i 2GB flash | 8x2.5" (4 SATA/ SAS, 4 AnyBay) HS | Open | None | None | x8 / x8 / x8, FHHL | Front VGA | Pull-out LCD | USB 3.0 | TPM 1.2 | XClarity Advanced | 2x1600W Platinum | 3-year | 07/17 |

ThinkSystem SR850 Models for Australia and New Zealand - Non TopSeller

Product Specifications Reference (PSREF)

| Model | Processor | Memory | RAID/HBA Adapter | Disk Bays | Disks | Networking (LOM/ML2/PCIe) | M.2 Boot Drive | Riser Card for Slot 3-5 | Front VGA | Front Panel | Front USB | Security | System Management | Power Supply | Base Warranty | Ann Date (mm/yy) |
|------------|---|------------------------------|-----------------------|-----------------------|-------|---------------------------|----------------|-------------------------|-----------|--------------|-----------|----------|----------------------|---------------------|---------------|------------------|
| 7X19A003AU | 2xXeon Gold 5115 10C/2.4GHz/ 13.75MB/85W/DDR4-2400 | 2x8GB RDIMM DDR4-2666 | 1x530-8i | 8x2.5" SATA/SAS HS | Open | 4xGbE RJ-45 LOM | None | None | None | Basic | USB 2.0 | TPM 1.2 | XClarity Advanced | 1x750W Platinum | 3-year | 07/17 |
| 7X19A009AU | 2xXeon Gold 5115 10C/2.4GHz/ 13.75MB/85W/DDR4-2400 | 2x16GB RDIMM DDR4-2666 | 1x930-8i 2GB flash | 8x2.5" SATA/SAS HS | Open | 4xGbE RJ-45 LOM | None | None | None | Basic | USB 2.0 | TPM 1.2 | XClarity Advanced | 1x750W Platinum | 3-year | 07/17 |
| 7X19A00DAU | 2xXeon Gold 6134 8C/3.2GHz/ 24.75MB/130W/DDR4-2666 | 2x16GB RDIMM DDR4-2666 | 1x930-8i 2GB flash | 8x2.5" SATA/SAS HS | Open | 4xGbE RJ-45 LOM | None | None | None | Pull-out LCD | USB 3.0 | TPM 1.2 | XClarity Advanced | 1x1100W Platinum | 3-year | 07/17 |
| 7X19A00MAU | 2xXeon Platinum 8176 28C/2.1GHz/ 38.5MB/165W/DDR4-2666 | 2x16GB RDIMM DDR4-2666 | 1x930-8i 2GB flash | 8x2.5" SATA/SAS HS | Open | 4xGbE RJ-45 LOM | None | None | None | Pull-out LCD | USB 3.0 | TPM 1.2 | XClarity Advanced | 1x1600W Platinum | 3-year | 07/17 |
| 7X19A00NAU | 2xXeon Gold 6142 16C/2.6GHz/ 22MB/150W/DDR4-2666 | 2x16GB RDIMM DDR4-2666 | 1x930-8i 2GB flash | 8x2.5" SATA/SAS HS | Open | 4xGbE RJ-45 LOM | None | None | None | Pull-out LCD | USB 3.0 | TPM 1.2 | XClarity Advanced | 1x1100W Platinum | 3-year | 07/17 |
| 7X19A00PAU | 2xXeon Platinum 8170 26C/2.1GHz/ 35.75MB/165W/DDR4-2666 | 2x16GB RDIMM DDR4-2666 | 1x930-8i 2GB flash | 8x2.5" SATA/SAS HS | Open | 4xGbE RJ-45 LOM | None | None | None | Pull-out LCD | USB 3.0 | TPM 1.2 | XClarity Advanced | 1x1600W Platinum | 3-year | 07/17 |
| 7X19A010AU | 2xXeon Gold 6136 12C/3.0GHz/ 24.75MB/150W/DDR4-2666 | 2x16GB RDIMM DDR4-2666 | 1x930-8i 2GB flash | 8x2.5" SATA/SAS HS | Open | 4xGbE RJ-45 LOM | None | None | None | Pull-out LCD | USB 3.0 | TPM 1.2 | XClarity Advanced | 1x1100W Platinum | 3-year | 07/17 |
| 7X19A01AAU | 2xXeon Platinum 8153 16C/2.0GHz/ 22MB/125W/DDR4-2666 | 2x16GB RDIMM DDR4-2666 | 1x930-8i 2GB flash | 8x2.5" SATA/SAS HS | Open | 4xGbE RJ-45 LOM | None | None | None | Pull-out LCD | USB 3.0 | TPM 1.2 | XClarity Advanced | 1x1100W Platinum | 3-year | 07/17 |
| 7X19A01DAU | 2xXeon Platinum 8160 24C/2.1GHz/ 33MB/150W/DDR4-2666 | 2x16GB RDIMM DDR4-2666 | 1x930-8i 2GB flash | 8x2.5" SATA/SAS HS | Open | 4xGbE RJ-45 LOM | None | None | None | Pull-out LCD | USB 3.0 | TPM 1.2 | XClarity Advanced | 1x1100W Platinum | 3-year | 07/17 |
| 7X19A01GAU | 2xXeon Gold 5120 14C/2.2GHz/ 19.25MB/105W/DDR4-2400 | 2x16GB RDIMM DDR4-2666 | 1x930-8i 2GB flash | 8x2.5" SATA/SAS HS | Open | 4xGbE RJ-45 LOM | None | None | None | Pull-out LCD | USB 3.0 | TPM 1.2 | XClarity Advanced | 1x750W Platinum | 3-year | 07/17 |
| 7X19A01MAU | 2xXeon Gold 6140 18C/2.3GHz/ 24.75MB/140W/DDR4-2666 | 2x16GB RDIMM DDR4-2666 | 1x930-8i 2GB flash | 8x2.5" SATA/SAS HS | Open | 4xGbE RJ-45 LOM | None | None | None | Pull-out LCD | USB 3.0 | TPM 1.2 | XClarity Advanced | 1x1100W Platinum | 3-year | 07/17 |
| 7X19A01VAU | 2xXeon Gold 6138 20C/2.0GHz/ 27.5MB/125W/DDR4-2666 | 2x16GB RDIMM DDR4-2666 | 1x930-8i 2GB flash | 8x2.5" SATA/SAS HS | Open | 4xGbE RJ-45 LOM | None | None | None | Pull-out LCD | USB 3.0 | TPM 1.2 | XClarity Advanced | 1x1100W Platinum | 3-year | 07/17 |
| 7X19A01ZAU | 2xXeon Platinum 8164 26C/2.0GHz/ 35.75MB/150W/DDR4-2666 | 2x16GB RDIMM DDR4-2666 | 1x930-8i 2GB flash | 8x2.5" SATA/SAS HS | Open | 4xGbE RJ-45 LOM | None | None | None | Pull-out LCD | USB 3.0 | TPM 1.2 | XClarity Advanced | 1x1100W Platinum | 3-year | 07/17 |
| 7X19A025AU | 2xXeon Gold 5118 12C/2.3GHz/ 16.5MB/105W/DDR4-2400 | 2x16GB RDIMM DDR4-2666 | 1x530-8i | 8x2.5" SATA/SAS HS | Open | 4xGbE RJ-45 LOM | None | None | None | Basic | USB 2.0 | TPM 1.2 | XClarity Advanced | 1x750W Platinum | 3-year | 07/17 |
| 7X19A029AU | 2xXeon Gold 5118 12C/2.3GHz/ 16.5MB/105W/DDR4-2400 | 2x16GB RDIMM DDR4-2666 | 1x930-8i 2GB flash | 8x2.5" SATA/SAS HS | Open | 4xGbE RJ-45 LOM | None | None | None | Basic | USB 2.0 | TPM 1.2 | XClarity Advanced | 1x750W Platinum | 3-year | 07/17 |
| 7X19A02CAU | 2xXeon Gold 6152 22C/2.1GHz/ 30.25MB/140W/DDR4-2666 | 2x16GB RDIMM DDR4-2666 | 1x930-8i 2GB flash | 8x2.5" SATA/SAS HS | Open | 4xGbE RJ-45 LOM | None | None | None | Pull-out LCD | USB 3.0 | TPM 1.2 | XClarity Advanced | 1x1100W Platinum | 3-year | 07/17 |

ThinkSystem SR850 Models for South East Asian (ASEAN) - Non TopSeller
Product Specifications Reference (PSREF)

| Model | Processor | Memory | RAID/HBA Adapter | Disk Bays | Disks | Networking (LOM/ML2/PCIe) | M.2 Boot Drive | Riser Card for Slot 3-5 | Front VGA | Front Panel | Front USB | Security | System Management | Power Supply | Base Warranty | Ann Date (mm/yy) |
|------------|---|------------------------------|------------------|-----------------------|-------|---------------------------|----------------|-------------------------|--------------|--------------|-----------|----------|----------------------|---------------------|---------------|------------------|
| 7X19A00GSG | 2xXeon Gold 5115 10C/2.4GHz/ 13.75MB/85W/DDR4-2400 | 2x16GB RDIMM DDR4-2666 | 1x530-8i | 8x2.5" SATA/SAS HS | Open | 4x10GbE RJ-45 LOM | None | x8 / x8 / x8, FHHL | Front VGA | Pull-out LCD | USB 3.0 | TPM 1.2 | XClarity Advanced | 1x1100W Platinum | 3-year | 07/17 |
| 7X19A00QSG | 2xXeon Gold 5118 12C/2.3GHz/ 16.5MB/105W/DDR4-2400 | 2x16GB RDIMM DDR4-2666 | 1x530-8i | 8x2.5" SATA/SAS HS | Open | 4x10GbE RJ-45 LOM | None | x8 / x8 / x8, FHHL | Front VGA | Pull-out LCD | USB 3.0 | TPM 1.2 | XClarity Advanced | 1x1100W Platinum | 3-year | 07/17 |
| 7X19A00VSG | 2xXeon Gold 6140 18C/2.3GHz/ 24.75MB/140W/DDR4-2666 | 2x32GB RDIMM DDR4-2666 | 1x530-8i | 8x2.5" SATA/SAS HS | Open | 4x10GbE RJ-45 LOM | None | x8 / x8 / x8, FHHL | Front VGA | Pull-out LCD | USB 3.0 | TPM 1.2 | XClarity Advanced | 1x1600W Platinum | 3-year | 07/17 |
| 7X19A00XSG | 2xXeon Gold 6130 16C/2.1GHz/ 22MB/125W/DDR4-2666 | 2x32GB RDIMM DDR4-2666 | 1x530-8i | 8x2.5" SATA/SAS HS | Open | 4x10GbE RJ-45 LOM | None | x8 / x8 / x8, FHHL | Front VGA | Pull-out LCD | USB 3.0 | TPM 1.2 | XClarity Advanced | 1x1100W Platinum | 3-year | 07/17 |
| 7X19A012SG | 2xXeon Gold 5120 14C/2.2GHz/ 19.25MB/105W/DDR4-2400 | 2x16GB RDIMM DDR4-2666 | 1x530-8i | 8x2.5" SATA/SAS HS | Open | 4x10GbE RJ-45 LOM | None | x8 / x8 / x8, FHHL | Front VGA | Pull-out LCD | USB 3.0 | TPM 1.2 | XClarity Advanced | 1x1100W Platinum | 3-year | 07/17 |
| 7X19A017SG | 2xXeon Gold 6134 8C/3.2GHz/ 24.75MB/130W/DDR4-2666 | 2x16GB RDIMM DDR4-2666 | 1x530-8i | 8x2.5" SATA/SAS HS | Open | 4x10GbE RJ-45 LOM | None | x8 / x8 / x8, FHHL | Front VGA | Pull-out LCD | USB 3.0 | TPM 1.2 | XClarity Advanced | 1x1100W Platinum | 3-year | 07/17 |
| 7X19A01BSG | 2xXeon Gold 6152 22C/2.1GHz/ 30.25MB/140W/DDR4-2666 | 2x32GB RDIMM DDR4-2666 | 1x530-8i | 8x2.5" SATA/SAS HS | Open | 4x10GbE RJ-45 LOM | None | x8 / x8 / x8, FHHL | Front VGA | Pull-out LCD | USB 3.0 | TPM 1.2 | XClarity Advanced | 1x1600W Platinum | 3-year | 07/17 |
| 7X19A01JSG | 2xXeon Gold 6148 20C/2.4GHz/ 27.5MB/150W/DDR4-2666 | 2x32GB RDIMM DDR4-2666 | 1x530-8i | 8x2.5" SATA/SAS HS | Open | 4x10GbE RJ-45 LOM | None | x8 / x8 / x8, FHHL | Front VGA | Pull-out LCD | USB 3.0 | TPM 1.2 | XClarity Advanced | 1x1600W Platinum | 3-year | 07/17 |
| 7X19A02BSG | 2xXeon Gold 6126 12C/2.6GHz/ 19.25MB/125W/DDR4-2666 | 2x16GB RDIMM DDR4-2666 | 1x530-8i | 8x2.5" SATA/SAS HS | Open | 4x10GbE RJ-45 LOM | None | x8 / x8 / x8, FHHL | Front VGA | Pull-out LCD | USB 3.0 | TPM 1.2 | XClarity Advanced | 1x1100W Platinum | 3-year | 07/17 |

ThinkSystem SR850 Models for Hong Kong, Taiwan, Korea (HTK) - Non TopSeller

Product Specifications Reference (PSREF)

| Model | Processor | Memory | RAID/HBA Adapter | Disk Bays | Disks | Networking (LOM/ML2/PCIe) | M.2 Boot Drive | Riser Card for Slot 3-5 | Front VGA | Front Panel | Front USB | Security | System Management | Power Supply | Base Warranty | Ann Date (mm/yy) |
|------------|---|------------------------------|------------------------|-------------------------|-------|---------------------------|----------------|-------------------------|-----------|-------------|-----------|----------|----------------------|--------------------|---------------|------------------|
| 7X19A004CN | 2xXeon Platinum 8160 24C/2.1GHz/ 33MB/150W/DDR4-2666 | 2x16GB RDIMM DDR4-2666 | 1x930-16i 4GB flash | 16x2.5" SATA/ SAS HS | Open | 4xGbE RJ-45 LOM | None | x8 / x8 / x8, FHHL | None | Basic | USB 3.0 | TPM 1.2 | XClarity Advanced | 1x750W Platinum | 3-year | 07/17 |
| 7X19A007CN | 2xXeon Platinum 8153 16C/2.0GHz/ 22MB/125W/DDR4-2666 | 2x16GB RDIMM DDR4-2666 | 1x930-16i 4GB flash | 16x2.5" SATA/ SAS HS | Open | 4xGbE RJ-45 LOM | None | x8 / x8 / x8, FHHL | None | Basic | USB 3.0 | TPM 1.2 | XClarity Advanced | 1x750W Platinum | 3-year | 07/17 |
| 7X19A00BCN | 2xXeon Gold 6152 22C/2.1GHz/ 30.25MB/140W/DDR4-2666 | 2x16GB RDIMM DDR4-2666 | 1x930-16i 4GB flash | 16x2.5" SATA/ SAS HS | Open | 4xGbE RJ-45 LOM | None | x8 / x8 / x8, FHHL | None | Basic | USB 3.0 | TPM 1.2 | XClarity Advanced | 1x750W Platinum | 3-year | 07/17 |
| 7X19A00CCN | 2xXeon Platinum 8164 26C/2.0GHz/ 35.75MB/150W/DDR4-2666 | 2x16GB RDIMM DDR4-2666 | 1x930-16i 4GB flash | 16x2.5" SATA/ SAS HS | Open | 4xGbE RJ-45 LOM | None | x8 / x8 / x8, FHHL | None | Basic | USB 3.0 | TPM 1.2 | XClarity Advanced | 1x750W Platinum | 3-year | 07/17 |
| 7X19A00ECN | 2xXeon Platinum 8176 28C/2.1GHz/ 38.5MB/165W/DDR4-2666 | 2x16GB RDIMM DDR4-2666 | 1x930-16i 4GB flash | 16x2.5" SATA/ SAS HS | Open | 4xGbE RJ-45 LOM | None | x8 / x8 / x8, FHHL | None | Basic | USB 3.0 | TPM 1.2 | XClarity Advanced | 1x750W Platinum | 3-year | 07/17 |
| 7X19A00FCN | 2xXeon Platinum 8170 26C/2.1GHz/ 35.75MB/165W/DDR4-2666 | 2x16GB RDIMM DDR4-2666 | 1x930-16i 4GB flash | 16x2.5" SATA/ SAS HS | Open | 4xGbE RJ-45 LOM | None | x8 / x8 / x8, FHHL | None | Basic | USB 3.0 | TPM 1.2 | XClarity Advanced | 1x750W Platinum | 3-year | 07/17 |
| 7X19A00RCN | 2xXeon Gold 6140 18C/2.3GHz/ 24.75MB/140W/DDR4-2666 | 2x16GB RDIMM DDR4-2666 | 1x930-16i 4GB flash | 16x2.5" SATA/ SAS HS | Open | 4xGbE RJ-45 LOM | None | x8 / x8 / x8, FHHL | None | Basic | USB 3.0 | TPM 1.2 | XClarity Advanced | 1x750W Platinum | 3-year | 07/17 |
| 7X19A00ZCN | 2xXeon Gold 6142 16C/2.6GHz/ 22MB/150W/DDR4-2666 | 2x16GB RDIMM DDR4-2666 | 1x930-16i 4GB flash | 16x2.5" SATA/ SAS HS | Open | 4xGbE RJ-45 LOM | None | x8 / x8 / x8, FHHL | None | Basic | USB 3.0 | TPM 1.2 | XClarity Advanced | 1x750W Platinum | 3-year | 07/17 |
| 7X19A011CN | 2xXeon Gold 6150 18C/2.7GHz/ 24.75MB/165W/DDR4-2666 | 2x16GB RDIMM DDR4-2666 | 1x930-16i 4GB flash | 16x2.5" SATA/ SAS HS | Open | 4xGbE RJ-45 LOM | None | x8 / x8 / x8, FHHL | None | Basic | USB 3.0 | TPM 1.2 | XClarity Advanced | 1x750W Platinum | 3-year | 07/17 |
| 7X19A01PCN | 2xXeon Gold 5122 4C/3.6GHz/ 16.5MB/105W/DDR4-2400 | 2x16GB RDIMM DDR4-2666 | 1x930-16i 4GB flash | 16x2.5" SATA/ SAS HS | Open | 4xGbE RJ-45 LOM | None | x8 / x8 / x8, FHHL | None | Basic | USB 3.0 | TPM 1.2 | XClarity Advanced | 1x750W Platinum | 3-year | 07/17 |
| 7X19A01RCN | 2xXeon Gold 5120 14C/2.2GHz/ 19.25MB/105W/DDR4-2400 | 2x16GB RDIMM DDR4-2666 | 1x930-16i 4GB flash | 16x2.5" SATA/ SAS HS | Open | 4xGbE RJ-45 LOM | None | x8 / x8 / x8, FHHL | None | Basic | USB 3.0 | TPM 1.2 | XClarity Advanced | 1x750W Platinum | 3-year | 07/17 |
| 7X19A01TCN | 2xXeon Gold 5118 12C/2.3GHz/ 16.5MB/105W/DDR4-2400 | 2x16GB RDIMM DDR4-2666 | 1x930-16i 4GB flash | 16x2.5" SATA/ SAS HS | Open | 4xGbE RJ-45 LOM | None | x8 / x8 / x8, FHHL | None | Basic | USB 3.0 | TPM 1.2 | XClarity Advanced | 1x750W Platinum | 3-year | 07/17 |
| 7X19A01WCN | 2xXeon Gold 6130 16C/2.1GHz/ 22MB/125W/DDR4-2666 | 2x16GB RDIMM DDR4-2666 | 1x930-16i 4GB flash | 16x2.5" SATA/ SAS HS | Open | 4xGbE RJ-45 LOM | None | x8 / x8 / x8, FHHL | None | Basic | USB 3.0 | TPM 1.2 | XClarity Advanced | 1x750W Platinum | 3-year | 07/17 |
| 7X19A021CN | 2xXeon Platinum 5115 10C/2.4GHz/ 13.75MB/85W/DDR4-2400 | 2x16GB RDIMM DDR4-2666 | 2x930-8i 2GB flash | 16x2.5" SATA/ SAS HS | Open | 4xGbE RJ-45 LOM | None | None | None | Basic | USB 2.0 | TPM 1.2 | XClarity Advanced | 1x750W Platinum | 3-year | 07/17 |
| 7X19A022CN | 2xXeon Gold 6126 12C/2.6GHz/ 19.25MB/125W/DDR4-2666 | 2x16GB RDIMM DDR4-2666 | 1x930-16i 4GB flash | 16x2.5" SATA/ SAS HS | Open | 4xGbE RJ-45 LOM | None | x8 / x8 / x8, FHHL | None | Basic | USB 3.0 | TPM 1.2 | XClarity Advanced | 1x750W Platinum | 3-year | 07/17 |
| 7X19A024CN | 2xXeon Platinum 8156 4C/3.6GHz/ 16.5MB/105W/DDR4-2666 | 2x16GB RDIMM DDR4-2666 | 1x930-16i 4GB flash | 16x2.5" SATA/ SAS HS | Open | 4xGbE RJ-45 LOM | None | x8 / x8 / x8, FHHL | None | Basic | USB 3.0 | TPM 1.2 | XClarity Advanced | 1x750W Platinum | 3-year | 07/17 |
| 7X19A026CN | 2xXeon Platinum 8158 12C/3.0GHz/ 24.75MB/150W/DDR4-2666 | 2x16GB RDIMM DDR4-2666 | 1x930-16i 4GB flash | 16x2.5" SATA/ SAS HS | Open | 4xGbE RJ-45 LOM | None | x8 / x8 / x8, FHHL | None | Basic | USB 3.0 | TPM 1.2 | XClarity Advanced | 1x750W Platinum | 3-year | 07/17 |
| 7X19A027CN | 2xXeon Gold 5120T 14C/2.2GHz/ 19.25MB/105W/DDR4-2400 | 2x16GB RDIMM DDR4-2666 | 1x930-16i 4GB flash | 16x2.5" SATA/ SAS HS | Open | 4xGbE RJ-45 LOM | None | x8 / x8 / x8, FHHL | None | Basic | USB 3.0 | TPM 1.2 | XClarity Advanced | 1x750W Platinum | 3-year | 07/17 |
| 7X19A02ACN | 2xXeon Gold 6136 12C/3.0GHz/ 24.75MB/150W/DDR4-2666 | 2x16GB RDIMM DDR4-2666 | 1x930-16i 4GB flash | 16x2.5" SATA/ SAS HS | Open | 4xGbE RJ-45 LOM | None | x8 / x8 / x8, FHHL | None | Basic | USB 3.0 | TPM 1.2 | XClarity Advanced | 1x750W Platinum | 3-year | 07/17 |
| 7X19A02DCN | 2xXeon Gold 6134 8C/3.2GHz/ 24.75MB/130W/DDR4-2666 | 2x16GB RDIMM DDR4-2666 | 1x930-16i 4GB flash | 16x2.5" SATA/ SAS HS | Open | 4xGbE RJ-45 LOM | None | x8 / x8 / x8, FHHL | None | Basic | USB 3.0 | TPM 1.2 | XClarity Advanced | 1x750W Platinum | 3-year | 07/17 |

ThinkSystem SR850 Models for India - Non TopSeller

Product Specifications Reference (PSREF)

| Model | Processor | Memory | RAID/HBA Adapter | Disk Bays | Disks | Networking (LOM/ML2/PCIe) | M.2 Boot Drive | Riser Card for Slot 3-5 | Front VGA | Front Panel | Front USB | Security | System Management | Power Supply | Base Warranty | Ann Date (mm/yy) |
|------------|---|------------------------------|-----------------------|-----------------------|-------|---------------------------|----------------|-------------------------|--------------|--------------|-----------|----------|----------------------|---------------------|---------------|------------------|
| 7X19A002SG | 2xXeon Platinum 8160 24C/2.1GHz/ 33MB/150W/DDR4-2666 | 2x16GB RDIMM DDR4-2666 | 1x930-8i 2GB flash | 8x2.5" SATA/SAS HS | Open | 4xGbE RJ-45 LOM | None | None | None | Pull-out LCD | USB 3.0 | TPM 1.2 | XClarity Advanced | 1x1100W Platinum | 3-year | 07/17 |
| 7X19A005SG | 2xXeon Gold 5118 12C/2.3GHz/ 16.5MB/105W/DDR4-2400 | 2x16GB RDIMM DDR4-2666 | 1x530-8i | 8x2.5" SATA/SAS HS | Open | 4xGbE RJ-45 LOM | None | None | Front VGA | Basic | USB 3.0 | TPM 1.2 | XClarity Advanced | 1x750W Platinum | 3-year | 07/17 |
| 7X19A006SG | 2xXeon Platinum 8153 16C/2.0GHz/ 22MB/125W/DDR4-2666 | 2x16GB RDIMM DDR4-2666 | 1x930-8i 2GB flash | 8x2.5" SATA/SAS HS | Open | 4xGbE RJ-45 LOM | None | None | None | Pull-out LCD | USB 3.0 | TPM 1.2 | XClarity Advanced | 1x1100W Platinum | 3-year | 07/17 |
| 7X19A00ASG | 2xXeon Gold 6152 22C/2.1GHz/ 30.25MB/140W/DDR4-2666 | 2x16GB RDIMM DDR4-2666 | 1x930-8i 2GB flash | 8x2.5" SATA/SAS HS | Open | 4xGbE RJ-45 LOM | None | None | None | Pull-out LCD | USB 3.0 | TPM 1.2 | XClarity Advanced | 1x1100W Platinum | 3-year | 07/17 |
| 7X19A00HSG | 2xXeon Platinum 8176 28C/2.1GHz/ 38.5MB/165W/DDR4-2666 | 2x16GB RDIMM DDR4-2666 | 1x930-8i 2GB flash | 8x2.5" SATA/SAS HS | Open | 4xGbE RJ-45 LOM | None | None | None | Pull-out LCD | USB 3.0 | TPM 1.2 | XClarity Advanced | 1x1600W Platinum | 3-year | 07/17 |
| 7X19A00KSG | 2xXeon Platinum 8170 26C/2.1GHz/ 35.75MB/165W/DDR4-2666 | 2x16GB RDIMM DDR4-2666 | 1x930-8i 2GB flash | 8x2.5" SATA/SAS HS | Open | 4xGbE RJ-45 LOM | None | None | None | Pull-out LCD | USB 3.0 | TPM 1.2 | XClarity Advanced | 1x1600W Platinum | 3-year | 07/17 |
| 7X19A00LSG | 2xXeon Platinum 8164 26C/2.0GHz/ 35.75MB/150W/DDR4-2666 | 2x16GB RDIMM DDR4-2666 | 1x930-8i 2GB flash | 8x2.5" SATA/SAS HS | Open | 4xGbE RJ-45 LOM | None | None | None | Pull-out LCD | USB 3.0 | TPM 1.2 | XClarity Advanced | 1x1100W Platinum | 3-year | 07/17 |
| 7X19A013SG | 2xXeon Gold 5115 10C/2.4GHz/ 13.75MB/85W/DDR4-2400 | 2x16GB RDIMM DDR4-2666 | 1x930-8i 2GB flash | 8x2.5" SATA/SAS HS | Open | 4xGbE RJ-45 LOM | None | None | None | Basic | USB 2.0 | TPM 1.2 | XClarity Advanced | 1x750W Platinum | 3-year | 07/17 |
| 7X19A016SG | 2xXeon Gold 5118 12C/2.3GHz/ 16.5MB/105W/DDR4-2400 | 2x16GB RDIMM DDR4-2666 | 1x530-8i | 8x2.5" SATA/SAS HS | Open | 4xGbE RJ-45 LOM | None | None | None | Basic | USB 2.0 | TPM 1.2 | XClarity Advanced | 1x750W Platinum | 3-year | 07/17 |
| 7X19A01ESG | 2xXeon Gold 5118 12C/2.3GHz/ 16.5MB/105W/DDR4-2400 | 2x16GB RDIMM DDR4-2666 | 1x930-8i 2GB flash | 8x2.5" SATA/SAS HS | Open | 4xGbE RJ-45 LOM | None | None | None | Basic | USB 2.0 | TPM 1.2 | XClarity Advanced | 1x750W Platinum | 3-year | 07/17 |
| 7X19A01FSG | 2xXeon Gold 6142 16C/2.6GHz/ 22MB/150W/DDR4-2666 | 2x16GB RDIMM DDR4-2666 | 1x930-8i 2GB flash | 8x2.5" SATA/SAS HS | Open | 4xGbE RJ-45 LOM | None | None | None | Pull-out LCD | USB 3.0 | TPM 1.2 | XClarity Advanced | 1x1100W Platinum | 3-year | 07/17 |
| 7X19A01HSG | 2xXeon Gold 6140 18C/2.3GHz/ 24.75MB/140W/DDR4-2666 | 2x16GB RDIMM DDR4-2666 | 1x930-8i 2GB flash | 8x2.5" SATA/SAS HS | Open | 4xGbE RJ-45 LOM | None | None | None | Pull-out LCD | USB 3.0 | TPM 1.2 | XClarity Advanced | 1x1100W Platinum | 3-year | 07/17 |
| 7X19A01KSG | 2xXeon Gold 5120 14C/2.2GHz/ 19.25MB/105W/DDR4-2400 | 2x16GB RDIMM DDR4-2666 | 1x930-8i 2GB flash | 8x2.5" SATA/SAS HS | Open | 4xGbE RJ-45 LOM | None | None | None | Pull-out LCD | USB 3.0 | TPM 1.2 | XClarity Advanced | 1x750W Platinum | 3-year | 07/17 |
| 7X19A01NSG | 2xXeon Gold 6136 12C/3.0GHz/ 24.75MB/150W/DDR4-2666 | 2x16GB RDIMM DDR4-2666 | 1x930-8i 2GB flash | 8x2.5" SATA/SAS HS | Open | 4xGbE RJ-45 LOM | None | None | None | Pull-out LCD | USB 3.0 | TPM 1.2 | XClarity Advanced | 1x1100W Platinum | 3-year | 07/17 |
| 7X19A01QSG | 2xXeon Gold 6134 8C/3.2GHz/ 24.75MB/130W/DDR4-2666 | 2x16GB RDIMM DDR4-2666 | 1x930-8i 2GB flash | 8x2.5" SATA/SAS HS | Open | 4xGbE RJ-45 LOM | None | None | None | Pull-out LCD | USB 3.0 | TPM 1.2 | XClarity Advanced | 1x1100W Platinum | 3-year | 07/17 |
| 7X19A020SG | 2xXeon Gold 5120 14C/2.2GHz/ 19.25MB/105W/DDR4-2400 | 2x16GB RDIMM DDR4-2666 | 1x930-8i 2GB flash | 8x2.5" SATA/SAS HS | Open | 4xGbE RJ-45 LOM | None | None | Front VGA | Basic | USB 3.0 | TPM 1.2 | XClarity Advanced | 1x750W Platinum | 3-year | 07/17 |
| 7X19A023SG | 2xXeon Gold 5115 10C/2.4GHz/ 13.75MB/85W/DDR4-2400 | 2x8GB RDIMM DDR4-2666 | 1x530-8i | 8x2.5" SATA/SAS HS | Open | 4xGbE RJ-45 LOM | None | None | None | Basic | USB 2.0 | TPM 1.2 | XClarity Advanced | 1x750W Platinum | 3-year | 07/17 |
| 7X19A028SG | 2xXeon Gold 6138 20C/2.0GHz/ 27.5MB/125W/DDR4-2666 | 2x16GB RDIMM DDR4-2666 | 1x930-8i 2GB flash | 8x2.5" SATA/SAS HS | Open | 4xGbE RJ-45 LOM | None | None | None | Pull-out LCD | USB 3.0 | TPM 1.2 | XClarity Advanced | 1x1100W Platinum | 3-year | 07/17 |

ThinkSystem SR850 Models for Japan - Non TopSeller

Product Specifications Reference (PSREF)

| Model | Processor | Memory | RAID/HBA Adapter | Disk Bays | Disks | Networking (LOM/ML2/PCIe) | M.2 Boot Drive | Riser Card for Slot 3-5 | Front VGA | Front Panel | Front USB | Security | System Management | Power Supply | Base Warranty | Ann Date (mm/yy) |
|------------|--|------------------------------|-----------------------|-----------------------|-------|---------------------------|----------------|-------------------------|--------------|--------------|-----------|----------|------------------------|---------------------|---------------|------------------|
| 7X19A01UJP | 2xXeon Gold 5115 10C/2.4GHz/ 13.75MB/85W/DDR4-2400 | 2x16GB RDIMM DDR4-2666 | 1x930-8i 2GB flash | 8x2.5" SATA/SAS HS | Open | 4x10GbE RJ-45 LOM | None | x8 / x8 / x8, FHHL | Front VGA | Pull-out LCD | USB 2.0 | TPM 1.2 | XClarity Advanced | 1x1100W Platinum | 3-year | 07/17 |
| 7X19A02EJP | 2xXeon Platinum 8176 28C/2.1GHz/ 38.5MB/165W/DDR4-2666 | 2x16GB RDIMM DDR4-2666 | 1x930-8i 2GB flash | 8x2.5" SATA/SAS HS | Open | 4x10GbE SFP+ LOM | None | None | Front VGA | Pull-out LCD | USB 3.0 | TPM 1.2 | XClarity Enterprise | 1x1600W Platinum | 3-year | 07/17 |
| 7X19A02FJP | 2xXeon Gold 6150 18C/2.7GHz/ 24.75MB/165W/DDR4-2666 | 2x16GB RDIMM DDR4-2666 | 1x930-8i 2GB flash | 8x2.5" SATA/SAS HS | Open | 4x10GbE SFP+ LOM | None | None | Front VGA | Pull-out LCD | USB 3.0 | TPM 1.2 | XClarity Enterprise | 1x1600W Platinum | 3-year | 07/17 |

ThinkSystem SR850 Models for Latin America - Non TopSeller

Product Specifications Reference (PSREF)

| Model | Processor | Memory | RAID/HBA Adapter | Disk Bays | Disks | Networking (LOM/ML2/PCIe) | M.2 Boot Drive | Riser Card for Slot 3-5 | Front VGA | Front Panel | Front USB | Security | System Management | Power Supply | Base Warranty | Ann Date (mm/yy) |
|------------|---|-------------------------------|---|---|-------|---|----------------|-------------------------|--------------|--------------|-----------|----------|------------------------|---------------------|---------------|------------------|
| 7X19A032LA | 2xXeon Platinum 8153 16C/2.0GHz/ 22MB/125W/DDR4-2666 | 12x32GB RDIMM DDR4-2666 | 1x930-8i 2GB flash | 8x2.5" SATA/SAS HS | Open | None | None | x8 / x8 / x8, FHHL | Front VGA | Pull-out LCD | USB 3.0 | TPM 1.2 | XClarity Enterprise | 2x1100W Platinum | 3-year | 07/17 |
| 7X19A033LA | 2xXeon Gold 6148 20C/2.4GHz/ 27.5MB/150W/DDR4-2666 | 12x16GB RDIMM DDR4-2666 | 1x930-8i 2GB flash | 8x2.5" SATA/SAS HS | Open | None | None | x8 / x8 / x8, FHHL | Front VGA | Pull-out LCD | USB 3.0 | TPM 1.2 | XClarity Enterprise | 2x1100W Platinum | 3-year | 07/17 |
| 7X19A037LA | 2xXeon Gold 6140 18C/2.3GHz/ 24.75MB/140W/DDR4-2666 | 12x16GB RDIMM DDR4-2666 | 1x930-8i 2GB flash | 8x2.5" SATA/SAS HS | Open | None | None | x8 / x8 / x8, FHHL | Front VGA | Pull-out LCD | USB 3.0 | TPM 1.2 | XClarity Enterprise | 2x1100W Platinum | 3-year | 07/17 |
| 7X19A03ALA | 2xXeon Platinum 8176 28C/2.1GHz/ 38.5MB/165W/DDR4-2666 | 12x32GB RDIMM DDR4-2666 | 1x930-8i 2GB flash | 8x2.5" SATA/SAS HS | Open | None | None | x8 / x8 / x8, FHHL | Front VGA | Pull-out LCD | USB 3.0 | TPM 1.2 | XClarity Enterprise | 2x1600W Platinum | 3-year | 07/17 |
| 7X19A03BLA | 2xXeon Platinum 8170 26C/2.1GHz/ 35.75MB/165W/DDR4-2666 | 12x32GB RDIMM DDR4-2666 | 1x930-8i 2GB flash | 8x2.5" SATA/SAS HS | Open | None | None | x8 / x8 / x8, FHHL | Front VGA | Pull-out LCD | USB 3.0 | TPM 1.2 | XClarity Enterprise | 2x1600W Platinum | 3-year | 07/17 |
| 7X19A03CLA | 2xXeon Platinum 8164 26C/2.0GHz/ 35.75MB/150W/DDR4-2666 | 12x32GB RDIMM DDR4-2666 | 1x930-8i 2GB flash | 8x2.5" SATA/SAS HS | Open | None | None | x8 / x8 / x8, FHHL | Front VGA | Pull-out LCD | USB 3.0 | TPM 1.2 | XClarity Enterprise | 2x1600W Platinum | 3-year | 07/17 |
| 7X19A03ELA | 2xXeon Platinum 8160 24C/2.1GHz/ 33MB/150W/DDR4-2666 | 12x32GB RDIMM DDR4-2666 | 1x930-8i 2GB flash | 8x2.5" SATA/SAS HS | Open | None | None | x8 / x8 / x8, FHHL | Front VGA | Pull-out LCD | USB 3.0 | TPM 1.2 | XClarity Enterprise | 2x1100W Platinum | 3-year | 07/17 |
| 7X19A03FLA | 4xXeon Platinum 8170 26C/2.1GHz/ 35.75MB/165W/DDR4-2666 | 16x32GB RDIMM DDR4-2666 | 1x930-16i 4GB flash, 2xFC dual-port | 16x2.5" (12 SATA/ SAS, 4 AnyBay) HS | Open | 4xGbE RJ-45 LOM+ 2x 2x10GbE SFP+ PCIe | None | x8 / x8 / x8, FHHL | Front VGA | Pull-out LCD | USB 3.0 | TPM 1.2 | XClarity Advanced | 2x1600W Platinum | 3-year | 07/17 |
| 7X19A03GLA | 4xXeon Platinum 8176 28C/2.1GHz/ 38.5MB/165W/DDR4-2666 | 16x32GB RDIMM DDR4-2666 | 1x930-16i 4GB flash, 2xFC dual-port | 16x2.5" (12 SATA/ SAS, 4 AnyBay) HS | Open | 4xGbE RJ-45 LOM+ 2x 2x10GbE SFP+ PCIe | None | x8 / x8 / x8, FHHL | Front VGA | Pull-out LCD | USB 3.0 | TPM 1.2 | XClarity Advanced | 2x1600W Platinum | 3-year | 07/17 |
| 7X19A03HLA | 4xXeon Platinum 8170 26C/2.1GHz/ 35.75MB/165W/DDR4-2666 | 32x16GB RDIMM DDR4-2666 | 1x930-16i 4GB flash, 2xFC dual-port | 16x2.5" (12 SATA/ SAS, 4 AnyBay) HS | Open | 4xGbE RJ-45 LOM+ 2x 2x10GbE SFP+ PCIe | None | x8 / x8 / x8, FHHL | Front VGA | Pull-out LCD | USB 3.0 | TPM 1.2 | XClarity Advanced | 2x1600W Platinum | 3-year | 07/17 |
| 7X19A03JLA | 4xXeon Platinum 8176 28C/2.1GHz/ 38.5MB/165W/DDR4-2666 | 32x16GB RDIMM DDR4-2666 | 1x930-16i 4GB flash, 2xFC dual-port | 16x2.5" (12 SATA/ SAS, 4 AnyBay) HS | Open | 4xGbE RJ-45 LOM +2x 2x10GbE SFP+ PCIe | None | x8 / x8 / x8, FHHL | Front VGA | Pull-out LCD | USB 3.0 | TPM 1.2 | XClarity Advanced | 2x1600W Platinum | 3-year | 07/17 |

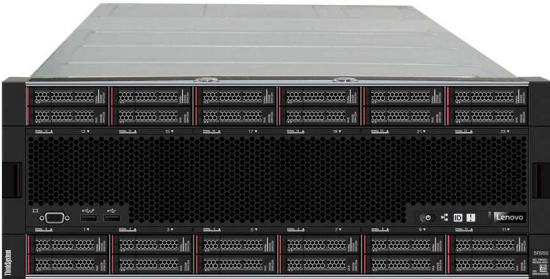

ThinkSystem SR950 Platform Specifications

Product Specifications Reference (PSREF)

| Components | Specification | | | | | | | | | | | | | | | | | | | | | | | | | | | | | | | | | | | | | | | | | | | | | | | | | | | | | | | | | | | | | | | | | | | | | | | | | | | | | | | | | |
|--------------------------------|--|-----------------------|---------------------------------|---------------------------|-------------|--------------------------|-------------------|--------------------------|-------------------------------|-------------------------------|-------------|---------------------|-------------|---------------------|---------------------------|--------------------------------|---------------------------|--------------|------------|--------|------------|----------|-------------|-----|-----|------|----|---|--------|------------|----------|------------------|-----|-----|--------------|-----|---|---------|------------|----------|------------------|-----|-----|--------------|-----|---|--------|------------|----------|---|-----|------|------|---|---|---------|------------|----------|---|-----|------|------|---|---|--------|------------|----------|------------------|-----|-----|--------------|-----|---|--------|------------|----------|---|-----|------|------|---|----|
| Form factor | 4U rack | | | | | | | | | | | | | | | | | | | | | | | | | | | | | | | | | | | | | | | | | | | | | | | | | | | | | | | | | | | | | | | | | | | | | | | | | | | | | | | | | |
| Dimensions | Height: 175.8 mm (6.9 in). Width: 483 mm (19.0 in) at EIA Flange. Depth: 853 mm (33.6 in) | | | | | | | | | | | | | | | | | | | | | | | | | | | | | | | | | | | | | | | | | | | | | | | | | | | | | | | | | | | | | | | | | | | | | | | | | | | | | | | | | |
| Weight | Maximum configuration: 129.4 lb (58.7 kg) | | | | | | | | | | | | | | | | | | | | | | | | | | | | | | | | | | | | | | | | | | | | | | | | | | | | | | | | | | | | | | | | | | | | | | | | | | | | | | | | | |
| Processor | Supports up to four Intel Xeon Scalable family processors, Gold or Platinum. Or up to eight Intel Xeon Scalable family processors, Platinum only. Processors and memory are located on system boards installed in compute trays: 2 processors per system board, 2 system boards per compute tray, up to 2 compute tray per system. Up to 28 cores at 2.5GHz, up to 3.6GHz with 4 cores. Up to three UPI (Ultra Path Interconnect) links at maximum 10.4GT/s each | | | | | | | | | | | | | | | | | | | | | | | | | | | | | | | | | | | | | | | | | | | | | | | | | | | | | | | | | | | | | | | | | | | | | | | | | | | | | | | | | |
| Chipset | Intel C624 Platform Controller Hub | | | | | | | | | | | | | | | | | | | | | | | | | | | | | | | | | | | | | | | | | | | | | | | | | | | | | | | | | | | | | | | | | | | | | | | | | | | | | | | | | |
| Memory | Up to 96 DIMM sockets. Each processor supports up to 12 DIMM sockets with 6 channels. DDR4-2666. RDIMMs, LRDIMMs, and 3DS RDIMMs are supported, but memory types cannot be intermixed. | | | | | | | | | | | | | | | | | | | | | | | | | | | | | | | | | | | | | | | | | | | | | | | | | | | | | | | | | | | | | | | | | | | | | | | | | | | | | | | | | |
| Memory capacity | Up to 3TB with 96 x 32GB RDIMMs and eight processors. Or up to 6TB with 96 x 64GB LRDIMMs and eight processors. Or up to 12TB with 96 x 128GB 3DS RDIMMs and eight -M suffix processors. -M suffix processor supports 1.5TB memory per socket, non -M suffix processor supports 768GB memory per socket | | | | | | | | | | | | | | | | | | | | | | | | | | | | | | | | | | | | | | | | | | | | | | | | | | | | | | | | | | | | | | | | | | | | | | | | | | | | | | | | | |
| Memory protection | ECC, memory mirroring, and memory rank sparing. | | | | | | | | | | | | | | | | | | | | | | | | | | | | | | | | | | | | | | | | | | | | | | | | | | | | | | | | | | | | | | | | | | | | | | | | | | | | | | | | | |
| Storage controllers | Up to two dedicated internal RAID slots for most RAID/HBA adapters. Supports the following RAID/HBA adapters: <table border="1"> <thead> <tr> <th>Feature</th> <th>Interface</th> <th>Drive type</th> <th>RAID levels</th> <th>JBOD</th> <th>Cache</th> <th>Cache protection</th> <th>FastPath</th> <th>Max qty</th> </tr> </thead> <tbody> <tr> <td>530-8i</td> <td>12Gbps SAS</td> <td>SATA/SAS</td> <td>0/1/10/5/50</td> <td>Yes</td> <td>None</td> <td>None</td> <td>Yes</td> <td>2</td> </tr> <tr> <td>730-8i</td> <td>12Gbps SAS</td> <td>SATA/SAS</td> <td>0/1/10/5/50</td> <td>Yes</td> <td>1GB</td> <td>None</td> <td>No</td> <td>2</td> </tr> <tr> <td>930-8i</td> <td>12Gbps SAS</td> <td>SATA/SAS</td> <td>0/1/10/5/50/6/60</td> <td>Yes</td> <td>2GB</td> <td>Flash backup</td> <td>Yes</td> <td>2</td> </tr> <tr> <td>930-16i</td> <td>12Gbps SAS</td> <td>SATA/SAS</td> <td>0/1/10/5/50/6/60</td> <td>Yes</td> <td>4GB</td> <td>Flash backup</td> <td>Yes</td> <td>2</td> </tr> <tr> <td>430-8i</td> <td>12Gbps SAS</td> <td>SATA/SAS</td> <td>-</td> <td>Yes</td> <td>None</td> <td>None</td> <td>-</td> <td>2</td> </tr> <tr> <td>430-16i</td> <td>12Gbps SAS</td> <td>SATA/SAS</td> <td>-</td> <td>Yes</td> <td>None</td> <td>None</td> <td>-</td> <td>2</td> </tr> <tr> <td>930-8e</td> <td>12Gbps SAS</td> <td>SATA/SAS</td> <td>0/1/10/5/50/6/60</td> <td>Yes</td> <td>4GB</td> <td>Flash backup</td> <td>Yes</td> <td>4</td> </tr> <tr> <td>430-8e</td> <td>12Gbps SAS</td> <td>SATA/SAS</td> <td>-</td> <td>Yes</td> <td>None</td> <td>None</td> <td>-</td> <td>14</td> </tr> </tbody> </table> <p>Note: 730-8i is available in China only. 930-8e should be placed in slot 7 firstly. 430-8e should be placed in slot 5 firstly.</p> | Feature | Interface | Drive type | RAID levels | JBOD | Cache | Cache protection | FastPath | Max qty | 530-8i | 12Gbps SAS | SATA/SAS | 0/1/10/5/50 | Yes | None | None | Yes | 2 | 730-8i | 12Gbps SAS | SATA/SAS | 0/1/10/5/50 | Yes | 1GB | None | No | 2 | 930-8i | 12Gbps SAS | SATA/SAS | 0/1/10/5/50/6/60 | Yes | 2GB | Flash backup | Yes | 2 | 930-16i | 12Gbps SAS | SATA/SAS | 0/1/10/5/50/6/60 | Yes | 4GB | Flash backup | Yes | 2 | 430-8i | 12Gbps SAS | SATA/SAS | - | Yes | None | None | - | 2 | 430-16i | 12Gbps SAS | SATA/SAS | - | Yes | None | None | - | 2 | 930-8e | 12Gbps SAS | SATA/SAS | 0/1/10/5/50/6/60 | Yes | 4GB | Flash backup | Yes | 4 | 430-8e | 12Gbps SAS | SATA/SAS | - | Yes | None | None | - | 14 |
| Feature | Interface | Drive type | RAID levels | JBOD | Cache | Cache protection | FastPath | Max qty | | | | | | | | | | | | | | | | | | | | | | | | | | | | | | | | | | | | | | | | | | | | | | | | | | | | | | | | | | | | | | | | | | | | | | | | | | |
| 530-8i | 12Gbps SAS | SATA/SAS | 0/1/10/5/50 | Yes | None | None | Yes | 2 | | | | | | | | | | | | | | | | | | | | | | | | | | | | | | | | | | | | | | | | | | | | | | | | | | | | | | | | | | | | | | | | | | | | | | | | | | |
| 730-8i | 12Gbps SAS | SATA/SAS | 0/1/10/5/50 | Yes | 1GB | None | No | 2 | | | | | | | | | | | | | | | | | | | | | | | | | | | | | | | | | | | | | | | | | | | | | | | | | | | | | | | | | | | | | | | | | | | | | | | | | | |
| 930-8i | 12Gbps SAS | SATA/SAS | 0/1/10/5/50/6/60 | Yes | 2GB | Flash backup | Yes | 2 | | | | | | | | | | | | | | | | | | | | | | | | | | | | | | | | | | | | | | | | | | | | | | | | | | | | | | | | | | | | | | | | | | | | | | | | | | |
| 930-16i | 12Gbps SAS | SATA/SAS | 0/1/10/5/50/6/60 | Yes | 4GB | Flash backup | Yes | 2 | | | | | | | | | | | | | | | | | | | | | | | | | | | | | | | | | | | | | | | | | | | | | | | | | | | | | | | | | | | | | | | | | | | | | | | | | | |
| 430-8i | 12Gbps SAS | SATA/SAS | - | Yes | None | None | - | 2 | | | | | | | | | | | | | | | | | | | | | | | | | | | | | | | | | | | | | | | | | | | | | | | | | | | | | | | | | | | | | | | | | | | | | | | | | | |
| 430-16i | 12Gbps SAS | SATA/SAS | - | Yes | None | None | - | 2 | | | | | | | | | | | | | | | | | | | | | | | | | | | | | | | | | | | | | | | | | | | | | | | | | | | | | | | | | | | | | | | | | | | | | | | | | | |
| 930-8e | 12Gbps SAS | SATA/SAS | 0/1/10/5/50/6/60 | Yes | 4GB | Flash backup | Yes | 4 | | | | | | | | | | | | | | | | | | | | | | | | | | | | | | | | | | | | | | | | | | | | | | | | | | | | | | | | | | | | | | | | | | | | | | | | | | |
| 430-8e | 12Gbps SAS | SATA/SAS | - | Yes | None | None | - | 14 | | | | | | | | | | | | | | | | | | | | | | | | | | | | | | | | | | | | | | | | | | | | | | | | | | | | | | | | | | | | | | | | | | | | | | | | | | |
| Disk drive bays | Up to 12 disk bays with maximum 6 AnyBay, or up to 24 disk bays with maximum 12 AnyBay. Optional one or two internal M.2 SSD for boot, dual M.2 SSD supports mirroring | | | | | | | | | | | | | | | | | | | | | | | | | | | | | | | | | | | | | | | | | | | | | | | | | | | | | | | | | | | | | | | | | | | | | | | | | | | | | | | | | |
| Internal storage | <table border="1"> <tbody> <tr> <td>2.5" NVMe SSD, AnyBay</td> <td>800GB/960GB/1.6TB/1.92TB/3.84TB</td> </tr> <tr> <td>2.5" HDD, SAS12Gbps, 7,2K</td> <td>1TB/2TB</td> </tr> <tr> <td>2.5" HDD, SAS12Gbps, 15K</td> <td>300GB/600GB/900GB</td> </tr> <tr> <td>2.5" HDD, SAS12Gbps, 10K</td> <td>300GB/600GB/900GB/1.2TB/1.8TB</td> </tr> <tr> <td>2.5" HDD, SAS12Gbps, 10K, SED</td> <td>300GB/600GB</td> </tr> <tr> <td>2.5" SSD, SATA6Gbps</td> <td>240GB/480GB</td> </tr> <tr> <td>2.5" SSD, SAS12Gbps</td> <td>400GB/800GB/3.84TB/7.68TB</td> </tr> <tr> <td>NVMe SSD, PCIe x4 HHHL adapter</td> <td>1.6TB/1.92TB/3.2TB/3.84TB</td> </tr> <tr> <td>M.2 SATA SSD</td> <td>32GB/128GB</td> </tr> </tbody> </table> | 2.5" NVMe SSD, AnyBay | 800GB/960GB/1.6TB/1.92TB/3.84TB | 2.5" HDD, SAS12Gbps, 7,2K | 1TB/2TB | 2.5" HDD, SAS12Gbps, 15K | 300GB/600GB/900GB | 2.5" HDD, SAS12Gbps, 10K | 300GB/600GB/900GB/1.2TB/1.8TB | 2.5" HDD, SAS12Gbps, 10K, SED | 300GB/600GB | 2.5" SSD, SATA6Gbps | 240GB/480GB | 2.5" SSD, SAS12Gbps | 400GB/800GB/3.84TB/7.68TB | NVMe SSD, PCIe x4 HHHL adapter | 1.6TB/1.92TB/3.2TB/3.84TB | M.2 SATA SSD | 32GB/128GB | | | | | | | | | | | | | | | | | | | | | | | | | | | | | | | | | | | | | | | | | | | | | | | | | | | | | | | | | | | | | | | |
| 2.5" NVMe SSD, AnyBay | 800GB/960GB/1.6TB/1.92TB/3.84TB | | | | | | | | | | | | | | | | | | | | | | | | | | | | | | | | | | | | | | | | | | | | | | | | | | | | | | | | | | | | | | | | | | | | | | | | | | | | | | | | | |
| 2.5" HDD, SAS12Gbps, 7,2K | 1TB/2TB | | | | | | | | | | | | | | | | | | | | | | | | | | | | | | | | | | | | | | | | | | | | | | | | | | | | | | | | | | | | | | | | | | | | | | | | | | | | | | | | | |
| 2.5" HDD, SAS12Gbps, 15K | 300GB/600GB/900GB | | | | | | | | | | | | | | | | | | | | | | | | | | | | | | | | | | | | | | | | | | | | | | | | | | | | | | | | | | | | | | | | | | | | | | | | | | | | | | | | | |
| 2.5" HDD, SAS12Gbps, 10K | 300GB/600GB/900GB/1.2TB/1.8TB | | | | | | | | | | | | | | | | | | | | | | | | | | | | | | | | | | | | | | | | | | | | | | | | | | | | | | | | | | | | | | | | | | | | | | | | | | | | | | | | | |
| 2.5" HDD, SAS12Gbps, 10K, SED | 300GB/600GB | | | | | | | | | | | | | | | | | | | | | | | | | | | | | | | | | | | | | | | | | | | | | | | | | | | | | | | | | | | | | | | | | | | | | | | | | | | | | | | | | |
| 2.5" SSD, SATA6Gbps | 240GB/480GB | | | | | | | | | | | | | | | | | | | | | | | | | | | | | | | | | | | | | | | | | | | | | | | | | | | | | | | | | | | | | | | | | | | | | | | | | | | | | | | | | |
| 2.5" SSD, SAS12Gbps | 400GB/800GB/3.84TB/7.68TB | | | | | | | | | | | | | | | | | | | | | | | | | | | | | | | | | | | | | | | | | | | | | | | | | | | | | | | | | | | | | | | | | | | | | | | | | | | | | | | | | |
| NVMe SSD, PCIe x4 HHHL adapter | 1.6TB/1.92TB/3.2TB/3.84TB | | | | | | | | | | | | | | | | | | | | | | | | | | | | | | | | | | | | | | | | | | | | | | | | | | | | | | | | | | | | | | | | | | | | | | | | | | | | | | | | | |
| M.2 SATA SSD | 32GB/128GB | | | | | | | | | | | | | | | | | | | | | | | | | | | | | | | | | | | | | | | | | | | | | | | | | | | | | | | | | | | | | | | | | | | | | | | | | | | | | | | | | |
| Network interfaces | One dedicated management port. One LOM slot for customized LOM with up to four RJ-45 or SFP+ ports, up to 10GbE. Wake-on-LAN and NC-SI are available on Port 0 of LOM. Optional ML2 or PCIe adapters are supported. One standard ML2 slot, one optional ML2 slot via optional riser card | | | | | | | | | | | | | | | | | | | | | | | | | | | | | | | | | | | | | | | | | | | | | | | | | | | | | | | | | | | | | | | | | | | | | | | | | | | | | | | | | |
| Security features | Power-on and admin password. Trusted Platform Module, TCG 1.2 compliant, upgrade to 2.0 via UEFI setting. Optional TCM, China only | | | | | | | | | | | | | | | | | | | | | | | | | | | | | | | | | | | | | | | | | | | | | | | | | | | | | | | | | | | | | | | | | | | | | | | | | | | | | | | | | |
| Operating systems supported | Microsoft Windows Server 2016/2012 R2. Red Hat Enterprise Linux 7.3/6.9. SUSE Linux Enterprise Server 12 SP2/11 SP4. VMware vSphere (ESXi) 6.5/6.0 U3 | | | | | | | | | | | | | | | | | | | | | | | | | | | | | | | | | | | | | | | | | | | | | | | | | | | | | | | | | | | | | | | | | | | | | | | | | | | | | | | | | |
| Systems management | XClarity Controller Enterprise. XClarity Administrator. XClarity Energy Manager. XClarity Provisioning Manager. XClarity Essentials. Lenovo Capacity Planner. Light Path Diagnostics with LCD diagnostic pull-out panel | | | | | | | | | | | | | | | | | | | | | | | | | | | | | | | | | | | | | | | | | | | | | | | | | | | | | | | | | | | | | | | | | | | | | | | | | | | | | | | | | |
| GPU support | None | | | | | | | | | | | | | | | | | | | | | | | | | | | | | | | | | | | | | | | | | | | | | | | | | | | | | | | | | | | | | | | | | | | | | | | | | | | | | | | | | |
| Base warranty | MT 7X11: 1-year limited onsite service with 9x5/NBD MT 7X12: 3-year limited onsite service with 9x5/NBD MT 7X13: 3-year limited onsite service with 9x5/NBD, SAP HANA optimized | | | | | | | | | | | | | | | | | | | | | | | | | | | | | | | | | | | | | | | | | | | | | | | | | | | | | | | | | | | | | | | | | | | | | | | | | | | | | | | | | |
| Power supply | Supports one, two or four hot-swap 1100W/1600W 80 PLUS Platinum qualified AC power supplies. Redundant with two or four power supplies (N+N, N = 1 or 2). 1600W Platinum is 200V - 240V, 1100W is 100V - 240V and de-rated to 1050W for operation from 110V input | | | | | | | | | | | | | | | | | | | | | | | | | | | | | | | | | | | | | | | | | | | | | | | | | | | | | | | | | | | | | | | | | | | | | | | | | | | | | | | | | |

| Components | Specification | | | | | | | | | | | | |
|---|--|-------------------------|---|--|-------------------------------|--|--------------------------------|----------------------|--------------------------------------|--------------------------------------|-----------------------------------|---|--------|
| Video | Integrated Matrox G200 in XClarity Controller | | | | | | | | | | | | |
| Cooling | Up to 12 hot-swap fans. N +1 redundancy. 6 fans per compute tray, 3 fans per storage tray | | | | | | | | | | | | |
| Front ports | One XClarity Controller USB connector, one USB 2.0, one VGA | | | | | | | | | | | | |
| Rear ports | One VGA, two USB 3.0, one serial, one XClarity Controller network connector | | | | | | | | | | | | |
| Environmental specification | Supports ASHRAE A4 with limitations. <table border="1"> <tbody> <tr> <td>Temperature - operating</td> <td>A4: 5°C to 45°C (41°F to 113°F) A3: 5°C to 40°C (41°F to 104°F) A2: 10°C to 35°C (50°F to 95°F)</td> </tr> <tr> <td>Temperature - non operating (no package)</td> <td>-10°C to 60°C (14°F to 140°F)</td> </tr> <tr> <td>Temperature - non operating (with package)</td> <td>-40°C to 70°C (-40°F to 158°F)</td> </tr> <tr> <td>Altitude - operating</td> <td>(Unpressurized): 0-10000ft (0-3048m)</td> </tr> <tr> <td>Humidity - operating, non-condensing</td> <td>A4: 8%-90%. A3:8%-85%. A2:20%-80%</td> </tr> <tr> <td>Humidity - storage (with package), non-condensing</td> <td>8%-90%</td> </tr> </tbody> </table> <p>Models should meet the following requirements to support A3 and A4: • 2.5" NVMe SSD and PCIe NVMe flash adapter not installed (NVMe devices are supported up to 35°C) • Processors with TDP more than or equal to 150-watt not installed</p> | Temperature - operating | A4: 5°C to 45°C (41°F to 113°F) A3: 5°C to 40°C (41°F to 104°F) A2: 10°C to 35°C (50°F to 95°F) | Temperature - non operating (no package) | -10°C to 60°C (14°F to 140°F) | Temperature - non operating (with package) | -40°C to 70°C (-40°F to 158°F) | Altitude - operating | (Unpressurized): 0-10000ft (0-3048m) | Humidity - operating, non-condensing | A4: 8%-90%. A3:8%-85%. A2:20%-80% | Humidity - storage (with package), non-condensing | 8%-90% |
| Temperature - operating | A4: 5°C to 45°C (41°F to 113°F) A3: 5°C to 40°C (41°F to 104°F) A2: 10°C to 35°C (50°F to 95°F) | | | | | | | | | | | | |
| Temperature - non operating (no package) | -10°C to 60°C (14°F to 140°F) | | | | | | | | | | | | |
| Temperature - non operating (with package) | -40°C to 70°C (-40°F to 158°F) | | | | | | | | | | | | |
| Altitude - operating | (Unpressurized): 0-10000ft (0-3048m) | | | | | | | | | | | | |
| Humidity - operating, non-condensing | A4: 8%-90%. A3:8%-85%. A2:20%-80% | | | | | | | | | | | | |
| Humidity - storage (with package), non-condensing | 8%-90% | | | | | | | | | | | | |
| Environmental certification | Energy Star Server 2.1 certified. More environmental information please see: www.lenovo.com/social_responsibility/us/en/environment/ | | | | | | | | | | | | |

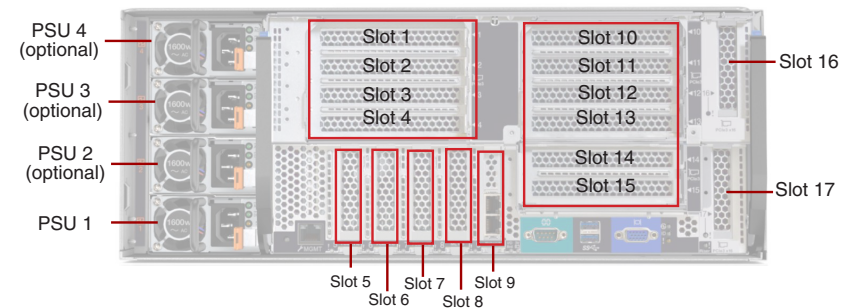

Note: All riser cards, expansion cards, and LOM adapters are optional.

Expansion slots

Supports five standard expansion slots (slot 5 - 9) and up to 12 optional expansion slots (slot 1 - 4, 10 - 15, 16 - 17) via 3 riser cards. The slots are as follows:

| | |
|---------------------------|--|
| Slot 1-4 (riser card 1) | Supports one of the following for riser card 1: Option 1: PCIe 3.0 x8/x8/x8/x8 (slot 1-4). Full height, half length Option 2: PCIe 3.0 x16/x16 (slot 3 and 4). Full height, half length Option 3: PCIe 3.0 x16/x16/x16/x16 (slot 1-4). Full height, half length |
| Slot 5 (on main I/O tray) | PCIe 3.0 x16, low profile |
| Slot 6 (on main I/O tray) | PCIe 3.0 x16, low profile |
| Slot 7 (on main I/O tray) | PCIe 3.0 x8, low profile |
| Slot 8 (on main I/O tray) | PCIe 3.0 x16 ML2, low profile |
| Slot 9 (on main I/O tray) | LOM slot, low profile |
| Slot 10-15 (riser card 2) | Supports one of the following for riser card 2: Option 1: PCIe 3.0 x8/x8/x8/x8 (slot 10-13). Full height, half length Option 2: PCIe 3.0 x16/x16 (slot 12 and 13). Full height, half length Option 3: PCIe 3.0 x16/x16/x16/x16 ML2 (slot 10-15). Full height, half length |
| Slot 16-17 (riser card 3) | PCIe 3.0 x8, low profile |

For riser cards configuration of each model, please see model configuration table.

ThinkSystem SR950 Models for USA and Canada - Non TopSeller

Product Specifications Reference (PSREF)

| Model | Processor | CPU Sockets (std/max) | Memory | Memory Sockets (std/max) | RAID/HBA Adapter | Disk Bays | Max Disk Bays | Disks | Networking (LOM/ML2/PCIe) | M.2 Boot Drive | Riser Card 1 for Slot 1-4 | Riser Card 2 for Slot 10-15 | Riser Card 3 for Slot 16-17 | Security | System Management | Power Supply | Base Warranty | Ann Date (mm/yy) |
|------------|--|-----------------------|------------------------------|--------------------------|------------------------|---|---------------|-------|---------------------------|----------------|---------------------------|-----------------------------|-----------------------------|----------|------------------------|---------------------|---------------|------------------|
| 7X12A01DNA | 2xXeon Gold 6130 16C/2.1GHz/ 22MB/125W/DDR4-2666 | 2/4 | 2x32GB RDIMM DDR4-2666 | 24/48 | 1x930-8i 2GB flash | 8x2.5" (6 SATA/SAS, 2 AnyBay) HS | 12 | Open | None | None | None | None | None | TPM 1.2 | XClarity Enterprise | 2x1100W Platinum | 3-year | 07/17 |
| 7X12A01GNA | 4xXeon Gold 5120 14C/2.2GHz/ 19.25MB/105W/DDR4-2400 | 4/4 | 4x32GB RDIMM DDR4-2666 | 48/48 | 1x930-8i 2GB flash | 8x2.5" (4 SATA/SAS, 4 AnyBay) HS | 12 | Open | None | None | x16 / x16, FHHL | x16 / x16, FHHL | x8 / x8, LP | TPM 1.2 | XClarity Enterprise | 2x1600W Platinum | 3-year | 07/17 |
| 7X12A01MNA | 4xXeon Platinum 8153 16C/2.0GHz/ 22MB/125W/DDR4-2666 | 4/8 | 4x32GB RDIMM DDR4-2666 | 48/96 | 1x930-8i 2GB flash | 8x2.5" (4 SATA/SAS, 4 AnyBay) HS | 12 | Open | None | None | x16 / x16, FHHL | x16 / x16, FHHL | x8 / x8, LP | TPM 1.2 | XClarity Enterprise | 2x1600W Platinum | 3-year | 07/17 |
| 7X12A01SNA | 8xXeon Platinum 8160 24C/2.1GHz/ 33MB/150W/DDR4-2666 | 8/8 | 8x32GB RDIMM DDR4-2666 | 96/96 | 2x930-16i 4GB flash | 24x2.5" (12 SATA/SAS, 12 AnyBay) HS | 24 | Open | None | None | 4 x16, FHHL | 5 x16 / x16 ML2, FHHL | x8 / x8, LP | TPM 1.2 | XClarity Enterprise | 4x1600W Platinum | 3-year | 07/17 |

ThinkSystem SR950 Models for EMEA - Non TopSeller

Product Specifications Reference (PSREF)

| Model | Processor | CPU Sockets (std/max) | Memory | Memory Sockets (std/max) | RAID/HBA Adapter | Disk Bays | Max Disk Bays | Disks | Networking (LOM/ML2/PCIe) | M.2 Boot Drive | Riser Card 1 for Slot 1-4 | Riser Card 2 for Slot 10-15 | Riser Card 3 for Slot 16-17 | Security | System Management | Power Supply | Base Warranty | Ann Date (mm/yy) |
|------------|--|-----------------------|------------------------------|--------------------------|------------------------|---|---------------|-------|---------------------------|----------------|---------------------------|-----------------------------|-----------------------------|----------|------------------------|---------------------|---------------|------------------|
| 7X12A017EA | 8xXeon Platinum 8160 24C/2.1GHz/33MB/150W/ DDR4-2666 | 8/8 | 8x32GB RDIMM DDR4-2666 | 96/96 | 2x930-16i 4GB flash | 24x2.5" (12 SATA/SAS, 12 AnyBay) HS | 24 | Open | None | None | 4 x16, FHHL | 5 x16 / x16 ML2, FHHL | x8 / x8, LP | TPM 1.2 | XClarity Enterprise | 4x1600W Platinum | 3-year | 07/17 |
| 7X12A018EA | 4xXeon Platinum 8153 16C/2.0GHz/22MB/125W/ DDR4-2666 | 4/8 | 4x32GB RDIMM DDR4-2666 | 48/96 | 1x930-16i 4GB flash | 12x2.5" (6 SATA/SAS, 6 AnyBay) HS | 12 | Open | None | None | x16 / x16, FHHL | x16 / x16, FHHL | x8 / x8, LP | TPM 1.2 | XClarity Enterprise | 2x1600W Platinum | 3-year | 07/17 |
| 7X12A019EA | 4xXeon Gold 5120 14C/2.2GHz/19.25MB/105W/ DDR4-2400 | 4/4 | 4x32GB RDIMM DDR4-2666 | 48/48 | 1x930-16i 4GB flash | 12x2.5" (6 SATA/SAS, 6 AnyBay) HS | 12 | Open | None | None | x16 / x16, FHHL | x16 / x16, FHHL | x8 / x8, LP | TPM 1.2 | XClarity Enterprise | 2x1600W Platinum | 3-year | 07/17 |
| 7X12A01AEA | 2xXeon Gold 6130 16C/2.1GHz/22MB/125W/ DDR4-2666 | 2/4 | 2x32GB RDIMM DDR4-2666 | 24/48 | 1x930-8i 2GB flash | 8x2.5" SATA/ SAS HS | 12 | Open | None | None | None | None | None | TPM 1.2 | XClarity Enterprise | 2x1600W Platinum | 3-year | 07/17 |

ThinkSystem SR950 Models for Australia and New Zealand - Non TopSeller

Product Specifications Reference (PSREF)

| Model | Processor | CPU Sockets (std/max) | Memory | Memory Sockets (std/max) | RAID/HBA Adapter | Disk Bays | Max Disk Bays | Disks | Networking (LOM/ML2/PCIe) | M.2 Boot Drive | Riser Card 1 for Slot 1-4 | Riser Card 2 for Slot 10-15 | Riser Card 3 for Slot 16-17 | Security | System Management | Power Supply | Base Warranty | Ann Date (mm/yy) |
|------------|--|-----------------------|------------------------------|--------------------------|------------------------|-------------------------|---------------|-------|---------------------------|----------------|---------------------------|-----------------------------|-----------------------------|----------|------------------------|---------------------|---------------|------------------|
| 7X12A003AU | 8xXeon Platinum 8160 24C/2.1GHz/33MB/150W/ DDR4-2666 | 8/8 | 8x32GB RDIMM DDR4-2666 | 96/96 | 2x930-16i 4GB flash | 24x2.5" SATA/ SAS HS | 24 | Open | None | None | 4 x16, FHHL | 5 x16 / x16 ML2, FHHL | x8 / x8, LP | TPM 1.2 | XClarity Enterprise | 4x1600W Platinum | 3-year | 07/17 |
| 7X12A00BAU | 2xXeon Gold 6130 16C/2.1GHz/22MB/125W/ DDR4-2666 | 2/4 | 2x32GB RDIMM DDR4-2666 | 24/48 | 1x930-8i 2GB flash | 8x2.5" SATA/ SAS HS | 12 | Open | None | None | None | None | None | TPM 1.2 | XClarity Enterprise | 2x1100W Platinum | 3-year | 07/17 |
| 7X12A00CAU | 4xXeon Gold 5120 14C/2.2GHz/19.25MB/105W/ DDR4-2400 | 4/4 | 4x32GB RDIMM DDR4-2666 | 48/48 | 1x930-8i 2GB flash | 8x2.5" SATA/ SAS HS | 12 | Open | None | None | x16 / x16, FHHL | x16 / x16, FHHL | x8 / x8, LP | TPM 1.2 | XClarity Enterprise | 2x1600W Platinum | 3-year | 07/17 |
| 7X12A00EAU | 8xXeon Platinum 8160 24C/2.1GHz/33MB/150W/ DDR4-2666 | 8/8 | 8x32GB RDIMM DDR4-2666 | 96/96 | 2x930-16i 4GB flash | 24x2.5" SATA/ SAS HS | 24 | Open | None | None | 4 x16, FHHL | 5 x16 / x16 ML2, FHHL | x8 / x8, LP | TPM 1.2 | XClarity Enterprise | 4x1600W Platinum | 3-year | 07/17 |
| 7X12A00FAU | 2xXeon Gold 6130 16C/2.1GHz/22MB/125W/ DDR4-2666 | 2/4 | 2x32GB RDIMM DDR4-2666 | 24/48 | 1x930-8i 2GB flash | 8x2.5" SATA/ SAS HS | 12 | Open | None | None | None | None | None | TPM 1.2 | XClarity Enterprise | 2x1100W Platinum | 3-year | 07/17 |
| 7X12A00HAU | 4xXeon Platinum 8153 16C/2.0GHz/22MB/125W/ DDR4-2666 | 4/8 | 4x32GB RDIMM DDR4-2666 | 48/96 | 1x930-8i 2GB flash | 8x2.5" SATA/ SAS HS | 12 | Open | None | None | x16 / x16, FHHL | x16 / x16, FHHL | x8 / x8, LP | TPM 1.2 | XClarity Enterprise | 2x1600W Platinum | 3-year | 07/17 |
| 7X12A00LAU | 4xXeon Platinum 8153 16C/2.0GHz/22MB/125W/ DDR4-2666 | 4/8 | 4x32GB RDIMM DDR4-2666 | 48/96 | 1x930-8i 2GB flash | 8x2.5" SATA/ SAS HS | 12 | Open | None | None | x16 / x16, FHHL | x16 / x16, FHHL | x8 / x8, LP | TPM 1.2 | XClarity Enterprise | 2x1600W Platinum | 3-year | 07/17 |
| 7X12A00NAU | 8xXeon Platinum 8160 24C/2.1GHz/33MB/150W/ DDR4-2666 | 8/8 | 8x32GB RDIMM DDR4-2666 | 96/96 | 2x930-16i 4GB flash | 24x2.5" SATA/ SAS HS | 24 | Open | None | None | 4 x16, FHHL | 5 x16 / x16 ML2, FHHL | x8 / x8, LP | TPM 1.2 | XClarity Enterprise | 4x1600W Platinum | 3-year | 07/17 |
| 7X12A00QAU | 4xXeon Platinum 8153 16C/2.0GHz/22MB/125W/ DDR4-2666 | 4/8 | 4x32GB RDIMM DDR4-2666 | 48/96 | 1x930-8i 2GB flash | 8x2.5" SATA/ SAS HS | 12 | Open | None | None | x16 / x16, FHHL | x16 / x16, FHHL | x8 / x8, LP | TPM 1.2 | XClarity Enterprise | 2x1600W Platinum | 3-year | 07/17 |
| 7X12A00RAU | 4xXeon Gold 5120 14C/2.2GHz/19.25MB/105W/ DDR4-2400 | 4/4 | 4x32GB RDIMM DDR4-2666 | 48/48 | 1x930-8i 2GB flash | 8x2.5" SATA/ SAS HS | 12 | Open | None | None | x16 / x16, FHHL | x16 / x16, FHHL | x8 / x8, LP | TPM 1.2 | XClarity Enterprise | 2x1600W Platinum | 3-year | 07/17 |
| 7X12A00SAU | 4xXeon Gold 5120 14C/2.2GHz/19.25MB/105W/ DDR4-2400 | 4/4 | 4x32GB RDIMM DDR4-2666 | 48/48 | 1x930-8i 2GB flash | 8x2.5" SATA/ SAS HS | 12 | Open | None | None | x16 / x16, FHHL | x16 / x16, FHHL | x8 / x8, LP | TPM 1.2 | XClarity Enterprise | 2x1600W Platinum | 3-year | 07/17 |
| 7X12A00UAU | 2xXeon Gold 6130 16C/2.1GHz/22MB/125W/ DDR4-2666 | 2/4 | 2x32GB RDIMM DDR4-2666 | 24/48 | 1x930-8i 2GB flash | 8x2.5" SATA/ SAS HS | 12 | Open | None | None | None | None | None | TPM 1.2 | XClarity Enterprise | 2x1100W Platinum | 3-year | 07/17 |

ThinkSystem SR950 Models for South East Asian (ASEAN) - Non TopSeller

Product Specifications Reference (PSREF)

| Model | Processor | CPU Sockets (std/max) | Memory | Memory Sockets (std/max) | RAID/HBA Adapter | Disk Bays | Max Disk Bays | Disks | Networking (LOM/ML2/PCIe) | M.2 Boot Drive | Riser Card 1 for Slot 1-4 | Riser Card 2 for Slot 10-15 | Riser Card 3 for Slot 16-17 | Security | System Management | Power Supply | Base Warranty | Ann Date (mm/yy) |
|------------|---|-----------------------|------------------------------|--------------------------|------------------------|-------------------------|---------------|-------|---------------------------|----------------|---------------------------|-----------------------------|-----------------------------|----------|------------------------|---------------------|---------------|------------------|
| 7X12A014SG | 2xXeon Platinum 8160 24C/2.1GHz/33MB/150W/ DDR4-2666 | 2/8 | 4x32GB RDIMM DDR4-2666 | 24/96 | 1x930-16i 4GB flash | 12x2.5" SATA/ SAS HS | 12 | Open | 4x10GbE RJ-45 LOM | None | None | None | None | TPM 1.2 | XClarity Enterprise | 2x1600W Platinum | 3-year | 07/17 |
| 7X12A015SG | 2xXeon Platinum 8153 16C/2.0GHz/22MB/125W/ DDR4-2666 | 2/8 | 4x32GB RDIMM DDR4-2666 | 24/96 | 1x930-16i 4GB flash | 12x2.5" SATA/ SAS HS | 12 | Open | 4x10GbE RJ-45 LOM | None | None | None | None | TPM 1.2 | XClarity Enterprise | 2x1600W Platinum | 3-year | 07/17 |
| 7X12A016SG | 2xXeon Platinum 8158 12C/3.0GHz/24.75MB/150W/ DDR4-2666 | 2/8 | 4x32GB RDIMM DDR4-2666 | 24/96 | 1x930-16i 4GB flash | 12x2.5" SATA/ SAS HS | 12 | Open | 4x10GbE RJ-45 LOM | None | None | None | None | TPM 1.2 | XClarity Enterprise | 2x1600W Platinum | 3-year | 07/17 |
| 7X12A01BSG | 2xXeon Platinum 8164 26C/2.0GHz/35.75MB/150W/ DDR4-2666 | 2/8 | 4x32GB RDIMM DDR4-2666 | 24/96 | 1x930-16i 4GB flash | 12x2.5" SATA/ SAS HS | 12 | Open | 4x10GbE RJ-45 LOM | None | None | None | None | TPM 1.2 | XClarity Enterprise | 2x1600W Platinum | 3-year | 07/17 |
| 7X12A01CSG | 2xXeon Platinum 8176 28C/2.1GHz/38.5MB/165W/ DDR4-2666 | 2/8 | 4x32GB RDIMM DDR4-2666 | 24/96 | 1x930-16i 4GB flash | 12x2.5" SATA/ SAS HS | 12 | Open | 4x10GbE RJ-45 LOM | None | None | None | None | TPM 1.2 | XClarity Enterprise | 2x1600W Platinum | 3-year | 07/17 |

ThinkSystem SR950 Models for Hong Kong, Taiwan, Korea (HTK) - Non TopSeller

Product Specifications Reference (PSREF)

| Model | Processor | CPU Sockets (std/max) | Memory | Memory Sockets (std/max) | RAID/HBA Adapter | Disk Bays | Max Disk Bays | Disks | Networking (LOM/ML2/PCIe) | M.2 Boot Drive | Riser Card 1 for Slot 1-4 | Riser Card 2 for Slot 10-15 | Riser Card 3 for Slot 16-17 | Security | System Management | Power Supply | Base Warranty | Ann Date (mm/yy) |
|------------|---|-----------------------|------------------------------|--------------------------|------------------------|-------------------------|---------------|-------|---------------------------|----------------|---------------------------|-----------------------------|-----------------------------|----------|------------------------|---------------------|---------------|------------------|
| 7X12A01ECN | 2xXeon Platinum 8180 28C/2.5GHz/38.5MB/205W/ DDR4-2666 | 2/8 | 2x16GB RDIMM DDR4-2666 | 24/96 | 1x930-16i 4GB flash | 12x2.5" SATA/ SAS HS | 12 | Open | 4xGbE RJ- 45 LOM | None | None | None | None | TPM 1.2 | XClarity Enterprise | 2x1600W Platinum | 3-year | 07/17 |
| 7X12A01FCN | 2xXeon Platinum 8170 26C/2.1GHz/35.75MB/165W/ DDR4-2666 | 2/8 | 2x16GB RDIMM DDR4-2666 | 24/96 | 1x930-16i 4GB flash | 12x2.5" SATA/ SAS HS | 12 | Open | 4xGbE RJ- 45 LOM | None | None | None | None | TPM 1.2 | XClarity Enterprise | 2x1600W Platinum | 3-year | 07/17 |
| 7X12A01HCN | 2xXeon Platinum 8156 4C/3.6GHz/16.5MB/105W/ DDR4-2666 | 2/8 | 2x16GB RDIMM DDR4-2666 | 24/96 | 1x930-16i 4GB flash | 12x2.5" SATA/ SAS HS | 12 | Open | 4xGbE RJ- 45 LOM | None | None | None | None | TPM 1.2 | XClarity Enterprise | 2x1600W Platinum | 3-year | 07/17 |
| 7X12A01JCN | 2xXeon Platinum 8153 16C/2.0GHz/22MB/125W/ DDR4-2666 | 2/8 | 2x16GB RDIMM DDR4-2666 | 24/96 | 1x930-16i 4GB flash | 12x2.5" SATA/ SAS HS | 12 | Open | 4xGbE RJ- 45 LOM | None | None | None | None | TPM 1.2 | XClarity Enterprise | 2x1600W Platinum | 3-year | 07/17 |
| 7X12A01KCN | 2xXeon Gold 6130 16C/2.1GHz/22MB/125W/ DDR4-2666 | 2/4 | 2x16GB RDIMM DDR4-2666 | 24/48 | 1x930-16i 4GB flash | 12x2.5" SATA/ SAS HS | 12 | Open | 4xGbE RJ- 45 LOM | None | None | None | None | TPM 1.2 | XClarity Enterprise | 2x1600W Platinum | 3-year | 07/17 |
| 7X12A01LCN | 2xXeon Gold 6152 22C/2.1GHz/30.25MB/140W/ DDR4-2666 | 2/4 | 2x16GB RDIMM DDR4-2666 | 24/48 | 1x930-16i 4GB flash | 12x2.5" SATA/ SAS HS | 12 | Open | 4xGbE RJ- 45 LOM | None | None | None | None | TPM 1.2 | XClarity Enterprise | 2x1600W Platinum | 3-year | 07/17 |
| 7X12A01NCN | 2xXeon Gold 6148 20C/2.4GHz/27.5MB/150W/ DDR4-2666 | 2/4 | 2x16GB RDIMM DDR4-2666 | 24/48 | 1x930-16i 4GB flash | 12x2.5" SATA/ SAS HS | 12 | Open | 4xGbE RJ- 45 LOM | None | None | None | None | TPM 1.2 | XClarity Enterprise | 2x1600W Platinum | 3-year | 07/17 |
| 7X12A01PCN | 2xXeon Gold 6142 16C/2.6GHz/22MB/150W/ DDR4-2666 | 2/4 | 2x16GB RDIMM DDR4-2666 | 24/48 | 1x930-16i 4GB flash | 12x2.5" SATA/ SAS HS | 12 | Open | 4xGbE RJ- 45 LOM | None | None | None | None | TPM 1.2 | XClarity Enterprise | 2x1600W Platinum | 3-year | 07/17 |
| 7X12A01QCN | 2xXeon Platinum 8160 24C/2.1GHz/33MB/150W/ DDR4-2666 | 2/8 | 2x16GB RDIMM DDR4-2666 | 24/96 | 1x930-16i 4GB flash | 12x2.5" SATA/ SAS HS | 12 | Open | 4xGbE RJ- 45 LOM | None | None | None | None | TPM 1.2 | XClarity Enterprise | 2x1600W Platinum | 3-year | 07/17 |
| 7X12A01RCN | 2xXeon Gold 6140 18C/2.3GHz/24.75MB/140W/ DDR4-2666 | 2/4 | 2x16GB RDIMM DDR4-2666 | 24/48 | 1x930-16i 4GB flash | 12x2.5" SATA/ SAS HS | 12 | Open | 4xGbE RJ- 45 LOM | None | None | None | None | TPM 1.2 | XClarity Enterprise | 2x1600W Platinum | 3-year | 07/17 |

ThinkSystem SR950 Models for India - Non TopSeller

Product Specifications Reference (PSREF)

| Model | Processor | CPU Sockets (std/max) | Memory | Memory Sockets (std/max) | RAID/HBA Adapter | Disk Bays | Max Disk Bays | Disks | Networking (LOM/ML2/PCIe) | M.2 Boot Drive | Riser Card 1 for Slot 1-4 | Riser Card 2 for Slot 10-15 | Riser Card 3 for Slot 16-17 | Security | System Management | Power Supply | Base Warranty | Ann Date (mm/yy) |
|------------|---|-----------------------|------------------------------|--------------------------|------------------------|------------------------|---------------|-------|---------------------------|----------------|---------------------------|-----------------------------|-----------------------------|----------|------------------------|---------------------|---------------|------------------|
| 7X12A001SG | 2xXeon Gold 6142M 16C/2.6GHz/22MB/150W/ DDR4-2666 | 2/4 | 2x32GB RDIMM DDR4-2666 | 24/48 | 1x930-16i 4GB flash | 4x2.5" SATA/ SAS HS | 12 | Open | 4xGbE RJ- 45 LOM | None | None | None | None | TPM 1.2 | XClarity Enterprise | 2x1100W Platinum | 3-year | 07/17 |
| 7X12A002SG | 2xXeon Gold 6132 14C/2.6GHz/19.25MB/140W/ DDR4-2666 | 2/4 | 2x16GB RDIMM DDR4-2666 | 24/48 | 1x930-16i 4GB flash | 4x2.5" SATA/ SAS HS | 12 | Open | 4xGbE RJ- 45 LOM | None | None | None | None | TPM 1.2 | XClarity Enterprise | 2x1100W Platinum | 3-year | 07/17 |
| 7X12A004SG | 2xXeon Gold 6142 16C/2.6GHz/22MB/150W/ DDR4-2666 | 2/4 | 2x16GB RDIMM DDR4-2666 | 24/48 | 1x930-16i 4GB flash | 4x2.5" SATA/ SAS HS | 12 | Open | 4xGbE RJ- 45 LOM | None | None | None | None | TPM 1.2 | XClarity Enterprise | 2x1100W Platinum | 3-year | 07/17 |
| 7X12A005SG | 2xXeon Gold 6152 22C/2.1GHz/30.25MB/140W/ DDR4-2666 | 2/4 | 2x16GB RDIMM DDR4-2666 | 24/48 | 1x930-16i 4GB flash | 4x2.5" SATA/ SAS HS | 12 | Open | 4xGbE RJ- 45 LOM | None | None | None | None | TPM 1.2 | XClarity Enterprise | 2x1100W Platinum | 3-year | 07/17 |
| 7X12A006SG | 2xXeon Gold 6140M 18C/2.3GHz/24.75MB/140W/ DDR4-2666 | 2/4 | 2x16GB RDIMM DDR4-2666 | 24/48 | 1x930-16i 4GB flash | 4x2.5" SATA/ SAS HS | 12 | Open | 4xGbE RJ- 45 LOM | None | None | None | None | TPM 1.2 | XClarity Enterprise | 2x1100W Platinum | 3-year | 07/17 |
| 7X12A008SG | 2xXeon Gold 6140 18C/2.3GHz/24.75MB/140W/ DDR4-2666 | 2/4 | 2x16GB RDIMM DDR4-2666 | 24/48 | 1x930-16i 4GB flash | 4x2.5" SATA/ SAS HS | 12 | Open | 4xGbE RJ- 45 LOM | None | None | None | None | TPM 1.2 | XClarity Enterprise | 2x1100W Platinum | 3-year | 07/17 |
| 7X12A009SG | 2xXeon Gold 6150 18C/2.7GHz/24.75MB/165W/ DDR4-2666 | 2/4 | 2x16GB RDIMM DDR4-2666 | 24/48 | 1x930-16i 4GB flash | 4x2.5" SATA/ SAS HS | 12 | Open | 4xGbE RJ- 45 LOM | None | None | None | None | TPM 1.2 | XClarity Enterprise | 2x1100W Platinum | 3-year | 07/17 |
| 7X12A00ASG | 2xXeon Gold 6148 20C/2.4GHz/27.5MB/150W/ DDR4-2666 | 2/4 | 2x16GB RDIMM DDR4-2666 | 24/48 | 1x930-16i 4GB flash | 4x2.5" SATA/ SAS HS | 12 | Open | 4xGbE RJ- 45 LOM | None | None | None | None | TPM 1.2 | XClarity Enterprise | 2x1100W Platinum | 3-year | 07/17 |
| 7X12A00DSG | 2xXeon Platinum 8160M 24C/2.1GHz/33MB/150W/ DDR4-2666 | 2/4 | 2x16GB RDIMM DDR4-2666 | 24/48 | 1x930-16i 4GB flash | 4x2.5" SATA/ SAS HS | 12 | Open | 4xGbE RJ- 45 LOM | None | None | None | None | TPM 1.2 | XClarity Enterprise | 2x1100W Platinum | 3-year | 07/17 |
| 7X12A00JSG | 2xXeon Gold 6134M 8C/3.2GHz/24.75MB/130W/ DDR4-2666 | 2/4 | 2x16GB RDIMM DDR4-2666 | 24/48 | 1x930-16i 4GB flash | 4x2.5" SATA/ SAS HS | 12 | Open | 4xGbE RJ- 45 LOM | None | None | None | None | TPM 1.2 | XClarity Enterprise | 2x1100W Platinum | 3-year | 07/17 |
| 7X12A00KSG | 2xXeon Gold 6134M 8C/3.2GHz/24.75MB/130W/ DDR4-2666 | 2/4 | 2x32GB RDIMM DDR4-2666 | 24/48 | 1x930-16i 4GB flash | 4x2.5" SATA/ SAS HS | 12 | Open | 4xGbE RJ- 45 LOM | None | None | None | None | TPM 1.2 | XClarity Enterprise | 2x1100W Platinum | 3-year | 07/17 |
| 7X12A00PSG | 2xXeon Platinum 8158 12C/3.0GHz/24.75MB/150W/ DDR4-2666 | 2/4 | 2x16GB RDIMM DDR4-2666 | 24/48 | 1x930-16i 4GB flash | 4x2.5" SATA/ SAS HS | 12 | Open | 4xGbE RJ- 45 LOM | None | None | None | None | TPM 1.2 | XClarity Enterprise | 2x1100W Platinum | 3-year | 07/17 |
| 7X12A00VSG | 2xXeon Gold 6126 12C/2.6GHz/19.25MB/125W/ DDR4-2666 | 2/4 | 2x16GB RDIMM DDR4-2666 | 24/48 | 1x930-16i 4GB flash | 4x2.5" SATA/ SAS HS | 12 | Open | 4xGbE RJ- 45 LOM | None | None | None | None | TPM 1.2 | XClarity Enterprise | 2x1100W Platinum | 3-year | 07/17 |
| 7X12A00YSG | 2xXeon Platinum 8180 28C/2.5GHz/38.5MB/205W/ DDR4-2666 | 2/8 | 2x16GB RDIMM DDR4-2666 | 24/96 | 1x930-16i 4GB flash | 4x2.5" SATA/ SAS HS | 12 | Open | 4xGbE RJ- 45 LOM | None | None | None | None | TPM 1.2 | XClarity Enterprise | 2x1100W Platinum | 3-year | 07/17 |
| 7X12A00ZSG | 2xXeon Platinum 8160M 24C/2.1GHz/33MB/150W/ DDR4-2666 | 2/4 | 2x32GB RDIMM DDR4-2666 | 24/48 | 1x930-16i 4GB flash | 4x2.5" SATA/ SAS HS | 12 | Open | 4xGbE RJ- 45 LOM | None | None | None | None | TPM 1.2 | XClarity Enterprise | 2x1100W Platinum | 3-year | 07/17 |
| 7X12A010SG | 2xXeon Gold 6142M 16C/2.6GHz/22MB/150W/ DDR4-2666 | 2/4 | 2x16GB RDIMM DDR4-2666 | 24/48 | 1x930-16i 4GB flash | 4x2.5" SATA/ SAS HS | 12 | Open | 4xGbE RJ- 45 LOM | None | None | None | None | TPM 1.2 | XClarity Enterprise | 2x1100W Platinum | 3-year | 07/17 |
| 7X12A011SG | 2xXeon Platinum 8164 26C/2.0GHz/35.75MB/150W/ DDR4-2666 | 2/8 | 2x16GB RDIMM DDR4-2666 | 24/96 | 1x930-16i 4GB flash | 4x2.5" SATA/ SAS HS | 12 | Open | 4xGbE RJ- 45 LOM | None | None | None | None | TPM 1.2 | XClarity Enterprise | 2x1100W Platinum | 3-year | 07/17 |

ThinkSystem SR950 Models for Japan - Non TopSeller

Product Specifications Reference (PSREF)

| Model | Processor | CPU Sockets (std/max) | Memory | Memory Sockets (std/max) | RAID/HBA Adapter | Disk Bays | Max Disk Bays | Disks | Networking (LOM/ML2/PCIe) | M.2 Boot Drive | Riser Card 1 for Slot 1-4 | Riser Card 2 for Slot 10-15 | Riser Card 3 for Slot 16-17 | Security | System Management | Power Supply | Base Warranty | Ann Date (mm/yy) |
|------------|--|-----------------------|------------------------------|--------------------------|------------------------|--|---------------|-------|---------------------------|----------------|---------------------------|-----------------------------|-----------------------------|----------|------------------------|---------------------|---------------|------------------|
| 7X12A00MJP | 2xXeon Gold 6128 6C/3.4GHz/19.25MB/115W/ DDR4-2666 | 2/4 | 4x16GB RDIMM DDR4-2666 | 24/48 | 1x930-16i 4GB flash | 4x2.5" (2 SATA/SAS, 2 AnyBay) | 12 | Open | 4x10GbE RJ-45 LOM | None | None | None | x8 / x8, LP | TPM 1.2 | XClarity Enterprise | 4x1100W Platinum | 3-year | 07/17 |
| 7X12A012JP | 4xXeon Platinum 8180 28C/2.5GHz/38.5MB/205W/ DDR4-2666 | 4/8 | 4x16GB RDIMM DDR4-2666 | 48/96 | 1x930-16i 4GB flash | 4x2.5" (2 SATA/SAS, 2 AnyBay) | 12 | Open | 4x10GbE RJ-45 LOM | None | None | None | x8 / x8, LP | TPM 1.2 | XClarity Enterprise | 4x1600W Platinum | 3-year | 07/17 |
| 7X12A013JP | 2xXeon Gold 6154 18C/3.0GHz/24.75MB/200W/ DDR4-2666 | 2/4 | 2x16GB RDIMM DDR4-2666 | 24/48 | 1x930-16i 4GB flash | 8x2.5" (6 SATA/SAS, 2 AnyBay) HS | 12 | Open | 4x10GbE RJ-45 LOM | None | None | None | x8 / x8, LP | TPM 1.2 | XClarity Enterprise | 2x1600W Platinum | 3-year | 07/17 |

ThinkSystem SR950 Models for Brazil - Non TopSeller

Product Specifications Reference (PSREF)

| Model | Processor | CPU Sockets (std/max) | Memory | Memory Sockets (std/max) | RAID/HBA Adapter | Disk Bays | Max Disk Bays | Disks | Networking (LOM/ML2/PCIe) | M.2 Boot Drive | Riser Card 1 for Slot 1-4 | Riser Card 2 for Slot 10-15 | Riser Card 3 for Slot 16-17 | Security | System Management | Power Supply | Base Warranty | Ann Date (mm/yy) |
|------------|--|-----------------------|------------------------------|--------------------------|------------------------|-------------------------|---------------|-------|---------------------------|----------------|---------------------------|-----------------------------|-----------------------------|----------|------------------------|---------------------|---------------|------------------|
| 7X12A01TBR | 2xXeon Gold 6130 16C/2.1GHz/22MB/125W/ DDR4-2666 | 2/4 | 2x32GB RDIMM DDR4-2666 | 24/48 | 1x930-8i 2GB flash | 8x2.5" SATA/ SAS HS | 12 | Open | None | None | None | None | None | TPM 1.2 | XClarity Enterprise | 2x1100W Platinum | 3-year | 07/17 |
| 7X12A01UBR | 8xXeon Platinum 8160 24C/2.1GHz/33MB/150W/ DDR4-2666 | 8/8 | 8x32GB RDIMM DDR4-2666 | 96/96 | 2x930-16i 4GB flash | 24x2.5" SATA/ SAS HS | 24 | Open | None | None | 4 x16, FHHL | 5 x16 / x16 ML2, FHHL | x8 / x8, LP | TPM 1.2 | XClarity Enterprise | 4x1600W Platinum | 3-year | 07/17 |
| 7X12A01VBR | 4xXeon Platinum 8153 16C/2.0GHz/22MB/125W/ DDR4-2666 | 4/8 | 4x32GB RDIMM DDR4-2666 | 48/96 | 1x930-8i 2GB flash | 8x2.5" SATA/ SAS HS | 12 | Open | None | None | x16 / x16, FHHL | x16 / x16, FHHL | x8 / x8, LP | TPM 1.2 | XClarity Enterprise | 2x1600W Platinum | 3-year | 07/17 |
| 7X12A01WBR | 4xXeon Gold 5120 14C/2.2GHz/19.25MB/105W/ DDR4-2400 | 4/4 | 4x32GB RDIMM DDR4-2666 | 48/48 | 1x930-8i 2GB flash | 8x2.5" SATA/ SAS HS | 12 | Open | None | None | x16 / x16, FHHL | x16 / x16, FHHL | x8 / x8, LP | TPM 1.2 | XClarity Enterprise | 2x1600W Platinum | 3-year | 07/17 |

LenovoTM

ThinkVision

PSREF



Product Specifications Reference

Version 508, June 2017

U.S.

Visit <http://psref.lenovo.com> for the latest version

Contents

| | | |
|---|-----------|--|
| Cover | | |
| Contents | | |
| Summary Of Change | | |
| 17 Inch - 20 Inch | | |
| ThinkVision E1922s | | |
| ThinkVision E1922s Platform Specifications | | |
| ThinkVision E2054 | | |
| ThinkVision E2054 Platform Specifications | | |
| ThinkVision LT1913p Square | | |
| ThinkVision LT1913p Square Platform Specifications | | |
| ThinkVision LT2024 | | |
| ThinkVision LT2024 Platform Specifications | | |
| ThinkVision T1714 | | |
| ThinkVision T1714 Platform Specifications | | |
| ThinkVision T1714p | | |
| ThinkVision T1714p Platform Specifications | | |
| ThinkVision T2054p | | |
| ThinkVision T2054p Platform Specifications | | |
| 21 Inch - 24 Inch | | |
| ThinkVision LT2423 | | |
| ThinkVision LT2423 Platform Specifications | | |
| ThinkVision P24h | | |
| ThinkVision P24h Platform Specifications | | |
| ThinkVision P24q | | |
| ThinkVision P24q Platform Specifications | | |
| ThinkVision T2224d | | |
| ThinkVision T2224d Platform Specifications | | |
| ThinkVision T2224z | | |
| ThinkVision T2224z Platform Specifications | | |
| ThinkVision T2254p | | |
| ThinkVision T2254p Platform Specifications | | |
| ThinkVision T22i | | |
| ThinkVision T22i Platform Specifications | | |
| ThinkVision T2324d | | |
| ThinkVision T2324d Platform Specifications | | |
| 1 ThinkVision T2364t | 34 | |
| 2 ThinkVision T2364t Platform Specifications | 35 | |
| 3 ThinkVision T23i | 36 | |
| 4 ThinkVision T23i Platform Specifications | 37 | |
| 4 ThinkVision T2424z | 38 | |
| 5 ThinkVision T2424z Platform Specifications | 39 | |
| 6 ThinkVision T2454p | 40 | |
| 7 ThinkVision T2454p Platform Specifications | 41 | |
| 8 ThinkVision T24d | 42 | |
| 9 ThinkVision T24d Platform Specifications | 43 | |
| 10 ThinkVision T24i | 44 | |
| 11 ThinkVision T24i Platform Specifications | 45 | |
| 12 ThinkVision X24 | 46 | |
| 13 ThinkVision X24 Platform Specifications | 47 | |
| 14 ThinkVision X24 Pro | 48 | |
| 15 ThinkVision X24 Pro Platform Specifications | 49 | |
| 16 Above 25 Inch | 50 | |
| 17 ThinkVision P27 | 50 | |
| 18 ThinkVision P27 Platform Specifications | 51 | |
| 18 ThinkVision P27h | 52 | |
| 19 ThinkVision P27h Platform Specifications | 53 | |
| 20 ThinkVision P27q | 54 | |
| 21 ThinkVision P27q Platform Specifications | 55 | |
| 22 ThinkVision Pro2820 | 56 | |
| 23 ThinkVision Pro2820 Platform Specifications | 57 | |
| 24 ThinkVision X1 | 58 | |
| 25 ThinkVision X1 Platform Specifications | 59 | |
| 26 Legal Information | 60 | |
| 27 | | |
| 28 | | |
| 29 | | |
| 30 | | |
| 31 | | |
| 32 | | |
| 33 | | |

Summary of Changes

This section describes the technical changes made in this edition.

This edition might also include minor corrections and editorial changes which are not identified.

June 21, 2017 - Version 508

Additions in this update

▶ **New product(s)**

ThinkVision T24d new product announced June 2017

▶ **New model(s)**

None

▶ **Others**

None

Changes in this update

None

Withdrawals in this update

None



| | | | | | |
|--|---|----------------------------------|---------|---------------------------------|---------|
| <p>Name E1922s Wide Flat Panel Monitor Case color Black Type-model 60G2AAT6US / 60G2AAR6US / 60G2AAT6EU Panel TFT-LCD, twisted nematic (TN), White LED backlight Viewable image size 18.5" (470mm) diagonal Max view area (W x H) 16.1" x 9.1" / 409.8mm x 230.4mm Native resolution 1366x768 Aspect ratio 16:9 Pixel pitch (mm) 0.3mm Dot/Pixel per Inch 85 dpi Brightness 200 nits or cd/m² (typical) Contrast ratio 600:1 (typical) Pixel response time 5ms (typical) Color gamut 72% Viewing angle at 10:1 CR 180° (+/- 90°) horizontal, 100° (+/- 50°) vertical Stand Tilt adjustable stand Bezel width Sides: 0.73" (18.5mm) Dimensions (HxWxD) 13.44" H x 17.65" W x 6.58" D; 341.5mm H x 448.4mm W x 167.2mm D Power supply 13.7 watts typical, 17 watts maximum, <0.5 watts standby/suspend, universal, integrated (no external brick-like power supply) Weight 6.03 lb; 2.74 kg Limited warranty⁴ 3 year (includes backlight) Available date March 2014</p> | <p style="text-align: center;">Features</p> <ul style="list-style-type: none"> • Widescreen 18.5-inch monitor • Supports HD 1366x768 resolution • Supports VESA mount (100mm) • Mercury free panel and arsenic free glass • Kensington lock slot ready for enhanced security • Support Lenovo Tiny PC via VESA mount • Supports optional soundbar • Microsoft® Windows® 7 certified • Microsoft Windows 8 / Windows 8.1 certified | | | | |
| <p>VESA-compliant² VESA DPMS-compliant Power management ENERGY STAR® 7.0 Ergonomics ISO 9241-307 Emission standards FCC Class B Environmental TCO (TCO Displays 7.0), WEEE, RoHS, EPEAT™ Gold rating</p> | <div style="text-align: center;">  <p>ThinkVision E1922s Wide Monitor</p> </div> | | | | |
| <p>Preset resolutions VGA: 640x350, 640x480, 720x400 SVGA: 800x600, 832x624 XGA: 1024x768, 1152x864 SXGA: 1280x1024 WXGA: 1366x768</p> <p>Presets / user settings Standard presets: 15 user settings: 16</p> | | | | | |
| <p>Viewing adjustments Tilt: 20° backward, -5° forward Rotating screen None On screen display On screen display with digital user controls (8 languages) Control features Direct access (control buttons on front) for automatic image setup and adjustment for brightness Multiple input None Monitor connectors VGA 15-pin D-shell, analog, blue Signal cables detachable, VGA 15-pin D-shell at each end, analog, 1.8 meter Mounting features Wall or desk mounting using the Extend Arm or third-party accessories meeting the VESA FPMPI® (100mm mount) Security Security keyhole for attachment of optional cable lock (Kensington® lock-compatible)</p> | | | | | |
| <p>Ship group Monitor with stand, 1.8 meter analog signal cable, 1.8 meter black power cord</p> | | | | | |
| <p style="text-align: center;">Limited Warranty</p> <p>See details at http://support.lenovo.com/en_US/guides-and-manuals/detail.page?DocID=UM008281</p> | <p style="text-align: center;">Accessories</p> <table border="0"> <tr> <td>Kensington MicroSaver Cable Lock</td> <td style="text-align: right;">73P2582</td> </tr> <tr> <td>Kensington Twin Head Cable Lock</td> <td style="text-align: right;">45K1620</td> </tr> </table> <p>See details at www.lenovo.com/support/monitoraccessories</p> <p>See all monitors at www.lenovo.com/thinkvision</p> | Kensington MicroSaver Cable Lock | 73P2582 | Kensington Twin Head Cable Lock | 45K1620 |
| Kensington MicroSaver Cable Lock | 73P2582 | | | | |
| Kensington Twin Head Cable Lock | 45K1620 | | | | |



| | |
|---|---|
| <p>Name E2054 Wide Flat Panel Monitor Case color Raven black Type-model 60DFAAR1US / 60DFAAT1US / 60DFAAT1EU Panel TFT-LCD, In-Plane Switching (IPS), LED backlight Viewable image size 19.5" (494mm) diagonal Max view area (W x H) 16.48" x 10.33" / 418.6mm x 262.4mm Native resolution 1440x900 Aspect ratio 16:10 Pixel pitch (mm) 0.097mm x 0.292mm Dot/Pixel per Inch 87 dpi Brightness 250 nits or cd/m² (typical) Contrast ratio 1000:1 (typical) Pixel response time 7ms (typical) Color gamut 72% Viewing angle at 10:1 CR 178° (+/- 89°) horizontal, 178° (+/- 89°) vertical Stand Tilt adjustable stand Bezel width Top: 0.71" (18.0mm) Bottom: 0.70" (17.9mm) Sides: 1.02" (26.0mm) Dimensions (HxWxD) 14.65" H x 17.95" W x 7.41" D; 372.0mm H x 456.0mm W x 188.3mm D Power supply 16 watts typical, 20 watts maximum, <0.5 watts standby/suspend, universal, integrated (no external brick-like power supply) Weight 6.17 lb; 2.8 kg Limited warranty 3 year (includes backlight) Available date November 2015</p> | <p style="text-align: center;">Features</p> <ul style="list-style-type: none"> • Widescreen 19.5-inch monitor • Supports HD 1440x900 resolution • Supports VESA mount (100mm) • Mercury free panel and arsenic free glass • Kensington lock slot ready for enhanced security • Support Lenovo Tiny PC via VESA mount • Microsoft® Windows® 7 certified • Microsoft Windows 8 / Windows 8.1 certified • Microsoft Windows 10 certified |
| <p>VESA-compliant VESA DPMS-compliant Power management ENERGY STAR® 6.0 Ergonomics ISO 9241-307 Emission standards FCC Class B Environmental TCO (TCO Displays 6.0), WEEE, RoHS, EPEAT™ Silver rating</p> | <div style="text-align: center;">  <p>ThinkVision E2054 Wide Monitor</p> </div> |
| <p>Preset resolutions VGA: 640x480, 720x400 SVGA: 800x600 XGA: 1024x768 SXGA: 1280x768, 1280x1024 WXGA: 1366x768 WXGA+: 1440x900</p> <p>Presets / user settings Standard presets: 18 user settings: 10</p> | |
| <p>Viewing adjustments Tilt: 22° backward, -5° forward Rotating screen None On screen display On screen display with digital user controls (8 languages) Control features Direct access (control buttons on front) for automatic image setup and adjustment for brightness Multiple input None Monitor connectors VGA 15-pin D-shell, analog, blue Signal cables detachable, VGA 15-pin D-shell at each end, analog, 1.8 meter Mounting features Wall or desk mounting using the Extend Arm or third-party accessories meeting the VESA FPMPI® (100mm mount) Security Security keyhole for attachment of optional cable lock (Kensington® lock-compatible)</p> | |
| <p>Ship group Monitor with stand, 1.8 meter analog signal cable, 1.8 meter black power cord</p> | |

| | | | | | |
|--|---|----------------------------------|---------|---------------------------------|---------|
| <p style="text-align: center;">Limited Warranty</p> <p>See details at http://support.lenovo.com/en_US/guides-and-manuals/detail.page?DocID=UM008281</p> | <p style="text-align: center;">Accessories</p> <table border="0"> <tr> <td>Kensington MicroSaver Cable Lock</td> <td style="text-align: right;">73P2582</td> </tr> <tr> <td>Kensington Twin Head Cable Lock</td> <td style="text-align: right;">45K1620</td> </tr> </table> <p>See details at www.lenovo.com/support/monitoraccessories</p> <p>See all monitors at www.lenovo.com/thinkvision</p> | Kensington MicroSaver Cable Lock | 73P2582 | Kensington Twin Head Cable Lock | 45K1620 |
| Kensington MicroSaver Cable Lock | 73P2582 | | | | |
| Kensington Twin Head Cable Lock | 45K1620 | | | | |



| | | | | | | | | | |
|--|--|----------------------------------|---------|---------------------------------|---------|----------------------------|---------|---------------------------------|---------|
| <p>Name LT1913p Square Flat Panel Monitor Case color Black Type-model 60FBHAR1US / 60FBHAT1US / 60FBHAT1EU Panel TFT-LCD, In-Plane Switching (IPS), White LED backlight Viewable image size 19.0" (480.0mm) diagonal Max view area (W x H) 14.76" x 11.80" (374.7mm x 299.8mm) Optimum resolution 1280x1024 Max pixel rate 205MHz (VGA), 165MHz (DVI) Aspect ratio 5:4 Pixel pitch (mm) 0.0976 (H) x 0.2928 (V) mm Dot/Pixel per Inch 86.8 dpi Brightness 250 nits or cd/m² (typical) Contrast ratio 1000:1 (typical) Pixel response time 7ms (typical) Color gamut 72% Viewing angle at 10:1 CR 178° horizontal, 178° vertical Stand Tilt, swivel, pivot, and height adjustable stand Bezel width Sides: 0.68" (17.4mm); top: 0.68" (17.4mm); bottom: 0.68" (17.4mm) Dimensions (HxWxD) 14.63" H x 16.18" W x 10.40" D; 371.5mm H x 411.0mm W x 264.2mm D Power supply 24 watts typical, 27 watts maximum, <0.5 watts standby/suspend, universal, integrated (no external brick-like power supply) Weight 10.69 lb; 4.85kg Limited warranty⁴ 3 year (includes backlight) Available date April 2015</p> | <p>Features</p> <ul style="list-style-type: none"> • 19-inch Square IPS LED backlight panel • Supports 1280x1024 resolution • Supports ThinkCentre Tiny Clamp Bracket • Mercury and arsenic free glass • Low Halogen • Recycled content in plastic material • Supports optional soundbar • Microsoft® Windows® 7 certified • Microsoft Windows 8 / Windows 8.1 certified • Microsoft Windows 10 certified | | | | | | | | |
| <p>VESA-compliant² VESA DDC2B/C1, EDID 1.3 Power management ENERGY STAR® 7.0 Ergonomics ISO 9241-307 Emission standards FCC Class B Environmental TCO Displays 7.0, TCO Certified Edge 1.1, WEEE, RoHS, EPEAT™ Gold rating, ULE Gold</p> <p>Preset resolutions VGA: 640x350, 640x480, 720x400 SVGA: 800x600, 823x624 XGA: 1024x768, 1152x864, 1152x900 SXGA: 1280x1024</p> <p>Presets / user settings Standard presets: 20; user settings: 20</p> |  <p>ThinkVision LT1913p Square Monitor</p> | | | | | | | | |
| <p>Viewing adjustments Tilt: 30° back, -5° forward; lift: 4.3" (110mm); swivel: +/- 45° Rotating screen Screen pivots 90 degrees from landscape to portrait On screen display On screen display with digital user controls (8 languages) Control features Direct access (buttons on front) for automatic image setup, input switch, and brightness Multiple input Dual input (two different PCs attach to two different connectors; one PC shows image; select via button) Monitor connectors (1) VGA 15-pin D-shell, analog, blue (2) Digital Visual Interface (DVI-D), digital, white, HDCP-compliant Signal cables (1) detachable, VGA 15-pin D-shell at each end, analog, 1.8 meter (2) detachable, DVI-D at each end, digital, 1.8 meter Mounting features Wall or desk mounting using the Extend Arm or third-party accessories meeting the VESA FPMPI® (100mm mount) Security Security keyhole for attachment of optional cable lock (Kensington® lock-compatible)</p> | | | | | | | | | |
| <p>Ship group Monitor, attached stand, Setup poster, Safety and Warranty Information, 1.8 meter analog signal cable, 1.8 meter DVI-D cable, 1.8 meter black power cord</p> | | | | | | | | | |
| <p>Limited Warranty</p> <p>See details at http://support.lenovo.com/en_US/guides-and-manuals/detail.page?DocID=UM008281</p> | <p>Accessories</p> <table border="0"> <tr> <td>Kensington MicroSaver Cable Lock</td> <td>73P2582</td> </tr> <tr> <td>Kensington Twin Head Cable Lock</td> <td>45K1620</td> </tr> <tr> <td>Lenovo Security Cable Lock</td> <td>57Y4303</td> </tr> <tr> <td>Lenovo Easy Reach Monitor Stand</td> <td>55Y9258</td> </tr> </table> <p>See details at www.lenovo.com/support/monitoraccessories</p> <p>See all monitors at www.lenovo.com/thinkvision</p> | Kensington MicroSaver Cable Lock | 73P2582 | Kensington Twin Head Cable Lock | 45K1620 | Lenovo Security Cable Lock | 57Y4303 | Lenovo Easy Reach Monitor Stand | 55Y9258 |
| Kensington MicroSaver Cable Lock | 73P2582 | | | | | | | | |
| Kensington Twin Head Cable Lock | 45K1620 | | | | | | | | |
| Lenovo Security Cable Lock | 57Y4303 | | | | | | | | |
| Lenovo Easy Reach Monitor Stand | 55Y9258 | | | | | | | | |



| | | | | | |
|--|---|----------------------------------|---------|---------------------------------|---------|
| <p>Name LT2024 Wide Flat Panel Monitor Case color Business black Type-model 60B9HAR1US Panel TFT-LCD, twisted nematic (TN), White LED backlight Viewable image size 20.0" (508mm) diagonal Max view area (W x H) 17.4" x 9.8" (442.8mm x 249.1mm) Native resolution 1600x900 Aspect ratio 16:9 Pixel pitch (mm) .276mm Dot/Pixel per Inch 92 dpi Brightness 250 nits or cd/m² (typical) Contrast ratio 1000:1 (typical) Pixel response time 5ms (typical) Color gamut 72% Viewing angle at 10:1 CR 170° (+/- 85°) horizontal, 160° (+/- 80°) vertical Stand Tilt adjustable stand Bezel width Sides: 0.567" (14.4mm) Dimensions (HxWxD) 13.68" H x 18.83" W x 6.33" D; 347.4mm H x 478.4mm W x 160.7mm D Power supply 19 watts typical, 22 watts maximum, <0.5 watts standby/suspend, universal, integrated (no external brick-like power supply) Weight 6.75 lb; 3.07 kg Limited warranty⁴ 3 year (includes backlight) Available date March 2014</p> | <p style="text-align: center;">Features</p> <ul style="list-style-type: none"> • Widescreen 20-inch monitor • Supports 1600x900 resolution • Includes dual input connection for attachment to two systems concurrently (analog and digital) • Arsenic / Mercury free glass • EPEAT Gold certified • Supports optional soundbar • Support Lenovo Tiny PC and 3rd party thin client • Microsoft® Windows® 7 certified • Microsoft Windows 8 / Windows 8.1 certified | | | | |
| <p>VESA-compliant² VESA DDC2B/CI Power management ENERGY STAR® qualified Ergonomics ISO 9241-307 Emission standards FCC Class B Environmental TCO Displays 6.0, TCO Certified Edge 1.2, WEEE, RoHS, EPEAT™ Gold rating</p> | <div style="text-align: center;">  <p>ThinkVision LT2024 Wide Monitor</p> </div> | | | | |
| <p>Preset resolutions VGA: 640x350, 640x480, 720x400 SVGA: 800x600, 832x624 XGA: 1024x768, 1152x864 SXGA: 1280x1024 WXGA: 1366x768 WXGA+: 1440x900, 1600x900</p> <p>Presets / user settings Standard presets: 24 user settings: 24</p> | | | | | |
| <p>Viewing adjustments Tilt: 22° backward, -5° forward Rotating screen None On screen display On screen display with digital user controls (8 languages) Control features Direct access (buttons on front) for automatic image setup, dual input and brightness Multiple input Dual input (two different PCs attach to two different connectors; one PC shows image; select via button) Monitor connectors (1) VGA 15-pin D-shell, analog, blue (2) Digital Visual Interface (DVI-D), digital, white, HDCP-compliant Signal cables (1) detachable, VGA 15-pin D-shell at each end, analog, 1.8 meter Mounting features Wall or desk mounting using the Extend Arm or third-party accessories meeting the VESA FPMPI® (100mm mount) Security Security keyhole for attachment of optional cable lock (Kensington® lock-compatible)</p> | | | | | |
| <p>Ship group Monitor with stand, Safety and Warranty Information, 1.8 meter analog signal cable, 1.8 meter black power cord</p> | | | | | |
| <p style="text-align: center;">Limited Warranty</p> <p>See details at http://support.lenovo.com/en_US/guides-and-manuals/detail.page?DocID=UM008281</p> | <p style="text-align: center;">Accessories</p> <table border="0" style="width: 100%;"> <tr> <td>Kensington MicroSaver Cable Lock</td> <td style="text-align: right;">73P2582</td> </tr> <tr> <td>Kensington Twin Head Cable Lock</td> <td style="text-align: right;">45K1620</td> </tr> </table> <p>See details at www.lenovo.com/support/monitoraccessories</p> <p>See all monitors at www.lenovo.com/thinkvision</p> | Kensington MicroSaver Cable Lock | 73P2582 | Kensington Twin Head Cable Lock | 45K1620 |
| Kensington MicroSaver Cable Lock | 73P2582 | | | | |
| Kensington Twin Head Cable Lock | 45K1620 | | | | |

See footnotes for important warranty information
 US model announced February 18, 2014



| | | | | | | | |
|---|---|----------------------------------|---------|---------------------------------|---------|---------------------------------|---------|
| <p>Name T1714 Square Flat Panel Monitor Case color Black Type-model 60FDHAT1EU / 60FDHAR1US / 60FDHAT1EU Panel TFT-LCD, twisted nematic (TN), White LED backlight Viewable image size 17.0" (432mm) diagonal Max view area (W x H) 13.3" x 10.6" (337.9mm x 270.3mm) Optimum resolution 1280x1024 Aspect ratio 5:4 Pixel pitch (mm) 0.264mm Dot/Pixel per Inch 96 dpi Brightness 250 nits or cd/m² (typical) Contrast ratio 1000:1 (typical) Pixel response time 5ms (typical) Color gamut 72% Viewing angle at 10:1 CR 170° (+/- 85°) horizontal, 160° (+/- 80°) vertical Stand Tilt stand Bezel width Sides: 0.69" (17.5mm) Dimensions (HxWxD, including stand) 14.72" H x 14.74" W x 7.87" D; 373.9mm H x 374.5mm W x 200mm D Power supply 14.0 watts typical, 18.0 watts maximum, <0.5 watts standby/suspend, universal, integrated (no external brick-like power supply) Weight 5.75 lb; 2.61kg Limited warranty 3 year (includes backlight) Available date September 2015</p> | <p>Features</p> <ul style="list-style-type: none"> • 17-inch Square LCD monitor • Supports SXGA 1280x1024 resolution • Includes dual input connection for attachment to two systems concurrently (analog and digital) • Mercury Arsenic free glass • Supports optional soundbar • Microsoft® Windows® 7 certified • Microsoft Windows 8 certified • Microsoft Windows 8.1 certified • Microsoft Windows 10 certified | | | | | | |
| <p>VESA-compliant VESA DDC2B/CI Power management ENERGY STAR® 7.0 Ergonomics ISO 9241-307 Emission standards FCC Class B Environmental TCO Displays 7.0, TCO Certified Edge 2.0, WEEE, RoHS, EPEAT™ Gold rating</p> | <div style="text-align: center;">  <p>ThinkVision T1714 Monitor</p> </div> | | | | | | |
| <p>Preset resolutions VGA: 640x350, 640x480, 720x400 SVGA: 800x600 XGA: 1024x768, 1152x864, SXGA: 1280x800, 1280x1024</p> <p>Presets / user settings Standard presets: 17; user settings: 17</p> | | | | | | | |
| <p>Viewing adjustments Tilt: 22° back, -5° forward Rotating screen None On screen display On screen display with digital user controls (8 languages) Control features Direct access (buttons on front) for automatic image setup and brightness Multiple input Dual input (two different PCs attach to two different connectors; one PC shows image; select via button) Monitor connectors (1) VGA 15-pin D-shell, analog, blue (2) Digital Visual Interface (DVI-D), digital, white, HDCP-compliant Signal cables (1) detachable, VGA 15-pin D-shell at each end, analog, 1.8 meter (2) detachable, DVI-D at each end, digital, 1.8 meter Mounting features Wall or desk mounting using the Extend Arm or third-party accessories meeting the VESA FPMPI® (100mm mount) Security Security keyhole for attachment of optional cable lock (Kensington® lock-compatible)</p> | | | | | | | |
| <p>Ship group Monitor and stand, Setup poster, Safety and Warranty Information, 1.8 meter analog signal cable, 1.8 meter DVI-D cable, 1.8 meter black power cord</p> | <p>Limited Warranty</p> <p>See details at http://support.lenovo.com/en_US/guides-and-manuals/detail.page?DocID=UM008281</p> <p>Accessories</p> <table border="0"> <tr> <td>Kensington MicroSaver Cable Lock</td> <td>73P2582</td> </tr> <tr> <td>Kensington Twin Head Cable Lock</td> <td>45K1620</td> </tr> <tr> <td>Lenovo Easy Reach Monitor Stand</td> <td>55Y9258</td> </tr> </table> <p>See details at www.lenovo.com/support/monitoraccessories</p> <p>See all monitors at www.lenovo.com/thinkvision</p> | Kensington MicroSaver Cable Lock | 73P2582 | Kensington Twin Head Cable Lock | 45K1620 | Lenovo Easy Reach Monitor Stand | 55Y9258 |
| Kensington MicroSaver Cable Lock | 73P2582 | | | | | | |
| Kensington Twin Head Cable Lock | 45K1620 | | | | | | |
| Lenovo Easy Reach Monitor Stand | 55Y9258 | | | | | | |



| | | | | | | | |
|---|---|----------------------------------|---------|---------------------------------|---------|---------------------------------|---------|
| <p>Name T1714p Square Flat Panel Monitor Case color Black Type-model 60FELAT1US / 60FELAR1US / 60FELAT1EU Panel TFT-LCD, twisted nematic (TN), White LED backlight Viewable image size 17.0" (432mm) diagonal Max view area (W x H) 13.3" x 10.6" (337.9mm x 270.3mm) Optimum resolution 1280x1024 Aspect ratio 5:4 Pixel pitch (mm) 0.264mm Dot/Pixel per Inch 96 dpi Brightness 250 nits or cd/m² (typical) Contrast ratio 1000:1 (typical) Pixel response time 5ms (typical) Color gamut 72% Viewing angle at 10:1 CR 170° (+/- 85°) horizontal, 160° (+/- 80°) vertical Stand Tilt height adjustable stand Bezel width Sides: 0.69" (17.5mm) Dimensions (HxWxD, including stand) 17.63" H x 14.74" W x 9.61" D; 447.9mm H x 374.5mm W x 244.2mm D Power supply 14.0 watts typical, 18.0 watts maximum, <0.5 watts standby/suspend, universal, integrated (no external brick-like power supply) Weight 8.71 lb; 3.95kg Limited warranty 3 year (includes backlight) Available date September 2015</p> | <p>Features</p> <ul style="list-style-type: none"> • 17-inch Square LCD monitor • Supports SXGA 1280x1024 resolution • Includes dual input connection for attachment to two systems concurrently (analog and digital) • Mercury Arsenic free glass • Supports Lenovo Tiny PC and 3rd party thin client via optional Lenovo bracket • Supports optional soundbar • Microsoft® Windows® 7 certified • Microsoft Windows 8 certified • Microsoft Windows 8.1 certified • Microsoft Windows 10 certified | | | | | | |
| <p>VESA-compliant VESA DDC2B/CI Power management ENERGY STAR® 7.0 Ergonomics ISO 9241-307 Emission standards FCC Class B Environmental TCO Displays 7.0, TCO Certified Edge 2.0, WEEE, RoHS, EPEAT™ Gold rating</p> | <div style="text-align: center;">  <p>ThinkVision T1714p Monitor</p> </div> | | | | | | |
| <p>Preset resolutions VGA: 640x350, 640x480, 720x400 SVGA: 800x600 XGA: 1024x768, 1152x864, SXGA: 1280x800, 1280x1024 Presets / user settings Standard presets: 22; user settings: 22</p> | | | | | | | |
| <p>Viewing adjustments Tilt: 22° back, -5° forward; lift: 4.3" (110mm) Rotating screen None On screen display On screen display with digital user controls (8 languages) Control features Direct access (buttons on front) for automatic image setup and brightness Multiple input Dual input (two different PCs attach to two different connectors; one PC shows image; select via button) Monitor connectors (1) VGA 15-pin D-shell, analog, blue (2) Digital Visual Interface (DVI-D), digital, white, HDCP-compliant (3) DisplayPort, digital, black, HDCP-compliant Signal cables (1) detachable, VGA 15-pin D-shell at each end, analog, 1.8 meter (2) detachable, DVI-D at each end, digital, 1.8 meter Mounting features Wall or desk mounting using the Extend Arm or third-party accessories meeting the VESA FPMPI® (100mm mount) Security Security keyhole for attachment of optional cable lock (Kensington® lock-compatible)</p> | <p>Ship group Monitor and stand, Setup poster, Safety and Warranty Information, 1.8 meter analog signal cable, 1.8 meter DVI-D cable, 1.8 meter black power cord</p> | | | | | | |
| <p style="text-align: center;">Limited Warranty</p> <p>See details at http://support.lenovo.com/en_US/guides-and-manuals/detail.page?DocID=UM008281</p> | <p style="text-align: center;">Accessories</p> <table border="0"> <tr> <td>Kensington MicroSaver Cable Lock</td> <td style="text-align: right;">73P2582</td> </tr> <tr> <td>Kensington Twin Head Cable Lock</td> <td style="text-align: right;">45K1620</td> </tr> <tr> <td>Lenovo Easy Reach Monitor Stand</td> <td style="text-align: right;">55Y9258</td> </tr> </table> <p>See details at www.lenovo.com/support/monitoraccessories</p> <p>See all monitors at www.lenovo.com/thinkvision</p> | Kensington MicroSaver Cable Lock | 73P2582 | Kensington Twin Head Cable Lock | 45K1620 | Lenovo Easy Reach Monitor Stand | 55Y9258 |
| Kensington MicroSaver Cable Lock | 73P2582 | | | | | | |
| Kensington Twin Head Cable Lock | 45K1620 | | | | | | |
| Lenovo Easy Reach Monitor Stand | 55Y9258 | | | | | | |



| | | | | | |
|--|--|----------------------------------|---------|---------------------------------|---------|
| <p>Name T2054p Wide Flat Panel Monitor Bezel color Raven black Type-model 60G1MAR2US / 60G1MAT2US / 60G1MAT2EU Panel TFT-LCD, In-Plane Switching (IPS), White LED backlight</p> <p>Viewable image size 19.5" (495mm) diagonal Max view area (W x H) 16.48" x 10.33" (418.6mm x 262.4mm) Native resolution 1440x900 Aspect ratio 16:10 Pixel pitch (mm) 0.2915 x 0.2915 mm Dot/Pixel per Inch 87 dpi Brightness 250 nits or cd/m² (typical) Contrast ratio 1000:1 (typical) Pixel response time 7ms (typical) Color gamut 72% Viewing angle at 10:1 CR 178° (+/- 89°) horizontal, 178° (+/- 89°) vertical Stand Tilt, swivel, and height adjustable Bezel width Sides: 0.67" (17.0mm) Dimensions (HxWxD) 13.62" H x 17.88" W x 9.55" D; 345.9mm H x 454.2mm W x 242.6mm D</p> <p>Power supply 14.5 watts typical, 21 watts maximum, <0.3 watts standby/suspend, universal, integrated (no external brick-like power supply)</p> <p>Weight 8.16 lb; 3.70 kg Limited warranty⁴ 3 year (includes backlight) Available date September 2015</p> | <p style="text-align: center;">Features</p> <ul style="list-style-type: none"> • Widescreen 19.5-inch monitor • Supports 1440x900 resolution • Supports ThinkCentre Tiny Clamp Bracket • Includes dual input connection for attachment to two systems concurrently (analog and digital) • EPEAT Gold certified • Supports optional soundbar • Microsoft® Windows® 7 certified • Microsoft Windows 8 / Windows 8.1 certified • Microsoft Windows 10 certified | | | | |
| <p>VESA-compliant² VESA DDC2B/CI Power management ENERGY STAR® qualified Ergonomics ISO 9241-307 Emission standards FCC Class B Environmental TCO Displays 7.0, TCO Certified Edge 2.0, WEEE, RoHS, EPEAT™ Gold rating</p> | <div style="text-align: center;">  <p>ThinkVision T2054p Wide Monitor</p> </div> | | | | |
| <p>Preset resolutions VGA: 640x480, 720x400, 720x576 SVGA: 800x600 XGA: 1024x768, 1152x864 SXGA: 1280x800, 1280x1024 WXGA: 1366x768 WXGA+: 1440x900</p> <p>Presets / user settings Standard presets: 22 user settings: 16</p> | | | | | |
| <p>Viewing adjustments Tilt: 22° backward, -5° forward; lift: 4.3" (110mm); swivel: +/-45°; detachable stand Rotating screen None On screen display On screen display with digital user controls (8 languages) Control features Direct access (buttons on front) for automatic image setup, dual input and brightness Multiple input Dual input (two different PCs attach to two different connectors; one PC shows image; select via button) Monitor connectors (1) VGA 15-pin D-shell, analog, blue (2) HDMI (1.4), digital, HDCP-compliant (3) DisplayPort, digital, black, HDCP-compliant</p> <p>Signal cables (1) detachable, VGA 15-pin D-shell at each end, analog, 1.8 meter (2) detachable, DisplayPort at each end, digital, 1.8 meter</p> <p>Mounting features Wall or desk mounting using the Extend Arm or third-party accessories, 100mm x 100mm mount Security Security keyhole for attachment of optional cable lock (Kensington® lock-compatible)</p> <p>Ship group Monitor with stand, Safety and Warranty Information, 1.8 meter analog signal cable, 1.8 meter DP signal cable, 1.8 meter black power cord</p> | | | | | |
| <p style="text-align: center;">Limited Warranty</p> <p>See details at http://support.lenovo.com/en_US/guides-and-manuals/detail.page?DocID=UM008281</p> | <p style="text-align: center;">Accessories</p> <table border="0"> <tr> <td>Kensington MicroSaver Cable Lock</td> <td style="text-align: right;">73P2582</td> </tr> <tr> <td>Kensington Twin Head Cable Lock</td> <td style="text-align: right;">45K1620</td> </tr> </table> <p>See details at www.lenovo.com/support/monitoraccessories</p> <p>See all monitors at www.lenovo.com/thinkvision</p> | Kensington MicroSaver Cable Lock | 73P2582 | Kensington Twin Head Cable Lock | 45K1620 |
| Kensington MicroSaver Cable Lock | 73P2582 | | | | |
| Kensington Twin Head Cable Lock | 45K1620 | | | | |



| | | | | | | | | | | | |
|--|--|----------------------------------|---------|---------------------------------|---------|----------------------------|---------|------------------------|---------|---------------------------------|---------|
| <p>Name LT2423 Wide Flat Panel Monitor Case color Business black Type-model 60A8KAR2US / 60A8KAT2US / 60A8KAT2EU Panel TFT-LCD, twisted nematic (TN), White LED backlight Viewable image size 24" (610mm) diagonal Max view area (W x H) 20.9" x 11.8" (531.4mm x 298.9mm) Optimum resolution 1920x1080 Max pixel rate 205MHz Aspect ratio 16:9 Pixel pitch (mm) 0.278mm Dot/Pixel per Inch 92 dpi Brightness 250 nits or cd/m² (typical) Contrast ratio 1000:1 (typical) Contrast ratio 2000000:1 Pixel response time 5ms Color gamut 72% Viewing angle at 10:1 CR 170° horizontal, 160° vertical Stand Tilt stand Bezel width Sides: 0.67" (17.0mm); top: 0.67" (17.0mm); bottom: 1.02" (26.0mm)</p> <p>Dimensions (HxWxD, excluding stand) 13.53" H x 22.33" W x 1.97" D; Dimensions (HxWxD, including stand) 343.7mm H x 567.1mm W x 50.0mm D Dimensions (HxWxD, including stand) 16.30" H x 22.33" W x 8.50" D; Dimensions (HxWxD, including stand) 414.3mm H x 567.1mm W x 216.7mm D Power supply 21 watts typical, 31 watts maximum, <0.5 watts standby/suspend, universal, integrated (no external brick-like power supply)</p> <p>Weight 8.30 lb; 3.76kg Limited warranty⁴ 3 year (includes backlight) Available date July 2013</p> | <p>Features</p> <ul style="list-style-type: none"> • Widescreen 24-inch monitor • Supports 1920x1080 resolution • Two 3W stereo speakers • Audio in (3.5mm) • Supports VGA and HDMI 1.4 interfaces • Supports optional soundbar • Support Lenovo Tiny PC and 3rd party thin client via optional Lenovo bracket • Microsoft® Windows® 8 certified • Arsenic/Lead/Mercury free | | | | | | | | | | |
| <p>VESA-compliant² VESA DDC2B/CI Power management ENERGY STAR® 6.0 Ergonomics ISO 9241-307 Emission standards MPR-2, FCC Class B Environmental TCO Displays 6.0, TCO Certified Edge 1.2, WEEE, RoHS, EPEAT™ Gold rating, ULE Gold</p> <p>Preset resolutions VGA: 640x350, 640x480, 720x400 SVGA: 800x600, 832x624 XGA: 1024x768, 1152x864 SXGA: 1280x1024 WXGA: 1366x768 WXGA+: 1440x900, 1600x900 WSXGA+: 1680x1050 Full HD: 1920x1080</p> <p>Presets / user settings Standard presets: 24; User settings: 20</p> |  <p>ThinkVision LT2423 Wide Monitor</p> | | | | | | | | | | |
| <p>Viewing adjustments Tilt: 22° back, -5° forward Rotating screen None On screen display On screen display with digital user controls (8 languages) Control features Direct access (buttons on front) for automatic image setup, input switch, and brightness Multimedia Integrated stereo speakers (3 watts x 2) Multiple input Dual input (two different PCs attach to two different connectors; one PC shows image; select via button) Monitor connectors (1) VGA 15-pin D-shell, analog, blue (2) HDMI (1.4), digital, HDCP-compliant Signal cables (1) detachable, VGA 15-pin D-shell at each end, analog, 1.8 meter Mounting features Wall or desk mounting using the Extend Arm or third-party accessories meeting the VESA FPMPI® (100mm mount) Security Security keyhole for attachment of optional cable lock (Kensington® lock-compatible)</p> | | | | | | | | | | | |
| <p>Ship group Monitor, attached stand, Setup poster, Safety and Warranty Information, 1.8 meter analog signal cable, 1.8 meter Audio cable, 1.8 meter black power cord</p> | | | | | | | | | | | |
| <p>Limited Warranty</p> <p>See details at http://support.lenovo.com/en_US/guides-and-manuals/detail.page?DocID=UM008281</p> | <p>Accessories</p> <table border="0"> <tr> <td>Kensington MicroSaver Cable Lock</td> <td>73P2582</td> </tr> <tr> <td>Kensington Twin Head Cable Lock</td> <td>45K1620</td> </tr> <tr> <td>Lenovo Security Cable Lock</td> <td>57Y4303</td> </tr> <tr> <td>ThinkCentre Extend Arm</td> <td>57Y4352</td> </tr> <tr> <td>Lenovo Easy Reach Monitor Stand</td> <td>55Y9258</td> </tr> </table> <p>See details at www.lenovo.com/support/monitoraccessories</p> <p>See all monitors at www.lenovo.com/thinkvision</p> | Kensington MicroSaver Cable Lock | 73P2582 | Kensington Twin Head Cable Lock | 45K1620 | Lenovo Security Cable Lock | 57Y4303 | ThinkCentre Extend Arm | 57Y4352 | Lenovo Easy Reach Monitor Stand | 55Y9258 |
| Kensington MicroSaver Cable Lock | 73P2582 | | | | | | | | | | |
| Kensington Twin Head Cable Lock | 45K1620 | | | | | | | | | | |
| Lenovo Security Cable Lock | 57Y4303 | | | | | | | | | | |
| ThinkCentre Extend Arm | 57Y4352 | | | | | | | | | | |
| Lenovo Easy Reach Monitor Stand | 55Y9258 | | | | | | | | | | |

See footnotes for important warranty information
 US model announced June 25, 2013



| | | | | | |
|---|--|----------------------------------|---------|---------------------------------|---------|
| <p>Name P24h Wide Flat Panel Monitor Bezel color Black Type-model 61AEGAR3US / 61AEGAT3EU Panel TFT-LCD, In-Plane Switching (IPS), White LED backlight Viewable image size 23.8" (604.7mm) diagonal Max view area (W x H) 20.74" x 11.67" (526.9mm x 296.4mm) Native resolution 2560x1440 Aspect ratio 16:9 Pixel pitch (mm) 0.2058x 0.2058 mm Dot/Pixel per Inch 124 dpi Brightness 300 nits or cd/m² (typical) Contrast ratio 1000:1 (typical) Pixel response time 4ms (extreme) / 6ms (typical) Color gamut 99% sRGB Viewing angle at 10:1 CR 178° (+/- 89°) horizontal, 178° (+/- 89°) vertical Stand Tilt, swivel, pivot, and height adjustable stand Bezel width <i>Sides:</i> 0.08" (2.0mm) Dimensions (HxWxD) 14.7" H x 21.26" W x 10.3" D; 373.4mm H x 540.2mm W x 261.75mm D Power supply 24 watts typical, 120 watts maximum (with USB 3.0 hub), <0.5 watts standby/suspend, universal, integrated (no external brick-like power supply) Weight 12.54 lb; 5.69 kg Limited warranty 3 year (includes backlight) Available date April 2017</p> | <p style="text-align: center;">Features</p> <ul style="list-style-type: none"> • Widescreen 23.8-inch monitor • Supports 2560x1440 resolution • Supports optional soundbar • Supports ThinkCentre Tiny Clamp Bracket • Includes dual input connection for attachment to two systems concurrently • EPEAT Gold certified • Microsoft® Windows® 7 certified • Microsoft Windows 10 certified | | | | |
| <p>VESA-compliant VESA DDC2B/CI Power management ENERGY STAR® qualified Ergonomics ISO 9241-307 Emission standards FCC Class B Environmental TCO Displays 7.0, TCO Certified Edge 2.0, WEEE, RoHS, EPEAT™ Gold rating</p> | <div style="text-align: center;">  <p>ThinkVision P24h Wide Monitor</p> </div> | | | | |
| <p>Preset resolutions VGA: 640x480, 720x400 SVGA: 800x600 XGA: 1024x768 SXGA: 1280x1024 WXGA: 1366x768 WXGA+: 1440x900, 1680x900 WSXGA+: 1680x1050 Full HD: 1920x1080, 1920x1200 QHD: 2560x1440 Presets display modes HDMI: 22; DP: 14</p> | | | | | |
| <p>Viewing adjustments <i>Tilt:</i> 30° back, -5° forward; <i>lift:</i> 4.3" (110mm); <i>swivel:</i> +/-45°; detachable stand Rotating screen Screen pivots 90 degrees from landscape to portrait On screen display On screen display with digital user controls (8 languages) Control features Direct access (buttons on front) for power, menu, input source select and brightness USB hub USB Hub: one USB Type-C upstream port, four USB 3.0 downstream ports Multimedia Audio-out, optional sound bar supported Camera None Multiple input Support HDMI, DisplayPort, USB 3.1 Type-C, DisplayPort-out Monitor connectors (1) 2*HDMI (1.4), digital, HDCP-compliant (2) DisplayPort (1.2), digital, HDCP-compliant (3) DisplayPort-out, digital (4) USB 3.1 Type-C Signal cables (1) USB 3.1 Type-C cable, 1.8 meter Mounting features Wall or desk mounting using the Extend Arm or third-party accessories, 100mm x 100mm mount Security Security keyhole for attachment of optional cable lock (Kensington® lock-compatible)</p> | | | | | |
| <p>Ship group Monitor with stand, Safety and Warranty Information, 1.8 meter USB 3.1 Type-C cable, 1.8 meter black power cord</p> | <p style="text-align: center;">Accessories</p> <table border="0" style="width: 100%;"> <tr> <td>Kensington MicroSaver Cable Lock</td> <td style="text-align: right;">73P2582</td> </tr> <tr> <td>Kensington Twin Head Cable Lock</td> <td style="text-align: right;">45K1620</td> </tr> </table> <p>See details at www.lenovo.com/support/monitoraccessories</p> <p>See all monitors at www.lenovo.com/thinkvision</p> | Kensington MicroSaver Cable Lock | 73P2582 | Kensington Twin Head Cable Lock | 45K1620 |
| Kensington MicroSaver Cable Lock | 73P2582 | | | | |
| Kensington Twin Head Cable Lock | 45K1620 | | | | |



| | | | | | | | |
|--|--|----------------------------------|---------|---------------------------------|---------|----------------------------|---------|
| <p>Name P24q Wide Flat Panel Monitor Case color Black Type-model 61A5GAR3US / 61A5GAT3EU Panel TFT-LCD, IPS (In-Plane Switching), White LED backlight Viewable image size 23.8" (604.5mm) diagonal Max view area (W x H) 20.74" x 11.67" (526.85mm x 296.35mm) Optimum resolution 2560x1440 Max pixel rate 300MHz Aspect ratio 16:9 Pixel pitch (mm) 0.2058 x 0.2058mm Dot/Pixel per Inch 123 dpi Brightness 300 nits or cd/m² (typical) Contrast ratio 1000:1 (typical) Pixel response time 4ms Color gamut 99% sRGB Viewing angle at 10:1 CR 178° horizontal, 178° vertical Stand Tilt, swivel, pivot, and height adjustable stand Bezel width <i>Sides:</i> 0.08" (2mm) Dimensions 14.7" H x 21.26" W x 10.3" D; (HxWxD, including stand) 373.4mm H x 540.2mm W x 261.75mm D Power supply 24 watts typical, 67 watts maximum (with USB), <0.5 watts sleep/off; <0.5 watts switch off integrated (no external brick-like power supply) Weight 12.35 lb; 5.6kg (including stand) Limited warranty 3 year Available date January 2017</p> | <p>Features</p> <ul style="list-style-type: none"> • 23.8-inch IPS LED backlight monitor • Supports 2560x1440 resolution • 5-Ports USB hub, support USB 3.0 • Support ThinkCentre Tiny • Supports optional soundbar • Microsoft® Windows® 7 certified • Microsoft Windows 10 certified | | | | | | |
| <p>VESA-compliant VESA DDC2B/CI Power management ENERGY STAR® 7.0 Ergonomics ISO 9241-307 Emission standards FCC Class B Environmental TCO Displays 7.0, RoHS, EPEAT™ Gold rating, ULE Gold</p> |  <p>ThinkVision P24q Monitor</p> | | | | | | |
| <p>Preset resolutions VGA: 640x480, 720x400 SVGA: 800x600 XGA: 1024x768 SXGA: 1280x1024 WXGA: 1366x768 WXGA+: 1440x900, 1600x900 WSXGA+: 1680x1050 Full HD: 1920x1080, 1920x1200 QHD: 2560x1440</p> <p>Presets / user settings Standard presets: 20; user settings: 24</p> | | | | | | | |
| <p>Viewing adjustments <i>Tilt:</i> 30° back, -5° forward; <i>lift:</i> 4.33" (110mm); <i>swivel:</i> +/-45° Rotating screen Screen pivots 90 degrees from landscape to portrait On screen display On screen display with digital user controls (8 languages) Control features Direct access for menu, source switch, and brightness USB hub USB Hub: one USB 3.0 upstream port, four USB 3.0 downstream ports Multimedia Audio-out, optional sound bar supported Camera None Multiple input Support HDMI, DisplayPort, mini DisplayPort, DisplayPort-out Monitor connectors (1) 2*HDMI (1.4), digital, HDCP-compliant (2) DisplayPort (1.2), digital, HDCP-compliant (3) Mini DisplayPort, digital, HDCP-compliant Signal cables (1) detachable, mini DisplayPort to DisplayPort, digital, 1.8 meter Mounting features Wall or desk mounting using the Extend Arm or third-party accessories meeting the VESA FPMPI® (100mm mount) Security Security keyhole for attachment of optional cable lock (Kensington® lock-compatible)</p> | | | | | | | |
| <p>Ship group Monitor, detachable stand, Quick start and safety poster, 1.8 meter USB 3.0 cable, 1.8 meter mini DP to DP cable, 1.8 meter black power cord</p> | <p>Limited Warranty</p> <p>See details at http://support.lenovo.com/en_US/guides-and-manuals/detail.page?DocID=UM008281</p> <p>Accessories</p> <table border="0"> <tr> <td>Kensington MicroSaver Cable Lock</td> <td>73P2582</td> </tr> <tr> <td>Kensington Twin Head Cable Lock</td> <td>45K1620</td> </tr> <tr> <td>Lenovo Security Cable Lock</td> <td>57Y4303</td> </tr> </table> <p>See details at www.lenovo.com/support/monitoraccessories</p> <p>See all monitors at www.lenovo.com/thinkvision</p> | Kensington MicroSaver Cable Lock | 73P2582 | Kensington Twin Head Cable Lock | 45K1620 | Lenovo Security Cable Lock | 57Y4303 |
| Kensington MicroSaver Cable Lock | 73P2582 | | | | | | |
| Kensington Twin Head Cable Lock | 45K1620 | | | | | | |
| Lenovo Security Cable Lock | 57Y4303 | | | | | | |



| | | | | | |
|---|--|----------------------------------|---------|---------------------------------|---------|
| <p>Name T2224d Wide Flat Panel Monitor Bezel color Black Type-model 61B1JAR1US / 61B1JAT1EU Panel TFT-LCD, In-Plane Switching (IPS), White LED backlight Viewable image size 21.5" (546mm) diagonal Max view area (W x H) 18.74" x 10.54" (476.1mm x 267.8mm) Native resolution 1920x1080 Aspect ratio 16:9 Pixel pitch (mm) 0.248 x 0.248 mm Dot/Pixel per Inch 102 dpi Brightness 250 nits or cd/m² (typical) Contrast ratio 1000:1 (typical) Pixel response time 7ms (typical); 4ms (extreme mode) Color gamut 72% Viewing angle at 10:1 CR 178° (+/- 89°) horizontal, 178° (+/- 89°) vertical Stand Tilt stand Bezel width <i>Sides:</i> 0.69" (17.6mm) Dimensions (HxWxD) 15.02" H x 20.19" W x 8.06" D; 381.4mm H x 512.9mm W x 204.9mm D Power supply 20 watts typical, 25 watts maximum <0.5 watts standby/suspend, universal, integrated (no external brick-like power supply) Weight 6.48 lb; 2.94 kg Limited warranty 3 year (includes backlight) Available date March 2017</p> | <p style="text-align: center;">Features</p> <ul style="list-style-type: none"> • Widescreen 21.5-inch monitor • Supports 1920x1080 resolution • Supports optional soundbar • Supports ThinkCentre Tiny via VESA back mount • Includes dual input connection for attachment to two systems concurrently (analog and digital) • EPEAT Gold certified • Microsoft® Windows® 7 certified • Microsoft Windows 10 certified | | | | |
| <p>VESA-compliant VESA DDC2B/CI Power management ENERGY STAR® qualified Ergonomics ISO 9241-307 Emission standards FCC Class B Environmental TCO Displays 7.0, TCO Certified Edge 2.0, WEEE, RoHS, EPEAT™ Gold rating</p> | <div style="text-align: center;">  <p>ThinkVision T2224d Wide Monitor</p> </div> | | | | |
| <p>Preset resolutions VGA: 640x350, 640x480, 720x400 SVGA: 800x600 XGA: 1024x768, 1152x864 SXGA: 1280x1024 WXGA: 1280x768, 1280x800, 1366x768 WXGA+: 1440x900 WSXGA+: 1680x1050 Full HD: 1920x1080 Presets / user settings Standard presets: 22; user settings: 22</p> | | | | | |
| <p>Viewing adjustments <i>Tilt:</i> 22° back, -5° forward Rotating screen None On screen display On screen display with digital user controls (8 languages) Control features Direct access (buttons on front) for automatic image setup, dual input and brightness USB hub None Multiple input Dual input (two different PCs attach to two different connectors; one PC shows image; select via button) Monitor connectors (1) VGA 15-pin D-shell, analog, blue (2) DisplayPort, digital, black, HDCP-compliant Signal cables (1) detachable, VGA 15-pin D-shell at each end, analog, 1.8 meter (2) detachable, DisplayPort at each end, digital, 1.8 meter Mounting features Wall or desk mounting using the Extend Arm or third-party accessories, 100mm x 100mm mount Security Security keyhole for attachment of optional cable lock (Kensington® lock-compatible)</p> | | | | | |
| <p>Ship group Monitor with stand, Safety and Warranty Information, 1.8 meter analog signal cable, 1.8 meter DP signal cable, 1.8 meter black power cord</p> | <p style="text-align: center;">Accessories</p> <table border="0" style="width: 100%;"> <tr> <td>Kensington MicroSaver Cable Lock</td> <td style="text-align: right;">73P2582</td> </tr> <tr> <td>Kensington Twin Head Cable Lock</td> <td style="text-align: right;">45K1620</td> </tr> </table> <p>See details at www.lenovo.com/support/monitoraccessories</p> <p>See all monitors at www.lenovo.com/thinkvision</p> | Kensington MicroSaver Cable Lock | 73P2582 | Kensington Twin Head Cable Lock | 45K1620 |
| Kensington MicroSaver Cable Lock | 73P2582 | | | | |
| Kensington Twin Head Cable Lock | 45K1620 | | | | |
| <p style="text-align: center;">Limited Warranty</p> <p>See details at http://support.lenovo.com/en_US/guides-and-manuals/detail.page?DocID=UM008281</p> | | | | | |



| | | | | | |
|---|---|----------------------------------|---------|---------------------------------|---------|
| <p>Name T2224z Wide Flat Panel Monitor Bezel color Raven black Type-model 60F5MAR6US / 60F5MAT6US / 60F5MAT6EU Panel TFT-LCD, In-Plane Switching (IPS), White LED backlight</p> <p>Viewable image size 21.5" (546mm) diagonal Max view area (W x H) 18.74" x 10.54" (476.1mm x 267.8mm) Native resolution 1920x1080 Aspect ratio 16:9 Pixel pitch (mm) 0.248 x 0.248 mm Dot/Pixel per Inch 102 dpi Brightness 250 nits or cd/m² (typical) Contrast ratio 1000:1 (typical) Pixel response time 7ms (typical) Color gamut 72% Viewing angle at 10:1 CR 178° (+/- 89°) horizontal, 178° (+/- 89°) vertical Stand Tilt, swivel, pivot, and height adjustable stand Bezel width <i>Sides:</i> 0.69" (17.6mm) Dimensions (HxWxD) 14.08" H x 20.19" W x 9.55" D; 357.8mm H x 512.9mm W x 242.7mm D</p> <p>Power supply 21 watts typical, 25 watts maximum (without USB 3.0 hub), 45 watts maximum (with USB 3.0 hub), <0.5 watts standby/suspend, universal, integrated (no external brick-like power supply)</p> <p>Weight 10.63 lb; 4.83 kg Limited warranty 3 year (includes backlight) Available date March 2015</p> | <p style="text-align: center;">Features</p> <ul style="list-style-type: none"> • Widescreen 21.5-inch monitor • Supports 1920x1080 resolution • Supports ThinkCentre Tiny Clamp Bracket • Supports optional soundbar • Includes dual input connection for attachment to two systems concurrently (analog and digital) • EPEAT Gold certified • Microsoft® Windows® 7 certified • Microsoft Windows 8 / Windows 8.1 certified • Microsoft Windows 10 certified | | | | |
| <p>VESA-compliant VESA DDC2B/CI Power management ENERGY STAR® qualified Ergonomics ISO 9241-307 Emission standards FCC Class B Environmental TCO Displays 7.0, TCO Certified Edge 2.0, WEEE, RoHS, EPEAT™ Gold rating</p> | <div style="text-align: center;">  <p>ThinkVision T2224z Wide Monitor</p> </div> | | | | |
| <p>Preset resolutions VGA: 640x350, 640x480, 720x400 SVGA: 800x600 XGA: 1024x768, 1152x864 SXGA: 1280x1024 WXGA: 1280x768, 1280x800, 1366x768 WXGA+: 1440x900 WSXGA+: 1680x1050 Full HD: 1920x1080</p> <p>Presets / user settings Standard presets: 27; user settings: 20</p> | | | | | |
| <p>Viewing adjustments <i>Tilt:</i> 30° back, -5° forward; <i>lift:</i> 4.3" (110mm); <i>swivel:</i> +/-45°; detachable stand Rotating screen Screen pivots 90 degrees from landscape to portrait On screen display On screen display with digital user controls (8 languages) Control features Direct access (buttons on front) for automatic image setup, dual input and brightness USB hub USB 3.0 Hub: 1 port into PC (USB 3.0); 2 ports for accessories (2 USB 3.0) Multimedia Integrated digital speakers (3 watts x 2) Camera Integrated camera (Full HD) and digital dual array microphone Multiple input Dual input (two different PCs attach to two different connectors; one PC shows image; select via button) Monitor connectors (1) VGA 15-pin D-shell, analog, blue (2) HDMI (1.4), digital, HDCP-compliant (3) DisplayPort, digital, black, HDCP-compliant</p> <p>Signal cables (1) detachable, VGA 15-pin D-shell at each end, analog, 1.8 meter (2) detachable, DisplayPort at each end, digital, 1.8 meter</p> <p>Mounting features Wall or desk mounting using the Extend Arm or third-party accessories, 100mm x 100mm mount Security Security keyhole for attachment of optional cable lock (Kensington® lock-compatible)</p> | | | | | |
| <p>Ship group Monitor with stand, Safety and Warranty Information, 1.8 meter analog signal cable, 1.8 meter DP signal cable, 1.8 meter USB signal cable, 1.8 meter black power cord</p> | | | | | |
| <p style="text-align: center;">Limited Warranty</p> <p>See details at http://support.lenovo.com/en_US/guides-and-manuals/detail.page?DocID=UM008281</p> | <p style="text-align: center;">Accessories</p> <table border="0"> <tr> <td>Kensington MicroSaver Cable Lock</td> <td style="text-align: right;">73P2582</td> </tr> <tr> <td>Kensington Twin Head Cable Lock</td> <td style="text-align: right;">45K1620</td> </tr> </table> <p>See details at www.lenovo.com/support/monitoraccessories</p> <p>See all monitors at www.lenovo.com/thinkvision</p> | Kensington MicroSaver Cable Lock | 73P2582 | Kensington Twin Head Cable Lock | 45K1620 |
| Kensington MicroSaver Cable Lock | 73P2582 | | | | |
| Kensington Twin Head Cable Lock | 45K1620 | | | | |



| | | | | | |
|---|---|----------------------------------|---------|---------------------------------|---------|
| <p>Name T2254p Wide Flat Panel Monitor Bezel color Raven black Type-model 60CCMAR2US / 60CCMAT2US / 60CCMAT2EU Panel TFT-LCD, twisted nematic (TN), White LED backlight Viewable image size 22.0" (559mm) diagonal Max view area (W x H) 18.70" x 11.70" (473.8mm x 296.1mm) Native resolution 1680x1050 Aspect ratio 16:10 Pixel pitch (mm) 0.282 x 0.282 mm Dot/Pixel per Inch 90 dpi Brightness 250 nits or cd/m² (typical) Contrast ratio 1000:1 (typical) Pixel response time 5ms (typical) Color gamut 72% Viewing angle at 10:1 CR 170° (+/- 85°) horizontal, 160° (+/- 80°) vertical Stand Tilt, swivel, pivot, and height adjustable stand Bezel width Sides: 0.67" (17.1mm) Dimensions (HxWxD) 14.63" H x 20.01" W x 9.55" D; 371.7mm H x 509.3mm W x 242.7mm D Power supply 20 watts typical, 25 watts maximum, <0.5 watts standby/suspend, universal, integrated (no external brick-like power supply) Weight 10.14 lb; 4.60 kg Limited warranty 3 year (includes backlight) Available date March 2015</p> | <p style="text-align: center;">Features</p> <ul style="list-style-type: none"> • Widescreen 22.0-inch monitor • Supports 1680x1050 resolution • Supports ThinkCentre Tiny Clamp Bracket • Supports optional soundbar • Includes dual input connection for attachment to two systems concurrently (analog and digital) • EPEAT Gold certified • Microsoft® Windows® 7 certified • Microsoft Windows 8 / Windows 8.1 certified • Microsoft Windows 10 certified | | | | |
| <p>VESA-compliant VESA DDC2B/CI Power management ENERGY STAR® qualified Ergonomics ISO 9241-307 Emission standards FCC Class B Environmental TCO Displays 7.0, TCO Certified Edge 2.0, WEEE, RoHS, EPEAT™ Gold rating</p> | <div style="text-align: center;">  <p>ThinkVision T2254p Wide Monitor</p> </div> | | | | |
| <p>Preset resolutions VGA: 640x350, 640x480, 720x400 SVGA: 800x600 XGA: 1024x768, 1152x864 SXGA: 1280x1024 WXGA: 1280x768, 1280x800, 1366x768 WXGA+: 1440x900 WSXGA+: 1600x900, 1680x1050 Presets / user settings Standard presets: 28; user settings: 20</p> | | | | | |
| <p>Viewing adjustments Tilt: 30° back, -5° forward; lift: 4.3" (110mm); swivel: +/-45°; detachable stand Rotating screen Screen pivots 90 degrees from landscape to portrait On screen display On screen display with digital user controls (8 languages) Control features Direct access (buttons on front) for automatic image setup, dual input and brightness USB hub None Multiple input Dual input (two different PCs attach to two different connectors; one PC shows image; select via button) Monitor connectors (1) VGA 15-pin D-shell, analog, blue (2) HDMI (1.4), digital, HDCP-compliant (3) DisplayPort, digital, black, HDCP-compliant Signal cables (1) detachable, VGA 15-pin D-shell at each end, analog, 1.8 meter (2) detachable, DisplayPort at each end, digital, 1.8 meter Mounting features Wall or desk mounting using the Extend Arm or third-party accessories, 100mm x 100mm mount Security Security keyhole for attachment of optional cable lock (Kensington® lock-compatible)</p> | | | | | |
| <p>Ship group Monitor with stand, Safety and Warranty Information, 1.8 meter analog signal cable, 1.8 meter DP signal cable, 1.8 meter black power cord</p> | | | | | |
| <p style="text-align: center;">Limited Warranty</p> <p>See details at http://support.lenovo.com/en_US/guides-and-manuals/detail.page?DocID=UM008281</p> | <p style="text-align: center;">Accessories</p> <table border="0"> <tr> <td>Kensington MicroSaver Cable Lock</td> <td style="text-align: right;">73P2582</td> </tr> <tr> <td>Kensington Twin Head Cable Lock</td> <td style="text-align: right;">45K1620</td> </tr> </table> <p>See details at www.lenovo.com/support/monitoraccessories</p> <p>See all monitors at www.lenovo.com/thinkvision</p> | Kensington MicroSaver Cable Lock | 73P2582 | Kensington Twin Head Cable Lock | 45K1620 |
| Kensington MicroSaver Cable Lock | 73P2582 | | | | |
| Kensington Twin Head Cable Lock | 45K1620 | | | | |



| | | | | | |
|--|---|----------------------------------|---------|---------------------------------|---------|
| <p>Name T22i Wide Flat Panel Monitor Bezel color Black Type-model 61A9MAR1US / 61A9MAT1EU Panel TFT-LCD, In-Plane Switching (IPS), White LED backlight Viewable image size 21.5" (546mm) diagonal Max view area (W x H) 18.74" x 10.54" (476.1mm x 267.8mm) Native resolution 1920x1080 Aspect ratio 16:9 Pixel pitch (mm) 0.248 x 0.248 mm Dot/Pixel per Inch 102 dpi Brightness 250 nits or cd/m² (typical) Contrast ratio 1000:1 (typical) Pixel response time 6ms (typical); 4ms (extreme mode) Color gamut 72% Viewing angle at 10:1 CR 178° (+/- 89°) horizontal, 178° (+/- 89°) vertical Stand Tilt, swivel, pivot, and height adjustable stand Bezel width <i>Sides:</i> 0.08" (2.0mm) Dimensions (HxWxD) 14.08" H x 19.28" W x 9.92" D; 357.6mm H x 489.7mm W x 251.9mm D Power supply 16.5 watts typical, 55 watts maximum (with USB 3.0 hub), <0.5 watts standby/suspend, universal, integrated (no external brick-like power supply) Weight 10.85 lb; 4.92 kg Limited warranty 3 year (includes backlight) Available date April 2017</p> | <p style="text-align: center;">Features</p> <ul style="list-style-type: none"> • Widescreen 21.5-inch monitor • Supports 1920x1080 resolution • Supports optional soundbar • Supports ThinkCentre Tiny via VESA back mount • Includes dual input connection for attachment to two systems concurrently • EPEAT Gold certified • Microsoft® Windows® 7 certified • Microsoft Windows 10 certified | | | | |
| <p>VESA-compliant VESA DDC2B/CI Power management ENERGY STAR® qualified Ergonomics ISO 9241-307 Emission standards FCC Class B Environmental TCO Displays 7.0, TCO Certified Edge 2.0, WEEE, RoHS, EPEAT™ Gold rating</p> | <div style="text-align: center;">  <p>ThinkVision T22i Wide Monitor</p> </div> | | | | |
| <p>Preset resolutions VGA: 640x350, 640x480, 720x400 SVGA: 800x600 XGA: 1024x768, 1152x864 SXGA: 1280x1024 WXGA: 1280x768, 1366x768 WXGA+: 1440x900, 1680x900 WSXGA+: 1680x1050 Full HD: 1920x1080 Presets display modes HDMI: 17; DP: 17</p> | | | | | |
| <p>Viewing adjustments <i>Tilt:</i> 30° back, -5° forward; <i>lift:</i> 4.3" (110mm); <i>swivel:</i> +/-45°; detachable stand Rotating screen Screen pivots 90 degrees from landscape to portrait On screen display On screen display with digital user controls (8 languages) Control features Direct access (buttons on front) for power, menu, input source select and brightness USB hub USB 3.0 Hub: 1 port into PC (USB 3.0); 4 ports for accessories (4 USB 3.0) Multiple input Dual input (two different PCs attach to two different connectors; one PC shows image; select via button) Monitor connectors (1) VGA 15-pin D-shell, analog, blue (2) HDMI (1.4), digital, HDCP-compliant (3) DisplayPort, digital, black, HDCP-compliant Signal cables (1) detachable, VGA 15-pin D-shell at each end, analog, 1.8 meter (2) detachable, DisplayPort at each end, digital, 1.8 meter Mounting features Wall or desk mounting using the Extend Arm or third-party accessories, 100mm x 100mm mount Security Security keyhole for attachment of optional cable lock (Kensington® lock-compatible)</p> | | | | | |
| <p>Ship group Monitor with stand, Safety and Warranty Information, 1.8 meter analog signal cable, 1.8 meter DP signal cable, 1.8 meter USB signal cable, 1.8 meter black power cord</p> | | | | | |
| <p style="text-align: center;">Limited Warranty</p> <p>See details at http://support.lenovo.com/en_US/guides-and-manuals/detail.page?DocID=UM008281</p> | <p style="text-align: center;">Accessories</p> <table border="0"> <tr> <td>Kensington MicroSaver Cable Lock</td> <td style="text-align: right;">73P2582</td> </tr> <tr> <td>Kensington Twin Head Cable Lock</td> <td style="text-align: right;">45K1620</td> </tr> </table> <p>See details at www.lenovo.com/support/monitoraccessories</p> <p>See all monitors at www.lenovo.com/thinkvision</p> | Kensington MicroSaver Cable Lock | 73P2582 | Kensington Twin Head Cable Lock | 45K1620 |
| Kensington MicroSaver Cable Lock | 73P2582 | | | | |
| Kensington Twin Head Cable Lock | 45K1620 | | | | |



| | | | | | |
|---|---|----------------------------------|---------|---------------------------------|---------|
| <p>Name T2324d Wide Flat Panel Monitor Bezel color Black Type-model 60F3JAR2US / 60F3JAT2US / 60F3JAT2EU Panel TFT-LCD, twisted nematic (TN), White LED backlight Viewable image size 23.0" (584mm) diagonal Max view area (W x H) 20.07" x 11.29" (509.8mm x 286.7mm) Native resolution 1920x1080 Aspect ratio 16:9 Pixel pitch (mm) 0.2655 x 0.2655 mm Dot/Pixel per Inch 96 dpi Brightness 250 nits or cd/m² (typical) Contrast ratio 1000:1 (typical) Pixel response time 5ms (typical) Color gamut 72% Viewing angle at 10:1 CR 170° (+/- 85°) horizontal, 160° (+/- 80°) vertical Stand Tilt stand Bezel width Sides: 0.68" (17.3mm) Dimensions (HxWxD) 15.75" H x 21.48" W x 8.06" D; 400.3mm H x 545.8mm W x 204.9mm D Power supply 20 watts typical, 27 watts maximum <0.3 watts standby/suspend, universal, integrated (no external brick-like power supply) Weight 7.06 lb; 3.20 kg Limited warranty 3 year (includes backlight) Available date June 2016</p> | <p style="text-align: center;">Features</p> <ul style="list-style-type: none"> • Widescreen 23.0-inch monitor • Supports 1920x1080 resolution • Supports optional soundbar • Supports ThinkCentre Tiny via VESA back mount • Includes dual input connection for attachment to two systems concurrently (analog and digital) • EPEAT Gold certified • Microsoft® Windows® 7 certified • Microsoft Windows 10 certified | | | | |
| <p>VESA-compliant VESA DDC2B/CI Power management ENERGY STAR® qualified Ergonomics ISO 9241-307 Emission standards FCC Class B Environmental TCO Displays 7.0, TCO Certified Edge 2.0, WEEE, RoHS, EPEAT™ Gold rating</p> | <div style="text-align: center;">  <p>ThinkVision T2324d Wide Monitor</p> </div> | | | | |
| <p>Preset resolutions VGA: 640x350, 640x480, 720x400 SVGA: 800x600 XGA: 1024x768, 1152x864 SXGA: 1280x1024 WXGA: 1280x768, 1280x800, 1366x768 WXGA+: 1440x900 WSXGA+: 1680x1050 Full HD: 1920x1080</p> <p>Presets / user settings Standard presets: 26; user settings: 16</p> | | | | | |
| <p>Viewing adjustments Tilt: 22° back, -5° Rotating screen None On screen display On screen display with digital user controls (8 languages) Control features Direct access (buttons on front) for automatic image setup, dual input and brightness USB hub None Multiple input Dual input (two different PCs attach to two different connectors; one PC shows image; select via button) Monitor connectors (1) VGA 15-pin D-shell, analog, blue (2) DisplayPort, digital, black, HDCP-compliant Signal cables (1) detachable, VGA 15-pin D-shell at each end, analog, 1.8 meter (2) detachable, DisplayPort at each end, digital, 1.8 meter Mounting features Wall or desk mounting using the Extend Arm or third-party accessories, 100mm x 100mm mount Security Security keyhole for attachment of optional cable lock (Kensington® lock-compatible)</p> | | | | | |
| <p>Ship group Monitor with stand, Safety and Warranty Information, 1.8 meter analog signal cable, 1.8 meter DP signal cable, 1.8 meter black power cord</p> | <p style="text-align: center;">Limited Warranty</p> <p>See details at http://support.lenovo.com/en_US/guides-and-manuals/detail.page?DocID=UM008281</p> <p style="text-align: center;">Accessories</p> <table border="0" style="width: 100%;"> <tr> <td>Kensington MicroSaver Cable Lock</td> <td style="text-align: right;">73P2582</td> </tr> <tr> <td>Kensington Twin Head Cable Lock</td> <td style="text-align: right;">45K1620</td> </tr> </table> <p>See details at www.lenovo.com/support/monitoraccessories</p> <p>See all monitors at www.lenovo.com/thinkvision</p> | Kensington MicroSaver Cable Lock | 73P2582 | Kensington Twin Head Cable Lock | 45K1620 |
| Kensington MicroSaver Cable Lock | 73P2582 | | | | |
| Kensington Twin Head Cable Lock | 45K1620 | | | | |



| | | | | | |
|--|---|----------------------------------|---------|---------------------------------|---------|
| <p>Name T2364t Wide Flat Panel Monitor Bezel color Black Type-model 60E9MAR1US / 60E9MAT1US / 60E9MAT1EU Panel TFT-LCD, In-Plane Switching (IPS), White LED backlight</p> <p>Viewable image size 23.0" (584mm) diagonal Max view area (W x H) 20.05" x 11.28" (509.2mm x 286.4mm) Native resolution 1920x1080 Touch Supports 10-point touch</p> <p>Aspect ratio 16:9 Pixel pitch (mm) 0.2652 x 0.2652 mm Dot/Pixel per Inch 95 dpi Brightness 250 nits or cd/m² (typical) Contrast ratio 1000:1 (typical) Pixel response time 7ms (typical) Color gamut 72% Viewing angle at 10:1 CR 178° (+/- 89°) horizontal, 178° (+/- 89°) vertical</p> <p>Stand Tilt adjustable stand Bezel width <i>Sides:</i> 0.079" (2.0mm) Dimensions (HxWxD) 12.53" H x 20.56" W x 2.86" D; 318.2mm H x 522.2mm W x 72.7mm D</p> <p>Power supply 22 watts typical, 45 watts maximum, <0.5 watts standby/suspend, universal, integrated (no external brick-like power supply)</p> <p>Weight 9.24 lb; 4.32 kg Limited warranty 3 year (includes backlight) Available date June 2015</p> | <p style="text-align: center;">Features</p> <ul style="list-style-type: none"> • Widescreen 23.0-inch monitor • Supports 1920x1080 resolution • Includes dual input connection for attachment to two systems concurrently • EPEAT Gold certified • 10-point touch screen • Microsoft® Windows® 7 certified • Microsoft Windows 10 certified | | | | |
| <p>VESA-compliant VESA DDC2B/CI Power management ENERGY STAR® qualified Ergonomics ISO 9241-307 Emission standards FCC Class B Environmental TCO Displays 7.0, TCO Certified Edge 2.0, WEEE, RoHS, EPEAT™ Gold rating</p> <p>Preset resolutions VGA: 640x350, 640x480, 720x400, 700x570 SVGA: 800x600, 832x624 XGA: 1024x768, 1152x864 SXGA: 1280x1024 WXGA: 1366x768 WXGA+: 1440x900, 1600x900 WSXGA+: 1680x1050 Full HD: 1920x1080</p> <p>Presets / user settings User settings: 20</p> |   <p style="text-align: center;">ThinkVision T2364t</p> | | | | |
| <p>Viewing adjustments <i>Tilt:</i> 10° - 70° degrees; detachable stand Rotating screen None On screen display On screen display with digital user controls (8 languages) Control features Direct access (buttons on front) for automatic image setup, dual input and brightness USB hub USB 3.0 Hub: 1 port into PC (USB 3.0); 3 ports for accessories (3 USB 3.0) Multiple input Dual input (two different PCs attach to two different connectors; one PC shows image; select via button) Monitor connectors (1) VGA 15-pin D-shell, analog, blue (2) HDMI (1.4), digital, HDCP-compliant (3) DisplayPort, digital, black, HDCP-compliant</p> <p>Signal cables (1) detachable, VGA 15-pin D-shell at each end, analog, 1.8 meter (2) detachable, HDMI at each end, digital, 1.8 meter (3) detachable, DisplayPort at each end, digital, 1.8 meter</p> <p>Mounting features Wall or desk mounting using the Extend Arm or third-party accessories, 100mm x 100mm mount Security Security keyhole for attachment of optional cable lock (Kensington® lock-compatible)</p> <p>Ship group Monitor with stand, Safety and Warranty Information, 1.8 meter analog signal cable, 1.8 meter HDMI cable, 1.8 meter DisplayPort cable, 1.8 meter USB signal cable, 1.8 meter black power cord</p> | <p style="text-align: center;">Accessories</p> <table border="0"> <tr> <td>Kensington MicroSaver Cable Lock</td> <td style="text-align: right;">73P2582</td> </tr> <tr> <td>Kensington Twin Head Cable Lock</td> <td style="text-align: right;">45K1620</td> </tr> </table> <p>See details at www.lenovo.com/support/monitoraccessories</p> <p>See all monitors at www.lenovo.com/thinkvision</p> | Kensington MicroSaver Cable Lock | 73P2582 | Kensington Twin Head Cable Lock | 45K1620 |
| Kensington MicroSaver Cable Lock | 73P2582 | | | | |
| Kensington Twin Head Cable Lock | 45K1620 | | | | |

| |
|--|
| Limited Warranty |
| See details at http://support.lenovo.com/en_US/guides-and-manuals/detail.page?DocID=UM008281 |

| | |
|---|---------|
| Accessories | |
| Kensington MicroSaver Cable Lock | 73P2582 |
| Kensington Twin Head Cable Lock | 45K1620 |
| See details at www.lenovo.com/support/monitoraccessories | |
| See all monitors at www.lenovo.com/thinkvision | |



| | | | | | |
|---|---|----------------------------------|---------|---------------------------------|---------|
| <p>Name T23i Wide Flat Panel Monitor Bezel color Black Type-model 61ABMAR1US / 61ABMAT1EU Panel TFT-LCD, In-Plane Switching (IPS), White LED backlight Viewable image size 23" (584.2mm) diagonal Max view area (W x H) 20.36" x 11.92" (517.2mm x 302.8mm) Native resolution 1920x1080 Aspect ratio 16:9 Pixel pitch (mm) 0.2652 x 0.2652 mm Dot/Pixel per Inch 95.8 dpi Brightness 250 nits or cd/m² (typical) Contrast ratio 1000:1 (typical) Pixel response time 6ms (typical) Color gamut 72% Viewing angle at 10:1 CR 178° (+/- 89°) horizontal, 178° (+/- 89°) vertical Stand Tilt, swivel, pivot, and height adjustable stand Bezel width Sides: 0.08" (2.0mm) Dimensions (HxWxD) 13.3" H x 20.56" W x 10.4" D; 337.7mm H x 522.2mm W x 264.2mm D Power supply 16 watts typical, 45 watts maximum (with USB 3.0 hub), <0.5 watts standby/suspend, universal, integrated (no external brick-like power supply) Weight 10.85 lb; 4.92 kg Limited warranty 3 year (includes backlight) Available date April 2017</p> | <p style="text-align: center;">Features</p> <ul style="list-style-type: none"> • Widescreen 23-inch monitor • Supports 1920x1080 resolution • Supports ThinkCentre Tiny Clamp Bracket • Includes dual input connection for attachment to two systems concurrently • EPEAT Gold certified • Microsoft® Windows® 7 certified • Microsoft Windows 10 certified | | | | |
| <p>VESA-compliant VESA DDC2B/CI Power management ENERGY STAR® qualified Ergonomics ISO 9241-307 Emission standards FCC Class B Environmental TCO Displays 7.0, TCO Certified Edge 2.0, WEEE, RoHS, EPEAT™ Gold rating</p> | <div style="text-align: center;">  <p>ThinkVision T23i Wide Monitor</p> </div> | | | | |
| <p>Preset resolutions VGA: 640x480, 720x400; SVGA: 800x600; XGA: 1024x768, 1152x864; SXGA: 1280x1024; WXGA+: 1440x900; WSXGA+: 1680x1050; Full HD: 1920x1080</p> <p>Presets display modes HDMI: 18; DP: 18</p> | | | | | |
| <p>Viewing adjustments Tilt: 30° back, -5° forward; lift: 4.3" (110mm); swivel: +/-45°; detachable stand Rotating screen Screen pivots 90 degrees from landscape to portrait On screen display On screen display with digital user controls (8 languages) Control features Direct access (buttons on front) for power, menu, input source select and brightness and automatic image setup USB hub USB 3.0 Hub: 1 port into PC (USB 3.0); 4 ports for accessories (4 USB 3.0) Multiple input Dual input (two different PCs attach to two different connectors; one PC shows image; select via button) Monitor connectors (1) VGA 15-pin D-shell, analog, blue; (2) HDMI (1.4), digital, HDCP-compliant; (3) DisplayPort, digital, black, HDCP-compliant Signal cables (1) detachable, VGA 15-pin D-shell at each end, analog, 1.8 meter; (2) detachable, DisplayPort at each end, digital, 1.8 meter Mounting features Wall or desk mounting using the Extend Arm or third-party accessories, 100mm x 100mm mount Security Security keyhole for attachment of optional cable lock (Kensington® lock-compatible)</p> | | | | | |
| <p>Ship group Monitor with stand, Safety and Warranty Information, 1.8 meter analog signal cable, 1.8 meter DP signal cable, 1.8 meter USB signal cable, 1.8 meter black power cord</p> | | | | | |
| <p style="text-align: center;">Limited Warranty</p> <p>See details at http://support.lenovo.com/en_US/guides-and-manuals/detail.page?DocID=UM008281</p> | <p style="text-align: center;">Accessories</p> <table border="0"> <tr> <td>Kensington MicroSaver Cable Lock</td> <td style="text-align: right;">73P2582</td> </tr> <tr> <td>Kensington Twin Head Cable Lock</td> <td style="text-align: right;">45K1620</td> </tr> </table> <p>See details at www.lenovo.com/support/monitoraccessories</p> <p>See all monitors at www.lenovo.com/thinkvision</p> | Kensington MicroSaver Cable Lock | 73P2582 | Kensington Twin Head Cable Lock | 45K1620 |
| Kensington MicroSaver Cable Lock | 73P2582 | | | | |
| Kensington Twin Head Cable Lock | 45K1620 | | | | |



| | | | | | |
|---|---|----------------------------------|---------|---------------------------------|---------|
| <p>Name T2424z Wide Flat Panel Monitor Bezel color Raven black Type-model 60F8MAR1US / 60F8MAT1US / 60F8MAT1EU Panel TFT-LCD, In-Plane Switching (IPS), White LED backlight</p> <p>Viewable image size 23.8" (604.7mm) diagonal Max view area (W x H) 20.75" x 11.67" (527.0mm x 296.5mm) Native resolution 1920x1080 Aspect ratio 16:9 Pixel pitch (mm) 0.2745 x 0.2745 mm Dot/Pixel per Inch 92 dpi Brightness 250 nits or cd/m² (typical) Contrast ratio 1000:1 (typical) Pixel response time 7ms (typical) Color gamut 72% Viewing angle at 10:1 CR 178° (+/- 89°) horizontal, 178° (+/- 89°) vertical Stand Tilt, swivel, pivot, and height adjustable stand Bezel width Sides: 0.69" (17.5mm) Dimensions (HxWxD) 19.53" H x 22.19" W x 10.39" D; 496.0mm H x 563.6mm W x 264.2mm D</p> <p>Power supply 22 watts typical, 40 watts maximum (without USB 3.0 hub), <0.5 watts standby/suspend, universal, integrated (no external brick-like power supply)</p> <p>Weight 12.90 lb; 5.85 kg Limited warranty 3 year (includes backlight) Available date June 2016</p> | <p style="text-align: center;">Features</p> <ul style="list-style-type: none"> • Widescreen 23.8-inch monitor • Supports 1920x1080 resolution • Supports ThinkCentre Tiny Clamp Bracket • Includes dual input connection for attachment to two systems concurrently (analog and digital) • EPEAT Gold certified • Supports optional soundbar • Microsoft® Windows® 7 certified • Microsoft Windows 8 / Windows 8.1 certified • Microsoft Windows 10 certified | | | | |
| <p>VESA-compliant VESA DDC2B/CI Power management ENERGY STAR® qualified Ergonomics ISO 9241-307 Emission standards FCC Class B Environmental TCO Displays 7.0, TCO Certified Edge 2.0, WEEE, RoHS, EPEAT™ Gold rating</p> | <div style="text-align: center;">  <p>ThinkVision T2424z Wide Monitor</p> </div> | | | | |
| <p>Preset resolutions VGA: 640x350, 640x480, 720x400 SVGA: 800x600 XGA: 1024x768, 1152x864 SXGA: 1280x1024 WXGA+: 1440x900, 1600x900 WSXGA+: 1680x1050 Full HD: 1920x1080</p> <p>Presets / user settings Standard presets: 31; user settings: 20</p> | | | | | |
| <p>Viewing adjustments Tilt: 30° back, -5° forward; lift: 4.3" (110mm); swivel: +/-45°; detachable stand Rotating screen Screen pivots 90 degrees from landscape to portrait On screen display On screen display with digital user controls (8 languages) Control features Direct access (buttons on front) for automatic image setup, dual input and brightness USB hub USB 3.0 Hub: 1 port into PC (USB 3.0); 2 ports for accessories (2 USB 3.0) Multimedia Integrated digital speakers (3 watts x 2) Camera Integrated camera (Full HD) and digital dual array microphone Multiple input Dual input (two different PCs attach to two different connectors; one PC shows image; select via button) Monitor connectors (1) VGA 15-pin D-shell, analog, blue (2) HDMI (1.4), digital, HDCP-compliant (3) DisplayPort, digital, black, HDCP-compliant</p> <p>Signal cables (1) detachable, VGA 15-pin D-shell at each end, analog, 1.8 meter (2) detachable, DisplayPort at each end, digital, 1.8 meter</p> <p>Mounting features Wall or desk mounting using the Extend Arm or third-party accessories, 100mm x 100mm mount Security Security keyhole for attachment of optional cable lock (Kensington® lock-compatible)</p> | | | | | |
| <p>Ship group Monitor with stand, Safety and Warranty Information, 1.8 meter analog signal cable, 1.8 meter DP signal cable, 1.8 meter USB signal cable, 1.8 meter black power cord</p> | <p style="text-align: center;">Accessories</p> <table border="0" style="width: 100%;"> <tr> <td>Kensington MicroSaver Cable Lock</td> <td style="text-align: right;">73P2582</td> </tr> <tr> <td>Kensington Twin Head Cable Lock</td> <td style="text-align: right;">45K1620</td> </tr> </table> <p>See details at www.lenovo.com/support/monitoraccessories</p> <p>See all monitors at www.lenovo.com/thinkvision</p> | Kensington MicroSaver Cable Lock | 73P2582 | Kensington Twin Head Cable Lock | 45K1620 |
| Kensington MicroSaver Cable Lock | 73P2582 | | | | |
| Kensington Twin Head Cable Lock | 45K1620 | | | | |
| <p style="text-align: center;">Limited Warranty</p> <p>See details at http://support.lenovo.com/en_US/guides-and-manuals/detail.page?DocID=UM008281</p> | | | | | |

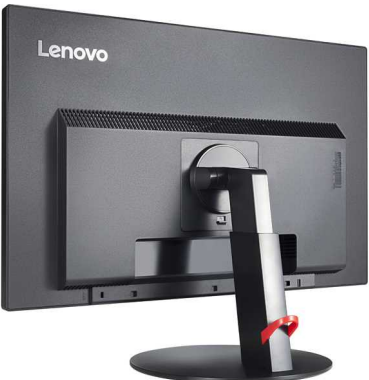

| | | | | | |
|--|---|----------------------------------|---------|---------------------------------|---------|
| <p>Name T2454p Wide Flat Panel Monitor Bezel color Raven black Type-model 60F9MAR1US / 60F9MAT1US / 60F9MAT1EU Panel TFT-LCD, In-Plane Switching (IPS), White LED backlight</p> <p>Viewable image size 24.0" (609.6mm) diagonal Max view area (W x H) 20.41" x 12.76" (518.4mm x 324.0mm) Native resolution 1920x1200 Aspect ratio 16:10 Pixel pitch (mm) 0.270 x 0.270 mm Dot/Pixel per Inch 94 dpi Brightness 300 nits or cd/m² (typical) Contrast ratio 1000:1 (typical) Pixel response time 7ms (typical) Color gamut 77.4% Viewing angle at 10:1 CR 178° (+/- 89°) horizontal, 178° (+/- 89°) vertical Stand Tilt, swivel, pivot, and height adjustable stand Bezel width Sides: 0.74" (18.8mm) Dimensions (HxWxD) 15.85" H x 21.94" W x 10.39" D; 402.5mm H x 557.4mm W x 264.2mm D</p> <p>Power supply 24 watts typical, 27 watts maximum (without USB 3.0 hub), 54 watts maximum (with USB 3.0 hub), <0.5 watts standby/suspend, universal, integrated (no external brick-like power supply)</p> <p>Weight 13.60 lb; 6.15 kg Limited warranty 3 year (includes backlight) Available date March 2015</p> | <p style="text-align: center;">Features</p> <ul style="list-style-type: none"> • Widescreen 24.0-inch monitor • Supports 1920x1200 resolution • Supports ThinkCentre Tiny Clamp Bracket • Supports optional soundbar • Includes dual input connection for attachment to two systems concurrently (analog and digital) • EPEAT Gold certified • Microsoft® Windows® 7 certified • Microsoft Windows 8 / Windows 8.1 certified • Microsoft Windows 10 certified | | | | |
| <p>VESA-compliant VESA DDC2B/CI Power management ENERGY STAR® qualified Ergonomics ISO 9241-307 Emission standards FCC Class B Environmental TCO Displays 7.0, TCO Certified Edge 2.0, WEEE, RoHS, EPEAT™ Gold rating</p> <p>Preset resolutions VGA: 640x350, 640x480, 720x400 SVGA: 800x600 XGA: 1024x768 SXGA: 1280x1024 WXGA: 1280x720, 1280x768, 1280x800 WXGA+: 1440x900 WSXGA+: 1680x1050, 1600x1200 Full HD: 1920x1080, 1920x1200</p> <p>Presets / user settings Standard presets: 21; user settings: 20</p> | <div style="text-align: center;">  <p>ThinkVision T2454p Wide Monitor</p> </div> | | | | |
| <p>Viewing adjustments Tilt: 30° back, -5° forward; lift: 4.3" (110mm); swivel: +/-45°; detachable stand Rotating screen Screen pivots 90 degrees from landscape to portrait On screen display On screen display with digital user controls (8 languages) Control features Direct access (buttons on front) for automatic image setup, dual input and brightness USB hub USB 3.0 Hub: 1 port into PC (USB 3.0); 4 ports for accessories (4 USB 3.0) Multiple input Dual input (two different PCs attach to two different connectors; one PC shows image; select via button) Monitor connectors (1) VGA 15-pin D-shell, analog, blue (2) HDMI (1.4), digital, HDCP-compliant (3) DisplayPort, digital, black, HDCP-compliant</p> <p>Signal cables (1) detachable, VGA 15-pin D-shell at each end, analog, 1.8 meter (2) detachable, DisplayPort at each end, digital, 1.8 meter</p> <p>Mounting features Wall or desk mounting using the Extend Arm or third-party accessories, 100mm x 100mm mount Security Security keyhole for attachment of optional cable lock (Kensington® lock-compatible)</p> | | | | | |
| <p>Ship group Monitor with stand, Safety and Warranty Information, 1.8 meter analog signal cable, 1.8 meter DisplayPort cable, 1.8 meter USB signal cable, 1.8 meter black power cord</p> | | | | | |
| <p style="text-align: center;">Limited Warranty</p> <p>See details at http://support.lenovo.com/en_US/guides-and-manuals/detail.page?DocID=UM008281</p> | <p style="text-align: center;">Accessories</p> <table border="0" style="width: 100%;"> <tr> <td>Kensington MicroSaver Cable Lock</td> <td style="text-align: right;">73P2582</td> </tr> <tr> <td>Kensington Twin Head Cable Lock</td> <td style="text-align: right;">45K1620</td> </tr> </table> <p>See details at www.lenovo.com/support/monitoraccessories</p> <p>See all monitors at www.lenovo.com/thinkvision</p> | Kensington MicroSaver Cable Lock | 73P2582 | Kensington Twin Head Cable Lock | 45K1620 |
| Kensington MicroSaver Cable Lock | 73P2582 | | | | |
| Kensington Twin Head Cable Lock | 45K1620 | | | | |



| | | | | | |
|---|---|----------------------------------|---------|---------------------------------|---------|
| <p>Name T24d Wide Flat Panel Monitor Bezel color Black Type-model 61B4MAR1US / 61B4MAT1EU Panel TFT-LCD, In-Plane Switching (IPS), White LED backlight</p> <p>Viewable image size 24" (609.6mm) diagonal Max view area (W x H) 20.41" x 12.75" (518.4mm x 324mm) Native resolution 1920x1200 Aspect ratio 16:10 Pixel pitch (mm) 0.27 x 0.27 mm Dot/Pixel per Inch 94 dpi Brightness 300 nits or cd/m² (typical) Contrast ratio 1000:1 (typical) Pixel response time 7ms (typical) Color gamut 99% Viewing angle at 10:1 CR 178° (+/- 89°) horizontal, 178° (+/- 89°) vertical Stand Tilt, swivel, pivot, and height adjustable stand Bezel width Sides: 0.08" (2.0mm) Dimensions (HxWxD) 19.58" H x 20.99" W x 10.25" D; 497.4mm H x 533.2mm W x 260.4mm D</p> <p>Power supply 22 watts typical, 64 watts maximum (with USB 3.0 hub), <0.3 watts standby/suspend, universal, integrated (no external brick-like power supply)</p> <p>Weight 12.41 lb; 5.63 kg Limited warranty 3 year (includes backlight) Available date June 2017</p> | <p style="text-align: center;">Features</p> <ul style="list-style-type: none"> • Widescreen 24-inch monitor • Supports 1920x1200 resolution • Supports ThinkCentre Tiny Clamp Bracket • Supports optional soundbar • Includes dual input connection for attachment to two systems concurrently • EPEAT Gold certified • Microsoft® Windows® 7 certified • Microsoft Windows 10 certified | | | | |
| <p>VESA-compliant VESA DDC2B/CI Power management ENERGY STAR® qualified Ergonomics ISO 9241-307 Emission standards FCC Class B Environmental TCO Displays 7.0, TCO Certified Edge 2.0, WEEE, RoHS, EPEAT™ Gold rating</p> <p>Preset resolutions VGA: 640x480, 720x400 SVGA: 800x600 XGA: 1024x768 SXGA: 1280x1024 WXGA: 1366x768 WXGA+: 1440x900 WSXGA+: 1680x1050 Full HD: 1920x1080 WUXGA: 1920x1200</p> <p>Presets display modes Standard presets: 22; user settings: 20</p> |  <p style="text-align: center;">ThinkVision T24d Wide Monitor</p> | | | | |
| <p>Viewing adjustments Tilt: 30° back, -5° forward; lift: 4.3" (110mm); swivel: +/-45°; detachable stand Rotating screen Screen pivots 90 degrees from landscape to portrait On screen display On screen display with digital user controls (8 languages) Control features Direct access (buttons on front) for power, menu, input source select and brightness USB hub USB 3.0 Hub: 1 port into PC (USB 3.0); 4 ports for accessories (4 USB 3.0) Multiple input Dual input (two different PCs attach to two different connectors; one PC shows image; select via button) Monitor connectors (1) VGA 15-pin D-shell, analog, blue (2) HDMI (1.4), digital, HDCP-compliant (3) DisplayPort, digital, black, HDCP-compliant</p> <p>Signal cables (1) detachable, VGA 15-pin D-shell at each end, analog, 1.8 meter (2) detachable, DisplayPort at each end, digital, 1.8 meter</p> <p>Mounting features Wall or desk mounting using the Extend Arm or third-party accessories, 100mm x 100mm mount Security Security keyhole for attachment of optional cable lock (Kensington® lock-compatible)</p> | <p>Ship group Monitor with stand, Safety and Warranty Information, 1.8 meter analog signal cable, 1.8 meter DP signal cable, 1.8 meter USB signal cable, 1.8 meter black power cord, 1.8 meter HDMI signal cable (NA only)</p> | | | | |
| <p style="text-align: center;">Limited Warranty</p> <p>See details at http://support.lenovo.com/en_US/guides-and-manuals/detail.page?DocID=UM008281</p> | <p style="text-align: center;">Accessories</p> <table border="0"> <tr> <td>Kensington MicroSaver Cable Lock</td> <td style="text-align: right;">73P2582</td> </tr> <tr> <td>Kensington Twin Head Cable Lock</td> <td style="text-align: right;">45K1620</td> </tr> </table> <p>See details at www.lenovo.com/support/monitoraccessories</p> <p>See all monitors at www.lenovo.com/thinkvision</p> | Kensington MicroSaver Cable Lock | 73P2582 | Kensington Twin Head Cable Lock | 45K1620 |
| Kensington MicroSaver Cable Lock | 73P2582 | | | | |
| Kensington Twin Head Cable Lock | 45K1620 | | | | |



| | | | | | |
|--|--|----------------------------------|---------|---------------------------------|---------|
| <p>Name T24i Wide Flat Panel Monitor Bezel color Black Type-model 61A6MAR3US / 61A6MAT3EU Panel TFT-LCD, In-Plane Switching (IPS), White LED backlight Viewable image size 23.8" (604.7mm) diagonal Max view area (W x H) 20.75" x 11.67" (527.04mm x 296.5mm) Native resolution 1920x1080 Aspect ratio 16:9 Pixel pitch (mm) 0.2745 x 0.2745 mm Dot/Pixel per Inch 93 dpi Brightness 250 nits or cd/m² (typical) Contrast ratio 1000:1 (typical) Pixel response time 6ms (typical) Color gamut 72% Viewing angle at 10:1 CR 178° (+/- 89°) horizontal, 178° (+/- 89°) vertical Stand Tilt, swivel, pivot, and height adjustable stand Bezel width <i>Sides:</i> 0.08" (2.0mm) Dimensions (HxWxD) 14.7" H x 21.26" W x 10.3" D; 373.4mm H x 540.2mm W x 261.75mm D Power supply 16.5 watts typical, 55 watts maximum (with USB 3.0 hub), <0.5 watts standby/suspend, universal, integrated (no external brick-like power supply) Weight 11.57 lb; 5.25 kg Limited warranty 3 year (includes backlight) Available date April 2017</p> | <p style="text-align: center;">Features</p> <ul style="list-style-type: none"> • Widescreen 23.8-inch monitor • Supports 1920x1080 resolution • Supports ThinkCentre Tiny Clamp Bracket • Supports optional soundbar • Includes dual input connection for attachment to two systems concurrently • EPEAT Gold certified • Microsoft® Windows® 7 certified • Microsoft Windows 10 certified | | | | |
| <p>VESA-compliant VESA DDC2B/CI Power management ENERGY STAR® qualified Ergonomics ISO 9241-307 Emission standards FCC Class B Environmental TCO Displays 7.0, TCO Certified Edge 2.0, WEEE, RoHS, EPEAT™ Gold rating</p> | <div style="text-align: center;">  <p>ThinkVision T24i Wide Monitor</p> </div> | | | | |
| <p>Preset resolutions VGA: 640x480, 720x400 SVGA: 800x600 XGA: 1024x768 SXGA: 1280x1024 WXGA: 1366x768 WXGA+: 1440x900, 1680x900 WSXGA+: 1680x1050 Full HD: 1920x1080 Presets display modes HDMI: 17; DP: 17</p> | | | | | |
| <p>Viewing adjustments <i>Tilt:</i> 30° back, -5° forward; <i>lift:</i> 4.3" (110mm); <i>swivel:</i> +/-45°; detachable stand Rotating screen Screen pivots 90 degrees from landscape to portrait On screen display On screen display with digital user controls (8 languages) Control features Direct access (buttons on front) for power, menu, input source select and brightness and automatic image setup USB hub USB 3.0 Hub: 1 port into PC (USB 3.0); 4 ports for accessories (4 USB 3.0) Multiple input Dual input (two different PCs attach to two different connectors; one PC shows image; select via button) Monitor connectors (1) VGA 15-pin D-shell, analog, blue (2) HDMI (1.4), digital, HDCP-compliant (3) DisplayPort, digital, black, HDCP-compliant Signal cables (1) detachable, VGA 15-pin D-shell at each end, analog, 1.8 meter (2) detachable, DisplayPort at each end, digital, 1.8 meter Mounting features Wall or desk mounting using the Extend Arm or third-party accessories, 100mm x 100mm mount Security Security keyhole for attachment of optional cable lock (Kensington® lock-compatible)</p> | <p>Viewing adjustments <i>Tilt:</i> 30° back, -5° forward; <i>lift:</i> 4.3" (110mm); <i>swivel:</i> +/-45°; detachable stand Rotating screen Screen pivots 90 degrees from landscape to portrait On screen display On screen display with digital user controls (8 languages) Control features Direct access (buttons on front) for power, menu, input source select and brightness and automatic image setup USB hub USB 3.0 Hub: 1 port into PC (USB 3.0); 4 ports for accessories (4 USB 3.0) Multiple input Dual input (two different PCs attach to two different connectors; one PC shows image; select via button) Monitor connectors (1) VGA 15-pin D-shell, analog, blue (2) HDMI (1.4), digital, HDCP-compliant (3) DisplayPort, digital, black, HDCP-compliant Signal cables (1) detachable, VGA 15-pin D-shell at each end, analog, 1.8 meter (2) detachable, DisplayPort at each end, digital, 1.8 meter Mounting features Wall or desk mounting using the Extend Arm or third-party accessories, 100mm x 100mm mount Security Security keyhole for attachment of optional cable lock (Kensington® lock-compatible)</p> | | | | |
| <p>Ship group Monitor with stand, Safety and Warranty Information, 1.8 meter analog signal cable, 1.8 meter DP signal cable, 1.8 meter USB signal cable, 1.8 meter black power cord</p> | <p>Monitor with stand, Safety and Warranty Information, 1.8 meter analog signal cable, 1.8 meter DP signal cable, 1.8 meter USB signal cable, 1.8 meter black power cord</p> | | | | |
| <p style="text-align: center;">Limited Warranty</p> <p>See details at http://support.lenovo.com/en_US/guides-and-manuals/detail.page?DocID=UM008281</p> | <p style="text-align: center;">Accessories</p> <table border="0"> <tr> <td>Kensington MicroSaver Cable Lock</td> <td style="text-align: right;">73P2582</td> </tr> <tr> <td>Kensington Twin Head Cable Lock</td> <td style="text-align: right;">45K1620</td> </tr> </table> <p>See details at www.lenovo.com/support/monitoraccessories</p> <p>See all monitors at www.lenovo.com/thinkvision</p> | Kensington MicroSaver Cable Lock | 73P2582 | Kensington Twin Head Cable Lock | 45K1620 |
| Kensington MicroSaver Cable Lock | 73P2582 | | | | |
| Kensington Twin Head Cable Lock | 45K1620 | | | | |



| | | | | | |
|---|--|----------------------------------|---------|---------------------------------|---------|
| <p>Name X24 Wide Flat Panel Monitor Bezel color Raven black Type-model 60FAGAR1US / 60FAGAT1US / 60FAGAT1EU Panel TFT-LCD, AH-IPS (In-Plane Switching), White LED backlight Viewable image size 23.8" (604.5mm) diagonal Max view area (W x H) 20.75" x 11.67" (527.0mm x 296.5mm) Native resolution 1920x1080 Aspect ratio 16:9 Pixel pitch (mm) 0.2745 x 0.2745 mm Dot/Pixel per Inch 92 dpi Brightness 250 nits or cd/m² (typical) Contrast ratio 1000:1 (typical) Pixel response time 7ms (typical) Color gamut 72% Viewing angle at 10:1 CR 178° (+/- 89°) horizontal, 178° (+/- 89°) vertical Stand Tilt stand Bezel width <i>Sides:</i> 0.08" (2.0mm) Dimensions (HxWxD) 16.25" H x 21.30" W x 8.66" D; 412.8mm H x 540.9mm W x 220.0mm D Power supply 20 watts typical, 27 watts maximum, <0.5 watts standby/suspend, universal, external power supply Weight 8.60 lb; 3.90 kg Limited warranty 3 year (includes backlight) Available date April 2015</p> | <p style="text-align: center;">Features</p> <ul style="list-style-type: none"> • Widescreen 23.8-inch monitor • Supports 1920x1080 resolution • Includes dual input connection for attachment to two systems concurrently (analog and digital) • EPEAT Silver certified • Microsoft® Windows® 7 certified • Microsoft Windows 8 / Windows 8.1 certified • Microsoft Windows 10 certified | | | | |
| <p>Power management ENERGY STAR® qualified Ergonomics ISO 9241-307 Emission standards FCC Class B Environmental TCO Displays 6.0, WEEE, RoHS, EPEAT™ Silver rating</p> | <div style="text-align: center;">  <p>ThinkVision X24 Wide Monitor</p> </div> | | | | |
| <p>Preset resolutions VGA: 640x350, 640x480, 720x400 SVGA: 800x600 XGA: 1024x768 SXGA: 1280x1024 WXGA: 1366x768 WXGA+: 1440x900, 1600x900 WSXGA+: 1680x1050 Full HD: 1920x1080 Presets / user settings Standard presets: 20; user settings: 16</p> | | | | | |
| <p>Viewing adjustments <i>Tilt:</i> 22° back, -5° forward Rotating screen None On screen display On screen display with digital user controls Control features Direct access (buttons on side bezel) for dual input and brightness USB hub None Multiple input Dual input (two different PCs attach to two different connectors; one PC shows image; select via button) Monitor connectors (1) HDMI (1.4), digital, HDCP-compliant (2) DisplayPort, digital, black, HDCP-compliant Signal cables (1) detachable, HDMI at each end, digital, 1.8 meter (2) detachable, DisplayPort at each end, digital, 1.8 meter Mounting features None Security None</p> | | | | | |
| <p>Ship group Monitor with stand, Safety and Warranty Information, 1.8 meter HDMI signal cable (consumer channel only), 1.8 meter DisplayPort signal cable (commercial channel only), 1.8 meter black power cord</p> | <p style="text-align: center;">Limited Warranty</p> <p>See details at http://support.lenovo.com/en_US/guides-and-manuals/detail.page?DocID=UM008281</p> <p style="text-align: center;">Accessories</p> <table border="0"> <tr> <td>Kensington MicroSaver Cable Lock</td> <td style="text-align: right;">73P2582</td> </tr> <tr> <td>Kensington Twin Head Cable Lock</td> <td style="text-align: right;">45K1620</td> </tr> </table> <p>See details at www.lenovo.com/support/monitoraccessories</p> <p>See all monitors at www.lenovo.com/thinkvision</p> | Kensington MicroSaver Cable Lock | 73P2582 | Kensington Twin Head Cable Lock | 45K1620 |
| Kensington MicroSaver Cable Lock | 73P2582 | | | | |
| Kensington Twin Head Cable Lock | 45K1620 | | | | |



| | | | | | |
|--|--|----------------------------------|---------|---------------------------------|---------|
| <p>Name X24 Pro Wide Flat Panel Monitor Bezel color Black Type-model 60E4ECR1US / 60E4ECT1US / 60E4ECT1EU Panel TFT-LCD, AH-IPS (In-Plane Switching), White LED backlight Viewable image size 23.8" (604.5mm) diagonal Max view area (W x H) 20.75" x 11.67" (527.0mm x 296.5mm) Native resolution 1920x1080 Aspect ratio 16:9 Pixel pitch (mm) 0.2745 x 0.2745 mm Dot/Pixel per Inch 92 dpi Brightness 250 nits or cd/m² (typical) Contrast ratio 1000:1 (typical) Pixel response time 7ms (typical) Color gamut 72% Viewing angle at 10:1 CR 178° (+/- 89°) horizontal, 178° (+/- 89°) vertical Stand Tilt stand Bezel width <i>Sides:</i> 0.09" (2.3mm) Dimensions (HxWxD) 17.61" H x 21.30" W x 9.39" D; 447.4mm H x 540.9mm W x 238.4mm D Power supply 20 watts typical, 90 watts maximum, <0.5 watts standby/suspend, universal, external power supply Weight 9.26 lb; 4.20 kg Limited warranty 1 year (includes backlight) Available date July 2016</p> | <p style="text-align: center;">Features</p> <ul style="list-style-type: none"> • Widescreen 23.8-inch monitor • Supports 1920x1080 resolution • Includes dual input connection for attachment to two systems concurrently • EPEAT Silver certified • Intel RealSense 3D camera • Stereo speakers 3 watts x 2 • One cable docking through USB 3.1 Type C with power delivery • Windows Hello certified • Microsoft® Windows® 10 certified | | | | |
| <p>Power management ENERGY STAR® qualified Ergonomics ISO 9241-307 Emission standards FCC Class B Environmental TCO Displays 6.0, WEEE, RoHS, EPEAT™ Silver rating</p> <p>Preset resolutions VGA: 640x350, 640x480, 720x400 SVGA: 800x600 XGA: 1024x768 SXGA: 1280x1024 WXGA: 1366x768 WXGA+: 1440x900, 1600x900 WSXGA+: 1680x1050 Full HD: 1920x1080</p> <p>Presets / user settings Standard presets: 16; user settings: 20</p> |  <p style="text-align: center;">ThinkVision X24 Pro Wide Monitor</p> | | | | |
| <p>Viewing adjustments <i>Tilt:</i> 22° back, -5° forward Rotating screen None On screen display On screen display with digital user controls Control features Direct access (buttons on side bezel) for dual input and brightness USB hub USB Hub: two USB 3.0 Type-C and one USB 3.0 ports Multimedia Integrated stereo speakers (3 watts x 2), built-in microphone Camera RealSense 3D camera SR300 Multiple input Dual input (two different PCs attach to two different connectors; one PC shows image; select via button) Monitor connectors (1) mDP, Mini DisplayPort, digital, HDCP-compliant (2) USB Type-C, digital Signal cables (1) detachable, mDP to DP, digital, 2.0 meter (2) DP to mDP adapter (3) Micro USB 3.0 cable Mounting features None Security Security keyhole for attachment of optional cable lock (Kensington® lock-compatible)</p> | <p>Ship group Monitor with stand, Safety and Warranty Information, ThinkPad 90W Square tip power adaptor, 2.0 meter Mini DisplayPort to DisplayPort signal cable (with DP to mDP adapter), Micro USB 3.0 cable (for using camera)</p> | | | | |
| <p style="text-align: center;">Limited Warranty</p> <p>See details at http://support.lenovo.com/en_US/guides-and-manuals/detail.page?DocID=UM008281</p> | <p style="text-align: center;">Accessories</p> <table border="0"> <tr> <td>Kensington MicroSaver Cable Lock</td> <td style="text-align: right;">73P2582</td> </tr> <tr> <td>Kensington Twin Head Cable Lock</td> <td style="text-align: right;">45K1620</td> </tr> </table> <p>See details at www.lenovo.com/support/monitoraccessories</p> <p>See all monitors at www.lenovo.com/thinkvision</p> | Kensington MicroSaver Cable Lock | 73P2582 | Kensington Twin Head Cable Lock | 45K1620 |
| Kensington MicroSaver Cable Lock | 73P2582 | | | | |
| Kensington Twin Head Cable Lock | 45K1620 | | | | |



| | | | | | | | |
|---|--|----------------------------------|---------|---------------------------------|---------|----------------------------|---------|
| <p>Name P27 Wide Flat Panel Monitor Case color Black Type-model 60E3GAR1US / 60E3GAT1US / 60E3GAT1EU Panel TFT-LCD, IPS (In-Plane Switching), White LED backlight Viewable image size 27" (684.7mm) diagonal Max view area (W x H) 23.49" x 13.21" (596.7mm x 335.7mm) Optimum resolution 3840x2160 Max pixel rate 600MHz Aspect ratio 16:9 Pixel pitch (mm) 0.16 x 0.16mm Dot/Pixel per Inch 163 dpi Brightness 300 nits or cd/m² (typical) Contrast ratio 1300:1 (typical) Pixel response time 6ms Color gamut 99% Viewing angle at 10:1 CR 178° horizontal, 178° vertical Stand Tilt, swivel, pivot, and height adjustable stand Bezel width Sides: 0.088" (2.23mm) Dimensions 18.59" H x 24.19" W x 11.81" D; (HxWxD, including stand) 472.3mm H x 614.5mm W x 299.9mm D Power supply 40 watts typical, 70 watts maximum (with USB), <0.5 watts sleep/off; <0.5 watts switch off Weight 15.12 lb; 6.86kg (including stand) Limited warranty⁴ 3 year Available date March 2016</p> | <p>Features</p> <ul style="list-style-type: none"> • 27-inch IPS LED backlight monitor with speaker • Supports 3840x2160 resolution • 5-Ports USB hub, support USB 3.0 • 3watts x 2 stereo speakers • Microsoft® Windows® 7 certified • Microsoft Windows 10 certified | | | | | | |
| <p>VESA-compliant² VESA DDC2B/CI Power management ENERGY STAR® 7.0 Ergonomics ISO 9241-307 Emission standards FCC Class B Environmental TCO Displays 7.0, RoHS, EPEAT™ Gold rating, ULE Gold</p> |  <p>ThinkVision P27 Monitor</p> | | | | | | |
| <p>Preset resolutions VGA: 640x350, 640x480, 720x400 SVGA: 800x600 XGA: 1024x768, 1152x864 SXGA: 1280x1024 WXGA: 1280x720, 1280x768, 1280x800, 1360x768 WXGA+: 1440x900, 1600x900 WSXGA+: 1680x1050 Full HD: 1920x1080, 1920x1200 UHD: 3840x2160</p> <p>Presets / user settings Standard presets: 20; user settings: 20</p> | | | | | | | |
| <p>Viewing adjustments Tilt: 30° back, -5° forward; lift: 3.15" (80mm); swivel: +/-45° Rotating screen Screen pivots 90 degrees from landscape to portrait On screen display On screen display with digital user controls (8 languages) Control features Direct access (touch buttons on front) for menu, mute, volume up/down, and brightness USB hub USB Hub: one USB 3.0 upstream port, four USB 3.0 downstream ports Multimedia Integrated stereo speakers (3 watts x 2) Camera None Multiple input Support HDMI, DisplayPort Monitor connectors (1) HDMI (2.0), digital, HDCP-compliant (2) DisplayPort (1.2), digital, HDCP-compliant Signal cables (1) detachable, DisplayPort at each end, digital, 1.8 meter Mounting features Wall or desk mounting using the Extend Arm or third-party accessories meeting the VESA FPMPI® (100mm mount) Security Security keyhole for attachment of optional cable lock (Kensington® lock-compatible)</p> | | | | | | | |
| <p>Ship group Monitor, detachable stand, Quick start and safety poster, 1.8 meter DisplayPort cable, 1.8 meter USB 3.0 cable, 1.8 meter black power cord, mini DP to DP adapter, power adapter (90W)</p> | <p>Limited Warranty</p> <p>See details at http://support.lenovo.com/en_US/guides-and-manuals/detail.page?DocID=UM008281</p> <p>Accessories</p> <table border="0"> <tr> <td>Kensington MicroSaver Cable Lock</td> <td>73P2582</td> </tr> <tr> <td>Kensington Twin Head Cable Lock</td> <td>45K1620</td> </tr> <tr> <td>Lenovo Security Cable Lock</td> <td>57Y4303</td> </tr> </table> <p>See details at www.lenovo.com/support/monitoraccessories</p> <p>See all monitors at www.lenovo.com/thinkvision</p> | Kensington MicroSaver Cable Lock | 73P2582 | Kensington Twin Head Cable Lock | 45K1620 | Lenovo Security Cable Lock | 57Y4303 |
| Kensington MicroSaver Cable Lock | 73P2582 | | | | | | |
| Kensington Twin Head Cable Lock | 45K1620 | | | | | | |
| Lenovo Security Cable Lock | 57Y4303 | | | | | | |

See footnotes for important warranty information



| | | | | | | | |
|--|--|----------------------------------|---------|---------------------------------|---------|----------------------------|---------|
| <p>Name P27h Wide Flat Panel Monitor Case color Black Type-model 61AFGAR1US / 61AFGAT1EU Panel TFT-LCD, IPS (In-Plane Switching), White LED backlight Viewable image size 27" (685.8mm) diagonal Max view area (W x H) 23.49" x 13.21" (596.7mm x 335.7mm) Optimum resolution 2560x1440 Max pixel rate 300MHz Aspect ratio 16:9 Pixel pitch (mm) 0.2331 x 0.2331mm Dot/Pixel per Inch 109 dpi Brightness 350 nits or cd/m² (typical) Contrast ratio 1000:1 (typical) Pixel response time 4ms (extreme) / 6ms (typical) Color gamut 99% sRGB Viewing angle at 10:1 CR 178° horizontal, 178° vertical Stand Tilt, swivel, pivot, and height adjustable stand Bezel width <i>Sides:</i> 0.08" (2mm) Dimensions 20.21" H x 24.08" W x 10.62" D; (HxWxD, including stand) 513mm H x 611.6mm W x 269.8mm D Power supply 38 watts typical, 140 watts maximum (with USB), <0.5 watts sleep/off; <0.5 watts switch off integrated (no external brick-like power supply) Weight 15.43 lb; 7.0kg (including stand) Limited warranty 3 year Available date April 2017</p> | <p style="text-align: center;">Features</p> <ul style="list-style-type: none"> • 27-inch IPS LED backlit monitor • Supports 2560x1440 resolution • 5-Ports USB hub, support USB 3.0 • Supports optional soundbar • Support ThinkCentre Tiny • Microsoft® Windows® 7 certified • Microsoft Windows 10 certified | | | | | | |
| <p>VESA-compliant VESA DDC2B/CI Power management ENERGY STAR® 7.0 Ergonomics ISO 9241-307 Emission standards FCC Class B Environmental TCO Displays 7.0, RoHS, EPEAT™ Gold rating, ULE Gold</p> | <div style="text-align: center;">  <p>ThinkVision P27h Monitor</p> </div> | | | | | | |
| <p>Preset resolutions VGA: 640x480, 720x400 SVGA: 800x600 XGA: 1024x768 SXGA: 1280x1024 WXGA: 1366x768 WXGA+: 1440x900, 1680x900 WSXGA+: 1680x1050 Full HD: 1920x1080, 1920x1200 QHD: 2560x1440</p> | | | | | | | |
| <p>Presets display modes HDMI: 22; DP: 14</p> | | | | | | | |
| <p>Viewing adjustments <i>Tilt:</i> 30° back, -5° forward; <i>lift:</i> 4.33" (110mm); <i>swivel:</i> +/-45° Rotating screen Screen pivots 90 degrees from landscape to portrait On screen display On screen display with digital user controls (8 languages) Control features Direct access (buttons on front) for power, menu, input source select and brightness USB hub USB Hub: one USB Type-C upstream port, four USB 3.0 downstream ports Multimedia Audio-out, optional sound bar supported Camera None Multiple input Support HDMI, DisplayPort, USB 3.1 Type-C, DisplayPort-out Monitor connectors (1) 2*HDMI (1.4), digital, HDCP-compliant (2) DisplayPort (1.2), digital, HDCP-compliant (3) DisplayPort-out, digital (4) USB 3.1 Type-C Signal cables (1) USB 3.1 Type-C cable, 1.8 meter Mounting features Wall or desk mounting using the Extend Arm or third-party accessories meeting the VESA FPMPI® (100mm mount) Security Security keyhole for attachment of optional cable lock (Kensington® lock-compatible)</p> | | | | | | | |
| <p>Ship group Monitor, detachable stand, Quick start and safety poster, 1.8 meter USB 3.1 Type-C cable, 1.8 meter black power cord</p> | | | | | | | |
| <p style="text-align: center;">Limited Warranty</p> <p>See details at http://support.lenovo.com/en_US/guides-and-manuals/detail.page?DocID=UM008281</p> | <p style="text-align: center;">Accessories</p> <table border="0"> <tr> <td>Kensington MicroSaver Cable Lock</td> <td style="text-align: right;">73P2582</td> </tr> <tr> <td>Kensington Twin Head Cable Lock</td> <td style="text-align: right;">45K1620</td> </tr> <tr> <td>Lenovo Security Cable Lock</td> <td style="text-align: right;">57Y4303</td> </tr> </table> <p>See details at www.lenovo.com/support/monitoraccessories See all monitors at www.lenovo.com/thinkvision</p> | Kensington MicroSaver Cable Lock | 73P2582 | Kensington Twin Head Cable Lock | 45K1620 | Lenovo Security Cable Lock | 57Y4303 |
| Kensington MicroSaver Cable Lock | 73P2582 | | | | | | |
| Kensington Twin Head Cable Lock | 45K1620 | | | | | | |
| Lenovo Security Cable Lock | 57Y4303 | | | | | | |



| | | | | | | | |
|--|--|----------------------------------|---------|---------------------------------|---------|----------------------------|---------|
| <p>Name P27q Wide Flat Panel Monitor Case color Black Type-model 61A8GAR1US / 61A8GAT1EU Panel TFT-LCD, IPS (In-Plane Switching), White LED backlight Viewable image size 27" (685.8mm) diagonal Max view area (W x H) 23.49" x 13.21" (596.7mm x 335.7mm) Optimum resolution 2560x1440 Max pixel rate 300MHz Aspect ratio 16:9 Pixel pitch (mm) 0.2331 x 0.2331mm Dot/Pixel per Inch 109 dpi Brightness 350 nits or cd/m² (typical) Contrast ratio 1000:1 (typical) Pixel response time 4ms Color gamut 99% sRGB Viewing angle at 10:1 CR 178° horizontal, 178° vertical Stand Tilt, swivel, pivot, and height adjustable stand Bezel width Sides: 0.08" (2mm) Dimensions (HxWxD, including stand) 513mm H x 614mm W x 269.8mm D Power supply 38 watts typical, 75 watts maximum (with USB), <0.5 watts sleep/off; <0.3 watts switch off integrated (no external brick-like power supply) Weight 15.43 lb; 7.0kg (including stand) Limited warranty 3 year Available date January 2017</p> | <p>Features</p> <ul style="list-style-type: none"> • 27-inch IPS LED backlight monitor • Supports 2560x1440 resolution • 5-Ports USB hub, support USB 3.0 • Support ThinkCentre Tiny • Supports optional soundbar • Microsoft® Windows® 7 certified • Microsoft Windows 10 certified | | | | | | |
| <p>VESA-compliant VESA DDC2B/CI Power management ENERGY STAR® 7.0 Ergonomics ISO 9241-307 Emission standards FCC Class B Environmental TCO Displays 7.0, RoHS, EPEAT™ Gold rating, ULE Gold</p> |  <p>ThinkVision P27q Monitor</p> | | | | | | |
| <p>Preset resolutions VGA: 640x480, 720x400 SVGA: 800x600 XGA: 1024x768 SXGA: 1280x1024 WXGA: 1366x768 WXGA+: 1440x900, 1600x900 WSXGA+: 1680x1050 Full HD: 1920x1080, 1920x1200 QHD: 2560x1440</p> <p>Presets / user settings Standard presets: 20; user settings: 24</p> | | | | | | | |
| <p>Viewing adjustments Tilt: 30° back, -5° forward; lift: 4.33" (110mm); swivel: +/-45° Rotating screen Screen pivots 90 degrees from landscape to portrait On screen display On screen display with digital user controls (8 languages) Control features Direct access for menu, source switch, and brightness USB hub USB Hub: one USB 3.0 upstream port, four USB 3.0 downstream ports Multimedia Audio-out, optional sound bar supported Camera None Multiple input Support HDMI, DisplayPort, mini DisplayPort, DisplayPort-out Monitor connectors (1) 2*HDMI (1.4), digital, HDCP-compliant (2) DisplayPort (1.2), digital, HDCP-compliant (3) Mini DisplayPort, digital, HDCP-compliant Signal cables (1) detachable, mini DisplayPort to DisplayPort, digital, 1.8 meter Mounting features Wall or desk mounting using the Extend Arm or third-party accessories meeting the VESA FPMPI® (100mm mount) Security Security keyhole for attachment of optional cable lock (Kensington® lock-compatible)</p> | | | | | | | |
| <p>Ship group Monitor, detachable stand, Quick start and safety poster, 1.8 meter USB 3.0 cable, 1.8 meter mini DP to DP cable, 1.8 meter black power cord</p> | <p>Limited Warranty</p> <p>See details at http://support.lenovo.com/en_US/guides-and-manuals/detail.page?DocID=UM008281</p> <p>Accessories</p> <table border="0"> <tr> <td>Kensington MicroSaver Cable Lock</td> <td>73P2582</td> </tr> <tr> <td>Kensington Twin Head Cable Lock</td> <td>45K1620</td> </tr> <tr> <td>Lenovo Security Cable Lock</td> <td>57Y4303</td> </tr> </table> <p>See details at www.lenovo.com/support/monitoraccessories</p> <p>See all monitors at www.lenovo.com/thinkvision</p> | Kensington MicroSaver Cable Lock | 73P2582 | Kensington Twin Head Cable Lock | 45K1620 | Lenovo Security Cable Lock | 57Y4303 |
| Kensington MicroSaver Cable Lock | 73P2582 | | | | | | |
| Kensington Twin Head Cable Lock | 45K1620 | | | | | | |
| Lenovo Security Cable Lock | 57Y4303 | | | | | | |



| | | | | | | | |
|---|---|----------------------------------|---------|---------------------------------|---------|----------------------------|---------|
| <p>Name Pro2820 Wide Flat Panel Monitor Case color Black Type-model 60FCRAR6US / 60FCRAT6US / 60FCRAT6EU Panel TFT-LCD, with wide viewing angle (WVA) technology, White LED backlight Viewable image size 28" (711mm) diagonal Max view area (W x H) 24.44" x 13.44" (620.9mm x 341.3mm) Optimum resolution 1920x1080 Max pixel rate 205MHz (VGA); 165MHz(DP/ HDMI); 149MHz (MHL) Frequency Supports 1920 x 10800 @ 60Hz Aspect ratio 16:9 Pixel pitch (mm) 0.32 x 0.32mm Dot/Pixel per Inch 79 dpi Brightness 300 nits or cd/m² (typical) Contrast ratio 3000:1 (typical) Pixel response time 6.5ms Color gamut 72% Viewing angle at 10:1 CR 178° horizontal, 178° vertical Stand Tilt, swivel, and height adjustable stand Bezel width Sides: 0.86" (21.85mm) Dimensions (HxWxD, excluding stand) 17.45" H x 26.21" W x 2.30" D; Dimensions (HxWxD, including stand) 443.3mm H x 665.9mm W x 58.2mm D Power supply 60 watts typical, 90 watts typical (with USB), 65 watts maximum, 95 watts maximum (with USB), <1.2 watts sleep/off; <0.5 watts switch off integrated (no external brick-like power supply) Weight 17.84 lb; 8.11kg (including stand) Limited warranty⁴ 3 year (includes backlight) Available date September 2014</p> | <p>Features</p> <ul style="list-style-type: none"> • 28-inch MVA (Multi-domain Vertical Alignment) panel LED backlit monitor • Supports 1920x1080 resolution • 5-Ports USB hub, support USB 3.0 • Arsenic/Mercury free • Microsoft® Windows® 7 • Windows 8/ Windows 8.1 certified | | | | | | |
| <p>VESA-compliant² VESA DDC2B/CI Power management ENERGY STAR® 6.0 Ergonomics ISO 9241-307 Emission standards FCC Class B Environmental TCO Displays 6.0, TCO Certified Edge 1.2, RoHS, EPEAT™ Gold rating, ULE Gold</p> <p>Preset resolutions VGA: 640x480, 720x400 SVGA: 800x600 XGA: 1024x768, 1024x760 SXGA: 1280x1024 WXGA: 1280x720, 1280x800, 1366x768 WXGA+: 1440x900, 1600x900 WSXGA+: 1680x1050 Full HD: 1920x1080 Others: 1152x864</p> <p>Presets / user settings Standard presets: 17; user settings: 17</p> |  <p>ThinkVision Pro2820 Monitor</p> | | | | | | |
| <p>Viewing adjustments Tilt: 25° back, -5° forward; lift: 4.3" (110mm); swivel: +/-45° Rotating screen Screen pivots 90 degrees from landscape to portrait On screen display On screen display with digital user controls (8 languages) Control features Direct access (touch buttons on front) for automatic image setup, input switch, and brightness USB hub USB Hub: one USB 3.0 upstream port, four USB 3.0 downstream ports Multimedia None Camera None Multiple input Support VGA, HDMI, DisplayPort, MHL connections (Mobile High-definition Link) Monitor connectors (1) VGA 15-pin D-shell, analog (2) HDMI (1.4), digital, HDCP-compliant (3) DisplayPort (1.2), digital, HDCP-compliant</p> <p>Signal cables (1) detachable, VGA 15-pin D-shell at each end, analog, 1.8 meter (2) detachable, DisplayPort at each end, digital, 1.8 meter</p> <p>Mounting features Wall or desk mounting using the Extend Arm or third-party accessories meeting the VESA FPMPI® (100mm mount) Security Security keyhole for attachment of optional cable lock (Kensington® lock-compatible)</p> | | | | | | | |
| <p>Ship group Monitor, detachable stand, Quick start and safety poster, 1.8 meter DisplayPort cable, 1.8 meter VGA cable, 1.8 meter USB 3.0 cable, 1.8 meter black power cord</p> | | | | | | | |
| <p>Limited Warranty</p> <p>See details at http://support.lenovo.com/en_US/guides-and-manuals/detail.page?DocID=UM008281</p> | <p>Accessories</p> <table border="0"> <tr> <td>Kensington MicroSaver Cable Lock</td> <td>73P2582</td> </tr> <tr> <td>Kensington Twin Head Cable Lock</td> <td>45K1620</td> </tr> <tr> <td>Lenovo Security Cable Lock</td> <td>57Y4303</td> </tr> </table> <p>See details at www.lenovo.com/support/monitoraccessories</p> <p>See all monitors at www.lenovo.com/thinkvision</p> | Kensington MicroSaver Cable Lock | 73P2582 | Kensington Twin Head Cable Lock | 45K1620 | Lenovo Security Cable Lock | 57Y4303 |
| Kensington MicroSaver Cable Lock | 73P2582 | | | | | | |
| Kensington Twin Head Cable Lock | 45K1620 | | | | | | |
| Lenovo Security Cable Lock | 57Y4303 | | | | | | |

See footnotes for important warranty information



| | | | | | | | |
|---|---|----------------------------------|---------|---------------------------------|---------|----------------------------|---------|
| <p>Name X1 Wide Flat Panel Monitor Case color Black Type-model 60E2GAR1US / 60E2GAT1US / 60E2GAT1EU Panel TFT-LCD, IPS (In-Plane Switching), White LED backlight Viewable image size 27" (684.7mm) diagonal Max view area (W x H) 23.49" x 13.21" (596.7mm x 335.7mm) Optimum resolution 3840x2160 Max pixel rate 600MHz Aspect ratio 16:9 Pixel pitch (mm) 0.16 x 0.16mm Dot/Pixel per Inch 163 dpi Brightness 300 nits or cd/m² (typical) Contrast ratio 1300:1 (typical) Pixel response time 6ms Color gamut 99% Viewing angle at 10:1 CR 178° horizontal, 178° vertical Stand Tilt stand Bezel width Sides: 0.088" (2.23mm) Dimensions (HxWxD, including stand) 19.35" H x 24.19" W x 10.63" D; 491.4mm H x 614.5mm W x 270.0mm D Power supply 40 watts typical, 130 watts maximum (with USB), <0.5 watts sleep/off; <0.5 watts switch off Weight 14.11 lb; 6.40kg (including stand) Limited warranty⁴ 3 year Available date March 2016</p> | <p>Features</p> <ul style="list-style-type: none"> • 27-inch IPS LED backlight monitor with speaker • Supports 3840x2160 resolution • 5-Ports USB hub, support USB Type-C • 3watts x 2 stereo speakers • Microsoft® Windows® 7 certified • Microsoft Windows 10 certified | | | | | | |
| <p>VESA-compliant² VESA DDC2B/CI Power management ENERGY STAR® 7.0 Ergonomics ISO 9241-307 Emission standards FCC Class B Environmental TCO Displays 7.0, RoHS, EPEAT™ Silver rating, ULE Gold</p> |  <p style="text-align: center;">ThinkVision X1 Monitor</p> | | | | | | |
| <p>Preset resolutions VGA: 640x350, 640x480, 720x400 SVGA: 800x600 XGA: 1024x768, 1152x864 SXGA: 1280x1024 WXGA: 1280x720, 1280x768, 1280x800, 1360x768 WXGA+: 1440x900, 1600x900 WSXGA+: 1680x1050 Full HD: 1920x1080, 1920x1200 UHD: 3840x2160</p> <p>Presets / user settings Standard presets: 20; user settings: 20</p> | | | | | | | |
| <p>Viewing adjustments <i>Tilt: 22° back, -5° forward;</i> Rotating screen None On screen display On screen display with digital user controls (8 languages) Control features Direct access (touch buttons on front) for menu, mute, volume up/down, and brightness USB hub USB Hub: one USB 3.0 Type-C upstream port, four USB 3.0 downstream ports Multimedia Integrated stereo speakers (3 watts x 2), built-in microphone Camera Full HD camera with LED light Multiple input Support HDMI, DisplayPort Monitor connectors (1) HDMI (1.4), digital, HDCP-compliant (2) DisplayPort (1.2), digital, HDCP-compliant Signal cables (1) detachable, HDMI at each end, digital, 1.8 meter (2) detachable, DisplayPort at each end, digital, 1.8 meter Mounting features Wall or desk mounting using the Extend Arm or third-party accessories meeting the VESA FPMPI® (100mm mount) Security Security keyhole for attachment of optional cable lock (Kensington® lock-compatible)</p> | | | | | | | |
| <p>Ship group Monitor, detachable stand, Quick start and safety poster, 1.8 meter DisplayPort cable, 1.8 meter HDMI cable, 1.8 meter USB Type-C cable, 1.8 meter USB Type-C to Type-A cable, 1.8 meter black power cord, mini DP to DP adapter, power adapter (135W)</p> | <p style="text-align: center;">Limited Warranty</p> <p>See details at http://support.lenovo.com/en_US/guides-and-manuals/detail.page?DocID=UM008281</p> <p style="text-align: center;">Accessories</p> <table border="0"> <tr> <td>Kensington MicroSaver Cable Lock</td> <td style="text-align: right;">73P2582</td> </tr> <tr> <td>Kensington Twin Head Cable Lock</td> <td style="text-align: right;">45K1620</td> </tr> <tr> <td>Lenovo Security Cable Lock</td> <td style="text-align: right;">57Y4303</td> </tr> </table> <p>See details at www.lenovo.com/support/monitoraccessories</p> <p>See all monitors at www.lenovo.com/thinkvision</p> | Kensington MicroSaver Cable Lock | 73P2582 | Kensington Twin Head Cable Lock | 45K1620 | Lenovo Security Cable Lock | 57Y4303 |
| Kensington MicroSaver Cable Lock | 73P2582 | | | | | | |
| Kensington Twin Head Cable Lock | 45K1620 | | | | | | |
| Lenovo Security Cable Lock | 57Y4303 | | | | | | |

See footnotes for important warranty information

This publication was developed for products and services offered in the United States and E.M.E.A countries. Lenovo may not offer the products, services or features discussed in this document in other countries. Lenovo may withdraw an offering at any time. Information is subject to change without notice. Consult your local representative for information on offerings available in your area.

Lenovo reserves the right to change specifications or other product information without notice. Lenovo is not responsible for photographic or typographical errors.

LENOVO PROVIDES THIS PUBLICATION "AS IS," WITHOUT WARRANTY OF ANY KIND, EITHER EXPRESS OR IMPLIED, INCLUDING THE IMPLIED WARRANTIES OF MERCHANTABILITY OR FITNESS FOR A PARTICULAR PURPOSE.

Some jurisdictions do not allow disclaimer of express or implied warranties in certain transactions, therefore this disclaimer may not apply to you.

Availability: All offers subject to availability. Lenovo reserves the right to alter product offerings and specifications at any time, without notice. Lenovo is not responsible for photographic or typographic errors.

General: Review key information provided by Microsoft that may apply to your system purchase, including details on Windows 10, Windows 8, Windows 7, and potential upgrades/downgrades. Lenovo makes no representation or warranty regarding third-party products or services.

Trademarks: Lenovo, ThinkPad, ThinkCentre, ThinkStation and the Lenovo logo are trademarks of Lenovo. Microsoft, Windows, Windows NT, and the Windows logo are trademarks of Microsoft Corporation. Ultrabook, Celeron, Celeron Inside, Core Inside, Intel, Intel Logo, Intel Atom, Intel Atom Inside, Intel Core, Intel Inside, Intel Inside Logo, Intel vPro, Itanium, Itanium Inside, Pentium, Pentium Inside, vPro Inside, Xeon, Xeon Phi, and Xeon Inside are trademarks of Intel Corporation in the U.S. and/or other countries. Other company, product or service names may be trademarks or service marks of others.

Warranty: For a copy of applicable warranties, write to: Lenovo Warranty Information, 1009 Think Place, Morrisville, NC, 27560. Lenovo makes no representation or warranty regarding third party products or services. The Lenovo Limited Warranty applies only to Lenovo hardware products purchased for your own use, and does not transfer upon resale.

Limited warranty: Support unrelated to a warranty issue may be subject to additional charges.

Lenovo Services:

Carry-in or Mail-in Service: Parts and labor repair coverage where the customer is responsible for shipping (including packaging) or delivery to authorized warranty provider or repair center.

Depot or Courier Service: Parts and labor repair coverage where shipping (including packaging) or delivery to the repair center is paid for by Lenovo.

Expedited Depot: Parts and labor coverage with expedited turnaround. Shipping (including packaging) or delivery to the repair center is paid for by Lenovo.

Onsite / In-home Service: Parts and labor repair coverage where labor is provided onsite at your place of business.

If Lenovo determines your product problem is covered by the product warranty and cannot be resolved over the telephone, a technician will be dispatched to arrive onsite, typically the next day.

International Warranty Service (IWS): PC repair coverage for customers who require a critical warranty repair while travelling internationally. Visit www.lenovo.com/internationalwarranty for details. Visit www.lenovo.com/warranty for Lenovo Warranty Services terms and conditions for complete details and restrictions.

Included software: may differ from its retail version (if available), and may not include user manuals or all program functionality. Software license agreements may apply.

Battery life: Battery life (and recharge times) will vary based on many factors including screen brightness, applications, features, power management, battery conditioning, and other customer preferences.

Visit <http://psref.lenovo.com/> for the latest version of Product Specifications Reference.

© Lenovo, 2017. All rights reserved.
Lenovo 1009 Think Place Morrisville, NC 27560 U.S.A.