

**Lenovo**™ **Think**Products

# PSREF



**Product Specifications Reference**

Version 511, August 2017

**U.S.**

Visit <http://psref.lenovo.com> for the latest version

**Lenovo** **ThinkPad** Laptops

# PSREF



**Product Specifications Reference**

Version 510, August 2017

**U.S.**

Visit <http://psref.lenovo.com> for the latest version

# Contents

---

<b>Cover</b>		
<b>Contents</b>		
<b>Summary Of Change</b>		
<b>11e Series</b>		
<b>ThinkPad 11e (3rd Gen)</b>		
ThinkPad 11e (3rd Gen) Platform Specifications		
ThinkPad 11e (3rd Gen) - TopSeller - 20GB		
<b>ThinkPad 11e (4th Gen)</b>		
ThinkPad 11e (4th Gen) Platform Specifications		
ThinkPad 11e (4th Gen) - TopSeller - 20HV		
<b>ThinkPad 11e Chromebook (3rd Gen)</b>		
ThinkPad 11e Chromebook (3rd Gen) Platform Specifications		
ThinkPad 11e Chromebook (3rd Gen) - TopSeller - 20GF		
<b>ThinkPad 11e Chromebook (4th Gen)</b>		
ThinkPad 11e Chromebook (4th Gen) Platform Specifications		
ThinkPad 11e Chromebook (4th Gen) - TopSeller - 20J0		
<b>13 Series</b>		
<b>ThinkPad 13 (2nd Gen)</b>		
ThinkPad 13 (2nd Gen) Platform Specifications		
ThinkPad 13 (2nd Gen) - TopSeller - 20J1 - 1 of 2		
ThinkPad 13 (2nd Gen) - TopSeller - 20J1 - 2 of 2		
<b>ThinkPad 13 Chromebook</b>		
ThinkPad 13 Chromebook Platform Specifications		
ThinkPad 13 Chromebook - TopSeller - 20GL		
<b>E Series</b>		
<b>ThinkPad E460</b>		
ThinkPad E460 Platform Specifications		
ThinkPad E460 - TopSeller - 20ET		
<b>ThinkPad E465</b>		
ThinkPad E465 Platform Specifications		
ThinkPad E465 - TopSeller - 20EX		
<b>ThinkPad E470</b>		
ThinkPad E470 Platform Specifications		
ThinkPad E470 - TopSeller - 20H1 - 1 of 2		
ThinkPad E470 - TopSeller - 20H1 - 2 of 2		
<b>1</b>	<b>ThinkPad E475</b>	<b>34</b>
<b>2</b>	ThinkPad E475 Platform Specifications	35
<b>4</b>	ThinkPad E475 - TopSeller - 20H4	36
<b>5</b>	<b>ThinkPad E560</b>	<b>37</b>
<b>5</b>	ThinkPad E560 Platform Specifications	38
<b>6</b>	ThinkPad E560 - TopSeller - 20EV - 1 of 2	39
<b>7</b>	ThinkPad E560 - TopSeller - 20EV - 2 of 2	40
<b>8</b>	<b>ThinkPad E565</b>	<b>41</b>
<b>9</b>	ThinkPad E565 Platform Specifications	42
<b>10</b>	ThinkPad E565 - TopSeller - 20EY - 1 of 2	43
<b>11</b>	ThinkPad E565 - TopSeller - 20EY - 2 of 2	44
<b>12</b>	<b>ThinkPad E570</b>	<b>45</b>
<b>13</b>	ThinkPad E570 Platform Specifications	46
<b>14</b>	ThinkPad E570 - TopSeller - 20H5	47
<b>15</b>	<b>ThinkPad E575</b>	<b>48</b>
<b>16</b>	ThinkPad E575 Platform Specifications	49
<b>17</b>	ThinkPad E575 - TopSeller - 20H8	50
<b>17</b>	<b>L Series</b>	<b>51</b>
<b>18</b>	<b>ThinkPad L470</b>	<b>51</b>
<b>19</b>	ThinkPad L470 Platform Specifications	52
<b>20</b>	ThinkPad L470 - TopSeller - 20J4	53
<b>21</b>	ThinkPad L470 - TopSeller - 20JU	54
<b>22</b>	<b>ThinkPad L570</b>	<b>55</b>
<b>23</b>	ThinkPad L570 Platform Specifications	56
<b>24</b>	ThinkPad L570 - TopSeller - 20J8	57
<b>24</b>	ThinkPad L570 - TopSeller - 20JQ	58
<b>25</b>	<b>P Series</b>	<b>59</b>
<b>26</b>	<b>ThinkPad P50</b>	<b>59</b>
<b>27</b>	ThinkPad P50 Platform Specifications	60
<b>28</b>	ThinkPad P50 - TopSeller - 20EN - 1 of 2	61
<b>29</b>	ThinkPad P50 - TopSeller - 20EN - 2 of 2	62
<b>30</b>	<b>ThinkPad P51</b>	<b>63</b>
<b>31</b>	ThinkPad P51 Platform Specifications	64
<b>32</b>	ThinkPad P51 - TopSeller - 20HH - 1 of 2	65
<b>33</b>	ThinkPad P51 - TopSeller - 20HH - 2 of 2	66

# Contents

---

<b>ThinkPad P51s</b>	<b>67</b>	ThinkPad X1 Carbon (5th Gen) - TopSeller - 20HR - 1 of 2	100
ThinkPad P51s Platform Specifications	68	ThinkPad X1 Carbon (5th Gen) - TopSeller - 20HR - 2 of 2	101
ThinkPad P51s - TopSeller - 20HB - 1 of 2	69	ThinkPad X1 Carbon (5th Gen) - TopSeller - 20K4	102
ThinkPad P51s - TopSeller - 20HB - 2 of 2	70	<b>ThinkPad X270</b>	<b>103</b>
ThinkPad P51s - TopSeller - 20JY	71	ThinkPad X270 Platform Specifications	104
<b>ThinkPad P70</b>	<b>72</b>	ThinkPad X270 - TopSeller - 20HN - 1 of 2	105
ThinkPad P70 Platform Specifications	73	ThinkPad X270 - TopSeller - 20HN - 2 of 2	106
ThinkPad P70 - TopSeller - 20ER - 1 of 2	74	ThinkPad X270 - TopSeller - 20K6	107
ThinkPad P70 - TopSeller - 20ER - 2 of 2	75	<b>Legal Information</b>	<b>108</b>
<b>ThinkPad P71</b>	<b>76</b>		
ThinkPad P71 Platform Specifications	77		
ThinkPad P71 - TopSeller - 20HK - 1 of 2	78		
ThinkPad P71 - TopSeller - 20HK - 2 of 2	79		
<b>T Series</b>	<b>80</b>		
<b>ThinkPad T470</b>	<b>80</b>		
ThinkPad T470 Platform Specifications	81		
ThinkPad T470 - TopSeller - 20HD - 1 of 2	82		
ThinkPad T470 - TopSeller - 20HD - 2 of 2	83		
ThinkPad T470 - TopSeller - 20JM	84		
<b>ThinkPad T470p</b>	<b>85</b>		
ThinkPad T470p Platform Specifications	86		
ThinkPad T470p - TopSeller - 20J6	87		
<b>ThinkPad T470s</b>	<b>88</b>		
ThinkPad T470s Platform Specifications	89		
ThinkPad T470s - TopSeller - 20HF - 1 of 2	90		
ThinkPad T470s - TopSeller - 20HF - 2 of 2	91		
ThinkPad T470s - TopSeller - 20JS	92		
<b>ThinkPad T570</b>	<b>93</b>		
ThinkPad T570 Platform Specifications	94		
ThinkPad T570 - TopSeller - 20H9 - 1 of 2	95		
ThinkPad T570 - TopSeller - 20H9 - 2 of 2	96		
ThinkPad T570 - TopSeller - 20JW	97		
<b>X Series</b>	<b>98</b>		
<b>ThinkPad X1 Carbon (5th Gen)</b>	<b>98</b>		
ThinkPad X1 Carbon (5th Gen) Platform Specifications	99		



# Summary of Changes

---

This section describes the technical changes made in this edition.

This edition might also include minor corrections and editorial changes which are not identified.

## August 2, 2017 - Version 510

### Additions in this update

► **New product(s)**

None

► **New model(s)**

ThinkPad T470 new models announced August 2017

ThinkPad T460s new models announced August 2017

ThinkPad T470s new models announced July 2017

ThinkPad X270 new models announced August 2017

ThinkPad X1 Carbon (5<sup>th</sup> Gen) new models announced July 2017

► **Others**

None

### Withdrawals in this update

► **Withdrawn product(s)**

ThinkPad L460

ThinkPad L560

ThinkPad T460

ThinkPad T460p

ThinkPad T460s

ThinkPad T560

ThinkPad P50s

ThinkPad 13

ThinkPad X260

ThinkPad X1 Carbon (4th Gen)



# ThinkPad 11e (3<sup>rd</sup> Gen) Platform Specifications

Product Specifications Reference (PSREF)

Processor	Intel® Celeron® Processor, Intel Pentium® Processor, or 6th Generation Intel Core™ i3 Processor							Media reader	4-in-1 reader (MMC, SD, SDHC, SDXC)																																	
								Ports	Two USB 3.0, HDMI, Ethernet (RJ-45)																																	
								Control buttons	Power button, volume control button																																	
								Camera	HD720p resolution, low light sensitive, fixed focus																																	
								Audio support	HD Audio, Realtek® ALC3245 codec / stereo speakers, 2W x 2 / monaural digital microphone, combo audio/microphone jack																																	
<table border="1"> <thead> <tr> <th>Processor Number</th> <th># of Cores</th> <th># of Threads</th> <th>Base Frequency</th> <th>Burst Frequency</th> <th>Cache</th> <th>Memory Types</th> <th>Processor Graphics</th> </tr> </thead> <tbody> <tr> <td>Cel N3150</td> <td rowspan="2">4</td> <td rowspan="2">4</td> <td>1.6 GHz</td> <td>2.08 GHz</td> <td>2MB</td> <td rowspan="4">DDR3L-1600</td> <td>Intel HD graphics</td> </tr> <tr> <td>Cel N3160</td> <td>1.6 GHz</td> <td>2.24 GHz</td> <td>2MB</td> <td>Intel HD graphics 400</td> </tr> <tr> <td>Pen 4405U</td> <td rowspan="2">2</td> <td rowspan="2">4</td> <td>2.1 GHz</td> <td>-</td> <td>2MB</td> <td>Intel HD graphics 510</td> </tr> <tr> <td>i3-6100U</td> <td>2.3 GHz</td> <td>-</td> <td>3MB</td> <td>Intel HD graphics 520</td> </tr> </tbody> </table>							Processor Number	# of Cores	# of Threads	Base Frequency	Burst Frequency	Cache	Memory Types	Processor Graphics	Cel N3150	4	4	1.6 GHz	2.08 GHz	2MB	DDR3L-1600	Intel HD graphics	Cel N3160	1.6 GHz	2.24 GHz	2MB	Intel HD graphics 400	Pen 4405U	2	4	2.1 GHz	-	2MB	Intel HD graphics 510	i3-6100U	2.3 GHz	-	3MB	Intel HD graphics 520	Keyboard	ThinkPad Windows keyboard, 6-row, multimedia Fn keys	
Processor Number	# of Cores	# of Threads	Base Frequency	Burst Frequency	Cache	Memory Types	Processor Graphics																																			
Cel N3150	4	4	1.6 GHz	2.08 GHz	2MB	DDR3L-1600	Intel HD graphics																																			
Cel N3160			1.6 GHz	2.24 GHz	2MB		Intel HD graphics 400																																			
Pen 4405U	2	4	2.1 GHz	-	2MB		Intel HD graphics 510																																			
i3-6100U			2.3 GHz	-	3MB		Intel HD graphics 520																																			
							Touchpad	Buttonless touchpad below keyboard, multi-touch																																		
Graphics	Intel HD Graphics, Intel HD Graphics 510, or Intel HD Graphics 520 in processor, supports external digital monitor via HDMI™; supports dual independent display; Max resolution: 1920X1080 (HDMI)@30Hz							Security	Power-on password, hard disk password, supervisor password, security keyhole																																	
Chipset	Intel SoC (System on Chip) platform							Security chip	<i>Win7 model:</i> discrete TPM 1.2, TCG Certified																																	
Memory	2GB, 4GB, or 8GB / PC3-12800 1600MHz DDR3L, one DDR3L SO-DIMM socket							vPro	None																																	
Display	11.6" (295mm) HD (1366x768), anti-glare, LED backlight, 220 nits, 16:9 aspect ratio, 500:1 contrast ratio							Fingerprint reader	None																																	
Multi-touch	None							Battery	Integrated Lithium Polymer 3-cell (42Wh)																																	
Hinge	Normal hinge, 180 degree							Max battery life <sup>10</sup>	<i>MobileMark® 2014:</i> 11.53 hr																																	
Storage	M.2 Solid State Drive (SSD), SATA 6.0Gb/s							AC adapter	45-watt AC adapter																																	
Optical	None							Preload	Windows 7 Professional 64 preinstalled through downgrade rights in Windows 10 Pro 64 • Lenovo Solution Center • ThinkVantage Product Recovery • Rescue and Recovery™ • ThinkVantage System Update • Adobe® Reader® • Microsoft® Office preloaded; purchase a product key to activate • McAfee® LiveSafe™ (30-day trial)																																	
Ethernet	Realtek RTL8111GUS-CG Gigabit Network Connection							Limited warranty <sup>12</sup>	<i>One of the following, configurable by model:</i> • 1-year depot repair service • 3-year/1-yr battery depot repair service (US only)																																	
WLAN <sup>4</sup>	<i>One of the following, configurable by model:</i> • 11ac+BT, Intel Dual Band Wireless-AC 3165, 1x1, M.2 card • 11ac+BT, Intel Dual Band Wireless-AC 7265, 2x2, M.2 card							Mil-Spec test	MIL-STD-810G military certification																																	
Bluetooth™	Bluetooth 4.0 wireless, integrated in Wi-Fi + Bluetooth combo adapter							Environment	EPEAT™ Gold (US only); ENERGY STAR® 6.1; RoHS-compliant																																	
WWAN	None																																									
Dimensions <sup>3</sup>	WxDxH: 11.81" x 8.27" x 0.88"; 300mm x 210mm x 22.3mm																																									
Weight <sup>2</sup>	Starting at 3.3 lb (1.5kg)																																									
Case color	<i>Display cover:</i> Graphite Black or Silver; <i>Bottom:</i> Graphite Black																																									
Case material	<i>Display cover:</i> PC+40%GF+TPU; <i>Bottom:</i> PCC																																									

ThinkPad 11e (3rd Gen) - TopSeller - 20GB

Product Specifications Reference (PSREF)

Model	Region	Processor	Graphics	Memory	Display	Multi-touch	Storage	Optical	WLAN + Bluetooth	Color	Camera	Keyboard	Finger-print Reader	TPM	Battery (internal)	Power Adapter	Operating System	Warranty	Ann Date (m/y)
20GB000JUS	US	Celeron N3150	Intel HD	4GBx1	11.6" HD (1366x768)	None	192GB SSD M.2	None	Intel 7265 ac, 2x2 + BT4.0	Black	720p	Non-backlit	None	dTPM1.2 + FW TPM2.0	3-cell (42Wh)	45W	Windows 10 Pro 64	1-year, Depot	02/16
20GB000KUS	US	Celeron N3150	Intel HD	8GBx1	11.6" HD (1366x768)	None	192GB SSD M.2	None	Intel 7265 ac, 2x2 + BT4.0	Black	720p	Non-backlit	None	dTPM1.2 + FW TPM2.0	3-cell (42Wh)	45W	Windows 10 Pro 64	1-year, Depot	02/16
20GB000LUS	US	Celeron N3150	Intel HD	8GBx1	11.6" HD (1366x768)	None	128GB SSD M.2	None	Intel 7265 ac, 2x2 + BT4.0	Black	720p	Non-backlit	None	dTPM1.2 + FW TPM2.0	3-cell (42Wh)	45W	Windows 10 Pro 64	1-year, Depot	02/16
20GB000MUS	US	Celeron N3150	Intel HD	8GBx1	11.6" HD (1366x768)	None	256GB SSD M.2 Opal2	None	Intel 7265 ac, 2x2 + BT4.0	Black	720p	Non-backlit	None	dTPM1.2 + FW TPM2.0	3-cell (42Wh)	45W	Windows 10 Pro 64	1-year, Depot	02/16
20GB000NUS	US	Celeron N3150	Intel HD	4GBx1	11.6" HD (1366x768)	None	128GB SSD M.2	None	Intel 7265 ac, 2x2 + BT4.0	Black	720p	Non-backlit	None	dTPM1.2 + FW TPM2.0	3-cell (42Wh)	45W	Windows 10 Pro 64	1-year, Depot	02/16
20GB000PUS	US	i3-6100U	Intel HD 520	4GBx1	11.6" HD (1366x768)	None	128GB SSD M.2	None	Intel 7265 ac, 2x2 + BT4.0	Black	720p	Non-backlit	None	dTPM1.2 + FW TPM2.0	3-cell (42Wh)	45W	Windows 10 Pro 64	1-year, Depot	02/16
20GB000QUS	US	i3-6100U	Intel HD 520	8GBx1	11.6" HD (1366x768)	None	128GB SSD M.2	None	Intel 7265 ac, 2x2 + BT4.0	Black	720p	Non-backlit	None	dTPM1.2 + FW TPM2.0	3-cell (42Wh)	45W	Windows 10 Pro 64	1-year, Depot	02/16
20GB000RUS	US	i3-6100U	Intel HD 520	8GBx1	11.6" HD (1366x768)	None	192GB SSD M.2	None	Intel 7265 ac, 2x2 + BT4.0	Black	720p	Non-backlit	None	dTPM1.2 + FW TPM2.0	3-cell (42Wh)	45W	Windows 10 Pro 64	1-year, Depot	02/16
20GB000SUS	US	i3-6100U	Intel HD 520	8GBx1	11.6" HD (1366x768)	None	256GB SSD M.2 Opal2	None	Intel 7265 ac, 2x2 + BT4.0	Black	720p	Non-backlit	None	dTPM1.2 + FW TPM2.0	3-cell (42Wh)	45W	Windows 10 Pro 64	1-year, Depot	02/16
20GB000UUS	US	i3-6100U	Intel HD 520	4GBx1	11.6" HD (1366x768)	None	192GB SSD M.2	None	Intel 7265 ac, 2x2 + BT4.0	Black	720p	Non-backlit	None	dTPM1.2 + FW TPM2.0	3-cell (42Wh)	45W	Windows 10 Pro 64	1-year, Depot	02/16
20GB001HUS	US	Celeron N3160	Intel HD 400	4GBx1	11.6" HD (1366x768)	None	128GB SSD M.2	None	Intel 7265 ac, 2x2 + BT4.0	Black	720p	Non-backlit	None	dTPM1.2 + FW TPM2.0	3-cell (42Wh)	45W	Windows 10 Pro 64	1-year, Depot	09/16
20GB001JUS	US	Celeron N3160	Intel HD 400	4GBx1	11.6" HD (1366x768)	None	256GB SSD M.2 Opal2	None	Intel 7265 ac, 2x2 + BT4.0	Black	720p	Non-backlit	None	dTPM1.2 + FW TPM2.0	3-cell (42Wh)	45W	Windows 10 Pro 64	1-year, Depot	09/16
20GB001KUS	US	Celeron N3160	Intel HD 400	8GBx1	11.6" HD (1366x768)	None	128GB SSD M.2	None	Intel 7265 ac, 2x2 + BT4.0	Black	720p	Non-backlit	None	dTPM1.2 + FW TPM2.0	3-cell (42Wh)	45W	Windows 10 Pro 64	1-year, Depot	09/16
20GB001LUS	US	Celeron N3160	Intel HD 400	8GBx1	11.6" HD (1366x768)	None	256GB SSD M.2 Opal2	None	Intel 7265 ac, 2x2 + BT4.0	Black	720p	Non-backlit	None	dTPM1.2 + FW TPM2.0	3-cell (42Wh)	45W	Windows 10 Pro 64	1-year, Depot	09/16



# ThinkPad 11e (4<sup>th</sup> Gen) Platform Specifications

Product Specifications Reference (PSREF)

Processor	Intel® Celeron® processor or 7th Generation Intel Core™ i3 Processor								Media reader	4-in-1 reader (MMC, SD, SDHC, SDXC)
	Processor Number	# of Cores	# of Threads	Base Frequency	Burst Frequency	Cache	Memory Types	Processor Graphics	Ports	Two USB 3.1 Gen 1 (USB 3.0), HDMI 1.4b, Ethernet (RJ-45)
	Cel N3450	4	4	1.1 GHz	2.2 GHz	2MB	DDR3L-1600	Intel HD Graphics 500	Control buttons	Power button, volume control button
	i3-7100U	2	4	2.4 GHz	-	3MB	DDR4-2133	Intel HD Graphics 620	Camera	HD720p resolution, low light sensitive, fixed focus
Graphics	Intel HD Graphics 500 or 620 in processor, supports external digital monitor via HDMI™; supports dual independent display; Max resolution: 1920X1080 (HDMI) @60Hz								Audio support	HD Audio, Realtek® ALC3268 codec / stereo speakers, 2W x 2 / monaural digital microphone, combo audio/microphone jack
	Chipset	Intel SoC (System on Chip) platform								Keyboard
Memory	4GB or 8GB / 1600MHz DDR3L or 2133MHz DDR4, one DDR3L or DDR4 SO-DIMM socket								Touchpad	Buttonless touchpad below keyboard, multi-touch
Display	11.6" (295mm) HD (1366x768), anti-glare, LED backlight, 250 nits, 16:9 aspect ratio, 500:1 contrast ratio								Security	Power-on password, hard disk password, supervisor password, security keyhole
Multi-touch	None								Security chip	Discrete TPM 2.0, TCG Certified
Hinge	Normal hinge, 180 degree								vPro	None
Storage	M.2 Solid State Drive (SSD), SATA 6.0Gb/s								Fingerprint reader	None
Optical	None								Battery	Integrated Lithium Polymer 3-cell (42Wh)
Ethernet	Realtek RTL8111GUS-CG Gigabit Network Connection								Max battery life	MobileMark® 2014: 13.65 hr
WLAN	Intel Dual Band Wireless-AC 7265, Wi-Fi 2x2 802.11ac + BT4.1, M.2 card								AC adapter	45W AC adapter
Bluetooth™	Bluetooth 4.1 wireless, integrated in Wi-Fi + Bluetooth combo adapter								Preload	Some: Windows® 10 Home 64 Some: Windows 10 Pro 64 • Lenovo Companion • Lenovo Setting • Microsoft Office preloaded; purchase a product key to activate
WWAN	None								Limited warranty	One of the following, configurable by model: • 1-year depot repair service • 3-year/1-yr battery depot repair service
Dimensions	WxDxH: 11.81" x 8.27" x 0.88"; 300mm x 210mm x 22.3mm								Mil-Spec test	MIL-STD-810G military certification
Weight	Starting at 3.3 lb (1.52kg)								Environment	EPEAT™ Gold (US only); ENERGY STAR® 6.1; RoHS-compliant
Case color	Display cover: Graphite Black;				Bottom: Graphite Black					
Case material	Display cover: PC+40%GF+TPU;				Bottom: PC/ABS plastic					

Lenovo  
July 2017

## ThinkPad 11e (4th Gen) - TopSeller - 20HV

Product Specifications Reference (PSREF)

Model	Region	Processor	vPro	Graphics	Memory	Display	Multi-touch	Storage(HDD/SSD)	Optical	WLAN + Bluetooth	Color	Camera	Key-board	Finger-print Reader	TPM	Battery (internal)	Power Adapter	Operating System	Warranty	Ann Date (m/y)
20HV0000US	US	i3-7100U	No	Intel HD 620	8GBx1 DDR4-2133	11.6" HD (1366x768)	None	128GB SSD M.2	None	Intel 7265 ac, 2x2 + BT4.1	Black	720p	Non-backlit	None	dTPM 2.0	3-cell (42Wh)	45W	Win10 Pro 64	1-year, Depot	03/17
20HV0001US	US	i3-7100U	No	Intel HD 620	4GBx1 DDR4-2133	11.6" HD (1366x768)	None	128GB SSD M.2	None	Intel 7265 ac, 2x2 + BT4.1	Black	720p	Non-backlit	None	dTPM 2.0	3-cell (42Wh)	45W	Win10 Pro 64	1-year, Depot	03/17
20HV000MUS	US	Celeron N3450	No	Intel HD 500	4GBx1 DDR3L-1600	11.6" HD (1366x768)	None	128GB SSD M.2	None	Intel 7265 ac, 2x2 + BT4.1	Black	720p	Non-backlit	None	dTPM 2.0	3-cell (42Wh)	45W	Win10 Pro 64	1-year, Depot	03/17
20HV000VUS	US	Celeron N3450	No	Intel HD 500	8GBx1 DDR3L-1600	11.6" HD (1366x768)	None	128GB SSD M.2	None	Intel 7265 ac, 2x2 + BT4.1	Black	720p	Non-backlit	None	dTPM 2.0	3-cell (42Wh)	45W	Win10 Pro 64	1-year, Depot	03/17
20HV000XUS	US	Celeron N3450	No	Intel HD 500	8GBx1 DDR3L-1600	11.6" HD (1366x768)	None	256GB SSD M.2 Opal2	None	Intel 7265 ac, 2x2 + BT4.1	Black	720p	Non-backlit	None	dTPM 2.0	3-cell (42Wh)	45W	Win10 Pro 64	1-year, Depot	03/17
20HV0015US	US	i3-7100U	No	Intel HD 620	8GBx1 DDR4-2133	11.6" HD (1366x768)	None	256GB SSD M.2 Opal2	None	Intel 7265 ac, 2x2 + BT4.1	Black	720p	Non-backlit	None	dTPM 2.0	3-cell (42Wh)	45W	Win10 Pro 64	1-year, Depot	03/17





# ThinkPad 11e Chromebook (3<sup>rd</sup> Gen) Platform Specifications

Product Specifications Reference (PSREF)

Processor	Intel® Celeron® Processor								Dimensions <sup>3</sup>	<i>WxDxH:</i> 11.81" x 8.27" x 0.88"; 300mm x 210mm x 22.3mm
	Processor Number	# of Cores	# of Threads	Base Frequency	Burst Frequency	Cache	Memory Types	Processor Graphics	Weight <sup>2</sup>	Starting at 3.3 lb (1.5kg)
	Cel N3150	4	4	1.6 GHz	2.08 GHz	2MB	DDR3L-1600	Intel HD graphics	Case color	<i>Display cover:</i> Graphite Black or Silver; <i>Bottom:</i> Graphite Black
Cel N3160			1.6 GHz	2.24 GHz	2MB	Intel HD graphics 400		Case material	<i>Display cover:</i> PC+40%GF+TPU; <i>Bottom:</i> PCC	
Graphics	Intel HD Graphics or Intel HD Graphics 400 in processor, supports external digital monitor via HDMI™; supports dual independent display; Max resolution: 1920X1080 (HDMI)@30Hz								Media reader	4-in-1 reader (MMC, SD, SDHC, SDXC)
Chipset	Intel SoC (System on Chip) platform								Ports	Two USB 3.0 (one Always On), HDMI
Memory	2GB or 4GB / 1600MHz LPDDR3 / soldered to systemboard, no sockets								Control buttons	None
Display	11.6" (295mm) HD (1366x768), anti-glare, LED backlight, 220 nits, 16:9 aspect ratio, 500:1 contrast ratio								Camera	HD720p resolution, low light sensitive, fixed focus
Multi-touch	None								Audio support	Realtek® ALC5650 codec / stereo speakers, 2W x 2 / monaural digital microphone, combo audio/microphone jack
Hinge	Normal hinge, 180 degree								Keyboard	ThinkPad Chrome keyboard, 6-row, multimedia Fn keys
Storage	16GB eMMC (embedded Multi Media Card) flash memory on board								Touchpad	Buttonless touchpad below keyboard, multi-touch
Optical	None								Security	Security keyhole
Ethernet	None								Security chip	Discrete TPM 1.2, TCG Certified
WLAN <sup>4</sup>	11ac+BT, Intel Dual Band Wireless-AC 7265, 2x2, M.2 card								vPro	None
Bluetooth™	Bluetooth 4.0 wireless, integrated in Wi-Fi + Bluetooth combo adapter								Fingerprint reader	None
WWAN	None								Battery	Integrated Lithium Polymer 3-cell (42Wh)
									Max battery life <sup>10</sup>	Up to 12 hr
									AC adapter	45-watt AC adapter
									Preload	Google Chrome OS
									Limited warranty <sup>12</sup>	1-year depot repair service
									Mil-Spec test	MIL-STD-810G military certification
									Environment	EPeAT™ Gold (US only); ENERGY STAR® 6.1; RoHS-compliant

Lenovo  
April 2017

# ThinkPad 11e Chromebook (3rd Gen) - TopSeller - 20GF

Product Specifications Reference (PSREF)

Model	Region	Processor	Graphics	Memory (Soldered)	Display	Multi-touch	Storage	Optical	WLAN + Bluetooth	Color	Camera	Key-board	Finger-print Reader	TPM	Battery (internal)	Power Adapter	Operating System	Warranty	Ann Date (m/y)
20GF0001US	US	Celeron N3150	Intel HD	4GB Soldered	11.6" HD (1366x768)	None	16GB eMMC	None	Intel 7265 ac, 2x2 + BT4.0	Black	720p	Non-backlit	None	dTPM 1.2	3-cell (42Wh)	45W	Chrome OS	1-year, Depot	03/16
20GF0003US	US	Celeron N3160	Intel HD 400	4GB Soldered	11.6" HD (1366x768)	None	16GB eMMC	None	Intel 7265 ac, 2x2 + BT4.0	Black	720p	Non-backlit	None	dTPM 1.2	3-cell (42Wh)	45W	Chrome OS	1-year, Depot	10/16



# ThinkPad 11e Chromebook (4<sup>th</sup> Gen) Platform Specifications

Product Specifications Reference (PSREF)

Processor	Intel® Celeron® Processor								Dimensions	<i>WxDxH:</i> 11.81" x 8.27" x 0.90"; 300mm x 210mm x 22.8mm
	Processor Number	# of Cores	# of Threads	Base Frequency	Burst Frequency	Cache	Memory Types	Processor Graphics	Weight	Starting at 3.2 lb (1.45kg)
	Cel N3450	4	4	1.1 GHz	2.2 GHz	2MB	LPDDR4-2400	Intel HD Graphics 500	Case color	<i>Display cover:</i> Graphite Black; <i>Bottom:</i> Graphite Black
									Case material	<i>Display cover:</i> PC+40%GF+TPU; <i>Bottom:</i> PC/ABS plastic
Graphics	Intel HD Graphics 500 in processor								Media reader	MicroSD card reader (MMC, SD, SDHC, SDXC)
Chipset	Intel SoC (System on Chip) platform								Ports	One USB 3.1 Gen 1 (USB 3.0), two USB Type-C
Memory	4GB / 3200MHz LPDDR4 / soldered to systemboard, no sockets * System clocks down for processors with lower memory controller								Control buttons	None
Display	11.6" (295mm) HD (1366x768), anti-glare, LED backlight, 250 nits, 16:9 aspect ratio, 500:1 contrast ratio								Camera	HD720p resolution, low light sensitive, fixed focus
Multi-touch	None								Audio support	Dialog Semiconductor DA7219 audio codec / stereo speakers, 2W x 2 / monaural digital microphone, combo audio/microphone jack
Hinge	Normal hinge, 180 degree								Keyboard	ThinkPad Chrome keyboard, 6-row, multimedia Fn keys
Storage	32GB eMMC (embedded Multi Media Card) flash memory on board								Touchpad	Buttonless touchpad below keyboard, multi-touch
Optical	None								Security	Security keyhole
Ethernet	None								Security chip	Discrete TPM 2.0, TCG Certified
WLAN	Intel Dual Band Wireless-AC 7265, Wi-Fi 2x2 802.11ac + BT4.1, M.2 card								vPro	None
Bluetooth™	Bluetooth 4.1 wireless, integrated in Wi-Fi + Bluetooth combo adapter								Fingerprint reader	None
WWAN	None								Battery	Integrated Lithium Polymer 3-cell (42Wh)
								Max battery life	Up to 11.84 hr	
								AC adapter	45W USB Type-C AC adapter	
								Preload	Google Chrome OS	
								Limited warranty	1-year depot repair service	
								Mil-Spec test	MIL-STD-810G military certification	
								Environment	EPEAT™ Gold (US only); ENERGY STAR® 6.1; RoHS-compliant	

Lenovo  
July 2017

# ThinkPad 11e Chromebook (4th Gen) - TopSeller - 20J0

Product Specifications Reference (PSREF)

Model	Region	Processor	vPro	Graphics	Memory (Soldered)	Display	Multi-touch	Storage	Optical	WLAN + Bluetooth	Color	Camera	Key-board	Finger-print Reader	TPM	Battery (internal)	Power Adapter	Operating System	Warranty	Ann Date (m/y)
20J00000US	US	Celeron N3450	No	Intel HD 500	4GB Soldered	11.6" HD (1366x768)	None	32GB eMMC	None	Intel 7265 ac, 2x2 + BT4.1	Black	720p	Non-backlit	None	dTPM 2.0	3-cell (42Wh)	45W USB-C	Chrome OS	1-year, Depot	04/17



# ThinkPad 13 (2nd Gen) Platform Specifications

Product Specifications Reference (PSREF)

Processor	Intel® Celeron® Processor or 7th Generation Intel Core™ i3 / i5 / i7 Processor								Smart card reader	None
	Processor Number	# of Cores	# of Threads	Base Frequency	Max Turbo Frequency	Cache	Memory Types	Processor Graphics	Media reader Ports	4-in-1 reader (MMC, SD, SDHC, SDXC) Three USB 3.1 Gen 1 (USB 3.0, one Always On), one USB Type-C, HDMI, Lenovo OneLink+ connector
	Cel 3865U	2	4	1.8 GHz	-	2MB	DDR4-2133	Intel HD Graphics 610	Camera Audio support	HD720p resolution, low light sensitive, fixed focus HD Audio, Realtek® ALC3268 codec / stereo speakers, 2W x 2 / dual array microphone, combo audio/microphone jack
	i3-7100U			2.4 GHz	-	3MB		Intel HD Graphics 620		
	i5-7200U			2.5 GHz	3.1 GHz	3MB				
i5-7300U	2.6 GHz			3.5 GHz	3MB					
i7-7500U	2.7 GHz	3.5 GHz	4MB					Keyboard UltraNav™	6-row, multimedia Fn keys, optional LED backlight TrackPoint® pointing device and buttonless Mylar surface touchpad, multi-touch	
Graphics	Intel HD Graphics 610 or 620 in processor, supports external digital monitor via HDMI or USB Type-C; supports three independent displays; Max resolution: 1920x1080 (HDMI)@60Hz, 3840x2160 (USB Type-C)@60Hz								Security Security chip vPro (optional) Fingerprint reader	Power-on password, hard disk password, supervisor password, security keyhole Discrete TPM 2.0, TCG Certified Intel vPro Technology <i>Optional</i> : swipe style fingerprint reader on the palm rest
Chipset Memory	Intel SoC (System on Chip) platform 32GB max / 2133MHz DDR4, two DDR4 SO-DIMM sockets								Battery Max battery life AC adapter	Integrated Lithium Polymer 3-cell (42Wh) <i>MobileMark® 2014</i> : 14.56 hr 45W AC adapter
Display	<i>Some</i> : 13.3" (338mm) HD (1366x768), anti-glare, LED backlight, 250 nits, 16:9 aspect ratio, 500:1 contrast ratio <i>Some</i> : 13.3" (338mm) FHD (1920x1080), anti-glare, LED backlight, IPS, 250 nits, 16:9 aspect ratio, 700:1 contrast ratio, 170° viewing angle								Preload	<i>Some</i> : Windows® 10 Home 64 <i>Some</i> : Windows 10 Pro 64 • Lenovo Companion • Lenovo Setting • Microsoft Office preloaded; purchase a product key to activate
Multi-touch (opt)	On-cell touch, supports 10-finger gesture (FHD only)								Limited warranty	<i>One of the following, configurable by model</i> : • 1-year depot repair service • 3-year/1-yr battery depot repair service • 3-year/1-yr battery limited onsite service
Storage	<i>Some</i> : M.2 SSD / SATA 6.0Gb/s (e.g. xxxG SSD) <i>Some</i> : M.2 SSD / PCIe NVMe, PCIe 3.0 x 4, 32Gb/s (e.g. xxxG SSD PCIe NVMe)								Mil-Spec test	MIL-STD-810G military certification
Optical	None								Environment	EPEAT™ Gold (US only); ENERGY STAR® 6.1; RoHS-compliant
Ethernet	Gigabit Ethernet via the accessional ThinkPad OneLink+ to RJ45 Adapter (4X90K06975) or ThinkPad OneLink+ to VGA/RJ45 adapter (4X90J31060) (by native Intel Ethernet Connection I219-V (Non-vPro) or I219-LM (vPro))									
WLAN Bluetooth™	Intel Dual Band Wireless-AC 8265, Wi-Fi 2x2 802.11ac + BT4.1, M.2 card Bluetooth 4.1 wireless, integrated in Wi-Fi + Bluetooth combo adapter * Intel 8265ac card supports Bluetooth 4.2 but is limited to BT 4.1 by Windows OS									
WWAN	None									
Dimensions	<i>WxDxH (silver)</i> : 12.69" x 8.77" x 0.75"; 322.4mm x 222.8mm x 19.1mm <i>WxDxH (black)</i> : 12.69" x 8.77" x 0.78"; 322.4mm x 222.8mm x 19.8mm									
Weight	Starting at 3.17 lb / 1.44 kg									
Case color	Pure Black or Silver									
Case material	<i>Black cover</i> : PC/ABS plastic; <i>Silver cover</i> : Aluminum									

Model	Region	Processor	vPro	Graphics	Memory	Display	Multi-touch	Storage(HDD/SSD)	Optical	WLAN + Bluetooth	Color	Camera	Keyboard	Fingerprint Reader	TPM	Battery (internal)	Power Adapter	Operating System	Warranty	Ann Date (m/y)
20J10006US	US	i3-7100U	No	Intel HD 620	4GBx1	13.3" HD (1366x768)	None	128GB SSD M.2	None	Intel 8265 ac, 2x2 + BT4.1	Black	720p	Non-backlit	Fingerprint Reader	dTPM 2.0	3-cell (42Wh)	45W	Windows 10 Pro 64	1-year, Depot	12/16
20J1000AUS	US	i5-7200U	No	Intel HD 620	4GBx1	13.3" HD (1366x768)	None	256GB SSD M.2 Opal2	None	Intel 8265 ac, 2x2 + BT4.1	Black	720p	Non-backlit	Fingerprint Reader	dTPM 2.0	3-cell (42Wh)	45W	Windows 10 Pro 64	1-year, Depot	12/16
20J1000EUS	US	i5-7200U	No	Intel HD 620	8GBx1	13.3" HD (1366x768)	None	256GB SSD M.2 Opal2	None	Intel 8265 ac, 2x2 + BT4.1	Black	720p	Non-backlit	Fingerprint Reader	dTPM 2.0	3-cell (42Wh)	45W	Windows 10 Pro 64	1-year, Depot	12/16
20J1001BUS	US	i3-7100U	No	Intel HD 620	4GBx1	13.3" FHD (1920x1080) IPS	10-point Multi-touch	128GB SSD M.2	None	Intel 8265 ac, 2x2 + BT4.1	Black	720p	Non-backlit	Fingerprint Reader	dTPM 2.0	3-cell (42Wh)	45W	Windows 10 Pro 64	1-year, Depot	12/16
20J1001CUS	US	i5-7200U	No	Intel HD 620	8GBx1	13.3" FHD (1920x1080) IPS	10-point Multi-touch	256GB SSD M.2 Opal2	None	Intel 8265 ac, 2x2 + BT4.1	Black	720p	Backlit	Fingerprint Reader	dTPM 2.0	3-cell (42Wh)	45W	Windows 10 Pro 64	3-year, Depot	12/16
20J1001DUS	US	i5-7200U	No	Intel HD 620	4GBx1	13.3" FHD (1920x1080) IPS	10-point Multi-touch	128GB SSD M.2	None	Intel 8265 ac, 2x2 + BT4.1	Black	720p	Non-backlit	Fingerprint Reader	dTPM 2.0	3-cell (42Wh)	45W	Windows 10 Pro 64	1-year, Depot	12/16
20J1001EUS	US	i3-7100U	No	Intel HD 620	4GBx1	13.3" FHD (1920x1080) IPS	10-point Multi-touch	128GB SSD M.2	None	Intel 8265 ac, 2x2 + BT4.1	Silver	720p	Non-backlit	None	dTPM 2.0	3-cell (42Wh)	45W	Windows 10 Pro 64	1-year, Depot	12/16
20J1001FUS	US	i5-7200U	No	Intel HD 620	4GBx1	13.3" HD (1366x768)	None	128GB SSD M.2	None	Intel 8265 ac, 2x2 + BT4.1	Silver	720p	Non-backlit	None	dTPM 2.0	3-cell (42Wh)	45W	Windows 10 Pro 64	1-year, Depot	12/16
20J1001GUS	US	i5-7200U	No	Intel HD 620	8GBx1	13.3" FHD (1920x1080) IPS	10-point Multi-touch	256GB SSD M.2 Opal2	None	Intel 8265 ac, 2x2 + BT4.1	Silver	720p	Backlit	None	dTPM 2.0	3-cell (42Wh)	45W	Windows 10 Pro 64	3-year, Depot	12/16
20J1001HUS	US	i3-7100U	No	Intel HD 620	4GBx1	13.3" HD (1366x768)	None	128GB SSD M.2	None	Intel 8265 ac, 2x2 + BT4.1	Silver	720p	Non-backlit	None	dTPM 2.0	3-cell (42Wh)	45W	Windows 10 Pro 64	1-year, Depot	12/16
20J1001JUS	US	i5-7200U	No	Intel HD 620	8GBx1	13.3" FHD (1920x1080) IPS	10-point Multi-touch	256GB SSD M.2 Opal2	None	Intel 8265 ac, 2x2 + BT4.1	Silver	720p	Non-backlit	None	dTPM 2.0	3-cell (42Wh)	45W	Windows 10 Pro 64	1-year, Depot	12/16
20J10022US	US	i5-7200U	No	Intel HD 620	4GBx1	13.3" HD (1366x768)	None	180GB SSD M.2	None	Intel 8265 ac, 2x2 + BT4.1	Black	720p	Non-backlit	Fingerprint Reader	dTPM 2.0	3-cell (42Wh)	45W	Windows 10 Pro 64	1-year, Depot	01/17
20J10023US	US	i3-7100U	No	Intel HD 620	4GBx1	13.3" HD (1366x768)	None	180GB SSD M.2	None	Intel 8265 ac, 2x2 + BT4.1	Black	720p	Non-backlit	Fingerprint Reader	dTPM 2.0	3-cell (42Wh)	45W	Windows 10 Pro 64	1-year, Depot	01/17
20J10024US	US	i5-7300U	vPro	Intel HD 620	4GBx1	13.3" HD (1366x768)	None	180GB SSD M.2	None	Intel 8265 ac, 2x2 + BT4.1	Black	720p	Non-backlit	Fingerprint Reader	dTPM 2.0	3-cell (42Wh)	45W	Windows 10 Pro 64	3-year, Depot	03/17
20J10025US	US	i5-7300U	vPro	Intel HD 620	8GBx1	13.3" FHD (1920x1080) IPS	10-point Multi-touch	256GB SSD M.2 Opal2	None	Intel 8265 ac, 2x2 + BT4.1	Black	720p	Backlit	Fingerprint Reader	dTPM 2.0	3-cell (42Wh)	45W	Windows 10 Pro 64	3-year, Depot	03/17
20J10045US	US	Celeron 3865U	No	Intel HD 610	4GBx1	13.3" HD (1366x768)	None	128GB SSD M.2	None	Intel 8265 ac, 2x2 + BT4.1	Silver	720p	Non-backlit	None	dTPM 2.0	3-cell (42Wh)	45W	Windows 10 Pro 64	3-year, Depot	03/17
20J10046US	US	Celeron 3865U	No	Intel HD 610	4GBx1	13.3" HD (1366x768)	None	128GB SSD M.2	None	Intel 8265 ac, 2x2 + BT4.1	Black	720p	Non-backlit	Fingerprint Reader	dTPM 2.0	3-cell (42Wh)	45W	Windows 10 Pro 64	1-year, Depot	03/17
20J10047US	US	Celeron 3865U	No	Intel HD 610	4GBx1	13.3" FHD (1920x1080) IPS	10-point Multi-touch	128GB SSD M.2	None	Intel 8265 ac, 2x2 + BT4.1	Black	720p	Non-backlit	Fingerprint Reader	dTPM 2.0	3-cell (42Wh)	45W	Windows 10 Pro 64	3-year, Depot	03/17
20J10048US	US	Celeron 3865U	No	Intel HD 610	4GBx1	13.3" HD (1366x768)	None	128GB SSD M.2	None	Intel 8265 ac, 2x2 + BT4.1	Black	720p	Non-backlit	Fingerprint Reader	dTPM 2.0	3-cell (42Wh)	45W	Windows 10 Pro 64	3-year, Depot	03/17
20J10049US	US	Celeron 3865U	No	Intel HD 610	4GBx1	13.3" FHD (1920x1080) IPS	10-point Multi-touch	128GB SSD M.2	None	Intel 8265 ac, 2x2 + BT4.1	Silver	720p	Non-backlit	None	dTPM 2.0	3-cell (42Wh)	45W	Windows 10 Pro 64	3-year, Depot	03/17



Model	Region	Processor	vPro	Graphics	Memory	Display	Multi-touch	Storage(HDD/SSD)	Optical	WLAN + Bluetooth	Color	Camera	Keyboard	Fingerprint Reader	TPM	Battery (internal)	Power Adapter	Operating System	Warranty	Ann Date (m/y)
20J1004AUS	US	Celeron 3865U	No	Intel HD 610	4GBx1	13.3" FHD (1920x1080) IPS	10-point Multi-touch	128GB SSD M.2	None	Intel 8265 ac, 2x2 + BT4.1	Black	720p	Non-backlit	Fingerprint Reader	dTPM 2.0	3-cell (42Wh)	45W	Windows 10 Pro 64	1-year, Depot	03/17
20J1004BUS	US	Celeron 3865U	No	Intel HD 610	4GBx2	13.3" FHD (1920x1080) IPS	10-point Multi-touch	128GB SSD M.2	None	Intel 8265 ac, 2x2 + BT4.1	Black	720p	Backlit	Fingerprint Reader	dTPM 2.0	3-cell (42Wh)	45W	Windows 10 Pro 64	3-year, Depot	03/17
20J1004CUS	US	Celeron 3865U	No	Intel HD 610	4GBx2	13.3" HD (1366x768)	None	128GB SSD M.2	None	Intel 8265 ac, 2x2 + BT4.1	Black	720p	Backlit	Fingerprint Reader	dTPM 2.0	3-cell (42Wh)	45W	Windows 10 Pro 64	3-year, Depot	03/17



# ThinkPad 13 Chromebook Platform Specifications

Product Specifications Reference (PSREF)

Processor	Intel® Celeron® Processor or 6th Generation Intel Core™ i3 / i5 Processor								Dimensions <sup>3</sup>	<i>WxDxH:</i> 12.69" x 8.77" x 0.78"; 322.4mm x 222.8mm x 19.8mm
	Processor Number	# of Cores	# of Threads	Base Frequency	Max Turbo Frequency	Cache	Memory Types	Processor Graphics	Weight <sup>2</sup>	Starting at 3.1 lb / 1.41 kg
	Cel 3855U	2	2	1.6 GHz	-	2MB	LPDDR3-1866	Intel HD graphics 510	Case color	Pure Black
	i3-6100U		4	2.3 GHz	-	3MB		Intel HD graphics 520	Case material	PC/ABS plastic
i5-6300U	4		2.4 GHz	3.0 GHz	3MB					
Graphics	Intel HD Graphics 510 or 520 in processor, supports external digital monitor via USB Type-C; supports three independent displays; Max resolution: 3840X2160 (USB Type-C) @60Hz								Smart card reader	None
Chipset	Intel SoC (System on Chip) platform								Media reader	4-in-1 reader (MMC, SD, SDHC, SDXC)
Memory	4GB or 8GB / 1866MHz LPDDR3 / soldered to systemboard, no sockets								Ports	Two USB 3.0 (Always On), two USB Type-C
Display	<i>Some:</i> 13.3" (338mm) HD (1366x768), anti-glare, LED backlight, 200 nits, 16:9 aspect ratio, 500:1 contrast ratio <i>Some:</i> 13.3" (338mm) FHD (1920x1080), anti-glare, LED backlight, IPS, 220 nits, 16:9 aspect ratio, 700:1 contrast ratio, 170° viewing angle <i>Some:</i> 13.3" (338mm) FHD (1920x1080), glossy, LED backlight, IPS, multi-touch, 250 nits, 16:9 aspect ratio, 800:1 contrast ratio, 170° viewing angle								Camera	HD720p resolution, low light sensitive, fixed focus
Multi-touch (opt)	Capacitive-type multi-touch, supports 10-finger gesture								Audio support	HD Audio, Nuvoton NAU88L25B codec / stereo speakers, 2W x 2 / dual array microphone, combo audio/microphone jack
Storage	16GB or 32GB eMMC (embedded Multi Media Card) flash memory on board								Keyboard	ThinkPad Chrome keyboard, 6-row, multimedia Fn keys
Optical	None								Touchpad	Buttonless touchpad below keyboard, multi-touch
Ethernet	None								Security	Security keyhole
WLAN <sup>4</sup>	11ac+BT, Intel Dual Band Wireless-AC 7265, 2x2, M.2 card								Security chip	Discrete TPM 1.2, TCG Certified
Bluetooth™	Bluetooth 4.0 wireless, integrated in Wi-Fi + Bluetooth combo adapter								vPro	None
WWAN	None								Fingerprint reader	None
									Battery	Integrated Lithium Polymer 3-cell (42Wh)
									Max battery life <sup>10</sup>	10 hr
									AC adapter	USB Type-C 45-watt AC adapter
									Preload	Google Chrome OS
									Limited warranty <sup>12</sup>	1-year depot repair service
									Mil-Spec test	MIL-STD-810G military certification
									Environment	EPEAT™ Gold (US only); ENERGY STAR® 6.1; RoHS-compliant

## ThinkPad 13 Chromebook - TopSeller - 20GL

Product Specifications Reference (PSREF)

Model	Region	Processor	vPro	Graphics	Storage	Memory (Soldered)	Display	Multi-touch	Optical	WLAN + Bluetooth	Color	Camera	Keyboard	Fingerprint Reader	TPM	Battery (internal)	Power Adapter	Operating System	Warranty	Ann Date (m/y)
20GL0000US	US	Celeron 3855U	No	Intel HD 510	16GB eMMC	4GB Soldered	13.3" HD (1366x768) Anti-glare	None	None	Intel 7265 ac, 2x2 + BT4.0	Black	720p	Non-backlit	None	dTPM 1.2	3-cell (42Wh)	45W	Chrome OS	1-year, Depot	05/16
20GL0002US	US	i3-6100U	No	Intel HD 520	16GB eMMC	4GB Soldered	13.3" HD (1366x768) Anti-glare	None	None	Intel 7265 ac, 2x2 + BT4.0	Black	720p	Non-backlit	None	dTPM 1.2	3-cell (42Wh)	45W	Chrome OS	1-year, Depot	05/16
20GL0004US	US	i5-6300U	No	Intel HD 520	32GB eMMC	8GB Soldered	13.3" FHD (1920x1080) IPS Anti-glare	None	None	Intel 7265 ac, 2x2 + BT4.0	Black	720p	Non-backlit	None	dTPM 1.2	3-cell (42Wh)	45W	Chrome OS	1-year, Depot	05/16
20GL0005US	US	i5-6300U	No	Intel HD 520	32GB eMMC	8GB Soldered	13.3" HD (1366x768) Anti-glare	None	None	Intel 7265 ac, 2x2 + BT4.0	Black	720p	Non-backlit	None	dTPM 1.2	3-cell (42Wh)	45W	Chrome OS	1-year, Depot	05/16
20GL0006US	US	Celeron 3855U	No	Intel HD 510	16GB eMMC	4GB Soldered	13.3" FHD (1920x1080) IPS Glossy	10-point Multi-touch	None	Intel 7265 ac, 2x2 + BT4.0	Black	720p	Non-backlit	None	dTPM 1.2	3-cell (42Wh)	45W	Chrome OS	1-year, Depot	10/16
20GL0007US	US	i5-6300U	No	Intel HD 520	32GB eMMC	8GB Soldered	13.3" FHD (1920x1080) IPS Glossy	10-point Multi-touch	None	Intel 7265 ac, 2x2 + BT4.0	Black	720p	Non-backlit	None	dTPM 1.2	3-cell (42Wh)	45W	Chrome OS	1-year, Depot	10/16
20GL0008US	US	i3-6100U	No	Intel HD 520	16GB eMMC	4GB Soldered	13.3" FHD (1920x1080) IPS Glossy	10-point Multi-touch	None	Intel 7265 ac, 2x2 + BT4.0	Black	720p	Non-backlit	None	dTPM 1.2	3-cell (42Wh)	45W	Chrome OS	1-year, Depot	10/16



# ThinkPad E460 Platform Specifications

Product Specifications Reference (PSREF)

Processor	6th Generation Intel® Core™ i3 / i5 / i7 Processor								Smart Card Reader	None
	Processor Number	# of Cores	# of Threads	Base Frequency	Max Turbo Frequency	Cache	Memory Types	Processor Graphics	ExpressCard	None
	i3-6100U	2	4	2.3 GHz	-	3MB	DDR3L-1600	Intel HD Graphics 520	Multicard Reader	4-in-1 reader (MMC, SD, SDHC, SDXC)
	i5-6200U			2.3 GHz	2.8 GHz	3MB			Ports	Three USB 3.0 (one Always On), HDMI, Ethernet (RJ-45), Lenovo OneLink connector, combo audio / microphone jack
i7-6500U	2.5 GHz			3.1 GHz	4MB	Monitor cable			None	
Graphics	Intel HD Graphics in processor only, or AMD Radeon R5 M330 Graphics, 2GB DDR3 memory, or AMD Radeon R7 M360 Graphics, 2GB DDR3 memory, digital monitor support via HDMI™ (supporting HDCP to output protected content); supports dual independent displays; Max resolution: 1920x1080 (HDMI) @60Hz								Camera	<i>Some:</i> HD720p resolution, fixed focus
Chipset	Intel SoC (System on Chip) platform								Audio support	HD Audio, Conexant® CX11852 codec, Dolby® Advanced Audio™ / stereo speakers, 2W x 2 / dual array microphone, combo audio / microphone jack
Memory	16GB max / PC3-12800 1600MHz DDR3L, non-parity, dual-channel capable, two 204-pin SO-DIMM sockets								Keyboard	6-row, spill-resistant, multimedia Fn keys
Display	<i>Some:</i> 14.0" (355mm) HD (1366x768) color, anti-glare, LED backlight, 220 nits, 16:9 aspect ratio <i>Some:</i> 14.0" (355mm) FHD (1920x1080) color, anti-glare, LED backlight, IPS, 250 nits, 16:9 aspect ratio								UltraNav™	TrackPoint® pointing device and multi-touch with 3+2 buttons click pad
Multi-touch	None								ThinkLight™	None
Storage	<i>Some:</i> SSD / SATA 6.0Gb/s, 2.5" wide, 7mm high, removable, upgradable <i>Some:</i> HDD / SATA 6.0Gb/s, 2.5" wide, removable, upgradable, Active Protection System™ <i>Some:</i> SSHD with 8GB NAND flash memory								Security	Power-on password, hard disk password, supervisor password, security keyhole
Optical	None								Security chip	TPM2.0 : Trusted Platform Module, TPM2.0 FW (firmware)
M.2 SSD	None								TPM1.2:	Trusted Platform Module, TCG 1.2-compliant
Ethernet	Gigabit Ethernet Connection								TPM :	TPM2.0 and TPM1.2
Bluetooth™	Bluetooth wireless, integrated in Wi-Fi + Bluetooth combo adapter								vPro	None
WLAN	<i>One of the following, configurable by model:</i> • Intel Dual Band Wireless-AC 3165, 1x1, Wi-Fi + BT combo adapter, M.2 Card • Intel Dual Band Wireless-AC 8260, 2x2, Wi-Fi + BT combo adapter, M.2 Card • BCM, Broadcom Wireless-AC, 1x1, Wi-Fi + Bluetooth combo adapter, M.2 Card • QCA, Qualcomm Wireless-AC, 2x2, Wi-Fi + Bluetooth combo adapter, M.2 Card								Fingerprint reader	<i>Some:</i> Fingerprint reader on the keyboard bezel, swipe sensor
WWAN	None								NFC	None
SIM card	None								Battery type	Li-Ion 6-cell (47Wh)
Dimensions	<i>Aluminum (WxDxH):</i> 13.35" x 9.41" x 0.90"; 339mm x 239mm x 22.9mm <i>PC/ABS (WxDxH):</i> 13.35" x 9.41" x 0.96"; 339mm x 239mm x 24.4mm								Battery life	6-cell (47Wh): up to 9.0 hr
Weight	From 4.23 lb (1.92kg)								AC adapter	<i>Some:</i> 45-watt AC adapter (Integrated Graphics) <i>Some:</i> 65-watt AC adapter (Discrete Graphics)
Case color	Graphite black								Preload	<i>Some:</i> No operating system <i>Some:</i> Windows® 7 Professional 64 preinstalled through downgrade rights in Windows 10 Pro 64 • Lenovo Solution Center • Lenovo SHAREit • ThinkVantage Product Recovery • Rescue and Recovery™ • ThinkVantage System Update • PC Device Stage • Adobe® Reader® • Microsoft® Office preloaded; purchase a product key to activate • McAfee® Live Safe (30-day trial)
Case material	<i>Aluminum:</i> Aluminum display cover <i>PC/ABS:</i> PolyCarbonate/Acrylonitrile-Butadiene-Styrene (PC/ABS) plastic display cover								Limited warranty	<b>1-year</b> - depot repair service / service upgrades available
									Mil-Spec test	None
									Environment	EPEAT™ Gold; ENERGY STAR®; RoHS-compliant

## ThinkPad E460 - TopSeller - 20ET

Product Specifications Reference (PSREF)

Model	Region	Processor	vPro	Graphics	Memory	Display	Multi-touch	Storage	Optical	WLAN + Bluetooth	WWAN	SIM Card	Color	Case Material	Camera	Keyboard	Fingerprint Reader	TPM	Battery	Power Adapter	Operating System	Warranty	Ann Date (m/y)
20ET000YUS	US	i3-6100U	No	Intel HD 520	4GBx1	14" HD (1366x768)	None	500GB 7200rpm	None	Intel 3165 ac, 1x1 + BT4.0	None	None	Black	PC/ABS	720p	Non-backlit	Fingerprint Reader	dTPM 1.2	6-cell (47Wh)	45W	Win10 DG Win7 Pro 64	1-year, Depot	11/15
20ET0010US	US	i5-6200U	No	Intel HD 520	8GBx1	14" HD (1366x768)	None	192GB SSD	None	Intel 3165 ac, 1x1 + BT4.0	None	None	Black	PC/ABS	720p	Non-backlit	Fingerprint Reader	dTPM 1.2	6-cell (47Wh)	45W	Win10 DG Win7 Pro 64	1-year, Depot	11/15
20ET0011US	US	i3-6100U	No	Intel HD 520	4GBx1	14" HD (1366x768)	None	500GB 7200rpm	None	Intel 3165 ac, 1x1 + BT4.0	None	None	Black	PC/ABS	720p	Non-backlit	Fingerprint Reader	dTPM1.2 + FW TPM2.0	6-cell (47Wh)	45W	Win10 Pro 64	1-year, Depot	11/15
20ET0012US	US	i5-6200U	No	Intel HD 520	4GBx1	14" HD (1366x768)	None	500GB 7200rpm	None	Intel 3165 ac, 1x1 + BT4.0	None	None	Black	PC/ABS	720p	Non-backlit	Fingerprint Reader	dTPM1.2 + FW TPM2.0	6-cell (47Wh)	45W	Win10 Pro 64	1-year, Depot	11/15
20ET0013US	US	i7-6500U	No	AMD R7 M360 2GB	8GBx1	14" FHD (1920x1080) IPS	None	500GB 7200rpm	None	Intel 8260 ac, 2x2 + BT4.0	None	None	Black	Aluminum	720p	Non-backlit	Fingerprint Reader	FW TPM 2.0	6-cell (47Wh)	65W	Win10 DG Win7 Pro 64	1-year, Depot	11/15
20ET0014US	US	i5-6200U	No	Intel HD 520	4GBx1	14" HD (1366x768)	None	500GB 7200rpm	None	Intel 3165 ac, 1x1 + BT4.0	None	None	Black	PC/ABS	720p	Non-backlit	Fingerprint Reader	dTPM 1.2	6-cell (47Wh)	45W	Win10 DG Win7 Pro 64	1-year, Depot	11/15
20ET0015US	US	i3-6100U	No	Intel HD 520	4GBx1	14" HD (1366x768)	None	192GB SSD	None	Intel 3165 ac, 1x1 + BT4.0	None	None	Black	PC/ABS	720p	Non-backlit	Fingerprint Reader	dTPM 1.2	6-cell (47Wh)	45W	Win10 DG Win7 Pro 64	1-year, Depot	11/15
20ET0016US	US	i5-6200U	No	Intel HD 520	8GBx1	14" HD (1366x768)	None	192GB SSD	None	Intel 3165 ac, 1x1 + BT4.0	None	None	Black	PC/ABS	720p	Non-backlit	Fingerprint Reader	dTPM1.2 + FW TPM2.0	6-cell (47Wh)	45W	Win10 Pro 64	1-year, Depot	11/15
20ET0017US	US	i5-6200U	No	Intel HD 520	4GBx1	14" HD (1366x768)	None	192GB SSD	None	Intel 3165 ac, 1x1 + BT4.0	None	None	Black	PC/ABS	720p	Non-backlit	Fingerprint Reader	dTPM1.2 + FW TPM2.0	6-cell (47Wh)	45W	Win10 Pro 64	1-year, Depot	11/15
20ET0018US	US	i3-6100U	No	Intel HD 520	4GBx1	14" HD (1366x768)	None	192GB SSD	None	Intel 3165 ac, 1x1 + BT4.0	None	None	Black	PC/ABS	720p	Non-backlit	Fingerprint Reader	dTPM1.2 + FW TPM2.0	6-cell (47Wh)	45W	Win10 Pro 64	1-year, Depot	11/15
20ET0019US	US	i7-6500U	No	AMD R7 M360 2GB	8GBx1	14" FHD (1920x1080) IPS	None	192GB SSD	None	Intel 8260 ac, 2x2 + BT4.0	None	None	Black	Aluminum	720p	Non-backlit	Fingerprint Reader	FW TPM 2.0	6-cell (47Wh)	65W	Win10 DG Win7 Pro 64	1-year, Depot	11/15
20ET001AUS	US	i5-6200U	No	Intel HD 520	4GBx1	14" HD (1366x768)	None	192GB SSD	None	Intel 3165 ac, 1x1 + BT4.0	None	None	Black	PC/ABS	720p	Non-backlit	Fingerprint Reader	dTPM 1.2	6-cell (47Wh)	45W	Win10 DG Win7 Pro 64	1-year, Depot	11/15
20ET001BUS	US	i7-6500U	No	AMD R7 M360 2GB	8GBx1	14" FHD (1920x1080) IPS	None	192GB SSD	None	Intel 8260 ac, 2x2 + BT4.0	None	None	Black	Aluminum	720p	Non-backlit	Fingerprint Reader	FW TPM 2.0	6-cell (47Wh)	65W	Win10 Pro 64	1-year, Depot	11/15
20ET001CUS	US	i7-6500U	No	AMD R7 M360 2GB	8GBx1	14" FHD (1920x1080) IPS	None	500GB 7200rpm	None	Intel 8260 ac, 2x2 + BT4.0	None	None	Black	Aluminum	720p	Non-backlit	Fingerprint Reader	FW TPM 2.0	6-cell (47Wh)	65W	Win10 Pro 64	1-year, Depot	11/15
20ET004GUS	US	i7-6500U	No	AMD R7 M360 2GB	8GBx1	14" FHD (1920x1080) IPS	None	256GB SSD Opal2	None	Intel 8260 ac, 2x2 + BT4.0	None	None	Black	Aluminum	720p	Non-backlit	Fingerprint Reader	FW TPM 2.0	6-cell (47Wh)	65W	Win10 Pro 64	1-year, Depot	04/16
20ET004HUS	US	i7-6500U	No	AMD R7 M360 2GB	8GBx1	14" FHD (1920x1080) IPS	None	256GB SSD Opal2	None	Intel 8260 ac, 2x2 + BT4.0	None	None	Black	Aluminum	720p	Non-backlit	Fingerprint Reader	FW TPM 2.0	6-cell (47Wh)	65W	Win10 DG Win7 Pro 64	1-year, Depot	04/16
20ET004VUS	US	i5-6200U	No	Intel HD 520	4GBx1	14" HD (1366x768)	None	256GB SSD Opal2	None	Intel 8260 ac, 2x2 + BT4.0	None	None	Black	PC/ABS	720p	Non-backlit	Fingerprint Reader	dTPM 1.2	6-cell (47Wh)	45W	Win10 DG Win7 Pro 64	1-year, Depot	09/16
20ET004WUS	US	i5-6200U	No	Intel HD 520	8GBx1	14" FHD (1920x1080) IPS	None	256GB SSD Opal2	None	Intel 8260 ac, 2x2 + BT4.0	None	None	Black	Aluminum	720p	Non-backlit	Fingerprint Reader	dTPM 1.2	6-cell (47Wh)	45W	Win10 DG Win7 Pro 64	1-year, Depot	09/16
20ET0054US	US	i5-6200U	No	Intel HD 520	8GBx1	14" HD (1366x768)	None	500GB 7200rpm	None	Intel 3165 ac, 1x1 + BT4.0	None	None	Black	PC/ABS	720p	Non-backlit	Fingerprint Reader	dTPM1.2 + FW TPM2.0	6-cell (47Wh)	45W	Win10 Pro 64	1-year, Depot	10/16
20ET0055US	US	i5-6200U	No	Intel HD 520	8GBx1	14" FHD (1920x1080) IPS	None	500GB 7200rpm	None	Intel 3165 ac, 1x1 + BT4.0	None	None	Black	Aluminum	720p	Non-backlit	Fingerprint Reader	dTPM1.2 + FW TPM2.0	6-cell (47Wh)	45W	Win10 Pro 64	1-year, Depot	10/16







# ThinkPad E465 Platform Specifications

Product Specifications Reference (PSREF)

Processor	AMD Accelerated Processor A6, A8, or A10 APU								Smart Card Reader	None
	Processor Number	# of Cores	# of Threads	Clock Speed	Max Turbo Frequency	Cache	Memory Types	Graphics	ExpressCard	None
	A6-8500P	2	6	1.6 GHz	3.0 GHz	1MB	DDR3L-1600	R5 Graphics	Multicard Reader	4-in-1 reader (MMC, SD, SDHC, SDXC)
	A6-8500P	2	6	1.6 GHz	3.0 GHz	1MB		R5 M330	Ports	Three USB 3.0 (one Always On), HDMI, Ethernet (RJ-45), Lenovo OneLink connector, combo audio / microphone jack
	A8-8600P	4	10	1.6 GHz	3.0 GHz	2MB		R6 M335DX (R6+R5 M330)	Monitor cable	None
A10-8700P	4	10	1.8 GHz	3.2 GHz	2MB	R6 M340DX (R6+R5 M330)		Camera	HD720p resolution, fixed focus	
Graphics	AMD Radeon™ R5 Graphics in processor only, or AMD Radeon R5 M330 Graphics, 2GB DDR3 memory, or Dual Graphics support for A8 and A10 APU digital monitor support via HDMI™ (supporting HDCP to output protected content); supports dual independent display Max resolution: 1920x1080 (HDMI) @60Hz								Keyboard	6-row, spill-resistant, multimedia Fn keys
	Chipset	AMD SoC (System on Chip) platform								UltraNav™
Memory	16GB max / PC3-12800 1600MHz DDR3L, non-parity, dual-channel capable, two 204-pin SO-DIMM sockets								ThinkLight™	None
Display	<i>Some:</i> 14.0" (355mm) HD (1366x768) color, anti-glare, LED backlight, 220 nits, 16:9 aspect ratio <i>Some:</i> 14.0" (355mm) FHD (1920x1080) color, anti-glare, LED backlight, IPS, 250 nits, 16:9 aspect ratio								Security	Power-on password, hard disk password, supervisor password, security keyhole
Multi-touch	None								Security chip	<i>TPM2.0:</i> Trusted Platform Module, TPM2.0 FW (firmware) <i>TPM1.2:</i> Trusted Platform Module, TCG 1.2-compliant <i>TPM:</i> TPM2.0 and TPM1.2
Storage	<i>Some:</i> SSD / SATA 6.0Gb/s, 2.5" wide, 7mm high, removable, upgradable <i>Some:</i> HDD / SATA 6.0Gb/s, 2.5" wide, removable, upgradable, Active Protection System™ <i>Some:</i> SSHD with 8GB NAND flash memory								vPro	None
Optical	None								Fingerprint reader	<i>Some:</i> Fingerprint reader on the keyboard bezel, swipe sensor
M.2 SSD	None								NFC	None
Ethernet	Gigabit Ethernet Connection								Battery type	Li-Ion 6-cell (47Wh)
Bluetooth™	Bluetooth wireless, integrated in Wi-Fi + Bluetooth combo adapter								Battery life	Up to 6.5 hr
WLAN	<i>One of the following, configurable by model:</i> <ul style="list-style-type: none"> <li>• BCM, Broadcom Wireless-AC, 1x1, Wi-Fi + Bluetooth combo adapter, M.2 Card</li> <li>• QCA, Qualcomm Wireless-AC, 2x2, Wi-Fi + Bluetooth combo adapter, M.2 Card</li> </ul>								AC adapter	<i>Some:</i> 45-watt AC adapter (Integrated Graphics) <i>Some:</i> 65-watt AC adapter (Discrete Graphics)
WWAN	None								Preload	<i>Some:</i> No operating system <i>Some:</i> Windows® 7 Professional 64 <i>Some:</i> Windows® 7 Professional 64 preinstalled through downgrade rights in Windows 10 Pro 64 <ul style="list-style-type: none"> <li>• Lenovo Solution Center</li> <li>• Lenovo SHAREit</li> <li>• ThinkVantage Product Recovery</li> <li>• Rescue and Recovery™</li> <li>• ThinkVantage System Update</li> <li>• PC Device Stage</li> <li>• Adobe® Reader®</li> <li>• Microsoft® Office preloaded; purchase a product key to activate</li> <li>• McAfee® Live Safe (30-day trial)</li> </ul>
SIM card	None								Limited warranty	1-year - depot repair service / service upgrades available
Dimensions	<i>Aluminum (WxDxH):</i> 13.35" x 9.41" x 0.90"; 339mm x 239mm x 22.9mm <i>PC/ABS (WxDxH):</i> 13.35" x 9.41" x 0.96"; 339mm x 239mm x 24.4mm								Environment	EPEAT™ Gold; ENERGY STAR®; RoHS-compliant
Weight	From 4.27 lb (1.94kg)									
Case color	Graphite black									
Case material	<i>Aluminum:</i> Aluminum display cover <i>PC/ABS:</i> PolyCarbonate/Acrylonitrile-Butadiene-Styrene (PC/ABS) plastic display cover									

## ThinkPad E465 - TopSeller - 20EX

Product Specifications Reference (PSREF)

Model	Region	Processor	vPro	Graphics	Memory	Display	Multi-touch	Storage	Optical	WLAN + Bluetooth	WWAN	SIM Card	Color	Case Material	Camera	Keyboard	Fingerprint Reader	TPM	Battery	Power Adapter	Operating System	Warranty	Ann Date (m/y)
20EX0008US	US	AMD A10-8700P	No	AMD R6 M340DX 2GB	4GBx1	14" HD (1366x768)	None	500GB 5400rpm	None	BCM43162 ac, 1x1 + BT4.0	None	None	Black	PC/ABS	720p	Non-backlit	None	FW TPM 2.0	6-cell (47Wh)	65W	Win10 DG Win7 Pro 64	1-year, Depot	11/15
20EX0009US	US	AMD A10-8700P	No	AMD R6 M340DX 2GB	8GBx1	14" HD (1366x768)	None	192GB SSD	None	BCM43162 ac, 1x1 + BT4.0	None	None	Black	PC/ABS	720p	Non-backlit	None	FW TPM 2.0	6-cell (47Wh)	65W	Win10 Pro 64	1-year, Depot	11/15
20EX000AUS	US	AMD A10-8700P	No	AMD R6 M340DX 2GB	4GBx1	14" HD (1366x768)	None	500GB 5400rpm	None	BCM43162 ac, 1x1 + BT4.0	None	None	Black	PC/ABS	720p	Non-backlit	None	FW TPM 2.0	6-cell (47Wh)	65W	Win10 Pro 64	1-year, Depot	11/15
20EX000BUS	US	AMD A10-8700P	No	AMD R6 M340DX 2GB	8GBx1	14" HD (1366x768)	None	500GB 5400rpm	None	BCM43162 ac, 1x1 + BT4.0	None	None	Black	PC/ABS	720p	Non-backlit	None	FW TPM 2.0	6-cell (47Wh)	65W	Win10 DG Win7 Pro 64	1-year, Depot	11/15
20EX000CUS	US	AMD A6-8500P	No	AMD R5 Graphics	4GBx1	14" HD (1366x768)	None	500GB 5400rpm	None	BCM43162 ac, 1x1 + BT4.0	None	None	Black	PC/ABS	720p	Non-backlit	None	dTPM 1.2	6-cell (47Wh)	45W	Win10 DG Win7 Pro 64	1-year, Depot	11/15
20EX000DUS	US	AMD A10-8700P	No	AMD R6 M340DX 2GB	8GBx1	14" HD (1366x768)	None	500GB 5400rpm	None	BCM43162 ac, 1x1 + BT4.0	None	None	Black	PC/ABS	720p	Non-backlit	None	FW TPM 2.0	6-cell (47Wh)	65W	Win10 Pro 64	1-year, Depot	11/15
20EX000EUS	US	AMD A10-8700P	No	AMD R6 M340DX 2GB	8GBx1	14" HD (1366x768)	None	192GB SSD	None	BCM43162 ac, 1x1 + BT4.0	None	None	Black	PC/ABS	720p	Non-backlit	None	FW TPM 2.0	6-cell (47Wh)	65W	Win10 DG Win7 Pro 64	1-year, Depot	11/15
20EX001JUS	US	AMD A10-8700P	No	AMD R6 M340DX 2GB	4GBx1	14" FHD (1920x1080) IPS	None	500GB 5400rpm	None	QCA435 ac, 1x1 + BT4.0	None	None	Black	Aluminum	720p	Non-backlit	None	FW TPM 2.0	6-cell (47Wh)	65W	Win10 Pro 64	1-year, Depot	06/16
20EX001KUS	US	AMD A10-8700P	No	AMD R6 M340DX 2GB	8GBx1	14" FHD (1920x1080) IPS	None	192GB SSD	None	QCA435 ac, 1x1 + BT4.0	None	None	Black	Aluminum	720p	Non-backlit	None	FW TPM 2.0	6-cell (47Wh)	65W	Win10 Pro 64	1-year, Depot	06/16
20EX001LUS	US	AMD A6-8500P	No	AMD R5 Graphics	4GBx1	14" HD (1366x768)	None	500GB 5400rpm	None	QCA435 ac, 1x1 + BT4.0	None	None	Black	PC/ABS	720p	Non-backlit	None	dTPM 1.2	6-cell (47Wh)	45W	Win10 DG Win7 Pro 64	1-year, Depot	06/16
20EX001MUS	US	AMD A10-8700P	No	AMD R6 M340DX 2GB	8GBx1	14" HD (1366x768)	None	192GB SSD	None	QCA435 ac, 1x1 + BT4.0	None	None	Black	PC/ABS	720p	Non-backlit	None	FW TPM 2.0	6-cell (47Wh)	65W	Win10 DG Win7 Pro 64	1-year, Depot	06/16
20EX001NUS	US	AMD A6-8500P	No	AMD R5 Graphics	4GBx1	14" HD (1366x768)	None	500GB 5400rpm	None	QCA435 ac, 1x1 + BT4.0	None	None	Black	PC/ABS	720p	Non-backlit	None	dTPM1.2 + FW TPM2.0	6-cell (47Wh)	45W	Win10 Pro 64	1-year, Depot	06/16
20EX001PUS	US	AMD A10-8700P	No	AMD R6 M340DX 2GB	8GBx1	14" HD (1366x768)	None	500GB 5400rpm	None	QCA435 ac, 1x1 + BT4.0	None	None	Black	PC/ABS	720p	Non-backlit	None	FW TPM 2.0	6-cell (47Wh)	65W	Win10 DG Win7 Pro 64	1-year, Depot	06/16
20EX001QUS	US	AMD A10-8700P	No	AMD R6 M340DX 2GB	8GBx1	14" FHD (1920x1080) IPS	None	500GB 5400rpm	None	QCA435 ac, 1x1 + BT4.0	None	None	Black	Aluminum	720p	Non-backlit	None	FW TPM 2.0	6-cell (47Wh)	65W	Win10 Pro 64	1-year, Depot	06/16
20EX001RUS	US	AMD A10-8700P	No	AMD R6 M340DX 2GB	4GBx1	14" HD (1366x768)	None	500GB 5400rpm	None	QCA435 ac, 1x1 + BT4.0	None	None	Black	PC/ABS	720p	Non-backlit	None	FW TPM 2.0	6-cell (47Wh)	65W	Win10 DG Win7 Pro 64	1-year, Depot	06/16

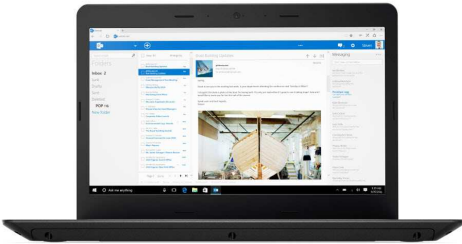

# ThinkPad E470 Platform Specifications

Product Specifications Reference (PSREF)

Processor	7th Generation Intel® Core™ i3 / i5 / i7 Processor								Dimensions <i>Aluminum (WxDxH):</i> 13.35" x 9.53" x 0.88"; 339mm x 242mm x 22.4mm <i>PC/ABS (WxDxH):</i> 13.35" x 9.53" x 0.93"; 339mm x 242mm x 23.7mm
	Processor Number	# of Cores	# of Threads	Base Frequency	Max Turbo Frequency	Cache	Memory Controller	Processor Graphics	
	i3-6100U	2	4	2.3 GHz	-	3MB	DDR4-2133	Intel HD Graphics 520	
	i5-6200U			2.3 GHz	2.8 GHz	3MB			
	i7-6500U			2.5 GHz	3.1 GHz	4MB			
	i3-7100U			2.4 GHz	-	3MB			
	i5-7200U			2.5 GHz	3.1 GHz	3MB	DDR4-2133	Intel HD Graphics 620	
	i7-7500U			2.7 GHz	3.5 GHz	4MB			

Weight	From 4.12 lb (1.87kg)
Case color	Black, Silver, Gold (in EMEA only black color available)
Case material	<i>Aluminum:</i> Aluminum display cover <i>PC/ABS:</i> PolyCarbonate/Acrylonitrile-Butadiene-Styrene display cover
Camera	<i>Some:</i> HD720p resolution, fixed focus
Audio support	HD Audio, Conexant® CX11852 codec, Dolby® Audio™ Premium / stereo speakers, 2W x 2 / dual array microphone, combo audio / microphone jack

Graphics	Intel HD Graphics in processor only, or NVidia GeForce 920MX Graphics, 2GB DDR3 memory, or NVidia GeForce 940MX Graphics, 2GB DDR3 memory, digital monitor support via HDMI™ (supporting HDCP to output protected content); supports dual independent displays; Max resolution: 1920x1080 (HDMI)@60Hz	Keyboard	6-row, spill-resistant, multimedia Fn keys
Memory	32GB max / 2133MHz DDR4, non-parity, dual-channel capable, two 260-pin SO-DIMM sockets * System clocks down for processors with lower memory controller	UltraNav™	TrackPoint® pointing device and multi-touch with 3+2 buttons click pad
		ThinkLight™	None
Display	Some: 14.0" (355mm) HD (1366x768), anti-glare, LED backlight, 220 nits, 16:9 aspect ratio, 400:1 contrast ratio Some: 14.0" (355mm) FHD (1920x1080), anti-glare, LED backlight, IPS, 250 nits, 16:9 aspect ratio, 400:1 contrast ratio Some: 14.0" (355mm) FHD (1920x1080), anti-glare, LED backlight, 220 nits, 16:9 aspect ratio, 400:1 contrast ratio	Fingerprint reader	<i>Some:</i> Fingerprint reader on the keyboard bezel, swipe sensor
		NFC	None
Multi-touch	None	Security	Power-on password, hard disk password, supervisor password, security keyhole
		Security chip	<i>fTPM2.0:</i> Firmware TPM 2.0, integrated in chipset <i>dTPM2.0:</i> Discrete TPM 2.0, TCG Certified
Storage	<i>Some:</i> SSD / SATA 6.0Gb/s, 2.5" wide, 7mm high, removable, upgradable <i>Some:</i> HDD / SATA 6.0Gb/s, 2.5" wide, removable, upgradable, Active Protection System™	vPro	No
M.2 SSD	None	Battery type	Li-Polymer 3-cell (45Wh)
Optical	None	Battery life	3-cell (45Wh): up to 8.4 hr
Ethernet	Gigabit Ethernet Connection, Realtek R8111GUS	AC adapter	<i>Some:</i> 45-watt AC adapter <i>Some:</i> 65-watt AC adapter <i>Some:</i> 90-watt AC adapter
		Preload	<i>Some:</i> Windows 10 Pro 64 <i>Some:</i> Windows 10 Home 64 • Lenovo Companion • Lenovo Settings • Microsoft Office preloaded; purchase a product key to activate • McAfee® Live Safe (30-day trial)
WLAN	<i>One of the following, configurable by model:</i> • Intel Dual Band Wireless-AC 8265, 2x2, Wi-Fi + BT combo adapter, M.2 Card • QCA, Qualcomm 344A-AC, 2x2, Wi-Fi + Bluetooth combo adapter, M.2 Card • QCA, Qualcomm 435-AC, 1x1, Wi-Fi + Bluetooth combo adapter, M.2 Card	Limited warranty	<b>1-year</b> - depot repair service / service upgrades available
Bluetooth™	Bluetooth wireless, integrated in Wi-Fi + Bluetooth combo adapter	Mil-Spec test	None
WWAN	None	Environment	EPEAT™ Gold; ENERGY STAR®; RoHS-compliant
SIM card	None		
Smart Card Reader	None		
ExpressCard	None		
Dock	None		
Multicard Reader	4-in-1 reader (MMC, SD, SDHC, SDXC)		
Ports	Two USB 3.0 (one Always On), one USB 2.0, HDMI, Ethernet (RJ-45), combo audio / microphone jack		
Monitor cable	None		

Model	Region	Processor	vPro	Graphics	Memory	Display	Multi-touch	Storage	Optical	WLAN + Bluetooth	WWAN	SIM Card	Color	Case Material	Camera	Keyboard	Fingerprint Reader	TPM	Battery	Power Adapter	Operating System	Warranty	Ann Date (m/y)
20H10038US	US	i3-7100U	No	Intel HD 620	4GBx1	14" HD (1366x768)	None	500GB 7200rpm	None	11ac, 1x1 + BT4.1	None	None	Black	PC/ABS	720p	Non-backlit	Fingerprint Reader	dTPM 2.0	3-cell (45Wh)	45W	Win10 Pro 64	1-year, Depot	09/16
20H10039US	US	i5-7200U	No	Intel HD 620	4GBx1	14" HD (1366x768)	None	500GB 7200rpm	None	11ac, 1x1 + BT4.1	None	None	Black	PC/ABS	720p	Non-backlit	Fingerprint Reader	dTPM 2.0	3-cell (45Wh)	45W	Win10 Pro 64	1-year, Depot	09/16
20H1003AUS	US	i5-7200U	No	Intel HD 620	8GBx1	14" HD (1366x768)	None	256GB SSD Opal2	None	11ac, 1x1 + BT4.1	None	None	Black	PC/ABS	720p	Non-backlit	Fingerprint Reader	dTPM 2.0	3-cell (45Wh)	45W	Win10 Pro 64	1-year, Depot	09/16
20H1003DUS	US	i3-6006U	No	Intel HD 520	4GBx1	14" HD (1366x768)	None	500GB 7200rpm	None	11ac, 1x1 + BT4.1	None	None	Black	PC/ABS	720p	Non-backlit	Fingerprint Reader	dTPM 2.0	3-cell (45Wh)	45W	Win10 Pro 64	1-year, Depot	11/16
20H1004RUS	US	i7-7500U	No	940MX 2GB	8GBx1	14" FHD (1920x1080) IPS	None	500GB 7200rpm	None	Intel 8265 ac, 2x2 + BT4.1	None	None	Black	PC/ABS	720p	Non-backlit	Fingerprint Reader	FW TPM 2.0	3-cell (45Wh)	65W	Win10 Pro 64	1-year, Depot	09/16
20H1004SUS	US	i5-7200U	No	Intel HD 620	8GBx1	14" FHD (1920x1080) IPS	None	256GB SSD Opal2	None	11ac, 1x1 + BT4.1	None	None	Black	PC/ABS	720p	Non-backlit	Fingerprint Reader	dTPM 2.0	3-cell (45Wh)	45W	Win10 Pro 64	1-year, Depot	09/16
20H1004TUS	US	i7-7500U	No	940MX 2GB	8GBx1	14" FHD (1920x1080) IPS	None	256GB SSD Opal2	None	Intel 8265 ac, 2x2 + BT4.1	None	None	Black	PC/ABS	720p	Non-backlit	Fingerprint Reader	FW TPM 2.0	3-cell (45Wh)	65W	Win10 Pro 64	1-year, Depot	09/16
20H10055US	US	i5-7200U	No	Intel HD 620	8GBx1	14" FHD (1920x1080) IPS	None	180GB SSD Opal2	None	11ac, 1x1 + BT4.1	None	None	Black	PC/ABS	720p	Non-backlit	Fingerprint Reader	dTPM 2.0	3-cell (45Wh)	45W	Win10 Pro 64	1-year, Depot	03/17
20H10059US	US	i3-7100U	No	Intel HD 620	4GBx1	14" HD (1366x768)	None	180GB SSD Opal2	None	11ac, 1x1 + BT4.1	None	None	Black	PC/ABS	720p	Non-backlit	Fingerprint Reader	dTPM 2.0	3-cell (45Wh)	45W	Win10 Pro 64	1-year, Depot	01/17
20H1005AUS	US	i5-7200U	No	Intel HD 620	4GBx1	14" HD (1366x768)	None	180GB SSD Opal2	None	11ac, 1x1 + BT4.1	None	None	Black	PC/ABS	720p	Non-backlit	Fingerprint Reader	dTPM 2.0	3-cell (45Wh)	45W	Win10 Pro 64	1-year, Depot	01/17
20H1005BUS	US	i5-7200U	No	Intel HD 620	8GBx1	14" HD (1366x768)	None	180GB SSD Opal2	None	11ac, 1x1 + BT4.1	None	None	Black	PC/ABS	720p	Non-backlit	Fingerprint Reader	dTPM 2.0	3-cell (45Wh)	45W	Win10 Pro 64	1-year, Depot	01/17
20H10065US	US	i3-6006U	No	Intel HD 520	4GBx1	14" HD (1366x768)	None	500GB 7200rpm	None	11ac, 1x1 + BT4.1	None	None	Black	PC/ABS	720p	Non-backlit	Fingerprint Reader	dTPM 2.0	3-cell (45Wh)	45W	Win10 DG Win7 Pro 64	1-year, Depot	03/17
20H10066US	US	i7-6500U	No	940MX 2GB	8GBx1	14" FHD (1920x1080) IPS	None	256GB SSD Opal2	None	Intel 8265 ac, 2x2 + BT4.1	None	None	Black	PC/ABS	720p	Non-backlit	Fingerprint Reader	FW TPM 2.0	3-cell (45Wh)	65W	Win10 DG Win7 Pro 64	1-year, Depot	03/17
20H10067US	US	i5-6200U	No	Intel HD 520	8GBx1	14" FHD (1920x1080) IPS	None	256GB SSD Opal2	None	11ac, 1x1 + BT4.1	None	None	Black	PC/ABS	720p	Non-backlit	Fingerprint Reader	dTPM 2.0	3-cell (45Wh)	45W	Win10 DG Win7 Pro 64	1-year, Depot	03/17
20H10068US	US	i7-6500U	No	940MX 2GB	8GBx1	14" FHD (1920x1080) IPS	None	500GB 7200rpm	None	Intel 8265 ac, 2x2 + BT4.1	None	None	Black	PC/ABS	720p	Non-backlit	Fingerprint Reader	FW TPM 2.0	3-cell (45Wh)	65W	Win10 DG Win7 Pro 64	1-year, Depot	03/17
20H10069US	US	i5-6200U	No	Intel HD 520	4GBx1	14" HD (1366x768)	None	500GB 7200rpm	None	11ac, 1x1 + BT4.1	None	None	Black	PC/ABS	720p	Non-backlit	Fingerprint Reader	dTPM 2.0	3-cell (45Wh)	45W	Win10 DG Win7 Pro 64	1-year, Depot	03/17
20H1006AUS	US	i5-6200U	No	Intel HD 520	8GBx1	14" HD (1366x768)	None	256GB SSD Opal2	None	11ac, 1x1 + BT4.1	None	None	Black	PC/ABS	720p	Non-backlit	Fingerprint Reader	dTPM 2.0	3-cell (45Wh)	45W	Win10 DG Win7 Pro 64	1-year, Depot	03/17
20H1006DUS	US	i5-7200U	No	Intel HD 620	8GBx1	14" FHD (1920x1080) IPS	None	500GB 7200rpm	None	11ac, 1x1 + BT4.1	None	None	Black	PC/ABS	720p	Non-backlit	Fingerprint Reader	dTPM 2.0	3-cell (45Wh)	45W	Win10 Pro 64	1-year, Depot	03/17
20H1006GCA	US	i3-6006U	No	Intel HD 520	4GBx1	14" HD (1366x768)	None	500GB 7200rpm	None	11ac, 1x1 + BT4.1	None	None	Black	PC/ABS	720p	Non-backlit	None	dTPM 2.0	3-cell (45Wh)	45W	Win10 DG Win7 Pro 64	1-year, Depot	03/17
20H1006GCC	US	i3-6006U	No	Intel HD 520	4GBx1	14" HD (1366x768)	None	500GB 7200rpm	None	11ac, 1x1 + BT4.1	None	None	Black	PC/ABS	720p	Non-backlit	None	dTPM 2.0	3-cell (45Wh)	45W	Win10 DG Win7 Pro 64	1-year, Depot	03/17

Model	Region	Processor	vPro	Graphics	Memory	Display	Multi-touch	Storage	Optical	WLAN + Bluetooth	WWAN	SIM Card	Color	Case Material	Camera	Keyboard	Fingerprint Reader	TPM	Battery	Power Adapter	Operating System	Warranty	Ann Date (m/y)
20H1006GUS	US	i3-6006U	No	Intel HD 520	4GBx1	14" HD (1366x768)	None	500GB 7200rpm	None	11ac, 1x1 + BT4.1	None	None	Black	PC/ABS	720p	Non-backlit	None	dTPM 2.0	3-cell (45Wh)	45W	Win10 DG Win7 Pro 64	1-year, Depot	03/17

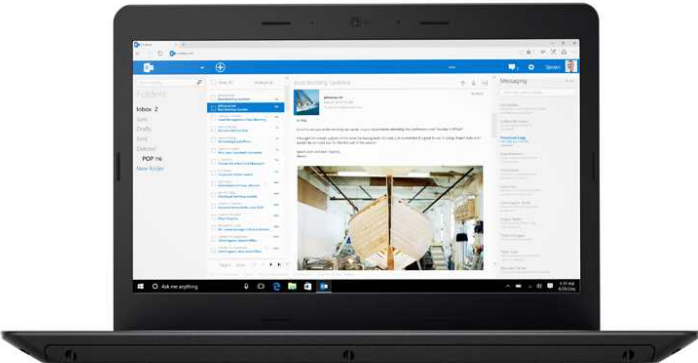

# ThinkPad E475 Platform Specifications

Product Specifications Reference (PSREF)

Processor	AMD Accelerated Processor A6, or A10 APU								Dimensions Weight Case color Case material	<i>PC/ABS (WxDxH):</i> 13.35" x 9.53" x 0.93"; 339mm x 242mm x 23.7mm From 4.12 lb (1.87kg) Black <i>PC/ABS:</i> PolyCarbonate/Acrylonitrile-Butadiene-Styrene display cover
	Processor Number	# of Cores	# of Threads	Base Frequency	Max Turbo Frequency	Cache	Memory Types	Processor Graphics		
	A6-9500B	2	4	2.3 GHz	3.2 GHz	2MB	DDR4-1866	R5 Graphics		
A10-9600P	4	8	2.4 GHz	3.3 GHz	2MB					
Graphics	AMD Radeon™ R5 Graphics in processor only, or AMD Radeon R5 M430 Graphics, 2GB DDR3 memory, or digital monitor support via HDMI™ (supporting HDCP to output protected content); supports dual independent displays; Max resolution: 1920x1080 (HDMI)@60Hz								Camera	HD720p resolution, fixed focus
Chipset	AMD SoC (System on Chip) platform								Audio support	HD Audio, Conexant® CX11852 codec, Dolby® Audio™ Premium / stereo speakers, 2W x 2 / dual array microphone, combo audio / microphone jack
Memory	32GB max / 2133MHz DDR4, non-parity, dual-channel capable, two 260-pin SO-DIMM sockets *System automatically clocks down with 1866MHz DDR4 memory controller								Keyboard	6-row, spill-resistant, multimedia Fn keys
Display	Some: 14.0" (355mm) HD (1366x768), anti-glare, LED backlight, 220 nits, 16:9 aspect ratio, 400:1 contrast ratio								UltraNav™	TrackPoint® pointing device and multi-touch with 3+2 buttons click pad
Multi-touch	None								ThinkLight™	None
Storage	Some: SSD / SATA 6.0Gb/s, 2.5" wide, 7mm high, removable, upgradable Some: HDD / SATA 6.0Gb/s, 2.5" wide, removable, upgradable, Active Protection System™								Fingerprint reader	None
M.2 SSD	None								NFC	None
Optical	None								Security	Power-on password, hard disk password, supervisor password, security keyhole
Ethernet	Gigabit Ethernet Connection, Realtek R8111GUS								Security chip	<i>FW TPM2.0:</i> Firmware TPM 2.0, integrated in chipset <i>dTPM2.0:</i> Discrete TPM 2.0, TCG Certified
WLAN	One of the following, configurable by model: • QCA, Qualcomm 344A-AC, 2x2, Wi-Fi + Bluetooth combo adapter, M.2 Card • QCA, Qualcomm 435-AC, 1x1, Wi-Fi + Bluetooth combo adapter, M.2 Card Bluetooth wireless, integrated in Wi-Fi + Bluetooth combo adapter								vPro	No
Bluetooth™	Bluetooth wireless, integrated in Wi-Fi + Bluetooth combo adapter								Battery type	Li-Polymer 3-cell (45Wh)
WWAN	None								Battery life	3-cell (45Wh): up to 6.5 hr
SIM card	None								AC adapter	Some: 45-watt AC adapter Some: 65-watt AC adapter
Smart Card Reader	None								Preload	Some: Windows 10 Pro 64 Some: Windows 10 Home 64 • Lenovo Companion • Lenovo Settings • Microsoft Office preloaded; purchase a product key to activate • McAfee® Live Safe (30-day trial)
ExpressCard	None								Limited warranty	1-year - depot repair service / service upgrades available
Dock	None								Mil-Spec test	None
Multicard Reader	4-in-1 reader (MMC, SD, SDHC, SDXC)								Environment	EPEAT™ Gold; ENERGY STAR®; RoHS-compliant
Ports	Two USB 3.0 (one Always On), one USB 2.0, HDMI, Ethernet (RJ-45), combo audio / microphone jack									
Monitor cable	None									



## ThinkPad E475 - TopSeller - 20H4

Product Specifications Reference (PSREF)

Model	Region	Processor	vPro	Graphics	Memory	Display	Multi-touch	Storage(HDD/SSD)	Optical	WLAN + Bluetooth	WWAN	SIM Card	Color	Case Material	Camera	Keyboard	Fingerprint Reader	TPM	Battery	Power Adapter	Operating System	Warranty	Ann Date (m/y)
20H40006US	US	AMD A6-9500B	No	AMD R5 Graphics	4GBx1	14" HD (1366x768)	None	500GB 7200rpm	None	QCA435 ac, 1x1 + BT4.1	None	None	Black	PC/ABS	720p	Non-backlit	None	dTPM 2.0	3-cell (45Wh)	45W	Windows 10 Pro 64	1-year, Depot	11/16
20H40007US	US	AMD A10-9600P	No	AMD R5 M430 2GB	8GBx1	14" HD (1366x768)	None	500GB 7200rpm	None	QCA435 ac, 1x1 + BT4.1	None	None	Black	PC/ABS	720p	Non-backlit	None	FW TPM 2.0	3-cell (45Wh)	65W	Windows 10 Pro 64	1-year, Depot	11/16
20H40008US	US	AMD A10-9600P	No	AMD R5 M430 2GB	4GBx1	14" HD (1366x768)	None	500GB 7200rpm	None	QCA435 ac, 1x1 + BT4.1	None	None	Black	PC/ABS	720p	Non-backlit	None	FW TPM 2.0	3-cell (45Wh)	65W	Windows 10 Pro 64	1-year, Depot	11/16
20H40009US	US	AMD A6-9500B	No	AMD R5 Graphics	8GBx1	14" HD (1366x768)	None	500GB 7200rpm	None	QCA435 ac, 1x1 + BT4.1	None	None	Black	PC/ABS	720p	Non-backlit	None	dTPM 2.0	3-cell (45Wh)	45W	Windows 10 Pro 64	1-year, Depot	11/16
20H4000AUS	US	AMD A10-9600P	No	AMD R5 M430 2GB	8GBx1	14" HD (1366x768)	None	256GB SSD Opal2	None	QCA435 ac, 1x1 + BT4.1	None	None	Black	PC/ABS	720p	Non-backlit	None	FW TPM 2.0	3-cell (45Wh)	65W	Windows 10 Pro 64	1-year, Depot	11/16
20H4000DUS	US	AMD A10-9600P	No	AMD R5 M430 2GB	8GBx1	14" HD (1366x768)	None	180GB SSD Opal2	None	QCA435 ac, 1x1 + BT4.1	None	None	Black	PC/ABS	720p	Non-backlit	None	FW TPM 2.0	3-cell (45Wh)	65W	Windows 10 Pro 64	1-year, Depot	01/17



# ThinkPad E560 Platform Specifications

Product Specifications Reference (PSREF)

Processor	6th Generation Intel® Core™ i3 / i5 / i7 Processor and Celeron Processor								Smart Card Reader ExpressCard Multicard Reader Ports Monitor cable Camera Audio support Keyboard UltraNav™ ThinkLight™ Security Security chip vPro Fingerprint reader NFC Battery type Battery life AC adapter Preload Limited warranty Mil-Spec test Environment	None None 4-in-1 reader (MMC, SD, SDHC, SDXC) Three USB 3.0 (one Always On), VGA, HDMI, Ethernet (RJ-45), Lenovo OneLink connector, combo audio/microphone jack None <i>Some:</i> HD720p resolution, fixed focus <i>Some:</i> 3D camera, Intel RealSense™ 3D Camera with MIC HD Audio, Conexant® CX11852 codec, Dolby® Advanced Audio™ / stereo speakers or JBL speakers, 2W x 2 / dual array microphone, combo audio / microphone jack 6-row, spill-resistant, multimedia Fn keys, numeric keypad TrackPoint® pointing device and multi-touch with 3+2 buttons click pad None Power-on password, hard disk password, supervisor password, security keyhole <i>TPM2.0 :</i> Trusted Platform Module, TPM2.0 FW (firmware) <i>TPM1.2:</i> Trusted Platform Module, TCG 1.2-compliant <i>TPM :</i> TPM2.0 and TPM1.2 None <i>Some:</i> Fingerprint reader on the keyboard bezel, swipe sensor None Li-Ion 6-cell (48Wh) 6-cell (48Wh): up to 9.0 hr <i>Some:</i> 45-watt AC adapter (Integrated Graphics) <i>Some:</i> 65-watt AC adapter (Discrete Graphics) <i>Some:</i> No operating system <i>Some:</i> Windows® 7 Professional 64 preinstalled through downgrade rights in Windows 10 Pro 64 • Lenovo Solution Center • Lenovo SHAREit • ThinkVantage Product Recovery • Rescue and Recovery™ • ThinkVantage System Update • PC Device Stage • Adobe® Reader® • Microsoft® Office preloaded; purchase a product key to activate • McAfee® Live Safe (30-day trial) <i>Some:</i> Windows 10 Pro 64 <i>Some:</i> Windows 10 Home 64 • Lenovo Solution Center • Lenovo REACHit • Lenovo SHAREit • Lenovo Companion • Lenovo Settings • ThinkVantage System Update • Microsoft Office preloaded; purchase a product key to activate • McAfee® Live Safe (30-day trial) <b>1-year</b> - depot repair service / service upgrades available None EPEAT™ Gold; ENERGY STAR®; RoHS-compliant
	Processor Number	# of Cores	# of Threads	Base Frequency	Max Turbo Frequency	Cache	Memory Types	Processor Graphics		
	Cel 3855U	2	2	1.6 GHz	-	2MB	DDR3L-1600	Intel HD Graphics 510		
	i3-6100U	2	4	2.3 GHz	-	3MB		Intel HD Graphics 520		
	i5-6200U			2.3 GHz	2.8 GHz	3MB				
i7-6500U	2.5 GHz			3.1 GHz	4MB					
Graphics	Intel HD Graphics in processor only, or AMD Radeon R7 M370 Graphics, 2GB GDDR5 memory, external analog monitor support via VGA DB-15 connector and digital monitor support via HDMI™ (supporting HDCP to output protected content); supports dual independent displays; Max resolution: 1920x1080 (HDMI)@60Hz									
Chipset Memory	Intel SoC (System on Chip) platform 16GB max / PC3-12800 1600MHz DDR3L, non-parity, dual-channel capable, two 204-pin SO-DIMM sockets									
Display	<i>Some:</i> 15.6" (396mm) HD (1366x768) color, anti-glare, LED backlight, 220 nits, 16:9 aspect ratio <i>Some:</i> 15.6" (396mm) FHD (1920x1080) color, anti-glare, LED backlight, IPS, 250 nits, 16:9 aspect ratio									
Multi-touch	None									
Storage	<i>Some:</i> SSD / SATA 6.0Gb/s, 2.5" wide, 7mm high, removable, upgradable <i>Some:</i> HDD / SATA 6.0Gb/s, 2.5" wide, removable, upgradable, Active Protection System™ <i>Some:</i> SSHD with 8GB NAND flash memory <i>Some:</i> DVD burner, 9.0mm high, removable <i>Some:</i> Blank Bezel									
Optical	None									
M.2 SSD	None									
Ethernet Bluetooth™	Gigabit Ethernet Connection Bluetooth wireless, integrated in Wi-Fi + Bluetooth combo adapter									
WLAN	<i>One of the following, configurable by model:</i> • Intel Dual Band Wireless-AC 3165, 1x1, Wi-Fi + BT combo adapter, M.2 Card • Intel Dual Band Wireless-AC 8260, 2x2, Wi-Fi + BT combo adapter, M.2 Card • BCM, Broadcom Wireless-AC, 1x1, Wi-Fi + Bluetooth combo adapter, M.2 Card • QCA, Qualcomm Wireless-AC, 2x2, Wi-Fi + Bluetooth combo adapter, M.2 Card									
WWAN	None									
SIM card	None									
Dimensions Weight Case color Case material	<i>All (WxDxH):</i> 14.84" x 10.04" x 1.07"; 377mm x 255mm x 27.1mm From 5.39 lb (2.45kg) Graphite Black PolyCarbonate/Acrylonitrile-Butadiene-Styrene (PC/ABS) plastic display cover									

Model	Region	Processor	vPro	Graphics	Memory	Display	Multi-touch	Storage(HDD/SSD)	Optical	WLAN + Bluetooth	WWAN	SIM Card	Color	Case Material	Camera	Keyboard	Fingerprint Reader	TPM	Battery	Power Adapter	Operating System	Warranty	Ann Date (m/y)
20EV0027US	US	i7-6500U	No	AMD R7 M370 2GB	8GBx1	15.6" FHD (1920x1080) IPS	None	192GB SSD	DVD±RW	Intel 8260 ac, 2x2 + BT4.0	None	None	Black	PC/ABS	3D Camera	Non-backlit	Fingerprint Reader	FW TPM 2.0	6-cell (48Wh)	65W	Win10 Pro 64	1-year, Depot	11/15
20EV002DUS	US	i3-6100U	No	Intel HD 520	4GBx1	15.6" HD (1366x768)	None	500GB 7200rpm	DVD±RW	Intel 3165 ac, 1x1 + BT4.0	None	None	Black	PC/ABS	720p	Non-backlit	Fingerprint Reader	dTPM 1.2	6-cell (48Wh)	45W	Win10 DG Win7 Pro 64	1-year, Depot	11/15
20EV002EUS	US	i3-6100U	No	Intel HD 520	4GBx1	15.6" HD (1366x768)	None	192GB SSD	DVD±RW	Intel 3165 ac, 1x1 + BT4.0	None	None	Black	PC/ABS	720p	Non-backlit	Fingerprint Reader	dTPM 1.2	6-cell (48Wh)	45W	Win10 DG Win7 Pro 64	1-year, Depot	11/15
20EV002FUS	US	i5-6200U	No	Intel HD 520	4GBx1	15.6" HD (1366x768)	None	500GB 7200rpm	DVD±RW	Intel 3165 ac, 1x1 + BT4.0	None	None	Black	PC/ABS	720p	Non-backlit	Fingerprint Reader	dTPM 1.2	6-cell (48Wh)	45W	Win10 DG Win7 Pro 64	1-year, Depot	11/15
20EV002GUS	US	i5-6200U	No	Intel HD 520	4GBx1	15.6" HD (1366x768)	None	192GB SSD	DVD±RW	Intel 3165 ac, 1x1 + BT4.0	None	None	Black	PC/ABS	720p	Non-backlit	Fingerprint Reader	dTPM 1.2	6-cell (48Wh)	45W	Win10 DG Win7 Pro 64	1-year, Depot	11/15
20EV002HUS	US	i5-6200U	No	Intel HD 520	8GBx1	15.6" HD (1366x768)	None	192GB SSD	DVD±RW	Intel 3165 ac, 1x1 + BT4.0	None	None	Black	PC/ABS	720p	Non-backlit	Fingerprint Reader	dTPM 1.2	6-cell (48Wh)	45W	Win10 DG Win7 Pro 64	1-year, Depot	11/15
20EV002JUS	US	i7-6500U	No	AMD R7 M370 2GB	8GBx1	15.6" FHD (1920x1080) IPS	None	500GB 7200rpm	DVD±RW	Intel 8260 ac, 2x2 + BT4.0	None	None	Black	PC/ABS	720p	Non-backlit	Fingerprint Reader	FW TPM 2.0	6-cell (48Wh)	65W	Win10 DG Win7 Pro 64	1-year, Depot	11/15
20EV002KUS	US	i7-6500U	No	AMD R7 M370 2GB	8GBx1	15.6" FHD (1920x1080) IPS	None	192GB SSD	DVD±RW	Intel 8260 ac, 2x2 + BT4.0	None	None	Black	PC/ABS	720p	Non-backlit	Fingerprint Reader	FW TPM 2.0	6-cell (48Wh)	65W	Win10 DG Win7 Pro 64	1-year, Depot	11/15
20EV002LLUS	US	i3-6100U	No	Intel HD 520	4GBx1	15.6" HD (1366x768)	None	500GB 7200rpm	DVD±RW	Intel 3165 ac, 1x1 + BT4.0	None	None	Black	PC/ABS	720p	Non-backlit	Fingerprint Reader	dTPM1.2 + FW TPM2.0	6-cell (48Wh)	45W	Win10 Pro 64	1-year, Depot	11/15
20EV002MUS	US	i3-6100U	No	Intel HD 520	4GBx1	15.6" HD (1366x768)	None	192GB SSD	DVD±RW	Intel 3165 ac, 1x1 + BT4.0	None	None	Black	PC/ABS	720p	Non-backlit	Fingerprint Reader	dTPM1.2 + FW TPM2.0	6-cell (48Wh)	45W	Win10 Pro 64	1-year, Depot	11/15
20EV002NUS	US	i5-6200U	No	Intel HD 520	4GBx1	15.6" HD (1366x768)	None	500GB 7200rpm	DVD±RW	Intel 3165 ac, 1x1 + BT4.0	None	None	Black	PC/ABS	720p	Non-backlit	Fingerprint Reader	dTPM1.2 + FW TPM2.0	6-cell (48Wh)	45W	Win10 Pro 64	1-year, Depot	11/15
20EV002PUS	US	i5-6200U	No	Intel HD 520	4GBx1	15.6" HD (1366x768)	None	192GB SSD	DVD±RW	Intel 3165 ac, 1x1 + BT4.0	None	None	Black	PC/ABS	720p	Non-backlit	Fingerprint Reader	dTPM1.2 + FW TPM2.0	6-cell (48Wh)	45W	Win10 Pro 64	1-year, Depot	11/15
20EV002QUS	US	i5-6200U	No	Intel HD 520	8GBx1	15.6" HD (1366x768)	None	192GB SSD	DVD±RW	Intel 3165 ac, 1x1 + BT4.0	None	None	Black	PC/ABS	720p	Non-backlit	Fingerprint Reader	dTPM1.2 + FW TPM2.0	6-cell (48Wh)	45W	Win10 Pro 64	1-year, Depot	11/15
20EV002RUS	US	i7-6500U	No	AMD R7 M370 2GB	8GBx1	15.6" FHD (1920x1080) IPS	None	500GB 7200rpm	DVD±RW	Intel 8260 ac, 2x2 + BT4.0	None	None	Black	PC/ABS	720p	Non-backlit	Fingerprint Reader	FW TPM 2.0	6-cell (48Wh)	65W	Win10 Pro 64	1-year, Depot	11/15
20EV002SUS	US	i7-6500U	No	AMD R7 M370 2GB	8GBx1	15.6" FHD (1920x1080) IPS	None	192GB SSD	DVD±RW	Intel 8260 ac, 2x2 + BT4.0	None	None	Black	PC/ABS	720p	Non-backlit	Fingerprint Reader	FW TPM 2.0	6-cell (48Wh)	65W	Win10 Pro 64	1-year, Depot	11/15
20EV003EUS	US	i7-6500U	No	AMD R7 M370 2GB	8GBx1	15.6" FHD (1920x1080) IPS	None	256GB SSD Opal2	DVD±RW	Intel 8260 ac, 2x2 + BT4.0	None	None	Black	PC/ABS	720p	Non-backlit	Fingerprint Reader	FW TPM 2.0	6-cell (48Wh)	65W	Win10 Pro 64	1-year, Depot	04/16
20EV003FUS	US	i7-6500U	No	AMD R7 M370 2GB	8GBx1	15.6" FHD (1920x1080) IPS	None	256GB SSD Opal2	DVD±RW	Intel 8260 ac, 2x2 + BT4.0	None	None	Black	PC/ABS	720p	Non-backlit	Fingerprint Reader	FW TPM 2.0	6-cell (48Wh)	65W	Win10 DG Win7 Pro 64	1-year, Depot	04/16
20EV003VUS	US	i5-6200U	No	Intel HD 520	4GBx1	15.6" HD (1366x768)	None	256GB SSD Opal2	DVD±RW	Intel 8260 ac, 2x2 + BT4.0	None	None	Black	PC/ABS	720p	Non-backlit	Fingerprint Reader	dTPM 1.2	6-cell (48Wh)	45W	Win10 DG Win7 Pro 64	1-year, Depot	09/16
20EV003WUS	US	i5-6200U	No	Intel HD 520	8GBx1	15.6" FHD (1920x1080) IPS	None	256GB SSD Opal2	DVD±RW	Intel 8260 ac, 2x2 + BT4.0	None	None	Black	PC/ABS	720p	Non-backlit	Fingerprint Reader	dTPM 1.2	6-cell (48Wh)	45W	Win10 DG Win7 Pro 64	1-year, Depot	09/16
20EV0043US	US	i5-6200U	No	Intel HD 520	8GBx1	15.6" FHD (1920x1080) IPS	None	500GB 7200rpm	DVD±RW	Intel 3165 ac, 1x1 + BT4.0	None	None	Black	PC/ABS	720p	Non-backlit	Fingerprint Reader	dTPM1.2 + FW TPM2.0	6-cell (48Wh)	45W	Win10 Pro 64	1-year, Depot	11/16

Model	Region	Processor	vPro	Graphics	Memory	Display	Multi-touch	Storage(HDD/SSD)	Optical	WLAN + Bluetooth	WWAN	SIM Card	Color	Case Material	Camera	Keyboard	Fingerprint Reader	TPM	Battery	Power Adapter	Operating System	Warranty	Ann Date (m/y)
20EVA05UUS	US	i5-6200U	No	Intel HD 520	8GBx1	15.6" HD (1366x768)	None	500GB 7200rpm	DVD±RW	Intel 3165 ac, 1x1 + BT4.0	None	None	Black	PC/ABS	720p	Non-backlit	Fingerprint Reader	dTPM1.2 + FW TPM2.0	6-cell (48Wh)	45W	Win10 Pro 64	1-year, Depot	10/16





# ThinkPad E565 Platform Specifications

Product Specifications Reference (PSREF)

Processor	AMD Accelerated Processor A6, A8, A10, or FX APU								Smart Card Reader	None	
	Processor Number	# of Cores	# of Threads	Clock Speed	Max Turbo Frequency	Cache	Memory Types	Graphics	ExpressCard	None	
	A6-8500P	2	6	1.6 GHz	3.0 GHz	1MB	DDR3L-1600	R5 Graphics	Multicard Reader	4-in-1 reader (MMC, SD, SDHC, SDXC)	
	A8-8600P	4	10	1.6 GHz	3.0 GHz	2MB		R6 Graphics	Ports	Three USB 3.0 (one Always On), VGA, HDMI, Ethernet (RJ-45), Lenovo OneLink connector, combo audio/microphone jack	
	A8-8600P	4	10	1.6 GHz	3.0 GHz	2MB		R6 M335DX (R6+R5 M330)	Monitor cable	None	
	A10-8700P	4	10	1.8 GHz	3.2 GHz	2MB		R6 M340DX (R6+R5 M330)	Camera	HD720p resolution, fixed focus	
FX-8800P	4	12	2.1 GHz	3.4 GHz	2MB	R8 M350DX (R7+R5 M330)		Audio support	HD Audio, Conexant® CX11852 codec, Dolby® Advanced Audio™ / stereo speakers, 2W x 2 / dual array microphone, combo audio/microphone jack		
Graphics	AMD Radeon™ R5 or R6 Graphics in processor only, or AMD Radeon R5 M330 Graphics, 2GB DDR3 memory, or Dual Graphics support for A8, A10 and FX APU external analog monitor support via VGA DB-15 connector and digital monitor support via HDMI™ (supporting HDCP to output protected content); supports dual independent display								Keyboard	6-row, spill-resistant, multimedia Fn keys, numeric keypad	
Chipset	AMD SoC (System on Chip) platform								UltraNav™	TrackPoint® pointing device and multi-touch with 3+2 buttons click pad	
Memory	16GB max / PC3-12800 1600MHz DDR3L, non-parity, dual-channel capable, two 204-pin SO-DIMM sockets								ThinkLight™	None	
Display	<i>Some:</i> 15.6" (396mm) HD (1366x768) color, anti-glare, LED backlight, 220 nits, 16:9 aspect ratio <i>Some:</i> 15.6" (396mm) FHD (1920x1080) color, anti-glare, LED backlight, IPS, 250 nits, 16:9 aspect ratio								Security	Power-on password, hard disk password, supervisor password, security keyhole	
Multi-touch	None								Security chip	TPM2.0 : Trusted Platform Module, TPM2.0 FW (firmware) TPM1.2: Trusted Platform Module, TCG 1.2-compliant TPM : TPM2.0 and TPM1.2	
Storage	<i>Some:</i> SSD / SATA 6.0Gb/s, 2.5" wide, 7mm high, removable, upgradable <i>Some:</i> HDD / SATA 6.0Gb/s, 2.5" wide, removable, upgradable, Active Protection System™ <i>Some:</i> SSHD with 8GB NAND flash memory								vPro	None	
Optical	<i>Some:</i> DVD burner, 9.0mm high, removable <i>Some:</i> Blank Bezel								Fingerprint reader	<i>Some:</i> Fingerprint reader on the keyboard bezel, swipe sensor	
M.2 SSD	None								NFC	None	
Ethernet	Gigabit Network Connection								Battery type	Li-Ion 6-cell (48Wh)	
Bluetooth™	Bluetooth wireless, integrated in Wi-Fi + Bluetooth combo adapter								Battery life	Up to 6.5 hr <i>Some:</i> 45-watt AC adapter (Integrated Graphics) <i>Some:</i> 65-watt AC adapter (Discrete Graphics)	
WLAN	<i>One of the following, configurable by model:</i> • BCM, Broadcom Wireless-AC, 1x1, Wi-Fi + Bluetooth combo adapter, M.2 Card • QCA, Qualcomm Wireless-AC, 2x2, Wi-Fi + Bluetooth combo adapter, M.2 Card								AC adapter	<i>Some:</i> 45-watt AC adapter (Integrated Graphics) <i>Some:</i> 65-watt AC adapter (Discrete Graphics)	
WWAN	None								Preload	<i>Some:</i> No operating system <i>Some:</i> Windows® 7 Professional 64 preinstalled through downgrade rights in Windows 10 Pro 64 • Lenovo Solution Center • Lenovo SHAREit • ThinkVantage Product Recovery • Rescue and Recovery™ • ThinkVantage System Update • PC Device Stage • Adobe® Reader® • Microsoft® Office preloaded; purchase a product key to activate • McAfee® Live Safe (30-day trial)	<i>Some:</i> Windows 10 Pro 64 <i>Some:</i> Windows 10 Home 64 • Lenovo Solution Center • Lenovo REACHit • Lenovo SHAREit • Lenovo Companion • Lenovo Settings • ThinkVantage System Update • Microsoft Office preloaded; purchase a product key to activate • McAfee® Live Safe (30-day trial)
SIM card	None								Limited warranty	1-year - depot repair service / service upgrades available	
Dimensions	<i>All (WxDxH):</i> 14.84" x 10.04" x 1.07"; 377mm x 255mm x 27.1mm								Environment	EPEAT™ Gold; ENERGY STAR®; RoHS-compliant	
Weight	From 5.46 lb (2.48kg)										
Case color	Graphite black										
Case material	PolyCarbonate/Acrylonitrile-Butadiene-Styrene (PC/ABS) plastic display cover										

Model	Region	Processor	vPro	Graphics	Memory	Display	Multi-touch	Storage(HDD/SSD)	Optical	WLAN + Bluetooth	WWAN	SIM Card	Color	Case Material	Camera	Keyboard	Fingerprint Reader	TPM	Battery	Power Adapter	Operating System	Warranty	Ann Date (m/y)
20EY0006US	US	AMD A10-8700P	No	AMD R6 M340DX 2GB	8GBx1	15.6" FHD (1920x1080) IPS	None	500GB 5400rpm	DVD±RW	BCM43162 ac, 1x1 + BT4.0	None	None	Black	PC/ABS	720p	Non-backlit	None	FW TPM 2.0	6-cell (48Wh)	65W	Win10 Pro 64	1-year, Depot	11/15
20EY0007US	US	AMD A10-8700P	No	AMD R6 M340DX 2GB	4GBx1	15.6" FHD (1920x1080) IPS	None	192GB SSD	DVD±RW	BCM43162 ac, 1x1 + BT4.0	None	None	Black	PC/ABS	720p	Non-backlit	None	FW TPM 2.0	6-cell (48Wh)	65W	Win10 Pro 64	1-year, Depot	11/15
20EY0008US	US	AMD A6-8500P	No	AMD R5 Graphics	8GBx1	15.6" HD (1366x768)	None	500GB 5400rpm	DVD±RW	BCM43162 ac, 1x1 + BT4.0	None	None	Black	PC/ABS	720p	Non-backlit	None	dTPM 1.2	6-cell (48Wh)	45W	Win10 DG Win7 Pro 64	1-year, Depot	11/15
20EY0009US	US	AMD A10-8700P	No	AMD R6 M340DX 2GB	8GBx1	15.6" HD (1366x768)	None	500GB 5400rpm	DVD±RW	BCM43162 ac, 1x1 + BT4.0	None	None	Black	PC/ABS	720p	Non-backlit	None	FW TPM 2.0	6-cell (48Wh)	65W	Win10 Pro 64	1-year, Depot	11/15
20EY000AUS	US	AMD A6-8500P	No	AMD R5 Graphics	4GBx1	15.6" HD (1366x768)	None	500GB 5400rpm	DVD±RW	BCM43162 ac, 1x1 + BT4.0	None	None	Black	PC/ABS	720p	Non-backlit	None	dTPM 1.2	6-cell (48Wh)	45W	Win10 DG Win7 Pro 64	1-year, Depot	11/15
20EY000BUS	US	AMD A10-8700P	No	AMD R6 M340DX 2GB	8GBx1	15.6" HD (1366x768)	None	500GB 5400rpm	DVD±RW	BCM43162 ac, 1x1 + BT4.0	None	None	Black	PC/ABS	720p	Non-backlit	None	FW TPM 2.0	6-cell (48Wh)	65W	Win10 DG Win7 Pro 64	1-year, Depot	11/15
20EY000CUS	US	AMD A10-8700P	No	AMD R6 M340DX 2GB	4GBx1	15.6" HD (1366x768)	None	500GB 5400rpm	DVD±RW	BCM43162 ac, 1x1 + BT4.0	None	None	Black	PC/ABS	720p	Non-backlit	None	FW TPM 2.0	6-cell (48Wh)	65W	Win10 DG Win7 Pro 64	1-year, Depot	11/15
20EY000DUS	US	AMD A10-8700P	No	AMD R6 M340DX 2GB	8GBx1	15.6" FHD (1920x1080) IPS	None	192GB SSD	DVD±RW	BCM43162 ac, 1x1 + BT4.0	None	None	Black	PC/ABS	720p	Non-backlit	None	FW TPM 2.0	6-cell (48Wh)	65W	Win10 DG Win7 Pro 64	1-year, Depot	11/15
20EY000EUS	US	AMD A10-8700P	No	AMD R6 M340DX 2GB	8GBx1	15.6" FHD (1920x1080) IPS	None	500GB 5400rpm	DVD±RW	BCM43162 ac, 1x1 + BT4.0	None	None	Black	PC/ABS	720p	Non-backlit	None	FW TPM 2.0	6-cell (48Wh)	65W	Win10 DG Win7 Pro 64	1-year, Depot	11/15
20EY000FUS	US	AMD A6-8500P	No	AMD R5 Graphics	8GBx1	15.6" HD (1366x768)	None	500GB 5400rpm	DVD±RW	BCM43162 ac, 1x1 + BT4.0	None	None	Black	PC/ABS	720p	Non-backlit	None	dTPM1.2 + FW TPM2.0	6-cell (48Wh)	45W	Win10 Pro 64	1-year, Depot	11/15
20EY000GUS	US	AMD A10-8700P	No	AMD R6 M340DX 2GB	4GBx1	15.6" FHD (1920x1080) IPS	None	192GB SSD	DVD±RW	BCM43162 ac, 1x1 + BT4.0	None	None	Black	PC/ABS	720p	Non-backlit	None	FW TPM 2.0	6-cell (48Wh)	65W	Win10 DG Win7 Pro 64	1-year, Depot	11/15
20EY000HUS	US	AMD A10-8700P	No	AMD R6 M340DX 2GB	8GBx1	15.6" FHD (1920x1080) IPS	None	192GB SSD	DVD±RW	BCM43162 ac, 1x1 + BT4.0	None	None	Black	PC/ABS	720p	Non-backlit	None	FW TPM 2.0	6-cell (48Wh)	65W	Win10 Pro 64	1-year, Depot	11/15
20EY000JUS	US	AMD A10-8700P	No	AMD R6 M340DX 2GB	4GBx1	15.6" HD (1366x768)	None	500GB 5400rpm	DVD±RW	BCM43162 ac, 1x1 + BT4.0	None	None	Black	PC/ABS	720p	Non-backlit	None	FW TPM 2.0	6-cell (48Wh)	65W	Win10 Pro 64	1-year, Depot	11/15
20EY000KUS	US	AMD A6-8500P	No	AMD R5 Graphics	4GBx1	15.6" HD (1366x768)	None	500GB 5400rpm	DVD±RW	BCM43162 ac, 1x1 + BT4.0	None	None	Black	PC/ABS	720p	Non-backlit	None	dTPM1.2 + FW TPM2.0	6-cell (48Wh)	45W	Win10 Pro 64	1-year, Depot	11/15
20EY001EUS	US	AMD A10-8700P	No	AMD R6 M340DX 2GB	8GBx1	15.6" HD (1366x768)	None	500GB 5400rpm	DVD±RW	QCA435 ac, 1x1 + BT4.0	None	None	Black	PC/ABS	720p	Non-backlit	None	FW TPM 2.0	6-cell (48Wh)	65W	Win10 DG Win7 Pro 64	1-year, Depot	06/16
20EY001FUS	US	AMD A10-8700P	No	AMD R6 M340DX 2GB	8GBx1	15.6" FHD (1920x1080) IPS	None	500GB 5400rpm	DVD±RW	QCA435 ac, 1x1 + BT4.0	None	None	Black	PC/ABS	720p	Non-backlit	None	FW TPM 2.0	6-cell (48Wh)	65W	Win10 DG Win7 Pro 64	1-year, Depot	06/16
20EY001GUS	US	AMD A6-8500P	No	AMD R5 Graphics	4GBx1	15.6" HD (1366x768)	None	500GB 5400rpm	DVD±RW	QCA435 ac, 1x1 + BT4.0	None	None	Black	PC/ABS	720p	Non-backlit	None	dTPM1.2 + FW TPM2.0	6-cell (48Wh)	45W	Win10 Pro 64	1-year, Depot	06/16
20EY001HUS	US	AMD A6-8500P	No	AMD R5 Graphics	8GBx1	15.6" HD (1366x768)	None	500GB 5400rpm	DVD±RW	QCA435 ac, 1x1 + BT4.0	None	None	Black	PC/ABS	720p	Non-backlit	None	dTPM1.2 + FW TPM2.0	6-cell (48Wh)	45W	Win10 Pro 64	1-year, Depot	06/16
20EY001JUS	US	AMD A10-8700P	No	AMD R6 M340DX 2GB	8GBx1	15.6" FHD (1920x1080) IPS	None	192GB SSD	DVD±RW	QCA435 ac, 1x1 + BT4.0	None	None	Black	PC/ABS	720p	Non-backlit	None	FW TPM 2.0	6-cell (48Wh)	65W	Win10 DG Win7 Pro 64	1-year, Depot	06/16
20EY001KUS	US	AMD A10-8700P	No	AMD R6 M340DX 2GB	8GBx1	15.6" FHD (1920x1080) IPS	None	500GB 5400rpm	DVD±RW	QCA435 ac, 1x1 + BT4.0	None	None	Black	PC/ABS	720p	Non-backlit	None	FW TPM 2.0	6-cell (48Wh)	65W	Win10 Pro 64	1-year, Depot	06/16



Model	Region	Processor	vPro	Graphics	Memory	Display	Multi-touch	Storage(HDD/SSD)	Optical	WLAN + Bluetooth	WWAN	SIM Card	Color	Case Material	Camera	Keyboard	Fingerprint Reader	TPM	Battery	Power Adapter	Operating System	Warranty	Ann Date (m/y)
20EY001LUS	US	AMD A10-8700P	No	AMD R6 M340DX 2GB	4GBx1	15.6" FHD (1920x1080) IPS	None	192GB SSD	DVD±RW	QCA435 ac, 1x1 + BT4.0	None	None	Black	PC/ABS	720p	Non-backlit	None	FW TPM 2.0	6-cell (48Wh)	65W	Win10 DG Win7 Pro 64	1-year, Depot	06/16
20EY001MUS	US	AMD A10-8700P	No	AMD R6 M340DX 2GB	4GBx1	15.6" FHD (1920x1080) IPS	None	500GB 5400rpm	DVD±RW	QCA435 ac, 1x1 + BT4.0	None	None	Black	PC/ABS	720p	Non-backlit	None	FW TPM 2.0	6-cell (48Wh)	65W	Win10 DG Win7 Pro 64	1-year, Depot	06/16
20EY001NUS	US	AMD A10-8700P	No	AMD R6 M340DX 2GB	4GBx1	15.6" HD (1366x768)	None	500GB 5400rpm	DVD±RW	QCA435 ac, 1x1 + BT4.0	None	None	Black	PC/ABS	720p	Non-backlit	None	FW TPM 2.0	6-cell (48Wh)	65W	Win10 DG Win7 Pro 64	1-year, Depot	06/16
20EY001PUS	US	AMD A10-8700P	No	AMD R6 M340DX 2GB	8GBx1	15.6" HD (1366x768)	None	500GB 5400rpm	DVD±RW	QCA435 ac, 1x1 + BT4.0	None	None	Black	PC/ABS	720p	Non-backlit	None	FW TPM 2.0	6-cell (48Wh)	65W	Win10 Pro 64	1-year, Depot	06/16
20EY001QUS	US	AMD A10-8700P	No	AMD R6 M340DX 2GB	4GBx1	15.6" HD (1366x768)	None	500GB 5400rpm	DVD±RW	QCA435 ac, 1x1 + BT4.0	None	None	Black	PC/ABS	720p	Non-backlit	None	FW TPM 2.0	6-cell (48Wh)	65W	Win10 Pro 64	1-year, Depot	06/16
20EY001RUS	US	AMD A6-8500P	No	AMD R5 Graphics	8GBx1	15.6" HD (1366x768)	None	500GB 5400rpm	DVD±RW	QCA435 ac, 1x1 + BT4.0	None	None	Black	PC/ABS	720p	Non-backlit	None	dTPM 1.2	6-cell (48Wh)	45W	Win10 DG Win7 Pro 64	1-year, Depot	06/16
20EY001SUS	US	AMD A10-8700P	No	AMD R6 M340DX 2GB	8GBx1	15.6" FHD (1920x1080) IPS	None	192GB SSD	DVD±RW	QCA435 ac, 1x1 + BT4.0	None	None	Black	PC/ABS	720p	Non-backlit	None	FW TPM 2.0	6-cell (48Wh)	65W	Win10 Pro 64	1-year, Depot	06/16
20EY001TUS	US	AMD A10-8700P	No	AMD R6 M340DX 2GB	4GBx1	15.6" FHD (1920x1080) IPS	None	192GB SSD	DVD±RW	QCA435 ac, 1x1 + BT4.0	None	None	Black	PC/ABS	720p	Non-backlit	None	FW TPM 2.0	6-cell (48Wh)	65W	Win10 Pro 64	1-year, Depot	06/16
20EY001UUS	US	AMD A10-8700P	No	AMD R6 M340DX 2GB	4GBx1	15.6" FHD (1920x1080) IPS	None	500GB 5400rpm	DVD±RW	QCA435 ac, 1x1 + BT4.0	None	None	Black	PC/ABS	720p	Non-backlit	None	FW TPM 2.0	6-cell (48Wh)	65W	Win10 Pro 64	1-year, Depot	06/16
20EY001VUS	US	AMD A6-8500P	No	AMD R5 Graphics	4GBx1	15.6" HD (1366x768)	None	500GB 5400rpm	DVD±RW	QCA435 ac, 1x1 + BT4.0	None	None	Black	PC/ABS	720p	Non-backlit	None	dTPM 1.2	6-cell (48Wh)	45W	Win10 DG Win7 Pro 64	1-year, Depot	06/16

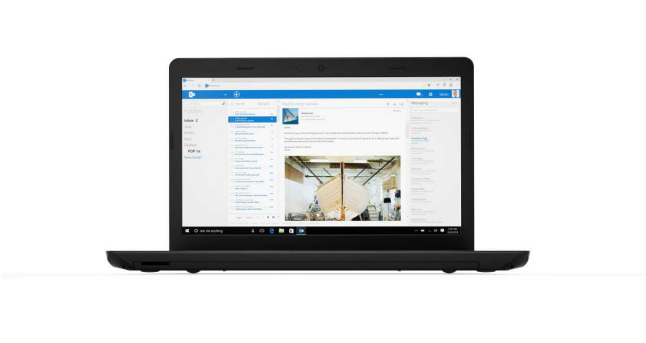

# ThinkPad E570 Platform Specifications

Product Specifications Reference (PSREF)

Processor	7th Generation Intel® Core™ i3 / i5 / i7 Processor								Dimensions <i>Aluminum (WxDxH):</i> 14.92" x 10.28" x 0.94" 379mm x 261mm x 23.9mm <i>PC/ABS (WxDxH):</i> 14.92" x 10.28" x 1.00"; 379mm x 261mm x 25.4mm
	Processor Number	# of Cores	# of Threads	Base Frequency	Max Turbo Frequency	Cache	Memory Controller	Processor Graphics	
	i3-6100U	2	4	2.3 GHz	-	3MB	DDR4-2133	Intel HD Graphics 520	
	i5-6200U			2.3 GHz	2.8 GHz	3MB			
	i7-6500U			2.5 GHz	3.1 GHz	4MB			
	i3-7100U			2.4 GHz	-	3MB	DDR4-2133	Intel HD Graphics 620	
	i5-7200U			2.5 GHz	3.1 GHz	3MB			
	i7-7500U			2.7 GHz	3.5 GHz	4MB			

Graphics	Intel HD Graphics in processor only, or NVidia GeForce 940MX Graphics, 2GB DDR5 memory, or NVidia GeForce GTX 950M Graphics, 2GB DDR5 memory, external analog monitor support via VGA DB-15 connector and digital monitor support via HDMI™ (supporting HDCP to output protected content); supports dual independent displays; Max resolution: 1920x1080 (HDMI)@60Hz	Weight Case color	From 5.07 lb (2.30kg) <i>LCD Rear :</i> Black, Silver, Gold (in EMEA only black color available) <i>Base Cover:</i> Black <i>Top Cover:</i> Black, Silver
Memory	32GB max / 2133MHz DDR4, non-parity, dual-channel capable, two 260-pin SO-DIMM sockets * System clocks down for processors with lower memory controller	Case material (LCD Rear)	<i>Aluminum:</i> Aluminum display cover <i>PC/ABS:</i> PolyCarbonate/Acrylonitrile-Butadiene-Styrene display cover
Display	Some: 15.6" (396mm) HD (1366x768), anti-glare, LED backlight, 220 nits, 16:9 aspect ratio, 400:1 contrast ratio Some: 15.6" (396mm) FHD (1920x1080), anti-glare, LED backlight, IPS, 250 nits, 16:9 aspect ratio, 600:1 contrast ratio Some: 15.6" (396mm) FHD (1920x1080), anti-glare, LED backlight, 250 nits, 16:9 aspect ratio, 600:1 contrast ratio	Camera Audio support	<i>Some:</i> HD720p resolution, fixed focus HD Audio, Conexant® CX11852 codec, Dolby® Audio™ Premium / stereo speakers, 2W x 2 / dual array microphone, combo audio / microphone jack
Multi-touch	None	Keyboard UltraNav™ ThinkLight™	6-row, spill-resistant, multimedia Fn keys TrackPoint® pointing device and multi-touch with 3+2 buttons click pad None
Storage	<i>Some:</i> M.2 SSD / SATA 6.0Gb/s <i>Some:</i> M.2 SSD / PCIe NVMe <i>Some:</i> HDD / SATA 6.0Gb/s, 2.5" wide, removable, upgradable, Active Protection System™	Fingerprint reader NFC	<i>Some:</i> Fingerprint reader on the keyboard bezel, swipe sensor None
Optical	<i>Some:</i> DVD burner, 9.0mm high, removable <i>Some:</i> Blank Bezel	Security Security chip	Power-on password, hard disk password, supervisor password, security keyhole <i>fTPM2.0:</i> Firmware TPM 2.0, integrated in chipset <i>dTPM2.0:</i> Discrete TPM 2.0, TCG Certified
Ethernet	Gigabit Ethernet Connection, Realtek R8111GUS	vPro	No
WLAN	<i>One of the following, configurable by model:</i> • Intel Dual Band Wireless-AC 8265, 2x2, Wi-Fi + BT combo adapter, M.2 Card • QCA, Qualcomm 344A-AC, 2x2, Wi-Fi + Bluetooth combo adapter, M.2 Card • QCA, Qualcomm 435-AC, 1x1, Wi-Fi + Bluetooth combo adapter, M.2 Card Bluetooth wireless, integrated in Wi-Fi + Bluetooth combo adapter	Battery type	<i>Some:</i> Li-Polymer 4-cell (32Wh) <i>Some:</i> Li-Ion 4-cell (41Wh)
Bluetooth™		Battery life	<i>Some:</i> Up to 5.0 hr for Li-Polymer 4-cell (32Wh) <i>Some:</i> Up to 7.0 hr for Li-Ion 4-cell (41Wh)
WWAN SIM card	None None	AC adapter	<i>Some:</i> 45-watt AC adapter <i>Some:</i> 65-watt AC adapter <i>Some:</i> 90-watt AC adapter
Smart Card Reader ExpressCard Dock	None None None	Preload	<i>Some:</i> Windows 10 Pro 64 <i>Some:</i> Windows 10 Home 64 • Lenovo Companion • Lenovo Settings • Microsoft Office preloaded; purchase a product key to activate • McAfee® Live Safe (30-day trial) <i>Some:</i> No operating system
Multicard Reader	4-in-1 reader (MMC, SD, SDHC, SDXC)	Limited warranty	<b>1-year</b> - depot repair service / service upgrades available
Ports	Two USB 3.0, one USB 2.0 (Always On), VGA, HDMI, Ethernet (RJ-45), combo audio / microphone jack, optional one USB 3.1 Type-C (standard for i5, i7 models in EMEA)	Mil-Spec test	None
Monitor cable	None	Environment	EPEAT™ Gold; ENERGY STAR®; RoHS-compliant

## ThinkPad E570 - TopSeller - 20H5

Product Specifications Reference (PSREF)

Model	Region	Processor	vPro	Graphics	Optional Ports	Memory	Display	Multi-touch	Storage(HDD/SSD)	Optical	WLAN + Bluetooth	WWAN	SIM Card	Color (LCD_Rear, Top_Cover)	Case Material	Fingerprint Reader	TPM	Battery	Power Adapter	Operating System	Warranty	Ann Date (m/y)
20H50042US	US	i3-7100U	No	Intel HD 620	None	4GBx1	15.6" HD (1366x768)	None	500GB 7200rpm	DVD±RW	11ac, 1x1 + BT4.1	None	None	Black, Black	PC/ABS	Fingerprint Reader	dTPM 2.0	4-cell (41Wh)	45W	Win10 Pro 64	1-year, Depot	09/16
20H50043US	US	i7-7500U	No	GTX 950M 2GB	None	8GBx1	15.6" FHD (1920x1080) IPS	None	500GB 7200rpm	DVD±RW	Intel 8265 ac, 2x2 + BT4.1	None	None	Black, Black	PC/ABS	Fingerprint Reader	FW TPM 2.0	4-cell (41Wh)	90W	Win10 Pro 64	1-year, Depot	09/16
20H50044US	US	i3-6006U	No	Intel HD 520	None	4GBx1	15.6" HD (1366x768)	None	500GB 7200rpm	DVD±RW	11ac, 1x1 + BT4.1	None	None	Black, Black	PC/ABS	None	dTPM 2.0	4-cell (41Wh)	45W	Win10 Pro 64	1-year, Depot	11/16
20H50045US	US	i5-7200U	No	Intel HD 620	None	8GBx1	15.6" FHD (1920x1080) IPS	None	256GB SSD M.2 PCIe NVMe Opal2	DVD±RW	Intel 8265 ac, 2x2 + BT4.1	None	None	Black, Black	PC/ABS	Fingerprint Reader	dTPM 2.0	4-cell (41Wh)	45W	Win10 Pro 64	1-year, Depot	09/16
20H50047US	US	i7-7500U	No	GTX 950M 2GB	None	8GBx1	15.6" FHD (1920x1080) IPS	None	256GB SSD M.2 PCIe NVMe Opal2	DVD±RW	Intel 8265 ac, 2x2 + BT4.1	None	None	Black, Black	PC/ABS	Fingerprint Reader	FW TPM 2.0	4-cell (41Wh)	90W	Win10 Pro 64	1-year, Depot	09/16
20H50048US	US	i5-7200U	No	Intel HD 620	None	4GBx1	15.6" HD (1366x768)	None	500GB 7200rpm	DVD±RW	11ac, 1x1 + BT4.1	None	None	Black, Black	PC/ABS	Fingerprint Reader	dTPM 2.0	4-cell (41Wh)	45W	Win10 Pro 64	1-year, Depot	09/16
20H5007UUS	US	i3-7100U	No	Intel HD 620	None	4GBx1	15.6" HD (1366x768)	None	180GB SSD M.2 Opal2	DVD±RW	11ac, 1x1 + BT4.1	None	None	Black, Black	PC/ABS	Fingerprint Reader	dTPM 2.0	4-cell (41Wh)	45W	Win10 Pro 64	1-year, Depot	01/17
20H5007VUS	US	i5-6200U	No	940MX 2GB	None	8GBx1	15.6" HD (1366x768)	None	180GB SSD M.2 Opal2	DVD±RW	11ac, 1x1 + BT4.1	None	None	Black, Black	PC/ABS	Fingerprint Reader	FW TPM 2.0	4-cell (41Wh)	65W	Win10 Pro 64	1-year, Depot	01/17
20H5007WUS	US	i5-6200U	No	940MX 2GB	None	4GBx1	15.6" HD (1366x768)	None	180GB SSD M.2 Opal2	DVD±RW	11ac, 1x1 + BT4.1	None	None	Black, Black	PC/ABS	Fingerprint Reader	FW TPM 2.0	4-cell (41Wh)	65W	Win10 Pro 64	1-year, Depot	01/17
20H5009FUS	US	i3-6006U	No	Intel HD 520	None	4GBx1	15.6" HD (1366x768)	None	500GB 7200rpm	DVD±RW	11ac, 1x1 + BT4.1	None	None	Black, Black	PC/ABS	Fingerprint Reader	dTPM 2.0	4-cell (41Wh)	45W	Win10 DG Win7 Pro 64	1-year, Depot	03/17
20H5009GUS	US	i7-6500U	No	940MX 2GB	None	8GBx1	15.6" FHD (1920x1080) IPS	None	256GB SSD M.2 PCIe NVMe Opal2	DVD±RW	Intel 8265 ac, 2x2 + BT4.1	None	None	Black, Black	PC/ABS	Fingerprint Reader	FW TPM 2.0	4-cell (41Wh)	65W	Win10 DG Win7 Pro 64	1-year, Depot	03/17
20H5009HUS	US	i3-6006U	No	Intel HD 520	None	4GBx1	15.6" HD (1366x768)	None	500GB 7200rpm	DVD±RW	11ac, 1x1 + BT4.1	None	None	Black, Black	PC/ABS	None	dTPM 2.0	4-cell (41Wh)	45W	Win10 DG Win7 Pro 64	1-year, Depot	03/17
20H5009JUS	US	i7-6500U	No	940MX 2GB	None	8GBx1	15.6" FHD (1920x1080) IPS	None	128GB SSD M.2	DVD±RW	Intel 8265 ac, 2x2 + BT4.1	None	None	Black, Black	PC/ABS	Fingerprint Reader	FW TPM 2.0	4-cell (41Wh)	65W	Win10 DG Win7 Pro 64	1-year, Depot	03/17
20H5009KUS	US	i5-6200U	No	Intel HD 520	None	4GBx1	15.6" HD (1366x768)	None	128GB SSD M.2	DVD±RW	11ac, 1x1 + BT4.1	None	None	Black, Black	PC/ABS	Fingerprint Reader	dTPM 2.0	4-cell (41Wh)	45W	Win10 DG Win7 Pro 64	1-year, Depot	03/17
20H5009LUS	US	i5-6200U	No	Intel HD 520	None	8GBx1	15.6" FHD (1920x1080) IPS	None	256GB SSD M.2 PCIe NVMe Opal2	DVD±RW	Intel 8265 ac, 2x2 + BT4.1	None	None	Black, Black	PC/ABS	Fingerprint Reader	dTPM 2.0	4-cell (41Wh)	45W	Win10 DG Win7 Pro 64	1-year, Depot	03/17
20H5009MUS	US	i7-6500U	No	940MX 2GB	None	8GBx1	15.6" FHD (1920x1080) IPS	None	500GB 7200rpm	DVD±RW	Intel 8265 ac, 2x2 + BT4.1	None	None	Black, Black	PC/ABS	Fingerprint Reader	FW TPM 2.0	4-cell (41Wh)	65W	Win10 DG Win7 Pro 64	1-year, Depot	03/17
20H5009NUS	US	i5-6200U	No	Intel HD 520	None	4GBx1	15.6" HD (1366x768)	None	500GB 7200rpm	DVD±RW	11ac, 1x1 + BT4.1	None	None	Black, Black	PC/ABS	Fingerprint Reader	dTPM 2.0	4-cell (41Wh)	45W	Win10 DG Win7 Pro 64	1-year, Depot	03/17
20H500A9US	US	i5-7200U	No	Intel HD 620	None	8GBx1	15.6" FHD (1920x1080) IPS	None	180GB SSD M.2 Opal2	DVD±RW	11ac, 1x1 + BT4.1	None	None	Black, Black	PC/ABS	Fingerprint Reader	dTPM 2.0	4-cell (41Wh)	45W	Win10 Pro 64	1-year, Depot	03/17
20H500AAUS	US	i5-7200U	No	Intel HD 620	None	8GBx1	15.6" FHD (1920x1080) IPS	None	500GB 7200rpm	DVD±RW	11ac, 1x1 + BT4.1	None	None	Black, Black	PC/ABS	Fingerprint Reader	dTPM 2.0	4-cell (41Wh)	45W	Win10 Pro 64	1-year, Depot	03/17

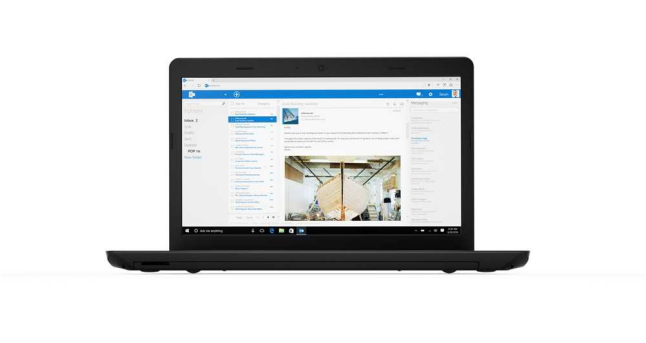

# ThinkPad E575 Platform Specifications

Product Specifications Reference (PSREF)

Processor	AMD Accelerated Processor A6, A10, or A12 APU								Dimensions Weight Case color Case material	<i>PC/ABS (WxDxH):</i> 14.92" x 10.28" x 1.00"; 379mm x 261mm x 25.4mm From 5.07 lb (2.30kg) Black <i>PC/ABS:</i> PolyCarbonate/Acrylonitrile-Butadiene-Styrene display cover	
	Processor Number	# of Cores	# of Threads	Base Frequency	Max Turbo Frequency	Cache	Memory Types	Processor Graphics			
	A6-9500B	2	4	2.3 GHz	3.2 GHz	2MB	DDR4-1866	R5 Graphics			
	A10-9600P	4	8	2.4 GHz	3.3 GHz	2MB		R5 Graphics			
A12-9700P	4	8	2.5 GHz	3.4 GHz	2MB	R7 Graphics					
Graphics	AMD Radeon™ R5 Graphics in processor only, or AMD Radeon R5 M430 Graphics, 2GB DDR3 memory, or external analog monitor support via VGA DB-15 connector and digital monitor support via HDMI™ (supporting HDCP to output protected content); supports dual independent displays; Max resolution: 1920x1080 (HDMI)@60Hz								Camera	<i>Some:</i> HD720p resolution, fixed focus	
									Audio support	HD Audio, Conexant® CX11852 codec, Dolby® Audio™ Premium / stereo speakers, 2W x 2 / dual array microphone, combo audio / microphone jack	
Chipset	AMD SoC (System on Chip) platform								Keyboard	6-row, spill-resistant, multimedia Fn keys	
Memory	32GB max / 2133MHz DDR4, non-parity, dual-channel capable, two 260-pin SO-DIMM sockets *System automatically clocks down with 1866MHz DDR4 memory controller								UltraNav™	TrackPoint® pointing device and multi-touch with 3+2 buttons click pad	
Display	Some: 15.6" (396mm) HD (1366x768), anti-glare, LED backlight, 220 nits, 16:9 aspect ratio, 400:1 contrast ratio								ThinkLight™	None	
	Some: 15.6" (396mm) FHD (1920x1080), anti-glare, LED backlight, IPS, 250 nits, 16:9 aspect ratio, 600:1 contrast ratio								Fingerprint reader	None	
Multi-touch	None								NFC	None	
Storage	<i>Some:</i> SSD / SATA 6.0Gb/s, 2.5" wide, 7mm high, removable, upgradable								Security	Power-on password, hard disk password, supervisor password, security keyhole	
	<i>Some:</i> HDD / SATA 6.0Gb/s, 2.5" wide, removable, upgradable, Active Protection System™								Security chip	<i>FW TPM2.0:</i> Firmware TPM 2.0, integrated in chipset <i>dTPM2.0:</i> Discrete TPM 2.0, TCG Certified	
Optical	<i>Some:</i> DVD burner, 9.0mm high, removable <i>Some:</i> Blank Bezel								vPro	No	
Ethernet	Gigabit Ethernet Connection, Realtek R8111GUS								Battery type	<i>Some:</i> Li-Ion 4-cell (41Wh)	
WLAN	<i>One of the following, configurable by model:</i> • QCA, Qualcomm 344A-AC, 2x2, Wi-Fi + Bluetooth combo adapter, M.2 Card • QCA, Qualcomm 435-AC, 1x1, Wi-Fi + Bluetooth combo adapter, M.2 Card								Battery life	<i>Some:</i> Up to 6.5 hr	
Bluetooth™	Bluetooth wireless, integrated in Wi-Fi + Bluetooth combo adapter								AC adapter	<i>Some:</i> 45-watt AC adapter <i>Some:</i> 65-watt AC adapter	
WWAN	None								Preload	<i>Some:</i> Windows 10 Pro 64	<i>Some:</i> No operating system
SIM card	None									<i>Some:</i> Windows 10 Home 64	
Smart Card Reader	None								Limited warranty	1-year - depot repair service / service upgrades available	
ExpressCard	None									Mil-Spec test	None
Dock	None								Environment	EPEAT™ Gold; ENERGY STAR®; RoHS-compliant	
Multicard Reader	4-in-1 reader (MMC, SD, SDHC, SDXC)										
Ports	Two USB 3.0, one USB 2.0 (Always On), VGA, HDMI, Ethernet (RJ-45), combo audio / microphone jack										
Monitor cable	None										

## ThinkPad E575 - TopSeller - 20H8

Product Specifications Reference (PSREF)

Model	Region	Processor	vPro	Graphics	Memory	Display	Multi-touch	Storage(HDD/SSD)	Optical	WLAN + Bluetooth	WWAN	SIM Card	Color	Case Material	Camera	Keyboard	Fingerprint Reader	TPM	Battery	Power Adapter	Operating System	Warranty	Ann Date (m/y)
20H8000CUS	US	AMD A10-9600P	No	AMD R5 M430 2GB	4GBx1	15.6" HD (1366x768)	None	500GB 7200rpm	DVD±RW	QCA435 ac, 1x1 + BT4.1	None	None	Black	PC/ABS	720p	Non-backlit	None	FW TPM 2.0	4-cell (41Wh)	65W	Windows 10 Pro 64	1-year, Depot	11/16
20H8000DUS	US	AMD A10-9600P	No	AMD R5 M430 2GB	8GBx1	15.6" FHD (1920x1080) IPS	None	500GB 7200rpm	DVD±RW	QCA435 ac, 1x1 + BT4.1	None	None	Black	PC/ABS	720p	Non-backlit	None	FW TPM 2.0	4-cell (41Wh)	65W	Windows 10 Pro 64	1-year, Depot	11/16
20H8000EUS	US	AMD A10-9600P	No	AMD R5 M430 2GB	8GBx1	15.6" HD (1366x768)	None	500GB 7200rpm	DVD±RW	QCA435 ac, 1x1 + BT4.1	None	None	Black	PC/ABS	720p	Non-backlit	None	FW TPM 2.0	4-cell (41Wh)	65W	Windows 10 Pro 64	1-year, Depot	11/16
20H8000FUS	US	AMD A6-9500B	No	AMD R5 Graphics	8GBx1	15.6" HD (1366x768)	None	500GB 7200rpm	DVD±RW	QCA435 ac, 1x1 + BT4.1	None	None	Black	PC/ABS	720p	Non-backlit	None	dTPM 1.2	4-cell (41Wh)	45W	Windows 10 Pro 64	1-year, Depot	11/16
20H8000GUS	US	AMD A10-9600P	No	AMD R5 M430 2GB	8GBx1	15.6" FHD (1920x1080) IPS	None	256GB SSD Opal2	DVD±RW	QCA435 ac, 1x1 + BT4.1	None	None	Black	PC/ABS	720p	Non-backlit	None	FW TPM 2.0	4-cell (41Wh)	65W	Windows 10 Pro 64	1-year, Depot	11/16
20H8000HUS	US	AMD A6-9500B	No	AMD R5 Graphics	4GBx1	15.6" HD (1366x768)	None	500GB 7200rpm	DVD±RW	QCA435 ac, 1x1 + BT4.1	None	None	Black	PC/ABS	720p	Non-backlit	None	dTPM 1.2	4-cell (41Wh)	45W	Windows 10 Pro 64	1-year, Depot	11/16
20H8000QUS	US	AMD A10-9600P	No	AMD R5 M430 2GB	8GBx1	15.6" HD (1366x768)	None	180GB SSD Opal2	DVD±RW	QCA435 ac, 1x1 + BT4.1	None	None	Black	PC/ABS	720p	Non-backlit	None	FW TPM 2.0	4-cell (41Wh)	65W	Windows 10 Pro 64	1-year, Depot	01/17





# ThinkPad L470 Platform Specifications

Product Specifications Reference (PSREF)

Processor	6th Generation Intel® Core™ i3 / i5 / i7 Processor (i7 processor is not available in EMEA) or	WWAN (optional) <i>One of the following, configurable by model:</i>																																														
	<table border="1"> <thead> <tr> <th>Processor Number</th> <th># of Cores</th> <th># of Threads</th> <th>Base Frequency</th> <th>Max Turbo Frequency</th> <th>Cache</th> <th>Memory Types</th> <th>Processor Graphics</th> </tr> </thead> <tbody> <tr> <td>i3-6006U</td> <td rowspan="3">2</td> <td rowspan="3">4</td> <td>2.0 GHz</td> <td>-</td> <td>3MB</td> <td rowspan="3">DDR4-2133</td> <td rowspan="3">Intel HD Graphics 520</td> </tr> <tr> <td>i5-6200U</td> <td>2.3 GHz</td> <td>2.8 GHz</td> <td>3MB</td> </tr> <tr> <td>i5-6300U</td> <td>2.4 GHz</td> <td>3.0 GHz</td> <td>3MB</td> </tr> </tbody> </table>	Processor Number	# of Cores	# of Threads	Base Frequency	Max Turbo Frequency	Cache	Memory Types	Processor Graphics	i3-6006U	2	4	2.0 GHz	-	3MB	DDR4-2133	Intel HD Graphics 520	i5-6200U	2.3 GHz	2.8 GHz	3MB	i5-6300U	2.4 GHz	3.0 GHz	3MB	<ul style="list-style-type: none"> <li>Wireless WAN upgradable</li> <li>Integrated Mobile Broadband 4G LTE-A, Qualcomm® Snapdragon™ X7 LTE-A (Sierra Wireless EM7455), M.2 card</li> <li>Integrated Mobile Broadband 4G LTE, Intel XMM™ 7160 (Fibocom L831-EAU), M.2 card (EMEA only)</li> </ul>																						
Processor Number	# of Cores	# of Threads	Base Frequency	Max Turbo Frequency	Cache	Memory Types	Processor Graphics																																									
i3-6006U	2	4	2.0 GHz	-	3MB	DDR4-2133	Intel HD Graphics 520																																									
i5-6200U			2.3 GHz	2.8 GHz	3MB																																											
i5-6300U			2.4 GHz	3.0 GHz	3MB																																											
	Intel Celeron® Processor or 7th Generation Intel Core i3 / i5 / i7 Processor	SIM card (opt) Micro-SIM card slot, opt Verizon LTE (US) or Lenovo® Connect (EMEA) SIM card																																														
	<table border="1"> <thead> <tr> <th>Processor Number</th> <th># of Cores</th> <th># of Threads</th> <th>Base Frequency</th> <th>Max Turbo Frequency</th> <th>Cache</th> <th>Memory Types</th> <th>Processor Graphics</th> </tr> </thead> <tbody> <tr> <td>Cel 3965U</td> <td rowspan="6">2</td> <td rowspan="6">4</td> <td>2.2 GHz</td> <td>-</td> <td>2MB</td> <td rowspan="6">DDR4-2133</td> <td>Intel HD Graphics 610</td> </tr> <tr> <td>i3-7100U</td> <td>2.4 GHz</td> <td>-</td> <td>3MB</td> <td rowspan="5">Intel HD Graphics 620</td> </tr> <tr> <td>i5-7200U</td> <td>2.5 GHz</td> <td>3.1 GHz</td> <td>3MB</td> </tr> <tr> <td>i5-7300U</td> <td>2.6 GHz</td> <td>3.5 GHz</td> <td>3MB</td> </tr> <tr> <td>i7-7500U</td> <td>2.7 GHz</td> <td>3.5 GHz</td> <td>4MB</td> </tr> <tr> <td>i7-7600U</td> <td>2.8 GHz</td> <td>3.9 GHz</td> <td>4MB</td> </tr> </tbody> </table>	Processor Number	# of Cores	# of Threads	Base Frequency	Max Turbo Frequency	Cache	Memory Types	Processor Graphics	Cel 3965U	2	4	2.2 GHz	-	2MB	DDR4-2133	Intel HD Graphics 610	i3-7100U	2.4 GHz	-	3MB	Intel HD Graphics 620	i5-7200U	2.5 GHz	3.1 GHz	3MB	i5-7300U	2.6 GHz	3.5 GHz	3MB	i7-7500U	2.7 GHz	3.5 GHz	4MB	i7-7600U	2.8 GHz	3.9 GHz	4MB	Dimensions <i>WxDxH:</i> 13.35" x 9.25" x 0.94"; 339mm x 235mm x 23.9mm Weight <table border="1"> <thead> <tr> <th>Models</th> <th>3-cell</th> <th>6-cell</th> </tr> </thead> <tbody> <tr> <td><i>Integrated model</i></td> <td>4.13 lb / 1.87 kg</td> <td>4.45 lb / 2.02 kg</td> </tr> <tr> <td><i>discrete model</i></td> <td>4.16 lb / 1.89 kg</td> <td>4.48 lb / 2.03 kg</td> </tr> </tbody> </table>	Models	3-cell	6-cell	<i>Integrated model</i>	4.13 lb / 1.87 kg	4.45 lb / 2.02 kg	<i>discrete model</i>	4.16 lb / 1.89 kg	4.48 lb / 2.03 kg
Processor Number	# of Cores	# of Threads	Base Frequency	Max Turbo Frequency	Cache	Memory Types	Processor Graphics																																									
Cel 3965U	2	4	2.2 GHz	-	2MB	DDR4-2133	Intel HD Graphics 610																																									
i3-7100U			2.4 GHz	-	3MB		Intel HD Graphics 620																																									
i5-7200U			2.5 GHz	3.1 GHz	3MB																																											
i5-7300U			2.6 GHz	3.5 GHz	3MB																																											
i7-7500U			2.7 GHz	3.5 GHz	4MB																																											
i7-7600U			2.8 GHz	3.9 GHz	4MB																																											
Models	3-cell	6-cell																																														
<i>Integrated model</i>	4.13 lb / 1.87 kg	4.45 lb / 2.02 kg																																														
<i>discrete model</i>	4.16 lb / 1.89 kg	4.48 lb / 2.03 kg																																														
Graphics	Intel HD Graphics 610 or 620 in processor only, or Intel HD Graphics 620 in processor and AMD Radeon™ R5 M430, 2GB memory; supports external analog monitor via VGA and digital monitor via Mini DisplayPort; supports three independent displays; Max resolution: 3840x2160@60Hz (DP via mDP cable); 1920x1200@60Hz (VGA)	Case color Black Case material PC/ABS plastic																																														
Chipset	Intel SoC (System on Chip) platform	Smart card reader <i>Optional:</i> Smart card reader																																														
Memory	32GB max / 2400MHz DDR4, dual-channel capable, two DDR4 SO-DIMM sockets * System clocks down for processors with lower memory controller	Media reader 4-in-1 reader (MMC, SD, SDHC, SDXC)																																														
Display	<i>Some:</i> 14.0" (355mm) HD (1366x768), anti-glare, LED backlight, 220 nits, 16:9 aspect ratio, 500:1 contrast ratio <i>Some:</i> 14.0" (355mm) FHD (1920x1080), anti-glare, LED backlight, IPS, 250 nits, 16:9 aspect ratio, 700:1 contrast ratio, 170° viewing angle	Ports Three USB 3.1 Gen 1 (USB 3.0, one Always On), VGA, Mini DisplayPort, Ethernet (RJ-45), Dock connector																																														
Multi-touch	None	Camera (optional) HD720p resolution, fixed focus																																														
Storage	<i>System has one HDD slot or one M.2 2280 slot exclusively for storage</i> <i>Some:</i> HDD / SATA 6.0Gb/s, 2.5" wide, 7mm or 9.5mm high, Active Protection System™ <i>Some:</i> SSD / SATA 6.0Gb/s, 2.5" wide, 7mm high (e.g. xxxGB SSD) <i>Some:</i> M.2 SSD / PCIe NVMe, PCIe 3.0 x 2, 16Gb/s <i>Some:</i> 128GB M.2 SSD / SATA 6.0Gb/s, in WWAN slot as 2nd Storage, mutually exclusive with WWAN	Audio support HD Audio, Realtek ALC3268 codec / stereo speakers, 1W x 2 / dual array microphone, combo audio/microphone jack																																														
Optical	None	Keyboard 6-row, spill-resistant, multimedia Fn keys UltraNav™ TrackPoint® pointing device and buttonless Mylar surface multi-touch touchpad																																														
Ethernet	<i>Non-vPro model:</i> Intel Ethernet Connection I219-V (Jacksonville) <i>vPro model:</i> Intel Ethernet Connection I219-LM (Jacksonville)	Security Power-on password, hard disk password, supervisor password, security keyhole Security chip Discrete TPM 2.0, TCG Certified vPro (optional) Intel vPro Technology Fingerprint reader <i>Optional:</i> Swipe style fingerprint reader on the keyboard bezel NFC None																																														
WLAN	<i>One of the following, configurable by model:</i> • Realtek® RTL8822BE, Wi-Fi 2x2 802.11ac + BT4.1, M.2 card • Intel Dual Band Wireless-AC 8260, Wi-Fi 2x2 802.11ac + BT4.1, M.2 card • Intel Dual Band Wireless-AC 8265, Wi-Fi 2x2 802.11ac + BT4.1, M.2 card	Battery Li-Ion 3-cell (24Wh) or 6-cell (48Wh or 72Wh) Max battery life <sup>10</sup> (MobileMark® 2014) <table border="1"> <thead> <tr> <th>Models</th> <th>3-cell</th> <th>6-cell 48Wh</th> <th>6-cell 72Wh</th> </tr> </thead> <tbody> <tr> <td><i>Integrated model</i></td> <td>7.24 hr</td> <td>14.48 hr</td> <td>21.72 hr</td> </tr> <tr> <td><i>discrete model</i></td> <td>4.34 hr</td> <td>8.68 hr</td> <td>13.02 hr</td> </tr> </tbody> </table>	Models	3-cell	6-cell 48Wh	6-cell 72Wh	<i>Integrated model</i>	7.24 hr	14.48 hr	21.72 hr	<i>discrete model</i>	4.34 hr	8.68 hr	13.02 hr																																		
Models	3-cell	6-cell 48Wh	6-cell 72Wh																																													
<i>Integrated model</i>	7.24 hr	14.48 hr	21.72 hr																																													
<i>discrete model</i>	4.34 hr	8.68 hr	13.02 hr																																													
Bluetooth™	Bluetooth 4.1 wireless, integrated in Wi-Fi + Bluetooth combo adapter * Intel 8265ac card supports BT4.2 but is limited to BT4.1 by Windows OS	AC adapter 45W or 65W AC adapter																																														
		Preload Windows® 7 Professional 64 preinstalled through downgrade rights in Windows 10 Pro 64 • Lenovo Solution Center • Lenovo PowerEngage • ThinkVantage Product Recovery • ThinkVantage System Update • Adobe® Reader® • Microsoft® Office preloaded; purchase a product key to activate • McAfee® LiveSafe™ (30-day trial)																																														
		Limited warranty <i>One of the following, configurable by model:</i> • 1-year depot repair service • 3-year/1-yr battery depot repair service • 3-year/1-yr battery limited onsite service																																														
		Mil-Spec test MIL-STD-810G military certification																																														
		Environment EPEAT™ Gold (US only); ENERGY STAR® 6.1; RoHS-compliant																																														

ThinkPad L470 - TopSeller - 20J4

Product Specifications Reference (PSREF)

Model	Region	Processor	vPro	Graphics	Memory	Display	Multi-touch	Storage(HDD/SSD)	Optical	WLAN + Bluetooth	WWAN	SIM Card	Smart Card Reader	Camera	Keyboard	Fingerprint Reader	TPM	Battery	Power Adapter	Operating System	Warranty	Ann Date (m/y)
20J4000RUS	US	i5-7200U	No	Intel HD 620	4GBx1	14" FHD (1920x1080) IPS	None	500GB 7200rpm	None	Intel 8265 ac, 2x2 + BT4.1	WWAN Upgradable	None	None	720p	Non-backlit	None	dTPM 2.0	6-cell (48Wh)	45W	Win10 Pro 64	1-year, Depot	01/17
20J4000SUS	US	i5-7200U	No	Intel HD 620	4GBx1	14" FHD (1920x1080) IPS	None	256GB SSD Opal2	None	Intel 8265 ac, 2x2 + BT4.1	WWAN Upgradable	None	None	720p	Non-backlit	None	dTPM 2.0	6-cell (48Wh)	45W	Win10 Pro 64	3-year, Depot	01/17
20J4000TUS	US	i5-7200U	No	Intel HD 620	4GBx1	14" HD (1366x768)	None	500GB 7200rpm	None	Intel 8265 ac, 2x2 + BT4.1	WWAN Upgradable	None	None	720p	Non-backlit	None	dTPM 2.0	6-cell (48Wh)	45W	Win10 Pro 64	1-year, Depot	01/17
20J4000UUS	US	i5-7200U	No	Intel HD 620	4GBx1	14" HD (1366x768)	None	256GB SSD Opal2	None	Intel 8265 ac, 2x2 + BT4.1	WWAN Upgradable	None	None	720p	Non-backlit	None	dTPM 2.0	6-cell (48Wh)	45W	Win10 Pro 64	3-year, Depot	01/17
20J40012US	US	i3-7100U	No	Intel HD 620	4GBx1	14" HD (1366x768)	None	500GB 7200rpm	None	Intel 8265 ac, 2x2 + BT4.1	WWAN Upgradable	None	None	720p	Non-backlit	None	dTPM 2.0	6-cell (48Wh)	45W	Win10 Pro 64	1-year, Depot	01/17
20J40013US	US	i5-7200U	No	Intel HD 620	8GBx1	14" FHD (1920x1080) IPS	None	256GB SSD Opal2	None	Intel 8265 ac, 2x2 + BT4.1	WWAN Upgradable	None	None	720p	Non-backlit	Fingerprint Reader	dTPM 2.0	6-cell (48Wh)	45W	Win10 Pro 64	1-year, Depot	01/17
20J40014US	US	i5-7300U	vPro	Intel HD 620	4GBx1	14" HD (1366x768)	None	500GB 7200rpm	None	Intel 8265 ac, 2x2 + BT4.1	WWAN Upgradable	None	None	720p	Non-backlit	None	dTPM 2.0	6-cell (48Wh)	45W	Win10 Pro 64	1-year, Depot	01/17
20J40015US	US	i5-7300U	vPro	Intel HD 620	8GBx1	14" FHD (1920x1080) IPS	None	256GB SSD Opal2	None	Intel 8265 ac, 2x2 + BT4.1	WWAN Upgradable	None	None	720p	Non-backlit	Fingerprint Reader	dTPM 2.0	6-cell (48Wh)	45W	Win10 Pro 64	1-year, Depot	01/17
20J40016US	US	i5-7200U	No	Intel HD 620	8GBx1	14" HD (1366x768)	None	256GB SSD Opal2	None	Intel 8265 ac, 2x2 + BT4.1	WWAN Upgradable	None	None	720p	Non-backlit	None	dTPM 2.0	6-cell (48Wh)	45W	Win10 Pro 64	3-year, Depot	01/17
20J4003EUS	US	i5-7200U	No	Intel HD 620	4GBx1	14" HD (1366x768)	None	500GB 7200rpm	None	Intel 8265 ac, 2x2 + BT4.1	Sierra EM7455	None	None	720p	Non-backlit	None	dTPM 2.0	6-cell (48Wh)	45W	Win10 Pro 64	3-year, Depot	04/17
20J4003FUS	US	i5-7300U	vPro	Intel HD 620	8GBx1	14" FHD (1920x1080) IPS	None	256GB SSD M.2 PCIe NVMe Opal2	None	Intel 8265 ac, 2x2 + BT4.1	WWAN Upgradable	None	None	720p	Non-backlit	Fingerprint Reader	dTPM 2.0	6-cell (48Wh)	45W	Win10 Pro 64	3-year, Depot	04/17
20J4003GUS	US	i5-7300U	vPro	Intel HD 620	8GBx1	14" FHD (1920x1080) IPS	None	256GB SSD Opal2	None	Intel 8265 ac, 2x2 + BT4.1	Sierra EM7455	None	None	720p	Non-backlit	Fingerprint Reader	dTPM 2.0	6-cell (48Wh)	45W	Win10 Pro 64	3-year, Depot	04/17

ThinkPad L470 - TopSeller - 20JU

Product Specifications Reference (PSREF)

Model	Region	Processor	vPro	Graphics	Memory	Display	Multi-touch	Storage(HDD/SSD)	Optical	WLAN + Bluetooth	WWAN	SIM Card	Smart Card Reader	Camera	Keyboard	Fingerprint Reader	TPM	Battery	Power Adapter	Operating System	Warranty	Ann Date (m/y)
20JU0008US	US	i5-6200U	No	Intel HD 520	4GBx1	14" FHD (1920x1080) IPS	None	500GB 7200rpm	None	Intel 8260 ac, 2x2 + BT4.1	WWAN Upgradable	None	None	720p	Non-backlit	None	dTPM 2.0	6-cell (48Wh)	45W	Win10 DG Win7 Pro 64	3-year, Depot	04/17
20JU0009US	US	i5-6200U	No	Intel HD 520	8GBx1	14" HD (1366x768)	None	180GB SSD Opal2	None	Intel 8260 ac, 2x2 + BT4.1	WWAN Upgradable	None	None	720p	Non-backlit	None	dTPM 2.0	6-cell (48Wh)	45W	Win10 DG Win7 Pro 64	3-year, Depot	04/17
20JU000AUS	US	i5-6200U	No	Intel HD 520	4GBx1	14" FHD (1920x1080) IPS	None	128GB SSD	None	Intel 8260 ac, 2x2 + BT4.1	WWAN Upgradable	None	None	720p	Non-backlit	None	dTPM 2.0	6-cell (48Wh)	45W	Win10 DG Win7 Pro 64	3-year, Depot	04/17
20JU000BUS	US	i5-6200U	No	Intel HD 520	8GBx1	14" FHD (1920x1080) IPS	None	180GB SSD Opal2	None	Intel 8260 ac, 2x2 + BT4.1	WWAN Upgradable	None	None	720p	Non-backlit	None	dTPM 2.0	6-cell (48Wh)	45W	Win10 DG Win7 Pro 64	3-year, Depot	04/17
20JU000CUS	US	i5-6200U	No	Intel HD 520	4GBx1	14" HD (1366x768)	None	128GB SSD	None	Intel 8260 ac, 2x2 + BT4.1	WWAN Upgradable	None	None	720p	Non-backlit	None	dTPM 2.0	6-cell (48Wh)	45W	Win10 DG Win7 Pro 64	3-year, Depot	04/17
20JU000DUS	US	i5-6200U	No	Intel HD 520	8GBx1	14" HD (1366x768)	None	256GB SSD Opal2	None	Intel 8260 ac, 2x2 + BT4.1	WWAN Upgradable	None	None	720p	Non-backlit	None	dTPM 2.0	6-cell (48Wh)	45W	Win10 DG Win7 Pro 64	3-year, Depot	04/17
20JU000EUS	US	i5-6200U	No	Intel HD 520	8GBx1	14" FHD (1920x1080) IPS	None	256GB SSD Opal2	None	Intel 8260 ac, 2x2 + BT4.1	WWAN Upgradable	None	None	720p	Non-backlit	None	dTPM 2.0	6-cell (48Wh)	45W	Win10 DG Win7 Pro 64	3-year, Depot	04/17
20JU000FUS	US	i5-6200U	No	Intel HD 520	4GBx1	14" HD (1366x768)	None	500GB 7200rpm	None	Intel 8260 ac, 2x2 + BT4.1	WWAN Upgradable	None	None	720p	Non-backlit	None	dTPM 2.0	6-cell (48Wh)	45W	Win10 DG Win7 Pro 64	3-year, Depot	04/17
20JU000QUS	US	i5-6200U	No	Intel HD 520	4GBx1	14" HD (1366x768)	None	500GB 7200rpm	None	Intel 8260 ac, 2x2 + BT4.1	Sierra EM7455	None	None	720p	Non-backlit	None	dTPM 2.0	6-cell (48Wh)	45W	Win10 DG Win7 Pro 64	3-year, Depot	04/17
20JU000RUS	US	i5-6200U	No	Intel HD 520	8GBx1	14" FHD (1920x1080) IPS	None	256GB SSD M.2 PCIe NVMe Opal2	None	Intel 8260 ac, 2x2 + BT4.1	WWAN Upgradable	None	None	720p	Non-backlit	Fingerprint Reader	dTPM 2.0	6-cell (48Wh)	45W	Win10 DG Win7 Pro 64	3-year, Depot	04/17
20JU000WUS	US	i5-6300U	vPro	Intel HD 520	8GBx1	14" FHD (1920x1080) IPS	None	256GB SSD Opal2	None	Intel 8260 ac, 2x2 + BT4.1	WWAN Upgradable	None	None	720p	Non-backlit	Fingerprint Reader	dTPM 2.0	6-cell (48Wh)	45W	Win10 DG Win7 Pro 64	1-year, Depot	05/17
20JU0018US	US	i5-6300U	vPro	Intel HD 520	4GBx1	14" HD (1366x768)	None	500GB 7200rpm	None	Intel 8260 ac, 2x2 + BT4.1	WWAN Upgradable	None	None	720p	Non-backlit	None	dTPM 2.0	6-cell (48Wh)	45W	Win10 DG Win7 Pro 64	1-year, Depot	05/17
20JU0019US	US	i5-6300U	vPro	Intel HD 520	4GBx1	14" HD (1366x768)	None	180GB SSD Opal2	None	Intel 8260 ac, 2x2 + BT4.1	WWAN Upgradable	None	None	720p	Non-backlit	Fingerprint Reader	dTPM 2.0	6-cell (48Wh)	45W	Win10 DG Win7 Pro 64	3-year, Depot	05/17



# ThinkPad L570 Platform Specifications

Product Specifications Reference (PSREF)

Processor	6th Generation Intel® Core™ i3 / i5 / i7 Processor (i7 processor is not available in EMEA) or							WWAN (optional) <i>One of the following, configurable by model:</i> <ul style="list-style-type: none"> <li>Wireless WAN upgradable</li> <li>Integrated Mobile Broadband 4G LTE-A, Qualcomm® Snapdragon™ X7 LTE-A (Sierra Wireless EM7455), M.2 card</li> <li>Integrated Mobile Broadband 4G LTE, Intel XMM™ 7160 (Fibocom L831-EAU), M.2 card (EMEA only)</li> </ul> SIM card (opt) Micro-SIM card slot, opt Verizon LTE (US) or Lenovo® Connect (EMEA) SIM card		
	Processor Number	# of Cores	# of Threads	Base Frequency	Max Turbo Frequency	Cache	Memory Types		Processor Graphics	
	i3-6006U	2	4	2.0 GHz	-	3MB	DDR4-2133	Intel HD Graphics 520		
	i3-6100U			2.3 GHz	-	3MB				
	i5-6200U			2.3 GHz	2.8 GHz	3MB				
	i5-6300U			2.4 GHz	3.0 GHz	3MB				
	i7-6500U			2.5 GHz	3.1 GHz	4MB				
	i7-6600U	2.6 GHz	3.4 GHz	4MB						
	Intel Celeron® Processor or 7th Generation Intel Core i3 / i5 / i7 Processor							ExpressCard (opt) One slot (ExpressCard/34) Smart card reader <i>Optional:</i> Smart card reader Media reader 4-in-1 reader (MMC, SD, SDHC, SDXC) Ports Four USB 3.1 Gen 1 (USB 3.0, one Always On), VGA, Mini DisplayPort, Ethernet (RJ-45), Dock connector Monitor cable <i>Optional:</i> Lenovo Mini-DisplayPort to DisplayPort Monitor Cable (MiniDP to DP) Camera (optional) HD720p resolution, fixed focus Audio support HD Audio, Realtek® ALC3245 codec / stereo speakers, 1.5W x 2 / dual array microphone, combo audio/microphone jack Keyboard 6-row, spill-resistant, multimedia Fn keys, numeric keypad UltraNav™ TrackPoint® pointing device and buttonless Mylar surface multi-touch touchpad		
Processor Number	# of Cores	# of Threads	Base Frequency	Max Turbo Frequency	Cache	Memory Types	Processor Graphics			
	Cel 3965U	2	4	2.2 GHz	-	2MB	DDR4-2133	Intel HD Graphics 610		
	i3-7100U			2.4 GHz	-	3MB				
	i5-7200U			2.5 GHz	3.1 GHz	3MB				
	i5-7300U			2.6 GHz	3.5 GHz	3MB				
	i7-7500U			2.7 GHz	3.5 GHz	4MB				
	i7-7600U			2.8 GHz	3.9 GHz	4MB				
Graphics	Intel HD Graphics 520, 610, or 620 in processor only; supports external analog monitor via VGA and digital monitor via Mini DisplayPort; supports three independent displays; Max resolution: 3840x2160@60Hz (DP via mDP cable); 1920x1200@60Hz (VGA)							Security Power-on password, hard disk password, supervisor password, security keyhole Security chip Discrete TPM 2.0, TCG Certified vPro (optional) Intel vPro Technology Fingerprint reader <i>Optional:</i> Swiipe style fingerprint reader on the palm rest NFC None		
Chipset Memory	Intel SoC (System on Chip) platform 32GB max / 2133MHz DDR4, dual-channel capable, two DDR4 SO-DIMM sockets							Battery Li-Ion 6-cell (48Wh) Max battery life <i>MobileMark® 2014:</i> 14.8 hr AC adapter 45W AC adapter		
Display	<i>Some:</i> 15.6" (396mm) HD (1366x768), anti-glare, LED backlight, 220 nits, 16:9 aspect ratio, 350:1 contrast ratio <i>Some:</i> 15.6" (396mm) FHD (1920x1080), anti-glare, LED backlight, 220 nits, 16:9 aspect ratio, 400:1 or 500:1 contrast ratio <i>Some:</i> 15.6" (396mm) FHD (1920x1080), anti-glare, LED backlight, IPS, 250 nits, 16:9 aspect ratio, 600:1 contrast ratio, 160° viewing angle							Preload Windows® 7 Professional 64 preinstalled through downgrade rights in Windows 10 Pro 64 <ul style="list-style-type: none"> <li>Lenovo Solution Center</li> <li>Lenovo PowerEngage</li> <li>ThinkVantage Product Recovery</li> <li>ThinkVantage System Update</li> <li>Adobe® Reader®</li> <li>Microsoft® Office preloaded; purchase a product key to activate</li> <li>McAfee® LiveSafe™ (30-day trial)</li> </ul> <i>Some:</i> Windows 10 Home 64 <ul style="list-style-type: none"> <li>Lenovo Companion</li> <li>Lenovo Setting</li> <li>Microsoft Office preloaded; purchase a product key to activate</li> </ul>		
Multi-touch	None							Limited warranty <i>One of the following, configurable by model:</i> <ul style="list-style-type: none"> <li>1-year depot repair service</li> <li>3-year/1-yr battery depot repair service</li> <li>3-year/1-yr battery limited onsite service</li> </ul>		
Storage	<i>Some:</i> HDD / SATA 6.0Gb/s, 2.5" wide, 7mm high, Active Protection System™ <i>Some:</i> SSD / SATA 6.0Gb/s, 2.5" wide, 7mm high (e.g. xxxGB SSD) <i>Some:</i> M.2 SSD / PCIe NVMe, PCIe 3.0 x 2, 16Gb/s <i>Some:</i> 128GB M.2 SSD / SATA 6.0Gb/s, in WWAN slot as 2nd Storage, mutually exclusive with WWAN							Mil-Spec test MIL-STD-810G military certification		
Optical (optional)	DVD-ROM or DVD burner, 9mm high, fixed, not removable, tray-in							Environment EPEAT™ Gold (US only); ENERGY STAR® 6.1; RoHS-compliant		
Ethernet	<i>Non-vPro model:</i> Intel Ethernet Connection I219-V (Jacksonville) <i>vPro model:</i> Intel Ethernet Connection I219-LM (Jacksonville)									
WLAN	<i>One of the following, configurable by model:</i> <ul style="list-style-type: none"> <li>Realtek® RTL8822BE, Wi-Fi 2x2 802.11ac + BT4.1, M.2 card (US only)</li> <li>Intel Dual Band Wireless-AC 8260, Wi-Fi 2x2 802.11ac + BT4.1, M.2 card</li> <li>Intel Dual Band Wireless-AC 8265, Wi-Fi 2x2 802.11ac + BT4.1, M.2 card</li> </ul> Bluetooth™ 4.1 wireless, integrated in Wi-Fi + Bluetooth combo adapter * Intel 8265ac card supports BT4.2 but is limited to BT4.1 by Windows OS									

Model	Region	Processor	vPro	Graphics	Memory	Display	Multi-touch	Storage(HDD/SSD)	Optical	WLAN + Bluetooth	WWAN	SIM Card	Smart Card Reader	ExpressCard	Monitor Cable	Camera	Key-board	Fingerprint Reader	TPM	Battery	Power Adapter	Operating System	Warranty	Ann Date (m/y)
20J8000WUS	US	i3-7100U	No	Intel HD 620	4GBx1	15.6" HD (1366x768)	None	180GB SSD Opal2	DVD±RW	Intel 8265 ac, 2x2 + BT4.1	WWAN Upgradable	None	None	None	None	720p	Non-backlit	None	dTPM 2.0	6-cell (48Wh)	45W	Win10 Pro 64	1-year, Depot	03/17
20J8000XUS	US	i5-7300U	vPro	Intel HD 620	8GBx1	15.6" FHD (1920x1080) IPS	None	256GB SSD Opal2	DVD±RW	Intel 8265 ac, 2x2 + BT4.1	WWAN Upgradable	None	None	None	None	720p	Non-backlit	Fingerprint Reader	dTPM 2.0	6-cell (48Wh)	45W	Win10 Pro 64	1-year, Depot	03/17
20J8000YUS	US	i5-7300U	vPro	Intel HD 620	4GBx1	15.6" HD (1366x768)	None	128GB SSD	DVD±RW	Intel 8265 ac, 2x2 + BT4.1	WWAN Upgradable	None	None	None	None	720p	Non-backlit	None	dTPM 2.0	6-cell (48Wh)	45W	Win10 Pro 64	1-year, Depot	03/17
20J80010US	US	i5-7200U	No	Intel HD 620	4GBx1	15.6" HD (1366x768)	None	500GB 7200rpm	DVD±RW	Intel 8265 ac, 2x2 + BT4.1	WWAN Upgradable	None	None	None	None	720p	Non-backlit	None	dTPM 2.0	6-cell (48Wh)	45W	Win10 Pro 64	1-year, Depot	03/17
20J80011US	US	i5-7200U	No	Intel HD 620	4GBx1	15.6" HD (1366x768)	None	180GB SSD Opal2	DVD±RW	Intel 8265 ac, 2x2 + BT4.1	WWAN Upgradable	None	None	None	None	720p	Non-backlit	None	dTPM 2.0	6-cell (48Wh)	45W	Win10 Pro 64	1-year, Depot	03/17
20J80012US	US	i5-7200U	No	Intel HD 620	4GBx1	15.6" HD (1366x768)	None	128GB SSD	DVD±RW	Intel 8265 ac, 2x2 + BT4.1	WWAN Upgradable	None	None	None	None	720p	Non-backlit	None	dTPM 2.0	6-cell (48Wh)	45W	Win10 Pro 64	1-year, Depot	03/17
20J80013US	US	i5-7200U	No	Intel HD 620	8GBx1	15.6" FHD (1920x1080) IPS	None	256GB SSD Opal2	DVD±RW	Intel 8265 ac, 2x2 + BT4.1	WWAN Upgradable	None	None	None	None	720p	Non-backlit	None	dTPM 2.0	6-cell (48Wh)	45W	Win10 Pro 64	1-year, Depot	03/17
20J80014US	US	i5-7200U	No	Intel HD 620	4GBx1	15.6" HD (1366x768)	None	256GB SSD Opal2	DVD±RW	Intel 8265 ac, 2x2 + BT4.1	WWAN Upgradable	None	None	None	None	720p	Non-backlit	None	dTPM 2.0	6-cell (48Wh)	45W	Win10 Pro 64	1-year, Depot	03/17
20J80015US	US	i3-7100U	No	Intel HD 620	4GBx1	15.6" HD (1366x768)	None	256GB SSD Opal2	DVD±RW	Intel 8265 ac, 2x2 + BT4.1	WWAN Upgradable	None	None	None	None	720p	Non-backlit	None	dTPM 2.0	6-cell (48Wh)	45W	Win10 Pro 64	1-year, Depot	03/17
20J80016US	US	i3-7100U	No	Intel HD 620	4GBx1	15.6" HD (1366x768)	None	500GB 7200rpm	DVD±RW	Intel 8265 ac, 2x2 + BT4.1	WWAN Upgradable	None	None	None	None	720p	Non-backlit	None	dTPM 2.0	6-cell (48Wh)	45W	Win10 Pro 64	1-year, Depot	03/17
20J80017US	US	i5-7300U	vPro	Intel HD 620	4GBx1	15.6" HD (1366x768)	None	500GB 7200rpm	DVD±RW	Intel 8265 ac, 2x2 + BT4.1	WWAN Upgradable	None	None	None	None	720p	Non-backlit	None	dTPM 2.0	6-cell (48Wh)	45W	Win10 Pro 64	1-year, Depot	03/17
20J8002EUS	US	i5-7300U	vPro	Intel HD 620	8GBx1	15.6" FHD (1920x1080) IPS	None	256GB SSD Opal2	DVD±RW	Intel 8265 ac, 2x2 + BT4.1	Sierra EM7455	None	None	ExpressCard / 34	None	720p	Non-backlit	Fingerprint Reader	dTPM 2.0	6-cell (48Wh)	45W	Win10 Pro 64	3-year, Depot	04/17
20J8002FUS	US	i5-7200U	No	Intel HD 620	4GBx1	15.6" HD (1366x768)	None	500GB 7200rpm	DVD±RW	Intel 8265 ac, 2x2 + BT4.1	Sierra EM7455	None	None	ExpressCard / 34	None	720p	Non-backlit	None	dTPM 2.0	6-cell (48Wh)	45W	Win10 Pro 64	3-year, Depot	04/17
20J8002GUS	US	i5-7300U	vPro	Intel HD 620	8GBx1	15.6" FHD (1920x1080) IPS	None	256GB SSD M.2 PCIe NVMe Opal2	DVD±RW	Intel 8265 ac, 2x2 + BT4.1	WWAN Upgradable	None	None	ExpressCard / 34	None	720p	Non-backlit	Fingerprint Reader	dTPM 2.0	6-cell (48Wh)	45W	Win10 Pro 64	3-year, Depot	04/17
20J8002LUS	US	i7-7500U	No	Intel HD 620	8GBx1	15.6" FHD (1920x1080) IPS	None	256GB SSD Opal2	DVD±RW	Intel 8265 ac, 2x2 + BT4.1	WWAN Upgradable	None	None	ExpressCard / 34	None	720p	Non-backlit	Fingerprint Reader	dTPM 2.0	6-cell (48Wh)	45W	Win10 Pro 64	3-year, Depot	06/17
20J8002MUS	US	i7-7600U	vPro	Intel HD 620	8GBx1	15.6" FHD (1920x1080) IPS	None	256GB SSD Opal2	DVD±RW	Intel 8265 ac, 2x2 + BT4.1	WWAN Upgradable	None	None	ExpressCard / 34	None	720p	Non-backlit	Fingerprint Reader	dTPM 2.0	6-cell (48Wh)	45W	Win10 Pro 64	3-year, Depot	06/17

ThinkPad L570 - TopSeller - 20JQ

Product Specifications Reference (PSREF)

Model	Region	Processor	vPro	Graphics	Memory	Display	Multi-touch	Storage(HDD/SSD)	Optical	WLAN + Bluetooth	WWAN	SIM Card	Smart Card Reader	ExpressCard	Monitor Cable	Camera	Key-board	Fingerprint Reader	TPM	Battery	Power Adapter	Operating System	Warranty	Ann Date (m/y)
20JQ000UUS	US	i3-6006U	No	Intel HD 520	4GBx1	15.6" HD (1366x768)	None	180GB SSD Opal2	DVD±RW	Intel 8260 ac, 2x2 + BT4.1	WWAN Upgradable	None	None	ExpressCard / 34	None	720p	Non-backlit	None	dTPM 2.0	6-cell (48Wh)	45W	Win10 DG Win7 Pro 64	1-year, Depot	06/17
20JQ000VUS	US	i5-6300U	vPro	Intel HD 520	4GBx1	15.6" HD (1366x768)	None	180GB SSD Opal2	DVD±RW	Intel 8260 ac, 2x2 + BT4.1	WWAN Upgradable	None	None	ExpressCard / 34	None	720p	Non-backlit	None	dTPM 2.0	6-cell (48Wh)	45W	Win10 DG Win7 Pro 64	1-year, Depot	06/17
20JQ000WUS	US	i5-6300U	vPro	Intel HD 520	4GBx1	15.6" FHD (1920x1080) IPS	None	256GB SSD Opal2	DVD±RW	Intel 8260 ac, 2x2 + BT4.1	WWAN Upgradable	None	None	ExpressCard / 34	None	720p	Non-backlit	None	dTPM 2.0	6-cell (48Wh)	45W	Win10 DG Win7 Pro 64	3-year, Depot	06/17
20JQ000XUS	US	i3-6006U	No	Intel HD 520	4GBx1	15.6" HD (1366x768)	None	500GB 7200rpm	DVD±RW	Intel 8260 ac, 2x2 + BT4.1	WWAN Upgradable	None	None	ExpressCard / 34	None	720p	Non-backlit	None	dTPM 2.0	6-cell (48Wh)	45W	Win10 DG Win7 Pro 64	1-year, Depot	06/17
20JQ000YUS	US	i5-6300U	vPro	Intel HD 520	4GBx1	15.6" FHD (1920x1080) IPS	None	500GB 7200rpm	DVD±RW	Intel 8260 ac, 2x2 + BT4.1	WWAN Upgradable	None	None	ExpressCard / 34	None	720p	Non-backlit	None	dTPM 2.0	6-cell (48Wh)	45W	Win10 DG Win7 Pro 64	3-year, Depot	06/17
20JQ0010US	US	i5-6300U	vPro	Intel HD 520	8GBx1	15.6" FHD (1920x1080) IPS	None	256GB SSD Opal2	DVD±RW	Intel 8260 ac, 2x2 + BT4.1	WWAN Upgradable	None	None	ExpressCard / 34	None	720p	Non-backlit	None	dTPM 2.0	6-cell (48Wh)	45W	Win10 DG Win7 Pro 64	3-year, Depot	06/17
20JQ0011US	US	i5-6300U	vPro	Intel HD 520	4GBx1	15.6" HD (1366x768)	None	500GB 7200rpm	DVD±RW	Intel 8260 ac, 2x2 + BT4.1	WWAN Upgradable	None	None	ExpressCard / 34	None	720p	Non-backlit	None	dTPM 2.0	6-cell (48Wh)	45W	Win10 DG Win7 Pro 64	1-year, Depot	06/17





# ThinkPad P50 Platform Specifications

Product Specifications Reference (PSREF)

Processor	6th Generation Intel® Core™ i7 Processor or Intel Xeon® Processor E3 v5 Family							Smart card reader	Optional: Smart card reader								
	Processor Number	# of Cores	# of Threads	Base Frequency	Max Turbo Frequency	Cache	Memory Types	Processor Graphics	ExpressCard	One slot (ExpressCard/34)							
	i7-6700HQ	4	8	2.6 GHz	3.5 GHz	6MB	DDR4-2133	Intel HD Graphics 530	Media reader	4-in-1 reader (MMC, SD, SDHC, SDXC), supports UHS-II SD card							
	i7-6820HQ			2.7 GHz	3.6 GHz	8MB			Ports	Four USB 3.0 (one Always On), USB Type-C / Thunderbolt 3, Mini DisplayPort, HDMI, Ethernet (RJ-45), Dock connector							
	E3-1505M v5			2.8 GHz	3.7 GHz	8MB			Camera (optional)	HD720p resolution, low light sensitive, fixed focus							
E3-1535M v5	2.9 GHz			3.8 GHz	8MB	Audio support			HD Audio, Realtek® ALC3268 codec / stereo speakers, 1.5W x 2 / dual array microphone, combo audio/microphone jack								
Graphics	Intel HD Graphics 530 or P530 in processor and NVIDIA Quadro® M1000M (2GB or 4GB memory) or M2000M (4GB memory); supports external digital monitor via HDMI, Mini DisplayPort, or Thunderbolt™; supports four independent displays; Max resolution: 3840x2160@60Hz (DisplayPort via Mini DisplayPort cable); 3840x2160@60Hz (Thunderbolt); 3840x2160@30Hz (HDMI)							Keyboard	6-row, spill-resistant, multimedia Fn keys, numeric keypad, optional LED backlight								
Chipset	Mobile Intel CM236 Chipset (Intel GL82CM236 PCH)							UltraNav™	3-button TrackPoint® pointing device and 3-button crystal silk surface multi-touch touchpad								
Memory	64GB max <sup>7</sup> / 2133MHz DDR4, ECC or non-ECC (ECC function supported only on Xeon processor), dual-channel capable, four DDR4 SO-DIMM sockets							Security	Power-on password, hard disk password, supervisor password, security keyhole								
Display	Some: 15.6" (396mm) FHD (1920x1080), anti-glare, LED backlight, IPS, 250 nits, 16:9 aspect ratio, 600:1 contrast ratio, 45% gamut, 160° viewing angle							Security chip	Discrete TPM 1.2 TCG Certified and Firmware TPM 2.0 integrated in chipset								
	Some: 15.6" (396mm) 4K (3840x2160), anti-glare, LED backlight, IPS, 300 nits, 16:9 aspect ratio, 1000:1 contrast ratio, 100% gamut, 178° viewing angle							ThinkEngine	Delivers improved thermal and power efficiency, up to 30 day standby, faster resume time, enhanced security, as well as anti-tampering measures								
Multi-touch (opt)	Capacitive-type multi-touch, supports 10-finger gesture, 220 nits							vPro (optional)	Intel vPro Technology								
Pen (optional)	ThinkPad Pen Pro, active pen for multi-touch display							Fingerprint reader	Touch style fingerprint reader on the palm rest								
Storage	Up to 3 drives (two M.2 SSD and one HDD)							Color calibration	Optional: Pantone® color calibrator by X-Rite® color calibration sensor in palm rest								
	Some: M.2 SSD / SATA 6.0Gb/s (e.g. xxxG SSD) Some: M.2 SSD / PCIe NVMe, PCIe 3.0 x 4, 32Gb/s (e.g. xxxG SSD PCIe NVMe) Some: HDD / SATA 6.0Gb/s, 2.5" wide, 7mm high, Shock Mounted Hard Drive, Active Protection System™							Battery	Lithium Polymer 4-cell (66Wh) or 6-cell (90Wh)								
Optical	None							Max battery life <sup>10</sup>	(MobileMark® 2014)								
	Ethernet							<table border="1"> <thead> <tr> <th>Model</th> <th>4-cell</th> <th>6-cell</th> </tr> </thead> <tbody> <tr> <td>Discrete Graphics</td> <td>7.1 hr</td> <td>9.7 hr</td> </tr> <tr> <td>Hybrid Graphics</td> <td>9.6 hr</td> <td>13.2 hr</td> </tr> </tbody> </table>		Model	4-cell	6-cell	Discrete Graphics	7.1 hr	9.7 hr	Hybrid Graphics	9.6 hr
Model	4-cell	6-cell															
Discrete Graphics	7.1 hr	9.7 hr															
Hybrid Graphics	9.6 hr	13.2 hr															
Ethernet	Non-vPro model: Intel Ethernet Connection I219-V (Jacksonville)							AC adapter	170W AC adapter								
	vPro model: Intel Ethernet Connection I219-LM (Jacksonville)							Preload	<p>Some: Genuine Windows® 7 Professional 64</p> <p>Some: Windows 7 Professional 64 preinstalled through downgrade rights in Windows 10 Pro 64</p> <ul style="list-style-type: none"> <li>Lenovo Solution Center</li> <li>Lenovo SHAREit</li> <li>ThinkVantage Product Recovery</li> <li>Rescue and Recovery™</li> <li>ThinkVantage System Update</li> <li>Adobe® Reader®</li> <li>Microsoft® Office preloaded; purchase a product key to activate</li> <li>McAfee® LiveSafe™ (30-day trial)</li> </ul> <p>For ISV certifications, please visit <a href="http://www.lenovo.com/support/ISV">www.lenovo.com/support/ISV</a></p>								
WLAN <sup>4</sup>	11ac+BT, Intel Dual Band Wireless-AC 8260, 2x2, M.2 card							Limited warranty <sup>12</sup>	One of the following, configurable by model:								
Bluetooth™	Bluetooth 4.1 wireless, integrated in Wi-Fi + Bluetooth combo adapter								<ul style="list-style-type: none"> <li>3-year/1-yr battery depot repair service</li> <li>3-year/1-yr battery limited onsite service<sup>24</sup></li> <li>3-year/1-yr battery limited onsite service, OID (Onsite International Delivery)</li> </ul>								
WWAN (optional)	Wireless WAN, Sierra Wireless EM7455, Qualcomm® 4G LTE-Advanced/DC-HSPA+/HSPA+/HSPA/UMTS/GNSS, M.2 card							Mil-Spec test	MIL-STD-810G military certification								
SIM card	Micro-SIM card slot							Environment	EPEAT™ Gold (US only); ENERGY STAR® 6.1; GREENGUARD®; RoHS-compliant								
Dimensions <sup>3</sup>	WxDxH: 14.86" x 9.93" x 0.96-1.16"; 377.4mm x 252.3mm x 24.5-29.4mm WxDxH(Touch): 14.86" x 9.93" x 1.02-1.21"; 377.4mm x 252.3mm x 25.8-30.7mm																
Weight <sup>2</sup>	Models		4-cell		6-cell												
	Non-touch		5.6 lb / 2.55kg		5.9 lb / 2.67kg												
	Multi-touch		6.2 lb / 2.82kg		6.4 lb / 2.90kg												
Case material	Display cover: Glass-Fiber Reinforced Plastic; Bottom: Magnesium/Aluminum																

Model	Region	Processor	vPro	Graphics	Memory	Display	Multi-touch	Pen	Storage(HDD/SSD)	RAID	Optical	WLAN + Bluetooth	WWAN	SIM Card	Smart Card Reader	Camera	Keyboard	Fingerprint Reader	Color Calibrator	Battery	Power Adapter	Operating System	Warranty	Ann Date (m/y)
20EN0012US	US	i7-6700HQ	No	M1000M 2GB	8GBx1 non-ECC	15.6" FHD (1920x1080) IPS	None	None	256GB SSD M.2 Opal2	No	None	Intel 8260 ac, 2x2 + BT4.1	None	None	None	720p	Backlit	Fingerprint Reader	None	6-cell (90Wh)	170W	Win10 DG Win7 Pro 64	3-year, Depot	11/15
20EN0013US	US	i7-6700HQ	No	M1000M 2GB	8GBx1 non-ECC	15.6" FHD (1920x1080) IPS	None	None	500GB 7200rpm	No	None	Intel 8260 ac, 2x2 + BT4.1	None	None	None	720p	Backlit	Fingerprint Reader	None	6-cell (90Wh)	170W	Win10 DG Win7 Pro 64	3-year, Depot	11/15
20EN0014US	US	i7-6700HQ	No	M1000M 2GB	8GBx1 non-ECC	15.6" FHD (1920x1080) IPS	None	None	1TB 5400rpm	No	None	Intel 8260 ac, 2x2 + BT4.1	None	None	None	720p	Backlit	Fingerprint Reader	None	6-cell (90Wh)	170W	Win10 DG Win7 Pro 64	3-year, Depot	11/15
20EN0015US	US	i7-6700HQ	No	M1000M 2GB	16GBx1 non-ECC	15.6" FHD (1920x1080) IPS	None	None	512GB SSD M.2 PCIe NVMe	No	None	Intel 8260 ac, 2x2 + BT4.1	None	None	None	720p	Backlit	Fingerprint Reader	None	6-cell (90Wh)	170W	Win10 DG Win7 Pro 64	3-year, Depot	11/15
20EN0016US	US	i7-6820HQ	vPro	M1000M 2GB	8GBx1 non-ECC	15.6" FHD (1920x1080) IPS	None	None	500GB 7200rpm	No	None	Intel 8260 ac, 2x2 + BT4.1	None	None	None	720p	Backlit	Fingerprint Reader	None	6-cell (90Wh)	170W	Win10 DG Win7 Pro 64	3-year, Depot	11/15
20EN0017US	US	i7-6820HQ	vPro	M1000M 2GB	8GBx1 non-ECC	15.6" FHD (1920x1080) IPS	None	None	1TB 5400rpm	No	None	Intel 8260 ac, 2x2 + BT4.1	None	None	None	720p	Backlit	Fingerprint Reader	None	6-cell (90Wh)	170W	Win10 DG Win7 Pro 64	3-year, Depot	11/15
20EN0018US	US	i7-6820HQ	vPro	M1000M 2GB	8GBx1 non-ECC	15.6" FHD (1920x1080) IPS	None	None	256GB SSD M.2 Opal2	No	None	Intel 8260 ac, 2x2 + BT4.1	None	None	None	720p	Backlit	Fingerprint Reader	None	6-cell (90Wh)	170W	Win10 DG Win7 Pro 64	3-year, Depot	11/15
20EN0019US	US	i7-6820HQ	vPro	M1000M 2GB	16GBx1 non-ECC	15.6" FHD (1920x1080) IPS	None	None	512GB SSD M.2 PCIe NVMe	No	None	Intel 8260 ac, 2x2 + BT4.1	None	None	None	720p	Backlit	Fingerprint Reader	None	6-cell (90Wh)	170W	Win10 DG Win7 Pro 64	3-year, Depot	11/15
20EN001AUS	US	i7-6820HQ	vPro	M2000M 4GB	8GBx1 non-ECC	15.6" FHD (1920x1080) IPS	None	None	500GB 7200rpm	No	None	Intel 8260 ac, 2x2 + BT4.1	None	None	None	720p	Backlit	Fingerprint Reader	None	6-cell (90Wh)	170W	Win10 DG Win7 Pro 64	3-year, Depot	11/15
20EN001BUS	US	i7-6820HQ	vPro	M2000M 4GB	8GBx1 non-ECC	15.6" FHD (1920x1080) IPS	None	None	256GB SSD M.2 Opal2	No	None	Intel 8260 ac, 2x2 + BT4.1	None	None	None	720p	Backlit	Fingerprint Reader	None	6-cell (90Wh)	170W	Win10 DG Win7 Pro 64	3-year, Depot	11/15
20EN001CUS	US	i7-6820HQ	vPro	M2000M 4GB	16GBx1 non-ECC	15.6" FHD (1920x1080) IPS	None	None	512GB SSD M.2 PCIe NVMe	No	None	Intel 8260 ac, 2x2 + BT4.1	None	None	None	720p	Backlit	Fingerprint Reader	None	6-cell (90Wh)	170W	Win10 DG Win7 Pro 64	3-year, Depot	11/15
20EN001DUS	US	i7-6820HQ	vPro	M2000M 4GB	16GBx1 non-ECC	15.6" 4K (3840x2160) IPS	None	None	500GB 7200rpm	No	None	Intel 8260 ac, 2x2 + BT4.1	None	None	None	720p	Backlit	Fingerprint Reader	X-Rite	6-cell (90Wh)	170W	Win10 DG Win7 Pro 64	3-year, Depot	11/15
20EN001EUS	US	i7-6820HQ	vPro	M2000M 4GB	16GBx1 non-ECC	15.6" 4K (3840x2160) IPS	None	None	256GB SSD M.2 Opal2	No	None	Intel 8260 ac, 2x2 + BT4.1	None	None	None	720p	Backlit	Fingerprint Reader	X-Rite	6-cell (90Wh)	170W	Win10 DG Win7 Pro 64	3-year, Depot	11/15
20EN001FUS	US	i7-6820HQ	vPro	M2000M 4GB	16GBx1 non-ECC	15.6" 4K (3840x2160) IPS	None	None	512GB SSD M.2 PCIe NVMe	No	None	Intel 8260 ac, 2x2 + BT4.1	None	None	None	720p	Backlit	Fingerprint Reader	X-Rite	6-cell (90Wh)	170W	Win10 DG Win7 Pro 64	3-year, Depot	11/15
20EN001GUS	US	i7-6700HQ	No	M1000M 2GB	8GBx1 non-ECC	15.6" FHD (1920x1080) IPS	10-point Multi-touch	None	500GB 7200rpm	No	None	Intel 8260 ac, 2x2 + BT4.1	None	None	None	720p	Backlit	Fingerprint Reader	X-Rite	6-cell (90Wh)	170W	Win10 Pro 64	3-year, Depot	11/15
20EN001HUS	US	i7-6700HQ	No	M1000M 2GB	8GBx1 non-ECC	15.6" FHD (1920x1080) IPS	10-point Multi-touch	None	256GB SSD M.2 Opal2	No	None	Intel 8260 ac, 2x2 + BT4.1	None	None	None	720p	Backlit	Fingerprint Reader	X-Rite	6-cell (90Wh)	170W	Win10 Pro 64	3-year, Depot	11/15
20EN001JUS	US	i7-6820HQ	vPro	M1000M 2GB	8GBx1 non-ECC	15.6" FHD (1920x1080) IPS	10-point Multi-touch	None	500GB 7200rpm	No	None	Intel 8260 ac, 2x2 + BT4.1	None	None	None	720p	Backlit	Fingerprint Reader	X-Rite	6-cell (90Wh)	170W	Win10 Pro 64	3-year, Depot	11/15
20EN001KUS	US	i7-6820HQ	vPro	M1000M 2GB	8GBx1 non-ECC	15.6" FHD (1920x1080) IPS	10-point Multi-touch	None	256GB SSD M.2 Opal2	No	None	Intel 8260 ac, 2x2 + BT4.1	None	None	None	720p	Backlit	Fingerprint Reader	X-Rite	6-cell (90Wh)	170W	Win10 Pro 64	3-year, Depot	11/15
20EN001LUS	US	i7-6820HQ	vPro	M2000M 4GB	16GBx1 non-ECC	15.6" FHD (1920x1080) IPS	10-point Multi-touch	None	256GB SSD M.2 Opal2	No	None	Intel 8260 ac, 2x2 + BT4.1	None	None	None	720p	Backlit	Fingerprint Reader	X-Rite	6-cell (90Wh)	170W	Win10 Pro 64	3-year, Depot	11/15
20EN001MUS	US	i7-6820HQ	vPro	M2000M 4GB	16GBx1 non-ECC	15.6" FHD (1920x1080) IPS	10-point Multi-touch	None	512GB SSD M.2 PCIe NVMe	No	None	Intel 8260 ac, 2x2 + BT4.1	None	None	None	720p	Backlit	Fingerprint Reader	X-Rite	6-cell (90Wh)	170W	Win10 Pro 64	3-year, Depot	11/15

Model	Region	Processor	vPro	Graphics	Memory	Display	Multi-touch	Pen	Storage(HDD/SSD)	RAID	Optical	WLAN + Bluetooth	WWAN	SIM Card	Smart Card Reader	Camera	Keyboard	Fingerprint Reader	Color Calibrator	Battery	Power Adapter	Operating System	Warranty	Ann Date (m/y)
20EN001NUS	US	Xeon E3-1505M v5	vPro	M2000M 4GB	16GBx1 non-ECC	15.6" FHD (1920x1080) IPS	10-point Multi-touch	None	256GB SSD M.2 Opal2	No	None	Intel 8260 ac, 2x2 + BT4.1	None	None	None	720p	Backlit	Fingerprint Reader	X-Rite	6-cell (90Wh)	170W	Win10 Pro 64	3-year, Depot	11/15
20EN001PUS	US	Xeon E3-1505M v5	vPro	M2000M 4GB	16GBx1 non-ECC	15.6" FHD (1920x1080) IPS	10-point Multi-touch	None	512GB SSD M.2 PCIe NVMe	No	None	Intel 8260 ac, 2x2 + BT4.1	None	None	None	720p	Backlit	Fingerprint Reader	X-Rite	6-cell (90Wh)	170W	Win10 Pro 64	3-year, Depot	11/15
20EN001QUS	US	Xeon E3-1505M v5	vPro	M2000M 4GB	16GBx1 non-ECC	15.6" 4K (3840x2160) IPS	None	None	256GB SSD M.2 Opal2	No	None	Intel 8260 ac, 2x2 + BT4.1	None	None	None	720p	Backlit	Fingerprint Reader	X-Rite	6-cell (90Wh)	170W	Win10 DG Win7 Pro 64	3-year, Depot	11/15
20EN001RUS	US	Xeon E3-1505M v5	vPro	M2000M 4GB	16GBx1 non-ECC	15.6" 4K (3840x2160) IPS	None	None	512GB SSD M.2 PCIe NVMe	No	None	Intel 8260 ac, 2x2 + BT4.1	None	None	None	720p	Backlit	Fingerprint Reader	X-Rite	6-cell (90Wh)	170W	Win10 DG Win7 Pro 64	3-year, Depot	11/15
20EN001SUS	US	Xeon E3-1505M v5	vPro	M2000M 4GB	16GBx1 non-ECC	15.6" FHD (1920x1080) IPS	None	None	256GB SSD M.2 Opal2	No	None	Intel 8260 ac, 2x2 + BT4.1	None	None	None	720p	Backlit	Fingerprint Reader	None	6-cell (90Wh)	170W	Win10 DG Win7 Pro 64	3-year, Depot	11/15
20EN001TUS	US	Xeon E3-1505M v5	vPro	M2000M 4GB	16GBx1 non-ECC	15.6" FHD (1920x1080) IPS	None	None	512GB SSD M.2 PCIe NVMe	No	None	Intel 8260 ac, 2x2 + BT4.1	None	None	None	720p	Backlit	Fingerprint Reader	None	6-cell (90Wh)	170W	Win10 DG Win7 Pro 64	3-year, Depot	11/15
20EN002FUS	US	i7-6700HQ	No	M1000M 2GB	16GBx1 non-ECC	15.6" FHD (1920x1080) IPS	None	None	500GB 7200rpm	No	None	Intel 8260 ac, 2x2 + BT4.1	None	None	None	720p	Backlit	Fingerprint Reader	None	6-cell (90Wh)	170W	Win10 DG Win7 Pro 64	3-year, Depot	11/15
20EN002GUS	US	i7-6700HQ	No	M1000M 2GB	16GBx1 non-ECC	15.6" FHD (1920x1080) IPS	None	None	500GB 7200rpm	No	None	Intel 8260 ac, 2x2 + BT4.1	None	None	None	720p	Backlit	Fingerprint Reader	None	6-cell (90Wh)	170W	Win10 Pro 64	3-year, Depot	11/15
20EN002HUS	US	i7-6700HQ	No	M1000M 2GB	16GBx1 non-ECC	15.6" FHD (1920x1080) IPS	None	None	256GB SSD M.2 Opal2	No	None	Intel 8260 ac, 2x2 + BT4.1	None	None	None	720p	Backlit	Fingerprint Reader	None	6-cell (90Wh)	170W	Win10 DG Win7 Pro 64	3-year, Depot	11/15
20EN002JUS	US	i7-6700HQ	No	M1000M 2GB	16GBx1 non-ECC	15.6" FHD (1920x1080) IPS	None	None	256GB SSD M.2 Opal2	No	None	Intel 8260 ac, 2x2 + BT4.1	None	None	None	720p	Backlit	Fingerprint Reader	None	6-cell (90Wh)	170W	Win10 Pro 64	3-year, Depot	11/15
20EN002KUS	US	i7-6820HQ	vPro	M1000M 2GB	16GBx1 non-ECC	15.6" FHD (1920x1080) IPS	None	None	256GB SSD M.2 Opal2	No	None	Intel 8260 ac, 2x2 + BT4.1	None	None	None	720p	Backlit	Fingerprint Reader	None	6-cell (90Wh)	170W	Win10 DG Win7 Pro 64	3-year, Depot	11/15
20EN002LUS	US	i7-6820HQ	vPro	M1000M 2GB	16GBx1 non-ECC	15.6" FHD (1920x1080) IPS	None	None	256GB SSD M.2 Opal2	No	None	Intel 8260 ac, 2x2 + BT4.1	None	None	None	720p	Backlit	Fingerprint Reader	None	6-cell (90Wh)	170W	Win10 Pro 64	3-year, Depot	11/15
20EN002MUS	US	i7-6820HQ	vPro	M2000M 4GB	16GBx1 non-ECC	15.6" FHD (1920x1080) IPS	None	None	256GB SSD M.2 Opal2	No	None	Intel 8260 ac, 2x2 + BT4.1	None	None	None	720p	Backlit	Fingerprint Reader	None	6-cell (90Wh)	170W	Win10 DG Win7 Pro 64	3-year, Depot	11/15
20EN002NUS	US	i7-6820HQ	vPro	M2000M 4GB	16GBx1 non-ECC	15.6" FHD (1920x1080) IPS	None	None	256GB SSD M.2 Opal2	No	None	Intel 8260 ac, 2x2 + BT4.1	None	None	None	720p	Backlit	Fingerprint Reader	None	6-cell (90Wh)	170W	Win10 Pro 64	3-year, Depot	11/15
20EN002PUS	US	Xeon E3-1505M v5	vPro	M2000M 4GB	16GBx1 non-ECC	15.6" FHD (1920x1080) IPS	None	None	256GB SSD M.2 Opal2	No	None	Intel 8260 ac, 2x2 + BT4.1	None	None	None	720p	Backlit	Fingerprint Reader	None	6-cell (90Wh)	170W	Win10 Pro 64	3-year, Depot	11/15
20EN002QUS	US	i7-6820HQ	vPro	M2000M 4GB	16GBx1 non-ECC	15.6" 4K (3840x2160) IPS	None	None	256GB SSD M.2 Opal2	No	None	Intel 8260 ac, 2x2 + BT4.1	None	None	None	720p	Backlit	Fingerprint Reader	X-Rite	6-cell (90Wh)	170W	Win10 Pro 64	3-year, Depot	11/15
20EN003LUS	US	i7-6820HQ	vPro	M1000M 4GB	8GBx4 non-ECC	15.6" FHD (1920x1080) IPS	None	None	512GB SSD M.2 PCIe NVMe	No	None	Intel 8260 ac, 2x2 + BT4.1	None	None	Smart Card Reader	720p	Backlit	Fingerprint Reader	None	6-cell (90Wh)	170W	Win10 Pro 64	3-year, Depot	07/16



# ThinkPad P51 Platform Specifications

Product Specifications Reference (PSREF)

Processor	7th Generation Intel® Core™ i7 Processor or Intel Xeon® Processor E3 v6 Family								Dimensions <i>WxDxH:</i> 14.86" x 9.93" x 0.96-1.16"; 377.4mm x 252.3mm x 24.5-29.4mm <i>WxDxH(Touch):</i> 14.86" x 9.93" x 1.02-1.21"; 377.4mm x 252.3mm x 25.8-30.7mm
	Processor Number	# of Cores	# of Threads	Base Frequency	Max Turbo Frequency	Cache	Memory Types	Processor Graphics	
	i7-7700HQ	4	8	2.8 GHz	3.8 GHz	6MB	DDR4-2400	Intel HD Graphics 630	
	i7-7820HQ			2.9 GHz	3.9 GHz			Intel HD Graphics P630	
	E3-1505M v6			3.0 GHz	4.0 GHz	8MB		Intel HD Graphics P630	
E3-1535M v6	3.1 GHz			4.2 GHz					
Graphics	Intel HD Graphics 630 or P630 in processor and NVIDIA Quadro® M1200M or M2200M, 4GB memory; supports external digital monitor via HDMI, Mini DisplayPort, or Thunderbolt™; supports four independent displays; Max resolution: 3840x2160@60Hz (DisplayPort via Mini DisplayPort cable); 3840x2160@60Hz (Thunderbolt); 4096x2160@24Hz (HDMI)								
Chipset	Mobile Intel CM238 Chipset								
Memory	64GB max <sup>7</sup> / 2400MHz DDR4, ECC or non-ECC (ECC function supported only on Xeon processor), dual-channel capable, four DDR4 SO-DIMM sockets								
Display	<i>Some:</i> 15.6" (396mm) FHD (1920x1080), anti-glare, LED backlight, IPS, 250 nits, 16:9 aspect ratio, 700:1 contrast ratio, 160° viewing angle <i>Some:</i> 15.6" (396mm) 4K (3840x2160), anti-glare, LED backlight, IPS, 300 nits, 16:9 aspect ratio, 1000:1 contrast ratio, 100% gamut, 170° viewing angle								
Multi-touch (opt)	Capacitive-type multi-touch, supports 10-finger gesture, 220 nits (FHD only)								
Pen (optional)	ThinkPad Pen Pro, active pen for multi-touch display								
Storage	<i>Up to 3 drives (two M.2 SSD and one HDD)</i> <i>Some:</i> M.2 SSD / PCIe NVMe, PCIe 3.0 x 4, 32Gb/s <i>Some:</i> HDD / SATA 6.0Gb/s, 2.5" wide, 7mm high, Active Protection System™								
Optical	None								
Ethernet	<i>Non-vPro model:</i> Intel Ethernet Connection I219-V (Jacksonville) <i>vPro model:</i> Intel Ethernet Connection I219-LM (Jacksonville)								
WLAN	Intel Dual Band Wireless-AC 8265, Wi-Fi 2x2 802.11ac + BT4.1, M.2 card								
Bluetooth™	Bluetooth 4.1 wireless, integrated in Wi-Fi + Bluetooth combo adapter * Intel 8265ac card support BT4.2 but is limited to BT4.1 by Windows OS								
WWAN (optional)	<i>One of the following, configurable by model:</i> • Wireless WAN upgradable • Integrated Mobile Broadband 4G LTE-A, Qualcomm® Snapdragon™ X7 LTE-A (Sierra Wireless EM7455), M.2 card								
SIM card (opt)	Micro-SIM card slot, opt Verizon LTE (US) or Lenovo® Connect (EMEA) SIM card								
Case color	Black								
Case material	<i>Display cover:</i> Glass-Fiber Reinforced Plastic; <i>Bottom:</i> Magnesium/Aluminum								
Smart card reader	<i>Optional:</i> Smart card reader								
ExpressCard	One slot (ExpressCard/34)								
Media reader	4-in-1 reader (MMC, SD, SDHC, SDXC), supports UHS-II SD card								
Ports	Four USB 3.1 Gen 1 (USB 3.0, one Always On), USB Type-C / Thunderbolt 3, Mini DisplayPort 1.2a, HDMI 1.4b, Ethernet (RJ-45), Dock connector								
Camera (optional)	HD720p resolution, fixed focus								
Audio support	HD Audio, Realtek® ALC3268 codec / stereo speakers, 2W x 2 / dual array microphone, combo audio/microphone jack								
Keyboard	6-row, spill-resistant, multimedia Fn keys, numeric keypad, optional LED backlight								
UltraNav™	3-button TrackPoint® pointing device and 3-button Mylar surface multi-touch touchpad								
Security	Power-on password, hard disk password, supervisor password, security keyhole								
Security chip	Discrete TPM 2.0, TCG Certified								
vPro (optional)	Intel vPro Technology								
Fingerprint reader	Touch style match on chip fingerprint reader on the palm rest								
Color calibration	<i>Optional:</i> Pantone® color calibrator by X-Rite® color calibration sensor in palm rest								
NFC	None								
Battery	Lithium Polymer 4-cell (66Wh) or 6-cell (90Wh)								
Max battery life <sup>10</sup>	<i>(MobileMark® 2014)</i>								
	<i>Model</i>	<i>4-cell</i>		<i>6-cell</i>					
	<i>Discrete Graphics</i>	4.5 hr		6.1 hr					
	<i>Hybrid Graphics</i>	6.5 hr		8.9 hr					
AC adapter	170W AC adapter								
Preload	<i>Some:</i> Windows® 10 Home 64 <i>Some:</i> Windows 10 Pro 64 • Lenovo Companion • Lenovo Setting • Microsoft Office preloaded; purchase a product key to activate								
Limited warranty	<i>One of the following, configurable by model:</i> • 1-year depot repair service • 3-year/1-yr battery depot repair service • 3-year/1-yr battery limited onsite service								
Mil-Spec test	MIL-STD-810G military certification								
Environment	EPEAT™ Gold (US only); ENERGY STAR® 6.1; RoHS-compliant								

Model	Region	Processor	vPro	Graphics	Chipset	Memory	Display	Multi-touch	Pen	Storage (HDD/SSD)	RAID	Optical	WLAN + Bluetooth	WWAN	SIM Card	Smart Card Reader	Camera	Key-board	Finger-print Reader	NFC	Color Calibrator	TPM	Battery	Power Adapter	Operating System	Warranty	Ann Date (mly)
20HH0004US	US	i7-7700HQ	No	M1200M 4GB	Intel CM238	8GBx1 non-ECC	15.6" FHD (1920x1080) IPS	None	None	512GB SSD M.2 PCIe NVMe Opal2	No	None	Intel 8265 ac, 2x2 + BT4.1	WWAN Upgradable	None	None	720p	Backlit	Finger-print Reader	None	None	dTPM 2.0	6-cell (90Wh)	170W	Win10 Pro 64	3-year, Depot	03/17
20HH0005US	US	Xeon E3-1505M v6	vPro	M2200M 4GB	Intel CM238	8GBx2 non-ECC	15.6" FHD (1920x1080) IPS	None	None	1TB 5400rpm	No	None	Intel 8265 ac, 2x2 + BT4.1	WWAN Upgradable	None	None	720p	Backlit	Finger-print Reader	None	None	dTPM 2.0	6-cell (90Wh)	170W	Win10 Pro 64	3-year, Depot	03/17
20HH0006US	US	Xeon E3-1535M v6	vPro	M2200M 4GB	Intel CM238	8GBx2 non-ECC	15.6" FHD (1920x1080) IPS	None	None	512GB SSD M.2 PCIe NVMe Opal2	No	None	Intel 8265 ac, 2x2 + BT4.1	WWAN Upgradable	None	None	720p	Backlit	Finger-print Reader	None	None	dTPM 2.0	6-cell (90Wh)	170W	Win10 Pro 64	3-year, Depot	03/17
20HH0007US	US	Xeon E3-1535M v6	vPro	M2200M 4GB	Intel CM238	8GBx2 non-ECC	15.6" FHD (1920x1080) IPS	None	None	256GB SSD M.2 PCIe NVMe Opal2	No	None	Intel 8265 ac, 2x2 + BT4.1	WWAN Upgradable	None	None	720p	Backlit	Finger-print Reader	None	None	dTPM 2.0	6-cell (90Wh)	170W	Win10 Pro 64	3-year, Depot	03/17
20HH0008US	US	Xeon E3-1535M v6	vPro	M2200M 4GB	Intel CM238	8GBx2 non-ECC	15.6" FHD (1920x1080) IPS	None	None	1TB SSD M.2 PCIe NVMe Opal2	No	None	Intel 8265 ac, 2x2 + BT4.1	WWAN Upgradable	None	None	720p	Backlit	Finger-print Reader	None	None	dTPM 2.0	6-cell (90Wh)	170W	Win10 Pro 64	3-year, Depot	03/17
20HH0009US	US	Xeon E3-1535M v6	vPro	M2200M 4GB	Intel CM238	8GBx2 non-ECC	15.6" FHD (1920x1080) IPS	10-point Multi-touch	None	512GB SSD M.2 PCIe NVMe Opal2	No	None	Intel 8265 ac, 2x2 + BT4.1	WWAN Upgradable	None	None	720p	Backlit	Finger-print Reader	None	X-Rite	dTPM 2.0	6-cell (90Wh)	170W	Win10 Pro 64	3-year, Depot	03/17
20HH000AUS	US	i7-7700HQ	No	M1200M 4GB	Intel CM238	8GBx2 non-ECC	15.6" FHD (1920x1080) IPS	None	None	1TB SSD M.2 PCIe NVMe Opal2	No	None	Intel 8265 ac, 2x2 + BT4.1	WWAN Upgradable	None	None	720p	Backlit	Finger-print Reader	None	None	dTPM 2.0	6-cell (90Wh)	170W	Win10 Pro 64	3-year, Depot	03/17
20HH000BUS	US	Xeon E3-1505M v6	vPro	M2200M 4GB	Intel CM238	8GBx2 non-ECC	15.6" FHD (1920x1080) IPS	None	None	512GB SSD M.2 PCIe NVMe Opal2	No	None	Intel 8265 ac, 2x2 + BT4.1	WWAN Upgradable	None	None	720p	Backlit	Finger-print Reader	None	None	dTPM 2.0	6-cell (90Wh)	170W	Win10 Pro 64	3-year, Depot	03/17
20HH000CUS	US	i7-7820HQ	vPro	M2200M 4GB	Intel CM238	8GBx2 non-ECC	15.6" 4K (3840x2160) IPS	None	None	512GB SSD M.2 PCIe NVMe Opal2	No	None	Intel 8265 ac, 2x2 + BT4.1	WWAN Upgradable	None	None	720p	Backlit	Finger-print Reader	None	X-Rite	dTPM 2.0	6-cell (90Wh)	170W	Win10 Pro 64	3-year, Depot	03/17
20HH000DUS	US	Xeon E3-1535M v6	vPro	M2200M 4GB	Intel CM238	8GBx2 non-ECC	15.6" 4K (3840x2160) IPS	None	None	512GB SSD M.2 PCIe NVMe Opal2	No	None	Intel 8265 ac, 2x2 + BT4.1	WWAN Upgradable	None	None	720p	Backlit	Finger-print Reader	None	X-Rite	dTPM 2.0	6-cell (90Wh)	170W	Win10 Pro 64	3-year, Depot	03/17
20HH000EUS	US	Xeon E3-1505M v6	vPro	M2200M 4GB	Intel CM238	8GBx2 non-ECC	15.6" FHD (1920x1080) IPS	10-point Multi-touch	None	1TB SSD M.2 PCIe NVMe Opal2	No	None	Intel 8265 ac, 2x2 + BT4.1	WWAN Upgradable	None	None	720p	Backlit	Finger-print Reader	None	X-Rite	dTPM 2.0	6-cell (90Wh)	170W	Win10 Pro 64	3-year, Depot	03/17
20HH000FUS	US	i7-7700HQ	No	M1200M 4GB	Intel CM238	8GBx1 non-ECC	15.6" FHD (1920x1080) IPS	None	None	1TB 5400rpm	No	None	Intel 8265 ac, 2x2 + BT4.1	WWAN Upgradable	None	None	720p	Backlit	Finger-print Reader	None	None	dTPM 2.0	6-cell (90Wh)	170W	Win10 Pro 64	3-year, Depot	03/17
20HH000GUS	US	i7-7820HQ	vPro	M1200M 4GB	Intel CM238	8GBx1 non-ECC	15.6" FHD (1920x1080) IPS	None	None	256GB SSD M.2 PCIe NVMe Opal2	No	None	Intel 8265 ac, 2x2 + BT4.1	WWAN Upgradable	None	None	720p	Backlit	Finger-print Reader	None	None	dTPM 2.0	6-cell (90Wh)	170W	Win10 Pro 64	3-year, Depot	03/17
20HH000HUS	US	Xeon E3-1535M v6	vPro	M2200M 4GB	Intel CM238	8GBx1 non-ECC	15.6" FHD (1920x1080) IPS	None	None	512GB SSD M.2 PCIe NVMe Opal2	No	None	Intel 8265 ac, 2x2 + BT4.1	WWAN Upgradable	None	None	720p	Backlit	Finger-print Reader	None	None	dTPM 2.0	6-cell (90Wh)	170W	Win10 Pro 64	3-year, Depot	03/17
20HH000JUS	US	Xeon E3-1535M v6	vPro	M2200M 4GB	Intel CM238	8GBx1 non-ECC	15.6" FHD (1920x1080) IPS	None	None	256GB SSD M.2 PCIe NVMe Opal2	No	None	Intel 8265 ac, 2x2 + BT4.1	WWAN Upgradable	None	None	720p	Backlit	Finger-print Reader	None	None	dTPM 2.0	6-cell (90Wh)	170W	Win10 Pro 64	3-year, Depot	03/17
20HH000KUS	US	Xeon E3-1505M v6	vPro	M2200M 4GB	Intel CM238	8GBx2 non-ECC	15.6" FHD (1920x1080) IPS	10-point Multi-touch	None	1TB 5400rpm	No	None	Intel 8265 ac, 2x2 + BT4.1	WWAN Upgradable	None	None	720p	Backlit	Finger-print Reader	None	X-Rite	dTPM 2.0	6-cell (90Wh)	170W	Win10 Pro 64	3-year, Depot	03/17
20HH000LUS	US	Xeon E3-1505M v6	vPro	M2200M 4GB	Intel CM238	8GBx2 non-ECC	15.6" 4K (3840x2160) IPS	None	None	512GB SSD M.2 PCIe NVMe Opal2	No	None	Intel 8265 ac, 2x2 + BT4.1	WWAN Upgradable	None	None	720p	Backlit	Finger-print Reader	None	X-Rite	dTPM 2.0	6-cell (90Wh)	170W	Win10 Pro 64	3-year, Depot	03/17
20HH000MUS	US	i7-7700HQ	No	M1200M 4GB	Intel CM238	8GBx1 non-ECC	15.6" FHD (1920x1080) IPS	None	None	1TB SSD M.2 PCIe NVMe Opal2	No	None	Intel 8265 ac, 2x2 + BT4.1	WWAN Upgradable	None	None	720p	Backlit	Finger-print Reader	None	None	dTPM 2.0	6-cell (90Wh)	170W	Win10 Pro 64	3-year, Depot	03/17
20HH000NUS	US	i7-7820HQ	vPro	M1200M 4GB	Intel CM238	8GBx1 non-ECC	15.6" FHD (1920x1080) IPS	None	None	512GB SSD M.2 PCIe NVMe Opal2	No	None	Intel 8265 ac, 2x2 + BT4.1	WWAN Upgradable	None	None	720p	Backlit	Finger-print Reader	None	None	dTPM 2.0	6-cell (90Wh)	170W	Win10 Pro 64	3-year, Depot	03/17
20HH000PUS	US	Xeon E3-1505M v6	vPro	M2200M 4GB	Intel CM238	8GBx1 non-ECC	15.6" FHD (1920x1080) IPS	None	None	256GB SSD M.2 PCIe NVMe Opal2	No	None	Intel 8265 ac, 2x2 + BT4.1	WWAN Upgradable	None	None	720p	Backlit	Finger-print Reader	None	None	dTPM 2.0	6-cell (90Wh)	170W	Win10 Pro 64	3-year, Depot	03/17

Model	Region	Processor	vPro	Memory	Graphics	Chipset	Display	Multi-touch	Pen	Storage (HDD/SSD)	RAID	Optical	WLAN + Bluetooth	WWAN	SIM Card	Smart Card Reader	Camera	Keyboard	Finger-print Reader	NFC	Color Calibrator	TPM	Battery	Power Adapter	Operating System	Warranty	Ann Date (m/y)
20HH000QUS	US	Xeon E3-1505M v6	vPro	M2200M 4GB	Intel CM238	8GBx1 non-ECC	15.6" FHD (1920x1080) IPS	None	None	256GB SSD M.2 PCIe NVMe Opal2	No	None	Intel 8265 ac, 2x2 + BT4.1	WWAN Upgradable	None	None	720p	Backlit	Finger-print Reader	None	None	dTPM 2.0	6-cell (90Wh)	170W	Win10 Pro 64	3-year, Depot	03/17
20HH000RUS	US	Xeon E3-1505M v6	vPro	M2200M 4GB	Intel CM238	8GBx1 non-ECC	15.6" FHD (1920x1080) IPS	None	None	512GB SSD M.2 PCIe NVMe Opal2	No	None	Intel 8265 ac, 2x2 + BT4.1	WWAN Upgradable	None	None	720p	Backlit	Finger-print Reader	None	None	dTPM 2.0	6-cell (90Wh)	170W	Win10 Pro 64	3-year, Depot	03/17
20HH000SUS	US	Xeon E3-1535M v6	vPro	M2200M 4GB	Intel CM238	8GBx2 non-ECC	15.6" FHD (1920x1080) IPS	None	None	512GB SSD M.2 PCIe NVMe Opal2	No	None	Intel 8265 ac, 2x2 + BT4.1	WWAN Upgradable	None	None	720p	Backlit	Finger-print Reader	None	None	dTPM 2.0	6-cell (90Wh)	170W	Win10 Pro 64	3-year, Depot	03/17
20HH000TUS	US	i7-7700HQ	No	M1200M 4GB	Intel CM238	8GBx2 non-ECC	15.6" FHD (1920x1080) IPS	None	None	512GB SSD M.2 PCIe NVMe Opal2	No	None	Intel 8265 ac, 2x2 + BT4.1	WWAN Upgradable	None	None	720p	Backlit	Finger-print Reader	None	None	dTPM 2.0	6-cell (90Wh)	170W	Win10 Pro 64	3-year, Depot	03/17
20HH000UUS	US	Xeon E3-1505M v6	vPro	M2200M 4GB	Intel CM238	8GBx2 non-ECC	15.6" FHD (1920x1080) IPS	None	None	512GB SSD M.2 PCIe NVMe Opal2	No	None	Intel 8265 ac, 2x2 + BT4.1	WWAN Upgradable	None	None	720p	Backlit	Finger-print Reader	None	None	dTPM 2.0	6-cell (90Wh)	170W	Win10 Pro 64	3-year, Depot	03/17
20HH000VUS	US	Xeon E3-1505M v6	vPro	M2200M 4GB	Intel CM238	8GBx1 non-ECC	15.6" FHD (1920x1080) IPS	None	None	1TB 5400rpm	No	None	Intel 8265 ac, 2x2 + BT4.1	WWAN Upgradable	None	None	720p	Backlit	Finger-print Reader	None	None	dTPM 2.0	6-cell (90Wh)	170W	Win10 Pro 64	3-year, Depot	03/17
20HH000WUS	US	i7-7700HQ	No	M1200M 4GB	Intel CM238	8GBx1 non-ECC	15.6" FHD (1920x1080) IPS	None	None	256GB SSD M.2 PCIe NVMe Opal2	No	None	Intel 8265 ac, 2x2 + BT4.1	WWAN Upgradable	None	None	720p	Backlit	Finger-print Reader	None	None	dTPM 2.0	6-cell (90Wh)	170W	Win10 Pro 64	3-year, Depot	03/17
20HH000XUS	US	i7-7700HQ	No	M1200M 4GB	Intel CM238	8GBx1 non-ECC	15.6" FHD (1920x1080) IPS	None	None	512GB SSD M.2 PCIe NVMe Opal2	No	None	Intel 8265 ac, 2x2 + BT4.1	WWAN Upgradable	None	None	720p	Backlit	Finger-print Reader	None	None	dTPM 2.0	6-cell (90Wh)	170W	Win10 Pro 64	3-year, Depot	03/17
20HH000YUS	US	i7-7700HQ	No	M1200M 4GB	Intel CM238	8GBx2 non-ECC	15.6" FHD (1920x1080) IPS	None	None	1TB 5400rpm	No	None	Intel 8265 ac, 2x2 + BT4.1	WWAN Upgradable	None	None	720p	Backlit	Finger-print Reader	None	None	dTPM 2.0	6-cell (90Wh)	170W	Win10 Pro 64	3-year, Depot	03/17
20HH0010US	US	Xeon E3-1505M v6	vPro	M2200M 4GB	Intel CM238	8GBx1 non-ECC	15.6" FHD (1920x1080) IPS	None	None	512GB SSD M.2 PCIe NVMe Opal2	No	None	Intel 8265 ac, 2x2 + BT4.1	WWAN Upgradable	None	None	720p	Backlit	Finger-print Reader	None	None	dTPM 2.0	6-cell (90Wh)	170W	Win10 Pro 64	3-year, Depot	03/17
20HH0011US	US	i7-7700HQ	No	M1200M 4GB	Intel CM238	8GBx1 non-ECC	15.6" FHD (1920x1080) IPS	None	None	500GB 7200rpm	No	None	Intel 8265 ac, 2x2 + BT4.1	WWAN Upgradable	None	None	720p	Backlit	Finger-print Reader	None	None	dTPM 2.0	6-cell (90Wh)	170W	Win10 Pro 64	3-year, Depot	03/17
20HH0012US	US	i7-7820HQ	vPro	M1200M 4GB	Intel CM238	8GBx1 non-ECC	15.6" FHD (1920x1080) IPS	None	None	1TB SSD M.2 PCIe NVMe Opal2	No	None	Intel 8265 ac, 2x2 + BT4.1	WWAN Upgradable	None	None	720p	Backlit	Finger-print Reader	None	None	dTPM 2.0	6-cell (90Wh)	170W	Win10 Pro 64	3-year, Depot	03/17
20HH0013US	US	Xeon E3-1505M v6	vPro	M2200M 4GB	Intel CM238	8GBx2 non-ECC	15.6" FHD (1920x1080) IPS	None	None	1TB SSD M.2 PCIe NVMe Opal2	No	None	Intel 8265 ac, 2x2 + BT4.1	WWAN Upgradable	None	None	720p	Backlit	Finger-print Reader	None	None	dTPM 2.0	6-cell (90Wh)	170W	Win10 Pro 64	3-year, Depot	03/17
20HH002LUS	US	i7-7820HQ	vPro	M2200M 4GB	Intel CM238	8GBx1 non-ECC	15.6" FHD (1920x1080) IPS	None	None	1TB SSD M.2 PCIe NVMe Opal2	No	None	Intel 8265 ac, 2x2 + BT4.1	WWAN Upgradable	None	None	720p	Backlit	Finger-print Reader	None	X-Rite	dTPM 2.0	6-cell (90Wh)	170W	Win10 Pro 64	3-year, Depot	05/17
20HH002MUS	US	i7-7700HQ	No	M1200M 4GB	Intel CM238	8GBx1 non-ECC	15.6" FHD (1920x1080) IPS	None	None	512GB SSD M.2 PCIe NVMe Opal2	No	None	Intel 8265 ac, 2x2 + BT4.1	WWAN Upgradable	None	None	720p	Backlit	Finger-print Reader	None	X-Rite	dTPM 2.0	6-cell (90Wh)	170W	Win10 Pro 64	3-year, Depot	05/17
20HH002NUS	US	i7-7820HQ	vPro	M2200M 4GB	Intel CM238	8GBx1 non-ECC	15.6" FHD (1920x1080) IPS	None	None	512GB SSD M.2 PCIe NVMe Opal2	No	None	Intel 8265 ac, 2x2 + BT4.1	WWAN Upgradable	None	None	720p	Backlit	Finger-print Reader	None	X-Rite	dTPM 2.0	6-cell (90Wh)	170W	Win10 Pro 64	3-year, Depot	05/17
20HH002PUS	US	i7-7820HQ	vPro	M2200M 4GB	Intel CM238	8GBx1 non-ECC	15.6" FHD (1920x1080) IPS	10-point Multi-touch	None	512GB SSD M.2 PCIe NVMe Opal2	No	None	Intel 8265 ac, 2x2 + BT4.1	WWAN Upgradable	None	None	720p	Backlit	Finger-print Reader	None	X-Rite	dTPM 2.0	6-cell (90Wh)	170W	Win10 Pro 64	3-year, Depot	05/17
20HH002QUS	US	i7-7700HQ	No	M1200M 4GB	Intel CM238	8GBx2 non-ECC	15.6" FHD (1920x1080) IPS	10-point Multi-touch	None	512GB SSD M.2 PCIe NVMe Opal2	No	None	Intel 8265 ac, 2x2 + BT4.1	WWAN Upgradable	None	None	720p	Backlit	Finger-print Reader	None	X-Rite	dTPM 2.0	6-cell (90Wh)	170W	Win10 Pro 64	3-year, Depot	05/17







# ThinkPad P51s Platform Specifications

Product Specifications Reference (PSREF)

Processor	6th Generation Intel® Core™ i7 Processor							Dimensions WxDxH: 14.40" x 9.95" x 0.79-0.80"; 365.8mm x 252.8mm x 19.95-20.2mm
	Processor Number	# of Cores	# of Threads	Base Frequency	Max Turbo Frequency	Cache	Memory Types	
	i7-6500U	2	4	2.5 GHz	3.1 GHz	4MB	DDR4-2133	Intel HD Graphics 520
	i7-6600U			2.6 GHz	3.4 GHz	4MB		
	or 7th Generation Intel Core i5 / i7 Processor							
	Processor Number	# of Cores	# of Threads	Base Frequency	Max Turbo Frequency	Cache	Memory Types	Processor Graphics
	i5-7300U	2	4	2.6 GHz	3.5 GHz	3MB	DDR4-2133	Intel HD Graphics 620
	i7-7500U			2.7 GHz	3.5 GHz	4MB		
	i7-7600U			2.8 GHz	3.9 GHz	4MB		
Graphics	Intel HD Graphics 520 or 620 in processor and NVIDIA Quadro® M520M, 2GB 2.5GHz GDDR5 memory; supports external digital monitor via HDMI or USB Type-C; supports three independent displays; Max resolution: 4096x2304@60Hz (USB Type-C); 3840x2160@30Hz (HDMI)							Case color Case material
Chipset	Intel SoC (System on Chip) platform							Smart card reader
Memory	32GB max / 2400MHz DDR4, dual-channel capable, two DDR4 SO-DIMM sockets * System clocks down for processors with lower memory controller							Media reader
Display	Some: 15.6" (396mm) FHD (1920x1080), anti-glare, LED backlight, IPS, 250 nits, 16:9 aspect ratio, 700:1 contrast ratio, 170° viewing angle Some: 15.6" (396mm) 4K (3840x2160), anti-glare, LED backlight, IPS, 300 nits, 16:9 aspect ratio, 1000:1 contrast ratio, 72% gamut, 170° viewing angle							Ports
Multi-touch (opt)	On-cell touch, supports 10-finger gesture (FHD only)							WiGig dock (opt)
Storage	System has one HDD slot or one M.2 2280 slot exclusively for storage Some: HDD / SATA 6.0Gb/s, 2.5" wide, 7mm high, Active Protection System™ Some: SSD / SATA 6.0Gb/s, 2.5" wide, 7mm high (e.g. xxxGB SSD) Some: M.2 SSD / PCIe NVMe, PCIe 3.0 x 2, 16Gb/s Some: 128GB M.2 SSD / SATA 6.0Gb/s, in WWAN slot as 2nd Storage, mutually exclusive with WWAN and WiGig							Monitor cable (optional)
Optical	None							Camera (optional)
Ethernet	Non-vPro model: Intel Ethernet Connection I219-V (Jacksonville) vPro model: Intel Ethernet Connection I219-LM (Jacksonville)							Audio support
WLAN	One of the following, configurable by model (WiGig can coexist with WWAN): • Realtek® RTL8822BE, Wi-Fi 2x2 802.11ac + BT4.1, M.2 card • Intel Dual Band Wireless-AC 8260, Wi-Fi 2x2 802.11ac + BT4.1, M.2 card • Intel Dual Band Wireless-AC 8265, Wi-Fi 2x2 802.11ac + BT4.1, M.2 card • Intel Tri-Band Wireless-AC 18265, WiGig 802.11ad + Wi-Fi 2x2 802.11ac + BT4.1, M.2 card							Keyboard
Bluetooth™	Bluetooth 4.1 wireless, integrated in Wi-Fi + Bluetooth combo adapter * Intel 8265ac / 18265ac card support BT4.2 but is limited to BT4.1 by Windows OS							UltraNav™
WWAN (optional)	One of the following, configurable by model (WWAN can coexist with WiGig): • Wireless WAN upgradable • Integrated Mobile Broadband 4G LTE-A, Qualcomm® Snapdragon™ X7 LTE-A (Sierra Wireless EM7455), M.2 card • Integrated Mobile Broadband 4G LTE, Intel XMM™ 7160 (Fibocom L831-EAU), M.2 card (EMEA only)							Security
SIM card (opt)	Micro-SIM card slot, opt Verizon LTE (US) or Lenovo® Connect (EMEA) SIM card							Security chip
								vPro (optional)
								Fingerprint reader
								NFC (optional)
								Internal battery
								External battery
								Max battery life (MobileMark® 2014)
								AC adapter
								Preload
								Limited warranty
								Mil-Spec test
								Environment

Model	Region	Processor	vPro	Graphics	Memory	Display	Multi-touch	Storage(HDD/SSD)	Optical	WLAN + Bluetooth	WWAN	SIM Card	Smart Card Reader	Dock	Monitor Cable	Camera	Key-board	Finger-print Reader	NFC	TPM	Battery (internal+ external)	Power Adapter	Operating System	Warranty	Ann Date (m/y)
20HB0004US	US	i7-7500U	No	M520M 2GB	8GBx1	15.6" FHD (1920x1080) IPS	None	1TB 5400rpm	None	Intel 8265 ac, 2x2 + BT4.1	WWAN Upgradable	None	None	None	None	720p	Backlit	Finger-print Reader	None	dTPM 2.0	4-cell(32Wh) + 3-cell(24Wh)	65W	Win10 Pro 64	3-year, Depot	03/17
20HB000AUS	US	i7-7500U	No	M520M 2GB	8GBx1	15.6" FHD (1920x1080) IPS	None	256GB SSD M.2 PCIe NVMe Opal2	None	Intel 8265 ac, 2x2 + BT4.1	WWAN Upgradable	None	None	None	None	720p	Backlit	Finger-print Reader	None	dTPM 2.0	4-cell(32Wh) + 3-cell(24Wh)	65W	Win10 Pro 64	3-year, Depot	03/17
20HB000WUS	US	i7-7600U	vPro	M520M 2GB	8GBx1	15.6" FHD (1920x1080) IPS	None	256GB SSD M.2 PCIe NVMe Opal2	None	Intel 8265 ac, 2x2 + BT4.1	WWAN Upgradable	None	None	None	None	720p	Backlit	Finger-print Reader	None	dTPM 2.0	4-cell(32Wh) + 3-cell(24Wh)	65W	Win10 Pro 64	3-year, Depot	03/17
20HB000XUS	US	i5-7300U	vPro	M520M 2GB	8GBx1	15.6" FHD (1920x1080) IPS	10-point Multi-touch	256GB SSD M.2 PCIe NVMe Opal2	None	Intel 8265 ac, 2x2 + BT4.1	WWAN Upgradable	None	None	None	None	720p	Backlit	Finger-print Reader	None	dTPM 2.0	4-cell(32Wh) + 3-cell(24Wh)	65W	Win10 Pro 64	3-year, Depot	03/17
20HB000YUS	US	i5-7300U	vPro	M520M 2GB	8GBx1	15.6" 4K (3840x2160) IPS	None	1TB 5400rpm	None	Intel 8265 ac, 2x2 + BT4.1	WWAN Upgradable	None	None	None	None	IR &720p	Backlit	Finger-print Reader	None	dTPM 2.0	4-cell(32Wh) + 3-cell(24Wh)	65W	Win10 Pro 64	3-year, Depot	03/17
20HB0010US	US	i5-7300U	vPro	M520M 2GB	8GBx1	15.6" FHD (1920x1080) IPS	None	512GB SSD M.2 PCIe NVMe Opal2	None	Intel 8265 ac, 2x2 + BT4.1	WWAN Upgradable	None	None	None	None	720p	Backlit	Finger-print Reader	None	dTPM 2.0	4-cell(32Wh) + 3-cell(24Wh)	65W	Win10 Pro 64	3-year, Depot	03/17
20HB0011US	US	i7-7600U	vPro	M520M 2GB	8GBx2	15.6" FHD (1920x1080) IPS	None	1TB SSD M.2 PCIe NVMe Opal2	None	Intel 8265 ac, 2x2 + BT4.1	WWAN Upgradable	None	None	None	None	IR &720p	Backlit	Finger-print Reader	None	dTPM 2.0	4-cell(32Wh) + 3-cell(24Wh)	65W	Win10 Pro 64	3-year, Depot	03/17
20HB0012US	US	i7-7600U	vPro	M520M 2GB	8GBx2	15.6" FHD (1920x1080) IPS	None	512GB SSD M.2 PCIe NVMe Opal2	None	Intel 8265 ac, 2x2 + BT4.1	WWAN Upgradable	None	None	None	None	IR &720p	Backlit	Finger-print Reader	None	dTPM 2.0	4-cell(32Wh) + 3-cell(24Wh)	65W	Win10 Pro 64	3-year, Depot	03/17
20HB0013US	US	i7-7600U	vPro	M520M 2GB	8GBx1	15.6" 4K (3840x2160) IPS	None	256GB SSD M.2 PCIe NVMe Opal2	None	Intel 8265 ac, 2x2 + BT4.1	WWAN Upgradable	None	None	None	None	IR &720p	Backlit	Finger-print Reader	None	dTPM 2.0	4-cell(32Wh) + 3-cell(24Wh)	65W	Win10 Pro 64	3-year, Depot	03/17
20HB0014US	US	i5-7300U	vPro	M520M 2GB	8GBx1	15.6" FHD (1920x1080) IPS	None	256GB SSD M.2 PCIe NVMe Opal2	None	Intel 8265 ac, 2x2 + BT4.1	WWAN Upgradable	None	None	None	None	720p	Backlit	Finger-print Reader	None	dTPM 2.0	4-cell(32Wh) + 3-cell(24Wh)	65W	Win10 Pro 64	3-year, Depot	03/17
20HB0015US	US	i7-7500U	No	M520M 2GB	8GBx1	15.6" FHD (1920x1080) IPS	None	512GB SSD M.2 PCIe NVMe Opal2	None	Intel 8265 ac, 2x2 + BT4.1	WWAN Upgradable	None	None	None	None	720p	Backlit	Finger-print Reader	None	dTPM 2.0	4-cell(32Wh) + 3-cell(24Wh)	65W	Win10 Pro 64	3-year, Depot	03/17
20HB0016US	US	i7-7600U	vPro	M520M 2GB	8GBx1	15.6" FHD (1920x1080) IPS	10-point Multi-touch	1TB SSD M.2 PCIe NVMe Opal2	None	Intel 8265 ac, 2x2 + BT4.1	WWAN Upgradable	None	None	None	None	720p	Backlit	Finger-print Reader	None	dTPM 2.0	4-cell(32Wh) + 3-cell(24Wh)	65W	Win10 Pro 64	3-year, Depot	03/17
20HB0017US	US	i5-7300U	vPro	M520M 2GB	8GBx1	15.6" FHD (1920x1080) IPS	None	256GB SSD M.2 PCIe NVMe Opal2	None	Intel 8265 ac, 2x2 + BT4.1	WWAN Upgradable	None	None	None	None	720p	Backlit	Finger-print Reader	None	dTPM 2.0	4-cell(32Wh) + 6-cell(72Wh)	65W	Win10 Pro 64	3-year, Depot	03/17
20HB0018US	US	i5-7300U	vPro	M520M 2GB	8GBx1	15.6" FHD (1920x1080) IPS	None	500GB 7200rpm	None	Intel 8265 ac, 2x2 + BT4.1	WWAN Upgradable	None	None	None	None	720p	Backlit	Finger-print Reader	None	dTPM 2.0	4-cell(32Wh) + 3-cell(24Wh)	65W	Win10 Pro 64	3-year, Depot	03/17
20HB0019US	US	i5-7300U	vPro	M520M 2GB	8GBx1	15.6" FHD (1920x1080) IPS	None	1TB 5400rpm	None	Intel 8265 ac, 2x2 + BT4.1	WWAN Upgradable	None	None	None	None	720p	Backlit	Finger-print Reader	None	dTPM 2.0	4-cell(32Wh) + 3-cell(24Wh)	65W	Win10 Pro 64	3-year, Depot	03/17
20HB001AUS	US	i5-7300U	vPro	M520M 2GB	8GBx1	15.6" FHD (1920x1080) IPS	None	1TB SSD M.2 PCIe NVMe Opal2	None	Intel 8265 ac, 2x2 + BT4.1	WWAN Upgradable	None	None	None	None	720p	Backlit	Finger-print Reader	None	dTPM 2.0	4-cell(32Wh) + 3-cell(24Wh)	65W	Win10 Pro 64	3-year, Depot	03/17
20HB001BUS	US	i7-7600U	vPro	M520M 2GB	8GBx1	15.6" FHD (1920x1080) IPS	None	1TB 5400rpm	None	Intel 8265 ac, 2x2 + BT4.1	WWAN Upgradable	None	None	None	None	720p	Backlit	Finger-print Reader	None	dTPM 2.0	4-cell(32Wh) + 3-cell(24Wh)	65W	Win10 Pro 64	3-year, Depot	03/17
20HB001CUS	US	i7-7600U	vPro	M520M 2GB	8GBx2	15.6" FHD (1920x1080) IPS	None	256GB SSD M.2 PCIe NVMe Opal2	None	Intel 8265 ac, 2x2 + BT4.1	WWAN Upgradable	None	None	None	None	IR &720p	Backlit	Finger-print Reader	None	dTPM 2.0	4-cell(32Wh) + 3-cell(24Wh)	65W	Win10 Pro 64	3-year, Depot	03/17
20HB001DUS	US	i5-7300U	vPro	M520M 2GB	8GBx2	15.6" FHD (1920x1080) IPS	None	512GB SSD M.2 PCIe NVMe Opal2	None	Intel 8265 ac, 2x2 + BT4.1	WWAN Upgradable	None	None	None	None	IR &720p	Backlit	Finger-print Reader	None	dTPM 2.0	4-cell(32Wh) + 3-cell(24Wh)	65W	Win10 Pro 64	3-year, Depot	03/17
20HB001EUS	US	i7-7600U	vPro	M520M 2GB	8GBx1	15.6" FHD (1920x1080) IPS	None	1TB SSD M.2 PCIe NVMe Opal2	None	Intel 8265 ac, 2x2 + BT4.1	WWAN Upgradable	None	None	None	None	720p	Backlit	Finger-print Reader	None	dTPM 2.0	4-cell(32Wh) + 3-cell(24Wh)	65W	Win10 Pro 64	3-year, Depot	03/17

Model	Region	Processor	vPro	Graphics	Memory	Display	Multi-touch	Storage(HDD/SSD)	Optical	WLAN + Bluetooth	WWAN	SIM Card	Smart Card Reader	Dock	Monitor Cable	Camera	Key-board	Finger-print Reader	NFC	TPM	Battery (internal+external)	Power Adapter	Operating System	Warranty	Ann Date (m/y)
20HB001FUS	US	i5-7300U	vPro	M520M 2GB	8GBx2	15.6" FHD (1920x1080) IPS	None	256GB SSD M.2 PCIe NVMe Opal2	None	Intel 8265 ac, 2x2 + BT4.1	WWAN Upgradable	None	None	None	None	IR &720p	Backlit	Finger-print Reader	None	dTPM 2.0	4-cell(32Wh) + 3-cell(24Wh)	65W USB-C	Win10 Pro 64	3-year, Depot	03/17
20HB001GUS	US	i7-7600U	vPro	M520M 2GB	8GBx1	15.6" FHD (1920x1080) IPS	None	512GB SSD M.2 PCIe NVMe Opal2	None	Intel 8265 ac, 2x2 + BT4.1	WWAN Upgradable	None	None	None	None	720p	Backlit	Finger-print Reader	None	dTPM 2.0	4-cell(32Wh) + 3-cell(24Wh)	65W USB-C	Win10 Pro 64	3-year, Depot	03/17
20HB001HUS	US	i5-7300U	vPro	M520M 2GB	4GBx1	15.6" FHD (1920x1080) IPS	None	500GB 7200rpm	None	Intel 8265 ac, 2x2 + BT4.1	WWAN Upgradable	None	None	None	None	720p	Backlit	Finger-print Reader	None	dTPM 2.0	4-cell(32Wh) + 3-cell(24Wh)	65W USB-C	Win10 Pro 64	3-year, Depot	03/17
20HB001JUS	US	i5-7300U	vPro	M520M 2GB	8GBx1	15.6" 4K (3840x2160) IPS	None	256GB SSD M.2 PCIe NVMe Opal2	None	Intel 8265 ac, 2x2 + BT4.1	WWAN Upgradable	None	None	None	None	IR &720p	Backlit	Finger-print Reader	None	dTPM 2.0	4-cell(32Wh) + 3-cell(24Wh)	65W USB-C	Win10 Pro 64	3-year, Depot	03/17
20HB001KUS	US	i7-7500U	No	M520M 2GB	8GBx1	15.6" FHD (1920x1080) IPS	None	500GB 7200rpm	None	Intel 8265 ac, 2x2 + BT4.1	WWAN Upgradable	None	None	None	None	720p	Backlit	Finger-print Reader	None	dTPM 2.0	4-cell(32Wh) + 3-cell(24Wh)	65W	Win10 Pro 64	3-year, Depot	03/17
20HB001NUS	US	i5-7300U	vPro	M520M 2GB	8GBx1	15.6" FHD (1920x1080) IPS	None	500GB 7200rpm	None	Intel 8265 ac, 2x2 + BT4.1	WWAN Upgradable	None	None	None	None	720p	Backlit	Finger-print Reader	None	dTPM 2.0	4-cell(32Wh) + 3-cell(24Wh)	65W	Win10 Pro 64	3-year, Depot	05/17
20HB001PUS	US	i7-7500U	No	M520M 2GB	16GBx1	15.6" FHD (1920x1080) IPS	10-point Multi-touch	500GB 7200rpm	None	Intel 8265 ac, 2x2 + BT4.1	WWAN Upgradable	None	None	None	None	720p	Backlit	Finger-print Reader	None	dTPM 2.0	4-cell(32Wh) + 3-cell(24Wh)	65W	Win10 Pro 64	3-year, Depot	05/17
20HB001QUS	US	i7-7500U	No	M520M 2GB	8GBx1	15.6" FHD (1920x1080) IPS	10-point Multi-touch	500GB 7200rpm	None	Intel 8265 ac, 2x2 + BT4.1	WWAN Upgradable	None	None	None	None	720p	Backlit	Finger-print Reader	None	dTPM 2.0	4-cell(32Wh) + 3-cell(24Wh)	65W	Win10 Pro 64	3-year, Depot	05/17
20HB001RUS	US	i5-7300U	vPro	M520M 2GB	8GBx1	15.6" FHD (1920x1080) IPS	10-point Multi-touch	500GB 7200rpm	None	Intel 8265 ac, 2x2 + BT4.1	WWAN Upgradable	None	None	None	None	720p	Backlit	Finger-print Reader	None	dTPM 2.0	4-cell(32Wh) + 3-cell(24Wh)	65W	Win10 Pro 64	3-year, Depot	05/17
20HB001SUS	US	i7-7500U	No	M520M 2GB	16GBx1	15.6" FHD (1920x1080) IPS	None	512GB SSD M.2 PCIe NVMe Opal2	None	Intel 8265 ac, 2x2 + BT4.1	WWAN Upgradable	None	None	None	None	IR &720p	Backlit	Finger-print Reader	None	dTPM 2.0	4-cell(32Wh) + 3-cell(24Wh)	65W	Win10 Pro 64	3-year, Depot	05/17
20HB001TUS	US	i7-7500U	No	M520M 2GB	8GBx1	15.6" FHD (1920x1080) IPS	10-point Multi-touch	256GB SSD M.2 PCIe NVMe Opal2	None	Intel 8265 ac, 2x2 + BT4.1	WWAN Upgradable	None	None	None	None	720p	Backlit	Finger-print Reader	None	dTPM 2.0	4-cell(32Wh) + 3-cell(24Wh)	65W	Win10 Pro 64	3-year, Depot	05/17
20HB001UUS	US	i7-7500U	No	M520M 2GB	16GBx1	15.6" FHD (1920x1080) IPS	10-point Multi-touch	512GB SSD M.2 PCIe NVMe Opal2	None	Intel 8265 ac, 2x2 + BT4.1	WWAN Upgradable	None	None	None	None	720p	Backlit	Finger-print Reader	None	dTPM 2.0	4-cell(32Wh) + 3-cell(24Wh)	65W	Win10 Pro 64	3-year, Depot	05/17
20HB001VUS	US	i7-7500U	No	M520M 2GB	16GBx1	15.6" FHD (1920x1080) IPS	None	512GB SSD M.2 PCIe NVMe Opal2	None	Intel 8265 ac, 2x2 + BT4.1	WWAN Upgradable	None	None	None	None	720p	Backlit	Finger-print Reader	None	dTPM 2.0	4-cell(32Wh) + 3-cell(24Wh)	65W	Win10 Pro 64	3-year, Depot	05/17
20HB001XUS	US	i7-7500U	No	M520M 2GB	16GBx1	15.6" FHD (1920x1080) IPS	None	512GB SSD M.2 PCIe NVMe Opal2	None	Intel 8265 ac, 2x2 + BT4.1	WWAN Upgradable	None	None	None	None	IR &720p	Backlit	Finger-print Reader	None	dTPM 2.0	4-cell(32Wh) + 3-cell(24Wh)	65W	Win10 Pro 64	3-year, Depot	05/17

ThinkPad P51s - TopSeller - 20JY

Product Specifications Reference (PSREF)

Model	Region	Processor	vPro	Graphics	Memory	Display	Multi-touch	Storage(HDD/SSD)	Optical	WLAN + Bluetooth	WWAN	SIM Card	Smart Card Reader	Dock	Monitor Cable	Camera	Key-board	Finger-print Reader	NFC	TPM	Battery (internal+external)	Power Adapter	Operating System	Warranty	Ann Date (m/y)
20JY0004US	US	i7-6500U	No	M520M 2GB	8GBx2	15.6" FHD (1920x1080) IPS	None	512GB SSD M.2 PCIe NVMe Opal2	None	Intel 8260 ac, 2x2 + BT4.1	WWAN Upgradable	None	None	None	None	720p	Backlit	Finger-print Reader	None	dTPM 2.0	4-cell(32Wh) + 3-cell(24Wh)	65W	Win10 DG Win7 Pro 64	3-year, Depot	03/17
20JY0005US	US	i7-6500U	No	M520M 2GB	8GBx2	15.6" FHD (1920x1080) IPS	None	256GB SSD M.2 PCIe NVMe Opal2	None	Intel 8260 ac, 2x2 + BT4.1	WWAN Upgradable	None	None	None	None	720p	Backlit	Finger-print Reader	None	dTPM 2.0	4-cell(32Wh) + 3-cell(24Wh)	65W	Win10 DG Win7 Pro 64	3-year, Depot	03/17
20JY0006US	US	i7-6500U	No	M520M 2GB	8GBx1	15.6" FHD (1920x1080) IPS	None	256GB SSD M.2 PCIe NVMe Opal2	None	Intel 8260 ac, 2x2 + BT4.1	WWAN Upgradable	None	None	None	None	720p	Backlit	Finger-print Reader	None	dTPM 2.0	4-cell(32Wh) + 3-cell(24Wh)	65W	Win10 DG Win7 Pro 64	3-year, Depot	03/17
20JY0007US	US	i7-6500U	No	M520M 2GB	8GBx2	15.6" 4K (3840x2160) IPS	None	256GB SSD M.2 PCIe NVMe Opal2	None	Intel 8260 ac, 2x2 + BT4.1	WWAN Upgradable	None	None	None	None	720p	Backlit	Finger-print Reader	None	dTPM 2.0	4-cell(32Wh) + 3-cell(24Wh)	65W	Win10 DG Win7 Pro 64	3-year, Depot	03/17
20JY0008US	US	i7-6500U	No	M520M 2GB	8GBx2	15.6" 4K (3840x2160) IPS	None	500GB 7200rpm	None	Intel 8260 ac, 2x2 + BT4.1	WWAN Upgradable	None	None	None	None	720p	Backlit	Finger-print Reader	None	dTPM 2.0	4-cell(32Wh) + 3-cell(24Wh)	65W	Win10 DG Win7 Pro 64	3-year, Depot	03/17
20JY0009US	US	i7-6500U	No	M520M 2GB	8GBx1	15.6" FHD (1920x1080) IPS	None	500GB 7200rpm	None	Intel 8260 ac, 2x2 + BT4.1	WWAN Upgradable	None	None	None	None	720p	Backlit	Finger-print Reader	None	dTPM 2.0	4-cell(32Wh) + 3-cell(24Wh)	65W	Win10 DG Win7 Pro 64	3-year, Depot	03/17
20JY000AUS	US	i7-6500U	No	M520M 2GB	16GBx2	15.6" FHD (1920x1080) IPS	None	1TB SSD M.2 PCIe NVMe Opal2	None	Intel 8260 ac, 2x2 + BT4.1	WWAN Upgradable	None	None	None	None	720p	Backlit	Finger-print Reader	None	dTPM 2.0	4-cell(32Wh) + 3-cell(24Wh)	65W	Win10 DG Win7 Pro 64	3-year, Depot	03/17
20JY000BUS	US	i7-6500U	No	M520M 2GB	8GBx2	15.6" 4K (3840x2160) IPS	None	512GB SSD M.2 PCIe NVMe Opal2	None	Intel 8260 ac, 2x2 + BT4.1	WWAN Upgradable	None	None	None	None	720p	Backlit	Finger-print Reader	None	dTPM 2.0	4-cell(32Wh) + 3-cell(24Wh)	65W	Win10 DG Win7 Pro 64	3-year, Depot	03/17
20JY000CUS	US	i7-6500U	No	M520M 2GB	16GBx2	15.6" FHD (1920x1080) IPS	None	512GB SSD M.2 PCIe NVMe Opal2	None	Intel 8260 ac, 2x2 + BT4.1	WWAN Upgradable	None	None	None	None	720p	Backlit	Finger-print Reader	None	dTPM 2.0	4-cell(32Wh) + 3-cell(24Wh)	65W	Win10 DG Win7 Pro 64	3-year, Depot	03/17



# ThinkPad P70 Platform Specifications

Product Specifications Reference (PSREF)

Processor	6th Generation Intel® Core™ i7 Processor or Intel Xeon® Processor E3 v5 Family							Smart card reader ExpressCard Media reader Ports	Optional: Smart card reader One slot (ExpressCard/34) 4-in-1 reader (MMC, SD, SDHC, SDXC), supports UHS-II SD card Four USB 3.0 (one Always On), two USB Type-C / Thunderbolt 3, Mini DisplayPort, HDMI, Ethernet (RJ-45), Dock connector						
	Processor Number	# of Cores	# of Threads	Base Frequency	Max Turbo Frequency	Cache	Memory Types			Processor Graphics					
	i7-6700HQ	4	8	2.6 GHz	3.5 GHz	6MB	DDR4-2133			Intel HD Graphics 530					
	i7-6820HQ			2.7 GHz	3.6 GHz	8MB				Intel HD Graphics P530					
	E3-1505M v5			2.8 GHz	3.7 GHz	8MB	DDR4-2133			Intel Iris™ Pro Graphics P580					
E3-1575M v5	3 GHz			3.9 GHz											
Graphics	Intel HD Graphics 530, Intel HD Graphics P530, or Intel Iris™ Pro Graphics P580 in processor and NVIDIA Quadro® M600M (2GB memory), M3000M (4GB memory), M4000M (4GB memory), or M5000M (8GB memory); supports external digital monitor via HDMI, Mini DisplayPort, or Thunderbolt™; supports five independent displays; Max resolution: 3840x2160@60Hz (DisplayPort via Mini DisplayPort cable); 3840x2160@60Hz (Thunderbolt); 3840x2160@30Hz (HDMI)							Camera (optional) Audio support	HD720p resolution, low light sensitive, fixed focus HD Audio, Realtek® ALC3268 codec / stereo speakers, 2W x 2 / dual array microphone, combo audio/microphone jack						
Chipset	Mobile Intel CM236 Chipset (Intel GL82CM236 PCH)							Keyboard UltraNav™	6-row, spill-resistant, multimedia Fn keys, numeric keypad, optional LED backlight 3-button TrackPoint® pointing device and 3-button crystal silk surface multi-touch touchpad						
Memory	64GB max <sup>7</sup> / 2133MHz DDR4, ECC or non-ECC (ECC function supported only on Xeon processor), dual-channel capable, four DDR4 SO-DIMM sockets							Security Security chip ThinkEngine	Power-on password, hard disk password, supervisor password, security keyhole Discrete TPM 1.2 TCG Certified and Firmware TPM 2.0 integrated in chipset Delivers improved thermal and power efficiency, up to 30 day standby, faster resume time, enhanced security, as well as anti-tampering measures						
Display	Some: 17.3" (439mm) FHD (1920x1080), anti-glare, LED backlight, IPS, 300 nits, 16:9 aspect ratio, 800:1 contrast ratio, 72% gamut, 170° viewing angle Some: 17.3" (439mm) 4K (3840x2160), anti-glare, LED backlight, IPS, 300 nits, 16:9 aspect ratio, 800:1 contrast ratio, 90% gamut, 170° viewing angle							vPro (optional) Fingerprint reader Color calibration	Intel vPro Technology Touch style fingerprint reader on the keyboard bezel Optional: Pantone® color calibrator by X-Rite® color calibration sensor in palm rest						
Multi-touch (opt) Pen (optional)	Capacitive-type multi-touch, supports 10-finger gesture, 270 nits ThinkPad Pen Pro, active pen for multi-touch display							Battery Max battery life <sup>10</sup> (MobileMark® 2014)	Li-Ion 8-cell (96Wh) <table border="1"> <thead> <tr> <th>Mode</th> <th>Discrete Graphics</th> <th>Hybrid Graphics</th> </tr> </thead> <tbody> <tr> <td>Max battery life</td> <td>8.5 hr</td> <td>10.8 hr</td> </tr> </tbody> </table>	Mode	Discrete Graphics	Hybrid Graphics	Max battery life	8.5 hr	10.8 hr
Mode	Discrete Graphics	Hybrid Graphics													
Max battery life	8.5 hr	10.8 hr													
Storage	Up to 4 drives (two M.2 SSD and two HDD, one of which is in the optical bay) Some: M.2 SSD / SATA 6.0Gb/s (e.g. xxxG SSD) Some: M.2 SSD / PCIe NVMe, PCIe 3.0 x 4, 32Gb/s (e.g. xxxG SSD PCIe NVMe) Some: HDD / SATA 6.0Gb/s, 2.5" wide, 7mm high, Shock Mounted Hard Drive, Active Protection System™							AC adapter	170W or 230W AC adapter						
Optical (optional)	DVD burner, 9.5mm high, fixed, tray-in							Preload	Some: Genuine Windows® 7 Professional 64 Some: Windows 7 Professional 64 preinstalled through downgrade rights in Windows 10 Pro 64 • Lenovo Solution Center • Lenovo SHAREit • ThinkVantage Product Recovery • Rescue and Recovery™ • ThinkVantage System Update • Adobe® Reader® • Microsoft® Office preloaded; purchase a product key to activate • McAfee® LiveSafe™ (30-day trial) For ISV certifications, please visit <a href="http://www.lenovo.com/support/ISV">www.lenovo.com/support/ISV</a>						
Ethernet	Non-vPro model: Intel Ethernet Connection I219-V (Jacksonville) vPro model: Intel Ethernet Connection I219-LM (Jacksonville)							Limited warranty <sup>12</sup>	One of the following, configurable by model: • 3-year/1-yr battery depot repair service • 3-year/1-yr battery limited onsite service <sup>24</sup> • 3-year/1-yr battery limited onsite service, OID (Onsite International Delivery)						
WLAN <sup>4</sup> Bluetooth™	11ac+BT, Intel Dual Band Wireless-AC 8260, 2x2, M.2 card Bluetooth 4.1 wireless, integrated in Wi-Fi + Bluetooth combo adapter							Mil-Spec test	MIL-STD-810G military certification						
WWAN (optional)	Wireless WAN, Sierra Wireless EM7455, Qualcomm® 4G LTE-Advanced/DC-HSPA+/HSPA+/HSPA/UMTS/GNSS, M.2 card							Environment	EPEAT™ Gold (US only); ENERGY STAR® 6.1; GREENGUARD®; RoHS-compliant						
SIM card	Micro-SIM card slot														
Dimensions <sup>3</sup>	WxDxH: 16.38" x 10.85" x 1.18-1.35"; 416mm x 275.5mm x 29.9-34.2mm WxDxH(Touch): 16.38" x 10.85" x 1.20-1.37"; 416mm x 275.5mm x 30.6-34.9mm														
Weight <sup>2</sup>	Non-touch model: starting at 7.3 lb (3.3kg); Multi-touch model: starting at 8.1 lb (3.7kg)														
Case material	Display cover: Glass-Fiber + PPS; Bottom: Magnesium/Aluminum														

Model	Region	Processor	vPro	Graphics	Memory	Display	Multi-touch	Pen	Storage(HDD/SSD)	RAID	Optical	WLAN + Bluetooth	WWAN	SIM Card	Smart Card Reader	Camera	Keyboard	Fingerprint Reader	Color Calibrator	Battery	Power Adapter	Operating System	Warranty	Ann Date (m/y)
20ER000FUS	US	i7-6700HQ	No	M600M 2GB	8GBx1 non-ECC	17.3" FHD (1920x1080) IPS	None	None	500GB 7200rpm	No	DVD±RW	Intel 8260 ac, 2x2 + BT4.1	None	None	None	720p	Backlit	Fingerprint Reader	None	8-cell (96Wh)	170W	Win10 DG Win7 Pro 64	3-year, Depot	10/15
20ER000GUS	US	i7-6700HQ	No	M3000M 4GB	8GBx1 non-ECC	17.3" FHD (1920x1080) IPS	None	None	500GB 7200rpm	No	DVD±RW	Intel 8260 ac, 2x2 + BT4.1	None	None	None	720p	Backlit	Fingerprint Reader	None	8-cell (96Wh)	230W	Win10 DG Win7 Pro 64	3-year, Depot	10/15
20ER000HUS	US	i7-6820HQ	vPro	M600M 2GB	8GBx1 non-ECC	17.3" FHD (1920x1080) IPS	None	None	500GB 7200rpm	No	DVD±RW	Intel 8260 ac, 2x2 + BT4.1	None	None	None	720p	Backlit	Fingerprint Reader	None	8-cell (96Wh)	170W	Win10 DG Win7 Pro 64	3-year, Depot	10/15
20ER000JUS	US	i7-6820HQ	vPro	M3000M 4GB	8GBx1 non-ECC	17.3" FHD (1920x1080) IPS	None	None	500GB 7200rpm	No	DVD±RW	Intel 8260 ac, 2x2 + BT4.1	None	None	None	720p	Backlit	Fingerprint Reader	None	8-cell (96Wh)	230W	Win10 DG Win7 Pro 64	3-year, Depot	10/15
20ER000LUS	US	Xeon E3-1505M v5	vPro	M600M 2GB	8GBx1 ECC	17.3" FHD (1920x1080) IPS	None	None	256GB SSD M.2 PCIe NVMe Opal2	No	DVD±RW	Intel 8260 ac, 2x2 + BT4.1	None	None	None	720p	Backlit	Fingerprint Reader	None	8-cell (96Wh)	170W	Win10 DG Win7 Pro 64	3-year, Depot	11/15
20ER000MUS	US	Xeon E3-1505M v5	vPro	M3000M 4GB	8GBx1 ECC	17.3" FHD (1920x1080) IPS	None	None	256GB SSD M.2 PCIe NVMe Opal2	No	DVD±RW	Intel 8260 ac, 2x2 + BT4.1	None	None	None	720p	Backlit	Fingerprint Reader	None	8-cell (96Wh)	230W	Win10 DG Win7 Pro 64	3-year, Depot	11/15
20ER000NUS	US	Xeon E3-1505M v5	vPro	M3000M 4GB	16GBx1 ECC	17.3" 4K (3840x2160) IPS	None	None	512GB SSD M.2 PCIe NVMe	No	DVD±RW	Intel 8260 ac, 2x2 + BT4.1	None	None	Smart Card Reader	720p	Backlit	Fingerprint Reader	X-Rite	8-cell (96Wh)	230W	Win10 DG Win7 Pro 64	3-year, Depot	11/15
20ER000RUS	US	i7-6820HQ	vPro	M3000M 4GB	16GBx1 non-ECC	17.3" 4K (3840x2160) IPS	None	None	512GB SSD M.2 PCIe NVMe	No	DVD±RW	Intel 8260 ac, 2x2 + BT4.1	None	None	Smart Card Reader	720p	Backlit	Fingerprint Reader	X-Rite	8-cell (96Wh)	230W	Win10 DG Win7 Pro 64	3-year, Depot	11/15
20ER000SUS	US	i7-6820HQ	vPro	M3000M 4GB	8GBx1 non-ECC	17.3" FHD (1920x1080) IPS	None	None	256GB SSD M.2 Opal2	No	DVD±RW	Intel 8260 ac, 2x2 + BT4.1	None	None	None	720p	Backlit	Fingerprint Reader	None	8-cell (96Wh)	230W	Win10 DG Win7 Pro 64	3-year, Depot	10/15
20ER000TUS	US	i7-6700HQ	No	M600M 2GB	8GBx1 non-ECC	17.3" FHD (1920x1080) IPS	None	None	1TB 5400rpm	No	DVD±RW	Intel 8260 ac, 2x2 + BT4.1	None	None	None	720p	Backlit	Fingerprint Reader	None	8-cell (96Wh)	170W	Win10 DG Win7 Pro 64	3-year, Depot	10/15
20ER000UUS	US	i7-6700HQ	No	M3000M 4GB	16GBx1 non-ECC	17.3" FHD (1920x1080) IPS	None	None	256GB SSD M.2 Opal2	No	DVD±RW	Intel 8260 ac, 2x2 + BT4.1	None	None	None	720p	Backlit	Fingerprint Reader	None	8-cell (96Wh)	230W	Win10 DG Win7 Pro 64	3-year, Depot	10/15
20ER000VUS	US	i7-6700HQ	No	M600M 2GB	8GBx1 non-ECC	17.3" FHD (1920x1080) IPS	None	None	500GB 7200rpm	No	Blank Bezel	Intel 8260 ac, 2x2 + BT4.1	None	None	None	720p	Backlit	Fingerprint Reader	None	8-cell (96Wh)	170W	Win10 DG Win7 Pro 64	3-year, Depot	10/15
20ER000WUS	US	i7-6820HQ	vPro	M4000M 4GB	16GBx1 non-ECC	17.3" 4K (3840x2160) IPS	None	None	512GB SSD M.2 PCIe NVMe	No	Blank Bezel	Intel 8260 ac, 2x2 + BT4.1	None	None	Smart Card Reader	720p	Backlit	Fingerprint Reader	X-Rite	8-cell (96Wh)	230W	Win10 DG Win7 Pro 64	3-year, Depot	11/15
20ER000XUS	US	Xeon E3-1505M v5	vPro	M4000M 4GB	16GBx1 ECC	17.3" 4K (3840x2160) IPS	None	None	512GB SSD M.2 PCIe NVMe	No	Blank Bezel	Intel 8260 ac, 2x2 + BT4.1	None	None	Smart Card Reader	720p	Backlit	Fingerprint Reader	X-Rite	8-cell (96Wh)	230W	Win10 DG Win7 Pro 64	3-year, Depot	11/15
20ER000YUS	US	i7-6820HQ	vPro	M3000M 4GB	8GBx1 non-ECC	17.3" FHD (1920x1080) IPS	None	None	1TB 5400rpm	No	DVD±RW	Intel 8260 ac, 2x2 + BT4.1	None	None	None	720p	Backlit	Fingerprint Reader	None	8-cell (96Wh)	230W	Win10 DG Win7 Pro 64	3-year, Depot	10/15
20ER002FUS	US	i7-6700HQ	No	M600M 2GB	8GBx1 non-ECC	17.3" FHD (1920x1080) IPS	None	None	500GB 7200rpm	No	DVD±RW	Intel 8260 ac, 2x2 + BT4.1	None	None	None	720p	Backlit	Fingerprint Reader	X-Rite	8-cell (96Wh)	170W	Win10 Pro 64	3-year, Depot	10/15
20ER002GUS	US	Xeon E3-1505M v5	vPro	M600M 2GB	16GBx1 non-ECC	17.3" FHD (1920x1080) IPS	None	None	256GB SSD M.2 Opal2	No	DVD±RW	Intel 8260 ac, 2x2 + BT4.1	None	None	None	720p	Backlit	Fingerprint Reader	None	8-cell (96Wh)	170W	Win10 DG Win7 Pro 64	3-year, Depot	10/15
20ER002HUS	US	Xeon E3-1505M v5	vPro	M3000M 4GB	16GBx1 non-ECC	17.3" FHD (1920x1080) IPS	None	None	256GB SSD M.2 Opal2	No	DVD±RW	Intel 8260 ac, 2x2 + BT4.1	None	None	None	720p	Backlit	Fingerprint Reader	None	8-cell (96Wh)	230W	Win10 Pro 64	3-year, Depot	10/15
20ER002JUS	US	i7-6820HQ	vPro	M3000M 4GB	16GBx1 non-ECC	17.3" FHD (1920x1080) IPS	None	None	256GB SSD M.2 Opal2	No	DVD±RW	Intel 8260 ac, 2x2 + BT4.1	None	None	None	720p	Backlit	Fingerprint Reader	None	8-cell (96Wh)	230W	Win10 Pro 64	3-year, Depot	10/15
20ER002KUS	US	i7-6700HQ	No	M600M 2GB	16GBx1 non-ECC	17.3" FHD (1920x1080) IPS	None	None	500GB 7200rpm	No	DVD±RW	Intel 8260 ac, 2x2 + BT4.1	None	None	None	720p	Backlit	Fingerprint Reader	None	8-cell (96Wh)	170W	Win10 DG Win7 Pro 64	3-year, Depot	10/15

Model	Region	Processor	vPro	Graphics	Memory	Display	Multi-touch	Pen	Storage(HDD/SSD)	RAID	Optical	WLAN + Bluetooth	WWAN	SIM Card	Smart Card Reader	Camera	Keyboard	Fingerprint Reader	Color Calibrator	Battery	Power Adapter	Operating System	Warranty	Ann Date (m/y)
20ER002LUS	US	i7-6820HQ	vPro	M3000M 4GB	16GBx1 non-ECC	17.3" FHD (1920x1080) IPS	None	None	256GB SSD M.2 Opal2	No	DVD±RW	Intel 8260 ac, 2x2 + BT4.1	None	None	None	720p	Backlit	Fingerprint Reader	None	8-cell (96Wh)	230W	Win10 DG Win7 Pro 64	3-year, Depot	10/15
20ER002MUS	US	Xeon E3-1505M v5	vPro	M3000M 4GB	16GBx1 non-ECC	17.3" FHD (1920x1080) IPS	None	None	256GB SSD M.2 Opal2	No	DVD±RW	Intel 8260 ac, 2x2 + BT4.1	None	None	None	720p	Backlit	Fingerprint Reader	None	8-cell (96Wh)	230W	Win10 DG Win7 Pro 64	3-year, Depot	10/15
20ER002NUS	US	i7-6700HQ	No	M600M 2GB	16GBx1 non-ECC	17.3" FHD (1920x1080) IPS	None	None	500GB 7200rpm	No	DVD±RW	Intel 8260 ac, 2x2 + BT4.1	None	None	None	720p	Backlit	Fingerprint Reader	X-Rite	8-cell (96Wh)	170W	Win10 Pro 64	3-year, Depot	10/15
20ER003KUS	US	Xeon E3-1575M v5	vPro	M3000M 4GB	16GBx2 non-ECC	17.3" FHD (1920x1080) IPS	None	None	1TB SSD M.2 PCIe NVMe	No	Blank Bezel	Intel 8260 ac, 2x2 + BT4.1	None	None	None	720p	Backlit	Fingerprint Reader	X-Rite	8-cell (96Wh)	230W	Win10 Pro 64	3-year, Depot	08/16





# ThinkPad P71 Platform Specifications

Product Specifications Reference (PSREF)

Processor	7th Generation Intel® Core™ i7 Processor or Intel Xeon® Processor E3 v6 Family							Dimensions	WxDxH: 16.38" x 10.85" x 1.18-1.35"; 416mm x 275.5mm x 29.9-34.2mm								
	Processor Number	# of Cores	# of Threads	Base Frequency	Max Turbo Frequency	Cache	Memory Types	Processor Graphics	Weight	Starting at 7.3 lb (3.3kg)							
	i7-7700HQ	4	8	2.8 GHz	3.8 GHz	6MB	DDR4-2400	Intel HD Graphics 630	Case color	Black							
	i7-7820HQ			2.9 GHz	3.9 GHz			Case material	Display cover: Glass-Fiber + PPS; Bottom: Magnesium/Aluminum								
E3-1505M v6	3.0 GHz			4.0 GHz	8MB	Intel HD Graphics P630		Smart card reader	Optional: Smart card reader								
E3-1535M v6	3.1 GHz			4.2 GHz		ExpressCard		One slot (ExpressCard/34)									
Graphics	Intel HD Graphics 630 or P630 in processor and NVIDIA Quadro® M620M (2GB memory), P3000M (6GB memory), P4000M (8GB memory), or P5000M (16GB memory); supports external digital monitor via HDMI, Mini DisplayPort, or Thunderbolt™; supports four independent displays; Max resolution: 3840x2160@60Hz (DisplayPort via Mini DisplayPort cable); 3840x2160@60Hz (Thunderbolt); 4096x2160@24Hz (HDMI)							Media reader	4-in-1 reader (MMC, SD, SDHC, SDXC), supports UHS-II SD card								
Chipset	Mobile Intel CM238 Chipset							Ports	Four USB 3.1 Gen 1 (USB 3.0, one Always On), two USB Type-C / Thunderbolt 3, Mini DisplayPort 1.2a, HDMI 1.4b, Ethernet (RJ-45), Dock connector								
Memory	64GB max / 2400MHz DDR4, ECC or non-ECC (ECC function supported only on Xeon processor), dual-channel capable, four DDR4 SO-DIMM sockets							Camera (optional)	HD720p resolution, fixed focus								
Display	Some: 17.3" (439mm) FHD (1920x1080), anti-glare, LED backlight, IPS, 300 nits, 16:9 aspect ratio, 800:1 contrast ratio, 72% gamut, 170° viewing angle Some: 17.3" (439mm) 4K (3840x2160), anti-glare, LED backlight, IPS, 300 nits, 16:9 aspect ratio, 800:1 contrast ratio, 90% gamut, 170° viewing angle							Audio support	HD Audio, Realtek® ALC3268 codec / stereo speakers, 2W x 2 / dual array microphone, combo audio/microphone jack								
Multi-touch Pen	None							Keyboard	6-row, spill-resistant, multimedia Fn keys, numeric keypad, optional LED backlight								
Storage	Up to 4 drives (two M.2 SSD and two HDD, one of which is in the optical bay) Some: M.2 SSD / PCIe NVMe, PCIe 3.0 x 4, 32Gb/s Some: HDD / SATA 6.0Gb/s, 2.5" wide, 7mm high, Active Protection System™							UltraNav™	3-button TrackPoint® pointing device and 3-button Mylar surface multi-touch touchpad								
Optical (optional)	DVD burner, 9.5mm high, fixed, tray-in							Security	Power-on password, hard disk password, supervisor password, security keyhole								
Ethernet	Non-vPro model: Intel Ethernet Connection I219-V (Jacksonville) vPro model: Intel Ethernet Connection I219-LM (Jacksonville)							Security chip	Discrete TPM 2.0, TCG Certified								
WLAN Bluetooth™	Intel Dual Band Wireless-AC 8265, Wi-Fi 2x2 802.11ac + BT4.1, M.2 card Bluetooth 4.1 wireless, integrated in Wi-Fi + Bluetooth combo adapter * Intel 8265ac card support BT4.2 but is limited to BT4.1 by Windows OS							vPro (optional)	Intel vPro Technology								
WWAN (optional)	One of the following, configurable by model: • Wireless WAN upgradable • Integrated Mobile Broadband 4G LTE-A, Qualcomm® Snapdragon™ X7 LTE-A (Sierra Wireless EM7455), M.2 card							Fingerprint reader	Touch style match on chip fingerprint reader on the keyboard bezel								
SIM card (opt)	Micro-SIM card slot, opt Verizon LTE (US) or Lenovo® Connect (EMEA) SIM card							Color calibration	Optional: Pantone® color calibrator by X-Rite® color calibration sensor in palm rest								
								NFC	None								
								Battery	Li-Ion 8-cell (96Wh)								
								Max battery life (MobileMark® 2014)	<table border="1"> <thead> <tr> <th>Mode</th> <th>Discrete Graphics</th> <th>Hybrid Graphics</th> </tr> </thead> <tbody> <tr> <td>Max battery life</td> <td>9.8 hr</td> <td>14.25 hr</td> </tr> </tbody> </table>			Mode	Discrete Graphics	Hybrid Graphics	Max battery life	9.8 hr	14.25 hr
Mode	Discrete Graphics	Hybrid Graphics															
Max battery life	9.8 hr	14.25 hr															
								AC adapter	170W or 230W AC adapter								
								Preload	Some: Windows® 10 Home 64 Some: Windows 10 Pro 64 • Lenovo Companion • Lenovo Setting • Microsoft Office preloaded; purchase a product key to activate								
								Limited warranty	One of the following, configurable by model: • 1-year depot repair service • 3-year/1-yr battery depot repair service • 3-year/1-yr battery limited onsite service								
								Mil-Spec test	MIL-STD-810G military certification								
								Environment	EPEAT™ Gold (US only); ENERGY STAR® 6.1; RoHS-compliant								

Model	Region	Processor	vPro	Graphics	Chipset	Memory	Display	Multi-touch	Pen	Storage (HDD/SSD)	RAID	Optical	WLAN + Bluetooth	WWAN	SIM Card	Smart Card Reader	Camera	Key-board	Color Calibrator	Finger-print Reader	NFC	TPM	Battery	Power Adapter	Operating System	Warranty	Ann Date (m/y)
20HK000VUS	US	Xeon E3-1535M v6	vPro	P3000M 6GB	Intel CM238	8GBx2 ECC	17.3" 4K (3840x2160) IPS	None	None	512GB SSD M.2 PCIe NVMe Opal2	No	Blank Bezel	Intel 8265 ac, 2x2 + BT4.1	WWAN Upgradable	None	None	720p	Backlit	X-Rite	Finger-print Reader	None	dTPM 2.0	8-cell (96Wh)	230W	Win10 Pro 64	3-year, Depot	04/17
20HK000WUS	US	Xeon E3-1505M v6	vPro	P4000M 8GB	Intel CM238	16GBx2 ECC	17.3" FHD (1920x1080) IPS	None	None	1TB SSD M.2 PCIe NVMe Opal2	No	Blank Bezel	Intel 8265 ac, 2x2 + BT4.1	WWAN Upgradable	None	Smart Card Reader	720p	Backlit	None	Finger-print Reader	None	dTPM 2.0	8-cell (96Wh)	230W	Win10 Pro 64	3-year, Depot	04/17
20HK000XUS	US	Xeon E3-1535M v6	vPro	P5000M 16GB	Intel CM238	16GBx1 ECC	17.3" 4K (3840x2160) IPS	None	None	1TB SSD M.2 PCIe NVMe Opal2	No	Blank Bezel	Intel 8265 ac, 2x2 + BT4.1	WWAN Upgradable	None	None	720p	Backlit	X-Rite	Finger-print Reader	None	dTPM 2.0	8-cell (96Wh)	230W	Win10 Pro 64	3-year, Depot	04/17
20HK000YUS	US	Xeon E3-1535M v6	vPro	P4000M 8GB	Intel CM238	8GBx2 ECC	17.3" 4K (3840x2160) IPS	None	None	512GB SSD M.2 PCIe NVMe Opal2	No	Blank Bezel	Intel 8265 ac, 2x2 + BT4.1	WWAN Upgradable	None	None	720p	Backlit	X-Rite	Finger-print Reader	None	dTPM 2.0	8-cell (96Wh)	230W	Win10 Pro 64	3-year, Depot	04/17
20HK0010US	US	Xeon E3-1535M v6	vPro	P5000M 16GB	Intel CM238	16GBx1 ECC	17.3" FHD (1920x1080) IPS	None	None	512GB SSD M.2 PCIe NVMe Opal2	No	Blank Bezel	Intel 8265 ac, 2x2 + BT4.1	WWAN Upgradable	None	Smart Card Reader	720p	Backlit	None	Finger-print Reader	None	dTPM 2.0	8-cell (96Wh)	230W	Win10 Pro 64	3-year, Depot	04/17
20HK0011US	US	i7-7700HQ	No	M620M 2GB	Intel CM238	8GBx1 non-ECC	17.3" FHD (1920x1080) IPS	None	None	1TB 5400rpm	No	Blank Bezel	Intel 8265 ac, 2x2 + BT4.1	WWAN Upgradable	None	None	720p	Backlit	None	Finger-print Reader	None	dTPM 2.0	8-cell (96Wh)	170W	Win10 Pro 64	3-year, Depot	04/17
20HK0012US	US	Xeon E3-1535M v6	vPro	P4000M 8GB	Intel CM238	16GBx1 ECC	17.3" FHD (1920x1080) IPS	None	None	512GB SSD M.2 PCIe NVMe Opal2	No	Blank Bezel	Intel 8265 ac, 2x2 + BT4.1	WWAN Upgradable	None	Smart Card Reader	720p	Backlit	None	Finger-print Reader	None	dTPM 2.0	8-cell (96Wh)	230W	Win10 Pro 64	3-year, Depot	04/17
20HK0013US	US	i7-7700HQ	No	M620M 2GB	Intel CM238	8GBx1 non-ECC	17.3" FHD (1920x1080) IPS	None	None	500GB 7200rpm	No	Blank Bezel	Intel 8265 ac, 2x2 + BT4.1	WWAN Upgradable	None	None	720p	Backlit	None	Finger-print Reader	None	dTPM 2.0	8-cell (96Wh)	170W	Win10 Pro 64	3-year, Depot	04/17
20HK0014US	US	Xeon E3-1505M v6	vPro	P3000M 6GB	Intel CM238	8GBx2 ECC	17.3" FHD (1920x1080) IPS	None	None	1TB SSD M.2 PCIe NVMe Opal2	No	Blank Bezel	Intel 8265 ac, 2x2 + BT4.1	WWAN Upgradable	None	Smart Card Reader	720p	Backlit	None	Finger-print Reader	None	dTPM 2.0	8-cell (96Wh)	230W	Win10 Pro 64	3-year, Depot	04/17
20HK0015US	US	Xeon E3-1505M v6	vPro	M620M 2GB	Intel CM238	8GBx2 ECC	17.3" FHD (1920x1080) IPS	None	None	256GB SSD M.2 PCIe NVMe Opal2	No	Blank Bezel	Intel 8265 ac, 2x2 + BT4.1	WWAN Upgradable	None	Smart Card Reader	720p	Backlit	None	Finger-print Reader	None	dTPM 2.0	8-cell (96Wh)	170W	Win10 Pro 64	3-year, Depot	04/17
20HK0016US	US	Xeon E3-1505M v6	vPro	M620M 2GB	Intel CM238	8GBx1 ECC	17.3" FHD (1920x1080) IPS	None	None	256GB SSD M.2 PCIe NVMe Opal2	No	Blank Bezel	Intel 8265 ac, 2x2 + BT4.1	WWAN Upgradable	None	Smart Card Reader	720p	Backlit	None	Finger-print Reader	None	dTPM 2.0	8-cell (96Wh)	170W	Win10 Pro 64	3-year, Depot	04/17
20HK0017US	US	i7-7820HQ	vPro	M620M 2GB	Intel CM238	8GBx1 non-ECC	17.3" FHD (1920x1080) IPS	None	None	500GB 7200rpm	No	Blank Bezel	Intel 8265 ac, 2x2 + BT4.1	WWAN Upgradable	None	None	720p	Backlit	None	Finger-print Reader	None	dTPM 2.0	8-cell (96Wh)	170W	Win10 Pro 64	3-year, Depot	04/17
20HK0018US	US	i7-7700HQ	No	M620M 2GB	Intel CM238	8GBx2 non-ECC	17.3" FHD (1920x1080) IPS	None	None	512GB SSD M.2 PCIe NVMe Opal2	No	Blank Bezel	Intel 8265 ac, 2x2 + BT4.1	WWAN Upgradable	None	Smart Card Reader	720p	Backlit	X-Rite	Finger-print Reader	None	dTPM 2.0	8-cell (96Wh)	170W	Win10 Pro 64	3-year, Depot	04/17
20HK0019US	US	Xeon E3-1505M v6	vPro	P4000M 8GB	Intel CM238	8GBx2 ECC	17.3" FHD (1920x1080) IPS	None	None	1TB SSD M.2 PCIe NVMe Opal2	No	Blank Bezel	Intel 8265 ac, 2x2 + BT4.1	WWAN Upgradable	None	Smart Card Reader	720p	Backlit	None	Finger-print Reader	None	dTPM 2.0	8-cell (96Wh)	230W	Win10 Pro 64	3-year, Depot	04/17
20HK001AUS	US	Xeon E3-1535M v6	vPro	P3000M 6GB	Intel CM238	16GBx1 ECC	17.3" 4K (3840x2160) IPS	None	None	512GB SSD M.2 PCIe NVMe Opal2	No	Blank Bezel	Intel 8265 ac, 2x2 + BT4.1	WWAN Upgradable	None	None	720p	Backlit	X-Rite	Finger-print Reader	None	dTPM 2.0	8-cell (96Wh)	230W	Win10 Pro 64	3-year, Depot	04/17
20HK001BUS	US	Xeon E3-1505M v6	vPro	P3000M 6GB	Intel CM238	8GBx2 ECC	17.3" FHD (1920x1080) IPS	None	None	256GB SSD M.2 PCIe NVMe Opal2	No	Blank Bezel	Intel 8265 ac, 2x2 + BT4.1	WWAN Upgradable	None	Smart Card Reader	720p	Backlit	None	Finger-print Reader	None	dTPM 2.0	8-cell (96Wh)	230W	Win10 Pro 64	3-year, Depot	04/17
20HK001CUS	US	Xeon E3-1505M v6	vPro	P3000M 6GB	Intel CM238	8GBx2 ECC	17.3" FHD (1920x1080) IPS	None	None	512GB SSD M.2 PCIe NVMe Opal2	No	Blank Bezel	Intel 8265 ac, 2x2 + BT4.1	WWAN Upgradable	None	Smart Card Reader	720p	Backlit	None	Finger-print Reader	None	dTPM 2.0	8-cell (96Wh)	230W	Win10 Pro 64	3-year, Depot	04/17
20HK001DUS	US	Xeon E3-1535M v6	vPro	P3000M 6GB	Intel CM238	16GBx1 ECC	17.3" FHD (1920x1080) IPS	None	None	512GB SSD M.2 PCIe NVMe Opal2	No	Blank Bezel	Intel 8265 ac, 2x2 + BT4.1	WWAN Upgradable	None	Smart Card Reader	720p	Backlit	None	Finger-print Reader	None	dTPM 2.0	8-cell (96Wh)	230W	Win10 Pro 64	3-year, Depot	04/17
20HK001EUS	US	i7-7820HQ	vPro	M620M 2GB	Intel CM238	8GBx1 non-ECC	17.3" FHD (1920x1080) IPS	None	None	1TB 5400rpm	No	Blank Bezel	Intel 8265 ac, 2x2 + BT4.1	WWAN Upgradable	None	None	720p	Backlit	None	Finger-print Reader	None	dTPM 2.0	8-cell (96Wh)	170W	Win10 Pro 64	3-year, Depot	04/17
20HK001FUS	US	Xeon E3-1535M v6	vPro	P5000M 16GB	Intel CM238	16GBx2 ECC	17.3" 4K (3840x2160) IPS	None	None	1TB SSD M.2 PCIe NVMe Opal2	No	Blank Bezel	Intel 8265 ac, 2x2 + BT4.1	WWAN Upgradable	None	None	720p	Backlit	X-Rite	Finger-print Reader	None	dTPM 2.0	8-cell (96Wh)	230W	Win10 Pro 64	3-year, Depot	04/17

Model	Region	Processor	vPro	Graphics	Chipset	Memory	Display	Multi-touch	Pen	Storage(HDD/SSD)	RAID	Optical	WLAN + Bluetooth	WWAN	SIM Card	Smart Card Reader	Camera	Key-board	Color Calibrator	Finger-print Reader	NFC	TPM	Battery	Power Adapter	Operating System	Warranty	Ann Date (m/y)
20HK001GUS	US	i7-7700HQ	No	M620M 2GB	Intel CM238	8GBx2 non-ECC	17.3" FHD (1920x1080) IPS	None	None	512GB SSD M.2 PCIe NVMe Opal2	No	Blank Bezel	Intel 8265 ac, 2x2 + BT4.1	WWAN Upgradable	None	Smart Card Reader	720p	Backlit	None	Finger-print Reader	None	dTPM 2.0	8-cell (96Wh)	170W	Win10 Pro 64	3-year, Depot	04/17
20HK001HUS	US	Xeon E3-1535M v6	vPro	P5000M 16GB	Intel CM238	8GBx2 ECC	17.3" 4K (3840x2160) IPS	None	None	512GB SSD M.2 PCIe NVMe Opal2	No	Blank Bezel	Intel 8265 ac, 2x2 + BT4.1	WWAN Upgradable	None	None	720p	Backlit	X-Rite	Finger-print Reader	None	dTPM 2.0	8-cell (96Wh)	230W	Win10 Pro 64	3-year, Depot	04/17
20HK001JUS	US	i7-7700HQ	No	M620M 2GB	Intel CM238	8GBx2 non-ECC	17.3" FHD (1920x1080) IPS	None	None	256GB SSD M.2 PCIe NVMe Opal2	No	Blank Bezel	Intel 8265 ac, 2x2 + BT4.1	WWAN Upgradable	None	Smart Card Reader	720p	Backlit	None	Finger-print Reader	None	dTPM 2.0	8-cell (96Wh)	170W	Win10 Pro 64	3-year, Depot	04/17
20HK001KUS	US	i7-7820HQ	vPro	M620M 2GB	Intel CM238	8GBx1 non-ECC	17.3" FHD (1920x1080) IPS	None	None	512GB SSD M.2 PCIe NVMe Opal2	No	Blank Bezel	Intel 8265 ac, 2x2 + BT4.1	WWAN Upgradable	None	None	720p	Backlit	None	Finger-print Reader	None	dTPM 2.0	8-cell (96Wh)	170W	Win10 Pro 64	3-year, Depot	04/17
20HK001LUS	US	Xeon E3-1535M v6	vPro	P4000M 8GB	Intel CM238	16GBx2 ECC	17.3" 4K (3840x2160) IPS	None	None	1TB SSD M.2 PCIe NVMe Opal2	No	Blank Bezel	Intel 8265 ac, 2x2 + BT4.1	WWAN Upgradable	None	None	720p	Backlit	X-Rite	Finger-print Reader	None	dTPM 2.0	8-cell (96Wh)	230W	Win10 Pro 64	3-year, Depot	04/17
20HK001MUS	US	i7-7820HQ	vPro	M620M 2GB	Intel CM238	8GBx2 non-ECC	17.3" FHD (1920x1080) IPS	None	None	256GB SSD M.2 PCIe NVMe Opal2	No	Blank Bezel	Intel 8265 ac, 2x2 + BT4.1	WWAN Upgradable	None	None	720p	Backlit	None	Finger-print Reader	None	dTPM 2.0	8-cell (96Wh)	170W	Win10 Pro 64	3-year, Depot	04/17
20HK001PUS	US	Xeon E3-1505M v6	vPro	P3000M 6GB	Intel CM238	8GBx2 non-ECC	17.3" 4K (3840x2160) IPS	None	None	512GB SSD M.2 PCIe NVMe Opal2	No	Blank Bezel	Intel 8265 ac, 2x2 + BT4.1	WWAN Upgradable	None	None	720p	Backlit	X-Rite	Finger-print Reader	None	dTPM 2.0	8-cell (96Wh)	230W	Win10 Pro 64	3-year, Depot	05/17
20HK001QUS	US	i7-7820HQ	vPro	P3000M 6GB	Intel CM238	8GBx2 non-ECC	17.3" FHD (1920x1080) IPS	None	None	1TB SSD M.2 PCIe NVMe Opal2	No	Blank Bezel	Intel 8265 ac, 2x2 + BT4.1	WWAN Upgradable	None	None	720p	Backlit	None	Finger-print Reader	None	dTPM 2.0	8-cell (96Wh)	230W	Win10 Pro 64	3-year, Depot	05/17
20HK001RUS	US	i7-7820HQ	vPro	P3000M 6GB	Intel CM238	8GBx2 non-ECC	17.3" FHD (1920x1080) IPS	None	None	512GB SSD M.2 PCIe NVMe Opal2	No	Blank Bezel	Intel 8265 ac, 2x2 + BT4.1	WWAN Upgradable	None	None	720p	Backlit	None	Finger-print Reader	None	dTPM 2.0	8-cell (96Wh)	230W	Win10 Pro 64	3-year, Depot	05/17
20HK001SUS	US	i7-7820HQ	vPro	P3000M 6GB	Intel CM238	8GBx2 non-ECC	17.3" 4K (3840x2160) IPS	None	None	512GB SSD M.2 PCIe NVMe Opal2	No	Blank Bezel	Intel 8265 ac, 2x2 + BT4.1	WWAN Upgradable	None	None	720p	Backlit	X-Rite	Finger-print Reader	None	dTPM 2.0	8-cell (96Wh)	230W	Win10 Pro 64	3-year, Depot	05/17
20HK001TUS	US	i7-7820HQ	vPro	P3000M 6GB	Intel CM238	8GBx2 non-ECC	17.3" FHD (1920x1080) IPS	None	None	500GB 7200rpm	No	Blank Bezel	Intel 8265 ac, 2x2 + BT4.1	WWAN Upgradable	None	None	720p	Backlit	None	Finger-print Reader	None	dTPM 2.0	8-cell (96Wh)	230W	Win10 Pro 64	3-year, Depot	05/17



# ThinkPad T470 Platform Specifications

Product Specifications Reference (PSREF)

<b>Processor</b>	<p>6th Generation Intel® Core™ i5 / i7 Processor (<i>i7-6500U is not available in EMEA</i>)</p> <table border="1"> <thead> <tr> <th>Processor Number</th> <th># of Cores</th> <th># of Threads</th> <th>Base Frequency</th> <th>Max Turbo Frequency</th> <th>Cache</th> <th>Memory Types</th> <th>Processor Graphics</th> </tr> </thead> <tbody> <tr> <td>i5-6200U</td> <td rowspan="4">2</td> <td rowspan="4">4</td> <td>2.3 GHz</td> <td>2.8 GHz</td> <td>3MB</td> <td rowspan="4">DDR4-2133</td> <td rowspan="4">Intel HD Graphics 520</td> </tr> <tr> <td>i5-6300U</td> <td>2.4 GHz</td> <td>3.0 GHz</td> <td>3MB</td> </tr> <tr> <td>i7-6500U</td> <td>2.5 GHz</td> <td>3.1 GHz</td> <td>4MB</td> </tr> <tr> <td>i7-6600U</td> <td>2.6 GHz</td> <td>3.4 GHz</td> <td>4MB</td> </tr> </tbody> </table> <p>or 7th Generation Intel Core i3 / i5 / i7 Processor</p> <table border="1"> <thead> <tr> <th>Processor Number</th> <th># of Cores</th> <th># of Threads</th> <th>Base Frequency</th> <th>Max Turbo Frequency</th> <th>Cache</th> <th>Memory Types</th> <th>Processor Graphics</th> </tr> </thead> <tbody> <tr> <td>i3-7100U</td> <td rowspan="5">2</td> <td rowspan="5">4</td> <td>2.4 GHz</td> <td>-</td> <td>3MB</td> <td rowspan="5">DDR4-2133</td> <td rowspan="5">Intel HD Graphics 620</td> </tr> <tr> <td>i5-7200U</td> <td>2.5 GHz</td> <td>3.1 GHz</td> <td>3MB</td> </tr> <tr> <td>i5-7300U</td> <td>2.6 GHz</td> <td>3.5 GHz</td> <td>3MB</td> </tr> <tr> <td>i7-7500U</td> <td>2.7 GHz</td> <td>3.5 GHz</td> <td>4MB</td> </tr> <tr> <td>i7-7600U</td> <td>2.8 GHz</td> <td>3.9 GHz</td> <td>4MB</td> </tr> </tbody> </table>	Processor Number	# of Cores	# of Threads	Base Frequency	Max Turbo Frequency	Cache	Memory Types	Processor Graphics	i5-6200U	2	4	2.3 GHz	2.8 GHz	3MB	DDR4-2133	Intel HD Graphics 520	i5-6300U	2.4 GHz	3.0 GHz	3MB	i7-6500U	2.5 GHz	3.1 GHz	4MB	i7-6600U	2.6 GHz	3.4 GHz	4MB	Processor Number	# of Cores	# of Threads	Base Frequency	Max Turbo Frequency	Cache	Memory Types	Processor Graphics	i3-7100U	2	4	2.4 GHz	-	3MB	DDR4-2133	Intel HD Graphics 620	i5-7200U	2.5 GHz	3.1 GHz	3MB	i5-7300U	2.6 GHz	3.5 GHz	3MB	i7-7500U	2.7 GHz	3.5 GHz	4MB	i7-7600U	2.8 GHz	3.9 GHz	4MB	<b>Dimensions</b> <b>Weight</b> <table border="1"> <tr> <td><i>WxDxH:</i></td> <td colspan="2">13.25" x 9.15" x 0.79"; 336.6mm x 232.5mm x 19.95mm</td> </tr> <tr> <td><i>Models</i></td> <td>3-cell or 3 + 3-cell</td> <td>6-cell or 3 + 6-cell</td> </tr> <tr> <td><i>Magnesium</i></td> <td>3.49 lb / 1.58 kg</td> <td>3.92 lb / 1.78 kg</td> </tr> <tr> <td><i>PPS</i></td> <td>3.63 lb / 1.65 kg</td> <td>4.35 lb / 1.85 kg</td> </tr> </table> <b>Case color</b> <b>Case material</b> <p>Black  <i>Display cover:</i> Magnesium Hybrid or PPS;  <i>Bottom:</i> Glass-Fiber Reinforced Plastic</p>	<i>WxDxH:</i>	13.25" x 9.15" x 0.79"; 336.6mm x 232.5mm x 19.95mm		<i>Models</i>	3-cell or 3 + 3-cell	6-cell or 3 + 6-cell	<i>Magnesium</i>	3.49 lb / 1.58 kg	3.92 lb / 1.78 kg	<i>PPS</i>	3.63 lb / 1.65 kg	4.35 lb / 1.85 kg
Processor Number	# of Cores	# of Threads	Base Frequency	Max Turbo Frequency	Cache	Memory Types	Processor Graphics																																																																			
i5-6200U	2	4	2.3 GHz	2.8 GHz	3MB	DDR4-2133	Intel HD Graphics 520																																																																			
i5-6300U			2.4 GHz	3.0 GHz	3MB																																																																					
i7-6500U			2.5 GHz	3.1 GHz	4MB																																																																					
i7-6600U			2.6 GHz	3.4 GHz	4MB																																																																					
Processor Number	# of Cores	# of Threads	Base Frequency	Max Turbo Frequency	Cache	Memory Types	Processor Graphics																																																																			
i3-7100U	2	4	2.4 GHz	-	3MB	DDR4-2133	Intel HD Graphics 620																																																																			
i5-7200U			2.5 GHz	3.1 GHz	3MB																																																																					
i5-7300U			2.6 GHz	3.5 GHz	3MB																																																																					
i7-7500U			2.7 GHz	3.5 GHz	4MB																																																																					
i7-7600U			2.8 GHz	3.9 GHz	4MB																																																																					
<i>WxDxH:</i>	13.25" x 9.15" x 0.79"; 336.6mm x 232.5mm x 19.95mm																																																																									
<i>Models</i>	3-cell or 3 + 3-cell	6-cell or 3 + 6-cell																																																																								
<i>Magnesium</i>	3.49 lb / 1.58 kg	3.92 lb / 1.78 kg																																																																								
<i>PPS</i>	3.63 lb / 1.65 kg	4.35 lb / 1.85 kg																																																																								
<b>Graphics</b>	<p>Intel HD Graphics 520 or 620 in processor only, or Intel HD Graphics 620 in processor and NVIDIA GeForce® 940MX, 2GB 2.5GHz GDDR5 memory (discrete models are NOT available in EMEA); supports external digital monitor via HDMI or USB Type-C; supports three independent displays; Max resolution: 4096x2304@60Hz (USB Type-C); 4096x2160@24Hz (HDMI)</p>	<b>Smart card reader</b> <b>Media reader</b> <b>Ports</b> <b>WiGig dock (opt)</b> <b>Monitor cable</b> <b>Camera (optional)</b> <b>Audio support</b> <b>Keyboard</b> <b>UltraNav™</b> <b>Security</b> <b>Security chip</b> <b>vPro (optional)</b> <b>Fingerprint reader</b> <b>NFC (optional)</b>																																																																								
<b>Chipset</b> <b>Memory</b>	<p>Intel SoC (System on Chip) platform          32GB max / 2400MHz DDR4, dual-channel capable, two DDR4 SO-DIMM sockets          * System clocks down for processors with lower memory controller</p>	<b>720p:</b> HD720p resolution, fixed focus <i>IR &amp; 720p:</i> IR camera and HD720p camera (mutually exclusive with WiGig) HD Audio, Realtek ALC3268 codec / stereo speakers, 2W x 2 / dual array microphone, combo audio/microphone jack 6-row, spill-resistant, multimedia Fn keys, optional LED backlight TrackPoint® pointing device and buttonless Mylar surface multi-touch touchpad Power-on password, hard disk password, supervisor password, security keyhole Discrete TPM 2.0, TCG Certified Intel vPro Technology <i>Optional:</i> Touch style match on chip fingerprint reader on the keyboard bezel Near Field Communication																																																																								
<b>Display</b> <b>Multi-touch (opt)</b>	<p><i>Some:</i> 14.0" (355mm) HD (1366x768), anti-glare, LED backlight, 220 nits, 16:9 aspect ratio, 400:1 contrast ratio  <i>Some:</i> 14.0" (355mm) FHD (1920x1080), anti-glare, LED backlight, 220 nits, 16:9 aspect ratio, 400:1 or 500:1 contrast ratio  <i>Some:</i> 14.0" (355mm) FHD (1920x1080), anti-glare, LED backlight, IPS, 250 nits, 16:9 aspect ratio, 700:1 contrast ratio, 170° viewing angle</p> <p>On-cell touch, supports 10-finger gesture (FHD only)</p>	<b>Internal battery</b> <b>External battery</b> <b>Max battery life (MobileMark® 2014)</b> <table border="1"> <thead> <tr> <th><i>Models</i></th> <th>3-cell</th> <th>3 + 3-cell</th> <th>6-cell 48Wh</th> <th>6-cell 72Wh</th> <th>3 + 6-cell 48Wh</th> <th>3 + 6-cell 72Wh</th> </tr> </thead> <tbody> <tr> <td><i>Integrated</i></td> <td>6.9 hr</td> <td>13.9 hr</td> <td>13.9 hr</td> <td>20.9 hr</td> <td>20.9 hr</td> <td>27.1 hr</td> </tr> <tr> <td><i>Discrete</i></td> <td>6.9 hr</td> <td>13.9 hr</td> <td>14.3 hr</td> <td>21.6 hr</td> <td>21.2 hr</td> <td>28.6 hr</td> </tr> </tbody> </table>	<i>Models</i>	3-cell	3 + 3-cell	6-cell 48Wh	6-cell 72Wh	3 + 6-cell 48Wh	3 + 6-cell 72Wh	<i>Integrated</i>	6.9 hr	13.9 hr	13.9 hr	20.9 hr	20.9 hr	27.1 hr	<i>Discrete</i>	6.9 hr	13.9 hr	14.3 hr	21.6 hr	21.2 hr	28.6 hr																																																			
<i>Models</i>	3-cell	3 + 3-cell	6-cell 48Wh	6-cell 72Wh	3 + 6-cell 48Wh	3 + 6-cell 72Wh																																																																				
<i>Integrated</i>	6.9 hr	13.9 hr	13.9 hr	20.9 hr	20.9 hr	27.1 hr																																																																				
<i>Discrete</i>	6.9 hr	13.9 hr	14.3 hr	21.6 hr	21.2 hr	28.6 hr																																																																				
<b>Storage</b> <b>Optical</b>	<p><i>System has one HDD slot or one M.2 2280 slot exclusively for storage</i>  <i>Some:</i> HDD / SATA 6.0Gb/s, 2.5" wide, 7mm high, Active Protection System™  <i>Some:</i> SSD / SATA 6.0Gb/s, 2.5" wide, 7mm high (e.g. xxxGB SSD)  <i>Some:</i> M.2 SSD / PCIe NVMe, PCIe 3.0 x 2, 16Gb/s  <i>Some:</i> 128GB M.2 SSD / SATA 6.0Gb/s, in WWAN slot as 2nd Storage, mutually exclusive with WWAN and WiGig</p> <p>None</p>	<b>AC adapter</b> <b>Preload</b> <p>45W or 65W AC adapter (slim tip), 45W or 65W USB Type-C AC adapter</p> <p>Windows® 7 Professional 64 preinstalled through downgrade rights in Windows 10 Pro 64  <i>Some:</i> Windows 10 Home 64  <i>Some:</i> Windows 10 Pro 64</p> <ul style="list-style-type: none"> <li>• Lenovo Solution Center</li> <li>• Lenovo PowerEngage</li> <li>• ThinkVantage Product Recovery</li> <li>• ThinkVantage System Update</li> <li>• Adobe® Reader®</li> <li>• Microsoft® Office preloaded; purchase a product key to activate</li> <li>• McAfee® LiveSafe™ (30-day trial)</li> </ul>																																																																								
<b>Ethernet</b> <b>WLAN</b>	<p><i>Non-vPro model:</i> Intel Ethernet Connection I219-V (Jacksonville)  <i>vPro model:</i> Intel Ethernet Connection I219-LM (Jacksonville)</p> <p><i>One of the following, configurable by model (WiGig can coexist with WWAN):</i></p> <ul style="list-style-type: none"> <li>• Realtek® RTL8822BE, Wi-Fi 2x2 802.11ac + BT4.1, M.2 card</li> <li>• Intel Dual Band Wireless-AC 8260, Wi-Fi 2x2 802.11ac + BT4.1, M.2 card</li> <li>• Intel Dual Band Wireless-AC 8265, Wi-Fi 2x2 802.11ac + BT4.1, M.2 card</li> <li>• Intel Tri-Band Wireless-AC 18265, WiGig 802.11ad + Wi-Fi 2x2 802.11ac + BT4.1, M.2 card</li> </ul>	<b>Limited warranty</b> <i>One of the following, configurable by model:</i> <ul style="list-style-type: none"> <li>• 1-year depot repair service</li> <li>• 3-year/1-yr battery depot repair service</li> <li>• 3-year/1-yr battery limited onsite service</li> </ul>																																																																								
<b>Bluetooth™</b>	<p>Bluetooth 4.1 wireless, integrated in Wi-Fi + Bluetooth combo adapter          * Intel 8265ac / 18265ac card support BT4.2 but is limited to BT4.1 by Windows OS</p>	<b>Mil-Spec test</b> <b>Environment</b> <p>MIL-STD-810G military certification          EPEAT™ Gold (US only); ENERGY STAR® 6.1; RoHS-compliant</p>																																																																								
<b>WWAN (optional)</b> <b>SIM card (opt)</b>	<p><i>One of the following, configurable by model (WWAN can coexist with WiGig):</i></p> <ul style="list-style-type: none"> <li>• Wireless WAN upgradable</li> <li>• Integrated Mobile Broadband 4G LTE-A, Qualcomm® Snapdragon™ X7 LTE-A (Sierra Wireless EM7455), M.2 card</li> <li>• Integrated Mobile Broadband 4G LTE, Intel XMM™ 7160 (Fibocom L831-EAU), M.2 card (EMEA only)</li> </ul> <p>Micro-SIM card slot, opt Verizon LTE (US) or Lenovo® Connect (EMEA) SIM card</p>																																																																									

Model	Region	Processor	vPro	Graphics	Memory	Display	Multi-touch	Storage (HDD/SSD)	Optical	WLAN + Bluetooth	WWAN	SIM Card	Smart Card Reader	Dock	Monitor Cable	Case Material	Camera	Key-board	Finger-print Reader	NFC	TPM	Battery (internal-external)	Power Adapter	Operating System	Warranty	Ann Date (m/y)
20HD000QUS	US	i5-7200U	No	Intel HD 620	8GBx1	14" FHD (1920x1080) IPS	None	500GB 7200rpm	None	Intel 8265 ac, 2x2 + BT4.1	WWAN Upgradable	None	None	None	None	PPS	720p	Non-backlit	Finger-print Reader	None	dTPM 2.0	3-cell(24Wh) + 3-cell(24Wh)	45W	Win10 Pro	1-year, Depot	01/17
20HD000RUS	US	i5-7300U	vPro	Intel HD 620	8GBx1	14" FHD (1920x1080) IPS	None	256GB SSD M.2 PCIe NVMe Opal2	None	Intel 8265 ac, 2x2 + BT4.1	WWAN Upgradable	None	None	None	None	PPS	720p	Backlit	Finger-print Reader	None	dTPM 2.0	3-cell(24Wh) + 3-cell(24Wh)	45W	Win10 Pro	3-year, Depot	01/17
20HD000SUS	US	i5-7200U	No	Intel HD 620	8GBx1	14" FHD (1920x1080) IPS	None	128GB SSD	None	Intel 8265 ac, 2x2 + BT4.1	WWAN Upgradable	None	None	None	None	PPS	720p	Backlit	Finger-print Reader	None	dTPM 2.0	3-cell(24Wh) + 3-cell(24Wh)	45W	Win10 Pro	3-year, Depot	01/17
20HD000TUS	US	i5-7200U	No	Intel HD 620	8GBx1	14" HD (1366x768)	None	500GB 7200rpm	None	Intel 8265 ac, 2x2 + BT4.1	WWAN Upgradable	None	None	None	None	PPS	720p	Non-backlit	Finger-print Reader	None	dTPM 2.0	3-cell(24Wh) + 3-cell(24Wh)	45W	Win10 Pro	1-year, Depot	01/17
20HD000UUS	US	i5-7200U	No	Intel HD 620	8GBx1	14" HD (1366x768)	None	128GB SSD	None	Intel 8265 ac, 2x2 + BT4.1	WWAN Upgradable	None	None	None	None	PPS	720p	Backlit	Finger-print Reader	None	dTPM 2.0	3-cell(24Wh) + 3-cell(24Wh)	45W	Win10 Pro	3-year, Depot	01/17
20HD000VUS	US	i5-7300U	vPro	Intel HD 620	8GBx1	14" FHD (1920x1080) IPS	None	512GB SSD M.2 PCIe NVMe Opal2	None	Intel 8265 ac, 2x2 + BT4.1	WWAN Upgradable	None	None	None	None	PPS	720p	Backlit	Finger-print Reader	None	dTPM 2.0	3-cell(24Wh) + 3-cell(24Wh)	45W	Win10 Pro	3-year, Depot	01/17
20HD000WUS	US	i5-7200U	No	Intel HD 620	8GBx1	14" FHD (1920x1080) IPS	None	256GB SSD M.2 PCIe NVMe Opal2	None	Intel 8265 ac, 2x2 + BT4.1	WWAN Upgradable	None	None	None	None	PPS	720p	Backlit	Finger-print Reader	None	dTPM 2.0	3-cell(24Wh) + 3-cell(24Wh)	45W	Win10 Pro	3-year, Depot	01/17
20HD000XUS	US	i5-7300U	vPro	Intel HD 620	8GBx1	14" FHD (1920x1080) IPS	None	500GB 7200rpm	None	Intel 8265 ac, 2x2 + BT4.1	WWAN Upgradable	None	None	None	None	PPS	720p	Backlit	Finger-print Reader	None	dTPM 2.0	3-cell(24Wh) + 3-cell(24Wh)	45W	Win10 Pro	3-year, Depot	01/17
20HD004AUS	US	i5-7300U	vPro	Intel HD 620	8GBx1	14" HD (1366x768)	None	500GB 7200rpm	None	Intel 8265 ac, 2x2 + BT4.1	WWAN Upgradable	None	None	None	None	PPS	720p	Non-backlit	Finger-print Reader	None	dTPM 2.0	3-cell(24Wh) + 3-cell(24Wh)	45W	Win10 Pro	1-year, Depot	03/17
20HD004BUS	US	i5-7300U	vPro	Intel HD 620	8GBx1	14" FHD (1920x1080) IPS	None	180GB SSD Opal2	None	Intel 8265 ac, 2x2 + BT4.1	WWAN Upgradable	None	None	None	None	PPS	720p	Backlit	Finger-print Reader	None	dTPM 2.0	3-cell(24Wh) + 3-cell(24Wh)	45W	Win10 Pro	3-year, Depot	03/17
20HD0056US	US	i5-7300U	vPro	Intel HD 620	8GBx1	14" FHD (1920x1080) IPS	None	256GB SSD M.2 PCIe NVMe Opal2	None	Intel 8265 ac, 2x2 + BT4.1	WWAN Upgradable	None	None	None	None	Magnesium	IR & 720p	Backlit	Finger-print Reader	None	dTPM 2.0	3-cell(24Wh) + 3-cell(24Wh)	45W	Win10 Pro	3-year, Depot	04/17
20HD0057US	US	i7-7600U	vPro	Intel HD 620	8GBx1	14" FHD (1920x1080) IPS	None	256GB SSD M.2 PCIe NVMe Opal2	None	Intel 8265 ac, 2x2 + BT4.1	WWAN Upgradable	None	None	None	None	Magnesium	IR & 720p	Backlit	Finger-print Reader	None	dTPM 2.0	3-cell(24Wh) + 3-cell(24Wh)	45W	Win10 Pro	3-year, Depot	04/17
20HD0058US	US	i7-7600U	vPro	Intel HD 620	8GBx1	14" FHD (1920x1080) IPS	10-point Multi-touch	256GB SSD M.2 PCIe NVMe Opal2	None	Intel 8265 ac, 2x2 + BT4.1	WWAN Upgradable	None	None	None	None	PPS	720p	Backlit	Finger-print Reader	None	dTPM 2.0	3-cell(24Wh) + 3-cell(24Wh)	45W	Win10 Pro	3-year, Depot	04/17
20HD005AUS	US	i5-7300U	vPro	Intel HD 620	8GBx1	14" FHD (1920x1080) IPS	None	256GB SSD M.2 PCIe NVMe Opal2	None	Intel 8265 ac, 2x2 + BT4.1	WWAN Upgradable	None	None	None	None	PPS	720p	Backlit	Finger-print Reader	None	dTPM 2.0	3-cell(24Wh) + 3-cell(24Wh)	45W	Win10 Pro	3-year, Depot	04/17
20HD005BUS	US	i7-7600U	vPro	Intel HD 620	8GBx1	14" FHD (1920x1080) IPS	None	256GB SSD M.2 PCIe NVMe Opal2	None	Intel 8265 ac, 2x2 + BT4.1	Sierra EM7455	None	None	None	None	PPS	720p	Backlit	Finger-print Reader	None	dTPM 2.0	3-cell(24Wh) + 3-cell(24Wh)	45W	Win10 Pro	3-year, Depot	04/17
20HD005CUS	US	i5-7300U	vPro	Intel HD 620	8GBx1	14" FHD (1920x1080) IPS	None	256GB SSD M.2 PCIe NVMe Opal2	None	Intel 8265 ac, 2x2 + BT4.1	Sierra EM7455	None	None	None	None	PPS	720p	Backlit	Finger-print Reader	None	dTPM 2.0	3-cell(24Wh) + 3-cell(24Wh)	45W	Win10 Pro	3-year, Depot	04/17
20HD005DUS	US	i7-7600U	vPro	Intel HD 620	8GBx1	14" FHD (1920x1080) IPS	10-point Multi-touch	256GB SSD M.2 PCIe NVMe Opal2	None	Intel 8265 ac, 2x2 + BT4.1	Sierra EM7455	None	None	None	None	PPS	720p	Backlit	Finger-print Reader	None	dTPM 2.0	3-cell(24Wh) + 3-cell(24Wh)	45W	Win10 Pro	3-year, Depot	04/17
20HD005EUS	US	i7-7600U	vPro	Intel HD 620	16GBx1	14" FHD (1920x1080) IPS	10-point Multi-touch	512GB SSD M.2 PCIe NVMe Opal2	None	Intel 8265 ac, 2x2 + BT4.1	WWAN Upgradable	None	None	None	None	PPS	720p	Backlit	Finger-print Reader	None	dTPM 2.0	3-cell(24Wh) + 3-cell(24Wh)	45W	Win10 Pro	3-year, Depot	04/17
20HD005FUS	US	i7-7600U	vPro	Intel HD 620	8GBx1	14" FHD (1920x1080) IPS	10-point Multi-touch	256GB SSD M.2 PCIe NVMe Opal2	None	Intel 8265 ac, 2x2 + BT4.1	WWAN Upgradable	None	None	None	None	PPS	IR & 720p	Backlit	Finger-print Reader	None	dTPM 2.0	3-cell(24Wh) + 3-cell(24Wh)	45W	Win10 Pro	3-year, Depot	04/17
20HD005GUS	US	i7-7600U	vPro	Intel HD 620	16GBx1	14" FHD (1920x1080) IPS	None	512GB SSD M.2 PCIe NVMe Opal2	None	Intel 8265 ac, 2x2 + BT4.1	WWAN Upgradable	None	None	None	None	PPS	720p	Backlit	Finger-print Reader	None	dTPM 2.0	3-cell(24Wh) + 3-cell(24Wh)	45W	Win10 Pro	3-year, Depot	04/17

Model	Region	Processor	vPro	Graphics	Memory	Display	Multi-touch	Storage(HDD/SSD)	Optical	WLAN + Bluetooth	WWAN	SIM Card	Smart Card Reader	Dock	Monitor Cable	Case Material	Camera	Key-board	Finger-print Reader	NFC	TPM	Battery (internal+external)	Power Adapter	Operating System	War-ranty	Ann Date (m/y)
20HD006FUS	US	i7-7600U	vPro	Intel HD 620	8GBx1	14" FHD (1920x1080) IPS	10-point Multi-touch	256GB SSD M.2 PCIe NVMe Opal2	None	Intel 8265 ac, 2x2 + BT4.1	WWAN Upgradable	None	None	None	None	PPS	720p	Backlit	Finger-print Reader	None	dTPM 2.0	3-cell(24Wh) + 3-cell(24Wh)	45W	Win10 Pro 64	3-year Depot	08/17



ThinkPad T470 - TopSeller - 20JM

Model	Region	Processor	vPro	Graphics	Memory	Display	Multi-touch	Storage(HDD/SSD)	Optical	WLAN + Bluetooth	WWAN	SIM Card	Smart Card Reader	Dock	Monitor Cable	Case Material	Camera	Key-board	Finger-print Reader	NFC	TPM	Battery (internal+external)	Power Adapter	Operating System	Warranty	Ann Date (m/y)
20JM0009US	US	i5-6300U	vPro	Intel HD 520	8GBx1	14" FHD (1920x1080) IPS	None	256GB SSD M.2 PCIe NVMe Opal2	None	Intel 8260 ac, 2x2 + BT4.1	WWAN Upgradable	None	None	None	None	PPS	720p	Backlit	Finger-print Reader	None	dTPM 2.0	3-cell(24Wh) + 3-cell(24Wh)	45W	Win10 DG Win7 Pro 64	3-year, Depot	03/17
20JM000AUS	US	i7-6600U	vPro	Intel HD 520	8GBx1	14" FHD (1920x1080) IPS	None	256GB SSD M.2 PCIe NVMe Opal2	None	Intel 8260 ac, 2x2 + BT4.1	WWAN Upgradable	None	None	None	None	PPS	720p	Backlit	Finger-print Reader	None	dTPM 2.0	3-cell(24Wh) + 3-cell(24Wh)	45W	Win10 DG Win7 Pro 64	3-year, Depot	03/17
20JM000BUS	US	i7-6500U	No	Intel HD 520	8GBx1	14" FHD (1920x1080) IPS	None	256GB SSD M.2 PCIe NVMe Opal2	None	Intel 8260 ac, 2x2 + BT4.1	WWAN Upgradable	None	None	None	None	PPS	720p	Backlit	Finger-print Reader	None	dTPM 2.0	3-cell(24Wh) + 3-cell(24Wh)	45W	Win10 DG Win7 Pro 64	3-year, Depot	03/17
20JM000CUS	US	i5-6200U	No	Intel HD 520	4GBx1	14" HD (1366x768)	None	500GB 7200rpm	None	Intel 8260 ac, 2x2 + BT4.1	WWAN Upgradable	None	None	None	None	PPS	720p	Non-backlit	Finger-print Reader	None	dTPM 2.0	3-cell(24Wh) + 3-cell(24Wh)	45W	Win10 DG Win7 Pro 64	1-year, Depot	03/17
20JM000EUS	US	i5-6300U	vPro	Intel HD 520	8GBx1	14" FHD (1920x1080) IPS	None	256GB SSD M.2 PCIe NVMe Opal2	None	Intel 8260 ac, 2x2 + BT4.1	WWAN Upgradable	None	None	None	None	PPS	720p	Backlit	Finger-print Reader	None	dTPM 2.0	3-cell(24Wh) + 3-cell(24Wh)	45W	Win10 DG Win7 Pro 64	3-year, Depot	04/17
20JM000FUS	US	i7-6600U	vPro	Intel HD 520	8GBx1	14" FHD (1920x1080) IPS	None	256GB SSD M.2 PCIe NVMe Opal2	None	Intel 8260 ac, 2x2 + BT4.1	WWAN Upgradable	None	None	None	None	PPS	720p	Backlit	Finger-print Reader	None	dTPM 2.0	3-cell(24Wh) + 3-cell(24Wh)	45W	Win10 DG Win7 Pro 64	3-year, Depot	04/17
20JM000GUS	US	i7-6600U	vPro	Intel HD 520	8GBx1	14" FHD (1920x1080) IPS	10-point Multi-touch	256GB SSD M.2 PCIe NVMe Opal2	None	Intel 8260 ac, 2x2 + BT4.1	WWAN Upgradable	None	None	None	None	PPS	720p	Backlit	Finger-print Reader	None	dTPM 2.0	3-cell(24Wh) + 3-cell(24Wh)	45W	Win10 DG Win7 Pro 64	3-year, Depot	04/17
20JM000HUS	US	i5-6300U	vPro	Intel HD 520	8GBx1	14" FHD (1920x1080) IPS	None	256GB SSD M.2 PCIe NVMe Opal2	None	Intel 8260 ac, 2x2 + BT4.1	Sierra EM7455	None	None	None	None	PPS	720p	Backlit	Finger-print Reader	None	dTPM 2.0	3-cell(24Wh) + 3-cell(24Wh)	45W	Win10 DG Win7 Pro 64	3-year, Depot	04/17
20JM000JUS	US	i7-6600U	vPro	Intel HD 520	8GBx1	14" FHD (1920x1080) IPS	10-point Multi-touch	256GB SSD M.2 PCIe NVMe Opal2	None	Intel 8260 ac, 2x2 + BT4.1	Sierra EM7455	None	None	None	None	PPS	720p	Backlit	Finger-print Reader	None	dTPM 2.0	3-cell(24Wh) + 3-cell(24Wh)	45W	Win10 DG Win7 Pro 64	3-year, Depot	04/17
20JM000KUS	US	i7-6600U	vPro	Intel HD 520	8GBx1	14" FHD (1920x1080) IPS	None	256GB SSD M.2 PCIe NVMe Opal2	None	Intel 8260 ac, 2x2 + BT4.1	Sierra EM7455	None	None	None	None	PPS	720p	Backlit	Finger-print Reader	None	dTPM 2.0	3-cell(24Wh) + 3-cell(24Wh)	45W	Win10 DG Win7 Pro 64	3-year, Depot	04/17
20JM000LUS	US	i7-6600U	vPro	Intel HD 520	16GBx1	14" FHD (1920x1080) IPS	10-point Multi-touch	512GB SSD M.2 PCIe NVMe Opal2	None	Intel 8260 ac, 2x2 + BT4.1	WWAN Upgradable	None	None	None	None	PPS	720p	Backlit	Finger-print Reader	None	dTPM 2.0	3-cell(24Wh) + 3-cell(24Wh)	45W	Win10 DG Win7 Pro 64	3-year, Depot	04/17
20JM000MUS	US	i7-6600U	vPro	Intel HD 520	16GBx1	14" FHD (1920x1080) IPS	None	512GB SSD M.2 PCIe NVMe Opal2	None	Intel 8260 ac, 2x2 + BT4.1	WWAN Upgradable	None	None	None	None	PPS	720p	Backlit	Finger-print Reader	None	dTPM 2.0	3-cell(24Wh) + 3-cell(24Wh)	45W	Win10 DG Win7 Pro 64	3-year, Depot	04/17
20JM000SUS	US	i5-6200U	No	Intel HD 520	8GBx1	14" HD (1366x768)	None	500GB 7200rpm	None	Intel 8260 ac, 2x2 + BT4.1	WWAN Upgradable	None	None	None	None	PPS	720p	Backlit	Finger-print Reader	None	dTPM 2.0	3-cell(24Wh) + 3-cell(24Wh)	45W	Win10 DG Win7 Pro 64	3-year, Depot	08/17



# ThinkPad T470p Platform Specifications

Product Specifications Reference (PSREF)

Processor	7th Generation Intel® Core™ i5 / i7 Processor							Dimensions <i>FHD (WxDxH):</i> 13.35" x 9.25" x 0.94"; 339mm x 235mm x 24mm <i>WQHD (WxDxH):</i> 13.35" x 9.25" x 0.96"; 339mm x 235mm x 24.4mm										
	Processor Number	# of Cores	# of Threads	Base Frequency	Max Turbo Frequency	Cache	Memory Types		Weight <table border="1"> <tr> <td><i>Models</i></td> <td><i>3-cell</i></td> <td><i>6-cell</i></td> </tr> <tr> <td><i>Integrated model</i></td> <td>3.83 lb / 1.74 kg</td> <td>4.16 lb / 1.89 kg</td> </tr> <tr> <td><i>discrete model</i></td> <td>4.01 lb / 1.82 kg</td> <td>4.33 lb / 1.96 kg</td> </tr> </table>	<i>Models</i>	<i>3-cell</i>	<i>6-cell</i>	<i>Integrated model</i>	3.83 lb / 1.74 kg	4.16 lb / 1.89 kg	<i>discrete model</i>	4.01 lb / 1.82 kg	4.33 lb / 1.96 kg
	<i>Models</i>	<i>3-cell</i>	<i>6-cell</i>															
	<i>Integrated model</i>	3.83 lb / 1.74 kg	4.16 lb / 1.89 kg															
<i>discrete model</i>	4.01 lb / 1.82 kg	4.33 lb / 1.96 kg																
i5-7300HQ	4	4	2.5 GHz	3.5 GHz	6MB	DDR4-2400	Intel HD Graphics 630											
i5-7440HQ			2.8 GHz	3.8 GHz	6MB													
i7-7700HQ		8	2.8 GHz	3.8 GHz	6MB													
i7-7820HQ	2.9 GHz		3.9 GHz	8MB														
Graphics	Intel HD Graphics 630 in processor only, or Intel HD Graphics 630 in processor and NVIDIA GeForce® 940MX, 2GB 2.5GHz GDDR5 memory; supports external digital monitor via HDMI or Mini DisplayPort; supports three independent displays; Max resolution: 4096x2304@60Hz (DisplayPort via Mini DisplayPort cable); 4096x2160@24Hz (HDMI)							Case color Case material										
Chipset	Mobile Intel QM175 Chipset							Smart card reader										
Memory	32GB max / 2400MHz DDR4, dual-channel capable, two DDR4 SO-DIMM sockets							Media reader										
Display	<i>Some:</i> 14.0" (355mm) FHD (1920x1080), anti-glare, LED backlight, IPS, 250 nits, 16:9 aspect ratio, 600:1 contrast ratio, 160° viewing angle <i>Some:</i> 14.0" (355mm) WQHD (2560x1440), anti-glare, LED backlight, IPS, 300 nits, 16:9 aspect ratio, 700:1 contrast ratio, 160° viewing angle							Ports										
Multi-touch (opt)	On-cell touch, supports 10-finger gesture (FHD only)							Monitor cable (optional)										
Storage	<i>System has one HDD slot or one M.2 2280 slot exclusively for storage</i> <i>Some:</i> HDD / SATA 6.0Gb/s, 2.5" wide, 7mm or 9.5mm high, Active Protection System™ <i>Some:</i> SSD / SATA 6.0Gb/s, 2.5" wide, 7mm high (e.g. xxxGB SSD) <i>Some:</i> M.2 SSD / PCIe NVMe, PCIe 3.0 x 2, 16Gb/s <i>Some:</i> 128GB M.2 SSD / SATA 6.0Gb/s, in WWAN slot as 2nd Storage, mutually exclusive with WWAN							Camera										
Optical	None							Audio support										
Ethernet	<i>Non-vPro model:</i> Intel Ethernet Connection I219-V (Jacksonville) <i>vPro model:</i> Intel Ethernet Connection I219-LM (Jacksonville)							Keyboard										
WLAN	<i>One of the following, configurable by model:</i> • Realtek® RTL8822BE, Wi-Fi 2x2 802.11ac + BT4.1, M.2 card • Intel Dual Band Wireless-AC 8265, Wi-Fi 2x2 802.11ac + BT4.1, M.2 card							UltraNav™										
Bluetooth™	Bluetooth 4.1 wireless, integrated in Wi-Fi + Bluetooth combo adapter * Intel 8265ac card support BT4.2 but is limited to BT4.1 by Windows OS							Security										
WWAN (optional)	<i>One of the following, configurable by model:</i> • Wireless WAN upgradable • Integrated Mobile Broadband 4G LTE-A, Qualcomm® Snapdragon™ X7 LTE-A (Sierra Wireless EM7455), M.2 card							Security chip										
SIM card (opt)	Micro-SIM card slot, opt Verizon LTE (US) or Lenovo® Connect (EMEA) SIM card							vPro (optional)										
							Fingerprint reader											
							NFC											
							Battery											
							Max battery life											
							AC adapter											
							Preload											
							Limited warranty											
							Mil-Spec test											
							Environment											

Lenovo  
July 2017

Model	Region	Processor	vPro	Graphics	Chipset	Memory	Display	Multi-touch	Storage(HDD/SSD)	Optical	WLAN + Bluetooth	WWAN	SIM Card	Smart Card Reader	Monitor Cable	Camera	Key-board	Finger-print Reader	NFC	TPM	Battery	Power Adapter	Operating System	Warranty	Ann Date (m/y)
20J6001BUS	US	i5-7440HQ	vPro	940MX 2GB	Intel QM175	8GBx1	14" FHD (1920x1080) IPS	10-point Multi-touch	512GB SSD M.2 PCIe NVMe Opal2	None	Intel 8265 ac, 2x2 + BT4.1	WWAN Upgradable	None	None	None	720p	Backlit	Finger-print Reader	None	dTPM 2.0	6-cell (48Wh)	135W	Win10 Pro 64	3-year, Depot	03/17
20J6001CUS	US	i5-7440HQ	vPro	940MX 2GB	Intel QM175	8GBx1	14" FHD (1920x1080) IPS	None	256GB SSD M.2 PCIe NVMe Opal2	None	Intel 8265 ac, 2x2 + BT4.1	WWAN Upgradable	None	None	None	720p	Backlit	Finger-print Reader	None	dTPM 2.0	6-cell (48Wh)	135W	Win10 Pro 64	3-year, Depot	02/17
20J6001DUS	US	i5-7440HQ	vPro	Intel HD 630	Intel QM175	4GBx2	14" FHD (1920x1080) IPS	10-point Multi-touch	256GB SSD M.2 PCIe NVMe Opal2	None	Intel 8265 ac, 2x2 + BT4.1	WWAN Upgradable	None	None	None	720p	Backlit	Finger-print Reader	None	dTPM 2.0	3-cell (24Wh)	90W	Win10 Pro 64	3-year, Depot	03/17
20J6001EUS	US	i5-7440HQ	vPro	940MX 2GB	Intel QM175	8GBx1	14" FHD (1920x1080) IPS	None	512GB SSD M.2 PCIe NVMe Opal2	None	Intel 8265 ac, 2x2 + BT4.1	WWAN Upgradable	None	None	None	720p	Backlit	Finger-print Reader	None	dTPM 2.0	6-cell (48Wh)	135W	Win10 Pro 64	3-year, Depot	02/17
20J6001FUS	US	i5-7440HQ	vPro	Intel HD 630	Intel QM175	4GBx2	14" FHD (1920x1080) IPS	None	256GB SSD M.2 PCIe NVMe Opal2	None	Intel 8265 ac, 2x2 + BT4.1	WWAN Upgradable	None	None	None	720p	Backlit	Finger-print Reader	None	dTPM 2.0	6-cell (48Wh)	90W	Win10 Pro 64	3-year, Depot	02/17
20J6001GUS	US	i5-7440HQ	vPro	Intel HD 630	Intel QM175	4GBx2	14" FHD (1920x1080) IPS	10-point Multi-touch	256GB SSD M.2 PCIe NVMe Opal2	None	Intel 8265 ac, 2x2 + BT4.1	WWAN Upgradable	None	None	None	720p	Backlit	Finger-print Reader	None	dTPM 2.0	6-cell (48Wh)	90W	Win10 Pro 64	3-year, Depot	03/17
20J6001HUS	US	i5-7440HQ	vPro	Intel HD 630	Intel QM175	4GBx2	14" FHD (1920x1080) IPS	None	256GB SSD M.2 PCIe NVMe Opal2	None	Intel 8265 ac, 2x2 + BT4.1	WWAN Upgradable	None	None	None	720p	Backlit	Finger-print Reader	None	dTPM 2.0	3-cell (24Wh)	90W	Win10 Pro 64	3-year, Depot	02/17
20J6001JUS	US	i5-7440HQ	vPro	940MX 2GB	Intel QM175	4GBx2	14" FHD (1920x1080) IPS	10-point Multi-touch	256GB SSD M.2 PCIe NVMe Opal2	None	Intel 8265 ac, 2x2 + BT4.1	WWAN Upgradable	None	None	None	720p	Backlit	Finger-print Reader	None	dTPM 2.0	6-cell (48Wh)	135W	Win10 Pro 64	3-year, Depot	03/17
20J6003JUS	US	i7-7820HQ	vPro	940MX 2GB	Intel QM175	16GBx1	14" WQHD (2560x1440) IPS	None	512GB SSD M.2 PCIe NVMe Opal2	None	Intel 8265 ac, 2x2 + BT4.1	WWAN Upgradable	None	None	None	720p	Backlit	Finger-print Reader	None	dTPM 2.0	6-cell (48Wh)	135W	Win10 Pro 64	3-year, Depot	04/17
20J6003KUS	US	i7-7820HQ	vPro	940MX 2GB	Intel QM175	16GBx1	14" FHD (1920x1080) IPS	None	512GB SSD M.2 PCIe NVMe Opal2	None	Intel 8265 ac, 2x2 + BT4.1	WWAN Upgradable	None	None	None	720p	Backlit	Finger-print Reader	None	dTPM 2.0	6-cell (48Wh)	135W	Win10 Pro 64	3-year, Depot	04/17
20J6003LUS	US	i7-7820HQ	vPro	940MX 2GB	Intel QM175	8GBx1	14" FHD (1920x1080) IPS	None	256GB SSD M.2 PCIe NVMe Opal2	None	Intel 8265 ac, 2x2 + BT4.1	WWAN Upgradable	None	None	None	720p	Backlit	Finger-print Reader	None	dTPM 2.0	6-cell (48Wh)	135W	Win10 Pro 64	3-year, Depot	04/17
20J6003MUS	US	i5-7440HQ	vPro	Intel HD 630	Intel QM175	8GBx1	14" FHD (1920x1080) IPS	None	256GB SSD M.2 PCIe NVMe Opal2	None	Intel 8265 ac, 2x2 + BT4.1	WWAN Upgradable	None	None	None	720p	Backlit	Finger-print Reader	None	dTPM 2.0	6-cell (48Wh)	90W	Win10 Pro 64	3-year, Depot	04/17
20J6003NUS	US	i5-7440HQ	vPro	Intel HD 630	Intel QM175	8GBx1	14" FHD (1920x1080) IPS	None	256GB SSD M.2 PCIe NVMe Opal2	None	Intel 8265 ac, 2x2 + BT4.1	Sierra EM7455	None	None	None	720p	Backlit	Finger-print Reader	None	dTPM 2.0	6-cell (48Wh)	90W	Win10 Pro 64	3-year, Depot	04/17
20J6003PUS	US	i7-7820HQ	vPro	940MX 2GB	Intel QM175	8GBx1	14" FHD (1920x1080) IPS	None	256GB SSD M.2 PCIe NVMe Opal2	None	Intel 8265 ac, 2x2 + BT4.1	Sierra EM7455	None	None	None	720p	Backlit	Finger-print Reader	None	dTPM 2.0	6-cell (48Wh)	135W	Win10 Pro 64	3-year, Depot	04/17
20J6003UUS	US	i7-7820HQ	vPro	940MX 2GB	Intel QM175	8GBx1	14" FHD (1920x1080) IPS	10-point Multi-touch	256GB SSD M.2 PCIe NVMe Opal2	None	Intel 8265 ac, 2x2 + BT4.1	WWAN Upgradable	None	None	None	720p	Backlit	Finger-print Reader	None	dTPM 2.0	6-cell (48Wh)	135W	Win10 Pro 64	3-year, Depot	06/17
20J6003VUS	US	i7-7820HQ	vPro	940MX 2GB	Intel QM175	8GBx1	14" FHD (1920x1080) IPS	None	256GB SSD M.2 PCIe NVMe Opal2	None	Intel 8265 ac, 2x2 + BT4.1	WWAN Upgradable	None	None	None	720p	Backlit	Finger-print Reader	None	dTPM 2.0	6-cell (48Wh)	135W	Win10 Pro 64	3-year, Depot	06/17
20J6003WUS	US	i5-7440HQ	vPro	Intel HD 630	Intel QM175	8GBx1	14" FHD (1920x1080) IPS	None	180GB SSD Opal2	None	Intel 8265 ac, 2x2 + BT4.1	WWAN Upgradable	None	None	None	720p	Backlit	Finger-print Reader	None	dTPM 2.0	6-cell (48Wh)	90W	Win10 Pro 64	3-year, Depot	06/17
20J6003XUS	US	i7-7820HQ	vPro	940MX 2GB	Intel QM175	16GBx1	14" FHD (1920x1080) IPS	10-point Multi-touch	512GB SSD M.2 PCIe NVMe Opal2	None	Intel 8265 ac, 2x2 + BT4.1	WWAN Upgradable	None	None	None	720p	Backlit	Finger-print Reader	None	dTPM 2.0	6-cell (48Wh)	135W	Win10 Pro 64	3-year, Depot	06/17
20J6003YUS	US	i5-7440HQ	vPro	Intel HD 630	Intel QM175	8GBx1	14" FHD (1920x1080) IPS	None	180GB SSD Opal2	None	Intel 8265 ac, 2x2 + BT4.1	WWAN Upgradable	None	None	None	720p	Backlit	Finger-print Reader	None	dTPM 2.0	3-cell (24Wh)	90W	Win10 Pro 64	3-year, Depot	06/17



# ThinkPad T470s Platform Specifications

Product Specifications Reference (PSREF)

Processor	6th Generation Intel® Core™ i5 / i7 Processor								Dimensions Weight Case color Case material	<i>WxDxH:</i> 13.03" x 8.93" x 0.67-0.74"; 331mm x 226.8mm x 16.9-18.8mm Starting at 2.9 lb (1.32kg) Black or Silver <i>Display cover:</i> CFRP Hybrid; <i>Bottom:</i> Magnesium
	Processor Number	# of Cores	# of Threads	Base Frequency	Max Turbo Frequency	Cache	Memory Types	Processor Graphics		
	i5-6300U	2	4	2.4 GHz	3.0 GHz	3MB	DDR4-2133	Intel HD Graphics 520	Smart card reader Media reader Ports	<i>Optional:</i> Smart card reader 4-in-1 reader (MMC, SD, SDHC, SDXC) Three USB 3.1 Gen 1 (USB 3.0, one Always On), USB 3.1 Type-C Gen 2 / Thunderbolt 3, HDMI 1.4b, Ethernet (RJ-45), Dock connector
	i7-6600U			2.6 GHz	3.4 GHz	4MB				
	or 7th Generation Intel Core i5 / i7 Processor								WiGig dock ( <i>opt</i> ) Monitor cable ( <i>optional</i> )	ThinkPad WiGig dock, mutually exclusive with WWAN HDMI to VGA: Lenovo HDMI to VGA Monitor Adapter USB-C to VGA: Lenovo USB-C to VGA Adapter
	Processor Number	# of Cores	# of Threads	Base Frequency	Max Turbo Frequency	Cache	Memory Types	Processor Graphics		
	i5-7200U	2	4	2.5 GHz	3.1 GHz	3MB	DDR4-2133	Intel HD Graphics 620	Camera ( <i>optional</i> ) Audio support	HD720p resolution, fixed focus (models without camera are unavailable in EMEA) HD Audio, Realtek® ALC3268 codec / stereo speakers, 1W x 2 / dual array microphone, combo audio/microphone jack
	i5-7300U			2.6 GHz	3.5 GHz	3MB				
	i7-7500U			2.7 GHz	3.5 GHz	4MB				
	i7-7600U			2.8 GHz	3.9 GHz	4MB				
Graphics	Intel HD Graphics 520 or 620 in processor; supports external digital monitor via HDMI or USB Type-C; supports three independent displays; Max resolution: 4096x2304@60Hz (USB Type-C); 4096x2160@24Hz (HDMI)								Keyboard UltraNav™	6-row, spill-resistant, multimedia Fn keys, optional LED backlight TrackPoint® pointing device and buttonless Mylar surface multi-touch touchpad
Chipset Memory	Intel SoC (System on Chip) platform 20GB or 24GB max <sup>7</sup> / 2400MHz DDR4, dual-channel capable, 4GB or 8GB memory soldered to systemboard, one DDR4 SO-DIMM socket * System clocks down for processors with lower memory controller								Security Security chip vPro ( <i>optional</i> ) Fingerprint reader NFC ( <i>optional</i> )	Power-on password, hard disk password, supervisor password, security keyhole Discrete TPM 2.0, TCG Certified Intel vPro Technology <i>Optional:</i> Touch style match on chip fingerprint reader on the palm rest Near Field Communication
Display	<i>Some:</i> 14.0" (355mm) FHD (1920x1080), anti-glare, LED backlight, IPS, 250 nits, 16:9 aspect ratio, 700:1 contrast ratio, 160° viewing angle <i>Some:</i> 14.0" (355mm) WQHD (2560x1440), anti-glare, LED backlight, IPS, 300 nits, 16:9 aspect ratio, 700:1 contrast ratio, 160° viewing angle								Internal battery Max battery life AC adapter	Front Li-Polymer 3-cell (23Wh) and rear Li-Ion 3-cell (26Wh), both Integrated <i>MobileMark® 2014:</i> up to 10.5 hr 45W AC adapter (slim tip), 45W or 65W USB Type-C AC adapter
Multi-touch ( <i>opt</i> )	On-cell touch, supports 10-finger gesture, 250 nits (FHD only)								Preload	Windows® 7 Professional 64 preinstalled through downgrade rights in Windows 10 Pro 64 • Lenovo Solution Center • Lenovo PowerEngage • ThinkVantage Product Recovery • ThinkVantage System Update • Adobe® Reader® • Microsoft® Office preloaded; purchase a product key to activate • McAfee® LiveSafe™ (30-day trial)
Storage	<i>Some:</i> M.2 SSD / SATA 6.0Gb/s (e.g. xxxG SSD) <i>Some:</i> M.2 SSD / PCIe NVMe, PCIe 3.0 x 4, 32Gb/s (e.g. xxxG SSD PCIe NVMe)								Limited warranty	<i>One of the following, configurable by model:</i> • 1-year depot repair service • 3-year/1-yr battery depot repair service • 3-year/1-yr battery limited onsite service
Optical	None									
Ethernet	<i>Non-vPro model:</i> Intel Ethernet Connection I219-V (Jacksonville) <i>vPro model:</i> Intel Ethernet Connection I219-LM (Jacksonville)								Mil-Spec test	MIL-STD-810G military certification
WLAN	<i>One of the following, configurable by model (WiGig is mutually exclusive with WWAN):</i> • Intel Dual Band Wireless-AC 8260, Wi-Fi 2x2 802.11ac + BT4.1, M.2 card • Intel Dual Band Wireless-AC 8265, Wi-Fi 2x2 802.11ac + BT4.1, M.2 card • Intel Tri-Band Wireless-AC 18265, WiGig 802.11ad + Wi-Fi 2x2 802.11ac + BT4.1, M.2 card								Environment	EPEAT™ Gold (US only); ENERGY STAR® 6.1; RoHS-compliant
Bluetooth™	Bluetooth 4.1 wireless, integrated in Wi-Fi + Bluetooth combo adapter * Intel 8265ac / 18265ac card support BT4.2 but is limited to BT4.1 by Windows OS									
WWAN ( <i>optional</i> )	<i>One of the following, configurable by model (mutually exclusive with WiGig):</i> • Wireless WAN upgradable • Integrated Mobile Broadband 4G LTE-A, Qualcomm® Snapdragon™ X7 LTE-A (Sierra Wireless EM7455), M.2 card • Micro-SIM card slot, opt Verizon LTE (US) or Lenovo® Connect (EMEA) SIM card									
SIM card ( <i>opt</i> )										



Model	Region	Processor	vPro	Graphics	Memory (Soldered +DIMM)	Display	Multi-touch	Storage(HDD/SSD)	Optical	WLAN + Bluetooth	WWAN	SIM Card	Smart Card Reader	Dock	Monitor Cable	Color	Camera	Key-board	Finger-print Reader	NFC	TPM	Battery (internal)	Power Adapter	Operating System	Warranty	Ann Date (m/y)
20HF0010US	US	i7-7600U	vPro	Intel HD 620	4GB + 8GB	14" WQHD (2560x1440) IPS	None	512GB SSD M.2 PCIe NVMe Opal2	None	Intel 8265 ac, 2x2 + BT4.1	WWAN Upgradable	None	None	None	None	Black	720p	Backlit	Finger-print Reader	None	dTPM 2.0	3-cell(23Wh) + 3-cell(26Wh)	45W	Win10 Pro 64	3-year, Depot	02/17
20HF0011US	US	i5-7300U	vPro	Intel HD 620	4GB + 4GB	14" FHD (1920x1080) IPS	None	256GB SSD M.2 PCIe NVMe Opal2	None	Intel 8265 ac, 2x2 + BT4.1	WWAN Upgradable	None	None	None	None	Black	720p	Backlit	Finger-print Reader	None	dTPM 2.0	3-cell(23Wh) + 3-cell(26Wh)	45W	Win10 Pro 64	3-year, Depot	02/17
20HF0012US	US	i5-7300U	vPro	Intel HD 620	4GB + 4GB	14" FHD (1920x1080) IPS	10-point Multi-touch	256GB SSD M.2 PCIe NVMe Opal2	None	Intel 8265 ac, 2x2 + BT4.1	WWAN Upgradable	None	None	None	None	Black	720p	Backlit	Finger-print Reader	None	dTPM 2.0	3-cell(23Wh) + 3-cell(26Wh)	45W	Win10 Pro 64	3-year, Depot	02/17
20HF0013US	US	i7-7600U	vPro	Intel HD 620	4GB + 4GB	14" FHD (1920x1080) IPS	None	256GB SSD M.2 PCIe NVMe Opal2	None	Intel 8265 ac, 2x2 + BT4.1	WWAN Upgradable	None	None	None	None	Black	720p	Backlit	Finger-print Reader	None	dTPM 2.0	3-cell(23Wh) + 3-cell(26Wh)	45W	Win10 Pro 64	3-year, Depot	02/17
20HF0014US	US	i5-7200U	No	Intel HD 620	4GB Soldered	14" FHD (1920x1080) IPS	None	128GB SSD M.2	None	Intel 8265 ac, 2x2 + BT4.1	WWAN Upgradable	None	None	None	None	Black	720p	Backlit	Finger-print Reader	None	dTPM 2.0	3-cell(23Wh) + 3-cell(26Wh)	45W	Win10 Pro 64	1-year, Depot	02/17
20HF0015US	US	i7-7600U	vPro	Intel HD 620	4GB + 4GB	14" FHD (1920x1080) IPS	10-point Multi-touch	256GB SSD M.2 PCIe NVMe Opal2	None	Intel 8265 ac, 2x2 + BT4.1	WWAN Upgradable	None	None	None	None	Black	720p	Backlit	Finger-print Reader	None	dTPM 2.0	3-cell(23Wh) + 3-cell(26Wh)	45W	Win10 Pro 64	3-year, Depot	02/17
20HF001DUS	US	i7-7600U	vPro	Intel HD 620	8GB + 16GB	14" FHD (1920x1080) IPS	None	1TB SSD M.2 PCIe NVMe Opal2	None	Intel 8265 ac, 2x2 + BT4.1	WWAN Upgradable	None	None	None	None	Black	720p	Backlit	Finger-print Reader	None	dTPM 2.0	3-cell(23Wh) + 3-cell(26Wh)	45W	Win10 Pro 64	3-year, Depot	04/17
20HF003QUS	US	i7-7600U	vPro	Intel HD 620	4GB + 8GB	14" WQHD (2560x1440) IPS	None	512GB SSD M.2 PCIe NVMe Opal2	None	Intel 8265 ac, 2x2 + BT4.1	WWAN Upgradable	None	None	None	None	Silver	720p	Backlit	Finger-print Reader	None	dTPM 2.0	3-cell(23Wh) + 3-cell(26Wh)	45W	Win10 Pro 64	3-year, Depot	02/17
20HF003RUS	US	i5-7200U	No	Intel HD 620	4GB + 4GB	14" WQHD (2560x1440) IPS	None	180GB SSD M.2 Opal2	None	Intel 8265 ac, 2x2 + BT4.1	WWAN Upgradable	None	None	None	None	Black	720p	Backlit	Finger-print Reader	None	dTPM 2.0	3-cell(23Wh) + 3-cell(26Wh)	45W	Win10 Pro 64	3-year, Depot	03/17
20HF003SUS	US	i5-7200U	No	Intel HD 620	4GB + 4GB	14" WQHD (2560x1440) IPS	None	180GB SSD M.2 Opal2	None	Intel 8265 ac, 2x2 + BT4.1	WWAN Upgradable	None	None	None	None	Silver	720p	Backlit	Finger-print Reader	None	dTPM 2.0	3-cell(23Wh) + 3-cell(26Wh)	45W	Win10 Pro 64	3-year, Depot	03/17
20HF003TUS	US	i7-7600U	vPro	Intel HD 620	4GB + 4GB	14" FHD (1920x1080) IPS	None	256GB SSD M.2 PCIe NVMe Opal2	None	Intel 8265 ac, 2x2 + BT4.1	WWAN Upgradable	None	None	None	None	Silver	720p	Backlit	Finger-print Reader	None	dTPM 2.0	3-cell(23Wh) + 3-cell(26Wh)	45W	Win10 Pro 64	3-year, Depot	02/17
20HF003UUS	US	i5-7300U	vPro	Intel HD 620	4GB + 4GB	14" FHD (1920x1080) IPS	10-point Multi-touch	256GB SSD M.2 PCIe NVMe Opal2	None	Intel 8265 ac, 2x2 + BT4.1	WWAN Upgradable	None	None	None	None	Silver	720p	Backlit	Finger-print Reader	None	dTPM 2.0	3-cell(23Wh) + 3-cell(26Wh)	45W	Win10 Pro 64	3-year, Depot	02/17
20HF003VUS	US	i5-7200U	No	Intel HD 620	4GB Soldered	14" FHD (1920x1080) IPS	None	128GB SSD M.2	None	Intel 8265 ac, 2x2 + BT4.1	WWAN Upgradable	None	None	None	None	Silver	720p	Backlit	Finger-print Reader	None	dTPM 2.0	3-cell(23Wh) + 3-cell(26Wh)	45W	Win10 Pro 64	1-year, Depot	02/17
20HF003WUS	US	i5-7300U	vPro	Intel HD 620	4GB + 4GB	14" FHD (1920x1080) IPS	None	256GB SSD M.2 PCIe NVMe Opal2	None	Intel 8265 ac, 2x2 + BT4.1	WWAN Upgradable	None	None	None	None	Silver	720p	Backlit	Finger-print Reader	None	dTPM 2.0	3-cell(23Wh) + 3-cell(26Wh)	45W	Win10 Pro 64	3-year, Depot	02/17
20HF0044US	US	i7-7600U	vPro	Intel HD 620	8GB + 8GB	14" FHD (1920x1080) IPS	None	512GB SSD M.2 PCIe NVMe Opal2	None	Intel 8265 ac, 2x2 + BT4.1	WWAN Upgradable	None	None	None	None	Black	720p	Backlit	Finger-print Reader	None	dTPM 2.0	3-cell(23Wh) + 3-cell(26Wh)	45W	Win10 Pro 64	3-year, Depot	07/17
20HF005GUS	US	i5-7300U	vPro	Intel HD 620	8GB Soldered	14" FHD (1920x1080) IPS	None	256GB SSD M.2 PCIe NVMe Opal2	None	Intel 8265 ac, 2x2 + BT4.1	Sierra EM7455	None	None	None	None	Black	720p	Backlit	Finger-print Reader	None	dTPM 2.0	3-cell(23Wh) + 3-cell(26Wh)	45W	Win10 Pro 64	3-year, Depot	04/17
20HF005HUS	US	i7-7600U	vPro	Intel HD 620	8GB Soldered	14" FHD (1920x1080) IPS	10-point Multi-touch	256GB SSD M.2 PCIe NVMe Opal2	None	Intel 8265 ac, 2x2 + BT4.1	Sierra EM7455	None	None	None	None	Black	720p	Backlit	Finger-print Reader	None	dTPM 2.0	3-cell(23Wh) + 3-cell(26Wh)	45W	Win10 Pro 64	3-year, Depot	04/17
20HF005JUS	US	i7-7600U	vPro	Intel HD 620	8GB Soldered	14" FHD (1920x1080) IPS	None	256GB SSD M.2 PCIe NVMe Opal2	None	Intel 8265 ac, 2x2 + BT4.1	Sierra EM7455	None	None	None	None	Black	720p	Backlit	Finger-print Reader	None	dTPM 2.0	3-cell(23Wh) + 3-cell(26Wh)	45W	Win10 Pro 64	3-year, Depot	04/17
20HF005KUS	US	i7-7600U	vPro	Intel HD 620	8GB + 16GB	14" FHD (1920x1080) IPS	10-point Multi-touch	1TB SSD M.2 PCIe NVMe Opal2	None	Intel 8265 ac, 2x2 + BT4.1	WWAN Upgradable	None	None	None	None	Silver	720p	Backlit	Finger-print Reader	None	dTPM 2.0	3-cell(23Wh) + 3-cell(26Wh)	45W	Win10 Pro 64	3-year, Depot	04/17
20HF005LUS	US	i7-7600U	vPro	Intel HD 620	8GB + 16GB	14" FHD (1920x1080) IPS	10-point Multi-touch	1TB SSD M.2 PCIe NVMe Opal2	None	Intel 8265 ac, 2x2 + BT4.1	WWAN Upgradable	None	None	None	None	Black	720p	Backlit	Finger-print Reader	None	dTPM 2.0	3-cell(23Wh) + 3-cell(26Wh)	45W	Win10 Pro 64	3-year, Depot	04/17

Model	Region	Processor	vPro	Graphics	Memory (Soldered +DIMM)	Display	Multi-touch	Storage(HDD/SSD)	Optical	WLAN + Bluetooth	WWAN	SIM Card	Smart Card Reader	Dock	Monitor Cable	Color	Camera	Key-board	Finger-print Reader	NFC	TPM	Battery (internal)	Power Adapter	Operating System	War-ranty	Ann Date (m/y)
20HF005MUS	US	i7-7600U	vPro	Intel HD 620	8GB + 16GB	14" WQHD (2560x1440) IPS	None	1TB SSD M.2 PCIe NVMe Opal2	None	Intel 8265 ac, 2x2 + BT4.1	WWAN Upgradable	None	None	None	None	Black	720p	Backlit	Finger-print Reader	None	dTPM 2.0	3-cell(23Wh) + 3-cell(26Wh)	45W	Win10 Pro 64	3-year, Depot	04/17
20HF005NUS	US	i5-7200U	No	Intel HD 620	4GB Soldered	14" FHD (1920x1080) IPS	None	180GB SSD M.2 Opal2	None	Intel 8265 ac, 2x2 + BT4.1	WWAN Upgradable	None	None	None	None	Black	720p	Backlit	Finger-print Reader	None	dTPM 2.0	3-cell(23Wh) + 3-cell(26Wh)	45W	Win10 Pro 64	1-year, Depot	04/17
20HF0063US	US	i5-7300U	vPro	Intel HD 620	8GB Soldered	14" FHD (1920x1080) IPS	10-point Multi-touch	256GB SSD M.2 PCIe NVMe Opal2	None	Intel 8265 ac, 2x2 + BT4.1	WWAN Upgradable	None	None	None	None	Black	720p	Backlit	Finger-print Reader	None	dTPM 2.0	3-cell(23Wh) + 3-cell(26Wh)	45W	Win10 Pro 64	3-year, Depot	06/17
20HF0064US	US	i5-7300U	vPro	Intel HD 620	8GB + 8GB	14" FHD (1920x1080) IPS	10-point Multi-touch	512GB SSD M.2 PCIe NVMe Opal2	None	Intel 8265 ac, 2x2 + BT4.1	WWAN Upgradable	None	None	None	None	Black	720p	Backlit	Finger-print Reader	None	dTPM 2.0	3-cell(23Wh) + 3-cell(26Wh)	45W	Win10 Pro 64	3-year, Depot	07/17
20HF0065US	US	i7-7600U	vPro	Intel HD 620	8GB + 8GB	14" FHD (1920x1080) IPS	10-point Multi-touch	512GB SSD M.2 PCIe NVMe Opal2	None	Intel 8265 ac, 2x2 + BT4.1	WWAN Upgradable	None	None	None	None	Black	720p	Backlit	Finger-print Reader	None	dTPM 2.0	3-cell(23Wh) + 3-cell(26Wh)	45W	Win10 Pro 64	3-year, Depot	07/17
20HF0066US	US	i5-7300U	vPro	Intel HD 620	8GB + 8GB	14" FHD (1920x1080) IPS	None	512GB SSD M.2 PCIe NVMe Opal2	None	Intel 8265 ac, 2x2 + BT4.1	WWAN Upgradable	None	None	None	None	Black	720p	Backlit	Finger-print Reader	None	dTPM 2.0	3-cell(23Wh) + 3-cell(26Wh)	45W	Win10 Pro 64	3-year, Depot	07/17



Model	Region	Processor	vPro	Graphics	Memory (Soldered +DIMM)	Display	Multi-touch	Storage(HDD/SSD)	Optical	WLAN + Bluetooth	WWAN	SIM Card	Smart Card Reader	Dock	Monitor Cable	Color	Camera	Key-board	Finger-print Reader	NFC	TPM	Battery (internal)	Power Adapter	Operating System	Warranty	Ann Date (m/y)
20JS0004US	US	i7-6600U	vPro	Intel HD 520	4GB + 4GB	14" FHD (1920x1080) IPS	None	256GB SSD M.2 PCIe NVMe Opal2	None	Intel 8260 ac, 2x2 + BT4.1	WWAN Upgradable	None	None	None	None	Black	720p	Backlit	Finger-print Reader	None	dTPM 2.0	3-cell(23Wh) + 3-cell(26Wh)	45W	Win10 DG Win7 Pro 64	3-year, Depot	03/17
20JS000MUS	US	i7-6600U	vPro	Intel HD 520	4GB + 4GB	14" FHD (1920x1080) IPS	None	256GB SSD M.2 PCIe NVMe Opal2	None	Intel 8260 ac, 2x2 + BT4.1	WWAN Upgradable	None	None	None	None	Black	720p	Backlit	Finger-print Reader	None	dTPM 2.0	3-cell(23Wh) + 3-cell(26Wh)	45W	Win10 DG Win7 Pro 64	3-year, Depot	06/17
20JS0014US	US	i5-6300U	vPro	Intel HD 520	4GB Soldered	14" FHD (1920x1080) IPS	None	128GB SSD M.2	None	Intel 8260 ac, 2x2 + BT4.1	WWAN Upgradable	None	None	None	None	Black	720p	Backlit	Finger-print Reader	None	dTPM 2.0	3-cell(23Wh) + 3-cell(26Wh)	45W	Win10 DG Win7 Pro 64	1-year, Depot	03/17
20JS0015US	US	i5-6300U	vPro	Intel HD 520	4GB + 4GB	14" FHD (1920x1080) IPS	None	256GB SSD M.2 PCIe NVMe Opal2	None	Intel 8260 ac, 2x2 + BT4.1	WWAN Upgradable	None	None	None	None	Black	720p	Backlit	Finger-print Reader	None	dTPM 2.0	3-cell(23Wh) + 3-cell(26Wh)	45W	Win10 DG Win7 Pro 64	3-year, Depot	03/17
20JS0016US	US	i5-6300U	vPro	Intel HD 520	4GB Soldered	14" FHD (1920x1080) IPS	None	180GB SSD M.2 Opal2	None	Intel 8260 ac, 2x2 + BT4.1	WWAN Upgradable	None	Smart Card Reader	None	None	Black	720p	Backlit	Finger-print Reader	None	dTPM 2.0	3-cell(23Wh) + 3-cell(26Wh)	45W	Win10 DG Win7 Pro 64	1-year, Depot	03/17
20JS0017US	US	i5-6300U	vPro	Intel HD 520	4GB + 4GB	14" FHD (1920x1080) IPS	None	180GB SSD M.2 Opal2	None	Intel 8260 ac, 2x2 + BT4.1	WWAN Upgradable	None	Smart Card Reader	None	None	Black	720p	Backlit	Finger-print Reader	None	dTPM 2.0	3-cell(23Wh) + 3-cell(26Wh)	45W	Win10 DG Win7 Pro 64	3-year, Depot	03/17
20JS0018US	US	i5-6300U	vPro	Intel HD 520	4GB Soldered	14" FHD (1920x1080) IPS	None	180GB SSD M.2 Opal2	None	Intel 8260 ac, 2x2 + BT4.1	WWAN Upgradable	None	None	None	None	Black	720p	Backlit	Finger-print Reader	None	dTPM 2.0	3-cell(23Wh) + 3-cell(26Wh)	45W	Win10 DG Win7 Pro 64	1-year, Depot	03/17
20JS0019US	US	i5-6300U	vPro	Intel HD 520	4GB + 4GB	14" FHD (1920x1080) IPS	None	256GB SSD M.2 PCIe NVMe Opal2	None	Intel 8260 ac, 2x2 + BT4.1	Sierra EM7455	None	None	None	None	Black	720p	Backlit	Finger-print Reader	None	dTPM 2.0	3-cell(23Wh) + 3-cell(26Wh)	45W	Win10 DG Win7 Pro 64	3-year, Depot	04/17
20JS001AUS	US	i7-6600U	vPro	Intel HD 520	4GB + 4GB	14" FHD (1920x1080) IPS	None	256GB SSD M.2 PCIe NVMe Opal2	None	Intel 8260 ac, 2x2 + BT4.1	Sierra EM7455	None	None	None	None	Black	720p	Backlit	Finger-print Reader	None	dTPM 2.0	3-cell(23Wh) + 3-cell(26Wh)	45W	Win10 DG Win7 Pro 64	3-year, Depot	04/17
20JS001BUS	US	i7-6600U	vPro	Intel HD 520	4GB + 4GB	14" FHD (1920x1080) IPS	10-point Multi-touch	256GB SSD M.2 PCIe NVMe Opal2	None	Intel 8260 ac, 2x2 + BT4.1	Sierra EM7455	None	None	None	None	Black	720p	Backlit	Finger-print Reader	None	dTPM 2.0	3-cell(23Wh) + 3-cell(26Wh)	45W	Win10 DG Win7 Pro 64	3-year, Depot	04/17
20JS001CUS	US	i7-6600U	vPro	Intel HD 520	4GB + 16GB	14" FHD (1920x1080) IPS	10-point Multi-touch	1TB SSD M.2 PCIe NVMe Opal2	None	Intel 8260 ac, 2x2 + BT4.1	Sierra EM7455	None	None	None	None	Black	720p	Backlit	Finger-print Reader	None	dTPM 2.0	3-cell(23Wh) + 3-cell(26Wh)	45W	Win10 DG Win7 Pro 64	3-year, Depot	04/17
20JS001DUS	US	i7-6600U	vPro	Intel HD 520	4GB + 16GB	14" FHD (1920x1080) IPS	None	1TB SSD M.2 PCIe NVMe Opal2	None	Intel 8260 ac, 2x2 + BT4.1	Sierra EM7455	None	None	None	None	Black	720p	Backlit	Finger-print Reader	None	dTPM 2.0	3-cell(23Wh) + 3-cell(26Wh)	45W	Win10 DG Win7 Pro 64	3-year, Depot	04/17
20JS001GUS	US	i5-6300U	vPro	Intel HD 520	4GB + 4GB	14" FHD (1920x1080) IPS	None	256GB SSD M.2 PCIe NVMe Opal2	None	Intel 8260 ac, 2x2 + BT4.1	WWAN Upgradable	None	None	None	None	Black	720p	Backlit	Finger-print Reader	None	dTPM 2.0	3-cell(23Wh) + 3-cell(26Wh)	45W	Win10 DG Win7 Pro 64	3-year, Depot	06/17
20JS001HUS	US	i5-6300U	vPro	Intel HD 520	4GB + 8GB	14" FHD (1920x1080) IPS	None	512GB SSD M.2 PCIe NVMe Opal2	None	Intel 8260 ac, 2x2 + BT4.1	WWAN Upgradable	None	None	None	None	Black	720p	Backlit	Finger-print Reader	None	dTPM 2.0	3-cell(23Wh) + 3-cell(26Wh)	45W	Win10 DG Win7 Pro 64	3-year, Depot	07/17
20JS001JUS	US	i7-6600U	vPro	Intel HD 520	4GB + 8GB	14" FHD (1920x1080) IPS	None	512GB SSD M.2 PCIe NVMe Opal2	None	Intel 8260 ac, 2x2 + BT4.1	WWAN Upgradable	None	None	None	None	Black	720p	Backlit	Finger-print Reader	None	dTPM 2.0	3-cell(23Wh) + 3-cell(26Wh)	45W	Win10 DG Win7 Pro 64	3-year, Depot	07/17
20JS001KUS	US	i7-6600U	vPro	Intel HD 520	4GB + 8GB	14" FHD (1920x1080) IPS	10-point Multi-touch	512GB SSD M.2 PCIe NVMe Opal2	None	Intel 8260 ac, 2x2 + BT4.1	WWAN Upgradable	None	None	None	None	Black	720p	Backlit	Finger-print Reader	None	dTPM 2.0	3-cell(23Wh) + 3-cell(26Wh)	45W	Win10 DG Win7 Pro 64	3-year, Depot	07/17
20JS001LUS	US	i5-6300U	vPro	Intel HD 520	4GB + 8GB	14" FHD (1920x1080) IPS	10-point Multi-touch	512GB SSD M.2 PCIe NVMe Opal2	None	Intel 8260 ac, 2x2 + BT4.1	WWAN Upgradable	None	None	None	None	Black	720p	Backlit	Finger-print Reader	None	dTPM 2.0	3-cell(23Wh) + 3-cell(26Wh)	45W	Win10 DG Win7 Pro 64	3-year, Depot	07/17



# ThinkPad T570 Platform Specifications

Product Specifications Reference (PSREF)

Processor	6th Generation Intel® Core™ i5 / i7 Processor							Dimensions Weight Case color Case material	<i>WxDxH:</i> 14.40" x 9.95" x 0.79-0.80"; 365.8mm x 252.8mm x 19.95-20.2mm Starting at 4.34 lb / 1.97 kg Black <i>Display cover:</i> Glass-Fiber Reinforced Plastic (PPS); <i>Bottom:</i> Glass-Fiber Reinforced Plastic																		
	Processor Number	# of Cores	# of Threads	Base Frequency	Max Turbo Frequency	Cache	Memory Types			Processor Graphics																	
	i5-6300U	2	4	2.4 GHz	3.0 GHz	3MB	DDR4-2133	Intel HD Graphics 520																			
	i7-6600U			2.6 GHz	3.4 GHz	4MB																					
	or 7th Generation Intel Core i5 / i7 Processor							Smart card reader Media reader Ports	<i>Optional:</i> Smart card reader 4-in-1 reader (MMC, SD, SDHC, SDXC), supports SD 3.0, UHS-I Three USB 3.1 Gen 1 (USB 3.0, one Always On), USB 3.1 Type-C Gen 2 / Thunderbolt 3, HDMI 1.4b, Ethernet (RJ-45), Dock connector ThinkPad WiGig dock (US only) <i>HDMI to VGA:</i> Lenovo HDMI to VGA Monitor Adapter <i>USB-C to VGA:</i> Lenovo USB-C to VGA Adapter																		
	Processor Number	# of Cores	# of Threads	Base Frequency	Max Turbo Frequency	Cache	Memory Types			Processor Graphics																	
	i5-7200U	2	4	2.5 GHz	3.1 GHz	3MB	DDR4-2133	Intel HD Graphics 620																			
	i5-7300U			2.6 GHz	3.5 GHz	3MB																					
	i7-7500U			2.7 GHz	3.5 GHz	4MB																					
	i7-7600U			2.8 GHz	3.9 GHz	4MB																					
Graphics	Intel HD Graphics 520 or 620 in processor only, or Intel HD Graphics 520 or 620 in processor and NVIDIA GeForce® 940MX, 2GB 2.5GHz GDDR5 memory; supports external digital monitor via HDMI or USB Type-C; supports three independent displays; Max resolution: 4096x2304@60Hz (USB Type-C); 4096x2160@24Hz (HDMI)							Camera ( <i>optional</i> )	<i>720p:</i> HD720p resolution, fixed focus <i>IR &amp; 720p:</i> IR camera and HD720p camera (mutually exclusive with WiGig)																		
Chipset	Intel SoC (System on Chip) platform							Audio support	HD Audio, Realtek ALC3268 codec / stereo speakers, 2W x 2 / dual array microphone, combo audio/microphone jack																		
Memory	32GB max / 2400MHz DDR4, dual-channel capable, two DDR4 SO-DIMM sockets * System clocks down for processors with lower memory controller							Keyboard	6-row, spill-resistant, multimedia Fn keys, numeric keypad, optional LED backlight																		
Display	<i>Some:</i> 15.6" (396mm) HD (1366x768), anti-glare, LED backlight, 220 nits, 16:9 aspect ratio, 400:1 contrast ratio <i>Some:</i> 15.6" (396mm) FHD (1920x1080), anti-glare, LED backlight, IPS, 250 nits, 16:9 aspect ratio, 700:1 contrast ratio, 170° viewing angle <i>Some:</i> 15.6" (396mm) 4K (3840x2160), anti-glare, LED backlight, IPS, 300 nits, 16:9 aspect ratio, 1000:1 contrast ratio, 72% gamut, 170° viewing angle							UltraNav™	TrackPoint® pointing device and buttonless Mylar surface multi-touch touchpad																		
Multi-touch ( <i>opt</i> )	On-cell touch, supports 10-finger gesture (FHD only)							Security	Power-on password, hard disk password, supervisor password, security keyhole																		
Storage	<i>System has one HDD slot or one M.2 2280 slot exclusively for storage</i> <i>Some:</i> HDD / SATA 6.0Gb/s, 2.5" wide, 7mm high, Active Protection System™ <i>Some:</i> SSD / SATA 6.0Gb/s, 2.5" wide, 7mm high (e.g. xxxGB SSD) <i>Some:</i> M.2 SSD / PCIe NVMe, PCIe 3.0 x 2, 16Gb/s <i>Some:</i> 128GB M.2 SSD / SATA 6.0Gb/s, in WWAN slot as 2nd Storage, mutually exclusive with WWAN and WiGig							Security chip	Discrete TPM 2.0, TCG Certified																		
								vPro ( <i>optional</i> )	Intel vPro Technology																		
								Fingerprint reader	<i>Optional:</i> Touch style match on chip fingerprint reader on the palm rest																		
								NFC ( <i>optional</i> )	Near Field Communication																		
								Internal battery	<i>Optional:</i> Integrated Li-Polymer 4-cell (32Wh)																		
								External battery	Li-Polymer 3-cell (24Wh) or Li-Ion 6-cell (48Wh or 72Wh)																		
								Max battery life ( <i>MobileMark® 2014</i> )	<table border="1"> <thead> <tr> <th>Models</th> <th>4 + 3-cell</th> <th>6-cell 48Wh</th> <th>6-cell 72Wh</th> <th>4 + 6-cell 48Wh</th> <th>4 + 6-cell 72Wh</th> </tr> </thead> <tbody> <tr> <td><i>Integrated</i></td> <td>13.8 hr</td> <td>12.5 hr</td> <td>18.5 hr</td> <td>20.3 hr</td> <td>27.1 hr</td> </tr> <tr> <td><i>discrete</i></td> <td>13.8 hr</td> <td>12.5 hr</td> <td>18.5 hr</td> <td>20.0 hr</td> <td>26.8 hr</td> </tr> </tbody> </table>	Models	4 + 3-cell	6-cell 48Wh	6-cell 72Wh	4 + 6-cell 48Wh	4 + 6-cell 72Wh	<i>Integrated</i>	13.8 hr	12.5 hr	18.5 hr	20.3 hr	27.1 hr	<i>discrete</i>	13.8 hr	12.5 hr	18.5 hr	20.0 hr	26.8 hr
Models	4 + 3-cell	6-cell 48Wh	6-cell 72Wh	4 + 6-cell 48Wh	4 + 6-cell 72Wh																						
<i>Integrated</i>	13.8 hr	12.5 hr	18.5 hr	20.3 hr	27.1 hr																						
<i>discrete</i>	13.8 hr	12.5 hr	18.5 hr	20.0 hr	26.8 hr																						
								AC adapter	45W or 65W AC adapter (slim tip), 45W or 65W USB Type-C AC adapter																		
Optical	None							Preload	Windows® 7 Professional 64 preinstalled through downgrade rights in Windows 10 Pro 64 • Lenovo Solution Center • Lenovo PowerEngage • ThinkVantage Product Recovery • ThinkVantage System Update • Adobe® Reader® • Microsoft® Office preloaded; purchase a product key to activate • McAfee® LiveSafe™ (30-day trial)																		
Ethernet	<i>Non-vPro model:</i> Intel Ethernet Connection I219-V (Jacksonville) <i>vPro model:</i> Intel Ethernet Connection I219-LM (Jacksonville)							Limited warranty	<i>One of the following, configurable by model:</i> • 1-year depot repair service • 3-year/1-yr battery depot repair service • 3-year/1-yr battery limited onsite service																		
WLAN	<i>One of the following, configurable by model (WiGig can coexist with WWAN):</i> • Realtek® RTL8822BE, Wi-Fi 2x2 802.11ac + BT4.1, M.2 card (US only) • Intel Dual Band Wireless-AC 8260, Wi-Fi 2x2 802.11ac + BT4.1, M.2 card • Intel Dual Band Wireless-AC 8265, Wi-Fi 2x2 802.11ac + BT4.1, M.2 card • Intel Tri-Band Wireless-AC 18265, WiGig 802.11ad + Wi-Fi 2x2 802.11ac + BT4.1, M.2 card							Mil-Spec test	MIL-STD-810G military certification																		
Bluetooth™	Bluetooth 4.1 wireless, integrated in Wi-Fi + Bluetooth combo adapter * Intel 8265ac / 18265ac card support BT4.2 but is limited to BT4.1 by Windows OS							Environment	EEPEAT™ Gold (US only); ENERGY STAR® 6.1; RoHS-compliant																		
WWAN ( <i>optional</i> )	<i>One of the following, configurable by model (WWAN can coexist with WiGig):</i> • Wireless WAN upgradable • Integrated Mobile Broadband 4G LTE-A, Qualcomm® Snapdragon™ X7 LTE-A (Sierra Wireless EM7455), M.2 card • Integrated Mobile Broadband 4G LTE, Intel XMM™ 7160 (Fibocom L831-EAU), M.2 card (EMEA only)																										
SIM card ( <i>opt</i> )	Micro-SIM card slot, opt Verizon LTE (US) or Lenovo® Connect (EMEA) SIM card																										

Model	Region	Processor	vPro	Graphics	Memory	Display	Multi-touch	Storage(HDD/SSD)	Optical	WLAN + Bluetooth	WWAN	SIM Card	Smart Card Reader	Dock	Monitor Cable	Camera	Key-board	Finger-print Reader	NFC	TPM	Battery (internal+ external)	Power Adapter	Operating System	Warranty	Ann Date (m/y)
20H9000MUS	US	i5-7200U	No	Intel HD 620	8GBx1	15.6" FHD (1920x1080) IPS	None	256GB SSD M.2 PCIe NVMe Opal2	None	Intel 8265 ac, 2x2 + BT4.1	WWAN Upgradable	None	None	None	None	720p	Backlit	Finger-print Reader	None	dTPM 2.0	4-cell(32Wh) + 3-cell(24Wh)	45W	Win10 Pro 64	3-year, Depot	01/17
20H9000NUS	US	i7-7600U	vPro	Intel HD 620	8GBx1	15.6" FHD (1920x1080) IPS	None	256GB SSD M.2 PCIe NVMe Opal2	None	Intel 8265 ac, 2x2 + BT4.1	WWAN Upgradable	None	None	None	None	720p	Backlit	Finger-print Reader	None	dTPM 2.0	4-cell(32Wh) + 3-cell(24Wh)	45W	Win10 Pro 64	3-year, Depot	01/17
20H9000PUS	US	i5-7300U	vPro	Intel HD 620	8GBx1	15.6" FHD (1920x1080) IPS	None	256GB SSD M.2 PCIe NVMe Opal2	None	Intel 8265 ac, 2x2 + BT4.1	WWAN Upgradable	None	None	None	None	720p	Backlit	Finger-print Reader	None	dTPM 2.0	4-cell(32Wh) + 3-cell(24Wh)	45W	Win10 Pro 64	3-year, Depot	01/17
20H9000QUS	US	i5-7200U	No	Intel HD 620	4GBx1	15.6" FHD (1920x1080) IPS	10-point Multi-touch	500GB 7200rpm	None	Intel 8265 ac, 2x2 + BT4.1	WWAN Upgradable	None	None	None	None	720p	Backlit	Finger-print Reader	None	dTPM 2.0	4-cell(32Wh) + 3-cell(24Wh)	45W	Win10 Pro 64	3-year, Depot	01/17
20H9000RUS	US	i5-7200U	No	Intel HD 620	8GBx1	15.6" FHD (1920x1080) IPS	10-point Multi-touch	256GB SSD M.2 PCIe NVMe Opal2	None	Intel 8265 ac, 2x2 + BT4.1	WWAN Upgradable	None	None	None	None	720p	Backlit	Finger-print Reader	None	dTPM 2.0	4-cell(32Wh) + 3-cell(24Wh)	45W	Win10 Pro 64	3-year, Depot	01/17
20H9000SUS	US	i5-7200U	No	Intel HD 620	4GBx1	15.6" FHD (1920x1080) IPS	None	500GB 7200rpm	None	Intel 8265 ac, 2x2 + BT4.1	WWAN Upgradable	None	None	None	None	720p	Backlit	Finger-print Reader	None	dTPM 2.0	4-cell(32Wh) + 3-cell(24Wh)	45W	Win10 Pro 64	1-year, Depot	01/17
20H9000TUS	US	i7-7600U	vPro	Intel HD 620	8GBx1	15.6" FHD (1920x1080) IPS	10-point Multi-touch	256GB SSD M.2 PCIe NVMe Opal2	None	Intel 8265 ac, 2x2 + BT4.1	WWAN Upgradable	None	None	None	None	720p	Backlit	Finger-print Reader	None	dTPM 2.0	4-cell(32Wh) + 3-cell(24Wh)	45W	Win10 Pro 64	3-year, Depot	01/17
20H9000UUS	US	i5-7300U	vPro	Intel HD 620	8GBx1	15.6" FHD (1920x1080) IPS	10-point Multi-touch	256GB SSD M.2 PCIe NVMe Opal2	None	Intel 8265 ac, 2x2 + BT4.1	WWAN Upgradable	None	None	None	None	720p	Backlit	Finger-print Reader	None	dTPM 2.0	4-cell(32Wh) + 3-cell(24Wh)	45W	Win10 Pro 64	3-year, Depot	01/17
20H9004FUS	US	i5-7200U	No	Intel HD 620	4GBx1	15.6" FHD (1920x1080) IPS	None	500GB 7200rpm	None	Intel 8265 ac, 2x2 + BT4.1	WWAN Upgradable	None	None	None	None	720p	Backlit	Finger-print Reader	None	dTPM 2.0	4-cell(32Wh) + 3-cell(24Wh)	45W	Win10 Pro 64	3-year, Depot	03/17
20H9004NUS	US	i7-7600U	vPro	Intel HD 620	8GBx1	15.6" FHD (1920x1080) IPS	None	256GB SSD M.2 PCIe NVMe Opal2	None	Intel 8265 ac, 2x2 + BT4.1	WWAN Upgradable	None	None	None	None	IR & 720p	Backlit	Finger-print Reader	None	dTPM 2.0	4-cell(32Wh) + 3-cell(24Wh)	45W	Win10 Pro 64	3-year, Depot	04/17
20H9004PUS	US	i7-7600U	vPro	Intel HD 620	8GBx1	15.6" FHD (1920x1080) IPS	10-point Multi-touch	256GB SSD M.2 PCIe NVMe Opal2	None	Intel 8265 ac, 2x2 + BT4.1	WWAN Upgradable	None	None	None	None	IR & 720p	Backlit	Finger-print Reader	None	dTPM 2.0	4-cell(32Wh) + 3-cell(24Wh)	45W	Win10 Pro 64	3-year, Depot	04/17
20H9004QUS	US	i5-7300U	vPro	Intel HD 620	8GBx1	15.6" FHD (1920x1080) IPS	None	256GB SSD M.2 PCIe NVMe Opal2	None	Intel 8265 ac, 2x2 + BT4.1	WWAN Upgradable	None	None	None	None	IR & 720p	Backlit	Finger-print Reader	None	dTPM 2.0	4-cell(32Wh) + 3-cell(24Wh)	45W	Win10 Pro 64	3-year, Depot	04/17
20H9004RUS	US	i7-7600U	vPro	Intel HD 620	16GBx1	15.6" 4K (3840x2160) IPS	None	512GB SSD M.2 PCIe NVMe Opal2	None	Intel 8265 ac, 2x2 + BT4.1	WWAN Upgradable	None	None	None	None	IR & 720p	Backlit	Finger-print Reader	None	dTPM 2.0	4-cell(32Wh) + 3-cell(24Wh)	45W	Win10 Pro 64	3-year, Depot	04/17
20H9004SUS	US	i7-7600U	vPro	Intel HD 620	16GBx1	15.6" FHD (1920x1080) IPS	10-point Multi-touch	512GB SSD M.2 PCIe NVMe Opal2	None	Intel 8265 ac, 2x2 + BT4.1	WWAN Upgradable	None	None	None	None	720p	Backlit	Finger-print Reader	None	dTPM 2.0	4-cell(32Wh) + 3-cell(24Wh)	45W	Win10 Pro 64	3-year, Depot	04/17
20H9004TUS	US	i7-7600U	vPro	Intel HD 620	16GBx1	15.6" FHD (1920x1080) IPS	None	512GB SSD M.2 PCIe NVMe Opal2	None	Intel 8265 ac, 2x2 + BT4.1	WWAN Upgradable	None	None	None	None	720p	Backlit	Finger-print Reader	None	dTPM 2.0	4-cell(32Wh) + 3-cell(24Wh)	45W	Win10 Pro 64	3-year, Depot	04/17
20H9004UUS	US	i7-7600U	vPro	Intel HD 620	8GBx1	15.6" FHD (1920x1080) IPS	10-point Multi-touch	256GB SSD M.2 PCIe NVMe Opal2	None	Intel 8265 ac, 2x2 + BT4.1	Sierra EM7455	None	None	None	None	720p	Backlit	Finger-print Reader	None	dTPM 2.0	4-cell(32Wh) + 3-cell(24Wh)	45W	Win10 Pro 64	3-year, Depot	04/17
20H9004VUS	US	i5-7300U	vPro	Intel HD 620	8GBx1	15.6" FHD (1920x1080) IPS	None	256GB SSD M.2 PCIe NVMe Opal2	None	Intel 8265 ac, 2x2 + BT4.1	Sierra EM7455	None	None	None	None	720p	Backlit	Finger-print Reader	None	dTPM 2.0	4-cell(32Wh) + 3-cell(24Wh)	45W	Win10 Pro 64	3-year, Depot	04/17
20H9004WUS	US	i7-7600U	vPro	Intel HD 620	8GBx1	15.6" FHD (1920x1080) IPS	None	256GB SSD M.2 PCIe NVMe Opal2	None	Intel 8265 ac, 2x2 + BT4.1	Sierra EM7455	None	None	None	None	720p	Backlit	Finger-print Reader	None	dTPM 2.0	4-cell(32Wh) + 3-cell(24Wh)	45W	Win10 Pro 64	3-year, Depot	04/17
20H90056US	US	i5-7200U	No	Intel HD 620	4GBx1	15.6" HD (1366x768)	None	500GB 7200rpm	None	Intel 8265 ac, 2x2 + BT4.1	WWAN Upgradable	None	None	None	None	720p	Backlit	Finger-print Reader	None	dTPM 2.0	4-cell(32Wh) + 3-cell(24Wh)	45W	Win10 Pro 64	3-year, Depot	06/17
20H90057US	US	i5-7300U	vPro	Intel HD 620	8GBx1	15.6" FHD (1920x1080) IPS	None	256GB SSD M.2 PCIe NVMe Opal2	None	Intel 8265 ac, 2x2 + BT4.1	WWAN Upgradable	None	None	None	None	720p	Backlit	Finger-print Reader	None	dTPM 2.0	4-cell(32Wh) + 3-cell(24Wh)	45W	Win10 Pro 64	3-year, Depot	06/17

Model	Region	Processor	vPro	Graphics	Memory	Display	Multi-touch	Storage(HDD/SSD)	Optical	WLAN + Bluetooth	WWAN	SIM Card	Smart Card Reader	Dock	Monitor Cable	Camera	Key-board	Finger-print Reader	NFC	TPM	Battery (internal+external)	Power Adapter	Operating System	Warranty	Ann Date (m/y)
20H90058US	US	i5-7200U	No	Intel HD 620	4GBx1	15.6" HD (1366x768)	None	180GB SSD Opal2	None	Intel 8265 ac, 2x2 + BT4.1	WWAN Upgradable	None	None	None	None	720p	Backlit	Finger-print Reader	None	dTPM 2.0	4-cell(32Wh) + 3-cell(24Wh)	45W	Win10 Pro 64	3-year, Depot	06/17
20H90059US	US	i7-7600U	vPro	Intel HD 620	8GBx1	15.6" FHD (1920x1080) IPS	10-point Multi-touch	256GB SSD M.2 PCIe NVMe Opal2	None	Intel 8265 ac, 2x2 + BT4.1	WWAN Upgradable	None	None	None	None	720p	Backlit	Finger-print Reader	None	dTPM 2.0	4-cell(32Wh) + 3-cell(24Wh)	45W	Win10 Pro 64	3-year, Depot	06/17

ThinkPad T570 - TopSeller - 20JW

Product Specifications Reference (PSREF)

Model	Region	Processor	vPro	Graphics	Memory	Display	Multi-touch	Storage(HDD/SSD)	Optical	WLAN + Bluetooth	WWAN	SIM Card	Smart Card Reader	Dock	Monitor Cable	Camera	Key-board	Finger-print Reader	NFC	TPM	Battery (internal+external)	Power Adapter	Operating System	Warranty	Ann Date (m/y)
20JW0004US	US	i7-6600U	vPro	Intel HD 520	8GBx1	15.6" FHD (1920x1080) IPS	None	256GB SSD M.2 PCIe NVMe Opal2	None	Intel 8260 ac, 2x2 + BT4.1	WWAN Upgradable	None	None	None	None	720p	Backlit	Finger-print Reader	None	dTPM 2.0	4-cell(32Wh) + 3-cell(24Wh)	45W	Win10 DG Win7 Pro 64	3-year, Depot	03/17
20JW0005US	US	i5-6300U	vPro	Intel HD 520	4GBx1	15.6" FHD (1920x1080) IPS	None	500GB 7200rpm	None	Intel 8260 ac, 2x2 + BT4.1	WWAN Upgradable	None	None	None	None	720p	Backlit	Finger-print Reader	None	dTPM 2.0	4-cell(32Wh) + 3-cell(24Wh)	45W	Win10 DG Win7 Pro 64	3-year, Depot	03/17
20JW0006US	US	i5-6300U	vPro	Intel HD 520	8GBx1	15.6" FHD (1920x1080) IPS	None	256GB SSD M.2 PCIe NVMe Opal2	None	Intel 8260 ac, 2x2 + BT4.1	WWAN Upgradable	None	None	None	None	720p	Backlit	Finger-print Reader	None	dTPM 2.0	4-cell(32Wh) + 3-cell(24Wh)	45W	Win10 DG Win7 Pro 64	3-year, Depot	03/17
20JW0007US	US	i7-6600U	vPro	Intel HD 520	16GBx1	15.6" FHD (1920x1080) IPS	None	512GB SSD M.2 PCIe NVMe Opal2	None	Intel 8260 ac, 2x2 + BT4.1	WWAN Upgradable	None	None	None	None	720p	Backlit	Finger-print Reader	None	dTPM 2.0	4-cell(32Wh) + 3-cell(24Wh)	45W	Win10 DG Win7 Pro 64	3-year, Depot	04/17
20JW0008US	US	i5-6300U	vPro	Intel HD 520	8GBx1	15.6" FHD (1920x1080) IPS	None	256GB SSD M.2 PCIe NVMe Opal2	None	Intel 8260 ac, 2x2 + BT4.1	Sierra EM7455	None	None	None	None	720p	Backlit	Finger-print Reader	None	dTPM 2.0	4-cell(32Wh) + 3-cell(24Wh)	45W	Win10 DG Win7 Pro 64	3-year, Depot	04/17
20JW0009US	US	i7-6600U	vPro	Intel HD 520	8GBx1	15.6" FHD (1920x1080) IPS	None	256GB SSD M.2 PCIe NVMe Opal2	None	Intel 8260 ac, 2x2 + BT4.1	Sierra EM7455	None	None	None	None	720p	Backlit	Finger-print Reader	None	dTPM 2.0	4-cell(32Wh) + 3-cell(24Wh)	45W	Win10 DG Win7 Pro 64	3-year, Depot	04/17
20JW000CUS	US	i7-6600U	vPro	Intel HD 520	8GBx1	15.6" FHD (1920x1080) IPS	None	256GB SSD M.2 PCIe NVMe Opal2	None	Intel 8260 ac, 2x2 + BT4.1	WWAN Upgradable	None	None	None	None	720p	Backlit	Finger-print Reader	None	dTPM 2.0	4-cell(32Wh) + 3-cell(24Wh)	45W	Win10 DG Win7 Pro 64	3-year, Depot	06/17
20JW000DUS	US	i5-6300U	vPro	Intel HD 520	8GBx1	15.6" FHD (1920x1080) IPS	None	256GB SSD M.2 PCIe NVMe Opal2	None	Intel 8260 ac, 2x2 + BT4.1	WWAN Upgradable	None	None	None	None	720p	Backlit	Finger-print Reader	None	dTPM 2.0	4-cell(32Wh) + 3-cell(24Wh)	45W	Win10 DG Win7 Pro 64	3-year, Depot	06/17



# ThinkPad X1 Carbon (5<sup>th</sup> Gen) Platform Specifications

Product Specifications Reference (PSREF)

Processor	6th Generation Intel® Core™ i5 / i7 Processor								Smart card reader None	Media reader MicroSD card reader, supports UHS-II microSD card	Ports Two USB 3.1 Gen 1 (USB 3.0, one Always On), two USB 3.1 Type-C Gen 2 / Thunderbolt 3 (support data, video, and power delivery), HDMI 1.4b, Ethernet extension connector									
	Processor Number	# of Cores	# of Threads	Base Frequency	Max Turbo Frequency	Cache	Memory Types	Processor Graphics												
	i5-6200U	2	4	2.3 GHz	2.8 GHz	3MB	LPDDR3-1866	Intel HD Graphics 520	WiGig dock (opt) ThinkPad WiGig dock	Monitor cable (optional) HDMI to VGA: Lenovo HDMI to VGA Monitor Adapter USB-C to VGA: Lenovo USB-C to VGA Adapter USB-C to DP: Lenovo USB-C to DisplayPort Adapter										
	i5-6300U			2.4 GHz	3.0 GHz	3MB														
	i7-6500U			2.5 GHz	3.1 GHz	4MB														
	i7-6600U			2.6 GHz	3.4 GHz	4MB														
	or 7th Generation Intel Core i5 / i7 Processor								Camera (optional) 720p: HD720p resolution, fixed focus IR & 720p: IR camera and HD720p camera	Audio support HD Audio, Conexant® CX11871 codec / stereo speakers, 2W x 2 / dual array microphone, combo audio/microphone jack										
	Processor Number	# of Cores	# of Threads	Base Frequency	Max Turbo Frequency	Cache	Memory Types	Processor Graphics												
	i5-7200U	2	4	2.5 GHz	3.1 GHz	3MB	LPDDR3-1866	Intel HD Graphics 620	Keyboard 6-row, spill-resistant, multimedia Fn keys, LED backlight	UltraNav™ TrackPoint® pointing device and buttonless Glass surface multi-touch touchpad										
	i5-7300U			2.6 GHz	3.5 GHz	3MB														
	i7-7500U			2.7 GHz	3.5 GHz	4MB														
	i7-7600U			2.8 GHz	3.9 GHz	4MB														
Graphics	Intel HD Graphics 520 or 620 in processor; supports external digital monitor via HDMI or USB Type-C; supports three independent displays; Max resolution: 4096x2304@60Hz (USB Type-C); 4096x2160@24Hz (HDMI)								Security Security chip vPro (optional) Intel vPro Technology	Fingerprint reader Touch style match on chip fingerprint reader on the palm rest	NFC (optional) Near Field Communication									
Chipset	Intel SoC (System on Chip) platform								Battery Integrated Li-Polymer 3-cell (57Wh) RapidCharge battery	Max battery life MobileMark® 2014: 15.5 hr	AC adapter 45W or 65W USB Type-C adapter									
Memory	8GB or 16GB / 1866MHz LPDDR3 / soldered to systemboard, no sockets								RapidCharge											
Display	Some: 14.0" (355mm) FHD (1920x1080), anti-glare, LED backlight, IPS, 300 nits, 16:9 aspect ratio, 700:1 contrast ratio, 170° viewing angle Some: 14.0" (355mm) WQHD (2560x1440), anti-glare, LED backlight, IPS, 300 nits, 16:9 aspect ratio, 700:1 contrast ratio, 170° viewing angle								<table border="1"> <tr> <td>AC adapter</td> <td>45W USB-C</td> <td>65W USB-C</td> </tr> <tr> <td>Charge to 80%</td> <td>Not support</td> <td>1.0 hr</td> </tr> <tr> <td>Charge to 100%</td> <td>Not support</td> <td>2.5 hr</td> </tr> </table>			AC adapter	45W USB-C	65W USB-C	Charge to 80%	Not support	1.0 hr	Charge to 100%	Not support	2.5 hr
AC adapter	45W USB-C	65W USB-C																		
Charge to 80%	Not support	1.0 hr																		
Charge to 100%	Not support	2.5 hr																		
Multi-touch	None								Preload Windows® 7 Professional 64 preinstalled through downgrade rights in Windows 10 Pro 64	Some: Windows 10 Home 64 Some: Windows 10 Pro 64	<ul style="list-style-type: none"> <li>• Lenovo Companion</li> <li>• Lenovo Setting</li> <li>• Microsoft Office preloaded; purchase a product key to activate</li> </ul>									
Storage	Some: M.2 SSD / SATA 6.0Gb/s (e.g. xxxG SSD) Some: M.2 SSD / PCIe NVMe, PCIe 3.0 x 4, 32Gb/s (e.g. xxxG SSD PCIe NVMe)											<ul style="list-style-type: none"> <li>• Lenovo Solution Center</li> <li>• Lenovo PowerEngage</li> <li>• ThinkVantage Product Recovery</li> <li>• ThinkVantage System Update</li> <li>• Adobe® Reader®</li> <li>• Microsoft® Office preloaded; purchase a product key to activate</li> <li>• McAfee® LiveSafe™ (30-day trial)</li> </ul>								
Optical	None								Limited warranty One of the following, configurable by model: <ul style="list-style-type: none"> <li>• 1-year depot repair service</li> <li>• 3-year/1-yr battery depot repair service</li> <li>• 3-year/1-yr battery limited onsite service</li> </ul>	<ul style="list-style-type: none"> <li>• Lenovo Companion</li> <li>• Lenovo Setting</li> <li>• Microsoft Office preloaded; purchase a product key to activate</li> </ul>										
Ethernet	Native Intel Ethernet Connection I219-V (Non-vPro) or I219-LM (vPro) via optional ThinkPad Ethernet Extension Cable										Mii-Spec test MIL-STD-810G military certification	Environment EPEAT™ Gold (US only); ENERGY STAR® 6.1; RoHS-compliant								
WLAN	One of the following, configurable by model (WiGig can coexist with WWAN): <ul style="list-style-type: none"> <li>• Intel Dual Band Wireless-AC 8260, Wi-Fi 2x2 802.11ac + BT4.1, M.2 card</li> <li>• Intel Dual Band Wireless-AC 8265, Wi-Fi 2x2 802.11ac + BT4.1, M.2 card</li> <li>• Intel Tri-Band Wireless-AC 18265, WiGig 802.11ad + Wi-Fi 2x2 802.11ac + BT4.1, M.2 card</li> </ul>																			
Bluetooth™	Bluetooth 4.1 wireless, integrated in Wi-Fi + Bluetooth combo adapter * Intel 8265ac / 18265ac card support BT4.2 but is limited to BT4.1 by Windows OS																			
WWAN (optional)	Integrated Mobile Broadband 4G LTE-A, Qualcomm® Snapdragon™ X7 LTE-A (Sierra Wireless EM7455)																			
SIM card (opt)	Micro-SIM card slot, opt Verizon LTE (US) or Lenovo® Connect (EMEA) SIM card																			
Dimensions	WxDxH: 12.74" x 8.55" x 0.63"; 323.5mm x 217.1mm x 15.95mm																			
Weight	Starting at 2.49 lb / 1.13 kg																			
Case color	Black or Silver (silver is not available in EMEA)																			
Case material	Display cover: CFRP/GFRP hybrid; Bottom: magnesium alloy hybrid																			



Model	Region	Processor	vPro	Graphics	Memory (Soldered)	Display	Multi-touch	Storage(HDD/SSD)	Optical	WLAN + Bluetooth	WWAN	SIM Card	Dock	Monitor Cable	Adapter	Color	Camera	Key-board	Finger-print Reader	NFC	TPM	Battery (internal)	Power Adapter	Operating System	Warranty	Ann Date (m/y)
20HR000DUS	US	i5-7300U	vPro	Intel HD 620	8GB Soldered	14" FHD (1920x1080) IPS	None	256GB SSD M.2 PCIe NVMe Opal2	None	8265 ac, 2x2 + BT4.1	None	None	None	None	None	Black	720p	Backlit	Finger-print Reader	None	dTPM 2.0	3-cell (57Wh)	65W USB-C	Win10 Pro 64	3-year, Depot	02/17
20HR000EUS	US	i7-7600U	vPro	Intel HD 620	8GB Soldered	14" FHD (1920x1080) IPS	None	256GB SSD M.2 PCIe NVMe Opal2	None	8265 ac, 2x2 + BT4.1	None	None	None	None	None	Silver	720p	Backlit	Finger-print Reader	None	dTPM 2.0	3-cell (57Wh)	65W USB-C	Win10 Pro 64	3-year, Depot	03/17
20HR000FUS	US	i7-7600U	vPro	Intel HD 620	16GB Soldered	14" FHD (1920x1080) IPS	None	512GB SSD M.2 PCIe NVMe Opal2	None	8265 ac, 2x2 + BT4.1	None	None	None	None	None	Black	720p	Backlit	Finger-print Reader	None	dTPM 2.0	3-cell (57Wh)	65W USB-C	Win10 Pro 64	3-year, Depot	02/17
20HR000GUS	US	i5-7200U	No	Intel HD 620	8GB Soldered	14" FHD (1920x1080) IPS	None	256GB SSD M.2 PCIe NVMe Opal2	None	8265 ac, 2x2 + BT4.1	None	None	None	None	None	Silver	720p	Backlit	Finger-print Reader	None	dTPM 2.0	3-cell (57Wh)	65W USB-C	Win10 Pro 64	3-year, Depot	03/17
20HR000HUS	US	i7-7600U	vPro	Intel HD 620	8GB Soldered	14" FHD (1920x1080) IPS	None	256GB SSD M.2 PCIe NVMe Opal2	None	8265 ac, 2x2 + BT4.1	None	None	None	None	None	Black	720p	Backlit	Finger-print Reader	None	dTPM 2.0	3-cell (57Wh)	65W USB-C	Win10 Pro 64	3-year, Depot	02/17
20HR000JUS	US	i7-7600U	vPro	Intel HD 620	16GB Soldered	14" FHD (1920x1080) IPS	None	512GB SSD M.2 PCIe NVMe Opal2	None	8265 ac, 2x2 + BT4.1	None	None	None	None	None	Silver	720p	Backlit	Finger-print Reader	None	dTPM 2.0	3-cell (57Wh)	65W USB-C	Win10 Pro 64	3-year, Depot	03/17
20HR000KUS	US	i5-7300U	vPro	Intel HD 620	16GB Soldered	14" FHD (1920x1080) IPS	None	256GB SSD M.2 PCIe NVMe Opal2	None	8265 ac, 2x2 + BT4.1	None	None	None	None	None	Silver	720p	Backlit	Finger-print Reader	None	dTPM 2.0	3-cell (57Wh)	65W USB-C	Win10 Pro 64	3-year, Depot	03/17
20HR000LUS	US	i5-7300U	vPro	Intel HD 620	8GB Soldered	14" FHD (1920x1080) IPS	None	256GB SSD M.2 PCIe NVMe Opal2	None	8265 ac, 2x2 + BT4.1	None	None	None	None	None	Silver	720p	Backlit	Finger-print Reader	None	dTPM 2.0	3-cell (57Wh)	65W USB-C	Win10 Pro 64	3-year, Depot	03/17
20HR000MUS	US	i5-7300U	vPro	Intel HD 620	16GB Soldered	14" FHD (1920x1080) IPS	None	256GB SSD M.2 PCIe NVMe Opal2	None	8265 ac, 2x2 + BT4.1	None	None	None	None	None	Black	720p	Backlit	Finger-print Reader	None	dTPM 2.0	3-cell (57Wh)	65W USB-C	Win10 Pro 64	3-year, Depot	02/17
20HR000WUS	US	i5-7200U	No	Intel HD 620	8GB Soldered	14" FHD (1920x1080) IPS	None	256GB SSD M.2 PCIe NVMe Opal2	None	8265 ac, 2x2 + BT4.1	None	None	None	None	None	Black	720p	Backlit	Finger-print Reader	None	dTPM 2.0	3-cell (57Wh)	65W USB-C	Win10 Pro 64	3-year, Depot	02/17
20HR0011US	US	i5-7200U	No	Intel HD 620	8GB Soldered	14" FHD (1920x1080) IPS	None	128GB SSD M.2	None	8265 ac, 2x2 + BT4.1	None	None	None	None	None	Black	720p	Backlit	Finger-print Reader	None	dTPM 2.0	3-cell (57Wh)	65W USB-C	Win10 Pro 64	3-year, Depot	02/17
20HR003CUS	US	i5-7300U	vPro	Intel HD 620	16GB Soldered	14" FHD (1920x1080) IPS	None	512GB SSD M.2 PCIe NVMe Opal2	None	8265 ac, 2x2 + BT4.1	None	None	None	None	None	Black	720p	Backlit	Finger-print Reader	None	dTPM 2.0	3-cell (57Wh)	65W USB-C	Win10 Pro 64	3-year, Depot	02/17
20HR003DUS	US	i7-7600U	vPro	Intel HD 620	8GB Soldered	14" FHD (1920x1080) IPS	None	512GB SSD M.2 PCIe NVMe Opal2	None	8265 ac, 2x2 + BT4.1	None	None	None	None	None	Black	720p	Backlit	Finger-print Reader	None	dTPM 2.0	3-cell (57Wh)	65W USB-C	Win10 Pro 64	3-year, Depot	02/17
20HR003EUS	US	i5-7300U	vPro	Intel HD 620	8GB Soldered	14" FHD (1920x1080) IPS	None	512GB SSD M.2 PCIe NVMe Opal2	None	8265 ac, 2x2 + BT4.1	None	None	None	None	None	Black	720p	Backlit	Finger-print Reader	None	dTPM 2.0	3-cell (57Wh)	65W USB-C	Win10 Pro 64	3-year, Depot	02/17
20HR0053US	US	i7-7500U	No	Intel HD 620	8GB Soldered	14" WQHD (2560x1440) IPS	None	256GB SSD M.2 PCIe NVMe Opal2	None	8265 ac, 2x2 + BT4.1	None	None	None	None	None	Black	720p	Backlit	Finger-print Reader	None	dTPM 2.0	3-cell (57Wh)	65W USB-C	Win10 Pro 64	3-year, Depot	03/17
20HR0057US	US	i7-7500U	No	Intel HD 620	8GB Soldered	14" FHD (1920x1080) IPS	None	256GB SSD M.2 PCIe NVMe Opal2	None	8265 ac, 2x2 + BT4.1	None	None	None	None	None	Black	720p	Backlit	Finger-print Reader	None	dTPM 2.0	3-cell (57Wh)	65W USB-C	Win10 Pro 64	3-year, Depot	03/17
20HR0058US	US	i7-7500U	No	Intel HD 620	8GB Soldered	14" FHD (1920x1080) IPS	None	512GB SSD M.2 PCIe NVMe Opal2	None	8265 ac, 2x2 + BT4.1	None	None	None	None	None	Black	720p	Backlit	Finger-print Reader	None	dTPM 2.0	3-cell (57Wh)	65W USB-C	Win10 Pro 64	3-year, Depot	03/17
20HR005FUS	US	i7-7600U	vPro	Intel HD 620	16GB Soldered	14" FHD (1920x1080) IPS	None	512GB SSD M.2 PCIe NVMe Opal2	None	8265 ac, 2x2 + BT4.1	Sierra EM7455	None	None	None	None	Black	720p	Backlit	Finger-print Reader	None	dTPM 2.0	3-cell (57Wh)	65W USB-C	Win10 Pro 64	3-year, Depot	04/17
20HR005HUS	US	i7-7600U	vPro	Intel HD 620	8GB Soldered	14" FHD (1920x1080) IPS	None	256GB SSD M.2 PCIe NVMe Opal2	None	8265 ac, 2x2 + BT4.1	Sierra EM7455	None	None	None	None	Black	720p	Backlit	Finger-print Reader	None	dTPM 2.0	3-cell (57Wh)	65W USB-C	Win10 Pro 64	3-year, Depot	04/17
20HR005KUS	US	i5-7300U	vPro	Intel HD 620	8GB Soldered	14" FHD (1920x1080) IPS	None	256GB SSD M.2 PCIe NVMe Opal2	None	8265 ac, 2x2 + BT4.1	Sierra EM7455	None	None	None	None	Black	720p	Backlit	Finger-print Reader	None	dTPM 2.0	3-cell (57Wh)	65W USB-C	Win10 Pro 64	3-year, Depot	04/17

Model	Region	Processor	vPro	Graphics	Memory (Soldered)	Display	Multi-touch	Storage(HDD/SSD)	Optical	WLAN + Bluetooth	WWAN	SIM Card	Dock	Monitor Cable	Adapter	Color	Camera	Key-board	Finger-print Reader	NFC	TPM	Battery (internal)	Power Adapter	Operating System	Warranty	Ann Date (m/y)
20HR006HUS	US	i5-7300U	vPro	Intel HD 620	16GB Soldered	14" WQHD (2560x1440) IPS	None	512GB SSD M.2 PCIe NVMe Opal2	None	8265 ac, 2x2 + BT4.1	None	None	None	None	None	Black	720p	Backlit	Finger-print Reader	None	dTPM 2.0	3-cell (57Wh)	65W USB-C	Win10 Pro 64	3-year, Depot	07/17
20HR006JUS	US	i7-7600U	vPro	Intel HD 620	16GB Soldered	14" WQHD (2560x1440) IPS	None	512GB SSD M.2 PCIe NVMe Opal2	None	8265 ac, 2x2 + BT4.1	None	None	None	None	None	Black	720p	Backlit	Finger-print Reader	None	dTPM 2.0	3-cell (57Wh)	65W USB-C	Win10 Pro 64	3-year, Depot	07/17
20HR006KUS	US	i7-7600U	vPro	Intel HD 620	8GB Soldered	14" FHD (1920x1080) IPS	None	256GB SSD M.2 PCIe NVMe Opal2	None	8265 ac, 2x2 + BT4.1	Sierra EM7455	None	None	None	None	Silver	720p	Backlit	Finger-print Reader	None	dTPM 2.0	3-cell (57Wh)	65W USB-C	Win10 Pro 64	3-year, Depot	07/17
20HR006LUS	US	i7-7600U	vPro	Intel HD 620	8GB Soldered	14" WQHD (2560x1440) IPS	None	256GB SSD M.2 PCIe NVMe Opal2	None	8265 ac, 2x2 + BT4.1	None	None	None	None	None	Black	720p	Backlit	Finger-print Reader	None	dTPM 2.0	3-cell (57Wh)	65W USB-C	Win10 Pro 64	3-year, Depot	07/17
20HR006MUS	US	i5-7300U	vPro	Intel HD 620	16GB Soldered	14" WQHD (2560x1440) IPS	None	512GB SSD M.2 PCIe NVMe Opal2	None	8265 ac, 2x2 + BT4.1	Sierra EM7455	None	None	None	None	Black	720p	Backlit	Finger-print Reader	None	dTPM 2.0	3-cell (57Wh)	65W USB-C	Win10 Pro 64	3-year, Depot	07/17
20HR006NUS	US	i5-7300U	vPro	Intel HD 620	8GB Soldered	14" FHD (1920x1080) IPS	None	256GB SSD M.2 PCIe NVMe Opal2	None	8265 ac, 2x2 + BT4.1	Sierra EM7455	None	None	None	None	Silver	720p	Backlit	Finger-print Reader	None	dTPM 2.0	3-cell (57Wh)	65W USB-C	Win10 Pro 64	3-year, Depot	07/17
20HR006PUS	US	i5-7300U	vPro	Intel HD 620	8GB Soldered	14" WQHD (2560x1440) IPS	None	256GB SSD M.2 PCIe NVMe Opal2	None	8265 ac, 2x2 + BT4.1	Sierra EM7455	None	None	None	None	Black	720p	Backlit	Finger-print Reader	None	dTPM 2.0	3-cell (57Wh)	65W USB-C	Win10 Pro 64	3-year, Depot	07/17
20HR006QUS	US	i7-7600U	vPro	Intel HD 620	8GB Soldered	14" WQHD (2560x1440) IPS	None	256GB SSD M.2 PCIe NVMe Opal2	None	8265 ac, 2x2 + BT4.1	Sierra EM7455	None	None	None	None	Black	720p	Backlit	Finger-print Reader	None	dTPM 2.0	3-cell (57Wh)	65W USB-C	Win10 Pro 64	3-year, Depot	07/17
20HR006RUS	US	i5-7300U	vPro	Intel HD 620	8GB Soldered	14" WQHD (2560x1440) IPS	None	256GB SSD M.2 PCIe NVMe Opal2	None	8265 ac, 2x2 + BT4.1	None	None	None	None	None	Black	720p	Backlit	Finger-print Reader	None	dTPM 2.0	3-cell (57Wh)	65W USB-C	Win10 Pro 64	3-year, Depot	07/17
20HR006SUS	US	i7-7600U	vPro	Intel HD 620	16GB Soldered	14" WQHD (2560x1440) IPS	None	1TB SSD M.2 PCIe NVMe Opal2	None	8265 ac, 2x2 + BT4.1	None	None	None	None	None	Black	720p	Backlit	Finger-print Reader	None	dTPM 2.0	3-cell (57Wh)	65W USB-C	Win10 Pro 64	3-year, Depot	07/17
20HR006TUS	US	i7-7600U	vPro	Intel HD 620	16GB Soldered	14" WQHD (2560x1440) IPS	None	512GB SSD M.2 PCIe NVMe Opal2	None	8265 ac, 2x2 + BT4.1	Sierra EM7455	None	None	None	None	Black	720p	Backlit	Finger-print Reader	None	dTPM 2.0	3-cell (57Wh)	65W USB-C	Win10 Pro 64	3-year, Depot	07/17
20HR006UUS	US	i7-7600U	vPro	Intel HD 620	16GB Soldered	14" WQHD (2560x1440) IPS	None	512GB SSD M.2 PCIe NVMe Opal2	None	8265 ac, 2x2 + BT4.1	None	None	None	None	None	Silver	720p	Backlit	Finger-print Reader	None	dTPM 2.0	3-cell (57Wh)	65W USB-C	Win10 Pro 64	3-year, Depot	07/17
20HR006VUS	US	i7-7600U	vPro	Intel HD 620	8GB Soldered	14" WQHD (2560x1440) IPS	None	256GB SSD M.2 PCIe NVMe Opal2	None	8265 ac, 2x2 + BT4.1	None	None	None	None	None	Silver	720p	Backlit	Finger-print Reader	None	dTPM 2.0	3-cell (57Wh)	65W USB-C	Win10 Pro 64	3-year, Depot	07/17

ThinkPad X1 Carbon (5th Gen) - TopSeller - 20K4

Product Specifications Reference (PSREF)

Model	Region	Processor	vPro	Graphics	Memory (Soldered)	Display	Multi-touch	Storage(HDD/SSD)	Optical	WLAN + Bluetooth	WWAN	SIM Card	Dock	Monitor Cable	Adapter	Color	Camera	Key-board	Finger-print Reader	NFC	TPM	Battery (internal)	Power Adapter	Operating System	Warranty	Ann Date (m/y)
20K4001WUS	US	i5-6200U	No	Intel HD 520	8GB Soldered	14" FHD (1920x1080) IPS	None	512GB SSD M.2 PCIe NVMe Opal2	None	8260 ac, 2x2 + BT4.1	None	None	None	None	None	Black	720p	Backlit	Finger-print Reader	None	dTPM 2.0	3-cell (57Wh)	65W USB-C	Win10 DG Win7 Pro 64	3-year, Depot	03/17
20K4001XUS	US	i5-6300U	vPro	Intel HD 520	8GB Soldered	14" FHD (1920x1080) IPS	None	256GB SSD M.2 PCIe NVMe Opal2	None	8260 ac, 2x2 + BT4.1	None	None	None	None	None	Black	720p	Backlit	Finger-print Reader	None	dTPM 2.0	3-cell (57Wh)	65W USB-C	Win10 DG Win7 Pro 64	3-year, Depot	03/17
20K4001YUS	US	i7-6600U	vPro	Intel HD 520	8GB Soldered	14" FHD (1920x1080) IPS	None	256GB SSD M.2 PCIe NVMe Opal2	None	8260 ac, 2x2 + BT4.1	None	None	None	None	None	Black	720p	Backlit	Finger-print Reader	None	dTPM 2.0	3-cell (57Wh)	65W USB-C	Win10 DG Win7 Pro 64	3-year, Depot	03/17
20K40020US	US	i7-6600U	vPro	Intel HD 520	8GB Soldered	14" FHD (1920x1080) IPS	None	512GB SSD M.2 PCIe NVMe Opal2	None	8260 ac, 2x2 + BT4.1	None	None	None	None	None	Black	720p	Backlit	Finger-print Reader	None	dTPM 2.0	3-cell (57Wh)	65W USB-C	Win10 DG Win7 Pro 64	3-year, Depot	03/17
20K40021US	US	i5-6200U	No	Intel HD 520	8GB Soldered	14" FHD (1920x1080) IPS	None	256GB SSD M.2 PCIe NVMe Opal2	None	8260 ac, 2x2 + BT4.1	None	None	None	None	None	Black	720p	Backlit	Finger-print Reader	None	dTPM 2.0	3-cell (57Wh)	65W USB-C	Win10 DG Win7 Pro 64	3-year, Depot	03/17
20K4002RUS	US	i7-6500U	No	Intel HD 520	8GB Soldered	14" FHD (1920x1080) IPS	None	256GB SSD M.2 PCIe NVMe Opal2	None	8260 ac, 2x2 + BT4.1	None	None	None	None	None	Black	720p	Backlit	Finger-print Reader	None	dTPM 2.0	3-cell (57Wh)	65W USB-C	Win10 DG Win7 Pro 64	3-year, Depot	03/17
20K4002SUS	US	i7-6500U	No	Intel HD 520	8GB Soldered	14" FHD (1920x1080) IPS	None	512GB SSD M.2 PCIe NVMe Opal2	None	8260 ac, 2x2 + BT4.1	None	None	None	None	None	Black	720p	Backlit	Finger-print Reader	None	dTPM 2.0	3-cell (57Wh)	65W USB-C	Win10 DG Win7 Pro 64	3-year, Depot	03/17
20K4002TUS	US	i7-6500U	No	Intel HD 520	8GB Soldered	14" WQHD (2560x1440) IPS	None	512GB SSD M.2 PCIe NVMe Opal2	None	8260 ac, 2x2 + BT4.1	None	None	None	None	None	Black	720p	Backlit	Finger-print Reader	None	dTPM 2.0	3-cell (57Wh)	65W USB-C	Win10 DG Win7 Pro 64	3-year, Depot	03/17
20K4002UUS	US	i5-6200U	No	Intel HD 520	8GB Soldered	14" FHD (1920x1080) IPS	None	180GB SSD M.2 Opal2	None	8260 ac, 2x2 + BT4.1	None	None	None	None	None	Black	720p	Backlit	Finger-print Reader	None	dTPM 2.0	3-cell (57Wh)	65W USB-C	Win10 DG Win7 Pro 64	3-year, Depot	03/17
20K4002WUS	US	i7-6600U	vPro	Intel HD 520	16GB Soldered	14" WQHD (2560x1440) IPS	None	512GB SSD M.2 PCIe NVMe Opal2	None	8260 ac, 2x2 + BT4.1	Sierra EM7455	None	None	None	None	Black	720p	Backlit	Finger-print Reader	None	dTPM 2.0	3-cell (57Wh)	65W USB-C	Win10 DG Win7 Pro 64	3-year, Depot	07/17
20K4002XUS	US	i5-6300U	vPro	Intel HD 520	8GB Soldered	14" WQHD (2560x1440) IPS	None	256GB SSD M.2 PCIe NVMe Opal2	None	8260 ac, 2x2 + BT4.1	Sierra EM7455	None	None	None	None	Black	720p	Backlit	Finger-print Reader	None	dTPM 2.0	3-cell (57Wh)	65W USB-C	Win10 DG Win7 Pro 64	3-year, Depot	07/17
20K4002YUS	US	i5-6300U	vPro	Intel HD 520	8GB Soldered	14" WQHD (2560x1440) IPS	None	256GB SSD M.2 PCIe NVMe Opal2	None	8260 ac, 2x2 + BT4.1	None	None	None	None	None	Black	720p	Backlit	Finger-print Reader	None	dTPM 2.0	3-cell (57Wh)	65W USB-C	Win10 DG Win7 Pro 64	3-year, Depot	07/17
20K40030US	US	i5-6300U	vPro	Intel HD 520	8GB Soldered	14" FHD (1920x1080) IPS	None	256GB SSD M.2 PCIe NVMe Opal2	None	8260 ac, 2x2 + BT4.1	Sierra EM7455	None	None	None	None	Black	720p	Backlit	Finger-print Reader	None	dTPM 2.0	3-cell (57Wh)	65W USB-C	Win10 DG Win7 Pro 64	3-year, Depot	07/17

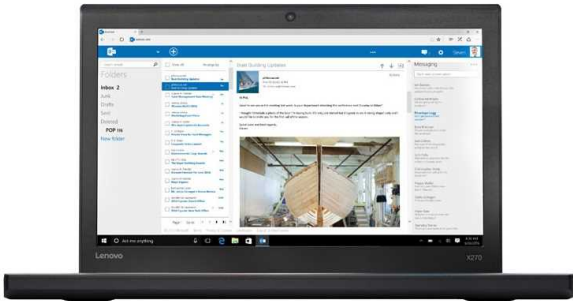

# ThinkPad X270 Platform Specifications

Product Specifications Reference (PSREF)

Processor	6th Generation Intel® Core™ i3 / i5 / i7 Processor								WWAN (optional) <i>One of the following, configurable by model (mutually exclusive with WiGig):</i> <ul style="list-style-type: none"> <li>Wireless WAN upgradable</li> <li>Integrated Mobile Broadband 4G LTE-A, Qualcomm® Snapdragon™ X7 LTE-A (Sierra Wireless EM7455)</li> <li>Integrated Mobile Broadband 4G LTE, Intel XMM™ 7160 (Fibocom L831-EAU) (EMEA only)</li> </ul> SIM card (opt) Micro-SIM card slot, opt Verizon LTE (US) or Lenovo® Connect (EMEA) SIM card
	Processor Number	# of Cores	# of Threads	Base Frequency	Max Turbo Frequency	Cache	Memory Types	Processor Graphics	
	i3-6006U	2	4	2.0 GHz	-	3MB	DDR4-2133	Intel HD Graphics 520	
	i3-6100U			2.3 GHz	-	3MB			
	i5-6200U			2.3 GHz	2.8 GHz	3MB			
	i5-6300U			2.4 GHz	3.0 GHz	3MB			
	i7-6500U			2.5 GHz	3.1 GHz	4MB			
	i7-6600U			2.6 GHz	3.4 GHz	4MB			
	or 7th Generation Intel Core i3 / i5 / i7 Processor								
	Processor Number	# of Cores	# of Threads	Base Frequency	Max Turbo Frequency	Cache	Memory Types	Processor Graphics	
	i3-7100U	2	4	2.4 GHz	-	3MB	DDR4-2133	Intel HD Graphics 620	
	i5-7200U			2.5 GHz	3.1 GHz	3MB			
	i5-7300U			2.6 GHz	3.5 GHz	3MB			
	i7-7500U			2.7 GHz	3.5 GHz	4MB			
	i7-7600U			2.8 GHz	3.9 GHz	4MB			

Graphics Intel HD Graphics 520 or 620 in processor; supports external digital monitor via HDMI or USB Type-C; supports three independent displays; Max resolution: 4096x2160@60Hz (USB Type-C); 4096x2160@24Hz (HDMI)

Chipset Memory Intel SoC (System on Chip) platform 16GB max / 2400MHz DDR4, one DDR4 SO-DIMM socket \* System clocks down for processors with lower memory controller

Display *Some:* 12.5" (317.5mm) HD (1366x768), anti-glare, LED backlight, 200 nits, 16:9 aspect ratio, 500:1 contrast ratio  
*Some:* 12.5" (317.5mm) HD (1366x768), anti-glare, LED backlight, IPS, 300 nits, 16:9 aspect ratio, 800:1 contrast ratio, 170° viewing angle  
*Some:* 12.5" (317.5mm) FHD (1920x1080), anti-glare, LED backlight, IPS, 300 nits, 16:9 aspect ratio, 700:1 contrast ratio, 170° viewing angle

Multi-touch (opt) On-cell touch, supports 10-finger gesture (FHD only)

Storage *System has one HDD slot or one M.2 2280 slot exclusively for storage*  
*Some:* HDD / SATA 6.0Gb/s, 2.5" wide, 7mm high, Active Protection System™  
*Some:* SSD / SATA 6.0Gb/s, 2.5" wide, 7mm high (e.g. xxxGB SSD)  
*Some:* M.2 SSD / PCIe NVMe, PCIe 3.0 x 2, 16Gb/s  
*Some:* 128GB M.2 SSD / SATA 6.0Gb/s, in WWAN slot as 2nd Storage, mutually exclusive with WWAN and WiGig

Optical None

Ethernet *Non-vPro model:* Intel Ethernet Connection I219-V (Jacksonville)  
*vPro model:* Intel Ethernet Connection I219-LM (Jacksonville)

WLAN *One of the following, configurable by model (WiGig is mutually exclusive with WWAN):*

- Realtek® RTL8822BE, Wi-Fi 2x2 802.11ac + BT4.1
- Intel Dual Band Wireless-AC 8260, Wi-Fi 2x2 802.11ac + BT4.1
- Intel Dual Band Wireless-AC 8265, Wi-Fi 2x2 802.11ac + BT4.1
- Intel Tri-Band Wireless-AC 18265, WiGig 802.11ad + Wi-Fi 2x2 802.11ac + BT4.1 (US only)

Bluetooth™ Bluetooth 4.1 wireless, integrated in Wi-Fi + Bluetooth combo adapter \* Intel 8265ac / 18265ac card support BT4.2 but is limited to BT4.1 by Windows OS

Case color Black  
Case material Glass-Fiber Reinforced Plastic

Smart card reader *Optional:* Smart card reader  
Media reader 4-in-1 reader (MMC, SD, SDHC, SDXC)  
Ports Two USB 3.1 Type-A Gen 1 / USB 3.0 (one Always On), USB 3.1 Type-C Gen 1, HDMI 1.4b, Ethernet (RJ-45), Dock connector  
WiGig dock (opt) ThinkPad WiGig dock, mutually exclusive with WWAN (US only)  
Monitor cable (optional) *HDMI to VGA:* Lenovo HDMI to VGA Monitor Adapter  
*USB-C to VGA:* Lenovo USB-C to VGA Adapter  
*USB-C to DP:* Lenovo USB-C to DisplayPort Adapter

Camera (optional) HD720p resolution, fixed focus  
Audio support HD Audio, Realtek ALC3268 codec / stereo speakers, 1.5W x 2 / dual array microphone, combo audio/microphone jack

Keyboard UltraNav™ 6-row, spill-resistant, multimedia Fn keys, optional LED backlight  
TrackPoint® pointing device and buttonless Mylar surface multi-touch touchpad

Security Power-on password, hard disk password, supervisor password, security keyhole  
Security chip Discrete TPM 2.0, TCG Certified  
vPro (optional) Intel vPro Technology  
Fingerprint reader *Optional:* Touch style match on chip fingerprint reader on the palm rest  
NFC (optional) Near Field Communication

Internal battery *Optional:* Integrated Li-Ion or Li-Polymer 3-cell (23Wh)  
External battery Li-Ion 3-cell (23Wh) or 6-cell (48Wh or 72Wh)

Models	No + 3-cell	3-cell + 3-cell	3-cell + 6-cell 48Wh	3-cell + 6-cell 72Wh
Max battery life (MobileMark® 2014)	6.52 hr	13.04 hr	20.1 hr	26.9 hr

AC adapter 45W AC adapter (slim tip) or 45W USB Type-C AC adapter

Preload Windows® 7 Professional 64 preinstalled through downgrade rights in Windows 10 Pro 64  

- Lenovo Solution Center
- Lenovo PowerEngage
- ThinkVantage Product Recovery
- ThinkVantage System Update
- Adobe® Reader®
- Microsoft® Office preloaded; purchase a product key to activate
- McAfee® LiveSafe™ (30-day trial)

*Some:* Windows 10 Home 64  
*Some:* Windows 10 Pro 64  

- Lenovo Companion
- Lenovo Setting
- Microsoft Office preloaded; purchase a product key to activate

Limited warranty *One of the following, configurable by model:*

- 1-year depot repair service
- 3-year/1-yr battery depot repair service
- 3-year/1-yr battery limited onsite service

Mil-Spec test MIL-STD-810G military certification

Environment EPEAT™ Gold (US only); ENERGY STAR® 6.1; RoHS-compliant

Model	Region	Processor	vPro	Graphics	Memory	Display	Multi-touch	Storage(HDD/SSD)	Optical	WLAN + Bluetooth	WWAN	SIM Card	Smart Card Reader	Dock	Monitor Cable	Camera	Key-board	Finger-print Reader	NFC	TPM	Battery (internal+external)	Power Adapter	Operating System	Warranty	Ann Date (m/y)
20HN001FUS	US	i5-7200U	No	Intel HD 620	8GBx1	12.5" FHD (1920x1080) IPS	None	256GB SSD M.2 PCIe NVMe Opal2	None	Intel 8265 ac, 2x2 + BT4.1	WWAN Upgradable	None	None	None	None	720p	Backlit	Finger-print Reader	None	dTPM 2.0	3-cell(23Wh) + 3-cell(23Wh)	45W	Win10 Pro 64	3-year, Depot	02/17
20HN001GUS	US	i7-7600U	vPro	Intel HD 620	16GBx1	12.5" FHD (1920x1080) IPS	None	512GB SSD M.2 PCIe NVMe Opal2	None	Intel 8265 ac, 2x2 + BT4.1	WWAN Upgradable	None	None	None	None	720p	Backlit	Finger-print Reader	None	dTPM 2.0	3-cell(23Wh) + 3-cell(23Wh)	45W	Win10 Pro 64	3-year, Depot	02/17
20HN001HUS	US	i7-7500U	No	Intel HD 620	16GBx1	12.5" FHD (1920x1080) IPS	None	256GB SSD M.2 PCIe NVMe Opal2	None	Intel 8265 ac, 2x2 + BT4.1	WWAN Upgradable	None	None	None	None	720p	Backlit	Finger-print Reader	None	dTPM 2.0	3-cell(23Wh) + 3-cell(23Wh)	45W	Win10 Pro 64	3-year, Depot	02/17
20HN001JUS	US	i5-7300U	vPro	Intel HD 620	8GBx1	12.5" FHD (1920x1080) IPS	None	256GB SSD M.2 PCIe NVMe Opal2	None	Intel 8265 ac, 2x2 + BT4.1	WWAN Upgradable	None	None	None	None	720p	Backlit	Finger-print Reader	None	dTPM 2.0	3-cell(23Wh) + 3-cell(23Wh)	45W	Win10 Pro 64	3-year, Depot	02/17
20HN001KUS	US	i5-7200U	No	Intel HD 620	8GBx1	12.5" HD (1366x768) IPS	None	500GB 7200rpm	None	Intel 8265 ac, 2x2 + BT4.1	WWAN Upgradable	None	None	None	None	720p	Backlit	Finger-print Reader	None	dTPM 2.0	3-cell(23Wh) + 3-cell(23Wh)	45W	Win10 Pro 64	3-year, Depot	02/17
20HN001LUS	US	i5-7300U	vPro	Intel HD 620	8GBx1	12.5" HD (1366x768) IPS	None	256GB SSD M.2 PCIe NVMe Opal2	None	Intel 8265 ac, 2x2 + BT4.1	WWAN Upgradable	None	None	None	None	720p	Backlit	Finger-print Reader	None	dTPM 2.0	3-cell(23Wh) + 3-cell(23Wh)	45W	Win10 Pro 64	3-year, Depot	02/17
20HN001MUS	US	i7-7500U	No	Intel HD 620	16GBx1	12.5" FHD (1920x1080) IPS	None	512GB SSD M.2 PCIe NVMe Opal2	None	Intel 8265 ac, 2x2 + BT4.1	WWAN Upgradable	None	None	None	None	720p	Backlit	Finger-print Reader	None	dTPM 2.0	3-cell(23Wh) + 3-cell(23Wh)	45W	Win10 Pro 64	3-year, Depot	02/17
20HN001NUS	US	i7-7600U	vPro	Intel HD 620	16GBx1	12.5" FHD (1920x1080) IPS	None	256GB SSD M.2 PCIe NVMe Opal2	None	Intel 8265 ac, 2x2 + BT4.1	WWAN Upgradable	None	None	None	None	720p	Backlit	Finger-print Reader	None	dTPM 2.0	3-cell(23Wh) + 3-cell(23Wh)	45W	Win10 Pro 64	3-year, Depot	02/17
20HN001PUS	US	i3-7100U	No	Intel HD 620	4GBx1	12.5" HD (1366x768) IPS	None	500GB 7200rpm	None	Intel 8265 ac, 2x2 + BT4.1	WWAN Upgradable	None	None	None	None	720p	Backlit	Finger-print Reader	None	dTPM 2.0	3-cell(23Wh) + 3-cell(23Wh)	45W	Win10 Pro 64	3-year, Depot	02/17
20HN001QUS	US	i7-7600U	vPro	Intel HD 620	8GBx1	12.5" FHD (1920x1080) IPS	None	256GB SSD M.2 PCIe NVMe Opal2	None	Intel 8265 ac, 2x2 + BT4.1	WWAN Upgradable	None	None	None	None	720p	Backlit	Finger-print Reader	None	dTPM 2.0	3-cell(23Wh) + 3-cell(23Wh)	45W	Win10 Pro 64	3-year, Depot	02/17
20HN001RUS	US	i7-7500U	No	Intel HD 620	8GBx1	12.5" FHD (1920x1080) IPS	None	256GB SSD M.2 PCIe NVMe Opal2	None	Intel 8265 ac, 2x2 + BT4.1	WWAN Upgradable	None	None	None	None	720p	Backlit	Finger-print Reader	None	dTPM 2.0	3-cell(23Wh) + 3-cell(23Wh)	45W	Win10 Pro 64	3-year, Depot	02/17
20HN004UUS	US	i5-7200U	No	Intel HD 620	8GBx1	12.5" FHD (1920x1080) IPS	None	180GB SSD Opal2	None	Intel 8265 ac, 2x2 + BT4.1	WWAN Upgradable	None	None	None	None	720p	Backlit	Finger-print Reader	None	dTPM 2.0	3-cell(23Wh) + 3-cell(23Wh)	45W	Win10 Pro 64	3-year, Depot	03/17
20HN004VUS	US	i5-7200U	No	Intel HD 620	8GBx1	12.5" HD (1366x768) IPS	None	180GB SSD Opal2	None	Intel 8265 ac, 2x2 + BT4.1	WWAN Upgradable	None	None	None	None	720p	Backlit	Finger-print Reader	None	dTPM 2.0	3-cell(23Wh) + 3-cell(23Wh)	45W	Win10 Pro 64	3-year, Depot	03/17
20HN006AUS	US	i7-7600U	vPro	Intel HD 620	16GBx1	12.5" FHD (1920x1080) IPS	10-point Multi-touch	512GB SSD M.2 PCIe NVMe Opal2	None	Intel 8265 ac, 2x2 + BT4.1	WWAN Upgradable	None	None	None	None	720p	Backlit	Finger-print Reader	None	dTPM 2.0	3-cell(23Wh) + 3-cell(23Wh)	45W	Win10 Pro 64	3-year, Depot	08/17
20HN006BUS	US	i5-7200U	No	Intel HD 620	8GBx1	12.5" FHD (1920x1080) IPS	10-point Multi-touch	256GB SSD M.2 PCIe NVMe Opal2	None	Intel 8265 ac, 2x2 + BT4.1	WWAN Upgradable	None	None	None	None	720p	Backlit	Finger-print Reader	None	dTPM 2.0	3-cell(23Wh) + 3-cell(23Wh)	45W	Win10 Pro 64	3-year, Depot	08/17
20HN006CUS	US	i5-7300U	vPro	Intel HD 620	8GBx1	12.5" FHD (1920x1080) IPS	10-point Multi-touch	256GB SSD M.2 PCIe NVMe Opal2	None	Intel 8265 ac, 2x2 + BT4.1	WWAN Upgradable	None	None	None	None	720p	Backlit	Finger-print Reader	None	dTPM 2.0	3-cell(23Wh) + 3-cell(23Wh)	45W	Win10 Pro 64	3-year, Depot	08/17
20HN006DUS	US	i7-7600U	vPro	Intel HD 620	8GBx1	12.5" FHD (1920x1080) IPS	10-point Multi-touch	256GB SSD M.2 PCIe NVMe Opal2	None	Intel 8265 ac, 2x2 + BT4.1	WWAN Upgradable	None	None	None	None	720p	Backlit	Finger-print Reader	None	dTPM 2.0	3-cell(23Wh) + 3-cell(23Wh)	45W	Win10 Pro 64	3-year, Depot	08/17
20HN006EUS	US	i5-7300U	vPro	Intel HD 620	8GBx1	12.5" FHD (1920x1080) IPS	10-point Multi-touch	180GB SSD Opal2	None	Intel 8265 ac, 2x2 + BT4.1	WWAN Upgradable	None	None	None	None	720p	Backlit	Finger-print Reader	None	dTPM 2.0	3-cell(23Wh) + 3-cell(23Wh)	45W	Win10 Pro 64	3-year, Depot	08/17
20HN006FUS	US	i7-7600U	vPro	Intel HD 620	16GBx1	12.5" FHD (1920x1080) IPS	10-point Multi-touch	256GB SSD M.2 PCIe NVMe Opal2	None	Intel 8265 ac, 2x2 + BT4.1	WWAN Upgradable	None	None	None	None	720p	Backlit	Finger-print Reader	None	dTPM 2.0	3-cell(23Wh) + 3-cell(23Wh)	45W	Win10 Pro 64	3-year, Depot	08/17
20HN006GUS	US	i7-7500U	No	Intel HD 620	16GBx1	12.5" FHD (1920x1080) IPS	10-point Multi-touch	512GB SSD M.2 PCIe NVMe Opal2	None	Intel 8265 ac, 2x2 + BT4.1	WWAN Upgradable	None	None	None	None	720p	Backlit	Finger-print Reader	None	dTPM 2.0	3-cell(23Wh) + 3-cell(23Wh)	45W	Win10 Pro 64	3-year, Depot	08/17

Model	Region	Processor	vPro	Graphics	Memory	Display	Multi-touch	Storage(HDD/SSD)	Optical	WLAN + Bluetooth	WWAN	SIM Card	Smart Card Reader	Dock	Monitor Cable	Camera	Key-board	Finger-print Reader	NFC	TPM	Battery (internal+external)	Power Adapter	Operating System	Warranty	Ann Date (m/y)
20HN006HUS	US	i5-7200U	No	Intel HD 620	8GBx1	12.5" FHD (1920x1080) IPS	10-point Multi-touch	180GB SSD Opal2	None	Intel 8265 ac, 2x2 + BT4.1	WWAN Upgradable	None	None	None	None	720p	Backlit	Finger-print Reader	None	dTPM 2.0	3-cell(23Wh) + 3-cell(23Wh)	45W	Win10 Pro 64	3-year, Depot	08/17
20HN006JUS	US	i7-7500U	No	Intel HD 620	16GBx1	12.5" FHD (1920x1080) IPS	10-point Multi-touch	256GB SSD M.2 PCIe NVMe Opal2	None	Intel 8265 ac, 2x2 + BT4.1	WWAN Upgradable	None	None	None	None	720p	Backlit	Finger-print Reader	None	dTPM 2.0	3-cell(23Wh) + 3-cell(23Wh)	45W	Win10 Pro 64	3-year, Depot	08/17
20HN006KUS	US	i5-7200U	No	Intel HD 620	8GBx1	12.5" FHD (1920x1080) IPS	10-point Multi-touch	500GB 7200rpm	None	Intel 8265 ac, 2x2 + BT4.1	WWAN Upgradable	None	None	None	None	720p	Backlit	Finger-print Reader	None	dTPM 2.0	3-cell(23Wh) + 3-cell(23Wh)	45W	Win10 Pro 64	3-year, Depot	08/17
20HN006VUS	US	i7-7500U	No	Intel HD 620	8GBx1	12.5" FHD (1920x1080) IPS	10-point Multi-touch	256GB SSD M.2 PCIe NVMe Opal2	None	Intel 8265 ac, 2x2 + BT4.1	WWAN Upgradable	None	None	None	None	720p	Backlit	Finger-print Reader	None	dTPM 2.0	3-cell(23Wh) + 3-cell(23Wh)	45W	Win10 Pro 64	3-year, Depot	08/17

ThinkPad X270 - TopSeller - 20K6

Product Specifications Reference (PSREF)

Model	Region	Processor	vPro	Graphics	Memory	Display	Multi-touch	Storage(HDD/SSD)	Optical	WLAN + Bluetooth	WWAN	SIM Card	Smart Card Reader	Dock	Monitor Cable	Camera	Key-board	Finger-print Reader	NFC	TPM	Battery (internal+ external)	Power Adapter	Operating System	Warranty	Ann Date (m/y)
20K6000LUS	US	i7-6600U	vPro	Intel HD 520	16GBx1	12.5" FHD (1920x1080) IPS	None	512GB SSD M.2 PCIe NVMe Opal2	None	Intel 8260 ac, 2x2 + BT4.1	WWAN Upgradable	None	None	None	None	720p	Backlit	Finger-print Reader	None	dTPM 2.0	3-cell(23Wh) + 3-cell(23Wh)	45W	Win10 DG Win7 Pro 64	3-year, Depot	03/17
20K6000MUS	US	i5-6200U	No	Intel HD 520	8GBx1	12.5" FHD (1920x1080) IPS	None	256GB SSD M.2 PCIe NVMe Opal2	None	Intel 8260 ac, 2x2 + BT4.1	WWAN Upgradable	None	None	None	None	720p	Backlit	Finger-print Reader	None	dTPM 2.0	3-cell(23Wh) + 3-cell(23Wh)	45W	Win10 DG Win7 Pro 64	3-year, Depot	03/17
20K6000NUS	US	i7-6600U	vPro	Intel HD 520	8GBx1	12.5" FHD (1920x1080) IPS	None	256GB SSD M.2 PCIe NVMe Opal2	None	Intel 8260 ac, 2x2 + BT4.1	WWAN Upgradable	None	None	None	None	720p	Backlit	Finger-print Reader	None	dTPM 2.0	3-cell(23Wh) + 3-cell(23Wh)	45W	Win10 DG Win7 Pro 64	3-year, Depot	03/17
20K6000PUS	US	i5-6300U	vPro	Intel HD 520	8GBx1	12.5" HD (1366x768)	None	256GB SSD M.2 PCIe NVMe Opal2	None	Intel 8260 ac, 2x2 + BT4.1	WWAN Upgradable	None	None	None	None	720p	Backlit	Finger-print Reader	None	dTPM 2.0	3-cell(23Wh) + 3-cell(23Wh)	45W	Win10 DG Win7 Pro 64	3-year, Depot	03/17
20K6000QUS	US	i5-6300U	vPro	Intel HD 520	8GBx1	12.5" FHD (1920x1080) IPS	None	256GB SSD M.2 PCIe NVMe Opal2	None	Intel 8260 ac, 2x2 + BT4.1	WWAN Upgradable	None	None	None	None	720p	Backlit	Finger-print Reader	None	dTPM 2.0	3-cell(23Wh) + 3-cell(23Wh)	45W	Win10 DG Win7 Pro 64	3-year, Depot	03/17
20K6000RUS	US	i7-6500U	No	Intel HD 520	8GBx1	12.5" FHD (1920x1080) IPS	None	512GB SSD M.2 PCIe NVMe Opal2	None	Intel 8260 ac, 2x2 + BT4.1	WWAN Upgradable	None	None	None	None	720p	Backlit	Finger-print Reader	None	dTPM 2.0	3-cell(23Wh) + 3-cell(23Wh)	45W	Win10 DG Win7 Pro 64	3-year, Depot	03/17
20K6000SUS	US	i7-6500U	No	Intel HD 520	8GBx1	12.5" FHD (1920x1080) IPS	None	256GB SSD M.2 PCIe NVMe Opal2	None	Intel 8260 ac, 2x2 + BT4.1	WWAN Upgradable	None	None	None	None	720p	Backlit	Finger-print Reader	None	dTPM 2.0	3-cell(23Wh) + 3-cell(23Wh)	45W	Win10 DG Win7 Pro 64	3-year, Depot	03/17
20K6000TUS	US	i7-6600U	vPro	Intel HD 520	16GBx1	12.5" FHD (1920x1080) IPS	None	256GB SSD M.2 PCIe NVMe Opal2	None	Intel 8260 ac, 2x2 + BT4.1	WWAN Upgradable	None	None	None	None	720p	Backlit	Finger-print Reader	None	dTPM 2.0	3-cell(23Wh) + 3-cell(23Wh)	45W	Win10 DG Win7 Pro 64	3-year, Depot	05/17
20K6000UUS	US	i5-6200U	No	Intel HD 520	8GBx1	12.5" HD (1366x768)	None	500GB 7200rpm	None	Intel 8260 ac, 2x2 + BT4.1	WWAN Upgradable	None	None	None	None	720p	Backlit	Finger-print Reader	None	dTPM 2.0	3-cell(23Wh) + 3-cell(23Wh)	45W	Win10 DG Win7 Pro 64	3-year, Depot	03/17
20K6000VUS	US	i7-6500U	No	Intel HD 520	16GBx1	12.5" FHD (1920x1080) IPS	None	512GB SSD M.2 PCIe NVMe Opal2	None	Intel 8260 ac, 2x2 + BT4.1	WWAN Upgradable	None	None	None	None	720p	Backlit	Finger-print Reader	None	dTPM 2.0	3-cell(23Wh) + 3-cell(23Wh)	45W	Win10 DG Win7 Pro 64	3-year, Depot	03/17
20K6001AUS	US	i5-6300U	vPro	Intel HD 520	8GBx1	12.5" FHD (1920x1080) IPS	10-point Multi-touch	180GB SSD Opal2	None	Intel 8260 ac, 2x2 + BT4.1	WWAN Upgradable	None	None	None	None	720p	Backlit	Finger-print Reader	None	dTPM 2.0	3-cell(23Wh) + 3-cell(23Wh)	45W	Win10 DG Win7 Pro 64	3-year, Depot	08/17
20K6001BUS	US	i7-6600U	vPro	Intel HD 520	16GBx1	12.5" FHD (1920x1080) IPS	10-point Multi-touch	512GB SSD M.2 PCIe NVMe Opal2	None	Intel 8260 ac, 2x2 + BT4.1	WWAN Upgradable	None	None	None	None	720p	Backlit	Finger-print Reader	None	dTPM 2.0	3-cell(23Wh) + 3-cell(23Wh)	45W	Win10 DG Win7 Pro 64	3-year, Depot	08/17
20K6001CUS	US	i5-6200U	No	Intel HD 520	8GBx1	12.5" FHD (1920x1080) IPS	10-point Multi-touch	256GB SSD M.2 PCIe NVMe Opal2	None	Intel 8260 ac, 2x2 + BT4.1	WWAN Upgradable	None	None	None	None	720p	Backlit	Finger-print Reader	None	dTPM 2.0	3-cell(23Wh) + 3-cell(23Wh)	45W	Win10 DG Win7 Pro 64	3-year, Depot	08/17
20K6001DUS	US	i5-6300U	vPro	Intel HD 520	8GBx1	12.5" FHD (1920x1080) IPS	10-point Multi-touch	256GB SSD M.2 PCIe NVMe Opal2	None	Intel 8260 ac, 2x2 + BT4.1	WWAN Upgradable	None	None	None	None	720p	Backlit	Finger-print Reader	None	dTPM 2.0	3-cell(23Wh) + 3-cell(23Wh)	45W	Win10 DG Win7 Pro 64	3-year, Depot	08/17
20K6001EUS	US	i7-6500U	No	Intel HD 520	16GBx1	12.5" FHD (1920x1080) IPS	10-point Multi-touch	512GB SSD M.2 PCIe NVMe Opal2	None	Intel 8260 ac, 2x2 + BT4.1	WWAN Upgradable	None	None	None	None	720p	Backlit	Finger-print Reader	None	dTPM 2.0	3-cell(23Wh) + 3-cell(23Wh)	45W	Win10 DG Win7 Pro 64	3-year, Depot	08/17
20K6001FUS	US	i5-6200U	No	Intel HD 520	8GBx1	12.5" FHD (1920x1080) IPS	10-point Multi-touch	180GB SSD Opal2	None	Intel 8260 ac, 2x2 + BT4.1	WWAN Upgradable	None	None	None	None	720p	Backlit	Finger-print Reader	None	dTPM 2.0	3-cell(23Wh) + 3-cell(23Wh)	45W	Win10 DG Win7 Pro 64	3-year, Depot	08/17
20K6001GUS	US	i7-6600U	vPro	Intel HD 520	8GBx1	12.5" FHD (1920x1080) IPS	10-point Multi-touch	256GB SSD M.2 PCIe NVMe Opal2	None	Intel 8260 ac, 2x2 + BT4.1	WWAN Upgradable	None	None	None	None	720p	Backlit	Finger-print Reader	None	dTPM 2.0	3-cell(23Wh) + 3-cell(23Wh)	45W	Win10 DG Win7 Pro 64	3-year, Depot	08/17
20K6001HUS	US	i7-6500U	No	Intel HD 520	8GBx1	12.5" FHD (1920x1080) IPS	10-point Multi-touch	256GB SSD M.2 PCIe NVMe Opal2	None	Intel 8260 ac, 2x2 + BT4.1	WWAN Upgradable	None	None	None	None	720p	Backlit	Finger-print Reader	None	dTPM 2.0	3-cell(23Wh) + 3-cell(23Wh)	45W	Win10 DG Win7 Pro 64	3-year, Depot	08/17



This publication was developed for products and services offered in the United States and E.M.E.A countries. Lenovo may not offer the products, services or features discussed in this document in other countries. Lenovo may withdraw an offering at any time. Information is subject to change without notice. Consult your local representative for information on offerings available in your area.

Lenovo reserves the right to change specifications or other product information without notice. Lenovo is not responsible for photographic or typographical errors.

LENOVO PROVIDES THIS PUBLICATION "AS IS," WITHOUT WARRANTY OF ANY KIND, EITHER EXPRESS OR IMPLIED, INCLUDING THE IMPLIED WARRANTIES OF MERCHANTABILITY OR FITNESS FOR A PARTICULAR PURPOSE.

Some jurisdictions do not allow disclaimer of express or implied warranties in certain transactions, therefore this disclaimer may not apply to you.

**Availability:** All offers subject to availability. Lenovo reserves the right to alter product offerings and specifications at any time, without notice. Lenovo is not responsible for photographic or typographic errors.

**General:** Review key information provided by Microsoft that may apply to your system purchase, including details on Windows 10, Windows 8, Windows 7, and potential upgrades/downgrades. Lenovo makes no representation or warranty regarding third-party products or services.

**Trademarks:** Lenovo, ThinkPad, ThinkCentre, ThinkStation and the Lenovo logo are trademarks of Lenovo. Microsoft, Windows, Windows NT, and the Windows logo are trademarks of Microsoft Corporation. Ultrabook, Celeron, Celeron Inside, Core Inside, Intel, Intel Logo, Intel Atom, Intel Atom Inside, Intel Core, Intel Inside, Intel Inside Logo, Intel vPro, Itanium, Itanium Inside, Pentium, Pentium Inside, vPro Inside, Xeon, Xeon Phi, and Xeon Inside are trademarks of Intel Corporation in the U.S. and/or other countries. Other company, product or service names may be trademarks or service marks of others.

**Warranty:** For a copy of applicable warranties, write to: Lenovo Warranty Information, 1009 Think Place, Morrisville, NC, 27560. Lenovo makes no representation or warranty regarding third party products or services. The Lenovo Limited Warranty applies only to Lenovo hardware products purchased for your own use, and does not transfer upon resale.

**Limited warranty:** Support unrelated to a warranty issue may be subject to additional charges.

#### **Lenovo Services:**

**Carry-in or Mail-in Service:** Parts and labor repair coverage where the customer is responsible for shipping (including packaging) or delivery to authorized warranty provider or repair center.

**Depot or Courier Service:** Parts and labor repair coverage where shipping (including packaging) or delivery to the repair center is paid for by Lenovo.

**Expedited Depot:** Parts and labor coverage with expedited turnaround. Shipping (including packaging) or delivery to the repair center is paid for by Lenovo.

**Onsite / In-home Service:** Parts and labor repair coverage where labor is provided onsite at your place of business.

If Lenovo determines your product problem is covered by the product warranty and cannot be resolved over the telephone, a technician will be dispatched to arrive onsite, typically the next day.

**International Warranty Service (IWS):** PC repair coverage for customers who require a critical warranty repair while travelling internationally. Visit [www.lenovo.com/internationalwarranty](http://www.lenovo.com/internationalwarranty) for details. Visit [www.lenovo.com/warranty](http://www.lenovo.com/warranty) for Lenovo Warranty Services terms and conditions for complete details and restrictions.

**Included software:** may differ from its retail version (if available), and may not include user manuals or all program functionality. Software license agreements may apply.

**Battery life:** Battery life (and recharge times) will vary based on many factors including screen brightness, applications, features, power management, battery conditioning, and other customer preferences.

Visit <http://psref.lenovo.com/> for the latest version of Product Specifications Reference.

© Lenovo, 2017. All rights reserved.  
Lenovo 1009 Think Place Morrisville, NC 27560 U.S.A.

**Lenovo** **ThinkPad** Tablets  
Convertibles

# PSREF



**Product Specifications Reference**

Version 509, July 2017

**U.S.**

Visit <http://psref.lenovo.com> for the latest version

# Contents

---

<b>Cover</b>	<b>1</b>
<b>Contents</b>	<b>2</b>
<b>Summary Of Change</b>	<b>3</b>
<b>ThinkPad Tablets</b>	<b>4</b>
<b>ThinkPad X1 Tablet (2nd Gen)</b>	<b>4</b>
ThinkPad X1 Tablet (2nd Gen) Platform Specifications	5
ThinkPad X1 Tablet (2nd Gen) - TopSeller - 20JB	6
<b>ThinkPad Yoga</b>	<b>7</b>
<b>ThinkPad P40 Yoga</b>	<b>7</b>
ThinkPad P40 Yoga Platform Specifications	8
ThinkPad P40 Yoga - TopSeller - 20GQ	9
<b>ThinkPad X1 Yoga (2nd Gen)</b>	<b>10</b>
ThinkPad X1 Yoga (2nd Gen) Platform Specifications	11
ThinkPad X1 Yoga (2nd Gen) - TopSeller - 20JD	12
ThinkPad X1 Yoga (2nd Gen) - TopSeller - 20JF	13
<b>ThinkPad Yoga 11e (3rd Gen)</b>	<b>14</b>
ThinkPad Yoga 11e (3rd Gen) Platform Specifications	15
ThinkPad Yoga 11e (3rd Gen) - TopSeller - 20GA	16
<b>ThinkPad Yoga 11e (4th Gen)</b>	<b>17</b>
ThinkPad Yoga 11e (4th Gen) Platform Specifications	18
ThinkPad Yoga 11e (4th Gen) - TopSeller - 20HU	19
<b>ThinkPad Yoga 11e Chromebook (3rd Gen)</b>	<b>20</b>
ThinkPad Yoga 11e Chromebook (3rd Gen) Platform Specifications	21
ThinkPad Yoga 11e Chromebook (3rd Gen) - TopSeller - 20GE	22
<b>ThinkPad Yoga 11e Chromebook (4th Gen)</b>	<b>23</b>
ThinkPad Yoga 11e Chromebook (4th Gen) Platform Specifications	24
ThinkPad Yoga 11e Chromebook (4th Gen) - TopSeller - 20HY	25
<b>ThinkPad Yoga 370</b>	<b>26</b>
ThinkPad Yoga 370 Platform Specifications	27
ThinkPad Yoga 370 - TopSeller - 20JH - 1 of 2	28
ThinkPad Yoga 370 - TopSeller - 20JH - 2 of 2	29
<b>Legal Information</b>	<b>30</b>

# Summary of Changes

---

This section describes the technical changes made in this edition.

This edition might also include minor corrections and editorial changes which are not identified.

## July 12, 2017 - Version 509

### Additions in this update

▶ **New product(s)**

None

▶ **New model(s)**

None

▶ **Others**

None

### Changes in this update

▶ None

### Withdrawals in this update

▶ **Withdrawn product(s)**

ThinkPad Yoga 260 withdraw July 2017

ThinkPad Yoga 460 withdraw July 2017

ThinkPad P40 Yoga withdraw July 2017

ThinkPad X1 Yoga (1st Gen) withdraw July 2017

ThinkPad X1 Tablet withdraw July 2017

ThinkPad 10 (2nd Gen) withdraw July 2017



# ThinkPad X1 Tablet (2<sup>nd</sup> Gen) Platform Specifications

Product Specifications Reference (PSREF)

Processor	7th Generation Intel® Core™ m / i5 / i7 Processor								Camera	<i>Front camera:</i> 2.0-megapixel, fixed focus <i>Rear camera:</i> 8.0-megapixel, auto focus, flash LED
	Processor Number	# of Cores	# of Threads	Base Frequency	Max Turbo Frequency	Cache	Memory Types	Processor Graphics	Video capture	1080p video capture
	m3-7Y30	2	4	1.0 GHz	2.6 GHz	4MB	LPDDR3-1866	Intel HD Graphics 615	Audio support	Realtek® ALC3268 codec / stereo speakers, 0.5W x 2 / three microphones, combo audio/microphone jack
	i5-7Y54			1.2 GHz	3.2 GHz	4MB				
	i5-7Y57			1.2 GHz	3.3 GHz	4MB				
i7-7Y75	1.3 GHz			3.6 GHz	4MB					
Graphics	Intel HD Graphics 615 in processor, supports 1080p video out via Mini DisplayPort connector								Pogo keyboard	Magnetic attached thin keyboard, with TrackPoint® pointing device and buttonless Mylar surface touchpad, multi-touch, backlit
Chipset	Intel SoC (System on Chip) platform								Keyboard color	Black, red, or silver
Memory	4GB, 8GB, or 16GB / 1866MHz LPDDR3 / soldered to systemboard, no sockets								Security	Kensington lock slot
Display	12.0" (304.8mm) FHD+ (2160x1440), glossy, LED backlight, IPS, anti-fingerprint display with Corning® Gorilla® Glass, WideView (170° viewing), 360 nits, 3:2 aspect ratio, 800:1 contrast ratio								Security chip	Discrete TPM 2.0 TCG Certified
Multi-touch	Capacitive touch panel, supports ten-finger gesture								vPro (optional)	Intel vPro Technology
Pen	<i>Optional:</i> ThinkPad Pen Pro, active pen for multi-touch display								Fingerprint reader	<i>Optional:</i> Touch style Fingerprint reader
Kick stand	Opening angle up to 90 degrees								NFC	None
Storage	<i>Some:</i> M.2 SSD / SATA 6.0Gb/s (e.g. xxxG SSD) <i>Some:</i> M.2 SSD / PCIe NVMe, PCIe 3.0 x 4, 32Gb/s (e.g. xxxG SSD PCIe NVMe)								Module	<i>One of the following, configurable by model:</i> • Productivity module, USB3.0 x 1, HDMI, OneLink+, 5 hrs battery (24Wh) • Presenter module, Pico projector, HDMI and 10Whr battery for presenter
Optical	None								Battery	Li-Polymer 2-cell (37Wh) battery
Storage extension	One microSD card slot, supports up to 32GB microSDHC or 64GB microSDXC								Max battery life	<i>MobileMark® 2014:</i> 10 hr (local video playback)
Ethernet	None								AC adapter	45W or 65W USB Type-C AC adapter
WLAN	Intel Dual Band Wireless-AC 8265, Wi-Fi 2x2 802.11ac + BT4.1, soldered M.2 chip								Light sensor	Ambient Light Sensor
Bluetooth™	Bluetooth 4.1 wireless, integrated in Wi-Fi + Bluetooth combo chip <i>* Intel 8265ac card supports BT4.2 but is limited to BT4.1 by Windows OS</i>								G-sensor	3D accelerometer
WiGig	Intel Wireless Gigabit 11000, WiGig 802.11ad, soldered M.2 chip								Compass	3D compass
WWAN (optional)	Integrated Mobile Broadband 4G LTE-A, Qualcomm® Snapdragon™ X7 LTE-A (Sierra Wireless EM7455)								Gyroscope	3D gyrometer
SIM card (opt)	Nano-SIM card slot, opt Verizon LTE (US) or Lenovo® Connect (EMEA) SIM card								GPS	GPS function is integrated into WWAN module
Dimensions	<i>Tablet only:</i> 11.48" x 8.25" x 0.34"; 291.5mm x 209.5mm x 8.45mm <i>Tablet + keyboard:</i> 11.48" x 8.25" x 0.56"; 291.5mm x 209.5mm x 14.15mm								Preload	<i>Some:</i> Windows 10 Pro 64 <i>Some:</i> Windows 10 Home 64 • Lenovo Connect • Lenovo Companion • Lenovo Setting • Microsoft® Office preloaded; purchase a product key to activate
Weight	<i>Tablet only:</i> starting at 1.69 lb (0.77kg) <i>Tablet+keyboard:</i> starting at 2.35 lb (1.07kg)								Limited warranty	<i>One of the following, configurable by model:</i> • 1-year depot repair service • 3-year/1-yr battery depot repair service • 3-year/1-yr battery limited onsite service
Case color	Black								Mil-Spec test	MIL-STD-810G military certification
Case material	Mg + PCGF Hybrid								Environment	EPeAT™ Gold, GREENGUARD, Low Halogen, RoHS
Smart card reader	None									
Media reader	One microSD card slot (microSD, microSDHC, microSDXC)									
Ports	One USB 3.1 Gen 1 / USB 3.0, one Mini DisplayPort, one USB 3.1 Type-C Gen 1 / Power Delivery 2.0, one Pogo keyboard connector, one cartridge connector for optional modules, one nano-SIM card slot									
Control buttons	Power button, volume control button, reset switch									
WiGig dock	<i>Optional:</i> ThinkPad WiGig dock									
Monitor cable	<i>MiniDP to HDMI:</i> Lenovo Mini DisplayPort to HDMI Monitor Cable									
(optional)	<i>MiniDP to VGA:</i> Lenovo Mini DisplayPort to VGA Monitor Cable									
Adapter (optional)	<i>USB to RJ45:</i> ThinkPad USB 3.0 Ethernet Adapter									
	<i>USB-C to VGA:</i> Lenovo USB C to VGA Plus Power Adapter									
	<i>USB-C to HDMI:</i> Lenovo USB-C to HDMI Plus Power Adapter									

ThinkPad X1 Tablet (2nd Gen) - TopSeller - 20JB

Product Specifications Reference (PSREF)

Model	Region	Processor	vPro	Graphics	Memory	Display	Multi-touch	Storage(HDD/SSD)	WLAN + Bluetooth	WWAN	SIM Card	Dock	Monitor Cable	Camera (Front / Rear)	Keyboard Docking	Pen	Fingerprint Reader	Module	Power Adapter	Operating System	Warranty	Global	Ann Date (mm/yy)
20JB0027US	US	i5-7Y57	vPro	Intel HD 615	8GB Soldered	12" FHD+ (2160x1440) IPS	10-point Multi-touch	512GB SSD M.2 PCIe NVMe Opal2	8265 ac, 2x2 + BT4.1	None	None	None	None	2.0MP / 8.0MP	Black Keyboard	Pogo Pen Pro	Fingerprint Reader	None	45W	Win10 Pro 64	3-year, Depot	No	03/17
20JB0029US	US	i7-7Y75	vPro	Intel HD 615	16GB Soldered	12" FHD+ (2160x1440) IPS	10-point Multi-touch	256GB SSD M.2 PCIe NVMe Opal2	8265 ac, 2x2 + BT4.1	None	None	None	None	2.0MP / 8.0MP	Black Keyboard	Pogo Pen Pro	Fingerprint Reader	None	45W	Win10 Pro 64	3-year, Depot	No	03/17
20JB002BUS	US	i7-7Y75	vPro	Intel HD 615	16GB Soldered	12" FHD+ (2160x1440) IPS	10-point Multi-touch	256GB SSD M.2 PCIe NVMe Opal2	8265 ac, 2x2 + BT4.1	Sierra EM7455	None	None	None	2.0MP / 8.0MP	Black Keyboard	Pogo Pen Pro	Fingerprint Reader	None	45W	Win10 Pro 64	3-year, Depot	No	03/17
20JB002CUS	US	i5-7Y54	No	Intel HD 615	8GB Soldered	12" FHD+ (2160x1440) IPS	10-point Multi-touch	256GB SSD M.2 PCIe NVMe Opal2	8265 ac, 2x2 + BT4.1	None	None	None	None	2.0MP / 8.0MP	Black Keyboard	Pogo Pen Pro	Fingerprint Reader	None	45W	Win10 Pro 64	1-year, Depot	No	03/17
20JB002DUS	US	i5-7Y54	No	Intel HD 615	8GB Soldered	12" FHD+ (2160x1440) IPS	10-point Multi-touch	512GB SSD M.2 PCIe NVMe Opal2	8265 ac, 2x2 + BT4.1	None	None	None	None	2.0MP / 8.0MP	Black Keyboard	Pogo Pen Pro	Fingerprint Reader	None	45W	Win10 Pro 64	1-year, Depot	No	03/17
20JB002EUS	US	i7-7Y75	vPro	Intel HD 615	16GB Soldered	12" FHD+ (2160x1440) IPS	10-point Multi-touch	512GB SSD M.2 PCIe NVMe Opal2	8265 ac, 2x2 + BT4.1	None	None	None	None	2.0MP / 8.0MP	Black Keyboard	Pogo Pen Pro	Fingerprint Reader	None	45W	Win10 Pro 64	3-year, Depot	No	03/17
20JB002FUS	US	i5-7Y57	vPro	Intel HD 615	8GB Soldered	12" FHD+ (2160x1440) IPS	10-point Multi-touch	256GB SSD M.2 PCIe NVMe Opal2	8265 ac, 2x2 + BT4.1	Sierra EM7455	None	None	None	2.0MP / 8.0MP	Black Keyboard	Pogo Pen Pro	Fingerprint Reader	None	45W	Win10 Pro 64	3-year, Depot	No	03/17
20JB002JUS	US	i5-7Y57	vPro	Intel HD 615	8GB Soldered	12" FHD+ (2160x1440) IPS	10-point Multi-touch	256GB SSD M.2 PCIe NVMe Opal2	8265 ac, 2x2 + BT4.1	None	None	None	None	2.0MP / 8.0MP	Black Keyboard	Pogo Pen Pro	Fingerprint Reader	None	45W	Win10 Pro 64	3-year, Depot	No	03/17
20JB002KUS	US	i7-7Y75	vPro	Intel HD 615	8GB Soldered	12" FHD+ (2160x1440) IPS	10-point Multi-touch	512GB SSD M.2 PCIe NVMe Opal2	8265 ac, 2x2 + BT4.1	Sierra EM7455	None	None	None	2.0MP / 8.0MP	Black Keyboard	Pogo Pen Pro	Fingerprint Reader	None	45W	Win10 Pro 64	3-year, Depot	No	03/17
20JB002LUS	US	i7-7Y75	vPro	Intel HD 615	8GB Soldered	12" FHD+ (2160x1440) IPS	10-point Multi-touch	256GB SSD M.2 PCIe NVMe Opal2	8265 ac, 2x2 + BT4.1	None	None	None	None	2.0MP / 8.0MP	Black Keyboard	Pogo Pen Pro	Fingerprint Reader	None	45W	Win10 Pro 64	3-year, Depot	No	03/17
20JB002MUS	US	i7-7Y75	vPro	Intel HD 615	8GB Soldered	12" FHD+ (2160x1440) IPS	10-point Multi-touch	256GB SSD M.2 PCIe NVMe Opal2	8265 ac, 2x2 + BT4.1	Sierra EM7455	None	None	None	2.0MP / 8.0MP	Black Keyboard	Pogo Pen Pro	Fingerprint Reader	None	45W	Win10 Pro 64	3-year, Depot	No	03/17
20JB002NUS	US	i7-7Y75	vPro	Intel HD 615	8GB Soldered	12" FHD+ (2160x1440) IPS	10-point Multi-touch	256GB SSD M.2 PCIe NVMe Opal2	8265 ac, 2x2 + BT4.1	None	None	None	None	2.0MP / 8.0MP	Black Keyboard	Pogo Pen Pro	Fingerprint Reader	None	45W	Win10 Pro 64	1-year, Depot	No	03/17
20JB0035US	US	i7-7Y75	vPro	Intel HD 615	8GB Soldered	12" FHD+ (2160x1440) IPS	10-point Multi-touch	512GB SSD M.2 PCIe NVMe Opal2	8265 ac, 2x2 + BT4.1	None	None	None	None	2.0MP / 8.0MP	Black Keyboard	Pogo Pen Pro	Fingerprint Reader	None	45W	Win10 Pro 64	3-year, Depot	No	03/17
20JB003RUS	US	i7-7Y75	vPro	Intel HD 615	16GB Soldered	12" FHD+ (2160x1440) IPS	10-point Multi-touch	512GB SSD M.2 PCIe NVMe Opal2	8265 ac, 2x2 + BT4.1	Sierra EM7455	None	None	None	2.0MP / 8.0MP	Black Keyboard	Pogo Pen Pro	Fingerprint Reader	None	45W	Win10 Pro 64	1-year, Depot	No	05/17





# ThinkPad P40 Yoga Platform Specifications

Product Specifications Reference (PSREF)

Processor	6th Generation Intel® Core™ i7 Processor									Ports	Three USB 3.0 (one Always On), Mini DisplayPort, HDMI, Onelink+ connector, combo audio / microphone jack	
	Processor Number	# of Cores	# of Threads	Base Frequency	Max Turbo Frequency	Cache	Memory Types	Processor Graphics	vPro	Monitor cable (optional)	HDMI-VGA: Lenovo HDMI to VGA Monitor Cable	
	i7-6500U	2	4	2.5 GHz	3.1 GHz	4MB	DDR3L-1600	Intel HD Graphics 520	No	Adapter (optional)	mDP-VGA: Lenovo Mini DisplayPort to VGA Monitor Cable	
	i7-6600U			2.6 GHz	3.4 GHz	4MB		Graphics 520	vPro	RJ45: ThinkPad Onelink+ to RJ45 adapter	VGA/RJ45: ThinkPad Onelink+ to VGA/RJ45 adapter	
Graphics	Intel HD Graphics 520 in processor and Nvidia Quadro M500M Graphics, 2GB DDR3 memory, supports external digital monitor via HDMI, or Mini DisplayPort; supports dual independent display; Max resolution: 3840x2160 (Mini DisplayPort)@60Hz; 1920x1080 (HDMI)@60Hz									Camera	HD720p resolution, fixed focus	
Chipset	Intel SoC (System on Chip) platform									Audio support	HD Audio, Conexant® CX11852 codec, Dolby® DAX2 / stereo speakers, 1.5W x 2 / dual array microphone, combo audio / microphone jack	
Memory	16GB max / 1600MHz DDR3L / one 204-pin SO-DIMM sockets									Keyboard	6-row, spill-resistant, multimedia Fn keys, LED backlit	
Display	Some: 14.0" (355mm) WQHD (2560x1440), glare, LED backlight, IPS, 300 nits, 16:9 aspect ratio, 700:1 contrast ratio Some: 14.0" (355mm) FHD (1920x1080), anti-glare, LED backlight, IPS, 250 nits, 16:9 aspect ratio, 700:1 contrast ratio									UltraNav™	TrackPoint® pointing device and buttonless Mylar surface touchpad, multi-touch	
Multi-touch	Capacitive touch panel, supports 10-finger gesture									Security	Power-on password, hard disk password, supervisor password, security keyhole	
Hinge	Yoga hinge, 360 degree									Security chip	Trusted Platform Module, TCG 1.2-compliant and Software TPM 2.0	
Convert-mode	Laptop, tent, stand, and tablet									vPro (optional)	Intel vPro Technology	
Pen	ThinkPad Pen Pro, active pen for multi-touch display									Fingerprint reader	Swipe fingerprint reader under C cover	
Storage	SSD / SATA 6.0Gb/s, 2.5" wide, 7mm high									NFC	None	
Optical	None									Battery type	Li-Polymer 3-cell (53Wh)	
Ethernet	Gigabit Ethernet via optional Ethernet (RJ-45) adapter (by native Intel Ethernet Connection I219-V (Non-vPro) or I219-LM (vPro))									Battery life	Up to 8.0 hr	
WLAN	11ac+BT, Intel Dual Band Wireless-AC 8260, 2x2, M.2 Card									AC adapter	65W AC adapter	
Bluetooth™	Bluetooth wireless, integrated in Wi-Fi + Bluetooth combo adapter									Light sensor	Ambient Light Sensor	
WWAN (optional)	Wireless WAN, Sierra Wireless EM7455, Qualcomm® 4G LTE-Advanced/DC-HSPA+/HSPA+/HSPA/UMTS/GNSS, M.2 card									G-sensor	3D accelerometer	
SIM card	Micro-SIM card slot									Compass	3D compass	
Dimensions	WxDxH: 13.30" x 9.30" x 0.78"; 338.0mm x 236.3mm x 19.9mm									Gyroscope	3D gyrometer	
Weight	From 3.96 lb (1.80kg)									Preload	Windows® 7 Professional 64 preinstalled through downgrade rights in Windows 10 Pro 64	
Case color	Black										Some: Windows 10 Pro 64	
Case material	Carbon-Fiber Hybrid										Some: Windows 10 Home 64	
Smart card reader	None										<ul style="list-style-type: none"> <li>• Lenovo Solution Center</li> <li>• Lenovo SHAREit</li> <li>• Lenovo Companion</li> <li>• Lenovo Settings</li> <li>• Microsoft Office preloaded; purchase a product key to activate</li> <li>• McAfee® Live Safe (30-day trial)</li> </ul>	
Media reader	4-in-1 reader (MMC, SD, SDHC, SDXC)									Limited warranty	One of the following, configurable by model: <ul style="list-style-type: none"> <li>• 1-year depot repair service</li> <li>• 3-year/1-yr battery depot repair service</li> </ul>	
										Mil-Spec test	MIL-STD-810G military certification	
										Environment	EPEAT™ Gold; ENERGY STAR®; RoHS-compliant	

# ThinkPad P40 Yoga - TopSeller - 20GQ

Product Specifications Reference (PSREF)

Model	Region	Processor	vPro	Graphics	Memory	Display	Multi-touch	Case Material	Storage	Optical	WLAN + Bluetooth	WWAN	SIM Card	Monitor Cable	Color	Camera	Keyboard	Pen	Finger-print Reader	NFC	TPM	Battery	Power Adapter	Operating System	Warranty	Global	End of Support	Ann Date (m/y)
20GQ000BUS	US	i7-6500U	No	M500M 2GB	8GBx1	14" FHD (1920x1080) IPS AG	10-point Multi-touch	Carbon	256GB SSD Opal2	None	Intel 8260 ac, 2x2 + BT4.1	None	None	None	Black	720p	Backlit	Pen Pro	Finger-print Reader	None	dTPM1.2 + FW TPM2.0	3-cell (53Wh)	65W	Win10 Pro 64	1-year, Depot	No	Feb 2, 2021	02/16
20GQ000CUS	US	i7-6600U	vPro	M500M 2GB	8GBx1	14" FHD (1920x1080) IPS AG	10-point Multi-touch	Carbon	256GB SSD Opal2	None	Intel 8260 ac, 2x2 + BT4.1	None	None	None	Black	720p	Backlit	Pen Pro	Finger-print Reader	None	dTPM1.2 + FW TPM2.0	3-cell (53Wh)	65W	Win10 Pro 64	1-year, Depot	No	Feb 2, 2021	02/16
20GQ000EUS	US	i7-6600U	vPro	M500M 2GB	16GBx1	14" WQHD (2560x1440) IPS Gloss	10-point Multi-touch	Carbon	512GB SSD	None	Intel 8260 ac, 2x2 + BT4.1	None	None	None	Black	720p	Backlit	Pen Pro	Finger-print Reader	None	dTPM1.2 + FW TPM2.0	3-cell (53Wh)	65W	Win10 Pro 64	1-year, Depot	No	Feb 2, 2021	02/16



# ThinkPad X1 Yoga (2<sup>nd</sup> Gen) Platform Specifications

Product Specifications Reference (PSREF)

Processor	7th Generation Intel® Core™ i5 / i7 Processor								Smart card reader None									
	Processor Number	# of Cores	# of Threads	Base Frequency	Max Turbo Frequency	Cache	Memory Types	Processor Graphics		Media reader Ports								
	i5-7200U	2	4	2.5 GHz	3.1 GHz	3MB	LPDDR3-1866	Intel HD Graphics 620	MicroSD card reader, supports UHS-II microSD card Three USB 3.1 Gen 1 (USB 3.0, one Always On), two USB 3.1 Type-C Gen 2 / Thunderbolt 3 (support data, video, and power delivery), HDMI 1.4b, Ethernet extension connector, combo audio / microphone jack									
	i5-7300U			2.6 GHz	3.5 GHz	3MB												
	i7-7500U			2.7 GHz	3.5 GHz	4MB												
	i7-7600U			2.8 GHz	3.9 GHz	4MB												
Graphics	Intel HD Graphics 620 in processor only, supports external digital monitor via HDMI or USB Type-C; supports three independent displays; Max resolution: 4096x2304@60Hz (USB Type-C); 4096x2160@24Hz (HDMI)								WiGig dock (opt) ThinkPad WiGig dock									
Chipset	Intel SoC (System on Chip) platform								Monitor cable (optional) HDMI to VGA: Lenovo HDMI to VGA Monitor Adapter USB-C to VGA: Lenovo USB-C to VGA Adapter USB-C to DP: Lenovo USB-C to DisplayPort Adapter									
Memory	8GB or 16GB / 1866MHz LPDDR3 / soldered to systemboard, no sockets								Camera (optional) 720p: HD720p resolution, fixed focus IR & 720p: IR camera and HD720p camera (Narrow Bezel FHD panel only)									
Display	<i>Some:</i> 14.0" (355mm) FHD (1920x1080), glossy, LED backlight, 300 nits, 16:9 aspect ratio, 700:1 contrast ratio, 72% gamut, 170° viewing angle, IPS <i>Some:</i> 14.0" (355mm) Narrow Bezel FHD (1920x1080), glossy, LED backlight, 300 nits, 16:9 aspect ratio, 700:1 contrast ratio, 72% gamut, 170° viewing angle, IPS <i>Some:</i> 14.0" (355mm) WQHD (2560x1440), glossy, LED backlight, 300 nits, 16:9 aspect ratio, 700:1 contrast ratio, 72% gamut, 170° viewing angle, IPS <i>Some:</i> 14.0" (355mm) WQHD (2560x1440), glossy, OLED, 300 nits, 16:9 aspect ratio, 54000:1 contrast ratio, 100% gamut, 176° viewing angle								Audio support HD Audio, Conexant® CX11771 codec / stereo speakers, 2W x 2 / dual array microphone, combo audio / microphone jack									
Multi-touch	<i>LED panel:</i> Capacitive-type multi-touch, AR (anti-reflection), AS (anti-smudge), supports 10-finger gesture <i>OLED panel:</i> OCTA, AS (anti-smudge), supports 10-finger gesture								Keyboard 6-row wave keyboard (rise & fall), spill-resistant, multimedia Fn keys, LED backlight UltraNav™ TrackPoint® pointing device and 3+2 buttons multi-touch clickpad									
Hinge	Yoga hinge, 360 degree								Security Power-on password, hard disk password, supervisor password, security keyhole									
Convert-mode	Laptop, tent, stand, and tablet								Security chip Discrete TPM 2.0 TCG Certified									
Pen (optional)	ThinkPad Pen Pro, active pen for multi-touch display								vPro (optional) Intel vPro Technology									
Storage	<i>Some:</i> M.2 SSD / SATA 6.0Gb/s (e.g. xxxG SSD) <i>Some:</i> M.2 SSD / PCIe NVMe, PCIe 3.0 x 4, 32Gb/s (e.g. xxxG SSD PCIe NVMe)								Fingerprint reader Touch style match on chip fingerprint reader on the palm rest									
Optical	None								NFC (optional) Near Field Communication									
Ethernet	Native Intel Ethernet Connection I219-V (Non-vPro) or I219-LM (vPro) via optional ThinkPad Ethernet Extension Cable								Battery Li-Polymer 4-cell (56Wh)									
WLAN	<i>One of the following, configurable by model (WiGig is mutually exclusive with WWAN):</i> <ul style="list-style-type: none"> <li>Intel Dual Band Wireless-AC 8265, Wi-Fi 2x2, 802.11ac + BT4.1, M.2 Card</li> <li>Intel Tri-Band Wireless-AC 18265, WiGig™ 802.11ad + Wi-Fi 2x2, 802.11ac + BT4.1, M.2 Card</li> </ul> <i>*WiGig adapter is only available in selected countries*</i>								Max battery life MobileMark® 2014: 15.5 hr									
Bluetooth™	Bluetooth 4.1 wireless, integrated in Wi-Fi + Bluetooth combo adapter <i>* Intel 8265ac / 18265ac card support BT4.2 but is limited to BT4.1 by Windows OS</i>								AC adapter 45W or 65W USB Type-C AC adapter									
WWAN (optional)	Integrated Mobile Broadband 4G LTE-A, Qualcomm® Snapdragon™ X7 LTE-A (Sierra Wireless EM7455)								RapidCharge									
SIM card (opt)	Micro-SIM card slot, opt Verizon LTE (US) or Lenovo® Connect (EMEA) SIM card								<table border="1"> <tr> <td>AC adapter</td> <td>45W USB-C</td> <td>65W USB-C</td> </tr> <tr> <td>Charge to 80%</td> <td>Not support</td> <td>1.0 hr</td> </tr> <tr> <td>Charge to 100%</td> <td>Not support</td> <td>2.8 hr</td> </tr> </table>	AC adapter	45W USB-C	65W USB-C	Charge to 80%	Not support	1.0 hr	Charge to 100%	Not support	2.8 hr
AC adapter	45W USB-C	65W USB-C																
Charge to 80%	Not support	1.0 hr																
Charge to 100%	Not support	2.8 hr																
Dimensions	WxDxH: 13.11" x 9.02" x 0.69"; 333mm x 229mm x 17.4mm								Light sensor Ambient Light Sensor									
Weight	Starting at 2.99 lb (1.36kg) for OLED model; 3.13 lb (1.42kg) for other model								G-sensor 3D accelerometer and 3D magnetometer									
Case color	Black or silver								Compass 3D compass									
Case material	Display cover: Carbon-Fiber Hybrid; Bottom: magnesium-PPS hybrid								Gyroscope 3D gyrometer									
									Preload <i>Some:</i> Windows 10 Home 64 <i>Some:</i> Windows 10 Pro 64 <ul style="list-style-type: none"> <li>Lenovo Companion</li> <li>Lenovo Settings</li> <li>Microsoft Office preloaded; purchase a product key to activate</li> </ul>									
									Limited warranty <i>One of the following, configurable by model:</i> <ul style="list-style-type: none"> <li>1-year depot repair service</li> <li>3-year/1-yr battery depot repair service</li> <li>3-year/1-yr battery limited onsite service</li> </ul>									
									Mil-Spec test MIL-STD-810G military certification									
									Environment EPEAT™ Gold (US only); ENERGY STAR®; RoHS-compliant									

ThinkPad X1 Yoga (2nd Gen) - TopSeller - 20JD

Product Specifications Reference (PSREF)

Model	Region	Processor	vPro	Graphics	Memory	Display	Multi-touch	Storage(HDD/SSD)	WLAN + Bluetooth	WWAN	SIM Card	Dock	Monitor Cable	Adapter	Color	Camera	Keyboard	Pen	Finger-print Reader	NFC	Power Adapter	Operating System	Warranty	Global	Ann Date (m/y)
20JD000PUS	US	i5-7300U	vPro	Intel HD 620	8GB Soldered	14" FHD (1920x1080) IPS NB	10-point Multi-touch	256GB SSD M.2 PCIe NVMe Opal2	Intel 8265 ac, 2x2 + BT4.1	None	None	None	None	None	Black	720p	Backlit	Pen Pro	Finger-print Reader	None	65W	Win10 Pro 64	3-year, Depot	No	04/17
20JD000QUS	US	i7-7600U	vPro	Intel HD 620	8GB Soldered	14" FHD (1920x1080) IPS NB	10-point Multi-touch	256GB SSD M.2 PCIe NVMe Opal2	Intel 8265 ac, 2x2 + BT4.1	None	None	None	None	None	Black	720p	Backlit	Pen Pro	Finger-print Reader	None	65W	Win10 Pro 64	3-year, Depot	No	04/17
20JD000RUS	US	i5-7300U	vPro	Intel HD 620	8GB Soldered	14" FHD (1920x1080) IPS Gloss	10-point Multi-touch	256GB SSD M.2 PCIe NVMe Opal2	Intel 8265 ac, 2x2 + BT4.1	Sierra EM7455	None	None	None	None	Black	720p	Backlit	Pen Pro	Finger-print Reader	None	65W	Win10 Pro 64	3-year, Depot	No	04/17
20JD000SUS	US	i7-7600U	vPro	Intel HD 620	16GB Soldered	14" WQHD (2560x1440) IPS Gloss	10-point Multi-touch	512GB SSD M.2 PCIe NVMe Opal2	Intel 8265 ac, 2x2 + BT4.1	Sierra EM7455	None	None	None	None	Black	720p	Backlit	Pen Pro	Finger-print Reader	None	65W	Win10 Pro 64	3-year, Depot	No	04/17
20JD000TUS	US	i7-7600U	vPro	Intel HD 620	16GB Soldered	14" WQHD (2560x1440) IPS Gloss	10-point Multi-touch	512GB SSD M.2 PCIe NVMe Opal2	Intel 8265 ac, 2x2 + BT4.1	None	None	None	None	None	Black	720p	Backlit	Pen Pro	Finger-print Reader	None	65W	Win10 Pro 64	3-year, Depot	No	04/17
20JD000UUS	US	i5-7300U	vPro	Intel HD 620	16GB Soldered	14" FHD (1920x1080) IPS NB	10-point Multi-touch	256GB SSD M.2 PCIe NVMe Opal2	Intel 8265 ac, 2x2 + BT4.1	None	None	None	None	None	Black	720p	Backlit	Pen Pro	Finger-print Reader	None	65W	Win10 Pro 64	3-year, Depot	No	04/17
20JD000VUS	US	i7-7600U	vPro	Intel HD 620	8GB Soldered	14" WQHD (2560x1440) IPS Gloss	10-point Multi-touch	512GB SSD M.2 PCIe NVMe Opal2	Intel 8265 ac, 2x2 + BT4.1	None	None	None	None	None	Black	720p	Backlit	Pen Pro	Finger-print Reader	None	65W	Win10 Pro 64	3-year, Depot	No	04/17
20JD000WUS	US	i7-7600U	vPro	Intel HD 620	16GB Soldered	14" WQHD (2560x1440) OLED Gloss	10-point Multi-touch	512GB SSD M.2 PCIe NVMe Opal2	Intel 8265 ac, 2x2 + BT4.1	None	None	None	None	None	Black	720p	Backlit	Pen Pro	Finger-print Reader	None	65W	Win10 Pro 64	3-year, Depot	No	04/17
20JD000XUS	US	i5-7200U	No	Intel HD 620	8GB Soldered	14" WQHD (2560x1440) IPS Gloss	10-point Multi-touch	512GB SSD M.2 PCIe NVMe Opal2	Intel 8265 ac, 2x2 + BT4.1	None	None	None	None	None	Black	720p	Backlit	Pen Pro	Finger-print Reader	None	65W	Win10 Pro 64	3-year, Depot	No	04/17
20JD000YUS	US	i5-7300U	vPro	Intel HD 620	16GB Soldered	14" FHD (1920x1080) IPS Gloss	10-point Multi-touch	256GB SSD M.2 PCIe NVMe Opal2	Intel 8265 ac, 2x2 + BT4.1	Sierra EM7455	None	None	None	None	Black	720p	Backlit	Pen Pro	Finger-print Reader	None	65W	Win10 Pro 64	3-year, Depot	No	04/17
20JD0015US	US	i5-7200U	No	Intel HD 620	8GB Soldered	14" FHD (1920x1080) IPS NB	10-point Multi-touch	256GB SSD M.2 PCIe NVMe Opal2	Intel 8265 ac, 2x2 + BT4.1	None	None	None	None	None	Black	720p	Backlit	Pen Pro	Finger-print Reader	None	65W	Win10 Pro 64	3-year, Depot	No	04/17
20JD0022US	US	i5-7200U	No	Intel HD 620	8GB Soldered	14" FHD (1920x1080) IPS NB	10-point Multi-touch	180GB SSD M.2 SATA3 Opal2	Intel 8265 ac, 2x2 + BT4.1	None	None	None	None	None	Black	720p	Backlit	Pen Pro	Finger-print Reader	None	65W	Win10 Pro 64	3-year, Depot	No	05/17
20JD004UUS	US	i7-7500U	No	Intel HD 620	8GB Soldered	14" WQHD (2560x1440) IPS Gloss	10-point Multi-touch	512GB SSD M.2 PCIe NVMe Opal2	Intel 8265 ac, 2x2 + BT4.1	None	None	None	None	None	Black	720p	Backlit	Pen Pro	Finger-print Reader	None	65W	Win10 Pro 64	3-year, Depot	No	05/17
20JD004VUS	US	i5-7300U	vPro	Intel HD 620	8GB Soldered	14" FHD (1920x1080) IPS NB	10-point Multi-touch	180GB SSD M.2 SATA3 Opal2	Intel 8265 ac, 2x2 + BT4.1	None	None	None	None	None	Black	720p	Backlit	Pen Pro	Finger-print Reader	None	65W	Win10 Pro 64	3-year, Depot	No	05/17

ThinkPad X1 Yoga (2nd Gen) - TopSeller - 20JF

Product Specifications Reference (PSREF)

Model	Region	Processor	vPro	Graphics	Memory	Display	Multi-touch	Storage(HDD/SSD)	WLAN + Bluetooth	WWAN	SIM Card	Dock	Monitor Cable	Adapter	Color	Camera	Keyboard	Pen	Finger-print Reader	NFC	Power Adapter	Operating System	Warranty	Global	Ann Date (m/y)
20JF000BUS	US	i5-7200U	No	Intel HD 620	8GB Soldered	14" FHD (1920x1080) IPS NB	10-point Multi-touch	256GB SSD M.2 PCIe NVMe Opal2	Intel 8265 ac, 2x2 + BT4.1	None	None	None	None	None	Silver	720p	Backlit Silver	Pen Pro	Finger-print Reader	None	65W	Win10 Pro 64	3-year, Depot	No	04/17
20JF000CUS	US	i5-7300U	vPro	Intel HD 620	16GB Soldered	14" FHD (1920x1080) IPS Gloss	10-point Multi-touch	256GB SSD M.2 PCIe NVMe Opal2	Intel 8265 ac, 2x2 + BT4.1	Sierra EM7455	None	None	None	None	Silver	720p	Backlit Silver	Pen Pro	Finger-print Reader	None	65W	Win10 Pro 64	3-year, Depot	No	04/17
20JF000DUS	US	i7-7600U	vPro	Intel HD 620	16GB Soldered	14" WQHD (2560x1440) IPS Gloss	10-point Multi-touch	512GB SSD M.2 PCIe NVMe Opal2	Intel 8265 ac, 2x2 + BT4.1	None	None	None	None	None	Silver	720p	Backlit Silver	Pen Pro	Finger-print Reader	None	65W	Win10 Pro 64	3-year, Depot	No	04/17
20JF000EUS	US	i7-7600U	vPro	Intel HD 620	8GB Soldered	14" FHD (1920x1080) IPS NB	10-point Multi-touch	256GB SSD M.2 PCIe NVMe Opal2	Intel 8265 ac, 2x2 + BT4.1	None	None	None	None	None	Silver	720p	Backlit Silver	Pen Pro	Finger-print Reader	None	65W	Win10 Pro 64	3-year, Depot	No	04/17
20JF000FUS	US	i5-7300U	vPro	Intel HD 620	16GB Soldered	14" FHD (1920x1080) IPS NB	10-point Multi-touch	256GB SSD M.2 PCIe NVMe Opal2	Intel 8265 ac, 2x2 + BT4.1	None	None	None	None	None	Silver	720p	Backlit Silver	Pen Pro	Finger-print Reader	None	65W	Win10 Pro 64	3-year, Depot	No	04/17
20JF000GUS	US	i5-7300U	vPro	Intel HD 620	8GB Soldered	14" FHD (1920x1080) IPS Gloss	10-point Multi-touch	256GB SSD M.2 PCIe NVMe Opal2	Intel 8265 ac, 2x2 + BT4.1	Sierra EM7455	None	None	None	None	Silver	720p	Backlit Silver	Pen Pro	Finger-print Reader	None	65W	Win10 Pro 64	3-year, Depot	No	04/17
20JF000HUS	US	i7-7600U	vPro	Intel HD 620	16GB Soldered	14" WQHD (2560x1440) OLED Gloss	10-point Multi-touch	512GB SSD M.2 PCIe NVMe Opal2	Intel 8265 ac, 2x2 + BT4.1	None	None	None	None	None	Silver	720p	Backlit Silver	Pen Pro	Finger-print Reader	None	65W	Win10 Pro 64	3-year, Depot	No	04/17
20JF000JUS	US	i7-7600U	vPro	Intel HD 620	8GB Soldered	14" WQHD (2560x1440) IPS Gloss	10-point Multi-touch	512GB SSD M.2 PCIe NVMe Opal2	Intel 8265 ac, 2x2 + BT4.1	None	None	None	None	None	Silver	720p	Backlit Silver	Pen Pro	Finger-print Reader	None	65W	Win10 Pro 64	3-year, Depot	No	04/17
20JF000KUS	US	i5-7200U	No	Intel HD 620	8GB Soldered	14" WQHD (2560x1440) IPS Gloss	10-point Multi-touch	512GB SSD M.2 PCIe NVMe Opal2	Intel 8265 ac, 2x2 + BT4.1	None	None	None	None	None	Silver	720p	Backlit Silver	Pen Pro	Finger-print Reader	None	65W	Win10 Pro 64	3-year, Depot	No	04/17
20JF000LUS	US	i5-7300U	vPro	Intel HD 620	8GB Soldered	14" FHD (1920x1080) IPS NB	10-point Multi-touch	256GB SSD M.2 PCIe NVMe Opal2	Intel 8265 ac, 2x2 + BT4.1	None	None	None	None	None	Silver	720p	Backlit Silver	Pen Pro	Finger-print Reader	None	65W	Win10 Pro 64	3-year, Depot	No	04/17
20JF000MUS	US	i7-7600U	vPro	Intel HD 620	16GB Soldered	14" WQHD (2560x1440) IPS Gloss	10-point Multi-touch	512GB SSD M.2 PCIe NVMe Opal2	Intel 8265 ac, 2x2 + BT4.1	Sierra EM7455	None	None	None	None	Silver	720p	Backlit Silver	Pen Pro	Finger-print Reader	None	65W	Win10 Pro 64	3-year, Depot	No	04/17



# ThinkPad Yoga 11e (3<sup>rd</sup> Gen) Platform Specifications

Product Specifications Reference (PSREF)

Processor	Intel® Celeron® processor, Intel Pentium® Processor, or 6th Generation Intel Core™ i3 Processor	Media reader Ports Control buttons	4-in-1 reader (MMC, SD, SDHC, SDXC) Two USB 3.0, HDMI, Ethernet (RJ-45) Power button, volume control button																																			
	<table border="1"> <thead> <tr> <th>Processor Number</th> <th># of Cores</th> <th># of Threads</th> <th>Base Frequency</th> <th>Burst Frequency</th> <th>Cache</th> <th>Memory Types</th> <th>Processor Graphics</th> </tr> </thead> <tbody> <tr> <td>Cel N3150</td> <td>4</td> <td>4</td> <td>1.6 GHz</td> <td>2.08 GHz</td> <td>2MB</td> <td rowspan="4">DDR3L-1600</td> <td>Intel HD graphics</td> </tr> <tr> <td>Cel N3160</td> <td>4</td> <td>4</td> <td>1.6 GHz</td> <td>2.24 GHz</td> <td>2MB</td> <td>Intel HD graphics</td> </tr> <tr> <td>Pen 4405U</td> <td rowspan="2">2</td> <td rowspan="2">4</td> <td>2.1 GHz</td> <td>-</td> <td>2MB</td> <td>Intel HD graphics 510</td> </tr> <tr> <td>i3-6100U</td> <td>2.3 GHz</td> <td>-</td> <td>3MB</td> <td>Intel HD graphics 520</td> </tr> </tbody> </table>	Processor Number	# of Cores	# of Threads	Base Frequency	Burst Frequency	Cache	Memory Types	Processor Graphics	Cel N3150	4	4	1.6 GHz	2.08 GHz	2MB	DDR3L-1600	Intel HD graphics	Cel N3160	4	4	1.6 GHz	2.24 GHz	2MB	Intel HD graphics	Pen 4405U	2	4	2.1 GHz	-	2MB	Intel HD graphics 510	i3-6100U	2.3 GHz	-	3MB	Intel HD graphics 520	Camera Audio support	HD720p resolution, low light sensitive, fixed focus HD Audio, Realtek® ALC3245 codec / stereo speakers, 2W x 2 / monaural digital microphone, combo audio/microphone jack
Processor Number	# of Cores	# of Threads	Base Frequency	Burst Frequency	Cache	Memory Types	Processor Graphics																															
Cel N3150	4	4	1.6 GHz	2.08 GHz	2MB	DDR3L-1600	Intel HD graphics																															
Cel N3160	4	4	1.6 GHz	2.24 GHz	2MB		Intel HD graphics																															
Pen 4405U	2	4	2.1 GHz	-	2MB		Intel HD graphics 510																															
i3-6100U			2.3 GHz	-	3MB		Intel HD graphics 520																															
Graphics	Intel HD Graphics, Intel HD Graphics 510, or Intel HD Graphics 520 in processor, supports external digital monitor via HDMI™; supports dual independent display; Max resolution: 1920X1080 (HDMI) @30Hz	Keyboard UltraNav™	ThinkPad Windows keyboard, 6-row, multimedia Fn keys Buttonless touchpad below keyboard, multi-touch																																			
Chipset	Intel SoC (System on Chip) platform	Security Security chip vPro Fingerprint reader	Power-on password, hard disk password, supervisor password, security keyhole Trusted Platform Module, TCG 1.2-compliant None None																																			
Memory	2GB, 4GB, or 8GB / PC3-12800 1600MHz DDR3L, one DDR3L SO-DIMM socket	Battery Max battery life <sup>10</sup> AC adapter	Integrated Lithium Polymer 3-cell (42Wh) MobileMark® 2014: 11.53 hr 45-watt AC adapter																																			
Display	11.6" (295mm) HD (1366x768), glare, LED backlight, IPS 250 nits, 16:9 aspect ratio, 800:1 contrast ratio	Preload	Some: Windows 10 Home 64 Some: Windows 10 Pro 64 • Lenovo Solution Center • Lenovo Companion • Lenovo Setting • Microsoft Office preloaded; purchase a product key to activate • McAfee® LiveSafe™ (30-day trial)																																			
MultiTouch	Yes, support 10 fingers																																					
Hinge	Yoga hinge, 360 degree																																					
Convertible mode	Laptop, tent, stand and tablet																																					
Pen	Some: Active pen, batteries required																																					
Storage	M.2 Solid State Drive (SSD), SATA 6.0Gb/s	Limited warranty <sup>12</sup>	One of the following, configurable by model: • 1-year depot repair service • 3-year/1-yr battery depot repair service (US only)																																			
Optical	None	Mil-Spec test	MIL-STD-810G military certification																																			
Ethernet	Realtek RTL8111GUS-CG Gigabit Network Connection	Environment	EPEAT™ Gold (US only); ENERGY STAR® 6.1; RoHS-compliant																																			
WLAN <sup>4</sup>	One of the following, configurable by model: • 11ac+BT, Intel Dual Band Wireless-AC 3165, 1x1, M.2 card • 11ac+BT, Intel Dual Band Wireless-AC 7265, 2x2, M.2 card																																					
Bluetooth™	Bluetooth 4.0 wireless, integrated in Wi-Fi + Bluetooth combo adapter																																					
WWAN	None																																					
Dimensions <sup>3</sup>	WxDxH: 11.81" x 8.27" x 0.90"; 300mm x 210mm x 22.9mm																																					
Weight <sup>2</sup>	from 3.5 lb (1.59kg)																																					
Case color	Display cover: Graphite Black or Silver; Bottom: Graphite Black																																					
Case material	Display cover: PC+40%GF+TPU; Bottom: PCC																																					

Lenovo  
July 2017



## ThinkPad Yoga 11e (3rd Gen) - TopSeller - 20GA

Product Specifications Reference (PSREF)

Model	Region	Processor	Graphics	Memory	Display	Multi-touch	Storage	Optical	WLAN + Bluetooth	Color	Camera	Pen	Finger-print Reader	Battery	Power Adapter	Operating System	Warranty	Global	Ann Date (m/y)
20GA000KUS	US	Celeron N3150	Intel HD	4GBx1	11.6" HD (1366x768) IPS	10-point Multi-touch	128GB SSD	None	Intel 7265 ac, 2x2 + BT4.0	Black	720p	None	None	3-cell (42Wh)	45W	Windows 10 Pro 64	1-year, Depot	No	03/16
20GA000LUS	US	Celeron N3150	Intel HD	8GBx1	11.6" HD (1366x768) IPS	10-point Multi-touch	128GB SSD	None	Intel 7265 ac, 2x2 + BT4.0	Black	720p	None	None	3-cell (42Wh)	45W	Windows 10 Pro 64	1-year, Depot	No	03/16
20GA000MUS	US	i3-6100U	Intel HD 520	8GBx1	11.6" HD (1366x768) IPS	10-point Multi-touch	128GB SSD	None	Intel 7265 ac, 2x2 + BT4.0	Black	720p	None	None	3-cell (42Wh)	45W	Windows 10 Pro 64	1-year, Depot	No	03/16
20GA000NUS	US	i3-6100U	Intel HD 520	8GBx1	11.6" HD (1366x768) IPS	10-point Multi-touch	256GB SSD Opal2	None	Intel 7265 ac, 2x2 + BT4.0	Black	720p	None	None	3-cell (42Wh)	45W	Windows 10 Pro 64	1-year, Depot	No	03/16
20GA000QUS	US	i3-6100U	Intel HD 520	8GBx1	11.6" HD (1366x768) IPS	10-point Multi-touch	192GB SSD	None	Intel 7265 ac, 2x2 + BT4.0	Black	720p	None	None	3-cell (42Wh)	45W	Windows 10 Pro 64	1-year, Depot	No	03/16
20GA000YUS	US	i3-6100U	Intel HD 520	4GBx1	11.6" HD (1366x768) IPS	10-point Multi-touch	192GB SSD	None	Intel 7265 ac, 2x2 + BT4.0	Black	720p	None	None	3-cell (42Wh)	45W	Windows 10 Pro 64	1-year, Depot	No	03/16
20GA001EUS	US	Celeron N3160	Intel HD	8GBx1	11.6" HD (1366x768) IPS	10-point Multi-touch	128GB SSD	None	Intel 7265 ac, 2x2 + BT4.0	Black	720p	None	None	3-cell (42Wh)	45W	Windows 10 Pro 64	1-year, Depot	No	09/16
20GA001FUS	US	Celeron N3160	Intel HD	4GBx1	11.6" HD (1366x768) IPS	10-point Multi-touch	128GB SSD	None	Intel 7265 ac, 2x2 + BT4.0	Black	720p	None	None	3-cell (42Wh)	45W	Windows 10 Pro 64	1-year, Depot	No	09/16



# ThinkPad Yoga 11e (4<sup>th</sup> Gen) Platform Specifications

Product Specifications Reference (PSREF)

Processor	Intel® Celeron® processor, or 7th Generation Intel Core™ i3 / i5 Processor							Media reader	4-in-1 reader (MMC, SD, SDHC, SDXC)	
	Processor Number	# of Cores	# of Threads	Base Frequency	Burst Frequency	Cache	Memory Controller	Processor Graphics	Ports	Two USB 3.1 Gen 1 / USB 3.0, HDMI, Ethernet (RJ-45)
	Cel N3450	4	4	1.1 GHz	2.2 GHz	2MB	DDR3L-1866	Intel HD graphics 500	Control buttons	Power button, volume control button
	i3-7100U	2	4	2.4 GHz	-	3MB	DDR4-2133	Intel HD graphics 620	Camera	HD720p resolution, low light sensitive, fixed focus
i5-7200U	2.5 GHz			3.1 GHz	3MB	Audio support			HD Audio, Realtek® ALC3268 codec / stereo speakers, 2W x 2 / monaural microphone, combo audio/microphone jack	
Graphics	Intel HD Graphics 500, or Intel HD Graphics 620 in processor, supports external digital monitor via HDMI™; supports dual independent display; Max resolution: 1920X1080 (HDMI) @30Hz							Keyboard	ThinkPad Windows keyboard, 6-row, multimedia Fn keys	
Chipset	Intel SoC (System on Chip) platform							UltraNav™	Two buttons click pad below keyboard, multi-touch	
Memory	4GB or 8GB / 1600MHz DDR3L or 2133MHz DDR4, one DDR3L or DDR4 SO-DIMM socket * System clocks down for processors with lower memory controller							Security	Power-on password, hard disk password, supervisor password, security keyhole	
Display	11.6" (295mm) HD (1366x768), anti-glare, LED backlight, IPS 250 nits, 16:9 aspect ratio, 800:1 contrast ratio							Security chip	Discrete TPM 2.0, TCG Certified	
MultiTouch	Yes, support 10 fingers							vPro	None	
Hinge	Yoga hinge, 360 degree							Fingerprint reader	None	
Convertible mode	Laptop, tent, stand and tablet							Battery	Integrated Lithium Polymer 3-cell (42Wh)	
Pen	Some: Active pen, batteries required							Max battery life	MobileMark® 2014: 11 hr	
Storage	M.2 Solid State Drive (SSD), SATA 6.0Gb/s							AC adapter	45-watt AC adapter	
Optical	None							Preload	Some: Windows 10 Home 64 Some: Windows 10 Pro 64 • Lenovo Connect • Lenovo Companion • Lenovo Setting • Microsoft Office preloaded; purchase a product key to activate	
Ethernet	Realtek RTL8111GUS-CG Gigabit Network Connection							Limited warranty	One of the following, configurable by model: • 1-year depot repair service • 3-year depot repair service	
WLAN	One of the following, configurable by model: • 11ac+BT, QCA NFA435, 1x1, M.2 card • 11ac+BT, Intel Dual Band Wireless-AC 7265, 2x2, M.2 card							Mil-Spec test	MIL-STD-810G military certification	
Bluetooth™	Bluetooth 4.1 wireless, integrated in Wi-Fi + Bluetooth combo adapter *Intel 7265ac card supports Bluetooth 4.2 but is limited to BT 4.1 by Windows OS							Environment	EPEAT™ Gold; ENERGY STAR® 6.1; RoHS-compliant	
WWAN	None									
Dimensions	WxDxH: 11.81" x 8.27" x 0.90"; 300mm x 210mm x 22.9mm									
Weight	from 3.5 lb (1.59kg)									
Case color	Display cover: Graphite Black;			Bottom: Graphite Black						
Case material	Display cover: PC+40%GF+TPU;			Bottom: PC+ABS						

# ThinkPad Yoga 11e (4th Gen) - TopSeller - 20HU

Product Specifications Reference (PSREF)

Model	Product	Region	Processor	Graphics	Memory	Display	Multi-touch	Color	Storage	Optical	WLAN + Bluetooth	Camera	Pen	Fingerprint Reader	Battery	Power Adapter	Operating System	Warranty	Global	Ann Date (mm/yy)
20HU0000US	ThinkPad Yoga 11e (4th Gen)	US	i3-7100U	Intel HD 620	8GBx1	11.6" HD (1366x768) IPS	10-point Multi-touch	Black	128GB SSD	None	Intel 7265 ac, 2x2 + BT4.1	720p	None	None	3-cell (42Wh)	45W	Windows 10 Pro 64	1-year, Depot	No	03/17
20HU0001US	ThinkPad Yoga 11e (4th Gen)	US	i3-7100U	Intel HD 620	8GBx1	11.6" HD (1366x768) IPS	10-point Multi-touch	Black	256GB SSD Opal2	None	Intel 7265 ac, 2x2 + BT4.1	720p	None	None	3-cell (42Wh)	45W	Windows 10 Pro 64	1-year, Depot	No	03/17
20HU0003US	ThinkPad Yoga 11e (4th Gen)	US	Celeron N3450	Intel HD 500	4GBx1	11.6" HD (1366x768) IPS	10-point Multi-touch	Black	128GB SSD	None	Intel 7265 ac, 2x2 + BT4.1	720p	None	None	3-cell (42Wh)	45W	Windows 10 Pro 64	1-year, Depot	No	03/17
20HU0004US	ThinkPad Yoga 11e (4th Gen)	US	Celeron N3450	Intel HD 500	8GBx1	11.6" HD (1366x768) IPS	10-point Multi-touch	Black	128GB SSD	None	Intel 7265 ac, 2x2 + BT4.1	720p	None	None	3-cell (42Wh)	45W	Windows 10 Pro 64	1-year, Depot	No	03/17



# ThinkPad Yoga 11e Chromebook (3<sup>rd</sup> Gen) Platform Specifications

Product Specifications Reference (PSREF)

Processor	Intel® Celeron® processor								Dimensions <sup>3</sup> Weight <sup>2</sup> Case color Case material	WxDxH: 11.81" x 8.27" x 0.88"; 300mm x 210mm x 22.3mm from 3.3 lb (1.50kg) Display cover: Graphite Black or Silver; Bottom: Graphite Black Display cover: PC+40%GF+TPU; Bottom: PCC
	Processor Number	# of Cores	# of Threads	Base Frequency	Burst Frequency	Cache	Memory Types	Processor Graphics		
	Cel N3150	4	4	1.6 GHz	2.08 GHz	2MB	LPDDR3-1600	Intel HD graphics		
	Cel N3160	4	4	1.6 GHz	2.24 GHz	2MB	LPDDR3-1600	Intel HD graphics		
Graphics	Intel HD Graphics in processor, supports external digital monitor via HDMI™; supports dual independent display; Max resolution: 1920X1080 (HDMI) @30Hz								Media reader	4-in-1 reader (MMC, SD, SDHC, SDXC)
									Ports	Two USB 3.0 (one Always On), HDMI
Chipset	Intel SoC (System on Chip) platform 2GB or 4GB / 1600MHz LPDDR3 / soldered to systemboard, no sockets								Control buttons	Power button, volume control button
									Camera	HD720p resolution, low light sensitive, fixed focus
Memory									Audio support	Realtek® ALC5650 codec / stereo speakers, 2W x 2 / monaural digital microphone, combo audio/microphone jack
Display	11.6" (295mm) HD (1366x768), glare, LED backlight, IPS 200 nits, 16:9 aspect ratio, 800:1 contrast ratio								Keyboard	ThinkPad Chrome keyboard, 6-row, multimedia Fn keys
MultiTouch	Yes, support 10 fingers								UltraNav™	Buttonless touchpad below keyboard, multi-touch
Hinge	Yoga hinge, 360 degree								Security	Security keyhole
Convertible mode	Laptop, tent, stand and tablet								Security chip	Trusted Platform Module, TCG 1.2-compliant
Pen	None								vPro	None
Storage	16GB eMMC (embedded Multi Media Card) flash memory on board								Fingerprint reader	None
Optical	None								Battery	Integrated Lithium Polymer 3-cell (42Wh)
Ethernet	None								Max battery life <sup>10</sup>	Up to 12 hr
WLAN <sup>4</sup>	11ac+BT, Intel Dual Band Wireless-AC 7265, 2x2, M.2 card								AC adapter	45-watt AC adapter
Bluetooth™	Bluetooth 4.0 wireless, integrated in Wi-Fi + Bluetooth combo adapter								Preload	Google Chrome OS
WWAN	None								Limited warranty <sup>12</sup>	1-year depot repair service
									Mil-Spec test	MIL-STD-810G military certification
									Environment	EPEAT™ Gold (US only); ENERGY STAR® 6.1; RoHS-compliant

## ThinkPad Yoga 11e Chromebook (3rd Gen) - TopSeller - 20GE

Product Specifications Reference (PSREF)

Model	Region	Processor	Graphics	Memory	Display	Multi-touch	Storage	Optical	WLAN + Bluetooth	Color	Camera	Pen	Finger-print Reader	Battery	Power Adapter	Operating System	Warranty	Global	Ann Date (m/y)
20GE0002US	US	Celeron N3150	Intel HD	4GBx1	11.6" HD (1366x768) IPS	10-point Multi-touch	16GB eMMC	None	Intel 7265 ac, 2x2 + BT4.0	Black	720p	None	None	3-cell (42Wh)	45W	Chrome OS	1-year, Depot	No	03/16
20GE0003US	US	Celeron N3160	Intel HD	4GBx1	11.6" HD (1366x768) IPS	10-point Multi-touch	16GB eMMC	None	Intel 7265 ac, 2x2 + BT4.0	Black	720p	None	None	3-cell (42Wh)	45W	Chrome OS	1-year, Depot	No	10/16

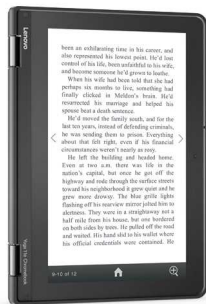



# ThinkPad Yoga 11e Chromebook (4<sup>th</sup> Gen) Platform Specifications

Product Specifications Reference (PSREF)

Processor	Intel® Celeron® processor								Media reader	3-in-1 reader (SD, SDHC, SDXC)
	Processor Number	# of Cores	# of Threads	Base Frequency	Burst Frequency	Cache	Memory Controller	Processor Graphics	Ports	Two USB 3.1 Type-C Gen 1, one USB 3.1 Gen 1 / USB 3.0
	Cel N3450	4	4	1.1 GHz	2.2 GHz	2MB	LPDDR4-2400	Intel HD graphics 500	Control buttons	Power button, volume control button
Graphics	Intel HD Graphics 500 in processor								Camera	HD720p resolution, low light sensitive, fixed focus
Chipset	Intel SoC (System on Chip) platform								Audio support	HD Audio, DA7219 codec / stereo speakers, 2W x 2 / monaural microphone, combo audio/microphone jack
Memory	4GB or 8GB 3200MHz LPDDR4 / soldered to systemboard, no sockets * System clocks down for processors with lower memory controller								Keyboard	ThinkPad Chrome keyboard, 6-row, multimedia Fn keys
Display	11.6" (295mm) HD (1366x768), anti-glare, LED backlight, IPS 250 nits, 16:9 aspect ratio, 800:1 contrast ratio								UltraNav™	Two buttons click pad below keyboard, multi-touch
MultiTouch	Yes, support 10 fingers								Security	Power-on password, hard disk password, supervisor password, security keyhole
Hinge	Yoga hinge, 360 degree								Security chip	None
Convertible mode	Laptop, tent, stand and tablet								vPro	None
Pen	Some: Active pen, batteries required								Fingerprint reader	None
Storage	32GB eMMC (embedded Multi Media Card) flash memory on board								Battery	Integrated Lithium Polymer 3-cell (42Wh)
Optical	None								Max battery life	Up to 10 hr
Ethernet	None								AC adapter	45-watt USB Type-C adapter
WLAN	11ac+BT, Intel Dual Band Wireless-AC 7265, 2x2, M.2 card								Preload	Google Chrome OS
Bluetooth™	Bluetooth 4.2 wireless, integrated in Wi-Fi + Bluetooth combo adapter								Limited warranty	• 1-year depot repair service
WWAN	None								Mil-Spec test	MIL-STD-810G military certification
Dimensions	WxDxH: 11.81" x 8.27" x 0.92"; 300mm x 210mm x 23.4mm								Environment	EPEAT™ Gold; ENERGY STAR® 6.1; RoHS-compliant
Weight	from 3.5 lb (1.59kg)									
Case color	Display cover: Graphite Black;				Bottom: Graphite Black					
Case material	Display cover: PC+40%GF+TPU;				Bottom: PC+ABS					

Lenovo  
July 2017

# ThinkPad Yoga 11e Chromebook (4th Gen) - TopSeller - 20HY

Product Specifications Reference (PSREF)

Model	Region	Processor	Graphics	Memory	Display	Multi-touch	Color	Storage	Optical	WLAN + Bluetooth	Camera	Pen	Finger-print Reader	Battery	Power Adapter	Operating System	Warranty	Global	Ann Date (m/y)
20HY0000US	US	Celeron N3450	Intel HD 500	4GB Soldered	11.6" HD (1366x768) IPS	10-point Multi-touch	Black	32GB eMMC	None	Intel 7265 ac, 2x2 + BT4.2	720p	None	None	3-cell (42Wh)	45W	Chrome OS	1-year, Depot	No	04/17



# ThinkPad Yoga 370 Platform Specifications

Product Specifications Reference (PSREF)

Processor	7th Generation Intel® Core™ i3 / i5 / i7 Processor							Dimensions	<i>WxDxH:</i> 12.34" x 8.75" x 0.72"; 313.5mm x 222.2mm x 18.2mm	
	Processor Number	# of Cores	# of Threads	Base Frequency	Max Turbo Frequency	Cache	Memory Types	Processor Graphics	Weight	Starting at 3.03 lb (1.37kg)
	i3-7100U	2	4	2.4 GHz	-	3MB	DDR4-2133	Intel HD Graphics 620	Case color	Black or silver
	i5-7200U			2.5 GHz	3.1 GHz	3MB			Case Material	Carbon-Fiber Hybrid
	i5-7300U			2.6 GHz	3.5 GHz	3MB			Smart card reader	<i>Optional:</i> Smart card reader (mutually exclusive with NFC)
	i7-7500U			2.7 GHz	3.5 GHz	4MB			Media reader	One microSD card slot (microSD, microSDHC, microSDXC), UHS-I
i7-7600U	2.8 GHz			3.9 GHz	4MB	Ports			Two USB 3.1 Gen 1 (USB 3.0, one Always On), USB 3.1 Type-C Gen 2 / Thunderbolt 3, HDMI 1.4b, Ethernet extension connector	
Graphics	Intel HD Graphics 620 in processor only; supports external digital monitor via HDMI; supports dual independent display; Max resolution: 4096x2160 (HDMI) @24Hz							WiGig dock	<i>Optional:</i> ThinkPad WiGig dock	
Chipset	Intel SoC (System on Chip) platform							Monitor cable	<i>USB-C to VGA:</i> Lenovo USB C to VGA Plus Power Adapter	
Memory	<i>WWAN model:</i> 8GB 2133MHz DDR4 soldered to systemboard <i>Non-WWAN model:</i> 16GB max / 2133MHz DDR4, one DDR4 SO-DIMM socket							<i>(optional)</i>	<i>USB-C to DP:</i> Lenovo USB-C to DisplayPort Adapter	
Display	13.3" (337.8mm) FHD (1920x1080), glossy, LED backlight, IPS 300 nits, 16:9 aspect ratio, 700:1 contrast ratio, 170° viewing angle							Camera	HD720p resolution, fixed focus	
Multi-touch	Capacitive-type multi-touch, AR (anti-reflection), AS (anti-smudge), supports 10-finger gesture							Audio support	HD Audio, Conexant® CX11771 codec, Dolby® DAXII / stereo speakers, 2W x 2 / dual array microphone, combo audio / microphone jack	
Hinge	Yoga hinge, 360 degree							Keyboard	6-row, spill-resistant, multimedia Fn keys, LED backlight	
Convert-mode	Laptop, tent, stand, yoga and tablet							UltraNav™	TrackPoint® pointing device and 3+2 buttons Mylar surface multi-touch click pad	
Pen	ThinkPad Pen Pro, active pen for multi-touch display, on-board charging							Security	Power-on password, hard disk password, supervisor password, security keyhole	
Storage	<i>Some:</i> M.2 SSD / SATA 6.0Gb/s (e.g. xxxG SSD) <i>Some:</i> M.2 SSD / PCIe NVMe, PCIe 3.0 x 4, 32Gb/s (e.g. xxxG SSD PCIe NVMe)							Security chip	Discrete TPM 2.0 TCG Certified	
Optical	None							vPro <i>(optional)</i>	Intel vPro Technology	
Ethernet	Native Intel Ethernet Connection I219-V ( <i>Non-vPro</i> ) or I219-LM ( <i>vPro</i> ) via optional ThinkPad Ethernet Extension Cable							Fingerprint reader	<i>Optional:</i> Touch style match on chip fingerprint reader on the palm rest	
WLAN	<i>One of the following, configurable by model (WiGig is mutually exclusive with WWAN):</i> <ul style="list-style-type: none"> <li>Intel Dual Band Wireless-AC 8265, Wi-Fi 2x2 802.11ac + BT4.1, M.2 card</li> <li>Intel Tri-Band Wireless-AC 18265, WiGig 802.11ad + Wi-Fi 2x2 802.11ac + BT4.1, M.2 card</li> </ul> <i>* WiGig adapter is only available in selected countries*</i>							NFC <i>(optional)</i>	Near Field Communication (mutually exclusive with smart card reader)	
Bluetooth™	Bluetooth 4.1 wireless, integrated in Wi-Fi + Bluetooth combo adapter							Battery	Li-Polymer 4-cell (51Wh) battery	
WWAN <i>(optional)</i>	Integrated Mobile Broadband 4G LTE-A, Qualcomm® Snapdragon™ X7 LTE-A (Sierra Wireless EM7455)							Max battery life	<i>MobileMark® 2014:</i> 12.5 hr	
SIM card <i>(opt)</i>	Micro-SIM card slot, optional Lenovo Connect (EMEA) SIM card							AC adapter	45W or 65W AC adapter (slim tip), 65W USB Type-C AC adapter	
Dimensions	<i>WxDxH:</i> 12.34" x 8.75" x 0.72"; 313.5mm x 222.2mm x 18.2mm							Light sensor	Ambient Light Sensor	
Weight	Starting at 3.03 lb (1.37kg)							G-sensor/	3D accelerometer and 3D magnetometer	
Case color	Black or silver							eCompass	3D compass	
Case Material	Carbon-Fiber Hybrid							Gyroscope	3D gyrometer	
								Preload	<i>Some:</i> Windows 10 Home 64 <i>Some:</i> Windows 10 Pro 64 <ul style="list-style-type: none"> <li>Lenovo Connect</li> <li>Lenovo Companion</li> <li>Lenovo Setting</li> <li>Microsoft Office preloaded; purchase a product key to activate</li> </ul>	
								Limited warranty	<i>One of the following, configurable by model:</i> <ul style="list-style-type: none"> <li>1-year depot repair service</li> <li>3-year/1-yr battery depot repair service</li> <li>3-year/1-yr battery limited onsite service</li> </ul>	
								Mil-Spec test	MIL-STD-810G military certification	
								Environment	EPPEAT™ Gold (US only); ENERGY STAR®; RoHS-compliant	

Model	Region	Processor	vPro	Graphics	Memory	Display	Case Material	Storage(HDD/SSD)	WLAN + Bluetooth	WWAN	SIM Card	Smart Card Reader	Dock	Monitor Cable	Adapter	Color	Pen	Fingerprint Reader	NFC	TPM	Power Adapter	Operating System	Warranty	Global	End of Support	Ann Date (mm/yy)
20JH001VUS	US	i5-7300U	vPro	Intel HD 620	16GBx1	13.3" FHD (1920x1080) IPS	Carbon	512GB SSD M.2 PCIe NVMe Opal2	Intel 8265 ac, 2x2 + BT4.1	None	None	None	None	None	None	Silver	Pen Pro	Fingerprint Reader	None	dTPM 2.0	45W	Win10 Pro 64	1-year, Depot	No	Apr 14, 2023	03/17
20JH001WUS	US	i5-7200U	No	Intel HD 620	8GBx1	13.3" FHD (1920x1080) IPS	Carbon	256GB SSD M.2 PCIe NVMe Opal2	Intel 8265 ac, 2x2 + BT4.1	None	None	None	None	None	None	Silver	Pen Pro	Fingerprint Reader	None	dTPM 2.0	45W	Win10 Pro 64	1-year, Depot	No	Apr 14, 2023	03/17
20JH001XUS	US	i5-7300U	vPro	Intel HD 620	8GBx1	13.3" FHD (1920x1080) IPS	Carbon	256GB SSD M.2 PCIe NVMe Opal2	Intel 8265 ac, 2x2 + BT4.1	None	None	None	None	None	None	Silver	Pen Pro	Fingerprint Reader	None	dTPM 2.0	45W	Win10 Pro 64	1-year, Depot	No	Apr 14, 2023	03/17
20JH001YUS	US	i7-7600U	vPro	Intel HD 620	16GBx1	13.3" FHD (1920x1080) IPS	Carbon	512GB SSD M.2 PCIe NVMe Opal2	Intel 8265 ac, 2x2 + BT4.1	None	None	None	None	None	None	Silver	Pen Pro	Fingerprint Reader	None	dTPM 2.0	45W	Win10 Pro 64	1-year, Depot	No	Apr 14, 2023	03/17
20JH0020US	US	i7-7500U	No	Intel HD 620	8GBx1	13.3" FHD (1920x1080) IPS	Carbon	256GB SSD M.2 PCIe NVMe Opal2	Intel 8265 ac, 2x2 + BT4.1	None	None	None	None	None	None	Silver	Pen Pro	Fingerprint Reader	None	dTPM 2.0	45W	Win10 Pro 64	1-year, Depot	No	Apr 14, 2023	03/17
20JH0021US	US	i7-7500U	No	Intel HD 620	16GBx1	13.3" FHD (1920x1080) IPS	Carbon	512GB SSD M.2 PCIe NVMe Opal2	Intel 8265 ac, 2x2 + BT4.1	None	None	None	None	None	None	Silver	Pen Pro	Fingerprint Reader	None	dTPM 2.0	45W	Win10 Pro 64	1-year, Depot	No	Apr 14, 2023	03/17
20JH0022US	US	i7-7600U	vPro	Intel HD 620	8GBx1	13.3" FHD (1920x1080) IPS	Carbon	256GB SSD M.2 PCIe NVMe Opal2	Intel 8265 ac, 2x2 + BT4.1	None	None	None	None	None	None	Silver	Pen Pro	Fingerprint Reader	None	dTPM 2.0	45W	Win10 Pro 64	1-year, Depot	No	Apr 14, 2023	03/17
20JH0023US	US	i5-7200U	No	Intel HD 620	4GBx1	13.3" FHD (1920x1080) IPS	Carbon	128GB SSD M.2 SATA3	Intel 8265 ac, 2x2 + BT4.1	None	None	None	None	None	None	Silver	Pen Pro	Fingerprint Reader	None	dTPM 2.0	45W	Win10 Pro 64	1-year, Depot	No	Apr 14, 2023	03/17
20JH0024US	US	i5-7200U	No	Intel HD 620	8GBx1	13.3" FHD (1920x1080) IPS	Carbon	256GB SSD M.2 PCIe NVMe Opal2	Intel 8265 ac, 2x2 + BT4.1	None	None	None	None	None	None	Black	Pen Pro	Fingerprint Reader	None	dTPM 2.0	45W	Win10 Pro 64	1-year, Depot	No	Apr 14, 2023	03/17
20JH0025US	US	i5-7200U	No	Intel HD 620	4GBx1	13.3" FHD (1920x1080) IPS	Carbon	128GB SSD M.2 SATA3	Intel 8265 ac, 2x2 + BT4.1	None	None	None	None	None	None	Black	Pen Pro	Fingerprint Reader	None	dTPM 2.0	45W	Win10 Pro 64	1-year, Depot	No	Apr 14, 2023	03/17
20JH0026US	US	i5-7200U	No	Intel HD 620	8GBx1	13.3" FHD (1920x1080) IPS	Carbon	512GB SSD M.2 PCIe NVMe Opal2	Intel 8265 ac, 2x2 + BT4.1	None	None	None	None	None	None	Black	Pen Pro	Fingerprint Reader	None	dTPM 2.0	45W	Win10 Pro 64	1-year, Depot	No	Apr 14, 2023	03/17
20JH0027US	US	i7-7500U	No	Intel HD 620	16GBx1	13.3" FHD (1920x1080) IPS	Carbon	512GB SSD M.2 PCIe NVMe Opal2	Intel 8265 ac, 2x2 + BT4.1	None	None	None	None	None	None	Black	Pen Pro	Fingerprint Reader	None	dTPM 2.0	45W	Win10 Pro 64	1-year, Depot	No	Apr 14, 2023	03/17
20JH0028US	US	i7-7500U	No	Intel HD 620	16GBx1	13.3" FHD (1920x1080) IPS	Carbon	256GB SSD M.2 PCIe NVMe Opal2	Intel 8265 ac, 2x2 + BT4.1	None	None	None	None	None	None	Black	Pen Pro	Fingerprint Reader	None	dTPM 2.0	45W	Win10 Pro 64	1-year, Depot	No	Apr 14, 2023	03/17
20JH0029US	US	i7-7600U	vPro	Intel HD 620	16GBx1	13.3" FHD (1920x1080) IPS	Carbon	512GB SSD M.2 PCIe NVMe Opal2	Intel 8265 ac, 2x2 + BT4.1	None	None	None	None	None	None	Black	Pen Pro	Fingerprint Reader	None	dTPM 2.0	45W	Win10 Pro 64	1-year, Depot	No	Apr 14, 2023	03/17
20JH002AUS	US	i5-7300U	vPro	Intel HD 620	8GBx1	13.3" FHD (1920x1080) IPS	Carbon	256GB SSD M.2 PCIe NVMe Opal2	Intel 8265 ac, 2x2 + BT4.1	None	None	None	None	None	None	Black	Pen Pro	Fingerprint Reader	None	dTPM 2.0	45W	Win10 Pro 64	1-year, Depot	No	Apr 14, 2023	03/17
20JH002BUS	US	i5-7300U	vPro	Intel HD 620	16GBx1	13.3" FHD (1920x1080) IPS	Carbon	512GB SSD M.2 PCIe NVMe Opal2	Intel 8265 ac, 2x2 + BT4.1	None	None	None	None	None	None	Black	Pen Pro	Fingerprint Reader	None	dTPM 2.0	45W	Win10 Pro 64	1-year, Depot	No	Apr 14, 2023	03/17
20JH002CUS	US	i5-7200U	No	Intel HD 620	4GBx1	13.3" FHD (1920x1080) IPS	Carbon	256GB SSD M.2 PCIe NVMe Opal2	Intel 8265 ac, 2x2 + BT4.1	None	None	None	None	None	None	Black	Pen Pro	Fingerprint Reader	None	dTPM 2.0	45W	Win10 Pro 64	1-year, Depot	No	Apr 14, 2023	03/17
20JH002DUS	US	i7-7600U	vPro	Intel HD 620	8GBx1	13.3" FHD (1920x1080) IPS	Carbon	256GB SSD M.2 PCIe NVMe Opal2	Intel 8265 ac, 2x2 + BT4.1	None	None	None	None	None	None	Black	Pen Pro	Fingerprint Reader	None	dTPM 2.0	45W	Win10 Pro 64	1-year, Depot	No	Apr 14, 2023	03/17
20JH002FUS	US	i7-7500U	No	Intel HD 620	8GBx1	13.3" FHD (1920x1080) IPS	Carbon	256GB SSD M.2 PCIe NVMe Opal2	Intel 8265 ac, 2x2 + BT4.1	None	None	None	None	None	None	Black	Pen Pro	Fingerprint Reader	None	dTPM 2.0	45W	Win10 Pro 64	1-year, Depot	No	Apr 14, 2023	03/17
20JH002GUS	US	i5-7300U	vPro	Intel HD 620	8GBx1	13.3" FHD (1920x1080) IPS	Carbon	512GB SSD M.2 PCIe NVMe Opal2	Intel 8265 ac, 2x2 + BT4.1	None	None	None	None	None	None	Black	Pen Pro	Fingerprint Reader	None	dTPM 2.0	45W	Win10 Pro 64	1-year, Depot	No	Apr 14, 2023	03/17

Model	Region	Processor	vPro	Graphics	Memory	Display	Case Material	Storage(HDD/SSD)	WLAN + Bluetooth	WWAN	SIM Card	Smart Card Reader	Dock	Monitor Cable	Adapter	Color	Pen	Fingerprint Reader	NFC	TPM	Power Adapter	Operating System	Warranty	Global	End of Support	Ann Date (mm/yy)
20JH002JUS	US	i7-7600U	vPro	Intel HD 620	8GBx1	13.3" FHD (1920x1080) IPS	Carbon	512GB SSD M.2 PCIe NVMe Opal2	Intel 8265 ac, 2x2 + BT4.1	None	None	None	None	None	None	Black	Pen Pro	Fingerprint Reader	None	dTPM 2.0	45W	Win10 Pro 64	1-year, Depot	No	Apr 14, 2023	03/17
20JH002WUS	US	i5-7200U	No	Intel HD 620	8GBx1	13.3" FHD (1920x1080) IPS	Carbon	180GB SSD M.2 SATA3 Opal2	Intel 8265 ac, 2x2 + BT4.1	None	None	None	None	None	None	Black	Pen Pro	Fingerprint Reader	None	dTPM 2.0	45W	Win10 Pro 64	3-year, Depot	No	Mar 14, 2022	03/17
20JH002XUS	US	i5-7200U	No	Intel HD 620	8GBx1	13.3" FHD (1920x1080) IPS	Carbon	180GB SSD M.2 SATA3 Opal2	Intel 8265 ac, 2x2 + BT4.1	None	None	None	None	None	None	Silver	Pen Pro	Fingerprint Reader	None	dTPM 2.0	45W	Win10 Pro 64	3-year, Depot	No	Mar 14, 2022	03/17

This publication was developed for products and services offered in the United States and E.M.E.A countries. Lenovo may not offer the products, services or features discussed in this document in other countries. Lenovo may withdraw an offering at any time. Information is subject to change without notice. Consult your local representative for information on offerings available in your area.

Lenovo reserves the right to change specifications or other product information without notice. Lenovo is not responsible for photographic or typographical errors.

LENOVO PROVIDES THIS PUBLICATION "AS IS," WITHOUT WARRANTY OF ANY KIND, EITHER EXPRESS OR IMPLIED, INCLUDING THE IMPLIED WARRANTIES OF MERCHANTABILITY OR FITNESS FOR A PARTICULAR PURPOSE.

Some jurisdictions do not allow disclaimer of express or implied warranties in certain transactions, therefore this disclaimer may not apply to you.

**Availability:** All offers subject to availability. Lenovo reserves the right to alter product offerings and specifications at any time, without notice. Lenovo is not responsible for photographic or typographic errors.

**General:** Review key information provided by Microsoft that may apply to your system purchase, including details on Windows 10, Windows 8, Windows 7, and potential upgrades/downgrades. Lenovo makes no representation or warranty regarding third-party products or services.

**Trademarks:** Lenovo, ThinkPad, ThinkCentre, ThinkStation and the Lenovo logo are trademarks of Lenovo. Microsoft, Windows, Windows NT, and the Windows logo are trademarks of Microsoft Corporation. Ultrabook, Celeron, Celeron Inside, Core Inside, Intel, Intel Logo, Intel Atom, Intel Atom Inside, Intel Core, Intel Inside, Intel Inside Logo, Intel vPro, Itanium, Itanium Inside, Pentium, Pentium Inside, vPro Inside, Xeon, Xeon Phi, and Xeon Inside are trademarks of Intel Corporation in the U.S. and/or other countries. Other company, product or service names may be trademarks or service marks of others.

**Warranty:** For a copy of applicable warranties, write to: Lenovo Warranty Information, 1009 Think Place, Morrisville, NC, 27560. Lenovo makes no representation or warranty regarding third party products or services. The Lenovo Limited Warranty applies only to Lenovo hardware products purchased for your own use, and does not transfer upon resale.

**Limited warranty:** Support unrelated to a warranty issue may be subject to additional charges.

#### **Lenovo Services:**

**Carry-in or Mail-in Service:** Parts and labor repair coverage where the customer is responsible for shipping (including packaging) or delivery to authorized warranty provider or repair center.

**Depot or Courier Service:** Parts and labor repair coverage where shipping (including packaging) or delivery to the repair center is paid for by Lenovo.

**Expedited Depot:** Parts and labor coverage with expedited turnaround. Shipping (including packaging) or delivery to the repair center is paid for by Lenovo.

**Onsite / In-home Service:** Parts and labor repair coverage where labor is provided onsite at your place of business.

If Lenovo determines your product problem is covered by the product warranty and cannot be resolved over the telephone, a technician will be dispatched to arrive onsite, typically the next day.

**International Warranty Service (IWS):** PC repair coverage for customers who require a critical warranty repair while travelling internationally. Visit [www.lenovo.com/internationalwarranty](http://www.lenovo.com/internationalwarranty) for details. Visit [www.lenovo.com/warranty](http://www.lenovo.com/warranty) for Lenovo Warranty Services terms and conditions for complete details and restrictions.

**Included software:** may differ from its retail version (if available), and may not include user manuals or all program functionality. Software license agreements may apply.

**Battery life:** Battery life (and recharge times) will vary based on many factors including screen brightness, applications, features, power management, battery conditioning, and other customer preferences.

Visit <http://psref.lenovo.com/> for the latest version of Product Specifications Reference.

© Lenovo, 2017. All rights reserved.  
Lenovo 1009 Think Place Morrisville, NC 27560 U.S.A.

**Lenovo**™ **ThinkCentre**®

# PSREF



**Product Specifications Reference**

Version 511, August 2017

**U.S.**

Visit <http://psref.lenovo.com> for the latest version



# Contents

<b>Cover</b>	1	ThinkCentre M600 Tiny - TopSeller - 10G9 - 2 of 2	36
<b>Contents</b>	2	ThinkCentre M600 Tiny - TopSeller - 10GB	37
<b>Summary Of Change</b>	5	ThinkCentre M600 Tiny - TopSeller - 10KH - 1 of 2	38
<b>M Series AIO</b>	6	ThinkCentre M600 Tiny - TopSeller - 10KH - 2 of 2	39
<b>ThinkCentre M700z AIO</b>	6	ThinkCentre M600 Tiny - 10G8	40
ThinkCentre M700z AIO Platform Specifications	7	ThinkCentre M600 Tiny - 10GA	41
ThinkCentre M700z AIO - TopSeller - 10EY - 1 of 2	8	ThinkCentre M600 Tiny - 10GC	42
ThinkCentre M700z AIO - TopSeller - 10EY - 2 of 2	9	ThinkCentre M600 Tiny - 10GE	43
ThinkCentre M700z AIO - 10F1	10	<b>ThinkCentre M700 SFF</b>	<b>44</b>
<b>ThinkCentre M800z AIO</b>	11	ThinkCentre M700 SFF Platform Specifications	45
ThinkCentre M800z AIO Platform Specifications	12	ThinkCentre M700 SFF - TopSeller - 10GT - 1 of 3	46
ThinkCentre M800z AIO - TopSeller - 10ET - 1 of 2	13	ThinkCentre M700 SFF - TopSeller - 10GT - 2 of 3	47
ThinkCentre M800z AIO - TopSeller - 10ET - 2 of 2	14	ThinkCentre M700 SFF - TopSeller - 10GT - 3 of 3	48
ThinkCentre M800z AIO - TopSeller - 10EU - 1 of 2	15	<b>ThinkCentre M700 Tiny</b>	<b>49</b>
ThinkCentre M800z AIO - TopSeller - 10EU - 2 of 2	16	ThinkCentre M700 Tiny Platform Specifications	50
ThinkCentre M800z AIO - 10EW	17	ThinkCentre M700 Tiny - TopSeller - 10HY - 1 of 4	51
<b>ThinkCentre M810z AIO</b>	18	ThinkCentre M700 Tiny - TopSeller - 10HY - 2 of 4	52
ThinkCentre M810z AIO Platform Specifications	19	ThinkCentre M700 Tiny - TopSeller - 10HY - 3 of 4	53
ThinkCentre M810z AIO - TopSeller - 10NX	20	ThinkCentre M700 Tiny - TopSeller - 10HY - 4 of 4	54
ThinkCentre M810z AIO - TopSeller - 10NY - 1 of 2	21	ThinkCentre M700 Tiny - TopSeller - 10JQ	55
ThinkCentre M810z AIO - TopSeller - 10NY - 2 of 2	22	<b>ThinkCentre M700 Tower</b>	<b>56</b>
<b>ThinkCentre M900z AIO</b>	23	ThinkCentre M700 Tower Platform Specifications	57
ThinkCentre M900z AIO Platform Specifications	24	ThinkCentre M700 Tower - TopSeller - 10GR - 1 of 3	58
ThinkCentre M900z AIO - TopSeller - 10F2	25	ThinkCentre M700 Tower - TopSeller - 10GR - 2 of 3	59
ThinkCentre M900z AIO - TopSeller - 10F3	26	ThinkCentre M700 Tower - TopSeller - 10GR - 3 of 3	60
ThinkCentre M900z AIO - 10F4	27	<b>ThinkCentre M710 SFF</b>	<b>61</b>
ThinkCentre M900z AIO - 10F5	28	ThinkCentre M710 SFF Platform Specifications	62
<b>ThinkCentre M910z AIO</b>	29	ThinkCentre M710 SFF - TopSeller - 10M7 - 1 of 3	63
ThinkCentre M910z AIO Platform Specifications	30	ThinkCentre M710 SFF - TopSeller - 10M7 - 2 of 3	64
ThinkCentre M910z AIO - TopSeller - 10NR	31	ThinkCentre M710 SFF - TopSeller - 10M7 - 3 of 3	65
ThinkCentre M910z AIO - TopSeller - 10NS	32	<b>ThinkCentre M710 Tiny</b>	<b>66</b>
<b>M Series Desktop</b>	33	ThinkCentre M710 Tiny Platform Specifications	67
<b>ThinkCentre M600 Tiny</b>	33	ThinkCentre M710 Tiny - TopSeller - 10MR - 1 of 3	68
ThinkCentre M600 Tiny Platform Specifications	34	ThinkCentre M710 Tiny - TopSeller - 10MR - 2 of 3	69
ThinkCentre M600 Tiny - TopSeller - 10G9 - 1 of 2	35	ThinkCentre M710 Tiny - TopSeller - 10MR - 3 of 3	70

# Contents

<b>ThinkCentre M710 Tower</b>	<b>71</b>	ThinkCentre M800 Tower Platform Specifications	<b>106</b>
ThinkCentre M710 Tower Platform Specifications	72	ThinkCentre M800 Tower - TopSeller - 10FW - 1 of 2	107
ThinkCentre M710 Tower - TopSeller - 10M9 - 1 of 3	73	ThinkCentre M800 Tower - TopSeller - 10FW - 2 of 2	108
ThinkCentre M710 Tower - TopSeller - 10M9 - 2 of 3	74	ThinkCentre M800 Tower - 10FV	109
ThinkCentre M710 Tower - TopSeller - 10M9 - 3 of 3	75	<b>ThinkCentre M900 SFF</b>	<b>110</b>
<b>ThinkCentre M715 SFF</b>	<b>76</b>	ThinkCentre M900 SFF Platform Specifications	111
ThinkCentre M715 SFF Platform Specifications	77	ThinkCentre M900 SFF - TopSeller - 10FH - 1 of 2	112
ThinkCentre M715 SFF - TopSeller - 10MB - 1 of 4	78	ThinkCentre M900 SFF - TopSeller - 10FH - 2 of 2	113
ThinkCentre M715 SFF - TopSeller - 10MB - 2 of 4	79	ThinkCentre M900 SFF - 10FG	114
ThinkCentre M715 SFF - TopSeller - 10MB - 3 of 4	80	<b>ThinkCentre M900 Tiny</b>	<b>115</b>
ThinkCentre M715 SFF - TopSeller - 10MB - 4 of 4	81	ThinkCentre M900 Tiny Platform Specifications	116
<b>ThinkCentre M715 Tiny</b>	<b>82</b>	ThinkCentre M900 Tiny - TopSeller - 10FM - 1 of 3	117
ThinkCentre M715 Tiny Platform Specifications	83	ThinkCentre M900 Tiny - TopSeller - 10FM - 2 of 3	118
ThinkCentre M715 Tiny - TopSeller - 10M3 - 1 of 2	84	ThinkCentre M900 Tiny - TopSeller - 10FM - 3 of 3	119
ThinkCentre M715 Tiny - TopSeller - 10M3 - 2 of 2	85	ThinkCentre M900 Tiny - TopSeller - 10NE	120
ThinkCentre M715 Tiny - TopSeller - 10RB - 1 of 2	86	ThinkCentre M900 Tiny - 10FL	121
ThinkCentre M715 Tiny - TopSeller - 10RB - 2 of 2	87	<b>ThinkCentre M900 Tower</b>	<b>122</b>
<b>ThinkCentre M79 SFF</b>	<b>88</b>	ThinkCentre M900 Tower Platform Specifications	123
ThinkCentre M79 SFF Platform Specifications	89	ThinkCentre M900 Tower - TopSeller - 10FD - 1 of 2	124
ThinkCentre M79 SFF - TopSeller - 10CV	90	ThinkCentre M900 Tower - TopSeller - 10FD - 2 of 2	125
ThinkCentre M79 SFF - TopSeller - 10JB	91	ThinkCentre M900 Tower - 10FC	126
ThinkCentre M79 SFF - 10CT	92	<b>ThinkCentre M900x Tiny</b>	<b>127</b>
ThinkCentre M79 SFF - 10CW	93	ThinkCentre M900x Tiny Platform Specifications	128
<b>ThinkCentre M79 Tower</b>	<b>94</b>	ThinkCentre M900x Tiny - TopSeller - 10LX	129
ThinkCentre M79 Tower Platform Specifications	95	<b>ThinkCentre M910 SFF</b>	<b>130</b>
ThinkCentre M79 Tower - TopSeller - 10CN	96	ThinkCentre M910 SFF Platform Specifications	131
ThinkCentre M79 Tower - TopSeller - 10J7	97	ThinkCentre M910 SFF - TopSeller - 10MK - 1 of 2	132
ThinkCentre M79 Tower - 10CQ	98	ThinkCentre M910 SFF - TopSeller - 10MK - 2 of 2	133
ThinkCentre M79 Tower - 10CS	99	<b>ThinkCentre M910 Tiny</b>	<b>134</b>
<b>ThinkCentre M800 SFF</b>	<b>100</b>	ThinkCentre M910 Tiny Platform Specifications	135
ThinkCentre M800 SFF Platform Specifications	101	ThinkCentre M910 Tiny - TopSeller - 10MV - 1 of 3	136
ThinkCentre M800 SFF - TopSeller - 10FY - 1 of 2	102	ThinkCentre M910 Tiny - TopSeller - 10MV - 2 of 3	137
ThinkCentre M800 SFF - TopSeller - 10FY - 2 of 2	103	ThinkCentre M910 Tiny - TopSeller - 10MV - 3 of 3	138
ThinkCentre M800 SFF - 10FX	104	<b>ThinkCentre M910 Tower</b>	<b>139</b>
<b>ThinkCentre M800 Tower</b>	<b>105</b>	ThinkCentre M910 Tower Platform Specifications	140

# Contents

---

ThinkCentre M910 Tower - TopSeller - 10MM - 1 of 2	141
ThinkCentre M910 Tower - TopSeller - 10MM - 2 of 2	142
<b>ThinkCentre M910x Tiny</b>	<b>143</b>
ThinkCentre M910x Tiny Platform Specifications	144
ThinkCentre M910x Tiny - TopSeller - 10N0 - 1 of 2	145
ThinkCentre M910x Tiny - TopSeller - 10N0 - 2 of 2	146
<b>Tiny-In-One</b>	<b>147</b>
<b>ThinkCentre Tiny-In-One 22</b>	<b>147</b>
ThinkCentre Tiny-In-One 22 Platform Specifications	148
ThinkCentre Tiny-In-One 22 - 10LK	149
<b>ThinkCentre Tiny-In-One 22 Gen3</b>	<b>150</b>
ThinkCentre Tiny-In-One 22 Gen3 Platform Specifications	151
ThinkCentre Tiny-In-One 22 Gen3 - 10R0	152
ThinkCentre Tiny-In-One 22 Gen3 - 10R1	153
<b>ThinkCentre Tiny-In-One 24</b>	<b>154</b>
ThinkCentre Tiny-In-One 24 Platform Specifications	155
ThinkCentre Tiny-In-One 24 - 10LL	156
<b>ThinkCentre Tiny-In-One 24 Gen3</b>	<b>157</b>
ThinkCentre Tiny-In-One 24 Gen3 Platform Specifications	158
ThinkCentre Tiny-In-One 24 Gen3 - 10QX	159
ThinkCentre Tiny-In-One 24 Gen3 - 10QY	160
<b>X Series AIO</b>	<b>161</b>
<b>ThinkCentre X1 AIO</b>	<b>161</b>
ThinkCentre X1 AIO Platform Specifications	162
ThinkCentre X1 AIO - TopSeller - 10KE	163
<b>Legal Information</b>	<b>164</b>

# Summary of Changes

---

This section describes the technical changes made in this edition.

This edition might also include minor corrections and editorial changes which are not identified.

## August 2017 - Version 511

### Additions in this update

▶ **New product(s)**

None

▶ **New model(s)**

None

▶ **Others**

None

### Withdrawals in this update

▶ **Withdrawn product(s)**

None

▶ **Withdrawn model(s)**

ThinkCentre M600 Tiny new models withdrawn August 2017



# ThinkCentre M700z Platform Specifications

Product Specifications Reference (PSREF)

Processor	Intel® Celeron®, Intel Pentium®, or 6th Generation Intel Core™ i3 / i5 / i7 Processor						Keyboard	<i>Some:</i> Preferred Pro USB Keyboard (USB connector), Lenovo logo <i>Some:</i> Lenovo Slim USB Keyboard (USB connector), black <i>Some:</i> Ultralim Plus Wireless Keyboard (2.4GHz via USB receiver), black <i>Some:</i> Enhanced Optical USB Mouse, black, Lenovo logo <i>Some:</i> Ultralim Plus Wireless Mouse (2.4GHz via USB receiver), black																		
	Processor	Cores / Threads	Frequency Base/Max(GHz)	Cache	Memory Types	Integrated Graphics	Mouse																			
	Celeron G3900T	2 / 2	2.6 G	2 MB	DDR4-2133	HD 510	Mechanical	<ul style="list-style-type: none"> <li>• Business black color</li> <li>• Toolless stand</li> <li>• Support VESA mount (100mm)</li> </ul>																		
	Pentium G4400T	2 / 2	2.9 G	3 MB	DDR4-2133	HD 510		<table border="1"> <thead> <tr> <th></th> <th>Dimensions (WxDxH)</th> <th>Max weight (lb / kg)</th> <th>Adjustments</th> </tr> </thead> <tbody> <tr> <td>Without stand:</td> <td>19.8 X 1.5 X 13.5 (inch); 503 X 38 X 344 (mm)</td> <td>10.2 / 4.62</td> <td>N/A</td> </tr> <tr> <td>With Basic Monitor stand:</td> <td>19.8 X 9.6 X 16.2 (inch); 503 X 245 X 412 (mm)</td> <td>14.6 / 6.6</td> <td>Tilt: 45° back, -5° forward</td> </tr> <tr> <td>With Full Function Monitor stand:</td> <td>19.8 X 9.6 X 15.7 (inch); 503 X 245 X 400 (mm)</td> <td>14.9 / 6.77</td> <td>Tilt: 45° back, -5° forward; Lift: 110mm; Swivel: +/-45°</td> </tr> </tbody> </table>				Dimensions (WxDxH)	Max weight (lb / kg)	Adjustments	Without stand:	19.8 X 1.5 X 13.5 (inch); 503 X 38 X 344 (mm)	10.2 / 4.62	N/A	With Basic Monitor stand:	19.8 X 9.6 X 16.2 (inch); 503 X 245 X 412 (mm)	14.6 / 6.6	Tilt: 45° back, -5° forward	With Full Function Monitor stand:	19.8 X 9.6 X 15.7 (inch); 503 X 245 X 400 (mm)	14.9 / 6.77	Tilt: 45° back, -5° forward; Lift: 110mm; Swivel: +/-45°
		Dimensions (WxDxH)	Max weight (lb / kg)	Adjustments																						
	Without stand:	19.8 X 1.5 X 13.5 (inch); 503 X 38 X 344 (mm)	10.2 / 4.62	N/A																						
	With Basic Monitor stand:	19.8 X 9.6 X 16.2 (inch); 503 X 245 X 412 (mm)	14.6 / 6.6	Tilt: 45° back, -5° forward																						
	With Full Function Monitor stand:	19.8 X 9.6 X 15.7 (inch); 503 X 245 X 400 (mm)	14.9 / 6.77	Tilt: 45° back, -5° forward; Lift: 110mm; Swivel: +/-45°																						
Core i3-6100T	2 / 4	3.2 G	3 MB	DDR4-2133	HD 530	Power supply	120 watts adapter, autosensing, 89% PSU																			
Core i5-6400T	4 / 4	2.2 G / 2.8 G	6 MB	DDR4-2133	HD 530	Limited warranty <sup>3</sup>	<i>Some:</i> <b>1-year or 3-year, depot repair service</b> <i>Some:</i> <b>1-year or 3-year, limited onsite service</b> <i>Some:</i> <b>3-years, limited onsite service, OID</b> (Onsite International Delivery) / <i>For Lenovo service upgrade options, please go to S-TC sheet</i>																			
Core i5-6500T	4 / 4	2.5 G / 3.1 G	6 MB	DDR4-2133	HD 530	Preload	<b>Preloaded operating system</b> <i>Some:</i> Windows® 7 Professional 64 preinstalled through downgrade rights in Windows 10 Pro 64-bit <i>Some:</i> Windows 7 Professional 64 <i>Some:</i> Windows 10 Pro 64-bit <i>Some:</i> Windows 10 Home 64-bit																			
Core i5-6600T	4 / 4	2.7 G / 3.5 G	6 MB	DDR4-2133	HD 530		<b>Preloaded applications (only some listed)</b> <ul style="list-style-type: none"> <li>• Desktop Power Manager</li> <li>• Lenovo Solution Center</li> <li>• Lenovo REACHit</li> <li>• Lenovo SHAREit</li> <li>• Lenovo Bluetooth Lock (for models with Wi-Fi/BT card)</li> <li>• McAfee® LiveSafe™ (30-day trial)</li> <li>• Microsoft Office preloaded; purchase a product key to activate</li> <li>• PowerDVD Create (DVD±RW)</li> <li>• Lenovo ThinkVantage Tools</li> <li>- Only for Window 10</li> <li>• Lenovo Companion</li> <li>• Cyberlink PowerDVD (DVD, DVD±RW)</li> <li>• Lenovo QuickOptimizer</li> <li>- Only for Window 7</li> <li>• Rescue and Recovery</li> <li>• Password Manager</li> <li>• ThinkVantage System Update</li> <li>• Lenovo Message Center Plus</li> <li>• Adobe® Reader®</li> </ul>																			
Core i7-6700T	4 / 8	2.8 G / 3.6 G	8 MB	DDR4-2133	HD 530	Environment	EPEAT™ Gold rating; ENERGY STAR® 6.1; TCO Certified; ErP Lot 3; GREENGUARD® certified; RoHS-compliant																			
Memory	32GB max, DDR4 2133, two 260-pin SO-DIMM sockets, dual-channel capable						MIL-SPEC test	MIL-STD-810G military certification (Low Pressure [Altitude], High Temperature, Low Temperature, Temperature Shock, Humidity, Sand and Dust, Vibration, Shock)																		
Disk	<i>Some:</i> SATA 6.0Gb/s, 2.5" Wide, 5400 rpm or 7200 rpm <i>Some:</i> Solid State Hybrid Drive (SSHD) / with 8GB MLC NAND flash memory, SATA 6.0Gb/s, 2.5" Wide, 5400 rpm <i>Some:</i> Solid State Drive (SSD) / SATA 6.0Gb/s, 2.5" Wide						Accessories	For compatible accessories, please go to TC-AQP sheet																		
Optical	<i>Some:</i> DVD, SATA 1.5Gb/s, 9.5mm high <i>Some:</i> DVD burner, SATA 1.5Gb/s, 9.5mm high																									
Media reader	Optional 9-in-1 media card reader																									
Graphics	<b>Intel HD Graphics 510/530</b> in processor, uses main memory, DirectX® 12, external monitor support via DisplayPort™; <i>Max resolution:</i> 4096x2304 (DP)@60Hz																									
Display	<b>20"</b> (508mm) <b>HD+ (1600x900) TFT color</b> , wide viewing angle 178° (Horizontal), LED backlight, 250 nits, 16:9 aspect ratio, 1000:1 contrast ratio, anti-glare																									
Light sensor	None																									
Multi-touch	None																									
Camera	Optional 1.0-megapixel camera, fixed focus, supports 720p, with digital microphone, LED indicator, physical switch on/off																									
Controls	Microphone mute, brightness up/down buttons, and power button																									
Chipset	<b>Intel H110 Chipset</b>																									
Rear ports	Four USB 2.0, ethernet (RJ-45), DisplayPort, optional serial (9-pin), Two USB 3.0 (one is Always On and fast charge), optional card reader, one headphone / microphone combo jack (3.5mm)																									
Side ports	One M.2 Card slot (for WLAN)																									
M.2 card slot	High Definition (HD) Audio, Realtek ALC233 / two internal stereo speakers (2W x 2), Dolby® Audio™ certified																									
Audio support	<i>Some:</i> 11ac wireless, M.2 Card, Qualcomm Atheros QCA9377 (dual band), Wi-Fi + Bluetooth 4.1 combo adapter, 1x1 <i>Some:</i> 11ac wireless, M.2 Card, Qualcomm Atheros QCA6174 (dual band), Wi-Fi + Bluetooth 4.1 combo adapter, 2x2 <i>Some:</i> 11ac wireless, M.2 Card, Intel Dual Band Wireless-AC 3165, Wi-Fi + Bluetooth 4.0 combo adapter, 1x1 <i>Some:</i> 11ac wireless, M.2 Card, Intel Dual Band Wireless-AC 8260, Wi-Fi + Bluetooth 4.1 combo adapter, 2x2																									
WLAN <sup>13</sup>	<i>Some:</i> Bluetooth 4.0 or 4.1 wireless, integrated in Wi-Fi + Bluetooth combo adapter Gigabit ethernet, Realtek RTL8111G, Wake on LAN®																									
Bluetooth™	None																									
Ethernet	Trusted Platform Module (TPM 1.2-compliant)																									
Manageability	<ul style="list-style-type: none"> <li>• Security slot (in rear for attachment of optional Kensington® MicroSaver® cable; Kensington lock also locks chassis)</li> <li>• Smart USB protection, allows keyboard/ mouse only, blocks all storage devices</li> <li>• Power-on, admin, hard disk password</li> <li>• Boot sequence control</li> <li>• Boot without keyboard and mouse</li> <li>• Individual USB port disablement</li> <li>• Optional Chassis intrusion switch</li> </ul>																									
Security chip																										
Security features																										

See footnotes for more detailed information

Model	Region	Processor	vPro	Graphics	Monitor Cable	Memory	Display	Multi-touch	Storage(HDD/SSD)	Optical	Media Reader	WLAN + Bluetooth	Optional Rear Ports	Camera	Chassis Intrusion Switch	Keyboard / Mouse	Stand	Power Supply	Operating System	Warranty	Ann Date (m/y)
10EY0006US	US	i3-6100T	No	Intel HD 530	None	8GBx1	20" HD+ (1600x900) WVA AG	None	256GB SSD	DVD±RW	9-in-1	3165 ac, 1x1 + BT4.0	None	720p	None	USB / USB	Monitor Stand	120W 89% Adapter	Win10 DG Win7 Pro 64	3-year, Onsite	12/15
10EY0007US	US	i3-6100T	No	Intel HD 530	None	4GBx1	20" HD+ (1600x900) WVA AG	None	120GB SSD	DVD±RW	9-in-1	3165 ac, 1x1 + BT4.0	None	720p	None	USB / USB	Monitor Stand	120W 89% Adapter	Win10 DG Win7 Pro 64	3-year, Onsite	12/15
10EY0008US	US	i5-6400T	No	Intel HD 530	None	4GBx1	20" HD+ (1600x900) WVA AG	None	120GB SSD	DVD±RW	9-in-1	3165 ac, 1x1 + BT4.0	None	720p	None	USB / USB	Monitor Stand	120W 89% Adapter	Win10 DG Win7 Pro 64	3-year, Onsite	12/15
10EY0009US	US	Celeron G3900T	No	Intel HD 510	None	4GBx1	20" HD+ (1600x900) WVA AG	None	500GB 7200rpm 2.5"	DVD±RW	9-in-1	3165 ac, 1x1 + BT4.0	None	720p	None	USB / USB	Monitor Stand	120W 89% Adapter	Win10 Pro 64	3-year, Onsite	12/15
10EY000AUS	US	i7-6700T	No	Intel HD 530	None	8GBx1	20" HD+ (1600x900) WVA AG	None	256GB SSD	DVD±RW	9-in-1	3165 ac, 1x1 + BT4.0	None	720p	None	USB / USB	Monitor Stand	120W 89% Adapter	Win10 DG Win7 Pro 64	3-year, Onsite	12/15
10EY000BUS	US	i3-6100T	No	Intel HD 530	None	8GBx1	20" HD+ (1600x900) WVA AG	None	500GB 7200rpm 2.5"	DVD±RW	9-in-1	3165 ac, 1x1 + BT4.0	None	720p	None	USB / USB	Monitor Stand	120W 89% Adapter	Win10 DG Win7 Pro 64	3-year, Onsite	12/15
10EY000CUS	US	i7-6700T	No	Intel HD 530	None	4GBx1	20" HD+ (1600x900) WVA AG	None	500GB 7200rpm 2.5"	DVD±RW	9-in-1	3165 ac, 1x1 + BT4.0	None	720p	None	USB / USB	Monitor Stand	120W 89% Adapter	Win10 Pro 64	3-year, Onsite	12/15
10EY000DUS	US	i7-6700T	No	Intel HD 530	None	4GBx1	20" HD+ (1600x900) WVA AG	None	120GB SSD	DVD±RW	9-in-1	3165 ac, 1x1 + BT4.0	None	720p	None	USB / USB	Monitor Stand	120W 89% Adapter	Win10 DG Win7 Pro 64	3-year, Onsite	12/15
10EY000EUS	US	i3-6100T	No	Intel HD 530	None	4GBx1	20" HD+ (1600x900) WVA AG	None	500GB 7200rpm 2.5"	DVD±RW	9-in-1	3165 ac, 1x1 + BT4.0	None	720p	None	USB / USB	Monitor Stand	120W 89% Adapter	Win10 DG Win7 Pro 64	3-year, Onsite	12/15
10EY000FUS	US	i5-6400T	No	Intel HD 530	None	8GBx1	20" HD+ (1600x900) WVA AG	None	500GB 7200rpm 2.5"	DVD±RW	9-in-1	3165 ac, 1x1 + BT4.0	None	720p	None	USB / USB	Monitor Stand	120W 89% Adapter	Win10 DG Win7 Pro 64	3-year, Onsite	12/15
10EY000GUS	US	i7-6700T	No	Intel HD 530	None	4GBx1	20" HD+ (1600x900) WVA AG	None	500GB 7200rpm 2.5"	DVD±RW	9-in-1	3165 ac, 1x1 + BT4.0	None	720p	None	USB / USB	Monitor Stand	120W 89% Adapter	Win10 DG Win7 Pro 64	3-year, Onsite	12/15
10EY000HUS	US	Pentium G4400T	No	Intel HD 510	None	4GBx1	20" HD+ (1600x900) WVA AG	None	500GB 7200rpm 2.5"	DVD±RW	9-in-1	3165 ac, 1x1 + BT4.0	None	720p	None	USB / USB	Monitor Stand	120W 89% Adapter	Win10 Pro 64	3-year, Onsite	12/15
10EY000JUS	US	i5-6400T	No	Intel HD 530	None	8GBx1	20" HD+ (1600x900) WVA AG	None	256GB SSD	DVD±RW	9-in-1	3165 ac, 1x1 + BT4.0	None	720p	None	USB / USB	Monitor Stand	120W 89% Adapter	Win10 DG Win7 Pro 64	3-year, Onsite	12/15
10EY000KUS	US	Celeron G3900T	No	Intel HD 510	None	4GBx1	20" HD+ (1600x900) WVA AG	None	500GB 7200rpm 2.5"	DVD±RW	9-in-1	3165 ac, 1x1 + BT4.0	None	720p	None	USB / USB	Monitor Stand	120W 89% Adapter	Win10 DG Win7 Pro 64	3-year, Onsite	12/15
10EY000LUS	US	i5-6400T	No	Intel HD 530	None	4GBx1	20" HD+ (1600x900) WVA AG	None	500GB 7200rpm 2.5"	DVD±RW	9-in-1	3165 ac, 1x1 + BT4.0	None	720p	None	USB / USB	Monitor Stand	120W 89% Adapter	Win10 DG Win7 Pro 64	3-year, Onsite	12/15
10EY000MUS	US	i3-6100T	No	Intel HD 530	None	4GBx1	20" HD+ (1600x900) WVA AG	None	500GB 7200rpm 2.5"	DVD±RW	9-in-1	3165 ac, 1x1 + BT4.0	None	720p	None	USB / USB	Monitor Stand	120W 89% Adapter	Win10 Pro 64	3-year, Onsite	12/15
10EY000NUS	US	i7-6700T	No	Intel HD 530	None	8GBx1	20" HD+ (1600x900) WVA AG	None	500GB 7200rpm 2.5"	DVD±RW	9-in-1	3165 ac, 1x1 + BT4.0	None	720p	None	USB / USB	Monitor Stand	120W 89% Adapter	Win10 DG Win7 Pro 64	3-year, Onsite	12/15
10EY000PUS	US	i5-6400T	No	Intel HD 530	None	4GBx1	20" HD+ (1600x900) WVA AG	None	500GB 7200rpm 2.5"	DVD±RW	9-in-1	3165 ac, 1x1 + BT4.0	None	720p	None	USB / USB	Monitor Stand	120W 89% Adapter	Win10 Pro 64	3-year, Onsite	12/15
10EY000QUS	US	Pentium G4400T	No	Intel HD 510	None	4GBx1	20" HD+ (1600x900) WVA AG	None	500GB 7200rpm 2.5"	DVD±RW	9-in-1	3165 ac, 1x1 + BT4.0	None	720p	None	USB / USB	Monitor Stand	120W 89% Adapter	Win10 DG Win7 Pro 64	3-year, Onsite	12/15
10EY002LUS	US	i5-6400T	No	Intel HD 530	None	8GBx1	20" HD+ (1600x900) WVA AG	None	256GB SSD Opal	DVD±RW	9-in-1	3165 ac, 1x1 + BT4.0	None	720p	None	USB / USB	Monitor Stand	120W 89% Adapter	Win10 DG Win7 Pro 64	3-year, Onsite	12/16

Model	Region	Processor	vPro	Graphics	Monitor Cable	Memory	Display	Multi-touch	Storage(HDD/SSD)	Optical	Media Reader	WLAN + Bluetooth	Optional Rear Ports	Camera	Chassis Intrusion Switch	Keyboard / Mouse	Stand	Power Supply	Operating System	Warranty	Ann Date (m/y)
10EY002MUS	US	i7-6700T	No	Intel HD 530	None	8GBx1	20" HD+ (1600x900) WVA AG	None	256GB SSD Opal	DVD±RW	9-in-1	3165 ac, 1x1 + BT4.0	None	720p	None	USB / USB	Monitor Stand	120W 89% Adapter	Win10 DG Win7 Pro 64	3-year, Onsite	12/16
10EY002NUS	US	i3-6100T	No	Intel HD 530	None	8GBx1	20" HD+ (1600x900) WVA AG	None	256GB SSD Opal	DVD±RW	9-in-1	3165 ac, 1x1 + BT4.0	None	720p	None	USB / USB	Monitor Stand	120W 89% Adapter	Win10 DG Win7 Pro 64	3-year, Onsite	12/16



Model	Region	Processor	vPro	Graphics	Monitor Cable	Memory	Display	Multi-touch	Storage(HDD/SSD)	Optical	Media Reader	WLAN + Bluetooth	Optional Rear Ports	Camera	Chassis Intrusion Switch	Keyboard / Mouse	Stand	Power Supply	Operating System	Warranty	Ann Date (m/y)
10F10001US	US	i5-6600T	No	Intel HD 530	None	4GBx2	20" HD+ (1600x900) WVA AG	None	120GB SSD	DVD±RW	9-in-1	8260 ac, 2x2, vPro + BT4.1	None	720p	Switch	2.4G / 2.4G	Monitor Stand	120W 89% Adapter	Win10 DG Win7 Pro 64	3-year, Onsite, OID	12/15
10F10002US	US	i5-6600T	No	Intel HD 530	None	4GBx2	20" HD+ (1600x900) WVA AG	None	128GB SSD	DVD±RW	9-in-1	8260 ac, 2x2, vPro + BT4.1	None	720p	Switch	2.4G / 2.4G	Monitor Stand	120W 89% Adapter	Win10 Pro 64	3-year, Onsite, OID	12/15
10F10003US	US	i5-6400T	No	Intel HD 530	None	4GBx1	20" HD+ (1600x900) WVA AG	None	1TB 5400rpm 2.5"	DVD±RW	9-in-1	8260 ac, 2x2, vPro + BT4.1	None	720p	Switch	USB / USB	Monitor Stand	120W 89% Adapter	Win10 DG Win7 Pro 64	3-year, Onsite, OID	12/15
10F10004US	US	i5-6400T	No	Intel HD 530	None	4GBx1	20" HD+ (1600x900) WVA AG	None	500GB 5400rpm 2.5"	DVD	None	3165 ac, 1x1 + BT4.0	None	720p	Switch	USB / USB	Basic Monitor Stand	120W 89% Adapter	Win10 DG Win7 Pro 64	3-year, Onsite, OID	12/15
10F10005US	US	i5-6400T	No	Intel HD 530	None	4GBx1	20" HD+ (1600x900) WVA AG	None	1TB 5400rpm 2.5"	DVD±RW	9-in-1	8260 ac, 2x2, vPro + BT4.1	None	720p	Switch	USB / USB	Monitor Stand	120W 89% Adapter	Win10 Pro 64	3-year, Onsite, OID	12/15
10F10006US	US	i5-6400T	No	Intel HD 530	None	4GBx1	20" HD+ (1600x900) WVA AG	None	500GB 5400rpm 2.5"	DVD	9-in-1	3165 ac, 1x1 + BT4.0	None	720p	Switch	USB / USB	Basic Monitor Stand	120W 89% Adapter	Win10 Pro 64	3-year, Onsite, OID	12/15



# ThinkCentre M800z Platform Specifications

Product Specifications Reference (PSREF)

Processor	Intel® Celeron®, Intel Pentium®, or 6th Generation Intel Core™ i3 / i5 / i7 Processor	Keyboard	<i>Some:</i> Preferred Pro USB Keyboard (USB connector), Lenovo logo <i>Some:</i> Lenovo Slim USB Keyboard (USB connector), black <i>Some:</i> Ultralim Plus Wireless Keyboard (2.4GHz via USB receiver), black <i>Some:</i> Enhanced Optical USB Mouse, black, Lenovo logo <i>Some:</i> Ultralim Plus Wireless Mouse (2.4GHz via USB receiver), black																																																												
	<table border="1"> <thead> <tr> <th>Processor</th> <th>Cores / Threads</th> <th>Frequency Base/Max(GHz)</th> <th>Cache</th> <th>Memory Types</th> <th>Integrated Graphics</th> </tr> </thead> <tbody> <tr> <td>Celeron G3900</td> <td>2 / 2</td> <td>2.8 G</td> <td>2 MB</td> <td>DDR4-2133</td> <td>HD 510</td> </tr> <tr> <td>Pentium G4400</td> <td>2 / 2</td> <td>3.3 G</td> <td>3 MB</td> <td>DDR4-2133</td> <td>HD 510</td> </tr> <tr> <td>Pentium G4500</td> <td>2 / 2</td> <td>3.5 G</td> <td>3 MB</td> <td>DDR4-2133</td> <td>HD 530</td> </tr> <tr> <td>Core i3-6100</td> <td>2 / 4</td> <td>3.7 G</td> <td>3 MB</td> <td>DDR4-2133</td> <td>HD 530</td> </tr> <tr> <td>Core i3-6300</td> <td>2 / 4</td> <td>3.8 G</td> <td>4 MB</td> <td>DDR4-2133</td> <td>HD 530</td> </tr> <tr> <td>Core i5-6400</td> <td>4 / 4</td> <td>2.7 G / 3.3 G</td> <td>6 MB</td> <td>DDR4-2133</td> <td>HD 530</td> </tr> <tr> <td>Core i5-6500</td> <td>4 / 4</td> <td>3.2 G / 3.6 G</td> <td>6 MB</td> <td>DDR4-2133</td> <td>HD 530</td> </tr> <tr> <td>Core i5-6600</td> <td>4 / 4</td> <td>3.3 G / 3.9 G</td> <td>6 MB</td> <td>DDR4-2133</td> <td>HD 530</td> </tr> <tr> <td>Core i7-6700</td> <td>4 / 8</td> <td>3.4 G / 4.0 G</td> <td>8 MB</td> <td>DDR4-2133</td> <td>HD 530</td> </tr> </tbody> </table>	Processor	Cores / Threads	Frequency Base/Max(GHz)	Cache	Memory Types	Integrated Graphics	Celeron G3900	2 / 2	2.8 G	2 MB	DDR4-2133	HD 510	Pentium G4400	2 / 2	3.3 G	3 MB	DDR4-2133	HD 510	Pentium G4500	2 / 2	3.5 G	3 MB	DDR4-2133	HD 530	Core i3-6100	2 / 4	3.7 G	3 MB	DDR4-2133	HD 530	Core i3-6300	2 / 4	3.8 G	4 MB	DDR4-2133	HD 530	Core i5-6400	4 / 4	2.7 G / 3.3 G	6 MB	DDR4-2133	HD 530	Core i5-6500	4 / 4	3.2 G / 3.6 G	6 MB	DDR4-2133	HD 530	Core i5-6600	4 / 4	3.3 G / 3.9 G	6 MB	DDR4-2133	HD 530	Core i7-6700	4 / 8	3.4 G / 4.0 G	8 MB	DDR4-2133	HD 530	Mouse	
Processor	Cores / Threads	Frequency Base/Max(GHz)	Cache	Memory Types	Integrated Graphics																																																										
Celeron G3900	2 / 2	2.8 G	2 MB	DDR4-2133	HD 510																																																										
Pentium G4400	2 / 2	3.3 G	3 MB	DDR4-2133	HD 510																																																										
Pentium G4500	2 / 2	3.5 G	3 MB	DDR4-2133	HD 530																																																										
Core i3-6100	2 / 4	3.7 G	3 MB	DDR4-2133	HD 530																																																										
Core i3-6300	2 / 4	3.8 G	4 MB	DDR4-2133	HD 530																																																										
Core i5-6400	4 / 4	2.7 G / 3.3 G	6 MB	DDR4-2133	HD 530																																																										
Core i5-6500	4 / 4	3.2 G / 3.6 G	6 MB	DDR4-2133	HD 530																																																										
Core i5-6600	4 / 4	3.3 G / 3.9 G	6 MB	DDR4-2133	HD 530																																																										
Core i7-6700	4 / 8	3.4 G / 4.0 G	8 MB	DDR4-2133	HD 530																																																										
		Mechanical	<ul style="list-style-type: none"> <li>Business black color</li> <li>Toolless stand</li> <li>Support VESA mount (100mm)</li> </ul> <table border="1"> <thead> <tr> <th></th> <th>Dimensions (WxDxH)</th> <th>Max weight (lb / kg)</th> <th>Adjustments</th> </tr> </thead> <tbody> <tr> <td>Without stand:</td> <td>21.1 X 1.8 X 14.3 (inch); 535 X 45 X 363 (mm)</td> <td>(Touch) 14.6 / 6.6 (Non-touch) 12.8 / 5.8</td> <td>N/A</td> </tr> <tr> <td>With Basic Monitor stand:</td> <td>21.1 X 9.6 X 17.0 (inch); 535 X 245 X 431 (mm)</td> <td>(Non-touch) 17.0 / 7.7</td> <td>Tilt: 45° back, -5° forward</td> </tr> <tr> <td>With UltraFlex II stand:</td> <td>21.1X 10.0 X 19.3 (inch); 535 X 253 X 489 (mm)</td> <td>(Touch) 20.3 / 9.2 (Non-touch) 18.3 / 8.3</td> <td>Tilt: 61° back, -5° forward; Lift: 160mm; Swivel: +/-45°</td> </tr> </tbody> </table>			Dimensions (WxDxH)	Max weight (lb / kg)	Adjustments	Without stand:	21.1 X 1.8 X 14.3 (inch); 535 X 45 X 363 (mm)	(Touch) 14.6 / 6.6 (Non-touch) 12.8 / 5.8	N/A	With Basic Monitor stand:	21.1 X 9.6 X 17.0 (inch); 535 X 245 X 431 (mm)	(Non-touch) 17.0 / 7.7	Tilt: 45° back, -5° forward	With UltraFlex II stand:	21.1X 10.0 X 19.3 (inch); 535 X 253 X 489 (mm)	(Touch) 20.3 / 9.2 (Non-touch) 18.3 / 8.3	Tilt: 61° back, -5° forward; Lift: 160mm; Swivel: +/-45°																																											
	Dimensions (WxDxH)	Max weight (lb / kg)	Adjustments																																																												
Without stand:	21.1 X 1.8 X 14.3 (inch); 535 X 45 X 363 (mm)	(Touch) 14.6 / 6.6 (Non-touch) 12.8 / 5.8	N/A																																																												
With Basic Monitor stand:	21.1 X 9.6 X 17.0 (inch); 535 X 245 X 431 (mm)	(Non-touch) 17.0 / 7.7	Tilt: 45° back, -5° forward																																																												
With UltraFlex II stand:	21.1X 10.0 X 19.3 (inch); 535 X 253 X 489 (mm)	(Touch) 20.3 / 9.2 (Non-touch) 18.3 / 8.3	Tilt: 61° back, -5° forward; Lift: 160mm; Swivel: +/-45°																																																												
Memory	32GB max, DDR4 2133, two 260-pin SO-DIMM sockets, dual-channel capable	Power supply	150 watts, autosensing, 85% PSU																																																												
Disk	<i>Some:</i> SATA 6.0Gb/s, 2.5" Wide, 5400 rpm or 7200 rpm <i>Some:</i> Solid State Hybrid Drive (SSHD) / with 8GB MLC NAND flash memory, SATA 6.0Gb/s, 2.5" Wide, 5400 rpm <i>Some:</i> Solid State Drive (SSD) / SATA 6.0Gb/s, 2.5" Wide	Limited warranty <sup>3</sup>	<i>Some:</i> <b>1-year or 3-year, depot repair service</b> <i>Some:</i> <b>1-year or 3-year, limited onsite service</b> <i>Some:</i> <b>3-years, limited onsite service, OID</b> (Onsite International Delivery) / <i>For Lenovo service upgrade options, please go to S-TC sheet</i>																																																												
Optical	<i>Some:</i> DVD, SATA 1.5Gb/s, 9.5mm high <i>Some:</i> DVD burner, SATA 1.5Gb/s, 9.5mm high	Preload	<b>Preloaded operating system</b> <i>Some:</i> Windows® 7 Professional 64 preinstalled through downgrade rights in Windows 10 Pro 64-bit <i>Some:</i> Windows 7 Professional 64 <i>Some:</i> Windows 10 Pro 64-bit <i>Some:</i> Windows 10 Home 64-bit																																																												
Media reader	Optional 9-in-1 media card reader		<b>Preloaded applications (only some listed)</b> <ul style="list-style-type: none"> <li>Desktop Power Manager</li> <li>Lenovo Solution Center</li> <li>Lenovo REACHit</li> <li>Lenovo SHAREit</li> <li>Lenovo Bluetooth Lock (for models with Wi-Fi/BT card)</li> <li>McAfee® LiveSafe™ (30-day trial)</li> <li>Microsoft Office preloaded; purchase a product key to activate</li> <li>PowerDVD Create (DVD±RW)</li> <li>Lenovo ThinkVantage Tools               <ul style="list-style-type: none"> <li>- Only for Window 10</li> <li>Lenovo Companion</li> <li>Cyberlink PowerDVD (DVD, DVD±RW)</li> <li>Lenovo QuickOptimizer</li> <li>- Only for Window 7</li> <li>Rescue and Recovery</li> <li>Password Manager</li> <li>ThinkVantage System Update</li> <li>Lenovo Message Center Plus</li> <li>Adobe® Reader®</li> </ul> </li> </ul>																																																												
Graphics	<b>Intel HD Graphics 510/530</b> in processor, uses main memory, DirectX® 12, external monitor support via DisplayPort™; <i>Max resolution:</i> 4096x2304 (DP)@60Hz																																																														
Display	<b>21.5"</b> (546.1mm) <b>Full HD 1080p (1920x1080) TFT color</b> , MVA panel, wide viewing angle (+/- 89°), LED backlight, 250 nits, 16:9 aspect ratio, 1000:1 contrast ratio, anti-glare for both touch models and non-touch models																																																														
Light sensor	None																																																														
Multi-touch	Optional Projected Capacitive Touch (PCT) technology, supports 10-point touch																																																														
Camera	Optional 1.0-megapixel camera, fixed focus, supports 720p, with digital microphone, LED indicator, physical switch on/off																																																														
Controls	Microphone mute, brightness up/down buttons, and power button																																																														
Chipset	<b>Intel H110 Chipset</b>																																																														
Rear ports	Four USB 2.0, ethernet (RJ-45), DisplayPort, optional serial (9-pin),																																																														
Side ports	Two USB 3.0 (one is Always On and fast charge), optional card reader, one headphone / microphone combo jack (3.5mm)																																																														
M.2 card slot	One M.2 Card slot (for WLAN)																																																														
Audio support	High Definition (HD) Audio, Realtek ALC233 / two internal stereo speakers (2W x 2), Dolby® Audio™ certified	Environment	EPEAT™ Gold rating; ENERGY STAR® 6.1; TCO Certified; ErP Lot 3; GREENGUARD® certified; RoHS-compliant																																																												
WLAN <sup>13</sup>	<i>Some:</i> 11ac wireless, M.2 Card, Qualcomm Atheros QCA9377 (dual band), Wi-Fi + Bluetooth 4.1 combo adapter, 1x1 <i>Some:</i> 11ac wireless, M.2 Card, Qualcomm Atheros QCA6174 (dual band), Wi-Fi + Bluetooth 4.1 combo adapter, 2x2 <i>Some:</i> 11ac wireless, M.2 Card, Intel Dual Band Wireless-AC 3165, Wi-Fi + Bluetooth 4.0 combo adapter, 1x1 <i>Some:</i> 11ac wireless, M.2 Card, Intel Dual Band Wireless-AC 8260, Wi-Fi + Bluetooth 4.1 combo adapter, 2x2	MIL-SPEC test	MIL-STD-810G military certification (Low Pressure [Altitude], High Temperature, Low Temperature, Temperature Shock, Humidity, Sand and Dust, Vibration, Shock)																																																												
Bluetooth™	<i>Some:</i> Bluetooth 4.0 or 4.1 wireless, integrated in Wi-Fi + Bluetooth combo adapter	Accessories	For compatible accessories, please go to TC-AQP sheet																																																												
Ethernet	Gigabit ethernet, Realtek RTL8111G, Wake on LAN®																																																														
Manageability	None																																																														
Security chip	Trusted Platform Module (TPM 1.2-compliant)																																																														
Security features	<ul style="list-style-type: none"> <li>Security slot (in rear for attachment of optional Kensington® MicroSaver® cable; Kensington lock also locks chassis)</li> <li>Smart USB protection, allows keyboard/mouse only, blocks all storage devices</li> <li>Power-on, admin, hard disk password</li> <li>Boot sequence control</li> <li>Boot without keyboard and mouse</li> <li>Individual USB port disablement</li> <li>Optional Chassis intrusion switch</li> </ul>																																																														

See footnotes for more detailed information

Model	Region	Processor	vPro	Graphics	Monitor Cable	Memory	Display	Multi-touch	Storage(HDD/SSD)	Optical	Media Reader	WLAN + Bluetooth	Optional Rear Ports	Camera	Chassis Intrusion Switch	Keyboard / Mouse	Stand	Power Supply	Operating System	Warranty	Ann Date (m/y)
10ET0002US	US	i5-6500	No	Intel HD 530	DP to HDMI	4GBx1	21.5" FHD (1920x1080) WVA AG	10-point Multi-touch	500GB 7200rpm 2.5"	DVD±RW	9-in-1	8260 ac, 2x2 + BT4.1	None	720p	None	USB / USB	UltraFlex II Stand	150W 85% Adapter	Win10 DG Win7 Pro 64	3-year, Onsite	11/15
10ET0003US	US	i7-6700	No	Intel HD 530	None	4GBx1	21.5" FHD (1920x1080) WVA AG	10-point Multi-touch	500GB 7200rpm 2.5"	DVD±RW	9-in-1	8260 ac, 2x2 + BT4.1	None	720p	None	USB / USB	UltraFlex II Stand	150W 85% Adapter	Win10 DG Win7 Pro 64	3-year, Onsite	11/15
10ET0004US	US	i5-6500	No	Intel HD 530	None	4GBx1	21.5" FHD (1920x1080) WVA AG	10-point Multi-touch	500GB 7200rpm 2.5"	DVD±RW	9-in-1	8260 ac, 2x2 + BT4.1	None	720p	None	USB / USB	UltraFlex II Stand	150W 85% Adapter	Win10 Pro 64	3-year, Onsite	11/15
10ET0005US	US	i7-6700	No	Intel HD 530	None	8GBx1	21.5" FHD (1920x1080) WVA AG	10-point Multi-touch	500GB 7200rpm 2.5"	DVD±RW	9-in-1	8260 ac, 2x2 + BT4.1	None	720p	None	USB / USB	UltraFlex II Stand	150W 85% Adapter	Win10 DG Win7 Pro 64	3-year, Onsite	11/15
10ET0007US	US	i5-6500	No	Intel HD 530	DP to HDMI	8GBx1	21.5" FHD (1920x1080) WVA AG	10-point Multi-touch	500GB 7200rpm 2.5"	DVD±RW	9-in-1	8260 ac, 2x2 + BT4.1	None	720p	None	USB / USB	UltraFlex II Stand	150W 85% Adapter	Win10 DG Win7 Pro 64	3-year, Onsite	11/15
10ET0009US	US	i5-6400	No	Intel HD 530	None	4GBx1	21.5" FHD (1920x1080) WVA AG	10-point Multi-touch	500GB 7200rpm 2.5"	DVD±RW	9-in-1	8260 ac, 2x2 + BT4.1	None	720p	None	USB / USB	UltraFlex II Stand	150W 85% Adapter	Win10 Pro 64	3-year, Onsite	11/15
10ET000AUS	US	i5-6400	No	Intel HD 530	None	4GBx1	21.5" FHD (1920x1080) WVA AG	10-point Multi-touch	500GB 7200rpm 2.5"	DVD±RW	9-in-1	8260 ac, 2x2 + BT4.1	None	720p	None	USB / USB	UltraFlex II Stand	150W 85% Adapter	Win10 DG Win7 Pro 64	3-year, Onsite	11/15
10ET000CUS	US	i5-6400	No	Intel HD 530	None	8GBx1	21.5" FHD (1920x1080) WVA AG	10-point Multi-touch	500GB 7200rpm 2.5"	DVD±RW	9-in-1	8260 ac, 2x2 + BT4.1	None	720p	None	USB / USB	UltraFlex II Stand	150W 85% Adapter	Win10 DG Win7 Pro 64	3-year, Onsite	11/15
10ET001AUS	US	Pentium G4400	No	Intel HD 510	None	4GBx1	21.5" FHD (1920x1080) WVA AG	10-point Multi-touch	500GB 7200rpm 2.5"	DVD±RW	9-in-1	8260 ac, 2x2 + BT4.1	None	720p	None	USB / USB	UltraFlex II Stand	150W 85% Adapter	Win10 DG Win7 Pro 64	3-year, Onsite	12/15
10ET001BUS	US	i7-6700	No	Intel HD 530	None	8GBx1	21.5" FHD (1920x1080) WVA AG	10-point Multi-touch	256GB SSD	DVD±RW	9-in-1	8260 ac, 2x2 + BT4.1	None	720p	None	USB / USB	UltraFlex II Stand	150W 85% Adapter	Win10 DG Win7 Pro 64	3-year, Onsite	11/15
10ET001CUS	US	i3-6100	No	Intel HD 530	None	4GBx1	21.5" FHD (1920x1080) WVA AG	10-point Multi-touch	120GB SSD	DVD±RW	9-in-1	8260 ac, 2x2 + BT4.1	None	720p	None	USB / USB	UltraFlex II Stand	150W 85% Adapter	Win10 DG Win7 Pro 64	3-year, Onsite	12/15
10ET001DUS	US	i3-6100	No	Intel HD 530	None	8GBx1	21.5" FHD (1920x1080) WVA AG	10-point Multi-touch	500GB 7200rpm 2.5"	DVD±RW	9-in-1	8260 ac, 2x2 + BT4.1	None	720p	None	USB / USB	UltraFlex II Stand	150W 85% Adapter	Win10 DG Win7 Pro 64	3-year, Onsite	12/15
10ET001EUS	US	i5-6400	No	Intel HD 530	None	8GBx1	21.5" FHD (1920x1080) WVA AG	10-point Multi-touch	256GB SSD	DVD±RW	9-in-1	8260 ac, 2x2 + BT4.1	None	720p	None	USB / USB	UltraFlex II Stand	150W 85% Adapter	Win10 DG Win7 Pro 64	3-year, Onsite	11/15
10ET001FUS	US	i3-6100	No	Intel HD 530	None	4GBx1	21.5" FHD (1920x1080) WVA AG	10-point Multi-touch	500GB 7200rpm 2.5"	DVD±RW	9-in-1	8260 ac, 2x2 + BT4.1	None	720p	None	USB / USB	UltraFlex II Stand	150W 85% Adapter	Win10 Pro 64	3-year, Onsite	12/15
10ET001GUS	US	Celeron G3900	No	Intel HD 510	None	4GBx1	21.5" FHD (1920x1080) WVA AG	10-point Multi-touch	500GB 7200rpm 2.5"	DVD±RW	9-in-1	8260 ac, 2x2 + BT4.1	None	720p	None	USB / USB	UltraFlex II Stand	150W 85% Adapter	Win10 DG Win7 Pro 64	3-year, Onsite	12/15
10ET001HUS	US	i7-6700	No	Intel HD 530	None	4GBx1	21.5" FHD (1920x1080) WVA AG	10-point Multi-touch	500GB 7200rpm 2.5"	DVD±RW	9-in-1	8260 ac, 2x2 + BT4.1	None	720p	None	USB / USB	UltraFlex II Stand	150W 85% Adapter	Win10 Pro 64	3-year, Onsite	11/15
10ET001JUS	US	i7-6700	No	Intel HD 530	None	4GBx1	21.5" FHD (1920x1080) WVA AG	10-point Multi-touch	120GB SSD	DVD±RW	9-in-1	8260 ac, 2x2 + BT4.1	None	720p	None	USB / USB	UltraFlex II Stand	150W 85% Adapter	Win10 DG Win7 Pro 64	3-year, Onsite	11/15
10ET001KUS	US	i5-6400	No	Intel HD 530	None	4GBx1	21.5" FHD (1920x1080) WVA AG	10-point Multi-touch	120GB SSD	DVD±RW	9-in-1	8260 ac, 2x2 + BT4.1	None	720p	None	USB / USB	UltraFlex II Stand	150W 85% Adapter	Win10 DG Win7 Pro 64	3-year, Onsite	11/15
10ET001LUS	US	i3-6100	No	Intel HD 530	None	8GBx1	21.5" FHD (1920x1080) WVA AG	10-point Multi-touch	256GB SSD	DVD±RW	9-in-1	8260 ac, 2x2 + BT4.1	None	720p	None	USB / USB	UltraFlex II Stand	150W 85% Adapter	Win10 DG Win7 Pro 64	3-year, Onsite	12/15
10ET001MUS	US	i3-6100	No	Intel HD 530	None	4GBx1	21.5" FHD (1920x1080) WVA AG	10-point Multi-touch	500GB 7200rpm 2.5"	DVD±RW	9-in-1	8260 ac, 2x2 + BT4.1	None	720p	None	USB / USB	UltraFlex II Stand	150W 85% Adapter	Win10 DG Win7 Pro 64	3-year, Onsite	12/15

Model	Region	Processor	vPro	Graphics	Monitor Cable	Memory	Display	Multi-touch	Storage(HDD/SSD)	Optical	Media Reader	WLAN + Bluetooth	Optional Rear Ports	Camera	Chassis Intrusion Switch	Keyboard / Mouse	Stand	Power Supply	Operating System	Warranty	Ann Date (m/y)
10ET0026US	US	i7-6700	No	Intel HD 530	None	8GBx1	21.5" FHD (1920x1080) WVA AG	10-point Multi-touch	256GB SSD Opal	DVD±RW	9-in-1	8260 ac, 2x2 + BT4.1	None	720p	None	USB / USB	UltraFlex II Stand	150W 85% Adapter	Win10 DG Win7 Pro 64	3-year, Onsite	12/16
10ET0027US	US	i5-6400	No	Intel HD 530	None	8GBx1	21.5" FHD (1920x1080) WVA AG	10-point Multi-touch	256GB SSD Opal	DVD±RW	9-in-1	8260 ac, 2x2 + BT4.1	None	720p	None	USB / USB	UltraFlex II Stand	150W 85% Adapter	Win10 DG Win7 Pro 64	3-year, Onsite	12/16
10ET0028US	US	i3-6100	No	Intel HD 530	None	8GBx1	21.5" FHD (1920x1080) WVA AG	10-point Multi-touch	256GB SSD Opal	DVD±RW	9-in-1	8260 ac, 2x2 + BT4.1	None	720p	None	USB / USB	UltraFlex II Stand	150W 85% Adapter	Win10 DG Win7 Pro 64	3-year, Onsite	12/16

Model	Region	Processor	vPro	Graphics	Monitor Cable	Memory	Display	Multi-touch	Storage(HDD/SSD)	Optical	Media Reader	WLAN + Bluetooth	Optional Rear Ports	Camera	Chassis Intrusion Switch	Keyboard / Mouse	Stand	Power Supply	Operating System	Warranty	Ann Date (m/y)
10EU001PUS	US	i5-6400	No	Intel HD 530	None	4GBx1	21.5" FHD (1920x1080) WVA AG	None	500GB 7200rpm 2.5"	DVD±RW	9-in-1	8260 ac, 2x2 + BT4.1	None	720p	None	USB / USB	Basic Monitor Stand	150W 85% Adapter	Win10 Pro 64	3-year, Onsite	11/15
10EU001QUS	US	i7-6700	No	Intel HD 530	None	4GBx1	21.5" FHD (1920x1080) WVA AG	None	500GB 7200rpm 2.5"	DVD±RW	9-in-1	8260 ac, 2x2 + BT4.1	None	720p	None	USB / USB	UltraFlex II Stand	150W 85% Adapter	Win10 DG Win7 Pro 64	3-year, Onsite	11/15
10EU001RUS	US	i7-6700	No	Intel HD 530	None	4GBx1	21.5" FHD (1920x1080) WVA AG	None	500GB 7200rpm 2.5"	DVD±RW	9-in-1	8260 ac, 2x2 + BT4.1	None	720p	None	USB / USB	Basic Monitor Stand	150W 85% Adapter	Win10 Pro 64	3-year, Onsite	11/15
10EU001SUS	US	i5-6400	No	Intel HD 530	None	4GBx1	21.5" FHD (1920x1080) WVA AG	None	500GB 7200rpm 2.5"	DVD±RW	9-in-1	8260 ac, 2x2 + BT4.1	None	720p	None	USB / USB	UltraFlex II Stand	150W 85% Adapter	Win10 Pro 64	3-year, Onsite	11/15
10EU001TUS	US	i5-6400	No	Intel HD 530	None	4GBx1	21.5" FHD (1920x1080) WVA AG	None	500GB 7200rpm 2.5"	DVD±RW	9-in-1	8260 ac, 2x2 + BT4.1	None	720p	None	USB / USB	UltraFlex II Stand	150W 85% Adapter	Win10 DG Win7 Pro 64	3-year, Onsite	11/15
10EU001UUS	US	i7-6700	No	Intel HD 530	None	4GBx1	21.5" FHD (1920x1080) WVA AG	None	500GB 7200rpm 2.5"	DVD±RW	9-in-1	8260 ac, 2x2 + BT4.1	None	720p	None	USB / USB	UltraFlex II Stand	150W 85% Adapter	Win10 Pro 64	3-year, Onsite	11/15
10EU001VUS	US	i7-6700	No	Intel HD 530	None	8GBx1	21.5" FHD (1920x1080) WVA AG	None	500GB 7200rpm 2.5"	DVD±RW	9-in-1	8260 ac, 2x2 + BT4.1	None	720p	None	USB / USB	UltraFlex II Stand	150W 85% Adapter	Win10 DG Win7 Pro 64	3-year, Onsite	11/15
10EU001WUS	US	i5-6400	No	Intel HD 530	None	8GBx1	21.5" FHD (1920x1080) WVA AG	None	500GB 7200rpm 2.5"	DVD±RW	9-in-1	8260 ac, 2x2 + BT4.1	None	720p	None	USB / USB	UltraFlex II Stand	150W 85% Adapter	Win10 DG Win7 Pro 64	3-year, Onsite	11/15
10EU002WUS	US	i7-6700	No	Intel HD 530	None	4GBx1	21.5" FHD (1920x1080) WVA AG	None	120GB SSD	DVD±RW	9-in-1	8260 ac, 2x2 + BT4.1	None	720p	None	USB / USB	UltraFlex II Stand	150W 85% Adapter	Win10 DG Win7 Pro 64	3-year, Onsite	11/15
10EU002XUS	US	i3-6100	No	Intel HD 530	None	8GBx1	21.5" FHD (1920x1080) WVA AG	None	256GB SSD	DVD±RW	9-in-1	8260 ac, 2x2 + BT4.1	None	720p	None	USB / USB	UltraFlex II Stand	150W 85% Adapter	Win10 DG Win7 Pro 64	3-year, Onsite	12/15
10EU002YUS	US	i5-6400	No	Intel HD 530	None	8GBx1	21.5" FHD (1920x1080) WVA AG	None	256GB SSD	DVD±RW	9-in-1	8260 ac, 2x2 + BT4.1	None	720p	None	USB / USB	UltraFlex II Stand	150W 85% Adapter	Win10 DG Win7 Pro 64	3-year, Onsite	11/15
10EU0030US	US	Pentium G4400	No	Intel HD 510	None	4GBx1	21.5" FHD (1920x1080) WVA AG	None	500GB 7200rpm 2.5"	DVD±RW	9-in-1	8260 ac, 2x2 + BT4.1	None	720p	None	USB / USB	UltraFlex II Stand	150W 85% Adapter	Win10 DG Win7 Pro 64	3-year, Onsite	12/15
10EU0031US	US	i3-6100	No	Intel HD 530	None	8GBx1	21.5" FHD (1920x1080) WVA AG	None	500GB 7200rpm 2.5"	DVD±RW	9-in-1	8260 ac, 2x2 + BT4.1	None	720p	None	USB / USB	UltraFlex II Stand	150W 85% Adapter	Win10 DG Win7 Pro 64	3-year, Onsite	12/15
10EU0032US	US	Celeron G3900	No	Intel HD 510	None	4GBx1	21.5" FHD (1920x1080) WVA AG	None	500GB 7200rpm 2.5"	DVD±RW	9-in-1	8260 ac, 2x2 + BT4.1	None	720p	None	USB / USB	UltraFlex II Stand	150W 85% Adapter	Win10 DG Win7 Pro 64	3-year, Onsite	03/16
10EU0033US	US	i5-6400	No	Intel HD 530	None	4GBx1	21.5" FHD (1920x1080) WVA AG	None	120GB SSD	DVD±RW	9-in-1	8260 ac, 2x2 + BT4.1	None	720p	None	USB / USB	UltraFlex II Stand	150W 85% Adapter	Win10 DG Win7 Pro 64	3-year, Onsite	11/15
10EU0034US	US	i3-6100	No	Intel HD 530	None	4GBx1	21.5" FHD (1920x1080) WVA AG	None	500GB 7200rpm 2.5"	DVD±RW	9-in-1	8260 ac, 2x2 + BT4.1	None	720p	None	USB / USB	UltraFlex II Stand	150W 85% Adapter	Win10 DG Win7 Pro 64	3-year, Onsite	12/15
10EU0035US	US	i3-6100	No	Intel HD 530	None	4GBx1	21.5" FHD (1920x1080) WVA AG	None	120GB SSD	DVD±RW	9-in-1	8260 ac, 2x2 + BT4.1	None	720p	None	USB / USB	UltraFlex II Stand	150W 85% Adapter	Win10 DG Win7 Pro 64	3-year, Onsite	12/15
10EU0036US	US	i7-6700	No	Intel HD 530	None	8GBx1	21.5" FHD (1920x1080) WVA AG	None	256GB SSD	DVD±RW	9-in-1	8260 ac, 2x2 + BT4.1	None	720p	None	USB / USB	UltraFlex II Stand	150W 85% Adapter	Win10 DG Win7 Pro 64	3-year, Onsite	11/15
10EU0037US	US	i3-6100	No	Intel HD 530	None	4GBx1	21.5" FHD (1920x1080) WVA AG	None	500GB 7200rpm 2.5"	DVD±RW	9-in-1	8260 ac, 2x2 + BT4.1	None	720p	None	USB / USB	UltraFlex II Stand	150W 85% Adapter	Win10 Pro 64	3-year, Onsite	12/15
10EU0048US	US	i7-6700	No	Intel HD 530	None	8GBx1	21.5" FHD (1920x1080) WVA AG	None	256GB SSD Opal	DVD±RW	9-in-1	8260 ac, 2x2 + BT4.1	None	720p	None	USB / USB	UltraFlex II Stand	150W 85% Adapter	Win10 DG Win7 Pro 64	3-year, Onsite	12/16

Model	Region	Processor	vPro	Graphics	Monitor Cable	Memory	Display	Multi-touch	Storage(HDD/SSD)	Optical	Media Reader	WLAN + Bluetooth	Optional Rear Ports	Camera	Chassis Intrusion Switch	Keyboard / Mouse	Stand	Power Supply	Operating System	Warranty	Ann Date (m/y)
10EU0049US	US	i3-6100	No	Intel HD 530	None	8GBx1	21.5" FHD (1920x1080) WVA AG	None	256GB SSD Opal	DVD±RW	9-in-1	8260 ac, 2x2 + BT4.1	None	720p	None	USB / USB	UltraFlex II Stand	150W 85% Adapter	Win10 DG Win7 Pro 64	3-year, Onsite	12/16
10EU004AUS	US	i5-6400	No	Intel HD 530	None	8GBx1	21.5" FHD (1920x1080) WVA AG	None	256GB SSD Opal	DVD±RW	9-in-1	8260 ac, 2x2 + BT4.1	None	720p	None	USB / USB	UltraFlex II Stand	150W 85% Adapter	Win10 DG Win7 Pro 64	3-year, Onsite	12/16

Model	Region	Processor	vPro	Graphics	Monitor Cable	Memory	Display	Multi-touch	Storage(HDD/SSD)	Optical	Media Reader	WLAN + Bluetooth	Optional Rear Ports	Camera	Chassis Intrusion Switch	Keyboard / Mouse	Stand	Power Supply	Operating System	Warranty	Ann Date (m/y)
10EW000UUS	US	i5-6400	No	Intel HD 530	None	4GBx1	21.5" FHD (1920x1080) WVA AG	None	1TB 5400rpm 2.5"	DVD±RW	9-in-1	8260 ac, 2x2 + BT4.1	None	720p	Switch	USB / USB	UltraFlex II Stand	150W 85% Adapter	Win10 DG Win7 Pro 64	3-year, Onsite, OID	11/15
10EW000VUS	US	i5-6400	No	Intel HD 530	None	4GBx1	21.5" FHD (1920x1080) WVA AG	None	1TB 5400rpm 2.5"	DVD±RW	9-in-1	8260 ac, 2x2 + BT4.1	None	720p	Switch	USB / USB	UltraFlex II Stand	150W 85% Adapter	Win10 Pro 64	3-year, Onsite, OID	11/15
10EW000WUS	US	i5-6400	No	Intel HD 530	None	4GBx1	21.5" FHD (1920x1080) WVA AG	None	500GB 5400rpm 2.5"	DVD	None	8260 ac, 2x2 + BT4.1	None	720p	Switch	USB / USB	Basic Monitor Stand	150W 85% Adapter	Win10 DG Win7 Pro 64	3-year, Onsite, OID	11/15
10EW000XUS	US	i5-6400	No	Intel HD 530	None	4GBx1	21.5" FHD (1920x1080) WVA AG	None	500GB 5400rpm 2.5"	DVD	None	8260 ac, 2x2 + BT4.1	None	720p	Switch	USB / USB	Basic Monitor Stand	150W 85% Adapter	Win10 Pro 64	3-year, Onsite, OID	11/15





# ThinkCentre M810z Platform Specifications

Product Specifications Reference (PSREF)

Processor	Intel® Celeron®, Intel Pentium®, or 6th / 7th Gen Intel Core™ i3 / i5 / i7 Processor						<b>Security features</b> <ul style="list-style-type: none"> <li>Security slot (in rear for attachment of optional Kensington® MicroSaver® cable; Kensington lock also locks chassis)</li> <li>Smart USB protection, allows keyboard/mouse only, blocks all storage devices</li> <li>Optional cable lock to physically lock keyboard and mouse</li> <li>Power-on, admin, hard disk password</li> <li>Boot sequence control</li> <li>Boot without keyboard and mouse</li> <li>Individual USB port disablement</li> <li>Optional Chassis intrusion switch</li> </ul>
	Processor	Cores / Threads	Frequency Base/Max(GHz)	Cache	Memory Support (Up to)	Integrated Graphics	
	Pentium G4400	2 / 2	3.3G	3 MB	DDR4-2133	HD 510	
	Pentium G4560	2 / 4	3.5G	3 MB	DDR4-2400	HD 610	
	Pentium G4600	2 / 4	3.6G	3 MB	DDR4-2400	HD 630	
	Core i3-6100	2 / 4	3.7G	3 MB	DDR4-2133	HD 530	
	Core i5-6500	4 / 4	3.2G / 3.6G	6 MB	DDR4-2133	HD 530	
	Core i7-6700	4 / 8	3.4G / 4.0G	8 MB	DDR4-2133	HD 530	
	Core i3-7100	2 / 4	3.9G	3 MB	DDR4-2400	HD 630	
	Core i5-7400	4 / 4	3.0G / 3.5G	6 MB	DDR4-2400	HD 630	
Core i5-7500	4 / 4	3.4G / 3.8G	6 MB	DDR4-2400	HD 630		
Core i5-7600	4 / 4	3.5G / 4.1G	6 MB	DDR4-2400	HD 630		
Core i7-7700	4 / 8	3.6G / 4.2G	8 MB	DDR4-2400	HD 630		
Memory	32GB max, DDR4-2400*, two 260-pin SO-DIMM sockets, dual-channel capable * System clocks down for the processors with lower memory controller						
Storage	<i>Some:</i> Hard Drive / SATA 6.0Gb/s, 2.5", 5400 rpm or 7200 rpm <i>Some:</i> Solid State Drive (SSD) / SATA 6.0Gb/s, 2.5" <i>Some:</i> M.2 Solid State Drive (SSD) / PCIe NVMe, PCIe 3.0 x 4, 32Gb/s <i>Some:</i> Intel Optane™ Memory Ready (models with 7th gen Core processor), M.2 <i>Some:</i> DVD-ROM SATA 1.5Gb/s Drive, slim (9.5mm)						
Optical	<i>Some:</i> DVD Burner (DVD±RW), SATA 1.5Gb/s Drive, slim (9.5mm)						
Media reader	Optional 9-in-1 media card reader						
Graphics	<b>Intel HD Graphics 510/530/610/630</b> in processor, uses main memory, DirectX® 12, external monitor support via DisplayPort™; <i>Max resolution:</i> 4096x2304 (DP)@60Hz, 1920x1080 (Panel)@60Hz						
Display	<b>21.5"</b> (546.1mm) <b>Full HD 1080p (1920x1080) TFT color</b> , MVA panel, wide viewing angle (+/- 89°), LED backlight, 250 nits, 16:9 aspect ratio, 1000:1 contrast ratio, anti-glare, support Low Blue Light Mode						
Multi-touch	Optional Projected Capacitive Touch (PCT) technology, supports 10-point touch						
Camera	Optional 1080p camera, fixed focus, with dual microphone, LED indicator, physical switch on/off						
Controls	Physical buttons for Microphone mute, brightness up/down, and power on/off						
Chipset	<b>Intel B250 Chipset</b>						
Rear ports	Four USB 3.1 Gen1, ethernet (RJ-45), DisplayPort, optional serial (9-pin),						
Side ports	Two USB 3.1 Gen1 (one is Always On and fast charge), optional card reader, one headphone / microphone combo jack (3.5mm)						
M.2 card slot	Two M.2 Card slots (one for WLAN, one for SSD/Optane)						
Audio support	High Definition (HD) Audio, Realtek ALC233 / two internal speakers (2W x 2), Dolby® Audio™ certified						
WLAN <sup>13</sup>	<i>Some:</i> 11ac wireless, M.2 Card, Qualcomm Atheros QCA9377A (dual band), Wi-Fi + Bluetooth 4.1 combo adapter, 1x1 <i>Some:</i> 11ac wireless, M.2 Card, Qualcomm Atheros QCA6174A (dual band), Wi-Fi + Bluetooth 4.1 combo adapter, 2x2 <i>Some:</i> 11ac wireless, M.2 Card, Intel Dual Band Wireless-AC 3165, Wi-Fi + Bluetooth 4.1 combo adapter, 1x1 <i>Some:</i> 11ac wireless, M.2 Card, Intel Dual Band Wireless-AC 8265, Wi-Fi + Bluetooth 4.1 combo adapter, 2x2						
Bluetooth™	<i>Some:</i> Bluetooth 4.1 wireless, integrated in Wi-Fi + Bluetooth combo adapter						
Ethernet	Gigabit ethernet, Realtek RTL8111G, Wake on LAN®						
Manageability	None						
Security chip	TPM (Trusted Platform Module) 2.0, TCG Certified * Downgrade to TPM1.2 for the models with Win10 DG Win7 32 OS						
Keyboard	<i>Some:</i> Lenovo Calliope Keyboard (USB connector), black <i>Some:</i> Lenovo Traditional Keyboard (USB connector), black <i>Some:</i> Lenovo Calliope Wireless Keyboard (2.4GHz via USB receiver), black						
Mouse	<i>Some:</i> Lenovo Calliope Mouse (USB connector), black <i>Some:</i> Lenovo Calliope Wireless Mouse (2.4GHz via USB receiver), black						
Mechanical	<ul style="list-style-type: none"> <li>Business black color</li> <li>Toolless stand</li> <li>Support VESA mount (100mm)</li> </ul>						
		Dimensions (WxDxH)		Max weight (lb / kg)		Adjustments	
	Without stand:	21.1 X 1.8 X 14.3 (inch); 535 X 45 X 363 (mm)		(Touch) 14.6 / 6.6 (Non-touch) 12.8 / 5.8		N/A	
	With Basic Monitor stand:	21.1 X 9.6 X 17.0 (inch); 535 X 245 X 431 (mm)		(Non-touch) 17.0 / 7.7		Tilt: 45° back, -5° forward	
	With UltraFlex II stand:	21.1X 10.0 X 19.3 (inch); 535 X 253 X 489 (mm)		(Touch) 20.3 / 9.2 (Non-touch) 18.3 / 8.3		Tilt: 61° back, -5° forward; Lift: 110mm; Swivel: +/-45°	
Power supply	150 watts, autosensing, 85% PSU						
Limited warranty <sup>3</sup>	<i>Some:</i> <b>1-year or 3-year, depot repair service</b> / service upgrades available <i>Some:</i> <b>1-year or 3-year, limited onsite service</b> / service upgrades available						
Preload	<b>Preloaded operating system</b> <i>Some:</i> Windows® 7 Professional 32/64 preinstalled through downgrade rights in Windows 10 Pro 64-bit <i>Some:</i> Windows 10 Pro 64-bit <i>Some:</i> Windows 10 Home 64-bit			<b>Preloaded applications (only some listed)</b> <ul style="list-style-type: none"> <li>Microsoft Office preloaded; purchase a product key to activate</li> <li>Cyberlink PowerDVD Create (DVD±RW)</li> <li>- Only for Window 10               <ul style="list-style-type: none"> <li>Lenovo Companion</li> <li>Lenovo ID</li> <li>Lenovo Settings</li> <li>Cyberlink PowerDVD (DVD, DVD±RW)</li> </ul> </li> <li>- Only for Window 7               <ul style="list-style-type: none"> <li>Lenovo Solution Center</li> <li>Lenovo ThinkVantage Tools</li> <li>ThinkVantage System Update</li> <li>Create Recovery Media</li> <li>Adobe® Reader®</li> </ul> </li> </ul>			
Environment	EPEAT™ Gold rating (North America); ENERGY STAR® 6.1; TCO AIO Computer Certified; ErP Lot 3; GREENGUARD® certified; RoHS-compliant						
MIL-SPEC test	MIL-STD-810G military certification (Low Pressure [Altitude], High Temperature, Low Temperature, Temperature Shock, Humidity, Sand and Dust, Vibration, Shock)						
Accessories	For compatible accessories, please go to <a href="http://www.lenovoquickpick.com">http://www.lenovoquickpick.com</a>						

See footnotes for more detailed information

Model	Region	Processor	Graphics	Monitor Cable	Memory	Display	Multi-touch	Power Supply	Storage(HDD/SSD)	Optical	Media Reader	USB Type-C	WLAN + Bluetooth	Optional Rear Ports	Camera	Chassis Intrusion Switch	Cable Lock	Keyboard / Mouse	Stand	Operating System	Warranty	End of Support	Ann Date (m/y)
10NX0000US	US	i5-7400	Intel HD 630	None	8GBx1	21.5" FHD (1920x1080) WVA AG	10-point Multi-touch	150W 85% Adapter	256GB SSD M.2 PCIe NVMe	DVD±RW	9-in-1	None	8265 ac, 2x2 + BT4.1	None	1080p	None	None	USB / USB	UltraFlex II Stand	Win10 Pro 64	3-year, Onsite	Apr 7, 2023	03/17
10NX0001US	US	i5-7500	Intel HD 630	None	8GBx1	21.5" FHD (1920x1080) WVA AG	10-point Multi-touch	150W 85% Adapter	256GB SSD M.2 PCIe NVMe	DVD±RW	9-in-1	None	8265 ac, 2x2 + BT4.1	None	1080p	None	None	USB / USB	UltraFlex II Stand	Win10 Pro 64	3-year, Onsite	Apr 7, 2023	03/17
10NX0002US	US	i5-7400	Intel HD 630	None	4GBx1	21.5" FHD (1920x1080) WVA AG	10-point Multi-touch	150W 85% Adapter	500GB 7200rpm 2.5" PCIe NVMe	DVD±RW	9-in-1	None	8265 ac, 2x2 + BT4.1	None	1080p	None	None	USB / USB	UltraFlex II Stand	Win10 Pro 64	3-year, Onsite	Apr 7, 2023	03/17
10NX0003US	US	i7-7700	Intel HD 630	None	8GBx1	21.5" FHD (1920x1080) WVA AG	10-point Multi-touch	150W 85% Adapter	512GB SSD M.2 PCIe NVMe	DVD±RW	9-in-1	None	8265 ac, 2x2 + BT4.1	None	1080p	None	None	USB / USB	UltraFlex II Stand	Win10 Pro 64	3-year, Onsite	Apr 7, 2023	03/17
10NX0005US	US	i7-7700	Intel HD 630	None	8GBx1	21.5" FHD (1920x1080) WVA AG	10-point Multi-touch	150W 85% Adapter	500GB 7200rpm 2.5" PCIe NVMe	DVD±RW	9-in-1	None	8265 ac, 2x2 + BT4.1	None	1080p	None	None	USB / USB	UltraFlex II Stand	Win10 Pro 64	3-year, Onsite	Apr 7, 2023	03/17
10NX0006US	US	i5-7400	Intel HD 630	None	8GBx1	21.5" FHD (1920x1080) WVA AG	10-point Multi-touch	150W 85% Adapter	500GB 7200rpm 2.5" PCIe NVMe	DVD±RW	9-in-1	None	8265 ac, 2x2 + BT4.1	None	1080p	None	None	USB / USB	UltraFlex II Stand	Win10 Pro 64	3-year, Onsite	Apr 7, 2023	03/17
10NX0007US	US	i5-7500	Intel HD 630	None	8GBx1	21.5" FHD (1920x1080) WVA AG	10-point Multi-touch	150W 85% Adapter	500GB 7200rpm 2.5" PCIe NVMe	DVD±RW	9-in-1	None	8265 ac, 2x2 + BT4.1	None	1080p	None	None	USB / USB	UltraFlex II Stand	Win10 Pro 64	3-year, Onsite	Apr 7, 2023	03/17
10NX0008US	US	i7-7700	Intel HD 630	None	8GBx1	21.5" FHD (1920x1080) WVA AG	10-point Multi-touch	150W 85% Adapter	256GB SSD M.2 PCIe NVMe	DVD±RW	9-in-1	None	8265 ac, 2x2 + BT4.1	None	1080p	None	None	USB / USB	UltraFlex II Stand	Win10 Pro 64	3-year, Onsite	Apr 7, 2023	03/17
10NX0009US	US	i5-7500	Intel HD 630	None	8GBx1	21.5" FHD (1920x1080) WVA AG	10-point Multi-touch	150W 85% Adapter	512GB SSD M.2 PCIe NVMe	DVD±RW	9-in-1	None	8265 ac, 2x2 + BT4.1	None	1080p	None	None	USB / USB	UltraFlex II Stand	Win10 Pro 64	3-year, Onsite	Apr 7, 2023	03/17
10NX000MUS	US	i5-7400	Intel HD 630	None	4GBx1	21.5" FHD (1920x1080) WVA AG	10-point Multi-touch	150W 85% Adapter	128GB SSD M.2 PCIe NVMe	DVD±RW	9-in-1	None	8265 ac, 2x2 + BT4.1	None	1080p	None	None	USB / USB	UltraFlex II Stand	Win10 Pro 64	3-year, Onsite	May 7, 2023	04/17
10NX000NUS	US	i5-7500	Intel HD 630	None	4GBx1	21.5" FHD (1920x1080) WVA AG	10-point Multi-touch	150W 85% Adapter	128GB SSD M.2 PCIe NVMe	DVD±RW	9-in-1	None	8265 ac, 2x2 + BT4.1	None	1080p	None	None	USB / USB	UltraFlex II Stand	Win10 Pro 64	3-year, Onsite	May 7, 2023	04/17
10NX000PUS	US	Pentium G4560	Intel HD 610	None	4GBx1	21.5" FHD (1920x1080) WVA AG	10-point Multi-touch	150W 85% Adapter	500GB 7200rpm 2.5" PCIe NVMe	DVD±RW	9-in-1	None	8265 ac, 2x2 + BT4.1	None	1080p	None	None	USB / USB	UltraFlex II Stand	Win10 Pro 64	3-year, Onsite	May 7, 2023	04/17
10NX000QUS	US	i3-7100	Intel HD 630	None	8GBx1	21.5" FHD (1920x1080) WVA AG	10-point Multi-touch	150W 85% Adapter	500GB 7200rpm 2.5" PCIe NVMe	DVD±RW	9-in-1	None	8265 ac, 2x2 + BT4.1	None	1080p	None	None	USB / USB	UltraFlex II Stand	Win10 Pro 64	3-year, Onsite	May 7, 2023	04/17
10NX000RUS	US	i3-7100	Intel HD 630	None	4GBx1	21.5" FHD (1920x1080) WVA AG	10-point Multi-touch	150W 85% Adapter	500GB 7200rpm 2.5" PCIe NVMe	DVD±RW	9-in-1	None	8265 ac, 2x2 + BT4.1	None	1080p	None	None	USB / USB	UltraFlex II Stand	Win10 Pro 64	3-year, Onsite	May 7, 2023	04/17

Model	Region	Processor	Graphics	Monitor Cable	Memory	Display	Multi-touch	Power Supply	Storage(HDD/SSD)	Optical	Media Reader	USB Type-C	WLAN + Bluetooth	Optional Rear Ports	Camera	Chassis Intrusion Switch	Cable Lock	Keyboard / Mouse	Stand	Operating System	Warranty	End of Support	Ann Date (m/y)
10NY0002US	US	i5-7500	Intel HD 630	None	8GBx1	21.5" FHD (1920x1080) WVA AG	None	150W 85% Adapter	512GB SSD M.2 PCIe NVMe	DVD±RW	9-in-1	None	8265 ac, 2x2 + BT4.1	None	1080p	None	None	USB / USB	UltraFlex II Stand	Win10 Pro 64	3-year, Onsite	Apr 7, 2023	03/17
10NY0003US	US	i7-7700	Intel HD 630	None	8GBx1	21.5" FHD (1920x1080) WVA AG	None	150W 85% Adapter	512GB SSD M.2 PCIe NVMe	DVD±RW	9-in-1	None	8265 ac, 2x2 + BT4.1	None	1080p	None	None	USB / USB	UltraFlex II Stand	Win10 Pro 64	3-year, Onsite	Apr 7, 2023	03/17
10NY0004US	US	i5-7500	Intel HD 630	None	8GBx1	21.5" FHD (1920x1080) WVA AG	None	150W 85% Adapter	256GB SSD M.2 PCIe NVMe	DVD±RW	9-in-1	None	8265 ac, 2x2 + BT4.1	None	1080p	None	None	USB / USB	UltraFlex II Stand	Win10 Pro 64	3-year, Onsite	Apr 7, 2023	03/17
10NY0005US	US	i7-7700	Intel HD 630	None	8GBx1	21.5" FHD (1920x1080) WVA AG	None	150W 85% Adapter	500GB 7200rpm 2.5" DVD±RW	DVD±RW	9-in-1	None	8265 ac, 2x2 + BT4.1	None	1080p	None	None	USB / USB	UltraFlex II Stand	Win10 Pro 64	3-year, Onsite	Apr 7, 2023	03/17
10NY0006US	US	i5-7400	Intel HD 630	None	8GBx1	21.5" FHD (1920x1080) WVA AG	None	150W 85% Adapter	500GB 7200rpm 2.5" DVD±RW	DVD±RW	9-in-1	None	8265 ac, 2x2 + BT4.1	None	1080p	None	None	USB / USB	UltraFlex II Stand	Win10 Pro 64	3-year, Onsite	Apr 7, 2023	03/17
10NY0007US	US	i5-7500	Intel HD 630	None	8GBx1	21.5" FHD (1920x1080) WVA AG	None	150W 85% Adapter	500GB 7200rpm 2.5" DVD±RW	DVD±RW	9-in-1	None	8265 ac, 2x2 + BT4.1	None	1080p	None	None	USB / USB	UltraFlex II Stand	Win10 Pro 64	3-year, Onsite	Apr 7, 2023	03/17
10NY0008US	US	i5-7400	Intel HD 630	None	4GBx1	21.5" FHD (1920x1080) WVA AG	None	150W 85% Adapter	500GB 7200rpm 2.5" DVD±RW	DVD±RW	9-in-1	None	8265 ac, 2x2 + BT4.1	None	1080p	None	None	USB / USB	UltraFlex II Stand	Win10 Pro 64	3-year, Onsite	Apr 7, 2023	03/17
10NY0009US	US	i5-7400	Intel HD 630	None	8GBx1	21.5" FHD (1920x1080) WVA AG	None	150W 85% Adapter	256GB SSD M.2 PCIe NVMe	DVD±RW	9-in-1	None	8265 ac, 2x2 + BT4.1	None	1080p	None	None	USB / USB	UltraFlex II Stand	Win10 Pro 64	3-year, Onsite	Apr 7, 2023	03/17
10NY000BUS	US	i7-7700	Intel HD 630	None	8GBx1	21.5" FHD (1920x1080) WVA AG	None	150W 85% Adapter	256GB SSD M.2 PCIe NVMe	DVD±RW	9-in-1	None	8265 ac, 2x2 + BT4.1	None	1080p	None	None	USB / USB	UltraFlex II Stand	Win10 Pro 64	3-year, Onsite	Apr 7, 2023	03/17
10NY000CUS	US	i5-7500	Intel HD 630	None	4GBx1	21.5" FHD (1920x1080) WVA AG	None	150W 85% Adapter	500GB 7200rpm 2.5" DVD±RW	DVD±RW	9-in-1	None	8265 ac, 2x2 + BT4.1	None	1080p	None	None	USB / USB	UltraFlex II Stand	Win10 Pro 64	3-year, Onsite	Apr 7, 2023	03/17
10NY000QUS	US	Pentium G4400	Intel HD 510	None	4GBx1	21.5" FHD (1920x1080) WVA AG	None	150W 85% Adapter	500GB 7200rpm 2.5" DVD±RW	DVD±RW	9-in-1	None	8265 ac, 2x2 + BT4.1	None	1080p	None	None	USB / USB	UltraFlex II Stand	Win10 DG Win7 Pro 64	3-year, Onsite	Apr 29, 2023	03/17
10NY000RUS	US	i5-6500	Intel HD 530	None	4GBx1	21.5" FHD (1920x1080) WVA AG	None	150W 85% Adapter	500GB 7200rpm 2.5" DVD±RW	DVD±RW	9-in-1	None	8265 ac, 2x2 + BT4.1	None	1080p	None	None	USB / USB	UltraFlex II Stand	Win10 DG Win7 Pro 64	3-year, Onsite	Apr 29, 2023	03/17
10NY000SUS	US	i5-7400	Intel HD 630	None	4GBx1	21.5" FHD (1920x1080) WVA AG	None	150W 85% Adapter	128GB SSD M.2 PCIe NVMe	DVD±RW	9-in-1	None	8265 ac, 2x2 + BT4.1	None	1080p	None	None	USB / USB	UltraFlex II Stand	Win10 Pro 64	3-year, Onsite	May 7, 2023	04/17
10NY000TUS	US	i5-6500	Intel HD 530	None	4GBx1	21.5" FHD (1920x1080) WVA AG	None	150W 85% Adapter	128GB SSD M.2 PCIe NVMe	DVD±RW	9-in-1	None	8265 ac, 2x2 + BT4.1	None	1080p	None	None	USB / USB	UltraFlex II Stand	Win10 DG Win7 Pro 64	3-year, Onsite	Apr 29, 2023	03/17
10NY000UUS	US	i7-6700	Intel HD 530	None	8GBx1	21.5" FHD (1920x1080) WVA AG	None	150W 85% Adapter	512GB SSD M.2 PCIe NVMe	DVD±RW	9-in-1	None	8265 ac, 2x2 + BT4.1	None	1080p	None	None	USB / USB	UltraFlex II Stand	Win10 DG Win7 Pro 64	3-year, Onsite	Apr 29, 2023	03/17
10NY000VUS	US	i7-6700	Intel HD 530	None	8GBx1	21.5" FHD (1920x1080) WVA AG	None	150W 85% Adapter	500GB 7200rpm 2.5" DVD±RW	DVD±RW	9-in-1	None	8265 ac, 2x2 + BT4.1	None	1080p	None	None	USB / USB	UltraFlex II Stand	Win10 DG Win7 Pro 64	3-year, Onsite	Apr 29, 2023	03/17
10NY000WUS	US	i7-6700	Intel HD 530	None	8GBx1	21.5" FHD (1920x1080) WVA AG	None	150W 85% Adapter	256GB SSD M.2 PCIe NVMe	DVD±RW	9-in-1	None	8265 ac, 2x2 + BT4.1	None	1080p	None	None	USB / USB	UltraFlex II Stand	Win10 DG Win7 Pro 64	3-year, Onsite	Apr 29, 2023	03/17
10NY000XUS	US	i5-6500	Intel HD 530	None	8GBx1	21.5" FHD (1920x1080) WVA AG	None	150W 85% Adapter	256GB SSD M.2 PCIe NVMe	DVD±RW	9-in-1	None	8265 ac, 2x2 + BT4.1	None	1080p	None	None	USB / USB	UltraFlex II Stand	Win10 DG Win7 Pro 64	3-year, Onsite	Apr 29, 2023	03/17
10NY000YUS	US	i3-6100	Intel HD 530	None	4GBx1	21.5" FHD (1920x1080) WVA AG	None	150W 85% Adapter	500GB 7200rpm 2.5" DVD±RW	DVD±RW	9-in-1	None	8265 ac, 2x2 + BT4.1	None	1080p	None	None	USB / USB	UltraFlex II Stand	Win10 DG Win7 Pro 64	3-year, Onsite	Apr 29, 2023	03/17
10NY0010US	US	i3-6100	Intel HD 530	None	8GBx1	21.5" FHD (1920x1080) WVA AG	None	150W 85% Adapter	500GB 7200rpm 2.5" DVD±RW	DVD±RW	9-in-1	None	8265 ac, 2x2 + BT4.1	None	1080p	None	None	USB / USB	UltraFlex II Stand	Win10 DG Win7 Pro 64	3-year, Onsite	Apr 29, 2023	03/17

Model	Region	Processor	Graphics	Monitor Cable	Memory	Display	Multi-touch	Power Supply	Storage(HDD/SSD)	Optical	Media Reader	USB Type-C	WLAN + Bluetooth	Optional Rear Ports	Camera	Chassis Intrusion Switch	Cable Lock	Keyboard / Mouse	Stand	Operating System	Warranty	End of Support	Ann Date (m/y)
10NY0011US	US	i5-7500	Intel HD 630	None	4GBx1	21.5" FHD (1920x1080) WVA AG	None	150W 85% Adapter	128GB SSD M.2 PCIe NVMe	DVD±RW	9-in-1	None	8265 ac, 2x2 + BT4.1	None	1080p	None	None	USB / USB	UltraFlex II Stand	Win10 Pro 64	3-year, Onsite	May 7, 2023	04/17
10NY0012US	US	i5-6500	Intel HD 530	None	8GBx1	21.5" FHD (1920x1080) WVA AG	None	150W 85% Adapter	500GB 7200rpm 2.5" PCIe NVMe	DVD±RW	9-in-1	None	8265 ac, 2x2 + BT4.1	None	1080p	None	None	USB / USB	UltraFlex II Stand	Win10 DG Win7 Pro 64	3-year, Onsite	Apr 29, 2023	03/17
10NY0013US	US	Pentium G4560	Intel HD 610	None	4GBx1	21.5" FHD (1920x1080) WVA AG	None	150W 85% Adapter	500GB 7200rpm 2.5" PCIe NVMe	DVD±RW	9-in-1	None	8265 ac, 2x2 + BT4.1	None	1080p	None	None	USB / USB	UltraFlex II Stand	Win10 Pro 64	3-year, Onsite	May 7, 2023	04/17
10NY0014US	US	i3-7100	Intel HD 630	None	8GBx1	21.5" FHD (1920x1080) WVA AG	None	150W 85% Adapter	500GB 7200rpm 2.5" PCIe NVMe	DVD±RW	9-in-1	None	8265 ac, 2x2 + BT4.1	None	1080p	None	None	USB / USB	UltraFlex II Stand	Win10 Pro 64	3-year, Onsite	May 7, 2023	04/17
10NY0015US	US	i3-7100	Intel HD 630	None	4GBx1	21.5" FHD (1920x1080) WVA AG	None	150W 85% Adapter	500GB 7200rpm 2.5" PCIe NVMe	DVD±RW	9-in-1	None	8265 ac, 2x2 + BT4.1	None	1080p	None	None	USB / USB	UltraFlex II Stand	Win10 Pro 64	3-year, Onsite	May 7, 2023	04/17

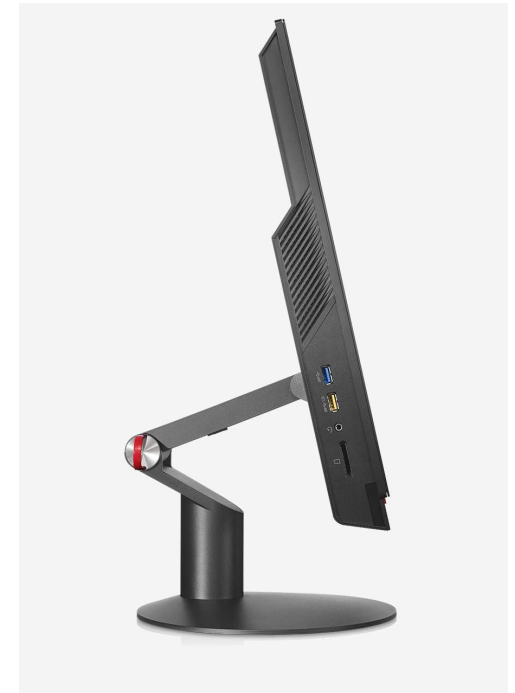
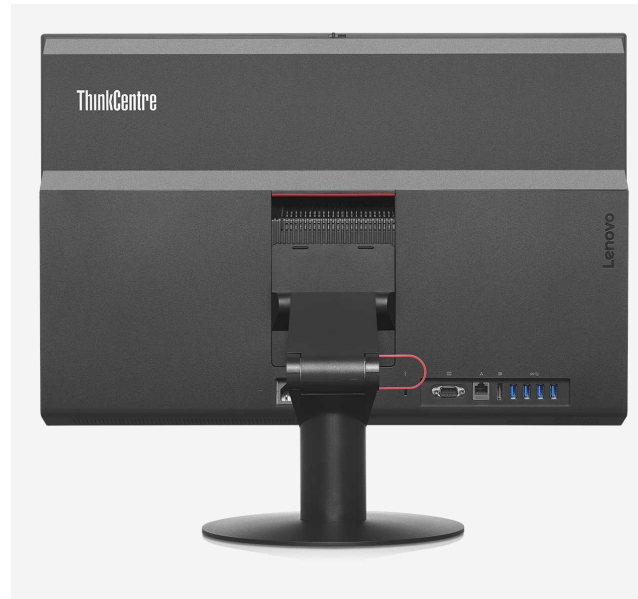



# ThinkCentre M900z Platform Specifications

Product Specifications Reference (PSREF)

Processor	Intel® Celeron®, Intel Pentium®, or 6th Generation Intel Core™ i3 / i5 / i7 Processor	Security chip	Trusted Platform Module (TPM 1.2-compliant)																																																															
	<table border="1"> <thead> <tr> <th>Processor</th> <th>Cores / Threads</th> <th>Frequency Base/Max(GHz)</th> <th>Cache</th> <th>Memory Types</th> <th>Integrated Graphics</th> <th>Intel vPro</th> </tr> </thead> <tbody> <tr> <td>Pentium G4400</td> <td>2 / 2</td> <td>3.3G</td> <td>3 MB</td> <td>DDR4-2133</td> <td>HD 510</td> <td>No</td> </tr> <tr> <td>Pentium G4500</td> <td>2 / 2</td> <td>3.5G</td> <td>3 MB</td> <td>DDR4-2133</td> <td>HD 530</td> <td>No</td> </tr> <tr> <td>Core i3-6100</td> <td>2 / 4</td> <td>3.7 G</td> <td>3 MB</td> <td>DDR4-2133</td> <td>HD 530</td> <td>No</td> </tr> <tr> <td>Core i3-6300</td> <td>2 / 4</td> <td>3.8 G</td> <td>4 MB</td> <td>DDR4-2133</td> <td>HD 530</td> <td>No</td> </tr> <tr> <td>Core i5-6400</td> <td>4 / 4</td> <td>2.7 G / 3.3 G</td> <td>6 MB</td> <td>DDR4-2133</td> <td>HD 530</td> <td>No</td> </tr> <tr> <td>Core i5-6500</td> <td>4 / 4</td> <td>3.2 G / 3.6 G</td> <td>6 MB</td> <td>DDR4-2133</td> <td>HD 530</td> <td>vPro</td> </tr> <tr> <td>Core i5-6600</td> <td>4 / 4</td> <td>3.3 G / 3.9 G</td> <td>6 MB</td> <td>DDR4-2133</td> <td>HD 530</td> <td>vPro</td> </tr> <tr> <td>Core i7-6700</td> <td>4 / 8</td> <td>3.4 G / 4.0 G</td> <td>8 MB</td> <td>DDR4-2133</td> <td>HD 530</td> <td>vPro</td> </tr> </tbody> </table>	Processor	Cores / Threads	Frequency Base/Max(GHz)	Cache	Memory Types	Integrated Graphics	Intel vPro	Pentium G4400	2 / 2	3.3G	3 MB	DDR4-2133	HD 510	No	Pentium G4500	2 / 2	3.5G	3 MB	DDR4-2133	HD 530	No	Core i3-6100	2 / 4	3.7 G	3 MB	DDR4-2133	HD 530	No	Core i3-6300	2 / 4	3.8 G	4 MB	DDR4-2133	HD 530	No	Core i5-6400	4 / 4	2.7 G / 3.3 G	6 MB	DDR4-2133	HD 530	No	Core i5-6500	4 / 4	3.2 G / 3.6 G	6 MB	DDR4-2133	HD 530	vPro	Core i5-6600	4 / 4	3.3 G / 3.9 G	6 MB	DDR4-2133	HD 530	vPro	Core i7-6700	4 / 8	3.4 G / 4.0 G	8 MB	DDR4-2133	HD 530	vPro	Security features	<ul style="list-style-type: none"> <li>Security slot (in rear for attachment of Kensington lock also locks chassis)</li> <li>Smart USB protection, allows keyboard/mouse only, blocks all storage devices</li> <li>Power-on, admin, hard disk password</li> <li>Boot sequence control</li> <li>Boot without keyboard and mouse</li> <li>Individual USB port disablement</li> <li>Optional Chassis intrusion switch</li> </ul>
Processor	Cores / Threads	Frequency Base/Max(GHz)	Cache	Memory Types	Integrated Graphics	Intel vPro																																																												
Pentium G4400	2 / 2	3.3G	3 MB	DDR4-2133	HD 510	No																																																												
Pentium G4500	2 / 2	3.5G	3 MB	DDR4-2133	HD 530	No																																																												
Core i3-6100	2 / 4	3.7 G	3 MB	DDR4-2133	HD 530	No																																																												
Core i3-6300	2 / 4	3.8 G	4 MB	DDR4-2133	HD 530	No																																																												
Core i5-6400	4 / 4	2.7 G / 3.3 G	6 MB	DDR4-2133	HD 530	No																																																												
Core i5-6500	4 / 4	3.2 G / 3.6 G	6 MB	DDR4-2133	HD 530	vPro																																																												
Core i5-6600	4 / 4	3.3 G / 3.9 G	6 MB	DDR4-2133	HD 530	vPro																																																												
Core i7-6700	4 / 8	3.4 G / 4.0 G	8 MB	DDR4-2133	HD 530	vPro																																																												
Memory	32GB max, DDR4 2133, two 260-pin SO-DIMM sockets, dual-channel capable	Keyboard	<i>Some:</i> Preferred Pro USB Keyboard (USB connector), Lenovo logo <i>Some:</i> Lenovo Slim USB Keyboard (USB connector), black <i>Some:</i> Ultralim Plus Wireless Keyboard (2.4GHz via USB receiver), black																																																															
Disk	<i>Some:</i> SATA 6.0Gb/s, 2.5" Wide, 5400 rpm or 7200 rpm <i>Some:</i> Solid State Hybrid Drive (SSHD) / with 8GB MLC NAND flash memory, SATA 6.0Gb/s, 2.5" Wide, 5400 rpm <i>Some:</i> Solid State Drive (SSD) / SATA 6.0Gb/s, 2.5" Wide	Mouse	<i>Some:</i> Enhanced Optical USB Mouse, black, Lenovo logo <i>Some:</i> Ultralim Plus Wireless Mouse (2.4GHz via USB receiver), black																																																															
Optical	<i>Some:</i> DVD, SATA 1.5Gb/s, 9.5mm high <i>Some:</i> DVD burner, SATA 1.5Gb/s, 9.5mm high	Mechanical	<ul style="list-style-type: none"> <li>Business black color</li> <li>Toolless back cover, stand, disk, memory removal</li> <li>Support VESA mount (100mm)</li> </ul>																																																															
Media reader	Optional 9-in-1 media card reader		<table border="1"> <thead> <tr> <th></th> <th>Dimensions (WxDxH)</th> <th>Max weight (lb / kg)</th> <th>Adjustments</th> </tr> </thead> <tbody> <tr> <td>Without stand:</td> <td>23.0 X 1.8 X 15.4 (inch); 584 X 45 X 390 (mm)</td> <td>(Touch) 17.2 / 7.8 (Non-touch) 15.0 / 6.8</td> <td>N/A</td> </tr> <tr> <td>With Basic Monitor stand:</td> <td>23.0 X 9.6 X 18.0 (inch); 584 X 245 X 458 (mm)</td> <td>(Non-touch) 19.4 / 8.8</td> <td>Tilt: 45° back, -5° forward</td> </tr> <tr> <td>With UltraFlex II stand:</td> <td>23.0X 10.0 X 19.9 (inch); 584 X 253 X 505 (mm)</td> <td>(Touch) 22.7 / 10.3 (Non-touch) 20.7 / 9.4</td> <td>Tilt: 61° back, -5° forward; Lift: 160mm; Swivel: +/-45°</td> </tr> </tbody> </table>		Dimensions (WxDxH)	Max weight (lb / kg)	Adjustments	Without stand:	23.0 X 1.8 X 15.4 (inch); 584 X 45 X 390 (mm)	(Touch) 17.2 / 7.8 (Non-touch) 15.0 / 6.8	N/A	With Basic Monitor stand:	23.0 X 9.6 X 18.0 (inch); 584 X 245 X 458 (mm)	(Non-touch) 19.4 / 8.8	Tilt: 45° back, -5° forward	With UltraFlex II stand:	23.0X 10.0 X 19.9 (inch); 584 X 253 X 505 (mm)	(Touch) 22.7 / 10.3 (Non-touch) 20.7 / 9.4	Tilt: 61° back, -5° forward; Lift: 160mm; Swivel: +/-45°																																															
	Dimensions (WxDxH)	Max weight (lb / kg)	Adjustments																																																															
Without stand:	23.0 X 1.8 X 15.4 (inch); 584 X 45 X 390 (mm)	(Touch) 17.2 / 7.8 (Non-touch) 15.0 / 6.8	N/A																																																															
With Basic Monitor stand:	23.0 X 9.6 X 18.0 (inch); 584 X 245 X 458 (mm)	(Non-touch) 19.4 / 8.8	Tilt: 45° back, -5° forward																																																															
With UltraFlex II stand:	23.0X 10.0 X 19.9 (inch); 584 X 253 X 505 (mm)	(Touch) 22.7 / 10.3 (Non-touch) 20.7 / 9.4	Tilt: 61° back, -5° forward; Lift: 160mm; Swivel: +/-45°																																																															
Graphics	<b>Intel HD Graphics 510/530</b> in processor, uses main memory, DirectX® 12, external monitor support via DisplayPort™; <i>Max resolution:</i> 4096x2304 (DP)@60Hz	Power supply	150 watts, autosensing, 85% PSU																																																															
Display	<b>23.8"</b> (604.5mm) <b>Full HD 1080p (1920x1080) TFT color</b> , WVA panel, wide viewing angle (+/- 89°), LED backlight, 250 nits, 16:9 aspect ratio, 1000:1 contrast ratio, anti-glare for both touch models and non-touch models, work as standalone monitor via DisplayPort (DP in / out combo)	Limited warranty <sup>3</sup>	<i>Some:</i> <b>1-year or 3-year, depot repair service</b> <i>Some:</i> <b>1-year or 3-year, limited onsite service</b> <i>Some:</i> <b>3-years, limited onsite service, OID</b> (Onsite International Delivery) / <i>For Lenovo service upgrade options, please go to S-TC sheet</i>																																																															
Light sensor	None	Preload	<b>Preloaded operating system</b> <i>Some:</i> Windows® 7 Professional 32/64 preinstalled through downgrade rights in Windows 10 Pro 64-bit <i>Some:</i> Windows 7 Professional 64 <i>Some:</i> Windows 10 Pro 64-bit <i>Some:</i> Windows 10 Home 64-bit																																																															
Multi-touch	Optional Projected Capacitive Touch (PCT) technology, supports 10-point touch		<b>Preloaded applications (only some listed)</b> <ul style="list-style-type: none"> <li>Desktop Power Manager</li> <li>Lenovo Solution Center</li> <li>Lenovo REACHit</li> <li>Lenovo SHAREit</li> <li>Lenovo Bluetooth Lock (for models with Wi-Fi/BT card)</li> <li>McAfee® LiveSafe™ (30-day trial)</li> <li>Microsoft Office preloaded; purchase a product key to activate</li> <li>PowerDVD Create (DVD±RW)</li> <li>Lenovo ThinkVantage Tools</li> <li>- Only for Window 10</li> <li>Lenovo Companion</li> <li>Cyberlink PowerDVD (DVD, DVD±RW)</li> <li>Lenovo QuickOptimizer</li> <li>- Only for Window 7</li> <li>Rescue and Recovery</li> <li>Password Manager</li> <li>ThinkVantage System Update</li> <li>Lenovo Message Center Plus</li> <li>Adobe® Reader®</li> </ul>																																																															
Camera	Optional 2.0-megapixel camera, fixed focus, supports 1080p, with dual array digital microphone, LED indicator, physical switch on/off, Skype for Business certified	Environment	EPEAT™ Gold rating; ENERGY STAR® 6.1; TCO Certified Edge; TUV Green Mark; ULE Gold; ErP Lot 3; GREENGUARD® certified; RoHS-compliant																																																															
Controls	Microphone mute, monitor mode switch, brightness up/down buttons, and power button	MIL-SPEC test	MIL-STD-810G military certification (Low Pressure [Altitude], High Temperature, Low Temperature, Temperature Shock, Humidity, Sand and Dust, Vibration, Shock)																																																															
Chipset	<b>Intel Q170 Chipset</b>	Accessories	For compatible accessories, please go to TC-AQP sheet																																																															
Rear ports	Four USB 3.0, ethernet (RJ-45), DisplayPort in/out combo port, optional serial (9-pin),																																																																	
Side ports	Two USB 3.0 (one is Always On and fast charge), optional card reader, one headphone / microphone combo jack (3.5mm)																																																																	
M.2 card slot	One M.2 Card slot (for WLAN)																																																																	
Audio support	High Definition (HD) Audio, Realtek ALC286 / two internal stereo speakers (3W x 2), Dolby® Audio™ certified, Skype for Business certified																																																																	
WLAN <sup>13</sup>	<i>Some:</i> 11ac wireless, M.2 Card, Qualcomm Atheros QCA9377 (dual band), Wi-Fi + Bluetooth 4.1 combo adapter, 1x1 <i>Some:</i> 11ac wireless, M.2 Card, Qualcomm Atheros QCA6174 (dual band), Wi-Fi + Bluetooth 4.1 combo adapter, 2x2 <i>Some:</i> 11ac wireless, M.2 Card, Intel Dual Band Wireless-AC 3165, Wi-Fi + Bluetooth 4.0 combo adapter, 1x1 <i>Some:</i> 11ac wireless, M.2 Card, Intel Dual Band Wireless-AC 8260, Wi-Fi + Bluetooth 4.1 combo adapter, 2x2 <i>Some:</i> 11ac wireless, M.2 Card, Intel Dual Band Wireless-AC 8260, Wi-Fi + Bluetooth 4.1 combo adapter, Intel vPro technology support, 2x2																																																																	
Bluetooth™	<i>Some:</i> Bluetooth 4.0 or 4.1 wireless, integrated in Wi-Fi + Bluetooth combo adapter																																																																	
Ethernet	Gigabit ethernet, Intel Ethernet Connection I219-LM (Jacksonville), Wake on LAN®																																																																	
Manageability	Intel Active Management Technology 11.0 (Intel AMT 11.0); Intel vPro technology on some models (require choosing a vPro-support Wi-Fi adapter to enable vPro function through wireless connection)																																																																	

See footnotes for more detailed information

Model	Region	Processor	vPro	Graphics	Monitor Cable	Memory	Display	Multi-touch	Storage(HDD/SSD)	Optical	Media Reader	WLAN + Bluetooth	Optional Rear Ports	Camera	Chassis Intrusion Switch	Keyboard / Mouse	Stand	Power Supply	Operating System	Warranty	Ann Date (m/y)
10F20005US	US	i7-6700	vPro	Intel HD 530	None	8GBx1	23.8" FHD (1920x1080) WVA AG	10-point Multi-touch	500GB 7200rpm 2.5"	DVD±RW	9-in-1	8260 ac, 2x2, vPro + BT4.1	None	1080p	Switch	USB / USB	UltraFlex II Stand	150W 85% Adapter	Win10 DG Win7 Pro 64	3-year, Onsite	11/15
10F20006US	US	i5-6500	vPro	Intel HD 530	None	8GBx1	23.8" FHD (1920x1080) WVA AG	10-point Multi-touch	500GB 7200rpm 2.5"	DVD±RW	9-in-1	8260 ac, 2x2, vPro + BT4.1	None	1080p	None	USB / USB	UltraFlex II Stand	150W 85% Adapter	Win10 DG Win7 Pro 64	3-year, Onsite	11/15
10F20008US	US	i5-6500	vPro	Intel HD 530	None	4GBx1	23.8" FHD (1920x1080) WVA AG	10-point Multi-touch	500GB 7200rpm 2.5"	DVD±RW	9-in-1	8260 ac, 2x2, vPro + BT4.1	None	1080p	None	USB / USB	UltraFlex II Stand	150W 85% Adapter	Win10 DG Win7 Pro 64	3-year, Onsite	11/15
10F20009US	US	i7-6700	vPro	Intel HD 530	None	4GBx1	23.8" FHD (1920x1080) WVA AG	10-point Multi-touch	500GB 7200rpm 2.5"	DVD±RW	9-in-1	8260 ac, 2x2, vPro + BT4.1	None	1080p	Switch	USB / USB	UltraFlex II Stand	150W 85% Adapter	Win10 DG Win7 Pro 64	3-year, Onsite	11/15
10F2000AUS	US	i5-6600	vPro	Intel HD 530	None	4GBx1	23.8" FHD (1920x1080) WVA AG	10-point Multi-touch	500GB 7200rpm 2.5"	DVD±RW	9-in-1	8260 ac, 2x2, vPro + BT4.1	None	1080p	None	USB / USB	UltraFlex II Stand	150W 85% Adapter	Win10 DG Win7 Pro 32	3-year, Onsite	11/15
10F2000YUS	US	i5-6500	vPro	Intel HD 530	None	4GBx1	23.8" FHD (1920x1080) WVA AG	10-point Multi-touch	500GB 7200rpm 2.5"	DVD±RW	9-in-1	8260 ac, 2x2, vPro + BT4.1	None	1080p	None	USB / USB	UltraFlex II Stand	150W 85% Adapter	Win10 Pro 64	3-year, Onsite	11/15
10F20010US	US	i7-6700	vPro	Intel HD 530	None	4GBx1	23.8" FHD (1920x1080) WVA AG	10-point Multi-touch	500GB 7200rpm 2.5"	DVD±RW	9-in-1	8260 ac, 2x2, vPro + BT4.1	None	1080p	None	USB / USB	UltraFlex II Stand	150W 85% Adapter	Win10 Pro 64	3-year, Onsite	11/15
10F2001BUS	US	i7-6700	vPro	Intel HD 530	None	4GBx2	23.8" FHD (1920x1080) WVA AG	10-point Multi-touch	128GB SSD	DVD±RW	9-in-1	8260 ac, 2x2, vPro + BT4.1	None	1080p	None	USB / USB	UltraFlex II Stand	150W 85% Adapter	Win10 Pro 64	1-year, Onsite	11/15
10F20022US	US	i5-6500	vPro	Intel HD 530	None	4GBx1	23.8" FHD (1920x1080) WVA AG	10-point Multi-touch	128GB SSD	DVD±RW	9-in-1	8260 ac, 2x2, vPro + BT4.1	None	1080p	None	USB / USB	UltraFlex II Stand	150W 85% Adapter	Win10 DG Win7 Pro 64	3-year, Onsite	03/16
10F20023US	US	i7-6700	vPro	Intel HD 530	None	4GBx1	23.8" FHD (1920x1080) WVA AG	10-point Multi-touch	128GB SSD	DVD±RW	9-in-1	8260 ac, 2x2, vPro + BT4.1	None	1080p	None	USB / USB	UltraFlex II Stand	150W 85% Adapter	Win10 Pro 64	3-year, Onsite	03/16
10F20024US	US	i7-6700	vPro	Intel HD 530	None	8GBx1	23.8" FHD (1920x1080) WVA AG	10-point Multi-touch	256GB SSD	DVD±RW	9-in-1	8260 ac, 2x2, vPro + BT4.1	None	1080p	None	USB / USB	UltraFlex II Stand	150W 85% Adapter	Win10 DG Win7 Pro 64	3-year, Onsite	03/16
10F20025US	US	i5-6500	vPro	Intel HD 530	None	4GBx1	23.8" FHD (1920x1080) WVA AG	10-point Multi-touch	128GB SSD	DVD±RW	9-in-1	8260 ac, 2x2, vPro + BT4.1	None	1080p	None	USB / USB	UltraFlex II Stand	150W 85% Adapter	Win10 Pro 64	3-year, Onsite	03/16
10F20026US	US	i7-6700	vPro	Intel HD 530	None	4GBx1	23.8" FHD (1920x1080) WVA AG	10-point Multi-touch	128GB SSD	DVD±RW	9-in-1	8260 ac, 2x2, vPro + BT4.1	None	1080p	None	USB / USB	UltraFlex II Stand	150W 85% Adapter	Win10 DG Win7 Pro 64	3-year, Onsite	03/16
10F20027US	US	i5-6500	vPro	Intel HD 530	None	8GBx1	23.8" FHD (1920x1080) WVA AG	10-point Multi-touch	256GB SSD	DVD±RW	9-in-1	8260 ac, 2x2, vPro + BT4.1	None	1080p	None	USB / USB	UltraFlex II Stand	150W 85% Adapter	Win10 Pro 64	3-year, Onsite	03/16
10F20028US	US	i5-6500	vPro	Intel HD 530	None	8GBx1	23.8" FHD (1920x1080) WVA AG	10-point Multi-touch	256GB SSD	DVD±RW	9-in-1	8260 ac, 2x2, vPro + BT4.1	None	1080p	None	USB / USB	UltraFlex II Stand	150W 85% Adapter	Win10 DG Win7 Pro 64	3-year, Onsite	03/16
10F20029US	US	i7-6700	vPro	Intel HD 530	None	8GBx1	23.8" FHD (1920x1080) WVA AG	10-point Multi-touch	256GB SSD	DVD±RW	9-in-1	8260 ac, 2x2, vPro + BT4.1	None	1080p	None	USB / USB	UltraFlex II Stand	150W 85% Adapter	Win10 Pro 64	3-year, Onsite	03/16
10F2002PUS	US	i7-6700	vPro	Intel HD 530	None	8GBx1	23.8" FHD (1920x1080) WVA AG	10-point Multi-touch	256GB SSD Opal	DVD±RW	9-in-1	8260 ac, 2x2, vPro + BT4.1	None	1080p	None	USB / USB	UltraFlex II Stand	150W 85% Adapter	Win10 DG Win7 Pro 64	3-year, Onsite	12/16
10F2002QUS	US	i5-6500	vPro	Intel HD 530	None	8GBx1	23.8" FHD (1920x1080) WVA AG	10-point Multi-touch	256GB SSD Opal	DVD±RW	9-in-1	8260 ac, 2x2, vPro + BT4.1	None	1080p	None	USB / USB	UltraFlex II Stand	150W 85% Adapter	Win10 Pro 64	3-year, Onsite	12/16
10F2002RUS	US	i5-6500	vPro	Intel HD 530	None	8GBx1	23.8" FHD (1920x1080) WVA AG	10-point Multi-touch	256GB SSD Opal	DVD±RW	9-in-1	8260 ac, 2x2, vPro + BT4.1	None	1080p	None	USB / USB	UltraFlex II Stand	150W 85% Adapter	Win10 DG Win7 Pro 64	3-year, Onsite	12/16
10F2002SUS	US	i7-6700	vPro	Intel HD 530	None	8GBx1	23.8" FHD (1920x1080) WVA AG	10-point Multi-touch	256GB SSD Opal	DVD±RW	9-in-1	8260 ac, 2x2, vPro + BT4.1	None	1080p	None	USB / USB	UltraFlex II Stand	150W 85% Adapter	Win10 Pro 64	3-year, Onsite	12/16



Model	Region	Processor	vPro	Graphics	Monitor Cable	Memory	Display	Multi-touch	Storage(HDD/SSD)	Optical	Media Reader	WLAN + Bluetooth	Optional Rear Ports	Camera	Chassis Intrusion Switch	Keyboard / Mouse	Stand	Power Supply	Operating System	Warranty	Ann Date (m/y)
10F30005US	US	i5-6500	vPro	Intel HD 530	None	4GBx1	23.8" FHD (1920x1080) WVA AG	None	500GB 7200rpm 2.5"	DVD±RW	9-in-1	8260 ac, 2x2, vPro + BT4.1	None	1080p	None	USB / USB	UltraFlex II Stand	150W 85% Adapter	Win10 DG Win7 Pro 64	3-year, Onsite	11/15
10F30006US	US	i5-6500	vPro	Intel HD 530	None	8GBx1	23.8" FHD (1920x1080) WVA AG	None	500GB 7200rpm 2.5"	DVD±RW	9-in-1	8260 ac, 2x2, vPro + BT4.1	None	1080p	None	USB / USB	UltraFlex II Stand	150W 85% Adapter	Win10 DG Win7 Pro 64	3-year, Onsite	11/15
10F30009US	US	i5-6500	vPro	Intel HD 530	None	4GBx1	23.8" FHD (1920x1080) WVA AG	None	500GB 7200rpm 2.5"	DVD±RW	9-in-1	8260 ac, 2x2, vPro + BT4.1	None	1080p	None	USB / USB	UltraFlex II Stand	150W 85% Adapter	Win10 Pro 64	3-year, Onsite	11/15
10F3000AUS	US	i7-6700	vPro	Intel HD 530	None	4GBx1	23.8" FHD (1920x1080) WVA AG	None	500GB 7200rpm 2.5"	DVD±RW	9-in-1	8260 ac, 2x2, vPro + BT4.1	None	1080p	None	USB / USB	UltraFlex II Stand	150W 85% Adapter	Win10 Pro 64	3-year, Onsite	11/15
10F3001FUS	US	i7-6700	vPro	Intel HD 530	None	4GBx1	23.8" FHD (1920x1080) WVA AG	None	128GB SSD	DVD±RW	9-in-1	8260 ac, 2x2, vPro + BT4.1	None	1080p	None	USB / USB	UltraFlex II Stand	150W 85% Adapter	Win10 Pro 64	3-year, Onsite	05/16
10F3001GUS	US	i5-6500	vPro	Intel HD 530	None	4GBx1	23.8" FHD (1920x1080) WVA AG	None	128GB SSD	DVD±RW	9-in-1	8260 ac, 2x2, vPro + BT4.1	None	1080p	None	USB / USB	UltraFlex II Stand	150W 85% Adapter	Win10 Pro 64	3-year, Onsite	05/16
10F3001HUS	US	i7-6700	vPro	Intel HD 530	None	8GBx1	23.8" FHD (1920x1080) WVA AG	None	256GB SSD	DVD±RW	9-in-1	8260 ac, 2x2, vPro + BT4.1	None	1080p	None	USB / USB	UltraFlex II Stand	150W 85% Adapter	Win10 Pro 64	3-year, Onsite	05/16
10F3001JUS	US	i5-6500	vPro	Intel HD 530	None	8GBx1	23.8" FHD (1920x1080) WVA AG	None	256GB SSD	DVD±RW	9-in-1	8260 ac, 2x2, vPro + BT4.1	None	1080p	None	USB / USB	UltraFlex II Stand	150W 85% Adapter	Win10 Pro 64	3-year, Onsite	05/16
10F30023US	US	i7-6700	vPro	Intel HD 530	None	8GBx1	23.8" FHD (1920x1080) WVA AG	None	256GB SSD Opal	DVD±RW	9-in-1	8260 ac, 2x2, vPro + BT4.1	None	1080p	None	USB / USB	UltraFlex II Stand	150W 85% Adapter	Win10 Pro 64	3-year, Onsite	12/16
10F30024US	US	i5-6500	vPro	Intel HD 530	None	8GBx1	23.8" FHD (1920x1080) WVA AG	None	256GB SSD Opal	DVD±RW	9-in-1	8260 ac, 2x2, vPro + BT4.1	None	1080p	None	USB / USB	UltraFlex II Stand	150W 85% Adapter	Win10 Pro 64	3-year, Onsite	12/16

Model	Region	Processor	vPro	Graphics	Monitor Cable	Memory	Display	Multi-touch	Storage(HDD/SSD)	Optical	Media Reader	WLAN + Bluetooth	Optional Rear Ports	Camera	Chassis Intrusion Switch	Keyboard / Mouse	Stand	Power Supply	Operating System	Warranty	Ann Date (m/y)
10F40013US	US	i7-6700	vPro	Intel HD 530	None	4GBx2	23.8" FHD (1920x1080) WVA AG	10-point Multi-touch	128GB SSD	DVD±RW	9-in-1	8260 ac, 2x2, vPro + BT4.1	None	1080p	Switch	2.4G / 2.4G	UltraFlex II Stand	150W 85% Adapter	Win10 Pro 64	3-year, Onsite, OID	11/15
10F40014US	US	i7-6700	vPro	Intel HD 530	None	4GBx2	23.8" FHD (1920x1080) WVA AG	10-point Multi-touch	128GB SSD	DVD±RW	9-in-1	8260 ac, 2x2, vPro + BT4.1	None	1080p	Switch	2.4G / 2.4G	UltraFlex II Stand	150W 85% Adapter	Win10 DG Win7 Pro 64	3-year, Onsite, OID	11/15

Model	Region	Processor	vPro	Graphics	Monitor Cable	Memory	Display	Multi-touch	Storage(HDD/SSD)	Optical	Media Reader	WLAN + Bluetooth	Optional Rear Ports	Camera	Chassis Intrusion Switch	Keyboard / Mouse	Stand	Power Supply	Operating System	Warranty	Ann Date (m/y)
10F5000XUS	US	i5-6500	vPro	Intel HD 530	None	4GBx1	23.8" FHD (1920x1080) WVA AG	None	1TB 5400rpm 2.5"	DVD±RW	9-in-1	8260 ac, 2x2, vPro + BT4.1	None	1080p	None	USB / USB	UltraFlex II Stand	150W 85% Adapter	Win10 Pro 64	3-year, Onsite, OID	11/15
10F5000YUS	US	i5-6500	vPro	Intel HD 530	None	4GBx1	23.8" FHD (1920x1080) WVA AG	None	1TB 5400rpm 2.5"	DVD±RW	9-in-1	8260 ac, 2x2, vPro + BT4.1	None	1080p	Switch	USB / USB	UltraFlex II Stand	150W 85% Adapter	Win10 DG Win7 Pro 64	3-year, Onsite, OID	11/15



# ThinkCentre M910z Platform Specifications

Product Specifications Reference (PSREF)

Processor	Intel® Celeron®, Intel Pentium®, or 6th / 7th Gen Intel Core™ i3 / i5 / i7 Processor						Security chip TPM (Trusted Platform Module) 2.0, TCG Certified * Downgrade to TPM1.2 for the models with Win10 DG Win7 32 OS																
	Processor	Cores / Threads	Frequency Base/Max(GHz)	Cache	Memory Support (Up to)	Integrated Graphics		Security features <ul style="list-style-type: none"> <li>Security slot (in rear for attachment of optional Kensington® MicroSaver® cable; Kensington lock also locks chassis)</li> <li>Smart USB protection, allows keyboard/mouse only, blocks all storage devices</li> <li>Optional cable lock to physically lock keyboard and mouse</li> </ul> <ul style="list-style-type: none"> <li>Power-on, admin, hard disk password</li> <li>Boot sequence control</li> <li>Boot without keyboard and mouse</li> <li>Individual USB port disablement</li> <li>Optional Chassis intrusion switch</li> </ul>															
	Core i5-6500	4 / 4	3.2G / 3.6G	6 MB	DDR4-2133	HD 530																	
	Core i7-6700	4 / 8	3.4G / 4.0G	8 MB	DDR4-2133	HD 530																	
	Core i5-7400	4 / 4	3.0G / 3.5G	6 MB	DDR4-2400	HD 630																	
	Core i5-7500	4 / 4	3.4G / 3.8G	6 MB	DDR4-2400	HD 630																	
	Core i5-7600	4 / 4	3.5G / 4.1G	6 MB	DDR4-2400	HD 630																	
Core i7-7700	4 / 8	3.6G / 4.2G	8 MB	DDR4-2400	HD 630																		
Memory	32GB max, DDR4-2400*, two 260-pin SO-DIMM sockets, dual-channel capable * System clocks down for the processors with lower memory controller						Keyboard <i>Some:</i> Lenovo Calliope Keyboard (USB connector), black <i>Some:</i> Lenovo Traditional Keyboard (USB connector), black <i>Some:</i> Lenovo Calliope Wireless Keyboard (2.4GHz via USB receiver), black																
Storage	<i>Some:</i> Hard Drive / SATA 6.0Gb/s, 2.5", 5400 rpm or 7200 rpm <i>Some:</i> Solid State Drive (SSD) / SATA 6.0Gb/s, 2.5" <i>Some:</i> M.2 Solid State Drive (SSD) / PCIe NVMe, PCIe 3.0 x 4, 32Gb/s <i>Some:</i> Intel Optane™ Memory Ready (models with 7th gen Core processor), M.2 <i>Some:</i> DVD-ROM SATA 1.5Gb/s Drive, slim (9.5mm) <i>Some:</i> DVD Burner (DVD±RW), SATA 1.5Gb/s Drive, slim (9.5mm) Optional 9-in-1 media card reader						Mouse <i>Some:</i> Lenovo Calliope Mouse (USB connector), black <i>Some:</i> Lenovo Calliope Wireless Mouse (2.4GHz via USB receiver), black																
Optical							Mechanical <ul style="list-style-type: none"> <li>Business black color</li> <li>Toolless back cover, stand, disk, memory removal</li> <li>Support VESA mount (100mm)</li> </ul> <table border="1"> <thead> <tr> <th></th> <th>Dimensions (WxDxH)</th> <th>Max weight (lb / kg)</th> <th>Adjustments</th> </tr> </thead> <tbody> <tr> <td>Without stand:</td> <td>23.0 X 1.8 X 15.4 (inch); 584 X 45 X 390 (mm)</td> <td>(Touch) 17.2 / 7.8 (Non-touch) 15.0 / 6.8</td> <td>N/A</td> </tr> <tr> <td>With Basic Monitor stand:</td> <td>23.0 X 9.6 X 18.0 (inch); 584 X 245 X 458 (mm)</td> <td>(Non-touch) 19.4 / 8.8</td> <td>Tilt: 45° back, -5° forward</td> </tr> <tr> <td>With UltraFlex II stand:</td> <td>23.0X 10.0 X 19.9 (inch); 584 X 253 X 505 (mm)</td> <td>(Touch) 22.7 / 10.3 (Non-touch) 20.7 / 9.4</td> <td>Tilt: 61° back, -5° forward; Lift: 110mm; Swivel: +/-45°</td> </tr> </tbody> </table>		Dimensions (WxDxH)	Max weight (lb / kg)	Adjustments	Without stand:	23.0 X 1.8 X 15.4 (inch); 584 X 45 X 390 (mm)	(Touch) 17.2 / 7.8 (Non-touch) 15.0 / 6.8	N/A	With Basic Monitor stand:	23.0 X 9.6 X 18.0 (inch); 584 X 245 X 458 (mm)	(Non-touch) 19.4 / 8.8	Tilt: 45° back, -5° forward	With UltraFlex II stand:	23.0X 10.0 X 19.9 (inch); 584 X 253 X 505 (mm)	(Touch) 22.7 / 10.3 (Non-touch) 20.7 / 9.4	Tilt: 61° back, -5° forward; Lift: 110mm; Swivel: +/-45°
	Dimensions (WxDxH)	Max weight (lb / kg)	Adjustments																				
Without stand:	23.0 X 1.8 X 15.4 (inch); 584 X 45 X 390 (mm)	(Touch) 17.2 / 7.8 (Non-touch) 15.0 / 6.8	N/A																				
With Basic Monitor stand:	23.0 X 9.6 X 18.0 (inch); 584 X 245 X 458 (mm)	(Non-touch) 19.4 / 8.8	Tilt: 45° back, -5° forward																				
With UltraFlex II stand:	23.0X 10.0 X 19.9 (inch); 584 X 253 X 505 (mm)	(Touch) 22.7 / 10.3 (Non-touch) 20.7 / 9.4	Tilt: 61° back, -5° forward; Lift: 110mm; Swivel: +/-45°																				
Media reader																							
Graphics	Intel HD Graphics 510/530/610/630 in processor, uses main memory, DirectX® 12, external monitor support via DisplayPort™; <i>Max resolution:</i> 4096x2304 (DP) @60Hz, 1920x1080 (Panel) @60Hz																						
Display	23.8" (604.5mm) Full HD 1080p (1920x1080) TFT color, WVA panel, wide viewing angle (+/- 89°), LED backlight, 250 nits, 16:9 aspect ratio, 1000:1 contrast ratio, anti-glare, support Low Blue Light Mode, work as standalone monitor via DisplayPort (DP in / out combo)																						
Multi-touch	Optional Projected Capacitive Touch (PCT) technology, supports 10-point touch																						
Camera	Optional 1080p camera, fixed focus, with dual microphone, LED indicator, physical switch on/off																						
Controls	Physical buttons for Microphone mute, monitor mode switch, brightness up/down, and power on/off																						
Chipset	Intel Q270 Chipset																						
Rear ports	Four USB 3.1 Gen1, ethernet (RJ-45), DisplayPort in/out combo port, optional serial (9-pin)																						
Side ports	Two USB 3.1 Gen1 (one is Always On and fast charge), optional card reader, one headphone / microphone combo jack (3.5mm), optional USB 3.1 Type-C Gen1																						
M.2 card slot	Two M.2 Card slots (one for WLAN, one for SSD/Optane)																						
Audio support	High Definition (HD) Audio, Realtek ALC233 / two internal speakers (3W x 2), Dolby® Audio™ certified																						
WLAN <sup>13</sup>	<i>Some:</i> 11ac wireless, M.2 Card, Qualcomm Atheros QCA9377A (dual band), Wi-Fi + Bluetooth 4.1 combo adapter, 1x1 <i>Some:</i> 11ac wireless, M.2 Card, Qualcomm Atheros QCA6174A (dual band), Wi-Fi + Bluetooth 4.1 combo adapter, 2x2 <i>Some:</i> 11ac wireless, M.2 Card, Intel Dual Band Wireless-AC 3165, Wi-Fi + Bluetooth 4.1 combo adapter, 1x1 <i>Some:</i> 11ac wireless, M.2 Card, Intel Dual Band Wireless-AC 8265, Wi-Fi + Bluetooth 4.1 combo adapter, 2x2 <i>Some:</i> 11ac wireless, M.2 Card, Intel Dual Band Wireless-AC 8265, Wi-Fi + Bluetooth 4.1 combo adapter, Intel vPro technology support, 2x2																						
Bluetooth™	<i>Some:</i> Bluetooth 4.1 wireless, integrated in Wi-Fi + Bluetooth combo adapter																						
Ethernet	Gigabit ethernet, Intel Ethernet Connection I219-LM (Jacksonville), Wake on LAN®																						
Manageability	Intel Active Management Technology 11.0 (Intel AMT 11.0); Intel vPro technology on some models (require choosing a vPro-support Wi-Fi adapter to enable vPro function through wireless connection)																						
Power supply	150 watts, autosensing, 85% PSU																						
Limited warranty <sup>3</sup>	<i>Some:</i> <b>1-year or 3-year, depot repair service</b> / service upgrades available <i>Some:</i> <b>1-year or 3-year, limited onsite service</b> / service upgrades available																						
Preload	<b>Preloaded operating system</b> <i>Some:</i> Windows® 7 Professional 32/64 preinstalled through downgrade rights in Windows 10 Pro 64-bit <i>Some:</i> Windows 10 Pro 64-bit <i>Some:</i> Windows 10 Home 64-bit			<b>Preloaded applications (only some listed)</b> <ul style="list-style-type: none"> <li>Microsoft Office preloaded; purchase a product key to activate</li> <li>Cyberlink PowerDVD Create (DVD±RW)</li> <li>- Only for Window 10</li> <li>Lenovo Companion</li> <li>Lenovo ID</li> <li>Lenovo Settings</li> <li>Cyberlink PowerDVD (DVD, DVD±RW)</li> <li>- Only for Window 7</li> <li>Lenovo Solution Center</li> <li>Lenovo ThinkVantage Tools</li> <li>ThinkVantage System Update</li> <li>Create Recovery Media</li> <li>Adobe® Reader®</li> </ul>																			
Environment	EPEAT™ Gold rating (North America); ENERGY STAR® 6.1; TCO AIO Computer Certified; ULE Gold; ErP Lot 3; GREENGUARD® certified; RoHS-compliant																						
MIL-SPEC test	MIL-STD-810G military certification (Low Pressure [Altitude], High Temperature, Low Temperature, Temperature Shock, Humidity, Sand and Dust, Vibration, Shock)																						
Accessories	For compatible accessories, please go to <a href="http://www.lenovoquickpick.com">http://www.lenovoquickpick.com</a>																						

See footnotes for more detailed information

© Lenovo  
(M910z-Spec) February 2017

Model	Region	Processor	vPro	Graphics	Monitor Cable	Memory	Display	Multi-touch	Power Supply	Storage(HDD/SSD)	Optical	Media Reader	USB Type-C	WLAN + Bluetooth	Optional Rear Ports	Camera	Chassis Intrusion Switch	Cable Lock	Keyboard / Mouse	Stand	Operating System	Warranty	End of Support	Ann Date (m/y)
10NR000HUS	US	i5-7500	vPro	Intel HD 630	None	8GBx1	23.8" FHD (1920x1080) WVA AG	10-point Multi-touch	150W 85% Adapter	256GB SSD M.2 PCIe NVMe Opal	DVD±RW	9-in-1	None	8265 ac, 2x2, vPro + BT4.1	None	1080p	None	None	USB / USB	UltraFlex II Stand	Win10 Pro 64	3-year, Onsite	Mar 28, 2023	02/17
10NR000KUS	US	i5-7500	vPro	Intel HD 630	None	8GBx1	23.8" FHD (1920x1080) WVA AG	10-point Multi-touch	150W 85% Adapter	512GB SSD M.2 PCIe NVMe Opal	DVD±RW	9-in-1	None	8265 ac, 2x2, vPro + BT4.1	None	1080p	None	None	USB / USB	UltraFlex II Stand	Win10 Pro 64	3-year, Onsite	Mar 28, 2023	02/17
10NR000LUS	US	i7-7700	vPro	Intel HD 630	None	8GBx1	23.8" FHD (1920x1080) WVA AG	10-point Multi-touch	150W 85% Adapter	256GB SSD M.2 PCIe NVMe Opal	DVD±RW	9-in-1	None	8265 ac, 2x2, vPro + BT4.1	None	1080p	None	None	USB / USB	UltraFlex II Stand	Win10 Pro 64	3-year, Onsite	Mar 28, 2023	02/17
10NR000MUS	US	i5-7500	vPro	Intel HD 630	None	8GBx1	23.8" FHD (1920x1080) WVA AG	10-point Multi-touch	150W 85% Adapter	500GB 7200rpm 2.5"	DVD±RW	9-in-1	None	8265 ac, 2x2, vPro + BT4.1	None	1080p	None	None	USB / USB	UltraFlex II Stand	Win10 Pro 64	3-year, Onsite	Mar 28, 2023	02/17
10NR000PUS	US	i7-7700	vPro	Intel HD 630	None	8GBx1	23.8" FHD (1920x1080) WVA AG	10-point Multi-touch	150W 85% Adapter	512GB SSD M.2 PCIe NVMe Opal	DVD±RW	9-in-1	None	8265 ac, 2x2, vPro + BT4.1	None	1080p	None	None	USB / USB	UltraFlex II Stand	Win10 Pro 64	3-year, Onsite	Mar 28, 2023	02/17
10NR000QUS	US	i7-7700	vPro	Intel HD 630	None	8GBx1	23.8" FHD (1920x1080) WVA AG	10-point Multi-touch	150W 85% Adapter	500GB 7200rpm 2.5"	DVD±RW	9-in-1	None	8265 ac, 2x2, vPro + BT4.1	None	1080p	None	None	USB / USB	UltraFlex II Stand	Win10 Pro 64	3-year, Onsite	Mar 28, 2023	02/17
10NR000RUS	US	i5-7500	vPro	Intel HD 630	None	4GBx1	23.8" FHD (1920x1080) WVA AG	10-point Multi-touch	150W 85% Adapter	500GB 7200rpm 2.5"	DVD±RW	9-in-1	None	8265 ac, 2x2, vPro + BT4.1	None	1080p	None	None	USB / USB	UltraFlex II Stand	Win10 Pro 64	3-year, Onsite	Mar 28, 2023	02/17
10NR0017US	US	i5-7500	vPro	Intel HD 630	None	4GBx1	23.8" FHD (1920x1080) WVA AG	10-point Multi-touch	150W 85% Adapter	128GB SSD M.2 PCIe NVMe	DVD±RW	9-in-1	None	8265 ac, 2x2, vPro + BT4.1	None	1080p	None	None	USB / USB	UltraFlex II Stand	Win10 Pro 64	3-year, Onsite	May 7, 2023	04/17
10NR0018US	US	i7-7700	vPro	Intel HD 630	None	8GBx1	23.8" FHD (1920x1080) WVA AG	10-point Multi-touch	150W 85% Adapter	128GB SSD M.2 PCIe NVMe	DVD±RW	9-in-1	None	8265 ac, 2x2, vPro + BT4.1	None	1080p	None	None	USB / USB	UltraFlex II Stand	Win10 Pro 64	3-year, Onsite	May 7, 2023	04/17

Model	Region	Processor	vPro	Graphics	Monitor Cable	Memory	Display	Multi-touch	Power Supply	Storage(HDD/SSD)	Optical	Media Reader	USB Type-C	WLAN + Bluetooth	Optional Rear Ports	Camera	Chassis Intrusion Switch	Cable Lock	Keyboard / Mouse	Stand	Operating System	Warranty	End of Support	Ann Date (m/y)
10NS0001US	US	i5-7500	vPro	Intel HD 630	None	4GBx1	23.8" FHD (1920x1080) WVA AG	None	150W 85% Adapter	500GB 7200rpm 2.5" DVD±RW	DVD±RW	9-in-1	None	8265 ac, 2x2, vPro + BT4.1	None	1080p	None	None	USB / USB	UltraFlex II Stand	Win10 Pro 64	3-year, Onsite	Mar 28, 2023	02/17
10NS0003US	US	i5-7500	vPro	Intel HD 630	None	8GBx1	23.8" FHD (1920x1080) WVA AG	None	150W 85% Adapter	256GB SSD M.2 PCIe NVMe Opal	DVD±RW	9-in-1	None	8265 ac, 2x2, vPro + BT4.1	None	1080p	None	None	USB / USB	UltraFlex II Stand	Win10 Pro 64	3-year, Onsite	Mar 28, 2023	02/17
10NS0004US	US	i7-7700	vPro	Intel HD 630	None	8GBx1	23.8" FHD (1920x1080) WVA AG	None	150W 85% Adapter	512GB SSD M.2 PCIe NVMe Opal	DVD±RW	9-in-1	None	8265 ac, 2x2, vPro + BT4.1	None	1080p	None	None	USB / USB	UltraFlex II Stand	Win10 Pro 64	3-year, Onsite	Mar 28, 2023	02/17
10NS0006US	US	i7-7700	vPro	Intel HD 630	None	8GBx1	23.8" FHD (1920x1080) WVA AG	None	150W 85% Adapter	500GB 7200rpm 2.5" DVD±RW	DVD±RW	9-in-1	None	8265 ac, 2x2, vPro + BT4.1	None	1080p	None	None	USB / USB	UltraFlex II Stand	Win10 Pro 64	3-year, Onsite	Mar 28, 2023	02/17
10NS0007US	US	i5-7500	vPro	Intel HD 630	None	8GBx1	23.8" FHD (1920x1080) WVA AG	None	150W 85% Adapter	500GB 7200rpm 2.5" DVD±RW	DVD±RW	9-in-1	None	8265 ac, 2x2, vPro + BT4.1	None	1080p	None	None	USB / USB	UltraFlex II Stand	Win10 Pro 64	3-year, Onsite	Mar 28, 2023	02/17
10NS0008US	US	i5-7500	vPro	Intel HD 630	None	8GBx1	23.8" FHD (1920x1080) WVA AG	None	150W 85% Adapter	512GB SSD M.2 PCIe NVMe Opal	DVD±RW	9-in-1	None	8265 ac, 2x2, vPro + BT4.1	None	1080p	None	None	USB / USB	UltraFlex II Stand	Win10 Pro 64	3-year, Onsite	Mar 28, 2023	02/17
10NS000AUS	US	i7-7700	vPro	Intel HD 630	None	8GBx1	23.8" FHD (1920x1080) WVA AG	None	150W 85% Adapter	256GB SSD M.2 PCIe NVMe Opal	DVD±RW	9-in-1	None	8265 ac, 2x2, vPro + BT4.1	None	1080p	None	None	USB / USB	UltraFlex II Stand	Win10 Pro 64	3-year, Onsite	Mar 28, 2023	02/17
10NS000UUS	US	i5-6500	vPro	Intel HD 530	None	8GBx1	23.8" FHD (1920x1080) WVA AG	None	150W 85% Adapter	128GB SSD M.2 PCIe NVMe	DVD±RW	9-in-1	None	8265 ac, 2x2, vPro + BT4.1	None	1080p	None	None	USB / USB	UltraFlex II Stand	Win10 DG Win7 Pro 64	3-year, Onsite	Apr 29, 2023	03/17
10NS000VUS	US	i7-6700	vPro	Intel HD 530	None	8GBx1	23.8" FHD (1920x1080) WVA AG	None	150W 85% Adapter	500GB 7200rpm 2.5" DVD±RW	DVD±RW	9-in-1	None	8265 ac, 2x2, vPro + BT4.1	None	1080p	None	None	USB / USB	UltraFlex II Stand	Win10 DG Win7 Pro 64	3-year, Onsite	Apr 29, 2023	03/17
10NS000WUS	US	i5-6500	vPro	Intel HD 530	None	8GBx1	23.8" FHD (1920x1080) WVA AG	None	150W 85% Adapter	256GB SSD M.2 PCIe NVMe Opal	DVD±RW	9-in-1	None	8265 ac, 2x2, vPro + BT4.1	None	1080p	None	None	USB / USB	UltraFlex II Stand	Win10 DG Win7 Pro 64	3-year, Onsite	Apr 29, 2023	03/17
10NS000XUS	US	i5-6500	vPro	Intel HD 530	None	4GBx1	23.8" FHD (1920x1080) WVA AG	None	150W 85% Adapter	500GB 7200rpm 2.5" DVD±RW	DVD±RW	9-in-1	None	8265 ac, 2x2, vPro + BT4.1	None	1080p	None	None	USB / USB	UltraFlex II Stand	Win10 DG Win7 Pro 64	3-year, Onsite	Apr 29, 2023	03/17
10NS000YUS	US	i7-6700	vPro	Intel HD 530	None	8GBx1	23.8" FHD (1920x1080) WVA AG	None	150W 85% Adapter	256GB SSD M.2 PCIe NVMe Opal	DVD±RW	9-in-1	None	8265 ac, 2x2, vPro + BT4.1	None	1080p	None	None	USB / USB	UltraFlex II Stand	Win10 DG Win7 Pro 64	3-year, Onsite	Apr 29, 2023	03/17
10NS0010US	US	i5-6500	vPro	Intel HD 530	None	8GBx1	23.8" FHD (1920x1080) WVA AG	None	150W 85% Adapter	500GB 7200rpm 2.5" DVD±RW	DVD±RW	9-in-1	None	8265 ac, 2x2, vPro + BT4.1	None	1080p	None	None	USB / USB	UltraFlex II Stand	Win10 DG Win7 Pro 64	3-year, Onsite	Apr 29, 2023	03/17
10NS0011US	US	i5-7500	vPro	Intel HD 630	None	8GBx1	23.8" FHD (1920x1080) WVA AG	None	150W 85% Adapter	128GB SSD M.2 PCIe NVMe	DVD±RW	9-in-1	None	8265 ac, 2x2, vPro + BT4.1	None	1080p	None	None	USB / USB	UltraFlex II Stand	Win10 Pro 64	3-year, Onsite	May 7, 2023	04/17
10NS0012US	US	i7-6700	vPro	Intel HD 530	None	8GBx1	23.8" FHD (1920x1080) WVA AG	None	150W 85% Adapter	512GB SSD M.2 PCIe NVMe Opal	DVD±RW	9-in-1	None	8265 ac, 2x2, vPro + BT4.1	None	1080p	None	None	USB / USB	UltraFlex II Stand	Win10 DG Win7 Pro 64	3-year, Onsite	Apr 29, 2023	03/17
10NS0013US	US	i7-7700	vPro	Intel HD 630	None	8GBx1	23.8" FHD (1920x1080) WVA AG	None	150W 85% Adapter	128GB SSD M.2 PCIe NVMe	DVD±RW	9-in-1	None	8265 ac, 2x2, vPro + BT4.1	None	1080p	None	None	USB / USB	UltraFlex II Stand	Win10 Pro 64	3-year, Onsite	May 7, 2023	04/17
10NS0014US	US	i5-6500	vPro	Intel HD 530	None	8GBx1	23.8" FHD (1920x1080) WVA AG	None	150W 85% Adapter	512GB SSD M.2 PCIe NVMe Opal	DVD±RW	9-in-1	None	8265 ac, 2x2, vPro + BT4.1	None	1080p	None	None	USB / USB	UltraFlex II Stand	Win10 DG Win7 Pro 64	3-year, Onsite	Apr 29, 2023	03/17
10NS0015US	US	i7-6700	vPro	Intel HD 530	None	8GBx1	23.8" FHD (1920x1080) WVA AG	None	150W 85% Adapter	128GB SSD M.2 PCIe NVMe	DVD±RW	9-in-1	None	8265 ac, 2x2, vPro + BT4.1	None	1080p	None	None	USB / USB	UltraFlex II Stand	Win10 DG Win7 Pro 64	3-year, Onsite	Apr 29, 2023	03/17
10NS0016US	US	i5-7500	vPro	Intel HD 630	None	4GBx1	23.8" FHD (1920x1080) WVA AG	None	150W 85% Adapter	128GB SSD M.2 PCIe NVMe	DVD±RW	9-in-1	None	8265 ac, 2x2, vPro + BT4.1	None	1080p	None	None	USB / USB	UltraFlex II Stand	Win10 Pro 64	3-year, Onsite	May 7, 2023	04/17
10NS0017US	US	i5-6500	vPro	Intel HD 530	None	4GBx1	23.8" FHD (1920x1080) WVA AG	None	150W 85% Adapter	128GB SSD M.2 PCIe NVMe	DVD±RW	9-in-1	None	8265 ac, 2x2, vPro + BT4.1	None	1080p	None	None	USB / USB	UltraFlex II Stand	Win10 DG Win7 Pro 64	3-year, Onsite	Apr 29, 2023	03/17





# ThinkCentre M600 Tiny Platform Specifications

Product Specifications Reference (PSREF)

Processor	Intel® Celeron® Processor N3000 Series or Intel Pentium® Processor N3000 Series						Keyboard <i>Some:</i> PS/2 Keyboard (PS/2 connector), Lenovo logo <i>Some:</i> Preferred Pro USB Keyboard (USB connector), Lenovo logo <i>Some:</i> Lenovo USB Fingerprint Keyboard (USB connector) <i>Some:</i> Ultralim Plus Wireless Keyboard (2.4GHz via USB receiver), black															
	Processor	Cores / Threads	Frequency (Base/Max)	Cache	Memory Types	Integrated Graphics																
	Celeron N3000	2 / 2	1.04 / 2.08 GHz	2MB	DDR3L-1600	Intel HD																
	Celeron N3010	2 / 2	1.04 / 2.24 GHz	2MB	DDR3L-1600	Intel HD 400																
	Celeron N3050	2 / 2	1.6 / 2.16 GHz	2MB	DDR3L-1600	Intel HD																
	Pentium N3700	4 / 4	1.6 / 2.4 GHz	2MB	DDR3L-1600	Intel HD																
	Pentium J3710	4 / 4	1.6 / 2.64 GHz	2MB	DDR3L-1600	Intel HD 405																
Chipset	Intel Architecture (IA) SoC that integrates Intel processor core, graphics, memory controller, and I/O interfaces into a single system-on-chip solution						Mouse <i>Some:</i> PS/2 Optical Wheel Mouse, black, Lenovo logo <i>Some:</i> Enhanced Optical USB Mouse, black, Lenovo logo <i>Some:</i> Ultralim Plus Wireless Mouse (2.4GHz via USB receiver), black															
Graphics	Intel HD Graphics in processor, uses main memory, DirectX® 11.1, twoDisplayPort™, one optional 3rd DP (not support DP to HDMI dongle) or VGA, supports triple independent display; Maximum resolution: 3840x2160(DP)@30Hz; 1920x1200(optional VGA)@60Hz; 1920x1080(DP to VGA dongle)@60Hz; 1920x1080(DP to DVI dongle)@60Hz; 3840x2160(DP to HDMI dongle)@30Hz																					
Monitor cable	Optional DP to VGA, DP to DVI-D (single link), or DP to HDMI 1.4 dongle																					
Memory	8GB max / DDR3 Low Voltage, DDR3L-1600, non-parity, one 204-pin SO-DIMM socket																					
Storage	<i>Some:</i> M.2 Solid State Drive (SSD), SATA interface <i>Some:</i> hard disk, 5400 or 7200 rpm, SATA 6.0Gb/s, 2.5" Wide <i>Some:</i> 500GB (5400 rpm) Solid State Hybrid Drive (SSHD) / with 8GB MLC NAND flash memory, SATA 6.0Gb/s, 2.5" wide																					
Optical	<i>Some:</i> Solid State Drive (SSD) / SATA 6.0Gb/s, 2.5" Wide <i>Some:</i> external ODD box with DVD-ROM, 9.5mm high, via USB <i>Some:</i> external ODD box with DVD±RW, 9.5mm high, via USB <i>Some:</i> external ODD box (for TIO) with DVD-ROM, 9.5mm high, via USB <i>Some:</i> external ODD box (for TIO) with DVD±RW, 9.5mm high, via USB																					
Onboard SATA Media reader	SATA 6.0Gb/s controller, one connectors on planar None						Mechanical • Tiny (1L or 2L), black color; metal case															
Front ports	Two USB 3.0 (one is Always On and fast charge), one microphone (stereo, 3.5mm), one headphone / microphone combo jack (stereo, 3.5mm)																					
Rear ports	Two USB 2.0, two USB 3.0 (optional external optical box or I/O box occupies one or two specific USB on some models), ethernet (RJ-45), two DisplayPort, one optional port (VGA, 3rd DP, or serial on some models), one headphone; additional four serial (9-pin), one parallel (25-pin), and two PS/2 ports on 2L models																					
I/O box	Optional external I/O box, extends two USB 2.0, two USB 3.0, and one serial on rear, two USB 2.0 on front, via USB (occupy two specific USB 3.0 of M600 Tiny)																					
Audio support	High Definition (HD) Audio, Realtek ALC223 / optional internal speaker (1 watt)																					
WLAN <sup>13</sup>	<i>Some:</i> 11ac wireless, M.2 Card, Realtek RTL8821AE (dual band), Wi-Fi + Bluetooth 4.0 combo adapter, 1x1 <i>Some:</i> 11ac wireless, M.2 Card, Qualcomm Atheros QCA9377 (dual band), Wi-Fi + Bluetooth 4.1 combo adapter, 1x1 <i>Some:</i> 11ac wireless, M.2 Card, Qualcomm Atheros QCA6174 (dual band), Wi-Fi + Bluetooth 4.1 combo adapter, 2x2 <i>Some:</i> 11ac wireless, M.2 Card, Intel Dual Band Wireless-AC 3165, Wi-Fi + Bluetooth 4.0 combo adapter, 1x1 <i>Some:</i> 11ac wireless, M.2 Card, Intel Dual Band Wireless-AC 8260, Wi-Fi + Bluetooth 4.1 combo adapter, 2x2																					
Bluetooth™	<i>Some:</i> Bluetooth 4.0 or 4.1 wireless, integrated in Wi-Fi + BT combo adapter						VESA mount Optional VESA mount bracket kit, supports VESA 75mm and 100mm Floor Stand Optional system floor stand for vertical orientation															
Ethernet Modem	One gigabit ethernet port, Realtek RTL8111GN, Wake on LAN® None																					
Manageability	None																					
Security chip	Trusted Platform Module, TCG 1.2-compliant																					
Security features	<ul style="list-style-type: none"> <li>• Security slot (in rear for optional Kensington® MicroSaver® cable)</li> <li>• Padlock loop</li> <li>• Smart USB protection, allows keyboard/mouse only, blocks all storage devices</li> <li>• Power-on password</li> <li>• Administrator password</li> <li>• Hard disk password</li> <li>• Boot sequence control</li> <li>• Boot without keyboard and mouse</li> <li>• Individual USB port disablement</li> <li>• Chassis intrusion switch</li> </ul>																					
Power supply	65 watts AC/DC adapter, autosensing, 88% PSU (not included for TIO models) 90 watts AC/DC adapter, autosensing, 88% PSU (only for models with I/O box)						<table border="1"> <thead> <tr> <th></th> <th>Dimensions (WxDxH)</th> <th>Max weight (lb / kg)</th> </tr> </thead> <tbody> <tr> <td>M600 Tiny only (1L)</td> <td>7.05" X 7.20" X 1.36" 179mm X 182.9mm X 34.5mm</td> <td>2.9 lb (1.3 kg)</td> </tr> <tr> <td>M600 Tiny only (2L)</td> <td>7.05" X 7.20" X 3.15" 179mm X 182.9mm X 80mm</td> <td>4.2 lb (1.9 kg)</td> </tr> <tr> <td>M600 Tiny (1L) with VESA mount &amp; ODD box</td> <td>7.42" X 7.30" X 2.48" 188.4mm X 185.38mm X 63mm</td> <td>4.12 lb (1.87 kg)</td> </tr> <tr> <td>M600 Tiny (1L) with VESA mount &amp; I/O box</td> <td>7.42" X 7.30" X 2.62" 188.4mm X 185.38mm X 66.6mm</td> <td>3.53 lb (1.6 kg)</td> </tr> </tbody> </table>		Dimensions (WxDxH)	Max weight (lb / kg)	M600 Tiny only (1L)	7.05" X 7.20" X 1.36" 179mm X 182.9mm X 34.5mm	2.9 lb (1.3 kg)	M600 Tiny only (2L)	7.05" X 7.20" X 3.15" 179mm X 182.9mm X 80mm	4.2 lb (1.9 kg)	M600 Tiny (1L) with VESA mount & ODD box	7.42" X 7.30" X 2.48" 188.4mm X 185.38mm X 63mm	4.12 lb (1.87 kg)	M600 Tiny (1L) with VESA mount & I/O box	7.42" X 7.30" X 2.62" 188.4mm X 185.38mm X 66.6mm	3.53 lb (1.6 kg)
	Dimensions (WxDxH)	Max weight (lb / kg)																				
M600 Tiny only (1L)	7.05" X 7.20" X 1.36" 179mm X 182.9mm X 34.5mm	2.9 lb (1.3 kg)																				
M600 Tiny only (2L)	7.05" X 7.20" X 3.15" 179mm X 182.9mm X 80mm	4.2 lb (1.9 kg)																				
M600 Tiny (1L) with VESA mount & ODD box	7.42" X 7.30" X 2.48" 188.4mm X 185.38mm X 63mm	4.12 lb (1.87 kg)																				
M600 Tiny (1L) with VESA mount & I/O box	7.42" X 7.30" X 2.62" 188.4mm X 185.38mm X 66.6mm	3.53 lb (1.6 kg)																				
Limited warranty <sup>3</sup>	<i>Some:</i> 1-year or 3-year, depot service / service upgrades available <i>Some:</i> 1-year or 3-year, limited onsite service / service upgrades available <i>Some:</i> 3-year, limited onsite service, OID (Onsite International Delivery) / service upgrades available <i>For Lenovo service upgrade options, please go to S-TC sheet</i>																					
Preload	<i>Some:</i> Windows® 7 Professional 64 preinstalled through downgrade rights in Windows 10 Pro 64-bit <i>Some:</i> Windows 7 Professional 64 <i>Some:</i> Windows 10 Pro 64-bit <i>Some:</i> Windows 10 Home 64-bit Preloaded applications (only some listed): <ul style="list-style-type: none"> <li>• Desktop Power Manager</li> <li>• Lenovo Solution Center</li> <li>• Lenovo REACHit</li> <li>• Lenovo SHAREit</li> <li>• Lenovo Bluetooth Lock</li> <li>• McAfee® LiveSafe™ (30-day trial)</li> <li>• Microsoft Office preloaded; purchase a product key to activate</li> <li>• PowerDVD Create (DVD±RW)</li> <li>• Lenovo ThinkVantage Tools</li> <li>- Only for Window 10</li> <li>• Lenovo Companion (Win10)</li> <li>• Cyberlink PowerDVD (DVD, DVD±RW)</li> <li>• Lenovo QuickOptimizer</li> <li>- Only for Window 7</li> <li>• Rescue and Recovery</li> <li>• Password Manager</li> <li>• ThinkVantage System Update</li> <li>• Lenovo Message Center Plus</li> <li>• Adobe® Reader®</li> </ul>																					
Environment	ENERGY STAR® 6.0*, EPEAT™ Gold rating* (*for Windows models only); GREENGUARD®; RoHS-compliant; Cisco EnergyWise compatible; ErP Lot 3																					
Accessories	For compatible accessories, please go to TC-AQP sheet																					

See footnotes for more detailed information

Model	Region	Case 1L/2L	Processor	vPro	Graphics	Monitor Cable	Memory	Storage	External Optical / I/O Box	WLAN + Bluetooth	Optional Rear Ports	Chassis Intrusion Switch	Kensington Cable Lock	Speaker	Adapter Cage	Toolless Chassis Screw	Keyboard / Mouse	VESA Mount	Stand	Power Supply	Operating System	Warranty	Ann Date (m/y)
10G9000NUS	US	1L	Pentium N3700	No	Intel HD	None	4GBx1	500GB 7200rpm 2.5"	None	Intel 8260 ac, 2x2 + BT4.1	None	Switch	None	1Wx1	None	None	USB / USB	None	Floor Stand	65W Adapter 88%	Win10 DG Win7 Pro 64	1-year, Onsite	10/15
10G9000WUS	US	1L	Pentium N3700	No	Intel HD	None	4GBx1	500GB 7200rpm 2.5"	None	Intel 3165 ac, 1x1 + BT4.0	Serial	Switch	None	1Wx1	None	None	USB / USB	None	Floor Stand	65W Adapter 88%	Win10 DG Win7 Pro 64	1-year, Onsite	04/16
10G9000XUS	US	1L	Pentium N3700	No	Intel HD	None	4GBx1	500GB 7200rpm 2.5"	None	Intel 3165 ac, 1x1 + BT4.0	VGA	Switch	None	1Wx1	None	None	USB / USB	None	Floor Stand	65W Adapter 88%	Win10 DG Win7 Pro 64	1-year, Onsite	05/16
10G9000YUS	US	1L	Pentium N3700	No	Intel HD	None	4GBx1	500GB 7200rpm 2.5"	None	Intel 3165 ac, 1x1 + BT4.0	3rd DP	Switch	None	1Wx1	None	None	USB / USB	None	Floor Stand	65W Adapter 88%	Win10 Pro 64	1-year, Onsite	05/16
10G90010US	US	1L	Pentium N3700	No	Intel HD	None	4GBx1	500GB 7200rpm 2.5"	None	Intel 3165 ac, 1x1 + BT4.0	Serial	Switch	None	1Wx1	None	None	USB / USB	None	Floor Stand	65W Adapter 88%	Win10 Pro 64	1-year, Onsite	05/16
10G90011US	US	1L	Pentium N3700	No	Intel HD	None	4GBx1	128GB SSD	None	Intel 3165 ac, 1x1 + BT4.0	None	Switch	None	1Wx1	None	None	USB / USB	None	Floor Stand	65W Adapter 88%	Win10 Pro 64	1-year, Onsite	05/16
10G90012US	US	1L	Pentium N3700	No	Intel HD	None	4GBx1	500GB 7200rpm 2.5"	None	Intel 3165 ac, 1x1 + BT4.0	None	Switch	None	1Wx1	None	None	USB / USB	None	Floor Stand	65W Adapter 88%	Win10 Pro 64	1-year, Onsite	05/16
10G90013US	US	1L	Pentium N3700	No	Intel HD	None	4GBx1	128GB SSD	None	Intel 3165 ac, 1x1 + BT4.0	None	Switch	None	1Wx1	None	None	USB / USB	None	Floor Stand	65W Adapter 88%	Win10 DG Win7 Pro 64	1-year, Onsite	05/16
10G90014US	US	1L	Pentium N3700	No	Intel HD	None	4GBx1	500GB 7200rpm 2.5"	None	Intel 3165 ac, 1x1 + BT4.0	None	Switch	None	1Wx1	None	None	USB / USB	None	Floor Stand	65W Adapter 88%	Win10 DG Win7 Pro 64	1-year, Onsite	05/16
10G90015US	US	1L	Pentium N3700	No	Intel HD	None	4GBx1	500GB 7200rpm 2.5"	None	Intel 3165 ac, 1x1 + BT4.0	VGA	Switch	None	1Wx1	None	None	USB / USB	None	Floor Stand	65W Adapter 88%	Win10 Pro 64	1-year, Onsite	05/16
10G90016US	US	1L	Pentium N3700	No	Intel HD	None	4GBx1	500GB 7200rpm 2.5"	None	Intel 3165 ac, 1x1 + BT4.0	3rd DP	Switch	None	1Wx1	None	None	USB / USB	None	Floor Stand	65W Adapter 88%	Win10 DG Win7 Pro 64	1-year, Onsite	05/16
10G9001CUS	US	1L	Pentium J3710	No	Intel HD 405	None	4GBx1	128GB SSD	None	Intel 8260 ac, 2x2 + BT4.1	3rd DP	Switch	None	1Wx1	None	None	USB / USB	None	Floor Stand	65W Adapter 88%	Win10 Pro 64	1-year, Onsite	07/16
10G9001DUS	US	1L	Pentium J3710	No	Intel HD 405	None	4GBx1	500GB 7200rpm 2.5"	None	Intel 3165 ac, 1x1 + BT4.0	3rd DP	Switch	None	1Wx1	None	None	USB / USB	None	Floor Stand	65W Adapter 88%	Win10 Pro 64	1-year, Onsite	07/16
10G9001EUS	US	1L	Pentium J3710	No	Intel HD 405	None	4GBx1	500GB 7200rpm 2.5"	None	Intel 3165 ac, 1x1 + BT4.0	VGA	Switch	None	1Wx1	None	None	USB / USB	None	Floor Stand	65W Adapter 88%	Win10 Pro 64	1-year, Onsite	07/16
10G9001FUS	US	1L	Pentium J3710	No	Intel HD 405	None	4GBx1	500GB 7200rpm 2.5"	None	Intel 3165 ac, 1x1 + BT4.0	None	Switch	None	1Wx1	None	None	USB / USB	None	Floor Stand	65W Adapter 88%	Win10 Pro 64	1-year, Onsite	07/16
10G9001GUS	US	1L	Pentium J3710	No	Intel HD 405	None	4GBx1	128GB SSD	None	Intel 3165 ac, 1x1 + BT4.0	None	Switch	None	1Wx1	None	None	USB / USB	None	Floor Stand	65W Adapter 88%	Win10 Pro 64	1-year, Onsite	07/16
10G9001HUS	US	1L	Pentium J3710	No	Intel HD 405	None	4GBx1	500GB 7200rpm 2.5"	None	Intel 3165 ac, 1x1 + BT4.0	Serial	Switch	None	1Wx1	None	None	USB / USB	None	Floor Stand	65W Adapter 88%	Win10 Pro 64	1-year, Onsite	07/16
10G9001QUS	US	1L	Pentium J3710	No	Intel HD 405	None	4GBx1	500GB 7200rpm 2.5"	None	Intel 8260 ac, 2x2 + BT4.1	3rd DP	Switch	None	1Wx1	None	None	USB / USB	None	Floor Stand	65W Adapter 88%	Win10 DG Win7 Pro 64	1-year, Onsite	09/16
10G9001RUS	US	1L	Pentium J3710	No	Intel HD 405	None	4GBx1	128GB SSD	None	Intel 3165 ac, 1x1 + BT4.0	None	Switch	None	1Wx1	None	None	USB / USB	None	Floor Stand	65W Adapter 88%	Win10 DG Win7 Pro 64	1-year, Onsite	09/16
10G9001SUS	US	1L	Pentium J3710	No	Intel HD 405	None	4GBx1	500GB 7200rpm 2.5"	None	Intel 3165 ac, 1x1 + BT4.0	3rd DP	Switch	None	1Wx1	None	None	USB / USB	None	Floor Stand	65W Adapter 88%	Win10 DG Win7 Pro 64	1-year, Onsite	09/16

Model	Region	Case 1L/2L	Processor	vPro	Graphics	Monitor Cable	Memory	Storage	External Optical / I/O Box	WLAN + Bluetooth	Optional Rear Ports	Chassis Intrusion Switch	Kensington Cable Lock	Speaker	Adapter Cage	Toolless Chassis Screw	Keyboard / Mouse	VESA Mount	Stand	Power Supply	Operating System	Warranty	Ann Date (m/y)
10G9001TUS	US	1L	Pentium J3710	No	Intel HD 405	None	4GBx1	128GB SSD	None	Intel 8260 ac, 2x2 + BT4.1	3rd DP	Switch	None	1Wx1	None	None	USB / USB	None	Floor Stand	65W Adapter 88%	Win10 DG Win7 Pro 64	1-year, Onsite	09/16
10G9001UUS	US	1L	Pentium J3710	No	Intel HD 405	None	4GBx1	500GB 7200rpm 2.5"	None	Intel 3165 ac, 1x1 + BT4.0	None	Switch	None	1Wx1	None	None	USB / USB	None	Floor Stand	65W Adapter 88%	Win10 DG Win7 Pro 64	1-year, Onsite	09/16
10G9001VUS	US	1L	Pentium J3710	No	Intel HD 405	None	4GBx1	500GB 7200rpm 2.5"	None	Intel 3165 ac, 1x1 + BT4.0	Serial	Switch	None	1Wx1	None	None	USB / USB	None	Floor Stand	65W Adapter 88%	Win10 DG Win7 Pro 64	1-year, Onsite	09/16
10G9001WUS	US	1L	Pentium J3710	No	Intel HD 405	None	4GBx1	500GB 7200rpm 2.5"	None	Intel 3165 ac, 1x1 + BT4.0	VGA	Switch	None	1Wx1	None	None	USB / USB	None	Floor Stand	65W Adapter 88%	Win10 DG Win7 Pro 64	1-year, Onsite	09/16

ThinkCentre M600 Tiny - TopSeller - 10GB

Product Specifications Reference (PSREF)

Model	Region	Case 1L/2L	Processor	vPro	Graphics	Monitor Cable	Memory	Storage	External Optical / I/O Box	WLAN + Bluetooth	Optional Rear Ports	Chassis Intrusion Switch	Kensington Cable Lock	Speaker	Adapter Cage	Toolless Chassis Screw	Keyboard / Mouse	VESA Mount	Stand	Power Supply	Operating System	Warranty	Ann Date (m/y)
10GB000JUS	US	1L	Celeron N3050	No	Intel HD	None	4GBx1	500GB 7200rpm 2.5"	None	Intel 8260 ac, 2x2 + BT4.1	None	Switch	None	1Wx1	None	None	USB / USB	None	Floor Stand	65W Adapter 88%	Win10 Pro 64	3-year, Onsite	10/15
10GB000KUS	US	1L	Celeron N3050	No	Intel HD	None	4GBx1	500GB 7200rpm 2.5"	None	Intel 8260 ac, 2x2 + BT4.1	None	Switch	None	1Wx1	None	None	USB / USB	None	Floor Stand	65W Adapter 88%	Win10 DG Win7 Pro 64	3-year, Onsite	10/15
10GB000LUS	US	1L	Celeron N3050	No	Intel HD	None	4GBx1	120GB SSD	None	Intel 8260 ac, 2x2 + BT4.1	None	Switch	None	1Wx1	None	None	USB / USB	None	Floor Stand	65W Adapter 88%	Win10 DG Win7 Pro 64	3-year, Onsite	10/15
10GB000MUS	US	1L	Celeron N3050	No	Intel HD	None	4GBx1	120GB SSD	None	Intel 8260 ac, 2x2 + BT4.1	None	Switch	None	1Wx1	None	None	USB / USB	None	Floor Stand	65W Adapter 88%	Win10 Pro 64	3-year, Onsite	10/15

Model	Region	Case 1L/2L	Processor	vPro	Graphics	Monitor Cable	Memory	Storage	External Optical / I/O Box	WLAN + Bluetooth	Optional Rear Ports	Chassis Intrusion Switch	Kensington Cable Lock	Speaker	Adapter Cage	Toolless Chassis Screw	Keyboard / Mouse	VESA Mount	Stand	Power Supply	Operating System	Warranty	Ann Date (m/y)
10KH0001US	US	1L	Celeron N3000	No	Intel HD	None	2GBx1	16GB SSD M.2	None	RTL8821AE ac, 1x1 + BT4.0	None	Switch	None	1Wx1	None	None	USB / USB	None	Floor Stand	65W Adapter 88%	WES 7	1-year, Onsite	01/16
10KH0003US	US	1L	Celeron N3000	No	Intel HD	None	4GBx1	16GB SSD M.2	None	RTL8821AE ac, 1x1 + BT4.0	VGA	Switch	None	1Wx1	None	None	USB / USB	None	Floor Stand	65W Adapter 88%	WES 7	1-year, Onsite	01/16
10KH0007US	US	1L	Celeron N3000	No	Intel HD	None	4GBx1	16GB SSD M.2	None	RTL8821AE ac, 1x1 + BT4.0	None	Switch	None	1Wx1	None	None	USB / USB	None	Floor Stand	65W Adapter 88%	WES 7	1-year, Onsite	01/16
10KH0008US	US	1L	Celeron N3000	No	Intel HD	None	4GBx1	16GB SSD M.2	None	RTL8821AE ac, 1x1 + BT4.0	3rd DP	Switch	None	1Wx1	None	None	USB / USB	None	Floor Stand	65W Adapter 88%	WES 7	1-year, Onsite	01/16
10KH000BUS	US	1L	Celeron N3000	No	Intel HD	None	2GBx1	16GB SSD M.2	None	RTL8821AE ac, 1x1 + BT4.0	None	Switch	None	1Wx1	None	None	USB / USB	None	Floor Stand	65W Adapter 88%	LeTOS	1-year, Onsite	01/16
10KH000CUS	US	1L	Celeron N3000	No	Intel HD	None	4GBx1	16GB SSD M.2	None	RTL8821AE ac, 1x1 + BT4.0	3rd DP	Switch	None	1Wx1	None	None	USB / USB	None	Floor Stand	65W Adapter 88%	LeTOS	1-year, Onsite	01/16
10KH000FUS	US	1L	Celeron N3000	No	Intel HD	None	4GBx1	16GB SSD M.2	None	RTL8821AE ac, 1x1 + BT4.0	None	Switch	None	1Wx1	None	None	USB / USB	None	Floor Stand	65W Adapter 88%	LeTOS	1-year, Onsite	01/16
10KH0023US	US	1L	Celeron N3010	No	Intel HD 400	None	2GBx1	16GB SSD M.2	None	RTL8821AE ac, 1x1 + BT4.0	None	Switch	None	1Wx1	None	None	USB / USB	None	Floor Stand	65W Adapter 88%	LeTOS	1-year, Onsite	07/16
10KH0024US	US	1L	Celeron N3010	No	Intel HD 400	None	4GBx1	16GB SSD M.2	None	RTL8821AE ac, 1x1 + BT4.0	VGA	Switch	None	1Wx1	None	None	USB / USB	None	Floor Stand	65W Adapter 88%	LeTOS	1-year, Onsite	07/16
10KH0025US	US	1L	Celeron N3010	No	Intel HD 400	None	4GBx1	16GB SSD M.2	None	RTL8821AE ac, 1x1 + BT4.0	None	Switch	None	1Wx1	None	None	USB / USB	None	Floor Stand	65W Adapter 88%	WES 7	1-year, Onsite	07/16
10KH0026US	US	1L	Celeron N3010	No	Intel HD 400	None	4GBx1	16GB SSD M.2	None	RTL8821AE ac, 1x1 + BT4.0	VGA	Switch	None	1Wx1	None	None	USB / USB	None	Floor Stand	65W Adapter 88%	WES 7	1-year, Onsite	07/16
10KH0027US	US	1L	Celeron N3010	No	Intel HD 400	None	4GBx1	16GB SSD M.2	None	RTL8821AE ac, 1x1 + BT4.0	Serial	Switch	None	1Wx1	None	None	USB / USB	None	Floor Stand	65W Adapter 88%	LeTOS	1-year, Onsite	07/16
10KH0028US	US	1L	Celeron N3010	No	Intel HD 400	None	4GBx1	16GB SSD M.2	None	RTL8821AE ac, 1x1 + BT4.0	3rd DP	Switch	None	1Wx1	None	None	USB / USB	None	Floor Stand	65W Adapter 88%	WES 7	1-year, Onsite	07/16
10KH0029US	US	1L	Celeron N3010	No	Intel HD 400	None	4GBx1	16GB SSD M.2	None	RTL8821AE ac, 1x1 + BT4.0	Serial	Switch	None	1Wx1	None	None	USB / USB	None	Floor Stand	65W Adapter 88%	WES 7	1-year, Onsite	07/16
10KH002VUS	US	1L	Celeron N3010	No	Intel HD 400	None	2GBx1	16GB SSD M.2	None	RTL8821AE ac, 1x1 + BT4.0	None	Switch	None	1Wx1	None	None	USB / USB	None	Floor Stand	65W Adapter 88%	LeTOS V2	1-year, Onsite	01/17
10KH002WUS	US	1L	Celeron N3010	No	Intel HD 400	None	4GBx1	16GB SSD M.2	None	RTL8821AE ac, 1x1 + BT4.0	None	Switch	None	1Wx1	None	None	USB / USB	None	Floor Stand	65W Adapter 88%	LeTOS V2	1-year, Onsite	01/17
10KH002XUS	US	1L	Celeron N3010	No	Intel HD 400	None	4GBx1	16GB SSD M.2	None	RTL8821AE ac, 1x1 + BT4.0	3rd DP	Switch	None	1Wx1	None	None	USB / USB	None	Floor Stand	65W Adapter 88%	LeTOS V2	1-year, Onsite	01/17
10KH002YUS	US	1L	Celeron N3010	No	Intel HD 400	None	4GBx1	32GB SSD M.2	None	RTL8821AE ac, 1x1 + BT4.0	VGA	Switch	None	1Wx1	None	None	USB / USB	None	Floor Stand	65W Adapter 88%	WES 7 V2	1-year, Onsite	01/17
10KH0030US	US	1L	Celeron N3010	No	Intel HD 400	None	4GBx1	16GB SSD M.2	None	RTL8821AE ac, 1x1 + BT4.0	VGA	Switch	None	1Wx1	None	None	USB / USB	None	Floor Stand	65W Adapter 88%	LeTOS V2	1-year, Onsite	01/17
10KH0031US	US	1L	Celeron N3010	No	Intel HD 400	None	4GBx1	32GB SSD M.2	None	RTL8821AE ac, 1x1 + BT4.0	Serial	Switch	None	1Wx1	None	None	USB / USB	None	Floor Stand	65W Adapter 88%	WES 7 V2	1-year, Onsite	01/17

Model	Region	Case 1L/2L	Processor	vPro	Graphics	Monitor Cable	Memory	Storage	External Optical / I/O Box	WLAN + Bluetooth	Optional Rear Ports	Chassis Intrusion Switch	Kensington Cable Lock	Speaker	Adapter Cage	Toolless Chassis Screw	Keyboard / Mouse	VESA Mount	Stand	Power Supply	Operating System	Warranty	Ann Date (m/y)
10KH0032US	US	1L	Celeron N3010	No	Intel HD 400	None	4GBx1	16GB SSD M.2	None	RTL8821AE ac, 1x1 + BT4.0	Serial	Switch	None	1Wx1	None	None	USB / USB	None	Floor Stand	65W Adapter 88%	LeTOS V2	1-year, Onsite	01/17
10KH0033US	US	1L	Celeron N3010	No	Intel HD 400	None	4GBx1	32GB SSD M.2	None	RTL8821AE ac, 1x1 + BT4.0	3rd DP	Switch	None	1Wx1	None	None	USB / USB	None	Floor Stand	65W Adapter 88%	WES 7 V2	1-year, Onsite	01/17
10KH0034US	US	1L	Celeron N3010	No	Intel HD 400	None	4GBx1	32GB SSD M.2	None	RTL8821AE ac, 1x1 + BT4.0	None	Switch	None	1Wx1	None	None	USB / USB	None	Floor Stand	65W Adapter 88%	WES 7 V2	1-year, Onsite	01/17
10KH003MUS	US	1L	Celeron N3010	No	Intel HD 400	None	4GBx1	32GB SSD M.2	None	None	None	Switch	None	1Wx1	None	None	USB / USB	None	Floor Stand	65W Adapter 88%	Windows 10 IoT Enterprise	1-year, Onsite	03/17
10KH003PUS	US	1L	Celeron N3010	No	Intel HD 400	None	4GBx1	32GB SSD M.2	None	RTL8821AE ac, 1x1 + BT4.0	3rd DP	Switch	None	1Wx1	None	None	USB / USB	None	Floor Stand	65W Adapter 88%	Windows 10 IoT Enterprise	1-year, Onsite	04/17
10KH003QUS	US	1L	Celeron N3010	No	Intel HD 400	None	4GBx1	32GB SSD M.2	None	RTL8821AE ac, 1x1 + BT4.0	None	Switch	None	1Wx1	None	None	USB / USB	None	Floor Stand	65W Adapter 88%	Windows 10 IoT Enterprise	1-year, Onsite	04/17
10KH003RUS	US	1L	Celeron N3010	No	Intel HD 400	None	4GBx1	32GB SSD M.2	None	RTL8821AE ac, 1x1 + BT4.0	VGA	Switch	None	1Wx1	None	None	USB / USB	None	Floor Stand	65W Adapter 88%	Windows 10 IoT Enterprise	1-year, Onsite	04/17
10KH003SUS	US	1L	Celeron N3010	No	Intel HD 400	None	8GBx1	32GB SSD M.2	None	RTL8821AE ac, 1x1 + BT4.0	3rd DP	Switch	None	1Wx1	None	None	USB / USB	None	Floor Stand	65W Adapter 88%	Windows 10 IoT Enterprise	1-year, Onsite	04/17
10KH0047US	US	1L	Celeron N3010	No	Intel HD 400	None	4GBx1	32GB SSD M.2	None	RTL8821AE ac, 1x1 + BT4.0	3rd DP	Switch	None	1Wx1	None	None	USB / USB	None	Floor Stand	65W Adapter 88%	LeTOS V2	1-year, Onsite	05/17
10KH0048US	US	1L	Celeron N3010	No	Intel HD 400	None	4GBx1	32GB SSD M.2	None	RTL8821AE ac, 1x1 + BT4.0	None	Switch	None	1Wx1	None	None	USB / USB	None	Floor Stand	65W Adapter 88%	LeTOS V2	1-year, Onsite	05/17
10KH0049US	US	1L	Celeron N3010	No	Intel HD 400	None	2GBx1	32GB SSD M.2	None	RTL8821AE ac, 1x1 + BT4.0	None	Switch	None	1Wx1	None	None	USB / USB	None	Floor Stand	65W Adapter 88%	LeTOS V2	1-year, Onsite	05/17
10KH004AUS	US	1L	Celeron N3010	No	Intel HD 400	None	4GBx1	32GB SSD M.2	None	RTL8821AE ac, 1x1 + BT4.0	Serial	Switch	None	1Wx1	None	None	USB / USB	None	Floor Stand	65W Adapter 88%	LeTOS V2	1-year, Onsite	05/17
10KH004BUS	US	1L	Celeron N3010	No	Intel HD 400	None	4GBx1	32GB SSD M.2	None	RTL8821AE ac, 1x1 + BT4.0	VGA	Switch	None	1Wx1	None	None	USB / USB	None	Floor Stand	65W Adapter 88%	LeTOS V2	1-year, Onsite	05/17

Model	Region	Case 1L/2L	Processor	vPro	Graphics	Monitor Cable	Memory	Storage	External Optical / I/O Box	WLAN + Bluetooth	Optional Rear Ports	Chassis Intrusion Switch	Kensington Cable Lock	Speaker	Adapter Cage	Toolless Chassis Screw	Keyboard / Mouse	VESA Mount	Stand	Power Supply	Operating System	Warranty	Ann Date (m/y)
10G8000QUS	US	1L	Pentium N3700	No	Intel HD	None	4GBx1	500GB 7200rpm 2.5"	DVD±RW	QCA6174 ac, 2x2 + BT4.1	None	Switch	None	1Wx1	None	None	USB / USB	VESA Mount	None	65W Adapter 88%	Win10 DG Win7 Pro 64	3-year, Onsite, OID	10/15
10G8000RUS	US	1L	Pentium N3700	No	Intel HD	None	4GBx1	500GB 7200rpm 2.5"	DVD±RW	QCA6174 ac, 2x2 + BT4.1	None	Switch	None	1Wx1	None	None	USB / USB	VESA Mount	None	65W Adapter 88%	Win10 Pro 64	3-year, Onsite, OID	10/15
10G8000SUS	US	1L	Pentium N3700	No	Intel HD	None	2GBx1	500GB 7200rpm 2.5"	None	QCA9377 ac, 1x1 + BT4.1	None	Switch	None	1Wx1	None	None	USB / USB	None	None	65W Adapter 88%	Win10 Pro 64	3-year, Onsite, OID	10/15
10G8000TUS	US	1L	Pentium N3700	No	Intel HD	None	2GBx1	500GB 7200rpm 2.5"	None	QCA9377 ac, 1x1 + BT4.1	None	Switch	None	1Wx1	None	None	USB / USB	None	None	65W Adapter 88%	Win10 DG Win7 Pro 64	3-year, Onsite, OID	10/15

# ThinkCentre M600 Tiny - 10GA

Product Specifications Reference (PSREF)

Model	Region	Case 1L/2L	Processor	vPro	Graphics	Monitor Cable	Memory	Storage	External Optical / I/O Box	WLAN + Bluetooth	Optional Rear Ports	Chassis Intrusion Switch	Kensington Cable Lock	Speaker	Adapter Cage	Toolless Chassis Screw	Keyboard / Mouse	VESA Mount	Stand	Power Supply	Operating System	Warranty	Ann Date (m/y)
10GA000JUS	US	1L	Celeron N3050	No	Intel HD	None	2GBx1	500GB 7200rpm 2.5"	None	None	None	Switch	None	1Wx1	None	None	USB / USB	None	None	65W Adapter 88%	Win10 DG Win7 Pro 64	3-year, Onsite, OID	10/15
10GA000KUS	US	1L	Celeron N3050	No	Intel HD	None	2GBx1	500GB 7200rpm 2.5"	DVD±RW	None	None	Switch	None	1Wx1	None	None	USB / USB	VESA Mount	None	65W Adapter 88%	Win10 Pro 64	3-year, Onsite, OID	10/15



# ThinkCentre M600 Tiny - 10GC

Product Specifications Reference (PSREF)

Model	Region	Case 1L/2L	Processor	vPro	Graphics	Monitor Cable	Memory	Storage	External Optical / I/O Box	WLAN + Bluetooth	Optional Rear Ports	Chassis Intrusion Switch	Kensington Cable Lock	Speaker	Adapter Cage	Toolless Chassis Screw	Keyboard / Mouse	VESA Mount	Stand	Power Supply	Operating System	Warranty	Ann Date (m/y)
10GC0001US	US	1L	Pentium N3700	No	Intel HD	None	4GBx1	500GB 7200rpm 2.5"	DVD±RW (TIO)	QCA6174 ac, 2x2 + BT4.1	None	Switch	None	1Wx1	None	None	USB / USB	None	None	None	Win10 Pro 64	3-year, Onsite, OID	10/15
10GC0002US	US	1L	Pentium N3700	No	Intel HD	None	4GBx1	500GB 7200rpm 2.5"	None	QCA6174 ac, 2x2 + BT4.1	None	Switch	None	1Wx1	None	None	USB / USB	None	None	None	Win10 DG Win7 Pro 64	3-year, Onsite, OID	10/15

# ThinkCentre M600 Tiny - 10GE

Product Specifications Reference (PSREF)

Model	Region	Case 1L/2L	Processor	vPro	Graphics	Monitor Cable	Memory	Storage	External Optical / I/O Box	WLAN + Bluetooth	Optional Rear Ports	Chassis Intrusion Switch	Kensington Cable Lock	Speaker	Adapter Cage	Toolless Chassis Screw	Keyboard / Mouse	VESA Mount	Stand	Power Supply	Operating System	Warranty	Ann Date (m/y)
10GE0001US	US	1L	Celeron N3050	No	Intel HD	None	2GBx1	500GB 7200rpm 2.5"	None	QCA9377 ac, 1x1 + BT4.1	None	Switch	None	1Wx1	None	None	USB / USB	None	None	None	Win10 DG Win7 Pro 64	3-year, Onsite, OID	10/15



# ThinkCentre M700 SFF Platform Specifications

Product Specifications Reference (PSREF)

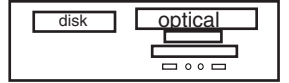
Processor	Intel® Celeron®, Intel Pentium®, or 6th Generation Intel Core™ i3 / i5 / i7 Processor	Security features	<ul style="list-style-type: none"> <li>One lock to secure both cover and entire system to fixed object: <ul style="list-style-type: none"> <li>-Padlock loop (in rear for opt padlock)</li> <li>-Security slot (in rear for optional Kensington® MicroSaver® cable)</li> </ul> </li> <li>Optional cable lock to physically lock both keyboard and mouse</li> </ul> <ul style="list-style-type: none"> <li>Power-on password</li> <li>Administrator password</li> <li>Hard disk password</li> <li>Boot sequence control</li> <li>Boot without keyboard and mouse</li> <li>Individual USB port disablement</li> <li>Optional chassis intrusion switch</li> </ul>																																																												
	<table border="1"> <thead> <tr> <th>Processor</th> <th>Cores / Threads</th> <th>Frequency Base/Max(GHz)</th> <th>Cache</th> <th>Memory Types</th> <th>Integrated Graphics</th> </tr> </thead> <tbody> <tr> <td>Celeron G3900</td> <td>2 / 2</td> <td>2.8 G</td> <td>2 MB</td> <td>DDR4-2133</td> <td>HD 510</td> </tr> <tr> <td>Pentium G4400</td> <td>2 / 2</td> <td>3.3 G</td> <td>3 MB</td> <td>DDR4-2133</td> <td>HD 510</td> </tr> <tr> <td>Pentium G4500</td> <td>2 / 2</td> <td>3.5 G</td> <td>3 MB</td> <td>DDR4-2133</td> <td>HD 530</td> </tr> <tr> <td>Core i3-6100</td> <td>2 / 4</td> <td>3.7 G</td> <td>3 MB</td> <td>DDR4-2133</td> <td>HD 530</td> </tr> <tr> <td>Core i3-6300</td> <td>2 / 4</td> <td>3.8 G</td> <td>4 MB</td> <td>DDR4-2133</td> <td>HD 530</td> </tr> <tr> <td>Core i5-6400</td> <td>4 / 4</td> <td>2.7 G / 3.3 G</td> <td>6 MB</td> <td>DDR4-2133</td> <td>HD 530</td> </tr> <tr> <td>Core i5-6500</td> <td>4 / 4</td> <td>3.2 G / 3.6 G</td> <td>6 MB</td> <td>DDR4-2133</td> <td>HD 530</td> </tr> <tr> <td>Core i5-6600</td> <td>4 / 4</td> <td>3.3 G / 3.9 G</td> <td>6 MB</td> <td>DDR4-2133</td> <td>HD 530</td> </tr> <tr> <td>Core i7-6700</td> <td>4 / 8</td> <td>3.4 G / 4.0 G</td> <td>8 MB</td> <td>DDR4-2133</td> <td>HD 530</td> </tr> </tbody> </table>	Processor	Cores / Threads	Frequency Base/Max(GHz)	Cache	Memory Types	Integrated Graphics	Celeron G3900	2 / 2	2.8 G	2 MB	DDR4-2133	HD 510	Pentium G4400	2 / 2	3.3 G	3 MB	DDR4-2133	HD 510	Pentium G4500	2 / 2	3.5 G	3 MB	DDR4-2133	HD 530	Core i3-6100	2 / 4	3.7 G	3 MB	DDR4-2133	HD 530	Core i3-6300	2 / 4	3.8 G	4 MB	DDR4-2133	HD 530	Core i5-6400	4 / 4	2.7 G / 3.3 G	6 MB	DDR4-2133	HD 530	Core i5-6500	4 / 4	3.2 G / 3.6 G	6 MB	DDR4-2133	HD 530	Core i5-6600	4 / 4	3.3 G / 3.9 G	6 MB	DDR4-2133	HD 530	Core i7-6700	4 / 8	3.4 G / 4.0 G	8 MB	DDR4-2133	HD 530	Keyboard	<i>Some:</i> PS/2 Keyboard (PS/2 connector), Lenovo logo <i>Some:</i> Preferred Pro USB Keyboard (USB connector), Lenovo logo <i>Some:</i> Lenovo USB Fingerprint Keyboard (USB connector) <i>Some:</i> Ultralim Plus Wireless Keyboard (2.4GHz via USB receiver), black
Processor	Cores / Threads	Frequency Base/Max(GHz)	Cache	Memory Types	Integrated Graphics																																																										
Celeron G3900	2 / 2	2.8 G	2 MB	DDR4-2133	HD 510																																																										
Pentium G4400	2 / 2	3.3 G	3 MB	DDR4-2133	HD 510																																																										
Pentium G4500	2 / 2	3.5 G	3 MB	DDR4-2133	HD 530																																																										
Core i3-6100	2 / 4	3.7 G	3 MB	DDR4-2133	HD 530																																																										
Core i3-6300	2 / 4	3.8 G	4 MB	DDR4-2133	HD 530																																																										
Core i5-6400	4 / 4	2.7 G / 3.3 G	6 MB	DDR4-2133	HD 530																																																										
Core i5-6500	4 / 4	3.2 G / 3.6 G	6 MB	DDR4-2133	HD 530																																																										
Core i5-6600	4 / 4	3.3 G / 3.9 G	6 MB	DDR4-2133	HD 530																																																										
Core i7-6700	4 / 8	3.4 G / 4.0 G	8 MB	DDR4-2133	HD 530																																																										
		Mouse	<i>Some:</i> PS/2 Optical Wheel Mouse, black, Lenovo logo <i>Some:</i> Enhanced Optical USB Mouse, black, Lenovo logo <i>Some:</i> Ultralim Plus Wireless Mouse (2.4GHz via USB receiver), black																																																												
Memory	32GB max, UDIMM, DDR4 2133, two 288-pin DIMM sockets, dual-channel capable	Mechanical	<ul style="list-style-type: none"> <li>SFF (9.7L), black color; metal case</li> <li>(WxDxH) 13.31" X 14.05" X 3.46"; 338mm X 357mm X 88mm</li> <li>12.3 lb (5.6 kg)</li> <li>Toolless cover, disk, optical removal</li> <li>Toolless graphics, PCI adapter retention</li> <li>Optional dust filter</li> </ul>  <p>Bay 1: N/A, 9.5mm high, external, std optical  Bay 2: 3.5", 1" high, internal, std disk  Bay 3: 2.5", N/A, internal, opt 2nd 2.5" disk (optional bay)  Bay 4: N/A, N/A, external, opt reader  Slot 1: Low Profile, PCI Express 3.0 x16  Slot 2: Low Profile, PCIe 2.0 x1  Slot 3: Low Profile, PCIe 2.0 x1</p>																																																												
Disk	<i>Some:</i> Hard disk, SATA 6.0Gb/s, 2.5"/ 3.5" wide, 5400 / 7200 rpm <i>Some:</i> Solid State Hybrid Drive (SSHD), 500GB (5400 rpm, 2.5") / 1TB or 2TB (7200 rpm, 3.5"), with 8GB NAND flash memory, SATA 6.0Gb/s <i>Some:</i> Solid State Drive (SSD) / SATA 6.0Gb/s, 2.5" Wide	Floor Stand	Optional system floor stand for vertical orientation																																																												
Optical	<i>Some:</i> DVD-ROM SATA 1.5Gb/s Drive <i>Some:</i> Super Multi-Burner DVD±RW SATA 1.5Gb/s Drive	Power supply	<i>Some:</i> 180 watts, autosensing, 85% PSU <i>Some:</i> 210 watts, autosensing, 85% PSU																																																												
Onboard SATA	Three onboard SATA 6.0Gb/s connectors	Limited warranty <sup>3</sup>	<i>Some:</i> <b>1-year</b> or <b>3-year, depot service</b> / service upgrades available <i>Some:</i> <b>1-year</b> or <b>3-year, limited onsite service</b> / service upgrades available <i>Some:</i> <b>3-year, limited onsite service, OID</b> (Onsite International Delivery) / service upgrades available <i>For Lenovo service upgrade options, please go to S-TC sheet</i>																																																												
Media reader	Optional 9-in-1 media reader	Preload	<b>Preloaded operating system</b> <i>Some:</i> Windows® 7 Professional 32/64 preinstalled through downgrade rights in Windows 10 Pro 64-bit <i>Some:</i> Windows 7 Professional 32/64 <i>Some:</i> Windows 10 Pro 64-bit <i>Some:</i> Windows 10 Home 64-bit																																																												
Graphics	<b>Intel HD Graphics 510/530</b> in processor, uses main memory, DirectX® 12, one VGA, one DisplayPort™, supports two independent displays, works along with discrete graphics to support more displays; <i>Max resolution:</i> 4096x2304 (DP)@60Hz; 1920x1200 (VGA)@60Hz <i>Some:</i> <b>NVIDIA® Quadro® K420</b> , DirectX 12, 2GB, PCIe 2.0 x16 adapter, one DVI-I, one DisplayPort, 41 watts; <i>Max resolution:</i> 3840x2160 (DisplayPort)@60Hz; 2560x1600 (DVI-I)@60Hz <i>Some:</i> <b>NVIDIA GeForce® GT 720</b> , DirectX 12, 2GB, PCIe 2.0 x8 adapter, one VGA, one HDMI, 25 watts; <i>Max resolution:</i> 1920x1080 (HDMI)@60Hz; 2048x1536 (VGA)@85Hz <i>Some:</i> <b>NVIDIA GeForce GT 720</b> , DirectX 12, 1GB, PCIe 2.0 x8 adapter, two DisplayPort, 25 watts; <i>Max resolution:</i> 3840x2160 (DisplayPort)@60Hz;		<b>Preloaded applications (only some listed)</b> <ul style="list-style-type: none"> <li>Desktop Power Manager</li> <li>Lenovo Solution Center</li> <li>Lenovo REACHit</li> <li>Lenovo SHAREit</li> <li>Lenovo Bluetooth Lock (for models with Wi-Fi/BT card)</li> <li>McAfee® LiveSafe™ (30-day trial)</li> <li>Microsoft Office preloaded; purchase a product key to activate</li> <li>PowerDVD Create (DVD±RW)</li> <li>Lenovo ThinkVantage Tools <ul style="list-style-type: none"> <li>- Only for Window 10</li> <li>- Lenovo Companion</li> <li>- Cyberlink PowerDVD (DVD, DVD±RW)</li> <li>- Lenovo QuickOptimizer <ul style="list-style-type: none"> <li>- Only for Window 7</li> <li>- Rescue and Recovery</li> <li>- Password Manager</li> <li>- ThinkVantage System Update</li> <li>- Lenovo Message Center Plus</li> <li>- Adobe® Reader®</li> </ul> </li> </ul> </li> </ul>																																																												
DP cable	Optional DP to VGA, DP to DVI-D (single link), or DP to HDMI 1.4 dongle	Environment	ENERGY STAR® 6.0*, EPEAT™ Gold rating* (*Need 85% PSU and Windows OS); ErP Lot 3; GREENGUARD®; RoHS-compliant																																																												
Chipset	<b>Intel H110 Chipset</b>	Accessories	For compatible accessories, please go to TC-AQP sheet																																																												
Front ports	Two USB 3.0, two optional USB 2.0, microphone (3.5mm), headphone (3.5mm)																																																														
Rear ports	Two USB 3.0, two USB 2.0, two optional USB 2.0, serial (9-pin), optional 2nd serial (9-pin), optional parallel (25-pin), ethernet (RJ-45), one VGA, one DisplayPort, two PS/2 ports (keyboard/mouse); additional VGA, DisplayPort, DVI-I or HDMI on optional graphics on some models																																																														
Rear audio ports	Line-in (3.5mm), line-out (3.5mm), microphone-in (3.5mm)																																																														
IEEE 1394	None																																																														
Audio support	High Definition (HD) Audio, Realtek ALC662 / optional internal speaker (1.5 watt )																																																														
WLAN <sup>13</sup>	<i>Some:</i> 11ac wireless, M.2 Card, Qualcomm Atheros QCA9377 (dual band), Wi-Fi + Bluetooth 4.1 combo adapter, 1x1 <i>Some:</i> 11ac wireless, M.2 Card, Qualcomm Atheros QCA6174 (dual band), Wi-Fi + Bluetooth 4.1 combo adapter, 2x2 <i>Some:</i> 11ac wireless, M.2 Card, Intel Dual Band Wireless-AC 3165, Wi-Fi + Bluetooth 4.0 combo adapter, 1x1 <i>Some:</i> 11ac wireless, M.2 Card, Intel Dual Band Wireless-AC 8260, Wi-Fi + Bluetooth 4.1 combo adapter, 2x2																																																														
Bluetooth™	<i>Some:</i> Bluetooth 4.0 or 4.1 wireless, integrated in Wi-Fi + BT combo adapter																																																														
Ethernet	Gigabit ethernet, Realtek RTL8111GN, Wake on LAN®																																																														
Modem	None																																																														
Manageability	None																																																														
Security chip	Trusted Platform Module, TCG 1.2-compliant																																																														

See footnotes for more detailed information

Model	Region	Processor	vPro	Graphics	Monitor Cable	Memory	Storage	Optical	Optional 2nd 2.5" Bay	Media Reader	WLAN + Bluetooth	Optional Front Ports	Optional Rear Ports	Chassis Intrusion Switch	Cable Lock	Dust Filter	Keyboard / Mouse	Stand	Power Supply	Operating System	Warranty	Ann Date (m/y)
10GT002DUS	US	i3-6100	No	Intel HD 530	None	4GBx1	500GB 7200rpm 3.5"	DVD±RW	Optional 2nd 2.5" Bay	None	None	None	None	None	None	None	USB / USB	Floor Stand	210W 85%	Win10 DG Win7 Pro 64	3-year, Onsite	01/16
10GT002EUS	US	i5-6400	No	Intel HD 530	None	4GBx1	500GB 7200rpm 3.5"	DVD±RW	Optional 2nd 2.5" Bay	None	None	None	None	None	None	None	USB / USB	Floor Stand	210W 85%	Win10 DG Win7 Pro 64	3-year, Onsite	01/16
10GT002FUS	US	Pentium G4400	No	Intel HD 510	None	4GBx1	500GB 7200rpm 3.5"	DVD±RW	Optional 2nd 2.5" Bay	None	None	None	None	None	None	None	USB / USB	Floor Stand	210W 85%	Win10 DG Win7 Pro 64	3-year, Onsite	01/16
10GT002GUS	US	i7-6700	No	Intel HD 530	None	8GBx1	1TB 7200rpm 3.5"	DVD±RW	Optional 2nd 2.5" Bay	None	None	None	None	None	None	None	USB / USB	Floor Stand	210W 85%	Win10 DG Win7 Pro 64	3-year, Onsite	01/16
10GT002HUS	US	i5-6400	No	Intel HD 530	None	8GBx1	128GB SSD	DVD±RW	Optional 2nd 2.5" Bay	None	None	None	None	None	None	None	USB / USB	Floor Stand	210W 85%	Win10 DG Win7 Pro 64	3-year, Onsite	01/16
10GT002JUS	US	i7-6700	No	Intel HD 530	None	8GBx1	1TB 7200rpm 3.5"	DVD±RW	None	None	None	None	None	None	None	None	USB / USB	Floor Stand	210W 85%	Win10 DG Win7 Pro 64	3-year, Onsite	01/16
10GT002KUS	US	i7-6700	No	Intel HD 530	None	8GBx1	192GB SSD	DVD±RW	None	None	None	None	None	None	None	None	USB / USB	Floor Stand	210W 85%	Win10 DG Win7 Pro 64	3-year, Onsite	01/16
10GT002LUS	US	i7-6700	No	GT 720 1GB	None	8GBx1	1TB 7200rpm 3.5"	DVD±RW	None	None	Intel 8260 ac, 2x2 + BT4.1	None	None	None	None	None	USB / USB	Floor Stand	210W 85%	Win10 DG Win7 Pro 64	3-year, Onsite	01/16
10GT002MUS	US	i7-6700	No	Intel HD 530	None	8GBx1	1TB 7200rpm 3.5"	DVD±RW	None	None	Intel 8260 ac, 2x2 + BT4.1	None	None	None	None	None	USB / USB	Floor Stand	210W 85%	Win10 DG Win7 Pro 64	3-year, Onsite	01/16
10GT002NUS	US	i5-6400	No	GT 720 2GB	None	8GBx1	1TB 7200rpm 3.5"	DVD±RW	None	None	Intel 8260 ac, 2x2 + BT4.1	None	None	None	None	None	USB / USB	Floor Stand	210W 85%	Win10 DG Win7 Pro 64	3-year, Onsite	01/16
10GT002PUS	US	i5-6400	No	Intel HD 530	None	4GBx1	500GB 7200rpm 3.5"	DVD±RW	None	None	None	None	None	None	None	None	USB / USB	Floor Stand	210W 85%	Win10 DG Win7 Pro 64	3-year, Onsite	01/16
10GT002QUS	US	i7-6700	No	Intel HD 530	None	8GBx1	120GB SSD	DVD±RW	None	None	None	None	None	None	None	None	USB / USB	Floor Stand	210W 85%	Win10 DG Win7 Pro 64	3-year, Onsite	01/16
10GT002RUS	US	i7-6700	No	Intel HD 530	None	8GBx1	500GB 7200rpm 3.5"	DVD±RW	None	None	None	None	None	None	None	None	USB / USB	Floor Stand	210W 85%	Win10 DG Win7 Pro 64	3-year, Onsite	01/16
10GT002SUS	US	i5-6400	No	Intel HD 530	None	8GBx1	1TB 7200rpm 3.5"	DVD±RW	None	None	None	None	None	None	None	None	USB / USB	Floor Stand	210W 85%	Win10 DG Win7 Pro 64	3-year, Onsite	01/16
10GT002TUS	US	i7-6700	No	Intel HD 530	None	8GBx1	256GB SSD Opal	DVD±RW	None	None	None	None	None	None	None	None	USB / USB	Floor Stand	210W 85%	Win10 DG Win7 Pro 64	3-year, Onsite	01/16
10GT002UUS	US	i5-6400	No	Intel HD 530	None	4GBx1	500GB 7200rpm 3.5"	DVD±RW	None	None	Intel 8260 ac, 2x2 + BT4.1	None	None	None	None	None	USB / USB	Floor Stand	210W 85%	Win10 DG Win7 Pro 64	3-year, Onsite	01/16
10GT002VUS	US	i5-6400	No	Intel HD 530	None	8GBx1	500GB 7200rpm 3.5"	DVD±RW	None	None	Intel 8260 ac, 2x2 + BT4.1	None	None	None	None	None	USB / USB	Floor Stand	210W 85%	Win10 DG Win7 Pro 64	3-year, Onsite	01/16
10GT002WUS	US	i5-6400	No	Intel HD 530	None	8GBx1	500GB 7200rpm 3.5"	DVD±RW	None	None	None	None	None	None	None	None	USB / USB	Floor Stand	210W 85%	Win10 DG Win7 Pro 64	3-year, Onsite	01/16
10GT0036US	US	i5-6400	No	Intel HD 530	None	8GBx1	256GB SSD Opal	DVD±RW	None	None	None	None	None	None	None	None	USB / USB	Floor Stand	210W 85%	Win10 DG Win7 Pro 64	3-year, Onsite	01/16
10GT0037US	US	i5-6400	No	Intel HD 530	None	8GBx1	192GB SSD	DVD±RW	None	None	None	None	None	None	None	None	USB / USB	Floor Stand	210W 85%	Win10 DG Win7 Pro 64	3-year, Onsite	01/16

Model	Region	Processor	vPro	Graphics	Monitor Cable	Memory	Storage	Optical	Optional 2nd 2.5" Bay	Media Reader	WLAN + Bluetooth	Optional Front Ports	Optional Rear Ports	Chassis Intrusion Switch	Cable Lock	Dust Filter	Keyboard / Mouse	Stand	Power Supply	Operating System	Warranty	Ann Date (m/y)
10GT0038US	US	i5-6400	No	Intel HD 530	None	8GBx1	120GB SSD	DVD±RW	None	None	None	None	None	None	None	None	USB / USB	Floor Stand	210W 85%	Win10 DG Win7 Pro 64	3-year, Onsite	01/16
10GT0039US	US	i3-6100	No	Intel HD 530	None	4GBx1	500GB 7200rpm 3.5"	DVD±RW	None	None	None	None	None	None	None	None	USB / USB	Floor Stand	210W 85%	Win10 DG Win7 Pro 64	3-year, Onsite	01/16
10GT003AUS	US	i3-6100	No	Intel HD 530	None	4GBx1	500GB 7200rpm 3.5"	DVD±RW	None	None	Intel 3165 ac, 1x1 + BT4.0	None	None	None	None	None	USB / USB	Floor Stand	210W 85%	Win10 DG Win7 Pro 64	3-year, Onsite	01/16
10GT003BUS	US	i3-6100	No	Intel HD 530	None	4GBx1	500GB 7200rpm 3.5"	DVD±RW	None	None	Intel 8260 ac, 2x2 + BT4.1	None	None	None	None	None	USB / USB	Floor Stand	210W 85%	Win10 DG Win7 Pro 64	3-year, Onsite	01/16
10GT003CUS	US	Pentium G4400	No	Intel HD 510	None	4GBx1	500GB 7200rpm 3.5"	DVD±RW	None	None	None	None	None	None	None	None	USB / USB	Floor Stand	210W 85%	Win10 DG Win7 Pro 64	3-year, Onsite	01/16
10GT003DUS	US	i7-6700	No	Intel HD 530	None	8GBx1	1TB 7200rpm 3.5"	DVD±RW	None	None	Intel 8260 ac, 2x2 + BT4.1	None	None	None	None	None	None / USB	Floor Stand	210W 85%	Win10 Pro 64	3-year, Onsite	01/16
10GT003EUS	US	i5-6400	No	Intel HD 530	None	4GBx1	500GB 7200rpm 3.5"	DVD±RW	None	None	Intel 8260 ac, 2x2 + BT4.1	None	None	None	None	None	None / USB	Floor Stand	210W 85%	Win10 Pro 64	3-year, Onsite	01/16
10GT003FUS	US	i3-6100	No	Intel HD 530	None	4GBx1	500GB 7200rpm 3.5"	DVD±RW	None	None	Intel 3165 ac, 1x1 + BT4.0	None	None	None	None	None	None / USB	Floor Stand	210W 85%	Win10 Pro 64	3-year, Onsite	01/16
10GT003GUS	US	Pentium G4400	No	Intel HD 510	None	4GBx1	500GB 7200rpm 3.5"	DVD±RW	None	None	Intel 3165 ac, 1x1 + BT4.0	None	None	None	None	None	None / USB	Floor Stand	210W 85%	Win10 Pro 64	3-year, Onsite	01/16
10GT004GUS	US	i5-6500	No	Intel HD 530	None	8GBx1	128GB SSD	DVD±RW	Optional 2nd 2.5" Bay	None	None	None	None	None	None	None	USB / USB	Floor Stand	210W 85%	Win10 DG Win7 Pro 64	3-year, Onsite	03/16
10GT004HUS	US	i5-6500	No	Intel HD 530	None	8GBx1	500GB 7200rpm 3.5"	DVD±RW	Optional 2nd 2.5" Bay	None	None	None	None	None	None	None	USB / USB	Floor Stand	210W 85%	Win10 DG Win7 Pro 64	3-year, Onsite	03/16
10GT004YUS	US	i5-6400	No	Intel HD 530	None	4GBx1	500GB 7200rpm 3.5"	DVD±RW	Optional 2nd 2.5" Bay	None	Intel 3165 ac, 1x1 + BT4.0	None	None	None	None	None	USB / USB	Floor Stand	210W 85%	Win10 Pro 64	3-year, Onsite	05/16
10GT0050US	US	i3-6100	No	Intel HD 530	None	4GBx1	500GB 7200rpm 3.5"	DVD±RW	Optional 2nd 2.5" Bay	None	None	None	None	None	None	None	USB / USB	Floor Stand	210W 85%	Win10 Pro 64	3-year, Onsite	05/16
10GT0051US	US	i5-6400	No	Intel HD 530	None	8GBx1	1TB 7200rpm 3.5"	DVD±RW	Optional 2nd 2.5" Bay	None	None	None	None	None	None	None	USB / USB	Floor Stand	210W 85%	Win10 Pro 64	3-year, Onsite	05/16
10GT0052US	US	i7-6700	No	Intel HD 530	None	8GBx1	1TB 7200rpm 3.5"	DVD±RW	Optional 2nd 2.5" Bay	None	None	None	None	None	None	None	USB / USB	Floor Stand	210W 85%	Win10 Pro 64	3-year, Onsite	05/16
10GT0053US	US	i7-6700	No	Intel HD 530	None	8GBx1	256GB SSD Opal	DVD±RW	Optional 2nd 2.5" Bay	None	None	None	None	None	None	None	USB / USB	Floor Stand	210W 85%	Win10 Pro 64	3-year, Onsite	05/16
10GT0054US	US	i7-6700	No	Intel HD 530	None	8GBx1	180GB SSD Opal	DVD±RW	Optional 2nd 2.5" Bay	None	None	None	None	None	None	None	USB / USB	Floor Stand	210W 85%	Win10 Pro 64	3-year, Onsite	05/16
10GT0055US	US	i7-6700	No	Intel HD 530	None	4GBx1	128GB SSD	DVD±RW	Optional 2nd 2.5" Bay	None	None	None	None	None	None	None	USB / USB	Floor Stand	210W 85%	Win10 Pro 64	3-year, Onsite	05/16
10GT0056US	US	i7-6700	No	GT 720 1GB	None	8GBx1	1TB 7200rpm 3.5"	DVD±RW	Optional 2nd 2.5" Bay	None	None	None	None	None	None	None	USB / USB	Floor Stand	210W 85%	Win10 Pro 64	3-year, Onsite	05/16
10GT005EUS	US	i7-6700	No	GT 720 1GB	None	8GBx1	1TB 7200rpm 3.5"	DVD±RW	Optional 2nd 2.5" Bay	None	None	None	None	None	None	None	USB / USB	Floor Stand	210W 85%	Win10 Pro 64	3-year, Onsite	10/16

Model	Region	Processor	vPro	Graphics	Monitor Cable	Memory	Storage	Optical	Optional 2nd 2.5" Bay	Media Reader	WLAN + Bluetooth	Optional Front Ports	Optional Rear Ports	Chassis Intrusion Switch	Cable Lock	Dust Filter	Keyboard / Mouse	Stand	Power Supply	Operating System	Warranty	Ann Date (m/y)
10GT005FUS	US	i7-6700	No	GT 720 1GB	None	8GBx1	1TB 7200rpm 3.5"	DVD±RW	Optional 2nd 2.5" Bay	None	Intel 8260 ac, 2x2 + BT4.1	None	None	None	None	None	USB / USB	Floor Stand	210W 85%	Win10 DG Win7 Pro 64	3-year, Onsite	10/16
10GT005GUS	US	i7-6700	No	GT 720 1GB	None	8GBx1	1TB 7200rpm 3.5"	DVD±RW	Optional 2nd 2.5" Bay	None	None	None	None	None	None	None	USB / USB	Floor Stand	210W 85%	Win10 DG Win7 Pro 64	3-year, Onsite	10/16
10GT005HUS	US	i7-6700	No	GT 720 1GB	None	8GBx1	1TB 7200rpm 3.5"	DVD±RW	Optional 2nd 2.5" Bay	None	Intel 8260 ac, 2x2 + BT4.1	None	None	None	None	None	USB / USB	Floor Stand	210W 85%	Win10 Pro 64	3-year, Onsite	10/16





# ThinkCentre M700 Tiny Platform Specifications

Product Specifications Reference (PSREF)

Processor	Intel® Celeron®, Intel Pentium®, or 6th Generation Intel Core™ i3 / i5 / i7 Processor						Keyboard	<i>Some:</i> Preferred Pro USB Keyboard (USB connector), Lenovo logo	
	Processor	Cores / Threads	Frequency Base/Max(GHz)	Cache	Memory Types	Integrated Graphics	Mouse	<i>Some:</i> Lenovo Slim USB Keyboard (USB connector), black, Lenovo logo <i>Some:</i> Lenovo USB Fingerprint Keyboard (USB connector) <i>Some:</i> Ultrasmil Plus Wireless Keyboard (2.4GHz via USB receiver), black <i>Some:</i> Enhanced Optical USB Mouse, black, Lenovo logo <i>Some:</i> Ultrasmil Plus Wireless Mouse (2.4GHz via USB receiver), black	
	Pentium G4400T	2 / 2	2.9 G	3 MB	DDR4-2133	HD 510			
	Pentium G4500T	2 / 2	3.0 G	3 MB	DDR4-2133	HD 530			
	Core i3-6100T	2 / 4	3.2 G	3 MB	DDR4-2133	HD 530			
	Core i3-6300T	2 / 4	3.3 G	4 MB	DDR4-2133	HD 530			
	Core i5-6400T	4 / 4	2.2 G / 2.8 G	6 MB	DDR4-2133	HD 530			
	Core i5-6500T	4 / 4	2.5 G / 3.1 G	6 MB	DDR4-2133	HD 530			
	Core i5-6600T	4 / 4	2.7 G / 3.5 G	6 MB	DDR4-2133	HD 530			
	Core i7-6700T	4 / 8	2.8 G / 3.6 G	8 MB	DDR4-2133	HD 530			
Memory	32GB max, DDR4 2133, two 260-pin SO-DIMM sockets, dual-channel capable						Mechanical	Tiny (1L), black color; metal case M700 Tiny only: 7.05" W X 7.20" D X 1.36" H 179mm W X 182.9mm D X 34.5mm H 2.9 lb (1.3 kg), weight may vary by configuration With VESA mount & ODD box: 7.42" W X 7.30" D X 2.48" H 188.4mm W X 185.38mm D X 63mm H 4.12 lb (1.87 kg), weight may vary by configuration With VESA mount & I/O box: 7.42" W X 7.30" D X 2.62" H 188.4mm W X 185.38mm D X 66.6mm H 3.53 lb (1.6 kg), weight may vary by configuration Optional VESA mount bracket kit, supports VESA 75mm and 100mm Optional system floor stand for vertical orientation	
Disk	<i>Some:</i> SATA 6.0Gb/s, 2.5" Wide, 5400 rpm or 7200 rpm <i>Some:</i> 500GB (5400 rpm) Solid State Hybrid Drive (SSHD) / with 8GB MLC NAND flash memory, SATA 6.0Gb/s, 2.5" wide <i>Some:</i> Solid State Drive (SSD) / SATA 6.0Gb/s, 2.5" Wide <i>Some:</i> M.2 Solid State Drive (SSD) / SATA interface						VESA mount	Optional VESA mount bracket kit, supports VESA 75mm and 100mm	
Optical	<i>Some:</i> external ODD box with DVD-ROM, 9.5mm high, via USB <i>Some:</i> external ODD box with DVD±RW, 9.5mm high, via USB <i>Some:</i> external ODD box (for TIO) with DVD-ROM, 9.5mm high, via USB <i>Some:</i> external ODD box (for TIO) with DVD±RW, 9.5mm high, via USB						Floor Stand	Optional system floor stand for vertical orientation	
Onboard SATA Media reader	One SATA cable (1-drop to device), one SATA 6.0Gb/s connector on planar None						Power supply	65 watts AC/DC adapter, autosensing, 88% PSU (not included for TIO models) 90 watts AC/DC adapter, autosensing, 88% PSU (only for models with I/O box)	
Graphics	<b>Intel HD Graphics 510/530</b> in processor, uses main memory, DirectX® 12, two DisplayPort™, one optional HDMI, VGA, or 3rd DP, up to 3 independent displays; <i>Max resolution:</i> 4096x2304 (DP) @60Hz; 4096x2160 (HDMI) @24Hz; 1920x1200 (VGA) @60Hz						Limited warranty <sup>3</sup>	<i>Some:</i> 1-year or 3-year, depot service / service upgrades available <i>Some:</i> 1-year or 3-year, limited onsite service / service upgrades available <i>Some:</i> 3-year, limited onsite service, OID (Onsite International Delivery) / service upgrades available <i>For Lenovo service upgrade options, please go to S-TC sheet</i>	
DP cable	Optional DP to VGA, DP to DVI-D (single link), or DP to HDMI 1.4 dongle						Preload	<i>Some:</i> Windows® 7 Professional 32/64 preinstalled through downgrade rights in Windows 10 Pro 64-bit <i>Some:</i> Windows 7 Professional 32/64 <i>Some:</i> Windows 10 Pro 64-bit <b>Preloaded applications (only some listed)</b> • Desktop Power Manager • Lenovo Solution Center • Lenovo REACHit • Lenovo SHAREit • Lenovo Bluetooth Lock (for models with Wi-Fi/BT card) • McAfee® LiveSafe™ (30-day trial) • Microsoft Office preloaded; purchase a product key to activate • PowerDVD Create (DVD±RW) • Lenovo ThinkVantage Tools • Intel Unite (vPro models only) - Only for Window 10 • Lenovo Companion • Cyberlink PowerDVD (DVD, DVD±RW) • Lenovo QuickOptimizer - Only for Window 7 • Rescue and Recovery • Password Manager • ThinkVantage System Update • Lenovo Message Center Plus • Adobe® Reader®	
Chipset	<b>Intel B150 Chipset</b>							<i>Some:</i> Windows® Embedded Standard 7 (WES 7) <i>Some:</i> LeTOS (Lenovo Terminal Operating System, Linux-based) <b>Preloaded applications (only some listed)</b> - WES 7 only: • RDP Client (RDP 8.1 support) • Citrix Client • VMware Client • Internet Explorer 11 • Java • Flash • .Net Framework • Microsoft® Silverlight • Echo Agent (client for LTM, Lenovo Thin Client Manager) • Adobe Reader • UltraVNC - LeTOS only: • xFreeRDP • Citrix ICA Client • VMware View Client • Java • Mozilla Firefox	
Front ports	Two USB 3.0 (one is Always On and fast charge), one microphone (stereo, 3.5mm), one headphone / microphone combo jack (stereo, 3.5mm)						Environment	ENERGY STAR® 6.0*, EPEAT™ Gold rating* (*for Windows models only); ErP Lot 3; GREENGUARD®; RoHS-compliant	
Rear ports	Four USB 3.0 (optional external optical box or external I/O box occupies one or two specific USB 3.0 on some models), ethernet (RJ-45), two DisplayPort, one optional port (VGA, 3rd DP, HDMI, or serial on some models), one headphone						MIL-SPEC test	MIL-STD-810G military certification (Low Pressure [Altitude], High Temperature, Low Temperature, Temperature Shock, Humidity, Sand and Dust, Vibration, Shock)	
I/O box	Optional external I/O box, extends two USB 2.0, two USB 3.0, and one serial on rear, two USB 2.0 on front, via USB (occupy two specific USB 3.0 of M700 Tiny)						Accessories	For compatible accessories, please go to TC-AQP sheet	
Audio support	High Definition (HD) Audio, Realtek ALC223 / optional internal speaker (1 watt)								
WLAN <sup>13</sup>	<i>Some:</i> 11ac wireless, M.2 Card, Realtek RTL8821AE (dual band), Wi-Fi + Bluetooth 4.0 combo adapter, 1x1 <i>Some:</i> 11ac wireless, M.2 Card, Qualcomm Atheros QCA9377 (dual band), Wi-Fi + Bluetooth 4.1 combo adapter, 1x1 <i>Some:</i> 11ac wireless, M.2 Card, Qualcomm Atheros QCA6174 (dual band), Wi-Fi + Bluetooth 4.1 combo adapter, 2x2 <i>Some:</i> 11ac wireless, M.2 Card, Intel Dual Band Wireless-AC 3165, Wi-Fi + Bluetooth 4.0 combo adapter, 1x1 <i>Some:</i> 11ac wireless, M.2 Card, Intel Dual Band Wireless-AC 8260, Wi-Fi + Bluetooth 4.1 combo adapter, 2x2								
Bluetooth™ Ethernet Modem	<i>Some:</i> Bluetooth 4.0 or 4.1 wireless, integrated in Wi-Fi + BT combo adapter Gigabit ethernet, Intel Ethernet Connection I219-LV (Jacksonville), Wake on LAN® None								
Manageability	None								
Security chip	Trusted Platform Module, TCG 1.2-compliant								
Security features	<ul style="list-style-type: none"> <li>• Security slot (in rear for optional Kensington® MicroSaver® cable)</li> <li>• Padlock loop</li> <li>• Smart USB protection, allows keyboard/mouse only, blocks all storage devices</li> <li>• Power-on password</li> <li>• Administrator password</li> <li>• Hard disk password</li> <li>• Boot sequence control</li> <li>• Boot without keyboard and mouse</li> <li>• Individual USB port disablement</li> <li>• Chassis intrusion switch</li> </ul>								

Model	Region	Processor	vPro	Graphics	Monitor Cable	Memory	Storage(HDD/SSD)	External Optical / I/O Box	WLAN + Bluetooth	Optional Rear Ports	Chassis Intrusion Switch	Kensington Cable Lock	Speaker	Adapter Cage	Toolless Chassis Screw	Dust Filter	Keyboard / Mouse	VESA Mount	Stand	Power Supply	Operating System	Warranty	Ann Date (m/y)
10HY0004US	US	i5-6400T	No	Intel HD 530	None	4GBx1	120GB SSD	None	Intel 8260 ac, 2x2 + BT4.1	None	Switch	None	1Wx1	None	None	None	USB / USB	None	Floor Stand	65W Adapter 88%	Win10 Pro 64	3-year, Onsite	01/16
10HY0005US	US	i5-6400T	No	Intel HD 530	None	4GBx1	180GB SSD Opal	None	Intel 8260 ac, 2x2 + BT4.1	None	Switch	None	1Wx1	None	None	None	USB / USB	None	Floor Stand	65W Adapter 88%	Win10 Pro 64	3-year, Onsite	01/16
10HY0006US	US	i5-6500T	No	Intel HD 530	None	4GBx1	120GB SSD	None	Intel 8260 ac, 2x2 + BT4.1	None	Switch	None	1Wx1	None	None	None	USB / USB	None	Floor Stand	65W Adapter 88%	Win10 Pro 64	3-year, Onsite	01/16
10HY0007US	US	i5-6500T	No	Intel HD 530	None	4GBx1	500GB 7200rpm 2.5"	None	Intel 8260 ac, 2x2 + BT4.1	None	Switch	None	1Wx1	None	None	None	USB / USB	None	Floor Stand	65W Adapter 88%	Win10 Pro 64	3-year, Onsite	01/16
10HY0008US	US	i5-6400T	No	Intel HD 530	None	4GBx1	500GB 7200rpm 2.5"	None	Intel 8260 ac, 2x2 + BT4.1	None	Switch	None	1Wx1	None	None	None	USB / USB	None	Floor Stand	65W Adapter 88%	Win10 Pro 64	3-year, Onsite	01/16
10HY0009US	US	i5-6400T	No	Intel HD 530	None	4GBx1	500GB 7200rpm 2.5"	DVD±RW	Intel 8260 ac, 2x2 + BT4.1	None	Switch	None	1Wx1	None	None	None	USB / USB	VESA Mount	None	65W Adapter 88%	Win10 Pro 64	3-year, Onsite	01/16
10HY000AUS	US	i7-6700T	No	Intel HD 530	None	8GBx1	500GB 7200rpm 2.5"	None	Intel 8260 ac, 2x2 + BT4.1	None	Switch	None	1Wx1	None	None	None	USB / USB	None	Floor Stand	65W Adapter 88%	Win10 Pro 64	3-year, Onsite	01/16
10HY000BUS	US	i7-6700T	No	Intel HD 530	None	8GBx1	120GB SSD	DVD±RW	Intel 8260 ac, 2x2 + BT4.1	None	Switch	None	1Wx1	None	None	None	USB / USB	VESA Mount	None	65W Adapter 88%	Win10 Pro 64	3-year, Onsite	01/16
10HY000CUS	US	i7-6700T	No	Intel HD 530	None	8GBx1	120GB SSD	None	Intel 8260 ac, 2x2 + BT4.1	None	Switch	None	1Wx1	None	None	None	USB / USB	None	Floor Stand	65W Adapter 88%	Win10 Pro 64	3-year, Onsite	01/16
10HY000DUS	US	i5-6400T	No	Intel HD 530	None	4GBx1	500GB 7200rpm 2.5"	DVD±RW	Intel 8260 ac, 2x2 + BT4.1	None	Switch	None	1Wx1	None	None	None	USB / USB	VESA Mount	None	65W Adapter 88%	Win10 DG Win7 Pro 64	3-year, Onsite	01/16
10HY000EUS	US	i7-6700T	No	Intel HD 530	None	8GBx1	120GB SSD	None	Intel 8260 ac, 2x2 + BT4.1	None	Switch	None	1Wx1	None	None	None	USB / USB	None	Floor Stand	65W Adapter 88%	Win10 DG Win7 Pro 64	3-year, Onsite	01/16
10HY000FUS	US	i7-6700T	No	Intel HD 530	None	8GBx1	120GB SSD	DVD±RW	Intel 8260 ac, 2x2 + BT4.1	None	Switch	None	1Wx1	None	None	None	USB / USB	VESA Mount	None	65W Adapter 88%	Win10 DG Win7 Pro 64	3-year, Onsite	01/16
10HY000GUS	US	i5-6400T	No	Intel HD 530	None	4GBx1	500GB 7200rpm 2.5"	None	Intel 8260 ac, 2x2 + BT4.1	None	Switch	None	1Wx1	None	None	None	USB / USB	None	Floor Stand	65W Adapter 88%	Win10 DG Win7 Pro 64	3-year, Onsite	01/16
10HY000HUS	US	i5-6500T	No	Intel HD 530	None	4GBx1	120GB SSD	None	Intel 8260 ac, 2x2 + BT4.1	None	Switch	None	1Wx1	None	None	None	USB / USB	None	Floor Stand	65W Adapter 88%	Win10 DG Win7 Pro 64	3-year, Onsite	01/16
10HY000JUS	US	i5-6400T	No	Intel HD 530	None	4GBx1	120GB SSD	None	Intel 8260 ac, 2x2 + BT4.1	None	Switch	None	1Wx1	None	None	None	USB / USB	None	Floor Stand	65W Adapter 88%	Win10 DG Win7 Pro 64	3-year, Onsite	01/16
10HY000KUS	US	i5-6500T	No	Intel HD 530	None	4GBx1	500GB 7200rpm 2.5"	None	Intel 8260 ac, 2x2 + BT4.1	None	Switch	None	1Wx1	None	None	None	USB / USB	None	Floor Stand	65W Adapter 88%	Win10 DG Win7 Pro 64	3-year, Onsite	01/16
10HY0013US	US	i7-6700T	No	Intel HD 530	None	8GBx1	500GB 7200rpm 2.5"	None	Intel 8260 ac, 2x2 + BT4.1	VGA	Switch	None	1Wx1	None	None	None	USB / USB	None	Floor Stand	65W Adapter 88%	Win10 Pro 64	3-year, Onsite	01/16
10HY0014US	US	i7-6700T	No	Intel HD 530	None	8GBx1	500GB 7200rpm 2.5"	None	Intel 8260 ac, 2x2 + BT4.1	HDMI	Switch	None	1Wx1	None	None	None	USB / USB	None	Floor Stand	65W Adapter 88%	Win10 Pro 64	3-year, Onsite	01/16
10HY0015US	US	i5-6400T	No	Intel HD 530	None	4GBx1	500GB 7200rpm 2.5"	None	Intel 8260 ac, 2x2 + BT4.1	HDMI	Switch	None	1Wx1	None	None	None	USB / USB	None	Floor Stand	65W Adapter 88%	Win10 Pro 64	3-year, Onsite	01/16
10HY0016US	US	i5-6400T	No	Intel HD 530	None	4GBx1	500GB 7200rpm 2.5"	None	Intel 8260 ac, 2x2 + BT4.1	3rd DP	Switch	None	1Wx1	None	None	None	USB / USB	None	Floor Stand	65W Adapter 88%	Win10 Pro 64	3-year, Onsite	01/16

Model	Region	Processor	vPro	Graphics	Monitor Cable	Memory	Storage(HDD/SSD)	External Optical / I/O Box	WLAN + Bluetooth	Optional Rear Ports	Chassis Intrusion Switch	Kensington Cable Lock	Speaker	Adapter Cage	Toolless Chassis Screw	Dust Filter	Keyboard / Mouse	VESA Mount	Stand	Power Supply	Operating System	Warranty	Ann Date (m/y)
10HY0017US	US	i5-6400T	No	Intel HD 530	None	4GBx1	500GB 7200rpm 2.5"	None	Intel 8260 ac, 2x2 + BT4.1	VGA	Switch	None	1Wx1	None	None	None	USB / USB	None	Floor Stand	65W Adapter 88%	Win10 Pro 64	3-year, Onsite	01/16
10HY0018US	US	i7-6700T	No	Intel HD 530	None	8GBx1	500GB 7200rpm 2.5"	None	Intel 8260 ac, 2x2 + BT4.1	3rd DP	Switch	None	1Wx1	None	None	None	USB / USB	None	Floor Stand	65W Adapter 88%	Win10 Pro 64	3-year, Onsite	01/16
10HY0019US	US	i5-6400T	No	Intel HD 530	None	4GBx1	500GB 7200rpm 2.5"	None	Intel 8260 ac, 2x2 + BT4.1	3rd DP	Switch	None	1Wx1	None	None	None	USB / USB	None	Floor Stand	65W Adapter 88%	Win10 DG Win7 Pro 64	3-year, Onsite	01/16
10HY001AUS	US	i7-6700T	No	Intel HD 530	None	8GBx1	500GB 7200rpm 2.5"	None	Intel 8260 ac, 2x2 + BT4.1	HDMI	Switch	None	1Wx1	None	None	None	USB / USB	None	Floor Stand	65W Adapter 88%	Win10 DG Win7 Pro 64	3-year, Onsite	01/16
10HY001BUS	US	i7-6700T	No	Intel HD 530	None	8GBx1	500GB 7200rpm 2.5"	None	Intel 8260 ac, 2x2 + BT4.1	VGA	Switch	None	1Wx1	None	None	None	USB / USB	None	Floor Stand	65W Adapter 88%	Win10 DG Win7 Pro 64	3-year, Onsite	01/16
10HY001CUS	US	i7-6700T	No	Intel HD 530	None	8GBx1	128GB SSD	None	Intel 8260 ac, 2x2 + BT4.1	HDMI	Switch	None	1Wx1	None	None	None	USB / USB	None	Floor Stand	65W Adapter 88%	Win10 DG Win7 Pro 64	3-year, Onsite	01/16
10HY001DUS	US	i5-6400T	No	Intel HD 530	None	4GBx1	500GB 7200rpm 2.5"	None	Intel 8260 ac, 2x2 + BT4.1	VGA	Switch	None	1Wx1	None	None	None	USB / USB	None	Floor Stand	65W Adapter 88%	Win10 DG Win7 Pro 64	3-year, Onsite	01/16
10HY001EUS	US	i7-6700T	No	Intel HD 530	None	8GBx1	180GB SSD Opal	None	Intel 8260 ac, 2x2 + BT4.1	None	Switch	None	1Wx1	None	None	None	USB / USB	None	Floor Stand	65W Adapter 88%	Win10 DG Win7 Pro 64	3-year, Onsite	01/16
10HY001FUS	US	i5-6400T	No	Intel HD 530	None	4GBx1	180GB SSD Opal	None	Intel 8260 ac, 2x2 + BT4.1	None	Switch	None	1Wx1	None	None	None	USB / USB	None	Floor Stand	65W Adapter 88%	Win10 DG Win7 Pro 64	3-year, Onsite	01/16
10HY001GUS	US	i7-6700T	No	Intel HD 530	None	8GBx1	500GB 7200rpm 2.5"	None	Intel 8260 ac, 2x2 + BT4.1	3rd DP	Switch	None	1Wx1	None	None	None	USB / USB	None	Floor Stand	65W Adapter 88%	Win10 DG Win7 Pro 64	3-year, Onsite	01/16
10HY001HUS	US	i7-6700T	No	Intel HD 530	None	8GBx1	128GB SSD	DVD±RW	Intel 8260 ac, 2x2 + BT4.1	HDMI	Switch	None	1Wx1	None	None	None	USB / USB	VESA Mount	None	65W Adapter 88%	Win10 DG Win7 Pro 64	3-year, Onsite	01/16
10HY001JUS	US	i5-6400T	No	Intel HD 530	None	4GBx1	500GB 7200rpm 2.5"	None	Intel 8260 ac, 2x2 + BT4.1	HDMI	Switch	None	1Wx1	None	None	None	USB / USB	None	Floor Stand	65W Adapter 88%	Win10 DG Win7 Pro 64	3-year, Onsite	01/16
10HY001KUS	US	i7-6700T	No	Intel HD 530	None	8GBx1	180GB SSD Opal	None	Intel 8260 ac, 2x2 + BT4.1	3rd DP	Switch	None	1Wx1	None	None	None	USB / USB	None	Floor Stand	65W Adapter 88%	Win10 DG Win7 Pro 64	3-year, Onsite	01/16
10HY001LUS	US	i7-6700T	No	Intel HD 530	None	8GBx1	128GB SSD	None	Intel 8260 ac, 2x2 + BT4.1	None	Switch	None	1Wx1	None	None	None	USB / USB	None	Floor Stand	65W Adapter 88%	Win10 DG Win7 Pro 64	3-year, Onsite	01/16
10HY001MUS	US	i5-6500T	No	Intel HD 530	None	4GBx1	180GB SSD Opal	None	Intel 8260 ac, 2x2 + BT4.1	None	Switch	None	1Wx1	None	None	None	USB / USB	None	Floor Stand	65W Adapter 88%	Win10 DG Win7 Pro 64	3-year, Onsite	01/16
10HY001NUS	US	i5-6400T	No	Intel HD 530	None	4GBx1	500GB 7200rpm 2.5"	DVD±RW	Intel 8260 ac, 2x2 + BT4.1	HDMI	Switch	None	1Wx1	None	None	None	USB / USB	VESA Mount	None	65W Adapter 88%	Win10 DG Win7 Pro 64	3-year, Onsite	01/16
10HY001PUS	US	i5-6400T	No	Intel HD 530	None	4GBx1	128GB SSD	None	Intel 8260 ac, 2x2 + BT4.1	None	Switch	None	1Wx1	None	None	None	USB / USB	None	Floor Stand	65W Adapter 88%	Win10 Pro 64	3-year, Onsite	01/16
10HY001QUS	US	i5-6400T	No	Intel HD 530	None	8GBx1	128GB SSD	None	Intel 8260 ac, 2x2 + BT4.1	None	Switch	None	1Wx1	None	None	None	USB / USB	None	None	65W Adapter 88%	Win10 DG Win7 Pro 64	3-year, Onsite	01/16
10HY001RUS	US	i5-6500T	No	Intel HD 530	None	8GBx1	128GB SSD	None	Intel 8260 ac, 2x2 + BT4.1	None	Switch	None	1Wx1	None	None	None	USB / USB	None	None	65W Adapter 88%	Win10 DG Win7 Pro 64	3-year, Onsite	01/16
10HY001SUS	US	i3-6100T	No	Intel HD 530	None	4GBx1	500GB 7200rpm 2.5"	None	Intel 3165 ac, 1x1 + BT4.0	None	Switch	None	1Wx1	None	None	None	USB / USB	None	Floor Stand	65W Adapter 88%	Win10 DG Win7 Pro 64	3-year, Onsite	01/16

Model	Region	Processor	vPro	Graphics	Monitor Cable	Memory	Storage(HDD/SSD)	External Optical / I/O Box	WLAN + Bluetooth	Optional Rear Ports	Chassis Intrusion Switch	Kensington Cable Lock	Speaker	Adapter Cage	Toolless Chassis Screw	Dust Filter	Keyboard / Mouse	VESA Mount	Stand	Power Supply	Operating System	Warranty	Ann Date (m/y)
10HY001TUS	US	i3-6100T	No	Intel HD 530	None	4GBx1	128GB SSD	None	Intel 3165 ac, 1x1 + BT4.0	3rd DP	Switch	None	1Wx1	None	None	None	USB / USB	None	Floor Stand	65W Adapter 88%	Win10 Pro 64	3-year, Onsite	01/16
10HY001UUS	US	i3-6100T	No	Intel HD 530	None	4GBx1	500GB 7200rpm 2.5"	DVD±RW	Intel 3165 ac, 1x1 + BT4.0	3rd DP	Switch	None	1Wx1	None	None	None	USB / USB	VESA Mount	None	65W Adapter 88%	Win10 Pro 64	3-year, Onsite	01/16
10HY001VUS	US	i3-6100T	No	Intel HD 530	None	4GBx1	128GB SSD	None	Intel 3165 ac, 1x1 + BT4.0	None	Switch	None	1Wx1	None	None	None	USB / USB	None	Floor Stand	65W Adapter 88%	Win10 DG Win7 Pro 64	3-year, Onsite	01/16
10HY001WUS	US	i3-6100T	No	Intel HD 530	None	4GBx1	128GB SSD	None	Intel 3165 ac, 1x1 + BT4.0	3rd DP	Switch	None	1Wx1	None	None	None	USB / USB	None	Floor Stand	65W Adapter 88%	Win10 DG Win7 Pro 64	3-year, Onsite	01/16
10HY001XUS	US	i3-6100T	No	Intel HD 530	None	4GBx1	500GB 7200rpm 2.5"	None	Intel 3165 ac, 1x1 + BT4.0	3rd DP	Switch	None	1Wx1	None	None	None	USB / USB	None	Floor Stand	65W Adapter 88%	Win10 DG Win7 Pro 64	3-year, Onsite	01/16
10HY001YUS	US	i3-6100T	No	Intel HD 530	None	4GBx1	500GB 7200rpm 2.5"	None	Intel 3165 ac, 1x1 + BT4.0	3rd DP	Switch	None	1Wx1	None	None	None	USB / USB	None	Floor Stand	65W Adapter 88%	Win10 Pro 64	3-year, Onsite	01/16
10HY0020US	US	i3-6100T	No	Intel HD 530	None	4GBx1	500GB 7200rpm 2.5"	None	Intel 3165 ac, 1x1 + BT4.0	VGA	Switch	None	1Wx1	None	None	None	USB / USB	None	Floor Stand	65W Adapter 88%	Win10 DG Win7 Pro 64	3-year, Onsite	01/16
10HY0021US	US	i3-6100T	No	Intel HD 530	None	8GBx1	128GB SSD	None	Intel 3165 ac, 1x1 + BT4.0	None	Switch	None	1Wx1	None	None	None	USB / USB	None	Floor Stand	65W Adapter 88%	Win10 DG Win7 Pro 64	3-year, Onsite	01/16
10HY0022US	US	i3-6100T	No	Intel HD 530	None	4GBx1	500GB 7200rpm 2.5"	DVD±RW	Intel 3165 ac, 1x1 + BT4.0	3rd DP	Switch	None	1Wx1	None	None	None	USB / USB	VESA Mount	None	65W Adapter 88%	Win10 DG Win7 Pro 64	3-year, Onsite	01/16
10HY0023US	US	i3-6100T	No	Intel HD 530	None	4GBx1	128GB SSD	DVD±RW	Intel 3165 ac, 1x1 + BT4.0	3rd DP	Switch	None	1Wx1	None	None	None	USB / USB	VESA Mount	None	65W Adapter 88%	Win10 DG Win7 Pro 64	3-year, Onsite	01/16
10HY0024US	US	i5-6500T	No	Intel HD 530	None	4GBx1	128GB SSD	None	Intel 8260 ac, 2x2 + BT4.1	None	Switch	None	1Wx1	None	None	None	USB / USB	None	Floor Stand	65W Adapter 88%	Win10 DG Win7 Pro 64	3-year, Onsite	01/16
10HY0025US	US	i7-6700T	No	Intel HD 530	None	8GBx1	128GB SSD	DVD±RW	Intel 8260 ac, 2x2 + BT4.1	None	Switch	None	1Wx1	None	None	None	USB / USB	VESA Mount	None	65W Adapter 88%	Win10 Pro 64	3-year, Onsite	01/16
10HY0026US	US	i7-6700T	No	Intel HD 530	None	8GBx1	128GB SSD	None	Intel 8260 ac, 2x2 + BT4.1	None	Switch	None	1Wx1	None	None	None	USB / USB	None	Floor Stand	65W Adapter 88%	Win10 Pro 64	3-year, Onsite	01/16
10HY0027US	US	Pentium G4400T	No	Intel HD 510	None	4GBx1	500GB 7200rpm 2.5"	None	Intel 3165 ac, 1x1 + BT4.0	None	Switch	None	1Wx1	None	None	None	USB / USB	None	Floor Stand	65W Adapter 88%	Win10 DG Win7 Pro 64	3-year, Onsite	01/16
10HY0028US	US	i5-6400T	No	Intel HD 530	None	4GBx1	256GB SSD Opal	None	Intel 8260 ac, 2x2 + BT4.1	3rd DP	Switch	None	1Wx1	None	None	None	USB / USB	None	Floor Stand	65W Adapter 88%	Win10 DG Win7 Pro 64	3-year, Onsite	01/16
10HY0029US	US	i5-6500T	No	Intel HD 530	None	4GBx1	256GB SSD Opal	None	Intel 8260 ac, 2x2 + BT4.1	3rd DP	Switch	None	1Wx1	None	None	None	USB / USB	None	Floor Stand	65W Adapter 88%	Win10 DG Win7 Pro 64	3-year, Onsite	01/16
10HY002AUS	US	i5-6500T	No	Intel HD 530	None	8GBx1	256GB SSD Opal	None	Intel 8260 ac, 2x2 + BT4.1	3rd DP	Switch	None	1Wx1	None	None	None	USB / USB	None	Floor Stand	65W Adapter 88%	Win10 DG Win7 Pro 64	3-year, Onsite	01/16
10HY002BUS	US	i5-6400T	No	Intel HD 530	None	8GBx1	256GB SSD Opal	None	Intel 8260 ac, 2x2 + BT4.1	3rd DP	Switch	None	1Wx1	None	None	None	USB / USB	None	Floor Stand	65W Adapter 88%	Win10 DG Win7 Pro 64	3-year, Onsite	01/16
10HY002CUS	US	i5-6400T	No	Intel HD 530	None	4GBx1	128GB SSD	None	Intel 8260 ac, 2x2 + BT4.1	None	Switch	None	1Wx1	None	None	None	USB / USB	None	Floor Stand	65W Adapter 88%	Win10 DG Win7 Pro 64	3-year, Onsite	01/16
10HY003HUS	US	i5-6500T	No	Intel HD 530	None	8GBx1	128GB SSD	None	Intel 8260 ac, 2x2 + BT4.1	VGA	Switch	None	1Wx1	None	None	None	USB / USB	None	Floor Stand	65W Adapter 88%	Win10 DG Win7 Pro 64	3-year, Onsite	03/16

Model	Region	Processor	vPro	Graphics	Monitor Cable	Memory	Storage(HDD/SSD)	External Optical / I/O Box	WLAN + Bluetooth	Optional Rear Ports	Chassis Intrusion Switch	Kensington Cable Lock	Speaker	Adapter Cage	Toolless Chassis Screw	Dust Filter	Keyboard / Mouse	VESA Mount	Stand	Power Supply	Operating System	Warranty	Ann Date (m/y)
10HY003JUS	US	i5-6600T	No	Intel HD 530	None	8GBx1	500GB 7200rpm 2.5"	None	Intel 8260 ac, 2x2 + BT4.1	3rd DP	Switch	None	1Wx1	None	None	None	USB / USB	None	Floor Stand	65W Adapter 88%	Win10 DG Win7 Pro 64	3-year, Onsite	03/16
10HY003KUS	US	i5-6600T	No	Intel HD 530	None	8GBx1	128GB SSD	None	Intel 8260 ac, 2x2 + BT4.1	3rd DP	Switch	None	1Wx1	None	None	None	USB / USB	None	Floor Stand	65W Adapter 88%	Win10 DG Win7 Pro 64	3-year, Onsite	03/16
10HY0057US	US	i5-6500T	No	Intel HD 530	None	8GBx1	256GB SSD Opal	None	Intel 8260 ac, 2x2 + BT4.1	3rd DP	Switch	None	1Wx1	None	None	None	USB / USB	None	Floor Stand	65W Adapter 88%	Win10 Pro 64	3-year, Onsite	07/16
10HY0058US	US	i5-6500T	No	Intel HD 530	None	8GBx1	128GB SSD	None	Intel 8260 ac, 2x2 + BT4.1	None	Switch	None	1Wx1	None	None	None	USB / USB	None	Floor Stand	65W Adapter 88%	Win10 Pro 64	3-year, Onsite	07/16
10HY0059US	US	i3-6100T	No	Intel HD 530	None	8GBx1	128GB SSD	None	Intel 3165 ac, 1x1 + BT4.0	None	Switch	None	1Wx1	None	None	None	USB / USB	None	Floor Stand	65W Adapter 88%	Win10 Pro 64	3-year, Onsite	07/16
10HY0068US	US	i3-6100T	No	Intel HD 530	None	8GBx1	500GB 7200rpm 2.5"	None	Intel 3165 ac, 1x1 + BT4.0	VGA	Switch	None	1Wx1	None	None	None	USB / USB	None	Floor Stand	65W Adapter 88%	Win10 Pro 64	3-year, Onsite	10/16
10HY0069US	US	i3-6100T	No	Intel HD 530	None	8GBx1	500GB 7200rpm 2.5"	None	Intel 3165 ac, 1x1 + BT4.0	3rd DP	Switch	None	1Wx1	None	None	None	USB / USB	None	Floor Stand	65W Adapter 88%	Win10 Pro 64	3-year, Onsite	10/16

Model	Region	Processor	vPro	Graphics	Monitor Cable	Memory	Storage(HDD/SSD)	External Optical / I/O Box	WLAN + Bluetooth	Optional Rear Ports	Chassis Intrusion Switch	Kensington Cable Lock	Speaker	Adapter Cage	Toolless Chassis Screw	Dust Filter	Keyboard / Mouse	VESA Mount	Stand	Power Supply	Operating System	Warranty	Ann Date (m/y)
10JQ0000US	US	Pentium G4400T	No	Intel HD 510	None	4GBx1	16GB SSD M.2	None	QCA6174 ac, 2x2 + BT4.1	None	Switch	None	1Wx1	None	None	None	USB / USB	None	Floor Stand	65W Adapter 88%	WES 7	3-year, Onsite	03/16
10JQ0001US	US	Pentium G4400T	No	Intel HD 510	None	4GBx1	16GB SSD M.2	None	QCA6174 ac, 2x2 + BT4.1	VGA	Switch	None	1Wx1	None	None	None	USB / USB	None	Floor Stand	65W Adapter 88%	WES 7	3-year, Onsite	03/16
10JQ0002US	US	i3-6100T	No	Intel HD 530	None	4GBx1	16GB SSD M.2	None	QCA6174 ac, 2x2 + BT4.1	3rd DP	Switch	None	1Wx1	None	None	None	USB / USB	None	Floor Stand	65W Adapter 88%	WES 7	3-year, Onsite	03/16
10JQ0003US	US	Pentium G4400T	No	Intel HD 510	None	4GBx1	16GB SSD M.2	None	QCA6174 ac, 2x2 + BT4.1	3rd DP	Switch	None	1Wx1	None	None	None	USB / USB	None	Floor Stand	65W Adapter 88%	WES 7	3-year, Onsite	03/16
10JQ0004US	US	Pentium G4400T	No	Intel HD 510	None	4GBx1	16GB SSD M.2	None	QCA6174 ac, 2x2 + BT4.1	Serial	Switch	None	1Wx1	None	None	None	USB / USB	None	Floor Stand	65W Adapter 88%	WES 7	3-year, Onsite	03/16
10JQ0005US	US	Pentium G4400T	No	Intel HD 510	None	4GBx1	16GB SSD M.2	None	QCA6174 ac, 2x2 + BT4.1	VGA	Switch	None	1Wx1	None	None	None	USB / USB	None	Floor Stand	65W Adapter 88%	LeTOS	3-year, Onsite	03/16
10JQ0006US	US	Pentium G4400T	No	Intel HD 510	None	4GBx1	16GB SSD M.2	None	QCA6174 ac, 2x2 + BT4.1	3rd DP	Switch	None	1Wx1	None	None	None	USB / USB	None	Floor Stand	65W Adapter 88%	LeTOS	3-year, Onsite	03/16
10JQ0007US	US	Pentium G4400T	No	Intel HD 510	None	4GBx1	16GB SSD M.2	None	QCA6174 ac, 2x2 + BT4.1	Serial	Switch	None	1Wx1	None	None	None	USB / USB	None	Floor Stand	65W Adapter 88%	LeTOS	3-year, Onsite	03/16
10JQ0008US	US	i3-6100T	No	Intel HD 530	None	4GBx1	16GB SSD M.2	None	QCA6174 ac, 2x2 + BT4.1	3rd DP	Switch	None	1Wx1	None	None	None	USB / USB	None	Floor Stand	65W Adapter 88%	LeTOS	3-year, Onsite	03/16
10JQ000EUS	US	Pentium G4400T	No	Intel HD 510	None	4GBx1	16GB SSD M.2	None	QCA6174 ac, 2x2 + BT4.1	None	Switch	None	1Wx1	None	None	None	USB / USB	None	Floor Stand	65W Adapter 88%	WES 7	3-year, Onsite	01/17
10JQ000FUS	US	Pentium G4400T	No	Intel HD 510	None	4GBx1	16GB SSD M.2	None	QCA6174 ac, 2x2 + BT4.1	3rd DP	Switch	None	1Wx1	None	None	None	USB / USB	None	Floor Stand	65W Adapter 88%	LeTOS	3-year, Onsite	01/17
10JQ000GUS	US	Pentium G4400T	No	Intel HD 510	None	4GBx1	16GB SSD M.2	None	QCA6174 ac, 2x2 + BT4.1	VGA	Switch	None	1Wx1	None	None	None	USB / USB	None	Floor Stand	65W Adapter 88%	WES 7	3-year, Onsite	01/17
10JQ000HUS	US	i3-6100T	No	Intel HD 530	None	4GBx1	16GB SSD M.2	None	QCA6174 ac, 2x2 + BT4.1	3rd DP	Switch	None	1Wx1	None	None	None	USB / USB	None	Floor Stand	65W Adapter 88%	WES 7	3-year, Onsite	01/17
10JQ000JUS	US	Pentium G4400T	No	Intel HD 510	None	4GBx1	16GB SSD M.2	None	QCA6174 ac, 2x2 + BT4.1	Serial	Switch	None	1Wx1	None	None	None	USB / USB	None	Floor Stand	65W Adapter 88%	LeTOS	3-year, Onsite	01/17
10JQ000KUS	US	Pentium G4400T	No	Intel HD 510	None	4GBx1	16GB SSD M.2	None	QCA6174 ac, 2x2 + BT4.1	VGA	Switch	None	1Wx1	None	None	None	USB / USB	None	Floor Stand	65W Adapter 88%	LeTOS	3-year, Onsite	01/17
10JQ000LUS	US	Pentium G4400T	No	Intel HD 510	None	4GBx1	16GB SSD M.2	None	QCA6174 ac, 2x2 + BT4.1	3rd DP	Switch	None	1Wx1	None	None	None	USB / USB	None	Floor Stand	65W Adapter 88%	WES 7	3-year, Onsite	01/17
10JQ000MUS	US	Pentium G4400T	No	Intel HD 510	None	4GBx1	16GB SSD M.2	None	QCA6174 ac, 2x2 + BT4.1	Serial	Switch	None	1Wx1	None	None	None	USB / USB	None	Floor Stand	65W Adapter 88%	WES 7	3-year, Onsite	01/17
10JQ000NUS	US	Pentium G4400T	No	Intel HD 510	None	4GBx1	16GB SSD M.2	None	QCA6174 ac, 2x2 + BT4.1	None	Switch	None	1Wx1	None	None	None	USB / USB	None	Floor Stand	65W Adapter 88%	LeTOS	3-year, Onsite	01/17





# ThinkCentre M700 Tower Platform Specifications

Product Specifications Reference (PSREF)

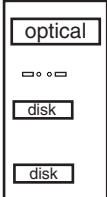
Processor	Intel® Celeron®, Intel Pentium®, or 6th Generation Intel Core™ i3 / i5 / i7 Processor	Security features	<ul style="list-style-type: none"> <li>One lock to secure both cover and entire system to fixed object:                     <ul style="list-style-type: none"> <li>-Padlock loop (in rear for opt padlock)</li> <li>-Security slot (in rear for optional Kensington® MicroSaver® cable)</li> </ul> </li> <li>Optional cable lock to physically lock both keyboard and mouse</li> </ul> <ul style="list-style-type: none"> <li>Power-on password</li> <li>Administrator password</li> <li>Hard disk password</li> <li>Boot sequence control</li> <li>Boot without keyboard and mouse</li> <li>Individual USB port disablement</li> <li>Optional chassis intrusion switch</li> </ul>																																																												
	<table border="1"> <thead> <tr> <th>Processor</th> <th>Cores / Threads</th> <th>Frequency Base/Max(GHz)</th> <th>Cache</th> <th>Memory Types</th> <th>Integrated Graphics</th> </tr> </thead> <tbody> <tr> <td>Celeron G3900</td> <td>2 / 2</td> <td>2.8 G</td> <td>2 MB</td> <td>DDR4-2133</td> <td>HD 510</td> </tr> <tr> <td>Pentium G4400</td> <td>2 / 2</td> <td>3.3G</td> <td>3 MB</td> <td>DDR4-2133</td> <td>HD 510</td> </tr> <tr> <td>Pentium G4500</td> <td>2 / 2</td> <td>3.5G</td> <td>3 MB</td> <td>DDR4-2133</td> <td>HD 530</td> </tr> <tr> <td>Core i3-6100</td> <td>2 / 4</td> <td>3.7 G</td> <td>3 MB</td> <td>DDR4-2133</td> <td>HD 530</td> </tr> <tr> <td>Core i3-6300</td> <td>2 / 4</td> <td>3.8 G</td> <td>4 MB</td> <td>DDR4-2133</td> <td>HD 530</td> </tr> <tr> <td>Core i5-6400</td> <td>4 / 4</td> <td>2.7 G / 3.3 G</td> <td>6 MB</td> <td>DDR4-2133</td> <td>HD 530</td> </tr> <tr> <td>Core i5-6500</td> <td>4 / 4</td> <td>3.2 G / 3.6 G</td> <td>6 MB</td> <td>DDR4-2133</td> <td>HD 530</td> </tr> <tr> <td>Core i5-6600</td> <td>4 / 4</td> <td>3.3 G / 3.9 G</td> <td>6 MB</td> <td>DDR4-2133</td> <td>HD 530</td> </tr> <tr> <td>Core i7-6700</td> <td>4 / 8</td> <td>3.4 G / 4.0 G</td> <td>8 MB</td> <td>DDR4-2133</td> <td>HD 530</td> </tr> </tbody> </table>	Processor	Cores / Threads	Frequency Base/Max(GHz)	Cache	Memory Types	Integrated Graphics	Celeron G3900	2 / 2	2.8 G	2 MB	DDR4-2133	HD 510	Pentium G4400	2 / 2	3.3G	3 MB	DDR4-2133	HD 510	Pentium G4500	2 / 2	3.5G	3 MB	DDR4-2133	HD 530	Core i3-6100	2 / 4	3.7 G	3 MB	DDR4-2133	HD 530	Core i3-6300	2 / 4	3.8 G	4 MB	DDR4-2133	HD 530	Core i5-6400	4 / 4	2.7 G / 3.3 G	6 MB	DDR4-2133	HD 530	Core i5-6500	4 / 4	3.2 G / 3.6 G	6 MB	DDR4-2133	HD 530	Core i5-6600	4 / 4	3.3 G / 3.9 G	6 MB	DDR4-2133	HD 530	Core i7-6700	4 / 8	3.4 G / 4.0 G	8 MB	DDR4-2133	HD 530	Keyboard	<i>Some:</i> PS/2 Keyboard (PS/2 connector), Lenovo logo <i>Some:</i> Preferred Pro USB Keyboard (USB connector), Lenovo logo <i>Some:</i> Lenovo USB Fingerprint Keyboard (USB connector) <i>Some:</i> Ultralim Plus Wireless Keyboard (2.4GHz via USB receiver), black
Processor	Cores / Threads	Frequency Base/Max(GHz)	Cache	Memory Types	Integrated Graphics																																																										
Celeron G3900	2 / 2	2.8 G	2 MB	DDR4-2133	HD 510																																																										
Pentium G4400	2 / 2	3.3G	3 MB	DDR4-2133	HD 510																																																										
Pentium G4500	2 / 2	3.5G	3 MB	DDR4-2133	HD 530																																																										
Core i3-6100	2 / 4	3.7 G	3 MB	DDR4-2133	HD 530																																																										
Core i3-6300	2 / 4	3.8 G	4 MB	DDR4-2133	HD 530																																																										
Core i5-6400	4 / 4	2.7 G / 3.3 G	6 MB	DDR4-2133	HD 530																																																										
Core i5-6500	4 / 4	3.2 G / 3.6 G	6 MB	DDR4-2133	HD 530																																																										
Core i5-6600	4 / 4	3.3 G / 3.9 G	6 MB	DDR4-2133	HD 530																																																										
Core i7-6700	4 / 8	3.4 G / 4.0 G	8 MB	DDR4-2133	HD 530																																																										
		Mouse	<i>Some:</i> PS/2 Optical Wheel Mouse, black, Lenovo logo <i>Some:</i> Enhanced Optical USB Mouse, black, Lenovo logo <i>Some:</i> Ultralim Plus Wireless Mouse (2.4GHz via USB receiver), black																																																												
Memory	32GB max, UDIMM, DDR4 2133, two 288-pin DIMM sockets, dual-channel capable	Mechanical	<ul style="list-style-type: none"> <li>Tower (20L), black color, metal case</li> <li>(WxDxH) 6.3" X 15.5" X 15.7"; 160mm X 394.5mm X 398mm</li> <li>19.8 lb (9.0 kg)</li> <li>Optional handle</li> <li>Optional dust filter</li> </ul> <p>Bay 1: 5.25", 1.6" high, access, std optical / opt front access HDD            Bay 2: 3.5", 1" high, no access, std disk            Bay 3: 3.5", 1" high, no access, opt disk            Bay 4: N/A, N/A, external, opt reader            Slot 1: half-length, full-height, PCIe 3.0 x16            Slot 2: half-length, full-height, PCIe 2.0 x1            Slot 3: half-length, full-height, PCIe 2.0 x1</p> 																																																												
Disk	<i>Some:</i> Hard disk, SATA 6.0Gb/s, 2.5"/ 3.5" wide, 5400 / 7200 rpm <i>Some:</i> Solid State Hybrid Drive (SSHD), 500GB (5400 rpm, 2.5") / 1TB or 2TB (7200 rpm, 3.5"), with 8GB NAND flash memory, SATA 6.0Gb/s <i>Some:</i> Solid State Drive (SSD) / SATA 6.0Gb/s, 2.5" Wide <i>Some:</i> Front accessible and removable HDD, 3.5", lockable via physical key	Power supply	<i>Some:</i> 180 watts, autosensing, 85% PSU <i>Some:</i> 250 watts, autosensing, 85% PSU																																																												
Optical	<i>Some:</i> DVD-ROM SATA 1.5Gb/s Drive <i>Some:</i> Super Multi-Burner DVD±RW SATA 1.5Gb/s Drive	Limited warranty <sup>3</sup>	<i>Some:</i> <b>1-year</b> or <b>3-year, depot service</b> / service upgrades available <i>Some:</i> <b>1-year</b> or <b>3-year, limited onsite service</b> / service upgrades available <i>Some:</i> <b>3-year, limited onsite service, OID</b> (Onsite International Delivery) / service upgrades available <i>For Lenovo service upgrade options, please go to S-TC sheet</i>																																																												
Onboard SATA Media reader	Three onboard SATA 6.0Gb/s connectors, Optional 9-in-1 media reader	Preload	<b>Preloaded operating system</b> <i>Some:</i> Windows® 7 Professional 32/64 preinstalled through downgrade rights in Windows 10 Pro 64-bit <i>Some:</i> Windows 7 Professional 32/64 <i>Some:</i> Windows 10 Pro 64-bit <i>Some:</i> Windows 10 Home 64-bit																																																												
Graphics	<b>Intel HD Graphics 510/530</b> in processor, uses main memory, DirectX® 12, one VGA, one DisplayPort™, supports two independent displays, works along with discrete graphics to support more displays; <i>Max resolution:</i> 4096x2304 (DP) @60Hz; 1920x1200 (VGA) @60Hz <i>Some:</i> <b>NVIDIA® Quadro® K420</b> , DirectX 12, 2GB, PCIe 2.0 x16 adapter, one DVI-I, one DisplayPort, 41 watts; <i>Max resolution:</i> 3840x2160 (DisplayPort) @60Hz; 2560x1600 (DVI-I) @60Hz <i>Some:</i> <b>NVIDIA GeForce® GT 720</b> , DirectX 12, 2GB, PCIe 2.0 x8 adapter, one VGA, one HDMI, 25 watts; <i>Max resolution:</i> 1920x1080 (HDMI) @60Hz; 2048x1536 (VGA) @85Hz <i>Some:</i> <b>NVIDIA GeForce GT 720</b> , DirectX 12, 1GB, PCIe 2.0 x8 adapter, two DisplayPort, 25 watts; <i>Max resolution:</i> 3840x2160 (DisplayPort) @60Hz;	<b>Preloaded applications (only some listed)</b> <ul style="list-style-type: none"> <li>Desktop Power Manager</li> <li>Lenovo Solution Center</li> <li>Lenovo REACHit</li> <li>Lenovo SHAREit</li> <li>Lenovo Bluetooth Lock (for models with Wi-Fi/BT card)</li> <li>McAfee® LiveSafe™ (30-day trial)</li> <li>Microsoft Office preloaded; purchase a product key to activate</li> <li>PowerDVD Create (DVD±RW)</li> <li>Lenovo ThinkVantage Tools</li> <li>- Only for Window 10</li> <li>Lenovo Companion</li> <li>Cyberlink PowerDVD (DVD, DVD±RW)</li> <li>Lenovo QuickOptimizer</li> <li>- Only for Window 7</li> <li>Rescue and Recovery</li> <li>Password Manager</li> <li>ThinkVantage System Update</li> <li>Lenovo Message Center Plus</li> <li>Adobe® Reader®</li> </ul>																																																													
DP cable	Optional DP to VGA, DP to DVI-D (single link), or DP to HDMI 1.4 dongle	Environment	ENERGY STAR® 6.0*, EPEAT™ Gold rating* (*Need 85% PSU and Windows OS); ErP Lot 3; GREENGUARD ; RoHS-compliant																																																												
Chipset	<b>Intel H110 Chipset</b>	Accessories	For compatible accessories, please go to TC-AQP sheet																																																												
Front ports	Two USB 3.0, two optional USB 2.0, microphone (3.5mm), headphone (3.5mm)																																																														
Rear ports	Two USB 3.0, two USB 2.0, two optional USB 2.0, serial (9-pin), optional 2nd serial (9-pin), optional parallel (25-pin), ethernet (RJ-45), one VGA, one DisplayPort, two PS/2 ports (keyboard/mouse); additional VGA, DisplayPort, DVI-I or HDMI on optional graphics on some models																																																														
Rear audio ports	Line-in (3.5mm), line-out (3.5mm), microphone-in (3.5mm)																																																														
IEEE 1394	None																																																														
Audio support	High Definition (HD) Audio, Realtek ALC662 / optional internal speaker (1.5 watt )																																																														
WLAN <sup>13</sup>	<i>Some:</i> 11ac wireless, M.2 Card, Qualcomm Atheros QCA9377 (dual band), Wi-Fi + Bluetooth 4.1 combo adapter, 1x1 <i>Some:</i> 11ac wireless, M.2 Card, Qualcomm Atheros QCA6174 (dual band), Wi-Fi + Bluetooth 4.1 combo adapter, 2x2 <i>Some:</i> 11ac wireless, M.2 Card, Intel Dual Band Wireless-AC 3165, Wi-Fi + Bluetooth 4.0 combo adapter, 1x1 <i>Some:</i> 11ac wireless, M.2 Card, Intel Dual Band Wireless-AC 8260, Wi-Fi + Bluetooth 4.1 combo adapter, 2x2																																																														
Bluetooth™	<i>Some:</i> Bluetooth 4.0 or 4.1 wireless, integrated in Wi-Fi + BT combo adapter																																																														
Ethernet	Gigabit ethernet, Realtek RTL8111GN, Wake on LAN®																																																														
Modem	None																																																														
Manageability	None																																																														
Security chip	Trusted Platform Module, TCG 1.2-compliant																																																														

See footnotes for more detailed information



Model	Region	Processor	vPro	Graphics	Monitor Cable	Memory	Storage	Optical	Media Reader	WLAN + Bluetooth	Optional Front Ports	Optional Rear Ports	Chassis Intrusion Switch	Cable Lock	Front Access HDD	Dust Filter	Keyboard / Mouse	Carry Handle	Power Supply	Operating System	Warranty	Ann Date (m/y)
10GR001MUS	US	i7-6700	No	Intel HD 530	None	8GBx1	1TB 7200rpm 3.5"	DVD±RW	None	None	None	None	None	None	None	None	None / USB	Carry Handle	250W 85%	Win10 DG Win7 Pro 64	3-year, Onsite	01/16
10GR001NUS	US	Pentium G4400	No	Intel HD 510	None	4GBx1	500GB 7200rpm 3.5"	DVD±RW	None	None	None	None	None	None	None	None	None / USB	Carry Handle	250W 85%	Win10 DG Win7 Pro 64	3-year, Onsite	01/16
10GR001PUS	US	i3-6100	No	Intel HD 530	None	4GBx1	500GB 7200rpm 3.5"	DVD±RW	None	None	None	None	None	None	None	None	None / USB	Carry Handle	250W 85%	Win10 DG Win7 Pro 64	3-year, Onsite	01/16
10GR001QUS	US	i5-6400	No	Intel HD 530	None	4GBx1	500GB 7200rpm 3.5"	DVD±RW	None	None	None	None	None	None	None	None	None / USB	Carry Handle	250W 85%	Win10 DG Win7 Pro 64	3-year, Onsite	01/16
10GR001RUS	US	i7-6700	No	Intel HD 530	None	8GBx1	256GB SSD Opal	DVD±RW	None	None	None	None	None	None	None	None	USB / USB	Carry Handle	250W 85%	Win10 DG Win7 Pro 64	3-year, Onsite	01/16
10GR001SUS	US	i7-6700	No	Intel HD 530	None	8GBx1	500GB 7200rpm 3.5"	DVD±RW	None	None	None	None	None	None	None	None	USB / USB	Carry Handle	250W 85%	Win10 DG Win7 Pro 64	3-year, Onsite	01/16
10GR001TUS	US	i7-6700	No	GT 720 1GB	None	8GBx1	1TB 7200rpm 3.5"	DVD±RW	None	Intel 8260 ac, 2x2 + BT4.1	None	None	None	None	None	None	USB / USB	Carry Handle	250W 85%	Win10 DG Win7 Pro 64	3-year, Onsite	01/16
10GR001UUS	US	i7-6700	No	Intel HD 530	None	8GBx1	1TB 7200rpm 3.5"	DVD±RW	None	None	None	None	None	None	None	None	USB / USB	Carry Handle	250W 85%	Win10 DG Win7 Pro 64	3-year, Onsite	01/16
10GR001VUS	US	i7-6700	No	Intel HD 530	None	8GBx1	120GB SSD	DVD±RW	None	None	None	None	None	None	None	None	USB / USB	Carry Handle	250W 85%	Win10 DG Win7 Pro 64	3-year, Onsite	01/16
10GR001WUS	US	i7-6700	No	Intel HD 530	None	8GBx1	128GB SSD	DVD±RW	None	None	None	None	None	None	None	None	USB / USB	Carry Handle	250W 85%	Win10 DG Win7 Pro 64	3-year, Onsite	01/16
10GR001XUS	US	i7-6700	No	Intel HD 530	None	8GBx1	1TB 7200rpm 3.5"	DVD±RW	None	Intel 8260 ac, 2x2 + BT4.1	None	None	None	None	None	None	USB / USB	Carry Handle	250W 85%	Win10 DG Win7 Pro 64	3-year, Onsite	01/16
10GR001YUS	US	i5-6400	No	Intel HD 530	None	8GBx1	500GB 7200rpm 3.5"	DVD±RW	None	Intel 8260 ac, 2x2 + BT4.1	None	None	None	None	None	None	USB / USB	Carry Handle	250W 85%	Win10 DG Win7 Pro 64	3-year, Onsite	01/16
10GR0020US	US	i5-6400	No	Intel HD 530	None	4GBx1	500GB 7200rpm 3.5"	DVD±RW	None	None	None	None	None	None	None	None	USB / USB	Carry Handle	250W 85%	Win10 DG Win7 Pro 64	3-year, Onsite	01/16
10GR0021US	US	i5-6400	No	Intel HD 530	None	4GBx1	500GB 7200rpm 3.5"	DVD±RW	None	Intel 8260 ac, 2x2 + BT4.1	None	None	None	None	None	None	USB / USB	Carry Handle	250W 85%	Win10 DG Win7 Pro 64	3-year, Onsite	01/16
10GR0022US	US	i5-6400	No	Intel HD 530	None	8GBx1	192GB SSD	DVD±RW	None	None	None	None	None	None	None	None	USB / USB	Carry Handle	250W 85%	Win10 DG Win7 Pro 64	3-year, Onsite	01/16
10GR0023US	US	i5-6400	No	Intel HD 530	None	8GBx1	1TB 7200rpm 3.5"	DVD±RW	None	None	None	None	None	None	None	None	USB / USB	Carry Handle	250W 85%	Win10 DG Win7 Pro 64	3-year, Onsite	01/16
10GR0024US	US	i5-6400	No	Intel HD 530	None	8GBx1	500GB 7200rpm 3.5"	DVD±RW	None	None	None	None	None	None	None	None	USB / USB	Carry Handle	250W 85%	Win10 DG Win7 Pro 64	3-year, Onsite	01/16
10GR0025US	US	i5-6400	No	GT 720 1GB	None	8GBx1	1TB 7200rpm 3.5"	DVD±RW	None	Intel 8260 ac, 2x2 + BT4.1	None	None	None	None	None	None	USB / USB	Carry Handle	250W 85%	Win10 DG Win7 Pro 64	3-year, Onsite	01/16
10GR0026US	US	i5-6400	No	Intel HD 530	None	8GBx1	120GB SSD	DVD±RW	None	None	None	None	None	None	None	None	USB / USB	Carry Handle	250W 85%	Win10 DG Win7 Pro 64	3-year, Onsite	01/16
10GR0027US	US	i5-6400	No	Intel HD 530	None	8GBx1	256GB SSD Opal	DVD±RW	None	None	None	None	None	None	None	None	USB / USB	Carry Handle	250W 85%	Win10 DG Win7 Pro 64	3-year, Onsite	01/16

Model	Region	Processor	vPro	Graphics	Monitor Cable	Memory	Storage	Optical	Media Reader	WLAN + Bluetooth	Optional Front Ports	Optional Rear Ports	Chassis Intrusion Switch	Cable Lock	Front Access HDD	Dust Filter	Keyboard / Mouse	Carry Handle	Power Supply	Operating System	Warranty	Ann Date (m/y)
10GR0028US	US	i3-6100	No	Intel HD 530	None	4GBx1	500GB 7200rpm 3.5"	DVD±RW	None	Intel 8260 ac, 2x2 + BT4.1	None	None	None	None	None	None	USB / USB	Carry Handle	250W 85%	Win10 DG Win7 Pro 64	3-year, Onsite	01/16
10GR0029US	US	i3-6100	No	Intel HD 530	None	4GBx1	500GB 7200rpm 3.5"	DVD±RW	None	None	None	None	None	None	None	None	USB / USB	Carry Handle	250W 85%	Win10 DG Win7 Pro 64	3-year, Onsite	01/16
10GR002AUS	US	i3-6100	No	Intel HD 530	None	4GBx1	500GB 7200rpm 3.5"	DVD±RW	None	Intel 3165 ac, 1x1 + BT4.0	None	None	None	None	None	None	USB / USB	Carry Handle	250W 85%	Win10 DG Win7 Pro 64	3-year, Onsite	01/16
10GR002BUS	US	Pentium G4400	No	Intel HD 510	None	4GBx1	500GB 7200rpm 3.5"	DVD±RW	None	None	None	None	None	None	None	None	USB / USB	Carry Handle	250W 85%	Win10 DG Win7 Pro 64	3-year, Onsite	01/16
10GR002CUS	US	i7-6700	No	Intel HD 530	None	8GBx1	1TB 7200rpm 3.5"	DVD±RW	None	Intel 8260 ac, 2x2 + BT4.1	None	None	None	None	None	None	USB / USB	Carry Handle	250W 85%	Win10 Pro 64	3-year, Onsite	01/16
10GR002DUS	US	Pentium G4400	No	Intel HD 510	None	4GBx1	500GB 7200rpm 3.5"	DVD±RW	None	Intel 3165 ac, 1x1 + BT4.0	None	None	None	None	None	None	USB / USB	Carry Handle	250W 85%	Win10 Pro 64	3-year, Onsite	01/16
10GR002EUS	US	i5-6400	No	Intel HD 530	None	4GBx1	500GB 7200rpm 3.5"	DVD±RW	None	Intel 8260 ac, 2x2 + BT4.1	None	None	None	None	None	None	USB / USB	Carry Handle	250W 85%	Win10 Pro 64	3-year, Onsite	01/16
10GR004FUS	US	i7-6700	No	GT 720 1GB	None	8GBx1	1TB 7200rpm 3.5"	DVD±RW	None	None	None	None	None	None	None	None	USB / USB	Carry Handle	250W 85%	Win10 Pro 64	3-year, Onsite	06/16
10GR004GUS	US	Pentium G4400	No	Intel HD 510	None	4GBx1	500GB 7200rpm 3.5"	DVD±RW	None	None	None	None	None	None	None	None	USB / USB	Carry Handle	250W 85%	Win10 Pro 64	3-year, Onsite	06/16
10GR004HUS	US	i5-6400	No	Intel HD 530	None	4GBx1	500GB 7200rpm 3.5"	DVD±RW	None	None	None	None	None	None	None	None	USB / USB	Carry Handle	250W 85%	Win10 Pro 64	3-year, Onsite	06/16
10GR004JUS	US	i3-6100	No	Intel HD 530	None	4GBx1	500GB 7200rpm 3.5"	DVD±RW	None	None	None	None	None	None	None	None	USB / USB	Carry Handle	250W 85%	Win10 Pro 64	3-year, Onsite	06/16
10GR004KUS	US	i3-6100	No	Intel HD 530	None	4GBx1	128GB SSD	DVD±RW	None	None	None	None	None	None	None	None	USB / USB	Carry Handle	250W 85%	Win10 Pro 64	3-year, Onsite	06/16
10GR004LUS	US	i5-6400	No	GT 720 1GB	None	8GBx1	1TB 7200rpm 3.5"	DVD±RW	None	None	None	None	None	None	None	None	USB / USB	Carry Handle	250W 85%	Win10 Pro 64	3-year, Onsite	06/16
10GR004MUS	US	i5-6400	No	Intel HD 530	None	8GBx1	1TB 7200rpm 3.5"	DVD±RW	None	None	None	None	None	None	None	None	USB / USB	Carry Handle	250W 85%	Win10 Pro 64	3-year, Onsite	06/16
10GR004NUS	US	i5-6400	No	Intel HD 530	None	8GBx1	256GB SSD Opal	DVD±RW	None	None	None	None	None	None	None	None	USB / USB	Carry Handle	250W 85%	Win10 Pro 64	3-year, Onsite	06/16
10GR004PUS	US	i5-6400	No	Intel HD 530	None	8GBx1	128GB SSD	DVD±RW	None	None	None	None	None	None	None	None	USB / USB	Carry Handle	250W 85%	Win10 Pro 64	3-year, Onsite	06/16
10GR004QUS	US	Pentium G4400	No	Intel HD 510	None	4GBx1	128GB SSD	DVD±RW	None	None	None	None	None	None	None	None	USB / USB	Carry Handle	250W 85%	Win10 Pro 64	3-year, Onsite	06/16
10GR004RUS	US	i7-6700	No	Intel HD 530	None	8GBx1	1TB 7200rpm 3.5"	DVD±RW	None	None	None	None	None	None	None	None	USB / USB	Carry Handle	250W 85%	Win10 Pro 64	3-year, Onsite	06/16
10GR004SUS	US	i7-6700	No	Intel HD 530	None	8GBx1	256GB SSD Opal	DVD±RW	None	None	None	None	None	None	None	None	USB / USB	Carry Handle	250W 85%	Win10 Pro 64	3-year, Onsite	06/16
10GR004TUS	US	i3-6100	No	Intel HD 530	None	8GBx1	128GB SSD	DVD±RW	None	None	None	None	None	None	None	None	USB / USB	Carry Handle	250W 85%	Win10 Pro 64	3-year, Onsite	06/16

Model	Region	Processor	vPro	Graphics	Monitor Cable	Memory	Storage	Optical	Media Reader	WLAN + Bluetooth	Optional Front Ports	Optional Rear Ports	Chassis Intrusion Switch	Cable Lock	Front Access HDD	Dust Filter	Keyboard / Mouse	Carry Handle	Power Supply	Operating System	Warranty	Ann Date (m/y)
10GR004UUS	US	i5-6400	No	Intel HD 530	None	8GBx1	1TB 7200rpm 3.5"	DVD±RW	None	Intel 3165 ac, 1x1 + BT4.0	None	None	None	None	None	None	USB / USB	Carry Handle	250W 85%	Win10 Pro 64	3-year, Onsite	06/16
10GR0056US	US	i7-6700	No	GT 720 1GB	None	8GBx1	1TB 7200rpm 3.5"	DVD±RW	None	None	None	None	None	None	None	None	USB / USB	Carry Handle	250W 85%	Win10 DG Win7 Pro 64	3-year, Onsite	10/16
10GR0057US	US	i5-6400	No	GT 720 1GB	None	8GBx1	1TB 7200rpm 3.5"	DVD±RW	None	Intel 8260 ac, 2x2 + BT4.1	None	None	None	None	None	None	USB / USB	Carry Handle	250W 85%	Win10 Pro 64	3-year, Onsite	10/16
10GR0058US	US	i7-6700	No	GT 720 1GB	None	8GBx1	1TB 7200rpm 3.5"	DVD±RW	None	Intel 8260 ac, 2x2 + BT4.1	None	None	None	None	None	None	USB / USB	Carry Handle	250W 85%	Win10 Pro 64	3-year, Onsite	10/16
10GR0059US	US	i5-6400	No	GT 720 1GB	None	8GBx1	1TB 7200rpm 3.5"	DVD±RW	None	Intel 8260 ac, 2x2 + BT4.1	None	None	None	None	None	None	USB / USB	Carry Handle	250W 85%	Win10 DG Win7 Pro 64	3-year, Onsite	10/16
10GR005AUS	US	i7-6700	No	GT 720 1GB	None	8GBx1	1TB 7200rpm 3.5"	DVD±RW	None	None	None	None	None	None	None	None	USB / USB	Carry Handle	250W 85%	Win10 Pro 64	3-year, Onsite	10/16
10GR005BUS	US	i5-6400	No	GT 720 1GB	None	8GBx1	1TB 7200rpm 3.5"	DVD±RW	None	None	None	None	None	None	None	None	USB / USB	Carry Handle	250W 85%	Win10 DG Win7 Pro 64	3-year, Onsite	10/16
10GR005CUS	US	i7-6700	No	GT 720 1GB	None	8GBx1	1TB 7200rpm 3.5"	DVD±RW	None	Intel 8260 ac, 2x2 + BT4.1	None	None	None	None	None	None	USB / USB	Carry Handle	250W 85%	Win10 DG Win7 Pro 64	3-year, Onsite	10/16
10GR005DUS	US	i5-6400	No	GT 720 1GB	None	8GBx1	1TB 7200rpm 3.5"	DVD±RW	None	None	None	None	None	None	None	None	USB / USB	Carry Handle	250W 85%	Win10 Pro 64	3-year, Onsite	10/16
10GR005EUS	US	i3-6100	No	Intel HD 530	None	8GBx1	500GB 7200rpm 3.5"	DVD±RW	None	None	None	None	None	None	None	None	USB / USB	Carry Handle	250W 85%	Win10 Pro 64	3-year, Onsite	10/16



# ThinkCentre M710 SFF Platform Specifications

Product Specifications Reference (PSREF)

Processor	Intel® Celeron®, Intel Pentium®, or 6/7th Generation Intel Core™ i3 / i5 / i7 Processor	Security features	<ul style="list-style-type: none"> <li>Security slot (in rear for optional Kensington® MicroSaver® cable)</li> <li>Padlock loop</li> <li>Smart USB protection, allows keyboard/mouse only, blocks all storage devices</li> <li>Optional cable lock to physically lock both keyboard and mouse</li> <li>Power-on password</li> <li>Administrator password</li> <li>Hard disk password</li> <li>Boot sequence control</li> <li>Boot without keyboard and mouse</li> <li>Individual USB port disablement</li> <li>Optional chassis intrusion switch</li> </ul>																																																																								
	<table border="1"> <thead> <tr> <th>Processor</th> <th>Cores / Threads</th> <th>Frequency Base/Max(GHz)</th> <th>Cache</th> <th>Memory Support (Up to)</th> <th>Integrated Graphics</th> </tr> </thead> <tbody> <tr> <td>Pentium G4400</td> <td>2 / 2</td> <td>3.3G</td> <td>3 MB</td> <td>DDR4-2133</td> <td>HD 510</td> </tr> <tr> <td>Pentium G4560</td> <td>2 / 4</td> <td>3.5G</td> <td>3 MB</td> <td>DDR4-2400</td> <td>HD 610</td> </tr> <tr> <td>Pentium G4600</td> <td>2 / 4</td> <td>3.6G</td> <td>3 MB</td> <td>DDR4-2400</td> <td>HD 630</td> </tr> <tr> <td>Core i3-6100</td> <td>2 / 4</td> <td>3.7G</td> <td>3 MB</td> <td>DDR4-2133</td> <td>HD 530</td> </tr> <tr> <td>Core i5-6500</td> <td>4 / 4</td> <td>3.2G / 3.6G</td> <td>6 MB</td> <td>DDR4-2133</td> <td>HD 530</td> </tr> <tr> <td>Core i7-6700</td> <td>4 / 8</td> <td>3.4G / 4.0G</td> <td>8 MB</td> <td>DDR4-2133</td> <td>HD 530</td> </tr> <tr> <td>Core i3-7100</td> <td>2 / 4</td> <td>3.9G</td> <td>3 MB</td> <td>DDR4-2400</td> <td>HD 630</td> </tr> <tr> <td>Core i5-7400</td> <td>4 / 4</td> <td>3.0G / 3.5G</td> <td>6 MB</td> <td>DDR4-2400</td> <td>HD 630</td> </tr> <tr> <td>Core i5-7500</td> <td>4 / 4</td> <td>3.4G / 3.8G</td> <td>6 MB</td> <td>DDR4-2400</td> <td>HD 630</td> </tr> <tr> <td>Core i5-7600</td> <td>4 / 4</td> <td>3.5G / 4.1G</td> <td>6 MB</td> <td>DDR4-2400</td> <td>HD 630</td> </tr> <tr> <td>Core i7-7700</td> <td>4 / 8</td> <td>3.6G / 4.2G</td> <td>8 MB</td> <td>DDR4-2400</td> <td>HD 630</td> </tr> </tbody> </table>	Processor	Cores / Threads	Frequency Base/Max(GHz)	Cache	Memory Support (Up to)	Integrated Graphics	Pentium G4400	2 / 2	3.3G	3 MB	DDR4-2133	HD 510	Pentium G4560	2 / 4	3.5G	3 MB	DDR4-2400	HD 610	Pentium G4600	2 / 4	3.6G	3 MB	DDR4-2400	HD 630	Core i3-6100	2 / 4	3.7G	3 MB	DDR4-2133	HD 530	Core i5-6500	4 / 4	3.2G / 3.6G	6 MB	DDR4-2133	HD 530	Core i7-6700	4 / 8	3.4G / 4.0G	8 MB	DDR4-2133	HD 530	Core i3-7100	2 / 4	3.9G	3 MB	DDR4-2400	HD 630	Core i5-7400	4 / 4	3.0G / 3.5G	6 MB	DDR4-2400	HD 630	Core i5-7500	4 / 4	3.4G / 3.8G	6 MB	DDR4-2400	HD 630	Core i5-7600	4 / 4	3.5G / 4.1G	6 MB	DDR4-2400	HD 630	Core i7-7700	4 / 8	3.6G / 4.2G	8 MB	DDR4-2400	HD 630	Keyboard	<i>Some:</i> Lenovo Calliope Keyboard (USB connector), black <i>Some:</i> Lenovo Traditional Keyboard (USB connector), black <i>Some:</i> Lenovo Calliope Wireless Keyboard (2.4GHz via USB receiver), black <i>Some:</i> Lenovo Calliope Mouse (USB connector), black <i>Some:</i> Lenovo Calliope Wireless Mouse (2.4GHz via USB receiver), black
Processor	Cores / Threads	Frequency Base/Max(GHz)	Cache	Memory Support (Up to)	Integrated Graphics																																																																						
Pentium G4400	2 / 2	3.3G	3 MB	DDR4-2133	HD 510																																																																						
Pentium G4560	2 / 4	3.5G	3 MB	DDR4-2400	HD 610																																																																						
Pentium G4600	2 / 4	3.6G	3 MB	DDR4-2400	HD 630																																																																						
Core i3-6100	2 / 4	3.7G	3 MB	DDR4-2133	HD 530																																																																						
Core i5-6500	4 / 4	3.2G / 3.6G	6 MB	DDR4-2133	HD 530																																																																						
Core i7-6700	4 / 8	3.4G / 4.0G	8 MB	DDR4-2133	HD 530																																																																						
Core i3-7100	2 / 4	3.9G	3 MB	DDR4-2400	HD 630																																																																						
Core i5-7400	4 / 4	3.0G / 3.5G	6 MB	DDR4-2400	HD 630																																																																						
Core i5-7500	4 / 4	3.4G / 3.8G	6 MB	DDR4-2400	HD 630																																																																						
Core i5-7600	4 / 4	3.5G / 4.1G	6 MB	DDR4-2400	HD 630																																																																						
Core i7-7700	4 / 8	3.6G / 4.2G	8 MB	DDR4-2400	HD 630																																																																						
Memory	64GB max, UDIMM, DDR4-2400, four 288-pin DIMM sockets, non-ECC, dual-channel capable* * System automatically clocks down for the processors with lower memory controller	Mouse																																																																									
Storage	<i>Some:</i> Hard Drive / SATA 6.0Gb/s, 2.5" or 3.5", 5400 rpm or 7200 rpm <i>Some:</i> Solid State Drive (SSD) / SATA 6.0Gb/s, 2.5" <i>Some:</i> M.2 Solid State Drive (SSD) / PCIe NVMe, PCIe 3.0 x 4, 32Gb/s <i>Some:</i> Intel Optane™ Memory Ready (models with 7th gen Core processor), M.2 <i>Some:</i> DVD-ROM SATA 1.5Gb/s Drive, slim (9.0mm) <i>Some:</i> DVD Burner (DVD±RW), SATA 1.5Gb/s Drive, slim (9.0mm)	Mechanical	<ul style="list-style-type: none"> <li>SFF (8.4L), black color; metal case</li> <li>(WxDxH) 3.6" X 11.4" X 13.5"; 92.5mm X 290.5mm X 343.5mm</li> <li>Approx. 13.2 lb (6.0 kg), weight may vary by configuration</li> <li>Toolless cover, disk, optical removal</li> <li>Optional dust filter</li> <li>Bay 1: Slim external ODD bay</li> <li>Bay 2: 3.5", 1" high, internal, HDD/SSD</li> <li>Bay 3: 2.5", internal, HDD/SSD (optional bay)</li> <li>Slot 1: low-profile (length &lt; 150mm, height &lt; 68mm), PCIe 3.0 x16*</li> <li>Slot 2: low-profile (length &lt; 150mm, height &lt; 68mm), PCIe 3.0 x1*</li> <li>Slot 3: low-profile (length &lt; 150mm, height &lt; 68mm), PCIe 3.0 x1*</li> <li>Slot 4: no slot, only bracket for optional port extension*</li> <li>M.2 card slots: Two (one for WLAN, one for SSD/Optane)</li> <li>* Optional front USB3.1 Type-C x2 module occupies PCIe x16 slot (x4 card), optional rear 2x USB2.0 / parallel / 2nd serial occupies one expansion slot</li> </ul>																																																																								
Optical	Three onboard SATA 6.0Gb/s connectors Optional 7-in-1 media reader	Floor Stand	Optional system floor stand for vertical orientation																																																																								
Onboard SATA Media reader		Power supply	<i>Some:</i> 180 watts, autosensing, 85% PSU <i>Some:</i> 210 watts, autosensing, 85% PSU <i>Some:</i> 210 watts, autosensing, 92% PSU (only available via special bid)																																																																								
Graphics	Intel HD Graphics 510/530/610/630 in processor, uses main memory, DirectX® 12, one VGA, two DisplayPort™, supports 3 independent displays, works along with discrete graphics to support more displays; Max resolution: 4096x2304 (DP) @60Hz; 2048x1536 (VGA) @50Hz <i>Some:</i> NVIDIA GeForce® GT 730, DirectX 12, 2GB, PCIe 2.0 x8 adapter, two DisplayPort, 35 watts; Max resolution: 3840x2160 (DisplayPort) @60Hz;	Limited warranty <sup>3</sup>	<i>Some:</i> <b>1-year</b> or <b>3-year, depot service</b> / service upgrades available <i>Some:</i> <b>1-year</b> or <b>3-year, limited onsite service</b> / service upgrades available																																																																								
Monitor cable	Optional DP to VGA, DP to DVI-D (single link), DP to dual DP, or DP to HDMI 1.4	Preload	<b>Preloaded operating system</b> <i>Some:</i> Windows® 7 Professional 32/64 preinstalled through downgrade rights in Windows 10 Pro 64-bit (not available with 7th Gen Intel processor) <i>Some:</i> Windows 10 Pro 64-bit <i>Some:</i> Windows 10 Home 64-bit <b>Preloaded applications (only some listed)</b> <ul style="list-style-type: none"> <li>Microsoft Office preloaded; purchase a product key to activate</li> <li>Cyberlink PowerDVD Create (DVD±RW)</li> <li>- Only for Window 10</li> <li>Lenovo Companion</li> <li>Lenovo ID</li> <li>Cyberlink PowerDVD (DVD, DVD±RW)</li> <li>- Only for Window 7</li> <li>Lenovo Solution Center</li> <li>Lenovo ThinkVantage Tools</li> <li>Create Recovery Media</li> <li>Adobe® Reader®</li> </ul>																																																																								
Chipset	Intel B250 Chipset	Environment	ENERGY STAR® 6.1, EPEAT™ Gold rating (North America), ErP Lot 3, GREENGUARD®, RoHS-compliant, TUV low noise verified (on some models)																																																																								
Front ports	Four USB 3.1 Gen1, optional two USB 3.1 Type-C Gen 2 (only available via special bid), microphone (3.5mm), headphone (3.5mm)	Accessories	For compatible accessories, please go to <a href="http://www.lenovoquickpick.com">http://www.lenovoquickpick.com</a>																																																																								
Rear ports	Two USB 3.1 Gen1, two USB 2.0, optional two USB 2.0, serial (9-pin), optional 2nd serial (9-pin), optional parallel (25-pin), ethernet (RJ-45), one VGA, two DisplayPort, two PS/2 ports (keyboard/mouse); additional DisplayPort on optional graphics on some models																																																																										
Rear audio ports IEEE 1394	Line-in (3.5mm), line-out (3.5mm), microphone-in (3.5mm) None																																																																										
Audio support	High Definition (HD) Audio, Realtek ALC662 / optional internal speaker (1.5 watt )																																																																										
WLAN <sup>13</sup>	<i>Some:</i> 11ac wireless, M.2 Card, Qualcomm Atheros QCA9377A (dual band), Wi-Fi + Bluetooth 4.1 combo adapter, 1x1 <i>Some:</i> 11ac wireless, M.2 Card, Qualcomm Atheros QCA6174A (dual band), Wi-Fi + Bluetooth 4.1 combo adapter, 2x2 <i>Some:</i> 11ac wireless, M.2 Card, Intel Dual Band Wireless-AC 3165, Wi-Fi + Bluetooth 4.1 combo adapter, 1x1 <i>Some:</i> 11ac wireless, M.2 Card, Intel Dual Band Wireless-AC 8265, Wi-Fi + Bluetooth 4.1 combo adapter, 2x2																																																																										
Bluetooth™ Ethernet Modem	<i>Some:</i> Bluetooth 4.1 wireless, integrated in Wi-Fi + BT combo adapter Gigabit ethernet, Realtek RTL8111GN, Wake on LAN® None																																																																										
Manageability Security chip	None TPM (Trusted Platform Module) 2.0, TCG Certified * Downgrade to TPM1.2 for the models with Win10 DG Win7 32 OS																																																																										

See footnotes for more detailed information

Model	Region	Processor	vPro	Graphics	Monitor Cable	Memory	Storage(HDD/SSD)	Optical	Optional 2nd 2.5" Bay	Media Reader	WLAN + Bluetooth	Optional Front Ports	Optional Rear Ports	Chassis Intrusion Switch	Cable Lock	Speaker	Dust Filter	Keyboard / Mouse	Stand	Power Supply	Operating System	Warranty	Ann Date (mm/yy)
10M7000DUS	US	i7-7700	No	GT 730 2GB	None	8GBx1	1TB 7200rpm 3.5"	DVD±RW	Optional 2nd 2.5" Bay	None	3165 ac, 1x1 + BT4.0	None	None	None	None	1.5Wx1	None	USB / USB	Floor Stand	210W 85%	Win10 Pro 64	3-year, Onsite	02/17
10M7000EUS	US	i7-7700	No	Intel HD 630	None	8GBx1	256GB SSD M.2 PCIe NVMe Opal	DVD±RW	Optional 2nd 2.5" Bay	None	3165 ac, 1x1 + BT4.0	None	None	None	None	1.5Wx1	None	USB / USB	Floor Stand	210W 85%	Win10 Pro 64	3-year, Onsite	02/17
10M7000FUS	US	i7-7700	No	Intel HD 630	None	8GBx1	1TB 7200rpm 3.5"	DVD±RW	Optional 2nd 2.5" Bay	None	None	None	None	None	None	1.5Wx1	None	USB / USB	Floor Stand	210W 85%	Win10 Pro 64	3-year, Onsite	02/17
10M7000GUS	US	i7-7700	No	Intel HD 630	None	8GBx1	512GB SSD M.2 PCIe NVMe Opal	DVD±RW	Optional 2nd 2.5" Bay	None	None	None	None	None	None	1.5Wx1	None	USB / USB	Floor Stand	210W 85%	Win10 Pro 64	3-year, Onsite	02/17
10M7000HUS	US	i5-7400	No	Intel HD 630	None	4GBx1	500GB 7200rpm 3.5"	DVD±RW	Optional 2nd 2.5" Bay	None	3165 ac, 1x1 + BT4.0	None	None	None	None	1.5Wx1	None	USB / USB	Floor Stand	210W 85%	Win10 Pro 64	3-year, Onsite	02/17
10M7000JUS	US	i5-7400	No	Intel HD 630	None	8GBx1	512GB SSD M.2 PCIe NVMe Opal	DVD±RW	Optional 2nd 2.5" Bay	None	3165 ac, 1x1 + BT4.0	None	None	None	None	1.5Wx1	None	USB / USB	Floor Stand	210W 85%	Win10 Pro 64	3-year, Onsite	02/17
10M7000KUS	US	i7-7700	No	GT 730 2GB	None	8GBx1	256GB SSD M.2 PCIe NVMe Opal	DVD±RW	Optional 2nd 2.5" Bay	None	3165 ac, 1x1 + BT4.0	None	None	None	None	1.5Wx1	None	USB / USB	Floor Stand	210W 85%	Win10 Pro 64	3-year, Onsite	02/17
10M7000LUS	US	i5-7400	No	Intel HD 630	None	8GBx1	256GB SSD M.2 PCIe NVMe Opal	DVD±RW	Optional 2nd 2.5" Bay	None	3165 ac, 1x1 + BT4.0	None	None	None	None	1.5Wx1	None	USB / USB	Floor Stand	210W 85%	Win10 Pro 64	3-year, Onsite	02/17
10M7000MUS	US	i7-7700	No	GT 730 2GB	None	8GBx1	1TB 7200rpm 3.5"	DVD±RW	Optional 2nd 2.5" Bay	None	None	None	None	None	None	1.5Wx1	None	USB / USB	Floor Stand	210W 85%	Win10 Pro 64	3-year, Onsite	02/17
10M7000NUS	US	i7-7700	No	GT 730 2GB	None	8GBx1	256GB SSD M.2 PCIe NVMe Opal	DVD±RW	Optional 2nd 2.5" Bay	None	None	None	None	None	None	1.5Wx1	None	USB / USB	Floor Stand	210W 85%	Win10 Pro 64	3-year, Onsite	02/17
10M7000PUS	US	i5-7400	No	Intel HD 630	None	4GBx1	500GB 7200rpm 3.5"	DVD±RW	Optional 2nd 2.5" Bay	None	None	None	None	None	None	1.5Wx1	None	USB / USB	Floor Stand	210W 85%	Win10 Pro 64	3-year, Onsite	02/17
10M7000QUS	US	i5-7400	No	Intel HD 630	None	8GBx1	256GB SSD M.2 PCIe NVMe Opal	DVD±RW	Optional 2nd 2.5" Bay	None	None	None	None	None	None	1.5Wx1	None	USB / USB	Floor Stand	210W 85%	Win10 Pro 64	3-year, Onsite	02/17
10M7000RUS	US	i7-7700	No	Intel HD 630	None	8GBx1	256GB SSD M.2 PCIe NVMe Opal	DVD±RW	Optional 2nd 2.5" Bay	None	None	None	None	None	None	1.5Wx1	None	USB / USB	Floor Stand	210W 85%	Win10 Pro 64	3-year, Onsite	02/17
10M7000SUS	US	i5-7400	No	Intel HD 630	None	8GBx1	1TB 7200rpm 3.5"	DVD±RW	Optional 2nd 2.5" Bay	None	None	None	None	None	None	1.5Wx1	None	USB / USB	Floor Stand	210W 85%	Win10 Pro 64	3-year, Onsite	02/17
10M7000TUS	US	i7-7700	No	Intel HD 630	None	8GBx1	1TB 7200rpm 3.5"	DVD±RW	Optional 2nd 2.5" Bay	None	3165 ac, 1x1 + BT4.0	None	None	None	None	1.5Wx1	None	USB / USB	Floor Stand	210W 85%	Win10 Pro 64	3-year, Onsite	02/17
10M7002WUS	US	i5-7400	No	Intel HD 630	None	8GBx1	1TB 7200rpm 3.5"	DVD±RW	Optional 2nd 2.5" Bay	None	3165 ac, 1x1 + BT4.0	None	None	None	None	1.5Wx1	None	USB / USB	Floor Stand	210W 85%	Win10 Pro 64	3-year, Onsite	03/17
10M7002XUS	US	Pentium G4560	No	Intel HD 610	None	4GBx1	500GB 7200rpm 3.5"	DVD±RW	Optional 2nd 2.5" Bay	None	3165 ac, 1x1 + BT4.0	None	None	None	None	1.5Wx1	None	USB / USB	Floor Stand	210W 85%	Win10 Pro 64	3-year, Onsite	03/17
10M7002YUS	US	i3-7100	No	Intel HD 630	None	8GBx1	128GB SSD M.2 PCIe NVMe	DVD±RW	Optional 2nd 2.5" Bay	None	None	None	None	None	None	1.5Wx1	None	USB / USB	Floor Stand	210W 85%	Win10 Pro 64	3-year, Onsite	03/17
10M70030US	US	i5-6500	No	Intel HD 530	None	8GBx1	1TB 7200rpm 3.5"	DVD±RW	Optional 2nd 2.5" Bay	None	None	None	None	None	None	1.5Wx1	None	USB / USB	Floor Stand	210W 85%	Win10 DG Win7 Pro 64	3-year, Onsite	03/17
10M70031US	US	i3-7100	No	Intel HD 630	None	4GBx1	500GB 7200rpm 3.5"	DVD±RW	Optional 2nd 2.5" Bay	None	None	None	None	None	None	1.5Wx1	None	USB / USB	Floor Stand	210W 85%	Win10 Pro 64	3-year, Onsite	03/17

Model	Region	Processor	vPro	Graphics	Monitor Cable	Memory	Storage(HDD/SSD)	Optical	Optional 2nd 2.5" Bay	Media Reader	WLAN + Bluetooth	Optional Front Ports	Optional Rear Ports	Chassis Intrusion Switch	Cable Lock	Speaker	Dust Filter	Keyboard / Mouse	Stand	Power Supply	Operating System	Warranty	Ann Date (mm/yy)
10M70032US	US	i7-6700	No	GT 730 2GB	None	8GBx1	256GB SSD M.2 PCIe NVMe Opal	DVD±RW	Optional 2nd 2.5" Bay	None	3165 ac, 1x1 + BT4.0	None	None	None	None	1.5Wx1	None	USB / USB	Floor Stand	210W 85%	Win10 DG Win7 Pro 64	3-year, Onsite	03/17
10M70033US	US	i7-6700	No	GT 730 2GB	None	8GBx1	1TB 7200rpm 3.5"	DVD±RW	Optional 2nd 2.5" Bay	None	3165 ac, 1x1 + BT4.0	None	None	None	None	1.5Wx1	None	USB / USB	Floor Stand	210W 85%	Win10 DG Win7 Pro 64	3-year, Onsite	03/17
10M70034US	US	i5-7400	No	Intel HD 630	None	4GBx1	128GB SSD M.2 PCIe NVMe	DVD±RW	Optional 2nd 2.5" Bay	None	None	None	None	None	None	1.5Wx1	None	USB / USB	Floor Stand	210W 85%	Win10 Pro 64	3-year, Onsite	03/17
10M70035US	US	i7-6700	No	GT 730 2GB	None	8GBx1	256GB SSD M.2 PCIe NVMe Opal	DVD±RW	Optional 2nd 2.5" Bay	None	None	None	None	None	None	1.5Wx1	None	USB / USB	Floor Stand	210W 85%	Win10 DG Win7 Pro 64	3-year, Onsite	03/17
10M70036US	US	Pentium G4400	No	Intel HD 510	None	4GBx1	500GB 7200rpm 3.5"	DVD±RW	Optional 2nd 2.5" Bay	None	3165 ac, 1x1 + BT4.0	None	None	None	None	1.5Wx1	None	USB / USB	Floor Stand	210W 85%	Win10 DG Win7 Pro 64	3-year, Onsite	03/17
10M70037US	US	i3-6100	No	Intel HD 530	None	8GBx1	1TB 7200rpm 3.5"	DVD±RW	Optional 2nd 2.5" Bay	None	None	None	None	None	None	1.5Wx1	None	USB / USB	Floor Stand	210W 85%	Win10 DG Win7 Pro 64	3-year, Onsite	03/17
10M70038US	US	i5-6500	No	Intel HD 530	None	8GBx1	1TB 7200rpm 3.5"	DVD±RW	Optional 2nd 2.5" Bay	None	3165 ac, 1x1 + BT4.0	None	None	None	None	1.5Wx1	None	USB / USB	Floor Stand	210W 85%	Win10 DG Win7 Pro 64	3-year, Onsite	03/17
10M70039US	US	i5-6500	No	Intel HD 530	None	4GBx1	500GB 7200rpm 3.5"	DVD±RW	Optional 2nd 2.5" Bay	None	None	None	None	None	None	1.5Wx1	None	USB / USB	Floor Stand	210W 85%	Win10 DG Win7 Pro 64	3-year, Onsite	03/17
10M7003AUS	US	i7-6700	No	Intel HD 530	None	8GBx1	256GB SSD M.2 PCIe NVMe Opal	DVD±RW	Optional 2nd 2.5" Bay	None	3165 ac, 1x1 + BT4.0	None	None	None	None	1.5Wx1	None	USB / USB	Floor Stand	210W 85%	Win10 DG Win7 Pro 64	3-year, Onsite	03/17
10M7003BUS	US	Pentium G4560	No	Intel HD 610	None	4GBx1	500GB 7200rpm 3.5"	DVD±RW	Optional 2nd 2.5" Bay	None	None	None	None	None	None	1.5Wx1	None	USB / USB	Floor Stand	210W 85%	Win10 Pro 64	3-year, Onsite	03/17
10M7003CUS	US	i3-6100	No	Intel HD 530	None	8GBx1	1TB 7200rpm 3.5"	DVD±RW	Optional 2nd 2.5" Bay	None	3165 ac, 1x1 + BT4.0	None	None	None	None	1.5Wx1	None	USB / USB	Floor Stand	210W 85%	Win10 DG Win7 Pro 64	3-year, Onsite	03/17
10M7003DUS	US	i3-7100	No	Intel HD 630	None	8GBx1	1TB 7200rpm 3.5"	DVD±RW	Optional 2nd 2.5" Bay	None	3165 ac, 1x1 + BT4.0	None	None	None	None	1.5Wx1	None	USB / USB	Floor Stand	210W 85%	Win10 Pro 64	3-year, Onsite	03/17
10M7003EUS	US	i7-6700	No	Intel HD 530	None	8GBx1	512GB SSD M.2 PCIe NVMe Opal	DVD±RW	Optional 2nd 2.5" Bay	None	None	None	None	None	None	1.5Wx1	None	USB / USB	Floor Stand	210W 85%	Win10 DG Win7 Pro 64	3-year, Onsite	03/17
10M7003FUS	US	i3-6100	No	Intel HD 530	None	8GBx1	128GB SSD M.2 PCIe NVMe	DVD±RW	Optional 2nd 2.5" Bay	None	None	None	None	None	None	1.5Wx1	None	USB / USB	Floor Stand	210W 85%	Win10 DG Win7 Pro 64	3-year, Onsite	03/17
10M7003GUS	US	i7-6700	No	Intel HD 530	None	8GBx1	256GB SSD M.2 PCIe NVMe Opal	DVD±RW	Optional 2nd 2.5" Bay	None	None	None	None	None	None	1.5Wx1	None	USB / USB	Floor Stand	210W 85%	Win10 DG Win7 Pro 64	3-year, Onsite	03/17
10M7003HUS	US	i7-6700	No	Intel HD 530	None	8GBx1	1TB 7200rpm 3.5"	DVD±RW	Optional 2nd 2.5" Bay	None	3165 ac, 1x1 + BT4.0	None	None	None	None	1.5Wx1	None	USB / USB	Floor Stand	210W 85%	Win10 DG Win7 Pro 64	3-year, Onsite	03/17
10M7003JUS	US	i5-6500	No	Intel HD 530	None	4GBx1	500GB 7200rpm 3.5"	DVD±RW	Optional 2nd 2.5" Bay	None	3165 ac, 1x1 + BT4.0	None	None	None	None	1.5Wx1	None	USB / USB	Floor Stand	210W 85%	Win10 DG Win7 Pro 64	3-year, Onsite	03/17
10M7003KUS	US	Pentium G4400	No	Intel HD 510	None	4GBx1	500GB 7200rpm 3.5"	DVD±RW	Optional 2nd 2.5" Bay	None	None	None	None	None	None	1.5Wx1	None	USB / USB	Floor Stand	210W 85%	Win10 DG Win7 Pro 64	3-year, Onsite	03/17
10M7003LUS	US	i3-7100	No	Intel HD 630	None	8GBx1	1TB 7200rpm 3.5"	DVD±RW	Optional 2nd 2.5" Bay	None	None	None	None	None	None	1.5Wx1	None	USB / USB	Floor Stand	210W 85%	Win10 Pro 64	3-year, Onsite	03/17
10M7003MUS	US	i5-6500	No	Intel HD 530	None	8GBx1	256GB SSD M.2 PCIe NVMe Opal	DVD±RW	Optional 2nd 2.5" Bay	None	None	None	None	None	None	1.5Wx1	None	USB / USB	Floor Stand	210W 85%	Win10 DG Win7 Pro 64	3-year, Onsite	03/17

Model	Region	Processor	vPro	Graphics	Monitor Cable	Memory	Storage(HDD/SSD)	Optical	Optional 2nd 2.5" Bay	Media Reader	WLAN + Bluetooth	Optional Front Ports	Optional Rear Ports	Chassis Intrusion Switch	Cable Lock	Speaker	Dust Filter	Keyboard / Mouse	Stand	Power Supply	Operating System	Warranty	Ann Date (mm/yy)
10M7003NUS	US	i7-6700	No	GT 730 2GB	None	8GBx1	1TB 7200rpm 3.5"	DVD±RW	Optional 2nd 2.5" Bay	None	None	None	None	None	None	1.5Wx1	None	USB / USB	Floor Stand	210W 85%	Win10 DG Win7 Pro 64	3-year, Onsite	03/17
10M7003PUS	US	i3-6100	No	Intel HD 530	None	4GBx1	1TB 7200rpm 3.5"	DVD±RW	Optional 2nd 2.5" Bay	None	None	None	None	None	None	1.5Wx1	None	USB / USB	Floor Stand	210W 85%	Win10 DG Win7 Pro 64	3-year, Onsite	03/17
10M7003QUS	US	i7-6700	No	Intel HD 530	None	8GBx1	1TB 7200rpm 3.5"	DVD±RW	Optional 2nd 2.5" Bay	None	None	None	None	None	None	1.5Wx1	None	USB / USB	Floor Stand	210W 85%	Win10 DG Win7 Pro 64	3-year, Onsite	03/17
10M7003RUS	US	i5-6500	No	Intel HD 530	None	4GBx1	128GB SSD M.2 PCIe NVMe	DVD±RW	Optional 2nd 2.5" Bay	None	None	None	None	None	None	1.5Wx1	None	USB / USB	Floor Stand	210W 85%	Win10 DG Win7 Pro 64	3-year, Onsite	03/17
10M7003SUS	US	i5-6500	No	Intel HD 530	None	8GBx1	256GB SSD M.2 PCIe NVMe Opal	DVD±RW	Optional 2nd 2.5" Bay	None	3165 ac, 1x1 + BT4.0	None	None	None	None	1.5Wx1	None	USB / USB	Floor Stand	210W 85%	Win10 DG Win7 Pro 64	3-year, Onsite	03/17
10M7003TUS	US	i3-6100	No	Intel HD 530	None	4GBx1	500GB 7200rpm 3.5"	DVD±RW	Optional 2nd 2.5" Bay	None	None	None	None	None	None	1.5Wx1	None	USB / USB	Floor Stand	210W 85%	Win10 DG Win7 Pro 64	3-year, Onsite	03/17
10M7003UUS	US	i3-7100	No	Intel HD 630	None	4GBx1	1TB 7200rpm 3.5"	DVD±RW	Optional 2nd 2.5" Bay	None	None	None	None	None	None	1.5Wx1	None	USB / USB	Floor Stand	210W 85%	Win10 Pro 64	3-year, Onsite	03/17





# ThinkCentre M710 Tiny Platform Specifications

Product Specifications Reference (PSREF)

Processor	Intel® Celeron®, Intel Pentium®, or 6/7th Generation Intel Core™ i3 / i5 / i7 Processor						<b>Security features</b> <ul style="list-style-type: none"> <li>Security slot (in rear for optional Kensington® MicroSaver® cable)</li> <li>Smart USB protection, allows keyboard/mouse only, blocks all storage devices</li> <li>Power-on password</li> <li>Administrator password</li> <li>Hard disk password</li> <li>Boot sequence control</li> <li>Boot without keyboard and mouse</li> <li>Individual USB port disablement</li> <li>Chassis intrusion switch</li> </ul>
	Processor	Cores / Threads	Frequency Base/Max(GHz)	Cache	Memory Support (Up to)	Integrated Graphics	
	Pentium G4400T	2 / 2	2.9G	3 MB	DDR4-2133	HD 510	
	Pentium G4560T	2 / 4	2.9G	3 MB	DDR4-2400	HD 610	
	Pentium G4600T	2 / 4	3.0G	3 MB	DDR4-2400	HD 630	
	Core i3-6100T	2 / 4	3.2G	3 MB	DDR4-2133	HD 530	
	Core i5-6500T	4 / 4	2.5G / 3.1G	6 MB	DDR4-2133	HD 530	
	Core i7-6700T	4 / 8	2.8G / 3.6G	8 MB	DDR4-2133	HD 530	
	Core i3-7100T	2 / 4	3.4G	3 MB	DDR4-2400	HD 630	
	Core i5-7400T	4 / 4	2.4G / 3.0G	6 MB	DDR4-2400	HD 630	
Core i5-7500T	4 / 4	2.7G / 3.3G	6 MB	DDR4-2400	HD 630		
Core i5-7600T	4 / 4	2.8G / 3.7G	6 MB	DDR4-2400	HD 630		
Core i7-7700T	4 / 8	2.9G / 3.8G	8 MB	DDR4-2400	HD 630		
Memory	32GB max, DDR4-2400*, two 260-pin SO-DIMM sockets, non-ECC, dual-channel capable * System automatically clocks down for the processors with lower memory controller						
Storage	<i>Some:</i> Hard Drive / SATA 6.0Gb/s, 2.5", 5400 rpm or 7200 rpm <i>Some:</i> Solid State Drive (SSD) / SATA 6.0Gb/s, 2.5" <i>Some:</i> M.2 Solid State Drive (SSD) / PCIe NVMe, PCIe 3.0 x 4, 32Gb/s <i>Some:</i> Intel Optane™ Memory Ready (models with 7th gen Core processor), M.2 <i>Some:</i> DVD-ROM, slim (9.0mm), via USB external ODD box <i>Some:</i> DVD Burner (DVD±RW), slim (9.0mm), via USB external ODD box						
Optical	One onboard SATA 6.0Gb/s connector None						
Onboard SATA Media reader	None						
Graphics	<b>Intel HD Graphics 510/530/610/630</b> in processor, uses main memory, DirectX® 12, two DisplayPort™, one optional video port (HDMI, VGA, 3rd DP, or USB 3.1 Type-C with DisplayPort Alternate Mode), up to 3 independent displays; <i>Max resolution:</i> 4096x2304 (DP) @60Hz; 4096x2304 (Type-C) @60Hz; 4096x2160 (HDMI) @24Hz; 1920x1200 (VGA) @60Hz						
Monitor cable	Optional DP to VGA, DP to DVI-D (single link), DP to dual DP, or DP to HDMI 1.4						
Chipset	<b>Intel B250 Chipset</b>						
Front ports	Two USB 3.1 Gen1 (one is Always On and fast charge), one microphone (3.5mm), one headphone / microphone combo jack (3.5mm)						
Rear ports	Four USB 3.1 Gen1 (optional external optical box or external I/O box occupies one or two specific USB 3.1 Gen1 on some models), ethernet (RJ-45), two DisplayPort, two optional ports (Port 1 for VGA / 3rd DP / HDMI / serial / USB 3.1 Type-C Gen 1 (with DisplayPort Alternate Mode), Port 2 for serial)						
I/O box	Optional external I/O box, extends two USB 2.0, two USB 3.1 Gen1, and one serial on rear, two USB 2.0 on front, via USB cable (occupy two specific USB 3.1 Gen1 of Tiny)						
Audio support	High Definition (HD) Audio, Realtek ALC294 / optional internal speaker (1w or 2w)						
WLAN <sup>13</sup>	<i>Some:</i> 11ac wireless, M.2 Card, Qualcomm Atheros QCA9377A (dual band), Wi-Fi + Bluetooth 4.1 combo adapter, 1x1 <i>Some:</i> 11ac wireless, M.2 Card, Qualcomm Atheros QCA6174A (dual band), Wi-Fi + Bluetooth 4.1 combo adapter, 2x2 <i>Some:</i> 11ac wireless, M.2 Card, Intel Dual Band Wireless-AC 3165, Wi-Fi + Bluetooth 4.1 combo adapter, 1x1 <i>Some:</i> 11ac wireless, M.2 Card, Intel Dual Band Wireless-AC 8265, Wi-Fi + Bluetooth 4.1 combo adapter, 2x2						
Bluetooth™	<i>Some:</i> Bluetooth 4.1 wireless, integrated in Wi-Fi + BT combo adapter						
Ethernet	Gigabit ethernet, Intel Ethernet Connection I219-V (Jacksonville), Wake on LAN®						
Modem	None						
Manageability	None						
Security chip	TPM (Trusted Platform Module) 2.0*, TCG Certified * Downgrade to TPM1.2 for the models with Win10 DG Win7 32 OS						
VESA mount	Optional VESA mount bracket kit, supports VESA 75mm and 100mm						
Floor Stand	Optional system floor stand for vertical orientation						
Power supply	65 watts AC/DC adapter, autosensing, 88% PSU (not included for TIO models) 90 watts AC/DC adapter, autosensing, 88% PSU (only for models with I/O box)						
Limited warranty <sup>3</sup>	<i>Some:</i> <b>1-year</b> or <b>3-year, depot service</b> / service upgrades available <i>Some:</i> <b>1-year</b> or <b>3-year, limited onsite service</b> / service upgrades available						
Preload	<i>Some:</i> Windows® 7 Professional 32/64 preinstalled through downgrade rights in Windows 10 Pro 64-bit (not available with 7th Gen Intel processor) <i>Some:</i> Windows 10 Pro 64-bit <i>Some:</i> Windows 10 Home 64-bit <b>Preloaded applications (only some listed)</b> <ul style="list-style-type: none"> <li>Microsoft Office preloaded; purchase a product key to activate</li> <li>Cyberlink PowerDVD Create (DVD±RW)</li> <li>- Only for Window 10</li> <li>Lenovo Companion</li> <li>Lenovo ID</li> <li>Cyberlink PowerDVD (DVD, DVD±RW)</li> <li>- Only for Window 7</li> <li>Lenovo Solution Center</li> <li>Lenovo ThinkVantage Tools</li> <li>Create Recovery Media</li> <li>Adobe® Reader®</li> </ul>						
Environment	ENERGY STAR® 6.1, EPEAT™ Gold rating (North America), ErP Lot 3, GREENGUARD®, RoHS-compliant, TUV low noise verified (on some models)						
MIL-SPEC test	MIL-STD-810G military certification (Low Pressure [Altitude], High Temperature, Low Temperature, Temperature Shock, Humidity, Sand and Dust, Vibration, Shock, Fungus, Solar Radiation)						
Accessories	For compatible accessories, please go to <a href="http://www.lenovoquickpick.com">http://www.lenovoquickpick.com</a>						

See footnotes for more detailed information

Model	Region	Processor	vPro	Graphics	Monitor Cable	Memory	Storage(HDD/SSD)	External Optical / I/O Box	WLAN + Bluetooth	Optional Rear Ports	Chassis Intrusion Switch	Kensington Cable Lock	Speaker	Adapter Cage	Toolless Chassis Screw	Dust Filter	Keyboard / Mouse	VESA Mount	Stand	Power Supply	Operating System	Warranty	End of Support	Ann Date (mm/yy)
10MR0001US	US	i7-7700T	No	Intel HD 630	None	8GBx1	500GB 7200rpm 2.5"	DVD±RW	8265 ac, 2x2 + BT4.1	HDMI	Switch	None	1Wx1	None	None	None	USB / USB	VESA Mount	None	65W Adapter 88%	Win10 Pro 64	3-year, Onsite	Mar 21, 2023	02/17
10MR0002US	US	i5-7500T	No	Intel HD 630	None	4GBx1	500GB 7200rpm 2.5"	None	3165 ac, 1x1 + BT4.0	VGA	Switch	None	1Wx1	None	None	None	USB / USB	None	Floor Stand	65W Adapter 88%	Win10 Pro 64	3-year, Onsite	Mar 21, 2023	02/17
10MR0003US	US	i7-7700T	No	Intel HD 630	None	8GBx1	256GB SSD M.2 PCIe NVMe Opal	None	8265 ac, 2x2 + BT4.1	3rd DP	Switch	None	1Wx1	None	None	None	USB / USB	None	Floor Stand	65W Adapter 88%	Win10 Pro 64	3-year, Onsite	Mar 21, 2023	02/17
10MR0004US	US	i5-7500T	No	Intel HD 630	None	8GBx1	256GB SSD M.2 PCIe NVMe Opal	None	8265 ac, 2x2 + BT4.1	3rd DP	Switch	None	1Wx1	None	None	None	USB / USB	None	Floor Stand	65W Adapter 88%	Win10 Pro 64	3-year, Onsite	Feb 21, 2022	02/17
10MR0005US	US	i5-7500T	No	Intel HD 630	None	8GBx1	128GB SSD M.2 PCIe NVMe	None	3165 ac, 1x1 + BT4.0	3rd DP	Switch	None	1Wx1	None	None	None	USB / USB	None	Floor Stand	65W Adapter 88%	Win10 Pro 64	3-year, Onsite	Mar 21, 2023	02/17
10MR0006US	US	i5-7500T	No	Intel HD 630	None	8GBx1	500GB 7200rpm 2.5"	DVD±RW	8265 ac, 2x2 + BT4.1	HDMI	Switch	None	1Wx1	None	None	None	USB / USB	VESA Mount	None	65W Adapter 88%	Win10 Pro 64	3-year, Onsite	Mar 21, 2023	02/17
10MR0007US	US	i5-7500T	No	Intel HD 630	None	4GBx1	500GB 7200rpm 2.5"	None	8265 ac, 2x2 + BT4.1	3rd DP	Switch	None	1Wx1	None	None	None	USB / USB	None	Floor Stand	65W Adapter 88%	Win10 Pro 64	3-year, Onsite	Mar 21, 2023	02/17
10MR0008US	US	i5-7500T	No	Intel HD 630	None	4GBx1	500GB 7200rpm 2.5"	None	3165 ac, 1x1 + BT4.0	None	Switch	None	1Wx1	None	None	None	USB / USB	None	Floor Stand	65W Adapter 88%	Win10 Pro 64	3-year, Onsite	Mar 21, 2023	02/17
10MR0009US	US	i5-7500T	No	Intel HD 630	None	4GBx1	500GB 7200rpm 2.5"	None	3165 ac, 1x1 + BT4.0	HDMI	Switch	None	1Wx1	None	None	None	USB / USB	None	Floor Stand	65W Adapter 88%	Win10 Pro 64	3-year, Onsite	Mar 21, 2023	02/17
10MR000AUS	US	i5-7500T	No	Intel HD 630	None	4GBx1	500GB 7200rpm 2.5"	None	8265 ac, 2x2 + BT4.1	None	Switch	None	1Wx1	None	None	None	USB / USB	None	Floor Stand	65W Adapter 88%	Win10 Pro 64	3-year, Onsite	Mar 21, 2023	02/17
10MR000BUS	US	i7-7700T	No	Intel HD 630	None	8GBx1	500GB 7200rpm 2.5"	None	8265 ac, 2x2 + BT4.1	3rd DP	Switch	None	1Wx1	None	None	None	USB / USB	None	Floor Stand	65W Adapter 88%	Win10 Pro 64	3-year, Onsite	Mar 21, 2023	02/17
10MR000CUS	US	i5-7500T	No	Intel HD 630	None	8GBx1	256GB SSD M.2 PCIe NVMe Opal	None	8265 ac, 2x2 + BT4.1	HDMI	Switch	None	1Wx1	None	None	None	USB / USB	None	Floor Stand	65W Adapter 88%	Win10 Pro 64	3-year, Onsite	Mar 21, 2023	02/17
10MR000DUS	US	i5-7500T	No	Intel HD 630	None	8GBx1	128GB SSD M.2 PCIe NVMe	None	8265 ac, 2x2 + BT4.1	HDMI	Switch	None	1Wx1	None	None	None	USB / USB	None	Floor Stand	65W Adapter 88%	Win10 Pro 64	3-year, Onsite	Mar 21, 2023	02/17
10MR000EUS	US	i7-7700T	No	Intel HD 630	None	8GBx1	256GB SSD M.2 PCIe NVMe Opal	None	8265 ac, 2x2 + BT4.1	HDMI	Switch	None	1Wx1	None	None	None	USB / USB	None	Floor Stand	65W Adapter 88%	Win10 Pro 64	3-year, Onsite	Mar 21, 2023	02/17
10MR000FUS	US	i5-7500T	No	Intel HD 630	None	4GBx1	500GB 7200rpm 2.5"	None	3165 ac, 1x1 + BT4.0	3rd DP	Switch	None	1Wx1	None	None	None	USB / USB	None	Floor Stand	65W Adapter 88%	Win10 Pro 64	3-year, Onsite	Mar 21, 2023	02/17
10MR000GUS	US	i5-7500T	No	Intel HD 630	None	4GBx1	500GB 7200rpm 2.5"	None	8265 ac, 2x2 + BT4.1	HDMI	Switch	None	1Wx1	None	None	None	USB / USB	None	Floor Stand	65W Adapter 88%	Win10 Pro 64	3-year, Onsite	Mar 21, 2023	02/17
10MR000HUS	US	i7-7700T	No	Intel HD 630	None	8GBx1	500GB 7200rpm 2.5"	None	8265 ac, 2x2 + BT4.1	HDMI	Switch	None	1Wx1	None	None	None	USB / USB	None	Floor Stand	65W Adapter 88%	Win10 Pro 64	3-year, Onsite	Mar 21, 2023	02/17
10MR000JUS	US	i5-7500T	No	Intel HD 630	None	8GBx1	500GB 7200rpm 2.5"	None	8265 ac, 2x2 + BT4.1	3rd DP	Switch	None	1Wx1	None	None	None	USB / USB	None	Floor Stand	65W Adapter 88%	Win10 Pro 64	3-year, Onsite	Mar 21, 2023	02/17
10MR000KUS	US	i5-7500T	No	Intel HD 630	None	4GBx1	500GB 7200rpm 2.5"	None	3165 ac, 1x1 + BT4.0	Serial	Switch	None	1Wx1	None	None	None	USB / USB	None	Floor Stand	65W Adapter 88%	Win10 Pro 64	3-year, Onsite	Mar 21, 2023	02/17
10MR002PUS	US	i3-7100T	No	Intel HD 630	None	8GBx1	500GB 7200rpm 2.5"	None	3165 ac, 1x1 + BT4.0	VGA	Switch	None	1Wx1	None	None	None	USB / USB	None	Floor Stand	65W Adapter 88%	Win10 Pro 64	3-year, Onsite	Apr 6, 2023	03/17

Model	Region	Processor	vPro	Graphics	Monitor Cable	Memory	Storage(HDD/SSD)	External Optical / I/O Box	WLAN + Bluetooth	Optional Rear Ports	Chassis Intrusion Switch	Kensington Cable Lock	Speaker	Adapter Cage	Toolless Chassis Screw	Dust Filter	Keyboard / Mouse	VESA Mount	Stand	Power Supply	Operating System	Warranty	End of Support	Ann Date (mm/yy)
10MR002QUS	US	i3-7100T	No	Intel HD 630	None	8GBx1	500GB 7200rpm 2.5"	None	3165 ac, 1x1 + BT4.0	3rd DP	Switch	None	1Wx1	None	None	None	USB / USB	None	Floor Stand	65W Adapter 88%	Win10 Pro 64	3-year, Onsite	Apr 6, 2023	03/17
10MR002RUS	US	Pentium G4560T	No	Intel HD 610	None	4GBx1	500GB 7200rpm 2.5"	None	3165 ac, 1x1 + BT4.0	None	Switch	None	1Wx1	None	None	None	USB / USB	None	Floor Stand	65W Adapter 88%	Win10 Pro 64	3-year, Onsite	Apr 6, 2023	03/17
10MR002SUS	US	i3-7100T	No	Intel HD 630	None	8GBx1	500GB 7200rpm 2.5"	None	3165 ac, 1x1 + BT4.0	None	Switch	None	1Wx1	None	None	None	USB / USB	None	Floor Stand	65W Adapter 88%	Win10 Pro 64	3-year, Onsite	Apr 6, 2023	03/17
10MR002TUS	US	i3-7100T	No	Intel HD 630	None	8GBx1	256GB SSD M.2 PCIe NVMe Opal	None	3165 ac, 1x1 + BT4.0	3rd DP	Switch	None	1Wx1	None	None	None	USB / USB	None	Floor Stand	65W Adapter 88%	Win10 Pro 64	3-year, Onsite	Apr 6, 2023	03/17
10MR002UUS	US	i3-7100T	No	Intel HD 630	None	8GBx1	500GB 7200rpm 2.5"	None	3165 ac, 1x1 + BT4.0	Serial	Switch	None	1Wx1	None	None	None	USB / USB	None	Floor Stand	65W Adapter 88%	Win10 Pro 64	3-year, Onsite	Apr 6, 2023	03/17
10MR002VUS	US	i3-7100T	No	Intel HD 630	None	4GBx1	500GB 7200rpm 2.5"	None	3165 ac, 1x1 + BT4.0	None	Switch	None	1Wx1	None	None	None	USB / USB	None	Floor Stand	65W Adapter 88%	Win10 Pro 64	3-year, Onsite	Apr 6, 2023	03/17
10MR002WUS	US	i3-7100T	No	Intel HD 630	None	8GBx1	128GB SSD M.2 PCIe NVMe	None	3165 ac, 1x1 + BT4.0	None	Switch	None	1Wx1	None	None	None	USB / USB	None	Floor Stand	65W Adapter 88%	Win10 Pro 64	3-year, Onsite	Apr 6, 2023	03/17
10MR002XUS	US	i3-7100T	No	Intel HD 630	None	8GBx1	128GB SSD M.2 PCIe NVMe	None	3165 ac, 1x1 + BT4.0	3rd DP	Switch	None	1Wx1	None	None	None	USB / USB	None	Floor Stand	65W Adapter 88%	Win10 Pro 64	3-year, Onsite	Apr 6, 2023	03/17
10MR003UUS	US	i5-7500T	No	Intel HD 630	None	8GBx1	128GB SSD M.2 PCIe NVMe	None	8265 ac, 2x2 + BT4.1	3rd DP	Switch	None	1Wx1	None	None	None	USB / USB	None	Floor Stand	65W Adapter 88%	Win10 Pro 64	3-year, Onsite	Apr 21, 2023	03/17
10MR003VUS	US	i5-7500T	No	Intel HD 630	None	8GBx1	512GB SSD M.2 PCIe NVMe Opal	None	8265 ac, 2x2 + BT4.1	3rd DP	Switch	None	1Wx1	None	None	None	USB / USB	None	Floor Stand	65W Adapter 88%	Win10 Pro 64	3-year, Onsite	Apr 21, 2023	03/17
10MR003WUS	US	i7-7700T	No	Intel HD 630	None	8GBx1	512GB SSD M.2 PCIe NVMe Opal	None	8265 ac, 2x2 + BT4.1	3rd DP	Switch	None	1Wx1	None	None	None	USB / USB	None	Floor Stand	65W Adapter 88%	Win10 Pro 64	3-year, Onsite	Apr 21, 2023	03/17
10MR003XUS	US	i5-7400T	No	Intel HD 630	None	4GBx1	500GB 7200rpm 2.5"	None	8265 ac, 2x2 + BT4.1	3rd DP	Switch	None	1Wx1	None	None	None	USB / USB	None	Floor Stand	65W Adapter 88%	Win10 Pro 64	3-year, Onsite	Apr 21, 2023	03/17
10MR003YUS	US	i5-7400T	No	Intel HD 630	None	8GBx1	500GB 7200rpm 2.5"	None	8265 ac, 2x2 + BT4.1	3rd DP	Switch	None	1Wx1	None	None	None	USB / USB	None	Floor Stand	65W Adapter 88%	Win10 Pro 64	3-year, Onsite	Apr 21, 2023	03/17
10MR0040US	US	i5-7400T	No	Intel HD 630	None	4GBx1	500GB 7200rpm 2.5"	None	3165 ac, 1x1 + BT4.0	3rd DP	Switch	None	1Wx1	None	None	None	USB / USB	None	Floor Stand	65W Adapter 88%	Win10 Pro 64	3-year, Onsite	Apr 21, 2023	03/17
10MR0041US	US	i5-7400T	No	Intel HD 630	None	8GBx1	500GB 7200rpm 2.5"	None	3165 ac, 1x1 + BT4.0	3rd DP	Switch	None	1Wx1	None	None	None	USB / USB	None	Floor Stand	65W Adapter 88%	Win10 Pro 64	3-year, Onsite	Apr 21, 2023	03/17
10MR0042US	US	i5-7400T	No	Intel HD 630	None	8GBx1	128GB SSD M.2 PCIe NVMe	None	3165 ac, 1x1 + BT4.0	3rd DP	Switch	None	1Wx1	None	None	None	USB / USB	None	Floor Stand	65W Adapter 88%	Win10 Pro 64	3-year, Onsite	Apr 21, 2023	03/17
10MR0043US	US	i5-7400T	No	Intel HD 630	None	8GBx1	128GB SSD M.2 PCIe NVMe	None	8265 ac, 2x2 + BT4.1	3rd DP	Switch	None	1Wx1	None	None	None	USB / USB	None	Floor Stand	65W Adapter 88%	Win10 Pro 64	3-year, Onsite	Apr 21, 2023	03/17
10MR0044US	US	i5-7400T	No	Intel HD 630	None	8GBx1	256GB SSD M.2 PCIe NVMe Opal	None	8265 ac, 2x2 + BT4.1	3rd DP	Switch	None	1Wx1	None	None	None	USB / USB	None	Floor Stand	65W Adapter 88%	Win10 Pro 64	3-year, Onsite	Apr 21, 2023	03/17
10MR0045US	US	i3-6100T	No	Intel HD 530	None	4GBx1	500GB 7200rpm 2.5"	None	3165 ac, 1x1 + BT4.0	None	Switch	None	1Wx1	None	None	None	USB / USB	None	Floor Stand	65W Adapter 88%	Win10 DG Win7 Pro 64	3-year, Onsite	Apr 21, 2023	03/17
10MR0046US	US	i7-6700T	No	Intel HD 530	None	8GBx1	256GB SSD M.2 PCIe NVMe Opal	None	8265 ac, 2x2 + BT4.1	3rd DP	Switch	None	1Wx1	None	None	None	USB / USB	None	Floor Stand	65W Adapter 88%	Win10 DG Win7 Pro 64	3-year, Onsite	Apr 21, 2023	03/17

Model	Region	Processor	vPro	Graphics	Monitor Cable	Memory	Storage(HDD/SSD)	External Optical / I/O Box	WLAN + Bluetooth	Optional Rear Ports	Chassis Intrusion Switch	Kensington Cable Lock	Speaker	Adapter Cage	Toolless Chassis Screw	Dust Filter	Keyboard / Mouse	VESA Mount	Stand	Power Supply	Operating System	Warranty	End of Support	Ann Date (mm/yy)
10MR0047US	US	i5-6500T	No	Intel HD 530	None	8GBx1	256GB SSD M.2 PCIe NVMe Opal	None	8265 ac, 2x2 + BT4.1	3rd DP	Switch	None	1Wx1	None	None	None	USB / USB	None	Floor Stand	65W Adapter 88%	Win10 DG Win7 Pro 64	3-year, Onsite	Mar 21, 2022	03/17
10MR0048US	US	i5-6500T	No	Intel HD 530	None	8GBx1	500GB 7200rpm 2.5"	None	3165 ac, 1x1 + BT4.0	3rd DP	Switch	None	1Wx1	None	None	None	USB / USB	None	Floor Stand	65W Adapter 88%	Win10 DG Win7 Pro 64	3-year, Onsite	Apr 21, 2023	03/17
10MR0049US	US	i3-6100T	No	Intel HD 530	None	4GBx1	500GB 7200rpm 2.5"	None	3165 ac, 1x1 + BT4.0	3rd DP	Switch	None	1Wx1	None	None	None	USB / USB	None	Floor Stand	65W Adapter 88%	Win10 DG Win7 Pro 64	3-year, Onsite	Apr 21, 2023	03/17
10MR004AUS	US	i3-6100T	No	Intel HD 530	None	4GBx1	128GB SSD M.2 PCIe NVMe	None	3165 ac, 1x1 + BT4.0	3rd DP	Switch	None	1Wx1	None	None	None	USB / USB	None	Floor Stand	65W Adapter 88%	Win10 DG Win7 Pro 64	3-year, Onsite	Apr 21, 2023	03/17
10MR004BUS	US	i5-6500T	No	Intel HD 530	None	8GBx1	512GB SSD M.2 PCIe NVMe Opal	None	8265 ac, 2x2 + BT4.1	3rd DP	Switch	None	1Wx1	None	None	None	USB / USB	None	Floor Stand	65W Adapter 88%	Win10 DG Win7 Pro 64	3-year, Onsite	Apr 21, 2023	03/17
10MR004CUS	US	i5-6500T	No	Intel HD 530	None	8GBx1	500GB 7200rpm 2.5"	DVD±RW	8265 ac, 2x2 + BT4.1	HDMI	Switch	None	1Wx1	None	None	None	USB / USB	VESA Mount	None	65W Adapter 88%	Win10 DG Win7 Pro 64	3-year, Onsite	Apr 21, 2023	03/17
10MR004DUS	US	i7-6700T	No	Intel HD 530	None	8GBx1	500GB 7200rpm 2.5"	None	8265 ac, 2x2 + BT4.1	3rd DP	Switch	None	1Wx1	None	None	None	USB / USB	None	Floor Stand	65W Adapter 88%	Win10 DG Win7 Pro 64	3-year, Onsite	Apr 21, 2023	03/17
10MR004EUS	US	i3-6100T	No	Intel HD 530	None	8GBx1	500GB 7200rpm 2.5"	None	3165 ac, 1x1 + BT4.0	3rd DP	Switch	None	1Wx1	None	None	None	USB / USB	None	Floor Stand	65W Adapter 88%	Win10 DG Win7 Pro 64	3-year, Onsite	Apr 21, 2023	03/17
10MR004FUS	US	i5-6500T	No	Intel HD 530	None	4GBx1	500GB 7200rpm 2.5"	None	3165 ac, 1x1 + BT4.0	3rd DP	Switch	None	1Wx1	None	None	None	USB / USB	None	Floor Stand	65W Adapter 88%	Win10 DG Win7 Pro 64	3-year, Onsite	Apr 21, 2023	03/17
10MR004GUS	US	i3-6100T	No	Intel HD 530	None	8GBx1	500GB 7200rpm 2.5"	DVD±RW	3165 ac, 1x1 + BT4.0	HDMI	Switch	None	1Wx1	None	None	None	USB / USB	VESA Mount	None	65W Adapter 88%	Win10 DG Win7 Pro 64	3-year, Onsite	Apr 21, 2023	03/17
10MR004HUS	US	i5-6500T	No	Intel HD 530	None	8GBx1	128GB SSD M.2 PCIe NVMe	None	8265 ac, 2x2 + BT4.1	3rd DP	Switch	None	1Wx1	None	None	None	USB / USB	None	Floor Stand	65W Adapter 88%	Win10 DG Win7 Pro 64	3-year, Onsite	Apr 21, 2023	03/17
10MR004JUS	US	i3-6100T	No	Intel HD 530	None	8GBx1	128GB SSD M.2 PCIe NVMe	None	3165 ac, 1x1 + BT4.0	3rd DP	Switch	None	1Wx1	None	None	None	USB / USB	None	Floor Stand	65W Adapter 88%	Win10 DG Win7 Pro 64	3-year, Onsite	Apr 21, 2023	03/17
10MR004KUS	US	i7-6700T	No	Intel HD 530	None	8GBx1	512GB SSD M.2 PCIe NVMe Opal	None	8265 ac, 2x2 + BT4.1	3rd DP	Switch	None	1Wx1	None	None	None	USB / USB	None	Floor Stand	65W Adapter 88%	Win10 DG Win7 Pro 64	3-year, Onsite	Apr 21, 2023	03/17
10MR004LUS	US	i7-6700T	No	Intel HD 530	None	8GBx1	500GB 7200rpm 2.5"	DVD±RW	8265 ac, 2x2 + BT4.1	HDMI	Switch	None	1Wx1	None	None	None	USB / USB	VESA Mount	None	65W Adapter 88%	Win10 DG Win7 Pro 64	3-year, Onsite	Apr 21, 2023	03/17
10MR004MUS	US	i5-6500T	No	Intel HD 530	None	8GBx1	128GB SSD M.2 PCIe NVMe	None	3165 ac, 1x1 + BT4.0	3rd DP	Switch	None	1Wx1	None	None	None	USB / USB	None	Floor Stand	65W Adapter 88%	Win10 DG Win7 Pro 64	3-year, Onsite	Apr 21, 2023	03/17

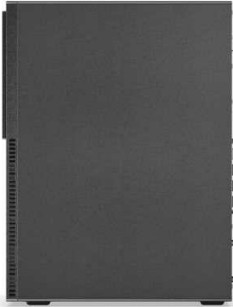

# ThinkCentre M710 Tower Platform Specifications

Product Specifications Reference (PSREF)

Processor	Intel® Celeron®, Intel Pentium®, or 6/7th Generation Intel Core™ i3 / i5 / i7 Processor						Manageability None Security chip TPM (Trusted Platform Module) 2.0, TCG Certified * Downgrade to TPM1.2 for the models with Win10 DG Win7 32 OS Security features <ul style="list-style-type: none"> <li>• Security slot (in rear for optional Kensington® MicroSaver® cable)</li> <li>• Padlock loop</li> <li>• Smart USB protection, allows keyboard/mouse only, blocks all storage devices</li> <li>• Optional cable lock to physically lock both keyboard and mouse</li> <li>• Power-on password</li> <li>• Administrator password</li> <li>• Hard disk password</li> <li>• Boot sequence control</li> <li>• Boot without keyboard and mouse</li> <li>• Individual USB port disablement</li> <li>• Optional chassis intrusion switch</li> </ul>
	Processor	Cores / Threads	Frequency Base/Max(GHz)	Cache	Memory Support (Up to)	Integrated Graphics	
	Pentium G4400	2 / 2	3.3G	3 MB	DDR4-2133	HD 510	
	Pentium G4560	2 / 4	3.5G	3 MB	DDR4-2400	HD 610	
	Pentium G4600	2 / 4	3.6G	3 MB	DDR4-2400	HD 630	
	Core i3-6100	2 / 4	3.7G	3 MB	DDR4-2133	HD 530	
	Core i5-6500	4 / 4	3.2G / 3.6G	6 MB	DDR4-2133	HD 530	
	Core i7-6700	4 / 8	3.4G / 4.0G	8 MB	DDR4-2133	HD 530	
	Core i3-7100	2 / 4	3.9G	3 MB	DDR4-2400	HD 630	
	Core i5-7400	4 / 4	3.0G / 3.5G	6 MB	DDR4-2400	HD 630	
	Core i5-7500	4 / 4	3.4G / 3.8G	6 MB	DDR4-2400	HD 630	
Core i5-7600	4 / 4	3.5G / 4.1G	6 MB	DDR4-2400	HD 630		
Core i7-7700	4 / 8	3.6G / 4.2G	8 MB	DDR4-2400	HD 630		
Memory	64GB max, UDIMM, DDR4-2400*, four 288-pin DIMM sockets, non-ECC, dual-channel capable * System automatically clocks down for the processors with lower memory controller						
Storage	<i>Some:</i> Hard Drive / SATA 6.0Gb/s, 2.5" or 3.5", 5400 rpm or 7200 rpm <i>Some:</i> Solid State Drive (SSD) / SATA 6.0Gb/s, 2.5" <i>Some:</i> M.2 Solid State Drive (SSD) / PCIe NVMe, PCIe 3.0 x 4, 32Gb/s <i>Some:</i> Intel Optane™ Memory Ready (models with 7th gen Core processor), M.2 <i>Some:</i> DVD-ROM SATA 1.5Gb/s Drive, slim (9.0mm)						
Optical	<i>Some:</i> DVD Burner (DVD±RW), SATA 1.5Gb/s Drive, slim (9.0mm)						
Onboard SATA Media reader	Three onboard SATA 6.0Gb/s connectors Optional 7-in-1 media reader						
Graphics	<b>Intel HD Graphics 510/530/610/630</b> in processor, uses main memory, DirectX® 12, one VGA, two DisplayPort™, supports 3 independent displays, works along with discrete graphics to support more displays; <i>Max resolution:</i> 4096x2304 (DP) @60Hz; 2048x1536 (VGA) @50Hz <i>Some:</i> <b>NVIDIA GeForce® GT 730</b> , DirectX 12, 2GB, PCIe 2.0 x8 adapter, two DisplayPort, 35 watts; <i>Max resolution:</i> 3840x2160 (DisplayPort) @60Hz; <i>Some:</i> <b>AMD Radeon™ R7 350</b> , DirectX 11, 2GB, PCIe 3.0 x8 adapter, one VGA, one HDMI, 75 watts, occupies two slots; <i>Max resolution:</i> 4096x2160 (HDMI) @24Hz; 2048x1536 (VGA) @85Hz						
Power supply	<i>Some:</i> 180 watts, autosensing, 85% PSU <i>Some:</i> 210 watts, autosensing, 85% PSU <i>Some:</i> 210 watts, autosensing, 92% PSU (only available via special bid)						
Limited warranty <sup>3</sup>	<i>Some:</i> <b>1-year or 3-year, depot service</b> / service upgrades available <i>Some:</i> <b>1-year or 3-year, limited onsite service</b> / service upgrades available						
Preload	<b>Preloaded operating system</b> <i>Some:</i> Windows® 7 Professional 32/64 <i>Some:</i> Windows 10 Pro 64-bit (not available with 7th Gen Intel processor) <i>Some:</i> Windows 10 Pro 64-bit <i>Some:</i> Windows 10 Home 64-bit		<b>Preloaded applications (only some listed)</b> <ul style="list-style-type: none"> <li>• Microsoft Office preloaded; purchase a product key to activate</li> <li>• Cyberlink PowerDVD Create (DVD±RW)</li> <li>- Only for Window 10</li> <li>• Lenovo Companion</li> <li>• Lenovo ID</li> <li>• Cyberlink PowerDVD (DVD, DVD±RW)</li> <li>- Only for Window 7</li> <li>• Lenovo Solution Center</li> <li>• Lenovo ThinkVantage Tools</li> <li>• Create Recovery Media</li> <li>• Adobe® Reader®</li> </ul>				
Monitor Cable	Optional DP to VGA, DP to DVI-D (single link), DP to dual DP, or DP to HDMI 1.4						
Chipset	<b>Intel B250 Chipset</b>						
Front ports	Four USB 3.1 Gen1, optional two USB 3.1 Type-C Gen 2 (only available via special bid), microphone (3.5mm), headphone (3.5mm)						
Rear ports	Two USB 3.1 Gen1, two USB 2.0, optional two USB 2.0, serial (9-pin), optional 2nd serial (9-pin), optional parallel (25-pin), ethernet (RJ-45), one VGA, two DisplayPort, two PS/2 ports (keyboard/mouse); additional VGA, DisplayPort, or HDMI on optional graphics on some models						
Rear audio ports IEEE 1394	Line-in (3.5mm), line-out (3.5mm), microphone-in (3.5mm) None						
Audio support	High Definition (HD) Audio, Realtek ALC662 / optional internal speaker (1.5 watt )						
WLAN <sup>13</sup>	<i>Some:</i> 11ac wireless, M.2 Card, Qualcomm Atheros QCA9377A (dual band), Wi-Fi + Bluetooth 4.1 combo adapter, 1x1 <i>Some:</i> 11ac wireless, M.2 Card, Qualcomm Atheros QCA6174A (dual band), Wi-Fi + Bluetooth 4.1 combo adapter, 2x2 <i>Some:</i> 11ac wireless, M.2 Card, Intel Dual Band Wireless-AC 3165, Wi-Fi + Bluetooth 4.1 combo adapter, 1x1 <i>Some:</i> 11ac wireless, M.2 Card, Intel Dual Band Wireless-AC 8265, Wi-Fi + Bluetooth 4.1 combo adapter, 2x2						
Bluetooth™	<i>Some:</i> Bluetooth 4.1 wireless, integrated in Wi-Fi + BT combo adapter						
Ethernet	Gigabit ethernet, Realtek RTL8111GN, Wake on LAN®						
Modem	None						
Environment	ENERGY STAR® 6.1, EPEAT™ Gold rating (North America), ErP Lot 3, GREENGUARD®, RoHS-compliant, TUV low noise verified (on some models)						
Accessories	For compatible accessories, please go to <a href="http://www.lenovoquickpick.com">http://www.lenovoquickpick.com</a>						

See footnotes for more detailed information



Model	Region	Processor	vPro	Graphics	Monitor Cable	Memory	Storage(HDD/SSD)	Optical	Media Reader	WLAN + Bluetooth	Optional Front Ports	Optional Rear Ports	Chassis Intrusion Switch	Cable Lock	Speaker	Dust Filter	Keyboard / Mouse	Power Supply	Operating System	Warranty	Ann Date (mm/yy)
10M9000EUS	US	i7-7700	No	GT 730 2GB	None	8GBx1	256GB SSD M.2 PCIe NVMe Opal	DVD±RW	None	3165 ac, 1x1 + BT4.0	None	None	None	None	1.5Wx1	None	USB / USB	210W 85%	Win10 Pro 64	3-year, Onsite	02/17
10M9000FUS	US	i5-7400	No	Intel HD 630	None	8GBx1	256GB SSD M.2 PCIe NVMe Opal	DVD±RW	None	None	None	None	None	None	1.5Wx1	None	USB / USB	210W 85%	Win10 Pro 64	3-year, Onsite	02/17
10M9000GUS	US	i7-7700	No	GT 730 2GB	None	8GBx1	1TB 7200rpm 3.5"	DVD±RW	None	None	None	None	None	None	1.5Wx1	None	USB / USB	210W 85%	Win10 Pro 64	3-year, Onsite	02/17
10M9000HUS	US	i5-7400	No	Intel HD 630	None	8GBx1	256GB SSD M.2 PCIe NVMe Opal	DVD±RW	None	3165 ac, 1x1 + BT4.0	None	None	None	None	1.5Wx1	None	USB / USB	210W 85%	Win10 Pro 64	3-year, Onsite	02/17
10M9000JUS	US	i5-7400	No	GT 730 2GB	None	8GBx1	1TB 7200rpm 3.5"	DVD±RW	None	None	None	None	None	None	1.5Wx1	None	USB / USB	210W 85%	Win10 Pro 64	3-year, Onsite	02/17
10M9000KUS	US	i7-7700	No	Intel HD 630	None	8GBx1	256GB SSD M.2 PCIe NVMe Opal	DVD±RW	None	3165 ac, 1x1 + BT4.0	None	None	None	None	1.5Wx1	None	USB / USB	210W 85%	Win10 Pro 64	3-year, Onsite	02/17
10M9000LUS	US	i7-7700	No	Intel HD 630	None	8GBx1	256GB SSD M.2 PCIe NVMe Opal	DVD±RW	None	None	None	None	None	None	1.5Wx1	None	USB / USB	210W 85%	Win10 Pro 64	3-year, Onsite	02/17
10M9000MUS	US	i5-7400	No	Intel HD 630	None	8GBx1	512GB SSD M.2 PCIe NVMe Opal	DVD±RW	None	None	None	None	None	None	1.5Wx1	None	USB / USB	210W 85%	Win10 Pro 64	3-year, Onsite	02/17
10M9000NUS	US	i5-7400	No	Intel HD 630	None	4GBx1	500GB 7200rpm 3.5"	DVD±RW	None	None	None	None	None	None	1.5Wx1	None	USB / USB	210W 85%	Win10 Pro 64	3-year, Onsite	02/17
10M9000PUS	US	i5-7400	No	GT 730 2GB	None	8GBx1	256GB SSD M.2 PCIe NVMe Opal	DVD±RW	None	None	None	None	None	None	1.5Wx1	None	USB / USB	210W 85%	Win10 Pro 64	3-year, Onsite	02/17
10M9000QUS	US	i7-7700	No	Intel HD 630	None	8GBx1	512GB SSD M.2 PCIe NVMe Opal	DVD±RW	None	None	None	None	None	None	1.5Wx1	None	USB / USB	210W 85%	Win10 Pro 64	3-year, Onsite	02/17
10M9000RUS	US	i5-7400	No	Intel HD 630	None	8GBx1	1TB 7200rpm 3.5"	DVD±RW	None	None	None	None	None	None	1.5Wx1	None	USB / USB	210W 85%	Win10 Pro 64	3-year, Onsite	02/17
10M9000SUS	US	i5-7400	No	GT 730 2GB	None	8GBx1	256GB SSD M.2 PCIe NVMe Opal	DVD±RW	None	3165 ac, 1x1 + BT4.0	None	None	None	None	1.5Wx1	None	USB / USB	210W 85%	Win10 Pro 64	3-year, Onsite	02/17
10M9000TUS	US	i7-7700	No	Intel HD 630	None	8GBx1	1TB 7200rpm 3.5"	DVD±RW	None	None	None	None	None	None	1.5Wx1	None	USB / USB	210W 85%	Win10 Pro 64	3-year, Onsite	02/17
10M9000UUS	US	i7-7700	No	GT 730 2GB	None	8GBx1	256GB SSD M.2 PCIe NVMe Opal	DVD±RW	None	None	None	None	None	None	1.5Wx1	None	USB / USB	210W 85%	Win10 Pro 64	3-year, Onsite	02/17
10M9002UUS	US	i3-6100	No	Intel HD 530	None	4GBx1	1TB 7200rpm 3.5"	DVD±RW	None	None	None	None	None	None	1.5Wx1	None	USB / USB	210W 85%	Win10 DG Win7 Pro 64	3-year, Onsite	03/17
10M9002VUS	US	i3-6100	No	Intel HD 530	None	8GBx1	1TB 7200rpm 3.5"	DVD±RW	None	None	None	None	None	None	1.5Wx1	None	USB / USB	210W 85%	Win10 DG Win7 Pro 64	3-year, Onsite	03/17
10M9002WUS	US	Pentium G4400	No	Intel HD 510	None	4GBx1	500GB 7200rpm 3.5"	DVD±RW	None	None	None	None	None	None	1.5Wx1	None	USB / USB	210W 85%	Win10 DG Win7 Pro 64	3-year, Onsite	03/17
10M9002XUS	US	i5-6500	No	Intel HD 530	None	8GBx1	256GB SSD M.2 PCIe NVMe Opal	DVD±RW	None	3165 ac, 1x1 + BT4.0	None	None	None	None	1.5Wx1	None	USB / USB	210W 85%	Win10 DG Win7 Pro 64	3-year, Onsite	03/17
10M9002YUS	US	i7-6700	No	Intel HD 530	None	8GBx1	512GB SSD M.2 PCIe NVMe Opal	DVD±RW	None	None	None	None	None	None	1.5Wx1	None	USB / USB	210W 85%	Win10 DG Win7 Pro 64	3-year, Onsite	03/17



Model	Region	Processor	vPro	Graphics	Monitor Cable	Memory	Storage(HDD/SSD)	Optical	Media Reader	WLAN + Bluetooth	Optional Front Ports	Optional Rear Ports	Chassis Intrusion Switch	Cable Lock	Speaker	Dust Filter	Keyboard / Mouse	Power Supply	Operating System	Warranty	Ann Date (mm/yy)
10M90030US	US	i7-6700	No	GT 730 2GB	None	8GBx1	1TB 7200rpm 3.5"	DVD±RW	None	None	None	None	None	None	1.5Wx1	None	USB / USB	210W 85%	Win10 DG Win7 Pro 64	3-year, Onsite	03/17
10M90031US	US	i5-6500	No	Intel HD 530	None	8GBx1	256GB SSD M.2 PCIe NVMe Opal	DVD±RW	None	None	None	None	None	None	1.5Wx1	None	USB / USB	210W 85%	Win10 DG Win7 Pro 64	3-year, Onsite	03/17
10M90032US	US	i5-7400	No	Intel HD 630	None	4GBx1	128GB SSD M.2 PCIe NVMe	DVD±RW	None	None	None	None	None	None	1.5Wx1	None	USB / USB	210W 85%	Win10 Pro 64	3-year, Onsite	03/17
10M90033US	US	i7-6700	No	GT 730 2GB	None	8GBx1	256GB SSD M.2 PCIe NVMe Opal	DVD±RW	None	3165 ac, 1x1 + BT4.0	None	None	None	None	1.5Wx1	None	USB / USB	210W 85%	Win10 DG Win7 Pro 64	3-year, Onsite	03/17
10M90034US	US	i7-6700	No	Intel HD 530	None	8GBx1	256GB SSD M.2 PCIe NVMe Opal	DVD±RW	None	3165 ac, 1x1 + BT4.0	None	None	None	None	1.5Wx1	None	USB / USB	210W 85%	Win10 DG Win7 Pro 64	3-year, Onsite	03/17
10M90035US	US	i3-7100	No	Intel HD 630	None	8GBx1	128GB SSD M.2 PCIe NVMe	DVD±RW	None	None	None	None	None	None	1.5Wx1	None	USB / USB	210W 85%	Win10 Pro 64	3-year, Onsite	03/17
10M90036US	US	i5-6500	No	Intel HD 530	None	4GBx1	500GB 7200rpm 3.5"	DVD±RW	None	None	None	None	None	None	1.5Wx1	None	USB / USB	210W 85%	Win10 DG Win7 Pro 64	3-year, Onsite	03/17
10M90037US	US	i3-7100	No	Intel HD 630	None	8GBx1	1TB 7200rpm 3.5"	DVD±RW	None	None	None	None	None	None	1.5Wx1	None	USB / USB	210W 85%	Win10 Pro 64	3-year, Onsite	03/17
10M90038US	US	i5-6500	No	GT 730 2GB	None	8GBx1	256GB SSD M.2 PCIe NVMe Opal	DVD±RW	None	3165 ac, 1x1 + BT4.0	None	None	None	None	1.5Wx1	None	USB / USB	210W 85%	Win10 DG Win7 Pro 64	3-year, Onsite	03/17
10M90039US	US	i5-6500	No	Intel HD 530	None	8GBx1	1TB 7200rpm 3.5"	DVD±RW	None	None	None	None	None	None	1.5Wx1	None	USB / USB	210W 85%	Win10 DG Win7 Pro 64	3-year, Onsite	03/17
10M9003AUS	US	i3-6100	No	Intel HD 530	None	4GBx1	500GB 7200rpm 3.5"	DVD±RW	None	None	None	None	None	None	1.5Wx1	None	USB / USB	210W 85%	Win10 DG Win7 Pro 64	3-year, Onsite	03/17
10M9003BUS	US	i3-6100	No	Intel HD 530	None	8GBx1	128GB SSD M.2 PCIe NVMe	DVD±RW	None	None	None	None	None	None	1.5Wx1	None	USB / USB	210W 85%	Win10 DG Win7 Pro 64	3-year, Onsite	03/17
10M9003CUS	US	i3-7100	No	Intel HD 630	None	4GBx1	500GB 7200rpm 3.5"	DVD±RW	None	None	None	None	None	None	1.5Wx1	None	USB / USB	210W 85%	Win10 Pro 64	3-year, Onsite	03/17
10M9003DUS	US	Pentium G4560	No	Intel HD 610	None	4GBx1	500GB 7200rpm 3.5"	DVD±RW	None	None	None	None	None	None	1.5Wx1	None	USB / USB	210W 85%	Win10 Pro 64	3-year, Onsite	03/17
10M9003EUS	US	i7-6700	No	Intel HD 530	None	8GBx1	1TB 7200rpm 3.5"	DVD±RW	None	None	None	None	None	None	1.5Wx1	None	USB / USB	210W 85%	Win10 DG Win7 Pro 64	3-year, Onsite	03/17
10M9003FUS	US	i7-6700	No	Intel HD 530	None	8GBx1	256GB SSD M.2 PCIe NVMe Opal	DVD±RW	None	None	None	None	None	None	1.5Wx1	None	USB / USB	210W 85%	Win10 DG Win7 Pro 64	3-year, Onsite	03/17
10M9003GUS	US	i5-6500	No	Intel HD 530	None	4GBx1	128GB SSD M.2 PCIe NVMe	DVD±RW	None	None	None	None	None	None	1.5Wx1	None	USB / USB	210W 85%	Win10 DG Win7 Pro 64	3-year, Onsite	03/17
10M9003HUS	US	i5-6500	No	GT 730 2GB	None	8GBx1	1TB 7200rpm 3.5"	DVD±RW	None	None	None	None	None	None	1.5Wx1	None	USB / USB	210W 85%	Win10 DG Win7 Pro 64	3-year, Onsite	03/17
10M9003JUS	US	i5-6500	No	GT 730 2GB	None	8GBx1	256GB SSD M.2 PCIe NVMe Opal	DVD±RW	None	None	None	None	None	None	1.5Wx1	None	USB / USB	210W 85%	Win10 DG Win7 Pro 64	3-year, Onsite	03/17
10M9003KUS	US	i7-6700	No	GT 730 2GB	None	8GBx1	256GB SSD M.2 PCIe NVMe Opal	DVD±RW	None	None	None	None	None	None	1.5Wx1	None	USB / USB	210W 85%	Win10 DG Win7 Pro 64	3-year, Onsite	03/17

Model	Region	Processor	vPro	Graphics	Monitor Cable	Memory	Storage(HDD/SSD)	Optical	Media Reader	WLAN + Bluetooth	Optional Front Ports	Optional Rear Ports	Chassis Intrusion Switch	Cable Lock	Speaker	Dust Filter	Keyboard / Mouse	Power Supply	Operating System	Warranty	Ann Date (mm/yy)
10M9003LUS	US	i3-7100	No	Intel HD 630	None	4GBx1	1TB 7200rpm 3.5"	DVD±RW	None	None	None	None	None	None	1.5Wx1	None	USB / USB	210W 85%	Win10 Pro 64	3-year, Onsite	03/17

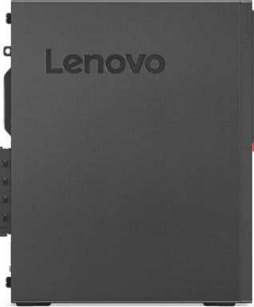

# ThinkCentre M715 SFF Platform Specifications

Product Specifications Reference (PSREF)

Processor	AMD A6 / A8 / A10 / A12 series APU and Ryzen 3 / 5 / 7 series processor	Security features	<ul style="list-style-type: none"> <li>Security slot (in rear for optional Kensington® MicroSaver® cable)</li> <li>Padlock loop</li> <li>Smart USB protection, allows keyboard/mouse only, blocks all storage devices</li> <li>Optional cable lock to physically lock both keyboard and mouse</li> <li>Power-on password</li> <li>Administrator password</li> <li>Hard disk password</li> <li>Boot sequence control</li> <li>Boot without keyboard and mouse</li> <li>Individual USB port disablement</li> <li>Optional chassis intrusion switch</li> </ul>																																																												
	<table border="1"> <thead> <tr> <th>APU / processor</th> <th>Cores / Threads</th> <th>Frequency (Base/Max)</th> <th>L2 Cache</th> <th>Integrated Graphics</th> </tr> </thead> <tbody> <tr> <td>Ryzen 3 PRO 1200</td> <td>4 / 4</td> <td>3.1 / 3.4</td> <td>2MB</td> <td>None</td> </tr> <tr> <td>Ryzen 3 PRO 1300</td> <td>4 / 4</td> <td>3.5 / 3.7</td> <td>2MB</td> <td>None</td> </tr> <tr> <td>Ryzen 5 PRO 1500</td> <td>4 / 8</td> <td>3.5 / 3.7</td> <td>2MB</td> <td>None</td> </tr> <tr> <td>Ryzen 7 PRO 1700</td> <td>8 / 16</td> <td>3.0 / 3.7</td> <td>4MB</td> <td>None</td> </tr> <tr> <td>PRO A6-8570</td> <td>2 / 2</td> <td>3.5 / 3.8</td> <td>1MB</td> <td>Radeon R5 Series</td> </tr> <tr> <td>PRO A10-8770</td> <td>4 / 4</td> <td>3.5 / 3.8</td> <td>2MB</td> <td>Radeon R7 Series</td> </tr> <tr> <td>PRO A12-8870</td> <td>4 / 4</td> <td>3.7 / 4.2</td> <td>2MB</td> <td>Radeon R7 Series</td> </tr> <tr> <td>PRO A6-9500</td> <td>2 / 2</td> <td>3.5 / 3.8</td> <td>1MB</td> <td>Radeon R5 Series</td> </tr> <tr> <td>PRO A8-9600</td> <td>4 / 4</td> <td>3.1 / 3.4</td> <td>2MB</td> <td>Radeon R7 Series</td> </tr> <tr> <td>PRO A10-9700</td> <td>4 / 4</td> <td>3.5 / 3.8</td> <td>2MB</td> <td>Radeon R7 Series</td> </tr> <tr> <td>PRO A12-9800</td> <td>4 / 4</td> <td>3.8 / 4.2</td> <td>2MB</td> <td>Radeon R7 Series</td> </tr> </tbody> </table>	APU / processor	Cores / Threads	Frequency (Base/Max)	L2 Cache	Integrated Graphics	Ryzen 3 PRO 1200	4 / 4	3.1 / 3.4	2MB	None	Ryzen 3 PRO 1300	4 / 4	3.5 / 3.7	2MB	None	Ryzen 5 PRO 1500	4 / 8	3.5 / 3.7	2MB	None	Ryzen 7 PRO 1700	8 / 16	3.0 / 3.7	4MB	None	PRO A6-8570	2 / 2	3.5 / 3.8	1MB	Radeon R5 Series	PRO A10-8770	4 / 4	3.5 / 3.8	2MB	Radeon R7 Series	PRO A12-8870	4 / 4	3.7 / 4.2	2MB	Radeon R7 Series	PRO A6-9500	2 / 2	3.5 / 3.8	1MB	Radeon R5 Series	PRO A8-9600	4 / 4	3.1 / 3.4	2MB	Radeon R7 Series	PRO A10-9700	4 / 4	3.5 / 3.8	2MB	Radeon R7 Series	PRO A12-9800	4 / 4	3.8 / 4.2	2MB	Radeon R7 Series	Keyboard	<i>Some:</i> Lenovo Calliope Keyboard (USB connector), black <i>Some:</i> Lenovo Traditional Keyboard (USB connector), black <i>Some:</i> Lenovo Calliope Wireless Keyboard (2.4GHz via USB receiver), black
APU / processor	Cores / Threads	Frequency (Base/Max)	L2 Cache	Integrated Graphics																																																											
Ryzen 3 PRO 1200	4 / 4	3.1 / 3.4	2MB	None																																																											
Ryzen 3 PRO 1300	4 / 4	3.5 / 3.7	2MB	None																																																											
Ryzen 5 PRO 1500	4 / 8	3.5 / 3.7	2MB	None																																																											
Ryzen 7 PRO 1700	8 / 16	3.0 / 3.7	4MB	None																																																											
PRO A6-8570	2 / 2	3.5 / 3.8	1MB	Radeon R5 Series																																																											
PRO A10-8770	4 / 4	3.5 / 3.8	2MB	Radeon R7 Series																																																											
PRO A12-8870	4 / 4	3.7 / 4.2	2MB	Radeon R7 Series																																																											
PRO A6-9500	2 / 2	3.5 / 3.8	1MB	Radeon R5 Series																																																											
PRO A8-9600	4 / 4	3.1 / 3.4	2MB	Radeon R7 Series																																																											
PRO A10-9700	4 / 4	3.5 / 3.8	2MB	Radeon R7 Series																																																											
PRO A12-9800	4 / 4	3.8 / 4.2	2MB	Radeon R7 Series																																																											
Memory	64GB max, UDIMM, DDR4-2400, four 288-pin DIMM sockets, non-ECC, dual-channel capable* * System automatically clocks down for the processors with lower memory controller	Mouse	<i>Some:</i> Lenovo Calliope Mouse (USB connector), black <i>Some:</i> Lenovo Calliope Wireless Mouse (2.4GHz via USB receiver), black <i>Some:</i> Lenovo Fingerprint Mouse (USB connector), Windows Hello support, black																																																												
Storage	<i>Some:</i> Hard Drive / SATA 6.0Gb/s, 2.5" or 3.5", 5400 rpm or 7200 rpm <i>Some:</i> Solid State Drive (SSD) / SATA 6.0Gb/s, 2.5" <i>Some:</i> M.2 Solid State Drive (SSD) / PCIe NVMe, PCIe 3.0 x 4, 32Gb/s	Mechanical	<ul style="list-style-type: none"> <li>SFF (8.4L), black color; metal case</li> <li>(WxDxH) 3.6" X 11.4" X 13.5"; 92.5mm X 290.5mm X 343.5mm</li> <li>Approx. 13.2 lb (6.0 kg), weight may vary by configuration</li> <li>Toolless cover, disk, optical removal</li> <li>Optional dust filter</li> <li>Bay 1: Slim external ODD bay</li> <li>Bay 2: 3.5", internal, HDD/SSD</li> <li>Bay 3: 2.5", internal, HDD/SSD (bay only comes with 2.5" 2nd disk)</li> <li>Slot 1: low-profile (length &lt; 150mm, height &lt; 68mm), PCIe 3.0 x16*</li> <li>Slot 2: low-profile (length &lt; 150mm, height &lt; 68mm), PCIe 2.0 x1*</li> <li>Slot 3: low-profile (length &lt; 150mm, height &lt; 68mm), PCIe 2.0 x1*</li> <li>Slot 4: no slot, only bracket for optional port extension*</li> <li>M.2 card slots: two (one for WLAN, one for SSD)</li> <li>* Optional front USB3.1 Type-C x2 module occupies PCIe x16 slot (x4 card), optional rear 2x USB2.0 / parallel / 2nd serial occupies one expansion slot</li> </ul>																																																												
Optical	<i>Some:</i> DVD-ROM SATA 1.5Gb/s Drive, slim (9.0mm) <i>Some:</i> DVD Burner (DVD±RW), SATA 1.5Gb/s Drive, slim (9.0mm)	Floor Stand	Optional system floor stand for vertical orientation																																																												
Onboard SATA	Three onboard SATA 6.0Gb/s connectors	Power supply	<i>Some:</i> 180 watts, autosensing, 85% PSU <i>Some:</i> 210 watts, autosensing, 85% PSU <i>Some:</i> 210 watts, autosensing, 92% PSU (only available via special bid)																																																												
Media reader	Optional 7-in-1 media reader	Limited warranty	<i>Some:</i> <b>1-year</b> or <b>3-year, depot service</b> / service upgrades available <i>Some:</i> <b>1-year</b> or <b>3-year, limited onsite service</b> / service upgrades available																																																												
Graphics	<b>AMD Radeon™ Graphics in processor</b> (not for AMD Ryzen processor), uses main memory, DirectX® 12, one VGA, two DisplayPort™ (Onboard VGA and DP ports are invalid on the models with AMD Ryzen processor), supports 3 independent displays, works along with AMD discrete graphics to support more displays; <i>Max resolution:</i> 4096x2160 (DP)@60Hz; 1920x1200 (VGA)@60Hz <i>Some:</i> <b>NVIDIA GeForce® GT 730</b> , DirectX 12, 2GB, PCIe 2.0 x8 adapter, two DisplayPort, 35 watts; <i>Max resolution:</i> 3840x2160 (DisplayPort)@60Hz;	Preload	<b>Preloaded operating system</b> <i>Some:</i> Windows® 7 Professional 32/64 preinstalled through downgrade rights in Windows 10 Pro 64-bit (Only available with Pro A6/A10/A12-8xxx APUs) <i>Some:</i> Windows 10 Pro 64-bit <i>Some:</i> Windows 10 Home 64-bit <b>Preloaded applications (only some listed)</b> <ul style="list-style-type: none"> <li>Microsoft Office preloaded; purchase a product key to activate</li> <li>Only for Window 10</li> <li>Lenovo Companion</li> <li>Lenovo ID</li> <li>Only for Window 7</li> <li>Lenovo Solution Center</li> <li>Lenovo ThinkVantage Tools</li> <li>Create Recovery Media</li> <li>Adobe® Reader®</li> <li>Cyberlink PowerDVD Create (DVD±RW)</li> </ul>																																																												
Monitor cable	Optional DP to VGA, DP to DVI-D (single link), DP to dual DP, or DP to HDMI 1.4	Environment	ENERGY STAR® 6.1, EPEAT™ Gold rating (North America), ErP Lot 3, GREENGUARD®, RoHS-compliant																																																												
Chipset	<b>AMD B350 Chipset</b>	Accessories	For compatible accessories, please go to <a href="http://www.lenovoquickpick.com">http://www.lenovoquickpick.com</a>																																																												
Front ports	Two USB 3.1 Gen2, two USB 3.1 Gen1, optional two USB 3.1 Type-C Gen 2 (only available via special bid), microphone (3.5mm), headphone (3.5mm)																																																														
Rear ports	Two USB 3.1 Gen1, two USB 2.0, optional two USB 2.0, serial (9-pin), optional 2nd serial (9-pin), optional parallel (25-pin), ethernet (RJ-45), one VGA and two DisplayPort (not available on models with AMD Ryzen processor), two PS/2 ports (keyboard / mouse); additional DisplayPort on optional graphics on some models																																																														
Rear audio ports	Line-in (3.5mm), line-out (3.5mm), microphone-in (3.5mm)																																																														
IEEE 1394	None																																																														
Audio support	High Definition (HD) Audio, Realtek ALC662 / optional internal speaker (1.5 watt )																																																														
WLAN	<i>Some:</i> 11ac wireless, M.2 Card, Realtek RTL8821AE (dual band), Wi-Fi + Bluetooth 4.0 combo adapter, 1x1 <i>Some:</i> 11ac wireless, M.2 Card, Qualcomm Atheros QCA6174A (dual band), Wi-Fi + Bluetooth 4.1 combo adapter, 2x2 <i>Some:</i> 11ac wireless, M.2 Card, Qualcomm Atheros QCA9377 (dual band), Wi-Fi + Bluetooth 4.1 combo adapter, 1x1																																																														
Bluetooth™	<i>Some:</i> Bluetooth 4.0 or 4.1 wireless, integrated in Wi-Fi + BT combo adapter																																																														
Ethernet	Gigabit ethernet, Realtek RTL8111EPV, Wake on LAN®																																																														
Modem	None																																																														
Manageability	DASH																																																														
Security chip	TPM (Trusted Platform Module) 2.0, TCG Certified * Downgrade to TPM1.2 for the models with Win10 DG Win7 32 OS																																																														

Model	Region	Processor	vPro	Graphics	Monitor Cable	Memory	Storage(HDD/SSD)	Optical	Media Reader	WLAN + Bluetooth	Optional Front Ports	Optional Rear Ports	Chassis Intrusion Switch	Cable Lock	Speaker	Dust Filter	Keyboard / Mouse	Stand	Power Supply	Operating System	Warranty	Ann Date (mm/yy)
10MB0018US	US	AMD PRO A8-9600	No	AMD R7 Graphics	None	4GBx1	1TB 7200rpm 3.5"	DVD±RW	None	None	None	None	None	None	1.5Wx1	None	USB / USB	Floor Stand	210W 85%	Win10 Pro 64	3-year, Onsite	06/17
10MB0019US	US	AMD PRO A12-9800	No	AMD R7 Graphics	None	4GBx1	1TB 7200rpm 3.5"	DVD±RW	None	None	None	None	None	None	1.5Wx1	None	USB / USB	Floor Stand	210W 85%	Win10 Pro 64	3-year, Onsite	06/17
10MB001AUS	US	AMD PRO A10-9700	No	AMD R7 Graphics	None	8GBx1	256GB SSD M.2 PCIe NVMe Opal	DVD±RW	None	None	None	None	None	None	1.5Wx1	None	USB / USB	Floor Stand	210W 85%	Win10 Pro 64	3-year, Onsite	06/17
10MB001BUS	US	AMD PRO A12-9800	No	AMD R7 Graphics	None	8GBx1	256GB SSD M.2 PCIe NVMe Opal	DVD±RW	None	None	None	None	None	None	1.5Wx1	None	USB / USB	Floor Stand	210W 85%	Win10 Pro 64	3-year, Onsite	06/17
10MB001CUS	US	AMD PRO A8-9600	No	AMD R7 Graphics	None	4GBx1	500GB 7200rpm 3.5"	DVD±RW	None	None	None	None	None	None	1.5Wx1	None	USB / USB	Floor Stand	210W 85%	Win10 Pro 64	3-year, Onsite	06/17
10MB001DUS	US	AMD PRO A10-9700	No	AMD R7 Graphics	None	8GBx1	128GB SSD M.2 PCIe NVMe	DVD±RW	None	None	None	None	None	None	1.5Wx1	None	USB / USB	Floor Stand	210W 85%	Win10 Pro 64	3-year, Onsite	06/17
10MB001EUS	US	AMD PRO A6-9500	No	AMD R5 Graphics	None	4GBx1	1TB 7200rpm 3.5"	DVD±RW	None	None	None	None	None	None	1.5Wx1	None	USB / USB	Floor Stand	210W 85%	Win10 Pro 64	3-year, Onsite	06/17
10MB001FUS	US	AMD PRO A6-9500	No	AMD R5 Graphics	None	8GBx1	1TB 7200rpm 3.5"	DVD±RW	None	None	None	None	None	None	1.5Wx1	None	USB / USB	Floor Stand	210W 85%	Win10 Pro 64	3-year, Onsite	06/17
10MB001GUS	US	AMD PRO A12-9800	No	AMD R7 Graphics	None	4GBx1	500GB 7200rpm 3.5"	DVD±RW	None	None	None	None	None	None	1.5Wx1	None	USB / USB	Floor Stand	210W 85%	Win10 Pro 64	3-year, Onsite	06/17
10MB001HUS	US	AMD PRO A10-9700	No	AMD R7 Graphics	None	8GBx1	1TB 7200rpm 3.5"	DVD±RW	None	None	None	None	None	None	1.5Wx1	None	USB / USB	Floor Stand	210W 85%	Win10 Pro 64	3-year, Onsite	06/17
10MB001JUS	US	AMD PRO A6-9500	No	AMD R5 Graphics	None	4GBx1	500GB 7200rpm 3.5"	DVD±RW	None	None	None	None	None	None	1.5Wx1	None	USB / USB	Floor Stand	210W 85%	Win10 Pro 64	3-year, Onsite	06/17
10MB001KUS	US	AMD PRO A6-9500	No	AMD R5 Graphics	None	8GBx1	128GB SSD M.2 PCIe NVMe	DVD±RW	None	None	None	None	None	None	1.5Wx1	None	USB / USB	Floor Stand	210W 85%	Win10 Pro 64	3-year, Onsite	06/17
10MB001LUS	US	AMD PRO A8-9600	No	AMD R7 Graphics	None	8GBx1	128GB SSD M.2 PCIe NVMe	DVD±RW	None	None	None	None	None	None	1.5Wx1	None	USB / USB	Floor Stand	210W 85%	Win10 Pro 64	3-year, Onsite	06/17
10MB001MUS	US	AMD PRO A12-9800	No	AMD R7 Graphics	None	8GBx1	128GB SSD M.2 PCIe NVMe	DVD±RW	None	None	None	None	None	None	1.5Wx1	None	USB / USB	Floor Stand	210W 85%	Win10 Pro 64	3-year, Onsite	06/17
10MB001NUS	US	AMD PRO A8-9600	No	AMD R7 Graphics	None	8GBx1	1TB 7200rpm 3.5"	DVD±RW	None	None	None	None	None	None	1.5Wx1	None	USB / USB	Floor Stand	210W 85%	Win10 Pro 64	3-year, Onsite	06/17
10MB001PUS	US	AMD PRO A10-9700	No	AMD R7 Graphics	None	4GBx1	1TB 7200rpm 3.5"	DVD±RW	None	None	None	None	None	None	1.5Wx1	None	USB / USB	Floor Stand	210W 85%	Win10 Pro 64	3-year, Onsite	06/17
10MB001QUS	US	AMD PRO A10-9700	No	AMD R7 Graphics	None	4GBx1	500GB 7200rpm 3.5"	DVD±RW	None	None	None	None	None	None	1.5Wx1	None	USB / USB	Floor Stand	210W 85%	Win10 Pro 64	3-year, Onsite	06/17
10MB001RUS	US	AMD PRO A12-9800	No	AMD R7 Graphics	None	8GBx1	1TB 7200rpm 3.5"	DVD±RW	None	None	None	None	None	None	1.5Wx1	None	USB / USB	Floor Stand	210W 85%	Win10 Pro 64	3-year, Onsite	06/17
10MB001SUS	US	AMD PRO A6-8570	No	AMD R5 Graphics	None	8GBx1	1TB 7200rpm 3.5"	DVD±RW	None	None	None	None	None	None	1.5Wx1	None	USB / USB	Floor Stand	210W 85%	Win10 DG Win7 Pro 64	3-year, Onsite	07/17
10MB001TUS	US	AMD PRO A12-8870	No	AMD R7 Graphics	None	8GBx1	128GB SSD M.2 PCIe NVMe	DVD±RW	None	None	None	None	None	None	1.5Wx1	None	USB / USB	Floor Stand	210W 85%	Win10 DG Win7 Pro 64	3-year, Onsite	07/17

Model	Region	Processor	vPro	Graphics	Monitor Cable	Memory	Storage(HDD/SSD)	Optical	Media Reader	WLAN + Bluetooth	Optional Front Ports	Optional Rear Ports	Chassis Intrusion Switch	Cable Lock	Speaker	Dust Filter	Keyboard / Mouse	Stand	Power Supply	Operating System	Warranty	Ann Date (mm/yy)
10MB001UUS	US	AMD PRO A6-8570	No	AMD R5 Graphics	None	8GBx1	128GB SSD M.2 PCIe NVMe	DVD±RW	None	None	None	None	None	None	1.5Wx1	None	USB / USB	Floor Stand	210W 85%	Win10 DG Win7 Pro 64	3-year, Onsite	07/17
10MB001VUS	US	AMD PRO A10-8770	No	AMD R7 Graphics	None	8GBx1	128GB SSD M.2 PCIe NVMe	DVD±RW	None	None	None	None	None	None	1.5Wx1	None	USB / USB	Floor Stand	210W 85%	Win10 DG Win7 Pro 64	3-year, Onsite	07/17
10MB001WUS	US	AMD PRO A10-8770	No	AMD R7 Graphics	None	4GBx1	500GB 7200rpm 3.5"	DVD±RW	None	None	None	None	None	None	1.5Wx1	None	USB / USB	Floor Stand	210W 85%	Win10 DG Win7 Pro 64	3-year, Onsite	07/17
10MB001XUS	US	AMD PRO A12-8870	No	AMD R7 Graphics	None	4GBx1	1TB 7200rpm 3.5"	DVD±RW	None	None	None	None	None	None	1.5Wx1	None	USB / USB	Floor Stand	210W 85%	Win10 DG Win7 Pro 64	3-year, Onsite	07/17
10MB001YUS	US	AMD PRO A10-8770	No	AMD R7 Graphics	None	8GBx1	1TB 7200rpm 3.5"	DVD±RW	None	RTL8821AE ac, 1x1 + BT4.0	None	None	None	None	1.5Wx1	None	USB / USB	Floor Stand	210W 85%	Win10 DG Win7 Pro 64	3-year, Onsite	07/17
10MB0020US	US	AMD PRO A12-8870	No	AMD R7 Graphics	None	4GBx1	500GB 7200rpm 3.5"	DVD±RW	None	None	None	None	None	None	1.5Wx1	None	USB / USB	Floor Stand	210W 85%	Win10 DG Win7 Pro 64	3-year, Onsite	07/17
10MB0021US	US	AMD PRO A10-8770	No	AMD R7 Graphics	None	8GBx1	256GB SSD M.2 PCIe NVMe Opal	DVD±RW	None	RTL8821AE ac, 1x1 + BT4.0	None	None	None	None	1.5Wx1	None	USB / USB	Floor Stand	210W 85%	Win10 DG Win7 Pro 64	3-year, Onsite	07/17
10MB0022US	US	AMD PRO A6-8570	No	AMD R5 Graphics	None	4GBx1	500GB 7200rpm 3.5"	DVD±RW	None	None	None	None	None	None	1.5Wx1	None	USB / USB	Floor Stand	210W 85%	Win10 DG Win7 Pro 64	3-year, Onsite	07/17
10MB0023US	US	AMD PRO A6-8570	No	AMD R5 Graphics	None	4GBx1	1TB 7200rpm 3.5"	DVD±RW	None	RTL8821AE ac, 1x1 + BT4.0	None	None	None	None	1.5Wx1	None	USB / USB	Floor Stand	210W 85%	Win10 DG Win7 Pro 64	3-year, Onsite	07/17
10MB0024US	US	AMD PRO A12-8870	No	AMD R7 Graphics	None	8GBx1	1TB 7200rpm 3.5"	DVD±RW	None	RTL8821AE ac, 1x1 + BT4.0	None	None	None	None	1.5Wx1	None	USB / USB	Floor Stand	210W 85%	Win10 DG Win7 Pro 64	3-year, Onsite	07/17
10MB0025US	US	AMD PRO A10-8770	No	AMD R7 Graphics	None	4GBx1	1TB 7200rpm 3.5"	DVD±RW	None	RTL8821AE ac, 1x1 + BT4.0	None	None	None	None	1.5Wx1	None	USB / USB	Floor Stand	210W 85%	Win10 DG Win7 Pro 64	3-year, Onsite	07/17
10MB0026US	US	AMD PRO A12-8870	No	AMD R7 Graphics	None	8GBx1	256GB SSD M.2 PCIe NVMe Opal	DVD±RW	None	None	None	None	None	None	1.5Wx1	None	USB / USB	Floor Stand	210W 85%	Win10 DG Win7 Pro 64	3-year, Onsite	07/17
10MB0027US	US	AMD PRO A10-8770	No	AMD R7 Graphics	None	8GBx1	1TB 7200rpm 3.5"	DVD±RW	None	None	None	None	None	None	1.5Wx1	None	USB / USB	Floor Stand	210W 85%	Win10 DG Win7 Pro 64	3-year, Onsite	07/17
10MB0028US	US	AMD PRO A10-8770	No	AMD R7 Graphics	None	8GBx1	256GB SSD M.2 PCIe NVMe Opal	DVD±RW	None	None	None	None	None	None	1.5Wx1	None	USB / USB	Floor Stand	210W 85%	Win10 DG Win7 Pro 64	3-year, Onsite	07/17
10MB0029US	US	AMD PRO A6-8570	No	AMD R5 Graphics	None	4GBx1	1TB 7200rpm 3.5"	DVD±RW	None	None	None	None	None	None	1.5Wx1	None	USB / USB	Floor Stand	210W 85%	Win10 DG Win7 Pro 64	3-year, Onsite	07/17
10MB002AUS	US	AMD PRO A12-8870	No	AMD R7 Graphics	None	8GBx1	1TB 7200rpm 3.5"	DVD±RW	None	None	None	None	None	None	1.5Wx1	None	USB / USB	Floor Stand	210W 85%	Win10 DG Win7 Pro 64	3-year, Onsite	07/17
10MB002BUS	US	AMD PRO A10-8770	No	AMD R7 Graphics	None	4GBx1	1TB 7200rpm 3.5"	DVD±RW	None	None	None	None	None	None	1.5Wx1	None	USB / USB	Floor Stand	210W 85%	Win10 DG Win7 Pro 64	3-year, Onsite	07/17
10MB002CUS	US	AMD PRO A12-8870	No	AMD R7 Graphics	None	8GBx1	256GB SSD M.2 PCIe NVMe Opal	DVD±RW	None	RTL8821AE ac, 1x1 + BT4.0	None	None	None	None	1.5Wx1	None	USB / USB	Floor Stand	210W 85%	Win10 DG Win7 Pro 64	3-year, Onsite	07/17
10MB002DUS	US	AMD PRO A10-9700	No	AMD R7 Graphics	None	4GBx1	1TB 7200rpm 3.5"	DVD±RW	None	RTL8821AE ac, 1x1 + BT4.0	None	None	None	None	1.5Wx1	None	USB / USB	Floor Stand	210W 85%	Win10 Pro 64	3-year, Onsite	06/17
10MB002EUS	US	AMD PRO A10-9700	No	AMD R7 Graphics	None	8GBx1	256GB SSD M.2 PCIe NVMe Opal	DVD±RW	None	RTL8821AE ac, 1x1 + BT4.0	None	None	None	None	1.5Wx1	None	USB / USB	Floor Stand	210W 85%	Win10 Pro 64	3-year, Onsite	07/17

Model	Region	Processor	vPro	Graphics	Monitor Cable	Memory	Storage(HDD/SSD)	Optical	Media Reader	WLAN + Bluetooth	Optional Front Ports	Optional Rear Ports	Chassis Intrusion Switch	Cable Lock	Speaker	Dust Filter	Keyboard / Mouse	Stand	Power Supply	Operating System	Warranty	Ann Date (mm/yy)
10MB002FUS	US	AMD PRO A8-9600	No	AMD R7 Graphics	None	4GBx1	1TB 7200rpm 3.5"	DVD±RW	None	RTL8821Ae ac, 1x1 + BT4.0	None	None	None	None	1.5Wx1	None	USB / USB	Floor Stand	210W 85%	Win10 Pro 64	3-year, Onsite	06/17
10MB002GUS	US	AMD PRO A8-9600	No	AMD R7 Graphics	None	8GBx1	1TB 7200rpm 3.5"	DVD±RW	None	RTL8821Ae ac, 1x1 + BT4.0	None	None	None	None	1.5Wx1	None	USB / USB	Floor Stand	210W 85%	Win10 Pro 64	3-year, Onsite	06/17
10MB002HUS	US	AMD PRO A12-9800	No	AMD R7 Graphics	None	8GBx1	1TB 7200rpm 3.5"	DVD±RW	None	RTL8821Ae ac, 1x1 + BT4.0	None	None	None	None	1.5Wx1	None	USB / USB	Floor Stand	210W 85%	Win10 Pro 64	3-year, Onsite	06/17
10MB002JUS	US	AMD PRO A10-9700	No	AMD R7 Graphics	None	8GBx1	1TB 7200rpm 3.5"	DVD±RW	None	RTL8821Ae ac, 1x1 + BT4.0	None	None	None	None	1.5Wx1	None	USB / USB	Floor Stand	210W 85%	Win10 Pro 64	3-year, Onsite	06/17
10MB002KUS	US	AMD PRO A12-9800	No	AMD R7 Graphics	None	8GBx1	256GB SSD M.2 PCIe NVMe Opal	DVD±RW	None	RTL8821Ae ac, 1x1 + BT4.0	None	None	None	None	1.5Wx1	None	USB / USB	Floor Stand	210W 85%	Win10 Pro 64	3-year, Onsite	06/17
10MB002LUS	US	AMD PRO A8-9600	No	AMD R7 Graphics	None	8GBx1	128GB SSD M.2 PCIe NVMe	DVD±RW	None	RTL8821Ae ac, 1x1 + BT4.0	None	None	None	None	1.5Wx1	None	USB / USB	Floor Stand	210W 85%	Win10 Pro 64	3-year, Onsite	06/17
10MB002MUS	US	AMD PRO A6-9500	No	AMD R5 Graphics	None	4GBx1	1TB 7200rpm 3.5"	DVD±RW	None	RTL8821Ae ac, 1x1 + BT4.0	None	None	None	None	1.5Wx1	None	USB / USB	Floor Stand	210W 85%	Win10 Pro 64	3-year, Onsite	06/17
10MB002PUS	US	AMD Ryzen 5 PRO 1500	No	GT 730 2GB	None	8GBx1	1TB 7200rpm 3.5"	DVD±RW	None	None	None	None	None	None	1.5Wx1	None	USB / USB	Floor Stand	210W 85%	Win10 Pro 64	3-year, Onsite	07/17
10MB002QUS	US	AMD Ryzen 5 PRO 1500	No	GT 730 2GB	None	8GBx1	128GB SSD M.2 PCIe NVMe	DVD±RW	None	None	None	None	None	None	1.5Wx1	None	USB / USB	Floor Stand	210W 85%	Win10 Pro 64	3-year, Onsite	07/17
10MB002RUS	US	AMD Ryzen 5 PRO 1500	No	GT 730 2GB	None	8GBx1	1TB 7200rpm 3.5"	DVD±RW	None	RTL8821Ae ac, 1x1 + BT4.0	None	None	None	None	1.5Wx1	None	USB / USB	Floor Stand	210W 85%	Win10 Pro 64	3-year, Onsite	07/17
10MB002SUS	US	AMD Ryzen 3 PRO 1200	No	GT 730 2GB	None	8GBx1	256GB SSD M.2 PCIe NVMe Opal	DVD±RW	None	None	None	None	None	None	1.5Wx1	None	USB / USB	Floor Stand	210W 85%	Win10 Pro 64	3-year, Onsite	07/17
10MB002TUS	US	AMD Ryzen 3 PRO 1200	No	GT 730 2GB	None	4GBx1	1TB 7200rpm 3.5"	DVD±RW	None	RTL8821Ae ac, 1x1 + BT4.0	None	None	None	None	1.5Wx1	None	USB / USB	Floor Stand	210W 85%	Win10 Pro 64	3-year, Onsite	07/17
10MB002UUS	US	AMD Ryzen 3 PRO 1200	No	GT 730 2GB	None	4GBx1	128GB SSD	DVD±RW	None	None	None	None	None	None	1.5Wx1	None	USB / USB	Floor Stand	210W 85%	Win10 Pro 64	3-year, Onsite	07/17
10MB002VUS	US	AMD Ryzen 3 PRO 1200	No	GT 730 2GB	None	8GBx1	128GB SSD M.2 PCIe NVMe	DVD±RW	None	None	None	None	None	None	1.5Wx1	None	USB / USB	Floor Stand	210W 85%	Win10 Pro 64	3-year, Onsite	07/17
10MB002WUS	US	AMD Ryzen 5 PRO 1500	No	GT 730 2GB	None	8GBx1	128GB SSD	DVD±RW	None	None	None	None	None	None	1.5Wx1	None	USB / USB	Floor Stand	210W 85%	Win10 Pro 64	3-year, Onsite	07/17
10MB002XUS	US	AMD Ryzen 7 PRO 1700	No	GT 730 2GB	None	8GBx1	1TB 7200rpm 3.5"	DVD±RW	None	RTL8821Ae ac, 1x1 + BT4.0	None	None	None	None	1.5Wx1	None	USB / USB	Floor Stand	210W 85%	Win10 Pro 64	3-year, Onsite	07/17
10MB002YUS	US	AMD Ryzen 5 PRO 1500	No	GT 730 2GB	None	4GBx1	500GB 7200rpm 3.5"	DVD±RW	None	RTL8821Ae ac, 1x1 + BT4.0	None	None	None	None	1.5Wx1	None	USB / USB	Floor Stand	210W 85%	Win10 Pro 64	3-year, Onsite	07/17
10MB0030US	US	AMD Ryzen 5 PRO 1500	No	GT 730 2GB	None	8GBx1	512GB SSD M.2 PCIe NVMe Opal	DVD±RW	None	None	None	None	None	None	1.5Wx1	None	USB / USB	Floor Stand	210W 85%	Win10 Pro 64	3-year, Onsite	07/17
10MB0031US	US	AMD Ryzen 3 PRO 1200	No	GT 730 2GB	None	8GBx1	256GB SSD M.2 PCIe NVMe Opal	DVD±RW	None	RTL8821Ae ac, 1x1 + BT4.0	None	None	None	None	1.5Wx1	None	USB / USB	Floor Stand	210W 85%	Win10 Pro 64	3-year, Onsite	07/17
10MB0032US	US	AMD Ryzen 5 PRO 1500	No	GT 730 2GB	None	8GBx1	256GB SSD M.2 PCIe NVMe Opal	DVD±RW	None	None	None	None	None	None	1.5Wx1	None	USB / USB	Floor Stand	210W 85%	Win10 Pro 64	3-year, Onsite	07/17

Model	Region	Processor	vPro	Graphics	Monitor Cable	Memory	Storage(HDD/SSD)	Optical	Media Reader	WLAN + Bluetooth	Optional Front Ports	Optional Rear Ports	Chassis Intrusion Switch	Cable Lock	Speaker	Dust Filter	Keyboard / Mouse	Stand	Power Supply	Operating System	Warranty	Ann Date (mm/yy)
10MB0033US	US	AMD Ryzen 7 PRO 1700	No	GT 730 2GB	None	8GBx1	1TB 7200rpm 3.5"	DVD±RW	None	None	None	None	None	None	1.5Wx1	None	USB / USB	Floor Stand	210W 85%	Win10 Pro 64	3-year, Onsite	07/17
10MB0034US	US	AMD Ryzen 5 PRO 1500	No	GT 730 2GB	None	4GBx1	500GB 7200rpm 3.5"	DVD±RW	None	None	None	None	None	None	1.5Wx1	None	USB / USB	Floor Stand	210W 85%	Win10 Pro 64	3-year, Onsite	07/17
10MB0035US	US	AMD Ryzen 3 PRO 1200	No	GT 730 2GB	None	8GBx1	1TB 7200rpm 3.5"	DVD±RW	None	None	None	None	None	None	1.5Wx1	None	USB / USB	Floor Stand	210W 85%	Win10 Pro 64	3-year, Onsite	07/17
10MB0036US	US	AMD Ryzen 3 PRO 1200	No	GT 730 2GB	None	8GBx1	128GB SSD	DVD±RW	None	None	None	None	None	None	1.5Wx1	None	USB / USB	Floor Stand	210W 85%	Win10 Pro 64	3-year, Onsite	07/17
10MB0037US	US	AMD Ryzen 7 PRO 1700	No	GT 730 2GB	None	8GBx1	256GB SSD M.2 PCIe NVMe Opal	DVD±RW	None	None	None	None	None	None	1.5Wx1	None	USB / USB	Floor Stand	210W 85%	Win10 Pro 64	3-year, Onsite	07/17
10MB0038US	US	AMD Ryzen 3 PRO 1200	No	GT 730 2GB	None	4GBx1	500GB 7200rpm 3.5"	DVD±RW	None	None	None	None	None	None	1.5Wx1	None	USB / USB	Floor Stand	210W 85%	Win10 Pro 64	3-year, Onsite	07/17
10MB0039US	US	AMD Ryzen 5 PRO 1500	No	GT 730 2GB	None	4GBx1	128GB SSD M.2 PCIe NVMe	DVD±RW	None	None	None	None	None	None	1.5Wx1	None	USB / USB	Floor Stand	210W 85%	Win10 Pro 64	3-year, Onsite	07/17
10MB003AUS	US	AMD Ryzen 7 PRO 1700	No	GT 730 2GB	None	8GBx1	256GB SSD M.2 PCIe NVMe Opal	DVD±RW	None	RTL8821AE ac, 1x1 + BT4.0	None	None	None	None	1.5Wx1	None	USB / USB	Floor Stand	210W 85%	Win10 Pro 64	3-year, Onsite	07/17
10MB003BUS	US	AMD Ryzen 3 PRO 1200	No	GT 730 2GB	None	4GBx1	1TB 7200rpm 3.5"	DVD±RW	None	None	None	None	None	None	1.5Wx1	None	USB / USB	Floor Stand	210W 85%	Win10 Pro 64	3-year, Onsite	07/17
10MB003CUS	US	AMD Ryzen 5 PRO 1500	No	GT 730 2GB	None	4GBx1	128GB SSD	DVD±RW	None	None	None	None	None	None	1.5Wx1	None	USB / USB	Floor Stand	210W 85%	Win10 Pro 64	3-year, Onsite	07/17
10MB003DUS	US	AMD Ryzen 5 PRO 1500	No	GT 730 2GB	None	8GBx1	256GB SSD M.2 PCIe NVMe Opal	DVD±RW	None	RTL8821AE ac, 1x1 + BT4.0	None	None	None	None	1.5Wx1	None	USB / USB	Floor Stand	210W 85%	Win10 Pro 64	3-year, Onsite	07/17
10MB003EUS	US	AMD Ryzen 3 PRO 1200	No	GT 730 2GB	None	4GBx1	128GB SSD M.2 PCIe NVMe	DVD±RW	None	RTL8821AE ac, 1x1 + BT4.0	None	None	None	None	1.5Wx1	None	USB / USB	Floor Stand	210W 85%	Win10 Pro 64	3-year, Onsite	07/17
10MB003FUS	US	AMD Ryzen 3 PRO 1200	No	GT 730 2GB	None	4GBx1	128GB SSD M.2 PCIe NVMe	DVD±RW	None	None	None	None	None	None	1.5Wx1	None	USB / USB	Floor Stand	210W 85%	Win10 Pro 64	3-year, Onsite	07/17
10MB003GUS	US	AMD Ryzen 7 PRO 1700	No	GT 730 2GB	None	8GBx1	512GB SSD M.2 PCIe NVMe Opal	DVD±RW	None	None	None	None	None	None	1.5Wx1	None	USB / USB	Floor Stand	210W 85%	Win10 Pro 64	3-year, Onsite	07/17
10MB003HUS	US	AMD Ryzen 3 PRO 1200	No	GT 730 2GB	None	8GBx1	1TB 7200rpm 3.5"	DVD±RW	None	RTL8821AE ac, 1x1 + BT4.0	None	None	None	None	1.5Wx1	None	USB / USB	Floor Stand	210W 85%	Win10 Pro 64	3-year, Onsite	07/17





# ThinkCentre M715 Tiny Platform Specifications

Product Specifications Reference (PSREF)

Processor	AMD A6, A10, or A12 series APUs						Keyboard	<i>Some:</i> Fullsize USB Keyboard (USB connector), Lenovo logo <i>Some:</i> Lenovo New Slim USB Keyboard (USB connector), black, Lenovo logo		
	APU	Cores	Frequency Base/Max	L2 Cache	Memory Types	Integrated Graphics	Mouse	<i>Some:</i> USB Optical Wheel Mouse, black, Lenovo logo		
	PRO A6-9500E	2	3.0 / 3.4 GHz	1 MB	DDR4-2400	Radeon R5 Series	Mechanical	Tiny (1L), black color; metal case		
	PRO A10-9700E	4	3.0 / 3.5 GHz	2 MB	DDR4-2400	Radeon R7 Series		M715 Tiny only: 7.05" W X 7.20" D X 1.36" H 179mm W X 182.9mm D X 34.5mm H 2.9 lb (1.3 kg), weight may vary by configuration		
	PRO A12-9800E	4	3.1 / 3.8 GHz	2 MB	DDR4-2400	Radeon R7 Series		With VESA mount & ODD box: 7.42" W X 7.30" D X 2.48" H 188.4mm W X 185.38mm D X 63mm H		
	PRO A6-8570E	2	3.0 / 3.4 GHz	1 MB	DDR4-2400	Radeon R5 Series		4.12 lb (1.87 kg), weight may vary by configuration		
	PRO A10-8770E	4	2.8 / 3.5 GHz	2 MB	DDR4-2400	Radeon R7 Series		With VESA mount & I/O box: 7.42" W X 7.30" D X 2.62" H 188.4mm W X 185.38mm D X 66.6mm H		
PRO A12-8870E	4	2.9 / 3.8 GHz	2 MB	DDR4-2400	Radeon R7 Series	3.53 lb (1.6 kg), weight may vary by configuration				
PRO A12-8870E	4	2.9 / 3.8 GHz	2 MB	DDR4-2400	Radeon R7 Series	Optional VESA mount bracket kit, supports VESA 75mm and 100mm Optional system floor stand for vertical orientation				
Memory	32GB max, DDR4 2400, two 260-pin SO-DIMM sockets, dual-channel capable *16GB single SO-DIMM is only available via special bid models						VESA mount Floor Stand	Optional system floor stand for vertical orientation		
Disk	<i>Some:</i> SATA 6.0Gb/s, 2.5" Wide, 5400 rpm or 7200 rpm <i>Some:</i> M.2 Solid State Drive (SSD) / SATA interface or PCIe NVMe interface						Power supply	65 watts AC/DC adapter, autosensing, 88% PSU (not included for TIO models) 90 watts AC/DC adapter, autosensing, 88% PSU (only for models with I/O box)		
Optical	<i>Some:</i> DVD-ROM, 9.0mm high, via USB external ODD box <i>Some:</i> DVD±RW, 9.0mm high, via USB external ODD box						Limited warranty <sup>3</sup>	<i>Some:</i> 1-year or 3-year, depot service / service upgrades available <i>Some:</i> 1-year or 3-year, limited onsite service / service upgrades available		
Onboard SATA Media reader	One SATA cable (1-drop to device), one SATA 6.0Gb/s connector on planar None						Preload	<b>Preloaded operating system</b> <i>Some:</i> Windows 10 Pro 64-bit <i>Some:</i> Windows 10 Home 64-bit <i>Some:</i> Windows® 7 Professional 64 preinstalled through downgrade rights in Windows 10 Pro 64-bit <i>Some:</i> Windows Embedded Standard 7 (WES 7) V2 <i>Some:</i> Windows 10 IoT Enterprise <i>Some:</i> LeTOS V2 (Lenovo Terminal Operating System, Linux-based)	<b>Preloaded applications (only some listed)</b> - <i>Windows 10 only</i> ● Lenovo Companion ● Lenovo ID ● Lenovo ThinkVantage Tools ● Microsoft Office preloaded; purchase a product key to activate ● Cyberlink PowerDVD (DVD, DVD±RW) ● PowerDVD Create (DVD±RW) - <i>Windows 7 only</i> ● Lenovo Solution Center ● ThinkVantage System Update ● Lenovo Display Manager ● Create Recovery Media ● Lenovo ThinkVantage Tools ● Cyberlink PowerDVD (DVD, DVD±RW) ● PowerDVD Create (DVD±RW) ● Microsoft Office preloaded; purchase a product key to activate ● Adobe® Reader®	
Graphics	<b>AMD Radeon™ Graphics</b> in processor, uses main memory, DirectX® 12, two DisplayPort™, one optional port (HDMI, VGA, or 3rd DP), supports 3 independent displays (supports maximum of 2 concurrent HDMI/DVI displays when using HDMI port or DP to DVI/HDMI dongles); <i>Max resolution:</i> 4096x2160 (DP)@60Hz; 4096x2160 (HDMI)@60Hz; 1920x1200 (VGA)@60Hz						Environment	ENERGY STAR® 6.1*, EPEAT™ Gold rating* (*for Windows models only); ErP Lot 3; GREENGUARD®; RoHS-compliant		
DP cable	Optional DP to VGA, DP to DVI-D (single link), or DP to HDMI 1.4 dongle						Accessories	For compatible accessories, please go to <a href="http://www.lenovoquickpick.com">http://www.lenovoquickpick.com</a>		
Chipset	<b>AMD B300 Chipset</b>									
Front ports	Two USB 3.0 (one is Always On and fast charge), one microphone (stereo, 3.5mm), one headphone / microphone combo jack (stereo, 3.5mm)									
Rear ports	One USB 3.0 and three USB 2.0 (optional external optical box or I/O box occupies one specific USB 2.0 on some models), ethernet (RJ-45), two DisplayPort, one optional port (VGA, 3rd DP, HDMI, or serial on some models), one headphone									
I/O box	Optional external I/O box, extends four USB 2.0 (two on front and two on rear), one serial, and two PS/2, via USB port (occupy one specific USB 2.0 of M715q Tiny)									
Audio support	High Definition (HD) Audio, Realtek ALC233-CG / internal speaker (1.5 watt)									
WLAN <sup>13</sup>	<i>Some:</i> 11ac wireless, M.2 Card, Realtek RTL8821AE (dual band), Wi-Fi + Bluetooth 4.0 combo adapter, 1x1 <i>Some:</i> 11ac wireless, M.2 Card, Realtek RTL8822BE (dual band), Wi-Fi + Bluetooth 4.1 combo adapter, 2x2 <i>Some:</i> 11ac wireless, M.2 Card, Qualcomm Atheros QCA9377 (dual band), Wi-Fi + Bluetooth 4.1 combo adapter, 1x1									
Bluetooth™ Ethernet Modem	<i>Some:</i> Bluetooth 4.0 or 4.1 wireless, integrated in Wi-Fi + BT combo adapter Gigabit ethernet, Realtek RTL8111EPV, Wake on LAN® None									
Manageability Security chip Security features	DASH 1.0/1.1 Discrete TPM 2.0, TCG Certified		● Security slot (in rear for optional Kensington® MicroSaver® cable)		● Administrator password ● Hard disk password ● Boot sequence control ● Boot without keyboard and mouse ● Individual USB port disablement ● Chassis intrusion switch					
	● Padlock loop		● Smart USB protection, allows keyboard/ mouse only, blocks all storage devices		● Power-on password					

Model	Region	Processor	vPro	Graphics	Monitor Cable	Memory	Storage(HDD/SSD)	External Optical / I/O Box	WLAN + Bluetooth	Optional Rear Ports	Speaker	Adapter Cage	Toolless Chassis Screw	Dust Filter	Keyboard / Mouse	VESA Mount	Stand	Power Supply	OS	Warranty	Ann Date (m/y)
10M30001US	US	AMD PRO A6-9500E	No	AMD R5 Graphics	None	4GBx1	500GB 7200rpm 2.5"	None	RTL8821AE ac, 1x1 + BT4.0	None	1Wx1	None	None	None	USB / USB	None	Floor Stand	65W Adapter 88%	Win10 Pro 64	3-year, Onsite	11/16
10M30002US	US	AMD PRO A10-9700E	No	AMD R7 Graphics	None	4GBx1	500GB 7200rpm 2.5"	None	RTL8821AE ac, 1x1 + BT4.0	Serial	1Wx1	None	None	None	USB / USB	None	Floor Stand	65W Adapter 88%	Win10 Pro 64	3-year, Onsite	10/16
10M30003US	US	AMD A10-9700E	No	AMD R7 Graphics	None	4GBx1	500GB 7200rpm 2.5"	None	RTL8821AE ac, 1x1 + BT4.0	VGA	1Wx1	None	None	None	USB / USB	None	Floor Stand	65W Adapter 88%	Win10 Pro 64	3-year, Onsite	10/16
10M30004US	US	AMD A10-9700E	No	AMD R7 Graphics	None	4GBx1	500GB 7200rpm 2.5"	None	RTL8821AE ac, 1x1 + BT4.0	3rd DP	1Wx1	None	None	None	USB / USB	None	Floor Stand	65W Adapter 88%	Win10 Pro 64	3-year, Onsite	10/16
10M30005US	US	AMD PRO A12-9800E	No	AMD R7 Graphics	None	4GBx1	500GB 7200rpm 2.5"	None	RTL8821AE ac, 1x1 + BT4.0	3rd DP	1Wx1	None	None	None	USB / USB	None	Floor Stand	65W Adapter 88%	Win10 Pro 64	3-year, Onsite	10/16
10M30006US	US	AMD PRO A10-9700E	No	AMD R7 Graphics	None	8GBx1	128GB SSD M.2 PCIe NVMe	None	RTL8821AE ac, 1x1 + BT4.0	3rd DP	1Wx1	None	None	None	USB / USB	None	Floor Stand	65W Adapter 88%	Win10 Pro 64	3-year, Onsite	10/16
10M30007US	US	AMD PRO A6-9500E	No	AMD R5 Graphics	None	4GBx1	500GB 7200rpm 2.5"	None	RTL8821AE ac, 1x1 + BT4.0	None	1Wx1	None	None	None	USB / USB	None	Floor Stand	65W Adapter 88%	Win10 Pro 64	3-year, Onsite	10/16
10M30008US	US	AMD PRO A10-9700E	No	AMD R7 Graphics	None	8GBx1	500GB 7200rpm 2.5"	None	RTL8821AE ac, 1x1 + BT4.0	None	1Wx1	None	None	None	USB / USB	None	Floor Stand	65W Adapter 88%	Win10 Pro 64	3-year, Onsite	10/16
10M30009US	US	AMD PRO A12-9800E	No	AMD R7 Graphics	None	8GBx1	128GB SSD M.2 PCIe NVMe	None	RTL8821AE ac, 1x1 + BT4.0	3rd DP	1Wx1	None	None	None	USB / USB	None	Floor Stand	65W Adapter 88%	Win10 Pro 64	3-year, Onsite	10/16
10M3000AUS	US	AMD PRO A12-9800E	No	AMD R7 Graphics	None	4GBx1	128GB SSD M.2 PCIe NVMe	None	RTL8821AE ac, 1x1 + BT4.0	None	1Wx1	None	None	None	USB / USB	None	Floor Stand	65W Adapter 88%	Win10 Pro 64	3-year, Onsite	10/16
10M3000BUS	US	AMD A10-9700E	No	AMD R7 Graphics	None	4GBx1	500GB 7200rpm 2.5"	None	RTL8821AE ac, 1x1 + BT4.0	None	1Wx1	None	None	None	USB / USB	None	Floor Stand	65W Adapter 88%	Win10 Pro 64	3-year, Onsite	10/16
10M3000CUS	US	AMD PRO A10-9700E	No	AMD R7 Graphics	None	4GBx1	128GB SSD M.2 PCIe NVMe	None	RTL8821AE ac, 1x1 + BT4.0	3rd DP	1Wx1	None	None	None	USB / USB	None	Floor Stand	65W Adapter 88%	Win10 Pro 64	3-year, Onsite	10/16
10M3000DUS	US	AMD PRO A10-9700E	No	AMD R7 Graphics	None	4GBx1	500GB 7200rpm 2.5"	DVD±RW	RTL8821AE ac, 1x1 + BT4.0	HDMI	1Wx1	None	None	None	USB / USB	VESA Mount	None	65W Adapter 88%	Win10 Pro 64	3-year, Onsite	10/16
10M3000NUS	US	AMD PRO A12-8870E	No	AMD R7 Graphics	None	8GBx2	512GB SSD M.2 PCIe NVMe	None	RTL8821AE ac, 1x1 + BT4.0	None	1Wx1	None	None	None	USB / USB	None	Floor Stand	65W Adapter 88%	Win10 DG Win7 Pro 64	3-year, Onsite	01/17
10M3000PUS	US	AMD PRO A12-9800E	No	AMD R7 Graphics	None	8GBx2	512GB SSD M.2 PCIe NVMe	None	RTL8821AE ac, 1x1 + BT4.0	None	1Wx1	None	None	None	USB / USB	None	Floor Stand	65W Adapter 88%	Win10 Pro 64	3-year, Onsite	01/17
10M3000QUS	US	AMD PRO A10-8770E	No	AMD R7 Graphics	None	8GBx1	256GB SSD M.2 PCIe NVMe	None	RTL8821AE ac, 1x1 + BT4.0	None	1Wx1	None	None	None	USB / USB	None	Floor Stand	65W Adapter 88%	Win10 DG Win7 Pro 64	3-year, Onsite	01/17
10M3000RUS	US	AMD PRO A10-8770E	No	AMD R7 Graphics	None	8GBx1	500GB 7200rpm 2.5"	None	RTL8821AE ac, 1x1 + BT4.0	None	1Wx1	None	None	None	USB / USB	None	Floor Stand	65W Adapter 88%	Win10 DG Win7 Pro 64	3-year, Onsite	01/17
10M3000SUS	US	AMD PRO A10-8770E	No	AMD R7 Graphics	None	8GBx1	500GB 7200rpm 2.5"	DVD±RW	RTL8821AE ac, 1x1 + BT4.0	3rd DP	1Wx1	None	None	None	USB / USB	VESA Mount	None	65W Adapter 88%	Win10 DG Win7 Pro 64	3-year, Onsite	01/17
10M3000TUS	US	AMD PRO A10-8770E	No	AMD R7 Graphics	None	4GBx1	500GB 7200rpm 2.5"	None	RTL8821AE ac, 1x1 + BT4.0	None	1Wx1	None	None	None	USB / USB	None	Floor Stand	65W Adapter 88%	Win10 DG Win7 Pro 64	3-year, Onsite	01/17

Model	Region	Processor	vPro	Graphics	Monitor Cable	Memory	Storage(HDD/SSD)	External Optical / I/O Box	WLAN + Bluetooth	Optional Rear Ports	Speaker	Adapter Cage	Toolless Chassis Screw	Dust Filter	Keyboard / Mouse	VESA Mount	Stand	Power Supply	OS	Warranty	Ann Date (m/y)
10M3000UUS	US	AMD PRO A10-8770E	No	AMD R7 Graphics	None	8GBx1	128GB SSD M.2 PCIe NVMe	None	RTL8821AE ac, 1x1 + BT4.0	3rd DP	1Wx1	None	None	None	USB / USB	None	Floor Stand	65W Adapter 88%	Win10 DG Win7 Pro 64	3-year, Onsite	01/17
10M3000VUS	US	AMD PRO A10-8770E	No	AMD R7 Graphics	None	8GBx1	256GB SSD M.2 PCIe NVMe	None	RTL8821AE ac, 1x1 + BT4.0	3rd DP	1Wx1	None	None	None	USB / USB	None	Floor Stand	65W Adapter 88%	Win10 DG Win7 Pro 64	3-year, Onsite	01/17
10M3000WUS	US	AMD PRO A10-9700E	No	AMD R7 Graphics	None	8GBx1	256GB SSD M.2 PCIe NVMe	None	RTL8821AE ac, 1x1 + BT4.0	None	1Wx1	None	None	None	USB / USB	None	Floor Stand	65W Adapter 88%	Win10 Pro 64	3-year, Onsite	01/17
10M3000XUS	US	AMD PRO A12-8870E	No	AMD R7 Graphics	None	8GBx1	256GB SSD M.2 PCIe NVMe	None	RTL8821AE ac, 1x1 + BT4.0	3rd DP	1Wx1	None	None	None	USB / USB	None	Floor Stand	65W Adapter 88%	Win10 DG Win7 Pro 64	3-year, Onsite	01/17
10M3000YUS	US	AMD PRO A10-8770E	No	AMD R7 Graphics	None	8GBx1	500GB 7200rpm 2.5"	None	RTL8821AE ac, 1x1 + BT4.0	3rd DP	1Wx1	None	None	None	USB / USB	None	Floor Stand	65W Adapter 88%	Win10 DG Win7 Pro 64	3-year, Onsite	01/17
10M30010US	US	AMD PRO A10-9700E	No	AMD R7 Graphics	None	4GBx1	500GB 7200rpm 2.5"	None	RTL8821AE ac, 1x1 + BT4.0	None	1Wx1	None	None	None	USB / USB	None	Floor Stand	65W Adapter 88%	Win10 Pro 64	3-year, Onsite	01/17
10M30011US	US	AMD PRO A12-8870E	No	AMD R7 Graphics	None	8GBx1	128GB SSD M.2 PCIe NVMe	None	RTL8821AE ac, 1x1 + BT4.0	None	1Wx1	None	None	None	USB / USB	None	Floor Stand	65W Adapter 88%	Win10 DG Win7 Pro 64	3-year, Onsite	01/17

Model	Region	Processor	vPro	Graphics	Monitor Cable	Memory	Storage(HDD/SSD)	External Optical / I/O Box	WLAN + Bluetooth	Optional Rear Ports	Speaker	Adapter Cage	Toolless Chassis Screw	Dust Filter	Keyboard / Mouse	VESA Mount	Stand	Power Supply	OS	Warranty	Ann Date (m/y)
10RB0000US	US	AMD PRO A6-8570E	No	AMD R5 Graphics	None	4GBx1	32GB SSD M.2 SATA	None	RTL8821AE ac, 1x1 + BT4.0	None	1Wx1	None	None	None	USB / USB	None	Floor Stand	65W Adapter 88%	WES 7 V2	3-year, Onsite	07/17
10RB0001US	US	AMD PRO A10-8770E	No	AMD R7 Graphics	None	4GBx1	32GB SSD M.2 SATA	None	RTL8821AE ac, 1x1 + BT4.0	None	1Wx1	None	None	None	USB / USB	None	Floor Stand	65W Adapter 88%	Windows 10 IoT Enterprise	3-year, Onsite	07/17
10RB0002US	US	AMD PRO A10-8770E	No	AMD R7 Graphics	None	4GBx1	32GB SSD M.2 SATA	None	RTL8821AE ac, 1x1 + BT4.0	HDMI	1Wx1	None	None	None	USB / USB	None	Floor Stand	65W Adapter 88%	WES 7 V2	3-year, Onsite	07/17
10RB0003US	US	AMD PRO A10-8770E	No	AMD R7 Graphics	None	4GBx1	32GB SSD M.2 SATA	None	RTL8821AE ac, 1x1 + BT4.0	3rd DP	1Wx1	None	None	None	USB / USB	None	Floor Stand	65W Adapter 88%	WES 7 V2	3-year, Onsite	07/17
10RB0004US	US	AMD PRO A10-8770E	No	AMD R7 Graphics	None	4GBx1	32GB SSD M.2 SATA	None	RTL8821AE ac, 1x1 + BT4.0	Serial	1Wx1	None	None	None	USB / USB	None	Floor Stand	65W Adapter 88%	LeTOS V2	3-year, Onsite	07/17
10RB0005US	US	AMD PRO A10-8770E	No	AMD R7 Graphics	None	4GBx1	32GB SSD M.2 SATA	None	RTL8821AE ac, 1x1 + BT4.0	3rd DP	1Wx1	None	None	None	USB / USB	None	Floor Stand	65W Adapter 88%	LeTOS V2	3-year, Onsite	07/17
10RB0006US	US	AMD PRO A6-8570E	No	AMD R5 Graphics	None	4GBx1	32GB SSD M.2 SATA	None	RTL8821AE ac, 1x1 + BT4.0	Serial	1Wx1	None	None	None	USB / USB	None	Floor Stand	65W Adapter 88%	LeTOS V2	3-year, Onsite	07/17
10RB0007US	US	AMD PRO A6-8570E	No	AMD R5 Graphics	None	4GBx1	32GB SSD M.2 SATA	None	RTL8821AE ac, 1x1 + BT4.0	VGA	1Wx1	None	None	None	USB / USB	None	Floor Stand	65W Adapter 88%	Windows 10 IoT Enterprise	3-year, Onsite	07/17
10RB0008US	US	AMD PRO A6-8570E	No	AMD R5 Graphics	None	4GBx1	32GB SSD M.2 SATA	None	RTL8821AE ac, 1x1 + BT4.0	HDMI	1Wx1	None	None	None	USB / USB	None	Floor Stand	65W Adapter 88%	Windows 10 IoT Enterprise	3-year, Onsite	07/17
10RB0009US	US	AMD PRO A10-8770E	No	AMD R7 Graphics	None	4GBx1	32GB SSD M.2 SATA	None	RTL8821AE ac, 1x1 + BT4.0	VGA	1Wx1	None	None	None	USB / USB	None	Floor Stand	65W Adapter 88%	WES 7 V2	3-year, Onsite	07/17
10RB000AUS	US	AMD PRO A10-8770E	No	AMD R7 Graphics	None	4GBx1	32GB SSD M.2 SATA	None	RTL8821AE ac, 1x1 + BT4.0	3rd DP	1Wx1	None	None	None	USB / USB	None	Floor Stand	65W Adapter 88%	Windows 10 IoT Enterprise	3-year, Onsite	07/17
10RB000BUS	US	AMD PRO A6-8570E	No	AMD R5 Graphics	None	4GBx1	32GB SSD M.2 SATA	None	RTL8821AE ac, 1x1 + BT4.0	Serial	1Wx1	None	None	None	USB / USB	None	Floor Stand	65W Adapter 88%	Windows 10 IoT Enterprise	3-year, Onsite	07/17
10RB000CUS	US	AMD PRO A10-8770E	No	AMD R7 Graphics	None	4GBx1	32GB SSD M.2 SATA	None	RTL8821AE ac, 1x1 + BT4.0	VGA	1Wx1	None	None	None	USB / USB	None	Floor Stand	65W Adapter 88%	LeTOS V2	3-year, Onsite	07/17
10RB000DUS	US	AMD PRO A10-8770E	No	AMD R7 Graphics	None	4GBx1	32GB SSD M.2 SATA	None	RTL8821AE ac, 1x1 + BT4.0	Serial	1Wx1	None	None	None	USB / USB	None	Floor Stand	65W Adapter 88%	Windows 10 IoT Enterprise	3-year, Onsite	07/17
10RB000EUS	US	AMD PRO A6-8570E	No	AMD R5 Graphics	None	4GBx1	32GB SSD M.2 SATA	None	RTL8821AE ac, 1x1 + BT4.0	None	1Wx1	None	None	None	USB / USB	None	Floor Stand	65W Adapter 88%	LeTOS V2	3-year, Onsite	07/17
10RB000FUS	US	AMD PRO A6-8570E	No	AMD R5 Graphics	None	4GBx1	32GB SSD M.2 SATA	None	RTL8821AE ac, 1x1 + BT4.0	None	1Wx1	None	None	None	USB / USB	None	Floor Stand	65W Adapter 88%	Windows 10 IoT Enterprise	3-year, Onsite	07/17
10RB000GUS	US	AMD PRO A10-8770E	No	AMD R7 Graphics	None	4GBx1	32GB SSD M.2 SATA	None	RTL8821AE ac, 1x1 + BT4.0	HDMI	1Wx1	None	None	None	USB / USB	None	Floor Stand	65W Adapter 88%	Windows 10 IoT Enterprise	3-year, Onsite	07/17
10RB000HUS	US	AMD PRO A6-8570E	No	AMD R5 Graphics	None	4GBx1	32GB SSD M.2 SATA	None	RTL8821AE ac, 1x1 + BT4.0	Serial	1Wx1	None	None	None	USB / USB	None	Floor Stand	65W Adapter 88%	WES 7 V2	3-year, Onsite	07/17
10RB000JUS	US	AMD PRO A6-8570E	No	AMD R5 Graphics	None	4GBx1	32GB SSD M.2 SATA	None	RTL8821AE ac, 1x1 + BT4.0	3rd DP	1Wx1	None	None	None	USB / USB	None	Floor Stand	65W Adapter 88%	Windows 10 IoT Enterprise	3-year, Onsite	07/17

Model	Region	Processor	vPro	Graphics	Monitor Cable	Memory	Storage(HDD/SSD)	External Optical / I/O Box	WLAN + Bluetooth	Optional Rear Ports	Speaker	Adapter Cage	Toolless Chassis Screw	Dust Filter	Keyboard / Mouse	VESA Mount	Stand	Power Supply	OS	Warranty	Ann Date (m/y)
10RB000KUS	US	AMD PRO A6-8570E	No	AMD R5 Graphics	None	4GBx1	32GB SSD M.2 SATA	None	RTL8821Ae ac, 1x1 + BT4.0	3rd DP	1Wx1	None	None	None	USB / USB	None	Floor Stand	65W Adapter 88%	LeTOS V2	3-year, Onsite	07/17
10RB000LUS	US	AMD PRO A10-8770E	No	AMD R7 Graphics	None	4GBx1	32GB SSD M.2 SATA	None	RTL8821Ae ac, 1x1 + BT4.0	VGA	1Wx1	None	None	None	USB / USB	None	Floor Stand	65W Adapter 88%	Windows 10 IoT Enterprise	3-year, Onsite	07/17
10RB000MUS	US	AMD PRO A10-8770E	No	AMD R7 Graphics	None	4GBx1	32GB SSD M.2 SATA	None	RTL8821Ae ac, 1x1 + BT4.0	None	1Wx1	None	None	None	USB / USB	None	Floor Stand	65W Adapter 88%	LeTOS V2	3-year, Onsite	07/17
10RB000NUS	US	AMD PRO A6-8570E	No	AMD R5 Graphics	None	4GBx1	32GB SSD M.2 SATA	None	RTL8821Ae ac, 1x1 + BT4.0	HDMI	1Wx1	None	None	None	USB / USB	None	Floor Stand	65W Adapter 88%	LeTOS V2	3-year, Onsite	07/17
10RB000PUS	US	AMD PRO A6-8570E	No	AMD R5 Graphics	None	4GBx1	32GB SSD M.2 SATA	None	RTL8821Ae ac, 1x1 + BT4.0	HDMI	1Wx1	None	None	None	USB / USB	None	Floor Stand	65W Adapter 88%	WES 7 V2	3-year, Onsite	07/17
10RB000QUS	US	AMD PRO A10-8770E	No	AMD R7 Graphics	None	4GBx1	32GB SSD M.2 SATA	None	RTL8821Ae ac, 1x1 + BT4.0	Serial	1Wx1	None	None	None	USB / USB	None	Floor Stand	65W Adapter 88%	WES 7 V2	3-year, Onsite	07/17
10RB000RUS	US	AMD PRO A10-8770E	No	AMD R7 Graphics	None	4GBx1	32GB SSD M.2 SATA	None	RTL8821Ae ac, 1x1 + BT4.0	None	1Wx1	None	None	None	USB / USB	None	Floor Stand	65W Adapter 88%	WES 7 V2	3-year, Onsite	07/17
10RB000SUS	US	AMD PRO A6-8570E	No	AMD R5 Graphics	None	4GBx1	32GB SSD M.2 SATA	None	RTL8821Ae ac, 1x1 + BT4.0	VGA	1Wx1	None	None	None	USB / USB	None	Floor Stand	65W Adapter 88%	LeTOS V2	3-year, Onsite	07/17
10RB000TUS	US	AMD PRO A6-8570E	No	AMD R5 Graphics	None	4GBx1	32GB SSD M.2 SATA	None	RTL8821Ae ac, 1x1 + BT4.0	3rd DP	1Wx1	None	None	None	USB / USB	None	Floor Stand	65W Adapter 88%	WES 7 V2	3-year, Onsite	07/17
10RB000UUS	US	AMD PRO A10-8770E	No	AMD R7 Graphics	None	4GBx1	32GB SSD M.2 SATA	None	RTL8821Ae ac, 1x1 + BT4.0	HDMI	1Wx1	None	None	None	USB / USB	None	Floor Stand	65W Adapter 88%	LeTOS V2	3-year, Onsite	07/17
10RB000VUS	US	AMD PRO A6-8570E	No	AMD R5 Graphics	None	4GBx1	32GB SSD M.2 SATA	None	RTL8821Ae ac, 1x1 + BT4.0	VGA	1Wx1	None	None	None	USB / USB	None	Floor Stand	65W Adapter 88%	WES 7 V2	3-year, Onsite	07/17





# ThinkCentre M79 SFF Platform Specifications

Product Specifications Reference (PSREF)

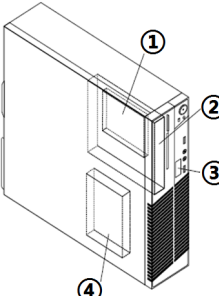
Processor	AMD A4, A6, A8, or A10 series APUs	<ul style="list-style-type: none"> <li>• Cable lock to physically lock both keyboard and mouse (optional)</li> <li>• Power-on password</li> <li>• Boot without keyboard and mouse</li> <li>• Individual USB port disablement</li> <li>• Optional Chassis intrusion switch</li> </ul>																																																																								
	<table border="1"> <thead> <tr> <th>APU</th> <th>Cores</th> <th>Frequency (Max/Base)</th> <th>L2 Cache</th> <th>Memory Types</th> <th>Integrated Graphics</th> </tr> </thead> <tbody> <tr> <td>A4-6300B</td> <td>2</td> <td>3.9 / 3.7</td> <td>1MB</td> <td>DDR3-1600</td> <td>HD 8370D</td> </tr> <tr> <td>A4 PRO-7300B</td> <td>2</td> <td>4.0 / 3.8</td> <td>1MB</td> <td>DDR3-1600</td> <td>HD 8470D</td> </tr> <tr> <td>PRO A4-8350B</td> <td>2</td> <td>3.9 / 3.5</td> <td>1MB</td> <td>DDR3-1866</td> <td>Radeon R5 Series</td> </tr> <tr> <td>A6-6400B</td> <td>2</td> <td>4.1 / 3.9</td> <td>1MB</td> <td>DDR3-1866</td> <td>HD 8470D</td> </tr> <tr> <td>A6 PRO-7400B</td> <td>2</td> <td>3.9 / 3.5</td> <td>1MB</td> <td>DDR3-1866</td> <td>Radeon R5 Series</td> </tr> <tr> <td>PRO A6-8550B</td> <td>2</td> <td>4.0 / 3.7</td> <td>1MB</td> <td>DDR3-2133</td> <td>Radeon R5 Series</td> </tr> <tr> <td>A8-6500B</td> <td>4</td> <td>4.1 / 3.5</td> <td>4MB</td> <td>DDR3-1866</td> <td>HD 8570D</td> </tr> <tr> <td>A8 PRO-7600B</td> <td>4</td> <td>3.8 / 3.1</td> <td>4MB</td> <td>DDR3-2133</td> <td>Radeon R7 Series</td> </tr> <tr> <td>PRO A8-8650B</td> <td>4</td> <td>3.9 / 3.2</td> <td>4MB</td> <td>DDR3-2133</td> <td>Radeon R7 Series</td> </tr> <tr> <td>A10 PRO-7800B</td> <td>4</td> <td>3.9 / 3.5</td> <td>4MB</td> <td>DDR3-2133</td> <td>Radeon R7 Series</td> </tr> <tr> <td>PRO A10-8750B</td> <td>4</td> <td>4.0 / 3.6</td> <td>4MB</td> <td>DDR3-2133</td> <td>Radeon R7 Series</td> </tr> </tbody> </table>	APU	Cores	Frequency (Max/Base)	L2 Cache	Memory Types	Integrated Graphics	A4-6300B	2	3.9 / 3.7	1MB	DDR3-1600	HD 8370D	A4 PRO-7300B	2	4.0 / 3.8	1MB	DDR3-1600	HD 8470D	PRO A4-8350B	2	3.9 / 3.5	1MB	DDR3-1866	Radeon R5 Series	A6-6400B	2	4.1 / 3.9	1MB	DDR3-1866	HD 8470D	A6 PRO-7400B	2	3.9 / 3.5	1MB	DDR3-1866	Radeon R5 Series	PRO A6-8550B	2	4.0 / 3.7	1MB	DDR3-2133	Radeon R5 Series	A8-6500B	4	4.1 / 3.5	4MB	DDR3-1866	HD 8570D	A8 PRO-7600B	4	3.8 / 3.1	4MB	DDR3-2133	Radeon R7 Series	PRO A8-8650B	4	3.9 / 3.2	4MB	DDR3-2133	Radeon R7 Series	A10 PRO-7800B	4	3.9 / 3.5	4MB	DDR3-2133	Radeon R7 Series	PRO A10-8750B	4	4.0 / 3.6	4MB	DDR3-2133	Radeon R7 Series	<p>Keyboard</p> <p>Some: Preferred Pro USB Keyboard (USB connector), Lenovo logo          Some: Lenovo USB Fingerprint Keyboard (USB connector)          Some: Ultralim Plus Wireless Keyboard (2.4GHz via USB receiver), black</p> <p>Mouse</p> <p>Some: Enhanced Optical USB Mouse, black, Lenovo logo          Some: Ultralim Plus Wireless Mouse (2.4GHz via USB receiver), black</p> <p>Mechanical</p> <ul style="list-style-type: none"> <li>• Business black color; metal case, 11L</li> <li>• 13.2" W X 15.0" D X 3.9" H</li> <li>• 335mm W X 382mm D X 101mm H</li> <li>• 14.6 lb (6.6 kg) in maximum configuration</li> <li>Bay 1: N/A, N/A, internal, opt SSD</li> <li>Bay 2: 5.25", 1.6" high, external, std optical</li> <li>Bay 3: N/A, N/A, external, opt reader</li> <li>Bay 4: 3.5", 1" high, internal, std disk</li> </ul> <p>*bay only available on models with HDD/SSD/reader installed</p> <p>Slot 1: Low Profile, PCI Express 3.0 x16 (40w max)          Slot 2: Low Profile, PCIe 2.0 x1          Slot 2: Low Profile, PCIe 2.0 x1          Slot 4: Low Profile, 32-bit PCI 2.3</p> <p>Floor Stand</p> <p>Optional system floor stand for vertical orientation</p>  <p>Power supply</p> <p>Some: 180 watts, autosensing, 100-240V (50-60Hz)          Some: 240 watts, autosensing, 100-240V (50-60Hz)          Some: 240 watts, autosensing, 85% PSU, 100-240V (50-60Hz)</p> <p>Limited warranty<sup>3</sup></p> <p>Some: <b>3-years, limited onsite service</b> / service upgrades available          Some: <b>3-years, limited onsite service, OID</b> (Onsite International Delivery) / service upgrades available          For Lenovo service upgrade options, please go to S-TC sheet</p> <p>Preload</p> <p>Some: Windows<sup>®</sup> 7 Professional 32/64 preinstalled through downgrade rights in Windows 8.1 Pro 64-bit          Some: Windows 7 Professional 32          Some: Windows 7 Professional 64</p> <p><b>Ready to install applications</b> (only some listed)</p> <ul style="list-style-type: none"> <li>• Rescue and Recovery™</li> <li>• Password Manager</li> </ul> <p><b>Preloaded applications</b> (only some listed)</p> <ul style="list-style-type: none"> <li>• ThinkVantage<sup>®</sup> Product Recovery</li> <li>• ThinkVantage System Update</li> <li>• ThinkVantage Communication Utility</li> <li>• ThinkVantage Device Experience</li> <li>• Desktop Power Manager</li> <li>• View Management Utility</li> <li>• Lenovo Solution Center</li> <li>• Lenovo Message Center Plus</li> <li>• Norton™ Internet Security (30 days of virus definitions)</li> <li>• Adobe<sup>®</sup> Reader<sup>®</sup></li> <li>• Skype™</li> <li>• Microsoft Office preloaded; purchase a product key to activate</li> <li>• Cyberlink Power2Go (DVD±RW)</li> <li>• Cyberlink PowerProducer (DVD±RW)</li> <li>• Evernote<sup>®</sup></li> <li>• Nitro Pro</li> </ul> <p>Some: Windows 8.1 64-bit          Some: Windows 8.1 Pro 64-bit          Some: Windows 10 Pro 64-bit</p> <p><b>Preloaded applications</b> (only some listed)</p> <ul style="list-style-type: none"> <li>• Desktop Power Manager</li> <li>• Lenovo Solution Center</li> <li>• Lenovo Companion</li> <li>• Lenovo SHAREit</li> <li>• Lenovo REACHit</li> <li>• McAfee<sup>®</sup> LiveSafe™(30-day trial)</li> <li>• Microsoft Office preloaded; purchase a product key to activate</li> <li>• Cyberlink PowerDVD (DVD±RW, DVD)</li> <li>• PowerDVD Create (DVD±RW)</li> <li>• PC Device Stage</li> </ul>
APU	Cores	Frequency (Max/Base)	L2 Cache	Memory Types	Integrated Graphics																																																																					
A4-6300B	2	3.9 / 3.7	1MB	DDR3-1600	HD 8370D																																																																					
A4 PRO-7300B	2	4.0 / 3.8	1MB	DDR3-1600	HD 8470D																																																																					
PRO A4-8350B	2	3.9 / 3.5	1MB	DDR3-1866	Radeon R5 Series																																																																					
A6-6400B	2	4.1 / 3.9	1MB	DDR3-1866	HD 8470D																																																																					
A6 PRO-7400B	2	3.9 / 3.5	1MB	DDR3-1866	Radeon R5 Series																																																																					
PRO A6-8550B	2	4.0 / 3.7	1MB	DDR3-2133	Radeon R5 Series																																																																					
A8-6500B	4	4.1 / 3.5	4MB	DDR3-1866	HD 8570D																																																																					
A8 PRO-7600B	4	3.8 / 3.1	4MB	DDR3-2133	Radeon R7 Series																																																																					
PRO A8-8650B	4	3.9 / 3.2	4MB	DDR3-2133	Radeon R7 Series																																																																					
A10 PRO-7800B	4	3.9 / 3.5	4MB	DDR3-2133	Radeon R7 Series																																																																					
PRO A10-8750B	4	4.0 / 3.6	4MB	DDR3-2133	Radeon R7 Series																																																																					
Memory	32GB max, UDIMM, PC3-12800 1600MHz DDR3, four 240-pin DIMM sockets																																																																									
Disk	Some: SATA 6.0Gb/s, 3.5" Wide, 7200 rpm Some: hybrid hard disk / with 8GB MLC NAND flash memory, SATA 6.0Gb/s, 5400 rpm 2.5" wide or 7200 rpm 3.5" wide																																																																									
Optical	Some: Solid State Drive (SSD) / SATA 6.0Gb/s, 2.5" Wide Some: DVD-ROM SATA 1.5Gb/s Drive Some: Super Multi-Burner DVD±RW SATA 1.5Gb/s Drive																																																																									
Onboard SATA	SATA 6.0Gb/s controller, three connectors on planar, RAID 0/1 support (only applicable on dual SSD models)																																																																									
Media reader	Optional 7-in-1 single slot media card reader																																																																									
Graphics	<p><b>AMD Radeon™ Graphics</b> in processor, uses main memory, one VGA, one DisplayPort™, one optional DP, supports up to three independent displays, works along with optional discrete graphics to support up to five independent displays; <i>Maximum resolution: 1920x1200 (VGA) @60Hz; 2560x2048 (DisplayPort) @60Hz</i></p> <p>Some: <b>AMD Radeon HD 8570</b>, DirectX 11, 3D Hardware Acceleration, 2GB, PCI Express 3.0 x16 adapter (8x elec), one VGA, one HDMI, 40W; <i>Max resolution: 4096x2160 (HDMI) @24Hz; 2048x1536 (VGA) @85Hz</i></p> <p>Some: <b>NVIDIA<sup>®</sup> GeForce<sup>®</sup> GT 620</b>, DirectX 11, 3D Hardware Acceleration, 1GB, PCI Express 2.0 x16 adapter, one VGA, one DisplayPort, 30 watts; <i>Max resolution: 2560x1600 (DisplayPort) @60Hz; 2048x1536 (VGA) @85Hz</i></p> <p>Some: <b>AMD Radeon™ HD 7450</b>, DirectX 11, 3D Hardware Acceleration, 1GB, PCI Express 2.0 x16 adapter, one DVI-I (includes DVI-to-VGA dongle), one DisplayPort, 25 watts; <i>Max resolution: 2560x1600 (DisplayPort, DVI-I) @60Hz</i></p>																																																																									
DP cable	Optional DisplayPort to DVI-D monitor cable																																																																									
Chipset	<b>AMD A78 FCH</b>																																																																									
Front ports	Two USB 2.0, microphone (stereo, 3.5mm), headphone (stereo, 3.5mm)																																																																									
Rear ports	Up to six USB ports (2x USB 3.0 + 2x USB 2.0 + 2x optional USB 2.0), serial (9-pin), optional 2nd serial (9-pin), optional parallel (25-pin), ethernet (RJ-45), VGA, DisplayPort (1x standard + 1x optional), two PS/2 ports																																																																									
Rear audio ports	Line-in (stereo, 3.5mm), line-out (stereo, 3.5mm), microphone (stereo, 3.5mm)																																																																									
IEEE 1394	Optional FireWire PCIe adapter, 1394a-2000, 400Mbps, two 6-pin ports on rear																																																																									
Audio support	High Definition (HD) Audio, Realtek ALC662 / internal speaker (1watt)																																																																									
WLAN <sup>13</sup>	Some: 11b/g/n wireless, Realtek RTL8723BE, Wi-Fi + BT 4.0 combo, 1x1 Some: 11b/g/n wireless, Realtek RTL8192EE, Wi-Fi + BT 4.0 combo, 2x2 Some: 11ac/b/g/n wireless, Broadcom BCM4352, 2.4/5GHz, Wi-Fi + BT 4.0, 2x2																																																																									
Bluetooth™	Some: Bluetooth 4.0 wireless, integrated in Wi-Fi + Bluetooth combo adapter																																																																									
Ethernet	One gigabit ethernet port, Realtek 8111EPV, Wake on LAN <sup>®</sup>																																																																									
Modem	None																																																																									
Manageability	Enhanced Manageability with DASH 1.1																																																																									
Security chip	Trusted Platform Module, TCG 1.2-compliant																																																																									
Security features	<ul style="list-style-type: none"> <li>• Padlock loop (in rear for opt padlock)</li> <li>• Security slot (in rear for optional Kensington<sup>®</sup> MicroSaver<sup>®</sup> cable)</li> <li>• Administrator password</li> <li>• Hard disk password</li> <li>• Boot sequence control</li> </ul>																																																																									
Environment	ENERGY STAR <sup>®</sup> 6.0 (Need 85% PSU and Windows OS); EPEAT™ Gold rating (Need 85% PSU and Windows OS); GREENGUARD <sup>®</sup> ; RoHS-compliant; Cisco EnergyWise compatible; ErP Lot 3																																																																									
Accessories	For compatible accessories, please go to TC-AQP sheet																																																																									



Model	Region	Processor	vPro	Graphics	Monitor Cable	Memory	Storage	Optical	Media Reader	WLAN + Bluetooth	Optional Rear Ports	Chassis Intrusion Switch	Cable Lock	Keyboard / Mouse	Stand	Power Supply	Operating System	Warranty	Ann Date (m/y)
10CV0000US	US	AMD A6-6400B	No	AMD HD 8470D	None	4GBx1	500GB 7200rpm 3.5"	DVD±RW	None	None	None	None	None	USB / USB	None	180W	Win8.1 DG Win7 Pro 64	3-year, Onsite	07/14
10CV0001US	US	AMD A8-6500B	No	AMD HD 8570D	None	4GBx1	500GB 7200rpm 3.5"	DVD±RW	None	None	None	None	None	USB / USB	None	180W	Win8.1 DG Win7 Pro 64	3-year, Onsite	07/14
10CV0002US	US	AMD A8 PRO-7600B	No	AMD R7 Graphics	None	4GBx1	500GB 7200rpm 3.5"	DVD±RW	None	None	None	None	None	USB / USB	None	240W	Win8.1 DG Win7 Pro 64	3-year, Onsite	07/14
10CV0003US	US	AMD A4-6300B	No	AMD HD 8370D	None	4GBx1	500GB 7200rpm 3.5"	DVD	None	None	None	None	None	USB / USB	None	180W	Win8.1 DG Win7 Pro 64	3-year, Onsite	10/14
10CV000TUS	US	AMD A10 PRO-7800B	No	AMD R7 Graphics	None	4GBx1	500GB 7200rpm 3.5"	DVD±RW	9-in-1	None	None	None	None	USB / USB	Floor Stand	180W	Win8.1 DG Win7 Pro 64	3-year, Onsite	02/15
10CV000UUS	US	AMD A10 PRO-7800B	No	AMD R7 Graphics	None	8GBx1	500GB 7200rpm 3.5"	DVD±RW	9-in-1	None	None	None	None	USB / USB	Floor Stand	180W	Win8.1 DG Win7 Pro 64	3-year, Onsite	02/15
10CV000VUS	US	AMD A6 PRO-7400B	No	AMD R5 Graphics	None	4GBx1	500GB 7200rpm 3.5"	DVD±RW	9-in-1	None	None	None	None	USB / USB	None	180W	Win8.1 DG Win7 Pro 64	3-year, Onsite	02/15
10CV000WUS	US	AMD A8 PRO-7600B	No	AMD R7 Graphics	None	4GBx1	500GB 7200rpm 3.5"	DVD±RW	None	None	2 Rear USB 2.0	None	Cable Lock	USB / USB	Floor Stand	180W	Win8.1 DG Win7 Pro 64	3-year, Onsite	02/15
10CV000XUS	US	AMD A8 PRO-7600B	No	AMD R7 Graphics	None	4GBx1	500GB 7200rpm 3.5"	DVD±RW	None	None	None	Switch	None	USB / USB	Floor Stand	180W	Win8.1 DG Win7 Pro 64	3-year, Onsite	07/15

Model	Region	Processor	vPro	Graphics	Monitor Cable	Memory	Storage	Optical	Media Reader	WLAN + Bluetooth	Optional Rear Ports	Chassis Intrusion Switch	Cable Lock	Keyboard / Mouse	Stand	Power Supply	Operating System	Warranty	Ann Date (m/y)
10JB0005US	US	AMD PRO A10-8750B	No	AMD R7 Graphics	None	4GBx1	500GB 7200rpm 3.5"	DVD±RW	None	RTL8723BE b/g/n, 1x1 + BT4.0	None	Switch	Cable Lock	USB / USB	None	240W 85%	Win10 DG Win7 Pro 64	3-year, Onsite	10/15
10JB0006US	US	AMD PRO A4-8350B	No	AMD R5 Graphics	None	4GBx1	500GB 7200rpm 3.5"	DVD±RW	None	RTL8723BE b/g/n, 1x1 + BT4.0	2nd DP	Switch	Cable Lock	USB / USB	None	240W 85%	Win10 DG Win7 Pro 64	3-year, Onsite	10/15
10JB0007US	US	AMD PRO A8-8650B	No	AMD R7 Graphics	None	4GBx1	500GB 7200rpm 3.5"	DVD±RW	None	RTL8723BE b/g/n, 1x1 + BT4.0	2nd DP + 1394	Switch	Cable Lock	USB / USB	None	240W 85%	Win10 DG Win7 Pro 64	3-year, Onsite	10/15
10JB0008US	US	AMD PRO A6-8550B	No	AMD R5 Graphics	None	4GBx1	500GB 7200rpm 3.5"	DVD±RW	None	RTL8723BE b/g/n, 1x1 + BT4.0	2nd DP	Switch	Cable Lock	USB / USB	None	240W 85%	Win10 DG Win7 Pro 64	3-year, Onsite	10/15
10JB0009US	US	AMD A4 PRO-7300B	No	AMD HD 8470D	DP to DVI	4GBx1	500GB 7200rpm 3.5"	DVD±RW	None	RTL8723BE b/g/n, 1x1 + BT4.0	None	None	None	USB / USB	None	240W 85%	Win10 Pro 64	3-year, Onsite	09/15
10JB000AUS	US	AMD A6 PRO-7400B	No	AMD R5 Graphics	DP to DVI	4GBx1	500GB 7200rpm 3.5"	DVD±RW	None	RTL8723BE b/g/n, 1x1 + BT4.0	None	None	None	USB / USB	None	240W 85%	Win10 Pro 64	3-year, Onsite	09/15
10JB000BUS	US	AMD A4 PRO-7300B	No	AMD HD 8470D	DP to DVI	4GBx1	500GB 7200rpm 3.5"	DVD±RW	None	RTL8723BE b/g/n, 1x1 + BT4.0	None	None	None	USB / USB	None	240W 85%	Win10 DG Win7 Pro 64	3-year, Onsite	10/15
10JB000CUS	US	AMD A6 PRO-7400B	No	AMD R5 Graphics	DP to DVI	4GBx1	500GB 7200rpm 3.5"	DVD±RW	None	RTL8723BE b/g/n, 1x1 + BT4.0	None	None	None	USB / USB	None	240W 85%	Win10 DG Win7 Pro 64	3-year, Onsite	10/15
10JB000DUS	US	AMD A10 PRO-7800B	No	AMD R7 Graphics	DP to DVI	4GBx1	500GB 7200rpm 3.5"	DVD±RW	None	RTL8723BE b/g/n, 1x1 + BT4.0	None	None	None	USB / USB	None	240W 85%	Win10 Pro 64	3-year, Onsite	09/15
10JB000EUS	US	AMD A10 PRO-7800B	No	AMD R7 Graphics	DP to DVI	4GBx1	500GB 7200rpm 3.5"	DVD±RW	None	RTL8723BE b/g/n, 1x1 + BT4.0	None	None	None	USB / USB	None	240W 85%	Win10 DG Win7 Pro 64	3-year, Onsite	10/15
10JB000FUS	US	AMD A8 PRO-7600B	No	AMD R7 Graphics	DP to DVI	4GBx1	500GB 7200rpm 3.5"	DVD±RW	None	RTL8723BE b/g/n, 1x1 + BT4.0	None	None	None	USB / USB	None	240W 85%	Win10 Pro 64	3-year, Onsite	09/15
10JB000GUS	US	AMD A8 PRO-7600B	No	AMD R7 Graphics	DP to DVI	4GBx1	500GB 7200rpm 3.5"	DVD±RW	None	RTL8723BE b/g/n, 1x1 + BT4.0	None	None	None	USB / USB	None	240W 85%	Win10 DG Win7 Pro 64	3-year, Onsite	10/15
10JB000HUS	US	AMD A10 PRO-7800B	No	AMD R7 Graphics	None	4GBx1	500GB 7200rpm 3.5"	DVD±RW	9-in-1	None	None	None	None	USB / USB	None	240W 85%	Win10 DG Win7 Pro 64	3-year, Onsite	12/15
10JB000JUS	US	AMD A8 PRO-7600B	No	AMD R7 Graphics	None	4GBx1	500GB 7200rpm 3.5"	DVD±RW	9-in-1	None	None	None	None	USB / USB	None	240W 85%	Win10 DG Win7 Pro 64	3-year, Onsite	12/15
10JB000KUS	US	AMD A4 PRO-7300B	No	AMD HD 8470D	None	4GBx1	500GB 7200rpm 3.5"	DVD±RW	9-in-1	None	None	None	None	USB / USB	None	240W 85%	Win10 DG Win7 Pro 64	3-year, Onsite	12/15
10JB000LUS	US	AMD A6 PRO-7400B	No	AMD R5 Graphics	None	4GBx1	500GB 7200rpm 3.5"	DVD±RW	9-in-1	None	None	None	None	USB / USB	None	240W 85%	Win10 DG Win7 Pro 64	3-year, Onsite	12/15

Model	Region	Processor	vPro	Graphics	Monitor Cable	Memory	Storage	Optical	Media Reader	WLAN + Bluetooth	Optional Rear Ports	Chassis Intrusion Switch	Cable Lock	Keyboard / Mouse	Stand	Power Supply	Operating System	Warranty	Ann Date (m/y)
10CT0006US	US	AMD A4-6300B	No	AMD HD 8370D	None	2GBx1	250GB 7200rpm 3.5"	DVD	None	None	None	Switch	None	USB / USB	None	240W 85%	Win7 Pro 32	3-year, Onsite	07/14
10CT0007US	US	AMD A6 PRO-7400B	No	AMD R5 Graphics	None	2GBx1	500GB 7200rpm 3.5"	DVD±RW	None	None	None	Switch	None	USB / USB	None	240W 85%	Win7 Pro 32	3-year, Onsite	07/14
10CT0008US	US	AMD A6-6400B	No	AMD HD 8470D	None	4GBx1	500GB 7200rpm 3.5"	DVD±RW	None	None	None	None	None	USB / USB	None	240W 85%	Win8.1 DG Win7 Pro 64	3-year, Onsite	08/14
10CT0009US	US	AMD A6-6400B	No	AMD HD 8470D	None	4GBx1	500GB 7200rpm 3.5"	DVD±RW	None	RTL8723BE b/g/n, 1x1 + BT4.0	None	None	None	USB / USB	None	240W 85%	Win8.1 DG Win7 Pro 64	3-year, Onsite	08/14
10CT000AUS	US	AMD A8 PRO-7600B	No	AMD R7 Graphics	None	8GBx1	500GB 7200rpm 3.5"	DVD±RW	None	None	None	None	None	USB / USB	None	240W 85%	Win8.1 DG Win7 Pro 64	3-year, Onsite	08/14
10CT000BUS	US	AMD A8 PRO-7600B	No	GT 620 1GB	None	8GBx1	500GB 7200rpm 3.5"	DVD±RW	None	RTL8723BE b/g/n, 1x1 + BT4.0	None	None	None	USB / USB	None	240W 85%	Win8.1 DG Win7 Pro 64	3-year, Onsite	08/14

Model	Region	Processor	vPro	Graphics	Monitor Cable	Memory	Storage	Optical	Media Reader	WLAN + Bluetooth	Optional Rear Ports	Chassis Intrusion Switch	Cable Lock	Keyboard / Mouse	Stand	Power Supply	Operating System	Warranty	Ann Date (m/y)
10CW000BUS	US	AMD A4-6300B	No	AMD HD 8370D	None	4GBx1	500GB 7200rpm 3.5"	DVD±RW	None	None	None	None	None	USB / USB	None	180W	Win8.1 DG Win7 Pro 64	3-year, Onsite	08/14

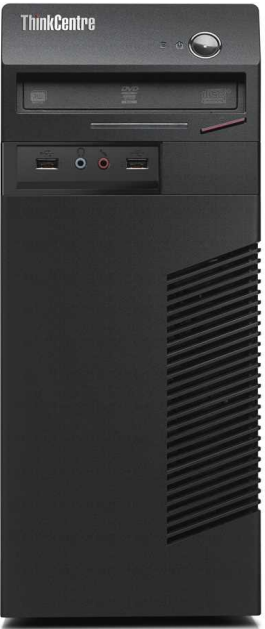

# ThinkCentre M79 Tower Platform Specifications

Product Specifications Reference (PSREF)

Processor	AMD A4, A6, A8, or A10 series APUs	<ul style="list-style-type: none"> <li>• Cable lock to physically lock both keyboard and mouse (optional)</li> <li>• Power-on password</li> <li>• Boot without keyboard and mouse</li> <li>• Individual USB port disablement</li> <li>• Optional <i>Chassis intrusion switch</i></li> </ul>																																																																								
	<table border="1"> <thead> <tr> <th>APU</th> <th>Cores</th> <th>Frequency (Max/Base)</th> <th>L2 Cache</th> <th>Memory Types</th> <th>Integrated Graphics</th> </tr> </thead> <tbody> <tr> <td>A4-6300B</td> <td>2</td> <td>3.9 / 3.7</td> <td>1MB</td> <td>DDR3-1600</td> <td>HD 8370D</td> </tr> <tr> <td>A4 PRO-7300B</td> <td>2</td> <td>4.0 / 3.8</td> <td>1MB</td> <td>DDR3-1600</td> <td>HD 8470D</td> </tr> <tr> <td>PRO A4-8350B</td> <td>2</td> <td>3.9 / 3.5</td> <td>1MB</td> <td>DDR3-1866</td> <td>Radeon R5 Series</td> </tr> <tr> <td>A6-6400B</td> <td>2</td> <td>4.1 / 3.9</td> <td>1MB</td> <td>DDR3-1866</td> <td>HD 8470D</td> </tr> <tr> <td>A6 PRO-7400B</td> <td>2</td> <td>3.9 / 3.5</td> <td>1MB</td> <td>DDR3-1866</td> <td>Radeon R5 Series</td> </tr> <tr> <td>PRO A6-8550B</td> <td>2</td> <td>4.0 / 3.7</td> <td>1MB</td> <td>DDR3-2133</td> <td>Radeon R5 Series</td> </tr> <tr> <td>A8-6500B</td> <td>4</td> <td>4.1 / 3.5</td> <td>4MB</td> <td>DDR3-1866</td> <td>HD 8570D</td> </tr> <tr> <td>A8 PRO-7600B</td> <td>4</td> <td>3.8 / 3.1</td> <td>4MB</td> <td>DDR3-2133</td> <td>Radeon R7 Series</td> </tr> <tr> <td>PRO A8-8650B</td> <td>4</td> <td>3.9 / 3.2</td> <td>4MB</td> <td>DDR3-2133</td> <td>Radeon R7 Series</td> </tr> <tr> <td>A10 PRO-7800B</td> <td>4</td> <td>3.9 / 3.5</td> <td>4MB</td> <td>DDR3-2133</td> <td>Radeon R7 Series</td> </tr> <tr> <td>PRO A10-8750B</td> <td>4</td> <td>4.0 / 3.6</td> <td>4MB</td> <td>DDR3-2133</td> <td>Radeon R7 Series</td> </tr> </tbody> </table>	APU	Cores	Frequency (Max/Base)	L2 Cache	Memory Types	Integrated Graphics	A4-6300B	2	3.9 / 3.7	1MB	DDR3-1600	HD 8370D	A4 PRO-7300B	2	4.0 / 3.8	1MB	DDR3-1600	HD 8470D	PRO A4-8350B	2	3.9 / 3.5	1MB	DDR3-1866	Radeon R5 Series	A6-6400B	2	4.1 / 3.9	1MB	DDR3-1866	HD 8470D	A6 PRO-7400B	2	3.9 / 3.5	1MB	DDR3-1866	Radeon R5 Series	PRO A6-8550B	2	4.0 / 3.7	1MB	DDR3-2133	Radeon R5 Series	A8-6500B	4	4.1 / 3.5	4MB	DDR3-1866	HD 8570D	A8 PRO-7600B	4	3.8 / 3.1	4MB	DDR3-2133	Radeon R7 Series	PRO A8-8650B	4	3.9 / 3.2	4MB	DDR3-2133	Radeon R7 Series	A10 PRO-7800B	4	3.9 / 3.5	4MB	DDR3-2133	Radeon R7 Series	PRO A10-8750B	4	4.0 / 3.6	4MB	DDR3-2133	Radeon R7 Series	<p>Keyboard</p> <p>Some: Preferred Pro USB Keyboard (USB connector), Lenovo logo</p> <p>Some: Lenovo USB Fingerprint Keyboard (USB connector)</p> <p>Some: Ultralim Plus Wireless Keyboard (2.4GHz via USB receiver), black</p> <p>Mouse</p> <p>Some: Enhanced Optical USB Mouse, black, Lenovo logo</p> <p>Some: Ultralim Plus Wireless Mouse (2.4GHz via USB receiver), black</p>
APU	Cores	Frequency (Max/Base)	L2 Cache	Memory Types	Integrated Graphics																																																																					
A4-6300B	2	3.9 / 3.7	1MB	DDR3-1600	HD 8370D																																																																					
A4 PRO-7300B	2	4.0 / 3.8	1MB	DDR3-1600	HD 8470D																																																																					
PRO A4-8350B	2	3.9 / 3.5	1MB	DDR3-1866	Radeon R5 Series																																																																					
A6-6400B	2	4.1 / 3.9	1MB	DDR3-1866	HD 8470D																																																																					
A6 PRO-7400B	2	3.9 / 3.5	1MB	DDR3-1866	Radeon R5 Series																																																																					
PRO A6-8550B	2	4.0 / 3.7	1MB	DDR3-2133	Radeon R5 Series																																																																					
A8-6500B	4	4.1 / 3.5	4MB	DDR3-1866	HD 8570D																																																																					
A8 PRO-7600B	4	3.8 / 3.1	4MB	DDR3-2133	Radeon R7 Series																																																																					
PRO A8-8650B	4	3.9 / 3.2	4MB	DDR3-2133	Radeon R7 Series																																																																					
A10 PRO-7800B	4	3.9 / 3.5	4MB	DDR3-2133	Radeon R7 Series																																																																					
PRO A10-8750B	4	4.0 / 3.6	4MB	DDR3-2133	Radeon R7 Series																																																																					
Memory	32GB max, UDIMM, PC3-12800 1600MHz DDR3, four 240-pin DIMM sockets																																																																									
Disk	<p>Some: SATA 6.0Gb/s, 3.5" Wide, 7200 rpm</p> <p>Some: hybrid hard disk / with 8GB MLC NAND flash memory, SATA 6.0Gb/s, 5400 rpm 2.5" wide or 7200 rpm 3.5" wide</p>																																																																									
Optical	<p>Some: Solid State Drive (SSD) / SATA 6.0Gb/s, 2.5" Wide</p> <p>Some: DVD-ROM SATA 1.5Gb/s Drive</p> <p>Some: Super Multi-Burner DVD±RW SATA 1.5Gb/s Drive</p>	<p>Bay 1: 5.25", 1.6" high, access, std optical</p> <p>Bay 2: N/A, N/A, access, opt reader</p> <p>Bay 3: 3.5", 1" high, no access, std disk</p> <p>Bay 4: 3.5", 1" high, no access, opt disk</p> <p>*bay only available on models with HDD/SSD/reader installed</p> <p>Slot 1: half-length, full-height, PCIe 3.0 x16 (60w max)</p> <p>Slot 2: half-length, full-height, PCIe 2.0 x1</p> <p>Slot 3: half-length, full-height, PCIe 2.0 x1</p> <p>Slot 4: half-length, full-height, 32-bit PCI 2.3</p>																																																																								
Onboard SATA Media reader	SATA 6.0Gb/s controller, three connectors on planar, RAID 0/1 support Optional 7-in-1 single slot media card reader	Power supply	<p>Some: 180 watts, autosensing, 100-240V (50-60Hz)</p> <p>Some: 280 watts, autosensing, 100-240V (50-60Hz)</p> <p>Some: 280 watts, autosensing, 85% PSU, 100-240V (50-60Hz)</p>																																																																							
Graphics	<p><b>AMD Radeon™ Graphics</b> in processor, uses main memory, one VGA, one DisplayPort™, one optional DP, supports up to three independent displays, works along with optional discrete graphics to support up to five independent displays;</p> <p><i>Maximum resolution: 1920x1200 (VGA)@60Hz; 2560x2048 (DisplayPort)@60Hz</i></p> <p>Some: <b>AMD Radeon HD 8570</b>, DirectX 11, 3D Hardware Acceleration, 2GB, PCI Express 3.0 x16 adapter (8x elec), one VGA, one HDMI, 40W; <i>Max resolution: 4096x2160 (HDMI)@24Hz; 2048x1536 (VGA)@85Hz</i></p> <p>Some: <b>NVIDIA® GeForce® GT 620</b>, DirectX 11, 3D Hardware Acceleration, 1GB, PCI Express 2.0 x16 adapter, one VGA, one DisplayPort, 30 watts; <i>Max resolution: 2560x1600 (DisplayPort)@60Hz; 2048x1536 (VGA)@85Hz</i></p> <p>Some: <b>AMD Radeon™ HD 7450</b>, DirectX 11, 3D Hardware Acceleration, 1GB, PCI Express 2.0 x16 adapter, one DVI-I (includes DVI-to-VGA dongle), one DisplayPort, 25 watts; <i>Max resolution: 2560x1600 (DisplayPort, DVI-I)@60Hz</i></p>	Limited warranty <sup>3</sup>	<p>Some: <b>3-years, limited onsite service</b> / service upgrades available</p> <p>Some: <b>3-years, limited onsite service, OID</b> (Onsite International Delivery) / service upgrades available</p> <p><i>For Lenovo service upgrade options, please go to S-TC sheet</i></p>																																																																							
DP cable	Optional DisplayPort to DVI-D monitor cable	Preload	<p>Some: Windows® 7 Professional 32/64 preinstalled through downgrade rights in Windows 8.1 Pro 64-bit</p> <p>Some: Windows 7 Professional 32</p> <p>Some: Windows 7 Professional 64</p> <p><b>Ready to install applications</b> (only some listed)</p> <ul style="list-style-type: none"> <li>• Rescue and Recovery™</li> <li>• Password Manager</li> </ul> <p><b>Preloaded applications</b> (only some listed)</p> <ul style="list-style-type: none"> <li>• ThinkVantage® Product Recovery</li> <li>• ThinkVantage System Update</li> <li>• ThinkVantage Communication Utility</li> <li>• ThinkVantage Device Experience</li> <li>• Desktop Power Manager</li> <li>• View Management Utility</li> <li>• Lenovo Solution Center</li> <li>• Lenovo Message Center Plus</li> <li>• Norton™ Internet Security (30 days of virus definitions)</li> <li>• Adobe® Reader®</li> <li>• Skype™</li> <li>• Microsoft Office preloaded; purchase a product key to activate</li> <li>• Cyberlink Power2Go (DVD±RW)</li> <li>• Cyberlink PowerProducer (DVD±RW)</li> <li>• Evernote®</li> <li>• Nitro Pro</li> </ul>																																																																							
Chipset	<b>AMD A78 FCH</b>	Environment	<p>ENERGY STAR® 6.0 (Need 85% PSU and Windows OS);</p> <p>EPEAT™ Gold rating (Need 85% PSU and Windows OS);</p> <p>GREENGUARD®; RoHS-compliant; Cisco EnergyWise compatible; ErP Lot 3</p>																																																																							
Front ports	Two USB 2.0, microphone (stereo, 3.5mm), headphone (stereo, 3.5mm)	Accessories	For compatible accessories, please go to TC-AQP sheet																																																																							
Rear ports	Up to six USB ports (2x USB 3.0 + 2x USB 2.0 + 2x optional USB 2.0), serial (9-pin), optional 2nd serial (9-pin), optional parallel (25-pin), ethernet (RJ-45), VGA, DisplayPort (1x standard + 1x optional), two PS/2 ports																																																																									
Rear audio ports	Line-in (stereo, 3.5mm), line-out (stereo, 3.5mm), microphone (stereo, 3.5mm)																																																																									
IEEE 1394	Optional FireWire PCIe adapter, 1394a-2000, 400Mbps, two 6-pin ports on rear																																																																									
Audio support	High Definition (HD) Audio, Realtek ALC662 / internal speaker (1.5watt)																																																																									
WLAN <sup>13</sup>	<p>Some: 11b/g/n wireless, Realtek RTL8723BE, Wi-Fi + BT 4.0 combo, 1x1</p> <p>Some: 11b/g/n wireless, Realtek RTL8192EE, Wi-Fi + BT 4.0 combo, 2x2</p> <p>Some: 11ac/b/g/n wireless, Broadcom BCM4352, 2.4/5GHz, Wi-Fi + BT 4.0, 2x2</p>																																																																									
Bluetooth™	Some: Bluetooth 4.0 wireless, integrated in Wi-Fi + Bluetooth combo adapter																																																																									
Ethernet	One gigabit ethernet port, Realtek 8111EPV, Wake on LAN®																																																																									
Modem	None																																																																									
Manageability	Enhanced Manageability with DASH 1.1																																																																									
Security chip	Trusted Platform Module, TCG 1.2-compliant																																																																									
Security features	<ul style="list-style-type: none"> <li>• Padlock loop (in rear for opt padlock)</li> <li>• Security slot (in rear for optional Kensington® MicroSaver® cable)</li> <li>• Administrator password</li> <li>• Hard disk password</li> <li>• Boot sequence control</li> </ul>																																																																									

See footnotes for more detailed information

(ALSK1-TW) September 2015 © Lenovo

## ThinkCentre M79 Tower - TopSeller - 10CN

Product Specifications Reference (PSREF)

Model	Region	Processor	vPro	Graphics	Monitor Cable	Memory	Storage	Optical	Media Reader	WLAN + Bluetooth	Optional Rear Ports	Chassis Intrusion Switch	Cable Lock	Keyboard / Mouse	Power Supply	Operating System	Warranty	Ann Date (m/y)
10CN0000US	US	AMD A4-6300B	No	AMD HD 8370D	None	4GBx1	500GB 7200rpm 3.5"	DVD±RW	None	None	None	None	None	USB / USB	180W	Win8.1 DG Win7 Pro 64	3-year, Onsite	07/14
10CN0001US	US	AMD A8-6500B	No	AMD HD 8570D	None	4GBx1	500GB 7200rpm 3.5"	DVD±RW	None	None	None	None	None	USB / USB	180W	Win8.1 DG Win7 Pro 64	3-year, Onsite	07/14
10CN0002US	US	AMD A8 PRO-7600B	No	AMD R7 Graphics	None	4GBx1	500GB 7200rpm 3.5"	DVD±RW	None	None	None	None	None	USB / USB	280W	Win8.1 DG Win7 Pro 64	3-year, Onsite	07/14
10CN0003US	US	AMD A6-6400B	No	AMD HD 8470D	None	4GBx1	500GB 7200rpm 3.5"	DVD±RW	None	None	None	None	None	USB / USB	180W	Win8.1 DG Win7 Pro 64	3-year, Onsite	07/14
10CN000VUS	US	AMD A10 PRO-7800B	No	AMD R7 Graphics	None	4GBx1	500GB 7200rpm 3.5"	DVD±RW	None	None	None	None	None	USB / USB	280W	Win8.1 DG Win7 Pro 64	3-year, Onsite	11/14
10CN000WUS	US	AMD A10 PRO-7800B	No	AMD R7 Graphics	None	8GBx1	500GB 7200rpm 3.5"	DVD±RW	None	None	None	None	None	USB / USB	280W	Win8.1 DG Win7 Pro 64	3-year, Onsite	11/14
10CN000XUS	US	AMD A6 PRO-7400B	No	AMD R5 Graphics	None	4GBx1	500GB 7200rpm 3.5"	DVD±RW	None	None	None	None	None	USB / USB	180W	Win8.1 DG Win7 Pro 64	3-year, Onsite	02/15
10CN000YUS	US	AMD A8 PRO-7600B	No	AMD R7 Graphics	None	4GBx1	500GB 7200rpm 3.5"	DVD±RW	9-in-1	None	None	None	None	USB / USB	180W	Win8.1 DG Win7 Pro 64	3-year, Onsite	07/15

Model	Region	Processor	vPro	Graphics	Monitor Cable	Memory	Storage	Optical	Media Reader	WLAN + Bluetooth	Optional Rear Ports	Chassis Intrusion Switch	Cable Lock	Keyboard / Mouse	Power Supply	Operating System	Warranty	Ann Date (m/y)
10J70009US	US	AMD PRO A4-8350B	No	AMD R5 Graphics	None	4GBx1	500GB 7200rpm 3.5"	DVD±RW	None	RTL8723BE b/g/n, 1x1 + BT4.0	None	Switch	Cable Lock	USB / USB	280W 85%	Win10 DG Win7 Pro 64	3-year, Onsite	10/15
10J7000AUS	US	AMD PRO A8-8650B	No	AMD R7 Graphics	None	4GBx1	500GB 7200rpm 3.5"	DVD±RW	None	RTL8723BE b/g/n, 1x1 + BT4.0	None	Switch	Cable Lock	USB / USB	280W 85%	Win10 DG Win7 Pro 64	3-year, Onsite	10/15
10J7000BUS	US	AMD PRO A10-8750B	No	AMD R7 Graphics	None	4GBx1	500GB 7200rpm 3.5"	DVD±RW	None	RTL8723BE b/g/n, 1x1 + BT4.0	None	Switch	Cable Lock	USB / USB	280W 85%	Win10 DG Win7 Pro 64	3-year, Onsite	10/15
10J7000CUS	US	AMD PRO A6-8550B	No	AMD R5 Graphics	None	4GBx1	500GB 7200rpm 3.5"	DVD±RW	None	RTL8723BE b/g/n, 1x1 + BT4.0	None	Switch	Cable Lock	USB / USB	280W 85%	Win10 DG Win7 Pro 64	3-year, Onsite	10/15
10J7000DUS	US	AMD A4 PRO-7300B	No	AMD HD 8470D	DP to DVI	4GBx1	500GB 7200rpm 3.5"	DVD±RW	None	RTL8723BE b/g/n, 1x1 + BT4.0	None	None	None	USB / USB	280W 85%	Win10 Pro 64	3-year, Onsite	09/15
10J7000EUS	US	AMD A8 PRO-7600B	No	AMD R7 Graphics	DP to DVI	4GBx1	500GB 7200rpm 3.5"	DVD±RW	None	RTL8723BE b/g/n, 1x1 + BT4.0	None	None	None	USB / USB	280W 85%	Win10 Pro 64	3-year, Onsite	07/16
10J7000FUS	US	AMD A6 PRO-7400B	No	AMD R5 Graphics	DP to DVI	4GBx1	500GB 7200rpm 3.5"	DVD±RW	None	RTL8723BE b/g/n, 1x1 + BT4.0	None	None	None	USB / USB	280W 85%	Win10 Pro 64	3-year, Onsite	09/15
10J7000GUS	US	AMD A4 PRO-7300B	No	AMD HD 8470D	DP to DVI	4GBx1	500GB 7200rpm 3.5"	DVD±RW	None	RTL8723BE b/g/n, 1x1 + BT4.0	None	None	None	USB / USB	280W 85%	Win10 DG Win7 Pro 64	3-year, Onsite	10/15
10J7000HUS	US	AMD A10 PRO-7800B	No	AMD R7 Graphics	DP to DVI	4GBx1	500GB 7200rpm 3.5"	DVD±RW	None	RTL8723BE b/g/n, 1x1 + BT4.0	None	None	None	USB / USB	280W 85%	Win10 Pro 64	3-year, Onsite	09/15
10J7000JUS	US	AMD A6 PRO-7400B	No	AMD R5 Graphics	DP to DVI	4GBx1	500GB 7200rpm 3.5"	DVD±RW	None	RTL8723BE b/g/n, 1x1 + BT4.0	None	None	None	USB / USB	280W 85%	Win10 DG Win7 Pro 64	3-year, Onsite	10/15
10J7000KUS	US	AMD A10 PRO-7800B	No	AMD R7 Graphics	DP to DVI	4GBx1	500GB 7200rpm 3.5"	DVD±RW	None	RTL8723BE b/g/n, 1x1 + BT4.0	None	None	Cable Lock	USB / USB	280W 85%	Win10 DG Win7 Pro 64	3-year, Onsite	10/15
10J7000LUS	US	AMD A8 PRO-7600B	No	AMD R7 Graphics	DP to DVI	4GBx1	500GB 7200rpm 3.5"	DVD±RW	None	RTL8723BE b/g/n, 1x1 + BT4.0	None	None	None	USB / USB	280W 85%	Win10 DG Win7 Pro 64	3-year, Onsite	10/15



## ThinkCentre M79 Tower - 10CQ

Product Specifications Reference (PSREF)

Model	Region	Processor	vPro	Graphics	Monitor Cable	Memory	Storage	Optical	Media Reader	WLAN + Bluetooth	Optional Rear Ports	Chassis Intrusion Switch	Cable Lock	Keyboard / Mouse	Power Supply	Operating System	Warranty	Ann Date (m/y)
10CQ0005US	US	AMD A4-6300B	No	AMD HD 8370D	None	2GBx1	250GB 7200rpm 3.5"	DVD	None	None	None	Switch	None	USB / USB	280W 85%	Win7 Pro 32	3-year, Onsite, OID	07/14
10CQ0006US	US	AMD A6 PRO-7400B	No	AMD R5 Graphics	None	2GBx1	500GB 7200rpm 3.5"	DVD±RW	None	None	None	Switch	None	USB / USB	280W 85%	Win7 Pro 32	3-year, Onsite, OID	07/14
10CQ0007US	US	AMD A8 PRO-7600B	No	AMD HD 8570 2GB	None	4GBx1	1TB 7200rpm 3.5"	DVD±RW	9-in-1	None	Parallel	Switch	None	USB / USB	280W 85%	Win7 Pro 64	3-year, Onsite, OID	07/14

# ThinkCentre M79 Tower - 10CS

Product Specifications Reference (PSREF)

Model	Region	Processor	vPro	Graphics	Monitor Cable	Memory	Storage	Optical	Media Reader	WLAN + Bluetooth	Optional Rear Ports	Chassis Intrusion Switch	Cable Lock	Keyboard / Mouse	Power Supply	Operating System	Warranty	Ann Date (m/y)
10CS0003US	US	AMD A4-6300B	No	AMD HD 8370D	None	4GBx1	500GB 7200rpm 3.5"	DVD±RW	None	None	None	None	None	USB / USB	180W	Win8.1 DG Win7 Pro 64	3-year, Onsite	08/14



# ThinkCentre M800 SFF Platform Specifications

Product Specifications Reference (PSREF)

Processor	Intel® Celeron®, Intel Pentium®, or 6th Generation Intel Core™ i3 / i5 / i7 Processor	Manageability	Intel Standard Manageability																																																						
	<table border="1"> <thead> <tr> <th>Processor</th> <th>Cores / Threads</th> <th>Frequency Base/Max(GHz)</th> <th>Cache</th> <th>Memory Types</th> <th>Integrated Graphics</th> </tr> </thead> <tbody> <tr> <td>Pentium G4400</td> <td>2 / 2</td> <td>3.3G</td> <td>3 MB</td> <td>DDR4-2133</td> <td>HD 510</td> </tr> <tr> <td>Pentium G4500</td> <td>2 / 2</td> <td>3.5G</td> <td>3 MB</td> <td>DDR4-2133</td> <td>HD 530</td> </tr> <tr> <td>Core i3-6100</td> <td>2 / 4</td> <td>3.7 G</td> <td>3 MB</td> <td>DDR4-2133</td> <td>HD 530</td> </tr> <tr> <td>Core i3-6300</td> <td>2 / 4</td> <td>3.8 G</td> <td>4 MB</td> <td>DDR4-2133</td> <td>HD 530</td> </tr> <tr> <td>Core i5-6400</td> <td>4 / 4</td> <td>2.7 G / 3.3 G</td> <td>6 MB</td> <td>DDR4-2133</td> <td>HD 530</td> </tr> <tr> <td>Core i5-6500</td> <td>4 / 4</td> <td>3.2 G / 3.6 G</td> <td>6 MB</td> <td>DDR4-2133</td> <td>HD 530</td> </tr> <tr> <td>Core i5-6600</td> <td>4 / 4</td> <td>3.3 G / 3.9 G</td> <td>6 MB</td> <td>DDR4-2133</td> <td>HD 530</td> </tr> <tr> <td>Core i7-6700</td> <td>4 / 8</td> <td>3.4 G / 4.0 G</td> <td>8 MB</td> <td>DDR4-2133</td> <td>HD 530</td> </tr> </tbody> </table>	Processor	Cores / Threads	Frequency Base/Max(GHz)	Cache	Memory Types	Integrated Graphics	Pentium G4400	2 / 2	3.3G	3 MB	DDR4-2133	HD 510	Pentium G4500	2 / 2	3.5G	3 MB	DDR4-2133	HD 530	Core i3-6100	2 / 4	3.7 G	3 MB	DDR4-2133	HD 530	Core i3-6300	2 / 4	3.8 G	4 MB	DDR4-2133	HD 530	Core i5-6400	4 / 4	2.7 G / 3.3 G	6 MB	DDR4-2133	HD 530	Core i5-6500	4 / 4	3.2 G / 3.6 G	6 MB	DDR4-2133	HD 530	Core i5-6600	4 / 4	3.3 G / 3.9 G	6 MB	DDR4-2133	HD 530	Core i7-6700	4 / 8	3.4 G / 4.0 G	8 MB	DDR4-2133	HD 530	Security chip	Trusted Platform Module, TCG 1.2-compliant
Processor	Cores / Threads	Frequency Base/Max(GHz)	Cache	Memory Types	Integrated Graphics																																																				
Pentium G4400	2 / 2	3.3G	3 MB	DDR4-2133	HD 510																																																				
Pentium G4500	2 / 2	3.5G	3 MB	DDR4-2133	HD 530																																																				
Core i3-6100	2 / 4	3.7 G	3 MB	DDR4-2133	HD 530																																																				
Core i3-6300	2 / 4	3.8 G	4 MB	DDR4-2133	HD 530																																																				
Core i5-6400	4 / 4	2.7 G / 3.3 G	6 MB	DDR4-2133	HD 530																																																				
Core i5-6500	4 / 4	3.2 G / 3.6 G	6 MB	DDR4-2133	HD 530																																																				
Core i5-6600	4 / 4	3.3 G / 3.9 G	6 MB	DDR4-2133	HD 530																																																				
Core i7-6700	4 / 8	3.4 G / 4.0 G	8 MB	DDR4-2133	HD 530																																																				
		Security features	<ul style="list-style-type: none"> <li>One lock to secure both cover and entire system to fixed object: <ul style="list-style-type: none"> <li>-Padlock loop (in rear for opt padlock)</li> <li>-Security slot (in rear for optional Kensington® MicroSaver® cable)</li> </ul> </li> <li>Power-on password</li> <li>Administrator password</li> <li>Hard disk password</li> <li>Boot sequence control</li> <li>Boot without keyboard and mouse</li> <li>Individual USB port disablement</li> <li>Optional chassis intrusion switch</li> </ul>																																																						
		Keyboard	<i>Some:</i> Preferred Pro USB Keyboard (USB connector), Lenovo logo <i>Some:</i> Lenovo USB Fingerprint Keyboard (USB connector) <i>Some:</i> Ultralim Plus Wireless Keyboard (2.4GHz via USB receiver), black																																																						
		Mouse	<i>Some:</i> Enhanced Optical USB Mouse, black, Lenovo logo <i>Some:</i> Ultralim Plus Wireless Mouse (2.4GHz via USB receiver), black																																																						
Memory	64GB max, UDIMM, DDR4 2133, four 288-pin DIMM sockets, dual-channel capable	Mechanical	<ul style="list-style-type: none"> <li>SFF (9.7L), black color; metal case</li> <li>(WxDxH) 13.31" X 14.05" X 3.46"; 338mm X 357mm X 88mm</li> <li>12.3 lb (5.6 kg)</li> <li>Toolless cover, disk, optical removal</li> <li>Toolless graphics, PCI adapter retention</li> <li>Optional dust filter</li> <li>Bay 1: N/A, 9.5mm high, external, std optical</li> <li>Bay 2: 3.5", 1" high, internal, std disk</li> <li>Bay 3: 2.5", N/A, internal, opt 2nd 2.5" disk (optional bay)</li> <li>Bay 4: N/A, N/A, external, opt reader</li> <li>Slot 1: Low Profile, PCI Express 3.0 x16 (45w max)</li> <li>Slot 2: Low Profile, PCIe 3.0 x1</li> <li>Slot 3: Low Profile, PCIe 3.0 x16 (x4 elec, 45w max)</li> <li>Slot 4: Low Profile, optional 32-bit PCI 2.3 (via M.2 to PCI adaptor)</li> </ul>																																																						
Disk	<i>Some:</i> Hard disk, SATA 6.0Gb/s, 2.5"/ 3.5" wide, 5400 / 7200 rpm <i>Some:</i> Solid State Hybrid Drive (SSHD), 500GB (5400 rpm, 2.5") / 1TB or 2TB (7200 rpm, 3.5"), with 8GB NAND flash memory, SATA 6.0Gb/s																																																								
Optical	<i>Some:</i> Solid State Drive (SSD) / SATA 6.0Gb/s, 2.5" Wide <i>Some:</i> DVD-ROM SATA 1.5Gb/s Drive <i>Some:</i> Super Multi-Burner DVD±RW SATA 1.5Gb/s Drive																																																								
Onboard SATA	Four onboard SATA 6.0Gb/s connectors, one is eSATA connector for optional rear eSATA port																																																								
Media reader	Optional 9-in-1 media reader																																																								
Graphics	<b>Intel HD Graphics 510/530</b> in processor, uses main memory, DirectX® 12, one VGA, two DisplayPort™, supports three independent displays, works along with discrete graphics to support more displays; <i>Max resolution:</i> 4096x2304 (DP) @60Hz; 1920x1200 (VGA) @60Hz <i>Some:</i> <b>NVIDIA® Quadro® K420</b> , DirectX 12, 2GB, PCIe 2.0 x16 adapter, one DVI-I, one DisplayPort, 41 watts; <i>Max resolution:</i> 3840x2160 (DisplayPort) @60Hz; 2560x1600 (DVI-I) @60Hz <i>Some:</i> <b>NVIDIA GeForce® GT 720</b> , DirectX 12, 2GB, PCIe 2.0 x8 adapter, one VGA, one HDMI, 25 watts; <i>Max resolution:</i> 1920x1080 (HDMI) @60Hz; 2048x1536 (VGA) @85Hz <i>Some:</i> <b>NVIDIA GeForce GT 720</b> , DirectX 12, 1GB, PCIe 2.0 x8 adapter, two DisplayPort, 25 watts; <i>Max resolution:</i> 3840x2160 (DisplayPort) @60Hz;	Floor Stand	Optional system floor stand for vertical orientation																																																						
DP cable	Optional DP to VGA, DP to DVI-D (single link), or DP to HDMI 1.4 dongle	Power supply	210 watts, autosensing, 85% PSU																																																						
Chipset	<b>Intel Q150 Chipset</b>	Limited warranty <sup>3</sup>	<i>Some:</i> <b>1-year or 3-year, limited onsite service</b> / service upgrades available <i>Some:</i> <b>3-year, limited onsite service, OID</b> (Onsite International Delivery) / service upgrades available <i>For Lenovo service upgrade options, please go to S-TC sheet</i>																																																						
Front ports	Two USB 3.0, two optional USB 2.0, microphone (3.5mm), headphone (3.5mm)	Preload	<b>Preloaded operating system</b> <i>Some:</i> Windows® 7 Professional 64 preinstalled through downgrade rights in Windows 10 Pro 64-bit <i>Some:</i> Windows 7 Professional 64 <i>Some:</i> Windows 10 Pro 64-bit <i>Some:</i> Windows 10 Home 64-bit																																																						
Rear ports	Four USB 3.0, two USB 2.0, two optional USB 2.0, serial (9-pin), optional 2nd serial (9-pin), optional parallel (25-pin), ethernet (RJ-45), one VGA, two DisplayPort, optional PS/2 ports (keyboard/mouse), one optional eSATA port additional VGA, DisplayPort, DVI-I or HDMI on optional graphics on some models		<b>Preloaded applications (only some listed)</b> <ul style="list-style-type: none"> <li>Desktop Power Manager</li> <li>Lenovo Solution Center</li> <li>Lenovo REACHit</li> <li>Lenovo SHAREit</li> <li>Lenovo Bluetooth Lock (for models with Wi-Fi/BT card)</li> <li>McAfee® LiveSafe™ (30-day trial)</li> <li>Microsoft Office preloaded; purchase a product key to activate</li> <li>PowerDVD Create (DVD±RW)</li> <li>Lenovo ThinkVantage Tools</li> <li>- Only for Window 10</li> <li>Lenovo Companion</li> <li>Cyberlink PowerDVD (DVD, DVD±RW)</li> <li>Lenovo QuickOptimizer</li> <li>- Only for Window 7</li> <li>Rescue and Recovery</li> <li>Password Manager</li> <li>ThinkVantage System Update</li> <li>Lenovo Message Center Plus</li> <li>Adobe® Reader®</li> </ul>																																																						
Rear audio ports	Line-in (3.5mm), line-out (3.5mm), microphone-in (3.5mm)																																																								
IEEE 1394	None	Environment	ENERGY STAR® 6.1>(*Need 85% PSU and Windows OS); ErP Lot 3; GREENGUARD®; RoHS-compliant; TUV Green Mark																																																						
Audio support	High Definition (HD) Audio, Realtek ALC662 / optional internal speaker (1.5 watt )	Accessories	For compatible accessories, please go to TC-AQP sheet																																																						
WLAN <sup>13</sup>	<i>Some:</i> 11ac wireless, M.2 Card, Qualcomm Atheros QCA9377 (dual band), Wi-Fi + Bluetooth 4.1 combo adapter, 1x1 <i>Some:</i> 11ac wireless, M.2 Card, Qualcomm Atheros QCA6174 (dual band), Wi-Fi + Bluetooth 4.1 combo adapter, 2x2 <i>Some:</i> 11ac wireless, M.2 Card, Intel Dual Band Wireless-AC 3165, Wi-Fi + Bluetooth 4.0 combo adapter, 1x1 <i>Some:</i> 11ac wireless, M.2 Card, Intel Dual Band Wireless-AC 8260, Wi-Fi + Bluetooth 4.1 combo adapter, 2x2																																																								
Bluetooth™	<i>Some:</i> Bluetooth 4.0 or 4.1 wireless, integrated in Wi-Fi + BT combo adapter																																																								
Ethernet	Gigabit ethernet, Intel Ethernet Connection I219-LM (Jacksonville), Wake on LAN®																																																								
Modem	None																																																								

See footnotes for more detailed information

Model	Region	Processor	vPro	Graphics	Monitor Cable	Memory	Storage	Optical	Optional 2nd 2.5" Bay	Media Reader	WLAN + Bluetooth	Optional Front Ports	Optional Rear Ports	Chassis Intrusion Switch	Cable Lock	PCI Slot	Dust Filter	Keyboard / Mouse	Stand	Power Supply	Operating System	Warranty	Ann Date (m/y)
10FY0004US	US	i7-6700	No	Intel HD 530	None	8GBx1	192GB SSD	DVD±RW	None	None	None	None	PS/2	None	None	None	None	USB / USB	Floor Stand	210W 85%	Win10 DG Win7 Pro 64	3-year, Onsite	11/15
10FY0005US	US	i5-6500	No	Intel HD 530	None	4GBx1	192GB SSD	DVD±RW	None	None	None	None	PS/2	None	None	None	None	USB / USB	Floor Stand	210W 85%	Win10 DG Win7 Pro 64	3-year, Onsite	11/15
10FY0006US	US	i5-6500	No	Intel HD 530	None	4GBx1	500GB 7200rpm 3.5"	DVD±RW	None	None	None	None	PS/2	None	None	None	None	USB / USB	Floor Stand	210W 85%	Win10 DG Win7 Pro 64	3-year, Onsite	11/15
10FY0007US	US	i7-6700	No	Intel HD 530	None	4GBx1	500GB 7200rpm 3.5"	DVD±RW	None	None	None	None	PS/2	None	None	None	None	USB / USB	Floor Stand	210W 85%	Win10 DG Win7 Pro 64	3-year, Onsite	11/15
10FY0008US	US	i7-6700	No	GT 720 1GB	None	8GBx1	1TB 7200rpm 3.5"	DVD±RW	None	None	None	None	PS/2	None	None	None	None	USB / USB	Floor Stand	210W 85%	Win10 DG Win7 Pro 64	3-year, Onsite	11/15
10FY0009US	US	i5-6500	No	Intel HD 530	None	4GBx1	1TB 7200rpm 3.5"	DVD±RW	None	None	None	None	PS/2	None	None	None	None	USB / USB	Floor Stand	210W 85%	Win10 DG Win7 Pro 64	3-year, Onsite	11/15
10FY000AUS	US	i7-6700	No	Intel HD 530	None	8GBx1	1TB 7200rpm 3.5"	DVD±RW	None	None	None	None	PS/2	None	None	None	None	USB / USB	Floor Stand	210W 85%	Win10 DG Win7 Pro 64	3-year, Onsite	11/15
10FY000CUS	US	i7-6700	No	Intel HD 530	None	8GBx1	1TB 7200rpm 3.5"	DVD±RW	None	None	None	None	PS/2	None	None	None	None	USB / USB	Floor Stand	210W 85%	Win10 Pro 64	3-year, Onsite	11/15
10FY000DUS	US	i5-6400	No	Intel HD 530	None	4GBx1	500GB 7200rpm 3.5"	DVD±RW	None	None	None	None	None	None	None	None	None	USB / USB	Floor Stand	210W 85%	Win10 Pro 64	3-year, Onsite	11/15
10FY000EUS	US	i7-6700	No	GT 720 1GB	None	8GBx1	1TB 7200rpm 3.5"	DVD±RW	None	None	None	None	None	None	None	None	None	USB / USB	Floor Stand	210W 85%	Win10 Pro 64	3-year, Onsite	11/15
10FY000FUS	US	i5-6500	No	Intel HD 530	None	4GBx1	500GB 7200rpm 3.5"	DVD±RW	None	None	None	None	None	None	None	None	None	USB / USB	Floor Stand	210W 85%	Win10 Pro 64	3-year, Onsite	11/15
10FY000QUS	US	i3-6100	No	Intel HD 530	None	4GBx1	500GB 7200rpm 3.5"	DVD±RW	Optional 2nd 2.5" Bay	None	None	None	None	None	None	None	None	USB / USB	Floor Stand	210W 85%	Win10 DG Win7 Pro 64	3-year, Onsite	12/15
10FY0012US	US	i3-6100	No	Intel HD 530	None	4GBx1	500GB 7200rpm 3.5"	DVD±RW	None	None	None	None	None	None	None	None	None	USB / USB	Floor Stand	210W 85%	Win10 DG Win7 Pro 64	3-year, Onsite	12/15
10FY0013US	US	i5-6400	No	Intel HD 530	None	4GBx1	500GB 7200rpm 3.5"	DVD±RW	Optional 2nd 2.5" Bay	None	None	None	None	None	None	None	None	USB / USB	Floor Stand	210W 85%	Win10 DG Win7 Pro 64	3-year, Onsite	12/15
10FY0014US	US	i5-6400	No	Intel HD 530	None	8GBx1	180GB SSD Opal	DVD±RW	Optional 2nd 2.5" Bay	None	None	None	None	None	None	None	None	USB / USB	Floor Stand	210W 85%	Win10 DG Win7 Pro 64	3-year, Onsite	12/15
10FY0015US	US	i7-6700	No	Intel HD 530	None	8GBx1	256GB SSD Opal	DVD±RW	Optional 2nd 2.5" Bay	None	None	None	None	None	None	None	None	USB / USB	Floor Stand	210W 85%	Win10 DG Win7 Pro 64	3-year, Onsite	12/15
10FY0016US	US	i7-6700	No	GT 720 1GB	None	8GBx1	1TB 7200rpm 3.5"	DVD±RW	Optional 2nd 2.5" Bay	None	None	None	None	None	None	None	None	USB / USB	Floor Stand	210W 85%	Win10 DG Win7 Pro 64	3-year, Onsite	12/15
10FY0017US	US	i7-6700	No	Intel HD 530	None	8GBx1	1TB 7200rpm 3.5"	DVD±RW	Optional 2nd 2.5" Bay	None	None	None	None	None	None	None	None	USB / USB	Floor Stand	210W 85%	Win10 DG Win7 Pro 64	3-year, Onsite	12/15
10FY0018US	US	i5-6400	No	Intel HD 530	None	8GBx1	1TB 7200rpm 3.5"	DVD±RW	Optional 2nd 2.5" Bay	None	None	None	None	None	None	None	None	USB / USB	Floor Stand	210W 85%	Win10 DG Win7 Pro 64	3-year, Onsite	12/15
10FY0019US	US	i7-6700	No	Intel HD 530	None	8GBx1	1TB 7200rpm 3.5"	DVD±RW	Optional 2nd 2.5" Bay	None	None	None	None	None	None	None	None	USB / USB	Floor Stand	210W 85%	Win10 Pro 64	3-year, Onsite	12/15

Model	Region	Processor	vPro	Graphics	Monitor Cable	Memory	Storage	Optical	Optional 2nd 2.5" Bay	Media Reader	WLAN + Bluetooth	Optional Front Ports	Optional Rear Ports	Chassis Intrusion Switch	Cable Lock	PCI Slot	Dust Filter	Keyboard / Mouse	Stand	Power Supply	Operating System	Warranty	Ann Date (m/y)
10FY001AUS	US	i7-6700	No	Intel HD 530	None	8GBx1	128GB SSD	DVD±RW	Optional 2nd 2.5" Bay	None	None	None	None	None	None	None	None	USB / USB	Floor Stand	210W 85%	Win10 DG Win7 Pro 64	3-year, Onsite	12/15
10FY001BUS	US	i5-6400	No	Intel HD 530	None	8GBx1	128GB SSD	DVD±RW	Optional 2nd 2.5" Bay	None	None	None	None	None	None	None	None	USB / USB	Floor Stand	210W 85%	Win10 DG Win7 Pro 64	3-year, Onsite	12/15
10FY001DUS	US	i5-6400	No	Intel HD 530	None	8GBx1	256GB SSD Opal	DVD±RW	Optional 2nd 2.5" Bay	None	None	None	None	None	None	None	None	USB / USB	Floor Stand	210W 85%	Win10 DG Win7 Pro 64	3-year, Onsite	12/15
10FY001EUS	US	i7-6700	No	GT 720 1GB	None	8GBx1	1TB 7200rpm 3.5"	DVD±RW	Optional 2nd 2.5" Bay	None	None	None	None	None	None	None	None	USB / USB	Floor Stand	210W 85%	Win10 Pro 64	3-year, Onsite	12/15
10FY001FUS	US	i5-6400	No	Intel HD 530	None	4GBx1	500GB 7200rpm 3.5"	DVD±RW	Optional 2nd 2.5" Bay	None	None	None	None	None	None	None	None	USB / USB	Floor Stand	210W 85%	Win10 Pro 64	3-year, Onsite	12/15
10FY001GUS	US	i7-6700	No	GT 720 1GB	None	8GBx2	1TB 7200rpm 3.5"	DVD±RW	Optional 2nd 2.5" Bay	None	None	None	None	None	None	None	None	USB / USB	Floor Stand	210W 85%	Win10 DG Win7 Pro 64	3-year, Onsite	12/15
10FY001HUS	US	i5-6400	No	Intel HD 530	None	8GBx1	500GB 7200rpm 3.5"	DVD±RW	Optional 2nd 2.5" Bay	None	None	None	None	None	None	None	None	USB / USB	Floor Stand	210W 85%	Win10 Pro 64	3-year, Onsite	12/15
10FY001JUS	US	i7-6700	No	GT 720 1GB	None	8GBx2	1TB 7200rpm 3.5"	DVD±RW	Optional 2nd 2.5" Bay	None	None	None	None	None	None	None	None	USB / USB	Floor Stand	210W 85%	Win10 Pro 64	3-year, Onsite	12/15
10FY001KUS	US	i3-6100	No	Intel HD 530	None	4GBx1	128GB SSD	DVD±RW	Optional 2nd 2.5" Bay	None	None	None	None	None	None	None	None	USB / USB	Floor Stand	210W 85%	Win10 DG Win7 Pro 64	3-year, Onsite	12/15
10FY001LUS	US	i3-6100	No	Intel HD 530	None	4GBx1	128GB SSD	DVD±RW	Optional 2nd 2.5" Bay	None	8260 ac, 2x2 + BT4.1	None	None	None	None	None	None	USB / USB	Floor Stand	210W 85%	Win10 Pro 64	3-year, Onsite	12/15
10FY001MUS	US	i3-6100	No	Intel HD 530	None	8GBx1	1TB 7200rpm 3.5"	DVD±RW	Optional 2nd 2.5" Bay	None	None	None	None	None	None	None	None	USB / USB	Floor Stand	210W 85%	Win10 DG Win7 Pro 64	3-year, Onsite	12/15
10FY001NUS	US	i3-6100	No	Intel HD 530	None	4GBx1	500GB 7200rpm 3.5"	DVD±RW	Optional 2nd 2.5" Bay	None	8260 ac, 2x2 + BT4.1	None	None	None	None	None	None	USB / USB	Floor Stand	210W 85%	Win10 DG Win7 Pro 64	3-year, Onsite	12/15
10FY001PUS	US	i3-6100	No	Intel HD 530	None	4GBx1	500GB 7200rpm 3.5"	DVD±RW	Optional 2nd 2.5" Bay	None	8260 ac, 2x2 + BT4.1	None	None	None	None	None	None	USB / USB	Floor Stand	210W 85%	Win10 Pro 64	3-year, Onsite	12/15
10FY0029US	US	i5-6400	No	Intel HD 530	None	8GBx1	1TB 7200rpm 3.5"	DVD±RW	Optional 2nd 2.5" Bay	None	None	None	None	None	None	None	None	USB / USB	Floor Stand	210W 85%	Win10 Pro 64	3-year, Onsite	10/16
10FY002GUS	US	i3-6100	No	Intel HD 530	None	4GBx1	500GB 7200rpm 2.5"	DVD±RW	Optional 2nd 2.5" Bay	None	None	None	None	None	None	None	None	USB / USB	Floor Stand	210W 85%	Win10 Pro 64	3-year, Onsite	07/16
10FY003BUS	US	i7-6700	No	GT 720 1GB	None	8GBx1	1TB 7200rpm 3.5"	DVD±RW	Optional 2nd 2.5" Bay	None	None	None	None	None	None	None	None	USB / USB	Floor Stand	210W 85%	Win10 DG Win7 Pro 64	3-year, Onsite	10/16
10FY003CUS	US	i7-6700	No	GT 720 1GB	None	8GBx2	1TB 7200rpm 3.5"	DVD±RW	Optional 2nd 2.5" Bay	None	None	None	None	None	None	None	None	USB / USB	Floor Stand	210W 85%	Win10 DG Win7 Pro 64	3-year, Onsite	10/16
10FY003DUS	US	i7-6700	No	GT 720 1GB	None	8GBx1	1TB 7200rpm 3.5"	DVD±RW	Optional 2nd 2.5" Bay	None	None	None	None	None	None	None	None	USB / USB	Floor Stand	210W 85%	Win10 Pro 64	3-year, Onsite	10/16
10FY003EUS	US	i7-6700	No	GT 720 1GB	None	8GBx2	1TB 7200rpm 3.5"	DVD±RW	Optional 2nd 2.5" Bay	None	None	None	None	None	None	None	None	USB / USB	Floor Stand	210W 85%	Win10 Pro 64	3-year, Onsite	10/16

Model	Region	Processor	vPro	Graphics	Monitor Cable	Memory	Storage	Optical	Optional 2nd 2.5" Bay	Media Reader	WLAN + Bluetooth	Optional Front Ports	Optional Rear Ports	Chassis Intrusion Switch	Cable Lock	PCI Slot	Dust Filter	Keyboard / Mouse	Stand	Power Supply	Operating System	Warranty	Ann Date (m/y)
10FX0005US	US	i5-6500	No	Intel HD 530	None	4GBx1	500GB 7200rpm 3.5"	DVD±RW	None	None	None	None	PS/2	None	None	None	None	USB / USB	Floor Stand	210W 85%	Win10 DG Win7 Pro 64	3-year, Onsite	11/15
10FX0006US	US	i7-6700	No	GT 720 1GB	None	8GBx1	1TB 7200rpm 3.5"	DVD±RW	None	None	None	None	PS/2	None	None	None	None	USB / USB	Floor Stand	210W 85%	Win10 DG Win7 Pro 64	3-year, Onsite	11/15
10FX0007US	US	i7-6700	No	Intel HD 530	None	8GBx1	120GB SSD	DVD±RW	None	None	None	None	PS/2	None	None	None	None	USB / USB	Floor Stand	210W 85%	Win10 DG Win7 Pro 64	3-year, Onsite	11/15
10FX0008US	US	i7-6700	No	Intel HD 530	None	4GBx1	500GB 7200rpm 3.5"	DVD±RW	None	None	None	None	PS/2	None	None	None	None	USB / USB	Floor Stand	210W 85%	Win10 DG Win7 Pro 64	3-year, Onsite	11/15
10FX0009US	US	i7-6700	No	Intel HD 530	None	8GBx1	1TB 7200rpm 3.5"	DVD±RW	None	None	None	None	PS/2	None	None	None	None	USB / USB	Floor Stand	210W 85%	Win10 DG Win7 Pro 64	3-year, Onsite	11/15
10FX000VUS	US	i5-6500	No	Intel HD 530	DP to HDMI	4GBx1	500GB 7200rpm 3.5"	DVD±RW	None	None	None	None	None	None	None	None	None	USB / USB	None	210W 85%	Win10 Pro 64	3-year, Onsite, OID	11/15
10FX0011US	US	i5-6500	No	GT 720 1GB	DP to VGA	4GBx1	1TB 7200rpm 3.5"	DVD±RW	None	9-in-1	None	None	None	None	None	None	None	USB / USB	None	210W 85%	Win10 Pro 64	3-year, Onsite, OID	11/15
10FX0012US	US	i5-6500	No	Intel HD 530	None	4GBx1	500GB 7200rpm 3.5"	DVD	None	None	None	None	None	None	None	None	None	USB / USB	None	210W 85%	Win10 DG Win7 Pro 64	3-year, Onsite, OID	11/15
10FX0013US	US	i5-6500	No	GT 720 1GB	None	4GBx1	1TB 7200rpm 3.5"	DVD±RW	None	9-in-1	None	None	None	None	None	None	Dust Filter	USB / USB	None	210W 85%	Win10 DG Win7 Pro 64	3-year, Onsite, OID	11/15
10FX0014US	US	i5-6500	No	Intel HD 530	None	4GBx1	500GB 7200rpm 3.5"	DVD±RW	None	None	None	None	None	None	None	None	None	USB / USB	None	210W 85%	Win10 DG Win7 Pro 64	3-year, Onsite, OID	11/15







# ThinkCentre M800 Tower Platform Specifications

Product Specifications Reference (PSREF)

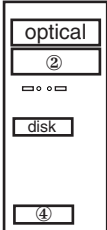
Processor	Intel® Celeron®, Intel Pentium®, or 6th Generation Intel Core™ i3 / i5 / i7 Processor	Manageability	Intel Standard Manageability																																																						
	<table border="1"> <thead> <tr> <th>Processor</th> <th>Cores / Threads</th> <th>Frequency Base/Max(GHz)</th> <th>Cache</th> <th>Memory Types</th> <th>Integrated Graphics</th> </tr> </thead> <tbody> <tr> <td>Pentium G4400</td> <td>2 / 2</td> <td>3.3G</td> <td>3 MB</td> <td>DDR4-2133</td> <td>HD 510</td> </tr> <tr> <td>Pentium G4500</td> <td>2 / 2</td> <td>3.5G</td> <td>3 MB</td> <td>DDR4-2133</td> <td>HD 530</td> </tr> <tr> <td>Core i3-6100</td> <td>2 / 4</td> <td>3.7 G</td> <td>3 MB</td> <td>DDR4-2133</td> <td>HD 530</td> </tr> <tr> <td>Core i3-6300</td> <td>2 / 4</td> <td>3.8 G</td> <td>4 MB</td> <td>DDR4-2133</td> <td>HD 530</td> </tr> <tr> <td>Core i5-6400</td> <td>4 / 4</td> <td>2.7 G / 3.3 G</td> <td>6 MB</td> <td>DDR4-2133</td> <td>HD 530</td> </tr> <tr> <td>Core i5-6500</td> <td>4 / 4</td> <td>3.2 G / 3.6 G</td> <td>6 MB</td> <td>DDR4-2133</td> <td>HD 530</td> </tr> <tr> <td>Core i5-6600</td> <td>4 / 4</td> <td>3.3 G / 3.9 G</td> <td>6 MB</td> <td>DDR4-2133</td> <td>HD 530</td> </tr> <tr> <td>Core i7-6700</td> <td>4 / 8</td> <td>3.4 G / 4.0 G</td> <td>8 MB</td> <td>DDR4-2133</td> <td>HD 530</td> </tr> </tbody> </table>	Processor	Cores / Threads	Frequency Base/Max(GHz)	Cache	Memory Types	Integrated Graphics	Pentium G4400	2 / 2	3.3G	3 MB	DDR4-2133	HD 510	Pentium G4500	2 / 2	3.5G	3 MB	DDR4-2133	HD 530	Core i3-6100	2 / 4	3.7 G	3 MB	DDR4-2133	HD 530	Core i3-6300	2 / 4	3.8 G	4 MB	DDR4-2133	HD 530	Core i5-6400	4 / 4	2.7 G / 3.3 G	6 MB	DDR4-2133	HD 530	Core i5-6500	4 / 4	3.2 G / 3.6 G	6 MB	DDR4-2133	HD 530	Core i5-6600	4 / 4	3.3 G / 3.9 G	6 MB	DDR4-2133	HD 530	Core i7-6700	4 / 8	3.4 G / 4.0 G	8 MB	DDR4-2133	HD 530	Security chip	Trusted Platform Module, TCG 1.2-compliant
Processor	Cores / Threads	Frequency Base/Max(GHz)	Cache	Memory Types	Integrated Graphics																																																				
Pentium G4400	2 / 2	3.3G	3 MB	DDR4-2133	HD 510																																																				
Pentium G4500	2 / 2	3.5G	3 MB	DDR4-2133	HD 530																																																				
Core i3-6100	2 / 4	3.7 G	3 MB	DDR4-2133	HD 530																																																				
Core i3-6300	2 / 4	3.8 G	4 MB	DDR4-2133	HD 530																																																				
Core i5-6400	4 / 4	2.7 G / 3.3 G	6 MB	DDR4-2133	HD 530																																																				
Core i5-6500	4 / 4	3.2 G / 3.6 G	6 MB	DDR4-2133	HD 530																																																				
Core i5-6600	4 / 4	3.3 G / 3.9 G	6 MB	DDR4-2133	HD 530																																																				
Core i7-6700	4 / 8	3.4 G / 4.0 G	8 MB	DDR4-2133	HD 530																																																				
Memory	64GB max, UDIMM, DDR4 2133, four 288-pin DIMM sockets, dual-channel capable	Security features	<ul style="list-style-type: none"> <li>One lock to secure both cover and entire system to fixed object: <ul style="list-style-type: none"> <li>-Padlock loop (in rear for opt padlock)</li> <li>-Security slot (in rear for optional Kensington® MicroSaver® cable)</li> <li>Power-on password</li> </ul> </li> <li>Administrator password</li> <li>Hard disk password</li> <li>Boot sequence control</li> <li>Boot without keyboard and mouse</li> <li>Individual USB port disablement</li> <li>Optional chassis intrusion switch</li> </ul>																																																						
Disk	<i>Some:</i> Hard disk, SATA 6.0Gb/s, 2.5"/ 3.5" wide, 5400 / 7200 rpm <i>Some:</i> Solid State Hybrid Drive (SSHD), 500GB (5400 rpm, 2.5") / 1TB or 2TB (7200 rpm, 3.5"), with 8GB NAND flash memory, SATA 6.0Gb/s <i>Some:</i> Solid State Drive (SSD) / SATA 6.0Gb/s, 2.5" Wide <i>Some:</i> Front accessible and removable HDD, 3.5", lockable via physical key	Keyboard	<i>Some:</i> Preferred Pro USB Keyboard (USB connector), Lenovo logo <i>Some:</i> Lenovo USB Fingerprint Keyboard (USB connector) <i>Some:</i> Ultralim Plus Wireless Keyboard (2.4GHz via USB receiver), black																																																						
Optical	<i>Some:</i> DVD-ROM SATA 1.5Gb/s Drive <i>Some:</i> Super Multi-Burner DVD±RW SATA 1.5Gb/s Drive	Mouse	<i>Some:</i> Enhanced Optical USB Mouse, black, Lenovo logo <i>Some:</i> Ultralim Plus Wireless Mouse (2.4GHz via USB receiver), black																																																						
Onboard SATA	Four onboard SATA 6.0Gb/s connectors, one is eSATA connector for optional rear eSATA port	Mechanical	<ul style="list-style-type: none"> <li>Tower (25L), black color, metal case</li> <li>(WxDxH) 6.89" X 16.26" X 15.98"; 175mm X 413mm X 406mm</li> <li>27.56 lb (12.5 kg)</li> <li>Toolless cover, disk, optical removal</li> <li>Toolless graphics, PCI adapter retention</li> <li>Optional dust filter</li> <li>Bay 1: 5.25", 1.6" high, access, std optical</li> <li>Bay 2: 5.25", 1.6" high, access, opt media reader / front access HDD</li> <li>Bay 3: 3.5", 1" high, no access, std disk</li> <li>Bay 4: 3.5", 1" high, no access, opt disk (optional 2nd 3.5" disk tray)</li> <li>Slot 1: half-length, full-height, PCIe 3.0 x16 (75w max)</li> <li>Slot 2: half-length, full-height, PCIe 3.0 x1</li> <li>Slot 3: half-length, full-height, PCIe 3.0 x16 (x4 elec, 75w max)</li> <li>Slot 4: half-length, full-height, optional 32-bit PCI 2.3 (via M.2 to PCI adaptor)</li> </ul> 																																																						
Media reader	Optional 29-in-1 media reader	Power supply	250 watts, autosensing, 85% PSU																																																						
Graphics	<b>Intel HD Graphics 510/530</b> in processor, uses main memory, DirectX® 12, one VGA, two DisplayPort™, supports three independent displays, works along with discrete graphics to support more displays; <i>Max resolution:</i> 4096x2304 (DP)@60Hz; 1920x1200 (VGA)@60Hz <i>Some:</i> <b>NVIDIA® Quadro® K420</b> , DirectX 12, 2GB, PCIe 2.0 x16 adapter, one DVI-I, one DisplayPort, 41 watts; <i>Max resolution:</i> 3840x2160 (DisplayPort)@60Hz; 2560x1600 (DVI-I)@60Hz <i>Some:</i> <b>NVIDIA GeForce® GT 720</b> , DirectX 12, 2GB, PCIe 2.0 x8 adapter, one VGA, one HDMI, 25 watts; <i>Max resolution:</i> 1920x1080 (HDMI)@60Hz; 2048x1536 (VGA)@85Hz <i>Some:</i> <b>NVIDIA GeForce GT 720</b> , DirectX 12, 1GB, PCIe 2.0 x8 adapter, two DisplayPort, 25 watts; <i>Max resolution:</i> 3840x2160 (DisplayPort)@60Hz; Optional DP to VGA, DP to DVI-D (single link), or DP to HDMI 1.4 dongle	Limited warranty <sup>3</sup>	<i>Some:</i> <b>1-year or 3-year, limited onsite service</b> / service upgrades available <i>Some:</i> <b>3-year, limited onsite service, OID</b> (Onsite International Delivery) / service upgrades available For Lenovo service upgrade options, please go to S-TC sheet																																																						
DP cable	Optional DP to VGA, DP to DVI-D (single link), or DP to HDMI 1.4 dongle	Preload	<b>Preloaded operating system</b> <i>Some:</i> Windows® 7 Professional 64 preinstalled through downgrade rights in Windows 10 Pro 64-bit <i>Some:</i> Windows 7 Professional 64 <i>Some:</i> Windows 10 Pro 64-bit <i>Some:</i> Windows 10 Home 64-bit																																																						
Chipset	<b>Intel Q150 Chipset</b>	<b>Preloaded applications (only some listed)</b>	<ul style="list-style-type: none"> <li>Desktop Power Manager</li> <li>Lenovo Solution Center</li> <li>Lenovo REACHit</li> <li>Lenovo SHAREit</li> <li>Lenovo Bluetooth Lock (for models with Wi-Fi/BT card)</li> <li>McAfee® LiveSafe™ (30-day trial)</li> <li>Microsoft Office preloaded; purchase a product key to activate</li> <li>PowerDVD Create (DVD±RW)</li> <li>Lenovo ThinkVantage Tools</li> <li>- Only for Window 10</li> <li>Lenovo Companion</li> <li>Cyberlink PowerDVD (DVD, DVD±RW)</li> <li>Lenovo QuickOptimizer</li> <li>- Only for Window 7</li> <li>Rescue and Recovery</li> <li>Password Manager</li> <li>ThinkVantage System Update</li> <li>Lenovo Message Center Plus</li> <li>Adobe® Reader®</li> </ul>																																																						
Front ports	Two USB 3.0, two optional USB 2.0, microphone (3.5mm), headphone (3.5mm)	Environment	ENERGY STAR® 6.1*(Need 85% PSU and Windows OS); ErP Lot 3; GREENGUARD®; RoHS-compliant; TUV Green Mark																																																						
Rear ports	Four USB 3.0, two USB 2.0, two optional USB 2.0, serial (9-pin), optional 2nd serial (9-pin), optional parallel (25-pin), ethernet (RJ-45), one VGA, two DisplayPort, optional PS/2 ports (keyboard/mouse), one optional eSATA port additional VGA, DisplayPort, DVI-I or HDMI on optional graphics on some models	Accessories	For compatible accessories, please go to TC-AQP sheet																																																						
Rear audio ports	Line-in (3.5mm), line-out (3.5mm), microphone-in (3.5mm)																																																								
IEEE 1394	None																																																								
Audio support	High Definition (HD) Audio, Realtek ALC662 / optional internal speaker (1.5 watt )																																																								
WLAN <sup>13</sup>	<i>Some:</i> 11ac wireless, M.2 Card, Qualcomm Atheros QCA9377 (dual band), Wi-Fi + Bluetooth 4.1 combo adapter, 1x1 <i>Some:</i> 11ac wireless, M.2 Card, Qualcomm Atheros QCA6174 (dual band), Wi-Fi + Bluetooth 4.1 combo adapter, 2x2 <i>Some:</i> 11ac wireless, M.2 Card, Intel Dual Band Wireless-AC 3165, Wi-Fi + Bluetooth 4.0 combo adapter, 1x1 <i>Some:</i> 11ac wireless, M.2 Card, Intel Dual Band Wireless-AC 8260, Wi-Fi + Bluetooth 4.1 combo adapter, 2x2																																																								
Bluetooth™	<i>Some:</i> Bluetooth 4.0 or 4.1 wireless, integrated in Wi-Fi + BT combo adapter																																																								
Ethernet	Gigabit ethernet, Intel Ethernet Connection I219-LM (Jacksonville), Wake on LAN®																																																								
Modem	None																																																								

See footnotes for more detailed information

Model	Region	Processor	vPro	Graphics	Monitor Cable	Memory	Storage	Optical	Optional 2nd 3.5" Tray	Media Reader	WLAN + Bluetooth	Optional Front Ports	Optional Rear Ports	Chassis Intrusion Switch	Cable Lock	Front Access HDD	PCI Slot	Dust Filter	Keyboard / Mouse	Carry Handle	Power Supply	Operating System	Warranty	Ann Date (m/y)	
10FW0002US	US	i7-6700	No	Intel HD 530	None	4GBx1	1TB 7200rpm 3.5"	DVD±RW	None	None	None	None	None	None	None	None	None	None	None	USB / USB	Carry Handle	250W 85%	Win10 DG Win7 Pro 64	3-year, Onsite	11/15
10FW0003US	US	i7-6700	No	K420 2GB	None	8GBx1	1TB 7200rpm 3.5"	DVD±RW	None	None	None	None	None	None	None	None	None	None	None	USB / USB	Carry Handle	250W 85%	Win10 DG Win7 Pro 64	3-year, Onsite	11/15
10FW0004US	US	i7-6700	No	Intel HD 530	None	8GBx1	120GB SSD	DVD±RW	None	None	None	None	None	None	None	None	None	None	None	USB / USB	Carry Handle	250W 85%	Win10 DG Win7 Pro 64	3-year, Onsite	11/15
10FW0005US	US	i5-6500	No	Intel HD 530	None	4GBx1	500GB 7200rpm 3.5"	DVD±RW	None	None	None	None	None	None	None	None	None	None	None	USB / USB	Carry Handle	250W 85%	Win10 DG Win7 Pro 64	3-year, Onsite	11/15
10FW0006US	US	i7-6700	No	Intel HD 530	None	8GBx1	500GB 7200rpm 3.5"	DVD±RW	None	None	None	None	None	None	None	None	None	None	None	USB / USB	Carry Handle	250W 85%	Win10 DG Win7 Pro 64	3-year, Onsite	11/15
10FW0007US	US	i5-6500	No	Intel HD 530	None	4GBx1	120GB SSD	DVD±RW	None	None	None	None	None	None	None	None	None	None	None	USB / USB	Carry Handle	250W 85%	Win10 DG Win7 Pro 64	3-year, Onsite	11/15
10FW000WUS	US	i5-6400	No	Intel HD 530	None	4GBx1	500GB 7200rpm 3.5"	DVD±RW	None	None	None	None	None	None	None	None	None	None	None	USB / USB	Carry Handle	250W 85%	Win10 Pro 64	3-year, Onsite	11/15
10FW000XUS	US	i7-6700	No	GT 720 1GB	None	8GBx1	1TB 7200rpm 3.5"	DVD±RW	None	None	None	None	None	None	None	None	None	None	None	USB / USB	Carry Handle	250W 85%	Win10 Pro 64	3-year, Onsite	11/15
10FW000YUS	US	i7-6700	No	Intel HD 530	None	8GBx1	1TB 7200rpm 3.5"	DVD±RW	None	None	None	None	None	None	None	None	None	None	None	USB / USB	Carry Handle	250W 85%	Win10 Pro 64	3-year, Onsite	11/15
10FW0010US	US	i5-6500	No	Intel HD 530	None	4GBx1	500GB 7200rpm 3.5"	DVD±RW	None	None	None	None	None	None	None	None	None	None	None	USB / USB	Carry Handle	250W 85%	Win10 Pro 64	3-year, Onsite	11/15
10FW001NUS	US	i7-6700	No	Intel HD 530	None	8GBx1	1TB 7200rpm 3.5"	DVD±RW	Optional 2nd 3.5" Tray	None	None	None	None	None	None	None	None	None	None	USB / USB	Carry Handle	250W 85%	Win10 Pro 64	3-year, Onsite	12/15
10FW001PUS	US	i5-6400	No	Intel HD 530	None	8GBx1	500GB 7200rpm 3.5"	DVD±RW	Optional 2nd 3.5" Tray	None	None	None	None	None	None	None	None	None	None	USB / USB	Carry Handle	250W 85%	Win10 Pro 64	3-year, Onsite	12/15
10FW001QUS	US	i7-6700	No	GT 720 1GB	None	8GBx2	1TB 7200rpm 3.5"	DVD±RW	Optional 2nd 3.5" Tray	None	None	None	None	None	None	None	None	None	None	USB / USB	Carry Handle	250W 85%	Win10 Pro 64	3-year, Onsite	12/15
10FW001RUS	US	i7-6700	No	GT 720 1GB	None	8GBx1	1TB 7200rpm 3.5"	DVD±RW	Optional 2nd 3.5" Tray	None	None	None	None	None	None	None	None	None	None	USB / USB	Carry Handle	250W 85%	Win10 Pro 64	3-year, Onsite	12/15
10FW001SUS	US	i5-6400	No	Intel HD 530	None	4GBx1	500GB 7200rpm 3.5"	DVD±RW	Optional 2nd 3.5" Tray	None	None	None	None	None	None	None	None	None	None	USB / USB	Carry Handle	250W 85%	Win10 Pro 64	3-year, Onsite	12/15
10FW001TUS	US	i3-6100	No	Intel HD 530	None	4GBx1	500GB 7200rpm 3.5"	DVD±RW	Optional 2nd 3.5" Tray	None	8260 ac, 2x2 + BT4.1	None	None	None	None	None	None	None	None	USB / USB	Carry Handle	250W 85%	Win10 Pro 64	3-year, Onsite	12/15
10FW001UUS	US	i3-6100	No	Intel HD 530	None	4GBx1	500GB 7200rpm 3.5"	DVD±RW	Optional 2nd 3.5" Tray	None	None	None	None	None	None	None	None	None	None	USB / USB	Carry Handle	250W 85%	Win10 DG Win7 Pro 64	3-year, Onsite	12/15
10FW001VUS	US	i3-6100	No	Intel HD 530	None	4GBx1	128GB SSD	DVD±RW	Optional 2nd 3.5" Tray	None	8260 ac, 2x2 + BT4.1	None	None	None	None	None	None	None	None	USB / USB	Carry Handle	250W 85%	Win10 Pro 64	3-year, Onsite	12/15
10FW001WUS	US	i3-6100	No	Intel HD 530	None	4GBx1	500GB 7200rpm 3.5"	DVD±RW	Optional 2nd 3.5" Tray	None	8260 ac, 2x2 + BT4.1	None	None	None	None	None	None	None	None	USB / USB	Carry Handle	250W 85%	Win10 DG Win7 Pro 64	3-year, Onsite	12/15
10FW001XUS	US	i3-6100	No	Intel HD 530	None	8GBx1	1TB 7200rpm 3.5"	DVD±RW	Optional 2nd 3.5" Tray	None	None	None	None	None	None	None	None	None	None	USB / USB	Carry Handle	250W 85%	Win10 DG Win7 Pro 64	3-year, Onsite	12/15

Model	Region	Processor	vPro	Graphics	Monitor Cable	Memory	Storage	Optical	Optional 2nd 3.5" Tray	Media Reader	WLAN + Bluetooth	Optional Front Ports	Optional Rear Ports	Chassis Intrusion Switch	Cable Lock	Front Access HDD	PCI Slot	Dust Filter	Keyboard / Mouse	Carry Handle	Power Supply	Operating System	Warranty	Ann Date (m/y)
10FW001YUS	US	i3-6100	No	Intel HD 530	None	4GBx1	128GB SSD	DVD±RW	Optional 2nd 3.5" Tray	None	None	None	None	None	None	None	None	None	USB / USB	Carry Handle	250W 85%	Win10 DG Win7 Pro 64	3-year, Onsite	12/15
10FW002TUS	US	i3-6100	No	Intel HD 530	None	4GBx1	500GB 7200rpm 3.5"	DVD±RW	Optional 2nd 3.5" Tray	None	None	None	None	None	None	None	None	None	USB / USB	Carry Handle	250W 85%	Win10 Pro 64	3-year, Onsite	07/16
10FW002UUS	US	i7-6700	No	Intel HD 530	None	8GBx1	128GB SSD	DVD±RW	Optional 2nd 3.5" Tray	None	None	None	None	None	None	None	None	None	USB / USB	Carry Handle	250W 85%	Win10 Pro 64	3-year, Onsite	07/16
10FW003DUS	US	i7-6700	No	GT 720 1GB	None	8GBx2	1TB 7200rpm 3.5"	DVD±RW	Optional 2nd 3.5" Tray	None	None	None	None	None	None	None	None	None	USB / USB	Carry Handle	250W 85%	Win10 Pro 64	3-year, Onsite	10/16
10FW003EUS	US	i7-6700	No	GT 720 1GB	None	8GBx2	1TB 7200rpm 3.5"	DVD±RW	Optional 2nd 3.5" Tray	None	None	None	None	None	None	None	None	None	USB / USB	Carry Handle	250W 85%	Win10 DG Win7 Pro 64	3-year, Onsite	10/16
10FW003FUS	US	i7-6700	No	GT 720 1GB	None	8GBx1	1TB 7200rpm 3.5"	DVD±RW	Optional 2nd 3.5" Tray	None	None	None	None	None	None	None	None	None	USB / USB	Carry Handle	250W 85%	Win10 DG Win7 Pro 64	3-year, Onsite	10/16
10FW003GUS	US	i7-6700	No	GT 720 1GB	None	8GBx1	1TB 7200rpm 3.5"	DVD±RW	Optional 2nd 3.5" Tray	None	None	None	None	None	None	None	None	None	USB / USB	Carry Handle	250W 85%	Win10 Pro 64	3-year, Onsite	10/16

Model	Region	Processor	vPro	Graphics	Monitor Cable	Memory	Storage	Optical	Optional 2nd 3.5" Tray	Media Reader	WLAN + Bluetooth	Optional Front Ports	Optional Rear Ports	Chassis Intrusion Switch	Cable Lock	Front Access HDD	PCI Slot	Dust Filter	Keyboard / Mouse	Carry Handle	Power Supply	Operating System	Warranty	Ann Date (m/y)
10FV0004US	US	i7-6700	No	K420 2GB	None	8GBx1	1TB 7200rpm 3.5"	DVD±RW	None	None	None	None	None	None	None	None	None	None	USB / USB	Carry Handle	250W 85%	Win10 DG Win7 Pro 64	3-year, Onsite	11/15
10FV0005US	US	i7-6700	No	Intel HD 530	None	8GBx1	120GB SSD	DVD±RW	None	None	None	None	None	None	None	None	None	None	USB / USB	Carry Handle	250W 85%	Win10 DG Win7 Pro 64	3-year, Onsite	11/15
10FV0006US	US	i7-6700	No	Intel HD 530	None	8GBx1	500GB 7200rpm 3.5"	DVD±RW	None	None	None	None	None	None	None	None	None	None	USB / USB	Carry Handle	250W 85%	Win10 DG Win7 Pro 64	3-year, Onsite	11/15
10FV0007US	US	i5-6500	No	Intel HD 530	None	4GBx1	120GB SSD	DVD±RW	None	None	None	None	None	None	None	None	None	None	USB / USB	Carry Handle	250W 85%	Win10 DG Win7 Pro 64	3-year, Onsite	11/15
10FV0008US	US	i7-6700	No	GT 720 1GB	None	8GBx1	1TB 7200rpm 3.5"	DVD±RW	None	None	None	None	None	None	None	None	None	None	USB / USB	Carry Handle	250W 85%	Win10 DG Win7 Pro 64	3-year, Onsite	11/15
10FV0009US	US	i7-6700	No	Intel HD 530	None	8GBx1	1TB 7200rpm 3.5"	DVD±RW	None	None	None	None	None	None	None	None	None	None	USB / USB	Carry Handle	250W 85%	Win10 DG Win7 Pro 64	3-year, Onsite	11/15
10FV000AUS	US	i5-6500	No	Intel HD 530	None	4GBx1	1TB 7200rpm 3.5"	DVD±RW	None	None	None	None	None	None	None	None	None	None	USB / USB	Carry Handle	250W 85%	Win10 DG Win7 Pro 64	3-year, Onsite	11/15
10FV000BUS	US	i5-6500	No	GT 720 1GB	None	4GBx1	1TB 7200rpm 3.5"	DVD±RW	None	None	None	None	None	None	None	None	None	None	USB / USB	Carry Handle	250W 85%	Win10 DG Win7 Pro 64	3-year, Onsite	11/15
10FV000CUS	US	i5-6500	No	Intel HD 530	None	4GBx1	500GB 7200rpm 3.5"	DVD±RW	None	None	None	None	None	None	None	None	None	None	USB / USB	Carry Handle	250W 85%	Win10 DG Win7 Pro 64	3-year, Onsite	11/15
10FV000MUS	US	i5-6500	No	Intel HD 530	None	4GBx1	500GB 7200rpm 3.5"	DVD	None	None	None	None	None	None	None	None	None	None	USB / USB	None	250W 85%	Win10 Pro 64	3-year, Onsite, OID	11/15
10FV000NUS	US	i5-6500	No	GT 720 1GB	DP to HDMI	4GBx1	1TB 7200rpm 3.5"	DVD±RW	None	29-in-1	None	None	None	None	None	None	None	None	USB / USB	None	250W 85%	Win10 Pro 64	3-year, Onsite, OID	11/15
10FV000PUS	US	i5-6500	No	Intel HD 530	None	4GBx1	500GB 7200rpm 3.5"	None	None	None	None	None	None	None	None	None	None	None	USB / USB	Carry Handle	250W 85%	Win10 Pro 64	3-year, Onsite, OID	11/15
10FV000QUS	US	i5-6500	No	GT 720 1GB	None	4GBx1	1TB 7200rpm 3.5"	DVD±RW	None	29-in-1	None	None	None	None	None	None	None	Dust Filter	USB / USB	Carry Handle	250W 85%	Win10 DG Win7 Pro 64	3-year, Onsite, OID	11/15
10FV000RUS	US	i5-6500	No	Intel HD 530	None	4GBx1	500GB 7200rpm 3.5"	DVD±RW	None	None	None	None	None	None	None	None	None	None	USB / USB	None	250W 85%	Win10 DG Win7 Pro 64	3-year, Onsite, OID	11/15
10FV000SUS	US	i5-6500	No	Intel HD 530	None	4GBx1	500GB 7200rpm 3.5"	DVD	None	None	None	None	None	None	None	None	None	None	USB / USB	None	250W 85%	Win10 DG Win7 Pro 64	3-year, Onsite, OID	11/15





# ThinkCentre M900 SFF Platform Specifications

Product Specifications Reference (PSREF)

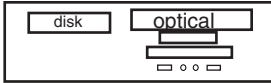
Processor	Intel® Celeron®, Intel Pentium®, or 6th Generation Intel Core™ i3 / i5 / i7 Processor							Manageability Intel Active Management Technology 11.0 (Intel AMT 11.0); Intel vPro technology on some models (require choosing a vPro-support Wi-Fi adapter to enable vPro function through wireless connection)
	Processor	Cores / Threads	Frequency Base/Max(GHz)	Cache	Memory Types	Integrated Graphics	Intel vPro	
	Pentium G4400	2 / 2	3.3G	3 MB	DDR4-2133	HD 510	No	
	Pentium G4500	2 / 2	3.5G	3 MB	DDR4-2133	HD 530	No	
	Core i3-6100	2 / 4	3.7 G	3 MB	DDR4-2133	HD 530	No	
	Core i3-6300	2 / 4	3.8 G	4 MB	DDR4-2133	HD 530	No	
	Core i5-6400	4 / 4	2.7 G / 3.3 G	6 MB	DDR4-2133	HD 530	No	
	Core i5-6500	4 / 4	3.2 G / 3.6 G	6 MB	DDR4-2133	HD 530	vPro	
Core i5-6600	4 / 4	3.3 G / 3.9 G	6 MB	DDR4-2133	HD 530	vPro		
Core i7-6700	4 / 8	3.4 G / 4.0 G	8 MB	DDR4-2133	HD 530	vPro		
Memory	64GB max, UDIMM, DDR4 2133, four 288-pin DIMM sockets, dual-channel capable							Security chip Trusted Platform Module, TCG 1.2-compliant
Disk	<i>Some:</i> Hard disk, SATA 6.0Gb/s, 2.5"/ 3.5" wide, 5400 / 7200 rpm <i>Some:</i> Solid State Hybrid Drive (SSHD), 500GB (5400 rpm, 2.5") / 1TB or 2TB (7200 rpm, 3.5"), with 8GB NAND flash memory, SATA 6.0Gb/s <i>Some:</i> Solid State Drive (SSD) / SATA 6.0Gb/s, 2.5" Wide <i>Some:</i> M.2 SSD, PCIe NVMe, PCIe 3.0 x4, 32Gb/s <i>Some:</i> DVD-ROM SATA 1.5Gb/s Drive <i>Some:</i> Super Multi-Burner DVD±RW SATA 1.5Gb/s Drive							
Optical	Four onboard SATA 6.0Gb/s connectors, one is eSATA connector for optional rear eSATA port, RAID 0, 1 support							Security features <ul style="list-style-type: none"> <li>• One lock to secure both cover and entire system to fixed object:             <ul style="list-style-type: none"> <li>-Padlock loop (in rear for opt padlock)</li> <li>-Security slot (in rear for optional Kensington® MicroSaver® cable)</li> <li>• Power-on password</li> </ul> </li> <li>• Administrator password</li> <li>• Hard disk password</li> <li>• Boot sequence control</li> <li>• Boot without keyboard and mouse</li> <li>• Individual USB port disablement</li> <li>• Optional chassis intrusion switch</li> </ul>
Onboard SATA	Optional 9-in-1 media reader							
Media reader	Optional 9-in-1 media reader							Keyboard <i>Some:</i> Preferred Pro USB Keyboard (USB connector), Lenovo logo <i>Some:</i> Lenovo USB Fingerprint Keyboard (USB connector) <i>Some:</i> Ultraslim Plus Wireless Keyboard (2.4GHz via USB receiver), black <i>Some:</i> Enhanced Optical USB Mouse, black, Lenovo logo <i>Some:</i> Ultraslim Plus Wireless Mouse (2.4GHz via USB receiver), black
Graphics	<b>Intel HD Graphics 510/530</b> in processor, uses main memory, DirectX® 12, one VGA, two DisplayPort™, supports three independent displays, works along with discrete graphics to support more displays; <i>Max resolution:</i> 4096x2304 (DP)@60Hz; 1920x1200 (VGA)@60Hz <i>Some:</i> <b>NVIDIA® Quadro® K420</b> , DirectX 12, 2GB, PCIe 2.0 x16 adapter, one DVI-I, one DisplayPort, 41 watts; <i>Max resolution:</i> 3840x2160 (DisplayPort)@60Hz; 2560x1600 (DVI-I)@60Hz <i>Some:</i> <b>NVIDIA GeForce® GT 720</b> , DirectX 12, 2GB, PCIe 2.0 x8 adapter, one VGA, one HDMI, 25 watts; <i>Max resolution:</i> 1920x1080 (HDMI)@60Hz; 2048x1536 (VGA)@85Hz <i>Some:</i> <b>NVIDIA GeForce GT 720</b> , DirectX 12, 1GB, PCIe 2.0 x8 adapter, two DisplayPort, 25 watts; <i>Max resolution:</i> 3840x2160 (DisplayPort)@60Hz;							
DP cable	Optional DP to VGA, DP to DVI-D (single link), or DP to HDMI 1.4 dongle							Mechanical <ul style="list-style-type: none"> <li>• SFF (9.7L), black color; metal case</li> <li>• (WxDxH) 13.31" X 14.05" X 3.46"; 338mm X 357mm X 88mm</li> <li>• 12.3 lb (5.6 kg)</li> <li>• Toolless cover, disk, optical removal</li> <li>• Toolless graphics, PCI adapter retention</li> <li>• Optional dust filter</li> </ul>  <p>Bay 1: N/A, 9.5mm high, external, std optical            Bay 2: 3.5", 1" high, internal, std disk            Bay 3: 2.5", N/A, internal, opt 2nd 2.5" disk (optional bay)            Bay 4: N/A, N/A, external, opt reader            Slot 1: Low Profile, PCI Express 3.0 x16 (45w max)            Slot 2: Low Profile, PCIe 3.0 x1            Slot 3: Low Profile, PCIe 3.0 x16 (x4 elec, 45w max)            Slot 4: Low Profile, optional 32-bit PCI 2.3 (via M.2 to PCI adaptor)</p>
Chipset	<b>Intel Q170 Chipset</b>							
Front ports	Two USB 3.0, two optional USB 2.0, microphone (3.5mm), headphone (3.5mm)							Floor Stand Optional system floor stand for vertical orientation
Rear ports	Six USB 3.0, two optional USB 2.0, serial (9-pin), optional 2nd serial (9-pin), optional parallel (25-pin), ethernet (RJ-45), one VGA, two DisplayPort, optional PS/2 ports (keyboard/mouse), one optional eSATA port additional VGA, DisplayPort, DVI-I or HDMI on optional graphics on some models							
Rear audio ports	Line-in (3.5mm), line-out (3.5mm), microphone-in (3.5mm)							Power supply 210 watts, autosensing, 85% PSU
IEEE 1394	None							
Audio support	High Definition (HD) Audio, Realtek ALC662 / optional internal speaker (1.5 watt )							Limited warranty <sup>3</sup> <i>Some:</i> <b>1-year or 3-year, limited onsite service</b> / service upgrades available <i>Some:</i> <b>3-year, limited onsite service, OID</b> (Onsite International Delivery) / service upgrades available <i>For Lenovo service upgrade options, please go to S-TC sheet</i>
WLAN <sup>13</sup>	<i>Some:</i> 11ac wireless, M.2 Card, Qualcomm Atheros QCA9377 (dual band), Wi-Fi + Bluetooth 4.1 combo adapter, 1x1 <i>Some:</i> 11ac wireless, M.2 Card, Qualcomm Atheros QCA6174 (dual band), Wi-Fi + Bluetooth 4.1 combo adapter, 2x2 <i>Some:</i> 11ac wireless, M.2 Card, Intel Dual Band Wireless-AC 3165, Wi-Fi + Bluetooth 4.0 combo adapter, 1x1 <i>Some:</i> 11ac wireless, M.2 Card, Intel Dual Band Wireless-AC 8260, Wi-Fi + Bluetooth 4.1 combo adapter, 2x2 <i>Some:</i> 11ac wireless, M.2 Card, Intel Dual Band Wireless-AC 8260, Wi-Fi + Bluetooth 4.1 combo adapter, Intel vPro technology support, 2x2							
Bluetooth™	<i>Some:</i> Bluetooth 4.0 or 4.1 wireless, integrated in Wi-Fi + BT combo adapter							Preload <b>Preloaded operating system</b> <i>Some:</i> Windows® 7 Professional 64 preinstalled through downgrade rights in Windows 10 Pro 64-bit <i>Some:</i> Windows 7 Professional 64 <i>Some:</i> Windows 10 Pro 64-bit <i>Some:</i> Windows 10 Home 64-bit <b>Preloaded applications (only some listed)</b> <ul style="list-style-type: none"> <li>• Desktop Power Manager</li> <li>• Lenovo Solution Center</li> <li>• Lenovo REACHit</li> <li>• Lenovo SHAREit</li> <li>• Lenovo Bluetooth Lock (for models with Wi-Fi/BT card)</li> <li>• McAfee® LiveSafe™ (30-day trial)</li> <li>• Microsoft Office preloaded; purchase a product key to activate</li> <li>• PowerDVD Create (DVD±RW)</li> <li>• Lenovo ThinkVantage Tools</li> <li>• Intel Unite (vPro models only)</li> <li>- Only for Window 10             <ul style="list-style-type: none"> <li>• Lenovo Companion</li> <li>• Cyberlink PowerDVD (DVD, DVD±RW)</li> <li>• Lenovo QuickOptimizer</li> </ul> </li> <li>- Only for Window 7             <ul style="list-style-type: none"> <li>• Rescue and Recovery</li> <li>• Password Manager</li> <li>• ThinkVantage System Update</li> <li>• Lenovo Message Center Plus</li> <li>• Adobe® Reader®</li> </ul> </li> </ul>
Ethernet	Gigabit ethernet, Intel Ethernet Connection I219-LM (Jacksonville), Wake on LAN®							
Modem	None							Environment ENERGY STAR® 6.1*; EPEAT™ Gold rating*; (*Need 85% PSU and Windows OS); ErP Lot 3; GREENGUARD®; RoHS-compliant; TUV Green Mark, ULE Gold
Accessories For compatible accessories, please go to TC-AQP sheet								

See footnotes for more detailed information

Model	Region	Processor	vPro	Graphics	Monitor Cable	Memory	Storage(HDD/SSD)	Optical	Optional 2nd 2.5" Bay	Media Reader	WLAN + Bluetooth	Optional Front Ports	Optional Rear Ports	Chassis Intrusion Switch	Cable Lock	PCI Slot	Dust Filter	Keyboard / Mouse	Stand	Power Supply	Operating System	Warranty	Ann Date (m/y)
10FH000KUS	US	i5-6500	vPro	Intel HD 530	None	4GBx1	500GB 7200rpm 3.5"	DVD±RW	None	None	None	None	None	None	None	None	None	USB / USB	Floor Stand	210W 85%	Win10 DG Win7 Pro 64	3-year, Onsite, OID	11/15
10FH000LUS	US	i7-6700	vPro	GT 720 1GB	None	8GBx1	1TB 7200rpm 3.5"	DVD±RW	None	None	8260 ac, 2x2, vPro + BT4.1	None	None	None	None	None	None	USB / USB	Floor Stand	210W 85%	Win10 Pro 64	3-year, Onsite, OID	11/15
10FH000MUS	US	i7-6700	vPro	GT 720 1GB	None	8GBx1	1TB 7200rpm 3.5"	DVD±RW	None	None	8260 ac, 2x2, vPro + BT4.1	None	None	None	None	None	None	USB / USB	Floor Stand	210W 85%	Win10 DG Win7 Pro 64	3-year, Onsite, OID	11/15
10FH000NUS	US	i5-6500	vPro	Intel HD 530	None	4GBx1	500GB 7200rpm 3.5"	DVD±RW	None	None	None	None	None	None	None	None	None	USB / USB	Floor Stand	210W 85%	Win10 Pro 64	3-year, Onsite, OID	11/15
10FH001YUS	US	i5-6500	vPro	GT 720 1GB	None	4GBx1	500GB 7200rpm 3.5"	DVD±RW	Optional 2nd 2.5" Bay	None	None	None	None	None	None	None	None	USB / USB	Floor Stand	210W 85%	Win10 DG Win7 Pro 64	3-year, Onsite	12/15
10FH0020US	US	i7-6700	vPro	GT 720 1GB	None	8GBx1	1TB 7200rpm 3.5"	DVD±RW	Optional 2nd 2.5" Bay	None	None	None	None	None	None	None	None	USB / USB	Floor Stand	210W 85%	Win10 Pro 64	3-year, Onsite	12/15
10FH0021US	US	i5-6500	vPro	Intel HD 530	None	4GBx1	180GB SSD Opal	DVD±RW	Optional 2nd 2.5" Bay	None	None	None	None	None	None	None	None	USB / USB	Floor Stand	210W 85%	Win10 DG Win7 Pro 64	3-year, Onsite	12/15
10FH0022US	US	i5-6500	vPro	Intel HD 530	None	8GBx1	256GB SSD Opal	DVD±RW	Optional 2nd 2.5" Bay	None	None	None	None	None	None	None	None	USB / USB	Floor Stand	210W 85%	Win10 DG Win7 Pro 64	3-year, Onsite	12/15
10FH0023US	US	i5-6500	vPro	Intel HD 530	None	8GBx1	192GB SSD	DVD±RW	Optional 2nd 2.5" Bay	None	None	None	None	None	None	None	None	USB / USB	Floor Stand	210W 85%	Win10 Pro 64	3-year, Onsite	12/15
10FH0024US	US	i5-6500	vPro	Intel HD 530	None	8GBx1	1TB 7200rpm 3.5"	DVD±RW	Optional 2nd 2.5" Bay	None	8260 ac, 2x2, vPro + BT4.1	None	None	None	None	None	None	USB / USB	Floor Stand	210W 85%	Win10 DG Win7 Pro 64	3-year, Onsite, OID	12/15
10FH0025US	US	i7-6700	vPro	GT 720 1GB	None	8GBx1	256GB SSD Opal	DVD±RW	Optional 2nd 2.5" Bay	None	None	None	None	None	None	None	None	USB / USB	Floor Stand	210W 85%	Win10 DG Win7 Pro 64	3-year, Onsite	12/15
10FH0026US	US	i5-6500	vPro	Intel HD 530	None	8GBx1	180GB SSD Opal	DVD±RW	Optional 2nd 2.5" Bay	None	None	None	None	None	None	None	None	USB / USB	Floor Stand	210W 85%	Win10 Pro 64	3-year, Onsite	12/15
10FH0027US	US	i7-6700	vPro	Intel HD 530	None	8GBx1	256GB SSD Opal	DVD±RW	Optional 2nd 2.5" Bay	None	None	None	None	None	None	None	None	USB / USB	Floor Stand	210W 85%	Win10 DG Win7 Pro 64	3-year, Onsite	12/15
10FH0028US	US	i5-6500	vPro	Intel HD 530	None	4GBx1	128GB SSD	DVD±RW	Optional 2nd 2.5" Bay	None	None	None	None	None	None	None	None	USB / USB	Floor Stand	210W 85%	Win10 DG Win7 Pro 64	3-year, Onsite	12/15
10FH0029US	US	i5-6500	vPro	Intel HD 530	None	4GBx1	192GB SSD	DVD±RW	Optional 2nd 2.5" Bay	None	None	None	None	None	None	None	None	USB / USB	Floor Stand	210W 85%	Win10 DG Win7 Pro 64	3-year, Onsite	12/15
10FH002AUS	US	i7-6700	vPro	Intel HD 530	None	8GBx1	256GB SSD Opal	DVD±RW	Optional 2nd 2.5" Bay	None	None	None	None	None	None	None	None	USB / USB	Floor Stand	210W 85%	Win10 Pro 64	3-year, Onsite	12/15
10FH002BUS	US	i5-6500	vPro	Intel HD 530	None	4GBx1	500GB 7200rpm 3.5"	DVD±RW	Optional 2nd 2.5" Bay	None	None	None	None	None	None	None	None	USB / USB	Floor Stand	210W 85%	Win10 DG Win7 Pro 64	3-year, Onsite, OID	12/15
10FH002CUS	US	i5-6500	vPro	Intel HD 530	None	8GBx1	500GB 7200rpm 3.5"	DVD±RW	Optional 2nd 2.5" Bay	None	None	None	None	None	None	None	None	USB / USB	Floor Stand	210W 85%	Win10 DG Win7 Pro 64	3-year, Onsite, OID	12/15
10FH002DUS	US	i7-6700	vPro	GT 720 1GB	None	8GBx1	1TB 7200rpm 3.5"	DVD±RW	Optional 2nd 2.5" Bay	None	None	None	None	None	None	None	None	USB / USB	Floor Stand	210W 85%	Win10 DG Win7 Pro 64	3-year, Onsite	12/15
10FH002EUS	US	i5-6500	vPro	GT 720 1GB	None	8GBx1	1TB 7200rpm 3.5"	DVD±RW	Optional 2nd 2.5" Bay	None	None	None	None	None	None	None	None	USB / USB	Floor Stand	210W 85%	Win10 DG Win7 Pro 64	3-year, Onsite	12/15

Model	Region	Processor	vPro	Graphics	Monitor Cable	Memory	Storage(HDD/SSD)	Optical	Optional 2nd 2.5" Bay	Media Reader	WLAN + Bluetooth	Optional Front Ports	Optional Rear Ports	Chassis Intrusion Switch	Cable Lock	PCI Slot	Dust Filter	Keyboard / Mouse	Stand	Power Supply	Operating System	Warranty	Ann Date (m/y)
10FH002FUS	US	i5-6500	vPro	Intel HD 530	None	8GBx1	1TB 7200rpm 3.5"	DVD±RW	Optional 2nd 2.5" Bay	None	None	None	None	None	None	None	None	USB / USB	Floor Stand	210W 85%	Win10 DG Win7 Pro 64	3-year, Onsite, OID	12/15
10FH002GUS	US	i5-6500	vPro	GT 720 1GB	None	8GBx1	1TB 7200rpm 3.5"	DVD±RW	Optional 2nd 2.5" Bay	None	None	None	None	None	None	None	None	USB / USB	Floor Stand	210W 85%	Win10 Pro 64	3-year, Onsite	12/15
10FH002HUS	US	i7-6700	vPro	Intel HD 530	None	8GBx1	1TB 7200rpm 3.5"	DVD±RW	Optional 2nd 2.5" Bay	None	None	None	None	None	None	None	None	USB / USB	Floor Stand	210W 85%	Win10 DG Win7 Pro 64	3-year, Onsite, OID	12/15
10FH002JUS	US	i5-6500	vPro	Intel HD 530	None	8GBx1	128GB SSD	DVD±RW	Optional 2nd 2.5" Bay	None	None	None	None	None	None	None	None	USB / USB	Floor Stand	210W 85%	Win10 Pro 64	3-year, Onsite	12/15
10FH002KUS	US	i5-6500	vPro	Intel HD 530	None	4GBx1	500GB 7200rpm 3.5"	DVD±RW	Optional 2nd 2.5" Bay	None	8260 ac, 2x2, vPro + BT4.1	None	None	None	None	None	None	USB / USB	Floor Stand	210W 85%	Win10 DG Win7 Pro 64	3-year, Onsite, OID	12/15
10FH002LUS	US	i7-6700	vPro	Intel HD 530	None	8GBx1	1TB 7200rpm 3.5"	DVD±RW	Optional 2nd 2.5" Bay	None	8260 ac, 2x2, vPro + BT4.1	None	None	None	None	None	None	USB / USB	Floor Stand	210W 85%	Win10 DG Win7 Pro 64	3-year, Onsite, OID	12/15
10FH003MUS	US	i5-6500	vPro	Intel HD 530	None	8GBx1	128GB SSD	DVD±RW	Optional 2nd 2.5" Bay	None	None	None	None	None	None	None	None	USB / USB	Floor Stand	210W 85%	Win10 DG Win7 Pro 64	3-year, Onsite	03/16
10FH003NUS	US	i5-6500	vPro	Intel HD 530	None	8GBx1	500GB 7200rpm 3.5"	DVD±RW	Optional 2nd 2.5" Bay	None	None	None	None	None	None	None	None	USB / USB	Floor Stand	210W 85%	Win10 DG Win7 Pro 64	3-year, Onsite	03/16
10FH004JUS	US	i5-6500	vPro	Intel HD 530	None	4GBx1	500GB 7200rpm 3.5"	DVD±RW	Optional 2nd 2.5" Bay	None	None	None	None	None	None	None	None	USB / USB	Floor Stand	210W 85%	Win10 Pro 64	3-year, Onsite	07/16
10FH0054US	US	i7-6700	vPro	GT 720 1GB	None	8GBx1	1TB 7200rpm 3.5"	DVD±RW	Optional 2nd 2.5" Bay	None	8260 ac, 2x2, vPro + BT4.1	None	None	None	None	None	None	USB / USB	Floor Stand	210W 85%	Win10 Pro 64	3-year, Onsite	07/16
10FH005JUS	US	i7-6700	vPro	GT 720 1GB	None	8GBx1	1TB 7200rpm 3.5"	DVD±RW	Optional 2nd 2.5" Bay	None	None	None	None	None	None	None	None	USB / USB	Floor Stand	210W 85%	Win10 DG Win7 Pro 64	3-year, Onsite	10/16
10FH005KUS	US	i7-6700	vPro	GT 720 1GB	None	8GBx1	256GB SSD Opal	DVD±RW	Optional 2nd 2.5" Bay	None	None	None	None	None	None	None	None	USB / USB	Floor Stand	210W 85%	Win10 DG Win7 Pro 64	3-year, Onsite	10/16
10FH005LUS	US	i5-6500	vPro	GT 720 1GB	None	4GBx1	500GB 7200rpm 2.5"	DVD±RW	Optional 2nd 2.5" Bay	None	None	None	None	None	None	None	None	USB / USB	Floor Stand	210W 85%	Win10 Pro 64	3-year, Onsite	10/16
10FH005MUS	US	i5-6500	vPro	GT 720 1GB	None	8GBx1	1TB 7200rpm 3.5"	DVD±RW	Optional 2nd 2.5" Bay	None	None	None	None	None	None	None	None	USB / USB	Floor Stand	210W 85%	Win10 DG Win7 Pro 64	3-year, Onsite	10/16
10FH005NUS	US	i7-6700	vPro	GT 720 1GB	None	8GBx1	1TB 7200rpm 3.5"	DVD±RW	Optional 2nd 2.5" Bay	None	None	None	None	None	None	None	None	USB / USB	Floor Stand	210W 85%	Win10 Pro 64	3-year, Onsite	10/16
10FH005PUS	US	i5-6500	vPro	GT 720 1GB	None	4GBx1	500GB 7200rpm 2.5"	DVD±RW	Optional 2nd 2.5" Bay	None	None	None	None	None	None	None	None	USB / USB	Floor Stand	210W 85%	Win10 DG Win7 Pro 64	3-year, Onsite	10/16
10FH005QUS	US	i7-6700	vPro	GT 720 1GB	None	8GBx1	1TB 7200rpm 3.5"	DVD±RW	Optional 2nd 2.5" Bay	None	8260 ac, 2x2, vPro + BT4.1	None	None	None	None	None	None	USB / USB	Floor Stand	210W 85%	Win10 DG Win7 Pro 64	3-year, Onsite	10/16
10FH005RUS	US	i5-6500	vPro	GT 720 1GB	None	8GBx1	1TB 7200rpm 3.5"	DVD±RW	Optional 2nd 2.5" Bay	None	None	None	None	None	None	None	None	USB / USB	Floor Stand	210W 85%	Win10 Pro 64	3-year, Onsite	10/16
10FH005SUS	US	i7-6700	vPro	GT 720 1GB	None	8GBx1	1TB 7200rpm 3.5"	DVD±RW	Optional 2nd 2.5" Bay	None	8260 ac, 2x2, vPro + BT4.1	None	None	None	None	None	None	USB / USB	Floor Stand	210W 85%	Win10 Pro 64	3-year, Onsite	10/16
10FH005TUS	US	i7-6700	vPro	GT 720 1GB	None	8GBx1	256GB SSD Opal	DVD±RW	Optional 2nd 2.5" Bay	None	None	None	None	None	None	None	None	USB / USB	Floor Stand	210W 85%	Win10 Pro 64	3-year, Onsite	10/16



Model	Region	Processor	vPro	Graphics	Monitor Cable	Memory	Storage(HDD/SSD)	Optical	Optional 2nd 2.5" Bay	Media Reader	WLAN + Bluetooth	Optional Front Ports	Optional Rear Ports	Chassis Intrusion Switch	Cable Lock	PCI Slot	Dust Filter	Keyboard / Mouse	Stand	Power Supply	Operating System	Warranty	Ann Date (m/y)
10FG0006US	US	i5-6500	vPro	Intel HD 530	None	4GBx1	500GB 7200rpm 3.5"	DVD±RW	None	None	None	None	None	None	None	None	None	USB / USB	Floor Stand	210W 85%	Win10 DG Win7 Pro 64	3-year, Onsite, OID	11/15
10FG0007US	US	i7-6700	vPro	GT 720 1GB	None	8GBx1	1TB 7200rpm 3.5"	DVD±RW	None	None	8260 ac, 2x2, vPro + BT4.1	None	None	None	None	None	None	USB / USB	Floor Stand	210W 85%	Win10 DG Win7 Pro 64	3-year, Onsite, OID	11/15
10FG000XUS	US	i5-6500	vPro	Intel HD 530	None	4GBx1	500GB 7200rpm 3.5"	DVD	None	None	None	None	None	None	None	None	None	USB / USB	None	210W 85%	Win10 Pro 64	3-year, Onsite, OID	11/15
10FG000YUS	US	i5-6600	vPro	Intel HD 530	None	4GBx1	500GB 7200rpm 3.5"	DVD±RW	None	None	None	None	None	None	None	None	None	USB / USB	None	210W 85%	Win10 Pro 64	3-year, Onsite, OID	11/15
10FG0013US	US	i7-6700	vPro	GT 720 1GB	None	4GBx1	1TB 7200rpm 3.5"	DVD±RW	None	9-in-1	None	None	None	None	None	None	None	USB / USB	None	210W 85%	Win10 Pro 64	3-year, Onsite, OID	11/15
10FG0014US	US	i7-6700	vPro	GT 720 1GB	None	4GBx1	1TB 7200rpm 3.5"	DVD±RW	None	9-in-1	None	None	None	None	None	None	Dust Filter	USB / USB	None	210W 85%	Win10 DG Win7 Pro 64	3-year, Onsite, OID	11/15
10FG0015US	US	i5-6600	vPro	Intel HD 530	None	4GBx1	500GB 7200rpm 3.5"	DVD±RW	None	None	None	None	None	None	None	None	None	USB / USB	None	210W 85%	Win10 DG Win7 Pro 64	3-year, Onsite, OID	11/15
10FG0016US	US	i5-6500	vPro	Intel HD 530	None	4GBx1	500GB 7200rpm 3.5"	DVD	None	None	None	None	None	None	None	None	None	USB / USB	None	210W 85%	Win10 DG Win7 Pro 64	3-year, Onsite, OID	11/15



# ThinkCentre M900 Tiny Platform Specifications

Product Specifications Reference (PSREF)

Processor	Intel® Celeron®, Intel Pentium®, or 6th Generation Intel Core™ i3 / i5 / i7 Processor							Security features <ul style="list-style-type: none"> <li>• Security slot (in rear for optional Kensington® MicroSaver® cable)</li> <li>• Padlock loop</li> <li>• Smart USB protection, allows keyboard/mouse only, blocks all storage devices</li> <li>• Power-on password</li> <li>• Administrator password</li> <li>• Hard disk password</li> <li>• Boot sequence control</li> <li>• Boot without keyboard and mouse</li> <li>• Individual USB port disablement</li> <li>• Chassis intrusion switch</li> </ul>
	Processor	Cores / Threads	Frequency Base/Max(GHz)	Cache	Memory Types	Integrated Graphics	Intel vPro	
	Pentium G4400T	2 / 2	2.9 G	3 MB	DDR4-2133	HD 510	No	
	Pentium G4500T	2 / 2	3.0 G	3 MB	DDR4-2133	HD 530	No	
	Core i3-6100T	2 / 4	3.2 G	3 MB	DDR4-2133	HD 530	No	
	Core i3-6300T	2 / 4	3.3 G	4 MB	DDR4-2133	HD 530	No	
	Core i5-6400T	4 / 4	2.2 G / 2.8 G	6 MB	DDR4-2133	HD 530	No	
	Core i5-6500T	4 / 4	2.5 G / 3.1 G	6 MB	DDR4-2133	HD 530	vPro	
	Core i5-6600T	4 / 4	2.7 G / 3.5 G	6 MB	DDR4-2133	HD 530	vPro	
Core i7-6700T	4 / 8	2.8 G / 3.6 G	8 MB	DDR4-2133	HD 530	vPro		
Memory	32GB max, DDR4 2133, two 260-pin SO-DIMM sockets, dual-channel capable							
Disk	Some: SATA 6.0Gb/s, 2.5" Wide, 5400 rpm or 7200 rpm Some: 500GB (5400 rpm) Solid State Hybrid Drive (SSHD) / with 8GB MLC NAND flash memory, SATA 6.0Gb/s, 2.5" wide Some: Solid State Drive (SSD) / SATA 6.0Gb/s, 2.5" Wide Some: M.2 SSD, PCIe or SATA interface							
Optical	Some: external ODD box with DVD-ROM, 9.5mm high, via USB Some: external ODD box with DVD±RW, 9.5mm high, via USB Some: external ODD box (for TIO) with DVD-ROM, 9.5mm high, via USB Some: external ODD box (for TIO) with DVD±RW, 9.5mm high, via USB							
Onboard SATA Media reader	One SATA cable (1-drop to device), one SATA 6.0Gb/s connector on planar None							
Graphics	Intel HD Graphics 510/530 in processor, uses main memory, DirectX® 12, two DisplayPort™, one optional HDMI, VGA, or 3rd DP, up to 3 independent displays; Max resolution: 4096x2304 (DP) @60Hz; 4096x2160 (HDMI) @24Hz; 1920x1200 (VGA) @60Hz							
DP cable	Optional DP to VGA, DP to DVI-D (single link), or DP to HDMI 1.4 dongle							
Chipset	<b>Intel Q170 Chipset</b>							
Front ports	Two USB 3.0 (one is Always On and fast charge), one microphone (stereo, 3.5mm), one headphone / microphone combo jack (stereo, 3.5mm)							
Rear ports	Four USB 3.0 (optional external optical box or external I/O box occupies one or two specific USB 3.0 on some models), ethernet (RJ-45), two DisplayPort, one optional port (VGA, 3rd DP, HDMI, or serial on some models), one headphone							
I/O box	Optional external I/O box, extends two USB 2.0, two USB 3.0, and one serial on rear, two USB 2.0 on front, via USB (occupy two specific USB 3.0 of M900 Tiny)							
Audio support	High Definition (HD) Audio, Realtek ALC223 / optional internal speaker (1 watt)							
WLAN <sup>13</sup>	Some: 11ac wireless, M.2 Card, Qualcomm Atheros QCA9377 (dual band), Wi-Fi + Bluetooth 4.1 combo adapter, 1x1 Some: 11ac wireless, M.2 Card, Qualcomm Atheros QCA6174 (dual band), Wi-Fi + Bluetooth 4.1 combo adapter, 2x2 Some: 11ac wireless, M.2 Card, Intel Dual Band Wireless-AC 3165, Wi-Fi + Bluetooth 4.0 combo adapter, 1x1 Some: 11ac wireless, M.2 Card, Intel Dual Band Wireless-AC 8260, Wi-Fi + Bluetooth 4.1 combo adapter, 2x2 Some: 11ac wireless, M.2 Card, Intel Dual Band Wireless-AC 8260, Wi-Fi + Bluetooth 4.1 combo adapter, Intel vPro technology support, 2x2							
Bluetooth™ Ethernet Modem	Some: Bluetooth 4.0 or 4.1 wireless, integrated in Wi-Fi + BT combo adapter Gigabit ethernet, Intel Ethernet Connection I219-LM (Jacksonville), Wake on LAN® None							
Manageability	Intel Active Management Technology 11.0 (Intel AMT 11.0); Intel vPro technology on some models (require choosing a vPro-support Wi-Fi adapter to enable vPro function through wireless connection)							
Security chip	Trusted Platform Module, TCG 1.2-compliant							
Keyboard	Some: Preferred Pro USB Keyboard (USB connector), Lenovo logo Some: Lenovo USB Fingerprint Keyboard (USB connector) Some: Ultralim Plus Wireless Keyboard (2.4GHz via USB receiver), black Some: Enhanced Optical USB Mouse, black, Lenovo logo Some: Ultralim Plus Wireless Mouse (2.4GHz via USB receiver), black							
Mouse	Some: Preferred Pro USB Keyboard (USB connector), Lenovo logo Some: Lenovo USB Fingerprint Keyboard (USB connector) Some: Ultralim Plus Wireless Keyboard (2.4GHz via USB receiver), black Some: Enhanced Optical USB Mouse, black, Lenovo logo Some: Ultralim Plus Wireless Mouse (2.4GHz via USB receiver), black							
Mechanical	Tiny (1L), black color; metal case M900 Tiny only: 7.05" W X 7.20" D X 1.36" H 179mm W X 182.9mm D X 34.5mm H 2.9 lb (1.3 kg), weight may vary by configuration With VESA mount & ODD box: 7.42" W X 7.30" D X 2.48" H 188.4mm W X 185.38mm D X 63mm H 4.12 lb (1.87 kg), weight may vary by configuration With VESA mount & I/O box: 7.42" W X 7.30" D X 2.62" H 188.4mm W X 185.38mm D X 66.6mm H 3.53 lb (1.6 kg), weight may vary by configuration Optional VESA mount bracket kit, supports VESA 75mm and 100mm Optional system floor stand for vertical orientation							
VESA mount Floor Stand	Optional VESA mount bracket kit, supports VESA 75mm and 100mm Optional system floor stand for vertical orientation							
Power supply	65 watts AC/DC adapter, autosensing, 88% PSU (not included for TIO models) 90 watts AC/DC adapter, autosensing, 88% PSU (only for models with I/O box)							
Limited warranty <sup>3</sup>	Some: 1-year or 3-year, depot service / service upgrades available Some: 1-year or 3-year, limited onsite service / service upgrades available Some: 3-year, limited onsite service, OID (Onsite International Delivery) / service upgrades available For Lenovo service upgrade options, please go to S-TC sheet							
Preload	<b>Preloaded operating system</b> Some: Windows® 7 Professional 64 preinstalled through downgrade rights in Windows 10 Pro 64-bit Some: Windows 7 Professional 64 Some: Windows 10 Pro 64-bit Some: Windows 10 Home 64-bit		<b>Preloaded applications (only some listed)</b> <ul style="list-style-type: none"> <li>• Desktop Power Manager</li> <li>• Lenovo Solution Center</li> <li>• Lenovo REACHit</li> <li>• Lenovo SHAREit</li> <li>• Lenovo Bluetooth Lock (for models with Wi-Fi/BT card)</li> <li>• McAfee® LiveSafe™ (30-day trial)</li> <li>• Microsoft Office preloaded; purchase a product key to activate</li> <li>• PowerDVD Create (DVD±RW)</li> <li>• Lenovo ThinkVantage Tools</li> <li>• Intel Unite (vPro models only)</li> <li>- Only for Window 10</li> <li>• Lenovo Companion</li> <li>• Cyberlink PowerDVD (DVD, DVD±RW)</li> <li>• Lenovo QuickOptimizer</li> <li>- Only for Window 7</li> <li>• Rescue and Recovery</li> <li>• Password Manager</li> <li>• ThinkVantage System Update</li> <li>• Lenovo Message Center Plus</li> <li>• Adobe® Reader®</li> </ul>					
Environment	ENERGY STAR® 6.1*; EPEAT™ Gold rating*; (*Need 85% PSU and Windows OS); ErP Lot 3; GREENGUARD®; RoHS-compliant; TUV Green Mark, ULE Gold							
MIL-SPEC test	MIL-STD-810G military certification (Low Pressure [Altitude], High Temperature, Low Temperature, Temperature Shock, Humidity, Sand and Dust, Vibration, Shock)							
Accessories	For compatible accessories, please go to TC-AQP sheet							

See footnotes for more detailed information

Model	Region	Processor	vPro	Graphics	Monitor Cable	Memory	Storage(HDD/SSD)	External Optical / I/O Box	WLAN + Bluetooth	Optional Rear Ports	Chassis Intrusion Switch	Kensington Cable Lock	Speaker	Adapter Cage	Toolless Chassis Screw	Dust Filter	Keyboard / Mouse	VESA Mount	Stand	Power Supply	Operating System	Warranty	Ann Date (m/y)
10FM0006US	US	i5-6500T	vPro	Intel HD 530	None	4GBx1	120GB SSD	None	8260 ac, 2x2, vPro + BT4.1	3rd DP	Switch	None	1Wx1	None	None	None	USB / USB	None	Floor Stand	65W Adapter 88%	Win10 DG Win7 Pro 64	3-year, Onsite	11/15
10FM0007US	US	i5-6500T	vPro	Intel HD 530	None	4GBx1	500GB 7200rpm 2.5"	None	8260 ac, 2x2, vPro + BT4.1	3rd DP	Switch	None	1Wx1	None	None	None	USB / USB	None	Floor Stand	65W Adapter 88%	Win10 DG Win7 Pro 64	3-year, Onsite	11/15
10FM0008US	US	i7-6700T	vPro	Intel HD 530	None	8GBx1	120GB SSD	DVD±RW	8260 ac, 2x2, vPro + BT4.1	HDMI	Switch	None	1Wx1	None	None	None	USB / USB	VESA Mount	None	65W Adapter 88%	Win10 DG Win7 Pro 64	3-year, Onsite	11/15
10FM0009US	US	i5-6500T	vPro	Intel HD 530	None	4GBx1	500GB 7200rpm 2.5"	None	8260 ac, 2x2, vPro + BT4.1	None	Switch	None	1Wx1	None	None	None	USB / USB	None	Floor Stand	65W Adapter 88%	Win10 DG Win7 Pro 64	3-year, Onsite	11/15
10FM000AUS	US	i5-6500T	vPro	Intel HD 530	None	4GBx1	120GB SSD	DVD±RW	8260 ac, 2x2, vPro + BT4.1	HDMI	Switch	None	1Wx1	None	None	None	USB / USB	VESA Mount	None	65W Adapter 88%	Win10 DG Win7 Pro 64	3-year, Onsite	11/15
10FM000BUS	US	i7-6700T	vPro	Intel HD 530	None	8GBx1	120GB SSD	None	8260 ac, 2x2, vPro + BT4.1	3rd DP	Switch	None	1Wx1	None	None	None	USB / USB	None	Floor Stand	65W Adapter 88%	Win10 DG Win7 Pro 64	3-year, Onsite	11/15
10FM0014US	US	i5-6500T	vPro	Intel HD 530	None	8GBx1	128GB SSD	DVD±RW	8260 ac, 2x2, vPro + BT4.1	HDMI	Switch	None	1Wx1	None	None	None	USB / USB	VESA Mount	None	65W Adapter 88%	Win10 DG Win7 Pro 64	3-year, Onsite	12/15
10FM0017US	US	i5-6500T	vPro	Intel HD 530	None	4GBx1	128GB SSD	None	8260 ac, 2x2, vPro + BT4.1	HDMI	Switch	None	1Wx1	None	None	None	USB / USB	None	Floor Stand	65W Adapter 88%	Win10 DG Win7 Pro 64	3-year, Onsite	12/15
10FM0018US	US	i7-6700T	vPro	Intel HD 530	None	8GBx1	180GB SSD Opal	DVD±RW	8260 ac, 2x2, vPro + BT4.1	HDMI	Switch	None	1Wx1	None	None	None	USB / USB	VESA Mount	None	65W Adapter 88%	Win10 DG Win7 Pro 64	3-year, Onsite	12/15
10FM0019US	US	i7-6700T	vPro	Intel HD 530	None	8GBx1	256GB SSD Opal	DVD±RW	8260 ac, 2x2, vPro + BT4.1	Serial	Switch	None	1Wx1	None	None	None	USB / USB	VESA Mount	None	65W Adapter 88%	Win10 DG Win7 Pro 64	3-year, Onsite	12/15
10FM001AUS	US	i7-6700T	vPro	Intel HD 530	None	8GBx1	500GB 7200rpm 2.5"	DVD±RW	8260 ac, 2x2, vPro + BT4.1	None	Switch	None	1Wx1	None	None	None	USB / USB	VESA Mount	None	65W Adapter 88%	Win10 DG Win7 Pro 64	3-year, Onsite	12/15
10FM001BUS	US	i7-6700T	vPro	Intel HD 530	None	8GBx1	256GB SSD Opal	DVD±RW	8260 ac, 2x2, vPro + BT4.1	HDMI	Switch	None	1Wx1	None	None	None	USB / USB	VESA Mount	None	65W Adapter 88%	Win10 DG Win7 Pro 64	3-year, Onsite	12/15
10FM001CUS	US	i5-6500T	vPro	Intel HD 530	None	4GBx1	500GB 7200rpm 2.5"	DVD±RW	8260 ac, 2x2, vPro + BT4.1	None	Switch	None	1Wx1	None	None	None	USB / USB	VESA Mount	None	65W Adapter 88%	Win10 DG Win7 Pro 64	3-year, Onsite	12/15
10FM001DUS	US	i7-6700T	vPro	Intel HD 530	None	8GBx1	180GB SSD Opal	DVD±RW	8260 ac, 2x2, vPro + BT4.1	3rd DP	Switch	None	1Wx1	None	None	None	USB / USB	VESA Mount	None	65W Adapter 88%	Win10 DG Win7 Pro 64	3-year, Onsite	12/15
10FM001EUS	US	i5-6500T	vPro	Intel HD 530	None	4GBx1	500GB 7200rpm 2.5"	DVD±RW	8260 ac, 2x2, vPro + BT4.1	3rd DP	Switch	None	1Wx1	None	None	None	USB / USB	VESA Mount	None	65W Adapter 88%	Win10 DG Win7 Pro 64	3-year, Onsite	12/15
10FM001FUS	US	i5-6500T	vPro	Intel HD 530	None	8GBx1	256GB SSD Opal	DVD±RW	8260 ac, 2x2, vPro + BT4.1	HDMI	Switch	None	1Wx1	None	None	None	USB / USB	VESA Mount	None	65W Adapter 88%	Win10 DG Win7 Pro 64	3-year, Onsite	12/15
10FM001GUS	US	i7-6700T	vPro	Intel HD 530	None	8GBx1	128GB SSD	None	8260 ac, 2x2, vPro + BT4.1	HDMI	Switch	None	1Wx1	None	None	None	USB / USB	None	Floor Stand	65W Adapter 88%	Win10 DG Win7 Pro 64	3-year, Onsite	12/15
10FM001HUS	US	i5-6500T	vPro	Intel HD 530	None	8GBx1	192GB SSD	DVD±RW	8260 ac, 2x2, vPro + BT4.1	HDMI	Switch	None	1Wx1	None	None	None	USB / USB	VESA Mount	None	65W Adapter 88%	Win10 DG Win7 Pro 64	3-year, Onsite	12/15
10FM001JUS	US	i7-6700T	vPro	Intel HD 530	None	8GBx1	128GB SSD	DVD±RW	8260 ac, 2x2, vPro + BT4.1	3rd DP	Switch	None	1Wx1	None	None	None	USB / USB	VESA Mount	None	65W Adapter 88%	Win10 DG Win7 Pro 64	3-year, Onsite	12/15
10FM001KUS	US	i7-6700T	vPro	Intel HD 530	None	8GBx1	192GB SSD	DVD±RW	8260 ac, 2x2, vPro + BT4.1	HDMI	Switch	None	1Wx1	None	None	None	USB / USB	VESA Mount	None	65W Adapter 88%	Win10 DG Win7 Pro 64	3-year, Onsite	12/15

Model	Region	Processor	vPro	Graphics	Monitor Cable	Memory	Storage(HDD/SSD)	External Optical / I/O Box	WLAN + Bluetooth	Optional Rear Ports	Chassis Intrusion Switch	Kensington Cable Lock	Speaker	Adapter Cage	Toolless Chassis Screw	Dust Filter	Keyboard / Mouse	VESA Mount	Stand	Power Supply	Operating System	Warranty	Ann Date (m/y)
10FM001LUS	US	i7-6700T	vPro	Intel HD 530	None	8GBx1	192GB SSD	DVD±RW	8260 ac, 2x2, vPro + BT4.1	3rd DP	Switch	None	1Wx1	None	None	None	USB / USB	VESA Mount	None	65W Adapter 88%	Win10 DG Win7 Pro 64	3-year, Onsite	12/15
10FM001MUS	US	i5-6500T	vPro	Intel HD 530	None	4GBx1	128GB SSD	DVD±RW	8260 ac, 2x2, vPro + BT4.1	3rd DP	Switch	None	1Wx1	None	None	None	USB / USB	VESA Mount	None	65W Adapter 88%	Win10 DG Win7 Pro 64	3-year, Onsite	12/15
10FM001NUS	US	i5-6500T	vPro	Intel HD 530	None	4GBx1	128GB SSD	None	8260 ac, 2x2, vPro + BT4.1	3rd DP	Switch	None	1Wx1	None	None	None	USB / USB	None	Floor Stand	65W Adapter 88%	Win10 DG Win7 Pro 64	3-year, Onsite	12/15
10FM001PUS	US	i5-6500T	vPro	Intel HD 530	None	4GBx1	500GB 7200rpm 2.5"	None	8260 ac, 2x2, vPro + BT4.1	Serial	Switch	None	1Wx1	None	None	None	USB / USB	None	Floor Stand	65W Adapter 88%	Win10 DG Win7 Pro 64	3-year, Onsite	12/15
10FM001QUS	US	i5-6500T	vPro	Intel HD 530	None	4GBx1	128GB SSD	None	8260 ac, 2x2, vPro + BT4.1	None	Switch	None	1Wx1	None	None	None	USB / USB	None	Floor Stand	65W Adapter 88%	Win10 DG Win7 Pro 64	3-year, Onsite	12/15
10FM001RUS	US	i5-6500T	vPro	Intel HD 530	None	8GBx1	192GB SSD	None	8260 ac, 2x2, vPro + BT4.1	None	Switch	None	1Wx1	None	None	None	USB / USB	None	Floor Stand	65W Adapter 88%	Win10 DG Win7 Pro 64	3-year, Onsite	12/15
10FM001SUS	US	i5-6500T	vPro	Intel HD 530	None	8GBx1	180GB SSD Opal	None	8260 ac, 2x2, vPro + BT4.1	3rd DP	Switch	None	1Wx1	None	None	None	USB / USB	None	Floor Stand	65W Adapter 88%	Win10 DG Win7 Pro 64	3-year, Onsite	12/15
10FM001TUS	US	i5-6500T	vPro	Intel HD 530	None	4GBx1	500GB 7200rpm 2.5"	None	8260 ac, 2x2, vPro + BT4.1	HDMI	Switch	None	1Wx1	None	None	None	USB / USB	None	Floor Stand	65W Adapter 88%	Win10 DG Win7 Pro 64	3-year, Onsite	12/15
10FM001UUS	US	i5-6500T	vPro	Intel HD 530	None	8GBx1	256GB SSD Opal	None	8260 ac, 2x2, vPro + BT4.1	3rd DP	Switch	None	1Wx1	None	None	None	USB / USB	None	Floor Stand	65W Adapter 88%	Win10 DG Win7 Pro 64	3-year, Onsite	12/15
10FM001VUS	US	i7-6700T	vPro	Intel HD 530	None	8GBx1	128GB SSD	None	8260 ac, 2x2, vPro + BT4.1	3rd DP	Switch	None	1Wx1	None	None	None	USB / USB	None	Floor Stand	65W Adapter 88%	Win10 DG Win7 Pro 64	3-year, Onsite	12/15
10FM001WUS	US	i7-6700T	vPro	Intel HD 530	None	8GBx1	192GB SSD	None	8260 ac, 2x2, vPro + BT4.1	3rd DP	Switch	None	1Wx1	None	None	None	USB / USB	None	Floor Stand	65W Adapter 88%	Win10 DG Win7 Pro 64	3-year, Onsite	12/15
10FM001XUS	US	i7-6700T	vPro	Intel HD 530	None	8GBx1	500GB 7200rpm 2.5"	None	8260 ac, 2x2, vPro + BT4.1	None	Switch	None	1Wx1	None	None	None	USB / USB	None	Floor Stand	65W Adapter 88%	Win10 DG Win7 Pro 64	3-year, Onsite	12/15
10FM001YUS	US	i7-6700T	vPro	Intel HD 530	None	8GBx1	180GB SSD Opal	None	8260 ac, 2x2, vPro + BT4.1	3rd DP	Switch	None	1Wx1	None	None	None	USB / USB	None	Floor Stand	65W Adapter 88%	Win10 DG Win7 Pro 64	3-year, Onsite	12/15
10FM0020US	US	i7-6700T	vPro	Intel HD 530	None	8GBx1	128GB SSD	None	8260 ac, 2x2, vPro + BT4.1	None	Switch	None	1Wx1	None	None	None	USB / USB	None	Floor Stand	65W Adapter 88%	Win10 DG Win7 Pro 64	3-year, Onsite	12/15
10FM0021US	US	i7-6700T	vPro	Intel HD 530	None	8GBx1	256GB SSD Opal	None	8260 ac, 2x2, vPro + BT4.1	3rd DP	Switch	None	1Wx1	None	None	None	USB / USB	None	Floor Stand	65W Adapter 88%	Win10 DG Win7 Pro 64	3-year, Onsite	12/15
10FM0022US	US	i7-6700T	vPro	Intel HD 530	None	8GBx1	128GB SSD	None	8260 ac, 2x2, vPro + BT4.1	3rd DP	Switch	None	1Wx1	None	None	None	USB / USB	None	Floor Stand	65W Adapter 88%	Win10 Pro 64	3-year, Onsite	12/15
10FM0023US	US	i5-6500T	vPro	Intel HD 530	None	4GBx1	500GB 7200rpm 2.5"	DVD±RW	8260 ac, 2x2, vPro + BT4.1	3rd DP	Switch	None	1Wx1	None	None	None	USB / USB	VESA Mount	None	65W Adapter 88%	Win10 Pro 64	3-year, Onsite	12/15
10FM0024US	US	i5-6500T	vPro	Intel HD 530	None	8GBx1	128GB SSD	DVD±RW	8260 ac, 2x2, vPro + BT4.1	3rd DP	Switch	None	1Wx1	None	None	None	USB / USB	VESA Mount	None	65W Adapter 88%	Win10 Pro 64	3-year, Onsite	12/15
10FM0025US	US	i7-6700T	vPro	Intel HD 530	None	8GBx1	128GB SSD	DVD±RW	8260 ac, 2x2, vPro + BT4.1	3rd DP	Switch	None	1Wx1	None	None	None	USB / USB	VESA Mount	None	65W Adapter 88%	Win10 Pro 64	3-year, Onsite	12/15
10FM0026US	US	i5-6500T	vPro	Intel HD 530	None	8GBx1	128GB SSD	None	8260 ac, 2x2, vPro + BT4.1	3rd DP	Switch	None	1Wx1	None	None	None	USB / USB	None	Floor Stand	65W Adapter 88%	Win10 Pro 64	3-year, Onsite	12/15

Model	Region	Processor	vPro	Graphics	Monitor Cable	Memory	Storage(HDD/SSD)	External Optical / I/O Box	WLAN + Bluetooth	Optional Rear Ports	Chassis Intrusion Switch	Kensington Cable Lock	Speaker	Adapter Cage	Toolless Chassis Screw	Dust Filter	Keyboard / Mouse	VESA Mount	Stand	Power Supply	Operating System	Warranty	Ann Date (m/y)
10FM0027US	US	i5-6500T	vPro	Intel HD 530	None	4GBx1	500GB 7200rpm 2.5"	None	8260 ac, 2x2, vPro + BT4.1	3rd DP	Switch	None	1Wx1	None	None	None	USB / USB	None	Floor Stand	65W Adapter 88%	Win10 Pro 64	3-year, Onsite	12/15
10FM002TUS	US	i7-6700T	vPro	Intel HD 530	None	8GBx1	256GB SSD Opal	None	8260 ac, 2x2, vPro + BT4.1	VGA	Switch	None	1Wx1	None	None	None	USB / USB	None	Floor Stand	65W Adapter 88%	Win10 DG Win7 Pro 64	3-year, Onsite	02/16
10FM002UUS	US	i5-6500T	vPro	Intel HD 530	None	4GBx1	500GB 7200rpm 2.5"	DVD±RW	8260 ac, 2x2, vPro + BT4.1	VGA	Switch	None	1Wx1	None	None	None	USB / USB	VESA Mount	None	65W Adapter 88%	Win10 DG Win7 Pro 64	3-year, Onsite	02/16
10FM002VUS	US	i5-6500T	vPro	Intel HD 530	None	4GBx1	500GB 7200rpm 2.5"	DVD±RW	8260 ac, 2x2, vPro + BT4.1	VGA	Switch	None	1Wx1	None	None	None	None / USB	VESA Mount	None	65W Adapter 88%	Win10 DG Win7 Pro 64	3-year, Onsite	02/16
10FM0030US	US	i5-6600T	vPro	Intel HD 530	None	8GBx1	128GB SSD	None	8260 ac, 2x2, vPro + BT4.1	3rd DP	Switch	None	1Wx1	None	None	None	USB / USB	None	Floor Stand	65W Adapter 88%	Win10 DG Win7 Pro 64	3-year, Onsite	03/16
10FM0031US	US	i5-6500T	vPro	Intel HD 530	None	8GBx1	128GB SSD	None	8260 ac, 2x2, vPro + BT4.1	VGA	Switch	None	1Wx1	None	None	None	USB / USB	None	Floor Stand	65W Adapter 88%	Win10 DG Win7 Pro 64	3-year, Onsite	03/16
10FM0032US	US	i5-6600T	vPro	Intel HD 530	None	8GBx1	500GB 7200rpm 2.5"	None	8260 ac, 2x2, vPro + BT4.1	3rd DP	Switch	None	1Wx1	None	None	None	USB / USB	None	Floor Stand	65W Adapter 88%	Win10 DG Win7 Pro 64	3-year, Onsite	03/16
10FM0033US	US	i7-6700T	vPro	Intel HD 530	None	8GBx1	128GB SSD	None	8260 ac, 2x2, vPro + BT4.1	HDMI	Switch	None	1Wx1	None	None	None	USB / USB	None	Floor Stand	65W Adapter 88%	Win10 Pro 64	3-year, Onsite	04/16
10FM0034US	US	i5-6500T	vPro	Intel HD 530	None	8GBx1	256GB SSD Opal	None	8260 ac, 2x2, vPro + BT4.1	3rd DP	Switch	None	1Wx1	None	None	None	USB / USB	None	Floor Stand	65W Adapter 88%	Win10 Pro 64	3-year, Onsite	04/16
10FM0039US	US	i5-6500T	vPro	Intel HD 530	None	8GBx1	500GB 7200rpm 2.5" + 128GB SSD M.2	None	8260 ac, 2x2, vPro + BT4.1	HDMI	Switch	None	1Wx1	None	None	None	USB / USB	None	Floor Stand	65W Adapter 88%	Win10 DG Win7 Pro 64	3-year, Onsite	05/16
10FM003AUS	US	i7-6700T	vPro	Intel HD 530	None	8GBx1	128GB SSD + 128GB SSD M.2 PCIe	None	8260 ac, 2x2, vPro + BT4.1	HDMI	Switch	None	1Wx1	None	None	None	USB / USB	None	Floor Stand	65W Adapter 88%	Win10 DG Win7 Pro 64	3-year, Onsite	05/16
10FM003BUS	US	i7-6700T	vPro	Intel HD 530	None	4GBx1	500GB 7200rpm 2.5"	None	8260 ac, 2x2, vPro + BT4.1	3rd DP	Switch	None	1Wx1	None	None	None	USB / USB	None	Floor Stand	65W Adapter 88%	Win10 DG Win7 Pro 64	3-year, Onsite	05/16
10FM003LUS	US	i5-6500T	vPro	Intel HD 530	None	4GBx1	500GB 7200rpm 2.5"	None	8260 ac, 2x2, vPro + BT4.1	Serial	Switch	None	1Wx1	None	None	None	USB / USB	None	Floor Stand	65W Adapter 88%	Win10 Pro 64	3-year, Onsite	07/16
10FM003YUS	US	i7-6700T	vPro	Intel HD 530	None	8GBx1	256GB SSD Opal	None	8260 ac, 2x2, vPro + BT4.1	HDMI	Switch	None	1Wx1	None	None	None	USB / USB	None	Floor Stand	65W Adapter 88%	Win10 Pro 64	3-year, Onsite	10/16

Model	Region	Processor	vPro	Graphics	Monitor Cable	Memory	Storage(HDD/SSD)	External Optical / I/O Box	WLAN + Bluetooth	Optional Rear Ports	Chassis Intrusion Switch	Kensington Cable Lock	Speaker	Adapter Cage	Toolless Chassis Screw	Dust Filter	Keyboard / Mouse	VESA Mount	Stand	Power Supply	Operating System	Warranty	Ann Date (m/y)
10NE0000US	US	i5-6500T	vPro	Intel HD 530	None	4GBx1	500GB 7200rpm 2.5"	None	8260 ac, 2x2, vPro + BT4.1	HDMI	Switch	None	1Wx1	None	None	None	USB / USB	None	Floor Stand	65W Adapter 88%	Win10 Pro 64	3-year, Onsite	07/16
10NE0001US	US	i5-6500T	vPro	Intel HD 530	None	4GBx1	500GB 7200rpm 2.5"	None	8260 ac, 2x2, vPro + BT4.1	3rd DP	Switch	None	1Wx1	None	None	None	USB / USB	None	Floor Stand	65W Adapter 88%	Win10 Pro 64	3-year, Onsite	07/16
10NE0002US	US	i5-6500T	vPro	Intel HD 530	None	8GBx1	256GB SSD Opal	None	8260 ac, 2x2, vPro + BT4.1	3rd DP	Switch	None	1Wx1	None	None	None	USB / USB	None	Floor Stand	65W Adapter 88%	Win10 Pro 64	3-year, Onsite	07/16
10NE0003US	US	i5-6500T	vPro	Intel HD 530	None	4GBx1	128GB SSD	None	8260 ac, 2x2, vPro + BT4.1	HDMI	Switch	None	1Wx1	None	None	None	USB / USB	None	Floor Stand	65W Adapter 88%	Win10 Pro 64	3-year, Onsite	07/16
10NE0004US	US	i7-6700T	vPro	Intel HD 530	None	8GBx1	128GB SSD	None	8260 ac, 2x2, vPro + BT4.1	HDMI	Switch	None	1Wx1	None	None	None	USB / USB	None	Floor Stand	65W Adapter 88%	Win10 Pro 64	3-year, Onsite	07/16
10NE0005US	US	i5-6500T	vPro	Intel HD 530	None	8GBx1	256GB SSD Opal	None	8260 ac, 2x2, vPro + BT4.1	HDMI	Switch	None	1Wx1	None	None	None	USB / USB	None	Floor Stand	65W Adapter 88%	Win10 Pro 64	3-year, Onsite	07/16
10NE000RUS	US	i7-6700T	vPro	Intel HD 530	None	8GBx1	256GB SSD Opal	None	8260 ac, 2x2, vPro + BT4.1	HDMI	Switch	None	1Wx1	None	None	None	USB / USB	None	Floor Stand	65W Adapter 88%	Win10 Pro 64	3-year, Onsite	10/16
10NE000SUS	US	i5-6500T	vPro	Intel HD 530	None	8GBx1	512GB SSD	None	8260 ac, 2x2, vPro + BT4.1	3rd DP	Switch	None	1Wx1	None	None	None	USB / USB	None	Floor Stand	65W Adapter 88%	Win10 DG Win7 Pro 64	3-year, Onsite	11/16
10NE000TUS	US	i7-6700T	vPro	Intel HD 530	None	8GBx1	512GB SSD	None	8260 ac, 2x2, vPro + BT4.1	3rd DP	Switch	None	1Wx1	None	None	None	USB / USB	None	Floor Stand	65W Adapter 88%	Win10 DG Win7 Pro 64	3-year, Onsite	11/16
10NE000UUS	US	i5-6500T	vPro	Intel HD 530	None	8GBx1	512GB SSD	None	8260 ac, 2x2, vPro + BT4.1	3rd DP	Switch	None	1Wx1	None	None	None	USB / USB	None	Floor Stand	65W Adapter 88%	Win10 Pro 64	3-year, Onsite	11/16
10NE000VUS	US	i7-6700T	vPro	Intel HD 530	None	8GBx1	512GB SSD	None	8260 ac, 2x2, vPro + BT4.1	3rd DP	Switch	None	1Wx1	None	None	None	USB / USB	None	Floor Stand	65W Adapter 88%	Win10 Pro 64	3-year, Onsite	11/16

Model	Region	Processor	vPro	Graphics	Monitor Cable	Memory	Storage(HDD/SSD)	External Optical / I/O Box	WLAN + Bluetooth	Optional Rear Ports	Chassis Intrusion Switch	Kensington Cable Lock	Speaker	Adapter Cage	Toolless Chassis Screw	Dust Filter	Keyboard / Mouse	VESA Mount	Stand	Power Supply	Operating System	Warranty	Ann Date (m/y)
10FL0003US	US	i5-6500T	vPro	Intel HD 530	None	4GBx1	500GB 7200rpm 2.5"	None	8260 ac, 2x2, vPro + BT4.1	3rd DP	Switch	None	1Wx1	None	None	None	USB / USB	None	Floor Stand	65W Adapter 88%	Win10 DG Win7 Pro 64	3-year, Onsite, OID	11/15
10FL0004US	US	i7-6700T	vPro	Intel HD 530	None	8GBx1	120GB SSD	None	8260 ac, 2x2, vPro + BT4.1	3rd DP	Switch	None	1Wx1	None	None	None	USB / USB	None	Floor Stand	65W Adapter 88%	Win10 DG Win7 Pro 64	3-year, Onsite, OID	11/15
10FL0005US	US	i5-6500T	vPro	Intel HD 530	None	4GBx1	120GB SSD	None	8260 ac, 2x2, vPro + BT4.1	3rd DP	Switch	None	1Wx1	None	None	None	USB / USB	None	Floor Stand	65W Adapter 88%	Win10 DG Win7 Pro 64	3-year, Onsite, OID	11/15
10FL0006US	US	i7-6700T	vPro	Intel HD 530	None	8GBx1	120GB SSD	DVD±RW	8260 ac, 2x2, vPro + BT4.1	HDMI	Switch	None	1Wx1	None	None	None	USB / USB	VESA Mount	None	65W Adapter 88%	Win10 DG Win7 Pro 64	3-year, Onsite, OID	11/15
10FL0007US	US	i5-6500T	vPro	Intel HD 530	None	4GBx1	500GB 7200rpm 2.5"	None	8260 ac, 2x2, vPro + BT4.1	None	Switch	None	1Wx1	None	None	None	USB / USB	None	Floor Stand	65W Adapter 88%	Win10 DG Win7 Pro 64	3-year, Onsite, OID	11/15
10FL0008US	US	i5-6500T	vPro	Intel HD 530	None	4GBx1	120GB SSD	DVD±RW	8260 ac, 2x2, vPro + BT4.1	HDMI	Switch	None	1Wx1	None	None	None	USB / USB	VESA Mount	None	65W Adapter 88%	Win10 DG Win7 Pro 64	3-year, Onsite, OID	11/15
10FL001RUS	US	i5-6600T	vPro	Intel HD 530	VGA	4GBx1	500GB 7200rpm 2.5"	None	8260 ac, 2x2 + BT4.1	VGA	Switch	None	1Wx1	None	None	None	USB / USB	None	Floor Stand	65W Adapter 88%	Win10 Pro 64	3-year, Onsite, OID	11/15
10FL001SUS	US	i5-6500T	vPro	Intel HD 530	None	4GBx1	500GB 7200rpm 2.5"	None	None	3rd DP	Switch	None	1Wx1	None	None	None	USB / USB	None	None	65W Adapter 88%	Win10 Pro 64	3-year, Onsite, OID	11/15
10FL001WUS	US	i5-6500T	vPro	Intel HD 530	None	4GBx1	500GB 7200rpm 2.5"	None	None	None	Switch	None	1Wx1	None	None	None	USB / USB	None	None	65W Adapter 88%	Win10 DG Win7 Pro 64	3-year, Onsite, OID	11/15
10FL001XUS	US	i5-6600T	vPro	Intel HD 530	None	4GBx1	500GB 7200rpm 2.5"	None	8260 ac, 2x2 + BT4.1	None	Switch	None	1Wx1	None	None	None	USB / USB	None	None	65W Adapter 88%	Win10 DG Win7 Pro 64	3-year, Onsite, OID	11/15
10FL0024US	US	i7-6700T	vPro	Intel HD 530	None	4GBx1	1TB 5400rpm 2.5"	DVD±RW	8260 ac, 2x2 + BT4.1	None	Switch	None	1Wx1	None	None	None	USB / USB	VESA Mount	None	65W Adapter 88%	Win10 Pro 64	3-year, Onsite, OID	11/15





# ThinkCentre M900 Mini Tower Platform Specifications

Product Specifications Reference (PSREF)

Processor	Intel® Celeron®, Intel Pentium®, or 6th Generation Intel Core™ i3 / i5 / i7 Processor							Manageability Intel Active Management Technology 11.0 (Intel AMT 11.0); Intel vPro technology on some models (require choosing a vPro-support Wi-Fi adapter to enable vPro function through wireless connection)
	Processor	Cores / Threads	Frequency Base/Max(GHz)	Cache	Memory Types	Integrated Graphics	Intel vPro	
	Pentium G4400	2 / 2	3.3G	3 MB	DDR4-2133	HD 510	No	
	Pentium G4500	2 / 2	3.5G	3 MB	DDR4-2133	HD 530	No	
	Core i3-6100	2 / 4	3.7 G	3 MB	DDR4-2133	HD 530	No	
	Core i3-6300	2 / 4	3.8 G	4 MB	DDR4-2133	HD 530	No	
	Core i5-6400	4 / 4	2.7 G / 3.3 G	6 MB	DDR4-2133	HD 530	No	
	Core i5-6500	4 / 4	3.2 G / 3.6 G	6 MB	DDR4-2133	HD 530	vPro	
	Core i5-6600	4 / 4	3.3 G / 3.9 G	6 MB	DDR4-2133	HD 530	vPro	
Core i7-6700	4 / 8	3.4 G / 4.0 G	8 MB	DDR4-2133	HD 530	vPro		
Memory	64GB max, UDIMM, DDR4 2133, four 288-pin DIMM sockets, dual-channel capable							Security chip Trusted Platform Module, TCG 1.2-compliant
Disk	<i>Some:</i> Hard disk, SATA 6.0Gb/s, 2.5" / 3.5" wide, 5400 / 7200 rpm							
	<i>Some:</i> Solid State Hybrid Drive (SSHD), 500GB (5400 rpm, 2.5") / 1TB or 2TB (7200 rpm, 3.5"), with 8GB NAND flash memory, SATA 6.0Gb/s							
Optical	<i>Some:</i> Solid State Drive (SSD) / SATA 6.0Gb/s, 2.5" Wide							
	<i>Some:</i> M.2 SSD, PCIe NVMe, PCIe 3.0 x4, 32Gb/s							
Onboard SATA	<i>Some:</i> Front accessible and removable HDD, 3.5", lockable via physical key							
	<i>Some:</i> DVD-ROM SATA 1.5Gb/s Drive							
Media reader	<i>Some:</i> Super Multi-Burner DVD±RW SATA 1.5Gb/s Drive							
	Four onboard SATA 6.0Gb/s connectors, one is eSATA connector for optional rear eSATA port, RAID 0, 1 support							
Graphics	Optional 29-in-1 media reader							
Mechanical	Intel HD Graphics 510/530 in processor, uses main memory, DirectX® 12, one VGA, two DisplayPort™, supports three independent displays, works along with discrete graphics to support more displays;							
	Max resolution: 4096x2304 (DP) @60Hz; 1920x1200 (VGA) @60Hz							
	<i>Some:</i> NVIDIA® Quadro® K420, DirectX 12, 2GB, PCIe 2.0 x16 adapter, one DVI-I, one DisplayPort, 41 watts;							
	Max resolution: 3840x2160 (DisplayPort) @60Hz; 2560x1600 (DVI-I) @60Hz							
	<i>Some:</i> NVIDIA GeForce® GT 720, DirectX 12, 2GB, PCIe 2.0 x8 adapter, one VGA, one HDMI, 25 watts;							
	Max resolution: 1920x1080 (HDMI) @60Hz; 2048x1536 (VGA) @85Hz							
	<i>Some:</i> NVIDIA GeForce GT 720, DirectX 12, 1GB, PCIe 2.0 x8 adapter, two DisplayPort, 25 watts;							
	Max resolution: 3840x2160 (DisplayPort) @60Hz;							
	Optional DP to VGA, DP to DVI-D (single link), or DP to HDMI 1.4 dongle							
Power supply	<i>Some:</i> 250 watts, autosensing, 85% PSU							
Limited warranty <sup>3</sup>	<i>Some:</i> 400 watts, autosensing, 92% PSU (available only via Special Bid)							
	<i>Some:</i> 1-year or 3-year, limited onsite service / service upgrades available							
Preload	<i>Some:</i> 3-year, limited onsite service, OID (Onsite International Delivery) / service upgrades available							
	For Lenovo service upgrade options, please go to S-TC sheet							
DP cable	<b>Preloaded operating system</b>			<b>Preloaded applications (only some listed)</b>				
	<i>Some:</i> Windows® 7 Professional 64 preinstalled through downgrade rights in Windows 10 Pro 64-bit			● Desktop Power Manager				
Chipset	<i>Some:</i> Windows 7 Professional 64			● Lenovo Solution Center				
	<i>Some:</i> Windows 10 Pro 64-bit			● Lenovo REACHit				
Front ports	<i>Some:</i> Windows 10 Home 64-bit			● Lenovo SHAREit				
				● Lenovo Bluetooth Lock				
Rear ports				(for models with Wi-Fi/BT card)				
				● McAfee® LiveSafe™ (30-day trial)				
Rear audio ports IEEE 1394				● Microsoft Office preloaded;				
				purchase a product key to activate				
Audio support				● PowerDVD Create (DVD±RW)				
				● Lenovo ThinkVantage Tools				
WLAN <sup>13</sup>	<i>Some:</i> 11ac wireless, M.2 Card, Qualcomm Atheros QCA9377 (dual band), Wi-Fi + Bluetooth 4.1 combo adapter, 1x1			● Intel Unite (vPro models only)				
	<i>Some:</i> 11ac wireless, M.2 Card, Qualcomm Atheros QCA6174 (dual band), Wi-Fi + Bluetooth 4.1 combo adapter, 2x2			- Only for Window 10				
Bluetooth™	<i>Some:</i> 11ac wireless, M.2 Card, Intel Dual Band Wireless-AC 3165, Wi-Fi + Bluetooth 4.0 combo adapter, 1x1			● Lenovo Companion				
	<i>Some:</i> 11ac wireless, M.2 Card, Intel Dual Band Wireless-AC 8260, Wi-Fi + Bluetooth 4.1 combo adapter, 2x2			● Cyberlink PowerDVD (DVD, DVD±RW)				
Ethernet Modem	<i>Some:</i> 11ac wireless, M.2 Card, Intel Dual Band Wireless-AC 8260, Wi-Fi + Bluetooth 4.1 combo adapter, Intel vPro technology support, 2x2			● Lenovo QuickOptimizer				
	<i>Some:</i> Bluetooth 4.0 or 4.1 wireless, integrated in Wi-Fi + BT combo adapter			- Only for Window 7				
Environment	Gigabit ethernet, Intel Ethernet Connection I219-LM (Jacksonville), Wake on LAN®			● Rescue and Recovery				
	None			● Password Manager				
Accessories	None			● ThinkVantage System Update				
				● Lenovo Message Center Plus				
			● Adobe® Reader®					
			ENERGY STAR® 6.1*; EPEAT™ Gold rating*; (*Need 85% PSU and Windows OS); ErP Lot 3; GREENGUARD®; RoHS-compliant; TUV Green Mark, ULE Gold					
			For compatible accessories, please go to TC-AQP sheet					

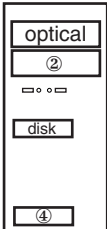

See footnotes for more detailed information

Model	Region	Processor	vPro	Graphics	Monitor Cable	Memory	Storage(HDD/SSD)	Optical	Optional 2nd 3.5" Tray	Media Reader	WLAN + Bluetooth	Optional Front Ports	Optional Rear Ports	Chassis Intrusion Switch	Cable Lock	Front Access HDD	PCI Slot	Dust Filter	Keyboard / Mouse	Carry Handle	Power Supply	Operating System	Warranty	Ann Date (m/y)	
10FD0007US	US	i7-6700	vPro	Intel HD 530	None	8GBx1	1TB 7200rpm 3.5"	DVD±RW	None	None	None	None	None	None	None	None	None	None	None	USB / USB	Carry Handle	250W 85%	Win10 DG Win7 Pro 64	3-year, Onsite, OID	11/15
10FD0008US	US	i5-6500	vPro	Intel HD 530	None	4GBx1	500GB 7200rpm 3.5"	DVD±RW	None	None	None	None	None	None	None	None	None	None	None	USB / USB	Carry Handle	250W 85%	Win10 DG Win7 Pro 64	3-year, Onsite, OID	11/15
10FD001WUS	US	i7-6700	vPro	Intel HD 530	None	8GBx1	1TB 7200rpm 3.5"	DVD±RW	Optional 2nd 3.5" Tray	None	None	None	None	None	None	None	None	None	None	USB / USB	Carry Handle	250W 85%	Win10 Pro 64	3-year, Onsite	11/15
10FD001XUS	US	i7-6700	vPro	Intel HD 530	None	8GBx1	1TB 7200rpm 3.5"	DVD±RW	Optional 2nd 3.5" Tray	None	None	None	None	None	None	None	None	None	None	USB / USB	Carry Handle	250W 85%	Win10 DG Win7 Pro 64	3-year, Onsite	11/15
10FD001YUS	US	i5-6500	vPro	Intel HD 530	None	4GBx1	500GB 7200rpm 3.5"	DVD±RW	Optional 2nd 3.5" Tray	None	None	None	None	None	None	None	None	None	None	USB / USB	Carry Handle	250W 85%	Win10 DG Win7 Pro 64	3-year, Onsite	11/15
10FD0020US	US	i5-6500	vPro	Intel HD 530	None	4GBx1	500GB 7200rpm 3.5"	DVD±RW	Optional 2nd 3.5" Tray	None	None	None	None	None	None	None	None	None	None	USB / USB	Carry Handle	250W 85%	Win10 Pro 64	3-year, Onsite	11/15
10FD0021US	US	i5-6500	vPro	Intel HD 530	None	8GBx1	500GB 7200rpm 3.5"	DVD±RW	Optional 2nd 3.5" Tray	None	None	None	None	None	None	None	None	None	None	USB / USB	Carry Handle	250W 85%	Win10 Pro 64	3-year, Onsite	11/15
10FD0022US	US	i5-6500	vPro	Intel HD 530	None	8GBx1	500GB 7200rpm 3.5"	DVD±RW	Optional 2nd 3.5" Tray	None	None	None	None	None	None	None	None	None	None	USB / USB	Carry Handle	250W 85%	Win10 DG Win7 Pro 64	3-year, Onsite	11/15
10FD0024US	US	i5-6500	vPro	Intel HD 530	None	4GBx1	128GB SSD	DVD±RW	Optional 2nd 3.5" Tray	None	None	None	None	None	None	None	None	None	None	USB / USB	Carry Handle	250W 85%	Win10 Pro 64	3-year, Onsite	12/15
10FD0025US	US	i5-6500	vPro	Intel HD 530	None	8GBx1	256GB SSD Opal	DVD±RW	Optional 2nd 3.5" Tray	None	None	None	None	None	None	None	None	None	None	USB / USB	Carry Handle	250W 85%	Win10 DG Win7 Pro 64	3-year, Onsite	12/15
10FD0026US	US	i7-6700	vPro	GT 720 1GB	None	8GBx1	256GB SSD Opal	DVD±RW	Optional 2nd 3.5" Tray	None	None	None	None	None	None	None	None	None	None	USB / USB	Carry Handle	250W 85%	Win10 DG Win7 Pro 64	3-year, Onsite	12/15
10FD0027US	US	i7-6700	vPro	GT 720 1GB	None	8GBx1	1TB 7200rpm 3.5"	DVD±RW	Optional 2nd 3.5" Tray	None	None	None	None	None	None	None	None	None	None	USB / USB	Carry Handle	250W 85%	Win10 Pro 64	3-year, Onsite	12/15
10FD0028US	US	i7-6700	vPro	Intel HD 530	None	8GBx1	256GB SSD Opal	DVD±RW	Optional 2nd 3.5" Tray	None	None	None	None	None	None	None	None	None	None	USB / USB	Carry Handle	250W 85%	Win10 DG Win7 Pro 64	3-year, Onsite	12/15
10FD0029US	US	i5-6500	vPro	GT 720 1GB	None	4GBx1	500GB 7200rpm 3.5"	DVD±RW	Optional 2nd 3.5" Tray	None	None	None	None	None	None	None	None	None	None	USB / USB	Carry Handle	250W 85%	Win10 DG Win7 Pro 64	3-year, Onsite	12/15
10FD002AUS	US	i5-6500	vPro	Intel HD 530	None	4GBx1	180GB SSD Opal	DVD±RW	Optional 2nd 3.5" Tray	None	None	None	None	None	None	None	None	None	None	USB / USB	Carry Handle	250W 85%	Win10 DG Win7 Pro 64	3-year, Onsite	12/15
10FD002BUS	US	i7-6700	vPro	GT 720 1GB	None	8GBx1	1TB 7200rpm 3.5"	DVD±RW	Optional 2nd 3.5" Tray	None	None	None	None	None	None	None	None	None	None	USB / USB	Carry Handle	250W 85%	Win10 DG Win7 Pro 64	3-year, Onsite	12/15
10FD002CUS	US	i7-6700	vPro	Intel HD 530	None	8GBx1	256GB SSD Opal	DVD±RW	Optional 2nd 3.5" Tray	None	None	None	None	None	None	None	None	None	None	USB / USB	Carry Handle	250W 85%	Win10 Pro 64	3-year, Onsite	12/15
10FD002DUS	US	i5-6500	vPro	Intel HD 530	None	4GBx1	128GB SSD	DVD±RW	Optional 2nd 3.5" Tray	None	None	None	None	None	None	None	None	None	None	USB / USB	Carry Handle	250W 85%	Win10 DG Win7 Pro 64	3-year, Onsite	12/15
10FD002EUS	US	i5-6500	vPro	Intel HD 530	None	8GBx1	180GB SSD Opal	DVD±RW	Optional 2nd 3.5" Tray	None	None	None	None	None	None	None	None	None	None	USB / USB	Carry Handle	250W 85%	Win10 Pro 64	3-year, Onsite	12/15
10FD002FUS	US	i5-6500	vPro	GT 720 1GB	None	8GBx1	1TB 7200rpm 3.5"	DVD±RW	Optional 2nd 3.5" Tray	None	None	None	None	None	None	None	None	None	None	USB / USB	Carry Handle	250W 85%	Win10 DG Win7 Pro 64	3-year, Onsite	12/15

Model	Region	Processor	vPro	Graphics	Monitor Cable	Memory	Storage(HDD/SSD)	Optical	Optional 2nd 3.5" Tray	Media Reader	WLAN + Bluetooth	Optional Front Ports	Optional Rear Ports	Chassis Intrusion Switch	Cable Lock	Front Access HDD	PCI Slot	Dust Filter	Keyboard / Mouse	Carry Handle	Power Supply	Operating System	Warranty	Ann Date (m/y)	
10FD002GUS	US	i5-6500	vPro	Intel HD 530	None	4GBx1	192GB SSD	DVD±RW	Optional 2nd 3.5" Tray	None	None	None	None	None	None	None	None	None	None	USB / USB	Carry Handle	250W 85%	Win10 DG Win7 Pro 64	3-year, Onsite	12/15
10FD002HUS	US	i5-6500	vPro	GT 720 1GB	None	8GBx1	1TB 7200rpm 3.5"	DVD±RW	Optional 2nd 3.5" Tray	None	None	None	None	None	None	None	None	None	None	USB / USB	Carry Handle	250W 85%	Win10 Pro 64	3-year, Onsite	12/15
10FD003PUS	US	i7-6700	vPro	GT 720 1GB	None	8GBx1	256GB SSD Opal	DVD±RW	Optional 2nd 3.5" Tray	None	None	None	None	None	None	None	None	None	None	USB / USB	Carry Handle	250W 85%	Win10 Pro 64	3-year, Onsite	10/16
10FD003QUS	US	i7-6700	vPro	GT 720 1GB	None	8GBx1	1TB 7200rpm 3.5"	DVD±RW	Optional 2nd 3.5" Tray	None	None	None	None	None	None	None	None	None	None	USB / USB	Carry Handle	250W 85%	Win10 DG Win7 Pro 64	3-year, Onsite	10/16
10FD003RUS	US	i7-6700	vPro	GT 720 1GB	None	8GBx1	1TB 7200rpm 3.5"	DVD±RW	Optional 2nd 3.5" Tray	None	None	None	None	None	None	None	None	None	None	USB / USB	Carry Handle	250W 85%	Win10 Pro 64	3-year, Onsite	10/16
10FD003SUS	US	i5-6500	vPro	GT 720 1GB	None	4GBx1	500GB 7200rpm 3.5"	DVD±RW	Optional 2nd 3.5" Tray	None	None	None	None	None	None	None	None	None	None	USB / USB	Carry Handle	250W 85%	Win10 Pro 64	3-year, Onsite	10/16
10FD003TUS	US	i7-6700	vPro	GT 720 1GB	None	8GBx1	256GB SSD Opal	DVD±RW	Optional 2nd 3.5" Tray	None	None	None	None	None	None	None	None	None	None	USB / USB	Carry Handle	250W 85%	Win10 DG Win7 Pro 64	3-year, Onsite	10/16
10FD003UUS	US	i5-6500	vPro	GT 720 1GB	None	4GBx1	500GB 7200rpm 3.5"	DVD±RW	Optional 2nd 3.5" Tray	None	None	None	None	None	None	None	None	None	None	USB / USB	Carry Handle	250W 85%	Win10 DG Win7 Pro 64	3-year, Onsite	10/16
10FD003VUS	US	i5-6500	vPro	GT 720 1GB	None	8GBx1	1TB 7200rpm 3.5"	DVD±RW	Optional 2nd 3.5" Tray	None	None	None	None	None	None	None	None	None	None	USB / USB	Carry Handle	250W 85%	Win10 Pro 64	3-year, Onsite	10/16
10FD003WUS	US	i5-6500	vPro	GT 720 1GB	None	8GBx1	1TB 7200rpm 3.5"	DVD±RW	Optional 2nd 3.5" Tray	None	None	None	None	None	None	None	None	None	None	USB / USB	Carry Handle	250W 85%	Win10 DG Win7 Pro 64	3-year, Onsite	10/16

ThinkCentre M900 Tower - 10FC

Model	Region	Processor	vPro	Graphics	Monitor Cable	Memory	Storage(HDD/SSD)	Optical	Optional 2nd 3.5" Tray	Media Reader	WLAN + Bluetooth	Optional Front Ports	Optional Rear Ports	Chassis Intrusion Switch	Cable Lock	Front Access HDD	PCI Slot	Dust Filter	Keyboard / Mouse	Carry Handle	Power Supply	Operating System	Warranty	Ann Date (m/y)
10FC0003US	US	i5-6500	vPro	Intel HD 530	None	4GBx1	500GB 7200rpm 3.5"	DVD±RW	None	None	None	None	None	None	None	None	None	None	USB / USB	None	250W 85%	Win10 Pro 64	3-year, Onsite, OID	11/15
10FC0004US	US	i5-6500	vPro	Intel HD 530	None	4GBx1	500GB 7200rpm 3.5"	DVD±RW	None	None	None	None	None	None	None	None	None	None	USB / USB	None	250W 85%	Win10 DG Win7 Pro 64	3-year, Onsite, OID	11/15
10FC0005US	US	i7-6700	vPro	Intel HD 530	None	8GBx1	1TB 7200rpm 3.5"	DVD±RW	None	None	None	None	None	None	None	None	None	None	USB / USB	None	250W 85%	Win10 DG Win7 Pro 64	3-year, Onsite, OID	11/15
10FC0006US	US	i7-6700	vPro	Intel HD 530	None	8GBx1	1TB 7200rpm 3.5"	DVD±RW	None	None	None	None	None	None	None	None	None	None	USB / USB	None	250W 85%	Win10 Pro 64	3-year, Onsite, OID	11/15
10FC000BUS	US	i5-6600	vPro	Intel HD 530	None	4GBx1	500GB 7200rpm 3.5"	DVD±RW	None	None	None	None	None	None	None	None	None	None	USB / USB	Carry Handle	250W 85%	Win10 Pro 64	3-year, Onsite, OID	11/15
10FC000GUS	US	i5-6500	vPro	Intel HD 530	None	4GBx1	500GB 7200rpm 3.5"	DVD	None	None	None	None	None	None	None	None	None	None	USB / USB	Carry Handle	250W 85%	Win10 Pro 64	3-year, Onsite, OID	11/15
10FC000HUS	US	i7-6700	vPro	GT 720 1GB	None	4GBx1	1TB 7200rpm 3.5"	DVD±RW	None	29-in-1	None	None	None	None	None	None	None	None	USB / USB	Carry Handle	250W 85%	Win10 Pro 64	3-year, Onsite, OID	11/15
10FC000KUS	US	i5-6600	vPro	Intel HD 530	None	4GBx1	500GB 7200rpm 3.5"	DVD±RW	None	None	None	None	None	None	None	None	None	None	USB / USB	None	250W 85%	Win10 DG Win7 Pro 64	3-year, Onsite, OID	11/15
10FC000LUS	US	i7-6700	vPro	GT 720 1GB	None	4GBx1	1TB 7200rpm 3.5"	DVD±RW	None	29-in-1	None	None	None	None	None	None	None	Dust Filter	USB / USB	Carry Handle	250W 85%	Win10 DG Win7 Pro 64	3-year, Onsite, OID	11/15
10FC000MUS	US	i5-6500	vPro	Intel HD 530	None	4GBx1	500GB 7200rpm 3.5"	DVD	None	None	None	None	None	None	None	None	None	None	USB / USB	None	250W 85%	Win10 DG Win7 Pro 64	3-year, Onsite, OID	11/15





# ThinkCentre M900x Tiny Platform Specifications

Product Specifications Reference (PSREF)

Processor	Intel® Celeron®, Intel Pentium®, or 6th Generation Intel Core™ i3 / i5 / i7 Processor	Security features	<ul style="list-style-type: none"> <li>Security slot (in rear for optional Kensington® MicroSaver® cable)</li> <li>Administrator password</li> <li>Padlock loop</li> <li>Hard disk password</li> <li>Smart USB protection, allows keyboard/mouse only, blocks all storage devices</li> <li>Boot sequence control</li> <li>Power-on password</li> <li>Boot without keyboard and mouse</li> <li>Individual USB port disablement</li> <li>Chassis intrusion switch</li> </ul>																																																	
	<table border="1"> <thead> <tr> <th>Processor</th> <th>Cores / Threads</th> <th>Frequency Base/Max(GHz)</th> <th>Cache</th> <th>Memory Types</th> <th>Integrated Graphics</th> <th>Intel vPro</th> </tr> </thead> <tbody> <tr> <td>Core i3-6100</td> <td>2 / 4</td> <td>3.7 G</td> <td>3 MB</td> <td>DDR4-2133</td> <td>HD 530</td> <td>No</td> </tr> <tr> <td>Core i3-6300</td> <td>2 / 4</td> <td>3.8 G</td> <td>4 MB</td> <td>DDR4-2133</td> <td>HD 530</td> <td>No</td> </tr> <tr> <td>Core i5-6400</td> <td>4 / 4</td> <td>2.7 G / 3.3 G</td> <td>6 MB</td> <td>DDR4-2133</td> <td>HD 530</td> <td>No</td> </tr> <tr> <td>Core i5-6500</td> <td>4 / 4</td> <td>3.2 G / 3.6 G</td> <td>6 MB</td> <td>DDR4-2133</td> <td>HD 530</td> <td>vPro</td> </tr> <tr> <td>Core i5-6600</td> <td>4 / 4</td> <td>3.3 G / 3.9 G</td> <td>6 MB</td> <td>DDR4-2133</td> <td>HD 530</td> <td>vPro</td> </tr> <tr> <td>Core i7-6700</td> <td>4 / 8</td> <td>3.4 G / 4.0 G</td> <td>8 MB</td> <td>DDR4-2133</td> <td>HD 530</td> <td>vPro</td> </tr> </tbody> </table>	Processor	Cores / Threads	Frequency Base/Max(GHz)	Cache	Memory Types	Integrated Graphics	Intel vPro	Core i3-6100	2 / 4	3.7 G	3 MB	DDR4-2133	HD 530	No	Core i3-6300	2 / 4	3.8 G	4 MB	DDR4-2133	HD 530	No	Core i5-6400	4 / 4	2.7 G / 3.3 G	6 MB	DDR4-2133	HD 530	No	Core i5-6500	4 / 4	3.2 G / 3.6 G	6 MB	DDR4-2133	HD 530	vPro	Core i5-6600	4 / 4	3.3 G / 3.9 G	6 MB	DDR4-2133	HD 530	vPro	Core i7-6700	4 / 8	3.4 G / 4.0 G	8 MB	DDR4-2133	HD 530	vPro	Keyboard	<i>Some:</i> Preferred Pro USB Keyboard (USB connector), Lenovo logo <i>Some:</i> Lenovo USB Fingerprint Keyboard (USB connector) <i>Some:</i> Ultralim Plus Wireless Keyboard (2.4GHz via USB receiver), black <i>Some:</i> Enhanced Optical USB Mouse, black, Lenovo logo <i>Some:</i> Ultralim Plus Wireless Mouse (2.4GHz via USB receiver), black
Processor	Cores / Threads	Frequency Base/Max(GHz)	Cache	Memory Types	Integrated Graphics	Intel vPro																																														
Core i3-6100	2 / 4	3.7 G	3 MB	DDR4-2133	HD 530	No																																														
Core i3-6300	2 / 4	3.8 G	4 MB	DDR4-2133	HD 530	No																																														
Core i5-6400	4 / 4	2.7 G / 3.3 G	6 MB	DDR4-2133	HD 530	No																																														
Core i5-6500	4 / 4	3.2 G / 3.6 G	6 MB	DDR4-2133	HD 530	vPro																																														
Core i5-6600	4 / 4	3.3 G / 3.9 G	6 MB	DDR4-2133	HD 530	vPro																																														
Core i7-6700	4 / 8	3.4 G / 4.0 G	8 MB	DDR4-2133	HD 530	vPro																																														
Memory	32GB max, DDR4 2133, two 260-pin SO-DIMM sockets, dual-channel capable	Mouse																																																		
Disk	<i>Some:</i> SATA 6.0Gb/s, 2.5" Wide, 5400 rpm or 7200 rpm <i>Some:</i> 500GB (5400 rpm) Solid State Hybrid Drive (SSHD) / with 8GB MLC NAND flash memory, SATA 6.0Gb/s, 2.5" wide <i>Some:</i> Solid State Drive (SSD) / SATA 6.0Gb/s, 2.5" Wide <i>Some:</i> M.2 SSD, PCIe or SATA interface	Mechanical	Tiny (1L), black color; metal case M900x Tiny only: 7.05" W X 7.20" D X 1.36" H 179mm W X 182.9mm D X 34.5mm H 2.9 lb (1.3 kg), weight may vary by configuration With VESA mount & ODD box: 7.42" W X 7.30" D X 2.48" H 188.4mm W X 185.38mm D X 63mm H 4.12 lb (1.87 kg), weight may vary by configuration With VESA mount & I/O box: 7.42" W X 7.30" D X 2.62" H 188.4mm W X 185.38mm D X 66.6mm H 3.53 lb (1.6 kg), weight may vary by configuration Optional VESA mount bracket kit, supports VESA 75mm and 100mm Optional system floor stand for vertical orientation																																																	
Optical	<i>Some:</i> external ODD box with DVD-ROM, 9.5mm high, via USB <i>Some:</i> external ODD box with DVD±RW, 9.5mm high, via USB <i>Some:</i> external ODD box (for TIO) with DVD-ROM, 9.5mm high, via USB <i>Some:</i> external ODD box (for TIO) with DVD±RW, 9.5mm high, via USB <i>One:</i> SATA cable (1-drop to device), one SATA 6.0Gb/s connector on planar	VESA mount																																																		
Onboard SATA Media reader	None	Floor Stand																																																		
Graphics	<b>Intel HD Graphics 510/530</b> in processor, uses main memory, DirectX® 12, two DisplayPort™, one optional HDMI, VGA, or 3rd DP, up to 3 independent displays; <i>Max resolution:</i> 4096x2304 (DP) @60Hz; 4096x2160 (HDMI) @24Hz; 1920x1200 (VGA) @60Hz	Power supply	135 watts AC/DC adapter, autosensing, 88% PSU																																																	
DP cable	Optional DP to VGA, DP to DVI-D (single link), or DP to HDMI 1.4 dongle	Limited warranty <sup>3</sup>	<i>Some:</i> 1-year or 3-year, depot service / service upgrades available <i>Some:</i> 1-year or 3-year, limited onsite service / service upgrades available <i>Some:</i> 3-year, limited onsite service, OID (Onsite International Delivery) / service upgrades available <i>For Lenovo service upgrade options, please go to S-TC sheet</i>																																																	
Chipset	<b>Intel Q170 Chipset</b>	Preload	<b>Preloaded operating system</b> <i>Some:</i> Windows® 7 Professional 64 preinstalled through downgrade rights in Windows 10 Pro 64-bit <i>Some:</i> Windows 7 Professional 64 <i>Some:</i> Windows 10 Pro 64-bit <b>Preloaded applications (only some listed)</b> <ul style="list-style-type: none"> <li>Desktop Power Manager</li> <li>Lenovo Solution Center</li> <li>Lenovo REACHit</li> <li>Lenovo SHAREit</li> <li>Lenovo Bluetooth Lock (for models with Wi-Fi/BT card)</li> <li>McAfee® LiveSafe™ (30-day trial)</li> <li>Microsoft Office preloaded; purchase a product key to activate</li> <li>PowerDVD Create (DVD±RW)</li> <li>Lenovo ThinkVantage Tools</li> <li>Intel Unite (vPro models only)</li> <li>- Only for Window 10</li> <li>Lenovo Companion</li> <li>Cyberlink PowerDVD (DVD, DVD±RW)</li> <li>Lenovo QuickOptimizer</li> <li>- Only for Window 7</li> <li>Rescue and Recovery</li> <li>Password Manager</li> <li>ThinkVantage System Update</li> <li>Lenovo Message Center Plus</li> <li>Adobe® Reader®</li> </ul>																																																	
Front ports	Two USB 3.0 (one is Always On and fast charge), one microphone (stereo, 3.5mm), one headphone / microphone combo jack (stereo, 3.5mm)	Environment	ENERGY STAR® 6.1*; EPEAT™ Gold rating*; (*Need 85% PSU and Windows OS); ErP Lot 3; GREENGUARD®; RoHS-compliant																																																	
Rear ports	Four USB 3.0 (optional external optical box or external I/O box occupies one or two specific USB 3.0 on some models), ethernet (RJ-45), two DisplayPort, one optional port (VGA, 3rd DP, HDMI, or serial on some models), one headphone	Accessories	For compatible accessories, please go to TC-AQP sheet																																																	
I/O box	Optional external I/O box, extends two USB 2.0, two USB 3.0, and one serial on rear, two USB 2.0 on front, via USB (occupy two specific USB 3.0 of M900x Tiny)																																																			
Audio support	High Definition (HD) Audio, Realtek ALC223 / optional internal speaker (1 watt)																																																			
WLAN <sup>13</sup>	<i>Some:</i> 11ac wireless, M.2 Card, Qualcomm Atheros QCA9377 (dual band), Wi-Fi + Bluetooth 4.1 combo adapter, 1x1 <i>Some:</i> 11ac wireless, M.2 Card, Qualcomm Atheros QCA6174 (dual band), Wi-Fi + Bluetooth 4.1 combo adapter, 2x2 <i>Some:</i> 11ac wireless, M.2 Card, Intel Dual Band Wireless-AC 3165, Wi-Fi + Bluetooth 4.0 combo adapter, 1x1 <i>Some:</i> 11ac wireless, M.2 Card, Intel Dual Band Wireless-AC 8260, Wi-Fi + Bluetooth 4.1 combo adapter, 2x2 <i>Some:</i> 11ac wireless, M.2 Card, Intel Dual Band Wireless-AC 8260, Wi-Fi + Bluetooth 4.1 combo adapter, Intel vPro technology support, 2x2																																																			
Bluetooth™	<i>Some:</i> Bluetooth 4.0 or 4.1 wireless, integrated in Wi-Fi + BT combo adapter																																																			
Ethernet	Gigabit ethernet, Intel Ethernet Connection I219-LM (Jacksonville), Wake on LAN®																																																			
Modem	None																																																			
Manageability	Intel Active Management Technology 11.0 (Intel AMT 11.0); Intel vPro technology on some models (require choosing a vPro-support Wi-Fi adapter to enable vPro function through wireless connection)																																																			
Security chip	Trusted Platform Module, TCG 1.2-compliant																																																			

See footnotes for more detailed information

ThinkCentre M900x Tiny - TopSeller - 10LX

Product Specifications Reference (PSREF)

Model	Region	Processor	vPro	Graphics	Monitor Cable	Memory	Storage(HDD/SSD)	External Optical / I/O Box	WLAN + Bluetooth	Optional Rear Ports	Chassis Intrusion Switch	Kensington Cable Lock	Speaker	Adapter Cage	Toolless Chassis Screw	Dust Filter	Keyboard / Mouse	VESA Mount	Stand	Power Supply	Operating System	Warranty	Ann Date (mm/yy)
10LX0002US	US	i7-6700	vPro	Intel HD 530	None	8GBx1	128GB SSD	None	8260 ac, 2x2, vPro + BT4.1	3rd DP	Switch	None	1Wx1	None	None	None	USB / USB	None	Floor Stand	135W Adapter 88%	Win10 Pro 64	3-year, Onsite	07/16
10LX0003US	US	i5-6500	vPro	Intel HD 530	None	4GBx1	500GB 7200rpm 2.5"	None	8260 ac, 2x2, vPro + BT4.1	VGA	Switch	None	1Wx1	None	None	None	USB / USB	None	Floor Stand	135W Adapter 88%	Win10 Pro 64	3-year, Onsite	07/16
10LX0004US	US	i5-6500	vPro	Intel HD 530	None	4GBx1	500GB 7200rpm 2.5"	None	8260 ac, 2x2, vPro + BT4.1	3rd DP	Switch	None	1Wx1	None	None	None	USB / USB	None	Floor Stand	135W Adapter 88%	Win10 Pro 64	3-year, Onsite	07/16
10LX0005US	US	i5-6500	vPro	Intel HD 530	None	4GBx1	500GB 7200rpm 2.5"	None	8260 ac, 2x2, vPro + BT4.1	None	Switch	None	1Wx1	None	None	None	USB / USB	None	Floor Stand	135W Adapter 88%	Win10 Pro 64	3-year, Onsite	07/16
10LX0006US	US	i5-6500	vPro	Intel HD 530	None	8GBx1	128GB SSD	None	8260 ac, 2x2, vPro + BT4.1	3rd DP	Switch	None	1Wx1	None	None	None	USB / USB	None	Floor Stand	135W Adapter 88%	Win10 Pro 64	3-year, Onsite	07/16
10LX0007US	US	i7-6700	vPro	Intel HD 530	None	8GBx1	256GB SSD Opal	None	8260 ac, 2x2, vPro + BT4.1	3rd DP	Switch	None	1Wx1	None	None	None	USB / USB	None	Floor Stand	135W Adapter 88%	Win10 DG Win7 Pro 64	3-year, Onsite	09/16
10LX0008US	US	i5-6500	vPro	Intel HD 530	None	8GBx1	256GB SSD Opal	None	8260 ac, 2x2, vPro + BT4.1	3rd DP	Switch	None	1Wx1	None	None	None	USB / USB	None	Floor Stand	135W Adapter 88%	Win10 DG Win7 Pro 64	3-year, Onsite	09/16
10LX0009US	US	i5-6500	vPro	Intel HD 530	None	4GBx1	500GB 7200rpm 2.5"	None	8260 ac, 2x2, vPro + BT4.1	VGA	Switch	None	1Wx1	None	None	None	USB / USB	None	Floor Stand	135W Adapter 88%	Win10 DG Win7 Pro 64	3-year, Onsite	09/16
10LX000AUS	US	i5-6500	vPro	Intel HD 530	None	4GBx1	500GB 7200rpm 2.5"	None	8260 ac, 2x2, vPro + BT4.1	None	Switch	None	1Wx1	None	None	None	USB / USB	None	Floor Stand	135W Adapter 88%	Win10 DG Win7 Pro 64	3-year, Onsite	09/16
10LX000BUS	US	i5-6500	vPro	Intel HD 530	None	4GBx1	500GB 7200rpm 2.5"	None	8260 ac, 2x2, vPro + BT4.1	3rd DP	Switch	None	1Wx1	None	None	None	USB / USB	None	Floor Stand	135W Adapter 88%	Win10 DG Win7 Pro 64	3-year, Onsite	09/16
10LX000CUS	US	i5-6500	vPro	Intel HD 530	None	8GBx1	128GB SSD	None	8260 ac, 2x2, vPro + BT4.1	3rd DP	Switch	None	1Wx1	None	None	None	USB / USB	None	Floor Stand	135W Adapter 88%	Win10 DG Win7 Pro 64	3-year, Onsite	09/16
10LX000DUS	US	i7-6700	vPro	Intel HD 530	None	8GBx1	128GB SSD	None	8260 ac, 2x2, vPro + BT4.1	3rd DP	Switch	None	1Wx1	None	None	None	USB / USB	None	Floor Stand	135W Adapter 88%	Win10 DG Win7 Pro 64	3-year, Onsite	09/16





# ThinkCentre M910 SFF Platform Specifications

Product Specifications Reference (PSREF)

Processor	Intel® Celeron®, Intel Pentium®, or 6/7th Generation Intel Core™ i3 / i5 / i7 Processor	Security features	<ul style="list-style-type: none"> <li>Security slot (in rear for optional Kensington® MicroSaver® cable)</li> <li>Padlock loop</li> <li>Smart USB protection, allows keyboard/mouse only, blocks all storage devices</li> <li>Optional cable lock to physically lock both keyboard and mouse</li> <li>Power-on password</li> <li>Administrator password</li> <li>Hard disk password</li> <li>Boot sequence control</li> <li>Boot without keyboard and mouse</li> <li>Individual USB port disablement</li> <li>Optional chassis intrusion switch</li> </ul>																																																
	<table border="1"> <thead> <tr> <th>Processor</th> <th>Cores / Threads</th> <th>Frequency Base/Max(GHz)</th> <th>Cache</th> <th>Memory Support (Up to)</th> <th>Integrated Graphics</th> </tr> </thead> <tbody> <tr> <td>Core i5-6500</td> <td>4 / 4</td> <td>3.2G / 3.6G</td> <td>6 MB</td> <td>DDR4-2133</td> <td>HD 530</td> </tr> <tr> <td>Core i7-6700</td> <td>4 / 8</td> <td>3.4G / 4.0G</td> <td>8 MB</td> <td>DDR4-2133</td> <td>HD 530</td> </tr> <tr> <td>Core i3-7300</td> <td>2 / 4</td> <td>4.0G / --</td> <td>4 MB</td> <td>DDR4-2400</td> <td>HD 630</td> </tr> <tr> <td>Core i5-7400</td> <td>4 / 4</td> <td>3.0G / 3.5G</td> <td>6 MB</td> <td>DDR4-2400</td> <td>HD 630</td> </tr> <tr> <td>Core i5-7500</td> <td>4 / 4</td> <td>3.4G / 3.8G</td> <td>6 MB</td> <td>DDR4-2400</td> <td>HD 630</td> </tr> <tr> <td>Core i5-7600</td> <td>4 / 4</td> <td>3.5G / 4.1G</td> <td>6 MB</td> <td>DDR4-2400</td> <td>HD 630</td> </tr> <tr> <td>Core i7-7700</td> <td>4 / 8</td> <td>3.6G / 4.2G</td> <td>8 MB</td> <td>DDR4-2400</td> <td>HD 630</td> </tr> </tbody> </table>	Processor	Cores / Threads	Frequency Base/Max(GHz)	Cache	Memory Support (Up to)	Integrated Graphics	Core i5-6500	4 / 4	3.2G / 3.6G	6 MB	DDR4-2133	HD 530	Core i7-6700	4 / 8	3.4G / 4.0G	8 MB	DDR4-2133	HD 530	Core i3-7300	2 / 4	4.0G / --	4 MB	DDR4-2400	HD 630	Core i5-7400	4 / 4	3.0G / 3.5G	6 MB	DDR4-2400	HD 630	Core i5-7500	4 / 4	3.4G / 3.8G	6 MB	DDR4-2400	HD 630	Core i5-7600	4 / 4	3.5G / 4.1G	6 MB	DDR4-2400	HD 630	Core i7-7700	4 / 8	3.6G / 4.2G	8 MB	DDR4-2400	HD 630	Keyboard	<i>Some:</i> Lenovo Calliope Keyboard (USB connector), black <i>Some:</i> Lenovo Traditional Keyboard (USB connector), black <i>Some:</i> Lenovo Calliope Wireless Keyboard (2.4GHz via USB receiver), black
Processor	Cores / Threads	Frequency Base/Max(GHz)	Cache	Memory Support (Up to)	Integrated Graphics																																														
Core i5-6500	4 / 4	3.2G / 3.6G	6 MB	DDR4-2133	HD 530																																														
Core i7-6700	4 / 8	3.4G / 4.0G	8 MB	DDR4-2133	HD 530																																														
Core i3-7300	2 / 4	4.0G / --	4 MB	DDR4-2400	HD 630																																														
Core i5-7400	4 / 4	3.0G / 3.5G	6 MB	DDR4-2400	HD 630																																														
Core i5-7500	4 / 4	3.4G / 3.8G	6 MB	DDR4-2400	HD 630																																														
Core i5-7600	4 / 4	3.5G / 4.1G	6 MB	DDR4-2400	HD 630																																														
Core i7-7700	4 / 8	3.6G / 4.2G	8 MB	DDR4-2400	HD 630																																														
		Mouse	<i>Some:</i> Lenovo Calliope Mouse (USB connector), black <i>Some:</i> Lenovo Calliope Wireless Mouse (2.4GHz via USB receiver), black																																																
Memory	64GB max, UDIMM, DDR4-2400*, four 288-pin DIMM sockets, non-ECC, dual-channel capable * System automatically clocks down for the processors with lower memory controller	Mechanical	<ul style="list-style-type: none"> <li>SFF (8.4L), black color, metal case</li> <li>(WxDxH) 3.6" X 11.4" X 13.5"; 92.5mm X 290.5mm X 343.5mm</li> <li>Approx. 11.92 lb (5.4 kg), weight may vary by configuration</li> <li>Toolless cover, disk, optical, graphic card removal</li> <li>Optional dust filter</li> <li>Bay 1: Slim external ODD bay</li> <li>Bay 2: 3.5", 1" high, internal, HDD/SSD</li> <li>Bay 3: 2.5", internal, HDD/SSD (optional bay)</li> <li>Slot 1: low-profile (length &lt; 150mm, height &lt; 68mm), PCIe 3.0 x16*</li> <li>Slot 2: low-profile (length &lt; 150mm, height &lt; 68mm), PCIe 3.0 x1*</li> <li>Slot 3: low-profile (length &lt; 150mm, height &lt; 68mm), PCIe 3.0 x16 (x4 signal)*</li> <li>Slot 4: no slot, only bracket for optional port extension*</li> <li>M.2 card slots: Two (one for WLAN, one for SSD/Optane)</li> <li>* Optional front USB3.1 Type-C x2 module occupies PCIe x16 (x4 signal) slot, optional rear 2x USB2.0 / parallel / 2nd serial / cable lock / Wi-Fi antenna occupies one expansion slot</li> </ul>																																																
Storage	<i>Some:</i> Hard Drive / SATA 6.0Gb/s, 2.5" or 3.5", 5400 rpm or 7200 rpm <i>Some:</i> Solid State Drive (SSD) / SATA 6.0Gb/s, 2.5" <i>Some:</i> M.2 Solid State Drive (SSD) / PCIe NVMe, PCIe 3.0 x 4, 32Gb/s <i>Some:</i> Intel Optane™ Memory Ready (models with 7th gen Core processor), M.2	Floor Stand	Optional system floor stand for vertical orientation																																																
Optical	<i>Some:</i> DVD-ROM SATA 1.5Gb/s Drive, slim (9.0mm) <i>Some:</i> DVD Burner (DVD±RW), SATA 1.5Gb/s Drive, slim (9.0mm)	Power supply	<i>Some:</i> 180 watts, autosensing, 85% PSU <i>Some:</i> 210 watts, autosensing, 85% PSU <i>Some:</i> 210 watts, autosensing, 92% PSU (only available via special bid)																																																
Onboard SATA	Four onboard SATA 6.0Gb/s connectors, RAID 0/1 support (RAID preset only available via special bid model)	Limited warranty <sup>3</sup>	<i>Some:</i> <b>1-year or 3-year, depot service</b> / service upgrades available <i>Some:</i> <b>1-year or 3-year, limited onsite service</b> / service upgrades available																																																
Media reader	Optional 7-in-1 media reader	Preload	<b>Preloaded operating system</b> <i>Some:</i> Windows® 7 Professional 32/64 preinstalled through downgrade rights in Windows 10 Pro 64-bit (not available with 7th Gen Intel processor) <i>Some:</i> Windows 10 Pro 64-bit <i>Some:</i> Windows 10 Home 64-bit																																																
Graphics	<b>Intel HD Graphics 510/530/610/630</b> in processor, uses main memory, DirectX® 12, one VGA, two DisplayPort™, supports 3 independent displays, works along with discrete graphics to support more displays; <i>Max resolution:</i> 4096x2304 (DP) @60Hz; 2048x1536 (VGA) @50Hz <i>Some:</i> <b>NVIDIA GeForce® GT 730</b> , DirectX 12, 2GB, PCIe 2.0 x8 adapter, two DisplayPort, 35 watts; <i>Max resolution:</i> 3840x2160 (DisplayPort) @60Hz;	Preloaded applications (only some listed)	<ul style="list-style-type: none"> <li>Microsoft Office preloaded; purchase a product key to activate</li> <li>Cyberlink Power2Go Create (DVD±RW)</li> <li>Intel Unite (vPro models only)</li> <li>- Only for Window 10</li> <li>Lenovo Companion</li> <li>Lenovo ID</li> <li>Cyberlink Power2Go (DVD, DVD±RW)</li> <li>- Only for Window 7</li> <li>Lenovo Solution Center</li> <li>Lenovo ThinkVantage Tools</li> <li>Create Recovery Media</li> <li>Adobe® Reader®</li> </ul>																																																
Monitor cable	Optional DP to VGA, DP to DVI-D (single link), DP to dual DP, or DP to HDMI 1.4	Environment	ENERGY STAR® 6.1, EPEAT™ Gold rating (North America), ErP Lot 3, GREENGUARD®, RoHS-compliant, TUV low noise verified (on some models)																																																
Chipset	<b>Intel Q270 Chipset</b>	Accessories	For compatible accessories, please go to <a href="http://www.lenovoquickpick.com">http://www.lenovoquickpick.com</a>																																																
Front ports	Four USB 3.1 Gen1, optional two USB 3.1 Type-C Gen 2 (only available via special bid), microphone (3.5mm), headphone (3.5mm)	Manageability	Intel Active Management Technology 11.0 (Intel AMT 11.0); Intel vPro technology on some models (require choosing a vPro-support Wi-Fi adapter to enable vPro function through wireless connection)																																																
Rear ports	Four USB 3.1 Gen1, optional two USB 2.0, serial (9-pin), optional 2nd serial (9-pin), optional parallel (25-pin), ethernet (RJ-45), one VGA, two DisplayPort, optional two PS/2 ports (keyboard/mouse); additional DisplayPort on optional graphics on some models	Security chip	TPM (Trusted Platform Module) 2.0, TCG Certified * Downgrade to TPM1.2 for the models with Win10 DG Win7 32 OS																																																
Rear audio ports IEEE 1394	Line-in (3.5mm), line-out (3.5mm), microphone-in (3.5mm) None																																																		
Audio support	High Definition (HD) Audio, Realtek ALC662 / optional internal speaker (1.5 watt )																																																		
WLAN <sup>13</sup>	<i>Some:</i> 11ac wireless, M.2 Card, Qualcomm Atheros QCA9377A (dual band), Wi-Fi + Bluetooth 4.1 combo adapter, 1x1 <i>Some:</i> 11ac wireless, M.2 Card, Qualcomm Atheros QCA6174A (dual band), Wi-Fi + Bluetooth 4.1 combo adapter, 2x2 <i>Some:</i> 11ac wireless, M.2 Card, Intel Dual Band Wireless-AC 3165, Wi-Fi + Bluetooth 4.1 combo adapter, 1x1 <i>Some:</i> 11ac wireless, M.2 Card, Intel Dual Band Wireless-AC 8265, Wi-Fi + Bluetooth 4.1 combo adapter, 2x2 <i>Some:</i> 11ac wireless, M.2 Card, Intel Dual Band Wireless-AC 8265, Wi-Fi + Bluetooth 4.1 combo adapter, Intel vPro technology support, 2x2																																																		
Bluetooth™	<i>Some:</i> Bluetooth 4.1 wireless, integrated in Wi-Fi + BT combo adapter																																																		
Ethernet	Gigabit ethernet, Intel Ethernet Connection I219-LM(Jacksonville), Wake on LAN®																																																		
Modem	None																																																		

Model	Region	Processor	vPro	Graphics	Monitor Cable	Memory	Storage(HDD/SSD)	Optical	Optional 2nd 2.5" Bay	Media Reader	WLAN + Bluetooth	Optional Front Ports	Optional Rear Ports	Chassis Intrusion Switch	Cable Lock	Front Access HDD	Speaker	Dust Filter	Keyboard / Mouse	Stand	Power Supply	Operating System	Warranty	End of Support	Ann Date (mm/yy)
10MK000AUS	US	i7-7700	vPro	Intel HD 630	None	8GBx1	1TB 7200rpm 3.5"	DVD±RW	Optional 2nd 2.5" Bay	None	8265 ac, 2x2, vPro + BT4.1	None	None	None	None	None	1.5Wx1	None	USB / USB	Floor Stand	210W 85%	Win10 Pro 64	3-year, Onsite	Mar 21, 2023	02/17
10MK000BUS	US	i7-7700	vPro	Intel HD 630	None	8GBx1	256GB SSD M.2 PCIe NVMe	DVD±RW	Optional 2nd 2.5" Bay	None	8265 ac, 2x2, vPro + BT4.1	None	None	None	None	None	1.5Wx1	None	USB / USB	Floor Stand	210W 85%	Win10 Pro 64	3-year, Onsite	Mar 21, 2023	02/17
10MK000CUS	US	i5-7500	vPro	GT 730 2GB	None	8GBx1	1TB 7200rpm 3.5"	DVD±RW	Optional 2nd 2.5" Bay	None	None	None	None	None	None	None	1.5Wx1	None	USB / USB	Floor Stand	210W 85%	Win10 Pro 64	3-year, Onsite	Mar 21, 2023	02/17
10MK000DUS	US	i5-7500	vPro	GT 730 2GB	None	8GBx1	512GB SSD M.2 PCIe NVMe	DVD±RW	Optional 2nd 2.5" Bay	None	8265 ac, 2x2, vPro + BT4.1	None	None	None	None	None	1.5Wx1	None	USB / USB	Floor Stand	210W 85%	Win10 Pro 64	3-year, Onsite	Mar 21, 2023	02/17
10MK000EUS	US	i7-7700	vPro	GT 730 2GB	None	8GBx1	256GB SSD M.2 PCIe NVMe	DVD±RW	Optional 2nd 2.5" Bay	None	None	None	None	None	None	None	1.5Wx1	None	USB / USB	Floor Stand	210W 85%	Win10 Pro 64	3-year, Onsite	Mar 21, 2023	02/17
10MK000FUS	US	i7-7700	vPro	GT 730 2GB	None	8GBx1	512GB SSD M.2 PCIe NVMe	DVD±RW	Optional 2nd 2.5" Bay	None	8265 ac, 2x2, vPro + BT4.1	None	None	None	None	None	1.5Wx1	None	USB / USB	Floor Stand	210W 85%	Win10 Pro 64	3-year, Onsite	Mar 21, 2023	02/17
10MK000GUS	US	i5-7500	vPro	Intel HD 630	None	4GBx1	500GB 7200rpm 3.5"	DVD±RW	Optional 2nd 2.5" Bay	None	None	None	None	None	None	None	1.5Wx1	None	USB / USB	Floor Stand	210W 85%	Win10 Pro 64	3-year, Onsite	Mar 21, 2023	02/17
10MK000HUS	US	i5-7500	vPro	Intel HD 630	None	8GBx1	256GB SSD M.2 PCIe NVMe	DVD±RW	Optional 2nd 2.5" Bay	None	None	None	None	None	None	None	1.5Wx1	None	USB / USB	Floor Stand	210W 85%	Win10 Pro 64	3-year, Onsite	Mar 21, 2023	02/17
10MK000KUS	US	i5-7500	vPro	GT 730 2GB	None	8GBx1	256GB SSD M.2 PCIe NVMe	DVD±RW	Optional 2nd 2.5" Bay	None	None	None	None	None	None	None	1.5Wx1	None	USB / USB	Floor Stand	210W 85%	Win10 Pro 64	3-year, Onsite	Mar 21, 2023	02/17
10MK000LUS	US	i7-7700	vPro	GT 730 2GB	None	8GBx1	1TB 7200rpm 3.5"	DVD±RW	Optional 2nd 2.5" Bay	None	None	None	None	None	None	None	1.5Wx1	None	USB / USB	Floor Stand	210W 85%	Win10 Pro 64	3-year, Onsite	Mar 21, 2023	02/17
10MK000MUS	US	i7-7700	vPro	Intel HD 630	None	8GBx1	512GB SSD M.2 PCIe NVMe	DVD±RW	Optional 2nd 2.5" Bay	None	None	None	None	None	None	None	1.5Wx1	None	USB / USB	Floor Stand	210W 85%	Win10 Pro 64	3-year, Onsite	Mar 21, 2023	02/17
10MK000NUS	US	i7-7700	vPro	Intel HD 630	None	8GBx1	1TB 7200rpm 3.5"	DVD±RW	Optional 2nd 2.5" Bay	None	None	None	None	None	None	None	1.5Wx1	None	USB / USB	Floor Stand	210W 85%	Win10 Pro 64	3-year, Onsite	Mar 21, 2023	02/17
10MK000PUS	US	i7-7700	vPro	Intel HD 630	None	8GBx1	256GB SSD M.2 PCIe NVMe	DVD±RW	Optional 2nd 2.5" Bay	None	None	None	None	None	None	None	1.5Wx1	None	USB / USB	Floor Stand	210W 85%	Win10 Pro 64	3-year, Onsite	Mar 21, 2023	02/17
10MK000QUS	US	i5-7500	vPro	Intel HD 630	None	8GBx1	1TB 7200rpm 3.5"	DVD±RW	Optional 2nd 2.5" Bay	None	None	None	None	None	None	None	1.5Wx1	None	USB / USB	Floor Stand	210W 85%	Win10 Pro 64	3-year, Onsite	Mar 21, 2023	02/17
10MK000RUS	US	i5-7500	vPro	Intel HD 630	None	8GBx1	1TB 7200rpm 3.5"	DVD±RW	Optional 2nd 2.5" Bay	None	8265 ac, 2x2, vPro + BT4.1	None	None	None	None	None	1.5Wx1	None	USB / USB	Floor Stand	210W 85%	Win10 Pro 64	3-year, Onsite	Mar 21, 2023	02/17
10MK000SUS	US	i5-7500	vPro	Intel HD 630	None	8GBx1	512GB SSD M.2 PCIe NVMe	DVD±RW	Optional 2nd 2.5" Bay	None	None	None	None	None	None	None	1.5Wx1	None	USB / USB	Floor Stand	210W 85%	Win10 Pro 64	3-year, Onsite	Mar 21, 2023	02/17
10MK000TUS	US	i5-7500	vPro	Intel HD 630	None	8GBx1	256GB SSD M.2 PCIe NVMe	DVD±RW	Optional 2nd 2.5" Bay	None	8265 ac, 2x2, vPro + BT4.1	None	None	None	None	None	1.5Wx1	None	USB / USB	Floor Stand	210W 85%	Win10 Pro 64	3-year, Onsite	Mar 21, 2023	02/17
10MK0035US	US	i5-6500	vPro	GT 730 2GB	None	8GBx1	512GB SSD M.2 PCIe NVMe	DVD±RW	Optional 2nd 2.5" Bay	None	8265 ac, 2x2, vPro + BT4.1	None	None	None	None	None	1.5Wx1	None	USB / USB	Floor Stand	210W 85%	Win10 DG Win7 Pro 64	3-year, Onsite	Apr 28, 2023	03/17
10MK0036US	US	i5-6500	vPro	Intel HD 530	None	4GBx1	128GB SSD M.2 PCIe NVMe	DVD±RW	Optional 2nd 2.5" Bay	None	None	None	None	None	None	None	1.5Wx1	None	USB / USB	Floor Stand	210W 85%	Win10 DG Win7 Pro 64	3-year, Onsite	Apr 28, 2023	03/17
10MK0037US	US	i5-6500	vPro	Intel HD 530	None	8GBx1	256GB SSD M.2 PCIe NVMe	DVD±RW	Optional 2nd 2.5" Bay	None	8265 ac, 2x2, vPro + BT4.1	None	None	None	None	None	1.5Wx1	None	USB / USB	Floor Stand	210W 85%	Win10 DG Win7 Pro 64	3-year, Onsite	Apr 28, 2023	03/17

Model	Region	Processor	vPro	Graphics	Monitor Cable	Memory	Storage(HDD/SSD)	Optical	Optional 2nd 2.5" Bay	Media Reader	WLAN + Bluetooth	Optional Front Ports	Optional Rear Ports	Chassis Intrusion Switch	Cable Lock	Front Access HDD	Speaker	Dust Filter	Keyboard / Mouse	Stand	Power Supply	Operating System	Warranty	End of Support	Ann Date (mm/yy)
10MK0038US	US	i7-6700	vPro	Intel HD 530	None	8GBx1	256GB SSD M.2 PCIe NVMe	DVD±RW	Optional 2nd 2.5" Bay	None	None	None	None	None	None	None	1.5Wx1	None	USB / USB	Floor Stand	210W 85%	Win10 DG Win7 Pro 64	3-year, Onsite	Apr 28, 2023	03/17
10MK0039US	US	i5-6500	vPro	Intel HD 530	None	8GBx1	1TB 7200rpm 3.5"	DVD±RW	Optional 2nd 2.5" Bay	None	None	None	None	None	None	None	1.5Wx1	None	USB / USB	Floor Stand	210W 85%	Win10 DG Win7 Pro 64	3-year, Onsite	Apr 28, 2023	03/17
10MK003AUS	US	i7-6700	vPro	GT 730 2GB	None	8GBx1	512GB SSD M.2 PCIe NVMe	DVD±RW	Optional 2nd 2.5" Bay	None	8265 ac, 2x2, vPro + BT4.1	None	None	None	None	None	1.5Wx1	None	USB / USB	Floor Stand	210W 85%	Win10 DG Win7 Pro 64	3-year, Onsite	Apr 28, 2023	03/17
10MK003BUS	US	i7-6700	vPro	Intel HD 530	None	8GBx1	1TB 7200rpm 3.5"	DVD±RW	Optional 2nd 2.5" Bay	None	None	None	None	None	None	None	1.5Wx1	None	USB / USB	Floor Stand	210W 85%	Win10 DG Win7 Pro 64	3-year, Onsite	Apr 28, 2023	03/17
10MK003CUS	US	i5-6500	vPro	GT 730 2GB	None	8GBx1	1TB 7200rpm 3.5"	DVD±RW	Optional 2nd 2.5" Bay	None	None	None	None	None	None	None	1.5Wx1	None	USB / USB	Floor Stand	210W 85%	Win10 DG Win7 Pro 64	3-year, Onsite	Apr 28, 2023	03/17
10MK003DUS	US	i5-6500	vPro	Intel HD 530	None	8GBx1	1TB 7200rpm 3.5"	DVD±RW	Optional 2nd 2.5" Bay	None	8265 ac, 2x2, vPro + BT4.1	None	None	None	None	None	1.5Wx1	None	USB / USB	Floor Stand	210W 85%	Win10 DG Win7 Pro 64	3-year, Onsite	Apr 28, 2023	03/17
10MK003EUS	US	i5-6500	vPro	GT 730 2GB	None	8GBx1	256GB SSD M.2 PCIe NVMe	DVD±RW	Optional 2nd 2.5" Bay	None	None	None	None	None	None	None	1.5Wx1	None	USB / USB	Floor Stand	210W 85%	Win10 DG Win7 Pro 64	3-year, Onsite	Apr 28, 2023	03/17
10MK003FUS	US	i5-6500	vPro	Intel HD 530	None	8GBx1	512GB SSD M.2 PCIe NVMe	DVD±RW	Optional 2nd 2.5" Bay	None	None	None	None	None	None	None	1.5Wx1	None	USB / USB	Floor Stand	210W 85%	Win10 DG Win7 Pro 64	3-year, Onsite	Apr 28, 2023	03/17
10MK003GUS	US	i7-6700	vPro	Intel HD 530	None	8GBx1	256GB SSD M.2 PCIe NVMe	DVD±RW	Optional 2nd 2.5" Bay	None	8265 ac, 2x2, vPro + BT4.1	None	None	None	None	None	1.5Wx1	None	USB / USB	Floor Stand	210W 85%	Win10 DG Win7 Pro 64	3-year, Onsite	Apr 28, 2023	03/17
10MK003HUS	US	i7-6700	vPro	GT 730 2GB	None	8GBx1	1TB 7200rpm 3.5"	DVD±RW	Optional 2nd 2.5" Bay	None	None	None	None	None	None	None	1.5Wx1	None	USB / USB	Floor Stand	210W 85%	Win10 DG Win7 Pro 64	3-year, Onsite	Apr 28, 2023	03/17
10MK003JUS	US	i5-6500	vPro	Intel HD 530	None	4GBx1	500GB 7200rpm 3.5"	DVD±RW	Optional 2nd 2.5" Bay	None	None	None	None	None	None	None	1.5Wx1	None	USB / USB	Floor Stand	210W 85%	Win10 DG Win7 Pro 64	3-year, Onsite	Apr 28, 2023	03/17
10MK003KUS	US	i5-6500	vPro	Intel HD 530	None	8GBx1	256GB SSD M.2 PCIe NVMe	DVD±RW	Optional 2nd 2.5" Bay	None	None	None	None	None	None	None	1.5Wx1	None	USB / USB	Floor Stand	210W 85%	Win10 DG Win7 Pro 64	3-year, Onsite	Apr 28, 2023	03/17
10MK003LUS	US	i7-6700	vPro	GT 730 2GB	None	8GBx1	256GB SSD M.2 PCIe NVMe	DVD±RW	Optional 2nd 2.5" Bay	None	None	None	None	None	None	None	1.5Wx1	None	USB / USB	Floor Stand	210W 85%	Win10 DG Win7 Pro 64	3-year, Onsite	Apr 28, 2023	03/17
10MK003MUS	US	i5-7500	vPro	Intel HD 630	None	4GBx1	128GB SSD M.2 PCIe NVMe	DVD±RW	Optional 2nd 2.5" Bay	None	None	None	None	None	None	None	1.5Wx1	None	USB / USB	Floor Stand	210W 85%	Win10 Pro 64	3-year, Onsite	Apr 28, 2023	03/17
10MK003NUS	US	i7-6700	vPro	Intel HD 530	None	8GBx1	512GB SSD M.2 PCIe NVMe	DVD±RW	Optional 2nd 2.5" Bay	None	None	None	None	None	None	None	1.5Wx1	None	USB / USB	Floor Stand	210W 85%	Win10 DG Win7 Pro 64	3-year, Onsite	Apr 28, 2023	03/17
10MK003PUS	US	i7-6700	vPro	Intel HD 530	None	8GBx1	1TB 7200rpm 3.5"	DVD±RW	Optional 2nd 2.5" Bay	None	8265 ac, 2x2, vPro + BT4.1	None	None	None	None	None	1.5Wx1	None	USB / USB	Floor Stand	210W 85%	Win10 DG Win7 Pro 64	3-year, Onsite	Apr 28, 2023	03/17



# ThinkCentre M910 Tiny Platform Specifications

Product Specifications Reference (PSREF)

Processor	Intel® Celeron®, Intel Pentium®, or 6/7th Generation Intel Core™ i3 / i5 / i7 Processor						<b>Security features</b> <ul style="list-style-type: none"> <li>Security slot (in rear for optional Kensington® MicroSaver® cable)</li> <li>Smart USB protection, allows keyboard/mouse only, blocks all storage devices</li> <li>Power-on password</li> <li>Administrator password</li> <li>Hard disk password</li> <li>Boot sequence control</li> <li>Boot without keyboard and mouse</li> <li>Individual USB port disablement</li> <li>Chassis intrusion switch</li> </ul>
	Processor	Cores / Threads	Frequency Base/Max(GHz)	Cache	Memory Support (Up to)	Integrated Graphics	
	Core i5-6500T	4 / 4	2.5G / 3.1G	6 MB	DDR4-2133	HD 530	
	Core i7-6700T	4 / 8	2.8G / 3.6G	8 MB	DDR4-2133	HD 530	
	Core i5-7500T	4 / 4	2.7G / 3.3G	6 MB	DDR4-2400	HD 630	
	Core i5-7600T	4 / 4	2.8G / 3.7G	6 MB	DDR4-2400	HD 630	
Core i7-7700T	4 / 8	2.9G / 3.8G	8 MB	DDR4-2400	HD 630		
Memory	32GB max, DDR4-2400*, two 260-pin SO-DIMM sockets, non-ECC, dual-channel capable * System automatically clocks down for the processors with lower memory controller						
Storage	<i>Some:</i> Hard Drive / SATA 6.0Gb/s, 2.5", 5400 rpm or 7200 rpm, APS <i>Some:</i> Solid State Drive (SSD) / SATA 6.0Gb/s, 2.5" <i>Some:</i> M.2 Solid State Drive (SSD) / PCIe NVMe, PCIe 3.0 x 4, 32Gb/s <i>Some:</i> Intel Optane™ Memory Ready (models with 7th gen Core processor), M.2 <i>Some:</i> DVD-ROM, slim (9.0mm), via USB external ODD box <i>Some:</i> DVD Burner (DVD±RW), slim (9.0mm), via USB external ODD box						
Optical	One onboard SATA 6.0Gb/s connector						
Onboard SATA Media reader	None						
Graphics	<b>Intel HD Graphics 510/530/610/630</b> in processor, uses main memory, DirectX® 12, two DisplayPort™, one optional video port (HDMI, VGA, 3rd DP, or USB 3.1 Type-C with DisplayPort Alternate Mode), up to 3 independent displays; <i>Max resolution:</i> 4096x2304 (DP) @60Hz; 4096x2304 (Type-C) @60Hz; 4096x2160 (HDMI) @24Hz; 1920x1200 (VGA) @60Hz						
Monitor cable	Optional DP to VGA, DP to DVI-D (single link), DP to dual DP, or DP to HDMI 1.4						
Chipset	<b>Intel Q270 Chipset</b>						
Front ports	Two USB 3.1 Gen1 (one is Always On and fast charge), one microphone (3.5mm), one headphone / microphone combo jack (3.5mm)						
Rear ports	Four USB 3.1 Gen1 (optional external optical box or external I/O box occupies one or two specific USB 3.1 Gen1 on some models), ethernet (RJ-45), two DisplayPort, two optional ports (Port 1 for VGA / 3rd DP / HDMI / serial / USB 3.1 Type-C Gen 1 (with DisplayPort Alternate Mode), Port 2 for serial)						
I/O box	Optional external I/O box, extends two USB 2.0, two USB 3.1 Gen1, and one serial on rear, two USB 2.0 on front, via USB cable (occupy two specific USB 3.1 Gen1 of Tiny)						
Audio support	High Definition (HD) Audio, Realtek ALC294 / optional internal speaker (1w or 2w)						
WLAN <sup>13</sup>	<i>Some:</i> 11ac wireless, M.2 Card, Qualcomm Atheros QCA9377A (dual band), Wi-Fi + Bluetooth 4.1 combo adapter, 1x1 <i>Some:</i> 11ac wireless, M.2 Card, Qualcomm Atheros QCA6174A (dual band), Wi-Fi + Bluetooth 4.1 combo adapter, 2x2 <i>Some:</i> 11ac wireless, M.2 Card, Intel Dual Band Wireless-AC 3165, Wi-Fi + Bluetooth 4.1 combo adapter, 1x1 <i>Some:</i> 11ac wireless, M.2 Card, Intel Dual Band Wireless-AC 8265, Wi-Fi + Bluetooth 4.1 combo adapter, 2x2						
Bluetooth™	<i>Some:</i> 11ac wireless, M.2 Card, Intel Dual Band Wireless-AC 8265, Wi-Fi + Bluetooth 4.1 combo adapter, Intel vPro technology support, 2x2 <i>Some:</i> Bluetooth 4.1 wireless, integrated in Wi-Fi + BT combo adapter						
Ethernet Modem	Gigabit ethernet, Intel Ethernet Connection I219-LM(Jacksonville), Wake on LAN® None						
Manageability	Intel Active Management Technology 11.0 (Intel AMT 11.0); Intel vPro technology on some models (require choosing a vPro-support Wi-Fi adapter to enable vPro function through wireless connection)						
Security chip	TPM (Trusted Platform Module) 2.0*, TCG Certified * Downgrade to TPM1.2 for the models with Win10 DG Win7 32 OS						
Keyboard	<i>Some:</i> Lenovo Calliope Keyboard (USB connector), black						
	<i>Some:</i> Lenovo Traditional Keyboard (USB connector), black						
Mouse	<i>Some:</i> Lenovo Calliope Wireless Keyboard (2.4GHz via USB receiver), black						
	<i>Some:</i> Lenovo Calliope Mouse (USB connector), black <i>Some:</i> Lenovo Calliope Wireless Mouse (2.4GHz via USB receiver), black						
Mechanical	Tiny (1L), black color; metal case						
	<ul style="list-style-type: none"> <li>Toolless chassis open</li> <li>Toolless HDD, SSD, memory removal</li> <li>Optional toolless chassis screw</li> <li>Optional dust filter</li> </ul>						
		Dimensions (WxDxH)		Weight (Approx. )			
	M910 Tiny only	7.05" X 7.20" X 1.36" 179mm X 182.9mm X 34.5mm		2.91 lb (1.32 kg), vary by config			
With VESA mount & ODD box	7.42" X 7.30" X 2.48" 188.4mm X 185.38mm X 63mm		3.66 lb (1.66 kg), vary by config				
With VESA mount & I/O box	7.42" X 7.30" X 2.62" 188.4mm X 185.38mm X 66.6mm		3.66 lb (1.66 kg), vary by config				
VESA mount Floor Stand	Optional VESA mount bracket kit, supports VESA 75mm and 100mm Optional system floor stand for vertical orientation						
Power supply	65 watts AC/DC adapter, autosensing, 88% PSU (not included for TIO models) 90 watts AC/DC adapter, autosensing, 88% PSU (only for models with I/O box)						
Limited warranty <sup>3</sup>	<i>Some:</i> <b>1-year</b> or <b>3-year, depot service</b> / service upgrades available <i>Some:</i> <b>1-year</b> or <b>3-year, limited onsite service</b> / service upgrades available						
Preload	<i>Some:</i> Windows® 7 Professional 32/64 preinstalled through downgrade rights in Windows 10 Pro 64-bit (not available with 7th Gen Intel processor)						
	<i>Some:</i> Windows 10 Pro 64-bit <i>Some:</i> Windows 10 Home 64-bit						
Environment	<b>ENERGY STAR® 6.1, EPEAT™ Gold rating</b> (North America), ErP Lot 3, GREENGUARD®, RoHS-compliant, TUV low noise verified (on some models)						
	MIL-SPEC test	MIL-STD-810G military certification (Low Pressure [Altitude], High Temperature, Low Temperature, Temperature Shock, Humidity, Sand and Dust, Vibration, Shock, Fungus, Solar Radiation)					
Accessories	For compatible accessories, please go to <a href="http://www.lenovoquickpick.com">http://www.lenovoquickpick.com</a>						

See footnotes for more detailed information

Model	Region	Processor	vPro	Graphics	Monitor Cable	Memory	Storage(HDD/SSD)	External Optical / I/O Box	WLAN + Bluetooth	Optional Rear Ports	Chassis Intrusion Switch	Kensington Cable Lock	Speaker	Adapter Cage	Toolless Chassis Screw	Dust Filter	Keyboard / Mouse	VESA Mount	Stand	Power Supply	Operating System	Warranty	End of Support	Ann Date (mm/yy)
10MV000JUS	US	i5-7500T	vPro	Intel HD 630	None	4GBx1	128GB SSD M.2 PCIe NVMe	None	8265 ac, 2x2, vPro + BT4.1	3rd DP	Switch	None	1Wx1	None	None	None	USB / USB	None	Floor Stand	65W Adapter 88%	Win10 Pro 64	3-year, Onsite	Mar 21, 2023	02/17
10MV000KUS	US	i7-7700T	vPro	Intel HD 630	None	8GBx1	256GB SSD M.2 PCIe NVMe	DVD±RW	8265 ac, 2x2, vPro + BT4.1	HDMI	Switch	None	1Wx1	None	None	None	USB / USB	VESA Mount	None	65W Adapter 88%	Win10 Pro 64	3-year, Onsite	Mar 21, 2023	02/17
10MV000LUS	US	i5-7500T	vPro	Intel HD 630	None	4GBx1	500GB 7200rpm 2.5"	None	8265 ac, 2x2, vPro + BT4.1	3rd DP	Switch	None	1Wx1	None	None	None	USB / USB	None	Floor Stand	65W Adapter 88%	Win10 Pro 64	3-year, Onsite	Mar 21, 2023	02/17
10MV000MUS	US	i5-7500T	vPro	Intel HD 630	None	8GBx1	500GB 7200rpm 2.5"	None	8265 ac, 2x2, vPro + BT4.1	HDMI	Switch	None	1Wx1	None	None	None	USB / USB	None	Floor Stand	65W Adapter 88%	Win10 Pro 64	3-year, Onsite	Mar 21, 2023	02/17
10MV000NUS	US	i5-7500T	vPro	Intel HD 630	None	8GBx1	256GB SSD M.2 PCIe NVMe	None	8265 ac, 2x2, vPro + BT4.1	3rd DP	Switch	None	1Wx1	None	None	None	USB / USB	None	Floor Stand	65W Adapter 88%	Win10 Pro 64	3-year, Onsite	Mar 21, 2023	02/17
10MV000PUS	US	i5-7500T	vPro	Intel HD 630	None	8GBx1	500GB 7200rpm 2.5"	DVD±RW	8265 ac, 2x2, vPro + BT4.1	HDMI	Switch	None	1Wx1	None	None	None	USB / USB	VESA Mount	None	65W Adapter 88%	Win10 Pro 64	3-year, Onsite	Mar 21, 2023	02/17
10MV000QUS	US	i5-7500T	vPro	Intel HD 630	None	8GBx1	256GB SSD M.2 PCIe NVMe	None	8265 ac, 2x2, vPro + BT4.1	HDMI	Switch	None	1Wx1	None	None	None	USB / USB	None	Floor Stand	65W Adapter 88%	Win10 Pro 64	3-year, Onsite	Mar 21, 2023	02/17
10MV000RUS	US	i5-7500T	vPro	Intel HD 630	None	4GBx1	128GB SSD M.2 PCIe NVMe	None	8265 ac, 2x2, vPro + BT4.1	None	Switch	None	1Wx1	None	None	None	USB / USB	None	Floor Stand	65W Adapter 88%	Win10 Pro 64	3-year, Onsite	Mar 21, 2023	02/17
10MV000SUS	US	i5-7500T	vPro	Intel HD 630	None	8GBx1	128GB SSD M.2 PCIe NVMe	None	8265 ac, 2x2, vPro + BT4.1	3rd DP	Switch	None	1Wx1	None	None	None	USB / USB	None	Floor Stand	65W Adapter 88%	Win10 Pro 64	3-year, Onsite	Mar 21, 2023	02/17
10MV000TUS	US	i5-7500T	vPro	Intel HD 630	None	8GBx1	500GB 7200rpm 2.5"	None	8265 ac, 2x2, vPro + BT4.1	3rd DP	Switch	None	1Wx1	None	None	None	USB / USB	None	Floor Stand	65W Adapter 88%	Win10 Pro 64	3-year, Onsite	Mar 21, 2023	02/17
10MV000UUS	US	i7-7700T	vPro	Intel HD 630	None	8GBx1	256GB SSD M.2 PCIe NVMe	None	8265 ac, 2x2, vPro + BT4.1	HDMI	Switch	None	1Wx1	None	None	None	USB / USB	None	Floor Stand	65W Adapter 88%	Win10 Pro 64	3-year, Onsite	Mar 21, 2023	02/17
10MV000VUS	US	i5-7500T	vPro	Intel HD 630	None	4GBx1	500GB 7200rpm 2.5"	None	8265 ac, 2x2, vPro + BT4.1	Serial	Switch	None	1Wx1	None	None	None	USB / USB	None	Floor Stand	65W Adapter 88%	Win10 Pro 64	3-year, Onsite	Mar 21, 2023	02/17
10MV000XUS	US	i5-7500T	vPro	Intel HD 630	None	4GBx1	500GB 7200rpm 2.5"	None	8265 ac, 2x2, vPro + BT4.1	None	Switch	None	1Wx1	None	None	None	USB / USB	None	Floor Stand	65W Adapter 88%	Win10 Pro 64	3-year, Onsite	Mar 21, 2023	02/17
10MV000YUS	US	i7-7700T	vPro	Intel HD 630	None	8GBx1	128GB SSD M.2 PCIe NVMe	None	8265 ac, 2x2, vPro + BT4.1	HDMI	Switch	None	1Wx1	None	None	None	USB / USB	None	Floor Stand	65W Adapter 88%	Win10 Pro 64	3-year, Onsite	Mar 21, 2023	02/17
10MV0010US	US	i7-7700T	vPro	Intel HD 630	None	8GBx1	500GB 7200rpm 2.5"	None	8265 ac, 2x2, vPro + BT4.1	HDMI	Switch	None	1Wx1	None	None	None	USB / USB	None	Floor Stand	65W Adapter 88%	Win10 Pro 64	3-year, Onsite	Mar 21, 2023	02/17
10MV0011US	US	i5-7500T	vPro	Intel HD 630	None	4GBx1	256GB SSD M.2 PCIe NVMe	None	8265 ac, 2x2, vPro + BT4.1	3rd DP	Switch	None	1Wx1	None	None	None	USB / USB	None	Floor Stand	65W Adapter 88%	Win10 Pro 64	3-year, Onsite	Mar 21, 2023	02/17
10MV0012US	US	i5-7500T	vPro	Intel HD 630	None	8GBx1	512GB SSD M.2 PCIe NVMe	None	8265 ac, 2x2, vPro + BT4.1	HDMI	Switch	None	1Wx1	None	None	None	USB / USB	None	Floor Stand	65W Adapter 88%	Win10 Pro 64	3-year, Onsite	Mar 21, 2023	02/17
10MV0013US	US	i7-7700T	vPro	Intel HD 630	None	8GBx1	512GB SSD M.2 PCIe NVMe	None	8265 ac, 2x2, vPro + BT4.1	HDMI	Switch	None	1Wx1	None	None	None	USB / USB	None	Floor Stand	65W Adapter 88%	Win10 Pro 64	3-year, Onsite	Mar 21, 2023	02/17
10MV0014US	US	i5-7500T	vPro	Intel HD 630	None	8GBx1	256GB SSD M.2 PCIe NVMe	DVD±RW	8265 ac, 2x2, vPro + BT4.1	HDMI	Switch	None	1Wx1	None	None	None	USB / USB	VESA Mount	None	65W Adapter 88%	Win10 Pro 64	3-year, Onsite	Mar 21, 2023	02/17
10MV002MUS	US	i7-6700T	vPro	Intel HD 530	None	8GBx1	512GB SSD M.2 PCIe NVMe	None	8265 ac, 2x2, vPro + BT4.1	HDMI	Switch	None	1Wx1	None	None	None	USB / USB	None	Floor Stand	65W Adapter 88%	Win10 DG Win7 Pro 64	3-year, Onsite	Apr 21, 2023	03/17



Model	Region	Processor	vPro	Graphics	Monitor Cable	Memory	Storage(HDD/SSD)	External Optical / I/O Box	WLAN + Bluetooth	Optional Rear Ports	Chassis Intrusion Switch	Kensington Cable Lock	Speaker	Adapter Cage	Toolless Chassis Screw	Dust Filter	Keyboard / Mouse	VESA Mount	Stand	Power Supply	Operating System	Warranty	End of Support	Ann Date (mm/yy)
10MV002NUS	US	i5-6500T	vPro	Intel HD 530	None	4GBx1	500GB 7200rpm 2.5"	None	8265 ac, 2x2, vPro + BT4.1	Serial	Switch	None	1Wx1	None	None	None	USB / USB	None	Floor Stand	65W Adapter 88%	Win10 DG Win7 Pro 64	3-year, Onsite	Apr 21, 2023	03/17
10MV002PUS	US	i5-7500T	vPro	Intel HD 630	None	8GBx2	512GB SSD M.2 PCIe NVMe	None	8265 ac, 2x2, vPro + BT4.1	3rd DP	Switch	None	1Wx1	None	None	None	USB / USB	None	Floor Stand	65W Adapter 88%	Win10 Pro 64	3-year, Onsite	Apr 21, 2023	03/17
10MV002QUS	US	i7-7700T	vPro	Intel HD 630	None	8GBx2	512GB SSD M.2 PCIe NVMe	None	8265 ac, 2x2, vPro + BT4.1	3rd DP	Switch	None	1Wx1	None	None	None	USB / USB	None	Floor Stand	65W Adapter 88%	Win10 Pro 64	3-year, Onsite	Apr 21, 2023	03/17
10MV002RUS	US	i7-7700T	vPro	Intel HD 630	None	8GBx1	500GB 7200rpm 2.5"	None	8265 ac, 2x2, vPro + BT4.1	3rd DP	Switch	None	1Wx1	None	None	None	USB / USB	None	Floor Stand	65W Adapter 88%	Win10 Pro 64	3-year, Onsite	Apr 21, 2023	03/17
10MV002SUS	US	i5-6500T	vPro	Intel HD 530	None	8GBx1	512GB SSD M.2 PCIe NVMe	None	8265 ac, 2x2, vPro + BT4.1	3rd DP	Switch	None	1Wx1	None	None	None	USB / USB	None	Floor Stand	65W Adapter 88%	Win10 DG Win7 Pro 64	3-year, Onsite	Apr 21, 2023	03/17
10MV002TUS	US	i7-6700T	vPro	Intel HD 530	None	16GBx1	512GB SSD M.2 PCIe NVMe	None	8265 ac, 2x2, vPro + BT4.1	3rd DP	Switch	None	1Wx1	None	None	None	USB / USB	None	Floor Stand	65W Adapter 88%	Win10 DG Win7 Pro 64	3-year, Onsite	Apr 21, 2023	03/17
10MV002UUS	US	i7-6700T	vPro	Intel HD 530	None	8GBx1	500GB 7200rpm 2.5"	None	8265 ac, 2x2, vPro + BT4.1	3rd DP	Switch	None	1Wx1	None	None	None	USB / USB	None	Floor Stand	65W Adapter 88%	Win10 DG Win7 Pro 64	3-year, Onsite	Apr 21, 2023	03/17
10MV002VUS	US	i7-7700T	vPro	Intel HD 630	None	8GBx2	500GB 7200rpm 2.5"	None	8265 ac, 2x2, vPro + BT4.1	3rd DP	Switch	None	1Wx1	None	None	None	USB / USB	None	Floor Stand	65W Adapter 88%	Win10 Pro 64	3-year, Onsite	Apr 21, 2023	03/17
10MV002WUS	US	i7-6700T	vPro	Intel HD 530	None	8GBx1	256GB SSD M.2 PCIe NVMe	None	8265 ac, 2x2, vPro + BT4.1	HDMI	Switch	None	1Wx1	None	None	None	USB / USB	None	Floor Stand	65W Adapter 88%	Win10 DG Win7 Pro 64	3-year, Onsite	Apr 21, 2023	03/17
10MV002XUS	US	i5-7500T	vPro	Intel HD 630	None	8GBx2	256GB SSD M.2 PCIe NVMe	None	8265 ac, 2x2, vPro + BT4.1	3rd DP	Switch	None	1Wx1	None	None	None	USB / USB	None	Floor Stand	65W Adapter 88%	Win10 Pro 64	3-year, Onsite	Apr 21, 2023	03/17
10MV002YUS	US	i5-6500T	vPro	Intel HD 530	None	8GBx2	512GB SSD M.2 PCIe NVMe	None	8265 ac, 2x2, vPro + BT4.1	3rd DP	Switch	None	1Wx1	None	None	None	USB / USB	None	Floor Stand	65W Adapter 88%	Win10 DG Win7 Pro 64	3-year, Onsite	Apr 21, 2023	03/17
10MV0030US	US	i5-6500T	vPro	Intel HD 530	None	4GBx1	500GB 7200rpm 2.5"	None	8265 ac, 2x2, vPro + BT4.1	None	Switch	None	1Wx1	None	None	None	USB / USB	None	Floor Stand	65W Adapter 88%	Win10 DG Win7 Pro 64	3-year, Onsite	Apr 21, 2023	03/17
10MV0031US	US	i5-6500T	vPro	Intel HD 530	None	4GBx1	500GB 7200rpm 2.5"	None	8265 ac, 2x2, vPro + BT4.1	VGA	Switch	None	1Wx1	None	None	None	USB / USB	None	Floor Stand	65W Adapter 88%	Win10 DG Win7 Pro 64	3-year, Onsite	Apr 21, 2023	03/17
10MV0032US	US	i5-6500T	vPro	Intel HD 530	None	8GBx1	256GB SSD M.2 PCIe NVMe	None	8265 ac, 2x2, vPro + BT4.1	3rd DP	Switch	None	1Wx1	None	None	None	USB / USB	None	Floor Stand	65W Adapter 88%	Win10 DG Win7 Pro 64	3-year, Onsite	Mar 21, 2022	03/17
10MV0033US	US	i7-6700T	vPro	Intel HD 530	None	8GBx1	512GB SSD M.2 PCIe NVMe	None	8265 ac, 2x2, vPro + BT4.1	3rd DP	Switch	None	1Wx1	None	None	None	USB / USB	None	Floor Stand	65W Adapter 88%	Win10 DG Win7 Pro 64	3-year, Onsite	Apr 21, 2023	03/17
10MV0034US	US	i5-6500T	vPro	Intel HD 530	None	8GBx1	128GB SSD M.2 PCIe NVMe	None	8265 ac, 2x2, vPro + BT4.1	3rd DP	Switch	None	1Wx1	None	None	None	USB / USB	None	Floor Stand	65W Adapter 88%	Win10 DG Win7 Pro 64	3-year, Onsite	Apr 21, 2023	03/17
10MV0035US	US	i7-7700T	vPro	Intel HD 630	None	8GBx2	256GB SSD M.2 PCIe NVMe	None	8265 ac, 2x2, vPro + BT4.1	3rd DP	Switch	None	1Wx1	None	None	None	USB / USB	None	Floor Stand	65W Adapter 88%	Win10 Pro 64	3-year, Onsite	Apr 21, 2023	03/17
10MV0036US	US	i5-6500T	vPro	Intel HD 530	None	8GBx1	500GB 7200rpm 2.5"	None	8265 ac, 2x2, vPro + BT4.1	3rd DP	Switch	None	1Wx1	None	None	None	USB / USB	None	Floor Stand	65W Adapter 88%	Win10 DG Win7 Pro 64	3-year, Onsite	Apr 21, 2023	03/17
10MV0037US	US	i5-6500T	vPro	Intel HD 530	None	8GBx2	256GB SSD M.2 PCIe NVMe	None	8265 ac, 2x2, vPro + BT4.1	3rd DP	Switch	None	1Wx1	None	None	None	USB / USB	None	Floor Stand	65W Adapter 88%	Win10 DG Win7 Pro 64	3-year, Onsite	Apr 21, 2023	03/17
10MV0038US	US	i5-6500T	vPro	Intel HD 530	None	4GBx1	500GB 7200rpm 2.5"	None	8265 ac, 2x2, vPro + BT4.1	3rd DP	Switch	None	1Wx1	None	None	None	USB / USB	None	Floor Stand	65W Adapter 88%	Win10 DG Win7 Pro 64	3-year, Onsite	Apr 21, 2023	03/17



Model	Region	Processor	vPro	Graphics	Monitor Cable	Memory	Storage(HDD/SSD)	External Optical / I/O Box	WLAN + Bluetooth	Optional Rear Ports	Chassis Intrusion Switch	Kensington Cable Lock	Speaker	Adapter Cage	Toolless Chassis Screw	Dust Filter	Keyboard / Mouse	VESA Mount	Stand	Power Supply	Operating System	Warranty	End of Support	Ann Date (mm/yy)
10MV0039US	US	i7-6700T	vPro	Intel HD 530	None	8GBx1	256GB SSD M.2 PCIe NVMe	None	8265 ac, 2x2, vPro + BT4.1	3rd DP	Switch	None	1Wx1	None	None	None	USB / USB	None	Floor Stand	65W Adapter 88%	Win10 DG Win7 Pro 64	3-year, Onsite	Apr 21, 2023	03/17

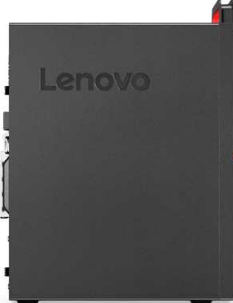

# ThinkCentre M910 Tower Platform Specifications

Product Specifications Reference (PSREF)

Processor	Intel® Celeron®, Intel Pentium®, or 6/7th Generation Intel Core™ i3 / i5 / i7 Processor	Manageability	Intel Active Management Technology 11.0 (Intel AMT 11.0); Intel vPro technology on some models (require choosing a vPro-support Wi-Fi adapter to enable vPro function through wireless connection)																																																
	<table border="1"> <thead> <tr> <th>Processor</th> <th>Cores / Threads</th> <th>Frequency Base/Max(GHz)</th> <th>Cache</th> <th>Memory Support (Up to)</th> <th>Integrated Graphics</th> </tr> </thead> <tbody> <tr> <td>Core i5-6500</td> <td>4 / 4</td> <td>3.2G / 3.6G</td> <td>6 MB</td> <td>DDR4-2133</td> <td>HD 530</td> </tr> <tr> <td>Core i7-6700</td> <td>4 / 8</td> <td>3.4G / 4.0G</td> <td>8 MB</td> <td>DDR4-2133</td> <td>HD 530</td> </tr> <tr> <td>Core i3-7300</td> <td>2 / 4</td> <td>4.0G / --</td> <td>4 MB</td> <td>DDR4-2400</td> <td>HD 630</td> </tr> <tr> <td>Core i5-7400</td> <td>4 / 4</td> <td>3.0G / 3.5G</td> <td>6 MB</td> <td>DDR4-2400</td> <td>HD 630</td> </tr> <tr> <td>Core i5-7500</td> <td>4 / 4</td> <td>3.4G / 3.8G</td> <td>6 MB</td> <td>DDR4-2400</td> <td>HD 630</td> </tr> <tr> <td>Core i5-7600</td> <td>4 / 4</td> <td>3.5G / 4.1G</td> <td>6 MB</td> <td>DDR4-2400</td> <td>HD 630</td> </tr> <tr> <td>Core i7-7700</td> <td>4 / 8</td> <td>3.6G / 4.2G</td> <td>8 MB</td> <td>DDR4-2400</td> <td>HD 630</td> </tr> </tbody> </table>	Processor	Cores / Threads	Frequency Base/Max(GHz)	Cache	Memory Support (Up to)	Integrated Graphics	Core i5-6500	4 / 4	3.2G / 3.6G	6 MB	DDR4-2133	HD 530	Core i7-6700	4 / 8	3.4G / 4.0G	8 MB	DDR4-2133	HD 530	Core i3-7300	2 / 4	4.0G / --	4 MB	DDR4-2400	HD 630	Core i5-7400	4 / 4	3.0G / 3.5G	6 MB	DDR4-2400	HD 630	Core i5-7500	4 / 4	3.4G / 3.8G	6 MB	DDR4-2400	HD 630	Core i5-7600	4 / 4	3.5G / 4.1G	6 MB	DDR4-2400	HD 630	Core i7-7700	4 / 8	3.6G / 4.2G	8 MB	DDR4-2400	HD 630	Security chip	TPM (Trusted Platform Module) 2.0, TCG Certified * Downgrade to TPM1.2 for the models with Win10 DG Win7 32 OS
Processor	Cores / Threads	Frequency Base/Max(GHz)	Cache	Memory Support (Up to)	Integrated Graphics																																														
Core i5-6500	4 / 4	3.2G / 3.6G	6 MB	DDR4-2133	HD 530																																														
Core i7-6700	4 / 8	3.4G / 4.0G	8 MB	DDR4-2133	HD 530																																														
Core i3-7300	2 / 4	4.0G / --	4 MB	DDR4-2400	HD 630																																														
Core i5-7400	4 / 4	3.0G / 3.5G	6 MB	DDR4-2400	HD 630																																														
Core i5-7500	4 / 4	3.4G / 3.8G	6 MB	DDR4-2400	HD 630																																														
Core i5-7600	4 / 4	3.5G / 4.1G	6 MB	DDR4-2400	HD 630																																														
Core i7-7700	4 / 8	3.6G / 4.2G	8 MB	DDR4-2400	HD 630																																														
		Security features	<ul style="list-style-type: none"> <li>Security slot (in rear for optional Kensington® MicroSaver® cable)</li> <li>Padlock loop</li> <li>Smart USB protection, allows keyboard/ mouse only, blocks all storage devices</li> <li>Optional cable lock to physically lock both keyboard and mouse</li> <li>Power-on password</li> <li>Administrator password</li> <li>Hard disk password</li> <li>Boot sequence control</li> <li>Boot without keyboard and mouse</li> <li>Individual USB port disablement</li> <li>Optional chassis intrusion switch</li> </ul>																																																
Memory	64GB max, UDIMM, DDR4-2400*, four 288-pin DIMM sockets, non-ECC, dual-channel capable * System automatically clocks down for the processors with lower memory controller	Keyboard	<i>Some:</i> Lenovo Calliope Keyboard (USB connector), black <i>Some:</i> Lenovo Traditional Keyboard (USB connector), black <i>Some:</i> Lenovo Calliope Wireless Keyboard (2.4GHz via USB receiver), black <i>Some:</i> Lenovo Calliope Mouse (USB connector), black <i>Some:</i> Lenovo Calliope Wireless Mouse (2.4GHz via USB receiver), black																																																
Storage	<i>Some:</i> Hard Drive / SATA 6.0Gb/s, 2.5" or 3.5", 5400 rpm or 7200 rpm <i>Some:</i> Solid State Drive (SSD) / SATA 6.0Gb/s, 2.5" <i>Some:</i> M.2 Solid State Drive (SSD) / PCIe NVMe, PCIe 3.0 x 4, 32Gb/s <i>Some:</i> Intel Optane™ Memory Ready (models with 7th gen Core processor), M.2 <i>Some:</i> Front accessible and removable HDD, 3.5", lockable via physical key <i>Some:</i> DVD-ROM, SATA 1.5Gb/s, 5.25" or slim (9.0mm) <i>Some:</i> DVD Burner (DVD±RW), SATA 1.5Gb/s, 5.25" or slim (9.0mm)	Mouse	<i>Some:</i> Lenovo Calliope Mouse (USB connector), black <i>Some:</i> Lenovo Calliope Wireless Mouse (2.4GHz via USB receiver), black																																																
Optical	<i>Some:</i> DVD-ROM, SATA 1.5Gb/s, 5.25" or slim (9.0mm) <i>Some:</i> DVD Burner (DVD±RW), SATA 1.5Gb/s, 5.25" or slim (9.0mm)	Mechanical	<ul style="list-style-type: none"> <li>Tower (18L), black color, metal case</li> <li>(WxDxH) 6.5" X 12.65" X 16.15"; 165mm X 321.35mm X 410.25mm</li> <li>Approx. 15.45 lb (7 kg), weight may vary by configuration</li> <li>Toolless cover, disk, optical, graphic card removal</li> <li>Optional carry handle, dust filter</li> <li>Bay 1: Slim external ODD bay</li> <li>Bay 2: 5.25", 1.6" high, external, ODD / optional front access HDD</li> <li>Bay 3: 3.5", 1" high, internal, HDD/SSD</li> <li>Bay 4: 3.5", 1" high, internal, HDD/SSD (optional bay, bay comes with disk)</li> <li>Bay 5: 2.5", internal, HDD/SSD (optional bay)</li> <li>Notes: M910 Tower supports up to 3 SATA devices (ODD/HDD/SSD) and 1 eSATA device (front access HDD)</li> <li>Slot 1: full-length full-height (length &lt; 268mm, height &lt; 112mm), PCIe 3.0 x16*</li> <li>Slot 2: full-length full-height (length &lt; 268mm, height &lt; 112mm), PCIe 3.0 x1*</li> <li>Slot 3: full-length full-height (length &lt; 268mm, height &lt; 112mm), PCIe 3.0 x16 (x4 signal)*</li> <li>Slot 4: no slot, only bracket for optional port extension*</li> <li>M.2 card slots: Two (one for WLAN, one for SSD/Optane)</li> <li>* Optional front USB3.1 Type-C x2 module occupies PCIe x16 (x4 signal) slot, optional rear 2x USB2.0 / parallel / 2nd serial occupies one expansion slot</li> </ul>																																																
Onboard SATA	Four onboard SATA 6.0Gb/s connectors (1x eSATA and 3x SATA), RAID 0/1 support (RAID preset only available via special bid model)	Power supply	<i>Some:</i> 180 watts, autosensing, 85% PSU <i>Some:</i> 250 watts, autosensing, 85% PSU <i>Some:</i> 400 watts, autosensing, 92% PSU (only available via special bid)																																																
Media reader	Optional 7-in-1 media reader	Limited warranty	<i>Some:</i> <b>1-year</b> or <b>3-year, depot service</b> / service upgrades available <i>Some:</i> <b>1-year</b> or <b>3-year, limited onsite service</b> / service upgrades available																																																
Graphics	<b>Intel HD Graphics 510/530/610/630</b> in processor, uses main memory, DirectX® 12, one VGA, two DisplayPort™, supports 3 independent displays, works along with discrete graphics to support more displays; <i>Max resolution:</i> 4096x2304 (DP) @60Hz; 2048x1536 (VGA) @50Hz <i>Some:</i> <b>NVIDIA GeForce® GT 730</b> , DirectX 12, 2GB, PCIe 2.0 x8 adapter, two DisplayPort, 35 watts; <i>Max resolution:</i> 3840x2160 (DisplayPort) @60Hz; <i>Some:</i> <b>AMD Radeon™ R7 350</b> , DirectX 11, 2GB, PCIe 3.0 x8 adapter, one VGA, one HDMI, 75 watts, occupies two slots; <i>Max resolution:</i> 4096x2160 (HDMI) @24Hz; 2048x1536 (VGA) @85Hz <i>Some:</i> <b>NVIDIA GeForce GTX™ 1080</b> (only available via special bid model), DirectX 12, 8GB, PCIe 3.0 x16 adapter, one DVI-D, one HDMI, three DisplayPort, 180 watts, occupies two slots; <i>Max resolution:</i> 2560x1600 (DVI-D) @60Hz; 4096x2160 (HDMI) @60Hz 7680x4320 (with Single DP) @60Hz	Preload	<b>Preloaded operating system</b> <i>Some:</i> Windows® 7 Professional 32/64 preinstalled through downgrade rights in Windows 10 Pro 64-bit (not available with 7th Gen Intel processor) <i>Some:</i> Windows 10 Pro 64-bit <i>Some:</i> Windows 10 Home 64-bit <b>Preloaded applications (only some listed)</b> <ul style="list-style-type: none"> <li>Microsoft Office preloaded; purchase a product key to activate</li> <li>Cyberlink PowerDVD Create (DVD±RW)</li> <li>Intel Unite (vPro models only)</li> <li>Only for Window 10</li> <li>Lenovo Companion</li> <li>Lenovo ID</li> <li>Cyberlink PowerDVD (DVD, DVD±RW)</li> <li>Only for Window 7</li> <li>Lenovo Solution Center</li> <li>Lenovo ThinkVantage Tools</li> <li>Create Recovery Media</li> <li>Adobe® Reader®</li> </ul>																																																
Monitor Cable	Optional DP to VGA, DP to DVI-D (single link), DP to dual DP, or DP to HDMI 1.4	Environment	ENERGY STAR® 6.1, EPEAT™ Gold rating (North America), ErP Lot 3, GREENGUARD®, RoHS-compliant, TUV low noise verified (on some models)																																																
Chipset	<b>Intel Q270 Chipset</b>	Accessories	For compatible accessories, please go to <a href="http://www.lenovoquickpick.com">http://www.lenovoquickpick.com</a>																																																
Front ports	Four USB 3.1 Gen1, optional two USB 3.1 Type-C Gen 2 (only available via special bid), microphone (3.5mm), headphone (3.5mm)																																																		
Rear ports	Four USB 3.1 Gen1, optional two USB 2.0, serial (9-pin), optional 2nd serial (9-pin), optional parallel (25-pin), ethernet (RJ-45), one VGA, two DisplayPort, optional two PS/2 ports (keyboard/mouse); additional VGA, DisplayPort, DVI-D, or HDMI on optional graphics on some models																																																		
Rear audio ports IEEE 1394	Line-in (3.5mm), line-out (3.5mm), microphone-in (3.5mm) None																																																		
Audio support	High Definition (HD) Audio, Realtek ALC662 / optional internal speaker (1.5 watt )																																																		
WLAN	<i>Some:</i> 11ac wireless, M.2 Card, Qualcomm Atheros QCA9377A (dual band), Wi-Fi + Bluetooth 4.1 combo adapter, 1x1 <i>Some:</i> 11ac wireless, M.2 Card, Qualcomm Atheros QCA6174A (dual band), Wi-Fi + Bluetooth 4.1 combo adapter, 2x2 <i>Some:</i> 11ac wireless, M.2 Card, Intel Dual Band Wireless-AC 3165, Wi-Fi + Bluetooth 4.1 combo adapter, 1x1 <i>Some:</i> 11ac wireless, M.2 Card, Intel Dual Band Wireless-AC 8265, Wi-Fi + Bluetooth 4.1 combo adapter, 2x2 <i>Some:</i> 11ac wireless, M.2 Card, Intel Dual Band Wireless-AC 8265, Wi-Fi + Bluetooth 4.1 combo adapter, Intel vPro technology support, 2x2																																																		
Bluetooth™	<i>Some:</i> Bluetooth 4.1 wireless, integrated in Wi-Fi + BT combo adapter																																																		
Ethernet	Gigabit ethernet, Intel Ethernet Connection I219-LM(Jacksonville), Wake on LAN®																																																		
Modem	None																																																		

Model	Region	Processor	vPro	Graphics	Monitor Cable	Memory	Storage(HDD/SSD)	Optical	Optional 2.5" Bay	Media Reader	WLAN + Bluetooth	Optional Front Ports	Optional Rear Ports	Chassis Intrusion Switch	Cable Lock	Front Access HDD	Speaker	Dust Filter	Keyboard / Mouse	Carry Handle	Power Supply	Operating System	Warranty	End of Support	Ann Date (mm/yy)
10MM000AUS	US	i5-7500	vPro	Intel HD 630	None	4GBx1	500GB 7200rpm 3.5"	DVD±RW	Optional 2.5" Bay	None	None	None	None	None	None	None	1.5Wx1	None	USB / USB	Carry Handle	250W 85%	Win10 Pro 64	3-year, Onsite	Mar 21, 2023	02/17
10MM000BUS	US	i7-7700	vPro	GT 730 2GB	None	8GBx1	256GB SSD M.2 PCIe NVMe	DVD±RW	Optional 2.5" Bay	None	None	None	None	None	None	None	1.5Wx1	None	USB / USB	Carry Handle	250W 85%	Win10 Pro 64	3-year, Onsite	Mar 21, 2023	02/17
10MM000CUS	US	i5-7500	vPro	Intel HD 630	None	8GBx1	512GB SSD M.2 PCIe NVMe	DVD±RW	Optional 2.5" Bay	None	None	None	None	None	None	None	1.5Wx1	None	USB / USB	Carry Handle	250W 85%	Win10 Pro 64	3-year, Onsite	Mar 21, 2023	02/17
10MM000DUS	US	i7-7700	vPro	Intel HD 630	None	8GBx1	256GB SSD M.2 PCIe NVMe	DVD±RW	Optional 2.5" Bay	None	None	None	None	None	None	None	1.5Wx1	None	USB / USB	Carry Handle	250W 85%	Win10 Pro 64	3-year, Onsite	Mar 21, 2023	02/17
10MM000EUS	US	i5-7500	vPro	GT 730 2GB	None	8GBx1	512GB SSD M.2 PCIe NVMe	DVD±RW	Optional 2.5" Bay	None	None	None	None	None	None	None	1.5Wx1	None	USB / USB	Carry Handle	250W 85%	Win10 Pro 64	3-year, Onsite	Mar 21, 2023	02/17
10MM000FUS	US	i5-7500	vPro	Intel HD 630	None	8GBx1	1TB 7200rpm 3.5"	DVD±RW	Optional 2.5" Bay	None	None	None	None	None	None	None	1.5Wx1	None	USB / USB	Carry Handle	250W 85%	Win10 Pro 64	3-year, Onsite	Mar 21, 2023	02/17
10MM000GUS	US	i5-7500	vPro	GT 730 2GB	None	8GBx1	1TB 7200rpm 3.5"	DVD±RW	Optional 2.5" Bay	None	None	None	None	None	None	None	1.5Wx1	None	USB / USB	Carry Handle	250W 85%	Win10 Pro 64	3-year, Onsite	Mar 21, 2023	02/17
10MM000HUS	US	i5-7500	vPro	Intel HD 630	None	8GBx1	256GB SSD M.2 PCIe NVMe	DVD±RW	Optional 2.5" Bay	None	None	None	None	None	None	None	1.5Wx1	None	USB / USB	Carry Handle	250W 85%	Win10 Pro 64	3-year, Onsite	Mar 21, 2023	02/17
10MM000JUS	US	i7-7700	vPro	GT 730 2GB	None	8GBx1	1TB 7200rpm 3.5"	DVD±RW	Optional 2.5" Bay	None	None	None	None	None	None	None	1.5Wx1	None	USB / USB	Carry Handle	250W 85%	Win10 Pro 64	3-year, Onsite	Mar 21, 2023	02/17
10MM000KUS	US	i7-7700	vPro	Intel HD 630	None	8GBx1	512GB SSD M.2 PCIe NVMe	DVD±RW	Optional 2.5" Bay	None	None	None	None	None	None	None	1.5Wx1	None	USB / USB	Carry Handle	250W 85%	Win10 Pro 64	3-year, Onsite	Mar 21, 2023	02/17
10MM000LUS	US	i7-7700	vPro	Intel HD 630	None	8GBx1	256GB SSD M.2 PCIe NVMe	DVD±RW	Optional 2.5" Bay	None	8265 ac, 2x2, vPro + BT4.1	None	None	None	None	None	1.5Wx1	None	USB / USB	Carry Handle	250W 85%	Win10 Pro 64	3-year, Onsite	Mar 21, 2023	02/17
10MM000MUS	US	i7-7700	vPro	GT 730 2GB	None	8GBx1	512GB SSD M.2 PCIe NVMe	DVD±RW	Optional 2.5" Bay	None	None	None	None	None	None	None	1.5Wx1	None	USB / USB	Carry Handle	250W 85%	Win10 Pro 64	3-year, Onsite	Mar 21, 2023	02/17
10MM000NUS	US	i5-7500	vPro	Intel HD 630	None	8GBx1	256GB SSD M.2 PCIe NVMe	DVD±RW	Optional 2.5" Bay	None	8265 ac, 2x2, vPro + BT4.1	None	None	None	None	None	1.5Wx1	None	USB / USB	Carry Handle	250W 85%	Win10 Pro 64	3-year, Onsite	Mar 21, 2023	02/17
10MM000PUS	US	i7-7700	vPro	Intel HD 630	None	8GBx1	1TB 7200rpm 3.5"	DVD±RW	Optional 2.5" Bay	None	None	None	None	None	None	None	1.5Wx1	None	USB / USB	Carry Handle	250W 85%	Win10 Pro 64	3-year, Onsite	Mar 21, 2023	02/17
10MM000QUS	US	i5-7500	vPro	GT 730 2GB	None	8GBx1	256GB SSD M.2 PCIe NVMe	DVD±RW	Optional 2.5" Bay	None	None	None	None	None	None	None	1.5Wx1	None	USB / USB	Carry Handle	250W 85%	Win10 Pro 64	3-year, Onsite	Mar 21, 2023	02/17
10MM002JUS	US	i5-6500	vPro	GT 730 2GB	None	8GBx1	256GB SSD M.2 PCIe NVMe	DVD±RW	Optional 2.5" Bay	None	8265 ac, 2x2, vPro + BT4.1	None	None	None	None	None	1.5Wx1	None	USB / USB	Carry Handle	250W 85%	Win10 DG Win7 Pro 64	3-year, Onsite	Apr 28, 2023	03/17
10MM002KUS	US	i5-6500	vPro	GT 730 2GB	None	8GBx1	512GB SSD M.2 PCIe NVMe	DVD±RW	Optional 2.5" Bay	None	None	None	None	None	None	None	1.5Wx1	None	USB / USB	Carry Handle	250W 85%	Win10 DG Win7 Pro 64	3-year, Onsite	Apr 28, 2023	03/17
10MM002LUS	US	i5-6500	vPro	Intel HD 530	None	8GBx1	256GB SSD M.2 PCIe NVMe	DVD±RW	Optional 2.5" Bay	None	None	None	None	None	None	None	1.5Wx1	None	USB / USB	Carry Handle	250W 85%	Win10 DG Win7 Pro 64	3-year, Onsite	Apr 28, 2023	03/17
10MM002MUS	US	i5-6500	vPro	Intel HD 530	None	4GBx1	128GB SSD M.2 PCIe NVMe	DVD±RW	Optional 2.5" Bay	None	None	None	None	None	None	None	1.5Wx1	None	USB / USB	Carry Handle	250W 85%	Win10 DG Win7 Pro 64	3-year, Onsite	Apr 28, 2023	03/17
10MM002NUS	US	i7-6700	vPro	GT 730 2GB	None	8GBx1	512GB SSD M.2 PCIe NVMe	DVD±RW	Optional 2.5" Bay	None	None	None	None	None	None	None	1.5Wx1	None	USB / USB	Carry Handle	250W 85%	Win10 DG Win7 Pro 64	3-year, Onsite	Apr 28, 2023	03/17

Model	Region	Processor	vPro	Graphics	Monitor Cable	Memory	Storage(HDD/SSD)	Optical	Optional 2.5" Bay	Media Reader	WLAN + Bluetooth	Optional Front Ports	Optional Rear Ports	Chassis Intrusion Switch	Cable Lock	Front Access HDD	Speaker	Dust Filter	Keyboard / Mouse	Carry Handle	Power Supply	Operating System	Warranty	End of Support	Ann Date (mm/yy)
10MM002PUS	US	i7-6700	vPro	GT 730 2GB	None	8GBx1	256GB SSD M.2 PCIe NVMe	DVD±RW	Optional 2.5" Bay	None	None	None	None	None	None	None	1.5Wx1	None	USB / USB	Carry Handle	250W 85%	Win10 DG Win7 Pro 64	3-year, Onsite	Apr 28, 2023	03/17
10MM002QUS	US	i5-7500	vPro	Intel HD 630	None	4GBx1	128GB SSD M.2 PCIe NVMe	DVD±RW	Optional 2.5" Bay	None	None	None	None	None	None	None	1.5Wx1	None	USB / USB	Carry Handle	250W 85%	Win10 Pro 64	3-year, Onsite	Apr 28, 2023	03/17
10MM002RUS	US	i7-6700	vPro	GT 730 2GB	None	8GBx1	1TB 7200rpm 3.5"	DVD±RW	Optional 2.5" Bay	None	None	None	None	None	None	None	1.5Wx1	None	USB / USB	Carry Handle	250W 85%	Win10 DG Win7 Pro 64	3-year, Onsite	Apr 28, 2023	03/17
10MM002SUS	US	i7-6700	vPro	Intel HD 530	None	8GBx1	256GB SSD M.2 PCIe NVMe	DVD±RW	Optional 2.5" Bay	None	None	None	None	None	None	None	1.5Wx1	None	USB / USB	Carry Handle	250W 85%	Win10 DG Win7 Pro 64	3-year, Onsite	Apr 28, 2023	03/17
10MM002TUS	US	i5-6500	vPro	Intel HD 530	None	4GBx1	500GB 7200rpm 3.5"	DVD±RW	Optional 2.5" Bay	None	None	None	None	None	None	None	1.5Wx1	None	USB / USB	Carry Handle	250W 85%	Win10 DG Win7 Pro 64	3-year, Onsite	Apr 28, 2023	03/17
10MM002UUS	US	i5-6500	vPro	GT 730 2GB	None	8GBx1	256GB SSD M.2 PCIe NVMe	DVD±RW	Optional 2.5" Bay	None	None	None	None	None	None	None	1.5Wx1	None	USB / USB	Carry Handle	250W 85%	Win10 DG Win7 Pro 64	3-year, Onsite	Apr 28, 2023	03/17
10MM002VUS	US	i5-6500	vPro	Intel HD 530	None	8GBx1	1TB 7200rpm 3.5"	DVD±RW	Optional 2.5" Bay	None	None	None	None	None	None	None	1.5Wx1	None	USB / USB	Carry Handle	250W 85%	Win10 DG Win7 Pro 64	3-year, Onsite	Apr 28, 2023	03/17
10MM002WUS	US	i5-6500	vPro	Intel HD 530	None	8GBx1	512GB SSD M.2 PCIe NVMe	DVD±RW	Optional 2.5" Bay	None	None	None	None	None	None	None	1.5Wx1	None	USB / USB	Carry Handle	250W 85%	Win10 DG Win7 Pro 64	3-year, Onsite	Apr 28, 2023	03/17
10MM002XUS	US	i7-6700	vPro	Intel HD 530	None	8GBx1	512GB SSD M.2 PCIe NVMe	DVD±RW	Optional 2.5" Bay	None	None	None	None	None	None	None	1.5Wx1	None	USB / USB	Carry Handle	250W 85%	Win10 DG Win7 Pro 64	3-year, Onsite	Apr 28, 2023	03/17
10MM002YUS	US	i5-6500	vPro	GT 730 2GB	None	8GBx1	1TB 7200rpm 3.5"	DVD±RW	Optional 2.5" Bay	None	None	None	None	None	None	None	1.5Wx1	None	USB / USB	Carry Handle	250W 85%	Win10 DG Win7 Pro 64	3-year, Onsite	Apr 28, 2023	03/17
10MM0030US	US	i7-6700	vPro	Intel HD 530	None	8GBx1	1TB 7200rpm 3.5"	DVD±RW	Optional 2.5" Bay	None	None	None	None	None	None	None	1.5Wx1	None	USB / USB	Carry Handle	250W 85%	Win10 DG Win7 Pro 64	3-year, Onsite	Apr 28, 2023	03/17
10MM0031US	US	i7-6700	vPro	GT 730 2GB	None	8GBx1	256GB SSD M.2 PCIe NVMe	DVD±RW	Optional 2.5" Bay	None	8265 ac, 2x2, vPro + BT4.1	None	None	None	None	None	1.5Wx1	None	USB / USB	Carry Handle	250W 85%	Win10 DG Win7 Pro 64	3-year, Onsite	Apr 28, 2023	03/17
10MM003AUS	US	i5-6500	vPro	Intel HD 530	None	8GBx1	256GB SSD M.2 PCIe NVMe	DVD±RW	Optional 2.5" Bay	None	8265 ac, 2x2, vPro + BT4.1	None	None	None	None	None	1.5Wx1	None	USB / USB	Carry Handle	250W 85%	Win10 DG Win7 Pro 64	3-year, Onsite	Apr 28, 2023	03/17
10MM003BUS	US	i7-6700	vPro	Intel HD 530	None	8GBx1	256GB SSD M.2 PCIe NVMe	DVD±RW	Optional 2.5" Bay	None	8265 ac, 2x2, vPro + BT4.1	None	None	None	None	None	1.5Wx1	None	USB / USB	Carry Handle	250W 85%	Win10 DG Win7 Pro 64	3-year, Onsite	Apr 28, 2023	03/17



# ThinkCentre M910x Tiny Platform Specifications

Product Specifications Reference (PSREF)

Processor	Intel® Celeron®, Intel Pentium®, or 6/7th Generation Intel Core™ i3 / i5 / i7 Processor						Manageability Intel Active Management Technology 11.0 (Intel AMT 11.0); Intel vPro technology on some models (require choosing a vPro-support Wi-Fi adapter to enable vPro function through wireless connection) Security chip TPM (Trusted Platform Module) 2.0*, TCG Certified * Downgrade to TPM1.2 for the models with Win10 DG Win7 32 OS Security features ● Security slot (in rear for optional Kensington® MicroSaver® cable) ● Smart USB protection, allows keyboard/mouse only, blocks all storage devices ● Power-on password ● Administrator password ● Hard disk password ● Boot sequence control ● Boot without keyboard and mouse ● Individual USB port disablement ● Chassis intrusion switch
	Processor	Cores / Threads	Frequency Base/Max(GHz)	Cache	Memory Support (Up to)	Integrated Graphics	
	Core i5-6500T	4 / 4	2.5G / 3.1G	6 MB	DDR4-2133	HD 530	
	Core i7-6700T	4 / 8	2.8G / 3.6G	8 MB	DDR4-2133	HD 530	
	Core i5-7500T	4 / 4	2.7G / 3.3G	6 MB	DDR4-2400	HD 630	
	Core i5-7600T	4 / 4	2.8G / 3.7G	6 MB	DDR4-2400	HD 630	
	Core i7-7700T	4 / 8	2.9G / 3.8G	8 MB	DDR4-2400	HD 630	
	Core i5-6500	4 / 4	3.2G / 3.6G	6 MB	DDR4-2133	HD 530	
	Core i7-6700	4 / 8	3.4G / 4.0G	8 MB	DDR4-2133	HD 530	
	Core i5-7500	4 / 4	3.4G / 3.8G	6 MB	DDR4-2400	HD 630	
Core i5-7600	4 / 4	3.5G / 4.1G	6 MB	DDR4-2400	HD 630		
Core i7-7700	4 / 8	3.6G / 4.2G	8 MB	DDR4-2400	HD 630		
Memory	32GB max, DDR4-2400*, two 260-pin SO-DIMM sockets, non-ECC, dual-channel capable * System automatically clocks down for the processors with lower memory controller						
Storage	<i>Some:</i> Hard Drive* / SATA 6.0Gb/s, 2.5", 5400 rpm or 7200 rpm, APS <i>Some:</i> Solid State Drive (SSD)* / SATA 6.0Gb/s, 2.5" (* 2.5" HDD/SSD and RX 460 graphics are mutually exclusive) <i>Some:</i> M.2 SSD (support up to two M.2 SSD) / PCIe NVMe, PCIe 3.0 x 4, 32Gb/s, RAID 0/1 support (RAID preset only available via special bid model)						
Optical	<i>Some:</i> Intel Optane™ Memory Ready (models with 7th gen Core processor), M.2 <i>Some:</i> DVD-ROM, slim (9.0mm), via USB external ODD box <i>Some:</i> DVD Burner (DVD±RW), slim (9.0mm), via USB external ODD box						
Onboard SATA Media reader	One onboard SATA 6.0Gb/s connector None						
Graphics	<b>Intel HD Graphics 510/530/610/630</b> in processor, uses main memory, DirectX® 12, two DisplayPort™, one optional video port (HDMI, VGA, 3rd DP, or USB 3.1 Type-C with DisplayPort Alternate Mode), up to 3 independent displays; <i>Max resolution:</i> 4096x2304 (DP) @60Hz; 4096x2304 (Type-C) @60Hz; 4096x2160 (HDMI) @24Hz; 1920x1200 (VGA) @60Hz <i>Some:</i> <b>AMD Radeon™ RX 460</b> , DirectX 12, 4GB, PCIe 3.0 x8 adapter (low profile), four mini DisplayPort, 35 watts (TDP), up to 4 independent displays, works along with 2 onboard DisplayPort to support up to 6 independent displays; <i>Max resolution:</i> 5120x2880 @60Hz (up to 2 mini DisplayPort); 4096x2160 @60Hz (up to 4 mini DisplayPort)						
VESA mount Floor Stand	Optional VESA mount bracket kit, supports VESA 75mm and 100mm Optional system floor stand for vertical orientation						
Power supply	135 watts AC/DC adapter, autosensing, 88% PSU						
Limited warranty <sup>3</sup>	<i>Some:</i> <b>1-year</b> or <b>3-year, depot service</b> / service upgrades available <i>Some:</i> <b>1-year</b> or <b>3-year, limited onsite service</b> / service upgrades available						
Preload	<i>Some:</i> Windows® 7 Professional 32/64 preinstalled through downgrade rights in Windows 10 Pro 64-bit (not available with 7th Gen Intel processor) <i>Some:</i> Windows 10 Pro 64-bit <i>Some:</i> Windows 10 Home 64-bit <b>Preloaded applications (only some listed)</b> ● Microsoft Office preloaded; purchase a product key to activate ● Cyberlink PowerDVD Create (DVD±RW) ● Intel Unite (vPro models only) - Only for Window 10 ● Lenovo Companion ● Lenovo ID ● Cyberlink PowerDVD (DVD, DVD±RW) - Only for Window 7 ● Lenovo Solution Center ● Lenovo ThinkVantage Tools ● Create Recovery Media ● Adobe® Reader®						
Monitor cable	Optional DP to VGA, DP to DVI-D, DP to dual DP, mini DP to DP, or DP to HDMI 1.4						
Chipset	<b>Intel Q270 Chipset</b>						
Front ports	Two USB 3.1 Gen1 (one is Always On and fast charge), one microphone (3.5mm), one headphone / microphone combo jack (3.5mm)						
Rear ports	Four USB 3.1 Gen1 (optional optical box or I/O box occupies one or two specific USB 3.1 Gen1), ethernet (RJ-45), two DisplayPort, two optional ports (not available for the models with RX 460 graphics): Port 1 for [VGA / 3rd DP / HDMI / serial / USB 3.1 Type-C Gen 1 (with DisplayPort Alternate Mode)]; Port 2 for [serial]						
I/O box	Optional external I/O box, extends two USB 2.0, two USB 3.1 Gen1, and one serial on rear, two USB 2.0 on front, via USB cable (occupy 2 specific USB 3.1 G1 of Tiny)						
Audio support	High Definition (HD) Audio, Realtek ALC294 / optional internal speaker (1w or 2w)						
WLAN <sup>13</sup>	<i>Some:</i> 11ac wireless, M.2 Card, Qualcomm Atheros QCA9377A (dual band), Wi-Fi + Bluetooth 4.1 combo adapter, 1x1 <i>Some:</i> 11ac wireless, M.2 Card, Qualcomm Atheros QCA6174A (dual band), Wi-Fi + Bluetooth 4.1 combo adapter, 2x2 <i>Some:</i> 11ac wireless, M.2 Card, Intel Dual Band Wireless-AC 3165, Wi-Fi + Bluetooth 4.1 combo adapter, 1x1 <i>Some:</i> 11ac wireless, M.2 Card, Intel Dual Band Wireless-AC 8265, Wi-Fi + Bluetooth 4.1 combo adapter, 2x2						
Bluetooth™	<i>Some:</i> 11ac wireless, M.2 Card, Intel Dual Band Wireless-AC 8265, Wi-Fi + Bluetooth 4.1 combo adapter, Intel vPro technology support, 2x2 <i>Some:</i> Bluetooth 4.1 wireless, integrated in Wi-Fi + BT combo adapter						
Ethernet Modem	Gigabit ethernet, Intel Ethernet Connection I219-LM(Jacksonville), Wake on LAN® None						
Environment	ENERGY STAR® 6.1, EPEAT™ Gold rating (North America), ErP Lot 3, GREENGUARD®, RoHS-compliant, TUV low noise verified (on some models)						
MIL-SPEC test	MIL-STD-810G military certification (Low Pressure [Altitude], High Temperature, Low Temperature, Temperature Shock, Humidity, Sand and Dust, Vibration, Shock, Fungus, Solar Radiation)						
Accessories	For compatible accessories, please go to <a href="http://www.lenovoquickpick.com">http://www.lenovoquickpick.com</a>						

See footnotes for more detailed information

© Lenovo (M910x Tiny-Spec) May 2017



Model	Region	Processor	vPro	Graphics	Monitor Cable	Memory	Storage(HDD/SSD)	External Optical / I/O Box	WLAN + Bluetooth	Optional Rear Ports	Chassis Intrusion Switch	Kensington Cable Lock	Speaker	Adapter Cage	Toolless Chassis Screw	Dust Filter	Keyboard / Mouse	VESA Mount	Stand	Power Supply	Operating System	Warranty	Ann Date (mm/yy)
10N00007SS	US	i5-7600	vPro	Intel HD 630	None	8GBx1	256GB SSD M.2 PCIe NVMe	None	8265 ac, 2x2, vPro + BT4.1	3rd DP	Switch	None	1Wx1	None	None	None	USB / USB	None	Floor Stand	135W Adapter 88%	Win10 Pro 64	3-year, Onsite	04/17
10N00007US	US	i5-7600	vPro	Intel HD 630	None	8GBx1	256GB SSD M.2 PCIe NVMe	None	8265 ac, 2x2, vPro + BT4.1	3rd DP	Switch	None	1Wx1	None	None	None	USB / USB	None	Floor Stand	135W Adapter 88%	Win10 Pro 64	3-year, Onsite	04/17
10N00008SS	US	i5-7500	vPro	Intel HD 630	None	4GBx1	500GB 7200rpm 2.5"	None	8265 ac, 2x2, vPro + BT4.1	3rd DP	Switch	None	1Wx1	None	None	None	USB / USB	None	Floor Stand	135W Adapter 88%	Win10 Pro 64	3-year, Onsite	04/17
10N00008US	US	i5-7500	vPro	Intel HD 630	None	4GBx1	500GB 7200rpm 2.5"	None	8265 ac, 2x2, vPro + BT4.1	3rd DP	Switch	None	1Wx1	None	None	None	USB / USB	None	Floor Stand	135W Adapter 88%	Win10 Pro 64	3-year, Onsite	04/17
10N00009SS	US	i7-7700	vPro	Intel HD 630	None	8GBx1	500GB 7200rpm 2.5"	None	8265 ac, 2x2, vPro + BT4.1	3rd DP	Switch	None	1Wx1	None	None	None	USB / USB	None	Floor Stand	135W Adapter 88%	Win10 Pro 64	3-year, Onsite	04/17
10N00009US	US	i7-7700	vPro	Intel HD 630	None	8GBx1	500GB 7200rpm 2.5"	None	8265 ac, 2x2, vPro + BT4.1	3rd DP	Switch	None	1Wx1	None	None	None	USB / USB	None	Floor Stand	135W Adapter 88%	Win10 Pro 64	3-year, Onsite	04/17
10N0000ASS	US	i5-7500	vPro	Intel HD 630	None	8GBx1	256GB SSD M.2 PCIe NVMe	None	8265 ac, 2x2, vPro + BT4.1	3rd DP	Switch	None	1Wx1	None	None	None	USB / USB	None	Floor Stand	135W Adapter 88%	Win10 Pro 64	3-year, Onsite	04/17
10N0000AUS	US	i5-7500	vPro	Intel HD 630	None	8GBx1	256GB SSD M.2 PCIe NVMe	None	8265 ac, 2x2, vPro + BT4.1	3rd DP	Switch	None	1Wx1	None	None	None	USB / USB	None	Floor Stand	135W Adapter 88%	Win10 Pro 64	3-year, Onsite	04/17
10N0000BSS	US	i5-7500	vPro	Intel HD 630	None	8GBx1	500GB 7200rpm 2.5"	None	8265 ac, 2x2, vPro + BT4.1	3rd DP	Switch	None	1Wx1	None	None	None	USB / USB	None	Floor Stand	135W Adapter 88%	Win10 Pro 64	3-year, Onsite	04/17
10N0000BUS	US	i5-7500	vPro	Intel HD 630	None	8GBx1	500GB 7200rpm 2.5"	None	8265 ac, 2x2, vPro + BT4.1	3rd DP	Switch	None	1Wx1	None	None	None	USB / USB	None	Floor Stand	135W Adapter 88%	Win10 Pro 64	3-year, Onsite	04/17
10N00014US	US	i5-6500T	vPro	AMD RX460 4GB	None	8GBx1	256GB SSD M.2 PCIe NVMe	None	8265 ac, 2x2, vPro + BT4.1	None	Switch	None	1Wx1	None	None	None	USB / USB	None	Floor Stand	135W Adapter 88%	Win10 DG Win7 Pro 64	3-year, Onsite	04/17
10N00015SS	US	i5-6500	vPro	Intel HD 530	None	8GBx1	512GB SSD M.2 PCIe NVMe	None	8265 ac, 2x2, vPro + BT4.1	3rd DP	Switch	None	1Wx1	None	None	None	USB / USB	None	Floor Stand	135W Adapter 88%	Win10 DG Win7 Pro 64	3-year, Onsite	04/17
10N00015US	US	i5-6500	vPro	Intel HD 530	None	8GBx1	512GB SSD M.2 PCIe NVMe	None	8265 ac, 2x2, vPro + BT4.1	3rd DP	Switch	None	1Wx1	None	None	None	USB / USB	None	Floor Stand	135W Adapter 88%	Win10 DG Win7 Pro 64	3-year, Onsite	04/17
10N00016SS	US	i7-6700	vPro	Intel HD 530	None	8GBx1	256GB SSD M.2 PCIe NVMe	None	8265 ac, 2x2, vPro + BT4.1	3rd DP	Switch	None	1Wx1	None	None	None	USB / USB	None	Floor Stand	135W Adapter 88%	Win10 DG Win7 Pro 64	3-year, Onsite	04/17
10N00016US	US	i7-6700	vPro	Intel HD 530	None	8GBx1	256GB SSD M.2 PCIe NVMe	None	8265 ac, 2x2, vPro + BT4.1	3rd DP	Switch	None	1Wx1	None	None	None	USB / USB	None	Floor Stand	135W Adapter 88%	Win10 DG Win7 Pro 64	3-year, Onsite	04/17
10N00017US	US	i7-6700T	vPro	AMD RX460 4GB	None	8GBx1	256GB SSD M.2 PCIe NVMe	None	8265 ac, 2x2, vPro + BT4.1	None	Switch	None	1Wx1	None	None	None	USB / USB	None	Floor Stand	135W Adapter 88%	Win10 DG Win7 Pro 64	3-year, Onsite	04/17
10N00018SS	US	i5-7500T	vPro	AMD RX460 4GB	None	8GBx1	256GB SSD M.2 PCIe NVMe	None	8265 ac, 2x2, vPro + BT4.1	None	Switch	None	1Wx1	None	None	None	USB / USB	None	Floor Stand	135W Adapter 88%	Win10 Pro 64	3-year, Onsite	04/17
10N00018US	US	i5-7500T	vPro	AMD RX460 4GB	None	8GBx1	256GB SSD M.2 PCIe NVMe	None	8265 ac, 2x2, vPro + BT4.1	None	Switch	None	1Wx1	None	None	None	USB / USB	None	Floor Stand	135W Adapter 88%	Win10 Pro 64	3-year, Onsite	04/17
10N00019US	US	i5-6500T	vPro	AMD RX460 4GB	None	8GBx1	512GB SSD M.2 PCIe NVMe	None	8265 ac, 2x2, vPro + BT4.1	None	Switch	None	1Wx1	None	None	None	USB / USB	None	Floor Stand	135W Adapter 88%	Win10 DG Win7 Pro 64	3-year, Onsite	04/17
10N0001ASS	US	i7-6700	vPro	Intel HD 530	None	8GBx1	500GB 7200rpm 2.5"	None	8265 ac, 2x2, vPro + BT4.1	3rd DP	Switch	None	1Wx1	None	None	None	USB / USB	None	Floor Stand	135W Adapter 88%	Win10 DG Win7 Pro 64	3-year, Onsite	04/17



Model	Region	Processor	vPro	Graphics	Monitor Cable	Memory	Storage(HDD/SSD)	External Optical / I/O Box	WLAN + Bluetooth	Optional Rear Ports	Chassis Intrusion Switch	Kensington Cable Lock	Speaker	Adapter Cage	Toolless Chassis Screw	Dust Filter	Keyboard / Mouse	VESA Mount	Stand	Power Supply	Operating System	Warranty	Ann Date (mm/yy)
10N0001AUS	US	i7-6700	vPro	Intel HD 530	None	8GBx1	500GB 7200rpm 2.5"	None	8265 ac, 2x2, vPro + BT4.1	3rd DP	Switch	None	1Wx1	None	None	None	USB / USB	None	Floor Stand	135W Adapter 88%	Win10 DG Win7 Pro 64	3-year, Onsite	04/17
10N0001BSS	US	i5-6500	vPro	Intel HD 530	None	8GBx1	256GB SSD M.2 PCIe NVMe	None	8265 ac, 2x2, vPro + BT4.1	3rd DP	Switch	None	1Wx1	None	None	None	USB / USB	None	Floor Stand	135W Adapter 88%	Win10 DG Win7 Pro 64	3-year, Onsite	04/17
10N0001BUS	US	i5-6500	vPro	Intel HD 530	None	8GBx1	256GB SSD M.2 PCIe NVMe	None	8265 ac, 2x2, vPro + BT4.1	3rd DP	Switch	None	1Wx1	None	None	None	USB / USB	None	Floor Stand	135W Adapter 88%	Win10 DG Win7 Pro 64	3-year, Onsite	04/17
10N0001CSS	US	i5-6500	vPro	Intel HD 530	None	8GBx1	500GB 7200rpm 2.5"	None	8265 ac, 2x2, vPro + BT4.1	3rd DP	Switch	None	1Wx1	None	None	None	USB / USB	None	Floor Stand	135W Adapter 88%	Win10 DG Win7 Pro 64	3-year, Onsite	04/17
10N0001CUS	US	i5-6500	vPro	Intel HD 530	None	8GBx1	500GB 7200rpm 2.5"	None	8265 ac, 2x2, vPro + BT4.1	3rd DP	Switch	None	1Wx1	None	None	None	USB / USB	None	Floor Stand	135W Adapter 88%	Win10 DG Win7 Pro 64	3-year, Onsite	04/17
10N0001DSS	US	i5-7500T	vPro	AMD RX460 4GB	None	8GBx1	512GB SSD M.2 PCIe NVMe	None	8265 ac, 2x2, vPro + BT4.1	None	Switch	None	1Wx1	None	None	None	USB / USB	None	Floor Stand	135W Adapter 88%	Win10 Pro 64	3-year, Onsite	04/17
10N0001DUS	US	i5-7500T	vPro	AMD RX460 4GB	None	8GBx1	512GB SSD M.2 PCIe NVMe	None	8265 ac, 2x2, vPro + BT4.1	None	Switch	None	1Wx1	None	None	None	USB / USB	None	Floor Stand	135W Adapter 88%	Win10 Pro 64	3-year, Onsite	04/17
10N0001ESS	US	i7-6700	vPro	Intel HD 530	None	8GBx1	512GB SSD M.2 PCIe NVMe	None	8265 ac, 2x2, vPro + BT4.1	3rd DP	Switch	None	1Wx1	None	None	None	USB / USB	None	Floor Stand	135W Adapter 88%	Win10 DG Win7 Pro 64	3-year, Onsite	04/17
10N0001EUS	US	i7-6700	vPro	Intel HD 530	None	8GBx1	512GB SSD M.2 PCIe NVMe	None	8265 ac, 2x2, vPro + BT4.1	3rd DP	Switch	None	1Wx1	None	None	None	USB / USB	None	Floor Stand	135W Adapter 88%	Win10 DG Win7 Pro 64	3-year, Onsite	04/17
10N0001FSS	US	i7-7700T	vPro	AMD RX460 4GB	None	8GBx1	256GB SSD M.2 PCIe NVMe	None	8265 ac, 2x2, vPro + BT4.1	None	Switch	None	1Wx1	None	None	None	USB / USB	None	Floor Stand	135W Adapter 88%	Win10 Pro 64	3-year, Onsite	04/17
10N0001FUS	US	i7-7700T	vPro	AMD RX460 4GB	None	8GBx1	256GB SSD M.2 PCIe NVMe	None	8265 ac, 2x2, vPro + BT4.1	None	Switch	None	1Wx1	None	None	None	USB / USB	None	Floor Stand	135W Adapter 88%	Win10 Pro 64	3-year, Onsite	04/17
10N0001GSS	US	i7-7700T	vPro	AMD RX460 4GB	None	8GBx1	512GB SSD M.2 PCIe NVMe	None	8265 ac, 2x2, vPro + BT4.1	None	Switch	None	1Wx1	None	None	None	USB / USB	None	Floor Stand	135W Adapter 88%	Win10 Pro 64	3-year, Onsite	04/17
10N0001GUS	US	i7-7700T	vPro	AMD RX460 4GB	None	8GBx1	512GB SSD M.2 PCIe NVMe	None	8265 ac, 2x2, vPro + BT4.1	None	Switch	None	1Wx1	None	None	None	USB / USB	None	Floor Stand	135W Adapter 88%	Win10 Pro 64	3-year, Onsite	04/17
10N0001HUS	US	i7-6700T	vPro	AMD RX460 4GB	None	8GBx1	512GB SSD M.2 PCIe NVMe	None	8265 ac, 2x2, vPro + BT4.1	None	Switch	None	1Wx1	None	None	None	USB / USB	None	Floor Stand	135W Adapter 88%	Win10 DG Win7 Pro 64	3-year, Onsite	04/17
10N0001JUS	US	i7-7700	vPro	Intel HD 630	None	8GBx1	256GB SSD M.2 PCIe NVMe	None	8265 ac, 2x2, vPro + BT4.1	3rd DP	Switch	None	1Wx1	None	None	None	USB / USB	None	Floor Stand	135W Adapter 88%	Win10 Pro 64	3-year, Onsite	07/17
10N0001KUS	US	i7-7700	vPro	Intel HD 630	None	8GBx1	512GB SSD M.2 PCIe NVMe	None	8265 ac, 2x2, vPro + BT4.1	3rd DP	Switch	None	1Wx1	None	None	None	USB / USB	None	Floor Stand	135W Adapter 88%	Win10 Pro 64	3-year, Onsite	07/17



# ThinkCentre Tiny-in-One (TIO) 22

Product Specifications Reference (PSREF)

Model	10LKPAR6++ / 10LKPAT6++		
Form factor	Tiny-in-One, offers a full All-In-One experience when optional Tiny slots into the back of TIO 22, clean cabling and effortless setup		
Compatible Tiny:	M900 Tiny, M700 Tiny, M600 Tiny, M93/p Tiny*, M83 Tiny, M73 Tiny*, or M53 Tiny, Chromebox * Non-TIO models can't be turned on by pressing power button of TIO 22		
Panel	TFT-LCD, In-Plane Switching (IPS), White LED backlight		
Viewable image size	21.5" (546.1mm) diagonal		
Max view area (W x H)	18.74" x 10.54" / 476.06mm x 267.79mm		
Bezel Width	Top / Side: 2mm, Bottom: 16.3mm		
Optimum resolution	<b>1920x1080</b>		
Aspect ratio	16:9		
Pixel pitch (mm)	0.24795mm		
Dot/Pixel per Inch	102.4 dpi		
Brightness	250 nits or cd/m <sup>2</sup> (typical)		
Contrast ratio	1000:1 (typical)		
Pixel response time	7ms		
Color gamut	72%		
Anti-reflective	Anti-glare		
Viewing angle at 10:1 CR	178° (+/- 89°) horizontal, 178° (+/- 89°) vertical		
Preset resolutions	640x350 @ 70Hz 640x480 @ 60Hz, 66Hz, 72Hz, 75Hz 720x400 @ 70Hz 800x600 @ 60Hz, 72Hz, 75Hz 1024x768 @ 60Hz, 70Hz, 75Hz 1152x864 @ 75Hz 1280x800 @ 60Hz 1280x1024 @ 60Hz, 72Hz, 75Hz 1366x768 @ 60Hz 1440x900 @ 60Hz, 75Hz 1600x1200 @ 60Hz, 70Hz, 75Hz 1680x1050 @ 60Hz 1920x1080 @ 60Hz		
Presets / user settings	Presets: 25; user settings: 25		
On screen display	On screen display with digital user controls (8 languages)		
Control features	Mode-switching (TIO mode / standalone monitor mode, switches video / audio / USB input sources) / Back button, Left shift button, Right shift / Brightness button, Selection button / Menu button, Power button		
Tiny-in-One Power On	Pressing Alt + P on keyboard or pressing Power button positioned on TIO can turn on both TIO and Tiny (only some Tiny support, see compatible list)		
Front ports	Two USB 3.0 or two USB 2.0 (when M73 or M53 installed or USB 2.0 connected via USB upstream port), one headphone / microphone combo jack (3.5mm) * The USB ports are only available when a Tiny is installed or a PC is connected via USB upstream port		
Side ports	Side ports offered by installed Tiny (optional)		
Rear ports	One DisplayPort 1.2 port, one USB upstream port, one power connector		
3-in-1 Cable	Undetachable 3-in-1 cable (Power connector, USB 3.0 [supports USB 3.0/USB 2.0], DisplayPort 1.2), only for connecting to Tiny installed (optional)		
Internal Speaker	1.5 watt x1		
Security	Security keyhole for attachment of optional cable lock (Kensington® lock compatible), locks optional Tiny with TIO 22 together, more security features offered by Tiny installed (optional)		
Mechanical	Dimensions	TIO 22 without stand	TIO 22 with stand
	W x D x H (inch)	19.25 x 2.65 x 12.47	19.25 x 9.90 x 14.02 - 18.35
	W x D x H (mm)	489.06 x 67.2 x 316.78	489.06 x 251.4 x 356.07 - 466.07
	Weight (approximately)	11.27 lb /5.11 kg (with stand)	
Mounting features	Wall or desk mounting using the extend arm or third-party accessories meeting the VESA FPMPMI® (100mm mount) <i>Tilt: 35° back, -5° forward; lift: 4.3" (110mm); swivel: +/-45°</i>		
Adjustable stand			
Power supply	90 watts AC/DC adapter, 88% PSU, universal		
Power consumption	15.57 watts typical, 35 watts maximum, <0.5 watts standby / suspend		
Limited warranty <sup>3</sup>	<b>3-years</b> , Customer Carry-In or Mail-In via Rapid Replacement Service		
VESA-compliant <sup>2</sup>	VESA DDC2B/CI, VESA DPMS-compliant		
Ergonomics	ISO 9241-307		
Emission standards	FCC Class B		
Environmental	TCO 7.0, TCO Edge 2.0, WEEE, RoHS, ENERGY STAR® 7.0 EPEAT™ Gold rating, ULE Gold, TUV, VOC		
Windows certifications	Windows 7, Windows 8/8.1, and Windows 10 certified		
Ship group	TIO 22 (Monitor), detachable stand, AC/DC power adapter, power cord, user's guide and driver CD, quick start and safety poster		
Accessories	For compatible accessories, please go to <a href="http://www.lenovoquickpick.com">http://www.lenovoquickpick.com</a>		
<b>ThinkCentre Tiny-in-One 22 Compatible list</b>			
Model	M900 Tiny, M700 Tiny, M600 Tiny, M83 Tiny, M53 Tiny	M93/p Tiny, M73 Tiny	Chromebox
Turn on TIO and Tiny together via Alt + P on USB KB	All models	All models	Not support
Turn on TIO and Tiny together via TIO Power Button	All models	TIO models	All models

See footnotes for more detailed information

Model	Region	Color	Display Size	Resolution	Aspect Ratio	Pixel Pitch	Dot / Pixel Per Inch	Brightness	Contrast Ratio	Pixel Response Time	Color Gamut	View Angle (H / V)	Stand	Power Consumption (Typical / Maximum)	Power Supply	Warranty	Ann Date (mm/yy)
10LKPAR6US	US	Black	21.5"	1920x1080	16:9	0.24795 mm	102.4 dpi	250 nits	1000:1	7 ms	72%	178 / 178	Adjustable Stand	15.57W / 35W	90W 88% Adapter	3-year	04/16
10LKPAT6US	US	Black	21.5"	1920x1080	16:9	0.24795 mm	102.4 dpi	250 nits	1000:1	7 ms	72%	178 / 178	Adjustable Stand	15.57W / 35W	90W 88% Adapter	3-year	04/16



# ThinkCentre Tiny-in-One (TIO) 22 Gen3

Product Specifications Reference (PSREF)

Model	<i>Non-touch model:</i> 10R1PAR1++/10R1PAT1++; <i>Touch model:</i> 10R0PAR1++/10R0PAT1++			Mounting features	Wall or desk mounting using the extend arm or third-party accessories meeting the VESA FPMPI® (100mm mount)																
Form factor	Tiny-in-One, offers a full All-In-One experience when optional Tiny slots into the back of TIO, clean cabling and effortless setup			Adjustable stand	<i>Tilt:</i> 30° back, -5° forward; <i>lift:</i> 4.3" (110mm); <i>swivel:</i> +/-45°; <i>Pivot:</i> clockwise 0° to 90°																
Compatible Tiny:	M910 / M710 / M900 / M700 / M600 / M715 / M93/p* / M83 / M73* / M53 / Chromebox Tiny * Non-TIO models can't be turned on by pressing power button of TIO			Power supply	90 watts AC/DC adapter, 88% PSU, universal																
Panel	TFT-LCD, In-Plane Switching technology**, White LED backlight <i>Notes:</i> In-Plane Switching may refer to VA, PLS, and IPS panels			Power consumption	19 watts typical, 32 watts maximum, <0.5 watts standby / suspend																
Viewable image size	21.5" (546.1mm) diagonal			Limited warranty	<b>3-years</b> , Customer Carry-In or Mail-In via Rapid Replacement Service																
Max view area (W x H)	18.74" x 10.54" / 476.1mm x 267.8mm			VESA-compliant	VESA DDC2B/CI, VESA DPMS-compliant																
Bezel Width	Top / Side: 2mm, Bottom: 22.1mm			Ergonomics	ISO 9241-307, TUV Eye Comfort certified																
Native resolution	<b>1920x1080</b>			Emission standards	FCC Class B																
Multi-touch	Optional 10-point multi-touch, supports Wake on Touch			Environmental	TCO 7.0, TCO Edge 2.0, WEEE, RoHS, ENERGY STAR® 7.0, EPEAT™ Gold rating, ULE Gold, TUV, VOC																
Aspect ratio	16:9			Windows certifications	Windows 7 and Windows 10 certified																
Pixel pitch (mm)	0.24795mm			Ship group	TIO (Monitor), detachable stand, AC/DC power adapter, power cord, user's guide and driver CD, quick start and safety poster																
Dot/Pixel per Inch	102.4 dpi			Accessories	For compatible accessories, please go to <a href="http://www.lenovoquickpick.com">http://www.lenovoquickpick.com</a>																
Brightness	250 nits or cd/m² (typical)			<table border="1"> <thead> <tr> <th colspan="4">ThinkCentre Tiny-in-One 22 Gen3 Compatible list</th> </tr> <tr> <th>Model</th> <th>M910 / M710 / M900 / M700 / M600 / M715 / M83 / M53 Tiny</th> <th>M93/p Tiny, M73 Tiny</th> <th>Chromebox</th> </tr> </thead> <tbody> <tr> <td>Turn on TIO and Tiny together via Alt + P on USB KB</td> <td>All models</td> <td>All models</td> <td>Not support</td> </tr> <tr> <td>Turn on TIO and Tiny together via TIO Power Button</td> <td>All models</td> <td>TIO models</td> <td>All models</td> </tr> </tbody> </table>		ThinkCentre Tiny-in-One 22 Gen3 Compatible list				Model	M910 / M710 / M900 / M700 / M600 / M715 / M83 / M53 Tiny	M93/p Tiny, M73 Tiny	Chromebox	Turn on TIO and Tiny together via Alt + P on USB KB	All models	All models	Not support	Turn on TIO and Tiny together via TIO Power Button	All models	TIO models	All models
ThinkCentre Tiny-in-One 22 Gen3 Compatible list																					
Model	M910 / M710 / M900 / M700 / M600 / M715 / M83 / M53 Tiny	M93/p Tiny, M73 Tiny	Chromebox																		
Turn on TIO and Tiny together via Alt + P on USB KB	All models	All models	Not support																		
Turn on TIO and Tiny together via TIO Power Button	All models	TIO models	All models																		
Contrast ratio	1000:1 (typical)																				
Pixel response time	14ms (default), over drive to 4ms, 6ms																				
Color gamut	72%																				
Anti-reflective	Anti-glare																				
Viewing angle at 10:1 CR	178° (+/- 89°) horizontal, 178° (+/- 89°) vertical																				
Preset resolutions	640x350 @ 70Hz 640x480 @ 60Hz, 66Hz, 72Hz, 75Hz 720x400 @ 70Hz 800x600 @ 60Hz, 72Hz, 75Hz 1024x768 @ 60Hz, 70Hz, 75Hz 1152x864 @ 75Hz 1280x800 @ 60Hz 1280x1024 @ 60Hz, 72Hz, 75Hz 1366x768 @ 60Hz 1440x900 @ 60Hz, 75Hz 1600x1200 @ 60Hz, 70Hz, 75Hz 1680x1050 @ 60Hz 1920x1080 @ 60Hz																				
Presets / user settings	Presets: 25; user settings: 25																				
On screen display	On screen display with digital user controls (8 languages)																				
Control features	<i>Font:</i> Exit button, Left / Mode-switching button (TIO / monitor mode), Right / Brightness button, Enter / Menu button, Power button <i>Bottom:</i> Volume up button, Volume down button																				
Tiny-in-One Power On	Pressing Alt + P on keyboard or pressing Power button positioned on TIO can turn on both TIO and Tiny (only some Tiny support, see compatible list)																				
Side ports (TIO)	One USB 3.1 Gen1 / USB 2.0 (when M73 or M53 installed or USB 2.0 connected via USB upstream port) <i>Notes:</i> The USB port is only available when a Tiny is installed or a PC is connected via USB upstream port																				
Side ports (Tiny)	Side ports offered by installed Tiny (optional)																				
Rear ports	One DisplayPort in port, one USB upstream port, one power connector																				
3-in-1 Cable	Undetachable 3-in-1 cable (Power connector, USB [supports USB 3.1 Gen1 / USB 2.0], DisplayPort), only for connecting to Tiny installed (optional)																				
Camera	720p camera with dual microphone for VOIP, LED indicator																				
Internal Speaker	2 watt x2																				
Security	Security keyhole for attachment of optional cable lock (Kensington® lock compatible), locks optional Tiny with TIO together, more security features offered by Tiny installed (optional)																				
Mechanical	<table border="1"> <thead> <tr> <th>Dimensions</th> <th>TIO without stand</th> <th>TIO with stand</th> </tr> </thead> <tbody> <tr> <td>W x D x H (inch)</td> <td>19.26 x 2.85 x 13.35</td> <td>19.26 x 10.76 x 14.59 - 18.93</td> </tr> <tr> <td>W x D x H (mm)</td> <td>489.3 x 72.5 x 339</td> <td>489.3 x 273.3 x 370.7 - 480.7</td> </tr> <tr> <td>Weight (Approx.)</td> <td>7.01 lb / 3.19 kg</td> <td>11.77 lb / 5.34 kg</td> </tr> </tbody> </table>			Dimensions	TIO without stand	TIO with stand	W x D x H (inch)	19.26 x 2.85 x 13.35	19.26 x 10.76 x 14.59 - 18.93	W x D x H (mm)	489.3 x 72.5 x 339	489.3 x 273.3 x 370.7 - 480.7	Weight (Approx.)	7.01 lb / 3.19 kg	11.77 lb / 5.34 kg						
Dimensions	TIO without stand	TIO with stand																			
W x D x H (inch)	19.26 x 2.85 x 13.35	19.26 x 10.76 x 14.59 - 18.93																			
W x D x H (mm)	489.3 x 72.5 x 339	489.3 x 273.3 x 370.7 - 480.7																			
Weight (Approx.)	7.01 lb / 3.19 kg	11.77 lb / 5.34 kg																			

# ThinkCentre Tiny-In-One 22 Gen3 - 10R0

Product Specifications Reference (PSREF)

Model	Product	Region	Color	Display Size	Multi-touch	Resolution	Aspect Ratio	Pixel Pitch	Dot / Pixel Per Inch	Brightness	Contrast Ratio	Pixel Response Time	Color Gamut	View Angle (H / V)	Stand	Power Consumption (Typical / Maximum)	Power Supply	Warranty	Ann Date (mm/yy)
10R0PAR1US	ThinkCentre Tiny-in-One 22 Gen3	US	Black	21.5"	10-point Multi-touch	1920x1080	16:9	0.24795 mm	102.4 dpi	250 nits	1000:1	4-14 ms	72%	178 / 178	Adjustable Stand	19W / 32W	90W 88% Adapter	3-year	07/17
10R0PAT1US	ThinkCentre Tiny-in-One 22 Gen3	US	Black	21.5"	10-point Multi-touch	1920x1080	16:9	0.24795 mm	102.4 dpi	250 nits	1000:1	4-14 ms	72%	178 / 178	Adjustable Stand	19W / 32W	90W 88% Adapter	3-year	07/17

ThinkCentre Tiny-In-One 22 Gen3 - 10R1

Product Specifications Reference (PSREF)

Model	Product	Region	Color	Display Size	Multi-touch	Resolution	Aspect Ratio	Pixel Pitch	Dot / Pixel Per Inch	Brightness	Contrast Ratio	Pixel Response Time	Color Gamut	View Angle (H / V)	Stand	Power Consumption (Typical / Maximum)	Power Supply	Warranty	Ann Date (mm/yy)
10R1PAR1US	ThinkCentre Tiny-in-One 22 Gen3	US	Black	21.5"	No	1920x1080	16:9	0.24795 mm	102.4 dpi	250 nits	1000:1	4-14 ms	72%	178 / 178	Adjustable Stand	19W / 32W	90W 88% Adapter	3-year	07/17
10R1PAT1US	ThinkCentre Tiny-in-One 22 Gen3	US	Black	21.5"	No	1920x1080	16:9	0.24795 mm	102.4 dpi	250 nits	1000:1	4-14 ms	72%	178 / 178	Adjustable Stand	19W / 32W	90W 88% Adapter	3-year	07/17





# ThinkCentre Tiny-in-One (TIO) 24

Product Specifications Reference (PSREF)

Model	10LLPAR6++ / 10LLPAT6++														
Form factor	Tiny-in-One, offers a full All-In-One experience when optional Tiny slots into the back of TIO 24, clean cabling and effortless setup														
Compatible Tiny:	M900 Tiny, M700 Tiny, M600 Tiny, M93/p Tiny*, M83 Tiny, M73 Tiny*, or M53 Tiny, Chromebox * Non-TIO models can't be turned on by pressing power button of TIO 24														
Panel	TFT-LCD, In-Plane Switching (IPS), White LED backlight														
Viewable image size	23.8" (604.7mm) diagonal														
Max view area (W x H)	21.06" x 12.32" / 535.0mm x 313.0mm														
Bezel Width	Top / Side: 2mm, Bottom: 16.3mm														
Optimum resolution	<b>1920x1080</b>														
Aspect ratio	16:9														
Pixel pitch (mm)	0.2745mm														
Dot/Pixel per Inch	92.6 dpi														
Brightness	250 nits or cd/m <sup>2</sup> (typical)														
Contrast ratio	1000:1 (typical)														
Pixel response time	7ms														
Color gamut	72%														
Anti-reflective	Anti-glare														
Viewing angle at 10:1 CR	178° (+/- 89°) horizontal, 178° (+/- 89°) vertical														
Preset resolutions	640x350 @ 70Hz 640x480 @ 60Hz, 66Hz, 72Hz, 75Hz 720x400 @ 70Hz 800x600 @ 60Hz, 72Hz, 75Hz 1024x768 @ 60Hz, 70Hz, 75Hz 1152x864 @ 75Hz 1280x800 @ 60Hz 1280x1024 @ 60Hz, 72Hz, 75Hz 1366x768 @ 60Hz 1440x900 @ 60Hz, 75Hz 1600x1200 @ 60Hz, 70Hz, 75Hz 1680x1050 @ 60Hz 1920x1080 @ 60Hz														
Presets / user settings	Presets: 25; user settings: 25														
On screen display	On screen display with digital user controls (8 languages)														
Control features	Mode-switching (TIO mode / standalone monitor mode, switches video / audio / USB input sources) / Back button, Left shift button, Right shift / Brightness button, Selection button / Menu button, Power button														
Tiny-in-One Power On	Pressing Alt + P on keyboard or pressing Power button positioned on TIO can turn on both TIO and Tiny (only some Tiny support, see compatible list)														
Front ports	Two USB 3.0 or two USB 2.0 (when M73 or M53 installed or USB 2.0 connected via USB upstream port), one headphone / microphone combo jack (3.5mm) * The USB ports are only available when a Tiny is installed or a PC is connected via USB upstream port														
Side ports	Side ports offered by installed Tiny (optional)														
Rear ports	One DisplayPort 1.2 port, one USB upstream port, one power connector														
3-in-1 Cable	Undetachable 3-in-1 cable (Power connector, USB 3.0 [supports USB 3.0/USB 2.0], DisplayPort 1.2), only for connecting to Tiny installed (optional)														
Internal Speaker	1.5 watt x1														
Security	Security keyhole for attachment of optional cable lock (Kensington® lock compatible), locks optional Tiny with TIO 24 together, more security features offered by Tiny installed (optional)														
Mechanical	<table border="1"> <thead> <tr> <th>Dimensions</th> <th>TIO 24 without stand</th> <th>TIO 24 with stand</th> </tr> </thead> <tbody> <tr> <td>W x D x H (inch)</td> <td>21.24 x 2.7 x 13.64</td> <td>21.24 x 9.90 x 15.16 - 19.46</td> </tr> <tr> <td>W x D x H (mm)</td> <td>539.6 x 68.2 x 346.45</td> <td>539.6 x 251.4 x 385.08 - 495.08</td> </tr> <tr> <td>Weight (approximately)</td> <td colspan="2">12.25 lb /5.57 kg (with stand)</td> </tr> </tbody> </table>			Dimensions	TIO 24 without stand	TIO 24 with stand	W x D x H (inch)	21.24 x 2.7 x 13.64	21.24 x 9.90 x 15.16 - 19.46	W x D x H (mm)	539.6 x 68.2 x 346.45	539.6 x 251.4 x 385.08 - 495.08	Weight (approximately)	12.25 lb /5.57 kg (with stand)	
Dimensions	TIO 24 without stand	TIO 24 with stand													
W x D x H (inch)	21.24 x 2.7 x 13.64	21.24 x 9.90 x 15.16 - 19.46													
W x D x H (mm)	539.6 x 68.2 x 346.45	539.6 x 251.4 x 385.08 - 495.08													
Weight (approximately)	12.25 lb /5.57 kg (with stand)														
Mounting features	Wall or desk mounting using the extend arm or third-party accessories meeting the VESA FPMPMI® (100mm mount)														
Adjustable stand	Tilt: 35° back, -5° forward; lift: 4.3" (110mm); swivel: +/-45°														
Power supply	90 watts AC/DC adapter, 88% PSU, universal														
Power consumption	16.7 watts typical, 35 watts maximum, <0.5 watts standby / suspend														
Limited warranty <sup>3</sup>	<b>3-years</b> , Customer Carry-In or Mail-In via Rapid Replacement Service														
VESA-compliant <sup>2</sup>	VESA DDC2B/CI, VESA DPMS-compliant														
Ergonomics	ISO 9241-307														
Emission standards	FCC Class B														
Environmental	TCO 7.0, TCO Edge 2.0, WEEE, RoHS, ENERGY STAR® 7.0														
Windows certifications	EPEAT™ Gold rating, ULE Gold, TUV, VOC Windows 7, Windows 8/8.1, and Windows 10 certified														
Ship group	TIO 24 (Monitor), detachable stand, AC/DC power adapter, power cord, user's guide and driver CD, quick start and safety poster														
Accessories	For compatible accessories, please go to <a href="http://www.lenovoquickpick.com">http://www.lenovoquickpick.com</a>														
<b>ThinkCentre Tiny-in-One 24 Compatible list</b>															
Model	M900 Tiny, M700 Tiny, M600 Tiny, M83 Tiny, M53 Tiny	M93/p Tiny, M73 Tiny	Chromebox												
Turn on TIO and Tiny together via Alt + P on USB KB	All models	All models	Not support												
Turn on TIO and Tiny together via TIO Power Button	All models	TIO models	All models												

See footnotes for more detailed information

Model	Region	Color	Display Size	Resolution	Aspect Ratio	Pixel Pitch	Dot / Pixel Per Inch	Brightness	Contrast Ratio	Pixel Response Time	Color Gamut	View Angle (H / V)	Stand	Power Consumption (Typical / Maximum)	Power Supply	Warranty	Ann Date (mm/yy)
10LLPAR6US	US	Black	23.8"	1920x1080	16:9	0.2745 mm	92.6 dpi	250 nits	1000:1	7 ms	72%	178 / 178	Adjustable Stand	16.7W / 35W	90W 88% Adapter	3-year	05/16
10LLPAT6US	US	Black	23.8"	1920x1080	16:9	0.2745 mm	92.6 dpi	250 nits	1000:1	7 ms	72%	178 / 178	Adjustable Stand	16.7W / 35W	90W 88% Adapter	3-year	05/16



# ThinkCentre Tiny-in-One (TIO) 24 Gen3

Product Specifications Reference (PSREF)

Model	<i>Non-touch model:</i> 10QYPAR1++/10QYPAT1++; <i>Touch model:</i> 10QXPAR1++/10QXPAT1++			Mounting features	Wall or desk mounting using the extend arm or third-party accessories meeting the VESA FPMPI® (100mm mount)																
Form factor	Tiny-in-One, offers a full All-In-One experience when optional Tiny slots into the back of TIO, clean cabling and effortless setup			Adjustable stand	<i>Tilt:</i> 30° back, -5° forward; <i>lift:</i> 4.3" (110mm); <i>swivel:</i> +/-45°; <i>Pivot:</i> clockwise 0° to 90°																
Compatible Tiny:	M910 / M710 / M900 / M700 / M600 / M715 / M93/p* / M83 / M73* / M53 / Chromebox Tiny * Non-TIO models can't be turned on by pressing power button of TIO			Power supply	90 watts AC/DC adapter, 88% PSU, universal																
Panel	TFT-LCD, In-Plane Switching technology**, White LED backlight <i>Notes:</i> In-Plane Switching may refer to VA, PLS, and IPS panels			Power consumption	19 watts typical, 32 watts maximum, <0.5 watts standby / suspend																
Viewable image size	23.8" (604.7mm) diagonal			Limited warranty	<b>3-years</b> , Customer Carry-In or Mail-In via Rapid Replacement Service																
Max view area (W x H)	21.06" x 12.32" / 535.0mm x 313.0mm			VESA-compliant	VESA DDC2B/CI, VESA DPMS-compliant																
Bezel Width	Top / Side: 2mm, Bottom: 22.1mm			Ergonomics	ISO 9241-307, TUV Eye Comfort certified																
Native resolution	<b>1920x1080</b>			Emission standards	FCC Class B																
Multi-touch	Optional 10-point multi-touch, supports Wake on Touch			Environmental	TCO 7.0, TCO Edge 2.0, WEEE, RoHS, ENERGY STAR® 7.0, EPEAT™ Gold rating, ULE Gold, TUV, VOC																
Aspect ratio	16:9			Windows certifications	Windows 7 and Windows 10 certified																
Pixel pitch (mm)	0.2745mm			Ship group	TIO 24 (Monitor), detachable stand, AC/DC power adapter, power cord, user's guide and driver CD, quick start and safety poster																
Dot/Pixel per Inch	92.6 dpi			Accessories	For compatible accessories, please go to <a href="http://www.lenovoquickpick.com">http://www.lenovoquickpick.com</a>																
Brightness	250 nits or cd/m <sup>2</sup> (typical)			<table border="1"> <thead> <tr> <th colspan="4">ThinkCentre Tiny-in-One 24 Gen3 Compatible list</th> </tr> </thead> <tbody> <tr> <td>Model</td> <td>M910 / M710 / M900 / M700 / M600 / M715 / M83 / M53 Tiny</td> <td>M93/p Tiny, M73 Tiny</td> <td>Chromebox</td> </tr> <tr> <td>Turn on TIO and Tiny together via Alt + P on USB KB</td> <td>All models</td> <td>All models</td> <td>Not support</td> </tr> <tr> <td>Turn on TIO and Tiny together via TIO Power Button</td> <td>All models</td> <td>TIO models</td> <td>All models</td> </tr> </tbody> </table>		ThinkCentre Tiny-in-One 24 Gen3 Compatible list				Model	M910 / M710 / M900 / M700 / M600 / M715 / M83 / M53 Tiny	M93/p Tiny, M73 Tiny	Chromebox	Turn on TIO and Tiny together via Alt + P on USB KB	All models	All models	Not support	Turn on TIO and Tiny together via TIO Power Button	All models	TIO models	All models
ThinkCentre Tiny-in-One 24 Gen3 Compatible list																					
Model	M910 / M710 / M900 / M700 / M600 / M715 / M83 / M53 Tiny	M93/p Tiny, M73 Tiny	Chromebox																		
Turn on TIO and Tiny together via Alt + P on USB KB	All models	All models	Not support																		
Turn on TIO and Tiny together via TIO Power Button	All models	TIO models	All models																		
Contrast ratio	1000:1 (typical)																				
Pixel response time	14ms (default), over drive to 4ms, 6ms																				
Color gamut	72%																				
Anti-reflective	Anti-glare																				
Viewing angle at 10:1 CR	178° (+/- 89°) horizontal, 178° (+/- 89°) vertical																				
Preset resolutions	640x350 @ 70Hz 640x480 @ 60Hz, 67Hz, 72Hz, 75Hz 720x400 @ 70Hz 800x600 @ 60Hz, 72Hz, 75Hz 1024x768 @ 60Hz, 70Hz, 75Hz 1152x864 @ 75Hz 1280x800 @ 60Hz 1280x1024 @ 60Hz, 72Hz, 75Hz 1366x768 @ 60Hz 1440x900 @ 60Hz, 75Hz 1600x1200 @ 60Hz, 70Hz, 75Hz 1680x1050 @ 60Hz 1920x1080 @ 60Hz																				
Presets / user settings	Presets: 25; user settings: 25																				
On screen display	On screen display with digital user controls (8 languages)																				
Control features	Font: Exit button, Left / Mode-switching button (TIO / monitor mode), Right / Brightness button, Enter / Menu button, Power button Bottom: Volume up button, Volume down button																				
Tiny-in-One Power On	Pressing Alt + P on keyboard or pressing Power button positioned on TIO can turn on both TIO and Tiny (only some Tiny support, see compatible list)																				
Side ports (TIO)	One USB 3.1 Gen1 / USB 2.0 (when M73 or M53 installed or USB 2.0 connected via USB upstream port) <i>Notes:</i> The USB port is only available when a Tiny is installed or a PC is connected via USB upstream port																				
Side ports (Tiny)	Side ports offered by installed Tiny (optional)																				
Rear ports	One DisplayPort in port, one USB upstream port, one power connector																				
3-in-1 Cable	Undetachable 3-in-1 cable (Power connector, USB [supports USB 3.1 Gen1 / USB 2.0], DisplayPort), only for connecting to Tiny installed (optional)																				
Camera	1080p camera with dual microphone for VOIP, LED indicator																				
Internal Speaker	2 watt x2																				
Security	Security keyhole for attachment of optional cable lock (Kensington® lock compatible), locks optional Tiny with TIO together, more security features offered by Tiny installed (optional)																				
Mechanical	<table border="1"> <thead> <tr> <th>Dimensions</th> <th>TIO without stand</th> <th>TIO with stand</th> </tr> </thead> <tbody> <tr> <td>W x D x H (inch)</td> <td>21.25 x 2.85 x 14.47</td> <td>21.25 x 11.11 x 15.72 - 20.06</td> </tr> <tr> <td>W x D x H (mm)</td> <td>539.8 x 72.5 x 367.6</td> <td>539.8 x 282.3 x 399.4 - 509.4</td> </tr> <tr> <td>Weight (Approx.)</td> <td>7.96 lb /3.61 kg</td> <td>12.92 lb /5.86 kg</td> </tr> </tbody> </table>			Dimensions	TIO without stand	TIO with stand	W x D x H (inch)	21.25 x 2.85 x 14.47	21.25 x 11.11 x 15.72 - 20.06	W x D x H (mm)	539.8 x 72.5 x 367.6	539.8 x 282.3 x 399.4 - 509.4	Weight (Approx.)	7.96 lb /3.61 kg	12.92 lb /5.86 kg						
Dimensions	TIO without stand	TIO with stand																			
W x D x H (inch)	21.25 x 2.85 x 14.47	21.25 x 11.11 x 15.72 - 20.06																			
W x D x H (mm)	539.8 x 72.5 x 367.6	539.8 x 282.3 x 399.4 - 509.4																			
Weight (Approx.)	7.96 lb /3.61 kg	12.92 lb /5.86 kg																			

# ThinkCentre Tiny-In-One 24 Gen3 - 10QX

Product Specifications Reference (PSREF)

Model	Product	Region	Color	Display Size	Multi-touch	Resolution	Aspect Ratio	Pixel Pitch	Dot / Pixel Per Inch	Brightness	Contrast Ratio	Pixel Response Time	Color Gamut	View Angle (H / V)	Stand	Power Consumption (Typical / Maximum)	Power Supply	Warranty	Ann Date (mm/yy)
10QXPAR1US	ThinkCentre Tiny-in-One 24 Gen3	US	Black	23.8"	10-point Multi-touch	1920x1080	16:9	0.2745 mm	92.6 dpi	250 nits	1000:1	4-14 ms	72%	178 / 178	Adjustable Stand	19W / 32W	90W 88% Adapter	3-year	07/17
10QXPAT1US	ThinkCentre Tiny-in-One 24 Gen3	US	Black	23.8"	10-point Multi-touch	1920x1080	16:9	0.2745 mm	92.6 dpi	250 nits	1000:1	4-14 ms	72%	178 / 178	Adjustable Stand	19W / 32W	90W 88% Adapter	3-year	07/17

# ThinkCentre Tiny-In-One 24 Gen3 - 10QY

Product Specifications Reference (PSREF)

Model	Product	Region	Color	Display Size	Multi-touch	Resolution	Aspect Ratio	Pixel Pitch	Dot / Pixel Per Inch	Brightness	Contrast Ratio	Pixel Response Time	Color Gamut	View Angle (H / V)	Stand	Power Consumption (Typical / Maximum)	Power Supply	Warranty	Ann Date (mm/yy)
10QYPAR1US	ThinkCentre Tiny-in-One 24 Gen3	US	Black	23.8"	No	1920x1080	16:9	0.2745 mm	92.6 dpi	250 nits	1000:1	4-14 ms	72%	178 / 178	Adjustable Stand	19W / 32W	90W 88% Adapter	3-year	07/17
10QYPAT1US	ThinkCentre Tiny-in-One 24 Gen3	US	Black	23.8"	No	1920x1080	16:9	0.2745 mm	92.6 dpi	250 nits	1000:1	4-14 ms	72%	178 / 178	Adjustable Stand	19W / 32W	90W 88% Adapter	3-year	07/17





# ThinkCentre X1 Platform Specifications

Product Specifications Reference (PSREF)

Processor	Intel® 6th Generation Intel Core™ i3 / i5 / i7 Processor	Security features	<ul style="list-style-type: none"> <li>Security slot (in rear for attachment of optional Kensington® MicroSaver® cable; Kensington lock also locks chassis)</li> <li>Smart USB protection, allows keyboard/mouse only, blocks all storage devices</li> <li>Power-on, admin, hard disk password</li> <li>Boot sequence control</li> <li>Boot without keyboard and mouse</li> <li>Individual USB port disablement</li> <li>Optional chassis intrusion switch</li> </ul>																																			
	<table border="1"> <thead> <tr> <th>Processor</th> <th>Cores / Threads</th> <th>Frequency Base/Max(GHz)</th> <th>Cache</th> <th>Memory Types</th> <th>Integrated Graphics</th> <th>Intel vPro</th> </tr> </thead> <tbody> <tr> <td>Core i3-6100U</td> <td>2 / 4</td> <td>2.3 G</td> <td>3 MB</td> <td>DDR4-2133</td> <td>HD 520</td> <td>No</td> </tr> <tr> <td>Core i5-6200U</td> <td>2 / 4</td> <td>2.3 G / 2.8 G</td> <td>3 MB</td> <td>DDR4-2133</td> <td>HD 520</td> <td>No</td> </tr> <tr> <td>Core i5-6300U</td> <td>2 / 4</td> <td>2.4 G / 3.0 G</td> <td>3 MB</td> <td>DDR4-2133</td> <td>HD 520</td> <td>vPro</td> </tr> <tr> <td>Core i7-6600U</td> <td>2 / 4</td> <td>2.6 G / 3.4 G</td> <td>4 MB</td> <td>DDR4-2133</td> <td>HD 520</td> <td>vPro</td> </tr> </tbody> </table> <p>Intel Architecture (IA) SoC that integrates Intel processor core, graphics, memory controller, and I/O interfaces into a single system-on-chip solution</p>	Processor	Cores / Threads	Frequency Base/Max(GHz)	Cache	Memory Types	Integrated Graphics	Intel vPro	Core i3-6100U	2 / 4	2.3 G	3 MB	DDR4-2133	HD 520	No	Core i5-6200U	2 / 4	2.3 G / 2.8 G	3 MB	DDR4-2133	HD 520	No	Core i5-6300U	2 / 4	2.4 G / 3.0 G	3 MB	DDR4-2133	HD 520	vPro	Core i7-6600U	2 / 4	2.6 G / 3.4 G	4 MB	DDR4-2133	HD 520	vPro	Keyboard	Some: Lenovo Slim USB Keyboard (USB connector), black Some: Ultralim Plus Wireless Keyboard (2.4GHz via USB receiver), black
Processor	Cores / Threads	Frequency Base/Max(GHz)	Cache	Memory Types	Integrated Graphics	Intel vPro																																
Core i3-6100U	2 / 4	2.3 G	3 MB	DDR4-2133	HD 520	No																																
Core i5-6200U	2 / 4	2.3 G / 2.8 G	3 MB	DDR4-2133	HD 520	No																																
Core i5-6300U	2 / 4	2.4 G / 3.0 G	3 MB	DDR4-2133	HD 520	vPro																																
Core i7-6600U	2 / 4	2.6 G / 3.4 G	4 MB	DDR4-2133	HD 520	vPro																																
Memory	16GB max, DDR4 2133, one 260-pin SO-DIMM socket	Mouse	Some: Enhanced Optical USB Mouse, black, Lenovo logo Some: Ultralim Plus Wireless Mouse (2.4GHz via USB receiver), black																																			
Disk	Some: SATA 6.0Gb/s, 2.5" Wide, 5400 rpm or 7200 rpm Some: Solid State Hybrid Drive (SSHD) / with 8GB MLC NAND flash memory, SATA 6.0Gb/s, 2.5" Wide, 5400 rpm Some: Solid State Drive (SSD) / SATA 6.0Gb/s, 2.5" Wide	Mechanical	<ul style="list-style-type: none"> <li>Business black color, Aluminum Alloy</li> <li>Toolless back cover and memory removal</li> <li>Optional VESA mount kit (100mm)</li> </ul> <table border="1"> <thead> <tr> <th></th> <th>Dimensions (WxDxH)</th> <th>Max weight (lb / kg)</th> <th>Adjustments</th> </tr> </thead> <tbody> <tr> <td>Without stand:</td> <td>22.4 X 1.3 X 14.2 (inch); 570 X 33 X 360 (mm)</td> <td>8.8 / 4</td> <td>N/A</td> </tr> <tr> <td>With Orchid tilt stand:</td> <td>22.4 X 9.4 X 17.8 (inch); 570 X 240 X 451 (mm)</td> <td>11.0 / 5</td> <td>Tilt: 45° back, -5° forward</td> </tr> </tbody> </table>		Dimensions (WxDxH)	Max weight (lb / kg)	Adjustments	Without stand:	22.4 X 1.3 X 14.2 (inch); 570 X 33 X 360 (mm)	8.8 / 4	N/A	With Orchid tilt stand:	22.4 X 9.4 X 17.8 (inch); 570 X 240 X 451 (mm)	11.0 / 5	Tilt: 45° back, -5° forward																							
	Dimensions (WxDxH)	Max weight (lb / kg)	Adjustments																																			
Without stand:	22.4 X 1.3 X 14.2 (inch); 570 X 33 X 360 (mm)	8.8 / 4	N/A																																			
With Orchid tilt stand:	22.4 X 9.4 X 17.8 (inch); 570 X 240 X 451 (mm)	11.0 / 5	Tilt: 45° back, -5° forward																																			
Optical Media reader	None Optional 9-in-1 media card reader	Power supply	90 watts adapter, autosensing, 88% PSU																																			
Graphics	<b>Intel HD Graphics 520</b> in processor, uses main memory, DirectX® 12, external monitor support via DisplayPort™; Max resolution: 4096x2304 (DP)@60Hz	Limited warranty <sup>3</sup>	Some: <b>1-year</b> or <b>3-year, limited onsite service</b> Some: <b>3-years, limited onsite service, OID</b> (Onsite International Delivery) / For <i>Lenovo service upgrade options, please go to S-TC sheet</i>																																			
DP Dongle Display	Optional DP to VGA, DP to DVI-D (single link), or DP to HDMI 1.4 dongle <b>23.8"</b> (604.5mm) <b>Full HD 1080p (1920x1080) TFT color</b> , IPS panel, wide viewing angle (+/- 89°), LED backlight, 250 nits, 16:9 aspect ratio, 1000:1 contrast ratio, anti-glare, work as standalone monitor via DisplayPort (DP in / out combo)	Preload	<b>Preloaded operating system</b> Some: Windows® 7 Professional 32/64 preinstalled through downgrade rights in Windows 10 Pro 64-bit Some: Windows 7 Professional 64 Some: Windows 10 Pro 64-bit Some: Windows 10 Home 64-bit <b>Preloaded applications (only some listed)</b> <ul style="list-style-type: none"> <li>Desktop Power Manager</li> <li>Lenovo Solution Center</li> <li>Lenovo REACHit</li> <li>Lenovo SHAREit</li> <li>Lenovo Bluetooth Lock (for models with Wi-Fi/BT card)</li> <li>McAfee® LiveSafe™ (30-day trial)</li> <li>Microsoft Office preloaded; purchase a product key to activate</li> <li>Lenovo ThinkVantage Tools <ul style="list-style-type: none"> <li>Only for Window 10</li> <li>Lenovo Companion</li> <li>Only for Window 7</li> </ul> </li> <li>Rescue and Recovery</li> <li>Password Manager</li> <li>ThinkVantage System Update</li> <li>Lenovo Message Center Plus</li> <li>Adobe® Reader®</li> </ul>																																			
Light sensor	None	Environment	EPEAT™ Gold rating; ENERGY STAR® 6.1; TCO Certified Edge; TUV Green Mark; ULE Gold; ErP Lot 3; GREENGUARD® certified; RoHS-compliant																																			
Multi-touch	None	MIL-SPEC test	MIL-STD-810G military certification (Low Pressure [Altitude], High Temperature, Low Temperature, Temperature Shock, Humidity, Sand and Dust, Vibration, Shock)																																			
Camera	2.0-megapixel camera, fixed focus, supports 1080p, with dual array digital microphone, LED indicator, physical switch on/off, Skype for Business certified	Accessories	For compatible accessories, please go to TC-AQP sheet																																			
Controls	Microphone mute, DP in / out switch, and power button																																					
Chipset	<b>Intel System-on-Chip (SoC) platform</b>																																					
Rear ports	Three USB 3.0, ethernet (RJ-45), DisplayPort in/out combo port,																																					
Side ports	Two USB 3.0 (one is Always On and fast charge), optional card reader, one headphone / microphone combo jack (3.5mm)																																					
M.2 card slot	One M.2 Card slot (for WLAN)																																					
Audio support	High Definition (HD) Audio, Realtek ALC233 / two internal speakers (5W x 2), Dolby® Audio™ certified, Skype for Business certified																																					
WLAN <sup>13</sup>	Some: 11ac wireless, M.2 Card, Qualcomm Atheros QCA6174 (dual band), Wi-Fi + Bluetooth 4.1 combo adapter, 2x2 Some: 11ac wireless, M.2 Card, Intel Dual Band Wireless-AC 8260, Wi-Fi + Bluetooth 4.1 combo adapter, 2x2 Some: 11ac wireless, M.2 Card, Intel Dual Band Wireless-AC 8260, Wi-Fi + Bluetooth 4.1 combo adapter, Intel vPro technology support, 2x2																																					
Bluetooth™ Ethernet	Some: Bluetooth 4.0 or 4.1 wireless, integrated in Wi-Fi + Bluetooth combo adapter Gigabit ethernet, Intel Ethernet Connection I219-LM (Jacksonville), Wake on LAN®																																					
Manageability	Intel Active Management Technology 11.0 (Intel AMT 11.0) on some models; Intel vPro technology on some models (require choosing a vPro-support Wi-Fi adapter to enable vPro function through wireless connection)																																					
Security chip	Trusted Platform Module (TPM 1.2-compliant)																																					

See footnotes for more detailed information

© Lenovo  
(X1-Spec) July 2016

ThinkCentre X1 AIO - TopSeller - 10KE

Product Specifications Reference (PSREF)

Model	Region	Processor	vPro	Graphics	Monitor Cable	Memory	Display	Multi-touch	Storage(HDD/SSD)	Media Reader	WLAN + Bluetooth	Camera	Chassis Intrusion Switch	Keyboard / Mouse	Stand	Power Supply	Operating System	Warranty	Global	Ann Date (mm/yy)
10KE0007US	US	i5-6200U	No	Intel HD 520	None	8GBx1	23.8" FHD (1920x1080) IPS Anti-glare	None	256GB SSD	9-in-1	8260 ac, 2x2 + BT4.1	1080p	None	2.4G / 2.4G	Orchid Tilt Stand	90W 88% Adapter	Win10 DG Win7 Pro 64	3-year, Onsite	No	01/16
10KE0008US	US	i5-6200U	No	Intel HD 520	None	4GBx1	23.8" FHD (1920x1080) IPS Anti-glare	None	120GB SSD	9-in-1	8260 ac, 2x2 + BT4.1	1080p	None	2.4G / 2.4G	Orchid Tilt Stand	90W 88% Adapter	Win10 DG Win7 Pro 64	3-year, Onsite	No	01/16
10KE001CUS	US	i5-6200U	No	Intel HD 520	None	8GBx1	23.8" FHD (1920x1080) IPS Anti-glare	None	256GB SSD	None	8260 ac, 2x2 + BT4.1	1080p	None	USB (Slim) / USB	Orchid Tilt Stand	90W 88% Adapter	Win10 Pro 64	3-year, Onsite	No	08/16
10KE001DUS	US	i5-6200U	No	Intel HD 520	None	4GBx1	23.8" FHD (1920x1080) IPS Anti-glare	None	128GB SSD	None	8260 ac, 2x2 + BT4.1	1080p	None	USB (Slim) / USB	Orchid Tilt Stand	90W 88% Adapter	Win10 Pro 64	3-year, Onsite	No	08/16
10KE001EUS	US	i5-6200U	No	Intel HD 520	None	4GBx1	23.8" FHD (1920x1080) IPS Anti-glare	None	128GB SSD	None	8260 ac, 2x2 + BT4.1	1080p	None	2.4G / 2.4G	Orchid Tilt Stand	90W 88% Adapter	Win10 Pro 64	3-year, Onsite	No	09/16
10KE001FUS	US	i5-6200U	No	Intel HD 520	None	8GBx1	23.8" FHD (1920x1080) IPS Anti-glare	None	256GB SSD	None	8260 ac, 2x2 + BT4.1	1080p	None	2.4G / 2.4G	Orchid Tilt Stand	90W 88% Adapter	Win10 Pro 64	3-year, Onsite	No	09/16
10KE001GUS	US	i5-6200U	No	Intel HD 520	None	4GBx1	23.8" FHD (1920x1080) IPS Anti-glare	None	500GB 7200rpm 2.5"	None	8260 ac, 2x2 + BT4.1	1080p	None	2.4G / 2.4G	Orchid Tilt Stand	90W 88% Adapter	Win10 Pro 64	3-year, Onsite	No	09/16
10KE001HUS	US	i5-6200U	No	Intel HD 520	None	4GBx1	23.8" FHD (1920x1080) IPS Anti-glare	None	500GB 7200rpm 2.5"	None	8260 ac, 2x2 + BT4.1	1080p	None	2.4G / 2.4G	Orchid Tilt Stand	90W 88% Adapter	Win10 DG Win7 Pro 64	3-year, Onsite	No	09/16
10KE001JUS	US	i5-6200U	No	Intel HD 520	None	4GBx1	23.8" FHD (1920x1080) IPS Anti-glare	None	128GB SSD	None	8260 ac, 2x2 + BT4.1	1080p	None	2.4G / 2.4G	Orchid Tilt Stand	90W 88% Adapter	Win10 DG Win7 Pro 64	3-year, Onsite	No	09/16
10KE001LUS	US	i5-6200U	No	Intel HD 520	None	8GBx1	23.8" FHD (1920x1080) IPS Anti-glare	None	256GB SSD Opal	9-in-1	8260 ac, 2x2 + BT4.1	1080p	None	2.4G / 2.4G	Orchid Tilt Stand	90W 88% Adapter	Win10 DG Win7 Pro 64	3-year, Onsite	No	12/16
10KE001MUS	US	i5-6200U	No	Intel HD 520	None	8GBx1	23.8" FHD (1920x1080) IPS Anti-glare	None	256GB SSD Opal	None	8260 ac, 2x2 + BT4.1	1080p	None	2.4G / 2.4G	Orchid Tilt Stand	90W 88% Adapter	Win10 Pro 64	3-year, Onsite	No	12/16
10KE001NUS	US	i5-6200U	No	Intel HD 520	None	8GBx1	23.8" FHD (1920x1080) IPS Anti-glare	None	256GB SSD Opal	None	8260 ac, 2x2 + BT4.1	1080p	None	USB (Slim) / USB	Orchid Tilt Stand	90W 88% Adapter	Win10 Pro 64	3-year, Onsite	No	12/16

This publication was developed for products and services offered in the United States and E.M.E.A countries. Lenovo may not offer the products, services or features discussed in this document in other countries. Lenovo may withdraw an offering at any time. Information is subject to change without notice. Consult your local representative for information on offerings available in your area.

Lenovo reserves the right to change specifications or other product information without notice. Lenovo is not responsible for photographic or typographical errors.

LENOVO PROVIDES THIS PUBLICATION "AS IS," WITHOUT WARRANTY OF ANY KIND, EITHER EXPRESS OR IMPLIED, INCLUDING THE IMPLIED WARRANTIES OF MERCHANTABILITY OR FITNESS FOR A PARTICULAR PURPOSE.

Some jurisdictions do not allow disclaimer of express or implied warranties in certain transactions, therefore this disclaimer may not apply to you.

**Availability:** All offers subject to availability. Lenovo reserves the right to alter product offerings and specifications at any time, without notice. Lenovo is not responsible for photographic or typographic errors.

**General:** Review key information provided by Microsoft that may apply to your system purchase, including details on Windows 10, Windows 8, Windows 7, and potential upgrades/downgrades. Lenovo makes no representation or warranty regarding third-party products or services.

**Trademarks:** Lenovo, ThinkPad, ThinkCentre, ThinkStation and the Lenovo logo are trademarks of Lenovo. Microsoft, Windows, Windows NT, and the Windows logo are trademarks of Microsoft Corporation. Ultrabook, Celeron, Celeron Inside, Core Inside, Intel, Intel Logo, Intel Atom, Intel Atom Inside, Intel Core, Intel Inside, Intel Inside Logo, Intel vPro, Itanium, Itanium Inside, Pentium, Pentium Inside, vPro Inside, Xeon, Xeon Phi, and Xeon Inside are trademarks of Intel Corporation in the U.S. and/or other countries. Other company, product or service names may be trademarks or service marks of others.

**Warranty:** For a copy of applicable warranties, write to: Lenovo Warranty Information, 1009 Think Place, Morrisville, NC, 27560. Lenovo makes no representation or warranty regarding third party products or services. The Lenovo Limited Warranty applies only to Lenovo hardware products purchased for your own use, and does not transfer upon resale.

**Limited warranty:** Support unrelated to a warranty issue may be subject to additional charges.

#### **Lenovo Services:**

**Carry-in or Mail-in Service:** Parts and labor repair coverage where the customer is responsible for shipping (including packaging) or delivery to authorized warranty provider or repair center.

**Depot or Courier Service:** Parts and labor repair coverage where shipping (including packaging) or delivery to the repair center is paid for by Lenovo.

**Expedited Depot:** Parts and labor coverage with expedited turnaround. Shipping (including packaging) or delivery to the repair center is paid for by Lenovo.

**Onsite / In-home Service:** Parts and labor repair coverage where labor is provided onsite at your place of business.

If Lenovo determines your product problem is covered by the product warranty and cannot be resolved over the telephone, a technician will be dispatched to arrive onsite, typically the next day.

**International Warranty Service (IWS):** PC repair coverage for customers who require a critical warranty repair while travelling internationally. Visit [www.lenovo.com/internationalwarranty](http://www.lenovo.com/internationalwarranty) for details. Visit [www.lenovo.com/warranty](http://www.lenovo.com/warranty) for Lenovo Warranty Services terms and conditions for complete details and restrictions.

**Included software:** may differ from its retail version (if available), and may not include user manuals or all program functionality. Software license agreements may apply.

**Battery life:** Battery life (and recharge times) will vary based on many factors including screen brightness, applications, features, power management, battery conditioning, and other customer preferences.

Visit <http://psref.lenovo.com/> for the latest version of Product Specifications Reference.

© Lenovo, 2017. All rights reserved.  
Lenovo 1009 Think Place Morrisville, NC 27560 U.S.A.

**Lenovo** ThinkStation.

**PSREF**

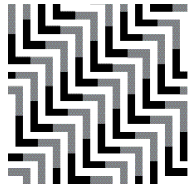

**Product Specifications Reference**

Version 511, August 2017

**U.S.**

Visit <http://psref.lenovo.com> for the latest version

# Contents

---

<b>Cover</b>	1	ThinkStation P510 Platform Specifications	34
<b>Contents</b>	2	ThinkStation P510 - TopSeller - 30B5 - 1 of 7	35
<b>Summary Of Change</b>	3	ThinkStation P510 - TopSeller - 30B5 - 2 of 7	36
<b>P Series</b>	5	ThinkStation P510 - TopSeller - 30B5 - 3 of 7	37
<b>ThinkStation P310 SFF</b>	5	ThinkStation P510 - TopSeller - 30B5 - 4 of 7	38
ThinkStation P310 SFF Platform Specifications	6	ThinkStation P510 - TopSeller - 30B5 - 5 of 7	39
ThinkStation P310 SFF - TopSeller - 30AV - 1 of 2	7	ThinkStation P510 - TopSeller - 30B5 - 6 of 7	40
ThinkStation P310 SFF - TopSeller - 30AV - 2 of 2	8	ThinkStation P510 - TopSeller - 30B5 - 7 of 7	41
<b>ThinkStation P310 Tower</b>	<b>9</b>	<b>ThinkStation P710</b>	<b>42</b>
ThinkStation P310 Tower Platform Specifications	10	ThinkStation P710 Platform Specifications	42
ThinkStation P310 Tower - TopSeller - 30AT - 1 of 3	11	ThinkStation P710 - TopSeller - 30B7 - 1 of 3	43
ThinkStation P310 Tower - TopSeller - 30AT - 2 of 3	12	ThinkStation P710 - TopSeller - 30B7 - 2 of 3	44
ThinkStation P310 Tower - TopSeller - 30AT - 3 of 3	13	ThinkStation P710 - TopSeller - 30B7 - 3 of 3	45
<b>ThinkStation P320 SFF</b>	<b>14</b>	<b>ThinkStation P910</b>	<b>46</b>
ThinkStation P320 SFF Platform Specifications	15	ThinkStation P910 Platform Specifications	46
ThinkStation P320 SFF - TopSeller - 30BK - 1 of 3	16	ThinkStation P910 - TopSeller - 30B9 - 1 of 2	47
ThinkStation P320 SFF - TopSeller - 30BK - 2 of 3	17	ThinkStation P910 - TopSeller - 30B9 - 2 of 2	48
ThinkStation P320 SFF - TopSeller - 30BK - 3 of 3	18	<b>Legal Information</b>	<b>49</b>
<b>ThinkStation P320 Tiny</b>	<b>19</b>		
ThinkStation P320 Tiny - TopSeller - 30C2 - 1 of 2	20		
ThinkStation P320 Tiny - TopSeller - 30C2 - 2 of 2	21		
<b>ThinkStation P320 Tower</b>	<b>22</b>		
ThinkStation P320 Tower Platform Specifications	23		
ThinkStation P320 Tower - TopSeller - 30BH - 1 of 4	24		
ThinkStation P320 Tower - TopSeller - 30BH - 2 of 4	25		
ThinkStation P320 Tower - TopSeller - 30BH - 3 of 4	26		
ThinkStation P320 Tower - TopSeller - 30BH - 4 of 4	27		
<b>ThinkStation P410</b>	<b>28</b>		
ThinkStation P410 Platform Specifications	28		
ThinkStation P410 - TopSeller - 30B3 - 1 of 5	29		
ThinkStation P410 - TopSeller - 30B3 - 2 of 5	30		
ThinkStation P410 - TopSeller - 30B3 - 3 of 5	31		
ThinkStation P410 - TopSeller - 30B3 - 4 of 5	32		
ThinkStation P410 - TopSeller - 30B3 - 5 of 5	33		
<b>ThinkStation P510</b>	<b>34</b>		

# Summary of Changes

---

This section describes the changes made in this version of ThinkStation PSREF and in previous version. This edition might also include minor corrections and editorial changes which are not identified.

## **August 23, 2017 - Version 511**

- ▶ New ThinkStation P320 Tiny models announced on August 2017

## **August 2, 2017 - Version 510**

- ▶ New ThinkStation P320 Tiny/P320 Tower/ P320 SFF/P410/P510 models announced on July 2017

## **June 21, 2017 - Version 508**

- ▶ New ThinkStation P320 Tiny announced on June 2017

## **May 26, 2017 - Version 507**

- ▶ Add ThinkStation P410/P510/P710/P910 Refresh 3.0 Wave 1 models and update platform specifications

## **April 19, 2017 - Version 505**

- ▶ New ThinkStation P320 Tower announced on April 2017
- ▶ New ThinkStation P320 SFF announced on April 2017

## **March 29, 2017 - Version 504**

- ▶ Added ThinkStation P310 Tower and SFF models announced on March 2017
- ▶ Added ThinkStation P410 models announced on March 2017

## **January 25, 2017 - Version 501**

- ▶ Update quantity of PCIe SSD adapter in ThinkStation P510/P910

## **January 4, 2017 - Version 500**

- ▶ Added ThinkStation P310 models announced on December 2016

## **December 14, 2016 - Version 499**

- ▶ Added ThinkStation P410/P510/P710/P910 EMEA models
- ▶ Added 1TB M.2 PCIe SSD, Quadro P5000, Quadro P6000 support on ThinkStation P510/P710/P910
- ▶ Added Quadro P5000 support on ThinkStation P410
- ▶ Added 6TB 7.2K SATA6Gbs HDD support on ThinkStation P410/P510/P710/P910
- ▶ Added ThinkStation P410/P510/P710/P910 models announced on December 2016

## **November 23, 2016 - Version 498**

- ▶ Removed ThinkStation P500/P900 due to EOL
- ▶ Added ThinkStation P310 Tower and SFF models announced on November 2016

## **October 12, 2016 - Version 496**

- ▶ Removed flash option on ThinkStation P510/P710/P910
- ▶ Added ThinkStation P310/P410/P510/P710/P910 models announced on September 2016

## **August 3, 2016 - Version 493**

- ▶ Removed ThinkStation P500/P700/P900 Windows 7 DG from Win8.1 U.S. models
- ▶ Added keyboard and mouse features on all ThinkStation

## **July 13, 2016 - Version 492**

- ▶ Added ThinkStation P500, P700, and P900 Windows 10 downgrade to Windows 7 models
- ▶ Updated Maximum configuration weight of ThinkStation P410
- ▶ Added ThinkStation P710 and P910 models announced on on July 2016
- ▶ Added "Maximum drives in 3.5" bay" feature on ThinkStation P500/P510/P700/P710/P900/P910

### **June 22, 2016 - Version 491**

- ▶ Added new product ThinkStation P410/P510
- ▶ Added NVIDIA Quadro M2000 on ThinkStation P310 Tower
- ▶ Added keyboard and mouse information on ThinkStation P710/P910
- ▶ Added internal USB information on ThinkStation P710/P910

### **June 2, 2016 - Version 490**

- ▶ Added ThinkStation P710/P910 US models
- ▶ Updated ThinkStation P710/P910 processor information

### **May 19, 2016 - Version 489**

- ▶ Added NVIDIA Quadro M2000 on compatible product
- ▶ Updated maximum weight on ThinkStation P710
- ▶ Removed 30AT000BUS

### **April 27, 2016 - Version 488**

- ▶ Added ThinkStation P710 and P910 models for EMEA, announced on April 2016
- ▶ Updated Energy star information on ThinkStation P500/P700/P710/P900/P910

### **April 6, 2016 - Version 487**

- ▶ New ThinkStation P710 and P910, announced April 5, 2016 (specification only)

### **March 23, 2016 - Version 486**

- ▶ Added processors specifications for P310/P500/P700/P900

### **February 24, 2016 - Version 485**

- ▶ Added ThinkStation P310 and P700 models for US, announced on February 2016
- ▶ Added ThinkStation P700 and P900 models for EMEA, announced on February 2016

### **December 9, 2015 - Version 482**

- ▶ New ThinkStation P310 Tower and SFF, announced November 24, 2015

### **November 18, 2015 - Version 481**

- ▶ Combines ThinkStation PSREF United States version and Western Europe version.
- ▶ Extends the supported GEO into Europe, Middle East and Africa.
- ▶ Covers all TopSeller and Relationship models for US and all focus models for EMEA





# ThinkStation P310 SFF Platform Specifications

Product Specifications Reference (PSREF)

Components	Specification																																			
Chipset	Intel C236 Chipset																																			
Intel AMT	Intel Active Management Technology 11 supported on Xeon models																																			
Processor	One LGA1151 socket, supports one the following processors:																																			
	Xeon E3-1280 v5	4C/3.7GHz/8MB/80W/DDR4-2133																																		
	Xeon E3-1275 v5	4C/3.6GHz/8MB/80W/DDR4-2133																																		
	Xeon E3-1270 v5	4C/3.6GHz/8MB/80W/DDR4-2133																																		
	Xeon E3-1245 v5	4C/3.5GHz/8MB/80W/DDR4-2133																																		
	Xeon E3-1240 v5	4C/3.5GHz/8MB/80W/DDR4-2133																																		
	Xeon E3-1230 v5	4C/3.4GHz/8MB/80W/DDR4-2133																																		
	Xeon E3-1225 v5	4C/3.3GHz/8MB/80W/DDR4-2133																																		
	Xeon E3-1220 v5	4C/3GHz/8MB/80W/DDR4-2133																																		
	Core i7-6700	4C/3.4GHz/8MB/65W/DDR4-2133																																		
	Core i5-6600	4C/3.3GHz/6MB/65W/DDR4-2133																																		
	Core i5-6500	4C/3.2GHz/6MB/65W/DDR4-2133																																		
	Core i5-6400	4C/2.7GHz/6MB/65W/DDR4-2133																																		
	Core i3-6320	2C/3.9GHz/4MB/51W/DDR4-2133																																		
Core i3-6300	2C/3.8GHz/4MB/51W/DDR4-2133																																			
Core i3-6100	2C/3.7GHz/3MB/51W/DDR4-2133																																			
Memory DIMM slots	4 DIMM slots, 2-channel (integrated memory controller in processor)																																			
Memory type/capacity	Up to 64GB ECC/non-ECC (4 x 16GB), DDR4-2133, UDIMM																																			
Intel HD Graphics in processor	Integrated Intel HD P530 in Xeon E3-12x5 v5 processors; or Intel HD 530 in Core i7, i5, or i3 processors. Works along with discrete graphics to support multi-display, enables three display connectors (2 DP, 1 VGA) on rear. Max Resolution: 4096 x 2304																																			
Discrete graphics	Two PCI Express 3.0 x16 slots for graphics adapters. Up to two Quadro K1200. Supports the following NVIDIA graphics adapters:																																			
	<table border="1"> <thead> <tr> <th>Adapter</th> <th>Cores</th> <th>Memory</th> <th>Power</th> <th>Connector</th> </tr> </thead> <tbody> <tr> <td>NVS 310</td> <td>48</td> <td>1GB</td> <td>19.5W</td> <td>2xDP</td> </tr> <tr> <td>NVS 315</td> <td>48</td> <td>1GB</td> <td>19.5W</td> <td>2xDVI-I SL/2xDP</td> </tr> <tr> <td>NVS 510</td> <td>192</td> <td>2GB</td> <td>33.4W</td> <td>4xmini DP</td> </tr> <tr> <td>Quadro K420</td> <td>192</td> <td>2GB</td> <td>41W</td> <td>1xDVI-I DL+1xDP</td> </tr> <tr> <td>Quadro K620</td> <td>384</td> <td>2GB</td> <td>45W</td> <td>1xDVI-I DL+1xDP</td> </tr> <tr> <td>Quadro K1200</td> <td>512</td> <td>4GB</td> <td>45W</td> <td>4xminiDP</td> </tr> </tbody> </table>	Adapter	Cores	Memory	Power	Connector	NVS 310	48	1GB	19.5W	2xDP	NVS 315	48	1GB	19.5W	2xDVI-I SL/2xDP	NVS 510	192	2GB	33.4W	4xmini DP	Quadro K420	192	2GB	41W	1xDVI-I DL+1xDP	Quadro K620	384	2GB	45W	1xDVI-I DL+1xDP	Quadro K1200	512	4GB	45W	4xminiDP
	Adapter	Cores	Memory	Power	Connector																															
	NVS 310	48	1GB	19.5W	2xDP																															
	NVS 315	48	1GB	19.5W	2xDVI-I SL/2xDP																															
	NVS 510	192	2GB	33.4W	4xmini DP																															
	Quadro K420	192	2GB	41W	1xDVI-I DL+1xDP																															
Quadro K620	384	2GB	45W	1xDVI-I DL+1xDP																																
Quadro K1200	512	4GB	45W	4xminiDP																																
Onboard drive controller	Five onboard SATA 6.0Gb/s connectors for optical and disk drives plus one SATA connector for optional eSATA. RAID 0, 1, 5* support * RAID 5 supports three 2.5" SSD drives only.																																			
Drive Bays	One external 5.25" bay, one internal 3.5" bay (see right). Up to one 9.5mm optical + 2 x 3.5" disk drive bays + 1 x 2.5" disk drive bay + one M.2 NVMe SSD																																			
Supporting disk drives	<table border="1"> <tbody> <tr> <td>3.5" SATA HDD (7.2K 6Gbs)</td> <td>500GB/1TB/2TB/3TB/4TB/6TB/1TB hybrid/2TB hybrid</td> </tr> <tr> <td>2.5" SATA SSD (6Gbs)</td> <td>128GB/180GB*/240GB*/256GB*/480GB*/512GB*/1TB*</td> </tr> <tr> <td>M.2 NVMe SSD</td> <td>256GB*/512GB*/1TB*, via PCIe 3.0 x4 adapter</td> </tr> </tbody> </table>	3.5" SATA HDD (7.2K 6Gbs)	500GB/1TB/2TB/3TB/4TB/6TB/1TB hybrid/2TB hybrid	2.5" SATA SSD (6Gbs)	128GB/180GB*/240GB*/256GB*/480GB*/512GB*/1TB*	M.2 NVMe SSD	256GB*/512GB*/1TB*, via PCIe 3.0 x4 adapter																													
	3.5" SATA HDD (7.2K 6Gbs)	500GB/1TB/2TB/3TB/4TB/6TB/1TB hybrid/2TB hybrid																																		
	2.5" SATA SSD (6Gbs)	128GB/180GB*/240GB*/256GB*/480GB*/512GB*/1TB*																																		
M.2 NVMe SSD	256GB*/512GB*/1TB*, via PCIe 3.0 x4 adapter																																			
	** Includes OPAL options																																			
Max internal storage	9TB (2 x 4TB 3.5" HDDs + 1 x 1TB 2.5" SSD) plus one 512GB M.2 NVMe SSD																																			
Media reader	9-in-1 card reader. Optional 29-in-1 card reader on selected models																																			
Power supply	210 watts with variable speed fan, autosensing, 85% PSU, Climate Savers Computing Bronze, 80 PLUS Bronze qualified																																			
Onboard Ethernet	One onboard gigabit ethernet, Intel I219LM, supports Wake-on-LAN																																			
HD Audio	Realtek ALC662 codec																																			
TPM	Standard, TCG 1.2-compliant																																			
Front ports	Two USB 3.0, microphone (3.5mm), headphone (3.5mm)																																			
Rear ports	1 VGA and 2 DisplayPort (functional only on Intel HD Graphics models), two USB 2.0, four USB 3.0 (blue), one serial (9-pin), one ethernet (RJ-45), three analog audio ports (line-in, line-out, mic-in)																																			
Additional ports	Supports the following optional ports: • Two IEEE 1394 (one on rear and one on front flex module) via PCIe adapter, up to one adapter per system. Supports one of the following per system: • Two rear USB 3.0 per PCIe adapter. • One front eSATA (on flex module), or one rear eSATA via cable and PCIe slot bracket, up to one eSATA port per system. • One additional serial port via cable. • One parallel port via cable																																			

Components	Specification
Mechanical	<ul style="list-style-type: none"> <li>Raven black color; metal case</li> <li>4.02"W x 15.53"D x 13.31"H</li> <li>102mm W x 394.5mm D x 338mm H</li> <li>17.2 lb (7.9kg) max configuration</li> <li>12.9-liter</li> </ul>
	Environmental certifications
Limited warranty	1 or 3-year limited onsite service with 9x5/NBD. Some parts are Customer Replaceable Units.

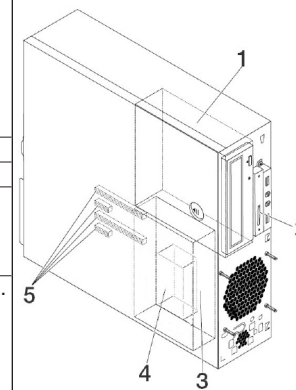

## Drive Bays and PCIe Slots

Bay 1	5.25", supports one of the following: HH optical/flex module***/9.5mm optical+3.5" HDD bay/ 3.5" HDD bay/Front Access Storage Enclosure *** Flex module supports one or more of the following: 9.5mm optical/ 29-in-1 reader/front IEEE 1394/front eSATA. Up to one flex module is supported per system.
Bay 2	Optional 9-in-1 single slot reader
Bay 3	Standard 3.5" HDD bay
Bay 4	Optional 2.5" HDD bay (under Bay 3)
5 - Slots	Four PCIe slots (top-down): Slot 1: Low Profile, PCIe 3.0 x16 (near CPU) Slot 2: Low Profile, PCIe 3.0 x1 Slot 3: Low Profile, PCIe 3.0 x16 (x4 elec) Slot 4: Low Profile, PCIe 3.0 x1

For the list of ISV certifications, please visit [www.thinkworkstations.com/isv-certifications/](http://www.thinkworkstations.com/isv-certifications/)  
For a list of all supported options, please visit [https://download.lenovo.com/pccbbs/options\\_iso/ocm\\_december\\_2016.xlsx](https://download.lenovo.com/pccbbs/options_iso/ocm_december_2016.xlsx) sheet

Model	Region	Processor	Graphics	Memory	Disks	M.2 Drives	Optical	Media Reader	Power Supply	Add-on Ports	Discrete Ethernet	Chassis Intrusion Switch	Keyboard / Mouse	Operating System	Warranty	Global	Ann Date (mm/yy)
30AV0007US	US	Core i5-6500 4C/3.2GHz/6MB/65W/DDR4-2133	Intel HD 530	1x4GB UDIMM DDR4-2133 Non-ECC	1x1TB HDD 7.2K 3.5" SATA6Gbps	None	HH DVD±RW	9-in-1	210W 85%	None	None	Switch	USB / USB	Win10 DG Win7 Pro 64	3-year	No	11/15
30AV0008US	US	Core i3-6100 2C/3.7GHz/3MB/51W/DDR4-2133	Intel HD 530	1x4GB UDIMM DDR4-2133 Non-ECC	1x1TB HDD 7.2K 3.5" SATA6Gbps	None	HH DVD±RW	9-in-1	210W 85%	None	None	Switch	USB / USB	Win10 DG Win7 Pro 64	3-year	No	11/15
30AV0009US	US	Core i3-6100 2C/3.7GHz/3MB/51W/DDR4-2133	Intel HD 530	1x4GB UDIMM DDR4-2133 Non-ECC	1x500GB HDD 7.2K 3.5" SATA6Gbps	None	HH DVD±RW	9-in-1	210W 85%	None	None	Switch	USB / USB	Win10 DG Win7 Pro 64	3-year	No	11/15
30AV000AUS	US	Core i5-6600 4C/3.3GHz/6MB/65W/DDR4-2133	Intel HD 530	1x8GB UDIMM DDR4-2133 Non-ECC	1x1TB HDD 7.2K 3.5" SATA6Gbps	None	HH DVD±RW	9-in-1	210W 85%	None	None	Switch	USB / USB	Win10 DG Win7 Pro 64	3-year	No	11/15
30AV000BUS	US	Core i7-6700 4C/3.4GHz/8MB/65W/DDR4-2133	Intel HD 530	1x8GB UDIMM DDR4-2133 Non-ECC	1x1TB HDD 7.2K 3.5" SATA6Gbps	None	HH DVD±RW	9-in-1	210W 85%	None	None	Switch	USB / USB	Win10 DG Win7 Pro 64	3-year	No	11/15
30AV000CUS	US	Core i7-6700 4C/3.4GHz/8MB/65W/DDR4-2133	Intel HD 530	1x8GB UDIMM DDR4-2133 Non-ECC	1x256GB SSD 2.5" SATA6Gbps Opal	None	HH DVD±RW	9-in-1	210W 85%	None	None	Switch	USB / USB	Win10 DG Win7 Pro 64	3-year	No	11/15
30AV000DUS	US	Xeon E3-1245 v5 4C/3.5GHz/8MB/80W/DDR4-2133	Intel HD P530	1x8GB UDIMM DDR4-2133 Non-ECC	1x256GB SSD 2.5" SATA6Gbps Opal	None	HH DVD±RW	9-in-1	210W 85%	None	None	Switch	USB / USB	Win10 DG Win7 Pro 64	3-year	No	11/15
30AV000EUS	US	Xeon E3-1240 v5 4C/3.5GHz/8MB/80W/DDR4-2133	NVIDIA Quadro K620 2GB	1x8GB UDIMM DDR4-2133 Non-ECC	1x256GB SSD 2.5" SATA6Gbps Opal	None	HH DVD±RW	9-in-1	210W 85%	None	None	Switch	USB / USB	Win10 DG Win7 Pro 64	3-year	No	11/15
30AV000VUS	US	Core i5-6500 4C/3.2GHz/6MB/65W/DDR4-2133	Intel HD 530 + NVIDIA Quadro K620 2GB	1x8GB UDIMM DDR4-2133 Non-ECC	1x1TB HDD 7.2K 3.5" SATA6Gbps	None	HH DVD±RW	9-in-1	210W 85%	None	None	Switch	USB / USB	Win10 DG Win7 Pro 64	3-year	No	02/16
30AV000WUS	US	Core i7-6700 4C/3.4GHz/8MB/65W/DDR4-2133	Intel HD 530 + NVIDIA Quadro K620 2GB	2x8GB UDIMM DDR4-2133 Non-ECC	1x256GB SSD 2.5" SATA6Gbps Opal	None	HH DVD±RW	9-in-1	210W 85%	None	None	Switch	USB / USB	Win10 DG Win7 Pro 64	3-year	No	02/16
30AV000XUS	US	Xeon E3-1230 v5 4C/3.4GHz/8MB/80W/DDR4-2133	NVIDIA Quadro K1200 4GB	4x8GB UDIMM DDR4-2133 Non-ECC	1x512GB SSD 2.5" SATA6Gbps	None	HH DVD±RW	9-in-1	210W 85%	None	None	Switch	USB / USB	Win10 DG Win7 Pro 64	3-year	No	02/16
30AV0012US	US	Core i7-6700 4C/3.4GHz/8MB/65W/DDR4-2133	Intel HD 530 + NVIDIA Quadro K620 2GB	1x8GB UDIMM DDR4-2133 Non-ECC	1x1TB HDD 7.2K 3.5" SATA6Gbps	None	HH DVD±RW	9-in-1	210W 85%	None	None	Switch	USB / USB	Win10 Pro 64	3-year	No	07/16
30AV001TUS	US	Core i7-6700 4C/3.4GHz/8MB/65W/DDR4-2133	Intel HD 530	1x8GB UDIMM DDR4-2133 Non-ECC	1x1TB HDD 7.2K 3.5" SATA6Gbps	None	HH DVD±RW	9-in-1	210W 85%	None	None	Switch	USB / USB	Win10 Pro 64	3-year	No	07/16
30AV001UUS	US	Core i5-6500 4C/3.2GHz/6MB/65W/DDR4-2133	Intel HD 530	1x8GB UDIMM DDR4-2133 Non-ECC	1x1TB HDD 7.2K 3.5" SATA6Gbps	None	HH DVD±RW	9-in-1	210W 85%	None	None	Switch	USB / USB	Win10 Pro 64	3-year	No	07/16

Model	Region	Processor	Graphics	Memory	Disks	M.2 Drives	Optical	Media Reader	Power Supply	Add-on Ports	Discrete Ethernet	Chassis Intrusion Switch	Keyboard / Mouse	Operating System	Warranty	Global	Ann Date (mm/yy)
30AV001VUS	US	Xeon E3-1240 v5 4C/3.5GHz/8MB/80W/DDR4-2133	NVIDIA Quadro K1200 4GB	1x8GB UDIMM DDR4-2133 ECC	1x256GB SSD 2.5" SATA6Gbps Opal	None	HH DVD±RW	9-in-1	210W 85%	None	None	Switch	USB / USB	Win10 Pro 64	3-year	No	07/16
30AV001WUS	US	Xeon E3-1240 v5 4C/3.5GHz/8MB/80W/DDR4-2133	NVIDIA Quadro K620 2GB	1x8GB UDIMM DDR4-2133 ECC	1x1TB HDD 7.2K 3.5" SATA6Gbps	None	HH DVD±RW	9-in-1	210W 85%	None	None	Switch	USB / USB	Win10 Pro 64	3-year	No	07/16
30AV001XUS	US	Xeon E3-1245 v5 4C/3.5GHz/8MB/80W/DDR4-2133	Intel HD P530	1x8GB UDIMM DDR4-2133 ECC	1x1TB HDD 7.2K 3.5" SATA6Gbps	None	HH DVD±RW	9-in-1	210W 85%	None	None	Switch	USB / USB	Win10 Pro 64	3-year	No	07/16
30AV001YUS	US	Core i3-6100 2C/3.7GHz/3MB/51W/DDR4-2133	Intel HD 530	1x8GB UDIMM DDR4-2133 Non-ECC	1x1TB HDD 7.2K 3.5" SATA6Gbps	None	HH DVD±RW	9-in-1	210W 85%	None	None	Switch	USB / USB	Win10 Pro 64	3-year	No	07/16
30AV0020US	US	Xeon E3-1245 v5 4C/3.5GHz/8MB/80W/DDR4-2133	Intel HD P530	1x8GB UDIMM DDR4-2133 ECC	1x256GB SSD 2.5" SATA6Gbps Opal	None	HH DVD±RW	9-in-1	210W 85%	None	None	Switch	USB / USB	Win10 Pro 64	3-year	No	07/16
30AV0021US	US	Xeon E3-1220 v5 4C/3.0GHz/8MB/80W/DDR4-2133	NVIDIA Quadro K620 2GB	1x8GB UDIMM DDR4-2133 ECC	1x1TB HDD 7.2K 3.5" SATA6Gbps	None	HH DVD±RW	9-in-1	210W 85%	None	None	Switch	USB / USB	Win10 Pro 64	3-year	No	07/16
30AV0022US	US	Xeon E3-1240 v5 4C/3.5GHz/8MB/80W/DDR4-2133	NVIDIA Quadro K1200 4GB	1x8GB UDIMM DDR4-2133 ECC	1x1TB HDD 7.2K 3.5" SATA6Gbps	None	HH DVD±RW	9-in-1	210W 85%	None	None	Switch	USB / USB	Win10 Pro 64	3-year	No	07/16
30AV0023US	US	Xeon E3-1240 v5 4C/3.5GHz/8MB/80W/DDR4-2133	NVIDIA Quadro K620 2GB	1x8GB UDIMM DDR4-2133 ECC	1x256GB SSD 2.5" SATA6Gbps Opal	None	HH DVD±RW	9-in-1	210W 85%	None	None	Switch	USB / USB	Win10 Pro 64	3-year	No	07/16
30AV002DUS	US	Core i7-6700 4C/3.4GHz/8MB/65W/DDR4-2133	Intel HD 530 + NVIDIA Quadro K620 2GB	2x8GB UDIMM DDR4-2133 Non-ECC	1x1TB HDD 7.2K 3.5" SATA6Gbps	None	HH DVD±RW	9-in-1	210W 85%	None	None	Switch	USB / USB	Win10 DG Win7 Pro 64	3-year	No	12/16
30AV002EUS	US	Core i5-6500 4C/3.2GHz/6MB/65W/DDR4-2133	Intel HD 530 + NVIDIA Quadro K620 2GB	1x8GB UDIMM DDR4-2133 Non-ECC	1x256GB SSD 2.5" SATA6Gbps Opal	None	HH DVD±RW	9-in-1	210W 85%	None	None	Switch	USB / USB	Win10 DG Win7 Pro 64	3-year	No	12/16

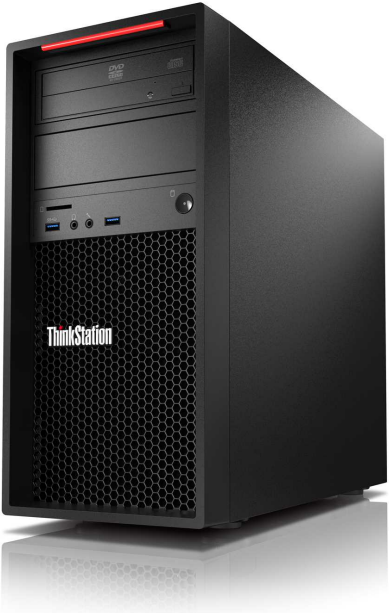

# ThinkStation P310 Tower Platform Specifications

Product Specifications Reference (PSREF)

Components	Specification																																																		
Chipset	Intel C236 Chipset																																																		
Intel AMT	Intel Active Management Technology 11 supported on Xeon models																																																		
Processor	One LGA1151 socket, supports one the following processors:																																																		
	Xeon E3-1280 v5	4C/3.7GHz/8MB/80W/DDR4-2133																																																	
	Xeon E3-1275 v5	4C/3.6GHz/8MB/80W/DDR4-2133																																																	
	Xeon E3-1270 v5	4C/3.6GHz/8MB/80W/DDR4-2133																																																	
	Xeon E3-1245 v5	4C/3.5GHz/8MB/80W/DDR4-2133																																																	
	Xeon E3-1240 v5	4C/3.5GHz/8MB/80W/DDR4-2133																																																	
	Xeon E3-1230 v5	4C/3.4GHz/8MB/80W/DDR4-2133																																																	
	Xeon E3-1225 v5	4C/3.3GHz/8MB/80W/DDR4-2133																																																	
	Xeon E3-1220 v5	4C/3GHz/8MB/80W/DDR4-2133																																																	
	Core i7-6700	4C/3.4GHz/8MB/65W/DDR4-2133																																																	
	Core i5-6600	4C/3.3GHz/6MB/65W/DDR4-2133																																																	
	Core i5-6500	4C/3.2GHz/6MB/65W/DDR4-2133																																																	
	Core i5-6400	4C/2.7GHz/6MB/65W/DDR4-2133																																																	
	Core i3-6320	2C/3.9GHz/4MB/51W/DDR4-2133																																																	
Core i3-6300	2C/3.8GHz/4MB/51W/DDR4-2133																																																		
Core i3-6100	2C/3.7GHz/3MB/51W/DDR4-2133																																																		
Memory DIMM slots	4 DIMM slots, 2-channel (integrated memory controller in processor)																																																		
Memory type/capacity	Up to 64GB ECC/non-ECC (4 x 16GB), DDR4-2133, UDIMM																																																		
Intel HD Graphics in processor	Integrated Intel HD P530 in Xeon E3-12x5 v5 processors; or Intel HD 530 in Core i7, i5, or i3 processors. Works along with discrete graphics to support multi-display, enables three display connectors (2 DP, 1 VGA) on rear. Max resolution: 4096 x 2304																																																		
Discrete graphics	Two PCI Express 3.0 x16 slots for graphics adapters. Up to two Quadro K1200 on 250 watts models. Or up to two Quadro K2200, or up to one Quadro M4000 on 400 watts models. Supports the following NVIDIA graphics adapters:																																																		
	<table border="1"> <thead> <tr> <th>Adapter</th> <th>Cores</th> <th>Memory</th> <th>Power</th> <th>Connector</th> </tr> </thead> <tbody> <tr> <td>NVS 310</td> <td>48</td> <td>1GB</td> <td>19.5W</td> <td>2xDP</td> </tr> <tr> <td>NVS 315</td> <td>48</td> <td>1GB</td> <td>19.5W</td> <td>2xDVI-I SL/2xDP</td> </tr> <tr> <td>NVS 510</td> <td>192</td> <td>2GB</td> <td>33.4W</td> <td>4xmini DP</td> </tr> <tr> <td>Quadro K420</td> <td>192</td> <td>2GB</td> <td>41W</td> <td>1xDVI-I DL+1xDP</td> </tr> <tr> <td>Quadro K620</td> <td>384</td> <td>2GB</td> <td>45W</td> <td>1xDVI-I DL+1xDP</td> </tr> <tr> <td>Quadro K1200</td> <td>512</td> <td>4GB</td> <td>45W</td> <td>4xminiDP</td> </tr> <tr> <td>Quadro K2200</td> <td>640</td> <td>4GB</td> <td>68W</td> <td>1xDVI-I DL+2xDP</td> </tr> <tr> <td>Quadro M2000</td> <td>768</td> <td>4GB</td> <td>75W</td> <td>4xDP</td> </tr> <tr> <td>Quadro M4000</td> <td>1664</td> <td>8GB</td> <td>120W</td> <td>4xDP</td> </tr> </tbody> </table>	Adapter	Cores	Memory	Power	Connector	NVS 310	48	1GB	19.5W	2xDP	NVS 315	48	1GB	19.5W	2xDVI-I SL/2xDP	NVS 510	192	2GB	33.4W	4xmini DP	Quadro K420	192	2GB	41W	1xDVI-I DL+1xDP	Quadro K620	384	2GB	45W	1xDVI-I DL+1xDP	Quadro K1200	512	4GB	45W	4xminiDP	Quadro K2200	640	4GB	68W	1xDVI-I DL+2xDP	Quadro M2000	768	4GB	75W	4xDP	Quadro M4000	1664	8GB	120W	4xDP
	Adapter	Cores	Memory	Power	Connector																																														
	NVS 310	48	1GB	19.5W	2xDP																																														
	NVS 315	48	1GB	19.5W	2xDVI-I SL/2xDP																																														
	NVS 510	192	2GB	33.4W	4xmini DP																																														
	Quadro K420	192	2GB	41W	1xDVI-I DL+1xDP																																														
	Quadro K620	384	2GB	45W	1xDVI-I DL+1xDP																																														
	Quadro K1200	512	4GB	45W	4xminiDP																																														
	Quadro K2200	640	4GB	68W	1xDVI-I DL+2xDP																																														
Quadro M2000	768	4GB	75W	4xDP																																															
Quadro M4000	1664	8GB	120W	4xDP																																															
Onboard drive controller	Five onboard SATA 6.0Gb/s connectors for optical and disk drives plus one SATA connector for optional eSATA. RAID 0, 1, 5, 10 support																																																		
Drive Bays	Two external 5.25" bays, two internal 3.5" bays (see right). Up to one 9.5mm optical plus 4 x 3.5" disk drive bays plus one M.2 NVMe SSD																																																		
Supporting disk drives	3.5" SATA HDD (7.2K 6Gbs)	500GB/1TB/2TB/3TB/4TB/6TB/1TB hybrid/2TB hybrid																																																	
	2.5" SATA SSD (6Gbs)	128GB/180GB*/240GB*/256GB*/480GB*/512GB*/1TB*																																																	
	M.2 NVMe SSD	256GB*/512GB*/1TB*, via PCIe 3.0 x4 adapter																																																	
	** Includes OPAL options																																																		
Max internal storage	16TB (4 x 4TB 3.5" HDDs) plus 512GB M.2 NVMe SSD																																																		
Media reader	9-in-1 card reader. Optional 29-in-1 card reader on selected models																																																		
Power supply	Supports one of the following: <ul style="list-style-type: none"> <li>250 watts with variable speed fan, autosensing, 85% PSU, Climate Savers Computing Bronze, 80 PLUS Bronze qualified</li> <li>400 watts with variable speed fan, autosensing, 92% PSU, Climate Savers Computing Platinum, 80 PLUS Platinum qualified</li> </ul>																																																		
Onboard Ethernet	One onboard gigabit ethernet, Intel I219LM, supports Wake-on-LAN																																																		
HD Audio	Realtek ALC662 codec																																																		
TPM	Standard, TCG 1.2-compliant																																																		
Front ports	Two USB 3.0, microphone (3.5mm), headphone (3.5mm)																																																		
Rear ports	1 VGA and 2 DisplayPort (for Intel HD Graphics models only), two USB 2.0, four USB 3.0 (blue), one serial (9-pin), one ethernet (RJ-45), three analog audio ports (line-in, line-out, mic-in)																																																		

Components	Specification
Additional ports	Supports the following optional ports: <ul style="list-style-type: none"> <li>Two IEEE 1394 (one on rear and one on front flex module) via PCIe adapter, up to one adapter per system.</li> </ul> Supports one of the following per system: <ul style="list-style-type: none"> <li>Two rear USB 3.0 per PCIe adapter.</li> <li>One rear Thunderbolt via PCIe adapter.</li> <li>One front eSATA (on flex module), or one rear eSATA via cable and PCIe slot bracket, up to one eSATA port per system.</li> <li>One additional serial port via cable.</li> <li>One parallel port via cable</li> </ul>
	Mechanical
Environmental certifications	GREENGUARD certified/RoHS-compliant/EPEAT Gold rating/ENERGY STAR 6.1 qualified
Limited warranty	3-year limited onsite service with 9x5/NBD. Some parts are Customer Replaceable Units.

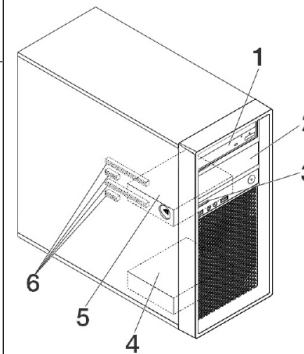

## Drive Bays and PCIe Slots

Bay 1 and Bay 2	5.25", support one of the following: HH optical/flex module**/9.5mm optical+3.5" HDD bay/3.5" HDD bay/Front Access Storage Enclosure ** Flex module supports one or more of the following: 9.5mm optical/29-in-1 reader/front IEEE 1394/front eSATA. Up to one flex module is supported per system.
Bay 3	Optional 9-in-1 single slot reader
Bay 4	Standard 3.5" HDD bay
Bay 5	Standard 3.5" HDD bay
6 -Slots	Four PCIe slots (top-down): Slot 1: Half length, full height, PCIe 3.0 x16 (near CPU) Slot 2: Half length, full height, PCIe 3.0 x1 Slot 3: Half length, full height, PCIe 3.0 x16 (x4 elec) Slot 4: Half length, full height, PCIe 3.0 x1

For the list of ISV certifications, please visit [www.thinkworkstations.com/isv-certifications/](http://www.thinkworkstations.com/isv-certifications/)  
For a list of all supported options, please visit [https://download.lenovo.com/pccbbs/options\\_iso/ocm\\_december\\_2016.xlsx](https://download.lenovo.com/pccbbs/options_iso/ocm_december_2016.xlsx) sheet

Model	Region	Processor	Graphics	Memory	Disks	M.2 Drives	Optical	Media Reader	Power Supply	Add-on Ports	Discrete Ethernet	Chassis Intrusion Switch	Keyboard / Mouse	Operating System	Warranty	Global	Ann Date (mm/yy)
30AT000BUS	US	Core i7-6700 4C/3.4GHz/8MB/65W/DDR4-2133	Intel HD 530	1x8GB UDIMM DDR4-2133 ECC	1x1TB HDD 7.2K 3.5" SATA6Gbps	None	HH DVD±RW	9-in-1	250W 85%	None	None	Switch	USB / USB	Win10 DG Win7 Pro 64	3-year	No	11/15
30AT000CUS	US	Xeon E3-1245 v5 4C/3.5GHz/8MB/80W/DDR4-2133	Intel HD P530	1x8GB UDIMM DDR4-2133 ECC	1x1TB HDD 7.2K 3.5" SATA6Gbps	None	HH DVD±RW	9-in-1	250W 85%	None	None	Switch	USB / USB	Win10 DG Win7 Pro 64	3-year	No	11/15
30AT000EUS	US	Core i7-6700 4C/3.4GHz/8MB/65W/DDR4-2133	Intel HD 530	1x8GB UDIMM DDR4-2133 Non-ECC	1x1TB HDD 7.2K 3.5" SATA6Gbps	None	HH DVD±RW	9-in-1	250W 85%	None	None	Switch	USB / USB	Win10 DG Win7 Pro 64	3-year	No	11/15
30AT000FUS	US	Xeon E3-1245 v5 4C/3.5GHz/8MB/80W/DDR4-2133	Intel HD P530	1x8GB UDIMM DDR4-2133 Non-ECC	1x1TB HDD 7.2K 3.5" SATA6Gbps	None	HH DVD±RW	9-in-1	250W 85%	None	None	Switch	USB / USB	Win10 DG Win7 Pro 64	3-year	No	11/15
30AT000GUS	US	Xeon E3-1245 v5 4C/3.5GHz/8MB/80W/DDR4-2133	Intel HD P530	1x8GB UDIMM DDR4-2133 Non-ECC	1x256GB SSD 2.5" SATA6Gbps Opal	None	HH DVD±RW	9-in-1	250W 85%	None	None	Switch	USB / USB	Win10 DG Win7 Pro 64	3-year	No	11/15
30AT000HUS	US	Xeon E3-1240 v5 4C/3.5GHz/8MB/80W/DDR4-2133	NVIDIA Quadro K620 2GB	1x8GB UDIMM DDR4-2133 Non-ECC	1x1TB HDD 7.2K 3.5" SATA6Gbps	None	HH DVD±RW	9-in-1	250W 85%	None	None	Switch	USB / USB	Win10 DG Win7 Pro 64	3-year	No	11/15
30AT000JUS	US	Core i7-6700 4C/3.4GHz/8MB/65W/DDR4-2133	Intel HD 530 + NVIDIA Quadro K620 2GB	1x8GB UDIMM DDR4-2133 Non-ECC	1x1TB HDD 7.2K 3.5" SATA6Gbps	None	HH DVD±RW	9-in-1	250W 85%	None	None	Switch	USB / USB	Win10 DG Win7 Pro 64	3-year	No	11/15
30AT000KUS	US	Core i7-6700 4C/3.4GHz/8MB/65W/DDR4-2133	Intel HD 530 + NVIDIA Quadro K2200 4GB	1x8GB UDIMM DDR4-2133 Non-ECC	1x1TB HDD 7.2K 3.5" SATA6Gbps	None	HH DVD±RW	9-in-1	250W 85%	None	None	Switch	USB / USB	Win10 DG Win7 Pro 64	3-year	No	11/15
30AT000LUS	US	Core i7-6700 4C/3.4GHz/8MB/65W/DDR4-2133	Intel HD 530 + NVIDIA Quadro K2200 4GB	2x8GB UDIMM DDR4-2133 Non-ECC	1x256GB SSD 2.5" SATA6Gbps Opal	None	HH DVD±RW	9-in-1	250W 85%	None	None	Switch	USB / USB	Win10 DG Win7 Pro 64	3-year	No	11/15
30AT000MUS	US	Core i7-6700 4C/3.4GHz/8MB/65W/DDR4-2133	Intel HD 530	2x8GB UDIMM DDR4-2133 Non-ECC	1x256GB SSD 2.5" SATA6Gbps Opal	None	HH DVD±RW	9-in-1	250W 85%	None	None	Switch	USB / USB	Win10 DG Win7 Pro 64	3-year	No	11/15
30AT000NUS	US	Core i5-6500 4C/3.2GHz/6MB/65W/DDR4-2133	Intel HD 530	1x8GB UDIMM DDR4-2133 Non-ECC	1x1TB HDD 7.2K 3.5" SATA6Gbps	None	HH DVD±RW	9-in-1	250W 85%	None	None	Switch	USB / USB	Win10 DG Win7 Pro 64	3-year	No	11/15
30AT000PUS	US	Xeon E3-1245 v5 4C/3.5GHz/8MB/80W/DDR4-2133	Intel HD P530	2x8GB UDIMM DDR4-2133 Non-ECC	Open	1x256GB SSD M.2 PCIe Opal	HH DVD±RW	9-in-1	400W 92%	None	None	Switch	USB / USB	Win10 DG Win7 Pro 64	3-year	No	11/15
30AT005CUS	US	Xeon E3-1240 v5 4C/3.5GHz/8MB/80W/DDR4-2133	NVIDIA Quadro K620 2GB	1x8GB UDIMM DDR4-2133 ECC	Open	1x256GB SSD M.2 PCIe Opal	HH DVD±RW	9-in-1	250W 85%	None	None	Switch	USB / USB	Win10 Pro 64	3-year	No	07/16

Model	Region	Processor	Graphics	Memory	Disks	M.2 Drives	Optical	Media Reader	Power Supply	Add-on Ports	Discrete Ethernet	Chassis Intrusion Switch	Keyboard / Mouse	Operating System	Warranty	Global	Ann Date (mm/yy)
30AT005DUS	US	Xeon E3-1220 v5 4C/3.0GHz/8MB/80W/DDR4-2133	NVIDIA Quadro K620 2GB	1x8GB UDIMM DDR4-2133 ECC	1x1TB HDD 7.2K 3.5" SATA6Gbps	None	HH DVD±RW	9-in-1	250W 85%	None	None	Switch	USB / USB	Win10 Pro 64	3-year	No	07/16
30AT005EUS	US	Xeon E3-1240 v5 4C/3.5GHz/8MB/80W/DDR4-2133	NVIDIA Quadro M2000 4GB	1x8GB UDIMM DDR4-2133 ECC	Open	1x256GB SSD M.2 PCIe Opal	HH DVD±RW	9-in-1	250W 85%	None	None	Switch	USB / USB	Win10 Pro 64	3-year	No	07/16
30AT005FUS	US	Xeon E3-1245 v5 4C/3.5GHz/8MB/80W/DDR4-2133	Intel HD P530	1x8GB UDIMM DDR4-2133 ECC	Open	1x256GB SSD M.2 PCIe Opal	HH DVD±RW	9-in-1	250W 85%	None	None	Switch	USB / USB	Win10 Pro 64	3-year	No	07/16
30AT005GUS	US	Core i7-6700 4C/3.4GHz/8MB/65W/DDR4-2133	Intel HD 530 + NVIDIA Quadro K620 2GB	1x8GB UDIMM DDR4-2133 Non-ECC	1x1TB HDD 7.2K 3.5" SATA6Gbps	None	HH DVD±RW	9-in-1	250W 85%	None	None	Switch	USB / USB	Win10 Pro 64	3-year	No	07/16
30AT005HUS	US	Core i7-6700 4C/3.4GHz/8MB/65W/DDR4-2133	Intel HD 530	1x8GB UDIMM DDR4-2133 Non-ECC	1x1TB HDD 7.2K 3.5" SATA6Gbps	None	HH DVD±RW	9-in-1	400W 92%	None	None	Switch	USB / USB	Win10 Pro 64	3-year	No	07/16
30AT005JUS	US	Xeon E3-1245 v5 4C/3.5GHz/8MB/80W/DDR4-2133	Intel HD P530	1x8GB UDIMM DDR4-2133 ECC	1x1TB HDD 7.2K 3.5" SATA6Gbps	None	HH DVD±RW	9-in-1	400W 92%	None	None	Switch	USB / USB	Win10 Pro 64	3-year	No	07/16
30AT005KUS	US	Core i5-6500 4C/3.2GHz/6MB/65W/DDR4-2133	Intel HD 530 + NVIDIA Quadro K620 2GB	1x8GB UDIMM DDR4-2133 Non-ECC	1x1TB HDD 7.2K 3.5" SATA6Gbps	None	HH DVD±RW	9-in-1	250W 85%	None	None	Switch	USB / USB	Win10 Pro 64	3-year	No	07/16
30AT005LUS	US	Core i3-6100 2C/3.7GHz/3MB/51W/DDR4-2133	Intel HD 530	1x8GB UDIMM DDR4-2133 Non-ECC	1x1TB HDD 7.2K 3.5" SATA6Gbps	None	HH DVD±RW	9-in-1	250W 85%	None	None	Switch	USB / USB	Win10 Pro 64	3-year	No	07/16
30AT005MUS	US	Xeon E3-1245 v5 4C/3.5GHz/8MB/80W/DDR4-2133	Intel HD P530	1x8GB UDIMM DDR4-2133 ECC	1x1TB HDD 7.2K 3.5" SATA6Gbps	None	HH DVD±RW	9-in-1	250W 85%	None	None	Switch	USB / USB	Win10 Pro 64	3-year	No	07/16
30AT005NUS	US	Xeon E3-1240 v5 4C/3.5GHz/8MB/80W/DDR4-2133	NVIDIA Quadro K620 2GB	1x8GB UDIMM DDR4-2133 ECC	1x1TB HDD 7.2K 3.5" SATA6Gbps	None	HH DVD±RW	9-in-1	250W 85%	None	None	Switch	USB / USB	Win10 Pro 64	3-year	No	07/16
30AT005PUS	US	Core i7-6700 4C/3.4GHz/8MB/65W/DDR4-2133	Intel HD 530 + NVIDIA Quadro M2000 4GB	1x8GB UDIMM DDR4-2133 Non-ECC	1x256GB SSD 2.5" SATA6Gbps Opal	None	HH DVD±RW	9-in-1	250W 85%	None	None	Switch	USB / USB	Win10 Pro 64	3-year	No	07/16
30AT006PUS	US	Core i7-6700 4C/3.4GHz/8MB/65W/DDR4-2133	Intel HD 530 + NVIDIA Quadro K1200 4GB	2x8GB UDIMM DDR4-2133 Non-ECC	1x512GB SSD 2.5" SATA6Gbps	None	HH DVD±RW	9-in-1	250W 85%	None	None	Switch	USB / USB	Win10 DG Win7 Pro 64	3-year	No	11/16
30AT006QUS	US	Core i7-6700 4C/3.4GHz/8MB/65W/DDR4-2133	Intel HD 530 + NVIDIA Quadro K620 2GB	2x8GB UDIMM DDR4-2133 Non-ECC	Open	1x512GB SSD M.2 PCIe	HH DVD±RW	9-in-1	250W 85%	None	None	Switch	USB / USB	Win10 DG Win7 Pro 64	3-year	No	11/16

Model	Region	Processor	Graphics	Memory	Disks	M.2 Drives	Optical	Media Reader	Power Supply	Add-on Ports	Discrete Ethernet	Chassis Intrusion Switch	Keyboard / Mouse	Operating System	Warranty	Global	Ann Date (mm/yy)
30AT006RUS	US	Core i7-6700 4C/3.4GHz/8MB/65W/DDR4-2133	Intel HD 530 + NVIDIA Quadro K620 2GB	2x8GB UDIMM DDR4-2133 Non-ECC	Open	1x256GB SSD M.2 PCIe Opal	HH DVD±RW	9-in-1	250W 85%	None	None	Switch	USB / USB	Win10 DG Win7 Pro 64	3-year	No	11/16
30AT006SUS	US	Core i7-6700 4C/3.4GHz/8MB/65W/DDR4-2133	Intel HD 530 + NVIDIA NVS 510 2GB	2x8GB UDIMM DDR4-2133 Non-ECC	1x512GB SSD 2.5" SATA6Gbps	None	HH DVD±RW	9-in-1	250W 85%	None	None	Switch	USB / USB	Win10 DG Win7 Pro 64	3-year	No	11/16
30AT006TUS	US	Core i7-6700 4C/3.4GHz/8MB/65W/DDR4-2133	Intel HD 530 + NVIDIA Quadro K1200 4GB	2x8GB UDIMM DDR4-2133 Non-ECC	Open	1x512GB SSD M.2 PCIe	HH DVD±RW	9-in-1	250W 85%	None	None	Switch	USB / USB	Win10 DG Win7 Pro 64	3-year	No	11/16
30AT006UUS	US	Core i7-6700 4C/3.4GHz/8MB/65W/DDR4-2133	Intel HD 530 + NVIDIA Quadro M2000 4GB	2x8GB UDIMM DDR4-2133 Non-ECC	Open	1x512GB SSD M.2 PCIe	HH DVD±RW	9-in-1	250W 85%	None	None	Switch	USB / USB	Win10 DG Win7 Pro 64	3-year	No	11/16
30AT006VUS	US	Core i7-6700 4C/3.4GHz/8MB/65W/DDR4-2133	Intel HD 530 + NVIDIA Quadro M2000 4GB	1x16GB UDIMM DDR4-2133 Non-ECC	1x256GB SSD 2.5" SATA6Gbps Opal	None	HH DVD±RW	9-in-1	250W 85%	None	None	Switch	USB / USB	Win10 DG Win7 Pro 64	3-year	No	11/16
30ATA023US	US	Core i7-6700 4C/3.4GHz/8MB/65W/DDR4-2133	Intel HD 530	2x8GB UDIMM DDR4-2133 Non-ECC	1x512GB SSD 2.5" SATA6Gbps	None	HH DVD±RW	9-in-1	250W 85%	None	None	Switch	USB / USB	Win10 DG Win7 Pro 64	3-year	No	11/16





# ThinkStation P320 SFF Platform Specifications

Product Specifications Reference (PSREF)

Components	Specification																																			
Chipset	Intel C236 Chipset																																			
Intel AMT	Intel Active Management Technology 11 on Xeon models, Intel Standard Manageability on other models																																			
Processor	One Intel "Kabylake" or "Skylake" processor as listed: "Kaby Lake"																																			
	<table border="1"> <tbody> <tr><td>Xeon E3-1280 v6</td><td>4C/3.9GHz/8MB/72W/DDR4-2400</td></tr> <tr><td>Xeon E3-1275 v6</td><td>4C/3.8GHz/8MB/73W/DDR4-2400</td></tr> <tr><td>Xeon E3-1270 v6</td><td>4C/3.8GHz/8MB/72W/DDR4-2400</td></tr> <tr><td>Xeon E3-1245 v6</td><td>4C/3.7GHz/8MB/73W/DDR4-2400</td></tr> <tr><td>Xeon E3-1240 v6</td><td>4C/3.7GHz/8MB/72W/DDR4-2400</td></tr> <tr><td>Xeon E3-1230 v6</td><td>4C/3.5GHz/8MB/72W/DDR4-2400</td></tr> <tr><td>Xeon E3-1225 v6</td><td>4C/3.3GHz/8MB/73W/DDR4-2400</td></tr> <tr><td>Xeon E3-1220 v6</td><td>4C/3GHz/8MB/72W/DDR4-2400</td></tr> <tr><td>Core i7-7700</td><td>4C/3.6GHz/8MB/65W/DDR4-2400</td></tr> <tr><td>Core i5-7600</td><td>4C/3.5GHz/6MB/65W/DDR4-2400</td></tr> <tr><td>Core i5-7500</td><td>4C/3.4GHz/6MB/65W/DDR4-2400</td></tr> <tr><td>Core i5-7400</td><td>4C/3GHz/6MB/65W/DDR4-2400</td></tr> <tr><td>Core i3-7300</td><td>2C/4GHz/4MB/51W/DDR4-2400</td></tr> <tr><td>Core i3-7100</td><td>2C/3.9GHz/3MB/51W/DDR4-2400</td></tr> </tbody> </table>	Xeon E3-1280 v6	4C/3.9GHz/8MB/72W/DDR4-2400	Xeon E3-1275 v6	4C/3.8GHz/8MB/73W/DDR4-2400	Xeon E3-1270 v6	4C/3.8GHz/8MB/72W/DDR4-2400	Xeon E3-1245 v6	4C/3.7GHz/8MB/73W/DDR4-2400	Xeon E3-1240 v6	4C/3.7GHz/8MB/72W/DDR4-2400	Xeon E3-1230 v6	4C/3.5GHz/8MB/72W/DDR4-2400	Xeon E3-1225 v6	4C/3.3GHz/8MB/73W/DDR4-2400	Xeon E3-1220 v6	4C/3GHz/8MB/72W/DDR4-2400	Core i7-7700	4C/3.6GHz/8MB/65W/DDR4-2400	Core i5-7600	4C/3.5GHz/6MB/65W/DDR4-2400	Core i5-7500	4C/3.4GHz/6MB/65W/DDR4-2400	Core i5-7400	4C/3GHz/6MB/65W/DDR4-2400	Core i3-7300	2C/4GHz/4MB/51W/DDR4-2400	Core i3-7100	2C/3.9GHz/3MB/51W/DDR4-2400							
	Xeon E3-1280 v6	4C/3.9GHz/8MB/72W/DDR4-2400																																		
	Xeon E3-1275 v6	4C/3.8GHz/8MB/73W/DDR4-2400																																		
	Xeon E3-1270 v6	4C/3.8GHz/8MB/72W/DDR4-2400																																		
	Xeon E3-1245 v6	4C/3.7GHz/8MB/73W/DDR4-2400																																		
	Xeon E3-1240 v6	4C/3.7GHz/8MB/72W/DDR4-2400																																		
	Xeon E3-1230 v6	4C/3.5GHz/8MB/72W/DDR4-2400																																		
	Xeon E3-1225 v6	4C/3.3GHz/8MB/73W/DDR4-2400																																		
	Xeon E3-1220 v6	4C/3GHz/8MB/72W/DDR4-2400																																		
	Core i7-7700	4C/3.6GHz/8MB/65W/DDR4-2400																																		
	Core i5-7600	4C/3.5GHz/6MB/65W/DDR4-2400																																		
	Core i5-7500	4C/3.4GHz/6MB/65W/DDR4-2400																																		
	Core i5-7400	4C/3GHz/6MB/65W/DDR4-2400																																		
	Core i3-7300	2C/4GHz/4MB/51W/DDR4-2400																																		
	Core i3-7100	2C/3.9GHz/3MB/51W/DDR4-2400																																		
	"Skylake"	<table border="1"> <tbody> <tr><td>Xeon E3-1245 v5</td><td>4C/3.5GHz/8MB/80W/DDR4-2133</td></tr> <tr><td>Xeon E3-1240 v5</td><td>4C/3.5GHz/8MB/80W/DDR4-2133</td></tr> <tr><td>Xeon E3-1230 v5</td><td>4C/3.4GHz/8MB/80W/DDR4-2133</td></tr> <tr><td>Xeon E3-1225 v5</td><td>4C/3.3GHz/8MB/80W/DDR4-2133</td></tr> <tr><td>Xeon E3-1220 v5</td><td>4C/3GHz/8MB/80W/DDR4-2133</td></tr> <tr><td>Core i7-6700</td><td>4C/3.4GHz/8MB/65W/DDR4-2133</td></tr> <tr><td>Core i5-6500</td><td>4C/3.2GHz/6MB/65W/DDR4-2133</td></tr> <tr><td>Core i5-6400</td><td>4C/2.7GHz/6MB/65W/DDR4-2133</td></tr> <tr><td>Core i3-6100</td><td>2C/3.7GHz/3MB/51W/DDR4-2133</td></tr> </tbody> </table>	Xeon E3-1245 v5	4C/3.5GHz/8MB/80W/DDR4-2133	Xeon E3-1240 v5	4C/3.5GHz/8MB/80W/DDR4-2133	Xeon E3-1230 v5	4C/3.4GHz/8MB/80W/DDR4-2133	Xeon E3-1225 v5	4C/3.3GHz/8MB/80W/DDR4-2133	Xeon E3-1220 v5	4C/3GHz/8MB/80W/DDR4-2133	Core i7-6700	4C/3.4GHz/8MB/65W/DDR4-2133	Core i5-6500	4C/3.2GHz/6MB/65W/DDR4-2133	Core i5-6400	4C/2.7GHz/6MB/65W/DDR4-2133	Core i3-6100	2C/3.7GHz/3MB/51W/DDR4-2133																
		Xeon E3-1245 v5	4C/3.5GHz/8MB/80W/DDR4-2133																																	
		Xeon E3-1240 v5	4C/3.5GHz/8MB/80W/DDR4-2133																																	
		Xeon E3-1230 v5	4C/3.4GHz/8MB/80W/DDR4-2133																																	
Xeon E3-1225 v5		4C/3.3GHz/8MB/80W/DDR4-2133																																		
Xeon E3-1220 v5		4C/3GHz/8MB/80W/DDR4-2133																																		
Core i7-6700		4C/3.4GHz/8MB/65W/DDR4-2133																																		
Core i5-6500		4C/3.2GHz/6MB/65W/DDR4-2133																																		
Core i5-6400		4C/2.7GHz/6MB/65W/DDR4-2133																																		
Core i3-6100		2C/3.7GHz/3MB/51W/DDR4-2133																																		
Memory DIMM slots	4 DIMM slots, 2-channel (integrated memory controller in processor)																																			
Memory type/capacity	Up to 64GB ECC/non-ECC (4 x 16GB), DDR4-2400. UDIMM. "Skylake" processor supports up to DDR4-2133. Core i7 and i5 processors cannot support ECC.																																			
Intel HD Graphics in processor	Integrated Intel HD P530 in Xeon E3-12x5 v5 processors, or Intel HD P630 in Xeon E3-12x5 v6 processors, or Intel HD 530 in Core i7, i5, or i3 6000 processors. or Intel HD 630 in Core i7, i5, or i3 7000 processors. Works along with discrete graphics to support multi-display, enables three display connectors (2 DP, 1 VGA) on rear.																																			
Discrete graphics	Two PCI Express 3.0 x16 slots for graphics adapters. Up to two NVIDIA Quadro P1000. Supports the following NVIDIA graphic adapters:																																			
	<table border="1"> <thead> <tr> <th>Adapter</th> <th>Cores</th> <th>Memory</th> <th>Power</th> <th>Connector</th> </tr> </thead> <tbody> <tr><td>NVS 310</td><td>48</td><td>1GB</td><td>19.5W</td><td>2xDP</td></tr> <tr><td>NVS 315</td><td>48</td><td>1GB</td><td>19.5W</td><td>2xDVI-I SL/2xDP</td></tr> <tr><td>NVS 510</td><td>192</td><td>2GB</td><td>33.4W</td><td>4xmini DP</td></tr> <tr><td>Quadro P400</td><td>256</td><td>2GB</td><td>30W</td><td>3xminiDP</td></tr> <tr><td>Quadro P600</td><td>384</td><td>2GB</td><td>40W</td><td>4xminiDP</td></tr> <tr><td>Quadro P1000</td><td>640</td><td>4GB</td><td>47W</td><td>4xminiDP</td></tr> </tbody> </table>	Adapter	Cores	Memory	Power	Connector	NVS 310	48	1GB	19.5W	2xDP	NVS 315	48	1GB	19.5W	2xDVI-I SL/2xDP	NVS 510	192	2GB	33.4W	4xmini DP	Quadro P400	256	2GB	30W	3xminiDP	Quadro P600	384	2GB	40W	4xminiDP	Quadro P1000	640	4GB	47W	4xminiDP
	Adapter	Cores	Memory	Power	Connector																															
	NVS 310	48	1GB	19.5W	2xDP																															
	NVS 315	48	1GB	19.5W	2xDVI-I SL/2xDP																															
	NVS 510	192	2GB	33.4W	4xmini DP																															
	Quadro P400	256	2GB	30W	3xminiDP																															
	Quadro P600	384	2GB	40W	4xminiDP																															
Quadro P1000	640	4GB	47W	4xminiDP																																
Onboard drive controller	Five onboard SATA 6.0Gb/s connectors for optical and disk drives plus one SATA connector for optional eSATA. RAID 0, 1, 5* support * RAID 5 needs three 2.5" SSD drives.																																			
Drive Bays	One external 5.25" bay, one internal 3.5" bay (see right). Up to one 9mm optical + 2 x 3.5" disk drive bays + 1 x 2.5" disk drive bay + two M.2 NVMe SSD																																			
Supporting disk drives	3.5" SATA HDD (7.2K 6Gbs)																																			
	2.5" SATA SSD (6Gbs)																																			
	M.2 NVMe SSD																																			
Max internal storage	10TB (2 x 4TB 3.5" HDDs + 1 x 2TB 2.5" SSD) plus two 1TB M.2 NVMe SSD																																			
Media reader	9-in-1 card reader. Optional 29-in-1 card reader on selected models																																			
Power supply	210 watts with variable speed fan, autosensing, Climate Savers Computing Bronze, 80 PLUS Bronze qualified																																			
Onboard Ethernet	One onboard gigabit ethernet, Intel I219LM, supports Wake-on-LAN																																			
HD Audio	Realtek ALC662 codec																																			
TPM	Standard, TCG 2.0-compliant																																			

Components	Specification
Front ports	Two USB 3.0, microphone (3.5mm), headphone (3.5mm)
Rear ports	1 VGA and 2 DisplayPort (for Intel HD Graphics models only), two USB 2.0, four USB 3.0, one serial (9-pin), one ethernet (RJ-45), three analog audio ports (line-in, line-out, mic-in)
Mechanical	<ul style="list-style-type: none"> <li>Raven black color; metal case</li> <li>4.02"W x 15.53"D x 13.31"H</li> <li>102mm W x 394.5mm D x 338mm H</li> <li>17.2 lb (7.9kg) max configuration</li> <li>12.9-liter</li> </ul>
Environmental certifications	GREENGUARD certified/RoHS-compliant/EPEAT Gold rating/ENERGY STAR 6.1 qualified
Limited warranty	1 or 3-year limited onsite service with 9x5/NBD. Some parts are Customer Replaceable Units.
ISV certifications	Please visit <a href="http://www.thinkworkstations.com/isv-certifications/">www.thinkworkstations.com/isv-certifications/</a>

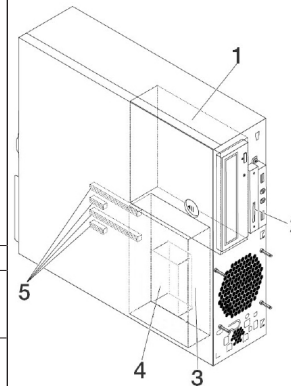

## Drive Bays and PCIe Slots

Bay 1	5.25", supports one of the following: HH optical/flex module***/9mm optical+3.5" HDD bay/ 3.5" HDD bay/Front Access Storage Enclosure *** Flex module supports one or more of the following: 9mm optical/ 29-in-1 reader/front IEEE 1394/front eSATA. Up to one flex module is supported per system.
Bay 2	Optional 9-in-1 single slot reader
Bay 3	Standard 3.5" HDD bay
Bay 4	Optional 2.5" HDD bay (under Bay 3)
5 -Slots	Four PCIe slots (top-down): Slot 1: Low Profile, PCIe 3.0 x16 (near CPU) Slot 2: Low Profile, PCIe 3.0 x1 Slot 3: Low Profile, PCIe 3.0 x16 (x4 elec) Slot 4: Low Profile, PCIe 3.0 x1

Model	Product	Region	Processor	Graphics	Memory	Disks	M.2 Drives	Optical	Media Reader	Power Supply	Add-on Ports	Keyboard / Mouse	Operating System	Warranty	Global	Ann Date (mm/yy)
30BK000LUS	ThinkStation P320 SFF	US	Core i5-6500 4C/3.2GHz/6MB/65W/DDR4-2133	Intel HD 530	1x8GB UDIMM DDR4-2400 Non-ECC	Open	1x256GB SSD M.2 PCIe Opal	HH DVD±RW	9-in-1	210W Bronze Fixed	None	USB / USB	Windows 10 DG Windows 7 Pro 64	3-year	No	04/17
30BK000MUS	ThinkStation P320 SFF	US	Xeon E3-1240 v6 4C/3.7GHz/8MB/72W/DDR4-2400	NVIDIA Quadro P600 2GB	2x8GB UDIMM DDR4-2400 Non-ECC	1x1TB HDD 7.2K 3.5" SATA6Gbps	None	HH DVD±RW	9-in-1	210W Bronze Fixed	None	USB / USB	Windows 10 Pro 64	3-year	No	04/17
30BK000NUS	ThinkStation P320 SFF	US	Core i7-7700 4C/3.6GHz/8MB/65W/DDR4-2400	Intel HD 630 + NVIDIA Quadro P600 2GB	1x8GB UDIMM DDR4-2400 Non-ECC	1x1TB HDD 7.2K 3.5" SATA6Gbps	None	HH DVD±RW	9-in-1	210W Bronze Fixed	None	USB / USB	Windows 10 Pro 64	3-year	No	04/17
30BK000PUS	ThinkStation P320 SFF	US	Core i5-7500 4C/3.4GHz/6MB/65W/DDR4-2400	Intel HD 630 + NVIDIA Quadro P400 2GB	1x8GB UDIMM DDR4-2400 Non-ECC	1x1TB HDD 7.2K 3.5" SATA6Gbps	None	HH DVD±RW	9-in-1	210W Bronze Fixed	None	USB / USB	Windows 10 Pro 64	3-year	No	04/17
30BK000QUS	ThinkStation P320 SFF	US	Core i7-6700 4C/3.4GHz/8MB/65W/DDR4-2133	Intel HD 530 + NVIDIA Quadro P1000 4GB	1x8GB UDIMM DDR4-2400 Non-ECC	1x1TB HDD 7.2K 3.5" SATA6Gbps	None	HH DVD±RW	9-in-1	210W Bronze Fixed	None	USB / USB	Windows 10 DG Windows 7 Pro 64	3-year	No	04/17
30BK000RUS	ThinkStation P320 SFF	US	Xeon E3-1245 v5 4C/3.5GHz/8MB/80W/DDR4-2133	Intel HD P530	1x8GB UDIMM DDR4-2400 Non-ECC	Open	1x256GB SSD M.2 PCIe Opal	HH DVD±RW	9-in-1	210W Bronze Fixed	None	USB / USB	Windows 10 DG Windows 7 Pro 64	3-year	No	04/17
30BK000SUS	ThinkStation P320 SFF	US	Xeon E3-1240 v5 4C/3.5GHz/8MB/80W/DDR4-2133	NVIDIA Quadro P600 2GB	1x8GB UDIMM DDR4-2400 Non-ECC	1x1TB HDD 7.2K 3.5" SATA6Gbps	None	HH DVD±RW	9-in-1	210W Bronze Fixed	None	USB / USB	Windows 10 DG Windows 7 Pro 64	3-year	No	04/17
30BK000TUS	ThinkStation P320 SFF	US	Core i5-7600 4C/3.5GHz/6MB/65W/DDR4-2400	Intel HD 630	1x8GB UDIMM DDR4-2400 Non-ECC	1x1TB HDD 7.2K 3.5" SATA6Gbps	None	HH DVD±RW	9-in-1	210W Bronze Fixed	None	USB / USB	Windows 10 Pro 64	3-year	No	04/17
30BK000UUS	ThinkStation P320 SFF	US	Core i7-6700 4C/3.4GHz/8MB/65W/DDR4-2133	Intel HD 530	1x8GB UDIMM DDR4-2400 Non-ECC	Open	1x256GB SSD M.2 PCIe Opal	HH DVD±RW	9-in-1	210W Bronze Fixed	PS/2	USB / PS2	Windows 10 DG Windows 7 Pro 64	3-year	No	04/17
30BK000VUS	ThinkStation P320 SFF	US	Xeon E3-1245 v6 4C/3.7GHz/8MB/73W/DDR4-2400	Intel HD P630	2x8GB UDIMM DDR4-2400 Non-ECC	Open	1x512GB SSD M.2 PCIe Opal	HH DVD±RW	9-in-1	210W Bronze Fixed	PS/2	USB / PS2	Windows 10 Pro 64	3-year	No	04/17
30BK000WUS	ThinkStation P320 SFF	US	Core i7-6700 4C/3.4GHz/8MB/65W/DDR4-2133	Intel HD 530 + NVIDIA Quadro P1000 4GB	2x8GB UDIMM DDR4-2400 Non-ECC	Open	1x512GB SSD M.2 PCIe Opal	HH DVD±RW	9-in-1	210W Bronze Fixed	None	USB / USB	Windows 10 DG Windows 7 Pro 64	3-year	No	04/17
30BK000XUS	ThinkStation P320 SFF	US	Xeon E3-1240 v6 4C/3.7GHz/8MB/72W/DDR4-2400	NVIDIA Quadro P600 2GB	2x8GB UDIMM DDR4-2400 Non-ECC	Open	1x512GB SSD M.2 PCIe Opal	HH DVD±RW	9-in-1	210W Bronze Fixed	None	USB / USB	Windows 10 Pro 64	3-year	No	04/17
30BK000YUS	ThinkStation P320 SFF	US	Core i7-7700 4C/3.6GHz/8MB/65W/DDR4-2400	Intel HD 630 + NVIDIA Quadro P1000 4GB	1x8GB UDIMM DDR4-2400 Non-ECC	1x1TB HDD 7.2K 3.5" SATA6Gbps	None	HH DVD±RW	9-in-1	210W Bronze Fixed	None	USB / USB	Windows 10 Pro 64	3-year	No	04/17
30BK0010US	ThinkStation P320 SFF	US	Xeon E3-1240 v5 4C/3.5GHz/8MB/80W/DDR4-2133	NVIDIA Quadro P1000 4GB	1x8GB UDIMM DDR4-2400 Non-ECC	1x1TB HDD 7.2K 3.5" SATA6Gbps	None	HH DVD±RW	9-in-1	210W Bronze Fixed	None	USB / USB	Windows 10 DG Windows 7 Pro 64	3-year	No	04/17
30BK0011US	ThinkStation P320 SFF	US	Core i5-7500 4C/3.4GHz/6MB/65W/DDR4-2400	Intel HD 630	1x8GB UDIMM DDR4-2400 Non-ECC	Open	1x256GB SSD M.2 PCIe Opal	HH DVD±RW	9-in-1	210W Bronze Fixed	None	USB / USB	Windows 10 Pro 64	3-year	No	04/17

Model	Product	Region	Processor	Graphics	Memory	Disks	M.2 Drives	Optical	Media Reader	Power Supply	Add-on Ports	Keyboard / Mouse	Operating System	Warranty	Global	Ann Date (mm/yy)
30BK0012US	ThinkStation P320 SFF	US	Core i7-7700 4C/3.6GHz/8MB/65W/DDR4-2400	Intel HD 630	1x8GB UDIMM DDR4-2400 Non-ECC	1x1TB HDD 7.2K 3.5" SATA6Gbps	None	HH DVD±RW	9-in-1	210W Bronze Fixed	None	USB / USB	Windows 10 Pro 64	3-year	No	04/17
30BK0013US	ThinkStation P320 SFF	US	Core i3-6100 2C/3.7GHz/3MB/51W/DDR4-2133	Intel HD 530 + NVIDIA Quadro P400 2GB	1x8GB UDIMM DDR4-2400 Non-ECC	1x1TB HDD 7.2K 3.5" SATA6Gbps	None	HH DVD±RW	9-in-1	210W Bronze Fixed	None	USB / USB	Windows 10 DG Windows 7 Pro 64	3-year	No	04/17
30BK0014US	ThinkStation P320 SFF	US	Xeon E3-1240 v6 4C/3.7GHz/8MB/72W/DDR4-2400	NVIDIA Quadro P1000 4GB	1x8GB UDIMM DDR4-2400 Non-ECC	1x1TB HDD 7.2K 3.5" SATA6Gbps	None	HH DVD±RW	9-in-1	210W Bronze Fixed	None	USB / USB	Windows 10 Pro 64	3-year	No	04/17
30BK0015US	ThinkStation P320 SFF	US	Core i5-6500 4C/3.2GHz/6MB/65W/DDR4-2133	Intel HD 530 + NVIDIA Quadro P400 2GB	1x8GB UDIMM DDR4-2400 Non-ECC	1x512GB SSD 2.5" SATA6Gbps Opal	None	HH DVD±RW	9-in-1	210W Bronze Fixed	None	USB / USB	Windows 10 DG Windows 7 Pro 64	3-year	No	04/17
30BK0016US	ThinkStation P320 SFF	US	Core i5-7500 4C/3.4GHz/6MB/65W/DDR4-2400	Intel HD 630 + NVIDIA Quadro P400 2GB	1x8GB UDIMM DDR4-2400 Non-ECC	1x512GB SSD 2.5" SATA6Gbps Opal	None	HH DVD±RW	9-in-1	210W Bronze Fixed	None	USB / USB	Windows 10 Pro 64	3-year	No	04/17
30BK0017US	ThinkStation P320 SFF	US	Xeon E3-1225 v6 4C/3.3GHz/8MB/73W/DDR4-2400	Intel HD P630	1x8GB UDIMM DDR4-2400 Non-ECC	1x1TB HDD 7.2K 3.5" SATA6Gbps	None	HH DVD±RW	9-in-1	210W Bronze Fixed	None	USB / USB	Windows 10 Pro 64	3-year	No	04/17
30BK0018US	ThinkStation P320 SFF	US	Core i3-6100 2C/3.7GHz/3MB/51W/DDR4-2133	Intel HD 530	1x8GB UDIMM DDR4-2400 Non-ECC	1x1TB HDD 7.2K 3.5" SATA6Gbps	None	HH DVD±RW	9-in-1	210W Bronze Fixed	None	USB / USB	Windows 10 DG Windows 7 Pro 64	3-year	No	04/17
30BK0019US	ThinkStation P320 SFF	US	Xeon E3-1245 v5 4C/3.5GHz/8MB/80W/DDR4-2133	Intel HD P530	1x8GB UDIMM DDR4-2400 Non-ECC	Open	1x512GB SSD M.2 PCIe Opal	HH DVD±RW	9-in-1	210W Bronze Fixed	PS/2	USB / PS2	Windows 10 DG Windows 7 Pro 64	3-year	No	04/17
30BK001AUS	ThinkStation P320 SFF	US	Core i7-6700 4C/3.4GHz/8MB/65W/DDR4-2133	Intel HD 530 + NVIDIA Quadro P600 2GB	1x8GB UDIMM DDR4-2400 Non-ECC	1x1TB HDD 7.2K 3.5" SATA6Gbps	None	HH DVD±RW	9-in-1	210W Bronze Fixed	None	USB / USB	Windows 10 DG Windows 7 Pro 64	3-year	No	04/17
30BK001BUS	ThinkStation P320 SFF	US	Core i7-7700 4C/3.6GHz/8MB/65W/DDR4-2400	Intel HD 630	1x8GB UDIMM DDR4-2400 Non-ECC	Open	1x256GB SSD M.2 PCIe Opal	HH DVD±RW	9-in-1	210W Bronze Fixed	PS/2	USB / PS2	Windows 10 Pro 64	3-year	No	04/17
30BK001CUS	ThinkStation P320 SFF	US	Core i5-7500 4C/3.4GHz/6MB/65W/DDR4-2400	Intel HD 630	1x8GB UDIMM DDR4-2400 Non-ECC	1x1TB HDD 7.2K 3.5" SATA6Gbps	None	HH DVD±RW	9-in-1	210W Bronze Fixed	None	USB / USB	Windows 10 Pro 64	3-year	No	04/17
30BK001DUS	ThinkStation P320 SFF	US	Core i7-6700 4C/3.4GHz/8MB/65W/DDR4-2133	Intel HD 530	1x8GB UDIMM DDR4-2400 Non-ECC	1x1TB HDD 7.2K 3.5" SATA6Gbps	None	HH DVD±RW	9-in-1	210W Bronze Fixed	None	USB / USB	Windows 10 DG Windows 7 Pro 64	3-year	No	04/17
30BK001EUS	ThinkStation P320 SFF	US	Xeon E3-1240 v5 4C/3.5GHz/8MB/80W/DDR4-2133	NVIDIA Quadro P600 2GB	2x8GB UDIMM DDR4-2400 Non-ECC	Open	1x512GB SSD M.2 PCIe Opal	HH DVD±RW	9-in-1	210W Bronze Fixed	None	USB / USB	Windows 10 DG Windows 7 Pro 64	3-year	No	04/17
30BK001FUS	ThinkStation P320 SFF	US	Core i3-7100 2C/3.9GHz/3MB/51W/DDR4-2400	Intel HD 630 + NVIDIA Quadro P400 2GB	1x8GB UDIMM DDR4-2400 Non-ECC	1x1TB HDD 7.2K 3.5" SATA6Gbps	None	HH DVD±RW	9-in-1	210W Bronze Fixed	None	USB / USB	Windows 10 Pro 64	3-year	No	04/17
30BK001GUS	ThinkStation P320 SFF	US	Xeon E3-1240 v5 4C/3.5GHz/8MB/80W/DDR4-2133	NVIDIA Quadro P1000 4GB	2x8GB UDIMM DDR4-2400 Non-ECC	Open	1x512GB SSD M.2 PCIe Opal	HH DVD±RW	9-in-1	210W Bronze Fixed	PS/2	USB / PS2	Windows 10 DG Windows 7 Pro 64	3-year	No	04/17

Model	Product	Region	Processor	Graphics	Memory	Disks	M.2 Drives	Optical	Media Reader	Power Supply	Add-on Ports	Keyboard / Mouse	Operating System	Warranty	Global	Ann Date (mm/yy)
30BK001HUS	ThinkStation P320 SFF	US	Core i5-6500 4C/3.2GHz/6MB/65W/DDR4-2133	Intel HD 530	1x8GB UDIMM DDR4-2400 Non-ECC	1x1TB HDD 7.2K 3.5" SATA6Gbps	None	HH DVD±RW	9-in-1	210W Bronze Fixed	None	USB / USB	Windows 10 DG Windows 7 Pro 64	3-year	No	04/17
30BK001JUS	ThinkStation P320 SFF	US	Core i3-7100 2C/3.9GHz/3MB/51W/DDR4-2400	Intel HD 630	1x8GB UDIMM DDR4-2400 Non-ECC	1x1TB HDD 7.2K 3.5" SATA6Gbps	None	HH DVD±RW	9-in-1	210W Bronze Fixed	None	USB / USB	Windows 10 Pro 64	3-year	No	04/17
30BK001KUS	ThinkStation P320 SFF	US	Xeon E3-1245 v6 4C/3.7GHz/8MB/73W/DDR4-2400	Intel HD P630	1x8GB UDIMM DDR4-2400 Non-ECC	Open	1x256GB SSD M.2 PCIe Opal	HH DVD±RW	9-in-1	210W Bronze Fixed	None	USB / USB	Windows 10 Pro 64	3-year	No	04/17
30BK001LUS	ThinkStation P320 SFF	US	Core i7-7700 4C/3.6GHz/8MB/65W/DDR4-2400	Intel HD 630 + NVIDIA Quadro P1000 4GB	2x8GB UDIMM DDR4-2400 Non-ECC	Open	1x512GB SSD M.2 PCIe Opal	HH DVD±RW	9-in-1	210W Bronze Fixed	None	USB / USB	Windows 10 Pro 64	3-year	No	04/17
30BK001MUS	ThinkStation P320 SFF	US	Xeon E3-1225 v5 4C/3.3GHz/8MB/80W/DDR4-2133	Intel HD P530	1x8GB UDIMM DDR4-2400 Non-ECC	1x1TB HDD 7.2K 3.5" SATA6Gbps	None	HH DVD±RW	9-in-1	210W Bronze Fixed	None	USB / USB	Windows 10 DG Windows 7 Pro 64	3-year	No	04/17
30BK001NUS	ThinkStation P320 SFF	US	Core i5-6500 4C/3.2GHz/6MB/65W/DDR4-2133	Intel HD 530 + NVIDIA Quadro P400 2GB	1x8GB UDIMM DDR4-2400 Non-ECC	1x1TB HDD 7.2K 3.5" SATA6Gbps	None	HH DVD±RW	9-in-1	210W Bronze Fixed	None	USB / USB	Windows 10 DG Windows 7 Pro 64	3-year	No	04/17



Model	Product	Region	Processor	Graphics	Memory	Disks	M.2 Drives	Optical	WLAN + Bluetooth	Stand	Cable Lock	Keyboard / Mouse	Operating System	Warranty	Global	Ann Date (mm/yy)
30C20014US	ThinkStation P320 Tiny	US	Core i5-7500T 4C/2.7GHz/6MB/35W/DDR4-2400	Intel HD 630 + NVIDIA Quadro P600 2GB	1x16GB SO-DIMM DDR4-2400 Non-ECC	None	512GB M.2 PCIe NVMe Opal	None	Intel 8265 ac, 2x2, vPro + BT4.1	Stand	None	USB / USB	Windows 10 Pro 64	3-year	No	06/17
30C20015US	ThinkStation P320 Tiny	US	Core i5-6500T 4C/2.5GHz/6MB/35W/DDR4-2133	Intel HD 530 + NVIDIA Quadro P600 2GB	1x8GB SO-DIMM DDR4-2400 Non-ECC	None	512GB M.2 PCIe NVMe Opal	None	Intel 8265 ac, 2x2, vPro + BT4.1	Stand	None	USB / USB	Windows 10 DG Windows 7 Pro 64	3-year	No	06/17
30C20016US	ThinkStation P320 Tiny	US	Core i7-6700T 4C/2.8GHz/8MB/35W/DDR4-2133	Intel HD 530 + NVIDIA Quadro P600 2GB	1x8GB SO-DIMM DDR4-2400 Non-ECC	None	256GB M.2 PCIe NVMe Opal	None	Intel 8265 ac, 2x2, vPro + BT4.1	Stand	None	USB / USB	Windows 10 DG Windows 7 Pro 64	3-year	No	06/17
30C20017US	ThinkStation P320 Tiny	US	Core i3-7100T 2C/3.4GHz/3MB/35W/DDR4-2400	Intel HD 630 + NVIDIA Quadro P600 2GB	1x16GB SO-DIMM DDR4-2400 Non-ECC	None	256GB M.2 PCIe NVMe Opal	None	Intel 8265 ac, 2x2 + BT4.1	Stand	None	USB / USB	Windows 10 Pro 64	3-year	No	06/17
30C20018US	ThinkStation P320 Tiny	US	Core i5-6500T 4C/2.5GHz/6MB/35W/DDR4-2133	Intel HD 530 + NVIDIA Quadro P600 2GB	1x8GB SO-DIMM DDR4-2400 Non-ECC	None	256GB M.2 PCIe NVMe Opal	None	Intel 8265 ac, 2x2, vPro + BT4.1	Stand	None	USB / USB	Windows 10 DG Windows 7 Pro 64	3-year	No	06/17
30C20019US	ThinkStation P320 Tiny	US	Core i3-6100T 2C/3.2GHz/3MB/35W/DDR4-2133	Intel HD 530 + NVIDIA Quadro P600 2GB	1x16GB SO-DIMM DDR4-2400 Non-ECC	None	512GB M.2 PCIe NVMe Opal	None	Intel 3165 ac, 1x1 + BT4.0	Stand	None	USB / USB	Windows 10 DG Windows 7 Pro 64	3-year	No	06/17
30C2001AUS	ThinkStation P320 Tiny	US	Core i3-7100T 2C/3.4GHz/3MB/35W/DDR4-2400	Intel HD 630 + NVIDIA Quadro P600 2GB	1x8GB SO-DIMM DDR4-2400 Non-ECC	None	256GB M.2 PCIe NVMe Opal	None	Intel 8265 ac, 2x2 + BT4.1	Stand	None	USB / USB	Windows 10 Pro 64	3-year	No	06/17
30C2001BUS	ThinkStation P320 Tiny	US	Core i3-7100T 2C/3.4GHz/3MB/35W/DDR4-2400	Intel HD 630 + NVIDIA Quadro P600 2GB	1x16GB SO-DIMM DDR4-2400 Non-ECC	None	512GB M.2 PCIe NVMe Opal	None	Intel 8265 ac, 2x2 + BT4.1	Stand	None	USB / USB	Windows 10 Pro 64	3-year	No	06/17
30C2001CUS	ThinkStation P320 Tiny	US	Core i7-7700T 4C/2.9GHz/8MB/35W/DDR4-2400	Intel HD 630 + NVIDIA Quadro P600 2GB	1x8GB SO-DIMM DDR4-2400 Non-ECC	None	512GB M.2 PCIe NVMe Opal	None	Intel 8265 ac, 2x2, vPro + BT4.1	Stand	None	USB / USB	Windows 10 Pro 64	3-year	No	06/17
30C2001DUS	ThinkStation P320 Tiny	US	Core i7-6700T 4C/2.8GHz/8MB/35W/DDR4-2133	Intel HD 530 + NVIDIA Quadro P600 2GB	1x16GB SO-DIMM DDR4-2400 Non-ECC	None	512GB M.2 PCIe NVMe Opal	None	Intel 8265 ac, 2x2, vPro + BT4.1	Stand	None	USB / USB	Windows 10 DG Windows 7 Pro 64	3-year	No	06/17
30C2001EUS	ThinkStation P320 Tiny	US	Core i7-7700T 4C/2.9GHz/8MB/35W/DDR4-2400	Intel HD 630 + NVIDIA Quadro P600 2GB	1x8GB SO-DIMM DDR4-2400 Non-ECC	None	256GB M.2 PCIe NVMe Opal	None	Intel 8265 ac, 2x2, vPro + BT4.1	Stand	None	USB / USB	Windows 10 Pro 64	3-year	No	06/17
30C2001FUS	ThinkStation P320 Tiny	US	Core i3-7100T 2C/3.4GHz/3MB/35W/DDR4-2400	Intel HD 630 + NVIDIA Quadro P600 2GB	1x4GB SO-DIMM DDR4-2400 Non-ECC	None	256GB M.2 PCIe NVMe Opal	None	Intel 8265 ac, 2x2 + BT4.1	Stand	None	USB / USB	Windows 10 Pro 64	3-year	No	06/17

Model	Product	Region	Processor	Graphics	Memory	Disks	M.2 Drives	Optical	WLAN + Bluetooth	Stand	Cable Lock	Keyboard / Mouse	Operating System	Warranty	Global	Ann Date (mm/yy)
30C2001GUS	ThinkStation P320 Tiny	US	Core i3-6100T 2C/3.2GHz/3MB/35W/DDR4-2133	Intel HD 530 + NVIDIA Quadro P600 2GB	1x4GB SO-DIMM DDR4-2400 Non-ECC	None	256GB M.2 PCIe NVMe Opal	None	Intel 3165 ac, 1x1 + BT4.0	Stand	None	USB / USB	Windows 10 DG Windows 7 Pro 64	3-year	No	06/17
30C2001HUS	ThinkStation P320 Tiny	US	Core i5-7500T 4C/2.7GHz/6MB/35W/DDR4-2400	Intel HD 630 + NVIDIA Quadro P600 2GB	1x8GB SO-DIMM DDR4-2400 Non-ECC	None	512GB M.2 PCIe NVMe Opal	None	Intel 8265 ac, 2x2, vPro + BT4.1	Stand	None	USB / USB	Windows 10 Pro 64	3-year	No	06/17
30C2001JUS	ThinkStation P320 Tiny	US	Core i5-6500T 4C/2.5GHz/6MB/35W/DDR4-2133	Intel HD 530 + NVIDIA Quadro P600 2GB	1x16GB SO-DIMM DDR4-2400 Non-ECC	None	512GB M.2 PCIe NVMe Opal	None	Intel 8265 ac, 2x2, vPro + BT4.1	Stand	None	USB / USB	Windows 10 DG Windows 7 Pro 64	3-year	No	06/17
30C2001KUS	ThinkStation P320 Tiny	US	Core i7-7700T 4C/2.9GHz/8MB/35W/DDR4-2400	Intel HD 630 + NVIDIA Quadro P600 2GB	1x16GB SO-DIMM DDR4-2400 Non-ECC	None	512GB M.2 PCIe NVMe Opal	None	Intel 8265 ac, 2x2, vPro + BT4.1	Stand	None	USB / USB	Windows 10 Pro 64	3-year	No	06/17
30C2001LUS	ThinkStation P320 Tiny	US	Core i5-7500T 4C/2.7GHz/6MB/35W/DDR4-2400	Intel HD 630 + NVIDIA Quadro P600 2GB	1x8GB SO-DIMM DDR4-2400 Non-ECC	None	256GB M.2 PCIe NVMe Opal	None	Intel 8265 ac, 2x2, vPro + BT4.1	Stand	None	USB / USB	Windows 10 Pro 64	3-year	No	06/17
30C2001MUS	ThinkStation P320 Tiny	US	Core i3-6100T 2C/3.2GHz/3MB/35W/DDR4-2133	Intel HD 530 + NVIDIA Quadro P600 2GB	1x16GB SO-DIMM DDR4-2400 Non-ECC	None	256GB M.2 PCIe NVMe Opal	None	Intel 3165 ac, 1x1 + BT4.0	Stand	None	USB / USB	Windows 10 DG Windows 7 Pro 64	3-year	No	06/17
30C2001NUS	ThinkStation P320 Tiny	US	Core i7-6700T 4C/2.8GHz/8MB/35W/DDR4-2133	Intel HD 530 + NVIDIA Quadro P600 2GB	1x8GB SO-DIMM DDR4-2400 Non-ECC	None	512GB M.2 PCIe NVMe Opal	None	Intel 8265 ac, 2x2, vPro + BT4.1	Stand	None	USB / USB	Windows 10 DG Windows 7 Pro 64	3-year	No	06/17
30C20025US	ThinkStation P320 Tiny	US	Core i5-7500T 4C/2.7GHz/6MB/35W/DDR4-2400	Intel HD 630 + NVIDIA Quadro P600 2GB	1x16GB SO-DIMM DDR4-2400 Non-ECC	None	1TB M.2 PCIe NVMe Opal	None	Intel 8265 ac, 2x2, vPro + BT4.1	Stand	None	USB / USB	Windows 10 Pro 64	3-year	No	06/17





# ThinkStation P320 Tower Platform Specifications

Product Specifications Reference (PSREF)

Components	Specification				
Chipset	Intel C236 Chipset				
Intel AMT	Intel Active Management Technology 11 on Xeon models, Intel Standard Manageability on other models				
Processor	One Intel "Kaby Lake" or "Skylake" processor as listed: "Kaby Lake"				
	Xeon E3-1280 v6	4C/3.9GHz/8MB/72W/DDR4-2400			
	Xeon E3-1275 v6	4C/3.8GHz/8MB/73W/DDR4-2400			
	Xeon E3-1270 v6	4C/3.8GHz/8MB/72W/DDR4-2400			
	Xeon E3-1245 v6	4C/3.7GHz/8MB/73W/DDR4-2400			
	Xeon E3-1240 v6	4C/3.7GHz/8MB/72W/DDR4-2400			
	Xeon E3-1230 v6	4C/3.5GHz/8MB/72W/DDR4-2400			
	Xeon E3-1225 v6	4C/3.3GHz/8MB/73W/DDR4-2400			
	Xeon E3-1220 v6	4C/3GHz/8MB/72W/DDR4-2400			
	Core i7-7700K	4C/4.2GHz/8MB/91W/DDR4-2400			
	Core i7-7700	4C/3.6GHz/8MB/65W/DDR4-2400			
	Core i5-7600	4C/3.5GHz/6MB/65W/DDR4-2400			
	Core i5-7500	4C/3.4GHz/6MB/65W/DDR4-2400			
	Core i5-7400	4C/3GHz/6MB/65W/DDR4-2400			
	Core i3-7300	2C/4GHz/4MB/51W/DDR4-2400			
	Core i3-7100	2C/3.9GHz/3MB/51W/DDR4-2400			
	"Skylake"	Xeon E3-1245 v5	4C/3.5GHz/8MB/80W/DDR4-2133		
Xeon E3-1240 v5		4C/3.5GHz/8MB/80W/DDR4-2133			
Xeon E3-1230 v5		4C/3.4GHz/8MB/80W/DDR4-2133			
Xeon E3-1225 v5		4C/3.3GHz/8MB/80W/DDR4-2133			
Xeon E3-1220 v5		4C/3GHz/8MB/80W/DDR4-2133			
Core i7-6700		4C/3.4GHz/8MB/65W/DDR4-2133			
Core i5-6500		4C/3.2GHz/6MB/65W/DDR4-2133			
Core i5-6400		4C/2.7GHz/6MB/65W/DDR4-2133			
Core i3-6100		2C/3.7GHz/3MB/51W/DDR4-2133			
Memory DIMM slots		4 DIMM slots, 2-channel (integrated memory controller in processor)			
Memory type/capacity	Up to 64GB ECC/non-ECC (4 x 16GB), DDR4-2400. UDIMM. "Skylake" processor supports up to DDR4-2133. Core i7 and i5 processors cannot support ECC.				
Intel HD Graphics in processor	Integrated Intel HD P530 in Xeon E3-12x5 v5 processors, or Intel HD P630 in Xeon E3-12x5 v6 processors, or Intel HD 530 in Core i7, i5, or i3 6000 processors. or Intel HD 630 in Core i7, i5, or i3 7000 processors. Works along with discrete graphics to support multi-display, enables three display connectors (2 DP, 1 VGA) on rear.				
Discrete graphics	Two PCI Express 3.0 x16 slots for graphics adapters. Up to two Quadro P1000 on 250 watts models. Or up to two Quadro P2000, or up to one Quadro P4000 on 400 watts models. Supports the following NVIDIA graphics adapters:				
	Adapter	Cores	Memory	Power	Connector
	NVS 310	48	1GB	19.5W	2xDP
	NVS 315	48	1GB	19.5W	2xDVI-I SL/2xDP
	NVS 510	192	2GB	33.4W	4xmini DP
	NVS 810	1024	4GB	68W	8xmini DP
	Quadro P400	256	2GB	30W	3xminiDP
	Quadro P600	384	2GB	40W	4xminiDP
	Quadro P1000	640	4GB	47W	4xminiDP
	Quadro P2000	1024	5GB	75W	4xDP
Quadro P4000	1792	8GB	105W	4xDP	
Onboard drive controller	Five onboard SATA 6.0Gb/s connectors for optical and disk drives plus one SATA connector for optional eSATA. RAID 0, 1, 5, 10 support				
Drive Bays	Two external 5.25" bays, two internal 3.5" bays (see right). Up to one 9mm optical plus 4 x 3.5" disk drive bays plus two M.2 NVMe SSD				
Supporting disk drives	3.5" SATA HDD (7.2K 6Gbs)	1TB/2TB/4TB/1TB hybrid/2TB hybrid			
	2.5" SATA SSD (6Gbs)	256GB Opal/512GB Opal/1TB Opal/2TB opal			
	M.2 NVMe SSD	256GB Opal/512GB Opal/1TB Opal, via PCIe 3.0 x4 adapter, up to 2			
Max internal storage	16TB (4 x 4TB 3.5" HDDs) plus 2TB (2 x 1TB) M.2 NVMe SSD				
Media reader	9-in-1 card reader. Optional 29-in-1 card reader on selected models				

Components	Specification
Power supply	One 250 watts with variable speed fan, autosensing, Climate Savers Computing Bronze, 80 PLUS Bronze qualified. Or one 400 watts with variable speed fan, autosensing, Climate Savers Computing Platinum, 80 PLUS Platinum qualified. US models use 400 watts PSU
Onboard Ethernet	One onboard gigabit ethernet, Intel I219LM, supports Wake-on-LAN
HD Audio	Realtek ALC662 codec
TPM	Standard, TCG 2.0-compliant
Front ports	Two USB 3.0, microphone (3.5mm), headphone (3.5mm)
Rear ports	1 VGA and 2 DisplayPort (for Intel HD Graphics models only), two USB 2.0, four USB 3.0, one serial (9-pin), one ethernet (RJ-45), three analog audio ports (line-in, line-out, mic-in)
Mechanical	<ul style="list-style-type: none"> <li>Raven black color; metal case</li> <li>6.89"W x 16.77"D x 14.8"H</li> <li>175mm W x 426mm D x 376mm H</li> <li>28.66 lb (13kg) max configuration</li> <li>25-liter</li> </ul>
Environmental certifications	GREENGUARD certified/RoHS-compliant/EPEAT Gold rating/ENERGY STAR 6.1 qualified
Limited warranty	1 or 3-year limited onsite service with 9x5/NBD. Some parts are Customer Replaceable Units.
ISV certifications	Please visit <a href="http://www.thinkworkstations.com/isv-certifications/">www.thinkworkstations.com/isv-certifications/</a>

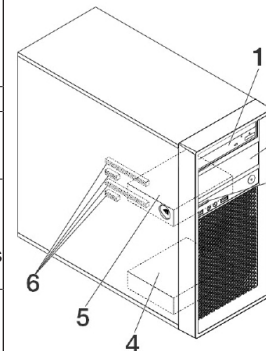

## Drive Bays and PCIe Slots

Bay 1 and Bay 2	5.25", support one of the following: HH optical/flex module/9mm optical+3.5" HDD bay/ 3.5" HDD bay/Front Access Storage Enclosure (FASE) <i>Note:</i> 1. Flex module supports one or more of the following: 9mm optical/ 29-in-1 reader/front IEEE 1394/front eSATA. 2. Up to one flex module/FASE per system.
Bay 3	Optional 9-in-1 single slot reader
Bay 4	Standard 3.5" HDD bay
Bay 5	Standard 3.5" HDD bay
6 -Slots	Four PCIe slots (top-down): Slot 1: Half length, full height, PCIe 3.0 x16 (near CPU) Slot 2: Half length, full height, PCIe 3.0 x1 Slot 3: Half length, full height, PCIe 3.0 x16 (x4 elec) Slot 4: Half length, full height, PCIe 3.0 x1 <i>Note:</i> 1. Both discrete graphics adapter and M.2 NVMe SSD should be installed on slot 1 or slot 3, the maximum quantity of discrete graphics adapter and M.2 NVMe SSD is 2. 2. When two discrete graphics adapters are used, no other PCIe card can be used.

ThinkStation P320 Tower - TopSeller - 30BH - 1 of 4

Product Specifications Reference (PSREF)

Model	Product	Region	Processor	Graphics	Memory	Disks	M.2 Drives	Optical	Media Reader	Power Supply	Add-on Ports	Keyboard / Mouse	Operating System	Warranty	Global	Ann Date (mm/yy)
30BH0022US	ThinkStation P320 Tower	US	Core i7-7700 4C/3.6GHz/8MB/65W/DDR4-2400	Intel HD 630	1x8GB UDIMM DDR4-2400 Non-ECC	1x1TB HDD 7.2K 3.5" SATA6Gbps	None	HH DVD±RW	9-in-1	250W Bronze Fixed	None	USB / USB	Windows 10 Pro 64	3-year	No	04/17
30BH0023US	ThinkStation P320 Tower	US	Xeon E3-1245 v5 4C/3.5GHz/8MB/80W/DDR4-2133	Intel HD P530	1x8GB UDIMM DDR4-2400 Non-ECC	Open	1x512GB SSD M.2 PCIe Opal	HH DVD±RW	9-in-1	250W Bronze Fixed	None	USB / USB	Windows 10 DG Windows 7 Pro 64	3-year	No	04/17
30BH0024US	ThinkStation P320 Tower	US	Core i7-7700 4C/3.6GHz/8MB/65W/DDR4-2400	Intel HD 630	1x8GB UDIMM DDR4-2400 Non-ECC	Open	1x512GB SSD M.2 PCIe Opal	HH DVD±RW	9-in-1	250W Bronze Fixed	None	USB / USB	Windows 10 Pro 64	3-year	No	04/17
30BH0025US	ThinkStation P320 Tower	US	Core i7-6700 4C/3.4GHz/8MB/65W/DDR4-2133	Intel HD 530	1x8GB UDIMM DDR4-2400 Non-ECC	Open	1x512GB SSD M.2 PCIe Opal	HH DVD±RW	9-in-1	250W Bronze Fixed	None	USB / USB	Windows 10 DG Windows 7 Pro 64	3-year	No	04/17
30BH0026US	ThinkStation P320 Tower	US	Xeon E3-1240 v6 4C/3.7GHz/8MB/72W/DDR4-2400	NVIDIA Quadro P2000 5GB	2x8GB UDIMM DDR4-2400 Non-ECC	1x1TB HDD 7.2K 3.5" SATA6Gbps	None	HH DVD±RW	9-in-1	250W Bronze Fixed	None	USB / USB	Windows 10 Pro 64	3-year	No	04/17
30BH0027US	ThinkStation P320 Tower	US	Core i7-7700K 4C/4.2GHz/8MB/91W/DDR4-2400	Intel HD 630	2x8GB UDIMM DDR4-2400 Non-ECC	Open	1x256GB SSD M.2 PCIe Opal	HH DVD±RW	9-in-1	250W Bronze Fixed	None	USB / USB	Windows 10 Pro 64	3-year	No	04/17
30BH0028US	ThinkStation P320 Tower	US	Core i5-7500 4C/3.4GHz/6MB/65W/DDR4-2400	Intel HD 630	1x8GB UDIMM DDR4-2400 Non-ECC	1x1TB HDD 7.2K 3.5" SATA6Gbps	None	HH DVD±RW	9-in-1	250W Bronze Fixed	None	USB / USB	Windows 10 Pro 64	3-year	No	04/17
30BH0029US	ThinkStation P320 Tower	US	Core i7-7700 4C/3.6GHz/8MB/65W/DDR4-2400	Intel HD 630	2x8GB UDIMM DDR4-2400 Non-ECC	Open	1x512GB SSD M.2 PCIe Opal	HH DVD±RW	9-in-1	250W Bronze Fixed	None	USB / USB	Windows 10 Pro 64	3-year	No	04/17
30BH002AUS	ThinkStation P320 Tower	US	Core i5-6500 4C/3.2GHz/6MB/65W/DDR4-2133	Intel HD 530	1x8GB UDIMM DDR4-2400 Non-ECC	1x1TB HDD 7.2K 3.5" SATA6Gbps	None	HH DVD±RW	9-in-1	250W Bronze Fixed	None	USB / USB	Windows 10 DG Windows 7 Pro 64	3-year	No	04/17
30BH002BUS	ThinkStation P320 Tower	US	Xeon E3-1240 v5 4C/3.5GHz/8MB/80W/DDR4-2133	NVIDIA Quadro P600 2GB	1x8GB UDIMM DDR4-2400 Non-ECC	1x1TB HDD 7.2K 3.5" SATA6Gbps	None	HH DVD±RW	9-in-1	250W Bronze Fixed	None	USB / USB	Windows 10 DG Windows 7 Pro 64	3-year	No	04/17
30BH002CUS	ThinkStation P320 Tower	US	Core i3-7100 2C/3.9GHz/3MB/51W/DDR4-2400	Intel HD 630	1x8GB UDIMM DDR4-2400 Non-ECC	1x1TB HDD 7.2K 3.5" SATA6Gbps	None	HH DVD±RW	9-in-1	250W Bronze Fixed	None	USB / USB	Windows 10 Pro 64	3-year	No	04/17
30BH002DUS	ThinkStation P320 Tower	US	Core i7-7700K 4C/4.2GHz/8MB/91W/DDR4-2400	Intel HD 630	2x8GB UDIMM DDR4-2400 Non-ECC	1x1TB HDD 7.2K 3.5" SATA6Gbps	None	HH DVD±RW	9-in-1	250W Bronze Fixed	None	USB / USB	Windows 10 Pro 64	3-year	No	04/17
30BH002EUS	ThinkStation P320 Tower	US	Core i7-7700 4C/3.6GHz/8MB/65W/DDR4-2400	Intel HD 630 + NVIDIA Quadro P1000 4GB	2x8GB UDIMM DDR4-2400 Non-ECC	1x1TB HDD 7.2K 3.5" SATA6Gbps	None	HH DVD±RW	9-in-1	250W Bronze Fixed	None	USB / USB	Windows 10 Pro 64	3-year	No	04/17
30BH002FUS	ThinkStation P320 Tower	US	Core i3-6100 2C/3.7GHz/3MB/51W/DDR4-2133	Intel HD 530	1x8GB UDIMM DDR4-2400 Non-ECC	1x1TB HDD 7.2K 3.5" SATA6Gbps	None	HH DVD±RW	9-in-1	250W Bronze Fixed	None	USB / USB	Windows 10 DG Windows 7 Pro 64	3-year	No	04/17

ThinkStation P320 Tower - TopSeller - 30BH - 2 of 4

Product Specifications Reference (PSREF)

Model	Product	Region	Processor	Graphics	Memory	Disks	M.2 Drives	Optical	Media Reader	Power Supply	Add-on Ports	Keyboard / Mouse	Operating System	Warranty	Global	Ann Date (mm/yy)
30BH002GUS	ThinkStation P320 Tower	US	Core i5-6500 4C/3.2GHz/6MB/65W/DDR4-2133	Intel HD 530	1x8GB UDIMM DDR4-2400 Non-ECC	Open	1x256GB SSD M.2 PCIe Opal	HH DVD±RW	9-in-1	250W Bronze Fixed	None	USB / USB	Windows 10 DG Windows 7 Pro 64	3-year	No	04/17
30BH002HUS	ThinkStation P320 Tower	US	Xeon E3-1240 v6 4C/3.7GHz/8MB/72W/DDR4-2400	NVIDIA Quadro P2000 5GB	2x8GB UDIMM DDR4-2400 Non-ECC	Open	1x512GB SSD M.2 PCIe Opal	HH DVD±RW	9-in-1	250W Bronze Fixed	None	USB / USB	Windows 10 Pro 64	3-year	No	04/17
30BH002JUS	ThinkStation P320 Tower	US	Core i7-6700 4C/3.4GHz/8MB/65W/DDR4-2133	Intel HD 530 + NVIDIA Quadro P1000 4GB	2x8GB UDIMM DDR4-2400 Non-ECC	1x1TB HDD 7.2K 3.5" SATA6Gbps	None	HH DVD±RW	9-in-1	250W Bronze Fixed	None	USB / USB	Windows 10 DG Windows 7 Pro 64	3-year	No	04/17
30BH002KUS	ThinkStation P320 Tower	US	Core i7-7700 4C/3.6GHz/8MB/65W/DDR4-2400	Intel HD 630	2x8GB UDIMM DDR4-2400 Non-ECC	Open	1x256GB SSD M.2 PCIe Opal	HH DVD±RW	9-in-1	250W Bronze Fixed	None	USB / USB	Windows 10 Pro 64	3-year	No	04/17
30BH002LUS	ThinkStation P320 Tower	US	Core i7-7700 4C/3.6GHz/8MB/65W/DDR4-2400	Intel HD 630 + NVIDIA Quadro P2000 5GB	2x8GB UDIMM DDR4-2400 Non-ECC	Open	1x512GB SSD M.2 PCIe Opal	HH DVD±RW	9-in-1	250W Bronze Fixed	None	USB / USB	Windows 10 Pro 64	3-year	No	04/17
30BH002MUS	ThinkStation P320 Tower	US	Core i7-7700 4C/3.6GHz/8MB/65W/DDR4-2400	Intel HD 630 + NVIDIA Quadro P2000 5GB	2x8GB UDIMM DDR4-2400 Non-ECC	1x2TB HDD 7.2K 3.5" SATA6Gbps	1x512GB SSD M.2 PCIe Opal	HH DVD±RW	9-in-1	250W Bronze Fixed	None	USB / USB	Windows 10 Pro 64	3-year	No	04/17
30BH002NUS	ThinkStation P320 Tower	US	Xeon E3-1230 v6 4C/3.5GHz/8MB/72W/DDR4-2400	NVIDIA Quadro P400 2GB	1x8GB UDIMM DDR4-2400 Non-ECC	1x1TB HDD 7.2K 3.5" SATA6Gbps	None	HH DVD±RW	9-in-1	250W Bronze Fixed	None	USB / USB	Windows 10 Pro 64	3-year	No	04/17
30BH002PUS	ThinkStation P320 Tower	US	Core i7-7700 4C/3.6GHz/8MB/65W/DDR4-2400	Intel HD 630	2x8GB UDIMM DDR4-2400 Non-ECC	Open	1x1TB SSD M.2 PCIe Opal	HH DVD±RW	9-in-1	250W Bronze Fixed	None	USB / USB	Windows 10 Pro 64	3-year	No	04/17
30BH002QUS	ThinkStation P320 Tower	US	Core i7-6700 4C/3.4GHz/8MB/65W/DDR4-2133	Intel HD 530	2x8GB UDIMM DDR4-2400 Non-ECC	Open	1x256GB SSD M.2 PCIe Opal	HH DVD±RW	9-in-1	250W Bronze Fixed	None	USB / USB	Windows 10 DG Windows 7 Pro 64	3-year	No	04/17
30BH002RUS	ThinkStation P320 Tower	US	Core i7-6700 4C/3.4GHz/8MB/65W/DDR4-2133	Intel HD 530	1x8GB UDIMM DDR4-2400 Non-ECC	1x1TB HDD 7.2K 3.5" SATA6Gbps	None	HH DVD±RW	9-in-1	250W Bronze Fixed	None	USB / USB	Windows 10 DG Windows 7 Pro 64	3-year	No	04/17
30BH002SUS	ThinkStation P320 Tower	US	Xeon E3-1245 v6 4C/3.7GHz/8MB/73W/DDR4-2400	Intel HD P630	2x8GB UDIMM DDR4-2400 Non-ECC	Open	1x512GB SSD M.2 PCIe Opal	HH DVD±RW	9-in-1	250W Bronze Fixed	None	USB / USB	Windows 10 Pro 64	3-year	No	04/17
30BH002TUS	ThinkStation P320 Tower	US	Core i5-7500 4C/3.4GHz/6MB/65W/DDR4-2400	Intel HD 630	1x8GB UDIMM DDR4-2400 Non-ECC	Open	1x256GB SSD M.2 PCIe Opal	HH DVD±RW	9-in-1	250W Bronze Fixed	None	USB / USB	Windows 10 Pro 64	3-year	No	04/17
30BH002UUS	ThinkStation P320 Tower	US	Core i7-6700 4C/3.4GHz/8MB/65W/DDR4-2133	Intel HD 530 + NVIDIA Quadro P2000 5GB	2x8GB UDIMM DDR4-2400 Non-ECC	Open	1x512GB SSD M.2 PCIe Opal	HH DVD±RW	9-in-1	250W Bronze Fixed	None	USB / USB	Windows 10 DG Windows 7 Pro 64	3-year	No	04/17
30BH002VUS	ThinkStation P320 Tower	US	Xeon E3-1240 v5 4C/3.5GHz/8MB/80W/DDR4-2133	NVIDIA Quadro P2000 5GB	2x8GB UDIMM DDR4-2400 Non-ECC	1x1TB HDD 7.2K 3.5" SATA6Gbps	None	HH DVD±RW	9-in-1	250W Bronze Fixed	None	USB / USB	Windows 10 DG Windows 7 Pro 64	3-year	No	04/17

Model	Product	Region	Processor	Graphics	Memory	Disks	M.2 Drives	Optical	Media Reader	Power Supply	Add-on Ports	Keyboard / Mouse	Operating System	Warranty	Global	Ann Date (mm/yy)
30BH002WUS	ThinkStation P320 Tower	US	Xeon E3-1245 v6 4C/3.7GHz/8MB/73W/DDR4-2400	Intel HD P630	1x8GB UDIMM DDR4-2400 Non-ECC	Open	1x512GB SSD M.2 PCIe Opal	HH DVD±RW	9-in-1	250W Bronze Fixed	None	USB / USB	Windows 10 Pro 64	3-year	No	04/17
30BH002XUS	ThinkStation P320 Tower	US	Xeon E3-1230 v5 4C/3.4GHz/8MB/80W/DDR4-2133	NVIDIA Quadro P400 2GB	1x8GB UDIMM DDR4-2400 Non-ECC	1x1TB HDD 7.2K 3.5" SATA6Gbps	None	HH DVD±RW	9-in-1	250W Bronze Fixed	None	USB / USB	Windows 10 DG Windows 7 Pro 64	3-year	No	04/17
30BH002YUS	ThinkStation P320 Tower	US	Xeon E3-1270 v6 4C/3.8GHz/8MB/72W/DDR4-2400	NVIDIA Quadro P2000 5GB	2x8GB UDIMM DDR4-2400 Non-ECC	Open	1x512GB SSD M.2 PCIe Opal	HH DVD±RW	9-in-1	250W Bronze Fixed	None	USB / USB	Windows 10 Pro 64	3-year	No	04/17
30BH0030US	ThinkStation P320 Tower	US	Xeon E3-1240 v5 4C/3.5GHz/8MB/80W/DDR4-2133	NVIDIA Quadro P2000 5GB	2x8GB UDIMM DDR4-2400 Non-ECC	Open	1x512GB SSD M.2 PCIe Opal	HH DVD±RW	9-in-1	250W Bronze Fixed	None	USB / USB	Windows 10 DG Windows 7 Pro 64	3-year	No	04/17
30BH0031US	ThinkStation P320 Tower	US	Core i7-6700 4C/3.4GHz/8MB/65W/DDR4-2133	Intel HD 530 + NVIDIA Quadro P2000 5GB	2x8GB UDIMM DDR4-2400 Non-ECC	1x2TB HDD 7.2K 3.5" SATA6Gbps	1x512GB SSD M.2 PCIe Opal	HH DVD±RW	9-in-1	250W Bronze Fixed	None	USB / USB	Windows 10 DG Windows 7 Pro 64	3-year	No	04/17
30BH0032US	ThinkStation P320 Tower	US	Xeon E3-1240 v6 4C/3.7GHz/8MB/72W/DDR4-2400	NVIDIA Quadro P600 2GB	1x8GB UDIMM DDR4-2400 Non-ECC	1x1TB HDD 7.2K 3.5" SATA6Gbps	None	HH DVD±RW	9-in-1	250W Bronze Fixed	None	USB / USB	Windows 10 Pro 64	3-year	No	04/17
30BH0033US	ThinkStation P320 Tower	US	Xeon E3-1245 v5 4C/3.5GHz/8MB/80W/DDR4-2133	Intel HD P530	2x8GB UDIMM DDR4-2400 Non-ECC	Open	1x512GB SSD M.2 PCIe Opal	HH DVD±RW	9-in-1	250W Bronze Fixed	None	USB / USB	Windows 10 DG Windows 7 Pro 64	3-year	No	04/17
30BH0034US	ThinkStation P320 Tower	US	Core i7-6700 4C/3.4GHz/8MB/65W/DDR4-2133	Intel HD 530	2x8GB UDIMM DDR4-2400 Non-ECC	Open	1x512GB SSD M.2 PCIe Opal	HH DVD±RW	9-in-1	250W Bronze Fixed	None	USB / USB	Windows 10 DG Windows 7 Pro 64	3-year	No	04/17
30BH0035US	ThinkStation P320 Tower	US	Core i7-7700K 4C/4.2GHz/8MB/91W/DDR4-2400	Intel HD 630 + NVIDIA Quadro P1000 4GB	1x8GB UDIMM DDR4-2400 Non-ECC	1x1TB SSD 2.5" SATA6Gbps Opal	None	HH DVD±RW	9-in-1	250W Bronze Fixed	None	USB / USB	Windows 10 Pro 64	3-year	No	04/17
30BH0036US	ThinkStation P320 Tower	US	Xeon E3-1245 v6 4C/3.7GHz/8MB/73W/DDR4-2400	Intel HD P630	2x8GB UDIMM DDR4-2400 ECC	Open	1x512GB SSD M.2 PCIe Opal	HH DVD±RW	9-in-1	250W Bronze Fixed	None	USB / USB	Windows 10 Pro 64	3-year	No	04/17
30BH0037US	ThinkStation P320 Tower	US	Core i5-7500 4C/3.4GHz/6MB/65W/DDR4-2400	Intel HD 630 + NVIDIA Quadro P600 2GB	1x8GB UDIMM DDR4-2400 Non-ECC	1x512GB SSD 2.5" SATA6Gbps Opal	None	HH DVD±RW	9-in-1	250W Bronze Fixed	None	USB / USB	Windows 10 Pro 64	3-year	No	04/17
30BH0038US	ThinkStation P320 Tower	US	Core i7-7700K 4C/4.2GHz/8MB/91W/DDR4-2400	Intel HD 630 + NVIDIA Quadro P400 2GB	1x8GB UDIMM DDR4-2400 Non-ECC	1x1TB SSD 2.5" SATA6Gbps Opal	None	HH DVD±RW	9-in-1	250W Bronze Fixed	None	USB / USB	Windows 10 Pro 64	3-year	No	04/17
30BH0039US	ThinkStation P320 Tower	US	Core i3-7100 2C/3.9GHz/3MB/51W/DDR4-2400	Intel HD 630 + NVIDIA Quadro P600 2GB	1x8GB UDIMM DDR4-2400 Non-ECC	1x1TB HDD 7.2K 3.5" SATA6Gbps	None	HH DVD±RW	9-in-1	250W Bronze Fixed	None	USB / USB	Windows 10 Pro 64	3-year	No	04/17
30BH003AUS	ThinkStation P320 Tower	US	Core i7-7700 4C/3.6GHz/8MB/65W/DDR4-2400	Intel HD 630 + NVIDIA Quadro P600 2GB	1x8GB UDIMM DDR4-2400 Non-ECC	1x512GB SSD 2.5" SATA6Gbps Opal	None	HH DVD±RW	9-in-1	250W Bronze Fixed	None	USB / USB	Windows 10 Pro 64	3-year	No	04/17

Model	Product	Region	Processor	Graphics	Memory	Disks	M.2 Drives	Optical	Media Reader	Power Supply	Add-on Ports	Keyboard / Mouse	Operating System	Warranty	Global	Ann Date (mm/yy)
30BH003BUS	ThinkStation P320 Tower	US	Core i7-7700K 4C/4.2GHz/8MB/91W/DDR4-2400	Intel HD 630 + NVIDIA Quadro P600 2GB	1x8GB UDIMM DDR4-2400 Non-ECC	1x1TB SSD 2.5" SATA6Gbps Opal	None	HH DVD±RW	9-in-1	250W Bronze Fixed	None	USB / USB	Windows 10 Pro 64	3-year	No	04/17
30BH003CUS	ThinkStation P320 Tower	US	Core i7-7700 4C/3.6GHz/8MB/65W/DDR4-2400	Intel HD 630 + NVIDIA Quadro P600 2GB	1x8GB UDIMM DDR4-2400 Non-ECC	1x1TB HDD 7.2K 3.5" SATA6Gbps	None	HH DVD±RW	9-in-1	250W Bronze Fixed	None	USB / USB	Windows 10 Pro 64	3-year	No	04/17
30BH003DUS	ThinkStation P320 Tower	US	Core i5-7500 4C/3.4GHz/6MB/65W/DDR4-2400	Intel HD 630 + NVIDIA Quadro P600 2GB	1x8GB UDIMM DDR4-2400 Non-ECC	1x1TB HDD 7.2K 3.5" SATA6Gbps	None	HH DVD±RW	9-in-1	250W Bronze Fixed	None	USB / USB	Windows 10 Pro 64	3-year	No	04/17
30BH003EUS	ThinkStation P320 Tower	US	Core i3-7100 2C/3.9GHz/3MB/51W/DDR4-2400	Intel HD 630 + NVIDIA Quadro P600 2GB	1x8GB UDIMM DDR4-2400 Non-ECC	1x512GB SSD 2.5" SATA6Gbps Opal	None	HH DVD±RW	9-in-1	250W Bronze Fixed	None	USB / USB	Windows 10 Pro 64	3-year	No	04/17

# ThinkStation P410 Platform Specifications

Product Specifications Reference (PSREF)

Components	Specification																																																																																																						
Chipset	Intel C612 Platform Controller Hub (PCH)																																																																																																						
System mgmt	Intel Active Management Technology 9																																																																																																						
Processor	Up to one 140W Intel Xeon E5-1600 v4 family processors. Some Intel Xeon E5-2600 v4 processors are also available:																																																																																																						
	E5-2637 v4	4C/3.5GHz/15MB/135W/DDR4-2400																																																																																																					
	E5-2623 v4	4C/2.6GHz/10MB/85W/DDR4-2133																																																																																																					
	E5-2620 v4	8C/2.1GHz/20MB/85W/DDR4-2133																																																																																																					
	E5-1680 v4	8C/3.4GHz/20MB/140W/DDR4-2400 333																																																																																																					
	E5-1660 v4	8C/3.2GHz/20MB/140W/DDR4-2400																																																																																																					
	E5-1650 v4	6C/3.6GHz/15MB/140W/DDR4-2400																																																																																																					
	E5-1630 v4	4C/3.7GHz/10MB/140W/DDR4-2400																																																																																																					
	E5-1620 v4	4C/3.5GHz/10MB/140W/DDR4-2400																																																																																																					
E5-1607 v4	4C/3.1GHz/10MB/140W/DDR4-2133																																																																																																						
E5-1603 v4	4C/2.8GHz/10MB/140W/DDR4-2133																																																																																																						
Coprocessor	None																																																																																																						
Memory DIMM slots	4 DIMM sockets. 4-channel capable. RDIMM. ECC. DDR4-2400																																																																																																						
Memory capacity	128GB (32GB x 4)																																																																																																						
Graphics	Two PCIe 3.0 x16 slots, up to two NVIDIA Quadro M4000, or up to one Quadro P5000																																																																																																						
Supporting Graphics and GPU computing	<table border="1"> <thead> <tr> <th>Adapter</th> <th>Cores</th> <th>Memory</th> <th>Power</th> <th>Connector***</th> <th>SLI</th> </tr> </thead> <tbody> <tr> <td>NVS 310</td> <td>48</td> <td>1GB</td> <td>19.5W</td> <td>2xDP</td> <td></td> </tr> <tr> <td>NVS 315</td> <td>48</td> <td>1GB</td> <td>19.5W</td> <td>2xDVI-I SL/2xDP</td> <td></td> </tr> <tr> <td>NVS 510</td> <td>192</td> <td>2GB</td> <td>35W</td> <td>4xmini DP</td> <td></td> </tr> <tr> <td>NVS 810</td> <td>1024</td> <td>4GB</td> <td>68W</td> <td>8xmini DP</td> <td></td> </tr> <tr> <td>Quadro K420</td> <td>192</td> <td>2GB</td> <td>41W</td> <td>DVI-I DL+DP</td> <td></td> </tr> <tr> <td>Quadro K620</td> <td>384</td> <td>2GB</td> <td>45W</td> <td>DVI-I DL+DP</td> <td></td> </tr> <tr> <td>Quadro K1200</td> <td>512</td> <td>4GB</td> <td>45W</td> <td>4xmini DP</td> <td></td> </tr> <tr> <td>Quadro M2000</td> <td>768</td> <td>4GB</td> <td>75W</td> <td>4xDP</td> <td></td> </tr> <tr> <td>Quadro M4000</td> <td>1664</td> <td>8GB</td> <td>120W</td> <td>4xDP</td> <td></td> </tr> <tr> <td>Quadro M5000</td> <td>2048</td> <td>8GB</td> <td>150W</td> <td>DVI-I DL+4xDP</td> <td></td> </tr> <tr> <td>Quadro P400</td> <td>256</td> <td>2GB</td> <td>30W</td> <td>3xminiDP</td> <td></td> </tr> <tr> <td>Quadro P600</td> <td>384</td> <td>2GB</td> <td>40W</td> <td>4xminiDP</td> <td></td> </tr> <tr> <td>Quadro P1000</td> <td>640</td> <td>4GB</td> <td>47W</td> <td>4xminiDP</td> <td></td> </tr> <tr> <td>Quadro P2000</td> <td>1024</td> <td>5GB</td> <td>75W</td> <td>4xDP</td> <td></td> </tr> <tr> <td>Quadro P4000</td> <td>1792</td> <td>8GB</td> <td>105W</td> <td>4xDP</td> <td>SLI</td> </tr> <tr> <td>Quadro P5000</td> <td>2560</td> <td>16GB</td> <td>180W</td> <td>DVI-D DL+4xDP</td> <td></td> </tr> </tbody> </table>	Adapter	Cores	Memory	Power	Connector***	SLI	NVS 310	48	1GB	19.5W	2xDP		NVS 315	48	1GB	19.5W	2xDVI-I SL/2xDP		NVS 510	192	2GB	35W	4xmini DP		NVS 810	1024	4GB	68W	8xmini DP		Quadro K420	192	2GB	41W	DVI-I DL+DP		Quadro K620	384	2GB	45W	DVI-I DL+DP		Quadro K1200	512	4GB	45W	4xmini DP		Quadro M2000	768	4GB	75W	4xDP		Quadro M4000	1664	8GB	120W	4xDP		Quadro M5000	2048	8GB	150W	DVI-I DL+4xDP		Quadro P400	256	2GB	30W	3xminiDP		Quadro P600	384	2GB	40W	4xminiDP		Quadro P1000	640	4GB	47W	4xminiDP		Quadro P2000	1024	5GB	75W	4xDP		Quadro P4000	1792	8GB	105W	4xDP	SLI	Quadro P5000	2560	16GB	180W	DVI-D DL+4xDP	
	Adapter	Cores	Memory	Power	Connector***	SLI																																																																																																	
	NVS 310	48	1GB	19.5W	2xDP																																																																																																		
	NVS 315	48	1GB	19.5W	2xDVI-I SL/2xDP																																																																																																		
	NVS 510	192	2GB	35W	4xmini DP																																																																																																		
	NVS 810	1024	4GB	68W	8xmini DP																																																																																																		
	Quadro K420	192	2GB	41W	DVI-I DL+DP																																																																																																		
	Quadro K620	384	2GB	45W	DVI-I DL+DP																																																																																																		
	Quadro K1200	512	4GB	45W	4xmini DP																																																																																																		
	Quadro M2000	768	4GB	75W	4xDP																																																																																																		
	Quadro M4000	1664	8GB	120W	4xDP																																																																																																		
	Quadro M5000	2048	8GB	150W	DVI-I DL+4xDP																																																																																																		
	Quadro P400	256	2GB	30W	3xminiDP																																																																																																		
	Quadro P600	384	2GB	40W	4xminiDP																																																																																																		
	Quadro P1000	640	4GB	47W	4xminiDP																																																																																																		
	Quadro P2000	1024	5GB	75W	4xDP																																																																																																		
	Quadro P4000	1792	8GB	105W	4xDP	SLI																																																																																																	
Quadro P5000	2560	16GB	180W	DVI-D DL+4xDP																																																																																																			
Disk drive controller	<b>RAID 0, 1, 5, 10</b> with onboard SATA controller in chipset, SATA 6Gb/s. Optional <b>RAID 0, 1, 10</b> with optional LSI 9340-8i PCIe adapter, 12Gb/s SAS and SATA, optional upgrade to RAID 5 is available																																																																																																						
Drive Bays	Two external 5.25" flex bays, two internal 3.5" bays. Up to one 9.5mm optical plus four 3.5"/2.5" disk drives plus three M.2 PCIe SSD (see right)																																																																																																						
Supporting storage	3.5" HDD, 7.2K SATA6Gbs	500GB/1TB/2TB/3TB/4TB/6TB, 1TB/2TB hybrid																																																																																																					
	2.5" HDD, 10K SAS12Gbs	300GB/600GB																																																																																																					
	2.5" SSD, SATA6Gbs	180GB/240GB/256GB/480GB/512GB with OPAL, 256GB/512GB/1TB without OPAL																																																																																																					
	PCIe SSD, M.2 via PCIe 3.0 x4 adapter	256GB/512GB/1TB, NVMe																																																																																																					
Flex connector	None																																																																																																						
Network interfaces	One onboard gigabit ethernet, Intel I218LM, supports Wake-on-LAN. Optional discrete ethernet adapters are available																																																																																																						
HD Audio	Realtek ALC662 codec																																																																																																						
TPM	TCG 1.2-compliant																																																																																																						
Power supply	One fixed 450 watts, autosensing, 92%, 80 PLUS Platinum qualified																																																																																																						
Front ports	Two USB 3.0, microphone (3.5mm), headphone (3.5mm)																																																																																																						
Rear ports	Two USB 2.0, four USB 3.0, one ethernet (RJ-45), three analog audio ports (line-in, line-out, mic-in)																																																																																																						

Components	Specification	
Additional ports	Supports the following optional ports: Two IEEE 1394 (one on rear and one on front flex module) via PCIe adapter, up to one adapter per system. Two rear USB 3.0 per PCIe adapter, up to three adapters per system. One rear Thunderbolt via PCIe adapter, or two front Thunderbolt (on flex module) via PCIe adapter, front and rear Thunderbolt cannot be intermixed. One rear serial via cable, up to one per system. One front eSATA (on flex module), or one rear eSATA via cable and PCIe slot bracket, up to one eSATA port per system	
Media reader	9-in-1 USB 2.0 card reader. Optional 29-in-1 USB 2.0 card reader on flex module	
Mechanical	<ul style="list-style-type: none"> <li>6.89"W x 16.77"D x 14.8"H</li> <li>175mm W x 426mm D x 376mm H</li> <li>30.86 lb (14kg) max configuration</li> <li>25-liter</li> </ul>	
Environmental specification	Temperature - operating	50 °F to 95 °F (10 °C to 35 °C)
	Temperature - non operating (no package)	14 °F to 140 °F (-10 °C to 60 °C)
	Temperature - non operating (with package)	-40 °F to 140 °F (-40 °C to 60 °C)
	Altitude - operating	(Unpressurized): 0-10000ft (0-3048m)
	Humidity - operating	10%-80%, non-condensing
	Humidity - storage (with package)	10%-90%, non-condensing
	RoHS-compliant, GREENGUARD on all models. EPEAT Gold rating, ENERGY STAR 6.1 qualified on selected models.	
Base warranty	1 or 3-year limited onsite service with 9x5/NBD	
ISV certifications	Please visit <a href="http://www.thinkworkstations.com/isv-certifications/">www.thinkworkstations.com/isv-certifications/</a>	

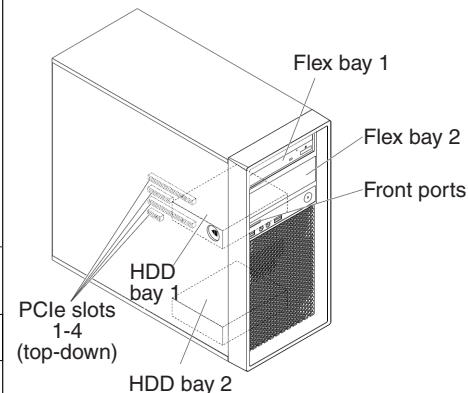

### Expansion slots

Slot 1	PCIe 3.0 x16, full length, full height
Slot 2	PCIe 3.0 x8, full length, full height
Slot 3	PCIe 3.0 x16, full length, full height
Slot 4	PCIe 2.0 x4, half length, full height

### Drive Bays

HDD bay 1	3.5", for one 3.5"/2.5" drive
HDD bay 2	3.5", for one 3.5"/2.5" drive
Flex bay 1	HH optical, or 3.5" HDD bay via optional conversion kit, or slim optical+3.5" HDD bay kit via optional conversion kit, or flex module
Flex bay 2	HH optical, or 3.5" HDD bay via optional conversion kit, or slim optical+3.5" HDD bay kit via optional conversion kit, or flex module

Note:

- HDD bay 2 is not available when one Quadro M5000, two Quadro M4000, or two NVS 810 are used.
- Flex module supports one or more of the following options: 9.5mm optical/29-in-1 USB 2.0 reader/one front IEEE 1394/one front eSATA/two front Thunderbolt. Up to one flex module is supported per system.
- Up to one slim optical+3.5" HDD bay kit is supported per system.



Model	Region	Processor	Graphics	Memory	Storage Controller	Disks	M.2 Drives	Optical	Media Reader	Power Supply	Add-on Ports	Discrete Ethernet	Chassis Intrusion Switch	Keyboard / Mouse	Operating System	Warranty	Ann Date (mm/yy)
30B3001PUS	US	Xeon E5-1620 v4 4C/3.5GHz/10MB/140W/DDR4-2400	NVIDIA Quadro K620 2GB	1x8GB RDIMM DDR4-2400 ECC	Onboard SATA	Open	1x256GB SSD M.2 PCIe Opal	HH DVD±RW	9-in-1	450W 92%	None	None	Switch	USB / USB	Windows 10 Pro 64	3-year	06/16
30B3001QUS	US	Xeon E5-1607 v4 4C/3.1GHz/10MB/140W/DDR4-2133	Open	1x8GB RDIMM DDR4-2400 ECC	Onboard SATA	1x1TB HDD 7.2K 3.5" SATA6Gbps	None	HH DVD±RW	9-in-1	450W 92%	None	None	Switch	USB / USB	Windows 10 Pro 64	3-year	06/16
30B3001RUS	US	Xeon E5-1630 v4 4C/3.7GHz/10MB/140W/DDR4-2400	NVIDIA Quadro K1200 4GB	1x8GB RDIMM DDR4-2400 ECC	Onboard SATA	Open	1x256GB SSD M.2 PCIe Opal	HH DVD±RW	9-in-1	450W 92%	None	None	Switch	USB / USB	Windows 10 Pro 64	3-year	06/16
30B3001SUS	US	Xeon E5-1630 v4 4C/3.7GHz/10MB/140W/DDR4-2400	NVIDIA Quadro M2000 4GB	2x8GB RDIMM DDR4-2400 ECC	Onboard SATA	1x256GB SSD 2.5" SATA6Gbps Opal	None	HH DVD±RW	9-in-1	450W 92%	None	None	Switch	USB / USB	Windows 10 Pro 64	3-year	06/16
30B3001TUS	US	Xeon E5-1620 v4 4C/3.5GHz/10MB/140W/DDR4-2400	NVIDIA Quadro K620 2GB	2x8GB RDIMM DDR4-2400 ECC	Onboard SATA	1x1TB SSD 2.5" SATA6Gbps	None	HH DVD±RW	9-in-1	450W 92%	None	None	Switch	USB / USB	Windows 10 Pro 64	3-year	06/16
30B3001UUS	US	Xeon E5-1620 v4 4C/3.5GHz/10MB/140W/DDR4-2400	Open	1x8GB RDIMM DDR4-2400 ECC	Onboard SATA	1x1TB HDD 7.2K 3.5" SATA6Gbps	None	HH DVD±RW	9-in-1	450W 92%	None	None	Switch	USB / USB	Windows 10 Pro 64	3-year	06/16
30B3001VUS	US	Xeon E5-1650 v4 6C/3.6GHz/15MB/140W/DDR4-2400	NVIDIA Quadro M2000 4GB	2x8GB RDIMM DDR4-2400 ECC	Onboard SATA	1x256GB SSD 2.5" SATA6Gbps Opal	None	HH DVD±RW	9-in-1	450W 92%	None	None	Switch	USB / USB	Windows 10 Pro 64	3-year	06/16
30B3001WUS	US	Xeon E5-1620 v4 4C/3.5GHz/10MB/140W/DDR4-2400	NVIDIA Quadro K620 2GB	1x8GB RDIMM DDR4-2400 ECC	Onboard SATA	1x1TB HDD 7.2K 3.5" SATA6Gbps	None	HH DVD±RW	9-in-1	450W 92%	None	None	Switch	USB / USB	Windows 10 Pro 64	3-year	06/16
30B3001XUS	US	Xeon E5-1630 v4 4C/3.7GHz/10MB/140W/DDR4-2400	NVIDIA Quadro K620 2GB	2x8GB RDIMM DDR4-2400 ECC	Onboard SATA	1x256GB SSD 2.5" SATA6Gbps Opal	None	HH DVD±RW	9-in-1	450W 92%	None	None	Switch	USB / USB	Windows 10 Pro 64	3-year	06/16
30B3001YUS	US	Xeon E5-1650 v4 6C/3.6GHz/15MB/140W/DDR4-2400	NVIDIA Quadro M4000 8GB	2x8GB RDIMM DDR4-2400 ECC	Onboard SATA	1x1TB SSD 2.5" SATA6Gbps	None	HH DVD±RW	9-in-1	450W 92%	None	None	Switch	USB / USB	Windows 10 Pro 64	3-year	06/16
30B30020US	US	Xeon E5-1650 v4 6C/3.6GHz/15MB/140W/DDR4-2400	Open	2x8GB RDIMM DDR4-2400 ECC	Onboard SATA	1x1TB HDD 7.2K 3.5" SATA6Gbps	None	HH DVD±RW	9-in-1	450W 92%	None	None	Switch	USB / USB	Windows 10 Pro 64	3-year	06/16
30B30021US	US	Xeon E5-1620 v4 4C/3.5GHz/10MB/140W/DDR4-2400	NVIDIA Quadro K1200 4GB	1x8GB RDIMM DDR4-2400 ECC	Onboard SATA	Open	1x256GB SSD M.2 PCIe Opal	HH DVD±RW	9-in-1	450W 92%	None	None	Switch	USB / USB	Windows 10 Pro 64	3-year	06/16



Model	Region	Processor	Graphics	Memory	Storage Controller	Disks	M.2 Drives	Optical	Media Reader	Power Supply	Add-on Ports	Discrete Ethernet	Chassis Intrusion Switch	Keyboard / Mouse	Operating System	Warranty	Ann Date (mm/yy)
30B30022US	US	Xeon E5-1650 v4 6C/3.6GHz/15MB/140W/DDR4-2400	NVIDIA Quadro K1200 4GB	2x8GB RDIMM DDR4-2400 ECC	Onboard SATA	Open	1x512GB SSD M.2 PCIe	HH DVD±RW	9-in-1	450W 92%	None	None	Switch	USB / CadMouse	Windows 10 Pro 64	3-year	06/16
30B3002AUS	US	Xeon E5-1607 v4 4C/3.1GHz/10MB/140W/DDR4-2133	Open	1x8GB RDIMM DDR4-2400 ECC	Onboard SATA	1x1TB HDD 7.2K 3.5" SATA6Gbps	None	HH DVD±RW	9-in-1	450W 92%	None	None	Switch	USB / USB	Windows 10 DG Windows 7 Pro 64	3-year	09/16
30B3002HUS	US	Xeon E5-1620 v4 4C/3.5GHz/10MB/140W/DDR4-2400	Open	1x8GB RDIMM DDR4-2400 ECC	Onboard SATA	1x1TB HDD 7.2K 3.5" SATA6Gbps	None	HH DVD±RW	9-in-1	450W 92%	None	None	Switch	USB / USB	Windows 10 DG Windows 7 Pro 64	3-year	09/16
30B3003KUS	US	Xeon E5-1620 v4 4C/3.5GHz/10MB/140W/DDR4-2400	NVIDIA Quadro K620 2GB	1x8GB RDIMM DDR4-2400 ECC	Onboard SATA	Open	1x256GB SSD M.2 PCIe Opal	HH DVD±RW	9-in-1	450W 92%	None	None	Switch	USB / USB	Windows 10 DG Windows 7 Pro 64	3-year	09/16
30B3003LUS	US	Xeon E5-1620 v4 4C/3.5GHz/10MB/140W/DDR4-2400	NVIDIA Quadro K620 2GB	2x8GB RDIMM DDR4-2400 ECC	Onboard SATA	1x1TB SSD 2.5" SATA6Gbps	None	HH DVD±RW	9-in-1	450W 92%	None	None	Switch	USB / USB	Windows 10 DG Windows 7 Pro 64	3-year	09/16
30B3003MUS	US	Xeon E5-1630 v4 4C/3.7GHz/10MB/140W/DDR4-2400	NVIDIA Quadro K620 2GB	2x8GB RDIMM DDR4-2400 ECC	Onboard SATA	1x256GB SSD 2.5" SATA6Gbps Opal	None	HH DVD±RW	9-in-1	450W 92%	None	None	Switch	USB / USB	Windows 10 DG Windows 7 Pro 64	3-year	09/16
30B3003NUS	US	Xeon E5-1650 v4 6C/3.6GHz/15MB/140W/DDR4-2400	NVIDIA Quadro M4000 8GB	2x8GB RDIMM DDR4-2400 ECC	Onboard SATA	1x1TB SSD 2.5" SATA6Gbps	None	HH DVD±RW	9-in-1	450W 92%	None	None	Switch	USB / USB	Windows 10 DG Windows 7 Pro 64	3-year	09/16
30B3003PUS	US	Xeon E5-1620 v4 4C/3.5GHz/10MB/140W/DDR4-2400	NVIDIA Quadro K620 2GB	1x8GB RDIMM DDR4-2400 ECC	Onboard SATA	1x1TB HDD 7.2K 3.5" SATA6Gbps	None	HH DVD±RW	9-in-1	450W 92%	None	None	Switch	USB / USB	Windows 10 DG Windows 7 Pro 64	3-year	09/16
30B3003QUS	US	Xeon E5-1650 v4 6C/3.6GHz/15MB/140W/DDR4-2400	NVIDIA Quadro K1200 4GB	2x8GB RDIMM DDR4-2400 ECC	Onboard SATA	Open	1x512GB SSD M.2 PCIe	HH DVD±RW	9-in-1	450W 92%	None	None	Switch	USB / CadMouse	Windows 10 DG Windows 7 Pro 64	3-year	09/16
30B3003RUS	US	Xeon E5-1650 v4 6C/3.6GHz/15MB/140W/DDR4-2400	Open	2x8GB RDIMM DDR4-2400 ECC	Onboard SATA	1x1TB HDD 7.2K 3.5" SATA6Gbps	None	HH DVD±RW	9-in-1	450W 92%	None	None	Switch	USB / USB	Windows 10 DG Windows 7 Pro 64	3-year	09/16
30B3003SUS	US	Xeon E5-1630 v4 4C/3.7GHz/10MB/140W/DDR4-2400	NVIDIA Quadro M2000 4GB	2x8GB RDIMM DDR4-2400 ECC	Onboard SATA	1x256GB SSD 2.5" SATA6Gbps Opal	None	HH DVD±RW	9-in-1	450W 92%	None	None	Switch	USB / USB	Windows 10 DG Windows 7 Pro 64	3-year	09/16
30B3003TUS	US	Xeon E5-1620 v4 4C/3.5GHz/10MB/140W/DDR4-2400	NVIDIA Quadro K1200 4GB	1x8GB RDIMM DDR4-2400 ECC	Onboard SATA	Open	1x256GB SSD M.2 PCIe Opal	HH DVD±RW	9-in-1	450W 92%	None	None	Switch	USB / USB	Windows 10 DG Windows 7 Pro 64	3-year	09/16

Model	Region	Processor	Graphics	Memory	Storage Controller	Disks	M.2 Drives	Optical	Media Reader	Power Supply	Add-on Ports	Discrete Ethernet	Chassis Intrusion Switch	Keyboard / Mouse	Operating System	Warranty	Ann Date (mm/yy)
30B3003UUS	US	Xeon E5-1650 v4 6C/3.6GHz/15MB/140W/DDR4-2400	NVIDIA Quadro M2000 4GB	2x8GB RDIMM DDR4-2400 ECC	Onboard SATA	1x256GB SSD 2.5" SATA6Gbps Opal	None	HH DVD±RW	9-in-1	450W 92%	None	None	Switch	USB / USB	Windows 10 DG Windows 7 Pro 64	3-year	09/16
30B3003VUS	US	Xeon E5-1630 v4 4C/3.7GHz/10MB/140W/DDR4-2400	NVIDIA Quadro K1200 4GB	1x8GB RDIMM DDR4-2400 ECC	Onboard SATA	Open	1x256GB SSD M.2 PCIe Opal	HH DVD±RW	9-in-1	450W 92%	None	None	Switch	USB / USB	Windows 10 DG Windows 7 Pro 64	3-year	09/16
30B3004JUS	US	Xeon E5-1630 v4 4C/3.7GHz/10MB/140W/DDR4-2400	NVIDIA Quadro M2000 4GB	2x16GB RDIMM DDR4-2400 ECC	Onboard SATA	1x512GB SSD 2.5" SATA6Gbps	1x256GB SSD M.2 PCIe Opal	None	None	450W 92%	None	None	Switch	USB / USB	Windows 10 DG Windows 7 Pro 64	3-year	09/16
30B3004MUS	US	Xeon E5-1620 v4 4C/3.5GHz/10MB/140W/DDR4-2400	NVIDIA Quadro K1200 4GB	2x8GB RDIMM DDR4-2400 ECC	Onboard SATA	Open	1x1TB SSD M.2 PCIe NVMe Opal	HH DVD±RW	9-in-1	450W 92%	None	None	Switch	USB / USB	Windows 10 DG Windows 7 Pro 64	3-year	12/16
30B3004NUS	US	Xeon E5-1620 v4 4C/3.5GHz/10MB/140W/DDR4-2400	Open	2x8GB RDIMM DDR4-2400 ECC	Onboard SATA	Open	1x1TB SSD M.2 PCIe NVMe Opal	HH DVD±RW	9-in-1	450W 92%	None	None	Switch	USB / USB	Windows 10 DG Windows 7 Pro 64	3-year	12/16
30B3004PUS	US	Xeon E5-1620 v4 4C/3.5GHz/10MB/140W/DDR4-2400	Open	2x8GB RDIMM DDR4-2400 ECC	Onboard SATA	1x1TB HDD 7.2K 3.5" SATA6Gbps	None	HH DVD±RW	9-in-1	450W 92%	None	None	Switch	USB / USB	Windows 10 DG Windows 7 Pro 64	3-year	12/16
30B3004QUS	US	Xeon E5-1630 v4 4C/3.7GHz/10MB/140W/DDR4-2400	NVIDIA Quadro P5000 16GB	2x8GB RDIMM DDR4-2400 ECC	Onboard SATA	Open	1x1TB SSD M.2 PCIe NVMe Opal	HH DVD±RW	9-in-1	450W 92%	None	None	Switch	USB / USB	Windows 10 DG Windows 7 Pro 64	3-year	12/16
30B3004RUS	US	Xeon E5-1620 v4 4C/3.5GHz/10MB/140W/DDR4-2400	Open	2x8GB RDIMM DDR4-2400 ECC	Onboard SATA	1x1TB HDD 7.2K 3.5" SATA6Gbps	None	None	9-in-1	450W 92%	None	None	Switch	USB / USB	Windows 10 DG Windows 7 Pro 64	3-year	12/16
30B3004SUS	US	Xeon E5-1630 v4 4C/3.7GHz/10MB/140W/DDR4-2400	Open	2x8GB RDIMM DDR4-2400 ECC	Onboard SATA	Open	1x1TB SSD M.2 PCIe NVMe Opal	HH DVD±RW	9-in-1	450W 92%	None	None	Switch	USB / USB	Windows 10 DG Windows 7 Pro 64	3-year	12/16
30B3004TUS	US	Xeon E5-1650 v4 6C/3.6GHz/15MB/140W/DDR4-2400	Open	2x8GB RDIMM DDR4-2400 ECC	Onboard SATA	Open	1x1TB SSD M.2 PCIe NVMe Opal	HH DVD±RW	9-in-1	450W 92%	None	None	Switch	USB / USB	Windows 10 DG Windows 7 Pro 64	3-year	12/16
30B3004UUS	US	Xeon E5-1620 v4 4C/3.5GHz/10MB/140W/DDR4-2400	Open	2x8GB RDIMM DDR4-2400 ECC	9340-8i PCIe	Open	1x256GB SSD M.2 PCIe Opal	HH DVD±RW	9-in-1	450W 92%	None	None	Switch	USB / USB	Windows 10 DG Windows 7 Pro 64	3-year	12/16
30B3004VUS	US	Xeon E5-1607 v4 4C/3.1GHz/10MB/140W/DDR4-2133	Open	2x8GB RDIMM DDR4-2400 ECC	Onboard SATA	Open	1x1TB SSD M.2 PCIe NVMe Opal	HH DVD±RW	9-in-1	450W 92%	None	None	Switch	USB / USB	Windows 10 DG Windows 7 Pro 64	3-year	12/16

Model	Region	Processor	Graphics	Memory	Storage Controller	Disks	M.2 Drives	Optical	Media Reader	Power Supply	Add-on Ports	Discrete Ethernet	Chassis Intrusion Switch	Keyboard / Mouse	Operating System	Warranty	Ann Date (mm/yy)
30B3005SUS	US	Xeon E5-1630 v4 4C/3.7GHz/10MB/140W/DDR4-2400	NVIDIA Quadro P600 2GB	2x8GB RDIMM DDR4-2400 ECC	Onboard SATA	1x256GB SSD 2.5" SATA6Gbps Opal	None	HH DVD±RW	9-in-1	450W 92%	None	None	Switch	USB / USB	Windows 10 Pro 64	3-year	04/17
30B3005TUS	US	Xeon E5-1630 v4 4C/3.7GHz/10MB/140W/DDR4-2400	NVIDIA Quadro P1000 4GB	1x8GB RDIMM DDR4-2400 ECC	Onboard SATA	Open	1x256GB SSD M.2 PCIe Opal	HH DVD±RW	9-in-1	450W 92%	None	None	Switch	USB / USB	Windows 10 DG Windows 7 Pro 64	3-year	04/17
30B3005UUS	US	Xeon E5-1620 v4 4C/3.5GHz/10MB/140W/DDR4-2400	NVIDIA Quadro P600 2GB	2x8GB RDIMM DDR4-2400 ECC	Onboard SATA	1x1TB SSD 2.5" SATA6Gbps	None	HH DVD±RW	9-in-1	450W 92%	None	None	Switch	USB / USB	Windows 10 Pro 64	3-year	04/17
30B3005VUS	US	Xeon E5-1620 v4 4C/3.5GHz/10MB/140W/DDR4-2400	NVIDIA Quadro P600 2GB	1x8GB RDIMM DDR4-2400 ECC	Onboard SATA	1x1TB HDD 7.2K 3.5" SATA6Gbps	None	HH DVD±RW	9-in-1	450W 92%	None	None	Switch	USB / USB	Windows 10 Pro 64	3-year	04/17
30B3005WUS	US	Xeon E5-1630 v4 4C/3.7GHz/10MB/140W/DDR4-2400	NVIDIA Quadro P2000 5GB	2x8GB RDIMM DDR4-2400 ECC	Onboard SATA	1x256GB SSD 2.5" SATA6Gbps Opal	None	HH DVD±RW	9-in-1	450W 92%	None	None	Switch	USB / USB	Windows 10 DG Windows 7 Pro 64	3-year	04/17
30B3005XUS	US	Xeon E5-1630 v4 4C/3.7GHz/10MB/140W/DDR4-2400	NVIDIA Quadro P600 2GB	2x8GB RDIMM DDR4-2400 ECC	Onboard SATA	1x256GB SSD 2.5" SATA6Gbps Opal	None	HH DVD±RW	9-in-1	450W 92%	None	None	Switch	USB / USB	Windows 10 DG Windows 7 Pro 64	3-year	04/17
30B3005YUS	US	Xeon E5-1630 v4 4C/3.7GHz/10MB/140W/DDR4-2400	NVIDIA Quadro P1000 4GB	1x8GB RDIMM DDR4-2400 ECC	Onboard SATA	Open	1x256GB SSD M.2 PCIe Opal	HH DVD±RW	9-in-1	450W 92%	None	None	Switch	USB / USB	Windows 10 Pro 64	3-year	04/17
30B30060US	US	Xeon E5-1620 v4 4C/3.5GHz/10MB/140W/DDR4-2400	NVIDIA Quadro P600 2GB	1x8GB RDIMM DDR4-2400 ECC	Onboard SATA	1x1TB HDD 7.2K 3.5" SATA6Gbps	None	HH DVD±RW	9-in-1	450W 92%	None	None	Switch	USB / USB	Windows 10 DG Windows 7 Pro 64	3-year	04/17
30B30061US	US	Xeon E5-1650 v4 6C/3.6GHz/15MB/140W/DDR4-2400	NVIDIA Quadro P1000 4GB	2x8GB RDIMM DDR4-2400 ECC	Onboard SATA	Open	1x512GB SSD M.2 PCIe	HH DVD±RW	9-in-1	450W 92%	None	None	Switch	USB / USB	Windows 10 DG Windows 7 Pro 64	3-year	04/17
30B30062US	US	Xeon E5-1650 v4 6C/3.6GHz/15MB/140W/DDR4-2400	NVIDIA Quadro P4000 8GB	2x8GB RDIMM DDR4-2400 ECC	Onboard SATA	1x1TB SSD 2.5" SATA6Gbps	None	HH DVD±RW	9-in-1	450W 92%	None	None	Switch	USB / USB	Windows 10 Pro 64	3-year	04/17
30B30063US	US	Xeon E5-1620 v4 4C/3.5GHz/10MB/140W/DDR4-2400	NVIDIA Quadro P1000 4GB	1x8GB RDIMM DDR4-2400 ECC	Onboard SATA	Open	1x256GB SSD M.2 PCIe Opal	HH DVD±RW	9-in-1	450W 92%	None	None	Switch	USB / USB	Windows 10 DG Windows 7 Pro 64	3-year	04/17
30B30064US	US	Xeon E5-1620 v4 4C/3.5GHz/10MB/140W/DDR4-2400	NVIDIA Quadro P1000 4GB	1x8GB RDIMM DDR4-2400 ECC	Onboard SATA	Open	1x256GB SSD M.2 PCIe Opal	HH DVD±RW	9-in-1	450W 92%	None	None	Switch	USB / USB	Windows 10 Pro 64	3-year	04/17

Model	Region	Processor	Graphics	Memory	Storage Controller	Disks	M.2 Drives	Optical	Media Reader	Power Supply	Add-on Ports	Discrete Ethernet	Chassis Intrusion Switch	Keyboard / Mouse	Operating System	Warranty	Ann Date (mm/yy)
30B30065US	US	Xeon E5-1650 v4 6C/3.6GHz/15MB/140W/DDR4-2400	NVIDIA Quadro P2000 5GB	2x8GB RDIMM DDR4-2400 ECC	Onboard SATA	1x256GB SSD 2.5" SATA6Gbps Opal	None	HH DVD±RW	9-in-1	450W 92%	None	None	Switch	USB / USB	Windows 10 DG Windows 7 Pro 64	3-year	04/17
30B30066US	US	Xeon E5-1650 v4 6C/3.6GHz/15MB/140W/DDR4-2400	NVIDIA Quadro P2000 5GB	2x8GB RDIMM DDR4-2400 ECC	Onboard SATA	1x256GB SSD 2.5" SATA6Gbps Opal	None	HH DVD±RW	9-in-1	450W 92%	None	None	Switch	USB / USB	Windows 10 Pro 64	3-year	04/17
30B30067US	US	Xeon E5-1650 v4 6C/3.6GHz/15MB/140W/DDR4-2400	NVIDIA Quadro P4000 8GB	2x8GB RDIMM DDR4-2400 ECC	Onboard SATA	1x1TB SSD 2.5" SATA6Gbps	None	HH DVD±RW	9-in-1	450W 92%	None	None	Switch	USB / USB	Windows 10 DG Windows 7 Pro 64	3-year	04/17
30B30068US	US	Xeon E5-1620 v4 4C/3.5GHz/10MB/140W/DDR4-2400	NVIDIA Quadro P600 2GB	1x8GB RDIMM DDR4-2400 ECC	Onboard SATA	Open	1x256GB SSD M.2 PCIe Opal	HH DVD±RW	9-in-1	450W 92%	None	None	Switch	USB / USB	Windows 10 Pro 64	3-year	04/17
30B30069US	US	Xeon E5-1630 v4 4C/3.7GHz/10MB/140W/DDR4-2400	NVIDIA Quadro P2000 5GB	2x8GB RDIMM DDR4-2400 ECC	Onboard SATA	1x256GB SSD 2.5" SATA6Gbps Opal	None	HH DVD±RW	9-in-1	450W 92%	None	None	Switch	USB / USB	Windows 10 Pro 64	3-year	04/17
30B3006AUS	US	Xeon E5-1650 v4 6C/3.6GHz/15MB/140W/DDR4-2400	NVIDIA Quadro P1000 4GB	2x8GB RDIMM DDR4-2400 ECC	Onboard SATA	Open	1x512GB SSD M.2 PCIe	HH DVD±RW	9-in-1	450W 92%	None	None	Switch	USB / USB	Windows 10 Pro 64	3-year	04/17
30B3006BUS	US	Xeon E5-1620 v4 4C/3.5GHz/10MB/140W/DDR4-2400	NVIDIA Quadro P600 2GB	2x8GB RDIMM DDR4-2400 ECC	Onboard SATA	1x1TB SSD 2.5" SATA6Gbps	None	HH DVD±RW	9-in-1	450W 92%	None	None	Switch	USB / USB	Windows 10 DG Windows 7 Pro 64	3-year	04/17
30B3006DUS	US	Xeon E5-1650 v4 6C/3.6GHz/15MB/140W/DDR4-2400	Open	1x16GB RDIMM DDR4-2400 ECC	Onboard SATA	Open	1x512GB SSD M.2 PCIe	HH DVD±RW	9-in-1	450W 92%	None	None	Switch	USB / USB	Windows 10 DG Windows 7 Pro 64	3-year	07/17
30B3006EUS	US	Xeon E5-1630 v4 4C/3.7GHz/10MB/140W/DDR4-2400	Open	1x16GB RDIMM DDR4-2400 ECC	Onboard SATA	Open	1x256GB SSD M.2 PCIe Opal	HH DVD±RW	9-in-1	450W 92%	None	None	Switch	USB / USB	Windows 10 DG Windows 7 Pro 64	3-year	07/17
30B3006FUS	US	Xeon E5-1620 v4 4C/3.5GHz/10MB/140W/DDR4-2400	Open	1x8GB RDIMM DDR4-2400 ECC	Onboard SATA	Open	1x256GB SSD M.2 PCIe Opal	HH DVD±RW	9-in-1	450W 92%	None	None	Switch	USB / USB	Windows 10 DG Windows 7 Pro 64	3-year	07/17

# ThinkStation P510 Platform Specifications

Components	Specification																																																																																																																																										
Chipset	Intel C612 Platform Controller Hub (PCH)																																																																																																																																										
System mgmt	Intel Active Management Technology 9																																																																																																																																										
Processor	Up to one 145W Intel Xeon E5-2600 v4 or E5-1600 v4 family processors. 22 cores up to 2.2GHz, 16 cores up to 2.6GHz, 14 cores up to 2.6GHz, 12 cores up to 2.2GHz, 10 cores up to 2.4GHz, 8 cores up to 3.4GHz, 6 cores up to 3.6GHz, 4 cores up to 3.7GHz Or up to one Intel Xeon E5-2600 v3 or E5-1600 v3 processors (not available in EMEA).																																																																																																																																										
Coprocessor	None																																																																																																																																										
Memory DIMM slots	8 DIMM sockets, 4-channel capable. RDIMM, ECC, DDR4, 2400MHz																																																																																																																																										
Memory capacity	256GB																																																																																																																																										
Graphics, GPU computing	Two PCIe 3.0 x16 slots for graphics and GPU computing adapters. Up to two NVIDIA Quadro M5000 SLI																																																																																																																																										
Supporting Graphics and GPU computing	<table border="1"> <thead> <tr> <th>Adapter</th> <th>Cores</th> <th>Memory</th> <th>Power</th> <th>Connector***</th> <th>SLI</th> </tr> </thead> <tbody> <tr> <td>NVS 310</td> <td>48</td> <td>1GB</td> <td>19.5W</td> <td>2xDP</td> <td></td> </tr> <tr> <td>NVS 315</td> <td>48</td> <td>1GB</td> <td>19.5W</td> <td>2xDVI-I SL/2xDP</td> <td></td> </tr> <tr> <td>NVS 510</td> <td>192</td> <td>2GB</td> <td>35W</td> <td>4xmini DP</td> <td></td> </tr> <tr> <td>NVS 810</td> <td>1024</td> <td>4GB</td> <td>68W</td> <td>8xmini DP</td> <td></td> </tr> <tr> <td>Quadro K420</td> <td>192</td> <td>2GB</td> <td>41W</td> <td>DVI-I DL+DP</td> <td></td> </tr> <tr> <td>Quadro K620</td> <td>384</td> <td>2GB</td> <td>45W</td> <td>DVI-I DL+DP</td> <td></td> </tr> <tr> <td>Quadro K1200</td> <td>512</td> <td>4GB</td> <td>45W</td> <td>4xmini DP</td> <td></td> </tr> <tr> <td>Quadro K2200</td> <td>640</td> <td>4GB</td> <td>68W</td> <td>DVI-I DL+2xDP</td> <td></td> </tr> <tr> <td>Quadro K4200</td> <td>1344</td> <td>4GB</td> <td>108W</td> <td>DVI-I DL+2xDP</td> <td></td> </tr> <tr> <td>Quadro K5200</td> <td>2304</td> <td>8GB</td> <td>150W</td> <td>DVI-I DL+DVI-D DL+2xDP</td> <td>SLI</td> </tr> <tr> <td>Quadro M2000</td> <td>768</td> <td>4GB</td> <td>75W</td> <td>4xDP</td> <td></td> </tr> <tr> <td>Quadro M4000</td> <td>1664</td> <td>8GB</td> <td>120W</td> <td>4xDP</td> <td></td> </tr> <tr> <td>Quadro M5000</td> <td>2048</td> <td>8GB</td> <td>150W</td> <td>DVI-I DL+4xDP</td> <td>SLI</td> </tr> <tr> <td>Quadro M6000</td> <td>3072</td> <td>24GB</td> <td>250W</td> <td>DVI-I DL+4xDP</td> <td></td> </tr> <tr> <td>Quadro P400</td> <td>256</td> <td>2GB</td> <td>30W</td> <td>3xminiDP</td> <td></td> </tr> <tr> <td>Quadro P600</td> <td>384</td> <td>2GB</td> <td>40W</td> <td>4xminiDP</td> <td></td> </tr> <tr> <td>Quadro P1000</td> <td>640</td> <td>4GB</td> <td>47W</td> <td>4xminiDP</td> <td></td> </tr> <tr> <td>Quadro P2000</td> <td>1024</td> <td>5GB</td> <td>75W</td> <td>4xDP</td> <td></td> </tr> <tr> <td>Quadro P4000</td> <td>1792</td> <td>8GB</td> <td>105W</td> <td>4xDP</td> <td>SLI</td> </tr> <tr> <td>Quadro P5000</td> <td>2560</td> <td>16GB</td> <td>180W</td> <td>DVI-D DL+4xDP</td> <td>SLI</td> </tr> <tr> <td>Quadro P6000</td> <td>3840</td> <td>24GB</td> <td>250W</td> <td>DVI-D DL+4xDP</td> <td></td> </tr> <tr> <td>Tesla K40</td> <td>2880</td> <td>12GB</td> <td>235W</td> <td></td> <td></td> </tr> </tbody> </table>	Adapter	Cores	Memory	Power	Connector***	SLI	NVS 310	48	1GB	19.5W	2xDP		NVS 315	48	1GB	19.5W	2xDVI-I SL/2xDP		NVS 510	192	2GB	35W	4xmini DP		NVS 810	1024	4GB	68W	8xmini DP		Quadro K420	192	2GB	41W	DVI-I DL+DP		Quadro K620	384	2GB	45W	DVI-I DL+DP		Quadro K1200	512	4GB	45W	4xmini DP		Quadro K2200	640	4GB	68W	DVI-I DL+2xDP		Quadro K4200	1344	4GB	108W	DVI-I DL+2xDP		Quadro K5200	2304	8GB	150W	DVI-I DL+DVI-D DL+2xDP	SLI	Quadro M2000	768	4GB	75W	4xDP		Quadro M4000	1664	8GB	120W	4xDP		Quadro M5000	2048	8GB	150W	DVI-I DL+4xDP	SLI	Quadro M6000	3072	24GB	250W	DVI-I DL+4xDP		Quadro P400	256	2GB	30W	3xminiDP		Quadro P600	384	2GB	40W	4xminiDP		Quadro P1000	640	4GB	47W	4xminiDP		Quadro P2000	1024	5GB	75W	4xDP		Quadro P4000	1792	8GB	105W	4xDP	SLI	Quadro P5000	2560	16GB	180W	DVI-D DL+4xDP	SLI	Quadro P6000	3840	24GB	250W	DVI-D DL+4xDP		Tesla K40	2880	12GB	235W		
	Adapter	Cores	Memory	Power	Connector***	SLI																																																																																																																																					
	NVS 310	48	1GB	19.5W	2xDP																																																																																																																																						
	NVS 315	48	1GB	19.5W	2xDVI-I SL/2xDP																																																																																																																																						
	NVS 510	192	2GB	35W	4xmini DP																																																																																																																																						
	NVS 810	1024	4GB	68W	8xmini DP																																																																																																																																						
	Quadro K420	192	2GB	41W	DVI-I DL+DP																																																																																																																																						
	Quadro K620	384	2GB	45W	DVI-I DL+DP																																																																																																																																						
	Quadro K1200	512	4GB	45W	4xmini DP																																																																																																																																						
	Quadro K2200	640	4GB	68W	DVI-I DL+2xDP																																																																																																																																						
	Quadro K4200	1344	4GB	108W	DVI-I DL+2xDP																																																																																																																																						
	Quadro K5200	2304	8GB	150W	DVI-I DL+DVI-D DL+2xDP	SLI																																																																																																																																					
	Quadro M2000	768	4GB	75W	4xDP																																																																																																																																						
	Quadro M4000	1664	8GB	120W	4xDP																																																																																																																																						
	Quadro M5000	2048	8GB	150W	DVI-I DL+4xDP	SLI																																																																																																																																					
	Quadro M6000	3072	24GB	250W	DVI-I DL+4xDP																																																																																																																																						
	Quadro P400	256	2GB	30W	3xminiDP																																																																																																																																						
	Quadro P600	384	2GB	40W	4xminiDP																																																																																																																																						
	Quadro P1000	640	4GB	47W	4xminiDP																																																																																																																																						
	Quadro P2000	1024	5GB	75W	4xDP																																																																																																																																						
Quadro P4000	1792	8GB	105W	4xDP	SLI																																																																																																																																						
Quadro P5000	2560	16GB	180W	DVI-D DL+4xDP	SLI																																																																																																																																						
Quadro P6000	3840	24GB	250W	DVI-D DL+4xDP																																																																																																																																							
Tesla K40	2880	12GB	235W																																																																																																																																								
RAID controller	Supports one of the following: <b>RAID 0, 1, 5, 10</b> with onboard SATA controller in chipset, SATA 6Gb/s. <b>RAID 0, 1, 5, 10</b> with optional LSI RAID flex adapter, 12Gb/s SAS and SATA. <b>RAID 0, 1, 5, 6, 10</b> with optional LSI 9364-8i PCIe adapter, 1GB memory, 12Gb/s SAS and SATA																																																																																																																																										
Drive Bays	Two external 5.25" flex bays for flex module, optical drives, or optional disk drives. Four 3.5" internal bays. Each 3.5" bay can support dual drives on selected models (see right).																																																																																																																																										
Flex bay	Two 5.25" flex bays for optical drives, Front Access Storage Enclosure drives, Flex Bay Storage Enclosure drives, or flex module. • Up to two half-height optical drives or up to one 9.5mm optical drive, DVD-ROM, DVD±RW, or Blu-Ray burner • Up to one Front Access Storage Enclosure for one 3.5" or 2.5" SATA drive. • Up to two Flex Bay Storage Enclosure for two 3.5" or 2.5" SATA drives.																																																																																																																																										
Supporting storage	3.5" HDD, 7.2K SATA6Gbs	500GB/1TB/2TB/3TB/4TB/6TB/1TB hybrid/2TB hybrid																																																																																																																																									
	2.5" HDD, 15K SAS12Gbs	300GB/600GB																																																																																																																																									
	2.5" SSD, SAS12Gbs	200GB/400GB/800GB																																																																																																																																									
	2.5" SAS HDD, 10K 12Gbs	300GB																																																																																																																																									
	2.5" SSD, SATA6Gbs	180GB/240GB/256GB/480GB/512GB with OPAL, 256GB/512GB/1TB without OPAL																																																																																																																																									
	PCIe SSD, U.2	400GB																																																																																																																																									
PCIe SSD, M.2	256 GB/512GB/1TB																																																																																																																																										
PCIe SSD adapter	400GB (up to 3 per system)																																																																																																																																										
Flex connector	One flex connector, supports one of the following: • Up to one LSI RAID flex adapter for SATA/SAS RAID • Up to one Multi-I/O flex adapters for one 2.5" PCIe SSD • Up to one M.2 flex adapters for one M.2 PCIe SSD																																																																																																																																										

Components	Specification	
Network interfaces	Integrated one Gigabit Ethernet (Intel i218LM), supports Wake-on-LAN. Optional discrete Ethernet is available	
HD Audio	Realtek ALC662 codec	
TPM	TCG 1.2-compliant	
Power supply	One fixed 490 watts, autosensing, 90%, 80 PLUS Gold qualified. Or one fixed 650 watts, autosensing, 92%, 80 PLUS Platinum qualified	
Front ports	Four USB 3.0 (one Diagnostic, one Always On), one combo audio/microphone jack (3.5mm)	
Rear ports	Four USB 2.0, four USB 3.0, one serial (9-pin), one ethernet (RJ-45), three analog audio ports (line-in, line-out, mic-in), two PS/2	
Add-on ports	Supports the following optional ports: Two IEEE 1394 (one on rear and one on front flex module) via PCIe adapter, up to one adapter per system. Two rear USB 3.0 per PCIe adapter, up to three adapters per system. One rear Thunderbolt via PCIe adapter. One front eSATA (on flex module), or one rear eSATA via cable (also needs one PCIe slot), up to one eSATA port per system. One internal USB 3.0 port via cable, cannot be intermixed with 29-in-1 reader	
Media reader	9-in-1 USB 2.0 or 29-in-1 USB 3.0 card reader	
Mechanical	<ul style="list-style-type: none"> <li>36-liter: 175mm/6.89" W x 470mm/18.5" D x 440mm/17.32" H (with feet)</li> <li>Tool-less parts: all except CPU fansink</li> <li>48.94 lb (22.2kg) max configuration</li> </ul>	
Environmental specification	Temperature - operating	50 °F to 95 °F (10 °C to 35 °C)
	Temperature - non operating (no package)	14 °F to 140 °F (-10 °C to 60 °C)
	Temperature - non operating (with package)	-40 °F to 140 °F (-40 °C to 60 °C)
	Altitude - operating	(Unpressurized): 0-10000ft (0-3048m)
Humidity - operating	Humidity - operating	10%-80%, non-condensing
	Humidity - storage (with package)	10%-90%, non-condensing
RoHS-compliant, GREENGUARD on all models. EPEAT Gold rating, ENERGY STAR 6.1 qualified on selected models.		
Base warranty	3-year limited onsite service with 9x5/NBD	
ISV certifications	Please visit <a href="http://www.thinkworkstations.com/isv-certifications/">www.thinkworkstations.com/isv-certifications/</a>	

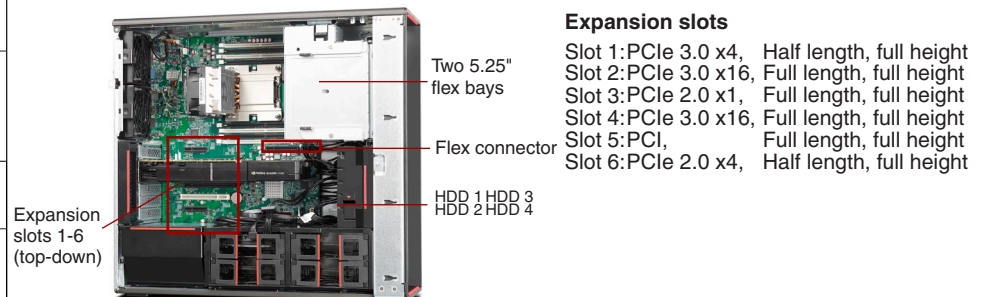

**Expansion slots**  
Slot 1: PCIe 3.0 x4, Half length, full height  
Slot 2: PCIe 3.0 x16, Full length, full height  
Slot 3: PCIe 2.0 x1, Full length, full height  
Slot 4: PCIe 3.0 x16, Full length, full height  
Slot 5: PCI, Full length, full height  
Slot 6: PCIe 2.0 x4, Half length, full height

**Drive Bays**  
HDD 1-4: Standard 3.5" HDD bay, up to four 3.5" or 2.5" disk drives.  
On selected models, each 3.5" bay can supports 2.5" (9mm or less) drive plus 3.5" drive, or two 2.5" (15mm or less) drives.  
Flex bay: Two 5.25" flex bays, for HH optical drives.  
Or up to one optional flex module (Flex module supports one or more of the following options: 9.5mm optical/29-in-1 USB 3.0 reader/front IEEE 1394/front eSATA).  
Or up to two HDD bays for two drives, 3.5" or 2.5" each, SATA only.

Model	Region	Processor	Graphics	Memory	Storage Controller	Max Drives in 3.5" Bays	Disks	M.2 Drives	Optical	Media Reader	Power Supply	Add-on Ports	Discrete Ethernet	Keyboard / Mouse	Operating System	Warranty	End of Support	Ann Date (mm/yy)
30B5000VUS	US	Xeon E5-1650 v4 6C/3.6GHz/15MB/140W/DDR4-2400	Open	1x8GB RDIMM DDR4-2400 ECC	Onboard SATA	4	1x1TB HDD 7.2K 3.5" SATA6Gbps	None	HH DVD±RW	9-in-1	650W 92%	None	None	USB / USB	Windows 10 Pro 64	3-year	Jun 14, 2021	06/16
30B50019US	US	Xeon E5-1630 v4 4C/3.7GHz/10MB/140W/DDR4-2400	Open	2x8GB RDIMM DDR4-2400 ECC	Onboard SATA	4	1x256GB SSD 2.5" SATA6Gbps Opal	None	HH DVD±RW	9-in-1	650W 92%	None	None	USB / USB	Windows 10 Pro 64	3-year	Jun 14, 2021	06/16
30B5001GUS	US	Xeon E5-1620 v4 4C/3.5GHz/10MB/140W/DDR4-2400	NVIDIA Quadro M2000 4GB	1x8GB RDIMM DDR4-2400 ECC	Onboard SATA	4	1x1TB HDD 7.2K 3.5" SATA6Gbps	None	HH DVD±RW	9-in-1	490W 90%	None	None	USB / USB	Windows 10 Pro 64	3-year	Jul 14, 2022	06/16
30B5001HUS	US	Xeon E5-1620 v4 4C/3.5GHz/10MB/140W/DDR4-2400	Open	1x8GB RDIMM DDR4-2400 ECC	Onboard SATA	4	1x1TB HDD 7.2K 3.5" SATA6Gbps	None	HH DVD±RW	9-in-1	650W 92%	None	None	USB / USB	Windows 10 Pro 64	3-year	Jul 14, 2022	06/16
30B5001JUS	US	Xeon E5-1620 v4 4C/3.5GHz/10MB/140W/DDR4-2400	NVIDIA Quadro M2000 4GB	2x8GB RDIMM DDR4-2400 ECC	Onboard SATA	4	1x512GB SSD 2.5" SATA6Gbps	None	HH DVD±RW	9-in-1	490W 90%	None	None	USB / USB	Windows 10 Pro 64	3-year	Jul 14, 2022	06/16
30B5001KUS	US	Xeon E5-1620 v4 4C/3.5GHz/10MB/140W/DDR4-2400	Open	1x8GB RDIMM DDR4-2400 ECC	Onboard SATA	4	1x1TB HDD 7.2K 3.5" SATA6Gbps	None	HH DVD±RW	9-in-1	490W 90%	None	None	USB / USB	Windows 10 Pro 64	3-year	Jul 14, 2022	06/16
30B5001LUS	US	Xeon E5-1607 v4 4C/3.1GHz/10MB/140W/DDR4-2133	NVIDIA Quadro K620 2GB	1x8GB RDIMM DDR4-2400 ECC	Onboard SATA	4	1x1TB HDD 7.2K 3.5" SATA6Gbps	None	HH DVD±RW	9-in-1	490W 90%	None	None	USB / USB	Windows 10 Pro 64	3-year	Jul 14, 2022	06/16
30B5001MUS	US	Xeon E5-1607 v4 4C/3.1GHz/10MB/140W/DDR4-2133	NVIDIA Quadro K620 2GB	1x8GB RDIMM DDR4-2400 ECC	Onboard SATA	4	1x500GB HDD 7.2K 3.5" SATA6Gbps	None	HH DVD±RW	9-in-1	490W 90%	None	None	USB / USB	Windows 10 Pro 64	3-year	Jul 14, 2022	06/16
30B5001NUS	US	Xeon E5-1630 v4 4C/3.7GHz/10MB/140W/DDR4-2400	NVIDIA Quadro M4000 8GB	2x8GB RDIMM DDR4-2400 ECC	Onboard SATA	4	1x512GB SSD 2.5" SATA6Gbps	None	HH DVD±RW	9-in-1	650W 92%	None	None	USB / USB	Windows 10 Pro 64	3-year	Jul 14, 2022	06/16
30B5001PUS	US	Xeon E5-1607 v4 4C/3.1GHz/10MB/140W/DDR4-2133	Open	1x8GB RDIMM DDR4-2400 ECC	Onboard SATA	4	1x1TB HDD 7.2K 3.5" SATA6Gbps	None	HH DVD±RW	9-in-1	490W 90%	None	None	USB / USB	Windows 10 Pro 64	3-year	Jul 14, 2022	06/16
30B5001QUS	US	Xeon E5-1630 v4 4C/3.7GHz/10MB/140W/DDR4-2400	NVIDIA Quadro M4000 8GB	2x8GB RDIMM DDR4-2400 ECC	Onboard SATA	4	1x1TB HDD 7.2K 3.5" SATA6Gbps	None	HH DVD±RW	9-in-1	650W 92%	None	None	USB / USB	Windows 10 Pro 64	3-year	Jul 14, 2022	06/16
30B50022US	US	Xeon E5-1650 v4 6C/3.6GHz/15MB/140W/DDR4-2400	Open	1x8GB RDIMM DDR4-2400 ECC	Onboard SATA	4	1x1TB HDD 7.2K 3.5" SATA6Gbps	None	HH DVD±RW	9-in-1	650W 92%	None	None	USB / USB	Windows 10 DG Windows 7 Pro 64	3-year	Oct 20, 2022	09/16

Model	Region	Processor	Graphics	Memory	Storage Controller	Max Drives in 3.5" Bays	Disks	M.2 Drives	Optical	Media Reader	Power Supply	Add-on Ports	Discrete Ethernet	Keyboard / Mouse	Operating System	Warranty	End of Support	Ann Date (mm/yy)
30B5002EUS	US	Xeon E5-1630 v4 4C/3.7GHz/10MB/140W/DDR4-2400	Open	2x8GB RDIMM DDR4-2400 ECC	Onboard SATA	4	1x256GB SSD 2.5" SATA6Gbps Opal	None	HH DVD±RW	9-in-1	650W 92%	None	None	USB / USB	Windows 10 DG Windows 7 Pro 64	3-year	Oct 20, 2022	09/16
30B5002TUS	US	Xeon E5-1620 v4 4C/3.5GHz/10MB/140W/DDR4-2400	NVIDIA Quadro K620 2GB	1x8GB RDIMM DDR4-2400 ECC	Onboard SATA	4	1x1TB HDD 7.2K 3.5" SATA6Gbps	None	HH DVD±RW	9-in-1	490W 90%	None	None	USB / USB	Windows 10 Pro 64	3-year	Jul 14, 2022	06/16
30B5002UUS	US	Xeon E5-1630 v4 4C/3.7GHz/10MB/140W/DDR4-2400	Open	1x8GB RDIMM DDR4-2400 ECC	Onboard SATA	4	1x256GB SSD 2.5" SATA6Gbps Opal	None	HH DVD±RW	9-in-1	490W 90%	None	None	USB / USB	Windows 10 Pro 64	3-year	Jul 14, 2022	06/16
30B5002VUS	US	Xeon E5-1630 v4 4C/3.7GHz/10MB/140W/DDR4-2400	NVIDIA Quadro K1200 4GB	1x8GB RDIMM DDR4-2400 ECC	Onboard SATA	4	1x256GB SSD 2.5" SATA6Gbps Opal	None	HH DVD±RW	9-in-1	490W 90%	None	None	USB / USB	Windows 10 Pro 64	3-year	Jul 14, 2022	06/16
30B5002WUS	US	Xeon E5-1630 v4 4C/3.7GHz/10MB/140W/DDR4-2400	NVIDIA Quadro M2000 4GB	1x8GB RDIMM DDR4-2400 ECC	Onboard SATA	4	1x256GB SSD 2.5" SATA6Gbps Opal	None	HH DVD±RW	9-in-1	490W 90%	None	None	USB / USB	Windows 10 Pro 64	3-year	Jul 14, 2022	06/16
30B5002XUS	US	Xeon E5-1630 v4 4C/3.7GHz/10MB/140W/DDR4-2400	NVIDIA Quadro K1200 4GB	1x8GB RDIMM DDR4-2400 ECC	Onboard SATA	4	1x1TB HDD 7.2K 3.5" SATA6Gbps	None	HH DVD±RW	9-in-1	490W 90%	None	None	USB / USB	Windows 10 Pro 64	3-year	Jul 14, 2022	06/16
30B5002YUS	US	Xeon E5-1620 v4 4C/3.5GHz/10MB/140W/DDR4-2400	NVIDIA Quadro M4000 8GB	2x8GB RDIMM DDR4-2400 ECC	Onboard SATA	4	1x1TB HDD 7.2K 3.5" SATA6Gbps	None	HH DVD±RW	9-in-1	650W 92%	None	None	USB / USB	Windows 10 Pro 64	3-year	Jun 14, 2021	06/16
30B50030US	US	Xeon E5-1630 v4 4C/3.7GHz/10MB/140W/DDR4-2400	Open	1x8GB RDIMM DDR4-2400 ECC	Onboard SATA	4	1x256GB SSD 2.5" SATA6Gbps Opal	None	HH DVD±RW	9-in-1	650W 92%	None	None	USB / USB	Windows 10 Pro 64	3-year	Jun 14, 2021	06/16
30B50031US	US	Xeon E5-1630 v4 4C/3.7GHz/10MB/140W/DDR4-2400	NVIDIA Quadro M2000 4GB	1x8GB RDIMM DDR4-2400 ECC	Onboard SATA	4	1x256GB SSD 2.5" SATA6Gbps Opal	None	HH DVD±RW	9-in-1	650W 92%	None	None	USB / USB	Windows 10 Pro 64	3-year	Jun 14, 2021	06/16
30B50032US	US	Xeon E5-1650 v4 6C/3.6GHz/15MB/140W/DDR4-2400	Open	2x8GB RDIMM DDR4-2400 ECC	Onboard SATA	4	1x256GB SSD 2.5" SATA6Gbps Opal	None	HH DVD±RW	9-in-1	650W 92%	None	None	USB / USB	Windows 10 Pro 64	3-year	Jun 14, 2021	06/16
30B50033US	US	Xeon E5-1650 v4 6C/3.6GHz/15MB/140W/DDR4-2400	NVIDIA Quadro M2000 4GB	2x8GB RDIMM DDR4-2400 ECC	Onboard SATA	4	1x1TB HDD 7.2K 3.5" SATA6Gbps	None	HH DVD±RW	9-in-1	650W 92%	None	None	USB / USB	Windows 10 Pro 64	3-year	Jun 14, 2021	06/16
30B50034US	US	Xeon E5-1650 v4 6C/3.6GHz/15MB/140W/DDR4-2400	NVIDIA Quadro M4000 8GB	2x8GB RDIMM DDR4-2400 ECC	Onboard SATA	4	1x1TB HDD 7.2K 3.5" SATA6Gbps	None	HH DVD±RW	9-in-1	650W 92%	None	None	USB / USB	Windows 10 Pro 64	3-year	Jun 14, 2021	06/16

Model	Region	Processor	Graphics	Memory	Storage Controller	Max Drives in 3.5" Bays	Disks	M.2 Drives	Optical	Media Reader	Power Supply	Add-on Ports	Discrete Ethernet	Keyboard / Mouse	Operating System	Warranty	End of Support	Ann Date (mm/yy)
30B50035US	US	Xeon E5-1650 v4 6C/3.6GHz/15MB/140W/DDR4-2400	NVIDIA Quadro M4000 8GB	2x8GB RDIMM DDR4-2400 ECC	Onboard SATA	4	1x512GB SSD 2.5" SATA6Gbps	None	HH DVD±RW	9-in-1	650W 92%	None	None	USB / USB	Windows 10 Pro 64	3-year	Jun 14, 2021	06/16
30B50036US	US	Xeon E5-1650 v4 6C/3.6GHz/15MB/140W/DDR4-2400	NVIDIA Quadro M5000 8GB	2x8GB RDIMM DDR4-2400 ECC	Onboard SATA	4	1x512GB SSD 2.5" SATA6Gbps	None	HH DVD±RW	9-in-1	650W 92%	None	None	USB / USB	Windows 10 Pro 64	3-year	Jun 14, 2021	06/16
30B5003KUS	US	Xeon E5-1607 v4 4C/3.1GHz/10MB/140W/DDR4-2133	Open	1x8GB RDIMM DDR4-2400 ECC	Onboard SATA	4	1x1TB HDD 7.2K 3.5" SATA6Gbps	None	HH DVD±RW	9-in-1	490W 90%	None	None	USB / USB	Windows 10 DG Windows 7 Pro 64	3-year	Oct 20, 2022	09/16
30B5003NUS	US	Xeon E5-1620 v4 4C/3.5GHz/10MB/140W/DDR4-2400	NVIDIA Quadro M4000 8GB	2x8GB RDIMM DDR4-2400 ECC	Onboard SATA	4	1x1TB HDD 7.2K 3.5" SATA6Gbps	None	HH DVD±RW	9-in-1	650W 92%	None	None	USB / USB	Windows 10 DG Windows 7 Pro 64	3-year	Oct 20, 2022	09/16
30B5003UUS	US	Xeon E5-1620 v4 4C/3.5GHz/10MB/140W/DDR4-2400	Open	1x8GB RDIMM DDR4-2400 ECC	Onboard SATA	4	1x1TB HDD 7.2K 3.5" SATA6Gbps	None	HH DVD±RW	9-in-1	490W 90%	None	None	USB / USB	Windows 10 DG Windows 7 Pro 64	3-year	Oct 20, 2022	09/16
30B5004YUS	US	Xeon E5-1630 v4 4C/3.7GHz/10MB/140W/DDR4-2400	NVIDIA Quadro M4000 8GB	2x8GB RDIMM DDR4-2400 ECC	Onboard SATA	4	1x1TB HDD 7.2K 3.5" SATA6Gbps	None	HH DVD±RW	9-in-1	650W 92%	None	None	USB / USB	Windows 10 DG Windows 7 Pro 64	3-year	Oct 20, 2022	09/16
30B50050US	US	Xeon E5-1630 v4 4C/3.7GHz/10MB/140W/DDR4-2400	NVIDIA Quadro M4000 8GB	2x8GB RDIMM DDR4-2400 ECC	Onboard SATA	4	1x512GB SSD 2.5" SATA6Gbps	None	HH DVD±RW	9-in-1	650W 92%	None	None	USB / USB	Windows 10 DG Windows 7 Pro 64	3-year	Oct 20, 2022	09/16
30B50051US	US	Xeon E5-1620 v4 4C/3.5GHz/10MB/140W/DDR4-2400	NVIDIA Quadro M2000 4GB	2x8GB RDIMM DDR4-2400 ECC	Onboard SATA	4	1x512GB SSD 2.5" SATA6Gbps	None	HH DVD±RW	9-in-1	490W 90%	None	None	USB / USB	Windows 10 DG Windows 7 Pro 64	3-year	Oct 20, 2022	09/16
30B50052US	US	Xeon E5-1607 v4 4C/3.1GHz/10MB/140W/DDR4-2133	NVIDIA Quadro K620 2GB	1x8GB RDIMM DDR4-2400 ECC	Onboard SATA	4	1x500GB HDD 7.2K 3.5" SATA6Gbps	None	HH DVD±RW	9-in-1	490W 90%	None	None	USB / USB	Windows 10 DG Windows 7 Pro 64	3-year	Oct 20, 2022	09/16
30B50053US	US	Xeon E5-1620 v4 4C/3.5GHz/10MB/140W/DDR4-2400	Open	1x8GB RDIMM DDR4-2400 ECC	Onboard SATA	4	1x1TB HDD 7.2K 3.5" SATA6Gbps	None	HH DVD±RW	9-in-1	650W 92%	None	None	USB / USB	Windows 10 DG Windows 7 Pro 64	3-year	Oct 20, 2022	09/16
30B50054US	US	Xeon E5-1607 v4 4C/3.1GHz/10MB/140W/DDR4-2133	NVIDIA Quadro K620 2GB	1x8GB RDIMM DDR4-2400 ECC	Onboard SATA	4	1x1TB HDD 7.2K 3.5" SATA6Gbps	None	HH DVD±RW	9-in-1	490W 90%	None	None	USB / USB	Windows 10 DG Windows 7 Pro 64	3-year	Oct 20, 2022	09/16
30B50055US	US	Xeon E5-1620 v4 4C/3.5GHz/10MB/140W/DDR4-2400	NVIDIA Quadro M2000 4GB	1x8GB RDIMM DDR4-2400 ECC	Onboard SATA	4	1x1TB HDD 7.2K 3.5" SATA6Gbps	None	HH DVD±RW	9-in-1	490W 90%	None	None	USB / USB	Windows 10 DG Windows 7 Pro 64	3-year	Oct 20, 2022	09/16



Model	Region	Processor	Graphics	Memory	Storage Controller	Max Drives in 3.5" Bays	Disks	M.2 Drives	Optical	Media Reader	Power Supply	Add-on Ports	Discrete Ethernet	Keyboard / Mouse	Operating System	Warranty	End of Support	Ann Date (mm/yy)
30B50056US	US	Xeon E5-1650 v4 6C/3.6GHz/15MB/140W/DDR4-2400	NVIDIA Quadro M4000 8GB	2x8GB RDIMM DDR4-2400 ECC	Onboard SATA	4	1x1TB HDD 7.2K 3.5" SATA6Gbps	None	HH DVD±RW	9-in-1	650W 92%	None	None	USB / USB	Windows 10 DG Windows 7 Pro 64	3-year	Oct 20, 2022	09/16
30B50057US	US	Xeon E5-1630 v4 4C/3.7GHz/10MB/140W/DDR4-2400	NVIDIA Quadro K1200 4GB	1x8GB RDIMM DDR4-2400 ECC	Onboard SATA	4	1x1TB HDD 7.2K 3.5" SATA6Gbps	None	HH DVD±RW	9-in-1	490W 90%	None	None	USB / USB	Windows 10 DG Windows 7 Pro 64	3-year	Oct 20, 2022	09/16
30B50058US	US	Xeon E5-1630 v4 4C/3.7GHz/10MB/140W/DDR4-2400	Open	1x8GB RDIMM DDR4-2400 ECC	Onboard SATA	4	1x256GB SSD 2.5" SATA6Gbps Opal	None	HH DVD±RW	9-in-1	490W 90%	None	None	USB / USB	Windows 10 DG Windows 7 Pro 64	3-year	Oct 20, 2022	09/16
30B50059US	US	Xeon E5-1630 v4 4C/3.7GHz/10MB/140W/DDR4-2400	NVIDIA Quadro M2000 4GB	1x8GB RDIMM DDR4-2400 ECC	Onboard SATA	4	1x256GB SSD 2.5" SATA6Gbps Opal	None	HH DVD±RW	9-in-1	490W 90%	None	None	USB / USB	Windows 10 DG Windows 7 Pro 64	3-year	Oct 20, 2022	09/16
30B5005AUS	US	Xeon E5-1650 v4 6C/3.6GHz/15MB/140W/DDR4-2400	NVIDIA Quadro M5000 8GB	2x8GB RDIMM DDR4-2400 ECC	Onboard SATA	4	1x512GB SSD 2.5" SATA6Gbps	None	HH DVD±RW	9-in-1	650W 92%	None	None	USB / USB	Windows 10 DG Windows 7 Pro 64	3-year	Oct 20, 2022	09/16
30B5005BUS	US	Xeon E5-1630 v4 4C/3.7GHz/10MB/140W/DDR4-2400	NVIDIA Quadro K1200 4GB	1x8GB RDIMM DDR4-2400 ECC	Onboard SATA	4	1x256GB SSD 2.5" SATA6Gbps Opal	None	HH DVD±RW	9-in-1	490W 90%	None	None	USB / USB	Windows 10 DG Windows 7 Pro 64	3-year	Oct 20, 2022	09/16
30B5005CUS	US	Xeon E5-1650 v4 6C/3.6GHz/15MB/140W/DDR4-2400	NVIDIA Quadro M2000 4GB	2x8GB RDIMM DDR4-2400 ECC	Onboard SATA	4	1x1TB HDD 7.2K 3.5" SATA6Gbps	None	HH DVD±RW	9-in-1	650W 92%	None	None	USB / USB	Windows 10 DG Windows 7 Pro 64	3-year	Oct 20, 2022	09/16
30B5005DUS	US	Xeon E5-1630 v4 4C/3.7GHz/10MB/140W/DDR4-2400	Open	1x8GB RDIMM DDR4-2400 ECC	Onboard SATA	4	1x256GB SSD 2.5" SATA6Gbps Opal	None	HH DVD±RW	9-in-1	650W 92%	None	None	USB / USB	Windows 10 DG Windows 7 Pro 64	3-year	Oct 20, 2022	09/16
30B5005EUS	US	Xeon E5-1650 v4 6C/3.6GHz/15MB/140W/DDR4-2400	Open	2x8GB RDIMM DDR4-2400 ECC	Onboard SATA	4	1x256GB SSD 2.5" SATA6Gbps Opal	None	HH DVD±RW	9-in-1	650W 92%	None	None	USB / USB	Windows 10 DG Windows 7 Pro 64	3-year	Oct 20, 2022	09/16
30B5005FUS	US	Xeon E5-1650 v4 6C/3.6GHz/15MB/140W/DDR4-2400	NVIDIA Quadro M4000 8GB	2x8GB RDIMM DDR4-2400 ECC	Onboard SATA	4	1x512GB SSD 2.5" SATA6Gbps	None	HH DVD±RW	9-in-1	650W 92%	None	None	USB / USB	Windows 10 DG Windows 7 Pro 64	3-year	Oct 20, 2022	09/16
30B5005GUS	US	Xeon E5-1620 v4 4C/3.5GHz/10MB/140W/DDR4-2400	NVIDIA Quadro K620 2GB	1x8GB RDIMM DDR4-2400 ECC	Onboard SATA	4	1x1TB HDD 7.2K 3.5" SATA6Gbps	None	HH DVD±RW	9-in-1	490W 90%	None	None	USB / USB	Windows 10 DG Windows 7 Pro 64	3-year	Oct 20, 2022	09/16
30B5005HUS	US	Xeon E5-1630 v4 4C/3.7GHz/10MB/140W/DDR4-2400	NVIDIA Quadro M2000 4GB	1x8GB RDIMM DDR4-2400 ECC	Onboard SATA	4	1x256GB SSD 2.5" SATA6Gbps Opal	None	HH DVD±RW	9-in-1	650W 92%	None	None	USB / USB	Windows 10 DG Windows 7 Pro 64	3-year	Oct 20, 2022	09/16

Model	Region	Processor	Graphics	Memory	Storage Controller	Max Drives in 3.5" Bays	Disks	M.2 Drives	Optical	Media Reader	Power Supply	Add-on Ports	Discrete Ethernet	Keyboard / Mouse	Operating System	Warranty	End of Support	Ann Date (mm/yy)
30B5005KUS	US	Xeon E5-1620 v4 4C/3.5GHz/10MB/140W/DDR4-2400	Open	2x8GB RDIMM DDR4-2400 ECC	9364-8i PCIe	4	Open	1x1TB SSD M.2 PCIe NVMe Opal	HH DVD±RW	9-in-1	650W 92%	None	None	USB / USB	Windows 10 DG Windows 7 Pro 64	3-year	Jan 5, 2023	12/16
30B5005LUS	US	Xeon E5-1650 v4 6C/3.6GHz/15MB/140W/DDR4-2400	Open	2x8GB RDIMM DDR4-2400 ECC	Onboard SATA	4	Open	1x1TB SSD M.2 PCIe NVMe Opal	HH DVD±RW	9-in-1	650W 92%	None	None	USB / USB	Windows 10 DG Windows 7 Pro 64	3-year	Jan 5, 2023	12/16
30B5005MUS	US	Xeon E5-1620 v4 4C/3.5GHz/10MB/140W/DDR4-2400	Open	2x8GB RDIMM DDR4-2400 ECC	Onboard SATA	4	Open	1x1TB SSD M.2 PCIe NVMe Opal	HH DVD±RW	9-in-1	650W 92%	None	None	USB / USB	Windows 10 DG Windows 7 Pro 64	3-year	Jan 5, 2023	12/16
30B5005NUS	US	Xeon E5-1607 v4 4C/3.1GHz/10MB/140W/DDR4-2133	Open	2x8GB RDIMM DDR4-2400 ECC	Onboard SATA	4	Open	1x1TB SSD M.2 PCIe NVMe Opal	HH DVD±RW	9-in-1	650W 92%	None	None	USB / USB	Windows 10 DG Windows 7 Pro 64	3-year	Jan 5, 2023	12/16
30B5005PUS	US	Xeon E5-1607 v4 4C/3.1GHz/10MB/140W/DDR4-2133	NVIDIA Quadro P5000 16GB	2x8GB RDIMM DDR4-2400 ECC	Onboard SATA	4	Open	1x1TB SSD M.2 PCIe NVMe Opal	HH DVD±RW	9-in-1	650W 92%	None	None	USB / USB	Windows 10 DG Windows 7 Pro 64	3-year	Jan 5, 2023	12/16
30B5005QUS	US	Xeon E5-1650 v4 6C/3.6GHz/15MB/140W/DDR4-2400	NVIDIA Quadro P5000 16GB	2x8GB RDIMM DDR4-2400 ECC	Onboard SATA	4	Open	1x1TB SSD M.2 PCIe NVMe Opal	HH DVD±RW	9-in-1	650W 92%	None	None	USB / USB	Windows 10 DG Windows 7 Pro 64	3-year	Jan 5, 2023	12/16
30B5005RUS	US	Xeon E5-1630 v4 4C/3.7GHz/10MB/140W/DDR4-2400	Open	2x8GB RDIMM DDR4-2400 ECC	Onboard SATA	4	Open	1x1TB SSD M.2 PCIe NVMe Opal	HH DVD±RW	9-in-1	650W 92%	None	None	USB / USB	Windows 10 DG Windows 7 Pro 64	3-year	Jan 5, 2023	12/16
30B5005SUS	US	Xeon E5-1620 v4 4C/3.5GHz/10MB/140W/DDR4-2400	Open	2x8GB RDIMM DDR4-2400 ECC	Onboard SATA	4	Open	1x1TB SSD M.2 PCIe NVMe Opal	HH DVD±RW	9-in-1	650W 92%	None	None	USB / USB	Windows 10 DG Windows 7 Pro 64	3-year	Jan 5, 2023	12/16
30B5005VUS	US	Xeon E5-1620 v4 4C/3.5GHz/10MB/140W/DDR4-2400	NVIDIA Quadro P600 2GB	1x8GB RDIMM DDR4-2400 ECC	Onboard SATA	4	1x1TB HDD 7.2K 3.5" SATA6Gbps	None	HH DVD±RW	9-in-1	490W 90%	None	None	USB / USB	Windows 10 DG Windows 7 Pro 64	3-year	Apr 24, 2022	04/17
30B5005WUS	US	Xeon E5-1620 v4 4C/3.5GHz/10MB/140W/DDR4-2400	NVIDIA Quadro P2000 5GB	2x8GB RDIMM DDR4-2400 ECC	Onboard SATA	4	1x512GB SSD 2.5" SATA6Gbps	None	HH DVD±RW	9-in-1	490W 90%	None	None	USB / USB	Windows 10 DG Windows 7 Pro 64	3-year	Apr 24, 2022	04/17
30B5005XUS	US	Xeon E5-1650 v4 6C/3.6GHz/15MB/140W/DDR4-2400	NVIDIA Quadro P2000 5GB	2x8GB RDIMM DDR4-2400 ECC	Onboard SATA	4	1x1TB HDD 7.2K 3.5" SATA6Gbps	None	HH DVD±RW	9-in-1	650W 92%	None	None	USB / USB	Windows 10 DG Windows 7 Pro 64	3-year	Apr 24, 2022	04/17
30B5005YUS	US	Xeon E5-1620 v4 4C/3.5GHz/10MB/140W/DDR4-2400	NVIDIA Quadro P4000 8GB	2x8GB RDIMM DDR4-2400 ECC	Onboard SATA	4	1x1TB HDD 7.2K 3.5" SATA6Gbps	None	HH DVD±RW	9-in-1	650W 92%	None	None	USB / USB	Windows 10 DG Windows 7 Pro 64	3-year	Apr 24, 2022	04/17

Model	Region	Processor	Graphics	Memory	Storage Controller	Max Drives in 3.5" Bays	Disks	M.2 Drives	Optical	Media Reader	Power Supply	Add-on Ports	Discrete Ethernet	Keyboard / Mouse	Operating System	Warranty	End of Support	Ann Date (mm/yy)
30B50060US	US	Xeon E5-1650 v4 6C/3.6GHz/15MB/140W/DDR4-2400	NVIDIA Quadro P4000 8GB	2x8GB RDIMM DDR4-2400 ECC	Onboard SATA	4	1x1TB HDD 7.2K 3.5" SATA6Gbps	None	HH DVD±RW	9-in-1	650W 92%	None	None	USB / USB	Windows 10 DG Windows 7 Pro 64	3-year	Apr 24, 2022	04/17
30B50061US	US	Xeon E5-1650 v4 6C/3.6GHz/15MB/140W/DDR4-2400	NVIDIA Quadro P2000 5GB	2x8GB RDIMM DDR4-2400 ECC	Onboard SATA	4	1x1TB HDD 7.2K 3.5" SATA6Gbps	None	HH DVD±RW	9-in-1	490W 90%	None	None	USB / USB	Windows 10 DG Windows 7 Pro 64	3-year	Apr 24, 2022	04/17
30B50062US	US	Xeon E5-1630 v4 4C/3.7GHz/10MB/140W/DDR4-2400	NVIDIA Quadro P4000 8GB	2x8GB RDIMM DDR4-2400 ECC	Onboard SATA	4	1x512GB SSD SATA6Gbps	None	HH DVD±RW	9-in-1	650W 92%	None	None	USB / USB	Windows 10 DG Windows 7 Pro 64	3-year	Apr 24, 2022	04/17
30B50063US	US	Xeon E5-1650 v4 6C/3.6GHz/15MB/140W/DDR4-2400	NVIDIA Quadro P2000 5GB	1x8GB RDIMM DDR4-2400 ECC	Onboard SATA	4	1x1TB HDD 7.2K 3.5" SATA6Gbps	None	HH DVD±RW	9-in-1	490W 90%	None	None	USB / USB	Windows 10 DG Windows 7 Pro 64	3-year	Apr 24, 2022	04/17
30B50064US	US	Xeon E5-1630 v4 4C/3.7GHz/10MB/140W/DDR4-2400	NVIDIA Quadro P2000 5GB	1x8GB RDIMM DDR4-2400 ECC	Onboard SATA	4	1x256GB SSD 2.5" SATA6Gbps Opal	None	HH DVD±RW	9-in-1	490W 90%	None	None	USB / USB	Windows 10 DG Windows 7 Pro 64	3-year	Apr 24, 2022	04/17
30B50065US	US	Xeon E5-1630 v4 4C/3.7GHz/10MB/140W/DDR4-2400	NVIDIA Quadro P1000 4GB	1x8GB RDIMM DDR4-2400 ECC	Onboard SATA	4	1x256GB SSD 2.5" SATA6Gbps Opal	None	HH DVD±RW	9-in-1	490W 90%	None	None	USB / USB	Windows 10 DG Windows 7 Pro 64	3-year	Apr 24, 2022	04/17
30B50066US	US	Xeon E5-1630 v4 4C/3.7GHz/10MB/140W/DDR4-2400	NVIDIA Quadro P2000 5GB	1x8GB RDIMM DDR4-2400 ECC	Onboard SATA	4	1x256GB SSD 2.5" SATA6Gbps Opal	None	HH DVD±RW	9-in-1	650W 92%	None	None	USB / USB	Windows 10 DG Windows 7 Pro 64	3-year	Apr 24, 2022	04/17
30B50067US	US	Xeon E5-1630 v4 4C/3.7GHz/10MB/140W/DDR4-2400	NVIDIA Quadro P1000 4GB	1x8GB RDIMM DDR4-2400 ECC	Onboard SATA	4	1x1TB HDD 7.2K 3.5" SATA6Gbps	None	HH DVD±RW	9-in-1	490W 90%	None	None	USB / USB	Windows 10 DG Windows 7 Pro 64	3-year	Apr 24, 2022	04/17
30B50068US	US	Xeon E5-1650 v4 6C/3.6GHz/15MB/140W/DDR4-2400	NVIDIA Quadro P4000 8GB	2x8GB RDIMM DDR4-2400 ECC	Onboard SATA	4	1x512GB SSD 2.5" SATA6Gbps	None	HH DVD±RW	9-in-1	650W 92%	None	None	USB / USB	Windows 10 DG Windows 7 Pro 64	3-year	Apr 24, 2022	04/17
30B50069US	US	Xeon E5-1607 v4 4C/3.1GHz/10MB/140W/DDR4-2133	NVIDIA Quadro P600 2GB	1x8GB RDIMM DDR4-2400 ECC	Onboard SATA	4	1x1TB HDD 7.2K 3.5" SATA6Gbps	None	HH DVD±RW	9-in-1	490W 90%	None	None	USB / USB	Windows 10 DG Windows 7 Pro 64	3-year	Apr 24, 2022	04/17
30B5006AUS	US	Xeon E5-1630 v4 4C/3.7GHz/10MB/140W/DDR4-2400	NVIDIA Quadro P600 2GB	1x8GB RDIMM DDR4-2400 ECC	Onboard SATA	4	1x1TB HDD 7.2K 3.5" SATA6Gbps	None	HH DVD±RW	9-in-1	490W 90%	None	None	USB / USB	Windows 10 DG Windows 7 Pro 64	3-year	Apr 24, 2022	04/17
30B5006BUS	US	Xeon E5-1630 v4 4C/3.7GHz/10MB/140W/DDR4-2400	NVIDIA Quadro P600 2GB	1x8GB RDIMM DDR4-2400 ECC	Onboard SATA	4	1x256GB SSD 2.5" SATA6Gbps Opal	None	HH DVD±RW	9-in-1	490W 90%	None	None	USB / USB	Windows 10 DG Windows 7 Pro 64	3-year	Apr 24, 2022	04/17

Model	Region	Processor	Graphics	Memory	Storage Controller	Max Drives in 3.5" Bays	Disks	M.2 Drives	Optical	Media Reader	Power Supply	Add-on Ports	Discrete Ethernet	Keyboard / Mouse	Operating System	Warranty	End of Support	Ann Date (mm/yy)
30B5006CUS	US	Xeon E5-1630 v4 4C/3.7GHz/ 10MB/140W/DDR4-2400	NVIDIA Quadro P4000 8GB	2x8GB RDIMM DDR4-2400 ECC	Onboard SATA	4	1x1TB HDD 7.2K 3.5" SATA6Gbps	None	HH DVD±RW	9-in-1	650W 92%	None	None	USB / USB	Windows 10 DG Windows 7 Pro 64	3-year	Apr 24, 2022	04/17
30B5006HUS	US	Xeon E5-1650 v4 6C/3.6GHz/ 15MB/140W/DDR4-2400	Open	1x16GB RDIMM DDR4-2400 ECC	Onboard SATA	4	Open	1x512GB SSD M.2 PCIe	HH DVD±RW	9-in-1	650W 92%	None	None	USB / USB	Windows 10 DG Windows 7 Pro 64	3-year	Jul 31, 2022	07/17
30B5006JUS	US	Xeon E5-1630 v4 4C/3.7GHz/ 10MB/140W/DDR4-2400	Open	1x16GB RDIMM DDR4-2400 ECC	Onboard SATA	4	Open	1x256GB SSD M.2 PCIe Opal	HH DVD±RW	9-in-1	650W 92%	None	None	USB / USB	Windows 10 DG Windows 7 Pro 64	3-year	Jul 31, 2022	07/17
30B5006KUS	US	Xeon E5-1620 v4 4C/3.5GHz/ 10MB/140W/DDR4-2400	Open	1x8GB RDIMM DDR4-2400 ECC	Onboard SATA	4	Open	1x256GB SSD M.2 PCIe Opal	HH DVD±RW	9-in-1	650W 92%	None	None	USB / USB	Windows 10 DG Windows 7 Pro 64	3-year	Jul 31, 2022	07/17

# ThinkStation P710 Platform Specifications

Components	Specification																																																																																																																																										
Chipset	Intel C612 Platform Controller Hub (PCH)																																																																																																																																										
System mgmt	Intel Active Management Technology 9																																																																																																																																										
Processor	Up to two 145W <b>Intel Xeon E5-2600 v4</b> family processors. Each processor supports up to 22 cores up to 2.2GHz, 16 cores up to 2.6GHz, 14 cores up to 2.6GHz, 12 cores up to 2.2GHz, 10 cores up to 2.4GHz, 8 cores up to 3.2GHz, 6 cores up to 3.4GHz, 4 cores up to 3.5GHz. Or up to two Intel Xeon E5-2620 v3 or E5-2609 v3 processors (not available in EMEA)																																																																																																																																										
Coprocessor	None																																																																																																																																										
Memory DIMM slots	12 DIMM sockets (6 DIMMs per processor), 8-channel capable (4-channel per processor). RDIMM, ECC, DDR4-2400																																																																																																																																										
Memory capacity	384GB, 2nd CPU is needed																																																																																																																																										
Graphics, GPU computing	Three PCIe 3.0 x16 slots, two via CPU1, one via CPU2. Up to three graphics and GPU computing adapters, 2nd CPU is needed																																																																																																																																										
	<table border="1"> <thead> <tr> <th>PSU</th> <th>Maximum quantity of PCIe x16 adapters per system (by power)</th> </tr> </thead> <tbody> <tr> <td>650W 1x150W+2x75W with onboard SATA controller and up to two 120W CPU each</td> <td>1x150W+2x75W</td> </tr> <tr> <td>850W 1x300W+2x75W (up to two 120W CPU each), or 2x150W+1x75W</td> <td>1x300W+2x75W</td> </tr> </tbody> </table>	PSU	Maximum quantity of PCIe x16 adapters per system (by power)	650W 1x150W+2x75W with onboard SATA controller and up to two 120W CPU each	1x150W+2x75W	850W 1x300W+2x75W (up to two 120W CPU each), or 2x150W+1x75W	1x300W+2x75W																																																																																																																																				
PSU	Maximum quantity of PCIe x16 adapters per system (by power)																																																																																																																																										
650W 1x150W+2x75W with onboard SATA controller and up to two 120W CPU each	1x150W+2x75W																																																																																																																																										
850W 1x300W+2x75W (up to two 120W CPU each), or 2x150W+1x75W	1x300W+2x75W																																																																																																																																										
Supporting Graphics and GPU computing	<table border="1"> <thead> <tr> <th>Adapter</th> <th>Cores</th> <th>Memory</th> <th>Power</th> <th>Connector***</th> <th>SLI</th> </tr> </thead> <tbody> <tr> <td>NVS 310</td> <td>48</td> <td>1GB</td> <td>19.5W</td> <td>2xDP</td> <td></td> </tr> <tr> <td>NVS 315</td> <td>48</td> <td>1GB</td> <td>19.5W</td> <td>2xDVI-I SL/2xDP</td> <td></td> </tr> <tr> <td>NVS 510</td> <td>192</td> <td>2GB</td> <td>35W</td> <td>4xmini DP</td> <td></td> </tr> <tr> <td>NVS 810</td> <td>1024</td> <td>4GB</td> <td>68W</td> <td>8xmini DP</td> <td></td> </tr> <tr> <td>Quadro K420</td> <td>192</td> <td>2GB</td> <td>41W</td> <td>DVI-I DL+DP</td> <td></td> </tr> <tr> <td>Quadro K620</td> <td>384</td> <td>2GB</td> <td>45W</td> <td>DVI-I DL+DP</td> <td></td> </tr> <tr> <td>Quadro K1200</td> <td>512</td> <td>4GB</td> <td>45W</td> <td>4xmini DP</td> <td></td> </tr> <tr> <td>Quadro K2200</td> <td>640</td> <td>4GB</td> <td>68W</td> <td>DVI-I DL+2xDP</td> <td></td> </tr> <tr> <td>Quadro K4200</td> <td>1344</td> <td>4GB</td> <td>108W</td> <td>DVI-I DL+2xDP</td> <td></td> </tr> <tr> <td>Quadro K5200</td> <td>2304</td> <td>8GB</td> <td>150W</td> <td>DVI-I DL+DVI-D DL+2xDP</td> <td>SLI</td> </tr> <tr> <td>Quadro M2000</td> <td>768</td> <td>4GB</td> <td>75W</td> <td>4xDP</td> <td></td> </tr> <tr> <td>Quadro M4000</td> <td>1664</td> <td>8GB</td> <td>120W</td> <td>4xDP</td> <td></td> </tr> <tr> <td>Quadro M5000</td> <td>2048</td> <td>8GB</td> <td>150W</td> <td>DVI-I DL+4xDP</td> <td>SLI</td> </tr> <tr> <td>Quadro M6000</td> <td>3072</td> <td>24GB</td> <td>250W</td> <td>DVI-I DL+4xDP</td> <td>SLI</td> </tr> <tr> <td>Quadro P400</td> <td>256</td> <td>2GB</td> <td>30W</td> <td>3xminiDP</td> <td></td> </tr> <tr> <td>Quadro P600</td> <td>384</td> <td>2GB</td> <td>40W</td> <td>4xminiDP</td> <td></td> </tr> <tr> <td>Quadro P1000</td> <td>640</td> <td>4GB</td> <td>47W</td> <td>4xminiDP</td> <td></td> </tr> <tr> <td>Quadro P2000</td> <td>1024</td> <td>5GB</td> <td>75W</td> <td>4xDP</td> <td></td> </tr> <tr> <td>Quadro P4000</td> <td>1792</td> <td>8GB</td> <td>105W</td> <td>4xDP</td> <td>SLI</td> </tr> <tr> <td>Quadro P5000</td> <td>2560</td> <td>16GB</td> <td>180W</td> <td>DVI-D DL+4xDP</td> <td>SLI</td> </tr> <tr> <td>Quadro P6000</td> <td>3840</td> <td>24GB</td> <td>250W</td> <td>DVI-D DL+4xDP</td> <td>SLI</td> </tr> <tr> <td>Tesla K40</td> <td>2880</td> <td>12GB</td> <td>235W</td> <td></td> <td></td> </tr> </tbody> </table>	Adapter	Cores	Memory	Power	Connector***	SLI	NVS 310	48	1GB	19.5W	2xDP		NVS 315	48	1GB	19.5W	2xDVI-I SL/2xDP		NVS 510	192	2GB	35W	4xmini DP		NVS 810	1024	4GB	68W	8xmini DP		Quadro K420	192	2GB	41W	DVI-I DL+DP		Quadro K620	384	2GB	45W	DVI-I DL+DP		Quadro K1200	512	4GB	45W	4xmini DP		Quadro K2200	640	4GB	68W	DVI-I DL+2xDP		Quadro K4200	1344	4GB	108W	DVI-I DL+2xDP		Quadro K5200	2304	8GB	150W	DVI-I DL+DVI-D DL+2xDP	SLI	Quadro M2000	768	4GB	75W	4xDP		Quadro M4000	1664	8GB	120W	4xDP		Quadro M5000	2048	8GB	150W	DVI-I DL+4xDP	SLI	Quadro M6000	3072	24GB	250W	DVI-I DL+4xDP	SLI	Quadro P400	256	2GB	30W	3xminiDP		Quadro P600	384	2GB	40W	4xminiDP		Quadro P1000	640	4GB	47W	4xminiDP		Quadro P2000	1024	5GB	75W	4xDP		Quadro P4000	1792	8GB	105W	4xDP	SLI	Quadro P5000	2560	16GB	180W	DVI-D DL+4xDP	SLI	Quadro P6000	3840	24GB	250W	DVI-D DL+4xDP	SLI	Tesla K40	2880	12GB	235W		
	Adapter	Cores	Memory	Power	Connector***	SLI																																																																																																																																					
	NVS 310	48	1GB	19.5W	2xDP																																																																																																																																						
	NVS 315	48	1GB	19.5W	2xDVI-I SL/2xDP																																																																																																																																						
	NVS 510	192	2GB	35W	4xmini DP																																																																																																																																						
	NVS 810	1024	4GB	68W	8xmini DP																																																																																																																																						
	Quadro K420	192	2GB	41W	DVI-I DL+DP																																																																																																																																						
	Quadro K620	384	2GB	45W	DVI-I DL+DP																																																																																																																																						
	Quadro K1200	512	4GB	45W	4xmini DP																																																																																																																																						
	Quadro K2200	640	4GB	68W	DVI-I DL+2xDP																																																																																																																																						
	Quadro K4200	1344	4GB	108W	DVI-I DL+2xDP																																																																																																																																						
	Quadro K5200	2304	8GB	150W	DVI-I DL+DVI-D DL+2xDP	SLI																																																																																																																																					
	Quadro M2000	768	4GB	75W	4xDP																																																																																																																																						
	Quadro M4000	1664	8GB	120W	4xDP																																																																																																																																						
	Quadro M5000	2048	8GB	150W	DVI-I DL+4xDP	SLI																																																																																																																																					
	Quadro M6000	3072	24GB	250W	DVI-I DL+4xDP	SLI																																																																																																																																					
	Quadro P400	256	2GB	30W	3xminiDP																																																																																																																																						
	Quadro P600	384	2GB	40W	4xminiDP																																																																																																																																						
	Quadro P1000	640	4GB	47W	4xminiDP																																																																																																																																						
	Quadro P2000	1024	5GB	75W	4xDP																																																																																																																																						
Quadro P4000	1792	8GB	105W	4xDP	SLI																																																																																																																																						
Quadro P5000	2560	16GB	180W	DVI-D DL+4xDP	SLI																																																																																																																																						
Quadro P6000	3840	24GB	250W	DVI-D DL+4xDP	SLI																																																																																																																																						
Tesla K40	2880	12GB	235W																																																																																																																																								
Disk drive controller	<b>RAID 0, 1, 5, 10</b> with onboard SATA controller in chipset, SATA 6Gb/s. <b>RAID 0, 1, 5, 10</b> with optional LSI RAID flex adapter, 12Gb/s SAS and SATA. <b>RAID 0, 1, 5, 6, 10</b> with optional LSI 9364-8i PCIe adapter, 1GB memory, 12Gb/s SAS and SATA																																																																																																																																										
Drive Bays	Two external 5.25" flex bays, four 3.5" internal bays. Each 3.5" bay can support dual drives on selected models (see right)																																																																																																																																										
Flex bay	Two 5.25" flex bays for optical drives, Front Access Storage Enclosure drives, Flex Bay Storage Enclosure drives, or flex module. • Up to two half-height optical drives or up to one 9.5mm optical drive, DVD-ROM, DVD±RW, or Blu-Ray burner • Up to one Front Access Storage Enclosure for one 3.5" or 2.5" SATA drive. • Up to two Flex Bay Storage Enclosure for two 3.5" or 2.5" SATA drives.																																																																																																																																										
Supporting storage	3.5" SATA HDD, 7.2K 6Gbs	500GB/1TB/2TB/3TB/4TB/6TB/1TB hybrid/2TB hybrid																																																																																																																																									
	2.5" SAS HDD, 15K 12Gbs	300GB/600GB																																																																																																																																									
	2.5" SAS SSD, 12Gbs	200GB/400GB/800GB																																																																																																																																									
	2.5" SAS HDD, 10K 12Gbs	300GB																																																																																																																																									
	2.5" SSD, SATA6Gbs	180GB/240GB/256GB/480GB/512GB with OPAL, 256GB/512GB/1TB without OPAL																																																																																																																																									
	PCIe SSD, 2.5"	400GB																																																																																																																																									
	PCIe SSD, M.2	256 GB/512GB/1TB																																																																																																																																									
PCIe SSD adapter	400GB (up to 4 per system, 2nd CPU is needed)																																																																																																																																										

Components	Specification	
Flex connector	One flex connectors (see right), supports one of the following: • Up to one LSI RAID flex adapter for SATA/SAS RAID • Up to one Multi-I/O flex adapters for two PCIe SSD • Up to one M.2 flex adapters for two M.2 PCIe SSD	
Network interfaces	Integrated two-port gigabit ethernet (Intel i218LM and i210AT), supports Wake-on-LAN. Optional discrete ethernet adapters are available	
HD Audio	Realtek ALC662 codec	
TPM	TCG 1.2-compliant	
Power supply	One fixed 650 watts or 850 watts, autosensing, 92%, 80 PLUS Platinum qualified	
Front ports	Four USB 3.0 (one Diagnostic, one Always On), one combo audio/microphone jack (3.5mm)	
Rear ports	Four USB 2.0, four USB 3.0 (blue), one serial (9-pin), two ethernet (RJ-45), three analog audio ports (line-in, line-out, mic-in), two PS/2	
Add-on ports	Supports the following optional ports: Two IEEE 1394 (one on rear and one on front flex module) via PCIe adapter, up to one adapter per system. Two rear USB 3.0 per PCIe adapter, up to three adapters per system. One rear Thunderbolt via PCIe adapter. One front eSATA (on flex module), or one rear eSATA via cable (also needs one PCIe slot), up to one eSATA port per system. One internal USB 3.0 port via cable, cannot be intermixed with 29-in-1 reader	
Media reader	9-in-1 USB 2.0 card reader. Optional 29-in-1 USB 3.0 card reader on flex module	
Mechanical	• 36-liter: 175mm/6.89" W x 485mm/19.1" D x 446mm/17.6" H (with feet) • Tool-less parts: all except CPU fansink • 52.25 lb (23.7kg) max configuration	
Environmental specification	Temperature - operating	50 °F to 95 °F (10 °C to 35 °C)
	Temperature - non operating (no package)	14 °F to 140 °F (-10 °C to 60 °C)
	Temperature - non operating (with package)	-40 °F to 140 °F (-40 °C to 60 °C)
	Altitude - operating	(Unpressurized): 0-10000ft (0-3048m)
	Humidity - operating	10%-80%, non-condensing
	Humidity - storage (with package)	10%-90%, non-condensing
	RoHS-compliant, GREENGUARD on all models. EPEAT Gold rating, ENERGY STAR 6.1 qualified on selected models.	
Base warranty	3-year limited onsite service with 9x5/NBD	
ISV certifications	Please visit <a href="http://www.thinkworkstations.com/isv-certifications/">www.thinkworkstations.com/isv-certifications/</a>	

**Expansion slots**  
Slot 1: PCIe 3.0 x16, half length, full height, CPU2 needed (full length, full height if no flex adapter)  
Slot 2: PCIe 3.0 x16, full length, full height  
Slot 3: PCIe 3.0 x8, full length, full height, CPU2 needed  
Slot 4: PCIe 3.0 x16, full length, full height  
Slot 5: PCI, full length, full height  
Slot 6: PCIe 2.0 x4, half length, full height  
Also supports one flex connector

**Drive Bays**  
HDD 1-4: Standard 3.5" HDD bay, up to four 3.5" or 2.5" disk drives.  
On selected models, each 3.5" bay can supports 2.5" (9mm or less) drive plus 3.5" drive, or two 2.5" (15mm or less) drives.  
Flex bay: Two 5.25" flex bays, for HH optical drives.  
Or up to one optional flex module (Flex module supports one or more of the following options: 9.5mm optical/29-in-1 USB 3.0 reader/front IEEE 1394/front eSATA).  
Or up to two HDD bays for two drives, 3.5" or 2.5" each, SATA only.

Model	Region	Processor	Graphics	Memory	Storage Controller	Max Drives in 3.5" Bays	Disks	M.2 Drives	Optical	Media Reader	Power Supply	Add-on Ports	Discrete Ethernet	Keyboard / Mouse	Operating System	Warranty	Ann Date (mm/yy)
30B7000RUS	US	2xXeon E5-2623 v4 4C/2.6GHz/10MB/85W/DDR4-2133	Open	2x8GB RDIMM DDR4-2400 ECC	Onboard SATA	4	1x256GB SSD 2.5" SATA6Gbps Opal	None	HH DVD±RW	9-in-1	650W 92%	None	None	USB / USB	Windows 10 Pro 64	3-year	04/16
30B7000SUS	US	1xXeon E5-2623 v4 4C/2.6GHz/10MB/85W/DDR4-2133	Open	2x8GB RDIMM DDR4-2400 ECC	Onboard SATA	4	1x256GB SSD 2.5" SATA6Gbps Opal	None	HH DVD±RW	9-in-1	650W 92%	None	None	USB / USB	Windows 10 Pro 64	3-year	04/16
30B7000TUS	US	2xXeon E5-2620 v4 8C/2.1GHz/20MB/85W/DDR4-2133	Open	2x8GB RDIMM DDR4-2400 ECC	Onboard SATA	4	1x1TB HDD 7.2K 3.5" SATA6Gbps	None	HH DVD±RW	9-in-1	850W 92%	None	None	USB / USB	Windows 10 Pro 64	3-year	04/16
30B7000UUS	US	2xXeon E5-2637 v4 4C/3.5GHz/15MB/135W/DDR4-2400	Open	2x8GB RDIMM DDR4-2400 ECC	Onboard SATA	4	1x256GB SSD 2.5" SATA6Gbps Opal	None	HH DVD±RW	9-in-1	850W 92%	None	None	USB / USB	Windows 10 Pro 64	3-year	04/16
30B7000VUS	US	1xXeon E5-2637 v4 4C/3.5GHz/15MB/135W/DDR4-2400	Open	2x8GB RDIMM DDR4-2400 ECC	Onboard SATA	4	1x256GB SSD 2.5" SATA6Gbps Opal	None	HH DVD±RW	9-in-1	850W 92%	None	None	USB / USB	Windows 10 Pro 64	3-year	04/16
30B7000WUS	US	2xXeon E5-2643 v4 6C/3.4GHz/20MB/135W/DDR4-2400	NVIDIA Quadro M4000 8GB	4x8GB RDIMM DDR4-2400 ECC	Onboard SATA	4	1x1TB SSD 2.5" SATA6Gbps	None	HH DVD±RW	9-in-1	850W 92%	None	None	USB / USB	Windows 10 Pro 64	3-year	04/16
30B7000XUS	US	2xXeon E5-2623 v4 4C/2.6GHz/10MB/85W/DDR4-2133	NVIDIA Quadro M2000 4GB	2x8GB RDIMM DDR4-2400 ECC	Onboard SATA	4	1x256GB SSD 2.5" SATA6Gbps Opal	None	HH DVD±RW	9-in-1	650W 92%	None	None	USB / USB	Windows 10 Pro 64	3-year	04/16
30B7000YUS	US	1xXeon E5-2620 v4 8C/2.1GHz/20MB/85W/DDR4-2133	Open	2x8GB RDIMM DDR4-2400 ECC	Onboard SATA	4	1x1TB HDD 7.2K 3.5" SATA6Gbps	None	HH DVD±RW	9-in-1	850W 92%	None	None	USB / USB	Windows 10 Pro 64	3-year	04/16
30B7001MUS	US	1xXeon E5-2650 v4 12C/2.2GHz/30MB/105W/DDR4-2400	NVIDIA Quadro M4000 8GB	2x8GB RDIMM DDR4-2400 ECC	Onboard SATA	4	1x1TB HDD 7.2K 3.5" SATA6Gbps	1x256GB SSD M.2 PCIe	HH DVD±RW	9-in-1	850W 92%	None	None	USB / USB	Windows 10 Pro 64	3-year	07/16
30B7001NUS	US	2xXeon E5-2620 v4 8C/2.1GHz/20MB/85W/DDR4-2133	Open	2x8GB RDIMM DDR4-2400 ECC	Onboard SATA	4	1x1TB HDD 7.2K 3.5" SATA6Gbps	1x256GB SSD M.2 PCIe	HH DVD±RW	9-in-1	850W 92%	None	None	USB / USB	Windows 10 Pro 64	3-year	07/16
30B7001PUS	US	2xXeon E5-2620 v4 8C/2.1GHz/20MB/85W/DDR4-2133	NVIDIA Quadro M2000 4GB	2x8GB RDIMM DDR4-2400 ECC	Onboard SATA	4	1x1TB HDD 7.2K 3.5" SATA6Gbps	1x256GB SSD M.2 PCIe	HH DVD±RW	9-in-1	850W 92%	None	None	USB / USB	Windows 10 Pro 64	3-year	07/16
30B70023US	US	2xXeon E5-2620 v4 8C/2.1GHz/20MB/85W/DDR4-2133	Open	2x8GB RDIMM DDR4-2400 ECC	Onboard SATA	4	1x1TB HDD 7.2K 3.5" SATA6Gbps	1x256GB SSD M.2 PCIe	HH DVD±RW	9-in-1	850W 92%	None	None	USB / USB	Windows 10 DG Windows 7 Pro 64	3-year	09/16
30B70024US	US	1xXeon E5-2650 v4 12C/2.2GHz/30MB/105W/DDR4-2400	NVIDIA Quadro M4000 8GB	2x8GB RDIMM DDR4-2400 ECC	Onboard SATA	4	1x1TB HDD 7.2K 3.5" SATA6Gbps	1x256GB SSD M.2 PCIe	HH DVD±RW	9-in-1	850W 92%	None	None	USB / USB	Windows 10 DG Windows 7 Pro 64	3-year	09/16

Model	Region	Processor	Graphics	Memory	Storage Controller	Max Drives in 3.5" Bays	Disks	M.2 Drives	Optical	Media Reader	Power Supply	Add-on Ports	Discrete Ethernet	Keyboard / Mouse	Operating System	Warranty	Ann Date (mm/yy)
30B70025US	US	2xXeon E5-2620 v4 8C/2.1GHz/20MB/85W/DDR4-2133	NVIDIA Quadro M2000 4GB	2x8GB RDIMM DDR4-2400 ECC	Onboard SATA	4	1x1TB HDD 7.2K 3.5" SATA6Gbps	1x256GB SSD M.2 PCIe	HH DVD±RW	9-in-1	850W 92%	None	None	USB / USB	Windows 10 DG Windows 7 Pro 64	3-year	09/16
30B70029US	US	2xXeon E5-2623 v4 4C/2.6GHz/10MB/85W/DDR4-2133	NVIDIA Quadro P5000 16GB	2x8GB RDIMM DDR4-2400 ECC	Onboard SATA	4	Open	1x1TB SSD M.2 PCIe NVMe Opal	HH DVD±RW	9-in-1	850W 92%	1xeSATA Rear	None	USB / USB	Windows 10 DG Windows 7 Pro 64	3-year	12/16
30B7002AUS	US	1xXeon E5-2623 v4 4C/2.6GHz/10MB/85W/DDR4-2133	NVIDIA Quadro M2000 4GB	2x8GB RDIMM DDR4-2400 ECC	Onboard SATA	4	1x512GB SSD 2.5" SATA6Gbps	None	HH DVD±RW	9-in-1	850W 92%	None	None	USB / USB	Windows 10 DG Windows 7 Pro 64	3-year	12/16
30B7002BUS	US	1xXeon E5-2623 v4 4C/2.6GHz/10MB/85W/DDR4-2133	NVIDIA Quadro P5000 16GB	2x8GB RDIMM DDR4-2400 ECC	Onboard SATA	4	Open	1x1TB SSD M.2 PCIe NVMe Opal	HH DVD±RW	9-in-1	850W 92%	1xeSATA Rear	None	USB / USB	Windows 10 DG Windows 7 Pro 64	3-year	12/16
30B7002CUS	US	1xXeon E5-2623 v4 4C/2.6GHz/10MB/85W/DDR4-2133	NVIDIA Quadro M2000 4GB	2x8GB RDIMM DDR4-2400 ECC	Onboard SATA	4	1x256GB SSD 2.5" SATA6Gbps Opal	None	HH DVD±RW	9-in-1	650W 92%	None	None	USB / USB	Windows 10 DG Windows 7 Pro 64	3-year	12/16
30B7002DUS	US	2xXeon E5-2637 v4 4C/3.5GHz/15MB/135W/DDR4-2400	NVIDIA Quadro P5000 16GB	2x16GB RDIMM DDR4-2400 ECC	Onboard SATA	4	Open	1x1TB SSD M.2 PCIe NVMe Opal	HH DVD±RW	9-in-1	850W 92%	1xeSATA Rear	None	USB / USB	Windows 10 DG Windows 7 Pro 64	3-year	12/16
30B7002EUS	US	1xXeon E5-2623 v4 4C/2.6GHz/10MB/85W/DDR4-2133	NVIDIA Quadro M2000 4GB	2x8GB RDIMM DDR4-2400 ECC	Onboard SATA	4	1x256GB SSD 2.5" SATA6Gbps Opal	None	HH DVD±RW	9-in-1	850W 92%	None	None	USB / USB	Windows 10 DG Windows 7 Pro 64	3-year	12/16
30B7002FUS	US	2xXeon E5-2643 v4 6C/3.4GHz/20MB/135W/DDR4-2400	NVIDIA Quadro M4000 8GB	4x8GB RDIMM DDR4-2400 ECC	Onboard SATA	4	1x1TB HDD 7.2K 3.5" SATA6Gbps	None	HH DVD±RW	9-in-1	850W 92%	None	None	USB / USB	Windows 10 DG Windows 7 Pro 64	3-year	12/16
30B7002GUS	US	1xXeon E5-2623 v4 4C/2.6GHz/10MB/85W/DDR4-2133	Open	2x8GB RDIMM DDR4-2400 ECC	Onboard SATA	4	Open	1x1TB SSD M.2 PCIe NVMe Opal	HH DVD±RW	9-in-1	850W 92%	1xeSATA Rear	None	USB / USB	Windows 10 DG Windows 7 Pro 64	3-year	12/16
30B7002MUS	US	2xXeon E5-2623 v4 4C/2.6GHz/10MB/85W/DDR4-2133	NVIDIA Quadro P2000 5GB	2x8GB RDIMM DDR4-2400 ECC	Onboard SATA	4	1x256GB SSD 2.5" SATA6Gbps Opal	None	HH DVD±RW	9-in-1	850W 92%	None	None	USB / USB	Windows 10 DG Windows 7 Pro 64	3-year	04/17
30B7002NUS	US	1xXeon E5-2650 v4 12C/2.2GHz/30MB/105W/DDR4-2400	NVIDIA Quadro P4000 8GB	2x8GB RDIMM DDR4-2400 ECC	Onboard SATA	4	1x1TB HDD 7.2K 3.5" SATA6Gbps	1x256GB SSD M.2 PCIe	HH DVD±RW	9-in-1	850W 92%	None	None	USB / USB	Windows 10 DG Windows 7 Pro 64	3-year	04/17
30B7002PUS	US	1xXeon E5-2623 v4 4C/2.6GHz/10MB/85W/DDR4-2133	NVIDIA Quadro P2000 5GB	2x8GB RDIMM DDR4-2400 ECC	Onboard SATA	4	1x512GB SSD 2.5" SATA6Gbps	None	HH DVD±RW	9-in-1	850W 92%	None	None	USB / USB	Windows 10 DG Windows 7 Pro 64	3-year	04/17
30B7002QUS	US	2xXeon E5-2623 v4 4C/2.6GHz/10MB/85W/DDR4-2133	NVIDIA Quadro P2000 5GB	2x8GB RDIMM DDR4-2400 ECC	Onboard SATA	4	1x256GB SSD 2.5" SATA6Gbps Opal	None	HH DVD±RW	9-in-1	650W 92%	None	None	USB / USB	Windows 10 DG Windows 7 Pro 64	3-year	04/17

Model	Region	Processor	Graphics	Memory	Storage Controller	Max Drives in 3.5" Bays	Disks	M.2 Drives	Optical	Media Reader	Power Supply	Add-on Ports	Discrete Ethernet	Keyboard / Mouse	Operating System	Warranty	Ann Date (mm/yy)
30B7002RUS	US	1xXeon E5-2620 v4 8C/2.1GHz/20MB/85W/DDR4-2133	NVIDIA Quadro P2000 5GB	2x8GB RDIMM DDR4-2400 ECC	Onboard SATA	4	1x1TB HDD 7.2K 3.5" SATA6Gbps	None	HH DVD±RW	9-in-1	850W 92%	None	None	USB / USB	Windows 10 DG Windows 7 Pro 64	3-year	04/17
30B7002SUS	US	2xXeon E5-2643 v4 6C/3.4GHz/20MB/135W/DDR4-2400	NVIDIA Quadro P4000 8GB	4x8GB RDIMM DDR4-2400 ECC	Onboard SATA	4	1x1TB HDD 7.2K 3.5" SATA6Gbps	None	HH DVD±RW	9-in-1	850W 92%	None	None	USB / USB	Windows 10 Pro 64	3-year	04/17
30B7002TUS	US	2xXeon E5-2643 v4 6C/3.4GHz/20MB/135W/DDR4-2400	NVIDIA Quadro P4000 8GB	4x8GB RDIMM DDR4-2400 ECC	Onboard SATA	4	1x1TB HDD 7.2K 3.5" SATA6Gbps	None	HH DVD±RW	9-in-1	850W 92%	None	None	USB / USB	Windows 10 DG Windows 7 Pro 64	3-year	04/17
30B7002UUS	US	2xXeon E5-2623 v4 4C/2.6GHz/10MB/85W/DDR4-2133	NVIDIA Quadro P2000 5GB	2x8GB RDIMM DDR4-2400 ECC	Onboard SATA	4	1x512GB SSD 2.5" SATA6Gbps	None	HH DVD±RW	9-in-1	850W 92%	None	None	USB / USB	Windows 10 DG Windows 7 Pro 64	3-year	04/17
30B7002VUS	US	1xXeon E5-2620 v4 8C/2.1GHz/20MB/85W/DDR4-2133	NVIDIA Quadro P2000 5GB	2x8GB RDIMM DDR4-2400 ECC	Onboard SATA	4	1x1TB HDD 7.2K 3.5" SATA6Gbps	1x256GB SSD M.2 PCIe	HH DVD±RW	9-in-1	850W 92%	None	None	USB / USB	Windows 10 DG Windows 7 Pro 64	3-year	04/17
30B7002WUS	US	1xXeon E5-2650 v4 12C/2.2GHz/30MB/105W/DDR4-2400	NVIDIA Quadro P4000 8GB	2x8GB RDIMM DDR4-2400 ECC	Onboard SATA	4	1x1TB HDD 7.2K 3.5" SATA6Gbps	1x256GB SSD M.2 PCIe	HH DVD±RW	9-in-1	850W 92%	None	None	USB / USB	Windows 10 Pro 64	3-year	04/17



# ThinkStation P910 Platform Specifications

Product Specifications Reference (PSREF)

Components	Specification																																																																																																																																										
Chipset	Intel C612 Platform Controller Hub (PCH)																																																																																																																																										
System mgmt	Intel Active Management Technology 9																																																																																																																																										
Processor	Up to two 160W <b>Intel Xeon E5-2600 v4</b> family processors. Each processor supports up to 22 cores up to 2.2GHz, 16 cores up to 2.6GHz, 14 cores up to 2.6GHz, 12 cores up to 3GHz, 10 cores up to 2.4GHz, 8 cores up to 3.2GHz, 6 cores up to 3.4GHz, 4 cores up to 3.5GHz. Or up to two Intel Xeon E5-2620 v3 or E5-2609 v3 processors (not available in EMEA)																																																																																																																																										
Coprocessor	Optional. Up to one Intel Xeon Phi Coprocessor 3120A, PCIe 2.0 x16 adapter, 57 cores, 1.1GHz, 28.5MB L2 cache, 6GB memory, 300W																																																																																																																																										
Memory DIMM slots	16 DIMM sockets (8 DIMMs per processor), 8-channel capable (4-channel per processor). RDIMM or LRDIMM (cannot be intermixed), ECC, DDR4, 2400MHz																																																																																																																																										
Memory capacity	896GB (LRDIMM, 14x64GB)/512GB (RDIMM, 16x32GB), 2nd CPU is needed																																																																																																																																										
Graphics and GPU computing	Four PCIe 3.0 x16 slots for graphics and GPU computing cards, two slots per processor <table border="1"> <thead> <tr> <th>Installed CPU</th> <th>Maximum quantity of PCIe x16 adapters per system (by power)</th> </tr> </thead> <tbody> <tr> <td>1</td> <td>1x300W+1x75W or 2x150W</td> </tr> <tr> <td>2</td> <td>2x300W+2x75W, or 1x300W+2x150W+1x75W, or 4x150W</td> </tr> </tbody> </table>	Installed CPU	Maximum quantity of PCIe x16 adapters per system (by power)	1	1x300W+1x75W or 2x150W	2	2x300W+2x75W, or 1x300W+2x150W+1x75W, or 4x150W																																																																																																																																				
Installed CPU	Maximum quantity of PCIe x16 adapters per system (by power)																																																																																																																																										
1	1x300W+1x75W or 2x150W																																																																																																																																										
2	2x300W+2x75W, or 1x300W+2x150W+1x75W, or 4x150W																																																																																																																																										
Supporting Graphics and GPU computing	<table border="1"> <thead> <tr> <th>Adapter</th> <th>Cores</th> <th>Memory</th> <th>Power</th> <th>Connector***</th> <th>SLI</th> </tr> </thead> <tbody> <tr><td>NVS 310</td><td>48</td><td>1GB</td><td>19.5W</td><td>2xDP</td><td></td></tr> <tr><td>NVS 315</td><td>48</td><td>1GB</td><td>19.5W</td><td>2xDVI-I SL/2xDP</td><td></td></tr> <tr><td>NVS 510</td><td>192</td><td>2GB</td><td>35W</td><td>4xmini DP</td><td></td></tr> <tr><td>NVS 810</td><td>1024</td><td>4GB</td><td>68W</td><td>8xmini DP</td><td></td></tr> <tr><td>Quadro K420</td><td>192</td><td>2GB</td><td>41W</td><td>DVI-I DL+DP</td><td></td></tr> <tr><td>Quadro K620</td><td>384</td><td>2GB</td><td>45W</td><td>DVI-I DL+DP</td><td></td></tr> <tr><td>Quadro K1200</td><td>512</td><td>4GB</td><td>45W</td><td>4xmini DP</td><td></td></tr> <tr><td>Quadro K2200</td><td>640</td><td>4GB</td><td>68W</td><td>DVI-I DL+2xDP</td><td></td></tr> <tr><td>Quadro K4200</td><td>1344</td><td>4GB</td><td>108W</td><td>DVI-I DL+2xDP</td><td></td></tr> <tr><td>Quadro K5200</td><td>2304</td><td>8GB</td><td>150W</td><td>DVI-I DL+DVI-D DL+2xDP</td><td>SLI</td></tr> <tr><td>Quadro M2000</td><td>768</td><td>4GB</td><td>75W</td><td>4xDP</td><td></td></tr> <tr><td>Quadro M4000</td><td>1664</td><td>8GB</td><td>120W</td><td>4xDP</td><td></td></tr> <tr><td>Quadro M5000</td><td>2048</td><td>8GB</td><td>150W</td><td>DVI-I DL+4xDP</td><td>SLI</td></tr> <tr><td>Quadro M6000</td><td>3072</td><td>24GB</td><td>250W</td><td>DVI-I DL+4xDP</td><td>SLI</td></tr> <tr><td>Quadro P400</td><td>256</td><td>2GB</td><td>30W</td><td>3xminiDP</td><td></td></tr> <tr><td>Quadro P600</td><td>384</td><td>2GB</td><td>40W</td><td>4xminiDP</td><td></td></tr> <tr><td>Quadro P1000</td><td>640</td><td>4GB</td><td>47W</td><td>4xminiDP</td><td></td></tr> <tr><td>Quadro P2000</td><td>1024</td><td>5GB</td><td>75W</td><td>4xDP</td><td></td></tr> <tr><td>Quadro P4000</td><td>1792</td><td>8GB</td><td>105W</td><td>4xDP</td><td>SLI</td></tr> <tr><td>Quadro P5000</td><td>2560</td><td>16GB</td><td>180W</td><td>DVI-D DL+4xDP</td><td>SLI</td></tr> <tr><td>Quadro P6000</td><td>3840</td><td>24GB</td><td>250W</td><td>DVI-D DL+4xDP</td><td>SLI</td></tr> <tr><td>Tesla K40</td><td>2880</td><td>12GB</td><td>235W</td><td></td><td></td></tr> </tbody> </table>	Adapter	Cores	Memory	Power	Connector***	SLI	NVS 310	48	1GB	19.5W	2xDP		NVS 315	48	1GB	19.5W	2xDVI-I SL/2xDP		NVS 510	192	2GB	35W	4xmini DP		NVS 810	1024	4GB	68W	8xmini DP		Quadro K420	192	2GB	41W	DVI-I DL+DP		Quadro K620	384	2GB	45W	DVI-I DL+DP		Quadro K1200	512	4GB	45W	4xmini DP		Quadro K2200	640	4GB	68W	DVI-I DL+2xDP		Quadro K4200	1344	4GB	108W	DVI-I DL+2xDP		Quadro K5200	2304	8GB	150W	DVI-I DL+DVI-D DL+2xDP	SLI	Quadro M2000	768	4GB	75W	4xDP		Quadro M4000	1664	8GB	120W	4xDP		Quadro M5000	2048	8GB	150W	DVI-I DL+4xDP	SLI	Quadro M6000	3072	24GB	250W	DVI-I DL+4xDP	SLI	Quadro P400	256	2GB	30W	3xminiDP		Quadro P600	384	2GB	40W	4xminiDP		Quadro P1000	640	4GB	47W	4xminiDP		Quadro P2000	1024	5GB	75W	4xDP		Quadro P4000	1792	8GB	105W	4xDP	SLI	Quadro P5000	2560	16GB	180W	DVI-D DL+4xDP	SLI	Quadro P6000	3840	24GB	250W	DVI-D DL+4xDP	SLI	Tesla K40	2880	12GB	235W		
Adapter	Cores	Memory	Power	Connector***	SLI																																																																																																																																						
NVS 310	48	1GB	19.5W	2xDP																																																																																																																																							
NVS 315	48	1GB	19.5W	2xDVI-I SL/2xDP																																																																																																																																							
NVS 510	192	2GB	35W	4xmini DP																																																																																																																																							
NVS 810	1024	4GB	68W	8xmini DP																																																																																																																																							
Quadro K420	192	2GB	41W	DVI-I DL+DP																																																																																																																																							
Quadro K620	384	2GB	45W	DVI-I DL+DP																																																																																																																																							
Quadro K1200	512	4GB	45W	4xmini DP																																																																																																																																							
Quadro K2200	640	4GB	68W	DVI-I DL+2xDP																																																																																																																																							
Quadro K4200	1344	4GB	108W	DVI-I DL+2xDP																																																																																																																																							
Quadro K5200	2304	8GB	150W	DVI-I DL+DVI-D DL+2xDP	SLI																																																																																																																																						
Quadro M2000	768	4GB	75W	4xDP																																																																																																																																							
Quadro M4000	1664	8GB	120W	4xDP																																																																																																																																							
Quadro M5000	2048	8GB	150W	DVI-I DL+4xDP	SLI																																																																																																																																						
Quadro M6000	3072	24GB	250W	DVI-I DL+4xDP	SLI																																																																																																																																						
Quadro P400	256	2GB	30W	3xminiDP																																																																																																																																							
Quadro P600	384	2GB	40W	4xminiDP																																																																																																																																							
Quadro P1000	640	4GB	47W	4xminiDP																																																																																																																																							
Quadro P2000	1024	5GB	75W	4xDP																																																																																																																																							
Quadro P4000	1792	8GB	105W	4xDP	SLI																																																																																																																																						
Quadro P5000	2560	16GB	180W	DVI-D DL+4xDP	SLI																																																																																																																																						
Quadro P6000	3840	24GB	250W	DVI-D DL+4xDP	SLI																																																																																																																																						
Tesla K40	2880	12GB	235W																																																																																																																																								
Disk drive controller	<b>RAID 0, 1, 5, 10</b> with onboard SATA controller in chipset, 6Gb/s SATA. <b>RAID 0, 1, 5, 10</b> with optional LSI RAID flex adapter, 12Gb/s SAS and SATA. <b>RAID 0, 1, 5, 6, 10</b> with optional LSI 9364-8i PCIe adapter, 1GB memory, 12Gb/s SAS and SATA																																																																																																																																										
Drive Bays	Three external 5.25" bays, four internal 3.5" dual drives bays (see right)																																																																																																																																										
Flex bay	Three 5.25" flex bays for optical drives, Front Access Storage Enclosure drives, Flex Bay Storage Enclosure drives, or flex module. <ul style="list-style-type: none"> <li>Up to three half-height optical drives or up to one 9.5mm optical drive, DVD-ROM, DVD±RW, or Blu-Ray burner</li> <li>Up to one Front Access Storage Enclosure for one 3.5" or 2.5" SATA drive.</li> <li>Up to two Flex Bay Storage Enclosure for two 3.5" or 2.5" SATA drives.</li> </ul>																																																																																																																																										
Supporting storage	<table border="1"> <tbody> <tr> <td>3.5" SATA HDD, 7.2K 6Gbs</td> <td>500GB/1TB/2TB/3TB/4TB/6TB/1TB hybrid/2TB hybrid</td> </tr> <tr> <td>2.5" SAS HDD, 15K 12Gbs</td> <td>300GB/600GB</td> </tr> <tr> <td>2.5" SAS HDD, 10K 12Gbs</td> <td>300GB</td> </tr> <tr> <td>2.5" SAS SSD, 12Gbs</td> <td>200GB/400GB/800GB</td> </tr> <tr> <td>2.5" SSD, SATA6Gbs</td> <td>180GB/240GB/256GB/480GB/512GB with OPAL, 256GB/512GB/1TB without OPAL</td> </tr> <tr> <td>PCIe SSD, 2.5"</td> <td>400GB</td> </tr> <tr> <td>PCIe SSD, M.2</td> <td>256 GB/512GB/1TB</td> </tr> <tr> <td>PCIe SSD adapter</td> <td>400GB (up to 4 per system, 2nd CPU is needed)</td> </tr> </tbody> </table>	3.5" SATA HDD, 7.2K 6Gbs	500GB/1TB/2TB/3TB/4TB/6TB/1TB hybrid/2TB hybrid	2.5" SAS HDD, 15K 12Gbs	300GB/600GB	2.5" SAS HDD, 10K 12Gbs	300GB	2.5" SAS SSD, 12Gbs	200GB/400GB/800GB	2.5" SSD, SATA6Gbs	180GB/240GB/256GB/480GB/512GB with OPAL, 256GB/512GB/1TB without OPAL	PCIe SSD, 2.5"	400GB	PCIe SSD, M.2	256 GB/512GB/1TB	PCIe SSD adapter	400GB (up to 4 per system, 2nd CPU is needed)																																																																																																																										
3.5" SATA HDD, 7.2K 6Gbs	500GB/1TB/2TB/3TB/4TB/6TB/1TB hybrid/2TB hybrid																																																																																																																																										
2.5" SAS HDD, 15K 12Gbs	300GB/600GB																																																																																																																																										
2.5" SAS HDD, 10K 12Gbs	300GB																																																																																																																																										
2.5" SAS SSD, 12Gbs	200GB/400GB/800GB																																																																																																																																										
2.5" SSD, SATA6Gbs	180GB/240GB/256GB/480GB/512GB with OPAL, 256GB/512GB/1TB without OPAL																																																																																																																																										
PCIe SSD, 2.5"	400GB																																																																																																																																										
PCIe SSD, M.2	256 GB/512GB/1TB																																																																																																																																										
PCIe SSD adapter	400GB (up to 4 per system, 2nd CPU is needed)																																																																																																																																										

Components	Specification												
Flex connector	Two flex connectors (see right), one per processor. Supports one of the following: <ul style="list-style-type: none"> <li>Up to one LSI RAID flex adapter for SATA/SAS RAID.</li> <li>Up to two Multi-I/O adapters for four PCIe SSD (two PCIe SSD per adapter).</li> <li>Up to two M.2 flex adapters for four M.2 PCIe SSD (two M.2 PCIe SSD per adapter)</li> </ul>												
Network interfaces	Integrated two-port gigabit ethernet (Intel i218LM and i210AT), supports Wake-on-LAN. Optional discrete ethernet adapters are available												
HD Audio	Realtek ALC662 codec												
TPM	TCG 1.2-compliant												
Power supply	<b>One fixed 1300 watts, autosensing, 92% PSU, 80 PLUS Platinum qualified</b> <i>Note: PSU will automatically operate in 1120W (restricted mode) if the system line input is 100-110V. For other supported system line input voltages, the PSU will operate at the full 1300W.</i>												
Front ports	Four USB 3.0 (one Diagnostic, one Always On), one combo audio/microphone jack (3.5mm)												
Rear ports	Four USB 2.0, four USB 3.0 (blue), one serial (9-pin), two ethernet (RJ-45), three analog audio ports (line-in, line-out, mic-in), two PS/2												
Add-on ports	Supports the following optional ports: Two IEEE 1394 (one on rear and one on front flex module) via PCIe adapter, up to one adapter per system. Two rear USB 3.0 per USB add-on PCIe adapter, up to 3 adapters per system. One rear Thunderbolt via PCIe adapter. One front eSATA (on flex module), or one rear eSATA via cable (also needs one PCIe slot), up to one eSATA port per system. One internal USB 3.0 port via cable, cannot be intermixed with 29-in-1 reader												
Media reader	9-in-1 USB 2.0 card reader. Optional 29-in-1 USB 3.0 card reader on flex module												
Mechanical	<ul style="list-style-type: none"> <li>55-liter: 200mm/7.87" W x 620mm/24.4" D x 446mm/17.56" H (with feet)</li> <li>Tool-less parts: all except CPU fansink</li> <li>71.3 lb (32.3kg) max configuration</li> </ul>												
Environmental specification	<table border="1"> <tbody> <tr> <td>Temperature - operating</td> <td>50 °F to 95 °F (10 °C to 35 °C)</td> </tr> <tr> <td>Temperature - non operating (no package)</td> <td>14 °F to 140 °F (-10 °C to 60 °C)</td> </tr> <tr> <td>Temperature - non operating (with package)</td> <td>-40 °F to 140 °F (-40 °C to 60 °C)</td> </tr> <tr> <td>Altitude - operating</td> <td>(Unpressurized): 0-10000ft (0-3048m)</td> </tr> <tr> <td>Humidity - operating</td> <td>10%-80%, non-condensing</td> </tr> <tr> <td>Humidity - storage (with package)</td> <td>10%-90%, non-condensing</td> </tr> </tbody> </table> <p>RoHS-compliant, GREENGUARD on all models. EPEAT Gold rating, ENERGY STAR 6.1 qualified on selected models.</p>	Temperature - operating	50 °F to 95 °F (10 °C to 35 °C)	Temperature - non operating (no package)	14 °F to 140 °F (-10 °C to 60 °C)	Temperature - non operating (with package)	-40 °F to 140 °F (-40 °C to 60 °C)	Altitude - operating	(Unpressurized): 0-10000ft (0-3048m)	Humidity - operating	10%-80%, non-condensing	Humidity - storage (with package)	10%-90%, non-condensing
Temperature - operating	50 °F to 95 °F (10 °C to 35 °C)												
Temperature - non operating (no package)	14 °F to 140 °F (-10 °C to 60 °C)												
Temperature - non operating (with package)	-40 °F to 140 °F (-40 °C to 60 °C)												
Altitude - operating	(Unpressurized): 0-10000ft (0-3048m)												
Humidity - operating	10%-80%, non-condensing												
Humidity - storage (with package)	10%-90%, non-condensing												
Base warranty	3-year limited onsite service with 9x5/NBD												
ISV certifications	Please visit <a href="http://www.thinkworkstations.com/isv-certifications/">www.thinkworkstations.com/isv-certifications/</a>												

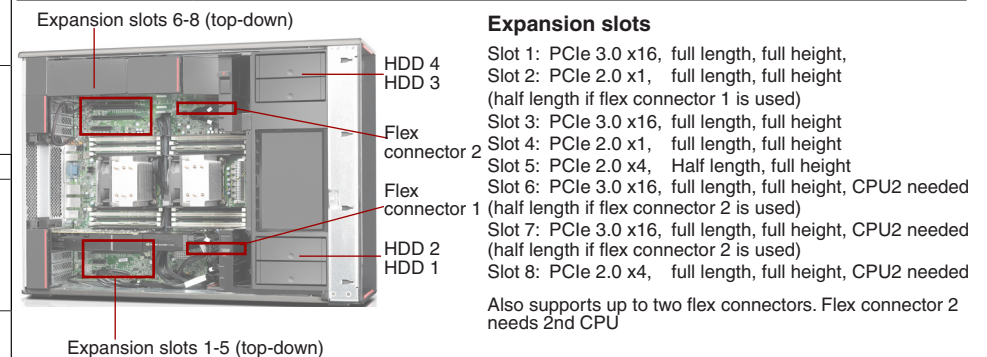

**Expansion slots**

Slot 1: PCIe 3.0 x16, full length, full height,  
Slot 2: PCIe 2.0 x1, full length, full height (half length if flex connector 1 is used)  
Slot 3: PCIe 3.0 x16, full length, full height  
Slot 4: PCIe 2.0 x1, full length, full height  
Slot 5: PCIe 2.0 x4, Half length, full height  
Slot 6: PCIe 3.0 x16, full length, full height, CPU2 needed (half length if flex connector 2 is used)  
Slot 7: PCIe 3.0 x16, full length, full height, CPU2 needed (half length if flex connector 2 is used)  
Slot 8: PCIe 2.0 x4, full length, full height, CPU2 needed

Also supports up to two flex connectors. Flex connector 2 needs 2nd CPU

**Drive bays**

HDD 1-4: Standard 3.5" HDD bay, up to four 3.5" or 2.5" disk drives.  
Each 3.5" bay supports 2.5" (9mm or less) drive plus 3.5" drive, or two 2.5" (15mm or less) drives. More than 4 drives requires LSI RAID flex adapter or 9364-8i adapter,  
Flex bay: Three 5.25" flex bays, for HH optical drives.  
Or up to one optional flex module (Flex module supports one or more of the following options: 9.5mm optical/29-in-1 USB 3.0 reader/front IEEE 1394/front eSATA).  
Or up to two HDD bays for two drives, 3.5" or 2.5" each, SATA only.

Model	Region	Processor	Graphics	Memory	Storage Controller	Max Drives in 3.5" Bays	Disks	M.2 Drives	Optical	Media Reader	Power Supply	Add-on Ports	Discrete Ethernet	Keyboard / Mouse	Operating System	Warranty	Ann Date (mm/yy)
30B9000EUS	US	1xXeon E5-2643 v4 6C/3.4GHz/20MB/135W/DDR4-2400	Open	2x8GB RDIMM DDR4-2400 ECC	Onboard SATA	4	1x512GB SSD 2.5" SATA6Gbps	None	HH DVD±RW	9-in-1	1300W 92%	None	None	USB / USB	Windows 10 Pro 64	3-year	04/16
30B9000FUS	US	2xXeon E5-2650 v4 12C/2.2GHz/30MB/105W/DDR4-2400	NVIDIA Quadro M5000 8GB	4x8GB RDIMM DDR4-2400 ECC	Onboard SATA	4	1x1TB SSD 2.5" SATA6Gbps	None	HH DVD±RW	9-in-1	1300W 92%	None	None	USB / USB	Windows 10 Pro 64	3-year	04/16
30B9000GUS	US	2xXeon E5-2643 v4 6C/3.4GHz/20MB/135W/DDR4-2400	Open	4x8GB RDIMM DDR4-2400 ECC	Onboard SATA	4	1x1TB SSD 2.5" SATA6Gbps	None	HH DVD±RW	9-in-1	1300W 92%	None	None	USB / USB	Windows 10 Pro 64	3-year	04/16
30B9000HUS	US	1xXeon E5-2623 v4 4C/2.6GHz/10MB/85W/DDR4-2133	Open	2x8GB RDIMM DDR4-2400 ECC	Onboard SATA	4	1x512GB SSD 2.5" SATA6Gbps	None	HH DVD±RW	9-in-1	1300W 92%	None	None	USB / USB	Windows 10 Pro 64	3-year	04/16
30B9001NUS	US	2xXeon E5-2650 v4 12C/2.2GHz/30MB/105W/DDR4-2400	NVIDIA Quadro M4000 8GB	4x8GB RDIMM DDR4-2400 ECC	Onboard SATA	4	1x1TB HDD 7.2K 3.5" SATA6Gbps	1x512GB SSD M.2 PCIe	HH DVD±RW	9-in-1	1300W 92%	None	None	USB / USB	Windows 10 Pro 64	3-year	07/16
30B9001PUS	US	2xXeon E5-2650 v4 12C/2.2GHz/30MB/105W/DDR4-2400	Open	4x8GB RDIMM DDR4-2400 ECC	Onboard SATA	4	1x1TB HDD 7.2K 3.5" SATA6Gbps	1x512GB SSD M.2 PCIe	HH DVD±RW	9-in-1	1300W 92%	None	None	USB / USB	Windows 10 Pro 64	3-year	07/16
30B9001UUS	US	2xXeon E5-2650 v4 12C/2.2GHz/30MB/105W/DDR4-2400	NVIDIA Quadro M4000 8GB	4x8GB RDIMM DDR4-2400 ECC	Onboard SATA	4	1x1TB HDD 7.2K 3.5" SATA6Gbps	1x512GB SSD M.2 PCIe	HH DVD±RW	9-in-1	1300W 92%	None	None	USB / USB	Windows 10 DG Windows 7 Pro 64	3-year	09/16
30B9001VUS	US	2xXeon E5-2650 v4 12C/2.2GHz/30MB/105W/DDR4-2400	Open	4x8GB RDIMM DDR4-2400 ECC	Onboard SATA	4	1x1TB HDD 7.2K 3.5" SATA6Gbps	1x512GB SSD M.2 PCIe	HH DVD±RW	9-in-1	1300W 92%	None	None	USB / USB	Windows 10 DG Windows 7 Pro 64	3-year	09/16
30B9001WUS	US	1xXeon E5-2643 v4 6C/3.4GHz/20MB/135W/DDR4-2400	Open	2x8GB RDIMM DDR4-2400 ECC	Onboard SATA	4	1x512GB SSD 2.5" SATA6Gbps	None	HH DVD±RW	9-in-1	1300W 92%	None	None	USB / USB	Windows 10 DG Windows 7 Pro 64	3-year	09/16
30B9001XUS	US	2xXeon E5-2650 v4 12C/2.2GHz/30MB/105W/DDR4-2400	NVIDIA Quadro M5000 8GB	4x8GB RDIMM DDR4-2400 ECC	Onboard SATA	4	1x1TB SSD 2.5" SATA6Gbps	None	HH DVD±RW	9-in-1	1300W 92%	None	None	USB / USB	Windows 10 DG Windows 7 Pro 64	3-year	09/16
30B9001YUS	US	2xXeon E5-2643 v4 6C/3.4GHz/20MB/135W/DDR4-2400	Open	4x8GB RDIMM DDR4-2400 ECC	Onboard SATA	4	1x1TB SSD 2.5" SATA6Gbps	None	HH DVD±RW	9-in-1	1300W 92%	None	None	USB / USB	Windows 10 DG Windows 7 Pro 64	3-year	09/16
30B90020US	US	1xXeon E5-2623 v4 4C/2.6GHz/10MB/85W/DDR4-2133	Open	2x8GB RDIMM DDR4-2400 ECC	Onboard SATA	4	1x512GB SSD 2.5" SATA6Gbps	None	HH DVD±RW	9-in-1	1300W 92%	None	None	USB / USB	Windows 10 DG Windows 7 Pro 64	3-year	09/16
30B9002DUS	US	2xXeon E5-2620 v4 8C/2.1GHz/20MB/85W/DDR4-2133	Open	2x16GB RDIMM DDR4-2400 ECC	Onboard SATA	4	Open	1x1TB SSD M.2 PCIe NVMe Opal	HH DVD±RW	9-in-1	1300W 92%	None	None	USB / USB	Windows 10 DG Windows 7 Pro 64	3-year	12/16

Model	Region	Processor	Graphics	Memory	Storage Controller	Max Drives in 3.5" Bays	Disks	M.2 Drives	Optical	Media Reader	Power Supply	Add-on Ports	Discrete Ethernet	Keyboard / Mouse	Operating System	Warranty	Ann Date (mm/yy)
30B9002EUS	US	2xXeon E5-2620 v4 8C/2.1GHz/20MB/85W/DDR4-2133	NVIDIA Quadro P5000 16GB	2x16GB RDIMM DDR4-2400 ECC	Onboard SATA	4	Open	1x1TB SSD M.2 PCIe NVMe Opal	HH DVD±RW	9-in-1	1300W 92%	None	None	USB / USB	Windows 10 DG Windows 7 Pro 64	3-year	12/16
30B9002FUS	US	2xXeon E5-2620 v4 8C/2.1GHz/20MB/85W/DDR4-2133	NVIDIA Quadro P6000 24GB	2x16GB RDIMM DDR4-2400 ECC	Onboard SATA	4	Open	1x1TB SSD M.2 PCIe NVMe Opal	HH DVD±RW	9-in-1	1300W 92%	None	None	USB / USB	Windows 10 DG Windows 7 Pro 64	3-year	12/16
30B9002XCA	US	1xXeon E5-2650 v4 12C/2.2GHz/30MB/105W/DDR4-2400	NVIDIA Quadro P4000 8GB	4x8GB RDIMM DDR4-2400 ECC	Onboard SATA	4	1x1TB HDD 7.2K 3.5" SATA6Gbps	1x512GB SSD M.2 PCIe	HH DVD±RW	9-in-1	1300W 92%	None	None	USB / USB	Windows 10 Pro 64	3-year	04/17
30B9002XCC	US	1xXeon E5-2650 v4 12C/2.2GHz/30MB/105W/DDR4-2400	NVIDIA Quadro P4000 8GB	4x8GB RDIMM DDR4-2400 ECC	Onboard SATA	4	1x1TB HDD 7.2K 3.5" SATA6Gbps	1x512GB SSD M.2 PCIe	HH DVD±RW	9-in-1	1300W 92%	None	None	USB / USB	Windows 10 Pro 64	3-year	04/17
30B9002XSS	US	1xXeon E5-2650 v4 12C/2.2GHz/30MB/105W/DDR4-2400	NVIDIA Quadro P4000 8GB	4x8GB RDIMM DDR4-2400 ECC	Onboard SATA	4	1x1TB HDD 7.2K 3.5" SATA6Gbps	1x512GB SSD M.2 PCIe	HH DVD±RW	9-in-1	1300W 92%	None	None	USB / USB	Windows 10 Pro 64	3-year	04/17
30B9002XUS	US	1xXeon E5-2650 v4 12C/2.2GHz/30MB/105W/DDR4-2400	NVIDIA Quadro P4000 8GB	4x8GB RDIMM DDR4-2400 ECC	Onboard SATA	4	1x1TB HDD 7.2K 3.5" SATA6Gbps	1x512GB SSD M.2 PCIe	HH DVD±RW	9-in-1	1300W 92%	None	None	USB / USB	Windows 10 Pro 64	3-year	04/17
30B9002YCA	US	1xXeon E5-2650 v4 12C/2.2GHz/30MB/105W/DDR4-2400	NVIDIA Quadro P4000 8GB	4x8GB RDIMM DDR4-2400 ECC	Onboard SATA	4	1x1TB HDD 7.2K 3.5" SATA6Gbps	1x512GB SSD M.2 PCIe	HH DVD±RW	9-in-1	1300W 92%	None	None	USB / USB	Windows 10 DG Windows 7 Pro 64	3-year	04/17
30B9002YCC	US	1xXeon E5-2650 v4 12C/2.2GHz/30MB/105W/DDR4-2400	NVIDIA Quadro P4000 8GB	4x8GB RDIMM DDR4-2400 ECC	Onboard SATA	4	1x1TB HDD 7.2K 3.5" SATA6Gbps	1x512GB SSD M.2 PCIe	HH DVD±RW	9-in-1	1300W 92%	None	None	USB / USB	Windows 10 DG Windows 7 Pro 64	3-year	04/17
30B9002YSS	US	1xXeon E5-2650 v4 12C/2.2GHz/30MB/105W/DDR4-2400	NVIDIA Quadro P4000 8GB	4x8GB RDIMM DDR4-2400 ECC	Onboard SATA	4	1x1TB HDD 7.2K 3.5" SATA6Gbps	1x512GB SSD M.2 PCIe	HH DVD±RW	9-in-1	1300W 92%	None	None	USB / USB	Windows 10 DG Windows 7 Pro 64	3-year	04/17
30B9002YUS	US	1xXeon E5-2650 v4 12C/2.2GHz/30MB/105W/DDR4-2400	NVIDIA Quadro P4000 8GB	4x8GB RDIMM DDR4-2400 ECC	Onboard SATA	4	1x1TB HDD 7.2K 3.5" SATA6Gbps	1x512GB SSD M.2 PCIe	HH DVD±RW	9-in-1	1300W 92%	None	None	USB / USB	Windows 10 DG Windows 7 Pro 64	3-year	04/17

This publication was developed for products and services offered in the United States and E.M.E.A countries. Lenovo may not offer the products, services or features discussed in this document in other countries. Lenovo may withdraw an offering at any time. Information is subject to change without notice. Consult your local representative for information on offerings available in your area.

Lenovo reserves the right to change specifications or other product information without notice. Lenovo is not responsible for photographic or typographical errors.

LENOVO PROVIDES THIS PUBLICATION "AS IS," WITHOUT WARRANTY OF ANY KIND, EITHER EXPRESS OR IMPLIED, INCLUDING THE IMPLIED WARRANTIES OF MERCHANTABILITY OR FITNESS FOR A PARTICULAR PURPOSE.

Some jurisdictions do not allow disclaimer of express or implied warranties in certain transactions, therefore this disclaimer may not apply to you.

**Availability:** All offers subject to availability. Lenovo reserves the right to alter product offerings and specifications at any time, without notice. Lenovo is not responsible for photographic or typographic errors.

**General:** Review key information provided by Microsoft that may apply to your system purchase, including details on Windows 10, Windows 8, Windows 7, and potential upgrades/downgrades. Lenovo makes no representation or warranty regarding third-party products or services.

**Trademarks:** Lenovo, ThinkPad, ThinkCentre, ThinkStation and the Lenovo logo are trademarks of Lenovo. Microsoft, Windows, Windows NT, and the Windows logo are trademarks of Microsoft Corporation. Ultrabook, Celeron, Celeron Inside, Core Inside, Intel, Intel Logo, Intel Atom, Intel Atom Inside, Intel Core, Intel Inside, Intel Inside Logo, Intel vPro, Itanium, Itanium Inside, Pentium, Pentium Inside, vPro Inside, Xeon, Xeon Phi, and Xeon Inside are trademarks of Intel Corporation in the U.S. and/or other countries. Other company, product or service names may be trademarks or service marks of others.

**Warranty:** For a copy of applicable warranties, write to: Lenovo Warranty Information, 1009 Think Place, Morrisville, NC, 27560. Lenovo makes no representation or warranty regarding third party products or services. The Lenovo Limited Warranty applies only to Lenovo hardware products purchased for your own use, and does not transfer upon resale.

**Limited warranty:** Support unrelated to a warranty issue may be subject to additional charges.

#### **Lenovo Services:**

**Carry-in or Mail-in Service:** Parts and labor repair coverage where the customer is responsible for shipping (including packaging) or delivery to authorized warranty provider or repair center.

**Depot or Courier Service:** Parts and labor repair coverage where shipping (including packaging) or delivery to the repair center is paid for by Lenovo.

**Expedited Depot:** Parts and labor coverage with expedited turnaround. Shipping (including packaging) or delivery to the repair center is paid for by Lenovo.

**Onsite / In-home Service:** Parts and labor repair coverage where labor is provided onsite at your place of business.

If Lenovo determines your product problem is covered by the product warranty and cannot be resolved over the telephone, a technician will be dispatched to arrive onsite, typically the next day.

**International Warranty Service (IWS):** PC repair coverage for customers who require a critical warranty repair while travelling internationally. Visit [www.lenovo.com/internationalwarranty](http://www.lenovo.com/internationalwarranty) for details. Visit [www.lenovo.com/warranty](http://www.lenovo.com/warranty) for Lenovo Warranty Services terms and conditions for complete details and restrictions.

**Included software:** may differ from its retail version (if available), and may not include user manuals or all program functionality. Software license agreements may apply.

**Battery life:** Battery life (and recharge times) will vary based on many factors including screen brightness, applications, features, power management, battery conditioning, and other customer preferences.

Visit <http://psref.lenovo.com/> for the latest version of Product Specifications Reference.

© Lenovo, 2017. All rights reserved.  
Lenovo 1009 Think Place Morrisville, NC 27560 U.S.A.

**Lenovo** ThinkServer

# PSREF

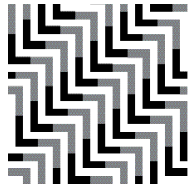

**Product Specifications Reference**

Version 511, August 2017

**U.S.**

Visit <http://psref.lenovo.com> for the latest version

# Contents

---

<b>Cover</b>		
<b>Contents</b>		
<b>Summary Of Change</b>		
<b>Racks</b>		
<b>ThinkServer RD350</b>		
ThinkServer RD350 Platform Specifications		
ThinkServer RD350 - TopSeller - 70D6		
ThinkServer RD350 - TopSeller - 70D8		
ThinkServer RD350 - TopSeller - 70QK		
ThinkServer RD350 - TopSeller - 70QM		
<b>ThinkServer RD450</b>		
ThinkServer RD450 Platform Specifications		
ThinkServer RD450 - TopSeller - 70DA		
ThinkServer RD450 - TopSeller - 70DC		
ThinkServer RD450 - TopSeller - 70DE		
ThinkServer RD450 - TopSeller - 70DV		
ThinkServer RD450 - TopSeller - 70Q9		
ThinkServer RD450 - TopSeller - 70QQ		
ThinkServer RD450 - TopSeller - 70QS		
ThinkServer RD450 - TopSeller - 70QW		
<b>ThinkServer RD550</b>		
ThinkServer RD550 Platform Specifications		
ThinkServer RD550 - TopSeller - 70CV		
ThinkServer RD550 - TopSeller - 70CX		
<b>ThinkServer RD650</b>		
ThinkServer RD650 Platform Specifications		
ThinkServer RD650 - TopSeller - 70D0		
ThinkServer RD650 - TopSeller - 70D2		
ThinkServer RD650 - TopSeller - 70D4		
ThinkServer RD650 - TopSeller - 70DR		
ThinkServer RD650 - TopSeller - 70DT		
<b>ThinkServer RS140</b>		
ThinkServer RS140 Platform Specifications		
ThinkServer RS140 - TopSeller - 70F3		
ThinkServer RS140 - TopSeller - 70F9		
1	ThinkServer RS140 - 70F2	36
2	ThinkServer RS140 - 70F8	37
3	<b>ThinkServer RS160</b>	<b>38</b>
5	ThinkServer RS160 Platform Specifications	39
5	ThinkServer RS160 - TopSeller - 70TE	40
6	ThinkServer RS160 - TopSeller - 70TG	41
7	<b>Towers</b>	<b>42</b>
8	<b>ThinkServer TD340</b>	<b>42</b>
9	ThinkServer TD340 Platform Specifications	43
10	ThinkServer TD340 - TopSeller - 70B5	44
11	ThinkServer TD340 - TopSeller - 70B7 - 1 of 2	45
12	ThinkServer TD340 - TopSeller - 70B7 - 2 of 2	46
13	ThinkServer TD340 - 70B6	47
14	<b>ThinkServer TD350</b>	<b>48</b>
15	ThinkServer TD350 Platform Specifications	49
16	ThinkServer TD350 - TopSeller - 70DG	50
17	ThinkServer TD350 - TopSeller - 70DJ	51
18	<b>ThinkServer TS150</b>	<b>52</b>
19	ThinkServer TS150 Platform Specifications	52
20	ThinkServer TS150 - TopSeller - 70LV	53
21	ThinkServer TS150 - TopSeller - 70LX	54
22	ThinkServer TS150 - TopSeller - 70UB	55
23	<b>ThinkServer TS440</b>	<b>56</b>
24	ThinkServer TS440 Platform Specifications	57
25	ThinkServer TS440 - TopSeller - 70AN	58
26	ThinkServer TS440 - TopSeller - 70AQ - 1 of 2	59
27	ThinkServer TS440 - TopSeller - 70AQ - 2 of 2	60
28	ThinkServer TS440 - 70AL	61
29	ThinkServer TS440 - 70AM	62
30	<b>ThinkServer TS460</b>	<b>63</b>
31	ThinkServer TS460 Platform Specifications	64
32	ThinkServer TS460 - TopSeller - 70TR - 1 of 2	65
33	ThinkServer TS460 - TopSeller - 70TR - 2 of 2	66
34	ThinkServer TS460 - TopSeller - 70TT	67
35	<b>Legal Information</b>	<b>68</b>

# Summary of Changes

---

This section describes the changes made in this version of ThinkServer PSREF and in previous version  
This edition might also include minor corrections and editorial changes which are not identified

## August 23, 2017 - Version 511

### Additions in this update

- ▶ Update ThinkServer RD650/RD550/RD450/RD350/TD350/TS460/RS160 platform specifications, add 12TB 7.2K SATA6Gbs HDD support

## June 21, 2017 - Version 508

### Additions in this update

- ▶ Add ThinkServer TS460 models announced June 2017
- ▶ Add ThinkServer RS160 models announced June 2017
- ▶ Update ThinkServer TS460 platform specifications, add new SBB support: Kaby Lake Xeon, Core i3, and Pentium processors. DDR4-2400 memory. 10TB 7.2K SATA6Gbs HDD, 10TB 7.2K SAS12Gbs HDD, 300GB/600GB 15K 2.5" SAS. Red Hat Enterprise Linux 7.3. SUSE Linux Enterprise Server 12 SP2/11 SP4
- ▶ Update ThinkServer RS160 platform specifications, add new SBB support: Kaby Lake Xeon, Core i3, Pentium, and Celeron processors. DDR4-2400 memory. 10TB 7.2K SATA6Gbs HDD, 10TB 7.2K SAS12Gbs HDD, 900GB 15K 2.5" SAS

## May 26, 2017 - Version 507

### Additions in this update

- ▶ Update ThinkServer RD650/RD550 platform specifications, add DDR4-2400 RDIMM memory, up to 1.92TB easy-swap NVMe SSD, and up to 3.84TB NVMe flash adapter

## April 19, 2017 - Version 505

### Additions in this update

- ▶ Add ThinkServer TS460 models announced April 2017
- ▶ Add ThinkServer TD350 models announced April 2017
- ▶ Add ThinkServer TS150 models announced April 2017
- ▶ Update ThinkServer TS150 platform specifications, add new Kaby Lake processors, DDR4-2400 memory, 10TB hard drive supports

## February 15, 2017 - Version 502

### Additions in this update

- ▶ Add ThinkServer RS160 models announced September 2016

### Withdrawals in this update

- ▶ ThinkServer TS140 had been end of life

## October 12, 2016 - Version 496

### Additions in this update

- ▶ New ThinkServer RS160 product announced September 2016
- ▶ New ThinkServer TS150 models announced August and October 2016

## September 14, 2016 - Version 495

### Additions in this update

- ▶ New ThinkServer RS160 product announced September 2016
- ▶ New ThinkServer TS140 models announced September 2016

## April 6, 2016 - Version 487

### Additions in this update

- ▶ New ThinkServer TD350, RD350, and RD450 models announced April 2016
- ▶ Add Intel Xeon E5-2600 v4 processors

### **March 23, 2016 - Version 486**

Additions in this update

- ▶ New ThinkServer TS140 models announced March 2016

### **February 24, 2016 - Version 485**

Additions in this update

- ▶ Add 8TB SATA and SAS 72K 6Gbs hard drive on ThinkServer RD350/RD450/RD550/RD650/TD350

### **December 30, 2015 - Version 483**

Additions in this update

- ▶ Updates ThinkServer RS140, TD340 specifications
- ▶ Updates the most recent ThinkServer RS140, TD340 models

### **December 9, 2015 - Version 482**

Additions in this update

- ▶ Updates ThinkServer TS140, TS440 specifications
- ▶ Updates the most recent ThinkServer TS140, TS440, RD350, RD450, RD550, RD650 models

### **October 28, 2015 - Version 480**

Additions in this update

- ▶ New ThinkServer TS140 models announced October 2015

### **July 30, 2015 - Version 476**

Additions in this update

- ▶ New ThinkServer TD350, RD550, and RD650 models announced July 2015

### **May 6, 2015 - Version 473**

Additions in this update

- ▶ Add 95mm optical support on TD350
- ▶ Add Red Hat Enterprise Linux 7 support on RD350/RD450/RD550/RD650/TD350
- ▶ Add 32 x 25" bay support on TD350
- ▶ Add AnyBay and 25" PCIe SSD support on RD550/RD650

### **April 15, 2015 - Version 471**

Additions in this update

- ▶ New ThinkServer TD350 models announced March 2015

### **March 25, 2015 - Version 470**

Additions in this update

- ▶ New ThinkServer TS140 and TS440 models announced March 2015





# ThinkServer RD350 Platform Specifications

Components	Specification	Components	Specification															
Dimensions	1U rack. Height: 43 mm (1.7 in), width: 482 mm (19 in), depth: 781.5 mm (30.77 in)	Systems management	Supports ThinkServer System Manager (TSM), optional TSM Premium. UEFI. Onboard Aspeed AST2400 graphics/management processor, IPMI 2.0-compliant baseboard management controller (BMC). Control Panel LEDs shows the status of power, ID, network, system. Supports ThinkServer management software: Diagnostics, Deployment Manager, Energy Manager, System Manager, Partner Pack for VMware vCenter and Microsoft System Center Operations Manager, Power Planner															
Weight	Minimum configuration: 13 kg (28.66 lb), maximum: 19.1 kg (42.11 lb)		Operating systems supported	Microsoft Windows Server 2016/2012 R2/2012/2008 R2. Windows Small Business Server 2011. Red Hat Enterprise Linux 6.5/6.6/7. SUSE Linux Enterprise Server 11. VMware vSphere (ESXi) 5.1 P5/5.5 U2/6.0														
Processor	Up to two <b>105W Intel Xeon E5-2600 v4 or E5-2600 v3</b> family processors.																	
	E5-2660 v4	14C/2GHz/35MB/105W/DDR4-2400	Base warranty															
	E5-2650 v4	12C/2.2GHz/30MB/105W/DDR4-2400																
	E5-2640 v4	10C/2.4GHz/25MB/90W/DDR4-2133																
	E5-2630 v4	10C/2.2GHz/20MB/85W/DDR4-2133																
	E5-2623 v4	4C/2.6GHz/10MB/85W/DDR4-2133																
	E5-2620 v4	8C/2.1GHz/20MB/85W/DDR4-2133																
	E5-2609 v4	8C/1.7GHz/20MB/85W/DDR4-1866																
	E5-2603 v4	6C/1.7GHz/15MB/85W/DDR4-1866																
	E5-2650L v4	14C/1.7GHz/35MB/65W/DDR4-2400																
	E5-2630L v4	10C/1.8GHz/25MB/55W/DDR4-2133																
	E5-2660 v3	10C/2.6GHz/25MB/105W/DDR4-2133																
	E5-2650 v3	10C/2.3GHz/25MB/105W/DDR4-2133																
	E5-2640 v3	8C/2.6GHz/20MB/90W/DDR4-1866																
	E5-2630 v3	8C/2.4GHz/20MB/85W/DDR4-1866																
	E5-2623 v3	4C/3GHz/10MB/105W/DDR4-1866																
	E5-2620 v3	6C/2.4GHz/15MB/85W/DDR4-1866																
	E5-2609 v3	6C/1.9GHz/15MB/85W/DDR4-1600																
	E5-2603 v3	6C/1.6GHz/15MB/85W/DDR4-1600																
	E5-2650L v3	12C/1.8GHz/30MB/65W/DDR4-2133																
E5-2630L v3	8C/1.8GHz/20MB/55W/DDR4-1866																	
Chipset	Intel C610 Series Chipset																	
Memory DIMMs	16 DIMM sockets. 4 channels per processor, 2 DIMMs per channel. <b>RDIMM</b> or <b>LRDIMM</b> (cannot be intermixed), DDR4-2133 or DDR4-2400																	
Memory capacity	512GB (RDIMM, 32GB x 16)/1024GB (LRDIMM, 64GB x 16), 2nd CPU is needed																	
Memory protection	ECC, memory mirroring, lockstep, and memory sparing																	
RAID controller	<b>RAID controller</b>	<b>Drive type</b>	<b>RAID support</b>															
	Onboard RAID110i	6Gbs SATA	0/1/10, 5 with optional key															
	RAID500 PCIe	6Gbs SAS/SATA	0/1/10, 5/50 with optional key															
	RAID520i PCIe	12Gbs SAS/SATA	0/1/10, 5/50 with optional key															
	RAID710 PCIe (1GB memory)	6Gbs SAS/SATA	0/1/10/5/50/6/60															
	RAID720i PCIe	12Gbs SAS/SATA	0/1/10/5/50, 6/60 with optional cache															
	Compatible models 4x3.5" HS/ES, 8x2.5" HS																	
	Optional cache for RAID 710: CacheVault flash cache with super capacitor, CacheCade Pro, or FastPath.																	
	Optional cache for RAID 720/AnyRAID 720i and 720ix: 1GB read-only memory or 1GB/2GB/4GB flash with super capacitor. Flash options include CacheVault, CacheCade Pro, and FastPath. 720ix must have cache. <i>Note: RAID 50 and 60 are available on 8 x 2.5" models only.</i>																	
Disk drive bays	Up to 4x3.5" hot-swap, 4x3.5" easy-swap, or 8x2.5" hot-swap disk bays on front. Supports external RDX tape drive via USB.																	
Maximum internal storage	3.5" model: up to 48TB with 7.2K SATA or 32TB with 7.2K SAS HDD, up to 7.2TB with 10K SAS HDD, up to 2.4TB with 15K SAS HDD, or up to 6.4TB with SATA SSD. 3.5" ES model: up to 12TB with 7.2K SATA, up to 24TB with 7.2K SAS. 2.5" model: up to 16TB with 7.2K SATA HDD, up to 14.4TB with 10K SAS HDD, up to 4.8TB with 15K SAS HDD, or up to 12.8TB with SATA or SAS SSD																	
SD module	Up to 2 SDHC flash cards via optional SD module, 8GB or 32GB each																	
Optical drive	Optional one 9.5mm optical, DVD-ROM or DVD±RW.																	
Network interfaces	One dedicated management port, two Gigabit Ethernet ports (RJ-45). Supports optional discrete network adapters via PCIe slots																	
Security features	Power-on and administrator password. Optional TPM (TCG 1.2-compliant)																	
			Power supply															
			Up to two redundant hot-swap 450W/550W/750W power supplies. 450 W is 80 PLUS Gold qualified. 550W is 80 PLUS Platinum qualified. 750W is 80 PLUS Platinum or Titanium qualified. 750W Titanium is 200V - 240V.															
			<table border="1"> <thead> <tr> <th rowspan="2">Disk bay configuration</th> <th colspan="3">PSU requirements</th> </tr> <tr> <th>450W</th> <th>550W</th> <th>750W</th> </tr> </thead> <tbody> <tr> <td>4x3.5"</td> <td>•</td> <td>•</td> <td>•</td> </tr> <tr> <td>8x2.5"</td> <td>•</td> <td>•</td> <td>•</td> </tr> </tbody> </table>	Disk bay configuration	PSU requirements			450W	550W	750W	4x3.5"	•	•	•	8x2.5"	•	•	•
Disk bay configuration	PSU requirements																	
	450W	550W	750W															
4x3.5"	•	•	•															
8x2.5"	•	•	•															
Graphics	Onboard Aspeed AST2400 with 16MB memory, one DisplayPort on front, one VGA on rear.																	
Front ports	Two USB 2.0. One DisplayPort (one VGA on E5-2600 v4 models instead)																	
Rear ports	One VGA, two USB 3.0, one RJ-45 (dedicated mgmt), two ethernet, one serial (9-pin)																	
Cooling	6 (5+1, dual processors) or 4 (3+1, single processor) fans, non-hot swap																	
Noise emissions	Operating: < 6.5 Bels. Idle: < 5.4 Bels (Maximum configuration)																	
Environmental specification	Temperature - operating	50 °F to 95 °F (10 °C to 35 °C)																
	Temperature - non operating (no package)	-10 °C to 60 °C																
	Temperature - non operating (with package)	-40 °C to 70 °C																
	Altitude - operating	(Unpressurized): 0-10000ft (0-3048m)																
	Humidity - operating	8%-90%, non-condensing																
	Humidity - storage (with package)	8%-90%, non-condensing																
<b>Expansion slots</b>																		
	Up to two PCIe 3.0 x 16 slots:																	
Slot 1	PCIe 3.0 x16, half length, full height, by CPU1																	
Slot 2 for dual processors model	PCIe 3.0 x16, low-profile, half length, requires 2nd riser card and 2nd CPU																	
Slot 2 for single processor model	PCIe 3.0 x16 (x8 electrical), low-profile, half length, by CPU1, requires 2nd riser card																	
For a list of all supported options, please see <a href="https://download.lenovo.com/pccbbs/options_iso/ocm_september_2016_thinkserver.xlsx">https://download.lenovo.com/pccbbs/options_iso/ocm_september_2016_thinkserver.xlsx</a> sheet																		

Model	Region	Processor	2nd CPU	Memory	Storage Controller	Disk Bays	Disks	Slots	Optical	Add-on NIC	TPM	System Mgmt	OS	Warranty	Power Supply	Ann Date (m/y)
70D6001YUX	US	1xE5-2603 v3 6C/1.6GHz/15MB/85W/DDR4-1600	4XG0F28848	1x4GB RDIMM DDR4-2133 ECC	RAID 110i	4x3.5" HS	Open	None	9.5mm DVD±RW	None	TPM	TSM	None	3-year	550Wx1 Platinum	12/14
70D60020UX	US	1xE5-2609 v3 6C/1.9GHz/15MB/85W/DDR4-1600	4XG0F28847	1x8GB RDIMM DDR4-2133 ECC	RAID 110i	4x3.5" HS	Open	1xFHHL	9.5mm DVD±RW	None	TPM	TSM	None	3-year	550Wx1 Platinum	12/14
70D60021UX	US	1xE5-2620 v3 6C/2.4GHz/15MB/85W/DDR4-1866	4XG0F28846	1x8GB RDIMM DDR4-2133 ECC	RAID 110i	4x3.5" HS	Open	1xFHHL	9.5mm DVD±RW	None	TPM	TSM	None	3-year	550Wx1 Platinum	12/14
70D60022UX	US	2xE5-2640 v3 8C/2.6GHz/20MB/90W/DDR4-1866	-	2x8GB RDIMM DDR4-2133 ECC	RAID 110i	4x3.5" HS	Open	1xFHHL+1xLP (2x16)	9.5mm DVD±RW	None	TPM	TSM	None	3-year	550Wx1 Platinum	12/14
70D60023UX	US	1xE5-2650 v3 10C/2.3GHz/25MB/105W/DDR4-2133	4XG0F28843	1x8GB RDIMM DDR4-2133 ECC	RAID 110i	4x3.5" HS	Open	1xFHHL	9.5mm DVD±RW	None	TPM	TSM	None	3-year	550Wx1 Platinum	12/14
70D60024UX	US	1xE5-2660 v3 10C/2.6GHz/25MB/105W/DDR4-2133	4XG0F28842	1x8GB RDIMM DDR4-2133 ECC	RAID 110i	4x3.5" HS	Open	1xFHHL	9.5mm DVD±RW	None	TPM	TSM	None	3-year	550Wx1 Platinum	12/14
70D60025UX	US	1xE5-2603 v3 6C/1.6GHz/15MB/85W/DDR4-1600	4XG0F28848	1x8GB RDIMM DDR4-2133 ECC	RAID 110i	4x3.5" HS	Open	1xFHHL	9.5mm DVD±RW	None	TPM	TSM	None	3-year	550Wx1 Platinum	12/14
70D60026UX	US	1xE5-2630 v3 8C/2.4GHz/20MB/85W/DDR4-1866	4XG0F28845	1x8GB RDIMM DDR4-2133 ECC	RAID 110i	4x3.5" HS	Open	1xFHHL	9.5mm DVD±RW	None	TPM	TSM	None	3-year	550Wx1 Platinum	12/14
70D60035UX	US	1xE5-2620 v3 6C/2.4GHz/15MB/85W/DDR4-1866	4XG0F28846	2x8GB RDIMM DDR4-2133 ECC	RAID 110i	4x3.5" HS	2x1TB HDD 7.2K 3.5" SATA6Gbps	1xFHHL	9.5mm DVD±RW	None	TPM	TSM Premium	None	3-year	750Wx2 Platinum	02/15
70D6003DUX	US	2xE5-2620 v3 6C/2.4GHz/15MB/85W/DDR4-1866	-	2x16GB RDIMM DDR4-2133 ECC	RAID 110i	4x3.5" HS	Open	1xFHHL+1xLP (2x16)	9.5mm DVD±RW	None	TPM	TSM	None	3-year	550Wx2 Platinum	09/15
70D6003PUX	US	1xE5-2609 v3 6C/1.9GHz/15MB/85W/DDR4-1600	4XG0F28847	4x16GB RDIMM DDR4-2133 ECC	RAID 110i	4x3.5" HS	4x1TB HDD 7.2K 3.5" SATA6Gbps	None	None	None	TPM	TSM Premium	None	3-year	550Wx2 Platinum	11/15

Model	Region	Processor	2nd CPU	Memory	Storage Controller	Disk Bays	Disks	Slots	Optical	Add-on NIC	TPM	System Mgmt	OS	Warranty	Power Supply	Ann Date (m/y)
70D8001TUX	US	1xE5-2603 v3 6C/1.6GHz/15MB/85W/DDR4-1600	4XG0F28848	1x4GB RDIMM DDR4-2133 ECC	RAID 110i	8x2.5" HS	Open	None	9.5mm DVD±RW	None	TPM	TSM	None	3-year	550Wx1 Platinum	12/14
70D8001UUX	US	1xE5-2609 v3 6C/1.9GHz/15MB/85W/DDR4-1600	4XG0F28847	1x8GB RDIMM DDR4-2133 ECC	RAID 110i	8x2.5" HS	Open	1xFHHL	9.5mm DVD±RW	None	TPM	TSM	None	3-year	550Wx1 Platinum	12/14
70D8001VUX	US	1xE5-2620 v3 6C/2.4GHz/15MB/85W/DDR4-1866	4XG0F28846	1x8GB RDIMM DDR4-2133 ECC	RAID 110i	8x2.5" HS	Open	1xFHHL	9.5mm DVD±RW	None	TPM	TSM	None	3-year	550Wx1 Platinum	12/14
70D8001WUX	US	1xE5-2640 v3 8C/2.6GHz/20MB/90W/DDR4-1866	4XG0F28844	1x8GB RDIMM DDR4-2133 ECC	RAID 110i	8x2.5" HS	Open	1xFHHL	9.5mm DVD±RW	None	TPM	TSM	None	3-year	550Wx1 Platinum	12/14
70D8001XUX	US	1xE5-2650 v3 10C/2.3GHz/25MB/105W/DDR4-2133	4XG0F28843	1x8GB RDIMM DDR4-2133 ECC	RAID 110i	8x2.5" HS	Open	1xFHHL	9.5mm DVD±RW	None	TPM	TSM	None	3-year	550Wx1 Platinum	12/14
70D8001YUX	US	1xE5-2660 v3 10C/2.6GHz/25MB/105W/DDR4-2133	4XG0F28842	1x8GB RDIMM DDR4-2133 ECC	RAID 110i	8x2.5" HS	Open	1xFHHL	9.5mm DVD±RW	None	TPM	TSM	None	3-year	550Wx1 Platinum	12/14
70D80020UX	US	1xE5-2603 v3 6C/1.6GHz/15MB/85W/DDR4-1600	4XG0F28848	1x8GB RDIMM DDR4-2133 ECC	RAID 110i	8x2.5" HS	Open	1xFHHL	9.5mm DVD±RW	None	TPM	TSM	None	3-year	550Wx1 Platinum	12/14
70D80021UX	US	1xE5-2630 v3 8C/2.4GHz/20MB/85W/DDR4-1866	4XG0F28845	1x8GB RDIMM DDR4-2133 ECC	RAID 110i	8x2.5" HS	Open	1xFHHL	9.5mm DVD±RW	None	TPM	TSM	None	3-year	550Wx1 Platinum	12/14

Model	Region	Processor	2nd CPU	Memory	Storage Controller	Disk Bays	Disks	Slots	Optical	Add-on NIC	TPM	System Mgmt	OS	Warranty	Power Supply	Ann Date (m/y)
70QK000VUX	US	1xE5-2603 v4 6C/1.7GHz/15MB/85W/DDR4-1866	4XG0G89089	1x16GB RDIMM DDR4-2400 ECC	RAID 110i	4x3.5" HS	Open	1xFHHL	None	None	TPM	TSM	None	3-year	750Wx1 Platinum	04/16
70QK000WUX	US	1xE5-2609 v4 8C/1.7GHz/20MB/85W/DDR4-1866	4XG0G89084	1x16GB RDIMM DDR4-2400 ECC	RAID 110i	4x3.5" HS	Open	1xFHHL	None	None	TPM	TSM	None	3-year	750Wx1 Platinum	04/16
70QK000XUX	US	1xE5-2620 v4 8C/2.1GHz/20MB/85W/DDR4-2133	4XG0G89079	1x16GB RDIMM DDR4-2400 ECC	RAID 110i	4x3.5" HS	Open	1xFHHL	None	None	TPM	TSM	None	3-year	750Wx1 Platinum	04/16
70QK000YUX	US	1xE5-2630 v4 10C/2.2GHz/20MB/85W/DDR4-2133	4XG0G89074	1x16GB RDIMM DDR4-2400 ECC	RAID 110i	4x3.5" HS	Open	1xFHHL	None	None	TPM	TSM	None	3-year	750Wx1 Platinum	04/16
70QK0010UX	US	1xE5-2640 v4 10C/2.4GHz/25MB/90W/DDR4-2133	4XG0G89069	1x16GB RDIMM DDR4-2400 ECC	RAID 110i	4x3.5" HS	Open	1xFHHL	None	None	TPM	TSM	None	3-year	750Wx1 Platinum	04/16
70QK0011UX	US	1xE5-2650 v4 12C/2.2GHz/30MB/105W/DDR4-2400	4XG0G89064	1x16GB RDIMM DDR4-2400 ECC	RAID 110i	4x3.5" HS	Open	1xFHHL	None	None	TPM	TSM	None	3-year	750Wx1 Platinum	04/16
70QK0012UX	US	1xE5-2660 v4 14C/2.0GHz/35MB/105W/DDR4-2400	4XG0G89059	1x16GB RDIMM DDR4-2400 ECC	RAID 110i	4x3.5" HS	Open	1xFHHL	None	None	TPM	TSM	None	3-year	750Wx1 Platinum	04/16
70QK0013UX	US	1xE5-2609 v4 8C/1.7GHz/20MB/85W/DDR4-1866	4XG0G89084	4x16GB RDIMM DDR4-2400 ECC	RAID 110i	4x3.5" HS	4x1TB HDD 7.2K 3.5" SATA6Gbps	1xFHHL	None	None	TPM	TSM Premium	None	3-year	750Wx2 Platinum	04/16
70QK0014UX	US	2xE5-2620 v4 8C/2.1GHz/20MB/85W/DDR4-2133	-	2x16GB RDIMM DDR4-2400 ECC	RAID 110i	4x3.5" HS	Open	1xFHHL+1xLP (2x16)	None	None	TPM	TSM Premium	None	3-year	750Wx2 Platinum	04/16

Model	Region	Processor	2nd CPU	Memory	Storage Controller	Disk Bays	Disks	Slots	Optical	Add-on NIC	TPM	System Mgmt	OS	Warranty	Power Supply	Ann Date (m/y)
70QM0010UX	US	1xE5-2603 v4 6C/1.7GHz/15MB/85W/DDR4-1866	4XG0G89089	1x16GB RDIMM DDR4-2400 ECC	RAID 110i	8x2.5" HS	Open	1xFHHL	None	None	TPM	TSM	None	3-year	750Wx1 Platinum	04/16
70QM0011UX	US	1xE5-2609 v4 8C/1.7GHz/20MB/85W/DDR4-1866	4XG0G89084	1x16GB RDIMM DDR4-2400 ECC	RAID 110i	8x2.5" HS	Open	1xFHHL	None	None	TPM	TSM	None	3-year	750Wx1 Platinum	04/16
70QM0012UX	US	1xE5-2620 v4 8C/2.1GHz/20MB/85W/DDR4-2133	4XG0G89079	1x16GB RDIMM DDR4-2400 ECC	RAID 110i	8x2.5" HS	Open	1xFHHL	None	None	TPM	TSM	None	3-year	750Wx1 Platinum	04/16
70QM0013UX	US	1xE5-2630L v4 10C/1.8GHz/25MB/55W/DDR4-2133	4XG0G89104	1x16GB RDIMM DDR4-2400 ECC	RAID 110i	8x2.5" HS	Open	1xFHHL	None	None	TPM	TSM	None	3-year	750Wx1 Platinum	04/16
70QM0014UX	US	1xE5-2630 v4 10C/2.2GHz/20MB/85W/DDR4-2133	4XG0G89074	1x16GB RDIMM DDR4-2400 ECC	RAID 110i	8x2.5" HS	Open	1xFHHL	None	None	TPM	TSM	None	3-year	750Wx1 Platinum	04/16
70QM0015UX	US	1xE5-2640 v4 10C/2.4GHz/25MB/90W/DDR4-2133	4XG0G89069	1x16GB RDIMM DDR4-2400 ECC	RAID 110i	8x2.5" HS	Open	1xFHHL	None	None	TPM	TSM	None	3-year	750Wx1 Platinum	04/16
70QM0016UX	US	1xE5-2650 v4 12C/2.2GHz/30MB/105W/DDR4-2400	4XG0G89064	1x16GB RDIMM DDR4-2400 ECC	RAID 110i	8x2.5" HS	Open	1xFHHL	None	None	TPM	TSM	None	3-year	750Wx1 Platinum	04/16
70QM0017UX	US	1xE5-2660 v4 14C/2.0GHz/35MB/105W/DDR4-2400	4XG0G89059	1x16GB RDIMM DDR4-2400 ECC	RAID 110i	8x2.5" HS	Open	1xFHHL	None	None	TPM	TSM	None	3-year	750Wx1 Platinum	04/16





# ThinkServer RD450 Platform Specifications

Product Specifications Reference (PSREF)

Components	Specification																																								
Dimensions	2U rack. Height: 87 mm (3.4 in), width: 482 mm (19 in), depth: 764 mm (30 in)																																								
Weight	Minimum configuration: 16 kg (35.3 lb), maximum: 27 kg (59.52 lb)																																								
Processor	Up to two <b>105W Intel Xeon E5-2600 v4 or E5-2600 v3</b> family processors.																																								
	E5-2660 v4	14C/2GHz/35MB/105W/DDR4-2400																																							
	E5-2650 v4	12C/2.2GHz/30MB/105W/DDR4-2400																																							
	E5-2640 v4	10C/2.4GHz/25MB/90W/DDR4-2133																																							
	E5-2630 v4	10C/2.2GHz/20MB/85W/DDR4-2133																																							
	E5-2623 v4	4C/2.6GHz/10MB/85W/DDR4-2133																																							
	E5-2620 v4	8C/2.1GHz/20MB/85W/DDR4-2133																																							
	E5-2609 v4	8C/1.7GHz/20MB/85W/DDR4-1866																																							
	E5-2603 v4	6C/1.7GHz/15MB/85W/DDR4-1866																																							
	E5-2650L v4	14C/1.7GHz/35MB/65W/DDR4-2400																																							
	E5-2630L v4	10C/1.8GHz/25MB/55W/DDR4-2133																																							
	E5-2660 v3	10C/2.6GHz/25MB/105W/DDR4-2133																																							
	E5-2650 v3	10C/2.3GHz/25MB/105W/DDR4-2133																																							
	E5-2640 v3	8C/2.6GHz/20MB/90W/DDR4-1866																																							
	E5-2630 v3	8C/2.4GHz/20MB/85W/DDR4-1866																																							
	E5-2623 v3	4C/3GHz/10MB/105W/DDR4-1866																																							
	E5-2620 v3	6C/2.4GHz/15MB/85W/DDR4-1866																																							
E5-2609 v3	6C/1.9GHz/15MB/85W/DDR4-1600																																								
E5-2603 v3	6C/1.6GHz/15MB/85W/DDR4-1600																																								
E5-2650L v3	12C/1.8GHz/30MB/65W/DDR4-2133																																								
E5-2630L v3	8C/1.8GHz/20MB/55W/DDR4-1866																																								
Chipset	Intel C610 Series Chipset																																								
Memory DIMMs	16 DIMM sockets with 8 channels. 4 channels per processor, 2 DIMMs per channel. <b>RDIMM</b> or <b>LRDIMM</b> (cannot be intermixed), DDR4, DDR4-2133 or DDR4-2400																																								
Memory capacity	512GB (RDIMM, 32GB x 16)/1024GB (LRDIMM, 64GB x 16), 2nd CPU is needed																																								
Memory protection	ECC, memory mirroring, lockstep, and memory sparing																																								
RAID controller	<table border="1"> <thead> <tr> <th>RAID controller</th> <th>Drive type</th> <th>RAID support</th> <th>Compatible models</th> </tr> </thead> <tbody> <tr> <td>Onboard RAID110i</td> <td>6Gbs SATA</td> <td>0/1/10, 5 with optional key</td> <td>8x3.5" HS/ES, 8x2.5" HS</td> </tr> <tr> <td>RAID500 PCIe</td> <td>6Gbs SAS/SATA</td> <td>0/1/10, 5/50 with optional key</td> <td>8x3.5" HS</td> </tr> <tr> <td>RAID520i PCIe</td> <td>12Gbs SAS/SATA</td> <td>0/1/10, 5/50 with optional key</td> <td>8x3.5" HS/ES, 8x2.5" HS</td> </tr> <tr> <td>RAID710 PCIe (1GB memory)</td> <td>6Gbs SAS/SATA</td> <td>0/1/10/5/50/6/60</td> <td>8x3.5" HS</td> </tr> <tr> <td>RAID720i PCIe</td> <td>12Gbs SAS/SATA</td> <td>0/1/10/5/50, 6/60 with optional cache</td> <td>8x3.5" HS/ES, 8x2.5" HS</td> </tr> <tr> <td>AnyRAID 110i</td> <td>6Gbs SATA</td> <td>0/1/10, 5 with optional key</td> <td>8x2.5" HS</td> </tr> <tr> <td>AnyRAID 510i</td> <td>6Gbs SAS/SATA</td> <td>0/1/10, 5/50 with optional key</td> <td>8x2.5" HS</td> </tr> <tr> <td>AnyRAID 720i</td> <td>12Gbs SAS/SATA</td> <td>0/1/10/5/50, 6/60 with optional cache</td> <td>8x2.5" HS</td> </tr> <tr> <td>AnyRAID 720ix</td> <td>12Gbs SAS/SATA</td> <td>0/1/10/5/50/6/60</td> <td>16/24x2.5" HS, 8x2.5" HS+optional tape</td> </tr> </tbody> </table>	RAID controller	Drive type	RAID support	Compatible models	Onboard RAID110i	6Gbs SATA	0/1/10, 5 with optional key	8x3.5" HS/ES, 8x2.5" HS	RAID500 PCIe	6Gbs SAS/SATA	0/1/10, 5/50 with optional key	8x3.5" HS	RAID520i PCIe	12Gbs SAS/SATA	0/1/10, 5/50 with optional key	8x3.5" HS/ES, 8x2.5" HS	RAID710 PCIe (1GB memory)	6Gbs SAS/SATA	0/1/10/5/50/6/60	8x3.5" HS	RAID720i PCIe	12Gbs SAS/SATA	0/1/10/5/50, 6/60 with optional cache	8x3.5" HS/ES, 8x2.5" HS	AnyRAID 110i	6Gbs SATA	0/1/10, 5 with optional key	8x2.5" HS	AnyRAID 510i	6Gbs SAS/SATA	0/1/10, 5/50 with optional key	8x2.5" HS	AnyRAID 720i	12Gbs SAS/SATA	0/1/10/5/50, 6/60 with optional cache	8x2.5" HS	AnyRAID 720ix	12Gbs SAS/SATA	0/1/10/5/50/6/60	16/24x2.5" HS, 8x2.5" HS+optional tape
	RAID controller	Drive type	RAID support	Compatible models																																					
	Onboard RAID110i	6Gbs SATA	0/1/10, 5 with optional key	8x3.5" HS/ES, 8x2.5" HS																																					
	RAID500 PCIe	6Gbs SAS/SATA	0/1/10, 5/50 with optional key	8x3.5" HS																																					
	RAID520i PCIe	12Gbs SAS/SATA	0/1/10, 5/50 with optional key	8x3.5" HS/ES, 8x2.5" HS																																					
	RAID710 PCIe (1GB memory)	6Gbs SAS/SATA	0/1/10/5/50/6/60	8x3.5" HS																																					
	RAID720i PCIe	12Gbs SAS/SATA	0/1/10/5/50, 6/60 with optional cache	8x3.5" HS/ES, 8x2.5" HS																																					
	AnyRAID 110i	6Gbs SATA	0/1/10, 5 with optional key	8x2.5" HS																																					
	AnyRAID 510i	6Gbs SAS/SATA	0/1/10, 5/50 with optional key	8x2.5" HS																																					
	AnyRAID 720i	12Gbs SAS/SATA	0/1/10/5/50, 6/60 with optional cache	8x2.5" HS																																					
AnyRAID 720ix	12Gbs SAS/SATA	0/1/10/5/50/6/60	16/24x2.5" HS, 8x2.5" HS+optional tape																																						
Optional cache for RAID 710: CacheVault flash cache with super capacitor, CacheCade Pro, or FastPath.																																									
Optional cache for RAID 720/AnyRAID 720i and 720ix: 1GB read-only memory or 1GB/2GB/4GB flash with super capacitor. Flash options include CacheVault, CacheCade Pro, and FastPath. 720ix must have cache.																																									
Disk drive bays	Up to 8x3.5" hot-swap, 8x3.5" easy-swap, or 24x2.5" hot-swap disk bays on front. Up to one internal LTO-6 SAS tape drive on 8x2.5" and 720ix model, or external RDX tape drive via USB.																																								
Maximum internal storage	3.5" HS model: up to 96TB with 7.2K SATA or 64TB with 7.2K SAS HDD, up to 14.4TB with 10K SAS HDD, up to 4.8TB with 15K SAS HDD, or up to 12.8TB with SATA SSD. 3.5" ES model: up to 24TB with 7.2K SATA, up to 48TB with 7.2K SAS. 2.5" HS model: up to 48TB with 7.2K SATA HDD, up to 43.2TB with 10K SAS HDD, up to 14.4TB with 15K SAS HDD, or up to 38.4TB with SATA or SAS SSD																																								
SD module	Up to 2 SDHC flash cards via optional SD module, 8GB or 32GB each																																								
PCIe SSD adapter	Supports 1.6TB or 3.2TB SSD via PCIe adapter																																								
Optical drive	Optional one 9.5mm optical on 3.5" or 8/16 x 2.5" models, DVD-ROM or DVD±RW.																																								

Components	Specification																																			
Network interfaces	One dedicated management port, two Gigabit Ethernet ports. Supports optional discrete network adapters via PCIe slots																																			
Security features	Power-on and administrator password. Optional TPM (TCG 1.2-compliant)																																			
Systems management	Supports ThinkServer System Manager (TSM), optional TSM Premium. UEFI. Onboard Aspeed AST2400 graphics/management processor, IPMI 2.0-compliant baseboard management controller (BMC). Control Panel LEDs shows the status of power, ID, network, system. Supports ThinkServer management software: Diagnostics, Deployment Manager, Energy Manager, System Manager, Partner Pack for VMware vCenter and Microsoft System Center Operations Manager, Power Planner																																			
Operating systems supported	Microsoft Windows Server 2016/2012 R2/2012/2008 R2. Windows Small Business Server 2011. Red Hat Enterprise Linux 6.5/6.6/7. SUSE Linux Enterprise Server 11. VMware vSphere (ESXi) 5.1 P5/5.5 U2/6.0																																			
Base warranty	1 or 3-year limited onsite service with 9x5/NBD																																			
Power supply	Up to two redundant hot-swap 450W/550W/750W/1100W power supplies. 450 W is 80 PLUS Gold qualified. 550W and 1100W are 80 PLUS Platinum qualified. 750W is 80 PLUS Platinum or Titanium qualified. 750W Titanium is 200V - 240V, others are 110V - 240V.																																			
	<table border="1"> <thead> <tr> <th>Disk bay configuration</th> <th colspan="4">PSU requirements</th> </tr> <tr> <th></th> <th>450W</th> <th>550W</th> <th>750W</th> <th>1100W</th> </tr> </thead> <tbody> <tr> <td>8x3.5"</td> <td>•</td> <td>•</td> <td>•</td> <td>•</td> </tr> <tr> <td>8x2.5"</td> <td>•</td> <td>•</td> <td>•</td> <td>•</td> </tr> <tr> <td>8x2.5" + Tape</td> <td>•</td> <td>•</td> <td>•</td> <td>•</td> </tr> <tr> <td>16x2.5"</td> <td>•</td> <td>•</td> <td>•</td> <td>•</td> </tr> <tr> <td>24x2.5"</td> <td>•</td> <td>•</td> <td>•</td> <td>•</td> </tr> </tbody> </table>	Disk bay configuration	PSU requirements					450W	550W	750W	1100W	8x3.5"	•	•	•	•	8x2.5"	•	•	•	•	8x2.5" + Tape	•	•	•	•	16x2.5"	•	•	•	•	24x2.5"	•	•	•	•
	Disk bay configuration	PSU requirements																																		
		450W	550W	750W	1100W																															
	8x3.5"	•	•	•	•																															
8x2.5"	•	•	•	•																																
8x2.5" + Tape	•	•	•	•																																
16x2.5"	•	•	•	•																																
24x2.5"	•	•	•	•																																
Graphics	Onboard Aspeed AST2400 with 16MB memory																																			
Front ports	Two USB 2.0. One DisplayPort (one VGA on E5-2600 v4 models instead)																																			
Rear ports	One VGA, two USB 3.0, one RJ-45 (dedicated mgmt), two ethernet, one serial (9-pin)																																			
Cooling	4 (3+1, dual processors) or 3 (2+1, single processor) fans, non-hot swap																																			
Noise emissions	Operating: < 6.5 Bels. Idle: < 5.6 Bels (Maximum configuration)																																			
Environmental specification	<table border="1"> <tbody> <tr> <td>Temperature - operating</td> <td>50 °F to 95 °F (10 °C to 35 °C)</td> </tr> <tr> <td>Temperature - non operating (no package)</td> <td>-10 °C to 60 °C</td> </tr> <tr> <td>Temperature - non operating (with package)</td> <td>-40 °C to 70 °C</td> </tr> <tr> <td>Altitude - operating</td> <td>(Unpressurized): 0-10000ft (0-3048m)</td> </tr> <tr> <td>Humidity - operating</td> <td>8%-90%, non-condensing</td> </tr> <tr> <td>Humidity - storage (with package)</td> <td>8%-90%, non-condensing</td> </tr> </tbody> </table>	Temperature - operating	50 °F to 95 °F (10 °C to 35 °C)	Temperature - non operating (no package)	-10 °C to 60 °C	Temperature - non operating (with package)	-40 °C to 70 °C	Altitude - operating	(Unpressurized): 0-10000ft (0-3048m)	Humidity - operating	8%-90%, non-condensing	Humidity - storage (with package)	8%-90%, non-condensing																							
	Temperature - operating	50 °F to 95 °F (10 °C to 35 °C)																																		
	Temperature - non operating (no package)	-10 °C to 60 °C																																		
	Temperature - non operating (with package)	-40 °C to 70 °C																																		
	Altitude - operating	(Unpressurized): 0-10000ft (0-3048m)																																		
Humidity - operating	8%-90%, non-condensing																																			
Humidity - storage (with package)	8%-90%, non-condensing																																			

## Expansion slots

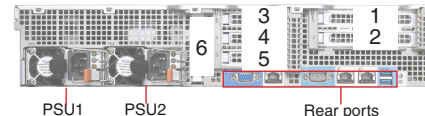

Slot 1 (riser card 1)	PCIe 3.0 x8, half length, full height, CPU1
Slot 2 (riser card 1)	PCIe 3.0 x8, half length, full height, CPU1
Slot 3 (riser card 2)	PCIe 3.0 x8, low-profile, half length, CPU2, requires 2nd riser card and 2nd CPU
Slot 4 (riser card 2)	PCIe 3.0 x8, low-profile, half length, CPU2, requires 2nd riser card and 2nd CPU
Slot 5 (riser card 2)	PCIe 3.0 x8, low-profile, half length, CPU1, requires 2nd riser card
Slot 6 (onboard)	PCIe 3.0 x16 (x8 elec), low-profile, half length, requires 2nd CPU

For a list of all supported options, please see [https://download.lenovo.com/pccbbs/options\\_iso/ocm\\_september\\_2016\\_thinkserver.xlsx](https://download.lenovo.com/pccbbs/options_iso/ocm_september_2016_thinkserver.xlsx) sheet



Model	Region	Processor	2nd CPU	Memory	Storage Controller	Disk Bays	Disks	Slots	Optical	Add-on NIC	TPM	System Mgmt	OS	Warranty	Power Supply	Ann Date (m/y)
70DA000XUX	US	1xE5-2603 v3 6C/1.6GHz/15MB/85W/DDR4-1600	4XG0F28860	1x4GB RDIMM DDR4-2133 ECC	110i (AnyRAID)	8x2.5" HS	Open	None	9.5mm DVD±RW	None	TPM	TSM	None	3-year	550Wx1 Platinum	12/14
70DA000YUX	US	1xE5-2609 v3 6C/1.9GHz/15MB/85W/DDR4-1600	4XG0F28859	1x8GB RDIMM DDR4-2133 ECC	110i (AnyRAID)	8x2.5" HS	Open	2xFH HL	9.5mm DVD±RW	None	TPM	TSM	None	3-year	550Wx1 Platinum	12/14
70DA0010UX	US	1xE5-2620 v3 6C/2.4GHz/15MB/85W/DDR4-1866	4XG0F28858	1x8GB RDIMM DDR4-2133 ECC	110i (AnyRAID)	8x2.5" HS	Open	2xFH HL	9.5mm DVD±RW	None	TPM	TSM	None	3-year	550Wx1 Platinum	12/14
70DA0011UX	US	1xE5-2630 v3 8C/2.4GHz/20MB/85W/DDR4-1866	4XG0F28857	1x8GB RDIMM DDR4-2133 ECC	110i (AnyRAID)	8x2.5" HS	Open	2xFH HL	9.5mm DVD±RW	None	TPM	TSM	None	3-year	550Wx1 Platinum	12/14
70DA0012UX	US	1xE5-2640 v3 8C/2.6GHz/20MB/90W/DDR4-1866	4XG0F28856	1x8GB RDIMM DDR4-2133 ECC	110i (AnyRAID)	8x2.5" HS	Open	2xFH HL	9.5mm DVD±RW	None	TPM	TSM	None	3-year	550Wx1 Platinum	12/14
70DA0013UX	US	1xE5-2660 v3 10C/2.6GHz/25MB/105W/DDR4-2133	4XG0F28854	1x8GB RDIMM DDR4-2133 ECC	110i (AnyRAID)	8x2.5" HS	Open	2xFH HL	9.5mm DVD±RW	None	TPM	TSM	None	3-year	550Wx1 Platinum	12/14
70DA0014UX	US	1xE5-2603 v3 6C/1.6GHz/15MB/85W/DDR4-1600	4XG0F28860	1x8GB RDIMM DDR4-2133 ECC	110i (AnyRAID)	8x2.5" HS	Open	2xFH HL	None	None	TPM	TSM	None	3-year	550Wx1 Platinum	12/14

Model	Region	Processor	2nd CPU	Memory	Storage Controller	Disk Bays	Disks	Slots	Optical	Add-on NIC	TPM	System Mgmt	OS	Warranty	Power Supply	Ann Date (m/y)
70DC001CUX	US	1xE5-2603 v3 6C/1.6GHz/15MB/85W/DDR4-1600	4XG0F28860	1x4GB RDIMM DDR4-2133 ECC	Onboard 110i (PCIe)	8x3.5" HS	Open	None	9.5mm DVD±RW	None	TPM	TSM	None	3-year	550Wx1 Platinum	12/14
70DC001DUX	US	1xE5-2609 v3 6C/1.9GHz/15MB/85W/DDR4-1600	4XG0F28859	1x8GB RDIMM DDR4-2133 ECC	Onboard 110i (PCIe)	8x3.5" HS	Open	2xFH HL	9.5mm DVD±RW	None	TPM	TSM	None	3-year	550Wx1 Platinum	12/14
70DC001EUX	US	1xE5-2620 v3 6C/2.4GHz/15MB/85W/DDR4-1866	4XG0F28858	1x8GB RDIMM DDR4-2133 ECC	Onboard 110i (PCIe)	8x3.5" HS	Open	2xFH HL	9.5mm DVD±RW	None	TPM	TSM	None	3-year	550Wx1 Platinum	12/14
70DC001FUX	US	1xE5-2630 v3 8C/2.4GHz/20MB/85W/DDR4-1866	4XG0F28857	1x8GB RDIMM DDR4-2133 ECC	Onboard 110i (PCIe)	8x3.5" HS	Open	2xFH HL	9.5mm DVD±RW	None	TPM	TSM	None	3-year	550Wx1 Platinum	12/14
70DC001GUX	US	1xE5-2640 v3 8C/2.6GHz/20MB/90W/DDR4-1866	4XG0F28856	1x8GB RDIMM DDR4-2133 ECC	Onboard 110i (PCIe)	8x3.5" HS	Open	2xFH HL	9.5mm DVD±RW	None	TPM	TSM	None	3-year	550Wx1 Platinum	12/14
70DC001HUX	US	1xE5-2650 v3 10C/2.3GHz/25MB/105W/DDR4-2133	4XG0F28855	1x8GB RDIMM DDR4-2133 ECC	Onboard 110i (PCIe)	8x3.5" HS	Open	2xFH HL	9.5mm DVD±RW	None	TPM	TSM	None	3-year	550Wx1 Platinum	12/14
70DC001JUX	US	1xE5-2660 v3 10C/2.6GHz/25MB/105W/DDR4-2133	4XG0F28854	1x8GB RDIMM DDR4-2133 ECC	Onboard 110i (PCIe)	8x3.5" HS	Open	2xFH HL	9.5mm DVD±RW	None	TPM	TSM	None	3-year	550Wx1 Platinum	12/14
70DC001KUX	US	1xE5-2603 v3 6C/1.6GHz/15MB/85W/DDR4-1600	4XG0F28860	1x8GB RDIMM DDR4-2133 ECC	Onboard 110i (PCIe)	8x3.5" HS	Open	2xFH HL	9.5mm DVD±RW	None	TPM	TSM	None	3-year	550Wx1 Platinum	12/14
70DC002EUX	US	1xE5-2620 v3 6C/2.4GHz/15MB/85W/DDR4-1866	4XG0F28858	2x8GB RDIMM DDR4-2133 ECC	Onboard 110i (PCIe)	8x3.5" HS	2x1TB HDD 7.2K 3.5" SATA6Gbps	2xFH HL	9.5mm DVD±RW	None	TPM	TSM Premium	None	3-year	750Wx2 Platinum	02/15
70DC002GUX	US	2xE5-2620 v3 6C/2.4GHz/15MB/85W/1866MH	-	2x16GB RDIMM DDR4-2133 ECC	Onboard 110i (PCIe)	8x3.5" HS	Open	2xFH HL + 4xLP HL	9.5mm DVD±RW	None	TPM	TSM Premium	None	3-year	750Wx2 Platinum	09/15
70DC002UUX	US	1xE5-2630 v3 8C/2.4GHz/20MB/85W/DDR4-1866	4XG0F28857	4x16GB RDIMM DDR4-2133 ECC	Onboard 110i (PCIe)	8x3.5" HS	4x1TB HDD 7.2K 3.5" SATA6Gbps	None	None	None	TPM	TSM Premium	None	3-year	550Wx2 Platinum	11/15

Model	Region	Processor	2nd CPU	Memory	Storage Controller	Disk Bays	Disks	Slots	Optical	Add-on NIC	TPM	System Mgmt	OS	Warranty	Power Supply	Ann Date (m/y)
70DE000BUX	US	1xE5-2650 v3 10C/2.3GHz/25MB/105W/DDR4-2133	4XG0F28855	1x16GB RDIMM DDR4-2133 ECC	720ix+1GB RAM (AnyRAID)	24x2.5" HS	Open	2xFH HL	None	None	TPM	TSM Premium	None	3-year	750Wx1 Platinum	12/14
70DE000CUX	US	2xE5-2620 v3 6C/2.4GHz/15MB/85W/1866MH	-	8x16GB RDIMM DDR4-2133 ECC	720ix+1GB RAM (AnyRAID)	24x2.5" HS	8x300GB HDD 10K 2.5" SAS6Gbps	2xFH HL + 4xLP HL	None	None	TPM	TSM Premium	None	3-year	750Wx2 Platinum	12/14
70DE000HUX	US	1xE5-2609 v3 6C/1.9GHz/15MB/85W/DDR4-1600	4XG0F28859	1x4GB RDIMM DDR4-2133 ECC	720ix+1GB RAM (AnyRAID)	24x2.5" HS	Open	None	None	None	TPM	TSM	None	3-year	750Wx1 Platinum	12/14
70DE000JUX	US	1xE5-2620 v3 6C/2.4GHz/15MB/85W/DDR4-1866	4XG0F28858	1x8GB RDIMM DDR4-2133 ECC	720ix+1GB RAM (AnyRAID)	24x2.5" HS	Open	2xFH HL	None	None	TPM	TSM	None	3-year	750Wx1 Platinum	12/14
70DE000KUX	US	1xE5-2640 v3 8C/2.6GHz/20MB/90W/DDR4-1866	4XG0F28856	1x8GB RDIMM DDR4-2133 ECC	720ix+1GB RAM (AnyRAID)	24x2.5" HS	Open	2xFH HL	None	None	TPM	TSM	None	3-year	750Wx1 Platinum	12/14

# ThinkServer RD450 - TopSeller - 70DV

Product Specifications Reference (PSREF)

Model	Region	Processor	2nd CPU	Memory	Storage Controller	Disk Bays	Disks	Slots	Optical	Add-on NIC	TPM	System Mgmt	OS	Warranty	Power Supply	Ann Date (m/y)
70DV0008UX	US	1xE5-2603 v3 6C/1.6GHz/15MB/85W/DDR4-1600	4XG0F28860	1x4GB RDIMM DDR4-2133 ECC	720ix+1GB RAM (AnyRAID)	16x2.5" HS	Open	None	None	None	TPM	TSM	None	3-year	750Wx1 Platinum	12/14
70DV0009UX	US	1xE5-2620 v3 6C/2.4GHz/15MB/85W/DDR4-1866	4XG0F28858	1x8GB RDIMM DDR4-2133 ECC	720ix+1GB RAM (AnyRAID)	16x2.5" HS	Open	2xFH HL	None	None	TPM	TSM	None	3-year	750Wx1 Platinum	12/14
70DV000AUX	US	1xE5-2640 v3 8C/2.6GHz/20MB/90W/DDR4-1866	4XG0F28856	1x8GB RDIMM DDR4-2133 ECC	720ix+1GB RAM (AnyRAID)	16x2.5" HS	Open	2xFH HL	None	None	TPM	TSM	None	3-year	750Wx1 Platinum	12/14

ThinkServer RD450 - TopSeller - 70Q9

Product Specifications Reference (PSREF)

Model	Region	Processor	2nd CPU	Memory	Storage Controller	Disk Bays	Disks	Slots	Optical	Add-on NIC	TPM	System Mgmt	OS	Warranty	Power Supply	Ann Date (m/y)
70Q9001DUX	US	1xE5-2603 v4 6C/1.7GHz/15MB/85W/DDR4-1866	4XG0G89090	1x16GB RDIMM DDR4-2400 ECC	110i (PCIe)	8x2.5" HS	Open	2xFH HL	None	None	TPM	TSM	None	3-year	750Wx1 Platinum	03/16
70Q9001EUX	US	1xE5-2609 v4 8C/1.7GHz/20MB/85W/DDR4-1866	4XG0G89085	1x16GB RDIMM DDR4-2400 ECC	110i (PCIe)	8x2.5" HS	Open	2xFH HL	None	None	TPM	TSM	None	3-year	750Wx1 Platinum	03/16
70Q9001FUX	US	1xE5-2620 v4 8C/2.1GHz/20MB/85W/DDR4-2133	4XG0G89080	1x16GB RDIMM DDR4-2400 ECC	110i (PCIe)	8x2.5" HS	Open	2xFH HL	None	None	TPM	TSM	None	3-year	750Wx1 Platinum	03/16
70Q9001GUX	US	1xE5-2630 v4 10C/2.2GHz/20MB/85W/DDR4-2133	4XG0G89075	1x16GB RDIMM DDR4-2400 ECC	110i (PCIe)	8x2.5" HS	Open	2xFH HL	None	None	TPM	TSM	None	3-year	750Wx1 Platinum	03/16
70Q9001HUX	US	1xE5-2640 v4 10C/2.4GHz/25MB/90W/DDR4-2133	4XG0G89070	1x16GB RDIMM DDR4-2400 ECC	110i (PCIe)	8x2.5" HS	Open	2xFH HL	None	None	TPM	TSM	None	3-year	750Wx1 Platinum	03/16
70Q9001JUX	US	1xE5-2650 v4 12C/2.2GHz/30MB/105W/DDR4-2400	4XG0G89065	1x16GB RDIMM DDR4-2400 ECC	110i (PCIe)	8x2.5" HS	Open	2xFH HL	None	None	TPM	TSM	None	3-year	750Wx1 Platinum	03/16
70Q9001KUX	US	1xE5-2660 v4 14C/2.0GHz/35MB/105W/DDR4-2400	4XG0G89060	1x16GB RDIMM DDR4-2400 ECC	110i (PCIe)	8x2.5" HS	Open	2xFH HL	None	None	TPM	TSM	None	3-year	750Wx1 Platinum	03/16

Model	Region	Processor	2nd CPU	Memory	Storage Controller	Disk Bays	Disks	Slots	Optical	Add-on NIC	TPM	System Mgmt	OS	Warranty	Power Supply	Ann Date (m/y)
70QQ0013UX	US	1xE5-2603 v4 6C/1.7GHz/15MB/85W/DDR4-1866	4XG0G89090	1x16GB RDIMM DDR4-2400 ECC	110i (PCIe)	8x3.5" HS	Open	2xFH HL	None	None	TPM	TSM	None	3-year	750Wx1 Platinum	03/16
70QQ0014UX	US	1xE5-2609 v4 8C/1.7GHz/20MB/85W/DDR4-1866	4XG0G89085	1x16GB RDIMM DDR4-2400 ECC	110i (PCIe)	8x3.5" HS	Open	2xFH HL	None	None	TPM	TSM	None	3-year	750Wx1 Platinum	03/16
70QQ0015UX	US	1xE5-2620 v4 8C/2.1GHz/20MB/85W/DDR4-2133	4XG0G89080	1x16GB RDIMM DDR4-2400 ECC	110i (PCIe)	8x3.5" HS	Open	2xFH HL	None	None	TPM	TSM	None	3-year	750Wx1 Platinum	03/16
70QQ0016UX	US	1xE5-2630 v4 10C/2.2GHz/20MB/85W/DDR4-2133	4XG0G89075	1x16GB RDIMM DDR4-2400 ECC	110i (PCIe)	8x3.5" HS	Open	2xFH HL	None	None	TPM	TSM	None	3-year	750Wx1 Platinum	03/16
70QQ0017UX	US	1xE5-2640 v4 10C/2.4GHz/25MB/90W/DDR4-2133	4XG0G89070	1x16GB RDIMM DDR4-2400 ECC	110i (PCIe)	8x3.5" HS	Open	2xFH HL	None	None	TPM	TSM	None	3-year	750Wx1 Platinum	03/16
70QQ0018UX	US	1xE5-2650 v4 12C/2.2GHz/30MB/105W/DDR4-2400	4XG0G89065	1x16GB RDIMM DDR4-2400 ECC	110i (PCIe)	8x3.5" HS	Open	2xFH HL	None	None	TPM	TSM	None	3-year	750Wx1 Platinum	03/16
70QQ0019UX	US	1xE5-2660 v4 14C/2.0GHz/35MB/105W/DDR4-2400	4XG0G89060	1x16GB RDIMM DDR4-2400 ECC	110i (PCIe)	8x3.5" HS	Open	2xFH HL	None	None	TPM	TSM	None	3-year	750Wx1 Platinum	03/16
70QQ001AUX	US	1xE5-2630 v4 10C/2.2GHz/20MB/85W/DDR4-2133	4XG0G89075	4x16GB RDIMM DDR4-2400 ECC	110i (PCIe)	8x3.5" HS	4x1TB HDD 7.2K 3.5" SATA6Gbps	2xFH HL	None	None	TPM	TSM Premium	None	3-year	750Wx2 Platinum	03/16
70QQ001BUX	US	2xE5-2620 v4 8C/2.1GHz/20MB/85W/DDR4-2133	-	2x16GB RDIMM DDR4-2400 ECC	110i (PCIe)	8x3.5" HS	Open	2xFH HL + 4xLP HL	None	None	TPM	TSM Premium	None	3-year	750Wx2 Platinum	03/16

Model	Region	Processor	2nd CPU	Memory	Storage Controller	Disk Bays	Disks	Slots	Optical	Add-on NIC	TPM	System Mgmt	OS	Warranty	Power Supply	Ann Date (m/y)
70QS0000UX	US	1xE5-2603 v4 6C/1.7GHz/15MB/85W/DDR4-1866	4XG0G89090	1x16GB RDIMM DDR4-2400 ECC	720ix+1GB Flash (AnyRAID)	24x2.5" HS	Open	2xFH HL	None	None	TPM	TSM	None	3-year	750Wx1 Platinum	03/16
70QS0001UX	US	1xE5-2609 v4 8C/1.7GHz/20MB/85W/DDR4-1866	4XG0G89085	1x16GB RDIMM DDR4-2400 ECC	720ix+1GB Flash (AnyRAID)	24x2.5" HS	Open	2xFH HL	None	None	TPM	TSM	None	3-year	750Wx1 Platinum	03/16
70QS0002UX	US	1xE5-2620 v4 8C/2.1GHz/20MB/85W/DDR4-2133	4XG0G89080	1x16GB RDIMM DDR4-2400 ECC	720ix+1GB Flash (AnyRAID)	24x2.5" HS	Open	2xFH HL	None	None	TPM	TSM	None	3-year	750Wx1 Platinum	03/16
70QS0003UX	US	1xE5-2630 v4 10C/2.2GHz/20MB/85W/DDR4-2133	4XG0G89075	1x16GB RDIMM DDR4-2400 ECC	720ix+1GB Flash (AnyRAID)	24x2.5" HS	Open	2xFH HL	None	None	TPM	TSM	None	3-year	750Wx1 Platinum	03/16
70QS0004UX	US	1xE5-2640 v4 10C/2.4GHz/25MB/90W/DDR4-2133	4XG0G89070	1x16GB RDIMM DDR4-2400 ECC	720ix+1GB Flash (AnyRAID)	24x2.5" HS	Open	2xFH HL	None	None	TPM	TSM	None	3-year	750Wx1 Platinum	03/16
70QS0005UX	US	1xE5-2650 v4 12C/2.2GHz/30MB/105W/DDR4-2400	4XG0G89065	1x16GB RDIMM DDR4-2400 ECC	720ix+1GB Flash (AnyRAID)	24x2.5" HS	Open	2xFH HL	None	None	TPM	TSM	None	3-year	750Wx1 Platinum	03/16
70QS0006UX	US	1xE5-2660 v4 14C/2.0GHz/35MB/105W/DDR4-2400	4XG0G89060	1x16GB RDIMM DDR4-2400 ECC	720ix+1GB Flash (AnyRAID)	24x2.5" HS	Open	2xFH HL	None	None	TPM	TSM	None	3-year	750Wx1 Platinum	03/16

Model	Region	Processor	2nd CPU	Memory	Storage Controller	Disk Bays	Disks	Slots	Optical	Add-on NIC	TPM	System Mgmt	OS	Warranty	Power Supply	Ann Date (m/y)
70QW0004UX	US	1xE5-2603 v4 6C/1.7GHz/15MB/85W/DDR4-1866	4XG0G89090	1x16GB RDIMM DDR4-2400 ECC	720ix+1GB Flash (AnyRAID)	16x2.5" HS	Open	2xFH HL	None	None	TPM	TSM	None	3-year	750Wx1 Platinum	03/16
70QW0005UX	US	1xE5-2609 v4 8C/1.7GHz/20MB/85W/DDR4-1866	4XG0G89085	1x16GB RDIMM DDR4-2400 ECC	720ix+1GB Flash (AnyRAID)	16x2.5" HS	Open	2xFH HL	None	None	TPM	TSM	None	3-year	750Wx1 Platinum	03/16
70QW0006UX	US	1xE5-2620 v4 8C/2.1GHz/20MB/85W/DDR4-2133	4XG0G89080	1x16GB RDIMM DDR4-2400 ECC	720ix+1GB Flash (AnyRAID)	16x2.5" HS	Open	2xFH HL	None	None	TPM	TSM	None	3-year	750Wx1 Platinum	03/16
70QW0007UX	US	1xE5-2630 v4 10C/2.2GHz/20MB/85W/DDR4-2133	4XG0G89075	1x16GB RDIMM DDR4-2400 ECC	720ix+1GB Flash (AnyRAID)	16x2.5" HS	Open	2xFH HL	None	None	TPM	TSM	None	3-year	750Wx1 Platinum	03/16
70QW0008UX	US	1xE5-2640 v4 10C/2.4GHz/25MB/90W/DDR4-2133	4XG0G89070	1x16GB RDIMM DDR4-2400 ECC	720ix+1GB Flash (AnyRAID)	16x2.5" HS	Open	2xFH HL	None	None	TPM	TSM	None	3-year	750Wx1 Platinum	03/16
70QW0009UX	US	1xE5-2650 v4 12C/2.2GHz/30MB/105W/DDR4-2400	4XG0G89065	1x16GB RDIMM DDR4-2400 ECC	720ix+1GB Flash (AnyRAID)	16x2.5" HS	Open	2xFH HL	None	None	TPM	TSM	None	3-year	750Wx1 Platinum	03/16
70QW000AUX	US	1xE5-2660 v4 14C/2.0GHz/35MB/105W/DDR4-2400	4XG0G89060	1x16GB RDIMM DDR4-2400 ECC	720ix+1GB Flash (AnyRAID)	16x2.5" HS	Open	2xFH HL	None	None	TPM	TSM	None	3-year	750Wx1 Platinum	03/16



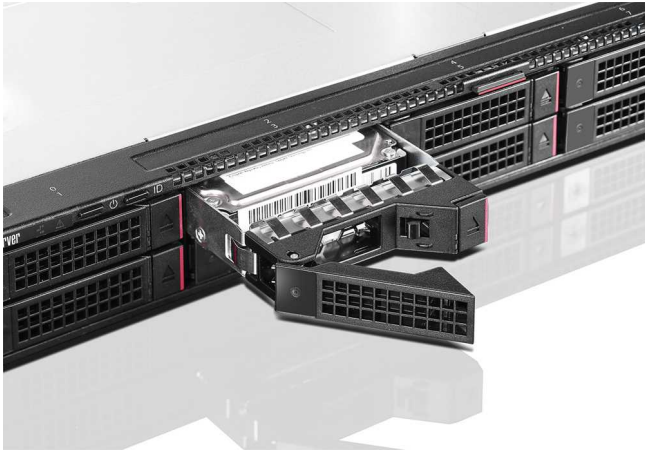



# ThinkServer RD550 Platform Specifications

Product Specifications Reference (PSREF)

Components	Specification																									
Dimensions	1U rack. Height: 43 mm (1.7 in), width: 482 mm (19 in), depth: 780 mm (30.7 in)																									
Weight	Minimum configuration: 13.5 kg (29.76 lb), maximum: 21 kg (46.3 lb)																									
Processor	Up to two <b>145W Intel Xeon E5-2600 v3</b> family (code name: Haswell) processors with 18 cores up to 2.3GHz, 16 cores up to 2.3GHz, 14 cores up to 2.6GHz, 12 cores up to 2.6GHz, 10 cores up to 2.6GHz, 8 cores up to 3.2GHz, 6 cores up to 3.4GHz, 4 cores up to 3.5GHz. Two QPI link up to 9.6 GT/s. Up to 2133MHz memory speed. Up to 45MB cache																									
Chipset	Intel C610 Series Chipset																									
Memory DIMMs	24 DIMM sockets (12 DIMMs per processor), 8-channel capable (4-channel per processor). RDIMM and LRDIMM (cannot be intermixed), DDR4, LRDIMM up to DDR4-2133, RDIMM up to DDR4-2400																									
Memory capacity	384GB (RDIMM, 16GB x 24)/768GB (LRDIMM, 32GB x 24)																									
Memory protection	ECC, memory mirroring, lockstep, and memory sparing																									
AnyRAID support	RAID 0, 1, 10 with AnyRAID 110i, 6Gb/s SATA, optional key for RAID 5. RAID 0, 1, 10 with AnyRAID 510i, 6Gb/s SAS/SATA, optional key for RAID 5/50. RAID 0, 1, 10, 5, 50, 6, 60 with AnyRAID 720i/720ix. 12Gb/s SAS/SATA. 720i needs cache for RAID 6/60 support. 720ix must have cache. Optional cache for 720i/720ix: 1GB read-only memory. 1GB/2GB/4GB flash with super capacitor. Flash options include CacheVault, CacheCade Pro, and FastPath <i>Note: At least 6 disk drives is required for RAID 50 and 60.</i>																									
Disk drive bays	Up to 4 3.5" or 12 2.5" hot-swap disk bays on front. Up to 2 of 12 2.5" bays can support easy-swap PCIe SSD via optional Anybay kit (consumes one PCIe slot). Up to 2 2.5" rear mounted hot-swap disk bays on 3.5" models, optional. Up to 2 M.2 SSD drives via optional M.2 module. Supports external RDX tape drive via USB. <table border="1"> <thead> <tr> <th>Disk bay configuration</th> <th colspan="4">AnyRAID requirements and optional drives supported</th> </tr> <tr> <th></th> <th>RAID110i</th> <th>RAID510i</th> <th>RAID720i</th> <th>RAID720ix</th> </tr> </thead> <tbody> <tr> <td>4x3.5"</td> <td>• (optional rear bay/M.2)</td> <td>• (optional rear bay/M.2)</td> <td>• (optional rear bay/M.2)</td> <td></td> </tr> <tr> <td>8x2.5"</td> <td>•</td> <td>•</td> <td>•</td> <td></td> </tr> <tr> <td>12x2.5"</td> <td></td> <td></td> <td></td> <td>• (optional Anybay/M.2)</td> </tr> </tbody> </table> <i>Note: 1. Rear disk drive and M.2 SSD can not be supported simultaneously. Only one can be selected per system. 2. On AnyRAID 110i and 8x2.5" model, 6 of 8 drives can be configured as RAID</i>	Disk bay configuration	AnyRAID requirements and optional drives supported					RAID110i	RAID510i	RAID720i	RAID720ix	4x3.5"	• (optional rear bay/M.2)	• (optional rear bay/M.2)	• (optional rear bay/M.2)		8x2.5"	•	•	•		12x2.5"				• (optional Anybay/M.2)
Disk bay configuration	AnyRAID requirements and optional drives supported																									
	RAID110i	RAID510i	RAID720i	RAID720ix																						
4x3.5"	• (optional rear bay/M.2)	• (optional rear bay/M.2)	• (optional rear bay/M.2)																							
8x2.5"	•	•	•																							
12x2.5"				• (optional Anybay/M.2)																						
Internal disk drive	3.5" HDD up to 12TB (SATA)/8TB(SAS). 2.5" HDD up to 1.8TB (SAS)/2TB (SATA). 2.5" SSD up to 1.6TB (SATA/SAS). Easy-swap PCIe SSD up to 1.92TB. PCIe SSD adapter up to 3.84TB. M.2 SSD up to 120GB. 2.5" SSD and HDD are compatible with 3.5" bay																									
SD module	Up to 2 SDHC flash cards via optional SD module, 8GB or 32GB each																									
Optical drive	Optional one 9.5mm optical drive on 3.5" model. DVD-ROM or DVD±RW																									
Network interfaces	One dedicated management port. One (3.5" model) or two (2.5" model) AnyFabric slots for customized LOM. Optional discrete network adapters via PCIe slots																									
Security features	Power-on and administrator password. Optional TPM (TCG 1.2-compliant)																									
Systems management	Supports ThinkServer System Manager (TSM), optional TSM Premium. UEFI. Onboard Aspeed AST2400 graphics/management processor, IPMI 2.0-compliant baseboard management controller (BMC). Control Panel LEDs shows the status of power, ID, network, system. Supports ThinkServer management software: Diagnostics, Deployment Manager, Energy Manager, System Manager, Partner Pack for VMware vCenter and Microsoft System Center Operations Manager, Power Planner																									

Components	Specification															
Operating systems supported	Microsoft Windows Server 2016/2012 R2/2012/2008 R2. Windows Small Business Server 2011. Red Hat Enterprise Linux 6.5/6.6/7. SUSE Linux Enterprise Server 11. VMware vSphere (ESXi) 5.1 P5/5.5 U2/6.0															
Base warranty	3-year limited onsite service with 9x5/NBD. Some parts are Customer Replaceable Units															
Power supply	Up to two redundant hot-swap 550W/750W/1100W power supplies. 550W and 1100W are 80 PLUS Platinum qualified. 750W is 80 PLUS Platinum or Titanium qualified. <table border="1"> <thead> <tr> <th rowspan="2">Disk bay configuration</th> <th colspan="3">PSU requirements</th> </tr> <tr> <th>550W</th> <th>750W</th> <th>1100W</th> </tr> </thead> <tbody> <tr> <td>4x3.5"</td> <td>•</td> <td>•</td> <td>•</td> </tr> <tr> <td>12x2.5"</td> <td>•</td> <td>•</td> <td>•</td> </tr> </tbody> </table> <i>Note: 750W Titanium is 200V - 240V, others are 110V - 240V.</i>	Disk bay configuration	PSU requirements			550W	750W	1100W	4x3.5"	•	•	•	12x2.5"	•	•	•
Disk bay configuration	PSU requirements															
	550W	750W	1100W													
4x3.5"	•	•	•													
12x2.5"	•	•	•													
Graphics	Onboard Aspeed AST2400 with 16MB memory, one DisplayPort on front, one DisplayPort on rear. Maximum resolution: 1920x1200@60Hz															
Front ports	(Only 3.5" model) Two USB 2.0, one DisplayPort															
Rear ports	One DisplayPort, two USB 3.0, one RJ-45 (dedicate mgmt), one serial (9-pin)															
Cooling	8 (7+1, dual processors) or 6 (5+1, single processor), hot-swap															
Noise emissions	Operating: < 6.5 Bels. Idle: < 6 Bels (Maximum configuration)															
Environmental specification	<table border="1"> <tbody> <tr> <td>Temperature - operating</td> <td>41 °F to 113 °F (5 °C to 45 °C)</td> </tr> <tr> <td>Temperature - non operating (no package)</td> <td>-10 °C to 60 °C</td> </tr> <tr> <td>Temperature - non operating (with package)</td> <td>-40 °C to 60 °C</td> </tr> <tr> <td>Altitude - operating</td> <td>(Unpressurized): 0-10000ft (0-3048m)</td> </tr> <tr> <td>Humidity - operating</td> <td>8%-90%, non-condensing</td> </tr> <tr> <td>Humidity - storage (with package)</td> <td>8%-90%, non-condensing</td> </tr> </tbody> </table> <i>Note: 45 °C continuous operation configuration limitation: no 145W CPU/no 135W 4, 6, or 8 cores CPU/no GPU card/redundant PSU/no FLFH card/no PCIe SSD adapter/no 1100W PSU.</i>	Temperature - operating	41 °F to 113 °F (5 °C to 45 °C)	Temperature - non operating (no package)	-10 °C to 60 °C	Temperature - non operating (with package)	-40 °C to 60 °C	Altitude - operating	(Unpressurized): 0-10000ft (0-3048m)	Humidity - operating	8%-90%, non-condensing	Humidity - storage (with package)	8%-90%, non-condensing			
Temperature - operating	41 °F to 113 °F (5 °C to 45 °C)															
Temperature - non operating (no package)	-10 °C to 60 °C															
Temperature - non operating (with package)	-40 °C to 60 °C															
Altitude - operating	(Unpressurized): 0-10000ft (0-3048m)															
Humidity - operating	8%-90%, non-condensing															
Humidity - storage (with package)	8%-90%, non-condensing															

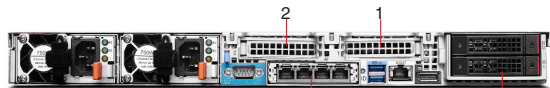
## Expansion slots

<b>3.5" model</b>	
	AnyFabric slot 1 (Network adapter is optional)    Optional 2 x 2.5" rear bays
Slot 1 (riser card 1)	PCIe 3.0 x 16, low-profile, half length
Slot 2 (riser card 2)	PCIe 3.0 x 16, low-profile, half length, requires 2nd riser card and 2nd CPU
<b>2.5" model</b>	
	AnyFabric slot 1 (Network adapter is optional)    AnyFabric slot 2 (Network adapter is optional)
Slot 1 (riser card 1)	PCIe 3.0 x 16 (x8 wired), low-profile, half length
Slot 2 (riser card 1)	PCIe 3.0 x 16 (x8 wired), low-profile, half length
Slot 3 (riser card 2)	PCIe 3.0 x 16, low-profile, half length, requires 2nd riser card and 2nd CPU

Model	Region	Processor	2nd CPU	Memory	Storage Controller	Disk Bays	Disks	Slots	Optical	Add-on NIC	TPM	System Mgmt	OS	Warranty	Power Supply	Ann Date (m/y)
70CV001CUX	US	1xXeon E5-2609 v3 6C/1.9GHz/15MB/85W/DDR4-1600	4XG0F28803	1x8GB RDIMM DDR4-2133 ECC	AnyRAID 110i	4x3.5" HS	Open	1xLP HL	9.5mm DVD±RW	None	TPM	TSM	None	3-year	750Wx1 Platinum	09/14
70CV001DUX	US	1xXeon E5-2620 v3 6C/2.4GHz/15MB/85W/DDR4-1866	4XG0F28802	1x8GB RDIMM DDR4-2133 ECC	AnyRAID 110i	4x3.5" HS	Open	1xLP HL	9.5mm DVD±RW	None	TPM	TSM	None	3-year	750Wx1 Platinum	09/14
70CV001EUX	US	1xXeon E5-2640 v3 8C/2.6GHz/20MB/90W/DDR4-1866	4XG0F28800	1x8GB RDIMM DDR4-2133 ECC	AnyRAID 510i	4x3.5" HS	Open	1xLP HL	9.5mm DVD±RW	None	TPM	TSM	None	3-year	750Wx1 Platinum	09/14
70CV001FUX	US	1xXeon E5-2650 v3 10C/2.3GHz/25MB/105W/DDR4-2133	4XG0F28799	1x8GB RDIMM DDR4-2133 ECC	AnyRAID 510i	4x3.5" HS	Open	1xLP HL	9.5mm DVD±RW	None	TPM	TSM	None	3-year	750Wx1 Platinum	09/14
70CV001GUX	US	1xXeon E5-2670 v3 12C/2.3GHz/30MB/120W/DDR4-2133	4XG0F28797	1x8GB RDIMM DDR4-2133 ECC	AnyRAID 720i+1GB RAM	4x3.5" HS	Open	1xLP HL	9.5mm DVD±RW	None	TPM	TSM	None	3-year	750Wx1 Platinum	09/14
70CV001JUX	US	1xXeon E5-2609 v3 6C/1.9GHz/15MB/85W/DDR4-1600	4XG0F28803	1x8GB RDIMM DDR4-2133 ECC	AnyRAID 510i	4x3.5" HS	Open	1xLP HL	9.5mm DVD±RW	None	TPM	TSM	None	3-year	750Wx1 Platinum	10/14
70CV001KUX	US	1xXeon E5-2620 v3 6C/2.4GHz/15MB/85W/DDR4-1866	4XG0F28802	1x8GB RDIMM DDR4-2133 ECC	AnyRAID 510i	4x3.5" HS	Open	1xLP HL	9.5mm DVD±RW	None	TPM	TSM	None	3-year	750Wx1 Platinum	10/14
70CV001LUX	US	1xXeon E5-2630 v3 8C/2.4GHz/20MB/85W/DDR4-1866	4XG0F28801	1x8GB RDIMM DDR4-2133 ECC	AnyRAID 510i	4x3.5" HS	Open	1xLP HL	9.5mm DVD±RW	None	TPM	TSM	None	3-year	750Wx1 Platinum	10/14
70CV001MUX	US	2xXeon E5-2630 v3 8C/2.4GHz/20MB/85W/DDR4-1866	-	2x8GB RDIMM DDR4-2133 ECC	AnyRAID 510i	4x3.5" HS	Open	2xLP HL	9.5mm DVD±RW	None	TPM	TSM	None	3-year	750Wx1 Platinum	10/14
70CV001NUX	US	1xXeon E5-2603 v3 6C/1.6GHz/15MB/85W/DDR4-1600	4XG0F28804	1x8GB RDIMM DDR4-2133 ECC	AnyRAID 110i	4x3.5" HS	Open	None	None	None	TPM	TSM	None	3-year	550Wx1 Platinum	10/14
70CV001SUX	US	1xXeon E5-2630 v3 8C/2.4GHz/20MB/85W/DDR4-1866	4XG0F28801	2x8GB RDIMM DDR4-2133 ECC	AnyRAID 110i	4x3.5" HS	2x1TB HDD 7.2K 3.5" SATA6Gbps	1xLP HL	9.5mm DVD±RW	GbEx4 RJ-45 AnyFabric	TPM	TSM Premium	None	3-year	750Wx2 Platinum	02/15
70CV001TUX	US	2xXeon E5-2620 v3 6C/2.4GHz/15MB/85W/DDR4-1866	-	2x16GB RDIMM DDR4-2133 ECC	AnyRAID 110i	4x3.5" HS	Open	2xLP HL	9.5mm DVD±RW	GbEx4 RJ-45 AnyFabric	TPM	TSM Premium	None	3-year	750Wx2 Platinum	09/15

Model	Region	Processor	2nd CPU	Memory	Storage Controller	Disk Bays	Disks	Slots	Optical	Add-on NIC	TPM	System Mgmt	OS	Warranty	Power Supply	Ann Date (m/y)
70CX001XUX	US	1xXeon E5-2620 v3 6C/2.4GHz/15MB/85W/DDR4-1866	4XG0F28802	1x8GB RDIMM DDR4-2133 ECC	AnyRAID 510i+Key	8x2.5" HS	Open	2xLP HL	None	None	TPM	TSM	None	3-year	750Wx1 Platinum	09/14
70CX001YUX	US	1xXeon E5-2640 v3 8C/2.6GHz/20MB/90W/DDR4-1866	4XG0F28800	1x8GB RDIMM DDR4-2133 ECC	AnyRAID 510i+Key	8x2.5" HS	Open	2xLP HL	None	None	TPM	TSM	None	3-year	750Wx1 Platinum	09/14
70CX0020UX	US	1xXeon E5-2650 v3 10C/2.3GHz/25MB/105W/DDR4-2133	4XG0F28799	1x8GB RDIMM DDR4-2133 ECC	AnyRAID 720ix+1GB RAM	12x2.5" HS	Open	2xLP HL	None	None	TPM	TSM	None	3-year	750Wx1 Platinum	09/14
70CX0021UX	US	1xXeon E5-2670 v3 12C/2.3GHz/30MB/120W/DDR4-2133	4XG0F28797	1x8GB RDIMM DDR4-2133 ECC	AnyRAID 720ix+1GB RAM	12x2.5" HS	Open	2xLP HL	None	None	TPM	TSM	None	3-year	750Wx1 Platinum	09/14
70CX0023UX	US	1xXeon E5-2620 v3 6C/2.4GHz/15MB/85W/DDR4-1866	4XG0F28802	1x8GB RDIMM DDR4-2133 ECC	AnyRAID 720ix+1GB RAM	12x2.5" HS	Open	2xLP HL	None	None	TPM	TSM	None	3-year	750Wx1 Platinum	10/14
70CX0024UX	US	1xXeon E5-2630 v3 8C/2.4GHz/20MB/85W/DDR4-1866	4XG0F28801	1x8GB RDIMM DDR4-2133 ECC	AnyRAID 720ix+1GB RAM	12x2.5" HS	Open	2xLP HL	None	None	TPM	TSM	None	3-year	750Wx1 Platinum	10/14
70CX0025UX	US	1xXeon E5-2630 v3 8C/2.4GHz/20MB/85W/DDR4-1866	4XG0F28801	1x8GB RDIMM DDR4-2133 ECC	AnyRAID 510i	8x2.5" HS	Open	2xLP HL	None	None	TPM	TSM	None	3-year	750Wx1 Platinum	10/14
70CX0027UX	US	1xXeon E5-2603 v3 6C/1.6GHz/15MB/85W/DDR4-1600	4XG0F28804	1x8GB RDIMM DDR4-2133 ECC	AnyRAID 110i	8x2.5" HS	Open	None	None	None	TPM	TSM	None	3-year	750Wx1 Platinum	10/14
70CX002VUX	US	1xXeon E5-2620 v3 6C/2.4GHz/15MB/85W/DDR4-1866	4XG0F28802	2x16GB RDIMM DDR4-2133 ECC	AnyRAID 510i+Key	8x2.5" HS	2x300GB HDD 15K 2.5" SAS12Gbps	None	None	GbEx4 RJ-45 AnyFabric	TPM	TSM Premium	None	3-year	750Wx2 Platinum	02/16



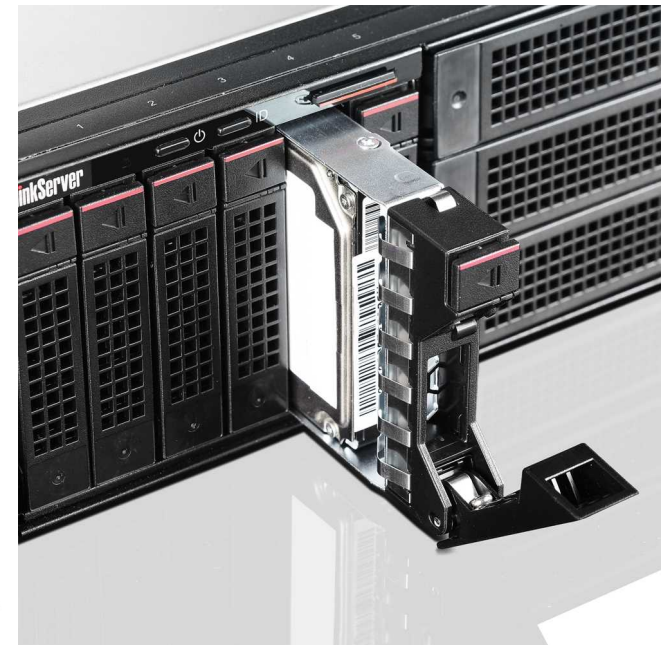
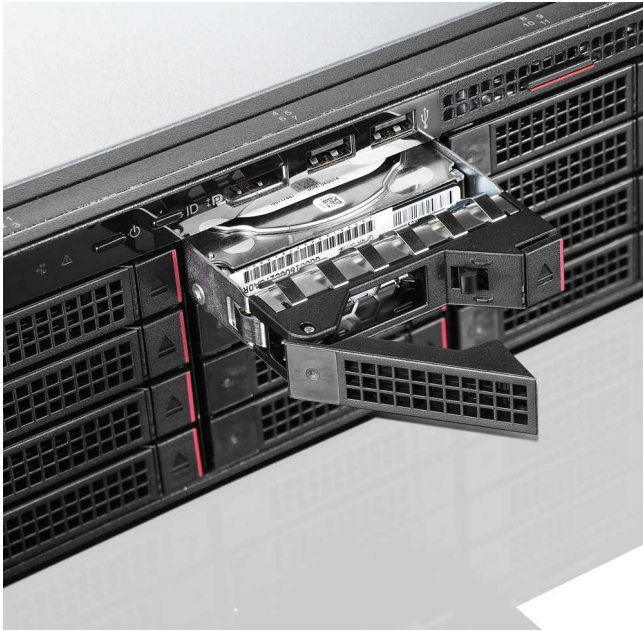

# ThinkServer RD650 Platform Specifications

Product Specifications Reference (PSREF)

Components	Specification																																							
Dimensions	2U rack. Height: 87 mm (3.4 in), width: 482 mm (19 in), depth: 764 mm (30 in)																																							
Weight	Minimum configuration: 16 kg (35.3 lb), maximum: 32 kg (70.5 lb)																																							
Processor	Up to two <b>145W Intel Xeon E5-2600 v3</b> family (code name: Haswell) processors with 18 cores up to 2.3GHz, 16 cores up to 2.3GHz, 14 cores up to 2.6GHz, 12 cores up to 2.6GHz, 10 cores up to 2.6GHz, 8 cores up to 3.2GHz, 6 cores up to 3.4GHz, 4 cores up to 3.5GHz. Two QPI link up to 9.6 GT/s. Up to 2133MHz memory speed. Up to 45MB cache																																							
Chipset	Intel C610 Series Chipset																																							
Memory DIMMs	24 DIMM sockets (12 DIMMs per processor), 8-channel capable (4-channel per processor). RDIMM and LRDIMM (cannot be intermixed), DDR4, LRDIMM up to DDR4-2133, RDIMM up to DDR4-2400																																							
Memory capacity	384GB (RDIMM, 16GB x 24)/768GB (LRDIMM, 32GB x 24)																																							
Memory protection	ECC, memory mirroring, lockstep, and memory sparing																																							
AnyRAID support	RAID 0, 1, 10 with AnyRAID 110i. 6Gb/s SATA, optional key for RAID 5. RAID 0, 1, 10 with AnyRAID 510i. 6Gb/s SAS/SATA, optional key for RAID 5/50. RAID 0, 1, 10, 5, 50, 6, 60 with AnyRAID 720i/720ix. 12Gb/s SAS/SATA. 720i needs cache for RAID 6/60 support. 720ix must have cache. Optional cache for 720i/720ix: 1GB read-only memory. 1GB/2GB/4GB flash with super capacitor. Flash options include CacheVault, CacheCade Pro, and FastPath																																							
Disk drive bays	Up to 12 3.5", 24 2.5", or 6 2.5" plus 9 3.5" hot-swap disk bays on front. Up to 4 2.5" bays on 24 2.5" or 2.5" + 3.5" models can support easy-swap PCIe SSD via optional Anybay kit (consumes two PCIe slots). Up to 2 2.5" rear mounted hot-swap disk bays, optional. Up to 2 M.2 SSD drives via optional M.2 module. Up to one internal LTO-6 SAS tape drive on 8 x 2.5" and 720ix model, or external RDX tape drive via USB.																																							
	<table border="1"> <thead> <tr> <th rowspan="2">Disk bay configuration</th> <th colspan="4">AnyRAID requirements and optional drives supported</th> </tr> <tr> <th>RAID110i</th> <th>RAID510i</th> <th>RAID720i</th> <th>RAID720ix</th> </tr> </thead> <tbody> <tr> <td>6x3.5"</td> <td>•</td> <td>•</td> <td>•</td> <td></td> </tr> <tr> <td>12x3.5"</td> <td></td> <td></td> <td></td> <td>• (optional rear bay/M.2)</td> </tr> <tr> <td>8x2.5"</td> <td></td> <td>•</td> <td>•</td> <td>• (optional tape/rear bay/M.2)</td> </tr> <tr> <td>16x2.5"</td> <td></td> <td></td> <td></td> <td>• (optional rear bay/M.2)</td> </tr> <tr> <td>24x2.5"</td> <td></td> <td></td> <td></td> <td>• (optional Anybay/rear bay/M.2)</td> </tr> <tr> <td>6x2.5"+9x3.5"</td> <td></td> <td></td> <td></td> <td>• (optional Anybay/rear bay/M.2)</td> </tr> </tbody> </table>	Disk bay configuration	AnyRAID requirements and optional drives supported				RAID110i	RAID510i	RAID720i	RAID720ix	6x3.5"	•	•	•		12x3.5"				• (optional rear bay/M.2)	8x2.5"		•	•	• (optional tape/rear bay/M.2)	16x2.5"				• (optional rear bay/M.2)	24x2.5"				• (optional Anybay/rear bay/M.2)	6x2.5"+9x3.5"				• (optional Anybay/rear bay/M.2)
Disk bay configuration	AnyRAID requirements and optional drives supported																																							
	RAID110i	RAID510i	RAID720i	RAID720ix																																				
6x3.5"	•	•	•																																					
12x3.5"				• (optional rear bay/M.2)																																				
8x2.5"		•	•	• (optional tape/rear bay/M.2)																																				
16x2.5"				• (optional rear bay/M.2)																																				
24x2.5"				• (optional Anybay/rear bay/M.2)																																				
6x2.5"+9x3.5"				• (optional Anybay/rear bay/M.2)																																				
Internal disk drive	3.5" HDD up to 12TB (SATA)/8TB(SAS). 2.5" HDD up to 1.8TB (SAS)/2TB (SATA). 2.5" SSD up to 1.6TB (SATA/SAS). Easy-swap PCIe SSD up to 1.92TB. PCIe SSD adapter up to 3.84TB. M.2 SSD up to 120GB. 2.5" SSD and HDD are compatible with 3.5" bay																																							
SD module	Up to 2 SDHC flash cards via optional SD module, 8GB or 32GB each																																							
Optical drive	Optional one 9.5mm optical drive on 8 or 16 x 2.5" model, DVD-ROM or DVD±RW																																							
Network interfaces	One dedicated management port, one AnyFabric slot for customized LOM. Discrete network options is also available via PCIe slots																																							
Security features	Power-on and administrator password. Optional TPM (TCG 1.2-compliant) Supports ThinkServer System Manager (TSM), optional TSM Premium. UEFI. Onboard Aspeed AST2400 graphics/management processor, IPMI 2.0-compliant baseboard management controller (BMC). Control Panel LEDs shows the status of power, ID, network, system.																																							
Systems management	Supports ThinkServer management software: Diagnostics, Deployment Manager, Energy Manager, System Manager, Partner Pack for VMware vCenter and Microsoft System Center Operations Manager, Power Planner																																							

Components	Specification																																							
Operating systems supported	Microsoft Windows Server 2016/2012 R2/2012/2008 R2. Windows Small Business Server 2011. Red Hat Enterprise Linux 6.5/6.6/7. SUSE Linux Enterprise Server 11. VMware vSphere (ESXi) 5.1 P5/5.5 U2/6.0																																							
Base warranty	3-year limited onsite service with 9x5/NBD.																																							
Power supply	Up to two redundant hot-swap 550W/750W/1100W/1600W power supplies. 550W, 1100W, and 1600W are 80 PLUS Platinum qualified. 750W is 80 PLUS Platinum or Titanium qualified.																																							
	<table border="1"> <thead> <tr> <th rowspan="2">Disk bay configuration</th> <th colspan="4">PSU requirements</th> </tr> <tr> <th>550W</th> <th>750W</th> <th>1100W</th> <th>1600W</th> </tr> </thead> <tbody> <tr> <td>6x3.5"</td> <td>•</td> <td>•</td> <td>•</td> <td>•</td> </tr> <tr> <td>12x3.5"</td> <td colspan="4">• (up to 135W CPU)</td> </tr> <tr> <td>8x2.5"</td> <td>•</td> <td>•</td> <td>•</td> <td>•</td> </tr> <tr> <td>16x2.5"</td> <td colspan="4">• (up to 105W CPU+24 DIMMs or 135W+16 DIMMs)</td> </tr> <tr> <td>24x2.5"</td> <td>•</td> <td>•</td> <td>•</td> <td>•</td> </tr> <tr> <td>2.5"+3.5"</td> <td>•</td> <td>•</td> <td>•</td> <td>•</td> </tr> </tbody> </table> <p>Note: 1. 750W Titanium is 200V - 240V, others are 110V - 240V. 2. 1600W will automatically operate in 1100W if the system line input is 100-127V.</p>	Disk bay configuration	PSU requirements				550W	750W	1100W	1600W	6x3.5"	•	•	•	•	12x3.5"	• (up to 135W CPU)				8x2.5"	•	•	•	•	16x2.5"	• (up to 105W CPU+24 DIMMs or 135W+16 DIMMs)				24x2.5"	•	•	•	•	2.5"+3.5"	•	•	•	•
Disk bay configuration	PSU requirements																																							
	550W	750W	1100W	1600W																																				
6x3.5"	•	•	•	•																																				
12x3.5"	• (up to 135W CPU)																																							
8x2.5"	•	•	•	•																																				
16x2.5"	• (up to 105W CPU+24 DIMMs or 135W+16 DIMMs)																																							
24x2.5"	•	•	•	•																																				
2.5"+3.5"	•	•	•	•																																				
Graphics	Onboard Aspeed AST2400 with 16MB memory, one DisplayPort on rear																																							
Front ports	(Only 2.5" bay models) Two USB 2.0, one DisplayPort																																							
Rear ports	One DisplayPort, two USB 3.0, one RJ-45 (dedicate mgmt), one serial (9-pin)																																							
Cooling	Six (5+1, dual processors) or four (3+1, single processor), hot-swap																																							
Noise emissions	Operating: < 6.5 Bels. Idle: < 6 Bels (Maximum configuration)																																							
Environmental specification	<table border="1"> <tbody> <tr> <td>Temperature - operating</td> <td>41 °F to 113 °F (5 °C to 45 °C)</td> </tr> <tr> <td>Temperature - non operating (no package)</td> <td>-10 °C to 60 °C</td> </tr> <tr> <td>Temperature - non operating (with package)</td> <td>-40 °C to 60 °C</td> </tr> <tr> <td>Altitude - operating</td> <td>(Unpressurized): 0-10000ft (0-3048m)</td> </tr> <tr> <td>Humidity - operating</td> <td>8%-90%, non-condensing</td> </tr> <tr> <td>Humidity - storage (with package)</td> <td>8%-90%, non-condensing</td> </tr> </tbody> </table> <p>Note: 45 °C continuous operation configuration limitation: no 135W or 145W CPU/no GPU card/redundant PSU/no FLFH card/no PCIe SSD adapter.</p>	Temperature - operating	41 °F to 113 °F (5 °C to 45 °C)	Temperature - non operating (no package)	-10 °C to 60 °C	Temperature - non operating (with package)	-40 °C to 60 °C	Altitude - operating	(Unpressurized): 0-10000ft (0-3048m)	Humidity - operating	8%-90%, non-condensing	Humidity - storage (with package)	8%-90%, non-condensing																											
Temperature - operating	41 °F to 113 °F (5 °C to 45 °C)																																							
Temperature - non operating (no package)	-10 °C to 60 °C																																							
Temperature - non operating (with package)	-40 °C to 60 °C																																							
Altitude - operating	(Unpressurized): 0-10000ft (0-3048m)																																							
Humidity - operating	8%-90%, non-condensing																																							
Humidity - storage (with package)	8%-90%, non-condensing																																							

## Expansion slots

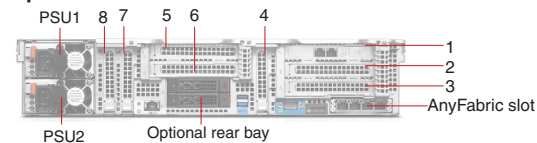

Slot 1 (riser card 1)	PCIe 3.0 x 16, half length, full height
Slot 2 (riser card 1)	PCIe 3.0 x 16, half length, full height
Slot 3 (riser card 1)	PCIe 3.0 x 16, half length, full height
Slot 4 (onboard)	PCIe 3.0 x 16, low-profile, half length, requires 2nd CPU
Slot 5 (riser card 2)	PCIe 3.0 x 16, half length, full height, requires 2nd riser card and 2nd CPU
Slot 6 (riser card 2)	PCIe 3.0 x 16, half length, full height, requires 2nd riser card and 2nd CPU
Slot 7 (onboard)	PCIe 3.0 x 16, low-profile, half length, requires 2nd CPU
Slot 8 (onboard)	PCIe 3.0 x 16, low-profile, half length, requires 2nd CPU

Notes:  
On 2.5" disk bay models, slots 1 and 2 can be replaced with one PCIe 3.0 x 16 slot, double wide, full length, full height. Slots 5 and 6 can be replaced with one PCIe 3.0 x 16 slot, double wide, full length, full height.

Model	Region	Processor	2nd CPU	Memory	Storage Controller	Disk Bays	Disks	Slots	Optical	Add-on NIC	TPM	System Mgmt	OS	Warranty	Power Supply	Ann Date (m/y)
70D0000FUX	US	1xE5-2609 v3 6C/1.9GHz/15MB/85W/DDR4-1600	4XG0F28820	1x8GB RDIMM DDR4-2133 ECC	AnyRAID 720ix+1GB RAM	12x3.5" HS	Open	3xFH HL	None	None	TPM	TSM	None	3-year	1100Wx1 Platinum	09/14
70D0000GUX	US	1xE5-2620 v3 6C/2.4GHz/15MB/85W/DDR4-1866	4XG0F28819	1x8GB RDIMM DDR4-2133 ECC	AnyRAID 720ix+1GB RAM	12x3.5" HS	Open	3xFH HL	None	None	TPM	TSM	None	3-year	1100Wx1 Platinum	09/14
70D0000HUX	US	1xE5-2640 v3 8C/2.6GHz/20MB/90W/DDR4-1866	4XG0F28817	1x8GB RDIMM DDR4-2133 ECC	AnyRAID 720ix+1GB RAM	12x3.5" HS	Open	3xFH HL	None	None	TPM	TSM	None	3-year	1100Wx1 Platinum	09/14
70D0000JUX	US	1xE5-2650 v3 10C/2.3GHz/25MB/105W/DDR4-2133	4XG0F28816	1x8GB RDIMM DDR4-2133 ECC	AnyRAID 720ix+1GB RAM	12x3.5" HS	Open	3xFH HL	None	None	TPM	TSM	None	3-year	1100Wx1 Platinum	09/14
70D0000KUX	US	1xE5-2690 v3 12C/2.6GHz/30MB/135W/DDR4-2133	4XG0F28811	1x8GB RDIMM DDR4-2133 ECC	AnyRAID 720ix+1GB RAM	12x3.5" HS	Open	3xFH HL	None	None	TPM	TSM	None	3-year	1100Wx1 Platinum	09/14
70D00025UX	US	1xE5-2630 v3 8C/2.4GHz/20MB/85W/DDR4-1866	4XG0F28818	1x8GB RDIMM DDR4-2133 ECC	AnyRAID 720ix+1GB RAM	12x3.5" HS	Open	3xFH HL	None	None	TPM	TSM	None	3-year	1100Wx1 Platinum	10/14
70D00026UX	US	1xE5-2603 v3 6C/1.6GHz/15MB/85W/DDR4-1600	4XG0F28821	1x8GB RDIMM DDR4-2133 ECC	AnyRAID 110i	6x3.5" HS	Open	None	None	None	TPM	TSM	None	3-year	550Wx1 Platinum	10/14
70D0002BUX	US	1xE5-2630 v3 8C/2.4GHz/20MB/85W/DDR4-1866	4XG0F28818	1x8GB RDIMM DDR4-2133 ECC	AnyRAID 720ix+1GB RAM	12x3.5" HS	Open	3xFH HL	None	None	TPM	TSM	None	3-year	750Wx1 Platinum	02/15

# ThinkServer RD650 - TopSeller - 70D2

Product Specifications Reference (PSREF)

Model	Region	Processor	2nd CPU	Memory	Storage Controller	Disk Bays	Disks	Slots	Optical	Add-on NIC	TPM	System Mgmt	OS	Warranty	Power Supply	Ann Date (m/y)
70D20024UX	US	1xE5-2603 v3 6C/1.6GHz/15MB/85W/DDR4-1600	4XG0F28821	1x8GB RDIMM DDR4-2133 ECC	AnyRAID 720ix+1GB RAM	24x2.5" HS	Open	None	None	None	TPM	TSM	None	3-year	750Wx1 Platinum	10/14



Model	Region	Processor	2nd CPU	Memory	Storage Controller	Disk Bays	Disks	Slots	Optical	Add-on NIC	TPM	System Mgmt	OS	Warranty	Power Supply	Ann Date (m/y)
70D4000CUX	US	1xE5-2620 v3 6C/2.4GHz/15MB/85W/DDR4-1866	4XG0F28819	1x8GB RDIMM DDR4-2133 ECC	AnyRAID 720ix+1GB RAM	6+9 HS	Open	3xFH HL	None	None	TPM	TSM	None	3-year	1100Wx1 Platinum	09/14
70D4000DUX	US	1xE5-2640 v3 8C/2.6GHz/20MB/90W/DDR4-1866	4XG0F28817	1x8GB RDIMM DDR4-2133 ECC	AnyRAID 720ix+1GB RAM	6+9 HS	Open	3xFH HL	None	None	TPM	TSM	None	3-year	1100Wx1 Platinum	09/14
70D4000EUX	US	1xE5-2650 v3 10C/2.3GHz/25MB/105W/DDR4-2133	4XG0F28816	1x8GB RDIMM DDR4-2133 ECC	AnyRAID 720ix+1GB RAM	6+9 HS	Open	3xFH HL	None	None	TPM	TSM	None	3-year	1100Wx1 Platinum	09/14
70D4000FUX	US	1xE5-2690 v3 12C/2.6GHz/30MB/135W/DDR4-2133	4XG0F28811	1x8GB RDIMM DDR4-2133 ECC	AnyRAID 720ix+1GB RAM	6+9 HS	Open	3xFH HL	None	None	TPM	TSM	None	3-year	1100Wx1 Platinum	09/14
70D4001RUX	US	1xE5-2603 v3 6C/1.6GHz/15MB/85W/DDR4-1600	4XG0F28821	1x8GB RDIMM DDR4-2133 ECC	AnyRAID 720ix+1GB RAM	6+9 HS	Open	None	None	None	TPM	TSM	None	3-year	750Wx1 Platinum	10/14
70D4001UUX	US	1xE5-2650 v3 10C/2.3GHz/25MB/105W/DDR4-2133	4XG0F28816	1x8GB RDIMM DDR4-2133 ECC	AnyRAID 720ix+1GB RAM	6+9 HS	Open	3xFH HL	None	None	TPM	TSM	None	3-year	750Wx1 Platinum	02/15
70D40025UX	US	2xE5-2620 v3 6C/2.4GHz/15MB/85W/DDR4-1866	-	2x16GB RDIMM DDR4-2133 ECC	AnyRAID 720ix+1GB Flash	6+9 HS	Open	5xFH HL + 3xLP HL	None	10GbEx2 RJ-45 AnyFabric	TPM	TSM Premium	None	3-year	750Wx2 Platinum	09/15
70D40026UX	US	2xE5-2690 v3 12C/2.6GHz/30MB/135W/DDR4-2133	-	8x16GB RDIMM DDR4-2133 ECC	AnyRAID 720ix+1GB RAM	6+9 HS	4x600GB HDD 10K 2.5" SAS12Gbps	3xLP HL	None	GbEx4 RJ-45 AnyFabric	TPM	TSM Premium	None	3-year	1100Wx2 Platinum	02/16
70D40027UX	US	1xE5-2650 v3 10C/2.3GHz/25MB/105W/DDR4-2133	4XG0F28816	4x16GB RDIMM DDR4-2133 ECC	AnyRAID 720ix+1GB RAM	6+9 HS	2x300GB HDD 15K 2.5" SAS12Gbps+2x2TB HDD 7.2K 3.5" SATA6Gbps	None	None	GbEx4 RJ-45 AnyFabric	TPM	TSM Premium	None	3-year	1100Wx2 Platinum	02/16
70D40028UX	US	2xE5-2650 v3 10C/2.3GHz/25MB/105W/DDR4-2133	-	8x16GB RDIMM DDR4-2133 ECC	AnyRAID 720ix+1GB RAM	6+9 HS (AnyBay)	2x120GB SSD 2.5" SATA6Gbps	3xFH HL + 3xLP HL	None	GbEx4 RJ-45 AnyFabric	TPM	TSM Premium	None	3-year	750Wx2 Platinum	11/15
70D40029UX	US	2xE5-2690 v3 12C/2.6GHz/30MB/135W/DDR4-2133	-	8x16GB RDIMM DDR4-2133 ECC	AnyRAID 720ix+1GB RAM	6+9 HS (AnyBay)	2x120GB SSD 2.5" SATA6Gbps	3xFH HL + 3xLP HL	None	GbEx4 RJ-45 AnyFabric	TPM	TSM Premium	None	3-year	750Wx2 Platinum	11/15

Model	Region	Processor	2nd CPU	Memory	Storage Controller	Disk Bays	Disks	Slots	Optical	Add-on NIC	TPM	System Mgmt	OS	Warranty	Power Supply	Ann Date (m/y)
70DR000QUX	US	1xE5-2609 v3 6C/1.9GHz/15MB/85W/DDR4-1600	4XG0F28820	1x8GB RDIMM DDR4-2133 ECC	AnyRAID 510i	8x2.5" HS	Open	3xFH HL	9.5mm DVD±RW	None	TPM	TSM	None	3-year	1100Wx1 Platinum	09/14
70DR000RUX	US	1xE5-2620 v3 6C/2.4GHz/15MB/85W/DDR4-1866	4XG0F28819	1x8GB RDIMM DDR4-2133 ECC	AnyRAID 510i	8x2.5" HS	Open	3xFH HL	9.5mm DVD±RW	None	TPM	TSM	None	3-year	1100Wx1 Platinum	09/14
70DR000SUX	US	1xE5-2640 v3 8C/2.6GHz/20MB/90W/DDR4-1866	4XG0F28817	1x8GB RDIMM DDR4-2133 ECC	AnyRAID 510i	8x2.5" HS	Open	3xFH HL	9.5mm DVD±RW	None	TPM	TSM	None	3-year	1100Wx1 Platinum	09/14
70DR000TUX	US	1xE5-2650 v3 10C/2.3GHz/25MB/105W/DDR4-2133	4XG0F28816	1x8GB RDIMM DDR4-2133 ECC	AnyRAID 510i	8x2.5" HS	Open	3xFH HL	9.5mm DVD±RW	None	TPM	TSM	None	3-year	1100Wx1 Platinum	09/14
70DR002KUX	US	1xE5-2630 v3 8C/2.4GHz/20MB/85W/DDR4-1866	4XG0F28818	1x8GB RDIMM DDR4-2133 ECC	AnyRAID 510i	8x2.5" HS	Open	3xFH HL	None	None	TPM	TSM	None	3-year	1100Wx1 Platinum	10/14
70DR002LUX	US	2xE5-2630 v3 8C/2.4GHz/20MB/85W/DDR4-1866	-	2x8GB RDIMM DDR4-2133 ECC	AnyRAID 510i	8x2.5" HS	Open	3xFH HL + 3xLP HL	None	None	TPM	TSM	None	3-year	1100Wx1 Platinum	10/14
70DR002MUX	US	1xE5-2603 v3 6C/1.6GHz/15MB/85W/DDR4-1600	4XG0F28821	1x8GB RDIMM DDR4-2133 ECC	AnyRAID 510i	8x2.5" HS	Open	3xFH HL	None	None	TPM	TSM	None	3-year	750Wx1 Platinum	10/14
70DR002RUX	US	1xE5-2620 v3 6C/2.4GHz/15MB/85W/DDR4-1866	4XG0F28819	2x8GB RDIMM DDR4-2133 ECC	AnyRAID 720i+1GB RAM	8x2.5" HS	2x300GB HDD 10K 2.5" SAS6Gbps	3xFH HL	None	GbEx4 RJ-45 AnyFabric	TPM	TSM Premium	None	3-year	750Wx2 Platinum	02/15
70DR002SUX	US	1xE5-2620 v3 6C/2.4GHz/15MB/85W/DDR4-1866	4XG0F28819	1x8GB RDIMM DDR4-2133 ECC	AnyRAID 510i	8x2.5" HS	Open	3xFH HL	None	None	TPM	TSM	None	3-year	750Wx1 Platinum	02/15

# ThinkServer RD650 - TopSeller - 70DT

Product Specifications Reference (PSREF)

Model	Region	Processor	2nd CPU	Memory	Storage Controller	Disk Bays	Disks	Slots	Optical	Add-on NIC	TPM	System Mgmt	OS	Warranty	Power Supply	Ann Date (m/y)
70DT000CUX	US	1xE5-2603 v3 6C/1.6GHz/15MB/85W/DDR4-1600	4XG0F28821	1x8GB RDIMM DDR4-2133 ECC	AnyRAID 720ix+1GB Flash	16x2.5" HS	Open	None	None	None	TPM	TSM	None	3-year	750Wx1 Platinum	10/14



# ThinkServer RS140 Platform Specifications

Components	Specification												
Dimensions	1U rack. Height: 43.5 mm (1.71 in), width: 430 mm (16.9 in), depth: 411 mm (16.2 in)												
Weight	Maximum configuration: 16.2 lb (7.36kg)												
Processor	Supports one of the following Intel processors (code name: Haswell): <ul style="list-style-type: none"> <li>Xeon E3-1200 v3: up to 4C/3.7GHz/8MB/84W/1600MHz</li> <li>Core i3: up to 2C/3.7GHz/4MB/54W/1600MHz</li> <li>Pentium: up to 2C/3.4GHz/3MB/53W/1600MHz</li> <li>Celeron: up to 2C/2.9GHz/2MB/53W/1333MHz</li> </ul> Note: Supports processors with integrated graphics only.												
Chipset	Intel C226 Platform Controller Hub (PCH)												
Memory DIMMs	4 DIMM sockets, 2-channel capable. UDIMM, DDR3												
Memory capacity	32GB (4 x 8GB)												
Memory protection	ECC												
RAID controller	RAID 0, 1, 5, 10 with onboard RAID 100, 6Gb/s SATA. RAID 0, 1, 10 with RAID 500, PCIe adapter, 6Gb/s SAS/SATA, optional key for RAID5. RAID 0, 1, 10, 5, 6 with RAID 700, PCIe adapter, 6Gb/s SAS/SATA, optional Intelligent Battery Backup Unit (iBBU08) Note: RAID 5, 6, and 10 needs 4 x 2.5" bays.												
Disk drive bays	Up to 2 3.5" disk bays or up to 4 2.5" disk bays. Direct cabled, non-hot swap. Supports optional external USB RDX tape drive												
Supporting disk drives	<table border="1"> <tbody> <tr> <td rowspan="2">For 3.5" bay</td> <td>3.5" SATA HDD</td> <td>7.2K 6Gbs: 500GB/1TB/2TB/3TB/4TB/6TB</td> </tr> <tr> <td>3.5" SAS HDD</td> <td>7.2K 6Gbs: 1TB/2TB/3TB/4TB</td> </tr> <tr> <td rowspan="3">For 2.5" bay</td> <td>2.5" SATA HDD</td> <td>7.2K 6Gbs: 500GB/1TB</td> </tr> <tr> <td>2.5" SAS HDD</td> <td>10K 6Gbs: 300GB/600GB/900GB. 15K 6Gbs: 146GB/300GB</td> </tr> <tr> <td>2.5" SATA SSD</td> <td>6Gbs: 120GB/240GB/300GB/480GB/600GB</td> </tr> </tbody> </table>	For 3.5" bay	3.5" SATA HDD	7.2K 6Gbs: 500GB/1TB/2TB/3TB/4TB/6TB	3.5" SAS HDD	7.2K 6Gbs: 1TB/2TB/3TB/4TB	For 2.5" bay	2.5" SATA HDD	7.2K 6Gbs: 500GB/1TB	2.5" SAS HDD	10K 6Gbs: 300GB/600GB/900GB. 15K 6Gbs: 146GB/300GB	2.5" SATA SSD	6Gbs: 120GB/240GB/300GB/480GB/600GB
For 3.5" bay	3.5" SATA HDD		7.2K 6Gbs: 500GB/1TB/2TB/3TB/4TB/6TB										
	3.5" SAS HDD	7.2K 6Gbs: 1TB/2TB/3TB/4TB											
For 2.5" bay	2.5" SATA HDD	7.2K 6Gbs: 500GB/1TB											
	2.5" SAS HDD	10K 6Gbs: 300GB/600GB/900GB. 15K 6Gbs: 146GB/300GB											
	2.5" SATA SSD	6Gbs: 120GB/240GB/300GB/480GB/600GB											
Optical drive	Up to one 9.5mm optical. DVD-ROM or DVD±RW												
Network interfaces	Two Gigabit Ethernet ports by Intel I210, on riser card. One Gigabit Ethernet port by Intel I217, dedicate/share management												
Security features	Power-on and administrator password. TPM (TCG 1.2-compliant).												
Systems management	Intel Active Management Technology 9 on models with Xeon processor. Remote presence is supported on models with Xeon processors. Supports ThinkServer EasyStartup/EasyUpdate												
Operating systems supported	Microsoft Windows Server 2016/2012 R2/2012/2008 R2. Windows Small Business Server 2011. Red Hat Enterprise Linux 6.5. SUSE Linux Enterprise Server 11 SP3. VMware vSphere (ESXi) 5.5 Note: VMware requires add-on network adapter.												

Components	Specification	
Base warranty	1 or 3-year limited onsite service with 9x5/NBD.	
Power supply	One fixed 300 watts power supply, 80 PLUS Gold qualified	
Graphics	Integrated Intel HD Graphics in processor	
Front ports	Two USB 2.0	
Rear ports	Four USB 3.0, two USB 2.0, one serial (9-pin), two ethernet (RJ-45), one RJ-45 (dedicate/share mgmt), one VGA, one DisplayPort. Optional two serial ports via PCIe adapter	
Noise emissions	Operating: < 5.2 Bels. Idle: < 5.0 Bels (Mainstream configuration)	
Environmental specification	RoHS-compliant.	
	Temperature - operating	50 °F to 95 °F (10 °C to 35 °C)
	Temperature - storage (with package)	-40 o C to 70 o C
	Altitude - operating	Supported Altitude (unpressurized): 0-10000ft (0-3048m)
	Humidity - operating	10%-80%, non-condensing
	Humidity - storage (with package)	10%-90%, non-condensing

### Expansion slots and disk bays

Supports one PCI-Express slot via riser card, half-length, full-height, PCIe 3.0 x8

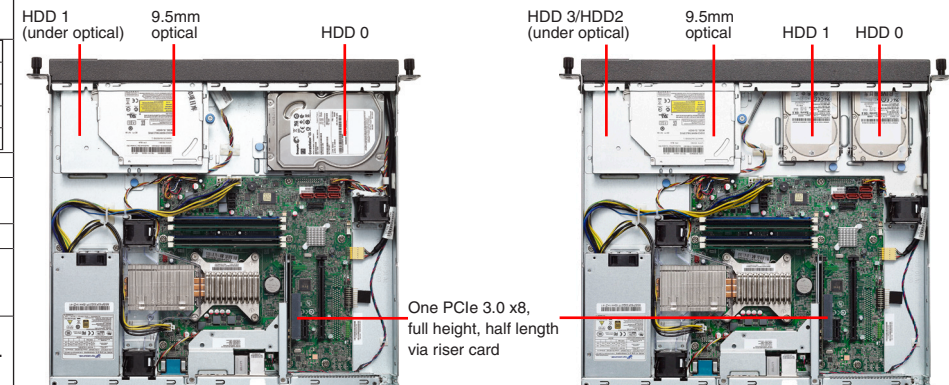

Model	Region	Processor	Memory	Storage Controller	Disk Bays	Disks	Optical	Add-on NIC	Add-on Ports	System Mgmt	OS	Warranty	Power Supply	Ann Date (m/y)
70F30006UX	US	Core i3-4130 2C/3.4GHz/3MB/54W/DDR3-1600	1x4GB UDIMM DDR3-1600 ECC	RAID 100	4x2.5" DC	Open	9.5mm DVD±RW	None	None	AMT9	None	1-year	300W Gold Fixed	06/14
70F30007UX	US	Xeon E3-1225 v3 4C/3.2GHz/8MB/84W/DDR3-1600	1x4GB UDIMM DDR3-1600 ECC	RAID 100	4x2.5" DC	Open	9.5mm DVD±RW	None	None	AMT9	None	1-year	300W Gold Fixed	06/14
70F30008UX	US	Xeon E3-1245 v3 4C/3.4GHz/8MB/84W/DDR3-1600	1x4GB UDIMM DDR3-1600 ECC	RAID 100	4x2.5" DC	Open	9.5mm DVD±RW	None	None	AMT9	None	1-year	300W Gold Fixed	06/14
70F30009UX	US	Xeon E3-1225 v3 4C/3.2GHz/8MB/84W/DDR3-1600	1x4GB UDIMM DDR3-1600 ECC	RAID 500	4x2.5" DC	Open	9.5mm DVD±RW	None	None	AMT9	None	1-year	300W Gold Fixed	06/14
70F3000AUX	US	Xeon E3-1245 v3 4C/3.4GHz/8MB/84W/DDR3-1600	1x4GB UDIMM DDR3-1600 ECC	RAID 500	4x2.5" DC	Open	9.5mm DVD±RW	None	None	AMT9	None	1-year	300W Gold Fixed	06/14
70F3000BUX	US	Xeon E3-1245 v3 4C/3.4GHz/8MB/84W/DDR3-1600	1x8GB UDIMM DDR3-1600 ECC	RAID 500+Key	4x2.5" DC	Open	9.5mm DVD±RW	None	None	AMT9	None	1-year	300W Gold Fixed	06/14
70F3000CUX	US	Xeon E3-1245 v3 4C/3.4GHz/8MB/84W/DDR3-1600	1x8GB UDIMM DDR3-1600 ECC	RAID 700	4x2.5" DC	Open	9.5mm DVD±RW	None	None	AMT9	None	1-year	300W Gold Fixed	06/14
70F3000DUS	US	Xeon E3-1225 v3 4C/3.2GHz/8MB/84W/DDR3-1600	2x4GB UDIMM DDR3-1600 ECC	RAID 500+Key	4x2.5" DC	2x500GB HDD 7.2K 2.5" SATA6Gbps	9.5mm DVD±RW	None	None	AMT9	2012 R2 Standard	1-year	300W Gold Fixed	06/14
70F3000EUS	US	Xeon E3-1245 v3 4C/3.4GHz/8MB/84W/DDR3-1600	2x8GB UDIMM DDR3-1600 ECC	RAID 700	4x2.5" DC	4x500GB HDD 7.2K 2.5" SATA6Gbps	9.5mm DVD±RW	None	None	AMT9	2012 R2 Standard	1-year	300W Gold Fixed	06/14
70F30017UX	US	Core i3-4150 2C/3.5GHz/3MB/54W/DDR3-1600	1x4GB UDIMM DDR3-1600 ECC	RAID 100	4x2.5" DC	Open	9.5mm DVD±RW	None	None	AMT9	None	1-year	300W Gold Fixed	09/14
70F30018UX	US	Xeon E3-1226 v3 4C/3.3GHz/8MB/84W/DDR3-1600	1x4GB UDIMM DDR3-1600 ECC	RAID 100	4x2.5" DC	Open	9.5mm DVD±RW	None	None	AMT9	None	1-year	300W Gold Fixed	09/14
70F30019UX	US	Xeon E3-1246 v3 4C/3.5GHz/8MB/84W/DDR3-1600	1x4GB UDIMM DDR3-1600 ECC	RAID 100	4x2.5" DC	Open	9.5mm DVD±RW	None	None	AMT9	None	1-year	300W Gold Fixed	09/14
70F3001AUX	US	Xeon E3-1226 v3 4C/3.3GHz/8MB/84W/DDR3-1600	1x4GB UDIMM DDR3-1600 ECC	RAID 500	4x2.5" DC	Open	9.5mm DVD±RW	None	None	AMT9	None	1-year	300W Gold Fixed	09/14
70F3001BUX	US	Xeon E3-1246 v3 4C/3.5GHz/8MB/84W/DDR3-1600	1x4GB UDIMM DDR3-1600 ECC	RAID 500	4x2.5" DC	Open	9.5mm DVD±RW	None	None	AMT9	None	1-year	300W Gold Fixed	09/14
70F3001EUS	US	Xeon E3-1226 v3 4C/3.3GHz/8MB/84W/DDR3-1600	1x4GB UDIMM DDR3-1600 ECC	RAID 100	4x2.5" DC	2x500GB HDD 7.2K 2.5" SATA6Gbps	9.5mm DVD±RW	None	None	AMT9	2012 R2 Foundations	1-year	300W Gold Fixed	09/14
70F3001FUS	US	Xeon E3-1226 v3 4C/3.3GHz/8MB/84W/DDR3-1600	1x4GB UDIMM DDR3-1600 ECC	RAID 100	4x2.5" DC	2x500GB HDD 7.2K 2.5" SATA6Gbps	9.5mm DVD±RW	None	None	AMT9	2012 R2 Essentials	1-year	300W Gold Fixed	09/14
70F3001GUS	US	Xeon E3-1226 v3 4C/3.3GHz/8MB/84W/DDR3-1600	1x4GB UDIMM DDR3-1600 ECC	RAID 100	4x2.5" DC	2x120GB SSD 2.5" SATA6Gbps	9.5mm DVD±RW	None	None	AMT9	2012 R2 Foundations	1-year	300W Gold Fixed	09/14
70F3001HUS	US	Xeon E3-1226 v3 4C/3.3GHz/8MB/84W/DDR3-1600	1x4GB UDIMM DDR3-1600 ECC	RAID 100	4x2.5" DC	2x120GB SSD 2.5" SATA6Gbps	9.5mm DVD±RW	None	None	AMT9	2012 R2 Essentials	1-year	300W Gold Fixed	09/14

Model	Region	Processor	Memory	Storage Controller	Disk Bays	Disks	Optical	Add-on NIC	Add-on Ports	System Mgmt	OS	Warranty	Power Supply	Ann Date (m/y)
70F90007UX	US	Core i3-4130 2C/3.4GHz/3MB/54W/DDR3-1600	1x4GB UDIMM DDR3-1600 ECC	RAID 100	2x3.5" DC	Open	9.5mm DVD±RW	None	None	AMT9	None	1-year	300W Gold Fixed	06/14
70F90008UX	US	Xeon E3-1225 v3 4C/3.2GHz/8MB/84W/DDR3-1600	1x4GB UDIMM DDR3-1600 ECC	RAID 100	2x3.5" DC	Open	9.5mm DVD±RW	None	None	AMT9	None	1-year	300W Gold Fixed	06/14
70F90009UX	US	Xeon E3-1245 v3 4C/3.4GHz/8MB/84W/DDR3-1600	1x4GB UDIMM DDR3-1600 ECC	RAID 100	2x3.5" DC	Open	9.5mm DVD±RW	None	None	AMT9	None	1-year	300W Gold Fixed	06/14
70F9000AUX	US	Core i3-4130 2C/3.4GHz/3MB/54W/DDR3-1600	1x4GB UDIMM DDR3-1600 ECC	RAID 500	2x3.5" DC	Open	9.5mm DVD±RW	None	None	AMT9	None	1-year	300W Gold Fixed	06/14
70F9000BUX	US	Xeon E3-1225 v3 4C/3.2GHz/8MB/84W/DDR3-1600	1x4GB UDIMM DDR3-1600 ECC	RAID 500	2x3.5" DC	Open	9.5mm DVD±RW	None	None	AMT9	None	1-year	300W Gold Fixed	06/14
70F9000CUX	US	Xeon E3-1245 v3 4C/3.4GHz/8MB/84W/DDR3-1600	1x4GB UDIMM DDR3-1600 ECC	RAID 500	2x3.5" DC	Open	9.5mm DVD±RW	None	None	AMT9	None	1-year	300W Gold Fixed	06/14
70F9000DUX	US	Xeon E3-1225 v3 4C/3.2GHz/8MB/84W/DDR3-1600	2x4GB UDIMM DDR3-1600 ECC	RAID 500	2x3.5" DC	Open	9.5mm DVD±RW	None	None	AMT9	None	1-year	300W Gold Fixed	06/14
70F9000EUX	US	Xeon E3-1245 v3 4C/3.4GHz/8MB/84W/DDR3-1600	2x8GB UDIMM DDR3-1600 ECC	RAID 500	2x3.5" DC	Open	9.5mm DVD±RW	None	None	AMT9	None	1-year	300W Gold Fixed	06/14
70F9000FUS	US	Xeon E3-1225 v3 4C/3.2GHz/8MB/84W/DDR3-1600	2x4GB UDIMM DDR3-1600 ECC	RAID 500	2x3.5" DC	2x500GB HDD 7.2K 3.5" SATA6Gbps	9.5mm DVD±RW	None	None	AMT9	2012 R2 Standard	1-year	300W Gold Fixed	06/14
70F9000GUS	US	Xeon E3-1245 v3 4C/3.4GHz/8MB/84W/DDR3-1600	2x8GB UDIMM DDR3-1600 ECC	RAID 500	2x3.5" DC	2x500GB HDD 7.2K 3.5" SATA6Gbps	9.5mm DVD±RW	None	None	AMT9	2012 R2 Standard	1-year	300W Gold Fixed	06/14
70F9000HUS	US	Xeon E3-1225 v3 4C/3.2GHz/8MB/84W/DDR3-1600	2x4GB UDIMM DDR3-1600 ECC	RAID 500	2x3.5" DC	2x500GB HDD 7.2K 3.5" SATA6Gbps	9.5mm DVD±RW	None	None	AMT9	2012 R2 Essentials	1-year	300W Gold Fixed	06/14
70F9001MUX	US	Core i3-4150 2C/3.5GHz/3MB/54W/DDR3-1600	1x4GB UDIMM DDR3-1600 ECC	RAID 100	2x3.5" DC	Open	9.5mm DVD±RW	None	None	AMT9	None	1-year	300W Gold Fixed	09/14
70F9001NUX	US	Xeon E3-1226 v3 4C/3.3GHz/8MB/84W/DDR3-1600	1x4GB UDIMM DDR3-1600 ECC	RAID 100	2x3.5" DC	Open	9.5mm DVD±RW	None	None	AMT9	None	1-year	300W Gold Fixed	09/14
70F9001PUX	US	Xeon E3-1246 v3 4C/3.5GHz/8MB/84W/DDR3-1600	1x4GB UDIMM DDR3-1600 ECC	RAID 100	2x3.5" DC	Open	9.5mm DVD±RW	None	None	AMT9	None	1-year	300W Gold Fixed	09/14
70F9001QUX	US	Xeon E3-1226 v3 4C/3.3GHz/8MB/84W/DDR3-1600	1x4GB UDIMM DDR3-1600 ECC	RAID 500	2x3.5" DC	Open	9.5mm DVD±RW	None	None	AMT9	None	1-year	300W Gold Fixed	09/14
70F9001RUX	US	Xeon E3-1246 v3 4C/3.5GHz/8MB/84W/DDR3-1600	1x4GB UDIMM DDR3-1600 ECC	RAID 500	2x3.5" DC	Open	9.5mm DVD±RW	None	None	AMT9	None	1-year	300W Gold Fixed	09/14
70F9001UUS	US	Xeon E3-1226 v3 4C/3.3GHz/8MB/84W/DDR3-1600	1x4GB UDIMM DDR3-1600 ECC	RAID 100	2x3.5" DC	2x500GB HDD 7.2K 3.5" SATA6Gbps	9.5mm DVD±RW	None	None	AMT9	2012 R2 Foundations	1-year	300W Gold Fixed	09/14
70F9001VUS	US	Xeon E3-1226 v3 4C/3.3GHz/8MB/84W/DDR3-1600	1x4GB UDIMM DDR3-1600 ECC	RAID 100	2x3.5" DC	2x500GB HDD 7.2K 3.5" SATA6Gbps	9.5mm DVD±RW	None	None	AMT9	2012 R2 Essentials	1-year	300W Gold Fixed	09/14

# ThinkServer RS140 - 70F2

Product Specifications Reference (PSREF)

Model	Region	Processor	Memory	Storage Controller	Disk Bays	Disks	Optical	Add-on NIC	Add-on Ports	System Mgmt	OS	Warranty	Power Supply	Ann Date (m/y)
70F20001UX	US	Xeon E3-1225 v3 4C/3.2GHz/8MB/84W/DDR3-1600	2x4GB UDIMM DDR3-1600 ECC	RAID 100	4x2.5" DC	Open	None	None	None	AMT9	None	3-year	300W Gold Fixed	06/14
70F20002UX	US	Xeon E3-1245 v3 4C/3.4GHz/8MB/84W/DDR3-1600	2x8GB UDIMM DDR3-1600 ECC	RAID 700	4x2.5" DC	Open	None	None	None	AMT9	None	3-year	300W Gold Fixed	06/14



# ThinkServer RS140 - 70F8

Product Specifications Reference (PSREF)

Model	Region	Processor	Memory	Storage Controller	Disk Bays	Disks	Optical	Add-on NIC	Add-on Ports	System Mgmt	OS	Warranty	Power Supply	Ann Date (m/y)
70F80000UX	US	Xeon E3-1225 v3 4C/3.2GHz/8MB/84W/DDR3-1600	2x4GB UDIMM DDR3-1600 ECC	RAID 100	2x3.5" DC	Open	9.5mm DVD±RW	None	None	AMT9	None	3-year	300W Gold Fixed	06/14
70F80001UX	US	Xeon E3-1245 v3 4C/3.4GHz/8MB/84W/DDR3-1600	2x8GB UDIMM DDR3-1600 ECC	RAID 500	2x3.5" DC	Open	9.5mm DVD±RW	None	None	AMT9	None	3-year	300W Gold Fixed	06/14



# ThinkServer RS160 Platform Specifications

Product Specifications Reference (PSREF)

Components	Specification																																					
Dimensions	1U rack. Height: 43.2 mm (1.7 in), width: 438.5 mm (17.26 in), depth: 393.7 mm (15.5 in)																																					
Weight	Minimum configuration: 6.2 kg (13.67 lb), maximum: 7.6 kg (16.76 lb)																																					
Processor	Supports one of the following Intel "Kaby Lake" processors:																																					
	<table border="1"> <tbody> <tr><td>Xeon E3-1280 v6</td><td>4C/3.9GHz/8MB/72W/DDR4-2400</td></tr> <tr><td>Xeon E3-1270 v6</td><td>4C/3.8GHz/8MB/72W/DDR4-2400</td></tr> <tr><td>Xeon E3-1240 v6</td><td>4C/3.7GHz/8MB/72W/DDR4-2400</td></tr> <tr><td>Xeon E3-1230 v6</td><td>4C/3.5GHz/8MB/72W/DDR4-2400</td></tr> <tr><td>Xeon E3-1225 v6</td><td>4C/3.3GHz/8MB/73W/DDR4-2400</td></tr> <tr><td>Xeon E3-1220 v6</td><td>4C/3GHz/8MB/72W/DDR4-2400</td></tr> <tr><td>Core i3-7320</td><td>2C/4.1GHz/4MB/51W/DDR4-2400</td></tr> <tr><td>Core i3-7300</td><td>2C/4GHz/4MB/51W/DDR4-2400</td></tr> <tr><td>Core i3-7300T</td><td>2C/3.5GHz/4MB/35W/DDR4-2400</td></tr> <tr><td>Core i3-7100</td><td>2C/3.9GHz/3MB/51W/DDR4-2400</td></tr> <tr><td>Core i3-7100T</td><td>2C/3.4GHz/3MB/35W/DDR4-2400</td></tr> <tr><td>Pentium G4620</td><td>2C/3.7GHz/3MB/51W/DDR4-2400</td></tr> <tr><td>Pentium G4600</td><td>2C/3.6GHz/3MB/51W/DDR4-2400</td></tr> <tr><td>Pentium G4600T</td><td>2C/3GHz/3MB/35W/DDR4-2400</td></tr> <tr><td>Pentium G4560</td><td>2C/3.5GHz/3MB/54W/DDR4-2400</td></tr> <tr><td>Pentium G4560T</td><td>2C/2.9GHz/3MB/35W/DDR4-2400</td></tr> <tr><td>Celeron G3950</td><td>2C/3GHz/2MB/51W/DDR4-2133</td></tr> <tr><td>Celeron G3930</td><td>2C/2.9GHz/2MB/51W/DDR4-2133</td></tr> <tr><td>Celeron G3930T</td><td>2C/2.7GHz/2MB/35W/DDR4-2133</td></tr> </tbody> </table>	Xeon E3-1280 v6	4C/3.9GHz/8MB/72W/DDR4-2400	Xeon E3-1270 v6	4C/3.8GHz/8MB/72W/DDR4-2400	Xeon E3-1240 v6	4C/3.7GHz/8MB/72W/DDR4-2400	Xeon E3-1230 v6	4C/3.5GHz/8MB/72W/DDR4-2400	Xeon E3-1225 v6	4C/3.3GHz/8MB/73W/DDR4-2400	Xeon E3-1220 v6	4C/3GHz/8MB/72W/DDR4-2400	Core i3-7320	2C/4.1GHz/4MB/51W/DDR4-2400	Core i3-7300	2C/4GHz/4MB/51W/DDR4-2400	Core i3-7300T	2C/3.5GHz/4MB/35W/DDR4-2400	Core i3-7100	2C/3.9GHz/3MB/51W/DDR4-2400	Core i3-7100T	2C/3.4GHz/3MB/35W/DDR4-2400	Pentium G4620	2C/3.7GHz/3MB/51W/DDR4-2400	Pentium G4600	2C/3.6GHz/3MB/51W/DDR4-2400	Pentium G4600T	2C/3GHz/3MB/35W/DDR4-2400	Pentium G4560	2C/3.5GHz/3MB/54W/DDR4-2400	Pentium G4560T	2C/2.9GHz/3MB/35W/DDR4-2400	Celeron G3950	2C/3GHz/2MB/51W/DDR4-2133	Celeron G3930	2C/2.9GHz/2MB/51W/DDR4-2133	Celeron G3930T
Xeon E3-1280 v6	4C/3.9GHz/8MB/72W/DDR4-2400																																					
Xeon E3-1270 v6	4C/3.8GHz/8MB/72W/DDR4-2400																																					
Xeon E3-1240 v6	4C/3.7GHz/8MB/72W/DDR4-2400																																					
Xeon E3-1230 v6	4C/3.5GHz/8MB/72W/DDR4-2400																																					
Xeon E3-1225 v6	4C/3.3GHz/8MB/73W/DDR4-2400																																					
Xeon E3-1220 v6	4C/3GHz/8MB/72W/DDR4-2400																																					
Core i3-7320	2C/4.1GHz/4MB/51W/DDR4-2400																																					
Core i3-7300	2C/4GHz/4MB/51W/DDR4-2400																																					
Core i3-7300T	2C/3.5GHz/4MB/35W/DDR4-2400																																					
Core i3-7100	2C/3.9GHz/3MB/51W/DDR4-2400																																					
Core i3-7100T	2C/3.4GHz/3MB/35W/DDR4-2400																																					
Pentium G4620	2C/3.7GHz/3MB/51W/DDR4-2400																																					
Pentium G4600	2C/3.6GHz/3MB/51W/DDR4-2400																																					
Pentium G4600T	2C/3GHz/3MB/35W/DDR4-2400																																					
Pentium G4560	2C/3.5GHz/3MB/54W/DDR4-2400																																					
Pentium G4560T	2C/2.9GHz/3MB/35W/DDR4-2400																																					
Celeron G3950	2C/3GHz/2MB/51W/DDR4-2133																																					
Celeron G3930	2C/2.9GHz/2MB/51W/DDR4-2133																																					
Celeron G3930T	2C/2.7GHz/2MB/35W/DDR4-2133																																					
Processor	Supports one of the following Intel "Skylake" processors:																																					
	<table border="1"> <tbody> <tr><td>Xeon E3-1280 v5</td><td>4C/3.7GHz/8MB/80W/DDR4-2133</td></tr> <tr><td>Xeon E3-1270 v5</td><td>4C/3.6GHz/8MB/80W/DDR4-2133</td></tr> <tr><td>Xeon E3-1240 v5</td><td>4C/3.5GHz/8MB/80W/DDR4-2133</td></tr> <tr><td>Xeon E3-1230 v5</td><td>4C/3.4GHz/8MB/80W/DDR4-2133</td></tr> <tr><td>Xeon E3-1220 v5</td><td>4C/3GHz/8MB/80W/DDR4-2133</td></tr> <tr><td>Xeon E3-1260L v5</td><td>4C/2.9GHz/8MB/45W/DDR4-2133</td></tr> <tr><td>Xeon E3-1240L v5</td><td>4C/2.1GHz/8MB/25W/DDR4-2133</td></tr> <tr><td>Xeon E3-1225 v5</td><td>4C/3.3GHz/8MB/80W/DDR4-2133</td></tr> <tr><td>Core i3-6320</td><td>2C/3.9GHz/4MB/51W/DDR4-2133</td></tr> <tr><td>Core i3-6300</td><td>2C/3.8GHz/4MB/51W/DDR4-2133</td></tr> <tr><td>Core i3-6100</td><td>2C/3.7GHz/3MB/51W/DDR4-2133</td></tr> <tr><td>Pentium G4520</td><td>2C/3.6GHz/3MB/51W/DDR4-2133</td></tr> <tr><td>Pentium G4500</td><td>2C/3.5GHz/3MB/51W/DDR4-2133</td></tr> <tr><td>Pentium G4400</td><td>2C/3.3GHz/3MB/54W/DDR4-2133</td></tr> <tr><td>Celeron G3920</td><td>2C/2.9GHz/2MB/51W/DDR4-2133</td></tr> <tr><td>Celeron G3900</td><td>2C/2.8GHz/2MB/51W/DDR4-2133</td></tr> <tr><td>Celeron G3900T</td><td>2C/2.6GHz/2MB/35W/DDR4-2133</td></tr> </tbody> </table>	Xeon E3-1280 v5	4C/3.7GHz/8MB/80W/DDR4-2133	Xeon E3-1270 v5	4C/3.6GHz/8MB/80W/DDR4-2133	Xeon E3-1240 v5	4C/3.5GHz/8MB/80W/DDR4-2133	Xeon E3-1230 v5	4C/3.4GHz/8MB/80W/DDR4-2133	Xeon E3-1220 v5	4C/3GHz/8MB/80W/DDR4-2133	Xeon E3-1260L v5	4C/2.9GHz/8MB/45W/DDR4-2133	Xeon E3-1240L v5	4C/2.1GHz/8MB/25W/DDR4-2133	Xeon E3-1225 v5	4C/3.3GHz/8MB/80W/DDR4-2133	Core i3-6320	2C/3.9GHz/4MB/51W/DDR4-2133	Core i3-6300	2C/3.8GHz/4MB/51W/DDR4-2133	Core i3-6100	2C/3.7GHz/3MB/51W/DDR4-2133	Pentium G4520	2C/3.6GHz/3MB/51W/DDR4-2133	Pentium G4500	2C/3.5GHz/3MB/51W/DDR4-2133	Pentium G4400	2C/3.3GHz/3MB/54W/DDR4-2133	Celeron G3920	2C/2.9GHz/2MB/51W/DDR4-2133	Celeron G3900	2C/2.8GHz/2MB/51W/DDR4-2133	Celeron G3900T	2C/2.6GHz/2MB/35W/DDR4-2133			
Xeon E3-1280 v5	4C/3.7GHz/8MB/80W/DDR4-2133																																					
Xeon E3-1270 v5	4C/3.6GHz/8MB/80W/DDR4-2133																																					
Xeon E3-1240 v5	4C/3.5GHz/8MB/80W/DDR4-2133																																					
Xeon E3-1230 v5	4C/3.4GHz/8MB/80W/DDR4-2133																																					
Xeon E3-1220 v5	4C/3GHz/8MB/80W/DDR4-2133																																					
Xeon E3-1260L v5	4C/2.9GHz/8MB/45W/DDR4-2133																																					
Xeon E3-1240L v5	4C/2.1GHz/8MB/25W/DDR4-2133																																					
Xeon E3-1225 v5	4C/3.3GHz/8MB/80W/DDR4-2133																																					
Core i3-6320	2C/3.9GHz/4MB/51W/DDR4-2133																																					
Core i3-6300	2C/3.8GHz/4MB/51W/DDR4-2133																																					
Core i3-6100	2C/3.7GHz/3MB/51W/DDR4-2133																																					
Pentium G4520	2C/3.6GHz/3MB/51W/DDR4-2133																																					
Pentium G4500	2C/3.5GHz/3MB/51W/DDR4-2133																																					
Pentium G4400	2C/3.3GHz/3MB/54W/DDR4-2133																																					
Celeron G3920	2C/2.9GHz/2MB/51W/DDR4-2133																																					
Celeron G3900	2C/2.8GHz/2MB/51W/DDR4-2133																																					
Celeron G3900T	2C/2.6GHz/2MB/35W/DDR4-2133																																					
Chipset	Intel C232 Platform Controller Hub (PCH)																																					
Memory DIMMs	4 DIMM sockets with 2-channels. UDIMM. DDR4-2133 or DDR4-2400																																					
Memory capacity	64GB (16GB x 4)																																					
Memory protection	ECC																																					
RAID controller	<table border="1"> <thead> <tr> <th>RAID controller</th> <th>Drive type</th> <th>RAID support</th> <th>Compatible models</th> </tr> </thead> <tbody> <tr> <td>Onboard RAID121i</td> <td>6Gbs SATA</td> <td>0/1/5/10</td> <td>2x3.5", 4x2.5"</td> </tr> <tr> <td>RAID520i PCIe</td> <td>12Gbs SAS/SATA</td> <td>0/1/10, 5 with optional key</td> <td>2x3.5", 4x2.5"</td> </tr> <tr> <td>RAID720i PCIe</td> <td>12Gbs SAS/SATA</td> <td>0/1/10/5, 6 with optional cache</td> <td>2x3.5", 4x2.5"</td> </tr> </tbody> </table>	RAID controller	Drive type	RAID support	Compatible models	Onboard RAID121i	6Gbs SATA	0/1/5/10	2x3.5", 4x2.5"	RAID520i PCIe	12Gbs SAS/SATA	0/1/10, 5 with optional key	2x3.5", 4x2.5"	RAID720i PCIe	12Gbs SAS/SATA	0/1/10/5, 6 with optional cache	2x3.5", 4x2.5"																					
	RAID controller	Drive type	RAID support	Compatible models																																		
	Onboard RAID121i	6Gbs SATA	0/1/5/10	2x3.5", 4x2.5"																																		
RAID520i PCIe	12Gbs SAS/SATA	0/1/10, 5 with optional key	2x3.5", 4x2.5"																																			
RAID720i PCIe	12Gbs SAS/SATA	0/1/10/5, 6 with optional cache	2x3.5", 4x2.5"																																			
	Optional cache for RAID720i: 1GB memory. 1GB, 2GB, or 4GB flash with super capacitor.																																					
Disk drive bays	Supports two 3.5" or four 2.5" disk drive bays. Non-hot swap. Cables are connected to onboard SATA connectors or PCIe RAID controller. Also supports one M.2 SATA SSD																																					
Supporting storage	3.5" HDD, 7.2K SATA6Gbs	1TB/2TB/4TB/6TB/8TB/10TB/12TB																																				
	3.5" HDD, 7.2K SAS12Gbs	1TB/2TB/4TB/6TB/8TB/10TB																																				
	3.5" SSD, SATA6Gbs (2.5" SSD with 3.5" tray)	240GB/480GB/960GB																																				
	2.5" HDD, 7.2K SATA6Gbs	1TB/2TB																																				
	2.5" HDD, 10K SAS12Gbs	300GB/600GB/900GB/1.2TB/2.4TB																																				
	2.5" HDD, 15K SAS12Gbs	900GB																																				
	2.5" SSD, SATA6Gbs	120GB/240GB/480GB/960GB																																				
	M.2 SATA SSD	32GB/128GB																																				

Components	Specification	
Optical drive	Optional one 9.5mm optical. DVD-ROM or DVD±RW	
Network interfaces	One dedicated management port, two Gigabit Ethernet ports. Supports optional discrete network adapters via riser card	
Security features	Power-on and administrator password. Optional TPM, TCG 1.2 or 2.0 compliant.	
Systems management	UEFI. Onboard Aspeed AST2400 graphics/management processor, IPMI 2.0-compliant baseboard management controller (BMC). Control Panel LEDs shows the status of power, ID, disk drives, network, system. Supports the following management software: EasyStartup, Power Planner. On November 2016, EasyUpdate, Lenovo ThinkServer Diagnostics Standalone, ToolsCenter Suite CLI inventory module on ThinkServer, and Lenovo xClarity Administrator will be available	
Operating systems	Microsoft Windows Server 2016 (Standard and Essentials)/2012 R2/2012. Windows 10 Pro. Red Hat Enterprise Linux 6.7/6.8/7.2. SUSE Linux Enterprise Server 11/12. VMware vSphere (ESXi) 6.0U0/U2	
Base warranty	1 or 3-year limited onsite service with 9x5/NBD	
Power supply	One fixed 300 watts power supply, Non-hot swap. 80 PLUS Gold qualified	
Graphics	Onboard Aspeed AST2400	
Front ports	Two USB 2.0	
Rear ports	One VGA, four USB 3.0, one RJ-45 (dedicated mgmt), two ethernet, one serial (9-pin)	
Cooling	3 fans for processor, PCIe slot, and disk drives	
Noise emissions	Operating: < 5.9 Bels. Idle: < 5.2 Bels (Maximum configuration)	
Environmental specification	Temperature - operating	50 °F to 95 °F (10 °C to 35 °C)
	Temperature - non operating (with package)	-40 °C to 60 °C
	Altitude - operating	(Unpressurized): 0-10000ft (0-3048m)
	Humidity - operating	8%~80%, non-condensing
	Humidity - storage (with package)	10%~90%, non-condensing

## Expansion slots and disk bays

Supports one PCIe slot via optional riser card, PCIe 3.0 x16, half length, half height

## Core options for ThinkServer RS160 (partial)

ThinkServer 8GB 2RX8 PC4-2133-E CL15 DDR4-2133 ECC-UDIMM	4X70G88316
ThinkServer 16GB 2RX8 PC4-2133-E CL15 DDR4-2133 ECC-UDIMM	4X70G88317
ThinkServer 3.5" 8TB 7.2K Enterprise SATA 6Gbps 512e Hard Drive for RS-Series	4XB0K12297
ThinkServer 2.5" 1.2TB 10K Enterprise SAS 12Gbps Hard Drive for RS-Series	4XB0K12306
ThinkServer 2.5" 2TB 7.2K Enterprise SATA 6Gbps Hard Drive for RS-Series	4XB0K12302
ThinkServer 2.5" 480GB S3510 Enterprise Entry SATA 6Gbps SSD for RS-Series	4XB0K12321
ThinkServer M.2 32GB Value Read-Optimized SATA 6Gbps Solid State Drive	4XB0K12310
ThinkServer RAID 520i RAID 5 Upgrade	4XC0G88841
ThinkServer RS160 Slim SATA DVD-RW Optical Disk Drive	4XA0G88613
Lenovo ThinkServer Gen 5 Trusted Platform Module v1.2 (Worldwide except China)	4XF0G45868

Model	Region	Processor	Memory	Storage Controller	Disk Bays	Disks	Optical	Add-on NIC	Slots	TPM	OS	Warranty	Power Supply	Ann Date (m/y)
70TE000DUX	US	Xeon E3-1220 v5 4C/3.0GHz/8MB/80W/DDR4-2133	1x8GB UDIMM DDR4-2133 ECC	RAID 121i	4x2.5" NHS	Open	None	None	None	TPM	None	1-year	300W 85% Fixed	09/16
70TE000EUX	US	Xeon E3-1230 v5 4C/3.4GHz/8MB/80W/DDR4-2133	1x8GB UDIMM DDR4-2133 ECC	RAID 121i	4x2.5" NHS	Open	None	None	None	TPM	None	1-year	300W 85% Fixed	09/16
70TE000FUX	US	Xeon E3-1240 v5 4C/3.5GHz/8MB/80W/DDR4-2133	1x8GB UDIMM DDR4-2133 ECC	RAID 121i	4x2.5" NHS	Open	None	None	None	TPM	None	1-year	300W 85% Fixed	09/16
70TE000GUX	US	Xeon E3-1270 v5 4C/3.6GHz/8MB/80W/DDR4-2133	1x8GB UDIMM DDR4-2133 ECC	RAID 121i	4x2.5" NHS	Open	None	None	None	TPM	None	1-year	300W 85% Fixed	09/16
70TE000HUX	US	Xeon E3-1280 v5 4C/3.7GHz/8MB/80W/DDR4-2133	1x8GB UDIMM DDR4-2133 ECC	RAID 121i	4x2.5" NHS	Open	None	None	None	TPM	None	1-year	300W 85% Fixed	09/16
70TE000YUX	US	Xeon E3-1220 v6 4C/3.0GHz/8MB/72W/DDR4-2400	1x8GB UDIMM DDR4-2400 ECC	RAID121i	4x2.5" NHS	Open	None	None	None	TPM2.0	None	1-year	300W 85% Fixed	06/17
70TE0010UX	US	Xeon E3-1230 v6 4C/3.5GHz/8MB/72W/DDR4-2400	1x8GB UDIMM DDR4-2400 ECC	RAID121i	4x2.5" NHS	Open	None	None	None	TPM2.0	None	1-year	300W 85% Fixed	06/17
70TE0011UX	US	Xeon E3-1240 v6 4C/3.7GHz/8MB/72W/DDR4-2400	1x8GB UDIMM DDR4-2400 ECC	RAID121i	4x2.5" NHS	Open	None	None	None	TPM2.0	None	1-year	300W 85% Fixed	06/17
70TE0012UX	US	Xeon E3-1270 v6 4C/3.8GHz/8MB/72W/DDR4-2400	1x8GB UDIMM DDR4-2400 ECC	RAID121i	4x2.5" NHS	Open	None	None	None	TPM2.0	None	1-year	300W 85% Fixed	06/17
70TE0013UX	US	Xeon E3-1280 v6 4C/3.9GHz/8MB/72W/DDR4-2400	1x8GB UDIMM DDR4-2400 ECC	RAID121i	4x2.5" NHS	Open	None	None	None	TPM2.0	None	1-year	300W 85% Fixed	06/17
70TER001UX	US	Xeon E3-1220 v5 4C/3.0GHz/8MB/80W/DDR4-2133	1x8GB UDIMM DDR4-2133 ECC	RAID 121i	4x2.5" NHS	Open	None	None	1xHHHL	TPM	None	1-year	300W 85% Fixed	09/16
70TER002UX	US	Xeon E3-1230 v5 4C/3.4GHz/8MB/80W/DDR4-2133	1x8GB UDIMM DDR4-2133 ECC	RAID 121i	4x2.5" NHS	Open	None	None	1xHHHL	TPM	None	1-year	300W 85% Fixed	09/16
70TER003UX	US	Xeon E3-1270 v5 4C/3.6GHz/8MB/80W/DDR4-2133	1x8GB UDIMM DDR4-2133 ECC	RAID 121i	4x2.5" NHS	Open	None	None	1xHHHL	TPM	None	1-year	300W 85% Fixed	09/16

Model	Region	Processor	Memory	Storage Controller	Disk Bays	Disks	Optical	Add-on NIC	Slots	TPM	OS	Warranty	Power Supply	Ann Date (m/y)
70TG000JUX	US	Pentium G4400 2C/3.3GHz/3MB/54W/DDR4-2133	1x8GB UDIMM DDR4-2133 ECC	RAID 121i	2x3.5" NHS	Open	None	None	None	TPM	None	1-year	300W 85% Fixed	09/16
70TG000KUX	US	Xeon E3-1220 v5 4C/3.0GHz/8MB/80W/DDR4-2133	1x8GB UDIMM DDR4-2133 ECC	RAID 121i	2x3.5" NHS	Open	None	None	None	TPM	None	1-year	300W 85% Fixed	09/16
70TG000LUX	US	Xeon E3-1230 v5 4C/3.4GHz/8MB/80W/DDR4-2133	1x8GB UDIMM DDR4-2133 ECC	RAID 121i	2x3.5" NHS	Open	None	None	None	TPM	None	1-year	300W 85% Fixed	09/16
70TG000MUX	US	Xeon E3-1240 v5 4C/3.5GHz/8MB/80W/DDR4-2133	1x8GB UDIMM DDR4-2133 ECC	RAID 121i	2x3.5" NHS	Open	None	None	None	TPM	None	1-year	300W 85% Fixed	09/16
70TG000NUX	US	Xeon E3-1270 v5 4C/3.6GHz/8MB/80W/DDR4-2133	1x8GB UDIMM DDR4-2133 ECC	RAID 121i	2x3.5" NHS	Open	None	None	None	TPM	None	1-year	300W 85% Fixed	09/16
70TG000PUX	US	Xeon E3-1280 v5 4C/3.7GHz/8MB/80W/DDR4-2133	1x8GB UDIMM DDR4-2133 ECC	RAID 121i	2x3.5" NHS	Open	None	None	None	TPM	None	1-year	300W 85% Fixed	09/16
70TG001RUX	US	Xeon E3-1220 v6 4C/3.0GHz/8MB/72W/DDR4-2400	1x8GB UDIMM DDR4-2400 ECC	RAID121i	2x3.5" NHS	Open	None	None	None	TPM2.0	None	1-year	300W 85% Fixed	06/17
70TG001SUX	US	Xeon E3-1230 v6 4C/3.5GHz/8MB/72W/DDR4-2400	1x8GB UDIMM DDR4-2400 ECC	RAID121i	2x3.5" NHS	Open	None	None	None	TPM2.0	None	1-year	300W 85% Fixed	06/17
70TG001TUX	US	Xeon E3-1240 v6 4C/3.7GHz/8MB/72W/DDR4-2400	1x8GB UDIMM DDR4-2400 ECC	RAID121i	2x3.5" NHS	Open	None	None	None	TPM2.0	None	1-year	300W 85% Fixed	06/17
70TG001UUX	US	Xeon E3-1270 v6 4C/3.8GHz/8MB/72W/DDR4-2400	1x8GB UDIMM DDR4-2400 ECC	RAID121i	2x3.5" NHS	Open	None	None	None	TPM2.0	None	1-year	300W 85% Fixed	06/17
70TG001VUX	US	Xeon E3-1280 v6 4C/3.9GHz/8MB/72W/DDR4-2400	1x8GB UDIMM DDR4-2400 ECC	RAID121i	2x3.5" NHS	Open	None	None	None	TPM2.0	None	1-year	300W 85% Fixed	06/17
70TGR001UX	US	Pentium G4400 2C/3.3GHz/3MB/54W/DDR4-2133	1x8GB UDIMM DDR4-2133 ECC	RAID 121i	2x3.5" NHS	Open	None	None	1xHHHL	TPM	None	1-year	300W 85% Fixed	09/16
70TGR002UX	US	Xeon E3-1220 v5 4C/3.0GHz/8MB/80W/DDR4-2133	1x8GB UDIMM DDR4-2133 ECC	RAID 121i	2x3.5" NHS	Open	None	None	1xHHHL	TPM	None	1-year	300W 85% Fixed	09/16
70TGR003UX	US	Xeon E3-1230 v5 4C/3.4GHz/8MB/80W/DDR4-2133	1x8GB UDIMM DDR4-2133 ECC	RAID 121i	2x3.5" NHS	Open	None	None	1xHHHL	TPM	None	1-year	300W 85% Fixed	09/16

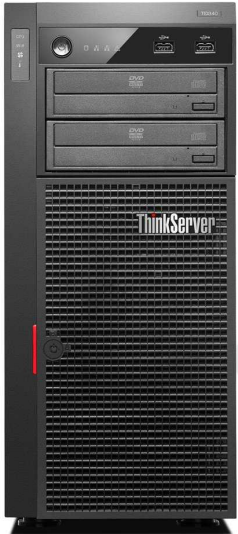

# ThinkServer TD340 Platform Specifications

Components	Specification																																									
Dimensions	Tower or 5U rack. Height: 430 mm (16.9 in), width: 195 mm (7.68 in), depth: 595 mm (23.4 in)																																									
Weight	Maximum: 26 kg (57.3 lb)																																									
Processor	Up to two <b>95W Intel Xeon E5-2400 v2</b> family (code name: Ivy Bridge EN) processors with 10 cores up to 2.4GHz, 8 cores up to 2.5GHz, 6 cores up to 2.5GHz, 4 cores up to 2.4GHz. One QPI link up to 8.0 GT/s. Up to 1600MHz memory speed. Up to 25MB cache. Or up to two <b>Intel Xeon E5-2420</b> (code name: Sandy Bridge EN) processors with 6 cores, 1.9GHz, 15MB cache, 95W, up to 1333MHz memory speed, one 7.2GT/s QPI link																																									
Chipset	Intel C606 Platform Controller Hub (PCH)																																									
Memory DIMMs	12 DIMM sockets (6 DIMMs per processor). 6-channel capable (3-channel per processor). RDIMM, LV RDIMM and LV UDIMM (cannot be intermixed). DDR3. Up to 1866MHz (RDIMM), 1600MHz (LV RDIMM) or 1600MHz (LV UDIMM)																																									
Memory capacity	192GB (RDIMM and LV RDIMM), 16GB x 12/48GB (LV UDIMM, 4GB x 12)																																									
Memory protection	ECC, memory mirroring, memory sparing																																									
AnyRAID support	Supports one of the following: RAID 0, 1, 10 with onboard RAID 100, 6Gb/s SATA, optional key for RAID 5. RAID 0, 1, 10 with onboard RAID 300, 6Gb/s SAS/SATA, optional key for RAID 5. RAID 0, 1, 10 with RAID 500, PCIe adapter, 6Gb/s SAS/SATA, optional key for RAID 5, 50. RAID 0, 1, 10, 5, 50, 6, 60 with RAID 700, PCIe adapter, 512MB cache, optional intelligent Battery Backup Unit (iBBU08). RAID 0, 1, 10, 5, 50, 6, 60 with RAID 710, PCIe adapter, 1GB cache, optional CacheVault flash cache with super capacitor/CacheCade Pro 2.0/FastPath key <i>Note: At least 6 disk drives is required for RAID 50 and 60.</i>																																									
Disk drive bays	Up to 8 3.5" hot-swap bays, or up to 16 2.5" hot-swap bays, or up to 4 3.5" non-hot swap bays. On front. Supports internal RDX tape drive, consumes 5.25" bay, also supports optional external SAS tape drive, additional SAS HBA card is needed. <table border="1"> <thead> <tr> <th rowspan="2">Disk bay configuration</th> <th colspan="5">RAID controller requirements</th> </tr> <tr> <th>RAID100</th> <th>RAID300</th> <th>RAID500</th> <th>RAID700</th> <th>RAID710</th> </tr> </thead> <tbody> <tr> <td>4x3.5" non-hot swap</td> <td>•</td> <td></td> <td></td> <td></td> <td></td> </tr> <tr> <td>4x3.5" HS</td> <td>•</td> <td>•</td> <td>•</td> <td>•</td> <td>•</td> </tr> <tr> <td>8x3.5" HS</td> <td></td> <td>•</td> <td>•</td> <td>•</td> <td>•</td> </tr> <tr> <td>8x2.5" HS</td> <td></td> <td>•</td> <td>•</td> <td>•</td> <td>•</td> </tr> <tr> <td>16x2.5" HS</td> <td></td> <td></td> <td>•</td> <td>•</td> <td>•</td> </tr> </tbody> </table>	Disk bay configuration	RAID controller requirements					RAID100	RAID300	RAID500	RAID700	RAID710	4x3.5" non-hot swap	•					4x3.5" HS	•	•	•	•	•	8x3.5" HS		•	•	•	•	8x2.5" HS		•	•	•	•	16x2.5" HS			•	•	•
Disk bay configuration	RAID controller requirements																																									
	RAID100	RAID300	RAID500	RAID700	RAID710																																					
4x3.5" non-hot swap	•																																									
4x3.5" HS	•	•	•	•	•																																					
8x3.5" HS		•	•	•	•																																					
8x2.5" HS		•	•	•	•																																					
16x2.5" HS			•	•	•																																					
Supporting disk drives	<table border="1"> <tbody> <tr> <td>3.5" SATA HDD (both HS and NHS)</td> <td>7.2K 6Gbs: 7.2K 6Gbs: 500GB/1TB/2TB/3TB/4TB</td> </tr> <tr> <td>3.5" SAS HDD (HS)</td> <td>7.2K 6Gbs: 1TB/2TB/3TB/4TB. 15K 6Gbs: 300GB/600GB</td> </tr> <tr> <td>2.5" SATA HDD (HS)</td> <td>7.2K 6Gbs: 500GB/1TB. 10K 6Gbs: 300GB/600GB/900GB</td> </tr> <tr> <td>2.5" SAS HDD (HS)</td> <td>15K 6Gbs: 146GB/300GB/600GB</td> </tr> <tr> <td>2.5" SATA SSD (HS, also supports 3.5" HS bay)</td> <td>6Gbs: 120GB/240GB/300GB/480GB/600GB</td> </tr> <tr> <td>2.5" SAS SSD (HS, also supports 3.5" HS bay)</td> <td>12Gbs: 200GB/400GB/800GB</td> </tr> <tr> <td>PCIe SSD</td> <td>1.4TB, via PCIe 2.0 x8 adapter</td> </tr> </tbody> </table> <p><i>Note: Supports up to 2 SSD drives on 8 x 3.5" HS model, up to 4 SSD drives on 16 x 2.5" HS model.</i></p>	3.5" SATA HDD (both HS and NHS)	7.2K 6Gbs: 7.2K 6Gbs: 500GB/1TB/2TB/3TB/4TB	3.5" SAS HDD (HS)	7.2K 6Gbs: 1TB/2TB/3TB/4TB. 15K 6Gbs: 300GB/600GB	2.5" SATA HDD (HS)	7.2K 6Gbs: 500GB/1TB. 10K 6Gbs: 300GB/600GB/900GB	2.5" SAS HDD (HS)	15K 6Gbs: 146GB/300GB/600GB	2.5" SATA SSD (HS, also supports 3.5" HS bay)	6Gbs: 120GB/240GB/300GB/480GB/600GB	2.5" SAS SSD (HS, also supports 3.5" HS bay)	12Gbs: 200GB/400GB/800GB	PCIe SSD	1.4TB, via PCIe 2.0 x8 adapter																											
3.5" SATA HDD (both HS and NHS)	7.2K 6Gbs: 7.2K 6Gbs: 500GB/1TB/2TB/3TB/4TB																																									
3.5" SAS HDD (HS)	7.2K 6Gbs: 1TB/2TB/3TB/4TB. 15K 6Gbs: 300GB/600GB																																									
2.5" SATA HDD (HS)	7.2K 6Gbs: 500GB/1TB. 10K 6Gbs: 300GB/600GB/900GB																																									
2.5" SAS HDD (HS)	15K 6Gbs: 146GB/300GB/600GB																																									
2.5" SATA SSD (HS, also supports 3.5" HS bay)	6Gbs: 120GB/240GB/300GB/480GB/600GB																																									
2.5" SAS SSD (HS, also supports 3.5" HS bay)	12Gbs: 200GB/400GB/800GB																																									
PCIe SSD	1.4TB, via PCIe 2.0 x8 adapter																																									
Optical drive	Two 5.25" bays for optical drive. DVD-ROM or DVD±RW. Half-height																																									
Network interfaces	Two Gigabit Ethernet port via two Intel 82574L. One port is shared with ThinkServer Management Module. Supports optional discrete network adapters via PCIe slots																																									

Components	Specification	
Security features	Power-on and administrator password. Optional TPM (TCG 1.2-compliant)	
Intelligent Diagnostics Module (IDM)	Supports IDM or IDM Premium on selected models, IDM LED lights indicate failing component category, IDM Premium LED lights indicate individual failing part	
Systems management	Supports ThinkServer Management Module (TMM), optional TMM Premium for remote presence. Onboard Aspeed AST2300 graphics/management processor, IPMI 2.0-compliant baseboard management controller (BMC). Front control panel LEDs shows the status of power, hard drive activity, network, system. Supports EasyStartup, EasyManage, EasyUpdate.	
Operating systems supported	Microsoft Windows Server 2012 R2/2012/2008 R2/2008. Windows Small Business Server 2011. Red Hat Enterprise Linux 7.1/7/6.7/6.5/6.4/5.10/5.9. SUSE Linux Enterprise Server 11/10. VMware vSphere (ESXi) 5.5/5.1	
Base warranty	1 or 3-year limited onsite service with 9x5/NBD.	
Power supply	One fixed 625 watts, universal, 80 PLUS Bronze qualified. Or up to two redundant 800 watts, two maximum, rear access, hot-swap, 80 PLUS Gold qualified, redundant with two power supplies	
Graphics	Onboard Aspeed AST2300 graphics/management processor	
Front ports	Two USB 2.0	
Rear ports	Four USB 2.0, one serial (9-pin), two ethernet (RJ-45, one for dedicate/share mgmt), one analog VGA DB-15 connector	
Noise emissions	Operating: < 42 dB(A). Idle: < 38 dB(A) (Maximum configuration)	
Environmental specification	Energy Star Server 1.1 qualified for 625W models, Energy Star Server 2.0 qualified for 800W models. RoHS-compliant.	
	Temperature - operating	50 °F to 95 °F (10 °C to 35 °C)
	Temperature - storage (with package)	-40 °C to 60 °C
	Altitude - operating	Supported Altitude (unpressurized): 0-10000ft (0-3048m)
	Humidity - operating	10%~80%, non-condensing
	Humidity - storage (with package)	8%~90%, non-condensing



### Expansion slots

Slot 1 (PCH)	32-bit PCI 2.3, half-length, full-height
Slot 2 (CPU1)	PCIe 3.0 x8 (x4 elec), half-length, full-height
Slot 3 (CPU2)	PCIe 3.0 x8, half-length, full-height
Slot 4 (CPU2)	PCIe 3.0 x8, half-length, full-height
Slot 5 (CPU1)	PCIe 3.0 x16, half-length, full-height
Slot 6 (CPU2)	PCIe 3.0 x8, half-length, full-height

# ThinkServer TD340 - TopSeller - 70B5

Product Specifications Reference (PSREF)

Model	Region	Processor	Memory	Storage Controller	Disk Bays	Disks	Optical	Add-on NIC	TPM	Diagnostics	System Mgmt	OS	Warranty	Power Supply	Ann Date (m/y)
70B5001TUX	US	1xE5-2403 v2 4C/1.8GHz/10MB/80W/DDR3-1333	1x8GB RDIMM DDR3-1600 ECC	RAID 300	4x3.5" HS	Open	HH DVD±RW	None	TPM	IDM Premium	TMM	None	1-year	625W Bronze Fixed	05/14



Model	Region	Processor	Memory	Storage Controller	Disk Bays	Disks	Optical	Add-on NIC	TPM	Diagnostics	System Mgmt	OS	Warranty	Power Supply	Ann Date (m/y)
70B7002GUX	US	1xE5-2403 v2 4C/1.8GHz/10MB/80W/DDR3-1333	1x8GB RDIMM DDR3-1600 ECC	RAID 300	4x3.5" HS	Open	HH DVD±RW	None	TPM	IDM	TMM	None	1-year	800Wx1 Gold	01/14
70B7002HUX	US	1xE5-2407 v2 4C/2.4GHz/10MB/80W/DDR3-1333	1x8GB RDIMM DDR3-1600 ECC	RAID 300	4x3.5" HS	Open	HH DVD±RW	None	TPM	IDM	TMM	None	1-year	800Wx1 Gold	01/14
70B7002JUX	US	1xE5-2403 v2 4C/1.8GHz/10MB/80W/DDR3-1333	1x8GB RDIMM DDR3-1600 ECC	RAID 300	4x3.5" HS	Open	HH DVD±RW	None	TPM	IDM Premium	TMM	None	3-year	800Wx1 Gold	01/14
70B7002KUX	US	1xE5-2407 v2 4C/2.4GHz/10MB/80W/DDR3-1333	1x8GB RDIMM DDR3-1600 ECC	RAID 300	4x3.5" HS	Open	HH DVD±RW	None	TPM	IDM Premium	TMM	None	3-year	800Wx1 Gold	01/14
70B7002LUX	US	1xE5-2420 v2 6C/2.2GHz/15MB/80W/DDR3-1600	1x8GB RDIMM DDR3-1600 ECC	RAID 300	4x3.5" HS	Open	HH DVD±RW	None	TPM	IDM Premium	TMM	None	3-year	800Wx1 Gold	01/14
70B7002MUX	US	1xE5-2430 v2 6C/2.5GHz/15MB/80W/DDR3-1600	1x8GB RDIMM DDR3-1600 ECC	RAID 300	4x3.5" HS	Open	HH DVD±RW	None	TPM	IDM Premium	TMM	None	3-year	800Wx1 Gold	01/14
70B7002NUX	US	1xE5-2440 v2 8C/1.9GHz/20MB/95W/DDR3-1600	1x8GB RDIMM DDR3-1600 ECC	RAID 300	4x3.5" HS	Open	HH DVD±RW	None	TPM	IDM Premium	TMM	None	3-year	800Wx1 Gold	01/14
70B7002PUX	US	1xE5-2450 v2 8C/2.5GHz/20MB/95W/DDR3-1600	1x8GB RDIMM DDR3-1600 ECC	RAID 300	4x3.5" HS	Open	HH DVD±RW	None	TPM	IDM Premium	TMM	None	3-year	800Wx1 Gold	01/14
70B7002QUX	US	1xE5-2470 v2 10C/2.4GHz/25MB/95W/DDR3-1600	1x8GB RDIMM DDR3-1600 ECC	RAID 300	4x3.5" HS	Open	HH DVD±RW	None	TPM	IDM Premium	TMM	None	3-year	800Wx1 Gold	01/14
70B7002RUX	US	1xE5-2420 v2 6C/2.2GHz/15MB/80W/DDR3-1600	1x8GB RDIMM DDR3-1600 ECC	RAID 300	8x3.5" HS	Open	HH DVD±RW	None	TPM	IDM Premium	TMM	None	3-year	800Wx1 Gold	01/14
70B7002SUX	US	1xE5-2430 v2 6C/2.5GHz/15MB/80W/DDR3-1600	1x8GB RDIMM DDR3-1600 ECC	RAID 300	8x3.5" HS	Open	HH DVD±RW	None	TPM	IDM Premium	TMM	None	3-year	800Wx1 Gold	01/14
70B7002TUX	US	1xE5-2440 v2 8C/1.9GHz/20MB/95W/DDR3-1600	1x8GB RDIMM DDR3-1600 ECC	RAID 300	8x3.5" HS	Open	HH DVD±RW	None	TPM	IDM Premium	TMM	None	3-year	800Wx1 Gold	01/14
70B7002UUX	US	1xE5-2450 v2 8C/2.5GHz/20MB/95W/DDR3-1600	1x8GB RDIMM DDR3-1600 ECC	RAID 300	8x3.5" HS	Open	HH DVD±RW	None	TPM	IDM Premium	TMM	None	3-year	800Wx1 Gold	01/14
70B7002VUX	US	1xE5-2470 v2 10C/2.4GHz/25MB/95W/DDR3-1600	1x8GB RDIMM DDR3-1600 ECC	RAID 300	8x3.5" HS	Open	HH DVD±RW	None	TPM	IDM Premium	TMM	None	3-year	800Wx1 Gold	01/14
70B7002WUX	US	1xE5-2420 v2 6C/2.2GHz/15MB/80W/DDR3-1600	1x8GB RDIMM DDR3-1600 ECC	RAID 300	8x2.5" HS	Open	HH DVD±RW	None	TPM	IDM Premium	TMM	None	3-year	800Wx1 Gold	01/14
70B7002XUX	US	1xE5-2430 v2 6C/2.5GHz/15MB/80W/DDR3-1600	1x8GB RDIMM DDR3-1600 ECC	RAID 300	8x2.5" HS	Open	HH DVD±RW	None	TPM	IDM Premium	TMM	None	3-year	800Wx1 Gold	01/14
70B7002YUX	US	1xE5-2440 v2 8C/1.9GHz/20MB/95W/DDR3-1600	1x8GB RDIMM DDR3-1600 ECC	RAID 300	8x2.5" HS	Open	HH DVD±RW	None	TPM	IDM Premium	TMM	None	3-year	800Wx1 Gold	01/14

Model	Region	Processor	Memory	Storage Controller	Disk Bays	Disks	Optical	Add-on NIC	TPM	Diagnostics	System Mgmt	OS	Warranty	Power Supply	Ann Date (m/y)
70B70030UX	US	1xE5-2450 v2 8C/2.5GHz/20MB/95W/DDR3-1600	1x8GB RDIMM DDR3-1600 ECC	RAID 300	8x2.5" HS	Open	HH DVD±RW	None	TPM	IDM Premium	TMM	None	3-year	800Wx1 Gold	01/14
70B70031UX	US	1xE5-2470 v2 10C/2.4GHz/25MB/95W/DDR3-1600	1x8GB RDIMM DDR3-1600 ECC	RAID 300	8x2.5" HS	Open	HH DVD±RW	None	TPM	IDM Premium	TMM	None	3-year	800Wx1 Gold	01/14
70B70032UX	US	1xE5-2420 v2 6C/2.2GHz/15MB/80W/DDR3-1600	1x8GB RDIMM DDR3-1600 ECC	RAID 700	16x2.5" HS	Open	HH DVD±RW	None	TPM	IDM Premium	TMM	None	3-year	800Wx1 Gold	01/14
70B70033UX	US	1xE5-2430 v2 6C/2.5GHz/15MB/80W/DDR3-1600	1x8GB RDIMM DDR3-1600 ECC	RAID 700	16x2.5" HS	Open	HH DVD±RW	None	TPM	IDM Premium	TMM	None	3-year	800Wx1 Gold	01/14
70B70034UX	US	1xE5-2440 v2 8C/1.9GHz/20MB/95W/DDR3-1600	1x8GB RDIMM DDR3-1600 ECC	RAID 700	16x2.5" HS	Open	HH DVD±RW	None	TPM	IDM Premium	TMM	None	3-year	800Wx1 Gold	01/14
70B70035UX	US	1xE5-2450 v2 8C/2.5GHz/20MB/95W/DDR3-1600	1x8GB RDIMM DDR3-1600 ECC	RAID 710	16x2.5" HS	Open	HH DVD±RW	None	TPM	IDM Premium	TMM	None	3-year	800Wx1 Gold	01/14
70B70036UX	US	1xE5-2470 v2 10C/2.4GHz/25MB/95W/DDR3-1600	1x8GB RDIMM DDR3-1600 ECC	RAID 710	16x2.5" HS	Open	HH DVD±RW	None	TPM	IDM Premium	TMM	None	3-year	800Wx1 Gold	01/14
70B7004DUX	US	2xE5-2420 v2 6C/2.2GHz/15MB/80W/DDR3-1600	2x16GB RDIMM DDR3-1866 ECC	RAID 300	8x3.5" HS	Open	HH DVD±RW	None	TPM	IDM Premium	TMM Premium	None	3-year	800Wx2 Gold	09/15

Model	Region	Processor	Memory	Storage Controller	Disk Bays	Disks	Optical	Add-on NIC	TPM	Diagnostics	System Mgmt	OS	Warranty	Power Supply	Ann Date (m/y)
70B60002UX	US	1xE5-2420 v2 6C/2.2GHz/15MB/80W/DDR3-1600	4x8GB RDIMM DDR3-1600 ECC	RAID 500+Key	4x3.5" HS	4x2TB HDD 7.2K 3.5" SATA6Gbps	HH DVD±RW	2xGbE	TPM	IDM Premium	TMM Premium	None	3-year	800Wx2 Gold	01/14
70B60003UX	US	2xE5-2440 v2 8C/1.9GHz/20MB/95W/DDR3-1600	8x8GB RDIMM DDR3-1600 ECC	RAID 700	8x3.5" HS	8x2TB HDD 7.2K 3.5" SAS6Gbps	HH DVD±RW	2xGbE	TPM	IDM Premium	TMM Premium	None	3-year	800Wx2 Gold	01/14
70B60004UX	US	2xE5-2450 v2 8C/2.5GHz/20MB/95W/DDR3-1600	12x8GB RDIMM DDR3-1600 ECC	RAID 710+CacheVault	16x2.5" HS	8x300GB HDD 15K 2.5" SAS6Gbps	HH DVD±RW	4xGbE	TPM	IDM Premium	TMM Premium	None	3-year	800Wx2 Gold	01/14
70B60005UX	US	1xE5-2407 v2 4C/2.4GHz/10MB/80W/DDR3-1333	1x8GB RDIMM DDR3-1600 ECC	RAID 300+Key	4x3.5" HS	Open	HH DVD±RW	None	TPM	IDM Premium	TMM	None	3-year	800Wx1 Gold	04/14
70B60006UX	US	1xE5-2420 v2 6C/2.2GHz/15MB/80W/DDR3-1600	1x8GB RDIMM DDR3-1600 ECC	RAID 500	8x3.5" HS	Open	HH DVD±RW	None	TPM	IDM Premium	TMM	None	3-year	800Wx1 Gold	04/14
70B60007UX	US	1xE5-2420 v2 6C/2.2GHz/15MB/80W/DDR3-1600	1x8GB RDIMM DDR3-1600 ECC	RAID 700	8x3.5" HS	Open	HH DVD±RW	None	TPM	IDM Premium	TMM Premium	None	3-year	800Wx2 Gold	04/14
70B60008UX	US	1xE5-2440 v2 8C/1.9GHz/20MB/95W/DDR3-1600	1x8GB RDIMM DDR3-1600 ECC	RAID 700	8x2.5" HS	Open	HH DVD±RW	None	TPM	IDM Premium	TMM	None	3-year	800Wx1 Gold	04/14
70B60009UX	US	1xE5-2450 v2 8C/2.5GHz/20MB/95W/DDR3-1600	1x16GB RDIMM DDR3-1600 ECC	RAID 710	16x2.5" HS	Open	HH DVD±RW	None	TPM	IDM Premium	TMM Premium	None	3-year	800Wx2 Gold	04/14



# ThinkServer TD350 Platform Specifications

Components	Specification																												
Dimensions	Tower or 4U rack. Tower: Height: 459 mm (18.1 in), width: 251 mm (9.9 in), depth: 686 mm (27 in) Rack: height: 173 mm (6.8 in), width: 482 mm (19 in), depth: 686 mm (27 in)																												
Weight	Minimum configuration: 22 kg (48.5 lb), maximum: 41.4 kg (91.27 lb)																												
Processor	Up to two <b>135W Intel Xeon E5-2600 v4 or E5-2600 v3</b> family processors.																												
	E5-2698 v4 20C/2.2GHz/50MB/135W/DDR4-2400																												
	E5-2695 v4 18C/2.1GHz/45MB/120W/DDR4-2400																												
	E5-2690 v4 14C/2.6GHz/35MB/135W/DDR4-2400																												
	E5-2683 v4 16C/2.1GHz/40MB/120W/DDR4-2400																												
	E5-2680 v4 14C/2.4GHz/35MB/120W/DDR4-2400																												
	E5-2667 v4 8C/3.2GHz/25MB/135W/DDR4-2400																												
	E5-2660 v4 14C/2GHz/35MB/105W/DDR4-2400																												
	E5-2650L v4 14C/1.7GHz/35MB/65W/DDR4-2400																												
	E5-2650 v4 12C/2.2GHz/30MB/105W/DDR4-2400																												
	E5-2643 v4 6C/3.4GHz/20MB/135W/DDR4-2400																												
	E5-2640 v4 10C/2.4GHz/25MB/90W/DDR4-2133																												
	E5-2637 v4 4C/3.5GHz/15MB/135W/DDR4-2400																												
	E5-2630L v4 10C/1.8GHz/25MB/55W/DDR4-2133																												
	E5-2630 v4 10C/2.2GHz/20MB/85W/DDR4-2133																												
	E5-2623 v4 4C/2.6GHz/10MB/85W/DDR4-2133																												
	E5-2620 v4 8C/2.1GHz/20MB/85W/DDR4-2133																												
	E5-2609 v4 8C/1.7GHz/20MB/85W/DDR4-1866																												
	E5-2603 v4 6C/1.7GHz/15MB/85W/DDR4-1866																												
	E5-2698 v3 16C/2.3GHz/40MB/135W/DDR4-2133																												
	E5-2695 v3 14C/2.3GHz/35MB/120W/DDR4-2133																												
	E5-2690 v3 12C/2.6GHz/30MB/135W/DDR4-2133																												
	E5-2685 v3 12C/2.6GHz/30MB/120W/DDR4-2133																												
	E5-2683 v3 14C/2GHz/35MB/120W/DDR4-2133																												
	E5-2680 v3 12C/2.5GHz/30MB/120W/DDR4-2133																												
	E5-2670 v3 12C/2.3GHz/30MB/120W/DDR4-2133																												
	E5-2667 v3 8C/3.2GHz/20MB/135W/DDR4-2133																												
	E5-2660 v3 10C/2.6GHz/25MB/105W/DDR4-2133																												
	E5-2650L v3 12C/1.8GHz/30MB/65W/DDR4-2133																												
	E5-2650 v3 10C/2.3GHz/25MB/105W/DDR4-2133																												
	E5-2643 v3 6C/3.4GHz/20MB/135W/DDR4-2133																												
	E5-2640 v3 8C/2.6GHz/20MB/90W/DDR4-1866																												
	E5-2637 v3 4C/3.5GHz/15MB/135W/DDR4-2133																												
E5-2630L v3 8C/1.8GHz/20MB/55W/DDR4-1866																													
E5-2630 v3 8C/2.4GHz/20MB/85W/DDR4-1866																													
E5-2623 v3 4C/3GHz/10MB/105W/DDR4-1866																													
E5-2620 v3 6C/2.4GHz/15MB/85W/DDR4-1866																													
E5-2609 v3 6C/1.9GHz/15MB/85W/DDR4-1600																													
E5-2603 v3 6C/1.6GHz/15MB/85W/DDR4-1600																													
Chipset	Intel C610 Series Chipset																												
Memory DIMMs	16 DIMM sockets (8 DIMMs per processor), 8-channel capable (4-channel per processor). RDIMM and LRDIMM (cannot be intermixed), DDR4, up to 2400MHz																												
Memory capacity	512GB (RDIMM, 32GB x 16)/1024GB (LRDIMM, 64GB x 16), 2nd CPU is needed																												
Memory protection	ECC, memory mirroring, lockstep, and memory sparing																												
RAID controller	<table border="1"> <thead> <tr> <th>RAID controller</th> <th>Drive type</th> <th>RAID support</th> <th>Compatible models</th> </tr> </thead> <tbody> <tr> <td>Onboard RAID110i</td> <td>6Gbs SATA</td> <td>0/1/10,5 with optional key</td> <td>5x3.5" HS/ES, 8x2.5" HS</td> </tr> <tr> <td>RAID520i PCIe</td> <td>12Gbs SAS/SATA</td> <td>0/1/10,5/50 with optional key</td> <td>5x3.5" HS, 8x2.5" HS</td> </tr> <tr> <td>RAID720i PCIe</td> <td>12Gbs SAS/SATA</td> <td>0/1/10/5/50,6/60 with optional cache</td> <td>5x3.5" HS, 8x2.5" HS</td> </tr> <tr> <td>AnyRAID 510i</td> <td>6Gbs SAS/SATA</td> <td>0/1/10,5/50 with optional key</td> <td>5x3.5" HS, 8x2.5" HS</td> </tr> <tr> <td>AnyRAID 720i</td> <td>12Gbs SAS/SATA</td> <td>0/1/10/5/50,6/60 with optional cache</td> <td>5x3.5" HS, 8x2.5" HS</td> </tr> <tr> <td>AnyRAID 720ix</td> <td>12Gbs SAS/SATA</td> <td>0/1/10/5/50/6/60</td> <td>15x3.5" HS, 16/32x2.5" HS</td> </tr> </tbody> </table>	RAID controller	Drive type	RAID support	Compatible models	Onboard RAID110i	6Gbs SATA	0/1/10,5 with optional key	5x3.5" HS/ES, 8x2.5" HS	RAID520i PCIe	12Gbs SAS/SATA	0/1/10,5/50 with optional key	5x3.5" HS, 8x2.5" HS	RAID720i PCIe	12Gbs SAS/SATA	0/1/10/5/50,6/60 with optional cache	5x3.5" HS, 8x2.5" HS	AnyRAID 510i	6Gbs SAS/SATA	0/1/10,5/50 with optional key	5x3.5" HS, 8x2.5" HS	AnyRAID 720i	12Gbs SAS/SATA	0/1/10/5/50,6/60 with optional cache	5x3.5" HS, 8x2.5" HS	AnyRAID 720ix	12Gbs SAS/SATA	0/1/10/5/50/6/60	15x3.5" HS, 16/32x2.5" HS
	RAID controller	Drive type	RAID support	Compatible models																									
	Onboard RAID110i	6Gbs SATA	0/1/10,5 with optional key	5x3.5" HS/ES, 8x2.5" HS																									
	RAID520i PCIe	12Gbs SAS/SATA	0/1/10,5/50 with optional key	5x3.5" HS, 8x2.5" HS																									
	RAID720i PCIe	12Gbs SAS/SATA	0/1/10/5/50,6/60 with optional cache	5x3.5" HS, 8x2.5" HS																									
	AnyRAID 510i	6Gbs SAS/SATA	0/1/10,5/50 with optional key	5x3.5" HS, 8x2.5" HS																									
AnyRAID 720i	12Gbs SAS/SATA	0/1/10/5/50,6/60 with optional cache	5x3.5" HS, 8x2.5" HS																										
AnyRAID 720ix	12Gbs SAS/SATA	0/1/10/5/50/6/60	15x3.5" HS, 16/32x2.5" HS																										
	Optional cache for RAID 720/AnyRAID 720i and 720ix: 1GB read-only memory or 1GB/2GB/4GB flash with super capacitor. Flash options include CacheVault, Cache-Cade Pro, and FastPath. 720ix must have cache.																												
Disk drive bays	Up to 15 3.5" or 32 2.5" hot-swap bays, or up to 5 3.5" easy-swap bays, on front. Up to 2 M.2 SSD drives via optional M.2 module. Up to one internal LTO-6 SAS tape drive on 720ix model, or external RDX tape drive via USB.																												

Components	Specification																																							
Maximum internal storage	3.5" model: up to 180TB (7.2K SATA)/120TB (SAS HDD,) up to 27TB with 10K SAS HDD, up to 9TB with 15K SAS HDD, or up to 24TB with SATA or SAS SSD. 2.5" model: up to 64TB with 7.2K SATA HDD, up to 57.6TB with 10K SAS HDD, up to 19.2TB with 15K SAS HDD, or up to 51.2TB with SATA or SAS SSD																																							
SD module	Up to 2 SDHC flash cards via optional SD module, 8GB or 32GB each																																							
Optical drive	Two 5.25" bays for optical drive. DVD-ROM or DVD±RW. Half-height or 9.5mm																																							
Network interfaces	One dedicate management port, two gigabit ethernet ports. Supports optional discrete network adapters via PCIe slots																																							
Security features	Power-on and administrator password. Optional TPM (TCG 1.2 or 2.0-compliant)																																							
Systems management	Supports ThinkServer System Manager (TSM), optional TSM Premium for remote presence. UEFI. Onboard Aspeed AST2400 graphics/management processor, IPMI 2.0-compliant baseboard management controller (BMC). Control Panel LEDs shows the status of power, ID, network, system. Supports ThinkServer Diagnostics, ThinkServer Deployment Manager, ThinkServer Energy Manager, ThinkServer System Manager CLI, Lenovo ThinkServer Partner Pack for VMware vCenter and Microsoft System Center Operations Manager, ThinkServer Power Planner.																																							
	Operating systems supported	Microsoft Windows Server 2016/2012 R2/2012/2008 R2. Windows Small Business Server 2011. Red Hat Enterprise Linux 6.5/6.6/7. SUSE Linux Enterprise Server 11. VMware vSphere (ESXi) 5.1 P5/5.5 U2/6.0																																						
Base warranty	1 or 3-year limited onsite service with 9x5/NBD.																																							
Power supply	Up to two redundant hot-swap 450W/550W/750W/1100W power supplies. 450 W is 80 PLUS Gold qualified. 550W and 1100W are 80 PLUS Platinum qualified. 750W is 80 PLUS Platinum or Titanium qualified. 750W Titanium is 200V - 240V, others are 110V - 240V.																																							
	<table border="1"> <thead> <tr> <th rowspan="2">Disk bay configuration</th> <th colspan="4">PSU requirements</th> </tr> <tr> <th>450W</th> <th>550W</th> <th>750W</th> <th>1100W</th> </tr> </thead> <tbody> <tr> <td>5x3.5" ES</td> <td>• (up to 1 CPU)</td> <td>•</td> <td>•</td> <td>•</td> </tr> <tr> <td>5x3.5" HS</td> <td>• (up to 1 CPU)</td> <td>•</td> <td>•</td> <td>•</td> </tr> <tr> <td>15x3.5" HS</td> <td>•</td> <td>•</td> <td>•</td> <td>•</td> </tr> <tr> <td>8x2.5" HS</td> <td>• (up to 1 CPU)</td> <td>•</td> <td>•</td> <td>•</td> </tr> <tr> <td>16x2.5" HS</td> <td>• (up to 1 CPU)</td> <td>•</td> <td>•</td> <td>•</td> </tr> <tr> <td>32x2.5" HS</td> <td>•</td> <td>•</td> <td>•</td> <td>•</td> </tr> </tbody> </table>	Disk bay configuration	PSU requirements				450W	550W	750W	1100W	5x3.5" ES	• (up to 1 CPU)	•	•	•	5x3.5" HS	• (up to 1 CPU)	•	•	•	15x3.5" HS	•	•	•	•	8x2.5" HS	• (up to 1 CPU)	•	•	•	16x2.5" HS	• (up to 1 CPU)	•	•	•	32x2.5" HS	•	•	•	•
	Disk bay configuration		PSU requirements																																					
		450W	550W	750W	1100W																																			
	5x3.5" ES	• (up to 1 CPU)	•	•	•																																			
5x3.5" HS	• (up to 1 CPU)	•	•	•																																				
15x3.5" HS	•	•	•	•																																				
8x2.5" HS	• (up to 1 CPU)	•	•	•																																				
16x2.5" HS	• (up to 1 CPU)	•	•	•																																				
32x2.5" HS	•	•	•	•																																				
Graphics	Onboard Aspeed AST2400 with 16MB memory, one VGA on rear																																							
Front ports	Two USB 2.0																																							
Rear ports	One VGA, four USB 3.0, one RJ-45 (dedicate/share mgmt), two ethernet (RJ-45), one serial (9-pin)																																							
Cooling	4 (3+1), hot-swap																																							
Noise emissions	Operating: < 6.5 Bels. Idle: < 6 Bels (Maximum configuration)																																							
Environmental specification	<table border="1"> <thead> <tr> <th>ASHRAE Class</th> <th>A4</th> <th>A3</th> <th>A2</th> </tr> </thead> <tbody> <tr> <td>Temperature - operating</td> <td>41 °F to 113 °F (5 °C to 45 °C)</td> <td>41 °F to 104 °F (5 °C to 40 °C)</td> <td>50 °F to 95 °F (10 °C to 35 °C)</td> </tr> <tr> <td>Temperature - storage (with package)</td> <td colspan="3">-40 °C to 60 °C</td> </tr> <tr> <td>Altitude - operating</td> <td colspan="3">(Unpressurized): 0-10000ft (0-3048m)</td> </tr> <tr> <td>Humidity - operating (non-condensing)</td> <td>8%-90%</td> <td>8%-85%</td> <td>20%-80%</td> </tr> <tr> <td>Humidity - storage (with package)</td> <td colspan="3">8%-90%, non-condensing</td> </tr> </tbody> </table>	ASHRAE Class	A4	A3	A2	Temperature - operating	41 °F to 113 °F (5 °C to 45 °C)	41 °F to 104 °F (5 °C to 40 °C)	50 °F to 95 °F (10 °C to 35 °C)	Temperature - storage (with package)	-40 °C to 60 °C			Altitude - operating	(Unpressurized): 0-10000ft (0-3048m)			Humidity - operating (non-condensing)	8%-90%	8%-85%	20%-80%	Humidity - storage (with package)	8%-90%, non-condensing																	
	ASHRAE Class	A4	A3	A2																																				
	Temperature - operating	41 °F to 113 °F (5 °C to 45 °C)	41 °F to 104 °F (5 °C to 40 °C)	50 °F to 95 °F (10 °C to 35 °C)																																				
	Temperature - storage (with package)	-40 °C to 60 °C																																						
	Altitude - operating	(Unpressurized): 0-10000ft (0-3048m)																																						
Humidity - operating (non-condensing)	8%-90%	8%-85%	20%-80%																																					
Humidity - storage (with package)	8%-90%, non-condensing																																							
	ASHRAE Class A4: ES or 8x2.5" HS bays/Lenovo-qualified CPU; maximum of 120W thermal design power; not low-power type (no L-suffix in the CPU name)/No internal tape/Two PSU installed for redundancy/Lenovo-qualified PCIe card; power consumption of each PCIe card does not exceed 15W. 32 x 2.5" models support ASHRAE Class A2, the other models support ASHRAE Class A3.																																							

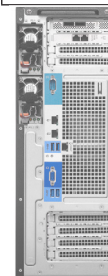

Expansion slots	
Slot 1 (CPU1)	PCIe 3.0 x16, full height, full length, double-wide
Slot 2 (CPU1)	PCIe 3.0 x16 (x8 elec), full height, full length
Slot 3 (CPU1)	PCIe 3.0 x16 (x8 elec), full height, full length
Slot 4 (CPU2)	PCIe 3.0 x16 (x8 elec), full height, full length
Slot 5 (CPU2)	PCIe 3.0 x16, full height, full length
Slot 6 (CPU2)	PCIe 3.0 x16 (x8 elec), full height, full length
Slot 7 (CPU2)	PCIe 3.0 x16 (x8 elec), full height, full length

For a list of all supported options, please see [https://download.lenovo.com/pccbbs/options\\_iso/ocm\\_september\\_2016\\_thinkserver.xlsx](https://download.lenovo.com/pccbbs/options_iso/ocm_september_2016_thinkserver.xlsx) sheet

Model	Region	Processor	2nd CPU	Memory	Storage Controller	Disk Bays	Disks	Optical	Add-on NIC	Add-on Ports	TPM	System Mgmt	OS	Warranty	Power Supply	Ann Date (m/y)
70DG0003UX	US	2xE5-2620 v3 6C/2.4GHz/15MB/85W/DDR4-1866	-	4x8GB RDIMM DDR4-2133 ECC	AnyRAID 110i+Key	5x3.5" HS	Open	HH DVD±RW	None	None	TPM 1.2	TSM	None	3-year	750Wx1 Platinum	09/14
70DG0007UX	US	1xE5-2603 v3 6C/1.6GHz/15MB/85W/DDR4-1600	4XG0F28787	1x8GB RDIMM DDR4-2133 ECC	AnyRAID 110i+Key	5x3.5" HS	Open	HH DVD±RW	None	None	TPM 1.2	TSM	None	3-year	550Wx1 Platinum	09/14
70DG0008UX	US	1xE5-2609 v3 6C/1.9GHz/15MB/85W/DDR4-1600	4XG0F28786	1x8GB RDIMM DDR4-2133 ECC	AnyRAID 110i+Key	5x3.5" HS	Open	HH DVD±RW	None	None	TPM 1.2	TSM	None	3-year	550Wx1 Platinum	09/14
70DG0009UX	US	1xE5-2620 v3 6C/2.4GHz/15MB/85W/DDR4-1866	4XG0F28785	1x8GB RDIMM DDR4-2133 ECC	AnyRAID 720ix+1GB RAM	15x3.5" HS	Open	HH DVD±RW	None	None	TPM 1.2	TSM	None	3-year	750Wx1 Platinum	09/14
70DG000AUX	US	1xE5-2640 v3 8C/2.6GHz/20MB/90W/DDR4-1866	4XG0F28783	1x8GB RDIMM DDR4-2133 ECC	AnyRAID 720ix+1GB RAM	15x3.5" HS	Open	HH DVD±RW	None	None	TPM 1.2	TSM	None	3-year	750Wx1 Platinum	09/14
70DG000BUX	US	1xE5-2650 v3 10C/2.3GHz/25MB/105W/DDR4-2133	4XG0F28782	1x8GB RDIMM DDR4-2133 ECC	AnyRAID 720ix+1GB RAM	15x3.5" HS	Open	HH DVD±RW	None	None	TPM 1.2	TSM	None	3-year	750Wx1 Platinum	09/14
70DG000CUX	US	1xE5-2670 v3 12C/2.3GHz/30MB/120W/DDR4-2133	4XG0F28780	1x8GB RDIMM DDR4-2133 ECC	AnyRAID 720ix+1GB RAM	15x3.5" HS	Open	HH DVD±RW	None	None	TPM 1.2	TSM	None	3-year	750Wx1 Platinum	09/14
70DG006NUX	US	1xE5-2603 v4 6C/1.7GHz/15MB/85W/DDR4-1866	4XG0G89088	1x16GB RDIMM DDR4-2400 ECC	Onboard 110i	5x3.5" HS	Open	None	None	None	TPM 1.2	TSM	None	3-year	750Wx1 Platinum	04/16
70DG006PUX	US	1xE5-2609 v4 8C/1.7GHz/20MB/85W/DDR4-1866	4XG0G89083	1x16GB RDIMM DDR4-2400 ECC	Onboard 110i	5x3.5" HS	Open	None	None	None	TPM 1.2	TSM	None	3-year	750Wx1 Platinum	04/16
70DG006QUX	US	1xE5-2620 v4 8C/2.1GHz/20MB/85W/DDR4-2133	4XG0G89078	1x16GB RDIMM DDR4-2400 ECC	Onboard 110i	5x3.5" HS	Open	None	None	None	TPM 1.2	TSM	None	3-year	750Wx1 Platinum	04/16
70DG006RUX	US	1xE5-2630 v4 10C/2.2GHz/20MB/85W/DDR4-2133	4XG0G89073	1x16GB RDIMM DDR4-2400 ECC	AnyRAID 720ix+1GB Flash	15x3.5" HS	Open	None	None	None	TPM 1.2	TSM	None	3-year	750Wx1 Platinum	04/16
70DG006SUX	US	1xE5-2640 v4 10C/2.4GHz/25MB/90W/DDR4-2133	4XG0G89068	1x16GB RDIMM DDR4-2400 ECC	AnyRAID 720ix+1GB Flash	15x3.5" HS	Open	None	None	None	TPM 1.2	TSM	None	3-year	750Wx1 Platinum	04/16
70DG006TUX	US	1xE5-2650 v4 12C/2.2GHz/30MB/105W/DDR4-2400	4XG0G89063	1x16GB RDIMM DDR4-2400 ECC	AnyRAID 720ix+1GB Flash	15x3.5" HS	Open	None	None	None	TPM 1.2	TSM	None	3-year	750Wx1 Platinum	04/16
70DG006UUX	US	1xE5-2660 v4 14C/2.0GHz/35MB/105W/DDR4-2400	4XG0G89058	1x16GB RDIMM DDR4-2400 ECC	AnyRAID 720ix+1GB Flash	15x3.5" HS	Open	None	None	None	TPM 1.2	TSM	None	3-year	750Wx1 Platinum	04/16
70DG006VUX	US	1xE5-2680 v4 14C/2.4GHz/35MB/120W/DDR4-2400	4XG0G89055	1x16GB RDIMM DDR4-2400 ECC	AnyRAID 720ix+1GB Flash	15x3.5" HS	Open	None	None	None	TPM 1.2	TSM	None	3-year	750Wx1 Platinum	04/16
70DG006WUX	US	2xE5-2620 v4 8C/2.1GHz/20MB/85W/DDR4-2133	-	2x16GB RDIMM DDR4-2400 ECC	AnyRAID 110i	5x3.5" HS	Open	None	None	None	TPM 1.2	TSM Premium	None	3-year	750Wx2 Platinum	04/16
70DG007QUX	US	1xE5-2620 v4 8C/2.1GHz/20MB/85W/DDR4-2133	4XG0G89078	1x16GB RDIMM DDR4-2400 ECC	AnyRAID 720ix+1GB RAM	15x3.5" HS	Open	None	None	None	TPM 1.2	TSM	None	3-year	750Wx1 Platinum	06/16

Model	Region	Processor	2nd CPU	Memory	Storage Controller	Disk Bays	Disks	Optical	Add-on NIC	Add-on Ports	TPM	System Mgmt	OS	Warranty	Power Supply	Ann Date (m/y)
70DJ006NUX	US	1xE5-2640 v4 10C/2.4GHz/25MB/90W/DDR4-2133	4XG0G89068	1x16GB RDIMM DDR4-2400 ECC	AnyRAID 720i+1GB RAM	8x2.5" HS	Open	None	None	None	TPM 2.0	TSM	None	3-year	750Wx1 Platinum	04/16



# ThinkServer TS150 Platform Specifications

Product Specifications Reference (PSREF)

Components	Specification									
Dimensions	Tower or 4U rack. Height: 375 mm (14.76 in), width: 175 mm (6.89 in), depth: 431 mm (16.97 in)									
Weight	Maximum configuration: 27.6 lb (12.5kg)									
Processor	One Intel "Kaby Lake" or "Skylake" processor as listed: "Kaby Lake" processors:									
	Xeon E3-1280 v6 4C/3.9GHz/8MB/72W/DDR4-2400									
	Xeon E3-1275 v6 4C/3.8GHz/8MB/73W/DDR4-2400									
	Xeon E3-1270 v6 4C/3.8GHz/8MB/72W/DDR4-2400									
	Xeon E3-1245 v6 4C/3.7GHz/8MB/73W/DDR4-2400									
	Xeon E3-1240 v6 4C/3.7GHz/8MB/72W/DDR4-2400									
	Xeon E3-1230 v6 4C/3.5GHz/8MB/72W/DDR4-2400									
	Xeon E3-1225 v6 4C/3.3GHz/8MB/73W/DDR4-2400									
	Xeon E3-1220 v6 4C/3GHz/8MB/72W/DDR4-2400									
	Core i3-7320 2C/4.1GHz/4MB/51W/DDR4-2400									
	Core i3-7300T 2C/3.5GHz/4MB/35W/DDR4-2400									
	Core i3-7300 2C/4GHz/4MB/51W/DDR4-2400									
	Core i3-7100T 2C/3.4GHz/3MB/35W/DDR4-2400									
	Core i3-7100 2C/3.9GHz/3MB/51W/DDR4-2400									
	Pentium G4620 2C/3.7GHz/3MB/51W/DDR4-2400									
	Pentium G4600T 2C/3GHz/3MB/35W/DDR4-2400									
	Pentium G4600 2C/3.6GHz/3MB/51W/DDR4-2400									
	Pentium G4560T 2C/2.9GHz/3MB/35W/DDR4-2400									
	Pentium G4560 2C/3.5GHz/3MB/54W/DDR4-2400									
	Celeron G3950 2C/3GHz/2MB/51W/DDR4-2133									
	Celeron G3930T 2C/2.7GHz/2MB/35W/DDR4-2133									
	Celeron G3930 2C/2.9GHz/2MB/51W/DDR4-2133									
	"Skylake" processors:									
	Xeon E3-1280 v5 4C/3.7GHz/8MB/80W/DDR4-2133									
	Xeon E3-1270 v5 4C/3.6GHz/8MB/80W/DDR4-2133									
	Xeon E3-1240 v5 4C/3.5GHz/8MB/80W/DDR4-2133									
	Xeon E3-1230 v5 4C/3.4GHz/8MB/80W/DDR4-2133									
	Xeon E3-1220 v5 4C/3GHz/8MB/80W/DDR4-2133									
	Xeon E3-1275 v5 4C/3.6GHz/8MB/80W/DDR4-2133									
	Xeon E3-1245 v5 4C/3.5GHz/8MB/80W/DDR4-2133									
	Xeon E3-1225 v5 4C/3.3GHz/8MB/80W/DDR4-2133									
	Core i3-6320 2C/3.9GHz/4MB/51W/DDR4-2133									
	Core i3-6300 2C/3.8GHz/4MB/51W/DDR4-2133									
	Core i3-6300T 2C/3.3GHz/4MB/35W/DDR4-2133									
	Core i3-6100 2C/3.7GHz/3MB/51W/DDR4-2133									
	Core i3-6100T 2C/3.2GHz/3MB/35W/DDR4-2133									
	Pentium G4520 2C/3.6GHz/3MB/51W/DDR4-2133									
	Pentium G4500 2C/3.5GHz/3MB/51W/DDR4-2133									
	Pentium G4500T 2C/3GHz/3MB/35W/DDR4-2133									
	Pentium G4400 2C/3.3GHz/3MB/54W/DDR4-2133									
Pentium G4400T 2C/2.9GHz/3MB/35W/DDR4-2133										
Celeron G3920 2C/2.9GHz/2MB/51W/DDR4-2133										
Celeron G3900 2C/2.8GHz/2MB/51W/DDR4-2133										
Celeron G3900T 2C/2.6GHz/2MB/35W/DDR4-2133										
Chipset	Intel C236 Platform Controller Hub (PCH)									
Memory DIMMs	4 DIMM sockets with 2 channels, 2 DIMMs per channel. UDIMM. Up to DDR4-2400									
Memory capacity	64GB (16GB x 4)									
Memory protection	ECC									
RAID controller	<table border="1"> <thead> <tr> <th>RAID controller</th> <th>Drive type</th> <th>RAID support</th> </tr> </thead> <tbody> <tr> <td>Onboard RAID121i</td> <td>6Gbs SATA</td> <td>0/1/5/10</td> </tr> <tr> <td>RAID520i PCIe</td> <td>12Gbs SAS/SATA</td> <td>0/1/10, 5 with optional key</td> </tr> </tbody> </table>	RAID controller	Drive type	RAID support	Onboard RAID121i	6Gbs SATA	0/1/5/10	RAID520i PCIe	12Gbs SAS/SATA	0/1/10, 5 with optional key
RAID controller	Drive type	RAID support								
Onboard RAID121i	6Gbs SATA	0/1/5/10								
RAID520i PCIe	12Gbs SAS/SATA	0/1/10, 5 with optional key								
Disk bays	Supports up to four 3.5" or hybrid 3.5" + 2.5" disk drives, or up to five 2.5" disk drives, one 9.5mm optical (see right). Non-hot swap. Cables are connected to onboard SATA connectors or PCIe RAID controller. Supports one optional internal USB RDX Tape drive									
Supporting storage	<table border="1"> <tbody> <tr> <td>3.5" HDD, 7.2K SATA6Gbs</td> <td>500GB/1TB/2TB/3TB/4TB/5TB/6TB/10TB</td> </tr> <tr> <td>2.5" HDD, 7.2K SATA6Gbs</td> <td>500GB/1TB/2TB</td> </tr> <tr> <td>2.5" SSD, SATA6Gbs</td> <td>120GB/240GB/480GB/600GB/800GB/960GB</td> </tr> </tbody> </table>	3.5" HDD, 7.2K SATA6Gbs	500GB/1TB/2TB/3TB/4TB/5TB/6TB/10TB	2.5" HDD, 7.2K SATA6Gbs	500GB/1TB/2TB	2.5" SSD, SATA6Gbs	120GB/240GB/480GB/600GB/800GB/960GB			
3.5" HDD, 7.2K SATA6Gbs	500GB/1TB/2TB/3TB/4TB/5TB/6TB/10TB									
2.5" HDD, 7.2K SATA6Gbs	500GB/1TB/2TB									
2.5" SSD, SATA6Gbs	120GB/240GB/480GB/600GB/800GB/960GB									

Components	Specification	
SD module	Optional. Up to 2 SDHC flash cards via SD module, 8GB each	
Optical drive	Up to two half-height optical drives or one 9.5mm optical. DVD-ROM or DVD±RW	
Network interfaces	One Gigabit Ethernet port, Intel i219LM. Supports optional discrete network adapters via PCIe slots	
Security features	Power-on and administrator password. TPM (TCG 1.2-compliant)	
Systems management	UEFI, system LEDs, EasyStartup, EasyUpdate, Power Planner, and Diagnostics. Intel Active Management Technology 11 on models with Xeon processors. Intel Standard Manageability on models with Core i3, Pentium, or Celeron processors. KVM is supported on models with Xeon E3-12x5 v5 processors	
Operating systems	Microsoft Windows Server 2016/2012 R2/2012, Windows MultiPoint Server 2012, Windows 10 Pro. Red Hat Enterprise Linux 6.7/7.2. SUSE Linux Enterprise Server 11/12. VMware vSphere (ESXi) 5.5U3/6.0U2	
Base warranty	1 or 3-year limited onsite service with 9x5/NBD	
Power supply	Supports one of the following: • One fixed 250 watts, autosensing, 85%, 80 PLUS Bronze qualified • One fixed 400 watts, autosensing, 92%, 80 PLUS Platinum qualified	
Graphics	Integrated Intel HD Graphics on Xeon E3-12x5 v5, Core i3, Pentium, and Celeron processors. Uses main memory, works along with discrete graphics to support multi-display, enables two display connectors (1 DP, 1 VGA) on rear ports. Also supports the following discrete graphics adapter options: • NVIDIA Quadro NVS 315, 1GB • NVIDIA Quadro K620, 2GB	
HD Audio	Realtek ALC662 codec	
Front ports	Two USB 3.0	
Rear ports	One VGA, one DisplayPort, six USB 3.0, one RJ-45, one serial (9-pin), three analog audio ports (line-in, line-out, mic-in). Optional parallel or serial ports via PCIe adapters	
Noise emissions	Operating: < 35 dB(A). Idle: < 34 dB(A) (Maximum configuration)	
Environmental specification	Temperature - operating	50 °F to 95 °F (10 °C to 35 °C)
	Temperature - non operating (with package)	-40 °C to 60 °C
	Altitude - operating	(Unpressurized): 0-10000ft (0-3048m)
	Humidity - operating	8%-80%, non-condensing
	Humidity - storage (with package)	10%-90%, non-condensing

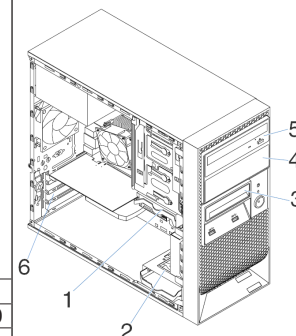

Note:  
1. PCIe cards are optional.  
2. Disk tray comes with the disk drive.

Disk Bays and PCIe Slots			
	4 x 3.5"	5 x 2.5"	4 x hybrid 3.5" + 2.5"
Bay 1	1st HDD bay	1st HDD bay	1st HDD bay, 3.5"/2.5"
Bay 2	2nd HDD bay	2nd HDD bay	2nd HDD bay, 3.5"/2.5"
Bay 3	Not supported	3rd HDD bay	Not supported on standard models. Supports one 2.5" disk drive for special bid only
Bay 4	2nd half-height optical, or RDX tape drive, or 3rd HDD bay	2nd half-height optical, or RDX tape drive, or 4th HDD bay	2nd half-height optical, or RDX tape drive, or 3rd HDD bay (3.5"/2.5")
Bay 5	1st half-height optical, or 9.5mm optical + 4th HDD bay	1st half-height optical, or 9.5mm optical + 5th HDD bay	1st half-height optical, or 9.5mm optical + 4th HDD bay (3.5"/2.5")
6	Four PCIe slots (top-down): Slot 1: PCIe 3.0 x16, full height, half length (near CPU) Slot 2: PCIe 3.0 x1, full height, half length Slot 3: PCIe 3.0 x16 (x4 elec), full height, half length Slot 4: PCIe 3.0 x1, full height, half length		



ThinkServer TS150 - TopSeller - 70LV

Product Specifications Reference (PSREF)

Model	Region	Processor	Memory	Storage Controller	Disk Bays	Disks	Optical	Add-on NIC	Add-on Ports	System Mgmt	OS	Warranty	Power Supply	Ann Date (m/y)
70LV002XUX	US	Xeon E3-1225 v5 4C/3.3GHz/8MB/80W/DDR4-2133	1x8GB UDIMM DDR4-2133 ECC	RAID 121i	Up to 5x2.5" DC	Open	None	None	None	AMT	None	1-year	Fixed 250W Bronze	08/16
70LV002YUX	US	Xeon E3-1245 v5 4C/3.5GHz/8MB/80W/DDR4-2133	1x8GB UDIMM DDR4-2133 ECC	RAID 121i	Up to 5x2.5" DC	Open	None	None	None	AMT	None	1-year	Fixed 250W Bronze	08/16
70LV0030UX	US	Xeon E3-1275 v5 4C/3.6GHz/8MB/80W/DDR4-2133	1x8GB UDIMM DDR4-2133 ECC	RAID 121i	Up to 5x2.5" DC	Open	None	None	None	AMT	None	1-year	Fixed 250W Bronze	08/16
70LV0031UX	US	Xeon E3-1225 v5 4C/3.3GHz/8MB/80W/DDR4-2133	1x8GB UDIMM DDR4-2133 ECC	RAID 121i	Up to 4x3.5" DC	Open	None	None	None	AMT	None	1-year	Fixed 250W Bronze	08/16
70LV0032UX	US	Xeon E3-1245 v5 4C/3.5GHz/8MB/80W/DDR4-2133	1x8GB UDIMM DDR4-2133 ECC	RAID 121i	Up to 4x3.5" DC	Open	None	None	None	AMT	None	1-year	Fixed 250W Bronze	08/16
70LV0033UX	US	Xeon E3-1275 v5 4C/3.6GHz/8MB/80W/DDR4-2133	1x8GB UDIMM DDR4-2133 ECC	RAID 121i	Up to 4x3.5" DC	Open	None	None	None	AMT	None	1-year	Fixed 250W Bronze	08/16
70LV0034UX	US	Core i3-6100T 2C/3.2GHz/3MB/35W/DDR4-2133	1x8GB UDIMM DDR4-2133 ECC	RAID 121i	Up to 4x3.5" DC/3 available	Open	HH DVD±RW	None	None	ISM	None	1-year	Fixed 250W Bronze	08/16
70LV0035UX	US	Core i3-6100T 2C/3.2GHz/3MB/35W/DDR4-2133	1x8GB UDIMM DDR4-2133 ECC	RAID 121i	Up to 4x3.5" DC	Open	None	None	None	ISM	None	1-year	Fixed 250W Bronze	08/16
70LV0036UX	US	Xeon E3-1225 v5 4C/3.3GHz/8MB/80W/DDR4-2133	1x8GB UDIMM DDR4-2133 ECC	RAID 121i	Up to 4x3.5" DC	Open	9.5mm DVD±RW	None	None	AMT	None	1-year	Fixed 250W Bronze	08/16
70LV0037UX	US	Xeon E3-1245 v5 4C/3.5GHz/8MB/80W/DDR4-2133	1x8GB UDIMM DDR4-2133 ECC	RAID 121i	Up to 4x3.5" DC	Open	9.5mm DVD±RW	None	None	AMT	None	1-year	Fixed 250W Bronze	08/16
70LV0038UX	US	Xeon E3-1275 v5 4C/3.6GHz/8MB/80W/DDR4-2133	1x8GB UDIMM DDR4-2133 ECC	RAID 121i	Up to 4x3.5" DC	Open	9.5mm DVD±RW	None	None	AMT	None	1-year	Fixed 250W Bronze	08/16
70LV0039UX	US	Xeon E3-1225 v5 4C/3.3GHz/8MB/80W/DDR4-2133	1x8GB UDIMM DDR4-2133 ECC	RAID 121i	Up to 5x2.5" DC	Open	9.5mm DVD±RW	None	None	AMT	None	1-year	Fixed 250W Bronze	08/16
70LV003AUX	US	Xeon E3-1245 v5 4C/3.5GHz/8MB/80W/DDR4-2133	1x8GB UDIMM DDR4-2133 ECC	RAID 121i	Up to 5x2.5" DC	Open	9.5mm DVD±RW	None	None	AMT	None	1-year	Fixed 250W Bronze	08/16
70LV003BUX	US	Xeon E3-1275 v5 4C/3.6GHz/8MB/80W/DDR4-2133	1x8GB UDIMM DDR4-2133 ECC	RAID 121i	Up to 5x2.5" DC	Open	9.5mm DVD±RW	None	None	AMT	None	1-year	Fixed 250W Bronze	08/16

# ThinkServer TS150 - TopSeller - 70LX

Product Specifications Reference (PSREF)

Model	Region	Processor	Memory	Storage Controller	Disk Bays	Disks	Optical	Add-on NIC	Add-on Ports	System Mgmt	OS	Warranty	Power Supply	Ann Date (m/y)
70LX0017UX	US	Xeon E3-1275 v5 4C/3.6GHz/8MB/80W/DDR4-2133	1x8GB UDIMM DDR4-2133 ECC	RAID 121i	Up to 4x3.5" DC	Open	None	None	None	AMT	None	1-year	Fixed 400W Platinum	08/16
70LX0018UX	US	Xeon E3-1275 v5 4C/3.6GHz/8MB/80W/DDR4-2133	1x8GB UDIMM DDR4-2133 ECC	RAID 121i	Up to 5x2.5" DC	Open	None	None	None	AMT	None	1-year	Fixed 400W Platinum	08/16

## ThinkServer TS150 - TopSeller - 70UB

Product Specifications Reference (PSREF)

Model	Region	Processor	Memory	Storage Controller	Disk Bays	Disks	Optical	Add-on NIC	Add-on Ports	System Mgmt	OS	Warranty	Power Supply	Ann Date (m/y)
70UB0009UX	US	Xeon E3-1225 v6 4C/3.3GHz/8MB/73W/DDR4-2400	1x8GB UDIMM DDR4-2400 ECC	RAID 121i	Up to 4x3.5" DC	Open	None	None	None	AMT	None	1-year	Fixed 250W Bronze	04/17
70UB000AUX	US	Xeon E3-1225 v6 4C/3.3GHz/8MB/73W/DDR4-2400	1x8GB UDIMM DDR4-2400 ECC	RAID 121i	Up to 4x3.5" DC	Open	9.5mm DVD±RW	None	None	AMT	None	1-year	Fixed 250W Bronze	04/17
70UB000BUX	US	Xeon E3-1245 v6 4C/3.7GHz/8MB/73W/DDR4-2400	1x8GB UDIMM DDR4-2400 ECC	RAID 121i	Up to 4x3.5" DC	Open	9.5mm DVD±RW	None	None	AMT	None	1-year	Fixed 250W Bronze	04/17
70UB000CUX	US	Xeon E3-1245 v6 4C/3.7GHz/8MB/73W/DDR4-2400	1x8GB UDIMM DDR4-2400 ECC	RAID 121i	Up to 4x3.5" DC	Open	None	None	None	AMT	None	1-year	Fixed 250W Bronze	04/17
70UB000DUX	US	Xeon E3-1275 v6 4C/3.8GHz/8MB/73W/DDR4-2400	1x8GB UDIMM DDR4-2400 ECC	RAID 121i	Up to 4x3.5" DC	Open	None	None	None	AMT	None	1-year	Fixed 250W Bronze	04/17
70UB000EUX	US	Xeon E3-1275 v6 4C/3.8GHz/8MB/73W/DDR4-2400	1x8GB UDIMM DDR4-2400 ECC	RAID 121i	Up to 4x3.5" DC	Open	9.5mm DVD±RW	None	None	AMT	None	1-year	Fixed 250W Bronze	04/17
70UB001WUX	US	Core i3-6100T 2C/3.2GHz/3MB/35W/DDR4-2133	1x8GB UDIMM DDR4-2400 ECC	RAID 121i	Up to 4x3.5" DC/3 available	Open	HH DVD±RW	None	None	ISM	None	1-year	Fixed 250W Bronze	04/17
70UB001XUX	US	Core i3-6100T 2C/3.2GHz/3MB/35W/DDR4-2133	1x8GB UDIMM DDR4-2400 ECC	RAID 121i	Up to 4x3.5" DC	Open	None	None	None	ISM	None	1-year	Fixed 250W Bronze	04/17



# ThinkServer TS440 Platform Specifications

Components	Specification																							
Dimensions	Tower or 5U rack. Height: 430 mm (16.9 in), width: 195 mm (7.68 in), depth: 595 mm (23.4 in)																							
Weight	Maximum configuration: 61.7 lb (28kg)																							
Processor	Supports one of the following Intel processors (code name: Haswell): • Xeon E3-1200 v3: up to 4C/3.7GHz/8MB/84W/1600MHz																							
Chipset	Intel C226 Platform Controller Hub (PCH)																							
Memory DIMMs	4 DIMM sockets, 2-channel capable. UDIMM, DDR3, up to 1600MHz																							
Memory capacity	32GB																							
Memory protection	ECC																							
RAID controller	Supports one of the following onboard or PCIe RAID adapters: • RAID 0, 1, 5, 10 with onboard RAID 100, 6Gb/s SATA. • RAID 0, 1, 10 with RAID 500, PCIe adapter, 6Gb/s SAS/SATA, optional key for RAID5/50. • RAID 0, 1, 5, 6, 10, 50, 60 with RAID 700, PCIe adapter, 6Gb/s SAS/SATA, optional Intelligent Battery Backup Unit (iBBU08). <i>Note: RAID 50 and 60 are supported on 8 hard drive bays models only.</i>																							
Disk drive bays	Up to 4 3.5" disk bays, non-hot swap, direct cable. Or up to 8 3.5" disk bays, hot-swap. Or up to 8 2.5" disk bays, hot-swap. On front. Supports internal RDX tape drive, consumes 5.25" bay, also supports optional external USB RDX tape drive. <table border="1" data-bbox="283 581 919 698"> <thead> <tr> <th rowspan="2">Disk bay configuration</th> <th colspan="3">RAID controller requirements and optional drives supported</th> </tr> <tr> <th>RAID100</th> <th>RAID500</th> <th>RAID700</th> </tr> </thead> <tbody> <tr> <td>4x3.5" non-hot swap</td> <td>•</td> <td></td> <td></td> </tr> <tr> <td>4x3.5" HS</td> <td>•</td> <td>•</td> <td>•</td> </tr> <tr> <td>8x3.5" HS</td> <td></td> <td>•</td> <td>•</td> </tr> <tr> <td>8x2.5" HS</td> <td></td> <td>•</td> <td>•</td> </tr> </tbody> </table>	Disk bay configuration	RAID controller requirements and optional drives supported			RAID100	RAID500	RAID700	4x3.5" non-hot swap	•			4x3.5" HS	•	•	•	8x3.5" HS		•	•	8x2.5" HS		•	•
Disk bay configuration	RAID controller requirements and optional drives supported																							
	RAID100	RAID500	RAID700																					
4x3.5" non-hot swap	•																							
4x3.5" HS	•	•	•																					
8x3.5" HS		•	•																					
8x2.5" HS		•	•																					
Maximum internal storage	3.5" non-hot swap model: up to 24TB with 7.2K SATA HDD. 3.5" hot swap model: up to 48TB with 7.2K SATA HDD, up to 32TB with 7.2K SAS HDD, up to 4.8TB with 15K SAS HDD, up to 2.4TB with SATA SSD 2.5" hot swap model: up to 8TB with 7.2K SATA HDD, up to 7.2TB with 10K SAS HDD, up to 4.8TB with 15K SAS HDD, up to 2.4TB with SATA SSD <i>Note: Supports up to 4 SSD drives.</i>																							
Optical drive	Two 5.25" bays for optical. DVD-ROM or DVD±RW. Half-height																							
Network interfaces	One onboard gigabit ethernet, Intel I217, shared with AMT. Supports optional discrete network adapters via PCIe slots																							
Security features	Power-on and administrator password. TPM (TCG 1.2-compliant). Optional padlock loop, Kensington cable lock																							
Systems management	Intel Active Management Technology 9 on models with Xeon processor. Remote presence is supported on models with Xeon E3-12x5 v3 or E3-12x6 v3 processor																							
Operating systems supported	Microsoft Windows Server 2016/2012 R2/2012/2008 R2. Windows Small Business Server 2011. Windows 8.1/8/7(except Home edition). Red Hat Enterprise Linux 6.4/6.5/6.7/7/7.1. SUSE Linux Enterprise Server 11/12. VMware vSphere (ESXi) 5.1 U1/5.1 U2/5.5/5.5 U1/5.5 U2/5.5 U3, Citrix Xen server 6.2 <i>Note: VMware requires processors with Intel HD, add-on network adapters, and PCIe RAID adapters.</i>																							

Components	Specification	
Base warranty	1 or 3-year limited onsite service with 9x5/NBD.	
Power supply	Supports one of the following, depending on models: • One fixed 450 watts, universal, 80 PLUS Platinum qualified. • Up to two redundant 450 watts, two maximum, rear access, hot-swap, 80 PLUS Gold qualified, redundant with two power supplies	
Graphics	Integrated Intel HD Graphics on Xeon E3-12x6 v3, Xeon E3-12x5 v3 processors. Uses main memory, works along with discrete graphics to support multi-display, enables one VGA connector on rear. Also supports the following optional discrete graphics adapters: • NVIDIA Quadro NVS 300, PCIe adapter, 512MB • NVIDIA Quadro NVS 315, PCIe adapter, 1GB	
Front ports	Two USB 3.0 (blue)	
Rear ports	One VGA for models with Intel HD Graphics, two USB 2.0, four USB 3.0 (blue), one serial (9-pin), one ethernet (RJ-45). Optional parallel or serial ports via PCI or PCIe adapters	
Noise emissions	Operating: < 42 dB(A). Idle: < 38 dB(A) (Maximum configuration)	
Environmental specification	GREENGUARD certified, Energy Star Server 1.1 qualified, RoHS-compliant	
	Temperature - operating	50 °F to 95 °F (10 °C to 35 °C)
	Temperature - storage (with package)	-40 °C to 70 °C
	Altitude - operating	Supported Altitude (unpressurized): 0-10000ft (0-3048m)
	Humidity - operating	10%-80%, non-condensing
	Humidity - storage (with package)	10%-90%, non-condensing

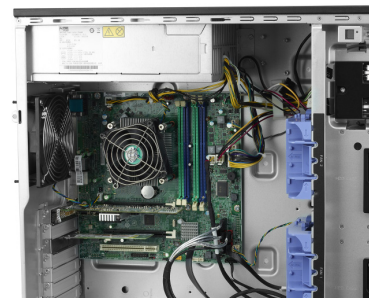

### Expansion slots

- Four PCIe slots (top-down):  
Slot 1: PCIe 3.0 x16, full height, half length (near CPU)  
Slot 2: PCIe 3.0 x1, full height, half length  
Slot 3: PCIe 2.0 x16 (x4 elec), full height, half length  
Slot 4: PCI 2.3, full height, half length  
*Note: All PCI/PCIe adapters are optional.*

# ThinkServer TS440 - TopSeller - 70AN

Product Specifications Reference (PSREF)

Model	Region	Processor	Memory	Storage Controller	Disk Bays	Disks	Optical	Add-on NIC	System Mgmt	OS	Warranty	Power Supply	Ann Date (m/y)
70AN0001UX	US	Xeon E3-1225 v3 4C/3.2GHz/8MB/84W/DDR3-1600	1x4GB UDIMM DDR3-1600 ECC	RAID 100	4x3.5" HS	Open	HH DVD	None	AMT9	None	1-year	450W Platinum Fixed	09/13
70AN0002UX	US	Xeon E3-1225 v3 4C/3.2GHz/8MB/84W/DDR3-1600	1x4GB UDIMM DDR3-1600 ECC	RAID 100	4x3.5" HS	Open	HH DVD	None	AMT9	None	3-year	450W Platinum Fixed	09/13
70AN000KUX	US	Xeon E3-1226 v3 4C/3.3GHz/8MB/84W/DDR3-1600	1x4GB UDIMM DDR3-1600 ECC	RAID 100	4x3.5" HS	Open	HH DVD	None	AMT9	None	1-year	450W Platinum Fixed	09/14

Model	Region	Processor	Memory	Storage Controller	Disk Bays	Disks	Optical	Add-on NIC	System Mgmt	OS	Warranty	Power Supply	Ann Date (m/y)
70AQ0005US	US	Xeon E3-1225 v3 4C/3.2GHz/8MB/84W/DDR3-1600	1x4GB UDIMM DDR3-1600 ECC	RAID 100	4x3.5" HS	2x500GB HDD 7.2K 3.5" SATA6Gbps	HH DVD±RW	None	AMT9	2012 Foundations	3-year	450Wx1 Gold	09/13
70AQ0006US	US	Xeon E3-1225 v3 4C/3.2GHz/8MB/84W/DDR3-1600	1x4GB UDIMM DDR3-1600 ECC	RAID 100	4x3.5" HS	2x500GB HDD 7.2K 3.5" SATA6Gbps	HH DVD±RW	None	AMT9	2012 Essentials	3-year	450Wx1 Gold	09/13
70AQ0007US	US	Xeon E3-1225 v3 4C/3.2GHz/8MB/84W/DDR3-1600	1x4GB UDIMM DDR3-1600 ECC	RAID 100	4x3.5" HS	2x500GB HDD 7.2K 3.5" SATA6Gbps	HH DVD±RW	None	AMT9	2012 Standard	3-year	450Wx1 Gold	09/13
70AQ0009UX	US	Xeon E3-1225 v3 4C/3.2GHz/8MB/84W/DDR3-1600	1x4GB UDIMM DDR3-1600 ECC	RAID 100	4x3.5" HS	Open	HH DVD±RW	None	AMT9	None	1-year	450Wx1 Gold	09/13
70AQ000AUX	US	Xeon E3-1225 v3 4C/3.2GHz/8MB/84W/DDR3-1600	1x4GB UDIMM DDR3-1600 ECC	RAID 100	4x3.5" HS	Open	HH DVD±RW	None	AMT9	None	3-year	450Wx1 Gold	09/13
70AQ000BUX	US	Xeon E3-1245 v3 4C/3.4GHz/8MB/84W/DDR3-1600	1x4GB UDIMM DDR3-1600 ECC	RAID 100	4x3.5" HS	Open	HH DVD±RW	None	AMT9	None	3-year	450Wx1 Gold	09/13
70AQ000CUX	US	Xeon E3-1245 v3 4C/3.4GHz/8MB/84W/DDR3-1600	1x4GB UDIMM DDR3-1600 ECC	RAID 500	8x3.5" HS	Open	HH DVD±RW	None	AMT9	None	3-year	450Wx1 Gold	09/13
70AQ000DUX	US	Xeon E3-1225 v3 4C/3.2GHz/8MB/84W/DDR3-1600	1x4GB UDIMM DDR3-1600 ECC	RAID 500	8x3.5" HS	Open	HH DVD±RW	None	AMT9	None	3-year	450Wx1 Gold	09/13
70AQ000EUX	US	Xeon E3-1225 v3 4C/3.2GHz/8MB/84W/DDR3-1600	1x4GB UDIMM DDR3-1600 ECC	RAID 500	8x2.5" HS	Open	HH DVD±RW	None	AMT9	None	3-year	450Wx1 Gold	09/13
70AQ000FUX	US	Xeon E3-1245 v3 4C/3.4GHz/8MB/84W/DDR3-1600	1x4GB UDIMM DDR3-1600 ECC	RAID 500	8x2.5" HS	Open	HH DVD±RW	None	AMT9	None	3-year	450Wx1 Gold	09/13
70AQ000GUX	US	Xeon E3-1275 v3 4C/3.5GHz/8MB/84W/DDR3-1600	1x4GB UDIMM DDR3-1600 ECC	RAID 100	4x3.5" HS	Open	HH DVD±RW	None	AMT9	None	3-year	450Wx1 Gold	09/13
70AQ000HUX	US	Xeon E3-1225 v3 4C/3.2GHz/8MB/84W/DDR3-1600	1x4GB UDIMM DDR3-1600 ECC	RAID 700	8x3.5" HS	Open	HH DVD±RW	None	AMT9	None	3-year	450Wx1 Gold	09/13
70AQ000NUX	US	Xeon E3-1225 v3 4C/3.2GHz/8MB/84W/DDR3-1600	1x4GB UDIMM DDR3-1600 ECC	RAID 500	4x3.5" HS	Open	HH DVD	None	AMT9	None	1-year	450Wx1 Gold	09/13
70AQ000PUX	US	Xeon E3-1225 v3 4C/3.2GHz/8MB/84W/DDR3-1600	1x4GB UDIMM DDR3-1600 ECC	RAID 500	4x3.5" HS	Open	HH DVD	None	AMT9	None	3-year	450Wx1 Gold	09/13
70AQ000XUX	US	Xeon E3-1225 v3 4C/3.2GHz/8MB/84W/DDR3-1600	1x4GB UDIMM DDR3-1600 ECC	RAID 500	8x3.5" HS	Open	HH DVD±RW	None	AMT9	None	1-year	450Wx1 Gold	05/14
70AQ000YUX	US	Xeon E3-1245 v3 4C/3.4GHz/8MB/84W/DDR3-1600	1x4GB UDIMM DDR3-1600 ECC	RAID 500	8x3.5" HS	Open	HH DVD±RW	None	AMT9	None	1-year	450Wx1 Gold	05/14
70AQ001JUX	US	Xeon E3-1226 v3 4C/3.3GHz/8MB/84W/DDR3-1600	1x4GB UDIMM DDR3-1600 ECC	RAID 100	4x3.5" HS	Open	HH DVD±RW	None	AMT9	None	1-year	450Wx1 Gold	09/14

Model	Region	Processor	Memory	Storage Controller	Disk Bays	Disks	Optical	Add-on NIC	System Mgmt	OS	Warranty	Power Supply	Ann Date (m/y)
70AQ001KUX	US	Xeon E3-1226 v3 4C/3.3GHz/8MB/84W/DDR3-1600	1x4GB UDIMM DDR3-1600 ECC	RAID 500	8x3.5" HS	Open	HH DVD±RW	None	AMT9	None	1-year	450Wx1 Gold	09/14
70AQ001LUX	US	Xeon E3-1226 v3 4C/3.3GHz/8MB/84W/DDR3-1600	1x4GB UDIMM DDR3-1600 ECC	RAID 100	4x3.5" HS	Open	HH DVD	None	AMT9	None	1-year	450Wx1 Gold	09/14
70AQ001MUS	US	Xeon E3-1226 v3 4C/3.3GHz/8MB/84W/DDR3-1600	1x4GB UDIMM DDR3-1600 ECC	RAID 100	4x3.5" HS	2x500GB HDD 7.2K 3.5" SATA6Gbps	HH DVD±RW	None	AMT9	2012 R2 Foundations	1-year	450Wx1 Gold	09/14
70AQ001NUS	US	Xeon E3-1226 v3 4C/3.3GHz/8MB/84W/DDR3-1600	1x4GB UDIMM DDR3-1600 ECC	RAID 100	4x3.5" HS	2x500GB HDD 7.2K 3.5" SATA6Gbps	HH DVD±RW	None	AMT9	2012 R2 Essentials	1-year	450Wx1 Gold	09/14
70AQ001PUS	US	Xeon E3-1226 v3 4C/3.3GHz/8MB/84W/DDR3-1600	1x4GB UDIMM DDR3-1600 ECC	RAID 100	4x3.5" HS	2x500GB HDD 7.2K 3.5" SATA6Gbps	HH DVD±RW	None	AMT9	2012 R2 Standard	1-year	450Wx1 Gold	09/14
70AQ001QUX	US	Xeon E3-1246 v3 4C/3.5GHz/8MB/84W/DDR3-1600	1x4GB UDIMM DDR3-1600 ECC	RAID 100	4x3.5" HS	Open	HH DVD±RW	None	AMT9	None	1-year	450Wx1 Gold	09/14
70AQ001RUX	US	Xeon E3-1246 v3 4C/3.5GHz/8MB/84W/DDR3-1600	1x4GB UDIMM DDR3-1600 ECC	RAID 500	8x3.5" HS	Open	HH DVD±RW	None	AMT9	None	1-year	450Wx1 Gold	09/14
70AQ001SUX	US	Xeon E3-1246 v3 4C/3.5GHz/8MB/84W/DDR3-1600	1x4GB UDIMM DDR3-1600 ECC	RAID 500	8x2.5" HS	Open	HH DVD±RW	None	AMT9	None	1-year	450Wx1 Gold	09/14
70AQ001TUX	US	Xeon E3-1276 v3 4C/3.6GHz/8MB/84W/DDR3-1600	1x4GB UDIMM DDR3-1600 ECC	RAID 700	8x3.5" HS	Open	HH DVD±RW	None	AMT9	None	1-year	450Wx1 Gold	09/14
70AQ001UUX	US	Xeon E3-1276 v3 4C/3.6GHz/8MB/84W/DDR3-1600	1x4GB UDIMM DDR3-1600 ECC	RAID 700	8x2.5" HS	Open	HH DVD±RW	None	AMT9	None	1-year	450Wx1 Gold	09/14



Model	Region	Processor	Memory	Storage Controller	Disk Bays	Disks	Optical	Add-on NIC	System Mgmt	OS	Warranty	Power Supply	Ann Date (m/y)
70AL0000US	US	Xeon E3-1225 v3 4C/3.2GHz/8MB/84W/DDR3-1600	3x8GB UDIMM DDR3-1600 ECC	RAID 100	4x3.5" HS	3x3TB HDD 7.2K 3.5" SATA6Gbps	HH DVD±RW	2xGbE	AMT9	2012 Foundations	1-year	450W Platinum Fixed	09/13
70AL0001US	US	Xeon E3-1245 v3 4C/3.4GHz/8MB/84W/DDR3-1600	1x4GB UDIMM DDR3-1600 ECC	RAID 500	8x2.5" HS	1x500GB HDD 7.2K 2.5" SATA6Gbps	2xHH DVD±RW	4xGbE	AMT9	2012 Foundations	1-year	450W Platinum Fixed	09/13
70AL0002UX	US	Xeon E3-1225 v3 4C/3.2GHz/8MB/84W/DDR3-1600	1x4GB UDIMM DDR3-1600 ECC	RAID 100	4x3.5" HS	1x500GB HDD 7.2K 3.5" SATA6Gbps	HH DVD	None	AMT9	None	3-year	450W Platinum Fixed	09/13
70AL0003UX	US	Xeon E3-1225 v3 4C/3.2GHz/8MB/84W/DDR3-1600	1x4GB UDIMM DDR3-1600 ECC	RAID 100	4x3.5" HS	Open	HH DVD	None	AMT9	None	3-year	450W Platinum Fixed	09/13

Model	Region	Processor	Memory	Storage Controller	Disk Bays	Disks	Optical	Add-on NIC	System Mgmt	OS	Warranty	Power Supply	Ann Date (m/y)
70AM0000US	US	Xeon E3-1225 v3 4C/3.2GHz/8MB/84W/DDR3-1600	2x2GB UDIMM DDR3-1600 ECC	RAID 100	4x3.5" DC	2x500GB HDD 7.2K 3.5" SATA6Gbps	HH DVD	1xGbE	AMT9	2012 Foundations	1-year	450Wx1 Gold	09/13
70AM0001US	US	Xeon E3-1275 v3 4C/3.5GHz/8MB/84W/DDR3-1600	4x2GB UDIMM DDR3-1600 ECC	RAID 500+Key	8x3.5" HS	8x2TB HDD 7.2K 3.5" SATA6Gbps	2xHH DVD±RW	1xGbE	AMT9	2012 Foundations	1-year	450Wx2 Gold	09/13
70AM0002UX	US	Xeon E3-1280 v3 4C/3.6GHz/8MB/82W/DDR3-1600	3x4GB UDIMM DDR3-1600 ECC	RAID 700	8x2.5" HS	3x600GB HDD 10K 2.5" SAS6Gbps	HH DVD	4xGbE	AMT9	None	1-year	450Wx1 Gold	09/13
70AM0003US	US	Xeon E3-1285 v3 4C/3.6GHz/8MB/84W/DDR3-1600	4x8GB UDIMM DDR3-1600 ECC	RAID 700	8x2.5" HS	8x900GB HDD 10K 2.5" SAS6Gbps	HH DVD±RW	2xGbE	AMT9	2012 Foundations	1-year	450Wx2 Gold	09/13
70AM0004UX	US	Xeon E3-1225 v3 4C/3.2GHz/8MB/84W/DDR3-1600	1x4GB UDIMM DDR3-1600 ECC	RAID 100	4x3.5" HS	Open	HH DVD	None	AMT9	None	3-year	450Wx1 Gold	09/13

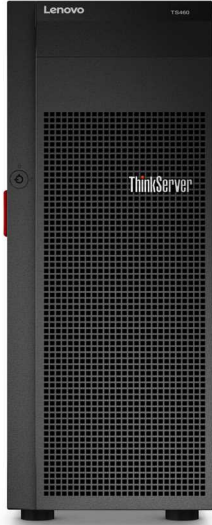

# ThinkServer TS460 Platform Specifications

Components	Specification			
Dimensions	42L tower or 4U rack. Height: 443.5 mm (17.46 in) with foot stands. Width: 173 mm (6.81 in). Depth: 593 mm (23.35 in) including front door and handle of hot-swap power supply			
Weight	Maximum configuration: 57.32 lb (26.5 kg)			
Processor	Supports one of the following Intel "Kaby Lake" processors:			
	Xeon E3-1280 v6	4C/3.9GHz/8MB/72W/DDR4-2400		
	Xeon E3-1270 v6	4C/3.8GHz/8MB/72W/DDR4-2400		
	Xeon E3-1240 v6	4C/3.7GHz/8MB/72W/DDR4-2400		
	Xeon E3-1230 v6	4C/3.5GHz/8MB/72W/DDR4-2400		
	Xeon E3-1220 v6	4C/3GHz/8MB/72W/DDR4-2400		
	Core i3-7320	2C/4.1GHz/4MB/51W/DDR4-2400		
	Core i3-7300	2C/4GHz/4MB/51W/DDR4-2400		
	Core i3-7300T	2C/3.5GHz/4MB/35W/DDR4-2400		
	Core i3-7100	2C/3.9GHz/3MB/51W/DDR4-2400		
	Core i3-7100T	2C/3.4GHz/3MB/35W/DDR4-2400		
	Pentium G4620	2C/3.7GHz/3MB/51W/DDR4-2400		
	Pentium G4600	2C/3.6GHz/3MB/51W/DDR4-2400		
	Pentium G4600T	2C/3GHz/3MB/35W/DDR4-2400		
	Pentium G4560	2C/3.5GHz/3MB/54W/DDR4-2400		
Pentium G4560T	2C/2.9GHz/3MB/35W/DDR4-2400			
Processor	Supports one of the following Intel "Skylake" processors:			
	Xeon E3-1280 v5	4C/3.7GHz/8MB/80W/DDR4-2133		
	Xeon E3-1270 v5	4C/3.6GHz/8MB/80W/DDR4-2133		
	Xeon E3-1240 v5	4C/3.5GHz/8MB/80W/DDR4-2133		
	Xeon E3-1230 v5	4C/3.4GHz/8MB/80W/DDR4-2133		
	Xeon E3-1220 v5	4C/3GHz/8MB/80W/DDR4-2133		
	Core i3-6320	2C/3.9GHz/4MB/51W/DDR4-2133		
	Core i3-6300T	2C/3.3GHz/4MB/35W/DDR4-2133		
	Core i3-6300	2C/3.8GHz/4MB/51W/DDR4-2133		
	Core i3-6100T	2C/3.2GHz/3MB/35W/DDR4-2133		
	Core i3-6100	2C/3.7GHz/3MB/51W/DDR4-2133		
	Pentium G4520	2C/3.6GHz/3MB/51W/DDR4-2133		
	Pentium G4500T	2C/3GHz/3MB/35W/DDR4-2133		
	Pentium G4500	2C/3.5GHz/3MB/51W/DDR4-2133		
	Pentium G4400T	2C/2.9GHz/3MB/35W/DDR4-2133		
Pentium G4400	2C/3.3GHz/3MB/54W/DDR4-2133			
Chipset	Intel C232 Platform Controller Hub (PCH)			
Memory DIMMs	4 DIMM sockets with 2-channels. UDIMM. DDR4-2133 or DDR4-2400			
Memory capacity	Up to 64GB (16GB x 4)			
Memory protection	ECC			
RAID controller	RAID controller			
	Drive type			
	RAID support			
RAID controller	Onboard RAID121i 6Gbs SATA 0/1/5/10 RAID520i PCIe 12Gbs SAS/SATA 0/1/10, 5 with optional key RAID720i PCIe 12Gbs SAS/SATA 0/1/10/5/50, 6/60 with optional cache			
	Optional cache for RAID720i: 1GB memory, or 1GB, 2GB, 4GB flash with super capacitor.			
Disk drive bays	Supports one of the following configurations:			
	Disk bays configuration	RAID controller	Optical	Tape drive
	4x3.5" SATA non-hot swap	121i	up to 2	RDX up to 1 LTO -
	4x3.5" SATA hot-swap	121i	up to 2	up to 1 -
	4x3.5" SATA/SAS hot-swap	520i or 720i	up to 2	up to 1 up to 1, 520i only
	8x3.5" SATA/SAS hot-swap	520i or 720i	up to 2	up to 1 -
	8x2.5" SATA/SAS hot-swap	520i or 720i	up to 2	up to 1 -
	16x2.5" SATA/SAS hot-swap	520i or 720i	up to 2	up to 1 -
	4x3.5" + 8x2.5" SATA/SAS hot-swap	520i or 720i	up to 2	up to 1 -
	4 x 3.5" HS can be upgraded to 8 x 3.5" HS or 4 x 3.5" + 8 x 2.5" HS, 8 x 2.5" HS can be upgraded to 16 x 2.5" HS or 4 x 3.5" + 8 x 2.5" HS, redundant PSU models only, RAID520i/RAID720i and expansion kit is needed, more that 8 disk bays needs expander card. Also supports one M.2 SATA SSD, 32GB or 128GB.			
Supporting disk drives	3.5" SATA HDD, 7.2K 6Gbs, HS or NHS 1TB/2TB/3TB/4TB/6TB/8TB/10TB/12TB 3.5" SAS HDD, 7.2K 12Gbs, HS 1TB/2TB/3TB/4TB/6TB/8TB/10TB 2.5" SAS HDD, 10K 12Gbs, HS, 2.5" or 3.5" bay 300GB/600GB/900GB/1.2TB/1.8TB/2.4TB 2.5" SAS HDD, 15K 12Gbs, HS, 2.5" or 3.5" bay 300GB/600GB 2.5" SATA SSD, 6Gbs, HS, 2.5" or 3.5" bay 120GB/240GB/480GB/800GB/960GB 2.5" SATA HDD, 7.2K 6Gbs, HS 1TB/2TB M.2 SATA SSD 32GB/128GB			

Components	Specification			
Maximum internal storage	Up to 64TB with 8TB 3.5" SAS or SATA HDDs, 8 x 3.5" HS bay			
Optical drive	Two 5.25" bays. Up to 2 optical drives. DVD-ROM or DVD±RW. Half-height. 2nd optical drive will be disable if M.2 SATA SSD is used			
Tape drive	Supports one tape drive in 5.25" bay. RDX or LTO. LTO Tape drive needs RAID520i			
Network interfaces	Two integrated Gigabit Ethernet 1000BASE-T ports (RJ-45) with Intel i210. One dedicate management port with Realtek RTL8211E			
Systems management	UEFI. Onboard Aspeed AST2400 graphics/management processor, IPMI 2.0-compliant baseboard management controller (BMC). Control Panel LEDs shows the status of power, disk drives, network, system. On rear system ID. Supports EasyStartup, Power Planner, Lenovo ThinkServer Diagnostics Standalone, ToolsCenter Suite CLI inventory module on ThinkServ-er, Lenovo xClarity Administrator			
Security features	Power-on and administrator password. Optional TPM, TCG 1.2 or 2.0 compliant.			
Operating systems	Microsoft Windows Server 2016/2012 R2. Red Hat Enterprise Linux 6.8/7.3(6.8 cannot support Kaby Lake processors). SUSE Linux Enterprise Server 12 SP2/11 SP4. VMware vSphere (ESXi) 6.0U2/6.5			
Base warranty	1 or 3-year limited onsite service with 9x5/NBD.			
Power supply	Supports one of the following, depending on models: • One fixed 300 watts, universal, 80 PLUS Bronze qualified. • Up to two redundant 450 watts, two maximum, rear access, hot-swap, 80 PLUS Gold qualified, universal, redundant with two power supplies			
Graphics	Integrated in onboard Aspeed AST2400 graphics/management processor. Optional NVIDIA Quadro K420			
Front ports	Two USB 3.0 (blue)			
Rear ports	One VGA, four USB 3.0, one RJ-45 (dedicated mgmt), two ethernet, one serial (9-pin). Add-on parallel or serial ports via optional PCIe adapters			
Noise emissions	Operating: < 43.6 dB(A). Idle: < 33 dB(A) (Maximum configuration)			
Environmental specification	All models supports ASHARE B. Models with the following configuration supports ASHARE A3: Xeon E3-1230 v5/8GBx2/DVD±RW/1TB SATAx4/RAID520i/450Wx2/TPM			
	Temperature - operating	ASHRAE A2 10°C to 35°C (50°F to 95°F)	ASHRAE A3 5°C to 40°C (41°F to 104°F)	ASHRAE B 5°C to 35°C (41°F to 95°F)
	Temperature - storage (with package)	-40°C to 60°C (-40°F to 140°F)	-40°C to 60°C (-40°F to 140°F)	-40°C to 60°C (-40°F to 140°F)
	Altitude - operating	20% to 80% (non-condensing)	8% to 85% (non-condensing)	8% to 80% (non-condensing)
	Humidity - storage (with package)	10% to 90% (non-condensing)	10% to 90% (non-condensing)	10% to 90% (non-condensing)
	Altitude - operating	0 m to 3048 m (0 ft to 10 000 ft) in an unpressurized environment		
	GREENGUARD certified, RoHS-compliant, Energy Star Server 2.1 qualified on redundant PSU models			

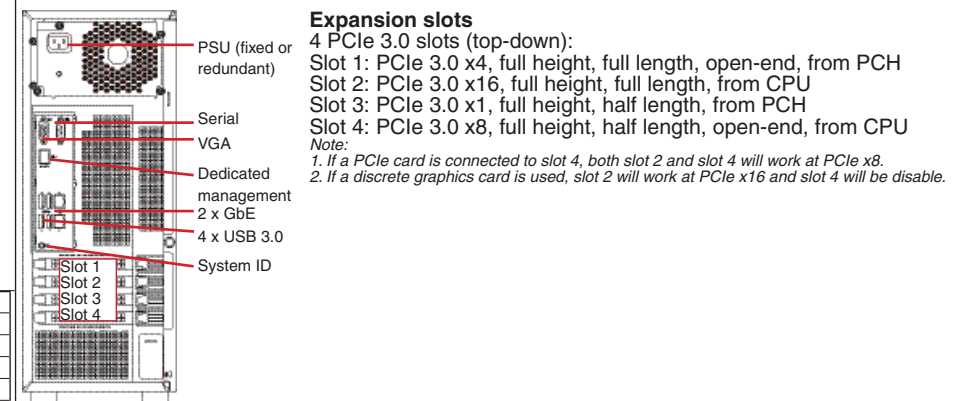

Model	Region	Processor	Memory	Storage Controller	Disk Bays	Disks	Optical	Add-on NIC	Add-on Ports	System Management	Operating System	Warranty	Power Supply	Ann Date (mm/yy)
70TR000LUX	US	Xeon E3-1220 v5 4C/3.0GHz/8MB/80W/DDR4-2133	1x8GB UDIMM DDR4-2133 ECC	RAID121i	4x3.5" HS	Open	Open	None	None	TPM 2.0	None	1-year	Fixed 300W Bronze	02/17
70TR000MUX	US	Xeon E3-1230 v5 4C/3.4GHz/8MB/80W/DDR4-2133	1x8GB UDIMM DDR4-2133 ECC	RAID121i	4x3.5" HS	Open	Open	None	None	TPM 2.0	None	1-year	Fixed 300W Bronze	02/17
70TR000NUX	US	Xeon E3-1240 v5 4C/3.5GHz/8MB/80W/DDR4-2133	1x8GB UDIMM DDR4-2133 ECC	RAID121i	4x3.5" HS	Open	Open	None	None	TPM 2.0	None	1-year	Fixed 300W Bronze	02/17
70TR000PUX	US	Xeon E3-1270 v5 4C/3.6GHz/8MB/80W/DDR4-2133	1x8GB UDIMM DDR4-2133 ECC	RAID121i	4x3.5" HS	Open	Open	None	None	TPM 2.0	None	1-year	Fixed 300W Bronze	02/17
70TR000QUX	US	Xeon E3-1220 v5 4C/3.0GHz/8MB/80W/DDR4-2133	1x8GB UDIMM DDR4-2133 ECC	RAID520i	8x2.5" HS	Open	Open	None	None	TPM 2.0	None	1-year	Fixed 300W Bronze	02/17
70TR000RUX	US	Xeon E3-1230 v5 4C/3.4GHz/8MB/80W/DDR4-2133	1x8GB UDIMM DDR4-2133 ECC	RAID520i	8x2.5" HS	Open	Open	None	None	TPM 2.0	None	1-year	Fixed 300W Bronze	02/17
70TR000SUX	US	Xeon E3-1240 v5 4C/3.5GHz/8MB/80W/DDR4-2133	1x8GB UDIMM DDR4-2133 ECC	RAID520i	8x2.5" HS	Open	Open	None	None	TPM 2.0	None	1-year	Fixed 300W Bronze	02/17
70TR000TUX	US	Xeon E3-1270 v5 4C/3.6GHz/8MB/80W/DDR4-2133	1x8GB UDIMM DDR4-2133 ECC	RAID520i	8x2.5" HS	Open	Open	None	None	TPM 2.0	None	1-year	Fixed 300W Bronze	02/17
70TR000UUX	US	Xeon E3-1220 v5 4C/3.0GHz/8MB/80W/DDR4-2133	1x8GB UDIMM DDR4-2133 ECC	RAID121i	4x3.5" NHS	Open	Open	None	None	TPM 2.0	None	1-year	Fixed 300W Bronze	02/17
70TR000VUX	US	Xeon E3-1230 v5 4C/3.4GHz/8MB/80W/DDR4-2133	1x8GB UDIMM DDR4-2133 ECC	RAID121i	4x3.5" NHS	Open	Open	None	None	TPM 2.0	None	1-year	Fixed 300W Bronze	02/17
70TR000WUX	US	Xeon E3-1240 v5 4C/3.5GHz/8MB/80W/DDR4-2133	1x8GB UDIMM DDR4-2133 ECC	RAID121i	4x3.5" NHS	Open	Open	None	None	TPM 2.0	None	1-year	Fixed 300W Bronze	02/17
70TR000XUX	US	Xeon E3-1270 v5 4C/3.6GHz/8MB/80W/DDR4-2133	1x8GB UDIMM DDR4-2133 ECC	RAID121i	4x3.5" NHS	Open	Open	None	None	TPM 2.0	None	1-year	Fixed 300W Bronze	02/17
70TR000YUX	US	Pentium G4400 2C/3.3GHz/3MB/54W/DDR4-2133	1x8GB UDIMM DDR4-2133 ECC	RAID121i	4x3.5" NHS	Open	Open	None	None	TPM 2.0	None	1-year	Fixed 300W Bronze	02/17
70TR0016UX	US	Xeon E3-1220 v6 4C/3.0GHz/8MB/72W/DDR4-2400	1x8GB UDIMM DDR4-2400 ECC	RAID121i	4x3.5" HS	Open	Open	None	None	TPM 2.0	None	1-year	Fixed 300W Bronze	06/17
70TR0017UX	US	Xeon E3-1230 v6 4C/3.5GHz/8MB/72W/DDR4-2400	1x8GB UDIMM DDR4-2400 ECC	RAID121i	4x3.5" HS	Open	Open	None	None	TPM 2.0	None	1-year	Fixed 300W Bronze	06/17
70TR0018UX	US	Xeon E3-1240 v6 4C/3.7GHz/8MB/72W/DDR4-2400	1x8GB UDIMM DDR4-2400 ECC	RAID121i	4x3.5" HS	Open	Open	None	None	TPM 2.0	None	1-year	Fixed 300W Bronze	06/17
70TR0019UX	US	Xeon E3-1270 v6 4C/3.8GHz/8MB/72W/DDR4-2400	1x8GB UDIMM DDR4-2400 ECC	RAID121i	4x3.5" HS	Open	Open	None	None	TPM 2.0	None	1-year	Fixed 300W Bronze	06/17

Model	Region	Processor	Memory	Storage Controller	Disk Bays	Disks	Optical	Add-on NIC	Add-on Ports	System Management	Operating System	Warranty	Power Supply	Ann Date (mm/yy)
70TR001AUX	US	Xeon E3-1220 v6 4C/3.0GHz/8MB/72W/DDR4-2400	1x8GB UDIMM DDR4-2400 ECC	RAID520i	8x2.5" HS	Open	Open	None	None	TPM 2.0	None	1-year	Fixed 300W Bronze	06/17
70TR001BUX	US	Xeon E3-1230 v6 4C/3.5GHz/8MB/72W/DDR4-2400	1x8GB UDIMM DDR4-2400 ECC	RAID520i	8x2.5" HS	Open	Open	None	None	TPM 2.0	None	1-year	Fixed 300W Bronze	06/17
70TR001CUX	US	Xeon E3-1240 v6 4C/3.7GHz/8MB/72W/DDR4-2400	1x8GB UDIMM DDR4-2400 ECC	RAID520i	8x2.5" HS	Open	Open	None	None	TPM 2.0	None	1-year	Fixed 300W Bronze	06/17
70TR001DUX	US	Xeon E3-1270 v6 4C/3.8GHz/8MB/72W/DDR4-2400	1x8GB UDIMM DDR4-2400 ECC	RAID520i	8x2.5" HS	Open	Open	None	None	TPM 2.0	None	1-year	Fixed 300W Bronze	06/17

Model	Region	Processor	Memory	Storage Controller	Disk Bays	Disks	Optical	Add-on NIC	Add-on Ports	System Management	Operating System	Warranty	Power Supply	Ann Date (mm/yy)
70TT000JUX	US	Xeon E3-1220 v5 4C/3.0GHz/8MB/80W/DDR4-2133	1x8GB UDIMM DDR4-2133 ECC	RAID121i	4x3.5" HS	Open	Open	None	None	TPM 2.0	None	1-year	1x450W Gold	02/17
70TT000KUX	US	Xeon E3-1230 v5 4C/3.4GHz/8MB/80W/DDR4-2133	1x8GB UDIMM DDR4-2133 ECC	RAID121i	4x3.5" HS	Open	Open	None	None	TPM 2.0	None	1-year	1x450W Gold	02/17
70TT000LUX	US	Xeon E3-1240 v5 4C/3.5GHz/8MB/80W/DDR4-2133	1x8GB UDIMM DDR4-2133 ECC	RAID121i	4x3.5" HS	Open	Open	None	None	TPM 2.0	None	1-year	1x450W Gold	02/17
70TT000MUX	US	Xeon E3-1270 v5 4C/3.6GHz/8MB/80W/DDR4-2133	1x8GB UDIMM DDR4-2133 ECC	RAID121i	4x3.5" HS	Open	Open	None	None	TPM 2.0	None	1-year	1x450W Gold	02/17
70TT000NUX	US	Xeon E3-1220 v5 4C/3.0GHz/8MB/80W/DDR4-2133	1x8GB UDIMM DDR4-2133 ECC	RAID520i	8x2.5" HS	Open	Open	None	None	TPM 2.0	None	1-year	1x450W Gold	02/17
70TT000PUX	US	Xeon E3-1230 v5 4C/3.4GHz/8MB/80W/DDR4-2133	1x8GB UDIMM DDR4-2133 ECC	RAID520i	8x2.5" HS	Open	Open	None	None	TPM 2.0	None	1-year	1x450W Gold	02/17
70TT000QUX	US	Xeon E3-1240 v5 4C/3.5GHz/8MB/80W/DDR4-2133	1x8GB UDIMM DDR4-2133 ECC	RAID520i	8x2.5" HS	Open	Open	None	None	TPM 2.0	None	1-year	1x450W Gold	02/17
70TT000RUX	US	Xeon E3-1270 v5 4C/3.6GHz/8MB/80W/DDR4-2133	1x8GB UDIMM DDR4-2133 ECC	RAID520i	8x2.5" HS	Open	Open	None	None	TPM 2.0	None	1-year	1x450W Gold	02/17
70TT001YUX	US	Xeon E3-1220 v6 4C/3.0GHz/8MB/72W/DDR4-2400	1x8GB UDIMM DDR4-2400 ECC	RAID121i	4x3.5" HS	Open	Open	None	None	TPM 2.0	None	1-year	1x450W Gold	06/17
70TT0020UX	US	Xeon E3-1230 v6 4C/3.5GHz/8MB/72W/DDR4-2400	1x8GB UDIMM DDR4-2400 ECC	RAID121i	4x3.5" HS	Open	Open	None	None	TPM 2.0	None	1-year	1x450W Gold	06/17
70TT0021UX	US	Xeon E3-1240 v6 4C/3.7GHz/8MB/72W/DDR4-2400	1x8GB UDIMM DDR4-2400 ECC	RAID121i	4x3.5" HS	Open	Open	None	None	TPM 2.0	None	1-year	1x450W Gold	06/17
70TT0022UX	US	Xeon E3-1270 v6 4C/3.8GHz/8MB/72W/DDR4-2400	1x8GB UDIMM DDR4-2400 ECC	RAID121i	4x3.5" HS	Open	Open	None	None	TPM 2.0	None	1-year	1x450W Gold	06/17
70TT0023UX	US	Xeon E3-1220 v6 4C/3.0GHz/8MB/72W/DDR4-2400	1x8GB UDIMM DDR4-2400 ECC	RAID520i	8x2.5" HS	Open	Open	None	None	TPM 2.0	None	1-year	1x450W Gold	06/17
70TT0024UX	US	Xeon E3-1230 v6 4C/3.5GHz/8MB/72W/DDR4-2400	1x8GB UDIMM DDR4-2400 ECC	RAID520i	8x2.5" HS	Open	Open	None	None	TPM 2.0	None	1-year	1x450W Gold	06/17
70TT0025UX	US	Xeon E3-1240 v6 4C/3.7GHz/8MB/72W/DDR4-2400	1x8GB UDIMM DDR4-2400 ECC	RAID520i	8x2.5" HS	Open	Open	None	None	TPM 2.0	None	1-year	1x450W Gold	06/17
70TT0026UX	US	Xeon E3-1270 v6 4C/3.8GHz/8MB/72W/DDR4-2400	1x8GB UDIMM DDR4-2400 ECC	RAID520i	8x2.5" HS	Open	Open	None	None	TPM 2.0	None	1-year	1x450W Gold	06/17

This publication was developed for products and services offered in the United States and E.M.E.A countries. Lenovo may not offer the products, services or features discussed in this document in other countries. Lenovo may withdraw an offering at any time. Information is subject to change without notice. Consult your local representative for information on offerings available in your area.

Lenovo reserves the right to change specifications or other product information without notice. Lenovo is not responsible for photographic or typographical errors.

LENOVO PROVIDES THIS PUBLICATION "AS IS," WITHOUT WARRANTY OF ANY KIND, EITHER EXPRESS OR IMPLIED, INCLUDING THE IMPLIED WARRANTIES OF MERCHANTABILITY OR FITNESS FOR A PARTICULAR PURPOSE.

Some jurisdictions do not allow disclaimer of express or implied warranties in certain transactions, therefore this disclaimer may not apply to you.

**Availability:** All offers subject to availability. Lenovo reserves the right to alter product offerings and specifications at any time, without notice. Lenovo is not responsible for photographic or typographic errors.

**General:** Review key information provided by Microsoft that may apply to your system purchase, including details on Windows 10, Windows 8, Windows 7, and potential upgrades/downgrades. Lenovo makes no representation or warranty regarding third-party products or services.

**Trademarks:** Lenovo, ThinkPad, ThinkCentre, ThinkStation and the Lenovo logo are trademarks of Lenovo. Microsoft, Windows, Windows NT, and the Windows logo are trademarks of Microsoft Corporation. Ultrabook, Celeron, Celeron Inside, Core Inside, Intel, Intel Logo, Intel Atom, Intel Atom Inside, Intel Core, Intel Inside, Intel Inside Logo, Intel vPro, Itanium, Itanium Inside, Pentium, Pentium Inside, vPro Inside, Xeon, Xeon Phi, and Xeon Inside are trademarks of Intel Corporation in the U.S. and/or other countries. Other company, product or service names may be trademarks or service marks of others.

**Warranty:** For a copy of applicable warranties, write to: Lenovo Warranty Information, 1009 Think Place, Morrisville, NC, 27560. Lenovo makes no representation or warranty regarding third party products or services. The Lenovo Limited Warranty applies only to Lenovo hardware products purchased for your own use, and does not transfer upon resale.

**Limited warranty:** Support unrelated to a warranty issue may be subject to additional charges.

#### **Lenovo Services:**

**Carry-in or Mail-in Service:** Parts and labor repair coverage where the customer is responsible for shipping (including packaging) or delivery to authorized warranty provider or repair center.

**Depot or Courier Service:** Parts and labor repair coverage where shipping (including packaging) or delivery to the repair center is paid for by Lenovo.

**Expedited Depot:** Parts and labor coverage with expedited turnaround. Shipping (including packaging) or delivery to the repair center is paid for by Lenovo.

**Onsite / In-home Service:** Parts and labor repair coverage where labor is provided onsite at your place of business.

If Lenovo determines your product problem is covered by the product warranty and cannot be resolved over the telephone, a technician will be dispatched to arrive onsite, typically the next day.

**International Warranty Service (IWS):** PC repair coverage for customers who require a critical warranty repair while travelling internationally. Visit [www.lenovo.com/internationalwarranty](http://www.lenovo.com/internationalwarranty) for details. Visit [www.lenovo.com/warranty](http://www.lenovo.com/warranty) for Lenovo Warranty Services terms and conditions for complete details and restrictions.

**Included software:** may differ from its retail version (if available), and may not include user manuals or all program functionality. Software license agreements may apply.

**Battery life:** Battery life (and recharge times) will vary based on many factors including screen brightness, applications, features, power management, battery conditioning, and other customer preferences.

Visit <http://psref.lenovo.com/> for the latest version of Product Specifications Reference.

© Lenovo, 2017. All rights reserved.  
Lenovo 1009 Think Place Morrisville, NC 27560 U.S.A.



**Lenovo**™ **ThinkSystem**

# PSREF



**Product Specifications Reference**

Version 509, July 2017

Visit <http://psref.lenovo.com> for the latest version

# Contents

---

<b>Cover</b>	<b>1</b>	ThinkSystem SR530 - TopSeller - LA	<b>35</b>
<b>Contents</b>	<b>2</b>	ThinkSystem SR530 - TopSeller - NA	<b>36</b>
<b>Summary Of Change</b>	<b>4</b>	ThinkSystem SR530 - Non TopSeller - ANZ - 1 of 2	<b>37</b>
<b>Mission-Critical</b>	<b>5</b>	ThinkSystem SR530 - Non TopSeller - ANZ - 2 of 2	<b>38</b>
<b>ThinkSystem SR850</b>	<b>5</b>	ThinkSystem SR530 - Non TopSeller - ASEAN	<b>39</b>
ThinkSystem SR850 Platform Specifications	<b>6</b>	ThinkSystem SR530 - Non TopSeller - Brazil - 1 of 2	<b>40</b>
ThinkSystem SR850 - Non TopSeller - ANZ - 1 of 2	<b>7</b>	ThinkSystem SR530 - Non TopSeller - Brazil - 2 of 2	<b>41</b>
ThinkSystem SR850 - Non TopSeller - ANZ - 2 of 2	<b>8</b>	ThinkSystem SR530 - Non TopSeller - EMEA	<b>42</b>
ThinkSystem SR850 - Non TopSeller - ASEAN	<b>9</b>	ThinkSystem SR530 - Non TopSeller - HTK - 1 of 2	<b>43</b>
ThinkSystem SR850 - Non TopSeller - EMEA	<b>10</b>	ThinkSystem SR530 - Non TopSeller - HTK - 2 of 2	<b>44</b>
ThinkSystem SR850 - Non TopSeller - HTK - 1 of 2	<b>11</b>	ThinkSystem SR530 - Non TopSeller - INDIA	<b>45</b>
ThinkSystem SR850 - Non TopSeller - HTK - 2 of 2	<b>12</b>	ThinkSystem SR530 - Non TopSeller - JAPAN	<b>46</b>
ThinkSystem SR850 - Non TopSeller - INDIA - 1 of 2	<b>13</b>	ThinkSystem SR530 - Non TopSeller - LA	<b>47</b>
ThinkSystem SR850 - Non TopSeller - INDIA - 2 of 2	<b>14</b>	ThinkSystem SR530 - Non TopSeller - NA	<b>48</b>
ThinkSystem SR850 - Non TopSeller - JAPAN	<b>15</b>	<b>ThinkSystem SR550</b>	<b>49</b>
ThinkSystem SR850 - Non TopSeller - LA	<b>16</b>	ThinkSystem SR550 Platform Specifications	<b>50</b>
ThinkSystem SR850 - Non TopSeller - NA	<b>17</b>	ThinkSystem SR550 - TopSeller - ANZ - 1 of 2	<b>51</b>
<b>ThinkSystem SR950</b>	<b>18</b>	ThinkSystem SR550 - TopSeller - ANZ - 2 of 2	<b>52</b>
ThinkSystem SR950 Platform Specifications	<b>19</b>	ThinkSystem SR550 - TopSeller - EMEA - 1 of 2	<b>53</b>
ThinkSystem SR950 - Non TopSeller - ANZ	<b>20</b>	ThinkSystem SR550 - TopSeller - EMEA - 2 of 2	<b>54</b>
ThinkSystem SR950 - Non TopSeller - ASEAN	<b>21</b>	ThinkSystem SR550 - TopSeller - JAPAN	<b>55</b>
ThinkSystem SR950 - Non TopSeller - Brazil	<b>22</b>	ThinkSystem SR550 - TopSeller - LA	<b>56</b>
ThinkSystem SR950 - Non TopSeller - EMEA	<b>23</b>	ThinkSystem SR550 - TopSeller - NA	<b>57</b>
ThinkSystem SR950 - Non TopSeller - HTK	<b>24</b>	ThinkSystem SR550 - Non TopSeller - ANZ - 1 of 2	<b>58</b>
ThinkSystem SR950 - Non TopSeller - INDIA - 1 of 2	<b>25</b>	ThinkSystem SR550 - Non TopSeller - ANZ - 2 of 2	<b>59</b>
ThinkSystem SR950 - Non TopSeller - INDIA - 2 of 2	<b>26</b>	ThinkSystem SR550 - Non TopSeller - ASEAN	<b>60</b>
ThinkSystem SR950 - Non TopSeller - JAPAN	<b>27</b>	ThinkSystem SR550 - Non TopSeller - Brazil	<b>61</b>
ThinkSystem SR950 - Non TopSeller - NA	<b>28</b>	ThinkSystem SR550 - Non TopSeller - EMEA	<b>62</b>
<b>Racks</b>	<b>29</b>	ThinkSystem SR550 - Non TopSeller - HTK - 1 of 2	<b>63</b>
<b>ThinkSystem SR530</b>	<b>29</b>	ThinkSystem SR550 - Non TopSeller - HTK - 2 of 2	<b>64</b>
ThinkSystem SR530 Platform Specifications	<b>30</b>	ThinkSystem SR550 - Non TopSeller - INDIA - 1 of 2	<b>65</b>
ThinkSystem SR530 - TopSeller - ANZ	<b>31</b>	ThinkSystem SR550 - Non TopSeller - INDIA - 2 of 2	<b>66</b>
ThinkSystem SR530 - TopSeller - EMEA - 1 of 2	<b>32</b>	ThinkSystem SR550 - Non TopSeller - JAPAN	<b>67</b>
ThinkSystem SR530 - TopSeller - EMEA - 2 of 2	<b>33</b>	ThinkSystem SR550 - Non TopSeller - LA	<b>68</b>
ThinkSystem SR530 - TopSeller - JAPAN	<b>34</b>	ThinkSystem SR550 - Non TopSeller - NA	<b>69</b>

# Contents

---

<b>ThinkSystem SR630</b>	<b>70</b>	ThinkSystem SR650 - Non TopSeller - EMEA - 1 of 2	105
ThinkSystem SR630 Platform Specifications	71	ThinkSystem SR650 - Non TopSeller - EMEA - 2 of 2	106
ThinkSystem SR630 - TopSeller - ANZ - 1 of 2	72	ThinkSystem SR650 - Non TopSeller - HTK - 1 of 3	107
ThinkSystem SR630 - TopSeller - ANZ - 2 of 2	73	ThinkSystem SR650 - Non TopSeller - HTK - 2 of 3	108
ThinkSystem SR630 - TopSeller - EMEA - 1 of 2	74	ThinkSystem SR650 - Non TopSeller - HTK - 3 of 3	109
ThinkSystem SR630 - TopSeller - EMEA - 2 of 2	75	ThinkSystem SR650 - Non TopSeller - INDIA	110
ThinkSystem SR630 - TopSeller - JAPAN	76	ThinkSystem SR650 - Non TopSeller - JAPAN	111
ThinkSystem SR630 - TopSeller - LA	77	ThinkSystem SR650 - Non TopSeller - LA	112
ThinkSystem SR630 - TopSeller - NA	78	ThinkSystem SR650 - Non TopSeller - NA - 1 of 2	113
ThinkSystem SR630 - Non TopSeller - ANZ - 1 of 3	79	ThinkSystem SR650 - Non TopSeller - NA - 2 of 2	114
ThinkSystem SR630 - Non TopSeller - ANZ - 2 of 3	80	<b>Towers</b>	<b>115</b>
ThinkSystem SR630 - Non TopSeller - ANZ - 3 of 3	81	<b>ThinkSystem ST550</b>	<b>115</b>
ThinkSystem SR630 - Non TopSeller - ASEAN	82	ThinkSystem ST550 Platform Specifications	116
ThinkSystem SR630 - Non TopSeller - EMEA - 1 of 2	83	ThinkSystem ST550 - TopSeller - ANZ - 1 of 2	117
ThinkSystem SR630 - Non TopSeller - EMEA - 2 of 2	84	ThinkSystem ST550 - TopSeller - ANZ - 2 of 2	118
ThinkSystem SR630 - Non TopSeller - HTK - 1 of 3	85	ThinkSystem ST550 - TopSeller - EMEA - 1 of 2	119
ThinkSystem SR630 - Non TopSeller - HTK - 2 of 3	86	ThinkSystem ST550 - TopSeller - EMEA - 2 of 2	120
ThinkSystem SR630 - Non TopSeller - HTK - 3 of 3	87	ThinkSystem ST550 - TopSeller - LA - 1 of 2	121
ThinkSystem SR630 - Non TopSeller - INDIA	88	ThinkSystem ST550 - TopSeller - LA - 2 of 2	122
ThinkSystem SR630 - Non TopSeller - JAPAN	89	ThinkSystem ST550 - TopSeller - NA	123
ThinkSystem SR630 - Non TopSeller - LA	90	ThinkSystem ST550 - Non TopSeller - ANZ - 1 of 2	124
ThinkSystem SR630 - Non TopSeller - NA	91	ThinkSystem ST550 - Non TopSeller - ANZ - 2 of 2	125
<b>ThinkSystem SR650</b>	<b>92</b>	ThinkSystem ST550 - Non TopSeller - ASEAN	126
ThinkSystem SR650 Platform Specifications	93	ThinkSystem ST550 - Non TopSeller - Brazil	127
ThinkSystem SR650 - TopSeller - ANZ	94	ThinkSystem ST550 - Non TopSeller - EMEA	128
ThinkSystem SR650 - TopSeller - EMEA - 1 of 3	95	ThinkSystem ST550 - Non TopSeller - HTK	129
ThinkSystem SR650 - TopSeller - EMEA - 2 of 3	96	ThinkSystem ST550 - Non TopSeller - INDIA - 1 of 2	130
ThinkSystem SR650 - TopSeller - EMEA - 3 of 3	97	ThinkSystem ST550 - Non TopSeller - INDIA - 2 of 2	131
ThinkSystem SR650 - TopSeller - HTK	98	ThinkSystem ST550 - Non TopSeller - JAPAN	132
ThinkSystem SR650 - TopSeller - JAPAN	99	ThinkSystem ST550 - Non TopSeller - LA	133
ThinkSystem SR650 - TopSeller - NA	100	ThinkSystem ST550 - Non TopSeller - NA	134
ThinkSystem SR650 - Non TopSeller - ANZ - 1 of 3	101	<b>Legal Information</b>	<b>135</b>
ThinkSystem SR650 - Non TopSeller - ANZ - 2 of 3	102		
ThinkSystem SR650 - Non TopSeller - ANZ - 3 of 3	103		
ThinkSystem SR650 - Non TopSeller - ASEAN	104		

# Summary of Changes

---

This section describes the changes made in this version of ThinkSystem PSREF and in previous version  
This edition might also include minor corrections and editorial changes which are not identified

## **June 21, 2017 - Version 509**

### Additions in this update

- ▶ Initial version, includes ThinkSystem rack servers SR650/SR630/SR550/SR530, tower server ST550, and mission-critical servers SR850 and SR950.



# ThinkSystem SR850 Platform Specifications

Product Specifications Reference (PSREF)

Components	Specification																																																																																										
Form factor	2U rack																																																																																										
Dimensions	Height: 86.5 mm (3.4 in). Width: 482 mm (19.0 in) with rack latches. Depth: 763.7 mm (30.1 in) without security bezel																																																																																										
Weight	Maximum configuration: 59.52 lb (27 kg)																																																																																										
Processor	Supports up to four 165W Intel Xeon Scalable family processors, Gold or Platinum. 2 processor sockets on system board, 2 processor sockets on optional processor and memory expansion tray. Up to 28 cores at 2.1GHz, up to 3.6GHz with 4 cores. Four processors are connected in ring topology with two 10.4GT/s UPI (Ultra Path Interconnect)																																																																																										
Chipset	Intel C624 Platform Controller Hub																																																																																										
Memory	Up to 48 DIMM sockets. 24 DIMM sockets on system main board, 24 DIMM sockets on optional processor and memory expansion tray. Each processor supports up to 12 DIMM sockets with 6 channels. DDR4-2666. RDIMMs, LRDIMMs, 3DS RDIMMs are supported, but memory types cannot be intermixed. 3DS RDIMM is planned to available later																																																																																										
Memory capacity	Up to 1.5TB with 48 x 32GB RDIMMs and four processors. Or up to 3TB with 48 x 64GB LRDIMMs and four processors. Or up to 6TB with 48 x 128GB 3DS RDIMMs and four -M suffix processors. -M suffix processor supports 1.5TB memory per socket, non -M suffix processor supports 768GB memory per socket																																																																																										
Memory protection	ECC, memory mirroring, and memory sparing																																																																																										
Storage controllers	Supports the following RAID/HBA adapters:																																																																																										
	<table border="1"> <thead> <tr> <th>Feature</th> <th>Interface</th> <th>Drive type</th> <th>RAID levels</th> <th>JBOD</th> <th>Cache</th> <th>Cache protection</th> <th>FastPath</th> <th>Max qty</th> </tr> </thead> <tbody> <tr> <td>530-8i</td> <td>12Gbps SAS</td> <td>SATA/SAS</td> <td>0/1/10/5/50</td> <td>Yes</td> <td>None</td> <td>None</td> <td>Yes</td> <td>2</td> </tr> <tr> <td>730-8i</td> <td>12Gbps SAS</td> <td>SATA/SAS</td> <td>0/1/10/5/50</td> <td>Yes</td> <td>1GB</td> <td>None</td> <td>No</td> <td>2</td> </tr> <tr> <td>930-8i</td> <td>12Gbps SAS</td> <td>SATA/SAS</td> <td>0/1/10/5/50/6/60</td> <td>Yes</td> <td>2GB</td> <td>Flash backup</td> <td>Yes</td> <td>2</td> </tr> <tr> <td>930-16i</td> <td>12Gbps SAS</td> <td>SATA/SAS</td> <td>0/1/10/5/50/6/60</td> <td>Yes</td> <td>4GB</td> <td>Flash backup</td> <td>Yes</td> <td>1</td> </tr> <tr> <td>430-8i</td> <td>12Gbps SAS</td> <td>SATA/SAS</td> <td>-</td> <td>Yes</td> <td>None</td> <td>None</td> <td>-</td> <td>2</td> </tr> <tr> <td>430-16i</td> <td>12Gbps SAS</td> <td>SATA/SAS</td> <td>-</td> <td>Yes</td> <td>None</td> <td>None</td> <td>-</td> <td>1</td> </tr> <tr> <td>930-8e</td> <td>12Gbps SAS</td> <td>SATA/SAS</td> <td>0/1/10/5/50/6/60</td> <td>Yes</td> <td>4GB</td> <td>Flash backup</td> <td>Yes</td> <td>4</td> </tr> <tr> <td>430-8e</td> <td>12Gbps SAS</td> <td>SATA/SAS</td> <td>-</td> <td>Yes</td> <td>None</td> <td>None</td> <td>-</td> <td>8</td> </tr> <tr> <td>430-16e</td> <td>12Gbps SAS</td> <td>SATA/SAS</td> <td>-</td> <td>Yes</td> <td>None</td> <td>None</td> <td>-</td> <td>8</td> </tr> </tbody> </table>	Feature	Interface	Drive type	RAID levels	JBOD	Cache	Cache protection	FastPath	Max qty	530-8i	12Gbps SAS	SATA/SAS	0/1/10/5/50	Yes	None	None	Yes	2	730-8i	12Gbps SAS	SATA/SAS	0/1/10/5/50	Yes	1GB	None	No	2	930-8i	12Gbps SAS	SATA/SAS	0/1/10/5/50/6/60	Yes	2GB	Flash backup	Yes	2	930-16i	12Gbps SAS	SATA/SAS	0/1/10/5/50/6/60	Yes	4GB	Flash backup	Yes	1	430-8i	12Gbps SAS	SATA/SAS	-	Yes	None	None	-	2	430-16i	12Gbps SAS	SATA/SAS	-	Yes	None	None	-	1	930-8e	12Gbps SAS	SATA/SAS	0/1/10/5/50/6/60	Yes	4GB	Flash backup	Yes	4	430-8e	12Gbps SAS	SATA/SAS	-	Yes	None	None	-	8	430-16e	12Gbps SAS	SATA/SAS	-	Yes	None	None	-	8
	Feature	Interface	Drive type	RAID levels	JBOD	Cache	Cache protection	FastPath	Max qty																																																																																		
	530-8i	12Gbps SAS	SATA/SAS	0/1/10/5/50	Yes	None	None	Yes	2																																																																																		
	730-8i	12Gbps SAS	SATA/SAS	0/1/10/5/50	Yes	1GB	None	No	2																																																																																		
	930-8i	12Gbps SAS	SATA/SAS	0/1/10/5/50/6/60	Yes	2GB	Flash backup	Yes	2																																																																																		
	930-16i	12Gbps SAS	SATA/SAS	0/1/10/5/50/6/60	Yes	4GB	Flash backup	Yes	1																																																																																		
	430-8i	12Gbps SAS	SATA/SAS	-	Yes	None	None	-	2																																																																																		
	430-16i	12Gbps SAS	SATA/SAS	-	Yes	None	None	-	1																																																																																		
	930-8e	12Gbps SAS	SATA/SAS	0/1/10/5/50/6/60	Yes	4GB	Flash backup	Yes	4																																																																																		
430-8e	12Gbps SAS	SATA/SAS	-	Yes	None	None	-	8																																																																																			
430-16e	12Gbps SAS	SATA/SAS	-	Yes	None	None	-	8																																																																																			
	<i>Note: 730-8i is available in China only</i>																																																																																										
Disk drive bays	Supports 8 front 2.5" SATA/SAS HS bays with maximum 4 AnyBay, or 16 front 2.5" SATA/SAS HS bays with maximum 8 AnyBay Optional one or two internal M.2 SSD for boot, dual M.2 SSD supports mirroring																																																																																										
Internal storage	2.5" HDD, SAS12Gbps, 7.2K																																																																																										
	2.5" HDD, SAS12Gbps, 10K																																																																																										
	2.5" HDD, SAS12Gbps, 15K																																																																																										
	2.5" SSD, SAS12Gbps																																																																																										
	2.5" SSD, SATA6Gbps																																																																																										
	2.5" NVMe SSD, AnyBay																																																																																										
	NVMe SSD, PCIe 3.0 x4, HHL adapter																																																																																										
M.2 SATA SSD for boot																																																																																											
Optical	No internal optical bay. Optional USB DVD±RW optical drive																																																																																										
Network interfaces	One dedicated management port. One LOM slot for customized LOM with up to four RJ-45 or SFP+ ports, up to 10GbE. Wake-on-LAN and NC-SI are available on one port of LOM. Optional ML2 or PCIe adapters are supported. ML2 adapter requires riser card with ML2 slot.																																																																																										
Security features	Power-on and admin password. Trusted Platform Module, TCG 1.2 compliant, upgrade to 2.0 via UEFI setting. Optional TCM in China only. Optional lockable security bezel																																																																																										
Operating systems supported	Microsoft Windows Server 2016/2012 R2. Red Hat Enterprise Linux 7.3/6.9. SUSE Linux Enterprise Server 12 SP2/11 SP4. VMware vSphere (ESXi) 6.5/6.0 U3																																																																																										
Systems management	XClarity Controller Advanced, optional upgrades to Enterprise is available. Energy Manager. XClarity Administrator. Lenovo Capacity Planner. Light Path Diagnostics with optional LCD diagnostic pull-out panel																																																																																										
GPU support	None																																																																																										
Base warranty	MT 7X18: 1-year limited onsite service with 9x5/NBD MT 7X19: 3-year limited onsite service with 9x5/NBD																																																																																										
Power supply	Up to two redundant hot-swap 750W/100W/1600W 80 PLUS Platinum qualified AC power supplies. 1600W Platinum are 200V - 240V, others are 100V - 240V																																																																																										

Components	Specification	
Video	Integrated Matrox G200 in XClarity Controller	
Cooling	Six hot-swap fans, N + 1 redundancy	
Front ports	One XClarity Controller USB connector, one USB 2.0 or USB 3.0 (model dependent), one optional VGA	
Rear ports	One VGA, two USB 3.0, one serial, one XClarity Controller network connector	
Environmental specification	Supports ASHRAE A4 with limitations.	
	Temperature - operating	A4: 5°C to 45°C (41°F to 113°F) A3: 5°C to 40°C (41°F to 104°F) A2: 10°C to 35°C (50°F to 95°F)
	Temperature - non operating (no package)	-10°C to 60°C (14°F to 140°F)
	Temperature - non operating (with package)	-40°C to 70°C (-40°F to 158°F)
	Altitude - operating	(Unpressurized): 0-10000ft (0-3048m)
	Humidity - operating, non-condensing	A4: 8%-90%. A3:8%-85%. A2:20%~80%
Humidity - storage (with package), non-condensing	8%~90%	
	<i>Models should meet the following requirements to support A3 and A4:</i>	
	<ul style="list-style-type: none"> <li>• NVMe drives not installed</li> <li>• PCIe flash adapter not installed</li> <li>• M.2 SSD not installed</li> </ul>	
Environmental certification	Energy Star Server 2.1 certified. More environmental information please see: <a href="http://www.lenovo.com/social_responsibility/us/en/environment/">www.lenovo.com/social_responsibility/us/en/environment/</a>	

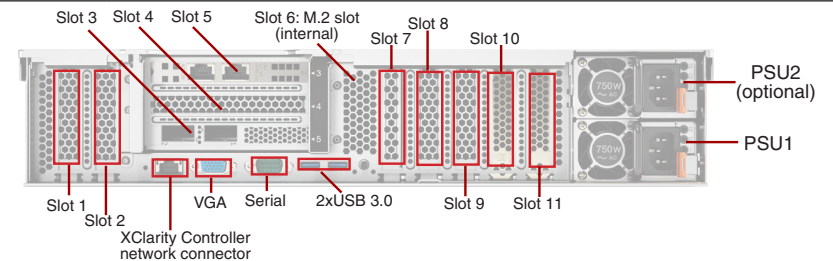

*Note: All riser cards, expansion cards, and LOM adapters are optional. Slots are labelled as 1, 2, 3, 4, 5, 7, 8, 9, 10, 11. Slot 6 is internal M.2 slot for optional M.2 enablement kit*

## Expansion slots

Slot 1 (onboard)	PCIe 3.0 x16, low profile, requires 2nd CPU
Slot 2 (onboard)	PCIe 3.0 x8, low profile, requires 2nd CPU
Slot 3-5 (riser card)	Supports one of the following for riser card: Option 1: PCIe 3.0 x8/x8/x8 (slot 3-5). Full height, half length. Option 2: PCIe 3.0 x8/x8/x8 ML2 (slot 3-5). Full height, half length Option 4: PCIe 3.0 x8/x16 ML2 (slot 3 and 5). Full height, half length Slot 3 - 5 requires 2nd CPU
Slot 7 (onboard)	LOM, low profile
Slot 8 (onboard)	PCIe 3.0 x8, low profile
Slot 9 (onboard)	PCIe 3.0 x8, low profile
Slot 10 (onboard)	PCIe 3.0 x8, low profile
Slot 11 (onboard)	PCIe 3.0 x16, low profile

## System unique options for ThinkSystem SR850

7B27A03953	ThinkSystem SR850/SR860 Processor and Memory Expansion Tray
7C57A03999	ThinkSystem SR850/SR860 2.5" Anybay 8-Bay BP Kit
7C57A03998	ThinkSystem SR850/SR860 2.5" SATA/SAS 8-Bay BP Kit
7X97A03954	ThinkSystem SR850 Front VGA Connector Upgrade Kit
7C57A03950	ThinkSystem SR850/SR860 x8/x8/x8 PCIe FH Riser Kit
7C57A03951	ThinkSystem SR850/SR860 x8/x8/x8ML2 PCIe FH Riser Kit
7C57A03952	ThinkSystem SR850/SR860 x8/x16ML2 PCIe FH Riser Kit

Model	Region	Processor	Memory	Storage Controller	Disk Bays	Disks	M.2 Drives	Networking (LOM/ML2/PCIe)	Available PCIe Slots	Front VGA	Front Panel	Front USB	Security	System Management	Power Supply	Base Warranty	Ann Date (mm/yy)
7X19A003AU	ANZ	2xXeon Gold 5115 10C/2.4GHz/13.75MB/85W/DDR4-2400	2x8GB RDIMM DDR4-2666	1x530-8i	8x2.5" SATA/SAS HS	Open	None	4xGbE RJ-45 LOM	2xLP x16/4xLP x8	None	Basic	USB 2.0	TPM 1.2	XClarity Advanced	1x750W Platinum	3-year	07/17
7X19A009AU	ANZ	2xXeon Gold 5115 10C/2.4GHz/13.75MB/85W/DDR4-2400	2x16GB RDIMM DDR4-2666	1x930-8i 2GB flash	8x2.5" SATA/SAS HS	Open	None	4xGbE RJ-45 LOM	2xLP x16/4xLP x8	None	Basic	USB 2.0	TPM 1.2	XClarity Advanced	1x750W Platinum	3-year	07/17
7X19A00DAU	ANZ	2xXeon Gold 6134 8C/3.2GHz/24.75MB/130W/DDR4-2666	2x16GB RDIMM DDR4-2666	1x930-8i 2GB flash	8x2.5" SATA/SAS HS	Open	None	4xGbE RJ-45 LOM	2xLP x16/4xLP x8	None	Pull-out LCD	USB 3.0	TPM 1.2	XClarity Advanced	1x1100W Platinum	3-year	07/17
7X19A00MAU	ANZ	2xXeon Platinum 8176 28C/2.1GHz/38.5MB/165W/DDR4-2666	2x16GB RDIMM DDR4-2666	1x930-8i 2GB flash	8x2.5" SATA/SAS HS	Open	None	4xGbE RJ-45 LOM	2xLP x16/4xLP x8	None	Pull-out LCD	USB 3.0	TPM 1.2	XClarity Advanced	1x1600W Platinum	3-year	07/17
7X19A00NAU	ANZ	2xXeon Gold 6142 16C/2.6GHz/22MB/150W/DDR4-2666	2x16GB RDIMM DDR4-2666	1x930-8i 2GB flash	8x2.5" SATA/SAS HS	Open	None	4xGbE RJ-45 LOM	2xLP x16/4xLP x8	None	Pull-out LCD	USB 3.0	TPM 1.2	XClarity Advanced	1x1100W Platinum	3-year	07/17
7X19A00PAU	ANZ	2xXeon Platinum 8170 26C/2.1GHz/35.75MB/165W/DDR4-2666	2x16GB RDIMM DDR4-2666	1x930-8i 2GB flash	8x2.5" SATA/SAS HS	Open	None	4xGbE RJ-45 LOM	2xLP x16/4xLP x8	None	Pull-out LCD	USB 3.0	TPM 1.2	XClarity Advanced	1x1600W Platinum	3-year	07/17
7X19A010AU	ANZ	2xXeon Gold 6136 12C/3.0GHz/24.75MB/150W/DDR4-2666	2x16GB RDIMM DDR4-2666	1x930-8i 2GB flash	8x2.5" SATA/SAS HS	Open	None	4xGbE RJ-45 LOM	2xLP x16/4xLP x8	None	Pull-out LCD	USB 3.0	TPM 1.2	XClarity Advanced	1x1100W Platinum	3-year	07/17
7X19A01AAU	ANZ	2xXeon Platinum 8153 16C/2.0GHz/22MB/125W/DDR4-2666	2x16GB RDIMM DDR4-2666	1x930-8i 2GB flash	8x2.5" SATA/SAS HS	Open	None	4xGbE RJ-45 LOM	2xLP x16/4xLP x8	None	Pull-out LCD	USB 3.0	TPM 1.2	XClarity Advanced	1x1100W Platinum	3-year	07/17
7X19A01DAU	ANZ	2xXeon Platinum 8160 24C/2.1GHz/33MB/150W/DDR4-2666	2x16GB RDIMM DDR4-2666	1x930-8i 2GB flash	8x2.5" SATA/SAS HS	Open	None	4xGbE RJ-45 LOM	2xLP x16/4xLP x8	None	Pull-out LCD	USB 3.0	TPM 1.2	XClarity Advanced	1x1100W Platinum	3-year	07/17
7X19A01GAU	ANZ	2xXeon Gold 5120 14C/2.2GHz/19.25MB/105W/DDR4-2400	2x16GB RDIMM DDR4-2666	1x930-8i 2GB flash	8x2.5" SATA/SAS HS	Open	None	4xGbE RJ-45 LOM	2xLP x16/4xLP x8	None	Pull-out LCD	USB 3.0	TPM 1.2	XClarity Advanced	1x750W Platinum	3-year	07/17
7X19A01MAU	ANZ	2xXeon Gold 6140 18C/2.3GHz/24.75MB/140W/DDR4-2666	2x16GB RDIMM DDR4-2666	1x930-8i 2GB flash	8x2.5" SATA/SAS HS	Open	None	4xGbE RJ-45 LOM	2xLP x16/4xLP x8	None	Pull-out LCD	USB 3.0	TPM 1.2	XClarity Advanced	1x1100W Platinum	3-year	07/17
7X19A01VAU	ANZ	2xXeon Gold 6138 20C/2.0GHz/27.5MB/125W/DDR4-2666	2x16GB RDIMM DDR4-2666	1x930-8i 2GB flash	8x2.5" SATA/SAS HS	Open	None	4xGbE RJ-45 LOM	2xLP x16/4xLP x8	None	Pull-out LCD	USB 3.0	TPM 1.2	XClarity Advanced	1x1100W Platinum	3-year	07/17
7X19A01ZAU	ANZ	2xXeon Platinum 8164 26C/2.0GHz/35.75MB/150W/DDR4-2666	2x16GB RDIMM DDR4-2666	1x930-8i 2GB flash	8x2.5" SATA/SAS HS	Open	None	4xGbE RJ-45 LOM	2xLP x16/4xLP x8	None	Pull-out LCD	USB 3.0	TPM 1.2	XClarity Advanced	1x1100W Platinum	3-year	07/17
7X19A025AU	ANZ	2xXeon Gold 5118 12C/2.3GHz/16.5MB/105W/DDR4-2400	2x16GB RDIMM DDR4-2666	1x530-8i	8x2.5" SATA/SAS HS	Open	None	4xGbE RJ-45 LOM	2xLP x16/4xLP x8	None	Basic	USB 2.0	TPM 1.2	XClarity Advanced	1x750W Platinum	3-year	07/17
7X19A029AU	ANZ	2xXeon Gold 5118 12C/2.3GHz/16.5MB/105W/DDR4-2400	2x16GB RDIMM DDR4-2666	1x930-8i 2GB flash	8x2.5" SATA/SAS HS	Open	None	4xGbE RJ-45 LOM	2xLP x16/4xLP x8	None	Basic	USB 2.0	TPM 1.2	XClarity Advanced	1x750W Platinum	3-year	07/17

Model	Region	Processor	Memory	Storage Controller	Disk Bays	Disks	M.2 Drives	Networking (LOM/ML2/PCIe)	Available PCIe Slots	Front VGA	Front Panel	Front USB	Security	System Management	Power Supply	Base Warranty	Ann Date (mm/yy)	
7X19A02CAU	ANZ	2xXeon Gold 6152 22C/2.1GHz/30.25MB/140W/DDR4-2666	2x16GB RDIMM DDR4-2666	1x930-8i 2GB flash	8x2.5"	SATA/SAS HS	Open	None	4xGbE RJ-45 LOM	2xLP x16/4xLP x8	None	Pull-out LCD	USB 3.0	TPM 1.2	XClarity Advanced	1x1100W Platinum	3-year	07/17



ThinkSystem SR850 - Non TopSeller - ASEAN

Product Specifications Reference (PSREF)

Model	Region	Processor	Memory	Storage Controller	Disk Bays	Disks	M.2 Drives	Networking (LOM/ML2/PCIe)	Available PCIe Slots	Front VGA	Front Panel	Front USB	Security	System Management	Power Supply	Base Warranty	Ann Date (mm/yy)
7X19A02BSG	ASEAN	2xXeon Gold 6126 12C/2.6GHz/19.25MB/125W/DDR4-2666	2x16GB RDIMM DDR4-2666	1x530-8i	8x2.5" SATA/SAS HS	Open	None	4x10GbE RJ-45 LOM	2xLP x16/4xLP x8/3xFHHL x8	Front VGA	Pull-out LCD	USB 3.0	TPM 1.2	XClarity Advanced	1x1100W Platinum	3-year	07/17
7X19A01JSG	ASEAN	2xXeon Gold 6148 20C/2.4GHz/27.5MB/150W/DDR4-2666	2x32GB RDIMM DDR4-2666	1x530-8i	8x2.5" SATA/SAS HS	Open	None	4x10GbE RJ-45 LOM	2xLP x16/4xLP x8/3xFHHL x8	Front VGA	Pull-out LCD	USB 3.0	TPM 1.2	XClarity Advanced	1x1600W Platinum	3-year	07/17
7X19A01BSG	ASEAN	2xXeon Gold 6152 22C/2.1GHz/30.25MB/140W/DDR4-2666	2x32GB RDIMM DDR4-2666	1x530-8i	8x2.5" SATA/SAS HS	Open	None	4x10GbE RJ-45 LOM	2xLP x16/4xLP x8/3xFHHL x8	Front VGA	Pull-out LCD	USB 3.0	TPM 1.2	XClarity Advanced	1x1600W Platinum	3-year	07/17
7X19A017SG	ASEAN	2xXeon Gold 6134 8C/3.2GHz/24.75MB/130W/DDR4-2666	2x16GB RDIMM DDR4-2666	1x530-8i	8x2.5" SATA/SAS HS	Open	None	4x10GbE RJ-45 LOM	2xLP x16/4xLP x8/3xFHHL x8	Front VGA	Pull-out LCD	USB 3.0	TPM 1.2	XClarity Advanced	1x1100W Platinum	3-year	07/17
7X19A00QSG	ASEAN	2xXeon Gold 5118 12C/2.3GHz/16.5MB/105W/DDR4-2400	2x16GB RDIMM DDR4-2666	1x530-8i	8x2.5" SATA/SAS HS	Open	None	4x10GbE RJ-45 LOM	2xLP x16/4xLP x8/3xFHHL x8	Front VGA	Pull-out LCD	USB 3.0	TPM 1.2	XClarity Advanced	1x1100W Platinum	3-year	07/17
7X19A00VSG	ASEAN	2xXeon Gold 6140 18C/2.3GHz/24.75MB/140W/DDR4-2666	2x32GB RDIMM DDR4-2666	1x530-8i	8x2.5" SATA/SAS HS	Open	None	4x10GbE RJ-45 LOM	2xLP x16/4xLP x8/3xFHHL x8	Front VGA	Pull-out LCD	USB 3.0	TPM 1.2	XClarity Advanced	1x1600W Platinum	3-year	07/17
7X19A00XSG	ASEAN	2xXeon Gold 6130 16C/2.1GHz/22MB/125W/DDR4-2666	2x32GB RDIMM DDR4-2666	1x530-8i	8x2.5" SATA/SAS HS	Open	None	4x10GbE RJ-45 LOM	2xLP x16/4xLP x8/3xFHHL x8	Front VGA	Pull-out LCD	USB 3.0	TPM 1.2	XClarity Advanced	1x1100W Platinum	3-year	07/17
7X19A012SG	ASEAN	2xXeon Gold 5120 14C/2.2GHz/19.25MB/105W/DDR4-2400	2x16GB RDIMM DDR4-2666	1x530-8i	8x2.5" SATA/SAS HS	Open	None	4x10GbE RJ-45 LOM	2xLP x16/4xLP x8/3xFHHL x8	Front VGA	Pull-out LCD	USB 3.0	TPM 1.2	XClarity Advanced	1x1100W Platinum	3-year	07/17
7X19A00GSG	ASEAN	2xXeon Gold 5115 10C/2.4GHz/13.75MB/85W/DDR4-2400	2x16GB RDIMM DDR4-2666	1x530-8i	8x2.5" SATA/SAS HS	Open	None	4x10GbE RJ-45 LOM	2xLP x16/4xLP x8/3xFHHL x8	Front VGA	Pull-out LCD	USB 3.0	TPM 1.2	XClarity Advanced	1x1100W Platinum	3-year	07/17

Model	Region	Processor	Memory	Storage Controller	Disk Bays	Disks	M.2 Drives	Networking (LOM/ML2/PCle)	Available PCIe Slots	Front VGA	Front Panel	Front USB	Security	System Management	Power Supply	Base Warranty	Ann Date (mm/yy)
7X19A02GEA	EMEA	4xXeon Gold 5115 10C/2.4GHz/13.75MB/85W/DDR4-2400	4x32GB RDIMM DDR4-2666	1x930-8i 2GB flash	8x2.5" HS (4 SATA/SAS, 4 AnyBay)	Open	None	None	2xLP x16/4xLP x8/3xFHHL x8	Front VGA	Pull-out LCD	USB 3.0	TPM 1.2	XClarity Advanced	2x1100W Platinum	3-year	07/17
7X19A02HEA	EMEA	4xXeon Gold 5118 12C/2.3GHz/16.5MB/105W/DDR4-2400	4x32GB RDIMM DDR4-2666	1x930-8i 2GB flash	8x2.5" HS (4 SATA/SAS, 4 AnyBay)	Open	None	None	2xLP x16/4xLP x8/3xFHHL x8	Front VGA	Pull-out LCD	USB 3.0	TPM 1.2	XClarity Advanced	2x1100W Platinum	3-year	07/17
7X19A02JEA	EMEA	4xXeon Gold 5120 14C/2.2GHz/19.25MB/105W/DDR4-2400	4x32GB RDIMM DDR4-2666	1x930-8i 2GB flash	8x2.5" HS (4 SATA/SAS, 4 AnyBay)	Open	None	None	2xLP x16/4xLP x8/3xFHHL x8	Front VGA	Pull-out LCD	USB 3.0	TPM 1.2	XClarity Advanced	2x1100W Platinum	3-year	07/17
7X19A02KEA	EMEA	4xXeon Gold 6126 12C/2.6GHz/19.25MB/125W/DDR4-2666	4x32GB RDIMM DDR4-2666	1x930-8i 2GB flash	8x2.5" HS (4 SATA/SAS, 4 AnyBay)	Open	None	None	2xLP x16/4xLP x8/3xFHHL x8	Front VGA	Pull-out LCD	USB 3.0	TPM 1.2	XClarity Advanced	2x1100W Platinum	3-year	07/17
7X19A02LEA	EMEA	4xXeon Gold 6130 16C/2.1GHz/22MB/125W/DDR4-2666	4x32GB RDIMM DDR4-2666	1x930-8i 2GB flash	8x2.5" HS (4 SATA/SAS, 4 AnyBay)	Open	None	None	2xLP x16/4xLP x8/3xFHHL x8	Front VGA	Pull-out LCD	USB 3.0	TPM 1.2	XClarity Advanced	2x1100W Platinum	3-year	07/17
7X19A02MEA	EMEA	4xXeon Gold 6138 20C/2.0GHz/27.5MB/125W/DDR4-2666	4x32GB RDIMM DDR4-2666	1x930-8i 2GB flash	8x2.5" HS (4 SATA/SAS, 4 AnyBay)	Open	None	None	2xLP x16/4xLP x8/3xFHHL x8	Front VGA	Pull-out LCD	USB 3.0	TPM 1.2	XClarity Advanced	2x1100W Platinum	3-year	07/17
7X19A02NEA	EMEA	4xXeon Gold 6148 20C/2.4GHz/27.5MB/150W/DDR4-2666	4x32GB RDIMM DDR4-2666	1x930-8i 2GB flash	8x2.5" HS (4 SATA/SAS, 4 AnyBay)	Open	None	None	2xLP x16/4xLP x8/3xFHHL x8	Front VGA	Pull-out LCD	USB 3.0	TPM 1.2	XClarity Advanced	2x1600W Platinum	3-year	07/17
7X19A02PEA	EMEA	4xXeon Gold 6150 18C/2.7GHz/24.75MB/165W/DDR4-2666	4x32GB RDIMM DDR4-2666	1x930-8i 2GB flash	8x2.5" HS (4 SATA/SAS, 4 AnyBay)	Open	None	None	2xLP x16/4xLP x8/3xFHHL x8	Front VGA	Pull-out LCD	USB 3.0	TPM 1.2	XClarity Advanced	2x1600W Platinum	3-year	07/17
7X19A02QEA	EMEA	4xXeon Gold 6152 22C/2.1GHz/30.25MB/140W/DDR4-2666	4x32GB RDIMM DDR4-2666	1x930-8i 2GB flash	8x2.5" HS (4 SATA/SAS, 4 AnyBay)	Open	None	None	2xLP x16/4xLP x8/3xFHHL x8	Front VGA	Pull-out LCD	USB 3.0	TPM 1.2	XClarity Advanced	2x1600W Platinum	3-year	07/17
7X19A02REA	EMEA	4xXeon Platinum 8160 24C/2.1GHz/33MB/150W/DDR4-2666	4x32GB RDIMM DDR4-2666	1x930-8i 2GB flash	8x2.5" HS (4 SATA/SAS, 4 AnyBay)	Open	None	None	2xLP x16/4xLP x8/3xFHHL x8	Front VGA	Pull-out LCD	USB 3.0	TPM 1.2	XClarity Advanced	2x1600W Platinum	3-year	07/17
7X19A02SEA	EMEA	4xXeon Platinum 8164 26C/2.0GHz/35.75MB/150W/DDR4-2666	4x32GB RDIMM DDR4-2666	1x930-8i 2GB flash	8x2.5" HS (4 SATA/SAS, 4 AnyBay)	Open	None	None	2xLP x16/4xLP x8/3xFHHL x8	Front VGA	Pull-out LCD	USB 3.0	TPM 1.2	XClarity Advanced	2x1600W Platinum	3-year	07/17
7X19A02TEA	EMEA	4xXeon Platinum 8170 26C/2.1GHz/35.75MB/165W/DDR4-2666	4x32GB RDIMM DDR4-2666	1x930-8i 2GB flash	8x2.5" HS (4 SATA/SAS, 4 AnyBay)	Open	None	None	2xLP x16/4xLP x8/3xFHHL x8	Front VGA	Pull-out LCD	USB 3.0	TPM 1.2	XClarity Advanced	2x1600W Platinum	3-year	07/17
7X19A02UEA	EMEA	4xXeon Platinum 8176 28C/2.1GHz/38.5MB/165W/DDR4-2666	4x32GB RDIMM DDR4-2666	1x930-8i 2GB flash	8x2.5" HS (4 SATA/SAS, 4 AnyBay)	Open	None	None	2xLP x16/4xLP x8/3xFHHL x8	Front VGA	Pull-out LCD	USB 3.0	TPM 1.2	XClarity Advanced	2x1600W Platinum	3-year	07/17

Model	Region	Processor	Memory	Storage Controller	Disk Bays	Disks	M.2 Drives	Networking (LOM/ML2/PCIe)	Available PCIe Slots	Front VGA	Front Panel	Front USB	Security	System Management	Power Supply	Base Warranty	Ann Date (mm/yy)
7X19A02DCN	HTK	2xXeon Gold 6134 8C/3.2GHz/24.75MB/130W/DDR4-2666	2x16GB RDIMM DDR4-2666	1x930-16i 4GB flash	16x2.5" SATA/SAS HS	Open	None	4xGbE RJ-45 LOM	2xLP x16/4xLP x8/3xFHHL x8	None	Basic	USB 3.0	TPM 1.2	XClarity Advanced	1x750W Platinum	3-year	07/17
7X19A00ECN	HTK	2xXeon Platinum 8176 28C/2.1GHz/38.5MB/165W/DDR4-2666	2x16GB RDIMM DDR4-2666	1x930-16i 4GB flash	16x2.5" SATA/SAS HS	Open	None	4xGbE RJ-45 LOM	2xLP x16/4xLP x8/3xFHHL x8	None	Basic	USB 3.0	TPM 1.2	XClarity Advanced	1x750W Platinum	3-year	07/17
7X19A00FCN	HTK	2xXeon Platinum 8170 26C/2.1GHz/35.75MB/165W/DDR4-2666	2x16GB RDIMM DDR4-2666	1x930-16i 4GB flash	16x2.5" SATA/SAS HS	Open	None	4xGbE RJ-45 LOM	2xLP x16/4xLP x8/3xFHHL x8	None	Basic	USB 3.0	TPM 1.2	XClarity Advanced	1x750W Platinum	3-year	07/17
7X19A00BCN	HTK	2xXeon Gold 6152 22C/2.1GHz/30.25MB/140W/DDR4-2666	2x16GB RDIMM DDR4-2666	1x930-16i 4GB flash	16x2.5" SATA/SAS HS	Open	None	4xGbE RJ-45 LOM	2xLP x16/4xLP x8/3xFHHL x8	None	Basic	USB 3.0	TPM 1.2	XClarity Advanced	1x750W Platinum	3-year	07/17
7X19A00CCN	HTK	2xXeon Platinum 8164 26C/2.0GHz/35.75MB/150W/DDR4-2666	2x16GB RDIMM DDR4-2666	1x930-16i 4GB flash	16x2.5" SATA/SAS HS	Open	None	4xGbE RJ-45 LOM	2xLP x16/4xLP x8/3xFHHL x8	None	Basic	USB 3.0	TPM 1.2	XClarity Advanced	1x750W Platinum	3-year	07/17
7X19A007CN	HTK	2xXeon Platinum 8153 16C/2.0GHz/22MB/125W/DDR4-2666	2x16GB RDIMM DDR4-2666	1x930-16i 4GB flash	16x2.5" SATA/SAS HS	Open	None	4xGbE RJ-45 LOM	2xLP x16/4xLP x8/3xFHHL x8	None	Basic	USB 3.0	TPM 1.2	XClarity Advanced	1x750W Platinum	3-year	07/17
7X19A004CN	HTK	2xXeon Platinum 8160 24C/2.1GHz/33MB/150W/DDR4-2666	2x16GB RDIMM DDR4-2666	1x930-16i 4GB flash	16x2.5" SATA/SAS HS	Open	None	4xGbE RJ-45 LOM	2xLP x16/4xLP x8/3xFHHL x8	None	Basic	USB 3.0	TPM 1.2	XClarity Advanced	1x750W Platinum	3-year	07/17
7X19A00ZCN	HTK	2xXeon Gold 6142 16C/2.6GHz/22MB/150W/DDR4-2666	2x16GB RDIMM DDR4-2666	1x930-16i 4GB flash	16x2.5" SATA/SAS HS	Open	None	4xGbE RJ-45 LOM	2xLP x16/4xLP x8/3xFHHL x8	None	Basic	USB 3.0	TPM 1.2	XClarity Advanced	1x750W Platinum	3-year	07/17
7X19A00RCN	HTK	2xXeon Gold 6140 18C/2.3GHz/24.75MB/140W/DDR4-2666	2x16GB RDIMM DDR4-2666	1x930-16i 4GB flash	16x2.5" SATA/SAS HS	Open	None	4xGbE RJ-45 LOM	2xLP x16/4xLP x8/3xFHHL x8	None	Basic	USB 3.0	TPM 1.2	XClarity Advanced	1x750W Platinum	3-year	07/17
7X19A011CN	HTK	2xXeon Gold 6150 18C/2.7GHz/24.75MB/165W/DDR4-2666	2x16GB RDIMM DDR4-2666	1x930-16i 4GB flash	16x2.5" SATA/SAS HS	Open	None	4xGbE RJ-45 LOM	2xLP x16/4xLP x8/3xFHHL x8	None	Basic	USB 3.0	TPM 1.2	XClarity Advanced	1x750W Platinum	3-year	07/17
7X19A01PCN	HTK	2xXeon Gold 5122 4C/3.6GHz/16.5MB/105W/DDR4-2400	2x16GB RDIMM DDR4-2666	1x930-16i 4GB flash	16x2.5" SATA/SAS HS	Open	None	4xGbE RJ-45 LOM	2xLP x16/4xLP x8/3xFHHL x8	None	Basic	USB 3.0	TPM 1.2	XClarity Advanced	1x750W Platinum	3-year	07/17
7X19A02ACN	HTK	2xXeon Gold 6136 12C/3.0GHz/24.75MB/150W/DDR4-2666	2x16GB RDIMM DDR4-2666	1x930-16i 4GB flash	16x2.5" SATA/SAS HS	Open	None	4xGbE RJ-45 LOM	2xLP x16/4xLP x8/3xFHHL x8	None	Basic	USB 3.0	TPM 1.2	XClarity Advanced	1x750W Platinum	3-year	07/17
7X19A024CN	HTK	2xXeon Platinum 8156 4C/3.6GHz/16.5MB/105W/DDR4-2666	2x16GB RDIMM DDR4-2666	1x930-16i 4GB flash	16x2.5" SATA/SAS HS	Open	None	4xGbE RJ-45 LOM	2xLP x16/4xLP x8/3xFHHL x8	None	Basic	USB 3.0	TPM 1.2	XClarity Advanced	1x750W Platinum	3-year	07/17
7X19A026CN	HTK	2xXeon Platinum 8158 12C/3.0GHz/24.75MB/150W/DDR4-2666	2x16GB RDIMM DDR4-2666	1x930-16i 4GB flash	16x2.5" SATA/SAS HS	Open	None	4xGbE RJ-45 LOM	2xLP x16/4xLP x8/3xFHHL x8	None	Basic	USB 3.0	TPM 1.2	XClarity Advanced	1x750W Platinum	3-year	07/17
7X19A027CN	HTK	2xXeon Gold 5120T 14C/2.2GHz/19.25MB/105W/DDR4-2400	2x16GB RDIMM DDR4-2666	1x930-16i 4GB flash	16x2.5" SATA/SAS HS	Open	None	4xGbE RJ-45 LOM	2xLP x16/4xLP x8/3xFHHL x8	None	Basic	USB 3.0	TPM 1.2	XClarity Advanced	1x750W Platinum	3-year	07/17

Model	Region	Processor	Memory	Storage Controller	Disk Bays	Disks	M.2 Drives	Networking (LOM/ML2/PCIe)	Available PCIe Slots	Front VGA	Front Panel	Front USB	Security	System Management	Power Supply	Base Warranty	Ann Date (mm/yy)
7X19A021CN	HTK	2xXeon Gold 5115 10C/2.4GHz/13.75MB/85W/DDR4-2400	2x16GB RDIMM DDR4-2666	2x930-8i 2GB flash	16x2.5" SATA/SAS HS	Open	None	4xGbE RJ-45 LOM	2xLP x16/4xLP x8	None	Basic	USB 2.0	TPM 1.2	XClarity Advanced	1x750W Platinum	3-year	07/17
7X19A022CN	HTK	2xXeon Gold 6126 12C/2.6GHz/19.25MB/125W/DDR4-2666	2x16GB RDIMM DDR4-2666	1x930-16i 4GB flash	16x2.5" SATA/SAS HS	Open	None	4xGbE RJ-45 LOM	2xLP x16/4xLP x8/3xFHHL x8	None	Basic	USB 3.0	TPM 1.2	XClarity Advanced	1x750W Platinum	3-year	07/17
7X19A01WCN	HTK	2xXeon Gold 6130 16C/2.1GHz/22MB/125W/DDR4-2666	2x16GB RDIMM DDR4-2666	1x930-16i 4GB flash	16x2.5" SATA/SAS HS	Open	None	4xGbE RJ-45 LOM	2xLP x16/4xLP x8/3xFHHL x8	None	Basic	USB 3.0	TPM 1.2	XClarity Advanced	1x750W Platinum	3-year	07/17
7X19A01RCN	HTK	2xXeon Gold 5120 14C/2.2GHz/19.25MB/105W/DDR4-2400	2x16GB RDIMM DDR4-2666	1x930-16i 4GB flash	16x2.5" SATA/SAS HS	Open	None	4xGbE RJ-45 LOM	2xLP x16/4xLP x8/3xFHHL x8	None	Basic	USB 3.0	TPM 1.2	XClarity Advanced	1x750W Platinum	3-year	07/17
7X19A01TCN	HTK	2xXeon Gold 5118 12C/2.3GHz/16.5MB/105W/DDR4-2400	2x16GB RDIMM DDR4-2666	1x930-16i 4GB flash	16x2.5" SATA/SAS HS	Open	None	4xGbE RJ-45 LOM	2xLP x16/4xLP x8/3xFHHL x8	None	Basic	USB 3.0	TPM 1.2	XClarity Advanced	1x750W Platinum	3-year	07/17

Model	Region	Processor	Memory	Storage Controller	Disk Bays	Disks	M.2 Drives	Networking (LOM/ML2/PCIe)	Available PCIe Slots	Front VGA	Front Panel	Front USB	Security	System Management	Power Supply	Base Warranty	Ann Date (mm/yy)
7X19A023SG	INDIA	2xXeon Gold 5115 10C/2.4GHz/13.75MB/85W/DDR4-2400	2x8GB RDIMM DDR4-2666	1x530-8i	8x2.5" SATA/SAS HS	Open	None	4xGbE RJ-45 LOM	2xLP x16/4xLP x8	None	Basic	USB 2.0	TPM 1.2	XClarity Advanced	1x750W Platinum	3-year	07/17
7X19A020SG	INDIA	2xXeon Gold 5120 14C/2.2GHz/19.25MB/105W/DDR4-2400	2x16GB RDIMM DDR4-2666	1x930-8i 2GB flash	8x2.5" SATA/SAS HS	Open	None	4xGbE RJ-45 LOM	2xLP x16/4xLP x8	Front VGA	Basic	USB 3.0	TPM 1.2	XClarity Advanced	1x750W Platinum	3-year	07/17
7X19A028SG	INDIA	2xXeon Gold 6138 20C/2.0GHz/27.5MB/125W/DDR4-2666	2x16GB RDIMM DDR4-2666	1x930-8i 2GB flash	8x2.5" SATA/SAS HS	Open	None	4xGbE RJ-45 LOM	2xLP x16/4xLP x8	None	Pull-out LCD	USB 3.0	TPM 1.2	XClarity Advanced	1x1100W Platinum	3-year	07/17
7X19A016SG	INDIA	2xXeon Gold 5118 12C/2.3GHz/16.5MB/105W/DDR4-2400	2x16GB RDIMM DDR4-2666	1x530-8i	8x2.5" SATA/SAS HS	Open	None	4xGbE RJ-45 LOM	2xLP x16/4xLP x8	None	Basic	USB 2.0	TPM 1.2	XClarity Advanced	1x750W Platinum	3-year	07/17
7X19A01QSG	INDIA	2xXeon Gold 6134 8C/3.2GHz/24.75MB/130W/DDR4-2666	2x16GB RDIMM DDR4-2666	1x930-8i 2GB flash	8x2.5" SATA/SAS HS	Open	None	4xGbE RJ-45 LOM	2xLP x16/4xLP x8	None	Pull-out LCD	USB 3.0	TPM 1.2	XClarity Advanced	1x1100W Platinum	3-year	07/17
7X19A01NSG	INDIA	2xXeon Gold 6136 12C/3.0GHz/24.75MB/150W/DDR4-2666	2x16GB RDIMM DDR4-2666	1x930-8i 2GB flash	8x2.5" SATA/SAS HS	Open	None	4xGbE RJ-45 LOM	2xLP x16/4xLP x8	None	Pull-out LCD	USB 3.0	TPM 1.2	XClarity Advanced	1x1100W Platinum	3-year	07/17
7X19A01KSG	INDIA	2xXeon Gold 5120 14C/2.2GHz/19.25MB/105W/DDR4-2400	2x16GB RDIMM DDR4-2666	1x930-8i 2GB flash	8x2.5" SATA/SAS HS	Open	None	4xGbE RJ-45 LOM	2xLP x16/4xLP x8	None	Pull-out LCD	USB 3.0	TPM 1.2	XClarity Advanced	1x750W Platinum	3-year	07/17
7X19A01HSG	INDIA	2xXeon Gold 6140 18C/2.3GHz/24.75MB/140W/DDR4-2666	2x16GB RDIMM DDR4-2666	1x930-8i 2GB flash	8x2.5" SATA/SAS HS	Open	None	4xGbE RJ-45 LOM	2xLP x16/4xLP x8	None	Pull-out LCD	USB 3.0	TPM 1.2	XClarity Advanced	1x1100W Platinum	3-year	07/17
7X19A01ESG	INDIA	2xXeon Gold 5118 12C/2.3GHz/16.5MB/105W/DDR4-2400	2x16GB RDIMM DDR4-2666	1x930-8i 2GB flash	8x2.5" SATA/SAS HS	Open	None	4xGbE RJ-45 LOM	2xLP x16/4xLP x8	None	Basic	USB 2.0	TPM 1.2	XClarity Advanced	1x750W Platinum	3-year	07/17
7X19A01FSG	INDIA	2xXeon Gold 6142 16C/2.6GHz/22MB/150W/DDR4-2666	2x16GB RDIMM DDR4-2666	1x930-8i 2GB flash	8x2.5" SATA/SAS HS	Open	None	4xGbE RJ-45 LOM	2xLP x16/4xLP x8	None	Pull-out LCD	USB 3.0	TPM 1.2	XClarity Advanced	1x1100W Platinum	3-year	07/17
7X19A002SG	INDIA	2xXeon Platinum 8160 24C/2.1GHz/33MB/150W/DDR4-2666	2x16GB RDIMM DDR4-2666	1x930-8i 2GB flash	8x2.5" SATA/SAS HS	Open	None	4xGbE RJ-45 LOM	2xLP x16/4xLP x8	None	Pull-out LCD	USB 3.0	TPM 1.2	XClarity Advanced	1x1100W Platinum	3-year	07/17
7X19A013SG	INDIA	2xXeon Gold 5115 10C/2.4GHz/13.75MB/85W/DDR4-2400	2x16GB RDIMM DDR4-2666	1x930-8i 2GB flash	8x2.5" SATA/SAS HS	Open	None	4xGbE RJ-45 LOM	2xLP x16/4xLP x8	None	Basic	USB 2.0	TPM 1.2	XClarity Advanced	1x750W Platinum	3-year	07/17
7X19A005SG	INDIA	2xXeon Gold 5118 12C/2.3GHz/16.5MB/105W/DDR4-2400	2x16GB RDIMM DDR4-2666	1x530-8i	8x2.5" SATA/SAS HS	Open	None	4xGbE RJ-45 LOM	2xLP x16/4xLP x8	Front VGA	Basic	USB 3.0	TPM 1.2	XClarity Advanced	1x750W Platinum	3-year	07/17
7X19A006SG	INDIA	2xXeon Platinum 8153 16C/2.0GHz/22MB/125W/DDR4-2666	2x16GB RDIMM DDR4-2666	1x930-8i 2GB flash	8x2.5" SATA/SAS HS	Open	None	4xGbE RJ-45 LOM	2xLP x16/4xLP x8	None	Pull-out LCD	USB 3.0	TPM 1.2	XClarity Advanced	1x1100W Platinum	3-year	07/17
7X19A00ASG	INDIA	2xXeon Gold 6152 22C/2.1GHz/30.25MB/140W/DDR4-2666	2x16GB RDIMM DDR4-2666	1x930-8i 2GB flash	8x2.5" SATA/SAS HS	Open	None	4xGbE RJ-45 LOM	2xLP x16/4xLP x8	None	Pull-out LCD	USB 3.0	TPM 1.2	XClarity Advanced	1x1100W Platinum	3-year	07/17

Model	Region	Processor	Memory	Storage Controller	Disk Bays	Disks	M.2 Drives	Networking (LOM/ML2/PCIe)	Available PCIe Slots	Front VGA	Front Panel	Front USB	Security	System Management	Power Supply	Base Warranty	Ann Date (mm/yy)
7X19A00HSG	INDIA	2xXeon Platinum 8176 28C/2.1GHz/38.5MB/165W/DDR4-2666	2x16GB RDIMM DDR4-2666	1x930-8i 2GB flash	8x2.5" SATA/SAS HS	Open	None	4xGbE RJ-45 LOM	2xLP x16/4xLP x8	None	Pull-out LCD	USB 3.0	TPM 1.2	XClarity Advanced	1x1600W Platinum	3-year	07/17
7X19A00KSG	INDIA	2xXeon Platinum 8170 26C/2.1GHz/35.75MB/165W/DDR4-2666	2x16GB RDIMM DDR4-2666	1x930-8i 2GB flash	8x2.5" SATA/SAS HS	Open	None	4xGbE RJ-45 LOM	2xLP x16/4xLP x8	None	Pull-out LCD	USB 3.0	TPM 1.2	XClarity Advanced	1x1600W Platinum	3-year	07/17
7X19A00LSG	INDIA	2xXeon Platinum 8164 26C/2.0GHz/35.75MB/150W/DDR4-2666	2x16GB RDIMM DDR4-2666	1x930-8i 2GB flash	8x2.5" SATA/SAS HS	Open	None	4xGbE RJ-45 LOM	2xLP x16/4xLP x8	None	Pull-out LCD	USB 3.0	TPM 1.2	XClarity Advanced	1x1100W Platinum	3-year	07/17

# ThinkSystem SR850 - Non TopSeller - JAPAN

Product Specifications Reference (PSREF)

Model	Region	Processor	Memory	Storage Controller	Disk Bays	Disks	M.2 Drives	Networking (LOM/ML2/PCIe)	Available PCIe Slots	Front VGA	Front Panel	Front USB	Security	System Management	Power Supply	Base Warranty	Ann Date (mm/yy)
7X19A01UJP	JAPAN	2xXeon Gold 5115 10C/2.4GHz/13.75MB/85W/DDR4-2400	2x16GB RDIMM DDR4-2666	1x930-8i 2GB flash	8x2.5" SATA/SAS HS	Open	None	4x10GbE RJ-45 LOM	2xLP x16/4xLP x8/3xFHHL x8	Front VGA	Pull-out LCD	USB 2.0	TPM 1.2	XClarity Advanced	1x1100W Platinum	3-year	07/17
7X19A02EJP	JAPAN	2xXeon Platinum 8176 28C/2.1GHz/38.5MB/165W/DDR4-2666	2x16GB RDIMM DDR4-2666	1x930-8i 2GB flash	8x2.5" SATA/SAS HS	Open	None	4x10GbE SFP+ LOM	2xLP x16/4xLP x8	Front VGA	Pull-out LCD	USB 3.0	TPM 1.2	XClarity Enterprise	1x1600W Platinum	3-year	07/17
7X19A02FJP	JAPAN	2xXeon Gold 6150 18C/2.7GHz/24.75MB/165W/DDR4-2666	2x16GB RDIMM DDR4-2666	1x930-8i 2GB flash	8x2.5" SATA/SAS HS	Open	None	4x10GbE SFP+ LOM	2xLP x16/4xLP x8	Front VGA	Pull-out LCD	USB 3.0	TPM 1.2	XClarity Enterprise	1x1600W Platinum	3-year	07/17

ThinkSystem SR850 - Non TopSeller - LA

Product Specifications Reference (PSREF)

Model	Region	Processor	Memory	Storage Controller	Disk Bays	Disks	M.2 Drives	Networking (LOM/ML2/PCIe)	Available PCIe Slots	Front VGA	Front Panel	Front USB	Security	System Management	Power Supply	Base Warranty	Ann Date (mm/yy)
7X19A032LA	LA	2xXeon Platinum 8153 16C/2.0GHz/22MB/125W/DDR4-2666	12x32GB RDIMM DDR4-2666	1x930-8i 2GB flash	8x2.5" SATA/SAS HS	Open	None	None	2xLP x16/4xLP x8/3xFHHL x8	Front VGA	Pull-out LCD	USB 3.0	TPM 1.2	XClarity Enterprise	2x1100W Platinum	3-year	07/17
7X19A033LA	LA	2xXeon Gold 6148 20C/2.4GHz/27.5MB/150W/DDR4-2666	12x16GB RDIMM DDR4-2666	1x930-8i 2GB flash	8x2.5" SATA/SAS HS	Open	None	None	2xLP x16/4xLP x8/3xFHHL x8	Front VGA	Pull-out LCD	USB 3.0	TPM 1.2	XClarity Enterprise	2x1100W Platinum	3-year	07/17
7X19A037LA	LA	2xXeon Gold 6140 18C/2.3GHz/24.75MB/140W/DDR4-2666	12x16GB RDIMM DDR4-2666	1x930-8i 2GB flash	8x2.5" SATA/SAS HS	Open	None	None	2xLP x16/4xLP x8/3xFHHL x8	Front VGA	Pull-out LCD	USB 3.0	TPM 1.2	XClarity Enterprise	2x1100W Platinum	3-year	07/17
7X19A03ALA	LA	2xXeon Platinum 8176 28C/2.1GHz/38.5MB/165W/DDR4-2666	12x32GB RDIMM DDR4-2666	1x930-8i 2GB flash	8x2.5" SATA/SAS HS	Open	None	None	2xLP x16/4xLP x8/3xFHHL x8	Front VGA	Pull-out LCD	USB 3.0	TPM 1.2	XClarity Enterprise	2x1600W Platinum	3-year	07/17
7X19A03BLA	LA	2xXeon Platinum 8170 26C/2.1GHz/35.75MB/165W/DDR4-2666	12x32GB RDIMM DDR4-2666	1x930-8i 2GB flash	8x2.5" SATA/SAS HS	Open	None	None	2xLP x16/4xLP x8/3xFHHL x8	Front VGA	Pull-out LCD	USB 3.0	TPM 1.2	XClarity Enterprise	2x1600W Platinum	3-year	07/17
7X19A03CLA	LA	2xXeon Platinum 8164 26C/2.0GHz/35.75MB/150W/DDR4-2666	12x32GB RDIMM DDR4-2666	1x930-8i 2GB flash	8x2.5" SATA/SAS HS	Open	None	None	2xLP x16/4xLP x8/3xFHHL x8	Front VGA	Pull-out LCD	USB 3.0	TPM 1.2	XClarity Enterprise	2x1600W Platinum	3-year	07/17
7X19A03ELA	LA	2xXeon Platinum 8160 24C/2.1GHz/33MB/150W/DDR4-2666	12x32GB RDIMM DDR4-2666	1x930-8i 2GB flash	8x2.5" SATA/SAS HS	Open	None	None	2xLP x16/4xLP x8/3xFHHL x8	Front VGA	Pull-out LCD	USB 3.0	TPM 1.2	XClarity Enterprise	2x1100W Platinum	3-year	07/17
7X19A03FLA	LA	4xXeon Platinum 8170 26C/2.1GHz/35.75MB/165W/DDR4-2666	16x32GB RDIMM DDR4-2666	2xFC dual- port1x930-16i 4GB flash	16x2.5" HS (12 SATA/SAS, 4 AnyBay)	Open	None	4xGbE RJ-45 LOM/2x 2x10GbE SFP+ PCIe	2xLP x16/4xLP x8/3xFHHL x8	Front VGA	Pull-out LCD	USB 3.0	TPM 1.2	XClarity Advanced	2x1600W Platinum	3-year	07/17
7X19A03GLA	LA	4xXeon Platinum 8176 28C/2.1GHz/38.5MB/165W/DDR4-2666	16x32GB RDIMM DDR4-2666	2xFC dual- port1x930-16i 4GB flash	16x2.5" HS (12 SATA/SAS, 4 AnyBay)	Open	None	4xGbE RJ-45 LOM/2x 2x10GbE SFP+ PCIe	2xLP x16/4xLP x8/3xFHHL x8	Front VGA	Pull-out LCD	USB 3.0	TPM 1.2	XClarity Advanced	2x1600W Platinum	3-year	07/17
7X19A03HLA	LA	4xXeon Platinum 8170 26C/2.1GHz/35.75MB/165W/DDR4-2666	32x16GB RDIMM DDR4-2666	2xFC dual- port1x930-16i 4GB flash	16x2.5" HS (12 SATA/SAS, 4 AnyBay)	Open	None	4xGbE RJ-45 LOM/2x 2x10GbE SFP+ PCIe	2xLP x16/4xLP x8/3xFHHL x8	Front VGA	Pull-out LCD	USB 3.0	TPM 1.2	XClarity Advanced	2x1600W Platinum	3-year	07/17
7X19A03JLA	LA	4xXeon Platinum 8176 28C/2.1GHz/38.5MB/165W/DDR4-2666	32x16GB RDIMM DDR4-2666	2xFC dual- port1x930-16i 4GB flash	16x2.5" HS (12 SATA/SAS, 4 AnyBay)	Open	None	4xGbE RJ-45 LOM/2x 2x10GbE SFP+ PCIe	2xLP x16/4xLP x8/3xFHHL x8	Front VGA	Pull-out LCD	USB 3.0	TPM 1.2	XClarity Advanced	2x1600W Platinum	3-year	07/17



## ThinkSystem SR850 - Non TopSeller - NA

Product Specifications Reference (PSREF)

Model	Region	Processor	Memory	Storage Controller	Disk Bays	Disks	M.2 Drives	Networking (LOM/ML2/PCIe)	Available PCIe Slots	Front VGA	Front Panel	Front USB	Security	System Management	Power Supply	Base Warranty	Ann Date (mm/yy)
7X19A01YNA	NA	4xXeon Platinum 8164 26C/2.0GHz/35.75MB/150W/DDR4-2666	4x32GB RDIMM DDR4-2666	1x930-8i 2GB flash	8x2.5" HS (4 SATA/SAS, 4 AnyBay)	Open	None	None	2xLP x16/4xLP x8/3xFHHL x8	Front VGA	Pull-out LCD	USB 2.0	TPM 1.2	XClarity Advanced	2x1600W Platinum	3-year	07/17
7X19A01CNA	NA	4xXeon Gold 6126 12C/2.6GHz/19.25MB/125W/DDR4-2666	4x32GB RDIMM DDR4-2666	1x930-8i 2GB flash	8x2.5" HS (4 SATA/SAS, 4 AnyBay)	Open	None	None	2xLP x16/4xLP x8/3xFHHL x8	Front VGA	Pull-out LCD	USB 2.0	TPM 1.2	XClarity Advanced	2x1100W Platinum	3-year	07/17
7X19A018NA	NA	4xXeon Gold 5118 12C/2.3GHz/16.5MB/105W/DDR4-2400	4x32GB RDIMM DDR4-2666	1x930-8i 2GB flash	8x2.5" HS (4 SATA/SAS, 4 AnyBay)	Open	None	None	2xLP x16/4xLP x8/3xFHHL x8	Front VGA	Pull-out LCD	USB 2.0	TPM 1.2	XClarity Advanced	2x1100W Platinum	3-year	07/17
7X19A019NA	NA	4xXeon Gold 5120 14C/2.2GHz/19.25MB/105W/DDR4-2400	4x32GB RDIMM DDR4-2666	1x930-8i 2GB flash	8x2.5" HS (4 SATA/SAS, 4 AnyBay)	Open	None	None	2xLP x16/4xLP x8/3xFHHL x8	Front VGA	Pull-out LCD	USB 2.0	TPM 1.2	XClarity Advanced	2x1100W Platinum	3-year	07/17
7X19A01LNA	NA	4xXeon Platinum 8160 24C/2.1GHz/33MB/150W/DDR4-2666	4x32GB RDIMM DDR4-2666	1x930-8i 2GB flash	8x2.5" HS (4 SATA/SAS, 4 AnyBay)	Open	None	None	2xLP x16/4xLP x8/3xFHHL x8	Front VGA	Pull-out LCD	USB 2.0	TPM 1.2	XClarity Advanced	2x1600W Platinum	3-year	07/17
7X19A00JNA	NA	4xXeon Platinum 8170 26C/2.1GHz/35.75MB/165W/DDR4-2666	4x32GB RDIMM DDR4-2666	1x930-8i 2GB flash	8x2.5" HS (4 SATA/SAS, 4 AnyBay)	Open	None	None	2xLP x16/4xLP x8/3xFHHL x8	Front VGA	Pull-out LCD	USB 2.0	TPM 1.2	XClarity Advanced	2x1600W Platinum	3-year	07/17
7X19A008NA	NA	4xXeon Gold 5115 10C/2.4GHz/13.75MB/85W/DDR4-2400	4x32GB RDIMM DDR4-2666	1x930-8i 2GB flash	8x2.5" HS (4 SATA/SAS, 4 AnyBay)	Open	None	None	2xLP x16/4xLP x8/3xFHHL x8	Front VGA	Pull-out LCD	USB 2.0	TPM 1.2	XClarity Advanced	2x1100W Platinum	3-year	07/17
7X19A014NA	NA	4xXeon Gold 6150 18C/2.7GHz/24.75MB/165W/DDR4-2666	4x32GB RDIMM DDR4-2666	1x930-8i 2GB flash	8x2.5" HS (4 SATA/SAS, 4 AnyBay)	Open	None	None	2xLP x16/4xLP x8/3xFHHL x8	Front VGA	Pull-out LCD	USB 2.0	TPM 1.2	XClarity Advanced	2x1600W Platinum	3-year	07/17
7X19A015NA	NA	4xXeon Gold 6152 22C/2.1GHz/30.25MB/140W/DDR4-2666	4x32GB RDIMM DDR4-2666	1x930-8i 2GB flash	8x2.5" HS (4 SATA/SAS, 4 AnyBay)	Open	None	None	2xLP x16/4xLP x8/3xFHHL x8	Front VGA	Pull-out LCD	USB 2.0	TPM 1.2	XClarity Advanced	2x1600W Platinum	3-year	07/17
7X19A00YNA	NA	4xXeon Gold 6148 20C/2.4GHz/27.5MB/150W/DDR4-2666	4x32GB RDIMM DDR4-2666	1x930-8i 2GB flash	8x2.5" HS (4 SATA/SAS, 4 AnyBay)	Open	None	None	2xLP x16/4xLP x8/3xFHHL x8	Front VGA	Pull-out LCD	USB 2.0	TPM 1.2	XClarity Advanced	2x1600W Platinum	3-year	07/17
7X19A00SNA	NA	4xXeon Gold 6130 16C/2.1GHz/22MB/125W/DDR4-2666	4x32GB RDIMM DDR4-2666	1x930-8i 2GB flash	8x2.5" HS (4 SATA/SAS, 4 AnyBay)	Open	None	None	2xLP x16/4xLP x8/3xFHHL x8	Front VGA	Pull-out LCD	USB 2.0	TPM 1.2	XClarity Advanced	2x1100W Platinum	3-year	07/17
7X19A00TNA	NA	4xXeon Platinum 8176 28C/2.1GHz/38.5MB/165W/DDR4-2666	4x32GB RDIMM DDR4-2666	1x930-8i 2GB flash	8x2.5" HS (4 SATA/SAS, 4 AnyBay)	Open	None	None	2xLP x16/4xLP x8/3xFHHL x8	Front VGA	Pull-out LCD	USB 2.0	TPM 1.2	XClarity Advanced	2x1600W Platinum	3-year	07/17
7X19A00UNA	NA	4xXeon Gold 6138 20C/2.0GHz/27.5MB/125W/DDR4-2666	4x32GB RDIMM DDR4-2666	1x930-8i 2GB flash	8x2.5" HS (4 SATA/SAS, 4 AnyBay)	Open	None	None	2xLP x16/4xLP x8/3xFHHL x8	Front VGA	Pull-out LCD	USB 2.0	TPM 1.2	XClarity Advanced	2x1100W Platinum	3-year	07/17

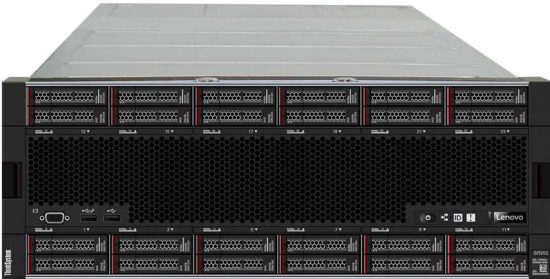

# ThinkSystem SR950 Platform Specifications

Components	Specification																																																																																
Form factor	4U rack																																																																																
Dimensions	Height: 175.8 mm (6.9 in). Width: 483 mm (19.0 in) at EIA Flange. Depth: 853 mm (33.6 in)																																																																																
Weight	Maximum configuration: 129.4 lb (58.7 kg)																																																																																
Processor	Supports up to four Intel Xeon Scalable family processors, Gold or Platinum. Or up to eight Intel Xeon Scalable family processors, Platinum only. Processors and memory are located on system boards installed in compute trays: 2 processors per system board, 2 system boards per compute tray, up to 2 compute tray per system. Up to 28 cores at 2.5GHz, up to 3.6GHz with 4 cores. Up to three UPI (Ultra Path Interconnect) links at maximum 10.4GT/s each																																																																																
Chipset	Intel C624 Platform Controller Hub																																																																																
Memory	Up to 96 DIMM sockets. Each processor supports up to 12 DIMM sockets with 6 channels. DDR4-2666. RDIMMs, LRDIMMs, and 3DS RDIMMs are supported, but memory types cannot be intermixed.																																																																																
Memory capacity	Up to 3TB with 96 x 32GB RDIMMs and eight processors. Or up to 6TB with 96 x 64GB LRDIMMs and eight processors. Or up to 12TB with 96 x 128GB 3DS RDIMMs and eight -M suffix processors. -M suffix processor supports 1.5TB memory per socket, non -M suffix processor supports 768GB memory per socket																																																																																
Memory protection	ECC, memory mirroring, and memory rank sparing.																																																																																
Storage controllers	Up to two dedicated internal RAID slots for most RAID/HBA adapters. Supports the following RAID/HBA adapters:																																																																																
	<table border="1"> <thead> <tr> <th>Feature</th> <th>Interface</th> <th>Drive type</th> <th>RAID levels</th> <th>JBOD</th> <th>Cache</th> <th>Cache protection</th> <th>FastPath</th> <th>Max qty</th> </tr> </thead> <tbody> <tr> <td>530-8i</td> <td>12Gbps SAS</td> <td>SATA/SAS</td> <td>0/1/10/5/50</td> <td>Yes</td> <td>None</td> <td>None</td> <td>Yes</td> <td>2</td> </tr> <tr> <td>730-8i</td> <td>12Gbps SAS</td> <td>SATA/SAS</td> <td>0/1/10/5/50</td> <td>Yes</td> <td>1GB</td> <td>None</td> <td>No</td> <td>2</td> </tr> <tr> <td>930-8i</td> <td>12Gbps SAS</td> <td>SATA/SAS</td> <td>0/1/10/5/50/6/60</td> <td>Yes</td> <td>2GB</td> <td>Flash backup</td> <td>Yes</td> <td>2</td> </tr> <tr> <td>930-16i</td> <td>12Gbps SAS</td> <td>SATA/SAS</td> <td>0/1/10/5/50/6/60</td> <td>Yes</td> <td>4GB</td> <td>Flash backup</td> <td>Yes</td> <td>2</td> </tr> <tr> <td>430-8i</td> <td>12Gbps SAS</td> <td>SATA/SAS</td> <td>-</td> <td>Yes</td> <td>None</td> <td>None</td> <td>-</td> <td>2</td> </tr> <tr> <td>430-16i</td> <td>12Gbps SAS</td> <td>SATA/SAS</td> <td>-</td> <td>Yes</td> <td>None</td> <td>None</td> <td>-</td> <td>2</td> </tr> <tr> <td>930-8e</td> <td>12Gbps SAS</td> <td>SATA/SAS</td> <td>0/1/10/5/50/6/60</td> <td>Yes</td> <td>4GB</td> <td>Flash backup</td> <td>Yes</td> <td>4</td> </tr> <tr> <td>430-8e</td> <td>12Gbps SAS</td> <td>SATA/SAS</td> <td>-</td> <td>Yes</td> <td>None</td> <td>None</td> <td>-</td> <td>14</td> </tr> </tbody> </table> <p>Note: 730-8i is available in China only. 930-8e should be placed in slot 7 firstly. 430-8e should be placed in slot 5 firstly.</p>	Feature	Interface	Drive type	RAID levels	JBOD	Cache	Cache protection	FastPath	Max qty	530-8i	12Gbps SAS	SATA/SAS	0/1/10/5/50	Yes	None	None	Yes	2	730-8i	12Gbps SAS	SATA/SAS	0/1/10/5/50	Yes	1GB	None	No	2	930-8i	12Gbps SAS	SATA/SAS	0/1/10/5/50/6/60	Yes	2GB	Flash backup	Yes	2	930-16i	12Gbps SAS	SATA/SAS	0/1/10/5/50/6/60	Yes	4GB	Flash backup	Yes	2	430-8i	12Gbps SAS	SATA/SAS	-	Yes	None	None	-	2	430-16i	12Gbps SAS	SATA/SAS	-	Yes	None	None	-	2	930-8e	12Gbps SAS	SATA/SAS	0/1/10/5/50/6/60	Yes	4GB	Flash backup	Yes	4	430-8e	12Gbps SAS	SATA/SAS	-	Yes	None	None	-
Feature	Interface	Drive type	RAID levels	JBOD	Cache	Cache protection	FastPath	Max qty																																																																									
530-8i	12Gbps SAS	SATA/SAS	0/1/10/5/50	Yes	None	None	Yes	2																																																																									
730-8i	12Gbps SAS	SATA/SAS	0/1/10/5/50	Yes	1GB	None	No	2																																																																									
930-8i	12Gbps SAS	SATA/SAS	0/1/10/5/50/6/60	Yes	2GB	Flash backup	Yes	2																																																																									
930-16i	12Gbps SAS	SATA/SAS	0/1/10/5/50/6/60	Yes	4GB	Flash backup	Yes	2																																																																									
430-8i	12Gbps SAS	SATA/SAS	-	Yes	None	None	-	2																																																																									
430-16i	12Gbps SAS	SATA/SAS	-	Yes	None	None	-	2																																																																									
930-8e	12Gbps SAS	SATA/SAS	0/1/10/5/50/6/60	Yes	4GB	Flash backup	Yes	4																																																																									
430-8e	12Gbps SAS	SATA/SAS	-	Yes	None	None	-	14																																																																									
Disk drive bays	Up to 12 disk bays with maximum 6 AnyBay, or up to 24 disk bays with maximum 12 AnyBay. Optional one or two internal M.2 SSD for boot, dual M.2 SSD supports mirroring																																																																																
Internal storage	2.5" NVMe SSD, AnyBay	800GB/960GB/1.6TB/1.92TB/3.84TB																																																																															
	2.5" HDD, SAS12Gbps, 7,2K	1TB/2TB																																																																															
	2.5" HDD, SAS12Gbps, 15K	300GB/600GB/900GB																																																																															
	2.5" HDD, SAS12Gbps, 10K	300GB/600GB/900GB/1.2TB/1.8TB																																																																															
	2.5" HDD, SAS12Gbps, 10K, SED	300GB/600GB																																																																															
	2.5" SSD, SATA6Gbps	240GB/480GB																																																																															
	2.5" SSD, SAS12Gbps	400GB/800GB/3.84TB/7.68TB																																																																															
	NVMe SSD, PCIe x4 HHHL adapter	1.6TB/1.92TB/3.2TB/3.84TB																																																																															
M.2 SATA SSD	32GB/128GB																																																																																
Network interfaces	One dedicated management port. One LOM slot for customized LOM with up to four RJ-45 or SFP+ ports, up to 10GbE. Wake-on-LAN and NC-SI are available on Port 0 of LOM. Optional ML2 or PCIe adapters are supported. One standard ML2 slot, one optional ML2 slot via optional riser card																																																																																
Security features	Power-on and admin password. Trusted Platform Module, TCG 1.2 compliant, upgrade to 2.0 via UEFI setting. Optional TCM, China only																																																																																
Operating systems supported	Microsoft Windows Server 2016/2012 R2. Red Hat Enterprise Linux 7.3/6.9. SUSE Linux Enterprise Server 12 SP2/11 SP4. VMware vSphere (ESXi) 6.5/6.0 U3																																																																																
Systems management	XClarity Controller Enterprise. XClarity Administrator. XClarity Energy Manager. XClarity Provisioning Manager. XClarity Essentials. Lenovo Capacity Planner. Light Path Diagnostics with LCD diagnostic pull-out panel																																																																																
GPU support	None																																																																																
Base warranty	MT 7X11: 1-year limited onsite service with 9x5/NBD MT 7X12: 3-year limited onsite service with 9x5/NBD MT 7X13: 3-year limited onsite service with 9x5/NBD, SAP HANA optimized																																																																																
Power supply	Supports one, two or four hot-swap 1100W/1600W 80 PLUS Platinum qualified AC power supplies. Redundant with two or four power supplies (N+N, N = 1 or 2). 1600W Platinum is 200V - 240V, 1100W is 100V - 240V and de-rated to 1050W for operation from 110V input																																																																																

Components	Specification	
Video	Integrated Matrox G200 in XClarity Controller	
Cooling	Up to 12 hot-swap fans. N +1 redundancy. 6 fans per compute tray, 3 fans per storage tray	
Front ports	One XClarity Controller USB connector, one USB 2.0, one VGA	
Rear ports	One VGA, two USB 3.0, one serial, one XClarity Controller network connector	
Environmental specification	Supports ASHRAE A4 with limitations.	
	Temperature - operating	A4: 5°C to 45°C (41°F to 113°F) A3: 5°C to 40°C (41°F to 104°F) A2: 10°C to 35°C (50°F to 95°F)
	Temperature - non operating (no package)	-10°C to 60°C (14°F to 140°F)
	Temperature - non operating (with package)	-40°C to 70°C (-40°F to 158°F)
	Altitude - operating	(Unpressurized): 0-10000ft (0-3048m)
	Humidity - operating, non-condensing	A4: 8%-90%. A3:8%-85%. A2:20%-80%
Humidity - storage (with package), non-condensing	8%-90%	
Models should meet the following requirements to support A3 and A4: • 2.5" NVMe SSD and PCIe NVMe flash adapter not installed (NVMe devices are supported up to 35°C) • Processors with TDP more than or equal to 150-watt not installed		
Environmental certification	Energy Star Server 2.1 certified. More environmental information please see: <a href="http://www.lenovo.com/social_responsibility/us/en/environment/">www.lenovo.com/social_responsibility/us/en/environment/</a>	

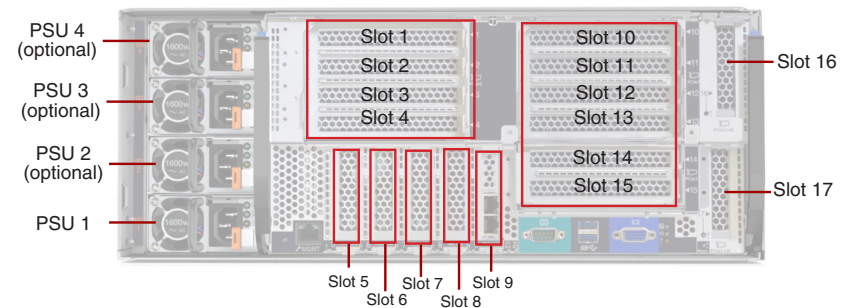

Note: All riser cards, expansion cards, and LOM adapters are optional.

### Expansion slots

Supports five standard expansion slots (slot 5 - 9) and up to 12 optional expansion slots (slot 1 - 4, 10 - 15, 16 - 17) via 3 riser cards. The slots are as follows:

Slot 1-4 (riser card 1)	Supports one of the following for riser card 1: Option 1: PCIe 3.0 x8/x8/x8/x8 (slot 1-4). Full height, half length Option 2: PCIe 3.0 x16/x16 (slot 3 and 4). Full height, half length Option 3: PCIe 3.0 x16/x16/x16/x16 (slot 1-4). Full height, half length
Slot 5 (on main I/O tray)	PCIe 3.0 x16, low profile
Slot 6 (on main I/O tray)	PCIe 3.0 x16, low profile
Slot 7 (on main I/O tray)	PCIe 3.0 x8, low profile
Slot 8 (on main I/O tray)	PCIe 3.0 x16 ML2, low profile
Slot 9 (on main I/O tray)	LOM slot, low profile
Slot 10-15 (riser card 2)	Supports one of the following for riser card 2: Option 1: PCIe 3.0 x8/x8/x8/x8 (slot 10-13). Full height, half length Option 2: PCIe 3.0 x16/x16 (slot 12 and 13). Full height, half length Option 3: PCIe 3.0 x16/x16/x16/x16 ML2 (slot 10-15). Full height, half length
Slot 16-17 (riser card 3)	PCIe 3.0 x8, low profile

For riser cards configuration of each model, please see model configuration table.

Model	Region	Processor	CPU Sockets (std/max)	Memory	Memory Sockets (std/max)	Storage Controller	Disk Bays	Max Disk Bays	Disks	M.2 Drives	Networking (LOM/ML2/PCIe)	Available PCIe Slots	Security	System Management	Power Supply	Base Warranty	Ann Date (mm/yy)
7X12A003AU	ANZ	8xXeon Platinum 8160 24C/2.1GHz/33MB/150W/DDR4-2666	8/8	8x32GB RDIMM DDR4-2666	96/96	2x930-16i 4GB flash	24x2.5" SATA/SAS HS	24	Open	None	None	2xLP x16/3xLP x8/1xLP x16 ML2/9xFHHL x16/1xFHHL x16 ML2	TPM 1.2	XClarity Enterprise	4x1600W Platinum	3-year	07/17
7X12A00BAU	ANZ	2xXeon Gold 6130 16C/2.1GHz/22MB/125W/DDR4-2666	2/4	2x32GB RDIMM DDR4-2666	24/48	1x930-8i 2GB flash	8x2.5" SATA/SAS HS	12	Open	None	None	2xLP x16/1xLP x8/1xLP x16 ML2	TPM 1.2	XClarity Enterprise	2x1100W Platinum	3-year	07/17
7X12A00CAU	ANZ	4xXeon Gold 5120 14C/2.2GHz/19.25MB/105W/DDR4-2400	4/4	4x32GB RDIMM DDR4-2666	48/48	1x930-8i 2GB flash	8x2.5" SATA/SAS HS	12	Open	None	None	2xLP x16/3xLP x8/1xLP x16 ML2/4xFHHL x16	TPM 1.2	XClarity Enterprise	2x1600W Platinum	3-year	07/17
7X12A00EAU	ANZ	8xXeon Platinum 8160 24C/2.1GHz/33MB/150W/DDR4-2666	8/8	8x32GB RDIMM DDR4-2666	96/96	2x930-16i 4GB flash	24x2.5" SATA/SAS HS	24	Open	None	None	2xLP x16/3xLP x8/1xLP x16 ML2/9xFHHL x16/1xFHHL x16 ML2	TPM 1.2	XClarity Enterprise	4x1600W Platinum	3-year	07/17
7X12A00FAU	ANZ	2xXeon Gold 6130 16C/2.1GHz/22MB/125W/DDR4-2666	2/4	2x32GB RDIMM DDR4-2666	24/48	1x930-8i 2GB flash	8x2.5" SATA/SAS HS	12	Open	None	None	2xLP x16/1xLP x8/1xLP x16 ML2	TPM 1.2	XClarity Enterprise	2x1100W Platinum	3-year	07/17
7X12A00HAU	ANZ	4xXeon Platinum 8153 16C/2.0GHz/22MB/125W/DDR4-2666	4/8	4x32GB RDIMM DDR4-2666	48/96	1x930-8i 2GB flash	8x2.5" SATA/SAS HS	12	Open	None	None	2xLP x16/3xLP x8/1xLP x16 ML2/4xFHHL x16	TPM 1.2	XClarity Enterprise	2x1600W Platinum	3-year	07/17
7X12A00LAU	ANZ	4xXeon Platinum 8153 16C/2.0GHz/22MB/125W/DDR4-2666	4/8	4x32GB RDIMM DDR4-2666	48/96	1x930-8i 2GB flash	8x2.5" SATA/SAS HS	12	Open	None	None	2xLP x16/3xLP x8/1xLP x16 ML2/4xFHHL x16	TPM 1.2	XClarity Enterprise	2x1600W Platinum	3-year	07/17
7X12A00NAU	ANZ	8xXeon Platinum 8160 24C/2.1GHz/33MB/150W/DDR4-2666	8/8	8x32GB RDIMM DDR4-2666	96/96	2x930-16i 4GB flash	24x2.5" SATA/SAS HS	24	Open	None	None	2xLP x16/3xLP x8/1xLP x16 ML2/9xFHHL x16/1xFHHL x16 ML2	TPM 1.2	XClarity Enterprise	4x1600W Platinum	3-year	07/17
7X12A00QAU	ANZ	4xXeon Platinum 8153 16C/2.0GHz/22MB/125W/DDR4-2666	4/8	4x32GB RDIMM DDR4-2666	48/96	1x930-8i 2GB flash	8x2.5" SATA/SAS HS	12	Open	None	None	2xLP x16/3xLP x8/1xLP x16 ML2/4xFHHL x16	TPM 1.2	XClarity Enterprise	2x1600W Platinum	3-year	07/17
7X12A00RAU	ANZ	4xXeon Gold 5120 14C/2.2GHz/19.25MB/105W/DDR4-2400	4/4	4x32GB RDIMM DDR4-2666	48/48	1x930-8i 2GB flash	8x2.5" SATA/SAS HS	12	Open	None	None	2xLP x16/3xLP x8/1xLP x16 ML2/4xFHHL x16	TPM 1.2	XClarity Enterprise	2x1600W Platinum	3-year	07/17
7X12A00SAU	ANZ	4xXeon Gold 5120 14C/2.2GHz/19.25MB/105W/DDR4-2400	4/4	4x32GB RDIMM DDR4-2666	48/48	1x930-8i 2GB flash	8x2.5" SATA/SAS HS	12	Open	None	None	2xLP x16/3xLP x8/1xLP x16 ML2/4xFHHL x16	TPM 1.2	XClarity Enterprise	2x1600W Platinum	3-year	07/17
7X12A00UAU	ANZ	2xXeon Gold 6130 16C/2.1GHz/22MB/125W/DDR4-2666	2/4	2x32GB RDIMM DDR4-2666	24/48	1x930-8i 2GB flash	8x2.5" SATA/SAS HS	12	Open	None	None	2xLP x16/1xLP x8/1xLP x16 ML2	TPM 1.2	XClarity Enterprise	2x1100W Platinum	3-year	07/17

ThinkSystem SR950 - Non TopSeller - ASEAN

Product Specifications Reference (PSREF)

Model	Region	Processor	CPU Sockets (std/max)	Memory	Memory Sockets (std/max)	Storage Controller	Disk Bays	Max Disk Bays	Disks	M.2 Drives	Networking (LOM/ML2/PCIe)	Available PCIe Slots	Security	System Management	Power Supply	Base Warranty	Ann Date (mm/yy)
7X12A014SG	ASEAN	2xXeon Platinum 8160 24C/2.1GHz/33MB/150W/DDR4-2666	2/8	4x32GB RDIMM DDR4-2666	24/96	1x930-16i 4GB flash	12x2.5" HS SATA/SAS	12	Open	None	4x10GbE RJ-45 LOM	2xLP x16/1xLP x8/1xLP x16 ML2	TPM 1.2	XClarity Enterprise	2x1600W Platinum	3-year	07/17
7X12A015SG	ASEAN	2xXeon Platinum 8153 16C/2.0GHz/22MB/125W/DDR4-2666	2/8	4x32GB RDIMM DDR4-2666	24/96	1x930-16i 4GB flash	12x2.5" HS SATA/SAS	12	Open	None	4x10GbE RJ-45 LOM	2xLP x16/1xLP x8/1xLP x16 ML2	TPM 1.2	XClarity Enterprise	2x1600W Platinum	3-year	07/17
7X12A016SG	ASEAN	2xXeon Platinum 8158 12C/3.0GHz/24.75MB/150W/DDR4-2666	2/8	4x32GB RDIMM DDR4-2666	24/96	1x930-16i 4GB flash	12x2.5" HS SATA/SAS	12	Open	None	4x10GbE RJ-45 LOM	2xLP x16/1xLP x8/1xLP x16 ML2	TPM 1.2	XClarity Enterprise	2x1600W Platinum	3-year	07/17
7X12A01BSG	ASEAN	2xXeon Platinum 8164 26C/2.0GHz/35.75MB/150W/DDR4-2666	2/8	4x32GB RDIMM DDR4-2666	24/96	1x930-16i 4GB flash	12x2.5" HS SATA/SAS	12	Open	None	4x10GbE RJ-45 LOM	2xLP x16/1xLP x8/1xLP x16 ML2	TPM 1.2	XClarity Enterprise	2x1600W Platinum	3-year	07/17
7X12A01CSG	ASEAN	2xXeon Platinum 8176 28C/2.1GHz/38.5MB/165W/DDR4-2666	2/8	4x32GB RDIMM DDR4-2666	24/96	1x930-16i 4GB flash	12x2.5" HS SATA/SAS	12	Open	None	4x10GbE RJ-45 LOM	2xLP x16/1xLP x8/1xLP x16 ML2	TPM 1.2	XClarity Enterprise	2x1600W Platinum	3-year	07/17

ThinkSystem SR950 - Non TopSeller - Brazil

Product Specifications Reference (PSREF)

Model	Region	Processor	CPU Sockets (std/max)	Memory	Memory Sockets (std/max)	Storage Controller	Disk Bays	Max Disk Bays	Disks	M.2 Drives	Networking (LOM/ML2/PCIe)	Available PCIe Slots	Security	System Management	Power Supply	Base Warranty	Ann Date (mm/yy)
7X12A01TBR	Brazil	2xXeon Gold 6130 16C/2.1GHz/22MB/125W/DDR4-2666	2/4	2x32GB RDIMM DDR4-2666	24/48	1x930-8i 2GB flash	8x2.5" SATA/SAS HS	12	Open	None	None	2xLP x16/1xLP x8/1xLP x16 ML2	TPM 1.2	XClarity Enterprise	2x1100W Platinum	3-year	07/17
7X12A01UBR	Brazil	8xXeon Platinum 8160 24C/2.1GHz/33MB/150W/DDR4-2666	8/8	8x32GB RDIMM DDR4-2666	96/96	2x930-16i 4GB flash	24x2.5" SATA/SAS HS	24	Open	None	None	2xLP x16/3xLP x8/1xLP x16 ML2/9xFHHL x16/1xFHHL x16 ML2	TPM 1.2	XClarity Enterprise	4x1600W Platinum	3-year	07/17
7X12A01VBR	Brazil	4xXeon Platinum 8153 16C/2.0GHz/22MB/125W/DDR4-2666	4/8	4x32GB RDIMM DDR4-2666	48/96	1x930-8i 2GB flash	8x2.5" SATA/SAS HS	12	Open	None	None	2xLP x16/3xLP x8/1xLP x16 ML2/4xFHHL x16	TPM 1.2	XClarity Enterprise	2x1600W Platinum	3-year	07/17
7X12A01WBR	Brazil	4xXeon Gold 5120 14C/2.2GHz/19.25MB/105W/DDR4-2400	4/4	4x32GB RDIMM DDR4-2666	48/48	1x930-8i 2GB flash	8x2.5" SATA/SAS HS	12	Open	None	None	2xLP x16/3xLP x8/1xLP x16 ML2/4xFHHL x16	TPM 1.2	XClarity Enterprise	2x1600W Platinum	3-year	07/17

Model	Region	Processor	CPU Sockets (std/max)	Memory	Memory Sockets (std/max)	Storage Controller	Disk Bays	Max Disk Bays	Disks	M.2 Drives	Networking (LOM/ML2/PCIe)	Available PCIe Slots	Security	System Management	Power Supply	Base Warranty	Ann Date (mm/yy)
7X12A017EA	EMEA	8xXeon Platinum 8160 24C/2.1GHz/33MB/150W/DDR4-2666	8/8	8x32GB RDIMM DDR4-2666	96/96	2x930-16i 4GB flash	24x2.5" HS (12 SATA/SAS, 12 AnyBay)	24	Open	None	None	2xLP x16/3xLP x8/1xLP x16 ML2/9xFHHL x16/1xFHHL x16 ML2	TPM 1.2	XClarity Enterprise	4x1600W Platinum	3-year	07/17
7X12A018EA	EMEA	4xXeon Platinum 8153 16C/2.0GHz/22MB/125W/DDR4-2666	4/8	4x32GB RDIMM DDR4-2666	48/96	1x930-16i 4GB flash	12x2.5" HS (6 SATA/SAS, 6 AnyBay)	12	Open	None	None	2xLP x16/3xLP x8/1xLP x16 ML2/4xFHHL x16	TPM 1.2	XClarity Enterprise	2x1600W Platinum	3-year	07/17
7X12A019EA	EMEA	4xXeon Gold 5120 14C/2.2GHz/19.25MB/105W/DDR4-2400	4/4	4x32GB RDIMM DDR4-2666	48/48	1x930-16i 4GB flash	12x2.5" HS (6 SATA/SAS, 6 AnyBay)	12	Open	None	None	2xLP x16/3xLP x8/1xLP x16 ML2/4xFHHL x16	TPM 1.2	XClarity Enterprise	2x1600W Platinum	3-year	07/17
7X12A01AEA	EMEA	2xXeon Gold 6130 16C/2.1GHz/22MB/125W/DDR4-2666	2/4	2x32GB RDIMM DDR4-2666	24/48	1x930-8i 2GB flash	8x2.5" SATA/SAS HS	12	Open	None	None	2xLP x16/1xLP x8/1xLP x16 ML2	TPM 1.2	XClarity Enterprise	2x1600W Platinum	3-year	07/17

Model	Region	Processor	CPU Sockets (std/max)	Memory	Memory Sockets (std/max)	Storage Controller	Disk Bays	Max Disk Bays	Disks	M.2 Drives	Networking (LOM/ML2/PCIe)	Available PCIe Slots	Security	System Management	Power Supply	Base Warranty	Ann Date (mm/yy)
7X12A01ECN	HTK	2xXeon Platinum 8180 28C/2.5GHz/38.5MB/205W/DDR4-2666	2/8	2x16GB RDIMM DDR4-2666	24/96	1x930-16i 4GB flash	12x2.5" HS SATA/SAS	12	Open	None	4xGbE RJ-45 LOM	2xLP x16/1xLP x8/1xLP x16 ML2	TPM 1.2	XClarity Enterprise	2x1600W Platinum	3-year	07/17
7X12A01FCN	HTK	2xXeon Platinum 8170 26C/2.1GHz/35.75MB/165W/DDR4-2666	2/8	2x16GB RDIMM DDR4-2666	24/96	1x930-16i 4GB flash	12x2.5" HS SATA/SAS	12	Open	None	4xGbE RJ-45 LOM	2xLP x16/1xLP x8/1xLP x16 ML2	TPM 1.2	XClarity Enterprise	2x1600W Platinum	3-year	07/17
7X12A01HCN	HTK	2xXeon Platinum 8156 4C/3.6GHz/16.5MB/105W/DDR4-2666	2/8	2x16GB RDIMM DDR4-2666	24/96	1x930-16i 4GB flash	12x2.5" HS SATA/SAS	12	Open	None	4xGbE RJ-45 LOM	2xLP x16/1xLP x8/1xLP x16 ML2	TPM 1.2	XClarity Enterprise	2x1600W Platinum	3-year	07/17
7X12A01JCN	HTK	2xXeon Platinum 8153 16C/2.0GHz/22MB/125W/DDR4-2666	2/8	2x16GB RDIMM DDR4-2666	24/96	1x930-16i 4GB flash	12x2.5" HS SATA/SAS	12	Open	None	4xGbE RJ-45 LOM	2xLP x16/1xLP x8/1xLP x16 ML2	TPM 1.2	XClarity Enterprise	2x1600W Platinum	3-year	07/17
7X12A01KCN	HTK	2xXeon Gold 6130 16C/2.1GHz/22MB/125W/DDR4-2666	2/4	2x16GB RDIMM DDR4-2666	24/48	1x930-16i 4GB flash	12x2.5" HS SATA/SAS	12	Open	None	4xGbE RJ-45 LOM	2xLP x16/1xLP x8/1xLP x16 ML2	TPM 1.2	XClarity Enterprise	2x1600W Platinum	3-year	07/17
7X12A01LCN	HTK	2xXeon Gold 6152 22C/2.1GHz/30.25MB/140W/DDR4-2666	2/4	2x16GB RDIMM DDR4-2666	24/48	1x930-16i 4GB flash	12x2.5" HS SATA/SAS	12	Open	None	4xGbE RJ-45 LOM	2xLP x16/1xLP x8/1xLP x16 ML2	TPM 1.2	XClarity Enterprise	2x1600W Platinum	3-year	07/17
7X12A01NCN	HTK	2xXeon Gold 6148 20C/2.4GHz/27.5MB/150W/DDR4-2666	2/4	2x16GB RDIMM DDR4-2666	24/48	1x930-16i 4GB flash	12x2.5" HS SATA/SAS	12	Open	None	4xGbE RJ-45 LOM	2xLP x16/1xLP x8/1xLP x16 ML2	TPM 1.2	XClarity Enterprise	2x1600W Platinum	3-year	07/17
7X12A01PCN	HTK	2xXeon Gold 6142 16C/2.6GHz/22MB/150W/DDR4-2666	2/4	2x16GB RDIMM DDR4-2666	24/48	1x930-16i 4GB flash	12x2.5" HS SATA/SAS	12	Open	None	4xGbE RJ-45 LOM	2xLP x16/1xLP x8/1xLP x16 ML2	TPM 1.2	XClarity Enterprise	2x1600W Platinum	3-year	07/17
7X12A01QCN	HTK	2xXeon Platinum 8160 24C/2.1GHz/33MB/150W/DDR4-2666	2/8	2x16GB RDIMM DDR4-2666	24/96	1x930-16i 4GB flash	12x2.5" HS SATA/SAS	12	Open	None	4xGbE RJ-45 LOM	2xLP x16/1xLP x8/1xLP x16 ML2	TPM 1.2	XClarity Enterprise	2x1600W Platinum	3-year	07/17
7X12A01RCN	HTK	2xXeon Gold 6140 18C/2.3GHz/24.75MB/140W/DDR4-2666	2/4	2x16GB RDIMM DDR4-2666	24/48	1x930-16i 4GB flash	12x2.5" HS SATA/SAS	12	Open	None	4xGbE RJ-45 LOM	2xLP x16/1xLP x8/1xLP x16 ML2	TPM 1.2	XClarity Enterprise	2x1600W Platinum	3-year	07/17



Model	Region	Processor	CPU Sockets (std/max)	Memory	Memory Sockets (std/max)	Storage Controller	Disk Bays	Max Disk Bays	Disks	M.2 Drives	Networking (LOM/ML2/PCIe)	Available PCIe Slots	Security	System Management	Power Supply	Base Warranty	Ann Date (mm/yy)
7X12A00VSG	INDIA	2xXeon Gold 6126 12C/2.6GHz/19.25MB/125W/DDR4-2666	2/4	2x16GB RDIMM DDR4-2666	24/48	1x930-16i 4GB flash	4x2.5" SATA/SAS HS	12	Open	None	4xGbE RJ-45 LOM	2xLP x16/1xLP x8/1xLP x16 ML2	TPM 1.2	XClarity Enterprise	2x1100W Platinum	3-year	07/17
7X12A00YSG	INDIA	2xXeon Platinum 8180 28C/2.5GHz/38.5MB/205W/DDR4-2666	2/8	2x16GB RDIMM DDR4-2666	24/96	1x930-16i 4GB flash	4x2.5" SATA/SAS HS	12	Open	None	4xGbE RJ-45 LOM	2xLP x16/1xLP x8/1xLP x16 ML2	TPM 1.2	XClarity Enterprise	2x1100W Platinum	3-year	07/17
7X12A00ZSG	INDIA	2xXeon Platinum 8160M 24C/2.1GHz/33MB/150W/DDR4-2666	2/4	2x32GB RDIMM DDR4-2666	24/48	1x930-16i 4GB flash	4x2.5" SATA/SAS HS	12	Open	None	4xGbE RJ-45 LOM	2xLP x16/1xLP x8/1xLP x16 ML2	TPM 1.2	XClarity Enterprise	2x1100W Platinum	3-year	07/17
7X12A010SG	INDIA	2xXeon Gold 6142M 16C/2.6GHz/22MB/150W/DDR4-2666	2/4	2x16GB RDIMM DDR4-2666	24/48	1x930-16i 4GB flash	4x2.5" SATA/SAS HS	12	Open	None	4xGbE RJ-45 LOM	2xLP x16/1xLP x8/1xLP x16 ML2	TPM 1.2	XClarity Enterprise	2x1100W Platinum	3-year	07/17
7X12A011SG	INDIA	2xXeon Platinum 8164 26C/2.0GHz/35.75MB/150W/DDR4-2666	2/8	2x16GB RDIMM DDR4-2666	24/96	1x930-16i 4GB flash	4x2.5" SATA/SAS HS	12	Open	None	4xGbE RJ-45 LOM	2xLP x16/1xLP x8/1xLP x16 ML2	TPM 1.2	XClarity Enterprise	2x1100W Platinum	3-year	07/17
7X12A00PSG	INDIA	2xXeon Platinum 8158 12C/3.0GHz/24.75MB/150W/DDR4-2666	2/4	2x16GB RDIMM DDR4-2666	24/48	1x930-16i 4GB flash	4x2.5" SATA/SAS HS	12	Open	None	4xGbE RJ-45 LOM	2xLP x16/1xLP x8/1xLP x16 ML2	TPM 1.2	XClarity Enterprise	2x1100W Platinum	3-year	07/17
7X12A00JSG	INDIA	2xXeon Gold 6134M 8C/3.2GHz/24.75MB/130W/DDR4-2666	2/4	2x16GB RDIMM DDR4-2666	24/48	1x930-16i 4GB flash	4x2.5" SATA/SAS HS	12	Open	None	4xGbE RJ-45 LOM	2xLP x16/1xLP x8/1xLP x16 ML2	TPM 1.2	XClarity Enterprise	2x1100W Platinum	3-year	07/17
7X12A00KSG	INDIA	2xXeon Gold 6134M 8C/3.2GHz/24.75MB/130W/DDR4-2666	2/4	2x32GB RDIMM DDR4-2666	24/48	1x930-16i 4GB flash	4x2.5" SATA/SAS HS	12	Open	None	4xGbE RJ-45 LOM	2xLP x16/1xLP x8/1xLP x16 ML2	TPM 1.2	XClarity Enterprise	2x1100W Platinum	3-year	07/17
7X12A00DSG	INDIA	2xXeon Platinum 8160M 24C/2.1GHz/33MB/150W/DDR4-2666	2/4	2x16GB RDIMM DDR4-2666	24/48	1x930-16i 4GB flash	4x2.5" SATA/SAS HS	12	Open	None	4xGbE RJ-45 LOM	2xLP x16/1xLP x8/1xLP x16 ML2	TPM 1.2	XClarity Enterprise	2x1100W Platinum	3-year	07/17
7X12A001SG	INDIA	2xXeon Gold 6142M 16C/2.6GHz/22MB/150W/DDR4-2666	2/4	2x32GB RDIMM DDR4-2666	24/48	1x930-16i 4GB flash	4x2.5" SATA/SAS HS	12	Open	None	4xGbE RJ-45 LOM	2xLP x16/1xLP x8/1xLP x16 ML2	TPM 1.2	XClarity Enterprise	2x1100W Platinum	3-year	07/17
7X12A002SG	INDIA	2xXeon Gold 6132 14C/2.6GHz/19.25MB/140W/DDR4-2666	2/4	2x16GB RDIMM DDR4-2666	24/48	1x930-16i 4GB flash	4x2.5" SATA/SAS HS	12	Open	None	4xGbE RJ-45 LOM	2xLP x16/1xLP x8/1xLP x16 ML2	TPM 1.2	XClarity Enterprise	2x1100W Platinum	3-year	07/17
7X12A004SG	INDIA	2xXeon Gold 6142 16C/2.6GHz/22MB/150W/DDR4-2666	2/4	2x16GB RDIMM DDR4-2666	24/48	1x930-16i 4GB flash	4x2.5" SATA/SAS HS	12	Open	None	4xGbE RJ-45 LOM	2xLP x16/1xLP x8/1xLP x16 ML2	TPM 1.2	XClarity Enterprise	2x1100W Platinum	3-year	07/17
7X12A005SG	INDIA	2xXeon Gold 6152 22C/2.1GHz/30.25MB/140W/DDR4-2666	2/4	2x16GB RDIMM DDR4-2666	24/48	1x930-16i 4GB flash	4x2.5" SATA/SAS HS	12	Open	None	4xGbE RJ-45 LOM	2xLP x16/1xLP x8/1xLP x16 ML2	TPM 1.2	XClarity Enterprise	2x1100W Platinum	3-year	07/17
7X12A006SG	INDIA	2xXeon Gold 6140M 18C/2.3GHz/24.75MB/140W/DDR4-2666	2/4	2x16GB RDIMM DDR4-2666	24/48	1x930-16i 4GB flash	4x2.5" SATA/SAS HS	12	Open	None	4xGbE RJ-45 LOM	2xLP x16/1xLP x8/1xLP x16 ML2	TPM 1.2	XClarity Enterprise	2x1100W Platinum	3-year	07/17
7X12A008SG	INDIA	2xXeon Gold 6140 18C/2.3GHz/24.75MB/140W/DDR4-2666	2/4	2x16GB RDIMM DDR4-2666	24/48	1x930-16i 4GB flash	4x2.5" SATA/SAS HS	12	Open	None	4xGbE RJ-45 LOM	2xLP x16/1xLP x8/1xLP x16 ML2	TPM 1.2	XClarity Enterprise	2x1100W Platinum	3-year	07/17

Model	Region	Processor	CPU Sockets (std/max)	Memory	Memory Sockets (std/max)	Storage Controller	Disk Bays	Max Disk Bays	Disks	M.2 Drives	Networking (LOM/ML2/PCIe)	Available PCIe Slots	Security	System Management	Power Supply	Base Warranty	Ann Date (mm/yy)
7X12A009SG	INDIA	2xXeon Gold 6150 18C/2.7GHz/24.75MB/165W/DDR4-2666	2/4	2x16GB RDIMM DDR4-2666	24/48	1x930-16i 4GB flash	4x2.5" SATA/SAS HS	12	Open	None	4xGbE RJ-45 LOM	2xLP x16/1xLP x8/1xLP x16 ML2	TPM 1.2	XClarity Enterprise	2x1100W Platinum	3-year	07/17
7X12A00ASG	INDIA	2xXeon Gold 6148 20C/2.4GHz/27.5MB/150W/DDR4-2666	2/4	2x16GB RDIMM DDR4-2666	24/48	1x930-16i 4GB flash	4x2.5" SATA/SAS HS	12	Open	None	4xGbE RJ-45 LOM	2xLP x16/1xLP x8/1xLP x16 ML2	TPM 1.2	XClarity Enterprise	2x1100W Platinum	3-year	07/17

## ThinkSystem SR950 - Non TopSeller - JAPAN

Product Specifications Reference (PSREF)

Model	Region	Processor	CPU Sockets (std/max)	Memory	Memory Sockets (std/max)	Storage Controller	Disk Bays	Max Disk Bays	Disk Drives	M.2 Drives	Networking (LOM/ML2/PCIe)	Available PCIe Slots	Security	System Management	Power Supply	Base Warranty	Ann Date (mm/yy)
7X12A00MJP	JAPAN	2xXeon Gold 6128 6C/3.4GHz/19.25MB/115W/DDR4-2666	2/4	4x16GB RDIMM DDR4-2666	24/48	1x930-16i 4GB flash	4x2.5" HS (2 SATA/SAS, 2 AnyBay)	12	Open	None	4x10GbE RJ-45 LOM	2xLP x16/3xLP x8/1xLP x16 ML2	TPM 1.2	XClarity Enterprise	4x1100W Platinum	3-year	07/17
7X12A012JP	JAPAN	4xXeon Platinum 8180 28C/2.5GHz/38.5MB/205W/DDR4-2666	4/8	4x16GB RDIMM DDR4-2666	48/96	1x930-16i 4GB flash	4x2.5" HS (2 SATA/SAS, 2 AnyBay)	12	Open	None	4x10GbE RJ-45 LOM	2xLP x16/3xLP x8/1xLP x16 ML2	TPM 1.2	XClarity Enterprise	4x1600W Platinum	3-year	07/17
7X12A013JP	JAPAN	2xXeon Gold 6154 18C/3.0GHz/24.75MB/200W/DDR4-2666	2/4	2x16GB RDIMM DDR4-2666	24/48	1x930-16i 4GB flash	8x2.5" HS (6 SATA/SAS, 2 AnyBay)	12	Open	None	4x10GbE RJ-45 LOM	2xLP x16/3xLP x8/1xLP x16 ML2	TPM 1.2	XClarity Enterprise	2x1600W Platinum	3-year	07/17

Model	Region	Processor	CPU Sockets (std/max)	Memory	Memory Sockets (std/max)	Storage Controller	Disk Bays	Max Disk Bays	Disks	M.2 Drives	Networking (LOM/ML2/PCIe)	Available PCIe Slots	Security	System Management	Power Supply	Base Warranty	Ann Date (mm/yy)
7X12A01GNA	NA	4xXeon Gold 5120 14C/2.2GHz/19.25MB/105W/DDR4-2400	4/4	4x32GB RDIMM DDR4-2666	48/48	1x930-8i 2GB flash	8x2.5" HS (4 SATA/SAS, 4 AnyBay)	12	Open	None	None	2xLP x16/3xLP x8/1xLP x16 ML2/4xFHHL x16	TPM 1.2	XClarity Enterprise	2x1600W Platinum	3-year	07/17
7X12A01DNA	NA	2xXeon Gold 6130 16C/2.1GHz/22MB/125W/DDR4-2666	2/4	2x32GB RDIMM DDR4-2666	24/48	1x930-8i 2GB flash	8x2.5" HS (6 SATA/SAS, 2 AnyBay)	12	Open	None	None	2xLP x16/1xLP x8/1xLP x16 ML2	TPM 1.2	XClarity Enterprise	2x1100W Platinum	3-year	07/17
7X12A01SNA	NA	8xXeon Platinum 8160 24C/2.1GHz/33MB/150W/DDR4-2666	8/8	8x32GB RDIMM DDR4-2666	96/96	2x930-16i 4GB flash	24x2.5" HS (12 SATA/SAS, 12 AnyBay)	24	Open	None	None	2xLP x16/3xLP x8/1xLP x16 ML2/9xFHHL x16/1xFHHL x16 ML2	TPM 1.2	XClarity Enterprise	4x1600W Platinum	3-year	07/17
7X12A01MNA	NA	4xXeon Platinum 8153 16C/2.0GHz/22MB/125W/DDR4-2666	4/8	4x32GB RDIMM DDR4-2666	48/96	1x930-8i 2GB flash	8x2.5" HS (4 SATA/SAS, 4 AnyBay)	12	Open	None	None	2xLP x16/3xLP x8/1xLP x16 ML2/4xFHHL x16	TPM 1.2	XClarity Enterprise	2x1600W Platinum	3-year	07/17



# ThinkSystem SR530 Platform Specifications

Product Specifications Reference (PSREF)

Components	Specification
Form factor	1U rack
Dimensions	Height: 43 mm (1.7 in). Width: 482 mm (19.0 in) with rack latches. Depth: 778.3 mm (30.64 in)
Weight	Maximum configuration: 35.27 lb (16 kg)
Processor	Up to two 125W Intel Xeon Scalable family processors, Bronze, Silver, Gold, or Platinum. Up to 20 cores at 2.0GHz, up to 3.6GHz with 4 cores. Two processors are connected with two UPI (Ultra Path Interconnect) links up to 10.4GT/s
Chipset	Intel C622 Platform Controller Hub
Memory	Up to 12 DIMM sockets. Each processor supports up to 6 DIMM sockets with 6 channels. DDR4-2666. RDIMMs and LRDIMMs are supported, but memory types cannot be intermixed
Memory capacity	With RDIMMs: Up to 384GB with 12 x 32 GB RDIMMs and two processors With LRDIMMs: Up to 768GB with 12 x 64 GB LRDIMMs and two processors
Memory protection	ECC, memory mirroring, and memory sparing
Storage controllers	Supports the following RAID/HBA adapters:
Disk drive bays	Support 4 front 3.5" SATA simple-swap bays, or 4 front 3.5" SATA/SAS HS bays, or 8 front 2.5" SATA/SAS HS bays. Optional one or two internal M.2 SSD for boot, dual M.2 SSD supports mirroring
Internal storage	For 3.5" SS bay
Optical	No internal optical bay. Optional USB DVD±RW optical drive
Network interfaces	Integrated one dedicated management port plus two GbE ports. One LOM slot for customized LOM with two RJ-45 or SFP+ ports, up to 10GbE. Optional ML2 or PCIe adapters are supported. ML2 adapter requires riser card with ML2 slot. Up to two ports supports Wake-on-LAN and NC-SI (see right)
Security features	Power-on and admin password. Trusted Platform Module, TCG 1.2 compliant, upgrade to 2.0 via UEFI setting. Optional TCM in China only. Optional lockable security bezel
Operating systems supported	Microsoft Windows Server 2016/2012 R2. Red Hat Enterprise Linux 7.3/6.9. SUSE Linux Enterprise Server 12 SP2/11 SP4. VMware vSphere (ESXi) 6.5/6.0 U3
Systems management	XClarity Controller Standard, optional upgrades to Advanced or Enterprise are available. Energy Manager. XClarity Administrator. Lenovo Capacity Planner. Provisioning Manager. Essentials. Light Path Diagnostics
GPU support	None

Components	Specification
Base warranty	MT 7X07: 1-year limited onsite service with 9x5/NBD MT 7X08: 3-year limited onsite service with 9x5/NBD
Power supply	Up to two redundant hot-swap 550W and 750W 80 PLUS Platinum qualified AC power supplies. Or up to two redundant hot-swap 750W Titanium qualified AC power supplies. 750W Titanium is 200V - 240V, others are 100V - 240V
Video	Integrated Matrox G200 in XClarity Controller
Cooling	Four fans (3+1) for single processor model, six fans (5+1) for dual processor model
Front ports	One XClarity Controller USB, one USB 3.0, one optional VGA
Rear ports	One VGA, two USB 3.0, two ethernet (RJ-45), one XClarity Controller connector. Optional COM port
Environmental specification	Supports ASHRAE A4 with limitations.
Environmental certification	Energy Star Server 2.1 certified. More environmental information please see: <a href="http://www.lenovo.com/social_responsibility/us/en/environment/">www.lenovo.com/social_responsibility/us/en/environment/</a>

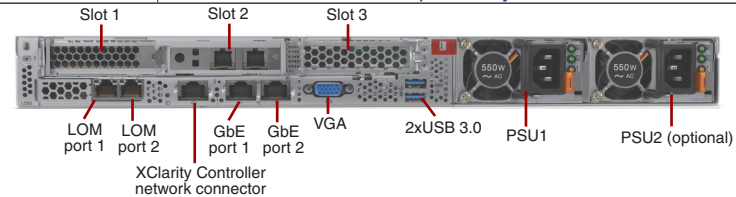

Note: GbE port 1 and LOM port 1 support Wake-on-LAN and NC-SI. Riser cards, expansion cards, and LOM adapters are optional.

Expansion slots	
Slot 1-2 (riser card 1)	Supports one of the following for riser card 1: Option 1: PCIe 3.0 x8/x16 (slot 1-2). Low profile for x8, low profile or full height half length for x16 Option 2: PCIe 3.0 x8/x8 ML2 (slot 1-2). Low profile
Slot 3 (riser card 2)	Option 1: PCIe 3.0 x 8, low profile, for single processor model Option 2: PCIe 3.0 x 16, low profile, for dual processor model When slot 2 is full height, slot 3 cannot be used

System unique options	
Option	Description
7XH7A05892	ThinkSystem SR530/SR570 x8/x8ML2 PCIe LP+LP Riser 1 kit
7XH7A02682	ThinkSystem SR530/SR570/SR630 x8/x16 PCIe LP+LP Riser 1 Kit
7XH7A05893	ThinkSystem SR530/SR570/SR630 x8/x16 PCIe LP+FH Riser 1 Kit
7XH7A05891	ThinkSystem SR530/SR570 x8 PCIe LP Riser 2 kit
7XH7A02685	ThinkSystem SR530/SR570/SR630 x16 PCIe LP Riser 2 Kit
7Z17A02579	ThinkSystem SR530/SR570/SR630 Front VGA Connector Upgrade Kit
7Z17A02581	ThinkSystem 1U Security Bezel
7Z17A02577	ThinkSystem COM Port Upgrade Kit
7XH7A05896	ThinkSystem SR530/SR630 2.5" SATA/SAS 8-Bay Backplane Kit

Model	Region	Processor	Memory	Storage Controller	Chassis	Disk Bays	Disks	M.2 Drives	Networking (LOM/ML2/PCIe)	Available PCIe Slots	Front VGA	Security	System Management	Power Supply	Base Warranty	Ann Date (mm/yy)
7X08A02RAU	ANZ	1xXeon Silver 4110 8C/2.1GHz/11MB/85W/DDR4-2400	1x16GB RDIMM DDR4-2666	1x930-8i 2GB flash	8x2.5"	8x2.5" SATA/SAS HS	Open	None	None	1xLP x8/1xLP x16	Front VGA	TPM 1.2	XClarity Advanced	1x750W Platinum	3-year	07/17
7X08A030AU	ANZ	1xXeon Bronze 3104 6C/1.7GHz/8.25MB/85W/DDR4-2133	1x16GB RDIMM DDR4-2666	Onboard SATA	4x3.5"	4x3.5" SATA SS	Open	None	None	None	Front VGA	TPM 1.2	XClarity Standard	1x550W Platinum	3-year	07/17
7X08A032AU	ANZ	1xXeon Silver 4110 8C/2.1GHz/11MB/85W/DDR4-2400	1x16GB RDIMM DDR4-2666	1x930-8i 2GB flash	4x3.5"	4x3.5" SATA/SAS HS	Open	None	None	1xLP x8/1xLP x16	Front VGA	TPM 1.2	XClarity Advanced	1x750W Platinum	3-year	07/17
7X08A034AU	ANZ	1xXeon Silver 4110 8C/2.1GHz/11MB/85W/DDR4-2400	2x32GB RDIMM DDR4-2666	1x930-8i 2GB flash	8x2.5"	8x2.5" SATA/SAS HS	2x600GB HDD 10K 2.5" SAS12Gbps	None	None	1xLP x8/1xLP x16	Front VGA	TPM 1.2	XClarity Advanced	2x750W Platinum	3-year	07/17
7X08A035AU	ANZ	1xXeon Silver 4114 10C/2.2GHz/13.75MB/85W/DDR4-2400	1x16GB RDIMM DDR4-2666	1x930-8i 2GB flash	8x2.5"	8x2.5" SATA/SAS HS	2x300GB HDD 10K 2.5" SAS12Gbps	None	None	1xLP x8/1xLP x16	Front VGA	TPM 1.2	XClarity Advanced	2x750W Platinum	3-year	07/17
7X08A03AAU	ANZ	1xXeon Silver 4108 8C/1.8GHz/11MB/85W/DDR4-2400	1x16GB RDIMM DDR4-2666	1x530-8i	8x2.5"	8x2.5" SATA/SAS HS	Open	None	None	1xLP x8/1xLP x16	Front VGA	TPM 1.2	XClarity Advanced	1x750W Platinum	3-year	07/17
7X08A038AU	ANZ	1xXeon Silver 4108 8C/1.8GHz/11MB/85W/DDR4-2400	1x16GB RDIMM DDR4-2666	1x930-8i 2GB flash	8x2.5"	8x2.5" SATA/SAS HS	Open	None	None	1xLP x8/1xLP x16	Front VGA	TPM 1.2	XClarity Advanced	1x750W Platinum	3-year	07/17
7X08A03MAU	ANZ	1xXeon Bronze 3104 6C/1.7GHz/8.25MB/85W/DDR4-2133	1x16GB RDIMM DDR4-2666	1x530-8i	4x3.5"	4x3.5" SATA/SAS HS	Open	None	None	1xLP x8/1xLP x16	Front VGA	TPM 1.2	XClarity Standard	1x550W Platinum	3-year	07/17
7X08A03JAU	ANZ	1xXeon Silver 4116 12C/2.1GHz/16.5MB/85W/DDR4-2400	1x16GB RDIMM DDR4-2666	1x930-8i 2GB flash	8x2.5"	8x2.5" SATA/SAS HS	Open	None	None	1xLP x8/1xLP x16	Front VGA	TPM 1.2	XClarity Advanced	1x750W Platinum	3-year	07/17
7X08A03QAU	ANZ	1xXeon Bronze 3104 6C/1.7GHz/8.25MB/85W/DDR4-2133	1x16GB RDIMM DDR4-2666	1x530-8i	8x2.5"	8x2.5" SATA/SAS HS	Open	None	None	1xLP x8/1xLP x16	Front VGA	TPM 1.2	XClarity Advanced	1x750W Platinum	3-year	07/17
7X08A03RAU	ANZ	1xXeon Silver 4114 10C/2.2GHz/13.75MB/85W/DDR4-2400	1x16GB RDIMM DDR4-2666	1x930-8i 2GB flash	8x2.5"	8x2.5" SATA/SAS HS	Open	None	None	1xLP x8/1xLP x16	Front VGA	TPM 1.2	XClarity Advanced	1x750W Platinum	3-year	07/17
7X08A03TAU	ANZ	1xXeon Gold 5118 12C/2.3GHz/16.5MB/105W/DDR4-2400	1x16GB RDIMM DDR4-2666	1x930-8i 2GB flash	8x2.5"	8x2.5" SATA/SAS HS	Open	None	None	1xLP x8/1xLP x16	Front VGA	TPM 1.2	XClarity Enterprise	1x750W Platinum	3-year	07/17
7X08A03ZAU	ANZ	1xXeon Gold 6130 16C/2.1GHz/22MB/125W/DDR4-2666	1x32GB RDIMM DDR4-2666	1x930-8i 2GB flash	8x2.5"	8x2.5" SATA/SAS HS	Open	None	None	1xLP x8/1xLP x16	Front VGA	TPM 1.2	XClarity Standard	1x750W Platinum	3-year	07/17

Model	Region	Processor	Memory	Storage Controller	Chassis	Disk Bays	Disks	M.2 Drives	Networking (LOM/ML2/PCIe)	Available PCIe Slots	Front VGA	Security	System Management	Power Supply	Base Warranty	Ann Date (mm/yy)
7X08A01HEA	EMEA	1xXeon Gold 6130 16C/2.1GHz/22MB/125W/DDR4-2666	1x32GB RDIMM DDR4-2666	1x930-8i 2GB flash	8x2.5"	8x2.5" SATA/SAS HS	Open	None	None	1xLP x8/1xLP x16	Front VGA	TPM 1.2	XClarity Standard	1x750W Platinum	3-year	07/17
7X08A04GEA	EMEA	1xXeon Silver 4110 8C/2.1GHz/11MB/85W/DDR4-2400	4x32GB RDIMM DDR4-2666	1x930-8i 2GB flash	8x2.5"	8x2.5" SATA/SAS HS	3x600GB HDD 10K 2.5" SAS12Gbps	None	None	1xLP x8/1xLP x16	Front VGA	TPM 1.2	XClarity Enterprise	2x750W Platinum	3-year	07/17
7X08A04TEA	EMEA	1xXeon Gold 5115 10C/2.4GHz/13.75MB/85W/DDR4-2400	1x16GB RDIMM DDR4-2666	1x930-8i 2GB flash	8x2.5"	8x2.5" SATA/SAS HS	Open	None	None	1xLP x8/1xLP x16	Front VGA	TPM 1.2	XClarity Enterprise	1x750W Platinum	3-year	07/17
7X08A01UEA	EMEA	1xXeon Silver 4108 8C/1.8GHz/11MB/85W/DDR4-2400	1x16GB RDIMM DDR4-2666	1x930-8i 2GB flash	8x2.5"	8x2.5" SATA/SAS HS	Open	None	None	1xLP x8/1xLP x16	Front VGA	TPM 1.2	XClarity Advanced	1x750W Platinum	3-year	07/17
7X08A01VEA	EMEA	1xXeon Silver 4110 8C/2.1GHz/11MB/85W/DDR4-2400	1x16GB RDIMM DDR4-2666	1x930-8i 2GB flash	4x3.5"	4x3.5" SATA/SAS HS	Open	None	None	1xLP x8/1xLP x16	Front VGA	TPM 1.2	XClarity Advanced	1x750W Platinum	3-year	07/17
7X08A01XEA	EMEA	1xXeon Silver 4116 12C/2.1GHz/16.5MB/85W/DDR4-2400	1x16GB RDIMM DDR4-2666	1x930-8i 2GB flash	8x2.5"	8x2.5" SATA/SAS HS	Open	None	None	1xLP x8/1xLP x16	Front VGA	TPM 1.2	XClarity Advanced	1x750W Platinum	3-year	07/17
7X08A020EA	EMEA	1xXeon Silver 4108 8C/1.8GHz/11MB/85W/DDR4-2400	1x16GB RDIMM DDR4-2666	1x530-8i	8x2.5"	8x2.5" SATA/SAS HS	Open	None	None	1xLP x8/1xLP x16	Front VGA	TPM 1.2	XClarity Advanced	1x750W Platinum	3-year	07/17
7X08A022EA	EMEA	1xXeon Bronze 3104 6C/1.7GHz/8.25MB/85W/DDR4-2133	1x16GB RDIMM DDR4-2666	Onboard SATA	4x3.5"	4x3.5" SATA SS	Open	None	None	None	Front VGA	TPM 1.2	XClarity Standard	1x550W Platinum	3-year	07/17
7X08A024EA	EMEA	1xXeon Silver 4114 10C/2.2GHz/13.75MB/85W/DDR4-2400	1x16GB RDIMM DDR4-2666	1x930-8i 2GB flash	8x2.5"	8x2.5" SATA/SAS HS	Open	None	None	1xLP x8/1xLP x16	Front VGA	TPM 1.2	XClarity Advanced	1x750W Platinum	3-year	07/17
7X08A025EA	EMEA	1xXeon Bronze 3104 6C/1.7GHz/8.25MB/85W/DDR4-2133	1x16GB RDIMM DDR4-2666	1x530-8i	8x2.5"	8x2.5" SATA/SAS HS	Open	None	None	1xLP x8/1xLP x16	Front VGA	TPM 1.2	XClarity Advanced	1x750W Platinum	3-year	07/17
7X08A027EA	EMEA	1xXeon Silver 4110 8C/2.1GHz/11MB/85W/DDR4-2400	2x32GB RDIMM DDR4-2666	1x930-8i 2GB flash	8x2.5"	8x2.5" SATA/SAS HS	2x600GB HDD 10K 2.5" SAS12Gbps	None	None	1xLP x8/1xLP x16	Front VGA	TPM 1.2	XClarity Advanced	2x750W Platinum	3-year	07/17
7X08A028EA	EMEA	1xXeon Bronze 3104 6C/1.7GHz/8.25MB/85W/DDR4-2133	1x16GB RDIMM DDR4-2666	1x530-8i	4x3.5"	4x3.5" SATA/SAS HS	Open	None	None	1xLP x8/1xLP x16	Front VGA	TPM 1.2	XClarity Standard	1x550W Platinum	3-year	07/17
7X08A029EA	EMEA	1xXeon Silver 4110 8C/2.1GHz/11MB/85W/DDR4-2400	1x16GB RDIMM DDR4-2666	1x930-8i 2GB flash	8x2.5"	8x2.5" SATA/SAS HS	Open	None	None	1xLP x8/1xLP x16	Front VGA	TPM 1.2	XClarity Advanced	1x750W Platinum	3-year	07/17
7X08A02BEA	EMEA	1xXeon Silver 4114 10C/2.2GHz/13.75MB/85W/DDR4-2400	1x16GB RDIMM DDR4-2666	1x930-8i 2GB flash	8x2.5"	8x2.5" SATA/SAS HS	2x300GB HDD 10K 2.5" SAS12Gbps	None	None	1xLP x8/1xLP x16	Front VGA	TPM 1.2	XClarity Advanced	2x750W Platinum	3-year	07/17
7X08A00XEA	EMEA	1xXeon Gold 6138 20C/2.0GHz/27.5MB/125W/DDR4-2666	1x32GB RDIMM DDR4-2666	1x930-8i 2GB flash	8x2.5"	8x2.5" SATA/SAS HS	Open	None	None	1xLP x8/1xLP x16	Front VGA	TPM 1.2	XClarity Standard	1x750W Platinum	3-year	07/17



Model	Region	Processor	Memory	Storage Controller	Chassis	Disk Bays	Disks	M.2 Drives	Networking (LOM/ML2/PCIe)	Available PCIe Slots	Front VGA	Security	System Management	Power Supply	Base Warranty	Ann Date (mm/yy)	
7X08A009EA	EMEA	1xXeon Gold 5118 12C/2.3GHz/16.5MB/105W/DDR4-2400	1x16GB RDIMM DDR4-2666	1x930-8i 2GB flash	8x2.5"	8x2.5"	SATA/SAS HS	Open	None	None	1xLP x8/1xLP x16	Front VGA	TPM 1.2	XClarity Enterprise	1x750W Platinum	3-year	07/17

# ThinkSystem SR530 - TopSeller - JAPAN

Product Specifications Reference (PSREF)

Model	Region	Processor	Memory	Storage Controller	Chassis	Disk Bays	Disks	M.2 Drives	Networking (LOM/ML2/PCIe)	Available PCIe Slots	Front VGA	Security	System Management	Power Supply	Base Warranty	Ann Date (mm/yy)
7X08A04UJP	JAPAN	1xXeon Silver 4110 8C/2.1GHz/11MB/85W/DDR4-2400	1x8GB RDIMM DDR4-2666	1x930-8i 2GB flash	8x2.5"	8x2.5" SATA/SAS HS	Open	None	None	1xLP x8/1xLP x16	None	TPM 1.2	XClarity Advanced	1x550W Platinum	3-year	07/17
7X08A04VJP	JAPAN	1xXeon Bronze 3104 6C/1.7GHz/8.25MB/85W/DDR4-2133	1x8GB RDIMM DDR4-2666	1x930-8i 2GB flash	8x2.5"	8x2.5" SATA/SAS HS	Open	None	None	1xLP x8/1xLP x16	None	TPM 1.2	XClarity Advanced	1x550W Platinum	3-year	07/17
7X08A04YJP	JAPAN	1xXeon Silver 4112 4C/2.6GHz/8.25MB/85W/DDR4-2400	1x8GB RDIMM DDR4-2666	1x930-8i 2GB flash	8x2.5"	8x2.5" SATA/SAS HS	Open	None	None	1xLP x8/1xLP x16	None	TPM 1.2	XClarity Advanced	1x550W Platinum	3-year	07/17
7X08A04ZJP	JAPAN	1xXeon Bronze 3104 6C/1.7GHz/8.25MB/85W/DDR4-2133	1x8GB RDIMM DDR4-2666	1x530-8i	4x3.5"	4x3.5" SATA/SAS HS	Open	None	None	1xLP x8/1xLP x16	None	TPM 1.2	XClarity Advanced	1x550W Platinum	3-year	07/17
7X08A050JP	JAPAN	1xXeon Bronze 3106 8C/1.7GHz/11MB/85W/DDR4-2133	1x8GB RDIMM DDR4-2666	1x930-8i 2GB flash	8x2.5"	8x2.5" SATA/SAS HS	Open	None	None	1xLP x8/1xLP x16	None	TPM 1.2	XClarity Advanced	1x550W Platinum	3-year	07/17

Model	Region	Processor	Memory	Storage Controller	Chassis	Disk Bays	Disks	M.2 Drives	Networking (LOM/ML2/PCIe)	Available PCIe Slots	Front VGA	Security	System Management	Power Supply	Base Warranty	Ann Date (mm/yy)
7X08A051LA	LA	1xXeon Bronze 3104 6C/1.7GHz/8.25MB/85W/DDR4-2133	1x8GB RDIMM DDR4-2666	1x530-8i	4x3.5"	4x3.5" SATA/SAS HS	Open	None	None	1xLP x8/1xLP x16	Front VGA	TPM 1.2	XClarity Standard	1x550W Platinum	3-year	07/17
7X08A053LA	LA	1xXeon Silver 4108 8C/1.8GHz/11MB/85W/DDR4-2400	1x16GB RDIMM DDR4-2666	1x530-8i	4x3.5"	4x3.5" SATA/SAS HS	2x600GB HDD 15K 3.5" SAS12Gbps	None	None	1xLP x8/1xLP x16	Front VGA	TPM 1.2	XClarity Advanced	2x750W Platinum	3-year	07/17
7X08A054LA	LA	1xXeon Bronze 3104 6C/1.7GHz/8.25MB/85W/DDR4-2133	1x8GB RDIMM DDR4-2666	1x530-8i	8x2.5"	8x2.5" SATA/SAS HS	Open	None	None	1xLP x8/1xLP x16	Front VGA	TPM 1.2	XClarity Standard	1x550W Platinum	3-year	07/17
7X08A059LA	LA	1xXeon Silver 4108 8C/1.8GHz/11MB/85W/DDR4-2400	1x16GB RDIMM DDR4-2666	1x530-8i	4x3.5"	4x3.5" SATA/SAS HS	2x2TB HDD 7.2K 3.5" SAS12Gbps	None	None	1xLP x8/1xLP x16	Front VGA	TPM 1.2	XClarity Advanced	2x750W Platinum	3-year	07/17
7X08A05ALA	LA	1xXeon Silver 4108 8C/1.8GHz/11MB/85W/DDR4-2400	1x16GB RDIMM DDR4-2666	1x530-8i	4x3.5"	4x3.5" SATA/SAS HS	2x2TB HDD 7.2K 3.5" SAS12Gbps	None	None	1xLP x8/1xLP x16	Front VGA	TPM 1.2	XClarity Advanced	2x750W Platinum	3-year	07/17
7X08A05CLA	LA	1xXeon Silver 4110 8C/2.1GHz/11MB/85W/DDR4-2400	1x8GB RDIMM DDR4-2666	1x530-8i	8x2.5"	8x2.5" SATA/SAS HS	Open	None	None	1xLP x8/1xLP x16	Front VGA	TPM 1.2	XClarity Standard	1x550W Platinum	3-year	07/17
7X08A05FLA	LA	1xXeon Bronze 3106 8C/1.7GHz/11MB/85W/DDR4-2133	1x8GB RDIMM DDR4-2666	1x530-8i	8x2.5"	8x2.5" SATA/SAS HS	Open	None	None	1xLP x8/1xLP x16	Front VGA	TPM 1.2	XClarity Standard	1x550W Platinum	3-year	07/17
7X08A05GLA	LA	1xXeon Silver 4108 8C/1.8GHz/11MB/85W/DDR4-2400	1x8GB RDIMM DDR4-2666	1x530-8i	4x3.5"	4x3.5" SATA/SAS HS	Open	None	None	1xLP x8/1xLP x16	Front VGA	TPM 1.2	XClarity Standard	1x550W Platinum	3-year	07/17
7X08A05HLA	LA	1xXeon Silver 4108 8C/1.8GHz/11MB/85W/DDR4-2400	1x8GB RDIMM DDR4-2666	1x530-8i	8x2.5"	8x2.5" SATA/SAS HS	Open	None	None	1xLP x8/1xLP x16	Front VGA	TPM 1.2	XClarity Standard	1x550W Platinum	3-year	07/17
7X08A05JLA	LA	1xXeon Silver 4114 10C/2.2GHz/13.75MB/85W/DDR4-2400	1x8GB RDIMM DDR4-2666	1x530-8i	4x3.5"	4x3.5" SATA/SAS HS	Open	None	None	1xLP x8/1xLP x16	Front VGA	TPM 1.2	XClarity Standard	1x550W Platinum	3-year	07/17
7X08A05LLA	LA	1xXeon Silver 4114 10C/2.2GHz/13.75MB/85W/DDR4-2400	2x16GB RDIMM DDR4-2666	1x530-8i	4x3.5"	4x3.5" SATA/SAS HS	3x600GB HDD 15K 3.5" SAS12Gbps	None	None	1xLP x8/1xLP x16	Front VGA	TPM 1.2	XClarity Advanced	2x750W Platinum	3-year	07/17
7X08A05QLA	LA	1xXeon Silver 4110 8C/2.1GHz/11MB/85W/DDR4-2400	2x16GB RDIMM DDR4-2666	1x530-8i	4x3.5"	4x3.5" SATA/SAS HS	2x2TB HDD 7.2K 3.5" SAS12Gbps	None	None	1xLP x8/1xLP x16	Front VGA	TPM 1.2	XClarity Advanced	2x750W Platinum	3-year	07/17
7X08A05ULA	LA	1xXeon Silver 4114 10C/2.2GHz/13.75MB/85W/DDR4-2400	1x8GB RDIMM DDR4-2666	1x530-8i	8x2.5"	8x2.5" SATA/SAS HS	Open	None	None	1xLP x8/1xLP x16	Front VGA	TPM 1.2	XClarity Standard	1x550W Platinum	3-year	07/17
7X08A05VLA	LA	1xXeon Silver 4110 8C/2.1GHz/11MB/85W/DDR4-2400	1x8GB RDIMM DDR4-2666	1x530-8i	4x3.5"	4x3.5" SATA/SAS HS	Open	None	None	1xLP x8/1xLP x16	Front VGA	TPM 1.2	XClarity Standard	1x550W Platinum	3-year	07/17
7X08A05YLA	LA	1xXeon Bronze 3106 8C/1.7GHz/11MB/85W/DDR4-2133	1x8GB RDIMM DDR4-2666	1x530-8i	4x3.5"	4x3.5" SATA/SAS HS	Open	None	None	1xLP x8/1xLP x16	Front VGA	TPM 1.2	XClarity Standard	1x550W Platinum	3-year	07/17

# ThinkSystem SR530 - TopSeller - NA

Product Specifications Reference (PSREF)

Model	Region	Processor	Memory	Storage Controller	Chassis	Disk Bays	Disks	M.2 Drives	Networking (LOM/ML2/PCIe)	Available PCIe Slots	Front VGA	Security	System Management	Power Supply	Base Warranty	Ann Date (mm/yy)
7X08A04FNA	NA	1xXeon Bronze 3106 8C/1.7GHz/11MB/85W/DDR4-2133	1x16GB RDIMM DDR4-2666	1x530-8i	4x3.5"	4x3.5" SATA/SAS HS	Open	None	None	1xLP x8/1xFHHL x16	Front VGA	TPM 1.2	XClarity Enterprise	1x750W Platinum	3-year	07/17
7X08A03SNA	NA	1xXeon Silver 4110 8C/2.1GHz/11MB/85W/DDR4-2400	1x16GB RDIMM DDR4-2666	1x530-8i	4x3.5"	4x3.5" SATA/SAS HS	Open	None	None	1xLP x8/1xFHHL x16	Front VGA	TPM 1.2	XClarity Enterprise	1x750W Platinum	3-year	07/17
7X08A045NA	NA	1xXeon Silver 4116 12C/2.1GHz/16.5MB/85W/DDR4-2400	1x32GB RDIMM DDR4-2666	1x530-8i	4x3.5"	4x3.5" SATA/SAS HS	Open	None	None	1xLP x8/1xFHHL x16	Front VGA	TPM 1.2	XClarity Enterprise	1x750W Platinum	3-year	07/17

Model	Region	Processor	Memory	Storage Controller	Chassis	Disk Bays	Disks	M.2 Drives	Networking (LOM/ML2/PCIe)	Availible PCIe Slots	Front VGA	Security	System Management	Power Supply	Base Warranty	Ann Date (mm/yy)
7X08A006AU	ANZ	1xXeon Gold 5120 14C/2.2GHz/19.25MB/105W/DDR4-2400	1x8GB RDIMM DDR4-2666	1x530-8i	8x2.5"	8x2.5" SATA/SAS HS	Open	None	None	1xLP x8/1xLP x8 ML2	Front VGA	TPM 1.2	XClarity Standard	1x550W Platinum	3-year	07/17
7X08A00DAU	ANZ	1xXeon Gold 5120 14C/2.2GHz/19.25MB/105W/DDR4-2400	1x8GB RDIMM DDR4-2666	1x530-8i	4x3.5"	4x3.5" SATA/SAS HS	Open	None	None	1xLP x8/1xLP x8 ML2	Front VGA	TPM 1.2	XClarity Standard	1x550W Platinum	3-year	07/17
7X08A00YAU	ANZ	1xXeon Gold 5120 14C/2.2GHz/19.25MB/105W/DDR4-2400	1x16GB RDIMM DDR4-2666	1x930-8i 2GB flash	8x2.5"	8x2.5" SATA/SAS HS	Open	None	None	1xLP x8/1xLP x16	Front VGA	TPM 1.2	XClarity Standard	1x550W Platinum	3-year	07/17
7X08A010AU	ANZ	1xXeon Gold 6126 12C/2.6GHz/19.25MB/125W/DDR4-2666	1x16GB RDIMM DDR4-2666	1x930-8i 2GB flash	8x2.5"	8x2.5" SATA/SAS HS	Open	None	None	1xLP x8/1xLP x16	Front VGA	TPM 1.2	XClarity Standard	1x750W Platinum	3-year	07/17
7X08A01NAU	ANZ	1xXeon Gold 5118 12C/2.3GHz/16.5MB/105W/DDR4-2400	1x8GB RDIMM DDR4-2666	Onboard SATA	4x3.5"	4x3.5" SATA SS	Open	None	None	None	Front VGA	TPM 1.2	XClarity Standard	1x550W Platinum	3-year	07/17
7X08A01PAU	ANZ	1xXeon Gold 5118 12C/2.3GHz/16.5MB/105W/DDR4-2400	1x8GB RDIMM DDR4-2666	1x530-8i	8x2.5"	8x2.5" SATA/SAS HS	Open	None	None	1xLP x8/1xLP x8 ML2	Front VGA	TPM 1.2	XClarity Standard	1x550W Platinum	3-year	07/17
7X08A01QAU	ANZ	1xXeon Gold 6138 20C/2.0GHz/27.5MB/125W/DDR4-2666	1x16GB RDIMM DDR4-2666	1x930-8i 2GB flash	8x2.5"	8x2.5" SATA/SAS HS	Open	None	None	1xLP x8/1xLP x16	Front VGA	TPM 1.2	XClarity Standard	1x750W Platinum	3-year	07/17
7X08A01RAU	ANZ	1xXeon Gold 6126 12C/2.6GHz/19.25MB/125W/DDR4-2666	1x16GB RDIMM DDR4-2666	1x530-8i	8x2.5"	8x2.5" SATA/SAS HS	Open	None	None	1xLP x8/1xLP x8 ML2	Front VGA	TPM 1.2	XClarity Standard	1x750W Platinum	3-year	07/17
7X08A01SAU	ANZ	1xXeon Gold 6130 16C/2.1GHz/22MB/125W/DDR4-2666	1x16GB RDIMM DDR4-2666	1x930-8i 2GB flash	8x2.5"	8x2.5" SATA/SAS HS	Open	None	None	1xLP x8/1xLP x16	Front VGA	TPM 1.2	XClarity Standard	1x750W Platinum	3-year	07/17
7X08A01EAU	ANZ	1xXeon Gold 5118 12C/2.3GHz/16.5MB/105W/DDR4-2400	1x16GB RDIMM DDR4-2666	1x930-8i 2GB flash	8x2.5"	8x2.5" SATA/SAS HS	Open	None	None	1xLP x8/1xLP x8 ML2	Front VGA	TPM 1.2	XClarity Standard	1x550W Platinum	3-year	07/17
7X08A01JAU	ANZ	1xXeon Gold 5118 12C/2.3GHz/16.5MB/105W/DDR4-2400	1x8GB RDIMM DDR4-2666	1x530-8i	4x3.5"	4x3.5" SATA/SAS HS	Open	None	None	1xLP x8/1xLP x8 ML2	Front VGA	TPM 1.2	XClarity Standard	1x550W Platinum	3-year	07/17
7X08A01KAU	ANZ	1xXeon Gold 5118 12C/2.3GHz/16.5MB/105W/DDR4-2400	1x16GB RDIMM DDR4-2666	1x530-8i	8x2.5"	8x2.5" SATA/SAS HS	Open	None	None	1xLP x8/1xLP x8 ML2	Front VGA	TPM 1.2	XClarity Standard	1x550W Platinum	3-year	07/17
7X08A02SAU	ANZ	1xXeon Silver 4110 8C/2.1GHz/11MB/85W/DDR4-2400	1x16GB RDIMM DDR4-2666	1x530-8i	8x2.5"	8x2.5" SATA/SAS HS	Open	None	None	1xLP x8/1xLP x16	None	TPM 1.2	XClarity Standard	1x750W Platinum	3-year	07/17
7X08A02XAU	ANZ	1xXeon Silver 4110 8C/2.1GHz/11MB/85W/DDR4-2400	1x16GB RDIMM DDR4-2666	1x930-8i 2GB flash	8x2.5"	8x2.5" SATA/SAS HS	Open	None	None	1xLP x8/1xLP x16	None	TPM 1.2	XClarity Standard	1x750W Platinum	3-year	07/17
7X08A033AU	ANZ	1xXeon Silver 4114 10C/2.2GHz/13.75MB/85W/DDR4-2400	1x16GB RDIMM DDR4-2666	1x930-8i 2GB flash	8x2.5"	8x2.5" SATA/SAS HS	Open	None	None	1xLP x8/1xLP x16	None	TPM 1.2	XClarity Standard	1x750W Platinum	3-year	07/17

Model	Region	Processor	Memory	Storage Controller	Chassis	Disk Bays	Disks	M.2 Drives	Networking (LOM/ML2/PCIe)	Available PCIe Slots	Front VGA	Security	System Management	Power Supply	Base Warranty	Ann Date (mm/yy)
7X08A037AU	ANZ	1xXeon Bronze 3106 8C/1.7GHz/11MB/85W/DDR4-2133	1x16GB RDIMM DDR4-2666	1x530-8i	8x2.5"	8x2.5" SATA/SAS HS	Open	None	None	1xLP x8/1xLP x16	None	TPM 1.2	XClarity Standard	1x750W Platinum	3-year	07/17
7X08A03FAU	ANZ	1xXeon Silver 4108 8C/1.8GHz/11MB/85W/DDR4-2400	1x16GB RDIMM DDR4-2666	1x530-8i	8x2.5"	8x2.5" SATA/SAS HS	Open	None	None	1xLP x8/1xLP x16	None	TPM 1.2	XClarity Standard	1x750W Platinum	3-year	07/17
7X08A03LAU	ANZ	1xXeon Silver 4116 12C/2.1GHz/16.5MB/85W/DDR4-2400	1x16GB RDIMM DDR4-2666	1x930-8i 2GB flash	8x2.5"	8x2.5" SATA/SAS HS	Open	None	None	1xLP x8/1xLP x16	None	TPM 1.2	XClarity Standard	1x750W Platinum	3-year	07/17
7X08A03NAU	ANZ	1xXeon Bronze 3104 6C/1.7GHz/8.25MB/85W/DDR4-2133	1x16GB RDIMM DDR4-2666	1x530-8i	8x2.5"	8x2.5" SATA/SAS HS	Open	None	None	1xLP x8/1xLP x16	None	TPM 1.2	XClarity Standard	1x750W Platinum	3-year	07/17
7X08A03HAU	ANZ	1xXeon Silver 4108 8C/1.8GHz/11MB/85W/DDR4-2400	1x16GB RDIMM DDR4-2666	1x530-8i	4x3.5"	4x3.5" SATA/SAS HS	Open	None	None	1xLP x8/1xLP x16	None	TPM 1.2	XClarity Standard	1x750W Platinum	3-year	07/17
7X08A03JUAU	ANZ	1xXeon Gold 6138 20C/2.0GHz/27.5MB/125W/DDR4-2666	1x32GB RDIMM DDR4-2666	1x930-8i 2GB flash	8x2.5"	8x2.5" SATA/SAS HS	Open	None	None	1xLP x8/1xLP x16	Front VGA	TPM 1.2	XClarity Standard	1x750W Platinum	3-year	07/17
7X08A03VAU	ANZ	1xXeon Gold 5118 12C/2.3GHz/16.5MB/105W/DDR4-2400	1x32GB RDIMM DDR4-2666	1x930-8i 2GB flash	8x2.5"	8x2.5" SATA/SAS HS	Open	None	None	1xLP x8/1xLP x16	Front VGA	TPM 1.2	XClarity Standard	1x750W Platinum	3-year	07/17
7X08A041AU	ANZ	1xXeon Gold 5120 14C/2.2GHz/19.25MB/105W/DDR4-2400	1x16GB RDIMM DDR4-2666	1x930-8i 2GB flash	8x2.5"	8x2.5" SATA/SAS HS	Open	None	None	1xLP x8/1xLP x16	Front VGA	TPM 1.2	XClarity Standard	1x750W Platinum	3-year	07/17
7X08A04MAU	ANZ	1xXeon Gold 5118 12C/2.3GHz/16.5MB/105W/DDR4-2400	1x16GB RDIMM DDR4-2666	1x930-8i 2GB flash	8x2.5"	8x2.5" SATA/SAS HS	Open	None	None	1xLP x8/1xLP x16	Front VGA	TPM 1.2	XClarity Standard	1x750W Platinum	3-year	07/17

## ThinkSystem SR530 - Non TopSeller - ASEAN

Product Specifications Reference (PSREF)

Model	Region	Processor	Memory	Storage Controller	Chassis	Disk Bays	Disks	M.2 Drives	Networking (LOM/ML2/PCIe)	Available PCIe Slots	Front VGA	Security	System Management	Power Supply	Base Warranty	Ann Date (mm/yy)
7X08A02CSG	ASEAN	1xXeon Gold 5118 12C/2.3GHz/16.5MB/105W/DDR4-2400	1x8GB RDIMM DDR4-2666	1x530-8i	8x2.5"	8x2.5" SATA/SAS HS	Open	None	2xGbE RJ-45 LOM	1xLP x8/1xLP x16	Front VGA	TPM 1.2	XClarity Standard	1x550W Platinum	3-year	07/17
7X08A02DSG	ASEAN	1xXeon Gold 5120 14C/2.2GHz/19.25MB/105W/DDR4-2400	1x8GB RDIMM DDR4-2666	1x530-8i	8x2.5"	8x2.5" SATA/SAS HS	Open	None	2xGbE RJ-45 LOM	1xLP x8/1xLP x16	Front VGA	TPM 1.2	XClarity Standard	1x550W Platinum	3-year	07/17
7X08A02ESG	ASEAN	1xXeon Gold 5122 4C/3.6GHz/16.5MB/105W/DDR4-2400	1x8GB RDIMM DDR4-2666	1x530-8i	8x2.5"	8x2.5" SATA/SAS HS	Open	None	2xGbE RJ-45 LOM	1xLP x8/1xLP x16	Front VGA	TPM 1.2	XClarity Standard	1x550W Platinum	3-year	07/17
7X08A02FSG	ASEAN	1xXeon Gold 6130 16C/2.1GHz/22MB/125W/DDR4-2666	1x8GB RDIMM DDR4-2666	1x530-8i	8x2.5"	8x2.5" SATA/SAS HS	Open	None	2xGbE RJ-45 LOM	1xLP x8/1xLP x16	Front VGA	TPM 1.2	XClarity Standard	1x550W Platinum	3-year	07/17
7X08A02GSG	ASEAN	1xXeon Gold 6138 20C/2.0GHz/27.5MB/125W/DDR4-2666	1x8GB RDIMM DDR4-2666	1x530-8i	8x2.5"	8x2.5" SATA/SAS HS	Open	None	2xGbE RJ-45 LOM	1xLP x8/1xLP x16	Front VGA	TPM 1.2	XClarity Standard	1x550W Platinum	3-year	07/17
7X08A02HSG	ASEAN	1xXeon Gold 5122 4C/3.6GHz/16.5MB/105W/DDR4-2400	1x8GB RDIMM DDR4-2666	1x530-8i	4x3.5"	4x3.5" SATA/SAS HS	Open	None	2xGbE RJ-45 LOM	1xLP x8/1xLP x16	Front VGA	TPM 1.2	XClarity Standard	1x550W Platinum	3-year	07/17
7X08A02JSG	ASEAN	1xXeon Silver 4110 8C/2.1GHz/11MB/85W/DDR4-2400	1x8GB RDIMM DDR4-2666	1x530-8i	8x2.5"	8x2.5" SATA/SAS HS	Open	None	None	1xLP x8/1xLP x16	None	TPM 1.2	XClarity Standard	1x550W Platinum	3-year	07/17
7X08A02KSG	ASEAN	1xXeon Silver 4112 4C/2.6GHz/8.25MB/85W/DDR4-2400	1x8GB RDIMM DDR4-2666	1x530-8i	8x2.5"	8x2.5" SATA/SAS HS	Open	None	None	1xLP x8/1xLP x16	None	TPM 1.2	XClarity Standard	1x550W Platinum	3-year	07/17
7X08A02LSG	ASEAN	1xXeon Bronze 3104 6C/1.7GHz/8.25MB/85W/DDR4-2133	1x8GB RDIMM DDR4-2666	1x530-8i	8x2.5"	8x2.5" SATA/SAS HS	Open	None	None	1xLP x8/1xLP x16	None	TPM 1.2	XClarity Standard	1x550W Platinum	3-year	07/17
7X08A02MSG	ASEAN	1xXeon Bronze 3106 8C/1.7GHz/11MB/85W/DDR4-2133	1x8GB RDIMM DDR4-2666	1x530-8i	8x2.5"	8x2.5" SATA/SAS HS	Open	None	None	1xLP x8/1xLP x16	None	TPM 1.2	XClarity Standard	1x550W Platinum	3-year	07/17
7X08A02NSG	ASEAN	1xXeon Silver 4114 10C/2.2GHz/13.75MB/85W/DDR4-2400	1x8GB RDIMM DDR4-2666	1x530-8i	8x2.5"	8x2.5" SATA/SAS HS	Open	None	None	1xLP x8/1xLP x16	None	TPM 1.2	XClarity Standard	1x550W Platinum	3-year	07/17
7X08A02PSG	ASEAN	1xXeon Silver 4116 12C/2.1GHz/16.5MB/85W/DDR4-2400	1x8GB RDIMM DDR4-2666	1x530-8i	8x2.5"	8x2.5" SATA/SAS HS	Open	None	None	1xLP x8/1xLP x16	None	TPM 1.2	XClarity Standard	1x550W Platinum	3-year	07/17
7X08A02QSG	ASEAN	1xXeon Silver 4112 4C/2.6GHz/8.25MB/85W/DDR4-2400	1x8GB RDIMM DDR4-2666	1x530-8i	4x3.5"	4x3.5" SATA/SAS HS	Open	None	None	1xLP x8/1xLP x16	None	TPM 1.2	XClarity Standard	1x550W Platinum	3-year	07/17

Model	Region	Processor	Memory	Storage Controller	Chassis	Disk Bays	Disks	M.2 Drives	Networking (LOM/ML2/PCIe)	Available PCIe Slots	Front VGA	Security	System Management	Power Supply	Base Warranty	Ann Date (mm/yy)
7X08A04NBR	Brazil	1xXeon Gold 6130 16C/2.1GHz/22MB/125W/DDR4-2666	1x16GB RDIMM DDR4-2666	1x530-8i	8x2.5"	8x2.5"	1x600GB HDD 10K 2.5" SAS12Gbps	None	None	1xLP x8/1xLP x16	Front VGA	TPM 1.2	XClarity Standard	1x750W Platinum	3-year	07/17
7X08A04PBR	Brazil	1xXeon Gold 5120 14C/2.2GHz/19.25MB/105W/DDR4-2400	1x8GB RDIMM DDR4-2666	1x530-8i	8x2.5"	8x2.5"	1x600GB HDD 10K 2.5" SAS12Gbps	None	None	1xLP x8/1xLP x16	Front VGA	TPM 1.2	XClarity Standard	1x750W Platinum	3-year	07/17
7X08A04QBR	Brazil	1xXeon Gold 5118 12C/2.3GHz/16.5MB/105W/DDR4-2400	1x32GB RDIMM DDR4-2666	1x530-8i	8x2.5"	8x2.5"	Open	None	None	1xLP x8/1xLP x16	Front VGA	TPM 1.2	XClarity Standard	1x750W Platinum	3-year	07/17
7X08A04RBR	Brazil	1xXeon Gold 5120 14C/2.2GHz/19.25MB/105W/DDR4-2400	1x16GB RDIMM DDR4-2666	1x530-8i	8x2.5"	8x2.5"	1x600GB HDD 10K 2.5" SAS12Gbps	None	None	1xLP x8/1xLP x16	Front VGA	TPM 1.2	XClarity Standard	1x750W Platinum	3-year	07/17
7X08A040BR	Brazil	1xXeon Gold 5118 12C/2.3GHz/16.5MB/105W/DDR4-2400	1x64GB DDR4-2666 LRDIMM	1x530-8i	8x2.5"	8x2.5"	Open	None	None	1xLP x8/1xLP x16	Front VGA	TPM 1.2	XClarity Standard	1x750W Platinum	3-year	07/17
7X08A04HBR	Brazil	1xXeon Gold 5118 12C/2.3GHz/16.5MB/105W/DDR4-2400	1x64GB DDR4-2666 LRDIMM	1x530-8i	8x2.5"	8x2.5"	1x600GB HDD 10K 2.5" SAS12Gbps	None	None	1xLP x8/1xLP x16	Front VGA	TPM 1.2	XClarity Standard	1x750W Platinum	3-year	07/17
7X08A04JBR	Brazil	1xXeon Gold 5118 12C/2.3GHz/16.5MB/105W/DDR4-2400	1x16GB RDIMM DDR4-2666	1x530-8i	8x2.5"	8x2.5"	Open	None	None	1xLP x8/1xLP x16	Front VGA	TPM 1.2	XClarity Standard	1x750W Platinum	3-year	07/17
7X08A04KBR	Brazil	1xXeon Gold 6130 16C/2.1GHz/22MB/125W/DDR4-2666	1x64GB DDR4-2666 LRDIMM	1x530-8i	8x2.5"	8x2.5"	Open	None	None	1xLP x8/1xLP x16	Front VGA	TPM 1.2	XClarity Standard	1x750W Platinum	3-year	07/17
7X08A04LBR	Brazil	1xXeon Gold 5118 12C/2.3GHz/16.5MB/105W/DDR4-2400	1x8GB RDIMM DDR4-2666	1x530-8i	8x2.5"	8x2.5"	1x600GB HDD 10K 2.5" SAS12Gbps	None	None	1xLP x8/1xLP x16	Front VGA	TPM 1.2	XClarity Standard	1x750W Platinum	3-year	07/17
7X08A046BR	Brazil	1xXeon Gold 6130 16C/2.1GHz/22MB/125W/DDR4-2666	1x8GB RDIMM DDR4-2666	1x530-8i	8x2.5"	8x2.5"	Open	None	None	1xLP x8/1xLP x16	Front VGA	TPM 1.2	XClarity Standard	1x750W Platinum	3-year	07/17
7X08A047BR	Brazil	1xXeon Gold 5120 14C/2.2GHz/19.25MB/105W/DDR4-2400	1x64GB DDR4-2666 LRDIMM	1x530-8i	8x2.5"	8x2.5"	1x600GB HDD 10K 2.5" SAS12Gbps	None	None	1xLP x8/1xLP x16	Front VGA	TPM 1.2	XClarity Standard	1x750W Platinum	3-year	07/17
7X08A048BR	Brazil	1xXeon Gold 5120 14C/2.2GHz/19.25MB/105W/DDR4-2400	1x16GB RDIMM DDR4-2666	1x530-8i	8x2.5"	8x2.5"	Open	None	None	1xLP x8/1xLP x16	Front VGA	TPM 1.2	XClarity Standard	1x750W Platinum	3-year	07/17
7X08A049BR	Brazil	1xXeon Gold 5120 14C/2.2GHz/19.25MB/105W/DDR4-2400	1x8GB RDIMM DDR4-2666	1x530-8i	8x2.5"	8x2.5"	Open	None	None	1xLP x8/1xLP x16	Front VGA	TPM 1.2	XClarity Standard	1x750W Platinum	3-year	07/17
7X08A04ABR	Brazil	1xXeon Gold 5120 14C/2.2GHz/19.25MB/105W/DDR4-2400	1x64GB DDR4-2666 LRDIMM	1x530-8i	8x2.5"	8x2.5"	Open	None	None	1xLP x8/1xLP x16	Front VGA	TPM 1.2	XClarity Standard	1x750W Platinum	3-year	07/17
7X08A04BBR	Brazil	1xXeon Gold 6130 16C/2.1GHz/22MB/125W/DDR4-2666	1x32GB RDIMM DDR4-2666	1x530-8i	8x2.5"	8x2.5"	Open	None	None	1xLP x8/1xLP x16	Front VGA	TPM 1.2	XClarity Standard	1x750W Platinum	3-year	07/17



Model	Region	Processor	Memory	Storage Controller	Chassis	Disk Bays	Disks	M.2 Drives	Networking (LOM/ML2/PCIe)	Available PCIe Slots	Front VGA	Security	System Management	Power Supply	Base Warranty	Ann Date (mm/yy)
7X08A04CBR	Brazil	1xXeon Gold 6130 16C/2.1GHz/22MB/125W/DDR4-2666	1x32GB RDIMM DDR4-2666	1x530-8i	8x2.5"	8x2.5"	1x600GB HDD 10K 2.5" SAS12Gbps	None	None	1xLP x8/1xLP x16	Front VGA	TPM 1.2	XClarity Standard	1x750W Platinum	3-year	07/17
7X08A04DBR	Brazil	1xXeon Gold 6130 16C/2.1GHz/22MB/125W/DDR4-2666	1x8GB RDIMM DDR4-2666	1x530-8i	8x2.5"	8x2.5"	1x600GB HDD 10K 2.5" SAS12Gbps	None	None	1xLP x8/1xLP x16	Front VGA	TPM 1.2	XClarity Standard	1x750W Platinum	3-year	07/17
7X08A04EBR	Brazil	1xXeon Gold 6130 16C/2.1GHz/22MB/125W/DDR4-2666	1x64GB DDR4-2666 LRDIMM	1x530-8i	8x2.5"	8x2.5"	1x600GB HDD 10K 2.5" SAS12Gbps	None	None	1xLP x8/1xLP x16	Front VGA	TPM 1.2	XClarity Standard	1x750W Platinum	3-year	07/17
7X08A042BR	Brazil	1xXeon Gold 5118 12C/2.3GHz/16.5MB/105W/DDR4-2400	1x16GB RDIMM DDR4-2666	1x530-8i	8x2.5"	8x2.5"	1x600GB HDD 10K 2.5" SAS12Gbps	None	None	1xLP x8/1xLP x16	Front VGA	TPM 1.2	XClarity Standard	1x750W Platinum	3-year	07/17
7X08A043BR	Brazil	1xXeon Gold 5118 12C/2.3GHz/16.5MB/105W/DDR4-2400	1x8GB RDIMM DDR4-2666	1x530-8i	8x2.5"	8x2.5"	Open	None	None	1xLP x8/1xLP x16	Front VGA	TPM 1.2	XClarity Standard	1x750W Platinum	3-year	07/17
7X08A044BR	Brazil	1xXeon Gold 5118 12C/2.3GHz/16.5MB/105W/DDR4-2400	1x32GB RDIMM DDR4-2666	1x530-8i	8x2.5"	8x2.5"	1x600GB HDD 10K 2.5" SAS12Gbps	None	None	1xLP x8/1xLP x16	Front VGA	TPM 1.2	XClarity Standard	1x750W Platinum	3-year	07/17
7X08A03WBR	Brazil	1xXeon Gold 5120 14C/2.2GHz/19.25MB/105W/DDR4-2400	1x32GB RDIMM DDR4-2666	1x530-8i	8x2.5"	8x2.5"	Open	None	None	1xLP x8/1xLP x16	Front VGA	TPM 1.2	XClarity Standard	1x750W Platinum	3-year	07/17
7X08A03XBR	Brazil	1xXeon Gold 6130 16C/2.1GHz/22MB/125W/DDR4-2666	1x16GB RDIMM DDR4-2666	1x530-8i	8x2.5"	8x2.5"	Open	None	None	1xLP x8/1xLP x16	Front VGA	TPM 1.2	XClarity Standard	1x750W Platinum	3-year	07/17
7X08A03YBR	Brazil	1xXeon Gold 5120 14C/2.2GHz/19.25MB/105W/DDR4-2400	1x32GB RDIMM DDR4-2666	1x530-8i	8x2.5"	8x2.5"	1x600GB HDD 10K 2.5" SAS12Gbps	None	None	1xLP x8/1xLP x16	Front VGA	TPM 1.2	XClarity Standard	1x750W Platinum	3-year	07/17

Model	Region	Processor	Memory	Storage Controller	Chassis	Disk Bays	Disks	M.2 Drives	Networking (LOM/ML2/PCIe)	Available PCIe Slots	Front VGA	Security	System Management	Power Supply	Base Warranty	Ann Date (mm/yy)
7X08A04SEA	EMEA	1xXeon Gold 5115 10C/2.4GHz/13.75MB/85W/DDR4-2400	1x16GB RDIMM DDR4-2666	1x930-8i 2GB flash	8x2.5"	8x2.5" SATA/SAS HS	Open	None	None	1xLP x8/1xLP x16	None	TPM 1.2	XClarity Standard	1x750W Platinum	3-year	07/17
7X08A01TEA	EMEA	1xXeon Bronze 3106 8C/1.7GHz/11MB/85W/DDR4-2133	1x16GB RDIMM DDR4-2666	1x530-8i	8x2.5"	8x2.5" SATA/SAS HS	Open	None	None	1xLP x8/1xLP x16	None	TPM 1.2	XClarity Standard	1x750W Platinum	3-year	07/17
7X08A01WEA	EMEA	1xXeon Silver 4108 8C/1.8GHz/11MB/85W/DDR4-2400	1x16GB RDIMM DDR4-2666	1x530-8i	8x2.5"	8x2.5" SATA/SAS HS	Open	None	None	1xLP x8/1xLP x16	None	TPM 1.2	XClarity Standard	1x750W Platinum	3-year	07/17
7X08A01YEA	EMEA	1xXeon Silver 4114 10C/2.2GHz/13.75MB/85W/DDR4-2400	1x16GB RDIMM DDR4-2666	1x930-8i 2GB flash	8x2.5"	8x2.5" SATA/SAS HS	Open	None	None	1xLP x8/1xLP x16	None	TPM 1.2	XClarity Standard	1x750W Platinum	3-year	07/17
7X08A01ZEA	EMEA	1xXeon Silver 4108 8C/1.8GHz/11MB/85W/DDR4-2400	1x16GB RDIMM DDR4-2666	1x530-8i	4x3.5"	4x3.5" SATA/SAS HS	Open	None	None	1xLP x8/1xLP x16	None	TPM 1.2	XClarity Standard	1x750W Platinum	3-year	07/17
7X08A021EA	EMEA	1xXeon Silver 4116 12C/2.1GHz/16.5MB/85W/DDR4-2400	1x16GB RDIMM DDR4-2666	1x930-8i 2GB flash	8x2.5"	8x2.5" SATA/SAS HS	Open	None	None	1xLP x8/1xLP x16	None	TPM 1.2	XClarity Standard	1x750W Platinum	3-year	07/17
7X08A023EA	EMEA	1xXeon Silver 4110 8C/2.1GHz/11MB/85W/DDR4-2400	1x16GB RDIMM DDR4-2666	1x930-8i 2GB flash	8x2.5"	8x2.5" SATA/SAS HS	Open	None	None	1xLP x8/1xLP x16	None	TPM 1.2	XClarity Standard	1x750W Platinum	3-year	07/17
7X08A026EA	EMEA	1xXeon Bronze 3104 6C/1.7GHz/8.25MB/85W/DDR4-2133	1x16GB RDIMM DDR4-2666	1x530-8i	8x2.5"	8x2.5" SATA/SAS HS	Open	None	None	1xLP x8/1xLP x16	None	TPM 1.2	XClarity Standard	1x750W Platinum	3-year	07/17
7X08A02AEA	EMEA	1xXeon Silver 4110 8C/2.1GHz/11MB/85W/DDR4-2400	1x16GB RDIMM DDR4-2666	1x530-8i	8x2.5"	8x2.5" SATA/SAS HS	Open	None	None	1xLP x8/1xLP x16	None	TPM 1.2	XClarity Standard	1x750W Platinum	3-year	07/17
7X08A00JEA	EMEA	1xXeon Gold 5120 14C/2.2GHz/19.25MB/105W/DDR4-2400	1x16GB RDIMM DDR4-2666	1x930-8i 2GB flash	8x2.5"	8x2.5" SATA/SAS HS	Open	None	None	1xLP x8/1xLP x16	None	TPM 1.2	XClarity Standard	1x750W Platinum	3-year	07/17
7X08A018EA	EMEA	1xXeon Gold 6138 20C/2.0GHz/27.5MB/125W/DDR4-2666	1x32GB RDIMM DDR4-2666	1x930-8i 2GB flash	8x2.5"	8x2.5" SATA/SAS HS	Open	None	None	1xLP x8/1xLP x16	None	TPM 1.2	XClarity Standard	1x750W Platinum	3-year	07/17
7X08A00NEA	EMEA	1xXeon Gold 6126 12C/2.6GHz/19.25MB/125W/DDR4-2666	1x16GB RDIMM DDR4-2666	1x930-8i 2GB flash	8x2.5"	8x2.5" SATA/SAS HS	Open	None	None	1xLP x8/1xLP x16	None	TPM 1.2	XClarity Standard	1x750W Platinum	3-year	07/17
7X08A00PEA	EMEA	1xXeon Gold 5118 12C/2.3GHz/16.5MB/105W/DDR4-2400	1x32GB RDIMM DDR4-2666	1x930-8i 2GB flash	8x2.5"	8x2.5" SATA/SAS HS	Open	None	None	1xLP x8/1xLP x16	None	TPM 1.2	XClarity Standard	1x750W Platinum	3-year	07/17
7X08A003EA	EMEA	1xXeon Gold 5118 12C/2.3GHz/16.5MB/105W/DDR4-2400	1x16GB RDIMM DDR4-2666	1x930-8i 2GB flash	8x2.5"	8x2.5" SATA/SAS HS	Open	None	None	1xLP x8/1xLP x16	None	TPM 1.2	XClarity Standard	1x750W Platinum	3-year	07/17

Model	Region	Processor	Memory	Storage Controller	Chassis	Disk Bays	Disks	M.2 Drives	Networking (LOM/ML2/PCIe)	Availible PCIe Slots	Front VGA	Security	System Management	Power Supply	Base Warranty	Ann Date (mm/yy)
7X08A00SCN	HTK	1xXeon Gold 6130 16C/2.1GHz/22MB/125W/DDR4-2666	1x16GB RDIMM DDR4-2666	1x930-8i 2GB flash	4x3.5"	4x3.5"	Open	None	2xGbE RJ-45 LOM	1xLP x8/1xFHHL x16	None	TPM 1.2	XClarity Standard	1x750W Platinum	3-year	07/17
7X08A00TCN	HTK	1xXeon Gold 6126 12C/2.6GHz/19.25MB/125W/DDR4-2666	1x16GB RDIMM DDR4-2666	1x930-8i 2GB flash	4x3.5"	4x3.5"	Open	None	2xGbE RJ-45 LOM	1xLP x8/1xFHHL x16	None	TPM 1.2	XClarity Standard	1x750W Platinum	3-year	07/17
7X08A00UCN	HTK	1xXeon Gold 5122 4C/3.6GHz/16.5MB/105W/DDR4-2400	1x16GB RDIMM DDR4-2666	1x930-8i 2GB flash	4x3.5"	4x3.5"	Open	None	2xGbE RJ-45 LOM	1xLP x8/1xFHHL x16	None	TPM 1.2	XClarity Standard	1x750W Platinum	3-year	07/17
7X08A00WCN	HTK	1xXeon Gold 5120 14C/2.2GHz/19.25MB/105W/DDR4-2400	1x16GB RDIMM DDR4-2666	1x930-8i 2GB flash	4x3.5"	4x3.5"	Open	None	2xGbE RJ-45 LOM	1xLP x8/1xFHHL x16	None	TPM 1.2	XClarity Standard	1x750W Platinum	3-year	07/17
7X08A01DCN	HTK	1xXeon Gold 6130 16C/2.1GHz/22MB/125W/DDR4-2666	1x16GB RDIMM DDR4-2666	1x930-8i 2GB flash	8x2.5"	8x2.5"	Open	None	2xGbE RJ-45 LOM	1xLP x8/1xFHHL x16	None	TPM 1.2	XClarity Standard	1x750W Platinum	3-year	07/17
7X08A016CN	HTK	1xXeon Gold 6126 12C/2.6GHz/19.25MB/125W/DDR4-2666	1x16GB RDIMM DDR4-2666	1x930-8i 2GB flash	8x2.5"	8x2.5"	Open	None	2xGbE RJ-45 LOM	1xLP x8/1xFHHL x16	None	TPM 1.2	XClarity Standard	1x750W Platinum	3-year	07/17
7X08A00ZCN	HTK	1xXeon Gold 5118 12C/2.3GHz/16.5MB/105W/DDR4-2400	1x16GB RDIMM DDR4-2666	1x930-8i 2GB flash	4x3.5"	4x3.5"	Open	None	2xGbE RJ-45 LOM	1xLP x8/1xFHHL x16	None	TPM 1.2	XClarity Standard	1x750W Platinum	3-year	07/17
7X08A014CN	HTK	1xXeon Gold 5122 4C/3.6GHz/16.5MB/105W/DDR4-2400	1x16GB RDIMM DDR4-2666	1x930-8i 2GB flash	8x2.5"	8x2.5"	Open	None	2xGbE RJ-45 LOM	1xLP x8/1xFHHL x16	None	TPM 1.2	XClarity Standard	1x750W Platinum	3-year	07/17
7X08A02TCN	HTK	1xXeon Bronze 3106 8C/1.7GHz/11MB/85W/DDR4-2133	1x16GB RDIMM DDR4-2666	1x930-8i 2GB flash	8x2.5"	8x2.5"	Open	None	2xGbE RJ-45 LOM	1xLP x8/1xLP x16	None	TPM 1.2	XClarity Standard	1x750W Platinum	3-year	07/17
7X08A02UCN	HTK	1xXeon Silver 4114 10C/2.2GHz/13.75MB/85W/DDR4-2400	1x16GB RDIMM DDR4-2666	1x930-8i 2GB flash	8x2.5"	8x2.5"	Open	None	2xGbE RJ-45 LOM	1xLP x8/1xLP x16	None	TPM 1.2	XClarity Standard	1x750W Platinum	3-year	07/17
7X08A02VCN	HTK	1xXeon Gold 5115 10C/2.4GHz/13.75MB/85W/DDR4-2400	1x16GB RDIMM DDR4-2666	1x930-8i 2GB flash	4x3.5"	4x3.5"	Open	None	2xGbE RJ-45 LOM	1xLP x8/1xLP x16	None	TPM 1.2	XClarity Standard	1x750W Platinum	3-year	07/17
7X08A02WCN	HTK	1xXeon Silver 4116 12C/2.1GHz/16.5MB/85W/DDR4-2400	1x16GB RDIMM DDR4-2666	1x930-8i 2GB flash	4x3.5"	4x3.5"	Open	None	2xGbE RJ-45 LOM	1xLP x8/1xLP x16	None	TPM 1.2	XClarity Standard	1x750W Platinum	3-year	07/17
7X08A01LCN	HTK	1xXeon Gold 5118 12C/2.3GHz/16.5MB/105W/DDR4-2400	1x16GB RDIMM DDR4-2666	1x930-8i 2GB flash	8x2.5"	8x2.5"	Open	None	2xGbE RJ-45 LOM	1xLP x8/1xFHHL x16	None	TPM 1.2	XClarity Standard	1x750W Platinum	3-year	07/17
7X08A01GCN	HTK	1xXeon Gold 5120 14C/2.2GHz/19.25MB/105W/DDR4-2400	1x16GB RDIMM DDR4-2666	1x930-8i 2GB flash	8x2.5"	8x2.5"	Open	None	2xGbE RJ-45 LOM	1xLP x8/1xFHHL x16	None	TPM 1.2	XClarity Standard	1x750W Platinum	3-year	07/17
7X08A03KCN	HTK	1xXeon Silver 4108 8C/1.8GHz/11MB/85W/DDR4-2400	1x16GB RDIMM DDR4-2666	1x930-8i 2GB flash	4x3.5"	4x3.5"	Open	None	2xGbE RJ-45 LOM	1xLP x8/1xLP x16	None	TPM 1.2	XClarity Standard	1x750W Platinum	3-year	07/17

Model	Region	Processor	Memory	Storage Controller	Chassis	Disk Bays	Disks	M.2 Drives	Networking (LOM/ML2/PCIe)	Availiable PCIe Slots	Front VGA	Security	System Management	Power Supply	Base Warranty	Ann Date (mm/yy)
7X08A03PCN	HTK	1xXeon Silver 4110 8C/2.1GHz/11MB/85W/DDR4-2400	1x16GB RDIMM DDR4-2666	1x930-8i 2GB flash	8x2.5"	8x2.5" SATA/SAS HS	Open	None	2xGbE RJ-45 LOM	1xLP x8/1xLP x16	None	TPM 1.2	XClarity Standard	1x750W Platinum	3-year	07/17
7X08A03GCN	HTK	1xXeon Silver 4110 8C/2.1GHz/11MB/85W/DDR4-2400	1x16GB RDIMM DDR4-2666	1x930-8i 2GB flash	4x3.5"	4x3.5" SATA/SAS HS	Open	None	2xGbE RJ-45 LOM	1xLP x8/1xLP x16	None	TPM 1.2	XClarity Standard	1x750W Platinum	3-year	07/17
7X08A039CN	HTK	1xXeon Silver 4108 8C/1.8GHz/11MB/85W/DDR4-2400	1x16GB RDIMM DDR4-2666	1x930-8i 2GB flash	8x2.5"	8x2.5" SATA/SAS HS	Open	None	2xGbE RJ-45 LOM	1xLP x8/1xLP x16	None	TPM 1.2	XClarity Standard	1x750W Platinum	3-year	07/17
7X08A03BCN	HTK	1xXeon Bronze 3104 6C/1.7GHz/8.25MB/85W/DDR4-2133	1x16GB RDIMM DDR4-2666	1x930-8i 2GB flash	8x2.5"	8x2.5" SATA/SAS HS	Open	None	2xGbE RJ-45 LOM	1xLP x8/1xLP x16	None	TPM 1.2	XClarity Standard	1x750W Platinum	3-year	07/17
7X08A03CCN	HTK	1xXeon Silver 4112 4C/2.6GHz/8.25MB/85W/DDR4-2400	1x16GB RDIMM DDR4-2666	1x930-8i 2GB flash	4x3.5"	4x3.5" SATA/SAS HS	Open	None	2xGbE RJ-45 LOM	1xLP x8/1xLP x16	None	TPM 1.2	XClarity Standard	1x750W Platinum	3-year	07/17
7X08A03DCN	HTK	1xXeon Silver 4112 4C/2.6GHz/8.25MB/85W/DDR4-2400	1x16GB RDIMM DDR4-2666	1x930-8i 2GB flash	8x2.5"	8x2.5" SATA/SAS HS	Open	None	2xGbE RJ-45 LOM	1xLP x8/1xLP x16	None	TPM 1.2	XClarity Standard	1x750W Platinum	3-year	07/17
7X08A03ECN	HTK	1xXeon Gold 5115 10C/2.4GHz/13.75MB/85W/DDR4-2400	1x16GB RDIMM DDR4-2666	1x930-8i 2GB flash	8x2.5"	8x2.5" SATA/SAS HS	Open	None	2xGbE RJ-45 LOM	1xLP x8/1xLP x16	None	TPM 1.2	XClarity Standard	1x750W Platinum	3-year	07/17
7X08A036CN	HTK	1xXeon Silver 4114 10C/2.2GHz/13.75MB/85W/DDR4-2400	1x16GB RDIMM DDR4-2666	1x930-8i 2GB flash	4x3.5"	4x3.5" SATA/SAS HS	Open	None	2xGbE RJ-45 LOM	1xLP x8/1xLP x16	None	TPM 1.2	XClarity Standard	1x750W Platinum	3-year	07/17
7X08A031CN	HTK	1xXeon Bronze 3106 8C/1.7GHz/11MB/85W/DDR4-2133	1x16GB RDIMM DDR4-2666	1x930-8i 2GB flash	4x3.5"	4x3.5" SATA/SAS HS	Open	None	2xGbE RJ-45 LOM	1xLP x8/1xLP x16	None	TPM 1.2	XClarity Standard	1x750W Platinum	3-year	07/17
7X08A02YCN	HTK	1xXeon Silver 4116 12C/2.1GHz/16.5MB/85W/DDR4-2400	1x16GB RDIMM DDR4-2666	1x930-8i 2GB flash	8x2.5"	8x2.5" SATA/SAS HS	Open	None	2xGbE RJ-45 LOM	1xLP x8/1xLP x16	None	TPM 1.2	XClarity Standard	1x750W Platinum	3-year	07/17
7X08A02ZCN	HTK	1xXeon Bronze 3104 6C/1.7GHz/8.25MB/85W/DDR4-2133	1x16GB RDIMM DDR4-2666	1x930-8i 2GB flash	4x3.5"	4x3.5" SATA/SAS HS	Open	None	2xGbE RJ-45 LOM	1xLP x8/1xLP x16	None	TPM 1.2	XClarity Standard	1x750W Platinum	3-year	07/17

Model	Region	Processor	Memory	Storage Controller	Chassis	Disk Bays	Disks	M.2 Drives	Networking (LOM/ML2/PCIe)	Available PCIe Slots	Front VGA	Security	System Management	Power Supply	Base Warranty	Ann Date (mm/yy)
7X08A015SG	INDIA	1xXeon Gold 6130 16C/2.1GHz/22MB/125W/DDR4-2666	1x16GB RDIMM DDR4-2666	1x930-8i 2GB flash	8x2.5"	8x2.5" SATA/SAS HS	Open	None	2xGbE RJ-45 LOM	1xLP x8/1xLP x8 ML2	Front VGA	TPM 1.2	XClarity Standard	1x750W Platinum	3-year	07/17
7X08A011SG	INDIA	1xXeon Gold 6126 12C/2.6GHz/19.25MB/125W/DDR4-2666	1x16GB RDIMM DDR4-2666	1x930-8i 2GB flash	8x2.5"	8x2.5" SATA/SAS HS	Open	None	2xGbE RJ-45 LOM	1xLP x8/1xLP x8 ML2	Front VGA	TPM 1.2	XClarity Standard	1x750W Platinum	3-year	07/17
7X08A013SG	INDIA	1xXeon Gold 6126 12C/2.6GHz/19.25MB/125W/DDR4-2666	1x16GB RDIMM DDR4-2666	1x530-8i	8x2.5"	8x2.5" SATA/SAS HS	Open	None	2xGbE RJ-45 LOM	1xLP x8/1xLP x8 ML2	Front VGA	TPM 1.2	XClarity Standard	1x750W Platinum	3-year	07/17
7X08A01BSG	INDIA	1xXeon Gold 6138 20C/2.0GHz/27.5MB/125W/DDR4-2666	1x16GB RDIMM DDR4-2666	1x930-8i 2GB flash	8x2.5"	8x2.5" SATA/SAS HS	Open	None	2xGbE RJ-45 LOM	1xLP x8/1xLP x8 ML2	Front VGA	TPM 1.2	XClarity Standard	1x750W Platinum	3-year	07/17
7X08A00FSG	INDIA	1xXeon Gold 5120 14C/2.2GHz/19.25MB/105W/DDR4-2400	1x8GB RDIMM DDR4-2666	1x530-8i	4x3.5"	4x3.5" SATA/SAS HS	Open	None	2xGbE RJ-45 LOM	1xLP x8/1xLP x8 ML2	Front VGA	TPM 1.2	XClarity Standard	1x550W Platinum	3-year	07/17
7X08A00GSG	INDIA	1xXeon Gold 5120 14C/2.2GHz/19.25MB/105W/DDR4-2400	1x8GB RDIMM DDR4-2666	1x930-8i 2GB flash	8x2.5"	8x2.5" SATA/SAS HS	Open	None	2xGbE RJ-45 LOM	1xLP x8/1xLP x8 ML2	Front VGA	TPM 1.2	XClarity Standard	1x550W Platinum	3-year	07/17
7X08A00ASG	INDIA	1xXeon Gold 5118 12C/2.3GHz/16.5MB/105W/DDR4-2400	1x8GB RDIMM DDR4-2666	1x530-8i	8x2.5"	8x2.5" SATA/SAS HS	Open	None	2xGbE RJ-45 LOM	1xLP x8/1xLP x8 ML2	Front VGA	TPM 1.2	XClarity Standard	1x550W Platinum	3-year	07/17
7X08A00BSG	INDIA	1xXeon Gold 5120 14C/2.2GHz/19.25MB/105W/DDR4-2400	1x8GB RDIMM DDR4-2666	1x530-8i	8x2.5"	8x2.5" SATA/SAS HS	Open	None	2xGbE RJ-45 LOM	1xLP x8/1xLP x8 ML2	Front VGA	TPM 1.2	XClarity Standard	1x550W Platinum	3-year	07/17
7X08A00CSG	INDIA	1xXeon Gold 5118 12C/2.3GHz/16.5MB/105W/DDR4-2400	1x16GB RDIMM DDR4-2666	1x930-8i 2GB flash	8x2.5"	8x2.5" SATA/SAS HS	Open	None	2xGbE RJ-45 LOM	1xLP x8/1xLP x8 ML2	Front VGA	TPM 1.2	XClarity Standard	1x550W Platinum	3-year	07/17
7X08A004SG	INDIA	1xXeon Gold 5118 12C/2.3GHz/16.5MB/105W/DDR4-2400	1x8GB RDIMM DDR4-2666	1x530-8i	4x3.5"	4x3.5" SATA/SAS HS	Open	None	2xGbE RJ-45 LOM	1xLP x8/1xLP x8 ML2	Front VGA	TPM 1.2	XClarity Standard	1x550W Platinum	3-year	07/17
7X08A007SG	INDIA	1xXeon Gold 5118 12C/2.3GHz/16.5MB/105W/DDR4-2400	1x8GB RDIMM DDR4-2666	Onboard SATA	4x3.5"	4x3.5" SATA SS	Open	None	2xGbE RJ-45 LOM	None	Front VGA	TPM 1.2	XClarity Standard	1x550W Platinum	3-year	07/17
7X08A008SG	INDIA	1xXeon Gold 5118 12C/2.3GHz/16.5MB/105W/DDR4-2400	1x16GB RDIMM DDR4-2666	1x530-8i	8x2.5"	8x2.5" SATA/SAS HS	Open	None	2xGbE RJ-45 LOM	1xLP x8/1xLP x8 ML2	Front VGA	TPM 1.2	XClarity Standard	1x550W Platinum	3-year	07/17

# ThinkSystem SR530 - Non TopSeller - JAPAN

Product Specifications Reference (PSREF)

Model	Region	Processor	Memory	Storage Controller	Chassis	Disk Bays	Disks	M.2 Drives	Networking (LOM/ML2/PCIe)	Avaliable PCIe Slots	Front VGA	Security	System Management	Power Supply	Base Warranty	Ann Date (mm/yy)
7X08A04WJP	JAPAN	1xXeon Gold 6138 20C/2.0GHz/27.5MB/125W/DDR4-2666	1x8GB RDIMM DDR4-2666	1x930-8i 2GB flash	8x2.5"	8x2.5"	SATA/SAS HS	Open	None	None	None	TPM 1.2	XClarity Advanced	1x550W Platinum	3-year	07/17
7X08A04XJP	JAPAN	1xXeon Gold 5122 4C/3.6GHz/16.5MB/105W/DDR4-2400	1x8GB RDIMM DDR4-2666	1x930-8i 2GB flash	8x2.5"	8x2.5"	SATA/SAS HS	Open	None	None	None	TPM 1.2	XClarity Advanced	1x550W Platinum	3-year	07/17

## ThinkSystem SR530 - Non TopSeller - LA

Product Specifications Reference (PSREF)

Model	Region	Processor	Memory	Storage Controller	Chassis	Disk Bays	Disks	M.2 Drives	Networking (LOM/ML2/PCIe)	Availiable PCIe Slots	Front VGA	Security	System Management	Power Supply	Base Warranty	Ann Date (mm/yy)	
7X08A00HLA	LA	1xXeon Gold 6130 16C/2.1GHz/22MB/125W/DDR4-2666	1x8GB RDIMM DDR4-2666	1x530-8i	8x2.5"	8x2.5"	SATA/SAS HS	Open	None	None	1xLP x8/1xLP x16	Front VGA	TPM 1.2	XClarity Standard	1x750W Platinum	3-year	07/17
7X08A01CLA	LA	1xXeon Gold 6130 16C/2.1GHz/22MB/125W/DDR4-2666	1x8GB RDIMM DDR4-2666	1x530-8i	4x3.5"	4x3.5"	SATA/SAS HS	Open	None	None	1xLP x8/1xLP x16	Front VGA	TPM 1.2	XClarity Standard	1x750W Platinum	3-year	07/17
7X08A017LA	LA	1xXeon Gold 5118 12C/2.3GHz/16.5MB/105W/DDR4-2400	1x8GB RDIMM DDR4-2666	1x530-8i	4x3.5"	4x3.5"	SATA/SAS HS	Open	None	None	1xLP x8/1xLP x16	Front VGA	TPM 1.2	XClarity Standard	1x750W Platinum	3-year	07/17
7X08A019LA	LA	1xXeon Gold 5120 14C/2.2GHz/19.25MB/105W/DDR4-2400	1x8GB RDIMM DDR4-2666	1x530-8i	4x3.5"	4x3.5"	SATA/SAS HS	Open	None	None	1xLP x8/1xLP x16	Front VGA	TPM 1.2	XClarity Standard	1x750W Platinum	3-year	07/17
7X08A00KLA	LA	1xXeon Gold 5120 14C/2.2GHz/19.25MB/105W/DDR4-2400	1x8GB RDIMM DDR4-2666	1x530-8i	8x2.5"	8x2.5"	SATA/SAS HS	Open	None	None	1xLP x8/1xLP x16	Front VGA	TPM 1.2	XClarity Standard	1x750W Platinum	3-year	07/17
7X08A00MLA	LA	1xXeon Gold 5118 12C/2.3GHz/16.5MB/105W/DDR4-2400	1x8GB RDIMM DDR4-2666	1x530-8i	8x2.5"	8x2.5"	SATA/SAS HS	Open	None	None	1xLP x8/1xLP x16	Front VGA	TPM 1.2	XClarity Standard	1x750W Platinum	3-year	07/17
7X08A05DLA	LA	1xXeon Gold 5115 10C/2.4GHz/13.75MB/85W/DDR4-2400	1x8GB RDIMM DDR4-2666	1x530-8i	4x3.5"	4x3.5"	SATA/SAS HS	Open	None	None	1xLP x8/1xLP x16	Front VGA	TPM 1.2	XClarity Standard	1x550W Platinum	3-year	07/17
7X08A05NLA	LA	1xXeon Gold 5115 10C/2.4GHz/13.75MB/85W/DDR4-2400	1x8GB RDIMM DDR4-2666	1x530-8i	8x2.5"	8x2.5"	SATA/SAS HS	Open	None	None	1xLP x8/1xLP x16	Front VGA	TPM 1.2	XClarity Standard	1x550W Platinum	3-year	07/17

## ThinkSystem SR530 - Non TopSeller - NA

Product Specifications Reference (PSREF)

Model	Region	Processor	Memory	Storage Controller	Chassis	Disk Bays	Disks	M.2 Drives	Networking (LOM/ML2/PCIe)	Available PCIe Slots	Front VGA	Security	System Management	Power Supply	Base Warranty	Ann Date (mm/yy)
7X08A05WNA	NA	1xXeon Bronze 3106 8C/1.7GHz/11MB/85W/DDR4-2133	1x16GB RDIMM DDR4-2666	1x530-8i	8x2.5"	8x2.5" SATA/SAS HS	Open	None	None	1xLP x8/1xLP x16	None	TPM 1.2	XClarity Standard	1x750W Platinum	3-year	07/17
7X08A05XNA	NA	1xXeon Silver 4108 8C/1.8GHz/11MB/85W/DDR4-2400	1x16GB RDIMM DDR4-2666	1x530-8i	8x2.5"	8x2.5" SATA/SAS HS	Open	None	None	1xLP x8/1xLP x16	None	TPM 1.2	XClarity Standard	1x750W Platinum	3-year	07/17
7X08A05RNA	NA	1xXeon Gold 5120 14C/2.2GHz/19.25MB/105W/DDR4-2400	1x16GB RDIMM DDR4-2666	1x930-8i 2GB flash	8x2.5"	8x2.5" SATA/SAS HS	Open	None	None	1xLP x8/1xLP x16	Front VGA	TPM 1.2	XClarity Standard	1x750W Platinum	3-year	07/17
7X08A05SNA	NA	1xXeon Gold 5118 12C/2.3GHz/16.5MB/105W/DDR4-2400	1x16GB RDIMM DDR4-2666	1x930-8i 2GB flash	8x2.5"	8x2.5" SATA/SAS HS	Open	None	None	1xLP x8/1xLP x16	Front VGA	TPM 1.2	XClarity Standard	1x750W Platinum	3-year	07/17
7X08A05TNA	NA	1xXeon Silver 4108 8C/1.8GHz/11MB/85W/DDR4-2400	1x16GB RDIMM DDR4-2666	1x530-8i	4x3.5"	4x3.5" SATA/SAS HS	Open	None	None	1xLP x8/1xLP x16	None	TPM 1.2	XClarity Standard	1x750W Platinum	3-year	07/17
7X08A05PNA	NA	1xXeon Gold 6126 12C/2.6GHz/19.25MB/125W/DDR4-2666	1x16GB RDIMM DDR4-2666	1x930-8i 2GB flash	8x2.5"	8x2.5" SATA/SAS HS	Open	None	None	1xLP x8/1xLP x16	Front VGA	TPM 1.2	XClarity Standard	1x750W Platinum	3-year	07/17
7X08A05MNA	NA	1xXeon Silver 4114 10C/2.2GHz/13.75MB/85W/DDR4-2400	1x16GB RDIMM DDR4-2666	1x930-8i 2GB flash	8x2.5"	8x2.5" SATA/SAS HS	Open	None	None	1xLP x8/1xLP x16	None	TPM 1.2	XClarity Standard	1x750W Platinum	3-year	07/17
7X08A05KNA	NA	1xXeon Silver 4116 12C/2.1GHz/16.5MB/85W/DDR4-2400	1x16GB RDIMM DDR4-2666	1x930-8i 2GB flash	8x2.5"	8x2.5" SATA/SAS HS	Open	None	None	1xLP x8/1xLP x16	None	TPM 1.2	XClarity Standard	1x750W Platinum	3-year	07/17
7X08A05ENA	NA	1xXeon Gold 5115 10C/2.4GHz/13.75MB/85W/DDR4-2400	1x16GB RDIMM DDR4-2666	1x930-8i 2GB flash	8x2.5"	8x2.5" SATA/SAS HS	Open	None	None	1xLP x8/1xLP x16	None	TPM 1.2	XClarity Standard	1x750W Platinum	3-year	07/17
7X08A055NA	NA	1xXeon Silver 4110 8C/2.1GHz/11MB/85W/DDR4-2400	1x16GB RDIMM DDR4-2666	1x930-8i 2GB flash	8x2.5"	8x2.5" SATA/SAS HS	Open	None	None	1xLP x8/1xLP x16	None	TPM 1.2	XClarity Standard	1x750W Platinum	3-year	07/17
7X08A056NA	NA	1xXeon Bronze 3104 6C/1.7GHz/8.25MB/85W/DDR4-2133	1x16GB RDIMM DDR4-2666	1x530-8i	8x2.5"	8x2.5" SATA/SAS HS	Open	None	None	1xLP x8/1xLP x16	None	TPM 1.2	XClarity Standard	1x750W Platinum	3-year	07/17
7X08A057NA	NA	1xXeon Silver 4110 8C/2.1GHz/11MB/85W/DDR4-2400	1x16GB RDIMM DDR4-2666	1x530-8i	8x2.5"	8x2.5" SATA/SAS HS	Open	None	None	1xLP x8/1xLP x16	None	TPM 1.2	XClarity Standard	1x750W Platinum	3-year	07/17
7X08A058NA	NA	1xXeon Gold 5118 12C/2.3GHz/16.5MB/105W/DDR4-2400	1x32GB RDIMM DDR4-2666	1x930-8i 2GB flash	8x2.5"	8x2.5" SATA/SAS HS	Open	None	None	1xLP x8/1xLP x16	Front VGA	TPM 1.2	XClarity Standard	1x750W Platinum	3-year	07/17
7X08A052NA	NA	1xXeon Gold 6138 20C/2.0GHz/27.5MB/125W/DDR4-2666	1x32GB RDIMM DDR4-2666	1x930-8i 2GB flash	8x2.5"	8x2.5" SATA/SAS HS	Open	None	None	1xLP x8/1xLP x16	Front VGA	TPM 1.2	XClarity Standard	1x750W Platinum	3-year	07/17







Model	Region	Processor	Memory	Storage Controller	Chassis	Disk Bays	Disks	M.2 Drives	Networking (LOM/ML2/PCIe)	Available PCIe Slots	Front VGA	Security	System Management	Power Supply	Base Warranty	Ann Date (mm/yy)
7X04A02AAU	ANZ	1xXeon Silver 4108 8C/1.8GHz/11MB/85W/DDR4-2400	1x16GB RDIMM DDR4-2666	1x930-8i 2GB flash	16x2.5"	8x2.5" SATA/SAS HS	Open	None	None	1xLP x8	Front VGA	TPM 1.2	XClarity Advanced	1x750W Platinum	3-year	07/17
7X04A02BAU	ANZ	1xXeon Silver 4108 8C/1.8GHz/11MB/85W/DDR4-2400	1x16GB RDIMM DDR4-2666	1x930-8i 2GB flash	16x2.5"	8x2.5" SATA/SAS HS	2x300GB HDD 10K 2.5" SAS12Gbps	None	None	1xLP x8	Front VGA	TPM 1.2	XClarity Advanced	2x750W Platinum	3-year	07/17
7X04A02GAU	ANZ	1xXeon Bronze 3104 6C/1.7GHz/8.25MB/85W/DDR4-2133	1x16GB RDIMM DDR4-2666	1xOnboard	12x3.5"	8x3.5" SATA SS	Open	None	None	1xLP x8	Front VGA	TPM 1.2	XClarity Standard	1x750W Platinum	3-year	07/17
7X04A02JAU	ANZ	1xXeon Silver 4110 8C/2.1GHz/11MB/85W/DDR4-2400	1x16GB RDIMM DDR4-2666	1x930-8i 2GB flash	12x3.5"	8x3.5" SATA/SAS HS	Open	None	None	1xLP x8	Front VGA	TPM 1.2	XClarity Advanced	1x750W Platinum	3-year	07/17
7X04A02RAU	ANZ	1xXeon Gold 6126 12C/2.6GHz/19.25MB/125W/DDR4-2666	1x32GB RDIMM DDR4-2666	1x930-8i 2GB flash	16x2.5"	8x2.5" SATA/SAS HS	Open	None	None	3xFHHL x8/1xLP x8	Front VGA	TPM 1.2	XClarity Advanced	1x750W Platinum	3-year	07/17
7X04A02VAU	ANZ	1xXeon Silver 4116 12C/2.1GHz/16.5MB/85W/DDR4-2400	1x16GB RDIMM DDR4-2666	1x930-8i 2GB flash	16x2.5"	8x2.5" SATA/SAS HS	Open	None	None	1xLP x8	Front VGA	TPM 1.2	XClarity Advanced	1x750W Platinum	3-year	07/17
7X04A02WAU	ANZ	1xXeon Silver 4110 8C/2.1GHz/11MB/85W/DDR4-2400	1x16GB RDIMM DDR4-2666	1x930-8i 2GB flash	16x2.5"	8x2.5" SATA/SAS HS	Open	None	None	1xLP x8	Front VGA	TPM 1.2	XClarity Advanced	1x750W Platinum	3-year	07/17
7X04A02YAU	ANZ	1xXeon Bronze 3106 8C/1.7GHz/11MB/85W/DDR4-2133	1x16GB RDIMM DDR4-2666	1x530-8i	16x2.5"	8x2.5" SATA/SAS HS	Open	None	None	1xLP x8	Front VGA	TPM 1.2	XClarity Advanced	1x750W Platinum	3-year	07/17
7X04A034AU	ANZ	1xXeon Gold 6138 20C/2.0GHz/27.5MB/125W/DDR4-2666	1x32GB RDIMM DDR4-2666	1x930-8i 2GB flash	16x2.5"	8x2.5" SATA/SAS HS	Open	None	None	3xFHHL x8/1xLP x8	Front VGA	TPM 1.2	XClarity Advanced	1x750W Platinum	3-year	07/17
7X04A035AU	ANZ	1xXeon Gold 6130 16C/2.1GHz/22MB/125W/DDR4-2666	1x32GB RDIMM DDR4-2666	1x930-8i 2GB flash	16x2.5"	8x2.5" SATA/SAS HS	Open	None	None	3xFHHL x8/1xLP x8	Front VGA	TPM 1.2	XClarity Advanced	1x750W Platinum	3-year	07/17
7X04A039AU	ANZ	1xXeon Gold 5118 12C/2.3GHz/16.5MB/105W/DDR4-2400	1x16GB RDIMM DDR4-2666	1x930-8i 2GB flash	16x2.5"	8x2.5" SATA/SAS HS	Open	None	None	3xFHHL x8/1xLP x8	Front VGA	TPM 1.2	XClarity Advanced	1x750W Platinum	3-year	07/17
7X04A03EAU	ANZ	1xXeon Gold 5122 4C/3.6GHz/16.5MB/105W/DDR4-2400	1x16GB RDIMM DDR4-2666	1x930-8i 2GB flash	16x2.5"	8x2.5" SATA/SAS HS	Open	None	None	3xFHHL x8/1xLP x8	Front VGA	TPM 1.2	XClarity Advanced	1x750W Platinum	3-year	07/17
7X04A03KAU	ANZ	1xXeon Silver 4110 8C/2.1GHz/11MB/85W/DDR4-2400	1x16GB RDIMM DDR4-2666	1x930-8i 2GB flash	16x2.5"	8x2.5" SATA/SAS HS	2x300GB HDD 10K 2.5" SAS12Gbps	None	None	1xLP x8	Front VGA	TPM 1.2	XClarity Advanced	2x750W Platinum	3-year	07/17
7X04A03ZAU	ANZ	1xXeon Gold 6126T 12C/2.6GHz/19.25MB/125W/DDR4-2666	1x32GB RDIMM DDR4-2666	1x930-8i 2GB flash	16x2.5"	8x2.5" SATA/SAS HS	Open	None	None	3xFHHL x8/1xLP x8	None	TPM 1.2	XClarity Enterprise	1x750W Platinum	3-year	07/17
7X04A040AU	ANZ	1xXeon Gold 5120 14C/2.2GHz/19.25MB/105W/DDR4-2400	1x16GB RDIMM DDR4-2666	1x930-8i 2GB flash	16x2.5"	8x2.5" SATA/SAS HS	Open	None	None	3xFHHL x8/1xLP x8	None	TPM 1.2	XClarity Enterprise	1x750W Platinum	3-year	07/17

Model	Region	Processor	Memory	Storage Controller	Chassis	Disk Bays	Disks	M.2 Drives	Networking (LOM/ML2/PCIe)	Available PCIe Slots	Front VGA	Security	System Management	Power Supply	Base Warranty	Ann Date (mm/yy)
7X04A045AU	ANZ	1xXeon Gold 5118 12C/2.3GHz/16.5MB/105W/DDR4-2400	1x16GB RDIMM DDR4-2666	1x930-8i 2GB flash	16x2.5"	8x2.5" SATA/SAS HS	Open	None	None	3xFHHL x8/1xLP x8	None	TPM 1.2	XClarity Enterprise	1x750W Platinum	3-year	07/17
7X04A046AU	ANZ	1xXeon Gold 6130 16C/2.1GHz/22MB/125W/DDR4-2666	1x32GB RDIMM DDR4-2666	1x930-8i 2GB flash	16x2.5"	8x2.5" SATA/SAS HS	Open	None	None	3xFHHL x8/1xLP x8	None	TPM 1.2	XClarity Enterprise	1x750W Platinum	3-year	07/17
7X04A047AU	ANZ	1xXeon Gold 6138 20C/2.0GHz/27.5MB/125W/DDR4-2666	1x16GB RDIMM DDR4-2666	1x930-8i 2GB flash	16x2.5"	8x2.5" SATA/SAS HS	Open	None	None	3xFHHL x8/1xLP x8	None	TPM 1.2	XClarity Enterprise	1x750W Platinum	3-year	07/17
7X04A048AU	ANZ	1xXeon Gold 5122 4C/3.6GHz/16.5MB/105W/DDR4-2400	1x16GB RDIMM DDR4-2666	1x930-8i 2GB flash	16x2.5"	8x2.5" SATA/SAS HS	Open	None	None	3xFHHL x8/1xLP x8	None	TPM 1.2	XClarity Enterprise	1x750W Platinum	3-year	07/17
7X04A03SAU	ANZ	1xXeon Gold 5120 14C/2.2GHz/19.25MB/105W/DDR4-2400	1x16GB RDIMM DDR4-2666	1x930-8i 2GB flash	16x2.5"	8x2.5" SATA/SAS HS	Open	None	None	3xFHHL x8/1xLP x8	Front VGA	TPM 1.2	XClarity Advanced	1x750W Platinum	3-year	07/17
7X04A03TAU	ANZ	1xXeon Bronze 3104 6C/1.7GHz/8.25MB/85W/DDR4-2133	1x16GB RDIMM DDR4-2666	1x530-8i	16x2.5"	8x2.5" SATA/SAS HS	Open	None	None	1xLP x8	Front VGA	TPM 1.2	XClarity Advanced	1x750W Platinum	3-year	07/17
7X04A03VAU	ANZ	1xXeon Silver 4114 10C/2.2GHz/13.75MB/85W/DDR4-2400	1x16GB RDIMM DDR4-2666	1x930-8i 2GB flash	16x2.5"	8x2.5" SATA/SAS HS	Open	None	None	1xLP x8	Front VGA	TPM 1.2	XClarity Advanced	1x750W Platinum	3-year	07/17
7X04A03WAU	ANZ	1xXeon Silver 4108 8C/1.8GHz/11MB/85W/DDR4-2400	1x16GB RDIMM DDR4-2666	1x930-8i 2GB flash	12x3.5"	8x3.5" SATA/SAS HS	Open	None	None	1xLP x8	Front VGA	TPM 1.2	XClarity Advanced	1x750W Platinum	3-year	07/17

Model	Region	Processor	Memory	Storage Controller	Chassis	Disk Bays	Disks	M.2 Drives	Networking (LOM/ML2/PCIe)	Available PCIe Slots	Front VGA	Security	System Management	Power Supply	Base Warranty	Ann Date (mm/yy)
7X04A00HEA	EMEA	1xXeon Silver 4108 8C/1.8GHz/11MB/85W/DDR4-2400	1x16GB RDIMM DDR4-2666	1x930-8i 2GB flash	16x2.5"	8x2.5" SATA/SAS HS	2x300GB HDD 10K 2.5" SAS12Gbps	None	None	1xLP x8	Front VGA	TPM 1.2	XClarity Advanced	2x750W Platinum	3-year	07/17
7X04A00MEA	EMEA	1xXeon Bronze 3104 6C/1.7GHz/8.25MB/85W/DDR4-2133	1x16GB RDIMM DDR4-2666	1xOnboard	12x3.5"	8x3.5" SATA SS	Open	None	None	1xLP x8	Front VGA	TPM 1.2	XClarity Standard	1x750W Platinum	3-year	07/17
7X04A00NEA	EMEA	1xXeon Silver 4108 8C/1.8GHz/11MB/85W/DDR4-2400	1x16GB RDIMM DDR4-2666	1x930-8i 2GB flash	12x3.5"	8x3.5" SATA/SAS HS	Open	None	None	1xLP x8	Front VGA	TPM 1.2	XClarity Advanced	1x750W Platinum	3-year	07/17
7X04A00QEA	EMEA	1xXeon Silver 4108 8C/1.8GHz/11MB/85W/DDR4-2400	1x16GB RDIMM DDR4-2666	1x930-8i 2GB flash	16x2.5"	8x2.5" SATA/SAS HS	Open	None	None	1xLP x8	Front VGA	TPM 1.2	XClarity Advanced	1x750W Platinum	3-year	07/17
7X04A00CEA	EMEA	1xXeon Bronze 3106 8C/1.7GHz/11MB/85W/DDR4-2133	1x16GB RDIMM DDR4-2666	1x530-8i	16x2.5"	8x2.5" SATA/SAS HS	Open	None	None	1xLP x8	Front VGA	TPM 1.2	XClarity Advanced	1x750W Platinum	3-year	07/17
7X04A00DEA	EMEA	1xXeon Bronze 3104 6C/1.7GHz/8.25MB/85W/DDR4-2133	1x16GB RDIMM DDR4-2666	1x530-8i	16x2.5"	8x2.5" SATA/SAS HS	Open	None	None	1xLP x8	Front VGA	TPM 1.2	XClarity Advanced	1x750W Platinum	3-year	07/17
7X04A00FEA	EMEA	1xXeon Silver 4110 8C/2.1GHz/11MB/85W/DDR4-2400	1x16GB RDIMM DDR4-2666	1x930-8i 2GB flash	12x3.5"	8x3.5" SATA/SAS HS	Open	None	None	1xLP x8	Front VGA	TPM 1.2	XClarity Advanced	1x750W Platinum	3-year	07/17
7X04A00AEA	EMEA	1xXeon Silver 4114 10C/2.2GHz/13.75MB/85W/DDR4-2400	1x16GB RDIMM DDR4-2666	1x930-8i 2GB flash	16x2.5"	8x2.5" SATA/SAS HS	Open	None	None	1xLP x8	Front VGA	TPM 1.2	XClarity Advanced	1x750W Platinum	3-year	07/17
7X04A007EA	EMEA	1xXeon Silver 4110 8C/2.1GHz/11MB/85W/DDR4-2400	1x16GB RDIMM DDR4-2666	1x930-8i 2GB flash	16x2.5"	8x2.5" SATA/SAS HS	2x300GB HDD 10K 2.5" SAS12Gbps	None	None	1xLP x8	Front VGA	TPM 1.2	XClarity Advanced	2x750W Platinum	3-year	07/17
7X04A002EA	EMEA	1xXeon Silver 4110 8C/2.1GHz/11MB/85W/DDR4-2400	1x16GB RDIMM DDR4-2666	1x930-8i 2GB flash	16x2.5"	8x2.5" SATA/SAS HS	Open	None	None	1xLP x8	Front VGA	TPM 1.2	XClarity Advanced	1x750W Platinum	3-year	07/17
7X04A003EA	EMEA	1xXeon Silver 4116 12C/2.1GHz/16.5MB/85W/DDR4-2400	1x16GB RDIMM DDR4-2666	1x930-8i 2GB flash	16x2.5"	8x2.5" SATA/SAS HS	Open	None	None	1xLP x8	Front VGA	TPM 1.2	XClarity Advanced	1x750W Platinum	3-year	07/17
7X04A01YEA	EMEA	1xXeon Gold 5122 4C/3.6GHz/16.5MB/105W/DDR4-2400	1x16GB RDIMM DDR4-2666	1x930-8i 2GB flash	16x2.5"	8x2.5" SATA/SAS HS	Open	None	None	1xLP x8	Front VGA	TPM 1.2	XClarity Advanced	1x750W Platinum	3-year	07/17
7X04A01ZEA	EMEA	1xXeon Gold 5120 14C/2.2GHz/19.25MB/105W/DDR4-2400	1x16GB RDIMM DDR4-2666	1x930-8i 2GB flash	16x2.5"	8x2.5" SATA/SAS HS	Open	None	None	1xLP x8	Front VGA	TPM 1.2	XClarity Advanced	1x750W Platinum	3-year	07/17
7X04A020EA	EMEA	1xXeon Gold 5118 12C/2.3GHz/16.5MB/105W/DDR4-2400	1x16GB RDIMM DDR4-2666	1x930-8i 2GB flash	16x2.5"	8x2.5" SATA/SAS HS	Open	None	None	1xLP x8	Front VGA	TPM 1.2	XClarity Advanced	1x750W Platinum	3-year	07/17
7X04A023EA	EMEA	1xXeon Gold 6138 20C/2.0GHz/27.5MB/125W/DDR4-2666	1x32GB RDIMM DDR4-2666	1x930-8i 2GB flash	16x2.5"	8x2.5" SATA/SAS HS	Open	None	None	1xLP x8	Front VGA	TPM 1.2	XClarity Advanced	1x750W Platinum	3-year	07/17

Model	Region	Processor	Memory	Storage Controller	Chassis	Disk Bays	Disks	M.2 Drives	Networking (LOM/ML2/PCIe)	Available PCIe Slots	Front VGA	Security	System Management	Power Supply	Base Warranty	Ann Date (mm/yy)
7X04A024EA	EMEA	1xXeon Gold 6130 16C/2.1GHz/22MB/125W/DDR4-2666	1x32GB RDIMM DDR4-2666	1x930-8i 2GB flash	16x2.5"	8x2.5" SATA/SAS HS	Open	None	None	1xLP x8	Front VGA	TPM 1.2	XClarity Advanced	1x750W Platinum	3-year	07/17
7X04A028EA	EMEA	1xXeon Gold 6126 12C/2.6GHz/19.25MB/125W/DDR4-2666	1x32GB RDIMM DDR4-2666	1x930-8i 2GB flash	16x2.5"	8x2.5" SATA/SAS HS	Open	None	None	1xLP x8	Front VGA	TPM 1.2	XClarity Advanced	1x750W Platinum	3-year	07/17
7X04A04BEA	EMEA	1xXeon Gold 5115 10C/2.4GHz/13.75MB/85W/DDR4-2400	1x16GB RDIMM DDR4-2666	1x930-8i 2GB flash	16x2.5"	8x2.5" SATA/SAS HS	Open	None	None	1xLP x8	Front VGA	TPM 1.2	XClarity Enterprise	1x750W Platinum	3-year	07/17

# ThinkSystem SR550 - TopSeller - JAPAN

Product Specifications Reference (PSREF)

Model	Region	Processor	Memory	Storage Controller	Chassis	Disk Bays	Disks	M.2 Drives	Networking (LOM/ML2/PCIe)	Available PCIe Slots	Front VGA	Security	System Management	Power Supply	Base Warranty	Ann Date (mm/yy)
7X04A04EJP	JAPAN	1xXeon Silver 4112 4C/2.6GHz/8.25MB/85W/DDR4-2400	1x8GB RDIMM DDR4-2666	1x930-8i 2GB flash	16x2.5"	8x2.5" SATA/SAS HS	Open	None	None	3xFHHL x8/1xLP x8	None	TPM 1.2	XClarity Advanced	1x550W Platinum	3-year	07/17
7X04A04FJP	JAPAN	1xXeon Silver 4110 8C/2.1GHz/11MB/85W/DDR4-2400	1x8GB RDIMM DDR4-2666	1x930-8i 2GB flash	16x2.5"	8x2.5" SATA/SAS HS	Open	None	None	3xFHHL x8/1xLP x8	None	TPM 1.2	XClarity Advanced	1x550W Platinum	3-year	07/17
7X04A04GJP	JAPAN	1xXeon Bronze 3106 8C/1.7GHz/11MB/85W/DDR4-2133	1x8GB RDIMM DDR4-2666	1x930-8i 2GB flash	16x2.5"	8x2.5" SATA/SAS HS	Open	None	None	3xFHHL x8/1xLP x8	None	TPM 1.2	XClarity Advanced	1x550W Platinum	3-year	07/17
7X04A04HJP	JAPAN	1xXeon Bronze 3104 6C/1.7GHz/8.25MB/85W/DDR4-2133	1x8GB RDIMM DDR4-2666	1x930-8i 2GB flash	12x3.5"	8x3.5" SATA/SAS HS	Open	None	None	3xFHHL x8/1xLP x8	None	TPM 1.2	XClarity Advanced	1x550W Platinum	3-year	07/17
7X04A04JJP	JAPAN	1xXeon Bronze 3104 6C/1.7GHz/8.25MB/85W/DDR4-2133	1x8GB RDIMM DDR4-2666	1x930-8i 2GB flash	16x2.5"	8x2.5" SATA/SAS HS	Open	None	None	3xFHHL x8/1xLP x8	None	TPM 1.2	XClarity Advanced	1x550W Platinum	3-year	07/17

Model	Region	Processor	Memory	Storage Controller	Chassis	Disk Bays	Disks	M.2 Drives	Networking (LOM/ML2/PCIe)	Available PCIe Slots	Front VGA	Security	System Management	Power Supply	Base Warranty	Ann Date (mm/yy)
7X04A04LLA	LA	1xXeon Silver 4110 8C/2.1GHz/11MB/85W/DDR4-2400	2x16GB RDIMM DDR4-2666	1x530-8i	12x3.5"	8x3.5" SATA/SAS HS	3x4TB HDD 7.2K 3.5" SAS12Gbps	None	None	3xFHHL x8/1xLP x8	Front VGA	TPM 1.2	XClarity Advanced	2x750W Platinum	3-year	07/17
7X04A04MLA	LA	1xXeon Silver 4108 8C/1.8GHz/11MB/85W/DDR4-2400	2x16GB RDIMM DDR4-2666	1x530-8i	12x3.5"	8x3.5" SATA/SAS HS	3x600GB HDD 15K 3.5" SAS12Gbps	None	None	3xFHHL x8/1xLP x8	Front VGA	TPM 1.2	XClarity Advanced	2x750W Platinum	3-year	07/17
7X04A05DLA	LA	1xXeon Bronze 3106 8C/1.7GHz/11MB/85W/DDR4-2133	1x8GB RDIMM DDR4-2666	1x530-8i	12x3.5"	8x3.5" SATA/SAS HS	Open	None	None	3xFHHL x8/1xLP x8	Front VGA	TPM 1.2	XClarity Standard	1x750W Platinum	3-year	07/17
7X04A05FLA	LA	1xXeon Bronze 3104 6C/1.7GHz/8.25MB/85W/DDR4-2133	1x8GB RDIMM DDR4-2666	1x530-8i	12x3.5"	8x3.5" SATA/SAS HS	Open	None	None	3xFHHL x8/1xLP x8	Front VGA	TPM 1.2	XClarity Standard	1x750W Platinum	3-year	07/17
7X04A04QLA	LA	1xXeon Silver 4108 8C/1.8GHz/11MB/85W/DDR4-2400	2x16GB RDIMM DDR4-2666	1x530-8i	12x3.5"	8x3.5" SATA/SAS HS	3x4TB HDD 7.2K 3.5" SAS12Gbps	None	None	3xFHHL x8/1xLP x8	Front VGA	TPM 1.2	XClarity Advanced	2x750W Platinum	3-year	07/17
7X04A04WLA	LA	1xXeon Silver 4108 8C/1.8GHz/11MB/85W/DDR4-2400	2x16GB RDIMM DDR4-2666	1x530-8i	12x3.5"	8x3.5" SATA/SAS HS	3x600GB HDD 15K 3.5" SAS12Gbps	None	None	3xFHHL x8/1xLP x8	Front VGA	TPM 1.2	XClarity Advanced	2x750W Platinum	3-year	07/17
7X04A04XLA	LA	1xXeon Silver 4110 8C/2.1GHz/11MB/85W/DDR4-2400	1x16GB RDIMM DDR4-2666	1x530-8i	12x3.5"	8x3.5" SATA/SAS HS	2x2TB HDD 7.2K 3.5" SAS12Gbps	None	None	3xFHHL x8/1xLP x8	Front VGA	TPM 1.2	XClarity Advanced	2x750W Platinum	3-year	07/17
7X04A050LA	LA	1xXeon Bronze 3104 6C/1.7GHz/8.25MB/85W/DDR4-2133	1x8GB RDIMM DDR4-2666	1x530-8i	16x2.5"	8x2.5" SATA/SAS HS	Open	None	None	3xFHHL x8/1xLP x8	Front VGA	TPM 1.2	XClarity Standard	1x750W Platinum	3-year	07/17
7X04A052LA	LA	1xXeon Bronze 3106 8C/1.7GHz/11MB/85W/DDR4-2133	1x8GB RDIMM DDR4-2666	1x530-8i	16x2.5"	8x2.5" SATA/SAS HS	Open	None	None	3xFHHL x8/1xLP x8	Front VGA	TPM 1.2	XClarity Standard	1x750W Platinum	3-year	07/17
7X04A058LA	LA	1xXeon Gold 5115 10C/2.4GHz/13.75MB/85W/DDR4-2400	1x16GB RDIMM DDR4-2666	1x530-8i	12x3.5"	8x3.5" SATA/SAS HS	2x2TB HDD 7.2K 3.5" SAS12Gbps	None	None	3xFHHL x8/1xLP x8	Front VGA	TPM 1.2	XClarity Advanced	2x750W Platinum	3-year	07/17
7X04A059LA	LA	1xXeon Silver 4110 8C/2.1GHz/11MB/85W/DDR4-2400	1x16GB RDIMM DDR4-2666	1x530-8i	12x3.5"	8x3.5" SATA/SAS HS	2x600GB HDD 15K 3.5" SAS12Gbps	None	None	3xFHHL x8/1xLP x8	Front VGA	TPM 1.2	XClarity Advanced	2x750W Platinum	3-year	07/17



Model	Region	Processor	Memory	Storage Controller	Chassis	Disk Bays	Disks	M.2 Drives	Networking (LOM/ML2/PCIe)	Available PCIe Slots	Front VGA	Security	System Management	Power Supply	Base Warranty	Ann Date (mm/yy)
7X04A02KNA	NA	1xXeon Silver 4110 8C/2.1GHz/11MB/85W/DDR4-2400	1x16GB RDIMM DDR4-2666	1x930-8i 2GB flash	12x3.5"	8x3.5" SATA/SAS HS	Open	None	None	1xLP x8	None	TPM 1.2	XClarity Enterprise	1x750W Platinum	3-year	07/17
7X04A02TNA	NA	1xXeon Silver 4116 12C/2.1GHz/16.5MB/85W/DDR4-2400	1x32GB RDIMM DDR4-2666	1x930-16i 4GB flash	12x3.5"	12x3.5" SATA/SAS HS	Open	None	None	1xLP x8	None	TPM 1.2	XClarity Enterprise	1x750W Platinum	3-year	07/17
7X04A02QNA	NA	1xXeon Bronze 3106 8C/1.7GHz/11MB/85W/DDR4-2133	1x16GB RDIMM DDR4-2666	1x530-8i	12x3.5"	8x3.5" SATA/SAS HS	Open	None	None	1xLP x8	None	TPM 1.2	XClarity Enterprise	1x750W Platinum	3-year	07/17

Model	Region	Processor	Memory	Storage Controller	Chassis	Disk Bays	Disks	M.2 Drives	Networking (LOM/ML2/PCIe)	Available PCIe Slots	Front VGA	Security	System Management	Power Supply	Base Warranty	Ann Date (mm/yy)
7X04A029AU	ANZ	1xXeon Gold 6138 20C/2.0GHz/27.5MB/125W/DDR4-2666	1x32GB RDIMM DDR4-2666	1x930-8i 2GB flash	16x2.5"	8x2.5" SATA/SAS HS	Open	None	None	3xFHHL x8/1xLP x8	Front VGA	TPM 1.2	XClarity Standard	1x750W Platinum	3-year	07/17
7X04A02HAU	ANZ	1xXeon Silver 4116 12C/2.1GHz/16.5MB/85W/DDR4-2400	1x16GB RDIMM DDR4-2666	1x930-8i 2GB flash	16x2.5"	8x2.5" SATA/SAS HS	Open	None	None	1xLP x8	None	TPM 1.2	XClarity Standard	1x750W Platinum	3-year	07/17
7X04A02SAU	ANZ	1xXeon Silver 4110 8C/2.1GHz/11MB/85W/DDR4-2400	1x16GB RDIMM DDR4-2666	1x930-8i 2GB flash	16x2.5"	8x2.5" SATA/SAS HS	Open	None	None	1xLP x8	None	TPM 1.2	XClarity Standard	1x750W Platinum	3-year	07/17
7X04A02XAU	ANZ	1xXeon Gold 6130 16C/2.1GHz/22MB/125W/DDR4-2666	1x32GB RDIMM DDR4-2666	1x930-8i 2GB flash	16x2.5"	8x2.5" SATA/SAS HS	Open	None	None	3xFHHL x8/1xLP x8	Front VGA	TPM 1.2	XClarity Standard	1x750W Platinum	3-year	07/17
7X04A033AU	ANZ	1xXeon Silver 4108 8C/1.8GHz/11MB/85W/DDR4-2400	1x16GB RDIMM DDR4-2666	1x930-8i 2GB flash	16x2.5"	8x2.5" SATA/SAS HS	Open	None	None	1xLP x8	None	TPM 1.2	XClarity Standard	1x750W Platinum	3-year	07/17
7X04A031AU	ANZ	1xXeon Gold 5118 12C/2.3GHz/16.5MB/105W/DDR4-2400	1x16GB RDIMM DDR4-2666	1x930-8i 2GB flash	16x2.5"	8x2.5" SATA/SAS HS	Open	None	None	3xFHHL x8/1xLP x8	Front VGA	TPM 1.2	XClarity Standard	1x750W Platinum	3-year	07/17
7X04A037AU	ANZ	1xXeon Gold 5120 14C/2.2GHz/19.25MB/105W/DDR4-2400	1x16GB RDIMM DDR4-2666	1x930-8i 2GB flash	16x2.5"	8x2.5" SATA/SAS HS	Open	None	None	3xFHHL x8/1xLP x8	Front VGA	TPM 1.2	XClarity Standard	1x750W Platinum	3-year	07/17
7X04A03AAU	ANZ	1xXeon Bronze 3104 6C/1.7GHz/8.25MB/85W/DDR4-2133	1x16GB RDIMM DDR4-2666	1x530-8i	16x2.5"	8x2.5" SATA/SAS HS	Open	None	None	1xLP x8	None	TPM 1.2	XClarity Standard	1x750W Platinum	3-year	07/17
7X04A03CAU	ANZ	1xXeon Silver 4108 8C/1.8GHz/11MB/85W/DDR4-2400	1x16GB RDIMM DDR4-2666	1x530-8i	16x2.5"	8x2.5" SATA/SAS HS	Open	None	None	1xLP x8	None	TPM 1.2	XClarity Standard	1x750W Platinum	3-year	07/17
7X04A03GAU	ANZ	1xXeon Silver 4114 10C/2.2GHz/13.75MB/85W/DDR4-2400	1x16GB RDIMM DDR4-2666	1x930-8i 2GB flash	16x2.5"	8x2.5" SATA/SAS HS	Open	None	None	1xLP x8	None	TPM 1.2	XClarity Standard	1x750W Platinum	3-year	07/17
7X04A03HAU	ANZ	1xXeon Gold 6126 12C/2.6GHz/19.25MB/125W/DDR4-2666	1x32GB RDIMM DDR4-2666	1x930-8i 2GB flash	16x2.5"	8x2.5" SATA/SAS HS	Open	None	None	3xFHHL x8/1xLP x8	Front VGA	TPM 1.2	XClarity Standard	1x750W Platinum	3-year	07/17
7X04A041AU	ANZ	1xXeon Gold 6130 16C/2.1GHz/22MB/125W/DDR4-2666	1x32GB RDIMM DDR4-2666	1x930-8i 2GB flash	16x2.5"	8x2.5" SATA/SAS HS	Open	None	None	3xFHHL x8/1xLP x8	None	TPM 1.2	XClarity Standard	1x750W Platinum	3-year	07/17
7X04A042AU	ANZ	1xXeon Gold 6138 20C/2.0GHz/27.5MB/125W/DDR4-2666	1x32GB RDIMM DDR4-2666	1x930-8i 2GB flash	16x2.5"	8x2.5" SATA/SAS HS	Open	None	None	3xFHHL x8/1xLP x8	None	TPM 1.2	XClarity Standard	1x750W Platinum	3-year	07/17
7X04A043AU	ANZ	1xXeon Gold 5120 14C/2.2GHz/19.25MB/105W/DDR4-2400	1x16GB RDIMM DDR4-2666	1x930-8i 2GB flash	16x2.5"	8x2.5" SATA/SAS HS	Open	None	None	3xFHHL x8/1xLP x8	None	TPM 1.2	XClarity Standard	1x750W Platinum	3-year	07/17
7X04A044AU	ANZ	1xXeon Gold 5118 12C/2.3GHz/16.5MB/105W/DDR4-2400	1x16GB RDIMM DDR4-2666	1x930-8i 2GB flash	16x2.5"	8x2.5" SATA/SAS HS	Open	None	None	3xFHHL x8/1xLP x8	None	TPM 1.2	XClarity Standard	1x750W Platinum	3-year	07/17

Model	Region	Processor	Memory	Storage Controller	Chassis	Disk Bays	Disks	M.2 Drives	Networking (LOM/ML2/PCIe)	Available PCIe Slots	Front VGA	Security	System Management	Power Supply	Base Warranty	Ann Date (mm/yy)
7X04A049AU	ANZ	1xXeon Gold 6126T 12C/2.6GHz/19.25MB/125W/DDR4-2666	1x32GB RDIMM DDR4-2666	1x930-8i 2GB flash	16x2.5"	8x2.5" SATA/SAS HS	Open	None	None	3xFHHL x8/1xLP x8	None	TPM 1.2	XClarity Standard	1x750W Platinum	3-year	07/17
7X04A03QAU	ANZ	1xXeon Silver 4110 8C/2.1GHz/11MB/85W/DDR4-2400	1x16GB RDIMM DDR4-2666	1x530-8i	16x2.5"	8x2.5" SATA/SAS HS	Open	None	None	1xLP x8	None	TPM 1.2	XClarity Standard	1x750W Platinum	3-year	07/17
7X04A03RAU	ANZ	1xXeon Silver 4114 10C/2.2GHz/13.75MB/85W/DDR4-2400	1x16GB RDIMM DDR4-2666	1x930-16i 4GB flash	12x3.5"	12x3.5" SATA/SAS HS	Open	None	None	1xLP x8	None	TPM 1.2	XClarity Standard	1x750W Platinum	3-year	07/17
7X04A04KAU	ANZ	1xXeon Gold 6138 20C/2.0GHz/27.5MB/125W/DDR4-2666	1x32GB RDIMM DDR4-2666	1x930-8i 2GB flash	16x2.5"	8x2.5" SATA/SAS HS	Open	None	None	3xFHHL x8/1xLP x8	Front VGA	TPM 1.2	XClarity Standard	1x750W Platinum	3-year	07/17

ThinkSystem SR550 - Non TopSeller - ASEAN

Product Specifications Reference (PSREF)

Model	Region	Processor	Memory	Storage Controller	Chassis	Disk Bays	Disks	M.2 Drives	Networking (LOM/ML2/PCIe)	Available PCIe Slots	Front VGA	Security	System Management	Power Supply	Base Warranty	Ann Date (mm/yy)
7X04A04TSG	ASEAN	1xXeon Gold 5118 12C/2.3GHz/16.5MB/105W/DDR4-2400	1x8GB RDIMM DDR4-2666	1x530-8i	16x2.5"	8x2.5" SATA/SAS HS	Open	None	2xGbE LOM	1xLP x8	None	TPM 1.2	XClarity Standard	1x750W Platinum	3-year	07/17
7X04A017SG	ASEAN	1xXeon Gold 5120 14C/2.2GHz/19.25MB/105W/DDR4-2400	1x8GB RDIMM DDR4-2666	1x530-8i	16x2.5"	8x2.5" SATA/SAS HS	Open	None	2xGbE LOM	1xLP x8	None	TPM 1.2	XClarity Standard	1x750W Platinum	3-year	07/17
7X04A01ASG	ASEAN	1xXeon Gold 6130 16C/2.1GHz/22MB/125W/DDR4-2666	1x8GB RDIMM DDR4-2666	1x530-8i	16x2.5"	8x2.5" SATA/SAS HS	Open	None	2xGbE LOM	1xLP x8	None	TPM 1.2	XClarity Standard	1x750W Platinum	3-year	07/17
7X04A01ESG	ASEAN	1xXeon Gold 5118 12C/2.3GHz/16.5MB/105W/DDR4-2400	1x8GB RDIMM DDR4-2666	1x530-8i	16x2.5"	8x2.5" SATA/SAS HS	Open	None	2xGbE LOM	1xLP x8	None	TPM 1.2	XClarity Standard	1x750W Platinum	3-year	07/17
7X04A01XSG	ASEAN	1xXeon Gold 6138 20C/2.0GHz/27.5MB/125W/DDR4-2666	1x8GB RDIMM DDR4-2666	1x530-8i	16x2.5"	8x2.5" SATA/SAS HS	Open	None	2xGbE LOM	1xLP x8	None	TPM 1.2	XClarity Standard	1x750W Platinum	3-year	07/17
7X04A006SG	ASEAN	1xXeon Silver 4112 4C/2.6GHz/8.25MB/85W/DDR4-2400	1x8GB RDIMM DDR4-2666	1x930-16i 4GB flash	12x3.5"	12x3.5" SATA/SAS HS	Open	None	None	1xLP x8	None	TPM 1.2	XClarity Standard	1x750W Platinum	3-year	07/17
7X04A008SG	ASEAN	1xXeon Silver 4114 10C/2.2GHz/13.75MB/85W/DDR4-2400	1x8GB RDIMM DDR4-2666	1x530-8i	16x2.5"	8x2.5" SATA/SAS HS	Open	None	None	1xLP x8	None	TPM 1.2	XClarity Standard	1x750W Platinum	3-year	07/17
7X04A00BSG	ASEAN	1xXeon Silver 4116 12C/2.1GHz/16.5MB/85W/DDR4-2400	1x8GB RDIMM DDR4-2666	1x530-8i	16x2.5"	8x2.5" SATA/SAS HS	Open	None	None	1xLP x8	None	TPM 1.2	XClarity Standard	1x750W Platinum	3-year	07/17
7X04A00KSG	ASEAN	1xXeon Silver 4112 4C/2.6GHz/8.25MB/85W/DDR4-2400	1x8GB RDIMM DDR4-2666	1x530-8i	16x2.5"	8x2.5" SATA/SAS HS	Open	None	None	1xLP x8	None	TPM 1.2	XClarity Standard	1x750W Platinum	3-year	07/17
7X04A00RSG	ASEAN	1xXeon Bronze 3104 6C/1.7GHz/8.25MB/85W/DDR4-2133	1x8GB RDIMM DDR4-2666	1x530-8i	16x2.5"	8x2.5" SATA/SAS HS	Open	None	None	1xLP x8	None	TPM 1.2	XClarity Standard	1x750W Platinum	3-year	07/17
7X04A00SSG	ASEAN	1xXeon Bronze 3106 8C/1.7GHz/11MB/85W/DDR4-2133	1x8GB RDIMM DDR4-2666	1x530-8i	16x2.5"	8x2.5" SATA/SAS HS	Open	None	None	1xLP x8	None	TPM 1.2	XClarity Standard	1x750W Platinum	3-year	07/17
7X04A00GSG	ASEAN	1xXeon Silver 4110 8C/2.1GHz/11MB/85W/DDR4-2400	1x8GB RDIMM DDR4-2666	1x530-8i	16x2.5"	8x2.5" SATA/SAS HS	Open	None	None	1xLP x8	None	TPM 1.2	XClarity Standard	1x750W Platinum	3-year	07/17
7X04A00VSG	ASEAN	1xXeon Gold 5122 4C/3.6GHz/16.5MB/105W/DDR4-2400	1x8GB RDIMM DDR4-2666	1x530-8i	16x2.5"	8x2.5" SATA/SAS HS	Open	None	2xGbE LOM	1xLP x8	None	TPM 1.2	XClarity Standard	1x750W Platinum	3-year	07/17
7X04A00XSG	ASEAN	1xXeon Gold 5122 4C/3.6GHz/16.5MB/105W/DDR4-2400	1x8GB RDIMM DDR4-2666	1x930-16i 4GB flash	12x3.5"	12x3.5" SATA/SAS HS	Open	None	2xGbE LOM	1xLP x8	None	TPM 1.2	XClarity Standard	1x750W Platinum	3-year	07/17

ThinkSystem SR550 - Non TopSeller - Brazil

Product Specifications Reference (PSREF)

Model	Region	Processor	Memory	Storage Controller	Chassis	Disk Bays	Disks	M.2 Drives	Networking (LOM/ML2/PCIe)	Available PCIe Slots	Front VGA	Security	System Management	Power Supply	Base Warranty	Ann Date (mm/yy)
7X04A063BR	Brazil	1xXeon Gold 5118 12C/2.3GHz/16.5MB/105W/DDR4-2400	1x16GB RDIMM DDR4-2666	1x530-8i	16x2.5"	8x2.5" SATA/SAS HS	Open	None	None	3xFHHL x8/1xLP x8	Front VGA	TPM 1.2	XClarity Standard	1x750W Platinum	3-year	07/17
7X04A064BR	Brazil	1xXeon Gold 5120 14C/2.2GHz/19.25MB/105W/DDR4-2400	1x16GB RDIMM DDR4-2666	1x530-8i	16x2.5"	8x2.5" SATA/SAS HS	Open	None	None	3xFHHL x8/1xLP x8	Front VGA	TPM 1.2	XClarity Standard	1x750W Platinum	3-year	07/17
7X04A065BR	Brazil	1xXeon Gold 6130 16C/2.1GHz/22MB/125W/DDR4-2666	1x16GB RDIMM DDR4-2666	1x530-8i	16x2.5"	8x2.5" SATA/SAS HS	Open	None	None	3xFHHL x8/1xLP x8	Front VGA	TPM 1.2	XClarity Standard	1x750W Platinum	3-year	07/17
7X04A066BR	Brazil	1xXeon Gold 5118 12C/2.3GHz/16.5MB/105W/DDR4-2400	1x16GB RDIMM DDR4-2666	1x530-8i	16x2.5"	8x2.5" SATA/SAS HS	Open	None	None	3xFHHL x8/1xLP x8	Front VGA	TPM 1.2	XClarity Standard	1x750W Platinum	3-year	07/17
7X04A067BR	Brazil	1xXeon Gold 5120 14C/2.2GHz/19.25MB/105W/DDR4-2400	1x16GB RDIMM DDR4-2666	1x530-8i	16x2.5"	8x2.5" SATA/SAS HS	Open	None	None	3xFHHL x8/1xLP x8	Front VGA	TPM 1.2	XClarity Standard	1x750W Platinum	3-year	07/17
7X04A068BR	Brazil	1xXeon Gold 6130 16C/2.1GHz/22MB/125W/DDR4-2666	1x16GB RDIMM DDR4-2666	1x530-8i	16x2.5"	8x2.5" SATA/SAS HS	Open	None	None	3xFHHL x8/1xLP x8	Front VGA	TPM 1.2	XClarity Standard	1x750W Platinum	3-year	07/17
7X04A069BR	Brazil	1xXeon Gold 5118 12C/2.3GHz/16.5MB/105W/DDR4-2400	1x16GB RDIMM DDR4-2666	1x530-8i	12x3.5"	8x3.5" SATA/SAS HS	Open	None	None	3xFHHL x8/1xLP x8	Front VGA	TPM 1.2	XClarity Standard	1x750W Platinum	3-year	07/17
7X04A06ABR	Brazil	1xXeon Gold 5120 14C/2.2GHz/19.25MB/105W/DDR4-2400	1x16GB RDIMM DDR4-2666	1x530-8i	12x3.5"	8x3.5" SATA/SAS HS	Open	None	None	3xFHHL x8/1xLP x8	Front VGA	TPM 1.2	XClarity Standard	1x750W Platinum	3-year	07/17
7X04A06BBR	Brazil	1xXeon Gold 6130 16C/2.1GHz/22MB/125W/DDR4-2666	1x16GB RDIMM DDR4-2666	1x530-8i	12x3.5"	8x3.5" SATA/SAS HS	Open	None	None	3xFHHL x8/1xLP x8	Front VGA	TPM 1.2	XClarity Standard	1x750W Platinum	3-year	07/17
7X04A06CBR	Brazil	1xXeon Gold 5118 12C/2.3GHz/16.5MB/105W/DDR4-2400	1x32GB RDIMM DDR4-2666	1x530-8i	12x3.5"	8x3.5" SATA/SAS HS	Open	None	None	3xFHHL x8/1xLP x8	Front VGA	TPM 1.2	XClarity Standard	1x750W Platinum	3-year	07/17
7X04A06DBR	Brazil	1xXeon Gold 5120 14C/2.2GHz/19.25MB/105W/DDR4-2400	1x32GB RDIMM DDR4-2666	1x530-8i	12x3.5"	8x3.5" SATA/SAS HS	Open	None	None	3xFHHL x8/1xLP x8	Front VGA	TPM 1.2	XClarity Standard	1x750W Platinum	3-year	07/17
7X04A06EBR	Brazil	1xXeon Gold 6130 16C/2.1GHz/22MB/125W/DDR4-2666	1x32GB RDIMM DDR4-2666	1x530-8i	12x3.5"	8x3.5" SATA/SAS HS	Open	None	None	3xFHHL x8/1xLP x8	Front VGA	TPM 1.2	XClarity Standard	1x750W Platinum	3-year	07/17

## ThinkSystem SR550 - Non TopSeller - EMEA

Product Specifications Reference (PSREF)

Model	Region	Processor	Memory	Storage Controller	Chassis	Disk Bays	Disks	M.2 Drives	Networking (LOM/ML2/PCIe)	Available PCIe Slots	Front VGA	Security	System Management	Power Supply	Base Warranty	Ann Date (mm/yy)
7X04A00JEA	EMEA	1xXeon Silver 4114 10C/2.2GHz/13.75MB/85W/DDR4-2400	1x16GB RDIMM DDR4-2666	1x930-16i 4GB flash	12x3.5"	12x3.5" SATA/SAS HS	Open	None	None	1xLP x8	None	TPM 1.2	XClarity Standard	1x750W Platinum	3-year	07/17
7X04A00LEA	EMEA	1xXeon Silver 4116 12C/2.1GHz/16.5MB/85W/DDR4-2400	1x16GB RDIMM DDR4-2666	1x930-8i 2GB flash	16x2.5"	8x2.5" SATA/SAS HS	Open	None	None	1xLP x8	None	TPM 1.2	XClarity Standard	1x750W Platinum	3-year	07/17
7X04A00PEA	EMEA	1xXeon Bronze 3104 6C/1.7GHz/8.25MB/85W/DDR4-2133	1x16GB RDIMM DDR4-2666	1x530-8i	16x2.5"	8x2.5" SATA/SAS HS	Open	None	None	1xLP x8	None	TPM 1.2	XClarity Standard	1x750W Platinum	3-year	07/17
7X04A00EEA	EMEA	1xXeon Silver 4114 10C/2.2GHz/13.75MB/85W/DDR4-2400	1x16GB RDIMM DDR4-2666	1x930-8i 2GB flash	16x2.5"	8x2.5" SATA/SAS HS	Open	None	None	1xLP x8	None	TPM 1.2	XClarity Standard	1x750W Platinum	3-year	07/17
7X04A009EA	EMEA	1xXeon Silver 4110 8C/2.1GHz/11MB/85W/DDR4-2400	1x16GB RDIMM DDR4-2666	1x530-8i	16x2.5"	8x2.5" SATA/SAS HS	Open	None	None	1xLP x8	None	TPM 1.2	XClarity Standard	1x750W Platinum	3-year	07/17
7X04A001EA	EMEA	1xXeon Silver 4110 8C/2.1GHz/11MB/85W/DDR4-2400	1x16GB RDIMM DDR4-2666	1x930-8i 2GB flash	16x2.5"	8x2.5" SATA/SAS HS	Open	None	None	1xLP x8	None	TPM 1.2	XClarity Standard	1x750W Platinum	3-year	07/17
7X04A004EA	EMEA	1xXeon Silver 4108 8C/1.8GHz/11MB/85W/DDR4-2400	1x16GB RDIMM DDR4-2666	1x930-8i 2GB flash	16x2.5"	8x2.5" SATA/SAS HS	Open	None	None	1xLP x8	None	TPM 1.2	XClarity Standard	1x750W Platinum	3-year	07/17
7X04A005EA	EMEA	1xXeon Silver 4108 8C/1.8GHz/11MB/85W/DDR4-2400	1x16GB RDIMM DDR4-2666	1x530-8i	16x2.5"	8x2.5" SATA/SAS HS	Open	None	None	1xLP x8	None	TPM 1.2	XClarity Standard	1x750W Platinum	3-year	07/17
7X04A021EA	EMEA	1xXeon Gold 5120 14C/2.2GHz/19.25MB/105W/DDR4-2400	1x16GB RDIMM DDR4-2666	1x930-8i 2GB flash	16x2.5"	8x2.5" SATA/SAS HS	Open	None	None	1xLP x8	None	TPM 1.2	XClarity Standard	1x750W Platinum	3-year	07/17
7X04A022EA	EMEA	1xXeon Gold 6138 20C/2.0GHz/27.5MB/125W/DDR4-2666	1x32GB RDIMM DDR4-2666	1x930-8i 2GB flash	16x2.5"	8x2.5" SATA/SAS HS	Open	None	None	1xLP x8	None	TPM 1.2	XClarity Standard	1x750W Platinum	3-year	07/17
7X04A025EA	EMEA	1xXeon Gold 5118 12C/2.3GHz/16.5MB/105W/DDR4-2400	1x16GB RDIMM DDR4-2666	1x930-8i 2GB flash	16x2.5"	8x2.5" SATA/SAS HS	Open	None	None	1xLP x8	None	TPM 1.2	XClarity Standard	1x750W Platinum	3-year	07/17
7X04A026EA	EMEA	1xXeon Gold 6126 12C/2.6GHz/19.25MB/125W/DDR4-2666	1x32GB RDIMM DDR4-2666	1x930-8i 2GB flash	16x2.5"	8x2.5" SATA/SAS HS	Open	None	None	1xLP x8	None	TPM 1.2	XClarity Standard	1x750W Platinum	3-year	07/17
7X04A027EA	EMEA	1xXeon Gold 6130 16C/2.1GHz/22MB/125W/DDR4-2666	1x32GB RDIMM DDR4-2666	1x930-8i 2GB flash	16x2.5"	8x2.5" SATA/SAS HS	Open	None	None	3xFHHL x8/1xLP x8	Front VGA	TPM 1.2	XClarity Standard	1x750W Platinum	3-year	07/17
7X04A04AEA	EMEA	1xXeon Gold 5115 10C/2.4GHz/13.75MB/85W/DDR4-2400	1x16GB RDIMM DDR4-2666	1x930-8i 2GB flash	16x2.5"	8x2.5" SATA/SAS HS	Open	None	None	1xLP x8	None	TPM 1.2	XClarity Standard	1x750W Platinum	3-year	07/17

Model	Region	Processor	Memory	Storage Controller	Chassis	Disk Bays	Disks	M.2 Drives	Networking (LOM/ML2/PCIe)	Available PCIe Slots	Front VGA	Security	System Management	Power Supply	Base Warranty	Ann Date (mm/yy)
7X04A02UCN	HTK	1xXeon Bronze 3106 8C/1.7GHz/11MB/85W/DDR4-2133	1x16GB RDIMM DDR4-2666	1x930-16i 4GB flash	12x3.5"	12x3.5" SATA/SAS HS	Open	None	2xGbE LOM	3xFHHL x8/1xLP x8	None	TPM 1.2	XClarity Standard	1x750W Platinum	3-year	07/17
7X04A03PCN	HTK	1xXeon Silver 4116 12C/2.1GHz/16.5MB/85W/DDR4-2400	1x16GB RDIMM DDR4-2666	1x930-16i 4GB flash	12x3.5"	12x3.5" SATA/SAS HS	Open	None	2xGbE LOM	3xFHHL x8/1xLP x8	None	TPM 1.2	XClarity Standard	1x750W Platinum	3-year	07/17
7X04A03UCN	HTK	1xXeon Silver 4116 12C/2.1GHz/16.5MB/85W/DDR4-2400	1x16GB RDIMM DDR4-2666	1x930-8i 2GB flash	16x2.5"	8x2.5" SATA/SAS HS	Open	None	2xGbE LOM	3xFHHL x8/1xLP x8	None	TPM 1.2	XClarity Standard	1x750W Platinum	3-year	07/17
7X04A03JCN	HTK	1xXeon Silver 4108 8C/1.8GHz/11MB/85W/DDR4-2400	1x16GB RDIMM DDR4-2666	1x930-8i 2GB flash	16x2.5"	8x2.5" SATA/SAS HS	Open	None	2xGbE LOM	3xFHHL x8/1xLP x8	None	TPM 1.2	XClarity Standard	1x750W Platinum	3-year	07/17
7X04A03FCN	HTK	1xXeon Bronze 3106 8C/1.7GHz/11MB/85W/DDR4-2133	1x16GB RDIMM DDR4-2666	1x930-8i 2GB flash	16x2.5"	8x2.5" SATA/SAS HS	Open	None	2xGbE LOM	3xFHHL x8/1xLP x8	None	TPM 1.2	XClarity Standard	1x750W Platinum	3-year	07/17
7X04A03DCN	HTK	1xXeon Silver 4112 4C/2.6GHz/8.25MB/85W/DDR4-2400	1x16GB RDIMM DDR4-2666	1x930-8i 2GB flash	16x2.5"	8x2.5" SATA/SAS HS	Open	None	2xGbE LOM	3xFHHL x8/1xLP x8	None	TPM 1.2	XClarity Standard	1x750W Platinum	3-year	07/17
7X04A03BCN	HTK	1xXeon Bronze 3104 6C/1.7GHz/8.25MB/85W/DDR4-2133	1x16GB RDIMM DDR4-2666	1x930-8i 2GB flash	16x2.5"	8x2.5" SATA/SAS HS	Open	None	2xGbE LOM	3xFHHL x8/1xLP x8	None	TPM 1.2	XClarity Standard	1x750W Platinum	3-year	07/17
7X04A038CN	HTK	1xXeon Gold 5115 10C/2.4GHz/13.75MB/85W/DDR4-2400	1x16GB RDIMM DDR4-2666	1x930-8i 2GB flash	16x2.5"	8x2.5" SATA/SAS HS	Open	None	2xGbE LOM	3xFHHL x8/1xLP x8	None	TPM 1.2	XClarity Standard	1x750W Platinum	3-year	07/17
7X04A032CN	HTK	1xXeon Silver 4108 8C/1.8GHz/11MB/85W/DDR4-2400	1x16GB RDIMM DDR4-2666	1x930-16i 4GB flash	12x3.5"	12x3.5" SATA/SAS HS	Open	None	2xGbE LOM	3xFHHL x8/1xLP x8	None	TPM 1.2	XClarity Standard	1x750W Platinum	3-year	07/17
7X04A02ZCN	HTK	1xXeon Silver 4114 10C/2.2GHz/13.75MB/85W/DDR4-2400	1x16GB RDIMM DDR4-2666	1x930-8i 2GB flash	16x2.5"	8x2.5" SATA/SAS HS	Open	None	2xGbE LOM	3xFHHL x8/1xLP x8	None	TPM 1.2	XClarity Standard	1x750W Platinum	3-year	07/17
7X04A030CN	HTK	1xXeon Gold 5115 10C/2.4GHz/13.75MB/85W/DDR4-2400	1x16GB RDIMM DDR4-2666	1x930-16i 4GB flash	12x3.5"	12x3.5" SATA/SAS HS	Open	None	2xGbE LOM	3xFHHL x8/1xLP x8	None	TPM 1.2	XClarity Standard	1x750W Platinum	3-year	07/17
7X04A016CN	HTK	1xXeon Gold 6138 20C/2.0GHz/27.5MB/125W/DDR4-2666	1x16GB RDIMM DDR4-2666	1x930-8i 2GB flash	16x2.5"	8x2.5" SATA/SAS HS	Open	None	2xGbE LOM	3xFHHL x8/1xLP x8	None	TPM 1.2	XClarity Standard	1x750W Platinum	3-year	07/17
7X04A02MCN	HTK	1xXeon Silver 4112 4C/2.6GHz/8.25MB/85W/DDR4-2400	1x16GB RDIMM DDR4-2666	1x930-16i 4GB flash	12x3.5"	12x3.5" SATA/SAS HS	Open	None	2xGbE LOM	3xFHHL x8/1xLP x8	None	TPM 1.2	XClarity Standard	1x750W Platinum	3-year	07/17
7X04A02NCN	HTK	1xXeon Silver 4114 10C/2.2GHz/13.75MB/85W/DDR4-2400	1x16GB RDIMM DDR4-2666	1x930-16i 4GB flash	12x3.5"	12x3.5" SATA/SAS HS	Open	None	2xGbE LOM	3xFHHL x8/1xLP x8	None	TPM 1.2	XClarity Standard	1x750W Platinum	3-year	07/17
7X04A01FCN	HTK	1xXeon Gold 6138 20C/2.0GHz/27.5MB/125W/DDR4-2666	1x16GB RDIMM DDR4-2666	1x930-16i 4GB flash	12x3.5"	12x3.5" SATA/SAS HS	Open	None	2xGbE LOM	3xFHHL x8/1xLP x8	None	TPM 1.2	XClarity Standard	1x750W Platinum	3-year	07/17

Model	Region	Processor	Memory	Storage Controller	Chassis	Disk Bays	Disks	M.2 Drives	Networking (LOM/ML2/PCIe)	Available PCIe Slots	Front VGA	Security	System Management	Power Supply	Base Warranty	Ann Date (mm/yy)
7X04A01GCN	HTK	1xXeon Gold 6130 16C/2.1GHz/22MB/125W/DDR4-2666	1x16GB RDIMM DDR4-2666	1x930-16i 4GB flash	12x3.5"	12x3.5" SATA/SAS HS	Open	None	2xGbE LOM	3xFHHL x8/1xLP x8	None	TPM 1.2	XClarity Standard	1x750W Platinum	3-year	07/17
7X04A01JCN	HTK	1xXeon Gold 5122 4C/3.6GHz/16.5MB/105W/DDR4-2400	1x16GB RDIMM DDR4-2666	1x930-16i 4GB flash	12x3.5"	12x3.5" SATA/SAS HS	Open	None	2xGbE LOM	3xFHHL x8/1xLP x8	None	TPM 1.2	XClarity Standard	1x750W Platinum	3-year	07/17
7X04A01CCN	HTK	1xXeon Gold 6130 16C/2.1GHz/22MB/125W/DDR4-2666	1x16GB RDIMM DDR4-2666	1x930-8i 2GB flash	16x2.5"	8x2.5" SATA/SAS HS	Open	None	2xGbE LOM	3xFHHL x8/1xLP x8	None	TPM 1.2	XClarity Standard	1x750W Platinum	3-year	07/17
7X04A01DCN	HTK	1xXeon Gold 5122 4C/3.6GHz/16.5MB/105W/DDR4-2400	1x16GB RDIMM DDR4-2666	1x930-8i 2GB flash	16x2.5"	8x2.5" SATA/SAS HS	Open	None	2xGbE LOM	3xFHHL x8/1xLP x8	None	TPM 1.2	XClarity Standard	1x750W Platinum	3-year	07/17
7X04A01MCN	HTK	1xXeon Gold 5120 14C/2.2GHz/19.25MB/105W/DDR4-2400	1x16GB RDIMM DDR4-2666	1x930-16i 4GB flash	12x3.5"	12x3.5" SATA/SAS HS	Open	None	2xGbE LOM	3xFHHL x8/1xLP x8	None	TPM 1.2	XClarity Standard	1x750W Platinum	3-year	07/17
7X04A02DCN	HTK	1xXeon Bronze 3104 6C/1.7GHz/8.25MB/85W/DDR4-2133	1x16GB RDIMM DDR4-2666	1x930-16i 4GB flash	12x3.5"	12x3.5" SATA/SAS HS	Open	None	2xGbE LOM	3xFHHL x8/1xLP x8	None	TPM 1.2	XClarity Standard	1x750W Platinum	3-year	07/17
7X04A02ECN	HTK	1xXeon Silver 4110 8C/2.1GHz/11MB/85W/DDR4-2400	1x16GB RDIMM DDR4-2666	1x930-8i 2GB flash	16x2.5"	8x2.5" SATA/SAS HS	Open	None	2xGbE LOM	3xFHHL x8/1xLP x8	None	TPM 1.2	XClarity Standard	1x750W Platinum	3-year	07/17
7X04A02FCN	HTK	1xXeon Silver 4110 8C/2.1GHz/11MB/85W/DDR4-2400	1x16GB RDIMM DDR4-2666	1x930-16i 4GB flash	12x3.5"	12x3.5" SATA/SAS HS	Open	None	2xGbE LOM	3xFHHL x8/1xLP x8	None	TPM 1.2	XClarity Standard	1x750W Platinum	3-year	07/17
7X04A01PCN	HTK	1xXeon Gold 5118 12C/2.3GHz/16.5MB/105W/DDR4-2400	1x16GB RDIMM DDR4-2666	1x930-16i 4GB flash	12x3.5"	12x3.5" SATA/SAS HS	Open	None	2xGbE LOM	3xFHHL x8/1xLP x8	None	TPM 1.2	XClarity Standard	1x750W Platinum	3-year	07/17
7X04A00WCN	HTK	1xXeon Gold 5118 12C/2.3GHz/16.5MB/105W/DDR4-2400	1x16GB RDIMM DDR4-2666	1x930-8i 2GB flash	16x2.5"	8x2.5" SATA/SAS HS	Open	None	2xGbE LOM	3xFHHL x8/1xLP x8	None	TPM 1.2	XClarity Standard	1x750W Platinum	3-year	07/17
7X04A00TCN	HTK	1xXeon Gold 5120 14C/2.2GHz/19.25MB/105W/DDR4-2400	1x16GB RDIMM DDR4-2666	1x930-8i 2GB flash	16x2.5"	8x2.5" SATA/SAS HS	Open	None	2xGbE LOM	3xFHHL x8/1xLP x8	None	TPM 1.2	XClarity Standard	1x750W Platinum	3-year	07/17



Model	Region	Processor	Memory	Storage Controller	Chassis	Disk Bays	Disks	M.2 Drives	Networking (LOM/ML2/PCle)	Available PCIe Slots	Front VGA	Security	System Management	Power Supply	Base Warranty	Ann Date (mm/yy)
7X04A00USG	INDIA	1xXeon Gold 5118 12C/2.3GHz/16.5MB/105W/DDR4-2400	1x8GB RDIMM DDR4-2666	1xOnboard	12x3.5"	8x3.5" SATA SS	Open	None	2xGbE LOM	1xLP x8	None	TPM 1.2	XClarity Standard	1x550W Platinum	3-year	07/17
7X04A00YSG	INDIA	1xXeon Gold 5118 12C/2.3GHz/16.5MB/105W/DDR4-2400	1x8GB RDIMM DDR4-2666	1x530-8i	16x2.5"	8x2.5" SATA/SAS HS	Open	None	2xGbE LOM	1xLP x8	None	TPM 1.2	XClarity Standard	1x550W Platinum	3-year	07/17
7X04A00ZSG	INDIA	1xXeon Gold 6130 16C/2.1GHz/22MB/125W/DDR4-2666	1x16GB RDIMM DDR4-2666	1x930-8i 2GB flash	16x2.5"	8x2.5" SATA/SAS HS	Open	None	2xGbE LOM	1xLP x8	None	TPM 1.2	XClarity Standard	1x750W Platinum	3-year	07/17
7X04A010SG	INDIA	1xXeon Gold 5118 12C/2.3GHz/16.5MB/105W/DDR4-2400	1x16GB RDIMM DDR4-2666	1x530-8i	12x3.5"	8x3.5" SATA/SAS HS	Open	None	2xGbE LOM	1xLP x8	None	TPM 1.2	XClarity Standard	1x550W Platinum	3-year	07/17
7X04A011SG	INDIA	1xXeon Gold 5118 12C/2.3GHz/16.5MB/105W/DDR4-2400	1x8GB RDIMM DDR4-2666	1x530-8i	12x3.5"	8x3.5" SATA/SAS HS	Open	None	2xGbE LOM	1xLP x8	None	TPM 1.2	XClarity Standard	1x550W Platinum	3-year	07/17
7X04A012SG	INDIA	1xXeon Gold 5118 12C/2.3GHz/16.5MB/105W/DDR4-2400	1x8GB RDIMM DDR4-2666	1x930-8i 2GB flash	12x3.5"	8x3.5" SATA/SAS HS	Open	None	2xGbE LOM	1xLP x8	None	TPM 1.2	XClarity Standard	1x550W Platinum	3-year	07/17
7X04A013SG	INDIA	1xXeon Gold 5120 14C/2.2GHz/19.25MB/105W/DDR4-2400	1x16GB RDIMM DDR4-2666	1x530-8i	16x2.5"	8x2.5" SATA/SAS HS	Open	None	2xGbE LOM	1xLP x8	None	TPM 1.2	XClarity Standard	1x550W Platinum	3-year	07/17
7X04A014SG	INDIA	1xXeon Gold 5118 12C/2.3GHz/16.5MB/105W/DDR4-2400	1x8GB RDIMM DDR4-2666	1x930-16i 4GB flash	12x3.5"	12x3.5" SATA/SAS HS	Open	None	2xGbE LOM	1xLP x8	None	TPM 1.2	XClarity Standard	1x550W Platinum	3-year	07/17
7X04A015SG	INDIA	1xXeon Gold 6138 20C/2.0GHz/27.5MB/125W/DDR4-2666	1x16GB RDIMM DDR4-2666	1x930-8i 2GB flash	16x2.5"	8x2.5" SATA/SAS HS	Open	None	2xGbE LOM	1xLP x8	None	TPM 1.2	XClarity Standard	1x750W Platinum	3-year	07/17
7X04A01QSG	INDIA	1xXeon Gold 5120 14C/2.2GHz/19.25MB/105W/DDR4-2400	1x16GB RDIMM DDR4-2666	1x930-8i 2GB flash	16x2.5"	8x2.5" SATA/SAS HS	Open	None	2xGbE LOM	1xLP x8	None	TPM 1.2	XClarity Standard	1x750W Platinum	3-year	07/17
7X04A01RSG	INDIA	1xXeon Gold 6126 12C/2.6GHz/19.25MB/125W/DDR4-2666	1x16GB RDIMM DDR4-2666	1x930-8i 2GB flash	16x2.5"	8x2.5" SATA/SAS HS	Open	None	2xGbE LOM	1xLP x8	None	TPM 1.2	XClarity Standard	1x750W Platinum	3-year	07/17
7X04A01SSG	INDIA	1xXeon Gold 5120 14C/2.2GHz/19.25MB/105W/DDR4-2400	1x16GB RDIMM DDR4-2666	1x930-8i 2GB flash	16x2.5"	8x2.5" SATA/SAS HS	Open	None	2xGbE LOM	1xLP x8	None	TPM 1.2	XClarity Standard	1x550W Platinum	3-year	07/17
7X04A01TSG	INDIA	1xXeon Gold 5122 4C/3.6GHz/16.5MB/105W/DDR4-2400	1x16GB RDIMM DDR4-2666	1x930-8i 2GB flash	16x2.5"	8x2.5" SATA/SAS HS	Open	None	2xGbE LOM	1xLP x8	None	TPM 1.2	XClarity Standard	1x550W Platinum	3-year	07/17
7X04A01USG	INDIA	1xXeon Gold 6126 12C/2.6GHz/19.25MB/125W/DDR4-2666	1x16GB RDIMM DDR4-2666	1x930-8i 2GB flash	16x2.5"	8x2.5" SATA/SAS HS	Open	None	2xGbE LOM	1xLP x8	None	TPM 1.2	XClarity Standard	1x550W Platinum	3-year	07/17
7X04A01VSG	INDIA	1xXeon Gold 6130 16C/2.1GHz/22MB/125W/DDR4-2666	1x16GB RDIMM DDR4-2666	1x930-8i 2GB flash	16x2.5"	8x2.5" SATA/SAS HS	Open	None	2xGbE LOM	1xLP x8	None	TPM 1.2	XClarity Standard	1x550W Platinum	3-year	07/17

Model	Region	Processor	Memory	Storage Controller	Chassis	Disk Bays	Disks	M.2 Drives	Networking (LOM/ML2/PCIe)	Available PCIe Slots	Front VGA	Security	System Management	Power Supply	Base Warranty	Ann Date (mm/yy)	
7X04A01NSG	INDIA	1xXeon Gold 5122 4C/3.6GHz/16.5MB/105W/DDR4-2400	1x16GB RDIMM DDR4-2666	1x930-8i 2GB flash	16x2.5"	8x2.5"	SATA/SAS HS	Open	None	2xGbE LOM	1xLP x8	None	TPM 1.2	XClarity Standard	1x750W Platinum	3-year	07/17
7X04A01KSG	INDIA	1xXeon Gold 6138 20C/2.0GHz/27.5MB/125W/DDR4-2666	1x16GB RDIMM DDR4-2666	1x930-8i 2GB flash	16x2.5"	8x2.5"	SATA/SAS HS	Open	None	2xGbE LOM	1xLP x8	None	TPM 1.2	XClarity Standard	1x550W Platinum	3-year	07/17

# ThinkSystem SR550 - Non TopSeller - JAPAN

Product Specifications Reference (PSREF)

Model	Region	Processor	Memory	Storage Controller	Chassis	Disk Bays	Disks	M.2 Drives	Networking (LOM/ML2/PCIe)	Available PCIe Slots	Front VGA	Security	System Management	Power Supply	Base Warranty	Ann Date (mm/yy)
7X04A04CJP	JAPAN	1xXeon Gold 5122 4C/3.6GHz/16.5MB/105W/DDR4-2400	1x8GB RDIMM DDR4-2666	1x930-8i 2GB flash	16x2.5"	8x2.5" SATA/SAS HS	Open	None	None	3xFHHL x8/1xLP x8	None	TPM 1.2	XClarity Standard	1x750W Platinum	3-year	07/17
7X04A04DJP	JAPAN	1xXeon Gold 6138 20C/2.0GHz/27.5MB/125W/DDR4-2666	1x8GB RDIMM DDR4-2666	1x930-8i 2GB flash	16x2.5"	8x2.5" SATA/SAS HS	Open	None	None	3xFHHL x8/1xLP x8	None	TPM 1.2	XClarity Standard	1x750W Platinum	3-year	07/17

## ThinkSystem SR550 - Non TopSeller - LA

Product Specifications Reference (PSREF)

Model	Region	Processor	Memory	Storage Controller	Chassis	Disk Bays	Disks	M.2 Drives	Networking (LOM/ML2/PCIe)	Available PCIe Slots	Front VGA	Security	System Management	Power Supply	Base Warranty	Ann Date (mm/yy)
7X04A03XLA	LA	1xXeon Gold 5120 14C/2.2GHz/19.25MB/105W/DDR4-2400	1x8GB RDIMM DDR4-2666	1x530-8i	16x2.5"	8x2.5" SATA/SAS HS	Open	None	None	3xFHHL x8/1xLP x8	Front VGA	TPM 1.2	XClarity Standard	1x750W Platinum	3-year	07/17
7X04A03YLA	LA	1xXeon Gold 5120 14C/2.2GHz/19.25MB/105W/DDR4-2400	1x8GB RDIMM DDR4-2666	1x930-8i 2GB flash	12x3.5"	8x3.5" SATA/SAS HS	Open	None	None	3xFHHL x8/1xLP x8	Front VGA	TPM 1.2	XClarity Standard	1x750W Platinum	3-year	07/17
7X04A02PLA	LA	1xXeon Gold 5118 12C/2.3GHz/16.5MB/105W/DDR4-2400	1x8GB RDIMM DDR4-2666	1x530-8i	16x2.5"	8x2.5" SATA/SAS HS	Open	None	None	3xFHHL x8/1xLP x8	Front VGA	TPM 1.2	XClarity Standard	1x750W Platinum	3-year	07/17
7X04A02LLA	LA	1xXeon Gold 6130 16C/2.1GHz/22MB/125W/DDR4-2666	1x8GB RDIMM DDR4-2666	1x930-8i 2GB flash	12x3.5"	8x3.5" SATA/SAS HS	Open	None	None	3xFHHL x8/1xLP x8	Front VGA	TPM 1.2	XClarity Standard	1x750W Platinum	3-year	07/17
7X04A036LA	LA	1xXeon Gold 6130 16C/2.1GHz/22MB/125W/DDR4-2666	1x8GB RDIMM DDR4-2666	1x930-8i 2GB flash	16x2.5"	8x2.5" SATA/SAS HS	Open	None	None	3xFHHL x8/1xLP x8	Front VGA	TPM 1.2	XClarity Standard	1x750W Platinum	3-year	07/17
7X04A03LLA	LA	1xXeon Gold 6130 16C/2.1GHz/22MB/125W/DDR4-2666	1x8GB RDIMM DDR4-2666	1x530-8i	16x2.5"	8x2.5" SATA/SAS HS	Open	None	None	3xFHHL x8/1xLP x8	Front VGA	TPM 1.2	XClarity Standard	1x750W Platinum	3-year	07/17
7X04A03MLA	LA	1xXeon Gold 5118 12C/2.3GHz/16.5MB/105W/DDR4-2400	1x8GB RDIMM DDR4-2666	1x930-8i 2GB flash	12x3.5"	8x3.5" SATA/SAS HS	Open	None	None	3xFHHL x8/1xLP x8	Front VGA	TPM 1.2	XClarity Standard	1x750W Platinum	3-year	07/17
7X04A03NLA	LA	1xXeon Gold 5120 14C/2.2GHz/19.25MB/105W/DDR4-2400	1x8GB RDIMM DDR4-2666	1x930-8i 2GB flash	16x2.5"	8x2.5" SATA/SAS HS	Open	None	None	3xFHHL x8/1xLP x8	Front VGA	TPM 1.2	XClarity Standard	1x750W Platinum	3-year	07/17
7X04A02CLA	LA	1xXeon Gold 5118 12C/2.3GHz/16.5MB/105W/DDR4-2400	1x8GB RDIMM DDR4-2666	1x930-8i 2GB flash	16x2.5"	8x2.5" SATA/SAS HS	Open	None	None	3xFHHL x8/1xLP x8	Front VGA	TPM 1.2	XClarity Standard	1x750W Platinum	3-year	07/17
7X04A05CLA	LA	1xXeon Silver 4116 12C/2.1GHz/16.5MB/85W/DDR4-2400	1x8GB RDIMM DDR4-2666	1x930-8i 2GB flash	16x2.5"	8x2.5" SATA/SAS HS	Open	None	None	3xFHHL x8/1xLP x8	Front VGA	TPM 1.2	XClarity Standard	1x750W Platinum	3-year	07/17
7X04A05ELA	LA	1xXeon Gold 5115 10C/2.4GHz/13.75MB/85W/DDR4-2400	1x8GB RDIMM DDR4-2666	1x930-8i 2GB flash	16x2.5"	8x2.5" SATA/SAS HS	Open	None	None	3xFHHL x8/1xLP x8	Front VGA	TPM 1.2	XClarity Standard	1x750W Platinum	3-year	07/17
7X04A05GLA	LA	1xXeon Silver 4110 8C/2.1GHz/11MB/85W/DDR4-2400	1x8GB RDIMM DDR4-2666	1x930-8i 2GB flash	16x2.5"	8x2.5" SATA/SAS HS	Open	None	None	3xFHHL x8/1xLP x8	Front VGA	TPM 1.2	XClarity Standard	1x750W Platinum	3-year	07/17
7X04A05HLA	LA	1xXeon Silver 4114 10C/2.2GHz/13.75MB/85W/DDR4-2400	1x8GB RDIMM DDR4-2666	1x930-8i 2GB flash	16x2.5"	8x2.5" SATA/SAS HS	Open	None	None	3xFHHL x8/1xLP x8	Front VGA	TPM 1.2	XClarity Standard	1x750W Platinum	3-year	07/17
7X04A054LA	LA	1xXeon Silver 4108 8C/1.8GHz/11MB/85W/DDR4-2400	1x8GB RDIMM DDR4-2666	1x930-8i 2GB flash	16x2.5"	8x2.5" SATA/SAS HS	Open	None	None	3xFHHL x8/1xLP x8	Front VGA	TPM 1.2	XClarity Standard	1x750W Platinum	3-year	07/17

## ThinkSystem SR550 - Non TopSeller - NA

Product Specifications Reference (PSREF)

Model	Region	Processor	Memory	Storage Controller	Chassis	Disk Bays	Disks	M.2 Drives	Networking (LOM/ML2/PCIe)	Available PCIe Slots	Front VGA	Security	System Management	Power Supply	Base Warranty	Ann Date (mm/yy)
7X04A05ANA	NA	1xXeon Silver 4114 10C/2.2GHz/13.75MB/85W/DDR4-2400	1x16GB RDIMM DDR4-2666	1x930-16i 4GB flash	12x3.5"	12x3.5" SATA/SAS HS	Open	None	None	1xLP x8	None	TPM 1.2	XClarity Standard	1x750W Platinum	3-year	07/17
7X04A05BNA	NA	1xXeon Gold 5115 10C/2.4GHz/13.75MB/85W/DDR4-2400	1x16GB RDIMM DDR4-2666	1x930-8i 2GB flash	16x2.5"	8x2.5" SATA/SAS HS	Open	None	None	1xLP x8	None	TPM 1.2	XClarity Standard	1x750W Platinum	3-year	07/17
7X04A055NA	NA	1xXeon Silver 4116 12C/2.1GHz/16.5MB/85W/DDR4-2400	1x16GB RDIMM DDR4-2666	1x930-8i 2GB flash	16x2.5"	8x2.5" SATA/SAS HS	Open	None	None	1xLP x8	None	TPM 1.2	XClarity Standard	1x750W Platinum	3-year	07/17
7X04A056NA	NA	1xXeon Silver 4108 8C/1.8GHz/11MB/85W/DDR4-2400	1x16GB RDIMM DDR4-2666	1x930-8i 2GB flash	16x2.5"	8x2.5" SATA/SAS HS	Open	None	None	1xLP x8	None	TPM 1.2	XClarity Standard	1x750W Platinum	3-year	07/17
7X04A057NA	NA	1xXeon Silver 4110 8C/2.1GHz/11MB/85W/DDR4-2400	1x16GB RDIMM DDR4-2666	1x930-8i 2GB flash	16x2.5"	8x2.5" SATA/SAS HS	Open	None	None	1xLP x8	None	TPM 1.2	XClarity Standard	1x750W Platinum	3-year	07/17
7X04A053NA	NA	1xXeon Silver 4114 10C/2.2GHz/13.75MB/85W/DDR4-2400	1x16GB RDIMM DDR4-2666	1x930-8i 2GB flash	16x2.5"	8x2.5" SATA/SAS HS	Open	None	None	1xLP x8	None	TPM 1.2	XClarity Standard	1x750W Platinum	3-year	07/17
7X04A051NA	NA	1xXeon Bronze 3104 6C/1.7GHz/8.25MB/85W/DDR4-2133	1x16GB RDIMM DDR4-2666	1x530-8i	16x2.5"	8x2.5" SATA/SAS HS	Open	None	None	1xLP x8	None	TPM 1.2	XClarity Standard	1x750W Platinum	3-year	07/17
7X04A04YNA	NA	1xXeon Silver 4110 8C/2.1GHz/11MB/85W/DDR4-2400	1x16GB RDIMM DDR4-2666	1x530-8i	16x2.5"	8x2.5" SATA/SAS HS	Open	None	None	1xLP x8	None	TPM 1.2	XClarity Standard	1x750W Platinum	3-year	07/17
7X04A04ZNA	NA	1xXeon Silver 4108 8C/1.8GHz/11MB/85W/DDR4-2400	1x16GB RDIMM DDR4-2666	1x530-8i	16x2.5"	8x2.5" SATA/SAS HS	Open	None	None	1xLP x8	None	TPM 1.2	XClarity Standard	1x750W Platinum	3-year	07/17
7X04A05JNA	NA	1xXeon Gold 5118 12C/2.3GHz/16.5MB/105W/DDR4-2400	1x16GB RDIMM DDR4-2666	1x930-8i 2GB flash	16x2.5"	8x2.5" SATA/SAS HS	Open	None	None	3xFHHL x8/1xLP x8	Front VGA	TPM 1.2	XClarity Standard	1x750W Platinum	3-year	07/17
7X04A04NNA	NA	1xXeon Gold 6138 20C/2.0GHz/27.5MB/125W/DDR4-2666	1x32GB RDIMM DDR4-2666	1x930-8i 2GB flash	16x2.5"	8x2.5" SATA/SAS HS	Open	None	None	3xFHHL x8/1xLP x8	Front VGA	TPM 1.2	XClarity Standard	1x750W Platinum	3-year	07/17
7X04A04PNA	NA	1xXeon Gold 6126 12C/2.6GHz/19.25MB/125W/DDR4-2666	1x32GB RDIMM DDR4-2666	1x930-8i 2GB flash	16x2.5"	8x2.5" SATA/SAS HS	Open	None	None	3xFHHL x8/1xLP x8	Front VGA	TPM 1.2	XClarity Standard	1x750W Platinum	3-year	07/17
7X04A04UNA	NA	1xXeon Gold 6130 16C/2.1GHz/22MB/125W/DDR4-2666	1x32GB RDIMM DDR4-2666	1x930-8i 2GB flash	16x2.5"	8x2.5" SATA/SAS HS	Open	None	None	3xFHHL x8/1xLP x8	Front VGA	TPM 1.2	XClarity Standard	1x750W Platinum	3-year	07/17
7X04A04VNA	NA	1xXeon Gold 5120 14C/2.2GHz/19.25MB/105W/DDR4-2400	1x16GB RDIMM DDR4-2666	1x930-8i 2GB flash	16x2.5"	8x2.5" SATA/SAS HS	Open	None	None	3xFHHL x8/1xLP x8	Front VGA	TPM 1.2	XClarity Standard	1x750W Platinum	3-year	07/17



# ThinkSystem SR630 Platform Specifications

Product Specifications Reference (PSREF)

Components	Specification																																																																																										
Form factor	1U rack																																																																																										
Dimensions	Height: 43 mm (1.7 in). Width: 482 mm (19.0 in) with rack latches. Depth: 778.3 mm (30.64 in)																																																																																										
Weight	Maximum configuration: 41.9 lb (19 kg)																																																																																										
Processor	Up to two 205W Intel Xeon Scalable family processors, Bronze, Silver, Gold, or Platinum. Up to 28 cores at 2.5GHz, up to 3.6GHz with 4 cores. Two processors are connected with two UPI (Ultra Path Interconnect) links up to 10.4GT/s																																																																																										
Chipset	Intel C624 Platform Controller Hub																																																																																										
Memory	Up to 24 DIMM sockets. Each processor supports up to 12 DIMM sockets with 6 channels. DDR4-2666. RDIMMs, LRDIMMs, 3DS RDIMMs are supported, but memory types cannot be intermixed. 3DS RDIMM is planned to available later																																																																																										
Memory capacity	Up to 768GB with 24 x 32 GB RDIMMs and two processors. Or up to 1.5TB with 24 x 64 GB LRDIMMs and two processors. Or up to 3TB with 24 x 128 GB 3DS LRDIMMs and two -M suffix processors. -M suffix processor supports 1.5TB memory per socket, non -M suffix processor supports 768GB memory per socket																																																																																										
Memory protection	ECC, memory mirroring, and memory sparing																																																																																										
Storage controllers	One dedicated internal RAID slot for most RAID/HBA adapters. Supports the following RAID/HBA adapters:																																																																																										
	<table border="1"> <thead> <tr> <th>Feature</th> <th>Interface</th> <th>Drive type</th> <th>RAID levels</th> <th>JBOD</th> <th>Cache</th> <th>Cache protection</th> <th>FastPath</th> <th>Max qty</th> </tr> </thead> <tbody> <tr> <td>530-8i</td> <td>12Gbps SAS</td> <td>SATA/SAS</td> <td>0/1/10/5/50</td> <td>Yes</td> <td>None</td> <td>None</td> <td>Yes</td> <td>1</td> </tr> <tr> <td>730-8i</td> <td>12Gbps SAS</td> <td>SATA/SAS</td> <td>0/1/10/5/50</td> <td>Yes</td> <td>1GB</td> <td>None</td> <td>No</td> <td>1</td> </tr> <tr> <td>930-8i</td> <td>12Gbps SAS</td> <td>SATA/SAS</td> <td>0/1/10/5/50/6/60</td> <td>Yes</td> <td>2GB</td> <td>Flash backup</td> <td>Yes</td> <td>1</td> </tr> <tr> <td>930-16i</td> <td>12Gbps SAS</td> <td>SATA/SAS</td> <td>0/1/10/5/50/6/60</td> <td>Yes</td> <td>4GB</td> <td>Flash backup</td> <td>Yes</td> <td>1</td> </tr> <tr> <td>430-8i</td> <td>12Gbps SAS</td> <td>SATA/SAS</td> <td>-</td> <td>Yes</td> <td>None</td> <td>None</td> <td>-</td> <td>1</td> </tr> <tr> <td>430-16i</td> <td>12Gbps SAS</td> <td>SATA/SAS</td> <td>-</td> <td>Yes</td> <td>None</td> <td>None</td> <td>-</td> <td>1</td> </tr> <tr> <td>930-8e</td> <td>12Gbps SAS</td> <td>SATA/SAS</td> <td>0/1/10/5/50/6/60</td> <td>Yes</td> <td>4GB</td> <td>Flash backup</td> <td>Yes</td> <td>2</td> </tr> <tr> <td>430-8e</td> <td>12Gbps SAS</td> <td>SATA/SAS</td> <td>-</td> <td>Yes</td> <td>None</td> <td>None</td> <td>-</td> <td>2</td> </tr> <tr> <td>430-16e</td> <td>12Gbps SAS</td> <td>SATA/SAS</td> <td>-</td> <td>Yes</td> <td>None</td> <td>None</td> <td>-</td> <td>2</td> </tr> </tbody> </table>	Feature	Interface	Drive type	RAID levels	JBOD	Cache	Cache protection	FastPath	Max qty	530-8i	12Gbps SAS	SATA/SAS	0/1/10/5/50	Yes	None	None	Yes	1	730-8i	12Gbps SAS	SATA/SAS	0/1/10/5/50	Yes	1GB	None	No	1	930-8i	12Gbps SAS	SATA/SAS	0/1/10/5/50/6/60	Yes	2GB	Flash backup	Yes	1	930-16i	12Gbps SAS	SATA/SAS	0/1/10/5/50/6/60	Yes	4GB	Flash backup	Yes	1	430-8i	12Gbps SAS	SATA/SAS	-	Yes	None	None	-	1	430-16i	12Gbps SAS	SATA/SAS	-	Yes	None	None	-	1	930-8e	12Gbps SAS	SATA/SAS	0/1/10/5/50/6/60	Yes	4GB	Flash backup	Yes	2	430-8e	12Gbps SAS	SATA/SAS	-	Yes	None	None	-	2	430-16e	12Gbps SAS	SATA/SAS	-	Yes	None	None	-	2
	Feature	Interface	Drive type	RAID levels	JBOD	Cache	Cache protection	FastPath	Max qty																																																																																		
	530-8i	12Gbps SAS	SATA/SAS	0/1/10/5/50	Yes	None	None	Yes	1																																																																																		
	730-8i	12Gbps SAS	SATA/SAS	0/1/10/5/50	Yes	1GB	None	No	1																																																																																		
	930-8i	12Gbps SAS	SATA/SAS	0/1/10/5/50/6/60	Yes	2GB	Flash backup	Yes	1																																																																																		
	930-16i	12Gbps SAS	SATA/SAS	0/1/10/5/50/6/60	Yes	4GB	Flash backup	Yes	1																																																																																		
	430-8i	12Gbps SAS	SATA/SAS	-	Yes	None	None	-	1																																																																																		
	430-16i	12Gbps SAS	SATA/SAS	-	Yes	None	None	-	1																																																																																		
	930-8e	12Gbps SAS	SATA/SAS	0/1/10/5/50/6/60	Yes	4GB	Flash backup	Yes	2																																																																																		
430-8e	12Gbps SAS	SATA/SAS	-	Yes	None	None	-	2																																																																																			
430-16e	12Gbps SAS	SATA/SAS	-	Yes	None	None	-	2																																																																																			
<i>Note: 730-8i is available in China only. 930-8e, 430-8e, and 430-16e will be placed in slot 2 firstly.</i>																																																																																											
Disk drive bays	Supports 4 front 3.5" SATA/SAS HS bays, or 8 front 2.5" SATA/SAS HS bays, or 10 front 2.5" SATA/SAS HS bays with 4 AnyBay support. 10 front 2.5" AnyBay will be available later. Optional 2 rear 2.5" HS bays are supported on 10 x 2.5" model, takes place in riser card 1 location. Optional one or two internal M.2 SSD for boot, dual M.2 SSD supports mirroring																																																																																										
Internal storage	For 3.5" bay	3.5" HDD, SATA6Gbps, 7.2K	1TB/2TB/4TB/6TB/8TB/10TB																																																																																								
	(3.5" disks or 2.5" disks with 3.5" tray)	3.5" HDD, SAS12Gbps, 7.2K	1TB/2TB/4TB/6TB SED FIPS/6TB/10TB																																																																																								
		2.5" HDD, SAS12Gbps, 15K	300GB/600GB																																																																																								
	For 2.5" bay	2.5" SSD, SATA6Gbps	240GB/480GB																																																																																								
		2.5" HDD, SATA6Gbps, 7.2K	1TB/2TB																																																																																								
		2.5" HDD, SAS12Gbps, 7.2K	1TB/2TB																																																																																								
		2.5" HDD, SAS12Gbps, 10K	300GB/300GB SED/600GB/600GB SED/900GB/1.2TB/1.8TB																																																																																								
2.5" HDD, SAS12Gbps, 15K		300GB/600GB/900GB																																																																																									
2.5" SSD, SAS12Gbps		400GB/800GB/3.84TB/7.68TB																																																																																									
PCIe 3.0 x4, HHHL adapter	2.5" SSD, SATA6Gbps	240GB/480GB																																																																																									
	2.5" NVMe SSD, AnyBay	800GB/960GB/1.6TB/1.92TB/3.84TB																																																																																									
	M.2 boot drive	M.2 SATA SSD	32GB/128GB																																																																																								
Optical	No internal optical bay. Optional USB DVD±RW optical drive																																																																																										
Network interfaces	One dedicated management port. One LOM slot for customized LOM with up to four RJ-45 or SFP+ ports, up to 10GbE. Wake-on-LAN and NC-SI are available on Port 0 of LOM. Optional ML2 or PCIe adapters are supported. ML2 adapter requires riser card with ML2 slot.																																																																																										
Security features	Power-on and admin password. Trusted Platform Module, TCG 1.2 compliant, upgrade to 2.0 via UEFI setting. Optional TCM in China only. Optional lockable security bezel																																																																																										
Operating systems supported	Microsoft Windows Server 2016/2012 R2. Red Hat Enterprise Linux 7.3/6.9. SUSE Linux Enterprise Server 12 SP2/11 SP4. VMware vSphere (ESXi) 6.5/6.0 U3																																																																																										
Systems management	XClarity Controller Standard, optional upgrades to Advanced or Enterprise are available. Energy Manager. XClarity Administrator. Lenovo Capacity Planner. Provisioning Manager. Essentials. Light Path Diagnostics																																																																																										

Components	Specification												
GPU support	Up to one optional GPU, requires riser card with PCIe x16 full height slot. Supports NVIDIA Quadro P2000												
Base warranty	MT 7X01: 1-year limited onsite service with 9x5/NBD MT 7X02: 3-year limited onsite service with 9x5/NBD												
Power supply	Up to two redundant hot-swap 550W/750W/1100W 80 PLUS Platinum qualified power supplies. Or up to two redundant hot-swap 750W Titanium qualified power supplies. 750W Titanium is 200V - 240V, others are 100V - 240V												
Video	Integrated Matrox G200 in XClarity Controller												
Cooling	Five fans (4+1) for single processor model, seven fans (6+1) for dual processor model												
Front ports	One XClarity Controller USB connector, one USB 3.0, one optional VGA												
Rear ports	One VGA, two USB 3.0, one XClarity Controller network connector. Optional COM port												
Environmental specification	Supports ASHRAE A4 with limitations.												
	<table border="1"> <tbody> <tr> <td>Temperature - operating</td> <td>A4: 5°C to 45°C (41°F to 113°F) A3: 5°C to 40°C (41°F to 104°F) A2: 10°C to 35°C (50°F to 95°F)</td> </tr> <tr> <td>Temperature - non operating (no package)</td> <td>-10°C to 60°C (14°F to 140°F)</td> </tr> <tr> <td>Temperature - non operating (with package)</td> <td>-40°C to 70°C (-40°F to 158°F)</td> </tr> <tr> <td>Altitude - operating</td> <td>(Unpressurized): 0-10000ft (0-3048m)</td> </tr> <tr> <td>Humidity - operating, non-condensing</td> <td>A4: 8%-90%. A3:8%-85%. A2:20%-80%</td> </tr> <tr> <td>Humidity - storage (with package), non-condensing</td> <td>8%-90%</td> </tr> </tbody> </table>	Temperature - operating	A4: 5°C to 45°C (41°F to 113°F) A3: 5°C to 40°C (41°F to 104°F) A2: 10°C to 35°C (50°F to 95°F)	Temperature - non operating (no package)	-10°C to 60°C (14°F to 140°F)	Temperature - non operating (with package)	-40°C to 70°C (-40°F to 158°F)	Altitude - operating	(Unpressurized): 0-10000ft (0-3048m)	Humidity - operating, non-condensing	A4: 8%-90%. A3:8%-85%. A2:20%-80%	Humidity - storage (with package), non-condensing	8%-90%
	Temperature - operating	A4: 5°C to 45°C (41°F to 113°F) A3: 5°C to 40°C (41°F to 104°F) A2: 10°C to 35°C (50°F to 95°F)											
	Temperature - non operating (no package)	-10°C to 60°C (14°F to 140°F)											
	Temperature - non operating (with package)	-40°C to 70°C (-40°F to 158°F)											
	Altitude - operating	(Unpressurized): 0-10000ft (0-3048m)											
	Humidity - operating, non-condensing	A4: 8%-90%. A3:8%-85%. A2:20%-80%											
	Humidity - storage (with package), non-condensing	8%-90%											
	<i>Models should meet the following requirements to support A3 and A4:</i>												
	<ul style="list-style-type: none"> <li>Processors with TDP higher than or equal to 150-Watt and Xeon 4112, 5122, 6126, 6128, 6132, 6134, 6134M, and 8156 processors not installed</li> <li>Both NVMe 2.5" SSD and NVMe PCIe adapter not installed</li> <li>GPU not installed</li> <li>Must have redundant PSU</li> <li>RAID super capacitor module cannot be installed on the bottom of the air baffle, but only can be installed on the chassis.</li> </ul>												
Environmental certification	Energy Star Server 2.1 certified. More environmental information please see: <a href="http://www.lenovo.com/social_responsibility/us/en/environment/">www.lenovo.com/social_responsibility/us/en/environment/</a>												

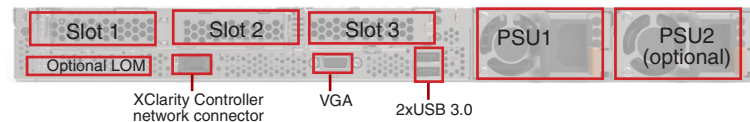

Expansion slots	
Slot 1-2 (riser card 1)	Supports one of the following for riser card 1: Option 1: PCIe 3.0 x8/x16 (slot 1-2). Low profile for x8, low profile or full height half length for x16 Option 2: PCIe 3.0 x8 ML2/x16 (slot 1-2). Low profile for x8 ML2, low profile or full height half length for x16 Option 3: PCIe 3.0 x16 ML2/x8 (slot 1-2). Low profile for x16 ML2, low profile or full height half length for x8 Option 4: 2x 2.5" drive bay, for 10 x 2.5" model only
Slot 3 (riser card 2)	PCIe 3.0 x 16, low profile, requires 2nd CPU. When slot 2 is full height, slot 3 cannot be used

System unique options	
7XH7A05896	Lenovo SR530/SR570/SR630 2.5" SATA/SAS 8-Bay Backplane Kit
7XH7A05893	Lenovo SR530/SR570/SR630 x8/x16 PCIe LP+FH Riser 1 Kit
7XH7A05895	Lenovo SR630 x16ML2/x8 PCIe LP+FH Riser 1 Kit
7XH7A05894	Lenovo SR630 x8ML2/x16 PCIe LP+FH Riser 1 Kit
7XH7A02682	Lenovo SR530/SR570/SR630 x8/x16 PCIe LP+LP Riser 1 Kit
7XH7A02683	Lenovo SR630 x8ML2/x16 PCIe LP+LP Riser 1 Kit
7XH7A02684	Lenovo SR630 x16ML2/x8 PCIe LP+LP Riser 1 Kit
7XH7A02685	Lenovo SR530/SR570/SR630 x16 PCIe LP Riser 2 Kit
7XH7A06252	Lenovo SR630 Rear HDD Kit
7Z17A02577	Lenovo COM Port Upgrade Kit
7Z17A02579	Lenovo SR530/SR570/SR630 Front VGA Connector Upgrade Kit
7Z17A02581	Lenovo 1U Security Bezel

Model	Region	Processor	Memory	Storage Controller	Chassis	Disk Bays	Disks	M.2 Drives	GPU	Networking (LOM/ML2/PCIe)	Available PCIe Slots	Front VGA	Security	System Management	Power Supply	Base Warranty	Ann Date (mm/yy)
7X02A03TAU	ANZ	1xXeon Silver 4114 10C/2.2GHz/13.75MB/85W/DDR4-2400	1x16GB RDIMM DDR4-2666	1x930-8i 2GB flash	8x2.5"	8x2.5" SATA/SAS HS	3x300GB HDD 10K 2.5" SAS12Gbps	None	None	None	1xLP x8/1xLP x16/1xRAID slot	Front VGA	TPM 1.2	XClarity Enterprise	2x750W Platinum	3-year	07/17
7X02A041AU	ANZ	1xXeon Gold 6130 16C/2.1GHz/22MB/125W/DDR4-2666	1x32GB RDIMM DDR4-2666	1x930-8i 2GB flash	8x2.5"	8x2.5" SATA/SAS HS	Open	None	None	None	1xLP x8/1xLP x16/1xRAID slot	Front VGA	TPM 1.2	XClarity Enterprise	1x750W Platinum	3-year	07/17
7X02A042AU	ANZ	1xXeon Silver 4110 8C/2.1GHz/11MB/85W/DDR4-2400	1x16GB RDIMM DDR4-2666	1x930-8i 2GB flash	8x2.5"	8x2.5" SATA/SAS HS	Open	None	None	None	1xLP x8/1xLP x16/1xRAID slot	Front VGA	TPM 1.2	XClarity Enterprise	1x750W Platinum	3-year	07/17
7X02A03VAU	ANZ	1xXeon Silver 4108 8C/1.8GHz/11MB/85W/DDR4-2400	1x16GB RDIMM DDR4-2666	1x530-8i	8x2.5"	8x2.5" SATA/SAS HS	Open	None	None	None	1xLP x8/1xLP x16/1xRAID slot	Front VGA	TPM 1.2	XClarity Enterprise	1x750W Platinum	3-year	07/17
7X02A048AU	ANZ	1xXeon Silver 4114 10C/2.2GHz/13.75MB/85W/DDR4-2400	1x32GB RDIMM DDR4-2666	1x930-8i 2GB flash	8x2.5"	8x2.5" SATA/SAS HS	Open	None	None	None	1xRAID slot slot	Front VGA	TPM 1.2	XClarity Enterprise	2x750W Platinum	3-year	07/17
7X02A049AU	ANZ	1xXeon Silver 4110 8C/2.1GHz/11MB/85W/DDR4-2400	1x32GB RDIMM DDR4-2666	1x930-8i 2GB flash	8x2.5"	8x2.5" SATA/SAS HS	Open	None	None	None	1xRAID slot slot	Front VGA	TPM 1.2	XClarity Enterprise	2x750W Platinum	3-year	07/17
7X02A04DAU	ANZ	1xXeon Bronze 3104 6C/1.7GHz/8.25MB/85W/DDR4-2133	1x8GB RDIMM DDR4-2666	1x530-8i	8x2.5"	8x2.5" SATA/SAS HS	Open	None	None	None	1xLP x8/1xLP x16/1xRAID slot	Front VGA	TPM 1.2	XClarity Enterprise	1x750W Platinum	3-year	07/17
7X02A04GAU	ANZ	1xXeon Silver 4116 12C/2.1GHz/16.5MB/85W/DDR4-2400	1x16GB RDIMM DDR4-2666	1x930-8i 2GB flash	8x2.5"	8x2.5" SATA/SAS HS	Open	None	None	None	1xLP x8/1xLP x16/1xRAID slot	Front VGA	TPM 1.2	XClarity Enterprise	1x750W Platinum	3-year	07/17
7X02A04KAU	ANZ	1xXeon Silver 4108 8C/1.8GHz/11MB/85W/DDR4-2400	1x16GB RDIMM DDR4-2666	1x930-8i 2GB flash	8x2.5"	8x2.5" SATA/SAS HS	Open	None	None	None	1xLP x8/1xLP x16/1xRAID slot	Front VGA	TPM 1.2	XClarity Enterprise	1x750W Platinum	3-year	07/17
7X02A04RAU	ANZ	1xXeon Gold 5115 10C/2.4GHz/13.75MB/85W/DDR4-2400	1x16GB RDIMM DDR4-2666	1x930-8i 2GB flash	8x2.5"	8x2.5" SATA/SAS HS	Open	None	None	None	1xLP x8/1xLP x16/1xRAID slot	Front VGA	TPM 1.2	XClarity Enterprise	1x750W Platinum	3-year	07/17
7X02A04WAU	ANZ	1xXeon Silver 4110 8C/2.1GHz/11MB/85W/DDR4-2400	1x16GB RDIMM DDR4-2666	1x530-8i	8x2.5"	8x2.5" SATA/SAS HS	Open	None	None	None	1xLP x8/1xLP x16/1xRAID slot	Front VGA	TPM 1.2	XClarity Enterprise	1x750W Platinum	3-year	07/17
7X02A051AU	ANZ	1xXeon Gold 5118 12C/2.3GHz/16.5MB/105W/DDR4-2400	4x32GB RDIMM DDR4-2666	1x930-8i 2GB flash	8x2.5"	8x2.5" SATA/SAS HS	Open	2x32GB	None	None	1xLP x8/1xLP x16/1xRAID slot	Front VGA	TPM 1.2	XClarity Enterprise	2x750W Platinum	3-year	07/17
7X02A054AU	ANZ	1xXeon Silver 4114 10C/2.2GHz/13.75MB/85W/DDR4-2400	1x16GB RDIMM DDR4-2666	1x930-8i 2GB flash	8x2.5"	8x2.5" SATA/SAS HS	HDD 10K 2.5" SAS12Gbps	None	None	None	1xLP x8/1xLP x16/1xRAID slot	Front VGA	TPM 1.2	XClarity Enterprise	2x750W Platinum	3-year	07/17
7X02A055AU	ANZ	1xXeon Gold 5118 12C/2.3GHz/16.5MB/105W/DDR4-2400	1x16GB RDIMM DDR4-2666	1x930-16i 4GB flash	10x2.5"	10x2.5" HS (6 SATA/SAS, 4 AnyBay)	Open	None	None	None	1xLP x8/1xLP x16/1xRAID slot	Front VGA	TPM 1.2	XClarity Enterprise	1x750W Platinum	3-year	07/17
7X02A056AU	ANZ	1xXeon Silver 4114 10C/2.2GHz/13.75MB/85W/DDR4-2400	1x16GB RDIMM DDR4-2666	1x930-8i 2GB flash	8x2.5"	8x2.5" SATA/SAS HS	Open	None	None	None	1xLP x8/1xLP x16/1xRAID slot	Front VGA	TPM 1.2	XClarity Enterprise	1x750W Platinum	3-year	07/17



Model	Region	Processor	Memory	Storage Controller	Chassis	Disk Bays	Disks	M.2 Drives	GPU	Networking (LOM/ML2/PCIe)	Available PCIe Slots	Front VGA	Security	System Management	Power Supply	Base Warranty	Ann Date (mm/yy)
7X02A057AU	ANZ	1xXeon Silver 4110 8C/2.1GHz/11MB/85W/DDR4-2400	1x16GB RDIMM DDR4-2666	1x930-16i 4GB flash	10x2.5"	10x2.5" HS (6 SATA/SAS, 4 AnyBay)	Open	None	None	None	1xLP x8/1xLP x16/1xRAID slot	Front VGA	TPM 1.2	XClarity Enterprise	1x750W Platinum	3-year	07/17
7X02A059AU	ANZ	1xXeon Gold 5118 12C/2.3GHz/16.5MB/105W/DDR4-2400	1x16GB RDIMM DDR4-2666	1x930-8i 2GB flash	8x2.5"	8x2.5" SATA/SAS HS	Open	None	None	None	1xLP x8/1xLP x16/1xRAID slot	Front VGA	TPM 1.2	XClarity Enterprise	1x750W Platinum	3-year	07/17

Model	Region	Processor	Memory	Storage Controller	Chassis	Disk Bays	Disks	M.2 Drives	GPU	Networking (LOM/ML2/PCIe)	Available PCIe Slots	Front VGA	Security	System Management	Power Supply	Base Warranty	Ann Date (mm/yy)
7X02A00HEA	EMEA	1xXeon Gold 5115 10C/2.4GHz/13.75MB/85W/DDR4-2400	1x16GB RDIMM DDR4-2666	1x930-8i 2GB flash	8x2.5"	8x2.5" SATA/SAS HS	Open	None	None	None	1xLP x8/1xLP x16/1xRAID slot	Front VGA	TPM 1.2	XClarity Enterprise	1x750W Platinum	3-year	07/17
7X02A006EA	EMEA	1xXeon Gold 6130 16C/2.1GHz/22MB/125W/DDR4-2666	1x32GB RDIMM DDR4-2666	1x930-8i 2GB flash	8x2.5"	8x2.5" SATA/SAS HS	Open	None	None	None	1xLP x8/1xLP x16/1xRAID slot	Front VGA	TPM 1.2	XClarity Enterprise	1x750W Platinum	3-year	07/17
7X02A008EA	EMEA	1xXeon Gold 5118 12C/2.3GHz/16.5MB/105W/DDR4-2400	1x16GB RDIMM DDR4-2666	1x930-8i 2GB flash	8x2.5"	8x2.5" SATA/SAS HS	Open	None	None	None	1xLP x8/1xLP x16/1xRAID slot	Front VGA	TPM 1.2	XClarity Enterprise	1x750W Platinum	3-year	07/17
7X02A00QEA	EMEA	1xXeon Gold 5118 12C/2.3GHz/16.5MB/105W/DDR4-2400	1x16GB RDIMM DDR4-2666	1x930-16i 4GB flash	10x2.5"	10x2.5" HS (6 SATA/SAS, 4 AnyBay)	Open	None	None	None	1xLP x8/1xLP x16/1xRAID slot	Front VGA	TPM 1.2	XClarity Enterprise	1x750W Platinum	3-year	07/17
7X02A01QEA	EMEA	2xXeon Gold 5118 12C/2.3GHz/16.5MB/105W/DDR4-2400	4x32GB RDIMM DDR4-2666	1x430-8i	8x2.5"	8x2.5" SATA/SAS HS	Open	2x32GB	None	None	1xLP x8/2xLP x16/1xRAID slot	Front VGA	TPM 1.2	XClarity Enterprise	2x750W Platinum	3-year	07/17
7X02A04GEA	EMEA	1xXeon Silver 4116 12C/2.1GHz/16.5MB/85W/DDR4-2400	1x16GB RDIMM DDR4-2666	1x930-8i 2GB flash	8x2.5"	8x2.5" SATA/SAS HS	Open	None	None	None	1xLP x8/1xLP x16/1xRAID slot	Front VGA	TPM 1.2	XClarity Enterprise	1x750W Platinum	3-year	07/17
7X02A04DEA	EMEA	1xXeon Bronze 3104 6C/1.7GHz/8.25MB/85W/DDR4-2133	1x8GB RDIMM DDR4-2666	1x530-8i	8x2.5"	8x2.5" SATA/SAS HS	Open	None	None	None	1xLP x8/1xLP x16/1xRAID slot	Front VGA	TPM 1.2	XClarity Enterprise	1x750W Platinum	3-year	07/17
7X02A049EA	EMEA	1xXeon Silver 4110 8C/2.1GHz/11MB/85W/DDR4-2400	1x32GB RDIMM DDR4-2666	1x930-8i 2GB flash	8x2.5"	8x2.5" SATA/SAS HS	Open	None	None	None	1xLP x8/1xLP x16/1xRAID slot	Front VGA	TPM 1.2	XClarity Enterprise	2x750W Platinum	3-year	07/17
7X02A048EA	EMEA	1xXeon Silver 4114 10C/2.2GHz/13.75MB/85W/DDR4-2400	1x32GB RDIMM DDR4-2666	1x930-8i 2GB flash	8x2.5"	8x2.5" SATA/SAS HS	Open	None	None	None	1xRAID slot	Front VGA	TPM 1.2	XClarity Enterprise	2x750W Platinum	3-year	07/17
7X02A03VEA	EMEA	1xXeon Silver 4108 8C/1.8GHz/11MB/85W/DDR4-2400	1x16GB RDIMM DDR4-2666	1x530-8i	8x2.5"	8x2.5" SATA/SAS HS	Open	None	None	None	1xLP x8/1xLP x16/1xRAID slot	Front VGA	TPM 1.2	XClarity Enterprise	1x750W Platinum	3-year	07/17
7X02A042EA	EMEA	1xXeon Silver 4110 8C/2.1GHz/11MB/85W/DDR4-2400	1x16GB RDIMM DDR4-2666	1x930-8i 2GB flash	8x2.5"	8x2.5" SATA/SAS HS	Open	None	None	None	1xLP x8/1xLP x16/1xRAID slot	Front VGA	TPM 1.2	XClarity Enterprise	1x750W Platinum	3-year	07/17
7X02A03TEA	EMEA	1xXeon Silver 4114 10C/2.2GHz/13.75MB/85W/DDR4-2400	1x16GB RDIMM DDR4-2666	1x930-8i 2GB flash	8x2.5"	8x2.5" SATA/SAS HS	3x300GB HDD 10K 2.5" SAS12Gbps	None	None	None	1xLP x8/1xLP x16/1xRAID slot	Front VGA	TPM 1.2	XClarity Enterprise	2x750W Platinum	3-year	07/17
7X02A02VEA	EMEA	2xXeon Gold 5118 12C/2.3GHz/16.5MB/105W/DDR4-2400	4x32GB RDIMM DDR4-2666	1x430-8i	8x2.5"	8x2.5" SATA/SAS HS	Open	2x32GB	None	None	1xLP x8/2xLP x16/1xRAID slot	None	TPM 1.2	XClarity Enterprise	2x750W Platinum	3-year	07/17
7X02A05AEA	EMEA	1xXeon Silver 4110 8C/2.1GHz/11MB/85W/DDR4-2400	4x32GB RDIMM DDR4-2666	1x930-8i 2GB flash	8x2.5"	8x2.5" SATA/SAS HS	3x1.2TB HDD 10K 2.5" SAS12Gbps	None	None	None	1xLP x8/1xLP x16/1xRAID slot	Front VGA	TPM 1.2	XClarity Enterprise	2x750W Platinum	3-year	07/17
7X02A057EA	EMEA	1xXeon Silver 4110 8C/2.1GHz/11MB/85W/DDR4-2400	1x16GB RDIMM DDR4-2666	1x930-16i 4GB flash	10x2.5"	10x2.5" HS (6 SATA/SAS, 4 AnyBay)	Open	None	None	None	1xLP x8/1xLP x16/1xRAID slot	Front VGA	TPM 1.2	XClarity Enterprise	1x750W Platinum	3-year	07/17

Model	Region	Processor	Memory	Storage Controller	Chassis	Disk Bays	Disks	M.2 Drives	GPU	Networking (LOM/ML2/PCIe)	Available PCIe Slots	Front VGA	Security	System Management	Power Supply	Base Warranty	Ann Date (mm/yy)
7X02A056EA	EMEA	1xXeon Silver 4114 10C/2.2GHz/13.75MB/85W/DDR4-2400	1x16GB RDIMM DDR4-2666	1x930-8i 2GB flash	8x2.5"	8x2.5" SATA/SAS HS	Open	None	None	None	1xLP x8/1xLP x16/1xRAID slot	Front VGA	TPM 1.2	XClarity Enterprise	1x750W Platinum	3-year	07/17
7X02A054EA	EMEA	1xXeon Silver 4114 10C/2.2GHz/13.75MB/85W/DDR4-2400	1x16GB RDIMM DDR4-2666	1x930-8i 2GB flash	8x2.5"	8x2.5" SATA/SAS HS	2x300GB HDD 10K 2.5" SAS12Gbps	None	None	None	1xLP x8/1xLP x16/1xRAID slot	Front VGA	TPM 1.2	XClarity Enterprise	2x750W Platinum	3-year	07/17
7X02A051EA	EMEA	1xXeon Gold 5118 12C/2.3GHz/16.5MB/105W/DDR4-2400	4x32GB RDIMM DDR4-2666	1x930-8i 2GB flash	8x2.5"	8x2.5" SATA/SAS HS	Open	2x32GB	None	None	1xLP x8/1xLP x16/1xRAID slot	Front VGA	TPM 1.2	XClarity Enterprise	2x750W Platinum	3-year	07/17
7X02A04WEA	EMEA	1xXeon Silver 4110 8C/2.1GHz/11MB/85W/DDR4-2400	1x16GB RDIMM DDR4-2666	1x530-8i	8x2.5"	8x2.5" SATA/SAS HS	Open	None	None	None	1xLP x8/1xLP x16/1xRAID slot	Front VGA	TPM 1.2	XClarity Enterprise	1x750W Platinum	3-year	07/17
7X02A04KEA	EMEA	1xXeon Silver 4108 8C/1.8GHz/11MB/85W/DDR4-2400	1x16GB RDIMM DDR4-2666	1x930-8i 2GB flash	8x2.5"	8x2.5" SATA/SAS HS	Open	None	None	None	1xLP x8/1xLP x16/1xRAID slot	Front VGA	TPM 1.2	XClarity Enterprise	1x750W Platinum	3-year	07/17

ThinkSystem SR630 - TopSeller - JAPAN

Product Specifications Reference (PSREF)

Model	Region	Processor	Memory	Storage Controller	Chassis	Disk Bays	Disks	M.2 Drives	GPU	Networking (LOM/ML2/PCIe)	Available PCIe Slots	Front VGA	Security	System Management	Power Supply	Base Warranty	Ann Date (mm/yy)	
7X02A01WJP	JAPAN	1xXeon Bronze 3104 6C/1.7GHz/8.25MB/85W/DDR4-2133	1x16GB RDIMM DDR4-2666	1x530-8i	4x3.5"	4x3.5"	SATA/SAS HS	Open	None	None	4xGbE RJ-45 LOM	1xLP x8/1xLP x16/1xRAID slot	None	TPM 1.2	XClarity Standard	1x550W Platinum	3-year	07/17
7X02A02RJP	JAPAN	1xXeon Bronze 3106 8C/1.7GHz/11MB/85W/DDR4-2133	1x16GB RDIMM DDR4-2666	1x930-8i 2GB flash	8x2.5"	8x2.5"	SATA/SAS HS	Open	None	None	4xGbE RJ-45 LOM	1xLP x8/1xLP x16/1xRAID slot	None	TPM 1.2	XClarity Standard	1x550W Platinum	3-year	07/17
7X02A02SJP	JAPAN	1xXeon Silver 4110 8C/2.1GHz/11MB/85W/DDR4-2400	1x16GB RDIMM DDR4-2666	1x930-8i 2GB flash	8x2.5"	8x2.5"	SATA/SAS HS	Open	None	None	4xGbE RJ-45 LOM	1xLP x8/1xLP x16/1xRAID slot	None	TPM 1.2	XClarity Standard	1x550W Platinum	3-year	07/17
7X02A02TJP	JAPAN	1xXeon Silver 4112 4C/2.6GHz/8.25MB/85W/DDR4-2400	1x16GB RDIMM DDR4-2666	1x930-8i 2GB flash	8x2.5"	8x2.5"	SATA/SAS HS	Open	None	None	4xGbE RJ-45 LOM	1xLP x8/1xLP x16/1xRAID slot	None	TPM 1.2	XClarity Standard	1x550W Platinum	3-year	07/17
7X02A02CJP	JAPAN	1xXeon Bronze 3104 6C/1.7GHz/8.25MB/85W/DDR4-2133	1x16GB RDIMM DDR4-2666	1x930-8i 2GB flash	8x2.5"	8x2.5"	SATA/SAS HS	Open	None	None	4xGbE RJ-45 LOM	1xLP x8/1xLP x16/1xRAID slot	None	TPM 1.2	XClarity Standard	1x550W Platinum	3-year	07/17

ThinkSystem SR630 - TopSeller - LA

Product Specifications Reference (PSREF)

Model	Region	Processor	Memory	Storage Controller	Chassis	Disk Bays	Disks	M.2 Drives	GPU	Networking (LOM/ML2/PCIe)	Available PCIe Slots	Front VGA	Security	System Management	Power Supply	Base Warranty	Ann Date (mm/yy)	
7X02A02LLA	LA	1xXeon Gold 5118 12C/2.3GHz/16.5MB/105W/DDR4-2400	1x16GB RDIMM DDR4-2666	1x930-8i 2GB flash	8x2.5"	8x2.5"	SATA/SAS HS	Open	None	None	None	1xLP x8/1xLP x16/1xRAID slot	Front VGA	TPM 1.2	XClarity Standard	1x750W Platinum	3-year	07/17
7X02A038LA	LA	1xXeon Gold 5115 10C/2.4GHz/13.75MB/85W/DDR4-2400	1x16GB RDIMM DDR4-2666	1x930-8i 2GB flash	8x2.5"	8x2.5"	SATA/SAS HS	Open	None	None	None	1xLP x8/1xLP x16/1xRAID slot	Front VGA	TPM 1.2	XClarity Standard	1x750W Platinum	3-year	07/17

# ThinkSystem SR630 - TopSeller - NA

Product Specifications Reference (PSREF)

Model	Region	Processor	Memory	Storage Controller	Chassis	Disk Bays	Disks	M.2 Drives	GPU	Networking (LOM/ML2/PCIe)	Available PCIe Slots	Front VGA	Security	System Management	Power Supply	Base Warranty	Ann Date (mm/yy)
7X02A03UNA	NA	1xXeon Silver 4110 8C/2.1GHz/11MB/85W/DDR4-2400	1x16GB RDIMM DDR4-2666	None	8x2.5"	Non BP	None	None	None	None	1xRAID slot slot	Front VGA	TPM 1.2	XClarity Enterprise	1x750W Platinum	3-year	07/17
7X02A04YNA	NA	1xXeon Gold 5118 12C/2.3GHz/16.5MB/105W/DDR4-2400	1x32GB RDIMM DDR4-2666	None	8x2.5"	Non BP	None	None	None	None	1xRAID slot slot	Front VGA	TPM 1.2	XClarity Enterprise	1x750W Platinum	3-year	07/17
7X02A04JNA	NA	1xXeon Silver 4116 12C/2.1GHz/16.5MB/85W/DDR4-2400	1x32GB RDIMM DDR4-2666	None	8x2.5"	Non BP	None	None	None	None	1xRAID slot slot	Front VGA	TPM 1.2	XClarity Enterprise	1x750W Platinum	3-year	07/17

Model	Region	Processor	Memory	Storage Controller	Chassis	Disk Bays	Disks	M.2 Drives	GPU	Networking (LOM/ML2/PCIe)	Available PCIe Slots	Front VGA	Security	System Management	Power Supply	Base Warranty	Ann Date (mm/yy)
7X02A00ZAU	ANZ	1xXeon Gold 5115 10C/2.4GHz/13.75MB/85W/DDR4-2400	1x8GB RDIMM DDR4-2666	1x530-8i	8x2.5"	8x2.5" SATA/SAS HS	Open	None	None	4xGbE RJ-45 LOM	1xLP x8/1xLP x16/1xRAID slot	Front VGA	TPM 1.2	XClarity Standard	1x550W Platinum	3-year	07/17
7X02A01SAU	ANZ	1xXeon Gold 5118 12C/2.3GHz/16.5MB/105W/DDR4-2400	1x16GB RDIMM DDR4-2666	1x930-8i 2GB flash	8x2.5"	8x2.5" SATA/SAS HS	Open	None	None	None	1xLP x8/1xLP x16/1xRAID slot	Front VGA	TPM 1.2	XClarity Standard	1x750W Platinum	3-year	07/17
7X02A01UUAU	ANZ	1xXeon Gold 6130 16C/2.1GHz/22MB/125W/DDR4-2666	1x32GB RDIMM DDR4-2666	1x930-8i 2GB flash	8x2.5"	8x2.5" SATA/SAS HS	Open	None	None	None	1xLP x8/1xLP x16/1xRAID slot	Front VGA	TPM 1.2	XClarity Standard	1x750W Platinum	3-year	07/17
7X02A020AU	ANZ	1xXeon Gold 5120 14C/2.2GHz/19.25MB/105W/DDR4-2400	1x16GB RDIMM DDR4-2666	1x530-8i	8x2.5"	8x2.5" SATA/SAS HS	Open	None	None	4xGbE RJ-45 LOM	1xLP x8/1xLP x16/1xRAID slot	Front VGA	TPM 1.2	XClarity Standard	1x550W Platinum	3-year	07/17
7X02A022AU	ANZ	1xXeon Gold 5122 4C/3.6GHz/16.5MB/105W/DDR4-2400	1x16GB RDIMM DDR4-2666	1x930-8i 2GB flash	8x2.5"	8x2.5" SATA/SAS HS	Open	None	None	4xGbE RJ-45 LOM	1xLP x8/1xLP x16/1xRAID slot	Front VGA	TPM 1.2	XClarity Standard	1x550W Platinum	3-year	07/17
7X02A023AU	ANZ	1xXeon Gold 5118 12C/2.3GHz/16.5MB/105W/DDR4-2400	1x16GB RDIMM DDR4-2666	1x930-16i 4GB flash	10x2.5"	10x2.5" HS (6 SATA/SAS, 4 AnyBay)	Open	None	None	None	1xLP x8/1xLP x16/1xRAID slot	Front VGA	TPM 1.2	XClarity Standard	1x750W Platinum	3-year	07/17
7X02A01XAU	ANZ	1xXeon Gold 6130 16C/2.1GHz/22MB/125W/DDR4-2666	1x16GB RDIMM DDR4-2666	1x930-8i 2GB flash	8x2.5"	8x2.5" SATA/SAS HS	Open	None	None	4xGbE RJ-45 LOM	1xLP x8/1xLP x16/1xRAID slot	Front VGA	TPM 1.2	XClarity Standard	1x550W Platinum	3-year	07/17
7X02A026AU	ANZ	1xXeon Gold 5115 10C/2.4GHz/13.75MB/85W/DDR4-2400	1x8GB RDIMM DDR4-2666	1x530-8i	4x3.5"	4x3.5" SATA/SAS HS	Open	None	None	4xGbE RJ-45 LOM	1xLP x8/1xLP x16/1xRAID slot	Front VGA	TPM 1.2	XClarity Standard	1x550W Platinum	3-year	07/17
7X02A02MAU	ANZ	1xXeon Gold 6126 12C/2.6GHz/19.25MB/125W/DDR4-2666	1x16GB RDIMM DDR4-2666	1x930-8i 2GB flash	8x2.5"	8x2.5" SATA/SAS HS	Open	None	None	4xGbE RJ-45 LOM	1xLP x8/1xLP x16/1xRAID slot	Front VGA	TPM 1.2	XClarity Standard	1x550W Platinum	3-year	07/17
7X02A02PAU	ANZ	1xXeon Gold 5118 12C/2.3GHz/16.5MB/105W/DDR4-2400	1x16GB RDIMM DDR4-2666	1x930-8i 2GB flash	8x2.5"	8x2.5" SATA/SAS HS	Open	None	None	4xGbE RJ-45 LOM	1xLP x8/1xLP x16/1xRAID slot	Front VGA	TPM 1.2	XClarity Standard	1x550W Platinum	3-year	07/17
7X02A030AU	ANZ	1xXeon Gold 5118 12C/2.3GHz/16.5MB/105W/DDR4-2400	1x16GB RDIMM DDR4-2666	1x530-8i	8x2.5"	8x2.5" SATA/SAS HS	Open	None	None	4xGbE RJ-45 LOM	1xLP x8/1xLP x16/1xRAID slot	Front VGA	TPM 1.2	XClarity Standard	1x550W Platinum	3-year	07/17
7X02A032AU	ANZ	1xXeon Gold 5118 12C/2.3GHz/16.5MB/105W/DDR4-2400	1x8GB RDIMM DDR4-2666	1x530-8i	8x2.5"	8x2.5" SATA/SAS HS	Open	None	None	4xGbE RJ-45 LOM	1xLP x8/1xLP x16/1xRAID slot	Front VGA	TPM 1.2	XClarity Standard	1x550W Platinum	3-year	07/17
7X02A033AU	ANZ	1xXeon Gold 6142 16C/2.6GHz/22MB/150W/DDR4-2666	1x16GB RDIMM DDR4-2666	1x930-8i 2GB flash	8x2.5"	8x2.5" SATA/SAS HS	Open	None	None	4xGbE RJ-45 LOM	1xLP x8/1xLP x16/1xRAID slot	Front VGA	TPM 1.2	XClarity Standard	1x550W Platinum	3-year	07/17
7X02A034AU	ANZ	1xXeon Gold 5120 14C/2.2GHz/19.25MB/105W/DDR4-2400	1x16GB RDIMM DDR4-2666	1x930-8i 2GB flash	8x2.5"	8x2.5" SATA/SAS HS	Open	None	None	4xGbE RJ-45 LOM	1xLP x8/1xLP x16/1xRAID slot	Front VGA	TPM 1.2	XClarity Standard	1x550W Platinum	3-year	07/17
7X02A035AU	ANZ	1xXeon Gold 5115 10C/2.4GHz/13.75MB/85W/DDR4-2400	1x16GB RDIMM DDR4-2666	1x930-8i 2GB flash	8x2.5"	8x2.5" SATA/SAS HS	Open	None	None	None	1xLP x8/1xLP x16/1xRAID slot	Front VGA	TPM 1.2	XClarity Standard	1x750W Platinum	3-year	07/17

Model	Region	Processor	Memory	Storage Controller	Chassis	Disk Bays	Disks	M.2 Drives	GPU	Networking (LOM/ML2/PCIe)	Available PCIe Slots	Front VGA	Security	System Management	Power Supply	Base Warranty	Ann Date (mm/yy)
7X02A03DAU	ANZ	1xXeon Gold 6154 18C/3.0GHz/24.75MB/200W/DDR4-2666	1x16GB RDIMM DDR4-2666	1x930-8i 2GB flash	8x2.5"	8x2.5" SATA/SAS HS	Open	None	None	4xGbE RJ-45 LOM	1xLP x8/1xLP x16/1xRAID slot	Front VGA	TPM 1.2	XClarity Standard	1x550W Platinum	3-year	07/17
7X02A03EAU	ANZ	1xXeon Gold 6148 20C/2.4GHz/27.5MB/150W/DDR4-2666	1x32GB RDIMM DDR4-2666	1x930-8i 2GB flash	8x2.5"	8x2.5" SATA/SAS HS	Open	None	None	None	1xLP x8/1xLP x16/1xRAID slot	Front VGA	TPM 1.2	XClarity Standard	1x750W Platinum	3-year	07/17
7X02A03FAU	ANZ	1xXeon Gold 6140 18C/2.3GHz/24.75MB/140W/DDR4-2666	1x32GB RDIMM DDR4-2666	1x930-8i 2GB flash	8x2.5"	8x2.5" SATA/SAS HS	Open	None	None	None	1xLP x8/1xLP x16/1xRAID slot	Front VGA	TPM 1.2	XClarity Standard	1x750W Platinum	3-year	07/17
7X02A03GAU	ANZ	1xXeon Gold 6152 22C/2.1GHz/30.25MB/140W/DDR4-2666	1x32GB RDIMM DDR4-2666	1x930-8i 2GB flash	8x2.5"	8x2.5" SATA/SAS HS	Open	None	None	None	1xLP x8/1xLP x16/1xRAID slot	Front VGA	TPM 1.2	XClarity Standard	1x750W Platinum	3-year	07/17
7X02A03HAU	ANZ	1xXeon Gold 6134 8C/3.2GHz/24.75MB/130W/DDR4-2666	1x32GB RDIMM DDR4-2666	1x930-8i 2GB flash	8x2.5"	8x2.5" SATA/SAS HS	Open	None	None	None	1xLP x8/1xLP x16/1xRAID slot	Front VGA	TPM 1.2	XClarity Standard	1x750W Platinum	3-year	07/17
7X02A03JAU	ANZ	1xXeon Platinum 8160 24C/2.1GHz/33MB/150W/DDR4-2666	1x32GB RDIMM DDR4-2666	1x930-8i 2GB flash	8x2.5"	8x2.5" SATA/SAS HS	Open	None	None	None	1xLP x8/1xLP x16/1xRAID slot	Front VGA	TPM 1.2	XClarity Standard	1x750W Platinum	3-year	07/17
7X02A03KAU	ANZ	2xXeon Gold 5118 12C/2.3GHz/16.5MB/105W/DDR4-2400	2x32GB RDIMM DDR4-2666	1x430-16i	10x2.5"	10x2.5" HS (6 SATA/SAS, 4 AnyBay)	Open	None	None	None	1xLP x8/2xLP x16/1xRAID slot	Front VGA	TPM 1.2	XClarity Standard	1x750W Platinum	3-year	07/17
7X02A03LAU	ANZ	1xXeon Gold 6142 16C/2.6GHz/22MB/150W/DDR4-2666	1x32GB RDIMM DDR4-2666	1x930-8i 2GB flash	8x2.5"	8x2.5" SATA/SAS HS	Open	None	None	None	1xLP x8/1xLP x16/1xRAID slot	Front VGA	TPM 1.2	XClarity Standard	1x750W Platinum	3-year	07/17
7X02A03MAU	ANZ	1xXeon Gold 5120 14C/2.2GHz/19.25MB/105W/DDR4-2400	1x16GB RDIMM DDR4-2666	1x930-8i 2GB flash	8x2.5"	8x2.5" SATA/SAS HS	Open	None	None	None	1xLP x8/1xLP x16/1xRAID slot	Front VGA	TPM 1.2	XClarity Standard	1x750W Platinum	3-year	07/17
7X02A03NAU	ANZ	1xXeon Gold 6126T 12C/2.6GHz/19.25MB/125W/DDR4-2666	1x32GB RDIMM DDR4-2666	1x930-8i 2GB flash	8x2.5"	8x2.5" SATA/SAS HS	Open	None	None	None	1xLP x8/1xLP x16/1xRAID slot	Front VGA	TPM 1.2	XClarity Standard	1x750W Platinum	3-year	07/17
7X02A03PAU	ANZ	1xXeon Gold 6150 18C/2.7GHz/24.75MB/165W/DDR4-2666	1x32GB RDIMM DDR4-2666	1x930-8i 2GB flash	8x2.5"	8x2.5" SATA/SAS HS	Open	None	None	None	1xLP x8/1xLP x16/1xRAID slot	Front VGA	TPM 1.2	XClarity Standard	1x750W Platinum	3-year	07/17
7X02A03SAU	ANZ	1xXeon Silver 4114 10C/2.2GHz/13.75MB/85W/DDR4-2400	1x16GB RDIMM DDR4-2666	1x930-8i 2GB flash	8x2.5"	8x2.5" SATA/SAS HS	Open	None	None	None	1xLP x8/1xLP x16/1xRAID slot	None	TPM 1.2	XClarity Standard	1x750W Platinum	3-year	07/17
7X02A040AU	ANZ	2xXeon Silver 4110 8C/2.1GHz/11MB/85W/DDR4-2400	2x32GB RDIMM DDR4-2666	1x430-16i	10x2.5"	10x2.5" HS (6 SATA/SAS, 4 AnyBay)	Open	None	None	None	1xLP x8/1xLP x16/1xRAID slot	None	TPM 1.2	XClarity Standard	1x750W Platinum	3-year	07/17
7X02A04AAU	ANZ	1xXeon Silver 4110 8C/2.1GHz/11MB/85W/DDR4-2400	1x16GB RDIMM DDR4-2666	1x930-8i 2GB flash	8x2.5"	8x2.5" SATA/SAS HS	Open	None	None	None	1xLP x8/1xLP x16/1xRAID slot	None	TPM 1.2	XClarity Standard	1x750W Platinum	3-year	07/17
7X02A04FAU	ANZ	1xXeon Silver 4108 8C/1.8GHz/11MB/85W/DDR4-2400	1x16GB RDIMM DDR4-2666	1x530-8i	8x2.5"	8x2.5" SATA/SAS HS	Open	None	None	None	1xLP x8/1xLP x16/1xRAID slot	None	TPM 1.2	XClarity Standard	1x750W Platinum	3-year	07/17



Model	Region	Processor	Memory	Storage Controller	Chassis	Disk Bays	Disks	M.2 Drives	GPU	Networking (LOM/ML2/PCIe)	Available PCIe Slots	Front VGA	Security	System Management	Power Supply	Base Warranty	Ann Date (mm/yy)
7X02A04HAU	ANZ	1xXeon Silver 4110 8C/2.1GHz/11MB/85W/DDR4-2400	1x16GB RDIMM DDR4-2666	1x930-16i 4GB flash	10x2.5"	10x2.5" HS (6 SATA/SAS, 4 AnyBay)	Open	None	None	None	1xLP x8/1xLP x16/1xRAID slot	None	TPM 1.2	XClarity Standard	1x750W Platinum	3-year	07/17
7X02A04LAU	ANZ	1xXeon Bronze 3106 8C/1.7GHz/11MB/85W/DDR4-2133	1x8GB RDIMM DDR4-2666	1x530-8i	8x2.5"	8x2.5" SATA/SAS HS	Open	None	None	None	1xLP x8/1xLP x16/1xRAID slot	None	TPM 1.2	XClarity Standard	1x750W Platinum	3-year	07/17
7X02A04UAU	ANZ	1xXeon Silver 4108 8C/1.8GHz/11MB/85W/DDR4-2400	1x16GB RDIMM DDR4-2666	1x530-8i	4x3.5"	4x3.5" SATA/SAS HS	Open	None	None	None	1xLP x8/1xLP x16/1xRAID slot	None	TPM 1.2	XClarity Standard	1x750W Platinum	3-year	07/17
7X02A050AU	ANZ	1xXeon Silver 4116 12C/2.1GHz/16.5MB/85W/DDR4-2400	1x16GB RDIMM DDR4-2666	1x930-8i 2GB flash	8x2.5"	8x2.5" SATA/SAS HS	Open	None	None	None	1xLP x8/1xLP x16/1xRAID slot	None	TPM 1.2	XClarity Standard	1x750W Platinum	3-year	07/17
7X02A04XAU	ANZ	1xXeon Silver 4110 8C/2.1GHz/11MB/85W/DDR4-2400	1x16GB RDIMM DDR4-2666	1x530-8i	8x2.5"	8x2.5" SATA/SAS HS	Open	None	None	None	1xLP x8/1xLP x16/1xRAID slot	None	TPM 1.2	XClarity Standard	1x750W Platinum	3-year	07/17
7X02A058AU	ANZ	1xXeon Bronze 3104 6C/1.7GHz/8.25MB/85W/DDR4-2133	1x8GB RDIMM DDR4-2666	1x530-8i	8x2.5"	8x2.5" SATA/SAS HS	Open	None	None	None	1xLP x8/1xLP x16/1xRAID slot	None	TPM 1.2	XClarity Standard	1x750W Platinum	3-year	07/17

ThinkSystem SR630 - Non TopSeller - ASEAN

Product Specifications Reference (PSREF)

Model	Region	Processor	Memory	Storage Controller	Chassis	Disk Bays	Disks	M.2 Drives	GPU	Networking (LOM/ML2/PCIe)	Available PCIe Slots	Front VGA	Security	System Management	Power Supply	Base Warranty	Ann Date (mm/yy)
7X02A00KSG	ASEAN	1xXeon Gold 5118 12C/2.3GHz/16.5MB/105W/DDR4-2400	1x16GB RDIMM DDR4-2666	1x930-8i 2GB flash	8x2.5"	8x2.5" SATA/SAS HS	Open	None	None	4x10GbE RJ-45 LOM	1xLP x8/1xLP x16/1xRAID slot	Front VGA	TPM 1.2	XClarity Standard	1x750W Platinum	3-year	07/17
7X02A00LSG	ASEAN	1xXeon Gold 5115 10C/2.4GHz/13.75MB/85W/DDR4-2400	1x16GB RDIMM DDR4-2666	1x930-8i 2GB flash	4x3.5"	4x3.5" SATA/SAS HS	Open	None	None	4x10GbE RJ-45 LOM	1xLP x8/1xLP x16/1xRAID slot	Front VGA	TPM 1.2	XClarity Standard	1x1100W Platinum	3-year	07/17
7X02A00MSG	ASEAN	1xXeon Gold 6152 22C/2.1GHz/30.25MB/140W/DDR4-2666	1x32GB RDIMM DDR4-2666	1x930-8i 2GB flash	8x2.5"	8x2.5" SATA/SAS HS	Open	None	None	4x10GbE RJ-45 LOM	1xLP x8/1xLP x16/1xRAID slot	Front VGA	TPM 1.2	XClarity Standard	1x1100W Platinum	3-year	07/17
7X02A00NSG	ASEAN	1xXeon Gold 6148 20C/2.4GHz/27.5MB/150W/DDR4-2666	1x32GB RDIMM DDR4-2666	1x930-8i 2GB flash	8x2.5"	8x2.5" SATA/SAS HS	Open	None	None	4x10GbE RJ-45 LOM	1xLP x8/1xLP x16/1xRAID slot	Front VGA	TPM 1.2	XClarity Standard	1x1100W Platinum	3-year	07/17
7X02A00SSG	ASEAN	1xXeon Gold 6140 18C/2.3GHz/24.75MB/140W/DDR4-2666	1x16GB RDIMM DDR4-2666	1x930-8i 2GB flash	8x2.5"	8x2.5" SATA/SAS HS	Open	None	None	4x10GbE RJ-45 LOM	1xLP x8/1xLP x16/1xRAID slot	Front VGA	TPM 1.2	XClarity Standard	1x1100W Platinum	3-year	07/17
7X02A001SG	ASEAN	1xXeon Gold 5115 10C/2.4GHz/13.75MB/85W/DDR4-2400	1x16GB RDIMM DDR4-2666	1x930-8i 2GB flash	8x2.5"	8x2.5" SATA/SAS HS	Open	None	None	4x10GbE RJ-45 LOM	1xLP x8/1xLP x16/1xRAID slot	Front VGA	TPM 1.2	XClarity Standard	1x750W Platinum	3-year	07/17
7X02A00BSG	ASEAN	1xXeon Gold 6130 16C/2.1GHz/22MB/125W/DDR4-2666	1x16GB RDIMM DDR4-2666	1x930-8i 2GB flash	8x2.5"	8x2.5" SATA/SAS HS	Open	None	None	4x10GbE RJ-45 LOM	1xLP x8/1xLP x16/1xRAID slot	Front VGA	TPM 1.2	XClarity Standard	1x1100W Platinum	3-year	07/17
7X02A00DSG	ASEAN	1xXeon Gold 6134 8C/3.2GHz/24.75MB/130W/DDR4-2666	1x16GB RDIMM DDR4-2666	1x930-8i 2GB flash	8x2.5"	8x2.5" SATA/SAS HS	Open	None	None	4x10GbE RJ-45 LOM	1xLP x8/1xLP x16/1xRAID slot	Front VGA	TPM 1.2	XClarity Standard	1x1100W Platinum	3-year	07/17
7X02A00FSG	ASEAN	1xXeon Gold 5120 14C/2.2GHz/19.25MB/105W/DDR4-2400	1x16GB RDIMM DDR4-2666	1x930-8i 2GB flash	8x2.5"	8x2.5" SATA/SAS HS	Open	None	None	4x10GbE RJ-45 LOM	1xLP x8/1xLP x16/1xRAID slot	Front VGA	TPM 1.2	XClarity Standard	1x750W Platinum	3-year	07/17

Model	Region	Processor	Memory	Storage Controller	Chassis	Disk Bays	Disks	M.2 Drives	GPU	Networking (LOM/ML2/PCIe)	Available PCIe Slots	Front VGA	Security	System Management	Power Supply	Base Warranty	Ann Date (mm/yy)
7X02A00GEA	EMEA	1xXeon Gold 6148 20C/2.4GHz/27.5MB/150W/DDR4-2666	1x32GB RDIMM DDR4-2666	1x930-8i 2GB flash	8x2.5"	8x2.5" SATA/SAS HS	Open	None	None	None	1xLP x8/1xLP x16/1xRAID slot	None	TPM 1.2	XClarity Standard	1x750W Platinum	3-year	07/17
7X02A00JEA	EMEA	1xXeon Gold 6126 12C/2.6GHz/19.25MB/125W/DDR4-2666	1x32GB RDIMM DDR4-2666	1x930-8i 2GB flash	8x2.5"	8x2.5" SATA/SAS HS	Open	None	None	None	1xLP x8/1xLP x16/1xRAID slot	None	TPM 1.2	XClarity Standard	1x750W Platinum	3-year	07/17
7X02A00EEA	EMEA	1xXeon Gold 5120 14C/2.2GHz/19.25MB/105W/DDR4-2400	1x16GB RDIMM DDR4-2666	1x930-8i 2GB flash	8x2.5"	8x2.5" SATA/SAS HS	Open	None	None	None	1xLP x8/1xLP x16/1xRAID slot	None	TPM 1.2	XClarity Standard	1x750W Platinum	3-year	07/17
7X02A00CEA	EMEA	1xXeon Gold 6134 8C/3.2GHz/24.75MB/130W/DDR4-2666	1x32GB RDIMM DDR4-2666	1x930-8i 2GB flash	8x2.5"	8x2.5" SATA/SAS HS	Open	None	None	None	1xLP x8/1xLP x16/1xRAID slot	None	TPM 1.2	XClarity Standard	1x750W Platinum	3-year	07/17
7X02A002EA	EMEA	1xXeon Gold 5118 12C/2.3GHz/16.5MB/105W/DDR4-2400	1x16GB RDIMM DDR4-2666	1x930-16i 4GB flash	10x2.5"	10x2.5" HS (6 SATA/SAS, 4 AnyBay)	Open	None	None	None	1xLP x8/1xLP x16/1xRAID slot	None	TPM 1.2	XClarity Standard	1x750W Platinum	3-year	07/17
7X02A003EA	EMEA	1xXeon Gold 5118 12C/2.3GHz/16.5MB/105W/DDR4-2400	1x16GB RDIMM DDR4-2666	1x930-8i 2GB flash	8x2.5"	8x2.5" SATA/SAS HS	Open	None	None	None	1xLP x8/1xLP x16/1xRAID slot	None	TPM 1.2	XClarity Standard	1x750W Platinum	3-year	07/17
7X02A004EA	EMEA	1xXeon Gold 5115 10C/2.4GHz/13.75MB/85W/DDR4-2400	1x16GB RDIMM DDR4-2666	1x930-8i 2GB flash	8x2.5"	8x2.5" SATA/SAS HS	Open	None	None	None	1xLP x8/1xLP x16/1xRAID slot	None	TPM 1.2	XClarity Standard	1x750W Platinum	3-year	07/17
7X02A005EA	EMEA	1xXeon Platinum 8160 24C/2.1GHz/33MB/150W/DDR4-2666	1x32GB RDIMM DDR4-2666	1x930-8i 2GB flash	8x2.5"	8x2.5" SATA/SAS HS	Open	None	None	None	1xLP x8/1xLP x16/1xRAID slot	Front VGA	TPM 1.2	XClarity Standard	1x750W Platinum	3-year	07/17
7X02A007EA	EMEA	1xXeon Gold 6152 22C/2.1GHz/30.25MB/140W/DDR4-2666	1x32GB RDIMM DDR4-2666	1x930-8i 2GB flash	8x2.5"	8x2.5" SATA/SAS HS	Open	None	None	None	1xLP x8/1xLP x16/1xRAID slot	None	TPM 1.2	XClarity Standard	1x750W Platinum	3-year	07/17
7X02A009EA	EMEA	1xXeon Gold 6150 18C/2.7GHz/24.75MB/165W/DDR4-2666	1x32GB RDIMM DDR4-2666	1x930-8i 2GB flash	8x2.5"	8x2.5" SATA/SAS HS	Open	None	None	None	1xLP x8/1xLP x16/1xRAID slot	None	TPM 1.2	XClarity Standard	1x750W Platinum	3-year	07/17
7X02A00AEA	EMEA	2xXeon Gold 5118 12C/2.3GHz/16.5MB/105W/DDR4-2400	2x32GB RDIMM DDR4-2666	1x430-16i	10x2.5"	10x2.5" HS (6 SATA/SAS, 4 AnyBay)	Open	None	None	None	1xLP x8/2xLP x16/1xRAID slot	None	TPM 1.2	XClarity Standard	1x750W Platinum	3-year	07/17
7X02A00PEA	EMEA	1xXeon Gold 6142 16C/2.6GHz/22MB/150W/DDR4-2666	1x32GB RDIMM DDR4-2666	1x930-8i 2GB flash	8x2.5"	8x2.5" SATA/SAS HS	Open	None	None	None	1xLP x8/1xLP x16/1xRAID slot	None	TPM 1.2	XClarity Standard	1x750W Platinum	3-year	07/17
7X02A00REA	EMEA	1xXeon Gold 6140 18C/2.3GHz/24.75MB/140W/DDR4-2666	1x32GB RDIMM DDR4-2666	1x930-8i 2GB flash	8x2.5"	8x2.5" SATA/SAS HS	Open	None	None	None	1xLP x8/1xLP x16/1xRAID slot	None	TPM 1.2	XClarity Standard	1x750W Platinum	3-year	07/17
7X02A04BEA	EMEA	1xXeon Silver 4110 8C/2.1GHz/11MB/85W/DDR4-2400	1x16GB RDIMM DDR4-2666	1x930-16i 4GB flash	10x2.5"	10x2.5" HS (6 SATA/SAS, 4 AnyBay)	Open	None	None	None	1xLP x8/1xLP x16/1xRAID slot	None	TPM 1.2	XClarity Standard	1x750W Platinum	3-year	07/17
7X02A03WEA	EMEA	1xXeon Silver 4108 8C/1.8GHz/11MB/85W/DDR4-2400	1x16GB RDIMM DDR4-2666	1x530-8i	4x3.5"	4x3.5" SATA/SAS HS	Open	None	None	None	1xLP x8/1xLP x16/1xRAID slot	None	TPM 1.2	XClarity Standard	1x750W Platinum	3-year	07/17

Model	Region	Processor	Memory	Storage Controller	Chassis	Disk Bays	Disks	M.2 Drives	GPU	Networking (LOM/ML2/PCIe)	Available PCIe Slots	Front VGA	Security	System Management	Power Supply	Base Warranty	Ann Date (mm/yy)
7X02A043EA	EMEA	2xXeon Silver 4110 8C/2.1GHz/11MB/85W/DDR4-2400	2x32GB RDIMM DDR4-2666	1x430-16i	10x2.5"	10x2.5" HS (6 SATA/SAS, 4 AnyBay)	Open	None	None	None	1xLP x8/1xLP x16/1xRAID slot	None	TPM 1.2	XClarity Standard	1x750W Platinum	3-year	07/17
7X02A044EA	EMEA	1xXeon Bronze 3104 6C/1.7GHz/8.25MB/85W/DDR4-2133	1x8GB RDIMM DDR4-2666	1x530-8i	8x2.5"	8x2.5" SATA/SAS HS	Open	None	None	None	1xLP x8/1xLP x16/1xRAID slot	None	TPM 1.2	XClarity Standard	1x750W Platinum	3-year	07/17
7X02A045EA	EMEA	1xXeon Silver 4108 8C/1.8GHz/11MB/85W/DDR4-2400	1x16GB RDIMM DDR4-2666	1x530-8i	8x2.5"	8x2.5" SATA/SAS HS	Open	None	None	None	1xLP x8/1xLP x16/1xRAID slot	None	TPM 1.2	XClarity Standard	1x750W Platinum	3-year	07/17
7X02A046EA	EMEA	1xXeon Silver 4114 10C/2.2GHz/13.75MB/85W/DDR4-2400	1x16GB RDIMM DDR4-2666	1x930-8i 2GB flash	8x2.5"	8x2.5" SATA/SAS HS	Open	None	None	None	1xLP x8/1xLP x16/1xRAID slot	None	TPM 1.2	XClarity Standard	1x750W Platinum	3-year	07/17
7X02A052EA	EMEA	1xXeon Silver 4116 12C/2.1GHz/16.5MB/85W/DDR4-2400	1x16GB RDIMM DDR4-2666	1x930-8i 2GB flash	8x2.5"	8x2.5" SATA/SAS HS	Open	None	None	None	1xLP x8/1xLP x16/1xRAID slot	None	TPM 1.2	XClarity Standard	1x750W Platinum	3-year	07/17
7X02A04VEA	EMEA	1xXeon Silver 4110 8C/2.1GHz/11MB/85W/DDR4-2400	1x16GB RDIMM DDR4-2666	1x530-8i	8x2.5"	8x2.5" SATA/SAS HS	Open	None	None	None	1xLP x8/1xLP x16/1xRAID slot	None	TPM 1.2	XClarity Standard	1x750W Platinum	3-year	07/17
7X02A03ZEA	EMEA	1xXeon Bronze 3106 8C/1.7GHz/11MB/85W/DDR4-2133	1x8GB RDIMM DDR4-2666	1x530-8i	8x2.5"	8x2.5" SATA/SAS HS	Open	None	None	None	1xLP x8/1xLP x16/1xRAID slot	None	TPM 1.2	XClarity Standard	1x750W Platinum	3-year	07/17
7X02A04TEA	EMEA	1xXeon Silver 4110 8C/2.1GHz/11MB/85W/DDR4-2400	1x16GB RDIMM DDR4-2666	1x930-8i 2GB flash	8x2.5"	8x2.5" SATA/SAS HS	Open	None	None	None	1xLP x8/1xLP x16/1xRAID slot	None	TPM 1.2	XClarity Standard	1x750W Platinum	3-year	07/17

Model	Region	Processor	Memory	Storage Controller	Chassis	Disk Bays	Disks	M.2 Drives	GPU	Networking (LOM/ML2/PCIe)	Available PCIe Slots	Front VGA	Security	System Management	Power Supply	Base Warranty	Ann Date (mm/yy)	
7X02A04MCN	HTK	1xXeon Silver 4108 8C/1.8GHz/11MB/85W/DDR4-2400	1x16GB RDIMM DDR4-2666	1x930-8i 2GB flash	8x2.5"	8x2.5"	SATA/SAS HS	Open	None	None	4xGbE RJ-45 LOM	1xLP x8/1xLP x16/1xRAID slot	None	TPM 1.2	XClarity Standard	1x750W Platinum	3-year	07/17
7X02A04NCN	HTK	1xXeon Bronze 3104 6C/1.7GHz/8.25MB/85W/DDR4-2133	1x16GB RDIMM DDR4-2666	1x930-8i 2GB flash	8x2.5"	8x2.5"	SATA/SAS HS	Open	None	None	4xGbE RJ-45 LOM	1xLP x8/1xLP x16/1xRAID slot	None	TPM 1.2	XClarity Standard	1x750W Platinum	3-year	07/17
7X02A04PCN	HTK	1xXeon Bronze 3106 8C/1.7GHz/11MB/85W/DDR4-2133	1x16GB RDIMM DDR4-2666	1x930-8i 2GB flash	8x2.5"	8x2.5"	SATA/SAS HS	Open	None	None	4xGbE RJ-45 LOM	1xLP x8/1xLP x16/1xRAID slot	None	TPM 1.2	XClarity Standard	1x750W Platinum	3-year	07/17
7X02A04QCN	HTK	1xXeon Silver 4116 12C/2.1GHz/16.5MB/85W/DDR4-2400	1x16GB RDIMM DDR4-2666	1x930-8i 2GB flash	8x2.5"	8x2.5"	SATA/SAS HS	Open	None	None	4xGbE RJ-45 LOM	1xLP x8/1xLP x16/1xRAID slot	None	TPM 1.2	XClarity Standard	1x750W Platinum	3-year	07/17
7X02A04SCN	HTK	1xXeon Bronze 3104 6C/1.7GHz/8.25MB/85W/DDR4-2133	1x16GB RDIMM DDR4-2666	1x930-8i 2GB flash	4x3.5"	4x3.5"	SATA/SAS HS	Open	None	None	4xGbE RJ-45 LOM	1xLP x8/1xLP x16/1xRAID slot	None	TPM 1.2	XClarity Standard	1x750W Platinum	3-year	07/17
7X02A053CN	HTK	1xXeon Gold 5115 10C/2.4GHz/13.75MB/85W/DDR4-2400	1x16GB RDIMM DDR4-2666	1x930-8i 2GB flash	8x2.5"	8x2.5"	SATA/SAS HS	Open	None	None	4xGbE RJ-45 LOM	1xLP x8/1xLP x16/1xRAID slot	None	TPM 1.2	XClarity Standard	1x750W Platinum	3-year	07/17
7X02A04ZCN	HTK	1xXeon Bronze 3106 8C/1.7GHz/11MB/85W/DDR4-2133	1x16GB RDIMM DDR4-2666	1x930-8i 2GB flash	4x3.5"	4x3.5"	SATA/SAS HS	Open	None	None	4xGbE RJ-45 LOM	1xLP x8/1xLP x16/1xRAID slot	None	TPM 1.2	XClarity Standard	1x750W Platinum	3-year	07/17
7X02A047CN	HTK	1xXeon Silver 4116 12C/2.1GHz/16.5MB/85W/DDR4-2400	1x16GB RDIMM DDR4-2666	1x930-8i 2GB flash	4x3.5"	4x3.5"	SATA/SAS HS	Open	None	None	4xGbE RJ-45 LOM	1xLP x8/1xLP x16/1xRAID slot	None	TPM 1.2	XClarity Standard	1x750W Platinum	3-year	07/17
7X02A03XCN	HTK	1xXeon Silver 4110 8C/2.1GHz/11MB/85W/DDR4-2400	1x16GB RDIMM DDR4-2666	1x930-8i 2GB flash	4x3.5"	4x3.5"	SATA/SAS HS	Open	None	None	4xGbE RJ-45 LOM	1xLP x8/1xLP x16/1xRAID slot	None	TPM 1.2	XClarity Standard	1x750W Platinum	3-year	07/17
7X02A03YCN	HTK	1xXeon Silver 4108 8C/1.8GHz/11MB/85W/DDR4-2400	1x16GB RDIMM DDR4-2666	1x930-8i 2GB flash	4x3.5"	4x3.5"	SATA/SAS HS	Open	None	None	4xGbE RJ-45 LOM	1xLP x8/1xLP x16/1xRAID slot	None	TPM 1.2	XClarity Standard	1x750W Platinum	3-year	07/17
7X02A03ACN	HTK	1xXeon Gold 5122 4C/3.6GHz/16.5MB/105W/DDR4-2400	1x16GB RDIMM DDR4-2666	1x930-8i 2GB flash	8x2.5"	8x2.5"	SATA/SAS HS	Open	None	1xQuadro P2000	4xGbE RJ-45 LOM	1xLP x8/1xFHHL x16/1xRAID slot	None	TPM 1.2	XClarity Standard	1x750W Platinum	3-year	07/17
7X02A04CCN	HTK	1xXeon Silver 4114 10C/2.2GHz/13.75MB/85W/DDR4-2400	1x16GB RDIMM DDR4-2666	1x930-8i 2GB flash	8x2.5"	8x2.5"	SATA/SAS HS	Open	None	None	4xGbE RJ-45 LOM	1xLP x8/1xLP x16/1xRAID slot	None	TPM 1.2	XClarity Standard	1x750W Platinum	3-year	07/17
7X02A04ECN	HTK	1xXeon Silver 4112 4C/2.6GHz/8.25MB/85W/DDR4-2400	1x16GB RDIMM DDR4-2666	1x930-8i 2GB flash	8x2.5"	8x2.5"	SATA/SAS HS	Open	None	None	4xGbE RJ-45 LOM	1xLP x8/1xLP x16/1xRAID slot	None	TPM 1.2	XClarity Standard	1x750W Platinum	3-year	07/17
7X02A03QCN	HTK	1xXeon Silver 4112 4C/2.6GHz/8.25MB/85W/DDR4-2400	1x16GB RDIMM DDR4-2666	1x930-8i 2GB flash	4x3.5"	4x3.5"	SATA/SAS HS	Open	None	None	4xGbE RJ-45 LOM	1xLP x8/1xLP x16/1xRAID slot	None	TPM 1.2	XClarity Standard	1x750W Platinum	3-year	07/17
7X02A03RCN	HTK	1xXeon Silver 4114 10C/2.2GHz/13.75MB/85W/DDR4-2400	1x16GB RDIMM DDR4-2666	1x930-8i 2GB flash	4x3.5"	4x3.5"	SATA/SAS HS	Open	None	None	4xGbE RJ-45 LOM	1xLP x8/1xLP x16/1xRAID slot	None	TPM 1.2	XClarity Standard	1x750W Platinum	3-year	07/17

Model	Region	Processor	Memory	Storage Controller	Chassis	Disk Bays	Disks	M.2 Drives	GPU	Networking (LOM/ML2/PCIe)	Available PCIe Slots	Front VGA	Security	System Management	Power Supply	Base Warranty	Ann Date (mm/yy)	
7X02A036CN	HTK	1xXeon Gold 6130 16C/2.1GHz/22MB/125W/DDR4-2666	1x16GB RDIMM DDR4-2666	1x930-8i 2GB flash	8x2.5"	8x2.5"	SATA/SAS HS	Open	None	1xQuadro P2000	4xGbE RJ-45 LOM	1xLP x8/1xFHHL x16/1xRAID slot	None	TPM 1.2	XClarity Standard	1x750W Platinum	3-year	07/17
7X02A037CN	HTK	1xXeon Gold 5120 14C/2.2GHz/19.25MB/105W/DDR4-2400	1x16GB RDIMM DDR4-2666	1x930-8i 2GB flash	8x2.5"	8x2.5"	SATA/SAS HS	Open	None	1xQuadro P2000	4xGbE RJ-45 LOM	1xLP x8/1xFHHL x16/1xRAID slot	None	TPM 1.2	XClarity Standard	1x750W Platinum	3-year	07/17
7X02A02QCN	HTK	1xXeon Gold 6152 22C/2.1GHz/30.25MB/140W/DDR4-2666	1x16GB RDIMM DDR4-2666	1x930-8i 2GB flash	8x2.5"	8x2.5"	SATA/SAS HS	Open	None	1xQuadro P2000	4xGbE RJ-45 LOM	1xLP x8/1xFHHL x16/1xRAID slot	Front VGA	TPM 1.2	XClarity Standard	1x750W Platinum	3-year	07/17
7X02A02KCN	HTK	1xXeon Silver 4110 8C/2.1GHz/11MB/85W/DDR4-2400	1x16GB RDIMM DDR4-2666	1x930-8i 2GB flash	8x2.5"	8x2.5"	SATA/SAS HS	Open	None	None	4xGbE RJ-45 LOM	1xLP x8/1xLP x16/1xRAID slot	None	TPM 1.2	XClarity Standard	1x750W Platinum	3-year	07/17
7X02A028CN	HTK	1xXeon Gold 5120 14C/2.2GHz/19.25MB/105W/DDR4-2400	1x16GB RDIMM DDR4-2666	1x930-8i 2GB flash	4x3.5"	4x3.5"	SATA/SAS HS	Open	None	None	4xGbE RJ-45 LOM	1xLP x8/1xLP x16/1xRAID slot	None	TPM 1.2	XClarity Standard	1x750W Platinum	3-year	07/17
7X02A01RCN	HTK	1xXeon Gold 6130 16C/2.1GHz/22MB/125W/DDR4-2666	1x16GB RDIMM DDR4-2666	1x930-8i 2GB flash	4x3.5"	4x3.5"	SATA/SAS HS	Open	None	None	4xGbE RJ-45 LOM	1xLP x8/1xLP x16/1xRAID slot	None	TPM 1.2	XClarity Standard	1x750W Platinum	3-year	07/17
7X02A01BCN	HTK	1xXeon Gold 6138T 20C/2.0GHz/27.5MB/125W/DDR4-2666	1x16GB RDIMM DDR4-2666	1x930-8i 2GB flash	8x2.5"	8x2.5"	SATA/SAS HS	Open	None	1xQuadro P2000	4xGbE RJ-45 LOM	1xLP x8/1xFHHL x16/1xRAID slot	Front VGA	TPM 1.2	XClarity Standard	1x750W Platinum	3-year	07/17
7X02A00XCN	HTK	1xXeon Gold 6140 18C/2.3GHz/24.75MB/140W/DDR4-2666	1x16GB RDIMM DDR4-2666	1x930-8i 2GB flash	8x2.5"	8x2.5"	SATA/SAS HS	Open	None	1xQuadro P2000	4xGbE RJ-45 LOM	1xLP x8/1xFHHL x16/1xRAID slot	Front VGA	TPM 1.2	XClarity Standard	1x750W Platinum	3-year	07/17
7X02A00YCN	HTK	1xXeon Gold 6142 16C/2.6GHz/22MB/150W/DDR4-2666	1x16GB RDIMM DDR4-2666	1x930-8i 2GB flash	8x2.5"	8x2.5"	SATA/SAS HS	Open	None	1xQuadro P2000	4xGbE RJ-45 LOM	1xLP x8/1xFHHL x16/1xRAID slot	Front VGA	TPM 1.2	XClarity Standard	1x750W Platinum	3-year	07/17
7X02A018CN	HTK	1xXeon Gold 6136 12C/3.0GHz/24.75MB/150W/DDR4-2666	1x16GB RDIMM DDR4-2666	1x930-8i 2GB flash	8x2.5"	8x2.5"	SATA/SAS HS	Open	None	1xQuadro P2000	4xGbE RJ-45 LOM	1xLP x8/1xFHHL x16/1xRAID slot	Front VGA	TPM 1.2	XClarity Standard	1x750W Platinum	3-year	07/17
7X02A019CN	HTK	1xXeon Gold 6134 8C/3.2GHz/24.75MB/130W/DDR4-2666	1x16GB RDIMM DDR4-2666	1x930-8i 2GB flash	8x2.5"	8x2.5"	SATA/SAS HS	Open	None	1xQuadro P2000	4xGbE RJ-45 LOM	1xLP x8/1xFHHL x16/1xRAID slot	None	TPM 1.2	XClarity Standard	1x750W Platinum	3-year	07/17
7X02A01DCN	HTK	1xXeon Gold 6130 16C/2.1GHz/22MB/125W/DDR4-2666	1x16GB RDIMM DDR4-2666	1x930-8i 2GB flash	8x2.5"	8x2.5"	SATA/SAS HS	Open	None	1xQuadro P2000	4xGbE RJ-45 LOM	1xLP x8/1xFHHL x16/1xRAID slot	Front VGA	TPM 1.2	XClarity Standard	1x750W Platinum	3-year	07/17
7X02A01ECN	HTK	1xXeon Gold 6134 8C/3.2GHz/24.75MB/130W/DDR4-2666	1x16GB RDIMM DDR4-2666	1x930-8i 2GB flash	8x2.5"	8x2.5"	SATA/SAS HS	Open	None	1xQuadro P2000	4xGbE RJ-45 LOM	1xLP x8/1xFHHL x16/1xRAID slot	Front VGA	TPM 1.2	XClarity Standard	1x750W Platinum	3-year	07/17
7X02A01YCN	HTK	1xXeon Gold 5122 4C/3.6GHz/16.5MB/105W/DDR4-2400	1x16GB RDIMM DDR4-2666	1x930-8i 2GB flash	4x3.5"	4x3.5"	SATA/SAS HS	Open	None	None	4xGbE RJ-45 LOM	1xLP x8/1xLP x16/1xRAID slot	None	TPM 1.2	XClarity Standard	1x750W Platinum	3-year	07/17
7X02A02ACN	HTK	1xXeon Gold 5118 12C/2.3GHz/16.5MB/105W/DDR4-2400	1x16GB RDIMM DDR4-2666	1x930-8i 2GB flash	8x2.5"	8x2.5"	SATA/SAS HS	Open	None	1xQuadro P2000	4xGbE RJ-45 LOM	1xLP x8/1xFHHL x16/1xRAID slot	None	TPM 1.2	XClarity Standard	1x750W Platinum	3-year	07/17

Model	Region	Processor	Memory	Storage Controller	Chassis	Disk Bays	Disks	M.2 Drives	GPU	Networking (LOM/ML2/PCIe)	Available PCIe Slots	Front VGA	Security	System Management	Power Supply	Base Warranty	Ann Date (mm/yy)	
7X02A02BCN	HTK	1xXeon Gold 5115 10C/2.4GHz/13.75MB/85W/DDR4-2400	1x16GB RDIMM DDR4-2666	1x930-8i 2GB flash	8x2.5"	8x2.5"	SATA/SAS HS	Open	None	1xQuadro P2000	4xGbE RJ-45 LOM	1xLP x8/1xFHHL x16/1xRAID slot	None	TPM 1.2	XClarity Standard	1x750W Platinum	3-year	07/17
7X02A01TCN	HTK	1xXeon Gold 6134 8C/3.2GHz/24.75MB/130W/DDR4-2666	1x16GB RDIMM DDR4-2666	1x930-8i 2GB flash	4x3.5"	4x3.5"	SATA/SAS HS	Open	None	None	4xGbE RJ-45 LOM	1xLP x8/1xLP x16/1xRAID slot	None	TPM 1.2	XClarity Standard	1x750W Platinum	3-year	07/17
7X02A00TCN	HTK	1xXeon Gold 6132 14C/2.6GHz/19.25MB/140W/DDR4-2666	1x16GB RDIMM DDR4-2666	1x930-8i 2GB flash	8x2.5"	8x2.5"	SATA/SAS HS	Open	None	1xQuadro P2000	4xGbE RJ-45 LOM	1xLP x8/1xFHHL x16/1xRAID slot	Front VGA	TPM 1.2	XClarity Standard	1x750W Platinum	3-year	07/17
7X02A00VCN	HTK	1xXeon Gold 5118 12C/2.3GHz/16.5MB/105W/DDR4-2400	1x16GB RDIMM DDR4-2666	None	8x2.5"	Non BP	None	None	None	4xGbE RJ-45 LOM	1xLP x8/1xLP x16/1xRAID slot	Front VGA	TPM 1.2	XClarity Standard	1x750W Platinum	3-year	07/17	
7X02A010CN	HTK	1xXeon Gold 5115 10C/2.4GHz/13.75MB/85W/DDR4-2400	1x16GB RDIMM DDR4-2666	1x930-8i 2GB flash	4x3.5"	4x3.5"	SATA/SAS HS	Open	None	None	4xGbE RJ-45 LOM	1xLP x8/1xLP x16/1xRAID slot	None	TPM 1.2	XClarity Standard	1x750W Platinum	3-year	07/17
7X02A011CN	HTK	1xXeon Gold 5118 12C/2.3GHz/16.5MB/105W/DDR4-2400	1x16GB RDIMM DDR4-2666	1x930-8i 2GB flash	4x3.5"	4x3.5"	SATA/SAS HS	Open	None	None	4xGbE RJ-45 LOM	1xLP x8/1xLP x16/1xRAID slot	None	TPM 1.2	XClarity Standard	1x750W Platinum	3-year	07/17
7X02A013CN	HTK	1xXeon Gold 5115 10C/2.4GHz/13.75MB/85W/DDR4-2400	1x16GB RDIMM DDR4-2666	1x930-8i 2GB flash	8x2.5"	8x2.5"	SATA/SAS HS	Open	None	1xQuadro P2000	4xGbE RJ-45 LOM	1xLP x8/1xFHHL x16/1xRAID slot	Front VGA	TPM 1.2	XClarity Standard	1x750W Platinum	3-year	07/17
7X02A014CN	HTK	1xXeon Gold 6126 12C/2.6GHz/19.25MB/125W/DDR4-2666	1x16GB RDIMM DDR4-2666	1x930-8i 2GB flash	8x2.5"	8x2.5"	SATA/SAS HS	Open	None	1xQuadro P2000	4xGbE RJ-45 LOM	1xLP x8/1xFHHL x16/1xRAID slot	Front VGA	TPM 1.2	XClarity Standard	1x750W Platinum	3-year	07/17
7X02A015CN	HTK	1xXeon Gold 5120 14C/2.2GHz/19.25MB/105W/DDR4-2400	1x16GB RDIMM DDR4-2666	1x930-8i 2GB flash	8x2.5"	8x2.5"	SATA/SAS HS	Open	None	1xQuadro P2000	4xGbE RJ-45 LOM	1xLP x8/1xFHHL x16/1xRAID slot	Front VGA	TPM 1.2	XClarity Standard	1x750W Platinum	3-year	07/17
7X02A016CN	HTK	1xXeon Gold 5122 4C/3.6GHz/16.5MB/105W/DDR4-2400	1x16GB RDIMM DDR4-2666	1x930-8i 2GB flash	8x2.5"	8x2.5"	SATA/SAS HS	Open	None	1xQuadro P2000	4xGbE RJ-45 LOM	1xLP x8/1xFHHL x16/1xRAID slot	Front VGA	TPM 1.2	XClarity Standard	1x750W Platinum	3-year	07/17

ThinkSystem SR630 - Non TopSeller - INDIA

Product Specifications Reference (PSREF)

Model	Region	Processor	Memory	Storage Controller	Chassis	Disk Bays	Disks	M.2 Drives	GPU	Networking (LOM/ML2/PCIe)	Available PCIe Slots	Front VGA	Security	System Management	Power Supply	Base Warranty	Ann Date (mm/yy)	
7X02A017SG	INDIA	1xXeon Gold 5115 10C/2.4GHz/13.75MB/85W/DDR4-2400	1x8GB RDIMM DDR4-2666	1x530-8i	4x3.5"	4x3.5"	SATA/SAS HS	Open	None	None	4xGbE RJ-45 LOM	1xRAID slot slot	Front VGA	TPM 1.2	XClarity Standard	1x550W Platinum	3-year	07/17
7X02A00WSG	INDIA	1xXeon Gold 5118 12C/2.3GHz/16.5MB/105W/DDR4-2400	1x16GB RDIMM DDR4-2666	1x530-8i	8x2.5"	8x2.5"	SATA/SAS HS	Open	None	None	4xGbE RJ-45 LOM	1xRAID slot slot	Front VGA	TPM 1.2	XClarity Standard	1x550W Platinum	3-year	07/17
7X02A00USG	INDIA	1xXeon Gold 5118 12C/2.3GHz/16.5MB/105W/DDR4-2400	1x16GB RDIMM DDR4-2666	1x930-8i 2GB flash	8x2.5"	8x2.5"	SATA/SAS HS	Open	None	None	4xGbE RJ-45 LOM	1xRAID slot slot	Front VGA	TPM 1.2	XClarity Standard	1x550W Platinum	3-year	07/17
7X02A027SG	INDIA	1xXeon Gold 5115 10C/2.4GHz/13.75MB/85W/DDR4-2400	1x8GB RDIMM DDR4-2666	1x530-8i	8x2.5"	8x2.5"	SATA/SAS HS	Open	None	None	4xGbE RJ-45 LOM	1xRAID slot slot	Front VGA	TPM 1.2	XClarity Standard	1x550W Platinum	3-year	07/17
7X02A01FSG	INDIA	1xXeon Gold 5120 14C/2.2GHz/19.25MB/105W/DDR4-2400	1x16GB RDIMM DDR4-2666	1x530-8i	8x2.5"	8x2.5"	SATA/SAS HS	Open	None	None	4xGbE RJ-45 LOM	1xRAID slot slot	Front VGA	TPM 1.2	XClarity Standard	1x550W Platinum	3-year	07/17
7X02A01GSG	INDIA	1xXeon Gold 5122 4C/3.6GHz/16.5MB/105W/DDR4-2400	1x16GB RDIMM DDR4-2666	1x930-8i 2GB flash	8x2.5"	8x2.5"	SATA/SAS HS	Open	None	None	4xGbE RJ-45 LOM	1xRAID slot slot	Front VGA	TPM 1.2	XClarity Standard	1x550W Platinum	3-year	07/17
7X02A01HSG	INDIA	1xXeon Gold 5120 14C/2.2GHz/19.25MB/105W/DDR4-2400	1x16GB RDIMM DDR4-2666	1x930-8i 2GB flash	8x2.5"	8x2.5"	SATA/SAS HS	Open	None	None	4xGbE RJ-45 LOM	1xRAID slot slot	Front VGA	TPM 1.2	XClarity Standard	1x550W Platinum	3-year	07/17
7X02A01JSG	INDIA	1xXeon Gold 6126 12C/2.6GHz/19.25MB/125W/DDR4-2666	1x16GB RDIMM DDR4-2666	1x930-8i 2GB flash	8x2.5"	8x2.5"	SATA/SAS HS	Open	None	None	4xGbE RJ-45 LOM	1xRAID slot slot	Front VGA	TPM 1.2	XClarity Standard	1x550W Platinum	3-year	07/17
7X02A01CSG	INDIA	1xXeon Gold 5118 12C/2.3GHz/16.5MB/105W/DDR4-2400	1x8GB RDIMM DDR4-2666	1x530-8i	8x2.5"	8x2.5"	SATA/SAS HS	Open	None	None	4xGbE RJ-45 LOM	1xRAID slot slot	Front VGA	TPM 1.2	XClarity Standard	1x550W Platinum	3-year	07/17
7X02A02WSG	INDIA	1xXeon Gold 6142 16C/2.6GHz/22MB/150W/DDR4-2666	1x16GB RDIMM DDR4-2666	1x930-8i 2GB flash	8x2.5"	8x2.5"	SATA/SAS HS	Open	None	None	4xGbE RJ-45 LOM	1xRAID slot slot	Front VGA	TPM 1.2	XClarity Standard	1x550W Platinum	3-year	07/17
7X02A02USG	INDIA	1xXeon Gold 6154 18C/3.0GHz/24.75MB/200W/DDR4-2666	1x16GB RDIMM DDR4-2666	1x930-8i 2GB flash	8x2.5"	8x2.5"	SATA/SAS HS	Open	None	None	4xGbE RJ-45 LOM	1xRAID slot slot	Front VGA	TPM 1.2	XClarity Standard	1x550W Platinum	3-year	07/17
7X02A02ZSG	INDIA	1xXeon Gold 6130 16C/2.1GHz/22MB/125W/DDR4-2666	1x16GB RDIMM DDR4-2666	1x930-8i 2GB flash	8x2.5"	8x2.5"	SATA/SAS HS	Open	None	None	4xGbE RJ-45 LOM	1xRAID slot slot	Front VGA	TPM 1.2	XClarity Standard	1x550W Platinum	3-year	07/17



ThinkSystem SR630 - Non TopSeller - JAPAN

Product Specifications Reference (PSREF)

Model	Region	Processor	Memory	Storage Controller	Chassis	Disk Bays	Disks	M.2 Drives	GPU	Networking (LOM/ML2/PCIe)	Available PCIe Slots	Front VGA	Security	System Management	Power Supply	Base Warranty	Ann Date (mm/yy)
7X02A02NJP	JAPAN	1xXeon Gold 5122 4C/3.6GHz/16.5MB/105W/DDR4-2400	1x16GB RDIMM DDR4-2666	1x930-8i 2GB flash	8x2.5"	8x2.5" SATA/SAS HS	Open	None	None	4x10GbE RJ-45 LOM	1xLP x8/1xLP x16/1xRAID slot	None	TPM 1.2	XClarity Standard	1x750W Platinum	3-year	07/17
7X02A024JP	JAPAN	1xXeon Platinum 8160 24C/2.1GHz/33MB/150W/DDR4-2666	1x16GB RDIMM DDR4-2666	1x930-16i 4GB flash	10x2.5"	10x2.5" HS (6 SATA/SAS, 4 AnyBay)	Open	None	None	4x10GbE RJ-45 LOM	1xLP x8/1xLP x16/1xRAID slot	Front VGA	TPM 1.2	XClarity Standard	1x1100W Platinum	3-year	07/17
7X02A012JP	JAPAN	1xXeon Gold 6134 8C/3.2GHz/24.75MB/130W/DDR4-2666	1x16GB RDIMM DDR4-2666	1x930-8i 2GB flash	8x2.5"	8x2.5" SATA/SAS HS	Open	None	None	4x10GbE RJ-45 LOM	1xLP x8/1xLP x16/1xRAID slot	None	TPM 1.2	XClarity Standard	1x750W Platinum	3-year	07/17
7X02A05DJP	JAPAN	2xXeon Gold 6150 18C/2.7GHz/24.75MB/165W/DDR4-2666	2x16GB RDIMM DDR4-2666	None	8x2.5"	Non BP	None	None	None	4xGbE RJ-45 LOM	1xLP x8/1xLP x16/1xRAID slot	None	TPM 1.2	XClarity Standard	1x750W Platinum	3-year	07/17
7X02A05EJP	JAPAN	1xXeon Platinum 8160 24C/2.1GHz/33MB/150W/DDR4-2666	1x16GB RDIMM DDR4-2666	None	8x2.5"	Non BP	None	None	None	4xGbE RJ-45 LOM	1xLP x8/1xLP x16/1xRAID slot	None	TPM 1.2	XClarity Standard	1x750W Platinum	3-year	07/17
7X02A05KJP	JAPAN	1xXeon Gold 6148 20C/2.4GHz/27.5MB/150W/DDR4-2666	1x16GB RDIMM DDR4-2666	None	8x2.5"	Non BP	None	None	None	4xGbE RJ-45 LOM	1xLP x8/1xLP x16/1xRAID slot	None	TPM 1.2	XClarity Standard	1x750W Platinum	3-year	07/17

ThinkSystem SR630 - Non TopSeller - LA

Product Specifications Reference (PSREF)

Model	Region	Processor	Memory	Storage Controller	Chassis	Disk Bays	Disks	M.2 Drives	GPU	Networking (LOM/ML2/PCIe)	Available PCIe Slots	Front VGA	Security	System Management	Power Supply	Base Warranty	Ann Date (mm/yy)
7X02A05MLA	LA	1xXeon Silver 4110 8C/2.1GHz/11MB/85W/DDR4-2400	1x16GB RDIMM DDR4-2666	1x930-8i 2GB flash	8x2.5"	8x2.5" SATA/SAS HS	Open	None	None	None	1xLP x8/1xLP x16/1xRAID slot	Front VGA	TPM 1.2	XClarity Standard	1x750W Platinum	3-year	07/17
7X02A05CLA	LA	1xXeon Silver 4116 12C/2.1GHz/16.5MB/85W/DDR4-2400	1x16GB RDIMM DDR4-2666	1x930-8i 2GB flash	8x2.5"	8x2.5" SATA/SAS HS	Open	None	None	None	1xLP x8/1xLP x16/1xRAID slot	Front VGA	TPM 1.2	XClarity Standard	1x750W Platinum	3-year	07/17
7X02A01KLA	LA	1xXeon Platinum 8160 24C/2.1GHz/33MB/150W/DDR4-2666	1x16GB RDIMM DDR4-2666	1x930-8i 2GB flash	8x2.5"	8x2.5" SATA/SAS HS	Open	None	None	None	1xLP x8/1xLP x16/1xRAID slot	Front VGA	TPM 1.2	XClarity Standard	1x1100W Platinum	3-year	07/17
7X02A02JLA	LA	1xXeon Gold 5120 14C/2.2GHz/19.25MB/105W/DDR4-2400	1x16GB RDIMM DDR4-2666	1x930-8i 2GB flash	8x2.5"	8x2.5" SATA/SAS HS	Open	None	None	None	1xLP x8/1xLP x16/1xRAID slot	Front VGA	TPM 1.2	XClarity Standard	1x1100W Platinum	3-year	07/17
7X02A02ELA	LA	1xXeon Gold 6148 20C/2.4GHz/27.5MB/150W/DDR4-2666	1x16GB RDIMM DDR4-2666	1x930-8i 2GB flash	8x2.5"	8x2.5" SATA/SAS HS	Open	None	None	None	1xLP x8/1xLP x16/1xRAID slot	Front VGA	TPM 1.2	XClarity Standard	1x1100W Platinum	3-year	07/17
7X02A02FLA	LA	1xXeon Gold 6140 18C/2.3GHz/24.75MB/140W/DDR4-2666	1x16GB RDIMM DDR4-2666	1x930-8i 2GB flash	8x2.5"	8x2.5" SATA/SAS HS	Open	None	None	None	1xLP x8/1xLP x16/1xRAID slot	Front VGA	TPM 1.2	XClarity Standard	1x1100W Platinum	3-year	07/17
7X02A02GLA	LA	1xXeon Gold 6130 16C/2.1GHz/22MB/125W/DDR4-2666	1x32GB RDIMM DDR4-2666	1x930-8i 2GB flash	8x2.5"	8x2.5" SATA/SAS HS	Open	None	None	None	1xLP x8/1xLP x16/1xRAID slot	Front VGA	TPM 1.2	XClarity Standard	1x1100W Platinum	3-year	07/17

Model	Region	Processor	Memory	Storage Controller	Chassis	Disk Bays	Disks	M.2 Drives	GPU	Networking (LOM/ML2/PCIe)	Available PCIe Slots	Front VGA	Security	System Management	Power Supply	Base Warranty	Ann Date (mm/yy)
7X02A039NA	NA	1xXeon Gold 6152 22C/2.1GHz/30.25MB/140W/DDR4-2666	1x32GB RDIMM DDR4-2666	1x930-8i 2GB flash	8x2.5"	8x2.5" SATA/SAS HS	Open	None	None	None	1xLP x8/1xLP x16/1xRAID slot	Front VGA	TPM 1.2	XClarity Standard	1x750W Platinum	3-year	07/17
7X02A02HNA	NA	1xXeon Gold 5120 14C/2.2GHz/19.25MB/105W/DDR4-2400	1x16GB RDIMM DDR4-2666	1x930-8i 2GB flash	8x2.5"	8x2.5" SATA/SAS HS	Open	None	None	None	1xLP x8/1xLP x16/1xRAID slot	Front VGA	TPM 1.2	XClarity Standard	1x750W Platinum	3-year	07/17
7X02A029NA	NA	2xXeon Gold 5118 12C/2.3GHz/16.5MB/105W/DDR4-2400	2x32GB RDIMM DDR4-2666	1x430-16i	10x2.5"	10x2.5" HS (6 SATA/SAS, 4 AnyBay)	Open	None	None	None	1xLP x8/2xLP x16/1xRAID slot	Front VGA	TPM 1.2	XClarity Standard	1x750W Platinum	3-year	07/17
7X02A02XNA	NA	1xXeon Gold 6150 18C/2.7GHz/24.75MB/165W/DDR4-2666	1x32GB RDIMM DDR4-2666	1x930-8i 2GB flash	8x2.5"	8x2.5" SATA/SAS HS	Open	None	None	None	1xLP x8/1xLP x16/1xRAID slot	Front VGA	TPM 1.2	XClarity Standard	1x750W Platinum	3-year	07/17
7X02A03BNA	NA	1xXeon Platinum 8160 24C/2.1GHz/33MB/150W/DDR4-2666	1x32GB RDIMM DDR4-2666	1x930-8i 2GB flash	8x2.5"	8x2.5" SATA/SAS HS	Open	None	None	None	1xLP x8/1xLP x16/1xRAID slot	Front VGA	TPM 1.2	XClarity Standard	1x750W Platinum	3-year	07/17
7X02A03CNA	NA	1xXeon Gold 6134 8C/3.2GHz/24.75MB/130W/DDR4-2666	1x32GB RDIMM DDR4-2666	1x930-8i 2GB flash	8x2.5"	8x2.5" SATA/SAS HS	Open	None	None	None	1xLP x8/1xLP x16/1xRAID slot	Front VGA	TPM 1.2	XClarity Standard	1x750W Platinum	3-year	07/17
7X02A01LNA	NA	1xXeon Gold 5115 10C/2.4GHz/13.75MB/85W/DDR4-2400	1x16GB RDIMM DDR4-2666	1x930-8i 2GB flash	8x2.5"	8x2.5" SATA/SAS HS	Open	None	None	None	1xLP x8/1xLP x16/1xRAID slot	Front VGA	TPM 1.2	XClarity Standard	1x750W Platinum	3-year	07/17
7X02A01MNA	NA	1xXeon Gold 5118 12C/2.3GHz/16.5MB/105W/DDR4-2400	1x16GB RDIMM DDR4-2666	1x930-8i 2GB flash	8x2.5"	8x2.5" SATA/SAS HS	Open	None	None	None	1xLP x8/1xLP x16/1xRAID slot	Front VGA	TPM 1.2	XClarity Standard	1x750W Platinum	3-year	07/17
7X02A01PNA	NA	1xXeon Gold 5118 12C/2.3GHz/16.5MB/105W/DDR4-2400	1x16GB RDIMM DDR4-2666	1x930-16i 4GB flash	10x2.5"	10x2.5" HS (6 SATA/SAS, 4 AnyBay)	Open	None	None	None	1xLP x8/1xLP x16/1xRAID slot	Front VGA	TPM 1.2	XClarity Standard	1x750W Platinum	3-year	07/17
7X02A01ANA	NA	1xXeon Gold 6140 18C/2.3GHz/24.75MB/140W/DDR4-2666	1x32GB RDIMM DDR4-2666	1x930-8i 2GB flash	8x2.5"	8x2.5" SATA/SAS HS	Open	None	None	None	1xLP x8/1xLP x16/1xRAID slot	Front VGA	TPM 1.2	XClarity Standard	1x750W Platinum	3-year	07/17
7X02A01VNA	NA	1xXeon Gold 6148 20C/2.4GHz/27.5MB/150W/DDR4-2666	1x32GB RDIMM DDR4-2666	1x930-8i 2GB flash	8x2.5"	8x2.5" SATA/SAS HS	Open	None	None	None	1xLP x8/1xLP x16/1xRAID slot	Front VGA	TPM 1.2	XClarity Standard	1x750W Platinum	3-year	07/17
7X02A02DNA	NA	1xXeon Gold 6126T 12C/2.6GHz/19.25MB/125W/DDR4-2666	1x32GB RDIMM DDR4-2666	1x930-8i 2GB flash	8x2.5"	8x2.5" SATA/SAS HS	Open	None	None	None	1xLP x8/1xLP x16/1xRAID slot	Front VGA	TPM 1.2	XClarity Standard	1x750W Platinum	3-year	07/17
7X02A01ZNA	NA	1xXeon Gold 6142 16C/2.6GHz/22MB/150W/DDR4-2666	1x32GB RDIMM DDR4-2666	1x930-8i 2GB flash	8x2.5"	8x2.5" SATA/SAS HS	Open	None	None	None	1xLP x8/1xLP x16/1xRAID slot	Front VGA	TPM 1.2	XClarity Standard	1x750W Platinum	3-year	07/17

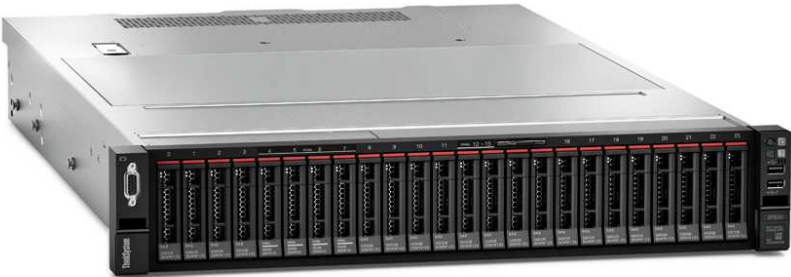

# ThinkSystem SR650 Platform Specifications

Product Specifications Reference (PSREF)

Components	Specification																																																																																																			
Form factor	2U rack																																																																																																			
Dimensions	Height: 86.5 mm (3.4 in). Width: 482 mm (19.0 in) with rack latches. Depth: 763.7 mm (30.1 in)																																																																																																			
Weight	Maximum configuration: 70.54 lb (32 kg)																																																																																																			
Processor	Up to two 205W Intel Xeon Scalable family processors, Bronze, Silver, Gold, or Platinum. Up to 28 cores at 2.5GHz, up to 3.6GHz with 4 cores. Two processors are connected with two UPI (Ultra Path Interconnect) links up to 10.4GT/s																																																																																																			
Chipset	Intel C624 Platform Controller Hub																																																																																																			
Memory	Up to 24 DIMM sockets. Each processor supports up to 12 DIMM sockets with 6 channels. DDR4-2666. RDIMMs, LRDIMMs, 3DS RDIMMs are supported, but memory types cannot be intermixed. 3DS RDIMM is planned to available later																																																																																																			
Memory capacity	Up to 768GB with 24 x 32 GB RDIMMs and two processors. Or up to 1.5TB with 24 x 64 GB LRDIMMs and two processors. Or up to 3TB with 24 x 128 GB 3DS LRDIMMs and two -M suffix processors. -M suffix processor supports 1.5TB memory per socket, non -M suffix processor supports 768GB memory per socket																																																																																																			
Memory protection	ECC, memory mirroring, and memory sparing																																																																																																			
Storage controllers	One dedicated internal RAID slot for most RAID/HBA adapters.																																																																																																			
	<table border="1"> <thead> <tr> <th>Feature</th> <th>Interface</th> <th>Drive type</th> <th>RAID levels</th> <th>JBOD</th> <th>Cache</th> <th>Cache protection</th> <th>FastPath</th> <th>Max qty</th> </tr> </thead> <tbody> <tr> <td>530-8i</td> <td>12Gbps SAS</td> <td>SATA/SAS</td> <td>0/1/10/5/50</td> <td>Yes</td> <td>None</td> <td>None</td> <td>Yes</td> <td>2</td> </tr> <tr> <td>730-8i</td> <td>12Gbps SAS</td> <td>SATA/SAS</td> <td>0/1/10/5/50</td> <td>Yes</td> <td>1GB</td> <td>None</td> <td>No</td> <td>3</td> </tr> <tr> <td>930-8i</td> <td>12Gbps SAS</td> <td>SATA/SAS</td> <td>0/1/10/5/50/6/60</td> <td>Yes</td> <td>2GB</td> <td>Flash backup</td> <td>Yes</td> <td>3</td> </tr> <tr> <td>930-16i</td> <td>12Gbps SAS</td> <td>SATA/SAS</td> <td>0/1/10/5/50/6/60</td> <td>Yes</td> <td>4GB</td> <td>Flash backup</td> <td>Yes</td> <td>1</td> </tr> <tr> <td>930-24i</td> <td>12Gbps SAS</td> <td>SATA/SAS</td> <td>0/1/10/5/50/6/60</td> <td>Yes</td> <td>4GB</td> <td>Flash backup</td> <td>Yes</td> <td>1</td> </tr> <tr> <td>430-8i</td> <td>12Gbps SAS</td> <td>SATA/SAS</td> <td>-</td> <td>Yes</td> <td>None</td> <td>None</td> <td>-</td> <td>3</td> </tr> <tr> <td>430-16i</td> <td>12Gbps SAS</td> <td>SATA/SAS</td> <td>-</td> <td>Yes</td> <td>None</td> <td>None</td> <td>-</td> <td>1</td> </tr> <tr> <td>930-8e</td> <td>12Gbps SAS</td> <td>SATA/SAS</td> <td>0/1/10/5/50/6/60</td> <td>Yes</td> <td>4GB</td> <td>Flash backup</td> <td>Yes</td> <td>5</td> </tr> <tr> <td>430-8e</td> <td>12Gbps SAS</td> <td>SATA/SAS</td> <td>-</td> <td>Yes</td> <td>None</td> <td>None</td> <td>-</td> <td>5</td> </tr> <tr> <td>430-16e</td> <td>12Gbps SAS</td> <td>SATA/SAS</td> <td>-</td> <td>Yes</td> <td>None</td> <td>None</td> <td>-</td> <td>5</td> </tr> </tbody> </table>	Feature	Interface	Drive type	RAID levels	JBOD	Cache	Cache protection	FastPath	Max qty	530-8i	12Gbps SAS	SATA/SAS	0/1/10/5/50	Yes	None	None	Yes	2	730-8i	12Gbps SAS	SATA/SAS	0/1/10/5/50	Yes	1GB	None	No	3	930-8i	12Gbps SAS	SATA/SAS	0/1/10/5/50/6/60	Yes	2GB	Flash backup	Yes	3	930-16i	12Gbps SAS	SATA/SAS	0/1/10/5/50/6/60	Yes	4GB	Flash backup	Yes	1	930-24i	12Gbps SAS	SATA/SAS	0/1/10/5/50/6/60	Yes	4GB	Flash backup	Yes	1	430-8i	12Gbps SAS	SATA/SAS	-	Yes	None	None	-	3	430-16i	12Gbps SAS	SATA/SAS	-	Yes	None	None	-	1	930-8e	12Gbps SAS	SATA/SAS	0/1/10/5/50/6/60	Yes	4GB	Flash backup	Yes	5	430-8e	12Gbps SAS	SATA/SAS	-	Yes	None	None	-	5	430-16e	12Gbps SAS	SATA/SAS	-	Yes	None	None	-	5
	Feature	Interface	Drive type	RAID levels	JBOD	Cache	Cache protection	FastPath	Max qty																																																																																											
	530-8i	12Gbps SAS	SATA/SAS	0/1/10/5/50	Yes	None	None	Yes	2																																																																																											
	730-8i	12Gbps SAS	SATA/SAS	0/1/10/5/50	Yes	1GB	None	No	3																																																																																											
	930-8i	12Gbps SAS	SATA/SAS	0/1/10/5/50/6/60	Yes	2GB	Flash backup	Yes	3																																																																																											
	930-16i	12Gbps SAS	SATA/SAS	0/1/10/5/50/6/60	Yes	4GB	Flash backup	Yes	1																																																																																											
	930-24i	12Gbps SAS	SATA/SAS	0/1/10/5/50/6/60	Yes	4GB	Flash backup	Yes	1																																																																																											
	430-8i	12Gbps SAS	SATA/SAS	-	Yes	None	None	-	3																																																																																											
	430-16i	12Gbps SAS	SATA/SAS	-	Yes	None	None	-	1																																																																																											
930-8e	12Gbps SAS	SATA/SAS	0/1/10/5/50/6/60	Yes	4GB	Flash backup	Yes	5																																																																																												
430-8e	12Gbps SAS	SATA/SAS	-	Yes	None	None	-	5																																																																																												
430-16e	12Gbps SAS	SATA/SAS	-	Yes	None	None	-	5																																																																																												
<i>Note: 730-8i is available in China only. 930-8e, 430-8e, and 430-16e will be placed in slot 4 firstly. 930-24i will be placed in slot 1 firstly.</i>																																																																																																				
Disk drive bays	Supports 8 front 3.5" SATA/SAS HS bays, or 12 front 3.5" SATA/SAS HS bays with maximum 4 AnyBay, or 8 front 2.5" SATA/SAS HS bays with maximum 4 AnyBay, or 16 front 2.5" SATA/SAS HS bays with maximum 8 AnyBay, or 24 front 2.5" SATA/SAS HS bays with maximum 4 AnyBay. Optional 2 rear 3.5" HS bays are supported on 12 x 3.5" model, takes place in riser card 1 location. Optional one or two internal M.2 SSD for boot, dual M.2 SSD supports mirroring																																																																																																			
Internal storage	For 3.5" bay	3.5" HDD, SATA6Gbps, 7.2K 1TB/2TB/4TB/6TB/8TB/10TB																																																																																																		
	(3.5" disks or 2.5" disks with 3.5" tray)	3.5" HDD, SAS12Gbps, 7.2K 1TB/2TB/4TB/6TB SED FIPS/6TB/10TB																																																																																																		
		2.5" HDD, SAS12Gbps, 15K 300GB/600GB																																																																																																		
	For 2.5" bay	2.5" SSD, SATA6Gbps 240GB/480GB																																																																																																		
		2.5" NVMe SSD, AnyBay 960GB/1.92TB/3.84TB																																																																																																		
2.5" HDD, SATA6Gbps, 7.2K 1TB/2TB																																																																																																				
2.5" HDD, SAS12Gbps, 7.2K 1TB/2TB																																																																																																				
2.5" HDD, SAS12Gbps, 10K 300GB/300GB SED/600GB/600GB SED/900GB/1.2TB/1.8TB																																																																																																				
2.5" HDD, SAS12Gbps, 15K 300GB/600GB/900GB																																																																																																				
2.5" SSD, SAS12Gbps 400GB/800GB/3.84TB/7.68TB																																																																																																				
2.5" SSD, SATA6Gbps 240GB/480GB																																																																																																				
2.5" NVMe SSD, AnyBay 800GB/960GB/1.6TB/1.92TB/3.84TB																																																																																																				
PCIe 3.0 x4, HHL adapter	NVMe SSD 1.6TB/1.92TB/3.2TB/3.84TB																																																																																																			
M.2 boot drive	M.2 SATA SSD 32GB/128GB																																																																																																			
Optical	No internal optical bay. Optional USB DVD±RW optical drive																																																																																																			
Network interfaces	One dedicated management port. One LOM slot for customized LOM with up to four RJ-45 or SFP+ ports, up to 10GbE. Wake-on-LAN and NC-SI are available on Port 0 of LOM. Optional ML2 or PCIe adapters are supported. ML2 adapter requires riser card with ML2 slot.																																																																																																			
Security features	Power-on and admin password. Trusted Platform Module, TCG 1.2 compliant, upgrade to 2.0 via UEFI setting. Optional TCM in China only. Optional lockable security bezel																																																																																																			
Operating systems supported	Microsoft Windows Server 2016/2012 R2. Red Hat Enterprise Linux 7.3/6.9. SUSE Linux Enterprise Server 12 SP2/11 SP4. VMware vSphere (ESXi) 6.5/6.0 U3																																																																																																			
Systems management	XClarity Controller Standard, optional upgrades to Advanced or Enterprise are available. Energy Manager. XClarity Administrator. Lenovo Capacity Planner. Provisioning Manager. Essentials. Light Path Diagnostics																																																																																																			
GPU support	Up to two optional GPU, requires riser card with PCIe x16 slot. 2nd GPU requires 2nd CPU. Supports Intel Xeon Phi 7240P, NVIDIA Quadro M60, or Quadro P100																																																																																																			

Components	Specification												
Base warranty	MT 7X05: 1-year limited onsite service with 9x5/NBD MT 7X06: 3-year limited onsite service with 9x5/NBD												
Power supply	Up to two redundant hot-swap 550W/750W/1100W/1600W 80 PLUS Platinum qualified AC power supplies. Or up to two redundant hot-swap 750W Titanium qualified AC power supplies. 750W Titanium and 1600W Platinum are 200V - 240V, others are 100V - 240V												
Video	Integrated Matrox G200 in XClarity Controller												
Cooling	Five fans (4+1) for single processor model, six fans (5+1) for dual processor model												
Front ports	One XClarity Controller USB connector, one USB 3.0, one optional VGA												
Rear ports	One VGA, two USB 3.0, one XClarity Controller network connector. Optional COM port												
Environmental specification	Supports ASHRAE A4 with limitations.												
	<table border="1"> <tbody> <tr> <td>Temperature - operating</td> <td>A4: 5°C to 45°C (41°F to 113°F) A3: 5°C to 40°C (41°F to 104°F) A2: 10°C to 35°C (50°F to 95°F)</td> </tr> <tr> <td>Temperature - non operating (no package)</td> <td>-10°C to 60°C (14°F to 140°F)</td> </tr> <tr> <td>Temperature - non operating (with package)</td> <td>-40°C to 70°C (-40°F to 158°F)</td> </tr> <tr> <td>Altitude - operating</td> <td>(Unpressurized): 0-10000ft (0-3048m)</td> </tr> <tr> <td>Humidity - operating, non-condensing</td> <td>A4: 8%-90%. A3:8%-85%. A2:20%~80%</td> </tr> <tr> <td>Humidity - storage (with package), non-condensing</td> <td>8%~90%</td> </tr> </tbody> </table>	Temperature - operating	A4: 5°C to 45°C (41°F to 113°F) A3: 5°C to 40°C (41°F to 104°F) A2: 10°C to 35°C (50°F to 95°F)	Temperature - non operating (no package)	-10°C to 60°C (14°F to 140°F)	Temperature - non operating (with package)	-40°C to 70°C (-40°F to 158°F)	Altitude - operating	(Unpressurized): 0-10000ft (0-3048m)	Humidity - operating, non-condensing	A4: 8%-90%. A3:8%-85%. A2:20%~80%	Humidity - storage (with package), non-condensing	8%~90%
	Temperature - operating	A4: 5°C to 45°C (41°F to 113°F) A3: 5°C to 40°C (41°F to 104°F) A2: 10°C to 35°C (50°F to 95°F)											
	Temperature - non operating (no package)	-10°C to 60°C (14°F to 140°F)											
	Temperature - non operating (with package)	-40°C to 70°C (-40°F to 158°F)											
Altitude - operating	(Unpressurized): 0-10000ft (0-3048m)												
Humidity - operating, non-condensing	A4: 8%-90%. A3:8%-85%. A2:20%~80%												
Humidity - storage (with package), non-condensing	8%~90%												
<i>Models should meet the following requirements to support A3 and A4:</i>													
<ul style="list-style-type: none"> <li>NVMe drives not installed</li> <li>PCIe flash adapter not installed</li> <li>Graphic processing unit (GPU) not installed</li> <li>Must have redundant PSU</li> <li>Certain processors not installed:                             <ul style="list-style-type: none"> <li>Processors with TDP more than or equal to 150-watt not installed</li> <li>On 16 x 2.5", 24 x 2.5", and 12 x 3.5" models, the following processors not installed: Intel Xeon 4112, 5122, 6126, 6128*, 6132*, 6134, 6134M*, and 8156 processors (Processors marked with * will be available later)</li> </ul> </li> </ul>													
Environmental certification	Energy Star Server 2.1 certified. More environmental information please see: <a href="http://www.lenovo.com/social_responsibility/us/en/environment/">www.lenovo.com/social_responsibility/us/en/environment/</a>												

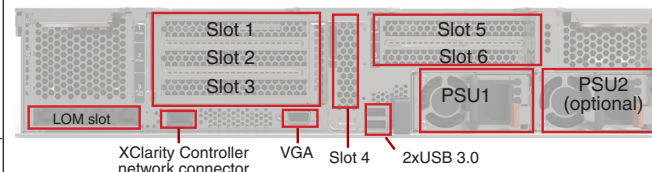

Expansion slots	
Slot 1-3 (riser card 1)	Supports one of the following for riser card 1: Option 1: PCIe 3.0 x8/x8/x8 (slot 1-3). Full height, half length. Option 2: PCIe 3.0 x16/x8 (slot 1 and 3). Full height, full length for x16. Full height, half length for x8 Option 3: PCIe 3.0 x8/x8/x8 ML2 (slot 1-3). Full height, half length Option 4: PCIe 3.0 x8/x16 ML2 (slot 1 and 3). Full height, half length Option 5: Two rear 3.5" disk bays, 12 x 3.5" models only
Slot 4 (onboard)	PCIe 3.0 x8, low profile
Slot 5 (riser card 2)	PCIe 3.0 x16, full height, full length, requires 2nd CPU
Slot 6 (riser card 2)	PCIe 3.0 x16, full height, half length, requires 2nd CPU

System unique options	
ZXH7A06253	ThinkSystem SR590/SR650 Rear HDD Kit
ZXH7A02681	ThinkSystem SR650 x8/x16ML2 PCIe FH Riser 1 Kit
ZXH7A02680	ThinkSystem SR550/SR590/SR650 x8/x8x8ML2 PCIe FH Riser 1 Kit
ZXH7A02678	ThinkSystem SR550/SR590/SR650 x16/x8 PCIe FH Riser 1 Kit
ZXH7A02677	ThinkSystem SR550/SR590/SR650 x8/x8/x8 PCIe FH Riser 1 Kit
ZXH7A02679	ThinkSystem SR550/SR590/SR650 x16/x8(or x16) PCIe FH Riser 2 Kit
ZXH7A06251	ThinkSystem SR650 2.5" AnyBay 8-Bay Backplane Kit
ZXH7A06254	ThinkSystem SR550/SR650 2.5" SATA/SAS 8-Bay Backplane Kit
Z217A02578	ThinkSystem SR550/SR590/SR650 EIA Latch w/ VGA Upgrade Kit
Z217A02580	ThinkSystem 2U Security Bezel
Z217A02577	ThinkSystem COM Port Upgrade Kit
ZXH7A05899	ThinkSystem SR650 2nd GPU Upgrade Kit
ZXH7A05897	ThinkSystem SR650 GPU Thermal Kit
ZXH7A05898	ThinkSystem SR650(GPU) 1U Heatsink Option Kit

Model	Region	Processor	Memory	Storage Controller	Chassis	Disk Bays	Disks	M.2 Drives	GPU	Networking (LOM/ML2/PCIe)	Available PCIe Slots	Front VGA	Security	System Management	Power Supply	Base Warranty	Ann Date (mm/yy)
7X06A05ZAU	ANZ	1xXeon Gold 6130 16C/2.1GHz/22MB/125W/DDR4-2666	1x32GB RDIMM DDR4-2666	1x930-8i 2GB flash	24x2.5"	8x2.5" SATA/SAS HS	Open	None	None	None	1xLP x8/1xRAID slot	Front VGA	TPM 1.2	XClarity Enterprise	1x1100W Platinum	3-year	07/17
7X06A060AU	ANZ	1xXeon Gold 5118 12C/2.3GHz/16.5MB/105W/DDR4-2400	1x16GB RDIMM DDR4-2666	1x930-8i 2GB flash	24x2.5"	8x2.5" SATA/SAS HS	Open	None	None	None	1xLP x8/1xRAID slot	Front VGA	TPM 1.2	XClarity Enterprise	1x1100W Platinum	3-year	07/17
7X06A061AU	ANZ	1xXeon Gold 5120 14C/2.2GHz/19.25MB/105W/DDR4-2400	1x16GB RDIMM DDR4-2666	1x930-8i 2GB flash	24x2.5"	8x2.5" SATA/SAS HS	Open	None	None	None	1xLP x8/1xRAID slot	Front VGA	TPM 1.2	XClarity Enterprise	1x1100W Platinum	3-year	07/17
7X06A062AU	ANZ	1xXeon Gold 6126 12C/2.6GHz/19.25MB/125W/DDR4-2666	1x32GB RDIMM DDR4-2666	1x930-8i 2GB flash	24x2.5"	8x2.5" SATA/SAS HS	Open	None	None	None	1xLP x8/1xRAID slot	Front VGA	TPM 1.2	XClarity Enterprise	1x750W Platinum	3-year	07/17
7X06A063AU	ANZ	1xXeon Gold 5118 12C/2.3GHz/16.5MB/105W/DDR4-2400	1x16GB RDIMM DDR4-2666	1x930-8i 2GB flash	24x2.5"	8x2.5" SATA/SAS HS	Open	None	None	None	1xLP x8/1xRAID slot	Front VGA	TPM 1.2	XClarity Enterprise	1x750W Platinum	3-year	07/17
7X06A064AU	ANZ	1xXeon Gold 6140 18C/2.3GHz/24.75MB/140W/DDR4-2666	1x32GB RDIMM DDR4-2666	1x930-8i 2GB flash	24x2.5"	8x2.5" SATA/SAS HS	Open	None	None	None	1xLP x8/1xRAID slot	Front VGA	TPM 1.2	XClarity Enterprise	1x1100W Platinum	3-year	07/17
7X06A065AU	ANZ	1xXeon Gold 5115 10C/2.4GHz/13.75MB/85W/DDR4-2400	1x16GB RDIMM DDR4-2666	1x930-8i 2GB flash	24x2.5"	8x2.5" SATA/SAS HS	Open	None	None	None	1xLP x8/1xRAID slot	Front VGA	TPM 1.2	XClarity Enterprise	1x1100W Platinum	3-year	07/17
7X06A066AU	ANZ	1xXeon Gold 5122 4C/3.6GHz/16.5MB/105W/DDR4-2400	1x32GB RDIMM DDR4-2666	1x930-8i 2GB flash	24x2.5"	8x2.5" SATA/SAS HS	Open	None	None	None	1xLP x8/1xRAID slot	Front VGA	TPM 1.2	XClarity Enterprise	1x1600W Platinum	3-year	07/17
7X06A067AU	ANZ	1xXeon Gold 5120 14C/2.2GHz/19.25MB/105W/DDR4-2400	1x16GB RDIMM DDR4-2666	1x930-8i 2GB flash	24x2.5"	8x2.5" SATA/SAS HS	Open	None	None	None	1xLP x8/1xRAID slot	Front VGA	TPM 1.2	XClarity Enterprise	1x750W Platinum	3-year	07/17
7X06A069AU	ANZ	1xXeon Platinum 8160 24C/2.1GHz/33MB/150W/DDR4-2666	1x32GB RDIMM DDR4-2666	1x930-8i 2GB flash	24x2.5"	8x2.5" SATA/SAS HS	Open	None	None	None	1xLP x8/1xRAID slot	Front VGA	TPM 1.2	XClarity Enterprise	1x1100W Platinum	3-year	07/17
7X06A06AAU	ANZ	1xXeon Gold 6152 22C/2.1GHz/30.25MB/140W/DDR4-2666	1x32GB RDIMM DDR4-2666	1x930-8i 2GB flash	24x2.5"	8x2.5" SATA/SAS HS	Open	None	None	None	1xLP x8/1xRAID slot	Front VGA	TPM 1.2	XClarity Enterprise	1x1100W Platinum	3-year	07/17
7X06A06BAU	ANZ	1xXeon Gold 6130 16C/2.1GHz/22MB/125W/DDR4-2666	1x32GB RDIMM DDR4-2666	1x930-8i 2GB flash	24x2.5"	8x2.5" SATA/SAS HS	Open	None	None	None	1xLP x8/1xRAID slot	Front VGA	TPM 1.2	XClarity Enterprise	1x750W Platinum	3-year	07/17
7X06A06CAU	ANZ	1xXeon Gold 6126 12C/2.6GHz/19.25MB/125W/DDR4-2666	1x32GB RDIMM DDR4-2666	1x930-8i 2GB flash	24x2.5"	8x2.5" SATA/SAS HS	Open	None	None	None	1xLP x8/1xRAID slot	Front VGA	TPM 1.2	XClarity Enterprise	1x1100W Platinum	3-year	07/17
7X06A06DAU	ANZ	1xXeon Gold 5115 10C/2.4GHz/13.75MB/85W/DDR4-2400	1x16GB RDIMM DDR4-2666	1x930-8i 2GB flash	24x2.5"	8x2.5" SATA/SAS HS	Open	None	None	None	1xLP x8/1xRAID slot	Front VGA	TPM 1.2	XClarity Enterprise	1x750W Platinum	3-year	07/17

Model	Region	Processor	Memory	Storage Controller	Chassis	Disk Bays	Disks	M.2 Drives	GPU	Networking (LOM/ML2/PCIe)	Available PCIe Slots	Front VGA	Security	System Management	Power Supply	Base Warranty	Ann Date (mm/yy)
7X06A01REA	EMEA	1xXeon Gold 6126 12C/2.6GHz/19.25MB/125W/DDR4-2666	1x32GB RDIMM DDR4-2666	1x930-8i 2GB flash	24x2.5"	8x2.5" SATA/SAS HS	Open	None	None	None	1xLP x8/1xRAID slot	Front VGA	TPM 1.2	XClarity Enterprise	1x750W Platinum	3-year	07/17
7X06A01SEA	EMEA	1xXeon Gold 5120 14C/2.2GHz/19.25MB/105W/DDR4-2400	1x16GB RDIMM DDR4-2666	1x930-8i 2GB flash	24x2.5"	8x2.5" SATA/SAS HS	Open	None	None	None	1xLP x8/1xRAID slot	Front VGA	TPM 1.2	XClarity Enterprise	1x750W Platinum	3-year	07/17
7X06A01NEA	EMEA	1xXeon Gold 6130 16C/2.1GHz/22MB/125W/DDR4-2666	1x32GB RDIMM DDR4-2666	1x930-8i 2GB flash	24x2.5"	8x2.5" SATA/SAS HS	Open	None	None	None	1xLP x8/1xRAID slot	Front VGA	TPM 1.2	XClarity Enterprise	1x750W Platinum	3-year	07/17
7X06A00KEA	EMEA	1xXeon Gold 5118 12C/2.3GHz/16.5MB/105W/DDR4-2400	1x16GB RDIMM DDR4-2666	1x930-8i 2GB flash	24x2.5"	8x2.5" SATA/SAS HS	Open	None	None	None	1xLP x8/1xRAID slot	Front VGA	TPM 1.2	XClarity Enterprise	1x750W Platinum	3-year	07/17
7X06A00LEA	EMEA	1xXeon Gold 5115 10C/2.4GHz/13.75MB/85W/DDR4-2400	1x16GB RDIMM DDR4-2666	1x930-8i 2GB flash	24x2.5"	8x2.5" SATA/SAS HS	Open	None	None	None	1xLP x8/1xRAID slot	Front VGA	TPM 1.2	XClarity Enterprise	1x750W Platinum	3-year	07/17
7X06A00NEA	EMEA	1xXeon Gold 6140 18C/2.3GHz/24.75MB/140W/DDR4-2666	1x32GB RDIMM DDR4-2666	1x930-8i 2GB flash	24x2.5"	8x2.5" SATA/SAS HS	Open	None	None	None	1xLP x8/1xRAID slot	Front VGA	TPM 1.2	XClarity Enterprise	1x1100W Platinum	3-year	07/17
7X06A00PEA	EMEA	1xXeon Gold 6130 16C/2.1GHz/22MB/125W/DDR4-2666	1x32GB RDIMM DDR4-2666	1x930-8i 2GB flash	24x2.5"	8x2.5" SATA/SAS HS	Open	None	None	None	1xLP x8/1xRAID slot	Front VGA	TPM 1.2	XClarity Enterprise	1x1100W Platinum	3-year	07/17
7X06A010EA	EMEA	1xXeon Gold 6152 22C/2.1GHz/30.25MB/140W/DDR4-2666	1x32GB RDIMM DDR4-2666	1x930-8i 2GB flash	24x2.5"	8x2.5" SATA/SAS HS	Open	None	None	None	1xLP x8/1xRAID slot	Front VGA	TPM 1.2	XClarity Enterprise	1x1100W Platinum	3-year	07/17
7X06A011EA	EMEA	1xXeon Gold 5115 10C/2.4GHz/13.75MB/85W/DDR4-2400	1x16GB RDIMM DDR4-2666	1x930-8i 2GB flash	24x2.5"	8x2.5" SATA/SAS HS	Open	None	None	None	1xLP x8/1xRAID slot	Front VGA	TPM 1.2	XClarity Enterprise	1x1100W Platinum	3-year	07/17
7X06A013EA	EMEA	1xXeon Platinum 8160 24C/2.1GHz/33MB/150W/DDR4-2666	1x32GB RDIMM DDR4-2666	1x930-8i 2GB flash	24x2.5"	8x2.5" SATA/SAS HS	Open	None	None	None	1xLP x8/1xRAID slot	Front VGA	TPM 1.2	XClarity Enterprise	1x1100W Platinum	3-year	07/17
7X06A014EA	EMEA	1xXeon Gold 5120 14C/2.2GHz/19.25MB/105W/DDR4-2400	1x16GB RDIMM DDR4-2666	1x930-8i 2GB flash	24x2.5"	8x2.5" SATA/SAS HS	Open	None	None	None	1xLP x8/1xRAID slot	Front VGA	TPM 1.2	XClarity Enterprise	1x1100W Platinum	3-year	07/17
7X06A01AEA	EMEA	1xXeon Gold 6140 18C/2.3GHz/24.75MB/140W/DDR4-2666	1x32GB RDIMM DDR4-2666	1x930-8i 2GB flash	24x2.5"	8x2.5" SATA/SAS HS	Open	None	None	None	1xLP x8/1xRAID slot	Front VGA	TPM 1.2	XClarity Enterprise	1x1100W Platinum	3-year	07/17
7X06A01BEA	EMEA	1xXeon Gold 5122 4C/3.6GHz/16.5MB/105W/DDR4-2400	1x32GB RDIMM DDR4-2666	1x930-8i 2GB flash	24x2.5"	8x2.5" SATA/SAS HS	Open	None	None	None	1xLP x8/1xRAID slot	Front VGA	TPM 1.2	XClarity Enterprise	1x1600W Platinum	3-year	07/17
7X06A01HEA	EMEA	1xXeon Gold 5118 12C/2.3GHz/16.5MB/105W/DDR4-2400	1x16GB RDIMM DDR4-2666	1x930-8i 2GB flash	24x2.5"	8x2.5" SATA/SAS HS	Open	None	None	None	1xLP x8/1xRAID slot	Front VGA	TPM 1.2	XClarity Enterprise	1x1100W Platinum	3-year	07/17
7X06A047EA	EMEA	1xXeon Silver 4108 8C/1.8GHz/11MB/85W/DDR4-2400	1x16GB RDIMM DDR4-2666	1x930-8i 2GB flash	24x2.5"	8x2.5" SATA/SAS HS	2x300GB HDD 10K 2.5" SAS12Gbps	None	None	None	1xLP x8/1xRAID slot	Front VGA	TPM 1.2	XClarity Enterprise	2x750W Platinum	3-year	07/17

Model	Region	Processor	Memory	Storage Controller	Chassis	Disk Bays	Disks	M.2 Drives	GPU	Networking (LOM/ML2/PCIe)	Available PCIe Slots	Front VGA	Security	System Management	Power Supply	Base Warranty	Ann Date (mm/yy)
7X06A048EA	EMEA	1xXeon Silver 4114 10C/2.2GHz/13.75MB/85W/DDR4-2400	1x16GB RDIMM DDR4-2666	1x930-16i 4GB flash	24x2.5"	16x2.5" SATA/SAS HS	Open	None	None	None	1xLP x8/1xRAID slot	Front VGA	TPM 1.2	XClarity Enterprise	2x750W Platinum	3-year	07/17
7X06A049EA	EMEA	1xXeon Silver 4110 8C/2.1GHz/11MB/85W/DDR4-2400	1x32GB RDIMM DDR4-2666	1x930-8i 2GB flash	24x2.5"	8x2.5" SATA/SAS HS	3x300GB HDD 10K 2.5" SAS12Gbps	None	None	None	1xLP x8/1xRAID slot	Front VGA	TPM 1.2	XClarity Enterprise	2x750W Platinum	3-year	07/17
7X06A04AEA	EMEA	1xXeon Silver 4114 10C/2.2GHz/13.75MB/85W/DDR4-2400	1x32GB RDIMM DDR4-2666	1x930-8i 2GB flash	24x2.5"	8x2.5" SATA/SAS HS	3x300GB HDD 10K 2.5" SAS12Gbps	None	None	None	1xLP x8/1xRAID slot	Front VGA	TPM 1.2	XClarity Enterprise	2x750W Platinum	3-year	07/17
7X06A04BEA	EMEA	1xXeon Silver 4110 8C/2.1GHz/11MB/85W/DDR4-2400	1x16GB RDIMM DDR4-2666	1x930-8i 2GB flash	24x2.5"	8x2.5" SATA/SAS HS	3x300GB HDD 10K 2.5" SAS12Gbps	None	None	None	1xLP x8/1xRAID slot	Front VGA	TPM 1.2	XClarity Enterprise	2x750W Platinum	3-year	07/17
7X06A04CEA	EMEA	1xXeon Silver 4108 8C/1.8GHz/11MB/85W/DDR4-2400	1x16GB RDIMM DDR4-2666	1x930-8i 2GB flash	24x2.5"	8x2.5" SATA/SAS HS	Open	None	None	None	1xLP x8/1xRAID slot	Front VGA	TPM 1.2	XClarity Enterprise	1x750W Platinum	3-year	07/17
7X06A04DEA	EMEA	1xXeon Silver 4116 12C/2.1GHz/16.5MB/85W/DDR4-2400	1x16GB RDIMM DDR4-2666	1x930-8i 2GB flash	24x2.5"	8x2.5" SATA/SAS HS	Open	None	None	None	1xLP x8/1xRAID slot	Front VGA	TPM 1.2	XClarity Enterprise	1x750W Platinum	3-year	07/17
7X06A04EEA	EMEA	1xXeon Silver 4110 8C/2.1GHz/11MB/85W/DDR4-2400	1x16GB RDIMM DDR4-2666	1x930-8i 2GB flash	24x2.5"	8x2.5" SATA/SAS HS	Open	None	None	None	1xLP x8/1xRAID slot	Front VGA	TPM 1.2	XClarity Enterprise	1x1100W Platinum	3-year	07/17
7X06A04FEA	EMEA	1xXeon Bronze 3106 8C/1.7GHz/11MB/85W/DDR4-2133	1x8GB RDIMM DDR4-2666	1x530-8i	24x2.5"	8x2.5" SATA/SAS HS	Open	None	None	None	1xLP x8/1xRAID slot	Front VGA	TPM 1.2	XClarity Enterprise	1x750W Platinum	3-year	07/17
7X06A04GEA	EMEA	1xXeon Silver 4110 8C/2.1GHz/11MB/85W/DDR4-2400	1x16GB RDIMM DDR4-2666	1x930-8i 2GB flash	24x2.5"	8x2.5" SATA/SAS HS	2x300GB HDD 10K 2.5" SAS12Gbps	None	None	None	1xLP x8/1xRAID slot	Front VGA	TPM 1.2	XClarity Enterprise	2x750W Platinum	3-year	07/17
7X06A04HEA	EMEA	1xXeon Silver 4110 8C/2.1GHz/11MB/85W/DDR4-2400	1x8GB RDIMM DDR4-2666	1x930-8i 2GB flash	12x3.5"	8x3.5" SATA/SAS HS	Open	None	None	None	1xLP x8/1xRAID slot	Front VGA	TPM 1.2	XClarity Enterprise	1x750W Platinum	3-year	07/17
7X06A04JEA	EMEA	1xXeon Bronze 3104 6C/1.7GHz/8.25MB/85W/DDR4-2133	1x8GB RDIMM DDR4-2666	1x530-8i	24x2.5"	8x2.5" SATA/SAS HS	Open	None	None	None	1xLP x8/1xRAID slot	Front VGA	TPM 1.2	XClarity Enterprise	1x750W Platinum	3-year	07/17
7X06A04KEA	EMEA	1xXeon Silver 4108 8C/1.8GHz/11MB/85W/DDR4-2400	1x16GB RDIMM DDR4-2666	1x930-8i 2GB flash	24x2.5"	8x2.5" SATA/SAS HS	Open	None	None	None	1xLP x8/1xRAID slot	Front VGA	TPM 1.2	XClarity Enterprise	1x1100W Platinum	3-year	07/17
7X06A04LEA	EMEA	1xXeon Silver 4110 8C/2.1GHz/11MB/85W/DDR4-2400	1x16GB RDIMM DDR4-2666	1x930-8i 2GB flash	24x2.5"	8x2.5" SATA/SAS HS	Open	None	None	None	1xLP x8/1xRAID slot	Front VGA	TPM 1.2	XClarity Enterprise	1x750W Platinum	3-year	07/17
7X06A04MEA	EMEA	1xXeon Silver 4110 8C/2.1GHz/11MB/85W/DDR4-2400	1x16GB RDIMM DDR4-2666	1x530-8i	24x2.5"	8x2.5" SATA/SAS HS	Open	None	None	None	1xLP x8/1xRAID slot	Front VGA	TPM 1.2	XClarity Enterprise	1x750W Platinum	3-year	07/17
7X06A04NEA	EMEA	1xXeon Silver 4108 8C/1.8GHz/11MB/85W/DDR4-2400	1x16GB RDIMM DDR4-2666	1x930-8i 2GB flash	24x2.5"	8x2.5" SATA/SAS HS	3x300GB HDD 10K 2.5" SAS12Gbps	None	None	None	1xLP x8/1xRAID slot	Front VGA	TPM 1.2	XClarity Enterprise	2x750W Platinum	3-year	07/17



Model	Region	Processor	Memory	Storage Controller	Chassis	Disk Bays	Disks	M.2 Drives	GPU	Networking (LOM/ML2/PCIe)	Available PCIe Slots	Front VGA	Security	System Management	Power Supply	Base Warranty	Ann Date (mm/yy)
7X06A04PEA	EMEA	1xXeon Silver 4110 8C/2.1GHz/11MB/85W/DDR4-2400	1x16GB RDIMM DDR4-2666	1x930-8i 2GB flash	24x2.5"	8x2.5" SATA/SAS HS	Open	None	None	None	1xLP x8/1xRAID slot	Front VGA	TPM 1.2	XClarity Enterprise	1x750W Platinum	3-year	07/17
7X06A04QEA	EMEA	1xXeon Silver 4114 10C/2.2GHz/13.75MB/85W/DDR4-2400	1x16GB RDIMM DDR4-2666	1x930-8i 2GB flash	24x2.5"	8x2.5" SATA/SAS HS	Open	None	None	None	1xLP x8/1xRAID slot	Front VGA	TPM 1.2	XClarity Enterprise	1x750W Platinum	3-year	07/17
7X06A04REA	EMEA	1xXeon Silver 4114 10C/2.2GHz/13.75MB/85W/DDR4-2400	1x16GB RDIMM DDR4-2666	1x930-8i 2GB flash	24x2.5"	8x2.5" SATA/SAS HS	Open	None	None	None	1xLP x8/1xRAID slot	Front VGA	TPM 1.2	XClarity Enterprise	1x1100W Platinum	3-year	07/17
7X06A04SEA	EMEA	1xXeon Silver 4116 12C/2.1GHz/16.5MB/85W/DDR4-2400	1x16GB RDIMM DDR4-2666	1x930-8i 2GB flash	24x2.5"	8x2.5" SATA/SAS HS	Open	None	None	None	1xLP x8/1xRAID slot	Front VGA	TPM 1.2	XClarity Enterprise	1x1100W Platinum	3-year	07/17
7X06A04TEA	EMEA	1xXeon Silver 4108 8C/1.8GHz/11MB/85W/DDR4-2400	1x16GB RDIMM DDR4-2666	1x530-8i	24x2.5"	8x2.5" SATA/SAS HS	Open	None	None	None	1xLP x8/1xRAID slot	Front VGA	TPM 1.2	XClarity Enterprise	1x750W Platinum	3-year	07/17
7X06A04UEA	EMEA	1xXeon Silver 4108 8C/1.8GHz/11MB/85W/DDR4-2400	1x8GB RDIMM DDR4-2666	1x930-8i 2GB flash	12x3.5"	8x3.5" SATA/SAS HS	Open	None	None	None	1xLP x8/1xRAID slot	Front VGA	TPM 1.2	XClarity Enterprise	1x750W Platinum	3-year	07/17

Model	Region	Processor	Memory	Storage Controller	Chassis	Disk Bays	Disks	M.2 Drives	GPU	Networking (LOM/ML2/PCIe)	Available PCIe Slots	Front VGA	Security	System Management	Power Supply	Base Warranty	Ann Date (mm/yy)	
7X06A01KCN	HTK	1xXeon Gold 5122 4C/3.6GHz/16.5MB/105W/DDR4-2400	1x16GB RDIMM DDR4-2666	1x930-16i 4GB flash	16x2.5"	16x2.5"	SATA/SAS HS	Open	None	None	4xGbE RJ-45 LOM	3xFHHL x8/1xLP x8/1xRAID slot	None	TPM 1.2	XClarity Standard	1x750W Platinum	3-year	07/17
7X06A01LCN	HTK	1xXeon Gold 5118 12C/2.3GHz/16.5MB/105W/DDR4-2400	1x16GB RDIMM DDR4-2666	1x930-16i 4GB flash	16x2.5"	16x2.5"	SATA/SAS HS	Open	None	None	4xGbE RJ-45 LOM	3xFHHL x8/1xLP x8/1xRAID slot	None	TPM 1.2	XClarity Standard	1x750W Platinum	3-year	07/17
7X06A01DCN	HTK	1xXeon Gold 5120T 14C/2.2GHz/19.25MB/105W/DDR4-2400	1x16GB RDIMM DDR4-2666	1x930-16i 4GB flash	16x2.5"	16x2.5"	SATA/SAS HS	Open	None	None	4xGbE RJ-45 LOM	3xFHHL x8/1xLP x8/1xRAID slot	None	TPM 1.2	XClarity Standard	1x750W Platinum	3-year	07/17
7X06A009CN	HTK	1xXeon Gold 5120 14C/2.2GHz/19.25MB/105W/DDR4-2400	1x16GB RDIMM DDR4-2666	1x930-16i 4GB flash	16x2.5"	16x2.5"	SATA/SAS HS	Open	None	None	4xGbE RJ-45 LOM	3xFHHL x8/1xLP x8/1xRAID slot	None	TPM 1.2	XClarity Standard	1x750W Platinum	3-year	07/17
7X06A027CN	HTK	1xXeon Gold 5115 10C/2.4GHz/13.75MB/85W/DDR4-2400	1x16GB RDIMM DDR4-2666	1x930-16i 4GB flash	16x2.5"	16x2.5"	SATA/SAS HS	Open	None	None	4xGbE RJ-45 LOM	3xFHHL x8/1xLP x8/1xRAID slot	None	TPM 1.2	XClarity Standard	1x750W Platinum	3-year	07/17

# ThinkSystem SR650 - TopSeller - JAPAN

Product Specifications Reference (PSREF)

Model	Region	Processor	Memory	Storage Controller	Chassis	Disk Bays	Disks	M.2 Drives	GPU	Networking (LOM/ML2/PCIe)	Available PCIe Slots	Front VGA	Security	System Management	Power Supply	Base Warranty	Ann Date (mm/yy)
7X06A01MJP	JAPAN	1xXeon Bronze 3104 6C/1.7GHz/8.25MB/85W/DDR4-2133	1x16GB RDIMM DDR4-2666	1x930-8i 2GB flash	12x3.5"	8x3.5" SATA/SAS HS	Open	None	None	4xGbE RJ-45 LOM	3xFHHL x8/1xLP x8/1xRAID slot	None	TPM 1.2	XClarity Advanced	1x550W Platinum	3-year	07/17
7X06A02BJP	JAPAN	1xXeon Silver 4112 4C/2.6GHz/8.25MB/85W/DDR4-2400	1x16GB RDIMM DDR4-2666	1x930-8i 2GB flash	24x2.5"	8x2.5" SATA/SAS HS	Open	None	None	4xGbE RJ-45 LOM	3xFHHL x8/1xLP x8/1xRAID slot	None	TPM 1.2	XClarity Advanced	1x550W Platinum	3-year	07/17
7X06A05AJP	JAPAN	1xXeon Bronze 3106 8C/1.7GHz/11MB/85W/DDR4-2133	1x16GB RDIMM DDR4-2666	1x930-8i 2GB flash	24x2.5"	8x2.5" SATA/SAS HS	Open	None	None	4xGbE RJ-45 LOM	3xFHHL x8/1xLP x8/1xRAID slot	None	TPM 1.2	XClarity Advanced	1x550W Platinum	3-year	07/17
7X06A05BJP	JAPAN	1xXeon Silver 4110 8C/2.1GHz/11MB/85W/DDR4-2400	1x16GB RDIMM DDR4-2666	1x930-8i 2GB flash	24x2.5"	8x2.5" SATA/SAS HS	Open	None	None	4xGbE RJ-45 LOM	3xFHHL x8/1xLP x8/1xRAID slot	None	TPM 1.2	XClarity Advanced	1x550W Platinum	3-year	07/17

# ThinkSystem SR650 - TopSeller - NA

Product Specifications Reference (PSREF)

Model	Region	Processor	Memory	Storage Controller	Chassis	Disk Bays	Disks	M.2 Drives	GPU	Networking (LOM/ML2/PCIe)	Available PCIe Slots	Front VGA	Security	System Management	Power Supply	Base Warranty	Ann Date (mm/yy)
7X06A04ZNA	NA	1xXeon Silver 4116 12C/2.1GHz/16.5MB/85W/DDR4-2400	1x32GB RDIMM DDR4-2666	None	24x2.5"	None	None	None	None	None	1xLP x8/1xRAID slot	Front VGA	TPM 1.2	XClarity Enterprise	1x750W Platinum	3-year	07/17
7X06A057NA	NA	1xXeon Silver 4110 8C/2.1GHz/11MB/85W/DDR4-2400	1x16GB RDIMM DDR4-2666	None	24x2.5"	None	None	None	None	None	1xLP x8/1xRAID slot	Front VGA	TPM 1.2	XClarity Enterprise	1x750W Platinum	3-year	07/17
7X06A05XNA	NA	1xXeon Gold 5118 12C/2.3GHz/16.5MB/105W/DDR4-2400	1x32GB RDIMM DDR4-2666	None	24x2.5"	None	None	None	None	None	1xLP x8/1xRAID slot	Front VGA	TPM 1.2	XClarity Enterprise	1x750W Platinum	3-year	07/17

Model	Region	Processor	Memory	Storage Controller	Chassis	Disk Bays	Disks	M.2 Drives	GPU	Networking (LOM/ML2/PCIe)	Available PCIe Slots	Front VGA	Security	System Management	Power Supply	Base Warranty	Ann Date (mm/yy)
7X06A04WAU	ANZ	1xXeon Gold 5115 10C/2.4GHz/13.75MB/85W/DDR4-2400	1x16GB RDIMM DDR4-2666	1x930-8i 2GB flash	24x2.5"	8x2.5" SATA/SAS HS	Open	None	None	None	1xLP x8/1xRAID slot	None	TPM 1.2	XClarity Advanced	1x750W Platinum	3-year	07/17
7X06A050AU	ANZ	1xXeon Gold 6148 20C/2.4GHz/27.5MB/150W/DDR4-2666	1x32GB RDIMM DDR4-2666	1x930-8i 2GB flash	24x2.5"	8x2.5" SATA/SAS HS	Open	None	None	None	1xLP x8/1xRAID slot	None	TPM 1.2	XClarity Standard	1x1100W Platinum	3-year	07/17
7X06A051AU	ANZ	1xXeon Gold 6152 22C/2.1GHz/30.25MB/140W/DDR4-2666	1x32GB RDIMM DDR4-2666	1x930-8i 2GB flash	24x2.5"	8x2.5" SATA/SAS HS	Open	None	None	None	1xLP x8/1xRAID slot	None	TPM 1.2	XClarity Standard	1x1100W Platinum	3-year	07/17
7X06A052AU	ANZ	1xXeon Gold 6140 18C/2.3GHz/24.75MB/140W/DDR4-2666	1x32GB RDIMM DDR4-2666	1x930-8i 2GB flash	24x2.5"	8x2.5" SATA/SAS HS	Open	None	None	None	1xLP x8/1xRAID slot	None	TPM 1.2	XClarity Standard	1x1100W Platinum	3-year	07/17
7X06A054AU	ANZ	1xXeon Gold 6130 16C/2.1GHz/22MB/125W/DDR4-2666	1x32GB RDIMM DDR4-2666	1x930-8i 2GB flash	24x2.5"	8x2.5" SATA/SAS HS	Open	None	None	None	1xLP x8/1xRAID slot	None	TPM 1.2	XClarity Standard	1x750W Platinum	3-year	07/17
7X06A04YAU	ANZ	1xXeon Platinum 8160 24C/2.1GHz/33MB/150W/DDR4-2666	1x32GB RDIMM DDR4-2666	1x930-8i 2GB flash	24x2.5"	8x2.5" SATA/SAS HS	Open	None	None	None	1xLP x8/1xRAID slot	None	TPM 1.2	XClarity Standard	1x1100W Platinum	3-year	07/17
7X06A05CAU	ANZ	2xXeon Gold 5120 14C/2.2GHz/19.25MB/105W/DDR4-2400	2x32GB RDIMM DDR4-2666	1x430-16i	24x2.5"	16x2.5" HS (12 SATA/SAS, 4 AnyBay)	Open	None	None	None	3xFHHL x8/1xLP x8/1xFHFL x16/1xFHHL x16/1xRAID slot	None	TPM 1.2	XClarity Enterprise	1x1100W Platinum	3-year	07/17
7X06A05DAU	ANZ	1xXeon Gold 5120 14C/2.2GHz/19.25MB/105W/DDR4-2400	1x16GB RDIMM DDR4-2666	1x930-8i 2GB flash	24x2.5"	8x2.5" SATA/SAS HS	Open	None	None	None	1xLP x8/1xRAID slot	None	TPM 1.2	XClarity Standard	1x750W Platinum	3-year	07/17
7X06A059AU	ANZ	1xXeon Platinum 8164 26C/2.0GHz/35.75MB/150W/DDR4-2666	1x32GB RDIMM DDR4-2666	1x930-8i 2GB flash	24x2.5"	8x2.5" SATA/SAS HS	Open	None	None	None	1xLP x8/1xRAID slot	None	TPM 1.2	XClarity Standard	1x1100W Platinum	3-year	07/17
7X06A05GAU	ANZ	1xXeon Gold 6150 18C/2.7GHz/24.75MB/165W/DDR4-2666	1x32GB RDIMM DDR4-2666	1x930-8i 2GB flash	24x2.5"	8x2.5" SATA/SAS HS	Open	None	None	None	1xLP x8/1xRAID slot	None	TPM 1.2	XClarity Standard	1x1100W Platinum	3-year	07/17
7X06A05HAU	ANZ	1xXeon Gold 6126 12C/2.6GHz/19.25MB/125W/DDR4-2666	1x32GB RDIMM DDR4-2666	1x930-8i 2GB flash	24x2.5"	8x2.5" SATA/SAS HS	Open	None	None	None	1xLP x8/1xRAID slot	None	TPM 1.2	XClarity Standard	1x750W Platinum	3-year	07/17
7X06A068AU	ANZ	1xXeon Gold 6126T 12C/2.6GHz/19.25MB/125W/DDR4-2666	1x32GB RDIMM DDR4-2666	1x930-8i 2GB flash	24x2.5"	8x2.5" SATA/SAS HS	Open	None	None	None	1xLP x8/1xRAID slot	None	TPM 1.2	XClarity Standard	1x750W Platinum	3-year	07/17
7X06A06FAU	ANZ	1xXeon Gold 6152 22C/2.1GHz/30.25MB/140W/DDR4-2666	1x32GB RDIMM DDR4-2666	1x930-8i 2GB flash	24x2.5"	8x2.5" SATA/SAS HS	Open	None	None	None	1xLP x8/1xRAID slot	None	TPM 1.2	XClarity Standard	1x1100W Platinum	3-year	07/17
7X06A06GAU	ANZ	1xXeon Gold 6134 8C/3.2GHz/24.75MB/130W/DDR4-2666	1x32GB RDIMM DDR4-2666	1x930-8i 2GB flash	24x2.5"	8x2.5" SATA/SAS HS	Open	None	None	None	1xLP x8/1xRAID slot	None	TPM 1.2	XClarity Standard	1x1100W Platinum	3-year	07/17
7X06A06HAU	ANZ	1xXeon Gold 6140 18C/2.3GHz/24.75MB/140W/DDR4-2666	1x16GB RDIMM DDR4-2666	1x930-8i 2GB flash	16x2.5"	8x2.5" SATA/SAS HS	Open	None	None	4xGbE RJ-45 LOM	1xLP x8/1xRAID slot	None	TPM 1.2	XClarity Standard	1x1100W Platinum	3-year	07/17

Model	Region	Processor	Memory	Storage Controller	Chassis	Disk Bays	Disks	M.2 Drives	GPU	Networking (LOM/ML2/PCIe)	Available PCIe Slots	Front VGA	Security	System Management	Power Supply	Base Warranty	Ann Date (mm/yy)
7X06A06JAU	ANZ	1xXeon Gold 5115 10C/2.4GHz/13.75MB/85W/DDR4-2400	1x16GB RDIMM DDR4-2666	1x530-8i	16x2.5"	8x2.5" SATA/SAS HS	Open	None	None	4xGbE RJ-45 LOM	1xLP x8/1xRAID slot	None	TPM 1.2	XClarity Standard	1x550W Platinum	3-year	07/17
7X06A06KAU	ANZ	1xXeon Gold 6148 20C/2.4GHz/27.5MB/150W/DDR4-2666	1x32GB RDIMM DDR4-2666	1x930-8i 2GB flash	24x2.5"	8x2.5" SATA/SAS HS	Open	None	None	None	1xLP x8/1xRAID slot	None	TPM 1.2	XClarity Standard	1x1100W Platinum	3-year	07/17
7X06A06LAU	ANZ	1xXeon Gold 6140 18C/2.3GHz/24.75MB/140W/DDR4-2666	1x32GB RDIMM DDR4-2666	1x930-8i 2GB flash	24x2.5"	8x2.5" SATA/SAS HS	Open	None	None	None	1xLP x8/1xRAID slot	None	TPM 1.2	XClarity Standard	1x1100W Platinum	3-year	07/17
7X06A06MAU	ANZ	1xXeon Platinum 8160 24C/2.1GHz/33MB/150W/DDR4-2666	1x32GB RDIMM DDR4-2666	1x930-8i 2GB flash	24x2.5"	8x2.5" SATA/SAS HS	Open	None	None	None	1xLP x8/1xRAID slot	None	TPM 1.2	XClarity Standard	1x1100W Platinum	3-year	07/17
7X06A06PAU	ANZ	1xXeon Gold 5115 10C/2.4GHz/13.75MB/85W/DDR4-2400	1x8GB RDIMM DDR4-2666	1x530-8i	16x2.5"	8x2.5" SATA/SAS HS	Open	None	None	4xGbE RJ-45 LOM	1xLP x8/1xRAID slot	None	TPM 1.2	XClarity Standard	1x550W Platinum	3-year	07/17
7X06A06QAU	ANZ	1xXeon Gold 5118 12C/2.3GHz/16.5MB/105W/DDR4-2400	1x16GB RDIMM DDR4-2666	1x930-8i 2GB flash	16x2.5"	8x2.5" SATA/SAS HS	Open	None	None	4xGbE RJ-45 LOM	1xLP x8/1xRAID slot	None	TPM 1.2	XClarity Standard	1x750W Platinum	3-year	07/17
7X06A06RAU	ANZ	1xXeon Gold 6150 18C/2.7GHz/24.75MB/165W/DDR4-2666	1x32GB RDIMM DDR4-2666	1x930-8i 2GB flash	24x2.5"	8x2.5" SATA/SAS HS	Open	None	None	None	1xLP x8/1xRAID slot	None	TPM 1.2	XClarity Standard	1x1100W Platinum	3-year	07/17
7X06A06SAU	ANZ	1xXeon Gold 5120 14C/2.2GHz/19.25MB/105W/DDR4-2400	1x16GB RDIMM DDR4-2666	1x930-8i 2GB flash	16x2.5"	8x2.5" SATA/SAS HS	Open	None	None	4xGbE RJ-45 LOM	1xLP x8/1xRAID slot	None	TPM 1.2	XClarity Standard	1x750W Platinum	3-year	07/17
7X06A06TAU	ANZ	1xXeon Gold 5118 12C/2.3GHz/16.5MB/105W/DDR4-2400	1x16GB RDIMM DDR4-2666	1x930-16i 4GB flash	12x3.5"	12x3.5" SATA/SAS HS	Open	None	None	4xGbE RJ-45 LOM	1xLP x8/1xRAID slot	None	TPM 1.2	XClarity Standard	1x750W Platinum	3-year	07/17
7X06A06UAU	ANZ	1xXeon Gold 6142 16C/2.6GHz/22MB/150W/DDR4-2666	1x32GB RDIMM DDR4-2666	1x930-8i 2GB flash	24x2.5"	8x2.5" SATA/SAS HS	Open	None	None	None	1xLP x8/1xRAID slot	None	TPM 1.2	XClarity Standard	1x1100W Platinum	3-year	07/17
7X06A06VAU	ANZ	1xXeon Gold 5120 14C/2.2GHz/19.25MB/105W/DDR4-2400	1x16GB RDIMM DDR4-2666	1x930-16i 4GB flash	16x2.5"	16x2.5" SATA/SAS HS	Open	None	None	4xGbE RJ-45 LOM	1xLP x8/1xRAID slot	None	TPM 1.2	XClarity Standard	1x750W Platinum	3-year	07/17
7X06A06WAU	ANZ	1xXeon Gold 5118 12C/2.3GHz/16.5MB/105W/DDR4-2400	1x16GB RDIMM DDR4-2666	1x930-8i 2GB flash	12x3.5"	8x3.5" SATA/SAS HS	Open	None	None	4xGbE RJ-45 LOM	1xLP x8/1xRAID slot	None	TPM 1.2	XClarity Standard	1x750W Platinum	3-year	07/17
7X06A06XAU	ANZ	1xXeon Platinum 8164 26C/2.0GHz/35.75MB/150W/DDR4-2666	1x32GB RDIMM DDR4-2666	1x930-8i 2GB flash	24x2.5"	8x2.5" SATA/SAS HS	Open	None	None	None	1xLP x8/1xRAID slot	None	TPM 1.2	XClarity Standard	1x1100W Platinum	3-year	07/17
7X06A06YAU	ANZ	1xXeon Platinum 8160 24C/2.1GHz/33MB/150W/DDR4-2666	1x16GB RDIMM DDR4-2666	1x930-16i 4GB flash	16x2.5"	16x2.5" SATA/SAS HS	Open	None	None	4xGbE RJ-45 LOM	1xLP x8/1xRAID slot	None	TPM 1.2	XClarity Standard	1x1100W Platinum	3-year	07/17
7X06A06ZAU	ANZ	1xXeon Gold 6130 16C/2.1GHz/22MB/125W/DDR4-2666	1x16GB RDIMM DDR4-2666	1x930-8i 2GB flash	16x2.5"	8x2.5" SATA/SAS HS	Open	None	None	4xGbE RJ-45 LOM	1xLP x8/1xRAID slot	None	TPM 1.2	XClarity Standard	1x750W Platinum	3-year	07/17

Model	Region	Processor	Memory	Storage Controller	Chassis	Disk Bays	Disks	M.2 Drives	GPU	Networking (LOM/ML2/PCIe)	Available PCIe Slots	Front VGA	Security	System Management	Power Supply	Base Warranty	Ann Date (mm/yy)
7X06A05NAU	ANZ	1xXeon Gold 5118 12C/2.3GHz/16.5MB/105W/DDR4-2400	1x16GB RDIMM DDR4-2666	1x930-8i 2GB flash	24x2.5"	8x2.5" SATA/SAS HS	Open	None	None	None	1xLP x8/1xRAID slot	None	TPM 1.2	XClarity Standard	1x750W Platinum	3-year	07/17
7X06A05PAU	ANZ	1xXeon Gold 6134 8C/3.2GHz/24.75MB/130W/DDR4-2666	1x32GB RDIMM DDR4-2666	1x930-8i 2GB flash	24x2.5"	8x2.5" SATA/SAS HS	Open	None	None	None	1xLP x8/1xRAID slot	None	TPM 1.2	XClarity Standard	1x1100W Platinum	3-year	07/17
7X06A05RAU	ANZ	1xXeon Gold 6142 16C/2.6GHz/22MB/150W/DDR4-2666	1x32GB RDIMM DDR4-2666	1x930-8i 2GB flash	24x2.5"	8x2.5" SATA/SAS HS	Open	None	None	None	1xLP x8/1xRAID slot	None	TPM 1.2	XClarity Standard	1x1100W Platinum	3-year	07/17
7X06A05SAU	ANZ	1xXeon Gold 6134 8C/3.2GHz/24.75MB/130W/DDR4-2666	1x32GB RDIMM DDR4-2666	1x930-8i 2GB flash	24x2.5"	8x2.5" SATA/SAS HS	Open	None	None	None	1xLP x8/1xRAID slot	None	TPM 1.2	XClarity Standard	1x750W Platinum	3-year	07/17

ThinkSystem SR650 - Non TopSeller - ASEAN

Product Specifications Reference (PSREF)

Model	Region	Processor	Memory	Storage Controller	Chassis	Disk Bays	Disks	M.2 Drives	GPU	Networking (LOM/ML2/PCIe)	Available PCIe Slots	Front VGA	Security	System Management	Power Supply	Base Warranty	Ann Date (mm/yy)
7X06A03TSG	ASEAN	1xXeon Gold 6148 20C/2.4GHz/27.5MB/150W/DDR4-2666	1x32GB RDIMM DDR4-2666	1x530-8i	24x2.5"	8x2.5" SATA/SAS HS	Open	None	None	4x10GbE RJ-45 LOM	1xLP x8/1xRAID slot	None	TPM 1.2	XClarity Advanced	1x1100W Platinum	3-year	07/17
7X06A03USG	ASEAN	1xXeon Gold 6140 18C/2.3GHz/24.75MB/140W/DDR4-2666	1x16GB RDIMM DDR4-2666	1x530-8i	24x2.5"	8x2.5" SATA/SAS HS	Open	None	None	4x10GbE RJ-45 LOM	1xLP x8/1xRAID slot	None	TPM 1.2	XClarity Advanced	1x1100W Platinum	3-year	07/17
7X06A03VSG	ASEAN	1xXeon Gold 6152 22C/2.1GHz/30.25MB/140W/DDR4-2666	1x32GB RDIMM DDR4-2666	1x530-8i	24x2.5"	8x2.5" SATA/SAS HS	Open	None	None	4x10GbE RJ-45 LOM	1xLP x8/1xRAID slot	None	TPM 1.2	XClarity Advanced	1x1100W Platinum	3-year	07/17
7X06A03XSG	ASEAN	1xXeon Gold 6130 16C/2.1GHz/22MB/125W/DDR4-2666	1x16GB RDIMM DDR4-2666	1x530-8i	24x2.5"	8x2.5" SATA/SAS HS	Open	None	None	4x10GbE RJ-45 LOM	1xLP x8/1xRAID slot	None	TPM 1.2	XClarity Advanced	1x1100W Platinum	3-year	07/17
7X06A042SG	ASEAN	1xXeon Gold 6134 8C/3.2GHz/24.75MB/130W/DDR4-2666	1x16GB RDIMM DDR4-2666	1x530-8i	24x2.5"	8x2.5" SATA/SAS HS	Open	None	None	4x10GbE RJ-45 LOM	1xLP x8/1xRAID slot	None	TPM 1.2	XClarity Advanced	1x1100W Platinum	3-year	07/17
7X06A03FSG	ASEAN	1xXeon Gold 5115 10C/2.4GHz/13.75MB/85W/DDR4-2400	1x16GB RDIMM DDR4-2666	1x530-8i	24x2.5"	8x2.5" SATA/SAS HS	Open	None	None	4x10GbE RJ-45 LOM	1xLP x8/1xRAID slot	None	TPM 1.2	XClarity Advanced	1x750W Platinum	3-year	07/17
7X06A03JSG	ASEAN	1xXeon Gold 5118 12C/2.3GHz/16.5MB/105W/DDR4-2400	1x16GB RDIMM DDR4-2666	1x530-8i	24x2.5"	8x2.5" SATA/SAS HS	Open	None	None	4x10GbE RJ-45 LOM	1xLP x8/1xRAID slot	None	TPM 1.2	XClarity Advanced	1x750W Platinum	3-year	07/17
7X06A03RSG	ASEAN	1xXeon Gold 5115 10C/2.4GHz/13.75MB/85W/DDR4-2400	1x16GB RDIMM DDR4-2666	1x930-16i 4GB flash	12x3.5"	12x3.5" SATA/SAS HS	Open	None	None	4x10GbE RJ-45 LOM	1xLP x8/1xRAID slot	None	TPM 1.2	XClarity Advanced	1x1100W Platinum	3-year	07/17
7X06A034SG	ASEAN	1xXeon Gold 5120 14C/2.2GHz/19.25MB/105W/DDR4-2400	1x16GB RDIMM DDR4-2666	1x530-8i	24x2.5"	8x2.5" SATA/SAS HS	Open	None	None	4x10GbE RJ-45 LOM	1xLP x8/1xRAID slot	None	TPM 1.2	XClarity Advanced	1x750W Platinum	3-year	07/17



Model	Region	Processor	Memory	Storage Controller	Chassis	Disk Bays	Disks	M.2 Drives	GPU	Networking (LOM/ML2/PCIe)	Available PCIe Slots	Front VGA	Security	System Management	Power Supply	Base Warranty	Ann Date (mm/yy)
7X06A035EA	EMEA	1xXeon Bronze 3104 6C/1.7GHz/8.25MB/85W/DDR4-2133	1x8GB RDIMM DDR4-2666	1x530-8i	24x2.5"	8x2.5" SATA/SAS HS	Open	None	None	None	1xLP x8/1xRAID slot	None	TPM 1.2	XClarity Standard	1x550W Platinum	3-year	07/17
7X06A036EA	EMEA	1xXeon Gold 5118 12C/2.3GHz/16.5MB/105W/DDR4-2400	1x16GB RDIMM DDR4-2666	1x930-8i 2GB flash	24x2.5"	8x2.5" SATA/SAS HS	Open	None	None	None	1xLP x8/1xRAID slot	None	TPM 1.2	XClarity Standard	1x750W Platinum	3-year	07/17
7X06A037EA	EMEA	1xXeon Silver 4108 8C/1.8GHz/11MB/85W/DDR4-2400	1x16GB RDIMM DDR4-2666	1x530-8i	24x2.5"	8x2.5" SATA/SAS HS	Open	None	None	None	1xLP x8/1xRAID slot	None	TPM 1.2	XClarity Standard	1x750W Platinum	3-year	07/17
7X06A038EA	EMEA	2xXeon Silver 4110 8C/2.1GHz/11MB/85W/DDR4-2400	2x32GB RDIMM DDR4-2666	1x430-16i	24x2.5"	16x2.5" HS (12 SATA/SAS, 4 AnyBay)	Open	None	None	None	1xLP x8/1xRAID slot	None	TPM 1.2	XClarity Enterprise	1x1100W Platinum	3-year	07/17
7X06A033EA	EMEA	2xXeon Gold 5120 14C/2.2GHz/19.25MB/105W/DDR4-2400	2x32GB RDIMM DDR4-2666	1x430-16i	24x2.5"	16x2.5" HS (12 SATA/SAS, 4 AnyBay)	Open	None	None	None	1xLP x8/1xFHFL x16/1xFHHL x16/1xRAID slot	None	TPM 1.2	XClarity Enterprise	1x1100W Platinum	3-year	07/17
7X06A02SEA	EMEA	1xXeon Gold 6134 8C/3.2GHz/24.75MB/130W/DDR4-2666	1x32GB RDIMM DDR4-2666	1x930-8i 2GB flash	24x2.5"	8x2.5" SATA/SAS HS	Open	None	None	None	1xLP x8/1xRAID slot	None	TPM 1.2	XClarity Standard	1x1100W Platinum	3-year	07/17
7X06A02WEA	EMEA	1xXeon Silver 4114 10C/2.2GHz/13.75MB/85W/DDR4-2400	1x16GB RDIMM DDR4-2666	1x930-8i 2GB flash	24x2.5"	8x2.5" SATA/SAS HS	Open	None	None	None	1xLP x8/1xRAID slot	None	TPM 1.2	XClarity Standard	1x750W Platinum	3-year	07/17
7X06A02XEA	EMEA	1xXeon Gold 6134 8C/3.2GHz/24.75MB/130W/DDR4-2666	1x32GB RDIMM DDR4-2666	1x930-8i 2GB flash	24x2.5"	8x2.5" SATA/SAS HS	Open	None	None	None	1xLP x8/1xRAID slot	None	TPM 1.2	XClarity Standard	1x750W Platinum	3-year	07/17
7X06A02YEA	EMEA	1xXeon Gold 6140 18C/2.3GHz/24.75MB/140W/DDR4-2666	1x32GB RDIMM DDR4-2666	1x930-8i 2GB flash	24x2.5"	8x2.5" SATA/SAS HS	Open	None	None	None	1xLP x8/1xRAID slot	None	TPM 1.2	XClarity Standard	1x1100W Platinum	3-year	07/17
7X06A03SEA	EMEA	1xXeon Silver 4108 8C/1.8GHz/11MB/85W/DDR4-2400	1x16GB RDIMM DDR4-2666	1x930-8i 2GB flash	24x2.5"	8x2.5" SATA/SAS HS	Open	None	None	None	1xLP x8/1xRAID slot	None	TPM 1.2	XClarity Standard	1x750W Platinum	3-year	07/17
7X06A03LEA	EMEA	1xXeon Platinum 8160 24C/2.1GHz/33MB/150W/DDR4-2666	1x32GB RDIMM DDR4-2666	1x930-8i 2GB flash	24x2.5"	8x2.5" SATA/SAS HS	Open	None	None	None	1xLP x8/1xRAID slot	None	TPM 1.2	XClarity Standard	1x1100W Platinum	3-year	07/17
7X06A03MEA	EMEA	1xXeon Platinum 8164 26C/2.0GHz/35.75MB/150W/DDR4-2666	1x32GB RDIMM DDR4-2666	1x930-8i 2GB flash	24x2.5"	8x2.5" SATA/SAS HS	Open	None	None	None	1xLP x8/1xRAID slot	None	TPM 1.2	XClarity Standard	1x1100W Platinum	3-year	07/17
7X06A03NEA	EMEA	1xXeon Gold 6152 22C/2.1GHz/30.25MB/140W/DDR4-2666	1x32GB RDIMM DDR4-2666	1x930-8i 2GB flash	24x2.5"	8x2.5" SATA/SAS HS	Open	None	None	None	1xLP x8/1xRAID slot	None	TPM 1.2	XClarity Standard	1x1100W Platinum	3-year	07/17
7X06A03PEA	EMEA	1xXeon Gold 6130 16C/2.1GHz/22MB/125W/DDR4-2666	1x32GB RDIMM DDR4-2666	1x930-8i 2GB flash	24x2.5"	8x2.5" SATA/SAS HS	Open	None	None	None	1xLP x8/1xRAID slot	None	TPM 1.2	XClarity Standard	1x750W Platinum	3-year	07/17
7X06A03QEA	EMEA	1xXeon Gold 6150 18C/2.7GHz/24.75MB/165W/DDR4-2666	1x32GB RDIMM DDR4-2666	1x930-8i 2GB flash	24x2.5"	8x2.5" SATA/SAS HS	Open	None	None	None	1xLP x8/1xRAID slot	None	TPM 1.2	XClarity Standard	1x1100W Platinum	3-year	07/17

Model	Region	Processor	Memory	Storage Controller	Chassis	Disk Bays	Disks	M.2 Drives	GPU	Networking (LOM/ML2/PCIe)	Available PCIe Slots	Front VGA	Security	System Management	Power Supply	Base Warranty	Ann Date (mm/yy)
7X06A03EEA	EMEA	1xXeon Gold 6142 16C/2.6GHz/22MB/150W/DDR4-2666	1x32GB RDIMM DDR4-2666	1x930-8i 2GB flash	24x2.5"	8x2.5" SATA/SAS HS	Open	None	None	None	1xLP x8/1xRAID slot	None	TPM 1.2	XClarity Standard	1x1100W Platinum	3-year	07/17
7X06A03HEA	EMEA	1xXeon Gold 6148 20C/2.4GHz/27.5MB/150W/DDR4-2666	1x32GB RDIMM DDR4-2666	1x930-8i 2GB flash	24x2.5"	8x2.5" SATA/SAS HS	Open	None	None	None	1xLP x8/1xRAID slot	None	TPM 1.2	XClarity Standard	1x1100W Platinum	3-year	07/17
7X06A03AEA	EMEA	1xXeon Gold 5115 10C/2.4GHz/13.75MB/85W/DDR4-2400	1x16GB RDIMM DDR4-2666	1x930-8i 2GB flash	24x2.5"	8x2.5" SATA/SAS HS	Open	None	None	None	1xLP x8/1xRAID slot	None	TPM 1.2	XClarity Standard	1x750W Platinum	3-year	07/17
7X06A03BEA	EMEA	1xXeon Silver 4116 12C/2.1GHz/16.5MB/85W/DDR4-2400	1x16GB RDIMM DDR4-2666	1x930-8i 2GB flash	24x2.5"	8x2.5" SATA/SAS HS	Open	None	None	None	1xLP x8/1xRAID slot	None	TPM 1.2	XClarity Standard	1x750W Platinum	3-year	07/17
7X06A03CEA	EMEA	1xXeon Silver 4110 8C/2.1GHz/11MB/85W/DDR4-2400	1x16GB RDIMM DDR4-2666	1x930-8i 2GB flash	24x2.5"	8x2.5" SATA/SAS HS	Open	None	None	None	1xLP x8/1xRAID slot	None	TPM 1.2	XClarity Standard	1x750W Platinum	3-year	07/17
7X06A03WEA	EMEA	1xXeon Silver 4114 10C/2.2GHz/13.75MB/85W/DDR4-2400	1x16GB RDIMM DDR4-2666	1x930-16i 4GB flash	12x3.5"	12x3.5" SATA/SAS HS	Open	None	None	None	1xLP x8/1xRAID slot	None	TPM 1.2	XClarity Standard	1x750W Platinum	3-year	07/17
7X06A044EA	EMEA	1xXeon Gold 6126 12C/2.6GHz/19.25MB/125W/DDR4-2666	1x32GB RDIMM DDR4-2666	1x930-8i 2GB flash	24x2.5"	8x2.5" SATA/SAS HS	Open	None	None	None	1xLP x8/1xRAID slot	None	TPM 1.2	XClarity Standard	1x750W Platinum	3-year	07/17
7X06A045EA	EMEA	1xXeon Silver 4110 8C/2.1GHz/11MB/85W/DDR4-2400	1x16GB RDIMM DDR4-2666	1x530-8i	24x2.5"	8x2.5" SATA/SAS HS	Open	None	None	None	1xLP x8/1xRAID slot	None	TPM 1.2	XClarity Standard	1x750W Platinum	3-year	07/17
7X06A041EA	EMEA	1xXeon Gold 5120 14C/2.2GHz/19.25MB/105W/DDR4-2400	1x16GB RDIMM DDR4-2666	1x930-8i 2GB flash	24x2.5"	8x2.5" SATA/SAS HS	Open	None	None	None	1xLP x8/1xRAID slot	None	TPM 1.2	XClarity Standard	1x750W Platinum	3-year	07/17

Model	Region	Processor	Memory	Storage Controller	Chassis	Disk Bays	Disks	M.2 Drives	GPU	Networking (LOM/ML2/PCIe)	Available PCIe Slots	Front VGA	Security	System Management	Power Supply	Base Warranty	Ann Date (mm/yy)
7X06A055CN	HTK	1xXeon Silver 4114 10C/2.2GHz/13.75MB/85W/DDR4-2400	1x16GB RDIMM DDR4-2666	1x930-8i 2GB flash	16x2.5"	8x2.5" SATA/SAS HS	Open	None	None	4xGbE RJ-45 LOM	3xFHHL x8/1xLP x8/1xRAID slot	None	TPM 1.2	XClarity Standard	1x750W Platinum	3-year	07/17
7X06A05ECN	HTK	1xXeon Bronze 3104 6C/1.7GHz/8.25MB/85W/DDR4-2133	1x16GB RDIMM DDR4-2666	1x930-8i 2GB flash	16x2.5"	8x2.5" SATA/SAS HS	Open	None	None	4xGbE RJ-45 LOM	3xFHHL x8/1xLP x8/1xRAID slot	None	TPM 1.2	XClarity Standard	1x750W Platinum	3-year	07/17
7X06A05FCN	HTK	1xXeon Silver 4108 8C/1.8GHz/11MB/85W/DDR4-2400	1x16GB RDIMM DDR4-2666	1x930-16i 4GB flash	12x3.5"	12x3.5" SATA/SAS HS	Open	None	None	4xGbE RJ-45 LOM	3xFHHL x8/1xLP x8/1xRAID slot	None	TPM 1.2	XClarity Standard	1x750W Platinum	3-year	07/17
7X06A04XCN	HTK	1xXeon Silver 4110 8C/2.1GHz/11MB/85W/DDR4-2400	1x16GB RDIMM DDR4-2666	1x930-8i 2GB flash	16x2.5"	8x2.5" SATA/SAS HS	Open	None	None	4xGbE RJ-45 LOM	3xFHHL x8/1xLP x8/1xRAID slot	None	TPM 1.2	XClarity Standard	1x750W Platinum	3-year	07/17
7X06A053CN	HTK	1xXeon Bronze 3106 8C/1.7GHz/11MB/85W/DDR4-2133	1x16GB RDIMM DDR4-2666	1x930-16i 4GB flash	12x3.5"	12x3.5" SATA/SAS HS	Open	None	None	4xGbE RJ-45 LOM	3xFHHL x8/1xLP x8/1xRAID slot	None	TPM 1.2	XClarity Standard	1x750W Platinum	3-year	07/17
7X06A04VCN	HTK	1xXeon Silver 4112 4C/2.6GHz/8.25MB/85W/DDR4-2400	1x16GB RDIMM DDR4-2666	1x930-8i 2GB flash	16x2.5"	8x2.5" SATA/SAS HS	Open	None	None	4xGbE RJ-45 LOM	3xFHHL x8/1xLP x8/1xRAID slot	None	TPM 1.2	XClarity Standard	1x750W Platinum	3-year	07/17
7X06A00ZCN	HTK	1xXeon Gold 6136 12C/3.0GHz/24.75MB/150W/DDR4-2666	1x16GB RDIMM DDR4-2666	1x930-8i 2GB flash	16x2.5"	8x2.5" SATA/SAS HS	Open	None	None	4xGbE RJ-45 LOM	3xFHHL x8/1xLP x8/1xRAID slot	None	TPM 1.2	XClarity Standard	1x750W Platinum	3-year	07/17
7X06A00UCN	HTK	1xXeon Gold 6148 20C/2.4GHz/27.5MB/150W/DDR4-2666	1x16GB RDIMM DDR4-2666	1x930-8i 2GB flash	16x2.5"	8x2.5" SATA/SAS HS	Open	None	None	4xGbE RJ-45 LOM	3xFHHL x8/1xLP x8/1xRAID slot	None	TPM 1.2	XClarity Standard	1x750W Platinum	3-year	07/17
7X06A00QCN	HTK	1xXeon Gold 6140 18C/2.3GHz/24.75MB/140W/DDR4-2666	1x16GB RDIMM DDR4-2666	1x930-8i 2GB flash	16x2.5"	8x2.5" SATA/SAS HS	Open	None	None	4xGbE RJ-45 LOM	3xFHHL x8/1xLP x8/1xRAID slot	None	TPM 1.2	XClarity Standard	1x750W Platinum	3-year	07/17
7X06A00MCN	HTK	1xXeon Gold 6130 16C/2.1GHz/22MB/125W/DDR4-2666	1x16GB RDIMM DDR4-2666	1x930-8i 2GB flash	16x2.5"	8x2.5" SATA/SAS HS	Open	None	None	4xGbE RJ-45 LOM	3xFHHL x8/1xLP x8/1xRAID slot	None	TPM 1.2	XClarity Standard	1x750W Platinum	3-year	07/17
7X06A00GCN	HTK	1xXeon Gold 6134 8C/3.2GHz/24.75MB/130W/DDR4-2666	1x16GB RDIMM DDR4-2666	1x930-8i 2GB flash	16x2.5"	8x2.5" SATA/SAS HS	Open	None	None	4xGbE RJ-45 LOM	3xFHHL x8/1xLP x8/1xRAID slot	None	TPM 1.2	XClarity Standard	1x750W Platinum	3-year	07/17
7X06A003CN	HTK	1xXeon Gold 5118 12C/2.3GHz/16.5MB/105W/DDR4-2400	1x16GB RDIMM DDR4-2666	1x930-8i 2GB flash	16x2.5"	8x2.5" SATA/SAS HS	Open	None	None	4xGbE RJ-45 LOM	3xFHHL x8/1xLP x8/1xRAID slot	None	TPM 1.2	XClarity Standard	1x750W Platinum	3-year	07/17
7X06A005CN	HTK	1xXeon Gold 5120 14C/2.2GHz/19.25MB/105W/DDR4-2400	1x16GB RDIMM DDR4-2666	1x930-8i 2GB flash	16x2.5"	8x2.5" SATA/SAS HS	Open	None	None	4xGbE RJ-45 LOM	3xFHHL x8/1xLP x8/1xRAID slot	None	TPM 1.2	XClarity Standard	1x750W Platinum	3-year	07/17
7X06A007CN	HTK	1xXeon Gold 5122 4C/3.6GHz/16.5MB/105W/DDR4-2400	1x16GB RDIMM DDR4-2666	1x930-8i 2GB flash	16x2.5"	8x2.5" SATA/SAS HS	Open	None	None	4xGbE RJ-45 LOM	3xFHHL x8/1xLP x8/1xRAID slot	None	TPM 1.2	XClarity Standard	1x750W Platinum	3-year	07/17
7X06A00ECN	HTK	1xXeon Gold 5115 10C/2.4GHz/13.75MB/85W/DDR4-2400	1x16GB RDIMM DDR4-2666	1x930-8i 2GB flash	16x2.5"	8x2.5" SATA/SAS HS	Open	None	None	4xGbE RJ-45 LOM	3xFHHL x8/1xLP x8/1xRAID slot	None	TPM 1.2	XClarity Standard	1x750W Platinum	3-year	07/17

Model	Region	Processor	Memory	Storage Controller	Chassis	Disk Bays	Disks	M.2 Drives	GPU	Networking (LOM/ML2/PCIe)	Available PCIe Slots	Front VGA	Security	System Management	Power Supply	Base Warranty	Ann Date (mm/yy)	
7X06A01QCN	HTK	1xXeon Gold 6134 8C/3.2GHz/24.75MB/130W/DDR4-2666	1x16GB RDIMM DDR4-2666	1x930-16i 4GB flash	12x3.5"	12x3.5"	SATA/SAS HS	Open	None	None	4xGbE RJ-45 LOM	3xFHHL x8/1xLP x8/1xRAID slot	None	TPM 1.2	XClarity Standard	1x750W Platinum	3-year	07/17
7X06A02FCN	HTK	1xXeon Gold 6152 22C/2.1GHz/30.25MB/140W/DDR4-2666	1x16GB RDIMM DDR4-2666	1x930-8i 2GB flash	16x2.5"	8x2.5"	SATA/SAS HS	Open	None	None	4xGbE RJ-45 LOM	3xFHHL x8/1xLP x8/1xRAID slot	None	TPM 1.2	XClarity Standard	1x750W Platinum	3-year	07/17
7X06A02HCN	HTK	1xXeon Gold 5115 10C/2.4GHz/13.75MB/85W/DDR4-2400	1x16GB RDIMM DDR4-2666	1x930-16i 4GB flash	16x2.5"	16x2.5"	SATA/SAS HS	Open	None	None	4xGbE RJ-45 LOM	3xFHHL x8/1xLP x8/1xRAID slot	None	TPM 1.2	XClarity Standard	1x750W Platinum	3-year	07/17
7X06A02JCN	HTK	1xXeon Gold 5115 10C/2.4GHz/13.75MB/85W/DDR4-2400	1x16GB RDIMM DDR4-2666	1x930-16i 4GB flash	12x3.5"	12x3.5"	SATA/SAS HS	Open	None	None	4xGbE RJ-45 LOM	3xFHHL x8/1xLP x8/1xRAID slot	None	TPM 1.2	XClarity Standard	1x750W Platinum	3-year	07/17
7X06A02KCN	HTK	1xXeon Gold 6140 18C/2.3GHz/24.75MB/140W/DDR4-2666	1x16GB RDIMM DDR4-2666	1x930-16i 4GB flash	12x3.5"	12x3.5"	SATA/SAS HS	Open	None	None	4xGbE RJ-45 LOM	3xFHHL x8/1xLP x8/1xRAID slot	None	TPM 1.2	XClarity Standard	1x750W Platinum	3-year	07/17
7X06A02LCN	HTK	1xXeon Gold 6148 20C/2.4GHz/27.5MB/150W/DDR4-2666	1x16GB RDIMM DDR4-2666	1x930-16i 4GB flash	12x3.5"	12x3.5"	SATA/SAS HS	Open	None	None	4xGbE RJ-45 LOM	3xFHHL x8/1xLP x8/1xRAID slot	None	TPM 1.2	XClarity Standard	1x750W Platinum	3-year	07/17
7X06A01TCN	HTK	1xXeon Gold 6136 12C/3.0GHz/24.75MB/150W/DDR4-2666	1x16GB RDIMM DDR4-2666	1x930-16i 4GB flash	12x3.5"	12x3.5"	SATA/SAS HS	Open	None	None	4xGbE RJ-45 LOM	3xFHHL x8/1xLP x8/1xRAID slot	None	TPM 1.2	XClarity Standard	1x750W Platinum	3-year	07/17
7X06A01UCN	HTK	1xXeon Gold 5118 12C/2.3GHz/16.5MB/105W/DDR4-2400	1x16GB RDIMM DDR4-2666	1x930-16i 4GB flash	12x3.5"	12x3.5"	SATA/SAS HS	Open	None	None	4xGbE RJ-45 LOM	3xFHHL x8/1xLP x8/1xRAID slot	None	TPM 1.2	XClarity Standard	1x750W Platinum	3-year	07/17
7X06A01VCN	HTK	1xXeon Gold 5120 14C/2.2GHz/19.25MB/105W/DDR4-2400	1x16GB RDIMM DDR4-2666	1x930-16i 4GB flash	12x3.5"	12x3.5"	SATA/SAS HS	Open	None	None	4xGbE RJ-45 LOM	3xFHHL x8/1xLP x8/1xRAID slot	None	TPM 1.2	XClarity Standard	1x750W Platinum	3-year	07/17
7X06A01YCN	HTK	1xXeon Gold 5122 4C/3.6GHz/16.5MB/105W/DDR4-2400	1x16GB RDIMM DDR4-2666	1x930-16i 4GB flash	12x3.5"	12x3.5"	SATA/SAS HS	Open	None	None	4xGbE RJ-45 LOM	3xFHHL x8/1xLP x8/1xRAID slot	None	TPM 1.2	XClarity Standard	1x750W Platinum	3-year	07/17
7X06A020CN	HTK	1xXeon Gold 6130 16C/2.1GHz/22MB/125W/DDR4-2666	1x16GB RDIMM DDR4-2666	1x930-16i 4GB flash	12x3.5"	12x3.5"	SATA/SAS HS	Open	None	None	4xGbE RJ-45 LOM	3xFHHL x8/1xLP x8/1xRAID slot	None	TPM 1.2	XClarity Standard	1x750W Platinum	3-year	07/17
7X06A021CN	HTK	1xXeon Silver 4114 10C/2.2GHz/13.75MB/85W/DDR4-2400	1x16GB RDIMM DDR4-2666	1x930-8i 2GB flash	16x2.5"	8x2.5"	SATA/SAS HS	Open	None	None	4xGbE RJ-45 LOM	3xFHHL x8/1xLP x8/1xRAID slot	None	TPM 1.2	XClarity Standard	1x750W Platinum	3-year	07/17
7X06A02QCN	HTK	1xXeon Gold 6152 22C/2.1GHz/30.25MB/140W/DDR4-2666	1x16GB RDIMM DDR4-2666	1x930-16i 4GB flash	12x3.5"	12x3.5"	SATA/SAS HS	Open	None	None	4xGbE RJ-45 LOM	3xFHHL x8/1xLP x8/1xRAID slot	None	TPM 1.2	XClarity Standard	1x750W Platinum	3-year	07/17
7X06A05TCN	HTK	1xXeon Silver 4116 12C/2.1GHz/16.5MB/85W/DDR4-2400	1x16GB RDIMM DDR4-2666	1x930-16i 4GB flash	12x3.5"	12x3.5"	SATA/SAS HS	Open	None	None	4xGbE RJ-45 LOM	3xFHHL x8/1xLP x8/1xRAID slot	None	TPM 1.2	XClarity Standard	1x750W Platinum	3-year	07/17
7X06A05UCN	HTK	1xXeon Silver 4116 12C/2.1GHz/16.5MB/85W/DDR4-2400	1x16GB RDIMM DDR4-2666	1x930-8i 2GB flash	16x2.5"	8x2.5"	SATA/SAS HS	Open	None	None	4xGbE RJ-45 LOM	3xFHHL x8/1xLP x8/1xRAID slot	None	TPM 1.2	XClarity Standard	1x750W Platinum	3-year	07/17

Model	Region	Processor	Memory	Storage Controller	Chassis	Disk Bays	Disks	M.2 Drives	GPU	Networking (LOM/ML2/PCIe)	Available PCIe Slots	Front VGA	Security	System Management	Power Supply	Base Warranty	Ann Date (mm/yy)	
7X06A05VCN	HTK	1xXeon Silver 4114 10C/2.2GHz/13.75MB/85W/DDR4-2400	1x16GB RDIMM DDR4-2666	1x930-16i 4GB flash	12x3.5"	12x3.5"	SATA/SAS HS	Open	None	None	4xGbE RJ-45 LOM	3xFHHL x8/1xLP x8/1xRAID slot	None	TPM 1.2	XClarity Standard	1x750W Platinum	3-year	07/17
7X06A05WCN	HTK	1xXeon Bronze 3106 8C/1.7GHz/11MB/85W/DDR4-2133	1x16GB RDIMM DDR4-2666	1x930-8i 2GB flash	16x2.5"	8x2.5"	SATA/SAS HS	Open	None	None	4xGbE RJ-45 LOM	3xFHHL x8/1xLP x8/1xRAID slot	None	TPM 1.2	XClarity Standard	1x750W Platinum	3-year	07/17
7X06A05QCN	HTK	1xXeon Silver 4110 8C/2.1GHz/11MB/85W/DDR4-2400	1x16GB RDIMM DDR4-2666	1x930-16i 4GB flash	12x3.5"	12x3.5"	SATA/SAS HS	Open	None	None	4xGbE RJ-45 LOM	3xFHHL x8/1xLP x8/1xRAID slot	None	TPM 1.2	XClarity Standard	1x750W Platinum	3-year	07/17
7X06A05KCN	HTK	1xXeon Silver 4112 4C/2.6GHz/8.25MB/85W/DDR4-2400	1x16GB RDIMM DDR4-2666	1x930-16i 4GB flash	12x3.5"	12x3.5"	SATA/SAS HS	Open	None	None	4xGbE RJ-45 LOM	3xFHHL x8/1xLP x8/1xRAID slot	None	TPM 1.2	XClarity Standard	1x750W Platinum	3-year	07/17
7X06A05LCN	HTK	1xXeon Silver 4108 8C/1.8GHz/11MB/85W/DDR4-2400	1x16GB RDIMM DDR4-2666	1x930-8i 2GB flash	16x2.5"	8x2.5"	SATA/SAS HS	Open	None	None	4xGbE RJ-45 LOM	3xFHHL x8/1xLP x8/1xRAID slot	None	TPM 1.2	XClarity Standard	1x750W Platinum	3-year	07/17
7X06A05MCN	HTK	1xXeon Bronze 3104 6C/1.7GHz/8.25MB/85W/DDR4-2133	1x16GB RDIMM DDR4-2666	1x930-16i 4GB flash	12x3.5"	12x3.5"	SATA/SAS HS	Open	None	None	4xGbE RJ-45 LOM	3xFHHL x8/1xLP x8/1xRAID slot	None	TPM 1.2	XClarity Standard	1x750W Platinum	3-year	07/17

Model	Region	Processor	Memory	Storage Controller	Chassis	Disk Bays	Disks	M.2 Drives	GPU	Networking (LOM/ML2/PCIe)	Available PCIe Slots	Front VGA	Security	System Management	Power Supply	Base Warranty	Ann Date (mm/yy)
7X06A00FSG	INDIA	1xXeon Gold 5115 10C/2.4GHz/13.75MB/85W/DDR4-2400	1x16GB RDIMM DDR4-2666	1x530-8i	16x2.5"	8x2.5" SATA/SAS HS	Open	None	None	4xGbE RJ-45 LOM	x8/1xRAID slot	None	TPM 1.2	XClarity Standard	1x550W Platinum	3-year	07/17
7X06A00ASG	INDIA	1xXeon Gold 5118 12C/2.3GHz/16.5MB/105W/DDR4-2400	1x16GB RDIMM DDR4-2666	1x930-8i 2GB flash	16x2.5"	8x2.5" SATA/SAS HS	Open	None	None	4xGbE RJ-45 LOM	x8/1xRAID slot	None	TPM 1.2	XClarity Standard	1x750W Platinum	3-year	07/17
7X06A00CSG	INDIA	1xXeon Gold 5118 12C/2.3GHz/16.5MB/105W/DDR4-2400	1x16GB RDIMM DDR4-2666	1x930-8i 2GB flash	12x3.5"	8x3.5" SATA/SAS HS	Open	None	None	4xGbE RJ-45 LOM	x8/1xRAID slot	None	TPM 1.2	XClarity Standard	1x750W Platinum	3-year	07/17
7X06A00JSG	INDIA	1xXeon Gold 5115 10C/2.4GHz/13.75MB/85W/DDR4-2400	1x8GB RDIMM DDR4-2666	1x530-8i	16x2.5"	8x2.5" SATA/SAS HS	Open	None	None	4xGbE RJ-45 LOM	x8/1xRAID slot	None	TPM 1.2	XClarity Standard	1x550W Platinum	3-year	07/17
7X06A00RSG	INDIA	1xXeon Gold 5120 14C/2.2GHz/19.25MB/105W/DDR4-2400	1x16GB RDIMM DDR4-2666	1x930-16i 4GB flash	16x2.5"	16x2.5" SATA/SAS HS	Open	None	None	4xGbE RJ-45 LOM	x8/1xRAID slot	None	TPM 1.2	XClarity Standard	1x750W Platinum	3-year	07/17
7X06A00SSG	INDIA	1xXeon Gold 5120 14C/2.2GHz/19.25MB/105W/DDR4-2400	1x16GB RDIMM DDR4-2666	1x930-8i 2GB flash	16x2.5"	8x2.5" SATA/SAS HS	Open	None	None	4xGbE RJ-45 LOM	x8/1xRAID slot	None	TPM 1.2	XClarity Standard	1x750W Platinum	3-year	07/17
7X06A00TSG	INDIA	1xXeon Gold 5118 12C/2.3GHz/16.5MB/105W/DDR4-2400	1x16GB RDIMM DDR4-2666	1x930-16i 4GB flash	12x3.5"	12x3.5" SATA/SAS HS	Open	None	None	4xGbE RJ-45 LOM	x8/1xRAID slot	None	TPM 1.2	XClarity Standard	1x750W Platinum	3-year	07/17
7X06A00WSG	INDIA	1xXeon Platinum 8160 24C/2.1GHz/33MB/150W/DDR4-2666	1x16GB RDIMM DDR4-2666	1x930-16i 4GB flash	16x2.5"	16x2.5" SATA/SAS HS	Open	None	None	4xGbE RJ-45 LOM	x8/1xRAID slot	None	TPM 1.2	XClarity Standard	1x1100W Platinum	3-year	07/17
7X06A00XSG	INDIA	1xXeon Gold 6140 18C/2.3GHz/24.75MB/140W/DDR4-2666	1x16GB RDIMM DDR4-2666	1x930-8i 2GB flash	16x2.5"	8x2.5" SATA/SAS HS	Open	None	None	4xGbE RJ-45 LOM	x8/1xRAID slot	None	TPM 1.2	XClarity Standard	1x1100W Platinum	3-year	07/17
7X06A00YSG	INDIA	1xXeon Gold 6130 16C/2.1GHz/22MB/125W/DDR4-2666	1x16GB RDIMM DDR4-2666	1x930-8i 2GB flash	16x2.5"	8x2.5" SATA/SAS HS	Open	None	None	4xGbE RJ-45 LOM	x8/1xRAID slot	None	TPM 1.2	XClarity Standard	1x750W Platinum	3-year	07/17

ThinkSystem SR650 - Non TopSeller - JAPAN

Product Specifications Reference (PSREF)

Model	Region	Processor	Memory	Storage Controller	Chassis	Disk Bays	Disks	M.2 Drives	GPU	Networking (LOM/ML2/PCIe)	Available PCIe Slots	Front VGA	Security	System Management	Power Supply	Base Warranty	Ann Date (mm/yy)
7X06A01JJP	JAPAN	1xXeon Bronze 3104 6C/1.7GHz/8.25MB/85W/DDR4-2133	1x16GB RDIMM DDR4-2666	1x930-8i 2GB flash	24x2.5"	8x2.5" SATA/SAS HS	Open	None	None	4xGbE RJ-45 LOM	3xFHHL x8/1xLP x8/1xRAID slot	None	TPM 1.2	XClarity Advanced	1x550W Platinum	3-year	07/17
7X06A05JJP	JAPAN	1xXeon Platinum 8160 24C/2.1GHz/33MB/150W/DDR4-2666	1x16GB RDIMM DDR4-2666	1x930-24i 4GB Flash	24x2.5"	24x2.5" HS (20 SATA/SAS, 4 AnyBay)	Open	None	None	4x10GbE RJ-45 LOM	3xFHHL x8/1xLP x8/1xRAID slot	Front VGA	TPM 1.2	XClarity Advanced	1x1600W Platinum	3-year	07/17
7X06A056JP	JAPAN	1xXeon Gold 6134 8C/3.2GHz/24.75MB/130W/DDR4-2666	1x16GB RDIMM DDR4-2666	1x930-24i 4GB Flash	24x2.5"	24x2.5" HS (20 SATA/SAS, 4 AnyBay)	Open	None	None	4x10GbE RJ-45 LOM	3xFHHL x8/1xLP x8/1xRAID slot	Front VGA	TPM 1.2	XClarity Advanced	1x1100W Platinum	3-year	07/17
7X06A058JP	JAPAN	1xXeon Gold 5122 4C/3.6GHz/16.5MB/105W/DDR4-2400	1x16GB RDIMM DDR4-2666	1x930-8i 2GB flash	24x2.5"	8x2.5" SATA/SAS HS	Open	None	None	4x10GbE RJ-45 LOM	3xFHHL x8/1xLP x8/1xRAID slot	Front VGA	TPM 1.2	XClarity Advanced	1x750W Platinum	3-year	07/17
7X06A05YJP	JAPAN	1xXeon Platinum 8180 28C/2.5GHz/38.5MB/205W/DDR4-2666	1x16GB RDIMM DDR4-2666	1x930-8i 2GB flash	24x2.5"	8x2.5" SATA/SAS HS	Open	None	None	4x10GbE RJ-45 LOM	3xFHHL x8/1xLP x8/1xRAID slot	Front VGA	TPM 1.2	XClarity Advanced	1x1100W Platinum	3-year	07/17

ThinkSystem SR650 - Non TopSeller - LA

Product Specifications Reference (PSREF)

Model	Region	Processor	Memory	Storage Controller	Chassis	Disk Bays	Disks	M.2 Drives	GPU	Networking (LOM/ML2/PCIe)	Available PCIe Slots	Front VGA	Security	System Management	Power Supply	Base Warranty	Ann Date (mm/yy)
7X06A023LA	LA	1xXeon Gold 6130 16C/2.1GHz/22MB/125W/DDR4-2666	1x16GB RDIMM DDR4-2666	1x930-8i 2GB flash	16x2.5"	8x2.5" SATA/SAS HS	Open	None	None	None	3xFHHL x8/1xLP x8/1xRAID slot	Front VGA	TPM 1.2	XClarity Standard	1x1100W Platinum	3-year	07/17
7X06A026LA	LA	1xXeon Gold 6148 20C/2.4GHz/27.5MB/150W/DDR4-2666	1x16GB RDIMM DDR4-2666	1x930-8i 2GB flash	16x2.5"	8x2.5" SATA/SAS HS	Open	None	None	None	3xFHHL x8/1xLP x8/1xRAID slot	Front VGA	TPM 1.2	XClarity Standard	1x1100W Platinum	3-year	07/17
7X06A01WLA	LA	1xXeon Platinum 8160 24C/2.1GHz/33MB/150W/DDR4-2666	1x16GB RDIMM DDR4-2666	1x930-8i 2GB flash	16x2.5"	8x2.5" SATA/SAS HS	Open	None	None	None	3xFHHL x8/1xLP x8/1xRAID slot	Front VGA	TPM 1.2	XClarity Standard	1x1100W Platinum	3-year	07/17
7X06A02NLA	LA	1xXeon Gold 6130 16C/2.1GHz/22MB/125W/DDR4-2666	1x16GB RDIMM DDR4-2666	1x930-8i 2GB flash	16x2.5"	8x2.5" SATA/SAS HS	Open	None	None	None	3xFHHL x8/1xLP x8/1xRAID slot	Front VGA	TPM 1.2	XClarity Standard	1x1100W Platinum	3-year	07/17
7X06A02ALA	LA	1xXeon Gold 5120 14C/2.2GHz/19.25MB/105W/DDR4-2400	1x16GB RDIMM DDR4-2666	1x930-8i 2GB flash	16x2.5"	8x2.5" SATA/SAS HS	Open	None	None	None	3xFHHL x8/1xLP x8/1xRAID slot	Front VGA	TPM 1.2	XClarity Standard	1x750W Platinum	3-year	07/17
7X06A01CLA	LA	1xXeon Gold 6148 20C/2.4GHz/27.5MB/150W/DDR4-2666	1x16GB RDIMM DDR4-2666	1x930-8i 2GB flash	16x2.5"	8x2.5" SATA/SAS HS	Open	None	None	None	3xFHHL x8/1xLP x8/1xRAID slot	Front VGA	TPM 1.2	XClarity Standard	1x1100W Platinum	3-year	07/17
7X06A00VLA	LA	1xXeon Gold 6140 18C/2.3GHz/24.75MB/140W/DDR4-2666	1x16GB RDIMM DDR4-2666	1x930-8i 2GB flash	16x2.5"	8x2.5" SATA/SAS HS	Open	None	None	None	3xFHHL x8/1xLP x8/1xRAID slot	Front VGA	TPM 1.2	XClarity Standard	1x1100W Platinum	3-year	07/17
7X06A016LA	LA	1xXeon Platinum 8160 24C/2.1GHz/33MB/150W/DDR4-2666	1x16GB RDIMM DDR4-2666	1x930-8i 2GB flash	16x2.5"	8x2.5" SATA/SAS HS	Open	None	None	None	3xFHHL x8/1xLP x8/1xRAID slot	Front VGA	TPM 1.2	XClarity Standard	1x1100W Platinum	3-year	07/17
7X06A008LA	LA	1xXeon Gold 6140 18C/2.3GHz/24.75MB/140W/DDR4-2666	1x16GB RDIMM DDR4-2666	1x930-8i 2GB flash	16x2.5"	8x2.5" SATA/SAS HS	Open	None	None	None	3xFHHL x8/1xLP x8/1xRAID slot	Front VGA	TPM 1.2	XClarity Standard	1x1100W Platinum	3-year	07/17
7X06A006LA	LA	1xXeon Gold 5120 14C/2.2GHz/19.25MB/105W/DDR4-2400	1x16GB RDIMM DDR4-2666	1x930-8i 2GB flash	16x2.5"	8x2.5" SATA/SAS HS	Open	None	None	None	3xFHHL x8/1xLP x8/1xRAID slot	Front VGA	TPM 1.2	XClarity Standard	1x750W Platinum	3-year	07/17



Model	Region	Processor	Memory	Storage Controller	Chassis	Disk Bays	Disks	M.2 Drives	GPU	Networking (LOM/ML2/PCIe)	Available PCIe Slots	Front VGA	Security	System Management	Power Supply	Base Warranty	Ann Date (mm/yy)
7X06A02CNA	NA	1xXeon Gold 6126 12C/2.6GHz/19.25MB/125W/DDR4-2666	1x32GB RDIMM DDR4-2666	None	24x2.5"	None	None	None	None	None	1xLP x8/1xRAID slot	Front VGA	TPM 1.2	XClarity Standard	1x750W Platinum	3-year	07/17
7X06A039NA	NA	1xXeon Gold 6130 16C/2.1GHz/22MB/125W/DDR4-2666	1x32GB RDIMM DDR4-2666	1x930-8i 2GB flash	24x2.5"	8x2.5" SATA/SAS HS	Open	None	None	None	1xLP x8/1xRAID slot	None	TPM 1.2	XClarity Standard	1x750W Platinum	3-year	07/17
7X06A02ZNA	NA	1xXeon Gold 6152 22C/2.1GHz/30.25MB/140W/DDR4-2666	1x32GB RDIMM DDR4-2666	1x930-8i 2GB flash	24x2.5"	8x2.5" SATA/SAS HS	Open	None	None	None	1xLP x8/1xRAID slot	None	TPM 1.2	XClarity Standard	1x1100W Platinum	3-year	07/17
7X06A030NA	NA	1xXeon Gold 5120 14C/2.2GHz/19.25MB/105W/DDR4-2400	1x16GB RDIMM DDR4-2666	1x930-8i 2GB flash	24x2.5"	8x2.5" SATA/SAS HS	Open	None	None	None	1xLP x8/1xRAID slot	None	TPM 1.2	XClarity Standard	1x750W Platinum	3-year	07/17
7X06A031NA	NA	1xXeon Platinum 8160 24C/2.1GHz/33MB/150W/DDR4-2666	1x32GB RDIMM DDR4-2666	1x930-8i 2GB flash	24x2.5"	8x2.5" SATA/SAS HS	Open	None	None	None	1xLP x8/1xRAID slot	None	TPM 1.2	XClarity Standard	1x1100W Platinum	3-year	07/17
7X06A032NA	NA	1xXeon Gold 6142 16C/2.6GHz/22MB/150W/DDR4-2666	1x32GB RDIMM DDR4-2666	1x930-8i 2GB flash	24x2.5"	8x2.5" SATA/SAS HS	Open	None	None	None	1xLP x8/1xRAID slot	None	TPM 1.2	XClarity Standard	1x1100W Platinum	3-year	07/17
7X06A02TNA	NA	1xXeon Gold 6134 8C/3.2GHz/24.75MB/130W/DDR4-2666	1x32GB RDIMM DDR4-2666	1x930-8i 2GB flash	24x2.5"	8x2.5" SATA/SAS HS	Open	None	None	None	1xLP x8/1xRAID slot	None	TPM 1.2	XClarity Standard	1x750W Platinum	3-year	07/17
7X06A02UNA	NA	1xXeon Gold 6150 18C/2.7GHz/24.75MB/165W/DDR4-2666	1x32GB RDIMM DDR4-2666	1x930-8i 2GB flash	24x2.5"	8x2.5" SATA/SAS HS	Open	None	None	None	1xLP x8/1xRAID slot	None	TPM 1.2	XClarity Standard	1x1100W Platinum	3-year	07/17
7X06A02VNA	NA	1xXeon Gold 6140 18C/2.3GHz/24.75MB/140W/DDR4-2666	1x32GB RDIMM DDR4-2666	1x930-8i 2GB flash	24x2.5"	8x2.5" SATA/SAS HS	Open	None	None	None	1xLP x8/1xRAID slot	None	TPM 1.2	XClarity Standard	1x1100W Platinum	3-year	07/17
7X06A046NA	NA	1xXeon Gold 6126 12C/2.6GHz/19.25MB/125W/DDR4-2666	1x32GB RDIMM DDR4-2666	1x930-8i 2GB flash	24x2.5"	8x2.5" SATA/SAS HS	Open	None	None	None	1xLP x8/1xRAID slot	None	TPM 1.2	XClarity Standard	1x750W Platinum	3-year	07/17
7X06A043NA	NA	2xXeon Gold 5120 14C/2.2GHz/19.25MB/105W/DDR4-2400	2x32GB RDIMM DDR4-2666	1x430-16i	24x2.5"	16x2.5" HS (12 SATA/SAS, 4 AnyBay)	Open	None	None	None	3xFHLL x8/1xLP x8/1xFHFL x16/1xFHLL x16/1xRAID slot	None	TPM 1.2	XClarity Enterprise	2x1100W Platinum	3-year	07/17
7X06A03ZNA	NA	1xXeon Gold 5118 12C/2.3GHz/16.5MB/105W/DDR4-2400	1x16GB RDIMM DDR4-2666	1x930-8i 2GB flash	24x2.5"	8x2.5" SATA/SAS HS	Open	None	None	None	1xLP x8/1xRAID slot	None	TPM 1.2	XClarity Standard	1x750W Platinum	3-year	07/17
7X06A040NA	NA	1xXeon Gold 6134 8C/3.2GHz/24.75MB/130W/DDR4-2666	1x32GB RDIMM DDR4-2666	1x930-8i 2GB flash	24x2.5"	8x2.5" SATA/SAS HS	Open	None	None	None	1xLP x8/1xRAID slot	None	TPM 1.2	XClarity Standard	1x1100W Platinum	3-year	07/17
7X06A03DNA	NA	1xXeon Platinum 8164 26C/2.0GHz/35.75MB/150W/DDR4-2666	1x32GB RDIMM DDR4-2666	1x930-8i 2GB flash	24x2.5"	8x2.5" SATA/SAS HS	Open	None	None	None	1xLP x8/1xRAID slot	None	TPM 1.2	XClarity Standard	1x1100W Platinum	3-year	07/17
7X06A03GNA	NA	1xXeon Gold 5115 10C/2.4GHz/13.75MB/85W/DDR4-2400	1x16GB RDIMM DDR4-2666	1x930-8i 2GB flash	24x2.5"	8x2.5" SATA/SAS HS	Open	None	None	None	1xLP x8/1xRAID slot	None	TPM 1.2	XClarity Standard	1x750W Platinum	3-year	07/17

Model	Region	Processor	Memory	Storage Controller	Chassis	Disk Bays	Disks	M.2 Drives	GPU	Networking (LOM/ML2/PCIe)	Available PCIe Slots	Front VGA	Security	System Management	Power Supply	Base Warranty	Ann Date (mm/yy)	
7X06A03KNA	NA	1xXeon Gold 6148 20C/2.4GHz/27.5MB/150W/DDR4-2666	1x32GB RDIMM DDR4-2666	1x930-8i 2GB flash	24x2.5"	8x2.5"	SATA/SAS HS	Open	None	None	None	1xLP x8/1xRAID slot	None	TPM 1.2	XClarity Standard	1x1100W Platinum	3-year	07/17



# ThinkSystem ST550 Platform Specifications

Product Specifications Reference (PSREF)

Components	Specification	
Form factor	Tower or 4U rack	
Dimensions	Without foot stands and security door: Height: 425.5 mm (16.8 in). Width: 175.8 mm (6.92 in). Depth: 666.4 mm (26.24 in)	
Weight	Maximum configuration: 81.35 lb (36.9 kg)	
Processor	Up to two 125W Intel Xeon Scalable family processors, Bronze, Silver, Gold, or Platinum. Up to 20 cores at 2.0GHz, up to 3.6GHz with 4 cores. Two processors are connected with two UPI (Ultra Path Interconnect) links up to 10.4GT/s	
Chipset	Intel C621 Platform Controller Hub	
Memory	Up to 12 DIMM sockets. Each processor supports up to 6 DIMM sockets with 6 channels. DDR4-2666. RDIMMs and LRDIMMs are supported, but memory types cannot be intermixed	
Memory capacity	With RDIMMs: Up to 384GB with 12 x 32 GB RDIMMs and two processors With LRDIMMs: Up to 768GB with 12 x 64 GB LRDIMMs and two processors	
Memory protection	ECC, memory mirroring, and memory sparing	
Storage controllers	Supports the following RAID/HBA adapters:	
Note: 730-8i is available in China only. All RAID/HBA adapters should be placed in slot 1 firstly.		
Disk drive bays	Supports 4 or 8 front 3.5" SATA simple-swap bays. Or 4 or 8 front 3.5" SATA/SAS HS bays. Or 8 or 16 front 2.5" SATA/SAS HS bays with maximum 4 AnyBay. Optional 4 front 2.5" HS bays are supported on hot-swap models, takes place in two 5.25" bays location Optional one or two internal M.2 SSD for boot, dual M.2 SSD supports mirroring	
Internal storage	For 3.5" SS bay	
	For 3.5" bay	
	(3.5" disks or 2.5" disks with 3.5" tray)	
	For 2.5" bay	
Optical	Two 5.25" bays for optical and tape drive. Supports DVD-ROM or DVD±RW drives, half-height. Supports LTO-6 SAS, LTO-7 SAS, and RDX USB 3.0 tape drives	
Network interfaces	Integrated one dedicated management port plus two GbE ports. Optional PCIe adapters are supported. NC-SI and Wake-on-LAN are available on GbE port 1 (See right)	
Security features	Power-on and admin password. Trusted Platform Module, TCG 1.2 compliant, upgrade to 2.0 via UEFI setting. Optional TCM in China only. Optional lockable security bezel. Optional chassis intrusion switch	
Operating systems supported	Microsoft Windows Server 2016/2012 R2. Red Hat Enterprise Linux 7.3/6.9. SUSE Linux Enterprise Server 12 SP2/11 SP4. VMware vSphere (ESXi) 6.5/6.0 U3	
Systems management	XClarity Controller Standard, optional upgrades to Advanced or Enterprise are available. Energy Manager. XClarity Administrator. Provisioning Manager. Essentials. LEDs on front panel show the status of power, ID, network, simple-swap disks, and system error	
GPU support	Up to two optional NVIDIA Quadro P2000 or Quadro P6000	

Components	Specification
Base warranty	MT 7X09: 1-year limited onsite service with 9x5/NBD MT 7X10: 3-year limited onsite service with 9x5/NBD
Power supply	Supports one fixed 450W 80 PLUS Gold qualified AC power supply, non-hot-swap, no redundant. Or up to two redundant hot-swap 550W/750W/1100W 80 PLUS Platinum qualified AC power supplies. Or up to two redundant hot-swap 750W Titanium qualified AC power supplies. 750W Titanium is 200V - 240V, others are 100V - 240V
Video	Integrated Matrox G200 in XClarity Controller
Cooling	Up to four fans with one for redundant. Two fans for single processor, three fans for dual processor or single processor with 4 x 2.5" HS bay installed. 4th fan is N + 1 redundant or GPU installed
Front ports	One XClarity Controller USB connector, one USB 3.0
Rear ports	One VGA, two USB 3.0, four USB 2.0, two ethernet (RJ-45), one XClarity Controller network connector. Optional COM port
Environmental specification	Supports ASHRAE A4 with limitations.
Environmental certification	Energy Star Server 2.1 certified. More environmental information please see: <a href="http://www.lenovo.com/social_responsibility/us/en/environment/">www.lenovo.com/social_responsibility/us/en/environment/</a>

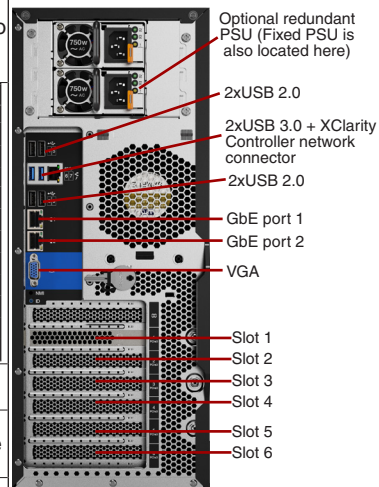

Expansion slots	
Slot 1 (CPU1)	PCIe 3.0 x8, full height, half length
Slot 2 (CPU1)	PCIe 3.0 x16, full height, half length
Slot 3 (CPU1)	PCIe 3.0 x16, full height, full length, double-width
Slot 4 (CPU2)	PCIe 3.0 x16 (x8 elec), full height, full length
Slot 5 (CPU2)	PCIe 3.0 x16, full height, full length, double-width
Slot 6 (CPU1)	PCIe 3.0 x8 (x4 elec), full height, full length

Note: All expansion cards and redundant PSU are optional.

## System unique options

7X77A03475	ThinkSystem ST550 2.5" SATA/SAS 4-Bay Backplane Kit
7X77A03476	ThinkSystem ST550 2.5" Anybay 8-Bay Backplane Kit
7TP7A04369	ThinkSystem ST550 2.5" 8-Bay Backplane Kit
7TP7A04370	ThinkSystem ST550 3.5" SATA/SAS 4-Bay Backplane kit
7X77A03481	ThinkSystem ST550 3.5" Simple Swap Bracket Plate
7X77A03484	ThinkSystem ST550 4U Security Bezel
7X77A03485	ThinkSystem ST550 CMA kit
7X77A03488	ThinkSystem ST550 4U Tower to Rack Conversion Kit
7Z17A02577	ThinkSystem ST550 COM Port Upgrade Kit
7XH7A06781	ThinkSystem ST550 Front Mid FAN Module for 4x2.5" ODD conversion
7TP7A04371	ThinkSystem ST550 Rear FAN Module for RDN FAN

Model	Region	Processor	Memory	Storage Controller	Chassis	Disk Bays	Disks	M.2 Drives	Optical	GPU	Networking (PCIe)	Security	System Management	Power Supply	Base Warranty	Ann Date (mm/yy)
7X10A029AU	ANZ	1xXeon Bronze 3106 8C/1.7GHz/11MB/85W/DDR4-2133	1x16GB RDIMM DDR4-2666	1x530-8i	16x2.5"	8x2.5" SATA/SAS HS	Open	None	DVD±RW HH	None	None	Security Bezel/Chassis Intrusion Switch/TPM 1.2	XClarity Standard	1x750W Platinum	3-year	07/17
7X10A02BAU	ANZ	1xXeon Gold 5115 10C/2.4GHz/13.75MB/85W/DDR4-2400	1x16GB RDIMM DDR4-2666	1x930-8i 2GB flash	16x2.5"	8x2.5" SATA/SAS HS	Open	None	DVD±RW HH	None	None	Security Bezel/Chassis Intrusion Switch/TPM 1.2	XClarity Standard	2x750W Platinum	3-year	07/17
7X10A02DAU	ANZ	1xXeon Silver 4110 8C/2.1GHz/11MB/85W/DDR4-2400	4x16GB RDIMM DDR4-2666	1x930-8i 2GB flash	16x2.5"	8x2.5" SATA/SAS HS	2x600GB HDD 10K 2.5" SAS12Gbps	None	DVD±RW HH	None	None	Security Bezel/Chassis Intrusion Switch/TPM 1.2	XClarity Standard	2x750W Platinum	3-year	07/17
7X10A02EAU	ANZ	1xXeon Silver 4114 10C/2.2GHz/13.75MB/85W/DDR4-2400	1x16GB RDIMM DDR4-2666	1x930-8i 2GB flash	8x3.5"	8x3.5" SATA/SAS HS	Open	None	None	None	None	Security Bezel/Chassis Intrusion Switch/TPM 1.2	XClarity Standard	1x750W Platinum	3-year	07/17
7X10A02GAU	ANZ	1xXeon Silver 4110 8C/2.1GHz/11MB/85W/DDR4-2400	1x16GB RDIMM DDR4-2666	1x930-8i 2GB flash	16x2.5"	8x2.5" SATA/SAS HS	3x300GB HDD 10K 2.5" SAS12Gbps	None	DVD±RW HH	None	None	Security Bezel/Chassis Intrusion Switch/TPM 1.2	XClarity Standard	2x750W Platinum	3-year	07/17
7X10A02JAU	ANZ	1xXeon Silver 4114 10C/2.2GHz/13.75MB/85W/DDR4-2400	1x16GB RDIMM DDR4-2666	1x930-8i 2GB flash	16x2.5"	8x2.5" SATA/SAS HS	Open	None	None	None	None	Security Bezel/Chassis Intrusion Switch/TPM 1.2	XClarity Standard	1x750W Platinum	3-year	07/17
7X10A02TAU	ANZ	1xXeon Bronze 3104 6C/1.7GHz/8.25MB/85W/DDR4-2133	1x16GB RDIMM DDR4-2666	1x530-8i	16x2.5"	8x2.5" SATA/SAS HS	Open	None	DVD±RW HH	None	None	Security Bezel/Chassis Intrusion Switch/TPM 1.2	XClarity Standard	1x750W Platinum	3-year	07/17
7X10A02VAU	ANZ	1xXeon Silver 4108 8C/1.8GHz/11MB/85W/DDR4-2400	1x16GB RDIMM DDR4-2666	1x930-8i 2GB flash	16x2.5"	8x2.5" SATA/SAS HS	Open	None	DVD±RW HH	None	None	Security Bezel/Chassis Intrusion Switch/TPM 1.2	XClarity Standard	1x750W Platinum	3-year	07/17
7X10A032AU	ANZ	1xXeon Silver 4108 8C/1.8GHz/11MB/85W/DDR4-2400	1x16GB RDIMM DDR4-2666	1x930-8i 2GB flash	16x2.5"	8x2.5" SATA/SAS HS	3x300GB HDD 10K 2.5" SAS12Gbps	None	DVD±RW HH	None	None	Security Bezel/Chassis Intrusion Switch/TPM 1.2	XClarity Standard	2x750W Platinum	3-year	07/17
7X10A036AU	ANZ	1xXeon Silver 4110 8C/2.1GHz/11MB/85W/DDR4-2400	1x16GB RDIMM DDR4-2666	1x930-8i 2GB flash	16x2.5"	8x2.5" SATA/SAS HS	Open	None	None	None	None	Security Bezel/Chassis Intrusion Switch/TPM 1.2	XClarity Standard	1x750W Platinum	3-year	07/17
7X10A038AU	ANZ	1xXeon Silver 4116 12C/2.1GHz/16.5MB/85W/DDR4-2400	1x16GB RDIMM DDR4-2666	1x930-8i 2GB flash	16x2.5"	8x2.5" SATA/SAS HS	Open	None	None	None	None	Security Bezel/Chassis Intrusion Switch/TPM 1.2	XClarity Standard	1x750W Platinum	3-year	07/17
7X10A03EAU	ANZ	1xXeon Bronze 3104 6C/1.7GHz/8.25MB/85W/DDR4-2133	1x16GB RDIMM DDR4-2666	1x530-8i	8x3.5"	8x3.5" SATA/SAS HS	Open	None	DVD±RW HH	None	None	Security Bezel/Chassis Intrusion Switch/TPM 1.2	XClarity Standard	1x750W Platinum	3-year	07/17
7X10A03FAU	ANZ	1xXeon Silver 4110 8C/2.1GHz/11MB/85W/DDR4-2400	1x16GB RDIMM DDR4-2666	1x930-8i 2GB flash	8x3.5"	8x3.5" SATA/SAS HS	Open	None	None	None	None	Security Bezel/Chassis Intrusion Switch/TPM 1.2	XClarity Standard	1x750W Platinum	3-year	07/17
7X10A03GAU	ANZ	1xXeon Bronze 3106 8C/1.7GHz/11MB/85W/DDR4-2133	1x16GB RDIMM DDR4-2666	1x530-8i	8x3.5"	8x3.5" SATA/SAS HS	Open	None	DVD±RW HH	None	None	Security Bezel/Chassis Intrusion Switch/TPM 1.2	XClarity Standard	1x750W Platinum	3-year	07/17
7X10A03HAU	ANZ	1xXeon Silver 4108 8C/1.8GHz/11MB/85W/DDR4-2400	1x16GB RDIMM DDR4-2666	1x930-8i 2GB flash	16x2.5"	8x2.5" SATA/SAS HS	Open	None	None	None	None	Security Bezel/Chassis Intrusion Switch/TPM 1.2	XClarity Standard	1x750W Platinum	3-year	07/17

Model	Region	Processor	Memory	Storage Controller	Chassis	Disk Bays	Disks	M.2 Drives	Optical	GPU	Networking (PCIe)	Security	System Management	Power Supply	Base Warranty	Ann Date (mm/yy)
7X10A03MAU	ANZ	1xXeon Bronze 3104 6C/1.7GHz/8.25MB/85W/DDR4-2133	1x16GB RDIMM DDR4-2666	1x930-8i 2GB flash	16x2.5"	8x2.5" SATA/SAS HS	Open	None	None	None	None	Security Bezel/Chassis Intrusion Switch/TPM 1.2	XClarity Standard	1x750W Platinum	3-year	07/17
7X10A03NAU	ANZ	1xXeon Silver 4108 8C/1.8GHz/11MB/85W/DDR4-2400	1x16GB RDIMM DDR4-2666	1x930-8i 2GB flash	16x2.5"	8x2.5" SATA/SAS HS	Open	None	DVD±RW HH	None	None	Security Bezel/Chassis Intrusion Switch/TPM 1.2	XClarity Standard	2x750W Platinum	3-year	07/17
7X10A03QAU	ANZ	1xXeon Silver 4110 8C/2.1GHz/11MB/85W/DDR4-2400	1x16GB RDIMM DDR4-2666	1x930-8i 2GB flash	16x2.5"	8x2.5" SATA/SAS HS	Open	None	DVD±RW HH	None	None	Security Bezel/Chassis Intrusion Switch/TPM 1.2	XClarity Standard	1x750W Platinum	3-year	07/17
7X10A03UUAU	ANZ	1xXeon Gold 5118 12C/2.3GHz/16.5MB/105W/DDR4-2400	1x16GB RDIMM DDR4-2666	1x930-8i 2GB flash	16x2.5"	8x2.5" SATA/SAS HS	Open	None	None	None	None	Security Bezel/Chassis Intrusion Switch/TPM 1.2	XClarity Standard	1x750W Platinum	3-year	07/17
7X10A03AAU	ANZ	1xXeon Silver 4116 12C/2.1GHz/16.5MB/85W/DDR4-2400	1x16GB RDIMM DDR4-2666	1x930-8i 2GB flash	16x2.5"	8x2.5" SATA/SAS HS	Open	None	DVD±RW HH	None	None	Security Bezel/Chassis Intrusion Switch/TPM 1.2	XClarity Standard	1x750W Platinum	3-year	07/17

Model	Region	Processor	Memory	Storage Controller	Chassis	Disk Bays	Disks	M.2 Drives	Optical	GPU	Networking (PCIe)	Security	System Management	Power Supply	Base Warranty	Ann Date (mm/yy)
7X10A03VEA	EMEA	1xXeon Silver 4110 8C/2.1GHz/11MB/85W/DDR4-2400	1x16GB RDIMM DDR4-2666	1x930-8i 2GB flash	16x2.5"	8x2.5" SATA/SAS HS	2x300GB HDD 10K 2.5" SAS12Gbps	None	DVD±RW HH	None	None	Security Bezel/Chassis Intrusion Switch/TPM 1.2	XClarity Standard	2x550W Platinum	3-year	07/17
7X10A03ZEA	EMEA	1xXeon Silver 4110 8C/2.1GHz/11MB/85W/DDR4-2400	4x32GB RDIMM DDR4-2666	1x930-8i 2GB flash	16x2.5"	8x2.5" SATA/SAS HS	3x900GB HDD 10K 2.5" SAS12Gbps	None	DVD±RW HH	None	None	Security Bezel/Chassis Intrusion Switch/TPM 1.2	XClarity Standard	2x750W Platinum	3-year	07/17
7X10A03KEA	EMEA	1xXeon Bronze 3106 8C/1.7GHz/11MB/85W/DDR4-2133	1x16GB RDIMM DDR4-2666	1x530-8i	8x3.5"	4x3.5" SATA/SAS HS	Open	None	DVD±RW HH	None	None	Security Bezel/Chassis Intrusion Switch/TPM 1.2	XClarity Standard	1x550W Platinum	3-year	07/17
7X10A039EA	EMEA	1xXeon Bronze 3106 8C/1.7GHz/11MB/85W/DDR4-2133	1x16GB RDIMM DDR4-2666	1x530-8i	8x3.5"	8x3.5" SATA/SAS HS	2x1TB HDD 7.2K 3.5" SATA6Gbps	None	None	None	None	Security Bezel/Chassis Intrusion Switch/TPM 1.2	XClarity Standard	1x550W Platinum	3-year	07/17
7X10A02YEA	EMEA	1xXeon Silver 4110 8C/2.1GHz/11MB/85W/DDR4-2400	1x16GB RDIMM DDR4-2666	1x930-8i 2GB flash	16x2.5"	8x2.5" SATA/SAS HS	Open	None	DVD±RW HH	None	None	Security Bezel/Chassis Intrusion Switch/TPM 1.2	XClarity Standard	1x550W Platinum	3-year	07/17
7X10A006EA	EMEA	1xXeon Gold 5122 4C/3.6GHz/16.5MB/105W/DDR4-2400	1x16GB RDIMM DDR4-2666	1x930-8i 2GB flash	16x2.5"	8x2.5" SATA/SAS HS	Open	None	DVD±RW HH	None	None	Security Bezel/Chassis Intrusion Switch/TPM 1.2	XClarity Standard	1x750W Platinum	3-year	07/17
7X10A00HEA	EMEA	1xXeon Gold 5115 10C/2.4GHz/13.75MB/85W/DDR4-2400	1x16GB RDIMM DDR4-2666	1x930-8i 2GB flash	16x2.5"	8x2.5" SATA/SAS HS	Open	None	DVD±RW HH	None	None	Security Bezel/Chassis Intrusion Switch/TPM 1.2	XClarity Standard	2x750W Platinum	3-year	07/17
7X10A013EA	EMEA	1xXeon Gold 5115 10C/2.4GHz/13.75MB/85W/DDR4-2400	1x16GB RDIMM DDR4-2666	1x930-8i 2GB flash	16x2.5"	8x2.5" SATA/SAS HS	Open	None	None	None	None	Security Bezel/Chassis Intrusion Switch/TPM 1.2	XClarity Standard	1x750W Platinum	3-year	07/17
7X10A02HEA	EMEA	1xXeon Gold 5118 12C/2.3GHz/16.5MB/105W/DDR4-2400	1x16GB RDIMM DDR4-2666	1x930-8i 2GB flash	16x2.5"	8x2.5" SATA/SAS HS	Open	None	None	None	None	Security Bezel/Chassis Intrusion Switch/TPM 1.2	XClarity Standard	1x750W Platinum	3-year	07/17
7X10A017EA	EMEA	1xXeon Silver 4110 8C/2.1GHz/11MB/85W/DDR4-2400	1x16GB RDIMM DDR4-2666	1x930-8i 2GB flash	16x2.5"	8x2.5" SATA/SAS HS	Open	None	DVD±RW HH	None	None	Security Bezel/Chassis Intrusion Switch/TPM 1.2	XClarity Standard	1x750W Platinum	3-year	07/17
7X10A018EA	EMEA	1xXeon Silver 4108 8C/1.8GHz/11MB/85W/DDR4-2400	1x16GB RDIMM DDR4-2666	1x930-8i 2GB flash	16x2.5"	8x2.5" SATA/SAS HS	Open	None	DVD±RW HH	None	None	Security Bezel/Chassis Intrusion Switch/TPM 1.2	XClarity Standard	1x750W Platinum	3-year	07/17
7X10A019EA	EMEA	1xXeon Silver 4108 8C/1.8GHz/11MB/85W/DDR4-2400	1x16GB RDIMM DDR4-2666	1x930-8i 2GB flash	16x2.5"	8x2.5" SATA/SAS HS	3x300GB HDD 10K 2.5" SAS12Gbps	None	DVD±RW HH	None	None	Security Bezel/Chassis Intrusion Switch/TPM 1.2	XClarity Standard	2x750W Platinum	3-year	07/17
7X10A01AEA	EMEA	1xXeon Silver 4110 8C/2.1GHz/11MB/85W/DDR4-2400	1x16GB RDIMM DDR4-2666	1x930-8i 2GB flash	16x2.5"	8x2.5" SATA/SAS HS	3x300GB HDD 10K 2.5" SAS12Gbps	None	DVD±RW HH	None	None	Security Bezel/Chassis Intrusion Switch/TPM 1.2	XClarity Standard	2x750W Platinum	3-year	07/17
7X10A01BEA	EMEA	1xXeon Silver 4116 12C/2.1GHz/16.5MB/85W/DDR4-2400	1x16GB RDIMM DDR4-2666	1x930-8i 2GB flash	16x2.5"	8x2.5" SATA/SAS HS	Open	None	None	None	None	Security Bezel/Chassis Intrusion Switch/TPM 1.2	XClarity Standard	1x750W Platinum	3-year	07/17
7X10A01CEA	EMEA	1xXeon Silver 4108 8C/1.8GHz/11MB/85W/DDR4-2400	1x16GB RDIMM DDR4-2666	1x930-8i 2GB flash	16x2.5"	8x2.5" SATA/SAS HS	Open	None	DVD±RW HH	None	None	Security Bezel/Chassis Intrusion Switch/TPM 1.2	XClarity Standard	2x750W Platinum	3-year	07/17

Model	Region	Processor	Memory	Storage Controller	Chassis	Disk Bays	Disks	M.2 Drives	Optical	GPU	Networking (PCIe)	Security	System Management	Power Supply	Base Warranty	Ann Date (mm/yy)
7X10A01DEA	EMEA	1xXeon Bronze 3106 8C/1.7GHz/11MB/85W/DDR4-2133	1x16GB RDIMM DDR4-2666	1x530-8i	16x2.5"	8x2.5" SATA/SAS HS	Open	None	DVD±RW HH	None	None	Security Bezel/Chassis Intrusion Switch/TPM 1.2	XClarity Standard	1x750W Platinum	3-year	07/17
7X10A01EEA	EMEA	1xXeon Silver 4110 8C/2.1GHz/11MB/85W/DDR4-2400	1x16GB RDIMM DDR4-2666	1x930-8i 2GB flash	16x2.5"	8x2.5" SATA/SAS HS	Open	None	None	None	None	Security Bezel/Chassis Intrusion Switch/TPM 1.2	XClarity Standard	1x750W Platinum	3-year	07/17
7X10A01FEA	EMEA	1xXeon Bronze 3106 8C/1.7GHz/11MB/85W/DDR4-2133	1x16GB RDIMM DDR4-2666	1x530-8i	8x3.5"	8x3.5" SATA/SAS HS	Open	None	DVD±RW HH	None	None	Security Bezel/Chassis Intrusion Switch/TPM 1.2	XClarity Standard	1x750W Platinum	3-year	07/17
7X10A01GEA	EMEA	1xXeon Silver 4116 12C/2.1GHz/16.5MB/85W/DDR4-2400	1x16GB RDIMM DDR4-2666	1x930-8i 2GB flash	16x2.5"	8x2.5" SATA/SAS HS	Open	None	DVD±RW HH	None	None	Security Bezel/Chassis Intrusion Switch/TPM 1.2	XClarity Standard	1x750W Platinum	3-year	07/17
7X10A01HEA	EMEA	1xXeon Bronze 3104 6C/1.7GHz/8.25MB/85W/DDR4-2133	1x16GB RDIMM DDR4-2666	1x530-8i	8x3.5"	8x3.5" SATA/SAS HS	Open	None	DVD±RW HH	None	None	Security Bezel/Chassis Intrusion Switch/TPM 1.2	XClarity Standard	1x750W Platinum	3-year	07/17
7X10A01JEA	EMEA	1xXeon Silver 4110 8C/2.1GHz/11MB/85W/DDR4-2400	1x16GB RDIMM DDR4-2666	1x930-8i 2GB flash	8x3.5"	8x3.5" SATA/SAS HS	Open	None	None	None	None	Security Bezel/Chassis Intrusion Switch/TPM 1.2	XClarity Standard	1x750W Platinum	3-year	07/17
7X10A01KEA	EMEA	1xXeon Silver 4110 8C/2.1GHz/11MB/85W/DDR4-2400	4x16GB RDIMM DDR4-2666	1x930-8i 2GB flash	16x2.5"	8x2.5" SATA/SAS HS	2x600GB HDD 10K 2.5" SAS12Gbps	None	DVD±RW HH	None	None	Security Bezel/Chassis Intrusion Switch/TPM 1.2	XClarity Standard	2x750W Platinum	3-year	07/17
7X10A01LEA	EMEA	1xXeon Silver 4108 8C/1.8GHz/11MB/85W/DDR4-2400	1x16GB RDIMM DDR4-2666	1x930-8i 2GB flash	16x2.5"	8x2.5" SATA/SAS HS	Open	None	None	None	None	Security Bezel/Chassis Intrusion Switch/TPM 1.2	XClarity Standard	1x750W Platinum	3-year	07/17
7X10A01MEA	EMEA	1xXeon Silver 4114 10C/2.2GHz/13.75MB/85W/DDR4-2400	1x16GB RDIMM DDR4-2666	1x930-8i 2GB flash	8x3.5"	8x3.5" SATA/SAS HS	Open	None	None	None	None	Security Bezel/Chassis Intrusion Switch/TPM 1.2	XClarity Standard	1x750W Platinum	3-year	07/17
7X10A01NEA	EMEA	1xXeon Bronze 3104 6C/1.7GHz/8.25MB/85W/DDR4-2133	1x16GB RDIMM DDR4-2666	1x530-8i	16x2.5"	8x2.5" SATA/SAS HS	Open	None	DVD±RW HH	None	None	Security Bezel/Chassis Intrusion Switch/TPM 1.2	XClarity Standard	1x750W Platinum	3-year	07/17
7X10A01PEA	EMEA	1xXeon Silver 4114 10C/2.2GHz/13.75MB/85W/DDR4-2400	1x16GB RDIMM DDR4-2666	1x930-8i 2GB flash	16x2.5"	8x2.5" SATA/SAS HS	Open	None	None	None	None	Security Bezel/Chassis Intrusion Switch/TPM 1.2	XClarity Standard	1x750W Platinum	3-year	07/17
7X10A01QEA	EMEA	1xXeon Bronze 3104 6C/1.7GHz/8.25MB/85W/DDR4-2133	1x16GB RDIMM DDR4-2666	1x930-8i 2GB flash	16x2.5"	8x2.5" SATA/SAS HS	Open	None	None	None	None	Security Bezel/Chassis Intrusion Switch/TPM 1.2	XClarity Standard	1x750W Platinum	3-year	07/17
7X10A035EA	EMEA	1xXeon Gold 5115 10C/2.4GHz/13.75MB/85W/DDR4-2400	1x16GB RDIMM DDR4-2666	1x930-8i 2GB flash	16x2.5"	8x2.5" SATA/SAS HS	Open	None	DVD±RW HH	None	None	Security Bezel/Chassis Intrusion Switch/TPM 1.2	XClarity Standard	2x750W Platinum	3-year	07/17



Model	Region	Processor	Memory	Storage Controller	Chassis	Disk Bays	Disks	M.2 Drives	Optical	GPU	Networking (PCIe)	Security	System Management	Power Supply	Base Warranty	Ann Date (mm/yy)
7X10A04ELA	LA	1xXeon Silver 4110 8C/2.1GHz/11MB/85W/DDR4-2400	1x8GB RDIMM DDR4-2666	1x530-8i	8x3.5"	4x3.5" SATA/SAS HS	Open	None	DVD±RW HH	None	None	Chassis Intrusion Switch/TPM 1.2	XClarity Standard	1x750W Platinum	3-year	07/17
7X10A04GLA	LA	1xXeon Silver 4108 8C/1.8GHz/11MB/85W/DDR4-2400	1x16GB RDIMM DDR4-2666	1x930-8i 2GB flash	8x3.5"	8x3.5" SATA/SAS HS	2x2TB HDD 7.2K 3.5" SAS12Gbps	None	DVD±RW HH	None	None	Chassis Intrusion Switch/TPM 1.2	XClarity Advanced	2x750W Platinum	3-year	07/17
7X10A04JLA	LA	1xXeon Silver 4108 8C/1.8GHz/11MB/85W/DDR4-2400	1x16GB RDIMM DDR4-2666	1x930-8i 2GB flash	8x3.5"	8x3.5" SATA/SAS HS	2x600GB HDD 15K 3.5" SAS12Gbps	None	DVD±RW HH	None	None	Chassis Intrusion Switch/TPM 1.2	XClarity Advanced	2x750W Platinum	3-year	07/17
7X10A04LLA	LA	1xXeon Silver 4110 8C/2.1GHz/11MB/85W/DDR4-2400	1x16GB RDIMM DDR4-2666	1x930-8i 2GB flash	16x2.5"	8x2.5" SATA/SAS HS	2x900GB HDD 10K 2.5" SAS12Gbps	None	DVD±RW HH	None	None	Chassis Intrusion Switch/TPM 1.2	XClarity Advanced	2x750W Platinum	3-year	07/17
7X10A04QLA	LA	1xXeon Silver 4110 8C/2.1GHz/11MB/85W/DDR4-2400	1x16GB RDIMM DDR4-2666	1x930-8i 2GB flash	8x3.5"	8x3.5" SATA/SAS HS	2x2TB HDD 7.2K 3.5" SAS12Gbps	None	DVD±RW HH	None	None	Chassis Intrusion Switch/TPM 1.2	XClarity Advanced	2x750W Platinum	3-year	07/17
7X10A04SLA	LA	1xXeon Bronze 3106 8C/1.7GHz/11MB/85W/DDR4-2133	1x8GB RDIMM DDR4-2666	1x530-8i	8x3.5"	4x3.5" SATA/SAS HS	Open	None	DVD±RW HH	None	None	Chassis Intrusion Switch/TPM 1.2	XClarity Standard	1x750W Platinum	3-year	07/17
7X10A04WLA	LA	1xXeon Silver 4108 8C/1.8GHz/11MB/85W/DDR4-2400	1x8GB RDIMM DDR4-2666	1x530-8i	8x3.5"	4x3.5" SATA/SAS HS	Open	None	DVD±RW HH	None	None	Chassis Intrusion Switch/TPM 1.2	XClarity Standard	1x750W Platinum	3-year	07/17
7X10A051LA	LA	1xXeon Silver 4108 8C/1.8GHz/11MB/85W/DDR4-2400	1x16GB RDIMM DDR4-2666	1x930-8i 2GB flash	8x3.5"	8x3.5" SATA/SAS HS	2x2TB HDD 7.2K 3.5" SAS12Gbps	None	DVD±RW HH	None	None	Chassis Intrusion Switch/TPM 1.2	XClarity Advanced	2x750W Platinum	3-year	07/17
7X10A052LA	LA	1xXeon Silver 4108 8C/1.8GHz/11MB/85W/DDR4-2400	1x8GB RDIMM DDR4-2666	1x530-8i	16x2.5"	8x2.5" SATA/SAS HS	Open	None	DVD±RW HH	None	None	Chassis Intrusion Switch/TPM 1.2	XClarity Standard	1x750W Platinum	3-year	07/17
7X10A053LA	LA	1xXeon Silver 4108 8C/1.8GHz/11MB/85W/DDR4-2400	1x16GB RDIMM DDR4-2666	1x930-8i 2GB flash	8x3.5"	8x3.5" SATA/SAS HS	2x600GB HDD 15K 3.5" SAS12Gbps	None	DVD±RW HH	None	None	Chassis Intrusion Switch/TPM 1.2	XClarity Advanced	2x750W Platinum	3-year	07/17
7X10A055LA	LA	1xXeon Bronze 3106 8C/1.7GHz/11MB/85W/DDR4-2133	1x8GB RDIMM DDR4-2666	1x530-8i	16x2.5"	8x2.5" SATA/SAS HS	Open	None	DVD±RW HH	None	None	Chassis Intrusion Switch/TPM 1.2	XClarity Standard	1x750W Platinum	3-year	07/17
7X10A057LA	LA	1xXeon Bronze 3104 6C/1.7GHz/8.25MB/85W/DDR4-2133	1x8GB RDIMM DDR4-2666	1x530-8i	8x3.5"	4x3.5" SATA/SAS HS	Open	None	DVD±RW HH	None	None	Chassis Intrusion Switch/TPM 1.2	XClarity Standard	1x750W Platinum	3-year	07/17
7X10A058LA	LA	1xXeon Silver 4110 8C/2.1GHz/11MB/85W/DDR4-2400	2x16GB RDIMM DDR4-2666	1x930-8i 2GB flash	8x3.5"	8x3.5" SATA/SAS HS	3x4TB HDD 7.2K 3.5" SAS12Gbps	None	DVD±RW HH	None	None	Chassis Intrusion Switch/TPM 1.2	XClarity Advanced	2x750W Platinum	3-year	07/17
7X10A05BLA	LA	1xXeon Silver 4108 8C/1.8GHz/11MB/85W/DDR4-2400	1x16GB RDIMM DDR4-2666	1x930-8i 2GB flash	8x3.5"	8x3.5" SATA/SAS HS	2x4TB HDD 7.2K 3.5" SAS12Gbps	None	DVD±RW HH	None	None	Chassis Intrusion Switch/TPM 1.2	XClarity Advanced	2x750W Platinum	3-year	07/17
7X10A05CLA	LA	1xXeon Bronze 3104 6C/1.7GHz/8.25MB/85W/DDR4-2133	1x8GB RDIMM DDR4-2666	1x530-8i	16x2.5"	8x2.5" SATA/SAS HS	Open	None	DVD±RW HH	None	None	Chassis Intrusion Switch/TPM 1.2	XClarity Standard	1x750W Platinum	3-year	07/17

Model	Region	Processor	Memory	Storage Controller	Chassis	Disk Bays	Disks	M.2 Drives	Optical	GPU	Networking (PCIe)	Security	System Management	Power Supply	Base Warranty	Ann Date (mm/yy)
7X10A05DLA	LA	1xXeon Silver 4114 10C/2.2GHz/13.75MB/85W/DDR4-2400	2x16GB RDIMM DDR4-2666	1x930-8i 2GB flash	8x3.5"	8x3.5" SATA/SAS HS	3x600GB HDD 15K 3.5" SAS12Gbps	None	DVD±RW HH	None	None	Chassis Intrusion Switch/TPM 1.2	XClarity Advanced	2x750W Platinum	3-year	07/17
7X10A05ELA	LA	1xXeon Silver 4110 8C/2.1GHz/11MB/85W/DDR4-2400	2x16GB RDIMM DDR4-2666	1x930-8i 2GB flash	16x2.5"	8x2.5" SATA/SAS HS	3x900GB HDD 10K 2.5" SAS12Gbps	None	DVD±RW HH	None	None	Chassis Intrusion Switch/TPM 1.2	XClarity Advanced	2x750W Platinum	3-year	07/17
7X10A05JLA	LA	1xXeon Silver 4110 8C/2.1GHz/11MB/85W/DDR4-2400	1x8GB RDIMM DDR4-2666	1x530-8i	16x2.5"	8x2.5" SATA/SAS HS	Open	None	DVD±RW HH	None	None	Chassis Intrusion Switch/TPM 1.2	XClarity Standard	1x750W Platinum	3-year	07/17

ThinkSystem ST550 - TopSeller - NA

Product Specifications Reference (PSREF)

Model	Region	Processor	Memory	Storage Controller	Chassis	Disk Bays	Disks	M.2 Drives	Optical	GPU	Networking (PCIe)	Security	System Management	Power Supply	Base Warranty	Ann Date (mm/yy)
7X10A03PNA	NA	1xXeon Bronze 3106 8C/1.7GHz/11MB/85W/DDR4-2133	1x16GB RDIMM DDR4-2666	1x530-8i	8x3.5"	4x3.5" SATA/SAS HS	Open	None	None	None	None	Chassis Intrusion Switch/TPM 1.2	XClarity Enterprise	1x750W Platinum	3-year	07/17
7X10A02PNA	NA	1xXeon Silver 4116 12C/2.1GHz/16.5MB/85W/DDR4-2400	1x32GB RDIMM DDR4-2666	1x930-8i 2GB flash	8x3.5"	8x3.5" SATA/SAS HS	Open	None	None	None	None	Chassis Intrusion Switch/TPM 1.2	XClarity Enterprise	1x750W Platinum	3-year	07/17
7X10A028NA	NA	1xXeon Silver 4110 8C/2.1GHz/11MB/85W/DDR4-2400	1x16GB RDIMM DDR4-2666	1x530-8i	8x3.5"	8x3.5" SATA/SAS HS	Open	None	None	None	None	Chassis Intrusion Switch/TPM 1.2	XClarity Enterprise	1x750W Platinum	3-year	07/17

Model	Region	Processor	Memory	Storage Controller	Chassis	Disk Bays	Disks	M.2 Drives	Optical	GPU	Networking (PCIe)	Security	System Management	Power Supply	Base Warranty	Ann Date (mm/yy)
7X10A005AU	ANZ	1xXeon Gold 5115 10C/2.4GHz/13.75MB/85W/DDR4-2400	1x16GB RDIMM DDR4-2666	1xOnboard	8x3.5"	4x3.5" SATA SS	Open	None	None	None	None	Security Bezel/Chassis Intrusion Switch/TPM 1.2	XClarity Standard	1x550W Platinum	3-year	07/17
7X10A00AAU	ANZ	1xXeon Gold 5115 10C/2.4GHz/13.75MB/85W/DDR4-2400	1x16GB RDIMM DDR4-2666	1x930-8i 2GB flash	16x2.5"	8x2.5" SATA/SAS HS	Open	None	None	None	None	Security Bezel/Chassis Intrusion Switch/TPM 1.2	XClarity Standard	2x750W Platinum	3-year	07/17
7X10A00KAU	ANZ	1xXeon Gold 5120 14C/2.2GHz/19.25MB/105W/DDR4-2400	1x16GB RDIMM DDR4-2666	1x930-8i 2GB flash	16x2.5"	8x2.5" SATA/SAS HS	Open	None	None	None	None	Security Bezel/Chassis Intrusion Switch/TPM 1.2	XClarity Standard	1x750W Platinum	3-year	07/17
7X10A00MAU	ANZ	1xXeon Gold 6126T 12C/2.6GHz/19.25MB/125W/DDR4-2666	1x32GB RDIMM DDR4-2666	1x930-8i 2GB flash	16x2.5"	8x2.5" SATA/SAS HS	Open	None	None	None	None	Security Bezel/Chassis Intrusion Switch/TPM 1.2	XClarity Standard	1x750W Platinum	3-year	07/17
7X10A00TAU	ANZ	1xXeon Gold 5115 10C/2.4GHz/13.75MB/85W/DDR4-2400	1x16GB RDIMM DDR4-2666	1x530-8i	8x3.5"	4x3.5" SATA/SAS HS	Open	None	None	None	None	Security Bezel/Chassis Intrusion Switch/TPM 1.2	XClarity Standard	1x550W Platinum	3-year	07/17
7X10A02AAU	ANZ	1xXeon Bronze 3104 6C/1.7GHz/8.25MB/85W/DDR4-2133	1x16GB RDIMM DDR4-2666	1xOnboard	8x3.5"	8x3.5" SATA SS	Open	None	DVD±RW HH	None	None	Security Bezel/Chassis Intrusion Switch/TPM 1.2	XClarity Standard	1x750W Platinum	3-year	07/17
7X10A02FAU	ANZ	1xXeon Bronze 3104 6C/1.7GHz/8.25MB/85W/DDR4-2133	1x16GB RDIMM DDR4-2666	1x530-8i	16x2.5"	8x2.5" SATA/SAS HS	Open	None	DVD HH	None	None	Security Bezel/Chassis Intrusion Switch/TPM 1.2	XClarity Standard	1x750W Platinum	3-year	07/17
7X10A011AU	ANZ	1xXeon Gold 6130T 16C/2.1GHz/22MB/125W/DDR4-2666	1x32GB RDIMM DDR4-2666	1x930-8i 2GB flash	16x2.5"	8x2.5" SATA/SAS HS	Open	None	None	None	None	Security Bezel/Chassis Intrusion Switch/TPM 1.2	XClarity Standard	1x750W Platinum	3-year	07/17
7X10A02LAU	ANZ	1xXeon Silver 4110 8C/2.1GHz/11MB/85W/DDR4-2400	1x16GB RDIMM DDR4-2666	1x530-8i	16x2.5"	8x2.5" SATA/SAS HS	Open	None	DVD HH	None	None	Security Bezel/Chassis Intrusion Switch/TPM 1.2	XClarity Standard	1x750W Platinum	3-year	07/17
7X10A02MAU	ANZ	1xXeon Bronze 3106 8C/1.7GHz/11MB/85W/DDR4-2133	1x16GB RDIMM DDR4-2666	1x530-8i	16x2.5"	8x2.5" SATA/SAS HS	Open	None	DVD HH	None	None	Security Bezel/Chassis Intrusion Switch/TPM 1.2	XClarity Standard	1x750W Platinum	3-year	07/17
7X10A02NAU	ANZ	1xXeon Silver 4108 8C/1.8GHz/11MB/85W/DDR4-2400	1x16GB RDIMM DDR4-2666	1x530-8i	16x2.5"	8x2.5" SATA/SAS HS	Open	None	DVD HH	None	None	Security Bezel/Chassis Intrusion Switch/TPM 1.2	XClarity Standard	1x750W Platinum	3-year	07/17
7X10A02RAU	ANZ	1xXeon Gold 5118 12C/2.3GHz/16.5MB/105W/DDR4-2400	1x16GB RDIMM DDR4-2666	1x930-8i 2GB flash	16x2.5"	8x2.5" SATA/SAS HS	Open	None	DVD HH	None	None	Security Bezel/Chassis Intrusion Switch/TPM 1.2	XClarity Standard	1x750W Platinum	3-year	07/17
7X10A02ZAU	ANZ	1xXeon Silver 4116 12C/2.1GHz/16.5MB/85W/DDR4-2400	1x16GB RDIMM DDR4-2666	1x530-8i	16x2.5"	8x2.5" SATA/SAS HS	Open	None	DVD HH	None	None	Security Bezel/Chassis Intrusion Switch/TPM 1.2	XClarity Standard	1x750W Platinum	3-year	07/17
7X10A03DAU	ANZ	1xXeon Silver 4108 8C/1.8GHz/11MB/85W/DDR4-2400	1x16GB RDIMM DDR4-2666	1xOnboard	8x3.5"	8x3.5" SATA SS	Open	None	DVD±RW HH	None	None	Security Bezel/Chassis Intrusion Switch/TPM 1.2	XClarity Standard	1x750W Platinum	3-year	07/17
7X10A03LAU	ANZ	1xXeon Gold 5120 14C/2.2GHz/19.25MB/105W/DDR4-2400	1x16GB RDIMM DDR4-2666	1x930-8i 2GB flash	16x2.5"	8x2.5" SATA/SAS HS	Open	None	DVD HH	None	None	Security Bezel/Chassis Intrusion Switch/TPM 1.2	XClarity Standard	1x750W Platinum	3-year	07/17

Model	Region	Processor	Memory	Storage Controller	Chassis	Disk Bays	Disks	M.2 Drives	Optical	GPU	Networking (PCIe)	Security	System Management	Power Supply	Base Warranty	Ann Date (mm/yy)
7X10A03RAU	ANZ	1xXeon Silver 4114 10C/2.2GHz/13.75MB/85W/DDR4-2400	1x16GB RDIMM DDR4-2666	1x530-8i	16x2.5"	8x2.5" SATA/SAS HS	Open	None	DVD HH	None	None	Security Bezel/Chassis Intrusion Switch/TPM 1.2	XClarity Standard	1x750W Platinum	3-year	07/17

## ThinkSystem ST550 - Non TopSeller - ASEAN

Product Specifications Reference (PSREF)

Model	Region	Processor	Memory	Storage Controller	Chassis	Disk Bays	Disks	M.2 Drives	Optical	GPU	Networking (PCIe)	Security	System Management	Power Supply	Base Warranty	Ann Date (mm/yy)
7X10A01ZSG	ASEAN	1xXeon Bronze 3104 6C/1.7GHz/8.25MB/85W/DDR4-2133	1x8GB RDIMM DDR4-2666	1x530-8i	8x3.5"	4x3.5" SATA/SAS HS	Open	None	None	None	None	Chassis Intrusion Switch/TPM 1.2	XClarity Standard	1x550W Platinum	3-year	07/17
7X10A020SG	ASEAN	1xXeon Silver 4110 8C/2.1GHz/11MB/85W/DDR4-2400	1x8GB RDIMM DDR4-2666	1x530-8i	8x3.5"	4x3.5" SATA/SAS HS	Open	None	None	None	None	Chassis Intrusion Switch/TPM 1.2	XClarity Standard	1x550W Platinum	3-year	07/17
7X10A021SG	ASEAN	1xXeon Bronze 3106 8C/1.7GHz/11MB/85W/DDR4-2133	1x8GB RDIMM DDR4-2666	1x530-8i	8x3.5"	4x3.5" SATA/SAS HS	Open	None	None	None	None	Chassis Intrusion Switch/TPM 1.2	XClarity Standard	1x550W Platinum	3-year	07/17
7X10A022SG	ASEAN	1xXeon Silver 4114 10C/2.2GHz/13.75MB/85W/DDR4-2400	1x8GB RDIMM DDR4-2666	1x530-8i	8x3.5"	4x3.5" SATA/SAS HS	Open	None	None	None	None	Chassis Intrusion Switch/TPM 1.2	XClarity Standard	1x550W Platinum	3-year	07/17
7X10A023SG	ASEAN	1xXeon Silver 4114 10C/2.2GHz/13.75MB/85W/DDR4-2400	1x8GB RDIMM DDR4-2666	1x530-8i	16x2.5"	8x2.5" SATA/SAS HS	Open	None	None	None	None	Chassis Intrusion Switch/TPM 1.2	XClarity Standard	1x750W Platinum	3-year	07/17
7X10A024SG	ASEAN	1xXeon Silver 4116 12C/2.1GHz/16.5MB/85W/DDR4-2400	1x8GB RDIMM DDR4-2666	1x530-8i	16x2.5"	8x2.5" SATA/SAS HS	Open	None	None	None	None	Chassis Intrusion Switch/TPM 1.2	XClarity Standard	1x750W Platinum	3-year	07/17
7X10A025SG	ASEAN	1xXeon Silver 4116 12C/2.1GHz/16.5MB/85W/DDR4-2400	1x8GB RDIMM DDR4-2666	1x530-8i	8x3.5"	4x3.5" SATA/SAS HS	Open	None	None	None	None	Chassis Intrusion Switch/TPM 1.2	XClarity Standard	1x550W Platinum	3-year	07/17
7X10A026SG	ASEAN	1xXeon Silver 4112 4C/2.6GHz/8.25MB/85W/DDR4-2400	1x8GB RDIMM DDR4-2666	1x530-8i	8x3.5"	4x3.5" SATA/SAS HS	Open	None	None	None	None	Chassis Intrusion Switch/TPM 1.2	XClarity Standard	1x550W Platinum	3-year	07/17
7X10A00GSG	ASEAN	1xXeon Gold 5122 4C/3.6GHz/16.5MB/105W/DDR4-2400	1x8GB RDIMM DDR4-2666	1x530-8i	8x3.5"	4x3.5" SATA/SAS HS	Open	None	None	None	None	Chassis Intrusion Switch/TPM 1.2	XClarity Standard	1x750W Platinum	3-year	07/17
7X10A00BSG	ASEAN	1xXeon Gold 6130 16C/2.1GHz/22MB/125W/DDR4-2666	1x8GB RDIMM DDR4-2666	1x530-8i	16x2.5"	8x2.5" SATA/SAS HS	Open	None	None	None	None	Chassis Intrusion Switch/TPM 1.2	XClarity Standard	1x750W Platinum	3-year	07/17
7X10A00DSG	ASEAN	1xXeon Gold 5120 14C/2.2GHz/19.25MB/105W/DDR4-2400	1x8GB RDIMM DDR4-2666	1x530-8i	16x2.5"	8x2.5" SATA/SAS HS	Open	None	None	None	None	Chassis Intrusion Switch/TPM 1.2	XClarity Standard	1x750W Platinum	3-year	07/17
7X10A00ESG	ASEAN	1xXeon Gold 5118 12C/2.3GHz/16.5MB/105W/DDR4-2400	1x8GB RDIMM DDR4-2666	1x530-8i	16x2.5"	8x2.5" SATA/SAS HS	Open	None	None	None	None	Chassis Intrusion Switch/TPM 1.2	XClarity Standard	1x750W Platinum	3-year	07/17
7X10A003SG	ASEAN	1xXeon Gold 5115 10C/2.4GHz/13.75MB/85W/DDR4-2400	1x8GB RDIMM DDR4-2666	1x530-8i	8x3.5"	4x3.5" SATA/SAS HS	Open	None	None	None	None	Chassis Intrusion Switch/TPM 1.2	XClarity Standard	1x750W Platinum	3-year	07/17
7X10A004SG	ASEAN	1xXeon Gold 5118 12C/2.3GHz/16.5MB/105W/DDR4-2400	1x8GB RDIMM DDR4-2666	1x530-8i	8x3.5"	4x3.5" SATA/SAS HS	Open	None	None	None	None	Chassis Intrusion Switch/TPM 1.2	XClarity Standard	1x750W Platinum	3-year	07/17

ThinkSystem ST550 - Non TopSeller - Brazil

Product Specifications Reference (PSREF)

Model	Region	Processor	Memory	Storage Controller	Chassis	Disk Bays	Disks	M.2 Drives	Optical	GPU	Networking (PCIe)	Security	System Management	Power Supply	Base Warranty	Ann Date (mm/yy)
7X10A03YBR	Brazil	1xXeon Gold 5120 14C/2.2GHz/19.25MB/105W/DDR4-2400	1x16GB RDIMM DDR4-2666	1x930-8i 2GB flash	16x2.5"	8x2.5" SATA/SAS HS	Open	None	DVD HH	None	None	Security Bezel/Chassis Intrusion Switch/TPM 1.2	XClarity Standard	1x750W Platinum	3-year	07/17
7X10A040BR	Brazil	1xXeon Gold 5115 10C/2.4GHz/13.75MB/85W/DDR4-2400	1x16GB RDIMM DDR4-2666	1x930-8i 2GB flash	16x2.5"	8x2.5" SATA/SAS HS	Open	None	DVD±RW HH	None	None	Security Bezel/Chassis Intrusion Switch/TPM 1.2	XClarity Standard	2x750W Platinum	3-year	07/17
7X10A041BR	Brazil	1xXeon Gold 5118 12C/2.3GHz/16.5MB/105W/DDR4-2400	1x16GB RDIMM DDR4-2666	1x930-8i 2GB flash	16x2.5"	8x2.5" SATA/SAS HS	Open	None	None	None	None	Security Bezel/Chassis Intrusion Switch/TPM 1.2	XClarity Standard	1x750W Platinum	3-year	07/17
7X10A042BR	Brazil	1xXeon Gold 5118 12C/2.3GHz/16.5MB/105W/DDR4-2400	1x16GB RDIMM DDR4-2666	1x930-8i 2GB flash	16x2.5"	8x2.5" SATA/SAS HS	Open	None	DVD HH	None	None	Security Bezel/Chassis Intrusion Switch/TPM 1.2	XClarity Standard	1x750W Platinum	3-year	07/17

## ThinkSystem ST550 - Non TopSeller - EMEA

Product Specifications Reference (PSREF)

Model	Region	Processor	Memory	Storage Controller	Chassis	Disk Bays	Disks	M.2 Drives	Optical	GPU	Networking (PCIe)	Security	System Management	Power Supply	Base Warranty	Ann Date (mm/yy)
7X10A03JEA	EMEA	1xXeon Gold 5120 14C/2.2GHz/19.25MB/105W/DDR4-2400	1x16GB RDIMM DDR4-2666	1x930-8i 2GB flash	16x2.5"	8x2.5" SATA/SAS HS	Open	None	DVD HH	None	None	Security Bezel/Chassis Intrusion Switch/TPM 1.2	XClarity Standard	1x750W Platinum	3-year	07/17
7X10A02UEA	EMEA	1xXeon Gold 5118 12C/2.3GHz/16.5MB/105W/DDR4-2400	1x16GB RDIMM DDR4-2666	1x930-8i 2GB flash	16x2.5"	8x2.5" SATA/SAS HS	Open	None	DVD HH	None	None	Security Bezel/Chassis Intrusion Switch/TPM 1.2	XClarity Standard	1x750W Platinum	3-year	07/17
7X10A00VEA	EMEA	1xXeon Gold 5120 14C/2.2GHz/19.25MB/105W/DDR4-2400	1x16GB RDIMM DDR4-2666	1x930-8i 2GB flash	16x2.5"	8x2.5" SATA/SAS HS	Open	None	DVD HH	None	None	Security Bezel/Chassis Intrusion Switch/TPM 1.2	XClarity Standard	1x750W Platinum	3-year	07/17
7X10A01REA	EMEA	1xXeon Bronze 3106 8C/1.7GHz/11MB/85W/DDR4-2133	1x16GB RDIMM DDR4-2666	1x530-8i	16x2.5"	8x2.5" SATA/SAS HS	Open	None	DVD HH	None	None	Security Bezel/Chassis Intrusion Switch/TPM 1.2	XClarity Standard	1x750W Platinum	3-year	07/17
7X10A01SEA	EMEA	1xXeon Silver 4116 12C/2.1GHz/16.5MB/85W/DDR4-2400	1x16GB RDIMM DDR4-2666	1x530-8i	16x2.5"	8x2.5" SATA/SAS HS	Open	None	DVD HH	None	None	Security Bezel/Chassis Intrusion Switch/TPM 1.2	XClarity Standard	1x750W Platinum	3-year	07/17
7X10A01TEA	EMEA	1xXeon Silver 4108 8C/1.8GHz/11MB/85W/DDR4-2400	1x16GB RDIMM DDR4-2666	1xOnboard	8x3.5"	8x3.5" SATA SS	Open	None	DVD±RW HH	None	None	Security Bezel/Chassis Intrusion Switch/TPM 1.2	XClarity Standard	1x750W Platinum	3-year	07/17
7X10A01UEA	EMEA	1xXeon Bronze 3104 6C/1.7GHz/8.25MB/85W/DDR4-2133	1x16GB RDIMM DDR4-2666	1xOnboard	8x3.5"	8x3.5" SATA SS	Open	None	DVD±RW HH	None	None	Security Bezel/Chassis Intrusion Switch/TPM 1.2	XClarity Standard	1x750W Platinum	3-year	07/17
7X10A01VEA	EMEA	1xXeon Silver 4108 8C/1.8GHz/11MB/85W/DDR4-2400	1x16GB RDIMM DDR4-2666	1x530-8i	16x2.5"	8x2.5" SATA/SAS HS	Open	None	DVD HH	None	None	Security Bezel/Chassis Intrusion Switch/TPM 1.2	XClarity Standard	1x750W Platinum	3-year	07/17
7X10A01WEA	EMEA	1xXeon Silver 4114 10C/2.2GHz/13.75MB/85W/DDR4-2400	1x16GB RDIMM DDR4-2666	1x530-8i	16x2.5"	8x2.5" SATA/SAS HS	Open	None	DVD HH	None	None	Security Bezel/Chassis Intrusion Switch/TPM 1.2	XClarity Standard	1x750W Platinum	3-year	07/17
7X10A01XEA	EMEA	1xXeon Bronze 3104 6C/1.7GHz/8.25MB/85W/DDR4-2133	1x16GB RDIMM DDR4-2666	1x530-8i	16x2.5"	8x2.5" SATA/SAS HS	Open	None	DVD HH	None	None	Security Bezel/Chassis Intrusion Switch/TPM 1.2	XClarity Standard	1x750W Platinum	3-year	07/17
7X10A01YEA	EMEA	1xXeon Silver 4110 8C/2.1GHz/11MB/85W/DDR4-2400	1x16GB RDIMM DDR4-2666	1x530-8i	16x2.5"	8x2.5" SATA/SAS HS	Open	None	DVD HH	None	None	Security Bezel/Chassis Intrusion Switch/TPM 1.2	XClarity Standard	1x750W Platinum	3-year	07/17



## ThinkSystem ST550 - Non TopSeller - HTK

Product Specifications Reference (PSREF)

Model	Region	Processor	Memory	Storage Controller	Chassis	Disk Bays	Disks	M.2 Drives	Optical	GPU	Networking (PCIe)	Security	System Management	Power Supply	Base Warranty	Ann Date (mm/yy)
7X10A014CN	HTK	1xXeon Gold 5122 4C/3.6GHz/16.5MB/105W/DDR4-2400	1x16GB RDIMM DDR4-2666	1x930-8i 2GB flash	16x2.5"	8x2.5" SATA/SAS HS	Open	None	None	None	None	Chassis Intrusion Switch/TPM 1.2	XClarity Standard	1x750W Platinum	3-year	07/17
7X10A00WCN	HTK	1xXeon Gold 5120 14C/2.2GHz/19.25MB/105W/DDR4-2400	1x16GB RDIMM DDR4-2666	1x930-8i 2GB flash	16x2.5"	8x2.5" SATA/SAS HS	Open	None	None	None	None	Chassis Intrusion Switch/TPM 1.2	XClarity Standard	1x750W Platinum	3-year	07/17
7X10A00XCN	HTK	1xXeon Gold 6130 16C/2.1GHz/22MB/125W/DDR4-2666	1x16GB RDIMM DDR4-2666	1x930-8i 2GB flash	16x2.5"	8x2.5" SATA/SAS HS	Open	None	None	None	None	Chassis Intrusion Switch/TPM 1.2	XClarity Standard	1x750W Platinum	3-year	07/17
7X10A00YCN	HTK	1xXeon Gold 5118 12C/2.3GHz/16.5MB/105W/DDR4-2400	1x16GB RDIMM DDR4-2666	1x930-8i 2GB flash	16x2.5"	8x2.5" SATA/SAS HS	Open	None	None	None	None	Chassis Intrusion Switch/TPM 1.2	XClarity Standard	1x750W Platinum	3-year	07/17
7X10A00ZCN	HTK	1xXeon Gold 6126 12C/2.6GHz/19.25MB/125W/DDR4-2666	1x16GB RDIMM DDR4-2666	1x930-8i 2GB flash	16x2.5"	8x2.5" SATA/SAS HS	Open	None	None	None	None	Chassis Intrusion Switch/TPM 1.2	XClarity Standard	1x750W Platinum	3-year	07/17
7X10A010CN	HTK	1xXeon Gold 5115 10C/2.4GHz/13.75MB/85W/DDR4-2400	1x16GB RDIMM DDR4-2666	1x930-8i 2GB flash	16x2.5"	8x2.5" SATA/SAS HS	Open	None	None	None	None	Chassis Intrusion Switch/TPM 1.2	XClarity Standard	1x750W Platinum	3-year	07/17
7X10A00PCN	HTK	1xXeon Gold 6130 16C/2.1GHz/22MB/125W/DDR4-2666	1x16GB RDIMM DDR4-2666	1x930-8i 2GB flash	8x3.5"	4x3.5" SATA/SAS HS	Open	None	None	None	None	Chassis Intrusion Switch/TPM 1.2	XClarity Standard	1x750W Platinum	3-year	07/17
7X10A00QCN	HTK	1xXeon Gold 6126 12C/2.6GHz/19.25MB/125W/DDR4-2666	1x16GB RDIMM DDR4-2666	1x930-8i 2GB flash	8x3.5"	4x3.5" SATA/SAS HS	Open	None	None	None	None	Chassis Intrusion Switch/TPM 1.2	XClarity Standard	1x750W Platinum	3-year	07/17
7X10A00RCN	HTK	1xXeon Gold 5120 14C/2.2GHz/19.25MB/105W/DDR4-2400	1x16GB RDIMM DDR4-2666	1x930-8i 2GB flash	8x3.5"	4x3.5" SATA/SAS HS	Open	None	None	None	None	Chassis Intrusion Switch/TPM 1.2	XClarity Standard	1x750W Platinum	3-year	07/17
7X10A00SCN	HTK	1xXeon Gold 5122 4C/3.6GHz/16.5MB/105W/DDR4-2400	1x16GB RDIMM DDR4-2666	1x930-8i 2GB flash	8x3.5"	4x3.5" SATA/SAS HS	Open	None	None	None	None	Chassis Intrusion Switch/TPM 1.2	XClarity Standard	1x750W Platinum	3-year	07/17
7X10A012CN	HTK	1xXeon Gold 6126 12C/2.6GHz/19.25MB/125W/DDR4-2666	1x8GB RDIMM DDR4-2666	1x530-8i	8x3.5"	4x3.5" SATA/SAS HS	Open	None	None	None	None	Chassis Intrusion Switch/TPM 1.2	XClarity Standard	1x750W Platinum	3-year	07/17

Model	Region	Processor	Memory	Storage Controller	Chassis	Disk Bays	Disks	M.2 Drives	Optical	GPU	Networking (PCIe)	Security	System Management	Power Supply	Base Warranty	Ann Date (mm/yy)
7X10A02KSG	INDIA	1xXeon Silver 4116 12C/2.1GHz/16.5MB/85W/DDR4-2400	1x16GB RDIMM DDR4-2666	1x930-16i 4GB flash	16x2.5"	16x2.5" SATA/SAS HS	Open	None	DVD±RW HH	None	None	Chassis Intrusion Switch/TPM 1.2	XClarity Standard	1x750W Platinum	3-year	07/17
7X10A02SSG	INDIA	1xXeon Bronze 3106 8C/1.7GHz/11MB/85W/DDR4-2133	1x8GB RDIMM DDR4-2666	1xOnboard	8x3.5"	4x3.5" SATA SS	Open	None	DVD±RW HH	None	None	Chassis Intrusion Switch/TPM 1.2	XClarity Standard	1x550W Platinum	3-year	07/17
7X10A02QSG	INDIA	1xXeon Silver 4114 10C/2.2GHz/13.75MB/85W/DDR4-2400	1x16GB RDIMM DDR4-2666	1x530-8i	16x2.5"	8x2.5" SATA/SAS HS	Open	None	DVD±RW HH	None	None	Chassis Intrusion Switch/TPM 1.2	XClarity Standard	1x550W Platinum	3-year	07/17
7X10A02WSG	INDIA	1xXeon Silver 4114 10C/2.2GHz/13.75MB/85W/DDR4-2400	1x16GB RDIMM DDR4-2666	1x530-8i	8x3.5"	4x3.5" SATA/SAS HS	Open	None	DVD±RW HH	None	None	Chassis Intrusion Switch/TPM 1.2	XClarity Standard	1x550W Platinum	3-year	07/17
7X10A02XSG	INDIA	1xXeon Silver 4116 12C/2.1GHz/16.5MB/85W/DDR4-2400	1x8GB RDIMM DDR4-2666	1x530-8i	16x2.5"	8x2.5" SATA/SAS HS	Open	None	DVD±RW HH	None	None	Chassis Intrusion Switch/TPM 1.2	XClarity Standard	1x550W Platinum	3-year	07/17
7X10A037SG	INDIA	1xXeon Silver 4110 8C/2.1GHz/11MB/85W/DDR4-2400	1x8GB RDIMM DDR4-2666	1x530-8i	8x3.5"	4x3.5" SATA/SAS HS	Open	None	DVD±RW HH	None	None	Chassis Intrusion Switch/TPM 1.2	XClarity Standard	1x550W Platinum	3-year	07/17
7X10A033SG	INDIA	1xXeon Bronze 3106 8C/1.7GHz/11MB/85W/DDR4-2133	1x8GB RDIMM DDR4-2666	1x530-8i	8x3.5"	4x3.5" SATA/SAS HS	Open	None	DVD±RW HH	None	None	Chassis Intrusion Switch/TPM 1.2	XClarity Standard	1x550W Platinum	3-year	07/17
7X10A034SG	INDIA	1xXeon Silver 4108 8C/1.8GHz/11MB/85W/DDR4-2400	1x8GB RDIMM DDR4-2666	1x530-8i	8x3.5"	4x3.5" SATA/SAS HS	Open	None	DVD±RW HH	None	None	Chassis Intrusion Switch/TPM 1.2	XClarity Standard	1x550W Platinum	3-year	07/17
7X10A030SG	INDIA	1xXeon Silver 4116 12C/2.1GHz/16.5MB/85W/DDR4-2400	1x16GB RDIMM DDR4-2666	1x930-8i 2GB flash	16x2.5"	8x2.5" SATA/SAS HS	Open	None	DVD±RW HH	None	None	Chassis Intrusion Switch/TPM 1.2	XClarity Standard	1x550W Platinum	3-year	07/17
7X10A03BSG	INDIA	1xXeon Bronze 3106 8C/1.7GHz/11MB/85W/DDR4-2133	1x16GB RDIMM DDR4-2666	1x530-8i	8x3.5"	4x3.5" SATA/SAS HS	Open	None	DVD±RW HH	None	None	Chassis Intrusion Switch/TPM 1.2	XClarity Standard	1x550W Platinum	3-year	07/17
7X10A03CSG	INDIA	1xXeon Silver 4114 10C/2.2GHz/13.75MB/85W/DDR4-2400	1x16GB RDIMM DDR4-2666	1x930-8i 2GB flash	16x2.5"	8x2.5" SATA/SAS HS	Open	None	DVD±RW HH	None	None	Chassis Intrusion Switch/TPM 1.2	XClarity Standard	1x550W Platinum	3-year	07/17
7X10A03WSG	INDIA	1xXeon Silver 4108 8C/1.8GHz/11MB/85W/DDR4-2400	1x16GB RDIMM DDR4-2666	1x930-8i 2GB flash	16x2.5"	8x2.5" SATA/SAS HS	Open	None	DVD±RW HH	None	None	Chassis Intrusion Switch/TPM 1.2	XClarity Standard	1x550W Platinum	3-year	07/17
7X10A03XSG	INDIA	1xXeon Silver 4116 12C/2.1GHz/16.5MB/85W/DDR4-2400	1x16GB RDIMM DDR4-2666	1x530-8i	8x3.5"	4x3.5" SATA/SAS HS	Open	None	DVD±RW HH	None	None	Chassis Intrusion Switch/TPM 1.2	XClarity Standard	1x550W Platinum	3-year	07/17
7X10A03SSG	INDIA	1xXeon Bronze 3104 6C/1.7GHz/8.25MB/85W/DDR4-2133	1x8GB RDIMM DDR4-2666	1xOnboard	8x3.5"	4x3.5" SATA SS	Open	None	DVD±RW HH	None	None	Chassis Intrusion Switch/TPM 1.2	XClarity Standard	1x550W Platinum	3-year	07/17
7X10A03TSG	INDIA	1xXeon Bronze 3106 8C/1.7GHz/11MB/85W/DDR4-2133	1x16GB RDIMM DDR4-2666	1x930-8i 2GB flash	16x2.5"	8x2.5" SATA/SAS HS	Open	None	DVD±RW HH	None	None	Chassis Intrusion Switch/TPM 1.2	XClarity Standard	1x550W Platinum	3-year	07/17

Model	Region	Processor	Memory	Storage Controller	Chassis	Disk Bays	Disks	M.2 Drives	Optical	GPU	Networking (PCIe)	Security	System Management	Power Supply	Base Warranty	Ann Date (mm/yy)
7X10A00USG	INDIA	1xXeon Gold 5120 14C/2.2GHz/19.25MB/105W/DDR4-2400	1x16GB RDIMM DDR4-2666	1x930-8i 2GB flash	16x2.5"	8x2.5" SATA/SAS HS	Open	None	DVD±RW HH	None	None	Chassis Intrusion Switch/TPM 1.2	XClarity Standard	1x750W Platinum	3-year	07/17
7X10A00NSG	INDIA	1xXeon Gold 6130 16C/2.1GHz/22MB/125W/DDR4-2666	1x16GB RDIMM DDR4-2666	1x930-8i 2GB flash	16x2.5"	8x2.5" SATA/SAS HS	Open	None	DVD±RW HH	None	None	Chassis Intrusion Switch/TPM 1.2	XClarity Standard	1x750W Platinum	3-year	07/17
7X10A015SG	INDIA	1xXeon Gold 5115 10C/2.4GHz/13.75MB/85W/DDR4-2400	1x16GB RDIMM DDR4-2666	1x530-8i	8x3.5"	4x3.5" SATA/SAS HS	Open	None	DVD±RW HH	None	None	Chassis Intrusion Switch/TPM 1.2	XClarity Standard	1x550W Platinum	3-year	07/17
7X10A016SG	INDIA	1xXeon Gold 5115 10C/2.4GHz/13.75MB/85W/DDR4-2400	1x16GB RDIMM DDR4-2666	1x530-8i	16x2.5"	8x2.5" SATA/SAS HS	Open	None	DVD±RW HH	None	None	Chassis Intrusion Switch/TPM 1.2	XClarity Standard	1x550W Platinum	3-year	07/17
7X10A00LSG	INDIA	1xXeon Gold 5118 12C/2.3GHz/16.5MB/105W/DDR4-2400	1x16GB RDIMM DDR4-2666	1x530-8i	16x2.5"	8x2.5" SATA/SAS HS	Open	None	DVD±RW HH	None	None	Chassis Intrusion Switch/TPM 1.2	XClarity Standard	1x550W Platinum	3-year	07/17
7X10A00FSG	INDIA	1xXeon Gold 5115 10C/2.4GHz/13.75MB/85W/DDR4-2400	1x8GB RDIMM DDR4-2666	1xOnboard	8x3.5"	4x3.5" SATA SS	Open	None	DVD±RW HH	None	None	Chassis Intrusion Switch/TPM 1.2	XClarity Standard	1x550W Platinum	3-year	07/17
7X10A007SG	INDIA	1xXeon Gold 6126 12C/2.6GHz/19.25MB/125W/DDR4-2666	1x16GB RDIMM DDR4-2666	1x930-16i 4GB flash	16x2.5"	16x2.5" SATA/SAS HS	Open	None	DVD±RW HH	None	None	Chassis Intrusion Switch/TPM 1.2	XClarity Standard	1x750W Platinum	3-year	07/17
7X10A008SG	INDIA	1xXeon Gold 5120 14C/2.2GHz/19.25MB/105W/DDR4-2400	1x16GB RDIMM DDR4-2666	1x530-8i	16x2.5"	8x2.5" SATA/SAS HS	Open	None	DVD±RW HH	None	None	Chassis Intrusion Switch/TPM 1.2	XClarity Standard	1x550W Platinum	3-year	07/17
7X10A001SG	INDIA	1xXeon Gold 5115 10C/2.4GHz/13.75MB/85W/DDR4-2400	1x8GB RDIMM DDR4-2666	1x530-8i	8x3.5"	4x3.5" SATA/SAS HS	Open	None	DVD±RW HH	None	None	Chassis Intrusion Switch/TPM 1.2	XClarity Standard	1x550W Platinum	3-year	07/17
7X10A002SG	INDIA	1xXeon Gold 6130 16C/2.1GHz/22MB/125W/DDR4-2666	1x16GB RDIMM DDR4-2666	1x930-16i 4GB flash	16x2.5"	16x2.5" SATA/SAS HS	Open	None	DVD±RW HH	None	None	Chassis Intrusion Switch/TPM 1.2	XClarity Standard	1x750W Platinum	3-year	07/17
7X10A02CSG	INDIA	1xXeon Bronze 3106 8C/1.7GHz/11MB/85W/DDR4-2133	1x8GB RDIMM DDR4-2666	1x530-8i	16x2.5"	8x2.5" SATA/SAS HS	Open	None	DVD±RW HH	None	None	Chassis Intrusion Switch/TPM 1.2	XClarity Standard	1x550W Platinum	3-year	07/17
7X10A027SG	INDIA	1xXeon Silver 4108 8C/1.8GHz/11MB/85W/DDR4-2400	1x16GB RDIMM DDR4-2666	1x530-8i	16x2.5"	8x2.5" SATA/SAS HS	Open	None	DVD±RW HH	None	None	Chassis Intrusion Switch/TPM 1.2	XClarity Standard	1x550W Platinum	3-year	07/17

ThinkSystem ST550 - Non TopSeller - JAPAN

Product Specifications Reference (PSREF)

Model	Region	Processor	Memory	Storage Controller	Chassis	Disk Bays	Disks	M.2 Drives	Optical	GPU	Networking (PCIe)	Security	System Management	Power Supply	Base Warranty	Ann Date (mm/yy)
7X10A009JP	JAPAN	1xXeon Gold 6130 16C/2.1GHz/22MB/125W/DDR4-2666	2x16GB RDIMM DDR4-2666	1x930-16i 4GB flash	16x2.5"	16x2.5" SATA/SAS HS	Open	None	DVD HH	None	None	Security Bezel/Chassis Intrusion Switch/TPM 1.2	XClarity Advanced	1x1100W Platinum	3-year	07/17
7X10A043JP	JAPAN	1xXeon Silver 4110 8C/2.1GHz/11MB/85W/DDR4-2400	2x16GB RDIMM DDR4-2666	1x930-16i 4GB flash	16x2.5"	16x2.5" SATA/SAS HS	Open	None	DVD HH	None	None	Security Bezel/Chassis Intrusion Switch/TPM 1.2	XClarity Advanced	1x1100W Platinum	3-year	07/17
7X10A044JP	JAPAN	1xXeon Bronze 3104 6C/1.7GHz/8.25MB/85W/DDR4-2133	2x16GB RDIMM DDR4-2666	1x930-8i 2GB flash	8x3.5"	8x3.5" SATA/SAS HS	Open	None	DVD HH	None	None	Security Bezel/Chassis Intrusion Switch/TPM 1.2	XClarity Advanced	1x550W Platinum	3-year	07/17
7X10A045JP	JAPAN	1xXeon Bronze 3106 8C/1.7GHz/11MB/85W/DDR4-2133	2x16GB RDIMM DDR4-2666	1x930-16i 4GB flash	16x2.5"	16x2.5" SATA/SAS HS	Open	None	DVD HH	None	None	Security Bezel/Chassis Intrusion Switch/TPM 1.2	XClarity Advanced	1x750W Platinum	3-year	07/17
7X10A046JP	JAPAN	1xXeon Silver 4110 8C/2.1GHz/11MB/85W/DDR4-2400	2x16GB RDIMM DDR4-2666	1x930-8i 2GB flash	8x3.5"	8x3.5" SATA/SAS HS	Open	None	DVD HH	None	None	Security Bezel/Chassis Intrusion Switch/TPM 1.2	XClarity Advanced	1x1100W Platinum	3-year	07/17
7X10A047JP	JAPAN	1xXeon Silver 4114 10C/2.2GHz/13.75MB/85W/DDR4-2400	2x16GB RDIMM DDR4-2666	1x930-8i 2GB flash	8x3.5"	8x3.5" SATA/SAS HS	Open	None	DVD HH	None	None	Security Bezel/Chassis Intrusion Switch/TPM 1.2	XClarity Advanced	1x750W Platinum	3-year	07/17
7X10A048JP	JAPAN	1xXeon Gold 6130 16C/2.1GHz/22MB/125W/DDR4-2666	2x16GB RDIMM DDR4-2666	1x930-24i 4GB flash	16x2.5"	20x2.5" SATA/SAS HS	Open	None	None	None	None	Security Bezel/Chassis Intrusion Switch/TPM 1.2	XClarity Advanced	1x1100W Platinum	3-year	07/17
7X10A049JP	JAPAN	1xXeon Gold 6130 16C/2.1GHz/22MB/125W/DDR4-2666	2x16GB RDIMM DDR4-2666	1x930-16i 4GB flash	16x2.5"	16x2.5" SATA/SAS HS	Open	None	DVD HH	None	None	Security Bezel/Chassis Intrusion Switch/TPM 1.2	XClarity Advanced	1x1100W Platinum	3-year	07/17

ThinkSystem ST550 - Non TopSeller - LA

Product Specifications Reference (PSREF)

Model	Region	Processor	Memory	Storage Controller	Chassis	Disk Bays	Disks	M.2 Drives	Optical	GPU	Networking (PCIe)	Security	System Management	Power Supply	Base Warranty	Ann Date (mm/yy)
7X10A04KLA	LA	1xXeon Gold 6130 16C/2.1GHz/22MB/125W/DDR4-2666	1x16GB RDIMM DDR4-2666	1x930-8i 2GB flash	8x3.5"	4x3.5" SATA/SAS HS	Open	None	DVD±RW HH	None	None	Chassis Intrusion Switch/TPM 1.2	XClarity Standard	1x750W Platinum	3-year	07/17
7X10A04RLA	LA	1xXeon Gold 5115 10C/2.4GHz/13.75MB/85W/DDR4-2400	1x16GB RDIMM DDR4-2666	1x930-8i 2GB flash	8x3.5"	4x3.5" SATA/SAS HS	Open	None	DVD±RW HH	None	None	Chassis Intrusion Switch/TPM 1.2	XClarity Standard	1x750W Platinum	3-year	07/17
7X10A04XLA	LA	1xXeon Gold 5118 12C/2.3GHz/16.5MB/105W/DDR4-2400	1x16GB RDIMM DDR4-2666	1x930-8i 2GB flash	8x3.5"	4x3.5" SATA/SAS HS	Open	None	DVD±RW HH	None	None	Chassis Intrusion Switch/TPM 1.2	XClarity Standard	1x750W Platinum	3-year	07/17
7X10A054LA	LA	1xXeon Gold 6138 20C/2.0GHz/27.5MB/125W/DDR4-2666	1x16GB RDIMM DDR4-2666	1x930-8i 2GB flash	16x2.5"	8x2.5" SATA/SAS HS	Open	None	DVD±RW HH	None	None	Chassis Intrusion Switch/TPM 1.2	XClarity Standard	1x750W Platinum	3-year	07/17
7X10A056LA	LA	1xXeon Gold 6130 16C/2.1GHz/22MB/125W/DDR4-2666	1x16GB RDIMM DDR4-2666	1x930-8i 2GB flash	16x2.5"	8x2.5" SATA/SAS HS	Open	None	DVD±RW HH	None	None	Chassis Intrusion Switch/TPM 1.2	XClarity Standard	1x750W Platinum	3-year	07/17
7X10A059LA	LA	1xXeon Gold 6138 20C/2.0GHz/27.5MB/125W/DDR4-2666	1x16GB RDIMM DDR4-2666	1x930-8i 2GB flash	8x3.5"	4x3.5" SATA/SAS HS	Open	None	DVD±RW HH	None	None	Chassis Intrusion Switch/TPM 1.2	XClarity Standard	1x750W Platinum	3-year	07/17
7X10A05ALA	LA	1xXeon Gold 5118 12C/2.3GHz/16.5MB/105W/DDR4-2400	1x16GB RDIMM DDR4-2666	1x930-8i 2GB flash	16x2.5"	8x2.5" SATA/SAS HS	Open	None	DVD±RW HH	None	None	Chassis Intrusion Switch/TPM 1.2	XClarity Standard	1x750W Platinum	3-year	07/17
7X10A05FLA	LA	1xXeon Gold 5115 10C/2.4GHz/13.75MB/85W/DDR4-2400	1x16GB RDIMM DDR4-2666	1x930-8i 2GB flash	16x2.5"	8x2.5" SATA/SAS HS	Open	None	DVD±RW HH	None	None	Chassis Intrusion Switch/TPM 1.2	XClarity Standard	1x750W Platinum	3-year	07/17
7X10A05GLA	LA	1xXeon Gold 5120 14C/2.2GHz/19.25MB/105W/DDR4-2400	1x16GB RDIMM DDR4-2666	1x930-8i 2GB flash	8x3.5"	4x3.5" SATA/SAS HS	Open	None	DVD±RW HH	None	None	Chassis Intrusion Switch/TPM 1.2	XClarity Standard	1x750W Platinum	3-year	07/17
7X10A05HLA	LA	1xXeon Silver 4114 10C/2.2GHz/13.75MB/85W/DDR4-2400	1x8GB RDIMM DDR4-2666	1x530-8i	16x2.5"	8x2.5" SATA/SAS HS	Open	None	DVD±RW HH	None	None	Chassis Intrusion Switch/TPM 1.2	XClarity Standard	1x750W Platinum	3-year	07/17
7X10A05KLA	LA	1xXeon Gold 5120 14C/2.2GHz/19.25MB/105W/DDR4-2400	1x16GB RDIMM DDR4-2666	1x930-8i 2GB flash	16x2.5"	8x2.5" SATA/SAS HS	Open	None	DVD±RW HH	None	None	Chassis Intrusion Switch/TPM 1.2	XClarity Standard	1x750W Platinum	3-year	07/17
7X10A05LLA	LA	1xXeon Silver 4114 10C/2.2GHz/13.75MB/85W/DDR4-2400	1x8GB RDIMM DDR4-2666	1x530-8i	8x3.5"	4x3.5" SATA/SAS HS	Open	None	DVD±RW HH	None	None	Chassis Intrusion Switch/TPM 1.2	XClarity Standard	1x750W Platinum	3-year	07/17

ThinkSystem ST550 - Non TopSeller - NA

Product Specifications Reference (PSREF)

Model	Region	Processor	Memory	Storage Controller	Chassis	Disk Bays	Disks	M.2 Drives	Optical	GPU	Networking (PCIe)	Security	System Management	Power Supply	Base Warranty	Ann Date (mm/yy)
7X10A04YNA	NA	1xXeon Gold 5118 12C/2.3GHz/16.5MB/105W/DDR4-2400	1x16GB RDIMM DDR4-2666	1x930-8i 2GB flash	16x2.5"	8x2.5" SATA/SAS HS	Open	None	DVD HH	None	None	Security Bezel/Chassis Intrusion Switch/TPM 1.2	XClarity Standard	1x750W Platinum	3-year	07/17
7X10A04ZNA	NA	1xXeon Gold 5120 14C/2.2GHz/19.25MB/105W/DDR4-2400	1x16GB RDIMM DDR4-2666	1x930-8i 2GB flash	16x2.5"	8x2.5" SATA/SAS HS	Open	None	DVD HH	None	None	Security Bezel/Chassis Intrusion Switch/TPM 1.2	XClarity Standard	1x750W Platinum	3-year	07/17
7X10A04TNA	NA	1xXeon Silver 4116 12C/2.1GHz/16.5MB/85W/DDR4-2400	1x16GB RDIMM DDR4-2666	1x530-8i	16x2.5"	8x2.5" SATA/SAS HS	Open	None	DVD HH	None	None	Security Bezel/Chassis Intrusion Switch/TPM 1.2	XClarity Standard	1x750W Platinum	3-year	07/17
7X10A04UNA	NA	1xXeon Bronze 3104 6C/1.7GHz/8.25MB/85W/DDR4-2133	1x16GB RDIMM DDR4-2666	1xOnboard	8x3.5"	8x3.5" SATA SS	Open	None	DVD±RW HH	None	None	Security Bezel/Chassis Intrusion Switch/TPM 1.2	XClarity Standard	1x750W Platinum	3-year	07/17
7X10A04VNA	NA	1xXeon Silver 4108 8C/1.8GHz/11MB/85W/DDR4-2400	1x16GB RDIMM DDR4-2666	1xOnboard	8x3.5"	8x3.5" SATA SS	Open	None	DVD±RW HH	None	None	Security Bezel/Chassis Intrusion Switch/TPM 1.2	XClarity Standard	1x750W Platinum	3-year	07/17
7X10A04NNA	NA	1xXeon Bronze 3104 6C/1.7GHz/8.25MB/85W/DDR4-2133	1x16GB RDIMM DDR4-2666	1x530-8i	16x2.5"	8x2.5" SATA/SAS HS	Open	None	DVD HH	None	None	Security Bezel/Chassis Intrusion Switch/TPM 1.2	XClarity Standard	1x750W Platinum	3-year	07/17
7X10A04PNA	NA	1xXeon Bronze 3106 8C/1.7GHz/11MB/85W/DDR4-2133	1x16GB RDIMM DDR4-2666	1x530-8i	16x2.5"	8x2.5" SATA/SAS HS	Open	None	DVD HH	None	None	Security Bezel/Chassis Intrusion Switch/TPM 1.2	XClarity Standard	1x750W Platinum	3-year	07/17
7X10A04HNA	NA	1xXeon Silver 4114 10C/2.2GHz/13.75MB/85W/DDR4-2400	1x16GB RDIMM DDR4-2666	1x530-8i	16x2.5"	8x2.5" SATA/SAS HS	Open	None	DVD HH	None	None	Security Bezel/Chassis Intrusion Switch/TPM 1.2	XClarity Standard	1x750W Platinum	3-year	07/17
7X10A04FNA	NA	1xXeon Silver 4110 8C/2.1GHz/11MB/85W/DDR4-2400	1x16GB RDIMM DDR4-2666	1x530-8i	16x2.5"	8x2.5" SATA/SAS HS	Open	None	DVD HH	None	None	Security Bezel/Chassis Intrusion Switch/TPM 1.2	XClarity Standard	1x750W Platinum	3-year	07/17
7X10A04DNA	NA	1xXeon Silver 4108 8C/1.8GHz/11MB/85W/DDR4-2400	1x16GB RDIMM DDR4-2666	1x530-8i	16x2.5"	8x2.5" SATA/SAS HS	Open	None	DVD HH	None	None	Security Bezel/Chassis Intrusion Switch/TPM 1.2	XClarity Standard	1x750W Platinum	3-year	07/17

This publication was developed for products and services offered in the United States and E.M.E.A countries. Lenovo may not offer the products, services or features discussed in this document in other countries. Lenovo may withdraw an offering at any time. Information is subject to change without notice. Consult your local representative for information on offerings available in your area.

Lenovo reserves the right to change specifications or other product information without notice. Lenovo is not responsible for photographic or typographical errors.

LENOVO PROVIDES THIS PUBLICATION "AS IS," WITHOUT WARRANTY OF ANY KIND, EITHER EXPRESS OR IMPLIED, INCLUDING THE IMPLIED WARRANTIES OF MERCHANTABILITY OR FITNESS FOR A PARTICULAR PURPOSE.

Some jurisdictions do not allow disclaimer of express or implied warranties in certain transactions, therefore this disclaimer may not apply to you.

**Availability:** All offers subject to availability. Lenovo reserves the right to alter product offerings and specifications at any time, without notice. Lenovo is not responsible for photographic or typographic errors.

**General:** Review key information provided by Microsoft that may apply to your system purchase, including details on Windows 10, Windows 8, Windows 7, and potential upgrades/downgrades. Lenovo makes no representation or warranty regarding third-party products or services.

**Trademarks:** Lenovo, ThinkPad, ThinkCentre, ThinkStation and the Lenovo logo are trademarks of Lenovo. Microsoft, Windows, Windows NT, and the Windows logo are trademarks of Microsoft Corporation. Ultrabook, Celeron, Celeron Inside, Core Inside, Intel, Intel Logo, Intel Atom, Intel Atom Inside, Intel Core, Intel Inside, Intel Inside Logo, Intel vPro, Itanium, Itanium Inside, Pentium, Pentium Inside, vPro Inside, Xeon, Xeon Phi, and Xeon Inside are trademarks of Intel Corporation in the U.S. and/or other countries. Other company, product or service names may be trademarks or service marks of others.

**Warranty:** For a copy of applicable warranties, write to: Lenovo Warranty Information, 1009 Think Place, Morrisville, NC, 27560. Lenovo makes no representation or warranty regarding third party products or services. The Lenovo Limited Warranty applies only to Lenovo hardware products purchased for your own use, and does not transfer upon resale.

**Limited warranty:** Support unrelated to a warranty issue may be subject to additional charges.

#### **Lenovo Services:**

**Carry-in or Mail-in Service:** Parts and labor repair coverage where the customer is responsible for shipping (including packaging) or delivery to authorized warranty provider or repair center.

**Depot or Courier Service:** Parts and labor repair coverage where shipping (including packaging) or delivery to the repair center is paid for by Lenovo.

**Expedited Depot:** Parts and labor coverage with expedited turnaround. Shipping (including packaging) or delivery to the repair center is paid for by Lenovo.

**Onsite / In-home Service:** Parts and labor repair coverage where labor is provided onsite at your place of business.

If Lenovo determines your product problem is covered by the product warranty and cannot be resolved over the telephone, a technician will be dispatched to arrive onsite, typically the next day.

**International Warranty Service (IWS):** PC repair coverage for customers who require a critical warranty repair while travelling internationally. Visit [www.lenovo.com/internationalwarranty](http://www.lenovo.com/internationalwarranty) for details. Visit [www.lenovo.com/warranty](http://www.lenovo.com/warranty) for Lenovo Warranty Services terms and conditions for complete details and restrictions.

**Included software:** may differ from its retail version (if available), and may not include user manuals or all program functionality. Software license agreements may apply.

**Battery life:** Battery life (and recharge times) will vary based on many factors including screen brightness, applications, features, power management, battery conditioning, and other customer preferences.

Visit <http://psref.lenovo.com/> for the latest version of Product Specifications Reference.

© Lenovo, 2017. All rights reserved.  
Lenovo 1009 Think Place Morrisville, NC 27560 U.S.A.

**Lenovo**<sup>TM</sup>

**ThinkVision**

**PSREF**



**Product Specifications Reference**

Version 511, August 2017

**U.S.**

Visit <http://psref.lenovo.com> for the latest version



# Contents

---

<b>Cover</b>		
<b>Contents</b>		
<b>Summary Of Change</b>		
<b>17 Inch - 20 Inch</b>		
<b>ThinkVision E1922s</b>		
ThinkVision E1922s Platform Specifications		
<b>ThinkVision E2054</b>		
ThinkVision E2054 Platform Specifications		
<b>ThinkVision LT1913p Square</b>		
ThinkVision LT1913p Square Platform Specifications		
<b>ThinkVision LT2024</b>		
ThinkVision LT2024 Platform Specifications		
<b>ThinkVision T1714</b>		
ThinkVision T1714 Platform Specifications		
<b>ThinkVision T1714p</b>		
ThinkVision T1714p Platform Specifications		
<b>ThinkVision T2054p</b>		
ThinkVision T2054p Platform Specifications		
<b>21 Inch - 24 Inch</b>		
<b>ThinkVision E24</b>		
ThinkVision E24 Platform Specifications		
<b>ThinkVision LT2423</b>		
ThinkVision LT2423 Platform Specifications		
<b>ThinkVision P24h</b>		
ThinkVision P24h Platform Specifications		
<b>ThinkVision P24q</b>		
ThinkVision P24q Platform Specifications		
<b>ThinkVision T2224d</b>		
ThinkVision T2224d Platform Specifications		
<b>ThinkVision T2224z</b>		
ThinkVision T2224z Platform Specifications		
<b>ThinkVision T2254p</b>		
ThinkVision T2254p Platform Specifications		
<b>ThinkVision T22i</b>		
ThinkVision T22i Platform Specifications		
<b>1 ThinkVision T2324d</b>	<b>34</b>	
<b>2 ThinkVision T2324d Platform Specifications</b>	<b>35</b>	
<b>3 ThinkVision T2364t</b>	<b>36</b>	
<b>4 ThinkVision T2364t Platform Specifications</b>	<b>37</b>	
<b>4 ThinkVision T23i</b>	<b>38</b>	
<b>5 ThinkVision T23i Platform Specifications</b>	<b>39</b>	
<b>6 ThinkVision T2424z</b>	<b>40</b>	
<b>7 ThinkVision T2424z Platform Specifications</b>	<b>41</b>	
<b>8 ThinkVision T2454p</b>	<b>42</b>	
<b>9 ThinkVision T2454p Platform Specifications</b>	<b>43</b>	
<b>10 ThinkVision T24d</b>	<b>44</b>	
<b>11 ThinkVision T24d Platform Specifications</b>	<b>45</b>	
<b>12 ThinkVision T24i</b>	<b>46</b>	
<b>13 ThinkVision T24i Platform Specifications</b>	<b>47</b>	
<b>14 ThinkVision X24</b>	<b>48</b>	
<b>15 ThinkVision X24 Platform Specifications</b>	<b>49</b>	
<b>16 ThinkVision X24 Pro</b>	<b>50</b>	
<b>17 ThinkVision X24 Pro Platform Specifications</b>	<b>51</b>	
<b>18 Above 25 Inch</b>	<b>52</b>	
<b>18 ThinkVision P27</b>	<b>52</b>	
<b>19 ThinkVision P27 Platform Specifications</b>	<b>53</b>	
<b>20 ThinkVision P27h</b>	<b>54</b>	
<b>21 ThinkVision P27h Platform Specifications</b>	<b>55</b>	
<b>22 ThinkVision P27q</b>	<b>56</b>	
<b>23 ThinkVision P27q Platform Specifications</b>	<b>57</b>	
<b>24 ThinkVision Pro2820</b>	<b>58</b>	
<b>25 ThinkVision Pro2820 Platform Specifications</b>	<b>59</b>	
<b>26 ThinkVision X1</b>	<b>60</b>	
<b>27 ThinkVision X1 Platform Specifications</b>	<b>61</b>	
<b>28 Legal Information</b>	<b>62</b>	
<b>29</b>		
<b>30</b>		
<b>31</b>		
<b>32</b>		
<b>33</b>		

# Summary of Changes

---

This section describes the technical changes made in this edition.

This edition might also include minor corrections and editorial changes which are not identified.

## August 23, 2017 - Version 511

### Additions in this update

▶ **New product(s)**

None

▶ **New model(s)**

None

▶ **Others**

None

### Changes in this update

ThinkVision models No. update (19 monitors)

### Withdrawals in this update

None



<p>Name <b>E1922s Wide Flat Panel Monitor</b>                  Case color <b>Black</b>                  Type-model <b>60G2AAR6US / 60G2AAT6EU</b>                  Panel <b>TFT-LCD, twisted nematic (TN), White LED backlight</b>                  Viewable image size <b>18.5" (470mm) diagonal</b>                  Max view area (W x H) <b>16.1" x 9.1" / 409.8mm x 230.4mm</b>                  Native resolution <b>1366x768</b>                  Aspect ratio <b>16:9</b>                  Pixel pitch (mm) <b>0.3mm</b>                  Dot/Pixel per Inch <b>85 dpi</b>                  Brightness <b>200 nits or cd/m<sup>2</sup> (typical)</b>                  Contrast ratio <b>600:1 (typical)</b>                  Pixel response time <b>5ms (typical)</b>                  Color gamut <b>72%</b>                  Viewing angle at 10:1 CR <b>180° (+/- 90°) horizontal, 100° (+/- 50°) vertical</b>                  Stand <b>Tilt adjustable stand</b>                  Bezel width <b>Sides: 0.73" (18.5mm)</b>                  Dimensions (HxWxD) <b>13.44" H x 17.65" W x 6.58" D;                  341.5mm H x 448.4mm W x 167.2mm D</b>                  Power supply <b>13.7 watts typical, 17 watts maximum,                  &lt;0.5 watts standby/suspend, universal,                  integrated (no external brick-like power supply)</b>                  Weight <b>6.03 lb; 2.74 kg</b>                  Limited warranty<sup>4</sup> <b>3 year (includes backlight)</b>                  Available date <b>March 2014</b></p>	<p style="text-align: center;"><b>Features</b></p> <ul style="list-style-type: none"> <li>• Widescreen 18.5-inch monitor</li> <li>• Supports HD 1366x768 resolution</li> <li>• Supports VESA mount (100mm)</li> <li>• Mercury free panel and arsenic free glass</li> <li>• Kensington lock slot ready for enhanced security</li> <li>• Support Lenovo Tiny PC via VESA mount</li> <li>• Supports optional soundbar</li> <li>• Microsoft® Windows® 7 certified</li> <li>• Microsoft Windows 8 / Windows 8.1 certified</li> </ul>				
<p>VESA-compliant<sup>2</sup> <b>VESA DPMS-compliant</b>                  Power management <b>ENERGY STAR® 7.0</b>                  Ergonomics <b>ISO 9241-307</b>                  Emission standards <b>FCC Class B</b>                  Environmental <b>TCO (TCO Displays 7.0), WEEE, RoHS,                  EPEAT™ Gold rating</b></p>	<div style="text-align: center;">  <p><b>ThinkVision E1922s Wide Monitor</b></p> </div>				
<p>Preset resolutions <b>VGA: 640x350, 640x480, 720x400                  SVGA: 800x600, 832x624                  XGA: 1024x768, 1152x864                  SXGA: 1280x1024                  WXGA: 1366x768</b></p> <p>Presets / user settings <b>Standard presets: 15                  user settings: 16</b></p>					
<p>Viewing adjustments <b>Tilt: 20° backward, -5° forward</b>                  Rotating screen <b>None</b>                  On screen display <b>On screen display with digital user controls (8 languages)</b>                  Control features <b>Direct access (control buttons on front) for automatic image setup and adjustment for brightness</b>                  Multiple input <b>None</b>                  Monitor connectors <b>VGA 15-pin D-shell, analog, blue</b>                  Signal cables <b>detachable, VGA 15-pin D-shell at each end, analog, 1.8 meter</b>                  Mounting features <b>Wall or desk mounting using the Extend Arm or third-party accessories meeting the VESA FPMPI® (100mm mount)</b>                  Security <b>Security keyhole for attachment of optional cable lock (Kensington® lock-compatible)</b></p>					
<p>Ship group <b>Monitor with stand, 1.8 meter analog signal cable, 1.8 meter black power cord</b></p>					
<p style="text-align: center;"><b>Limited Warranty</b></p> <p>See details at <a href="http://support.lenovo.com/en_US/guides-and-manuals/detail.page?DocID=UM008281">http://support.lenovo.com/en_US/guides-and-manuals/detail.page?DocID=UM008281</a></p>	<p style="text-align: center;"><b>Accessories</b></p> <table border="0" style="width: 100%;"> <tr> <td>Kensington MicroSaver Cable Lock</td> <td style="text-align: right;">73P2582</td> </tr> <tr> <td>Kensington Twin Head Cable Lock</td> <td style="text-align: right;">45K1620</td> </tr> </table> <p>See details at <a href="http://www.lenovo.com/support/monitoraccessories">www.lenovo.com/support/monitoraccessories</a></p> <p>See all monitors at <a href="http://www.lenovo.com/thinkvision">www.lenovo.com/thinkvision</a></p>	Kensington MicroSaver Cable Lock	73P2582	Kensington Twin Head Cable Lock	45K1620
Kensington MicroSaver Cable Lock	73P2582				
Kensington Twin Head Cable Lock	45K1620				



<p>Name <b>E2054 Wide Flat Panel Monitor</b>                  Case color <b>Raven black</b>                  Type-model <b>60DFAAR1US / 60DFAAT1EU</b>                  Panel <b>TFT-LCD, In-Plane Switching (IPS), LED backlight</b>                  Viewable image size <b>19.5" (494mm) diagonal</b>                  Max view area (W x H) <b>16.48" x 10.33" / 418.6mm x 262.4mm</b>                  Native resolution <b>1440x900</b>                  Aspect ratio <b>16:10</b>                  Pixel pitch (mm) <b>0.097mm x 0.292mm</b>                  Dot/Pixel per Inch <b>87 dpi</b>                  Brightness <b>250 nits or cd/m<sup>2</sup> (typical)</b>                  Contrast ratio <b>1000:1 (typical)</b>                  Pixel response time <b>7ms (typical)</b>                  Color gamut <b>72%</b>                  Viewing angle at 10:1 CR <b>178° (+/- 89°) horizontal, 178° (+/- 89°) vertical</b>                  Stand <b>Tilt adjustable stand</b>                  Bezel width <b>Top: 0.71" (18.0mm)</b>  <b>Bottom: 0.70" (17.9mm)</b>  <b>Sides: 1.02" (26.0mm)</b>                  Dimensions (HxWxD) <b>14.65" H x 17.95" W x 7.41" D;</b>  <b>372.0mm H x 456.0mm W x 188.3mm D</b>                  Power supply <b>16 watts typical, 20 watts maximum,</b>  <b>&lt;0.5 watts standby/suspend, universal,</b>  <b>integrated (no external brick-like power supply)</b>                  Weight <b>6.17 lb; 2.8 kg</b>                  Limited warranty <b>3 year (includes backlight)</b>                  Available date <b>November 2015</b></p>	<p style="text-align: center;"><b>Features</b></p> <ul style="list-style-type: none"> <li>• Widescreen 19.5-inch monitor</li> <li>• Supports HD 1440x900 resolution</li> <li>• Supports VESA mount (100mm)</li> <li>• Mercury free panel and arsenic free glass</li> <li>• Kensington lock slot ready for enhanced security</li> <li>• Support Lenovo Tiny PC via VESA mount</li> <li>• Microsoft® Windows® 7 certified</li> <li>• Microsoft Windows 8 / Windows 8.1 certified</li> <li>• Microsoft Windows 10 certified</li> </ul>				
<p>VESA-compliant <b>VESA DPMS-compliant</b>                  Power management <b>ENERGY STAR® 6.0</b>                  Ergonomics <b>ISO 9241-307</b>                  Emission standards <b>FCC Class B</b>                  Environmental <b>TCO (TCO Displays 6.0), WEEE, RoHS,</b>  <b>EPEAT™ Silver rating</b></p>	<div style="text-align: center;">  <p><b>ThinkVision E2054 Wide Monitor</b></p> </div>				
<p>Preset resolutions <b>VGA: 640x480, 720x400</b>  <b>SVGA: 800x600</b>  <b>XGA: 1024x768</b>  <b>SXGA: 1280x768, 1280x1024</b>  <b>WXGA: 1366x768</b>  <b>WXGA+: 1440x900</b></p> <p>Presets / user settings <b>Standard presets: 18</b>  <b>user settings: 10</b></p>					
<p>Viewing adjustments <b>Tilt: 22° backward, -5° forward</b>                  Rotating screen <b>None</b>                  On screen display <b>On screen display with digital user controls (8 languages)</b>                  Control features <b>Direct access (control buttons on front) for automatic image setup and adjustment for brightness</b>                  Multiple input <b>None</b>                  Monitor connectors <b>VGA 15-pin D-shell, analog, blue</b>                  Signal cables <b>detachable, VGA 15-pin D-shell at each end, analog, 1.8 meter</b>                  Mounting features <b>Wall or desk mounting using the Extend Arm or third-party accessories meeting the VESA FPMPI® (100mm mount)</b>                  Security <b>Security keyhole for attachment of optional cable lock (Kensington® lock-compatible)</b></p>					
<p>Ship group <b>Monitor with stand, 1.8 meter analog signal cable, 1.8 meter black power cord</b></p>					
<p style="text-align: center;"><b>Limited Warranty</b></p> <p>See details at <a href="http://support.lenovo.com/en_US/guides-and-manuals/detail.page?DocID=UM008281">http://support.lenovo.com/en_US/guides-and-manuals/detail.page?DocID=UM008281</a></p>	<p style="text-align: center;"><b>Accessories</b></p> <table border="0"> <tr> <td>Kensington MicroSaver Cable Lock</td> <td style="text-align: right;">73P2582</td> </tr> <tr> <td>Kensington Twin Head Cable Lock</td> <td style="text-align: right;">45K1620</td> </tr> </table> <p>See details at <a href="http://www.lenovo.com/support/monitoraccessories">www.lenovo.com/support/monitoraccessories</a></p> <p>See all monitors at <a href="http://www.lenovo.com/thinkvision">www.lenovo.com/thinkvision</a></p>	Kensington MicroSaver Cable Lock	73P2582	Kensington Twin Head Cable Lock	45K1620
Kensington MicroSaver Cable Lock	73P2582				
Kensington Twin Head Cable Lock	45K1620				





<p>Name <b>LT1913p Square Flat Panel Monitor</b>                  Case color <b>Black</b>                  Type-model <b>60FBHAR1US / 60FBHAT1EU</b>                  Panel TFT-LCD, In-Plane Switching (IPS), White LED backlight                  Viewable image size <b>19.0" (480.0mm) diagonal</b>                  Max view area (W x H) <b>14.76" x 11.80" (374.7mm x 299.8mm)</b>                  Optimum resolution <b>1280x1024</b>                  Max pixel rate <b>205MHz (VGA), 165MHz (DVI)</b>                  Aspect ratio <b>5:4</b>                  Pixel pitch (mm) <b>0.0976 (H) x 0.2928 (V) mm</b>                  Dot/Pixel per Inch <b>86.8 dpi</b>                  Brightness <b>250 nits or cd/m<sup>2</sup> (typical)</b>                  Contrast ratio <b>1000:1 (typical)</b>                  Pixel response time <b>7ms (typical)</b>                  Color gamut <b>72%</b>                  Viewing angle at 10:1 CR <b>178° horizontal, 178° vertical</b>                  Stand <b>Tilt, swivel, pivot, and height adjustable stand</b>                  Bezel width <b>Sides: 0.68" (17.4mm); top: 0.68" (17.4mm); bottom: 0.68" (17.4mm)</b>                  Dimensions (HxWxD) <b>14.63" H x 16.18" W x 10.40" D; 371.5mm H x 411.0mm W x 264.2mm D</b>                  Power supply <b>24 watts typical, 27 watts maximum, &lt;0.5 watts standby/suspend, universal, integrated (no external brick-like power supply)</b>                  Weight <b>10.69 lb; 4.85kg</b>                  Limited warranty<sup>4</sup> <b>3 year (includes backlight)</b>                  Available date <b>April 2015</b></p>	<p><b>Features</b></p> <ul style="list-style-type: none"> <li>• 19-inch Square IPS LED backlit panel</li> <li>• Supports 1280x1024 resolution</li> <li>• Supports ThinkCentre Tiny Clamp Bracket</li> <li>• Mercury and arsenic free glass</li> <li>• Low Halogen</li> <li>• Recycled content in plastic material</li> <li>• Supports optional soundbar</li> <li>• Microsoft® Windows® 7 certified</li> <li>• Microsoft Windows 8 / Windows 8.1 certified</li> <li>• Microsoft Windows 10 certified</li> </ul>								
<p>VESA-compliant<sup>2</sup> <b>VESA DDC2B/C1, EDID 1.3</b>                  Power management <b>ENERGY STAR® 7.0</b>                  Ergonomics <b>ISO 9241-307</b>                  Emission standards <b>FCC Class B</b>                  Environmental <b>TCO Displays 7.0, TCO Certified Edge 1.1, WEEE, RoHS, EPEAT™ Gold rating, ULE Gold</b></p> <p>Preset resolutions <b>VGA: 640x350, 640x480, 720x400</b>  <b>SVGA: 800x600, 823x624</b>  <b>XGA: 1024x768, 1152x864, 1152x900</b>  <b>SXGA: 1280x1024</b></p> <p>Presets / user settings <b>Standard presets: 20; user settings: 20</b></p>	 <p><b>ThinkVision LT1913p Square Monitor</b></p>								
<p>Viewing adjustments <b>Tilt: 30° back, -5° forward; lift: 4.3" (110mm); swivel: +/- 45°</b>                  Rotating screen <b>Screen pivots 90 degrees from landscape to portrait</b>                  On screen display <b>On screen display with digital user controls (8 languages)</b>                  Control features <b>Direct access (buttons on front) for automatic image setup, input switch, and brightness</b>                  Multiple input <b>Dual input (two different PCs attach to two different connectors; one PC shows image; select via button)</b>                  Monitor connectors <b>(1) VGA 15-pin D-shell, analog, blue</b>  <b>(2) Digital Visual Interface (DVI-D), digital, white, HDCP-compliant</b>                  Signal cables <b>(1) detachable, VGA 15-pin D-shell at each end, analog, 1.8 meter</b>  <b>(2) detachable, DVI-D at each end, digital, 1.8 meter</b>                  Mounting features <b>Wall or desk mounting using the Extend Arm or third-party accessories meeting the VESA FPMPI® (100mm mount)</b>                  Security <b>Security keyhole for attachment of optional cable lock (Kensington® lock-compatible)</b>                  Ship group <b>Monitor, attached stand, Setup poster, Safety and Warranty Information, 1.8 meter analog signal cable, 1.8 meter DVI-D cable, 1.8 meter black power cord</b></p>									
<p><b>Limited Warranty</b></p> <p>See details at <a href="http://support.lenovo.com/en_US/guides-and-manuals/detail.page?DocID=UM008281">http://support.lenovo.com/en_US/guides-and-manuals/detail.page?DocID=UM008281</a></p>	<p><b>Accessories</b></p> <table border="0"> <tr> <td>Kensington MicroSaver Cable Lock</td> <td>73P2582</td> </tr> <tr> <td>Kensington Twin Head Cable Lock</td> <td>45K1620</td> </tr> <tr> <td>Lenovo Security Cable Lock</td> <td>57Y4303</td> </tr> <tr> <td>Lenovo Easy Reach Monitor Stand</td> <td>55Y9258</td> </tr> </table> <p>See details at <a href="http://www.lenovo.com/support/monitoraccessories">www.lenovo.com/support/monitoraccessories</a></p> <p>See all monitors at <a href="http://www.lenovo.com/thinkvision">www.lenovo.com/thinkvision</a></p>	Kensington MicroSaver Cable Lock	73P2582	Kensington Twin Head Cable Lock	45K1620	Lenovo Security Cable Lock	57Y4303	Lenovo Easy Reach Monitor Stand	55Y9258
Kensington MicroSaver Cable Lock	73P2582								
Kensington Twin Head Cable Lock	45K1620								
Lenovo Security Cable Lock	57Y4303								
Lenovo Easy Reach Monitor Stand	55Y9258								







<p>Name <b>LT2024 Wide Flat Panel Monitor</b>                  Case color <b>Business black</b>                  Type-model <b>60B9HAR1US</b>                  Panel <b>TFT-LCD, twisted nematic (TN), White LED backlight</b>                  Viewable image size <b>20.0" (508mm) diagonal</b>                  Max view area (W x H) <b>17.4" x 9.8" (442.8mm x 249.1mm)</b>                  Native resolution <b>1600x900</b>                  Aspect ratio <b>16:9</b>                  Pixel pitch (mm) <b>.276mm</b>                  Dot/Pixel per Inch <b>92 dpi</b>                  Brightness <b>250 nits or cd/m<sup>2</sup> (typical)</b>                  Contrast ratio <b>1000:1 (typical)</b>                  Pixel response time <b>5ms (typical)</b>                  Color gamut <b>72%</b>                  Viewing angle at 10:1 CR <b>170° (+/- 85°) horizontal, 160° (+/- 80°) vertical</b>                  Stand <b>Tilt adjustable stand</b>                  Bezel width <b>Sides: 0.567" (14.4mm)</b>                  Dimensions (HxWxD) <b>13.68" H x 18.83" W x 6.33" D;                  347.4mm H x 478.4mm W x 160.7mm D</b>                  Power supply <b>19 watts typical, 22 watts maximum,                  &lt;0.5 watts standby/suspend, universal,                  integrated (no external brick-like power supply)</b>                  Weight <b>6.75 lb; 3.07 kg</b>                  Limited warranty<sup>4</sup> <b>3 year (includes backlight)</b>                  Available date <b>March 2014</b></p>	<p style="text-align: center;"><b>Features</b></p> <ul style="list-style-type: none"> <li>• Widescreen 20-inch monitor</li> <li>• Supports 1600x900 resolution</li> <li>• Includes dual input connection for attachment to two systems concurrently (analog and digital)</li> <li>• Arsenic / Mercury free glass</li> <li>• EPEAT Gold certified</li> <li>• Supports optional soundbar</li> <li>• Support Lenovo Tiny PC and 3rd party thin client</li> <li>• Microsoft® Windows® 7 certified</li> <li>• Microsoft Windows 8 / Windows 8.1 certified</li> </ul>				
<p>VESA-compliant<sup>2</sup> <b>VESA DDC2B/CI</b>                  Power management <b>ENERGY STAR® qualified</b>                  Ergonomics <b>ISO 9241-307</b>                  Emission standards <b>FCC Class B</b>                  Environmental <b>TCO Displays 6.0, TCO Certified Edge 1.2, WEEE,                  RoHS, <b>EPEAT™ Gold rating</b></b></p>	<div style="text-align: center;">  <p><b>ThinkVision LT2024 Wide Monitor</b></p> </div>				
<p>Preset resolutions <b>VGA: 640x350, 640x480, 720x400                  SVGA: 800x600, 832x624                  XGA: 1024x768, 1152x864                  SXGA: 1280x1024                  WXGA: 1366x768                  WXGA+: 1440x900, 1600x900</b></p> <p>Presets / user settings <b>Standard presets: 24                  user settings: 24</b></p>					
<p>Viewing adjustments <b>Tilt: 22° backward, -5° forward</b>                  Rotating screen <b>None</b>                  On screen display <b>On screen display with digital user controls (8 languages)</b>                  Control features <b>Direct access (buttons on front) for automatic image setup, dual input and brightness</b>                  Multiple input <b>Dual input (two different PCs attach to two different connectors; one PC shows image; select via button)</b>                  Monitor connectors <b>(1) VGA 15-pin D-shell, analog, blue                  (2) Digital Visual Interface (DVI-D), digital, white, <b>HDCP-compliant</b></b>                  Signal cables <b>(1) detachable, VGA 15-pin D-shell at each end, analog, 1.8 meter</b>                  Mounting features <b>Wall or desk mounting using the Extend Arm or third-party accessories meeting the VESA FPMPI® (100mm mount)</b>                  Security <b>Security keyhole for attachment of optional cable lock (Kensington® lock-compatible)</b></p>					
<p>Ship group <b>Monitor with stand, Safety and Warranty Information, 1.8 meter analog signal cable, 1.8 meter black power cord</b></p>					
<p style="text-align: center;"><b>Limited Warranty</b></p> <p>See details at <a href="http://support.lenovo.com/en_US/guides-and-manuals/detail.page?DocID=UM008281">http://support.lenovo.com/en_US/guides-and-manuals/detail.page?DocID=UM008281</a></p>	<p style="text-align: center;"><b>Accessories</b></p> <table border="0"> <tr> <td>Kensington MicroSaver Cable Lock</td> <td style="text-align: right;">73P2582</td> </tr> <tr> <td>Kensington Twin Head Cable Lock</td> <td style="text-align: right;">45K1620</td> </tr> </table> <p>See details at <a href="http://www.lenovo.com/support/monitoraccessories">www.lenovo.com/support/monitoraccessories</a></p> <p>See all monitors at <a href="http://www.lenovo.com/thinkvision">www.lenovo.com/thinkvision</a></p>	Kensington MicroSaver Cable Lock	73P2582	Kensington Twin Head Cable Lock	45K1620
Kensington MicroSaver Cable Lock	73P2582				
Kensington Twin Head Cable Lock	45K1620				

See footnotes for important warranty information  
 US model announced February 18, 2014



<p>Name <b>T1714 Square Flat Panel Monitor</b>                  Case color <b>Black</b>                  Type-model <b>60FDHAR1US / 60FDHAT1EU</b>                  Panel <b>TFT-LCD, twisted nematic (TN), White LED backlight</b>                  Viewable image size <b>17.0" (432mm) diagonal</b>                  Max view area (W x H) <b>13.3" x 10.6" (337.9mm x 270.3mm)</b>                  Optimum resolution <b>1280x1024</b>                  Aspect ratio <b>5:4</b>                  Pixel pitch (mm) <b>0.264mm</b>                  Dot/Pixel per Inch <b>96 dpi</b>                  Brightness <b>250 nits or cd/m<sup>2</sup> (typical)</b>                  Contrast ratio <b>1000:1 (typical)</b>                  Pixel response time <b>5ms (typical)</b>                  Color gamut <b>72%</b>                  Viewing angle at 10:1 CR <b>170° (+/- 85°) horizontal, 160° (+/- 80°) vertical</b>                  Stand <b>Tilt stand</b>                  Bezel width <b>Sides: 0.69" (17.5mm)</b>                  Dimensions (HxWxD, including stand) <b>14.72" H x 14.74" W x 7.87" D;                  373.9mm H x 374.5mm W x 200mm D</b>                  Power supply <b>14.0 watts typical, 18.0 watts maximum,                  &lt;0.5 watts standby/suspend, universal,                  integrated (no external brick-like power supply)</b>                  Weight <b>5.75 lb; 2.61kg</b>                  Limited warranty <b>3 year (includes backlight)</b>                  Available date <b>September 2015</b></p>	<p><b>Features</b></p> <ul style="list-style-type: none"> <li>• 17-inch Square LCD monitor</li> <li>• Supports SXGA 1280x1024 resolution</li> <li>• Includes dual input connection for attachment to two systems concurrently (analog and digital)</li> <li>• Mercury Arsenic free glass</li> <li>• Supports optional soundbar</li> <li>• Microsoft® Windows® 7 certified</li> <li>• Microsoft Windows 8 certified</li> <li>• Microsoft Windows 8.1 certified</li> <li>• Microsoft Windows 10 certified</li> </ul>						
<p>VESA-compliant <b>VESA DDC2B/CI</b>                  Power management <b>ENERGY STAR® 7.0</b>                  Ergonomics <b>ISO 9241-307</b>                  Emission standards <b>FCC Class B</b>                  Environmental <b>TCO Displays 7.0, TCO Certified Edge 2.0, WEEE,                  RoHS, EPEAT™ Gold rating</b></p>	<div style="text-align: center;">  <p><b>ThinkVision T1714 Monitor</b></p> </div>						
<p>Preset resolutions <b>VGA: 640x350, 640x480, 720x400                  SVGA: 800x600                  XGA: 1024x768, 1152x864,                  SXGA: 1280x800, 1280x1024</b></p> <p>Presets / user settings <b>Standard presets: 17;                  user settings: 17</b></p>							
<p>Viewing adjustments <b>Tilt: 22° back, -5° forward</b>                  Rotating screen <b>None</b>                  On screen display <b>On screen display with digital user controls (8 languages)</b>                  Control features <b>Direct access (buttons on front) for automatic image setup and brightness</b>                  Multiple input <b>Dual input (two different PCs attach to two different connectors; one PC shows image; select via button)</b>                  Monitor connectors <b>(1) VGA 15-pin D-shell, analog, blue                  (2) Digital Visual Interface (DVI-D), digital, white, <b>HDCP-compliant</b></b>                  Signal cables <b>(1) detachable, VGA 15-pin D-shell at each end, analog, 1.8 meter                  (2) detachable, DVI-D at each end, digital, 1.8 meter</b>                  Mounting features <b>Wall or desk mounting using the Extend Arm or third-party accessories meeting the VESA FPMPI® (100mm mount)</b>                  Security <b>Security keyhole for attachment of optional cable lock (Kensington® lock-compatible)</b></p>							
<p>Ship group <b>Monitor and stand, Setup poster, Safety and Warranty Information, 1.8 meter analog signal cable,                  1.8 meter DVI-D cable, 1.8 meter black power cord</b></p>							
<p style="text-align: center;"><b>Limited Warranty</b></p> <p>See details at <a href="http://support.lenovo.com/en_US/guides-and-manuals/detail.page?DocID=UM008281">http://support.lenovo.com/en_US/guides-and-manuals/detail.page?DocID=UM008281</a></p>	<p style="text-align: center;"><b>Accessories</b></p> <table border="0"> <tr> <td>Kensington MicroSaver Cable Lock</td> <td style="text-align: right;">73P2582</td> </tr> <tr> <td>Kensington Twin Head Cable Lock</td> <td style="text-align: right;">45K1620</td> </tr> <tr> <td>Lenovo Easy Reach Monitor Stand</td> <td style="text-align: right;">55Y9258</td> </tr> </table> <p>See details at <a href="http://www.lenovo.com/support/monitoraccessories">www.lenovo.com/support/monitoraccessories</a></p> <p>See all monitors at <a href="http://www.lenovo.com/thinkvision">www.lenovo.com/thinkvision</a></p>	Kensington MicroSaver Cable Lock	73P2582	Kensington Twin Head Cable Lock	45K1620	Lenovo Easy Reach Monitor Stand	55Y9258
Kensington MicroSaver Cable Lock	73P2582						
Kensington Twin Head Cable Lock	45K1620						
Lenovo Easy Reach Monitor Stand	55Y9258						



<p>Name <b>T1714p Square Flat Panel Monitor</b>                  Case color <b>Black</b>                  Type-model <b>60FELAR1US / 60FELAT1EU</b>                  Panel <b>TFT-LCD, twisted nematic (TN), White LED backlight</b>                  Viewable image size <b>17.0" (432mm) diagonal</b>                  Max view area (W x H) <b>13.3" x 10.6" (337.9mm x 270.3mm)</b>                  Optimum resolution <b>1280x1024</b>                  Aspect ratio <b>5:4</b>                  Pixel pitch (mm) <b>0.264mm</b>                  Dot/Pixel per Inch <b>96 dpi</b>                  Brightness <b>250 nits or cd/m<sup>2</sup> (typical)</b>                  Contrast ratio <b>1000:1 (typical)</b>                  Pixel response time <b>5ms (typical)</b>                  Color gamut <b>72%</b>                  Viewing angle at 10:1 CR <b>170° (+/- 85°) horizontal, 160° (+/- 80°) vertical</b>                  Stand <b>Tilt height adjustable stand</b>                  Bezel width <b>Sides: 0.69" (17.5mm)</b>                  Dimensions (HxWxD, including stand) <b>17.63" H x 14.74" W x 9.61" D; 447.9mm H x 374.5mm W x 244.2mm D</b>                  Power supply <b>14.0 watts typical, 18.0 watts maximum, &lt;0.5 watts standby/suspend, universal, integrated (no external brick-like power supply)</b>                  Weight <b>8.71 lb; 3.95kg</b>                  Limited warranty <b>3 year (includes backlight)</b>                  Available date <b>September 2015</b></p>	<p><b>Features</b></p> <ul style="list-style-type: none"> <li>• 17-inch Square LCD monitor</li> <li>• Supports SXGA 1280x1024 resolution</li> <li>• Includes dual input connection for attachment to two systems concurrently (analog and digital)</li> <li>• Mercury Arsenic free glass</li> <li>• Supports Lenovo Tiny PC and 3rd party thin client via optional Lenovo bracket</li> <li>• Supports optional soundbar</li> <li>• Microsoft® Windows® 7 certified</li> <li>• Microsoft Windows 8 certified</li> <li>• Microsoft Windows 8.1 certified</li> <li>• Microsoft Windows 10 certified</li> </ul>						
<p>VESA-compliant <b>VESA DDC2B/CI</b>                  Power management <b>ENERGY STAR® 7.0</b>                  Ergonomics <b>ISO 9241-307</b>                  Emission standards <b>FCC Class B</b>                  Environmental <b>TCO Displays 7.0, TCO Certified Edge 2.0, WEEE, RoHS, EPEAT™ Gold rating</b></p>	<div style="text-align: center;">  <p><b>ThinkVision T1714p Monitor</b></p> </div>						
<p>Preset resolutions <b>VGA: 640x350, 640x480, 720x400</b>  <b>SVGA: 800x600</b>  <b>XGA: 1024x768, 1152x864,</b>  <b>SXGA: 1280x800, 1280x1024</b>                  Presets / user settings <b>Standard presets: 22;</b>  <b>user settings: 22</b></p>							
<p>Viewing adjustments <b>Tilt: 22° back, -5° forward; lift: 4.3" (110mm)</b>                  Rotating screen <b>None</b>                  On screen display <b>On screen display with digital user controls (8 languages)</b>                  Control features <b>Direct access (buttons on front) for automatic image setup and brightness</b>                  Multiple input <b>Dual input (two different PCs attach to two different connectors; one PC shows image; select via button)</b>                  Monitor connectors <b>(1) VGA 15-pin D-shell, analog, blue</b>  <b>(2) Digital Visual Interface (DVI-D), digital, white, HDCP-compliant</b>  <b>(3) DisplayPort, digital, black, HDCP-compliant</b>                  Signal cables <b>(1) detachable, VGA 15-pin D-shell at each end, analog, 1.8 meter</b>  <b>(2) detachable, DVI-D at each end, digital, 1.8 meter</b>                  Mounting features <b>Wall or desk mounting using the Extend Arm or third-party accessories meeting the VESA FPMPI® (100mm mount)</b>                  Security <b>Security keyhole for attachment of optional cable lock (Kensington® lock-compatible)</b></p>	<p>Ship group <b>Monitor and stand, Setup poster, Safety and Warranty Information, 1.8 meter analog signal cable, 1.8 meter DVI-D cable, 1.8 meter black power cord</b></p>						
<p style="text-align: center;"><b>Limited Warranty</b></p> <p>See details at <a href="http://support.lenovo.com/en_US/guides-and-manuals/detail.page?DocID=UM008281">http://support.lenovo.com/en_US/guides-and-manuals/detail.page?DocID=UM008281</a></p>	<p style="text-align: center;"><b>Accessories</b></p> <table border="0"> <tr> <td>Kensington MicroSaver Cable Lock</td> <td style="text-align: right;">73P2582</td> </tr> <tr> <td>Kensington Twin Head Cable Lock</td> <td style="text-align: right;">45K1620</td> </tr> <tr> <td>Lenovo Easy Reach Monitor Stand</td> <td style="text-align: right;">55Y9258</td> </tr> </table> <p>See details at <a href="http://www.lenovo.com/support/monitoraccessories">www.lenovo.com/support/monitoraccessories</a></p> <p>See all monitors at <a href="http://www.lenovo.com/thinkvision">www.lenovo.com/thinkvision</a></p>	Kensington MicroSaver Cable Lock	73P2582	Kensington Twin Head Cable Lock	45K1620	Lenovo Easy Reach Monitor Stand	55Y9258
Kensington MicroSaver Cable Lock	73P2582						
Kensington Twin Head Cable Lock	45K1620						
Lenovo Easy Reach Monitor Stand	55Y9258						







<p>Name <b>T2054p Wide Flat Panel Monitor</b>                  Bezel color <b>Raven black</b>                  Type-model <b>60G1MAR2US / 60G1MAT2EU</b>                  Panel TFT-LCD, In-Plane Switching (IPS), White LED backlight</p> <p>Viewable image size <b>19.5" (495mm) diagonal</b>                  Max view area (W x H) <b>16.48" x 10.33" (418.6mm x 262.4mm)</b>                  Native resolution <b>1440x900</b>                  Aspect ratio <b>16:10</b>                  Pixel pitch (mm) <b>0.2915 x 0.2915 mm</b>                  Dot/Pixel per Inch <b>87 dpi</b>                  Brightness <b>250 nits or cd/m<sup>2</sup> (typical)</b>                  Contrast ratio <b>1000:1 (typical)</b>                  Pixel response time <b>7ms (typical)</b>                  Color gamut <b>72%</b>                  Viewing angle at 10:1 CR <b>178° (+/- 89°) horizontal, 178° (+/- 89°) vertical</b>                  Stand <b>Tilt, swivel, and height adjustable</b>                  Bezel width <b>Sides: 0.67" (17.0mm)</b>                  Dimensions (HxWxD) <b>13.62" H x 17.88" W x 9.55" D;                  345.9mm H x 454.2mm W x 242.6mm D</b></p> <p>Power supply <b>14.5 watts typical, 21 watts maximum,                  &lt;0.3 watts standby/suspend, universal,                  integrated (no external brick-like power supply)</b></p> <p>Weight <b>8.16 lb; 3.70 kg</b>                  Limited warranty<sup>4</sup> <b>3 year (includes backlight)</b>                  Available date <b>September 2015</b></p>	<p style="text-align: center;"><b>Features</b></p> <ul style="list-style-type: none"> <li>• Widescreen 19.5-inch monitor</li> <li>• Supports 1440x900 resolution</li> <li>• Supports ThinkCentre Tiny Clamp Bracket</li> <li>• Includes dual input connection for attachment to two systems concurrently (analog and digital)</li> <li>• EPEAT Gold certified</li> <li>• Supports optional soundbar</li> <li>• Microsoft® Windows® 7 certified</li> <li>• Microsoft Windows 8 / Windows 8.1 certified</li> <li>• Microsoft Windows 10 certified</li> </ul>				
<p>VESA-compliant<sup>2</sup> <b>VESA DDC2B/CI</b>                  Power management <b>ENERGY STAR® qualified</b>                  Ergonomics <b>ISO 9241-307</b>                  Emission standards <b>FCC Class B</b>                  Environmental <b>TCO Displays 7.0, TCO Certified Edge 2.0, WEEE, RoHS, EPEAT™ Gold rating</b></p>	<div style="text-align: center;">  <p><b>ThinkVision T2054p Wide Monitor</b></p> </div>				
<p>Preset resolutions <b>VGA: 640x480, 720x400, 720x576                  SVGA: 800x600                  XGA: 1024x768, 1152x864                  SXGA: 1280x800, 1280x1024                  WXGA: 1366x768                  WXGA+: 1440x900</b></p> <p>Presets / user settings <b>Standard presets: 22                  user settings: 16</b></p>					
<p>Viewing adjustments <b>Tilt: 22° backward, -5° forward; lift: 4.3" (110mm); swivel: +/-45°; detachable stand</b>                  Rotating screen <b>None</b>                  On screen display <b>On screen display with digital user controls (8 languages)</b>                  Control features <b>Direct access (buttons on front) for automatic image setup, dual input and brightness</b>                  Multiple input <b>Dual input (two different PCs attach to two different connectors; one PC shows image; select via button)</b>                  Monitor connectors <b>(1) VGA 15-pin D-shell, analog, blue                  (2) HDMI (1.4), digital, <b>HDCP-compliant</b>                  (3) DisplayPort, digital, black, <b>HDCP-compliant</b></b></p> <p>Signal cables <b>(1) detachable, VGA 15-pin D-shell at each end, analog, 1.8 meter                  (2) detachable, DisplayPort at each end, digital, 1.8 meter</b></p> <p>Mounting features <b>Wall or desk mounting using the Extend Arm or third-party accessories, 100mm x 100mm mount</b>                  Security <b>Security keyhole for attachment of optional cable lock (Kensington® lock-compatible)</b></p>					
<p>Ship group <b>Monitor with stand, Safety and Warranty Information, 1.8 meter analog signal cable, 1.8 meter DP signal cable, 1.8 meter black power cord</b></p>					
<p style="text-align: center;"><b>Limited Warranty</b></p> <p>See details at <a href="http://support.lenovo.com/en_US/guides-and-manuals/detail.page?DocID=UM008281">http://support.lenovo.com/en_US/guides-and-manuals/detail.page?DocID=UM008281</a></p>	<p style="text-align: center;"><b>Accessories</b></p> <table border="0"> <tr> <td>Kensington MicroSaver Cable Lock</td> <td style="text-align: right;">73P2582</td> </tr> <tr> <td>Kensington Twin Head Cable Lock</td> <td style="text-align: right;">45K1620</td> </tr> </table> <p>See details at <a href="http://www.lenovo.com/support/monitoraccessories">www.lenovo.com/support/monitoraccessories</a></p> <p>See all monitors at <a href="http://www.lenovo.com/thinkvision">www.lenovo.com/thinkvision</a></p>	Kensington MicroSaver Cable Lock	73P2582	Kensington Twin Head Cable Lock	45K1620
Kensington MicroSaver Cable Lock	73P2582				
Kensington Twin Head Cable Lock	45K1620				





<p>Name <b>E24 Wide Flat Panel Monitor</b>                  Bezel color <b>Black</b>                  Type-model <b>61B7JAR6US / 61B7JAT6EU</b>                  Panel TFT-LCD, In-Plane Switching (IPS), White LED backlight                  Viewable image size <b>23.8" (604.7mm)</b> diagonal                  Max view area (W x H) <b>20.75" x 11.67"</b> (527.04mm x 296.46mm)                  Native resolution <b>1920x1080</b>                  Aspect ratio 16:9                  Pixel pitch (mm) 0.2745 x 0.2745 mm                  Dot/Pixel per Inch 92.5 dpi                  Brightness 250 nits or cd/m<sup>2</sup> (typical)                  Contrast ratio 1000:1 (typical)                  Pixel response time 6ms (typical)                  Color gamut 72%                  Viewing angle at 10:1 CR 178° (+/- 89°) horizontal, 178° (+/- 89°) vertical                  Stand Tilt adjustable stand                  Bezel width <i>Sides:</i> 0.51" (13mm)                  Dimensions (HxWxD) 15.9" H x 21.81" W x 8.07" D;                  403.8mm H x 554mm W x 204.9mm D                  Power supply 18 watts typical,                  23 watts maximum,                  &lt;0.3 watts standby/suspend, universal,                  integrated (no external brick-like power supply)                  Weight 8.2 lb; 3.7 kg                  Limited warranty <b>3 year</b> (includes backlight)                  Available date August 2017</p>	<p style="text-align: center;"><b>Features</b></p> <ul style="list-style-type: none"> <li>• Widescreen 23.8-inch monitor</li> <li>• Supports 1920x1080 resolution</li> <li>• Supports ThinkCentre Tiny Clamp Bracket</li> <li>• Supports optional soundbar</li> <li>• Includes dual input connection for attachment to two systems concurrently</li> <li>• EPEAT Gold certified</li> <li>• Microsoft® Windows® 7 certified</li> <li>• Microsoft Windows 10 certified</li> </ul>				
<p>VESA-compliant VESA DDC2B/CI                  Power management ENERGY STAR® qualified                  Ergonomics ISO 9241-307                  Emission standards FCC Class B                  Environmental TCO Displays 7.0, TCO Certified Edge 2.0, WEEE, RoHS, <b>EPEAT™ Gold rating</b></p>	<div style="text-align: center;">  <p><b>ThinkVision E24 Wide Monitor</b></p> </div>				
<p>Preset resolutions                  VGA: 640x350, 640x480, 720x400                  SVGA: 800x600, 832x624                  XGA: 1024x768, 1152x864                  SXGA: 1280x1024                  WXGA: 1366x768                  WXGA+: 1440x900, 1600x900                  WSXGA+: 1680x1050                  Full HD: 1920x1080</p> <p>Presets display modes Standard presets: 24; user settings: 20</p>					
<p>Viewing adjustments <i>Tilt:</i> 22° back, -5° forward                  Rotating screen None                  On screen display On screen display with digital user controls (8 languages)                  Control features Direct access (buttons on front) for power, menu, input source select and brightness                  USB hub None                  Multiple input Dual input (two different PCs attach to two different connectors; one PC shows image; select via button)                  Monitor connectors (1) VGA 15-pin D-shell, analog, blue                  (2) DisplayPort, digital, black, <b>HDCP-compliant</b>                  Signal cables (1) detachable, VGA 15-pin D-shell at each end, analog, 1.8 meter                  (2) detachable, DisplayPort at each end, digital, 1.8 meter                  Mounting features Wall or desk mounting using the Extend Arm or third-party accessories, 100mm x 100mm mount                  Security Security keyhole for attachment of optional cable lock (Kensington® lock-compatible)</p>					
<p>Ship group Monitor with stand, Safety and Warranty Information, 1.8 meter analog signal cable, 1.8 meter DP signal cable, 1.8 meter black power cord</p>	<p style="text-align: center;"><b>Accessories</b></p> <table border="0"> <tr> <td>Kensington MicroSaver Cable Lock</td> <td style="text-align: right;">73P2582</td> </tr> <tr> <td>Kensington Twin Head Cable Lock</td> <td style="text-align: right;">45K1620</td> </tr> </table> <p>See details at <a href="http://www.lenovo.com/support/monitoraccessories">www.lenovo.com/support/monitoraccessories</a></p> <p>See all monitors at <a href="http://www.lenovo.com/thinkvision">www.lenovo.com/thinkvision</a></p>	Kensington MicroSaver Cable Lock	73P2582	Kensington Twin Head Cable Lock	45K1620
Kensington MicroSaver Cable Lock	73P2582				
Kensington Twin Head Cable Lock	45K1620				
<p style="text-align: center;"><b>Limited Warranty</b></p> <p>See details at <a href="http://support.lenovo.com/en_US/guides-and-manuals/detail.page?DocID=UM008281">http://support.lenovo.com/en_US/guides-and-manuals/detail.page?DocID=UM008281</a></p>					



<p>Name <b>LT2423 Wide Flat Panel Monitor</b>                  Case color <b>Business black</b>                  Type-model <b>60A8KAR2US / 60A8KAT2EU</b>                  Panel <b>TFT-LCD, twisted nematic (TN), White LED backlight</b>                  Viewable image size <b>24" (610mm) diagonal</b>                  Max view area (W x H) <b>20.9" x 11.8" (531.4mm x 298.9mm)</b>                  Optimum resolution <b>1920x1080</b>                  Max pixel rate <b>205MHz</b>                  Aspect ratio <b>16:9</b>                  Pixel pitch (mm) <b>0.278mm</b>                  Dot/Pixel per Inch <b>92 dpi</b>                  Brightness <b>250 nits or cd/m<sup>2</sup> (typical)</b>                  Contrast ratio <b>1000:1 (typical)</b>                  Contrast ratio <b>2000000:1</b>                  Pixel response time <b>5ms</b>                  Color gamut <b>72%</b>                  Viewing angle at 10:1 CR <b>170° horizontal, 160° vertical</b>                  Stand <b>Tilt stand</b>                  Bezel width <b>Sides: 0.67" (17.0mm); top: 0.67" (17.0mm); bottom: 1.02" (26.0mm)</b></p> <p>Dimensions (HxWxD, excluding stand) <b>13.53" H x 22.33" W x 1.97" D;</b>                  Dimensions (HxWxD, including stand) <b>343.7mm H x 567.1mm W x 50.0mm D</b>                  Dimensions (HxWxD, including stand) <b>16.30" H x 22.33" W x 8.50" D;</b>                  Dimensions (HxWxD, including stand) <b>414.3mm H x 567.1mm W x 216.7mm D</b>                  Power supply <b>21 watts typical, 31 watts maximum, &lt;0.5 watts standby/suspend, universal, integrated (no external brick-like power supply)</b></p> <p>Weight <b>8.30 lb; 3.76kg</b>                  Limited warranty<sup>4</sup> <b>3 year (includes backlight)</b>                  Available date <b>July 2013</b></p>	<p><b>Features</b></p> <ul style="list-style-type: none"> <li>• Widescreen 24-inch monitor</li> <li>• Supports 1920x1080 resolution</li> <li>• Two 3W stereo speakers</li> <li>• Audio in (3.5mm)</li> <li>• Supports VGA and HDMI 1.4 interfaces</li> <li>• Supports optional soundbar</li> <li>• Support Lenovo Tiny PC and 3rd party thin client via optional Lenovo bracket</li> <li>• Microsoft® Windows® 8 certified</li> <li>• Arsenic/Lead/Mercury free</li> </ul>										
<p>VESA-compliant<sup>2</sup> <b>VESA DDC2B/CI</b>                  Power management <b>ENERGY STAR® 6.0</b>                  Ergonomics <b>ISO 9241-307</b>                  Emission standards <b>MPR-2, FCC Class B</b>                  Environmental <b>TCO Displays 6.0, TCO Certified Edge 1.2, WEEE, RoHS, EPEAT™ Gold rating, ULE Gold</b></p> <p>Preset resolutions <b>VGA: 640x350, 640x480, 720x400</b>  <b>SVGA: 800x600, 832x624</b>  <b>XGA: 1024x768, 1152x864</b>  <b>SXGA: 1280x1024</b>  <b>WXGA: 1366x768</b>  <b>WXGA+: 1440x900, 1600x900</b>  <b>WSXGA+: 1680x1050</b>  <b>Full HD: 1920x1080</b></p> <p>Presets / user settings <b>Standard presets: 24; User settings: 20</b></p>	 <p><b>ThinkVision LT2423 Wide Monitor</b></p>										
<p>Viewing adjustments <b>Tilt: 22° back, -5° forward</b>                  Rotating screen <b>None</b>                  On screen display <b>On screen display with digital user controls (8 languages)</b>                  Control features <b>Direct access (buttons on front) for automatic image setup, input switch, and brightness</b>                  Multimedia <b>Integrated stereo speakers (3 watts x 2)</b>                  Multiple input <b>Dual input (two different PCs attach to two different connectors; one PC shows image; select via button)</b>                  Monitor connectors <b>(1) VGA 15-pin D-shell, analog, blue</b>  <b>(2) HDMI (1.4), digital, HDCP-compliant</b>                  Signal cables <b>(1) detachable, VGA 15-pin D-shell at each end, analog, 1.8 meter</b>                  Mounting features <b>Wall or desk mounting using the Extend Arm or third-party accessories meeting the VESA FPMPI® (100mm mount)</b>                  Security <b>Security keyhole for attachment of optional cable lock (Kensington® lock-compatible)</b></p>											
<p>Ship group <b>Monitor, attached stand, Setup poster, Safety and Warranty Information, 1.8 meter analog signal cable, 1.8 meter Audio cable, 1.8 meter black power cord</b></p>											
<p><b>Limited Warranty</b></p> <p>See details at <a href="http://support.lenovo.com/en_US/guides-and-manuals/detail.page?DocID=UM008281">http://support.lenovo.com/en_US/guides-and-manuals/detail.page?DocID=UM008281</a></p>	<p><b>Accessories</b></p> <table border="0"> <tr> <td>Kensington MicroSaver Cable Lock</td> <td>73P2582</td> </tr> <tr> <td>Kensington Twin Head Cable Lock</td> <td>45K1620</td> </tr> <tr> <td>Lenovo Security Cable Lock</td> <td>57Y4303</td> </tr> <tr> <td>ThinkCentre Extend Arm</td> <td>57Y4352</td> </tr> <tr> <td>Lenovo Easy Reach Monitor Stand</td> <td>55Y9258</td> </tr> </table> <p>See details at <a href="http://www.lenovo.com/support/monitoraccessories">www.lenovo.com/support/monitoraccessories</a></p> <p>See all monitors at <a href="http://www.lenovo.com/thinkvision">www.lenovo.com/thinkvision</a></p>	Kensington MicroSaver Cable Lock	73P2582	Kensington Twin Head Cable Lock	45K1620	Lenovo Security Cable Lock	57Y4303	ThinkCentre Extend Arm	57Y4352	Lenovo Easy Reach Monitor Stand	55Y9258
Kensington MicroSaver Cable Lock	73P2582										
Kensington Twin Head Cable Lock	45K1620										
Lenovo Security Cable Lock	57Y4303										
ThinkCentre Extend Arm	57Y4352										
Lenovo Easy Reach Monitor Stand	55Y9258										



<p>Name <b>P24h Wide Flat Panel Monitor</b>                  Bezel color <b>Black</b>                  Type-model <b>61AEGAR3US / 61AEGAT3EU</b>                  Panel TFT-LCD, In-Plane Switching (IPS), White LED backlight                  Viewable image size <b>23.8" (604.7mm)</b> diagonal                  Max view area (W x H) <b>20.74" x 11.67"</b> (526.9mm x 296.4mm)                  Native resolution <b>2560x1440</b>                  Aspect ratio 16:9                  Pixel pitch (mm) 0.2058x 0.2058 mm                  Dot/Pixel per Inch 124 dpi                  Brightness 300 nits or cd/m<sup>2</sup> (typical)                  Contrast ratio 1000:1 (typical)                  Pixel response time 4ms (extreme) / 6ms (typical)                  Color gamut 99% sRGB                  Viewing angle at 10:1 CR 178° (+/- 89°) horizontal, 178° (+/- 89°) vertical                  Stand Tilt, swivel, pivot, and height adjustable stand                  Bezel width <i>Sides:</i> 0.08" (2.0mm)                  Dimensions (HxWxD) 14.7" H x 21.26" W x 10.3" D;                  373.4mm H x 540.2mm W x 261.75mm D                  Power supply 24 watts typical,                  120 watts maximum (with USB 3.0 hub),                  &lt;0.5 watts standby/suspend, universal,                  integrated (no external brick-like power supply)                  Weight 12.54 lb; 5.69 kg                  Limited warranty <b>3 year</b> (includes backlight)                  Available date April 2017</p>	<p style="text-align: center;"><b>Features</b></p> <ul style="list-style-type: none"> <li>• Widescreen 23.8-inch monitor</li> <li>• Supports 2560x1440 resolution</li> <li>• Supports optional soundbar</li> <li>• Supports ThinkCentre Tiny Clamp Bracket</li> <li>• Includes dual input connection for attachment to two systems concurrently</li> <li>• EPEAT Gold certified</li> <li>• Microsoft® Windows® 7 certified</li> <li>• Microsoft Windows 10 certified</li> </ul>				
<p>VESA-compliant VESA DDC2B/CI                  Power management ENERGY STAR® qualified                  Ergonomics ISO 9241-307                  Emission standards FCC Class B                  Environmental TCO Displays 7.0, TCO Certified Edge 2.0, WEEE, RoHS, <b>EPEAT™ Gold rating</b></p>	<div style="text-align: center;">  <p><b>ThinkVision P24h Wide Monitor</b></p> </div>				
<p>Preset resolutions                  VGA: 640x480, 720x400                  SVGA: 800x600                  XGA: 1024x768                  SXGA: 1280x1024                  WXGA: 1366x768                  WXGA+: 1440x900, 1680x900                  WSXGA+: 1680x1050                  Full HD: 1920x1080, 1920x1200                  QHD: 2560x1440                  Presets display modes HDMI: 22; DP: 14</p>					
<p>Viewing adjustments <i>Tilt:</i> 30° back, -5° forward; <i>lift:</i> 4.3" (110mm); <i>swivel:</i> +/-45°; detachable stand                  Rotating screen Screen pivots 90 degrees from landscape to portrait                  On screen display On screen display with digital user controls (8 languages)                  Control features Direct access (buttons on front) for power, menu, input source select and brightness                  USB hub USB Hub: one USB Type-C upstream port, four USB 3.0 downstream ports                  Multimedia Audio-out, optional sound bar supported                  Camera None                  Multiple input Support HDMI, DisplayPort, USB 3.1 Type-C, DisplayPort-out                  Monitor connectors (1) 2*HDMI (1.4), digital, <b>HDCP-compliant</b>                  (2) DisplayPort (1.2), digital, <b>HDCP-compliant</b>                  (3) DisplayPort-out, digital                  (4) USB 3.1 Type-C                  Signal cables (1) USB 3.1 Type-C cable, 1.8 meter                  Mounting features Wall or desk mounting using the Extend Arm or third-party accessories, 100mm x 100mm mount                  Security Security keyhole for attachment of optional cable lock (Kensington® lock-compatible)</p>					
<p>Ship group Monitor with stand, Safety and Warranty Information, 1.8 meter USB 3.1 Type-C cable, 1.8 meter black power cord</p>	<p style="text-align: center;"><b>Accessories</b></p> <table border="0" style="width: 100%;"> <tr> <td>Kensington MicroSaver Cable Lock</td> <td style="text-align: right;">73P2582</td> </tr> <tr> <td>Kensington Twin Head Cable Lock</td> <td style="text-align: right;">45K1620</td> </tr> </table> <p>See details at <a href="http://www.lenovo.com/support/monitoraccessories">www.lenovo.com/support/monitoraccessories</a></p> <p>See all monitors at <a href="http://www.lenovo.com/thinkvision">www.lenovo.com/thinkvision</a></p>	Kensington MicroSaver Cable Lock	73P2582	Kensington Twin Head Cable Lock	45K1620
Kensington MicroSaver Cable Lock	73P2582				
Kensington Twin Head Cable Lock	45K1620				





<p>Name <b>P24q Wide Flat Panel Monitor</b>                  Case color <b>Black</b>                  Type-model <b>61A5GAR3US / 61A5GAT3EU</b>                  Panel TFT-LCD, IPS (In-Plane Switching), White LED backlight                  Viewable image size <b>23.8" (604.5mm) diagonal</b>                  Max view area (W x H) <b>20.74" x 11.67" (526.85mm x 296.35mm)</b>                  Optimum resolution <b>2560x1440</b>                  Max pixel rate 300MHz                  Aspect ratio 16:9                  Pixel pitch (mm) 0.2058 x 0.2058mm                  Dot/Pixel per Inch 123 dpi                  Brightness 300 nits or cd/m<sup>2</sup> (typical)                  Contrast ratio 1000:1 (typical)                  Pixel response time 4ms                  Color gamut 99% sRGB                  Viewing angle at 10:1 CR 178° horizontal, 178° vertical                  Stand Tilt, swivel, pivot, and height adjustable stand                  Bezel width <i>Sides:</i> 0.08" (2mm)                  Dimensions (HxWxD, including stand) 373.4mm H x 540.2mm W x 261.75mm D                  Power supply 24 watts typical, 67 watts maximum (with USB), &lt;0.5 watts sleep/off; &lt;0.5 watts switch off integrated (no external brick-like power supply)                  Weight 12.35 lb; 5.6kg (including stand)                  Limited warranty <b>3 year</b>                  Available date January 2017</p>	<p><b>Features</b></p> <ul style="list-style-type: none"> <li>• 23.8-inch IPS LED backlight monitor</li> <li>• Supports 2560x1440 resolution</li> <li>• 5-Ports USB hub, support USB 3.0</li> <li>• Support ThinkCentre Tiny</li> <li>• Supports optional soundbar</li> <li>• Microsoft® Windows® 7 certified</li> <li>• Microsoft Windows 10 certified</li> </ul>						
<p>VESA-compliant VESA DDC2B/CI                  Power management ENERGY STAR® 7.0                  Ergonomics ISO 9241-307                  Emission standards FCC Class B                  Environmental TCO Displays 7.0, RoHS, <b>EPEAT™ Gold rating</b>, ULE Gold</p>	 <p><b>ThinkVision P24q Monitor</b></p>						
<p>Preset resolutions                  VGA: 640x480, 720x400                  SVGA: 800x600                  XGA: 1024x768                  SXGA: 1280x1024                  WXGA: 1366x768                  WXGA+: 1440x900, 1600x900                  WSXGA+: 1680x1050                  Full HD: 1920x1080, 1920x1200                  QHD: 2560x1440</p> <p>Presets / user settings Standard presets: 20; user settings: 24</p>							
<p>Viewing adjustments <i>Tilt:</i> 30° back, -5° forward; <i>lift:</i> 4.33" (110mm); <i>swivel:</i> +/-45°                  Rotating screen <b>Screen pivots 90 degrees from landscape to portrait</b>                  On screen display On screen display with digital user controls (8 languages)                  Control features Direct access for menu, source switch, and brightness                  USB hub USB Hub: one USB 3.0 upstream port, four USB 3.0 downstream ports                  Multimedia Audio-out, optional sound bar supported                  Camera None                  Multiple input Support HDMI, DisplayPort, mini DisplayPort, DisplayPort-out                  Monitor connectors (1) 2*HDMI (1.4), digital, <b> HDCP-compliant</b>                  (2) DisplayPort (1.2), digital, <b> HDCP-compliant</b>                  (3) Mini DisplayPort, digital, <b> HDCP-compliant</b>                  Signal cables (1) detachable, mini DisplayPort to DisplayPort, digital, 1.8 meter                  Mounting features Wall or desk mounting using the Extend Arm or third-party accessories meeting the VESA FPMPI® (100mm mount)                  Security Security keyhole for attachment of optional cable lock (Kensington® lock-compatible)</p>							
<p>Ship group Monitor, detachable stand, Quick start and safety poster, 1.8 meter USB 3.0 cable, 1.8 meter mini DP to DP cable, 1.8 meter black power cord</p>	<p><b>Limited Warranty</b></p> <p>See details at <a href="http://support.lenovo.com/en_US/guides-and-manuals/detail.page?DocID=UM008281">http://support.lenovo.com/en_US/guides-and-manuals/detail.page?DocID=UM008281</a></p> <p><b>Accessories</b></p> <table border="0"> <tr> <td>Kensington MicroSaver Cable Lock</td> <td>73P2582</td> </tr> <tr> <td>Kensington Twin Head Cable Lock</td> <td>45K1620</td> </tr> <tr> <td>Lenovo Security Cable Lock</td> <td>57Y4303</td> </tr> </table> <p>See details at <a href="http://www.lenovo.com/support/monitoraccessories">www.lenovo.com/support/monitoraccessories</a></p> <p>See all monitors at <a href="http://www.lenovo.com/thinkvision">www.lenovo.com/thinkvision</a></p>	Kensington MicroSaver Cable Lock	73P2582	Kensington Twin Head Cable Lock	45K1620	Lenovo Security Cable Lock	57Y4303
Kensington MicroSaver Cable Lock	73P2582						
Kensington Twin Head Cable Lock	45K1620						
Lenovo Security Cable Lock	57Y4303						





<p>Name <b>T2224d Wide Flat Panel Monitor</b>                  Bezel color <b>Black</b>                  Type-model <b>61B1JAR1US / 61B1JAT1EU</b>                  Panel TFT-LCD, In-Plane Switching (IPS), White LED backlight                  Viewable image size <b>21.5" (546mm) diagonal</b>                  Max view area (W x H) <b>18.74" x 10.54" (476.1mm x 267.8mm)</b>                  Native resolution <b>1920x1080</b>                  Aspect ratio 16:9                  Pixel pitch (mm) 0.248 x 0.248 mm                  Dot/Pixel per Inch 102 dpi                  Brightness 250 nits or cd/m<sup>2</sup> (typical)                  Contrast ratio 1000:1 (typical)                  Pixel response time 7ms (typical); 4ms (extreme mode)                  Color gamut 72%                  Viewing angle at 10:1 CR 178° (+/- 89°) horizontal, 178° (+/- 89°) vertical                  Stand Tilt stand                  Bezel width <i>Sides:</i> 0.69" (17.6mm)                  Dimensions (HxWxD) 15.02" H x 20.19" W x 8.06" D;                  381.4mm H x 512.9mm W x 204.9mm D                  Power supply 20 watts typical,                  25 watts maximum                  &lt;0.5 watts standby/suspend, universal, integrated (no external brick-like power supply)                  Weight 6.48 lb; 2.94 kg                  Limited warranty <b>3 year</b> (includes backlight)                  Available date March 2017</p>	<p style="text-align: center;"><b>Features</b></p> <ul style="list-style-type: none"> <li>• Widescreen 21.5-inch monitor</li> <li>• Supports 1920x1080 resolution</li> <li>• Supports optional soundbar</li> <li>• Supports ThinkCentre Tiny via VESA back mount</li> <li>• Includes dual input connection for attachment to two systems concurrently (analog and digital)</li> <li>• EPEAT Gold certified</li> <li>• Microsoft® Windows® 7 certified</li> <li>• Microsoft Windows 10 certified</li> </ul>				
<p>VESA-compliant VESA DDC2B/CI                  Power management ENERGY STAR® qualified                  Ergonomics ISO 9241-307                  Emission standards FCC Class B                  Environmental TCO Displays 7.0, TCO Certified Edge 2.0, WEEE, RoHS, <b>EPEAT™ Gold rating</b></p>	<div style="text-align: center;">  <p><b>ThinkVision T2224d Wide Monitor</b></p> </div>				
<p>Preset resolutions                  VGA: 640x350, 640x480, 720x400                  SVGA: 800x600                  XGA: 1024x768, 1152x864                  SXGA: 1280x1024                  WXGA: 1280x768, 1280x800, 1366x768                  WXGA+: 1440x900                  WSXGA+: 1680x1050                  Full HD: 1920x1080                  Presets / user settings Standard presets: 22; user settings: 22</p>					
<p>Viewing adjustments <i>Tilt:</i> 22° back, -5° forward                  Rotating screen None                  On screen display On screen display with digital user controls (8 languages)                  Control features Direct access (buttons on front) for automatic image setup, dual input and brightness                  USB hub None                  Multiple input Dual input (two different PCs attach to two different connectors; one PC shows image; select via button)                  Monitor connectors (1) VGA 15-pin D-shell, analog, blue                  (2) DisplayPort, digital, black, <b>HDCP-compliant</b>                  Signal cables (1) detachable, VGA 15-pin D-shell at each end, analog, 1.8 meter                  (2) detachable, DisplayPort at each end, digital, 1.8 meter                  Mounting features Wall or desk mounting using the Extend Arm or third-party accessories, 100mm x 100mm mount                  Security Security keyhole for attachment of optional cable lock (Kensington® lock-compatible)</p>					
<p>Ship group Monitor with stand, Safety and Warranty Information, 1.8 meter analog signal cable, 1.8 meter DP signal cable, 1.8 meter black power cord</p>					
<p style="text-align: center;"><b>Limited Warranty</b></p> <p>See details at <a href="http://support.lenovo.com/en_US/guides-and-manuals/detail.page?DocID=UM008281">http://support.lenovo.com/en_US/guides-and-manuals/detail.page?DocID=UM008281</a></p>	<p style="text-align: center;"><b>Accessories</b></p> <table border="0"> <tr> <td>Kensington MicroSaver Cable Lock</td> <td style="text-align: right;">73P2582</td> </tr> <tr> <td>Kensington Twin Head Cable Lock</td> <td style="text-align: right;">45K1620</td> </tr> </table> <p>See details at <a href="http://www.lenovo.com/support/monitoraccessories">www.lenovo.com/support/monitoraccessories</a></p> <p>See all monitors at <a href="http://www.lenovo.com/thinkvision">www.lenovo.com/thinkvision</a></p>	Kensington MicroSaver Cable Lock	73P2582	Kensington Twin Head Cable Lock	45K1620
Kensington MicroSaver Cable Lock	73P2582				
Kensington Twin Head Cable Lock	45K1620				



<p>Name <b>T2224z Wide Flat Panel Monitor</b>                  Bezel color <b>Raven black</b>                  Type-model <b>60F5MARG6US / 60F5MAT6EU</b>                  Panel TFT-LCD, In-Plane Switching (IPS), White LED backlight</p> <p>Viewable image size <b>21.5" (546mm) diagonal</b>                  Max view area (W x H) <b>18.74" x 10.54" (476.1mm x 267.8mm)</b>                  Native resolution <b>1920x1080</b>                  Aspect ratio 16:9                  Pixel pitch (mm) 0.248 x 0.248 mm                  Dot/Pixel per Inch 102 dpi                  Brightness 250 nits or cd/m<sup>2</sup> (typical)                  Contrast ratio 1000:1 (typical)                  Pixel response time 7ms (typical)                  Color gamut 72%                  Viewing angle at 10:1 CR 178° (+/- 89°) horizontal, 178° (+/- 89°) vertical                  Stand Tilt, swivel, pivot, and height adjustable stand                  Bezel width <i>Sides:</i> 0.69" (17.6mm)                  Dimensions (HxWxD) 14.08" H x 20.19" W x 9.55" D;                  357.8mm H x 512.9mm W x 242.7mm D</p> <p>Power supply 21 watts typical,                  25 watts maximum (without USB 3.0 hub),                  45 watts maximum (with USB 3.0 hub),                  &lt;0.5 watts standby/suspend, universal,                  integrated (no external brick-like power supply)</p> <p>Weight 10.63 lb; 4.83 kg                  Limited warranty <b>3 year</b> (includes backlight)                  Available date March 2015</p>	<p style="text-align: center;"><b>Features</b></p> <ul style="list-style-type: none"> <li>• Widescreen 21.5-inch monitor</li> <li>• Supports 1920x1080 resolution</li> <li>• Supports ThinkCentre Tiny Clamp Bracket</li> <li>• Supports optional soundbar</li> <li>• Includes dual input connection for attachment to two systems concurrently (analog and digital)</li> <li>• EPEAT Gold certified</li> <li>• Microsoft® Windows® 7 certified</li> <li>• Microsoft Windows 8 / Windows 8.1 certified</li> <li>• Microsoft Windows 10 certified</li> </ul>				
<p>VESA-compliant VESA DDC2B/CI                  Power management ENERGY STAR® qualified                  Ergonomics ISO 9241-307                  Emission standards FCC Class B                  Environmental TCO Displays 7.0, TCO Certified Edge 2.0, WEEE, RoHS, <b>EPEAT™ Gold rating</b></p> <p>Preset resolutions                  VGA: 640x350, 640x480, 720x400                  SVGA: 800x600                  XGA: 1024x768, 1152x864                  SXGA: 1280x1024                  WXGA: 1280x768, 1280x800, 1366x768                  WXGA+: 1440x900                  WSXGA+: 1680x1050                  Full HD: 1920x1080</p> <p>Presets / user settings Standard presets: 27; user settings: 20</p>	 <p style="text-align: center;"><b>ThinkVision T2224z Wide Monitor</b></p>				
<p>Viewing adjustments <i>Tilt:</i> 30° back, -5° forward; <i>lift:</i> 4.3" (110mm); <i>swivel:</i> +/-45°; detachable stand                  Rotating screen Screen pivots 90 degrees from landscape to portrait                  On screen display On screen display with digital user controls (8 languages)                  Control features Direct access (buttons on front) for automatic image setup, dual input and brightness                  USB hub USB 3.0 Hub: 1 port into PC (USB 3.0); 2 ports for accessories (2 USB 3.0)                  Multimedia Integrated digital speakers (3 watts x 2)                  Camera Integrated camera (Full HD) and digital dual array microphone                  Multiple input Dual input (two different PCs attach to two different connectors; one PC shows image; select via button)                  Monitor connectors (1) VGA 15-pin D-shell, analog, blue                  (2) HDMI (1.4), digital, <b>HDCP-compliant</b>                  (3) DisplayPort, digital, black, <b>HDCP-compliant</b></p> <p>Signal cables (1) detachable, VGA 15-pin D-shell at each end, analog, 1.8 meter                  (2) detachable, DisplayPort at each end, digital, 1.8 meter</p> <p>Mounting features Wall or desk mounting using the Extend Arm or third-party accessories, 100mm x 100mm mount                  Security Security keyhole for attachment of optional cable lock (Kensington® lock-compatible)</p>	<p>Ship group Monitor with stand, Safety and Warranty Information, 1.8 meter analog signal cable, 1.8 meter DP signal cable, 1.8 meter USB signal cable, 1.8 meter black power cord</p>				
<p style="text-align: center;"><b>Limited Warranty</b></p> <p>See details at <a href="http://support.lenovo.com/en_US/guides-and-manuals/detail.page?DocID=UM008281">http://support.lenovo.com/en_US/guides-and-manuals/detail.page?DocID=UM008281</a></p>	<p style="text-align: center;"><b>Accessories</b></p> <table border="0"> <tr> <td>Kensington MicroSaver Cable Lock</td> <td style="text-align: right;">73P2582</td> </tr> <tr> <td>Kensington Twin Head Cable Lock</td> <td style="text-align: right;">45K1620</td> </tr> </table> <p>See details at <a href="http://www.lenovo.com/support/monitoraccessories">www.lenovo.com/support/monitoraccessories</a></p> <p>See all monitors at <a href="http://www.lenovo.com/thinkvision">www.lenovo.com/thinkvision</a></p>	Kensington MicroSaver Cable Lock	73P2582	Kensington Twin Head Cable Lock	45K1620
Kensington MicroSaver Cable Lock	73P2582				
Kensington Twin Head Cable Lock	45K1620				





<p>Name <b>T2254p Wide Flat Panel Monitor</b>                  Bezel color <b>Raven black</b>                  Type-model <b>60CCMAR2US / 60CCMAT2EU</b>                  Panel <b>TFT-LCD, twisted nematic (TN), White LED backlight</b>                  Viewable image size <b>22.0" (559mm) diagonal</b>                  Max view area (W x H) <b>18.70" x 11.70" (473.8mm x 296.1mm)</b>                  Native resolution <b>1680x1050</b>                  Aspect ratio <b>16:10</b>                  Pixel pitch (mm) <b>0.282 x 0.282 mm</b>                  Dot/Pixel per Inch <b>90 dpi</b>                  Brightness <b>250 nits or cd/m<sup>2</sup> (typical)</b>                  Contrast ratio <b>1000:1 (typical)</b>                  Pixel response time <b>5ms (typical)</b>                  Color gamut <b>72%</b>                  Viewing angle at 10:1 CR <b>170° (+/- 85°) horizontal, 160° (+/- 80°) vertical</b>                  Stand <b>Tilt, swivel, pivot, and height adjustable stand</b>                  Bezel width <b>Sides: 0.67" (17.1mm)</b>                  Dimensions (HxWxD) <b>14.63" H x 20.01" W x 9.55" D;                  371.7mm H x 509.3mm W x 242.7mm D</b>                  Power supply <b>20 watts typical,                  25 watts maximum,                  &lt;0.5 watts standby/suspend, universal,                  integrated (no external brick-like power supply)</b>                  Weight <b>10.14 lb; 4.60 kg</b>                  Limited warranty <b>3 year (includes backlight)</b>                  Available date <b>March 2015</b></p>	<p style="text-align: center;"><b>Features</b></p> <ul style="list-style-type: none"> <li>• Widescreen 22.0-inch monitor</li> <li>• Supports 1680x1050 resolution</li> <li>• Supports ThinkCentre Tiny Clamp Bracket</li> <li>• Supports optional soundbar</li> <li>• Includes dual input connection for attachment to two systems concurrently (analog and digital)</li> <li>• EPEAT Gold certified</li> <li>• Microsoft® Windows® 7 certified</li> <li>• Microsoft Windows 8 / Windows 8.1 certified</li> <li>• Microsoft Windows 10 certified</li> </ul>				
<p>VESA-compliant <b>VESA DDC2B/CI</b>                  Power management <b>ENERGY STAR® qualified</b>                  Ergonomics <b>ISO 9241-307</b>                  Emission standards <b>FCC Class B</b>                  Environmental <b>TCO Displays 7.0, TCO Certified Edge 2.0, WEEE, RoHS, EPEAT™ Gold rating</b></p>	<div style="text-align: center;">  <p><b>ThinkVision T2254p Wide Monitor</b></p> </div>				
<p>Preset resolutions <b>VGA: 640x350, 640x480, 720x400                  SVGA: 800x600                  XGA: 1024x768, 1152x864                  SXGA: 1280x1024                  WXGA: 1280x768, 1280x800, 1366x768                  WXGA+: 1440x900                  WSXGA+: 1600x900, 1680x1050</b></p> <p>Presets / user settings <b>Standard presets: 28;                  user settings: 20</b></p>					
<p>Viewing adjustments <b>Tilt: 30° back, -5° forward; lift: 4.3" (110mm); swivel: +/-45°; detachable stand</b>                  Rotating screen <b>Screen pivots 90 degrees from landscape to portrait</b>                  On screen display <b>On screen display with digital user controls (8 languages)</b>                  Control features <b>Direct access (buttons on front) for automatic image setup, dual input and brightness</b>                  USB hub <b>None</b>                  Multiple input <b>Dual input (two different PCs attach to two different connectors; one PC shows image; select via button)</b>                  Monitor connectors <b>(1) VGA 15-pin D-shell, analog, blue                  (2) HDMI (1.4), digital, <b>HDCP-compliant</b>                  (3) DisplayPort, digital, black, <b>HDCP-compliant</b></b>                  Signal cables <b>(1) detachable, VGA 15-pin D-shell at each end, analog, 1.8 meter                  (2) detachable, DisplayPort at each end, digital, 1.8 meter</b>                  Mounting features <b>Wall or desk mounting using the Extend Arm or third-party accessories, 100mm x 100mm mount</b>                  Security <b>Security keyhole for attachment of optional cable lock (Kensington® lock-compatible)</b></p>					
<p>Ship group <b>Monitor with stand, Safety and Warranty Information, 1.8 meter analog signal cable, 1.8 meter DP signal cable, 1.8 meter black power cord</b></p>					
<p style="text-align: center;"><b>Limited Warranty</b></p> <p>See details at <a href="http://support.lenovo.com/en_US/guides-and-manuals/detail.page?DocID=UM008281">http://support.lenovo.com/en_US/guides-and-manuals/detail.page?DocID=UM008281</a></p>	<p style="text-align: center;"><b>Accessories</b></p> <table border="0"> <tr> <td>Kensington MicroSaver Cable Lock</td> <td style="text-align: right;">73P2582</td> </tr> <tr> <td>Kensington Twin Head Cable Lock</td> <td style="text-align: right;">45K1620</td> </tr> </table> <p>See details at <a href="http://www.lenovo.com/support/monitoraccessories">www.lenovo.com/support/monitoraccessories</a></p> <p>See all monitors at <a href="http://www.lenovo.com/thinkvision">www.lenovo.com/thinkvision</a></p>	Kensington MicroSaver Cable Lock	73P2582	Kensington Twin Head Cable Lock	45K1620
Kensington MicroSaver Cable Lock	73P2582				
Kensington Twin Head Cable Lock	45K1620				





<p>Name <b>T22i Wide Flat Panel Monitor</b>                  Bezel color <b>Black</b>                  Type-model <b>61A9MAR1US / 61A9MAT1EU</b>                  Panel TFT-LCD, In-Plane Switching (IPS), White LED backlight                  Viewable image size <b>21.5" (546mm) diagonal</b>                  Max view area (W x H) <b>18.74" x 10.54" (476.1mm x 267.8mm)</b>                  Native resolution <b>1920x1080</b>                  Aspect ratio 16:9                  Pixel pitch (mm) 0.248 x 0.248 mm                  Dot/Pixel per Inch 102 dpi                  Brightness 250 nits or cd/m<sup>2</sup> (typical)                  Contrast ratio 1000:1 (typical)                  Pixel response time 6ms (typical); 4ms (extreme mode)                  Color gamut 72%                  Viewing angle at 10:1 CR 178° (+/- 89°) horizontal, 178° (+/- 89°) vertical                  Stand Tilt, swivel, pivot, and height adjustable stand                  Bezel width <i>Sides:</i> 0.08" (2.0mm)                  Dimensions (HxWxD) 14.08" H x 19.28" W x 9.92" D;                  357.6mm H x 489.7mm W x 251.9mm D                  Power supply 16.5 watts typical,                  55 watts maximum (with USB 3.0 hub),                  &lt;0.5 watts standby/suspend, universal,                  integrated (no external brick-like power supply)                  Weight 10.85 lb; 4.92 kg                  Limited warranty <b>3 year</b> (includes backlight)                  Available date April 2017</p>	<p style="text-align: center;"><b>Features</b></p> <ul style="list-style-type: none"> <li>• Widescreen 21.5-inch monitor</li> <li>• Supports 1920x1080 resolution</li> <li>• Supports optional soundbar</li> <li>• Supports ThinkCentre Tiny via VESA back mount</li> <li>• Includes dual input connection for attachment to two systems concurrently</li> <li>• EPEAT Gold certified</li> <li>• Microsoft® Windows® 7 certified</li> <li>• Microsoft Windows 10 certified</li> </ul>				
<p>VESA-compliant VESA DDC2B/CI                  Power management ENERGY STAR® qualified                  Ergonomics ISO 9241-307                  Emission standards FCC Class B                  Environmental TCO Displays 7.0, TCO Certified Edge 2.0, WEEE, RoHS, <b>EPEAT™ Gold rating</b></p>	<div style="text-align: center;">  <p><b>ThinkVision T22i Wide Monitor</b></p> </div>				
<p>Preset resolutions                  VGA: 640x350, 640x480, 720x400                  SVGA: 800x600                  XGA: 1024x768, 1152x864                  SXGA: 1280x1024                  WXGA: 1280x768, 1366x768                  WXGA+: 1440x900, 1680x900                  WSXGA+: 1680x1050                  Full HD: 1920x1080                  Presets display modes HDMI: 17; DP: 17</p>					
<p>Viewing adjustments <i>Tilt:</i> 30° back, -5° forward; <i>lift:</i> 4.3" (110mm); <i>swivel:</i> +/-45°; detachable stand                  Rotating screen Screen pivots 90 degrees from landscape to portrait                  On screen display On screen display with digital user controls (8 languages)                  Control features Direct access (buttons on front) for power, menu, input source select and brightness                  USB hub USB 3.0 Hub: 1 port into PC (USB 3.0); 4 ports for accessories (4 USB 3.0)                  Multiple input Dual input (two different PCs attach to two different connectors; one PC shows image; select via button)                  Monitor connectors (1) VGA 15-pin D-shell, analog, blue                  (2) HDMI (1.4), digital, <b>HDCP-compliant</b>                  (3) DisplayPort, digital, black, <b>HDCP-compliant</b>                  Signal cables (1) detachable, VGA 15-pin D-shell at each end, analog, 1.8 meter                  (2) detachable, DisplayPort at each end, digital, 1.8 meter                  Mounting features Wall or desk mounting using the Extend Arm or third-party accessories, 100mm x 100mm mount                  Security Security keyhole for attachment of optional cable lock (Kensington® lock-compatible)</p>					
<p>Ship group Monitor with stand, Safety and Warranty Information, 1.8 meter analog signal cable, 1.8 meter DP signal cable, 1.8 meter USB signal cable, 1.8 meter black power cord</p>					
<p style="text-align: center;"><b>Limited Warranty</b></p> <p>See details at <a href="http://support.lenovo.com/en_US/guides-and-manuals/detail.page?DocID=UM008281">http://support.lenovo.com/en_US/guides-and-manuals/detail.page?DocID=UM008281</a></p>	<p style="text-align: center;"><b>Accessories</b></p> <table border="0"> <tr> <td>Kensington MicroSaver Cable Lock</td> <td style="text-align: right;">73P2582</td> </tr> <tr> <td>Kensington Twin Head Cable Lock</td> <td style="text-align: right;">45K1620</td> </tr> </table> <p>See details at <a href="http://www.lenovo.com/support/monitoraccessories">www.lenovo.com/support/monitoraccessories</a></p> <p>See all monitors at <a href="http://www.lenovo.com/thinkvision">www.lenovo.com/thinkvision</a></p>	Kensington MicroSaver Cable Lock	73P2582	Kensington Twin Head Cable Lock	45K1620
Kensington MicroSaver Cable Lock	73P2582				
Kensington Twin Head Cable Lock	45K1620				





<p>Name <b>T2324d Wide Flat Panel Monitor</b>                  Bezel color <b>Black</b>                  Type-model <b>60F3JAR2US / 60F3JAT2EU</b>                  Panel <b>TFT-LCD, twisted nematic (TN), White LED backlight</b>                  Viewable image size <b>23.0" (584mm) diagonal</b>                  Max view area (W x H) <b>20.07" x 11.29" (509.8mm x 286.7mm)</b>                  Native resolution <b>1920x1080</b>                  Aspect ratio <b>16:9</b>                  Pixel pitch (mm) <b>0.2655 x 0.2655 mm</b>                  Dot/Pixel per Inch <b>96 dpi</b>                  Brightness <b>250 nits or cd/m<sup>2</sup> (typical)</b>                  Contrast ratio <b>1000:1 (typical)</b>                  Pixel response time <b>5ms (typical)</b>                  Color gamut <b>72%</b>                  Viewing angle at 10:1 CR <b>170° (+/- 85°) horizontal, 160° (+/- 80°) vertical</b>                  Stand <b>Tilt stand</b>                  Bezel width <b>Sides: 0.68" (17.3mm)</b>                  Dimensions (HxWxD) <b>15.75" H x 21.48" W x 8.06" D;                  400.3mm H x 545.8mm W x 204.9mm D</b>                  Power supply <b>20 watts typical,                  27 watts maximum                  &lt;0.3 watts standby/suspend, universal,                  integrated (no external brick-like power supply)</b>                  Weight <b>7.06 lb; 3.20 kg</b>                  Limited warranty <b>3 year (includes backlight)</b>                  Available date <b>June 2016</b></p>	<p style="text-align: center;"><b>Features</b></p> <ul style="list-style-type: none"> <li>• Widescreen 23.0-inch monitor</li> <li>• Supports 1920x1080 resolution</li> <li>• Supports optional soundbar</li> <li>• Supports ThinkCentre Tiny via VESA back mount</li> <li>• Includes dual input connection for attachment to two systems concurrently (analog and digital)</li> <li>• EPEAT Gold certified</li> <li>• Microsoft® Windows® 7 certified</li> <li>• Microsoft Windows 10 certified</li> </ul>				
<p>VESA-compliant <b>VESA DDC2B/CI</b>                  Power management <b>ENERGY STAR® qualified</b>                  Ergonomics <b>ISO 9241-307</b>                  Emission standards <b>FCC Class B</b>                  Environmental <b>TCO Displays 7.0, TCO Certified Edge 2.0, WEEE,                  RoHS, EPEAT™ Gold rating</b></p>	<div style="text-align: center;">  <p><b>ThinkVision T2324d Wide Monitor</b></p> </div>				
<p>Preset resolutions <b>VGA: 640x350, 640x480, 720x400                  SVGA: 800x600                  XGA: 1024x768, 1152x864                  SXGA: 1280x1024                  WXGA: 1280x768, 1280x800, 1366x768                  WXGA+: 1440x900                  WSXGA+: 1680x1050                  Full HD: 1920x1080</b></p> <p>Presets / user settings <b>Standard presets: 26; user settings: 16</b></p>					
<p>Viewing adjustments <b>Tilt: 22° back, -5°</b>                  Rotating screen <b>None</b>                  On screen display <b>On screen display with digital user controls (8 languages)</b>                  Control features <b>Direct access (buttons on front) for automatic image setup, dual input and brightness</b>                  USB hub <b>None</b>                  Multiple input <b>Dual input (two different PCs attach to two different connectors; one PC shows image; select via button)</b>                  Monitor connectors <b>(1) VGA 15-pin D-shell, analog, blue                  (2) DisplayPort, digital, black, <b>HDCP-compliant</b></b>                  Signal cables <b>(1) detachable, VGA 15-pin D-shell at each end, analog, 1.8 meter                  (2) detachable, DisplayPort at each end, digital, 1.8 meter</b>                  Mounting features <b>Wall or desk mounting using the Extend Arm or third-party accessories, 100mm x 100mm mount</b>                  Security <b>Security keyhole for attachment of optional cable lock (Kensington® lock-compatible)</b></p>					
<p>Ship group <b>Monitor with stand, Safety and Warranty Information, 1.8 meter analog signal cable, 1.8 meter DP signal cable, 1.8 meter black power cord</b></p>	<p style="text-align: center;"><b>Limited Warranty</b></p> <p>See details at <a href="http://support.lenovo.com/en_US/guides-and-manuals/detail.page?DocID=UM008281">http://support.lenovo.com/en_US/guides-and-manuals/detail.page?DocID=UM008281</a></p> <p style="text-align: center;"><b>Accessories</b></p> <table border="0" style="width: 100%;"> <tr> <td>Kensington MicroSaver Cable Lock</td> <td style="text-align: right;">73P2582</td> </tr> <tr> <td>Kensington Twin Head Cable Lock</td> <td style="text-align: right;">45K1620</td> </tr> </table> <p>See details at <a href="http://www.lenovo.com/support/monitoraccessories">www.lenovo.com/support/monitoraccessories</a></p> <p>See all monitors at <a href="http://www.lenovo.com/thinkvision">www.lenovo.com/thinkvision</a></p>	Kensington MicroSaver Cable Lock	73P2582	Kensington Twin Head Cable Lock	45K1620
Kensington MicroSaver Cable Lock	73P2582				
Kensington Twin Head Cable Lock	45K1620				



<p>Name <b>T2364t Wide Flat Panel Monitor</b>                  Bezel color <b>Black</b>                  Type-model <b>60E9MAR1US / 60E9MAT1EU</b>                  Panel TFT-LCD, In-Plane Switching (IPS), White LED backlight</p> <p>Viewable image size <b>23.0" (584mm)</b> diagonal                  Max view area (W x H) <b>20.05" x 11.28" (509.2mm x 286.4mm)</b>                  Native resolution <b>1920x1080</b></p> <p>Touch Supports 10-point touch</p> <p>Aspect ratio 16:9                  Pixel pitch (mm) 0.2652 x 0.2652 mm                  Dot/Pixel per Inch 95 dpi                  Brightness 250 nits or cd/m<sup>2</sup> (typical)                  Contrast ratio 1000:1 (typical)                  Pixel response time 7ms (typical)                  Color gamut 72%</p> <p>Viewing angle at 10:1 CR 178° (+/- 89°) horizontal, 178° (+/- 89°) vertical</p> <p>Stand Tilt adjustable stand                  Bezel width <i>Sides:</i> 0.079" (2.0mm)                  Dimensions (HxWxD) 12.53" H x 20.56" W x 2.86" D;                  318.2mm H x 522.2mm W x 72.7mm D</p> <p>Power supply 22 watts typical, 45 watts maximum, &lt;0.5 watts standby/suspend, universal, integrated (no external brick-like power supply)</p> <p>Weight 9.24 lb; 4.32 kg                  Limited warranty <b>3 year</b> (includes backlight)                  Available date June 2015</p>	<p style="text-align: center;"><b>Features</b></p> <ul style="list-style-type: none"> <li>• Widescreen 23.0-inch monitor</li> <li>• Supports 1920x1080 resolution</li> <li>• Includes dual input connection for attachment to two systems concurrently</li> <li>• EPEAT Gold certified</li> <li>• 10-point touch screen</li> <li>• Microsoft® Windows® 7 certified</li> <li>• Microsoft Windows 10 certified</li> </ul>																
<p>VESA-compliant VESA DDC2B/CI                  Power management ENERGY STAR® qualified                  Ergonomics ISO 9241-307                  Emission standards FCC Class B                  Environmental TCO Displays 7.0, TCO Certified Edge 2.0, WEEE, RoHS, <b>EPEAT™ Gold rating</b></p>	<div style="text-align: center;">     </div> <p style="text-align: center;"><b>ThinkVision T2364t</b></p>																
<p>Preset resolutions</p> <table border="0"> <tr><td>VGA:</td><td>640x350, 640x480, 720x400, 700x570</td></tr> <tr><td>SVGA:</td><td>800x600, 832x624</td></tr> <tr><td>XGA:</td><td>1024x768, 1152x864</td></tr> <tr><td>SXGA:</td><td>1280x1024</td></tr> <tr><td>WXGA:</td><td>1366x768</td></tr> <tr><td>WXGA+:</td><td>1440x900, 1600x900</td></tr> <tr><td>WSXGA+:</td><td>1680x1050</td></tr> <tr><td>Full HD:</td><td>1920x1080</td></tr> </table> <p>Presets / user settings User settings: 20</p>	VGA:	640x350, 640x480, 720x400, 700x570	SVGA:	800x600, 832x624	XGA:	1024x768, 1152x864	SXGA:	1280x1024	WXGA:	1366x768	WXGA+:	1440x900, 1600x900	WSXGA+:	1680x1050	Full HD:	1920x1080	<p>Viewing adjustments <i>Tilt:</i> 10° - 70° degrees; detachable stand                  Rotating screen None                  On screen display On screen display with digital user controls (8 languages)                  Control features Direct access (buttons on front) for automatic image setup, dual input and brightness                  USB hub USB 3.0 Hub: 1 port into PC (USB 3.0); 3 ports for accessories (3 USB 3.0)                  Multiple input Dual input (two different PCs attach to two different connectors; one PC shows image; select via button)                  Monitor connectors (1) VGA 15-pin D-shell, analog, blue                  (2) HDMI (1.4), digital, HDCP-compliant                  (3) DisplayPort, digital, black, HDCP-compliant</p> <p>Signal cables (1) detachable, VGA 15-pin D-shell at each end, analog, 1.8 meter                  (2) detachable, HDMI at each end, digital, 1.8 meter                  (3) detachable, DisplayPort at each end, digital, 1.8 meter</p> <p>Mounting features Wall or desk mounting using the Extend Arm or third-party accessories, 100mm x 100mm mount                  Security Security keyhole for attachment of optional cable lock (Kensington® lock-compatible)</p> <p>Ship group Monitor with stand, Safety and Warranty Information, 1.8 meter analog signal cable, 1.8 meter HDMI cable, 1.8 meter DisplayPort cable, 1.8 meter USB signal cable, 1.8 meter black power cord</p>
VGA:	640x350, 640x480, 720x400, 700x570																
SVGA:	800x600, 832x624																
XGA:	1024x768, 1152x864																
SXGA:	1280x1024																
WXGA:	1366x768																
WXGA+:	1440x900, 1600x900																
WSXGA+:	1680x1050																
Full HD:	1920x1080																

<p style="text-align: center;"><b>Limited Warranty</b></p> <p>See details at <a href="http://support.lenovo.com/en_US/guides-and-manuals/detail.page?DocID=UM008281">http://support.lenovo.com/en_US/guides-and-manuals/detail.page?DocID=UM008281</a></p>	<p style="text-align: center;"><b>Accessories</b></p> <table border="0"> <tr> <td>Kensington MicroSaver Cable Lock</td> <td style="text-align: right;">73P2582</td> </tr> <tr> <td>Kensington Twin Head Cable Lock</td> <td style="text-align: right;">45K1620</td> </tr> </table> <p>See details at <a href="http://www.lenovo.com/support/monitoraccessories">www.lenovo.com/support/monitoraccessories</a></p> <p>See all monitors at <a href="http://www.lenovo.com/thinkvision">www.lenovo.com/thinkvision</a></p>	Kensington MicroSaver Cable Lock	73P2582	Kensington Twin Head Cable Lock	45K1620
Kensington MicroSaver Cable Lock	73P2582				
Kensington Twin Head Cable Lock	45K1620				





<p>Name <b>T23i Wide Flat Panel Monitor</b>                  Bezel color <b>Black</b>                  Type-model <b>61ABMAR1US / 61ABMAT1EU</b>                  Panel TFT-LCD, In-Plane Switching (IPS), White LED backlight                  Viewable image size <b>23" (584.2mm) diagonal</b>                  Max view area (W x H) <b>20.36" x 11.92" (517.2mm x 302.8mm)</b>                  Native resolution <b>1920x1080</b>                  Aspect ratio <b>16:9</b>                  Pixel pitch (mm) <b>0.2652 x 0.2652 mm</b>                  Dot/Pixel per Inch <b>95.8 dpi</b>                  Brightness <b>250 nits or cd/m<sup>2</sup> (typical)</b>                  Contrast ratio <b>1000:1 (typical)</b>                  Pixel response time <b>6ms (typical)</b>                  Color gamut <b>72%</b>                  Viewing angle at 10:1 CR <b>178° (+/- 89°) horizontal, 178° (+/- 89°) vertical</b>                  Stand <b>Tilt, swivel, pivot, and height adjustable stand</b>                  Bezel width <b>Sides: 0.08" (2.0mm)</b>                  Dimensions (HxWxD) <b>13.3" H x 20.56" W x 10.4" D; 337.7mm H x 522.2mm W x 264.2mm D</b>                  Power supply <b>16 watts typical, 45 watts maximum (with USB 3.0 hub), &lt;0.5 watts standby/suspend, universal, integrated (no external brick-like power supply)</b>                  Weight <b>10.85 lb; 4.92 kg</b>                  Limited warranty <b>3 year (includes backlight)</b>                  Available date <b>April 2017</b></p>	<p style="text-align: center;"><b>Features</b></p> <ul style="list-style-type: none"> <li>• Widescreen 23-inch monitor</li> <li>• Supports 1920x1080 resolution</li> <li>• Supports ThinkCentre Tiny Clamp Bracket</li> <li>• Includes dual input connection for attachment to two systems concurrently</li> <li>• EPEAT Gold certified</li> <li>• Microsoft® Windows® 7 certified</li> <li>• Microsoft Windows 10 certified</li> </ul>				
<p>VESA-compliant <b>VESA DDC2B/CI</b>                  Power management <b>ENERGY STAR® qualified</b>                  Ergonomics <b>ISO 9241-307</b>                  Emission standards <b>FCC Class B</b>                  Environmental <b>TCO Displays 7.0, TCO Certified Edge 2.0, WEEE, RoHS, EPEAT™ Gold rating</b></p>	<div style="text-align: center;">  <p><b>ThinkVision T23i Wide Monitor</b></p> </div>				
<p>Preset resolutions <b>VGA: 640x480, 720x400</b>  <b>SVGA: 800x600</b>  <b>XGA: 1024x768, 1152x864</b>  <b>SXGA: 1280x1024</b>  <b>WXGA+: 1440x900</b>  <b>WSXGA+: 1680x1050</b>  <b>Full HD: 1920x1080</b></p> <p>Presets display modes <b>HDMI: 18; DP: 18</b></p>					
<p>Viewing adjustments <b>Tilt: 30° back, -5° forward; lift: 4.3" (110mm); swivel: +/-45°; detachable stand</b>                  Rotating screen <b>Screen pivots 90 degrees from landscape to portrait</b>                  On screen display <b>On screen display with digital user controls (8 languages)</b>                  Control features <b>Direct access (buttons on front) for power, menu, input source select and brightness and automatic image setup</b>                  USB hub <b>USB 3.0 Hub: 1 port into PC (USB 3.0); 4 ports for accessories (4 USB 3.0)</b>                  Multiple input <b>Dual input (two different PCs attach to two different connectors; one PC shows image; select via button)</b>                  Monitor connectors <b>(1) VGA 15-pin D-shell, analog, blue</b>  <b>(2) HDMI (1.4), digital, <b>HDCP-compliant</b></b>  <b>(3) DisplayPort, digital, black, <b>HDCP-compliant</b></b>                  Signal cables <b>(1) detachable, VGA 15-pin D-shell at each end, analog, 1.8 meter</b>  <b>(2) detachable, DisplayPort at each end, digital, 1.8 meter</b>                  Mounting features <b>Wall or desk mounting using the Extend Arm or third-party accessories, 100mm x 100mm mount</b>                  Security <b>Security keyhole for attachment of optional cable lock (Kensington® lock-compatible)</b></p>					
<p>Ship group <b>Monitor with stand, Safety and Warranty Information, 1.8 meter analog signal cable, 1.8 meter DP signal cable, 1.8 meter USB signal cable, 1.8 meter black power cord</b></p>	<p style="text-align: center;"><b>Accessories</b></p> <table border="0"> <tr> <td>Kensington MicroSaver Cable Lock</td> <td style="text-align: right;">73P2582</td> </tr> <tr> <td>Kensington Twin Head Cable Lock</td> <td style="text-align: right;">45K1620</td> </tr> </table> <p>See details at <a href="http://www.lenovo.com/support/monitoraccessories">www.lenovo.com/support/monitoraccessories</a></p> <p>See all monitors at <a href="http://www.lenovo.com/thinkvision">www.lenovo.com/thinkvision</a></p>	Kensington MicroSaver Cable Lock	73P2582	Kensington Twin Head Cable Lock	45K1620
Kensington MicroSaver Cable Lock	73P2582				
Kensington Twin Head Cable Lock	45K1620				
<p style="text-align: center;"><b>Limited Warranty</b></p> <p>See details at <a href="http://support.lenovo.com/en_US/guides-and-manuals/detail.page?DocID=UM008281">http://support.lenovo.com/en_US/guides-and-manuals/detail.page?DocID=UM008281</a></p>					



<p>Name <b>T2424z Wide Flat Panel Monitor</b>                  Bezel color <b>Raven black</b>                  Type-model <b>60F8MAR1US / 60F8MAT1EU</b>                  Panel TFT-LCD, In-Plane Switching (IPS), White LED backlight</p> <p>Viewable image size <b>23.8" (604.7mm)</b> diagonal                  Max view area (W x H) <b>20.75" x 11.67"</b> (527.0mm x 296.5mm)                  Native resolution <b>1920x1080</b>                  Aspect ratio 16:9                  Pixel pitch (mm) 0.2745 x 0.2745 mm                  Dot/Pixel per Inch 92 dpi                  Brightness 250 nits or cd/m<sup>2</sup> (typical)                  Contrast ratio 1000:1 (typical)                  Pixel response time 7ms (typical)                  Color gamut 72%                  Viewing angle at 10:1 CR <b>178° (+/- 89°) horizontal, 178° (+/- 89°) vertical</b>                  Stand Tilt, swivel, pivot, and height adjustable stand                  Bezel width <b>Sides: 0.69" (17.5mm)</b>                  Dimensions (HxWxD) <b>19.53" H x 22.19" W x 10.39" D;</b>  <b>496.0mm H x 563.6mm W x 264.2mm D</b></p> <p>Power supply 22 watts typical,                  40 watts maximum (without USB 3.0 hub),                  &lt;0.5 watts standby/suspend, universal,                  integrated (no external brick-like power supply)</p> <p>Weight <b>12.90 lb; 5.85 kg</b>                  Limited warranty <b>3 year</b> (includes backlight)                  Available date June 2016</p>	<p style="text-align: center;"><b>Features</b></p> <ul style="list-style-type: none"> <li>• Widescreen 23.8-inch monitor</li> <li>• Supports 1920x1080 resolution</li> <li>• Supports ThinkCentre Tiny Clamp Bracket</li> <li>• Includes dual input connection for attachment to two systems concurrently (analog and digital)</li> <li>• EPEAT Gold certified</li> <li>• Microsoft® Windows® 7 certified</li> <li>• Microsoft Windows 8 / Windows 8.1 certified</li> <li>• Microsoft Windows 10 certified</li> </ul>				
<p>VESA-compliant VESA DDC2B/CI                  Power management ENERGY STAR® qualified                  Ergonomics ISO 9241-307                  Emission standards FCC Class B                  Environmental TCO Displays 7.0, TCO Certified Edge 2.0, WEEE, RoHS, <b>EPEAT™ Gold rating</b></p>	<div style="text-align: center;">  <p><b>ThinkVision T2424z Wide Monitor</b></p> </div>				
<p>Preset resolutions                  VGA: 640x350, 640x480, 720x400                  SVGA: 800x600                  XGA: 1024x768, 1152x864                  SXGA: 1280x1024                  WXGA+: 1440x900, 1600x900                  WSXGA+: 1680x1050                  Full HD: 1920x1080</p> <p>Presets / user settings Standard presets: 31; user settings: 20</p>					
<p>Viewing adjustments <i>Tilt: 30° back, -5° forward; lift: 4.3" (110mm); swivel: +/-45°; detachable stand</i>                  Rotating screen Screen pivots 90 degrees from landscape to portrait                  On screen display On screen display with digital user controls (8 languages)                  Control features Direct access (buttons on front) for automatic image setup, dual input and brightness                  USB hub USB 3.0 Hub: 1 port into PC (USB 3.0); 2 ports for accessories (2 USB 3.0)                  Multimedia Integrated digital speakers (3 watts x 2)                  Camera Integrated camera (Full HD) and digital dual array microphone                  Multiple input Dual input (two different PCs attach to two different connectors; one PC shows image; select via button)                  Monitor connectors (1) VGA 15-pin D-shell, analog, blue                  (2) HDMI (1.4), digital, <b>HDCP-compliant</b>                  (3) DisplayPort, digital, black, <b>HDCP-compliant</b></p> <p>Signal cables (1) detachable, VGA 15-pin D-shell at each end, analog, 1.8 meter                  (2) detachable, DisplayPort at each end, digital, 1.8 meter</p> <p>Mounting features Wall or desk mounting using the Extend Arm or third-party accessories, 100mm x 100mm mount                  Security Security keyhole for attachment of optional cable lock (Kensington® lock-compatible)</p>					
<p>Ship group Monitor with stand, Safety and Warranty Information, 1.8 meter analog signal cable, 1.8 meter DP signal cable, 1.8 meter USB signal cable, 1.8 meter black power cord</p>	<p style="text-align: center;"><b>Accessories</b></p> <table border="0" style="width: 100%;"> <tr> <td>Kensington MicroSaver Cable Lock</td> <td style="text-align: right;">73P2582</td> </tr> <tr> <td>Kensington Twin Head Cable Lock</td> <td style="text-align: right;">45K1620</td> </tr> </table> <p>See details at <a href="http://www.lenovo.com/support/monitoraccessories">www.lenovo.com/support/monitoraccessories</a></p> <p>See all monitors at <a href="http://www.lenovo.com/thinkvision">www.lenovo.com/thinkvision</a></p>	Kensington MicroSaver Cable Lock	73P2582	Kensington Twin Head Cable Lock	45K1620
Kensington MicroSaver Cable Lock	73P2582				
Kensington Twin Head Cable Lock	45K1620				
<p style="text-align: center;"><b>Limited Warranty</b></p> <p>See details at <a href="http://support.lenovo.com/en_US/guides-and-manuals/detail.page?DocID=UM008281">http://support.lenovo.com/en_US/guides-and-manuals/detail.page?DocID=UM008281</a></p>					





<p>Name <b>T2454p Wide Flat Panel Monitor</b>                  Bezel color <b>Raven black</b>                  Type-model <b>60F9MAR1US / 60F9MAT1EU</b>                  Panel TFT-LCD, In-Plane Switching (IPS), White LED backlight</p> <p>Viewable image size <b>24.0" (609.6mm) diagonal</b>                  Max view area (W x H) <b>20.41" x 12.76" (518.4mm x 324.0mm)</b>                  Native resolution <b>1920x1200</b>                  Aspect ratio <b>16:10</b>                  Pixel pitch (mm) <b>0.270 x 0.270 mm</b>                  Dot/Pixel per Inch <b>94 dpi</b>                  Brightness <b>300 nits or cd/m<sup>2</sup> (typical)</b>                  Contrast ratio <b>1000:1 (typical)</b>                  Pixel response time <b>7ms (typical)</b>                  Color gamut <b>77.4%</b>                  Viewing angle at 10:1 CR <b>178° (+/- 89°) horizontal, 178° (+/- 89°) vertical</b>                  Stand <b>Tilt, swivel, pivot, and height adjustable stand</b>                  Bezel width <b>Sides: 0.74" (18.8mm)</b>                  Dimensions (HxWxD) <b>15.85" H x 21.94" W x 10.39" D; 402.5mm H x 557.4mm W x 264.2mm D</b></p> <p>Power supply <b>24 watts typical, 27 watts maximum (without USB 3.0 hub), 54 watts maximum (with USB 3.0 hub), &lt;0.5 watts standby/suspend, universal, integrated (no external brick-like power supply)</b></p> <p>Weight <b>13.60 lb; 6.15 kg</b>                  Limited warranty <b>3 year (includes backlight)</b>                  Available date <b>March 2015</b></p>	<p style="text-align: center;"><b>Features</b></p> <ul style="list-style-type: none"> <li>• Widescreen 24.0-inch monitor</li> <li>• Supports 1920x1200 resolution</li> <li>• Supports ThinkCentre Tiny Clamp Bracket</li> <li>• Supports optional soundbar</li> <li>• Includes dual input connection for attachment to two systems concurrently (analog and digital)</li> <li>• EPEAT Gold certified</li> <li>• Microsoft® Windows® 7 certified</li> <li>• Microsoft Windows 8 / Windows 8.1 certified</li> <li>• Microsoft Windows 10 certified</li> </ul>				
<p>VESA-compliant <b>VESA DDC2B/CI</b>                  Power management <b>ENERGY STAR® qualified</b>                  Ergonomics <b>ISO 9241-307</b>                  Emission standards <b>FCC Class B</b>                  Environmental <b>TCO Displays 7.0, TCO Certified Edge 2.0, WEEE, RoHS, EPEAT™ Gold rating</b></p> <p>Preset resolutions <b>VGA: 640x350, 640x480, 720x400</b>  <b>SVGA: 800x600</b>  <b>XGA: 1024x768</b>  <b>SXGA: 1280x1024</b>  <b>WXGA: 1280x720, 1280x768, 1280x800</b>  <b>WXGA+: 1440x900</b>  <b>WSXGA+: 1680x1050, 1600x1200</b>  <b>Full HD: 1920x1080, 1920x1200</b></p> <p>Presets / user settings <b>Standard presets: 21; user settings: 20</b></p>	<div style="text-align: center;">  <p><b>ThinkVision T2454p Wide Monitor</b></p> </div>				
<p>Viewing adjustments <b>Tilt: 30° back, -5° forward; lift: 4.3" (110mm); swivel: +/-45°; detachable stand</b>                  Rotating screen <b>Screen pivots 90 degrees from landscape to portrait</b>                  On screen display <b>On screen display with digital user controls (8 languages)</b>                  Control features <b>Direct access (buttons on front) for automatic image setup, dual input and brightness</b>                  USB hub <b>USB 3.0 Hub: 1 port into PC (USB 3.0); 4 ports for accessories (4 USB 3.0)</b>                  Multiple input <b>Dual input (two different PCs attach to two different connectors; one PC shows image; select via button)</b>                  Monitor connectors <b>(1) VGA 15-pin D-shell, analog, blue</b>  <b>(2) HDMI (1.4), digital, <b>HDCP-compliant</b></b>  <b>(3) DisplayPort, digital, black, <b>HDCP-compliant</b></b></p> <p>Signal cables <b>(1) detachable, VGA 15-pin D-shell at each end, analog, 1.8 meter</b>  <b>(2) detachable, DisplayPort at each end, digital, 1.8 meter</b></p> <p>Mounting features <b>Wall or desk mounting using the Extend Arm or third-party accessories, 100mm x 100mm mount</b>                  Security <b>Security keyhole for attachment of optional cable lock (Kensington® lock-compatible)</b></p>					
<p>Ship group <b>Monitor with stand, Safety and Warranty Information, 1.8 meter analog signal cable, 1.8 meter DisplayPort cable, 1.8 meter USB signal cable, 1.8 meter black power cord</b></p>					
<p style="text-align: center;"><b>Limited Warranty</b></p> <p>See details at <a href="http://support.lenovo.com/en_US/guides-and-manuals/detail.page?DocID=UM008281">http://support.lenovo.com/en_US/guides-and-manuals/detail.page?DocID=UM008281</a></p>	<p style="text-align: center;"><b>Accessories</b></p> <table border="0" style="width: 100%;"> <tr> <td>Kensington MicroSaver Cable Lock</td> <td style="text-align: right;">73P2582</td> </tr> <tr> <td>Kensington Twin Head Cable Lock</td> <td style="text-align: right;">45K1620</td> </tr> </table> <p>See details at <a href="http://www.lenovo.com/support/monitoraccessories">www.lenovo.com/support/monitoraccessories</a></p> <p>See all monitors at <a href="http://www.lenovo.com/thinkvision">www.lenovo.com/thinkvision</a></p>	Kensington MicroSaver Cable Lock	73P2582	Kensington Twin Head Cable Lock	45K1620
Kensington MicroSaver Cable Lock	73P2582				
Kensington Twin Head Cable Lock	45K1620				



<p>Name <b>T24d Wide Flat Panel Monitor</b>                  Bezel color <b>Black</b>                  Type-model <b>61B4MAR1US / 61B4MAT1EU</b>                  Panel TFT-LCD, In-Plane Switching (IPS), White LED backlight                  Viewable image size <b>24" (609.6mm) diagonal</b>                  Max view area (W x H) <b>20.41" x 12.75" (518.4mm x 324mm)</b>                  Native resolution <b>1920x1200</b>                  Aspect ratio <b>16:10</b>                  Pixel pitch (mm) <b>0.27 x 0.27 mm</b>                  Dot/Pixel per Inch <b>94 dpi</b>                  Brightness <b>300 nits or cd/m<sup>2</sup> (typical)</b>                  Contrast ratio <b>1000:1 (typical)</b>                  Pixel response time <b>7ms (typical)</b>                  Color gamut <b>99%</b>                  Viewing angle at 10:1 CR <b>178° (+/- 89°) horizontal, 178° (+/- 89°) vertical</b>                  Stand <b>Tilt, swivel, pivot, and height adjustable stand</b>                  Bezel width <b>Sides: 0.08" (2.0mm)</b>                  Dimensions (HxWxD) <b>19.58" H x 20.99" W x 10.25" D; 497.4mm H x 533.2mm W x 260.4mm D</b>                  Power supply <b>22 watts typical, 64 watts maximum (with USB 3.0 hub), &lt;0.3 watts standby/suspend, universal, integrated (no external brick-like power supply)</b>                  Weight <b>12.41 lb; 5.63 kg</b>                  Limited warranty <b>3 year (includes backlight)</b>                  Available date <b>June 2017</b></p>	<p style="text-align: center;"><b>Features</b></p> <ul style="list-style-type: none"> <li>• Widescreen 24-inch monitor</li> <li>• Supports 1920x1200 resolution</li> <li>• Supports ThinkCentre Tiny Clamp Bracket</li> <li>• Supports optional soundbar</li> <li>• Includes dual input connection for attachment to two systems concurrently</li> <li>• EPEAT Gold certified</li> <li>• Microsoft® Windows® 7 certified</li> <li>• Microsoft Windows 10 certified</li> </ul>																		
<p>VESA-compliant <b>VESA DDC2B/CI</b>                  Power management <b>ENERGY STAR® qualified</b>                  Ergonomics <b>ISO 9241-307</b>                  Emission standards <b>FCC Class B</b>                  Environmental <b>TCO Displays 7.0, TCO Certified Edge 2.0, WEEE, RoHS, EPEAT™ Gold rating</b></p> <p>Preset resolutions</p> <table border="0"> <tr><td>VGA:</td><td>640x480, 720x400</td></tr> <tr><td>SVGA:</td><td>800x600</td></tr> <tr><td>XGA:</td><td>1024x768</td></tr> <tr><td>SXGA:</td><td>1280x1024</td></tr> <tr><td>WXGA:</td><td>1366x768</td></tr> <tr><td>WXGA+:</td><td>1440x900</td></tr> <tr><td>WSXGA+:</td><td>1680x1050</td></tr> <tr><td>Full HD:</td><td>1920x1080</td></tr> <tr><td>WUXGA:</td><td>1920x1200</td></tr> </table> <p>Presets display modes Standard presets: 22; user settings: 20</p>	VGA:	640x480, 720x400	SVGA:	800x600	XGA:	1024x768	SXGA:	1280x1024	WXGA:	1366x768	WXGA+:	1440x900	WSXGA+:	1680x1050	Full HD:	1920x1080	WUXGA:	1920x1200	<div style="text-align: center;">  <p><b>ThinkVision T24d Wide Monitor</b></p> </div>
VGA:	640x480, 720x400																		
SVGA:	800x600																		
XGA:	1024x768																		
SXGA:	1280x1024																		
WXGA:	1366x768																		
WXGA+:	1440x900																		
WSXGA+:	1680x1050																		
Full HD:	1920x1080																		
WUXGA:	1920x1200																		
<p>Viewing adjustments <i>Tilt: 30° back, -5° forward; lift: 4.3" (110mm); swivel: +/-45°; detachable stand</i>                  Rotating screen <i>Screen pivots 90 degrees from landscape to portrait</i>                  On screen display <i>On screen display with digital user controls (8 languages)</i>                  Control features <i>Direct access (buttons on front) for power, menu, input source select and brightness</i>                  USB hub <i>USB 3.0 Hub: 1 port into PC (USB 3.0); 4 ports for accessories (4 USB 3.0)</i>                  Multiple input <i>Dual input (two different PCs attach to two different connectors; one PC shows image; select via button)</i>                  Monitor connectors <i>(1) VGA 15-pin D-shell, analog, blue                  (2) HDMI (1.4), digital, <b>HDCP-compliant</b>                  (3) DisplayPort, digital, black, <b>HDCP-compliant</b></i>                  Signal cables <i>(1) detachable, VGA 15-pin D-shell at each end, analog, 1.8 meter                  (2) detachable, DisplayPort at each end, digital, 1.8 meter</i>                  Mounting features <i>Wall or desk mounting using the Extend Arm or third-party accessories, 100mm x 100mm mount</i>                  Security <i>Security keyhole for attachment of optional cable lock (Kensington® lock-compatible)</i></p>	<p>Ship group <i>Monitor with stand, Safety and Warranty Information, 1.8 meter analog signal cable, 1.8 meter DP signal cable, 1.8 meter USB signal cable, 1.8 meter black power cord, 1.8 meter HDMI signal cable (NA only)</i></p>																		
<p style="text-align: center;"><b>Limited Warranty</b></p> <p>See details at <a href="http://support.lenovo.com/en_US/guides-and-manuals/detail.page?DocID=UM008281">http://support.lenovo.com/en_US/guides-and-manuals/detail.page?DocID=UM008281</a></p>	<p style="text-align: center;"><b>Accessories</b></p> <table border="0"> <tr> <td>Kensington MicroSaver Cable Lock</td> <td style="text-align: right;">73P2582</td> </tr> <tr> <td>Kensington Twin Head Cable Lock</td> <td style="text-align: right;">45K1620</td> </tr> </table> <p>See details at <a href="http://www.lenovo.com/support/monitoraccessories">www.lenovo.com/support/monitoraccessories</a></p> <p>See all monitors at <a href="http://www.lenovo.com/thinkvision">www.lenovo.com/thinkvision</a></p>	Kensington MicroSaver Cable Lock	73P2582	Kensington Twin Head Cable Lock	45K1620														
Kensington MicroSaver Cable Lock	73P2582																		
Kensington Twin Head Cable Lock	45K1620																		



<p>Name <b>T24i Wide Flat Panel Monitor</b>                  Bezel color <b>Black</b>                  Type-model <b>61A6MAR3US / 61A6MAT3EU</b>                  Panel TFT-LCD, In-Plane Switching (IPS), White LED backlight                  Viewable image size <b>23.8" (604.7mm)</b> diagonal                  Max view area (W x H) <b>20.75" x 11.67"</b> (527.04mm x 296.5mm)                  Native resolution <b>1920x1080</b>                  Aspect ratio 16:9                  Pixel pitch (mm) 0.2745 x 0.2745 mm                  Dot/Pixel per Inch 93 dpi                  Brightness 250 nits or cd/m<sup>2</sup> (typical)                  Contrast ratio 1000:1 (typical)                  Pixel response time 6ms (typical)                  Color gamut 72%                  Viewing angle at 10:1 CR <b>178° (+/- 89°)</b> horizontal, <b>178° (+/- 89°)</b> vertical                  Stand Tilt, swivel, pivot, and height adjustable stand                  Bezel width <i>Sides:</i> 0.08" (2.0mm)                  Dimensions (HxWxD) 14.7" H x 21.26" W x 10.3" D;                  373.4mm H x 540.2mm W x 261.75mm D                  Power supply 16.5 watts typical,                  55 watts maximum (with USB 3.0 hub),                  &lt;0.5 watts standby/suspend, universal,                  integrated (no external brick-like power supply)                  Weight 11.57 lb; 5.25 kg                  Limited warranty <b>3 year</b> (includes backlight)                  Available date April 2017</p>	<p style="text-align: center;"><b>Features</b></p> <ul style="list-style-type: none"> <li>• Widescreen 23.8-inch monitor</li> <li>• Supports 1920x1080 resolution</li> <li>• Supports ThinkCentre Tiny Clamp Bracket</li> <li>• Supports optional soundbar</li> <li>• Includes dual input connection for attachment to two systems concurrently</li> <li>• EPEAT Gold certified</li> <li>• Microsoft® Windows® 7 certified</li> <li>• Microsoft Windows 10 certified</li> </ul>				
<p>VESA-compliant VESA DDC2B/CI                  Power management ENERGY STAR® qualified                  Ergonomics ISO 9241-307                  Emission standards FCC Class B                  Environmental TCO Displays 7.0, TCO Certified Edge 2.0, WEEE, RoHS, <b>EPEAT™ Gold rating</b></p>	<div style="text-align: center;">  <p><b>ThinkVision T24i Wide Monitor</b></p> </div>				
<p>Preset resolutions                  VGA: 640x480, 720x400                  SVGA: 800x600                  XGA: 1024x768                  SXGA: 1280x1024                  WXGA: 1366x768                  WXGA+: 1440x900, 1680x900                  WSXGA+: 1680x1050                  Full HD: 1920x1080                  Presets display modes HDMI: 17; DP: 17</p>					
<p>Viewing adjustments <i>Tilt:</i> 30° back, -5° forward; <i>lift:</i> 4.3" (110mm); <i>swivel:</i> +/-45°; detachable stand                  Rotating screen Screen pivots 90 degrees from landscape to portrait                  On screen display On screen display with digital user controls (8 languages)                  Control features Direct access (buttons on front) for power, menu, input source select and brightness and automatic image setup                  USB hub USB 3.0 Hub: 1 port into PC (USB 3.0); 4 ports for accessories (4 USB 3.0)                  Multiple input Dual input (two different PCs attach to two different connectors; one PC shows image; select via button)                  Monitor connectors (1) VGA 15-pin D-shell, analog, blue                  (2) HDMI (1.4), digital, <b>HDCP-compliant</b>                  (3) DisplayPort, digital, black, <b>HDCP-compliant</b>                  Signal cables (1) detachable, VGA 15-pin D-shell at each end, analog, 1.8 meter                  (2) detachable, DisplayPort at each end, digital, 1.8 meter                  Mounting features Wall or desk mounting using the Extend Arm or third-party accessories, 100mm x 100mm mount                  Security Security keyhole for attachment of optional cable lock (Kensington® lock-compatible)</p>	<p>Viewing adjustments <i>Tilt:</i> 30° back, -5° forward; <i>lift:</i> 4.3" (110mm); <i>swivel:</i> +/-45°; detachable stand                  Rotating screen Screen pivots 90 degrees from landscape to portrait                  On screen display On screen display with digital user controls (8 languages)                  Control features Direct access (buttons on front) for power, menu, input source select and brightness and automatic image setup                  USB hub USB 3.0 Hub: 1 port into PC (USB 3.0); 4 ports for accessories (4 USB 3.0)                  Multiple input Dual input (two different PCs attach to two different connectors; one PC shows image; select via button)                  Monitor connectors (1) VGA 15-pin D-shell, analog, blue                  (2) HDMI (1.4), digital, <b>HDCP-compliant</b>                  (3) DisplayPort, digital, black, <b>HDCP-compliant</b>                  Signal cables (1) detachable, VGA 15-pin D-shell at each end, analog, 1.8 meter                  (2) detachable, DisplayPort at each end, digital, 1.8 meter                  Mounting features Wall or desk mounting using the Extend Arm or third-party accessories, 100mm x 100mm mount                  Security Security keyhole for attachment of optional cable lock (Kensington® lock-compatible)</p>				
<p>Ship group Monitor with stand, Safety and Warranty Information, 1.8 meter analog signal cable, 1.8 meter DP signal cable, 1.8 meter USB signal cable, 1.8 meter black power cord</p>					
<p style="text-align: center;"><b>Limited Warranty</b></p> <p>See details at <a href="http://support.lenovo.com/en_US/guides-and-manuals/detail.page?DocID=UM008281">http://support.lenovo.com/en_US/guides-and-manuals/detail.page?DocID=UM008281</a></p>	<p style="text-align: center;"><b>Accessories</b></p> <table border="0"> <tr> <td>Kensington MicroSaver Cable Lock</td> <td style="text-align: right;">73P2582</td> </tr> <tr> <td>Kensington Twin Head Cable Lock</td> <td style="text-align: right;">45K1620</td> </tr> </table> <p>See details at <a href="http://www.lenovo.com/support/monitoraccessories">www.lenovo.com/support/monitoraccessories</a></p> <p>See all monitors at <a href="http://www.lenovo.com/thinkvision">www.lenovo.com/thinkvision</a></p>	Kensington MicroSaver Cable Lock	73P2582	Kensington Twin Head Cable Lock	45K1620
Kensington MicroSaver Cable Lock	73P2582				
Kensington Twin Head Cable Lock	45K1620				







<p>Name <b>X24 Wide Flat Panel Monitor</b>                  Bezel color <b>Raven black</b>                  Type-model <b>60FAGAR1US / 60FAGAT1EU</b>                  Panel TFT-LCD, AH-IPS (In-Plane Switching), White LED backlight                  Viewable image size <b>23.8" (604.5mm)</b> diagonal                  Max view area (W x H) <b>20.75" x 11.67"</b> (527.0mm x 296.5mm)                  Native resolution <b>1920x1080</b>                  Aspect ratio 16:9                  Pixel pitch (mm) 0.2745 x 0.2745 mm                  Dot/Pixel per Inch 92 dpi                  Brightness 250 nits or cd/m<sup>2</sup> (typical)                  Contrast ratio 1000:1 (typical)                  Pixel response time 7ms (typical)                  Color gamut 72%                  Viewing angle at 10:1 CR <b>178° (+/- 89°) horizontal, 178° (+/- 89°) vertical</b>                  Stand Tilt stand                  Bezel width <i>Sides:</i> 0.08" (2.0mm)                  Dimensions (HxWxD) 16.25" H x 21.30" W x 8.66" D;                  412.8mm H x 540.9mm W x 220.0mm D                  Power supply 20 watts typical,                  27 watts maximum,                  &lt;0.5 watts standby/suspend, universal, external power supply                  Weight 8.60 lb; 3.90 kg                  Limited warranty <b>3 year</b> (includes backlight)                  Available date April 2015</p>	<p style="text-align: center;"><b>Features</b></p> <ul style="list-style-type: none"> <li>• Widescreen 23.8-inch monitor</li> <li>• Supports 1920x1080 resolution</li> <li>• Includes dual input connection for attachment to two systems concurrently (analog and digital)</li> <li>• EPEAT Silver certified</li> <li>• Microsoft® Windows® 7 certified</li> <li>• Microsoft Windows 8 / Windows 8.1 certified</li> <li>• Microsoft Windows 10 certified</li> </ul>				
<p>Power management ENERGY STAR® qualified                  Ergonomics ISO 9241-307                  Emission standards FCC Class B                  Environmental TCO Displays 6.0, WEEE, RoHS, <b>EPEAT™ Silver rating</b></p>	<div style="text-align: center;">  <p><b>ThinkVision X24 Wide Monitor</b></p> </div>				
<p>Preset resolutions                  VGA: 640x350, 640x480, 720x400                  SVGA: 800x600                  XGA: 1024x768                  SXGA: 1280x1024                  WXGA: 1366x768                  WXGA+: 1440x900, 1600x900                  WSXGA+: 1680x1050                  Full HD: 1920x1080                  Presets / user settings Standard presets: 20;                  user settings: 16</p>					
<p>Viewing adjustments <i>Tilt:</i> 22° back, -5° forward                  Rotating screen None                  On screen display On screen display with digital user controls                  Control features Direct access (buttons on side bezel) for dual input and brightness                  USB hub None                  Multiple input Dual input (two different PCs attach to two different connectors; one PC shows image; select via button)                  Monitor connectors (1) HDMI (1.4), digital, <b>HDCP-compliant</b>                  (2) DisplayPort, digital, black, <b>HDCP-compliant</b>                  Signal cables (1) detachable, HDMI at each end, digital, 1.8 meter                  (2) detachable, DisplayPort at each end, digital, 1.8 meter                  Mounting features None                  Security None</p>					
<p>Ship group Monitor with stand, Safety and Warranty Information, 1.8 meter HDMI signal cable (consumer channel only), 1.8 meter DisplayPort signal cable (commercial channel only), 1.8 meter black power cord</p>	<p style="text-align: center;"><b>Limited Warranty</b></p> <p>See details at <a href="http://support.lenovo.com/en_US/guides-and-manuals/detail.page?DocID=UM008281">http://support.lenovo.com/en_US/guides-and-manuals/detail.page?DocID=UM008281</a></p> <p style="text-align: center;"><b>Accessories</b></p> <table border="0"> <tr> <td>Kensington MicroSaver Cable Lock</td> <td style="text-align: right;">73P2582</td> </tr> <tr> <td>Kensington Twin Head Cable Lock</td> <td style="text-align: right;">45K1620</td> </tr> </table> <p>See details at <a href="http://www.lenovo.com/support/monitoraccessories">www.lenovo.com/support/monitoraccessories</a></p> <p>See all monitors at <a href="http://www.lenovo.com/thinkvision">www.lenovo.com/thinkvision</a></p>	Kensington MicroSaver Cable Lock	73P2582	Kensington Twin Head Cable Lock	45K1620
Kensington MicroSaver Cable Lock	73P2582				
Kensington Twin Head Cable Lock	45K1620				



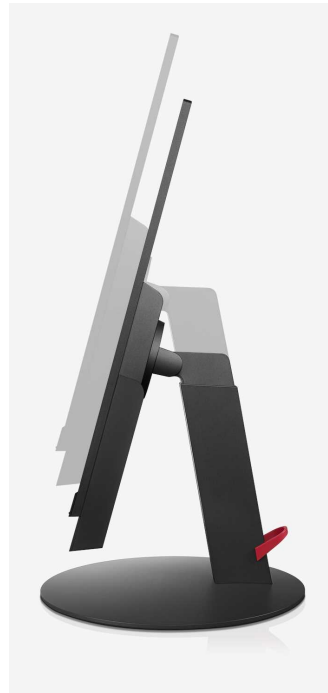

<p>Name <b>X24 Pro Wide Flat Panel Monitor</b>                  Bezel color <b>Black</b>                  Type-model <b>60E4ECR1US / 60E4ECT1EU</b>                  Panel TFT-LCD, AH-IPS (In-Plane Switching), White LED backlight                  Viewable image size <b>23.8" (604.5mm)</b> diagonal                  Max view area (W x H) <b>20.75" x 11.67"</b> (527.0mm x 296.5mm)                  Native resolution <b>1920x1080</b>                  Aspect ratio 16:9                  Pixel pitch (mm) 0.2745 x 0.2745 mm                  Dot/Pixel per Inch 92 dpi                  Brightness 250 nits or cd/m<sup>2</sup> (typical)                  Contrast ratio 1000:1 (typical)                  Pixel response time 7ms (typical)                  Color gamut 72%                  Viewing angle at 10:1 CR <b>178° (+/- 89°) horizontal, 178° (+/- 89°) vertical</b>                  Stand Tilt stand                  Bezel width <i>Sides:</i> 0.09" (2.3mm)                  Dimensions (HxWxD) 17.61" H x 21.30" W x 9.39" D;                  447.4mm H x 540.9mm W x 238.4mm D                  Power supply 20 watts typical,                  90 watts maximum,                  &lt;0.5 watts standby/suspend, universal, external power supply                  Weight 9.26 lb; 4.20 kg                  Limited warranty <b>1 year</b> (includes backlight)                  Available date July 2016</p>	<p style="text-align: center;"><b>Features</b></p> <ul style="list-style-type: none"> <li>• Widescreen 23.8-inch monitor</li> <li>• Supports 1920x1080 resolution</li> <li>• Includes dual input connection for attachment to two systems concurrently</li> <li>• EPEAT Silver certified</li> <li>• Intel RealSense 3D camera</li> <li>• Stereo speakers 3 watts x 2</li> <li>• One cable docking through USB 3.1 Type C with power delivery</li> <li>• Windows Hello certified</li> <li>• Microsoft® Windows® 10 certified</li> </ul>				
<p>Power management ENERGY STAR® qualified                  Ergonomics ISO 9241-307                  Emission standards FCC Class B                  Environmental TCO Displays 6.0, WEEE, RoHS, <b>EPEAT™ Silver rating</b></p> <p>Preset resolutions                  VGA: 640x350, 640x480, 720x400                  SVGA: 800x600                  XGA: 1024x768                  SXGA: 1280x1024                  WXGA: 1366x768                  WXGA+: 1440x900, 1600x900                  WSXGA+: 1680x1050                  Full HD: 1920x1080</p> <p>Presets / user settings                  Standard presets: 16;                  user settings: 20</p>	<div style="text-align: center;">  <p><b>ThinkVision X24 Pro Wide Monitor</b></p> </div>				
<p>Viewing adjustments <i>Tilt:</i> 22° back, -5° forward                  Rotating screen None                  On screen display On screen display with digital user controls                  Control features Direct access (buttons on side bezel) for dual input and brightness                  USB hub USB Hub: two USB 3.0 Type-C and one USB 3.0 ports                  Multimedia Integrated stereo speakers (3 watts x 2), built-in microphone                  Camera RealSense 3D camera SR300                  Multiple input Dual input (two different PCs attach to two different connectors; one PC shows image; select via button)                  Monitor connectors (1) mDP, Mini DisplayPort, digital, <b>HDCP-compliant</b>                  (2) USB Type-C, digital                  Signal cables (1) detachable, mDP to DP, digital, 2.0 meter                  (2) DP to mDP adaptor                  (3) USB 3.0 cable                  Mounting features None                  Security Security keyhole for attachment of optional cable lock (Kensington® lock-compatible)</p>	<p>Ship group Monitor with stand, Safety and Warranty Information, 2.0 meter Mini DisplayPort to DisplayPort signal cable, ThinkPad 90W Square tip power adaptor</p>				
<p style="text-align: center;"><b>Limited Warranty</b></p> <p>See details at <a href="http://support.lenovo.com/en_US/guides-and-manuals/detail.page?DocID=UM008281">http://support.lenovo.com/en_US/guides-and-manuals/detail.page?DocID=UM008281</a></p>	<p style="text-align: center;"><b>Accessories</b></p> <table border="0"> <tr> <td>Kensington MicroSaver Cable Lock</td> <td style="text-align: right;">73P2582</td> </tr> <tr> <td>Kensington Twin Head Cable Lock</td> <td style="text-align: right;">45K1620</td> </tr> </table> <p>See details at <a href="http://www.lenovo.com/support/monitoraccessories">www.lenovo.com/support/monitoraccessories</a></p> <p>See all monitors at <a href="http://www.lenovo.com/thinkvision">www.lenovo.com/thinkvision</a></p>	Kensington MicroSaver Cable Lock	73P2582	Kensington Twin Head Cable Lock	45K1620
Kensington MicroSaver Cable Lock	73P2582				
Kensington Twin Head Cable Lock	45K1620				



<p>Name <b>P27 Wide Flat Panel Monitor</b>                  Case color <b>Black</b>                  Type-model <b>60E3GAR1US / 60E3GAT1EU</b>                  Panel TFT-LCD, IPS (In-Plane Switching), White LED backlight                  Viewable image size <b>27" (684.7mm) diagonal</b>                  Max view area (W x H) <b>23.49" x 13.21" (596.7mm x 335.7mm)</b>                  Optimum resolution <b>3840x2160</b>                  Max pixel rate <b>600MHz</b>                  Aspect ratio <b>16:9</b>                  Pixel pitch (mm) <b>0.16 x 0.16mm</b>                  Dot/Pixel per Inch <b>163 dpi</b>                  Brightness <b>300 nits or cd/m<sup>2</sup> (typical)</b>                  Contrast ratio <b>1300:1 (typical)</b>                  Pixel response time <b>6ms</b>                  Color gamut <b>99%</b>                  Viewing angle at 10:1 CR <b>178° horizontal, 178° vertical</b>                  Stand <b>Tilt, swivel, pivot, and height adjustable stand</b>                  Bezel width <b>Sides: 0.088" (2.23mm)</b>                  Dimensions (HxWxD, including stand) <b>18.59" H x 24.19" W x 11.81" D; 472.3mm H x 614.5mm W x 299.9mm D</b>                  Power supply <b>40 watts typical, 70 watts maximum (with USB), &lt;0.5 watts sleep/off; &lt;0.5 watts switch off</b>                  Weight <b>15.12 lb; 6.86kg (including stand)</b>                  Limited warranty<sup>4</sup> <b>3 year</b>                  Available date <b>March 2016</b></p>	<p><b>Features</b></p> <ul style="list-style-type: none"> <li>• 27-inch IPS LED backlight monitor with speaker</li> <li>• Supports 3840x2160 resolution</li> <li>• 5-Ports USB hub, support USB 3.0</li> <li>• 3watts x 2 stereo speakers</li> <li>• Microsoft® Windows® 7 certified</li> <li>• Microsoft Windows 10 certified</li> </ul>						
<p>VESA-compliant<sup>2</sup> <b>VESA DDC2B/CI</b>                  Power management <b>ENERGY STAR® 7.0</b>                  Ergonomics <b>ISO 9241-307</b>                  Emission standards <b>FCC Class B</b>                  Environmental <b>TCO Displays 7.0, RoHS, EPEAT™ Gold rating, ULE Gold</b></p>	 <p><b>ThinkVision P27 Monitor</b></p>						
<p>Preset resolutions                  VGA: 640x350, 640x480, 720x400                  SVGA: 800x600                  XGA: 1024x768, 1152x864                  SXGA: 1280x1024                  WXGA: 1280x720, 1280x768, 1280x800, 1360x768                  WXGA+: 1440x900, 1600x900                  WSXGA+: 1680x1050                  Full HD: 1920x1080, 1920x1200                  UHD: 3840x2160</p> <p>Presets / user settings Standard presets: 20; user settings: 20</p>							
<p>Viewing adjustments <b>Tilt: 30° back, -5° forward; lift: 3.15" (80mm); swivel: +/-45°</b>                  Rotating screen <b>Screen pivots 90 degrees from landscape to portrait</b>                  On screen display <b>On screen display with digital user controls (8 languages)</b>                  Control features <b>Direct access (touch buttons on front) for menu, mute, volume up/down, and brightness</b>                  USB hub <b>USB Hub: one USB 3.0 upstream port, four USB 3.0 downstream ports</b>                  Multimedia <b>Integrated stereo speakers (3 watts x 2)</b>                  Camera <b>None</b>                  Multiple input <b>Support HDMI, DisplayPort</b>                  Monitor connectors <b>(1) HDMI (2.0), digital, HDCP-compliant (2) DisplayPort (1.2), digital, HDCP-compliant</b>                  Signal cables <b>(1) detachable, DisplayPort at each end, digital, 1.8 meter</b>                  Mounting features <b>Wall or desk mounting using the Extend Arm or third-party accessories meeting the VESA FPMPI® (100mm mount)</b>                  Security <b>Security keyhole for attachment of optional cable lock (Kensington® lock-compatible)</b></p>							
<p>Ship group <b>Monitor, detachable stand, Quick start and safety poster, 1.8 meter DisplayPort cable, 1.8 meter USB 3.0 cable, 1.8 meter black power cord, mini DP to DP adapter, power adapter (90W)</b></p>	<p><b>Limited Warranty</b></p> <p>See details at <a href="http://support.lenovo.com/en_US/guides-and-manuals/detail.page?DocID=UM008281">http://support.lenovo.com/en_US/guides-and-manuals/detail.page?DocID=UM008281</a></p> <p><b>Accessories</b></p> <table border="0"> <tr> <td>Kensington MicroSaver Cable Lock</td> <td>73P2582</td> </tr> <tr> <td>Kensington Twin Head Cable Lock</td> <td>45K1620</td> </tr> <tr> <td>Lenovo Security Cable Lock</td> <td>57Y4303</td> </tr> </table> <p>See details at <a href="http://www.lenovo.com/support/monitoraccessories">www.lenovo.com/support/monitoraccessories</a></p> <p>See all monitors at <a href="http://www.lenovo.com/thinkvision">www.lenovo.com/thinkvision</a></p>	Kensington MicroSaver Cable Lock	73P2582	Kensington Twin Head Cable Lock	45K1620	Lenovo Security Cable Lock	57Y4303
Kensington MicroSaver Cable Lock	73P2582						
Kensington Twin Head Cable Lock	45K1620						
Lenovo Security Cable Lock	57Y4303						



<p>Name <b>P27h Wide Flat Panel Monitor</b>                  Case color <b>Black</b>                  Type-model <b>61AFGAR1US / 61AFGAT1EU</b>                  Panel TFT-LCD, IPS (In-Plane Switching), White LED backlight                  Viewable image size <b>27" (685.8mm)</b> diagonal                  Max view area (W x H) <b>23.49" x 13.21"</b> (596.7mm x 335.7mm)                  Optimum resolution <b>2560x1440</b>                  Max pixel rate 300MHz                  Aspect ratio 16:9                  Pixel pitch (mm) 0.2331 x 0.2331mm                  Dot/Pixel per Inch 109 dpi                  Brightness 350 nits or cd/m<sup>2</sup> (typical)                  Contrast ratio 1000:1 (typical)                  Pixel response time 4ms (extreme) / 6ms (typical)                  Color gamut 99% sRGB                  Viewing angle at 10:1 CR 178° horizontal, 178° vertical                  Stand Tilt, swivel, pivot, and height adjustable stand                  Bezel width <i>Sides:</i> 0.08" (2mm)                  Dimensions 20.21" H x 24.08" W x 10.62" D;                  (HxWxD, including stand) 513mm H x 611.6mm W x 269.8mm D                  Power supply 38 watts typical,                  140 watts maximum (with USB),                  &lt;0.5 watts sleep/off;                  &lt;0.5 watts switch off                  integrated (no external brick-like power supply)                  Weight 15.43 lb; 7.0kg (including stand)                  Limited warranty <b>3 year</b>                  Available date April 2017</p>	<p style="text-align: center;"><b>Features</b></p> <ul style="list-style-type: none"> <li>• 27-inch IPS LED backlit monitor</li> <li>• Supports 2560x1440 resolution</li> <li>• 5-Ports USB hub, support USB 3.0</li> <li>• Supports optional soundbar</li> <li>• Support ThinkCentre Tiny</li> <li>• Microsoft® Windows® 7 certified</li> <li>• Microsoft Windows 10 certified</li> </ul>						
<p>VESA-compliant VESA DDC2B/CI                  Power management ENERGY STAR® 7.0                  Ergonomics ISO 9241-307                  Emission standards FCC Class B                  Environmental TCO Displays 7.0, RoHS, <b>EPEAT™ Gold rating</b>, ULE Gold</p>	<div style="text-align: center;">  <p><b>ThinkVision P27h Monitor</b></p> </div>						
<p>Preset resolutions                  VGA: 640x480, 720x400                  SVGA: 800x600                  XGA: 1024x768                  SXGA: 1280x1024                  WXGA: 1366x768                  WXGA+: 1440x900, 1680x900                  WSXGA+: 1680x1050                  Full HD: 1920x1080, 1920x1200                  QHD: 2560x1440</p>							
<p>Presets display modes HDMI: 22; DP: 14</p>							
<p>Viewing adjustments <i>Tilt:</i> 30° back, -5° forward; <i>lift:</i> 4.33" (110mm); <i>swivel:</i> +/-45°                  Rotating screen <b>Screen pivots 90 degrees from landscape to portrait</b>                  On screen display On screen display with digital user controls (8 languages)                  Control features Direct access (buttons on front) for power, menu, input source select and brightness                  USB hub USB Hub: one USB Type-C upstream port, four USB 3.0 downstream ports                  Multimedia Audio-out, optional sound bar supported                  Camera None                  Multiple input Support HDMI, DisplayPort, USB 3.1 Type-C, DisplayPort-out                  Monitor connectors (1) 2*HDMI (1.4), digital, <b>HDCP-compliant</b>                  (2) DisplayPort (1.2), digital, <b>HDCP-compliant</b>                  (3) DisplayPort-out, digital                  (4) USB 3.1 Type-C                  Signal cables (1) USB 3.1 Type-C cable, 1.8 meter                  Mounting features Wall or desk mounting using the Extend Arm or third-party accessories meeting the VESA FPMPI® (100mm mount)                  Security Security keyhole for attachment of optional cable lock (Kensington® lock-compatible)</p>							
<p>Ship group Monitor, detachable stand, Quick start and safety poster, 1.8 meter USB 3.1 Type-C cable, 1.8 meter black power cord</p>							
<p style="text-align: center;"><b>Limited Warranty</b></p> <p>See details at <a href="http://support.lenovo.com/en_US/guides-and-manuals/detail.page?DocID=UM008281">http://support.lenovo.com/en_US/guides-and-manuals/detail.page?DocID=UM008281</a></p>	<p style="text-align: center;"><b>Accessories</b></p> <table border="0"> <tr> <td>Kensington MicroSaver Cable Lock</td> <td style="text-align: right;">73P2582</td> </tr> <tr> <td>Kensington Twin Head Cable Lock</td> <td style="text-align: right;">45K1620</td> </tr> <tr> <td>Lenovo Security Cable Lock</td> <td style="text-align: right;">57Y4303</td> </tr> </table> <p>See details at <a href="http://www.lenovo.com/support/monitoraccessories">www.lenovo.com/support/monitoraccessories</a>                  See all monitors at <a href="http://www.lenovo.com/thinkvision">www.lenovo.com/thinkvision</a></p>	Kensington MicroSaver Cable Lock	73P2582	Kensington Twin Head Cable Lock	45K1620	Lenovo Security Cable Lock	57Y4303
Kensington MicroSaver Cable Lock	73P2582						
Kensington Twin Head Cable Lock	45K1620						
Lenovo Security Cable Lock	57Y4303						







<p>Name <b>P27q Wide Flat Panel Monitor</b>                  Case color <b>Black</b>                  Type-model <b>61A8GAR1US / 61A8GAT1EU</b>                  Panel TFT-LCD, IPS (In-Plane Switching), White LED backlight                  Viewable image size <b>27" (685.8mm) diagonal</b>                  Max view area (W x H) <b>23.49" x 13.21" (596.7mm x 335.7mm)</b>                  Optimum resolution <b>2560x1440</b>                  Max pixel rate <b>300MHz</b>                  Aspect ratio <b>16:9</b>                  Pixel pitch (mm) <b>0.2331 x 0.2331mm</b>                  Dot/Pixel per Inch <b>109 dpi</b>                  Brightness <b>350 nits or cd/m<sup>2</sup> (typical)</b>                  Contrast ratio <b>1000:1 (typical)</b>                  Pixel response time <b>4ms</b>                  Color gamut <b>99% sRGB</b>                  Viewing angle at 10:1 CR <b>178° horizontal, 178° vertical</b>                  Stand <b>Tilt, swivel, pivot, and height adjustable stand</b>                  Bezel width <b>Sides: 0.08" (2mm)</b>                  Dimensions <b>20.21" H x 24.17" W x 10.62" D;</b>                  (HxWxD, including stand) <b>513mm H x 614mm W x 269.8mm D</b>                  Power supply <b>38 watts typical, 75 watts maximum (with USB), &lt;0.5 watts sleep/off; &lt;0.3 watts switch off integrated (no external brick-like power supply)</b>                  Weight <b>15.43 lb; 7.0kg (including stand)</b>                  Limited warranty <b>3 year</b>                  Available date <b>January 2017</b></p>	<p><b>Features</b></p> <ul style="list-style-type: none"> <li>• 27-inch IPS LED backlight monitor</li> <li>• Supports 2560x1440 resolution</li> <li>• 5-Ports USB hub, support USB 3.0</li> <li>• Support ThinkCentre Tiny</li> <li>• Supports optional soundbar</li> <li>• Microsoft® Windows® 7 certified</li> <li>• Microsoft Windows 10 certified</li> </ul>						
<p>VESA-compliant <b>VESA DDC2B/CI</b>                  Power management <b>ENERGY STAR® 7.0</b>                  Ergonomics <b>ISO 9241-307</b>                  Emission standards <b>FCC Class B</b>                  Environmental <b>TCO Displays 7.0, RoHS, EPEAT™ Gold rating, ULE Gold</b></p>	 <p><b>ThinkVision P27q Monitor</b></p>						
<p>Preset resolutions                  VGA: 640x480, 720x400                  SVGA: 800x600                  XGA: 1024x768                  SXGA: 1280x1024                  WXGA: 1366x768                  WXGA+: 1440x900, 1600x900                  WSXGA+: 1680x1050                  Full HD: 1920x1080, 1920x1200                  QHD: 2560x1440</p> <p>Presets / user settings Standard presets: 20; user settings: 24</p>							
<p>Viewing adjustments <b>Tilt: 30° back, -5° forward; lift: 4.33" (110mm); swivel: +/-45°</b>                  Rotating screen <b>Screen pivots 90 degrees from landscape to portrait</b>                  On screen display <b>On screen display with digital user controls (8 languages)</b>                  Control features <b>Direct access for menu, source switch, and brightness</b>                  USB hub <b>USB Hub: one USB 3.0 upstream port, four USB 3.0 downstream ports</b>                  Multimedia <b>Audio-out, optional sound bar supported</b>                  Camera <b>None</b>                  Multiple input <b>Support HDMI, DisplayPort, mini DisplayPort, DisplayPort-out</b>                  Monitor connectors <b>(1) 2*HDMI (1.4), digital, HDCP-compliant                  (2) DisplayPort (1.2), digital, HDCP-compliant                  (3) Mini DisplayPort, digital, HDCP-compliant</b>                  Signal cables <b>(1) detachable, mini DisplayPort to DisplayPort, digital, 1.8 meter</b>                  Mounting features <b>Wall or desk mounting using the Extend Arm or third-party accessories meeting the VESA FPMPI® (100mm mount)</b>                  Security <b>Security keyhole for attachment of optional cable lock (Kensington® lock-compatible)</b></p>							
<p>Ship group <b>Monitor, detachable stand, Quick start and safety poster, 1.8 meter USB 3.0 cable, 1.8 meter mini DP to DP cable, 1.8 meter black power cord</b></p>	<p><b>Limited Warranty</b></p> <p>See details at <a href="http://support.lenovo.com/en_US/guides-and-manuals/detail.page?DocID=UM008281">http://support.lenovo.com/en_US/guides-and-manuals/detail.page?DocID=UM008281</a></p> <p><b>Accessories</b></p> <table border="0"> <tr> <td>Kensington MicroSaver Cable Lock</td> <td>73P2582</td> </tr> <tr> <td>Kensington Twin Head Cable Lock</td> <td>45K1620</td> </tr> <tr> <td>Lenovo Security Cable Lock</td> <td>57Y4303</td> </tr> </table> <p>See details at <a href="http://www.lenovo.com/support/monitoraccessories">www.lenovo.com/support/monitoraccessories</a></p> <p>See all monitors at <a href="http://www.lenovo.com/thinkvision">www.lenovo.com/thinkvision</a></p>	Kensington MicroSaver Cable Lock	73P2582	Kensington Twin Head Cable Lock	45K1620	Lenovo Security Cable Lock	57Y4303
Kensington MicroSaver Cable Lock	73P2582						
Kensington Twin Head Cable Lock	45K1620						
Lenovo Security Cable Lock	57Y4303						





<p>Name Case color Type-model Panel</p> <p>Viewable image size Max view area (W x H) Optimum resolution Max pixel rate Frequency Aspect ratio Pixel pitch (mm) Dot/Pixel per Inch Brightness Contrast ratio Pixel response time Color gamut Viewing angle at 10:1 CR Stand Bezel width Dimensions (HxWxD, excluding stand) Dimensions (HxWxD, including stand) Power supply</p> <p>Weight Limited warranty<sup>4</sup> Available date</p>	<p><b>Pro2820 Wide Flat Panel Monitor</b> <b>Black</b> <b>60FCRAR6US / 60FCRAT6EU</b> TFT-LCD, with wide viewing angle (WVA) technology, White LED backlight <b>28" (711mm) diagonal</b> 24.44" x 13.44" (620.9mm x 341.3mm) <b>1920x1080</b> 205MHz (VGA); 165MHz(DP/ HDMI); 149MHz (MHL) Supports 1920 x 10800 @ 60Hz 16:9 0.32 x 0.32mm 79 dpi 300 nits or cd/m<sup>2</sup> (typical) 3000:1 (typical) 6.5ms 72% 178° horizontal, 178° vertical Tilt, swivel, and height adjustable stand Sides: 0.86" (21.85mm) 17.45" H x 26.21" W x 2.30" D; 443.3mm H x 665.9mm W x 58.2mm D 17.45" H x 26.21" W x 11.41" D; 443.3mm H x 665.9mm W x 289.9mm D 60 watts typical, 90 watts typical (with USB), 65 watts maximum, 95 watts maximum (with USB), &lt;1.2 watts sleep/off; &lt;0.5 watts switch off integrated (no external brick-like power supply) 17.84 lb; 8.11kg (including stand) <b>3 year</b> (includes backlight) September 2014</p>						
<p>VESA-compliant<sup>2</sup> Power management Ergonomics Emission standards Environmental</p>	<p><b>Features</b></p> <ul style="list-style-type: none"> <li>• 28-inch MVA (Multi-domain Vertical Alignment) panel LED backlit monitor</li> <li>• Supports 1920x1080 resolution</li> <li>• 5-Ports USB hub, support USB 3.0</li> <li>• Arsenic/Mercury free</li> <li>• Microsoft® Windows® 7</li> <li>• Windows 8/ Windows 8.1 certified</li> </ul>  <p><b>ThinkVision Pro2820 Monitor</b></p>						
<p>Preset resolutions</p> <p>Presets / user settings</p>	<p>VGA: 640x480, 720x400 SVGA: 800x600 XGA: 1024x768, 1024x760 SXGA: 1280x1024 WXGA: 1280x720, 1280x800, 1366x768 WXGA+: 1440x900, 1600x900 WSXGA+: 1680x1050 Full HD: 1920x1080 Others: 1152x864</p> <p>Standard presets: 17; user settings: 17</p>						
<p>Viewing adjustments Rotating screen On screen display Control features USB hub Multimedia Camera Multiple input Monitor connectors</p> <p>Signal cables</p> <p>Mounting features Security</p>	<p>Tilt: 25° back, -5° forward; lift: 4.3" (110mm); swivel: +/-45° <b>Screen pivots 90 degrees from landscape to portrait</b> On screen display with digital user controls (8 languages) Direct access (touch buttons on front) for automatic image setup, input switch, and brightness USB Hub: one USB 3.0 upstream port, four USB 3.0 downstream ports None None Support VGA, HDMI, DisplayPort, MHL connections (Mobile High-definition Link) (1) VGA 15-pin D-shell, analog (2) HDMI (1.4), digital, <b>HDCP-compliant</b> (3) DisplayPort (1.2), digital, <b>HDCP-compliant</b> (1) detachable, VGA 15-pin D-shell at each end, analog, 1.8 meter (2) detachable, DisplayPort at each end, digital, 1.8 meter Wall or desk mounting using the Extend Arm or third-party accessories meeting the VESA FPMPI® (100mm mount) Security keyhole for attachment of optional cable lock (Kensington® lock-compatible)</p>						
<p>Ship group</p>	<p>Monitor, detachable stand, Quick start and safety poster, 1.8 meter DisplayPort cable, 1.8 meter VGA cable, 1.8 meter USB 3.0 cable, 1.8 meter black power cord</p>						
<p><b>Limited Warranty</b></p> <p>See details at <a href="http://support.lenovo.com/en_US/guides-and-manuals/detail.page?DocID=UM008281">http://support.lenovo.com/en_US/guides-and-manuals/detail.page?DocID=UM008281</a></p>	<p><b>Accessories</b></p> <table border="0"> <tr> <td>Kensington MicroSaver Cable Lock</td> <td>73P2582</td> </tr> <tr> <td>Kensington Twin Head Cable Lock</td> <td>45K1620</td> </tr> <tr> <td>Lenovo Security Cable Lock</td> <td>57Y4303</td> </tr> </table> <p>See details at <a href="http://www.lenovo.com/support/monitoraccessories">www.lenovo.com/support/monitoraccessories</a></p> <p>See all monitors at <a href="http://www.lenovo.com/thinkvision">www.lenovo.com/thinkvision</a></p>	Kensington MicroSaver Cable Lock	73P2582	Kensington Twin Head Cable Lock	45K1620	Lenovo Security Cable Lock	57Y4303
Kensington MicroSaver Cable Lock	73P2582						
Kensington Twin Head Cable Lock	45K1620						
Lenovo Security Cable Lock	57Y4303						



<p>Name <b>X1 Wide Flat Panel Monitor</b>                  Case color <b>Black</b>                  Type-model <b>60E2GAR1US / 60E2GAT1EU</b>                  Panel TFT-LCD, IPS (In-Plane Switching), White LED backlight                  Viewable image size <b>27" (684.7mm) diagonal</b>                  Max view area (W x H) <b>23.49" x 13.21" (596.7mm x 335.7mm)</b>                  Optimum resolution <b>3840x2160</b>                  Max pixel rate <b>600MHz</b>                  Aspect ratio <b>16:9</b>                  Pixel pitch (mm) <b>0.16 x 0.16mm</b>                  Dot/Pixel per Inch <b>163 dpi</b>                  Brightness <b>300 nits or cd/m<sup>2</sup> (typical)</b>                  Contrast ratio <b>1300:1 (typical)</b>                  Pixel response time <b>6ms</b>                  Color gamut <b>99%</b>                  Viewing angle at 10:1 CR <b>178° horizontal, 178° vertical</b>                  Stand <b>Tilt stand</b>                  Bezel width <b>Sides: 0.088" (2.23mm)</b>                  Dimensions <b>19.35" H x 24.19" W x 10.63" D;</b>                  (HxWxD, including stand) <b>491.4mm H x 614.5mm W x 270.0mm D</b>                  Power supply <b>40 watts typical, 130 watts maximum (with USB), &lt;0.5 watts sleep/off; &lt;0.5 watts switch off</b>                  Weight <b>14.11 lb; 6.40kg (including stand)</b>                  Limited warranty<sup>4</sup> <b>3 year</b>                  Available date <b>March 2016</b></p>	<p><b>Features</b></p> <ul style="list-style-type: none"> <li>• 27-inch IPS LED backlight monitor with speaker</li> <li>• Supports 3840x2160 resolution</li> <li>• 5-Ports USB hub, support USB Type-C</li> <li>• 3watts x 2 stereo speakers</li> <li>• Microsoft® Windows® 7 certified</li> <li>• Microsoft Windows 10 certified</li> </ul>						
<p>VESA-compliant<sup>2</sup> <b>VESA DDC2B/CI</b>                  Power management <b>ENERGY STAR® 7.0</b>                  Ergonomics <b>ISO 9241-307</b>                  Emission standards <b>FCC Class B</b>                  Environmental <b>TCO Displays 7.0, RoHS, EPEAT™ Silver rating, ULE Gold</b></p>	 <p style="text-align: center;"><b>ThinkVision X1 Monitor</b></p>						
<p>Preset resolutions <b>VGA: 640x350, 640x480, 720x400</b>  <b>SVGA: 800x600</b>  <b>XGA: 1024x768, 1152x864</b>  <b>SXGA: 1280x1024</b>  <b>WXGA: 1280x720, 1280x768, 1280x800, 1360x768</b>  <b>WXGA+: 1440x900, 1600x900</b>  <b>WSXGA+: 1680x1050</b>  <b>Full HD: 1920x1080, 1920x1200</b>  <b>UHD: 3840x2160</b></p> <p>Presets / user settings <b>Standard presets: 20; user settings: 20</b></p>							
<p>Viewing adjustments <b>Tilt: 22° back, -5° forward;</b>                  Rotating screen <b>None</b>                  On screen display <b>On screen display with digital user controls (8 languages)</b>                  Control features <b>Direct access (touch buttons on front) for menu, mute, volume up/down, and brightness</b>                  USB hub <b>USB Hub: one USB 3.0 Type-C upstream port, four USB 3.0 downstream ports</b>                  Multimedia <b>Integrated stereo speakers (3 watts x 2), built-in microphone</b>                  Camera <b>Full HD camera with LED light</b>                  Multiple input <b>Support HDMI, DisplayPort</b>                  Monitor connectors <b>(1) HDMI (1.4), digital, <b>HDCP-compliant</b></b>  <b>(2) DisplayPort (1.2), digital, <b>HDCP-compliant</b></b>                  Signal cables <b>(1) detachable, HDMI at each end, digital, 1.8 meter</b>  <b>(2) detachable, DisplayPort at each end, digital, 1.8 meter</b>                  Mounting features <b>Wall or desk mounting using the Extend Arm or third-party accessories meeting the VESA FPMPI® (100mm mount)</b>                  Security <b>Security keyhole for attachment of optional cable lock (Kensington® lock-compatible)</b></p>							
<p>Ship group <b>Monitor, detachable stand, Quick start and safety poster, 1.8 meter DisplayPort cable, 1.8 meter HDMI cable, 1.8 meter USB Type-C cable, 1.8 meter USB Type-C to Type-A cable, 1.8 meter black power cord, mini DP to DP adapter, power adapter (135W)</b></p>	<p style="text-align: center;"><b>Limited Warranty</b></p> <p>See details at <a href="http://support.lenovo.com/en_US/guides-and-manuals/detail.page?DocID=UM008281">http://support.lenovo.com/en_US/guides-and-manuals/detail.page?DocID=UM008281</a></p> <p style="text-align: center;"><b>Accessories</b></p> <table border="0"> <tr> <td>Kensington MicroSaver Cable Lock</td> <td style="text-align: right;">73P2582</td> </tr> <tr> <td>Kensington Twin Head Cable Lock</td> <td style="text-align: right;">45K1620</td> </tr> <tr> <td>Lenovo Security Cable Lock</td> <td style="text-align: right;">57Y4303</td> </tr> </table> <p>See details at <a href="http://www.lenovo.com/support/monitoraccessories">www.lenovo.com/support/monitoraccessories</a></p> <p>See all monitors at <a href="http://www.lenovo.com/thinkvision">www.lenovo.com/thinkvision</a></p>	Kensington MicroSaver Cable Lock	73P2582	Kensington Twin Head Cable Lock	45K1620	Lenovo Security Cable Lock	57Y4303
Kensington MicroSaver Cable Lock	73P2582						
Kensington Twin Head Cable Lock	45K1620						
Lenovo Security Cable Lock	57Y4303						

This publication was developed for products and services offered in the United States and E.M.E.A countries. Lenovo may not offer the products, services or features discussed in this document in other countries. Lenovo may withdraw an offering at any time. Information is subject to change without notice. Consult your local representative for information on offerings available in your area.

Lenovo reserves the right to change specifications or other product information without notice. Lenovo is not responsible for photographic or typographical errors.

LENOVO PROVIDES THIS PUBLICATION "AS IS," WITHOUT WARRANTY OF ANY KIND, EITHER EXPRESS OR IMPLIED, INCLUDING THE IMPLIED WARRANTIES OF MERCHANTABILITY OR FITNESS FOR A PARTICULAR PURPOSE.

Some jurisdictions do not allow disclaimer of express or implied warranties in certain transactions, therefore this disclaimer may not apply to you.

**Availability:** All offers subject to availability. Lenovo reserves the right to alter product offerings and specifications at any time, without notice. Lenovo is not responsible for photographic or typographic errors.

**General:** Review key information provided by Microsoft that may apply to your system purchase, including details on Windows 10, Windows 8, Windows 7, and potential upgrades/downgrades. Lenovo makes no representation or warranty regarding third-party products or services.

**Trademarks:** Lenovo, ThinkPad, ThinkCentre, ThinkStation and the Lenovo logo are trademarks of Lenovo. Microsoft, Windows, Windows NT, and the Windows logo are trademarks of Microsoft Corporation. Ultrabook, Celeron, Celeron Inside, Core Inside, Intel, Intel Logo, Intel Atom, Intel Atom Inside, Intel Core, Intel Inside, Intel Inside Logo, Intel vPro, Itanium, Itanium Inside, Pentium, Pentium Inside, vPro Inside, Xeon, Xeon Phi, and Xeon Inside are trademarks of Intel Corporation in the U.S. and/or other countries. Other company, product or service names may be trademarks or service marks of others.

**Warranty:** For a copy of applicable warranties, write to: Lenovo Warranty Information, 1009 Think Place, Morrisville, NC, 27560. Lenovo makes no representation or warranty regarding third party products or services. The Lenovo Limited Warranty applies only to Lenovo hardware products purchased for your own use, and does not transfer upon resale.

**Limited warranty:** Support unrelated to a warranty issue may be subject to additional charges.

#### **Lenovo Services:**

**Carry-in or Mail-in Service:** Parts and labor repair coverage where the customer is responsible for shipping (including packaging) or delivery to authorized warranty provider or repair center.

**Depot or Courier Service:** Parts and labor repair coverage where shipping (including packaging) or delivery to the repair center is paid for by Lenovo.

**Expedited Depot:** Parts and labor coverage with expedited turnaround. Shipping (including packaging) or delivery to the repair center is paid for by Lenovo.

**Onsite / In-home Service:** Parts and labor repair coverage where labor is provided onsite at your place of business.

If Lenovo determines your product problem is covered by the product warranty and cannot be resolved over the telephone, a technician will be dispatched to arrive onsite, typically the next day.

**International Warranty Service (IWS):** PC repair coverage for customers who require a critical warranty repair while travelling internationally. Visit [www.lenovo.com/internationalwarranty](http://www.lenovo.com/internationalwarranty) for details. Visit [www.lenovo.com/warranty](http://www.lenovo.com/warranty) for Lenovo Warranty Services terms and conditions for complete details and restrictions.

**Included software:** may differ from its retail version (if available), and may not include user manuals or all program functionality. Software license agreements may apply.

**Battery life:** Battery life (and recharge times) will vary based on many factors including screen brightness, applications, features, power management, battery conditioning, and other customer preferences.

Visit <http://psref.lenovo.com/> for the latest version of Product Specifications Reference.

© Lenovo, 2017. All rights reserved.  
Lenovo 1009 Think Place Morrisville, NC 27560 U.S.A.