

**Lenovo**™ **Think**Products

# PSREF



**Product Specifications Reference**

Version 549, September 2019

Visit <http://psref.lenovo.com> for the latest version

**Lenovo** ThinkPad Laptops

# PSREF



**Product Specifications Reference**

Version 549, October 2019

Visit <http://psref.lenovo.com> for the latest version

# Contents

---

<b>Cover</b>		<b>33</b>
<b>Contents</b>		
<b>Summary Of Change</b>		
<b>11e Series</b>		
<b>ThinkPad 11e (5th Gen)</b>		
ThinkPad 11e (5th Gen) Platform Specifications		
<b>A Series</b>		
<b>ThinkPad A275</b>		
ThinkPad A275 Platform Specifications		
<b>ThinkPad A285</b>		
ThinkPad A285 Platform Specifications		
<b>ThinkPad A475</b>		
ThinkPad A475 Platform Specifications		
<b>ThinkPad A485</b>		
ThinkPad A485 Platform Specifications		
<b>E Series</b>		
<b>ThinkPad E14</b>		
ThinkPad E14 Platform Specifications		
<b>ThinkPad E15</b>		
ThinkPad E15 Platform Specifications		
<b>ThinkPad E480</b>		
ThinkPad E480 Platform Specifications		
<b>ThinkPad E490</b>		
ThinkPad E490 Platform Specifications		
<b>ThinkPad E490s</b>		
ThinkPad E490s Platform Specifications		
<b>ThinkPad E495</b>		
ThinkPad E495 Platform Specifications		
<b>ThinkPad E580</b>		
ThinkPad E580 Platform Specifications		
<b>ThinkPad E590</b>		
ThinkPad E590 Platform Specifications		
<b>ThinkPad E595</b>		
ThinkPad E595 Platform Specifications		
<b>L Series</b>		
<b>1 ThinkPad L380</b>		<b>33</b>
<b>2 ThinkPad L380 Platform Specifications</b>		<b>34</b>
<b>4 ThinkPad L390</b>		<b>35</b>
<b>5 ThinkPad L390 Platform Specifications</b>		<b>36</b>
<b>5 ThinkPad L480</b>		<b>37</b>
<b>6 ThinkPad L480 Platform Specifications</b>		<b>38</b>
<b>7 ThinkPad L490</b>		<b>39</b>
<b>7 ThinkPad L490 Platform Specifications</b>		<b>40</b>
<b>8 ThinkPad L570</b>		<b>41</b>
<b>9 ThinkPad L570 Platform Specifications</b>		<b>42</b>
<b>10 ThinkPad L580</b>		<b>43</b>
<b>11 ThinkPad L580 Platform Specifications</b>		<b>44</b>
<b>12 ThinkPad L590</b>		<b>45</b>
<b>13 ThinkPad L590 Platform Specifications</b>		<b>46</b>
<b>14 P Series</b>		<b>47</b>
<b>15 ThinkPad P1</b>		<b>47</b>
<b>15 ThinkPad P1 Platform Specifications</b>		<b>48</b>
<b>16 ThinkPad P1 (2nd Gen)</b>		<b>49</b>
<b>17 ThinkPad P1 (2nd Gen) Platform Specifications</b>		<b>50</b>
<b>18 ThinkPad P43s</b>		<b>51</b>
<b>19 ThinkPad P43s Platform Specifications</b>		<b>52</b>
<b>20 ThinkPad P51</b>		<b>53</b>
<b>21 ThinkPad P51 Platform Specifications</b>		<b>54</b>
<b>22 ThinkPad P52</b>		<b>55</b>
<b>23 ThinkPad P52 Platform Specifications</b>		<b>56</b>
<b>24 ThinkPad P52s</b>		<b>57</b>
<b>25 ThinkPad P52s Platform Specifications</b>		<b>58</b>
<b>26 ThinkPad P53</b>		<b>59</b>
<b>27 ThinkPad P53 Platform Specifications</b>		<b>60</b>
<b>28 ThinkPad P53s</b>		<b>61</b>
<b>29 ThinkPad P53s Platform Specifications</b>		<b>62</b>
<b>30 ThinkPad P72</b>		<b>63</b>
<b>31 ThinkPad P72 Platform Specifications</b>		<b>64</b>
<b>32 ThinkPad P73</b>		<b>65</b>
<b>33 ThinkPad P73 Platform Specifications</b>		<b>66</b>

# Contents

---

<b>T Series</b>	<b>67</b>	ThinkPad X390 Platform Specifications	<b>100</b>
<b>ThinkPad T470</b>	<b>67</b>	<b>ThinkPad X395</b>	<b>101</b>
ThinkPad T470 Platform Specifications	68	ThinkPad X395 Platform Specifications	102
<b>ThinkPad T470s</b>	<b>69</b>	<b>Legal Information</b>	<b>103</b>
ThinkPad T470s Platform Specifications	70		
<b>ThinkPad T480</b>	<b>71</b>		
ThinkPad T480 Platform Specifications	72		
<b>ThinkPad T480s</b>	<b>73</b>		
ThinkPad T480s Platform Specifications	74		
<b>ThinkPad T490</b>	<b>75</b>		
ThinkPad T490 Platform Specifications	76		
<b>ThinkPad T490s</b>	<b>77</b>		
ThinkPad T490s Platform Specifications	78		
<b>ThinkPad T495</b>	<b>79</b>		
ThinkPad T495 Platform Specifications	80		
<b>ThinkPad T495s</b>	<b>81</b>		
ThinkPad T495s Platform Specifications	82		
<b>ThinkPad T580</b>	<b>83</b>		
ThinkPad T580 Platform Specifications	84		
<b>ThinkPad T590</b>	<b>85</b>		
ThinkPad T590 Platform Specifications	86		
<b>X Series</b>	<b>87</b>		
<b>ThinkPad X1 Carbon (6th Gen)</b>	<b>87</b>		
ThinkPad X1 Carbon (6th Gen) Platform Specifications	88		
<b>ThinkPad X1 Carbon (7th Gen)</b>	<b>89</b>		
ThinkPad X1 Carbon (7th Gen) Platform Specifications	90		
<b>ThinkPad X1 Extreme</b>	<b>91</b>		
ThinkPad X1 Extreme Platform Specifications	92		
<b>ThinkPad X1 Extreme (2nd Gen)</b>	<b>93</b>		
ThinkPad X1 Extreme (2nd Gen) Platform Specifications	94		
<b>ThinkPad X270</b>	<b>95</b>		
ThinkPad X270 Platform Specifications	96		
<b>ThinkPad X280</b>	<b>97</b>		
ThinkPad X280 Platform Specifications	98		
<b>ThinkPad X390</b>	<b>99</b>		



# Summary of Changes

---

This section describes the technical changes made in this edition.

This edition might also include minor corrections and editorial changes which are not identified.

## October 9, 2019 - Version 549

### Additions in this update

► **New product(s)**

ThinkPad E14 models announced October 2019

ThinkPad E15 models announced October 2019

ThinkPad T490 Secure Access / Healthcare Edition separated from ThinkPad T490

► **Others**

ThinkPad E490s - Spec updated

ThinkPad T490 - Spec updated

ThinkPad T495s - Spec updated

### Withdrawals in this update

► **Withdrawn product(s)**

None

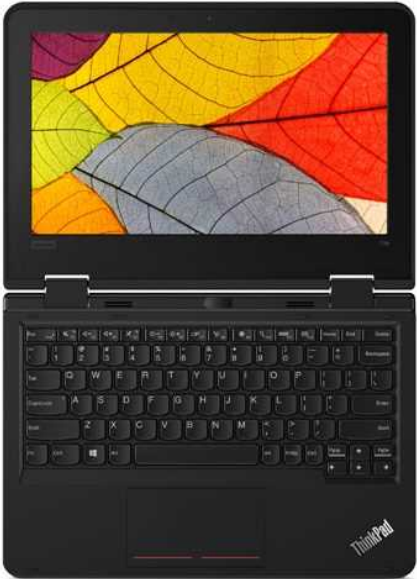

# ThinkPad 11e (5<sup>th</sup> Gen) Platform Specifications

Product Specifications Reference (PSREF)

Processor	7th Generation Intel® Core™ m / i5 Processor, Intel Celeron® processor, or Intel Pentium® Silver processor								Dimensions Weight		WxDxH: 11.81" x 8.27" x 0.86"; 300mm x 210mm x 21.9mm Starting at 2.99 lb / 1.36 kg			
	Processor Number	# of Cores	# of Threads	Base Frequency	Burst Frequency	Cache	Memory Types	Processor Graphics	Case color	Black		Case material	Display cover: PC/ABS+GF; Bottom: PC/ABS plastic	
	m3-7Y30	2	4	1.0 GHz	2.6 GHz	4MB	LPDDR3-1866	Intel HD Graphics 615	Smart card reader				None	
	i5-7Y54			1.2 GHz	3.2 GHz	4MB		Intel UHD Graphics 615	Media reader				MicroSD card reader	
	Celeron N4100	4	4	1.1 GHz	2.4 GHz	4MB	DDR4-2400	Intel UHD Graphics 600	Ports				Two USB 3.1 Gen 1, one USB 3.1 Type-C Gen 1 (with the function of Power Delivery and DisplayPort), HDMI 1.4b, Ethernet (RJ-45), headphone / microphone combo jack, microSD card reader, security keyhole	
	Pentium Silver N5000			1.1 GHz	2.7 GHz	4MB		Intel UHD Graphics 605	* Depending on many factors, actual data transfer speed may be lower than theoretical speed					
Graphics	Intel HD Graphics 615, Intel UHD Graphics 600 or 605 in processor, supports external digital monitor via HDMI or USB Type-C; supports dual independent display; Max resolution: 3840x2160@60Hz (USB Type-C); 4096x2160@30Hz (HDMI)								Camera	HD720p camera, fixed focus				
Chipset	Intel SoC (System on Chip) platform 4GB or 8GB / 1866MHz LPDDR3 or 2400MHz DDR4 / soldered to systemboard, no sockets								Audio support	HD Audio, Realtek® ALC3287 codec, stereo speakers, 2W x 2, Dolby® Audio™, mono digital microphone, combo audio/microphone jack				
Memory									Keyboard	6-row, spill-resistant, multimedia Fn keys				
Display	Size	Resolution	Type	Surface	Brightness	Aspect Ratio	Contrast Ratio	Color Gamut	Viewing Angle	Touchpad	Buttonless Mylar surface touchpad below keyboard, multi-touch			
	11.6"	HD (1366x768)	TN	Anti-glare	250 nits	16:9	400:1 or 500:1	45%	90°	Security	Power-on password, supervisor password, security keyhole			
	11.6"	HD (1366x768)	IPS	Anti-glare	250 nits	16:9	800:1	45%	170°	Security chip	Discrete TPM 2.0, TCG Certified			
Multi-touch (opt)	Capacitive-type multi-touch, supports 10-finger gesture (HD IPS only)								System Mgt	None				
Storage	eMMC flash memory on board or M.2 SSD / PCIe NVMe, PCIe 3.0 x 2, 16Gb/s								Fingerprint reader	None				
Optical	None								NFC	None				
Ethernet	Realtek RTL8111GUS Gigabit Network Connection								Battery	Integrated Li-ion 42Wh battery				
WLAN + Bluetooth™	One of the following, configurable by model: • Intel Wireless-AC 9260, Wi-Fi 2x2 802.11ac + Bluetooth 5.0, M.2 card • Intel Wireless-AC 9560, Wi-Fi 2x2 802.11ac + Bluetooth 5.0, M.2 card (US only)								Max battery life	MobileMark® 2014: 13.9 hr * Battery life varies significantly with settings, usage, & other factors				
WWAN	None								AC adapter	45W or 65W slim tip AC adapter, 45W or 65W USB Type-C AC adapter				
									Operating system (optional)	One of the following, configurable by model: • Windows® 10 Home 64 • Windows 10 Pro 64 • Windows 10 Pro in S mode • No OS				
									Limited warranty	One of the following, configurable by model: • 1-year depot repair service • 3-year/1-yr battery depot repair service				
									Mil-Spec test	MIL-STD-810G military testing				
									Environment	EPEAT™ Silver; ENERGY STAR® 6.1; RoHS-compliant				

Note: The specifications above may not be available in all regions.

Lenovo  
August 2019



# ThinkPad A275 Platform Specifications

Product Specifications Reference (PSREF)

Processor	AMD PRO A-Series APUs								Smart card reader Media reader Ports  Monitor cable (optional)  Camera (optional) Audio support	Optional: Smart card reader 4-in-1 reader (MMC, SD, SDHC, SDXC) Two USB 3.1 Gen 1 (USB 3.0, one Always On), USB 3.1 Type-C Gen 1 (with the function of Power Delivery and DisplayPort), HDMI 1.4b, Ethernet (RJ-45) <i>* Depending on many factors, actual data transfer speed may be lower than theoretical speed</i> HDMI to VGA: Lenovo HDMI to VGA Monitor Adapter USB-C to VGA: Lenovo USB-C to VGA Adapter USB-C to DP: Lenovo USB-C to DisplayPort Adapter  HD720p resolution, fixed focus HD Audio, Realtek ALC3268 codec / stereo speakers, 1.5W x 2 / dual array microphone, combo audio/microphone jack								
	Processor Number	# of Cores	# of Threads	Base Frequency	Max Turbo Frequency	Cache	Memory Types	Processor Graphics										
	PRO A10-8730B	4	4	2.4 GHz	3.3 GHz	2MB	DDR4-1866	AMD Radeon™ R5 Graphics										
	PRO A12-8830B			2.5 GHz	3.4 GHz			AMD Radeon R7 Graphics										
	PRO A10-9700B			2.5 GHz	3.4 GHz													
PRO A12-9800B	2.7 GHz			3.6 GHz														
<i>* Windows 7 is only supported by PRO A10-8730B and PRO A12-8830B</i>																		
Graphics	AMD Radeon R5 or R7 Graphics in processor only; supports external digital monitor via HDMI or USB Type-C; supports three independent displays; Max resolution: 4096x2160@60Hz (USB Type-C); 4096x2160@30Hz (HDMI)								Keyboard UltraNav™	6-row, spill-resistant, multimedia Fn keys, optional LED backlight TrackPoint® pointing device and buttonless Mylar surface multi-touch touchpad								
Chipset Memory	AMD SoC (System on Chip) platform 16GB max / 1866MHz DDR4, one DDR4 SO-DIMM socket								Security Security chip	Power-on password, hard disk password, supervisor password, security keyhole <i>dTPM 1.2:</i> discrete TPM 1.2, TCG Certified <i>dTPM 2.0:</i> discrete TPM 2.0, TCG Certified								
Display	<i>Some:</i> 12.5" (317.5mm) HD (1366x768), anti-glare, LED backlight, 220 nits, 16:9 aspect ratio, 500:1 contrast ratio <i>Some:</i> 12.5" (317.5mm) FHD (1920x1080), anti-glare, LED backlight, IPS, 300 nits, 16:9 aspect ratio, 700:1 contrast ratio, 170° viewing angle								Fingerprint reader NFC	Optional: Touch style match on chip fingerprint reader on the palm rest None								
Multi-touch (opt)	On-cell touch, supports 10-finger gesture (FHD only, US only)								Internal battery External battery Max battery life (MobileMark® 2014)	Optional: Integrated Li-ion or Li-Polymer 3-cell (23Wh) Li-ion 3-cell (23Wh) or 6-cell (48Wh) <table border="1"> <thead> <tr> <th>Models</th> <th>No + 3-cell</th> <th>3-cell + 3-cell</th> <th>3-cell + 6-cell 48Wh</th> </tr> </thead> <tbody> <tr> <td>Max battery life</td> <td>5.05 hr</td> <td>10.1 hr</td> <td>15.6 hr</td> </tr> </tbody> </table> <i>* Battery life varies significantly with settings, usage, &amp; other factors</i>	Models	No + 3-cell	3-cell + 3-cell	3-cell + 6-cell 48Wh	Max battery life	5.05 hr	10.1 hr	15.6 hr
Models	No + 3-cell	3-cell + 3-cell	3-cell + 6-cell 48Wh															
Max battery life	5.05 hr	10.1 hr	15.6 hr															
Storage	<i>System has one HDD slot or one M.2 slot exclusively for storage</i> <i>Some:</i> HDD / SATA 6.0Gb/s, 2.5" wide, 7mm high, Active Protection System™ <i>Some:</i> SSD / SATA 6.0Gb/s, 2.5" wide, 7mm high (e.g. xxxGB SSD) <i>Some:</i> M.2 SSD / PCIe NVMe, PCIe 3.0 x 2, 16Gb/s								AC adapter	45W slim tip AC adapter or 45W USB Type-C AC adapter								
Optical	None								Operating system	<i>One of the following, configurable by model:</i> • Windows® 7 Professional 64 preinstalled through downgrade rights in Windows 10 Pro 64 • Windows 10 Home 64 • Windows 10 Pro 64								
Ethernet	Realtek® RTL8111EPV Gigabit Ethernet connection								Limited warranty	<i>One of the following, configurable by model:</i> • 1-year depot repair service • 3-year/1-yr battery depot repair service • 3-year/1-yr battery limited onsite service								
WLAN Bluetooth™	Realtek RTL8822BE, Wi-Fi 2x2 802.11ac + BT4.1, M.2 card Bluetooth 4.1 wireless, integrated in Wi-Fi + Bluetooth combo adapter								Mil-Spec test	MIL-STD-810G military testing								
WWAN (optional)	<i>One of the following, configurable by model:</i> • Wireless WAN upgradable • Integrated Mobile Broadband 4G LTE-A, Qualcomm® Snapdragon™ X7 LTE-A (Sierra Wireless EM7455) <i>* For non-WWAN model, it means the model is NOT WWAN upgradable</i>								Environment	EPEAT™ Gold (US only); ENERGY STAR® 6.1; RoHS-compliant								
SIM card (opt)	Micro-SIM card slot, opt Verizon LTE (US) SIM card																	
Dimensions Weight	<i>WxDxH:</i> 12.03" x 8.21" x 0.80"; 305.5mm x 208.5mm x 20.3mm <table border="1"> <thead> <tr> <th>Models</th> <th>No + 3-cell</th> <th>3-cell + 3-cell</th> <th>3 + 6-cell</th> </tr> </thead> <tbody> <tr> <td>Weight</td> <td>2.79 lb / 1.27 kg</td> <td>2.98 lb / 1.36 kg</td> <td>3.33 lb / 1.52 kg</td> </tr> </tbody> </table>								Models	No + 3-cell	3-cell + 3-cell	3 + 6-cell	Weight	2.79 lb / 1.27 kg	2.98 lb / 1.36 kg	3.33 lb / 1.52 kg		
Models	No + 3-cell	3-cell + 3-cell	3 + 6-cell															
Weight	2.79 lb / 1.27 kg	2.98 lb / 1.36 kg	3.33 lb / 1.52 kg															
Case color Case material	Black Glass-Fiber Reinforced Plastic																	

Note: The specifications above may not be available in all regions.

Lenovo  
August 2019



# ThinkPad A285 Platform Specifications

Product Specifications Reference (PSREF)

Processor	AMD Ryzen™ PRO Mobile Processors with Radeon™ Vega Graphics	Smart card reader Media reader Ports	Optional: Smart card reader MicroSD card reader, in the combo slot with nano-SIM card One USB 3.1 Gen 1 (Always On), one USB 3.1 Gen 2, two USB 3.1 Type-C Gen 2 (with the function of Power Delivery and DisplayPort), HDMI 2.0, Ethernet extension connector, combo slot of nano-SIM card (WWAN models) and microSD card reader, headphone / microphone combo jack, optional smart card reader, side docking connector, security keyhole <i>* Depending on many factors, actual data transfer speed may be lower than theoretical speed</i>																										
	<table border="1"> <thead> <tr> <th>Processor Number</th> <th># of Cores</th> <th># of Threads</th> <th>Base Frequency</th> <th>Max Turbo Frequency</th> <th>Cache</th> <th>Memory Types</th> <th>Processor Graphics</th> </tr> </thead> <tbody> <tr> <td>Ryzen 3 PRO 2300U</td> <td rowspan="3">4</td> <td>4</td> <td>2.0 GHz</td> <td>3.4 GHz</td> <td rowspan="3">2MB L2 / 4MB L3</td> <td rowspan="3">DDR4-2400</td> <td>Radeon Vega 6 Graphics</td> </tr> <tr> <td>Ryzen 5 PRO 2500U</td> <td>8</td> <td>2.0 GHz</td> <td>3.6 GHz</td> <td>Radeon Vega 8 Graphics</td> </tr> <tr> <td>Ryzen 7 PRO 2700U</td> <td>8</td> <td>2.2 GHz</td> <td>3.8 GHz</td> <td>Radeon Vega 10 Graphics</td> </tr> </tbody> </table>	Processor Number	# of Cores	# of Threads	Base Frequency	Max Turbo Frequency	Cache	Memory Types	Processor Graphics	Ryzen 3 PRO 2300U	4	4	2.0 GHz	3.4 GHz	2MB L2 / 4MB L3	DDR4-2400	Radeon Vega 6 Graphics	Ryzen 5 PRO 2500U	8	2.0 GHz	3.6 GHz	Radeon Vega 8 Graphics	Ryzen 7 PRO 2700U	8	2.2 GHz	3.8 GHz	Radeon Vega 10 Graphics	Monitor cable (optional) Bundled Accy	HDMI to VGA: Lenovo HDMI to VGA Monitor Adapter USB-C to VGA: Lenovo USB-C to VGA Adapter USB-C to DP: Lenovo USB-C to DisplayPort Adapter Optional: ThinkPad Ethernet Extension Adapter Gen 2
Processor Number	# of Cores	# of Threads	Base Frequency	Max Turbo Frequency	Cache	Memory Types	Processor Graphics																						
Ryzen 3 PRO 2300U	4	4	2.0 GHz	3.4 GHz	2MB L2 / 4MB L3	DDR4-2400	Radeon Vega 6 Graphics																						
Ryzen 5 PRO 2500U		8	2.0 GHz	3.6 GHz			Radeon Vega 8 Graphics																						
Ryzen 7 PRO 2700U		8	2.2 GHz	3.8 GHz			Radeon Vega 10 Graphics																						
Graphics	AMD Radeon Vega 6, Vega 8, or Vega 10 Graphics in processor only; supports external digital monitor via HDMI or USB Type-C; supports four independent displays; Max resolution: 5120x2880@60Hz (USB Type-C); 4096x2160@60Hz (HDMI)	Camera (optional)	One of the following, configurable by model: • HD720p camera with ThinkShutter camera privacy, fixed focus • IR camera and HD720p camera, fixed focus																										
Chipset	AMD SoC (System on Chip) platform	Audio support	HD Audio, Realtek ALC3287 codec / stereo speakers, 2W x 2, Dolby® Audio™ Premium / dual array microphone, headphone / microphone combo jack																										
Memory	8GB or 16GB / 2400MHz DDR4, soldered to systemboard, no sockets	Keyboard	6-row, spill-resistant, multimedia Fn keys, optional LED backlight																										
Display	Some: 12.5" (317.5mm) HD (1366x768), anti-glare, LED backlight, 220 nits, 16:9 aspect ratio, 400:1 contrast ratio Some: 12.5" (317.5mm) FHD (1920x1080), anti-glare, LED backlight, IPS, 300 nits, 16:9 aspect ratio, 800:1 contrast ratio, 170° viewing angle	UltraNav™	TrackPoint® pointing device and buttonless Mylar surface multi-touch touchpad																										
Multi-touch (opt)	On-cell touch, supports 10-finger gesture (FHD only)	Security	Power-on password, hard disk password, supervisor password, security keyhole																										
Storage	One of the following, configurable by model: • M.2 SSD / SATA 6.0Gb/s • M.2 SSD / PCIe NVMe, PCIe 3.0 x 4, 32Gb/s	Security chip	Discrete TPM 2.0, TCG Certified																										
Optical	None	System Mgt	DASH Management																										
Ethernet	Gigabit Ethernet connection via bundled or optional ThinkPad Ethernet Extension Adapter Gen 2	Fingerprint reader	Optional: Touch style match on chip fingerprint reader on the palm rest																										
WLAN	Realtek® RTL8822BE, Wi-Fi 2x2 802.11ac + Bluetooth 4.2, M.2 card	NFC	None																										
Bluetooth™	Bluetooth 4.2 wireless, integrated in Wi-Fi + Bluetooth combo adapter	Battery	Integrated Li-ion 48Wh battery, supports Rapid Charge (charge up to 80% in 1hr) with 65W USB Type-C AC adapter																										
WWAN (optional)	Integrated Mobile Broadband 4G LTE-A, Intel XMM™ 7360 (Fibocom L850-GL), M.2 card <i>* For non-WWAN model, it means the model is NOT WWAN upgradable</i>	Max battery life	MobileMark® 2014: 10.55 hr <i>* Battery life varies significantly with settings, usage, &amp; other factors</i>																										
SIM card (opt)	Nano-SIM card slot, in the combo slot with microSD card reader, optional Verizon LTE (US) SIM card	AC adapter	45W or 65W USB Type-C AC adapter																										
Dimensions	WxDxH (HD & FHD multi-touch): 12.11" x 8.26" x 0.69"; 307.7mm x 209.8mm x 17.4mm WxDxH (FHD non-touch): 12.11" x 8.26" x 0.70"; 307.7mm x 209.8mm x 17.8mm	Operating system	Windows® 10 Home 64 or Windows 10 Pro 64																										
Weight	FHD non-touch model: 2.49 lb / 1.13 kg; HD non-touch model: 2.78 lb / 1.26 kg; FHD multi-touch model: 2.79 lb / 1.27 kg	Limited warranty	One of the following, configurable by model: • 1-year depot repair service • 3-year/1-yr battery depot repair service • 3-year/1-yr battery limited onsite service																										
Case color	Black	Mil-Spec test	MIL-STD-810G military testing																										
Case material	Display cover: Carbon Fiber (FHD non-touch model) or PPS (HD & FHD multi-touch model); Bottom: Magnesium/Aluminum	Environment	EPEAT™ Gold (US only); ENERGY STAR® 6.1; RoHS-compliant																										

Note: The specifications above may not be available in all regions.

Lenovo  
April 2019





# ThinkPad A475 Platform Specifications

Product Specifications Reference (PSREF)

Processor	AMD PRO A-Series APUs							Dimensions Weight	WxDxH: 13.25" x 9.15" x 0.79"; 336.6mm x 232.5mm x 19.95mm				
	Processor Number	# of Cores	# of Threads	Base Frequency	Max Turbo Frequency	Cache	Memory Types		Processor Graphics	Models	3-cell or 3 + 3-cell	6-cell or 3 + 6-cell	
	PRO A10-8730B	4	4	2.4 GHz	3.3 GHz	2MB	DDR4-1866		AMD Radeon™ R5 Graphics	Magnesium	3.49 lb / 1.58 kg	3.92 lb / 1.78 kg	
	PRO A12-8830B			2.5 GHz	3.4 GHz				AMD	PPS	3.63 lb / 1.65 kg	4.35 lb / 1.85 kg	
	PRO A10-9700B			2.5 GHz	3.4 GHz				Radeon				
PRO A12-9800B	2.7 GHz			3.6 GHz	R7 Graphics								
* Windows 7 is only supported by PRO A10-8730B and PRO A12-8830B							Case color	Black					
Graphics	AMD Radeon R5 or R7 Graphics in processor only; supports external digital monitor via HDMI or USB Type-C; supports three independent displays; Max resolution: 4096x2160@60Hz (USB Type-C); 4096x2160@30Hz (HDMI)							Case material	Display cover: Magnesium Hybrid or PPS (Magnesium Hybrid for US only); Bottom: Glass-Fiber Reinforced Plastic				
	Chipset	AMD SoC (System on Chip) platform							Smart card reader	Optional: Smart card reader			
Memory	32GB max / 1866MHz DDR4, dual-channel capable, two DDR4 SO-DIMM sockets							Media reader	4-in-1 reader (MMC, SD, SDHC, SDXC), supports SD 3.0, UHS-I				
Display	Some: 14.0" (355mm) HD (1366x768), anti-glare, LED backlight, 220 nits, 16:9 aspect ratio, 350:1 contrast ratio Some: 14.0" (355mm) FHD (1920x1080), anti-glare, LED backlight, IPS, 250 nits, 16:9 aspect ratio, 700:1 contrast ratio, 170° viewing angle							Ports	Three USB 3.1 Gen 1 (USB 3.0, one Always On), USB 3.1 Type-C Gen 2 (with the function of Power Delivery and DisplayPort), HDMI 1.4b, Ethernet (RJ-45), Dock connector * Depending on many factors, actual data transfer speed may be lower than theoretical speed Optional: Lenovo USB-C to VGA Adapter				
Multi-touch (opt)	On-cell touch, supports 10-finger gesture (FHD only, US only)							Monitor cable	Optional: Lenovo USB-C to VGA Adapter				
Storage	System has one HDD slot or one M.2 2280 slot exclusively for storage Some: HDD / SATA 6.0Gb/s, 2.5" wide, 7mm high, Active Protection System™ Some: SSD / SATA 6.0Gb/s, 2.5" wide, 7mm high (e.g. xxxGB SSD) Some: M.2 SSD / PCIe NVMe, PCIe 3.0 x 2, 16Gb/s * Installed M.2 SSD is PCIe 3.0 x 4 but run at PCIe 3.0 x 2 due to M.2 SSD adapter limitation							Camera (optional)	HD720p resolution, fixed focus				
Optical	None							Audio support	HD Audio, Realtek ALC3268 codec / stereo speakers, 2W x 2 / dual array microphone, combo audio/microphone jack				
Ethernet	Realtek® RTL8111EPV Gigabit Ethernet connection							Keyboard	6-row, spill-resistant, multimedia Fn keys, optional LED backlight UltraNav™ TrackPoint® pointing device and buttonless Mylar surface multi-touch touchpad				
WLAN	Realtek RTL8822BE, Wi-Fi 2x2 802.11ac + BT4.1, M.2 card							Security	Power-on password, hard disk password, supervisor password, security keyhole				
Bluetooth™	Bluetooth 4.1 wireless, integrated in Wi-Fi + Bluetooth combo adapter							Security chip	dTPM 1.2: discrete TPM 1.2, TCG Certified dTPM 2.0: discrete TPM 2.0, TCG Certified				
WWAN (optional)	One of the following, configurable by model: • Wireless WAN upgradable • Integrated Mobile Broadband 4G LTE-A, Qualcomm® Snapdragon™ X7 LTE-A (Sierra Wireless EM7455) * For non-WWAN model, it means the model is NOT WWAN upgradable							Fingerprint reader	Optional: Touch style match on chip fingerprint reader on the keyboard bezel				
SIM card (opt)	Micro-SIM card slot, opt Verizon LTE (US) SIM card							NFC	None				
							Internal battery	Optional: Integrated Li-Polymer 3-cell (24Wh)					
							External battery	Li-Polymer 3-cell (24Wh) or Li-ion 6-cell (48Wh)					
							Max battery life (MobileMark® 2014)	Models	3-cell	3 + 3-cell	6-cell 48Wh	3 + 6-cell 48Wh	
								Max battery life	5.13 hr	10.26 hr	10.26 hr	15.4 hr	
									* Battery life varies significantly with settings, usage, & other factors				
							AC adapter	45W or 65W slim tip AC adapter, 45W or 65W USB Type-C AC adapter					
							Operating system	One of the following, configurable by model: • Windows® 7 Professional 64 preinstalled through downgrade rights in Windows 10 Pro 64 • Windows 10 Home 64 • Windows 10 Pro 64					
							Limited warranty	One of the following, configurable by model: • 1-year depot repair service • 3-year/1-yr battery depot repair service • 3-year/1-yr battery limited onsite service					
							Mil-Spec test	MIL-STD-810G military testing					
							Environment	EPEAT™ Gold (US only); ENERGY STAR® 6.1; RoHS-compliant					

Note: The specifications above may not be available in all regions.

Lenovo  
August 2019



# ThinkPad A485 Platform Specifications

Product Specifications Reference (PSREF)

Processor	AMD Ryzen™ PRO Mobile Processors with Radeon™ Vega Graphics	Smart card reader Media reader Ports	Optional: Smart card reader 4-in-1 reader (MMC, SD, SDHC, SDXC), supports SD 3.0, UHS-I One USB 3.1 Gen 1 (Always On), one USB 3.1 Gen 2, two USB 3.1 Type-C Gen 2 (with the function of Power Delivery and DisplayPort), HDMI 2.0, Ethernet (RJ-45), nano-SIM card slot (WWAN models), headphone / microphone combo jack, optional smart card reader, 4-in-1 media reader (MMC, SD, SDHC, SDXC), side docking connector, security keyhole <i>* Depending on many factors, actual data transfer speed may be lower than theoretical speed</i>																										
	<table border="1"> <thead> <tr> <th>Processor Number</th> <th># of Cores</th> <th># of Threads</th> <th>Base Frequency</th> <th>Max Turbo Frequency</th> <th>Cache</th> <th>Memory Types</th> <th>Processor Graphics</th> </tr> </thead> <tbody> <tr> <td>Ryzen 3 PRO 2300U</td> <td rowspan="3">4</td> <td>4</td> <td>2.0 GHz</td> <td>3.4 GHz</td> <td rowspan="3">2MB L2 / 4MB L3</td> <td rowspan="3">DDR4-2400</td> <td>Radeon Vega 6 Graphics</td> </tr> <tr> <td>Ryzen 5 PRO 2500U</td> <td>8</td> <td>2.0 GHz</td> <td>3.6 GHz</td> <td>Radeon Vega 8 Graphics</td> </tr> <tr> <td>Ryzen 7 PRO 2700U</td> <td>8</td> <td>2.2 GHz</td> <td>3.8 GHz</td> <td>Radeon Vega 10 Graphics</td> </tr> </tbody> </table>	Processor Number	# of Cores	# of Threads	Base Frequency	Max Turbo Frequency	Cache	Memory Types	Processor Graphics	Ryzen 3 PRO 2300U	4	4	2.0 GHz	3.4 GHz	2MB L2 / 4MB L3	DDR4-2400	Radeon Vega 6 Graphics	Ryzen 5 PRO 2500U	8	2.0 GHz	3.6 GHz	Radeon Vega 8 Graphics	Ryzen 7 PRO 2700U	8	2.2 GHz	3.8 GHz	Radeon Vega 10 Graphics	Monitor cable (opt) Bundled Accy Camera (optional) Audio support	HDMI to VGA: Lenovo HDMI to VGA Monitor Adapter USB-C to DP: Lenovo USB-C to DisplayPort Adapter None <i>One of the following, configurable by model:</i> • HD720p camera with ThinkShutter camera privacy, fixed focus • IR camera and HD720p camera, fixed focus HD Audio, Realtek® ALC3287 codec / stereo speakers, 2W x 2, Dolby® Audio™ Premium / dual array microphone, headphone / microphone combo jack
Processor Number	# of Cores	# of Threads	Base Frequency	Max Turbo Frequency	Cache	Memory Types	Processor Graphics																						
Ryzen 3 PRO 2300U	4	4	2.0 GHz	3.4 GHz	2MB L2 / 4MB L3	DDR4-2400	Radeon Vega 6 Graphics																						
Ryzen 5 PRO 2500U		8	2.0 GHz	3.6 GHz			Radeon Vega 8 Graphics																						
Ryzen 7 PRO 2700U		8	2.2 GHz	3.8 GHz			Radeon Vega 10 Graphics																						
Graphics	AMD Radeon Vega 6, Vega 8, or Vega 10 Graphics in processor only; supports external digital monitor via HDMI or USB Type-C; supports four independent displays; Max resolution: 5120x2880@60Hz (USB Type-C); 4096x2160@60Hz (HDMI)	Keyboard UltraNav™	6-row, spill-resistant, multimedia Fn keys, optional LED backlight TrackPoint® pointing device and buttonless Mylar surface multi-touch touchpad																										
Chipset Memory	AMD SoC (System on Chip) platform 32GB max / 2400MHz DDR4, dual-channel capable, two DDR4 SO-DIMM sockets <i>* Installed DIMMs are actually 2666MHz but run at 2400MHz due to AMD limitation</i>	Security Security chip System Mgt Fingerprint reader NFC	Power-on password, hard disk password, supervisor password, security keyhole Discrete TPM 2.0, TCG Certified DASH Management <i>Optional:</i> Touch style match on chip fingerprint reader on the keyboard bezel None																										
Display	<i>Some:</i> 14.0" (355mm) HD (1366x768), anti-glare, LED backlight, 220 nits, 16:9 aspect ratio, 400:1 contrast ratio <i>Some:</i> 14.0" (355mm) FHD (1920x1080), anti-glare, LED backlight, IPS, 250 nits, 16:9 aspect ratio, 700:1 contrast ratio, 170° viewing angle	Battery	Integrated Li-ion 24Wh battery and external Li-ion 24Wh, 48Wh, or 72Wh battery																										
Multi-touch (opt)	On-cell touch, supports 10-finger gesture (FHD only)	Max battery life (MobileMark® 2014)	<table border="1"> <thead> <tr> <th>Models</th> <th>24Wh</th> <th>48Wh</th> <th>72Wh</th> <th>24Wh + 24Wh</th> <th>24Wh + 48Wh</th> <th>24Wh + 72Wh</th> </tr> </thead> <tbody> <tr> <td>Max battery life</td> <td>5.37 hr</td> <td>10.76 hr</td> <td>16.4 hr</td> <td>10.76 hr</td> <td>16.4 hr</td> <td>22.15 hr</td> </tr> </tbody> </table>	Models	24Wh	48Wh	72Wh	24Wh + 24Wh	24Wh + 48Wh	24Wh + 72Wh	Max battery life	5.37 hr	10.76 hr	16.4 hr	10.76 hr	16.4 hr	22.15 hr												
Models	24Wh	48Wh	72Wh	24Wh + 24Wh	24Wh + 48Wh	24Wh + 72Wh																							
Max battery life	5.37 hr	10.76 hr	16.4 hr	10.76 hr	16.4 hr	22.15 hr																							
Storage	<i>System has one HDD slot or one M.2 2280 slot exclusively for storage</i> <i>Some:</i> HDD / SATA 6.0Gb/s, 2.5" wide, 7mm high, Active Protection System™ <i>Some:</i> SSD / SATA 6.0Gb/s, 2.5" wide, 7mm high <i>Some:</i> M.2 SSD / PCIe NVMe, PCIe 3.0 x 4 <i>Some:</i> 128GB M.2 SSD / PCIe NVMe, PCIe 3.0 x 2, in WWAN slot as 2nd Storage, mutually exclusive with WWAN <i>* Installed M.2 SSD is PCIe 3.0 x 4 but run at PCIe 3.0 x 2 due to M.2 SSD adapter limitation</i>	AC adapter	45W or 65W USB Type-C AC adapter																										
Optical	None	Operating system	Windows® 10 Home 64 or Windows 10 Pro 64																										
Ethernet	Realtek® RTL8111GUL Gigabit Ethernet connection	Limited warranty	<i>One of the following, configurable by model:</i> • 1-year depot repair service • 3-year/1-yr battery depot repair service • 3-year/1-yr battery limited onsite service																										
WLAN Bluetooth™	Realtek RTL8822BE, Wi-Fi 2x2 802.11ac + Bluetooth 4.1, M.2 card Bluetooth 4.1 wireless, integrated in Wi-Fi + Bluetooth combo adapter	Mil-Spec test	MIL-STD-810G military testing																										
WWAN (optional)	Integrated Mobile Broadband 4G LTE-A, Intel XMM™ 7360 (Fibocom L850-GL), M.2 card <i>* For non-WWAN model, it means the model is NOT WWAN upgradable</i>	Environment	EPEAT™ Gold (US only); ENERGY STAR® 6.1; RoHS-compliant																										
SIM card (opt)	Nano-SIM card slot, optional Verizon LTE (US) SIM card																												
Dimensions Weight	<i>WxDxH:</i> 13.25" x 9.15" x 0.79"; 336.6mm x 232.5mm x 19.95mm <table border="1"> <thead> <tr> <th>Models</th> <th>24Wh or 24Wh + 24Wh</th> <th>48Wh, 72Wh, or 24Wh + 48Wh / 72Wh</th> </tr> </thead> <tbody> <tr> <td>Magnesium</td> <td>3.49 lb / 1.58 kg</td> <td>3.92 lb / 1.78 kg</td> </tr> <tr> <td>PPS</td> <td>3.63 lb / 1.65 kg</td> <td>4.08 lb / 1.85 kg</td> </tr> </tbody> </table>	Models	24Wh or 24Wh + 24Wh	48Wh, 72Wh, or 24Wh + 48Wh / 72Wh	Magnesium	3.49 lb / 1.58 kg	3.92 lb / 1.78 kg	PPS	3.63 lb / 1.65 kg	4.08 lb / 1.85 kg																			
Models	24Wh or 24Wh + 24Wh	48Wh, 72Wh, or 24Wh + 48Wh / 72Wh																											
Magnesium	3.49 lb / 1.58 kg	3.92 lb / 1.78 kg																											
PPS	3.63 lb / 1.65 kg	4.08 lb / 1.85 kg																											
Case color Case material	Black <i>Display cover:</i> Magnesium Hybrid or PPS; <i>Bottom:</i> Glass-Fiber Reinforced Plastic																												

Note: The specifications above may not be available in all regions.

Lenovo  
May 2019



# ThinkPad E14 Platform Specifications

Product Specifications Reference (PSREF)

Processor	10th Generation Intel® Core™ i3 / i5 / i7 Processor								Dimensions	<i>Case Material</i>		<i>Dimensions (WxDxH)</i>		
	Processor Number	# of Cores	# of Threads	Base Frequency	Max Turbo Frequency	Cache	Memory Types	Processor Graphics		Aluminum	12.80" x 9.13" x 0.70"; 325mm x 232mm x 17.9mm			
	i3-10110U	2	4	2.1 GHz	4.1 GHz	4MB	DDR4-2666	Intel UHD Graphics		PC/ABS	12.80" x 9.13" x 0.81"; 325mm x 232mm x 20.5mm			
	i5-10210U	4	8	1.6 GHz	4.2 GHz	6MB				Aluminum Display cover + PC/ABS Bottom	12.80" x 9.13" x 0.74"; 325mm x 232mm x 18.9mm			
	i7-10510U			1.8 GHz	4.9 GHz	8MB								
i7-10710U	6	12	1.1 GHz	4.7 GHz	12MB									
Graphics	Intel UHD Graphics in processor only or Intel UHD Graphics in processor and AMD Radeon RX 640 Graphics, 2GB GDDR5 memory; supports external digital monitor via HDMI or USB Type-C; supports three independent displays; Max resolution: 3840x2160@60Hz (USB Type-C); 3840x2160@30Hz (HDMI)								Weight	<i>Case Material</i>		<i>Weight</i>		
										Aluminum	starting at 3.81 lb / 1.73 kg			
Chipset Memory	Intel SoC (System on Chip) platform 16GB max / 2666MHz DDR4, one DDR4 SO-DIMM socket								Case color Case material	Black or silver		Display cover: Aluminum or PC/ABS plastic; Bottom: Aluminum or PC/ABS plastic		
Display	None								Smart card reader	None				
	Size	Resolution	Type	Surface	Brightness	Aspect Ratio	Contrast Ratio	Viewing Angle		Media reader	None			
	14.0" FHD (1920x1080)		TN	Anti-glare	220 nits	16:9	400:1	90°		Ports	One USB 2.0, two USB 3.1 Gen 1 (one Always On), one USB 3.1 Type-C Gen 1 (with the function of Power Delivery and DisplayPort), HDMI 1.4b, Ethernet (RJ-45), headphone / microphone combo jack, security keyhole * Depending on many factors, actual data transfer speed may be lower than theoretical speed			
Multi-touch	None								Monitor cable	None				
										Bundled Accy				
Storage	Up to two drives (one M.2 SSD and one HDD) • HDD / SATA 6.0Gb/s, 2.5" wide, 7mm high, Active Protection System™ • M.2 2280 SSD / SATA 6.0Gb/s • M.2 2242 SSD / PCIe NVMe, PCIe 3.0 x 2 or PCIe 3.0 x 4 • M.2 2280 SSD / PCIe NVMe, PCIe 3.0 x 4 • Intel Optane™ Memory H10 with Solid State Storage, M.2 2280, PCIe NVMe 3.0 x 4								Camera	HD720p camera with optional ThinkShutter camera privacy, fixed focus				
										Audio support	HD Audio, Synaptic® CX11880 codec / stereo speakers, 2W x 2, Dolby® Advanced Audio / dual array microphone, headphone / microphone combo jack			
Optical	None								Keyboard		6-row, spill-resistant, multimedia Fn keys, optional LED backlight			
Ethernet	Gigabit Ethernet Connection, Realtek R811GUS								UltraNav™	TrackPoint® pointing device and buttonless Mylar surface multi-touch touchpad				
WLAN + Bluetooth™	One of the following, configurable by model: • Realtek® RTL8822CE, Wi-Fi 2x2 802.11ac + Bluetooth 5.0, M.2 card • Intel Wi-Fi 6 AX201, Wi-Fi 2x2 802.11ax + Bluetooth 5.0, M.2 card								Security	Power-on password, hard disk password, supervisor password, security keyhole				
WWAN	None								Security chip	<i>Integrated model:</i> discrete TPM 2.0, TCG Certified <i>Discrete model:</i> firmware TPM 2.0 integrated in chipset				
SIM card	None								System Mgt	None				
									Fingerprint reader	<i>Optional:</i> Touch style fingerprint reader on power button				
									NFC	None				
									Battery	Integrated Li-ion 45Wh battery, supports Rapid Charge (charge up to 80% in 1hr) with 65W USB Type-C AC adapter				
									Max battery life	MobileMark® 2014: 12.8 hr * Battery life varies significantly with settings, usage, & other factors				
									AC adapter	45W or 65W USB Type-C AC adapter				
									Operating system (optional)	One of the following, configurable by model: • Windows® 10 Home 64 • Windows 10 Pro 64 • Windows 10 Pro in S mode • No OS				
									Limited warranty (optional)	• 1-year mail-in repair service • 1-year depot repair service • 1-year depot with 2-year planar repair service				
									Mil-Spec test	MIL-STD-810G military testing (by the end of Dec. 2019)				
									Environment	EPEAT™ Silver; ENERGY STAR® 7.1; RoHS-compliant				

Note: The specifications above may not be available in all regions.

Lenovo  
October 2019



# ThinkPad E15 Platform Specifications

Product Specifications Reference (PSREF)

Processor	10th Generation Intel® Core™ i3 / i5 / i7 Processor								Dimensions	WxDxH: 14.49" x 9.65" x 0.74"; 368mm x 245mm x 18.9mm		
	Processor Number	# of Cores	# of Threads	Base Frequency	Max Turbo Frequency	Cache	Memory Types	Processor Graphics	Weight	Starting at 4.3 lb / 1.9 kg		
	i3-10110U	2	4	2.1 GHz	4.1 GHz	4MB	DDR4-2666	Intel UHD Graphics	Case color	Black or silver		
	i5-10210U	4	8	1.6 GHz	4.2 GHz	6MB			Case material	Display cover: Aluminum; Bottom: PC/ABS plastic		
	i7-10510U			1.8 GHz	4.9 GHz	8MB			Smart card reader	None		
	i7-10710U	6	12	1.1 GHz	4.7 GHz	12MB			Media reader	None		
Graphics	Intel UHD Graphics in processor only or Intel UHD Graphics in processor and AMD Radeon RX 640 Graphics, 2GB GDDR5 memory; supports external digital monitor via HDMI or USB Type-C; supports three independent displays; Max resolution: 3840x2160@60Hz (USB Type-C); 3840x2160@30Hz (HDMI)								Ports	One USB 2.0, two USB 3.1 Gen 1 (one Always On), one USB 3.1 Type-C Gen 2 (with the function of Power Delivery and DisplayPort), HDMI 1.4b, Ethernet (RJ-45), headphone / microphone combo jack, security keyhole <i>* Depending on many factors, actual data transfer speed may be lower than theoretical speed</i>		
Chipset	Intel SoC (System on Chip) platform								Monitor cable	None		
Memory	16GB max / 2666MHz DDR4, one DDR4 SO-DIMM socket								Bundled Accy	None		
Display	Size	Resolution	Type	Surface	Brightness	Aspect Ratio	Contrast Ratio	Viewing Angle	Camera	HD720p camera with optional ThinkShutter camera privacy, fixed focus		
	15.6" FHD (1920x1080)		TN	Anti-glare	220 nits	16:9	400:1	90°	Audio support	HD Audio, Synaptic® CX11880 codec / stereo speakers, 2W x 2, Dolby® Advanced Audio / dual array microphone, headphone / microphone combo jack		
	15.6" FHD (1920x1080)		IPS	Anti-glare	250 nits	16:9	700:1	170°	Keyboard	6-row, spill-resistant, multimedia Fn keys, numeric keypad, optional LED backlight UltraNav™ TrackPoint® pointing device and buttonless Mylar surface multi-touch touchpad		
Multi-touch	None								Security chip	Power-on password, hard disk password, supervisor password, security keyhole <i>Integrated model:</i> discrete TPM 2.0, TCG Certified <i>Discrete model:</i> firmware TPM 2.0 integrated in chipset		
Storage	Up to two drives (one M.2 SSD and one HDD) • HDD / SATA 6.0Gb/s, 2.5" wide, 7mm high, Active Protection System™ • M.2 2280 SSD / SATA 6.0Gb/s • M.2 2242 SSD / PCIe NVMe, PCIe 3.0 x 2 or PCIe 3.0 x 4 • M.2 2280 SSD / PCIe NVMe, PCIe 3.0 x 4 • Intel Optane™ Memory H10 with Solid State Storage, M.2 2280, PCIe NVMe 3.0 x 4								System Mgt	None		
Optical	None								Fingerprint reader	<i>Optional:</i> Touch style fingerprint reader on the palm rest		
Ethernet	Gigabit Ethernet Connection, Realtek R8111GUS								NFC	None		
WLAN + Bluetooth™	One of the following, configurable by model: • Realtek® RTL8822CE, Wi-Fi 2x2 802.11ac + Bluetooth 5.0, M.2 card • Intel Wi-Fi 6 AX201, Wi-Fi 2x2 802.11ax + Bluetooth 5.0, M.2 card								Battery	Integrated Li-ion 45Wh battery, supports Rapid Charge (charge up to 80% in 1hr) with 65W USB Type-C AC adapter		
WWAN SIM card	None								Max battery life	MobileMark® 2014: 12.2 hr <i>* Battery life varies significantly with settings, usage, &amp; other factors</i>		
									AC adapter	45W or 65W USB Type-C AC adapter		
									Operating system (optional)	One of the following, configurable by model: • Windows® 10 Home 64 • Windows 10 Pro 64 • Windows 10 Pro in S mode • No OS		
									Limited warranty (optional)	• 1-year mail-in repair service • 1-year depot repair service • 1-year depot with 2-year planar repair service		
									Mil-Spec test	MIL-STD-810G military testing (by the end of Jan. 2020)		
									Environment	EPEAT™ Silver; ENERGY STAR® 7.1; RoHS-compliant		

Note: The specifications above may not be available in all regions.

Lenovo  
October 2019





# ThinkPad E480 Platform Specifications

Product Specifications Reference (PSREF)

Processor	7th Generation Intel® Core™ i3 / i5 Processor (i3-7130U is NOT available in US and EMEA) or							Dimensions	Aluminum (WxDxH): 12.96" x 9.53" x 0.78"; 329mm x 242mm x 19.9mm PC/ABS (WxDxH): 12.96" x 9.53" x 0.83"; 329mm x 242mm x 21.9mm	
	Processor Number	# of Cores	# of Threads	Base Frequency	Max Turbo Frequency	Cache	Memory Types	Processor Graphics	Weight	
	i3-7020U	2	4	2.3 GHz	-	3MB	DDR4-2133	Intel HD Graphics 620	Starting at 3.87 lb / 1.75kg	
	i3-7130U			2.7 GHz	-	3MB			Case color	Black or silver
	i5-7200U			2.5 GHz	3.1 GHz	3MB			Case material	Display cover: Aluminum or PC/ABS plastic; Bottom: PC/ABS plastic
	8th Generation Intel Core i3 / i5 / i7 Processor							Smart card reader	None	
	Processor Number	# of Cores	# of Threads	Base Frequency	Max Turbo Frequency	Cache	Memory Types	Processor Graphics	Media reader	
	i3-8130U	2	4	2.2 GHz	3.4 GHz	4MB	DDR4-2400	Intel UHD Graphics 620	MicroSD card reader	
	i5-8250U	4	8	1.6 GHz	3.4 GHz	6MB			Ports	One USB 2.0, two USB 3.1 Gen 1 (one Always On), one USB 3.1 Type-C Gen 2 (with the function of Power Delivery and DisplayPort), HDMI 1.4b, Ethernet (RJ-45), headphone / microphone combo jack, microSD card reader, security keyhole * Depending on many factors, actual data transfer speed may be lower than theoretical speed
	i7-8550U			1.8 GHz	4.0 GHz	8MB			Camera	HD720p camera, fixed focus
Graphics	Intel HD Graphics 620 or Intel UHD Graphics 620 in processor only or Intel HD Graphics 620 or Intel UHD Graphics 620 in processor and AMD Radeon RX 550 Graphics, 2GB GDDR5 memory; supports external digital monitor via HDMI or USB Type-C; supports dual independent display; Max resolution: 1920x1080 (HDMI) @60Hz							Audio support	HD Audio, Synaptic® CX11852 codec / stereo speakers, 1.5W x 2, Dolby® Advanced Audio / dual array microphone, headphone / microphone combo jack	
Chipset	Intel SoC (System on Chip) platform							Keyboard	6-row, spill-resistant, multimedia Fn keys, optional LED backlight	
Memory	32GB max / 2400MHz DDR4, dual-channel capable, two DDR4 SO-DIMM sockets * System clocks down for processors with lower memory controller							UltraNav™	TrackPoint® pointing device and buttonless Mylar surface multi-touch touchpad	
Display	Some: 14.0" (355mm) HD (1366x768), anti-glare, LED backlight, 220 nits, 16:9 aspect ratio, 400:1 contrast ratio Some: 14.0" (355mm) FHD (1920x1080), anti-glare, LED backlight, IPS, 250 nits, 16:9 aspect ratio, 400:1 contrast ratio							Security	Power-on password, hard disk password, supervisor password, security keyhole	
Multi-touch	None							Security chip (opt)	Firmware TPM 2.0 integrated in chipset or discrete TPM 2.0 TCG Certified	
Storage	Up to 2 drives (one M.2 SSD and one HDD) Some: HDD / SATA 6.0Gb/s, 2.5" wide, removable, upgradable, Active Protection System™ Some: M.2 SSD / PCIe NVMe							vPro	None	
Optane™ memory	Optional: Intel Optane memory, PCIe NVMe, PCIe 3.0 x 2							Fingerprint reader	Optional: Touch style fingerprint reader on the palm rest	
Optical	None							NFC	None	
Ethernet	Gigabit Ethernet Connection, Realtek R8111GUS							Battery	Integrated Li-ion 45Wh battery, supports Rapid Charge (charge up to 80% in 1hr) with 65W USB Type-C AC adapter	
WLAN + Bluetooth™	One of the following, configurable by model: • Realtek® RTL8821CE, Wi-Fi 1x1 802.11ac + Bluetooth 4.1, M.2 card • Realtek RTL8822BE, Wi-Fi 2x2 802.11ac + Bluetooth 4.1, M.2 card • Intel Dual Band Wireless-AC 3165, 1x1, Wi-Fi + Bluetooth 4.1, M.2 Card * Intel 3165ac card supports BT4.2 but is limited to BT4.1 by Windows OS							Max battery life	MobileMark® 2014: 13.51 hr * Battery life varies significantly with settings, usage, & other factors	
WWAN	None							AC adapter	45W or 65W USB Type-C AC adapter	
SIM card	None							Operating system	Optional: Windows® 10 Home 64 or Windows 10 Pro 64	
								Limited warranty	One of the following, configurable by model: • 1-year mail-in repair service • 1-year depot repair service	
								Mil-Spec test	MIL-STD-810G military testing	
								Environment	EPEAT™ Gold (US only); ENERGY STAR® 6.1; RoHS-compliant	

Note: The specifications above may not be available in all regions.

Lenovo  
August 2019



# ThinkPad E490 Platform Specifications

Product Specifications Reference (PSREF)

Processor	8th Generation Intel® Core™ i3 / i5 / i7 Processor								Dimensions <i>Aluminum (WxDxH):</i> 12.96" x 9.53" x 0.78"; 329mm x 242mm x 19.9mm <i>PC/ABS (WxDxH):</i> 12.96" x 9.53" x 0.83"; 329mm x 242mm x 21.9mm
	Processor Number	# of Cores	# of Threads	Base Frequency	Max Turbo Frequency	Cache	Memory Types	Processor Graphics	
	i3-8145U	2	4	2.1 GHz	3.9 GHz	4MB	DDR4-2400	Intel UHD Graphics 620	
	i5-8265U	4	8	1.6 GHz	3.9 GHz	6MB			
i7-8565U	1.8 GHz			4.6 GHz	8MB				
Graphics	Intel UHD Graphics 620 in processor only or Intel UHD Graphics 620 in processor and AMD Radeon RX 550X Graphics, 2GB GDDR5 memory; supports external digital monitor via HDMI or USB Type-C; supports dual independent display; Max resolution: 4096x2304@60Hz (USB Type-C); 4096x2160@24Hz (HDMI)								Weight Case color Case material
Chipset	Intel SoC (System on Chip) platform								Smart card reader
Memory	32GB max / 2400MHz DDR4, dual-channel capable, two DDR4 SO-DIMM sockets <i>* Installed memory is actually 2666MHz but run at 2400MHz due to Intel limitation</i>								Media reader
Display	Size / Resolution	Surface	Type	Brightness	Aspect Ratio	Contrast Ratio	Viewing Angle	Multi-touch	Ports
	14.0" HD (1366x768)	Anti-glare	TN	220 nits	16:9	400:1	90°	Non-touch	One USB 2.0, two USB 3.1 Gen 1 (one Always On), one USB 3.1 Type-C Gen 2 (with the function of Power Delivery and DisplayPort), HDMI 1.4b, Ethernet (RJ-45), headphone / microphone combo jack, microSD card reader, security keyhole <i>* Depending on many factors, actual data transfer speed may be lower than theoretical speed</i>
	14.0" FHD (1920x1080)	Anti-glare	IPS	250 nits	16:9	600:1	170°	Non-touch	
Multi-touch	None								Monitor cable
Storage	Up to two drives (one M.2 SSD and one HDD) • HDD / SATA 6.0Gb/s, 2.5" wide, 7mm high, Active Protection System™ • M.2 2280 SSD / SATA 6.0Gb/s • M.2 2280 SSD / PCIe NVMe, PCIe 3.0 x 2 • M.2 2242 SSD / PCIe NVMe, PCIe 3.0 x 2								Bundled Accy
	Optane™ memory	Optional: Intel Optane memory, PCIe NVMe, PCIe 3.0 x 2							Camera
Optical	None								Audio support
Ethernet	Gigabit Ethernet Connection, Realtek R8111GUS								Keyboard
WLAN + Bluetooth™	One of the following, configurable by model: • Realtek® RTL8822BE, Wi-Fi 2x2 802.11ac + Bluetooth 4.2, M.2 card • Intel Wireless-AC 9260, Wi-Fi 2x2 802.11ac + Bluetooth 5.0, M.2 card								UltraNav™
WWAN	None								Security
SIM card	None								Security chip
									System Mgt
									Fingerprint reader
									NFC
									Battery
									Max battery life
									AC adapter
									Operating system
									Limited warranty
									Mil-Spec test
									Environment

Note: The specifications above may not be available in all regions.

Lenovo  
August 2019



# ThinkPad E490s Platform Specifications

Product Specifications Reference (PSREF)

Processor	8th Generation Intel® Core™ i5 / i7 Processor								Dimensions	<i>WxDxH:</i> 12.96" x 9.13" x 0.70"; 329mm x 232mm x 17.9mm																								
	Processor Number	# of Cores	# of Threads	Base Frequency	Max Turbo Frequency	Cache	Memory Types	Processor Graphics	Weight	Starting at 3.68 lb / 1.67 kg																								
	i5-8265U i7-8565U	4	8	1.6 GHz 1.8 GHz	3.9 GHz 4.5 GHz	6MB 8MB	DDR4-2400	Intel UHD Graphics 620	Case color	Black or silver																								
Graphics	Intel UHD Graphics 620 in processor only or Intel UHD Graphics 620 in processor and AMD Radeon RX 540X Graphics, 2GB GDDR5 memory; supports external digital monitor via HDMI or USB Type-C; supports three independent display; Max resolution: 4096x2304@60Hz (USB Type-C); 4096x2160@24Hz (HDMI)								Case material	Aluminum																								
									Smart card reader	None																								
Chipset	Intel SoC (System on Chip) platform								Media reader	MicroSD card reader																								
Memory	32GB max / 2400MHz DDR4, dual-channel capable, two DDR4 SO-DIMM sockets <i>* Installed memory is actually 2666MHz but run at 2400MHz due to Intel limitation</i>								Ports	One USB 2.0, two USB 3.1 Gen 1 (one Always On), one USB 3.1 Type-C Gen 2 (with the function of Power Delivery and DisplayPort), HDMI 1.4b, Ethernet (RJ-45), headphone / microphone combo jack, microSD card reader, security keyhole <i>* Depending on many factors, actual data transfer speed may be lower than theoretical speed</i>																								
Display	<table border="1"> <thead> <tr> <th>Size / Resolution</th> <th>Surface</th> <th>Type</th> <th>Brightness</th> <th>Aspect Ratio</th> <th>Contrast Ratio</th> <th>Viewing Angle</th> <th>Multi-touch</th> </tr> </thead> <tbody> <tr> <td>14.0" FHD (1920x1080)</td> <td>Anti-glare</td> <td>TN</td> <td>220 nits</td> <td>16:9</td> <td>400:1</td> <td>90°</td> <td>Non-touch</td> </tr> <tr> <td>14.0" FHD (1920x1080)</td> <td>Anti-glare</td> <td>IPS</td> <td>250 nits</td> <td>16:9</td> <td>600:1</td> <td>170°</td> <td>Non-touch</td> </tr> </tbody> </table>								Size / Resolution	Surface	Type	Brightness	Aspect Ratio	Contrast Ratio	Viewing Angle	Multi-touch	14.0" FHD (1920x1080)	Anti-glare	TN	220 nits	16:9	400:1	90°	Non-touch	14.0" FHD (1920x1080)	Anti-glare	IPS	250 nits	16:9	600:1	170°	Non-touch	Monitor cable	None
									Size / Resolution	Surface	Type	Brightness	Aspect Ratio	Contrast Ratio	Viewing Angle	Multi-touch																		
									14.0" FHD (1920x1080)	Anti-glare	TN	220 nits	16:9	400:1	90°	Non-touch																		
14.0" FHD (1920x1080)	Anti-glare	IPS	250 nits	16:9	600:1	170°	Non-touch																											
Bundled Accy	None																																	
Camera	HD720p camera, fixed focus								Audio support	HD Audio, Synaptic® CX11880 codec / stereo speakers, 2W x 2, Dolby® Audio™ Premium / dual array microphone, headphone / microphone combo jack																								
Keyboard	6-row, spill-resistant, multimedia Fn keys, optional LED backlight								UltraNav™	TrackPoint® pointing device and buttonless Mylar surface multi-touch touchpad																								
Multi-touch	None								Security	Power-on password, hard disk password, supervisor password, security keyhole																								
Storage	<i>One of the following, configurable by model:</i> <ul style="list-style-type: none"> <li>M.2 2280 SSD / SATA 6.0Gb/s</li> <li>M.2 2242 SSD / PCIe NVMe, PCIe 3.0 x 2</li> </ul>								Security chip	<i>Integrated model:</i> discrete TPM 2.0, TCG Certified <i>Discrete model:</i> firmware TPM 2.0 integrated in chipset																								
Optical	None								System Mgt	None																								
Ethernet	Gigabit Ethernet Connection, Realtek R8111GUS								Fingerprint reader	Touch style fingerprint reader on the palm rest																								
WLAN + Bluetooth™	<i>One of the following, configurable by model:</i> <ul style="list-style-type: none"> <li>Realtek® RTL8822BE, Wi-Fi 2x2 802.11ac + Bluetooth 4.2, M.2 card</li> <li>Intel Wireless-AC 9260, Wi-Fi 2x2 802.11ac + Bluetooth 5.0, M.2 card</li> </ul>								NFC	None																								
WWAN SIM card	None								Battery	Integrated Li-ion 42Wh battery, supports Rapid Charge (charge up to 80% in 1hr) with 65W USB Type-C AC adapter																								
									Max battery life	<i>MobileMark® 2014:</i> 11.5 hr <i>* Battery life varies significantly with settings, usage, &amp; other factors</i>																								
									AC adapter	45W or 65W USB Type-C AC adapter																								
									Operating system	<i>Optional:</i> Windows® 10 Home 64 or Windows 10 Pro 64																								
									Limited warranty	1-year depot repair service																								
									Mil-Spec test	MIL-STD-810G military testing																								
									Environment	EPEAT™ Silver; ENERGY STAR® 7.1; RoHS-compliant																								

Note: The specifications above may not be available in all regions.

Lenovo  
August 2019



# ThinkPad E495 Platform Specifications

Product Specifications Reference (PSREF)

Processor	AMD Ryzen™ Mobile Processors with Radeon™ Vega Graphics								Dimensions <i>Aluminum (WxDxH):</i> 12.96" x 9.53" x 0.78"; 329mm x 242mm x 19.9mm <i>PC/ABS (WxDxH):</i> 12.96" x 9.53" x 0.83"; 329mm x 242mm x 21.9mm																							
	Processor Number	# of Cores	# of Threads	Base Frequency	Max Turbo Frequency	Cache	Memory Controller	Processor Graphics		Weight Starting at 3.87 lb / 1.75 kg Case color Black Case material <i>Display cover:</i> Aluminum or PC/ABS plastic; <i>Bottom:</i> PC/ABS plastic																						
	Ryzen 3 3200U	2	4	2.6 GHz	3.5 GHz	1MB L2 / 4MB L3	DDR4-2400	Radeon Vega 3 Graphics																								
	Ryzen 5 3500U	4	8	2.1 GHz	3.7 GHz	2MB L2 / 4MB L3		Radeon Vega 8 Graphics																								
Ryzen 7 3700U	2.3 GHz			4.0 GHz	2MB L2 / 4MB L3	Radeon RX Vega 10 Graphics																										
Graphics	AMD Radeon Vega 3, Vega 8, or RX Vega 10 Graphics in processor; supports external digital monitor via HDMI or USB Type-C; supports dual independent display; Max resolution: 3840x2160@60Hz (USB Type-C); 3840x2160@30Hz (HDMI)								Smart card reader None Media reader MicroSD card reader Ports One USB 2.0, two USB 3.1 Gen 1 (one Always On), one USB 3.1 Type-C Gen 1 (with the function of Power Delivery and DisplayPort), HDMI 1.4b, Ethernet (RJ-45), headphone / microphone combo jack, microSD card reader, security keyhole <i>* Depending on many factors, actual data transfer speed may be lower than theoretical speed</i> Monitor cable None Bundled Accy None Camera HD720p camera, fixed focus Audio support HD Audio, Synaptic® CX11880 codec / stereo speakers, 1.5W x 2, Dolby® Advanced Audio / dual array microphone, headphone / microphone combo jack																							
Chipset	AMD SoC (System on Chip) platform																															
Memory	32GB max / 2400MHz DDR4, dual-channel capable, two DDR4 SO-DIMM sockets <i>* Installed memory is actually 2666MHz but run at 2400MHz due to AMD limitation</i>																															
Display	<table border="1"> <thead> <tr> <th>Size / Resolution</th> <th>Surface</th> <th>Type</th> <th>Brightness</th> <th>Aspect Ratio</th> <th>Contrast Ratio</th> <th>Viewing Angle</th> <th>Multi-touch</th> </tr> </thead> <tbody> <tr> <td>14.0" HD (1366x768)</td> <td>Anti-glare</td> <td>TN</td> <td>220 nits</td> <td>16:9</td> <td>400:1</td> <td>90°</td> <td>Non-touch</td> </tr> <tr> <td>14.0" FHD (1920x1080)</td> <td>Anti-glare</td> <td>IPS</td> <td>250 nits</td> <td>16:9</td> <td>600:1</td> <td>170°</td> <td>Non-touch</td> </tr> </tbody> </table>									Size / Resolution	Surface	Type	Brightness	Aspect Ratio	Contrast Ratio	Viewing Angle	Multi-touch	14.0" HD (1366x768)	Anti-glare	TN	220 nits	16:9	400:1	90°	Non-touch	14.0" FHD (1920x1080)	Anti-glare	IPS	250 nits	16:9	600:1	170°
Size / Resolution	Surface	Type	Brightness	Aspect Ratio	Contrast Ratio	Viewing Angle	Multi-touch																									
14.0" HD (1366x768)	Anti-glare	TN	220 nits	16:9	400:1	90°	Non-touch																									
14.0" FHD (1920x1080)	Anti-glare	IPS	250 nits	16:9	600:1	170°	Non-touch																									
Multi-touch	None								Keyboard 6-row, spill-resistant, multimedia Fn keys UltraNav™ TrackPoint® pointing device and buttonless Mylar surface multi-touch touchpad																							
Storage	Up to two drives (one M.2 SSD and one HDD) • HDD / SATA 6.0Gb/s, 2.5" wide, 7mm high, Active Protection System™ • M.2 2242 SSD / PCIe NVMe, PCIe 3.0 x 2 or PCIe 3.0 x 4																															
Optical	None																															
Ethernet	Gigabit Ethernet Connection, Realtek R8111GUS																															
WLAN + Bluetooth™	One of the following, configurable by model: • Realtek® RTL8822BE, Wi-Fi 2x2 802.11ac + Bluetooth 4.2, M.2 card • Intel Wireless-AC 9260, Wi-Fi 2x2 802.11ac + Bluetooth 5.0, M.2 card								Security Power-on password, hard disk password, supervisor password, security keyhole Security chip Discrete TPM 2.0, TCG Certified Fingerprint reader None NFC None Battery Integrated Li-ion 45Wh battery, supports Rapid Charge (charge up to 80% in 1hr) with 65W USB Type-C AC adapter Max battery life <i>MobileMark® 2014: 11 hr</i> <i>* Battery life varies significantly with settings, usage, &amp; other factors</i> AC adapter 45W or 65W USB Type-C AC adapter Operating system <i>Optional:</i> Windows® 10 Home 64 or Windows 10 Pro 64																							
WWAN	None																															
SIM card	None																															
Limited warranty	1-year depot repair service																															
Mil-Spec test	None								Environment EPEAT™ Silver; ENERGY STAR® 7.1; RoHS-compliant																							
Environment																																

Note: The specifications above may not be available in all regions.

Lenovo  
August 2019





# ThinkPad E580 Platform Specifications

Product Specifications Reference (PSREF)

Processor	7th Generation Intel® Core™ i3 / i5 Processor or								WLAN + Bluetooth™ <i>One of the following, configurable by model:</i> • Realtek® RTL8821CE, Wi-Fi 1x1 802.11ac + Bluetooth 4.1, M.2 card • Realtek RTL8822BE, Wi-Fi 2x2 802.11ac + Bluetooth 4.1, M.2 card • Intel Dual Band Wireless-AC 3165, 1x1, Wi-Fi + Bluetooth 4.1, M.2 Card * Intel 3165ac card supports BT4.2 but is limited to BT4.1 by Windows OS
	Processor Number	# of Cores	# of Threads	Base Frequency	Max Turbo Frequency	Cache	Memory Types	Processor Graphics	
	i3-7020U	2	4	2.3 GHz	-	3MB	DDR4-2133	Intel HD Graphics 620	
	i3-7130U			2.7 GHz	-	3MB			
i5-7200U	2.5 GHz			3.1 GHz	3MB				
Processor	8th Generation Intel Core i3 / i5 / i7 Processor								WLAN + Bluetooth™ <i>One of the following, configurable by model:</i> • Realtek® RTL8821CE, Wi-Fi 1x1 802.11ac + Bluetooth 4.1, M.2 card • Realtek RTL8822BE, Wi-Fi 2x2 802.11ac + Bluetooth 4.1, M.2 card • Intel Dual Band Wireless-AC 3165, 1x1, Wi-Fi + Bluetooth 4.1, M.2 Card * Intel 3165ac card supports BT4.2 but is limited to BT4.1 by Windows OS
	Processor Number	# of Cores	# of Threads	Base Frequency	Max Turbo Frequency	Cache	Memory Types	Processor Graphics	
	i3-8130U	2	4	2.2 GHz	3.4 GHz	4MB	DDR4-2400	Intel UHD Graphics 620	
	i5-8250U			1.6 GHz	3.4 GHz	6MB			
i7-8550U	1.8 GHz			4.0 GHz	8MB				
* i3-7130U is NOT available in US and EMEA									
Graphics	Intel HD Graphics 620 or Intel UHD Graphics 620 in processor only or Intel HD Graphics 620 or Intel UHD Graphics 620 in processor and AMD Radeon RX 550 Graphics, 2GB GDDR5 memory; supports external digital monitor via HDMI or USB Type-C; supports dual independent display; Max resolution: 1920x1080 (HDMI) @60Hz								Dimensions Weight Case color Case material
Chipset	Intel SoC (System on Chip) platform 32GB max / 2400MHz DDR4, dual-channel capable, two DDR4 SO-DIMM sockets * System clocks down for processors with lower memory controller								Smart card reader Media reader Ports
Display	Some: 15.6" (396mm) HD (1366x768), anti-glare, LED backlight, 220 nits, 16:9 aspect ratio, 400:1 contrast ratio Some: 15.6" (396mm) FHD (1920x1080), anti-glare, LED backlight, IPS, 250 nits, 16:9 aspect ratio, 600:1 contrast ratio								Camera Audio support
Multi-touch	None								Keyboard UltraNav™
Storage	Up to 2 drives (one M.2 SSD and one HDD) Some: HDD / SATA 6.0Gb/s, 2.5" wide, removable, upgradable, Active Protection System™ Some: M.2 SSD / PCIe NVMe								Security Security chip (opt) vPro Fingerprint reader NFC
Optane™ memory	Optional: Intel Optane memory, PCIe NVMe, PCIe 3.0 x 2								Battery
Optical	None								Max battery life
Ethernet	Gigabit Ethernet Connection, Realtek R8111GUS								AC adapter
Operating system									Optional: Windows® 10 Home 64 or Windows 10 Pro 64
Limited warranty									One of the following, configurable by model: • 1-year mail-in repair service • 1-year depot repair service
Mil-Spec test									MIL-STD-810G military testing
Environment									EPEAT™ Gold (US only); ENERGY STAR® 6.1; RoHS-compliant

Note: The specifications above may not be available in all regions.

Lenovo  
August 2019



# ThinkPad E590 Platform Specifications

Product Specifications Reference (PSREF)

Processor	8th Generation Intel® Core™ i3 / i5 / i7 Processor								Dimensions	<i>WxDxH:</i> 14.53" x 9.94" x 0.78"; 369mm x 252.5mm x 19.9mm
	Processor Number	# of Cores	# of Threads	Base Frequency	Max Turbo Frequency	Cache	Memory Types	Processor Graphics	Weight	Starting at 4.68 lb / 2.12 kg
	i3-8145U	2	4	2.1 GHz	3.9 GHz	4MB	DDR4-2400	Intel UHD Graphics 620	Case color	Black or silver
	i5-8265U	4	8	1.6 GHz	3.9 GHz	6MB			Case material	<i>Display cover:</i> Aluminum; <i>Bottom:</i> PC/ABS plastic
i7-8565U	1.8 GHz			4.6 GHz	8MB	Smart card reader			None	
Graphics	Intel UHD Graphics 620 in processor only or Intel UHD Graphics 620 in processor and AMD Radeon RX 550X Graphics, 2GB GDDR5 memory; supports external digital monitor via HDMI or USB Type-C; supports dual independent display; Max resolution: 4096x2304@60Hz (USB Type-C); 4096x2160@24Hz (HDMI)								Media reader	MicroSD card reader
Chipset	Intel SoC (System on Chip) platform								Ports	One USB 2.0, two USB 3.1 Gen 1 (one Always On), one USB 3.1 Type-C Gen 2 (with the function of Power Delivery and DisplayPort), HDMI 1.4b, Ethernet (RJ-45), headphone / microphone combo jack, microSD card reader, security keyhole <i>* Depending on many factors, actual data transfer speed may be lower than theoretical speed</i>
Memory	32GB max / 2400MHz DDR4, dual-channel capable, two DDR4 SO-DIMM sockets <i>* Installed memory is actually 2666MHz but run at 2400MHz due to Intel limitation</i>								Monitor cable	None
Display	Size / Resolution	Surface	Type	Brightness	Aspect Ratio	Contrast Ratio	Viewing Angle	Multi-touch	Bundled Accy	None
	15.6" HD (1366x768)	Anti-glare	TN	220 nits	16:9	400:1	90°	Non-touch	Camera	HD720p camera, fixed focus
	15.6" FHD (1920x1080)	Anti-glare	IPS	250 nits	16:9	600:1	170°	Non-touch	Audio support	HD Audio, Synaptic® CX11880 codec / stereo speakers, 2W x 2, Dolby® Advanced Audio / dual array microphone, headphone / microphone combo jack
Multi-touch	None								Keyboard	6-row, spill-resistant, multimedia Fn keys, numeric keypad, optional LED backlight
Storage	Up to two drives (one M.2 SSD and one HDD) <ul style="list-style-type: none"> <li>HDD / SATA 6.0Gb/s, 2.5" wide, 7mm high, Active Protection System™</li> <li>M.2 2280 SSD / SATA 6.0Gb/s</li> <li>M.2 2280 SSD / PCIe NVMe, PCIe 3.0 x 2</li> <li>M.2 2242 SSD / PCIe NVMe, PCIe 3.0 x 2</li> </ul>								UltraNav™	TrackPoint® pointing device and buttonless Mylar surface multi-touch touchpad
Optane™ memory	Optional: Intel Optane memory, PCIe NVMe, PCIe 3.0 x 2								Security	Power-on password, hard disk password, supervisor password, security keyhole
Optical	None								Security chip	<i>Integrated model:</i> discrete TPM 2.0, TCG Certified <i>Discrete model:</i> firmware TPM 2.0 integrated in chipset
Ethernet	Gigabit Ethernet Connection, Realtek R8111GUS								System Mgt	None
WLAN + Bluetooth™	One of the following, configurable by model: <ul style="list-style-type: none"> <li>Realtek® RTL8822BE, Wi-Fi 2x2 802.11ac + Bluetooth 4.2, M.2 card</li> <li>Intel Wireless-AC 9260, Wi-Fi 2x2 802.11ac + Bluetooth 5.0, M.2 card</li> </ul>								Fingerprint reader	<i>Optional:</i> Touch style fingerprint reader on the palm rest
WWAN	None								NFC	None
SIM card	None								Battery	Integrated Li-ion 45Wh battery, supports Rapid Charge (charge up to 80% in 1hr) with 65W USB Type-C AC adapter
									Max battery life	<i>MobileMark® 2014:</i> 11 hr <i>* Battery life varies significantly with settings, usage, &amp; other factors</i>
									AC adapter	45W or 65W USB Type-C AC adapter
									Operating system	<i>Optional:</i> Windows® 10 Home 64 or Windows 10 Pro 64
									Limited warranty	<i>One of the following, configurable by model:</i> <ul style="list-style-type: none"> <li>1-year mail-in repair service</li> <li>1-year depot repair service</li> </ul>
									Mil-Spec test	MIL-STD-810G military testing
									Environment	EPEAT™ Silver; ENERGY STAR® 7.1; RoHS-compliant

Note: The specifications above may not be available in all regions.

Lenovo  
August 2019



# ThinkPad E595 Platform Specifications

Product Specifications Reference (PSREF)

Processor	AMD Ryzen™ Mobile Processors with Radeon™ Vega Graphics								Dimensions	<i>WxDxH:</i> 14.53" x 9.92" x 0.78"; 369mm x 252mm x 19.9mm	
	Processor Number	# of Cores	# of Threads	Base Frequency	Max Turbo Frequency	Cache	Memory Controller	Processor Graphics	Weight	Starting at 4.7 lb / 2.1 kg	
	Ryzen 3 3200U	2	4	2.6 GHz	3.5 GHz	1MB L2 / 4MB L3	DDR4-2400	Radeon Vega 3 Graphics	Case color	Black	
	Ryzen 5 3500U	4	8	2.1 GHz	3.7 GHz	2MB L2 / 4MB L3		Radeon Vega 8 Graphics	Case material	<i>Display cover:</i> Aluminum; <i>Bottom:</i> PC/ABS plastic	
Ryzen 7 3700U	2.3 GHz			4.0 GHz	2MB L2 / 4MB L3	Radeon RX Vega 10 Graphics		Smart card reader	None		
Graphics	AMD Radeon Vega 3, Vega 8, or RX Vega 10 Graphics in processor; supports external digital monitor via HDMI or USB Type-C; supports dual independent display; Max resolution: 3840x2160@60Hz (USB Type-C); 3840x2160@30Hz (HDMI)								Media reader	MicroSD card reader	
Chipset	AMD SoC (System on Chip) platform								Ports	One USB 2.0, two USB 3.1 Gen 1 (one Always On), one USB 3.1 Type-C Gen 1 (with the function of Power Delivery and DisplayPort), HDMI 1.4b, Ethernet (RJ-45), headphone / microphone combo jack, microSD card reader, security keyhole <i>* Depending on many factors, actual data transfer speed may be lower than theoretical speed</i>	
Memory	32GB max / 2400MHz DDR4, dual-channel capable, two DDR4 SO-DIMM sockets <i>* Installed memory is actually 2666MHz but run at 2400MHz due to AMD limitation</i>								Monitor cable	None	
Display	Size / Resolution		Surface	Type	Brightness	Aspect Ratio	Contrast Ratio	Viewing Angle	Multi-touch	Bundled Accy	None
	15.6" HD (1366x768)		Anti-glare	TN	220 nits	16:9	400:1	90°	Non-touch	Camera	HD720p camera, fixed focus
	15.6" FHD (1920x1080)		Anti-glare	IPS	250 nits	16:9	600:1	170°	Non-touch	Audio support	HD Audio, Synaptic® CX11880 codec / stereo speakers, 2W x 2, Dolby® Advanced Audio / dual array microphone, headphone / microphone combo jack
Multi-touch	None								Keyboard	6-row, spill-resistant, multimedia Fn keys	
Storage	Up to two drives (one M.2 SSD and one HDD) • HDD / SATA 6.0Gb/s, 2.5" wide, 7mm high, Active Protection System™ • M.2 2242 SSD / PCIe NVMe, PCIe 3.0 x 2 or PCIe 3.0 x 4								UltraNav™	TrackPoint® pointing device and buttonless Mylar surface multi-touch touchpad	
Optical	None								Security	Power-on password, hard disk password, supervisor password, security keyhole	
Ethernet	Gigabit Ethernet Connection, Realtek R8111GUS								Security chip	Discrete TPM 2.0, TCG Certified	
WLAN + Bluetooth™	One of the following, configurable by model: • Realtek® RTL8822BE, Wi-Fi 2x2 802.11ac + Bluetooth 4.2, M.2 card • Intel Wireless-AC 9260, Wi-Fi 2x2 802.11ac + Bluetooth 5.0, M.2 card								Fingerprint reader	None	
WWAN	None								NFC	None	
SIM card	None								Battery	Integrated Li-ion 45Wh battery, supports Rapid Charge (charge up to 80% in 1hr) with 65W USB Type-C AC adapter	
									Max battery life	<i>MobileMark® 2014:</i> 10.3 hr <i>* Battery life varies significantly with settings, usage, &amp; other factors</i>	
									AC adapter	45W or 65W USB Type-C AC adapter	
									Operating system	<i>Optional:</i> Windows® 10 Home 64 or Windows 10 Pro 64	
									Limited warranty	<i>One of the following, configurable by model:</i> • 1-year mail-in repair service • 1-year depot repair service	
									Mil-Spec test	None	
									Environment	EPEAT™ Silver; ENERGY STAR® 7.1; RoHS-compliant	

Note: The specifications above may not be available in all regions.

Lenovo  
August 2019



# ThinkPad L380 Platform Specifications

Product Specifications Reference (PSREF)

Processor	Intel® Celeron® Processor, 7th Generation Intel Core™ i3 / i5 Processor or								Dimensions	<i>WxDxH:</i> 12.67" x 8.83" x 0.74"; 321.8mm x 224.2mm x 18.8mm
	Processor Number	# of Cores	# of Threads	Base Frequency	Max Turbo Frequency	Cache	Memory Types	Processor Graphics	Weight	Starting at 3.22 lb / 1.46 kg
	Cel 3965U	2	2	2.2 GHz	-	2MB	DDR4-2133	Intel HD Graphics 610	Case color	Black or Silver
	i3-7020U			2.3 GHz	-	3MB		Intel HD Graphics 620		
	i3-7130U			2.7 GHz	-	3MB				
	i5-7200U			2.5 GHz	3.1 GHz	3MB				
	8th Generation Intel Core i5 / i7 Processor								Smart card reader	None
	Processor Number	# of Cores	# of Threads	Base Frequency	Max Turbo Frequency	Cache	Memory Types	Processor Graphics	Media reader	MicroSD card reader
	i3-8130U	2	4	2.2 GHz	3.4 GHz	4MB	DDR4-2400	Intel UHD Graphics 620	Ports	Two USB 3.1 Gen 1 (one Always On), two USB 3.1 Type-C Gen 1 (with the function of Power Delivery and DisplayPort), HDMI 1.4b, Ethernet extension connector, headphone / microphone combo jack, microSD card reader, security keyhole
	i5-8250U			1.6 GHz	3.4 GHz	6MB				
i5-8350U	1.7 GHz			3.6 GHz	6MB					
i7-8550U	1.8 GHz			4.0 GHz	8MB					
Graphics	Intel HD Graphics 610, 620 or Intel UHD Graphics 620 in processor; supports external digital monitor via HDMI or USB Type-C; supports three independent displays; Max resolution: 4096x2304@60Hz (USB Type-C); 4096x2160@30Hz (HDMI)								Monitor cable (optional)	HDMI to VGA: Lenovo HDMI to VGA Monitor Adapter USB-C to VGA: Lenovo USB-C to VGA Adapter USB-C to DP: Lenovo USB-C to DisplayPort Adapter
Chipset	Intel SoC (System on Chip) platform								Bundled Accy	Optional: ThinkPad Ethernet Extension Cable
Memory	32GB max / 2400MHz DDR4, dual-channel capable, two DDR4 SO-DIMM sockets <i>* System clocks down for processors with lower memory controller</i>								Camera	HD720p camera, fixed focus
Display	<i>Some:</i> 13.3" (338mm) HD (1366x768), anti-glare, LED backlight, 250 nits, 16:9 aspect ratio, 500:1 contrast ratio <i>Some:</i> 13.3" (338mm) FHD (1920x1080), anti-glare, LED backlight, IPS, 250 nits, 16:9 aspect ratio, 700:1 contrast ratio, 170° viewing angle								Audio support	HD Audio, Realtek ALC3287 codec / stereo speakers, 2W x 2, Dolby® Audio™ / dual array microphone, headphone / microphone combo jack
Multi-touch (opt)	on-cell touch, supports 10-finger gesture								Keyboard	6-row, spill-resistant, multimedia Fn keys, optional LED backlight
Storage	<i>One of the following, configurable by model:</i> • M.2 SSD / SATA 6.0Gb/s (e.g. xxxGB SSD M.2) • M.2 SSD / PCIe NVMe, PCIe 3.0 x 4, 32Gb/s (e.g. xxxGB SSD M.2 PCIe NVMe)								UltraNav™	TrackPoint® pointing device and buttonless Mylar surface touchpad, multi-touch
Optical	None								Security	Power-on password, hard disk password, supervisor password, security keyhole
Ethernet	Native Intel Ethernet Connection I219-V (Non-vPro) or I219-LM (vPro) via optional ThinkPad Ethernet Extension Cable								Security chip	Discrete TPM 2.0, TCG Certified
WLAN + Bluetooth™	Intel Dual Band Wireless-AC 8265, Wi-Fi 2x2 802.11ac + Bluetooth 4.1, M.2 card <i>* Intel 8265ac card supports BT4.2 but is limited to BT4.1 by Windows OS</i>								vPro (optional)	Intel vPro Technology
WWAN	None								Fingerprint reader	Optional: Touch style fingerprint reader on the keyboard bezel, anti-spoofing technology
SIM card	None								NFC (optional)	Near Field Communication
									Battery	Integrated Li-ion 45Wh battery, supports Rapid Charge (charge up to 80% in 1hr) with 65W USB Type-C AC adapter
									Max battery life	MobileMark® 2014: 16.1 hr <i>* Battery life varies significantly with settings, usage, &amp; other factors</i>
									AC adapter	45W or 65W USB Type-C AC adapter
									Operating system	Optional: Windows® 10 Home 64 or Windows 10 Pro 64
									Limited warranty	<i>One of the following, configurable by model:</i> • 1-year depot repair service • 3-year/1-yr battery depot repair service • 3-year/1-yr battery limited onsite service
									Mil-Spec test	MIL-STD-810G military testing
									Environment	EPEAT™ Gold (US only); ENERGY STAR® 6.1; RoHS-compliant

Note: The specifications above may not be available in all regions.

Lenovo  
August 2019





# ThinkPad L390 Platform Specifications

Product Specifications Reference (PSREF)

Processor	8th Generation Intel® Core™ i3 / i5 / i7 Processor								Smart card reader	None
	Processor Number	# of Cores	# of Threads	Base Frequency	Max Turbo Frequency	Cache	Memory Types	Processor Graphics	Media reader	MicroSD card reader
	i3-8145U	2	4	2.1 GHz	3.9 GHz	4MB	DDR4-2400	Intel UHD Graphics 620	Ports	Two USB 3.1 Gen 1 (one Always On), two USB 3.1 Type-C Gen 1 (with the function of Power Delivery and DisplayPort), HDMI 1.4b, Ethernet extension connector, headphone / microphone combo jack, microSD card reader, security keyhole
	i5-8265U	4	8	1.6 GHz	3.9 GHz	6MB				
	i5-8365U			1.6 GHz	4.1 GHz	6MB				
i7-8565U	1.8 GHz			4.6 GHz	8MB					
Graphics	Intel UHD Graphics 620 in processor; supports external digital monitor via HDMI or USB Type-C; supports three independent displays; Max resolution: 4096x2304@60Hz (USB Type-C); 4096x2160@30Hz (HDMI)								Monitor cable (optional)	<ul style="list-style-type: none"> <li>USB-C to VGA Adapter: Lenovo USB-C to VGA Adapter</li> <li>USB-C to VGA (plus Power) Adapter: Lenovo USB-C to VGA plus Power Adapter</li> <li>USB-C to HDMI Adapter: Lenovo USB-C to HDMI Adapter</li> <li>USB-C to HDMI (plus Power) Adapter: Lenovo USB-C to HDMI plus Power Adapter</li> <li>USB-C to DisplayPort Adapter: Lenovo USB-C to DisplayPort Adapter</li> <li>USB-C to Ethernet Adapter: Lenovo USB-C to Ethernet Adapter</li> </ul>
Chipset Memory	Intel SoC (System on Chip) platform 32GB max / 2400MHz DDR4, dual-channel capable, two DDR4 SO-DIMM sockets * Installed memory is actually 2666MHz but run at 2400MHz due to Intel limitation								Bundled Accessories (optional)	<ul style="list-style-type: none"> <li>USB-C to USB-A Adapter: Lenovo USB-C to USB-A Adapter</li> <li>USB-C to USB-C Cable 2m: Lenovo USB-C to USB-C Cable 2m</li> </ul>
Display	Size	Resolution	Surface	Type	Brightness	Aspect Ratio	Contrast Ratio	Viewing Angle	Camera	HD720p camera, fixed focus
	13.3"	HD (1366x768)	Anti-glare	TN	250 nits	16:9	500:1	90°	Audio support	HD Audio, Realtek ALC3287 codec / stereo speakers, 2W x 2, Dolby® Audio™ Premium / dual array microphone, headphone / microphone combo jack
	13.3"	FHD (1920x1080)	Anti-glare	IPS	250 nits	16:9	700:1 (non-touch) 800:1 (multi-touch)	170°	Keyboard	6-row, spill-resistant, multimedia Fn keys, optional LED backlight
Multi-touch (opt)	On-cell touch, supports 10-finger gesture (FHD only)								UltraNav™	TrackPoint® pointing device and buttonless Mylar surface touchpad, multi-touch
Storage	<i>One of the following, configurable by model:</i> <ul style="list-style-type: none"> <li>M.2 2280 SSD / SATA 6.0Gb/s</li> <li>M.2 2242 SSD / PCIe NVMe, PCIe 3.0 x 2</li> <li>M.2 2280 SSD / PCIe NVMe, PCIe 3.0 x 4</li> <li>Intel Optane™ Memory H10 with Solid State Storage, M.2 2280, PCIe NVMe 3.0 x 4</li> </ul>								Security	Power-on password, hard disk password, supervisor password, security keyhole
Optical	None								Security chip	Discrete TPM 2.0, TCG Certified
Ethernet	Native Intel Ethernet Connection I219-V (Non-vPro) or I219-LM (vPro) via optional ThinkPad Ethernet Extension Cable or Lenovo USB-C to Ethernet Adapter								System Mgt (opt)	Intel vPro Technology
WLAN	Intel Wireless-AC 9560, Wi-Fi 2x2 802.11ac + Bluetooth 5.0, M.2 card								Fingerprint reader	Optional: Touch style fingerprint reader on the palm rest
Bluetooth™	Bluetooth 5.0 wireless, integrated in Wi-Fi + Bluetooth combo adapter								NFC (optional)	Near Field Communication
WWAN	None								Battery	Integrated Li-ion 45Wh battery, supports Rapid Charge (charge up to 80% in 1hr) with 65W USB Type-C AC adapter
SIM card	None								Max battery life	MobileMark® 2014: 14.61 hr * Battery life varies significantly with settings, usage, & other factors
Dimensions	WxDxH: 12.67" x 8.83" x 0.74"; 321.8mm x 224.2mm x 18.8mm								AC adapter	45W or 65W USB Type-C AC adapter
Weight	Starting at 3.22 lb / 1.46 kg								Operating system	Optional: Windows® 10 Home 64 or Windows 10 Pro 64
Case color	Black or Silver								Limited warranty	<i>One of the following, configurable by model:</i> <ul style="list-style-type: none"> <li>1-year depot repair service</li> <li>1-year depot with 2-year planar repair service</li> <li>3-year/1-yr battery depot repair service</li> <li>3-year/1-yr battery limited onsite service</li> </ul>
Case material	Display cover: Aluminum Bottom: GFRP								Mil-Spec test	MIL-STD-810G military testing
									Environment	EPEAT™ Silver; ENERGY STAR® 7.1; RoHS-compliant

Note: The specifications above may not be available in all regions.

Lenovo  
August 2019



# ThinkPad L480 Platform Specifications

Product Specifications Reference (PSREF)

Processor	7th Generation Intel® Core™ i3 / i5 Processor or								WWAN (optional) <i>One of the following, configurable by model:</i> <ul style="list-style-type: none"> <li>Integrated Mobile Broadband 4G LTE, Intel XMM™ 7262 (Fibocom L830-EB), M.2 card (EMEA only)</li> <li>Integrated Mobile Broadband 4G LTE-A, Intel XMM™ 7360 (Fibocom L850-GL), M.2 card</li> </ul> * For non-WWAN model, it means the model is NOT WWAN upgradable SIM card (opt) Nano-SIM card slot, optional Verizon LTE (US) SIM card
	Processor Number	# of Cores	# of Threads	Base Frequency	Max Turbo Frequency	Cache	Memory Types	Processor Graphics	
	i3-7020U	2	4	2.3 GHz	-	3MB	DDR4-2133	Intel HD Graphics 620	
	i3-7130U			2.7 GHz	-	3MB			
	i5-7200U			2.5 GHz	3.1 GHz	3MB			
	i5-7300U			2.6 GHz	3.5 GHz	3MB			
	8th Generation Intel Core i3 / i5 / i7 Processor								
	Processor Number	# of Cores	# of Threads	Base Frequency	Max Turbo Frequency	Cache	Memory Types	Processor Graphics	
	i3-8130U	2	4	2.2 GHz	3.4 GHz	4MB	DDR4-2400	Intel UHD Graphics 620	
	i5-8250U	4	8	1.6 GHz	3.4 GHz	6MB			
	i5-8350U			1.7 GHz	3.6 GHz	6MB			
	i7-8550U			1.8 GHz	4.0 GHz	8MB			
	* i3-7130U is NOT available in US and EMEA								
Graphics	Intel HD Graphics 620 or Intel UHD Graphics 620 in processor only or Intel HD Graphics 620 or Intel UHD Graphics 620 in processor and AMD Radeon 530, 2GB GDDR5 memory (discrete models are NOT available in EMEA); supports external digital monitor via HDMI or USB Type-C; supports three independent displays; Max resolution: 4096x2304@60Hz (USB Type-C); 4096x2160@30Hz (HDMI)								
Chipset	Intel SoC (System on Chip) platform								
Memory	32GB max / 2400MHz DDR4, dual-channel capable, two DDR4 SO-DIMM sockets * System clocks down for processors with lower memory controller								
Display	Some: 14.0" (355mm) HD (1366x768), anti-glare, LED backlight, 220 nits, 16:9 aspect ratio, 500:1 contrast ratio Some: 14.0" (355mm) FHD (1920x1080), anti-glare, LED backlight, IPS, 250 nits, 16:9 aspect ratio, 800:1 contrast ratio, 170° viewing angle								
Multi-touch (opt)	On-cell touch, supports 10-finger gesture (FHD only)								
Storage	System has one HDD slot or one M.2 2280 slot exclusively for storage Some: HDD / SATA 6.0Gb/s, 2.5" wide, 7mm high, Active Protection System™ Some: SSD / SATA 6.0Gb/s, 2.5" wide, 7mm high (e.g. xxxGB SSD) Some: M.2 SSD / PCIe NVMe, PCIe 3.0 x 2, 16Gb/s Some: 128GB M.2 SSD / PCIe NVMe, PCIe 3.0 x 2, 16Gb/s, in WWAN slot as 2nd Storage, mutually exclusive with WWAN								
Optical	None								
Ethernet	Non-vPro model: Intel Ethernet Connection I219-V (Jacksonville) vPro model: Intel Ethernet Connection I219-LM (Jacksonville)								
WLAN + Bluetooth™ (optional)	One of the following, configurable by model: <ul style="list-style-type: none"> <li>Realtek® RTL8822BE, Wi-Fi 2x2 802.11ac + Bluetooth 4.1, M.2 card (US only)</li> <li>Intel Dual Band Wireless-AC 8265, Wi-Fi 2x2 802.11ac + Bluetooth 4.1, M.2 card</li> </ul> * Intel 8265ac card supports BT4.2 but is limited to BT4.1 by Windows OS								
	Dimensions <i>WxDxH:</i> 13.19" x 9.25" x 0.89"; 335mm x 235mm x 22.5mm Weight Starting at 3.71 lb / 1.68 kg Case color Black Case material PC/ABS plastic								
	Smart card reader <i>Optional:</i> Smart card reader Media reader MicroSD card reader Ports Two USB 3.1 Gen 1 (one Always On), two USB 3.1 Type-C Gen 1 (with the function of Power Delivery and DisplayPort), HDMI 1.4b, Ethernet (RJ-45), nano-SIM card slot (WWAN models), headphone / microphone combo jack, optional smart card reader, microSD card reader, side docking connector, security keyhole * Depending on many factors, actual data transfer speed may be lower than theoretical speed Monitor cable (optional) <i>HDMI to VGA:</i> Lenovo HDMI to VGA Monitor Adapter <i>USB-C to VGA:</i> Lenovo USB-C to VGA Adapter								
	Camera (optional) <i>One of the following, configurable by model:</i> <ul style="list-style-type: none"> <li>HD720p camera, fixed focus</li> <li>IR camera and HD720p camera, fixed focus</li> </ul> Audio support HD Audio, Realtek ALC3287 codec / stereo speakers, 2W x 2, Dolby® Audio™ / dual array microphone, headphone / microphone combo jack								
	Keyboard 6-row, spill-resistant, multimedia Fn keys, optional LED backlight UltraNav™ TrackPoint® pointing device and buttonless Mylar surface multi-touch touchpad								
	Security Security chip Power-on password, hard disk password, supervisor password, security keyhole Security chip Discrete TPM 2.0, TCG Certified vPro (optional) Intel vPro Technology								
	Fingerprint reader <i>Optional:</i> Touch style match on chip fingerprint reader on the keyboard bezel, anti-spoofing technology								
	NFC (optional) Near Field Communication								
	Battery Integrated Li-ion 45Wh battery, supports Rapid Charge (charge up to 80% in 1hr) with 65W USB Type-C AC adapter Max battery life <i>MobileMark® 2014:</i> 12.2 hr * Battery life varies significantly with settings, usage, & other factors								
	AC adapter 45W or 65W USB Type-C AC adapter								
	Operating system <i>Optional:</i> Windows® 10 Home 64 or Windows 10 Pro 64								
	Limited warranty <i>One of the following, configurable by model:</i> <ul style="list-style-type: none"> <li>1-year depot repair service</li> <li>3-year/1-yr battery depot repair service</li> <li>3-year/1-yr battery limited onsite service</li> </ul>								
	Mil-Spec test MIL-STD-810G military testing								
	Environment EPEAT™ Gold (US only); ENERGY STAR® 6.1; RoHS-compliant								

Note: The specifications above may not be available in all regions.

Lenovo  
August 2019



# ThinkPad L490 Platform Specifications

Product Specifications Reference (PSREF)

Processor	Intel® Celeron® Processor or 8th Generation Intel Core™ i3 / i5 / i7 Processor									Dimensions	<i>WxDxH:</i> 13.19" x 9.25" x 0.89"; 335mm x 235mm x 22.5mm	
	Processor Number	# of Cores	# of Threads	Base Frequency	Max Turbo Frequency	Cache	Memory Types	Processor Graphics		Weight	Starting at 3.72 lb / 1.69 kg	
	Cel 4305U	2	2	2.2 GHz	-	2MB	DDR4-2133	Intel UHD Graphics 610		Case color	Black	
	i3-8145U	2	4	2.1 GHz	3.9 GHz	4MB	DDR4-2400	Intel UHD Graphics 620		Case material	PC/ABS plastic	
	i5-8265U	4	8	1.6 GHz	3.9 GHz	6MB				Smart card reader	<i>Optional:</i> Smart card reader	
	i5-8365U	4	8	1.6 GHz	4.1 GHz	6MB				Media reader	MicroSD card reader	
i7-8565U	4	8	1.8 GHz	4.6 GHz	8MB	Ports				Two USB 3.1 Gen 1 (one Always On), one USB 3.1 Type-C Gen 1 (with the function of Power Delivery and DisplayPort), one USB 3.1 Type-C Gen 2 (with the function of Power Delivery and DisplayPort), HDMI 1.4b, Ethernet (RJ-45), nano-SIM card slot (WWAN models), headphone / microphone combo jack, optional smart card reader, microSD card reader, side docking connector, security keyhole		
i7-8665U	4	8	1.9 GHz	4.8 GHz	8MB			* Depending on many factors, actual data transfer speed may be lower than theoretical speed				
Graphics	Intel UHD Graphics 610 or 620 in processor only or Intel UHD Graphics 620 in processor and AMD Radeon 535, 2GB GDDR5 memory (discrete models are NOT available in EMEA); supports external digital monitor via HDMI or USB Type-C; supports three independent displays; Max resolution: 4096x2304@60Hz (USB Type-C); 4096x2160@24Hz (HDMI)									Monitor cable (optional)	HDMI to VGA: Lenovo HDMI to VGA Monitor Adapter USB-C to VGA: Lenovo USB-C to VGA Adapter USB-C to DP: Lenovo USB-C to DisplayPort Adapter	
Chipset	Intel SoC (System on Chip) platform									Camera (optional)	One of the following, configurable by model:	
Memory	64GB max / 2400MHz DDR4, dual-channel capable, two DDR4 SO-DIMM sockets * Installed memory is actually 2666MHz but run at 2133MHz or 2400MHz due to Intel limitation									Audio support	HD Audio, Realtek ALC3287 codec / stereo speakers, 2W x 2, Dolby® Advanced Audio / dual array microphone, headphone / microphone combo jack	
Display	Size	Resolution	Type	Surface	Brightness	Aspect Ratio	Contrast Ratio	Color Gamut	Viewing Angle	Keyboard		
	14.0"	HD (1366x768)	TN	Anti-glare	220 nits	16:9	400:1	45%	90°	6-row, spill-resistant, multimedia Fn keys, optional LED backlight		
Multi-touch (opt)	14.0"	FHD (1920x1080)	IPS	Anti-glare	250 nits	16:9	700:1	45%	170°	UltraNav™ TrackPoint® pointing device and buttonless Mylar surface multi-touch touchpad		
	On-cell touch, supports 10-finger gesture (FHD only)									Security	Power-on password, hard disk password, supervisor password, security keyhole	
Storage	<ul style="list-style-type: none"> <li>HDD / SATA 6.0Gb/s, 2.5" wide, 7mm high, Active Protection System™</li> <li>SSD / SATA 6.0Gb/s, 2.5" wide, 7mm high</li> <li>M.2 2280 SSD / PCIe NVMe, PCIe 3.0 x 4</li> <li>M.2 2242 SSD / PCIe NVMe, PCIe 3.0 x 2</li> </ul> * Installed M.2 2280 SSD is PCIe 3x4 but run at PCIe 3x2 due to M.2 SSD adapter limitation									Security chip	Discrete TPM 2.0, TCG Certified	
Optane™ memory	Optional: Intel Optane memory, PCIe NVMe, PCIe 3.0 x 2									System Mgt (opt)	Intel vPro Technology	
Optical	None									Fingerprint reader	Optional: Touch style match on chip fingerprint reader on the palm rest	
Ethernet	<i>Non-vPro model:</i> Intel Ethernet Connection I219-V (Jacksonville) <i>vPro model:</i> Intel Ethernet Connection I219-LM (Jacksonville)									NFC (optional)	Near Field Communication	
WLAN + Bluetooth™ (optional)	<i>One of the following, configurable by model:</i> <ul style="list-style-type: none"> <li>Realtek® RTL8822BE, Wi-Fi 2x2 802.11ac + Bluetooth 4.2, M.2 card (NOT available in EMEA)</li> <li>Intel Wireless-AC 9260, Wi-Fi 2x2 802.11ac + Bluetooth 5.0</li> <li>Intel Wi-Fi 6 AX200, Wi-Fi 2x2 802.11ax + Bluetooth 5.0</li> </ul>									Battery	Integrated Li-ion 45Wh battery, supports Rapid Charge (charge up to 80% in 1hr) with 65W USB Type-C AC adapter	
WWAN (optional)	<i>One of the following, configurable by model:</i> <ul style="list-style-type: none"> <li>Wireless WAN upgradable</li> <li>Integrated Mobile Broadband 4G LTE, Fibocom L830-EB, M.2 card (EMEA only)</li> <li>Integrated Mobile Broadband 4G LTE-A, Fibocom L850-GL, M.2 card</li> </ul> * For non-WWAN model, it means the model is NOT WWAN upgradable									Max battery life	<i>MobileMark® 2014:</i> 12 hr * Battery life varies significantly with settings, usage, & other factors	
SIM card	None									AC adapter	45W, 65W, or 65W slim USB-C AC adapter	
										Operating system	Optional: Windows® 10 Home 64 or Windows 10 Pro 64	
										Limited warranty	<i>One of the following, configurable by model:</i> <ul style="list-style-type: none"> <li>1-year depot repair service</li> <li>3-year/1-yr battery depot repair service</li> </ul>	
										Mil-Spec test	MIL-STD-810G military testing	
										Environment	EPEAT™ Silver; ENERGY STAR® 7.1; RoHS-compliant	

Note: The specifications above may not be available in all regions.

Lenovo  
September 2019



# ThinkPad L570 Platform Specifications

Product Specifications Reference (PSREF)

Processor	6th Generation Intel® Core™ i3 / i5 / i7 Processor or								WWAN (optional) <i>One of the following, configurable by model:</i> <ul style="list-style-type: none"> <li>Wireless WAN upgradable</li> <li>Integrated Mobile Broadband 4G LTE-A, Qualcomm® Snapdragon™ X7 LTE-A (Sierra Wireless EM7455), M.2 card</li> <li>Integrated Mobile Broadband 4G LTE, Intel XMM™ 7160 (Fibocom L831-EAU), M.2 card (EMEA only)</li> </ul> SIM card (opt) Micro-SIM card slot, opt Verizon LTE (US) or Lenovo® Connect (EMEA) SIM card
	Processor Number	# of Cores	# of Threads	Base Frequency	Max Turbo Frequency	Cache	Memory Types	Processor Graphics	
	i3-6006U	2	4	2.0 GHz	-	3MB	DDR4-2133	Intel HD Graphics 520	
	i3-6100U			2.3 GHz	-	3MB			
	i5-6200U			2.3 GHz	2.8 GHz	3MB			
	i5-6300U			2.4 GHz	3.0 GHz	3MB			
	i7-6500U			2.5 GHz	3.1 GHz	4MB			
	i7-6600U			2.6 GHz	3.4 GHz	4MB			
	Intel Celeron® Processor or 7th Generation Intel Core i3 / i5 / i7 Processor								
	Processor Number	# of Cores	# of Threads	Base Frequency	Max Turbo Frequency	Cache	Memory Types	Processor Graphics	
	Cel 3965U	2	4	2.2 GHz	-	2MB	DDR4-2133	Intel HD Graphics 610	
	i3-7100U			2.4 GHz	-	3MB		Intel HD Graphics 620	
	i5-7200U			2.5 GHz	3.1 GHz	3MB			
	i5-7300U			2.6 GHz	3.5 GHz	3MB			
	i7-7500U			2.7 GHz	3.5 GHz	4MB			
	i7-7600U			2.8 GHz	3.9 GHz	4MB			
	<i>* i7 processor is NOT available in EMEA</i>								
Graphics	Intel HD Graphics 520, 610, or 620 in processor only; supports external analog monitor via VGA and digital monitor via Mini DisplayPort; supports three independent displays; Max resolution: 3840x2160@60Hz (DP via mDP cable); 1920x1200@60Hz (VGA)								
Chipset	Intel SoC (System on Chip) platform								
Memory	32GB max / 2400MHz DDR4, dual-channel capable, two DDR4 SO-DIMM sockets <i>* System clocks down for processors with lower memory controller</i>								
Display	Some: 15.6" (396mm) HD (1366x768), anti-glare, LED backlight, 220 nits, 16:9 aspect ratio, 350:1 contrast ratio Some: 15.6" (396mm) FHD (1920x1080), anti-glare, LED backlight, 220 nits, 16:9 aspect ratio, 400:1 or 500:1 contrast ratio Some: 15.6" (396mm) FHD (1920x1080), anti-glare, LED backlight, IPS, 250 nits, 16:9 aspect ratio, 600:1 contrast ratio, 160° viewing angle								
Multi-touch	None								
Storage	Some: HDD / SATA 6.0Gb/s, 2.5" wide, 7mm high, Active Protection System™ Some: SSD / SATA 6.0Gb/s, 2.5" wide, 7mm high (e.g. xxxGB SSD) Some: M.2 SSD / PCIe NVMe, PCIe 3.0 x 2, 16Gb/s Some: 128GB M.2 SSD / SATA 6.0Gb/s, in WWAN slot as 2nd Storage, mutually exclusive with WWAN								
Optical (optional)	DVD-ROM or DVD burner, 9mm high, fixed, not removable, tray-in								
Ethernet	Non-vPro model: Intel Ethernet Connection I219-V (Jacksonville) vPro model: Intel Ethernet Connection I219-LM (Jacksonville)								
WLAN	One of the following, configurable by model: <ul style="list-style-type: none"> <li>Realtek® RTL8822BE, Wi-Fi 2x2 802.11ac + BT4.1, M.2 card (US only)</li> <li>Intel Dual Band Wireless-AC 8260, Wi-Fi 2x2 802.11ac + BT4.1, M.2 card</li> <li>Intel Dual Band Wireless-AC 8265, Wi-Fi 2x2 802.11ac + BT4.1, M.2 card</li> </ul>								
Bluetooth™	Bluetooth 4.1 wireless, integrated in Wi-Fi + Bluetooth combo adapter * Intel 8260ac / 8265ac card support BT4.2 but is limited to BT4.1 by Windows OS								
Keyboard	6-row, spill-resistant, multimedia Fn keys, numeric keypad								
UltraNav™	TrackPoint® pointing device and buttonless Mylar surface multi-touch touchpad								
Security	Power-on password, hard disk password, supervisor password, security keyhole								
Security chip	Discrete TPM 2.0, TCG Certified								
vPro (optional)	Intel vPro Technology								
Fingerprint reader	Optional: Swipe style fingerprint reader on the palm rest								
NFC	None								
Battery	Li-ion 6-cell (48Wh)								
Max battery life	MobileMark® 2014: 14.8 hr * Battery life varies significantly with settings, usage, & other factors								
AC adapter	45W slim tip AC adapter								
Operating system	One of the following, configurable by model: <ul style="list-style-type: none"> <li>Windows® 7 Professional 64 preinstalled through downgrade rights in Windows 10 Pro 64</li> <li>Windows 10 Home 64</li> <li>Windows 10 Pro 64</li> </ul>								
Limited warranty	One of the following, configurable by model: <ul style="list-style-type: none"> <li>1-year depot repair service</li> <li>3-year/1-yr battery depot repair service</li> <li>3-year/1-yr battery limited onsite service</li> </ul>								
Mil-Spec test	MIL-STD-810G military testing								
Environment	EPEAT™ Gold (US only); ENERGY STAR® 6.1; RoHS-compliant								

Note: The specifications above may not be available in all regions.

Lenovo  
September 2018





# ThinkPad L580 Platform Specifications

Product Specifications Reference (PSREF)

Processor	Intel® Celeron® Processor, 7th Generation Intel Core™ i3 / i5 Processor or							WWAN (optional) <i>One of the following, configurable by model:</i> <ul style="list-style-type: none"> <li>Integrated Mobile Broadband 4G LTE, Intel XMM™ 7262 (Fibocom L830-EB), M.2 card (EMEA only)</li> <li>Integrated Mobile Broadband 4G LTE-A, Intel XMM™ 7360 (Fibocom L850-GL), M.2 card</li> </ul> * For non-WWAN model, it means the model is NOT WWAN upgradable Nano-SIM card slot, optional Verizon LTE (US) SIM card	
	Processor Number	# of Cores	# of Threads	Base Frequency	Max Turbo Frequency	Cache	Memory Types		Processor Graphics
	Cel 3965U	2	4	2.2 GHz	-	2MB	DDR4-2133	Intel HD Graphics 610	
	i3-7020U			2.3 GHz	-	3MB		Intel HD Graphics 620	
	i3-7130U			2.7 GHz	-	3MB			
	i5-7200U			2.5 GHz	3.1 GHz	3MB			
	i5-7300U			2.6 GHz	3.5 GHz	3MB			
	8th Generation Intel Core i3 / i5 / i7 Processor								
	Processor Number	# of Cores	# of Threads	Base Frequency	Max Turbo Frequency	Cache	Memory Types	Processor Graphics	
	i3-8130U	2	4	2.2 GHz	3.4 GHz	4MB	DDR4-2400	Intel UHD Graphics 620	
	i5-8250U	4	8	1.6 GHz	3.4 GHz	6MB			
	i5-8350U			1.7 GHz	3.6 GHz	6MB			
	i7-8550U			1.8 GHz	4.0 GHz	8MB			
	* i3-7130U is NOT available in US and EMEA								
Graphics	Intel HD Graphics 610, 620 or Intel UHD Graphics 620 in processor only or Intel HD Graphics 620 or Intel UHD Graphics 620 in processor and AMD Radeon 530, 2GB GDDR5 memory (discrete models are NOT available in EMEA); supports external digital monitor via HDMI or USB Type-C; supports three independent displays; Max resolution: 4096x2304@60Hz (USB Type-C); 4096x2160@30Hz (HDMI)							ExpressCard None Smart card reader <i>Optional:</i> Smart card reader Media reader MicroSD card reader Ports Two USB 3.1 Gen 1 (one Always On), two USB 3.1 Type-C Gen 1 (with the function of Power Delivery and DisplayPort), HDMI 1.4b, Ethernet (RJ-45), nano-SIM card slot (WWAN models), headphone / microphone combo jack, optional smart card reader, microSD card reader, side docking connector, security keyhole * Depending on many factors, actual data transfer speed may be lower than theoretical speed	
Chipset	Intel SoC (System on Chip) platform							Monitor cable (optional)	HDMI to VGA: Lenovo HDMI to VGA Monitor Adapter USB-C to VGA: Lenovo USB-C to VGA Adapter
Memory	32GB max / 2400MHz DDR4, dual-channel capable, two DDR4 SO-DIMM sockets * System clocks down for processors with lower memory controller							Camera (optional)	HD720p camera, fixed focus
Display	Some: 15.6" (396mm) HD (1366x768), anti-glare, LED backlight, 220 nits, 16:9 aspect ratio, 500:1 contrast ratio Some: 15.6" (396mm) FHD (1920x1080), anti-glare, LED backlight, IPS, 250 nits, 16:9 aspect ratio, 800:1 contrast ratio, 170° viewing angle							Audio support	HD Audio, Realtek ALC3287 codec / stereo speakers, 2W x 2, Dolby® Audio™ / dual array microphone, headphone / microphone combo jack
Multi-touch	None							Keyboard	6-row, spill-resistant, multimedia Fn keys, numeric keypad, optional LED backlight
Storage	System has one HDD slot or one M.2 2280 slot exclusively for storage Some: HDD / SATA 6.0Gb/s, 2.5" wide, 7mm high, Active Protection System™ Some: SSD / SATA 6.0Gb/s, 2.5" wide, 7mm high (e.g. xxxGB SSD) Some: M.2 SSD / PCIe NVMe, PCIe 3.0 x 2, 16Gb/s Some: 128GB M.2 SSD / PCIe NVMe, PCIe 3.0 x 2, 16Gb/s, in WWAN slot as 2nd Storage, mutually exclusive with WWAN							UltraNav™	TrackPoint® pointing device and buttonless Mylar surface multi-touch touchpad
Optical	None							Security	Power-on password, hard disk password, supervisor password, security keyhole
Ethernet	Non-vPro model: Intel Ethernet Connection I219-V (Jacksonville) vPro model: Intel Ethernet Connection I219-LM (Jacksonville)							Security chip	Discrete TPM 2.0, TCG Certified
WLAN + Bluetooth™ (optional)	One of the following, configurable by model: • Realtek® RTL8822BE, Wi-Fi 2x2 802.11ac + Bluetooth 4.1, M.2 card (US only) • Intel Dual Band Wireless-AC 8265, Wi-Fi 2x2 802.11ac + Bluetooth 4.1, M.2 card * Intel 8265ac card supports BT4.2 but is limited to BT4.1 by Windows OS							vPro (optional)	Intel vPro Technology
								Fingerprint reader	<i>Optional:</i> Touch style match on chip fingerprint reader on the palm rest, anti-spoofing technology
								NFC (optional)	Near Field Communication
								Battery	Integrated Li-ion 45Wh battery, supports Rapid Charge (charge up to 80% in 1hr) with 65W USB Type-C AC adapter
								Max battery life	MobileMark® 2014: 12 hr * Battery life varies significantly with settings, usage, & other factors
								AC adapter	45W or 65W USB Type-C AC adapter
								Operating system	<i>Optional:</i> Windows® 10 Home 64 or Windows 10 Pro 64
								Limited warranty	One of the following, configurable by model: <ul style="list-style-type: none"> <li>1-year depot repair service</li> <li>3-year/1-yr battery depot repair service</li> <li>3-year/1-yr battery limited onsite service</li> </ul>
								Mil-Spec test	MIL-STD-810G military testing
								Environment	EPEAT™ Gold (US only); ENERGY STAR® 6.1; RoHS-compliant

Note: The specifications above may not be available in all regions.

Lenovo  
August 2019

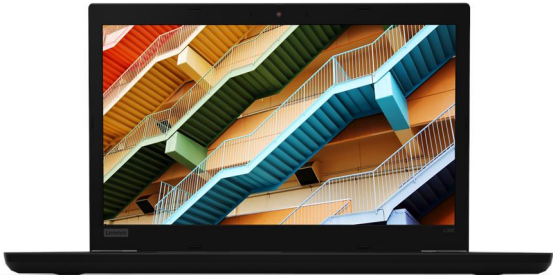

# ThinkPad L590 Platform Specifications

Product Specifications Reference (PSREF)

Processor	Intel® Celeron® Processor or 8th Generation Intel Core™ i3 / i5 / i7 Processor									Dimensions	<i>WxDxH:</i> 14.82" x 10.02" x 0.90"; 376.5mm x 254.5mm x 22.95mm	
	Processor Number	# of Cores	# of Threads	Base Frequency	Max Turbo Frequency	Cache	Memory Types	Processor Graphics	Weight	Starting at 4.48 lb / 2.0 kg		
	Cel 4305U	2	2	2.2 GHz	-	2MB	DDR4-2133	Intel UHD Graphics 610	Case color	Black		
	i3-8145U	2	4	2.1 GHz	3.9 GHz	4MB	DDR4-2400	Intel UHD Graphics 620	Case material	PC/ABS plastic		
	i5-8265U	4	8	1.6 GHz	3.9 GHz	6MB			Smart card reader	<i>Optional:</i> Smart card reader		
	i5-8365U	4	8	1.6 GHz	4.1 GHz	6MB			Media reader	MicroSD card reader		
i7-8565U	4	8	1.8 GHz	4.6 GHz	8MB	Ports			Two USB 3.1 Gen 1 (one Always On), one USB 3.1 Type-C Gen 1 (with the function of Power Delivery and DisplayPort), one USB 3.1 Type-C Gen 2 (with the function of Power Delivery and DisplayPort), HDMI 1.4b, Ethernet (RJ-45), nano-SIM card slot (WWAN models), headphone / microphone combo jack, optional smart card reader, microSD card reader, side docking connector, security keyhole			
i7-8665U	4	8	1.9 GHz	4.8 GHz	8MB			* Depending on many factors, actual data transfer speed may be lower than theoretical speed				
Graphics	Intel UHD Graphics 610 or 620 in processor only or Intel UHD Graphics 620 in processor and AMD Radeon 535, 2GB GDDR5 memory (discrete models are NOT available in EMEA); supports external digital monitor via HDMI or USB Type-C; supports three independent displays; Max resolution: 4096x2304@60Hz (USB Type-C); 4096x2160@24Hz (HDMI)									Monitor cable (optional)	HDMI to VGA: Lenovo HDMI to VGA Monitor Adapter USB-C to VGA: Lenovo USB-C to VGA Adapter USB-C to DP: Lenovo USB-C to DisplayPort Adapter	
Chipset	Intel SoC (System on Chip) platform									Camera (optional)	One of the following, configurable by model:	
Memory	64GB max / 2400MHz DDR4, dual-channel capable, two DDR4 SO-DIMM sockets * Installed memory is actually 2666MHz but run at 2133MHz or 2400MHz due to Intel limitation									Audio support	HD Audio, Realtek ALC3287 codec / stereo speakers, 2W x 2, Dolby® Advanced Audio / dual array microphone, headphone / microphone combo jack	
Display	Size	Resolution	Type	Surface	Brightness	Aspect Ratio	Contrast Ratio	Color Gamut	Viewing Angle	Keyboard	6-row, spill-resistant, multimedia Fn keys, numeric keypad, optional LED backlight	
	15.6"	HD (1366x768)	TN	Anti-glare	220 nits	16:9	400:1	45%	90°		UltraNav™	TrackPoint® pointing device and buttonless Mylar surface multi-touch touchpad
Multi-touch	None									Security	Power-on password, hard disk password, supervisor password, security keyhole	
Storage	<ul style="list-style-type: none"> <li>HDD / SATA 6.0Gb/s, 2.5" wide, 7mm high, Active Protection System™</li> <li>SSD / SATA 6.0Gb/s, 2.5" wide, 7mm high</li> <li>M.2 2280 SSD / PCIe NVMe, PCIe 3.0 x 4</li> <li>M.2 2242 SSD / PCIe NVMe, PCIe 3.0 x 2</li> </ul> * Installed M.2 2280 SSD is PCIe 3x4 but run at PCIe 3x2 due to M.2 SSD adapter limitation									Security chip	Discrete TPM 2.0, TCG Certified	
										System Mgt (opt)	Intel vPro Technology	
Optane™ memory	Optional: Intel Optane memory, PCIe NVMe, PCIe 3.0 x 2									Fingerprint reader	Optional: Touch style fingerprint reader on the palm rest	
Optical	None									NFC (optional)	Near Field Communication	
Ethernet	Non-vPro model: Intel Ethernet Connection I219-V (Jacksonville) vPro model: Intel Ethernet Connection I219-LM (Jacksonville)									Battery	Integrated Li-ion 45Wh battery, supports Rapid Charge (charge up to 80% in 1hr) with 65W USB Type-C AC adapter	
WLAN + Bluetooth™ (optional)	One of the following, configurable by model: <ul style="list-style-type: none"> <li>Realtek® RTL8822BE, Wi-Fi 2x2 802.11ac + Bluetooth 4.2, M.2 card (NOT available in EMEA)</li> <li>Intel Wireless-AC 9260, Wi-Fi 2x2 802.11ac + Bluetooth 5.0</li> <li>Intel Wi-Fi 6 AX200, Wi-Fi 2x2 802.11ax + Bluetooth 5.0</li> </ul>									Max battery life	MobileMark® 2014: 12 hr * Battery life varies significantly with settings, usage, & other factors	
WWAN (optional)	One of the following, configurable by model: <ul style="list-style-type: none"> <li>Wireless WAN upgradable</li> <li>Integrated Mobile Broadband 4G LTE, Fibocom L830-EB, M.2 card (EMEA only)</li> <li>Integrated Mobile Broadband 4G LTE-A, Fibocom L850-GL, M.2 card</li> </ul> * For non-WWAN model, it means the model is NOT WWAN upgradable									AC adapter	45W, 65W, or 65W slim USB-C AC adapter	
SIM card	None									Operating system	Optional: Windows® 10 Home 64 or Windows 10 Pro 64	
										Limited warranty	One of the following, configurable by model: <ul style="list-style-type: none"> <li>1-year depot repair service</li> <li>3-year/1-yr battery depot repair service</li> </ul>	
										Mil-Spec test	MIL-STD-810G military testing	
										Environment	EPEAT™ Silver; ENERGY STAR® 7.1; RoHS-compliant	

Note: The specifications above may not be available in all regions.

Lenovo  
September 2019



# ThinkPad P1 Platform Specifications

Product Specifications Reference (PSREF)

Processor	8th Generation Intel® Core™ i5 / i7 Processor or Intel Xeon® E Processor								Smart card reader	<i>Optional</i> : Smart card reader
	Processor Number	# of Cores	# of Threads	Base Frequency	Max Turbo Frequency	Cache	Memory Types	Processor Graphics	ExpressCard	None
	i5-8400H	4	8	2.5 GHz	4.2 GHz	8MB	DDR4-2666	Intel UHD Graphics 630	Media reader	SD Card reader (SD, SDHC, SDXC), supports UHS-II SD card
	i7-8750H	6	12	2.2 GHz	4.1 GHz	9MB			Ports	Two USB 3.1 Gen 1 (one Always On), two USB Type-C / Thunderbolt 3 (with the function of Power Delivery and DP), HDMI 2.0, Ethernet extension connector, headphone / microphone combo jack, optional smart card reader, SD card reader, security keyhole
	i7-8850H			2.6 GHz	4.3 GHz	9MB		Intel UHD Graphics P630		
	E-2176M			2.7 GHz	4.4 GHz	12MB				* Power Delivery only supports power-out for charging peripherals * Depending on many factors, actual data transfer speed may be lower than theoretical speed
Graphics	Intel UHD Graphics 630 or P630 in processor and NVIDIA® Quadro® P1000 or P2000, 4GB GDDR5 memory; supports external digital monitor via HDMI or Thunderbolt™; supports four independent displays; Max resolution: 5K@60Hz (Thunderbolt); 4K@60Hz (HDMI)								Monitor cable ( <i>optional</i> )	HDMI to VGA: Lenovo HDMI to VGA Monitor Adapter USB-C to DP: Lenovo USB-C to DisplayPort Adapter
Chipset	Mobile Intel CM246 Chipset								Bundled Accy	<i>Optional</i> : ThinkPad Ethernet Extension Cable
Memory	64GB max / 2666MHz DDR4, ECC or non-ECC (ECC function supported only on Xeon processor), dual-channel capable, two DDR4 SO-DIMM sockets								Camera ( <i>optional</i> )	<i>One of the following, configurable by model:</i> • HD720p camera with ThinkShutter camera privacy, fixed focus • IR camera and HD720p camera, fixed focus
Display	<i>Some</i> : 15.6" (396mm) FHD (1920x1080), anti-glare, LED backlight, IPS, 300 nits, 16:9 aspect ratio, 700:1 contrast ratio, 72% gamut, 170° viewing angle <i>Some</i> : 15.6" (396mm) UHD (3840x2160), anti-glare, LED backlight, IPS, 400 nits, 16:9 aspect ratio, 1200:1 contrast ratio, 100% gamut, 170° viewing angle, multi-touch, anti-reflection (AR)								Audio support	HD Audio, Realtek® ALC3286 codec / stereo speakers, 2W x 2, Dolby™ Premium / dual array microphone, headphone / microphone combo jack, Dolby Atmos® headphone
Multi-touch ( <i>opt</i> )	Capacitive-type multi-touch, supports 10-finger gesture (4K only)								Keyboard	6-row, spill-resistant, multimedia Fn keys, LED backlight
Pen	Supports pen accessory, please see the accessory compatibility for details								UltraNav™	TrackPoint® pointing device and buttonless glass surface multi-touch touchpad
Storage	<i>Up to 2 drives (two M.2 SSD)</i> M.2 SSD / PCIe NVMe, PCIe 3.0 x 4, 32Gb/s								Security	Power-on password, hard disk password, supervisor password, security keyhole
RAID ( <i>optional</i> )	RAID 0/1 support								Security chip	Discrete TPM 2.0, TCG Certified
Optical	None								vPro ( <i>optional</i> )	Intel vPro Technology
Ethernet	Native Intel Ethernet Connection I219-V ( <i>Non-vPro</i> ) or I219-LM ( <i>vPro</i> ) via bundled or optional ThinkPad Ethernet Extension Cable								Fingerprint reader	Touch style match on chip fingerprint reader on the keyboard bezel
WLAN	Intel Wireless-AC 9560, Wi-Fi 2x2 802.11ac + Bluetooth 5.0, M.2 card								Color calibration	None
Bluetooth™	Bluetooth 5.0 wireless, integrated in Wi-Fi + Bluetooth combo adapter								NFC	None
WWAN	None								Battery	Integrated Li-ion 80Wh battery, supports Rapid Charge (charge up to 80% in 1hr)
SIM card	None								Max battery life ( <i>MobileMark 2014</i> )	<i>Discrete mode</i> : 7.36 hr; <i>Hybrid mode</i> : 13.87 hr * Battery life varies significantly with settings, usage, & other factors
Dimensions	<i>WxDxH (non-touch)</i> : 14.24" x 9.67" x 0.72"; 361.8mm x 245.7mm x 18.4mm <i>WxDxH (multi-touch)</i> : 14.24" x 9.67" x 0.74"; 361.8mm x 245.7mm x 18.7mm								AC adapter	135W slim tip AC adapter
Weight	<i>Non-touch model</i> : starting at 3.76 lb / 1.7 kg; <i>Multi-touch model</i> : starting at 4.06 lb / 1.8 kg								Operating system	<i>One of the following, configurable by model:</i> • Windows® 10 Home 64 • Windows 10 Pro 64 • Windows 10 Pro 64 for Workstations
Case color	Black								Limited warranty	<i>One of the following, configurable by model:</i> • 1-year depot repair service • 1-year depot with 2-year planar repair service • 3-year/1-yr battery depot repair service • 3-year/1-yr battery limited onsite service
Case material	<i>Display cover</i> : CFRP/GFRP hybrid; <i>Bottom</i> : Aluminum alloy								Mil-Spec test	MIL-STD-810G military testing
									Environment	EPEAT™ Gold (US only); ENERGY STAR® 6.1; RoHS-compliant

Note: The specifications above may not be available in all regions.

Lenovo  
August 2019

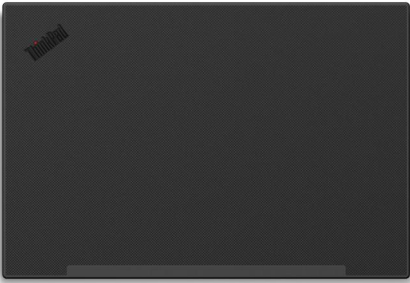

# ThinkPad P1 (2nd Gen) Platform Specifications

Product Specifications Reference (PSREF)

Processor	9th Generation Intel® Core™ i5 / i7 / i9 Processor or Intel Xeon® E Processor									Dimensions	<i>WxDxH (non-touch):</i> 14.24" x 9.67" x 0.72"; 361.8mm x 245.7mm x 18.4mm <i>WxDxH (multi-touch):</i> 14.24" x 9.67" x 0.74"; 361.8mm x 245.7mm x 18.7mm		
	Processor Number	# of Cores	# of Threads	Base Frequency	Max Turbo Frequency	Cache	Memory Types	Processor Graphics		Weight	<i>Non-touch model:</i> starting at 3.75 lb / 1.7 kg; <i>Multi-touch model:</i> starting at 4.0 lb / 1.81 kg		
	i5-9400H	4	8	2.5 GHz	4.3 GHz	8MB	DDR4-2666	Intel UHD Graphics 630		Case color	Black paint (FHD model) or black weave (UHD model)		
	i7-9750H	6	12	2.6 GHz	4.5 GHz	12MB		Intel UHD Graphics 630		Case material	<i>Display cover:</i> CFRP/GFRP hybrid; <i>Bottom:</i> Aluminum alloy		
	i7-9850H	6	12	2.6 GHz	4.6 GHz	12MB		Intel UHD Graphics 630		Smart card reader	<i>Optional:</i> Smart card reader		
	i9-9880H	8	16	2.3 GHz	4.8 GHz	16MB		Intel UHD Graphics P630		Media reader	SD Card reader (SD, SDHC, SDXC), supports UHS-II SD card		
Graphics	Intel UHD Graphics 630 in processor only or Intel UHD Graphics 630 or P630 in processor and NVIDIA® Quadro® T1000 or T2000, 4GB GDDR5 memory; supports external digital monitor via HDMI or Thunderbolt™; supports four independent displays; Max resolution: 5K@60Hz (Thunderbolt); 4K@60Hz (HDMI)									Ports	Two USB 3.1 Gen 1 (one Always On), two USB 3.1 Type-C Gen 2 / Thunderbolt 3 (with the function of Power Delivery and DisplayPort), HDMI 2.0, Ethernet extension connector, headphone / microphone combo jack, optional smart card reader, SD card reader, security keyhole <i>* Power Delivery only supports power-out for charging peripherals</i> <i>* Depending on many factors, actual data transfer speed may be lower than theoretical speed</i>		
Chipset	Mobile Intel CM246 Chipset									Monitor cable (optional)	<i>HDMI to VGA:</i> Lenovo HDMI to VGA Monitor Adapter <i>USB-C to VGA:</i> Lenovo USB-C to VGA Adapter <i>USB-C to DP:</i> Lenovo USB-C to DisplayPort Adapter		
Memory	64GB max / 2666MHz DDR4, ECC or non-ECC (ECC function supported only on Xeon processor), dual-channel capable, two DDR4 SO-DIMM sockets									Bundled Accy	<i>Optional:</i> ThinkPad Ethernet Extension Cable		
Display	Size	Resolution	Type	Surface	Brightness	Aspect Ratio	Contrast Ratio	Color Gamut	Viewing Angle	Camera (optional)	<i>One of the following, configurable by model:</i> • HD720p camera with ThinkShutter camera privacy, fixed focus • IR camera and HD720p camera with ThinkShutter camera privacy, fixed focus		
	15.6"	FHD (1920x1080)	IPS	Anti-glare	300 nits	16:9	700:1	72% NTSC	170°	Audio support	HD Audio, Synaptic® CX11880 codec / stereo speakers, 2W x 2, Dolby® Audio™ Premium / dual array far-field microphone, headphone / microphone combo jack, Dolby Atmos® sound system		
	15.6"	FHD (1920x1080) Dolby Vision™ HDR	IPS	Anti-glare	500 nits	16:9	1200:1	72% NTSC	170°	Keyboard	6-row, spill-resistant, multimedia Fn keys, LED backlight UltraNav™ TrackPoint® pointing device and buttonless glass surface multi-touch touchpad		
	15.6"	UHD (3840x2160) Dolby Vision HDR	IPS	Anti-glare	500 nits	16:9	1200:1	100% Adobe	170°	Security	Power-on password, hard disk password, supervisor password, security keyhole		
	15.6"	UHD (3840x2160) Dolby Vision HDR, Multi-touch	OLED	AR, AS	SDR 400nit, HDR 500nit (peak)	16:9	100000:1	100% DCI-P3	170°	Security chip	Discrete TPM 2.0, TCG Certified		
Multi-touch (opt)	Capacitive-type multi-touch, supports 10-finger gesture (UHD OLED only), anti-reflection (AR), anti-smudge (AS) coating									System Mgt (opt)	Intel vPro Technology		
Pen	Supports pen accessory, please see the accessory compatibility for details									Fingerprint reader	Touch style match on chip fingerprint reader on the keyboard bezel		
Storage	<i>Up to two M.2 SSD</i> M.2 2280 SSD / PCIe NVMe 3.0 x 4									Color calibration	<i>Optional:</i> X-Rite Pantone factory color calibration (UHD model only)		
RAID (optional)	RAID 0/1 support									NFC	None		
Optical	None									Battery	Integrated Li-ion 80Wh battery, supports Rapid Charge (charge up to 80% in 1hr)		
Ethernet	Native Intel Ethernet Connection I219-V (Non-vPro) or I219-LM (vPro) via bundled or optional ThinkPad Ethernet Extension Cable									Max battery life	<i>MobileMark® 2014:</i> 13.8 hr <i>* Battery life varies significantly with settings, usage, &amp; other factors</i>		
WLAN	Intel Wi-Fi 6 AX200, Wi-Fi 2x2 802.11ax + Bluetooth 5.0									AC adapter	135W slim tip AC adapter		
Bluetooth™	Bluetooth 5.0 wireless, integrated in Wi-Fi + Bluetooth combo adapter									Operating system	<i>One of the following, configurable by model:</i> • Windows® 10 Home 64 • Windows 10 Pro 64 • Windows 10 Pro 64 for Workstations		
WWAN	None									Limited warranty	<i>One of the following, configurable by model:</i> • 1-year depot repair service • 1-year depot with 2-year planar repair service • 3-year/1-yr battery depot repair service • 3-year/1-yr battery limited onsite service		
SIM card	None									Mil-Spec test	MIL-STD-810G military testing		
										Environment	EPEAT™ Silver; ENERGY STAR® 7.1; RoHS-compliant		

Note: The specifications above may not be available in all regions.

Lenovo  
September 2019





# ThinkPad P43s Platform Specifications

Product Specifications Reference (PSREF)

Processor	8th Generation Intel® Core™ i7 Processor								Dimensions Weight	WxDxH: 12.95" x 8.94" x 0.70"; 329mm x 227mm x 17.9mm																																																
	Processor Number	# of Cores	# of Threads	Base Frequency	Max Turbo Frequency	Cache	Memory Types	Processor Graphics		Models	FHD	FHD Low Power	WQHD																																													
Graphics	i7-8565U	4	8	1.8 GHz	4.6 GHz	8MB	DDR4-2400	Intel UHD Graphics 620	Weight																																																	
	i7-8665U			1.9 GHz	4.8 GHz	8MB			Weight	3.43 lb / 1.55 kg	3.28 lb / 1.49 kg	3.24 lb / 1.47 kg																																														
Chipset Memory	Intel SoC (System on Chip) platform 48GB max / 2400MHz DDR4, dual-channel capable, 8GB or 16GB memory soldered to systemboard, one DDR4 SO-DIMM socket * Installed memory is actually 2666MHz but run at 2400MHz due to Intel limitation								Case color	Black																																																
Display	<table border="1"> <thead> <tr> <th>Size</th> <th>Resolution</th> <th>Type</th> <th>Surface</th> <th>Brightness</th> <th>Aspect Ratio</th> <th>Contrast Ratio</th> <th>Color Gamut</th> <th>Viewing Angle</th> </tr> </thead> <tbody> <tr> <td>14.0"</td> <td>FHD (1920x1080)</td> <td>IPS</td> <td>Anti-glare</td> <td>250 nits (non-touch) 300 nits (multi-touch)</td> <td>16:9</td> <td>700:1</td> <td>45%</td> <td>170°</td> </tr> <tr> <td>14.0"</td> <td>FHD (1920x1080) Low Power</td> <td>IPS</td> <td>Anti-glare</td> <td>400 nits</td> <td>16:9</td> <td>800:1</td> <td>72%</td> <td>170°</td> </tr> <tr> <td>14.0"</td> <td>FHD (1920x1080) ThinkPad Privacy Guard</td> <td>IPS</td> <td>Anti-glare</td> <td>400 nits</td> <td>16:9</td> <td>1000:1</td> <td>72%</td> <td>170°</td> </tr> <tr> <td>14.0"</td> <td>WQHD (2560x1440) Dolby Vision™ HDR</td> <td>IPS</td> <td>Glossy</td> <td>500 nits</td> <td>16:9</td> <td>1500:1</td> <td>100% Adobe</td> <td>170°</td> </tr> </tbody> </table>								Size	Resolution	Type	Surface	Brightness	Aspect Ratio	Contrast Ratio	Color Gamut	Viewing Angle	14.0"	FHD (1920x1080)	IPS	Anti-glare	250 nits (non-touch) 300 nits (multi-touch)	16:9	700:1	45%	170°	14.0"	FHD (1920x1080) Low Power	IPS	Anti-glare	400 nits	16:9	800:1	72%	170°	14.0"	FHD (1920x1080) ThinkPad Privacy Guard	IPS	Anti-glare	400 nits	16:9	1000:1	72%	170°	14.0"	WQHD (2560x1440) Dolby Vision™ HDR	IPS	Glossy	500 nits	16:9	1500:1	100% Adobe	170°	Case material	Display cover: PPS / 50% GF; Bottom: PA / 50% GF			
									Size	Resolution	Type	Surface	Brightness	Aspect Ratio	Contrast Ratio	Color Gamut	Viewing Angle																																									
									14.0"	FHD (1920x1080)	IPS	Anti-glare	250 nits (non-touch) 300 nits (multi-touch)	16:9	700:1	45%	170°																																									
									14.0"	FHD (1920x1080) Low Power	IPS	Anti-glare	400 nits	16:9	800:1	72%	170°																																									
									14.0"	FHD (1920x1080) ThinkPad Privacy Guard	IPS	Anti-glare	400 nits	16:9	1000:1	72%	170°																																									
14.0"	WQHD (2560x1440) Dolby Vision™ HDR	IPS	Glossy	500 nits	16:9	1500:1	100% Adobe	170°																																																		
Multi-touch (opt)	On-cell touch, supports 10-finger gesture (FHD only)								Smart card reader	Optional: Smart card reader																																																
Pen	None								Media reader	MicroSD card reader																																																
Storage	<ul style="list-style-type: none"> <li>M.2 2280 SSD / SATA 6.0Gb/s</li> <li>M.2 2280 SSD / PCIe NVMe, PCIe 3.0 x 4</li> <li>M.2 2242 SSD / PCIe NVMe, PCIe 3.0 x 2</li> <li>Intel Optane™ Memory H10 with Solid State Storage, M.2 2280, PCIe NVMe 3.0 x 4</li> </ul>								Ports	Two USB 3.1 Gen 1 (one Always On), one USB 3.1 Type-C Gen 1 (with the function of Power Delivery and DisplayPort), one USB 3.1 Type-C Gen 2 / Thunderbolt 3 (with the function of PD and DP), HDMI 1.4b, Ethernet (RJ-45), nano-SIM card slot (WWAN models), headphone / microphone combo jack, optional smart card reader, microSD card reader, side docking connector, security keyhole * Depending on many factors, actual data transfer speed may be lower than theoretical speed																																																
Optical	None								Monitor cable (optional)	HDMI to VGA: Lenovo HDMI to VGA Monitor Adapter USB-C to VGA: Lenovo USB-C to VGA Adapter USB-C to HDMI: Lenovo USB-C to HDMI Adapter USB-C to DP: Lenovo USB-C to DisplayPort Adapter																																																
Ethernet	Non-vPro model: Intel Ethernet Connection I219-V (Jacksonville) vPro model: Intel Ethernet Connection I219-LM (Jacksonville)								Bundled Accy	None																																																
WLAN	Intel Wireless-AC 9560, Wi-Fi 2x2 802.11ac + Bluetooth 5.0								Camera (optional)	One of the following, configurable by model: • HD720p camera with ThinkShutter camera privacy, fixed focus • IR camera and HD720p camera with ThinkShutter camera privacy, fixed focus																																																
Bluetooth™	Bluetooth 5.0 wireless, integrated in Wi-Fi + Bluetooth combo adapter								Audio support	HD Audio, Realtek® ALC3287 codec / stereo speakers, 2W x 2, Dolby® Audio™ Premium / dual array far-field microphone, headphone / microphone combo jack																																																
WWAN (optional)	One of the following, configurable by model: • Wireless WAN upgradable • Integrated Mobile Broadband 4G LTE, Fibocom L830-EB, M.2 card (EMEA only) • Integrated Mobile Broadband 4G LTE-A, Fibocom L850-GL, M.2 card * For non-WWAN model, it means the model is NOT WWAN upgradable								Keyboard	6-row, spill-resistant, multimedia Fn keys, LED backlight																																																
SIM card (opt)	Nano-SIM card slot, optional Verizon LTE (US) SIM card								UltraNav™	TrackPoint® pointing device and buttonless Mylar surface multi-touch touchpad																																																
Note: The specifications above may not be available in all regions.									Security	Power-on password, hard disk password, supervisor password, security keyhole																																																
									Security chip	Discrete TPM 2.0, TCG Certified																																																
									System Mgt (opt)	Intel vPro Technology																																																
									Fingerprint reader	Optional: Touch style match on chip fingerprint reader on the palm rest																																																
									NFC (optional)	Near Field Communication																																																
									Battery	Integrated Li-ion 50Wh battery, supports Rapid Charge (charge up to 80% in 1hr)																																																
									Max battery life	MobileMark® 2014: 14.7 hr * Battery life varies significantly with settings, usage, & other factors																																																
									AC adapter	65W or 65W slim USB Type-C AC adapter																																																
									Operating system	Windows® 10 Home 64 or Windows 10 Pro 64																																																
									Limited warranty	One of the following, configurable by model: • 1-year depot repair service • 3-year/1-yr battery depot repair service • 3-year/1-yr battery limited onsite service																																																
									Mil-Spec test	MIL-STD-810G military testing																																																
									Environment	EPEAT™ Silver; ENERGY STAR® 7.1; RoHS-compliant																																																



# ThinkPad P51 Platform Specifications

Product Specifications Reference (PSREF)

Processor	6th or 7th Generation Intel® Core™ i7 Processor or Intel Xeon® Processor E3 v5 or v6 Family							Dimensions	<i>WxDxH:</i> 14.86" x 9.93" x 0.96-1.16"; 377.4mm x 252.3mm x 24.5-29.4mm <i>WxDxH(Touch):</i> 14.86" x 9.93" x 1.02-1.21"; 377.4mm x 252.3mm x 25.8-30.7mm											
	Processor Number	# of Cores	# of Threads	Base Frequency	Max Turbo Frequency	Cache	Memory Types	Processor Graphics	Weight	<table border="1"> <thead> <tr> <th>Models</th> <th>4-cell</th> <th>6-cell</th> </tr> </thead> <tbody> <tr> <td>Non-touch</td> <td>5.6 lb / 2.55kg</td> <td>5.9 lb / 2.67kg</td> </tr> <tr> <td>Multi-touch</td> <td>6.2 lb / 2.82kg</td> <td>6.4 lb / 2.90kg</td> </tr> </tbody> </table>			Models	4-cell	6-cell	Non-touch	5.6 lb / 2.55kg	5.9 lb / 2.67kg	Multi-touch	6.2 lb / 2.82kg
Models	4-cell	6-cell																		
Non-touch	5.6 lb / 2.55kg	5.9 lb / 2.67kg																		
Multi-touch	6.2 lb / 2.82kg	6.4 lb / 2.90kg																		
	i7-6820HQ	4	8	2.7 GHz	3.6 GHz	8MB	DDR4-2133	Intel HD Graphics 530	Case color	Black										
	E3-1505M v5			2.8 GHz	3.7 GHz			Intel HD Graphics P530	Case material	<i>Display cover:</i> Glass-Fiber Reinforced Plastic; <i>Bottom:</i> Magnesium/Aluminum										
	i7-7700HQ			2.8 GHz	3.8 GHz			6MB	DDR4-2400	Intel HD Graphics 630	Smart card reader	<i>Optional:</i> Smart card reader								
	i7-7820HQ			2.9 GHz	3.9 GHz	8MB	Intel HD Graphics P630	ExpressCard		One slot (ExpressCard/34)										
	E3-1505M v6			3.0 GHz	4.0 GHz		Intel HD Graphics P630	Media reader		4-in-1 reader (MMC, SD, SDHC, SDXC), supports UHS-II SD card										
	E3-1535M v6			3.1 GHz	4.2 GHz			Ports		Four USB 3.1 Gen 1 (USB 3.0, one Always On), USB Type-C / Thunderbolt 3, Mini DisplayPort 1.2a, HDMI 1.4b, Ethernet (RJ-45), Dock connector <i>* Depending on many factors, actual data transfer speed may be lower than theoretical speed</i>										
Graphics	Intel HD Graphics 530, 630, P530, or P630 in processor and NVIDIA Quadro® M1200 or M2200, 4GB memory; supports external digital monitor via HDMI, Mini DisplayPort, or Thunderbolt™; supports four independent displays; Max resolution: 3840x2160@60Hz (DisplayPort via Mini DisplayPort cable); 3840x2160@60Hz (Thunderbolt); 4096x2160@24Hz (HDMI)							Camera ( <i>optional</i> )	HD720p resolution, fixed focus											
Chipset	Mobile Intel CM238 Chipset							Audio support	HD Audio, Realtek® ALC3268 codec / stereo speakers, 2W x 2 / dual array microphone, combo audio/microphone jack											
Memory	64GB max / 2400MHz DDR4, ECC or non-ECC (ECC function supported only on Xeon processor), dual-channel capable, four DDR4 SO-DIMM sockets <i>* System clocks down for processors with lower memory controller</i>							Keyboard	6-row, spill-resistant, multimedia Fn keys, numeric keypad, optional LED backlight											
Display	<i>Some:</i> 15.6" (396mm) FHD (1920x1080), anti-glare, LED backlight, IPS, 250 nits, 16:9 aspect ratio, 700:1 contrast ratio, 160° viewing angle <i>Some:</i> 15.6" (396mm) 4K (3840x2160), anti-glare, LED backlight, IPS, 300 nits, 16:9 aspect ratio, 1000:1 contrast ratio, 100% gamut, 170° viewing angle							UltraNav™	3-button TrackPoint® pointing device and 3-button Mylar surface multi-touch touchpad											
Multi-touch ( <i>opt</i> )	Capacitive-type multi-touch, supports 10-finger gesture, 220 nits (FHD only)							Security	Power-on password, hard disk password, supervisor password, security keyhole											
Pen ( <i>optional</i> )	ThinkPad Pen Pro, active pen for multi-touch display							Security chip	Discrete TPM 2.0, TCG Certified											
Storage	<i>Up to 3 drives (two M.2 SSD and one HDD)</i> <i>Some:</i> HDD / SATA 6.0Gb/s, 2.5" wide, 7mm high, Active Protection System™ <i>Some:</i> M.2 SSD / PCIe NVMe, PCIe 3.0 x 4, 32Gb/s							vPro ( <i>optional</i> )	Intel vPro Technology											
RAID ( <i>optional</i> )	RAID 0/1 support							Fingerprint reader	Touch style match on chip fingerprint reader on the palm rest											
Optical	None							Color calibration	<i>Optional:</i> Pantone® color calibrator by X-Rite® color calibration sensor in palm rest											
Ethernet	<i>Non-vPro model:</i> Intel Ethernet Connection I219-V (Jacksonville) <i>vPro model:</i> Intel Ethernet Connection I219-LM (Jacksonville)							NFC	None											
WLAN	<i>One of the following, configurable by model:</i> • Intel Dual Band Wireless-AC 8260, Wi-Fi 2x2 802.11ac + BT4.1, M.2 card • Intel Dual Band Wireless-AC 8265, Wi-Fi 2x2 802.11ac + BT4.1, M.2 card							Battery	Lithium Polymer 4-cell (66Wh) or 6-cell (90Wh)											
Bluetooth™	Bluetooth 4.1 wireless, integrated in Wi-Fi + Bluetooth combo adapter <i>* Intel 8260ac / 8265ac card support BT4.2 but is limited to BT4.1 by Windows OS</i>							Max battery life <sup>10</sup> ( <i>MobileMark® 2014</i> )	<table border="1"> <thead> <tr> <th>Model</th> <th>4-cell</th> <th>6-cell</th> </tr> </thead> <tbody> <tr> <td>Discrete Graphics</td> <td>4.5 hr</td> <td>6.1 hr</td> </tr> <tr> <td>Hybrid Graphics</td> <td>6.5 hr</td> <td>8.9 hr</td> </tr> </tbody> </table>			Model	4-cell	6-cell	Discrete Graphics	4.5 hr	6.1 hr	Hybrid Graphics	6.5 hr	8.9 hr
Model	4-cell	6-cell																		
Discrete Graphics	4.5 hr	6.1 hr																		
Hybrid Graphics	6.5 hr	8.9 hr																		
WWAN ( <i>optional</i> )	<i>One of the following, configurable by model:</i> • Wireless WAN upgradable • Integrated Mobile Broadband 4G LTE-A, Qualcomm® Snapdragon™ X7 LTE-A (Sierra Wireless EM7455), M.2 card							<i>* Battery life varies significantly with settings, usage, &amp; other factors</i>												
SIM card ( <i>opt</i> )	Micro-SIM card slot, opt Verizon LTE (US) or Lenovo® Connect (EMEA) SIM card							AC adapter	170W slim tip AC adapter											
								Operating system	<i>One of the following, configurable by model:</i> • Windows® 7 Professional 64 preinstalled through downgrade rights in Windows 10 Pro 64 • Windows® 10 Home 64 • Windows 10 Pro 64 • Windows 10 Pro 64 for Workstations											
								Limited warranty	<i>One of the following, configurable by model:</i> • 1-year depot repair service • 3-year/1-yr battery depot repair service • 3-year/1-yr battery limited onsite service											
								Mil-Spec test	MIL-STD-810G military testing											
								Environment	EPEAT™ Gold (US only); ENERGY STAR® 6.1; RoHS-compliant											

Note: The specifications above may not be available in all regions.

Lenovo  
September 2018



# ThinkPad P52 Platform Specifications

Product Specifications Reference (PSREF)

Processor	8th Generation Intel® Core™ i7 / i9 Processor or Intel Xeon® E Processor								Dimensions	<i>WxDxH:</i> 14.86" x 9.93" x 0.96-1.16"; 377.4mm x 252.3mm x 24.5-29.4mm <i>WxDxH(Touch):</i> 14.86" x 9.93" x 1.02-1.21"; 377.4mm x 252.3mm x 25.8-30.7mm
	Processor Number	# of Cores	# of Threads	Base Frequency	Max Turbo Frequency	Cache	Memory Types	Processor Graphics	Weight	<i>Non-touch model:</i> starting at 5.4 lb / 2.45kg; <i>Multi-touch model:</i> starting at 6.4 lb / 2.9kg
	i7-8750H	6	12	2.2 GHz	4.1 GHz	9MB	DDR4-2400	Intel UHD Graphics 630	Case color	Black
	i7-8850H			2.6 GHz	4.3 GHz	9MB			Case material	<i>Display cover:</i> Glass-Fiber Reinforced Plastic; <i>Bottom:</i> Magnesium/Aluminum
	i9-8950HK			2.9 GHz	4.8 GHz	12MB		Intel UHD Graphics P630	Smart card reader	<i>Optional:</i> Smart card reader
E-2176M	2.7 GHz			4.4 GHz	12MB			ExpressCard	None	
Graphics	Intel UHD Graphics 630 or P630 in processor and NVIDIA Quadro® P1000 (4GB memory), P2000 (4GB memory), or P3200 (6GB memory, VR ready); supports external digital monitor via HDMI, Mini DisplayPort, or Thunderbolt™; supports four independent displays; Max resolution: 3840X2160@60Hz (DisplayPort via Mini DisplayPort cable); 5120X2880@30Hz (Thunderbolt); 4096x2160@60Hz (HDMI)								Media reader	4-in-1 reader (MMC, SD, SDHC, SDXC), supports UHS-II SD card
Chipset	Mobile Intel CM246 Chipset								Ports	Three USB 3.1 Gen 1 (one Always On), two USB Type-C / Thunderbolt 3 (with the function of Power Delivery and DP), Mini DisplayPort 1.4, HDMI 2.0, Ethernet (RJ-45), nano-SIM card slot (WWAN models), headphone / microphone combo jack, optional smart card reader, 4-in-1 reader (MMC, SD, SDHC, SDXC), security keyhole <i>* Power Delivery only supports power-out for charging peripherals</i> <i>* Depending on many factors, actual data transfer speed may be lower than theoretical speed</i>
Memory	128GB non-ECC or 64GB ECC max / 2400MHz DDR4 (ECC function supported only on Xeon processor), dual-channel capable, four DDR4 SO-DIMM sockets <i>* Installed DIMMs are actually 2666MHz but run at 2400MHz due to Intel limitation</i> <i>* 128GB non-ECC memory for special bid only</i>								Camera (optional)	<i>One of the following, configurable by model:</i> • HD720p camera with ThinkShutter camera privacy, fixed focus • IR camera and HD720p camera, fixed focus
Display	<i>Some:</i> 15.6" (396mm) FHD (1920x1080), anti-glare, LED backlight, IPS, 300 nits, 16:9 aspect ratio, 700:1 contrast ratio, 72% gamut, 160° viewing angle <i>Some:</i> 15.6" (396mm) 4K (3840x2160), anti-glare, LED backlight, IPS, 400 nits, 16:9 aspect ratio, 1000:1 contrast ratio, 100% gamut, 170° viewing angle, multi-touch								Audio support	HD Audio, Realtek® ALC3286 codec / stereo speakers, 2W x 2, Dolby® Audio™ Premium / dual array microphone, headphone / microphone combo jack, Dolby Atmos® headphone
Multi-touch (opt)	Capacitive-type multi-touch, supports 10-finger gesture (4K only)								Keyboard	6-row, spill-resistant, multimedia Fn keys, numeric keypad, LED backlight
Pen	Supports pen accessory, please see the accessory compatibility for details								UltraNav™	3-button TrackPoint® pointing device and 3-button Mylar surface multi-touch touchpad
Storage	<i>Up to 3 drives (two M.2 SSD and one HDD)</i> <i>Some:</i> HDD / SATA 6.0Gb/s, 2.5" wide, 7mm high, Active Protection System™ <i>Some:</i> M.2 SSD / PCIe NVMe, PCIe 3.0 x 4, 32Gb/s								Security	Power-on password, hard disk password, supervisor password, security keyhole
Optane™ memory	<i>Optional:</i> Intel Optane memory, PCIe NVMe, PCIe 3.0 x 2								Security chip	Discrete TPM 2.0, TCG Certified
RAID (optional)	RAID 0/1 support								vPro (optional)	Intel vPro Technology
Optical	None								Fingerprint reader	Touch style match on chip fingerprint reader on the palm rest
Ethernet	<i>Non-vPro model:</i> Intel Ethernet Connection I219-V (Jacksonville) <i>vPro model:</i> Intel Ethernet Connection I219-LM (Jacksonville)								Color calibration	None
WLAN	Intel Wireless-AC 9560, Wi-Fi 2x2 802.11ac + Bluetooth 5.0, M.2 card								NFC (optional)	Near Field Communication
Bluetooth™	Bluetooth 5.0 wireless, integrated in Wi-Fi + Bluetooth combo adapter								Battery	Swappable Li-ion 90Wh battery
WWAN (optional)	Integrated Mobile Broadband 4G LTE-A, Intel XMM™ 7360 (Fibocom L850-GL), M.2 card								Max battery life	<i>Discrete mode:</i> 6.1 hr; <i>Hybrid mode:</i> 8.9 hr <i>(MobileMark® 2014)</i> <i>* Battery life varies significantly with settings, usage, &amp; other factors</i>
SIM card (opt)	Nano-SIM card slot, optional Verizon LTE (US) SIM card								AC adapter	170W slim tip AC adapter
									Operating system	<i>One of the following, configurable by model:</i> • Windows® 10 Home 64 • Windows 10 Pro 64 • Windows 10 Pro 64 for Workstations
									Limited warranty	<i>One of the following, configurable by model:</i> • 1-year depot repair service • 3-year/1-yr battery depot repair service • 3-year/1-yr battery limited onsite service
									Mil-Spec test	MIL-STD-810G military testing
									Environment	EPEAT™ Silver; ENERGY STAR® 6.1; RoHS-compliant

Note: The specifications above may not be available in all regions.

Lenovo  
August 2019



# ThinkPad P52s Platform Specifications

Product Specifications Reference (PSREF)

Processor	8th Generation Intel® Core™ i5 / i7 Processor								Dimensions	<i>WxDxH:</i> 14.40" x 9.95" x 0.79-0.80"; 365.8mm x 252.8mm x 19.95-20.2mm																	
	Processor Number	# of Cores	# of Threads	Base Frequency	Max Turbo Frequency	Cache	Memory Types	Processor Graphics	Weight	starting at 4.39 lb / 1.99 kg																	
	i5-8350U	4	8	1.7 GHz	3.6 GHz	6MB	DDR4-2400	Intel UHD Graphics 620	Case color	Black																	
	i7-8550U			1.8 GHz	4.0 GHz	8MB			Case material	<i>Display cover:</i> Glass-Fiber Reinforced Plastic (PPS); <i>Bottom:</i> Glass-Fiber Reinforced Plastic																	
i7-8650U	1.9 GHz			4.2 GHz	8MB																						
Graphics	Intel UHD Graphics 620 in processor and NVIDIA Quadro® P500, 2GB GDDR5 memory; supports external digital monitor via HDMI or USB Type-C; supports three independent displays; Max resolution: 4096x2304@60Hz (USB Type-C); 4096x2160@30Hz (HDMI)								Smart card reader	<i>Optional:</i> Smart card reader																	
Chipset	Intel SoC (System on Chip) platform								Media reader	4-in-1 reader (MMC, SD, SDHC, SDXC)																	
Memory	32GB max / 2400MHz DDR4, dual-channel capable, two DDR4 SO-DIMM sockets <i>* System clocks down for processors with lower memory controller</i>								Ports	Two USB 3.1 Gen 1 (one Always On), one USB 3.1 Type-C Gen 1 (with the function of Power Delivery and DisplayPort), one USB 3.1 Type-C Gen 2 / Thunderbolt 3 (with the function of PD and DP), HDMI 1.4b, Ethernet (RJ-45), nano-SIM card slot (WWAN models), headphone / microphone combo jack, optional smart card reader, 4-in-1 reader (MMC, SD, SDHC, SDXC), side docking connector, security keyhole <i>* Depending on many factors, actual data transfer speed may be lower than theoretical speed</i>																	
Display	<i>Some:</i> 15.6" (396mm) FHD (1920x1080), anti-glare, LED backlight, IPS, 250 nits, 16:9 aspect ratio, 700:1 contrast ratio, 170° viewing angle <i>Some:</i> 15.6" (396mm) UHD (3840x2160), anti-glare, LED backlight, IPS, 300 nits, 16:9 aspect ratio, 1000:1 contrast ratio, 72% gamut, 170° viewing angle								Monitor cable (optional)	<i>HDMI to VGA:</i> Lenovo HDMI to VGA Monitor Adapter <i>USB-C to DP:</i> Lenovo USB-C to DisplayPort Adapter																	
Multi-touch (opt)	On-cell touch, supports 10-finger gesture (FHD only)								Camera (optional)	<i>One of the following, configurable by model:</i> • HD720p camera with ThinkShutter camera privacy, fixed focus • IR camera and HD720p camera, fixed focus																	
Pen	None								Audio support	HD Audio, Realtek® ALC3287 codec / stereo speakers, 2W x 2, Dolby® Audio™ Premium / dual array microphone, headphone / microphone combo jack																	
Storage	<i>System has one HDD slot or one M.2 2280 slot exclusively for storage</i> <i>Some:</i> HDD / SATA 6.0Gb/s, 2.5" wide, 7mm high, Active Protection System™ <i>Some:</i> SSD / SATA 6.0Gb/s, 2.5" wide, 7mm high (e.g. xxxGB SSD) <i>Some:</i> M.2 SSD / PCIe NVMe, PCIe 3.0 x 2, 16Gb/s <i>Some:</i> 128GB M.2 SSD / PCIe NVMe, PCIe 3.0 x 2, 16Gb/s, in WWAN slot as 2nd Storage, mutually exclusive with WWAN								Keyboard	6-row, spill-resistant, multimedia Fn keys, numeric keypad, optional LED backlight UltraNav™ TrackPoint® pointing device and buttonless Mylar surface multi-touch touchpad																	
Optane™ memory	<i>Optional:</i> Intel Optane memory, PCIe NVMe, PCIe 3.0 x 2								Security	Power-on password, hard disk password, supervisor password, security keyhole																	
Optical	None								Security chip	Discrete TPM 2.0, TCG Certified																	
Ethernet	<i>Non-vPro model:</i> Intel Ethernet Connection I219-V (Jacksonville) <i>vPro model:</i> Intel Ethernet Connection I219-LM (Jacksonville)								vPro (optional)	Intel vPro Technology																	
WLAN + Bluetooth™	Intel Dual Band Wireless-AC 8265, Wi-Fi 2x2 802.11ac + Bluetooth 4.1, M.2 card <i>* Intel 8265ac card supports BT4.2 but is limited to BT4.1 by Windows OS</i>								Fingerprint reader	<i>Optional:</i> Touch style match on chip fingerprint reader on the palm rest anti-spoofing technology																	
WWAN (optional)	<i>One of the following, configurable by model:</i> • Wireless WAN upgradable • Integrated Mobile Broadband 4G LTE, Intel XMM™ 7262 (Fibocom L830-EB), M.2 card (EMEA only) • Integrated Mobile Broadband 4G LTE-A, Intel XMM™ 7360 (Fibocom L850-GL), M.2 card <i>* For non-WWAN model, it means the model is NOT WWAN upgradable</i>								NFC (optional)	Near Field Communication																	
SIM card (opt)	Nano-SIM card slot, optional Verizon LTE (US) SIM card								Battery	Optional integrated Li-ion 32Wh battery and swappable Li-ion 24Wh, 48Wh, or 72Wh battery																	
									Max battery life (MobileMark® 2014)	<table border="1"> <thead> <tr> <th>Models</th> <th>48Wh</th> <th>72Wh</th> <th>32Wh + 24Wh</th> <th>32Wh + 48Wh</th> <th>32Wh + 72Wh</th> </tr> </thead> <tbody> <tr> <td><i>Max battery life</i></td> <td>12.2 hr</td> <td>18.5 hr</td> <td>13.5 hr</td> <td>20.1 hr</td> <td>26.3 hr</td> </tr> </tbody> </table>						Models	48Wh	72Wh	32Wh + 24Wh	32Wh + 48Wh	32Wh + 72Wh	<i>Max battery life</i>	12.2 hr	18.5 hr	13.5 hr	20.1 hr	26.3 hr
Models	48Wh	72Wh	32Wh + 24Wh	32Wh + 48Wh	32Wh + 72Wh																						
<i>Max battery life</i>	12.2 hr	18.5 hr	13.5 hr	20.1 hr	26.3 hr																						
									AC adapter	65W USB Type-C AC adapter																	
									Operating system	Windows® 10 Home 64 or Windows 10 Pro 64																	
									Limited warranty	<i>One of the following, configurable by model:</i> • 1-year depot repair service • 1-year depot with 2-year planar repair service • 3-year/1-yr battery depot repair service • 3-year/1-yr battery limited onsite service • 3-year (including battery) limited onsite service																	
									Mil-Spec test	MIL-STD-810G military testing																	
									Environment	EPEAT™ Silver; ENERGY STAR® 6.1; RoHS-compliant																	

Note: The specifications above may not be available in all regions.

Lenovo  
August 2019





# ThinkPad P53 Platform Specifications

Product Specifications Reference (PSREF)

Processor	<p>9th Generation Intel® Core™ i5 / i7 / i9 Processor or Intel Xeon® E Processor</p> <table border="1"> <thead> <tr> <th>Processor Number</th> <th># of Cores</th> <th># of Threads</th> <th>Base Frequency</th> <th>Max Turbo Frequency</th> <th>Cache</th> <th>Memory Types</th> <th>Processor Graphics</th> </tr> </thead> <tbody> <tr> <td>i5-9400H</td> <td>4</td> <td>8</td> <td>2.5 GHz</td> <td>4.3 GHz</td> <td>8MB</td> <td rowspan="4">DDR4-2666</td> <td rowspan="4">Intel UHD Graphics 630</td> </tr> <tr> <td>i7-9750H</td> <td>6</td> <td>12</td> <td>2.6 GHz</td> <td>4.5 GHz</td> <td>12MB</td> </tr> <tr> <td>i7-9850H</td> <td>6</td> <td>12</td> <td>2.6 GHz</td> <td>4.6 GHz</td> <td>12MB</td> </tr> <tr> <td>i9-9880H</td> <td>8</td> <td>16</td> <td>2.3 GHz</td> <td>4.8 GHz</td> <td>16MB</td> </tr> <tr> <td>E-2276M</td> <td>6</td> <td>12</td> <td>2.8 GHz</td> <td>4.7 GHz</td> <td>12MB</td> <td></td> <td>Intel UHD Graphics P630</td> </tr> </tbody> </table>	Processor Number	# of Cores	# of Threads	Base Frequency	Max Turbo Frequency	Cache	Memory Types	Processor Graphics	i5-9400H	4	8	2.5 GHz	4.3 GHz	8MB	DDR4-2666	Intel UHD Graphics 630	i7-9750H	6	12	2.6 GHz	4.5 GHz	12MB	i7-9850H	6	12	2.6 GHz	4.6 GHz	12MB	i9-9880H	8	16	2.3 GHz	4.8 GHz	16MB	E-2276M	6	12	2.8 GHz	4.7 GHz	12MB		Intel UHD Graphics P630	Dimensions	<p><i>WxDxH (non-touch):</i> 14.86" x 9.93" x 0.96-1.16"; 377.4mm x 252.3mm x 24.5-29.4mm</p> <p><i>WxDxH (multi-touch):</i> 14.86" x 9.93" x 1.02-1.21"; 377.4mm x 252.3mm x 25.8-30.7mm</p>			
Processor Number	# of Cores	# of Threads	Base Frequency	Max Turbo Frequency	Cache	Memory Types	Processor Graphics																																									
i5-9400H	4	8	2.5 GHz	4.3 GHz	8MB	DDR4-2666	Intel UHD Graphics 630																																									
i7-9750H	6	12	2.6 GHz	4.5 GHz	12MB																																											
i7-9850H	6	12	2.6 GHz	4.6 GHz	12MB																																											
i9-9880H	8	16	2.3 GHz	4.8 GHz	16MB																																											
E-2276M	6	12	2.8 GHz	4.7 GHz	12MB		Intel UHD Graphics P630																																									
Graphics	<p>Intel UHD Graphics 630 or P630 in processor and NVIDIA® Quadro® T1000 (4GB GDDR5), T2000 (4GB GDDR5), RTX 3000 (6GB GDDR6, VR ready), RTX 4000 (8GB GDDR6, VR ready), or RTX 5000 (16GB GDDR6, VR ready); supports external digital monitor via HDMI, Mini DisplayPort, or Thunderbolt™; supports five independent displays; Max resolution: 5K@60Hz (Thunderbolt); 4K@60Hz (USB-C or HDMI)</p>	Weight	<p><i>Non-touch model:</i> starting at 5.51 lb / 2.5 kg; <i>Multi-touch model:</i> starting at 6.4 lb / 2.9 kg</p>																																													
Chipset Memory	<p>Mobile Intel CM246 Chipset 128GB max / 2666MHz DDR4 (ECC function supported only on Xeon processor), dual-channel capable, four DDR4 SO-DIMM sockets</p>	Case color	<p>Black</p>																																													
Display	<table border="1"> <thead> <tr> <th>Size</th> <th>Resolution</th> <th>Type</th> <th>Surface</th> <th>Brightness</th> <th>Aspect Ratio</th> <th>Contrast Ratio</th> <th>Color Gamut</th> <th>Viewing Angle</th> </tr> </thead> <tbody> <tr> <td>15.6"</td> <td>FHD (1920x1080)</td> <td>IPS</td> <td>Anti-glare</td> <td>300 nits</td> <td>16:9</td> <td>700:1</td> <td>72%</td> <td>160°</td> </tr> <tr> <td>15.6"</td> <td>FHD (1920x1080) Dolby Vision™ HDR</td> <td>IPS</td> <td>Anti-glare</td> <td>500 nits</td> <td>16:9</td> <td>1200:1</td> <td>72%</td> <td>160°</td> </tr> <tr> <td>15.6"</td> <td>UHD (3840x2160) Dolby Vision HDR</td> <td>IPS</td> <td>Anti-glare</td> <td>500 nits</td> <td>16:9</td> <td>1200:1</td> <td>100%</td> <td>170°</td> </tr> <tr> <td>15.6"</td> <td>UHD (3840x2160) Dolby Vision HDR, Multi-touch</td> <td>OLED</td> <td>AR, AS</td> <td>SDR 400nit, HDR 500nit (peak)</td> <td>16:9</td> <td>100000:1</td> <td>100% DCI-P3</td> <td>170°</td> </tr> </tbody> </table>	Size	Resolution	Type	Surface	Brightness	Aspect Ratio	Contrast Ratio	Color Gamut	Viewing Angle	15.6"	FHD (1920x1080)	IPS	Anti-glare	300 nits	16:9	700:1	72%	160°	15.6"	FHD (1920x1080) Dolby Vision™ HDR	IPS	Anti-glare	500 nits	16:9	1200:1	72%	160°	15.6"	UHD (3840x2160) Dolby Vision HDR	IPS	Anti-glare	500 nits	16:9	1200:1	100%	170°	15.6"	UHD (3840x2160) Dolby Vision HDR, Multi-touch	OLED	AR, AS	SDR 400nit, HDR 500nit (peak)	16:9	100000:1	100% DCI-P3	170°	Case material	<p><i>Display cover:</i> Glass-Fiber Reinforced Plastic; <i>Bottom:</i> Magnesium/Aluminum</p>
Size	Resolution	Type	Surface	Brightness	Aspect Ratio	Contrast Ratio	Color Gamut	Viewing Angle																																								
15.6"	FHD (1920x1080)	IPS	Anti-glare	300 nits	16:9	700:1	72%	160°																																								
15.6"	FHD (1920x1080) Dolby Vision™ HDR	IPS	Anti-glare	500 nits	16:9	1200:1	72%	160°																																								
15.6"	UHD (3840x2160) Dolby Vision HDR	IPS	Anti-glare	500 nits	16:9	1200:1	100%	170°																																								
15.6"	UHD (3840x2160) Dolby Vision HDR, Multi-touch	OLED	AR, AS	SDR 400nit, HDR 500nit (peak)	16:9	100000:1	100% DCI-P3	170°																																								
Multi-touch (opt) Pen	<p>Capacitive-type multi-touch, supports 10-finger gesture (UHD only), anti-reflection (AR), anti-smudge (AS) coating Supports pen accessory, please see the accessory compatibility for details</p>	Smart card reader	<p><i>Optional:</i> Smart card reader</p>																																													
Storage	<p><i>Up to 3 drives</i></p> <ul style="list-style-type: none"> <li>HDD / SATA 6.0Gb/s, 2.5" wide, 7mm high, Active Protection System™</li> <li>M.2 2280 SSD / PCIe NVMe, PCIe 3.0 x 4</li> </ul>	ExpressCard	<p>None</p>																																													
Optane™ memory RAID (optional) Optical	<p><i>Optional:</i> Intel Optane memory, PCIe NVMe, PCIe 3.0 x 2 RAID 0/1/5 support None</p>	Media reader	<p>4-in-1 reader (MMC, SD, SDHC, SDXC), supports UHS-II SD card</p>																																													
Ethernet	<p><i>Non-vPro model:</i> Intel Ethernet Connection I219-V (Jacksonville) <i>vPro model:</i> Intel Ethernet Connection I219-LM (Jacksonville)</p>	Ports	<p>Two USB 3.1 Gen 1 (one Always On), one USB 3.1 Type-C Gen 1 (with the function of Power Delivery and DisplayPort), two USB 3.1 Type-C Gen 2 / Thunderbolt 3 (with the function of PD and DP), HDMI 2.0, Ethernet (RJ-45), nano-SIM card slot (WWAN models), headphone / microphone combo jack, optional smart card reader, 4-in-1 reader (MMC, SD, SDHC, SDXC), security keyhole <i>* Power Delivery only supports power-out for charging peripherals</i> <i>* USB-C Dock is not supported in right-side USB-C port</i> <i>* Depending on many factors, actual data transfer speed may be lower than theoretical speed</i></p>																																													
WLAN (optional) Bluetooth™ (opt)	<p>Intel Wi-Fi 6 AX200, Wi-Fi 2x2 802.11ax + Bluetooth 5.0 Bluetooth 5.0 wireless, integrated in Wi-Fi + Bluetooth combo adapter</p>	Monitor cable (optional)	<p><i>HDMI to VGA:</i> Lenovo HDMI to VGA Monitor Adapter <i>USB-C to VGA:</i> Lenovo USB-C to VGA Adapter <i>USB-C to DP:</i> Lenovo USB-C to DisplayPort Adapter</p>																																													
WWAN (optional)	<p><i>One of the following, configurable by model:</i></p> <ul style="list-style-type: none"> <li>Wireless WAN upgradable</li> <li>Integrated Mobile Broadband 4G LTE-A, Fibocom L850-GL, M.2 card <i>* For non-WWAN model, it means the model is NOT WWAN upgradable</i></li> </ul>	Bundled Accy	<p>None</p>																																													
SIM card (opt)	<p>Nano-SIM card slot, optional Verizon LTE (US) SIM card</p>	Camera (optional)	<p><i>One of the following, configurable by model:</i></p> <ul style="list-style-type: none"> <li>HD720p camera with ThinkShutter camera privacy, fixed focus</li> <li>IR camera and HD720p camera with ThinkShutter camera privacy, fixed focus</li> </ul>																																													
		Audio support	<p>HD Audio, Synaptic® CX11880 codec / stereo speakers, 2W x 2 / dual array far-field microphone, headphone / microphone combo jack, Dolby Atmos® sound system</p>																																													
		Keyboard UltraNav™	<p>6-row, spill-resistant, multimedia Fn keys, numeric keypad, LED backlight 3-button TrackPoint® pointing device and 3-button Mylar surface multi-touch touchpad</p>																																													
		Security Security chip vPro (optional) Fingerprint reader	<p>Power-on password, hard disk password, supervisor password, security keyhole Discrete TPM 2.0, TCG Certified Intel vPro Technology Touch style match on chip fingerprint reader on the palm rest</p>																																													
		Color calibration NFC (optional)	<p><i>Optional:</i> X-Rite Pantone factory color calibration (UHD model only) Near Field Communication</p>																																													

Note: The specifications above may not be available in all regions.



# ThinkPad P53s Platform Specifications

Product Specifications Reference (PSREF)

Processor	8th Generation Intel® Core™ i7 Processor									Dimensions Weight Case color Case material	<i>WxDxH:</i> 14.40" x 9.76" x 0.75"; 365.8mm x 248mm x 19.1mm starting at 3.87 lb / 1.75 kg Black <i>Display cover:</i> PPS / 50% GF; <i>Bottom:</i> PA / 50% GF
	Processor Number	# of Cores	# of Threads	Base Frequency	Max Turbo Frequency	Cache	Memory Types	Processor Graphics			
	i7-8565U	4	8	1.8 GHz	4.6 GHz	8MB	DDR4-2400	Intel UHD Graphics 620		Smart card reader Media reader Ports	Optional: Smart card reader MicroSD card reader Two USB 3.1 Gen 1 (one Always On), one USB 3.1 Type-C Gen 1 (with the function of Power Delivery and DisplayPort), one USB 3.1 Type-C Gen 2 / Thunderbolt 3 (with the function of PD and DP), HDMI 1.4b, Ethernet (RJ-45), nano-SIM card slot (WWAN models), headphone / microphone combo jack, optional smart card reader, microSD card reader, side docking connector, security keyhole <i>* Depending on many factors, actual data transfer speed may be lower than theoretical speed</i>
	i7-8665U			1.9 GHz	4.8 GHz	8MB					
Graphics	Intel UHD Graphics 620 in processor and NVIDIA Quadro® P520, 2GB GDDR5 memory; supports external digital monitor via HDMI or USB Type-C; supports three independent displays; Max resolution: 3840x2160@60Hz (USB-C); 3840x2160@30Hz (HDMI)									Monitor cable (optional)	* Depending on many factors, actual data transfer speed may be lower than theoretical speed <i>HDMI to VGA:</i> Lenovo HDMI to VGA Monitor Adapter <i>USB-C to VGA:</i> Lenovo USB-C to VGA Adapter <i>USB-C to DP:</i> Lenovo USB-C to DisplayPort Adapter
Chipset	Intel SoC (System on Chip) platform 48GB max / 2400MHz DDR4, dual-channel capable, 8GB or 16GB memory soldered to systemboard, one DDR4 SO-DIMM socket * Installed memory is actually 2666MHz but run at 2400MHz due to Intel limitation										
Memory										Bundled Accy	None
Display	Size	Resolution	Type	Surface	Brightness	Aspect Ratio	Contrast Ratio	Color Gamut	Viewing Angle		
	15.6"	FHD (1920x1080)	IPS	Anti-glare	250 nits	16:9	700:1	45%	170°	Camera (optional)	One of the following, configurable by model: • HD720p camera with ThinkShutter camera privacy, fixed focus • IR camera and HD720p camera with ThinkShutter camera privacy, fixed focus HD Audio, Realtek® ALC3287 codec / stereo speakers, 2W x 2, Dolby® Audio™ Premium / dual array far-field microphone, headphone / microphone combo jack
	15.6"	UHD (3840x2160) Dolby Vision™ HDR	IPS	Anti-glare	500 nits	16:9	1200:1	100% Adobe	170°		
Multi-touch (opt)	On-cell touch, supports 10-finger gesture (FHD only)									Keyboard	6-row, spill-resistant, multimedia Fn keys, numeric keypad, optional LED backlight
Pen	None										
Storage	<ul style="list-style-type: none"> <li>M.2 2280 SSD / SATA 6.0Gb/s</li> <li>M.2 2280 SSD / PCIe NVMe, PCIe 3.0 x 4</li> <li>M.2 2242 SSD / PCIe NVMe, PCIe 3.0 x 2</li> <li>Intel Optane™ Memory H10 with Solid State Storage, M.2 2280, PCIe NVMe 3.0 x 4</li> </ul>									UltraNav™	TrackPoint® pointing device and buttonless Mylar surface multi-touch touchpad
Optical	None										
Ethernet	<i>Non-vPro model:</i> Intel Ethernet Connection I219-V (Jacksonville) <i>vPro model:</i> Intel Ethernet Connection I219-LM (Jacksonville)									Security	Power-on password, hard disk password, supervisor password, security keyhole
WLAN	Intel Wireless-AC 9560, Wi-Fi 2x2 802.11ac + Bluetooth 5.0										
Bluetooth™	Bluetooth 5.0 wireless, integrated in Wi-Fi + Bluetooth combo adapter									Security chip	Discrete TPM 2.0, TCG Certified
WWAN (optional)	One of the following, configurable by model: • Wireless WAN upgradable • Integrated Mobile Broadband 4G LTE, Fibocom L830-EB, M.2 card (EMEA only) • Integrated Mobile Broadband 4G LTE-A, Fibocom L850-GL, M.2 card * For non-WWAN model, it means the model is NOT WWAN upgradable										
SIM card (opt)	Nano-SIM card slot, optional Verizon LTE (US) SIM card									System Mgt (opt)	Intel vPro Technology
										Fingerprint reader	Optional: Touch style match on chip fingerprint reader on the palm rest
										NFC (optional)	Near Field Communication
										Battery	Integrated Li-ion 57Wh battery, supports Rapid Charge (charge up to 80% in 1hr)
										Max battery life	MobileMark® 2014: 15 hr (FHD model) / 10 hr (UHD model) * Battery life varies significantly with settings, usage, & other factors
										AC adapter	65W USB Type-C AC adapter
										Operating system	Windows® 10 Home 64 or Windows 10 Pro 64
										Limited warranty	One of the following, configurable by model: • 1-year depot repair service • 3-year/1-yr battery depot repair service • 3-year/1-yr battery limited onsite service
										MIL-Spec test	MIL-STD-810G military testing
										Environment	EPEAT™ Silver; ENERGY STAR® 7.1; RoHS-compliant

Note: The specifications above may not be available in all regions.

Lenovo  
August 2019

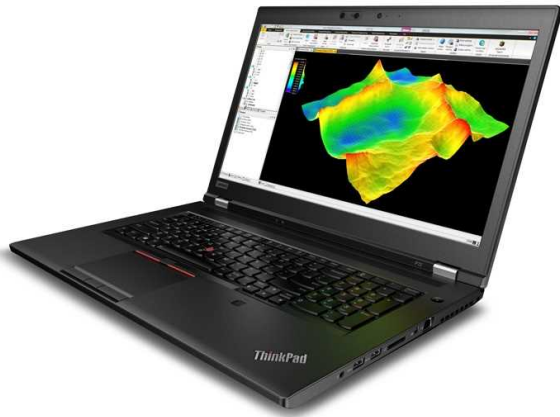

# ThinkPad P72 Platform Specifications

Product Specifications Reference (PSREF)

Processor	8th Generation Intel® Core™ i7 Processor or Intel Xeon® E Processor								Dimensions	<i>WxDxH:</i> 16.38" x 11.06" x 0.96-1.16"; 416mm x 281mm x 24.5-29.4mm
	Processor Number	# of Cores	# of Threads	Base Frequency	Max Turbo Frequency	Cache	Memory Types	Processor Graphics	Weight	Starting at 7.5 lb / 3.4kg
	i7-8750H	6	12	2.2 GHz	4.1 GHz	9MB	DDR4-2400	Intel UHD Graphics 630	Case color	Black
	i7-8850H			2.6 GHz	4.3 GHz	9MB		Intel UHD Graphics P630	Case material	<i>Display cover:</i> GFRP + PPS; <i>Bottom:</i> Magnesium/Aluminum
	E-2176M			2.7 GHz	4.4 GHz	12MB		Intel UHD Graphics P630	Smart card reader	<i>Optional:</i> Smart card reader
E-2186M	2.9 GHz			4.8 GHz	12MB	ExpressCard		None		
Graphics	Intel UHD Graphics 630 or P630 in processor and NVIDIA Quadro® P600 (4GB memory), P2000 (4GB memory), P3200 (6GB memory), P4200 (8GB memory), or P5200 (16GB memory); supports external digital monitor via HDMI, Mini DisplayPort, or Thunderbolt™; supports four independent displays; Max resolution: 3840X2160@60Hz (DisplayPort via Mini DisplayPort cable); 5120X2880@30Hz (Thunderbolt); 4096x2160@60Hz (HDMI)								Media reader	4-in-1 reader (MMC, SD, SDHC, SDXC), supports UHS-II SD card
Chipset	Mobile Intel CM246 Chipset								Ports	Four USB 3.1 Gen 1 (one Always On), two USB Type-C / Thunderbolt 3 (with the function of Power Delivery and DP), Mini DisplayPort 1.4, HDMI 2.0, Ethernet (RJ-45), headphone / microphone combo jack, optional smart card reader, 4-in-1 reader (MMC, SD, SDHC, SDXC), security keyhole <i>* Power Delivery only supports power-out for charging peripherals</i> <i>* Depending on many factors, actual data transfer speed may be lower than theoretical speed</i>
Memory	128GB non-ECC or 64GB ECC max / 2400MHz DDR4 (ECC function supported only on Xeon processor), dual-channel capable, four DDR4 SO-DIMM sockets <i>* Installed DIMMs are actually 2666MHz but run at 2400MHz due to Intel limitation</i>								Monitor cable	<i>Optional:</i> Lenovo Mini-DisplayPort to DisplayPort Monitor Cable
Display	<i>Some:</i> 17.3" (439mm) FHD (1920x1080), anti-glare, LED backlight, IPS, 300 nits, 16:9 aspect ratio, 800:1 contrast ratio, 72% gamut, 170° viewing angle <i>Some:</i> 17.3" (439mm) 4K (3840x2160), anti-glare, LED backlight, IPS, 400 nits, 16:9 aspect ratio, 1000:1 contrast ratio, 100% Adobe CG, 170° viewing angle								Camera ( <i>optional</i> )	IR camera and HD720p camera, fixed focus
Multi-touch Pen	None Supports pen accessory, please see the accessory compatibility for details								Audio support	HD Audio, Realtek® ALC3286 codec / stereo speakers, 2W x 2, Dolby® Audio™ Premium / dual array microphone, headphone / microphone combo jack, Dolby Atmos® headphone
Storage	<i>Up to 3 drives (two M.2 SSD and one HDD)</i> <i>Some:</i> HDD / SATA 6.0Gb/s, 2.5" wide, 7mm high, Active Protection System™ <i>Some:</i> M.2 SSD / PCIe NVMe, PCIe 3.0 x 4, 32Gb/s								Keyboard	6-row, spill-resistant, multimedia Fn keys, numeric keypad, LED backlight
Optane™ memory	<i>Optional:</i> Intel Optane memory, PCIe NVMe, PCIe 3.0 x 2								UltraNav™	3-button TrackPoint® pointing device and 3-button Mylar surface multi-touch touchpad
RAID ( <i>optional</i> )	RAID 0/1 support								Security	Power-on password, hard disk password, supervisor password, security keyhole
Optical	None								Security chip	Discrete TPM 2.0, TCG Certified
Ethernet	<i>Non-vPro model:</i> Intel Ethernet Connection I219-V (Jacksonville) <i>vPro model:</i> Intel Ethernet Connection I219-LM (Jacksonville)								vPro ( <i>optional</i> )	Intel vPro Technology
WLAN	Intel Wireless-AC 9560, Wi-Fi 2x2 802.11ac + Bluetooth 5.0, M.2 card								Fingerprint reader	Touch style match on chip fingerprint reader on the palm rest
Bluetooth™	Bluetooth 5.0 wireless, integrated in Wi-Fi + Bluetooth combo adapter								Color calibration	None
WWAN	None								NFC ( <i>optional</i> )	Near Field Communication
SIM card	None								Battery	Li-ion 99Wh battery, supports Rapid Charge (charge up to 80% in 1hr)
									Max battery life	<i>MobileMark® 2014:</i> 16 hr <i>* Battery life varies significantly with settings, usage, &amp; other factors</i>
									AC adapter	230W slim tip AC adapter
									Operating system	<i>One of the following, configurable by model:</i> • Windows® 10 Home 64 • Windows 10 Pro 64 • Windows 10 Pro 64 for Workstations
									Limited warranty	<i>One of the following, configurable by model:</i> • 1-year depot repair service • 3-year/1-yr battery depot repair service • 3-year/1-yr battery limited onsite service
									Mil-Spec test	MIL-STD-810G military testing
									Environment	EPPEAT™ Gold (US only); ENERGY STAR® 7.0; RoHS-compliant

Note: The specifications above may not be available in all regions.

Lenovo  
May 2019



# ThinkPad P73 Platform Specifications

Product Specifications Reference (PSREF)

Processor	9th Generation Intel® Core™ i5 / i7 / i9 Processor or Intel Xeon® E Processor									Dimensions <i>WxDxH:</i> 16.38" x 11.06" x 1.02-1.22"; 416mm x 281mm x 25.9-31mm Weight Starting at 7.5 lb (3.4kg) Case color Black Case material <i>Display cover:</i> GFRP + PPS; <i>Bottom:</i> Magnesium/Aluminum
	Processor Number	# of Cores	# of Threads	Base Frequency	Max Turbo Frequency	Cache	Memory Types	Processor Graphics		
	i5-9400H	4	8	2.5 GHz	4.3 GHz	8MB	DDR4-2666	Intel UHD Graphics 630		
	i7-9750H	6	12	2.6 GHz	4.5 GHz	12MB		Intel UHD Graphics 630		
	i7-9850H	6	12	2.6 GHz	4.6 GHz	12MB		Intel UHD Graphics 630		
i9-9880H	8	16	2.3 GHz	4.8 GHz	16MB	Intel UHD Graphics 630				
E-2276M	6	12	2.8 GHz	4.7 GHz	12MB	Intel UHD Graphics P630				
Graphics	Intel UHD Graphics 630 or P630 in processor and NVIDIA Quadro® P620 (4GB GDDR5), T2000 (4GB GDDR5), RTX 3000 (6GB GDDR6, VR ready), RTX 4000 Max-Q (8GB GDDR6, VR ready), or RTX 5000 Max-Q (16GB GDDR6, VR ready); supports external digital monitor via HDMI or Thunderbolt™; supports five independent displays; Max resolution: 5K@60Hz (Thunderbolt); 4K@60Hz (USB-C or HDMI)									Smart card reader <i>Optional:</i> Smart card reader ExpressCard None Media reader 4-in-1 reader (MMC, SD, SDHC, SDXC), supports UHS-II SD card Ports Three USB 3.1 Gen 1 (one Always On), one USB 3.1 Type-C Gen 1 (with the function of Power Delivery and DisplayPort), two USB 3.1 Type-C Gen 2 / Thunderbolt 3 (with the function of PD and DP), HDMI 2.0, Ethernet (RJ-45), headphone / microphone combo jack, optional smart card reader, 4-in-1 reader (MMC, SD, SDHC, SDXC), security keyhole <i>* Power Delivery only supports power-out for charging peripherals</i> <i>* Depending on many factors, actual data transfer speed may be lower than theoretical speed</i> Monitor cable <i>(optional)</i> <i>HDMI to VGA:</i> Lenovo HDMI to VGA Monitor Adapter <i>USB-C to VGA:</i> Lenovo USB-C to VGA Adapter <i>USB-C to DP:</i> Lenovo USB-C to DisplayPort Adapter Bundled Accy None Camera <i>(optional)</i> One of the following, configurable by model: • HD720p camera with ThinkShutter camera privacy, fixed focus • IR camera and HD720p camera with ThinkShutter camera privacy, fixed focus Audio support HD Audio, Synaptic® CX11880 codec / stereo speakers, 2W x 2 / dual array far-field microphone, headphone / microphone combo jack, Dolby Atmos® sound system Keyboard UltraNav™ 6-row, spill-resistant, multimedia Fn keys, numeric keypad, LED backlight 3-button TrackPoint® pointing device and 3-button Mylar surface multi-touch touchpad Security Power-on password, hard disk password, supervisor password, security keyhole Security chip Discrete TPM 2.0, TCG Certified <i>vPro (optional)</i> Intel vPro Technology Fingerprint reader Touch style match on chip fingerprint reader on the palm rest Color calibration <i>Optional:</i> X-Rite Pantone factory color calibration (UHD model only) NFC <i>(optional)</i> Near Field Communication Battery Integrated Li-ion 99Wh battery, supports Rapid Charge (charge up to 80% in 1hr) Max battery life <i>MobileMark® 2014:</i> 17.2 hr <i>* Battery life varies significantly with settings, usage, &amp; other factors</i> AC adapter 170W or 230W slim tip AC adapter Operating system <i>One of the following, configurable by model:</i> • Windows® 10 Home 64 • Windows 10 Pro 64 • Windows 10 Pro 64 for Workstations Limited warranty <i>One of the following, configurable by model:</i> • 1-year depot repair service • 3-year/1-yr battery depot repair service • 3-year/1-yr battery limited onsite service Mil-Spec test MIL-STD-810G military testing Environment EPEAT™ Silver; ENERGY STAR® 7.1; RoHS-compliant
Chipset	Mobile Intel CM246 Chipset									
Memory	128GB max / 2666MHz DDR4 (ECC function supported only on Xeon processor), dual-channel capable, four DDR4 SO-DIMM sockets <i>* Installed DIMMs are actually 2666MHz but run at 2400MHz due to Intel limitation</i>									
Display	Size	Resolution	Type	Surface	Brightness	Aspect Ratio	Contrast Ratio	Color Gamut	Viewing Angle	
	17.3"	FHD (1920x1080)	IPS	Anti-glare	300 nits	16:9	700:1	72%	160°	
Multi-touch	None									
	Pen	None								
Storage	<i>Up to 3 drives (two M.2 SSD and one HDD)</i> • HDD / SATA 6.0Gb/s, 2.5" wide, 7mm high, Active Protection System™ • M.2 2280 SSD / PCIe NVMe, PCIe 3.0 x 4									
Optane™ memory	<i>Optional:</i> Intel Optane memory, PCIe NVMe, PCIe 3.0 x 2									
RAID <i>(optional)</i>	RAID 0/1 support									
Optical	None									
Ethernet	<i>Non-vPro model:</i> Intel Ethernet Connection I219-V (Jacksonville) <i>vPro model:</i> Intel Ethernet Connection I219-LM (Jacksonville)									
WLAN	Intel Wi-Fi 6 AX200, Wi-Fi 2x2 802.11ax + Bluetooth 5.0									
Bluetooth™	Bluetooth 5.0 wireless, integrated in Wi-Fi + Bluetooth combo adapter									
WWAN	None									
SIM card	None									

Note: The specifications above may not be available in all regions.

Lenovo  
August 2019





# ThinkPad T470 Platform Specifications

Product Specifications Reference (PSREF)

Processor	6th Generation Intel® Core™ i5 / i7 Processor or								WWAN (optional) <i>One of the following, configurable by model (WWAN can coexist with WiGig):</i> <ul style="list-style-type: none"> <li>Wireless WAN upgradable</li> <li>Integrated Mobile Broadband 4G LTE-A, Qualcomm® Snapdragon™ X7 LTE-A (Sierra Wireless EM7455), M.2 card</li> <li>Integrated Mobile Broadband 4G LTE, Intel XMM™ 7160 (Fibocom L831-EAU), M.2 card (EMEA only)</li> </ul> SIM card (opt) Micro-SIM card slot, opt Verizon LTE (US) or Lenovo® Connect (EMEA) SIM card								
	Processor Number	# of Cores	# of Threads	Base Frequency	Max Turbo Frequency	Cache	Memory Types	Processor Graphics									
	i5-6200U	2	4	2.3 GHz	2.8 GHz	3MB	DDR4-2133	Intel HD Graphics 520									
	i5-6300U			2.4 GHz	3.0 GHz	3MB											
	i7-6500U			2.5 GHz	3.1 GHz	4MB											
	i7-6600U			2.6 GHz	3.4 GHz	4MB											
	7th Generation Intel Core i3 / i5 / i7 Processor																
	Processor Number	# of Cores	# of Threads	Base Frequency	Max Turbo Frequency	Cache	Memory Types	Processor Graphics									
	i3-7100U	2	4	2.4 GHz	-	3MB	DDR4-2133	Intel HD Graphics 620									
	i5-7200U			2.5 GHz	3.1 GHz	3MB											
	i5-7300U			2.6 GHz	3.5 GHz	3MB											
	i7-7500U			2.7 GHz	3.5 GHz	4MB											
	i7-7600U			2.8 GHz	3.9 GHz	4MB											
	<i>* i7-6500U is NOT available in EMEA</i>																
Graphics	Intel HD Graphics 520 or 620 in processor only, or Intel HD Graphics 620 in processor and NVIDIA GeForce® 940MX, 2GB 2.5GHz GDDR5 memory (discrete models are NOT available in EMEA); supports external digital monitor via HDMI or USB Type-C; supports three independent displays; Max resolution: 4096x2304@60Hz (USB Type-C); 4096x2160@24Hz (HDMI)																
Chipset	Intel SoC (System on Chip) platform																
Memory	32GB max / 2400MHz DDR4, dual-channel capable, two DDR4 SO-DIMM sockets <i>* System clocks down for processors with lower memory controller</i>																
Display	<i>Some:</i> 14.0" (355mm) HD (1366x768), anti-glare, LED backlight, 220 nits, 16:9 aspect ratio, 400:1 contrast ratio <i>Some:</i> 14.0" (355mm) FHD (1920x1080), anti-glare, LED backlight, 220 nits, 16:9 aspect ratio, 400:1 or 500:1 contrast ratio <i>Some:</i> 14.0" (355mm) FHD (1920x1080), anti-glare, LED backlight, IPS, 250 nits, 16:9 aspect ratio, 700:1 contrast ratio, 170° viewing angle																
Multi-touch (opt)	On-cell touch, supports 10-finger gesture (FHD IPS panel with PPS cover only)																
Storage	<i>System has one HDD slot or one M.2 2280 slot exclusively for storage</i> <i>Some:</i> HDD / SATA 6.0Gb/s, 2.5" wide, 7mm high, Active Protection System™ <i>Some:</i> SSD / SATA 6.0Gb/s, 2.5" wide, 7mm high (e.g. xxxGB SSD) <i>Some:</i> M.2 SSD / PCIe NVMe, PCIe 3.0 x 2, 16Gb/s <i>Some:</i> 128GB M.2 SSD / SATA 6.0Gb/s, in WWAN slot as 2nd Storage, mutually exclusive with WWAN and WiGig																
Optical	None																
Ethernet	<i>Non-vPro model:</i> Intel Ethernet Connection I219-V (Jacksonville) <i>vPro model:</i> Intel Ethernet Connection I219-LM (Jacksonville)																
WLAN	<i>One of the following, configurable by model (WiGig can coexist with WWAN):</i> <ul style="list-style-type: none"> <li>Realtek® RTL8822BE, Wi-Fi 2x2 802.11ac + BT4.1, M.2 card</li> <li>Intel Dual Band Wireless-AC 8260, Wi-Fi 2x2 802.11ac + BT4.1, M.2 card</li> <li>Intel Dual Band Wireless-AC 8265, Wi-Fi 2x2 802.11ac + BT4.1, M.2 card</li> <li>Intel Tri-Band Wireless-AC 18265, WiGig 802.11ad + Wi-Fi 2x2 802.11ac + BT4.1, M.2 card</li> </ul>																
Bluetooth™	Bluetooth 4.1 wireless, integrated in Wi-Fi + Bluetooth combo adapter <i>* Intel 8265ac / 18265ac card support BT4.2 but is limited to BT4.1 by Windows OS</i>																
Dimensions	WxDxH: 13.25" x 9.15" x 0.79"; 336.6mm x 232.5mm x 19.95mm Weight <table border="1"> <tr> <td>Models</td> <td>3-cell or 3 + 3-cell</td> <td>6-cell or 3 + 6-cell</td> </tr> <tr> <td>Magnesium</td> <td>3.49 lb / 1.58 kg</td> <td>3.92 lb / 1.78 kg</td> </tr> <tr> <td>PPS</td> <td>3.63 lb / 1.65 kg</td> <td>4.35 lb / 1.85 kg</td> </tr> </table>								Models	3-cell or 3 + 3-cell	6-cell or 3 + 6-cell	Magnesium	3.49 lb / 1.58 kg	3.92 lb / 1.78 kg	PPS	3.63 lb / 1.65 kg	4.35 lb / 1.85 kg
Models	3-cell or 3 + 3-cell	6-cell or 3 + 6-cell															
Magnesium	3.49 lb / 1.58 kg	3.92 lb / 1.78 kg															
PPS	3.63 lb / 1.65 kg	4.35 lb / 1.85 kg															
Case color	Black																
Case material	Display cover: Magnesium Hybrid or PPS; Bottom: Glass-Fiber Reinforced Plastic																
Smart card reader	Optional: Smart card reader																
Media reader	4-in-1 reader (MMC, SD, SDHC, SDXC), supports SD 3.0, UHS-I																
Ports	Three USB 3.1 Gen 1 (USB 3.0, one Always On), USB 3.1 Type-C Gen 2 / Thunderbolt 3 (w/ the function of Power Delivery and DP), HDMI 1.4b, Ethernet (RJ-45), Dock connector <i>* Depending on many factors, actual data transfer speed may be lower than theoretical speed</i>																
WiGig dock (opt)	ThinkPad WiGig dock																
Monitor cable	Optional: Lenovo USB-C to VGA Adapter																
Camera (optional)	720p: HD720p resolution, fixed focus IR & 720p: IR camera and HD720p camera (mutually exclusive with WiGig)																
Audio support	HD Audio, Realtek ALC3268 codec / stereo speakers, 2W x 2 / dual array microphone, combo audio/microphone jack																
Keyboard	6-row, spill-resistant, multimedia Fn keys, optional LED backlight																
UltraNav™	TrackPoint® pointing device and buttonless Mylar surface multi-touch touchpad																
Security	Power-on password, hard disk password, supervisor password, security keyhole																
Security chip	Discrete TPM 2.0, TCG Certified																
vPro (optional)	Intel vPro Technology																
Fingerprint reader	Optional: Touch style match on chip fingerprint reader on the keyboard bezel																
NFC (optional)	Near Field Communication																
Internal battery	Optional: Integrated Li-Polymer 3-cell (24Wh)																
External battery	Li-Polymer 3-cell (24Wh) or Li-ion 6-cell (48Wh or 72Wh)																
Max battery life (MobileMark® 2014)	Models	3-cell	3 + 3-cell	6-cell 48Wh	6-cell 72Wh	3 + 6-cell 48Wh	3 + 6-cell 72Wh										
	Integrated	6.9 hr	13.9 hr	13.9 hr	20.9 hr	20.9 hr	27.1 hr										
	Discrete	6.9 hr	13.9 hr	14.3 hr	21.6 hr	21.2 hr	28.6 hr										
	<i>* Battery life varies significantly with settings, usage, &amp; other factors</i>																
AC adapter	45W or 65W slim tip AC adapter, 45W or 65W USB Type-C AC adapter																
Operating system	One of the following, configurable by model: <ul style="list-style-type: none"> <li>Windows® 7 Professional 64 preinstalled through downgrade rights in Windows 10 Pro 64</li> <li>Windows 10 Home 64</li> <li>Windows 10 Pro 64</li> </ul>																
Limited warranty	One of the following, configurable by model: <ul style="list-style-type: none"> <li>1-year depot repair service</li> <li>3-year/1-yr battery depot repair service</li> <li>3-year/1-yr battery limited onsite service</li> </ul>																
Mil-Spec test	MIL-STD-810G military testing																
Environment	EPEAT™ Gold (US only); ENERGY STAR® 6.1; RoHS-compliant																

Note: The specifications above may not be available in all regions.

Lenovo  
September 2018



# ThinkPad T470s Platform Specifications

Product Specifications Reference (PSREF)

Processor	6th Generation Intel® Core™ i5 / i7 Processor								Dimensions WxDxH: 13.03" x 8.93" x 0.67-0.74"; 331mm x 226.8mm x 16.9-18.8mm Weight Starting at 2.9 lb / 1.32 kg Case color Black or Silver Case material Display cover: CFRP Hybrid; Bottom: Magnesium
	Processor Number	# of Cores	# of Threads	Base Frequency	Max Turbo Frequency	Cache	Memory Types	Processor Graphics	
	i5-6200U	2	4	2.3 GHz	2.8 GHz	3MB	DDR4-2133	Intel HD Graphics 520	
	i5-6300U			2.4 GHz	3.0 GHz	3MB			
i7-6600U	2.6 GHz			3.4 GHz	4MB				
Processor	or 7th Generation Intel Core i5 / i7 Processor								Smart card reader <i>Optional:</i> Smart card reader Media reader 4-in-1 reader (MMC, SD, SDHC, SDXC) Ports Three USB 3.1 Gen 1 (USB 3.0, one Always On), USB 3.1 Type-C Gen 2 / Thunderbolt 3 (w/ the function of Power Delivery and DP), HDMI 1.4b, Ethernet (RJ-45), Dock connector <i>* Depending on many factors, actual data transfer speed may be lower than theoretical speed</i> WiGig dock (opt) ThinkPad WiGig dock, mutually exclusive with WWAN Monitor cable (optional) HDMI to VGA: Lenovo HDMI to VGA Monitor Adapter USB-C to VGA: Lenovo USB-C to VGA Adapter Camera (optional) HD720p resolution, fixed focus (models without camera are NOT available in EMEA) Audio support HD Audio, Realtek® ALC3268 codec / stereo speakers, 1W x 2 / dual array microphone, combo audio/microphone jack Keyboard 6-row, spill-resistant, multimedia Fn keys, optional LED backlight UltraNav™ TrackPoint® pointing device and buttonless Mylar surface multi-touch touchpad Security Power-on password, hard disk password, supervisor password, security keyhole Security chip Discrete TPM 2.0, TCG Certified vPro (optional) Intel vPro Technology Fingerprint reader <i>Optional:</i> Touch style match on chip fingerprint reader on the palm rest NFC (optional) Near Field Communication Internal battery Front Li-Polymer 3-cell (23Wh) and rear Li-ion 3-cell (26Wh), both Integrated Max battery life <i>MobileMark® 2014:</i> up to 10.5 hr <i>* Battery life varies significantly with settings, usage, &amp; other factors</i> AC adapter 45W slim tip AC adapter, 45W or 65W USB Type-C AC adapter Operating system <i>One of the following, configurable by model:</i> • Windows® 7 Professional 64 preinstalled through downgrade rights in Windows 10 Pro 64 • Windows 10 Home 64 • Windows 10 Pro 64 Limited warranty <i>One of the following, configurable by model:</i> • 1-year depot repair service • 3-year/1-yr battery depot repair service • 3-year/1-yr battery limited onsite service Mil-Spec test MIL-STD-810G military testing Environment EPEAT™ Gold (US only); ENERGY STAR® 6.1; RoHS-compliant
	Processor Number	# of Cores	# of Threads	Base Frequency	Max Turbo Frequency	Cache	Memory Types	Processor Graphics	
	i5-7200U	2	4	2.5 GHz	3.1 GHz	3MB	DDR4-2133	Intel HD Graphics 620	
	i5-7300U			2.6 GHz	3.5 GHz	3MB			
i7-7500U	2.7 GHz			3.5 GHz	4MB				
i7-7600U	2.8 GHz			3.9 GHz	4MB				
Graphics	Intel HD Graphics 520 or 620 in processor; supports external digital monitor via HDMI or USB Type-C; supports three independent displays; Max resolution: 4096x2304@60Hz (USB Type-C); 4096x2160@24Hz (HDMI)								
Chipset	Intel SoC (System on Chip) platform								
Memory	20GB or 24GB max <sup>7</sup> / 2400MHz DDR4, dual-channel capable, 4GB or 8GB memory soldered to systemboard, one DDR4 SO-DIMM socket <i>* System clocks down for processors with lower memory controller</i>								
Display	<i>Some:</i> 14.0" (355mm) FHD (1920x1080), anti-glare, LED backlight, IPS, 250 nits, 16:9 aspect ratio, 700:1 contrast ratio, 160° viewing angle <i>Some:</i> 14.0" (355mm) WQHD (2560x1440), anti-glare, LED backlight, IPS, 300 nits, 16:9 aspect ratio, 700:1 contrast ratio, 160° viewing angle								
Multi-touch (opt)	On-cell touch, supports 10-finger gesture, 250 nits (FHD only)								
Storage	<i>One of the following, configurable by model:</i> • M.2 SSD / SATA 6.0Gb/s (e.g. xxxGB SSD M.2) • M.2 SSD / PCIe NVMe, PCIe 3.0 x 4, 32Gb/s (e.g. xxxGB SSD M.2 PCIe NVMe)								
Optical	None								
Ethernet	<i>Non-vPro model:</i> Intel Ethernet Connection I219-V (Jacksonville) <i>vPro model:</i> Intel Ethernet Connection I219-LM (Jacksonville)								
WLAN	<i>One of the following, configurable by model (WiGig is mutually exclusive with WWAN):</i> • Intel Dual Band Wireless-AC 8260, Wi-Fi 2x2 802.11ac + BT4.1, M.2 card • Intel Dual Band Wireless-AC 8265, Wi-Fi 2x2 802.11ac + BT4.1, M.2 card • Intel Tri-Band Wireless-AC 18265, WiGig 802.11ad + Wi-Fi 2x2 802.11ac + BT4.1, M.2 card								
Bluetooth™	Bluetooth 4.1 wireless, integrated in Wi-Fi + Bluetooth combo adapter <i>* Intel 8265ac / 18265ac card support BT4.2 but is limited to BT4.1 by Windows OS</i>								
WWAN (optional)	<i>One of the following, configurable by model (mutually exclusive with WiGig):</i> • Wireless WAN upgradable • Integrated Mobile Broadband 4G LTE-A, Qualcomm® Snapdragon™ X7 LTE-A (Sierra Wireless EM7455), M.2 card								
SIM card (opt)	• Micro-SIM card slot, opt Verizon LTE (US) or Lenovo® Connect (EMEA) SIM card								



# ThinkPad T480 Platform Specifications

Product Specifications Reference (PSREF)

Processor	7th Generation Intel® Core™ i5 Processor							Dimensions Weight	WxDxH: 13.25" x 9.15" x 0.79"; 336.6mm x 232.5mm x 19.95mm						
	Processor Number	# of Cores	# of Threads	Base Frequency	Max Turbo Frequency	Cache	Memory Types		Processor Graphics	Models	24Wh or 24Wh + 24Wh	48Wh, 72Wh, or 24Wh + 48Wh / 72Wh			
	i5-7200U	2	4	2.5 GHz	3.1 GHz	3MB	DDR4-2133	Intel HD Graphics 620	Integrated Magnesium	3.49 lb / 1.58 kg	3.92 lb / 1.78 kg				
	i5-7300U			2.6 GHz	3.5 GHz	3MB			Integrated PPS	3.63 lb / 1.65 kg	4.08 lb / 1.85 kg				
	or 8th Generation Intel Core i3 / i5 / i7 Processor							Case color Case material	Black Display cover: Magnesium Hybrid or PPS; Bottom: Glass-Fiber Reinforced Plastic						
	Processor Number	# of Cores	# of Threads	Base Frequency	Max Turbo Frequency	Cache	Memory Types		Processor Graphics	Smart card reader	Optional: Smart card reader				
	i3-8130U	4	8	2.2 GHz	3.4 GHz	4MB	DDR4-2400	Intel UHD Graphics 620	Media reader	4-in-1 reader (MMC, SD, SDHC, SDXC)					
	i5-8250U			1.6 GHz	3.4 GHz	6MB			Ports	Two USB 3.1 Gen 1 (one Always On), one USB 3.1 Type-C Gen 1 (with the function of Power Delivery and DisplayPort), one USB 3.1 Type-C Gen 2 / Thunderbolt 3 (with the function of PD and DP), HDMI 1.4b, Ethernet (RJ-45), nano-SIM card slot (WWAN models), headphone / microphone combo jack, optional smart card reader, 4-in-1 media reader (MMC, SD, SDHC, SDXC), side docking connector, security keyhole					
	i5-8350U			1.7 GHz	3.6 GHz	6MB				* Depending on many factors, actual data transfer speed may be lower than theoretical speed					
	i7-8550U			1.8 GHz	4.0 GHz	8MB				HDMI to VGA: Lenovo HDMI to VGA Monitor Adapter					
	i7-8650U			1.9 GHz	4.2 GHz	8MB				USB-C to DP: Lenovo USB-C to DisplayPort Adapter					
Graphics	Intel HD Graphics 620 or Intel UHD Graphics 620 in processor only or Intel HD Graphics 620 or Intel UHD Graphics 620 in processor and NVIDIA® GeForce® MX150, 2GB GDDR5 memory (discrete graphics is available only on i7 models in EMEA); supports external digital monitor via HDMI or USB Type-C; supports three independent displays; Max resolution: 4096x2304@60Hz (USB Type-C); 4096x2160@30Hz (HDMI)							Monitor cable (optional)	HDMI to VGA: Lenovo HDMI to VGA Monitor Adapter USB-C to DP: Lenovo USB-C to DisplayPort Adapter						
Chipset	Intel SoC (System on Chip) platform							Camera (optional)	One of the following, configurable by model: • HD720p camera with ThinkShutter camera privacy, fixed focus • IR camera and HD720p camera, fixed focus						
Memory	32GB max / 2400MHz DDR4, dual-channel capable, two DDR4 SO-DIMM sockets * System clocks down for processors with lower memory controller							Audio support	HD Audio, Realtek® ALC3287 codec / stereo speakers, 2W x 2, Dolby® Audio™ Premium / dual array microphone, headphone / microphone combo jack						
Display	Some:	14.0" (355mm) HD (1366x768), anti-glare, LED backlight, 220 nits, 16:9 aspect ratio, 400:1 contrast ratio					Keyboard UltraNav™	6-row, spill-resistant, multimedia Fn keys, optional LED backlight TrackPoint® pointing device and buttonless Mylar surface multi-touch touchpad							
	Some:	14.0" (355mm) FHD (1920x1080), anti-glare, LED backlight, IPS, 250 nits, 16:9 aspect ratio, 700:1 contrast ratio, 170° viewing angle						Security	Power-on password, hard disk password, supervisor password, security keyhole						
	Some:	14.0" (355mm) WQHD (2560x1440), anti-glare, LED backlight, IPS, 300 nits, 16:9 aspect ratio, 700:1 contrast ratio, 72% gamut, 170° viewing angle						Security chip	Discrete TPM 2.0, TCG Certified						
Multi-touch (opt)	On-cell touch, supports 10-finger gesture (FHD only)							vPro (optional)	Intel vPro Technology						
Storage	System has one HDD slot or one M.2 2280 slot exclusively for storage Some: HDD / SATA 6.0Gb/s, 2.5" wide, 7mm high, Active Protection System™ Some: SSD / SATA 6.0Gb/s, 2.5" wide, 7mm high (e.g. xxxGB SSD) Some: M.2 SSD / PCIe NVMe, PCIe 3.0 x 4 Some: 128GB M.2 SSD / PCIe NVMe, PCIe 3.0 x 2, in WWAN slot as 2nd Storage, mutually exclusive with WWAN * Installed M.2 SSD is PCIe 3.0 x 4 but run at PCIe 3.0 x 2 due to M.2 SSD adapter limitation							Fingerprint reader	Optional: Touch style match on chip fingerprint reader on the keyboard bezel, anti-spoofing technology						
Optane™ memory	Intel Optane memory, PCIe NVMe, PCIe 3.0 x 2							NFC (optional)	Near Field Communication						
Optical	None							Battery	Optional integrated Li-ion 24Wh battery and external Li-ion 24Wh, 48Wh, or 72Wh battery						
Ethernet	Non-vPro model: Intel Ethernet Connection I219-V (Jacksonville) vPro model: Intel Ethernet Connection I219-LM (Jacksonville)							Max battery life (MobileMark® 2014)	Models	24Wh	48Wh	72Wh	24Wh + 24Wh	24Wh + 48Wh	24Wh + 72Wh
WLAN + Bluetooth™	Intel Dual Band Wireless-AC 8265, Wi-Fi 2x2 802.11ac + Bluetooth 4.1, M.2 card * Intel 8265ac card supports BT4.2 but is limited to BT4.1 by Windows OS							AC adapter	45W or 65W USB Type-C AC adapter						
WWAN (optional)	One of the following, configurable by model (mutually exclusive with Intel Optane memory): • Wireless WAN upgradable • Integrated Mobile Broadband 4G LTE, Intel XMM™ 7262 (Fibocom L830-EB), M.2 card (EMEA only) • Integrated Mobile Broadband 4G LTE-A, Intel XMM™ 7360 (Fibocom L850-GL), M.2 card							Operating system	Optional: Windows® 10 Home 64 or Windows 10 Pro 64						
SIM card (opt)	* For non-WWAN model, it means the model is NOT WWAN upgradable Nano-SIM card slot, optional Verizon LTE (US) SIM card							Limited warranty	One of the following, configurable by model: • 1-year depot repair service • 1-year depot with 2-year planar repair service • 3-year/1-yr battery depot repair service • 3-year/1-yr battery limited onsite service						
								Mil-Spec test	MIL-STD-810G military testing						
								Environment	EPEAT™ Gold (US only); ENERGY STAR® 6.1; RoHS-compliant						

Note: The specifications above may not be available in all regions.

Lenovo  
August 2019



# ThinkPad T480s Platform Specifications

Product Specifications Reference (PSREF)

Processor	7th Generation Intel® Core™ i5 Processor							Dimensions Weight Case color Case material	<i>WxDxH:</i> 13.03" x 8.93" x 0.73"; 331mm x 226.8mm x 18.45mm Starting at 2.9 lb / 1.32 kg Black or Silver <i>Display cover:</i> CFRP Hybrid; <i>Bottom:</i> Magnesium
	Processor Number	# of Cores	# of Threads	Base Frequency	Max Turbo Frequency	Cache	Memory Types		
	i5-7200U	2	4	2.5 GHz	3.1 GHz	3MB	DDR4-2133	Intel HD Graphics 620	
	i5-7300U			2.6 GHz	3.5 GHz	3MB			
	or 8th Generation Intel Core i5 / i7 Processor							Smart card reader Media reader Ports	<i>Optional:</i> Smart card reader 4-in-1 reader (MMC, SD, SDHC, SDXC) Two USB 3.1 Gen 1 (one Always On), one USB 3.1 Type-C Gen 1 (with the function of Power Delivery and DisplayPort), one USB 3.1 Type-C Gen 2 / Thunderbolt 3 (with the function of PD and DP), HDMI 1.4b, Ethernet (RJ-45), nano-SIM card slot (WWAN models), headphone / microphone combo jack, optional smart card reader, 4-in-1 reader (MMC, SD, SDHC, SDXC), side docking connector, security keyhole <i>* Depending on many factors, actual data transfer speed may be lower than theoretical speed</i>
	Processor Number	# of Cores	# of Threads	Base Frequency	Max Turbo Frequency	Cache	Memory Types		
	i5-8250U	4	8	1.6 GHz	3.4 GHz	6MB	DDR4-2400	Intel UHD Graphics 620	
	i5-8350U			1.7 GHz	3.6 GHz	6MB			
	i7-8550U			1.8 GHz	4.0 GHz	8MB			
	i7-8650U			1.9 GHz	4.2 GHz	8MB			
Graphics	Intel HD Graphics 620 or Intel UHD Graphics 620 in processor only or Intel UHD Graphics 620 in processor and NVIDIA® GeForce® MX150, 2GB GDDR5 memory (discrete models are NOT available in EMEA); supports external digital monitor via HDMI or USB Type-C; supports three independent displays; Max resolution: 4096x2304@60Hz (USB Type-C); 4096x2160@30Hz (HDMI)							Monitor cable (optional)	USB-C to VGA: Lenovo USB-C to VGA Adapter USB-C to DP: Lenovo USB-C to DisplayPort Adapter
Chipset Memory	Intel SoC (System on Chip) platform 20GB or 24GB max / 2400MHz DDR4, dual-channel capable, 4GB or 8GB memory soldered to systemboard, one DDR4 SO-DIMM socket <i>* System clocks down for processors with lower memory controller</i>							Camera	<i>One of the following, configurable by model:</i> • HD720p camera with ThinkShutter camera privacy, fixed focus • IR camera and HD720p camera, fixed focus
Display	<i>Some:</i> 14.0" (355mm) FHD (1920x1080), anti-glare, LED backlight, IPS, 250 nits, 16:9 aspect ratio, 700:1 contrast ratio, 170° viewing angle, supports ThinkPad Privacy Guard on some models <i>Some:</i> 14.0" (355mm) WQHD (2560x1440), anti-glare, LED backlight, IPS, 300 nits, 16:9 aspect ratio, 700:1 contrast ratio, 72% gamut, 170° viewing angle							Audio support	HD Audio, Realtek® ALC3287 codec / stereo speakers, 1W x 2, Dolby® Audio™ Premium / dual array microphone, headphone / microphone combo jack
Multi-touch (opt)	On-cell touch, supports 10-finger gesture, 250 nits (FHD only)							Keyboard UltraNav™	6-row, spill-resistant, multimedia Fn keys, optional LED backlight TrackPoint® pointing device and buttonless Mylar surface multi-touch touchpad
Storage	<i>One of the following, configurable by model:</i> • M.2 SSD / SATA 6.0Gb/s • M.2 SSD / PCIe NVMe, PCIe 3.0 x 4, 32Gb/s							Security Security chip vPro (optional) Fingerprint reader	Power-on password, hard disk password, supervisor password, security keyhole Discrete TPM 2.0, TCG Certified Intel vPro Technology <i>Optional:</i> Touch style match on chip fingerprint reader on the palm rest, anti-spoofing technology
Optical	None							NFC (optional)	Near Field Communication
Ethernet	<i>Non-vPro model:</i> Intel Ethernet Connection I219-V (Jacksonville) <i>vPro model:</i> Intel Ethernet Connection I219-LM (Jacksonville)							Battery	Integrated Li-ion 57Wh battery, supports Rapid Charge (0-80% in 60 mins) with 65W USB Type-C AC adapter Max battery life <i>MobileMark® 2014:</i> 15.6 hr <i>* Battery life varies significantly with settings, usage, &amp; other factors</i>
WLAN + Bluetooth™	Intel Dual Band Wireless-AC 8265, Wi-Fi 2x2 802.11ac + Bluetooth 4.1, M.2 card <i>* Intel 8265ac card supports BT4.2 but is limited to BT4.1 by Windows OS</i>							AC adapter	45W or 65W USB Type-C AC adapter
WWAN (optional)	<i>One of the following, configurable by model:</i> • Wireless WAN upgradable • Integrated Mobile Broadband 4G LTE, Intel XMM™ 7262 (Fibocom L830-EB), M.2 card (EMEA only) • Integrated Mobile Broadband 4G LTE-A, Intel XMM™ 7360 (Fibocom L850-GL), M.2 card							Operating system	<i>Optional:</i> Windows® 10 Home 64 or Windows 10 Pro 64
SIM card (opt)	Nano-SIM card slot, optional Verizon LTE (US) SIM card							Limited warranty	<i>One of the following, configurable by model:</i> • 1-year depot repair service • 1-year depot with 2-year planar repair service • 3-year/1-yr battery depot repair service • 3-year/1-yr battery limited onsite service
								Mil-Spec test	MIL-STD-810G military testing
								Environment	EPEAT™ Silver; ENERGY STAR® 6.1; RoHS-compliant

Note: The specifications above may not be available in all regions.

Lenovo  
August 2019

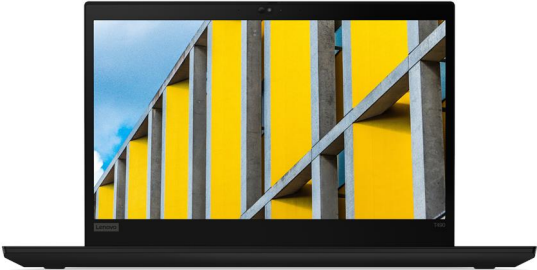



# ThinkPad T490 Platform Specifications

Product Specifications Reference (PSREF)

Processor	8th Generation Intel® Core™ i5 / i7 Processor								Dimensions	<i>WxDxH:</i> 12.95" x 8.94" x 0.70"; 329mm x 227mm x 17.9mm				
	Processor Number	# of Cores	# of Threads	Base Frequency	Max Turbo Frequency	Cache	Memory Types	Processor Graphics	Weight	Models	HD	FHD	FHD Low Power / WQHD	Privacy Guard
	i5-8265U	4	8	1.6 GHz	3.9 GHz	6MB	DDR4-2400	Intel UHD Graphics 620	Weight	3.37 lb / 1.53 kg	3.41 lb / 1.55 kg	3.23 lb / 1.46 kg	3.56 lb / 1.61 kg	
	i5-8365U			1.6 GHz	4.1 GHz	6MB								
	i7-8565U			1.8 GHz	4.6 GHz	8MB								
	i7-8665U			1.9 GHz	4.8 GHz	8MB								
	or 10th Generation Intel Core i5 / i7 Processor (NOT available in EMEA)								Case color	Black				
	Processor Number	# of Cores	# of Threads	Base Frequency	Max Turbo Frequency	Cache	Memory Types	Processor Graphics	Case material	<i>Display cover:</i> PPS / 50% GF; <i>Bottom:</i> PA / 50% GF				
	i5-10210U	4	8	1.6 GHz	4.2 GHz	6MB	DDR4-2400	Intel UHD Graphics	Smart card reader	Optional: Smart card reader				
	i7-10510U			1.8 GHz	4.9 GHz	8MB			Media reader	MicroSD card reader				
Graphics	Intel UHD Graphics 620 or Intel UHD Graphics in processor only or Intel UHD Graphics 620 or Intel UHD Graphics in processor and NVIDIA® GeForce® MX250, 2GB GDDR5 memory; supports external digital monitor via HDMI or Thunderbolt; supports three independent displays; Max resolution: 4096x2304@60Hz (Thunderbolt); 4096x2160@24Hz (HDMI)								Ports	Two USB 3.1 Gen 1 (one Always On), one USB 3.1 Type-C Gen 1 (with the function of Power Delivery and DisplayPort), one USB 3.1 Type-C Gen 2 / Thunderbolt 3 (with the function of PD and DP), HDMI 1.4b, Ethernet (RJ-45), nano-SIM card slot (WWAN models), headphone / microphone combo jack, optional smart card reader, microSD card reader, side docking connector, security keyhole <i>* Depending on many factors, actual data transfer speed may be lower than theoretical speed</i>				
Chipset	Intel SoC (System on Chip) platform								Monitor cable (optional)	<i>HDMI to VGA:</i> Lenovo HDMI to VGA Monitor Adapter <i>USB-C to VGA:</i> Lenovo USB-C to VGA Adapter <i>USB-C to HDMI:</i> Lenovo USB-C to HDMI Adapter <i>USB-C to DP:</i> Lenovo USB-C to DisplayPort Adapter				
Memory	48GB max / 2400MHz DDR4, dual-channel capable, 8GB or 16GB memory soldered to systemboard, one DDR4 SO-DIMM socket <i>* Installed memory is actually 2666MHz but run at 2400MHz due to Intel limitation</i>								Bundled Accy	None				
Display	Size	Resolution	Type	Surface	Brightness	Aspect Ratio	Contrast Ratio	Color Gamut	Viewing Angle	Camera (optional)	<i>One of the following, configurable by model:</i> • HD720p camera with ThinkShutter camera privacy, fixed focus • IR camera and HD720p camera with ThinkShutter camera privacy, fixed focus			
	14.0"	HD (1366x768)	TN	Anti-glare	220 nits	16:9	400:1	45%	90°	Audio support	HD Audio, Realtek® ALC3287 codec / stereo speakers, 2W x 2, Dolby® Audio™ Premium / dual array far-field microphone, headphone / microphone combo jack			
	14.0"	FHD (1920x1080)	IPS	Anti-glare	250 nits (non-touch) 300 nits (multi-touch)	16:9	700:1	45%	170°	Keyboard	6-row, spill-resistant, multimedia Fn keys, optional LED backlight UltraNav™ TrackPoint® pointing device and buttonless Mylar surface multi-touch touchpad			
	14.0"	FHD (1920x1080) Low Power	IPS	Anti-glare	400 nits	16:9	800:1	72%	170°	Security	Power-on password, hard disk password, supervisor password, security keyhole			
	14.0"	FHD (1920x1080) ThinkPad Privacy Guard	IPS	Anti-glare	400 nits	16:9	1000:1	72%	170°	Security chip	Discrete TPM 2.0, TCG Certified			
	14.0"	WQHD (2560x1440) HDR, Dolby Vision™	IPS	Glossy	500 nits	16:9	1500:1	100% Adobe	170°	System Mgt (opt)	Intel vPro Technology			
Multi-touch (opt)	On-cell touch, supports 10-finger gesture (FHD only)								Fingerprint reader	Optional: Touch style match on chip fingerprint reader on the palm rest				
Storage	<ul style="list-style-type: none"> <li>M.2 2280 SSD / SATA 6.0Gb/s (NOT available in EMEA)</li> <li>M.2 2280 SSD / PCIe NVMe, PCIe 3.0 x 4</li> <li>M.2 2242 SSD / PCIe NVMe, PCIe 3.0 x 2</li> <li>Intel Optane™ Memory H10 with Solid State Storage, M.2 2280, PCIe NVMe 3.0 x 4</li> </ul>								NFC (optional)	Near Field Communication				
Optical	None								Battery	Integrated Li-ion 50Wh battery, supports Rapid Charge (charge up to 80% in 1hr) <i>MobileMark® 2014:</i> 16.11 hr <i>* Battery life varies significantly with settings, usage, &amp; other factors</i>				
Ethernet	<i>Non-vPro model:</i> Intel Ethernet Connection I219-V (Jacksonville) <i>vPro model:</i> Intel Ethernet Connection I219-LM (Jacksonville)								Max battery life	45W, 65W, or 65W slim USB-C AC adapter				
WLAN + Bluetooth™ (optional)	<i>One of the following, configurable by model:</i> <ul style="list-style-type: none"> <li>Intel Wireless-AC 9560, Wi-Fi 2x2 802.11ac + Bluetooth 5.0</li> <li>Intel Wi-Fi 6 AX201, Wi-Fi 2x2 802.11ax + Bluetooth 5.0 (AX201 for 10th Gen processor only)</li> </ul>								AC adapter	45W, 65W, or 65W slim USB-C AC adapter				
WWAN (optional)	<i>One of the following, configurable by model:</i> <ul style="list-style-type: none"> <li>Wireless WAN upgradable</li> <li>Integrated Mobile Broadband 4G LTE, Fibocom L830-EB, M.2 card (EMEA only)</li> <li>Integrated Mobile Broadband 4G LTE-A, Fibocom L850-GL, M.2 card</li> <li>Integrated Mobile Broadband 4G LTE-A, Fibocom L860-GL, MIMO 4x4, M.2 card</li> </ul> <i>* For non-WWAN model, it means the model is NOT WWAN upgradable</i>								Preload	<i>One of the following, configurable by model:</i> <ul style="list-style-type: none"> <li>Windows® 10 Home 64</li> <li>Windows 10 Pro 64</li> <li>Windows 10 Pro in S mode</li> <li>No OS</li> </ul>				
SIM card (opt)	Nano-SIM card slot, optional Verizon LTE (US) SIM card								Limited warranty	<i>One of the following, configurable by model:</i> <ul style="list-style-type: none"> <li>1-year depot repair service</li> <li>1-year depot with 2-year planar repair service</li> <li>3-year/1-yr battery depot repair service</li> <li>3-year/1-yr battery limited onsite service</li> </ul>				
									Mil-Spec test	MIL-STD-810G military testing				
									Environment	EPEAT™ Silver; ENERGY STAR® 7.1; RoHS-compliant				

Note: The specifications above may not be available in all regions.



# ThinkPad T490s Platform Specifications

Product Specifications Reference (PSREF)

<p><b>Processor</b> 8th Generation Intel® Core™ i5 / i7 Processor</p> <table border="1"> <thead> <tr> <th>Processor Number</th> <th># of Cores</th> <th># of Threads</th> <th>Base Frequency</th> <th>Max Turbo Frequency</th> <th>Cache</th> <th>Memory Types</th> <th>Processor Graphics</th> </tr> </thead> <tbody> <tr> <td>i5-8265U</td> <td rowspan="4">4</td> <td rowspan="4">8</td> <td>1.6 GHz</td> <td>3.9 GHz</td> <td>6MB</td> <td rowspan="4">DDR4-2400</td> <td rowspan="4">Intel UHD Graphics 620</td> </tr> <tr> <td>i5-8365U</td> <td>1.6 GHz</td> <td>4.1 GHz</td> <td>6MB</td> </tr> <tr> <td>i7-8565U</td> <td>1.8 GHz</td> <td>4.6 GHz</td> <td>8MB</td> </tr> <tr> <td>i7-8665U</td> <td>1.9 GHz</td> <td>4.8 GHz</td> <td>8MB</td> </tr> </tbody> </table>	Processor Number	# of Cores	# of Threads	Base Frequency	Max Turbo Frequency	Cache	Memory Types	Processor Graphics	i5-8265U	4	8	1.6 GHz	3.9 GHz	6MB	DDR4-2400	Intel UHD Graphics 620	i5-8365U	1.6 GHz	4.1 GHz	6MB	i7-8565U	1.8 GHz	4.6 GHz	8MB	i7-8665U	1.9 GHz	4.8 GHz	8MB	<p><b>Dimensions</b> <i>WxDxH (black with FHD / Privacy Guard):</i> 12.95" x 8.90" x 0.66"; 329.0mm x 226.15mm x 16.7mm <i>WxDxH (black with FHD Low Power / WQHD):</i> 12.94" x 8.89" x 0.63"; 328.8mm x 225.8mm x 16.1mm <i>WxDxH (silver):</i> 12.96" x 8.92" x 0.68"; 329.15mm x 226.45mm x 17.2mm</p> <p><b>Weight</b></p> <table border="1"> <thead> <tr> <th>Models</th> <th>Black with FHD</th> <th>Black with FHD Low Power / WQHD / Privacy Guard</th> <th>Silver</th> </tr> </thead> <tbody> <tr> <td>Weight</td> <td>2.98 lb / 1.35 kg</td> <td>2.81 lb / 1.27 kg</td> <td>3.29 lb / 1.49 kg</td> </tr> </tbody> </table>	Models	Black with FHD	Black with FHD Low Power / WQHD / Privacy Guard	Silver	Weight	2.98 lb / 1.35 kg	2.81 lb / 1.27 kg	3.29 lb / 1.49 kg									
Processor Number	# of Cores	# of Threads	Base Frequency	Max Turbo Frequency	Cache	Memory Types	Processor Graphics																																							
i5-8265U	4	8	1.6 GHz	3.9 GHz	6MB	DDR4-2400	Intel UHD Graphics 620																																							
i5-8365U			1.6 GHz	4.1 GHz	6MB																																									
i7-8565U			1.8 GHz	4.6 GHz	8MB																																									
i7-8665U			1.9 GHz	4.8 GHz	8MB																																									
Models	Black with FHD	Black with FHD Low Power / WQHD / Privacy Guard	Silver																																											
Weight	2.98 lb / 1.35 kg	2.81 lb / 1.27 kg	3.29 lb / 1.49 kg																																											
<p><b>Graphics</b> Intel UHD Graphics 620 in processor; supports external digital monitor via HDMI or Thunderbolt; supports three independent displays; Max resolution: 4096x2304@60Hz (Thunderbolt); 4096x2160@24Hz (HDMI)</p>	<p><b>Case color</b> Black or Silver <b>Case material</b> <i>Display cover:</i> CFRP Hybrid (black) or Aluminum (silver); <i>Bottom:</i> Magnesium</p>																																													
<p><b>Chipset</b> Intel SoC (System on Chip) platform <b>Memory</b> 8GB, 16GB or 32GB / 2400MHz DDR4 / soldered to systemboard, no sockets <i>* Installed memory is actually 2666MHz but run at 2400MHz due to Intel limitation</i></p>	<p><b>Smart card reader</b> <i>Optional:</i> Smart card reader <b>Media reader</b> MicroSD card reader <b>Ports</b> Two USB 3.1 Gen 1 (one Always On), one USB 3.1 Type-C Gen 1 (with the function of Power Delivery and DisplayPort), one USB 3.1 Type-C Gen 2 / Thunderbolt 3 (with the function of PD and DP), HDMI 1.4b, Ethernet extension connector, nano-SIM card slot (WWAN models), headphone / microphone combo jack, optional smart card reader, microSD card reader, side docking connector, security keyhole <i>* Depending on many factors, actual data transfer speed may be lower than theoretical speed</i></p>																																													
<p><b>Display</b></p> <table border="1"> <thead> <tr> <th>Size</th> <th>Resolution</th> <th>Type</th> <th>Surface</th> <th>Brightness</th> <th>Aspect Ratio</th> <th>Contrast Ratio</th> <th>Color Gamut</th> <th>Viewing Angle</th> </tr> </thead> <tbody> <tr> <td>14.0"</td> <td>FHD (1920x1080)</td> <td>IPS</td> <td>Anti-glare</td> <td>250 nits (non-touch) 300 nits (multi-touch)</td> <td>16:9</td> <td>700:1</td> <td>45%</td> <td>170°</td> </tr> <tr> <td>14.0"</td> <td>FHD (1920x1080) Low Power</td> <td>IPS</td> <td>Anti-glare</td> <td>400 nits</td> <td>16:9</td> <td>800:1</td> <td>72%</td> <td>170°</td> </tr> <tr> <td>14.0"</td> <td>FHD (1920x1080) ThinkPad Privacy Guard</td> <td>IPS</td> <td>Anti-glare</td> <td>400 nits</td> <td>16:9</td> <td>1000:1</td> <td>72%</td> <td>170°</td> </tr> <tr> <td>14.0"</td> <td>WQHD (2560x1440) HDR, Dolby Vision™</td> <td>IPS</td> <td>Glossy</td> <td>500 nits</td> <td>16:9</td> <td>1500:1</td> <td>100% Adobe</td> <td>170°</td> </tr> </tbody> </table>	Size	Resolution	Type	Surface	Brightness	Aspect Ratio	Contrast Ratio	Color Gamut	Viewing Angle	14.0"	FHD (1920x1080)	IPS	Anti-glare	250 nits (non-touch) 300 nits (multi-touch)	16:9	700:1	45%	170°	14.0"	FHD (1920x1080) Low Power	IPS	Anti-glare	400 nits	16:9	800:1	72%	170°	14.0"	FHD (1920x1080) ThinkPad Privacy Guard	IPS	Anti-glare	400 nits	16:9	1000:1	72%	170°	14.0"	WQHD (2560x1440) HDR, Dolby Vision™	IPS	Glossy	500 nits	16:9	1500:1	100% Adobe	170°	<p><b>Monitor cable (optional)</b> <i>HDMI to VGA:</i> Lenovo HDMI to VGA Monitor Adapter <i>USB-C to VGA:</i> Lenovo USB-C to VGA Adapter <i>USB-C to DP:</i> Lenovo USB-C to DisplayPort Adapter <i>Optional:</i> ThinkPad Ethernet Extension Adapter Gen 2</p> <p><b>Bundled Accy</b> <i>Optional:</i> ThinkPad Ethernet Extension Adapter Gen 2</p> <p><b>Camera</b> <i>One of the following, configurable by model:</i> • HD720p camera with ThinkShutter camera privacy, fixed focus • IR camera and HD720p camera with ThinkShutter camera privacy, fixed focus</p> <p><b>Audio support</b> HD Audio, Realtek® ALC3287 codec / stereo speakers, 1W x 2, Dolby® Audio™ Premium / dual array far-field microphone, headphone / microphone combo jack</p>
Size	Resolution	Type	Surface	Brightness	Aspect Ratio	Contrast Ratio	Color Gamut	Viewing Angle																																						
14.0"	FHD (1920x1080)	IPS	Anti-glare	250 nits (non-touch) 300 nits (multi-touch)	16:9	700:1	45%	170°																																						
14.0"	FHD (1920x1080) Low Power	IPS	Anti-glare	400 nits	16:9	800:1	72%	170°																																						
14.0"	FHD (1920x1080) ThinkPad Privacy Guard	IPS	Anti-glare	400 nits	16:9	1000:1	72%	170°																																						
14.0"	WQHD (2560x1440) HDR, Dolby Vision™	IPS	Glossy	500 nits	16:9	1500:1	100% Adobe	170°																																						
<p><b>Multi-touch (opt)</b> On-cell touch, supports 10-finger gesture (FHD only)</p>																																														
<p><b>Storage</b></p> <ul style="list-style-type: none"> <li>• M.2 2280 SSD / SATA 6.0Gb/s</li> <li>• M.2 2280 SSD / PCIe NVMe, PCIe 3.0 x 4</li> <li>• M.2 2242 SSD / PCIe NVMe, PCIe 3.0 x 2</li> <li>• Intel Optane™ Memory H10 with Solid State Storage, M.2 2280, PCIe NVMe 3.0 x 4</li> </ul>	<p><b>Keyboard</b> 6-row, spill-resistant, multimedia Fn keys, optional LED backlight <b>UltraNav™</b> TrackPoint® pointing device and buttonless Mylar surface multi-touch touchpad</p>																																													
<p><b>Optical</b> None</p>	<p><b>Security</b> Power-on password, hard disk password, supervisor password, security keyhole <b>Security chip</b> Discrete TPM 2.0, TCG Certified <b>System Mgt (opt)</b> Intel vPro Technology</p>																																													
<p><b>Ethernet</b> Native Intel Ethernet Connection I219-V (<i>Non-vPro</i>) or I219-LM (<i>vPro</i>) via bundled or optional ThinkPad Ethernet Extension Adapter Gen 2</p>	<p><b>Fingerprint reader</b> <i>Optional:</i> Touch style match on chip fingerprint reader on the palm rest <b>NFC (optional)</b> Near Field Communication</p>																																													
<p><b>WLAN + Bluetooth™ (optional)</b> <i>One of the following, configurable by model:</i> • Intel Wireless-AC 9560, Wi-Fi 2x2 802.11ac + Bluetooth 5.0 • Intel Wi-Fi 6 AX200, Wi-Fi 2x2 802.11ax + Bluetooth 5.0</p>	<p><b>Battery</b> Integrated Li-ion 57Wh battery, supports Rapid Charge (charge up to 80% in 1hr) <b>Max battery life</b> <i>MobileMark® 2014:</i> 20 hr <i>* Battery life varies significantly with settings, usage, &amp; other factors</i> <b>AC adapter</b> 45W, 65W, or 65W slim USB-C AC adapter</p>																																													
<p><b>WWAN (optional)</b> <i>One of the following, configurable by model:</i> • Wireless WAN upgradable • Integrated Mobile Broadband 4G LTE, Fibocom L830-EB, M.2 card (EMEA only) • Integrated Mobile Broadband 4G LTE-A, Fibocom L850-GL, M.2 card <i>* For non-WWAN model, it means the model is NOT WWAN upgradable</i></p>	<p><b>Operating system</b> <i>Optional:</i> Windows® 10 Home 64 or Windows 10 Pro 64</p>																																													
<p><b>SIM card (opt)</b> Nano-SIM card slot, optional Verizon LTE (US) SIM card</p>	<p><b>Limited warranty</b> <i>One of the following, configurable by model:</i> • 1-year depot repair service • 1-year depot with 2-year planar repair service • 3-year/1-yr battery depot repair service • 3-year/1-yr battery limited onsite service</p> <p><b>Mil-Spec test</b> MIL-STD-810G military testing</p> <p><b>Environment</b> EPEAT™ Silver; ENERGY STAR® 7.1; RoHS-compliant</p>																																													

Note: The specifications above may not be available in all regions.

Lenovo  
August 2019



AMD



AMD



AMD



AMD



AMD



AMD

# ThinkPad T495 Platform Specifications

Product Specifications Reference (PSREF)

Processor	AMD Ryzen™ PRO Mobile Processors with Radeon™ Vega Graphics									Dimensions WxDxH: 12.95" x 8.94" x 0.70"; 329mm x 227mm x 17.9mm
	Processor Number	# of Cores	# of Threads	Base Frequency	Max Turbo Frequency	Cache	Memory Controller	Processor Graphics		
	Ryzen 3 Pro 3300U	4	4	2.1 GHz	3.5 GHz	2MB L2 / 4MB L3	DDR4-2400	Radeon Vega 6 Graphics		
	Ryzen 5 Pro 3500U	4	8	2.1 GHz	3.7 GHz	2MB L2 / 4MB L3		Radeon Vega 8 Graphics		
Ryzen 7 Pro 3700U	4	8	2.3 GHz	4.0 GHz	2MB L2 / 4MB L3	Radeon Vega 10 Graphics				
Graphics	AMD Radeon Vega 6, Vega 8, or Vega 10 Graphics in processor; supports external digital monitor via USB-C or HDMI; supports four independent displays; Max resolution: 5120x2880@60Hz (USB-C); 4096x2160@60Hz (HDMI)									Case color Black Case material Display cover: PPS / 50% GF; Bottom: PA / 50% GF
Chipset	AMD SoC (System on Chip) platform									
Memory	32GB max / 2400MHz DDR4, dual-channel capable, 8GB or 16GB memory soldered to systemboard, one DDR4 SO-DIMM socket * Installed memory is actually 2666MHz but run at 2400MHz due to AMD limitation									
Display	Size	Resolution	Type	Surface	Brightness	Aspect Ratio	Contrast Ratio	Color Gamut	Viewing Angle	
	14.0"	HD (1366x768)	TN	Anti-glare	220 nits	16:9	400:1	45%	90°	
	14.0"	FHD (1920x1080)	IPS	Anti-glare	250 nits (non-touch) 300 nits (multi-touch)	16:9	700:1	45%	170°	
	14.0"	FHD (1920x1080) Low Power	IPS	Anti-glare	400 nits	16:9	800:1	72%	170°	
Multi-touch (opt)	On-cell touch, supports 10-finger gesture (FHD only)									Smart card reader Optional: Smart card reader Media reader MicroSD card reader Ports One USB 3.1 Gen 1 (Always On), one USB 3.1 Gen 2, two USB 3.1 Type-C Gen 2 (with the function of Power Delivery and DisplayPort), HDMI 2.0, Ethernet (RJ-45), nano-SIM card slot (WWAN models), headphone / microphone combo jack, optional smart card reader, microSD card reader, side docking connector, security keyhole * Depending on many factors, actual data transfer speed may be lower than theoretical speed Monitor cable (optional) HDMI to VGA: Lenovo HDMI to VGA Monitor Adapter USB-C to VGA: Lenovo USB-C to VGA Adapter USB-C to DP: Lenovo USB-C to DisplayPort Adapter Bundled Accy None
Storage	<ul style="list-style-type: none"> <li>M.2 2280 SSD / SATA 6.0Gb/s</li> <li>M.2 2280 SSD / PCIe NVMe, PCIe 3.0 x 4</li> <li>M.2 2242 SSD / PCIe NVMe, PCIe 3.0 x 2</li> </ul>									
Optical	None									
Ethernet	Realtek® RTL8111 Gigabit Ethernet connection									
WLAN	Intel Wireless-AC 9260, Wi-Fi 2x2 802.11ac + Bluetooth 5.0									Camera (optional) One of the following, configurable by model: • HD720p camera with ThinkShutter camera privacy, fixed focus • IR camera and HD720p camera with ThinkShutter camera privacy, fixed focus Audio support HD Audio, Realtek® ALC3287 codec / stereo speakers, 2W x 2, Dolby® Audio™ Premium / dual array far-field microphone, headphone / microphone combo jack Keyboard 6-row, spill-resistant, multimedia Fn keys, optional LED backlight UltraNav™ TrackPoint® pointing device and buttonless Mylar surface multi-touch touchpad Security Power-on password, hard disk password, supervisor password, security keyhole Security chip Discrete TPM 2.0, TCG Certified System Mgt DASH Management Fingerprint reader Optional: Touch style match on chip fingerprint reader on the palm rest NFC None Battery Integrated Li-ion 50Wh battery, supports Rapid Charge (charge up to 80% in 1hr) Max battery life MobileMark® 2014: 13.4 hr * Battery life varies significantly with settings, usage, & other factors AC adapter 45W or 65W USB Type-C AC adapter Operating system Windows® 10 Home 64 or Windows 10 Pro 64 Limited warranty One of the following, configurable by model: • 1-year depot repair service • 3-year/1-yr battery depot repair service Mil-Spec test MIL-STD-810G military testing Environment EPEAT™ Silver; ENERGY STAR® 7.1; RoHS-compliant
Bluetooth™	Bluetooth 5.0 wireless, integrated in Wi-Fi + Bluetooth combo adapter									
WWAN (optional)	One of the following, configurable by model: <ul style="list-style-type: none"> <li>Wireless WAN upgradable</li> <li>Integrated Mobile Broadband 4G LTE-A, Fibocom L850-GL, M.2 card</li> </ul> * For non-WWAN model, it means the model is NOT WWAN upgradable									
SIM card (opt)	Nano-SIM card slot, optional Verizon LTE (US) SIM card									

Note: The specifications above may not be available in all regions.

Lenovo  
July 2019



AMD



AMD



AMD



AMD



AMD



AMD

# ThinkPad T495s Platform Specifications

Product Specifications Reference (PSREF)

Processor	AMD Ryzen™ PRO Mobile Processors with Radeon™ Vega Graphics									Dimensions	<i>WxDxH (FHD / Privacy Guard):</i> 12.95" x 8.90" x 0.66"; 329.0mm x 226.15mm x 16.7mm			
	Processor Number	# of Cores	# of Threads	Base Frequency	Max Turbo Frequency	Cache	Memory Controller	Processor Graphics			<i>WxDxH (Low Power):</i> 12.94" x 8.89" x 0.63"; 328.8mm x 225.8mm x 16.1mm			
Graphics	Ryzen 5 Pro 3500U	4	8	2.1 GHz	3.7 GHz	2MB L2 / 4MB L3	DDR4-2400	Radeon Vega 8 Graphics		Weight	Models	FHD	FHD Low Power	FHD Privacy Guard
	Ryzen 7 Pro 3700U	4	8	2.3 GHz	4.0 GHz	2MB L2 / 4MB L3		Radeon Vega 10 Graphics			Weight	2.92 lb / 1.33 kg	2.76 lb / 1.25 kg	2.89 lb / 1.31 kg
Chipset	AMD SoC (System on Chip) platform									Case color	Black			
Memory	8GB or 16GB / 2400MHz DDR4 / soldered to systemboard, no sockets <i>* Installed memory is actually 2666MHz but run at 2400MHz due to AMD limitation</i>									Case material	<i>Display cover:</i> CFRP Hybrid; <i>Bottom:</i> Magnesium/Aluminum			
Display	Size	Resolution	Type	Surface	Brightness	Aspect Ratio	Contrast Ratio	Color Gamut	Viewing Angle	Smart card reader	Optional: Smart card reader			
	14.0"	FHD (1920x1080)	IPS	Anti-glare	250 nits (non-touch) 300 nits (multi-touch)	16:9	700:1	45%	170°	Media reader	MicroSD card reader			
	14.0"	FHD (1920x1080) Low Power	IPS	Anti-glare	400 nits	16:9	800:1	72%	170°	Ports	One USB 3.1 Gen 1 (Always On), one USB 3.1 Gen 2, two USB 3.1 Type-C Gen 2 (with the function of Power Delivery and DisplayPort), HDMI 2.0, Ethernet extension connector, nano-SIM card slot (WWAN models), headphone / microphone combo jack, optional smart card reader, microSD card reader, side docking connector, security keyhole <i>* Depending on many factors, actual data transfer speed may be lower than theoretical speed</i>			
	14.0"	FHD (1920x1080) ThinkPad Privacy Guard	IPS	Anti-glare	400 nits	16:9	1000:1	72%	170°	Monitor cable (optional)	HDMI to VGA: Lenovo HDMI to VGA Monitor Adapter USB-C to VGA: Lenovo USB-C to VGA Adapter Optional: ThinkPad Ethernet Extension Adapter Gen 2			
Multi-touch (opt)	On-cell touch, supports 10-finger gesture (FHD only)									Camera	<i>One of the following, configurable by model:</i> • HD720p camera with ThinkShutter camera privacy, fixed focus • IR camera and HD720p camera with ThinkShutter camera privacy, fixed focus			
Storage	M.2 2280 SSD / PCIe NVMe, PCIe 3.0 x 4									Audio support	HD Audio, Realtek® ALC3287 codec / stereo speakers, 1W x 2, Dolby® Audio™ Premium / dual array far-field microphone, headphone / microphone combo jack			
Optical	None									Keyboard	6-row, spill-resistant, multimedia Fn keys, optional LED backlight			
Ethernet	Realtek® RTL8111EPV Gigabit Ethernet connection									UltraNav™	TrackPoint® pointing device and buttonless Mylar surface multi-touch touchpad			
WLAN (optional)	Intel Wireless-AC 9260, Wi-Fi 2x2 802.11ac + Bluetooth 5.0									Security	Power-on password, hard disk password, supervisor password, security keyhole			
Bluetooth™	Bluetooth 5.0 wireless, integrated in Wi-Fi + Bluetooth combo adapter									Security chip	Discrete TPM 2.0, TCG Certified			
WWAN (optional)	<i>One of the following, configurable by model:</i> • Wireless WAN upgradable • Integrated Mobile Broadband 4G LTE-A, Fibocom L850-GL, M.2 card <i>* For non-WWAN model, it means the model is NOT WWAN upgradable</i>									System Mgt	DASH Management			
SIM card (opt)	Nano-SIM card slot, optional Verizon LTE (US) SIM card									Fingerprint reader	Optional: Touch style match on chip fingerprint reader on the palm rest			
										NFC	None			
										Battery	Integrated Li-ion 57Wh battery, supports Rapid Charge (charge up to 80% in 1hr)			
										Max battery life	<i>MobileMark® 2014:</i> 16.4 hr <i>* Battery life varies significantly with settings, usage, &amp; other factors</i>			
										AC adapter	45W or 65W USB Type-C AC adapter			
										Operating system	Optional: Windows® 10 Home 64 or Windows 10 Pro 64			
										Limited warranty	<i>One of the following, configurable by model:</i> • 1-year depot repair service • 3-year/1-yr battery depot repair service			
										Mil-Spec test	MIL-STD-810G military testing			
										Environment	EPEAT™ Silver; ENERGY STAR® 7.1; RoHS-compliant			

Note: The specifications above may not be available in all regions.

Lenovo  
October 2019





# ThinkPad T580 Platform Specifications

Product Specifications Reference (PSREF)

Processor	7th Generation Intel® Core™ i5 Processor							Dimensions Weight	<i>WxDxH:</i> 14.40" x 9.95" x 0.79-0.80"; 365.8mm x 252.8mm x 19.95-20.2mm <i>Integrated model:</i> starting at 4.29 lb / 1.95 kg; <i>Discrete model:</i> starting at 4.39 lb / 1.99 kg																			
	Processor Number	# of Cores	# of Threads	Base Frequency	Max Turbo Frequency	Cache	Memory Types		Processor Graphics	Case color	Black																	
	i5-7200U	2	4	2.5 GHz	3.1 GHz	3MB	DDR4-2133	Intel HD Graphics 620	Case material	<i>Display cover:</i> Glass-Fiber Reinforced Plastic (PPS); <i>Bottom:</i> Glass-Fiber Reinforced Plastic																		
	i5-7300U			2.6 GHz	3.5 GHz	3MB																						
	or 8th Generation Intel Core i5 / i7 Processor							Smart card reader	<i>Optional:</i> Smart card reader																			
	Processor Number	# of Cores	# of Threads	Base Frequency	Max Turbo Frequency	Cache	Memory Types	Processor Graphics	Media reader	4-in-1 reader (MMC, SD, SDHC, SDXC)																		
	i5-8250U	4	8	1.6 GHz	3.4 GHz	6MB	DDR4-2400	Intel UHD Graphics 620	Ports	Two USB 3.1 Gen 1 (one Always On), one USB 3.1 Type-C Gen 1 (with the function of Power Delivery and DisplayPort), one USB 3.1 Type-C Gen 2 / Thunderbolt 3 (with the function of PD and DP), HDMI 1.4b, Ethernet (RJ-45), nano-SIM card slot (WWAN models), headphone / microphone combo jack, optional smart card reader, 4-in-1 reader (MMC, SD, SDHC, SDXC), side docking connector, security keyhole <i>* Depending on many factors, actual data transfer speed may be lower than theoretical speed</i>																		
	i5-8350U			1.7 GHz	3.6 GHz	6MB																						
	i7-8550U			1.8 GHz	4.0 GHz	8MB																						
	i7-8650U			1.9 GHz	4.2 GHz	8MB																						
Graphics	Intel HD Graphics 620 or Intel UHD Graphics 620 in processor only or Intel HD Graphics 620 or Intel UHD Graphics 620 in processor and NVIDIA® GeForce® MX150, 2GB GDDR5 memory; supports external digital monitor via HDMI or USB Type-C; supports three independent displays; Max resolution: 4096x2304@60Hz (USB Type-C); 4096x2160@30Hz (HDMI)							Monitor cable <i>(optional)</i>	<i>HDMI to VGA:</i> Lenovo HDMI to VGA Monitor Adapter <i>USB-C to DP:</i> Lenovo USB-C to DisplayPort Adapter																			
Chipset	Intel SoC (System on Chip) platform							Camera <i>(optional)</i>	<i>One of the following, configurable by model:</i> • HD720p camera with ThinkShutter camera privacy, fixed focus • IR camera and HD720p camera, fixed focus																			
Memory	32Gb max / 2400MHz DDR4, dual-channel capable, two DDR4 SO-DIMM sockets <i>* System clocks down for processors with lower memory controller</i>							Audio support	HD Audio, Realtek® ALC3287 codec / stereo speakers, 2W x 2, Dolby® Audio™ Premium / dual array microphone, headphone / microphone combo jack																			
Display	<i>Some:</i> 15.6" (396mm) FHD (1920x1080), anti-glare, LED backlight, IPS, 250 nits, 16:9 aspect ratio, 700:1 contrast ratio, 170° viewing angle <i>Some:</i> 15.6" (396mm) UHD (3840x2160), anti-glare, LED backlight, IPS, 300 nits, 16:9 aspect ratio, 1000:1 contrast ratio, 72% gamut, 170° viewing angle							Keyboard	6-row, spill-resistant, multimedia Fn keys, numeric keypad, optional LED backlight UltraNav™ TrackPoint® pointing device and buttonless Mylar surface multi-touch touchpad																			
Multi-touch <i>(opt)</i>	On-cell touch, supports 10-finger gesture (FHD only)							Security	Power-on password, hard disk password, supervisor password, security keyhole																			
Storage	<i>System has one HDD slot or one M.2 2280 slot exclusively for storage</i> <i>Some:</i> HDD / SATA 6.0Gb/s, 2.5" wide, 7mm high, Active Protection System™ <i>Some:</i> SSD / SATA 6.0Gb/s, 2.5" wide, 7mm high (e.g. xxxGB SSD) <i>Some:</i> M.2 SSD / PCIe NVMe, PCIe 3.0 x 2, 16Gb/s <i>Some:</i> 128GB M.2 SSD / PCIe NVMe, PCIe 3.0 x 2, 16Gb/s, in WWAN slot as 2nd Storage, mutually exclusive with WWAN							Security chip <i>vPro (optional)</i>	Discrete TPM 2.0, TCG Certified Intel vPro Technology																			
Optane™ memory	<i>Optional:</i> Intel Optane memory, PCIe NVMe, PCIe 3.0 x 2							Fingerprint reader	<i>Optional:</i> Touch style match on chip fingerprint reader on the palm rest, anti-spoofing technology																			
Optical	None							NFC <i>(optional)</i>	Near Field Communication																			
Ethernet	<i>Non-vPro model:</i> Intel Ethernet Connection I219-V (Jacksonville) <i>vPro model:</i> Intel Ethernet Connection I219-LM (Jacksonville)							Battery	Optional integrated Li-ion 32Wh battery and external Li-ion 24Wh, 48Wh, or 72Wh battery																			
WLAN + Bluetooth™	Intel Dual Band Wireless-AC 8265, Wi-Fi 2x2 802.11ac + Bluetooth 4.1, M.2 card <i>* Intel 8265ac card supports BT4.2 but is limited to BT4.1 by Windows OS</i>							Max battery life <i>(MobileMark® 2014)</i>	<table border="1"> <thead> <tr> <th>Models</th> <th>24Wh</th> <th>48Wh</th> <th>72Wh</th> <th>32Wh + 24Wh</th> <th>32Wh + 48Wh</th> <th>32Wh + 72Wh</th> </tr> </thead> <tbody> <tr> <td><i>Max battery life</i></td> <td>5.8 hr</td> <td>12.5 hr</td> <td>18.1 hr</td> <td>13.8 hr</td> <td>20.3 hr</td> <td>26.1 hr</td> </tr> </tbody> </table>						Models	24Wh	48Wh	72Wh	32Wh + 24Wh	32Wh + 48Wh	32Wh + 72Wh	<i>Max battery life</i>	5.8 hr	12.5 hr	18.1 hr	13.8 hr	20.3 hr	26.1 hr
Models	24Wh	48Wh	72Wh	32Wh + 24Wh	32Wh + 48Wh	32Wh + 72Wh																						
<i>Max battery life</i>	5.8 hr	12.5 hr	18.1 hr	13.8 hr	20.3 hr	26.1 hr																						
WWAN <i>(optional)</i>	<i>One of the following, configurable by model:</i> • Integrated Mobile Broadband 4G LTE, Intel XMM™ 7262 (Fibocom L830-EB), M.2 card (EMEA only) • Integrated Mobile Broadband 4G LTE-A, Intel XMM™ 7360 (Fibocom L850-GL), M.2 card <i>* For non-WWAN model, it means the model is NOT WWAN upgradable</i>							AC adapter	45W or 65W USB Type-C AC adapter																			
SIM card <i>(opt)</i>	Nano-SIM card slot, optional Verizon LTE (US) SIM card							Operating system	<i>Optional:</i> Windows® 10 Home 64 or Windows 10 Pro 64																			
								Limited warranty	<i>One of the following, configurable by model:</i> • 1-year depot repair service • 1-year depot with 2-year planar repair service • 3-year/1-yr battery depot repair service • 3-year/1-yr battery limited onsite service																			
								Mil-Spec test	MIL-STD-810G military testing																			
								Environment	EPEAT™ Silver; ENERGY STAR® 6.1; RoHS-compliant																			

Note: The specifications above may not be available in all regions.

Lenovo  
August 2019



# ThinkPad T590 Platform Specifications

Product Specifications Reference (PSREF)

Processor	8th Generation Intel® Core™ i5 / i7 Processor									Dimensions	<i>WxDxH:</i> 14.40" x 9.76" x 0.75"; 365.8mm x 248mm x 19.1mm
	Processor Number	# of Cores	# of Threads	Base Frequency	Max Turbo Frequency	Cache	Memory Types	Processor Graphics	Weight	<i>FHD model:</i> 3.87 lb / 1.75 kg; <i>UHD model:</i> 3.86 lb / 1.75 kg	
	i5-8265U	4	8	1.6 GHz	3.9 GHz	6MB	DDR4-2400	Intel UHD Graphics 620	Case color	Black	
	i5-8365U			1.6 GHz	4.1 GHz	6MB			Case material	<i>Display cover:</i> PPS / 50% GF; <i>Bottom:</i> PA / 50% GF	
	i7-8565U			1.8 GHz	4.6 GHz	8MB			Smart card reader	<i>Optional:</i> Smart card reader	
i7-8665U	1.9 GHz			4.8 GHz	8MB	Media reader			MicroSD card reader		
Graphics	Intel UHD Graphics 620 in processor only or Intel UHD Graphics 620 in processor and NVIDIA® GeForce® MX250, 2GB GDDR5 memory; supports external digital monitor via HDMI or Thunderbolt; supports three independent displays; Max resolution: 4096x2304@60Hz (Thunderbolt); 4096x2160@24Hz (HDMI)									Ports	Two USB 3.1 Gen 1 (one Always On), one USB 3.1 Type-C Gen 1 (with the function of Power Delivery and DisplayPort), one USB 3.1 Type-C Gen 2 / Thunderbolt 3 (with the function of PD and DP), HDMI 1.4b, Ethernet (RJ-45), nano-SIM card slot (WWAN models), headphone / microphone combo jack, optional smart card reader, microSD card reader, side docking connector, security keyhole <i>* Depending on many factors, actual data transfer speed may be lower than theoretical speed</i>
Chipset	Intel SoC (System on Chip) platform									Monitor cable (optional)	<i>HDMI to VGA:</i> Lenovo HDMI to VGA Monitor Adapter <i>USB-C to VGA:</i> Lenovo USB-C to VGA Adapter (NOT available in EMEA) <i>USB-C to DP:</i> Lenovo USB-C to DisplayPort Adapter (NOT available in EMEA)
Memory	48GB max / 2400MHz DDR4, dual-channel capable, 8GB or 16GB memory soldered to systemboard, one DDR4 SO-DIMM socket <i>* Installed memory is actually 2666MHz but run at 2400MHz due to Intel limitation</i>									Bundled Accy	None
Display	Size	Resolution	Type	Surface	Brightness	Aspect Ratio	Contrast Ratio	Color Gamut	Viewing Angle	Camera (optional)	<i>One of the following, configurable by model:</i> • HD720p camera with ThinkShutter camera privacy, fixed focus • IR camera and HD720p camera with ThinkShutter camera privacy, fixed focus
	15.6"	FHD (1920x1080)	IPS	Anti-glare	250 nits	16:9	700:1	45%	170°	Audio support	HD Audio, Realtek® ALC3287 codec / stereo speakers, 2W x 2, Dolby® Audio™ Premium / dual array far-field microphone, headphone / microphone combo jack
	15.6"	UHD (3840x2160) HDR, Dolby Vision™	IPS	Anti-glare	500 nits	16:9	1200:1	100% Adobe	170°	Keyboard	6-row, spill-resistant, multimedia Fn keys, numeric keypad, optional LED backlight
Multi-touch (opt)	On-cell touch, supports 10-finger gesture (FHD only)									UltraNav™	TrackPoint® pointing device and buttonless Mylar surface multi-touch touchpad
Storage	<ul style="list-style-type: none"> <li>M.2 2280 SSD / SATA 6.0Gb/s</li> <li>M.2 2280 SSD / PCIe NVMe, PCIe 3.0 x 4</li> <li>M.2 2242 SSD / PCIe NVMe, PCIe 3.0 x 2</li> <li>Intel Optane™ Memory H10 with Solid State Storage, M.2 2280, PCIe NVMe 3.0 x 4</li> </ul>									Security	Power-on password, hard disk password, supervisor password, security keyhole
Optical	None									Security chip	Discrete TPM 2.0, TCG Certified
Ethernet	<i>Non-vPro model:</i> Intel Ethernet Connection I219-V (Jacksonville) <i>vPro model:</i> Intel Ethernet Connection I219-LM (Jacksonville)									System Mgt (opt)	Intel vPro Technology
WLAN (optional)	Intel Wireless-AC 9560, Wi-Fi 2x2 802.11ac + Bluetooth 5.0									Fingerprint reader	<i>Optional:</i> Touch style match on chip fingerprint reader on the palm rest
Bluetooth™	Bluetooth 5.0 wireless, integrated in Wi-Fi + Bluetooth combo adapter									NFC (optional)	Near Field Communication
WWAN (optional)	<i>One of the following, configurable by model:</i> • Wireless WAN upgradable • Integrated Mobile Broadband 4G LTE, Fibocom L830-EB, M.2 card (EMEA only) • Integrated Mobile Broadband 4G LTE-A, Fibocom L850-GL, M.2 card <i>* For non-WWAN model, it means the model is NOT WWAN upgradable</i>									Battery	Integrated Li-ion 57Wh battery, supports Rapid Charge (charge up to 80% in 1hr) with 65W USB Type-C AC adapter
SIM card	Nano-SIM card slot, optional Verizon LTE (US) SIM card									Max battery life	<i>MobileMark® 2014:</i> 14.98 hr (9.5 hr for UHD model with discrete graphics) <i>* Battery life varies significantly with settings, usage, &amp; other factors</i>
										AC adapter	45W or 65W USB Type-C AC adapter
										Operating system	<i>Optional:</i> Windows® 10 Home 64 or Windows 10 Pro 64
										Limited warranty	<i>One of the following, configurable by model:</i> • 1-year depot repair service • 1-year depot with 2-year planar repair service • 3-year/1-yr battery depot repair service • 3-year/1-yr battery limited onsite service
										Mil-Spec test	MIL-STD-810G military testing
										Environment	EPPEATM Silver; ENERGY STAR® 7.1; RoHS-compliant

Note: The specifications above may not be available in all regions.

Lenovo  
August 2019



# ThinkPad X1 Carbon (6<sup>th</sup> Gen) Platform Specifications

Product Specifications Reference (PSREF)

Processor	7th Generation Intel® Core™ i5 Processor								Dimensions	<i>WxDxH:</i> 12.74" x 8.55" x 0.63"; 323.5mm x 217.1mm x 15.95mm
	Processor Number	# of Cores	# of Threads	Base Frequency	Max Turbo Frequency	Cache	Memory Types	Processor Graphics	Weight	Starting at 2.49 lb / 1.13 kg
	i5-7300U	2	4	2.6 GHz	3.5 GHz	3MB	LPDDR3-1866	Intel HD Graphics 620	Case color	Black or Silver (silver case is NOT available in EMEA)
	or 8th Generation Intel Core i5 / i7 Processor								Case material	<i>Display cover:</i> CFRP/GFRP hybrid; <i>Bottom:</i> magnesium alloy / PPS hybrid
	Processor Number	# of Cores	# of Threads	Base Frequency	Max Turbo Frequency	Cache	Memory Types	Processor Graphics	Smart card reader	None
	i5-8250U	4	8	1.6 GHz	3.4 GHz	6MB	LPDDR3-2133	Intel UHD Graphics 620	Media reader	MicroSD card reader, supports UHS-II
	i5-8350U			1.7 GHz	3.6 GHz	6MB			Ports	Two USB 3.1 Gen 1 (one Always On), two USB 3.1 Type-C Gen 2 / Thunderbolt 3 (with the function of Power Delivery and DisplayPort), HDMI 1.4b, Ethernet extension connector, nano-SIM card slot (WWAN models), headphone / microphone combo jack, microSD card reader, side docking connector, security keyhole
	i7-8550U			1.8 GHz	4.0 GHz	8MB			Monitor cable	<i>HDMI to VGA:</i> Lenovo HDMI to VGA Monitor Adapter
	i7-8650U			1.9 GHz	4.2 GHz	8MB			<i>(optional)</i>	<i>USB-C to VGA:</i> Lenovo USB-C to VGA Adapter
Graphics	Intel HD Graphics 620 or Intel UHD Graphics 620 in processor; supports external digital monitor via HDMI or USB Type-C; supports three independent displays; Max resolution: 5120x2880@60Hz (USB Type-C); 4096x2160@30Hz (HDMI)								Bundled Accy	<i>Optional:</i> ThinkPad Ethernet Extension Adapter Gen 2
Chipset	Intel SoC (System on Chip) platform								Camera <i>(optional)</i>	<i>One of the following, configurable by model:</i>
Memory	8GB or 16GB / 2133MHz LPDDR3 / soldered to systemboard, no sockets <i>* System clocks down for processors with lower memory controller</i>								Audio support	<ul style="list-style-type: none"> <li>• HD720p camera with ThinkShutter camera privacy, fixed focus</li> <li>• IR camera and HD720p camera, fixed focus</li> </ul>
Display	<i>One of the following, configurable by model:</i> <ul style="list-style-type: none"> <li>• 14.0" (355mm) FHD (1920x1080), anti-glare, LED backlight, IPS, 300 nits, 16:9 aspect ratio, 700:1 contrast ratio, 72% gamut, 170° viewing angle</li> <li>• 14.0" (355mm) WQHD (2560x1440), anti-glare, LED backlight, IPS, 300 nits, 16:9 aspect ratio, 700:1 contrast ratio, 72% gamut, 170° viewing angle</li> <li>• 14.0" (355mm) HDR WQHD (2560x1440) with Dolby Vision™, glossy, LED backlight, IPS, 500 nits, 16:9 aspect ratio, 1500:1 contrast ratio, 100% gamut, 170° viewing angle</li> </ul>								Keyboard	6-row, spill-resistant, multimedia Fn keys, LED backlight
Multi-touch <i>(opt)</i>	On-cell touch, supports 10-finger gesture (FHD only)								UltraNav™	TrackPoint® pointing device and buttonless glass surface multi-touch touchpad
Storage	<i>One of the following, configurable by model:</i> <ul style="list-style-type: none"> <li>• M.2 SSD / SATA 6.0Gb/s (e.g. xxxGB SSD M.2)</li> <li>• M.2 SSD / PCIe NVMe, PCIe 3.0 x 4, 32Gb/s (e.g. xxxGB SSD M.2 PCIe NVMe)</li> </ul>								Security chip	Power-on password, hard disk password, supervisor password, security keyhole
Optical	None								vPro <i>(optional)</i>	Intel vPro Technology
Ethernet	Native Intel Ethernet Connection I219-V ( <i>Non-vPro</i> ) or I219-LM ( <i>vPro</i> ) via bundled or optional ThinkPad Ethernet Extension Adapter Gen 2								Fingerprint reader	Touch style match on chip fingerprint reader on the palm rest, anti-spoofing technology
WLAN + Bluetooth™	Intel Dual Band Wireless-AC 8265, Wi-Fi 2x2 802.11ac + Bluetooth 4.1, M.2 card <i>* Intel 8265ac card supports BT4.2 but is limited to BT4.1 by Windows OS</i>								NFC <i>(optional)</i>	Near Field Communication
WWAN <i>(optional)</i>	Integrated Mobile Broadband 4G LTE-A, Intel XMM™ 7360 (Fibocom L850-GL), M.2 card <i>* For non-WWAN model, it means the model is NOT WWAN upgradable</i>								Battery	Integrated Li-ion 57Wh battery, supports Rapid Charge (charge up to 80% in 1hr) with 65W USB Type-C AC adapter
SIM card <i>(opt)</i>	Nano-SIM card slot, optional Verizon LTE (US) SIM card								Max battery life	<i>MobileMark® 2014:</i> 19.3 hr <i>* Battery life varies significantly with settings, usage, &amp; other factors</i>
									AC adapter	45W, 65W, or 65W Low Halogen USB-C AC adapter
									Operating system	<i>Optional:</i> Windows® 10 Home 64 or Windows 10 Pro 64
									Limited warranty	<i>One of the following, configurable by model:</i> <ul style="list-style-type: none"> <li>• 1-year depot repair service</li> <li>• 1-year depot with 2-year planar repair service</li> <li>• 3-year/1-yr battery depot repair service</li> <li>• 3-year/1-yr battery limited onsite service</li> </ul>
									Mil-Spec test	MIL-STD-810G military testing
									Environment	EPeAT™ Gold (US only); ENERGY STAR® 6.1; RoHS-compliant



# ThinkPad X1 Carbon (7<sup>th</sup> Gen) Platform Specifications

Product Specifications Reference (PSREF)

Processor	8th Generation Intel® Core™ i5 / i7 Processor									WWAN (optional) <i>One of the following, configurable by model:</i> • Integrated Mobile Broadband 4G LTE-A, Fibocom L850-GL, M.2 card • Integrated Mobile Broadband 4G LTE-A, Fibocom L860-GL, MIMO 2x2, M.2 card * For non-WWAN model, it means the model is NOT WWAN upgradable Nano-SIM card slot, optional Verizon LTE (US) SIM card
	Processor Number	# of Cores	# of Threads	Base Frequency	Max Turbo Frequency	Cache	Memory Types	Processor Graphics		
	i5-8265U	4	8	1.6 GHz	3.9 GHz	6MB	LPDDR3-2133	Intel UHD Graphics 620		
	i5-8365U			1.6 GHz	4.1 GHz	6MB				
	i7-8565U			1.8 GHz	4.6 GHz	8MB				
	i7-8665U			1.9 GHz	4.8 GHz	8MB				
	or 10th Generation Intel Core i5 / i7 Processor (NOT available in EMEA)									
	Processor Number	# of Cores	# of Threads	Base Frequency	Max Turbo Frequency	Cache	Memory Types	Processor Graphics		
	i5-10210U	4	8	1.6 GHz	4.2 GHz	6MB	LPDDR3-2133	Intel UHD Graphics		
	i7-10510U			1.8 GHz	4.9 GHz	8MB				
	i7-10710U	6	12	1.1 GHz	4.7 GHz	12MB				
Graphics	Intel UHD Graphics 620 or Intel UHD Graphics in processor; supports external digital monitor via HDMI or USB Type-C / Thunderbolt; supports three independent displays; Max resolution: 5K@60Hz (Thunderbolt); 4K@24Hz (HDMI)									
Chipset	Intel SoC (System on Chip) platform									
Memory	8GB or 16GB / 2133MHz LPDDR3 / soldered to systemboard, no sockets									
Display	Size	Resolution	Type	Surface	Brightness	Aspect Ratio	Contrast Ratio	Color Gamut	Viewing Angle	
	14.0"	FHD (1920x1080) Multi-touch	IPS	Anti-glare	300 nits	16:9	700:1	72%	170°	
	14.0"	FHD (1920x1080) Low Power	IPS	Anti-glare	400 nits	16:9	800:1	72%	170°	
	14.0"	FHD (1920x1080) ThinkPad Privacy Guard	IPS	Anti-glare	400 nits	16:9	1000:1	72%	170°	
	14.0"	WQHD (2560x1440)	IPS	Anti-glare	300 nits	16:9	700:1	72%	170°	
	14.0"	UHD (3840x2160) HDR 400, Dolby Vision™	IPS	Glossy	500 nits	16:9	1400:1	90%	170°	
Multi-touch (opt)	Capacitive-type multi-touch, supports 10-finger gesture (FHD only), anti-reflection (AR), anti-smudge coating									
Storage	One of the following, configurable by model: • M.2 2280 SSD / SATA 6.0Gb/s • M.2 2280 SSD / PCIe NVMe 3.0 x 4 • Intel Optane™ Memory H10 with Solid State Storage, M.2 2280, PCIe NVMe 3.0 x 4 • Intel Optane SSD, M.2 2280, PCIe NVMe 3.0 x 2									
Optical	None									
Ethernet	Native Intel Ethernet Connection I219-V (Non-vPro) or I219-LM (vPro) via bundled or optional ThinkPad Ethernet Extension Adapter Gen 2									
WLAN + Bluetooth™	One of the following, configurable by model: • Intel Wireless-AC 9560, Wi-Fi 2x2 802.11ac + Bluetooth 5.0 • Intel Wi-Fi 6 AX201, Wi-Fi 2x2 802.11ax + Bluetooth 5.0 (AX201 for 10th Gen processor only)									
	Smart card reader	None								
	Media reader	None								
	Ports	Two USB 3.1 Gen 1 (one Always On), two USB 3.1 Type-C Gen 2 / Thunderbolt 3 (with the function of Power Delivery and DisplayPort), HDMI 1.4b, Ethernet extension connector, nano-SIM card slot (WWAN models), headphone / microphone combo jack, side docking connector, security keyhole * Depending on many factors, actual data transfer speed may be lower than theoretical speed								
	Monitor cable	Optional: Lenovo HDMI to VGA Monitor Adapter								
	Bundled Accy	Optional: ThinkPad Ethernet Extension Adapter Gen 2								
	Camera (optional)	One of the following, configurable by model: • HD720p camera with ThinkShutter camera privacy, fixed focus • IR camera and HD720p camera with ThinkShutter camera privacy, fixed focus								
	Audio support	HD Audio, Realtek® ALC3286 codec / Dolby® Atmos™ speaker system, 2W x 2, 0.8 x 2 / 4 array far-field microphones, headphone / microphone combo jack								
	Keyboard	6-row, spill-resistant, multimedia Fn keys, LED backlight								
	UltraNav™	TrackPoint® pointing device and buttonless glass surface multi-touch touchpad								
	Security	Power-on password, hard disk password, supervisor password, security keyhole								
	Security chip	Discrete TPM 2.0, TCG Certified								
	System Mgt (opt)	Intel vPro Technology								
	Fingerprint reader	Touch style match on chip fingerprint reader on the palm rest								
	NFC (optional)	Near Field Communication								
	Battery	Integrated Li-ion 51Wh battery, supports Rapid Charge (charge up to 80% in 1hr) with 65W USB Type-C AC adapter								
	Max battery life	MobileMark® 2014: 18.3 hr * Battery life varies significantly with settings, usage, & other factors								
	AC adapter	45W, 65W, or 65W slim USB-C AC adapter								
	Operating system	Optional: Windows® 10 Home 64 or Windows 10 Pro 64								
	Limited warranty	One of the following, configurable by model: • 1-year depot repair service • 1-year depot with 2-year planar repair service • 3-year/1-yr battery depot repair service • 3-year/1-yr battery limited onsite service								
	Mil-Spec test	MIL-STD-810G military testing								
	Environment	EPEAT™ Silver; ENERGY STAR® 7.1; RoHS-compliant								

Note: The specifications above may not be available in all regions.

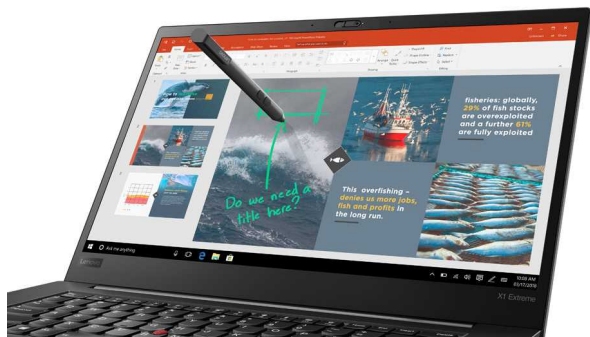



# ThinkPad X1 Extreme Platform Specifications

Product Specifications Reference (PSREF)

Processor	8th Generation Intel® Core™ i5 / i7 Processor								Smart card reader	Optional: Smart card reader	
	Processor Number	# of Cores	# of Threads	Base Frequency	Max Turbo Frequency	Cache	Memory Types	Processor Graphics	Media reader	SD Card reader (SD, SDHC, SDXC), supports UHS-II SD card	
	i5-8300H	4	8	2.3 GHz	4.0 GHz	8MB	DDR4-2666	Intel UHD Graphics 630	Ports	Two USB 3.1 Gen 1 (one Always On), two USB 3.1 Type-C Gen 2 / Thunderbolt 3 (with the function of Power Delivery and DisplayPort), HDMI 2.0, Ethernet extension connector, headphone / microphone combo jack, optional smart card reader, SD card reader, security keyhole	
	i5-8400H			2.5 GHz	4.2 GHz						
	i7-8750H	6	12	2.2 GHz	4.1 GHz	9MB					* Power Delivery only supports power-out for charging peripherals
	i7-8850H			2.6 GHz	4.3 GHz						* Depending on many factors, actual data transfer speed may be lower than theoretical speed
Graphics	Intel UHD Graphics 630 in processor and NVIDIA® GeForce® GTX 1050 Ti, 4GB GDDR5 memory; supports external digital monitor via HDMI or Thunderbolt™; supports four independent displays; Max resolution: 5K@60Hz (Thunderbolt); 4K@60Hz (HDMI)								Monitor cable (optional)	HDMI to VGA: Lenovo HDMI to VGA Monitor Adapter	
Chipset	Mobile Intel CM246 Chipset								Bundled Accy	Optional: ThinkPad Ethernet Extension Cable	
Memory	64GB max / 2666MHz DDR4, dual-channel capable, two DDR4 SO-DIMM sockets								Camera (optional)	One of the following, configurable by model:	
Display	<i>Some:</i> 15.6" (396mm) FHD (1920x1080), anti-glare, LED backlight, IPS, 300 nits, 16:9 aspect ratio, 700:1 contrast ratio, 72% gamut, 170° viewing angle <i>Some:</i> 15.6" (396mm) HDR UHD (3840x2160) with Dolby Vision™, anti-glare, LED backlight, IPS, 400 nits, 16:9 aspect ratio, 1200:1 contrast ratio, 100% gamut, 170° viewing angle, multi-touch, anti-reflection (AR)								Audio support	HD Audio, Realtek® ALC3286 codec / stereo speakers, 2W x 2, Dolby® Audio™ Premium / dual array microphone, headphone / microphone combo jack, Dolby Atmos® headphone	
Multi-touch (opt)	Capacitive-type multi-touch, supports 10-finger gesture (4K only)								Keyboard	6-row, spill-resistant, multimedia Fn keys, LED backlight	
Pen	Supports pen accessory, please see the accessory compatibility for details								UltraNav™	TrackPoint® pointing device and buttonless glass surface multi-touch touchpad	
Storage	Up to 2 drives (two M.2 SSD) • M.2 SSD / SATA 6.0Gb/s (e.g. xxxGB SSD M.2) • M.2 SSD / PCIe NVMe, PCIe 3.0 x 4, 32Gb/s (e.g. xxxGB SSD M.2 PCIe NVMe)								Security	Power-on password, hard disk password, supervisor password, security keyhole	
RAID (optional)	RAID 0/1 support								Security chip	Discrete TPM 2.0, TCG Certified	
Optical	None								vPro (optional)	Intel vPro Technology	
Ethernet	Native Intel Ethernet Connection I219-V (Non-vPro) or I219-LM (vPro) via bundled or optional ThinkPad Ethernet Extension Cable								Fingerprint reader	Touch style match on chip fingerprint reader on the keyboard bezel	
WLAN	Intel Wireless-AC 9560, Wi-Fi 2x2 802.11ac + Bluetooth 5.0, M.2 card								Color calibration	None	
Bluetooth™	Bluetooth 5.0 wireless, integrated in Wi-Fi + Bluetooth combo adapter								NFC	None	
WWAN	None								Battery	Integrated Li-ion 80Wh battery, supports Rapid Charge (charge up to 80% in 1hr)	
SIM card	None								Max battery life (MobileMark 2014)	Discrete mode: 9.5 hr; Hybrid mode: 14.9 hr	
Dimensions	<i>WxDxH (non-touch):</i> 14.24" x 9.67" x 0.72"; 361.8mm x 245.7mm x 18.4mm <i>WxDxH (multi-ouch):</i> 14.24" x 9.67" x 0.74"; 361.8mm x 245.7mm x 18.7mm <i>Non-touch model:</i> starting at 3.76 lb / 1.7 kg; <i>Multi-touch model:</i> starting at 4.06 lb / 1.8 kg								AC adapter	135W slim tip AC adapter	
Weight									Operating system	Windows® 10 Home 64 or Windows 10 Pro 64	
Case color	Black								Limited warranty	One of the following, configurable by model:	
Case material	<i>Display cover:</i> CFRP/GFRP hybrid; <i>Bottom:</i> Aluminum alloy									<ul style="list-style-type: none"> <li>• 1-year depot repair service</li> <li>• 3-year/1-yr battery depot repair service</li> <li>• 3-year/1-yr battery limited onsite service</li> </ul>	
									Mil-Spec test	MIL-STD-810G military testing	
									Environment	EPEAT™ Gold (US only); ENERGY STAR® 7.0; RoHS-compliant	

Note: The specifications above may not be available in all regions.

Lenovo  
August 2019



# ThinkPad X1 Extreme (2nd Gen) Platform Specifications

Product Specifications Reference (PSREF)

Processor	9th Generation Intel® Core™ i5 / i7 / i9 Processor									Dimensions	<i>WxDxH (non-touch):</i> 14.24" x 9.67" x 0.72"; 361.8mm x 245.7mm x 18.4mm <i>WxDxH (multi-touch):</i> 14.24" x 9.67" x 0.74"; 361.8mm x 245.7mm x 18.7mm		
	Processor Number	# of Cores	# of Threads	Base Frequency	Max Turbo Frequency	Cache	Memory Types	Processor Graphics		Weight	<i>Non-touch model:</i> starting at 3.75 lb / 1.7 kg; <i>Multi-touch model:</i> starting at 4.0 lb / 1.81 kg		
	i5-9300H	4	8	2.4 GHz	4.1 GHz	8MB	DDR4-2666	Intel UHD Graphics 630		Case color	Black paint (FHD model) or black weave (UHD model)		
	i5-9400H	4	8	2.5 GHz	4.3 GHz	8MB				Case material	<i>Display cover:</i> CFRP/GFRP hybrid; <i>Bottom:</i> Aluminum alloy		
	i7-9750H	6	12	2.6 GHz	4.5 GHz	12MB				Smart card reader	<i>Optional:</i> Smart card reader		
	i7-9850H	6	12	2.6 GHz	4.6 GHz	12MB				Media reader	SD Card reader (SD, SDHC, SDXC), supports UHS-II SD card		
	i9-9880H	8	16	2.3 GHz	4.8 GHz	16MB				Ports	Two USB 3.1 Gen 1 (one Always On), two USB 3.1 Type-C Gen 2 / Thunderbolt 3 (with the function of Power Delivery and DisplayPort), HDMI 2.0, Ethernet extension connector, headphone / microphone combo jack, optional smart card reader, SD card reader, security keyhole, slim tip AC adapter <i>* Power Delivery only supports power-out for charging peripherals</i> <i>* Depending on many factors, actual data transfer speed may be lower than theoretical speed</i>		
Graphics	Intel UHD Graphics 630 in processor and NVIDIA® GeForce® GTX 1650, 4GB GDDR5 memory; supports external digital monitor via HDMI or Thunderbolt™; supports four independent displays; Max resolution: 5K@60Hz (Thunderbolt); 4K@60Hz (HDMI)									Monitor cable (optional)	<i>HDMI to VGA:</i> Lenovo HDMI to VGA Monitor Adapter <i>USB-C to VGA:</i> Lenovo USB-C to VGA Adapter <i>USB-C to DP:</i> Lenovo USB-C to DisplayPort Adapter		
Chipset	Mobile Intel CM246 Chipset									Bundled Accy	<i>Optional:</i> ThinkPad Ethernet Extension Cable		
Memory	64GB max / 2666MHz DDR4, dual-channel capable, two DDR4 SO-DIMM sockets									Camera (optional)	<i>One of the following, configurable by model:</i> • HD720p camera with ThinkShutter camera privacy, fixed focus • IR camera and HD720p camera with ThinkShutter camera privacy, fixed focus		
Display	Size	Resolution	Type	Surface	Brightness	Aspect Ratio	Contrast Ratio	Color Gamut	Viewing Angle	Audio support	HD Audio, Synaptic® CX11880 codec / stereo speakers, 2W x 2, Dolby® Audio™ Premium / dual 360° far-field microphone, headphone / microphone combo jack, Dolby Atmos® sound system		
	15.6"	FHD (1920x1080)	IPS	Anti-glare	300 nits	16:9	700:1	72% NTSC	170°	Keyboard	6-row, spill-resistant, multimedia Fn keys, LED backlight		
	15.6"	FHD (1920x1080) Dolby Vision™ HDR	IPS	Anti-glare	500 nits	16:9	1200:1	72% NTSC	170°	UltraNav™	TrackPoint® pointing device and buttonless glass surface multi-touch touchpad		
	15.6"	UHD (3840x2160) Dolby Vision HDR	IPS	Anti-glare	500 nits	16:9	1200:1	100% Adobe	170°	Security	Power-on password, hard disk password, supervisor password, security keyhole		
	15.6"	UHD (3840x2160) Dolby Vision HDR, Multi-touch	OLED	AR, AS	SDR 400nit, HDR 500nit (peak)	16:9	100000:1	100% DCI-P3	170°	Security chip	Discrete TPM 2.0, TCG Certified		
Multi-touch (opt)	Capacitive-type multi-touch, supports 10-finger gesture (UHD OLED only), anti-reflection (AR), anti-smudge (AS) coating									System Mgt (opt)	Intel vPro Technology		
Pen	Supports pen accessory, please see the accessory compatibility for details									Fingerprint reader	Touch style match on chip fingerprint reader on the keyboard bezel		
Storage	<i>Up to two M.2 SSD</i> M.2 2280 SSD / PCIe NVMe 3.0 x 4									Color calibration	<i>Optional:</i> X-Rite Pantone factory color calibration (UHD model only)		
RAID (optional)	RAID 0/1 support									NFC	None		
Optical	None									Battery	Integrated Li-ion 80Wh battery, supports Rapid Charge (charge up to 80% in 1hr)		
Ethernet	Native Intel Ethernet Connection I219-V ( <i>Non-vPro</i> ) or I219-LM ( <i>vPro</i> ) via bundled or optional ThinkPad Ethernet Extension Cable									Max battery life	<i>MobileMark® 2014:</i> 14 hr <i>* Battery life varies significantly with settings, usage, &amp; other factors</i>		
WLAN (optional)	Intel Wi-Fi 6 AX200, Wi-Fi 2x2 802.11ax + Bluetooth 5.0									AC adapter	135W slim tip AC adapter		
Bluetooth™	Bluetooth 5.0 wireless, integrated in Wi-Fi + Bluetooth combo adapter									Operating system	Windows® 10 Home 64 or Windows 10 Pro 64		
WWAN	None									Limited warranty	<i>One of the following, configurable by model:</i> • 1-year depot repair service • 3-year/1-yr battery depot repair service • 3-year/1-yr battery limited onsite service		
SIM card	None									Mil-Spec test	MIL-STD-810G military testing		
										Environment	EPEAT™ Silver; ENERGY STAR® 7.1; RoHS-compliant		

Note: The specifications above may not be available in all regions.

Lenovo  
September 2019



# ThinkPad X270 Platform Specifications

Product Specifications Reference (PSREF)

Processor	6th Generation Intel® Core™ i3 / i5 / i7 Processor							Dimensions WxDxH: 12.03" x 8.21" x 0.80"; 305.5mm x 208.5mm x 20.3mm	Weight	<table border="1"> <tr> <th>Models</th> <th>No + 3-cell</th> <th>3-cell + 3-cell</th> <th>3 + 6-cell</th> </tr> <tr> <td></td> <td>2.79 lb / 1.27 kg</td> <td>2.98 lb / 1.36 kg</td> <td>3.33 lb / 1.52 kg</td> </tr> </table>				Models	No + 3-cell	3-cell + 3-cell	3 + 6-cell		2.79 lb / 1.27 kg	2.98 lb / 1.36 kg	3.33 lb / 1.52 kg																				
	Models	No + 3-cell	3-cell + 3-cell	3 + 6-cell																																					
	2.79 lb / 1.27 kg	2.98 lb / 1.36 kg	3.33 lb / 1.52 kg																																						
	<table border="1"> <thead> <tr> <th>Processor Number</th> <th># of Cores</th> <th># of Threads</th> <th>Base Frequency</th> <th>Max Turbo Frequency</th> <th>Cache</th> <th>Memory Types</th> <th>Processor Graphics</th> </tr> </thead> <tbody> <tr> <td>i3-6006U</td> <td rowspan="6">2</td> <td rowspan="6">4</td> <td>2.0 GHz</td> <td>-</td> <td>3MB</td> <td rowspan="6">DDR4-2133</td> <td rowspan="6">Intel HD Graphics 520</td> </tr> <tr> <td>i3-6100U</td> <td>2.3 GHz</td> <td>-</td> <td>3MB</td> </tr> <tr> <td>i5-6200U</td> <td>2.3 GHz</td> <td>2.8 GHz</td> <td>3MB</td> </tr> <tr> <td>i5-6300U</td> <td>2.4 GHz</td> <td>3.0 GHz</td> <td>3MB</td> </tr> <tr> <td>i7-6500U</td> <td>2.5 GHz</td> <td>3.1 GHz</td> <td>4MB</td> </tr> <tr> <td>i7-6600U</td> <td>2.6 GHz</td> <td>3.4 GHz</td> <td>4MB</td> </tr> </tbody> </table>	Processor Number	# of Cores	# of Threads	Base Frequency	Max Turbo Frequency	Cache	Memory Types	Processor Graphics	i3-6006U	2	4	2.0 GHz	-	3MB	DDR4-2133	Intel HD Graphics 520	i3-6100U	2.3 GHz	-	3MB	i5-6200U	2.3 GHz	2.8 GHz	3MB	i5-6300U	2.4 GHz	3.0 GHz	3MB	i7-6500U	2.5 GHz	3.1 GHz	4MB	i7-6600U	2.6 GHz	3.4 GHz	4MB				
Processor Number	# of Cores	# of Threads	Base Frequency	Max Turbo Frequency	Cache	Memory Types	Processor Graphics																																		
i3-6006U	2	4	2.0 GHz	-	3MB	DDR4-2133	Intel HD Graphics 520																																		
i3-6100U			2.3 GHz	-	3MB																																				
i5-6200U			2.3 GHz	2.8 GHz	3MB																																				
i5-6300U			2.4 GHz	3.0 GHz	3MB																																				
i7-6500U			2.5 GHz	3.1 GHz	4MB																																				
i7-6600U			2.6 GHz	3.4 GHz	4MB																																				
	or 7th Generation Intel Core i3 / i5 / i7 Processor																																								
	<table border="1"> <thead> <tr> <th>Processor Number</th> <th># of Cores</th> <th># of Threads</th> <th>Base Frequency</th> <th>Max Turbo Frequency</th> <th>Cache</th> <th>Memory Types</th> <th>Processor Graphics</th> </tr> </thead> <tbody> <tr> <td>i3-7100U</td> <td rowspan="6">2</td> <td rowspan="6">4</td> <td>2.4 GHz</td> <td>-</td> <td>3MB</td> <td rowspan="6">DDR4-2133</td> <td rowspan="6">Intel HD Graphics 620</td> </tr> <tr> <td>i5-7200U</td> <td>2.5 GHz</td> <td>3.1 GHz</td> <td>3MB</td> </tr> <tr> <td>i5-7300U</td> <td>2.6 GHz</td> <td>3.5 GHz</td> <td>3MB</td> </tr> <tr> <td>i7-7500U</td> <td>2.7 GHz</td> <td>3.5 GHz</td> <td>4MB</td> </tr> <tr> <td>i7-7600U</td> <td>2.8 GHz</td> <td>3.9 GHz</td> <td>4MB</td> </tr> </tbody> </table>	Processor Number	# of Cores	# of Threads	Base Frequency	Max Turbo Frequency	Cache	Memory Types	Processor Graphics	i3-7100U	2	4	2.4 GHz	-	3MB	DDR4-2133	Intel HD Graphics 620	i5-7200U	2.5 GHz	3.1 GHz	3MB	i5-7300U	2.6 GHz	3.5 GHz	3MB	i7-7500U	2.7 GHz	3.5 GHz	4MB	i7-7600U	2.8 GHz	3.9 GHz	4MB								
Processor Number	# of Cores	# of Threads	Base Frequency	Max Turbo Frequency	Cache	Memory Types	Processor Graphics																																		
i3-7100U	2	4	2.4 GHz	-	3MB	DDR4-2133	Intel HD Graphics 620																																		
i5-7200U			2.5 GHz	3.1 GHz	3MB																																				
i5-7300U			2.6 GHz	3.5 GHz	3MB																																				
i7-7500U			2.7 GHz	3.5 GHz	4MB																																				
i7-7600U			2.8 GHz	3.9 GHz	4MB																																				
Graphics			Intel HD Graphics 520 or 620 in processor; supports external digital monitor via HDMI or USB Type-C; supports three independent displays; Max resolution: 4096x2160@60Hz (USB Type-C); 4096x2160@24Hz (HDMI)							Keyboard	6-row, spill-resistant, multimedia Fn keys, optional LED backlight UltraNav™																														
Chipset	Intel SoC (System on Chip) platform							Security	Power-on password, hard disk password, supervisor password, security keyhole																																
Memory	16GB max / 2400MHz DDR4, one DDR4 SO-DIMM socket * System clocks down for processors with lower memory controller							Security chip	Discrete TPM 2.0, TCG Certified																																
Display	<i>Some:</i> 12.5" (317.5mm) HD (1366x768), anti-glare, LED backlight, 220 nits, 16:9 aspect ratio, 500:1 contrast ratio <i>Some:</i> 12.5" (317.5mm) HD (1366x768), anti-glare, LED backlight, IPS, 300 nits, 16:9 aspect ratio, 800:1 contrast ratio, 170° viewing angle <i>Some:</i> 12.5" (317.5mm) FHD (1920x1080), anti-glare, LED backlight, IPS, 300 nits, 16:9 aspect ratio, 700:1 contrast ratio, 170° viewing angle							vPro (optional)	Intel vPro Technology																																
Multi-touch (opt)	On-cell touch, supports 10-finger gesture (FHD only)							Fingerprint reader	Optional: Touch style match on chip fingerprint reader on the palm rest																																
Storage	<i>System has one HDD slot or one M.2 2280 slot exclusively for storage</i> <i>Some:</i> HDD / SATA 6.0Gb/s, 2.5" wide, 7mm high, Active Protection System™ <i>Some:</i> SSD / SATA 6.0Gb/s, 2.5" wide, 7mm high (e.g. xxxGB SSD) <i>Some:</i> M.2 SSD / PCIe NVMe, PCIe 3.0 x 2, 16Gb/s <i>Some:</i> 128GB M.2 SSD / SATA 6.0Gb/s, in WWAN slot as 2nd Storage, mutually exclusive with WWAN and WiGig							NFC (optional)	Near Field Communication																																
Optical	None							Internal battery	Optional: Integrated Li-ion or Li-Polymer 3-cell (23Wh)																																
Ethernet	<i>Non-vPro model:</i> Intel Ethernet Connection I219-V (Jacksonville) <i>vPro model:</i> Intel Ethernet Connection I219-LM (Jacksonville)							External battery	Li-ion 3-cell (23Wh) or 6-cell (48Wh or 72Wh)																																
WLAN	<i>One of the following, configurable by model (WiGig is mutually exclusive with WWAN):</i> • Realtek® RTL8822BE, Wi-Fi 2x2 802.11ac + BT4.1 • Intel Dual Band Wireless-AC 8260, Wi-Fi 2x2 802.11ac + BT4.1 • Intel Dual Band Wireless-AC 8265, Wi-Fi 2x2 802.11ac + BT4.1 • Intel Tri-Band Wireless-AC 18265, WiGig 802.11ad + Wi-Fi 2x2 802.11ac + BT4.1 (US only)							Max battery life (MobileMark® 2014)	<table border="1"> <tr> <th>Models</th> <th>No + 3-cell</th> <th>3-cell + 3-cell</th> <th>3-cell + 6-cell 48Wh</th> <th>3-cell + 6-cell 72Wh</th> </tr> <tr> <td></td> <td>6.52 hr</td> <td>13.04 hr</td> <td>20.1 hr</td> <td>26.9 hr</td> </tr> </table>				Models	No + 3-cell	3-cell + 3-cell	3-cell + 6-cell 48Wh	3-cell + 6-cell 72Wh		6.52 hr	13.04 hr	20.1 hr	26.9 hr																			
Models	No + 3-cell	3-cell + 3-cell	3-cell + 6-cell 48Wh	3-cell + 6-cell 72Wh																																					
	6.52 hr	13.04 hr	20.1 hr	26.9 hr																																					
Bluetooth™	Bluetooth 4.1 wireless, integrated in Wi-Fi + Bluetooth combo adapter * Intel 8265ac / 18265ac card support BT4.2 but is limited to BT4.1 by Windows OS							AC adapter	45W slim tip AC adapter or 45W USB Type-C AC adapter																																
WWAN (optional)	<i>One of the following, configurable by model (mutually exclusive with WiGig):</i> • Wireless WAN upgradable • Integrated Mobile Broadband 4G LTE-A, Qualcomm® Snapdragon™ X7 LTE-A (Sierra Wireless EM7455) • Integrated Mobile Broadband 4G LTE, Intel XMM™ 7160 (Fibocom L831-EAU) (EMEA only)							Operating system	<i>One of the following, configurable by model:</i> • Windows® 7 Professional 64 preinstalled through downgrade rights in Windows 10 Pro 64 • Windows 10 Home 64 • Windows 10 Pro 64																																
SIM card (opt)	Micro-SIM card slot, opt Verizon LTE (US) or Lenovo® Connect (EMEA) SIM card							Limited warranty	<i>One of the following, configurable by model:</i> • 1-year depot repair service • 3-year/1-yr battery depot repair service • 3-year/1-yr battery limited onsite service																																
								Mil-Spec test	MIL-STD-810G military testing																																
								Environment	EPEAT™ Gold (US only); ENERGY STAR® 6.1; RoHS-compliant																																



# ThinkPad X280 Platform Specifications

Product Specifications Reference (PSREF)

Processor	7th Generation Intel® Core™ i3 / i5 Processor <i>* i3-7130U is NOT available in US and EMEA; i5-7200U is NOT available in US</i>							Dimensions	WxDxH: 12.11" x 8.26" x 0.69-0.70"; 307.7mm x 209.8mm x 17.4-17.8mm		
	Processor Number	# of Cores	# of Threads	Base Frequency	Max Turbo Frequency	Cache	Memory Types	Processor Graphics	Weight	FHD non-touch model: 2.49 lb / 1.13 kg; HD non-touch model: 2.78 lb / 1.26 kg; FHD multi-touch model: 2.79 lb / 1.27 kg	
	i3-7020U	2	4	2.3 GHz	-	3MB	DDR4-2133	Intel HD Graphics 620	Case color	Black	
	i3-7130U			2.7 GHz	-	3MB			Case material	Display cover: Carbon Fiber (FHD non-touch model) or Glass Fiber (HD & FHD multi-touch model); Bottom: Magnesium/Aluminum	
	i5-7200U			2.5 GHz	3.1 GHz	3MB					
	i5-7300U			2.6 GHz	3.5 GHz	3MB					
	or 8th Generation Intel Core i3 / i5 / i7 Processor							Smart card reader	Optional: Smart card reader		
	Processor Number	# of Cores	# of Threads	Base Frequency	Max Turbo Frequency	Cache	Memory Types	Processor Graphics	Media reader	MicroSD card reader, in the combo slot with nano-SIM card	
	i3-8130U	2	4	2.2 GHz	3.4 GHz	4MB	DDR4-2400	Intel UHD Graphics 620	Ports	Two USB 3.1 Gen 1 (one Always On), one USB 3.1 Type-C Gen 1 (with the function of Power Delivery and DisplayPort), one USB 3.1 Type-C Gen 2 / Thunderbolt 3 (with the function of PD and DP), HDMI 1.4b, Ethernet extension connector, combo slot of nano-SIM card (WWAN models) and microSD card reader, headphone / microphone combo jack, optional smart card reader, side docking connector, security keyhole <i>* Depending on many factors, actual data transfer speed may be lower than theoretical speed</i>	
	i5-8250U	4	8	1.6 GHz	3.4 GHz	6MB			Monitor cable (optional)	HDMI to VGA: Lenovo HDMI to VGA Monitor Adapter	
	i5-8350U			1.7 GHz	3.6 GHz	6MB			Bundled Accy	Optional: ThinkPad Ethernet Extension Adapter Gen 2	
	i7-8550U			1.8 GHz	4.0 GHz	8MB			Camera (optional)	One of the following, configurable by model: • HD720p camera with ThinkShutter camera privacy, fixed focus • IR camera and HD720p camera, fixed focus	
	i7-8650U			1.9 GHz	4.2 GHz	8MB			Audio support	HD Audio, Realtek® ALC3287 codec / stereo speakers, 2W x 2, Dolby® Audio™ Premium / dual array microphone, headphone / microphone combo jack	
Graphics	Intel HD Graphics 620 or Intel UHD Graphics 620 in processor; supports external digital monitor via HDMI or USB Type-C; supports three independent displays; Max resolution: 4096x2304@60Hz (USB Type-C); 4096x2160@30Hz (HDMI)							Keyboard	6-row, spill-resistant, multimedia Fn keys, optional LED backlight TrackPoint® pointing device and buttonless Mylar surface multi-touch touchpad		
Chipset	Intel SoC (System on Chip) platform 4GB, 8GB, or 16GB / 2400MHz DDR4 / soldered to systemboard, no sockets <i>* 4GB memory is NOT available in US and EMEA</i> <i>* System clocks down for processors with lower memory controller</i>							Security	Power-on password, hard disk password, supervisor password, security keyhole		
Memory								Security chip	Discrete TPM 2.0, TCG Certified		
Display	Some: 12.5" (317.5mm) HD (1366x768), anti-glare, LED backlight, 220 nits, 16:9 aspect ratio, 400:1 contrast ratio Some: 12.5" (317.5mm) FHD (1920x1080), anti-glare, LED backlight, IPS, 300 nits, 16:9 aspect ratio, 700:1 contrast ratio, 170° viewing angle							vPro (optional)	Intel vPro Technology		
Multi-touch (opt)	On-cell touch, supports 10-finger gesture (FHD only) <i>* FHD non-touch model is NOT available in US</i>							Fingerprint reader	Optional: Touch style match on chip fingerprint reader on the palm rest, anti-spoofing technology		
Storage	One of the following, configurable by model: • M.2 SSD / SATA 6.0Gb/s (e.g. xxxGB SSD M.2) • M.2 SSD / PCIe NVMe, PCIe 3.0 x 4, 32Gb/s (e.g. xxxGB SSD M.2 PCIe NVMe)							NFC (optional)	Near Field Communication		
Optical	None							Battery	Integrated Li-ion 48Wh battery, supports Rapid Charge (charge up to 80% in 1hr) with 65W USB Type-C AC adapter		
Ethernet	Native Intel Ethernet Connection I219-V (Non-vPro) or I219-LM (vPro) via bundled or optional ThinkPad Ethernet Extension Adapter Gen 2							Max battery life	MobileMark® 2014: 16.6 hr <i>* Battery life varies significantly with settings, usage, &amp; other factors</i>		
WLAN + Bluetooth™	Intel Dual Band Wireless-AC 8265, Wi-Fi 2x2 802.11ac + Bluetooth 4.1, M.2 card <i>* Intel 8265ac card supports BT4.2 but is limited to BT4.1 by Windows OS</i>							AC adapter	45W or 65W USB-C AC adapter		
WWAN (optional)	One of the following, configurable by model: • Integrated Mobile Broadband 4G LTE, Intel XMM™ 7262 (Fibocom L830-EB), M.2 card (EMEA only) • Integrated Mobile Broadband 4G LTE-A, Intel XMM™ 7360 (Fibocom L850-GL), M.2 card <i>* For non-WWAN model, it means the model is NOT WWAN upgradable</i>							Operating system	Optional: Windows® 10 Home 64 or Windows 10 Pro 64		
SIM card (opt)	Nano-SIM card slot, in the combo slot with microSD card reader, optional Verizon LTE (US) SIM card							Limited warranty	One of the following, configurable by model: • 1-year depot repair service • 1-year depot with 2-year planar repair service • 3-year/1-yr battery depot repair service • 3-year/1-yr battery limited onsite service		
								Mil-Spec test	MIL-STD-810G military testing		
								Environment	EPEAT™ Gold (US only); ENERGY STAR® 6.1; RoHS-compliant		

Note: The specifications above may not be available in all regions.

Lenovo  
September 2019





# ThinkPad X390 Platform Specifications

Product Specifications Reference (PSREF)

Processor	8th Generation Intel® Core™ i3 / i5 / i7 Processor								Dimensions	Models	FHD Non-touch	HD / FHD Multi-touch	
	Processor Number	# of Cores	# of Threads	Base Frequency	Max Turbo Frequency	Cache	Memory Types	Processor Graphics		Carbon Fiber	311.9mm x 217.0mm x 16.5mm 12.28" x 8.54" x 0.65"	-	
Processor	or 10th Generation Intel Core i5 / i7 Processor (NOT available in EMEA)								Weight	PPS	312.0mm x 217.2mm x 16.9mm 12.28" x 8.55" x 0.67"	312mm x 217.2mm x 16.9mm 12.28" x 8.55" x 0.67"	
	Processor Number	# of Cores	# of Threads	Base Frequency	Max Turbo Frequency	Cache	Memory Types	Processor Graphics		Models	FHD Non-touch	HD	FHD Multi-touch
Processor	or 10th Generation Intel Core i5 / i7 Processor (NOT available in EMEA)								Case color	Black			
	Processor Number	# of Cores	# of Threads	Base Frequency	Max Turbo Frequency	Cache	Memory Types	Processor Graphics		Case material	<i>Display cover:</i> Carbon Fiber (FHD non-touch only) or PPS; <i>Bottom:</i> Magnesium/Aluminum		
Processor	or 10th Generation Intel Core i5 / i7 Processor (NOT available in EMEA)								Smart card reader	Optional: Smart card reader			
	Processor Number	# of Cores	# of Threads	Base Frequency	Max Turbo Frequency	Cache	Memory Types	Processor Graphics		Media reader	MicroSD card reader, in the combo slot with nano-SIM card		
Processor	or 10th Generation Intel Core i5 / i7 Processor (NOT available in EMEA)								Ports	Two USB 3.1 Gen 1 (one Always On), one USB 3.1 Type-C Gen 1 (with the function of Power Delivery and DisplayPort), one USB 3.1 Type-C Gen 2 / Thunderbolt 3 (with the function of PD and DP), HDMI 1.4b, Ethernet extension connector, combo slot of nano-SIM card (WWAN models) and microSD card reader, headphone / microphone combo jack, optional smart card reader, side docking connector, security keyhole			
	Processor Number	# of Cores	# of Threads	Base Frequency	Max Turbo Frequency	Cache	Memory Types	Processor Graphics		* Depending on many factors, actual data transfer speed may be lower than theoretical speed			
Graphics	Intel UHD Graphics 620 or Intel UHD Graphics in processor; supports external digital monitor via HDMI or USB Type-C; supports three independent displays; Max resolution: 4096x2304@60Hz (Thunderbolt); 4096x2160@24Hz (HDMI)								Monitor cable (optional)	HDMI to VGA: Lenovo HDMI to VGA Monitor Adapter USB-C to VGA: Lenovo USB-C to VGA Adapter USB-C to DP: Lenovo USB-C to DisplayPort Adapter			
Chipset	Intel SoC (System on Chip) platform								Bundled Accy	Optional: ThinkPad Ethernet Extension Adapter Gen 2			
Memory	4GB, 8GB, 16GB or 32GB / 2400MHz DDR4 / soldered to systemboard, no sockets * Installed memory is actually 2666MHz but run at 2400MHz due to Intel limitation								Camera (optional)	One of the following, configurable by model: • HD720p camera with ThinkShutter camera privacy, fixed focus • IR camera and HD720p camera with ThinkShutter camera privacy, fixed focus			
Display	Size	Resolution	Type	Surface	Brightness	Aspect Ratio	Contrast Ratio	Color Gamut	Viewing Angle	Audio support			
	13.3"	HD (1366x768)	TN	Anti-glare	250 nits	16:9	500:1	45%	90°	HD Audio, Realtek® ALC3287 codec / stereo speakers, 1W x 2, Dolby® Audio™ Premium / dual array far-field microphone, headphone / microphone combo jack			
	13.3"	FHD (1920x1080)	IPS	Anti-glare	300 nits	16:9	800:1 (non-touch) 700:1 (multi-touch)	72%	170°				
Display	13.3"	FHD (1920x1080) ThinkPad Privacy Guard	IPS	Anti-glare	400 nits	16:9	1000:1	72%	178°	Keyboard			
	Multi-touch (opt) On-cell touch, supports 10-finger gesture (FHD only)									UltraNav™	6-row, spill-resistant, multimedia Fn keys, optional LED backlight TrackPoint® pointing device and buttonless Mylar surface multi-touch touchpad		
Storage	<ul style="list-style-type: none"> <li>M.2 2280 SSD / SATA 6.0Gb/s</li> <li>M.2 2280 SSD / PCIe NVMe, PCIe 3.0 x 4</li> <li>M.2 2242 SSD / PCIe NVMe, PCIe 3.0 x 2</li> <li>Intel Optane™ Memory H10 with Solid State Storage, M.2 2280, PCIe NVMe 3.0 x 4</li> </ul>								Security	Power-on password, hard disk password, supervisor password, security keyhole			
Optical	None								Security chip	Discrete TPM 2.0, TCG Certified			
	Ethernet								System Mgt (opt)	Intel vPro Technology			
WLAN (optional)	Native Intel Ethernet Connection I219-V (Non-vPro) or I219-LM (vPro) via bundled or optional ThinkPad Ethernet Adapter Gen 2								Fingerprint reader	Optional: Touch style match on chip fingerprint reader on the palm rest			
	One of the following, configurable by model: <ul style="list-style-type: none"> <li>Intel Wireless-AC 9560, Wi-Fi 2x2 802.11ac + Bluetooth 5.0</li> <li>Intel Wi-Fi 6 AX200, Wi-Fi 2x2 802.11ax + Bluetooth 5.0</li> </ul>								NFC (optional)	Near Field Communication			
Bluetooth™	Bluetooth 5.0 wireless, integrated in Wi-Fi + Bluetooth combo adapter								Battery	Integrated Li-ion 48Wh battery, supports Rapid Charge (charge up to 80% in 1hr) with 65W USB Type-C AC adapter			
WWAN (optional)	One of the following, configurable by model: <ul style="list-style-type: none"> <li>Wireless WAN upgradable</li> <li>Integrated Mobile Broadband 4G LTE, Fibocom L830-EB, M.2 card (EMEA only)</li> <li>Integrated Mobile Broadband 4G LTE-A, Fibocom L850-GL, M.2 card</li> </ul> * For non-WWAN model, it means the model is NOT WWAN upgradable								Max battery life	MobileMark® 2014: 17.6 hr * Battery life varies significantly with settings, usage, & other factors			
									AC adapter	45W, 65W, or 65W slim USB-C AC adapter			
								Operating system	Optional: Windows® 10 Home 64 or Windows 10 Pro 64				
								Limited warranty	One of the following, configurable by model: <ul style="list-style-type: none"> <li>1-year depot repair service</li> <li>1-year depot with 2-year planar repair service</li> <li>3-year/1-yr battery depot repair service</li> <li>3-year/1-yr battery limited onsite service</li> </ul>				
								Mil-Spec test	MIL-STD-810G military testing				
								Environment	EPEAT™ Silver; ENERGY STAR® 7.1; RoHS-compliant				

Note: The specifications above may not be available in all regions.

Lenovo  
September 2019



AMD

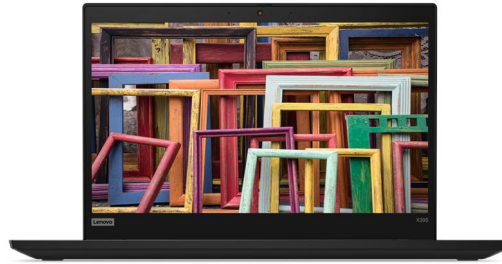

AMD



AMD



AMD



AMD



AMD



This publication was developed for products and services offered in the North America, E.M.E.A and Asia & Pacific countries. Lenovo may not offer the products, services or features discussed in this document in other countries. Lenovo may withdraw an offering at any time. Information is subject to change without notice. Consult your local representative for information on offerings available in your area.

Lenovo reserves the right to change specifications or other product information without notice. Lenovo is not responsible for photographic or typographical errors.

LENOVO PROVIDES THIS PUBLICATION "AS IS," WITHOUT WARRANTY OF ANY KIND, EITHER EXPRESS OR IMPLIED, INCLUDING THE IMPLIED WARRANTIES OF MERCHANTABILITY OR FITNESS FOR A PARTICULAR PURPOSE.

Some jurisdictions do not allow disclaimer of express or implied warranties in certain transactions, therefore this disclaimer may not apply to you.

**Availability:** All offers subject to availability. Lenovo reserves the right to alter product offerings and specifications at any time, without notice. Lenovo is not responsible for photographic or typographic errors.

**General:** Review key information provided by Microsoft that may apply to your system purchase, including details on Windows 10, Windows 8, Windows 7, and potential upgrades/downgrades. Lenovo makes no representation or warranty regarding third-party products or services.

**Trademarks:** Lenovo, ThinkPad, ThinkBook, ThinkCentre, ThinkStation, ThinkVision and the Lenovo logo are trademarks of Lenovo. Microsoft, Windows, Windows NT, and the Windows logo are trademarks of Microsoft Corporation. Ultrabook, Celeron, Celeron Inside, Core Inside, Intel, Intel Logo, Intel Atom, Intel Atom Inside, Intel Core, Intel Inside, Intel Inside Logo, Intel vPro, Itanium, Itanium Inside, Pentium, Pentium Inside, vPro Inside, Xeon, Xeon Phi, and Xeon Inside are trademarks of Intel Corporation in the U.S. and/or other countries. Other company, product or service names may be trademarks or service marks of others.

**Warranty:** For a copy of applicable warranties, write to: Lenovo Warranty Information, 1009 Think Place, Morrisville, NC, 27560. Lenovo makes no representation or warranty regarding third party products or services. The Lenovo Limited Warranty applies only to Lenovo hardware products purchased for your own use, and does not transfer upon resale.

**Limited warranty:** Support unrelated to a warranty issue may be subject to additional charges.

**Lenovo Services:**

**Carry-in or Mail-in Service:** Parts and labor repair coverage where the customer is responsible for shipping (including packaging) or delivery to authorized warranty provider or repair center.

**Depot or Courier Service:** Parts and labor repair coverage where shipping (including packaging) or delivery to the repair center is paid for by Lenovo.

**Expedited Depot:** Parts and labor coverage with expedited turnaround. Shipping (including packaging) or delivery to the repair center is paid for by Lenovo.

**Onsite / In-home Service:** Parts and labor repair coverage where labor is provided onsite at your place of business.

If Lenovo determines your product problem is covered by the product warranty and cannot be resolved over the telephone, a technician will be dispatched to arrive onsite, typically the next day.

**International Warranty Service (IWS):** PC repair coverage for customers who require a critical warranty repair while travelling internationally. Visit [www.lenovo.com/internationalwarranty](http://www.lenovo.com/internationalwarranty) for details. Visit [www.lenovo.com/warranty](http://www.lenovo.com/warranty) for Lenovo Warranty Services terms and conditions for complete details and restrictions.

**Included software:** may differ from its retail version (if available), and may not include user manuals or all program functionality. Software license agreements may apply.

**Battery life:** Battery life (and recharge times) will vary based on many factors including screen brightness, applications, features, power management, battery conditioning, and other customer preferences.

Visit <http://psref.lenovo.com/> for the latest version of Product Specifications Reference.

© Lenovo, 2019. All rights reserved.  
Lenovo 1009 Think Place Morrisville, NC 27560 U.S.A.

**Lenovo** **ThinkPad** Tablets  
Convertibles

# PSREF



**Product Specifications Reference**

Version 549, October 2019

Visit <http://psref.lenovo.com> for the latest version

# Contents

---

<b>Cover</b>	<b>1</b>
<b>Contents</b>	<b>2</b>
<b>Summary Of Change</b>	<b>3</b>
<b>ThinkPad Tablets</b>	<b>4</b>
<b>ThinkPad X1 Tablet (3rd Gen)</b>	<b>4</b>
ThinkPad X1 Tablet (3rd Gen) Platform Specifications	5
<b>ThinkPad Yoga</b>	<b>6</b>
<b>ThinkPad L380 Yoga</b>	<b>6</b>
ThinkPad L380 Yoga Platform Specifications	7
<b>ThinkPad L390 Yoga</b>	<b>8</b>
ThinkPad L390 Yoga Platform Specifications	9
<b>ThinkPad X1 Yoga (3rd Gen)</b>	<b>10</b>
ThinkPad X1 Yoga (3rd Gen) Platform Specifications	11
<b>ThinkPad X1 Yoga (4th Gen)</b>	<b>12</b>
ThinkPad X1 Yoga (4th Gen) Platform Specifications	13
<b>ThinkPad X380 Yoga</b>	<b>14</b>
ThinkPad X380 Yoga Platform Specifications	15
<b>ThinkPad X390 Yoga</b>	<b>16</b>
ThinkPad X390 Yoga Platform Specifications	17
<b>ThinkPad Yoga 11e (5th Gen)</b>	<b>18</b>
ThinkPad Yoga 11e (5th Gen) Platform Specifications	19
<b>Legal Information</b>	<b>20</b>

# Summary of Changes

---

This section describes the technical changes made in this edition.

This edition might also include minor corrections and editorial changes which are not identified.

## October 9, 2019 - Version 549

### Additions in this update

▶ **New product(s)**

None

▶ **New model(s)**

None

▶ **Others**

ThinkPad X390 Yoga - Spec updated

### Withdrawals in this update

▶ **Withdrawn product(s)**

None

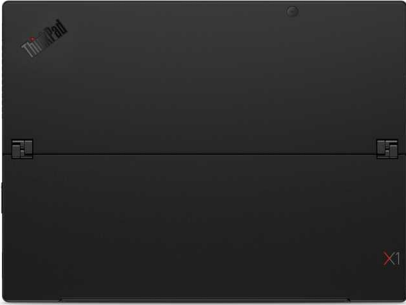



# ThinkPad X1 Tablet (3<sup>rd</sup> Gen) Platform Specifications

Product Specifications Reference (PSREF)

Processor	8th Generation Intel® Core™ i5 / i7 Processor								Control buttons	Power button, volume control button, reset switch
	Processor Number	# of Cores	# of Threads	Base Frequency	Max Turbo Frequency	Cache	Memory Types	Processor Graphics	Dock	Optional: Thin Keyboard or USB-C Dock
	i5-8250U	4	8	1.6 GHz	3.4 GHz	6MB	LPDDR3-2133	Intel UHD Graphics 620	Monitor cable	None
	i5-8350U			1.7 GHz	3.6 GHz	6MB			Bundled Accy (optional)	USB-C to RJ45: Lenovo USB-C to Ethernet Adapter
	i7-8550U			1.8 GHz	4.0 GHz	8MB			USB-C to VGA: Lenovo USB C to VGA Plus Power Adapter	
i7-8650U	1.9 GHz			4.2 GHz	8MB	USB-C to HDMI: Lenovo USB-C to HDMI Plus Power Adapter				
Graphics	Intel UHD Graphics 620 in processor, supports external digital monitor via USB Type-C								Camera	Front camera: 2.0-megapixel, fixed focus Rear camera: 8.0-megapixel, auto focus
Chipset	Intel SoC (System on Chip) platform								IR Camera	Optional: IR camera, fixed focus (mutually exclusive with NFC)
Memory	8GB or 16GB / 2133MHz LPDDR3, soldered to systemboard, no sockets								Audio support	Realtek® ALC3278 codec / stereo speakers, 1W x 2 / dual array microphones, combo audio/microphone jack
Display	13.0" (330mm) QHD+ (3000x2000), glossy, LED backlight, IPS, anti-fingerprint display with Corning® Gorilla® Glass, WideView (160° viewing), 400 nits, 3:2 aspect ratio, 1200:1 contrast ratio								Pogo keyboard	Magnetic attached thin keyboard, with TrackPoint® pointing device and buttonless Mylar surface touchpad, multi-touch, backlit
Multi-touch	Capacitive touch panel, supports ten-finger gesture								Keyboard color	Black
Pen (optional)	Lenovo Pen Pro or Lenovo Active Pen (ThinkPad Pen Pro)								Security	Kensington lock slot
Kick stand	Opening angle up to 170 degrees								Security chip	Discrete TPM 2.0 TCG Certified
Storage	One of the following, configurable by model: • M.2 2280 SSD / SATA 6.0Gb/s • M.2 2280 SSD / PCIe NVMe, PCIe 3.0 x 4, 32Gb/s								System Mgt (opt)	Intel vPro Technology
Optical	None								Fingerprint reader	Optional: Touch style Fingerprint reader
Storage extension	One microSD card reader, in the combo slot with nano-SIM card, support USH-I, microSDHC, microSDXC								NFC (optional)	Near Field Communication (mutually exclusive with IR camera)
Ethernet	None								Battery	Integrated Li-Ion 42Wh battery
WLAN	Intel Dual Band Wireless-AC 8265, Wi-Fi 2x2 802.11ac + Bluetooth 4.2, M.2 card								Max battery life	MobileMark® 2014: 9.5 hrs * Battery life varies significantly with settings, usage, & other factors
Bluetooth™	Bluetooth 4.2 wireless, integrated in Wi-Fi + Bluetooth combo adapter								AC adapter	45W or 65W USB Type-C AC adapter
WWAN (optional)	Integrated Mobile Broadband 4G LTE-A, Qualcomm® Snapdragon™ X7 LTE-A (Sierra Wireless EM7455)								Light sensor	Ambient Light Sensor
SIM card (opt)	Nano-SIM card slot, in the combo slot with microSD card reader								G-sensor	3D accelerometer
Dimensions	Tablet only: 11.97" x 8.9" x 0.35"; 304.1mm x 226mm x 8.9mm Tablet + keyboard: 11.97" x 8.9" x 0.57"; 304.1mm x 226mm x 14.4mm								Gyroscope	3D gyrometer
Weight	Tablet only: starting at 1.96 lb / 0.89kg Tablet+ keyboard: starting at 2.8 lb / 1.27kg								GPS (optional)	GPS function is integrated into WWAN module
Case color	Black								Preload	One of the following, configurable by model: • Windows® 10 Pro 64 • Windows 10 Home 64
Case material	Magnesium/Aluminum								Limited warranty	One of the following, configurable by model: • 1-year depot repair service • 3-year/1-yr battery depot repair service • 3-year/1-yr battery limited onsite service
Smart card reader	None								Mil-Spec test	MIL-STD-810G military testing
Ports	Two USB 3.1 Type-C Gen 1 (with the function of Power Delivery and DisplayPort), one Pogo keyboard connector, one Pen holder slot, headphone / microphone combo jack, combo slot of nano-SIM card (WWAN models) and microSD card reader * Depending on many factors, actual data transfer speed may be lower than theoretical speed								Environment	EPEAT™ Silver, GREENGUARD, Low Halogen, RoHS



# ThinkPad L380 Yoga Platform Specifications

Product Specifications Reference (PSREF)

Processor	7th Generation Intel® Core™ i3 / i5 Processor								Dimensions Weight Case color Case material	<i>WxDxH:</i> 12.67" x 8.82" x 0.74"; 322mm x 224.2mm x 18.8mm Starting at 3.44 lb / 1.56 kg Black or Silver <i>Display cover:</i> Aluminum <i>Bottom:</i> GFRP
	Processor Number	# of Cores	# of Threads	Base Frequency	Max Turbo Frequency	Cache	Memory Types	Processor Graphics		
	i3-7020U	2	4	2.3 GHz	//	3MB	DDR4-2133	Intel HD Graphics 620	Smart card reader Media reader Ports	None MicroSD card reader Two USB 3.1 Gen 1 (one Always On), two USB 3.1 Type-C Gen 1 (with the function of Power Delivery and DisplayPort), HDMI 1.4b, Ethernet extension connector, headphone / microphone combo jack, microSD card reader, security keyhole <i>* Depending on many factors, actual data transfer speed may be lower than theoretical speed</i>
	i5-7200U	2	4	2.5 GHz	3.1 GHz	3MB				
Graphics	8th Generation Intel Core i3 / i5 / i7 Processor								Monitor cable (optional) <i>HDMI to VGA:</i> Lenovo HDMI to VGA Monitor Adapter <i>USB-C to VGA:</i> Lenovo USB-C to VGA Adapter <i>USB-C to DP:</i> Lenovo USB-C to DisplayPort Adapter	
	Processor Number	# of Cores	# of Threads	Base Frequency	Max Turbo Frequency	Cache	Memory Types	Processor Graphics		
	i3-8130U	2	4	2.2 GHz	3.4 GHz	4MB	DDR4-2400	Intel UHD Graphics 620	Camera <i>720p:</i> HD720p resolution, low light sensitive, fixed focus <i>IR &amp; 720p:</i> IR camera and HD720p camera, fixed focus <i>World facing:</i> Rear camera, 5MP resolution, auto focus HD Audio, Realtek ALC3287 codec, Dolby® Advance / stereo speakers, 2W x 2 / dual array microphone, headphone / microphone combo jack	
	i5-8250U	4	8	1.6 GHz	3.4 GHz	6MB				
	i5-8350U			1.7 GHz	3.6 GHz	6MB				
	i7-8550U			1.8 GHz	4.0 GHz	8MB				
Graphics	Intel HD Graphics 620 or Intel UHD Graphics 620 in processor; supports external digital monitor via HDMI or USB Type-C; supports three independent displays; Max resolution: 4096x2304@60Hz (USB Type-C); 4096x2160@30Hz (HDMI)								Audio support	Keyboard UltraNav™
Chipset	Intel SoC (System on Chip) platform								Security	Power-on password, hard disk password, supervisor password, security keyhole Discrete TPM 2.0, TCG Certified Intel vPro Technology Fingerprint reader
Memory	Up to 32GB max / 2400MHz DDR4, dual-channel capable, two DDR4 SO-DIMM sockets * System clocks down for processors with lower memory controller								Security chip	Discrete TPM 2.0, TCG Certified Intel vPro Technology Fingerprint reader
Display	13.3" (338mm) FHD (1920x1080), glossy, LED backlight, IPS, 300 nits, 16:9 aspect ratio, 800:1 contrast ratio, 170° viewing angle								System Mgt (opt)	Intel vPro Technology
Multi-touch (opt)	Capacitive-type multi-touch, AR (anti-reflection), supports 10-finger gesture								Fingerprint reader	Optional: Touch style fingerprint reader on the keyboard bezel, anti-spoofing technology
Hinge	Yoga hinge, 360 degree								NFC (optional)	Near Field Communication (mutually exclusive with smart card reader)
Convert-mode	Laptop, tent, stand, yoga and tablet								Battery	Integrated Li-Ion 45Wh battery, supports Rapid Charge (charge up to 80% in 1hr) with 65W USB Type-C AC adapter Max battery life
Pen	ThinkPad Pen Pro, active pen for multi-touch display, on-board garage								AC adapter	45W or 65W USB Type-C AC adapter
Storage	One of the following, configurable by model: • M.2 SSD / SATA 6.0Gb/s (e.g. xxxGB SSD M.2) • M.2 SSD / PCIe NVMe, PCIe 3.0 x 4, 32Gb/s (e.g. xxxGB SSD M.2 PCIe NVMe)								Preload	Windows® 10 Home 64 or Windows 10 Pro 64
Optane Memory	None								Limited warranty	One of the following, configurable by model: • 1-year depot repair service • 1-year depot with 2-year planar • 3-year/1-yr battery depot repair service • 3-year/1-yr battery limited onsite service
Optical	None								Mil-Spec test	MIL-STD-810G military testing
Ethernet	Native Intel Ethernet Connection I219-V (Non-vPro) or I219-LM (vPro) via optional ThinkPad Ethernet Extension Cable Gen 2								Environment	EPEAT™ Gold; ENERGY STAR® 6.1; RoHS-compliant
WLAN + Bluetooth™	Intel Dual Band Wireless-AC 8265, Wi-Fi 2x2 802.11ac + Bluetooth 4.1, M.2 card * Wireless card supports BT4.2 but is limited to BT4.1 by Windows OS									
WWAN	None									
SIM card	None									



# ThinkPad L390 Yoga Platform Specifications

Product Specifications Reference (PSREF)

Processor	8th Generation Intel® Core™ i3 / i5 / i7 Processor								Smart card reader	None
	Processor Number	# of Cores	# of Threads	Base Frequency	Max Turbo Frequency	Cache	Memory Types	Processor Graphics	Media reader	MicroSD card reader
	i3-8145U	2	4	2.1 GHz	3.9 GHz	4MB	DDR4-2400	Intel UHD Graphics 620	Ports	Two USB 3.1 Gen 1 (one Always On), two USB 3.1 Type-C Gen 1 (with the function of Power Delivery and DisplayPort), HDMI 1.4b, Ethernet extension connector, headphone / microphone combo jack, microSD card reader, security keyhole
	i5-8265U	4	8	1.6 GHz	3.9 GHz	6MB			Monitor cable (optional)	<ul style="list-style-type: none"> <li>USB-C to VGA: Lenovo USB-C to VGA Adapter</li> <li>USB-C to VGA + Power Adapter: Lenovo USB-C to VGA plus Power Adapter</li> <li>USB-C to HDMI: Lenovo USB-C to HDMI Adapter</li> <li>USB-C to HDMI + Power Adapter: Lenovo USB-C to HDMI plus Power Adapter</li> <li>USB-C to DP: Lenovo USB-C to DisplayPort Adapter</li> <li>USB-C to RJ45: Lenovo USB-C to Ethernet Adapter</li> </ul>
	i5-8365U	4	8	1.6 GHz	4.1 GHz	6MB			Bundled	<ul style="list-style-type: none"> <li>USB-C to USB-A: Lenovo USB-C to USB-A Adapter</li> <li>USB-C to USB-C: Lenovo USB-C to USB-C Cable 2M</li> </ul>
	i7-8565U	4	8	1.8 GHz	4.6 GHz	8MB			Accessories (optional)	
Graphics	Intel UHD Graphics 620 in processor; supports external digital monitor via HDMI or USB Type-C; supports three independent displays; Max resolution: 4096x2304@60Hz (USB Type-C); 4096x2160@30Hz (HDMI)								Camera	<ul style="list-style-type: none"> <li>720p: HD720p resolution, low light sensitive, fixed focus</li> <li>IR &amp; 720p: IR camera and HD720p camera, fixed focus (black model only)</li> <li>World facing: 5MP resolution, auto focus (mutually exclusive with fingerprint reader)</li> </ul>
Chipset	Intel SoC (System on Chip) platform								Audio support	HD Audio, Realtek ALC3287 codec, Dolby® Audio™ Premium / stereo speakers, 2W x 2 / dual array microphone, headphone / microphone combo jack
Memory	32GB max / 2400MHz DDR4, dual-channel capable, two DDR4 SO-DIMM sockets								Keyboard	6-row, spill-resistant, multimedia Fn keys, optional LED backlight
Display	13.3" (338mm) FHD (1920x1080), glossy, LED backlight, IPS, 300 nits, 16:9 aspect ratio, 800:1 contrast ratio, 72% gamut, 170° viewing angle								UltraNav™	TrackPoint® pointing device and buttonless Mylar surface touchpad, multi-touch
Multi-touch	Capacitive-type multi-touch, AR (anti-reflection), supports 10-finger gesture								Security	Power-on password, supervisor password, system management password, hard disk password, security keyhole
Hinge	Yoga hinge, 360 degree								Security chip	Discrete TPM 2.0, TCG Certified
Multi-mode	Notebook, stand, tent, tablet								System Mgt (opt)	Intel vPro Technology
Pen (optional)	ThinkPad Pen Pro, active pen for multi-touch display, on-board garage								Fingerprint reader	Optional: Touch style fingerprint reader on the palm rest (mutually exclusive with World facing camera)
Storage	<i>One of the following, configurable by model:</i> <ul style="list-style-type: none"> <li>M.2 SSD / SATA 6.0Gb/s</li> <li>M.2 (2242) SSD / PCIe NVMe, PCIe 3.0 x 2</li> <li>M.2 (2280) SSD / PCIe NVMe, PCIe 3.0 x 4</li> <li>Intel Optane Memory H10 with Solid State Storage, M.2 2280, PCIe NVMe 3.0 x 4</li> </ul>								NFC (optional)	Near Field Communication
Optane™ Memory	Optional: Intel Optane Memory H10								Battery	Integrated Li-Ion 45Wh battery, supports Rapid Charge (charge up to 80% in 1hr) with 65W USB Type-C AC adapter
Optical	None								Max battery life	MobileMark® 2014: 12.17 hrs <i>* Battery life varies significantly with settings, usage, &amp; other factors</i>
Storage	<i>One of the following, configurable by model:</i> <ul style="list-style-type: none"> <li>M.2 SSD / SATA 6.0Gb/s (e.g. xxxGB SSD M.2)</li> <li>M.2 SSD / PCIe NVMe, PCIe 3.0 x 4, 32Gb/s (e.g. xxxGB SSD M.2 PCIe NVMe)</li> </ul>								AC adapter	45W or 65W USB Type-C AC adapter
Optical	None								Preload	Windows® 10 Home 64 or Windows 10 Pro 64
Ethernet	Native Intel Ethernet Connection I219-V (Non-vPro) or I219-LM (vPro) via optional ThinkPad Ethernet Extension Cable or Lenovo USB-C to Ethernet Adapter								Limited warranty	<i>One of the following, configurable by model:</i> <ul style="list-style-type: none"> <li>1-year depot repair service</li> <li>1-year depot with 2-year planar</li> <li>3-year/1-yr battery depot repair service</li> <li>3-year/1-yr battery limited onsite service</li> </ul>
WLAN	Intel Wireless-AC 9560, Wi-Fi 2x2 802.11ac + Bluetooth 5.0, M.2 card								Mil-Spec test	MIL-STD-810G military testing
Bluetooth™	Bluetooth 5.0 wireless, integrated in Wi-Fi + Bluetooth combo adapter								Environment	EPEAT™ Silver; ENERGY STAR® 7.1; RoHS-compliant
WWAN	None									
Dimensions	WxDxH: 12.67" x 8.82" x 0.74"; 321.8mm x 224.2mm x 18.8mm									
Weight	Starting at 3.44 lbs / 1.56 kg									
Case color	Black or Silver									
Case material	Display cover: Magnesium / Aluminum Bottom: GFRP									

Lenovo  
July 2019





# ThinkPad X1 Yoga (3<sup>rd</sup> Gen) Platform Specifications

Product Specifications Reference (PSREF)

Processor	7th Generation Intel® Core™ i5 Processor								Smart card reader None
	Processor Number	# of Cores	# of Threads	Base Frequency	Max Turbo Frequency	Cache	Memory Types	Processor Graphics	
	i5-7300U	2	4	2.6 GHz	3.5 GHz	3MB	LPDDR3-1866	Intel HD Graphics 620	
	8th Generation Intel Core i5 / i7 Processor								Media reader Ports Two USB 3.1 Gen 1 (one Always On), two USB 3.1 Type-C Gen 2 / Thunderbolt 3, HDMI 1.4, Ethernet extension connector, nano-SIM card slot (WWAN models), headphone / microphone combo jack, microSD card reader <i>* Depending on many factors, actual data transfer speed may be lower than theoretical speed</i>
	Processor Number	# of Cores	# of Threads	Base Frequency	Max Turbo Frequency	Cache	Memory Types	Processor Graphics	
	i5-8250U	4	8	1.6 GHz	3.4 GHz	6MB	LPDDR3-2133	Intel UHD Graphics 620	
	i5-8350U			1.7 GHz	3.6 GHz	6MB			
	i7-8550U			1.8 GHz	4.0 GHz	8MB			
	i7-8650U			1.9 GHz	4.2 GHz	8MB			
Graphics	Intel HD Graphics 620 or Intel UHD Graphics 620 in processor; supports external digital monitor via HDMI or USB Type-C; supports three independent displays; Max resolution: 5120x2880@60Hz (USB Type-C); 4096x2160@30Hz (HDMI)								WiGig dock None
Chipset	Intel SoC (System on Chip) platform								Monitor cable (optional) HDMI to VGA: Lenovo HDMI to VGA Monitor Adapter USB-C to VGA: Lenovo USB-C to VGA Adapter USB-C to DP: Lenovo USB-C to DisplayPort Adapter
Memory	8GB or 16GB / 2133MHz LPDDR3 / soldered to systemboard, no sockets								Camera (optional) <i>One of the following, configurable by model:</i> 720p: HD720p camera with ThinkShutter camera privacy, fixed focus IR & 720p: IR camera and HD720p camera, fixed focus <i>* WWAN models and HDR panel models can not support IR camera</i>
Display	<i>Some:</i> 14.0" (355mm) FHD (1920x1080), LED backlight, 300 nits, 16:9 aspect ratio, 700:1 contrast ratio, 72% gamut, 170° viewing angle, IPS <i>Some:</i> 14.0" (355mm) WQHD (2560x1440), LED backlight, 300 nits, 16:9 aspect ratio, 700:1 contrast ratio, 72% gamut, 170° viewing angle, IPS <i>Some:</i> 14.0" (355mm) HDR WQHD (2560x1440) with Dolby Vision™, LED backlight, 500 nits, 16:9 aspect ratio, 1500:1 contrast ratio, 100% gamut, 170° viewing angle, IPS								Audio support HD Audio, Realtek® ALC3286 codec, Dolby® Audio™ Premium / stereo speakers, 1W x 2 / dual array microphone, headphone / microphone combo jack
Multi-touch	Capacitive-type multi-touch, AR (anti-reflection), AS (anti-smudge), supports 10-finger gesture, reduces overall display brightness by 10%								Keyboard 6-row wave keyboard (rise & fall), spill-resistant, multimedia Fn keys, LED backlit
Hinge	Yoga hinge, 360 degree								UltraNav™ TrackPoint® pointing device and 3+2 buttons multi-touch clickpad
Convert-mode	Laptop, tent, stand, and tablet								Security Power-on password, hard disk password, supervisor password, security keyhole
Pen (optional)	ThinkPad Pen Pro, active pen for multi-touch display, on-board rechargeable								Security chip Discrete TPM 2.0 TCG Certified
Storage	<i>Some:</i> M.2 SSD / SATA 6.0Gb/s (e.g. xxxG SSD) <i>Some:</i> M.2 SSD / PCIe NVMe, PCIe 3.0 x 4, 32Gb/s (e.g. xxxG SSD PCIe NVMe)								System Mgt (opt) Intel vPro Technology
Optical	None								Fingerprint reader Touch style match on chip fingerprint reader on the palm rest
Ethernet	Native Intel Ethernet Connection WGI219-LM (vPro) via optional ThinkPad Ethernet Extension Cable								NFC (optional) Near Field Communication
WLAN	Intel Dual Band Wireless-AC 8265, Wi-Fi 2x2 802.11ac + Bluetooth 4.1, M.2 card <i>* Intel 8265ac card supports BT4.2 but is limited to BT4.1 by Windows OS</i>								Battery Integrated Li-Ion 54Wh battery, supports Rapid Charge (charge up to 80% in 1hr) with 65W USB Type-C AC adapter
Bluetooth™	Bluetooth 4.1 wireless, integrated in Wi-Fi + Bluetooth combo adapter								Max battery life <i>MobileMark® 2014: 15.4 hrs</i> <i>* Battery life varies significantly with settings, usage, &amp; other factors</i>
WWAN (optional)	Integrated Mobile Broadband 4G LTE-A, Intel XMM™ 7360 (Fibocom L850-GL), M.2 card								AC adapter 45W or 65W USB Type-C AC adapter
SIM card (opt)	Nano-SIM card slot, optional Verizon LTE (US) SIM card								Light sensor Ambient Light Sensor
Dimensions	<i>WxDxH:</i> 13.11" x 9.02" x 0.67"; 333mm x 229mm x 17.05mm								G-sensor 3D accelerometer
Weight	Starting at 3.08 lb (1.4kg)								Gyroscope 3D gyrometer
Case color	Black or silver								GPS GPS function is integrated into WWAN module
Case material	<i>Display cover:</i> Carbon-Fiber and Glass-Fiber hybrid; <i>Bottom:</i> magnesium-PPS hybrid								Preload Windows® 10 Pro 64
									Limited warranty <i>One of the following, configurable by model:</i> • 1-year depot repair service • 1-year depot with 2-year planar • 3-year/1-yr battery depot repair service
									Mil-Spec test MIL-STD-810G military testing
									Environment EPEAT™ Silver; ENERGY STAR®; RoHS-compliant





# ThinkPad X1 Yoga (4<sup>th</sup> Gen) Platform Specifications

Product Specifications Reference (PSREF)

Processor	8th Generation Intel® Core™ i5 / i7 Processor or 10th Generation Intel® Core™ i5 / i7 Processor (Not available in EMEA)									Dimensions	WxDxH: 12.71" x 8.58" x 0.61"; 323mm x 218mm x 15.5mm								
										Weight	Privacy Guard model: starting at 3.24lb / 1.47kg Other model: starting at 2.99 lb / 1.36kg								
	Processor Number	# of Cores	# of Threads	Base Frequency	Max Turbo Frequency	Cache	Memory Types	Processor Graphics		Case color	Iron Grey								
	i5-8265U	4	8	1.6 GHz	3.9 GHz	6MB	LPDDR3-2133	Intel UHD Graphics 620		Case material	Display cover: Aluminium; Bottom: Magnesium								
	i5-8365U			1.6 GHz	4.1 GHz	6MB													
	i7-8565U			1.8 GHz	4.6 GHz	8MB													
	i7-8665U			1.9 GHz	4.8 GHz	8MB													
	i5-10210U			1.6 GHz	4.2 GHz	6MB													
	i7-10510U	1.8 GHz	4.9 GHz	8MB			Smart card reader	None											
	i7-10710U	6	12	1.1 GHz	4.7 GHz	12MB			Media reader	None									
Graphics	Intel UHD Graphics 620 or Intel UHD Graphics in processor; supports external digital monitor via HDMI or USB Type-C™ / Thunderbolt; supports three independent displays; Max resolution: 5120x2880@60Hz (USB Type-C); 4096x2160@24Hz (HDMI)									Ports	Two USB 3.1 Gen 1 (one Always On), two USB 3.1 Type-C Gen 2 / Thunderbolt 3 (with the function of Power Delivery and DisplayPort), HDMI 1.4b, Ethernet extension connector, nano-SIM card slot (WWAN models), headphone / microphone combo jack, side docking connector, security keyhole <i>* Depending on many factors, actual data transfer speed may be lower than theoretical speed</i>								
Chipset	Intel SoC (System on Chip) platform									Monitor cabl	Optional: Lenovo HDMI to VGA Monitor Adapter								
Memory	8GB or 16GB / 2133MHz LPDDR3 / soldered to systemboard, no sockets									Bundled Accy	Optional: ThinkPad Ethernet Extension Adapter Gen 2								
Display	Size	Resolution	Type	Surface	Brightness	Aspect Ratio	Contrast Ratio	Color Gamut	Viewing Angle	Camera (optional)	One of the following, configurable by model: • HD720p camera with ThinkShutter camera privacy, fixed focus • IR camera and HD720p camera with ThinkShutter camera privacy, fixed focus								
	14.0"	FHD (1920x1080) Low Power	IPS	Glossy	380 nits	16:9	800:1	72%	170°	Audio support	HD Audio, Realtek® ALC1012L codec, Stereo speakers, 2W x 2, 0.8W x 2, Dolby® Audio™ Atmos / 4 array 360-degree far-field microphones, headphone / microphone combo jack								
	14.0"	FHD (1920x1080) ThinkPad Privacy Guard	IPS	Glossy	380 nits	16:9	1000:1	72%	170°	Keyboard	6-row, spill-resistant, multimedia Fn keys, LED backlight UltraNav™ TrackPoint® pointing device and buttonless Glass surface multi-touch touchpad								
	14.0"	WQHD (2560x1440)	IPS	Glossy	280 nits	16:9	800:1	72%	170°	Security	Power-on password, supervisor password, system management password, hard disk password								
	14.0"	UHD (3840x2160) Dolby Vision™ HDR400	IPS	Glossy	470 nits	16:9	1400:1	90%	170°	Security chip	Discrete TPM 2.0 TCG Certified								
Multi-touch	Capacitive-type multi-touch, AR (anti-reflection), AS (anti-smudge), Supports 10-finger gesture									System Mgt	Optional: Intel vPro Technology								
Hinge	Yoga hinge, 360 degree									Fingerprint reader	Touch style match on chip fingerprint reader on the palm rest								
Convert-mode	Laptop, tent, stand, and tablet									NFC	Optional: Near Field Communication								
Pen	ThinkPad Pen Pro, active pen for multi-touch display, on-board rechargeable									Battery	Integrated Li-Ion 51Wh battery, supports Rapid Charge (charge up to 80% in 1hr) with 65W USB Type-C AC adapter								
Storage	One of the following, configurable by model: • M.2 2280 SSD / SATA 6.0Gb/s • M.2 2280 SSD / PCIe NVMe, PCIe 3.0 x 4 • Intel Optane™ Memory H10 with Solid State Storage, M.2 2280, PCIe NVMe 3.0 x 4									Max battery life	MobileMark® 2014: 18.1 hrs <i>* Battery life varies significantly with settings, usage, &amp; other factors</i>								
Optical	None									AC adapter	45W or 65W USB Type-C AC adapter								
Ethernet	Native Intel Ethernet Connection I219-LM (vPro) or I219-V (Non-vPro) via bundled or optional ThinkPad Ethernet Extension Adapter Gen 2									G-sensor	3D accelerometer								
WLAN	Intel Wireless-AC 9560, Wi-Fi 2x2 802.11ac + Bluetooth 5.0, M.2 card									Gyroscope	3D gyrometer								
Bluetooth™	Bluetooth 5.0 wireless, integrated in Wi-Fi + Bluetooth combo adapter									GPS	GPS function is integrated into WWAN module								
WWAN (optional)	One of the following, configurable by model: • Integrated Mobile Broadband 4G LTE-A, Fibocom L850-GL, M.2 card • Integrated Mobile Broadband 4G LTE-A, Fibocom L860-GL, MIMO 2x2, M.2 card									Preload	One of the following, configurable by model: • Windows® 10 Pro 64 • Windows 10 Home 64								
SIM card (opt)	Nano-SIM card slot, optional Verizon LTE (US) SIM card									Limited warranty	One of the following, configurable by model: • 1-year depot repair service • 1-year depot with 2-year planar • 3-year/1-yr battery depot repair service								
										Mil-Spec test	MIL-STD-810G military testing								
										Environment	EPEAT™ Gold; ENERGY STAR® 7.1; RoHS-compliant								



# ThinkPad X380 Yoga Platform Specifications

Product Specifications Reference (PSREF)

Processor	8th Generation Intel® Core™ i3 / i5 / i7 Processor								Dimensions <i>WxDxH:</i> 12.34" x 8.75" x 0.72"; 313.5mm x 222.2mm x 18.2mm Weight Starting at 3.17 lb (1.43kg) Case color Black or silver Case Material Carbon-Fiber Hybrid
	Processor Number	# of Cores	# of Threads	Base Frequency	Max Turbo Frequency	Cache	Memory Types	Processor Graphics	
	i3-8130U	2	4	2.2 GHz	3.4 GHz	4MB	DDR4-2400	Intel UHD Graphics 620	
	i5-8250U	4	8	1.6 GHz	3.4 GHz	6MB			
	i5-8350U			1.7 GHz	3.6 GHz	6MB			
i7-8550U	1.8 GHz			4.0 GHz	8MB				
i7-8650U	1.9 GHz			4.2 GHz	8MB				
Graphics	Intel UHD Graphics 620 in processor only; supports external digital monitor via HDMI or USB Type-C; supports three independent displays; Max resolution: 4096x2304@60Hz (USB Type-C); 4096x2160@30Hz (HDMI)								Smart card reader <i>Optional:</i> Smart card reader (mutually exclusive with NFC) Media reader One microSD card slot (microSD, microSDHC, microSDXC), UHS-I Ports Two USB 3.1 Gen 1 (one Always On), Ethernet extension connector, one USB 3.1 Type-C Gen 2 / Thunderbolt 3, HDMI 1.4b, microSD card reader, nano-SIM card slot (WWAN models), headphone / microphone combo jack <i>* Depending on many factors, actual data transfer speed may be lower than theoretical speed</i>
Chipset	Intel SoC (System on Chip) platform								WiGig dock Monitor cable <i>(optional)</i> <i>USB-C to VGA:</i> Lenovo USB-C to VGA Plus Power Adapter <i>USB-C to DP:</i> Lenovo USB-C to DisplayPort Adapter <i>HDMI to VGA:</i> Lenovo HDMI to VGA Monitor Adapter
Memory	8GB or 16GB / 2400MHz DDR4 / soldered to systemboard, no sockets <i>* System clocks down for processors with lower memory controller</i>								Camera <i>One of the following, configurable by model:</i> <i>720p:</i> HD720p camera, fixed focus <i>IR &amp; 720p:</i> IR camera and HD720p camera, fixed focus
Display	13.3" (337.8mm) FHD (1920x1080), LED backlight, IPS 300 nits, 16:9 aspect ratio, 800:1 contrast ratio, 170° viewing angle								Audio support HD Audio, Conexant® CX11771 codec / stereo speakers, 2W x 2 / dual array microphone, headphone / microphone combo jack
Multi-touch	Capacitive-type multi-touch, AR (anti-reflection), AS (anti-smudge), supports 10-finger gesture								Keyboard 6-row, spill-resistant, multimedia Fn keys, LED backlight UltraNav™ TrackPoint® pointing device and 3+2 buttons Mylar surface multi-touch click pad
Hinge	Yoga hinge, 360 degree								
Convert-mode	Laptop, tent, stand, yoga and tablet								Security Power-on password, hard disk password, supervisor password, security keyhole
Pen	ThinkPad Pen Pro, active pen for multi-touch display, on-board rechargeable								Security chip Discrete TPM 2.0 TCG Certified
Storage	<i>Some:</i> M.2 SSD / SATA 6.0Gb/s (e.g. xxxG SSD) <i>Some:</i> M.2 SSD / PCIe NVMe, PCIe 3.0 x 4, 32Gb/s (e.g. xxxG SSD PCIe NVMe)								System Mgt <i>(opt)</i> Intel vPro Technology
Optical	None								Fingerprint reader <i>Optional:</i> Touch style match on chip fingerprint reader on the palm rest
Optane Memory	None								NFC <i>(optional)</i> Near Field Communication (mutually exclusive with smart card reader)
Ethernet	Native Intel Ethernet Connection I219-V ( <i>Non-vPro</i> ) or I219-LM ( <i>vPro</i> ) via optional ThinkPad Ethernet Extension Cable								Battery Li-Ion 51Wh battery Max battery life <i>MobileMark® 2014:</i> 13.6 hrs <i>* Battery life varies significantly with settings, usage, &amp; other factors</i>
WLAN	Intel Dual Band Wireless-AC 8265, Wi-Fi 2x2 802.11ac + Bluetooth 4.1, M.2 card <i>* Intel 8265ac card supports BT4.2 but is limited to BT4.1 by Windows OS</i>								AC adapter 45W or 65W AC adapter (slim tip), 45W or 65W USB Type-C AC adapter
Bluetooth™	Bluetooth 4.1 wireless, integrated in Wi-Fi + Bluetooth combo adapter								Light sensor Ambient Light Sensor
WWAN <i>(optional)</i>	Integrated Mobile Broadband 4G LTE, Intel XMM™ 7262 (Fibocom L830-EB), M.2 card (EMEA only)								G-sensor/ eCompass 3D accelerometer and 3D magnetometer
SIM card <i>(opt)</i>	Nano-SIM card slot								3D compass Gyroscope 3D gyrometer
Preload <i>Some:</i> Windows® 10 Home 64 <i>Some:</i> Windows 10 Pro 64									
Limited warranty <i>One of the following, configurable by model:</i> • 1-year depot repair service • 1-year depot with 2-year planar • 3-year/1-yr battery depot repair service									
Mil-Spec test MIL-STD-810G military testing									
Environment EPEAT™ Gold; ENERGY STAR®; RoHS-compliant									



# ThinkPad X390 Yoga Platform Specifications

Product Specifications Reference (PSREF)

Processor	8th Generation Intel® Core™ i5 / i7 Processor								Smart card reader Media reader Ports	<i>Optional:</i> Smart card reader MicroSD card reader, in the combo slot with nano-SIM card Two USB 3.1 Gen 1 (one Always On), one USB 3.1 Type-C Gen 1 (with the function of Power Delivery and Display Port), one USB 3.1 Type-C Gen 2 / Thunderbolt 3 (with the function of PD and DP), HDMI 1.4b, Ethernet extension connector, combo slot of nano-SIM card (WWAN models) and microSD card reader, headphone / microphone combo jack, optional smart card reader, side docking connector, security keyhole * <i>Depending on many factors, actual data transfer speed may be lower than theoretical speed</i> USB-C to HDMI: Lenovo USB-C to HDMI Adapter USB-C to VGA: Lenovo USB-C to VGA Adapter USB-C to DP: Lenovo USB-C to DisplayPort Adapter <i>Optional:</i> ThinkPad Ethernet Extension Adapter Gen 2
	Processor Number	# of Cores	# of Threads	Base Frequency	Max Turbo Frequency	Cache	Memory Types	Processor Graphics		
	i5-8265U	4	8	1.6 GHz	3.9 GHz	6MB	DDR4-2400	Intel UHD Graphics 620		
	i5-8365U	4	8	1.6 GHz	4.1 GHz	6MB				
	i7-8565U	4	8	1.8 GHz	4.6 GHz	8MB				
i7-8665U	4	8	1.9 GHz	4.8 GHz	8MB					
Graphics	Intel UHD Graphics 620 in processor only; supports external digital monitor via HDMI or USB Type-C; supports three independent displays; Max resolution: 4096x2304@60Hz (USB Type-C); 4096x2160@24Hz (HDMI)								Monitor cable (optional)	* <i>Depending on many factors, actual data transfer speed may be lower than theoretical speed</i> USB-C to HDMI: Lenovo USB-C to HDMI Adapter USB-C to VGA: Lenovo USB-C to VGA Adapter USB-C to DP: Lenovo USB-C to DisplayPort Adapter
Chipset Memory	Intel SoC (System on Chip) platform 8GB or 16GB / 2400MHz DDR4 / soldered to systemboard, no sockets * <i>Installed memory is actually 2666MHz but run at 2400MHz due to Intel limitation</i>								Bundled Accy	<i>Optional:</i> ThinkPad Ethernet Extension Adapter Gen 2
Display	13.3" (337.8mm) FHD (1920x1080), LED backlight, IPS, Glossy, 270 nits, 16:9 aspect ratio, 800:1 contrast ratio, Color Gamut 72%, 170° viewing angle, capacitive-type multi-touch, AR (anti-reflection), AS (anti-smudge)								Camera	One of the following, configurable by model: • HD720p camera, with ThinkShutter camera privacy, fixed focus • IR camera and HD720p camera, with ThinkShutter camera privacy, fixed focus
Multi-touch	supports 10-finger gesture								Audio support	HD Audio, Realtek® ALC3287 codec / stereo speakers, 2W x 2, Dolby® Audio™ Premium / dual array microphone, headphone / microphone combo jack
Hinge	Yoga hinge, 360 degree								Keyboard	6-row, spill-resistant, multimedia Fn keys, LED backlight
Convert-mode	Laptop, tent, stand and tablet								UltraNav™	TrackPoint® pointing device and buttonless Mylar surface multi-touch touchpad
Pen	ThinkPad Pen Pro, active pen for multi-touch display, on-board rechargeable								Security	Power-on password, supervisor password, system management password, hard disk password, security keyhole
Storage	<ul style="list-style-type: none"> <li>• M.2 2280 SSD / SATA 6.0Gb/s</li> <li>• M.2 2280 SSD / PCIe NVMe, PCIe 3.0 x 4</li> <li>• M.2 2242 SSD / PCIe NVMe, PCIe 3.0 x 2</li> <li>• Intel Optane Memory H10 with Solid State Storage, M.2 2280, PCIe NVMe 3.0 x 4</li> </ul>								Security chip	Discrete TPM 2.0 TCG Certified
Optane™ memory	<i>Optional:</i> Intel Optane Memory H10								System Mgt (opt)	Intel vPro Technology
Optical	None								Fingerprint reader	Touch style match on chip fingerprint reader on the palm rest
Ethernet	Native Intel Ethernet Connection I219-V (Non-vPro) or I219-LM (vPro) via bundled or optional ThinkPad Ethernet Extension Adapter Gen 2								NFC (optional)	Near Field Communication
WLAN	One of the following, configurable by model: • Intel Wireless-AC 9560, Wi-Fi 2x2 802.11ac + Bluetooth 5.0 • Intel Wi-Fi 6 AX200, Wi-Fi 2x2 802.11ax + Bluetooth 5.0								Battery	Integrated Li-ion 50Wh battery, supports Rapid Charge (charge up to 80% in 1hr) with 65W USB Type-C AC adapter
Bluetooth™	Bluetooth 5.0 wireless, integrated in Wi-Fi + Bluetooth combo adapter								Max battery life	<i>MobileMark® 2014:</i> 14.5 hrs * <i>Battery life varies significantly with settings, usage, &amp; other factors</i>
WWAN (optional)	One of the following, configurable by model: • Integrated Mobile Broadband 4G LTE, Fibocom L830-EB, M.2 card (EMEA only) • Integrated Mobile Broadband 4G LTE-A, Fibocom L850-GL, M.2 card * <i>For non-WWAN model, it means the model is NOT WWAN upgradable</i>								AC adapter	45W or 65W USB Type-C AC adapter
Dimensions	WxDxH: 12.22" x 8.62" x 0.63"; 310.4mm x 219mm x 15.95mm								Light sensor	None
Weight	Starting at 2.85 lb (1.29kg)								G-sensor	3D accelerometer
Case color	Black or silver (Silver is not available in EMEA)								Gyroscope	3D gyrometer
Case Material	Display cover: Carbon-Fiber Hybrid Bottom: Carbon-Fiber Hybrid								Preload	Windows® 10 Home 64 or Windows 10 Pro 64
									Limited warranty	One of the following, configurable by model: • 1-year depot repair service • 1-year depot with 2-year planar • 3-year/1-yr battery depot repair service • 3-year/1-yr battery limited onsite service
									Mil-Spec test	MIL-STD-810G military testing
									Environment	EPEAT™ Silver; ENERGY STAR® 7.1; RoHS-compliant



# ThinkPad Yoga 11e (5<sup>th</sup> Gen) Platform Specifications

Product Specifications Reference (PSREF)

Processor	7th Generation Intel® Core™ m / i5 Processor, Intel Celeron® processor, or Intel Pentium® Silver processor							Dimensions	<i>WxDxH:</i> 11.81" x 8.27" x 0.89"; 300mm x 210mm x 22.5mm
								Weight	From 3.4 lb (1.54kg)
								Case color	Black
								Case material	<i>Display cover:</i> PC/ABS+GF; <i>Bottom:</i> PC/ABS plastic
								Media reader	MicroSD card reader
							Ports	Two USB 3.1 Gen 1, one USB 3.1 Type-C Gen 1, HDMI 1.4, Ethernet (RJ-45), headphone / microphone combo jack, microSD card reader, security keyhole <i>* Depending on many factors, actual data transfer speed may be lower than theoretical speed</i>	
							Control buttons	Power button, volume control button	
							Camera	<i>One of the following, configurable by model:</i> <i>720p:</i> HD720p resolution, low light sensitive, fixed focus <i>World facing:</i> Rear camera, 5MP resolution, auto focuss	
Graphics	Intel HD Graphics 615, Intel UHD Graphics 600 or 605 in processor, supports external digital monitor via HDMI or USB Type-C; supports dual independent display; Max resolution: 3840x2160@60Hz (USB Type-C); 4096x2160@30Hz (HDMI)							Audio support	HD Audio, Realtek® ALC3287 codec Dolby Audio / stereo speakers, 2W x 2 / monaural microphone, headphone / microphone combo jack
Chipset	Intel SoC (System on Chip) platform							Keyboard	6-row, multimedia Fn keys
Memory	4GB or 8GB / 1866MHz LPDDR3 or 2400MHz DDR4 / soldered to systemboard, no sockets							UltraNav™	Two buttons click pad below keyboard, multi-touch
Display	11.6" (295mm) HD (1366x768), anti-glare, LED backlight, IPS 250 nits, 16:9 aspect ratio, 800:1 contrast ratio, 170° viewing angle							Security	Power-on password, hard disk password, supervisor password, security keyhole
MultiTouch	Capacitive-type multi-touch, support 10 fingers							Security chip	Discrete TPM 2.0, TCG Certified
Hinge	Yoga hinge, 360 degree							System Mgt (opt)	None
Convertible mode	Laptop, tent, stand and tablet							Fingerprint reader	None
Pen	<i>Optional:</i> ThinkPad Pen Pro, batteries required, on-board garage							Battery	Integrated Li-Ion 42Wh battery
Storage	eMMC flash memory on board or M.2 SSD / PCIe NVMe, PCIe 3.0 x 2, 16Gb/s							Max battery life	<i>MobileMark® 2014:</i> 12 hrs <i>* Battery life varies significantly with settings, usage, &amp; other factors</i>
Optical	None							AC adapter	45W or 65W slim tip AC adapter or USB Type-C AC adapter
Ethernet	Realtek RTL8111GUS-CG Gigabit Network Connection							Preload	<i>Some:</i> Windows® 10 Home 64 <i>Some:</i> Windows 10 Pro 64
WLAN	<i>One of the following, configurable by model:</i> • Intel Wireless-AC 9260, Wi-Fi 2x2 802.11ac + Bluetooth 5.0, M.2 card • Intel Wireless-AC 9560, Wi-Fi 2x2 802.11ac + Bluetooth 5.0, M.2 card							Limited warranty	<i>One of the following, configurable by model:</i> • 1-year depot repair service • 3-year depot repair service
Bluetooth™	Bluetooth wireless, integrated in Wi-Fi + Bluetooth combo adapter							Mil-Spec test	MIL-STD-810G military testing
WWAN	None							Environment	EPEAT™ Gold; ENERGY STAR® 6.1; RoHS-compliant

Lenovo  
March 2019



This publication was developed for products and services offered in the North America, E.M.E.A and Asia & Pacific countries. Lenovo may not offer the products, services or features discussed in this document in other countries. Lenovo may withdraw an offering at any time. Information is subject to change without notice. Consult your local representative for information on offerings available in your area.

Lenovo reserves the right to change specifications or other product information without notice. Lenovo is not responsible for photographic or typographical errors.

LENOVO PROVIDES THIS PUBLICATION "AS IS," WITHOUT WARRANTY OF ANY KIND, EITHER EXPRESS OR IMPLIED, INCLUDING THE IMPLIED WARRANTIES OF MERCHANTABILITY OR FITNESS FOR A PARTICULAR PURPOSE.

Some jurisdictions do not allow disclaimer of express or implied warranties in certain transactions, therefore this disclaimer may not apply to you.

**Availability:** All offers subject to availability. Lenovo reserves the right to alter product offerings and specifications at any time, without notice. Lenovo is not responsible for photographic or typographic errors.

**General:** Review key information provided by Microsoft that may apply to your system purchase, including details on Windows 10, Windows 8, Windows 7, and potential upgrades/downgrades. Lenovo makes no representation or warranty regarding third-party products or services.

**Trademarks:** Lenovo, ThinkPad, ThinkBook, ThinkCentre, ThinkStation, ThinkVision and the Lenovo logo are trademarks of Lenovo. Microsoft, Windows, Windows NT, and the Windows logo are trademarks of Microsoft Corporation. Ultrabook, Celeron, Celeron Inside, Core Inside, Intel, Intel Logo, Intel Atom, Intel Atom Inside, Intel Core, Intel Inside, Intel Inside Logo, Intel vPro, Itanium, Itanium Inside, Pentium, Pentium Inside, vPro Inside, Xeon, Xeon Phi, and Xeon Inside are trademarks of Intel Corporation in the U.S. and/or other countries. Other company, product or service names may be trademarks or service marks of others.

**Warranty:** For a copy of applicable warranties, write to: Lenovo Warranty Information, 1009 Think Place, Morrisville, NC, 27560. Lenovo makes no representation or warranty regarding third party products or services. The Lenovo Limited Warranty applies only to Lenovo hardware products purchased for your own use, and does not transfer upon resale.

**Limited warranty:** Support unrelated to a warranty issue may be subject to additional charges.

**Lenovo Services:**

**Carry-in or Mail-in Service:** Parts and labor repair coverage where the customer is responsible for shipping (including packaging) or delivery to authorized warranty provider or repair center.

**Depot or Courier Service:** Parts and labor repair coverage where shipping (including packaging) or delivery to the repair center is paid for by Lenovo.

**Expedited Depot:** Parts and labor coverage with expedited turnaround. Shipping (including packaging) or delivery to the repair center is paid for by Lenovo.

**Onsite / In-home Service:** Parts and labor repair coverage where labor is provided onsite at your place of business.

If Lenovo determines your product problem is covered by the product warranty and cannot be resolved over the telephone, a technician will be dispatched to arrive onsite, typically the next day.

**International Warranty Service (IWS):** PC repair coverage for customers who require a critical warranty repair while travelling internationally. Visit [www.lenovo.com/internationalwarranty](http://www.lenovo.com/internationalwarranty) for details. Visit [www.lenovo.com/warranty](http://www.lenovo.com/warranty) for Lenovo Warranty Services terms and conditions for complete details and restrictions.

**Included software:** may differ from its retail version (if available), and may not include user manuals or all program functionality. Software license agreements may apply.

**Battery life:** Battery life (and recharge times) will vary based on many factors including screen brightness, applications, features, power management, battery conditioning, and other customer preferences.

Visit <http://psref.lenovo.com/> for the latest version of Product Specifications Reference.

© Lenovo, 2019. All rights reserved.  
Lenovo 1009 Think Place Morrisville, NC 27560 U.S.A.



**Lenovo**™ **ThinkCentre**®

**PSREF**



**Product Specifications Reference**

Version 549, September 2019

Visit <http://psref.lenovo.com> for the latest version

# Contents

---

<b>Cover</b>		
<b>Contents</b>		
<b>Summary Of Change</b>		
<b>M Series AIO</b>		
<b>ThinkCentre M810z AIO</b>		
ThinkCentre M810z AIO Platform Specifications		
<b>ThinkCentre M820z AIO</b>		
ThinkCentre M820z AIO Platform Specifications		
<b>ThinkCentre M910z AIO</b>		
ThinkCentre M910z AIO Platform Specifications		
<b>ThinkCentre M920z AIO</b>		
ThinkCentre M920z AIO Platform Specifications		
<b>M Series Desktop</b>		
<b>ThinkCentre M600 Tiny</b>		
ThinkCentre M600 Tiny Platform Specifications		
<b>ThinkCentre M600 Tiny Thin Client</b>		
ThinkCentre M600 Tiny Thin Client Platform Specifications		
<b>ThinkCentre M625 Tiny</b>		
ThinkCentre M625 Tiny Platform Specifications		
<b>ThinkCentre M625 Tiny Thin Client</b>		
ThinkCentre M625 Tiny Thin Client Platform Specifications		
<b>ThinkCentre M630e Tiny</b>		
ThinkCentre M630e Tiny Platform Specifications		
<b>ThinkCentre M710 SFF</b>		
ThinkCentre M710 SFF Platform Specifications		
<b>ThinkCentre M710 Tiny</b>		
ThinkCentre M710 Tiny Platform Specifications		
<b>ThinkCentre M710 Tower</b>		
ThinkCentre M710 Tower Platform Specifications		
<b>ThinkCentre M710e SFF</b>		
ThinkCentre M710e SFF Platform Specifications		
<b>ThinkCentre M715 SFF</b>		
ThinkCentre M715 SFF Platform Specifications		
<b>ThinkCentre M715 Tiny (2nd Gen)</b>		
ThinkCentre M715 Tiny (2nd Gen) Platform Specifications		
<b>1 ThinkCentre M715 Tiny Thin Client</b>		<b>36</b>
<b>2 ThinkCentre M715 Tiny Thin Client Platform Specifications</b>		<b>37</b>
<b>4 ThinkCentre M715 Tiny Thin Client (2nd Gen)</b>		<b>38</b>
<b>6 ThinkCentre M715 Tiny Thin Client (2nd Gen) Platform Specifications</b>		<b>39</b>
<b>6 ThinkCentre M715 Tower</b>		<b>40</b>
<b>7 ThinkCentre M715 Tower Platform Specifications</b>		<b>41</b>
<b>8 ThinkCentre M720 SFF</b>		<b>42</b>
<b>9 ThinkCentre M720 SFF Platform Specifications</b>		<b>43</b>
<b>10 ThinkCentre M720 Tiny</b>		<b>44</b>
<b>11 ThinkCentre M720 Tiny Platform Specifications</b>		<b>45</b>
<b>12 ThinkCentre M720 Tower</b>		<b>46</b>
<b>13 ThinkCentre M720 Tower Platform Specifications</b>		<b>47</b>
<b>14 ThinkCentre M720e SFF</b>		<b>48</b>
<b>14 ThinkCentre M720e SFF Platform Specifications</b>		<b>49</b>
<b>15 ThinkCentre M725 SFF</b>		<b>50</b>
<b>16 ThinkCentre M725 SFF Platform Specifications</b>		<b>51</b>
<b>17 ThinkCentre M75s SFF</b>		<b>52</b>
<b>18 ThinkCentre M75s SFF Platform Specifications</b>		<b>53</b>
<b>19 ThinkCentre M90n-1 Nano</b>		<b>54</b>
<b>20 ThinkCentre M90n-1 Nano Platform Specifications</b>		<b>55</b>
<b>21 ThinkCentre M90n-1 Nano IoT</b>		<b>56</b>
<b>22 ThinkCentre M90n-1 Nano IoT Platform Specifications</b>		<b>57</b>
<b>23 ThinkCentre M910 SFF</b>		<b>58</b>
<b>24 ThinkCentre M910 SFF Platform Specifications</b>		<b>59</b>
<b>25 ThinkCentre M910 Tiny</b>		<b>60</b>
<b>26 ThinkCentre M910 Tiny Platform Specifications</b>		<b>61</b>
<b>27 ThinkCentre M910 Tower</b>		<b>62</b>
<b>28 ThinkCentre M910 Tower Platform Specifications</b>		<b>63</b>
<b>29 ThinkCentre M920 SFF</b>		<b>64</b>
<b>30 ThinkCentre M920 SFF Platform Specifications</b>		<b>65</b>
<b>31 ThinkCentre M920 Tiny</b>		<b>66</b>
<b>32 ThinkCentre M920 Tiny Platform Specifications</b>		<b>67</b>
<b>33 ThinkCentre M920 Tower</b>		<b>68</b>
<b>34 ThinkCentre M920 Tower Platform Specifications</b>		<b>69</b>
<b>35 ThinkCentre M920x Tiny</b>		<b>70</b>

# Contents

---

ThinkCentre M920x Tiny Platform Specifications	71
<b>Smart Office</b>	<b>72</b>
<b>ThinkSmart Hub 500</b>	<b>72</b>
ThinkSmart Hub 500 Platform Specifications	73
<b>ThinkSmart Hub 500 for Zoom</b>	<b>74</b>
ThinkSmart Hub 500 for Zoom Platform Specifications	75
<b>Tiny-In-One</b>	<b>76</b>
<b>ThinkCentre Tiny-In-One 22</b>	<b>76</b>
ThinkCentre Tiny-In-One 22 Platform Specifications	77
<b>ThinkCentre Tiny-In-One 22 Gen3</b>	<b>78</b>
ThinkCentre Tiny-In-One 22 Gen3 Platform Specifications	79
<b>ThinkCentre Tiny-In-One 24</b>	<b>80</b>
ThinkCentre Tiny-In-One 24 Platform Specifications	81
<b>ThinkCentre Tiny-In-One 24 Gen3</b>	<b>82</b>
ThinkCentre Tiny-In-One 24 Gen3 Platform Specifications	83
<b>ThinkCentre Tiny-In-One 27</b>	<b>84</b>
ThinkCentre Tiny-In-One 27 Platform Specifications	85
<b>Legal Information</b>	<b>86</b>

# Contents

<b>Summary of Changes</b> .....	1	ThinkCentre M800z (10EW) - TopSeller .....	70
<b>ThinkCentre Chromebox</b> .....	2	ThinkCentre M800z (10ET) - TopSeller .....	71
ThinkCentre Chromebox Platform Specifications .....	3	ThinkCentre M800z (10EW) .....	72
ThinkCentre Chromebox (10H8) - TIO .....	4	ThinkCentre M800z (10EV) .....	73
ThinkCentre Chromebox (10H9) - TIO (TopSeller) .....	5	<b>ThinkCentre M900 Tiny</b> .....	<b>74</b>
ThinkCentre Chromebox (10H6) - TIO .....	6	ThinkCentre M900 Tiny Platform Specifications .....	75
ThinkCentre Chromebox (10H2) .....	7	ThinkCentre M900 Tiny (10FM) - TopSeller .....	76
ThinkCentre Chromebox (10H3) - TopSeller .....	8	ThinkCentre M900 Tiny (10FM) - TopSeller - II .....	77
ThinkCentre Chromebox (10H4) .....	9	ThinkCentre M900 Tiny (10NE) - TopSeller .....	78
ThinkCentre Chromebox (10H5) - TopSeller .....	10	ThinkCentre M900 Tiny (10NE) - TopSeller - II .....	79
<b>ThinkCentre Tiny-in-One 22</b> .....	<b>11</b>	ThinkCentre M900 Tiny (10FL) .....	80
ThinkCentre Tiny-in-One (TIO) 22 .....	12	<b>ThinkCentre M900 SFF</b> .....	<b>81</b>
<b>ThinkCentre Tiny-in-One 23</b> .....	<b>13</b>	ThinkCentre M900 SFF Platform Specifications .....	82
ThinkCentre Tiny-in-One (TIO) 23 .....	14	ThinkCentre M900 SFF (10FH) - TopSeller .....	83
<b>ThinkCentre Tiny-in-One 24</b> .....	<b>15</b>	ThinkCentre M900 SFF (10FG) .....	84
ThinkCentre Tiny-in-One (TIO) 24 .....	16	<b>ThinkCentre M900 Tower</b> .....	<b>85</b>
<b>ThinkCentre M600 Tiny</b> .....	<b>17</b>	ThinkCentre M900 Tower Platform Specifications .....	86
ThinkCentre M600 Tiny Platform Specifications .....	18	ThinkCentre M900 Tower (10FD) - TopSeller .....	87
ThinkCentre M600 Tiny (10G9) - TopSeller .....	19	ThinkCentre M900 Tower (10FD) - TopSeller - II .....	88
ThinkCentre M600 Tiny (10KH) - Thin Client (TopSeller) .....	20	ThinkCentre M900 Tower (10FC) .....	89
ThinkCentre M600 Tiny (10GK) - Thin Client (TopSeller) .....	21	<b>ThinkCentre M900z All-In-One</b> .....	<b>90</b>
ThinkCentre M600 Tiny (10KK) - TIO (Thin Client) - TopSeller .....	22	ThinkCentre M900z Platform Specifications .....	91
ThinkCentre M600 Tiny (10GA) - OID .....	23	ThinkCentre M900z (10F3) - TopSeller .....	92
ThinkCentre M600 Tiny (10G8) - OID .....	24	ThinkCentre M900z (10F2) - TopSeller .....	93
ThinkCentre M600 Tiny (10GE) - TIO (OID) .....	25	ThinkCentre M900z (10F5) .....	94
ThinkCentre M600 Tiny (10GC) - TIO (OID) .....	26	ThinkCentre M900z (10F4) .....	95
ThinkCentre M600 Tiny (10KG) - Thin Client .....	27	<b>ThinkCentre X1</b> .....	<b>96</b>
ThinkCentre M600 Tiny (10GJ) - Thin Client .....	28	ThinkCentre X1 Platform Specifications .....	97
ThinkCentre M600 Tiny (10KJ) - TIO (Thin Client) .....	29	ThinkCentre X1 (10JX) - TopSeller .....	98
<b>ThinkCentre M700 Tiny</b> .....	<b>30</b>	ThinkCentre X1 (10KE) - TopSeller .....	99
ThinkCentre M700 Tiny Platform Specifications .....	31	ThinkCentre X1 (10KF) .....	100
ThinkCentre M700 Tiny (10HY) - TopSeller .....	32	ThinkCentre X1 (10HU) .....	101
ThinkCentre M700 Tiny (10HY) - TopSeller - II .....	33	ThinkCentre X1 (10K0) - TopSeller .....	102
ThinkCentre M700 Tiny (10J0) .....	34	<b>ThinkCentre E63z All-In-One</b> .....	<b>103</b>
<b>ThinkCentre M700 SFF</b> .....	<b>35</b>	ThinkCentre E63z Platform Specifications .....	104
ThinkCentre M700 SFF Platform Specifications .....	36	ThinkCentre E63z (10D4) - TopSeller .....	105
ThinkCentre M700 SFF (10GT) - TopSeller .....	37	ThinkCentre E63z (10D6) - Multi-touch (TopSeller) .....	106
ThinkCentre M700 SFF (10GT) - TopSeller - II .....	38	ThinkCentre E63z (10EK) .....	107
ThinkCentre M700 SFF (10GS) .....	39	ThinkCentre E63z (10E0) - TopSeller .....	108
<b>ThinkCentre M700 Tower</b> .....	<b>40</b>	ThinkCentre E63z (10EL) - TopSeller .....	109
ThinkCentre M700 Tower Platform Specifications .....	41	ThinkCentre E63z (10E1) .....	110
ThinkCentre M700 Tower (10GR) - TopSeller .....	42	ThinkCentre E63z (10E1) - Win10 .....	111
ThinkCentre M700 Tower (10GQ) .....	43	ThinkCentre E63z (10EM) .....	112
<b>ThinkCentre M700z All-In-One</b> .....	<b>44</b>	ThinkCentre E63z (10E2) - Multi-touch (TopSeller) .....	113
ThinkCentre M700z Platform Specifications .....	45	ThinkCentre E63z (10E2) - Multi-touch (TopSeller) - Win10 .....	114
ThinkCentre M700z (10EY) - TopSeller .....	46	ThinkCentre E63z (10E3) - Multi-touch .....	115
ThinkCentre M700z (10F1) .....	47	<b>ThinkCentre E73 SFF and Tower</b> .....	<b>116</b>
<b>ThinkCentre M79 SFF and Tower</b> .....	<b>48</b>	ThinkCentre E73 SFF (10AU) - TopSeller .....	117
ThinkCentre M79 SFF Platform Specifications .....	49	ThinkCentre E73 SFF (10AU) - TopSeller - II .....	118
ThinkCentre M79 Tower Platform Specifications .....	50	ThinkCentre E73 SFF (10AU) - TopSeller - III .....	119
ThinkCentre M79 SFF (10CU) - TopSeller .....	51	ThinkCentre E73 SFF (10AW) - ES 6.0 (TopSeller) .....	120
ThinkCentre M79 SFF (10JB) - TopSeller .....	52	ThinkCentre E73 SFF (10AW) - ES 6.0 (TopSeller) - II .....	121
ThinkCentre M79 SFF (10CT) .....	53	ThinkCentre E73 SFF (10AW) - ES 6.0 (TopSeller) - III .....	122
ThinkCentre M79 SFF (10JA) .....	54	ThinkCentre E73 SFF (10DU) - ES 6.0 (TopSeller) .....	123
ThinkCentre M79 Tower (10CR) - TopSeller .....	55	ThinkCentre E73 SFF (10DU) - ES 6.0 (TopSeller) - II .....	124
ThinkCentre M79 Tower (10J7) - TopSeller .....	56	ThinkCentre E73 SFF (10DU) - ES 6.0 (TopSeller) - III .....	125
ThinkCentre M79 Tower (10CQ) .....	57	ThinkCentre E73 SFF (10DU) - ES 6.0 (Win10) - TopSeller .....	126
ThinkCentre M79 Tower (10J6) .....	58	<b>Withdrawn Product Books</b> .....	<b>127</b>
<b>ThinkCentre M800 SFF</b> .....	<b>59</b>	<b>Legal Information and Trademarks</b> .....	<b>128</b>
ThinkCentre M800 SFF Platform Specifications .....	60		
ThinkCentre M800 SFF (10FY) - TopSeller .....	61		
ThinkCentre M800 SFF (10FX) .....	62		
<b>ThinkCentre M800 Tower</b> .....	<b>63</b>		
ThinkCentre M800 Tower Platform Specifications .....	64		
ThinkCentre M800 Tower (10FW) - TopSeller .....	65		
ThinkCentre M800 Tower (10FV) .....	66		
<b>ThinkCentre M800z All-In-One</b> .....	<b>67</b>		
ThinkCentre M800z Platform Specifications .....	68		
ThinkCentre M800z (10EU) - TopSeller .....	69		

# Summary of Changes

---

This section describes the technical changes made in this edition.

This edition might also include minor corrections and editorial changes which are not identified.

## September 2019 - Version 549

### Additions in this update

- ▶ **New product(s)**
  - ThinkCentre M75s SFF
  - ThinkCentre M720e SFF
- ▶ **New model(s)**
  - None
- ▶ **Others**
  - None

### Withdrawals in this update

- ▶ **Withdrawn product(s)**
  - None
- ▶ **Withdrawn model(s)**
  - None



# ThinkCentre M810z Platform Specifications

Product Specifications Reference (PSREF)

Processor	Intel® Celeron®, Intel Pentium®, or 6th / 7th Gen Intel Core™ i3 / i5 / i7 Processor						Security features	<ul style="list-style-type: none"> <li>Security slot (in rear for attachment of optional Kensington® MicroSaver® cable; Kensington lock also locks chassis)</li> <li>Smart USB protection, allows keyboard/mouse only, blocks all storage devices</li> <li>Optional cable lock to physically lock keyboard and mouse</li> </ul>	<ul style="list-style-type: none"> <li>Power-on, admin, hard disk password</li> <li>Boot sequence control</li> <li>Boot without keyboard and mouse</li> <li>Individual USB port disablement</li> <li>Optional Chassis intrusion switch</li> </ul>
	Processor	Cores / Threads	Frequency Base/Max(GHz)	Cache	Memory Support (Up to)	Integrated Graphics			
	Pentium G4400	2 / 2	3.3G	3 MB	DDR4-2133	HD 510			
	Pentium G4560	2 / 4	3.5G	3 MB	DDR4-2400	HD 610			
	Pentium G4600	2 / 4	3.6G	3 MB	DDR4-2400	HD 630			
	Core i3-6100	2 / 4	3.7G	3 MB	DDR4-2133	HD 530			
	Core i5-6500	4 / 4	3.2G / 3.6G	6 MB	DDR4-2133	HD 530			
	Core i7-6700	4 / 8	3.4G / 4.0G	8 MB	DDR4-2133	HD 530			
	Core i3-7100	2 / 4	3.9G	3 MB	DDR4-2400	HD 630			
	Core i5-7400	4 / 4	3.0G / 3.5G	6 MB	DDR4-2400	HD 630			
Core i5-7500	4 / 4	3.4G / 3.8G	6 MB	DDR4-2400	HD 630				
Core i5-7600	4 / 4	3.5G / 4.1G	6 MB	DDR4-2400	HD 630				
Core i7-7700	4 / 8	3.6G / 4.2G	8 MB	DDR4-2400	HD 630				
Memory	32GB max, DDR4-2400*, two 260-pin SO-DIMM sockets, dual-channel capable * System clocks down for the processors with lower memory controller						Keyboard	<i>Some:</i> Lenovo Calliope Keyboard (USB connector), black <i>Some:</i> Lenovo Traditional Keyboard (USB connector), black <i>Some:</i> Lenovo Calliope Wireless Keyboard (2.4GHz via USB receiver), black	Mouse <i>Some:</i> Lenovo Calliope Mouse (USB connector), black <i>Some:</i> Lenovo Calliope Wireless Mouse (2.4GHz via USB receiver), black
Storage	<i>Some:</i> Hard Drive / SATA 6.0Gb/s, 2.5", 5400 rpm or 7200 rpm <i>Some:</i> Solid State Drive (SSD) / SATA 6.0Gb/s, 2.5" <i>Some:</i> M.2 Solid State Drive (SSD) / PCIe NVMe, PCIe 3.0 x 4, 32Gb/s <i>Some:</i> Intel Optane™ Memory (models with 7th gen Core processor), M.2 <i>Some:</i> DVD-ROM SATA 1.5Gb/s Drive, slim (9.5mm) <i>Some:</i> DVD Burner (DVD±RW), SATA 1.5Gb/s Drive, slim (9.5mm)								
Optical	Optional 9-in-1 media card reader								
Media reader	Optional 9-in-1 media card reader								
Graphics	<b>Intel HD Graphics 510/530/610/630</b> in processor, uses main memory, DirectX® 12, external monitor support via DisplayPort™; <i>Max resolution:</i> 4096x2304 (DP)@60Hz, 1920x1080 (Panel)@60Hz								
Display	<b>21.5"</b> (546.1mm) <b>Full HD 1080p (1920x1080) TFT color</b> , MVA panel, wide viewing angle (+/- 89°), LED backlight, 250 nits, 16:9 aspect ratio, 1000:1 contrast ratio, anti-glare, support Low Blue Light Mode								
Multi-touch	Optional Projected Capacitive Touch (PCT) technology, supports 10-point touch								
Camera	Optional 1080p camera, fixed focus, with dual microphone, LED indicator, physical switch on/off								
Controls	Physical buttons for Microphone mute, brightness up/down, and power on/off								
Chipset	<b>Intel B250 Chipset</b>								
Rear ports*	Four USB 3.1 Gen1, ethernet (RJ-45), DisplayPort, optional serial (9-pin), Two USB 3.1 Gen1 (one is Always On and fast charge), optional card reader, one headphone / microphone combo jack (3.5mm)								
Side ports*	* Depending on many factors, actual data transfer speed may be lower than theoretical speed								
M.2 card slot	Two M.2 Card slots (one for WLAN, one for SSD/Optane)								
Audio support	High Definition (HD) Audio, Realtek ALC233 / two internal speakers (2W x 2), Dolby® Audio™ certified								
WLAN <sup>13</sup>	<i>Some:</i> 11ac wireless, M.2 Card, Qualcomm Atheros QCA9377A (dual band), Wi-Fi + Bluetooth 4.1 combo adapter, 1x1 <i>Some:</i> 11ac wireless, M.2 Card, Qualcomm Atheros QCA6174A (dual band), Wi-Fi + Bluetooth 4.1 combo adapter, 2x2 <i>Some:</i> 11ac wireless, M.2 Card, Intel Dual Band Wireless-AC 3165, Wi-Fi + Bluetooth 4.1 combo adapter, 1x1 <i>Some:</i> 11ac wireless, M.2 Card, Intel Dual Band Wireless-AC 8265, Wi-Fi + Bluetooth 4.1 combo adapter, 2x2								
Bluetooth™	<i>Some:</i> Bluetooth 4.1 wireless, integrated in Wi-Fi + Bluetooth combo adapter								
Ethernet	Gigabit ethernet, Realtek RTL8111G, Wake on LAN®								
Manageability	None								
Security chip	TPM (Trusted Platform Module) 2.0, TCG Certified * Downgrade to TPM1.2 for the models with Win10 DG Win7 32 OS								
Power supply	150 watts, autosensing, 85% PSU								
Limited warranty <sup>3</sup>	<i>Some:</i> <b>1-year or 3-year, depot repair service</b> / service upgrades available <i>Some:</i> <b>1-year or 3-year, limited onsite service</b> / service upgrades available								
Preload	<b>Preloaded operating system</b> <i>Some:</i> Windows® 7 Professional 32/64 preinstalled through downgrade rights in Windows 10 Pro 64-bit <i>Some:</i> Windows 10 Pro 64-bit <i>Some:</i> Windows 10 Home 64-bit								
Environment	<b>Preloaded applications (only some listed)</b> <ul style="list-style-type: none"> <li>Microsoft Office preloaded; purchase a product key to activate</li> <li>Only for Window 10</li> <li>Lenovo Companion</li> <li>Only for Window 7</li> <li>Lenovo Solution Center</li> <li>Lenovo ThinkVantage Tools</li> <li>ThinkVantage System Update</li> <li>Create Recovery Media</li> <li>Adobe® Reader®</li> <li>Cyberlink PowerDVD Create (DVD±RW)</li> </ul>								
MIL-SPEC test	EPEAT™ Gold rating (North America); ENERGY STAR® 6.1; TCO AIO Computer Certified; ErP Lot 3; GREENGUARD® certified; RoHS-compliant								
Accessories	MIL-STD-810G military certification (Low Pressure [Altitude], High Temperature, Low Temperature, Temperature Shock, Humidity, Sand and Dust, Vibration, Shock)								
	For compatible accessories, please go to <a href="http://www.lenovoquickpick.com">http://www.lenovoquickpick.com</a>								

See footnotes for more detailed information





# ThinkCentre M820z Platform Specifications

Product Specifications Reference (PSREF)

Processor	Intel® Celeron®, Intel Pentium®, or 8th / 9th Gen Intel Core™ i3 / i5 / i7 / i9 series						WLAN <i>Some:</i> 11ac wireless, M.2 Card, Realtek RTL8821CE (dual band), Wi-Fi + Bluetooth 4.2 combo adapter, 1x1 <i>Some:</i> 11ac wireless, M.2 Card, Realtek RTL8822BE (dual band), Wi-Fi + Bluetooth 4.2 combo adapter, 2x2 <i>Some:</i> 11ac wireless, M.2 Card, Intel Dual Band Wireless-AC 3165, Wi-Fi + Bluetooth 4.2 combo adapter, 1x1 <i>Some:</i> 11ac wireless, M.2 Card, Intel Dual Band Wireless-AC 8265, Wi-Fi + Bluetooth 4.2 combo adapter, 2x2 Bluetooth™ Ethernet <i>Some:</i> Bluetooth 4.2 wireless, integrated in Wi-Fi + BT combo adapter Gigabit ethernet, Realtek RTL8111G, Wake on LAN®																				
	Processor	Cores / Threads	Frequency Base/Max(GHz)	Cache	Memory Support (Up to)	Integrated Graphics																					
	Celeron G4900	2 / 2	3.1G	2 MB	DDR4-2400	UHD 610																					
	Celeron G4920	2 / 2	3.2G	2 MB	DDR4-2400	UHD 610																					
	Celeron G4930	2 / 2	3.2G	2 MB	DDR4-2400	UHD 610																					
	Celeron G4950	2 / 2	3.3G	2 MB	DDR4-2400	UHD 610																					
	Pentium Gold G5400	2 / 4	3.7G	4 MB	DDR4-2400	UHD 610																					
	Pentium Gold G5420	2 / 4	3.8G	4 MB	DDR4-2400	UHD 610																					
	Pentium Gold G5500	2 / 4	3.8G	4 MB	DDR4-2400	UHD 630																					
	Pentium Gold G5600	2 / 4	3.9G	4 MB	DDR4-2400	UHD 630																					
	Pentium Gold G5620	2 / 4	4.0G	4 MB	DDR4-2400	UHD 630																					
	Core i3-8100	4 / 4	3.6G	6 MB	DDR4-2400	UHD 630																					
	Core i3-8300	4 / 4	3.7G	8 MB	DDR4-2400	UHD 630																					
	Core i5-8400	6 / 6	2.8G / 4.0G	9 MB	DDR4-2666	UHD 630																					
	Core i5-8500	6 / 6	3.0G / 4.1G	9 MB	DDR4-2666	UHD 630																					
	Core i5-8600	6 / 6	3.1G / 4.3G	9 MB	DDR4-2666	UHD 630																					
	Core i7-8700	6 / 12	3.2G / 4.6G	12 MB	DDR4-2666	UHD 630																					
	Core i3-9100	4 / 4	3.6G / 4.2G	6 MB	DDR4-2400	UHD 630																					
	Core i3-9300	4 / 4	3.7G / 4.3G	8 MB	DDR4-2400	UHD 630																					
	Core i5-9400	6 / 6	2.9G / 4.1G	9 MB	DDR4-2666	UHD 630																					
Core i5-9500	6 / 6	3.0G / 4.4G	9 MB	DDR4-2666	UHD 630																						
Core i5-9600	6 / 6	3.1G / 4.6G	9 MB	DDR4-2666	UHD 630																						
Core i7-9700	8 / 8	3.0G / 4.7G	12 MB	DDR4-2666	UHD 630																						
Core i9-9900	8 / 16	3.1G / 5.0G	16 MB	DDR4-2666	UHD 630																						
Memory	32GB max (16GB SO-DIMM only available via special bid models), DDR4-2666*, two 260-pin SO-DIMM sockets, dual-channel capable * System clocks down for the processors with lower memory controller																										
Storage	<i>Some:</i> Hard Drive / SATA 6.0Gb/s, 2.5", 5400 rpm or 7200 rpm <i>Some:</i> Solid State Drive (SSD) / SATA 6.0Gb/s, 2.5" <i>Some:</i> M.2 SSD / PCIe NVMe, PCIe 3.0 x 4*, 32Gb/s * 128GB SSD M.2 (2242) PCIe NVMe only supports PCIe 3.0 x 2, 16Gb/s <i>Some:</i> Intel Optane™ Memory (not support Celeron / Pentium Processor), M.2 <i>Some:</i> DVD-ROM SATA 1.5Gb/s Drive, slim (9.0mm) <i>Some:</i> DVD Burner (DVD±RW), SATA 1.5Gb/s Drive, slim (9.0mm) Optional 3-in-1 media card reader																										
Optical																											
Media reader																											
Graphics	Intel HD Graphics 610/630 in processor, uses main memory, DirectX® 12, external monitor support via DisplayPort™; <i>Max resolution:</i> 4096x2304 (DP)@60Hz, 1920x1080 (Panel)@60Hz <b>21.5"</b> (546.1mm) <b>Full HD 1080p (1920x1080) TFT color</b> , Borderless design, MVA panel, wide viewing angle (+/- 89°), LED backlight, 250 nits, 16:9 aspect ratio, 1000:1 contrast ratio, anti-glare, support Low Blue Light Mode Optional multi-touch, supports 10-point, AIT (Advanced In-cell Touch) technology Optional 1080p camera, with dual microphone, LED indicator, physical switch on/off, supports multi-degree rotation (horizontal 0° to 180°, vertical -25° to 25°) Physical buttons on side for microphone mute and power on/off																										
Display																											
Multi-touch																											
Camera																											
Controls																											
Chipset	Intel B360 Chipset																										
Rear ports*	Four USB 3.1 Gen1 (one supports Smart Power On), one ethernet (RJ-45), one DisplayPort, one optional serial (9-pin),																										
Side ports*	one USB 3.1 Gen2 (one is Always On and fast charge), one USB 3.1 Type-C Gen 1, one optional card reader, one headphone / microphone combo jack (3.5mm) * Depending on many factors, actual data transfer speed may be lower than theoretical speed																										
M.2 card slot	Two M.2 Card slots (one for WLAN, one for SSD/Optane)																										
Audio support	High Definition (HD) Audio, Realtek ALC233 / two internal speakers (2W x 2), Dolby® Audio™ Premium																										
Manageability	None																										
Security chip	Discrete TPM 2.0, TCG Certified																										
Security features	<ul style="list-style-type: none"> <li>Security slot (in rear for attachment of optional Kensington® MicroSaver® cable; Kensington lock also locks chassis)</li> <li>Smart USB protection, allows keyboard/mouse only, blocks all storage devices</li> <li>Power-on, admin, hard disk password</li> <li>Boot sequence control</li> <li>Boot without keyboard and mouse</li> <li>Individual USB port disablement</li> <li>Optional Chassis intrusion switch</li> </ul>																										
Keyboard	<i>Some:</i> Lenovo Calliope Keyboard (USB connector), black <i>Some:</i> Lenovo Traditional Keyboard (USB connector), black <i>Some:</i> Lenovo Calliope Wireless Keyboard (2.4GHz via USB receiver), black																										
Mouse	<i>Some:</i> Lenovo Calliope Mouse (USB connector), black <i>Some:</i> Lenovo Fingerprint Mouse (USB connector), Windows Hello support, black <i>Some:</i> Lenovo Calliope Wireless Mouse (2.4GHz via USB receiver), black																										
Mechanical	<ul style="list-style-type: none"> <li>Business black color</li> <li>Toolless back cover, stand, memory removal</li> <li>Support VESA mount (100mm)</li> </ul> <table border="1"> <thead> <tr> <th>Dimensions (WxDxH)</th> <th>Max weight (lb / kg)</th> <th>Adjustments</th> </tr> </thead> <tbody> <tr> <td colspan="3">Without stand (No camera):</td> </tr> <tr> <td>19.3 X 1.9 X 13.5 (inch) 491 X 49 X 342 (mm)</td> <td>(Touch) 11.6 / 5.25 (Non-touch) 11.1 / 5.05</td> <td>N/A</td> </tr> <tr> <td colspan="3">With Full Function Monitor stand (No camera):</td> </tr> <tr> <td>19.3 X 9.9 X 14.8 to 19.1 (inch) 491 X 252 X 377 to 486 (mm)</td> <td>(Non-touch) 15.8 / 7.18</td> <td>Tilt: 45° back, -5° forward; Lift: 110mm; Swivel: +/-45°</td> </tr> <tr> <td colspan="3">With UltraFlex III stand (No camera):</td> </tr> <tr> <td>19.3 X 9.9 X 16.4 (highest) (inch) 491 X 252 X 416 (highest) (mm)</td> <td>(Touch) 17.3 / 7.85 (Non-touch) 16.9 / 7.65</td> <td>Tilt: 70° back, -5° forward; Lift: 136mm; Swivel: +/-45°</td> </tr> </tbody> </table>						Dimensions (WxDxH)	Max weight (lb / kg)	Adjustments	Without stand (No camera):			19.3 X 1.9 X 13.5 (inch) 491 X 49 X 342 (mm)	(Touch) 11.6 / 5.25 (Non-touch) 11.1 / 5.05	N/A	With Full Function Monitor stand (No camera):			19.3 X 9.9 X 14.8 to 19.1 (inch) 491 X 252 X 377 to 486 (mm)	(Non-touch) 15.8 / 7.18	Tilt: 45° back, -5° forward; Lift: 110mm; Swivel: +/-45°	With UltraFlex III stand (No camera):			19.3 X 9.9 X 16.4 (highest) (inch) 491 X 252 X 416 (highest) (mm)	(Touch) 17.3 / 7.85 (Non-touch) 16.9 / 7.65	Tilt: 70° back, -5° forward; Lift: 136mm; Swivel: +/-45°
Dimensions (WxDxH)	Max weight (lb / kg)	Adjustments																									
Without stand (No camera):																											
19.3 X 1.9 X 13.5 (inch) 491 X 49 X 342 (mm)	(Touch) 11.6 / 5.25 (Non-touch) 11.1 / 5.05	N/A																									
With Full Function Monitor stand (No camera):																											
19.3 X 9.9 X 14.8 to 19.1 (inch) 491 X 252 X 377 to 486 (mm)	(Non-touch) 15.8 / 7.18	Tilt: 45° back, -5° forward; Lift: 110mm; Swivel: +/-45°																									
With UltraFlex III stand (No camera):																											
19.3 X 9.9 X 16.4 (highest) (inch) 491 X 252 X 416 (highest) (mm)	(Touch) 17.3 / 7.85 (Non-touch) 16.9 / 7.65	Tilt: 70° back, -5° forward; Lift: 136mm; Swivel: +/-45°																									
Power supply	150 watts, autosensing, 90% PSU																										
Limited warranty <sup>3</sup>	<i>Some:</i> <b>1-year or 3-year, depot repair service</b> / service upgrades available <i>Some:</i> <b>1-year or 3-year, limited onsite service</b> / service upgrades available																										
Preload	<b>Preloaded operating system</b> <i>Some:</i> Windows 10 Pro 64-bit <i>Some:</i> Windows 10 Home 64-bit <b>Preloaded applications (only some listed)</b> <ul style="list-style-type: none"> <li>Lenovo Vantage</li> <li>Microsoft Office preloaded; purchase a product key to activate</li> <li>Cyberlink PowerDVD (only for models with DVD / DVD±RW)</li> <li>Cyberlink Power2GO (only for models with DVD±RW)</li> <li>LinkedIn</li> </ul>																										
Environment	ENERGY STAR® 7.0*, EPEAT™ Silver rating* (*not for non-OS models), ErP Lot 3, TCO AIO Computer certified, GREENGUARD® certified, TUV Eye comfort certified (for Full Function Monitor Stand only), TUV Low Blue Light certified, TUV Ultra Low Noise certified (on some models), RoHS-compliant																										
MIL-SPEC test	MIL-STD-810G military certification (Low Pressure [Altitude], High Temperature, Low Temperature, Temperature Shock, Humidity, Sand and Dust, Vibration, Shock, Fungus)																										
Accessories	For compatible accessories, please go to <a href="http://smartfind.lenovo.com">http://smartfind.lenovo.com</a>																										

Note: The specifications above may not be available in all regions.

Lenovo, June 2019

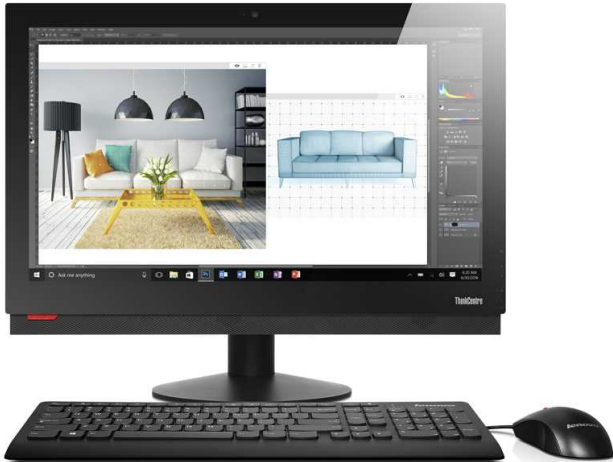

# ThinkCentre M910z Platform Specifications

Product Specifications Reference (PSREF)

Processor	Intel® Celeron®, Intel Pentium®, or 6th / 7th Gen Intel Core™ i3 / i5 / i7 Processor						Security chip TPM (Trusted Platform Module) 2.0, TCG Certified * Downgrade to TPM1.2 for the models with Win10 DG Win7 32 OS															
	Processor	Cores / Threads	Frequency Base/Max(GHz)	Cache	Memory Support (Up to)	Integrated Graphics																
	Core i3-6100	2 / 4	3.7G	3 MB	DDR4-2133	HD 530																
	Core i5-6500	4 / 4	3.2G / 3.6G	6 MB	DDR4-2133	HD 530																
	Core i7-6700	4 / 8	3.4G / 4.0G	8 MB	DDR4-2133	HD 530																
	Core i3-7100	2 / 4	3.9G	3 MB	DDR4-2400	HD 630																
	Core i5-7400	4 / 4	3.0G / 3.5G	6 MB	DDR4-2400	HD 630																
	Core i5-7500	4 / 4	3.4G / 3.8G	6 MB	DDR4-2400	HD 630																
Core i5-7600	4 / 4	3.5G / 4.1G	6 MB	DDR4-2400	HD 630																	
Core i7-7700	4 / 8	3.6G / 4.2G	8 MB	DDR4-2400	HD 630																	
Memory	32GB max, DDR4-2400*, two 260-pin SO-DIMM sockets, dual-channel capable * System clocks down for the processors with lower memory controller						Security features <ul style="list-style-type: none"> <li>Security slot (in rear for attachment of optional Kensington® MicroSaver® cable; Kensington lock also locks chassis)</li> <li>Smart USB protection, allows keyboard/mouse only, blocks all storage devices</li> <li>Optional cable lock to physically lock keyboard and mouse</li> <li>Power-on, admin, hard disk password</li> <li>Boot sequence control</li> <li>Boot without keyboard and mouse</li> <li>Individual USB port disablement</li> <li>Optional Chassis intrusion switch</li> </ul>															
Storage	<i>Some:</i> Hard Drive / SATA 6.0Gb/s, 2.5", 5400 rpm or 7200 rpm <i>Some:</i> Solid State Drive (SSD) / SATA 6.0Gb/s, 2.5" <i>Some:</i> M.2 Solid State Drive (SSD) / PCIe NVMe, PCIe 3.0 x 4, 32Gb/s <i>Some:</i> Intel Optane™ Memory (models with 7th gen Core processor), M.2																					
Optical	<i>Some:</i> DVD-ROM SATA 1.5Gb/s Drive, slim (9.5mm) <i>Some:</i> DVD Burner (DVD±RW), SATA 1.5Gb/s Drive, slim (9.5mm)																					
Media reader	Optional 9-in-1 media card reader																					
Graphics	<b>Intel HD Graphics 530/630</b> in processor, uses main memory, DirectX® 12, external monitor support via DisplayPort™; <i>Max resolution:</i> 4096x2304 (DP)@60Hz, 1920x1080 (Panel)@60Hz																					
Display	<b>23.8"</b> (604.5mm) <b>Full HD 1080p (1920x1080) TFT color</b> , WVA panel, wide viewing angle (+/- 89°), LED backlight, 250 nits, 16:9 aspect ratio, 1000:1 contrast ratio, anti-glare, support Low Blue Light Mode, work as standalone monitor via DisplayPort (DP in / out combo)																					
Multi-touch	Optional Projected Capacitive Touch (PCT) technology, supports 10-point touch																					
Camera	Optional 1080p camera, fixed focus, with dual microphone, LED indicator, physical switch on/off																					
Controls	Physical buttons for Microphone mute, monitor mode switch, brightness up/down, and power on/off																					
Chipset	<b>Intel Q270 Chipset</b>																					
Rear ports*	Four USB 3.1 Gen1, ethernet (RJ-45), DisplayPort in/out combo port, optional serial (9-pin)																					
Side ports*	Two USB 3.1 Gen1 (one is Always On and fast charge), optional card reader, one headphone / microphone combo jack (3.5mm), optional USB 3.1 Type-C Gen1																					
M.2 card slot	* Depending on many factors, actual data transfer speed may be lower than theoretical speed Two M.2 Card slots (one for WLAN, one for SSD/Optane)																					
Audio support	High Definition (HD) Audio, Realtek ALC233 / two internal speakers (3W x 2), Dolby® Audio™ certified																					
WLAN <sup>13</sup>	<i>Some:</i> 11ac wireless, M.2 Card, Qualcomm Atheros QCA9377A (dual band), Wi-Fi + Bluetooth 4.1 combo adapter, 1x1 <i>Some:</i> 11ac wireless, M.2 Card, Qualcomm Atheros QCA6174A (dual band), Wi-Fi + Bluetooth 4.1 combo adapter, 2x2 <i>Some:</i> 11ac wireless, M.2 Card, Intel Dual Band Wireless-AC 3165, Wi-Fi + Bluetooth 4.1 combo adapter, 1x1 <i>Some:</i> 11ac wireless, M.2 Card, Intel Dual Band Wireless-AC 8265, Wi-Fi + Bluetooth 4.1 combo adapter, 2x2 <i>Some:</i> 11ac wireless, M.2 Card, Intel Dual Band Wireless-AC 8265, Wi-Fi + Bluetooth 4.1 combo adapter, Intel vPro technology support, 2x2																					
Bluetooth™	<i>Some:</i> Bluetooth 4.1 wireless, integrated in Wi-Fi + Bluetooth combo adapter																					
Ethernet	Gigabit ethernet, Intel Ethernet Connection I219-LM (Jacksonville), Wake on LAN®																					
Manageability	Intel Active Management Technology 11.0 (Intel AMT 11.0); Intel vPro technology on some models (require choosing a vPro-support Wi-Fi adapter to enable vPro function through wireless connection)																					
Keyboard	<i>Some:</i> Lenovo Calliope Keyboard (USB connector), black <i>Some:</i> Lenovo Traditional Keyboard (USB connector), black <i>Some:</i> Lenovo Calliope Wireless Keyboard (2.4GHz via USB receiver), black <i>Some:</i> Lenovo Calliope Mouse (USB connector), black <i>Some:</i> Lenovo Calliope Wireless Mouse (2.4GHz via USB receiver), black																					
Mouse																						
Mechanical	<ul style="list-style-type: none"> <li>Business black color</li> <li>Toolless back cover, stand, disk, memory removal</li> <li>Support VESA mount (100mm)</li> </ul> <table border="1"> <thead> <tr> <th></th> <th>Dimensions (WxDxH)</th> <th>Max weight (lb / kg)</th> <th>Adjustments</th> </tr> </thead> <tbody> <tr> <td>Without stand:</td> <td>23.0 X 1.8 X 15.4 (inch); 584 X 45 X 390 (mm)</td> <td>(Touch) 17.2 / 7.8 (Non-touch) 15.0 / 6.8</td> <td>N/A</td> </tr> <tr> <td>With Basic Monitor stand:</td> <td>23.0 X 9.6 X 18.0 (inch); 584 X 245 X 458 (mm)</td> <td>(Non-touch) 19.4 / 8.8</td> <td>Tilt: 45° back, -5° forward</td> </tr> <tr> <td>With UltraFlex II stand:</td> <td>23.0X 10.0 X 19.9 (inch); 584 X 253 X 505 (mm)</td> <td>(Touch) 22.7 / 10.3 (Non-touch) 20.7 / 9.4</td> <td>Tilt: 61° back, -5° forward; Lift: 110mm; Swivel: +/-45°</td> </tr> </tbody> </table>							Dimensions (WxDxH)	Max weight (lb / kg)	Adjustments	Without stand:	23.0 X 1.8 X 15.4 (inch); 584 X 45 X 390 (mm)	(Touch) 17.2 / 7.8 (Non-touch) 15.0 / 6.8	N/A	With Basic Monitor stand:	23.0 X 9.6 X 18.0 (inch); 584 X 245 X 458 (mm)	(Non-touch) 19.4 / 8.8	Tilt: 45° back, -5° forward	With UltraFlex II stand:	23.0X 10.0 X 19.9 (inch); 584 X 253 X 505 (mm)	(Touch) 22.7 / 10.3 (Non-touch) 20.7 / 9.4	Tilt: 61° back, -5° forward; Lift: 110mm; Swivel: +/-45°
	Dimensions (WxDxH)	Max weight (lb / kg)	Adjustments																			
Without stand:	23.0 X 1.8 X 15.4 (inch); 584 X 45 X 390 (mm)	(Touch) 17.2 / 7.8 (Non-touch) 15.0 / 6.8	N/A																			
With Basic Monitor stand:	23.0 X 9.6 X 18.0 (inch); 584 X 245 X 458 (mm)	(Non-touch) 19.4 / 8.8	Tilt: 45° back, -5° forward																			
With UltraFlex II stand:	23.0X 10.0 X 19.9 (inch); 584 X 253 X 505 (mm)	(Touch) 22.7 / 10.3 (Non-touch) 20.7 / 9.4	Tilt: 61° back, -5° forward; Lift: 110mm; Swivel: +/-45°																			
Power supply	150 watts, autosensing, 85% PSU																					
Limited warranty <sup>3</sup>	<i>Some:</i> <b>1-year or 3-year, depot repair service</b> / service upgrades available <i>Some:</i> <b>1-year or 3-year, limited onsite service</b> / service upgrades available																					
Preload	<b>Preloaded operating system</b> <i>Some:</i> Windows® 7 Professional 32/64 preinstalled through downgrade rights in Windows 10 Pro 64-bit <i>Some:</i> Windows 10 Pro 64-bit <i>Some:</i> Windows 10 Home 64-bit																					
	<b>Preloaded applications (only some listed)</b> <ul style="list-style-type: none"> <li>Microsoft Office preloaded; purchase a product key to activate</li> <li>Only for Window 10</li> <li>Lenovo Companion</li> <li>Only for Window 7</li> <li>Lenovo Solution Center</li> <li>Lenovo ThinkVantage Tools</li> <li>ThinkVantage System Update</li> <li>Create Recovery Media</li> <li>Adobe® Reader®</li> <li>Cyberlink PowerDVD Create (DVD±RW)</li> </ul>																					
Environment	EPEAT™ Gold rating (North America); ENERGY STAR® 6.1; TCO AIO Computer Certified; ULE Gold; ErP Lot 3; GREENGUARD® certified; RoHS-compliant																					
MIL-SPEC test	MIL-STD-810G military certification (Low Pressure [Altitude], High Temperature, Low Temperature, Temperature Shock, Humidity, Sand and Dust, Vibration, Shock)																					
Accessories	For compatible accessories, please go to <a href="http://www.lenovoquickpick.com">http://www.lenovoquickpick.com</a>																					

See footnotes for more detailed information





# ThinkCentre M920z Platform Specifications

Product Specifications Reference (PSREF)

Processor	Intel® Celeron®, Intel Pentium®, or 8th / 9th Gen Intel Core™ i3 / i5 / i7 / i9 series						Audio support	High Definition (HD) Audio, Realtek ALC233 / two internal speakers (3W x 2), Dolby® Audio™ Premium	
	Processor	Cores / Threads	Frequency Base/Max(GHz)	Cache	Memory Support (Up to)	Integrated Graphics	WLAN	<i>Some:</i> 11ac wireless, M.2 Card, Realtek RTL8821CE (dual band), Wi-Fi + Bluetooth 4.2 combo adapter, 1x1 <i>Some:</i> 11ac wireless, M.2 Card, Realtek RTL8822BE (dual band), Wi-Fi + Bluetooth 4.2 combo adapter, 2x2 <i>Some:</i> 11ac wireless, M.2 Card, Intel Dual Band Wireless-AC 3165, Wi-Fi + Bluetooth 4.2 combo adapter, 1x1 <i>Some:</i> 11ac wireless, M.2 Card, Intel Dual Band Wireless-AC 8265, Wi-Fi + Bluetooth 4.2 combo adapter, 2x2 <i>Some:</i> 11ac wireless, M.2 Card, Intel Wireless-AC 9560 (dual band), Wi-Fi + Bluetooth 5.0 combo adapter, Intel vPro technology support, 2x2 <i>Some:</i> Bluetooth 4.2/5.0 wireless, integrated in Wi-Fi + BT combo adapter Gigabit ethernet, Intel Ethernet Connection I219-LM (Jacksonville), Wake on LAN®	
	Celeron G4900	2 / 2	3.1G	2 MB	DDR4-2400	UHD 610	Bluetooth™ Ethernet	Manageability	
	Celeron G4920	2 / 2	3.2G	2 MB	DDR4-2400	UHD 610			
	Celeron G4930	2 / 2	3.2G	2 MB	DDR4-2400	UHD 610			
	Celeron G4950	2 / 2	3.3G	2 MB	DDR4-2400	UHD 610			
	Pentium Gold G5400	2 / 4	3.7G	4 MB	DDR4-2400	UHD 610			
	Pentium Gold G5420	2 / 4	3.8G	4 MB	DDR4-2400	UHD 610			
	Pentium Gold G5500	2 / 4	3.8G	4 MB	DDR4-2400	UHD 630			
	Pentium Gold G5600	2 / 4	3.9G	4 MB	DDR4-2400	UHD 630			
	Pentium Gold G5620	2 / 4	4.0G	4 MB	DDR4-2400	UHD 630			
	Core i3-8100	4 / 4	3.6G	6 MB	DDR4-2400	UHD 630			
	Core i3-8300	4 / 4	3.7G	8 MB	DDR4-2400	UHD 630			
	Core i5-8400	6 / 6	2.8G / 4.0G	9 MB	DDR4-2666	UHD 630			
	Core i5-8500	6 / 6	3.0G / 4.1G	9 MB	DDR4-2666	UHD 630			
	Core i5-8600	6 / 6	3.1G / 4.3G	9 MB	DDR4-2666	UHD 630			
	Core i7-8700	6 / 12	3.2G / 4.6G	12 MB	DDR4-2666	UHD 630			
	Core i3-9100	4 / 4	3.6G / 4.2G	6 MB	DDR4-2400	UHD 630			
	Core i3-9300	4 / 4	3.7G / 4.3G	8 MB	DDR4-2400	UHD 630			
	Core i5-9400	6 / 6	2.9G / 4.1G	9 MB	DDR4-2666	UHD 630			
Core i5-9500	6 / 6	3.0G / 4.4G	9 MB	DDR4-2666	UHD 630				
Core i5-9600	6 / 6	3.1G / 4.6G	9 MB	DDR4-2666	UHD 630				
Core i7-9700	8 / 8	3.0G / 4.7G	12 MB	DDR4-2666	UHD 630				
Core i9-9900	8 / 16	3.1G / 5.0G	16 MB	DDR4-2666	UHD 630				
Memory	32GB max (16GB SO-DIMM only available via special bid models), DDR4-2666*, two 260-pin SO-DIMM sockets, dual-channel capable * System clocks down for the processors with lower memory controller						Mechanical	<ul style="list-style-type: none"> <li>Business black color</li> <li>Toolless back cover, stand, disk, memory removal</li> <li>Support VESA mount (100mm)</li> </ul>	
Storage	<i>Some:</i> Hard Drive / SATA 6.0Gb/s, 2.5", 5400 rpm or 7200 rpm, supports up to two HDDs (2nd HDD occupies ODD bay), RAID0/1 support (RAID preset only available via special bid model) <i>Some:</i> Solid State Drive (SSD) / SATA 6.0Gb/s, 2.5" <i>Some:</i> M.2 SSD / PCIe NVMe, PCIe 3.0 x 4*, 32Gb/s * 128GB SSD M.2 (2242) PCIe NVMe only supports PCIe 3.0 x 2, 16Gb/s <i>Some:</i> Intel Optane™ Memory (not support Celeron / Pentium Processor), M.2 <i>Some:</i> DVD-ROM SATA 1.5Gb/s Drive, slim (9.0mm) <i>Some:</i> DVD Burner (DVD±RW), SATA 1.5Gb/s Drive, slim (9.0mm)								
Optical	Optional 3-in-1 media card reader								
Media reader	Optional 3-in-1 media card reader								
Graphics	Intel HD Graphics 610/630 in processor, uses main memory, DirectX® 12, external monitor support via DisplayPort™; Max resolution: 4096x2304 (DP) @60Hz, 1920x1080 (Panel)@60Hz								
Display	23.8" (604.5mm) Full HD 1080p (1920x1080) TFT color, Borderless design, WVA panel, wide viewing angle (+/- 89°), LED backlight, 250 nits, 16:9 aspect ratio, 1000:1 contrast ratio, anti-glare, support Low Blue Light Mode, work as standalone monitor via DisplayPort (DP in / out combo)								
Multi-touch	Optional multi-touch, supports 10-point, AIT (Advanced In-cell Touch) technology								
Camera	<i>Some:</i> 1080p camera, with dual microphone, LED indicator, physical switch on/off, supports multi-degree rotation (horizontal 0° to 180°, vertical -25° to 25°) <i>Some:</i> RGBIR camera, 1080p, with dual microphone, physical switch on/off, supports multi-degree rotation (horizontal 0° to 180°, vertical -25° to 25°) Windows Hello support, only available via special bid models								
Controls	Physical buttons on side for microphone mute and power on/off								
Chipset	Intel Q370 Chipset								
Rear ports*	Four USB 3.1 Gen1 (one supports Smart Power On), one ethernet (RJ-45), one DisplayPort in/out combo port, one optional serial (9-pin)								
Side ports*	one USB 3.1 Gen2 (one is Always On and fast charge), one USB 3.1 Gen1, one USB 3.1 Type-C Gen 1, one optional card reader, one headphone / microphone combo jack (3.5mm)								
M.2 card slot	Two M.2 Card slots (one for WLAN, one for SSD/Optane) * Depending on many factors, actual data transfer speed may be lower than theoretical speed								
Power supply									150 watts, autosensing, 90% PSU
Limited warranty <sup>3</sup>									<i>Some:</i> <b>1-year</b> or <b>3-year, depot repair service</b> / service upgrades available <i>Some:</i> <b>1-year</b> or <b>3-year, limited onsite service</b> / service upgrades available
Preload									<b>Preloaded operating system</b> <i>Some:</i> Windows 10 Pro 64-bit <i>Some:</i> Windows 10 Home 64-bit <b>Preloaded applications (only some listed)</b> <ul style="list-style-type: none"> <li>Lenovo Vantage</li> <li>Microsoft Office preloaded; purchase a product key to activate</li> <li>Cyberlink PowerDVD (only for models with DVD / DVD±RW)</li> <li>Cyberlink Power2GO (only for models with DVD±RW)</li> <li>LinkedIn</li> </ul>
Environment									ENERGY STAR® 7.0*, EPEAT™ Silver rating* (*not for non-OS models), ErP Lot 3, TCO AIO Computer certified, GREENGUARD® certified, TUV Eye comfort certified, TUV Low Blue Light certified, TUV Ultra Low Noise certified (on some models), RoHS-compliant
MIL-SPEC test									MIL-STD-810G military certification (Low Pressure [Altitude], High Temperature, Low Temperature, Temperature Shock, Humidity, Sand and Dust, Vibration, Shock, Fungus)
Accessories									For compatible accessories, please go to <a href="http://smartfind.lenovo.com">http://smartfind.lenovo.com</a>

Note: The specifications above may not be available in all regions.

Lenovo, June 2019



# ThinkCentre M600 Tiny Platform Specifications

Product Specifications Reference (PSREF)

Processor	Intel® Celeron® Processor N3000 Series or Intel Pentium® Processor N3000 Series						Keyboard <i>Some:</i> Preferred Pro USB Keyboard (USB connector), Lenovo logo <i>Some:</i> Lenovo USB Fingerprint Keyboard (USB connector) <i>Some:</i> Ultralim Plus Wireless Keyboard (2.4GHz via USB receiver), black <i>Some:</i> Enhanced Optical USB Mouse, black, Lenovo logo <i>Some:</i> Ultralim Plus Wireless Mouse (2.4GHz via USB receiver), black												
	Processor	Cores / Threads	Frequency (Base/Max)	Cache	Memory Types	Integrated Graphics													
	Celeron N3050	2 / 2	1.6 / 2.16 GHz	2MB	DDR3L-1600	Intel HD													
	Celeron J3060	2 / 2	1.6 / 2.48 GHz	2MB	DDR3L-1600	Intel HD 400													
	Pentium N3700	4 / 4	1.6 / 2.4 GHz	2MB	DDR3L-1600	Intel HD													
	Pentium J3710	4 / 4	1.6 / 2.64 GHz	2MB	DDR3L-1600	Intel HD 405													
Chipset	Intel Architecture (IA) SoC that integrates Intel processor core, graphics, memory controller, and I/O interfaces into a single system-on-chip solution						Mechanical • Tiny (1L), black color, metal case <table border="1"> <thead> <tr> <th></th> <th>Dimensions (WxDxH)</th> <th>Max weight (lb / kg)</th> </tr> </thead> <tbody> <tr> <td>M600 Tiny only (1L)</td> <td>7.05" X 7.20" X 1.36" 179mm X 182.9mm X 34.5mm</td> <td>2.9 lb (1.3 kg)</td> </tr> <tr> <td>M600 Tiny (1L) with VESA mount &amp; ODD box</td> <td>7.42" X 7.30" X 2.48" 188.4mm X 185.38mm X 63mm</td> <td>4.12 lb (1.87 kg)</td> </tr> <tr> <td>M600 Tiny (1L) with VESA mount &amp; I/O box</td> <td>7.42" X 7.30" X 2.62" 188.4mm X 185.38mm X 66.6mm</td> <td>3.53 lb (1.6 kg)</td> </tr> </tbody> </table>		Dimensions (WxDxH)	Max weight (lb / kg)	M600 Tiny only (1L)	7.05" X 7.20" X 1.36" 179mm X 182.9mm X 34.5mm	2.9 lb (1.3 kg)	M600 Tiny (1L) with VESA mount & ODD box	7.42" X 7.30" X 2.48" 188.4mm X 185.38mm X 63mm	4.12 lb (1.87 kg)	M600 Tiny (1L) with VESA mount & I/O box	7.42" X 7.30" X 2.62" 188.4mm X 185.38mm X 66.6mm	3.53 lb (1.6 kg)
	Dimensions (WxDxH)	Max weight (lb / kg)																	
M600 Tiny only (1L)	7.05" X 7.20" X 1.36" 179mm X 182.9mm X 34.5mm	2.9 lb (1.3 kg)																	
M600 Tiny (1L) with VESA mount & ODD box	7.42" X 7.30" X 2.48" 188.4mm X 185.38mm X 63mm	4.12 lb (1.87 kg)																	
M600 Tiny (1L) with VESA mount & I/O box	7.42" X 7.30" X 2.62" 188.4mm X 185.38mm X 66.6mm	3.53 lb (1.6 kg)																	
Graphics	Intel HD Graphics in processor, uses main memory, DirectX® 11.1, twoDisplayPort™, one optional 3rd DP (not support DP to HDMI dongle) or VGA, supports triple independent display; Maximum resolution: 3840x2160(DP)@30Hz; 1920x1200(optional VGA)@60Hz; 1920x1080(DP to VGA dongle)@60Hz; 1920x1080(DP to DVI dongle)@60Hz; 3840x2160(DP to HDMI dongle)@30Hz																		
Monitor cable	Optional DP to VGA, DP to DVI-D (single link), or DP to HDMI 1.4 dongle																		
Memory	8GB max / DDR3 Low Voltage, DDR3L-1600, non-parity, one 204-pin SO-DIMM socket																		
Storage	<i>Some:</i> hard disk, 5400 or 7200 rpm, SATA 6.0Gb/s, 2.5" Wide <i>Some:</i> 500GB (5400 rpm) Solid State Hybrid Drive (SSHD) / with 8GB MLC NAND flash memory, SATA 6.0Gb/s, 2.5" wide																		
Optical	<i>Some:</i> Solid State Drive (SSD) / SATA 6.0Gb/s, 2.5" Wide <i>Some:</i> external ODD box with DVD-ROM, 9.5mm high, via USB <i>Some:</i> external ODD box with DVD±RW, 9.5mm high, via USB <i>Some:</i> external ODD box (for TIO) with DVD-ROM, 9.5mm high, via USB <i>Some:</i> external ODD box (for TIO) with DVD±RW, 9.5mm high, via USB																		
Onboard SATA Media reader	SATA 6.0Gb/s controller, one connectors on planar None																		
Front ports*	Two USB 3.0 (one is Always On and fast charge), one microphone (stereo, 3.5mm), one headphone / microphone combo jack (stereo, 3.5mm)																		
Rear ports*	Two USB 2.0, two USB 3.0 (optional external optical box or I/O box occupies one or two specific USB on some models), ethernet (RJ-45), two DisplayPort, one optional port (VGA, 3rd DP, or serial on some models), one headphone																		
I/O box*	Optional external I/O box, extends two USB 2.0, two USB 3.0, and one serial on rear, two USB 2.0 on front, via USB (occupy two specific USB 3.0 of M600 Tiny) * Depending on many factors, actual data transfer speed may be lower than theoretical speed																		
Audio support	High Definition (HD) Audio, Realtek ALC223 / optional internal speaker (1 watt)																		
WLAN <sup>13</sup>	<i>Some:</i> 11ac wireless, M.2 Card, Realtek RTL8821AE (dual band), Wi-Fi + Bluetooth 4.0 combo adapter, 1x1 <i>Some:</i> 11ac wireless, M.2 Card, Qualcomm Atheros QCA9377 (dual band), Wi-Fi + Bluetooth 4.1 combo adapter, 1x1 <i>Some:</i> 11ac wireless, M.2 Card, Qualcomm Atheros QCA6174 (dual band), Wi-Fi + Bluetooth 4.1 combo adapter, 2x2 <i>Some:</i> 11ac wireless, M.2 Card, Intel Dual Band Wireless-AC 3165, Wi-Fi + Bluetooth 4.0 combo adapter, 1x1 <i>Some:</i> 11ac wireless, M.2 Card, Intel Dual Band Wireless-AC 8260, Wi-Fi + Bluetooth 4.1 combo adapter, 2x2																		
Bluetooth™	<i>Some:</i> Bluetooth 4.0 or 4.1 wireless, integrated in Wi-Fi + BT combo adapter																		
Ethernet	One gigabit ethernet port, Realtek RTL8111GN, Wake on LAN®																		
Modem	None																		
Manageability	None																		
Security chip	Trusted Platform Module, TCG 1.2-compliant																		
Security features	<ul style="list-style-type: none"> <li>• Security slot (in rear for optional Kensington® MicroSaver® cable)</li> <li>• Padlock loop</li> <li>• Smart USB protection, allows keyboard/mouse only, blocks all storage devices</li> <li>• Power-on password</li> <li>• Administrator password</li> <li>• Hard disk password</li> <li>• Boot sequence control</li> <li>• Boot without keyboard and mouse</li> <li>• Individual USB port disablement</li> <li>• Chassis intrusion switch</li> </ul>																		
Environment	ENERGY STAR® 6.0*, EPEAT™ Gold rating* (*not for non-OS models); GREENGUARD®; RoHS-compliant; Cisco EnergyWise compatible; ErP Lot 3																		
Accessories	For compatible accessories, please go to TC-AQP sheet																		

See footnotes for more detailed information

Lenovo, November 2017





# ThinkCentre M600 Tiny Thin Client Platform Specifications

Product Specifications Reference (PSREF)

Processor	Intel® Celeron® Processor N3000 Series or Intel Pentium® Processor N3000 Series						Keyboard <i>Some:</i> PS/2 Keyboard (PS/2 connector), Lenovo logo (for 2L models) <i>Some:</i> Preferred Pro USB Keyboard (USB connector), Lenovo logo <i>Some:</i> Ultralim Plus Wireless Keyboard (2.4GHz via USB receiver), black <i>Some:</i> PS/2 Optical Wheel Mouse, black, Lenovo logo (for 2L models) <i>Some:</i> Enhanced Optical USB Mouse, black, Lenovo logo <i>Some:</i> Ultralim Plus Wireless Mouse (2.4GHz via USB receiver), black
	Processor	Cores / Threads	Frequency (Base/Max)	Cache	Memory Types	Integrated Graphics	
	Celeron N3000	2 / 2	1.04 / 2.08 GHz	2MB	DDR3L-1600	Intel HD	
	Celeron N3010	2 / 2	1.04 / 2.24 GHz	2MB	DDR3L-1600	Intel HD 400	
Chipset	Intel Architecture (IA) SoC that integrates Intel processor core, graphics, memory controller, and I/O interfaces into a single system-on-chip solution						Mechanical • Tiny (1L or 2L), black color, metal case
Graphics	Intel HD Graphics in processor, uses main memory, DirectX® 11.1, twoDisplayPort™, one optional 3rd DP (not support DP to HDMI dongle) or VGA, supports triple independent display; Maximum resolution: 3840x2160(DP)@30Hz; 1920x1200(optional VGA)@60Hz; 1920x1080(DP to VGA dongle)@60Hz; 1920x1080(DP to DVI dongle)@60Hz; 3840x2160(DP to HDMI dongle)@30Hz Optional DP to VGA, DP to DVI-D (single link), or DP to HDMI 1.4 dongle						
Monitor cable	Optional DP to VGA, DP to DVI-D (single link), or DP to HDMI 1.4 dongle						VESA mount Optional VESA mount bracket kit, supports VESA 75mm and 100mm Floor Stand Optional system floor stand for vertical orientation
Memory	8GB max / DDR3 Low Voltage, DDR3L-1600, non-parity, one 204-pin SO-DIMM socket						
Storage	16GB, 32GB, or 128GB M.2 Solid State Drive (SSD), SATA interface						Power supply 65 watts AC/DC adapter, autosensing, 88% PSU (not included for TIO models)
Optical	None						
Onboard SATA	SATA 6.0Gb/s controller, one connectors on planar						Limited warranty <sup>3</sup> <i>Some:</i> 1-year or 3-year, depot service / service upgrades available <i>Some:</i> 1-year or 3-year, limited onsite service / service upgrades available <i>Some:</i> 3-year, limited onsite service, OID (Onsite International Delivery) / service upgrades available <i>For Lenovo service upgrade options, please go to S-TC sheet</i>
Media reader	None						
Front ports*	Two USB 3.0 (one is Always On and fast charge), one microphone (stereo, 3.5mm), one headphone / microphone combo jack (stereo, 3.5mm)						Preload <i>Some:</i> Windows Embedded Standard 7 (WES 7) <i>Some:</i> Windows Embedded Standard 7 V2 (WES 7 V2) <i>Some:</i> Windows 10 IoT Enterprise <i>Some:</i> LeTOS (Lenovo Terminal Operating System, Linux-based) <i>Some:</i> LeTOS V2 (Lenovo Terminal Operating System, Linux-based)
Rear ports*	Two USB 2.0, two USB 3.0, ethernet (RJ-45), two DisplayPort, one optional port (VGA, 3rd DP, or serial on some models), one headphone; additional four serial (9-pin), one parallel (25-pin), and two PS/2 ports on 2L models * Depending on many factors, actual data transfer speed may be lower than theoretical speed						
I/O box	None						Environment ENERGY STAR® 6.0*, EPEAT™ Gold rating* (*not for non-OS models); GREENGUARD®; RoHS-compliant; Cisco EnergyWise compatible; ErP Lot 3
Audio support	High Definition (HD) Audio, Realtek ALC223 / optional internal speaker (1 watt)						
WLAN <sup>13</sup>	<i>Some:</i> 11ac wireless, M.2 Card, Realtek RTL8821AE (dual band), Wi-Fi + Bluetooth 4.0 combo adapter, 1x1 <i>Some:</i> 11ac wireless, M.2 Card, Qualcomm Atheros QCA9377 (dual band), Wi-Fi + Bluetooth 4.1 combo adapter, 1x1 <i>Some:</i> 11ac wireless, M.2 Card, Qualcomm Atheros QCA6174 (dual band), Wi-Fi + Bluetooth 4.1 combo adapter, 2x2 <i>Some:</i> 11ac wireless, M.2 Card, Intel Dual Band Wireless-AC 3165, Wi-Fi + Bluetooth 4.0 combo adapter, 1x1 (only for 1L models)						Accessories For compatible accessories, please go to TC-AQP sheet
Bluetooth™	<i>Some:</i> Bluetooth 4.0 or 4.1 wireless, integrated in Wi-Fi + BT combo adapter						
Ethernet	One gigabit ethernet port, Realtek RTL8111GN, Wake on LAN®						
Modem	None						
Manageability	None						
Security chip	Trusted Platform Module, TCG 1.2-compliant						
Security features	<ul style="list-style-type: none"> <li>• Security slot (in rear for optional Kensington® MicroSaver® cable)</li> <li>• Padlock loop</li> <li>• Smart USB protection, allows keyboard/mouse only, blocks all storage devices</li> <li>• Power-on password</li> <li>• Administrator password</li> <li>• Hard disk password</li> <li>• Boot sequence control</li> <li>• Boot without keyboard and mouse</li> <li>• Individual USB port disablement</li> <li>• Chassis intrusion switch</li> </ul>						

Note: The specifications above may not be available in all regions.

Lenovo, November 2017



# ThinkCentre M625 Tiny Platform Specifications

Product Specifications Reference (PSREF)

Processor	AMD A9 series APU						Keyboard Mouse	Some: Fullsize USB Keyboard (USB connector), black, Lenovo logo Some: USB Optical Wheel Mouse, black, Lenovo logo	
	APU	Cores	Frequency Base/Max	L2 Cache	Memory Support (Up to)	Integrated Graphics		Mechanical	Tiny (1L), black color; metal case • Toolless chassis open (for models with optional toolless chassis screw) • Toolless HDD, SSD, memory, Wi-Fi removal • Optional dust filter M625 Tiny only: 7.05" W X 7.20" D X 1.36" H 179mm W X 182.9mm D X 34.5mm H 2.9 lb (1.3 kg), weight may vary by configuration VESA mount Optional VESA mount bracket kit, supports VESA 75mm and 100mm Floor Stand Optional system floor stand for vertical orientation
Memory	8GB max, DDR4-2666, one 260-pin SO-DIMM socket * System frequency automatically clocks down for the lower capability of memory controller in processor						Disk		Power supply
Optical	None							Onboard SATA	65 watts AC/DC adapter, autosensing, 88% PSU (not included for TIO models)
Media reader	None						Graphics		Limited warranty <sup>3</sup>
Graphics	AMD Radeon™ Graphics in processor, uses main memory, DirectX® 12, two DisplayPort™, one optional port (VGA or USB 2.0 Type-C with DisplayPort Alternate Mode), supports up to 2 independent displays; Max resolution: 3840x2160 (DP)@60Hz; 2048x1280 (VGA)@60Hz; 3840x2160 (USB 2.0 Type-C)@60Hz							Preload	Preloaded operating system Some: Windows® 10 Pro 64-bit Some: Windows 7 Professional 64 preinstalled through downgrade rights in Windows 10 Pro 64-bit
Monitor cable	Optional DP to VGA, DP to DVI-D (single link), or DP to HDMI 1.4 dongle						Chipset		Preloaded applications (only some listed) - Windows 10 only • Lenovo Vantage • LinkedIn • Microsoft Office preloaded; purchase a product key to activate - Windows 7 only • Lenovo Solution Center • Lenovo System Update • Factory Recovery • User Guide Viewer • Microsoft Office preloaded; purchase a product key to activate • Adobe® Reader®
Front ports*	Two USB 3.1 Gen1 (one is Always On and fast charge), one microphone (3.5mm), one headphone / microphone combo jack (3.5mm)							Rear ports*	
I/O box	None						Audio support		
WLAN <sup>13</sup>	Some: 11ac wireless, M.2 Card, Realtek RTL8822BE (dual band), Wi-Fi + Bluetooth 4.2* combo adapter, 2x2 Some: 11ac wireless, M.2 Card, Qualcomm Atheros QCA6174A (dual band), Wi-Fi + Bluetooth 4.2* combo adapter, 2x2							Environment	ENERGY STAR® 6.1*, EPEAT™ Silver rating* (*Not for non-OS models), ErP Lot 3, RoHS-compliant, WEEE, TCO
Bluetooth™	Some: Bluetooth 4.2* wireless, integrated in Wi-Fi + BT combo adapter * Win 10 RS3 and Win10 earlier version only support Bluetooth 4.1						MIL-SPEC test		MIL-STD-810G military certification (Low Pressure [Altitude], High Temperature, Low Temperature, Temperature Shock, Humidity, Sand and Dust, Vibration, Shock, Fungus, Solar Radiation)
Ethernet Modem	Gigabit ethernet, Realtek RTL8111HN, Wake on LAN®							Accessories	For compatible accessories, please go to <a href="http://smartfind.lenovo.com">http://smartfind.lenovo.com</a>
Manageability	None						Security chip		
Security features	Discrete TPM 2.0, TCG Certified • Security slot (in rear for optional Kensington® MicroSaver® cable) • Smart USB protection, allows keyboard/mouse only, blocks all storage devices • Power-on password • Administrator password • Hard disk password • Boot sequence control • Boot without keyboard and mouse • Individual USB port disablement • Chassis intrusion switch								



# ThinkCentre M625 Tiny Thin Client Platform Specifications

Product Specifications Reference (PSREF)

Processor	AMD E2 series APU						Keyboard	<i>Some:</i> Fullsize USB Keyboard (USB connector), black, Lenovo logo
	APU	Cores	Frequency Base/Max	L2 Cache	Memory Support (Up to)	Integrated Graphics	Mouse	<i>Some:</i> USB Optical Wheel Mouse, black, Lenovo logo
	E2-9000e	2	1.5 / 2.0 GHz	1 MB	DDR4-1866	Radeon R2 Series	Mechanical	Tiny (1L), fan-less design, black color, metal case <ul style="list-style-type: none"> <li>• Toolless chassis open (for models with optional toolless chassis screw)</li> <li>• Toolless SSD, memory, Wi-Fi removal</li> </ul> M625 Tiny Thin Client only: 7.05" W X 7.20" D X 1.36" H 179mm W X 182.9mm D X 34.5mm H 2.9 lb (1.3 kg), weight may vary by configuration Optional VESA mount bracket kit, supports VESA 75mm and 100mm Optional system floor stand for vertical orientation
Memory	8GB max, DDR4-2666, one 260-pin SO-DIMM socket * System frequency automatically clocks down for the lower capability of memory controller in processor						VESA mount	
Disk	<i>Some:</i> 32GB M.2 Solid State Drive (SSD) / SATA interface <i>Some:</i> 128GB M.2 Solid State Drive (SSD) / PCIe NVMe interface						Floor Stand	
Optical	None						Power supply	65 watts AC/DC adapter, autosensing, 88% PSU (not included for TIO models)
Onboard SATA	one SATA 6.0Gb/s connector on planar						Limited warranty <sup>3</sup>	<i>Some:</i> 1-year, depot service / service upgrades available <i>Some:</i> 1-year, limited onsite service / service upgrades available
Media reader	None						Preload	<b>Preloaded operating system</b> <i>Some:</i> Windows Embedded Standard 7 V2 (WES 7 V2) <i>Some:</i> Windows 10 IoT Enterprise <i>Some:</i> LeTOS V2 (Lenovo Terminal Operating System, Linux-based)
Graphics	<b>AMD Radeon™ Graphics</b> in processor, uses main memory, DirectX® 12, two DisplayPort™, one optional port (VGA or USB 2.0 Type-C with DisplayPort Alternate Mode), supports up to 2 independent displays; <i>Max resolution:</i> 3840x2160 (DP) @60Hz; 2048x1280 (VGA) @60Hz; 3840x2160 (USB 2.0 Type-C) @60Hz						Environment	ENERGY STAR® 6.1*, EPEAT™ Silver rating* (*Not for non-OS models), ErP Lot 3, RoHS-compliant, WEEE, TCO
Monitor cable	Optional DP to VGA, DP to DVI-D (single link), or DP to HDMI 1.4 dongle						MIL-SPEC test	MIL-STD-810G military certification (Low Pressure [Altitude], High Temperature, Low Temperature, Temperature Shock, Humidity, Sand and Dust, Vibration, Shock, Fungus, Solar Radiation)
Chipset	<b>AMD SoC platform</b>						Accessories	For compatible accessories, please go to <a href="http://smartfind.lenovo.com">http://smartfind.lenovo.com</a>
Front ports*	Two USB 3.1 Gen1 (one is Always On and fast charge), one microphone (3.5mm), one headphone / microphone combo jack (3.5mm)							
Rear ports*	One USB 3.1 Gen1, three USB 2.0, ethernet (RJ-45), two DisplayPort, two optional ports (Port 1 for VGA / serial / USB 2.0 Type-C (with DisplayPort Alternate Mode), Port 2 for serial) * Depending on many factors, actual data transfer speed may be lower than theoretical speed							
I/O box	None							
Audio support	High Definition (HD) Audio, Realtek ALC233-VB2-CG / internal speaker (1.5 watt)							
WLAN <sup>13</sup>	<i>Some:</i> 11ac wireless, M.2 Card, Realtek RTL8821CE (dual band), Wi-Fi + Bluetooth 4.2* combo adapter, 1x1 <i>Some:</i> 11ac wireless, M.2 Card, Qualcomm Atheros QCA9377 (dual band), Wi-Fi + Bluetooth 4.2* combo adapter, 1x1 <i>Some:</i> 11ac wireless, M.2 Card, Realtek RTL8822BE (dual band), Wi-Fi + Bluetooth 4.2* combo adapter, 2x2 <i>Some:</i> 11ac wireless, M.2 Card, Qualcomm Atheros QCA6174A (dual band), Wi-Fi + Bluetooth 4.2* combo adapter, 2x2							
Bluetooth™	<i>Some:</i> Bluetooth 4.2* wireless, integrated in Wi-Fi + BT combo adapter * Win 10 RS3 and Win10 earlier version only support Bluetooth 4.1							
Ethernet	Gigabit ethernet, Realtek RTL8111HN, Wake on LAN®							
Modem	None							
Manageability	None							
Security chip	Discrete TPM 2.0, TCG Certified							
Security features	<ul style="list-style-type: none"> <li>• Security slot (in rear for optional Kensington® MicroSaver® cable)</li> <li>• Smart USB protection, allows keyboard/mouse only, blocks all storage devices</li> <li>• Power-on password</li> <li>• Administrator password</li> <li>• Hard disk password</li> <li>• Boot sequence control</li> <li>• Boot without keyboard and mouse</li> <li>• Individual USB port disablement</li> <li>• Chassis intrusion switch</li> </ul>							





# ThinkCentre M630e Tiny Platform Specifications

Product Specifications Reference (PSREF)

Processor	Intel® Pentium®, or 8th Generation Intel Core™ i3 / i5 Processor						Manageability Security chip Security features	None								
	Processor	Cores / Threads	Frequency Base/Max(GHz)	Cache	Memory Support (Up to)	Integrated Graphics		Firmware TPM 2.0, integrated in chipset								
	Pentium Gold 5405U	2 / 4	2.3G	2 MB	DDR4-2133	UHD 610		<ul style="list-style-type: none"> <li>Security slot (in rear for optional Kensington® MicroSaver® cable)</li> <li>Chassis intrusion switch</li> <li>Power-on password</li> <li>Administrator password</li> <li>Hard disk password</li> </ul>								
	Core i3-8145U	2 / 4	2.1G / 3.9G	4 MB	DDR4-2400	UHD 620		<ul style="list-style-type: none"> <li>Boot sequence control</li> <li>Boot without keyboard and mouse</li> <li>Individual USB port disablement</li> <li>Smart USB protection, allows keyboard/mouse only, blocks all storage devices</li> </ul>								
	Core i5-8265U	4 / 8	1.6G / 3.9G	6 MB	DDR4-2400	UHD 620										
Memory	16GB max, DDR4-2666*, one 260-pin SO-DIMM sockets, non-ECC * System automatically clocks down for the processors with lower memory controller						Keyboard Mouse	<i>Some:</i> Lenovo Calliope Keyboard (USB connector), black <i>Some:</i> Lenovo Calliope Mouse (USB connector), black								
Storage	<i>Some:</i> Hard Drive / SATA 6.0Gb/s, 2.5", 5400 rpm or 7200 rpm <i>Some:</i> Solid State Drive (SSD) / SATA 6.0Gb/s, 2.5" <i>Some:</i> M.2 SSD (2280) / PCIe NVMe, PCIe 3.0 x 4, 32Gb/s <i>Some:</i> M.2 SSD (2242) / PCIe NVMe, PCIe 3.0 x 2, 16Gb/s						Mechanical	Tiny (1L), black color; metal case <ul style="list-style-type: none"> <li>Optional dust filter</li> <li>One 2.5" bay for HDD/SSD, two M.2 slots (one for WLAN, one for M.2 SSD)</li> </ul>								
Onboard SATA	One onboard SATA 6.0Gb/s connector						<table border="1"> <thead> <tr> <th></th> <th>Dimensions (WxDxH)</th> <th>Weight (Approx. )</th> </tr> </thead> <tbody> <tr> <td>Tiny only</td> <td>7.05" X 7.20" X 1.36" 179mm X 182.9mm X 34.5mm</td> <td>2.91 lb (1.32 kg), vary by config</td> </tr> </tbody> </table>					Dimensions (WxDxH)	Weight (Approx. )	Tiny only	7.05" X 7.20" X 1.36" 179mm X 182.9mm X 34.5mm	2.91 lb (1.32 kg), vary by config
	Dimensions (WxDxH)	Weight (Approx. )														
Tiny only	7.05" X 7.20" X 1.36" 179mm X 182.9mm X 34.5mm	2.91 lb (1.32 kg), vary by config														
Graphics	<b>Intel HD Graphics 610/620</b> in processor, uses main memory, DirectX® 12, one DisplayPort™, one HDMI, up to 2 independent displays; <i>Max resolution:</i> 4096x2304 (DP) @60Hz; 4096x2304 (HDMI) @24Hz						VESA mount Floor Stand	None Optional system floor stand for vertical orientation								
Monitor cable	Optional DP to VGA dongle or DP to HDMI 1.4 dongle						Power supply	<i>Some:</i> 65 watts adapter, autosensing, 88% PSU								
Chipset	<b>Intel SoC (System on Chip) platform</b>						Limited warranty	<i>Some:</i> <b>1-year, depot service</b> / service upgrades available <i>Some:</i> <b>1-year, limited onsite service</b> / service upgrades available								
Front ports* (Std.)	One USB 3.1 Gen1, one USB 3.1 Type-C Gen 1, one microphone (3.5mm), one headphone / microphone combo jack (3.5mm)						Preload	<b>Preloaded operating system</b> <i>Some:</i> Windows® 10 Pro 64-bit <i>Some:</i> Windows 10 Home 64-bit <b>Preloaded applications (only some listed)</b> <ul style="list-style-type: none"> <li>Lenovo Vantage</li> <li>Microsoft Office preloaded; purchase a product key to activate</li> <li>LinkedIn</li> </ul>								
Rear ports* (Std.)	Two USB 3.1 Gen1, two USB 2.0, one ethernet (RJ-45), one DisplayPort, one HDMI						Environment	ENERGY STAR® 7.0, EPEAT™ Silver rating, ErP Lot 3, TCO, RoHS-compliant, WEEE, REACH								
Rear ports* (Opt.)	None * Depending on many factors, actual data transfer speed may be lower than theoretical speed						MIL-SPEC test	Coming soon								
Audio support	Realtek ALC233VB / internal speaker (1.5 watt)						Accessories	For compatible accessories, please go to <a href="http://smartfind.lenovo.com">http://smartfind.lenovo.com</a>								
WLAN	<i>Some:</i> 11ac wireless, M.2 Card, Realtek RTL8821CE (dual band), Wi-Fi + Bluetooth 4.2 combo adapter, 1x1 <i>Some:</i> 11ac wireless, M.2 Card, Realtek RTL8822BE (dual band), Wi-Fi + Bluetooth 4.2 combo adapter, 2x2 <i>Some:</i> 11ac wireless, M.2 Card, Intel Dual Band Wireless-AC 3165, Wi-Fi + Bluetooth 4.2 combo adapter, 1x1 <i>Some:</i> 11ac wireless, M.2 Card, Intel Dual Band Wireless-AC 8265, Wi-Fi + Bluetooth 4.2 combo adapter, 2x2															
Bluetooth	<i>Some:</i> Bluetooth 4.2 wireless, integrated in Wi-Fi + BT combo adapter															
Ethernet	Gigabit ethernet, Realtek RTL8111HN-CG															
Ethernet (Opt.)	None															

Note: The specifications above may not be available in all regions.

Lenovo, Mar 2019

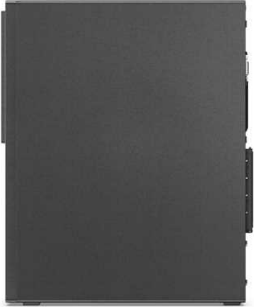



# ThinkCentre M710 SFF Platform Specifications

Product Specifications Reference (PSREF)

Processor	Intel® Celeron®, Intel Pentium®, or 6/7th Generation Intel Core™ i3 / i5 / i7 Processor	Security features	<ul style="list-style-type: none"> <li>Security slot (in rear for optional Kensington® MicroSaver® cable)</li> <li>Padlock loop</li> <li>Smart USB protection, allows keyboard/mouse only, blocks all storage devices</li> <li>Optional cable lock to physically lock both keyboard and mouse</li> <li>Power-on password</li> <li>Administrator password</li> <li>Hard disk password</li> <li>Boot sequence control</li> <li>Boot without keyboard and mouse</li> <li>Individual USB port disablement</li> <li>Optional chassis intrusion switch</li> </ul>																																																																								
	<table border="1"> <thead> <tr> <th>Processor</th> <th>Cores / Threads</th> <th>Frequency Base/Max(GHz)</th> <th>Cache</th> <th>Memory Support (Up to)</th> <th>Integrated Graphics</th> </tr> </thead> <tbody> <tr> <td>Pentium G4400</td> <td>2 / 2</td> <td>3.3G</td> <td>3 MB</td> <td>DDR4-2133</td> <td>HD 510</td> </tr> <tr> <td>Pentium G4560</td> <td>2 / 4</td> <td>3.5G</td> <td>3 MB</td> <td>DDR4-2400</td> <td>HD 610</td> </tr> <tr> <td>Pentium G4600</td> <td>2 / 4</td> <td>3.6G</td> <td>3 MB</td> <td>DDR4-2400</td> <td>HD 630</td> </tr> <tr> <td>Core i3-6100</td> <td>2 / 4</td> <td>3.7G</td> <td>3 MB</td> <td>DDR4-2133</td> <td>HD 530</td> </tr> <tr> <td>Core i5-6500</td> <td>4 / 4</td> <td>3.2G / 3.6G</td> <td>6 MB</td> <td>DDR4-2133</td> <td>HD 530</td> </tr> <tr> <td>Core i7-6700</td> <td>4 / 8</td> <td>3.4G / 4.0G</td> <td>8 MB</td> <td>DDR4-2133</td> <td>HD 530</td> </tr> <tr> <td>Core i3-7100</td> <td>2 / 4</td> <td>3.9G</td> <td>3 MB</td> <td>DDR4-2400</td> <td>HD 630</td> </tr> <tr> <td>Core i5-7400</td> <td>4 / 4</td> <td>3.0G / 3.5G</td> <td>6 MB</td> <td>DDR4-2400</td> <td>HD 630</td> </tr> <tr> <td>Core i5-7500</td> <td>4 / 4</td> <td>3.4G / 3.8G</td> <td>6 MB</td> <td>DDR4-2400</td> <td>HD 630</td> </tr> <tr> <td>Core i5-7600</td> <td>4 / 4</td> <td>3.5G / 4.1G</td> <td>6 MB</td> <td>DDR4-2400</td> <td>HD 630</td> </tr> <tr> <td>Core i7-7700</td> <td>4 / 8</td> <td>3.6G / 4.2G</td> <td>8 MB</td> <td>DDR4-2400</td> <td>HD 630</td> </tr> </tbody> </table>	Processor	Cores / Threads	Frequency Base/Max(GHz)	Cache	Memory Support (Up to)	Integrated Graphics	Pentium G4400	2 / 2	3.3G	3 MB	DDR4-2133	HD 510	Pentium G4560	2 / 4	3.5G	3 MB	DDR4-2400	HD 610	Pentium G4600	2 / 4	3.6G	3 MB	DDR4-2400	HD 630	Core i3-6100	2 / 4	3.7G	3 MB	DDR4-2133	HD 530	Core i5-6500	4 / 4	3.2G / 3.6G	6 MB	DDR4-2133	HD 530	Core i7-6700	4 / 8	3.4G / 4.0G	8 MB	DDR4-2133	HD 530	Core i3-7100	2 / 4	3.9G	3 MB	DDR4-2400	HD 630	Core i5-7400	4 / 4	3.0G / 3.5G	6 MB	DDR4-2400	HD 630	Core i5-7500	4 / 4	3.4G / 3.8G	6 MB	DDR4-2400	HD 630	Core i5-7600	4 / 4	3.5G / 4.1G	6 MB	DDR4-2400	HD 630	Core i7-7700	4 / 8	3.6G / 4.2G	8 MB	DDR4-2400	HD 630	Keyboard	<i>Some:</i> Lenovo Calliope Keyboard (USB connector), black <i>Some:</i> Lenovo Traditional Keyboard (USB connector), black <i>Some:</i> Lenovo Calliope Wireless Keyboard (2.4GHz via USB receiver), black <i>Some:</i> Lenovo Calliope Mouse (USB connector), black <i>Some:</i> Lenovo Calliope Wireless Mouse (2.4GHz via USB receiver), black
Processor	Cores / Threads	Frequency Base/Max(GHz)	Cache	Memory Support (Up to)	Integrated Graphics																																																																						
Pentium G4400	2 / 2	3.3G	3 MB	DDR4-2133	HD 510																																																																						
Pentium G4560	2 / 4	3.5G	3 MB	DDR4-2400	HD 610																																																																						
Pentium G4600	2 / 4	3.6G	3 MB	DDR4-2400	HD 630																																																																						
Core i3-6100	2 / 4	3.7G	3 MB	DDR4-2133	HD 530																																																																						
Core i5-6500	4 / 4	3.2G / 3.6G	6 MB	DDR4-2133	HD 530																																																																						
Core i7-6700	4 / 8	3.4G / 4.0G	8 MB	DDR4-2133	HD 530																																																																						
Core i3-7100	2 / 4	3.9G	3 MB	DDR4-2400	HD 630																																																																						
Core i5-7400	4 / 4	3.0G / 3.5G	6 MB	DDR4-2400	HD 630																																																																						
Core i5-7500	4 / 4	3.4G / 3.8G	6 MB	DDR4-2400	HD 630																																																																						
Core i5-7600	4 / 4	3.5G / 4.1G	6 MB	DDR4-2400	HD 630																																																																						
Core i7-7700	4 / 8	3.6G / 4.2G	8 MB	DDR4-2400	HD 630																																																																						
Memory	64GB max, UDIMM, DDR4-2400, four 288-pin DIMM sockets, non-ECC, dual-channel capable* * System automatically clocks down for the processors with lower memory controller	Mouse																																																																									
Storage	<i>Some:</i> Hard Drive / SATA 6.0Gb/s, 2.5" or 3.5", 5400 rpm or 7200 rpm <i>Some:</i> Solid State Drive (SSD) / SATA 6.0Gb/s, 2.5" <i>Some:</i> M.2 Solid State Drive (SSD) / PCIe NVMe, PCIe 3.0 x 4, 32Gb/s <i>Some:</i> Intel Optane™ Memory (models with 7th gen Core processor), M.2 <i>Some:</i> DVD-ROM SATA 1.5Gb/s Drive, slim (9.0mm) <i>Some:</i> DVD Burner (DVD±RW), SATA 1.5Gb/s Drive, slim (9.0mm)	Mechanical	<ul style="list-style-type: none"> <li>SFF (8.4L), black color; metal case</li> <li>(WxDxH) 3.6" X 11.4" X 13.5"; 92.5mm X 290.5mm X 343.5mm</li> <li>Approx. 13.2 lb (6.0 kg), weight may vary by configuration</li> <li>Toolless cover, disk, optical removal</li> <li>Optional dust filter</li> <li>Bay 1: Slim external ODD bay</li> <li>Bay 2: 3.5", 1" high, internal, HDD/SSD</li> <li>Bay 3: 2.5", internal, HDD/SSD (optional bay)</li> <li>Slot 1: low-profile (length &lt; 150mm, height &lt; 68mm), PCIe 3.0 x16*</li> <li>Slot 2: low-profile (length &lt; 150mm, height &lt; 68mm), PCIe 3.0 x1*</li> <li>Slot 3: low-profile (length &lt; 150mm, height &lt; 68mm), PCIe 3.0 x1*</li> <li>Slot 4: no slot, only bracket for optional port extension*</li> <li>M.2 card slots: Two (one for WLAN, one for SSD/Optane)</li> <li>* Optional 2 front USB3.1 Type-C ports module occupies PCIe x16 slot (x4 card), optional rear 2x USB2.0 / parallel / 2nd serial occupies one expansion slot</li> </ul>																																																																								
Optical	Three onboard SATA 6.0Gb/s connectors Optional 7-in-1 media reader	Floor Stand	Optional system floor stand for vertical orientation																																																																								
Onboard SATA Media reader		Power supply	<i>Some:</i> 180 watts, autosensing, 85% PSU <i>Some:</i> 210 watts, autosensing, 85% PSU <i>Some:</i> 210 watts, autosensing, 92% PSU (only available via special bid)																																																																								
Graphics	Intel HD Graphics 510/530/610/630 in processor, uses main memory, DirectX® 12, one VGA, two DisplayPort™, supports 3 independent displays, works along with discrete graphics to support more displays; Max resolution: 4096x2304 (DP) @60Hz; 2048x1536 (VGA) @50Hz <i>Some:</i> NVIDIA GeForce® GT 730, DirectX 12, 2GB, PCIe 2.0 x8 adapter, two DisplayPort, 35 watts; Max resolution: 3840x2160 (DisplayPort) @60Hz;	Limited warranty <sup>3</sup>	<i>Some:</i> <b>1-year</b> or <b>3-year, depot service</b> / service upgrades available <i>Some:</i> <b>1-year</b> or <b>3-year, limited onsite service</b> / service upgrades available																																																																								
Monitor cable	Optional DP to VGA, DP to DVI-D (single link), DP to dual DP, or DP to HDMI 1.4	Preload	<b>Preloaded operating system</b> <i>Some:</i> Windows® 7 Professional 32/64 preinstalled through downgrade rights in Windows 10 Pro 64-bit (not available with 7th Gen Intel processor) <i>Some:</i> Windows 10 Pro 64-bit <i>Some:</i> Windows 10 Home 64-bit <b>Preloaded applications (only some listed)</b> <ul style="list-style-type: none"> <li>Microsoft Office preloaded; purchase a product key to activate</li> <li>- Only for Window 10</li> <li>Lenovo Companion</li> <li>- Only for Window 7</li> <li>Lenovo Solution Center</li> <li>Lenovo ThinkVantage Tools</li> <li>Create Recovery Media</li> <li>Adobe® Reader®</li> <li>Cyberlink Power2Go Create (DVD±RW)</li> </ul>																																																																								
Chipset	Intel B250 Chipset	Environment	ENERGY STAR® 6.1, EPEAT™ Gold rating (North America), ErP Lot 3, GREENGUARD®, RoHS-compliant, TUV low noise verified (on some models)																																																																								
Front ports*	Four USB 3.1 Gen1, optional two USB 3.1 Type-C Gen 2 (only available via special bid), microphone (3.5mm), headphone (3.5mm)	Accessories	For compatible accessories, please go to <a href="http://www.lenovoquickpick.com">http://www.lenovoquickpick.com</a>																																																																								
Rear ports*	Two USB 3.1 Gen1, two USB 2.0, optional two USB 2.0, serial (9-pin), optional 2nd serial (9-pin), optional parallel (25-pin), ethernet (RJ-45), one VGA, two DisplayPort, two PS/2 ports (keyboard/mouse); additional DisplayPort on optional graphics on some models	Manageability	None																																																																								
Rear audio ports* IEEE 1394*	Line-in (3.5mm), line-out (3.5mm), microphone-in (3.5mm) None * Depending on many factors, actual data transfer speed may be lower than theoretical speed	Security chip	TPM (Trusted Platform Module) 2.0, TCG Certified * Downgrade to TPM1.2 for the models with Win10 DG Win7 32 OS																																																																								
Audio support	High Definition (HD) Audio, Realtek ALC662 / optional internal speaker (1.5 watt )																																																																										
WLAN <sup>13</sup>	<i>Some:</i> 11ac wireless, M.2 Card, Qualcomm Atheros QCA9377A (dual band), Wi-Fi + Bluetooth 4.1 combo adapter, 1x1 <i>Some:</i> 11ac wireless, M.2 Card, Qualcomm Atheros QCA6174A (dual band), Wi-Fi + Bluetooth 4.1 combo adapter, 2x2 <i>Some:</i> 11ac wireless, M.2 Card, Intel Dual Band Wireless-AC 3165, Wi-Fi + Bluetooth 4.1 combo adapter, 1x1 <i>Some:</i> 11ac wireless, M.2 Card, Intel Dual Band Wireless-AC 8265, Wi-Fi + Bluetooth 4.1 combo adapter, 2x2																																																																										
Bluetooth™	<i>Some:</i> Bluetooth 4.1 wireless, integrated in Wi-Fi + BT combo adapter																																																																										
Ethernet	Gigabit ethernet, Realtek RTL8111GN, Wake on LAN®																																																																										
Modem	None																																																																										

Note: The specifications above may not be available in all regions.

Lenovo, June 2017



# ThinkCentre M710 Tiny Platform Specifications

Product Specifications Reference (PSREF)

Processor	Intel® Celeron®, Intel Pentium®, or 6/7th Generation Intel Core™ i3 / i5 / i7 Processor						<b>Security features</b> <ul style="list-style-type: none"> <li>Security slot (in rear for optional Kensington® MicroSaver® cable)</li> <li>Smart USB protection, allows keyboard/mouse only, blocks all storage devices</li> <li>Power-on password</li> <li>Administrator password</li> <li>Hard disk password</li> <li>Boot sequence control</li> <li>Boot without keyboard and mouse</li> <li>Individual USB port disablement</li> <li>Chassis intrusion switch</li> </ul>
	Processor	Cores / Threads	Frequency Base/Max(GHz)	Cache	Memory Support (Up to)	Integrated Graphics	
	Pentium G4400T	2 / 2	2.9G	3 MB	DDR4-2133	HD 510	
	Pentium G4560T	2 / 4	2.9G	3 MB	DDR4-2400	HD 610	
	Pentium G4600T	2 / 4	3.0G	3 MB	DDR4-2400	HD 630	
	Core i3-6100T	2 / 4	3.2G	3 MB	DDR4-2133	HD 530	
	Core i5-6500T	4 / 4	2.5G / 3.1G	6 MB	DDR4-2133	HD 530	
	Core i7-6700T	4 / 8	2.8G / 3.6G	8 MB	DDR4-2133	HD 530	
	Core i3-7100T	2 / 4	3.4G	3 MB	DDR4-2400	HD 630	
	Core i5-7400T	4 / 4	2.4G / 3.0G	6 MB	DDR4-2400	HD 630	
	Core i5-7500T	4 / 4	2.7G / 3.3G	6 MB	DDR4-2400	HD 630	
	Core i5-7600T	4 / 4	2.8G / 3.7G	6 MB	DDR4-2400	HD 630	
Core i7-7700T	4 / 8	2.9G / 3.8G	8 MB	DDR4-2400	HD 630		
Memory	32GB max, DDR4-2400*, two 260-pin SO-DIMM sockets, non-ECC, dual-channel capable * System automatically clocks down for the processors with lower memory controller						
Storage	<i>Some:</i> Hard Drive / SATA 6.0Gb/s, 2.5", 5400 rpm or 7200 rpm <i>Some:</i> Solid State Drive (SSD) / SATA 6.0Gb/s, 2.5" <i>Some:</i> M.2 Solid State Drive (SSD) / PCIe NVMe, PCIe 3.0 x 4, 32Gb/s <i>Some:</i> Intel Optane™ Memory (models with 7th gen Core processor), M.2 <i>Some:</i> DVD-ROM, slim (9.0mm), via USB external ODD box <i>Some:</i> DVD Burner (DVD±RW), slim (9.0mm), via USB external ODD box						
Optical	None						
Onboard SATA Media reader	One onboard SATA 6.0Gb/s connector						
Graphics	<b>Intel HD Graphics 510/530/610/630</b> in processor, uses main memory, DirectX® 12, two DisplayPort™, one optional video port (HDMI, VGA, 3rd DP, or USB 3.1 Type-C with DisplayPort Alternate Mode), up to 3 independent displays; <i>Max resolution:</i> 4096x2304 (DP) @60Hz; 4096x2304 (Type-C) @60Hz; 4096x2160 (HDMI) @24Hz; 1920x1200 (VGA) @60Hz						
Monitor cable	Optional DP to VGA, DP to DVI-D (single link), DP to dual DP, or DP to HDMI 1.4						
Chipset	<b>Intel B250 Chipset</b>						
Front ports*	Two USB 3.1 Gen1 (one is Always On and fast charge), one microphone (3.5mm), one headphone / microphone combo jack (3.5mm)						
Rear ports*	Four USB 3.1 Gen1 (optional external optical box or external I/O box occupies one or two specific USB 3.1 Gen1 on some models), ethernet (RJ-45), two DisplayPort, two optional ports (Port 1 for VGA / 3rd DP / HDMI / serial / USB 3.1 Type-C Gen 1 (with DisplayPort Alternate Mode), Port 2 for serial)						
I/O box*	Optional external I/O box, extends two USB 2.0, two USB 3.1 Gen1, and one serial on rear, two USB 2.0 on front, via USB cable (occupy two specific USB 3.1 Gen1 of Tiny) * Depending on many factors, actual data transfer speed may be lower than theoretical speed						
Audio support	High Definition (HD) Audio, Realtek ALC294 / optional internal speaker (1w or 2w)						
WLAN <sup>13</sup>	<i>Some:</i> 11ac wireless, M.2 Card, Qualcomm Atheros QCA9377A (dual band), Wi-Fi + Bluetooth 4.1 combo adapter, 1x1 <i>Some:</i> 11ac wireless, M.2 Card, Qualcomm Atheros QCA6174A (dual band), Wi-Fi + Bluetooth 4.1 combo adapter, 2x2 <i>Some:</i> 11ac wireless, M.2 Card, Intel Dual Band Wireless-AC 3165, Wi-Fi + Bluetooth 4.1 combo adapter, 1x1 <i>Some:</i> 11ac wireless, M.2 Card, Intel Dual Band Wireless-AC 8265, Wi-Fi + Bluetooth 4.1 combo adapter, 2x2						
Bluetooth™ Ethernet Modem	<i>Some:</i> Bluetooth 4.1 wireless, integrated in Wi-Fi + BT combo adapter Gigabit ethernet, Intel Ethernet Connection I219-V (Jacksonville), Wake on LAN® None						
Manageability Security chip	None TPM (Trusted Platform Module) 2.0*, TCG Certified * Downgrade to TPM1.2 for the models with Win10 DG Win7 32 OS						
VESA mount Floor Stand	Optional VESA mount bracket kit, supports VESA 75mm and 100mm Optional system floor stand for vertical orientation						
Power supply	65 watts AC/DC adapter, autosensing, 88% PSU (not included for TIO models) 90 watts AC/DC adapter, autosensing, 88% PSU (only for models with I/O box)						
Limited warranty <sup>3</sup>	<i>Some:</i> <b>1-year</b> or <b>3-year, depot service</b> / service upgrades available <i>Some:</i> <b>1-year</b> or <b>3-year, limited onsite service</b> / service upgrades available						
Preload	<i>Some:</i> Windows® 7 Professional 32/64 preinstalled through downgrade rights in Windows 10 Pro 64-bit (not available with 7th Gen Intel processor) <i>Some:</i> Windows 10 Pro 64-bit <i>Some:</i> Windows 10 Home 64-bit <b>Preloaded applications (only some listed)</b> <ul style="list-style-type: none"> <li>Microsoft Office preloaded; purchase a product key to activate</li> <li>- Only for Window 10</li> <li>Lenovo Companion</li> <li>- Only for Window 7</li> <li>Lenovo Solution Center</li> <li>Lenovo ThinkVantage Tools</li> <li>Create Recovery Media</li> <li>Adobe® Reader®</li> <li>Cyberlink PowerDVD Create (DVD±RW)</li> </ul>						
Environment	ENERGY STAR® 6.1, EPEAT™ Gold rating (North America), ErP Lot 3, GREENGUARD®, RoHS-compliant, TUV low noise verified (on some models)						
MIL-SPEC test	MIL-STD-810G military certification (Low Pressure [Altitude], High Temperature, Low Temperature, Temperature Shock, Humidity, Sand and Dust, Vibration, Shock, Fungus, Solar Radiation)						
Accessories	For compatible accessories, please go to <a href="http://www.lenovoquickpick.com">http://www.lenovoquickpick.com</a>						

See footnotes for more detailed information

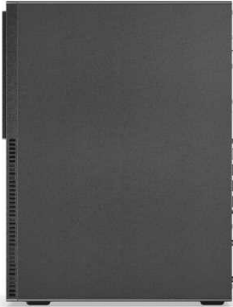



# ThinkCentre M710 Tower Platform Specifications

Product Specifications Reference (PSREF)

Processor	Intel® Celeron®, Intel Pentium®, or 6/7th Generation Intel Core™ i3 / i5 / i7 Processor						Manageability	None																																																																								
	<table border="1"> <thead> <tr> <th>Processor</th> <th>Cores / Threads</th> <th>Frequency Base/Max(GHz)</th> <th>Cache</th> <th>Memory Support (Up to)</th> <th>Integrated Graphics</th> </tr> </thead> <tbody> <tr> <td>Pentium G4400</td> <td>2 / 2</td> <td>3.3G</td> <td>3 MB</td> <td>DDR4-2133</td> <td>HD 510</td> </tr> <tr> <td>Pentium G4560</td> <td>2 / 4</td> <td>3.5G</td> <td>3 MB</td> <td>DDR4-2400</td> <td>HD 610</td> </tr> <tr> <td>Pentium G4600</td> <td>2 / 4</td> <td>3.6G</td> <td>3 MB</td> <td>DDR4-2400</td> <td>HD 630</td> </tr> <tr> <td>Core i3-6100</td> <td>2 / 4</td> <td>3.7G</td> <td>3 MB</td> <td>DDR4-2133</td> <td>HD 530</td> </tr> <tr> <td>Core i5-6500</td> <td>4 / 4</td> <td>3.2G / 3.6G</td> <td>6 MB</td> <td>DDR4-2133</td> <td>HD 530</td> </tr> <tr> <td>Core i7-6700</td> <td>4 / 8</td> <td>3.4G / 4.0G</td> <td>8 MB</td> <td>DDR4-2133</td> <td>HD 530</td> </tr> <tr> <td>Core i3-7100</td> <td>2 / 4</td> <td>3.9G</td> <td>3 MB</td> <td>DDR4-2400</td> <td>HD 630</td> </tr> <tr> <td>Core i5-7400</td> <td>4 / 4</td> <td>3.0G / 3.5G</td> <td>6 MB</td> <td>DDR4-2400</td> <td>HD 630</td> </tr> <tr> <td>Core i5-7500</td> <td>4 / 4</td> <td>3.4G / 3.8G</td> <td>6 MB</td> <td>DDR4-2400</td> <td>HD 630</td> </tr> <tr> <td>Core i5-7600</td> <td>4 / 4</td> <td>3.5G / 4.1G</td> <td>6 MB</td> <td>DDR4-2400</td> <td>HD 630</td> </tr> <tr> <td>Core i7-7700</td> <td>4 / 8</td> <td>3.6G / 4.2G</td> <td>8 MB</td> <td>DDR4-2400</td> <td>HD 630</td> </tr> </tbody> </table>						Processor	Cores / Threads	Frequency Base/Max(GHz)	Cache	Memory Support (Up to)	Integrated Graphics	Pentium G4400	2 / 2	3.3G	3 MB	DDR4-2133	HD 510	Pentium G4560	2 / 4	3.5G	3 MB	DDR4-2400	HD 610	Pentium G4600	2 / 4	3.6G	3 MB	DDR4-2400	HD 630	Core i3-6100	2 / 4	3.7G	3 MB	DDR4-2133	HD 530	Core i5-6500	4 / 4	3.2G / 3.6G	6 MB	DDR4-2133	HD 530	Core i7-6700	4 / 8	3.4G / 4.0G	8 MB	DDR4-2133	HD 530	Core i3-7100	2 / 4	3.9G	3 MB	DDR4-2400	HD 630	Core i5-7400	4 / 4	3.0G / 3.5G	6 MB	DDR4-2400	HD 630	Core i5-7500	4 / 4	3.4G / 3.8G	6 MB	DDR4-2400	HD 630	Core i5-7600	4 / 4	3.5G / 4.1G	6 MB	DDR4-2400	HD 630	Core i7-7700	4 / 8	3.6G / 4.2G	8 MB	DDR4-2400	HD 630	Security chip	TPM (Trusted Platform Module) 2.0, TCG Certified * Downgrade to TPM1.2 for the models with Win10 DG Win7 32 OS
	Processor	Cores / Threads	Frequency Base/Max(GHz)	Cache	Memory Support (Up to)	Integrated Graphics																																																																										
	Pentium G4400	2 / 2	3.3G	3 MB	DDR4-2133	HD 510																																																																										
	Pentium G4560	2 / 4	3.5G	3 MB	DDR4-2400	HD 610																																																																										
	Pentium G4600	2 / 4	3.6G	3 MB	DDR4-2400	HD 630																																																																										
	Core i3-6100	2 / 4	3.7G	3 MB	DDR4-2133	HD 530																																																																										
	Core i5-6500	4 / 4	3.2G / 3.6G	6 MB	DDR4-2133	HD 530																																																																										
	Core i7-6700	4 / 8	3.4G / 4.0G	8 MB	DDR4-2133	HD 530																																																																										
	Core i3-7100	2 / 4	3.9G	3 MB	DDR4-2400	HD 630																																																																										
	Core i5-7400	4 / 4	3.0G / 3.5G	6 MB	DDR4-2400	HD 630																																																																										
Core i5-7500	4 / 4	3.4G / 3.8G	6 MB	DDR4-2400	HD 630																																																																											
Core i5-7600	4 / 4	3.5G / 4.1G	6 MB	DDR4-2400	HD 630																																																																											
Core i7-7700	4 / 8	3.6G / 4.2G	8 MB	DDR4-2400	HD 630																																																																											
						Security features	<ul style="list-style-type: none"> <li>Security slot (in rear for optional Kensington® MicroSaver® cable)</li> <li>Padlock loop</li> <li>Smart USB protection, allows keyboard/mouse only, blocks all storage devices</li> <li>Optional cable lock to physically lock both keyboard and mouse</li> <li>Power-on password</li> <li>Administrator password</li> <li>Hard disk password</li> <li>Boot sequence control</li> <li>Boot without keyboard and mouse</li> <li>Individual USB port disablement</li> <li>Optional chassis intrusion switch</li> </ul>																																																																									
						Keyboard	<i>Some:</i> Lenovo Calliope Keyboard (USB connector), black <i>Some:</i> Lenovo Traditional Keyboard (USB connector), black <i>Some:</i> Lenovo Calliope Wireless Keyboard (2.4GHz via USB receiver), black <i>Some:</i> Lenovo Calliope Mouse (USB connector), black <i>Some:</i> Lenovo Calliope Wireless Mouse (2.4GHz via USB receiver), black																																																																									
						Mouse	<i>Some:</i> Lenovo Calliope Mouse (USB connector), black <i>Some:</i> Lenovo Calliope Wireless Mouse (2.4GHz via USB receiver), black																																																																									
Memory	64GB max, UDIMM, DDR4-2400*, four 288-pin DIMM sockets, non-ECC, dual-channel capable * System automatically clocks down for the processors with lower memory controller						Mechanical	<ul style="list-style-type: none"> <li>Tower (15L), black color, metal case</li> <li>(WxDxH) 5.7" X 11.5" X 14.4"; 145mm X 292.7mm X 366mm</li> <li>Approx. 14.3 lb (6.5 kg), weight may vary by configuration</li> <li>Optional dust filter</li> <li>Bay 1: Slim external ODD bay</li> <li>Bay 2: 3.5", 1" high, internal, HDD/SSD</li> <li>Bay 3: 3.5", 1" high, internal, HDD/SSD</li> <li>Slot 1: half-length full-height (length &lt; 189mm, height &lt; 104mm), PCIe 3.0 x16*</li> <li>Slot 2: half-length full-height (length &lt; 189mm, height &lt; 104mm), PCIe 3.0 x1*</li> <li>Slot 3: half-length full-height (length &lt; 189mm, height &lt; 104mm), PCIe 3.0 x1*</li> <li>Slot 4: no slot, only bracket for optional port extension*</li> <li>M.2 card slots: Two (one for WLAN, one for SSD/Optane)</li> <li>* Optional 2 front USB3.1 Type-C ports module occupies PCIe x16 slot (x4 card), optional rear 2x USB2.0 / parallel occupies one expansion slot</li> </ul>																																																																								
Storage	<i>Some:</i> Hard Drive / SATA 6.0Gb/s, 2.5" or 3.5", 5400 rpm or 7200 rpm <i>Some:</i> Solid State Drive (SSD) / SATA 6.0Gb/s, 2.5" <i>Some:</i> M.2 Solid State Drive (SSD) / PCIe NVMe, PCIe 3.0 x 4, 32Gb/s <i>Some:</i> Intel Optane™ Memory (models with 7th gen Core processor), M.2 <i>Some:</i> DVD-ROM SATA 1.5Gb/s Drive, slim (9.0mm) <i>Some:</i> DVD Burner (DVD±RW), SATA 1.5Gb/s Drive, slim (9.0mm)						Power supply	<i>Some:</i> 180 watts, autosensing, 85% PSU <i>Some:</i> 210 watts, autosensing, 85% PSU <i>Some:</i> 210 watts, autosensing, 92% PSU (only available via special bid)																																																																								
Optical	<i>Some:</i> Intel Optane™ Memory (models with 7th gen Core processor), M.2 <i>Some:</i> DVD-ROM SATA 1.5Gb/s Drive, slim (9.0mm) <i>Some:</i> DVD Burner (DVD±RW), SATA 1.5Gb/s Drive, slim (9.0mm)						Limited warranty <sup>3</sup>	<i>Some:</i> <b>1-year</b> or <b>3-year, depot service</b> / service upgrades available <i>Some:</i> <b>1-year</b> or <b>3-year, limited onsite service</b> / service upgrades available																																																																								
Onboard SATA Media reader	Three onboard SATA 6.0Gb/s connectors Optional 7-in-1 media reader						Preload	<b>Preloaded operating system</b> <i>Some:</i> Windows® 7 Professional 32/64 preinstalled through downgrade rights in Windows 10 Pro 64-bit (not available with 7th Gen Intel processor) <i>Some:</i> Windows 10 Pro 64-bit <i>Some:</i> Windows 10 Home 64-bit <b>Preloaded applications (only some listed)</b> <ul style="list-style-type: none"> <li>Microsoft Office preloaded; purchase a product key to activate</li> <li>Only for Window 10</li> <li>Lenovo Companion</li> <li>Only for Window 7</li> <li>Lenovo Solution Center</li> <li>Lenovo ThinkVantage Tools</li> <li>Create Recovery Media</li> <li>Adobe® Reader®</li> <li>Cyberlink PowerDVD Create (DVD±RW)</li> </ul>																																																																								
Graphics	<b>Intel HD Graphics 510/530/610/630</b> in processor, uses main memory, DirectX® 12, one VGA, two DisplayPort™, supports 3 independent displays, works along with discrete graphics to support more displays; <i>Max resolution:</i> 4096x2304 (DP)@60Hz; 2048x1536 (VGA)@50Hz <i>Some:</i> <b>NVIDIA GeForce® GT 730</b> , DirectX 12, 2GB, PCIe 2.0 x8 adapter, two DisplayPort, 35 watts; <i>Max resolution:</i> 3840x2160 (DisplayPort)@60Hz; <i>Some:</i> <b>AMD Radeon™ R7 350</b> , DirectX 11, 2GB, PCIe 3.0 x8 adapter, one VGA, one HDMI, 75 watts, occupies two slots; <i>Max resolution:</i> 4096x2160 (HDMI)@24Hz; 2048x1536 (VGA)@85Hz						Environment	ENERGY STAR® 6.1, EPEAT™ Gold rating (North America), ErP Lot 3, GREENGUARD®, RoHS-compliant, TUV low noise verified (on some models)																																																																								
Monitor Cable	Optional DP to VGA, DP to DVI-D (single link), DP to dual DP, or DP to HDMI 1.4						Accessories	For compatible accessories, please go to <a href="http://www.lenovoquickpick.com">http://www.lenovoquickpick.com</a>																																																																								
Chipset	<b>Intel B250 Chipset</b>																																																																															
Front ports*	Four USB 3.1 Gen1, optional two USB 3.1 Type-C Gen 2 (only available via special bid), microphone (3.5mm), headphone (3.5mm)																																																																															
Rear ports*	Two USB 3.1 Gen1, two USB 2.0, optional two USB 2.0, serial (9-pin), optional 2nd serial (9-pin), optional parallel (25-pin), ethernet (RJ-45), one VGA, two DisplayPort, two PS/2 ports (keyboard/mouse); additional VGA, DisplayPort, or HDMI on optional graphics on some models																																																																															
Rear audio ports* IEEE 1394*	Line-in (3.5mm), line-out (3.5mm), microphone-in (3.5mm) None * Depending on many factors, actual data transfer speed may be lower than theoretical speed																																																																															
Audio support	High Definition (HD) Audio, Realtek ALC662 / optional internal speaker (1.5 watt )																																																																															
WLAN <sup>13</sup>	<i>Some:</i> 11ac wireless, M.2 Card, Qualcomm Atheros QCA9377A (dual band), Wi-Fi + Bluetooth 4.1 combo adapter, 1x1 <i>Some:</i> 11ac wireless, M.2 Card, Qualcomm Atheros QCA6174A (dual band), Wi-Fi + Bluetooth 4.1 combo adapter, 2x2 <i>Some:</i> 11ac wireless, M.2 Card, Intel Dual Band Wireless-AC 3165, Wi-Fi + Bluetooth 4.1 combo adapter, 1x1 <i>Some:</i> 11ac wireless, M.2 Card, Intel Dual Band Wireless-AC 8265, Wi-Fi + Bluetooth 4.1 combo adapter, 2x2																																																																															
Bluetooth™	<i>Some:</i> Bluetooth 4.1 wireless, integrated in Wi-Fi + BT combo adapter																																																																															
Ethernet	Gigabit ethernet, Realtek RTL8111GN, Wake on LAN®																																																																															
Modem	None																																																																															

Note: The specifications above may not be available in all regions.

Lenovo, June 2017



# ThinkCentre M710e SFF Platform Specifications

Product Specifications Reference (PSREF)

Processor	Intel® Celeron®, Intel Pentium®, or 6/7th Generation Intel Core™ i3 / i5 / i7 Processor						<p><b>Security features</b></p> <ul style="list-style-type: none"> <li>Security slot (in rear for optional Kensington® MicroSaver® cable)</li> <li>Padlock loop</li> <li>Smart USB protection, allows keyboard/mouse only, blocks all storage devices</li> <li>Optional smart cable clip to physically lock both keyboard and mouse</li> <li>Power-on password</li> <li>Administrator password</li> <li>Hard disk password</li> <li>Boot sequence control</li> <li>Boot without keyboard and mouse</li> <li>Individual USB port disablement</li> <li>Optional chassis intrusion switch</li> </ul> <p><b>Keyboard</b> Some: Lenovo Calliope Keyboard (USB connector), black Some: Lenovo Traditional Keyboard (USB connector), black</p> <p><b>Mouse</b> Some: Lenovo Calliope Mouse (USB connector), black Some: Lenovo Fingerprint Mouse (USB connector), Windows Hello support, black</p> <p><b>Mechanical</b></p> <ul style="list-style-type: none"> <li>SFF (7.4L), black color, metal case</li> <li>(WxDxH) 3.9" X 11.9" X 10.8"; 100mm X 303.5mm X 273.5mm</li> <li>Approx. 9.37 lb (4.25 kg), weight may vary by configuration</li> <li>Bay 1: Slim external ODD bay</li> <li>Bay 2: 3.5", 1" high, internal, supports 2.5" or 3.5" HDD/SSD (2.5 to 3.5 bracket comes with disk)</li> <li>Slot 1: low-profile (length &lt; 152mm, height &lt; 64mm), PCIe 3.0 x16*</li> <li>Slot 2: low-profile (length &lt; 152mm, height &lt; 64mm), PCIe 3.0 x1*</li> <li>M.2 card slots: one for SSD</li> <li>*Optional rear 2x USB2.0 / parallel occupies one expansion slot</li> </ul> <p><b>Floor Stand</b> Optional system floor stand for vertical orientation</p>
	Processor	Cores / Threads	Frequency Base/Max(GHz)	Cache	Memory Support (Up to)	Integrated Graphics	
	Celeron G3900	2 / 2	2.8G	2 MB	DDR4-2133	HD 510	
	Celeron G3930	2 / 2	2.9G	3 MB	DDR4-2133	HD 610	
	Pentium G4400	2 / 2	3.3G	3 MB	DDR4-2133	HD 510	
	Pentium G4500	2 / 2	3.5G	3 MB	DDR4-2133	HD 530	
	Pentium G4560	2 / 4	3.5G	3 MB	DDR4-2400	HD 610	
	Pentium G4600	2 / 4	3.6G	3 MB	DDR4-2400	HD 630	
	Core i3-6100	2 / 4	3.7G	3 MB	DDR4-2133	HD 530	
	Core i5-6400	4 / 4	2.7G / 3.3G	6 MB	DDR4-2133	HD 530	
	Core i5-6500	4 / 4	3.2G / 3.6G	6 MB	DDR4-2133	HD 530	
	Core i7-6700	4 / 8	3.4G / 4.0G	8 MB	DDR4-2133	HD 530	
	Core i3-7100	2 / 4	3.9G	3 MB	DDR4-2400	HD 630	
	Core i3-7300	2 / 4	4.0G	4 MB	DDR4-2400	HD 630	
	Core i5-7400	4 / 4	3.0G / 3.5G	6 MB	DDR4-2400	HD 630	
	Core i5-7500	4 / 4	3.4G / 3.8G	6 MB	DDR4-2400	HD 630	
	Core i5-7600	4 / 4	3.5G / 4.1G	6 MB	DDR4-2400	HD 630	
Core i7-7700	4 / 8	3.6G / 4.2G	8 MB	DDR4-2400	HD 630		
Memory	32GB max, UDIMM, DDR4-2400*, two 288-pin DIMM sockets, non-ECC, dual-channel capable *System automatically clocks down for the processors with lower memory controller						
Storage	Some: Hard Drive / SATA 6.0Gb/s, 2.5" or 3.5", 5400 rpm or 7200 rpm Some: Solid State Drive (SSD) / SATA 6.0Gb/s, 2.5" Some: M.2 Solid State Drive (SSD) / PCIe NVMe, PCIe 3.0 x 4, 32Gb/s						
Optical	Some: DVD-ROM SATA 1.5Gb/s Drive, slim (9.0mm) Some: DVD Burner (DVD±RW), SATA 1.5Gb/s Drive, slim (9.0mm)						
Onboard SATA	Two onboard SATA 6.0Gb/s connectors						
Media reader	Optional 7-in-1 media reader						
Graphics	Intel HD Graphics 510/530/610/630 in processor, uses main memory, DirectX® 12, one VGA, one DisplayPort™, supports 2 independent displays, works along with discrete graphics to support more displays; Max resolution: 4096x2160 (DP)@60Hz; 1920x1200 (VGA)@60Hz Some: NVIDIA GeForce® GT 730, DirectX 12, 2GB, PCIe 2.0 x8 adapter, two DisplayPort, 35 watts; Max resolution: 3840x2160 (DisplayPort)@60Hz;						
Monitor cable	Optional DP to VGA, DP to DVI-D (single link), DP to dual DP, or DP to HDMI 1.4						
Chipset	Intel B250 Chipset						
Front ports*	Two USB 3.1 Gen1, microphone (3.5mm), one headphone / microphone combo jack (3.5mm)						
Rear ports*	Two USB 3.1 Gen1, two USB 2.0, optional two USB 2.0, serial (9-pin), optional 2nd serial (9-pin), optional parallel (25-pin), ethernet (RJ-45), one VGA, one DisplayPort, optional external USB to PS/2 ports cable (for PS/2 keyboard / mouse); additional DisplayPort on optional graphics on some models						
Rear audio ports*	Line-out jack (3.5mm)						
IEEE 1394*	None * Depending on many factors, actual data transfer speed may be lower than theoretical speed						
Audio support	High Definition (HD) Audio, Realtek ALC233 / internal speaker (1.5 watt )						
WLAN <sup>13</sup>	None						
Bluetooth™	None						
Ethernet	Gigabit ethernet, Realtek RTL8111HN, Wake on LAN®						
Modem	None						
Manageability	None						
Security chip	TPM (Trusted Platform Module) 2.0, TCG Certified * Downgrade to TPM1.2 for the models with Win10 DG Win7 32 OS						
Packaging	• (WxDxH) 7.7" X 15.4" X 19.7"; 195mm X 390mm X 500mm • Cross weight (approx.) 14.22 lb (6.45 kg)						
Power supply	Some: 180 watts, autosensing, 85% PSU						
Limited warranty <sup>3</sup>	Some: <b>1-year</b> or <b>3-year, depot service</b> / service upgrades available Some: <b>1-year</b> or <b>3-year, limited onsite service</b> / service upgrades available						
Preload	<p><b>Preloaded operating system</b></p> <p>Some: Windows® 10 Pro 64-bit Some: Windows 10 Home 64-bit Some: Windows 7 Professional 32/64 preinstalled through downgrade rights in Windows 10 Pro 64-bit(not available with 7th Gen Intel processor)</p> <p><b>Preloaded applications (only some listed)</b></p> <ul style="list-style-type: none"> <li>Microsoft Office preloaded; purchase a product key to activate</li> <li>Cyberlink PowerDVD (DVD, DVD±RW)</li> <li>Cyberlink PowerDVD Create (DVD±RW)</li> <li>- Only for Window 10</li> <li>Lenovo Companion</li> <li>- Only for Window 7</li> <li>Lenovo Solution Center</li> <li>Lenovo System Update</li> <li>Create Recovery Media</li> <li>Adobe® Reader®</li> </ul>						
Environment	ENERGY STAR® 6.1, EPEAT™ Silver rating (North America), ErP Lot 3, RoHS-compliant, WEEE						
Accessories	For compatible accessories, please go to <a href="http://www.lenovoquickpick.com">http://www.lenovoquickpick.com</a>						

Note: The specifications above may not be available in all regions.

Lenovo, January 2018





# ThinkCentre M715 SFF Platform Specifications

Product Specifications Reference (PSREF)

Processor	AMD A6 / A8 / A10 / A12 series APU and Ryzen 3 / 5 / 7 series processor	Security features	<ul style="list-style-type: none"> <li>Security slot (in rear for optional Kensington® MicroSaver® cable)</li> <li>Padlock loop</li> <li>Smart USB protection, allows keyboard/ mouse only, blocks all storage devices</li> <li>Optional cable lock to physically lock both keyboard and mouse</li> <li>Power-on password</li> <li>Administrator password</li> <li>Hard disk password</li> <li>Boot sequence control</li> <li>Boot without keyboard and mouse</li> <li>Individual USB port disablement</li> <li>Optional chassis intrusion switch</li> </ul>																																																												
	<table border="1"> <thead> <tr> <th>APU / processor</th> <th>Cores / Threads</th> <th>Frequency (Base/Max)</th> <th>L2 Cache</th> <th>Integrated Graphics</th> </tr> </thead> <tbody> <tr> <td>Ryzen 3 PRO 1200</td> <td>4 / 4</td> <td>3.1 / 3.4</td> <td>2MB</td> <td>None</td> </tr> <tr> <td>Ryzen 3 PRO 1300</td> <td>4 / 4</td> <td>3.5 / 3.7</td> <td>2MB</td> <td>None</td> </tr> <tr> <td>Ryzen 5 PRO 1500</td> <td>4 / 8</td> <td>3.5 / 3.7</td> <td>2MB</td> <td>None</td> </tr> <tr> <td>Ryzen 7 PRO 1700</td> <td>8 / 16</td> <td>3.0 / 3.7</td> <td>4MB</td> <td>None</td> </tr> <tr> <td>PRO A6-8570</td> <td>2 / 2</td> <td>3.5 / 3.8</td> <td>1MB</td> <td>Radeon R5 Series</td> </tr> <tr> <td>PRO A10-8770</td> <td>4 / 4</td> <td>3.5 / 3.8</td> <td>2MB</td> <td>Radeon R7 Series</td> </tr> <tr> <td>PRO A12-8870</td> <td>4 / 4</td> <td>3.7 / 4.2</td> <td>2MB</td> <td>Radeon R7 Series</td> </tr> <tr> <td>PRO A6-9500</td> <td>2 / 2</td> <td>3.5 / 3.8</td> <td>1MB</td> <td>Radeon R5 Series</td> </tr> <tr> <td>PRO A8-9600</td> <td>4 / 4</td> <td>3.1 / 3.4</td> <td>2MB</td> <td>Radeon R7 Series</td> </tr> <tr> <td>PRO A10-9700</td> <td>4 / 4</td> <td>3.5 / 3.8</td> <td>2MB</td> <td>Radeon R7 Series</td> </tr> <tr> <td>PRO A12-9800</td> <td>4 / 4</td> <td>3.8 / 4.2</td> <td>2MB</td> <td>Radeon R7 Series</td> </tr> </tbody> </table>	APU / processor	Cores / Threads	Frequency (Base/Max)	L2 Cache	Integrated Graphics	Ryzen 3 PRO 1200	4 / 4	3.1 / 3.4	2MB	None	Ryzen 3 PRO 1300	4 / 4	3.5 / 3.7	2MB	None	Ryzen 5 PRO 1500	4 / 8	3.5 / 3.7	2MB	None	Ryzen 7 PRO 1700	8 / 16	3.0 / 3.7	4MB	None	PRO A6-8570	2 / 2	3.5 / 3.8	1MB	Radeon R5 Series	PRO A10-8770	4 / 4	3.5 / 3.8	2MB	Radeon R7 Series	PRO A12-8870	4 / 4	3.7 / 4.2	2MB	Radeon R7 Series	PRO A6-9500	2 / 2	3.5 / 3.8	1MB	Radeon R5 Series	PRO A8-9600	4 / 4	3.1 / 3.4	2MB	Radeon R7 Series	PRO A10-9700	4 / 4	3.5 / 3.8	2MB	Radeon R7 Series	PRO A12-9800	4 / 4	3.8 / 4.2	2MB	Radeon R7 Series	Keyboard	<i>Some:</i> Lenovo Calliope Keyboard (USB connector), black <i>Some:</i> Lenovo Traditional Keyboard (USB connector), black <i>Some:</i> Lenovo Calliope Wireless Keyboard (2.4GHz via USB receiver), black
APU / processor	Cores / Threads	Frequency (Base/Max)	L2 Cache	Integrated Graphics																																																											
Ryzen 3 PRO 1200	4 / 4	3.1 / 3.4	2MB	None																																																											
Ryzen 3 PRO 1300	4 / 4	3.5 / 3.7	2MB	None																																																											
Ryzen 5 PRO 1500	4 / 8	3.5 / 3.7	2MB	None																																																											
Ryzen 7 PRO 1700	8 / 16	3.0 / 3.7	4MB	None																																																											
PRO A6-8570	2 / 2	3.5 / 3.8	1MB	Radeon R5 Series																																																											
PRO A10-8770	4 / 4	3.5 / 3.8	2MB	Radeon R7 Series																																																											
PRO A12-8870	4 / 4	3.7 / 4.2	2MB	Radeon R7 Series																																																											
PRO A6-9500	2 / 2	3.5 / 3.8	1MB	Radeon R5 Series																																																											
PRO A8-9600	4 / 4	3.1 / 3.4	2MB	Radeon R7 Series																																																											
PRO A10-9700	4 / 4	3.5 / 3.8	2MB	Radeon R7 Series																																																											
PRO A12-9800	4 / 4	3.8 / 4.2	2MB	Radeon R7 Series																																																											
		Mouse	<i>Some:</i> Lenovo Calliope Mouse (USB connector), black <i>Some:</i> Lenovo Calliope Wireless Mouse (2.4GHz via USB receiver), black <i>Some:</i> Lenovo Fingerprint Mouse (USB connector), Windows Hello support, black																																																												
Memory	64GB max, UDIMM, DDR4-2400, four 288-pin DIMM sockets, non-ECC, dual-channel capable* * System automatically clocks down for the processors with lower memory controller	Mechanical	<ul style="list-style-type: none"> <li>SFF (8.4L), black color; metal case</li> <li>(WxDxH) 3.6" X 11.4" X 13.5"; 92.5mm X 290.5mm X 343.5mm</li> <li>Approx. 13.2 lb (6.0 kg), weight may vary by configuration</li> <li>Toolless cover, disk, optical removal</li> <li>Optional dust filter</li> <li>Bay 1: Slim external ODD bay</li> <li>Bay 2: 3.5", internal, HDD/SSD</li> <li>Bay 3: 2.5", internal, HDD/SSD (bay only comes with 2.5" 2nd disk)</li> <li>Slot 1: low-profile (length &lt; 150mm, height &lt; 68mm), PCIe 3.0 x16*</li> <li>Slot 2: low-profile (length &lt; 150mm, height &lt; 68mm), PCIe 2.0 x1*</li> <li>Slot 3: low-profile (length &lt; 150mm, height &lt; 68mm), PCIe 2.0 x1*</li> <li>Slot 4: no slot, only bracket for optional port extension*</li> <li>M.2 card slots: two (one for WLAN, one for SSD)</li> <li>* Optional front USB3.1 Type-C x2 module occupies PCIe x16 slot (x4 card), optional rear 2x USB2.0 / parallel / 2nd serial occupies one expansion slot</li> </ul>																																																												
Storage	<i>Some:</i> Hard Drive / SATA 6.0Gb/s, 2.5" or 3.5", 5400 rpm or 7200 rpm <i>Some:</i> Solid State Drive (SSD) / SATA 6.0Gb/s, 2.5" <i>Some:</i> M.2 Solid State Drive (SSD) / PCIe NVMe, PCIe 3.0 x 4, 32Gb/s	Floor Stand	Optional system floor stand for vertical orientation																																																												
Optical	<i>Some:</i> DVD-ROM SATA 1.5Gb/s Drive, slim (9.0mm) <i>Some:</i> DVD Burner (DVD±RW), SATA 1.5Gb/s Drive, slim (9.0mm)	Power supply	<i>Some:</i> 180 watts, autosensing, 85% PSU <i>Some:</i> 210 watts, autosensing, 85% PSU <i>Some:</i> 210 watts, autosensing, 92% PSU (only available via special bid)																																																												
Onboard SATA Media reader	Three onboard SATA 6.0Gb/s connectors Optional 7-in-1 media reader	Limited warranty	<i>Some:</i> <b>1-year or 3-year, depot service</b> / service upgrades available <i>Some:</i> <b>1-year or 3-year, limited onsite service</b> / service upgrades available																																																												
Graphics	<b>AMD Radeon™ Graphics in processor</b> (not for AMD Ryzen processor), uses main memory, DirectX® 12, one VGA, two DisplayPort™ (Onboard VGA and DP ports are invalid on the models with AMD Ryzen processor), supports 3 independent displays, works along with AMD discrete graphics to support more displays; <i>Max resolution:</i> 4096x2160 (DP) @60Hz; 1920x1200 (VGA) @60Hz <i>Some:</i> <b>NVIDIA GeForce® GT 730</b> , DirectX 12, 2GB, PCIe 2.0 x8 adapter, two DisplayPort, 35 watts; <i>Max resolution:</i> 3840x2160 (DisplayPort) @60Hz;	Preload	<b>Preloaded operating system</b> <i>Some:</i> Windows® 7 Professional 32/64 preinstalled through downgrade rights in Windows 10 Pro 64-bit (Only available with Pro A6/A10/A12-8xxx APUs) <i>Some:</i> Windows 10 Pro 64-bit <i>Some:</i> Windows 10 Home 64-bit <b>Preloaded applications (only some listed)</b> <ul style="list-style-type: none"> <li>Microsoft Office preloaded; purchase a product key to activate</li> <li>- Only for Window 10</li> <li>Lenovo Companion</li> <li>- Only for Window 7</li> <li>Lenovo Solution Center</li> <li>Lenovo ThinkVantage Tools</li> <li>Create Recovery Media</li> <li>Adobe® Reader®</li> <li>Cyberlink Power2Go Create (DVD±RW)</li> </ul>																																																												
Monitor cable	Optional DP to VGA, DP to DVI-D (single link), DP to dual DP, or DP to HDMI 1.4	Environment	ENERGY STAR® 6.1, EPEAT™ Gold rating (North America), ErP Lot 3, GREENGUARD®, RoHS-compliant																																																												
Chipset	<b>AMD B350 Chipset</b>	Accessories	For compatible accessories, please go to <a href="http://www.lenovoquickpick.com">http://www.lenovoquickpick.com</a>																																																												
Front ports*	Two USB 3.1 Gen2, two USB 3.1 Gen1, optional two USB 3.1 Type-C Gen 2 (only available via special bid), microphone (3.5mm), headphone (3.5mm)																																																														
Rear ports*	Two USB 3.1 Gen1, two USB 2.0, optional two USB 2.0, serial (9-pin), optional 2nd serial (9-pin), optional parallel (25-pin), ethernet (RJ-45), one VGA and two DisplayPort (not available on models with AMD Ryzen processor), two PS/2 ports (keyboard / mouse); additional DisplayPort on optional graphics on some models																																																														
Rear audio ports* IEEE 1394*	Line-in (3.5mm), line-out (3.5mm), microphone-in (3.5mm) None * Depending on many factors, actual data transfer speed may be lower than theoretical speed																																																														
Audio support	High Definition (HD) Audio, Realtek ALC662 / optional internal speaker (1.5 watt )																																																														
WLAN	<i>Some:</i> 11ac wireless, M.2 Card, Realtek RTL8821AE (dual band), Wi-Fi + Bluetooth 4.0 combo adapter, 1x1 <i>Some:</i> 11ac wireless, M.2 Card, Qualcomm Atheros QCA6174A (dual band), Wi-Fi + Bluetooth 4.1 combo adapter, 2x2 <i>Some:</i> 11ac wireless, M.2 Card, Qualcomm Atheros QCA9377 (dual band), Wi-Fi + Bluetooth 4.1 combo adapter, 1x1																																																														
Bluetooth™ Ethernet Modem	<i>Some:</i> Bluetooth 4.0 or 4.1 wireless, integrated in Wi-Fi + BT combo adapter Gigabit ethernet, Realtek RTL8111EPV, Wake on LAN® None																																																														
Manageability Security chip	DASH TPM (Trusted Platform Module) 2.0, TCG Certified * Downgrade to TPM1.2 for the models with Win10 DG Win7 32 OS																																																														

Note: The specifications above may not be available in all regions.

Lenovo, July 2017

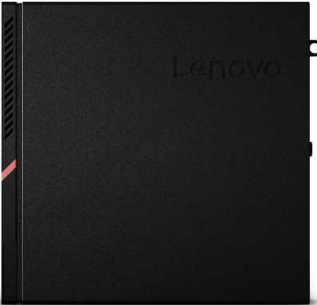

# ThinkCentre M715 Tiny (2<sup>nd</sup> Gen) Platform Specifications

Product Specifications Reference (PSREF)

Processor	AMD Athlon, A6, A10, A12, or Ryzen processor	Security features	<ul style="list-style-type: none"> <li>Security slot (in rear for optional Kensington® MicroSaver® cable)</li> <li>Administrator password</li> <li>Padlock loop</li> <li>Hard disk password</li> <li>Smart USB protection, allows keyboard/mouse only, blocks all storage devices</li> <li>Boot sequence control</li> <li>Power-on password</li> <li>Boot without keyboard and mouse</li> <li>Individual USB port disablement</li> <li>Chassis intrusion switch</li> </ul>																																																																								
	<table border="1"> <thead> <tr> <th>Processor</th> <th>Cores / Threads</th> <th>Frequency Base/Max</th> <th>L2 / L3 Cache</th> <th>Memory Support (Up to)</th> <th>Integrated Graphics</th> </tr> </thead> <tbody> <tr> <td>Athlon 200GE</td> <td>2 / 4</td> <td>3.2 GHz</td> <td>1 MB / 4MB</td> <td>DDR4-2933</td> <td>Radeon Vega 3</td> </tr> <tr> <td>Athlon PRO 200GE</td> <td>2 / 4</td> <td>3.2 GHz</td> <td>1 MB / 4MB</td> <td>DDR4-2933</td> <td>Radeon Vega 3</td> </tr> <tr> <td>PRO A6-8570E</td> <td>2 / 2</td> <td>3.0 / 3.4 GHz</td> <td>1 MB</td> <td>DDR4-2400</td> <td>Radeon R5</td> </tr> <tr> <td>PRO A10-8770E</td> <td>4 / 4</td> <td>2.8 / 3.5 GHz</td> <td>2 MB</td> <td>DDR4-2400</td> <td>Radeon R7</td> </tr> <tr> <td>PRO A6-9500E</td> <td>2 / 2</td> <td>3.0 / 3.4 GHz</td> <td>1 MB</td> <td>DDR4-2400</td> <td>Radeon R5</td> </tr> <tr> <td>PRO A10-9700E</td> <td>4 / 4</td> <td>3.0 / 3.5 GHz</td> <td>2 MB</td> <td>DDR4-2400</td> <td>Radeon R7</td> </tr> <tr> <td>PRO A12-9800E</td> <td>4 / 4</td> <td>3.1 / 3.8 GHz</td> <td>2 MB</td> <td>DDR4-2400</td> <td>Radeon R7</td> </tr> <tr> <td>Ryzen 3 2200GE</td> <td>4 / 4</td> <td>3.2 / 3.6 GHz</td> <td>2 MB / 4MB</td> <td>DDR4-2933</td> <td>Radeon Vega 8</td> </tr> <tr> <td>Ryzen 3 PRO 2200GE</td> <td>4 / 4</td> <td>3.2 / 3.6 GHz</td> <td>2 MB / 4MB</td> <td>DDR4-2933</td> <td>Radeon Vega 8</td> </tr> <tr> <td>Ryzen 5 2400GE</td> <td>4 / 8</td> <td>3.2 / 3.8 GHz</td> <td>2 MB / 4MB</td> <td>DDR4-2933</td> <td>Radeon RX Vega 11</td> </tr> <tr> <td>Ryzen 5 PRO 2400GE</td> <td>4 / 8</td> <td>3.2 / 3.8 GHz</td> <td>2 MB / 4MB</td> <td>DDR4-2933</td> <td>Radeon RX Vega 11</td> </tr> </tbody> </table>	Processor	Cores / Threads	Frequency Base/Max	L2 / L3 Cache	Memory Support (Up to)	Integrated Graphics	Athlon 200GE	2 / 4	3.2 GHz	1 MB / 4MB	DDR4-2933	Radeon Vega 3	Athlon PRO 200GE	2 / 4	3.2 GHz	1 MB / 4MB	DDR4-2933	Radeon Vega 3	PRO A6-8570E	2 / 2	3.0 / 3.4 GHz	1 MB	DDR4-2400	Radeon R5	PRO A10-8770E	4 / 4	2.8 / 3.5 GHz	2 MB	DDR4-2400	Radeon R7	PRO A6-9500E	2 / 2	3.0 / 3.4 GHz	1 MB	DDR4-2400	Radeon R5	PRO A10-9700E	4 / 4	3.0 / 3.5 GHz	2 MB	DDR4-2400	Radeon R7	PRO A12-9800E	4 / 4	3.1 / 3.8 GHz	2 MB	DDR4-2400	Radeon R7	Ryzen 3 2200GE	4 / 4	3.2 / 3.6 GHz	2 MB / 4MB	DDR4-2933	Radeon Vega 8	Ryzen 3 PRO 2200GE	4 / 4	3.2 / 3.6 GHz	2 MB / 4MB	DDR4-2933	Radeon Vega 8	Ryzen 5 2400GE	4 / 8	3.2 / 3.8 GHz	2 MB / 4MB	DDR4-2933	Radeon RX Vega 11	Ryzen 5 PRO 2400GE	4 / 8	3.2 / 3.8 GHz	2 MB / 4MB	DDR4-2933	Radeon RX Vega 11	Keyboard	<i>Some:</i> Lenovo Calliope Keyboard (USB connector), black <i>Some:</i> Lenovo Traditional Keyboard (USB connector), black <i>Some:</i> Lenovo Calliope Wireless Keyboard (2.4GHz via USB receiver), black
Processor	Cores / Threads	Frequency Base/Max	L2 / L3 Cache	Memory Support (Up to)	Integrated Graphics																																																																						
Athlon 200GE	2 / 4	3.2 GHz	1 MB / 4MB	DDR4-2933	Radeon Vega 3																																																																						
Athlon PRO 200GE	2 / 4	3.2 GHz	1 MB / 4MB	DDR4-2933	Radeon Vega 3																																																																						
PRO A6-8570E	2 / 2	3.0 / 3.4 GHz	1 MB	DDR4-2400	Radeon R5																																																																						
PRO A10-8770E	4 / 4	2.8 / 3.5 GHz	2 MB	DDR4-2400	Radeon R7																																																																						
PRO A6-9500E	2 / 2	3.0 / 3.4 GHz	1 MB	DDR4-2400	Radeon R5																																																																						
PRO A10-9700E	4 / 4	3.0 / 3.5 GHz	2 MB	DDR4-2400	Radeon R7																																																																						
PRO A12-9800E	4 / 4	3.1 / 3.8 GHz	2 MB	DDR4-2400	Radeon R7																																																																						
Ryzen 3 2200GE	4 / 4	3.2 / 3.6 GHz	2 MB / 4MB	DDR4-2933	Radeon Vega 8																																																																						
Ryzen 3 PRO 2200GE	4 / 4	3.2 / 3.6 GHz	2 MB / 4MB	DDR4-2933	Radeon Vega 8																																																																						
Ryzen 5 2400GE	4 / 8	3.2 / 3.8 GHz	2 MB / 4MB	DDR4-2933	Radeon RX Vega 11																																																																						
Ryzen 5 PRO 2400GE	4 / 8	3.2 / 3.8 GHz	2 MB / 4MB	DDR4-2933	Radeon RX Vega 11																																																																						
		Mouse	<i>Some:</i> Lenovo Calliope Mouse (USB connector), black <i>Some:</i> Lenovo Fingerprint Mouse (USB connector), Windows Hello support, black <i>Some:</i> Lenovo Calliope Wireless Mouse (2.4GHz via USB receiver), black																																																																								
Memory	32GB max, DDR4 2666*, two 260-pin SO-DIMM sockets, dual-channel capable * System automatically clocks down for the lower memory controller	Mechanical	Tiny (1L), black color; metal case <ul style="list-style-type: none"> <li>Toolless chassis open (need optional toolless chassis screw)</li> <li>Optional dust filter</li> </ul> M715 Gen2 Tiny only: 7.05" W X 7.20" D X 1.36" H 179mm W X 182.9mm D X 34.5mm H 2.91 lb (1.32 kg), weight may vary by configuration With VESA mount & ODD box: 7.42" W X 7.30" D X 2.48" H 188.4mm W X 185.38mm D X 63mm H 3.66 lb (1.66 kg), weight may vary by configuration																																																																								
Disk	<i>Some:</i> Hard Drive / SATA 6.0Gb/s, 2.5", 5400 rpm or 7200 rpm <i>Some:</i> Solid State Drive (SSD) / SATA 6.0Gb/s, 2.5" <i>Some:</i> M.2 SSD / PCIe NVMe, PCIe 3.0 x 4*, 32Gb/s * 128GB SSD M.2 (2242) PCIe NVMe only supports PCIe 3.0 x 2, 16Gb/s	VESA mount Floor Stand	Optional VESA mount bracket kit, supports VESA 75mm and 100mm Optional system floor stand for vertical orientation																																																																								
Optical	<i>Some:</i> DVD-ROM, 9.0mm high, via USB external ODD box <i>Some:</i> DVD±RW, 9.0mm high, via USB external ODD box	Power supply	65 watts AC/DC adapter, autosensing, 88% PSU (not included for TIO models)																																																																								
Onboard SATA	One SATA cable (1-drop to device), one SATA 6.0Gb/s connector on planar	Limited warranty	1-year or 3-year, limited onsite service / service upgrades available																																																																								
Graphics	<b>AMD Radeon™ Graphics</b> in processor, uses main memory, DirectX® 12, two DisplayPort™, one optional port (HDMI, VGA, or 3rd DP), supports 3 independent displays (supports maximum of 2 concurrent HDMI/DVI displays when using HDMI port or DP to DVI/HDMI dongles, and Athlon / Athlon PRO only support 2 displays); <i>Max resolution:</i> 4096x2160 (DP) @60Hz; 4096x2160 (HDMI) @30Hz; 1920x1200 (VGA) @60Hz	Preload	<b>Preloaded operating system</b> <i>Some:</i> Windows® 10 Pro 64-bit <i>Some:</i> Windows 10 Home 64-bit <i>Some:</i> Windows 7 Professional 64 preinstalled through downgrade rights in Windows 10 Pro 64-bit																																																																								
Monitor cable	Optional DP to VGA dongle, DP to DVI-D dongle, or DP to HDMI 1.4 dongle		<b>Preloaded applications (only some listed)</b> - Windows 10 only <ul style="list-style-type: none"> <li>Lenovo Vantage</li> <li>Microsoft Office preloaded; purchase a product key to activate</li> <li>Cyberlink PowerDVD (only for models with DVD / DVD±RW)</li> <li>Cyberlink Power2GO (only for models with DVD±RW)</li> <li>LinkedIn</li> <li>- Windows 7 only</li> <li>Lenovo Solution Center</li> <li>ThinkVantage System Update</li> <li>Create Recovery Media</li> <li>Microsoft Office preloaded; purchase a product key to activate</li> <li>Adobe® Reader®</li> </ul>																																																																								
Chipset	<b>AMD B300 Chipset</b>	Environment	ENERGY STAR® 7.0*, EPEAT™ Silver rating* (*Not for non-OS models); ErP Lot 3; ; RoHS-compliant																																																																								
Front ports* (Std.)	Two USB 3.1 Gen1 (one is Always On and fast charge), one microphone (stereo, 3.5mm), one headphone / microphone combo jack (stereo, 3.5mm)	MIL-SPEC test	MIL-STD-810G military certification (Low Pressure [Altitude], High Temperature, Low Temperature, Temperature Shock, Humidity, Sand and Dust, Vibration, Shock)																																																																								
Rear ports* (Std.)	One USB 3.1 Gen1 and three USB 2.0, ethernet (RJ-45), two DisplayPort, one headphone	Accessories	For compatible accessories, please go to <a href="http://smartfind.lenovo.com">http://smartfind.lenovo.com</a>																																																																								
Rear ports* (Opt.)	One optional port (VGA**, 3rd DP**, HDMI**, or serial on some models) * Depending on many factors, actual data transfer speed may be lower than theoretical speed ** Not support VGA, 3rd DP, HDMI for the models with Athlon / Athlon PRO																																																																										
Audio support	High Definition (HD) Audio, Realtek ALC233-VB2 / internal speaker (1.5 watt)																																																																										
WLAN	<i>Some:</i> 11ac wireless, M.2 Card, Realtek RTL8821CE (dual band), Wi-Fi + Bluetooth 4.2* combo adapter, 1x1 <i>Some:</i> 11ac wireless, M.2 Card, Qualcomm Atheros QCA9377 (dual band), Wi-Fi + Bluetooth 4.2* combo adapter, 1x1 <i>Some:</i> 11ac wireless, M.2 Card, Realtek RTL8822BE (dual band), Wi-Fi + Bluetooth 4.2* combo adapter, 2x2 <i>Some:</i> 11ac wireless, M.2 Card, Qualcomm Atheros QCA6174A (dual band), Wi-Fi + Bluetooth 4.2* combo adapter, 2x2 <i>Some:</i> Bluetooth 4.2* wireless, integrated in Wi-Fi + BT combo adapter * Hardware supports BT 4.2, but Win10 RS3 and earlier only supports BT 4.1 Gigabit ethernet, Realtek RTL8111EPV, Wake on LAN®																																																																										
Bluetooth																																																																											
Ethernet																																																																											
Manageability	DASH 1.0/1.1																																																																										
Security chip	Discrete TPM 2.0, TCG Certified																																																																										

Note: The specifications above may not be available in all regions.

Lenovo, July 2018



# ThinkCentre M715 Tiny Thin Client Platform Specifications

Product Specifications Reference (PSREF)

Processor	AMD A6, A10, or A12 series APUs						Keyboard	<i>Some:</i> Fullsize USB Keyboard (USB connector), Lenovo logo
							Mouse	<i>Some:</i> USB Optical Wheel Mouse, black, Lenovo logo
	APU	Cores	Frequency Base/Max	L2 Cache	Memory Types	Integrated Graphics	Mechanical	Tiny (1L), black color; metal case M715 Tiny only: 7.05" W X 7.20" D X 1.36" H 179mm W X 182.9mm D X 34.5mm H 2.9 lb (1.3 kg), weight may vary by configuration Optional VESA mount bracket kit, supports VESA 75mm and 100mm Optional system floor stand for vertical orientation
	PRO A6-8570E	2	3.0 / 3.4 GHz	1 MB	DDR4-2400	Radeon R5 Series	VESA mount	Optional VESA mount bracket kit, supports VESA 75mm and 100mm
PRO A10-8770E	4	2.8 / 3.5 GHz	2 MB	DDR4-2400	Radeon R7 Series	Floor Stand	Optional system floor stand for vertical orientation	
PRO A12-8870E*	4	2.9 / 3.8 GHz	2 MB	DDR4-2400	Radeon R7 Series			
*PRO A12-8870E (support Windows 10 IOT only) is only available via special bid models								
Memory	4GB max, DDR4 2400, two 260-pin SO-DIMM sockets							
Disk	<i>Some:</i> 256GB Solid State Drive (SSD) / SATA 6.0Gb/s, 2.5"* *256GB SATA (support Windows 10 IOT only) is only available via special bid models <i>Some:</i> 32GB M.2 Solid State Drive (SSD) / SATA interface <i>Some:</i> 128GB M.2 Solid State Drive (SSD) / PCIe NVMe interface							
Optical	None							
Onboard SATA	One SATA cable (1-drop to device), one SATA 6.0Gb/s connector on planar							
Media reader	None							
Graphics	<b>AMD Radeon™ Graphics</b> in processor, uses main memory, DirectX® 12, two DisplayPort™, one optional port (HDMI, VGA, or 3rd DP), supports 3 independent displays (supports maximum of 2 concurrent HDMI/DVI displays when using HDMI port or DP to DVI/HDMI dongles); <i>Max resolution:</i> 4096x2160 (DP) @60Hz; 4096x2160 (HDMI) @30Hz; 1920x1200 (VGA) @60Hz							
DP cable	Optional DP to VGA, DP to DVI-D (single link), or DP to HDMI 1.4 dongle							
Chipset	<b>AMD B300 Chipset</b>							
Front ports*	Two USB 3.0 (one is Always On and fast charge), one microphone (stereo, 3.5mm), one headphone / microphone combo jack (stereo, 3.5mm)							
Rear ports*	One USB 3.0 and three USB 2.0 (optional external optical box or I/O box occupies one specific USB 2.0 on some models), ethernet (RJ-45), two DisplayPort, one optional port (VGA, 3rd DP, HDMI, or serial on some models), one headphone							
I/O box	* Depending on many factors, actual data transfer speed may be lower than theoretical speed None							
Audio support	High Definition (HD) Audio, Realtek ALC233-CG / internal speaker (1.5 watt)							
WLAN <sup>13</sup>	<i>Some:</i> 11ac wireless, M.2 Card, Realtek RTL8821AE (dual band), Wi-Fi + Bluetooth 4.0 combo adapter, 1x1							
Bluetooth™	<i>Some:</i> Bluetooth 4.0 or 4.1 wireless, integrated in Wi-Fi + BT combo adapter							
Ethernet	Gigabit ethernet, Realtek RTL8111EPV, Wake on LAN®							
Modem	None							
Manageability	DASH 1.0/1.1							
Security chip	Discrete TPM 2.0, TCG Certified							
Security features	<ul style="list-style-type: none"> <li>● Security slot (in rear for optional Kensington® MicroSaver® cable)</li> <li>● Padlock loop</li> <li>● Smart USB protection, allows keyboard/mouse only, blocks all storage devices</li> <li>● Power-on password</li> <li>● Administrator password</li> <li>● Hard disk password</li> <li>● Boot sequence control</li> <li>● Boot without keyboard and mouse</li> <li>● Individual USB port disablement</li> <li>● Chassis intrusion switch</li> </ul>							

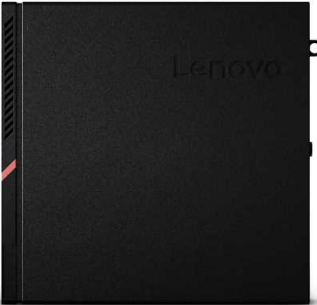



# ThinkCentre M715 Tiny Thin Client (2<sup>nd</sup> Gen) Platform Specifications

Product Specifications Reference (PSREF)

Processor	AMD Athlon, A6, A10, or Ryzen processor						Keyboard	<i>Some:</i> Lenovo Calliope Keyboard (USB connector), black <i>Some:</i> Lenovo Traditional Keyboard (USB connector), black <i>Some:</i> Lenovo Calliope Wireless Keyboard (2.4GHz via USB receiver), black <i>Some:</i> Lenovo Calliope Mouse (USB connector), black <i>Some:</i> Lenovo Fingerprint Mouse (USB connector), Windows Hello support, black <i>Some:</i> Lenovo Calliope Wireless Mouse (2.4GHz via USB receiver), black
	APU	Cores / Threads	Frequency Base/Max	L2 / L3 Cache	Memory Sup-port (Up to)	Integrated Graphics	Mouse	
	Athlon PRO 200GE	2 / 4	3.2 GHz	1 MB / 4MB	DDR4-2933	Radeon Vega 3		
	PRO A6-8570E	2 / 2	3.0 / 3.4 GHz	1 MB	DDR4-2400	Radeon R5		
	PRO A10-8770E	4 / 4	2.8 / 3.5 GHz	2 MB	DDR4-2400	Radeon R7		
	Ryzen 3 PRO 2200GE	4 / 4	3.2 / 3.6 GHz	2 MB / 4MB	DDR4-2933	Radeon Vega 8		
Memory	8GB max, DDR4 2666*, two 260-pin SO-DIMM sockets, dual-channel capable * System automatically clocks down for the lower memory controller						Mechanical	Tiny (1L), black color; metal case • Toolless chassis open (need optional toolless chassis screw) • Optional dust filter M715 Gen2 Tiny only: 7.05" W X 7.20" D X 1.36" H 179mm W X 182.9mm D X 34.5mm H 2.91 lb (1.32 kg), weight may vary by configuration VESA mount Optional VESA mount bracket kit, supports VESA 75mm and 100mm Floor Stand Optional system floor stand for vertical orientation
Disk	<i>Some:</i> 32GB M.2 Solid State Drive (SSD) / SATA interface <i>Some:</i> 128GB M.2 Solid State Drive (SSD) / PCIe NVMe, PCIe 3.0 x 2						Power supply	65 watts AC/DC adapter, autosensing, 88% PSU (not included for TIO models)
Optical	None						Limited warranty	1-year or 3-year, limited onsite service / service upgrades available
Onboard SATA	One SATA cable (1-drop to device), one SATA 6.0Gb/s connector on planar						Preload	<b>Preloaded operating system</b> <i>Some:</i> Windows Embedded Standard 7 V2 (WES 7 V2) <i>Some:</i> Windows 10 IoT Enterprise <i>Some:</i> LeTOS V2 (Lenovo Terminal Operating System, Linux-based)
Graphics	<b>AMD Radeon™ Graphics</b> in processor, uses main memory, DirectX® 12, two DisplayPort™, one optional port (HDMI, VGA, or 3rd DP), supports 3 independent displays (supports maximum of 2 concurrent HDMI/DVI displays when using HDMI port or DP to DVI/HDMI dongles, and Athlon / Athlon PRO only support 2 displays); <i>Max resolution:</i> 4096x2160 (DP) @60Hz; 4096x2160 (HDMI) @30Hz; 1920x1200 (VGA) @60Hz						Environment	ENERGY STAR® 6.1*, EPEAT™ Silver rating* (*not for non-OS models); ErP Lot 3; RoHS-compliant
Monitor cable	Optional DP to VGA dongle, DP to DVI-D dongle, or DP to HDMI 1.4 dongle						MIL-SPEC test	MIL-STD-810G military certification (Low Pressure [Altitude], High Temperature, Low Temperature, Temperature Shock, Humidity, Sand and Dust, Vibration, Shock)
Chipset	<b>AMD B300 Chipset</b>						Accessories	For compatible accessories, please go to <a href="http://smartfind.lenovo.com">http://smartfind.lenovo.com</a>
Front ports* (Std.)	Two USB 3.1 Gen1 (one is Always On and fast charge), one microphone (stereo, 3.5mm), one headphone / microphone combo jack (stereo, 3.5mm)							
Rear ports* (Std.)	One USB 3.1 Gen1 and three USB 2.0, ethernet (RJ-45), two DisplayPort, one headphone							
Rear ports* (Opt.)	One optional port (VGA**, 3rd DP**, HDMI**, or serial on some models) * Depending on many factors, actual data transfer speed may be lower than theoretical speed ** Not support VGA, 3rd DP, HDMI for the models with Athlon / Athlon PRO							
Audio support	High Definition (HD) Audio, Realtek ALC233-VB2 / internal speaker (1.5 watt)							
WLAN	<i>Some:</i> 11ac wireless, M.2 Card, Realtek RTL8821CE (dual band), Wi-Fi + Bluetooth 4.2* combo adapter, 1x1 <i>Some:</i> 11ac wireless, M.2 Card, Qualcomm Atheros QCA9377 (dual band), Wi-Fi + Bluetooth 4.2* combo adapter, 1x1 <i>Some:</i> 11ac wireless, M.2 Card, Realtek RTL8822BE (dual band), Wi-Fi + Bluetooth 4.2* combo adapter, 2x2 <i>Some:</i> 11ac wireless, M.2 Card, Qualcomm Atheros QCA6174A (dual band), Wi-Fi + Bluetooth 4.2* combo adapter, 2x2 <i>Some:</i> Bluetooth 4.2* wireless, integrated in Wi-Fi + BT combo adapter							
Bluetooth	* Hardware supports BT 4.2, but Win10 RS3 and earlier only supports BT 4.1							
Ethernet	Gigabit ethernet, Realtek RTL8111EPV, Wake on LAN®							
Manageability	DASH 1.0/1.1							
Security chip	Discrete TPM 2.0, TCG Certified							
Security features	<ul style="list-style-type: none"> <li>• Security slot (in rear for optional Kensington® MicroSaver® cable)</li> <li>• Padlock loop</li> <li>• Smart USB protection, allows keyboard/ mouse only, blocks all storage devices</li> <li>• Power-on password</li> <li>• Administrator password</li> <li>• Hard disk password</li> <li>• Boot sequence control</li> <li>• Boot without keyboard and mouse</li> <li>• Individual USB port disablement</li> <li>• Chassis intrusion switch</li> </ul>							

Note: The specifications above may not be available in all regions.

Lenovo, July 2018

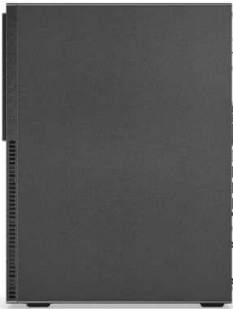



# ThinkCentre M715 Tower Platform Specifications

Product Specifications Reference (PSREF)

Processor	AMD A6 / A8 / A10 / A12 series APU and Ryzen 3 / 5 / 7 series processor	Manageability	DASH																																																												
	<table border="1"> <thead> <tr> <th>APU / processor</th> <th>Cores / Threads</th> <th>Frequency (Base/Max)</th> <th>L2 Cache</th> <th>Integrated Graphics</th> </tr> </thead> <tbody> <tr> <td>Ryzen 3 PRO 1200</td> <td>4 / 4</td> <td>3.1 / 3.4</td> <td>2MB</td> <td>None</td> </tr> <tr> <td>Ryzen 3 PRO 1300</td> <td>4 / 4</td> <td>3.5 / 3.7</td> <td>2MB</td> <td>None</td> </tr> <tr> <td>Ryzen 5 PRO 1500</td> <td>4 / 8</td> <td>3.5 / 3.7</td> <td>2MB</td> <td>None</td> </tr> <tr> <td>Ryzen 7 PRO 1700</td> <td>8 / 16</td> <td>3.0 / 3.7</td> <td>4MB</td> <td>None</td> </tr> <tr> <td>PRO A6-8570</td> <td>2 / 2</td> <td>3.5 / 3.8</td> <td>1MB</td> <td>Radeon R5 Series</td> </tr> <tr> <td>PRO A10-8770</td> <td>4 / 4</td> <td>3.5 / 3.8</td> <td>2MB</td> <td>Radeon R7 Series</td> </tr> <tr> <td>PRO A12-8870</td> <td>4 / 4</td> <td>3.7 / 4.2</td> <td>2MB</td> <td>Radeon R7 Series</td> </tr> <tr> <td>PRO A6-9500</td> <td>2 / 2</td> <td>3.5 / 3.8</td> <td>1MB</td> <td>Radeon R5 Series</td> </tr> <tr> <td>PRO A8-9600</td> <td>4 / 4</td> <td>3.1 / 3.4</td> <td>2MB</td> <td>Radeon R7 Series</td> </tr> <tr> <td>PRO A10-9700</td> <td>4 / 4</td> <td>3.5 / 3.8</td> <td>2MB</td> <td>Radeon R7 Series</td> </tr> <tr> <td>PRO A12-9800</td> <td>4 / 4</td> <td>3.8 / 4.2</td> <td>2MB</td> <td>Radeon R7 Series</td> </tr> </tbody> </table>	APU / processor	Cores / Threads	Frequency (Base/Max)	L2 Cache	Integrated Graphics	Ryzen 3 PRO 1200	4 / 4	3.1 / 3.4	2MB	None	Ryzen 3 PRO 1300	4 / 4	3.5 / 3.7	2MB	None	Ryzen 5 PRO 1500	4 / 8	3.5 / 3.7	2MB	None	Ryzen 7 PRO 1700	8 / 16	3.0 / 3.7	4MB	None	PRO A6-8570	2 / 2	3.5 / 3.8	1MB	Radeon R5 Series	PRO A10-8770	4 / 4	3.5 / 3.8	2MB	Radeon R7 Series	PRO A12-8870	4 / 4	3.7 / 4.2	2MB	Radeon R7 Series	PRO A6-9500	2 / 2	3.5 / 3.8	1MB	Radeon R5 Series	PRO A8-9600	4 / 4	3.1 / 3.4	2MB	Radeon R7 Series	PRO A10-9700	4 / 4	3.5 / 3.8	2MB	Radeon R7 Series	PRO A12-9800	4 / 4	3.8 / 4.2	2MB	Radeon R7 Series	Security chip	TPM (Trusted Platform Module) 2.0, TCG Certified * Downgrade to TPM1.2 for the models with Win10 DG Win7 32 OS
APU / processor	Cores / Threads	Frequency (Base/Max)	L2 Cache	Integrated Graphics																																																											
Ryzen 3 PRO 1200	4 / 4	3.1 / 3.4	2MB	None																																																											
Ryzen 3 PRO 1300	4 / 4	3.5 / 3.7	2MB	None																																																											
Ryzen 5 PRO 1500	4 / 8	3.5 / 3.7	2MB	None																																																											
Ryzen 7 PRO 1700	8 / 16	3.0 / 3.7	4MB	None																																																											
PRO A6-8570	2 / 2	3.5 / 3.8	1MB	Radeon R5 Series																																																											
PRO A10-8770	4 / 4	3.5 / 3.8	2MB	Radeon R7 Series																																																											
PRO A12-8870	4 / 4	3.7 / 4.2	2MB	Radeon R7 Series																																																											
PRO A6-9500	2 / 2	3.5 / 3.8	1MB	Radeon R5 Series																																																											
PRO A8-9600	4 / 4	3.1 / 3.4	2MB	Radeon R7 Series																																																											
PRO A10-9700	4 / 4	3.5 / 3.8	2MB	Radeon R7 Series																																																											
PRO A12-9800	4 / 4	3.8 / 4.2	2MB	Radeon R7 Series																																																											
		Security features	<ul style="list-style-type: none"> <li>Security slot (in rear for optional Kensington® MicroSaver® cable)</li> <li>Padlock loop</li> <li>Smart USB protection, allows keyboard/mouse only, blocks all storage devices</li> <li>Optional cable lock to physically lock both keyboard and mouse</li> <li>Power-on password</li> <li>Administrator password</li> <li>Hard disk password</li> <li>Boot sequence control</li> <li>Boot without keyboard and mouse</li> <li>Individual USB port disablement</li> <li>Optional chassis intrusion switch</li> </ul>																																																												
		Keyboard	<i>Some:</i> Lenovo Calliope Keyboard (USB connector), black <i>Some:</i> Lenovo Traditional Keyboard (USB connector), black <i>Some:</i> Lenovo Calliope Wireless Keyboard (2.4GHz via USB receiver), black <i>Some:</i> Lenovo Calliope Mouse (USB connector), black <i>Some:</i> Lenovo Calliope Wireless Mouse (2.4GHz via USB receiver), black <i>Some:</i> Lenovo Fingerprint Mouse (USB connector), Windows Hello support, black																																																												
		Mouse	<i>Some:</i> Lenovo Calliope Mouse (USB connector), black <i>Some:</i> Lenovo Calliope Wireless Mouse (2.4GHz via USB receiver), black <i>Some:</i> Lenovo Fingerprint Mouse (USB connector), Windows Hello support, black																																																												
Memory	64GB max, UDIMM, DDR4-2400*, four 288-pin DIMM sockets, non-ECC, dual-channel capable * System automatically clocks down for the processors with lower memory controller	Mechanical	<ul style="list-style-type: none"> <li>Tower (15L), black color, metal case</li> <li>(WxDxH) 5.7" X 11.5" X 14.4"; 145mm X 292.7mm X 366mm</li> <li>Approx. 14.3 lb (6.5 kg), weight may vary by configuration</li> <li>Optional dust filter</li> <li>Bay 1: Slim external ODD bay</li> <li>Bay 2: 3.5", internal, HDD/SSD</li> <li>Bay 3: 2.5", internal, HDD/SSD</li> <li>Slot 1: half-length full-height (length &lt; 189mm, height &lt; 104mm), PCIe 3.0 x16*</li> <li>Slot 2: half-length full-height (length &lt; 189mm, height &lt; 104mm), PCIe 2.0 x1*</li> <li>Slot 3: half-length full-height (length &lt; 189mm, height &lt; 104mm), PCIe 2.0 x1*</li> <li>Slot 4: no slot, only bracket for optional port extension*</li> <li>M.2 card slots: two (one for WLAN, one for SSD)</li> <li>* Optional front USB3.1 Type-C x2 module occupies PCIe x16 slot (x4 card), optional rear 2x USB2.0 / parallel / 2nd serial occupies one expansion slot</li> </ul>																																																												
Storage	<i>Some:</i> Hard Drive / SATA 6.0Gb/s, 2.5" or 3.5", 5400 rpm or 7200 rpm <i>Some:</i> Solid State Drive (SSD) / SATA 6.0Gb/s, 2.5" <i>Some:</i> M.2 Solid State Drive (SSD) / PCIe NVMe, PCIe 3.0 x 4, 32Gb/s	Power supply	<i>Some:</i> 180 watts, autosensing, 85% PSU <i>Some:</i> 210 watts, autosensing, 85% PSU <i>Some:</i> 210 watts, autosensing, 92% PSU (only available via special bid)																																																												
Optical	<i>Some:</i> DVD-ROM SATA 1.5Gb/s Drive, slim (9.0mm) <i>Some:</i> DVD Burner (DVD±RW), SATA 1.5Gb/s Drive, slim (9.0mm)	Limited warranty	<i>Some:</i> <b>1-year</b> or <b>3-year, depot service</b> / service upgrades available <i>Some:</i> <b>1-year</b> or <b>3-year, limited onsite service</b> / service upgrades available																																																												
Onboard SATA Media reader	Three onboard SATA 6.0Gb/s connectors Optional 7-in-1 media reader	Preload	<b>Preloaded operating system</b> <i>Some:</i> Windows® 7 Professional 32/64 preinstalled through downgrade rights in Windows 10 Pro 64-bit (Only available with Pro A6/A10/A12-8xxx APUs) <i>Some:</i> Windows 10 Pro 64-bit <i>Some:</i> Windows 10 Home 64-bit <b>Preloaded applications (only some listed)</b> <ul style="list-style-type: none"> <li>Microsoft Office preloaded; purchase a product key to activate</li> <li>Only for Window 10</li> <li>Lenovo Companion</li> <li>Only for Window 7</li> <li>Lenovo Solution Center</li> <li>Lenovo ThinkVantage Tools</li> <li>Create Recovery Media</li> <li>Adobe® Reader®</li> <li>Cyberlink PowerDVD Create (DVD±RW)</li> </ul>																																																												
Graphics	<b>AMD Radeon™ Graphics in processor</b> (not for AMD Ryzen processor), uses main memory, DirectX® 12, one VGA, two DisplayPort™ (Onboard VGA and DP ports are invalid on the models with AMD Ryzen processor), supports 3 independent displays, works along with AMD discrete graphics to support more displays; <i>Max resolution:</i> 4096x2160 (DP)@60Hz; 1920x1200 (VGA)@60Hz <i>Some:</i> <b>NVIDIA GeForce® GT 730</b> , DirectX 12, 2GB, PCIe 2.0 x8 adapter, two DisplayPort, 35 watts; <i>Max resolution:</i> 3840x2160 (DisplayPort)@60Hz; <i>Some:</i> <b>AMD Radeon™ RX 550</b> , DirectX 12, 2GB, PCIe 3.0 x8 adapter, one VGA, one HDMI, one DisplayPort, 50 watts, occupies two slots; <i>Max resolution:</i> 4096x2160 (HDMI)@60Hz; 2048x1536 (VGA)@60Hz; 5120x2880 (DP)@60Hz	Monitor Cable	Optional DP to VGA, DP to DVI-D (single link), DP to dual DP, or DP to HDMI 1.4																																																												
Chipset	<b>AMD B350 Chipset</b>	Front ports*	Two USB 3.1 Gen2, two USB 3.1 Gen1, optional two USB 3.1 Type-C Gen 2 (only available via special bid), microphone (3.5mm), headphone (3.5mm)																																																												
Monitor Cable	Optional DP to VGA, DP to DVI-D (single link), DP to dual DP, or DP to HDMI 1.4	Rear ports*	Two USB 3.1 Gen1, two USB 2.0, optional two USB 2.0, serial (9-pin), optional 2nd serial (9-pin), optional parallel (25-pin), ethernet (RJ-45), one VGA and two DisplayPort (not available on models with AMD Ryzen processor), two PS/2 ports (keyboard / mouse); additional VGA, DisplayPort, or HDMI on optional graphics on some models																																																												
Chipset	<b>AMD B350 Chipset</b>	Rear audio ports* IEEE 1394*	Line-in (3.5mm), line-out (3.5mm), microphone-in (3.5mm) None * Depending on many factors, actual data transfer speed may be lower than theoretical speed																																																												
Front ports*	Two USB 3.1 Gen2, two USB 3.1 Gen1, optional two USB 3.1 Type-C Gen 2 (only available via special bid), microphone (3.5mm), headphone (3.5mm)	Audio support	High Definition (HD) Audio, Realtek ALC662 / optional internal speaker (1.5 watt )																																																												
Rear ports*	Two USB 3.1 Gen1, two USB 2.0, optional two USB 2.0, serial (9-pin), optional 2nd serial (9-pin), optional parallel (25-pin), ethernet (RJ-45), one VGA and two DisplayPort (not available on models with AMD Ryzen processor), two PS/2 ports (keyboard / mouse); additional VGA, DisplayPort, or HDMI on optional graphics on some models	WLAN	<i>Some:</i> 11ac wireless, M.2 Card, Realtek RTL8821AE (dual band), Wi-Fi + Bluetooth 4.0 combo adapter, 1x1 <i>Some:</i> 11ac wireless, M.2 Card, Qualcomm Atheros QCA6174A (dual band), Wi-Fi + Bluetooth 4.1 combo adapter, 2x2 <i>Some:</i> 11ac wireless, M.2 Card, Qualcomm Atheros QCA9377 (dual band), Wi-Fi + Bluetooth 4.1 combo adapter, 1x1																																																												
Rear audio ports* IEEE 1394*	Line-in (3.5mm), line-out (3.5mm), microphone-in (3.5mm) None * Depending on many factors, actual data transfer speed may be lower than theoretical speed	Bluetooth™	<i>Some:</i> Bluetooth 4.0 or 4.1 wireless, integrated in Wi-Fi + BT combo adapter																																																												
Audio support	High Definition (HD) Audio, Realtek ALC662 / optional internal speaker (1.5 watt )	Ethernet	Gigabit ethernet, Realtek RTL8111EPV, Wake on LAN®																																																												
WLAN	<i>Some:</i> 11ac wireless, M.2 Card, Realtek RTL8821AE (dual band), Wi-Fi + Bluetooth 4.0 combo adapter, 1x1 <i>Some:</i> 11ac wireless, M.2 Card, Qualcomm Atheros QCA6174A (dual band), Wi-Fi + Bluetooth 4.1 combo adapter, 2x2 <i>Some:</i> 11ac wireless, M.2 Card, Qualcomm Atheros QCA9377 (dual band), Wi-Fi + Bluetooth 4.1 combo adapter, 1x1	Modem	None																																																												
Bluetooth™	<i>Some:</i> Bluetooth 4.0 or 4.1 wireless, integrated in Wi-Fi + BT combo adapter	Environment	ENERGY STAR® 6.1, EPEAT™ Gold rating (North America), ErP Lot 3, GREENGUARD®, RoHS-compliant																																																												
Ethernet	Gigabit ethernet, Realtek RTL8111EPV, Wake on LAN®	Accessories	For compatible accessories, please go to <a href="http://www.lenovoquickpick.com">http://www.lenovoquickpick.com</a>																																																												
Modem	None																																																														

Note: The specifications above may not be available in all regions.

Lenovo, July 2017



# ThinkCentre M720 SFF Platform Specifications

Product Specifications Reference (PSREF)

Processor	Intel® Celeron®, Intel Pentium®, or 8th / 9th Gen Intel Core™ i3 / i5 / i7 / i9 Processor	<p><i>Some:</i> 11ac wireless, M.2 Card, Realtek RTL8822BE (dual band), Wi-Fi + Bluetooth 4.2 combo adapter, 2x2</p> <p><i>Some:</i> 11ac wireless, M.2 Card, Intel Dual Band Wireless-AC 3165, Wi-Fi + Bluetooth 4.2 combo adapter, 1x1</p> <p><i>Some:</i> 11ac wireless, M.2 Card, Intel Dual Band Wireless-AC 8265, Wi-Fi + Bluetooth 4.2 combo adapter, 2x2</p> <p><i>Some:</i> Bluetooth 4.2 wireless, integrated in Wi-Fi + BT combo adapter</p>																																																																																																																								
	<table border="1"> <thead> <tr> <th>Processor</th> <th>Cores / Threads</th> <th>Frequency Base/Max(GHz)</th> <th>Cache</th> <th>Memory Support (Up to)</th> <th>Integrated Graphics</th> </tr> </thead> <tbody> <tr><td>Celeron G4900</td><td>2 / 2</td><td>3.1G</td><td>2 MB</td><td>DDR4-2400</td><td>UHD 610</td></tr> <tr><td>Celeron G4920</td><td>2 / 2</td><td>3.2G</td><td>2 MB</td><td>DDR4-2400</td><td>UHD 610</td></tr> <tr><td>Pentium Gold G5400</td><td>2 / 4</td><td>3.7G</td><td>4 MB</td><td>DDR4-2400</td><td>UHD 610</td></tr> <tr><td>Pentium Gold G5500</td><td>2 / 4</td><td>3.8G</td><td>4 MB</td><td>DDR4-2400</td><td>UHD 630</td></tr> <tr><td>Pentium Gold G5600</td><td>2 / 4</td><td>3.9G</td><td>4 MB</td><td>DDR4-2400</td><td>UHD 630</td></tr> <tr><td>Core i3-8100</td><td>4 / 4</td><td>3.6G</td><td>6 MB</td><td>DDR4-2400</td><td>UHD 630</td></tr> <tr><td>Core i3-8300</td><td>4 / 4</td><td>3.7G</td><td>8 MB</td><td>DDR4-2400</td><td>UHD 630</td></tr> <tr><td>Core i5-8400</td><td>6 / 6</td><td>2.8G / 4.0G</td><td>9 MB</td><td>DDR4-2666</td><td>UHD 630</td></tr> <tr><td>Core i5-8500</td><td>6 / 6</td><td>3.0G / 4.1G</td><td>9 MB</td><td>DDR4-2666</td><td>UHD 630</td></tr> <tr><td>Core i5-8600</td><td>6 / 6</td><td>3.1G / 4.3G</td><td>9 MB</td><td>DDR4-2666</td><td>UHD 630</td></tr> <tr><td>Core i7-8700</td><td>6 / 12</td><td>3.2G / 4.6G</td><td>12 MB</td><td>DDR4-2666</td><td>UHD 630</td></tr> <tr><td>Core i3-9100</td><td>4 / 4</td><td>3.6G / 4.2G</td><td>6 MB</td><td>DDR4-2400</td><td>UHD 630</td></tr> <tr><td>Core i3-9300</td><td>4 / 4</td><td>3.7G / 4.3G</td><td>8 MB</td><td>DDR4-2400</td><td>UHD 630</td></tr> <tr><td>Core i3-9320</td><td>4 / 4</td><td>3.7G / 4.4G</td><td>8 MB</td><td>DDR4-2400</td><td>UHD 630</td></tr> <tr><td>Core i5-9400</td><td>6 / 6</td><td>2.9G / 4.1G</td><td>9 MB</td><td>DDR4-2666</td><td>UHD 630</td></tr> <tr><td>Core i5-9500</td><td>6 / 6</td><td>3.0G / 4.4G</td><td>9 MB</td><td>DDR4-2666</td><td>UHD 630</td></tr> <tr><td>Core i5-9600</td><td>6 / 6</td><td>3.1G / 4.6G</td><td>9 MB</td><td>DDR4-2666</td><td>UHD 630</td></tr> <tr><td>Core i7-9700</td><td>8 / 8</td><td>3.0G / 4.7G</td><td>12 MB</td><td>DDR4-2666</td><td>UHD 630</td></tr> <tr><td>Core i9-9900</td><td>8 / 16</td><td>3.1G / 5.0G</td><td>16 MB</td><td>DDR4-2666</td><td>UHD 630</td></tr> </tbody> </table>	Processor	Cores / Threads	Frequency Base/Max(GHz)	Cache	Memory Support (Up to)	Integrated Graphics	Celeron G4900	2 / 2	3.1G	2 MB	DDR4-2400	UHD 610	Celeron G4920	2 / 2	3.2G	2 MB	DDR4-2400	UHD 610	Pentium Gold G5400	2 / 4	3.7G	4 MB	DDR4-2400	UHD 610	Pentium Gold G5500	2 / 4	3.8G	4 MB	DDR4-2400	UHD 630	Pentium Gold G5600	2 / 4	3.9G	4 MB	DDR4-2400	UHD 630	Core i3-8100	4 / 4	3.6G	6 MB	DDR4-2400	UHD 630	Core i3-8300	4 / 4	3.7G	8 MB	DDR4-2400	UHD 630	Core i5-8400	6 / 6	2.8G / 4.0G	9 MB	DDR4-2666	UHD 630	Core i5-8500	6 / 6	3.0G / 4.1G	9 MB	DDR4-2666	UHD 630	Core i5-8600	6 / 6	3.1G / 4.3G	9 MB	DDR4-2666	UHD 630	Core i7-8700	6 / 12	3.2G / 4.6G	12 MB	DDR4-2666	UHD 630	Core i3-9100	4 / 4	3.6G / 4.2G	6 MB	DDR4-2400	UHD 630	Core i3-9300	4 / 4	3.7G / 4.3G	8 MB	DDR4-2400	UHD 630	Core i3-9320	4 / 4	3.7G / 4.4G	8 MB	DDR4-2400	UHD 630	Core i5-9400	6 / 6	2.9G / 4.1G	9 MB	DDR4-2666	UHD 630	Core i5-9500	6 / 6	3.0G / 4.4G	9 MB	DDR4-2666	UHD 630	Core i5-9600	6 / 6	3.1G / 4.6G	9 MB	DDR4-2666	UHD 630	Core i7-9700	8 / 8	3.0G / 4.7G	12 MB	DDR4-2666	UHD 630	Core i9-9900	8 / 16	3.1G / 5.0G	16 MB	DDR4-2666	UHD 630	<p><i>Some:</i> Gigabit ethernet, Intel Ethernet Connection I219-V (Jacksonville), Wake on LAN®</p> <p><i>Some:</i> Intel Ethernet Server Adapter I350-T4*, gigabit ethernet, 4x RJ-45, PCIe x4</p> <p><i>Some:</i> Bitland BN8E88*, gigabit ethernet, PCIe x1 (only available via special bid)</p> <p>* Choose either I350-T4 or BN8E88</p>
Processor	Cores / Threads	Frequency Base/Max(GHz)	Cache	Memory Support (Up to)	Integrated Graphics																																																																																																																					
Celeron G4900	2 / 2	3.1G	2 MB	DDR4-2400	UHD 610																																																																																																																					
Celeron G4920	2 / 2	3.2G	2 MB	DDR4-2400	UHD 610																																																																																																																					
Pentium Gold G5400	2 / 4	3.7G	4 MB	DDR4-2400	UHD 610																																																																																																																					
Pentium Gold G5500	2 / 4	3.8G	4 MB	DDR4-2400	UHD 630																																																																																																																					
Pentium Gold G5600	2 / 4	3.9G	4 MB	DDR4-2400	UHD 630																																																																																																																					
Core i3-8100	4 / 4	3.6G	6 MB	DDR4-2400	UHD 630																																																																																																																					
Core i3-8300	4 / 4	3.7G	8 MB	DDR4-2400	UHD 630																																																																																																																					
Core i5-8400	6 / 6	2.8G / 4.0G	9 MB	DDR4-2666	UHD 630																																																																																																																					
Core i5-8500	6 / 6	3.0G / 4.1G	9 MB	DDR4-2666	UHD 630																																																																																																																					
Core i5-8600	6 / 6	3.1G / 4.3G	9 MB	DDR4-2666	UHD 630																																																																																																																					
Core i7-8700	6 / 12	3.2G / 4.6G	12 MB	DDR4-2666	UHD 630																																																																																																																					
Core i3-9100	4 / 4	3.6G / 4.2G	6 MB	DDR4-2400	UHD 630																																																																																																																					
Core i3-9300	4 / 4	3.7G / 4.3G	8 MB	DDR4-2400	UHD 630																																																																																																																					
Core i3-9320	4 / 4	3.7G / 4.4G	8 MB	DDR4-2400	UHD 630																																																																																																																					
Core i5-9400	6 / 6	2.9G / 4.1G	9 MB	DDR4-2666	UHD 630																																																																																																																					
Core i5-9500	6 / 6	3.0G / 4.4G	9 MB	DDR4-2666	UHD 630																																																																																																																					
Core i5-9600	6 / 6	3.1G / 4.6G	9 MB	DDR4-2666	UHD 630																																																																																																																					
Core i7-9700	8 / 8	3.0G / 4.7G	12 MB	DDR4-2666	UHD 630																																																																																																																					
Core i9-9900	8 / 16	3.1G / 5.0G	16 MB	DDR4-2666	UHD 630																																																																																																																					
		<p>None</p> <p>Discrete TPM 2.0, TCG Certified</p> <p>Security chip</p> <p>Security features</p> <ul style="list-style-type: none"> <li>• Security slot (in rear for optional Kensington® MicroSaver® cable)</li> <li>• Padlock loop</li> <li>• Optional cable lock to physically lock both keyboard and mouse</li> <li>• Optional chassis intrusion switch</li> <li>• Optional chassis E-Lock (special bid)</li> <li>• Power-on password</li> <li>• Administrator password</li> <li>• Hard disk password</li> <li>• Boot sequence control</li> <li>• Boot without keyboard and mouse</li> <li>• Individual USB port disablement</li> <li>• Smart USB protection, allows keyboard/mouse only, blocks all storage devices</li> </ul>																																																																																																																								
		<p>Keyboard</p> <p><i>Some:</i> Lenovo Calliope Keyboard (USB connector), black</p> <p><i>Some:</i> Lenovo Traditional Keyboard (USB connector), black</p> <p><i>Some:</i> Lenovo Calliope Wireless Keyboard (2.4GHz via USB receiver), black</p> <p><i>Some:</i> Lenovo Keyboard (PS/2 connector), black (only available via special bid)</p> <p><i>Some:</i> Lenovo Calliope Mouse (USB connector), black</p> <p><i>Some:</i> Lenovo Fingerprint Mouse (USB connector), Windows Hello support, black</p> <p><i>Some:</i> Lenovo Calliope Wireless Mouse (2.4GHz via USB receiver), black</p> <p><i>Some:</i> Lenovo Mouse (PS/2 connector), black (only available via special bid)</p>																																																																																																																								
Memory	64GB max, UDIMM, DDR4-2666, four 288-pin DIMM sockets, non-ECC, dual-channel capable* * System automatically clocks down for the processors with lower memory controller																																																																																																																									
Storage	<p><i>Some:</i> Hard Drive / SATA 6.0Gb/s, 2.5" or 3.5", 5400 rpm or 7200 rpm</p> <p><i>Some:</i> Solid State Drive (SSD) / SATA 6.0Gb/s, 2.5"</p> <p><i>Some:</i> M.2 Solid State Drive (SSD) / PCIe NVMe, PCIe 3.0 x 4*, 32Gb/s</p> <p>* M.2 SSD (2242) PCIe NVMe only supports PCIe 3.0 x 2, 16Gb/s</p> <p><i>Some:</i> Intel Optane™ Memory (not support Celeron / Pentium Processor), M.2</p>																																																																																																																									
Optical	<p><i>Some:</i> DVD-ROM SATA 1.5Gb/s Drive, slim (9.0mm)</p> <p><i>Some:</i> DVD Burner (DVD±RW), SATA 1.5Gb/s Drive, slim (9.0mm)</p>																																																																																																																									
Onboard SATA Media reader	Three onboard SATA 6.0Gb/s connectors Optional 7-in-1 media reader																																																																																																																									
Graphics	<p><b>Intel UHD Graphics 610/630</b> in processor, uses main memory, DirectX® 12, one VGA, two DisplayPort™, supports 3 independent displays, works along with discrete graphics to support more displays;</p> <p><i>Max resolution:</i> 4096x2304 (DP)@60Hz; 2048x1536 (VGA)@50Hz</p> <p><i>Some:</i> <b>NVIDIA GeForce® GT 730</b>, DirectX 12, 2GB, PCIe 2.0 x16 adapter, two DisplayPort, 35 watts;</p> <p><i>Max resolution:</i> 3840x2160 (DisplayPort)@60Hz;</p>																																																																																																																									
Monitor cable	Optional DP to VGA dongle, DP to DVI-D dongle, DP to dual DP dongle (for Collage Display with intel integrated graphics), or DP to HDMI 1.4 dongle																																																																																																																									
Chipset	<b>Intel B360 Chipset</b>																																																																																																																									
Front ports* (Std.)	2x USB 3.1 Gen2, 2x USB 3.1 Gen1, 1x USB 3.1 Type-C Gen1 (15W charging), 1x microphone (3.5mm), 1x headphone / microphone combo jack (3.5mm)																																																																																																																									
Front ports* (Opt.)	Optional: 1x media reader																																																																																																																									
Rear ports* (Std.)	4x USB 2.0, 1x serial (9-pin), 1x ethernet (RJ-45), 1x VGA, 2x DisplayPort, 1x line-out (3.5mm)																																																																																																																									
Rear ports* (Opt.)	Optional: 2x USB 3.1 Gen1 via PCI2 x1**, 2x USB 3.1 Type-C Gen2 via PCIe x4** (special bid only), 1x 2nd serial (9-pin), 4x serial (9-pin) via PCIe x1, 1x parallel (25-pin), 2x PS/2 ports (keyboard/mouse), additional RJ-45 and video ports available on optional graphics or ethernet card																																																																																																																									
	* Depending on many factors, actual data transfer speed may be lower than theoretical speed																																																																																																																									
	** Choose either 2x USB 3.1 Gen1 or 2x USB 3.1 Type-C Gen2																																																																																																																									
Audio support	High Definition (HD) Audio, Realtek ALC233VB2 / internal speaker (2 watt)																																																																																																																									
WLAN	<i>Some:</i> 11ac wireless, M.2 Card, Realtek RTL8821CE (dual band), Wi-Fi + Bluetooth 4.2 combo adapter, 1x1																																																																																																																									
Mechanical	<ul style="list-style-type: none"> <li>• SFF (8.4L), black color; metal case</li> <li>• (WxDxH) 3.64" X 11.44" X 13.52"; 92.5mm X 290.5mm X 343.5mm</li> <li>• Approx. 13.24 lb (6.0 kg), weight may vary by configuration</li> <li>• Toolless cover, disk, optical, and extension card removal</li> <li>• Optional dust filter</li> </ul> <p>Bay 1: Slim external ODD bay Bay 2: 3.5", 1" high, internal, HDD/SSD Bay 3: 2.5", internal, HDD/SSD (optional bay) Slot 1: low-profile (length &lt; 147mm, height &lt; 68.9mm), PCIe 3.0 x16 Slot 2: low-profile (length &lt; 147mm, height &lt; 68.9mm), PCIe 3.0 x1 Slot 3: low-profile (length &lt; 147mm, height &lt; 68.9mm), PCIe 3.0 x1 Slot 4: no slot, only bracket for optional port extension M.2 card slots: Two (one for WLAN, one for SSD/Optane)</p>																																																																																																																									
Floor Stand	Optional system floor stand for vertical orientation																																																																																																																									
Power supply	<p><i>Some:</i> 180 watts, autosensing, 85% PSU</p> <p><i>Some:</i> 210 watts, autosensing, 85% PSU</p> <p><i>Some:</i> 260 watts, autosensing, 92% PSU (only available via special bid)</p>																																																																																																																									
Limited warranty <sup>3</sup>	<p><i>Some:</i> <b>1-year</b> or <b>3-year, depot service</b> / service upgrades available</p> <p><i>Some:</i> <b>1-year</b> or <b>3-year, limited onsite service</b> / service upgrades available</p>																																																																																																																									
Preload	<p><b>Preloaded operating system</b></p> <p><i>Some:</i> Windows® 10 Pro 64-bit</p> <p><i>Some:</i> Windows 10 Home 64-bit</p> <p><b>Preloaded applications (only some listed)</b></p> <ul style="list-style-type: none"> <li>• Lenovo Vantage</li> <li>• Microsoft Office preloaded; purchase a product key to activate</li> <li>• Cyberlink PowerDVD (only for models with DVD / DVD±RW)</li> <li>• Cyberlink Power2GO (only for models with DVD±RW)</li> <li>• LinkedIn</li> </ul>																																																																																																																									
Environment	ENERGY STAR® 6.1, EPEAT™ Silver rating (North America), ErP Lot 3, TCO, TUV low noise verified (coming soon, on some models), RoHS-compliant																																																																																																																									
Accessories	For compatible accessories, please go to <a href="http://smartfind.lenovo.com">http://smartfind.lenovo.com</a>																																																																																																																									

Note: The specifications above may not be available in all regions.

Lenovo, June 2019





# ThinkCentre M720 Tiny Platform Specifications

Product Specifications Reference (PSREF)

Processor	Intel® Celeron®, Intel Pentium®, or 8th / 9th Gen Intel Core™ i3 / i5 / i7 / i9 Processor						<b>Manageability</b> None <b>Security chip</b> Discrete TPM 2.0, TCG Certified <b>Security features</b> <ul style="list-style-type: none"> <li>Security slot (in rear for optional Kensington® MicroSaver® cable)</li> <li>Chassis intrusion switch</li> <li>Power-on password</li> <li>Administrator password</li> <li>Hard disk password</li> <li>Boot sequence control</li> <li>Boot without keyboard and mouse</li> <li>Individual USB port disablement</li> <li>Smart USB protection, allows keyboard/mouse only, blocks all storage devices</li> </ul>						
	Processor	Cores / Threads	Frequency Base/Max(GHz)	Cache	Memory Support (Up to)	Integrated Graphics							
	Celeron G4900T	2 / 2	2.9G	2 MB	DDR4-2400	UHD 610							
	Pentium Gold G5400T	2 / 4	3.1G	4 MB	DDR4-2400	UHD 610							
	Pentium Gold G5500T	2 / 4	3.2G	4 MB	DDR4-2400	UHD 630							
	Core i3-8100T	4 / 4	3.1G	6 MB	DDR4-2400	UHD 630							
	Core i3-8300T	4 / 4	3.2G	8 MB	DDR4-2400	UHD 630							
	Core i5-8400T	6 / 6	1.7G / 3.3G	9 MB	DDR4-2666	UHD 630							
	Core i5-8500T	6 / 6	2.1G / 3.5G	9 MB	DDR4-2666	UHD 630							
	Core i5-8600T	6 / 6	2.3G / 3.7G	9 MB	DDR4-2666	UHD 630							
	Core i7-8700T	6 / 12	2.4G / 4.0G	12 MB	DDR4-2666	UHD 630							
	Core i3-9100T	4 / 4	3.1G / 3.7G	6 MB	DDR4-2400	UHD 630							
	Core i3-9300T	4 / 4	3.2G / 3.8G	8 MB	DDR4-2400	UHD 630							
	Core i5-9400T	6 / 6	1.8G / 3.4G	9 MB	DDR4-2666	UHD 630							
	Core i5-9500T	6 / 6	2.2G / 3.7G	9 MB	DDR4-2666	UHD 630							
	Core i5-9600T	6 / 6	2.3G / 3.9G	9 MB	DDR4-2666	UHD 630							
	Core i7-9700T	8 / 8	2.0G / 4.3G	12 MB	DDR4-2666	UHD 630							
Core i9-9900T	8 / 16	2.1G / 4.4G	16 MB	DDR4-2666	UHD 630								
Memory	32GB max, DDR4-2666*, two 260-pin SO-DIMM sockets, non-ECC, dual-channel capable * System automatically clocks down for the processors with lower memory controller												
Storage	<i>Some:</i> Hard Drive / SATA 6.0Gb/s, 2.5", 5400 rpm or 7200 rpm <i>Some:</i> Solid State Drive (SSD) / SATA 6.0Gb/s, 2.5" <i>Some:</i> M.2 SSD / PCIe NVMe, PCIe 3.0 x 4*, 32Gb/s * 128GB SSD M.2 (2242) PCIe NVMe only supports PCIe 3.0 x 2, 16Gb/s <i>Some:</i> Intel Optane™ Memory (not support Celeron / Pentium Processor), M.2 <i>Some:</i> DVD-ROM, slim (9.0mm), via USB external ODD box <i>Some:</i> DVD Burner (DVD±RW), slim (9.0mm), via USB external ODD box One onboard SATA 6.0Gb/s connector												
Optical													
Onboard SATA													
Graphics	<b>Intel HD Graphics 610/630</b> in processor, uses main memory, DirectX® 12, one DisplayPort™, one HDMI, one optional video port (2nd HDMI, VGA, 2nd DP, or USB 3.1 Type-C Gen1 with DisplayPort function), up to 3 independent displays; <i>Max resolution:</i> 4096x2304 (DP)@60Hz; 4096x2304 (Type-C)@60Hz; 4096x2160 (onboard HDMI)@24Hz; 2048x1536 (VGA)@50Hz Optional DP to VGA dongle, DP to DVI-D dongle, DP to dual DP dongle (for Collage Display with intel integrated graphics), or DP to HDMI 1.4 dongle												
Monitor cable													
Chipset	<b>Intel B360 Chipset</b>												
Front ports* (Std.)	one USB 3.1 Gen1 (Always On and fast charge), one USB 3.1 Type-C Gen 1, one microphone (3.5mm), one headphone / microphone combo jack (3.5mm)												
Rear ports* (Std.)	2x USB 3.1 Gen2, 2x USB 3.1 Gen1, 1x ethernet (RJ-45), 1x DisplayPort, 1x HDMI												
Rear ports* (Opt.)	Two optional ports (mutually exclusive with PCIe card): Port 1 for VGA / 2nd DP / 2nd HDMI / serial / USB 3.1 Type-C Gen 1 with DP function); Port 2 for serial; Optional ports via PCIe card: 2x USB 3.1 Gen1 via PCIe x1, 4x serial (9-pin) via PCIe x1 * Depending on many factors, actual data transfer speed may be lower than theoretical speed												
Audio support	Realtek ALC233VB2 / optional internal speaker (1.5 watt or 2 watt)												
WLAN	<i>Some:</i> 11ac wireless, M.2 Card, Realtek RTL8821CE (dual band), Wi-Fi + Bluetooth 4.2 combo adapter, 1x1 <i>Some:</i> 11ac wireless, M.2 Card, Realtek RTL8822BE (dual band), Wi-Fi + Bluetooth 4.2 combo adapter, 2x2 <i>Some:</i> 11ac wireless, M.2 Card, Intel Dual Band Wireless-AC 3165, Wi-Fi + Bluetooth 4.2 combo adapter, 1x1 <i>Some:</i> 11ac wireless, M.2 Card, Intel Dual Band Wireless-AC 8265, Wi-Fi + Bluetooth 4.2 combo adapter, 2x2												
Bluetooth	<i>Some:</i> Bluetooth 4.2 wireless, integrated in Wi-Fi + BT combo adapter												
Ethernet	Gigabit ethernet, Intel Ethernet Connection I219-V (Jacksonville), Wake on LAN®												
Ethernet (Opt.)	<i>Some:</i> Intel Ethernet Server Adapter I350-T4, gigabit ethernet, 4x RJ-45, PCIe x4												
		<table border="1"> <thead> <tr> <th></th> <th>Dimensions (WxDxH)</th> <th>Weight (Approx. )</th> </tr> </thead> <tbody> <tr> <td>Tiny only</td> <td>7.05" X 7.20" X 1.36" 179mm X 182.9mm X 34.5mm</td> <td>2.91 lb (1.32 kg), vary by config</td> </tr> <tr> <td>With VESA mount &amp; ODD box</td> <td>7.42" X 7.30" X 2.48" 188.4mm X 185.38mm X 63mm</td> <td>3.66 lb (1.66 kg), vary by config</td> </tr> </tbody> </table>			Dimensions (WxDxH)	Weight (Approx. )	Tiny only	7.05" X 7.20" X 1.36" 179mm X 182.9mm X 34.5mm	2.91 lb (1.32 kg), vary by config	With VESA mount & ODD box	7.42" X 7.30" X 2.48" 188.4mm X 185.38mm X 63mm	3.66 lb (1.66 kg), vary by config	
	Dimensions (WxDxH)	Weight (Approx. )											
Tiny only	7.05" X 7.20" X 1.36" 179mm X 182.9mm X 34.5mm	2.91 lb (1.32 kg), vary by config											
With VESA mount & ODD box	7.42" X 7.30" X 2.48" 188.4mm X 185.38mm X 63mm	3.66 lb (1.66 kg), vary by config											
VESA mount	Optional VESA mount bracket kit, supports VESA 75mm and 100mm												
Floor Stand	Optional system floor stand for vertical orientation												
Power supply	<i>Some:</i> 65 watts AC/DC adapter, autosensing, 88% PSU <i>Some:</i> 90 watts AC/DC adapter, autosensing, 88% PSU <i>Some:</i> 135 watts AC/DC adapter, autosensing, 88% PSU												
Limited warranty	<i>Some:</i> <b>1-year</b> or <b>3-year, depot service</b> / service upgrades available <i>Some:</i> <b>1-year</b> or <b>3-year, limited onsite service</b> / service upgrades available												
Preload	<b>Preloaded operating system</b> <i>Some:</i> Windows® 10 Pro 64-bit <i>Some:</i> Windows 10 Home 64-bit <b>Preloaded applications (only some listed)</b> <ul style="list-style-type: none"> <li>Lenovo Vantage</li> <li>Microsoft Office preloaded; purchase a product key to activate</li> <li>Cyberlink Power2GO (only for models with DVD / DVD±RW)</li> <li>Cyberlink Power2GO (only for models with DVD±RW)</li> <li>LinkedIn</li> </ul>												
Environment	ENERGY STAR® 7.0, EPEAT™ Gold rating (North America), ErP Lot 3, TCO, TUV ultra low noise verified (coming soon, on some models), RoHS-compliant												
MIL-SPEC test	MIL-STD-810G military certification (Low Pressure [Altitude], High Temperature, Low Temperature, Temperature Shock, Humidity, Sand and Dust, Vibration, Shock, Fungus, Solar Radiation)												
Accessories	For compatible accessories, please go to <a href="http://smartfind.lenovo.com">http://smartfind.lenovo.com</a>												

Note: The specifications above may not be available in all regions.

Lenovo, June 2019



# ThinkCentre M720 Tower Platform Specifications

Product Specifications Reference (PSREF)

<p>Processor</p> <table border="1"> <thead> <tr> <th>Processor</th> <th>Cores / Threads</th> <th>Frequency Base/Max(GHz)</th> <th>Cache</th> <th>Memory Support (Up to)</th> <th>Integrated Graphics</th> </tr> </thead> <tbody> <tr><td>Celeron G4900</td><td>2 / 2</td><td>3.1G</td><td>2 MB</td><td>DDR4-2400</td><td>UHD 610</td></tr> <tr><td>Celeron G4920</td><td>2 / 2</td><td>3.2G</td><td>2 MB</td><td>DDR4-2400</td><td>UHD 610</td></tr> <tr><td>Pentium Gold G5400</td><td>2 / 4</td><td>3.7G</td><td>4 MB</td><td>DDR4-2400</td><td>UHD 610</td></tr> <tr><td>Pentium Gold G5500</td><td>2 / 4</td><td>3.8G</td><td>4 MB</td><td>DDR4-2400</td><td>UHD 630</td></tr> <tr><td>Pentium Gold G5600</td><td>2 / 4</td><td>3.9G</td><td>4 MB</td><td>DDR4-2400</td><td>UHD 630</td></tr> <tr><td>Core i3-8100</td><td>4 / 4</td><td>3.6G</td><td>6 MB</td><td>DDR4-2400</td><td>UHD 630</td></tr> <tr><td>Core i3-8300</td><td>4 / 4</td><td>3.7G</td><td>8 MB</td><td>DDR4-2400</td><td>UHD 630</td></tr> <tr><td>Core i5-8400</td><td>6 / 6</td><td>2.8G / 4.0G</td><td>9 MB</td><td>DDR4-2666</td><td>UHD 630</td></tr> <tr><td>Core i5-8500</td><td>6 / 6</td><td>3.0G / 4.1G</td><td>9 MB</td><td>DDR4-2666</td><td>UHD 630</td></tr> <tr><td>Core i5-8600</td><td>6 / 6</td><td>3.1G / 4.3G</td><td>9 MB</td><td>DDR4-2666</td><td>UHD 630</td></tr> <tr><td>Core i7-8700</td><td>6 / 12</td><td>3.2G / 4.6G</td><td>12 MB</td><td>DDR4-2666</td><td>UHD 630</td></tr> <tr><td>Core i3-9100</td><td>4 / 4</td><td>3.6G / 4.2G</td><td>6 MB</td><td>DDR4-2400</td><td>UHD 630</td></tr> <tr><td>Core i3-9300</td><td>4 / 4</td><td>3.7G / 4.3G</td><td>8 MB</td><td>DDR4-2400</td><td>UHD 630</td></tr> <tr><td>Core i3-9320</td><td>4 / 4</td><td>3.7G / 4.4G</td><td>8 MB</td><td>DDR4-2400</td><td>UHD 630</td></tr> <tr><td>Core i5-9400</td><td>6 / 6</td><td>2.9G / 4.1G</td><td>9 MB</td><td>DDR4-2666</td><td>UHD 630</td></tr> <tr><td>Core i5-9500</td><td>6 / 6</td><td>3.0G / 4.4G</td><td>9 MB</td><td>DDR4-2666</td><td>UHD 630</td></tr> <tr><td>Core i5-9600</td><td>6 / 6</td><td>3.1G / 4.6G</td><td>9 MB</td><td>DDR4-2666</td><td>UHD 630</td></tr> <tr><td>Core i7-9700</td><td>8 / 8</td><td>3.0G / 4.7G</td><td>12 MB</td><td>DDR4-2666</td><td>UHD 630</td></tr> <tr><td>Core i9-9900</td><td>8 / 16</td><td>3.1G / 5.0G</td><td>16 MB</td><td>DDR4-2666</td><td>UHD 630</td></tr> </tbody> </table>	Processor	Cores / Threads	Frequency Base/Max(GHz)	Cache	Memory Support (Up to)	Integrated Graphics	Celeron G4900	2 / 2	3.1G	2 MB	DDR4-2400	UHD 610	Celeron G4920	2 / 2	3.2G	2 MB	DDR4-2400	UHD 610	Pentium Gold G5400	2 / 4	3.7G	4 MB	DDR4-2400	UHD 610	Pentium Gold G5500	2 / 4	3.8G	4 MB	DDR4-2400	UHD 630	Pentium Gold G5600	2 / 4	3.9G	4 MB	DDR4-2400	UHD 630	Core i3-8100	4 / 4	3.6G	6 MB	DDR4-2400	UHD 630	Core i3-8300	4 / 4	3.7G	8 MB	DDR4-2400	UHD 630	Core i5-8400	6 / 6	2.8G / 4.0G	9 MB	DDR4-2666	UHD 630	Core i5-8500	6 / 6	3.0G / 4.1G	9 MB	DDR4-2666	UHD 630	Core i5-8600	6 / 6	3.1G / 4.3G	9 MB	DDR4-2666	UHD 630	Core i7-8700	6 / 12	3.2G / 4.6G	12 MB	DDR4-2666	UHD 630	Core i3-9100	4 / 4	3.6G / 4.2G	6 MB	DDR4-2400	UHD 630	Core i3-9300	4 / 4	3.7G / 4.3G	8 MB	DDR4-2400	UHD 630	Core i3-9320	4 / 4	3.7G / 4.4G	8 MB	DDR4-2400	UHD 630	Core i5-9400	6 / 6	2.9G / 4.1G	9 MB	DDR4-2666	UHD 630	Core i5-9500	6 / 6	3.0G / 4.4G	9 MB	DDR4-2666	UHD 630	Core i5-9600	6 / 6	3.1G / 4.6G	9 MB	DDR4-2666	UHD 630	Core i7-9700	8 / 8	3.0G / 4.7G	12 MB	DDR4-2666	UHD 630	Core i9-9900	8 / 16	3.1G / 5.0G	16 MB	DDR4-2666	UHD 630	<p>Intel® Celeron®, Intel Pentium®, or 8th / 9th Gen Intel Core™ i3 / i5 / i7 / i9 Processor</p>	<p>WLAN<sup>13</sup> <i>Some:</i> 11ac wireless, M.2 Card, Realtek RTL8821CE (dual band), Wi-Fi + Bluetooth 4.2 combo adapter, 1x1 <i>Some:</i> 11ac wireless, M.2 Card, Realtek RTL8822BE (dual band), Wi-Fi + Bluetooth 4.2 combo adapter, 2x2 <i>Some:</i> 11ac wireless, M.2 Card, Intel Dual Band Wireless-AC 3165, Wi-Fi + Bluetooth 4.2 combo adapter, 1x1 <i>Some:</i> 11ac wireless, M.2 Card, Intel Dual Band Wireless-AC 8265, Wi-Fi + Bluetooth 4.2 combo adapter, 2x2 <i>Some:</i> Bluetooth 4.2 wireless, integrated in Wi-Fi + BT combo adapter</p> <p>Bluetooth™</p> <p>Ethernet Ethernet (Opt.) <i>Some:</i> Gigabit ethernet, Intel Ethernet Connection I219-V (Jacksonville), Wake on LAN® <i>Some:</i> Intel Ethernet Server Adapter I350-T4*, gigabit ethernet, 4x RJ-45, PCIe x4 <i>Some:</i> Bitland BN8E88*, gigabit ethernet, 1x RJ-45, PCIe x1 (special bid only) * Choose either I350-T4 or BN8E88</p> <p>Manageability Security chip None Discrete TPM 2.0, TCG Certified</p> <p>Security features</p> <ul style="list-style-type: none"> <li>Security slot (in rear for optional Kensington® MicroSaver® cable)</li> <li>Padlock loop</li> <li>Optional cable lock to physically lock both keyboard and mouse</li> <li>Optional chassis intrusion switch</li> <li>Optional chassis E-Lock (special bid)</li> <li>Power-on password</li> <li>Administrator password</li> <li>Hard disk password</li> <li>Boot sequence control</li> <li>Boot without keyboard and mouse</li> <li>Individual USB port disablement</li> <li>Smart USB protection, allows keyboard/mouse only, blocks all storage devices</li> </ul> <p>Keyboard <i>Some:</i> Lenovo Calliope Keyboard (USB connector), black <i>Some:</i> Lenovo Traditional Keyboard (USB connector), black <i>Some:</i> Lenovo Calliope Wireless Keyboard (2.4GHz via USB receiver), black <i>Some:</i> Lenovo Keyboard (PS/2 connector), black (only available via special bid) <i>Some:</i> Lenovo Calliope Mouse (USB connector), black <i>Some:</i> Lenovo Fingerprint Mouse (USB connector), Windows Hello support, black <i>Some:</i> Lenovo Calliope Wireless Mouse (2.4GHz via USB receiver), black <i>Some:</i> Lenovo Mouse (PS/2 connector), black (only available via special bid)</p> <p>Mouse</p> <p>Mechanical</p> <ul style="list-style-type: none"> <li>Tower (15L), black color, metal case</li> <li>(WxDxH) 5.91" X 10.65" X 14.17"; 150mm X 270.5mm X 360mm</li> <li>Approx. 15.21 lb (6.9 kg), weight may vary by configuration</li> <li>Optional dust filter</li> <li>Bay 1: Slim external ODD bay</li> <li>Bay 2: 3.5", 1" high, internal, HDD/SSD</li> <li>Bay 3: 3.5", 1" high, internal, HDD/SSD (optional bay)</li> <li>Slot 1: half-length full-height (length &lt; 189mm, height &lt; 104mm), PCIe 3.0 x16</li> <li>Slot 2: half-length full-height (length &lt; 189mm, height &lt; 104mm), PCIe 3.0 x1</li> <li>Slot 3: half-length full-height (length &lt; 189mm, height &lt; 104mm), PCIe 3.0 x1</li> <li>Slot 4: no slot, only bracket for optional port extension</li> <li>M.2 card slots: Two (one for WLAN, one for SSD/Optane)</li> </ul> <p>Power supply <i>Some:</i> 180 watts, autosensing, 85% PSU <i>Some:</i> 210 watts, autosensing, 85% PSU <i>Some:</i> 260 watts, autosensing, 92% PSU (only available via special bid)</p> <p>Limited warranty<sup>3</sup> <i>Some:</i> 1-year or 3-year, depot service / service upgrades available <i>Some:</i> 1-year or 3-year, limited onsite service / service upgrades available</p> <p>Preload <b>Preloaded operating system</b> <i>Some:</i> Windows® 10 Pro 64-bit <i>Some:</i> Windows 10 Home 64-bit <b>Preloaded applications (only some listed)</b></p> <ul style="list-style-type: none"> <li>Lenovo Vantage</li> <li>Microsoft Office preloaded; purchase a product key to activate</li> <li>Cyberlink PowerDVD (only for models with DVD / DVD±RW)</li> <li>Cyberlink Power2GO (only for models with DVD±RW)</li> <li>LinkedIn</li> </ul> <p>Environment ENERGY STAR® 6.1, EPEAT™ Silver rating (North America), ErP Lot 3, TCO, TUV low noise verified (coming soon, on some models), RoHS-compliant</p> <p>Accessories For compatible accessories, please go to <a href="http://smartfind.lenovo.com">http://smartfind.lenovo.com</a></p>
Processor	Cores / Threads	Frequency Base/Max(GHz)	Cache	Memory Support (Up to)	Integrated Graphics																																																																																																																					
Celeron G4900	2 / 2	3.1G	2 MB	DDR4-2400	UHD 610																																																																																																																					
Celeron G4920	2 / 2	3.2G	2 MB	DDR4-2400	UHD 610																																																																																																																					
Pentium Gold G5400	2 / 4	3.7G	4 MB	DDR4-2400	UHD 610																																																																																																																					
Pentium Gold G5500	2 / 4	3.8G	4 MB	DDR4-2400	UHD 630																																																																																																																					
Pentium Gold G5600	2 / 4	3.9G	4 MB	DDR4-2400	UHD 630																																																																																																																					
Core i3-8100	4 / 4	3.6G	6 MB	DDR4-2400	UHD 630																																																																																																																					
Core i3-8300	4 / 4	3.7G	8 MB	DDR4-2400	UHD 630																																																																																																																					
Core i5-8400	6 / 6	2.8G / 4.0G	9 MB	DDR4-2666	UHD 630																																																																																																																					
Core i5-8500	6 / 6	3.0G / 4.1G	9 MB	DDR4-2666	UHD 630																																																																																																																					
Core i5-8600	6 / 6	3.1G / 4.3G	9 MB	DDR4-2666	UHD 630																																																																																																																					
Core i7-8700	6 / 12	3.2G / 4.6G	12 MB	DDR4-2666	UHD 630																																																																																																																					
Core i3-9100	4 / 4	3.6G / 4.2G	6 MB	DDR4-2400	UHD 630																																																																																																																					
Core i3-9300	4 / 4	3.7G / 4.3G	8 MB	DDR4-2400	UHD 630																																																																																																																					
Core i3-9320	4 / 4	3.7G / 4.4G	8 MB	DDR4-2400	UHD 630																																																																																																																					
Core i5-9400	6 / 6	2.9G / 4.1G	9 MB	DDR4-2666	UHD 630																																																																																																																					
Core i5-9500	6 / 6	3.0G / 4.4G	9 MB	DDR4-2666	UHD 630																																																																																																																					
Core i5-9600	6 / 6	3.1G / 4.6G	9 MB	DDR4-2666	UHD 630																																																																																																																					
Core i7-9700	8 / 8	3.0G / 4.7G	12 MB	DDR4-2666	UHD 630																																																																																																																					
Core i9-9900	8 / 16	3.1G / 5.0G	16 MB	DDR4-2666	UHD 630																																																																																																																					
<p>Memory</p>	<p>64GB max, UDIMM, DDR4-2666*, four 288-pin DIMM sockets, non-ECC, dual-channel capable * System automatically clocks down for the processors with lower memory controller</p>																																																																																																																									
<p>Storage</p>	<p><i>Some:</i> Hard Drive / SATA 6.0Gb/s, 2.5" or 3.5", 5400 rpm or 7200 rpm <i>Some:</i> Solid State Drive (SSD) / SATA 6.0Gb/s, 2.5" <i>Some:</i> M.2 Solid State Drive (SSD) / PCIe NVMe, PCIe 3.0 x 4*, 32Gb/s * 128GB SSD M.2 (2242) PCIe NVMe only supports PCIe 3.0 x 2, 16Gb/s <i>Some:</i> Intel Optane™ Memory (not support Celeron / Pentium Processor), M.2</p>																																																																																																																									
<p>Optical</p>	<p><i>Some:</i> DVD-ROM SATA 1.5Gb/s Drive, slim (9.0mm) <i>Some:</i> DVD Burner (DVD±RW), SATA 1.5Gb/s Drive, slim (9.0mm)</p>																																																																																																																									
<p>Onboard SATA Media reader</p>	<p>Three onboard SATA 6.0Gb/s connectors Optional 7-in-1 media reader</p>																																																																																																																									
<p>Graphics</p>	<p><b>Intel UHD Graphics 610/630</b> in processor, uses main memory, DirectX® 12, one VGA, two DisplayPort™, supports 3 independent displays, works along with discrete graphics to support more displays; <i>Max resolution:</i> 4096x2304 (DP)@60Hz; 2048x1536 (VGA)@50Hz <i>Some:</i> <b>NVIDIA GeForce® GT 730</b>, DirectX 12, 2GB, PCIe 2.0 x16 adapter, two DisplayPort, 35 watts; <i>Max resolution:</i> 3840x2160 (DisplayPort)@60Hz;</p>																																																																																																																									
<p>Monitor Cable</p>	<p>Optional DP to VGA dongle, DP to DVI-D dongle, DP to dual DP dongle (for Collage Display with intel integrated graphics), or DP to HDMI 1.4 dongle</p>																																																																																																																									
<p>Chipset</p> <p>Front ports* (Std.) 2x USB 3.1 Gen2, 2x USB 3.1 Gen1, 1x USB 3.1 Type-C Gen1 (15W charging), 1x microphone (3.5mm), 1x headphone / microphone combo jack (3.5mm)</p> <p>Front ports* (Opt.) <i>Optional:</i> 1x media reader</p> <p>Rear ports* (Std.) 4x USB 2.0, 1x serial (9-pin), 1x ethernet (RJ-45), 1x VGA, 2x DisplayPort, 1x line-out (3.5mm)</p> <p>Rear ports* (Opt.) <i>Optional:</i> 2x USB 3.1 Gen1 via PCIe x1**, 2x USB 3.1 Type-C Gen2 via PCIe x4** (special bid only), 1x 2nd serial (9-pin), 4x serial (9-pin) via PCIe x1, 1x parallel (25-pin), 2x PS/2 ports (keyboard/mouse), additional RJ-45 and video ports available on optional graphics or ethernet card * Depending on many factors, actual data transfer speed may be lower than theoretical speed ** Choose either 2x USB 3.1 Gen1 or 2x USB 3.1 Type-C Gen2</p>	<p><b>Intel B360 Chipset</b></p>																																																																																																																									
<p>Audio support</p>	<p>High Definition (HD) Audio, Realtek ALC233VB2 / internal speaker (2 watt)</p>																																																																																																																									

Note: The specifications above may not be available in all regions.

Lenovo, June 2019





# ThinkCentre M720e SFF Platform Specifications

Product Specifications Reference (PSREF)

Processor	Intel® Celeron®, Intel Pentium®, or 8th / 9th Gen Intel Core™ i3 / i5 / i7 / i9 Processor	Manageability	None																																																																																																																								
	<table border="1"> <thead> <tr> <th>Processor</th> <th>Cores / Threads</th> <th>Frequency Base/Max(GHz)</th> <th>Cache</th> <th>Memory Support (Up to)</th> <th>Integrated Graphics</th> </tr> </thead> <tbody> <tr><td>Celeron G4900</td><td>2 / 2</td><td>3.1G</td><td>2 MB</td><td>DDR4-2400</td><td>UHD 610</td></tr> <tr><td>Celeron G4920</td><td>2 / 2</td><td>3.2G</td><td>2 MB</td><td>DDR4-2400</td><td>UHD 610</td></tr> <tr><td>Celeron G4930</td><td>2 / 2</td><td>3.2G</td><td>2 MB</td><td>DDR4-2400</td><td>UHD 610</td></tr> <tr><td>Celeron G4950</td><td>2 / 2</td><td>3.3G</td><td>2 MB</td><td>DDR4-2400</td><td>UHD 610</td></tr> <tr><td>Pentium Gold G5500</td><td>2 / 4</td><td>3.8G</td><td>4 MB</td><td>DDR4-2400</td><td>UHD 630</td></tr> <tr><td>Pentium Gold G5600</td><td>2 / 4</td><td>3.9G</td><td>4 MB</td><td>DDR4-2400</td><td>UHD 630</td></tr> <tr><td>Pentium Gold G5420</td><td>2 / 4</td><td>3.8G</td><td>4 MB</td><td>DDR4-2400</td><td>UHD 610</td></tr> <tr><td>Pentium Gold G5620</td><td>2 / 4</td><td>4.0G</td><td>4 MB</td><td>DDR4-2400</td><td>UHD 630</td></tr> <tr><td>Core i3-8100</td><td>4 / 4</td><td>3.6G</td><td>6 MB</td><td>DDR4-2400</td><td>UHD 630</td></tr> <tr><td>Core i5-8400</td><td>6 / 6</td><td>2.8G / 4.0G</td><td>9 MB</td><td>DDR4-2666</td><td>UHD 630</td></tr> <tr><td>Core i5-8500</td><td>6 / 6</td><td>3.0G / 4.1G</td><td>9 MB</td><td>DDR4-2666</td><td>UHD 630</td></tr> <tr><td>Core i7-8700</td><td>6 / 12</td><td>3.2G / 4.6G</td><td>12 MB</td><td>DDR4-2666</td><td>UHD 630</td></tr> <tr><td>Core i3-9100</td><td>4 / 4</td><td>3.6G / 4.2G</td><td>6 MB</td><td>DDR4-2400</td><td>UHD 630</td></tr> <tr><td>Core i3-9300</td><td>4 / 4</td><td>3.7G / 4.3G</td><td>8 MB</td><td>DDR4-2400</td><td>UHD 630</td></tr> <tr><td>Core i5-9400</td><td>6 / 6</td><td>2.9G / 4.1G</td><td>9 MB</td><td>DDR4-2666</td><td>UHD 630</td></tr> <tr><td>Core i5-9500</td><td>6 / 6</td><td>3.0G / 4.4G</td><td>9 MB</td><td>DDR4-2666</td><td>UHD 630</td></tr> <tr><td>Core i5-9600</td><td>6 / 6</td><td>3.1G / 4.6G</td><td>9 MB</td><td>DDR4-2666</td><td>UHD 630</td></tr> <tr><td>Core i7-9700</td><td>8 / 8</td><td>3.0G / 4.7G</td><td>12 MB</td><td>DDR4-2666</td><td>UHD 630</td></tr> <tr><td>Core i9-9900</td><td>8 / 16</td><td>3.1G / 5.0G</td><td>16 MB</td><td>DDR4-2666</td><td>UHD 630</td></tr> </tbody> </table>	Processor	Cores / Threads	Frequency Base/Max(GHz)	Cache	Memory Support (Up to)	Integrated Graphics	Celeron G4900	2 / 2	3.1G	2 MB	DDR4-2400	UHD 610	Celeron G4920	2 / 2	3.2G	2 MB	DDR4-2400	UHD 610	Celeron G4930	2 / 2	3.2G	2 MB	DDR4-2400	UHD 610	Celeron G4950	2 / 2	3.3G	2 MB	DDR4-2400	UHD 610	Pentium Gold G5500	2 / 4	3.8G	4 MB	DDR4-2400	UHD 630	Pentium Gold G5600	2 / 4	3.9G	4 MB	DDR4-2400	UHD 630	Pentium Gold G5420	2 / 4	3.8G	4 MB	DDR4-2400	UHD 610	Pentium Gold G5620	2 / 4	4.0G	4 MB	DDR4-2400	UHD 630	Core i3-8100	4 / 4	3.6G	6 MB	DDR4-2400	UHD 630	Core i5-8400	6 / 6	2.8G / 4.0G	9 MB	DDR4-2666	UHD 630	Core i5-8500	6 / 6	3.0G / 4.1G	9 MB	DDR4-2666	UHD 630	Core i7-8700	6 / 12	3.2G / 4.6G	12 MB	DDR4-2666	UHD 630	Core i3-9100	4 / 4	3.6G / 4.2G	6 MB	DDR4-2400	UHD 630	Core i3-9300	4 / 4	3.7G / 4.3G	8 MB	DDR4-2400	UHD 630	Core i5-9400	6 / 6	2.9G / 4.1G	9 MB	DDR4-2666	UHD 630	Core i5-9500	6 / 6	3.0G / 4.4G	9 MB	DDR4-2666	UHD 630	Core i5-9600	6 / 6	3.1G / 4.6G	9 MB	DDR4-2666	UHD 630	Core i7-9700	8 / 8	3.0G / 4.7G	12 MB	DDR4-2666	UHD 630	Core i9-9900	8 / 16	3.1G / 5.0G	16 MB	DDR4-2666	UHD 630	Security chip	Discrete TPM 2.0, TCG Certified
Processor	Cores / Threads	Frequency Base/Max(GHz)	Cache	Memory Support (Up to)	Integrated Graphics																																																																																																																						
Celeron G4900	2 / 2	3.1G	2 MB	DDR4-2400	UHD 610																																																																																																																						
Celeron G4920	2 / 2	3.2G	2 MB	DDR4-2400	UHD 610																																																																																																																						
Celeron G4930	2 / 2	3.2G	2 MB	DDR4-2400	UHD 610																																																																																																																						
Celeron G4950	2 / 2	3.3G	2 MB	DDR4-2400	UHD 610																																																																																																																						
Pentium Gold G5500	2 / 4	3.8G	4 MB	DDR4-2400	UHD 630																																																																																																																						
Pentium Gold G5600	2 / 4	3.9G	4 MB	DDR4-2400	UHD 630																																																																																																																						
Pentium Gold G5420	2 / 4	3.8G	4 MB	DDR4-2400	UHD 610																																																																																																																						
Pentium Gold G5620	2 / 4	4.0G	4 MB	DDR4-2400	UHD 630																																																																																																																						
Core i3-8100	4 / 4	3.6G	6 MB	DDR4-2400	UHD 630																																																																																																																						
Core i5-8400	6 / 6	2.8G / 4.0G	9 MB	DDR4-2666	UHD 630																																																																																																																						
Core i5-8500	6 / 6	3.0G / 4.1G	9 MB	DDR4-2666	UHD 630																																																																																																																						
Core i7-8700	6 / 12	3.2G / 4.6G	12 MB	DDR4-2666	UHD 630																																																																																																																						
Core i3-9100	4 / 4	3.6G / 4.2G	6 MB	DDR4-2400	UHD 630																																																																																																																						
Core i3-9300	4 / 4	3.7G / 4.3G	8 MB	DDR4-2400	UHD 630																																																																																																																						
Core i5-9400	6 / 6	2.9G / 4.1G	9 MB	DDR4-2666	UHD 630																																																																																																																						
Core i5-9500	6 / 6	3.0G / 4.4G	9 MB	DDR4-2666	UHD 630																																																																																																																						
Core i5-9600	6 / 6	3.1G / 4.6G	9 MB	DDR4-2666	UHD 630																																																																																																																						
Core i7-9700	8 / 8	3.0G / 4.7G	12 MB	DDR4-2666	UHD 630																																																																																																																						
Core i9-9900	8 / 16	3.1G / 5.0G	16 MB	DDR4-2666	UHD 630																																																																																																																						
		Security features	<ul style="list-style-type: none"> <li>Security slot (in rear for optional Kensington® MicroSaver® cable)</li> <li>Padlock loop</li> <li>Smart USB protection, allows keyboard/ mouse only, blocks all storage devices</li> <li>Optional smart cable clip to physically lock both keyboard and mouse</li> <li>Power-on password</li> <li>Administrator password</li> <li>Hard disk password</li> <li>Boot sequence control</li> <li>Boot without keyboard and mouse</li> <li>Individual USB port disablement</li> <li>Optional chassis intrusion switch</li> </ul>																																																																																																																								
		Keyboard	Some: Lenovo Calliope Keyboard (USB connector), black																																																																																																																								
		Mouse	Some: Lenovo Traditional Keyboard (USB connector), black Some: Lenovo Calliope Mouse (USB connector), black Some: Lenovo Fingerprint Mouse (USB connector), Windows Hello support, black																																																																																																																								
		Mechanical	<ul style="list-style-type: none"> <li>SFF (7.4L), black color, metal case</li> <li>(WxDxH) 3.9" X 11.9" X 10.8"; 100mm X 303.5mm X 274.8mm</li> <li>Approx. 9.37 lb (4.25 kg), weight may vary by configuration</li> <li>Bay 1: Slim ODD bay</li> <li>Bay 2: 3.5" disk bay, supports 2.5" HDD (2.5 to 3.5 bracket comes with 2.5" disk)</li> <li>Slot 1: low-profile (length &lt; 152mm, height &lt; 64mm), PCIe 3.0 x16*</li> <li>Slot 2: low-profile (length &lt; 152mm, height &lt; 64mm), PCIe 3.0 x1*</li> <li>M.2 card slot: one for SSD</li> <li>*Optional rear 2x USB2.0 / parallel occupies one expansion slot</li> </ul>																																																																																																																								
		Floor Stand	Optional system floor stand for vertical orientation																																																																																																																								
		Packaging	<ul style="list-style-type: none"> <li>(WxDxH) 7.7" X 15.4" X 19.7"; 195mm X 390mm X 500mm</li> <li>Cross weight (approx.) 14.48 lb (6.57 kg)</li> </ul>																																																																																																																								
Memory	32GB max, UDIMM, DDR4-2666*, two 288-pin DIMM sockets, non-ECC, dual-channel capable * Memory may be underclocked to DDR4-2400 for the lower memory controller in processor	Power supply	180 watts, autosensing, 85% PSU																																																																																																																								
		Limited warranty <sup>3</sup>	Some: <b>1-year</b> or <b>3-year, depot service</b> / service upgrades available Some: <b>1-year</b> or <b>3-year, limited onsite service</b> / service upgrades available																																																																																																																								
Storage	Some: Hard Drive / SATA 6.0Gb/s, 2.5" or 3.5", 5400 rpm or 7200 rpm Some: M.2 Solid State Drive (SSD) / PCIe NVMe, PCIe 3.0 x2 or PCIe 3.0 x4	Preload	<b>Preloaded operating system</b> Some: Windows® 10 Pro 64-bit Some: Windows 10 Home 64-bit Some: Linux Ubuntu																																																																																																																								
Optane memory	Some: Intel Optane™ Memory, M.2 2280, PCIe NVMe, PCIe 3.0 x 2	Environment	ENERGY STAR® 7, EPEAT™ Silver rating (North America), ErP Lot 3, RoHS-compliant, WEEE																																																																																																																								
Optical	Some: DVD-ROM SATA 1.5Gb/s Drive, slim (9.0mm) Some: DVD Burner (DVD±RW), SATA 1.5Gb/s Drive, slim (9.0mm)	Accessories	For compatible accessories, please go to <a href="http://www.lenovoquickpick.com">http://www.lenovoquickpick.com</a>																																																																																																																								
Onboard SATA	Two onboard SATA 6.0Gb/s connectors																																																																																																																										
Media reader	Optional 7-in-1 media reader																																																																																																																										
Graphics	<b>Intel HD Graphics 610/630</b> in processor, uses main memory, DirectX® 12, one VGA, one DisplayPort™, supports 2 independent displays, works along with discrete graphics to support more displays; Max resolution: 4096x2304 (DP)@60Hz; 2048x1536 (VGA)@50Hz Some: <b>AMD Radeon™ 520</b> , DirectX 12, 2GB GDDR5, PCIe 3.0 x8 adapter, one VGA, one HDMI, 30 watts (Max); Max resolution: 3840x2160 (HDMI)@30Hz; 2048x1536 (VGA)@85Hz																																																																																																																										
Monitor cable	Optional DP to VGA, DP to DVI-D (single link), DP to dual DP, or DP to HDMI 1.4																																																																																																																										
Chipset	<b>Intel B365 Chipset</b>																																																																																																																										
Front ports* (Std.)	Two USB 3.1 Gen1, microphone (3.5mm), one headphone / microphone combo jack (3.5mm)																																																																																																																										
Front ports* (Opt.)	None																																																																																																																										
Rear ports* (Std.)	Two USB 3.1 Gen1, two USB 2.0, serial (9-pin), ethernet (RJ-45), one VGA, one DisplayPort, Line-out jack (3.5mm)																																																																																																																										
Rear ports* (Opt.)	optional two USB 2.0, optional 2nd serial (9-pin), optional parallel (25-pin), optional external USB to PS/2 ports cable (for PS/2 keyboard / mouse); additional video ports or RJ-45 on optional graphics / ethernet card on some models * Depending on many factors, actual data transfer speed may be lower than theoretical speed																																																																																																																										
Audio support	High Definition (HD) Audio, Realtek ALC623 / internal speaker (2 watt )																																																																																																																										
WLAN <sup>13</sup>	None																																																																																																																										
Bluetooth™	None																																																																																																																										
Ethernet	Gigabit ethernet, Realtek RTL8111HN, Wake on LAN®																																																																																																																										
Ethernet (Opt.)	Some: Bitland BN8E88*, gigabit ethernet, PCIe x1																																																																																																																										
Modem	None																																																																																																																										

Note: The specifications above may not be available in all regions.

Lenovo, September 2019

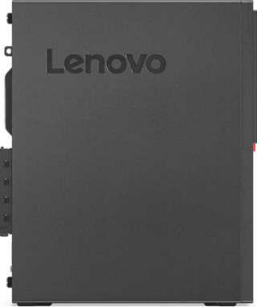

# ThinkCentre M725 SFF Platform Specifications

Product Specifications Reference (PSREF)

Processor	AMD A6 / A8 / A10 / A12 and Ryzen 3 / 5 / 7 series processor					Ethernet	Gigabit ethernet, Realtek RTL8111EPV, Wake on LAN®																																																																		
	<table border="1"> <thead> <tr> <th>Processor</th> <th>Cores / Threads</th> <th>Frequency (Base/Max)</th> <th>L2 / L3 Cache</th> <th>Memory Support (Up to)</th> <th>Integrated Graphics</th> </tr> </thead> <tbody> <tr> <td>PRO A6-9500</td> <td>2 / 2</td> <td>3.5 / 3.8</td> <td>1MB</td> <td>DDR4-2400</td> <td>Radeon R5</td> </tr> <tr> <td>PRO A8-9600</td> <td>4 / 4</td> <td>3.1 / 3.4</td> <td>2MB</td> <td>DDR4-2400</td> <td>Radeon R7</td> </tr> <tr> <td>PRO A10-9700</td> <td>4 / 4</td> <td>3.5 / 3.8</td> <td>2MB</td> <td>DDR4-2400</td> <td>Radeon R7</td> </tr> <tr> <td>PRO A12-9800</td> <td>4 / 4</td> <td>3.8 / 4.2</td> <td>2MB</td> <td>DDR4-2400</td> <td>Radeon R7</td> </tr> <tr> <td>Ryzen 3 2300X</td> <td>4 / 4</td> <td>3.5 / 4.0</td> <td>2MB / 8MB</td> <td>DDR4-2933</td> <td>None</td> </tr> <tr> <td>Ryzen 5 2500X</td> <td>4 / 8</td> <td>3.6 / 4.0</td> <td>2MB / 8MB</td> <td>DDR4-2933</td> <td>None</td> </tr> <tr> <td>Ryzen 3 PRO 2200G</td> <td>4 / 4</td> <td>3.5 / 3.6</td> <td>2MB / 4MB</td> <td>DDR4-2933</td> <td>Radeon Vega 8</td> </tr> <tr> <td>Ryzen 5 PRO 2400G</td> <td>4 / 8</td> <td>3.6 / 3.8</td> <td>2MB / 4MB</td> <td>DDR4-2933</td> <td>Radeon RX Vega 11</td> </tr> <tr> <td>Ryzen 5 PRO 2600</td> <td>6 / 12</td> <td>3.4 / 3.9</td> <td>3MB / 16MB</td> <td>DDR4-2933</td> <td>None</td> </tr> <tr> <td>Ryzen 7 PRO 2700</td> <td>8 / 16</td> <td>3.2 / 4.1</td> <td>4MB / 16MB</td> <td>DDR4-2933</td> <td>None</td> </tr> </tbody> </table>					Processor	Cores / Threads	Frequency (Base/Max)	L2 / L3 Cache	Memory Support (Up to)	Integrated Graphics	PRO A6-9500	2 / 2	3.5 / 3.8	1MB	DDR4-2400	Radeon R5	PRO A8-9600	4 / 4	3.1 / 3.4	2MB	DDR4-2400	Radeon R7	PRO A10-9700	4 / 4	3.5 / 3.8	2MB	DDR4-2400	Radeon R7	PRO A12-9800	4 / 4	3.8 / 4.2	2MB	DDR4-2400	Radeon R7	Ryzen 3 2300X	4 / 4	3.5 / 4.0	2MB / 8MB	DDR4-2933	None	Ryzen 5 2500X	4 / 8	3.6 / 4.0	2MB / 8MB	DDR4-2933	None	Ryzen 3 PRO 2200G	4 / 4	3.5 / 3.6	2MB / 4MB	DDR4-2933	Radeon Vega 8	Ryzen 5 PRO 2400G	4 / 8	3.6 / 3.8	2MB / 4MB	DDR4-2933	Radeon RX Vega 11	Ryzen 5 PRO 2600	6 / 12	3.4 / 3.9	3MB / 16MB	DDR4-2933	None	Ryzen 7 PRO 2700	8 / 16	3.2 / 4.1	4MB / 16MB	DDR4-2933	None	Ethernet (Opt.)	Some: Bitland BN8E88, gigabit ethernet, 1x RJ-45, PCIe x1 (special bid only)
	Processor	Cores / Threads	Frequency (Base/Max)	L2 / L3 Cache	Memory Support (Up to)	Integrated Graphics																																																																			
	PRO A6-9500	2 / 2	3.5 / 3.8	1MB	DDR4-2400	Radeon R5																																																																			
	PRO A8-9600	4 / 4	3.1 / 3.4	2MB	DDR4-2400	Radeon R7																																																																			
	PRO A10-9700	4 / 4	3.5 / 3.8	2MB	DDR4-2400	Radeon R7																																																																			
	PRO A12-9800	4 / 4	3.8 / 4.2	2MB	DDR4-2400	Radeon R7																																																																			
	Ryzen 3 2300X	4 / 4	3.5 / 4.0	2MB / 8MB	DDR4-2933	None																																																																			
	Ryzen 5 2500X	4 / 8	3.6 / 4.0	2MB / 8MB	DDR4-2933	None																																																																			
	Ryzen 3 PRO 2200G	4 / 4	3.5 / 3.6	2MB / 4MB	DDR4-2933	Radeon Vega 8																																																																			
Ryzen 5 PRO 2400G	4 / 8	3.6 / 3.8	2MB / 4MB	DDR4-2933	Radeon RX Vega 11																																																																				
Ryzen 5 PRO 2600	6 / 12	3.4 / 3.9	3MB / 16MB	DDR4-2933	None																																																																				
Ryzen 7 PRO 2700	8 / 16	3.2 / 4.1	4MB / 16MB	DDR4-2933	None																																																																				
Manageability						DASH 10/1.1																																																																			
Security chip						Discrete TPM 2.0, TCG Certified																																																																			
Security features						<ul style="list-style-type: none"> <li>Security slot (in rear for optional Kensington® MicroSaver® cable)</li> <li>Padlock loop</li> <li>Smart USB protection, allows keyboard/ mouse only, blocks all storage devices</li> <li>Optional cable lock to physically lock both keyboard and mouse</li> </ul>																																																																			
						<ul style="list-style-type: none"> <li>Power-on password</li> <li>Administrator password</li> <li>Hard disk password</li> <li>Boot sequence control</li> <li>Boot without keyboard and mouse</li> <li>Individual USB port disablement</li> <li>Optional chassis intrusion switch</li> </ul>																																																																			
Keyboard						<i>Some:</i> Lenovo Calliope Keyboard (USB connector), black <i>Some:</i> Lenovo Traditional Keyboard (USB connector), black <i>Some:</i> Lenovo Calliope Wireless Keyboard (2.4GHz via USB receiver), black <i>Some:</i> Lenovo Keyboard (PS/2 connector), black (only available via special bid)																																																																			
Mouse						<i>Some:</i> Lenovo Calliope Mouse (USB connector), black <i>Some:</i> Lenovo Fingerprint Mouse (USB connector), Windows Hello support, black <i>Some:</i> Lenovo Calliope Wireless Mouse (2.4GHz via USB receiver), black <i>Some:</i> Lenovo Mouse (PS/2 connector), black (only available via special bid)																																																																			
Memory	64GB max, UDIMM, DDR4-2666*, four 288-pin DIMM sockets, non-ECC, dual-channel capable * Systemboard supports up to DDR4-2666, memory frequency may automatically clocks down for the lower capability of memory controller in processor																																																																								
Storage	<i>Some:</i> Hard Drive / SATA 6.0Gb/s, 2.5" or 3.5", 5400 rpm or 7200 rpm <i>Some:</i> Solid State Drive (SSD) / SATA 6.0Gb/s, 2.5" <i>Some:</i> M.2 SSD / PCIe NVMe, PCIe 3.0 x 4*, 32Gb/s * 128GB SSD M.2 (2242) PCIe NVMe and AMD A6 / A8 / A10 / A12 processor only supports PCIe 3.0 x 2, 16Gb/s					Mechanical																																																																			
Optical	<i>Some:</i> DVD-ROM SATA 1.5Gb/s Drive, slim (9.0mm) <i>Some:</i> DVD Burner (DVD±RW), SATA 1.5Gb/s Drive, slim (9.0mm)					<ul style="list-style-type: none"> <li>SFF (8.4L), black color; metal case</li> <li>(WxDxH) 3.6" X 11.4" X 13.5"; 92.5mm X 290.5mm X 343.5mm</li> <li>Approx. 13.2 lb (6.0 kg), weight may vary by configuration</li> <li>Toolless cover, disk, optical removal</li> <li>Optional dust filter</li> </ul>																																																																			
Onboard SATA	Three onboard SATA 6.0Gb/s connectors, RAID 0/1 support (RAID preset only available via special bid model)					Bay 1: Slim external ODD bay Bay 2: 3.5", internal, HDD/SSD Bay 3: 2.5", internal, HDD/SSD (bay only comes with 2.5" 2nd disk)																																																																			
Media reader	Optional 7-in-1 media reader					Slot 1: low-profile (length < 150mm, height < 68mm), PCIe 3.0 x16 Slot 2: low-profile (length < 150mm, height < 68mm), PCIe 2.0 x1 Slot 3: low-profile (length < 150mm, height < 68mm), PCIe 2.0 x1 Slot 4: low-profile (length < 150mm, height < 68mm), PCI 3.0 M.2 card slots: two (one for WLAN, one for SSD)																																																																			
Graphics	<b>AMD Radeon™ Graphics in processor</b> (only for some processors), uses main memory, DirectX® 12, one VGA, two DisplayPort™ (Onboard VGA and DP ports are only available on the models with integrated graphics), supports 3 independent displays, works along with AMD discrete graphics to support more displays; <i>Max resolution:</i> 4096x2160 (DP) @60Hz; 1920x1200 (VGA) @60Hz <i>Some:</i> <b>NVIDIA GeForce® GT 730</b> , DirectX 12, 2GB GDDR5, PCIe 2.0 x16 (x8 elec.) adapter, two DisplayPort, 35 watts; <i>Max resolution:</i> 3840x2160 (DisplayPort) @60Hz					Floor Stand																																																																			
Monitor cable	Optional DP to VGA dongle, DP to DVI-D dongle, DP to dual DP dongle, or DP to HDMI 1.4 dongle					Power supply <i>Some:</i> 180 watts, autosensing, 85% PSU <i>Some:</i> 210 watts, autosensing, 85% PSU <i>Some:</i> 260 watts, autosensing, 92% PSU (only available via special bid)																																																																			
Chipset	<b>AMD B450 Chipset</b>					Limited warranty																																																																			
Front ports* (Std.)	2x USB 3.1 Gen2, 2x USB 3.1 Gen1, 1x microphone (3.5mm), 1x headphone (3.5mm)					<b>1-year or 3-year, limited onsite service / service upgrades available</b>																																																																			
Front ports* (Opt.)	Optional: 1x media reader, 2x USB 3.1 Type-C Gen2 via PCIe card (special bid only)					Preload																																																																			
Rear ports* (Std.)	2x USB 3.1 Gen1, 2x USB 2.0, 1x serial (9-pin), 1x ethernet (RJ-45), 1x VGA**, 2x DisplayPort**, 2x PS/2 ports (keyboard / mouse); 1x line-in (3.5mm), 1x line-out (3.5mm), 1x microphone (3.5mm)					<b>Preloaded operating system</b> <i>Some:</i> Windows 10 Pro 64-bit <i>Some:</i> Windows 10 Home 64-bit <b>Preloaded applications (only some listed)</b> <ul style="list-style-type: none"> <li>Lenovo Vantage</li> <li>Microsoft Office preloaded; purchase a product key to activate</li> <li>Cyberlink PowerDVD (only for models with DVD / DVD±RW)</li> <li>Cyberlink Power2GO (only for models with DVD±RW)</li> <li>LinkedIn</li> </ul>																																																																			
Rear ports* (Opt.)	Optional: 2x USB 2.0, 1x 2nd serial (9-pin), 1x parallel (25-pin), additional RJ-45 and video ports available on optional graphics or ethernet card					Environment																																																																			
** Depending on many factors, actual data transfer speed may be lower than theoretical speed ** only available on the models with integrated graphics						<b>ENERGY STAR® 7.0*</b> , EPEAT™ Silver rating* (*not for non-OS models); ErP Lot 3; RoHS-compliant																																																																			
Audio support	High Definition (HD) Audio, Realtek ALC662 / optional internal speaker (1 watt)					Accessories																																																																			
WLAN	<i>Some:</i> 11ac wireless, M.2 Card, Realtek RTL8821CE (dual band), Wi-Fi + Bluetooth 4.2 combo adapter, 1x1 <i>Some:</i> 11ac wireless, M.2 Card, Qualcomm Atheros QCA9377A (dual band), Wi-Fi + Bluetooth 4.2* combo adapter, 1x1 <i>Some:</i> 11ac wireless, M.2 Card, Realtek RTL8822BE (dual band), Wi-Fi + Bluetooth 4.2* combo adapter, 2x2 <i>Some:</i> 11ac wireless, M.2 Card, Qualcomm Atheros QCA6174A (dual band), Wi-Fi + Bluetooth 4.2* combo adapter, 2x2					For compatible accessories, please go to <a href="http://smartfind.lenovo.com">http://smartfind.lenovo.com</a>																																																																			
Bluetooth™	<i>Some:</i> Bluetooth 4.2* wireless, integrated in Wi-Fi + BT combo adapter * Hardware supports BT 4.2, but Win10 RS3 and earlier only supports BT 4.1																																																																								

Note: The specifications above may not be available in all regions.

Lenovo, July 2018

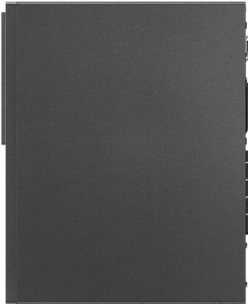

# ThinkCentre M75s-1 SFF Platform Specifications

Product Specifications Reference (PSREF)

Processor	AMD Athlon PRO and Ryzen 3 / 5 / 7 PRO series processor					Ethernet	Gigabit ethernet, Realtek RTL8111EPV, Wake on LAN®
						Ethernet (Opt.)	None
	Processor	Cores / Threads	Frequency (Base/Max)	L2 / L3 Cache	Memory Support (Up to)	Integrated Graphics	
	Athlon PRO 300GE	2 / 4	3.4 / 3.4	1MB / 4MB	DDR4-2666	Radeon Vega 3	
Ryzen 3 PRO 3200G	4 / 4	3.6 / 4.0	2MB / 4MB	DDR4-2933	Radeon Vega 8		
Ryzen 5 PRO 3400G	4 / 8	3.7 / 4.2	2MB / 4MB	DDR4-2933	Radeon Vega 11		
Memory	64GB max, UDIMM, DDR4-2666*, four 288-pin DIMM sockets, non-ECC, dual-channel capable * Memory may be underclocked to DDR4 -1866, DDR4-2133, or DDR4-2400 for the lower capability of memory controller in processor					Manageability	DASH 10/1.1
Storage	<i>Some:</i> Hard Drive / SATA 6.0Gb/s, 2.5" or 3.5", 5400 rpm or 7200 rpm <i>Some:</i> M.2 SSD (2242 / 2280) / PCIe NVMe, PCIe 3.0 x2 or PCIe 3.0 x4					Security chip	Discrete TPM 2.0, TCG Certified
Optical	<i>Some:</i> DVD-ROM SATA 1.5Gb/s Drive, slim (9.0mm) <i>Some:</i> DVD Burner (DVD±RW), SATA 1.5Gb/s Drive, slim (9.0mm)					Security features	<ul style="list-style-type: none"> <li>• Security slot (in rear for optional Kensington® MicroSaver® cable)</li> <li>• Padlock loop</li> <li>• Smart USB protection, allows keyboard/ mouse only, blocks all storage devices</li> <li>• Optional smart cable clip to physically lock both keyboard and mouse</li> </ul>
Onboard SATA	Three onboard SATA 6.0Gb/s connectors, RAID 0/1 support (RAID preset only available via special bid model)					Keyboard	<ul style="list-style-type: none"> <li>• Power-on password</li> <li>• Administrator password</li> <li>• Hard disk password</li> <li>• Boot sequence control</li> <li>• Boot without keyboard and mouse</li> <li>• Individual USB port disablement</li> <li>• Optional chassis intrusion switch</li> </ul>
Media reader	Optional 7-in-1 media reader					Mouse	<ul style="list-style-type: none"> <li>• <i>Some:</i> Lenovo Traditional Keyboard (USB connector), black</li> <li>• <i>Some:</i> Lenovo Calliope Wireless Keyboard (2.4GHz via USB receiver), black</li> <li>• <i>Some:</i> Lenovo Keyboard (PS/2 connector), black (only available via special bid)</li> <li>• <i>Some:</i> Lenovo Calliope Mouse (USB connector), black</li> <li>• <i>Some:</i> Lenovo Calliope Mouse (USB connector), Windows Hello support, black</li> <li>• <i>Some:</i> Lenovo Calliope Wireless Mouse (2.4GHz via USB receiver), black</li> <li>• <i>Some:</i> Lenovo Mouse (PS/2 connector), black (only available via special bid)</li> </ul>
Graphics	<b>AMD Radeon™ Graphics in processor</b> (only for some processors), uses main memory, DirectX® 12, one VGA, two DisplayPort™ (Onboard VGA and DP ports are only available on the models with integrated graphics), supports 3 independent displays, works along with AMD discrete graphics to support more displays; <i>Max resolution:</i> 4096x2160 (DP)@60Hz; <i>Some:</i> <b>AMD Radeon™ 520</b> , DirectX 12, 2GB GDDR5, PCIe 3.0 x8 adapter, two DisplayPort, 30 watts (Max); <i>Max resolution:</i> 4096x2160 (DP)@60Hz					Mechanical	<ul style="list-style-type: none"> <li>• SFF (8.4L), black color; metal case</li> <li>• (WxDxH) 3.6" X 11.4" X 13.5"; 92.5mm X 290.5mm X 343.5mm</li> <li>• Approx. 13.2 lb (6.0 kg), weight may vary by configuration</li> <li>• Toolless cover, disk, optical, and extension card removal</li> <li>• Optional dust filter</li> <li>• Bay 1: Slim external ODD bay</li> <li>• Bay 2: 3.5", internal, HDD/SSD</li> <li>• Bay 3: 2.5", internal, HDD/SSD (bay only comes with 2.5" 2nd disk)</li> <li>• Slot 1: low-profile (length &lt; 150mm, height &lt; 68mm), PCIe 3.0 x16</li> <li>• Slot 2: low-profile (length &lt; 150mm, height &lt; 68mm), PCIe 2.0 x1</li> <li>• Slot 3: low-profile (length &lt; 150mm, height &lt; 68mm), PCIe 2.0 x1</li> <li>• Slot 4: low-profile (length &lt; 150mm, height &lt; 68mm), PCI 3.0</li> <li>• M.2 card slots: two (one for WLAN, one for SSD)</li> </ul>
Monitor cable	Optional DP to VGA, DP to DVI-D (single link), DP to dual DP, or DP to HDMI 1.4					Floor Stand	Optional system floor stand for vertical orientation
Chipset	<b>AMD PRO 560 FCH</b>					Power supply	<ul style="list-style-type: none"> <li>• <i>Some:</i> 180 watts, autosensing, 85% PSU</li> <li>• <i>Some:</i> 210 watts, autosensing, 85% PSU</li> <li>• <i>Some:</i> 260 watts, autosensing, 92% PSU (only available via special bid)</li> </ul>
Front ports* (Std.)	2x USB 3.1 Gen2, 2x USB 3.1 Gen1, 1x microphone (3.5mm), 1x headphone (3.5mm)					Limited warranty	<b>1-year or 3-year, limited onsite service</b> / service upgrades available
Front ports* (Opt.)	<i>Optional:</i> 1x media reader					Preload	<b>Preloaded operating system</b> <ul style="list-style-type: none"> <li>• <i>Some:</i> Windows 10 Pro 64-bit</li> <li>• <i>Some:</i> Windows 10 Home 64-bit</li> <li>• <i>Some:</i> Windows 10 IoT Enterprise</li> <li>• <i>Some:</i> Linux Ubuntu</li> </ul>
Rear ports* (Std.)	2x USB 3.1 Gen1 (one support Smart Power-On), 2x USB 2.0, 1x serial (9-pin), 1x ethernet (RJ-45), 1x VGA**, 2x DisplayPort**, 2x PS/2 ports (keyboard / mouse); 1x line-in (3.5mm), 1x line-out (3.5mm), 1x microphone (3.5mm)					Environment	ENERGY STAR® 7.0*, EPEAT™ Silver rating* (*not for non-OS models); ErP Lot 3; RoHS-compliant, WEEE
Rear ports* (Opt.)	<i>Optional:</i> 2x USB 2.0, 1x parallel (25-pin), additional video ports available on optional graphics card * Depending on many factors, actual data transfer speed may be lower than theoretical speed ** only available on the models with integrated graphics					Accessories	For compatible accessories, please go to <a href="http://smartfind.lenovo.com">http://smartfind.lenovo.com</a>
Audio support	High Definition (HD) Audio, Realtek ALC662 / optional internal speaker (1 watt )						
WLAN	<ul style="list-style-type: none"> <li>• <i>Some:</i> 11ac wireless, M.2 Card, Realtek RTL8822CE (dual band), Wi-Fi + Bluetooth 5.0 combo adapter, 2x2</li> <li>• <i>Some:</i> 11ac wireless, M.2 Card, Qualcomm Atheros QCA6174A (dual band), Wi-Fi + Bluetooth 4.2 combo adapter, 2x2</li> <li>• <i>Some:</i> 11ac wireless, M.2 Card, Intel Wireless-AC 9560 (dual band), Wi-Fi + Bluetooth 5.0 combo adapter, 2x2</li> </ul>						
Bluetooth™	<i>Some:</i> Bluetooth 4.2 / 5.0 wireless, integrated in Wi-Fi + BT combo adapter						

Note: The specifications above may not be available in all regions.

Lenovo, September 2019



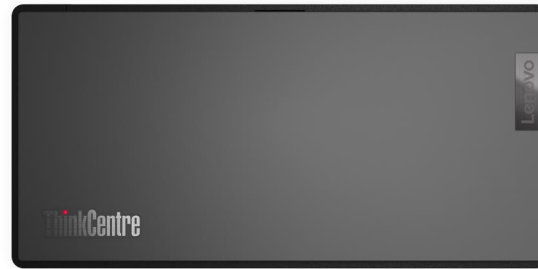

# ThinkCentre M90n-1 Nano Platform Specifications

Product Specifications Reference (PSREF)

Processor	Intel® 8th Generation Intel Core™ i3 / i5 / i7 Processor						Manageability Intel vPro technology on some models (require choosing a vPro-support Wi-Fi adapter to enable vPro function through wireless connection)						
	Processor	Cores / Threads	Frequency Base/Max(GHz)	Cache	Memory Support (Up to)	Integrated Graphics		Security chip Discrete TPM 2.0, TCG Certified Security features <ul style="list-style-type: none"> <li>• Security slot (in rear for optional Kensington® MicroSaver® cable)</li> <li>• Chassis intrusion switch</li> <li>• Power-on password</li> <li>• Administrator password</li> <li>• Hard disk password</li> <li>• Boot sequence control</li> <li>• Boot without keyboard and mouse</li> <li>• Individual USB port disablement</li> <li>• Smart USB protection, allows keyboard/mouse only, blocks all storage devices</li> </ul>					
	Core i3-8145U	2 / 4	2.1G / 3.9G	4 MB	DDR4-2400	UHD 620							
	Core i5-8265U	4 / 8	1.6G / 3.9G	6 MB	DDR4-2400	UHD 620							
	Core i5-8365U	4 / 8	1.6G / 4.1G	6 MB	DDR4-2400	UHD 620							
Core i7-8665U	4 / 8	1.9G / 4.8G	8 MB	DDR4-2400	UHD 620								
Memory	8GB or 16GB / DDR4-2666* / soldered to systemboard, no sockets, non-ECC * System automatically clocks down for the processors with lower memory controller						Keyboard <i>Some:</i> Lenovo Calliope Keyboard (USB connector), black <i>Some:</i> Lenovo Traditional Keyboard (USB connector), black <i>Some:</i> Lenovo Calliope Wireless Keyboard (2.4GHz via USB receiver), black Mouse <i>Some:</i> Lenovo Calliope Mouse (USB connector), black <i>Some:</i> Lenovo Fingerprint Mouse (USB connector), Windows Hello support, black <i>Some:</i> Lenovo Calliope Wireless Mouse (2.4GHz via USB receiver), black						
Storage	Support up to two M.2 SSD <i>Some:</i> M.2 2280 SSD / PCIe NVMe, PCIe 3.0 x 4* <i>Some:</i> M.2 2242 SSD / PCIe NVMe, PCIe 3.0 x 2 <i>Some:</i> Intel Optane™ Memory H10 with Solid State Storage, M.2 2280, PCIe NVMe 3.0 x 4 (not support Celeron) * M.2 SSD / Optane with SSD in PCIe 3.0 x 2 M.2 slot can only run at PCIe 3.0 x2												
RAID	RAID 0/1 support (RAID preset only available via special bid model)						Mechanical Nano (0.35L), black color; metal case Three M.2 slots: two for M.2 SSD (one PCIe 3.0 x4 and one PCIe 3.0 x2) and one for WLAN						
Optical	None												
Graphics	Intel UHD Graphics 620 in processor, uses main memory, DirectX® 12, one DisplayPort™, one USB 3.1 Type-C Gen2 with display function, up to 2 independent displays; <i>Max resolution:</i> 4096x2304 (DP)@60Hz; 4096x2304 (Type-C)@60Hz;						<table border="1"> <thead> <tr> <th></th> <th>Dimensions (WxDxH)</th> <th>Weight (Approx. )</th> </tr> </thead> <tbody> <tr> <td>M90n-1 Nano (with fan, 0.35L)</td> <td>7.05" X 3.46" X 0.87" 179mm X 88mm X 22mm</td> <td>1.11 lb (0.505 kg), vary by config</td> </tr> </tbody> </table>		Dimensions (WxDxH)	Weight (Approx. )	M90n-1 Nano (with fan, 0.35L)	7.05" X 3.46" X 0.87" 179mm X 88mm X 22mm	1.11 lb (0.505 kg), vary by config
	Dimensions (WxDxH)	Weight (Approx. )											
M90n-1 Nano (with fan, 0.35L)	7.05" X 3.46" X 0.87" 179mm X 88mm X 22mm	1.11 lb (0.505 kg), vary by config											
Monitor cable	Optional DP to VGA dongle, DP to HDMI dongle, Type-C to VGA dongle, Type-C to HDMI dongle, Type-C to DP dongle												
Chipset	Intel SoC (System on Chip) platform						Mounting <i>Some:</i> VESA mount bracket kit, supports VESA 75mm <i>Some:</i> VESA mount bracket kit with adapter holder, supports VESA 75mm <i>Some:</i> DIN rail mount bracket kit						
Front ports (Std.)*	2x USB 3.1 Gen2, 1x USB 3.1 Type-C Gen 2, one headphone / microphone combo jack (3.5mm)						Floor Stand None						
Rear ports (Std.)*	2x USB 3.1 Gen2, 1x USB 3.1 Type-C Gen 2 (with display function, support power-in [20V and >45W]), 1x ethernet (RJ-45), 1x DisplayPort * Depending on many factors, actual data transfer speed may be lower than theoretical speed						Power supply 65 watts AC/DC adapter, autosensing, 88% PSU (Not for TIO models)						
Audio support	Realtek ALC233VB / internal speaker (1 watt)						Limited warranty <i>Some:</i> <b>1-year, limited onsite service</b> / service upgrades available <i>Some:</i> <b>3-year, limited onsite service</b> / service upgrades available						
WLAN	<i>Some:</i> 11ac wireless, M.2 Card, Realtek RTL8822CE (dual band), Wi-Fi + Bluetooth 5.0 combo adapter, 1x1 <i>Some:</i> 11ac wireless, M.2 Card, Realtek RTL8822CE (dual band), Wi-Fi + Bluetooth 5.0 combo adapter, 2x2 <i>Some:</i> 11ac wireless, M.2 Card, Intel Wireless-AC 9462 (dual band), Wi-Fi + Bluetooth 5.0 combo adapter, 1x1 <i>Some:</i> 11ac wireless, M.2 Card, Intel Wireless-AC 9560 (dual band), Wi-Fi + Bluetooth 5.0 combo adapter, 2x2 <i>Some:</i> 11ac wireless, M.2 Card, Intel Wireless-AC 9560 (dual band), Wi-Fi + Bluetooth 5.0 combo adapter, Intel vPro technology support, 2x2						Preload <b>Preloaded operating system</b> <i>Some:</i> Windows® 10 Pro 64-bit <i>Some:</i> Windows 10 Home 64-bit						
Bluetooth	<i>Some:</i> Bluetooth 5.0 wireless, integrated in Wi-Fi + BT combo adapter						Environment ENERGY STAR® 7.1, EPEAT™ Silver rating (North America), ErP Lot 3, TCO 8.0, TUV ultra low noise verified (on some models), RoHS, WEEE, REACH						
Ethernet	Gigabit ethernet, Intel Ethernet Connection I219-LM(Jacksonville), Wake on LAN®						MIL-SPEC test MIL-STD-810H (Low Pressure [Altitude], High Temperature, Low Temperature, Temperature Shock, Humidity, Sand and Dust, Vibration, Shock, Solar Radiation)						
							Accessories For compatible accessories, please go to <a href="http://smartfind.lenovo.com">http://smartfind.lenovo.com</a>						

Note: The specifications above may not be available in all regions.

Lenovo, July 2019





# ThinkCentre M90n-1 Nano IoT Platform Specifications

Product Specifications Reference (PSREF)

Processor	Intel® Celeron® or 8th Generation Intel Core™ i3 Processor						Manageability Security chip Security features	None Discrete TPM 2.0, TCG Certified ● Security slot (in rear for optional Kensington® MicroSaver® cable) ● Chassis intrusion switch ● Power-on password ● Administrator password ● Hard disk password ● Boot sequence control ● Boot without keyboard and mouse ● Individual USB port disablement
	Processor	Cores / Threads	Frequency Base/Max(GHz)	Cache	Memory Support (Up to)	Integrated Graphics		
	Celeron 4205U	2 / 2	1.8G	2 MB	DDR4-2133	UHD 610		
	Core i3-8145U	2 / 4	2.1G / 3.9G	4 MB	DDR4-2400	UHD 620		
Memory	4GB / DDR4-2666* / soldered to systemboard, no sockets, non-ECC * System automatically clocks down for the processors with lower memory controller							
Storage	Support up to two M.2 SSD <i>Some:</i> M.2 2280 SSD / PCIe NVMe, PCIe 3.0 x 4* <i>Some:</i> M.2 2242 SSD / PCIe NVMe, PCIe 3.0 x 2 <i>Some:</i> Intel Optane™ Memory H10 with Solid State Storage, M.2 2280, PCIe NVMe 3.0 x 4 (not support Celeron) * M.2 SSD / Optane with SSD in PCIe 3.0 x 2 M.2 slot can only run at PCIe 3.0 x2						Keyboard	<i>Some:</i> Lenovo Calliope Keyboard (USB connector), black <i>Some:</i> Lenovo Traditional Keyboard (USB connector), black <i>Some:</i> Lenovo Calliope Wireless Keyboard (2.4GHz via USB receiver), black
RAID Optical	RAID 0/1 support (RAID preset only available via special bid model) None						Mouse	<i>Some:</i> Lenovo Calliope Mouse (USB connector), black <i>Some:</i> Lenovo Fingerprint Mouse (USB connector), Windows Hello support, black <i>Some:</i> Lenovo Calliope Wireless Mouse (2.4GHz via USB receiver), black
Graphics	Intel UHD Graphics 610/620 in processor, uses main memory, DirectX® 12, one DisplayPort™, one USB 3.1 Type-C Gen2 with display function, up to 2 independent displays; <i>Max resolution:</i> 4096x2304 (DP)@60Hz; 4096x2304 (Type-C)@60Hz;						Mechanical	Nano (fanless 0.55L), black color; metal case Four M.2 slots: two for M.2 SSD (one PCIe 3.0 x4 and one PCIe 3.0 x2), one for WLAN, and one for WWAN
Monitor cable	Optional DP to VGA dongle, DP to HDMI dongle, Type-C to VGA dongle, Type-C to HDMI dongle, Type-C to DP dongle							
Chipset	Intel SoC (System on Chip) platform							
Front ports (Std.)	2x USB 3.1 Gen2, 1x USB 3.1 Type-C Gen 2, one headphone / microphone combo jack (3.5mm), 2x serial							
Rear ports (Std.)	* <i>With Celeron:</i> 1x USB 2.0, 1x USB 3.1 Type-C Gen 2 (with display function, support power-in [20V, > 45W]), 1x ethernet (RJ-45), 1x DisplayPort <i>With Core i3:</i> 1x USB 3.1 Gen2, 1x USB 3.1 Type-C Gen 2 (with display function, support power-in [20V, > 45W]), 2x ethernet (RJ-45), 1x DisplayPort * Depending on many factors, actual data transfer speed may be lower than theoretical speed						Mounting	<i>Some:</i> VESA mount bracket kit, supports VESA 75mm <i>Some:</i> VESA mount bracket kit with adapter holder, supports VESA 75mm <i>Some:</i> DIN rail mount bracket kit
Audio support	Realtek ALC233VB / internal speaker (1watt)						Floor Stand	None
WLAN	<i>Some:</i> 11ac wireless, M.2 Card, Realtek RTL8822CE (dual band), Wi-Fi + Bluetooth 5.0 combo adapter, 1x1 <i>Some:</i> 11ac wireless, M.2 Card, Realtek RTL8822CE (dual band), Wi-Fi + Bluetooth 5.0 combo adapter, 2x2 <i>Some:</i> 11ac wireless, M.2 Card, Intel Wireless-AC 9462 (dual band), Wi-Fi + Bluetooth 5.0 combo adapter, 1x1 <i>Some:</i> 11ac wireless, M.2 Card, Intel Wireless-AC 9560 (dual band), Wi-Fi + Bluetooth 5.0 combo adapter, 2x2 <i>Some:</i> 11ac wireless, M.2 Card, Intel Wireless-AC 9560 (dual band), Wi-Fi + Bluetooth 5.0 combo adapter, Intel vPro technology support, 2x2						Power supply	<i>Some:</i> 65 watts AC/DC adapter, autosensing, 88% PSU <i>Some:</i> 65 watts AC/DC adapter (wide temperature), autosensing, 88% PSU (only for Machine Type 11AS)
Bluetooth Ethernet	<i>Some:</i> Bluetooth 5.0 wireless, integrated in Wi-Fi + BT combo adapter <i>With Celeron:</i> Gigabit ethernet, Realtek RTL8111K, 1x RJ-45, Wake on LAN® <i>With Core i3:</i> Two gigabit ethernet, Realtek RTL8111K and RTL8111HN, 2x RJ-45 Wake on LAN®						Limited warranty	<i>Some:</i> <b>1-year, limited onsite service</b> / service upgrades available <i>Some:</i> <b>3-year, limited onsite service</b> / service upgrades available
							Preload	<b>Preloaded operating system</b> <i>Some:</i> Windows® 10 Pro 64-bit <i>Some:</i> Windows 10 Home 64-bit <i>Some:</i> Windows 10 IoT Enterprise (only available via special bid model)
							Environment	ENERGY STAR® 7.1, EPEAT™ Silver rating (North America), ErP Lot 3, TCO 8.0, TUV ultra low noise verified (on some models), RoHS, WEEE, REACH
							MIL-SPEC test	MIL-STD-810H (Low Pressure [Altitude], High Temperature, Low Temperature, Temperature Shock, Humidity, Sand and Dust, Vibration, Shock, Solar Radiation)
							Accessories	For compatible accessories, please go to <a href="http://smartfind.lenovo.com">http://smartfind.lenovo.com</a>

Note: The specifications above may not be available in all regions.

Lenovo, July 2019

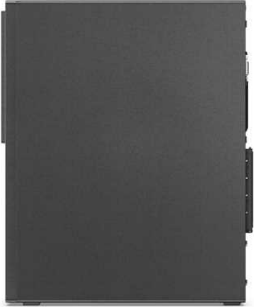

# ThinkCentre M910 SFF Platform Specifications

Product Specifications Reference (PSREF)

Processor	Intel® Celeron®, Intel Pentium®, or 6/7th Generation Intel Core™ i3 / i5 / i7 Processor	Security features	<ul style="list-style-type: none"> <li>Security slot (in rear for optional Kensington® MicroSaver® cable)</li> <li>Padlock loop</li> <li>Smart USB protection, allows keyboard/mouse only, blocks all storage devices</li> <li>Optional cable lock to physically lock both keyboard and mouse</li> <li>Power-on password</li> <li>Administrator password</li> <li>Hard disk password</li> <li>Boot sequence control</li> <li>Boot without keyboard and mouse</li> <li>Individual USB port disablement</li> <li>Optional chassis intrusion switch</li> </ul>																																																
	<table border="1"> <thead> <tr> <th>Processor</th> <th>Cores / Threads</th> <th>Frequency Base/Max(GHz)</th> <th>Cache</th> <th>Memory Support (Up to)</th> <th>Integrated Graphics</th> </tr> </thead> <tbody> <tr> <td>Core i5-6500</td> <td>4 / 4</td> <td>3.2G / 3.6G</td> <td>6 MB</td> <td>DDR4-2133</td> <td>HD 530</td> </tr> <tr> <td>Core i7-6700</td> <td>4 / 8</td> <td>3.4G / 4.0G</td> <td>8 MB</td> <td>DDR4-2133</td> <td>HD 530</td> </tr> <tr> <td>Core i3-7300</td> <td>2 / 4</td> <td>4.0G / --</td> <td>4 MB</td> <td>DDR4-2400</td> <td>HD 630</td> </tr> <tr> <td>Core i5-7400</td> <td>4 / 4</td> <td>3.0G / 3.5G</td> <td>6 MB</td> <td>DDR4-2400</td> <td>HD 630</td> </tr> <tr> <td>Core i5-7500</td> <td>4 / 4</td> <td>3.4G / 3.8G</td> <td>6 MB</td> <td>DDR4-2400</td> <td>HD 630</td> </tr> <tr> <td>Core i5-7600</td> <td>4 / 4</td> <td>3.5G / 4.1G</td> <td>6 MB</td> <td>DDR4-2400</td> <td>HD 630</td> </tr> <tr> <td>Core i7-7700</td> <td>4 / 8</td> <td>3.6G / 4.2G</td> <td>8 MB</td> <td>DDR4-2400</td> <td>HD 630</td> </tr> </tbody> </table>	Processor	Cores / Threads	Frequency Base/Max(GHz)	Cache	Memory Support (Up to)	Integrated Graphics	Core i5-6500	4 / 4	3.2G / 3.6G	6 MB	DDR4-2133	HD 530	Core i7-6700	4 / 8	3.4G / 4.0G	8 MB	DDR4-2133	HD 530	Core i3-7300	2 / 4	4.0G / --	4 MB	DDR4-2400	HD 630	Core i5-7400	4 / 4	3.0G / 3.5G	6 MB	DDR4-2400	HD 630	Core i5-7500	4 / 4	3.4G / 3.8G	6 MB	DDR4-2400	HD 630	Core i5-7600	4 / 4	3.5G / 4.1G	6 MB	DDR4-2400	HD 630	Core i7-7700	4 / 8	3.6G / 4.2G	8 MB	DDR4-2400	HD 630	Keyboard	<i>Some:</i> Lenovo Calliope Keyboard (USB connector), black <i>Some:</i> Lenovo Traditional Keyboard (USB connector), black <i>Some:</i> Lenovo Calliope Wireless Keyboard (2.4GHz via USB receiver), black
Processor	Cores / Threads	Frequency Base/Max(GHz)	Cache	Memory Support (Up to)	Integrated Graphics																																														
Core i5-6500	4 / 4	3.2G / 3.6G	6 MB	DDR4-2133	HD 530																																														
Core i7-6700	4 / 8	3.4G / 4.0G	8 MB	DDR4-2133	HD 530																																														
Core i3-7300	2 / 4	4.0G / --	4 MB	DDR4-2400	HD 630																																														
Core i5-7400	4 / 4	3.0G / 3.5G	6 MB	DDR4-2400	HD 630																																														
Core i5-7500	4 / 4	3.4G / 3.8G	6 MB	DDR4-2400	HD 630																																														
Core i5-7600	4 / 4	3.5G / 4.1G	6 MB	DDR4-2400	HD 630																																														
Core i7-7700	4 / 8	3.6G / 4.2G	8 MB	DDR4-2400	HD 630																																														
		Mouse	<i>Some:</i> Lenovo Calliope Mouse (USB connector), black <i>Some:</i> Lenovo Calliope Wireless Mouse (2.4GHz via USB receiver), black																																																
Memory	64GB max, UDIMM, DDR4-2400*, four 288-pin DIMM sockets, non-ECC, dual-channel capable * System automatically clocks down for the processors with lower memory controller	Mechanical	<ul style="list-style-type: none"> <li>SFF (8.4L), black color, metal case</li> <li>(WxDxH) 3.6" X 11.4" X 13.5"; 92.5mm X 290.5mm X 343.5mm</li> <li>Approx. 11.92 lb (5.4 kg), weight may vary by configuration</li> <li>Toolless cover, disk, optical, graphic card removal</li> <li>Optional dust filter</li> <li>Bay 1: Slim external ODD bay</li> <li>Bay 2: 3.5", 1" high, internal, HDD/SSD</li> <li>Bay 3: 2.5", internal, HDD/SSD (optional bay)</li> <li>Slot 1: low-profile (length &lt; 150mm, height &lt; 68mm), PCIe 3.0 x16*</li> <li>Slot 2: low-profile (length &lt; 150mm, height &lt; 68mm), PCIe 3.0 x1*</li> <li>Slot 3: low-profile (length &lt; 150mm, height &lt; 68mm), PCIe 3.0 x16 (x4 signal)*</li> <li>Slot 4: no slot, only bracket for optional port extension*</li> <li>M.2 card slots: Two (one for WLAN, one for SSD/Optane)</li> <li>* Optional 2 front USB3.1 Type-C ports module occupies PCIe x16 (x4 signal) slot, optional rear 2x USB2.0 / parallel / 2nd serial / cable lock / Wi-Fi antenna occupies one expansion slot</li> </ul>																																																
Storage	<i>Some:</i> Hard Drive / SATA 6.0Gb/s, 2.5" or 3.5", 5400 rpm or 7200 rpm <i>Some:</i> Solid State Drive (SSD) / SATA 6.0Gb/s, 2.5" <i>Some:</i> M.2 Solid State Drive (SSD) / PCIe NVMe, PCIe 3.0 x 4, 32Gb/s <i>Some:</i> Intel Optane™ Memory (models with 7th gen Core processor), M.2 <i>Some:</i> DVD-ROM SATA 1.5Gb/s Drive, slim (9.0mm) <i>Some:</i> DVD Burner (DVD±RW), SATA 1.5Gb/s Drive, slim (9.0mm)	Floor Stand	Optional system floor stand for vertical orientation																																																
Optical	Four onboard SATA 6.0Gb/s connectors, RAID 0/1 support (RAID preset only available via special bid model)	Power supply	<i>Some:</i> 180 watts, autosensing, 85% PSU <i>Some:</i> 210 watts, autosensing, 85% PSU <i>Some:</i> 210 watts, autosensing, 92% PSU (only available via special bid)																																																
Onboard SATA	Optional 7-in-1 media reader	Limited warranty <sup>3</sup>	<i>Some:</i> <b>1-year or 3-year, depot service</b> / service upgrades available <i>Some:</i> <b>1-year or 3-year, limited onsite service</b> / service upgrades available																																																
Media reader	Optional 7-in-1 media reader	Preload	<b>Preloaded operating system</b> <i>Some:</i> Windows® 7 Professional 32/64 preinstalled through downgrade rights in Windows 10 Pro 64-bit (not available with 7th Gen Intel processor) <i>Some:</i> Windows 10 Pro 64-bit <i>Some:</i> Windows 10 Home 64-bit <b>Preloaded applications (only some listed)</b> <ul style="list-style-type: none"> <li>Microsoft Office preloaded; purchase a product key to activate</li> <li>Only for Window 10</li> <li>Lenovo Companion - Only for Window 7</li> <li>Lenovo Solution Center</li> <li>Lenovo ThinkVantage Tools</li> <li>Create Recovery Media</li> <li>Adobe® Reader®</li> <li>Cyberlink PowerDVD Create (DVD±RW)</li> </ul>																																																
Graphics	Intel HD Graphics 510/530/610/630 in processor, uses main memory, DirectX® 12, one VGA, two DisplayPort™, supports 3 independent displays, works along with discrete graphics to support more displays; Max resolution: 4096x2304 (DP)@60Hz; 2048x1536 (VGA)@50Hz <i>Some:</i> NVIDIA GeForce® GT 730, DirectX 12, 2GB, PCIe 2.0 x8 adapter, two DisplayPort, 35 watts; Max resolution: 3840x2160 (DisplayPort)@60Hz;	Environment	ENERGY STAR® 6.1, EPEAT™ Gold rating (North America), ErP Lot 3, GREENGUARD®, RoHS-compliant, TUV low noise verified (on some models)																																																
Monitor cable	Optional DP to VGA, DP to DVI-D (single link), DP to dual DP, or DP to HDMI 1.4	Accessories	For compatible accessories, please go to <a href="http://www.lenovoquickpick.com">http://www.lenovoquickpick.com</a>																																																
Chipset	Intel Q270 Chipset	Manageability	Intel Active Management Technology 11.0 (Intel AMT 11.0); Intel vPro technology on some models (require choosing a vPro-support Wi-Fi adapter to enable vPro function through wireless connection)																																																
Front ports*	Four USB 3.1 Gen1, optional two USB 3.1 Type-C Gen 2 (only available via special bid), microphone (3.5mm), headphone (3.5mm)	Security chip	TPM (Trusted Platform Module) 2.0, TCG Certified * Downgrade to TPM1.2 for the models with Win10 DG Win7 32 OS																																																
Rear ports*	Four USB 3.1 Gen1, optional two USB 2.0, serial (9-pin), optional 2nd serial (9-pin), optional parallel (25-pin), ethernet (RJ-45), one VGA, two DisplayPort, optional two PS/2 ports (keyboard/mouse); additional DisplayPort on optional graphics on some models																																																		
Rear audio ports* IEEE 1394*	Line-in (3.5mm), line-out (3.5mm), microphone-in (3.5mm) None * Depending on many factors, actual data transfer speed may be lower than theoretical speed																																																		
Audio support	High Definition (HD) Audio, Realtek ALC662 / optional internal speaker (1.5 watt )																																																		
WLAN <sup>13</sup>	<i>Some:</i> 11ac wireless, M.2 Card, Qualcomm Atheros QCA9377A (dual band), Wi-Fi + Bluetooth 4.1 combo adapter, 1x1 <i>Some:</i> 11ac wireless, M.2 Card, Qualcomm Atheros QCA6174A (dual band), Wi-Fi + Bluetooth 4.1 combo adapter, 2x2 <i>Some:</i> 11ac wireless, M.2 Card, Intel Dual Band Wireless-AC 3165, Wi-Fi + Bluetooth 4.1 combo adapter, 1x1 <i>Some:</i> 11ac wireless, M.2 Card, Intel Dual Band Wireless-AC 8265, Wi-Fi + Bluetooth 4.1 combo adapter, 2x2 <i>Some:</i> 11ac wireless, M.2 Card, Intel Dual Band Wireless-AC 8265, Wi-Fi + Bluetooth 4.1 combo adapter, Intel vPro technology support, 2x2																																																		
Bluetooth™ Ethernet Modem	<i>Some:</i> Bluetooth 4.1 wireless, integrated in Wi-Fi + BT combo adapter Gigabit ethernet, Intel Ethernet Connection I219-LM(Jacksonville), Wake on LAN® None																																																		

Note: The specifications above may not be available in all regions.

Lenovo, August 2017



# ThinkCentre M910 Tiny Platform Specifications

Product Specifications Reference (PSREF)

Processor	Intel® Celeron®, Intel Pentium®, or 6/7th Generation Intel Core™ i3 / i5 / i7 Processor						<b>Security features</b> <ul style="list-style-type: none"> <li>Security slot (in rear for optional Kensington® MicroSaver® cable)</li> <li>Smart USB protection, allows keyboard/mouse only, blocks all storage devices</li> <li>Power-on password</li> <li>Administrator password</li> <li>Hard disk password</li> <li>Boot sequence control</li> <li>Boot without keyboard and mouse</li> <li>Individual USB port disablement</li> <li>Chassis intrusion switch</li> </ul>
	Processor	Cores / Threads	Frequency Base/Max(GHz)	Cache	Memory Support (Up to)	Integrated Graphics	
	Core i5-6500T	4 / 4	2.5G / 3.1G	6 MB	DDR4-2133	HD 530	
	Core i7-6700T	4 / 8	2.8G / 3.6G	8 MB	DDR4-2133	HD 530	
	Core i5-7500T	4 / 4	2.7G / 3.3G	6 MB	DDR4-2400	HD 630	
	Core i5-7600T	4 / 4	2.8G / 3.7G	6 MB	DDR4-2400	HD 630	
Core i7-7700T	4 / 8	2.9G / 3.8G	8 MB	DDR4-2400	HD 630		
Memory	32GB max, DDR4-2400*, two 260-pin SO-DIMM sockets, non-ECC, dual-channel capable * System automatically clocks down for the processors with lower memory controller						
Storage	<i>Some:</i> Hard Drive / SATA 6.0Gb/s, 2.5", 5400 rpm or 7200 rpm, APS <i>Some:</i> Solid State Drive (SSD) / SATA 6.0Gb/s, 2.5" <i>Some:</i> M.2 Solid State Drive (SSD) / PCIe NVMe, PCIe 3.0 x 4, 32Gb/s <i>Some:</i> Intel Optane™ Memory (models with 7th gen Core processor), M.2 <i>Some:</i> DVD-ROM, slim (9.0mm), via USB external ODD box <i>Some:</i> DVD Burner (DVD±RW), slim (9.0mm), via USB external ODD box						
Optical	One onboard SATA 6.0Gb/s connector None						
Onboard SATA Media reader	None						
Graphics	<b>Intel HD Graphics 510/530/610/630</b> in processor, uses main memory, DirectX® 12, two DisplayPort™, one optional video port (HDMI, VGA, 3rd DP, or USB 3.1 Type-C with DisplayPort Alternate Mode), up to 3 independent displays; <i>Max resolution:</i> 4096x2304 (DP)@60Hz; 4096x2304 (Type-C)@60Hz; 4096x2160 (HDMI)@24Hz; 1920x1200 (VGA)@60Hz						
Monitor cable	Optional DP to VGA, DP to DVI-D (single link), DP to dual DP, or DP to HDMI 1.4						
Chipset	<b>Intel Q270 Chipset</b>						
Front ports*	Two USB 3.1 Gen1 (one is Always On and fast charge), one microphone (3.5mm), one headphone / microphone combo jack (3.5mm)						
Rear ports*	Four USB 3.1 Gen1 (optional external optical box or external I/O box occupies one or two specific USB 3.1 Gen1 on some models), ethernet (RJ-45), two DisplayPort, two optional ports (Port 1 for VGA / 3rd DP / HDMI / serial / USB 3.1 Type-C Gen 1 (with DisplayPort Alternate Mode), Port 2 for serial)						
I/O box*	Optional external I/O box, extends two USB 2.0, two USB 3.1 Gen1, and one serial on rear, two USB 2.0 on front, via USB cable (occupy two specific USB 3.1 Gen1 of Tiny) * Depending on many factors, actual data transfer speed may be lower than theoretical speed						
Audio support	High Definition (HD) Audio, Realtek ALC294 / optional internal speaker (1w or 2w)						
WLAN <sup>13</sup>	<i>Some:</i> 11ac wireless, M.2 Card, Qualcomm Atheros QCA9377A (dual band), Wi-Fi + Bluetooth 4.2 combo adapter, 1x1 <i>Some:</i> 11ac wireless, M.2 Card, Qualcomm Atheros QCA6174A (dual band), Wi-Fi + Bluetooth 4.2 combo adapter, 2x2 <i>Some:</i> 11ac wireless, M.2 Card, Intel Dual Band Wireless-AC 3165, Wi-Fi + Bluetooth 4.2 combo adapter, 1x1 <i>Some:</i> 11ac wireless, M.2 Card, Intel Dual Band Wireless-AC 8265, Wi-Fi + Bluetooth 4.2 combo adapter, 2x2 <i>Some:</i> 11ac wireless, M.2 Card, Intel Dual Band Wireless-AC 8265, Wi-Fi + Bluetooth 4.2 combo adapter, Intel vPro technology support, 2x2						
Bluetooth™	<i>Some:</i> Bluetooth 4.2 wireless, integrated in Wi-Fi + BT combo adapter * Hardware supports BT 4.2, but Win10 RS3 and earlier only supports BT 4.1						
Ethernet	Gigabit ethernet, Intel Ethernet Connection I219-LM(Jacksonville), Wake on LAN®						
Manageability	Intel Active Management Technology 11.0 (Intel AMT 11.0); Intel vPro technology on some models (require choosing a vPro-support Wi-Fi adapter to enable vPro function through wireless connection)						
Security chip	TPM (Trusted Platform Module) 2.0*, TCG Certified * Downgrade to TPM1.2 for the models with Win10 DG Win7 32 OS						
Keyboard	<i>Some:</i> Lenovo Calliope Keyboard (USB connector), black <i>Some:</i> Lenovo Traditional Keyboard (USB connector), black <i>Some:</i> Lenovo Calliope Wireless Keyboard (2.4GHz via USB receiver), black <i>Some:</i> Lenovo Calliope Mouse (USB connector), black <i>Some:</i> Lenovo Calliope Wireless Mouse (2.4GHz via USB receiver), black						
Mouse	<i>Some:</i> Lenovo Calliope Keyboard (USB connector), black <i>Some:</i> Lenovo Traditional Keyboard (USB connector), black <i>Some:</i> Lenovo Calliope Wireless Keyboard (2.4GHz via USB receiver), black <i>Some:</i> Lenovo Calliope Mouse (USB connector), black <i>Some:</i> Lenovo Calliope Wireless Mouse (2.4GHz via USB receiver), black						
Mechanical	Tiny (1L), black color; metal case <ul style="list-style-type: none"> <li>Toolless chassis open</li> <li>Toolless HDD, SSD, memory removal</li> <li>Optional toolless chassis screw</li> <li>Optional dust filter</li> </ul>						
VESA mount Floor Stand	Optional VESA mount bracket kit, supports VESA 75mm and 100mm Optional system floor stand for vertical orientation						
Power supply	65 watts AC/DC adapter, autosensing, 88% PSU (not included for TIO models) 90 watts AC/DC adapter, autosensing, 88% PSU (only for models with I/O box)						
Limited warranty <sup>3</sup>	<i>Some:</i> <b>1-year</b> or <b>3-year, depot service</b> / service upgrades available <i>Some:</i> <b>1-year</b> or <b>3-year, limited onsite service</b> / service upgrades available						
Preload	<i>Some:</i> Windows® 7 Professional 32/64 preinstalled through downgrade rights in Windows 10 Pro 64-bit (not available with 7th Gen Intel processor) <i>Some:</i> Windows 10 Pro 64-bit <i>Some:</i> Windows 10 Home 64-bit <b>Preloaded applications (only some listed)</b> <ul style="list-style-type: none"> <li>Microsoft Office preloaded; purchase a product key to activate</li> <li>Only for Window 10</li> <li>Lenovo Companion</li> <li>Intel Unite download link (vPro models only)</li> <li>Only for Window 7</li> <li>Lenovo Solution Center</li> <li>Lenovo ThinkVantage Tools</li> <li>Create Recovery Media</li> <li>Adobe® Reader®</li> <li>Cyberlink Power2Go Create (DVD±RW)</li> <li>Intel Unite (vPro models only)</li> </ul>						
Environment	ENERGY STAR® 6.1, EPEAT™ Gold rating (North America), ErP Lot 3, GREENGUARD®, RoHS-compliant, TUV low noise verified (on some models)						
MIL-SPEC test	MIL-STD-810G military certification (Low Pressure [Altitude], High Temperature, Low Temperature, Temperature Shock, Humidity, Sand and Dust, Vibration, Shock, Fungus, Solar Radiation)						
Accessories	For compatible accessories, please go to <a href="http://www.lenovoquickpick.com">http://www.lenovoquickpick.com</a>						

See footnotes for more detailed information





# ThinkCentre M910 Tower Platform Specifications

Product Specifications Reference (PSREF)

Processor	Intel® Celeron®, Intel Pentium®, or 6/7th Generation Intel Core™ i3 / i5 / i7 Processor						Ethernet Modem	Gigabit ethernet, Intel Ethernet Connection I219-LM(Jacksonville), Wake on LAN® None
	Processor	Cores / Threads	Frequency Base/Max(GHz)	Cache	Memory Support (Up to)	Integrated Graphics	Manageability	Intel Active Management Technology 11.0 (Intel AMT 11.0); Intel vPro technology on some models (require choosing a vPro-support Wi-Fi adapter to enable vPro function through wireless connection)
	Core i5-6500	4 / 4	3.2G / 3.6G	6 MB	DDR4-2133	HD 530	Security chip	TPM (Trusted Platform Module) 2.0, TCG Certified * Downgrade to TPM1.2 for the models with Win10 DG Win7 32 OS
	Core i7-6700	4 / 8	3.4G / 4.0G	8 MB	DDR4-2133	HD 530	Security features	<ul style="list-style-type: none"> <li>Security slot (in rear for optional Kensington® MicroSaver® cable)</li> <li>Power-on password</li> <li>Administrator password</li> <li>Padlock loop</li> <li>Hard disk password</li> <li>Smart USB protection, allows keyboard/ mouse only, blocks all storage devices</li> <li>Boot sequence control</li> <li>Boot without keyboard and mouse</li> <li>Optional cable lock to physically lock both keyboard and mouse</li> <li>Individual USB port disablement</li> <li>Optional chassis intrusion switch</li> </ul>
	Core i3-7300	2 / 4	4.0G / --	4 MB	DDR4-2400	HD 630		
	Core i5-7400	4 / 4	3.0G / 3.5G	6 MB	DDR4-2400	HD 630		
	Core i5-7500	4 / 4	3.4G / 3.8G	6 MB	DDR4-2400	HD 630		
	Core i5-7600	4 / 4	3.5G / 4.1G	6 MB	DDR4-2400	HD 630		
Core i7-7700	4 / 8	3.6G / 4.2G	8 MB	DDR4-2400	HD 630			
Memory	64GB max, UDIMM, DDR4-2400*, four 288-pin DIMM sockets, non-ECC, dual-channel capable * System automatically clocks down for the processors with lower memory controller						Keyboard	Some: Lenovo Calliope Keyboard (USB connector), black Some: Lenovo Traditional Keyboard (USB connector), black
Storage	Some: Hard Drive / SATA 6.0Gb/s, 2.5" or 3.5", 5400 rpm or 7200 rpm Some: Solid State Drive (SSD) / SATA 6.0Gb/s, 2.5" Some: M.2 Solid State Drive (SSD) / PCIe NVMe, PCIe 3.0 x 4, 32Gb/s Some: Intel Optane™ Memory (models with 7th gen Core processor), M.2 Some: Front accessible and removable HDD, 3.5", lockable via physical key						Mouse	Some: Lenovo Calliope Wireless Keyboard (2.4GHz via USB receiver), black Some: Lenovo Calliope Mouse (USB connector), black Some: Lenovo Calliope Wireless Mouse (2.4GHz via USB receiver), black
Optical	Some: DVD-ROM, SATA 1.5Gb/s, 5.25" or slim (9.0mm) Some: DVD Burner (DVD±RW), SATA 1.5Gb/s, 5.25" or slim (9.0mm)						Mechanical	<ul style="list-style-type: none"> <li>Tower (18L), black color, metal case</li> <li>(WxDxH) 6.5" X 12.65" X 16.15"; 165mm X 321.35mm X 410.25mm</li> <li>Approx. 15.45 lb (7 kg), weight may vary by configuration</li> <li>Toolless cover, disk, optical, graphic card removal</li> <li>Optional carry handle, dust filter</li> <li>Bay 1: Slim external ODD bay</li> <li>Bay 2: 5.25", 1.6" high, external, ODD / optional front access HDD</li> <li>Bay 3: 3.5", 1" high, internal, HDD/SSD</li> <li>Bay 4: 3.5", 1" high, internal, HDD/SSD (optional bay, bay comes with disk)</li> <li>Bay 5: 2.5", internal, HDD/SSD (optional bay)</li> <li>Notes: M910 Tower supports up to 3 SATA devices (ODD/HDD/SSD) and 1 eSATA device (front access HDD)</li> <li>Slot 1: full-length full-height (length &lt; 268mm, height &lt; 112mm), PCIe 3.0 x16*</li> <li>Slot 2: full-length full-height (length &lt; 268mm, height &lt; 112mm), PCIe 3.0 x1*</li> <li>Slot 3: full-length full-height (length &lt; 268mm, height &lt; 112mm), PCIe 3.0 x16 (x4 signal)*</li> <li>Slot 4: no slot, only bracket for optional port extension*</li> <li>M.2 card slots: Two (one for WLAN, one for SSD/Optane)</li> <li>* Optional 2 front USB3.1 Type-C ports module occupies PCIe x16 (x4 signal) slot, optional rear 2x USB2.0 / parallel / 2nd serial occupies one expansion slot</li> </ul>
Onboard SATA	Four onboard SATA 6.0Gb/s connectors (1x eSATA and 3x SATA), RAID 0/1 support (RAID preset only available via special bid model)							
Media reader	Optional 7-in-1 media reader							
Graphics	Intel HD Graphics 510/530/610/630 in processor, uses main memory, DirectX® 12, one VGA, two DisplayPort™, supports 3 independent displays, works along with discrete graphics to support more displays; Max resolution: 4096x2304 (DP) @60Hz; 2048x1536 (VGA) @50Hz Some: NVIDIA GeForce® GT 730, DirectX 12, 2GB, PCIe 2.0 x8 adapter, two DisplayPort, 35 watts; Max resolution: 3840x2160 (DisplayPort) @60Hz; Some: AMD Radeon™ R7 350, DirectX 11, 2GB, PCIe 3.0 x8 adapter, one VGA, one HDMI, 75 watts, occupies two slots; Max resolution: 4096x2160 (HDMI) @24Hz; 2048x1536 (VGA) @85Hz Some: NVIDIA GeForce GTX™ 1080 (only available via special bid model), DirectX 12, 8GB, PCIe 3.0 x16 adapter, one DVI-D, one HDMI, three DisplayPort, 180 watts, occupies two slots; Max resolution: 2560x1600 (DVI-D) @60Hz; 4096x2160 (HDMI) @60Hz 7680x4320 (with Single DP) @60Hz							
Monitor Cable	Optional DP to VGA, DP to DVI-D (single link), DP to dual DP, or DP to HDMI 1.4						Power supply	Some: 180 watts, autosensing, 85% PSU Some: 250 watts, autosensing, 85% PSU Some: 400 watts, autosensing, 92% PSU (only available via special bid)
Chipset	Intel Q270 Chipset						Limited warranty	Some: 1-year or 3-year, depot service / service upgrades available Some: 1-year or 3-year, limited onsite service / service upgrades available
Front ports*	Four USB 3.1 Gen1, optional two USB 3.1 Type-C Gen 2 (only available via special bid), microphone (3.5mm), headphone (3.5mm)						Preload	<b>Preloaded operating system</b> Some: Windows® 7 Professional 32/64 preinstalled through downgrade rights in Windows 10 Pro 64-bit (not available with 7th Gen Intel processor) Some: Windows 10 Pro 64-bit Some: Windows 10 Home 64-bit  <b>Preloaded applications (only some listed)</b> <ul style="list-style-type: none"> <li>Microsoft Office preloaded; purchase a product key to activate</li> <li>Only for Window 10</li> <li>Lenovo Companion</li> <li>Only for Window 7</li> <li>Lenovo Solution Center</li> <li>Lenovo ThinkVantage Tools</li> <li>Create Recovery Media</li> <li>Adobe® Reader®</li> <li>Cyberlink PowerDVD Create (DVD±RW)</li> </ul>
Rear ports*	Four USB 3.1 Gen1, optional two USB 2.0, serial (9-pin), optional 2nd serial (9-pin), optional parallel (25-pin), ethernet (RJ-45), one VGA, two DisplayPort, optional two PS/2 ports (keyboard/mouse); additional VGA, DisplayPort, DVI-D, or HDMI on optional graphics on some models							
Rear audio ports* IEEE 1394*	Line-in (3.5mm), line-out (3.5mm), microphone-in (3.5mm) None * Depending on many factors, actual data transfer speed may be lower than theoretical speed						Environment	ENERGY STAR® 6.1, EPEAT™ Gold rating (North America), ErP Lot 3, GREENGUARD®, RoHS-compliant, TUV low noise verified (on some models)
Audio support	High Definition (HD) Audio, Realtek ALC662 / optional internal speaker (1.5 watt )						Accessories	For compatible accessories, please go to <a href="http://www.lenovoquickpick.com">http://www.lenovoquickpick.com</a>
WLAN	Some: 11ac wireless, M.2 Card, Qualcomm Atheros QCA9377A (dual band), Wi-Fi + Bluetooth 4.1 combo adapter, 1x1 Some: 11ac wireless, M.2 Card, Qualcomm Atheros QCA6174A (dual band), Wi-Fi + Bluetooth 4.1 combo adapter, 2x2 Some: 11ac wireless, M.2 Card, Intel Dual Band Wireless-AC 3165, Wi-Fi + Bluetooth 4.1 combo adapter, 1x1 Some: 11ac wireless, M.2 Card, Intel Dual Band Wireless-AC 8265, Wi-Fi + Bluetooth 4.1 combo adapter, 2x2 Some: 11ac wireless, M.2 Card, Intel Dual Band Wireless-AC 8265, Wi-Fi + Bluetooth 4.1 combo adapter, Intel vPro technology support, 2x2						Bluetooth™	Some: Bluetooth 4.1 wireless, integrated in Wi-Fi + BT combo adapter

Note: The specifications above may not be available in all regions.

Lenovo, August 2017





# ThinkCentre M920 SFF Platform Specifications

Product Specifications Reference (PSREF)

Processor	Intel® Celeron®, Intel Pentium®, or 8th / 9th Gen Intel Core™ i3 / i5 / i7 / i9 Processor	Audio support	High Definition (HD) Audio, Realtek ALC233VB2 / internal speaker (2 watt )																																																																																																																																															
	<table border="1"> <thead> <tr> <th>Processor</th> <th>Cores / Threads</th> <th>Frequency Base/Max(GHz)</th> <th>Cache</th> <th>Memory Support (Up to)</th> <th>Integrated Graphics</th> </tr> </thead> <tbody> <tr><td>Celeron G4900</td><td>2 / 2</td><td>3.1G</td><td>2 MB</td><td>DDR4-2400</td><td>UHD 610</td></tr> <tr><td>Celeron G4920</td><td>2 / 2</td><td>3.2G</td><td>2 MB</td><td>DDR4-2400</td><td>UHD 610</td></tr> <tr><td>Celeron G4930</td><td>2 / 2</td><td>3.2G</td><td>2 MB</td><td>DDR4-2400</td><td>UHD 610</td></tr> <tr><td>Celeron G4950</td><td>2 / 2</td><td>3.3G</td><td>2 MB</td><td>DDR4-2400</td><td>UHD 610</td></tr> <tr><td>Pentium Gold G5400</td><td>2 / 4</td><td>3.7G</td><td>4 MB</td><td>DDR4-2400</td><td>UHD 610</td></tr> <tr><td>Pentium Gold G5500</td><td>2 / 4</td><td>3.8G</td><td>4 MB</td><td>DDR4-2400</td><td>UHD 630</td></tr> <tr><td>Pentium Gold G5600</td><td>2 / 4</td><td>3.9G</td><td>4 MB</td><td>DDR4-2400</td><td>UHD 630</td></tr> <tr><td>Pentium Gold G5420</td><td>2 / 4</td><td>3.8G</td><td>4 MB</td><td>DDR4-2400</td><td>UHD 610</td></tr> <tr><td>Pentium Gold G5620</td><td>2 / 4</td><td>4.0G</td><td>4 MB</td><td>DDR4-2400</td><td>UHD 630</td></tr> <tr><td>Core i3-8100</td><td>4 / 4</td><td>3.6G</td><td>6 MB</td><td>DDR4-2400</td><td>UHD 630</td></tr> <tr><td>Core i3-8300</td><td>4 / 4</td><td>3.7G</td><td>8 MB</td><td>DDR4-2400</td><td>UHD 630</td></tr> <tr><td>Core i5-8400</td><td>6 / 6</td><td>2.8G / 4.0G</td><td>9 MB</td><td>DDR4-2666</td><td>UHD 630</td></tr> <tr><td>Core i5-8500</td><td>6 / 6</td><td>3.0G / 4.1G</td><td>9 MB</td><td>DDR4-2666</td><td>UHD 630</td></tr> <tr><td>Core i5-8600</td><td>6 / 6</td><td>3.1G / 4.3G</td><td>9 MB</td><td>DDR4-2666</td><td>UHD 630</td></tr> <tr><td>Core i7-8700</td><td>6 / 12</td><td>3.2G / 4.6G</td><td>12 MB</td><td>DDR4-2666</td><td>UHD 630</td></tr> <tr><td>Core i3-9100</td><td>4 / 4</td><td>3.6G / 4.2G</td><td>6 MB</td><td>DDR4-2400</td><td>UHD 630</td></tr> <tr><td>Core i3-9300</td><td>4 / 4</td><td>3.7G / 4.3G</td><td>8 MB</td><td>DDR4-2400</td><td>UHD 630</td></tr> <tr><td>Core i3-9320</td><td>4 / 4</td><td>3.7G / 4.4G</td><td>8 MB</td><td>DDR4-2400</td><td>UHD 630</td></tr> <tr><td>Core i5-9400</td><td>6 / 6</td><td>2.9G / 4.1G</td><td>9 MB</td><td>DDR4-2666</td><td>UHD 630</td></tr> <tr><td>Core i5-9500</td><td>6 / 6</td><td>3.0G / 4.4G</td><td>9 MB</td><td>DDR4-2666</td><td>UHD 630</td></tr> <tr><td>Core i5-9600</td><td>6 / 6</td><td>3.1G / 4.6G</td><td>9 MB</td><td>DDR4-2666</td><td>UHD 630</td></tr> <tr><td>Core i7-9700</td><td>8 / 8</td><td>3.0G / 4.7G</td><td>12 MB</td><td>DDR4-2666</td><td>UHD 630</td></tr> <tr><td>Core i9-9900</td><td>8 / 16</td><td>3.1G / 5.0G</td><td>16 MB</td><td>DDR4-2666</td><td>UHD 630</td></tr> </tbody> </table>	Processor	Cores / Threads	Frequency Base/Max(GHz)	Cache	Memory Support (Up to)	Integrated Graphics	Celeron G4900	2 / 2	3.1G	2 MB	DDR4-2400	UHD 610	Celeron G4920	2 / 2	3.2G	2 MB	DDR4-2400	UHD 610	Celeron G4930	2 / 2	3.2G	2 MB	DDR4-2400	UHD 610	Celeron G4950	2 / 2	3.3G	2 MB	DDR4-2400	UHD 610	Pentium Gold G5400	2 / 4	3.7G	4 MB	DDR4-2400	UHD 610	Pentium Gold G5500	2 / 4	3.8G	4 MB	DDR4-2400	UHD 630	Pentium Gold G5600	2 / 4	3.9G	4 MB	DDR4-2400	UHD 630	Pentium Gold G5420	2 / 4	3.8G	4 MB	DDR4-2400	UHD 610	Pentium Gold G5620	2 / 4	4.0G	4 MB	DDR4-2400	UHD 630	Core i3-8100	4 / 4	3.6G	6 MB	DDR4-2400	UHD 630	Core i3-8300	4 / 4	3.7G	8 MB	DDR4-2400	UHD 630	Core i5-8400	6 / 6	2.8G / 4.0G	9 MB	DDR4-2666	UHD 630	Core i5-8500	6 / 6	3.0G / 4.1G	9 MB	DDR4-2666	UHD 630	Core i5-8600	6 / 6	3.1G / 4.3G	9 MB	DDR4-2666	UHD 630	Core i7-8700	6 / 12	3.2G / 4.6G	12 MB	DDR4-2666	UHD 630	Core i3-9100	4 / 4	3.6G / 4.2G	6 MB	DDR4-2400	UHD 630	Core i3-9300	4 / 4	3.7G / 4.3G	8 MB	DDR4-2400	UHD 630	Core i3-9320	4 / 4	3.7G / 4.4G	8 MB	DDR4-2400	UHD 630	Core i5-9400	6 / 6	2.9G / 4.1G	9 MB	DDR4-2666	UHD 630	Core i5-9500	6 / 6	3.0G / 4.4G	9 MB	DDR4-2666	UHD 630	Core i5-9600	6 / 6	3.1G / 4.6G	9 MB	DDR4-2666	UHD 630	Core i7-9700	8 / 8	3.0G / 4.7G	12 MB	DDR4-2666	UHD 630	Core i9-9900	8 / 16	3.1G / 5.0G	16 MB	DDR4-2666	UHD 630	<p>WLAN</p> <p><i>Some:</i> 11ac wireless, M.2 Card, Realtek RTL8821CE (dual band), Wi-Fi + Bluetooth 4.2 combo adapter, 1x1</p> <p><i>Some:</i> 11ac wireless, M.2 Card, Realtek RTL8822BE (dual band), Wi-Fi + Bluetooth 4.2 combo adapter, 2x2</p> <p><i>Some:</i> 11ac wireless, M.2 Card, Intel Dual Band Wireless-AC 3165, Wi-Fi + Bluetooth 4.2 combo adapter, 1x1</p> <p><i>Some:</i> 11ac wireless, M.2 Card, Intel Dual Band Wireless-AC 8265, Wi-Fi + Bluetooth 4.2 combo adapter, 2x2</p> <p><i>Some:</i> 11ac wireless, M.2 Card, Intel Wireless-AC 9560 (dual band), Wi-Fi + Bluetooth 5.0 combo adapter, Intel vPro technology support, 2x2</p> <p>Bluetooth</p> <p>Ethernet</p> <p>Ethernet (Opt.)</p> <p><i>Some:</i> Bluetooth 4.2/5.0 wireless, integrated in Wi-Fi + BT combo adapter</p> <p><i>Some:</i> Gigabit ethernet, Intel Ethernet Connection I219-LM(Jacksonville), Wake on LAN®</p> <p><i>Some:</i> Intel Ethernet Server Adapter I350-T4, gigabit ethernet, 4x RJ-45, PCIe x4</p> <p><i>Some:</i> Bitland BN8E88, gigabit ethernet, 1x RJ-45, PCIe x1 (special bid only)</p> <p>Manageability</p> <p>Intel Active Management Technology 12 (Intel AMT 12); Intel vPro technology on some models (require choosing a vPro-support Wi-Fi adapter to enable vPro function through wireless connection)</p> <p>Security chip</p> <p>Discrete TPM 2.0, TCG Certified</p> <p>Security features</p> <ul style="list-style-type: none"> <li>• Security slot (in rear for optional Kensington® MicroSaver® cable)</li> <li>• Padlock loop</li> <li>• Optional cable lock to physically lock both keyboard and mouse</li> <li>• Optional chassis intrusion switch</li> <li>• Optional chassis E-Lock (special bid)</li> <li>• Power-on password</li> <li>• Administrator password</li> <li>• Hard disk password</li> <li>• Boot sequence control</li> <li>• Boot without keyboard and mouse</li> <li>• Individual USB port disablement</li> <li>• Smart USB protection, allows keyboard/mouse only, blocks all storage devices</li> </ul> <p>Keyboard</p> <p><i>Some:</i> Lenovo Calliope Keyboard (USB connector), black</p> <p><i>Some:</i> Lenovo Traditional Keyboard (USB connector), black</p> <p><i>Some:</i> Lenovo Calliope Wireless Keyboard (2.4GHz via USB receiver), black</p> <p><i>Some:</i> Lenovo Keyboard (PS/2 connector), black (only available via special bid)</p> <p><i>Some:</i> Lenovo Calliope Mouse (USB connector), black</p> <p><i>Some:</i> Lenovo Fingerprint Mouse (USB connector), Windows Hello support, black</p> <p><i>Some:</i> Lenovo Calliope Wireless Mouse (2.4GHz via USB receiver), black</p> <p><i>Some:</i> Lenovo Mouse (PS/2 connector), black (only available via special bid)</p> <p>Mouse</p> <p>Mechanical</p> <ul style="list-style-type: none"> <li>• SFF (8.4L), black color, metal case</li> <li>• (WxDxH) 3.6" X 11.4" X 13.5"; 92.5mm X 290.5mm X 343.5mm</li> <li>• Approx. 13.23 lb (6 kg), weight may vary by configuration</li> <li>• Toolless cover, disk, optical, extension card removal</li> <li>• Optional dust filter</li> <li>Bay 1: Slim external ODD bay</li> <li>Bay 2: 3.5", 1" high, internal, HDD/SSD</li> <li>Bay 3: 2.5", internal, HDD/SSD (optional bay)</li> <li>Slot 1: low-profile (length &lt; 150mm, height &lt; 68mm), PCIe 3.0 x16</li> <li>Slot 2: low-profile (length &lt; 150mm, height &lt; 68mm), PCIe 3.0 x1</li> <li>Slot 3: low-profile (length &lt; 150mm, height &lt; 68mm), PCIe 3.0 x16 (x4 signal)</li> <li>Slot 4: no slot, only bracket for optional port extension</li> <li>M.2 card slots: Two (one for WLAN, one for SSD/Optane)</li> </ul> <p>Floor Stand</p> <p>Optional system floor stand for vertical orientation</p> <p>Power supply</p> <p><i>Some:</i> 180 watts, autosensing, 85% PSU</p> <p><i>Some:</i> 210 watts, autosensing, 85% PSU</p> <p><i>Some:</i> 260 watts, autosensing, 92% PSU (only available via special bid)</p> <p>Limited warranty</p> <p><i>Some:</i> <b>1-year</b> or <b>3-year, depot service</b> / service upgrades available</p> <p><i>Some:</i> <b>1-year</b> or <b>3-year, limited onsite service</b> / service upgrades available</p> <p>Preload</p> <p><i>Some:</i> Windows® 10 Pro 64-bit</p> <p><i>Some:</i> Windows 10 Home 64-bit</p> <p>Environment</p> <p>ENERGY STAR® 6.1, EPEAT™ Silver rating (North America), ErP Lot 3, TCO, TUV low noise verified (coming soon, on some models), RoHS-compliant</p> <p>Accessories</p> <p>For compatible accessories, please go to <a href="http://smartfind.lenovo.com">http://smartfind.lenovo.com</a></p>
Processor	Cores / Threads	Frequency Base/Max(GHz)	Cache	Memory Support (Up to)	Integrated Graphics																																																																																																																																													
Celeron G4900	2 / 2	3.1G	2 MB	DDR4-2400	UHD 610																																																																																																																																													
Celeron G4920	2 / 2	3.2G	2 MB	DDR4-2400	UHD 610																																																																																																																																													
Celeron G4930	2 / 2	3.2G	2 MB	DDR4-2400	UHD 610																																																																																																																																													
Celeron G4950	2 / 2	3.3G	2 MB	DDR4-2400	UHD 610																																																																																																																																													
Pentium Gold G5400	2 / 4	3.7G	4 MB	DDR4-2400	UHD 610																																																																																																																																													
Pentium Gold G5500	2 / 4	3.8G	4 MB	DDR4-2400	UHD 630																																																																																																																																													
Pentium Gold G5600	2 / 4	3.9G	4 MB	DDR4-2400	UHD 630																																																																																																																																													
Pentium Gold G5420	2 / 4	3.8G	4 MB	DDR4-2400	UHD 610																																																																																																																																													
Pentium Gold G5620	2 / 4	4.0G	4 MB	DDR4-2400	UHD 630																																																																																																																																													
Core i3-8100	4 / 4	3.6G	6 MB	DDR4-2400	UHD 630																																																																																																																																													
Core i3-8300	4 / 4	3.7G	8 MB	DDR4-2400	UHD 630																																																																																																																																													
Core i5-8400	6 / 6	2.8G / 4.0G	9 MB	DDR4-2666	UHD 630																																																																																																																																													
Core i5-8500	6 / 6	3.0G / 4.1G	9 MB	DDR4-2666	UHD 630																																																																																																																																													
Core i5-8600	6 / 6	3.1G / 4.3G	9 MB	DDR4-2666	UHD 630																																																																																																																																													
Core i7-8700	6 / 12	3.2G / 4.6G	12 MB	DDR4-2666	UHD 630																																																																																																																																													
Core i3-9100	4 / 4	3.6G / 4.2G	6 MB	DDR4-2400	UHD 630																																																																																																																																													
Core i3-9300	4 / 4	3.7G / 4.3G	8 MB	DDR4-2400	UHD 630																																																																																																																																													
Core i3-9320	4 / 4	3.7G / 4.4G	8 MB	DDR4-2400	UHD 630																																																																																																																																													
Core i5-9400	6 / 6	2.9G / 4.1G	9 MB	DDR4-2666	UHD 630																																																																																																																																													
Core i5-9500	6 / 6	3.0G / 4.4G	9 MB	DDR4-2666	UHD 630																																																																																																																																													
Core i5-9600	6 / 6	3.1G / 4.6G	9 MB	DDR4-2666	UHD 630																																																																																																																																													
Core i7-9700	8 / 8	3.0G / 4.7G	12 MB	DDR4-2666	UHD 630																																																																																																																																													
Core i9-9900	8 / 16	3.1G / 5.0G	16 MB	DDR4-2666	UHD 630																																																																																																																																													
Memory	64GB max, DDR4-2666*, four 288-pin DIMM sockets, dual-channel capable * System automatically clocks down for the processors with lower memory controller																																																																																																																																																	
Storage	<i>Some:</i> Hard Drive / SATA 6.0Gb/s, 2.5" or 3.5", 5400 rpm or 7200 rpm <i>Some:</i> Solid State Drive (SSD) / SATA 6.0Gb/s, 2.5" <i>Some:</i> M.2 Solid State Drive (SSD) / PCIe NVMe, PCIe 3.0 x 4*, 32Gb/s * 128GB SSD M.2 (2242) PCIe NVMe only supports PCIe 3.0 x 2, 16Gb/s <i>Some:</i> Intel Optane™ Memory (not support Celeron / Pentium Processor), M.2 <i>Some:</i> DVD-ROM, SATA 1.5Gb/s Drive, slim (9.0mm)																																																																																																																																																	
Optical	<i>Some:</i> DVD Burner (DVD±RW), SATA 1.5Gb/s Drive, slim (9.0mm)																																																																																																																																																	
Onboard SATA	Four onboard SATA 6.0Gb/s connectors, RAID 0/1 support (RAID preset only available via special bid model)																																																																																																																																																	
Media reader	Optional 7-in-1 media reader																																																																																																																																																	
Graphics	<b>Intel UHD Graphics 610/630</b> in processor, uses main memory, DirectX® 12, one VGA, two DisplayPort™, supports 3 independent displays, works along with discrete graphics to support more displays: <i>Max resolution:</i> 4096x2304 (DP)@60Hz; 2048x1536 (VGA)@50Hz <i>Some:</i> <b>NVIDIA GeForce® GT 730</b> , DirectX 12, 2GB, PCIe 2.0 x16 adapter, two DisplayPort, 35 watts; <i>Max resolution:</i> 3840x2160 (DisplayPort)@60Hz;																																																																																																																																																	
Monitor cable	Optional DP to VGA dongle, DP to DVI-D dongle, DP to dual DP dongle (for Collage Display with intel integrated graphics), or DP to HDMI 1.4 dongle																																																																																																																																																	
Chipset	<b>Intel Q370 Chipset</b>																																																																																																																																																	
Front ports* (Std.)	2x USB 3.1 Gen2, 2x USB 3.1 Gen1, 1x USB 3.1 Type-C Gen1 (15W charging), 1x microphone (3.5mm), 1x headphone / microphone combo jack (3.5mm)																																																																																																																																																	
Front ports* (Opt.)	<i>Optional:</i> 1x media reader																																																																																																																																																	
Rear ports* (Std.)	4x USB 3.1 Gen1, 1x serial (9-pin), 1x ethernet (RJ-45), 1x VGA, 2x DisplayPort, 1x line-out (3.5mm)																																																																																																																																																	
Rear ports* (Opt.)	<i>Optional:</i> 2x USB 2.0, 2x USB 3.1 Gen1 via PCIe x1, 2x USB 3.1 Type-C Gen2 via PCIe x4 (special bid only), 1x 2nd serial (9-pin), 4x serial (9-pin) via PCIe x1, 1x parallel (25-pin), 2x PS/2 ports (keyboard/mouse), 1x Thunderbolt 3 (combo USB3.1 Type-C Gen 2 / DisplayPort) via PCIe x4 (available on 09/30/2018), additional RJ-45 and video ports available on optional graphics or ethernet card * Depending on many factors, actual data transfer speed may be lower than theoretical speed																																																																																																																																																	

Note: The specifications above may not be available in all regions.

Lenovo, June 2019



# ThinkCentre M920 Tiny Platform Specifications

Product Specifications Reference (PSREF)

Processor	Intel® Celeron®, Intel Pentium®, or 8th / 9th Gen Intel Core™ i3 / i5 / i7 / i9 Processor						Bluetooth Ethernet (Opt.) Some: Bluetooth 4.2/5.0 wireless, integrated in Wi-Fi + BT combo adapter Gigabit ethernet, Intel Ethernet Connection I219-LM(Jacksonville), Wake on LAN® Some: Intel Ethernet Server Adapter I350-T4, gigabit ethernet, 4x RJ-45, PCIe x4
	Processor	Cores / Threads	Frequency Base/Max(GHz)	Cache	Memory Support (Up to)	Integrated Graphics	
	Celeron G4900T	2 / 2	2.9G	2 MB	DDR4-2400	UHD 610	
	Celeron G4930T	2 / 2	3.0G	2 MB	DDR4-2400	UHD 610	
	Pentium Gold G5400T	2 / 4	3.1G	4 MB	DDR4-2400	UHD 610	
	Pentium Gold G5500T	2 / 4	3.2G	4 MB	DDR4-2400	UHD 630	
	Pentium Gold G5600T	2 / 4	3.3G	4 MB	DDR4-2400	UHD 630	
	Pentium Gold G5420T	2 / 4	3.2G	4 MB	DDR4-2400	UHD 610	
	Core i3-8100T	4 / 4	3.1G	6 MB	DDR4-2400	UHD 630	
	Core i3-8300T	4 / 4	3.2G	8 MB	DDR4-2400	UHD 630	
	Core i5-8400T	6 / 6	1.7G / 3.3G	9 MB	DDR4-2666	UHD 630	
	Core i5-8500T	6 / 6	2.1G / 3.5G	9 MB	DDR4-2666	UHD 630	
	Core i5-8600T	6 / 6	2.3G / 3.7G	9 MB	DDR4-2666	UHD 630	
	Core i7-8700T	6 / 12	2.4G / 4.0G	12 MB	DDR4-2666	UHD 630	
	Core i3-9100T	4 / 4	3.1G / 3.7G	6 MB	DDR4-2400	UHD 630	
	Core i3-9300T	4 / 4	3.2G / 3.8G	8 MB	DDR4-2400	UHD 630	
	Core i5-9400T	6 / 6	1.8G / 3.4G	9 MB	DDR4-2666	UHD 630	
	Core i5-9500T	6 / 6	2.2G / 3.7G	9 MB	DDR4-2666	UHD 630	
	Core i5-9600T	6 / 6	2.3G / 3.9G	9 MB	DDR4-2666	UHD 630	
	Core i7-9700T	8 / 8	2.0G / 4.3G	12 MB	DDR4-2666	UHD 630	
Core i9-9900T	8 / 16	2.1G / 4.4G	16 MB	DDR4-2666	UHD 630		
Memory	32GB max, DDR4-2666*, two 260-pin SO-DIMM sockets, dual-channel capable * System automatically clocks down for the processors with lower memory controller						Manageability Intel Active Management Technology 12 (Intel AMT 12); Intel vPro technology on some models (require choosing a vPro-support Wi-Fi adapter to enable vPro function through wireless connection)  Security chip Discrete TPM 2.0, TCG Certified Security features <ul style="list-style-type: none"> <li>Security slot (in rear for optional Kensington® MicroSaver® cable)</li> <li>Chassis intrusion switch</li> <li>Power-on password</li> <li>Administrator password</li> <li>Hard disk password</li> <li>Boot sequence control</li> <li>Boot without keyboard and mouse</li> <li>Individual USB port disablement</li> <li>Smart USB protection, allows keyboard/mouse only, blocks all storage devices</li> </ul> Keyboard Some: Lenovo Calliope Keyboard (USB connector), black Some: Lenovo Traditional Keyboard (USB connector), black Some: Lenovo Calliope Wireless Keyboard (2.4GHz via USB receiver), black Some: Lenovo Calliope Mouse (USB connector), black Some: Lenovo Fingerprint Mouse (USB connector), Windows Hello support, black Some: Lenovo Calliope Wireless Mouse (2.4GHz via USB receiver), black  Mouse Some: Lenovo Calliope Mouse (USB connector), black Some: Lenovo Fingerprint Mouse (USB connector), Windows Hello support, black Some: Lenovo Calliope Wireless Mouse (2.4GHz via USB receiver), black  Mechanical Tiny (1L), black color; metal case <ul style="list-style-type: none"> <li>Toolless chassis open (need optional toolless chassis screw)</li> <li>Toolless HDD, SSD, memory removal</li> <li>Optional dust filter</li> </ul> one 2.5" bay for HDD/SSD, one PCIe 3.0 x8 slot (low-profile), two M.2 slots (one for WLAN, one for M.2 SSD), 2.5" HDD/SSD and PCIe card are mutually exclusive  VESA mount Optional VESA mount bracket kit, supports VESA 75mm and 100mm Floor Stand Optional system floor stand for vertical orientation  Power supply Some: 65 watts AC/DC adapter, autosensing, 88% PSU Some: 90 watts AC/DC adapter, autosensing, 88% PSU Some: 135 watts AC/DC adapter, autosensing, 88% PSU  Limited warranty Some: <b>1-year</b> or <b>3-year, depot service</b> / service upgrades available Some: <b>1-year</b> or <b>3-year, limited onsite service</b> / service upgrades available  Preload <b>Preloaded operating system</b> Some: Windows® 10 Pro 64-bit Some: Windows 10 Home 64-bit <b>Preloaded applications (only some listed)</b> <ul style="list-style-type: none"> <li>Lenovo Vantage</li> <li>Microsoft Office preloaded; purchase a product key to activate</li> <li>Cyberlink PowerDVD (only for models with DVD / DVD±RW)</li> <li>Cyberlink Power2GO (only for models with DVD±RW)</li> <li>LinkedIn</li> <li>Intel Unite (Machine Type 10V8 models only)</li> </ul> Environment ENERGY STAR® 7.0, EPEAT™ Silver rating (North America), ErP Lot 3, TCO, TUV ultra low noise verified (coming soon, on some models), RoHS-compliant  MIL-SPEC test MIL-STD-810G military certification (Low Pressure [Altitude], High Temperature, Low Temperature, Temperature Shock, Humidity, Sand and Dust, Vibration, Shock, Fungus, Solar Radiation)  Accessories For compatible accessories, please go to <a href="http://smartfind.lenovo.com">http://smartfind.lenovo.com</a>
Storage	Some: Hard Drive / SATA 6.0Gb/s, 2.5", 5400 rpm or 7200 rpm Some: Solid State Drive (SSD) / SATA 6.0Gb/s, 2.5" Some: M.2 SSD / PCIe NVMe, PCIe 3.0 x 4", 32Gb/s * 128GB SSD M.2 (2242) PCIe NVMe only supports PCIe 3.0 x 2, 16Gb/s Some: Intel Optane™ Memory (not support Celeron / Pentium Processor), M.2						
Optical	Some: DVD-ROM, slim (9.0mm), via USB external ODD box Some: DVD Burner (DVD±RW), slim (9.0mm), via USB external ODD box						
Onboard SATA	One onboard SATA 6.0Gb/s connector						
Graphics	<b>Intel HD Graphics 610/630</b> in processor, uses main memory, DirectX® 12, one DisplayPort™, one HDMI, one optional video port (2nd HDMI, VGA, 2nd DP, or USB 3.1 Type-C Gen1 with DisplayPort function), up to 3 independent displays; Max resolution: 4096x2304 (DP)@60Hz; 4096x2304 (Type-C)@60Hz; 4096x2160 (onboard HDMI)@24Hz; 2048x1536 (VGA)@50Hz						
Monitor cable	Optional DP to VGA dongle, DP to DVI-D dongle, DP to dual DP dongle (for Collage Display with intel integrated graphics), or DP to HDMI 1.4 dongle						
Chipset	<b>Intel Q370 Chipset</b>						
Front ports (Std.)	* one USB 3.1 Gen1 (Always On and fast charge), one USB 3.1 Type-C Gen 1, one microphone (3.5mm), one headphone / microphone combo jack (3.5mm)						
Rear ports (Std.)	* 2x USB 3.1 Gen2, 2x USB 3.1 Gen1, 1x ethernet (RJ-45), 1x DisplayPort, 1x HDMI						
Rear ports (Opt.)	* Two optional ports (mutually exclusive with PCIe card): Port 1 for VGA / 2nd DP / 2nd HDMI / serial / USB 3.1 Type-C Gen 1 with DP function); Port 2 for serial; Optional ports via PCIe card: 2x USB 3.1 Gen1 via PCIe x1, 4x serial (9-pin) via PCIe x1, 1x Thunderbolt 3 (combo USB3.1 Type-C Gen 2 / DisplayPort) via PCIe x4 * Depending on many factors, actual data transfer speed may be lower than theoretical speed						
Audio support	Realtek ALC233VB2 / optional internal speaker (1.5 watt or 2 watt)						
WLAN	Some: 11ac wireless, M.2 Card, Realtek RTL8821CE (dual band), Wi-Fi + Bluetooth 4.2 combo adapter, 1x1 Some: 11ac wireless, M.2 Card, Realtek RTL8822BE (dual band), Wi-Fi + Bluetooth 4.2 combo adapter, 2x2 Some: 11ac wireless, M.2 Card, Intel Dual Band Wireless-AC 3165, Wi-Fi + Bluetooth 4.2 combo adapter, 1x1 Some: 11ac wireless, M.2 Card, Intel Dual Band Wireless-AC 8265, Wi-Fi + Bluetooth 4.2 combo adapter, 2x2 Some: 11ac wireless, M.2 Card, Intel Wireless-AC 9560 (dual band), Wi-Fi + Bluetooth 5.0 combo adapter, Intel vPro technology support, 2x2						

Note: The specifications above may not be available in all regions.

Lenovo, June 2019





# ThinkCentre M920 Tower Platform Specifications

Product Specifications Reference (PSREF)

Processor	Intel® Celeron®, Intel Pentium®, or 8th /9th Gen Intel Core™ i3 / i5 / i7 / i9 Processor	USB3.1 Type-C Gen 2 / DisplayPort) via PCIe x4 (available on 09/30/2018), additional RJ-45 and video ports available on optional graphics or ethernet card * Depending on many factors, actual data transfer speed may be lower than theoretical speed																																																																																																																																																
	<table border="1"> <thead> <tr> <th>Processor</th> <th>Cores / Threads</th> <th>Frequency Base/Max(GHz)</th> <th>Cache</th> <th>Memory Support (Up to)</th> <th>Integrated Graphics</th> </tr> </thead> <tbody> <tr><td>Celeron G4900</td><td>2 / 2</td><td>3.1G</td><td>2 MB</td><td>DDR4-2400</td><td>UHD 610</td></tr> <tr><td>Celeron G4920</td><td>2 / 2</td><td>3.2G</td><td>2 MB</td><td>DDR4-2400</td><td>UHD 610</td></tr> <tr><td>Celeron G4930</td><td>2 / 2</td><td>3.2G</td><td>2 MB</td><td>DDR4-2400</td><td>UHD 610</td></tr> <tr><td>Celeron G4950</td><td>2 / 2</td><td>3.3G</td><td>2 MB</td><td>DDR4-2400</td><td>UHD 610</td></tr> <tr><td>Pentium Gold G5400</td><td>2 / 4</td><td>3.7G</td><td>4 MB</td><td>DDR4-2400</td><td>UHD 610</td></tr> <tr><td>Pentium Gold G5500</td><td>2 / 4</td><td>3.8G</td><td>4 MB</td><td>DDR4-2400</td><td>UHD 630</td></tr> <tr><td>Pentium Gold G5600</td><td>2 / 4</td><td>3.9G</td><td>4 MB</td><td>DDR4-2400</td><td>UHD 630</td></tr> <tr><td>Pentium Gold G5420</td><td>2 / 4</td><td>3.8G</td><td>4 MB</td><td>DDR4-2400</td><td>UHD 610</td></tr> <tr><td>Pentium Gold G5620</td><td>2 / 4</td><td>4.0G</td><td>4 MB</td><td>DDR4-2400</td><td>UHD 630</td></tr> <tr><td>Core i3-8100</td><td>4 / 4</td><td>3.6G</td><td>6 MB</td><td>DDR4-2400</td><td>UHD 630</td></tr> <tr><td>Core i3-8300</td><td>4 / 4</td><td>3.7G</td><td>8 MB</td><td>DDR4-2400</td><td>UHD 630</td></tr> <tr><td>Core i5-8400</td><td>6 / 6</td><td>2.8G / 4.0G</td><td>9 MB</td><td>DDR4-2666</td><td>UHD 630</td></tr> <tr><td>Core i5-8500</td><td>6 / 6</td><td>3.0G / 4.1G</td><td>9 MB</td><td>DDR4-2666</td><td>UHD 630</td></tr> <tr><td>Core i5-8600</td><td>6 / 6</td><td>3.1G / 4.3G</td><td>9 MB</td><td>DDR4-2666</td><td>UHD 630</td></tr> <tr><td>Core i7-8700</td><td>6 / 12</td><td>3.2G / 4.6G</td><td>12 MB</td><td>DDR4-2666</td><td>UHD 630</td></tr> <tr><td>Core i3-9100</td><td>4 / 4</td><td>3.6G / 4.2G</td><td>6 MB</td><td>DDR4-2400</td><td>UHD 630</td></tr> <tr><td>Core i3-9300</td><td>4 / 4</td><td>3.7G / 4.3G</td><td>8 MB</td><td>DDR4-2400</td><td>UHD 630</td></tr> <tr><td>Core i3-9320</td><td>4 / 4</td><td>3.7G / 4.4G</td><td>8 MB</td><td>DDR4-2400</td><td>UHD 630</td></tr> <tr><td>Core i5-9400</td><td>6 / 6</td><td>2.9G / 4.1G</td><td>9 MB</td><td>DDR4-2666</td><td>UHD 630</td></tr> <tr><td>Core i5-9500</td><td>6 / 6</td><td>3.0G / 4.4G</td><td>9 MB</td><td>DDR4-2666</td><td>UHD 630</td></tr> <tr><td>Core i5-9600</td><td>6 / 6</td><td>3.1G / 4.6G</td><td>9 MB</td><td>DDR4-2666</td><td>UHD 630</td></tr> <tr><td>Core i7-9700</td><td>8 / 8</td><td>3.0G / 4.7G</td><td>12 MB</td><td>DDR4-2666</td><td>UHD 630</td></tr> <tr><td>Core i9-9900</td><td>8 / 16</td><td>3.1G / 5.0G</td><td>16 MB</td><td>DDR4-2666</td><td>UHD 630</td></tr> </tbody> </table>	Processor	Cores / Threads	Frequency Base/Max(GHz)	Cache	Memory Support (Up to)	Integrated Graphics	Celeron G4900	2 / 2	3.1G	2 MB	DDR4-2400	UHD 610	Celeron G4920	2 / 2	3.2G	2 MB	DDR4-2400	UHD 610	Celeron G4930	2 / 2	3.2G	2 MB	DDR4-2400	UHD 610	Celeron G4950	2 / 2	3.3G	2 MB	DDR4-2400	UHD 610	Pentium Gold G5400	2 / 4	3.7G	4 MB	DDR4-2400	UHD 610	Pentium Gold G5500	2 / 4	3.8G	4 MB	DDR4-2400	UHD 630	Pentium Gold G5600	2 / 4	3.9G	4 MB	DDR4-2400	UHD 630	Pentium Gold G5420	2 / 4	3.8G	4 MB	DDR4-2400	UHD 610	Pentium Gold G5620	2 / 4	4.0G	4 MB	DDR4-2400	UHD 630	Core i3-8100	4 / 4	3.6G	6 MB	DDR4-2400	UHD 630	Core i3-8300	4 / 4	3.7G	8 MB	DDR4-2400	UHD 630	Core i5-8400	6 / 6	2.8G / 4.0G	9 MB	DDR4-2666	UHD 630	Core i5-8500	6 / 6	3.0G / 4.1G	9 MB	DDR4-2666	UHD 630	Core i5-8600	6 / 6	3.1G / 4.3G	9 MB	DDR4-2666	UHD 630	Core i7-8700	6 / 12	3.2G / 4.6G	12 MB	DDR4-2666	UHD 630	Core i3-9100	4 / 4	3.6G / 4.2G	6 MB	DDR4-2400	UHD 630	Core i3-9300	4 / 4	3.7G / 4.3G	8 MB	DDR4-2400	UHD 630	Core i3-9320	4 / 4	3.7G / 4.4G	8 MB	DDR4-2400	UHD 630	Core i5-9400	6 / 6	2.9G / 4.1G	9 MB	DDR4-2666	UHD 630	Core i5-9500	6 / 6	3.0G / 4.4G	9 MB	DDR4-2666	UHD 630	Core i5-9600	6 / 6	3.1G / 4.6G	9 MB	DDR4-2666	UHD 630	Core i7-9700	8 / 8	3.0G / 4.7G	12 MB	DDR4-2666	UHD 630	Core i9-9900	8 / 16	3.1G / 5.0G	16 MB	DDR4-2666	UHD 630	<p>Audio support High Definition (HD) Audio, Realtek ALC233VB2 / internal speaker (2 watt )</p> <p>WLAN  <i>Some:</i> 11ac Wi-Fi + BT 4.2, M.2 Card, Realtek RTL8821CE (dual band), 1x1  <i>Some:</i> 11ac Wi-Fi + BT 4.2, M.2 Card, Realtek RTL8822BE (dual band), 2x2  <i>Some:</i> 11ac Wi-Fi + BT 4.2, M.2 Card, Intel Dual Band Wireless-AC 3165, 1x1  <i>Some:</i> 11ac wireless, M.2 Card, Intel Dual Band Wireless-AC 8265, 2x2  <i>Some:</i> 11ac Wi-Fi + BT 5.0, M.2 Card, Intel Wireless-AC 9560 (dual band), Intel vPro technology support, 2x2</p> <p>Bluetooth™ Ethernet Ethernet (Opt.)  <i>Some:</i> Bluetooth 4.2/5.0 wireless, integrated in Wi-Fi + BT combo adapter  Gigabit ethernet, Intel Ethernet Connection I219-LM(Jacksonville), Wake on LAN®  <i>Some:</i> Intel Ethernet Server Adapter I350-T4, gigabit ethernet, 4x RJ-45, PCIe x4  <i>Some:</i> Bitland BN8E88, gigabit ethernet, 1x RJ-45, PCIe x1 (special bid only)</p> <p>Manageability Intel Active Management Technology 12 (Intel AMT 12); Intel vPro technology on some models (require choosing a vPro-support Wi-Fi adapter to enable vPro function through wireless connection)</p> <p>Security chip Discrete TPM 2.0, TCG Certified</p> <p>Security features <ul style="list-style-type: none"> <li>• Security slot (in rear for optional Kensington® MicroSaver® cable)</li> <li>• Padlock loop</li> <li>• Optional cable lock to physically lock both keyboard and mouse</li> <li>• Optional chassis intrusion switch</li> <li>• Optional chassis E-Lock (special bid)</li> <li>• Power-on password</li> <li>• Administrator password</li> <li>• Hard disk password</li> <li>• Boot sequence control</li> <li>• Boot without keyboard and mouse</li> <li>• Individual USB port disablement</li> <li>• Smart USB protection, allows keyboard/mouse only, blocks all storage devices</li> </ul> </p> <p>Keyboard  <i>Some:</i> Lenovo Calliope Keyboard (USB connector), black  <i>Some:</i> Lenovo Traditional Keyboard (USB connector), black  <i>Some:</i> Lenovo Calliope Wireless Keyboard (2.4GHz via USB receiver), black  <i>Some:</i> Lenovo Keyboard (PS/2 connector), black (only available via special bid)</p> <p>Mouse  <i>Some:</i> Lenovo Calliope Mouse (USB connector), black  <i>Some:</i> Lenovo Fingerprint Mouse (USB connector), Windows Hello support, black  <i>Some:</i> Lenovo Calliope Wireless Mouse (2.4GHz via USB receiver), black  <i>Some:</i> Lenovo Mouse (PS/2 connector), black (only available via special bid)</p> <p>Mechanical <ul style="list-style-type: none"> <li>• Tower (18L), black color, metal case</li> <li>• (WxDxH) 6.5" X 12.65" X 16.15"; 165mm X 321.35mm X 410.25mm</li> <li>• Approx. 15.45 lb (7 kg), weight may vary by configuration</li> <li>• Toolless cover, disk, optical, extension card removal</li> <li>• Optional carry handle, dust filter</li> <li>Bay 1: Slim external ODD bay</li> <li>Bay 2: 5.25", 1.6" high, external, ODD / optional front access HDD</li> <li>Bay 3: 3.5", 1" high, internal, HDD/SSD</li> <li>Bay 4: 3.5", 1" high, internal, HDD/SSD (optional bay, bay comes with disk)</li> <li>Bay 5: 2.5", internal, HDD/SSD (optional bay)</li> <li>Notes: M920 Tower supports up to 3 SATA devices (ODD/HDD/SSD) and 1 eSATA device (front access HDD)</li> <li>Slot 1: full-length (&lt; 268mm) full-height (&lt; 112mm), PCIe 3.0 x16</li> <li>Slot 2: full-length (&lt; 268mm) full-height (&lt; 112mm), PCIe 3.0 x1</li> <li>Slot 3: full-length (&lt; 268mm) full-height (&lt; 112mm), PCIe 3.0 x16 (x4 signal)</li> <li>Slot 4: no slot, only bracket for optional port extension</li> <li>M.2 card slots: Two (one for WLAN, one for SSD/Optane)</li> </ul> </p> <p>Power supply  <i>Some:</i> 180 watts, autosensing, 85% PSU  <i>Some:</i> 250 watts, autosensing, 85% PSU  <i>Some:</i> 400 watts, autosensing, 92% PSU (only available via special bid)</p> <p>Limited warranty  <i>Some:</i> <b>1-year</b> or <b>3-year, depot service</b> / service upgrades available  <i>Some:</i> <b>1-year</b> or <b>3-year, limited onsite service</b> / service upgrades available</p> <p>Preload  <i>Some:</i> Windows® 10 Pro 64-bit  <i>Some:</i> Windows 10 Home 64-bit</p> <p>Environment ENERGY STAR® 6.1, EPEAT™ Silver rating (North America), ErP Lot 3, TCO, TUV low noise verified (coming soon, on some models), RoHS-compliant</p> <p>Accessories For compatible accessories, please go to <a href="http://smartfind.lenovo.com">http://smartfind.lenovo.com</a></p>
Processor	Cores / Threads	Frequency Base/Max(GHz)	Cache	Memory Support (Up to)	Integrated Graphics																																																																																																																																													
Celeron G4900	2 / 2	3.1G	2 MB	DDR4-2400	UHD 610																																																																																																																																													
Celeron G4920	2 / 2	3.2G	2 MB	DDR4-2400	UHD 610																																																																																																																																													
Celeron G4930	2 / 2	3.2G	2 MB	DDR4-2400	UHD 610																																																																																																																																													
Celeron G4950	2 / 2	3.3G	2 MB	DDR4-2400	UHD 610																																																																																																																																													
Pentium Gold G5400	2 / 4	3.7G	4 MB	DDR4-2400	UHD 610																																																																																																																																													
Pentium Gold G5500	2 / 4	3.8G	4 MB	DDR4-2400	UHD 630																																																																																																																																													
Pentium Gold G5600	2 / 4	3.9G	4 MB	DDR4-2400	UHD 630																																																																																																																																													
Pentium Gold G5420	2 / 4	3.8G	4 MB	DDR4-2400	UHD 610																																																																																																																																													
Pentium Gold G5620	2 / 4	4.0G	4 MB	DDR4-2400	UHD 630																																																																																																																																													
Core i3-8100	4 / 4	3.6G	6 MB	DDR4-2400	UHD 630																																																																																																																																													
Core i3-8300	4 / 4	3.7G	8 MB	DDR4-2400	UHD 630																																																																																																																																													
Core i5-8400	6 / 6	2.8G / 4.0G	9 MB	DDR4-2666	UHD 630																																																																																																																																													
Core i5-8500	6 / 6	3.0G / 4.1G	9 MB	DDR4-2666	UHD 630																																																																																																																																													
Core i5-8600	6 / 6	3.1G / 4.3G	9 MB	DDR4-2666	UHD 630																																																																																																																																													
Core i7-8700	6 / 12	3.2G / 4.6G	12 MB	DDR4-2666	UHD 630																																																																																																																																													
Core i3-9100	4 / 4	3.6G / 4.2G	6 MB	DDR4-2400	UHD 630																																																																																																																																													
Core i3-9300	4 / 4	3.7G / 4.3G	8 MB	DDR4-2400	UHD 630																																																																																																																																													
Core i3-9320	4 / 4	3.7G / 4.4G	8 MB	DDR4-2400	UHD 630																																																																																																																																													
Core i5-9400	6 / 6	2.9G / 4.1G	9 MB	DDR4-2666	UHD 630																																																																																																																																													
Core i5-9500	6 / 6	3.0G / 4.4G	9 MB	DDR4-2666	UHD 630																																																																																																																																													
Core i5-9600	6 / 6	3.1G / 4.6G	9 MB	DDR4-2666	UHD 630																																																																																																																																													
Core i7-9700	8 / 8	3.0G / 4.7G	12 MB	DDR4-2666	UHD 630																																																																																																																																													
Core i9-9900	8 / 16	3.1G / 5.0G	16 MB	DDR4-2666	UHD 630																																																																																																																																													
Memory	64GB max, DDR4-2666*, four 288-pin DIMM sockets, dual-channel capable * System automatically clocks down for the processors with lower memory controller																																																																																																																																																	
Storage	<i>Some:</i> Hard Drive / SATA 6.0Gb/s, 2.5" or 3.5", 5400 rpm or 7200 rpm <i>Some:</i> Solid State Drive (SSD) / SATA 6.0Gb/s, 2.5" <i>Some:</i> M.2 Solid State Drive (SSD) / PCIe NVMe, PCIe 3.0 x 4*, 32Gb/s * SSD M.2 (2242) PCIe NVMe only supports PCIe 3.0 x 2, 16Gb/s <i>Some:</i> Intel Optane™ Memory (not support Celeron / Pentium Processor), M.2 Optional DVD-ROM or DVD Burner (DVD±RW), SATA 1.5Gb/s Drive, slim (9.0mm)																																																																																																																																																	
Optical	Optional DVD-ROM or DVD Burner (DVD±RW), SATA 1.5Gb/s Drive, slim (9.0mm)																																																																																																																																																	
Onboard SATA	Four onboard SATA 6.0Gb/s connectors, RAID 0/1 support (RAID preset only available via special bid model)																																																																																																																																																	
Media reader	Optional 7-in-1 media reader																																																																																																																																																	
Graphics	<b>Intel UHD Graphics 610/630</b> in processor, uses main memory, DirectX® 12, one VGA, two DisplayPort™, supports 3 independent displays, works along with discrete graphics to support more displays; <i>Max resolution:</i> 4096x2304 (DP) @60Hz; 2048x1536 (VGA) @50Hz <i>Some:</i> <b>NVIDIA GeForce® GT 730</b> , DirectX 12, 2GB, PCIe 2.0 x16 adapter, two DisplayPort, 35 watts; <i>Max resolution:</i> 3840x2160 (DisplayPort) @60Hz; <i>Some:</i> <b>NVIDIA GeForce GTX 1060</b> (special bid only), DirectX 12, 6GB, PCIe 3.0 x16 adapter, 1x DVI-D, 1x HDMI, 3x DP, 120 watts, occupies two slots; <i>Max resolution:</i> 2560x1600 (DVI-D) @60Hz; 4096x2160 (HDMI) @60Hz 5120x3200 (DP) @60Hz																																																																																																																																																	
Monitor Cable	Optional DP to VGA dongle, DP to DVI-D dongle, DP to dual DP dongle (for Collage Display with intel integrated graphics), or DP to HDMI 1.4 dongle																																																																																																																																																	
Chipset	<b>Intel Q370 Chipset</b>																																																																																																																																																	
Front ports* (Std.)	2x USB 3.1 Gen2, 2x USB 3.1 Gen1, 1x USB 3.1 Type-C Gen1 (15W charging), 1x microphone (3.5mm), 1x headphone / microphone combo jack (3.5mm)																																																																																																																																																	
Front ports* (Opt.)	<i>Optional:</i> 1x media reader																																																																																																																																																	
Rear ports* (Std.)	4x USB 3.1 Gen1, 1x serial (9-pin), 1x ethernet (RJ-45), 1x VGA, 2x DisplayPort, 1x line-out (3.5mm)																																																																																																																																																	
Rear ports* (Opt.)	<i>Optional:</i> 2x USB 2.0, 2x USB 3.1 Gen1 via PCIe x1, 2x USB 3.1 Type-C Gen2 via PCIe x4 (special bid only), 1x 2nd serial (9-pin), 4x serial (9-pin) via PCIe x1, 1x parallel (25-pin), 2x PS/2 ports (keyboard/mouse), 1x Thunderbolt 3 (combo)																																																																																																																																																	

Note: The specifications above may not be available in all regions.

Lenovo, June 2019



# ThinkCentre M920x Tiny Platform Specifications

Product Specifications Reference (PSREF)

Processor		Intel® Celeron®, Intel Pentium®, or 8th / 9th Gen Intel Core™ i3 / i5 / i7 / i9 Processor													
Processor	Cores / Threads	Frequency Base/Max(GHz)	Cache	Memory Support (Up to)	Integrated Graphics										
Celeron G4900	2 / 2	3.1G	2 MB	DDR4-2400	UHD 610	4x Mini DisplayPort, up to 4 independent displays, works along with onboard DP and HDMI to support up to 6 independent displays; <i>Max resolution:</i> 5120x2880@60Hz ((up to 2 Mini DisplayPort); 4096x2160@60Hz ((up to 4 Mini DisplayPort)									
Celeron G4920	2 / 2	3.2G	2 MB	DDR4-2400	UHD 610										
Celeron G4930	2 / 2	3.2G	2 MB	DDR4-2400	UHD 610	Optional DP to VGA dongle, DP to DVI-D dongle, DP to dual DP dongle (for Collage Display with Intel integrated graphics), or DP to HDMI 1.4 dongle, Mini DP to DP									
Celeron G4950	2 / 2	3.3G	2 MB	DDR4-2400	UHD 610										
Pentium Gold G5400	2 / 4	3.7G	4 MB	DDR4-2400	UHD 610	<b>Intel Q370 Chipset</b>									
Pentium Gold G5500	2 / 4	3.8G	4 MB	DDR4-2400	UHD 630										
Pentium Gold G5600	2 / 4	3.9G	4 MB	DDR4-2400	UHD 630	Front ports (Std.)* one USB 3.1 Gen1 (Always On and fast charge), one USB 3.1 Type-C Gen 1, one microphone (3.5mm), one headphone / microphone combo jack (3.5mm)									
Pentium Gold G5420	2 / 4	3.8G	4 MB	DDR4-2400	UHD 610										
Pentium Gold G5620	2 / 4	4.0G	4 MB	DDR4-2400	UHD 630	Rear ports (Std.)* 2x USB 3.1 Gen2, 2x USB 3.1 Gen1, 1x ethernet (RJ-45), 1x DP, 1x HDMI									
Core i3-8100	4 / 4	3.6G	6 MB	DDR4-2400	UHD 630										
Core i3-8300	4 / 4	3.7G	8 MB	DDR4-2400	UHD 630	Rear ports (Opt.)* Two optional ports (mutually exclusive with PCIe card): Port 1 for VGA / 2nd DP / 2nd HDMI / serial / USB 3.1 Type-C Gen 1 with DP function); Port 2 for serial; Optional ports via PCIe card: 2x USB 3.1 Gen1 via PCIe x1, 4x serial (9-pin) via PCIe x1, 1x Thunderbolt 3 (combo USB3.1 Type-C Gen 2 / DP) via PCIe x4 * Depending on many factors, actual data transfer speed may be lower than theoretical speed									
Core i5-8400	6 / 6	2.8G / 4.0G	9 MB	DDR4-2666	UHD 630										
Core i5-8500	6 / 6	3.0G / 4.1G	9 MB	DDR4-2666	UHD 630	Audio support Realtek ALC233VB2 / optional internal speaker (1.5 watt or 2 watt)									
Core i5-8600	6 / 6	3.1G / 4.3G	9 MB	DDR4-2666	UHD 630										
Core i7-8700	6 / 12	3.2G / 4.6G	12 MB	DDR4-2666	UHD 630	WLAN <i>Some:</i> 11ac Wi-Fi + BT 4.2, M.2 Card, Realtek RTL8821CE (dual band), 1x1 <i>Some:</i> 11ac Wi-Fi + BT 4.2, M.2 Card, Realtek RTL8822BE (dual band), 2x2 <i>Some:</i> 11ac Wi-Fi + BT 4.2, M.2 Card, Intel Dual Band Wireless-AC 3165, 1x1 <i>Some:</i> 11ac Wi-Fi + BT 4.2, M.2 Card, Intel Dual Band Wireless-AC 8265, 2x2 <i>Some:</i> 11ac Wi-Fi + BT 5.0, M.2 Card, Intel Wireless-AC 9560 (dual band), Intel vPro technology support, 2x2									
Core i3-9100	4 / 4	3.6G / 4.2G	6 MB	DDR4-2400	UHD 630										
Core i3-9300	4 / 4	3.7G / 4.3G	8 MB	DDR4-2400	UHD 630	Bluetooth <i>Some:</i> Bluetooth 4.2/5.0 wireless, integrated in Wi-Fi + BT combo adapter									
Core i3-9320	4 / 4	3.7G / 4.4G	8 MB	DDR4-2400	UHD 630										
Core i5-9400	6 / 6	2.9G / 4.1G	9 MB	DDR4-2666	UHD 630	Ethernet Gigabit ethernet, Intel Ethernet Connection I219-LM(Jacksonville), Wake on LAN® <i>Some:</i> Intel Ethernet Server Adapter I350-T4, gigabit ethernet, 4x RJ-45, PCIe x4									
Core i5-9500	6 / 6	3.0G / 4.4G	9 MB	DDR4-2666	UHD 630										
Core i5-9600	6 / 6	3.1G / 4.6G	9 MB	DDR4-2666	UHD 630	Manageability Intel Active Management Technology 12 (Intel AMT 12); Intel vPro technology on some models (require choosing a vPro-support Wi-Fi adapter to enable vPro function through wireless connection)									
Celeron G4900T	2 / 2	2.9G	2 MB	DDR4-2400	UHD 610										
Celeron G4930T	2 / 2	3.0G	2 MB	DDR4-2400	UHD 610	Security chip Discrete TPM 2.0, TCG Certified									
Pentium Gold G5400T	2 / 4	3.1G	4 MB	DDR4-2400	UHD 610										
Pentium Gold G5500T	2 / 4	3.2G	4 MB	DDR4-2400	UHD 630	Security features <ul style="list-style-type: none"> <li>Security slot (in rear for optional Kensington® MicroSaver® cable)</li> <li>Chassis intrusion switch</li> <li>Power-on password</li> <li>Administrator password</li> <li>Hard disk password</li> </ul> <ul style="list-style-type: none"> <li>Boot sequence control</li> <li>Boot without keyboard and mouse</li> <li>Individual USB port disablement</li> <li>Smart USB protection, allows keyboard/mouse only, blocks all storage devices</li> </ul>									
Pentium Gold G5600T	2 / 4	3.3G	4 MB	DDR4-2400	UHD 630										
Pentium Gold G5420T	2 / 4	3.2G	4 MB	DDR4-2400	UHD 610	Keyboard <i>Some:</i> Lenovo Calliope Keyboard (USB connector), black <i>Some:</i> Lenovo Traditional Keyboard (USB connector), black <i>Some:</i> Lenovo Calliope Wireless Keyboard (2.4GHz via USB receiver), black									
Core i3-8100T	4 / 4	3.1G	6 MB	DDR4-2400	UHD 630										
Core i3-8300T	4 / 4	3.2G	8 MB	DDR4-2400	UHD 630	Mouse <i>Some:</i> Lenovo Calliope Mouse (USB connector), black <i>Some:</i> Lenovo Fingerprint Mouse (USB connector), Windows Hello support, black <i>Some:</i> Lenovo Calliope Wireless Mouse (2.4GHz via USB receiver), black									
Core i5-8400T	6 / 6	1.7G / 3.3G	9 MB	DDR4-2666	UHD 630										
Core i5-8500T	6 / 6	2.1G / 3.5G	9 MB	DDR4-2666	UHD 630	Mechanical Tiny (1L), black color; metal case <ul style="list-style-type: none"> <li>Toolless chassis open (need optional toolless chassis screw)</li> <li>Toolless HDD, SSD, memory removal</li> <li>Optional dust filter</li> </ul> one 2.5" bay for HDD/SSD, one PCIe 3.0 x8 slot (low-profile), three M.2 slots (one for WLAN, two for M.2 SSD), 2.5" HDD/SSD and PCIe card are mutually exclusive									
Core i5-8600T	6 / 6	2.3G / 3.7G	9 MB	DDR4-2666	UHD 630										
Core i7-8700T	6 / 12	2.4G / 4.0G	12 MB	DDR4-2666	UHD 630	<table border="1"> <thead> <tr> <th></th> <th>Dimensions (WxDxH)</th> <th>Weight (Approx.)</th> </tr> </thead> <tbody> <tr> <td>Tiny only</td> <td>7.05" X 7.20" X 1.36" 179mm X 182.9mm X 34.5mm</td> <td>2.91 lb (1.32 kg), vary by config</td> </tr> <tr> <td>With VESA mount &amp; ODD box</td> <td>7.42" X 7.30" X 2.48" 188.4mm X 185.38mm X 63mm</td> <td>3.66 lb (1.66 kg), vary by config</td> </tr> </tbody> </table>		Dimensions (WxDxH)	Weight (Approx.)	Tiny only	7.05" X 7.20" X 1.36" 179mm X 182.9mm X 34.5mm	2.91 lb (1.32 kg), vary by config	With VESA mount & ODD box	7.42" X 7.30" X 2.48" 188.4mm X 185.38mm X 63mm	3.66 lb (1.66 kg), vary by config
	Dimensions (WxDxH)	Weight (Approx.)													
Tiny only	7.05" X 7.20" X 1.36" 179mm X 182.9mm X 34.5mm	2.91 lb (1.32 kg), vary by config													
With VESA mount & ODD box	7.42" X 7.30" X 2.48" 188.4mm X 185.38mm X 63mm	3.66 lb (1.66 kg), vary by config													
Core i3-9100T	4 / 4	3.1G / 3.7G	6 MB	DDR4-2400	UHD 630										
Core i3-9300T	4 / 4	3.2G / 3.8G	8 MB	DDR4-2400	UHD 630	VESA mount Optional VESA mount bracket kit, supports VESA 75mm and 100mm Optional system floor stand for vertical orientation									
Core i5-9400T	6 / 6	1.8G / 3.4G	9 MB	DDR4-2666	UHD 630										
Core i5-9500T	6 / 6	2.2G / 3.7G	9 MB	DDR4-2666	UHD 630	Power supply 135 watts AC/DC adapter, autosensing, 88% PSU									
Core i5-9600T	6 / 6	2.3G / 3.9G	9 MB	DDR4-2666	UHD 630										
Core i7-9700T	8 / 8	2.0G / 4.3G	12 MB	DDR4-2666	UHD 630	Limited warranty <i>Some:</i> <b>1-year or 3-year, depot service</b> / service upgrades available <i>Some:</i> <b>1-year or 3-year, limited onsite service</b> / service upgrades available									
Core i9-9900T	8 / 16	2.1G / 4.4G	16 MB	DDR4-2666	UHD 630										
Memory	32GB max, DDR4-2666*, two 260-pin SO-DIMM sockets, dual-channel capable * System automatically clocks down for the processors with lower memory controller					Preload <i>Some:</i> Windows® 10 Pro 64-bit <i>Some:</i> Windows 10 Home 64-bit									
Storage	<i>Some:</i> Hard Drive / SATA 6.0Gb/s, 2.5", 5400 rpm or 7200 rpm <i>Some:</i> Solid State Drive (SSD) / SATA 6.0Gb/s, 2.5" <i>Some:</i> M.2 SSD (support up to two M.2 SSD) / PCIe NVMe, PCIe 3.0 x 4", 32Gb/s, RAID 0/1 support (RAID preset only available via special bid model) * 128GB SSD M.2 (2242) PCIe NVMe only supports PCIe 3.0 x 2, 16Gb/s <i>Some:</i> Intel Optane™ Memory (not support Celeron / Pentium Processor), M.2														
Optical	<i>Some:</i> DVD-ROM, slim (9.0mm), via USB external ODD box <i>Some:</i> DVD Burner (DVD±RW), slim (9.0mm), via USB external ODD box					Environment ENERGY STAR® 7.0, EPEAT™ Silver rating (North America), ErP Lot 3, TCO, TUV ultra low noise verified (coming soon, on some models), RoHS-compliant									
Onboard SATA	One onboard SATA 6.0Gb/s connector														
Graphics	<b>Intel HD Graphics 610/630</b> in processor, uses main memory, DirectX® 12, one DisplayPort™, one HDMI, one optional video port (2nd HDMI, VGA, 2nd DP, or USB 3.1 Type-C Gen1 with DisplayPort function), up to 3 independent displays; <i>Max resolution:</i> c4096x2304 (DP) @60Hz; 4096x2304 (Type-C) @60Hz; 4096x2160 (onboard HDMI) @24Hz; 2048x1536 (VGA) @50Hz <i>Some:</i> <b>AMD Radeon™ RX 560</b> , DirectX 12, 4GB GDDR5, PCIe 3.0 x8 adapter,					MIL-SPEC test MIL-STD-810G military certification (Low Pressure [Altitude], High Temperature, Low Temperature, Temperature Shock, Humidity, Sand and Dust, Vibration, Shock, Fungus, Solar Radiation)									
							Accessories For compatible accessories, please go to <a href="http://smartfind.lenovo.com">http://smartfind.lenovo.com</a>								

Note: The specifications above may not be available in all regions.

Lenovo, June 2019





# ThinkSmart Hub 500 Platform Specifications

Product Specifications Reference (PSREF)

Positioning	Purpose-built Skype Room Systems device						Security chip	TPM (Trusted Platform Module) 2.0, TCG Certified
Processor	7th Gen Intel Core™ i5 Processor with vPro						Security features	<ul style="list-style-type: none"> <li>• Security slot (in rear for attachment of optional Kensington® MicroSaver® cable; Kensington lock also locks chassis)</li> <li>• Secure cable management door</li> <li>• Power-on, admin, hard disk password</li> <li>• Boot sequence control</li> <li>• Boot without keyboard and mouse</li> <li>• USB port disablement</li> </ul>
	Processor	Cores / Threads	Frequency Base/Max(GHz)	Cache	Memory Support (Up to)	Integrated Graphics		
	Core i5-7500T	4 / 4	2.7G / 3.3G	6 MB	DDR4-2400	HD 630		
Memory	4GBx2, DDR4-2400, two 260-pin SO-DIMM sockets, dual-channel capable						Keyboard	None
Storage	128GB M.2 Solid State Drive (SSD) / PCIe NVMe, PCIe 3.0 x 4, 32Gb/s						Mouse	None
Graphics Display	<b>Intel HD Graphics 630</b> in processor, uses main memory, DirectX® 12 <b>11.6"</b> (294.64mm) <b>Full HD 1080p (1920x1080) TFT color</b> , wide viewing angle (+/- 85°), LED backlight, 300 nits, 16:9 aspect ratio, 800:1 contrast ratio, anti-glare, smudge resistant						Mechanical	<ul style="list-style-type: none"> <li>• Business black color</li> <li>• (WxDxH) 7.60" X 10.98" X 7.02"; 193.25mm X 278.9mm X 178.45mm</li> <li>• Approx. 5.51 lb (2.5 kg)</li> <li>• Secure Cable Management Door, secures physical ports and prevents cables being accidentally disconnected</li> <li>• 360 degree rotatable Display</li> </ul>
Multi-touch Sensor	Supports 10-point touch, OGS IR Presence/Motion sensor, automatically dim / brighten display (Detection angle: +/- 45% (from display); detection distance: 3 meters at minimum)						Power supply	90 watts adapter, autosensing, 88% efficiency
LED indicators	360 degree LED ring on hinge neck, indicates Skype status for all users in the room; power LED on power button						Limited warranty <sup>3</sup>	<b>3-year, limited onsite service</b> / service upgrades available
Chipset	<b>Intel Q270 Chipset</b>						Preload	<b>Preloaded operating system</b> Windows® 10 IoT Enterprise CBB X64 (RS3) <b>Preloaded applications</b> Microsoft Skype Room Systems App
Ports*	Four USB 3.1 Gen1(Type A), two HDMI-out, one HDMI-in (1920x1080@60Hz at maximum), one ethernet (RJ-45), one headphone / microphone combo jack (3.5mm), one power connector <small>* Depending on many factors, actual data transfer speed may be lower than theoretical speed</small>						Certification	Skype for Business Group Certified
M.2 card slot	Two M.2 Card slots (one for WLAN, one for SSD)						Environment	ErP Lot 26, GREENGUARD® certified, RoHS, WEEE
Audio support	Dual 4W speakers, 2 omnidirectional microphones for 360 degree audio capture						Accessories	For compatible accessories, please go to <a href="http://www.lenovoquickpick.com">http://www.lenovoquickpick.com</a>
WLAN <sup>13</sup>	11ac wireless, M.2 Card, Intel Dual Band Wireless-AC 8265,Wi-Fi + Bluetooth 4.1* combo adapter, Intel vPro technology support, 2x2							
Bluetooth™	Bluetooth 4.1* wireless, integrated in Wi-Fi + Bluetooth combo adapter * Hardware supports Bluetooth 4.2, but Win10 RS3 only supports Bluetooth 4.1							
Ethernet	Gigabit ethernet, Intel Ethernet Connection I219-LM (Jacksonville), Wake on LAN®							
Manageability	Intel Active Management Technology 11.0 (Intel AMT 11.0), Intel vPro technology							

See footnotes for more detailed information

© Lenovo  
(Hub500-Spec) March 2018



# ThinkSmart Hub 500 for Zoom Platform Specifications

Product Specifications Reference (PSREF)

Positioning	Purpose-built Zoom Rooms device						Security chip	TPM (Trusted Platform Module) 2.0, TCG Certified
Processor	7th Gen Intel Core™ i5 Processor with vPro						Security features	<ul style="list-style-type: none"> <li>• Security slot (in rear for attachment of optional Kensington® MicroSaver® cable; Kensington lock also locks chassis)</li> <li>• Secure cable management door</li> <li>• Power-on, admin, hard disk password</li> <li>• Boot sequence control</li> <li>• Boot without keyboard and mouse</li> <li>• USB port disablement</li> </ul>
	Processor	Cores / Threads	Frequency Base/Max(GHz)	Cache	Memory Support (Up to)	Integrated Graphics		
	Core i5-7500T	4 / 4	2.7G / 3.3G	6 MB	DDR4-2400	HD 630		
Memory	4GBx2, DDR4-2400, two 260-pin SO-DIMM sockets, dual-channel capable						Keyboard	None
Storage	128GB M.2 Solid State Drive (SSD) / PCIe NVMe, PCIe 3.0 x 4, 32Gb/s						Mouse	None
Graphics Display	<b>Intel HD Graphics 630</b> in processor, uses main memory, DirectX® 12 <b>11.6"</b> (294.64mm) <b>Full HD 1080p (1920x1080) TFT color</b> , wide viewing angle (+/- 85°), LED backlight, 300 nits, 16:9 aspect ratio, 800:1 contrast ratio, anti-glare, smudge resistant						Mechanical	<ul style="list-style-type: none"> <li>• Business black color</li> <li>• (WxDxH) 7.60" X 10.98" X 7.02"; 193.25mm X 278.9mm X 178.45mm</li> <li>• Approx. 5.51 lb (2.5 kg)</li> <li>• Secure Cable Management Door, secures physical ports and prevents cables being accidentally disconnected</li> <li>• 360 degree rotatable Display</li> </ul>
Multi-touch Sensor	Supports 10-point touch, OGS IR Presence/Motion sensor, automatically dim / brighten display (Detection angle: +/- 45% (from display); detection distance: 3 meters at minimum)							
LED indicators	360 degree LED ring on hinge neck, indicates Skype status for all users in the room; power LED on power button							
Chipset	<b>Intel Q270 Chipset</b>						Power supply	90 watts adapter, autosensing, 88% efficiency
Ports*	Four USB 3.1 Gen1(Type A), two HDMI-out, one HDMI-in (1920x1080@60Hz at maximum), one ethernet (RJ-45), one headphone / microphone combo jack (3.5mm), one power connector <small>* Depending on many factors, actual data transfer speed may be lower than theoretical speed</small>						Limited warranty <sup>3</sup>	<b>3-year, limited onsite service</b> / service upgrades available
M.2 card slot	Two M.2 Card slots (one for WLAN, one for SSD)						Preload	<b>Preloaded operating system</b> Windows® 10 IoT Enterprise SAC X64 (RS5) <b>Preloaded applications</b> Zoom Rooms Application
Audio support	Dual 5W speakers, 2 omnidirectional microphones for 360 degree audio capture						Certification	Zoom Recommended Hardware
WLAN <sup>13</sup>	11ac wireless, M.2 Card, Intel Dual Band Wireless-AC 8265,Wi-Fi + Bluetooth 4.1* combo adapter, Intel vPro technology support, 2x2						Environment	ErP Lot 26, GREENGUARD® certified, RoHS, WEEE
Bluetooth™	Bluetooth 4.1* wireless, integrated in Wi-Fi + Bluetooth combo adapter <small>* Hardware supports Bluetooth 4.2, but Win10 RS3 only supports Bluetooth 4.1</small>						Accessories	For compatible accessories, please go to <a href="http://smartfind.lenovo.com">http://smartfind.lenovo.com</a>
Ethernet	Gigabit ethernet, Intel Ethernet Connection I219-LM (Jacksonville), Wake on LAN®							
Manageability	Intel Active Management Technology 11.0 (Intel AMT 11.0), Intel vPro technology							

See footnotes for more detailed information

© Lenovo  
August 2019



# ThinkCentre Tiny-in-One (TIO) 22

Product Specifications Reference (PSREF)

Model	10LKPAR6++ / 10LKPAT6++		
Form factor	Tiny-in-One, offers a full All-In-One experience when optional Tiny slots into the back of TIO 22, clean cabling and effortless setup		
Compatible Tiny:	M900 Tiny, M700 Tiny, M600 Tiny, M93/p Tiny*, M83 Tiny, M73 Tiny*, or M53 Tiny, Chromebox * Non-TIO models can't be turned on by pressing power button of TIO 22		
Panel	TFT-LCD, In-Plane Switching (IPS), White LED backlight		
Viewable image size	21.5" (546.1mm) diagonal		
Max view area (W x H)	18.74" x 10.54" / 476.06mm x 267.79mm		
Bezel Width	Top / Side: 2mm, Bottom: 16.3mm		
Optimum resolution	<b>1920x1080</b>		
Aspect ratio	16:9		
Pixel pitch (mm)	0.24795mm		
Dot/Pixel per Inch	102.4 dpi		
Brightness	250 nits or cd/m <sup>2</sup> (typical)		
Contrast ratio	1000:1 (typical)		
Pixel response time	7ms		
Color gamut	72%		
Anti-reflective	Anti-glare		
Viewing angle at 10:1 CR	178° (+/- 89°) horizontal, 178° (+/- 89°) vertical		
Preset resolutions	640x350 @ 70Hz 640x480 @ 60Hz, 66Hz, 72Hz, 75Hz 720x400 @ 70Hz 800x600 @ 60Hz, 72Hz, 75Hz 1024x768 @ 60Hz, 70Hz, 75Hz 1152x864 @ 75Hz 1280x800 @ 60Hz 1280x1024 @ 60Hz, 72Hz, 75Hz 1366x768 @ 60Hz 1440x900 @ 60Hz, 75Hz 1600x1200 @ 60Hz, 70Hz, 75Hz 1680x1050 @ 60Hz 1920x1080 @ 60Hz		
Presets / user settings	Presets: 25; user settings: 25		
On screen display	On screen display with digital user controls (8 languages)		
Control features	Mode-switching (TIO mode / standalone monitor mode, switches video / audio / USB input sources) / Back button, Left shift button, Right shift / Brightness button, Selection button / Menu button, Power button		
Tiny-in-One Power On	Pressing Alt + P on keyboard or pressing Power button positioned on TIO can turn on both TIO and Tiny (only some Tiny support, see compatible list)		
Front ports	Two USB 3.0 or two USB 2.0 (when M73 or M53 installed or USB 2.0 connected via USB upstream port), one headphone / microphone combo jack (3.5mm) * The USB ports are only available when a Tiny is installed or a PC is connected via USB upstream port		
Side ports	Side ports offered by installed Tiny (optional)		
Rear ports	One DisplayPort 1.2 port, one USB upstream port, one power connector		
3-in-1 Cable	Undetachable 3-in-1 cable (Power connector, USB 3.0 [supports USB 3.0/USB 2.0], DisplayPort 1.2), only for connecting to Tiny installed (optional)		
Internal Speaker	1.5 watt x1		
Security	Security keyhole for attachment of optional cable lock (Kensington® lock compatible), locks optional Tiny with TIO 22 together, more security features offered by Tiny installed (optional)		
Mechanical	Dimensions	TIO 22 without stand	TIO 22 with stand
	W x D x H (inch)	19.25 x 2.65 x 12.47	19.25 x 9.90 x 14.02 - 18.35
	W x D x H (mm)	489.06 x 67.2 x 316.78	489.06 x 251.4 x 356.07 - 466.07
	Weight (approximately)	11.27 lb /5.11 kg (with stand)	
Mounting features	Wall or desk mounting using the extend arm or third-party accessories meeting the VESA FPMPMI® (100mm mount) <i>Tilt: 35° back, -5° forward; lift: 4.3" (110mm); swivel: +/-45°</i>		
Adjustable stand			
Power supply	90 watts AC/DC adapter, 88% PSU, universal		
Power consumption	15.57 watts typical, 35 watts maximum, <0.5 watts standby / suspend		
Limited warranty <sup>3</sup>	<b>3-years</b> , Customer Carry-In or Mail-In via Rapid Replacement Service		
VESA-compliant <sup>2</sup>	VESA DDC2B/CI, VESA DPMS-compliant		
Ergonomics	ISO 9241-307		
Emission standards	FCC Class B		
Environmental	TCO 7.0, TCO Edge 2.0, WEEE, RoHS, ENERGY STAR® 7.0 EPEAT™ Gold rating, ULE Gold, TUV, VOC		
Windows certifications	Windows 7, Windows 8/8.1, and Windows 10 certified		
Ship group	TIO 22 (Monitor), detachable stand, AC/DC power adapter, power cord, user's guide and driver CD, quick start and safety poster		
Accessories	For compatible accessories, please go to <a href="http://www.lenovoquickpick.com">http://www.lenovoquickpick.com</a>		
<b>ThinkCentre Tiny-in-One 22 Compatible list</b>			
Model	M900 Tiny, M700 Tiny, M600 Tiny, M83 Tiny, M53 Tiny	M93/p Tiny, M73 Tiny	Chromebox
Turn on TIO and Tiny together via Alt + P on USB KB	All models	All models	Not support
Turn on TIO and Tiny together via TIO Power Button	All models	TIO models	All models

See footnotes for more detailed information



# ThinkCentre Tiny-in-One (TIO) 22 Gen3

Product Specifications Reference (PSREF)

Model	<i>Non-touch model:</i> 10R1PAR1++/10R1PAT1++; <i>Touch model:</i> 10R0PAR1++/10R0PAT1++			Mounting features	Wall or desk mounting using the extend arm or third-party accessories meeting the VESA FPMPI® (100mm mount)
Form factor	Tiny-in-One, offers a full All-In-One experience when optional Tiny slots into the back of TIO, clean cabling and effortless setup			Adjustable stand	<i>Tilt:</i> 30° back, -5° forward; <i>lift:</i> 4.3" (110mm); <i>swivel:</i> +/-45°; <i>Pivot:</i> clockwise 0° to 90°
Compatible Tiny:	M910 / M710 / M900 / M700 / M600 / M715 / M93/p* / M83 / M73* / M53 / Chromebox Tiny * Non-TIO models can't be turned on by pressing power button of TIO			Power supply	90 watts AC/DC adapter, 88% PSU, universal
Panel	TFT-LCD, In-Plane Switching technology**, White LED backlight <i>Notes:</i> In-Plane Switching may refer to VA, PLS, and IPS panels			Power consumption	19 watts typical, 32 watts maximum, <0.5 watts standby / suspend
Viewable image size	21.5" (546.1mm) diagonal			Limited warranty	<b>3-years</b> , Customer Carry-In or Mail-In via Rapid Replacement Service
Max view area (W x H)	18.74" x 10.54" / 476.1mm x 267.8mm			VESA-compliant	VESA DDC2B/CI, VESA DPMS-compliant
Bezel Width	Top / Side: 2mm, Bottom: 22.1mm			Ergonomics	ISO 9241-307, TUV Eye Comfort certified
Native resolution	<b>1920x1080</b>			Emission standards	FCC Class B
Multi-touch	Optional 10-point multi-touch, supports Wake on Touch			Environmental	TCO 7.0, TCO Edge 2.0, WEEE, RoHS, ENERGY STAR® 7.0, EPEAT™ Silver rating, ULE Gold, TUV, VOC
Aspect ratio	16:9			Windows certifications	Windows 7 and Windows 10 certified
Pixel pitch (mm)	0.24795mm			Ship group	TIO (Monitor), detachable stand, AC/DC power adapter, power cord, user's guide and driver CD, quick start and safety poster
Dot/Pixel per Inch	102.4 dpi			Accessories	For compatible accessories, please go to <a href="http://www.lenovoquickpick.com">http://www.lenovoquickpick.com</a>
Brightness	250 nits or cd/m² (typical)				
Contrast ratio	1000:1 (typical)				
Pixel response time	14ms (default), over drive to 4ms, 6ms				
Color gamut	72%				
Anti-reflective	Anti-glare				
Viewing angle at 10:1 CR	178° (+/- 89°) horizontal, 178° (+/- 89°) vertical				
Preset resolutions	640x350 @ 70Hz 640x480 @ 60Hz, 66Hz, 72Hz, 75Hz 720x400 @ 70Hz 800x600 @ 60Hz, 72Hz, 75Hz 1024x768 @ 60Hz, 70Hz, 75Hz 1152x864 @ 75Hz 1280x800 @ 60Hz 1280x1024 @ 60Hz, 72Hz, 75Hz 1366x768 @ 60Hz 1440x900 @ 60Hz, 75Hz 1600x1200 @ 60Hz, 70Hz, 75Hz 1680x1050 @ 60Hz 1920x1080 @ 60Hz				
Presets / user settings	Presets: 25; user settings: 25				
On screen display	On screen display with digital user controls (8 languages)				
Control features	<i>Font:</i> Exit button, Left / Mode-switching button (TIO / monitor mode), Right / Brightness button, Enter / Menu button, Power button <i>Bottom:</i> Volume up button, Volume down button				
Tiny-in-One Power On	Pressing Alt + P on keyboard or pressing Power button positioned on TIO can turn on both TIO and Tiny (only some Tiny support, see compatible list)				
Side ports (TIO)	One USB 3.1 Gen1 / USB 2.0 (when M73 or M53 installed or USB 2.0 connected via USB upstream port) <i>Notes:</i> The USB port is only available when a Tiny is installed or a PC is connected via USB upstream port				
Side ports (Tiny)	Side ports offered by installed Tiny (optional)				
Rear ports	One DisplayPort in port, one USB upstream port, one power connector				
3-in-1 Cable	Undetachable 3-in-1 cable (Power connector, USB [supports USB 3.1 Gen1 / USB 2.0], DisplayPort), only for connecting to Tiny installed (optional)				
Camera	720p camera with dual microphone for VOIP, LED indicator				
Internal Speaker	2 watt x2				
Security	Security keyhole for attachment of optional cable lock (Kensington® lock compatible), locks optional Tiny with TIO together, more security features offered by Tiny installed (optional)				
Mechanical					
	Dimensions	TIO without stand	TIO with stand		
	W x D x H (inch)	19.26 x 2.85 x 13.35	19.26 x 10.76 x 14.59 - 18.93		
	W x D x H (mm)	489.3 x 72.5 x 339	489.3 x 273.3 x 370.7 - 480.7		
	Weight (Approx.)	7.01 lb / 3.19 kg	11.77 lb / 5.34 kg		

ThinkCentre Tiny-in-One 22 Gen3 Compatible list			
Model	M910 / M710 / M900 / M700 / M600 / M715 / M83 / M53 Tiny	M93/p Tiny, M73 Tiny	Chromebox
Turn on TIO and Tiny together via Alt + P on USB KB	All models	All models	Not support
Turn on TIO and Tiny together via TIO Power Button	All models	TIO models	All models







# ThinkCentre Tiny-in-One (TIO) 24

Product Specifications Reference (PSREF)

Model	10LLPAR6++ / 10LLPAT6++														
Form factor	Tiny-in-One, offers a full All-In-One experience when optional Tiny slots into the back of TIO 24, clean cabling and effortless setup														
Compatible Tiny:	M900 Tiny, M700 Tiny, M600 Tiny, M93/p Tiny*, M83 Tiny, M73 Tiny*, or M53 Tiny, Chromebox * Non-TIO models can't be turned on by pressing power button of TIO 24														
Panel	TFT-LCD, In-Plane Switching (IPS), White LED backlight														
Viewable image size	23.8" (604.7mm) diagonal														
Max view area (W x H)	21.06" x 12.32" / 535.0mm x 313.0mm														
Bezel Width	Top / Side: 2mm, Bottom: 16.3mm														
Optimum resolution	<b>1920x1080</b>														
Aspect ratio	16:9														
Pixel pitch (mm)	0.2745mm														
Dot/Pixel per Inch	92.6 dpi														
Brightness	250 nits or cd/m <sup>2</sup> (typical)														
Contrast ratio	1000:1 (typical)														
Pixel response time	7ms														
Color gamut	72%														
Anti-reflective	Anti-glare														
Viewing angle at 10:1 CR	178° (+/- 89°) horizontal, 178° (+/- 89°) vertical														
Preset resolutions	640x350 @ 70Hz 640x480 @ 60Hz, 66Hz, 72Hz, 75Hz 720x400 @ 70Hz 800x600 @ 60Hz, 72Hz, 75Hz 1024x768 @ 60Hz, 70Hz, 75Hz 1152x864 @ 75Hz 1280x800 @ 60Hz 1280x1024 @ 60Hz, 72Hz, 75Hz 1366x768 @ 60Hz 1440x900 @ 60Hz, 75Hz 1600x1200 @ 60Hz, 70Hz, 75Hz 1680x1050 @ 60Hz 1920x1080 @ 60Hz														
Presets / user settings	Presets: 25; user settings: 25														
On screen display	On screen display with digital user controls (8 languages)														
Control features	Mode-switching (TIO mode / standalone monitor mode, switches video / audio / USB input sources) / Back button, Left shift button, Right shift / Brightness button, Selection button / Menu button, Power button														
Tiny-in-One Power On	Pressing Alt + P on keyboard or pressing Power button positioned on TIO can turn on both TIO and Tiny (only some Tiny support, see compatible list)														
Front ports	Two USB 3.0 or two USB 2.0 (when M73 or M53 installed or USB 2.0 connected via USB upstream port), one headphone / microphone combo jack (3.5mm) * The USB ports are only available when a Tiny is installed or a PC is connected via USB upstream port														
Side ports	Side ports offered by installed Tiny (optional)														
Rear ports	One DisplayPort 1.2 port, one USB upstream port, one power connector														
3-in-1 Cable	Undetachable 3-in-1 cable (Power connector, USB 3.0 [supports USB 3.0/USB 2.0], DisplayPort 1.2), only for connecting to Tiny installed (optional)														
Internal Speaker	1.5 watt x1														
Security	Security keyhole for attachment of optional cable lock (Kensington® lock compatible), locks optional Tiny with TIO 24 together, more security features offered by Tiny installed (optional)														
Mechanical	<table border="1"> <thead> <tr> <th>Dimensions</th> <th>TIO 24 without stand</th> <th>TIO 24 with stand</th> </tr> </thead> <tbody> <tr> <td>W x D x H (inch)</td> <td>21.24 x 2.7 x 13.64</td> <td>21.24 x 9.90 x 15.16 - 19.46</td> </tr> <tr> <td>W x D x H (mm)</td> <td>539.6 x 68.2 x 346.45</td> <td>539.6 x 251.4 x 385.08 - 495.08</td> </tr> <tr> <td>Weight (approximately)</td> <td colspan="2">12.25 lb /5.57 kg (with stand)</td> </tr> </tbody> </table>			Dimensions	TIO 24 without stand	TIO 24 with stand	W x D x H (inch)	21.24 x 2.7 x 13.64	21.24 x 9.90 x 15.16 - 19.46	W x D x H (mm)	539.6 x 68.2 x 346.45	539.6 x 251.4 x 385.08 - 495.08	Weight (approximately)	12.25 lb /5.57 kg (with stand)	
Dimensions	TIO 24 without stand	TIO 24 with stand													
W x D x H (inch)	21.24 x 2.7 x 13.64	21.24 x 9.90 x 15.16 - 19.46													
W x D x H (mm)	539.6 x 68.2 x 346.45	539.6 x 251.4 x 385.08 - 495.08													
Weight (approximately)	12.25 lb /5.57 kg (with stand)														
Mounting features	Wall or desk mounting using the extend arm or third-party accessories meeting the VESA FPMPMI® (100mm mount)														
Adjustable stand	Tilt: 35° back, -5° forward; lift: 4.3" (110mm); swivel: +/-45°														
Power supply	90 watts AC/DC adapter, 88% PSU, universal														
Power consumption	16.7 watts typical, 35 watts maximum, <0.5 watts standby / suspend														
Limited warranty <sup>3</sup>	<b>3-years</b> , Customer Carry-In or Mail-In via Rapid Replacement Service														
VESA-compliant <sup>2</sup>	VESA DDC2B/CI, VESA DPMS-compliant														
Ergonomics	ISO 9241-307														
Emission standards	FCC Class B														
Environmental	TCO 7.0, TCO Edge 2.0, WEEE, RoHS, ENERGY STAR® 7.0														
Windows certifications	EPEAT™ Gold rating, ULE Gold, TUV, VOC Windows 7, Windows 8/8.1, and Windows 10 certified														
Ship group	TIO 24 (Monitor), detachable stand, AC/DC power adapter, power cord, user's guide and driver CD, quick start and safety poster														
Accessories	For compatible accessories, please go to <a href="http://www.lenovoquickpick.com">http://www.lenovoquickpick.com</a>														
<b>ThinkCentre Tiny-in-One 24 Compatible list</b>															
Model	M900 Tiny, M700 Tiny, M600 Tiny, M83 Tiny, M53 Tiny	M93/p Tiny, M73 Tiny	Chromebox												
Turn on TIO and Tiny together via Alt + P on USB KB	All models	All models	Not support												
Turn on TIO and Tiny together via TIO Power Button	All models	TIO models	All models												

See footnotes for more detailed information



# ThinkCentre Tiny-in-One (TIO) 24 Gen3

Product Specifications Reference (PSREF)

Model	<i>Non-touch model:</i> 10QYPAR1++/10QYPAT1++; <i>Touch model:</i> 10QXPAR1++/10QXPAT1++			Mounting features	Wall or desk mounting using the extend arm or third-party accessories meeting the VESA FPMPI® (100mm mount)																
Form factor	Tiny-in-One, offers a full All-In-One experience when optional Tiny slots into the back of TIO, clean cabling and effortless setup			Adjustable stand	<i>Tilt:</i> 30° back, -5° forward; <i>lift:</i> 4.3" (110mm); <i>swivel:</i> +/-45°; <i>Pivot:</i> clockwise 0° to 90°																
Compatible Tiny:	M910 / M710 / M900 / M700 / M600 / M715 / M93/p* / M83 / M73* / M53 / Chromebox Tiny * Non-TIO models can't be turned on by pressing power button of TIO			Power supply	90 watts AC/DC adapter, 88% PSU, universal																
Panel	TFT-LCD, In-Plane Switching technology**, White LED backlight <i>Notes:</i> In-Plane Switching may refer to VA, PLS, and IPS panels			Power consumption	19 watts typical, 32 watts maximum, <0.5 watts standby / suspend																
Viewable image size	23.8" (604.7mm) diagonal			Limited warranty	<b>3-years</b> , Customer Carry-In or Mail-In via Rapid Replacement Service																
Max view area (W x H)	21.06" x 12.32" / 535.0mm x 313.0mm			VESA-compliant	VESA DDC2B/CI, VESA DPMS-compliant																
Bezel Width	Top / Side: 2mm, Bottom: 22.1mm			Ergonomics	ISO 9241-307, TUV Eye Comfort certified																
Native resolution	<b>1920x1080</b>			Emission standards	FCC Class B																
Multi-touch	Optional 10-point multi-touch, supports Wake on Touch			Environmental	TCO 7.0, TCO Edge 2.0, WEEE, RoHS, ENERGY STAR® 7.0, EPEAT™ Silver rating, ULE Gold, TUV, VOC																
Aspect ratio	16:9			Windows certifications	Windows 7 and Windows 10 certified																
Pixel pitch (mm)	0.2745mm			Ship group	TIO 24 (Monitor), detachable stand, AC/DC power adapter, power cord, user's guide and driver CD, quick start and safety poster																
Dot/Pixel per Inch	92.6 dpi			Accessories	For compatible accessories, please go to <a href="http://www.lenovoquickpick.com">http://www.lenovoquickpick.com</a>																
Brightness	250 nits or cd/m² (typical)			<table border="1"> <thead> <tr> <th colspan="4">ThinkCentre Tiny-in-One 24 Gen3 Compatible list</th> </tr> <tr> <th>Model</th> <th>M910 / M710 / M900 / M700 / M600 / M715 / M83 / M53 Tiny</th> <th>M93/p Tiny, M73 Tiny</th> <th>Chromebox</th> </tr> </thead> <tbody> <tr> <td>Turn on TIO and Tiny together via Alt + P on USB KB</td> <td>All models</td> <td>All models</td> <td>Not support</td> </tr> <tr> <td>Turn on TIO and Tiny together via TIO Power Button</td> <td>All models</td> <td>TIO models</td> <td>All models</td> </tr> </tbody> </table>		ThinkCentre Tiny-in-One 24 Gen3 Compatible list				Model	M910 / M710 / M900 / M700 / M600 / M715 / M83 / M53 Tiny	M93/p Tiny, M73 Tiny	Chromebox	Turn on TIO and Tiny together via Alt + P on USB KB	All models	All models	Not support	Turn on TIO and Tiny together via TIO Power Button	All models	TIO models	All models
ThinkCentre Tiny-in-One 24 Gen3 Compatible list																					
Model	M910 / M710 / M900 / M700 / M600 / M715 / M83 / M53 Tiny	M93/p Tiny, M73 Tiny	Chromebox																		
Turn on TIO and Tiny together via Alt + P on USB KB	All models	All models	Not support																		
Turn on TIO and Tiny together via TIO Power Button	All models	TIO models	All models																		
Contrast ratio	1000:1 (typical)																				
Pixel response time	14ms (default), over drive to 4ms, 6ms																				
Color gamut	72%																				
Anti-reflective	Anti-glare																				
Viewing angle at 10:1 CR	178° (+/- 89°) horizontal, 178° (+/- 89°) vertical																				
Preset resolutions	640x350 @ 70Hz 640x480 @ 60Hz, 67Hz, 72Hz, 75Hz 720x400 @ 70Hz 800x600 @ 60Hz, 72Hz, 75Hz 1024x768 @ 60Hz, 70Hz, 75Hz 1152x864 @ 75Hz 1280x800 @ 60Hz 1280x1024 @ 60Hz, 72Hz, 75Hz 1366x768 @ 60Hz 1440x900 @ 60Hz, 75Hz 1600x1200 @ 60Hz, 70Hz, 75Hz 1680x1050 @ 60Hz 1920x1080 @ 60Hz																				
Presets / user settings	Presets: 25; user settings: 25																				
On screen display	On screen display with digital user controls (8 languages)																				
Control features	Font: Exit button, Left / Mode-switching button (TIO / monitor mode), Right / Brightness button, Enter / Menu button, Power button Bottom: Volume up button, Volume down button																				
Tiny-in-One Power On	Pressing Alt + P on keyboard or pressing Power button positioned on TIO can turn on both TIO and Tiny (only some Tiny support, see compatible list)																				
Side ports (TIO)	One USB 3.1 Gen1 / USB 2.0 (when M73 or M53 installed or USB 2.0 connected via USB upstream port) <i>Notes:</i> The USB port is only available when a Tiny is installed or a PC is connected via USB upstream port																				
Side ports (Tiny)	Side ports offered by installed Tiny (optional)																				
Rear ports	One DisplayPort in port, one USB upstream port, one power connector																				
3-in-1 Cable	Undetachable 3-in-1 cable (Power connector, USB [supports USB 3.1 Gen1 / USB 2.0], DisplayPort), only for connecting to Tiny installed (optional)																				
Camera	1080p camera with dual microphone for VOIP, LED indicator																				
Internal Speaker	2 watt x2																				
Security	Security keyhole for attachment of optional cable lock (Kensington® lock compatible), locks optional Tiny with TIO together, more security features offered by Tiny installed (optional)																				
Mechanical	<table border="1"> <thead> <tr> <th>Dimensions</th> <th>TIO without stand</th> <th>TIO with stand</th> </tr> </thead> <tbody> <tr> <td>W x D x H (inch)</td> <td>21.25 x 2.85 x 14.47</td> <td>21.25 x 11.11 x 15.72 - 20.06</td> </tr> <tr> <td>W x D x H (mm)</td> <td>539.8 x 72.5 x 367.6</td> <td>539.8 x 282.3 x 399.4 - 509.4</td> </tr> <tr> <td>Weight (Approx.)</td> <td>7.96 lb /3.61 kg</td> <td>12.92 lb /5.86 kg</td> </tr> </tbody> </table>			Dimensions	TIO without stand	TIO with stand	W x D x H (inch)	21.25 x 2.85 x 14.47	21.25 x 11.11 x 15.72 - 20.06	W x D x H (mm)	539.8 x 72.5 x 367.6	539.8 x 282.3 x 399.4 - 509.4	Weight (Approx.)	7.96 lb /3.61 kg	12.92 lb /5.86 kg						
Dimensions	TIO without stand	TIO with stand																			
W x D x H (inch)	21.25 x 2.85 x 14.47	21.25 x 11.11 x 15.72 - 20.06																			
W x D x H (mm)	539.8 x 72.5 x 367.6	539.8 x 282.3 x 399.4 - 509.4																			
Weight (Approx.)	7.96 lb /3.61 kg	12.92 lb /5.86 kg																			



# ThinkCentre Tiny-in-One (TIO) 27

Product Specifications Reference (PSREF)

Form factor	Tiny-in-One, offers a full All-In-One experience when optional Tiny slots into the back of TIO, clean cabling and effortless setup	Mechanical		TIO without stand	TIO with stand
Compatible Tiny:	ThinkCentre Tiny, ThinkCentre Nano, and ThinkStation Tiny		Dimensions (W x D x H mm / inch)	614.0 x 73.89 x 413.1 / 24.17 x 2.91 x 16.26	614.0 x 329.0 x 444.25 - 554.25 / 24.17 x 12.95 x 17.49 - 21.82
Panel	TFT-LCD, In-Plane Switching technology**, White LED backlight **Notes: In-Plane Switching may refer to IPS, PLS, ADS, AHVA, and AA	Mounting features	Weight (Approx.)	4.91 kg / 10.82 lb	7.95 kg / 17.53 lb
Viewable image size	27" (685.8mm) diagonal		Adjustable stand	Wall or desk mounting using the extend arm or third-party accessories meeting the VESA FPMPI® (100mm mount) Tilt: 35° back, -5° forward; lift: 4.3" (110mm); swivel: +/-45°; Pivot: clockwise -5° to 90°	
Max view area (W x H)	23.49" x 13.22" / 596.7mm x 335.7mm	Power supply	170 watts adapter, 88% PSU, universal		
Bezel Width	Top / Side: 2mm, Bottom: 23.3mm	Power consumption	37 watts typical, 57 watts maximum, <0.5 watts standby / suspend		
Native resolution	<b>2560x1440</b>	Limited warranty	<b>3-years</b> , Product Exchange Service (US and EMEA) or Customer Carry-In Service (EMEA)		
Multi-touch	None	VESA-compliant	VESA DDC/CI, VESA DPMS-compliant		
Aspect ratio	16:9	Ergonomics	ISO 9241-307, TUV Eye Comfort certified		
Pixel pitch (mm)	0.2331mm	Emission standards	FCC Class B		
Dot/Pixel per Inch	109 dpi	Environmental	TCO 8.0, TCO Edge 2.0, WEEE, RoHS, ENERGY STAR® 7.0, EPEAT™ Silver rating, ULE Gold, TUV, VOC		
Brightness	350 nits or cd/m² (typical)	Windows certifications	Windows 7 and Windows 10 certified		
Contrast ratio	1000:1 (typical)	Ship group	TIO 27 (Monitor), detachable stand, power adapter, power cord, reference and driver CD		
Pixel response time	14ms (default), over drive to 4ms, 6ms	Accessories	For compatible accessories, please go to <a href="http://smartfind.lenovo.com">http://smartfind.lenovo.com</a>		
Color gamut	99% sRGB				
Anti-glare	Yes (25%)				
Viewing angle at 10:1 CR	178° (+/- 89°) horizontal, 178° (+/- 89°) vertical				
Preset resolutions	640x350 @ 70Hz 640x480 @ 60Hz, 66Hz, 72Hz, 75Hz 720x400 @ 70Hz 800x600 @ 60Hz, 72Hz, 75Hz 1024x768 @ 60Hz, 70Hz, 75Hz 1152x864 @ 75Hz 1280x768 @ 60Hz 1280x800 @ 60Hz 1280x1024 @ 60Hz, 72Hz, 75Hz 1366x768 @ 60Hz 1440x900 @ 60Hz, 75Hz 1600x1200 @ 60Hz, 70Hz, 75Hz 1680x1050 @ 60Hz 1920x1080 @ 60Hz 2560x1440 @ 60Hz				
Presets / user settings	Presets: 27; user settings: 25				
On screen display	On screen display with digital user controls (8 languages)				
Control features	Font: Exit button, Left / Mode-switching button (TIO / monitor mode), Right / Brightness button, Enter / Menu button, Power button Bottom: Volume up button, Volume down button				
Tiny-in-One Power On	Pressing Alt + P on keyboard or pressing Power button positioned on TIO can turn on both TIO and Tiny (only some support, see Compatible Matrix)				
Side ports (TIO)	Two USB 3.1 Gen1 (downgrade to USB 2.0 when installing M73 or M53 or connecting USB 2.0 via USB upstream port), one headphone / microphone combo jack Notes: The USB ports are enabled by installing a Tiny or connecting USB upstream port; the audio port is enabled by installing a Tiny or connecting USB upstream, DisplayPort(in), or HDMI(in) port				
Side ports (Tiny)	Side ports offered by the installed Tiny (optional)				
Rear ports	One DisplayPort(in) port, one HDMI(in) port, one USB (Type-B) upstream port, one power connector				
3-in-1 Cable	Undetachable 3-in-1 cable, connecting to the power connector, one USB, and one DisplayPort of the installed Tiny (optional)				
Camera	RGBIR camera with dual microphone, supports Window Hello and Facial Recognition, Think Shutter for Privacy Security, LED indicator				
Internal Speaker	2 watt x2				
Security	Security keyhole for attachment of optional cable lock (Kensington® lock compatible), locks optional Tiny with TIO together, more security features offered by Tiny installed (optional)				

ThinkCentre Tiny-in-One 27 Compatible Matrix			
Model	P320 / P330 / M920(x) / M720 / M910(x) / M710 / M900(x) / M700 / M600 / M715 / M83 / M53 Tiny	M93/p Tiny, M73 Tiny	Chromebox
Turn on TIO and Tiny together via Alt + P on USB KB	All models	All models	Not support
Turn on TIO and Tiny together via TIO Power Button	All models	TIO models	All models

This publication was developed for products and services offered in the United States and E.M.E.A countries. Lenovo may not offer the products, services or features discussed in this document in other countries. Lenovo may withdraw an offering at any time. Information is subject to change without notice. Consult your local representative for information on offerings available in your area.

Lenovo reserves the right to change specifications or other product information without notice. Lenovo is not responsible for photographic or typographical errors.

LENOVO PROVIDES THIS PUBLICATION "AS IS," WITHOUT WARRANTY OF ANY KIND, EITHER EXPRESS OR IMPLIED, INCLUDING THE IMPLIED WARRANTIES OF MERCHANTABILITY OR FITNESS FOR A PARTICULAR PURPOSE.

Some jurisdictions do not allow disclaimer of express or implied warranties in certain transactions, therefore this disclaimer may not apply to you.

**Availability:** All offers subject to availability. Lenovo reserves the right to alter product offerings and specifications at any time, without notice. Lenovo is not responsible for photographic or typographic errors.

**General:** Review key information provided by Microsoft that may apply to your system purchase, including details on Windows 10, Windows 8, Windows 7, and potential upgrades/downgrades. Lenovo makes no representation or warranty regarding third-party products or services.

**Trademarks:** Lenovo, ThinkPad, ThinkCentre, ThinkStation and the Lenovo logo are trademarks of Lenovo. Microsoft, Windows, Windows NT, and the Windows logo are trademarks of Microsoft Corporation. Ultrabook, Celeron, Celeron Inside, Core Inside, Intel, Intel Logo, Intel Atom, Intel Atom Inside, Intel Core, Intel Inside, Intel Inside Logo, Intel vPro, Itanium, Itanium Inside, Pentium, Pentium Inside, vPro Inside, Xeon, Xeon Phi, and Xeon Inside are trademarks of Intel Corporation in the U.S. and/or other countries. Other company, product or service names may be trademarks or service marks of others.

**Warranty:** For a copy of applicable warranties, write to: Lenovo Warranty Information, 1009 Think Place, Morrisville, NC, 27560. Lenovo makes no representation or warranty regarding third party products or services. The Lenovo Limited Warranty applies only to Lenovo hardware products purchased for your own use, and does not transfer upon resale.

**Limited warranty:** Support unrelated to a warranty issue may be subject to additional charges.

#### **Lenovo Services:**

**Carry-in or Mail-in Service:** Parts and labor repair coverage where the customer is responsible for shipping (including packaging) or delivery to authorized warranty provider or repair center.

**Depot or Courier Service:** Parts and labor repair coverage where shipping (including packaging) or delivery to the repair center is paid for by Lenovo.

**Expedited Depot:** Parts and labor coverage with expedited turnaround. Shipping (including packaging) or delivery to the repair center is paid for by Lenovo.

**Onsite / In-home Service:** Parts and labor repair coverage where labor is provided onsite at your place of business.

If Lenovo determines your product problem is covered by the product warranty and cannot be resolved over the telephone, a technician will be dispatched to arrive onsite, typically the next day.

**International Warranty Service (IWS):** PC repair coverage for customers who require a critical warranty repair while travelling internationally. Visit [www.lenovo.com/internationalwarranty](http://www.lenovo.com/internationalwarranty) for details. Visit [www.lenovo.com/warranty](http://www.lenovo.com/warranty) for Lenovo Warranty Services terms and conditions for complete details and restrictions.

**Included software:** may differ from its retail version (if available), and may not include user manuals or all program functionality. Software license agreements may apply.

**Battery life:** Battery life (and recharge times) will vary based on many factors including screen brightness, applications, features, power management, battery conditioning, and other customer preferences.

Visit <http://psref.lenovo.com/> for the latest version of Product Specifications Reference.

© Lenovo, 2019. All rights reserved.  
Lenovo 1009 Think Place Morrisville, NC 27560 U.S.A.

**Lenovo** ThinkStation.

# PSREF

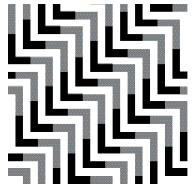

**Product Specifications Reference**

Version 546, August 2019

**U.S.**

**EMEA**

Visit <http://psref.lenovo.com> for the latest version



# Summary of Changes

---

This section describes the changes made in this version of ThinkStation PSREF and in previous version. This edition might also include minor corrections and editorial changes which are not identified.

## **August 7, 2019 - Version 546**

- ▶ Update processor information on ThinkStation P330 Tiny

## **July 17, 2019 - Version 545**

- ▶ Update EPEAT rating to Silver on most ThinkStation

## **June 26, 2019 - Version 544**

- ▶ Add ThinkStation P330 Tower Gen 2/P330 SFF Gen 2 CPU Async update

## **May 15, 2019 - Version 542**

- ▶ New ThinkStation P330 Tower Gen 2/P330 SFF Gen 2 announced on April 2019
- ▶ Update ThinkStation P920/P720/P520 specifications, add Quadro RTX 8000, DDR4-2933, Xeon Scalable Gen 2

## **March 13, 2019 - Version 539**

- ▶ Add Intel vPro information on ThinkStation P330 Tower/P330 SFF/P520c/P520/P720/P920

## **February 20, 2019 - Version 538**

- ▶ New ThinkStation P330 Tower models announced on February 2019
- ▶ Update ThinkStation P920/P720/P520/P520c specifications, add Quadro RTX4000/5000/6000

## **August 22, 2018 - Version 529**

- ▶ New ThinkStation P330 Tower/SFF/Tiny models announced on August 2018
- ▶ Update ThinkStation P920/P720 specifications, update flex bay and graphics adapter section

## **August 1, 2018 - Version 528**

- ▶ New product ThinkStation P330 Tower/SFF/Tiny announced on July 2018
- ▶ Update ThinkStation P920/P720/P520/P520c, add Refresh 2.0 information
- ▶ Remove all MTM PNs from PDF version

## **June 20, 2018 - Version 526**

- ▶ New ThinkStation P320 Tower models announced on June 2018
- ▶ Update ThinkStation P720 and P920 models, remove EOL models for US
- ▶ Update Windows 10 Pro 64 for Workstations for some ThinkStation P720/P920 models

## **May 30, 2018 - Version 525**

- ▶ Added ThinkStation P720/P920 EMEA May 2018 models

## **April 18, 2018 - Version 523**

- ▶ New ThinkStation P320 Tower/ P320 SFF/P520c/P520/P720/P920 models announced on April 2018

## **March 28, 2018 - Version 522**

- ▶ New ThinkStation P320 Tower/ P320 SFF/P520c/P520/P920 announced on March 2018

## **March 7, 2018 - Version 521**

- ▶ New ThinkStation P320 Tower/ P320 SFF/P720/P920 announced on February 2018

## **January 30, 2018 - Version 519**

- ▶ New ThinkStation P520c and P520 announced on January 2018
- ▶ New ThinkStation P320 Tower/P320 SFF announced on January 2018



### **December 20, 2017 - Version 517**

- ▶ New ThinkStation P920 models announced on December 2017
- ▶ Add Optional Ports on ThinkStation P320 Tiny

### **September 29, 2017 - Version 513**

- ▶ New ThinkStation P920 and P720 announced on September 2017
- ▶ New ThinkStation P320 Tower/P320 SFF/P410/P510/P710/P910 announced on September 2017

### **September 12, 2017 - Version 512**

- ▶ New ThinkStation P320 Tower and P320 SFF models announced on August 2017

### **August 23, 2017 - Version 511**

- ▶ New ThinkStation P320 Tiny models announced on August 2017

### **August 2, 2017 - Version 510**

- ▶ New ThinkStation P320 Tiny/P320 Tower/ P320 SFF/P410/P510 models announced on July 2017

### **June 21, 2017 - Version 508**

- ▶ New ThinkStation P320 Tiny announced on June 2017

### **May 26, 2017 - Version 507**

- ▶ Add ThinkStation P410/P510/P710/P910 Refresh 3.0 Wave 1 models and update platform specifications

### **April 19, 2017 - Version 505**

- ▶ New ThinkStation P320 Tower announced on April 2017
- ▶ New ThinkStation P320 SFF announced on April 2017

### **March 29, 2017 - Version 504**

- ▶ Added ThinkStation P310 Tower and SFF models announced on March 2017
- ▶ Added ThinkStation P410 models announced on March 2017

### **January 25, 2017 - Version 501**

- ▶ Update quantity of PCIe SSD adapter in ThinkStation P510/P910

### **January 4, 2017 - Version 500**

- ▶ Added ThinkStation P310 models announced on December 2016

### **December 14, 2016 - Version 499**

- ▶ Added ThinkStation P410/P510/P710/P910 EMEA models
- ▶ Added 1TB M.2 PCIe SSD, Quadro P5000, Quadro P6000 support on ThinkStation P510/P710/P910
- ▶ Added Quadro P5000 support on ThinkStation P410
- ▶ Added 6TB 7.2K SATA6Gbs HDD support on ThinkStation P410/P510/P710/P910
- ▶ Added ThinkStation P410/P510/P710/P910 models announced on December 2016

### **November 23, 2016 - Version 498**

- ▶ Removed ThinkStation P500/P900 due to EOL
- ▶ Added ThinkStation P310 Tower and SFF models announced on November 2016

### **October 12, 2016 - Version 496**

- ▶ Removed flash option on ThinkStation P510/P710/P910
- ▶ Added ThinkStation P310/P410/P510/P710/P910 models announced on September 2016

### **August 3, 2016 - Version 493**

- ▶ Removed ThinkStation P500/P700/P900 Windows 7 DG from Win8.1 U.S. models
- ▶ Added keyboard and mouse features on all ThinkStation

### **July 13, 2016 - Version 492**

- ▶ Added ThinkStation P500, P700, and P900 Windows 10 downgrade to Windows 7 models
- ▶ Updated Maximum configuration weight of ThinkStation P410
- ▶ Added ThinkStation P710 and P910 models announced on July 2016
- ▶ Added "Maximum drives in 3.5" bay" feature on ThinkStation P500/P510/P700/P710/P900/P910

### **June 22, 2016 - Version 491**

- ▶ Added new product ThinkStation P410/P510
- ▶ Added NVIDIA Quadro M2000 on ThinkStation P310 Tower
- ▶ Added keyboard and mouse information on ThinkStation P710/P910
- ▶ Added internal USB information on ThinkStation P710/P910

### **June 2, 2016 - Version 490**

- ▶ Added ThinkStation P710/P910 US models
- ▶ Updated ThinkStation P710/P910 processor information

### **May 19, 2016 - Version 489**

- ▶ Added NVIDIA Quadro M2000 on compatible product
- ▶ Updated maximum weight on ThinkStation P710
- ▶ Removed 30AT000BUS

### **April 27, 2016 - Version 488**

- ▶ Added ThinkStation P710 and P910 models for EMEA, announced on April 2016
- ▶ Updated Energy star information on ThinkStation P500/P700/P710/P900/P910

### **April 6, 2016 - Version 487**

- ▶ New ThinkStation P710 and P910, announced April 5, 2016 (specification only)

### **March 23, 2016 - Version 486**

- ▶ Added processors specifications for P310/P500/P700/P900

### **February 24, 2016 - Version 485**

- ▶ Added ThinkStation P310 and P700 models for US, announced on February 2016
- ▶ Added ThinkStation P700 and P900 models for EMEA, announced on February 2016

### **December 9, 2015 - Version 482**

- ▶ New ThinkStation P310 Tower and SFF, announced November 24, 2015

### **November 18, 2015 - Version 481**

- ▶ Combines ThinkStation PSREF United States version and Western Europe version.
- ▶ Extends the supported GEO into Europe, Middle East and Africa.
- ▶ Covers all TopSeller and Relationship models for US and all focus models for EMEA



# ThinkStation P320 SFF Platform Specifications

Product Specifications Reference (PSREF)

Components	Specification																																			
Chipset	Intel C236 Chipset																																			
Intel AMT	Intel Active Management Technology 11 on Xeon models, Intel Standard Manageability on other models																																			
Processor	One Intel "Kabylake" or "Skylake" processor as listed: "Kaby Lake"																																			
	Xeon E3-1280 v6	4C/3.9GHz/8MB/72W/DDR4-2400																																		
	Xeon E3-1275 v6	4C/3.8GHz/8MB/73W/DDR4-2400																																		
	Xeon E3-1270 v6	4C/3.8GHz/8MB/72W/DDR4-2400																																		
	Xeon E3-1245 v6	4C/3.7GHz/8MB/73W/DDR4-2400																																		
	Xeon E3-1240 v6	4C/3.7GHz/8MB/72W/DDR4-2400																																		
	Xeon E3-1230 v6	4C/3.5GHz/8MB/72W/DDR4-2400																																		
	Xeon E3-1225 v6	4C/3.3GHz/8MB/73W/DDR4-2400																																		
	Xeon E3-1220 v6	4C/3GHz/8MB/72W/DDR4-2400																																		
	Core i7-7700	4C/3.6GHz/8MB/65W/DDR4-2400																																		
	Core i5-7600	4C/3.5GHz/6MB/65W/DDR4-2400																																		
	Core i5-7500	4C/3.4GHz/6MB/65W/DDR4-2400																																		
	Core i5-7400	4C/3GHz/6MB/65W/DDR4-2400																																		
	Core i3-7300	2C/4GHz/4MB/51W/DDR4-2400																																		
	Core i3-7100	2C/3.9GHz/3MB/51W/DDR4-2400																																		
	"Skylake"																																			
	Xeon E3-1245 v5	4C/3.5GHz/8MB/80W/DDR4-2133																																		
Xeon E3-1240 v5	4C/3.5GHz/8MB/80W/DDR4-2133																																			
Xeon E3-1230 v5	4C/3.4GHz/8MB/80W/DDR4-2133																																			
Xeon E3-1225 v5	4C/3.3GHz/8MB/80W/DDR4-2133																																			
Xeon E3-1220 v5	4C/3GHz/8MB/80W/DDR4-2133																																			
Core i7-6700	4C/3.4GHz/8MB/65W/DDR4-2133																																			
Core i5-6500	4C/3.2GHz/6MB/65W/DDR4-2133																																			
Core i5-6400	4C/2.7GHz/6MB/65W/DDR4-2133																																			
Core i3-6100	2C/3.7GHz/3MB/51W/DDR4-2133																																			
Memory DIMM slots	4 DIMM slots, 2-channel (integrated memory controller in processor)																																			
Memory type/capacity	Up to 64GB ECC/non-ECC (4 x 16GB), DDR4-2400. UDIMM. "Skylake" processor supports up to DDR4-2133. Core i7 and i5 processors cannot support ECC.																																			
Intel HD Graphics in processor	Integrated Intel HD P530 in Xeon E3-12x5 v5 processors, or Intel HD P630 in Xeon E3-12x5 v6 processors, or Intel HD 530 in Core i7, i5, or i3 6000 processors. or Intel HD 630 in Core i7, i5, or i3 7000 processors. Works along with discrete graphics to support multi-display, enables three display connectors (2 DP, 1 VGA) on rear.																																			
Discrete graphics	Two PCI Express 3.0 x16 slots for graphics adapters. Up to two NVIDIA Quadro P1000. Supports the following NVIDIA graphic adapters:																																			
	<table border="1"> <thead> <tr> <th>Adapter</th> <th>Cores</th> <th>Memory</th> <th>Power</th> <th>Connector</th> </tr> </thead> <tbody> <tr> <td>NVS 310</td> <td>48</td> <td>1GB</td> <td>19.5W</td> <td>2xDP</td> </tr> <tr> <td>NVS 315</td> <td>48</td> <td>1GB</td> <td>19.5W</td> <td>2xDVI-I SL/2xDP</td> </tr> <tr> <td>NVS 510</td> <td>192</td> <td>2GB</td> <td>33.4W</td> <td>4xmini DP</td> </tr> <tr> <td>Quadro P400</td> <td>256</td> <td>2GB</td> <td>30W</td> <td>3xminiDP</td> </tr> <tr> <td>Quadro P600</td> <td>384</td> <td>2GB</td> <td>40W</td> <td>4xminiDP</td> </tr> <tr> <td>Quadro P1000</td> <td>640</td> <td>4GB</td> <td>47W</td> <td>4xminiDP</td> </tr> </tbody> </table>	Adapter	Cores	Memory	Power	Connector	NVS 310	48	1GB	19.5W	2xDP	NVS 315	48	1GB	19.5W	2xDVI-I SL/2xDP	NVS 510	192	2GB	33.4W	4xmini DP	Quadro P400	256	2GB	30W	3xminiDP	Quadro P600	384	2GB	40W	4xminiDP	Quadro P1000	640	4GB	47W	4xminiDP
	Adapter	Cores	Memory	Power	Connector																															
	NVS 310	48	1GB	19.5W	2xDP																															
	NVS 315	48	1GB	19.5W	2xDVI-I SL/2xDP																															
	NVS 510	192	2GB	33.4W	4xmini DP																															
	Quadro P400	256	2GB	30W	3xminiDP																															
	Quadro P600	384	2GB	40W	4xminiDP																															
Quadro P1000	640	4GB	47W	4xminiDP																																
Onboard drive controller	Five onboard SATA 6.0Gb/s connectors for optical and disk drives plus one SATA connector for optional eSATA. RAID 0, 1, 5* support * RAID 5 needs three 2.5" SSD drives.																																			
Drive Bays	One external 5.25" bay, one internal 3.5" bay (see right). Up to one 9mm optical + 2 x 3.5" disk drive bays + 1 x 2.5" disk drive bay + two M.2 NVMe SSD																																			
Supporting disk drives	3.5" SATA HDD (7.2K 6Gbs)	1TB/2TB/4TB/1TB hybrid/2TB hybrid																																		
	2.5" SATA SSD (6Gbs)	256GB Opal/512GB/512GB Opal/1TB Opal/2TB opal																																		
	M.2 NVMe SSD, via PCIe adapter	256GB Opal/512GB Opal/1TB Opal, via PCIe 3.0 x4 adapter, up to 2; or 16GB Intel Optane Memory, PCIe 3.0 x2																																		
Max internal storage	10TB (2 x 4TB 3.5" HDDs + 1 x 2TB 2.5" SSD) plus two 1TB M.2 NVMe SSD																																			
Media reader	9-in-1 card reader. Optional 29-in-1 card reader on selected models																																			
Power supply	210 watts with variable speed fan, autosensing, Climate Savers Computing Bronze, 80 PLUS Bronze qualified																																			
Onboard Ethernet	One onboard gigabit ethernet, Intel I219LM, supports Wake-on-LAN																																			
HD Audio	Realtek ALC662 codec																																			
TPM	Standard, TCG 2.0-compliant																																			

Components	Specification
Front ports	Two USB 3.0, microphone (3.5mm), headphone (3.5mm)
Rear ports	1 VGA and 2 DisplayPort (for Intel HD Graphics models only), two USB 2.0, four USB 3.0, one serial (9-pin), one ethernet (RJ-45), three analog audio ports (line-in, line-out, mic-in)
Mechanical	<ul style="list-style-type: none"> <li>Raven black color; metal case</li> <li>4.02"W x 15.53"D x 13.31"H</li> <li>102mm W x 394.5mm D x 338mm H</li> <li>17.2 lb (7.9kg) max configuration</li> <li>12.9-liter</li> </ul>
Environmental certifications	GREENGUARD certified/RoHS-compliant/EPEAT Gold rating/ENERGY STAR 6.1 qualified
Limited warranty	1 or 3-year limited onsite service with 9x5/NBD. Some parts are Customer Replaceable Units.
ISV certifications	Please visit <a href="http://www.thinkworkstations.com/isv-certifications/">www.thinkworkstations.com/isv-certifications/</a>

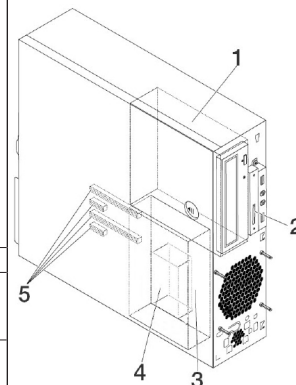

### Drive Bays and PCIe Slots

Bay 1	5.25", supports one of the following: HH optical/flex module***/9mm optical+3.5" HDD bay/ 3.5" HDD bay/Front Access Storage Enclosure *** Flex module supports one or more of the following: 9mm optical/ 29-in-1 reader/front IEEE 1394/front eSATA. Up to one flex module is supported per system.
Bay 2	Optional 9-in-1 single slot reader
Bay 3	Standard 3.5" HDD bay
Bay 4	Optional 2.5" HDD bay (under Bay 3)
5 -Slots	Four PCIe slots (top-down): Slot 1: Low Profile, PCIe 3.0 x16 (near CPU) Slot 2: Low Profile, PCIe 3.0 x1 Slot 3: Low Profile, PCIe 3.0 x16 (x4 elec) Slot 4: Low Profile, PCIe 3.0 x1





# ThinkStation P320 Tower Platform Specifications

Product Specifications Reference (PSREF)

Components	Specification																																																		
Chipset	Intel C236 Chipset																																																		
Intel AMT	Intel Active Management Technology 11 on Xeon models, Intel Standard Manageability on other models																																																		
Processor	One Intel "Kaby Lake" or "Skylake" processor as listed: "Kaby Lake"																																																		
	<table border="1"> <tbody> <tr><td>Xeon E3-1280 v6</td><td>4C/3.9GHz/8MB/72W/DDR4-2400</td></tr> <tr><td>Xeon E3-1275 v6</td><td>4C/3.8GHz/8MB/73W/DDR4-2400</td></tr> <tr><td>Xeon E3-1270 v6</td><td>4C/3.8GHz/8MB/72W/DDR4-2400</td></tr> <tr><td>Xeon E3-1245 v6</td><td>4C/3.7GHz/8MB/73W/DDR4-2400</td></tr> <tr><td>Xeon E3-1240 v6</td><td>4C/3.7GHz/8MB/72W/DDR4-2400</td></tr> <tr><td>Xeon E3-1230 v6</td><td>4C/3.5GHz/8MB/72W/DDR4-2400</td></tr> <tr><td>Xeon E3-1225 v6</td><td>4C/3.3GHz/8MB/73W/DDR4-2400</td></tr> <tr><td>Xeon E3-1220 v6</td><td>4C/3GHz/8MB/72W/DDR4-2400</td></tr> <tr><td>Core i7-7700K</td><td>4C/4.2GHz/8MB/91W/DDR4-2400</td></tr> <tr><td>Core i7-7700</td><td>4C/3.6GHz/8MB/65W/DDR4-2400</td></tr> <tr><td>Core i5-7600</td><td>4C/3.5GHz/6MB/65W/DDR4-2400</td></tr> <tr><td>Core i5-7500</td><td>4C/3.4GHz/6MB/65W/DDR4-2400</td></tr> <tr><td>Core i5-7400</td><td>4C/3GHz/6MB/65W/DDR4-2400</td></tr> <tr><td>Core i3-7300</td><td>2C/4GHz/4MB/51W/DDR4-2400</td></tr> <tr><td>Core i3-7100</td><td>2C/3.9GHz/3MB/51W/DDR4-2400</td></tr> </tbody> </table>	Xeon E3-1280 v6	4C/3.9GHz/8MB/72W/DDR4-2400	Xeon E3-1275 v6	4C/3.8GHz/8MB/73W/DDR4-2400	Xeon E3-1270 v6	4C/3.8GHz/8MB/72W/DDR4-2400	Xeon E3-1245 v6	4C/3.7GHz/8MB/73W/DDR4-2400	Xeon E3-1240 v6	4C/3.7GHz/8MB/72W/DDR4-2400	Xeon E3-1230 v6	4C/3.5GHz/8MB/72W/DDR4-2400	Xeon E3-1225 v6	4C/3.3GHz/8MB/73W/DDR4-2400	Xeon E3-1220 v6	4C/3GHz/8MB/72W/DDR4-2400	Core i7-7700K	4C/4.2GHz/8MB/91W/DDR4-2400	Core i7-7700	4C/3.6GHz/8MB/65W/DDR4-2400	Core i5-7600	4C/3.5GHz/6MB/65W/DDR4-2400	Core i5-7500	4C/3.4GHz/6MB/65W/DDR4-2400	Core i5-7400	4C/3GHz/6MB/65W/DDR4-2400	Core i3-7300	2C/4GHz/4MB/51W/DDR4-2400	Core i3-7100	2C/3.9GHz/3MB/51W/DDR4-2400																				
	Xeon E3-1280 v6	4C/3.9GHz/8MB/72W/DDR4-2400																																																	
	Xeon E3-1275 v6	4C/3.8GHz/8MB/73W/DDR4-2400																																																	
	Xeon E3-1270 v6	4C/3.8GHz/8MB/72W/DDR4-2400																																																	
	Xeon E3-1245 v6	4C/3.7GHz/8MB/73W/DDR4-2400																																																	
	Xeon E3-1240 v6	4C/3.7GHz/8MB/72W/DDR4-2400																																																	
	Xeon E3-1230 v6	4C/3.5GHz/8MB/72W/DDR4-2400																																																	
	Xeon E3-1225 v6	4C/3.3GHz/8MB/73W/DDR4-2400																																																	
	Xeon E3-1220 v6	4C/3GHz/8MB/72W/DDR4-2400																																																	
	Core i7-7700K	4C/4.2GHz/8MB/91W/DDR4-2400																																																	
	Core i7-7700	4C/3.6GHz/8MB/65W/DDR4-2400																																																	
	Core i5-7600	4C/3.5GHz/6MB/65W/DDR4-2400																																																	
	Core i5-7500	4C/3.4GHz/6MB/65W/DDR4-2400																																																	
	Core i5-7400	4C/3GHz/6MB/65W/DDR4-2400																																																	
	Core i3-7300	2C/4GHz/4MB/51W/DDR4-2400																																																	
	Core i3-7100	2C/3.9GHz/3MB/51W/DDR4-2400																																																	
		"Skylake"																																																	
		<table border="1"> <tbody> <tr><td>Xeon E3-1245 v5</td><td>4C/3.5GHz/8MB/80W/DDR4-2133</td></tr> <tr><td>Xeon E3-1240 v5</td><td>4C/3.5GHz/8MB/80W/DDR4-2133</td></tr> <tr><td>Xeon E3-1230 v5</td><td>4C/3.4GHz/8MB/80W/DDR4-2133</td></tr> <tr><td>Xeon E3-1225 v5</td><td>4C/3.3GHz/8MB/80W/DDR4-2133</td></tr> <tr><td>Xeon E3-1220 v5</td><td>4C/3GHz/8MB/80W/DDR4-2133</td></tr> <tr><td>Core i7-6700</td><td>4C/3.4GHz/8MB/65W/DDR4-2133</td></tr> <tr><td>Core i5-6500</td><td>4C/3.2GHz/6MB/65W/DDR4-2133</td></tr> <tr><td>Core i5-6400</td><td>4C/2.7GHz/6MB/65W/DDR4-2133</td></tr> <tr><td>Core i3-6100</td><td>2C/3.9GHz/3MB/51W/DDR4-2133</td></tr> </tbody> </table>	Xeon E3-1245 v5	4C/3.5GHz/8MB/80W/DDR4-2133	Xeon E3-1240 v5	4C/3.5GHz/8MB/80W/DDR4-2133	Xeon E3-1230 v5	4C/3.4GHz/8MB/80W/DDR4-2133	Xeon E3-1225 v5	4C/3.3GHz/8MB/80W/DDR4-2133	Xeon E3-1220 v5	4C/3GHz/8MB/80W/DDR4-2133	Core i7-6700	4C/3.4GHz/8MB/65W/DDR4-2133	Core i5-6500	4C/3.2GHz/6MB/65W/DDR4-2133	Core i5-6400	4C/2.7GHz/6MB/65W/DDR4-2133	Core i3-6100	2C/3.9GHz/3MB/51W/DDR4-2133																															
	Xeon E3-1245 v5	4C/3.5GHz/8MB/80W/DDR4-2133																																																	
Xeon E3-1240 v5	4C/3.5GHz/8MB/80W/DDR4-2133																																																		
Xeon E3-1230 v5	4C/3.4GHz/8MB/80W/DDR4-2133																																																		
Xeon E3-1225 v5	4C/3.3GHz/8MB/80W/DDR4-2133																																																		
Xeon E3-1220 v5	4C/3GHz/8MB/80W/DDR4-2133																																																		
Core i7-6700	4C/3.4GHz/8MB/65W/DDR4-2133																																																		
Core i5-6500	4C/3.2GHz/6MB/65W/DDR4-2133																																																		
Core i5-6400	4C/2.7GHz/6MB/65W/DDR4-2133																																																		
Core i3-6100	2C/3.9GHz/3MB/51W/DDR4-2133																																																		
Memory DIMM slots	4 DIMM slots, 2-channel (integrated memory controller in processor)																																																		
Memory type/capacity	Up to 64GB ECC/non-ECC (4 x 16GB), DDR4-2400. UDIMM. "Skylake" processor supports up to DDR4-2133. Core i7 and i5 processors cannot support ECC.																																																		
Intel HD Graphics in processor	Integrated Intel HD P530 in Xeon E3-12x5 v5 processors, or Intel HD P630 in Xeon E3-12x5 v6 processors, or Intel HD 530 in Core i7, i5, or i3 6000 processors. or Intel HD 630 in Core i7, i5, or i3 7000 processors. Works along with discrete graphics to support multi-display, enables three display connectors (2 DP, 1 VGA) on rear.																																																		
Discrete graphics	Two PCI Express 3.0 x16 slots for graphics adapters. Up to two Quadro P1000 on 250 watts models. Or up to two Quadro P2000, or up to one Quadro P4000 on 400 watts models. Supports the following NVIDIA graphics adapters:																																																		
	<table border="1"> <thead> <tr> <th>Adapter</th> <th>Cores</th> <th>Memory</th> <th>Power</th> <th>Connector</th> </tr> </thead> <tbody> <tr><td>NVS 310</td><td>48</td><td>1GB</td><td>19.5W</td><td>2xDP</td></tr> <tr><td>NVS 315</td><td>48</td><td>1GB</td><td>19.5W</td><td>2xDVI-I SL/2xDP</td></tr> <tr><td>NVS 510</td><td>192</td><td>2GB</td><td>33.4W</td><td>4xmini DP</td></tr> <tr><td>NVS 810</td><td>1024</td><td>4GB</td><td>68W</td><td>8xmini DP</td></tr> <tr><td>Quadro P400</td><td>256</td><td>2GB</td><td>30W</td><td>3xminiDP</td></tr> <tr><td>Quadro P600</td><td>384</td><td>2GB</td><td>40W</td><td>4xminiDP</td></tr> <tr><td>Quadro P1000</td><td>640</td><td>4GB</td><td>47W</td><td>4xminiDP</td></tr> <tr><td>Quadro P2000</td><td>1024</td><td>5GB</td><td>75W</td><td>4xDP</td></tr> <tr><td>Quadro P4000</td><td>1792</td><td>8GB</td><td>105W</td><td>4xDP</td></tr> </tbody> </table>	Adapter	Cores	Memory	Power	Connector	NVS 310	48	1GB	19.5W	2xDP	NVS 315	48	1GB	19.5W	2xDVI-I SL/2xDP	NVS 510	192	2GB	33.4W	4xmini DP	NVS 810	1024	4GB	68W	8xmini DP	Quadro P400	256	2GB	30W	3xminiDP	Quadro P600	384	2GB	40W	4xminiDP	Quadro P1000	640	4GB	47W	4xminiDP	Quadro P2000	1024	5GB	75W	4xDP	Quadro P4000	1792	8GB	105W	4xDP
	Adapter	Cores	Memory	Power	Connector																																														
	NVS 310	48	1GB	19.5W	2xDP																																														
	NVS 315	48	1GB	19.5W	2xDVI-I SL/2xDP																																														
	NVS 510	192	2GB	33.4W	4xmini DP																																														
	NVS 810	1024	4GB	68W	8xmini DP																																														
	Quadro P400	256	2GB	30W	3xminiDP																																														
	Quadro P600	384	2GB	40W	4xminiDP																																														
	Quadro P1000	640	4GB	47W	4xminiDP																																														
Quadro P2000	1024	5GB	75W	4xDP																																															
Quadro P4000	1792	8GB	105W	4xDP																																															
Onboard drive controller	Five onboard SATA 6.0Gb/s connectors for optical and disk drives plus one SATA connector for optional eSATA. RAID 0, 1, 5, 10 support																																																		
Drive Bays	Two external 5.25" bays, two internal 3.5" bays (see right). Up to one 9mm optical plus 4 x 3.5" disk drive bays plus two M.2 NVMe SSD																																																		
Supporting disk drives	3.5" SATA HDD (7.2K 6Gbs)																																																		
	2.5" SATA SSD (6Gbs)																																																		
	M.2 NVMe SSD, via PCIe adapter																																																		
Max internal storage	16TB (4 x 4TB 3.5" HDDs) plus 2TB (2 x 1TB) M.2 NVMe SSD																																																		
Media reader	9-in-1 card reader. Optional 29-in-1 card reader on selected models																																																		

Components	Specification
Power supply	One 250 watts with variable speed fan, autosensing, Climate Savers Computing Bronze, 80 PLUS Bronze qualified. Or one 400 watts with variable speed fan, autosensing, Climate Savers Computing Platinum, 80 PLUS Platinum qualified.
Onboard Ethernet	One onboard gigabit ethernet, Intel I219LM, supports Wake-on-LAN
HD Audio	Realtek ALC662 codec
TPM	Standard, TCG 2.0-compliant
Front ports	Two USB 3.0, microphone (3.5mm), headphone (3.5mm)
Rear ports	1 VGA and 2 DisplayPort (for Intel HD Graphics models only), two USB 2.0, four USB 3.0, one serial (9-pin), one ethernet (RJ-45), three analog audio ports (line-in, line-out, mic-in)
Mechanical	<ul style="list-style-type: none"> <li>Raven black color; metal case</li> <li>6.89"W x 16.77"D x 14.8"H</li> <li>175mm W x 426mm D x 376mm H</li> <li>28.66 lb (13kg) max configuration</li> <li>25-liter</li> </ul>
Environmental certifications	GREENGUARD certified/RoHS-compliant/EPEAT Gold rating/ENERGY STAR 6.1 qualified
Limited warranty	1 or 3-year limited onsite service with 9x5/NBD. Some parts are Customer Replaceable Units.
ISV certifications	Please visit <a href="http://www.thinkworkstations.com/isv-certifications/">www.thinkworkstations.com/isv-certifications/</a>

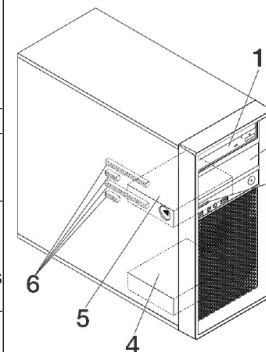

## Drive Bays and PCIe Slots

Bay 1 and Bay 2	5.25", support one of the following: HH optical/flex module/9mm optical+3.5" HDD bay/ 3.5" HDD bay/Front Access Storage Enclosure (FASE) <i>Note:</i> 1. Flex module supports one or more of the following: 9mm optical/ 29-in-1 reader/front IEEE 1394/front eSATA. 2. Up to one flex module/FASE per system.
Bay 3	Optional 9-in-1 single slot reader
Bay 4	Standard 3.5" HDD bay
Bay 5	Standard 3.5" HDD bay
6 -Slots	Four PCIe slots (top-down): Slot 1: Half length, full height, PCIe 3.0 x16 (near CPU) Slot 2: Half length, full height, PCIe 3.0 x16 Slot 3: Half length, full height, PCIe 3.0 x16 (x4 elec) Slot 4: Half length, full height, PCIe 3.0 x1 <i>Note:</i> 1. Both discrete graphics adapter and M.2 NVMe SSD should be installed on slot 1 or slot 3, the maximum quantity of discrete graphics adapter and M.2 NVMe SSD is 2. 2. When two discrete graphics adapters are used, no other PCIe card can be used.



# ThinkStation P330 SFF Platform Specifications

Components	Specification																							
Machine Type	MT 30C7 for Transactional model and MT 30C8 for Relationship model. For configuration of all 30C7 EMEA and US models, please visit: <a href="http://psref.lenovo.com/Product/ThinkStation/ThinkStation_P330_SFF">http://psref.lenovo.com/Product/ThinkStation/ThinkStation_P330_SFF</a>																							
Form factor	8.4L mini-tower																							
Dimensions	Height: 343.5 mm (13.5 in). Width: 92.5 mm (3.6 in). Depth: 305.6 mm (12 in)																							
Weight	Maximum configuration: 13.23 lb (6.0kg)																							
Processor	Up to one Intel Xeon E-2100 family processor, up to 80W, up to 6 cores at 3.7GHz, up to 3.8GHz with 4 cores, up to 12MB cache, DDR4-2666 memory speed. Or up to one 8th Intel Core family processor, i7, i5, or i3, up to 65W, up to 6 cores at 3.2GHz, up to 3.7GHz with 4 cores, up to 12MB cache, up to DDR4-2666 memory speed. Or up to one Intel Pentium G5400 via Special Bids, 58W, 2 cores at 3.7GHz, 4MB cache, DDR4-2400 memory speed																							
Chipset	Intel C246 Chipset																							
Memory	4 DIMM sockets. DDR4-2666. UDIMM. ECC and non-ECC are supported, but memory types cannot be intermixed																							
Memory capacity	Up to 64GB with 4x 16GB, both ECC and non-ECC																							
Memory protection	ECC with ECC UDIMM. Core i7 and i5 processors cannot support ECC UDIMM																							
Expansion slots	Three PCIe 3.0 slots as following:																							
	Slot 1 PCIe 3.0 x16, full height, half length, links to CPU																							
	Slot 2 PCIe 3.0 x1, full height, full length, links to PCH																							
Graphics - Processor graphics	Slot 3 PCIe 3.0 x16 (negotiable link width x4), full height, half length, links to PCH																							
	Integrated Intel UHD Graphics P630 in -G suffix Xeon processors, or Intel UHD Graphics 630 in Core i7, i5, or i3 processors, or Intel UHD Graphics 610 in Pentium Gold G5400. Works along with discrete graphics to support multi-display, enables three display connectors (2x DP, 1x HDMI. HDMI is optional) on rear																							
Graphics - Discrete graphics card	Up to two PCIe 3.0 x16 slots for discrete graphics adapter (Slot 1 and 3). Supports the following graphics adapters:																							
	<table border="1"> <thead> <tr> <th>Adapter</th> <th>Cores</th> <th>Memory</th> <th>Power</th> <th>Connectors</th> <th>Max qty</th> </tr> </thead> <tbody> <tr> <td>Quadro P400</td> <td>256</td> <td>2GB GDDR5</td> <td>30W</td> <td>3x miniDP</td> <td>2</td> </tr> <tr> <td>Quadro P620</td> <td>512</td> <td>2GB GDDR5</td> <td>40W</td> <td>4x miniDP</td> <td>2</td> </tr> <tr> <td>Quadro P1000</td> <td>640</td> <td>4GB GDDR5</td> <td>47W</td> <td>4x miniDP</td> <td>2</td> </tr> </tbody> </table>	Adapter	Cores	Memory	Power	Connectors	Max qty	Quadro P400	256	2GB GDDR5	30W	3x miniDP	2	Quadro P620	512	2GB GDDR5	40W	4x miniDP	2	Quadro P1000	640	4GB GDDR5	47W	4x miniDP
Adapter	Cores	Memory	Power	Connectors	Max qty																			
Quadro P400	256	2GB GDDR5	30W	3x miniDP	2																			
Quadro P620	512	2GB GDDR5	40W	4x miniDP	2																			
Quadro P1000	640	4GB GDDR5	47W	4x miniDP	2																			
Storage controllers	Integrated Intel SATA AHCI/RAID controller in chipset, 6Gbps SATA, RAID 0/1. Four onboard SATA ports for max 4 SATA HDD/SSD/ODD																							
Internal storage bay	Up to 3 bays with two disk bays and one slim optical bay:																							
	Bay 1 Primary 3.5" SATA bay																							
	Bay 2 2.5" SATA bay (Optional) Bay 3 9mm Slim ODD bay																							
Disks	3.5" HDD supports up to 4TB each, 6Gbps SATA, 7.2K. 2.5" SSD supports up to 1TB each, 6Gbps SATA																							
M.2 slot for SSD	Up to 3x M.2 SSD with one dedicated onboard M.2 slot plus two PCIe to M.2 adapters. PCIe to M.2 adapter uses slot 1 or 3. Supports RAID 0/1 with PCH, When used as RAID, M.2 SSD should be installed in onboard M.2 slot and slot 3. Up to one Optane memory per system; Optane memory must work with a HDD or SSD; Optane memory cannot supported on Pentium G5400 models																							
M.2 SSD	M.2 SSD supports up to 1TB each, PCIe 3.0 x4, NVMe, Opal. Optane memory supports 32GB, PCIe 3.0 x2, NVMe, 3D Xpoint																							
M.2 slot for Wi-Fi and Bluetooth	One dedicated onboard M.2 slot for optional Intel Wireless-AC 9560, 2x2, 2.4GHz/5GHz (160MHz channels), 802.11ac, Bluetooth 5, up to 1.73Gbps																							

Components	Specification
Media reader	Optional SD card reader on most models
Network interfaces	One onboard GbE port via integrated gigabit ethernet Intel i219LM, supports Wake-on-LAN. Optional PCIe ethernet adapters are available
Security features	Power-on and admin password. Trusted Platform Module, TCG 2.0 compliant. Optional chassis intrusion switch, cable lock, Kensington lock, and pad lock
Intel vPro	Supports Intel vPro on Xeon models. vPro also requires Wireless-AC 9560 if Wi-Fi is needed
Intel AMT	Intel Active Management Technology 12 on Xeon models, Intel Standard Manageability on other models
Base warranty	US models comes with 3-year limited onsite service with 9x5/NBD. 1 or 3-year limited onsite service with 9x5/NBD in EMEA or other GEOs
HD Audio	Intel HD Audio interface with Realtek ALC233 Codec
Front ports	2x USB 3.1 Gen 1 Type A. 2x USB 3.1 Gen 2 Type A. 1x USB 3.1 Gen 1 Type-C. 1x Mic-in. 1x Combo jack
Rear ports	2x USB 3.1 Gen 1 Type A. 2x USB 2.0 Type-A. 1x RJ-45. 1x COM. 2x DP. 1x Audio line-out <i>Notes: DP needs Core, Pentium, or -G suffix Xeon processor</i>
Optional rear ports	2x USB 3.1 Type-C. 1x COM. PS/2. 1x Parallel. 1x Thunderbolt. 1x IEEE1394. 1x HDMI. 1x Audio line-out <i>Notes: HDMI needs Core, Pentium, or -G suffix Xeon processor</i>
Temperature	Operating: 41 °F to 104 °F (10 °C to 35 °C) Non operating (no package): 14 °F to 140 °F (-10 °C to 60 °C) Non operating (with package): -40 °F to 140 °F (-40 °C to 60 °C)
Altitude	Operating: -15.2 m (-50 ft) to 3048 m (10 000 ft). Storage: -15.2 m (-50 ft) to 10, 668 m (35 000 ft)
Humidity	Operating: 30%-90%, non-condensing Storage (with package): 20%-90%, non-condensing
Environmental certification	RoHS-compliant. GREENGUARD. EPEAT Silver rating and ENERGY STAR 7 qualified
Power supply	Supports one 210W or 260W power supply. 210W is 100V - 240V, 85% PSU, Climate Savers Computing Bronze and 80 PLUS Bronze qualified. 260W is 100V - 240V, 92% PSU, Climate Savers Computing Platinum and 80 PLUS Platinum qualified
ISV certifications	Please visit <a href="http://www.thinkworkstations.com/isv-certifications/">www.thinkworkstations.com/isv-certifications/</a>

Note:  
1. Depending on many factors, actual data transfer speed mentioned on this page may be lower than theoretical speed.  
2. Any questions or advice on ThinkStation PSREF, please contact [ThinkStation PSREF developer](#)

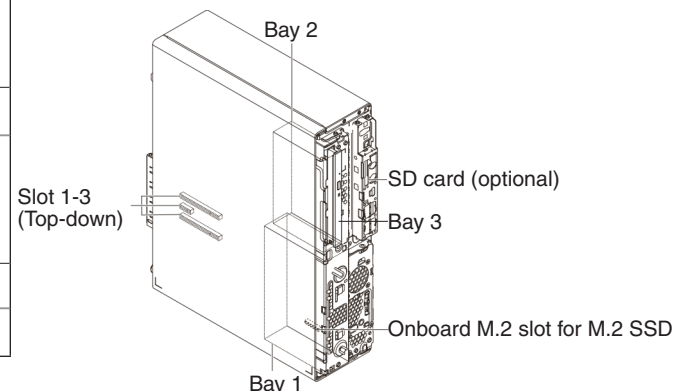





# ThinkStation P330 SFF Gen 2 (30D1 and 30D2) Platform Specifications

Product Specifications Reference (PSREF)

Components	Specification					
Form factor	8.4L mini-tower					
Dimensions	Height: 343.5 mm (13.5 in). Width: 92.5 mm (3.6 in). Depth: 305.6 mm (12 in)					
Weight	Maximum configuration: 13.23 lb (6.0kg) Supports one of the following processor:					
Processor	Xeon E-2278G 8C/16T/3.4GHz/16MB/80W/DDR4-2666 (260W PSU needed)					
	Xeon E-2276G 6C/12T/3.8GHz/12MB/80W/DDR4-2666					
	Xeon E-2274G 4C/8T/4.0GHz/8MB/83W/DDR4-2666					
	Xeon E-2246G 6C/12T/3.6GHz/12MB/80W/DDR4-2666					
	Xeon E-2244G 4C/8T/3.8GHz/8MB/71W/DDR4-2666					
	Xeon E-2236 6C/12T/3.4GHz/12MB/80W/DDR4-2666					
	Xeon E-2234 4C/8T/3.6GHz/8MB/71W/DDR4-2666					
	Xeon E-2226G 6C/6T/3.4GHz/12MB/80W/DDR4-2666					
	Xeon E-2224G 4C/4T/3.5GHz/8MB/71W/DDR4-2666					
	Xeon E-2224 4C/4T/3.4GHz/8MB/71W/DDR4-2666					
	Xeon E-2174G 4C/8T/3.8GHz/8MB/71W/DDR4-2666					
	Core i9-9900 8C/16T/3.1GHz/16MB/65W/DDR4-2666					
	Core i7-9700 8C/8T/3.0GHz/12MB/65W/DDR4-2666					
	Core i7-8700 6C/12T/3.2GHz/12MB/65W/DDR4-2666					
	Core i5-9600 6C/6T/3.1GHz/9MB/65W/DDR4-2666					
	Core i5-9500 6C/6T/3.0GHz/9MB/65W/DDR4-2666					
	Core i5-9400 6C/6T/2.9GHz/9MB/65W/DDR4-2666					
	Core i5-8500 6C/6T/3.0GHz/9MB/65W/DDR4-2666					
	Core i3-9300 4C/4T/3.7GHz/8MB/62W/DDR4-2400					
	Core i3-9100 4C/4T/3.6GHz/6MB/65W/DDR4-2400					
	Core i3-8300 4C/4T/3.7GHz/8MB/62W/DDR4-2400					
Core i3-8100 4C/4T/3.6GHz/6MB/65W/DDR4-2400						
Pentium Gold G5620 2C/4T/4.0GHz/4MB/54W/DDR4-2400						
Chipset	Intel C246 Chipset					
Memory Sockets	4 DIMM sockets with 2 channels					
Memory Types	8GB/16GB DDR4-2666 UDIMM ECC or 4GB/8GB/16GB/32GB DDR4-2666 UDIMM non-ECC					
Memory Capacity	64GB with 4 x 16GB for UDIMM ECC or 128GB with 4 x 32GB UDIMM non-ECC					
Memory Protection	ECC on models with UDIMM ECC memory					
Expansion slots	Three PCIe 3.0 slots as following:					
	Slot 1 PCIe 3.0 x16, low profile, links to CPU					
	Slot 2 PCIe 3.0 x1, low profile, links to PCH					
Processor graphics	Slot 3 PCIe 3.0 x16 (negotiable link width x4), low profile, links to PCH					
	Integrated Intel UHD Graphics P630 in -G suffix Xeon processors, or Intel UHD Graphics 630 in Core i5 or i3 processors.					
	Works along with discrete graphics to support multi-display, enables three rear display connectors (2 DP standard, 1 DP or HDMI optional)					
Discrete graphics card	Up to two PCIe 3.0 x16 slots for discrete graphics adapter (Slot 1 and 3). Supports the following graphics adapters:					
	Adapter	Cores	Memory	Power	Connectors	Max qty
	Quadro P400	256	2GB GDDR5	30W	3x miniDP	2
	Quadro P620	512	2GB GDDR5	40W	4x miniDP	2
Quadro P1000	640	4GB GDDR5	47W	4x miniDP	2	
Storage Controller	Storage Controller	Type	Interface	Disk Type	RAID	
	Onboard Intel RST SATA RAID	Std	SATA 6Gb/s	HDD or SSD	0/1	
	Onboard Intel RST PCIe RAID	Std	PCIe NVMe	M.2 PCIe SSD	0/1	
Notes: M.2 SSD support is limited, please see Storage bay section for more information						
Storage Support	Disk Type	Interface	RPM	Offering	Max Qty	
	3.5" SATA HDD	SATA 6Gb/s	7.2K	1TB/2TB/4TB	1	
	2.5" SATA HDD	SATA 6Gb/s	7.2K	500GB FIPS	2	
	2.5" SATA SSD	SATA 6Gb/s		256GB/512GB/1TB	2	
	Optane Memory	PCIe NVMe		32GB	1, used with HDD/SSD	
M.2 PCIe SSD	PCIe NVMe		256GB/512GB/1TB	3		

Components	Specification	
Storage bay	Up to 3 bays with two disk bays and one slim optical bay:	
	Bay 1	Primary 3.5" SATA bay
	Bay 2	2.5" SATA bay (Optional)
	Bay 3	9mm Slim ODD bay
M.2	3x M.2 SSD (1 onboard, 2 via PCIe to M.2 adapter) Notes: Support 1x M.2 SSD at present, 3x M.2 SSD support is pending availability	
M.2 slot for Wi-Fi and Bluetooth	One dedicated onboard M.2 slot for optional Intel Wireless-AC 9560, 2x2, 2.4GHz/5GHz (160MHz channels), 802.11ac, Bluetooth 5, up to 1.73Gbps	
Media reader	Optional SD card reader on most models	
Network interfaces	One onboard GbE port via integrated gigabit ethernet Intel i219LM, supports Wake-on-LAN. Optional PCIe ethernet adapters are available	
Security features	Power-on and admin password. Trusted Platform Module, TCG 2.0 compliant. Optional chassis intrusion switch, cable lock, Kensington lock, and pad lock	
Intel vPro	Supports Intel vPro on Xeon models. vPro also requires Wireless-AC 9560 if Wi-Fi is needed	
Intel AMT	Intel Active Management Technology 12 on Xeon models, Intel Standard Manageability on other models	
Base warranty	US models comes with 3-year limited onsite service with 9x5/NBD. 1 or 3-year limited onsite service with 9x5/NBD in EMEA or other GEOs	
HD Audio	Intel HD Audio interface with Realtek ALC233 Codec	
Front ports	2x USB 3.1 Gen 1 Type A. 2x USB 3.1 Gen 2 Type A. 1x USB 3.1 Gen 1 Type-C. 1x Mic-in. 1x Combo jack	
Rear ports	2x USB 3.1 Gen 1 Type A. 2x USB 2.0 Type-A. 1x RJ-45. 1x COM. 2x DP. 1x Audio line-out Notes: DP needs Core, Pentium, or -G suffix Xeon processor	
Optional rear ports	Supports the following via cable: 1x COM. 1x Parallel. 2x PS/2. 1x DP or 1x HDMI. 2x USB 2.0	
	Supports the following via PCIe adapter: 4x COM. 2x USB 3.1 Type-C. 2x USB 3.0. 1x Thunderbolt. Notes: DP or HDMI needs Core, Pentium, or -G suffix Xeon processor	
Temperature	Operating: 50 °F to 95 °F (10 °C to 35 °C) Non operating (no package): 14 °F to 140 °F (-10 °C to 60 °C) Non operating (with package): -40 °F to 140 °F (-40 °C to 60 °C)	
Altitude	Operating: -15.2 m (-50 ft) to 3048 m (10 000 ft). Storage: -15.2 m (-50 ft) to 10, 668 m (35 000 ft)	
Humidity	Operating: 30%~90%, non-condensing Storage (with package): 20%~90%, non-condensing	
Environmental certification	RoHS-compliant. GREENGUARD. EPEAT Silver rating and ENERGY STAR 7 qualified	
Power supply	Supports one 210W or 260W power supply. 210W is 100V - 240V, 85% PSU, Climate Savers Computing Bronze and 80 PLUS Bronze qualified. 260W is 100V - 240V, 92% PSU, Climate Savers Computing Platinum and 80 PLUS Platinum qualified	
ISV certifications	Please visit <a href="http://www.thinkworkstations.com/isv-certifications/">www.thinkworkstations.com/isv-certifications/</a>	

Note:  
1. Depending on many factors, actual data transfer speed mentioned on this page may be lower than theoretical speed.  
2. Any questions or advice on ThinkStation PSREF, please contact [ThinkStation PSREF developer](mailto:ThinkStation_PSREF_developer@lenovo.com)

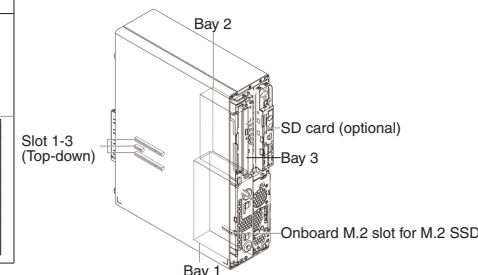



# ThinkStation P330 Tiny Platform Specifications - I of II

Components	Specification	Components	Specification																																																																																																																																																																																																																
Form factor	1L. Optional VESA mount bracket kit, supports VESA 75mm and 100mm. Optional floor stand for vertical orientation. Optional tool-less chassis open. Optional dust filter	Chipset	Intel Q370 Chipset																																																																																																																																																																																																																
Dimensions	Height: 179 mm (7.0 in). Width: 36.5 mm (1.437 in). Depth: 182.9 mm (7.2 in)	Memory	2 DIMM sockets. DDR4-2666. SoDIMM. Non-ECC																																																																																																																																																																																																																
Weight	Maximum configuration: 3.08 lb (1.4kg)	Expansion slots	One PCIe slot via specific riser card: PCIe 3.0 x16 (negotiable link width x8) and low profile for discrete graphics card; PCIe 3.0 x4 and low profile for i350-T4 adapter and quad COM ports adapter																																																																																																																																																																																																																
Supported TIO monitors	Tiny-in-One 23 (MT: 10DQ). Tiny-in-One 22 (MT: 10LK). Tiny-in-One 24 (MT: 10LL). Tiny-in-One22 Gen3 (MT: 10R1). Tiny-in-One22 Gen3 Touch (MT: 10R0). Tiny-in-One24 Gen3 (MT: 10QY). Tiny-in-One24 Gen3 Touch (MT: 10QX).	Graphics	65W or 62W processor models supports processor graphics only. 35W processor models come with processor graphics plus a discrete graphics adapter																																																																																																																																																																																																																
		Graphics - Processor graphics	Integrated Intel UHD Graphics 630. Works along with discrete graphics to support multi-display																																																																																																																																																																																																																
Recommended monitors	Lenovo recommends ThinkVision P series monitors for best display performance and productivity Supports one of the following:	Graphics - Discrete graphics card	One of the following discrete graphics cards on 35W processor models:																																																																																																																																																																																																																
			<table border="1"> <thead> <tr> <th>Adapter</th> <th>Cores</th> <th>Memory</th> <th>Power</th> <th>Connectors</th> </tr> </thead> <tbody> <tr> <td>Quadro P620</td> <td>512</td> <td>2GB GDDR5</td> <td>40W</td> <td>4x miniDP</td> </tr> <tr> <td>Quadro P1000</td> <td>640</td> <td>4GB GDDR5</td> <td>47W</td> <td>4x miniDP</td> </tr> </tbody> </table>	Adapter	Cores	Memory	Power	Connectors	Quadro P620	512	2GB GDDR5	40W	4x miniDP	Quadro P1000	640	4GB GDDR5	47W	4x miniDP																																																																																																																																																																																																	
Adapter	Cores	Memory	Power	Connectors																																																																																																																																																																																																															
Quadro P620	512	2GB GDDR5	40W	4x miniDP																																																																																																																																																																																																															
Quadro P1000	640	4GB GDDR5	47W	4x miniDP																																																																																																																																																																																																															
Processor	<table border="1"> <thead> <tr> <th>Processor Number</th> <th>Cores</th> <th>Threads</th> <th>Base Frequency</th> <th>Cache</th> <th>TDP</th> <th>Memory Types</th> <th>Processor Graphics</th> </tr> </thead> <tbody> <tr><td>Core i9-9900T</td><td>8</td><td>16</td><td>2.1GHz</td><td>16MB</td><td>35W</td><td>DDR4-2666</td><td>Intel UHD Graphics 630</td></tr> <tr><td>Core i7-9700T</td><td>8</td><td>8</td><td>2.0GHz</td><td>12MB</td><td>35W</td><td>DDR4-2666</td><td>Intel UHD Graphics 630</td></tr> <tr><td>Core i5-9600T</td><td>6</td><td>6</td><td>2.3GHz</td><td>9MB</td><td>35W</td><td>DDR4-2666</td><td>Intel UHD Graphics 630</td></tr> <tr><td>Core i5-9600</td><td>6</td><td>6</td><td>3.1GHz</td><td>9MB</td><td>65W</td><td>DDR4-2666</td><td>Intel UHD Graphics 630</td></tr> <tr><td>Core i5-9500T</td><td>6</td><td>6</td><td>2.2GHz</td><td>9MB</td><td>35W</td><td>DDR4-2666</td><td>Intel UHD Graphics 630</td></tr> <tr><td>Core i5-9500</td><td>6</td><td>6</td><td>3.0GHz</td><td>9MB</td><td>65W</td><td>DDR4-2666</td><td>Intel UHD Graphics 630</td></tr> <tr><td>Core i5-9400T</td><td>6</td><td>6</td><td>1.8GHz</td><td>9MB</td><td>35W</td><td>DDR4-2666</td><td>Intel UHD Graphics 630</td></tr> <tr><td>Core i5-9400</td><td>6</td><td>6</td><td>2.9GHz</td><td>9MB</td><td>65W</td><td>DDR4-2666</td><td>Intel UHD Graphics 630</td></tr> <tr><td>Core i3-9320</td><td>4</td><td>4</td><td>3.7GHz</td><td>8MB</td><td>62W</td><td>DDR4-2400</td><td>Intel UHD Graphics 630</td></tr> <tr><td>Core i3-9300T</td><td>4</td><td>4</td><td>3.2GHz</td><td>8MB</td><td>35W</td><td>DDR4-2400</td><td>Intel UHD Graphics 630</td></tr> <tr><td>Core i3-9300</td><td>4</td><td>4</td><td>3.7GHz</td><td>8MB</td><td>62W</td><td>DDR4-2400</td><td>Intel UHD Graphics 630</td></tr> <tr><td>Core i3-9100T</td><td>4</td><td>4</td><td>3.1GHz</td><td>6MB</td><td>35W</td><td>DDR4-2400</td><td>Intel UHD Graphics 630</td></tr> <tr><td>Core i3-9100</td><td>4</td><td>4</td><td>3.6GHz</td><td>6MB</td><td>65W</td><td>DDR4-2400</td><td>Intel UHD Graphics 630</td></tr> <tr><td>Core i7-8700T</td><td>6</td><td>12</td><td>2.4GHz</td><td>12MB</td><td>35W</td><td>DDR4-2666</td><td>Intel UHD Graphics 630</td></tr> <tr><td>Core i7-8700</td><td>6</td><td>12</td><td>3.2GHz</td><td>12MB</td><td>65W</td><td>DDR4-2666</td><td>Intel UHD Graphics 630</td></tr> <tr><td>Core i5-8600T</td><td>6</td><td>6</td><td>2.3GHz</td><td>9MB</td><td>35W</td><td>DDR4-2666</td><td>Intel UHD Graphics 630</td></tr> <tr><td>Core i5-8600</td><td>6</td><td>6</td><td>3.1GHz</td><td>9MB</td><td>65W</td><td>DDR4-2666</td><td>Intel UHD Graphics 630</td></tr> <tr><td>Core i5-8500T</td><td>6</td><td>6</td><td>2.1GHz</td><td>9MB</td><td>35W</td><td>DDR4-2666</td><td>Intel UHD Graphics 630</td></tr> <tr><td>Core i5-8500</td><td>6</td><td>6</td><td>3.0GHz</td><td>9MB</td><td>65W</td><td>DDR4-2666</td><td>Intel UHD Graphics 630</td></tr> <tr><td>Core i5-8400T</td><td>6</td><td>6</td><td>1.7GHz</td><td>9MB</td><td>35W</td><td>DDR4-2666</td><td>Intel UHD Graphics 630</td></tr> <tr><td>Core i5-8400</td><td>6</td><td>6</td><td>2.8GHz</td><td>9MB</td><td>65W</td><td>DDR4-2666</td><td>Intel UHD Graphics 630</td></tr> <tr><td>Core i3-8300T</td><td>4</td><td>4</td><td>3.2GHz</td><td>8MB</td><td>35W</td><td>DDR4-2400</td><td>Intel UHD Graphics 630</td></tr> <tr><td>Core i3-8300</td><td>4</td><td>4</td><td>3.7GHz</td><td>8MB</td><td>62W</td><td>DDR4-2400</td><td>Intel UHD Graphics 630</td></tr> <tr><td>Core i3-8100T</td><td>4</td><td>4</td><td>3.1GHz</td><td>6MB</td><td>35W</td><td>DDR4-2400</td><td>Intel UHD Graphics 630</td></tr> <tr><td>Core i3-8100</td><td>4</td><td>4</td><td>3.6GHz</td><td>6MB</td><td>65W</td><td>DDR4-2400</td><td>Intel UHD Graphics 630</td></tr> </tbody> </table>	Processor Number	Cores	Threads	Base Frequency	Cache	TDP	Memory Types	Processor Graphics	Core i9-9900T	8	16	2.1GHz	16MB	35W	DDR4-2666	Intel UHD Graphics 630	Core i7-9700T	8	8	2.0GHz	12MB	35W	DDR4-2666	Intel UHD Graphics 630	Core i5-9600T	6	6	2.3GHz	9MB	35W	DDR4-2666	Intel UHD Graphics 630	Core i5-9600	6	6	3.1GHz	9MB	65W	DDR4-2666	Intel UHD Graphics 630	Core i5-9500T	6	6	2.2GHz	9MB	35W	DDR4-2666	Intel UHD Graphics 630	Core i5-9500	6	6	3.0GHz	9MB	65W	DDR4-2666	Intel UHD Graphics 630	Core i5-9400T	6	6	1.8GHz	9MB	35W	DDR4-2666	Intel UHD Graphics 630	Core i5-9400	6	6	2.9GHz	9MB	65W	DDR4-2666	Intel UHD Graphics 630	Core i3-9320	4	4	3.7GHz	8MB	62W	DDR4-2400	Intel UHD Graphics 630	Core i3-9300T	4	4	3.2GHz	8MB	35W	DDR4-2400	Intel UHD Graphics 630	Core i3-9300	4	4	3.7GHz	8MB	62W	DDR4-2400	Intel UHD Graphics 630	Core i3-9100T	4	4	3.1GHz	6MB	35W	DDR4-2400	Intel UHD Graphics 630	Core i3-9100	4	4	3.6GHz	6MB	65W	DDR4-2400	Intel UHD Graphics 630	Core i7-8700T	6	12	2.4GHz	12MB	35W	DDR4-2666	Intel UHD Graphics 630	Core i7-8700	6	12	3.2GHz	12MB	65W	DDR4-2666	Intel UHD Graphics 630	Core i5-8600T	6	6	2.3GHz	9MB	35W	DDR4-2666	Intel UHD Graphics 630	Core i5-8600	6	6	3.1GHz	9MB	65W	DDR4-2666	Intel UHD Graphics 630	Core i5-8500T	6	6	2.1GHz	9MB	35W	DDR4-2666	Intel UHD Graphics 630	Core i5-8500	6	6	3.0GHz	9MB	65W	DDR4-2666	Intel UHD Graphics 630	Core i5-8400T	6	6	1.7GHz	9MB	35W	DDR4-2666	Intel UHD Graphics 630	Core i5-8400	6	6	2.8GHz	9MB	65W	DDR4-2666	Intel UHD Graphics 630	Core i3-8300T	4	4	3.2GHz	8MB	35W	DDR4-2400	Intel UHD Graphics 630	Core i3-8300	4	4	3.7GHz	8MB	62W	DDR4-2400	Intel UHD Graphics 630	Core i3-8100T	4	4	3.1GHz	6MB	35W	DDR4-2400	Intel UHD Graphics 630	Core i3-8100	4	4	3.6GHz	6MB	65W	DDR4-2400	Intel UHD Graphics 630	Storage controllers	Integrated Intel SATA AHCI controller in chipset, 6Gbps SATA, one onboard SATA port for 2.5" HDD
	Processor Number	Cores	Threads	Base Frequency	Cache	TDP	Memory Types	Processor Graphics																																																																																																																																																																																																											
	Core i9-9900T	8	16	2.1GHz	16MB	35W	DDR4-2666	Intel UHD Graphics 630																																																																																																																																																																																																											
	Core i7-9700T	8	8	2.0GHz	12MB	35W	DDR4-2666	Intel UHD Graphics 630																																																																																																																																																																																																											
	Core i5-9600T	6	6	2.3GHz	9MB	35W	DDR4-2666	Intel UHD Graphics 630																																																																																																																																																																																																											
	Core i5-9600	6	6	3.1GHz	9MB	65W	DDR4-2666	Intel UHD Graphics 630																																																																																																																																																																																																											
	Core i5-9500T	6	6	2.2GHz	9MB	35W	DDR4-2666	Intel UHD Graphics 630																																																																																																																																																																																																											
	Core i5-9500	6	6	3.0GHz	9MB	65W	DDR4-2666	Intel UHD Graphics 630																																																																																																																																																																																																											
	Core i5-9400T	6	6	1.8GHz	9MB	35W	DDR4-2666	Intel UHD Graphics 630																																																																																																																																																																																																											
	Core i5-9400	6	6	2.9GHz	9MB	65W	DDR4-2666	Intel UHD Graphics 630																																																																																																																																																																																																											
	Core i3-9320	4	4	3.7GHz	8MB	62W	DDR4-2400	Intel UHD Graphics 630																																																																																																																																																																																																											
	Core i3-9300T	4	4	3.2GHz	8MB	35W	DDR4-2400	Intel UHD Graphics 630																																																																																																																																																																																																											
	Core i3-9300	4	4	3.7GHz	8MB	62W	DDR4-2400	Intel UHD Graphics 630																																																																																																																																																																																																											
	Core i3-9100T	4	4	3.1GHz	6MB	35W	DDR4-2400	Intel UHD Graphics 630																																																																																																																																																																																																											
	Core i3-9100	4	4	3.6GHz	6MB	65W	DDR4-2400	Intel UHD Graphics 630																																																																																																																																																																																																											
	Core i7-8700T	6	12	2.4GHz	12MB	35W	DDR4-2666	Intel UHD Graphics 630																																																																																																																																																																																																											
	Core i7-8700	6	12	3.2GHz	12MB	65W	DDR4-2666	Intel UHD Graphics 630																																																																																																																																																																																																											
	Core i5-8600T	6	6	2.3GHz	9MB	35W	DDR4-2666	Intel UHD Graphics 630																																																																																																																																																																																																											
	Core i5-8600	6	6	3.1GHz	9MB	65W	DDR4-2666	Intel UHD Graphics 630																																																																																																																																																																																																											
	Core i5-8500T	6	6	2.1GHz	9MB	35W	DDR4-2666	Intel UHD Graphics 630																																																																																																																																																																																																											
	Core i5-8500	6	6	3.0GHz	9MB	65W	DDR4-2666	Intel UHD Graphics 630																																																																																																																																																																																																											
	Core i5-8400T	6	6	1.7GHz	9MB	35W	DDR4-2666	Intel UHD Graphics 630																																																																																																																																																																																																											
	Core i5-8400	6	6	2.8GHz	9MB	65W	DDR4-2666	Intel UHD Graphics 630																																																																																																																																																																																																											
	Core i3-8300T	4	4	3.2GHz	8MB	35W	DDR4-2400	Intel UHD Graphics 630																																																																																																																																																																																																											
	Core i3-8300	4	4	3.7GHz	8MB	62W	DDR4-2400	Intel UHD Graphics 630																																																																																																																																																																																																											
	Core i3-8100T	4	4	3.1GHz	6MB	35W	DDR4-2400	Intel UHD Graphics 630																																																																																																																																																																																																											
	Core i3-8100	4	4	3.6GHz	6MB	65W	DDR4-2400	Intel UHD Graphics 630																																																																																																																																																																																																											
	Internal storage bay	Up to one 2.5" HDD	Disks	2.5" HDD supports up to 1TB, 6Gbps SATA, 7.2K or 5.4K																																																																																																																																																																																																															
	M.2 slot for SSD	Two onboard M.2 slots for M.2 SSD, one for M.2 2280 SSD, one for M.2 2280 or 2242 SSD	M.2 SSD	M.2 2280 SSD supports up to 1TB each, PCIe 3.0 x4, NVMe, optional Opal. M.2 2242 SSD supports up to 128GB, PCIe 3.0 x2, NVMe																																																																																																																																																																																																															
	Optane memory	Up to one 16GB Optane memory per system. Optane memory must work with a 2.5" HDD	M.2 slot for Wi-Fi and Bluetooth	One dedicated M.2 2230 slot for optional Wi-Fi card, supports one of the following: Intel Wireless-AC 9560, 2x2, 2.4GHz/5GHz (160MHz channels), 802.11ac, Bluetooth 5, up to 1.73Gbps. Intel Wireless-AC 8265, 2x2, 2.4GHz/5GHz, 802.11ac, Bluetooth 4.2, up to 867Mbps. <i>Note: Wi-Fi card, or specific functions of Wi-Fi card may not be supported in some countries</i>																																																																																																																																																																																																															
	Wi-Fi antenna	Optional Tiny 2.4GHz/5GHz SMA antenna kit	Optical	Optional one 9.0mm optical drive via optical drive kit, DVD-ROM or DVD±RW. VESA mount is required																																																																																																																																																																																																															
	Media reader	None. Using USB adapter	Network interfaces	One onboard GbE port via integrated gigabit ethernet Intel i219LM, supports Wake-on-LAN. Optional Intel i350-T4 for 4x GbE ports, using PCIe slot																																																																																																																																																																																																															
Security features	Power-on and admin password. Trusted Platform Module, TCG 2.0 compliant. Chassis intrusion switch. Optional Kensington lock	Security features	Power-on and admin password. Trusted Platform Module, TCG 2.0 compliant. Chassis intrusion switch. Optional Kensington lock																																																																																																																																																																																																																
Intel vPro Technology	Supports vPro on models with the following processors: Core i7-8700T, Core i7-8700, Core i5-8600T, Core i5-8600, Core i5-8500T, Core i5-8500. vPro also requires Wireless-AC 9560 if Wi-Fi is needed	Systems management	Intel Active Management Technology 12 on vPro models, Intel Standard Manageability on other models																																																																																																																																																																																																																
Base warranty	US models comes with 3-year limited onsite service with 9x5/NBD. 1 or 3-year limited onsite service with 9x5/NBD in EMEA or other GEOs	HD Audio	Intel HD Audio interface with Realtek ALC233 Codec																																																																																																																																																																																																																
Front standard ports	1x USB 3.1 Gen 1 Type A (charging). 1x USB 3.1 Gen 1 Type-C. 1x Mic-in. 1x Combo jack	Rear standard ports	2x USB 3.1 Gen 2 Type A. 2x USB 3.1 Gen 1 Type-A. 1x RJ-45. 1x DP. 1x HDMI																																																																																																																																																																																																																
Optional rear ports - via punch out cable	Up to two optional rear ports via punch out cable. Port 1 supports one of the following: 1x USB 3.1 Gen 1 Type-C, also supports DP function. 1x COM. 1x VGA. 1x DP. 1x HDMI. Port 2 supports one COM																																																																																																																																																																																																																		

## ThinkStation P330 Tiny Platform Specifications - II of II

Product Specifications Reference (PSREF)

Components	Specification
Optional rear ports - via punch out cable	Up to two optional rear ports via punch out cable. Port 1 supports one of the following: 1x USB 3.1 Gen 1 Type-C, also supports DP function. 1x COM. 1x VGA. 1x DP. 1x HDMI. Port 2 supports one COM
Optional rear ports - via PCIe adapter	Supports one of the following: 4x miniDP with Quadro P620 or P1000, 35W processor models only 2x USB 3.1 Gen 1. 4x RJ-45 GbE with Intel I350-T4. 4x COM <i>Note: Punch out cable and PCIe adapter are mutually exclusive</i>
Temperature	Operating: 50 °F to 95 °F (10 °C to 35 °C) Non operating (with package): -40 °F to 140 °F (-40 °C to 60 °C)
Altitude	Operating: -15.2 m (-50 ft) to 3048 m (10 000 ft). Storage: -15.2 m (-50 ft) to 10, 668 m (35 000 ft)
Humidity	Operating: 20%~80%, non-condensing Storage (with package): 20%~90%, non-condensing
MIL-SPEC	Certified
Environmental certification	RoHS-compliant. GREENGUARD. EPEAT Silver rating and ENERGY STAR 7 qualified
Power supply	Supports one 135W power adapter, 100V - 240V, 88% PSU
ISV certifications	Please visit <a href="http://www.thinkworkstations.com/isv-certifications/">www.thinkworkstations.com/isv-certifications/</a>





# ThinkStation P330 Tower Platform Specifications

Product Specifications Reference (PSREF)

Components	Specification																																				
Machine Type	MT 30C5 for Transactional model and MT 30C6 for Relationship model. For configuration of all 30C5 EMEA and US models, please visit: <a href="http://psref.lenovo.com/Product/ThinkStation/ThinkStation_P330_Tower">http://psref.lenovo.com/Product/ThinkStation/ThinkStation_P330_Tower</a>																																				
Form factor	18L Tower																																				
Dimensions	Height: 376 mm (14.8 in). Width: 165 mm (6.5 in). Depth: 328 mm (12.9 in)																																				
Weight	Maximum configuration: 23.4 lb (10.6kg)																																				
Processor	Up to one Intel Xeon E family processor, up to 95W, up to 6 cores at 3.8GHz, up to 12MB cache, up to DDR4-2666 memory speed. Or up to one 8th Intel Core family processor, i7, i5, or i3, up to 95W, up to 6 cores at 3.7GHz, up to 12MB cache, up to DDR4-2666 memory speed. Or up to one Intel Pentium Gold G5400 via Special Bids, 54W, 2 cores at 3.7GHz, 4MB cache, DDR4-2400 memory speed																																				
Chipset	Intel C246 Chipset																																				
Memory	4 DIMM sockets. DDR4-2666. UDIMM. ECC and non-ECC are supported, but memory types cannot be intermixed																																				
Memory capacity	Up to 64GB with 4x 16GB, both ECC and non-ECC																																				
Memory protection	ECC with ECC UDIMM. Core i7 and i5 processors cannot support ECC UDIMM																																				
Expansion slots	Three PCIe 3.0 slots as following:																																				
	Slot 1 PCIe 3.0 x16, full height, half length, links to CPU																																				
	Slot 2 PCIe 3.0 x1, full height, full length, links to PCH																																				
	Slot 3 PCIe 3.0 x16 (negotiable link width x4), full height, half length, links to PCH																																				
Graphics - Processor graphics	Integrated Intel UHD Graphics P630 in -G suffix Xeon processors, or Intel UHD Graphics 630 in Core i7, i5, or i3 processors, or Intel UHD Graphics 610 in Pentium Gold G5400. Works along with discrete graphics to support multi-display, enables three display connectors (2x DP, 1x HDMI. HDMI is optional) on rear																																				
Graphics - Discrete graphics card	Up to two PCIe 3.0 x16 slots for discrete graphics card (Slot 1 and 3). Supports the following graphics adapters:																																				
	<table border="1"> <thead> <tr> <th>Adapter</th> <th>Cores</th> <th>Memory</th> <th>Power</th> <th>Connectors</th> <th>Max qty</th> </tr> </thead> <tbody> <tr> <td>Quadro P400</td> <td>256</td> <td>2GB GDDR5</td> <td>30W</td> <td>3x miniDP</td> <td>2</td> </tr> <tr> <td>Quadro P620</td> <td>512</td> <td>2GB GDDR5</td> <td>40W</td> <td>4x miniDP</td> <td>2</td> </tr> <tr> <td>Quadro P1000</td> <td>640</td> <td>4GB GDDR5</td> <td>47W</td> <td>4x miniDP</td> <td>2</td> </tr> <tr> <td>Quadro P2000</td> <td>1024</td> <td>5GB GDDR5</td> <td>75W</td> <td>4x DP</td> <td>2</td> </tr> <tr> <td>Quadro P4000</td> <td>1792</td> <td>8GB GDDR5</td> <td>105W</td> <td>4x DP</td> <td>1</td> </tr> </tbody> </table>	Adapter	Cores	Memory	Power	Connectors	Max qty	Quadro P400	256	2GB GDDR5	30W	3x miniDP	2	Quadro P620	512	2GB GDDR5	40W	4x miniDP	2	Quadro P1000	640	4GB GDDR5	47W	4x miniDP	2	Quadro P2000	1024	5GB GDDR5	75W	4x DP	2	Quadro P4000	1792	8GB GDDR5	105W	4x DP	1
	Adapter	Cores	Memory	Power	Connectors	Max qty																															
	Quadro P400	256	2GB GDDR5	30W	3x miniDP	2																															
	Quadro P620	512	2GB GDDR5	40W	4x miniDP	2																															
	Quadro P1000	640	4GB GDDR5	47W	4x miniDP	2																															
	Quadro P2000	1024	5GB GDDR5	75W	4x DP	2																															
Quadro P4000	1792	8GB GDDR5	105W	4x DP	1																																
<i>Notes: Quadro P4000 and 2x Quadro P2000 need 400W PSU.</i>																																					
Storage controllers	Integrated Intel SATA AHCI/RAID controller in chipset, 6Gbps SATA, RAID 0/1/10/5. Four onboard SATA ports for max 4 SATA HDD/SSD/ODD																																				
Internal storage bay	Up to five bays with four disk bays plus one slim optical bay, supports up to 3x 3.5" HDD plus 1x 2.5" SSD, or 4x 2.5" SSD																																				
	Bay 1 Primary disk bay, 3.5" or 2.5"																																				
	Bay 2 2.5" SATA bay, cannot be available when 2nd Quadro P2000 is used																																				
	Bay 3 Secondary disk bay, 3.5" or 2.5"																																				
	Bay 4 5.25" Flex bay, supports one of the following: <ul style="list-style-type: none"> <li>Flex module for optional front eSATA/Thunderbolt/IEEE1394</li> <li>3rd disk bay, 3.5" or 2.5", removable, via Front Access Storage Enclosure, using SATA 4 connector as eSATA mode</li> <li>3rd disk bay, 3.5" or 2.5", via 5.25" to 3.5" HDD Kit</li> <li>M.2 drive, via Front removable M.2 enclosure, also occupies slot 1 or 3</li> </ul>																																				
	Bay 5 9mm Slim ODD bay																																				
Disks	3.5" HDD supports up to 4TB each, 6Gbps SATA, 7.2K 2.5" SSD supports up to 1TB each, 6Gbps SATA																																				

Components	Specification
M.2 slot for SSD	Up to 3x M.2 SSD with one dedicated onboard M.2 slot plus two PCIe to M.2 adapters. PCIe to M.2 adapter uses slot 1 or 3. Supports RAID 0/1 with PCH. When used as RAID, M.2 SSD should be installed in onboard M.2 slot and slot 3. Up to one Optane memory per system; Optane memory must work with a HDD or SSD; Optane memory cannot supported on Pentium G5400 models
M.2 SSD	M.2 SSD supports up to 1TB each, PCIe 3.0 x4, NVMe, Opal. Optane memory supports 32GB, PCIe 3.0 x2, NVMe, 3D Xpoint
M.2 slot for Wi-Fi and Bluetooth	One dedicated onboard M.2 slot for optional Intel Wireless-AC 9560, 2x2, 2.4GHz/5GHz (160MHz channels), 802.11ac, Bluetooth 5, up to 1.73Gbps
Media reader	Optional SD card reader on most models
Network interfaces	One onboard GbE port via integrated gigabit ethernet Intel i219LM, supports Wake-on-LAN. Optional PCIe ethernet adapters are available
Security features	Power-on and admin password. Trusted Platform Module, TCG 2.0 compliant. Optional chassis intrusion switch, cable lock, Kensington lock, and pad lock
Intel vPro	Supports Intel vPro on Xeon models. vPro also requires Wireless-AC 9560 if Wi-Fi is needed
Intel AMT	Intel Active Management Technology 12 on Xeon models, Intel Standard Manageability on other models
Base warranty	US models comes with 3-year limited onsite service with 9x5/NBD. 1 or 3-year limited onsite service with 9x5/NBD in EMEA or other GEOs
HD Audio	Intel HD Audio interface with Realtek ALC233 Codec
Front ports	2x USB 3.1 Gen 1 Type A. 2x USB 3.1 Gen 2 Type A. 1x USB 3.1 Gen 1 Type-C. 1x Mic-in. 1x Combo jack
Rear ports	2x USB 3.1 Gen 1 Type A. 2x USB 2.0 Type-A. 1x RJ-45. 1x COM. 2x DP. 1x Audio line-out <i>Notes: DP needs Core, Pentium, or -G suffix Xeon processor</i>
Optional front ports (on flex module)	2x Thunderbolt (USB Type-C), one of two ports supports video-out. 1x eSATA. 1x IEEE1394
Optional rear ports	2x USB 3.1 Type-C. 1x COM. PS/2. 1x Parallel. 1x Thunderbolt. 1x IEEE1394. 1x HDMI. <i>Notes: HDMI needs Core, Pentium, or -G suffix Xeon processor</i>
Temperature	Operating: 41 °F to 104 °F (10 °C to 35 °C) Non operating (no package): 14 °F to 140 °F (-10 °C to 60 °C) Non operating (with package): -40 °F to 140 °F (-40 °C to 60 °C)
Altitude	Operating: -15.2 m (-50 ft) to 3048 m (10 000 ft). Storage: -15.2 m (-50 ft) to 10, 668 m (35 000 ft)
Humidity	Operating: 30%-90%, non-condensing Storage (with package): 20%-90%, non-condensing
Environmental certification	RoHS-compliant. GREENGUARD. EPEAT Silver rating and ENERGY STAR 7 qualified
Power supply	Supports one 250W or 400W power supply, 100V - 240V, 92% PSU. Climate Savers Computing Platinum and 80 PLUS Platinum qualified. 400W PSU supports one 6+2-pin aux power connector.
ISV certifications	Please visit <a href="http://www.thinkworkstations.com/isv-certifications/">www.thinkworkstations.com/isv-certifications/</a>

*Note:*  
1. Depending on many factors, actual data transfer speed mentioned on this page may be lower than theoretical speed.  
2. Any questions or advice on ThinkStation PSREF, please contact [ThinkStation PSREF developer](mailto:ThinkStation_PSREF_developer)

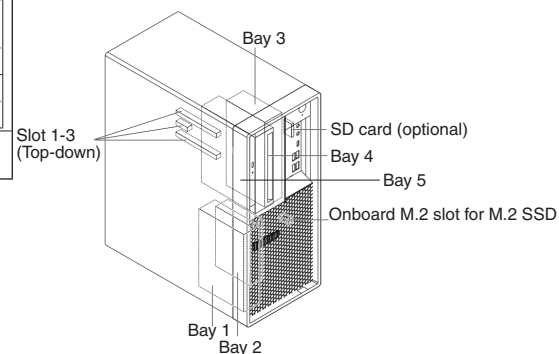





# ThinkStation P330 Tower Gen 2 (30CY and 30D0) Platform Specifications - I of II

Product Specifications Reference (PSREF)

Components	Specification																																																																																																																
Form factor	18L Tower																																																																																																																
Dimensions	Height: 376 mm (14.8 in). Width: 165 mm (6.5 in). Depth: 328 mm (12.9 in)																																																																																																																
Weight	Maximum configuration: 28.22 lb (12.8kg)																																																																																																																
Processor	Supports one of the following processors:																																																																																																																
	<table border="1"> <thead> <tr> <th>Processor</th> <th>Cache</th> <th>Power</th> <th>PSU</th> </tr> </thead> <tbody> <tr> <td>Xeon E-2286G</td> <td>6C/12T/4.0GHz/12MB/95W/DDR4-2666</td> <td>400W PSU needed</td> <td></td> </tr> <tr> <td>Xeon E-2278G</td> <td>8C/16T/3.4GHz/16MB/80W/DDR4-2666</td> <td>400W PSU needed</td> <td></td> </tr> <tr> <td>Xeon E-2276G</td> <td>6C/12T/3.8GHz/12MB/80W/DDR4-2666</td> <td></td> <td></td> </tr> <tr> <td>Xeon E-2274G</td> <td>4C/8T/4.0GHz/8MB/83W/DDR4-2666</td> <td></td> <td></td> </tr> <tr> <td>Xeon E-2246G</td> <td>6C/12T/3.6GHz/12MB/80W/DDR4-2666</td> <td></td> <td></td> </tr> <tr> <td>Xeon E-2244G</td> <td>4C/8T/3.8GHz/8MB/71W/DDR4-2666</td> <td></td> <td></td> </tr> <tr> <td>Xeon E-2236</td> <td>6C/12T/3.4GHz/12MB/80W/DDR4-2666</td> <td></td> <td></td> </tr> <tr> <td>Xeon E-2234</td> <td>4C/8T/3.6GHz/8MB/71W/DDR4-2666</td> <td></td> <td></td> </tr> <tr> <td>Xeon E-2226G</td> <td>6C/6T/3.4GHz/12MB/80W/DDR4-2666</td> <td></td> <td></td> </tr> <tr> <td>Xeon E-2224G</td> <td>4C/4T/3.5GHz/8MB/71W/DDR4-2666</td> <td></td> <td></td> </tr> <tr> <td>Xeon E-2224</td> <td>4C/4T/3.4GHz/8MB/71W/DDR4-2666</td> <td></td> <td></td> </tr> <tr> <td>Xeon E-2186G</td> <td>6C/12T/3.8GHz/12MB/95W/DDR4-2666</td> <td>400W PSU needed</td> <td></td> </tr> <tr> <td>Xeon E-2174G</td> <td>4C/8T/3.8GHz/8MB/71W/DDR4-2666</td> <td></td> <td></td> </tr> <tr> <td>Pentium Gold G5620</td> <td>2C/4T/4.0GHz/4MB/54W/DDR4-2400</td> <td></td> <td></td> </tr> <tr> <td>Core i9-9900</td> <td>8C/16T/3.1GHz/16MB/65W/DDR4-2666</td> <td></td> <td></td> </tr> <tr> <td>Core i7-9700K</td> <td>8C/8T/3.6GHz/12MB/95W/DDR4-2666</td> <td>400W PSU needed</td> <td></td> </tr> <tr> <td>Core i7-9700</td> <td>8C/8T/3.0GHz/12MB/65W/DDR4-2666</td> <td></td> <td></td> </tr> <tr> <td>Core i7-8700</td> <td>6C/12T/3.2GHz/12MB/65W/DDR4-2666</td> <td></td> <td></td> </tr> <tr> <td>Core i5-9600K</td> <td>6C/6T/3.7GHz/9MB/95W/DDR4-2666</td> <td>400W PSU needed</td> <td></td> </tr> <tr> <td>Core i5-9600</td> <td>6C/6T/3.1GHz/9MB/65W/DDR4-2666</td> <td></td> <td></td> </tr> <tr> <td>Core i5-9500</td> <td>6C/6T/3.0GHz/9MB/65W/DDR4-2666</td> <td></td> <td></td> </tr> <tr> <td>Core i5-9400</td> <td>6C/6T/2.9GHz/9MB/65W/DDR4-2666</td> <td></td> <td></td> </tr> <tr> <td>Core i5-8500</td> <td>6C/6T/3.0GHz/9MB/65W/DDR4-2666</td> <td></td> <td></td> </tr> <tr> <td>Core i3-9300</td> <td>4C/4T/3.7GHz/8MB/62W/DDR4-2400</td> <td></td> <td></td> </tr> <tr> <td>Core i3-9100</td> <td>4C/4T/3.6GHz/6MB/65W/DDR4-2400</td> <td></td> <td></td> </tr> <tr> <td>Core i3-8300</td> <td>4C/4T/3.7GHz/8MB/62W/DDR4-2400</td> <td></td> <td></td> </tr> <tr> <td>Core i3-8100</td> <td>4C/4T/3.6GHz/6MB/65W/DDR4-2400</td> <td></td> <td></td> </tr> </tbody> </table>	Processor	Cache	Power	PSU	Xeon E-2286G	6C/12T/4.0GHz/12MB/95W/DDR4-2666	400W PSU needed		Xeon E-2278G	8C/16T/3.4GHz/16MB/80W/DDR4-2666	400W PSU needed		Xeon E-2276G	6C/12T/3.8GHz/12MB/80W/DDR4-2666			Xeon E-2274G	4C/8T/4.0GHz/8MB/83W/DDR4-2666			Xeon E-2246G	6C/12T/3.6GHz/12MB/80W/DDR4-2666			Xeon E-2244G	4C/8T/3.8GHz/8MB/71W/DDR4-2666			Xeon E-2236	6C/12T/3.4GHz/12MB/80W/DDR4-2666			Xeon E-2234	4C/8T/3.6GHz/8MB/71W/DDR4-2666			Xeon E-2226G	6C/6T/3.4GHz/12MB/80W/DDR4-2666			Xeon E-2224G	4C/4T/3.5GHz/8MB/71W/DDR4-2666			Xeon E-2224	4C/4T/3.4GHz/8MB/71W/DDR4-2666			Xeon E-2186G	6C/12T/3.8GHz/12MB/95W/DDR4-2666	400W PSU needed		Xeon E-2174G	4C/8T/3.8GHz/8MB/71W/DDR4-2666			Pentium Gold G5620	2C/4T/4.0GHz/4MB/54W/DDR4-2400			Core i9-9900	8C/16T/3.1GHz/16MB/65W/DDR4-2666			Core i7-9700K	8C/8T/3.6GHz/12MB/95W/DDR4-2666	400W PSU needed		Core i7-9700	8C/8T/3.0GHz/12MB/65W/DDR4-2666			Core i7-8700	6C/12T/3.2GHz/12MB/65W/DDR4-2666			Core i5-9600K	6C/6T/3.7GHz/9MB/95W/DDR4-2666	400W PSU needed		Core i5-9600	6C/6T/3.1GHz/9MB/65W/DDR4-2666			Core i5-9500	6C/6T/3.0GHz/9MB/65W/DDR4-2666			Core i5-9400	6C/6T/2.9GHz/9MB/65W/DDR4-2666			Core i5-8500	6C/6T/3.0GHz/9MB/65W/DDR4-2666			Core i3-9300	4C/4T/3.7GHz/8MB/62W/DDR4-2400			Core i3-9100	4C/4T/3.6GHz/6MB/65W/DDR4-2400			Core i3-8300	4C/4T/3.7GHz/8MB/62W/DDR4-2400			Core i3-8100	4C/4T/3.6GHz/6MB/65W/DDR4-2400		
	Processor	Cache	Power	PSU																																																																																																													
	Xeon E-2286G	6C/12T/4.0GHz/12MB/95W/DDR4-2666	400W PSU needed																																																																																																														
	Xeon E-2278G	8C/16T/3.4GHz/16MB/80W/DDR4-2666	400W PSU needed																																																																																																														
	Xeon E-2276G	6C/12T/3.8GHz/12MB/80W/DDR4-2666																																																																																																															
	Xeon E-2274G	4C/8T/4.0GHz/8MB/83W/DDR4-2666																																																																																																															
	Xeon E-2246G	6C/12T/3.6GHz/12MB/80W/DDR4-2666																																																																																																															
	Xeon E-2244G	4C/8T/3.8GHz/8MB/71W/DDR4-2666																																																																																																															
	Xeon E-2236	6C/12T/3.4GHz/12MB/80W/DDR4-2666																																																																																																															
	Xeon E-2234	4C/8T/3.6GHz/8MB/71W/DDR4-2666																																																																																																															
	Xeon E-2226G	6C/6T/3.4GHz/12MB/80W/DDR4-2666																																																																																																															
	Xeon E-2224G	4C/4T/3.5GHz/8MB/71W/DDR4-2666																																																																																																															
	Xeon E-2224	4C/4T/3.4GHz/8MB/71W/DDR4-2666																																																																																																															
	Xeon E-2186G	6C/12T/3.8GHz/12MB/95W/DDR4-2666	400W PSU needed																																																																																																														
	Xeon E-2174G	4C/8T/3.8GHz/8MB/71W/DDR4-2666																																																																																																															
	Pentium Gold G5620	2C/4T/4.0GHz/4MB/54W/DDR4-2400																																																																																																															
	Core i9-9900	8C/16T/3.1GHz/16MB/65W/DDR4-2666																																																																																																															
	Core i7-9700K	8C/8T/3.6GHz/12MB/95W/DDR4-2666	400W PSU needed																																																																																																														
	Core i7-9700	8C/8T/3.0GHz/12MB/65W/DDR4-2666																																																																																																															
	Core i7-8700	6C/12T/3.2GHz/12MB/65W/DDR4-2666																																																																																																															
	Core i5-9600K	6C/6T/3.7GHz/9MB/95W/DDR4-2666	400W PSU needed																																																																																																														
	Core i5-9600	6C/6T/3.1GHz/9MB/65W/DDR4-2666																																																																																																															
	Core i5-9500	6C/6T/3.0GHz/9MB/65W/DDR4-2666																																																																																																															
	Core i5-9400	6C/6T/2.9GHz/9MB/65W/DDR4-2666																																																																																																															
	Core i5-8500	6C/6T/3.0GHz/9MB/65W/DDR4-2666																																																																																																															
Core i3-9300	4C/4T/3.7GHz/8MB/62W/DDR4-2400																																																																																																																
Core i3-9100	4C/4T/3.6GHz/6MB/65W/DDR4-2400																																																																																																																
Core i3-8300	4C/4T/3.7GHz/8MB/62W/DDR4-2400																																																																																																																
Core i3-8100	4C/4T/3.6GHz/6MB/65W/DDR4-2400																																																																																																																
Chipset	Intel C246 Chipset																																																																																																																
Memory Sockets	4 DIMM sockets with 2 channels																																																																																																																
Memory Types	8GB/16GB DDR4-2666 UDIMM ECC or 4GB/8GB/16GB/32GB DDR4-2666 UDIMM non-ECC																																																																																																																
Memory Capacity	64GB with 4 x 16GB for UDIMM ECC or 128GB with 4 x 32GB UDIMM non-ECC																																																																																																																
Memory Protection	ECC on models with UDIMM ECC memory																																																																																																																
Expansion slots	Three PCIe 3.0 slots as following:																																																																																																																
	Slot 1 PCIe 3.0 x16, full height, half length, links to CPU																																																																																																																
	Slot 2 PCIe 3.0 x1, full height, full length, links to PCH																																																																																																																
	Slot 3 PCIe 3.0 x16 (negotiable link width x4), full height, half length, links to PCH																																																																																																																
Processor graphics	Integrated Intel UHD Graphics P630 in -G suffix Xeon processors, or Intel UHD Graphics 630 in Core i7, i5, i3, or Pentium processors. Works along with discrete graphics to support multi-display, enables three rear display connectors (2 DP standard, 1 DP or HDMI optional)																																																																																																																
Discrete Graphics Offering	Up to two PCIe 3.0 x16 slots for discrete graphics card (Slot 1 and 3). Supports the following graphics adapters:																																																																																																																
	<table border="1"> <thead> <tr> <th>Graphics</th> <th>Memory</th> <th>Power</th> <th>Connector</th> <th>Max Qty</th> </tr> </thead> <tbody> <tr> <td>Quadro P400</td> <td>2GB GDDR5</td> <td>30W</td> <td>3x miniDP</td> <td>2</td> </tr> <tr> <td>Quadro P620</td> <td>2GB GDDR5</td> <td>40W</td> <td>4x miniDP</td> <td>2</td> </tr> <tr> <td>Quadro P1000</td> <td>4GB GDDR5</td> <td>50W</td> <td>4x miniDP</td> <td>2</td> </tr> <tr> <td>Quadro P2000</td> <td>5GB GDDR5</td> <td>75W</td> <td>4x DP</td> <td>2</td> </tr> <tr> <td>Quadro P2200</td> <td>5GB GDDR5X</td> <td>75W</td> <td>4x DP</td> <td>2</td> </tr> <tr> <td>Quadro P4000</td> <td>8GB GDDR5</td> <td>105W</td> <td>4x DP</td> <td>1</td> </tr> <tr> <td>Quadro P5000</td> <td>16GB GDDR5X</td> <td>180W</td> <td>DVI-D DL + 4x DP</td> <td>1</td> </tr> <tr> <td>Quadro RTX 4000</td> <td>8GB GDDR6</td> <td>160W</td> <td>3x DP, 1x VirtualLink</td> <td>1</td> </tr> </tbody> </table>	Graphics	Memory	Power	Connector	Max Qty	Quadro P400	2GB GDDR5	30W	3x miniDP	2	Quadro P620	2GB GDDR5	40W	4x miniDP	2	Quadro P1000	4GB GDDR5	50W	4x miniDP	2	Quadro P2000	5GB GDDR5	75W	4x DP	2	Quadro P2200	5GB GDDR5X	75W	4x DP	2	Quadro P4000	8GB GDDR5	105W	4x DP	1	Quadro P5000	16GB GDDR5X	180W	DVI-D DL + 4x DP	1	Quadro RTX 4000	8GB GDDR6	160W	3x DP, 1x VirtualLink	1																																																																			
	Graphics	Memory	Power	Connector	Max Qty																																																																																																												
	Quadro P400	2GB GDDR5	30W	3x miniDP	2																																																																																																												
	Quadro P620	2GB GDDR5	40W	4x miniDP	2																																																																																																												
	Quadro P1000	4GB GDDR5	50W	4x miniDP	2																																																																																																												
	Quadro P2000	5GB GDDR5	75W	4x DP	2																																																																																																												
	Quadro P2200	5GB GDDR5X	75W	4x DP	2																																																																																																												
	Quadro P4000	8GB GDDR5	105W	4x DP	1																																																																																																												
	Quadro P5000	16GB GDDR5X	180W	DVI-D DL + 4x DP	1																																																																																																												
Quadro RTX 4000	8GB GDDR6	160W	3x DP, 1x VirtualLink	1																																																																																																													
<i>Note: 2x Quadro P2000, Quadro P4000, Quadro P5000, or Quadro RTX 4000 needs 400W PSU</i>																																																																																																																	

Components	Specification				
Storage Controller	Storage Controller				
	Onboard Intel RST SATA RAID	Type: Std	Interface: SATA 6Gb/s	Disk Type: HDD or SSD	RAID: 0/1/10/5
	Onboard Intel RST PCIe RAID	Type: Std	Interface: PCIe NVMe	Disk Type: M.2 PCIe SSD	RAID: 0/1
Storage Support	Disk Type	Interface	RPM	Offering	Max Qty
	3.5" SATA HDD	SATA 6Gb/s	7.2K	1TB/2TB/4TB	3
	2.5" SATA HDD	SATA 6Gb/s	7.2K	500GB FIPS	4
	2.5" SATA SSD	SATA 6Gb/s		256GB/512GB/1TB	4
	Optane Memory	PCIe NVMe		32GB	1, used with HDD/SSD
	M.2 PCIe SSD	PCIe NVMe		256GB/512GB/1TB	3
Storage Bays	Up to five bays with four disk bays plus one slim optical bay, supports up to 3x 3.5" HDD plus 1x 2.5" SSD, or 4x 2.5" HDD/SSD				
	Bay 1	Primary disk bay, 3.5" or 2.5"			
	Bay 2	2.5" SATA bay, cannot be available when 2nd Quadro P2000 is used			
	Bay 3	Secondary disk bay, 3.5" or 2.5"			
	Bay 4	5.25" Flex bay, supports one of the following:			
		<ul style="list-style-type: none"> <li>Flex module for optional front eSATA/Thunderbolt/IEEE1394</li> <li>3rd disk bay, 3.5" or 2.5", removable, via Front Access Storage Enclosure, using SATA 4 connector as eSATA mode</li> <li>3rd disk bay, 3.5" or 2.5", via 5.25" to 3.5" HDD Kit</li> </ul>			
	Bay 5	9mm Slim ODD bay			
	M.2	3x M.2 SSD (1 onboard, 2 via PCIe to M.2 adapter)			
	Media reader	Optional SD card reader on most models			
	Network interfaces	One onboard GbE port via integrated gigabit ethernet Intel i219LM, supports Wake-on-LAN. Optional PCIe ethernet adapters are available			
WLAN + Bluetooth	One dedicated onboard M.2 slot for optional Intel Wireless-AC 9560, 2x2, 2.4GHz/5GHz (160MHz channels), 802.11ac, Bluetooth 5, up to 1.73Gbps				
Security features	Power-on and admin password. Trusted Platform Module, TCG 2.0 compliant. Optional chassis intrusion switch, e-lock, cable lock, Kensington lock, and pad lock				
Intel vPro	Supports Intel vPro on Xeon models. vPro also requires Wireless-AC 9560 if Wi-Fi is needed				
Intel AMT	Intel Active Management Technology 12 on Xeon models, Intel Standard Manageability on other models				
Base warranty	US models comes with 3-year limited onsite service with 9x5/NBD. 1 or 3-year limited onsite service with 9x5/NBD in EMEA or other GEOs				
HD Audio	Intel HD Audio interface with Realtek ALC233 Codec				
Front ports	2x USB 3.1 Gen 1 Type A. 2x USB 3.1 Gen 2 Type A. 1x USB 3.1 Gen 1 Type-C. 1x Mic-in. 1x Combo jack				
Rear ports	2x USB 3.1 Gen 1 Type A. 2x USB 2.0 Type-A. 1x RJ-45. 1x COM. 2x DP. 1x Audio line-out <i>Notes: DP needs Core, Pentium, or -G suffix Xeon processor</i>				
Optional front ports (on flex module)	2x Thunderbolt (USB Type-C), one of two ports supports video-out. 1x eSATA. 1x IEEE1394				
Optional rear ports	Supports the following via cable: 1x COM. 1x Parallel. 2x PS/2. 1x DP or 1x HDMI. 2x USB 2.0 Supports the following via PCIe adapter: 4x COM. 2x USB 3.1 Type-C. 2x USB 3.0. 1x Thunderbolt. <i>Notes: DP or HDMI needs Core, Pentium, or -G suffix Xeon processor</i>				
Temperature	Operating: 50 °F to 95 °F (10 °C to 35 °C) Non operating (no package): 14 °F to 140 °F (-10 °C to 60 °C) Non operating (with package): -40 °F to 140 °F (-40 °C to 60 °C)				

Components	Specification
Altitude	Operating: -15.2 m (-50 ft) to 3048 m (10 000 ft). Storage: -15.2 m (-50 ft) to 10, 668 m (35 000 ft)
Humidity	Operating: 30%~90%, non-condensing Storage (with package): 20%~90%, non-condensing
Environmental certification	RoHS-compliant. GREENGUARD. EPEAT Silver rating and ENERGY STAR 7 qualified
Power supply	Supports one 250W or 400W power supply, 100V - 240V, 92% PSU. Climate Savers Computing Platinum and 80 PLUS Platinum qualified. 400W PSU supports one 6+2-pin aux power connector.
ISV certifications	Please visit <a href="http://www.thinkworkstations.com/isv-certifications/">www.thinkworkstations.com/isv-certifications/</a>

**Note:**

1. Depending on many factors, actual data transfer speed mentioned on this page may be lower than theoretical speed.
2. Any questions or advice on ThinkStation PSREF, please contact [ThinkStation PSREF developer](#)

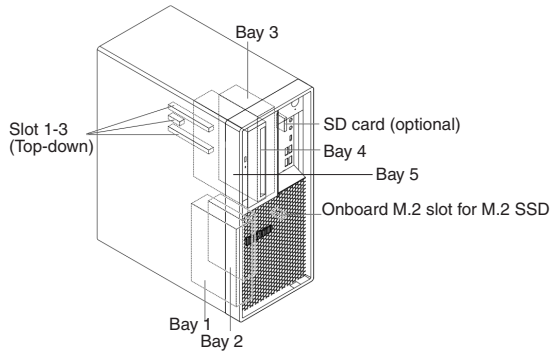



# ThinkStation P520 Platform Specifications

Form factor	33L Tower						
Dimensions	165mm/6.5" W x 460mm/18.1" D x 440mm/17.3" H (with feet)						
Weight	Maximum configuration: 52.91 lb (24kg)						
Processor Support	Processor	# of Cores	# of Threads	Base Frequency	Cache	TDP	Memory Types
	Xeon W-2195	18	36	2.3GHz	24.75MB	140W	DDR4-2666
	Xeon W-2175	14	28	2.5GHz	19MB	140W	DDR4-2666
	Xeon W-2155	10	20	3.3GHz	13.75MB	140W	DDR4-2666
	Xeon W-2145	8	16	3.7GHz	11MB	140W	DDR4-2666
	Xeon W-2135	6	12	3.7GHz	8.25MB	140W	DDR4-2666
	Xeon W-2133	6	12	3.6GHz	8.25MB	140W	DDR4-2666
	Xeon W-2125	4	8	4.0GHz	8.25MB	120W	DDR4-2666
	Xeon W-2123	4	8	3.6GHz	8.25MB	120W	DDR4-2666
	Xeon W-2104	4	4	3.2GHz	8.25MB	120W	DDR4-2400
Xeon W-2102	4	4	2.9GHz	8.25MB	120W	DDR4-2400	
Processor Sockets	1x FCLGA2066						
Chipset	Intel C422 Chipset						
Memory Sockets	8 DIMM sockets with 4 channels						
Memory Types	DDR4-2666 RDIMM						
Memory Capacity	256GB with 8 x 32GB RDIMMs						
Memory Protection	ECC						
Expansion slots	Slot 1 (CPU)	PCIe 3.0 x8, full height, full length, 25W, open ended					
	Slot 2 (CPU)	PCIe 3.0 x16, full height, full length, 75W, double-width					
	Slot 3 (PCH)	PCIe 3.0 x4, full height, half length, 25W, open ended					
	Slot 4 (CPU)	PCIe 3.0 x16, full height, full length, 75W, double-width					
	Slot 5	PCI, full height, full length, 25W					
	Slot 6 (PCH)	PCIe 3.0 x4, full height, half length, 25W, open ended					
Discrete Graphics Offering	Graphics	Memory	Power	Connector	SLI / NV-link	Max Qty	
	NVS 810	4GB DDR3	68W	8xmini DP		2	
	Quadro P400	2GB GDDR5	30W	3xminiDP		2	
	Quadro P600	2GB GDDR5	45W	4xminiDP		2	
	Quadro P620	2GB GDDR5	40W	4xminiDP		2	
	Quadro P1000	4GB GDDR5	50W	4xminiDP		2	
	Quadro P2000	5GB GDDR5	75W	4xDP		2	
	Quadro P4000	8GB GDDR5	120W	4xDP		2	
	Quadro P5000	16GB GDDR5X	180W	DVI-D DL+4xDP	SLI	2	
	Quadro P6000	24GB GDDR5X	250W	DVI-D DL+4xDP		1	
	Quadro RTX 4000	8GB GDDR6	160W	3xDP, 1xVirtualLink		2	
	Quadro RTX 5000	16GB GDDR6	265W	4xDP, 1xVirtualLink		1	
	Quadro RTX 6000	24GB GDDR6	295W	4xDP, 1xVirtualLink		1	
	Quadro RTX 8000	48GB GDDR6	295W	4xDP, 1xVirtualLink		1	
Quadro GP100	16GB HBM2	235W	1xDVI-D DL, 4xDP	NVLink	2		
Quadro GV100	32GB HBM2	250W	4xDP		1		
Storage Controller	Storage Controller	Type	Interface	RAID	Cache		
	Onboard Intel RSTe	Std	SATA 6Gb/s	0/1/10/5			
	9440-8i PCIe	Opt	SAS 12Gb/s, SATA 6Gb/s	0/1/10/5			
	9460-16i PCIe	Opt	SAS 12Gb/s, SATA 6Gb/s	0/1/10/5/6	4GB DDR4, SuperCap		
	NVMe Basic	Opt	PCIe NVMe	0/1/10			
	NVMe Premium	Opt	PCIe NVMe	0/1/10/5			
NVMe for Intel SSD	Opt	PCIe NVMe	0/1/10/5				
Storage Support	Disk Type	Interface	RPM	Offering	Max Qty		
	3.5" SATA HDD	SATA 6Gb/s	7.2K	1TB/2TB/4TB/6TB	6		
	2.5" SATA HDD	SATA 6Gb/s	7.2K	500GB/500GB FIPS	6		
	2.5" SATA SSD	SATA 6Gb/s		256GB/512GB/1TB/2TB	6		
	M.2 PCIe SSD	PCIe NVMe		256GB/512GB/1TB/2TB	9		
	PCIe AIC SSD	PCIe NVMe		480GB	2 (1 when quad M.2 adapter used)		

Storage Bays	Bay Type	Maximum Drives Qty
	M.2 slot	9x M.2 SSD (2 onboard, 7 via PCIe to M.2 adapter)
	Flex Bay	2 flex bays. Supports the following: <ul style="list-style-type: none"> <li>• 2x half-height optical drives</li> <li>• 2x 5.25" 9.0mm optical drives</li> <li>• 1x 5.25" 9.0mm optical drive + 2x 3.5"/2.5" SATA SSD/HDD</li> <li>• 1x 3.5"/2.5" SATA SSD/HDD with Front Access Storage Enclosure</li> </ul> 1x flex module for the following options: <ul style="list-style-type: none"> <li>• Tray 1: 9.0mm optical display</li> <li>• Tray 2: 15-in-1 USB 3.0 reader, 2x Thunderbolt, or 4-digit diagnostic display</li> <li>• Port 1 and 2: Front USB 3.0 Type-C or eSATA</li> <li>• 2x M.2 SSD with 2x Front Removable Drive Enclosures</li> </ul>
Disk bay	Up to 4x 3.5" or 2.5" disks with 4 disk bays (2 bays standard, 2 bays optional)	
Max Storage	Supports up to 9x M.2 SSD + 6x 3.5" HDD/6x 2.5" SATA disks/4x 2.5" SAS HDD + 1x PCIe AIC SSD. All HDD: 36TB using 6x 3.5" HDD All SSD: 30.48TB using 6x 2.5" SATA SSD, 9x M.2 SSD, and 1x PCIe AIC SSD	
Power supply	Supports one of the following: <ul style="list-style-type: none"> <li>• One fixed 690W, autosensing, 92%, 80 PLUS Platinum qualified</li> <li>• One fixed 900W, autosensing, 92%, 80 PLUS Platinum qualified</li> </ul>	
Media reader	SD USB 2.0 card reader on most models. Optional UHS-II 15-in-1 USB 3.0 reader on flex module	
Network interfaces	Integrated one gigabit ethernet (Intel i219LM), supports Wake-on-LAN. Optional PCIe ethernet or wireless adapters are available	
WLAN + Bluetooth	Optional Intel Wireless-AC 8265, 2x2, 2.4GHz/5GHz, 802.11ac, Bluetooth 4.2, up to 867Mbps	
Security features	Power-on and admin password. Trusted Platform Module, TCG 2.0 compliant, switch to 1.2 via UEFI setting. Optional access panel lock, Kensington lock, and pad lock	
Intel vPro	Intel vPro technology supported. vPro requires Wireless-AC 8265 if Wi-Fi is needed	
Intel AMT	Intel Active Management Technology 11	
Diagnostic	Front panel warning LED. ThinkStation Diagnostics for Windows. Photo-audio transfer with Lenovo PC Diagnostics for Android and iOS. Optional front 4-digit diagnostic display on flex module	
Base warranty	1 or 3-year limited onsite service with 9x5/NBD	
HD Audio	Realtek ALC662 codec	
Front ports	4x USB 3.0 (includes one 11W charging), 1x combo audio/microphone jack (3.5mm)	
Rear ports	2x USB 2.0, 4x USB 3.0, 1x RJ-45, 3x analog audio ports (line-in, line-out, mic-in), 2x PS/2	
Optional ports	Front:	<ul style="list-style-type: none"> <li>• 2x Thunderbolt ports (USB Type-C) on flex module, one of two ports supports video-out</li> <li>• 1x eSATA on flex module</li> <li>• 1x USB Type-C on flex module, USB 3.1 gen 1</li> </ul>
	Rear:	<ul style="list-style-type: none"> <li>• 1x COM port</li> <li>• 2x USB Type-C ports via PCIe adapter, USB 3.1 gen 2. One 15W, one 5W</li> </ul>
	Internal:	<ul style="list-style-type: none"> <li>• 1x internal USB 3.0 port</li> </ul>
	Internal:	
Environmental specification	Temperature - operating	50 °F to 95 °F (10 °C to 35 °C)
	Temperature - storage (no package)	14 °F to 140 °F (-10 °C to 60 °C)
	Temperature - storage (with package)	-40 °F to 140 °F (-40 °C to 60 °C)
	Altitude - operating	(Unpressurized): -50ft-10000ft (-15.2m-3048m)
	Humidity - operating	10%~80%, non-condensing
	Humidity - storage (with package)	10%~90%, non-condensing
Environmental Certifications	RoHS-compliant. GREENGUARD. EPEAT Silver rating. ENERGY STAR 6.1 qualified on model 30BE0008US and 30BE0009US	
iSV certifications	Please visit <a href="http://www.thinkworkstations.com/isv-certifications/">www.thinkworkstations.com/isv-certifications/</a>	
Note:	<p>1. Depending on many factors, actual data transfer speed mentioned on this page may be lower than theoretical speed.</p> <p>2. To support the maximum expandability, 900W power supply may be needed.</p> <p>3. Any questions or advice on ThinkStation PSREF, please contact <a href="mailto:ThinkStation_PSREF_developer">ThinkStation PSREF developer</a></p>	





# ThinkStation P520c Platform Specifications

Product Specifications Reference (PSREF)

Form factor	25L Tower						
Dimensions	175mm/6.89" W x 426mm/16.77" D x 376mm/14.8" H (with feet)						
Weight	Maximum configuration: 31.97 lb (14.5kg)						
Processor Support	Processor	# of Cores	# of Threads	Base Frequency	Cache	TDP	Memory Types
	Xeon W-2195	18	36	2.3GHz	24.75MB	140W	DDR4-2666
	Xeon W-2175	14	28	2.5GHz	19MB	140W	DDR4-2666
	Xeon W-2155	10	20	3.3GHz	13.75MB	140W	DDR4-2666
	Xeon W-2145	8	16	3.7GHz	11MB	140W	DDR4-2666
	Xeon W-2135	6	12	3.7GHz	8.25MB	140W	DDR4-2666
	Xeon W-2133	6	12	3.6GHz	8.25MB	140W	DDR4-2666
	Xeon W-2125	4	8	4.0GHz	8.25MB	120W	DDR4-2666
	Xeon W-2123	4	8	3.6GHz	8.25MB	120W	DDR4-2666
	Xeon W-2104	4	4	3.2GHz	8.25MB	120W	DDR4-2400
Xeon W-2102	4	4	2.9GHz	8.25MB	120W	DDR4-2400	
Processor Sockets	1x FCLGA2066						
Chipset	Intel C422 Chipset						
Memory Sockets	4 DIMM sockets with 4 channels						
Memory Types	DDR4-2666 RDIMM						
Memory Capacity	128GB with 4 x 32GB RDIMMs						
Memory Protection	ECC						
Expansion slots	Slot 1 (CPU)	PCIe 3.0 x16, full height, full length, 75W,					
	Slot 2 (CPU)	PCIe 3.0 x8, full height, full length, 25W, open ended					
	Slot 3 (CPU)	PCIe 3.0 x16, full height, full length, 75W					
	Slot 4 (PCH)	PCIe 3.0 x4, full height, half length, 25W, open ended					
Discrete Graphics Offering	Graphics	Memory	Power	Connector	SLI / NV-link	Max Qty	
	NVS 810	4GB DDR3	68W	8xmini DP		1	
	Quadro P400	2GB GDDR5	30W	3xminiDP		2	
	Quadro P600	2GB GDDR5	45W	4xminiDP		2	
	Quadro P620	2GB GDDR5	40W	4x miniDP		2	
	Quadro P1000	4GB GDDR5	50W	4xminiDP		2	
	Quadro P2000	5GB GDDR5	75W	4xDP		2	
	Quadro P4000	8GB GDDR5	120W	4xDP		2	
	Quadro P5000	16GB GDDR5X	180W	DVI-D DL+4xDP		1	
Quadro RTX 4000	8GB GDDR6	160W	3xDP, 1xVirtualLink		1		
Storage Controller	Storage Controller	Type	Interface		RAID	Cache	
	Onboard Intel RSTe	Std	SATA 6Gb/s		0/1/10/5	-	
	9440-8i PCIe	Opt	SAS 12Gb/s, SATA 6Gb/s		0/1/10/5	-	
	NVMe Basic	Opt	PCIe NVMe		0/1/10	-	
	NVMe for Intel SSD	Opt	PCIe NVMe		0/1/10/5	-	
Storage Support	Disk Type	Interface	RPM	Offering		Max Qty	
	3.5" SATA HDD	SATA 6Gb/s	7.2K	1TB/2TB/4TB/6TB		4	
	2.5" SATA HDD	SATA 6Gb/s	7.2K	500GB/500GB FIPS		4	
	2.5" SATA SSD	SATA 6Gb/s		256GB/512GB/1TB/2TB		4	
	M.2 PCIe SSD	PCIe NVMe		256GB/512GB/1TB/2TB		5	
Storage Bays	Bay Type	Maximum Drives Qty					
	M.2 slot	5x M.2 SSD (2 onboard, 3 via PCIe to M.2 adapter)					
	Flex Bay	2 flex bays. Supports the following: <ul style="list-style-type: none"> <li>2x half-height optical drives</li> <li>2x 5.25" 9.0mm optical drives</li> <li>1x 5.25" 9.0mm optical drive + 2x 3.5"/2.5" SATA SSD/HDD</li> <li>1x 3.5"/2.5" SATA SSD/HDD with Front Access Storage Enclosure</li> </ul> 1x flex module for the following options: Tray 1: 9.0mm optical Tray 2: 15-in-1 USB 3.0 reader, 2x Thunderbolt, or 4-digit diagnostic display Port 1 and 2: Front USB 3.0 Type-C or eSATA <ul style="list-style-type: none"> <li>2x M.2 SSD with 2x Front Removable Drive Enclosures</li> </ul>					
	Disk bay	Up to 2x 3.5"/2.5" disks with 2 disk bays					

Max Storage	Supports up to 5x M.2 SSD + 4x 3.5" HDD/4x 2.5" SSD/4x 2.5" HDD All HDD: 24TB using 4x 3.5" HDD All SSD: 18TB using 4x 2.5" SATA SSD and 5x M.2 SSD												
Power supply	One fixed 500W, autosensing, 92%, 80 PLUS Platinum qualified												
Media reader	SD USB 2.0 card reader on most models. Optional UHS-II 15-in-1 USB 3.0 reader on flex module												
Network interfaces	Integrated one gigabit ethernet (Intel i219LM), supports Wake-on-LAN. Optional PCIe ethernet or wireless adapters are available												
WLAN + Bluetooth	Optional Intel Wireless-AC 8265, 2x2, 2.4GHz/5GHz, 802.11ac, Bluetooth 4.2, up to 867Mbps												
Security features	Power-on and admin password. Trusted Platform Module, TCG 2.0 compliant, switch to 1.2 via UEFI setting. Optional access panel lock, Kensington lock, and pad lock												
Intel vPro	Intel vPro technology supported. vPro requires Wireless-AC 8265 if Wi-Fi is needed												
Intel AMT	Intel Active Management Technology 11												
Diagnostic	ThinkStation Diagnostics for Windows. Optional front 4-digit diagnostic display on flex module												
Base warranty	1 or 3-year limited onsite service with 9x5/NBD												
HD Audio	Realtek ALC662 codec												
Front ports	2x USB 3.0, microphone (3.5mm), headphone (3.5mm)												
Rear ports	2x USB 2.0, 4x USB 3.0, 1x RJ-45, 3x analog audio ports (line-in, line-out, mic-in), 2x PS/2												
Optional ports	Supports the following optional ports: Front: <ul style="list-style-type: none"> <li>2x Thunderbolt ports (USB Type-C) on flex module, one of two ports supports video-out</li> <li>1x eSATA on flex module</li> <li>1x USB Type-C on flex module, USB 3.1 gen 1</li> </ul> Rear: <ul style="list-style-type: none"> <li>1x COM port</li> <li>2x USB Type-C ports via PCIe adapter, USB 3.1 gen 2. One 15W, one 5W</li> </ul> Internal: <ul style="list-style-type: none"> <li>1x internal USB 3.0 port</li> </ul>												
	Environmental specification	<table border="1"> <tr> <td>Temperature - operating</td> <td>50 °F to 95 °F (10 °C to 35 °C)</td> </tr> <tr> <td>Temperature - storage (no package)</td> <td>14 °F to 140 °F (-10 °C to 60 °C)</td> </tr> <tr> <td>Temperature - storage (with package)</td> <td>-40 °F to 140 °F (-40 °C to 60 °C)</td> </tr> <tr> <td>Altitude - operating</td> <td>(Unpressurized): -50ft-10000ft (-15.2m-3048m)</td> </tr> <tr> <td>Humidity - operating</td> <td>10%~80%, non-condensing</td> </tr> <tr> <td>Humidity - storage (with package)</td> <td>10%~90%, non-condensing</td> </tr> </table>	Temperature - operating	50 °F to 95 °F (10 °C to 35 °C)	Temperature - storage (no package)	14 °F to 140 °F (-10 °C to 60 °C)	Temperature - storage (with package)	-40 °F to 140 °F (-40 °C to 60 °C)	Altitude - operating	(Unpressurized): -50ft-10000ft (-15.2m-3048m)	Humidity - operating	10%~80%, non-condensing	Humidity - storage (with package)
Temperature - operating	50 °F to 95 °F (10 °C to 35 °C)												
Temperature - storage (no package)	14 °F to 140 °F (-10 °C to 60 °C)												
Temperature - storage (with package)	-40 °F to 140 °F (-40 °C to 60 °C)												
Altitude - operating	(Unpressurized): -50ft-10000ft (-15.2m-3048m)												
Humidity - operating	10%~80%, non-condensing												
Humidity - storage (with package)	10%~90%, non-condensing												
Environmental Certifications	RoHS-compliant. GREENGUARD. EPEAT Silver rating. ENERGY STAR 6.1 qualified on model 30BX0008US and 30BX0009US												
ISV certifications	Please visit <a href="http://www.thinkworkstations.com/isv-certifications/">www.thinkworkstations.com/isv-certifications/</a>												

Note:  
 1. Depending on many factors, actual data transfer speed mentioned on this page may be lower than theoretical speed.  
 2. Any questions or advice on ThinkStation PSREF, please contact [ThinkStation PSREF developer](mailto:ThinkStation_PSREF_developer)





**Expansion slots**

Slot 1 (CPU2)	PCIe 3.0 x16, full height, full length, 75W
Slot 2 (CPU1)	PCIe 3.0 x16, full height, full length, 75W, double-width
Slot 3 (CPU1)	PCIe 3.0 x8, full height, full length, 25W, open ended
Slot 4 (CPU1)	PCIe 3.0 x16, full height, full length, 75W, double-width
Slot 5	PCI, full height, full length, 25W
Slot 6 (PCH)	PCIe 3.0 x4, full height, half length, 25W, open ended

900W PSU supports two 6+2-pin aux power connectors.  
690W PSU supports one 6+2-pin aux power connector.

Note: All expansion cards are optional

# ThinkStation P720 Platform Specifications

Product Specifications Reference (PSREF)

Form factor	36L Tower						
Dimensions	175mm/6.89" W x 485mm/19.1" D x 446mm/17.6" H (with feet)						
Weight	Maximum configuration: 52.25 lb (23.7kg)						
Processor Sockets	2x FCLGA3647						
Processor Support	Up to two 150 W Gen 1 or Gen 2 Intel Xeon Scalable family processors, Bronze, Silver, Gold, or Platinum						
Processor Offering	Processor	# of Cores	# of Threads	Base Frequency	Cache	TDP	Memory Types
	Xeon Gold 6242	16	32	2.8GHz	22MB	150W	DDR4-2933
	Xeon Gold 6238T	22	44	1.9GHz	30MB	125W	DDR4-2933
	Xeon Gold 6234	8	16	3.3GHz	25MB	130W	DDR4-2933
	Xeon Gold 6230	20	40	2.1GHz	28MB	125W	DDR4-2933
	Xeon Gold 5222	4	8	3.8GHz	17MB	105W	DDR4-2933
	Xeon Gold 5218	16	32	2.3GHz	22MB	125W	DDR4-2666
	Xeon Gold 5217	8	16	3.0GHz	11MB	115W	DDR4-2666
	Xeon Gold 5215	10	20	2.5GHz	13.75MB	85W	DDR4-2666
	Xeon Silver 4216	16	32	2.1GHz	22MB	100W	DDR4-2400
	Xeon Silver 4215	8	16	2.5GHz	11MB	85W	DDR4-2400
	Xeon Silver 4214	12	24	2.2GHz	17MB	85W	DDR4-2400
	Xeon Silver 4210	10	20	2.2GHz	14MB	85W	DDR4-2400
	Xeon Silver 4209T	8	16	2.2GHz	11MB	70W	DDR4-2400
	Xeon Silver 4208	8	16	2.1GHz	11MB	85W	DDR4-2400
	Xeon Bronze 3204	6	6	1.9GHz	8.25MB	85W	DDR4-2133
	Xeon Platinum 8160T	24	48	2.1GHz	33MB	150W	DDR4-2666
	Xeon Gold 6142	16	32	2.6GHz	22MB	150W	DDR4-2666
	Xeon Gold 6136	12	24	3.0GHz	24.75MB	150W	DDR4-2666
	Xeon Gold 6134	8	16	3.2GHz	24.75MB	130W	DDR4-2666
	Xeon Gold 6128	6	12	3.4GHz	19.25MB	115W	DDR4-2666
	Xeon Gold 5122	4	8	3.6GHz	16.5MB	105W	DDR4-2666
	Xeon Gold 5120T	14	28	2.2GHz	19.25MB	105W	DDR4-2400
	Xeon Gold 5118	12	24	2.3GHz	16.5MB	105W	DDR4-2400
	Xeon Gold 5115	10	20	2.4GHz	13.75MB	85W	DDR4-2400
	Xeon Silver 4116	12	24	2.1GHz	16.5MB	85W	DDR4-2400
	Xeon Silver 4114T	10	20	2.2GHz	13.75MB	85W	DDR4-2400
	Xeon Silver 4114	10	20	2.2GHz	13.75MB	85W	DDR4-2400
	Xeon Silver 4112	4	8	2.6GHz	8.25MB	85W	DDR4-2400
	Xeon Silver 4110	8	16	2.1GHz	11MB	85W	DDR4-2400
	Xeon Silver 4109T	8	16	2.0GHz	11MB	70W	DDR4-2400
	Xeon Silver 4108	8	16	1.8GHz	11MB	85W	DDR4-2400
	Chipset	Intel C621 Chipset					
Memory Sockets	12 DIMM sockets with 12 channels. 6 DIMM sockets with 6 channels per processor						
Memory Types	DDR4-2666 RDIMM						
Memory Capacity	768GB (DDR4-2933 RDIMM) or 384GB (DDR4-2666 RDIMM)						
Memory Protection	ECC						
Expansion slots	Slot 1 (CPU2)	PCIe 3.0 x16, full height, full length, 75W					
	Slot 2 (CPU1)	PCIe 3.0 x16, full height, full length, 75W, double-width					
	Slot 3 (CPU1)	PCIe 3.0 x8, full height, full length, 25W, open ended					
	Slot 4 (CPU1)	PCIe 3.0 x16, full height, full length, 75W, double-width					
	Slot 5	PCI, full height, full length, 25W					
	Slot 6 (PCH)	PCIe 3.0 x4, full height, half length, 25W, open ended					
Discrete Graphics Offering	Graphics	Memory	Pow-er	Connector	SLI / NVlink	Max Qty	
	NVS 810	4GB DDR3	68W	8xmini DP		2	
	Quadro P400	2GB GDDR5	30W	3xminiDP		3	
	Quadro P600	2GB GDDR5	45W	4xminiDP		3	
	Quadro P620	2GB GDDR5	40W	4xminiDP		3	
	Quadro P1000	4GB GDDR5	50W	4xminiDP		3	
	Quadro P2000	5GB GDDR5	75W	4xDP		3	
	Quadro P4000	8GB GDDR5	120W	4xDP		2	
	Quadro P5000	16GB GDDR5X	180W	DVI-D DL+4xDP	SLI	2	
Quadro P6000	24GB GDDR5X	250W	DVI-D DL+4xDP		1		

Discrete Graphics Offering	Graphics	Memory	Pow-er	Connector	SLI / NVlink	Max Qty
	Quadro RTX 4000	8GB GDDR6	160W	3xDP, 1xVirtualLink		2
	Quadro RTX 5000	16GB GDDR6	265W	4xDP, 1xVirtualLink		1
	Quadro RTX 6000	24GB GDDR6	295W	4xDP, 1xVirtualLink		1
	Quadro RTX 8000	48GB GDDR6	295W	4xDP, 1xVirtualLink		1
	Quadro GP100	16GB HBM2	235W	1xDVI-D DL, 4xDP		1
Quadro GV100	32GB HBM2	250W	4xDP		1	
Storage Controller	Storage Controller	Type	Interface	RAID	Cache	
	Onboard Intel RSTe	Std	SATA 6Gb/s	0/1/10/5		
	9440-8i PCIe	Opt	SAS 12Gb/s, SATA 6Gb/s	0/1/10/5		
	9460-16i PCIe	Opt	SAS 12Gb/s, SATA 6Gb/s	0/1/10/5/6	4GB DDR4, SuperCap	
	NVMe Basic	Opt	PCIe NVMe	0/1/10		
	NVMe Premium	Opt	PCIe NVMe	0/1/10/5		
	NVMe for Intel SSD	Opt	PCIe NVMe	0/1/10/5		
Storage Support	Disk Type	Interface	RPM	Offering	Max Qty (Blind connection + 9460 used)	
	3.5" SATA HDD	SATA 6Gb/s	7.2K	1TB/2TB/4TB/6TB	6 (Also supports additional 4x 2.5" SATA SSD/HDD)	
	2.5" SATA HDD	SATA 6Gb/s	7.2K	500GB/500GB FIPS	10	
	2.5" SAS HDD	SAS 12Gb/s	10K	300GB/600GB	8	
	2.5" SATA SSD	SATA 6Gb/s		256GB/512GB/1TB/2TB	10	
	2.5" PCIe SSD	PCIe NVMe		1.5TB	2	
	M.2 PCIe SSD	PCIe NVMe		256GB/512GB/1TB/2TB	9	
	PCIe AIC SSD	PCIe NVMe		480GB	2	
	Storage Bays	Bay Type	Maximum Drives Qty			
M.2 slot		9x M.2 SSD (2 onboard, 7 via PCIe to M.2 adapter)				
Flex Bay		2 flex bays. Supports the following: <ul style="list-style-type: none"> <li>• 2x half-height optical drives</li> <li>• 2x 5.25" 9.0mm optical drives</li> <li>• 1x 5.25" 9.0mm optical drive + 1x 3.5"/2.5" SATA SSD/HDD</li> <li>• 1x 3.5"/2.5" SATA SSD/HDD with Front Access Storage Enclosure</li> <li>• 1x flex module for the following options:                             <ul style="list-style-type: none"> <li>Tray 1: 9.0mm optical</li> <li>Tray 2: 15-in-1 USB 3.0 reader or 2x Thunderbolt</li> </ul> </li> <li>• 2x M.2 SSD with 2x Front Removable Drive Enclosures</li> </ul>				
Disk bay		4 disk bays (2 bays standard, 2 bays optional). Supports one of the following configurations: <ul style="list-style-type: none"> <li>• 4x 3.5" SATA HDD</li> <li>• 4x 3.5" SATA HDD + 4x 2.5" SATA SSD/HDD (Blind connection needed)</li> <li>• 8x 2.5" SATA SSD/HDD or 8x 2.5" SAS HDD (Blind connection needed)</li> <li>• 2x 2.5" PCIe SSD + 2x 3.5"/2.5" disks (Blind connection needed)</li> </ul>				
Max Storage	Supports up to 9x M.2 SSD + 6x 3.5" HDD/10x 2.5" SSD/10x 2.5" HDD + 2x PCIe AIC SSD. All HDD: 36TB using 6x 3.5" HDD All SSD: 38.96TB using 10x 2.5" SATA SSD, 9x M.2 SSD, and 2x PCIe AIC SSD					

# ThinkStation P720 Platform Specifications

Power supply	Supports one of the following: <ul style="list-style-type: none"> <li>• One fixed 690W, autosensing, 92%, 80 PLUS Platinum qualified</li> <li>• One fixed 900W, autosensing, 92%, 80 PLUS Platinum qualified</li> </ul>	
Media reader	SD USB 2.0 card reader on most models. Optional UHS-II 15-in-1 USB 3.0 reader on flex module	
Network interfaces	Integrated two-port gigabit ethernet (Intel i219LM and i210AT), supports Wake-on-LAN on both two ports. Optional PCIe ethernet are available	
WLAN + Bluetooth	Optional Intel Wireless-AC 8265, 2x2, 2.4GHz/5GHz, 802.11ac, Bluetooth 4.2, up to 867Mbps	
Security features	Power-on and admin password. Trusted Platform Module, TCG 2.0 compliant, switch to 1.2 via UEFI setting. Chassis intrusion switch. Optional access panel lock, Kensington lock, and pad lock	
Intel vPro	Intel vPro technology supported. vPro requires Wireless-AC 8265 if Wi-Fi is needed	
Intel AMT	Intel Active Management Technology 11	
Diagnostic	Front panel warning LED. ThinkStation Diagnostics for Windows. Photo-audio transfer with Lenovo PC Diagnostics for Android and iOS. Optional front 4-digit diagnostic display on flex module	
Base warranty	1 or 3-year limited onsite service with 9x5/NBD	
HD Audio	Realtek ALC662 codec	
Front ports	4x USB 3.0 (includes one 11W charging), 1x combo audio/microphone jack (3.5mm)	
Rear ports	2x USB 2.0, 4x USB 3.0, 2x RJ-45, 3x analog audio ports (line-in, line-out, mic-in), 2x PS/2	
Optional ports	Supports the following optional ports: Front: <ul style="list-style-type: none"> <li>• 2x Thunderbolt ports (USB Type-C) on flex module, one of two ports supports video-out</li> <li>• 1x eSATA on flex module</li> <li>• 1x USB Type-C on flex module, USB 3.1 gen 1</li> </ul> Rear: <ul style="list-style-type: none"> <li>• 1x COM port</li> <li>• 2x USB Type-C ports via PCIe adapter, USB 3.1 gen 2. One 15W, one 5W</li> </ul> Internal: <ul style="list-style-type: none"> <li>• 1x internal USB 3.0 port</li> </ul>	
Environmental specification	Temperature - operating	50 °F to 95 °F (10 °C to 35 °C)
	Temperature - storage (no package)	14 °F to 140 °F (-10 °C to 60 °C)
	Temperature - storage (with package)	-40 °F to 140 °F (-40 °C to 60 °C)
	Altitude - operating	(Unpressurized): 0-10000ft (0-3048m)
	Humidity - operating	10%~80%, non-condensing
	Humidity - storage (with package)	10%~90%, non-condensing
Environmental Certifications	RoHS-compliant. GREENGUARD. EPEAT Silver rating. ENERGY STAR 6.1 qualified on model 30BA0007US and 30BA0008US	
ISV certifications	Please visit <a href="http://www.thinkworkstations.com/isv-certifications/">www.thinkworkstations.com/isv-certifications/</a>	

**Note:**

1. Depending on many factors, actual data transfer speed mentioned on this page may be lower than theoretical speed.
2. To support the maximum expandability, 900W power supply may be needed.
3. Any questions or advice on ThinkStation PSREF, please contact [ThinkStation PSREF developer](#)





# ThinkStation P920 Platform Specifications

Form factor	55L Tower						
Dimensions	200mm/7.87" W x 620mm/24.4" D x 446mm/17.56" H (with feet)						
Weight	Maximum configuration: 71.3 lb (32.3kg)						
Processor Sockets	2x FCLGA3647						
Processor Support	Up to two 205 W Gen 1 or Gen 2 Intel Xeon Scalable family processors, Bronze, Silver, Gold, or Platinum						
Processor Offering	Processor	# of Cores	# of Threads	Base Frequency	Cache	TDP	Memory Types
	Xeon Platinum 8280	28	56	2.7GHz	39MB	205W	DDR4-2933
	Xeon Gold 6254	18	36	3.1GHz	25MB	200W	DDR4-2933
	Xeon Gold 6242	16	32	2.8GHz	22MB	150W	DDR4-2933
	Xeon Gold 6238T	22	44	1.9GHz	30MB	125W	DDR4-2933
	Xeon Gold 6234	8	16	3.3GHz	25MB	130W	DDR4-2933
	Xeon Gold 6230	20	40	2.1GHz	28MB	125W	DDR4-2933
	Xeon Gold 5222	4	8	3.8GHz	17MB	105W	DDR4-2933
	Xeon Gold 5218	16	32	2.3GHz	22MB	125W	DDR4-2666
	Xeon Gold 5217	8	16	3.0GHz	11MB	115W	DDR4-2666
	Xeon Gold 5215	10	20	2.5GHz	13.75MB	85W	DDR4-2666
	Xeon Silver 4216	16	32	2.1GHz	22MB	100W	DDR4-2400
	Xeon Silver 4215	8	16	2.5GHz	11MB	85W	DDR4-2400
	Xeon Silver 4214	12	24	2.2GHz	17MB	85W	DDR4-2400
	Xeon Silver 4210	10	20	2.2GHz	14MB	85W	DDR4-2400
	Xeon Silver 4209T	8	16	2.2GHz	11MB	70W	DDR4-2400
	Xeon Silver 4208	8	16	2.1GHz	11MB	85W	DDR4-2400
	Xeon Bronze 3204	6	6	1.9GHz	8.25MB	85W	DDR4-2133
	Xeon Platinum 8160T	24	48	2.1GHz	33MB	150W	DDR4-2666
	Xeon Gold 6154	18	36	3.0GHz	24.75MB	200W	DDR4-2666
	Xeon Gold 6142	16	32	2.6GHz	22MB	150W	DDR4-2666
	Xeon Gold 6136	12	24	3.0GHz	24.75MB	150W	DDR4-2666
	Xeon Gold 6134	8	16	3.2GHz	24.75MB	130W	DDR4-2666
	Xeon Gold 6128	6	12	3.4GHz	19.25MB	115W	DDR4-2666
	Xeon Gold 5122	4	8	3.6GHz	16.5MB	105W	DDR4-2666
	Xeon Gold 5120T	14	28	2.2GHz	19.25MB	105W	DDR4-2400
	Xeon Gold 5118	12	24	2.3GHz	16.5MB	105W	DDR4-2400
	Xeon Gold 5115	10	20	2.4GHz	13.75MB	85W	DDR4-2400
Xeon Silver 4116	12	24	2.1GHz	16.5MB	85W	DDR4-2400	
Xeon Silver 4114T	10	20	2.2GHz	13.75MB	85W	DDR4-2400	
Xeon Silver 4114	10	20	2.2GHz	13.75MB	85W	DDR4-2400	
Xeon Silver 4112	4	8	2.6GHz	8.25MB	85W	DDR4-2400	
Xeon Silver 4110	8	16	2.1GHz	11MB	85W	DDR4-2400	
Xeon Silver 4109T	8	16	2.0GHz	11MB	70W	DDR4-2400	
Xeon Silver 4108	8	16	1.8GHz	11MB	85W	DDR4-2400	
Chipset	Intel C621 Chipset						
Memory Sockets	16 DIMM sockets with 12 channels. 8 DIMM sockets with 6 channels per processor						
Memory Types	DDR4-2666 RDIMM, DDR4-2666 LRDIMM, or DDR4-2933 RDIMM						
Memory Capacity	1TB (DDR4-2666 LRDIMM or DDR4-2933 RDIMM) or 512GB (DDR4-2666 RDIMM)						
Memory Protection	ECC						
Expansion slots	Slot 1 (CPU1)	PCIe 3.0 x16, full height, full length, 75W, double-width					
	Slot 2 (CPU1)	PCIe 3.0 x4, full height, full length, 25W, open ended					
	Slot 3 (CPU1)	PCIe 3.0 x16, full height, full length, 75W, double-width					
	Slot 4 (CPU1)	PCIe 3.0 x4, full height, full length, 25W, open ended					
	Slot 5 (PCH)	PCIe 3.0 x4, full height, half length, 25W, open ended					
	Slot 6 (CPU2)	PCIe 3.0 x16, full height, half length, 75W					
	Slot 7 (CPU2)	PCIe 3.0 x16, full height, full length, 75W, double-width					
	Slot 8 (CPU2)	PCIe 3.0 x16, full height, full length, 75W					

Discrete Graphics Offering	Graphics	Memory	Power	Connector	SLI / NVLink	Max Qty
	NVS 810	4GB DDR3	68W	8xmini DP		2
	Quadro P400	2GB GDDR5	30W	3xminiDP		5
	Quadro P600	2GB GDDR5	45W	4xminiDP		4
	Quadro P620	2GB GDDR5	40W	4xminiDP		4
	Quadro P1000	4GB GDDR5	50W	4xminiDP		4
	Quadro P2000	5GB GDDR5	75W	4xDP		4
	Quadro P4000	8GB GDDR5	120W	4xDP		4
	Quadro P5000	16GB GDDR5X	180W	DVI-D DL+4xDP	SLI	3
	Quadro P6000	24GB GDDR5X	250W	DVI-D DL+4xDP	SLI	3
	Quadro RTX 4000	8GB GDDR6	160W	3xDP, 1xVirtualLink		3
	Quadro RTX 5000	16GB GDDR6	265W	4xDP, 1xVirtualLink	NVLink	3
	Quadro RTX 6000	24GB GDDR6	295W	4xDP, 1xVirtualLink	NVLink	2
	Quadro RTX 8000	48GB GDDR6	295W	4xDP, 1xVirtualLink	NVLink	2
Quadro GP100	16GB HBM2	235W	1xDVI-D DL, 4xDP	NVLink	3	
Quadro GV100	32GB HBM2	250W	4xDP	NVLink	3	
Storage Controller	Storage Controller	Type	Interface	RAID	Cache	
	Onboard Intel RSTe	Std	SATA 6Gb/s	0/1/10/5		
	9440-8i PCIe	Opt	SAS 12Gb/s, SATA 6Gb/s	0/1/10/5		
	9460-16i PCIe	Opt	SAS 12Gb/s, SATA 6Gb/s	0/1/10/5/6		4GB DDR4, SuperCap
	NVMe Basic	Opt	PCIe NVMe	0/1/10		
	NVMe Premium	Opt	PCIe NVMe	0/1/10/5		
NVMe for Intel SSD	Opt	PCIe NVMe	0/1/10/5			
Storage Support	Disk Type	Interface	RPM	Offering	Max Qty (9460 used)	
	3.5" SATA HDD	SATA 6Gb/s	7.2K	1TB/2TB/4TB/6TB	6 (Also supports additional 4x 2.5" SATA SSD/HDD)	
	2.5" SATA HDD	SATA 6Gb/s	7.2K	500GB/500GB FIPS	10	
	2.5" SAS HDD	SAS 12Gb/s	10K	300GB/600GB	8	
	2.5" SATA SSD	SATA 6Gb/s		256GB/512GB/1TB/2TB	10	
	2.5" PCIe SSD	PCIe NVMe		1.5TB	4	
	M.2 PCIe SSD	PCIe NVMe		256GB/512GB/1TB/2TB	9	
	PCIe AIC SSD	PCIe NVMe		480GB	2	
Storage Bays	Bay Type	Maximum Drives Qty				
	M.2 slot	9x M.2 SSD (2 onboard, 7 via PCIe to M.2 adapter)				
	Flex Bay	2x 3.5" or 2.5" disks. Supports the following: <ul style="list-style-type: none"> <li>• 3x half-height optical drives</li> <li>• 2x 5.25" 9.0mm optical drives</li> <li>• 1x 5.25" 9.0mm optical drive + 1x 3.5"/2.5" SATA SSD/HDD</li> <li>• 1x 3.5"/2.5" SATA SSD/HDD with Front Access Storage Enclosure</li> </ul> 1x flex module for the following options: Tray 1: 9.0mm optical Tray 2: 15-in-1 USB 3.0 reader or 2x Thunderbolt Port 1 and 2: Front USB 3.0 Type-C or eSATA <ul style="list-style-type: none"> <li>• 3x M.2 SSD with 3x Front Removable Drive Enclosures</li> </ul>				
	Disk bay	8 disk drives with 4 bays (2 bays standard, 2 bays optional). Supports one of the following configurations: <ul style="list-style-type: none"> <li>• 4x 3.5" SATA HDD</li> <li>• 4x 3.5" SATA HDD + 4x 2.5" SATA SSD/HDD</li> <li>• 8x 2.5" SATA SSD/HDD or 8x 2.5" SAS HDD</li> </ul>				

## ThinkStation P920 Platform Specifications

Max Storage	Supports up to 9x M.2 SSD + 6x 3.5" HDD/10x 2.5" SSD/10x 2.5" HDD + 2x PCIe AIC SSD. All HDD: 36TB using 6x 3.5" HDD All SSD: 38.96TB using 10x 2.5" SATA SSD, 9x M.2 SSD, and 2x PCIe AIC SSD	
Power supply	One fixed 1400 watts, autosensing, 92% PSU, 80 PLUS Platinum qualified. Countries with input voltage under 115V, output power limited to 1125 watts	
Media reader	SD USB 2.0 card reader on most models. Optional UHS-II 15-in-1 USB 3.0 reader on flex module	
Network interfaces	Integrated two-port gigabit ethernet (Intel i219LM and i210AT), supports Wake-on-LAN on both two ports. Optional PCIe ethernet are available	
WLAN + Bluetooth	Optional Intel Wireless-AC 8265, 2x2, 2.4GHz/5GHz, 802.11ac, Bluetooth 4.2, up to 867Mbps	
Security features	Power-on and admin password. Trusted Platform Module, TCG 2.0 compliant, switch to 1.2 via UEFI setting. Chassis intrusion switch. Optional access panel lock, Kensington lock, and pad lock	
Intel vPro	Intel vPro technology supported. vPro requires Wireless-AC 8265 if Wi-Fi is needed	
Intel AMT	Intel Active Management Technology 11	
Diagnostic	Front 4-digit diagnostic display. ThinkStation Diagnostics for Windows. Photo-audio transfer with Lenovo PC Diagnostics for Android and iOS	
Base warranty	1 or 3-year limited onsite service with 9x5/NBD	
HD Audio	Realtek ALC662 codec	
Front ports	4x USB 3.0 (includes one 11W charging), 1x combo audio/microphone jack (3.5mm)	
Rear ports	2x USB 2.0, 4x USB 3.0, 2x RJ-45, 3x analog audio ports (line-in, line-out, mic-in), 2x PS/2	
Optional ports	Supports the following optional ports: Front: <ul style="list-style-type: none"> <li>• 2x Thunderbolt ports (USB Type-C) on flex module, one of two ports supports video-out</li> <li>• 1x eSATA on flex module</li> <li>• 1x USB Type-C on flex module, USB 3.1 gen 1</li> </ul> Rear: <ul style="list-style-type: none"> <li>• 1x COM port</li> <li>• 2x USB Type-C ports via PCIe adapter, USB 3.1 gen 2. One 15W, one 5W</li> </ul> Internal: <ul style="list-style-type: none"> <li>• 1x internal USB 3.0 port</li> </ul>	
Environmental specification	Temperature - operating	50 °F to 95 °F (10 °C to 35 °C)
	Temperature - storage (no package)	14 °F to 140 °F (-10 °C to 60 °C)
	Temperature - storage (with package)	-40 °F to 140 °F (-40 °C to 60 °C)
	Altitude - operating	(Unpressurized): 0-10000ft (0-3048m)
	Humidity - operating	10%~80%, non-condensing
	Humidity - storage (with package)	10%~90%, non-condensing
Environmental Certifications	RoHS-compliant. GREENGUARD. EPEAT Silver rating. ENERGY STAR 6.1 qualified on model 30BC0008US and 30BC0009US	
ISV certifications	Please visit <a href="http://www.thinkworkstations.com/isv-certifications/">www.thinkworkstations.com/isv-certifications/</a>	

**Note:**

1. Depending on many factors, actual data transfer speed mentioned on this page may be lower than theoretical speed.
2. Any questions or advice on ThinkStation PSREF, please contact [ThinkStation PSREF developer \(houyf@lenovo.com\)](mailto:houyf@lenovo.com)

This publication was developed for products and services offered in the United States and E.M.E.A countries. Lenovo may not offer the products, services or features discussed in this document in other countries. Lenovo may withdraw an offering at any time. Information is subject to change without notice. Consult your local representative for information on offerings available in your area.

Lenovo reserves the right to change specifications or other product information without notice. Lenovo is not responsible for photographic or typographical errors.

LENOVO PROVIDES THIS PUBLICATION "AS IS," WITHOUT WARRANTY OF ANY KIND, EITHER EXPRESS OR IMPLIED, INCLUDING THE IMPLIED WARRANTIES OF MERCHANTABILITY OR FITNESS FOR A PARTICULAR PURPOSE.

Some jurisdictions do not allow disclaimer of express or implied warranties in certain transactions, therefore this disclaimer may not apply to you.

**Availability:** All offers subject to availability. Lenovo reserves the right to alter product offerings and specifications at any time, without notice. Lenovo is not responsible for photographic or typographic errors.

**General:** Review key information provided by Microsoft that may apply to your system purchase, including details on Windows 10, Windows 8, Windows 7, and potential upgrades/downgrades. Lenovo makes no representation or warranty regarding third-party products or services.

**Trademarks:** Lenovo, ThinkPad, ThinkCentre, ThinkStation and the Lenovo logo are trademarks of Lenovo. Microsoft, Windows, Windows NT, and the Windows logo are trademarks of Microsoft Corporation. Ultrabook, Celeron, Celeron Inside, Core Inside, Intel, Intel Logo, Intel Atom, Intel Atom Inside, Intel Core, Intel Inside, Intel Inside Logo, Intel vPro, Itanium, Itanium Inside, Pentium, Pentium Inside, vPro Inside, Xeon, Xeon Phi, and Xeon Inside are trademarks of Intel Corporation in the U.S. and/or other countries. Other company, product or service names may be trademarks or service marks of others.

**Warranty:** For a copy of applicable warranties, write to: Lenovo Warranty Information, 1009 Think Place, Morrisville, NC, 27560. Lenovo makes no representation or warranty regarding third party products or services. The Lenovo Limited Warranty applies only to Lenovo hardware products purchased for your own use, and does not transfer upon resale.

**Limited warranty:** Support unrelated to a warranty issue may be subject to additional charges.

#### **Lenovo Services:**

**Carry-in or Mail-in Service:** Parts and labor repair coverage where the customer is responsible for shipping (including packaging) or delivery to authorized warranty provider or repair center.

**Depot or Courier Service:** Parts and labor repair coverage where shipping (including packaging) or delivery to the repair center is paid for by Lenovo.

**Expedited Depot:** Parts and labor coverage with expedited turnaround. Shipping (including packaging) or delivery to the repair center is paid for by Lenovo.

**Onsite / In-home Service:** Parts and labor repair coverage where labor is provided onsite at your place of business.

If Lenovo determines your product problem is covered by the product warranty and cannot be resolved over the telephone, a technician will be dispatched to arrive onsite, typically the next day.

**International Warranty Service (IWS):** PC repair coverage for customers who require a critical warranty repair while travelling internationally. Visit [www.lenovo.com/internationalwarranty](http://www.lenovo.com/internationalwarranty) for details. Visit [www.lenovo.com/warranty](http://www.lenovo.com/warranty) for Lenovo Warranty Services terms and conditions for complete details and restrictions.

**Included software:** may differ from its retail version (if available), and may not include user manuals or all program functionality. Software license agreements may apply.

**Battery life:** Battery life (and recharge times) will vary based on many factors including screen brightness, applications, features, power management, battery conditioning, and other customer preferences.

Visit <http://psref.lenovo.com/> for the latest version of Product Specifications Reference.

© Lenovo, 2018. All rights reserved.  
Lenovo 1009 Think Place Morrisville, NC 27560 U.S.A.



**Lenovo**™ **ThinkVision**

# PSREF



**Product Specifications Reference**

Version 545, July 2019

Visit <http://psref.lenovo.com> for the latest version

# Contents

---

<b>Cover</b>		
<b>Contents</b>		
<b>Summary Of Change</b>		
<b>13 Inch - 16 Inch</b>		
<b>ThinkVision M14</b>		
ThinkVision M14 Platform Specifications		
<b>17 Inch - 20 Inch</b>		
<b>ThinkVision E1922s</b>		
ThinkVision E1922s Platform Specifications		
<b>ThinkVision E2054</b>		
ThinkVision E2054 Platform Specifications		
<b>ThinkVision LT1913p Square</b>		
ThinkVision LT1913p Square Platform Specifications		
<b>ThinkVision T1714</b>		
ThinkVision T1714 Platform Specifications		
<b>ThinkVision T1714p</b>		
ThinkVision T1714p Platform Specifications		
<b>ThinkVision T2054p</b>		
ThinkVision T2054p Platform Specifications		
<b>21 Inch - 24 Inch</b>		
<b>ThinkVision E21</b>		
ThinkVision E21 Platform Specifications		
<b>ThinkVision E24</b>		
ThinkVision E24 Platform Specifications		
<b>ThinkVision P24h</b>		
ThinkVision P24h Platform Specifications		
<b>ThinkVision P24q</b>		
ThinkVision P24q Platform Specifications		
<b>ThinkVision S22e</b>		
ThinkVision S22e Platform Specifications		
<b>ThinkVision S24e</b>		
ThinkVision S24e Platform Specifications		
<b>ThinkVision T2224d</b>		
ThinkVision T2224d Platform Specifications		
<b>ThinkVision T2254</b>		
1 ThinkVision T2254 Platform Specifications	34	
2 <b>ThinkVision T2254p</b>	<b>35</b>	
4 ThinkVision T2254p Platform Specifications	36	
5 <b>ThinkVision T22i</b>	<b>37</b>	
5 ThinkVision T22i Platform Specifications	38	
6 <b>ThinkVision T22v</b>	<b>39</b>	
7 ThinkVision T22v Platform Specifications	40	
7 <b>ThinkVision T2324d</b>	<b>41</b>	
8 ThinkVision T2324d Platform Specifications	42	
9 <b>ThinkVision T23d</b>	<b>43</b>	
10 ThinkVision T23d Platform Specifications	44	
11 <b>ThinkVision T23i</b>	<b>45</b>	
12 ThinkVision T23i Platform Specifications	46	
13 <b>ThinkVision T2454p</b>	<b>47</b>	
14 ThinkVision T2454p Platform Specifications	48	
15 <b>ThinkVision T24d</b>	<b>49</b>	
16 ThinkVision T24d Platform Specifications	50	
17 <b>ThinkVision T24i-10</b>	<b>51</b>	
18 ThinkVision T24i-10 Platform Specifications	52	
19 <b>ThinkVision T24i-19</b>	<b>53</b>	
19 ThinkVision T24i-19 Platform Specifications	54	
20 <b>ThinkVision T24m</b>	<b>55</b>	
21 ThinkVision T24m Platform Specifications	56	
22 <b>ThinkVision T24v</b>	<b>57</b>	
23 ThinkVision T24v Platform Specifications	58	
24 <b>ThinkVision X24 Pro</b>	<b>59</b>	
25 ThinkVision X24 Pro Platform Specifications	60	
26 <b>ThinkVision X24-20</b>	<b>61</b>	
27 ThinkVision X24-20 Platform Specifications	62	
28 <b>Above 25 Inch</b>	<b>63</b>	
29 <b>ThinkVision P27h</b>	<b>63</b>	
30 ThinkVision P27h Platform Specifications	64	
31 <b>ThinkVision P27q</b>	<b>65</b>	
32 ThinkVision P27q Platform Specifications	66	
33 <b>ThinkVision P27u</b>	<b>67</b>	

# Contents

---

ThinkVision P27u Platform Specifications	68
<b>ThinkVision P32u</b>	<b>69</b>
ThinkVision P32u Platform Specifications	70
<b>ThinkVision P44w-10</b>	<b>71</b>
ThinkVision P44w-10 Platform Specifications	72
<b>ThinkVision S27i</b>	<b>73</b>
ThinkVision S27i Platform Specifications	74
<b>ThinkVision T25d-10</b>	<b>75</b>
ThinkVision T25d-10 Platform Specifications	76
<b>ThinkVision T25m-10</b>	<b>77</b>
ThinkVision T25m-10 Platform Specifications	78
<b>ThinkVision T27i</b>	<b>79</b>
ThinkVision T27i Platform Specifications	80
<b>ThinkVision T27p-10</b>	<b>81</b>
ThinkVision T27p-10 Platform Specifications	82
<b>ThinkVision X1</b>	<b>83</b>
ThinkVision X1 Platform Specifications	84
<b>ThinkVision X1 (2nd Gen)</b>	<b>85</b>
ThinkVision X1 (2nd Gen) Platform Specifications	86
<b>Legal Information</b>	<b>88</b>

# Summary of Changes

---

This section describes the technical changes made in this edition.

This edition might also include minor corrections and editorial changes which are not identified.

## **JuJj , 2019 - Version 5%&**

### **Additions in this update**

▶ **New product(s)**

ThinkVision M14 announced June 2019

▶ **New model(s)**

None

▶ **Others**

None

### **Withdrawals in this update**

▶ **Withdrawn product(s)**

None

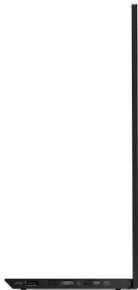
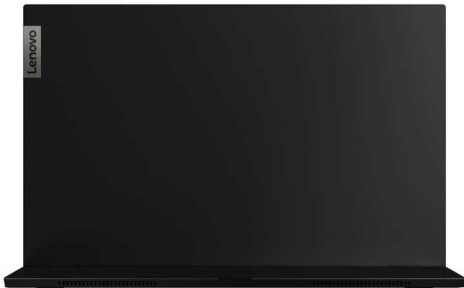





## PORTABLE USB-C MONITOR CRAFTED FOR IMPROVED PRODUCTIVITY

The ThinkVision M14 is an ultraslim and ultralight mobile monitor. Its 14-inch screen helps you extend your workspace comfortably no matter where work takes you. Compatible with notebooks of any screen size that come with an advanced USB Type-C port\*, the ThinkVision M14 can either extend or duplicate your notebook display with one plug. The USB Type-C ports on either side allow both left- and right-handed users to work efficiently, and the ergonomic design enhances user experience. Packed with impressive portability, connectivity, and flexibility features, the ThinkVision M14 is ideal for mobile productivity.



**Extreme Portability**



**Superior Connectivity**



**Remarkable Flexibility**

### ACHIEVE TARGETS ON THE GO

The ThinkVision M14 boosts productivity with its thin and light form factor. Weighing 570g, this 4.4mm sleek mobile monitor enables easy portability. The stylish design with a Full HD, IPS display provides vivid lifelike visuals, ensuring you never miss out on any detail. With a brightness of 300 nits, the ThinkVision M14 offers a stunning visual experience while consuming content online.



4.4mm sleek: approximately as thin as two USD \$1 coins



**Weight**  
570g



**Screen Size**  
14 inches



**Brightness**  
300 nits (Typical)



### EXPERIENCE ADVANCED CONNECTIVITY

Two innovative USB Type-C ports on either side of the monitor make connectivity effortless. These ports support both power and video delivery simultaneously from a single port. The ThinkVision M14 also offers a 'power pass through' design that powers the mobile monitor by an adapter and charges the notebook at the same time. This feature is suitable for smartphones or notebooks with one USB Type-C port\*. The ambidextrous design of this monitor enhances user comfort.



**USB Ports**  
2 x USB Type-C



**Cable**  
USB Type-C to C

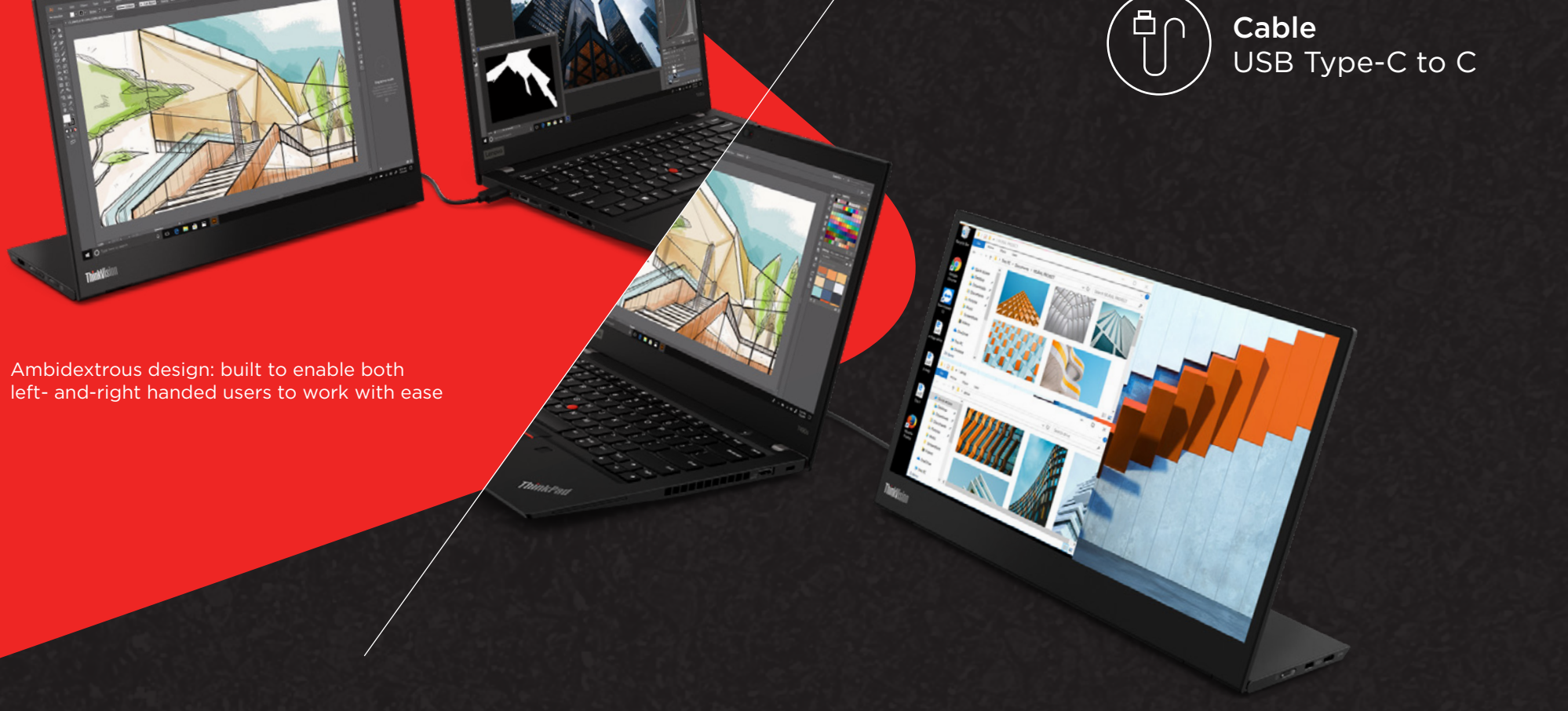

Ambidextrous design: built to enable both left- and right-handed users to work with ease

### WORK THE WAY YOU LIKE

The ThinkVision M14 with its admirable flexibility is built for varied job roles. With a tilt angle of -5°-90°, you can position your monitor in a way that suits your style. Compare content with ease even as you use laptops of different screen sizes with the ergonomic height adjustable foot. Also, you can wall mount your monitor effortlessly with mounting support for a hands-free viewing experience. The advanced low blue light technology minimizes eye strain, making extended working hours easy.



**Height Adjustable Foot**  
Tilt 0°-90°

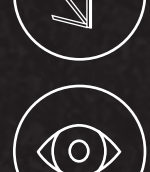

**Monitor Stand**  
Tilt -5°-90°



**Eye-care Technology**  
Low blue light



Height Adjustable Foot  
Tilt angle: 0°-90°

Monitor Stand  
Tilt angle: -5°-90°

Remarkable flexibility: position the monitor in the way that suits your style

\*For charging usage, a Lenovo branded 65W adapter (Part No.: SA10E75874) is recommended

### TECH SPECS

#### LCD PANEL

- Panel Size: 14-inch
- Screen Dimensions (W x H, mm): 309.31 x 173.99 mm
- Panel Type: In-Plane Switching
- Backlight: WLED
- Aspect Ratio: 16:9
- Resolution: 1920 x 1080
- Pixel Pitch (H x V, mm): 0.1611 x 0.1611 mm
- Dot/Pixel Per Inch (DPI/PPI): 157
- Viewing angle (H x V @ CR 10:1): 178° / 178°
- Response Time (typical): 6ms with OD
- Refresh Rate: 60 Hz
- Brightness (typical): 300 cd/m<sup>2</sup>
- Contrast Ratio (typical): 700:1
- Dynamic Contrast Ratio (typical): 3M:1
- Colour Gamut NTSC (CIE 1931): 72%
- Color Support (typical): 16.7 Million
- Color Depth: 8bit (6bit + FRC)
- Anti-Glare: Yes

#### CONNECTIVITY

- Video Input Signals: 2 x USB 3.1 Type-C (DPI.2 Alt Mode)

#### POWER

- Power Consumption (Typ./Max): 6 W / 7.5 W (Without USB Type-C output)
- ENERGY STAR® Power Consumption (P<sub>on</sub>): 4.88 W
- ENERGY STAR® Power Consumption (E<sub>TEC</sub>): 15.53 kWh
- Power Consumption Sleep/Off Mode: < 0.3 W

#### Power Consumption Switch-Off Mode

- < 0.3 W
- USB Type-C/Power Delivery: Up to 65 W
- Power Supply: External (no adapter bundle)
- Voltage Required: DC 5 V to 20 V

#### MECHANICAL

- Tilt Angle (front/back): -5° / 90°
- Mounting Support: Yes (100 mm)
- Kensington™ Lock Slot: Yes
- Cable Management: Yes
- Bezel Color: Raven Black
- Bezel Width (Side): 5.48mm
- Bezel Width (top / bottom): 5.47 mm / 23.87 mm

#### DIMENSIONS

- Size Packed (D x H x W) (mm / inch): 276 x 61 x 402 mm / 10.87 x 2.40 x 15.83 inches
- Size Unpacked w/stand (D x H x W) (mm / inch) (Lowest position): 96.54 x 209.03 x 323.37 mm / 3.8 x 8.23 x 12.73 inches
- Size Unpacked w/stand (D x H x W) (mm / inch) (Highest position): 96.54 x 220.03 x 323.37 mm / 3.8 x 8.66 x 12.73 inches
- Stand base footprint area (mm<sup>2</sup>): 260.87 x 69.55 mm / 10.27 x 2.74 inches
- Weight Packed (kg / lbs.): 1.67 kg / 3.67 lbs.
- Weight Unpacked (kg / lbs.): 0.57 kg / 1.26 lbs.

#### WHATS IN THE BOX

- 1 x Monitor with stand
- 1 x ThinkVision M14 sleeve
- 1 x USB Type-C cable (1 m)
- 1 x QSG
- 1 x Pair of clips

#### ENVIRONMENTAL

- Temperature - Operating: 0° to 40°C
- Temperature - Non-operating: -20° to 60°C
- Humidity - Operating: 30 to 80%
- Humidity - Non-operating: 30 to 90%
- Altitude - Operating: 0 to 5000 m
- Altitude - Non-operating: 0 to 40,000 ft
- Arsenic-free Glass: Yes
- PVC free: Yes
- Mercury free: Yes
- PCC % of plastic resins: 85%

#### WARRANTY

- Geography Availability: WW
- Warranty: 3 Years

#### CERTIFICATIONS

- ENERGY STAR® Rating: 7,1
- CCC: Yes
- EPEAT: Bronze
- RoHS (EU 2002/95/EC): Yes (Arsenic free / Pb free / Mercury free)
- Windows Certification: Windows 7 / 10
- Image Quality Capability: ISO 9241-307
- China Energy Efficiency Standard: Tier 2
- Low Blue Light / Eye Comfort: Yes (Low BlueLight)

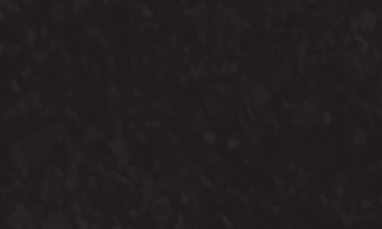









<p>Name <b>E1922s Wide Flat Panel Monitor</b>                  Case color <b>Black</b>                  Type-model <b>60G2AAR6US / 60G2AAT6EU</b>                  Panel <b>TFT-LCD, twisted nematic (TN), White LED backlight</b>                  Viewable image size <b>18.5" (470mm) diagonal</b>                  Max view area (W x H) <b>16.1" x 9.1" / 409.8mm x 230.4mm</b>                  Native resolution <b>1366x768</b>                  Aspect ratio <b>16:9</b>                  Pixel pitch (mm) <b>0.3mm</b>                  Dot/Pixel per Inch <b>85 dpi</b>                  Brightness <b>200 nits or cd/m<sup>2</sup> (typical)</b>                  Contrast ratio <b>600:1 (typical)</b>                  Pixel response time <b>5ms (typical)</b>                  Color gamut <b>72%</b>                  Viewing angle at 10:1 CR <b>180° (+/- 90°) horizontal, 100° (+/- 50°) vertical</b>                  Stand <b>Tilt adjustable stand</b>                  Bezel width <b>Sides: 0.73" (18.5mm)</b>                  Dimensions (HxWxD) <b>13.44" H x 17.65" W x 6.58" D;                  341.5mm H x 448.4mm W x 167.2mm D</b>                  Power supply <b>13.7 watts typical, 17 watts maximum,                  &lt;0.5 watts standby/suspend, universal,                  integrated (no external brick-like power supply)</b>                  Weight <b>6.03 lb; 2.74 kg</b>                  Limited warranty<sup>4</sup> <b>3 year (includes backlight)</b>                  Available date <b>March 2014</b></p>	<p style="text-align: center;"><b>Features</b></p> <ul style="list-style-type: none"> <li>• Widescreen 18.5-inch monitor</li> <li>• Supports HD 1366x768 resolution</li> <li>• Supports VESA mount (100mm)</li> <li>• Mercury free panel and arsenic free glass</li> <li>• Kensington lock slot ready for enhanced security</li> <li>• Support Lenovo Tiny PC via VESA mount</li> <li>• Supports optional soundbar</li> <li>• Microsoft® Windows® 7 certified</li> <li>• Microsoft Windows 8 / Windows 8.1 certified</li> </ul>				
<p>VESA-compliant<sup>2</sup> <b>VESA DPMS-compliant</b>                  Power management <b>ENERGY STAR® 7.0</b>                  Ergonomics <b>ISO 9241-307</b>                  Emission standards <b>FCC Class B</b>                  Environmental <b>TCO (TCO Displays 7.0), WEEE, RoHS,                  EPEAT™ Silver rating</b></p>	<div style="text-align: center;">  <p><b>ThinkVision E1922s Wide Monitor</b></p> </div>				
<p>Preset resolutions <b>VGA: 640x350, 640x480, 720x400                  SVGA: 800x600, 832x624                  XGA: 1024x768, 1152x864                  SXGA: 1280x1024                  WXGA: 1366x768</b></p> <p>Presets / user settings <b>Standard presets: 15                  user settings: 16</b></p>					
<p>Viewing adjustments <b>Tilt: 20° backward, -5° forward</b>                  Rotating screen <b>None</b>                  On screen display <b>On screen display with digital user controls (8 languages)</b>                  Control features <b>Direct access (control buttons on front) for automatic image setup and adjustment for brightness</b>                  Multiple input <b>None</b>                  Monitor connectors <b>VGA 15-pin D-shell, analog, blue</b>                  Signal cables <b>detachable, VGA 15-pin D-shell at each end, analog, 1.8 meter</b>                  Mounting features <b>Wall or desk mounting using the Extend Arm or third-party accessories meeting the VESA FPMPI® (100mm mount)</b>                  Security <b>Security keyhole for attachment of optional cable lock (Kensington® lock-compatible)</b></p>					
<p>Ship group <b>Monitor with stand, 1.8 meter analog signal cable, 1.8 meter black power cord</b></p>					
<p style="text-align: center;"><b>Limited Warranty</b></p> <p>See details at <a href="http://support.lenovo.com/en_US/guides-and-manuals/detail.page?DocID=UM008281">http://support.lenovo.com/en_US/guides-and-manuals/detail.page?DocID=UM008281</a></p>	<p style="text-align: center;"><b>Accessories</b></p> <table border="0"> <tr> <td>Kensington MicroSaver Cable Lock</td> <td style="text-align: right;">73P2582</td> </tr> <tr> <td>Kensington Twin Head Cable Lock</td> <td style="text-align: right;">45K1620</td> </tr> </table> <p>See details at <a href="http://www.lenovo.com/support/monitoraccessories">www.lenovo.com/support/monitoraccessories</a></p> <p>See all monitors at <a href="http://www.lenovo.com/thinkvision">www.lenovo.com/thinkvision</a></p>	Kensington MicroSaver Cable Lock	73P2582	Kensington Twin Head Cable Lock	45K1620
Kensington MicroSaver Cable Lock	73P2582				
Kensington Twin Head Cable Lock	45K1620				



<p>Name <b>E2054 Wide Flat Panel Monitor</b>                  Case color <b>Raven black</b>                  Type-model <b>60DFAAR1US / 60DFAAT1EU</b>                  Panel TFT-LCD, In-Plane Switching (IPS), LED backlight                  Viewable image size <b>19.5" (494mm)</b> diagonal                  Max view area (W x H) <b>16.48" x 10.33" / 418.6mm x 262.4mm</b>                  Native resolution <b>1440x900</b>                  Aspect ratio <b>16:10</b>                  Pixel pitch (mm) <b>0.097mm x 0.292mm</b>                  Dot/Pixel per Inch <b>87 dpi</b>                  Brightness <b>250 nits or cd/m<sup>2</sup> (typical)</b>                  Contrast ratio <b>1000:1 (typical)</b>                  Pixel response time <b>7ms (typical)</b>                  Color gamut <b>72%</b>                  Viewing angle at 10:1 CR <b>178° (+/- 89°) horizontal, 178° (+/- 89°) vertical</b>                  Stand <b>Tilt adjustable stand</b>                  Bezel width <b>Top: 0.71" (18.0mm)</b>  <b>Bottom: 0.70" (17.9mm)</b>  <b>Sides: 1.02" (26.0mm)</b>                  Dimensions (HxWxD) <b>14.65" H x 17.95" W x 7.41" D;</b>  <b>372.0mm H x 456.0mm W x 188.3mm D</b>                  Power supply <b>16 watts typical, 20 watts maximum,</b>  <b>&lt;0.5 watts standby/suspend, universal,</b>  <b>integrated (no external brick-like power supply)</b>                  Weight <b>6.17 lb; 2.8 kg</b>                  Limited warranty <b>3 year (includes backlight)</b>                  Available date <b>November 2015</b></p>	<p style="text-align: center;"><b>Features</b></p> <ul style="list-style-type: none"> <li>• Widescreen 19.5-inch monitor</li> <li>• Supports HD 1440x900 resolution</li> <li>• Supports VESA mount (100mm)</li> <li>• Mercury free panel and arsenic free glass</li> <li>• Kensington lock slot ready for enhanced security</li> <li>• Support Lenovo Tiny PC via VESA mount</li> <li>• Microsoft® Windows® 7 certified</li> <li>• Microsoft Windows 8 / Windows 8.1 certified</li> <li>• Microsoft Windows 10 certified</li> </ul>				
<p>VESA-compliant <b>VESA DPMS-compliant</b>                  Power management <b>ENERGY STAR® 6.0</b>                  Ergonomics <b>ISO 9241-307</b>                  Emission standards <b>FCC Class B</b>                  Environmental <b>TCO (TCO Displays 6.0), WEEE, RoHS,</b>  <b>EPEAT™ Silver rating</b></p>	<div style="text-align: center;">  <p><b>ThinkVision E2054 Wide Monitor</b></p> </div>				
<p>Preset resolutions <b>VGA: 640x480, 720x400</b>  <b>SVGA: 800x600</b>  <b>XGA: 1024x768</b>  <b>SXGA: 1280x768, 1280x1024</b>  <b>WXGA: 1366x768</b>  <b>WXGA+: 1440x900</b></p> <p>Presets / user settings <b>Standard presets: 18</b>  <b>user settings: 10</b></p>					
<p>Viewing adjustments <b>Tilt: 22° backward, -5° forward</b>                  Rotating screen <b>None</b>                  On screen display <b>On screen display with digital user controls (8 languages)</b>                  Control features <b>Direct access (control buttons on front) for automatic image setup and adjustment for brightness</b>                  Multiple input <b>None</b>                  Monitor connectors <b>VGA 15-pin D-shell, analog, blue</b>                  Signal cables <b>detachable, VGA 15-pin D-shell at each end, analog, 1.8 meter</b>                  Mounting features <b>Wall or desk mounting using the Extend Arm or third-party accessories meeting the VESA FPMPI® (100mm mount)</b>                  Security <b>Security keyhole for attachment of optional cable lock (Kensington® lock-compatible)</b></p>					
<p>Ship group <b>Monitor with stand, 1.8 meter analog signal cable, 1.8 meter black power cord</b></p>					
<p style="text-align: center;"><b>Limited Warranty</b></p> <p>See details at <a href="http://support.lenovo.com/en_US/guides-and-manuals/detail.page?DocID=UM008281">http://support.lenovo.com/en_US/guides-and-manuals/detail.page?DocID=UM008281</a></p>	<p style="text-align: center;"><b>Accessories</b></p> <table border="0"> <tr> <td>Kensington MicroSaver Cable Lock</td> <td style="text-align: right;">73P2582</td> </tr> <tr> <td>Kensington Twin Head Cable Lock</td> <td style="text-align: right;">45K1620</td> </tr> </table> <p>See details at <a href="http://www.lenovo.com/support/monitoraccessories">www.lenovo.com/support/monitoraccessories</a></p> <p>See all monitors at <a href="http://www.lenovo.com/thinkvision">www.lenovo.com/thinkvision</a></p>	Kensington MicroSaver Cable Lock	73P2582	Kensington Twin Head Cable Lock	45K1620
Kensington MicroSaver Cable Lock	73P2582				
Kensington Twin Head Cable Lock	45K1620				



<p>Name <b>LT1913p Square Flat Panel Monitor</b>                  Case color <b>Black</b>                  Type-model <b>60FBHAR1US / 60FBHAT1EU</b>                  Panel TFT-LCD, In-Plane Switching (IPS), White LED backlight</p> <p>Viewable image size <b>19.0" (480.0mm) diagonal</b>                  Max view area (W x H) <b>14.76" x 11.80" (374.7mm x 299.8mm)</b>                  Optimum resolution <b>1280x1024</b>                  Max pixel rate <b>205MHz (VGA), 165MHz (DVI)</b>                  Aspect ratio <b>5:4</b>                  Pixel pitch (mm) <b>0.0976 (H) x 0.2928 (V) mm</b>                  Dot/Pixel per Inch <b>86.8 dpi</b>                  Brightness <b>250 nits or cd/m<sup>2</sup> (typical)</b>                  Contrast ratio <b>1000:1 (typical)</b>                  Pixel response time <b>7ms (typical)</b>                  Color gamut <b>72%</b>                  Viewing angle at 10:1 CR <b>178° horizontal, 178° vertical</b></p> <p>Stand <b>Tilt, swivel, pivot, and height adjustable stand</b>                  Bezel width <b>Sides: 0.68" (17.4mm); top: 0.68" (17.4mm); bottom: 0.68" (17.4mm)</b></p> <p>Dimensions (HxWxD) <b>14.63" H x 16.18" W x 10.40" D; 371.5mm H x 411.0mm W x 264.2mm D</b></p> <p>Power supply <b>24 watts typical, 27 watts maximum, &lt;0.5 watts standby/suspend, universal, integrated (no external brick-like power supply)</b></p> <p>Weight <b>10.69 lb; 4.85kg</b></p> <p>Limited warranty<sup>4</sup> <b>3 year (includes backlight)</b>                  Available date <b>April 2015</b></p>	<p><b>Features</b></p> <ul style="list-style-type: none"> <li>• 19-inch Square IPS LED backlit panel</li> <li>• Supports 1280x1024 resolution</li> <li>• Supports ThinkCentre Tiny Clamp Bracket</li> <li>• Mercury and arsenic free glass</li> <li>• Low Halogen</li> <li>• Recycled content in plastic material</li> <li>• Supports optional soundbar</li> <li>• Microsoft® Windows® 7 certified</li> <li>• Microsoft Windows 8 / Windows 8.1 certified</li> <li>• Microsoft Windows 10 certified</li> </ul>								
<p>VESA-compliant<sup>2</sup> <b>VESA DDC2B/C1, EDID 1.3</b>                  Power management <b>ENERGY STAR® 7.0</b>                  Ergonomics <b>ISO 9241-307</b>                  Emission standards <b>FCC Class B</b>                  Environmental <b>TCO Displays 7.0, TCO Certified Edge 1.1, WEEE, RoHS, EPEAT™ Silver rating, ULE Gold</b></p> <p>Preset resolutions <b>VGA: 640x350, 640x480, 720x400                  SVGA: 800x600, 823x624                  XGA: 1024x768, 1152x864, 1152x900                  SXGA: 1280x1024</b></p> <p>Presets / user settings <b>Standard presets: 20;                  user settings: 20</b></p>	 <p><b>ThinkVision LT1913p Square Monitor</b></p>								
<p>Viewing adjustments <b>Tilt: 30° back, -5° forward; lift: 4.3" (110mm); swivel: +/- 45°</b>                  Rotating screen <b>Screen pivots 90 degrees from landscape to portrait</b>                  On screen display <b>On screen display with digital user controls (8 languages)</b>                  Control features <b>Direct access (buttons on front) for automatic image setup, input switch, and brightness</b>                  Multiple input <b>Dual input (two different PCs attach to two different connectors; one PC shows image; select via button)</b>                  Monitor connectors <b>(1) VGA 15-pin D-shell, analog, blue                  (2) Digital Visual Interface (DVI-D), digital, white, <b>HDCP-compliant</b></b>                  Signal cables <b>(1) detachable, VGA 15-pin D-shell at each end, analog, 1.8 meter                  (2) detachable, DVI-D at each end, digital, 1.8 meter</b>                  Mounting features <b>Wall or desk mounting using the Extend Arm or third-party accessories meeting the VESA FPMPI® (100mm mount)</b>                  Security <b>Security keyhole for attachment of optional cable lock (Kensington® lock-compatible)</b></p> <p>Ship group <b>Monitor, attached stand, Setup poster, Safety and Warranty Information, 1.8 meter analog signal cable, 1.8 meter DVI-D cable, 1.8 meter black power cord</b></p>									
<p><b>Limited Warranty</b></p> <p>See details at <a href="http://support.lenovo.com/en_US/guides-and-manuals/detail.page?DocID=UM008281">http://support.lenovo.com/en_US/guides-and-manuals/detail.page?DocID=UM008281</a></p>	<p><b>Accessories</b></p> <table border="0"> <tr> <td>Kensington MicroSaver Cable Lock</td> <td>73P2582</td> </tr> <tr> <td>Kensington Twin Head Cable Lock</td> <td>45K1620</td> </tr> <tr> <td>Lenovo Security Cable Lock</td> <td>57Y4303</td> </tr> <tr> <td>Lenovo Easy Reach Monitor Stand</td> <td>55Y9258</td> </tr> </table> <p>See details at <a href="http://www.lenovo.com/support/monitoraccessories">www.lenovo.com/support/monitoraccessories</a></p> <p>See all monitors at <a href="http://www.lenovo.com/thinkvision">www.lenovo.com/thinkvision</a></p>	Kensington MicroSaver Cable Lock	73P2582	Kensington Twin Head Cable Lock	45K1620	Lenovo Security Cable Lock	57Y4303	Lenovo Easy Reach Monitor Stand	55Y9258
Kensington MicroSaver Cable Lock	73P2582								
Kensington Twin Head Cable Lock	45K1620								
Lenovo Security Cable Lock	57Y4303								
Lenovo Easy Reach Monitor Stand	55Y9258								









<p>Name <b>T1714 Square Flat Panel Monitor</b>                  Case color <b>Black</b>                  Type-model <b>60FDHAR1US / 60FDHAT1EU</b>                  Panel <b>TFT-LCD, twisted nematic (TN), White LED backlight</b>                  Viewable image size <b>17.0" (432mm) diagonal</b>                  Max view area (W x H) <b>13.3" x 10.6" (337.9mm x 270.3mm)</b>                  Optimum resolution <b>1280x1024</b>                  Aspect ratio <b>5:4</b>                  Pixel pitch (mm) <b>0.264mm</b>                  Dot/Pixel per Inch <b>96 dpi</b>                  Brightness <b>250 nits or cd/m<sup>2</sup> (typical)</b>                  Contrast ratio <b>1000:1 (typical)</b>                  Pixel response time <b>5ms (typical)</b>                  Color gamut <b>72%</b>                  Viewing angle at 10:1 CR <b>170° (+/- 85°) horizontal, 160° (+/- 80°) vertical</b>                  Stand <b>Tilt stand</b>                  Bezel width <b>Sides: 0.69" (17.5mm)</b>                  Dimensions (HxWxD, including stand) <b>14.72" H x 14.74" W x 7.87" D;                  373.9mm H x 374.5mm W x 200mm D</b>                  Power supply <b>14.0 watts typical, 18.0 watts maximum,                  &lt;0.5 watts standby/suspend, universal,                  integrated (no external brick-like power supply)</b>                  Weight <b>5.75 lb; 2.61kg</b>                  Limited warranty <b>3 year (includes backlight)</b>                  Available date <b>September 2015</b></p>	<p><b>Features</b></p> <ul style="list-style-type: none"> <li>• 17-inch Square LCD monitor</li> <li>• Supports SXGA 1280x1024 resolution</li> <li>• Includes dual input connection for attachment to two systems concurrently (analog and digital)</li> <li>• Mercury Arsenic free glass</li> <li>• Supports optional soundbar</li> <li>• Microsoft® Windows® 7 certified</li> <li>• Microsoft Windows 8 certified</li> <li>• Microsoft Windows 8.1 certified</li> <li>• Microsoft Windows 10 certified</li> </ul>						
<p>VESA-compliant <b>VESA DDC2B/CI</b>                  Power management <b>ENERGY STAR® 7.0</b>                  Ergonomics <b>ISO 9241-307</b>                  Emission standards <b>FCC Class B</b>                  Environmental <b>TCO Displays 7.0, TCO Certified Edge 2.0, WEEE,                  RoHS, EPEAT™ <b>Silver rating</b></b></p>	<div style="text-align: center;">  <p><b>ThinkVision T1714 Monitor</b></p> </div>						
<p>Preset resolutions <b>VGA: 640x350, 640x480, 720x400                  SVGA: 800x600                  XGA: 1024x768, 1152x864,                  SXGA: 1280x800, 1280x1024</b></p> <p>Presets / user settings <b>Standard presets: 17;                  user settings: 17</b></p>							
<p>Viewing adjustments <b>Tilt: 22° back, -5° forward</b>                  Rotating screen <b>None</b>                  On screen display <b>On screen display with digital user controls (8 languages)</b>                  Control features <b>Direct access (buttons on front) for automatic image setup and brightness</b>                  Multiple input <b>Dual input (two different PCs attach to two different connectors; one PC shows image; select via button)</b>                  Monitor connectors <b>(1) VGA 15-pin D-shell, analog, blue                  (2) Digital Visual Interface (DVI-D), digital, white, <b>HDCP-compliant</b></b>                  Signal cables <b>(1) detachable, VGA 15-pin D-shell at each end, analog, 1.8 meter                  (2) detachable, DVI-D at each end, digital, 1.8 meter</b>                  Mounting features <b>Wall or desk mounting using the Extend Arm or third-party accessories meeting the VESA FPMPI® (100mm mount)</b>                  Security <b>Security keyhole for attachment of optional cable lock (Kensington® lock-compatible)</b></p>							
<p>Ship group <b>Monitor and stand, Setup poster, Safety and Warranty Information, 1.8 meter analog signal cable,                  1.8 meter DVI-D cable, 1.8 meter black power cord</b></p>	<p><b>Limited Warranty</b></p> <p>See details at <a href="http://support.lenovo.com/en_US/guides-and-manuals/detail.page?DocID=UM008281">http://support.lenovo.com/en_US/guides-and-manuals/detail.page?DocID=UM008281</a></p> <p><b>Accessories</b></p> <table border="0"> <tr> <td>Kensington MicroSaver Cable Lock</td> <td>73P2582</td> </tr> <tr> <td>Kensington Twin Head Cable Lock</td> <td>45K1620</td> </tr> <tr> <td>Lenovo Easy Reach Monitor Stand</td> <td>55Y9258</td> </tr> </table> <p>See details at <a href="http://www.lenovo.com/support/monitoraccessories">www.lenovo.com/support/monitoraccessories</a></p> <p>See all monitors at <a href="http://www.lenovo.com/thinkvision">www.lenovo.com/thinkvision</a></p>	Kensington MicroSaver Cable Lock	73P2582	Kensington Twin Head Cable Lock	45K1620	Lenovo Easy Reach Monitor Stand	55Y9258
Kensington MicroSaver Cable Lock	73P2582						
Kensington Twin Head Cable Lock	45K1620						
Lenovo Easy Reach Monitor Stand	55Y9258						



<p>Name <b>T1714p Square Flat Panel Monitor</b>                  Case color <b>Black</b>                  Type-model <b>60FELAR1US / 60FELAT1EU</b>                  Panel <b>TFT-LCD, twisted nematic (TN), White LED backlight</b>                  Viewable image size <b>17.0" (432mm) diagonal</b>                  Max view area (W x H) <b>13.3" x 10.6" (337.9mm x 270.3mm)</b>                  Optimum resolution <b>1280x1024</b>                  Aspect ratio <b>5:4</b>                  Pixel pitch (mm) <b>0.264mm</b>                  Dot/Pixel per Inch <b>96 dpi</b>                  Brightness <b>250 nits or cd/m<sup>2</sup> (typical)</b>                  Contrast ratio <b>1000:1 (typical)</b>                  Pixel response time <b>5ms (typical)</b>                  Color gamut <b>72%</b>                  Viewing angle at 10:1 CR <b>170° (+/- 85°) horizontal, 160° (+/- 80°) vertical</b>                  Stand <b>Tilt height adjustable stand</b>                  Bezel width <b>Sides: 0.69" (17.5mm)</b>                  Dimensions (HxWxD, including stand) <b>17.63" H x 14.74" W x 9.61" D; 447.9mm H x 374.5mm W x 244.2mm D</b>                  Power supply <b>14.0 watts typical, 18.0 watts maximum, &lt;0.5 watts standby/suspend, universal, integrated (no external brick-like power supply)</b>                  Weight <b>8.71 lb; 3.95kg</b>                  Limited warranty <b>3 year (includes backlight)</b>                  Available date <b>September 2015</b></p>	<p><b>Features</b></p> <ul style="list-style-type: none"> <li>• 17-inch Square LCD monitor</li> <li>• Supports SXGA 1280x1024 resolution</li> <li>• Includes dual input connection for attachment to two systems concurrently (analog and digital)</li> <li>• Mercury Arsenic free glass</li> <li>• Supports Lenovo Tiny PC and 3rd party thin client via optional Lenovo bracket</li> <li>• Supports optional soundbar</li> <li>• Microsoft® Windows® 7 certified</li> <li>• Microsoft Windows 8 certified</li> <li>• Microsoft Windows 8.1 certified</li> <li>• Microsoft Windows 10 certified</li> </ul>						
<p>VESA-compliant <b>VESA DDC2B/CI</b>                  Power management <b>ENERGY STAR® 7.0</b>                  Ergonomics <b>ISO 9241-307</b>                  Emission standards <b>FCC Class B</b>                  Environmental <b>TCO Displays 7.0, TCO Certified Edge 2.0, WEEE, RoHS, EPEAT™ Silver rating</b></p>	<div style="text-align: center;">  <p><b>ThinkVision T1714p Monitor</b></p> </div>						
<p>Preset resolutions <b>VGA: 640x350, 640x480, 720x400</b>  <b>SVGA: 800x600</b>  <b>XGA: 1024x768, 1152x864,</b>  <b>SXGA: 1280x800, 1280x1024</b>                  Presets / user settings <b>Standard presets: 22;</b>  <b>user settings: 22</b></p>							
<p>Viewing adjustments <b>Tilt: 22° back, -5° forward; lift: 4.3" (110mm)</b>                  Rotating screen <b>None</b>                  On screen display <b>On screen display with digital user controls (8 languages)</b>                  Control features <b>Direct access (buttons on front) for automatic image setup and brightness</b>                  Multiple input <b>Dual input (two different PCs attach to two different connectors; one PC shows image; select via button)</b>                  Monitor connectors <b>(1) VGA 15-pin D-shell, analog, blue</b>  <b>(2) Digital Visual Interface (DVI-D), digital, white, HDCP-compliant</b>  <b>(3) DisplayPort, digital, black, HDCP-compliant</b>                  Signal cables <b>(1) detachable, VGA 15-pin D-shell at each end, analog, 1.8 meter</b>  <b>(2) detachable, DVI-D at each end, digital, 1.8 meter</b>                  Mounting features <b>Wall or desk mounting using the Extend Arm or third-party accessories meeting the VESA FPMPI® (100mm mount)</b>                  Security <b>Security keyhole for attachment of optional cable lock (Kensington® lock-compatible)</b></p>	<p>Ship group <b>Monitor and stand, Setup poster, Safety and Warranty Information, 1.8 meter analog signal cable, 1.8 meter DVI-D cable, 1.8 meter black power cord</b></p>						
<p style="text-align: center;"><b>Limited Warranty</b></p> <p>See details at <a href="http://support.lenovo.com/en_US/guides-and-manuals/detail.page?DocID=UM008281">http://support.lenovo.com/en_US/guides-and-manuals/detail.page?DocID=UM008281</a></p>	<p style="text-align: center;"><b>Accessories</b></p> <table border="0"> <tr> <td>Kensington MicroSaver Cable Lock</td> <td style="text-align: right;">73P2582</td> </tr> <tr> <td>Kensington Twin Head Cable Lock</td> <td style="text-align: right;">45K1620</td> </tr> <tr> <td>Lenovo Easy Reach Monitor Stand</td> <td style="text-align: right;">55Y9258</td> </tr> </table> <p>See details at <a href="http://www.lenovo.com/support/monitoraccessories">www.lenovo.com/support/monitoraccessories</a></p> <p>See all monitors at <a href="http://www.lenovo.com/thinkvision">www.lenovo.com/thinkvision</a></p>	Kensington MicroSaver Cable Lock	73P2582	Kensington Twin Head Cable Lock	45K1620	Lenovo Easy Reach Monitor Stand	55Y9258
Kensington MicroSaver Cable Lock	73P2582						
Kensington Twin Head Cable Lock	45K1620						
Lenovo Easy Reach Monitor Stand	55Y9258						



<p>Name <b>T2054p Wide Flat Panel Monitor</b>                  Bezel color <b>Raven black</b>                  Type-model <b>60G1MAR2US / 60G1MAT2EU</b>                  Panel TFT-LCD, In-Plane Switching (IPS), White LED backlight</p> <p>Viewable image size <b>19.5" (495mm) diagonal</b>                  Max view area (W x H) <b>16.48" x 10.33" (418.6mm x 262.4mm)</b>                  Native resolution <b>1440x900</b>                  Aspect ratio 16:10                  Pixel pitch (mm) 0.2915 x 0.2915 mm                  Dot/Pixel per Inch 87 dpi                  Brightness 250 nits or cd/m<sup>2</sup> (typical)                  Contrast ratio 1000:1 (typical)                  Pixel response time 7ms (typical)                  Color gamut 72%                  Viewing angle at 10:1 CR <b>178° (+/- 89°) horizontal, 178° (+/- 89°) vertical</b>                  Stand Tilt, swivel, and height adjustable                  Bezel width <b>Sides: 0.67" (17.0mm)</b>                  Dimensions (HxWxD) <b>13.62" H x 17.88" W x 9.55" D; 345.9mm H x 454.2mm W x 242.6mm D</b></p> <p>Power supply 14.5 watts typical, 21 watts maximum, &lt;0.3 watts standby/suspend, universal, integrated (no external brick-like power supply)</p> <p>Weight 8.16 lb; 3.70 kg                  Limited warranty<sup>4</sup> <b>3 year</b> (includes backlight)                  Available date September 2015</p>	<p style="text-align: center;"><b>Features</b></p> <ul style="list-style-type: none"> <li>• Widescreen 19.5-inch monitor</li> <li>• Supports 1440x900 resolution</li> <li>• Supports ThinkCentre Tiny Clamp Bracket</li> <li>• Includes dual input connection for attachment to two systems concurrently (analog and digital)</li> <li>• EPEAT Gold certified</li> <li>• Supports optional soundbar</li> <li>• Microsoft® Windows® 7 certified</li> <li>• Microsoft Windows 8 / Windows 8.1 certified</li> <li>• Microsoft Windows 10 certified</li> </ul>				
<p>VESA-compliant<sup>2</sup> VESA DDC2B/CI                  Power management ENERGY STAR® qualified                  Ergonomics ISO 9241-307                  Emission standards FCC Class B                  Environmental TCO Displays 7.0, TCO Certified Edge 2.0, WEEE, RoHS, <b>EPEAT™ Silver rating</b></p>	<div style="text-align: center;">  <p><b>ThinkVision T2054p Wide Monitor</b></p> </div>				
<p>Preset resolutions VGA: 640x480, 720x400, 720x576                  SVGA: 800x600                  XGA: 1024x768, 1152x864                  SXGA: 1280x800, 1280x1024                  WXGA: 1366x768                  WXGA+: 1440x900</p> <p>Presets / user settings Standard presets: 22                  user settings: 16</p>					
<p>Viewing adjustments <i>Tilt: 22° backward, -5° forward; lift: 4.3" (110mm); swivel: +/-45°; detachable stand</i>                  Rotating screen None                  On screen display On screen display with digital user controls (8 languages)                  Control features Direct access (buttons on front) for automatic image setup, dual input and brightness                  Multiple input Dual input (two different PCs attach to two different connectors; one PC shows image; select via button)                  Monitor connectors (1) VGA 15-pin D-shell, analog, blue                  (2) HDMI (1.4), digital, <b>HDCP-compliant</b>                  (3) DisplayPort, digital, black, <b>HDCP-compliant</b></p> <p>Signal cables (1) detachable, VGA 15-pin D-shell at each end, analog, 1.8 meter                  (2) detachable, DisplayPort at each end, digital, 1.8 meter</p> <p>Mounting features Wall or desk mounting using the Extend Arm or third-party accessories, 100mm x 100mm mount                  Security Security keyhole for attachment of optional cable lock (Kensington® lock-compatible)</p>	<p>Ship group Monitor with stand, Safety and Warranty Information, 1.8 meter analog signal cable, 1.8 meter DP signal cable, 1.8 meter black power cord</p>				
<p style="text-align: center;"><b>Limited Warranty</b></p> <p>See details at <a href="http://support.lenovo.com/en_US/guides-and-manuals/detail.page?DocID=UM008281">http://support.lenovo.com/en_US/guides-and-manuals/detail.page?DocID=UM008281</a></p>	<p style="text-align: center;"><b>Accessories</b></p> <table border="0"> <tr> <td>Kensington MicroSaver Cable Lock</td> <td style="text-align: right;">73P2582</td> </tr> <tr> <td>Kensington Twin Head Cable Lock</td> <td style="text-align: right;">45K1620</td> </tr> </table> <p>See details at <a href="http://www.lenovo.com/support/monitoraccessories">www.lenovo.com/support/monitoraccessories</a></p> <p>See all monitors at <a href="http://www.lenovo.com/thinkvision">www.lenovo.com/thinkvision</a></p>	Kensington MicroSaver Cable Lock	73P2582	Kensington Twin Head Cable Lock	45K1620
Kensington MicroSaver Cable Lock	73P2582				
Kensington Twin Head Cable Lock	45K1620				





<p>Name <b>E21 Wide Flat Panel Monitor</b>                  Bezel color <b>Black</b>                  Type-model <b>61B9JAR1US / 61B9JAT1EU</b>                  Panel TFT-LCD, twisted nematic (TN), White LED backlight                  Viewable image size <b>20.7" (525.78mm)</b> diagonal                  Max view area (W x H) <b>18.03" x 10.14" (457.92mm x 257.58mm)</b>                  Native resolution <b>1920x1080</b>                  Aspect ratio <b>16:9</b>                  Pixel pitch (mm) <b>0.2385 x 0.2385 mm</b>                  Dot/Pixel per Inch <b>106 dpi</b>                  Brightness <b>250 nits or cd/m<sup>2</sup> (typical)</b>                  Contrast ratio <b>1000:1 (typical)</b>                  Pixel response time <b>5ms (typical)</b>                  Color gamut <b>72%</b>                  Viewing angle at 10:1 CR <b>170° (+/- 85°) horizontal, 160° (+/- 80°) vertical</b>                  Stand <b>Tilt adjustable stand</b>                  Bezel width <b>Sides: 0.6" (15.3mm)</b>                  Dimensions (HxWxD) <b>14.6" H x 19.31" W x 8.07" D;                  370.9mm H x 490.5mm W x 204.9mm D</b>                  Power supply <b>18 watts typical,                  23 watts maximum,                  &lt;0.3 watts standby/suspend, universal,                  integrated (no external brick-like power supply)</b>                  Weight <b>5.82 lb; 2.64 kg</b>                  Limited warranty <b>3 year (includes backlight)</b>                  Available date <b>August 2017</b></p>	<p style="text-align: center;"><b>Features</b></p> <ul style="list-style-type: none"> <li>• Widescreen 20.7-inch monitor</li> <li>• Supports 1920x1080 resolution</li> <li>• Supports ThinkCentre Tiny Clamp Bracket</li> <li>• Supports optional soundbar</li> <li>• EPEAT Gold certified</li> <li>• Low Blue Light certification</li> <li>• Microsoft® Windows® 7 certified</li> <li>• Microsoft Windows 10 certified</li> </ul>				
<p>VESA-compliant <b>VESA DDC2B/CI</b>                  Power management <b>ENERGY STAR® qualified</b>                  Ergonomics <b>ISO 9241-307</b>                  Emission standards <b>FCC Class B</b>                  Environmental <b>TCO Displays 7.0, TCO Certified Edge 2.0, WEEE,                  RoHS, EPEAT™ Silver rating</b></p>	<div style="text-align: center;">  <p><b>ThinkVision E21 Wide Monitor</b></p> </div>				
<p>Preset resolutions <b>VGA: 640x350, 640x480, 720x400                  SVGA: 800x600, 832x624                  XGA: 1024x768, 1152x864                  SXGA: 1280x1024                  WXGA+: 1440x900                  WSXGA+: 1680x1050                  Full HD: 1920x1080</b></p> <p>Presets display modes <b>Standard presets: 22</b></p>					
<p>Viewing adjustments <b>Tilt: 22° back, -5° forward</b>                  Rotating screen <b>None</b>                  On screen display <b>On screen display with digital user controls (8 languages)</b>                  Control features <b>Direct access (buttons on front) for power, menu, input source select and brightness</b>                  USB hub <b>None</b>                  Multiple input <b>Dual input (two different PCs attach to two different connectors; one PC shows image; select via button)</b>                  Monitor connectors <b>(1) VGA 15-pin D-shell, analog, blue                  (2) DisplayPort (1.2), digital, black, <b>HDCP-compliant</b></b>                  Signal cables <b>(1) detachable, VGA 15-pin D-shell at each end, analog, 1.8 meter</b>                  Mounting features <b>Wall or desk mounting using the Extend Arm or third-party accessories, 100mm x 100mm mount</b>                  Security <b>Security keyhole for attachment of optional cable lock (Kensington® lock-compatible)</b></p>					
<p>Ship group <b>Monitor with stand, Safety and Warranty Information, 1.8 meter analog signal cable, 1.8 meter black power cord</b></p>	<p style="text-align: center;"><b>Accessories</b></p> <table border="0"> <tr> <td>Kensington MicroSaver Cable Lock</td> <td style="text-align: right;">73P2582</td> </tr> <tr> <td>Kensington Twin Head Cable Lock</td> <td style="text-align: right;">45K1620</td> </tr> </table> <p>See details at <a href="http://www.lenovo.com/support/monitoraccessories">www.lenovo.com/support/monitoraccessories</a></p> <p>See all monitors at <a href="http://www.lenovo.com/thinkvision">www.lenovo.com/thinkvision</a></p>	Kensington MicroSaver Cable Lock	73P2582	Kensington Twin Head Cable Lock	45K1620
Kensington MicroSaver Cable Lock	73P2582				
Kensington Twin Head Cable Lock	45K1620				



<p>Name <b>E24 Wide Flat Panel Monitor</b>                  Bezel color <b>Black</b>                  Type-model <b>61B7JAR6US / 61B7JAT6EU</b>                  Panel TFT-LCD, In-Plane Switching (IPS), White LED backlight                  Viewable image size <b>23.8" (604.7mm)</b> diagonal                  Max view area (W x H) <b>20.75" x 11.67"</b> (527.04mm x 296.46mm)                  Native resolution <b>1920x1080</b>                  Aspect ratio 16:9                  Pixel pitch (mm) 0.2745 x 0.2745 mm                  Dot/Pixel per Inch 92.5 dpi                  Brightness 250 nits or cd/m<sup>2</sup> (typical)                  Contrast ratio 1000:1 (typical)                  Pixel response time 6ms (typical)                  Color gamut 72%                  Viewing angle at 10:1 CR 178° (+/- 89°) horizontal, 178° (+/- 89°) vertical                  Stand Tilt adjustable stand                  Bezel width <i>Sides:</i> 0.51" (13mm)                  Dimensions (HxWxD) 15.9" H x 21.81" W x 8.07" D;                  403.8mm H x 554mm W x 204.9mm D                  Power supply 18 watts typical,                  23 watts maximum,                  &lt;0.3 watts standby/suspend, universal,                  integrated (no external brick-like power supply)                  Weight 8.2 lb; 3.7 kg                  Limited warranty <b>3 year</b> (includes backlight)                  Available date August 2017</p>	<p style="text-align: center;"><b>Features</b></p> <ul style="list-style-type: none"> <li>• Widescreen 23.8-inch monitor</li> <li>• Supports 1920x1080 resolution</li> <li>• Supports ThinkCentre Tiny VESA mount</li> <li>• Supports optional soundbar</li> <li>• Includes dual input connection for attachment to two systems concurrently</li> <li>• EPEAT Gold certified</li> <li>• Microsoft® Windows® 7 certified</li> <li>• Microsoft Windows 10 certified</li> </ul>				
<p>VESA-compliant VESA DDC2B/CI                  Power management ENERGY STAR® qualified                  Ergonomics ISO 9241-307                  Emission standards FCC Class B                  Environmental TCO Displays 7.0, TCO Certified Edge 2.0, WEEE, RoHS, <b>EPEAT™ Gold rating</b></p>	<div style="text-align: center;">  <p><b>ThinkVision E24 Wide Monitor</b></p> </div>				
<p>Preset resolutions                  VGA: 640x350, 640x480, 720x400                  SVGA: 800x600, 832x624                  XGA: 1024x768, 1152x864                  SXGA: 1280x1024                  WXGA: 1366x768                  WXGA+: 1440x900, 1600x900                  WSXGA+: 1680x1050                  Full HD: 1920x1080</p> <p>Presets display modes Standard presets: 24; user settings: 20</p>					
<p>Viewing adjustments <i>Tilt:</i> 22° back, -5° forward                  Rotating screen None                  On screen display On screen display with digital user controls (8 languages)                  Control features Direct access (buttons on front) for power, menu, input source select and brightness                  USB hub None                  Multiple input Dual input (two different PCs attach to two different connectors; one PC shows image; select via button)                  Monitor connectors (1) VGA 15-pin D-shell, analog, blue                  (2) DisplayPort, digital, black, <b>HDCP-compliant</b>                  Signal cables (1) detachable, VGA 15-pin D-shell at each end, analog, 1.8 meter                  (2) detachable, DisplayPort at each end, digital, 1.8 meter                  Mounting features Wall or desk mounting using the Extend Arm or third-party accessories, 100mm x 100mm mount                  Security Security keyhole for attachment of optional cable lock (Kensington® lock-compatible)</p>					
<p>Ship group Monitor with stand, Safety and Warranty Information, 1.8 meter analog signal cable, 1.8 meter DP signal cable, 1.8 meter black power cord</p>	<p style="text-align: center;"><b>Accessories</b></p> <table border="0"> <tr> <td>Kensington MicroSaver Cable Lock</td> <td style="text-align: right;">73P2582</td> </tr> <tr> <td>Kensington Twin Head Cable Lock</td> <td style="text-align: right;">45K1620</td> </tr> </table> <p>See details at <a href="http://www.lenovo.com/support/monitoraccessories">www.lenovo.com/support/monitoraccessories</a></p> <p>See all monitors at <a href="http://www.lenovo.com/thinkvision">www.lenovo.com/thinkvision</a></p>	Kensington MicroSaver Cable Lock	73P2582	Kensington Twin Head Cable Lock	45K1620
Kensington MicroSaver Cable Lock	73P2582				
Kensington Twin Head Cable Lock	45K1620				
<p style="text-align: center;"><b>Limited Warranty</b></p> <p>See details at <a href="http://support.lenovo.com/en_US/guides-and-manuals/detail.page?DocID=UM008281">http://support.lenovo.com/en_US/guides-and-manuals/detail.page?DocID=UM008281</a></p>					



<p>Name <b>P24h Wide Flat Panel Monitor</b>                  Bezel color <b>Black</b>                  Type-model <b>61AEGAR3US / 61AEGAT3EU</b>                  Panel TFT-LCD, In-Plane Switching (IPS), White LED backlight                  Viewable image size <b>23.8" (604.7mm)</b> diagonal                  Max view area (W x H) <b>20.74" x 11.67"</b> (526.9mm x 296.4mm)                  Native resolution <b>2560x1440</b>                  Aspect ratio 16:9                  Pixel pitch (mm) 0.2058x 0.2058 mm                  Dot/Pixel per Inch 124 dpi                  Brightness 300 nits or cd/m<sup>2</sup> (typical)                  Contrast ratio 1000:1 (typical)                  Pixel response time 4ms (extreme) / 6ms (typical)                  Color gamut 99% sRGB                  Viewing angle at 10:1 CR 178° (+/- 89°) horizontal, 178° (+/- 89°) vertical                  Stand Tilt, swivel, pivot, and height adjustable stand                  Bezel width <i>Sides:</i> 0.08" (2.0mm)                  Dimensions (HxWxD) 14.7" H x 21.26" W x 10.3" D;                  373.4mm H x 540.2mm W x 261.75mm D                  Power supply 24 watts typical,                  120 watts maximum (with USB 3.0 hub),                  &lt;0.5 watts standby/suspend, universal,                  integrated (no external brick-like power supply)                  Weight 12.54 lb; 5.69 kg                  Limited warranty <b>3 year</b> (includes backlight)                  Available date April 2017</p>	<p style="text-align: center;"><b>Features</b></p> <ul style="list-style-type: none"> <li>• Widescreen 23.8-inch monitor</li> <li>• Supports 2560x1440 resolution</li> <li>• Supports optional soundbar</li> <li>• Supports ThinkCentre Tiny Clamp Bracket</li> <li>• Includes dual input connection for attachment to two systems concurrently</li> <li>• EPEAT Gold certified</li> <li>• Microsoft® Windows® 7 certified</li> <li>• Microsoft Windows 10 certified</li> </ul>				
<p>VESA-compliant VESA DDC2B/CI                  Power management ENERGY STAR® qualified                  Ergonomics ISO 9241-307                  Emission standards FCC Class B                  Environmental TCO Displays 7.0, TCO Certified Edge 2.0, WEEE, RoHS, <b>EPEAT™ Silver rating</b></p>	<div style="text-align: center;">  <p><b>ThinkVision P24h Wide Monitor</b></p> </div>				
<p>Preset resolutions                  VGA: 640x480, 720x400                  SVGA: 800x600                  XGA: 1024x768                  SXGA: 1280x1024                  WXGA: 1366x768                  WXGA+: 1440x900, 1680x900                  WSXGA+: 1680x1050                  Full HD: 1920x1080, 1920x1200                  QHD: 2560x1440                  Presets display modes HDMI: 22; DP: 14</p>					
<p>Viewing adjustments <i>Tilt:</i> 30° back, -5° forward; <i>lift:</i> 4.3" (110mm); <i>swivel:</i> +/-45°; detachable stand                  Rotating screen Screen pivots 90 degrees from landscape to portrait                  On screen display On screen display with digital user controls (8 languages)                  Control features Direct access (buttons on front) for power, menu, input source select and brightness                  USB hub USB Hub: one USB 3.1 Type-C upstream port, four USB 3.0 Type-A downstream ports                  Multimedia Audio-out, optional sound bar supported                  Camera None                  Multiple input Support HDMI, DisplayPort, USB 3.1 Type-C, DisplayPort-out                  Monitor connectors (1) 2*HDMI (1.4), digital, <b>HDCP-compliant</b>                  (2) DisplayPort (1.2), digital, <b>HDCP-compliant</b>                  (3) DisplayPort-out, digital                  (4) USB 3.1 Type-C                  Signal cables (1) USB 3.1 Type-C cable, 1.8 meter                  Mounting features Wall or desk mounting using the Extend Arm or third-party accessories, 100mm x 100mm mount                  Security Security keyhole for attachment of optional cable lock (Kensington® lock-compatible)</p>					
<p>Ship group Monitor with stand, Safety and Warranty Information, 1.8 meter USB 3.1 Type-C cable, 1.8 meter black power cord</p>	<p style="text-align: center;"><b>Accessories</b></p> <table border="0"> <tr> <td>Kensington MicroSaver Cable Lock</td> <td style="text-align: right;">73P2582</td> </tr> <tr> <td>Kensington Twin Head Cable Lock</td> <td style="text-align: right;">45K1620</td> </tr> </table> <p>See details at <a href="http://www.lenovo.com/support/monitoraccessories">www.lenovo.com/support/monitoraccessories</a></p> <p>See all monitors at <a href="http://www.lenovo.com/thinkvision">www.lenovo.com/thinkvision</a></p>	Kensington MicroSaver Cable Lock	73P2582	Kensington Twin Head Cable Lock	45K1620
Kensington MicroSaver Cable Lock	73P2582				
Kensington Twin Head Cable Lock	45K1620				
<p style="text-align: center;"><b>Limited Warranty</b></p> <p>See details at <a href="http://support.lenovo.com/en_US/guides-and-manuals/detail.page?DocID=UM008281">http://support.lenovo.com/en_US/guides-and-manuals/detail.page?DocID=UM008281</a></p>					





<p>Name <b>P24q Wide Flat Panel Monitor</b>                  Case color <b>Black</b>                  Type-model <b>61A5GAR3US / 61A5GAT3EU</b>                  Panel TFT-LCD, IPS (In-Plane Switching), White LED backlight                  Viewable image size <b>23.8" (604.5mm) diagonal</b>                  Max view area (W x H) <b>20.74" x 11.67" (526.85mm x 296.35mm)</b>                  Optimum resolution <b>2560x1440</b>                  Max pixel rate <b>300MHz</b>                  Aspect ratio <b>16:9</b>                  Pixel pitch (mm) <b>0.2058 x 0.2058mm</b>                  Dot/Pixel per Inch <b>123 dpi</b>                  Brightness <b>300 nits or cd/m<sup>2</sup> (typical)</b>                  Contrast ratio <b>1000:1 (typical)</b>                  Pixel response time <b>4ms</b>                  Color gamut <b>99% sRGB</b>                  Viewing angle at 10:1 CR <b>178° horizontal, 178° vertical</b>                  Stand <b>Tilt, swivel, pivot, and height adjustable stand</b>                  Bezel width <b>Sides: 0.08" (2mm)</b>                  Dimensions (HxWxD, including stand) <b>373.4mm H x 540.2mm W x 261.75mm D</b>                  Power supply <b>24 watts typical, 67 watts maximum (with USB), &lt;0.5 watts sleep/off; &lt;0.5 watts switch off integrated (no external brick-like power supply)</b>                  Weight <b>12.35 lb; 5.6kg (including stand)</b>                  Limited warranty <b>3 year</b>                  Available date <b>January 2017</b></p>	<p><b>Features</b></p> <ul style="list-style-type: none"> <li>• 23.8-inch IPS LED backlight monitor</li> <li>• Supports 2560x1440 resolution</li> <li>• 5-Ports USB hub, support USB 3.0</li> <li>• Support ThinkCentre Tiny</li> <li>• Supports optional soundbar</li> <li>• Microsoft® Windows® 7 certified</li> <li>• Microsoft Windows 10 certified</li> </ul>						
<p>VESA-compliant <b>VESA DDC2B/CI</b>                  Power management <b>ENERGY STAR® 7.0</b>                  Ergonomics <b>ISO 9241-307</b>                  Emission standards <b>FCC Class B</b>                  Environmental <b>TCO Displays 7.0, RoHS, EPEAT™ Silver rating, ULE Gold</b></p>	<div style="text-align: center;">  <p><b>ThinkVision P24q Monitor</b></p> </div>						
<p>Preset resolutions                  VGA: 640x480, 720x400                  SVGA: 800x600                  XGA: 1024x768                  SXGA: 1280x1024                  WXGA: 1366x768                  WXGA+: 1440x900, 1600x900                  WSXGA+: 1680x1050                  Full HD: 1920x1080, 1920x1200                  QHD: 2560x1440</p> <p>Presets / user settings Standard presets: 20; user settings: 24</p>							
<p>Viewing adjustments <i>Tilt: 30° back, -5° forward; lift: 4.33" (110mm); swivel: +/-45°</i>                  Rotating screen <b>Screen pivots 90 degrees from landscape to portrait</b>                  On screen display <b>On screen display with digital user controls (8 languages)</b>                  Control features <b>Direct access for menu, source switch, and brightness</b>                  USB hub <b>USB Hub: one USB 3.0 upstream port, four USB 3.0 downstream ports</b>                  Multimedia <b>Audio-out, optional sound bar supported</b>                  Camera <b>None</b>                  Multiple input <b>Support HDMI, DisplayPort, mini DisplayPort, DisplayPort-out</b>                  Monitor connectors <b>(1) 2*HDMI (1.4), digital, HDCP-compliant                  (2) DisplayPort (1.2), digital, HDCP-compliant                  (3) Mini DisplayPort, digital, HDCP-compliant</b>                  Signal cables <b>(1) detachable, mini DisplayPort to DisplayPort, digital, 1.8 meter</b>                  Mounting features <b>Wall or desk mounting using the Extend Arm or third-party accessories meeting the VESA FPMPI® (100mm mount)</b>                  Security <b>Security keyhole for attachment of optional cable lock (Kensington® lock-compatible)</b></p>							
<p>Ship group <b>Monitor, detachable stand, Quick start and safety poster, 1.8 meter USB 3.0 cable, 1.8 meter mini DP to DP cable, 1.8 meter black power cord</b></p>	<p><b>Limited Warranty</b></p> <p>See details at <a href="http://support.lenovo.com/en_US/guides-and-manuals/detail.page?DocID=UM008281">http://support.lenovo.com/en_US/guides-and-manuals/detail.page?DocID=UM008281</a></p> <p><b>Accessories</b></p> <table border="0"> <tr> <td>Kensington MicroSaver Cable Lock</td> <td>73P2582</td> </tr> <tr> <td>Kensington Twin Head Cable Lock</td> <td>45K1620</td> </tr> <tr> <td>Lenovo Security Cable Lock</td> <td>57Y4303</td> </tr> </table> <p>See details at <a href="http://www.lenovo.com/support/monitoraccessories">www.lenovo.com/support/monitoraccessories</a></p> <p>See all monitors at <a href="http://www.lenovo.com/thinkvision">www.lenovo.com/thinkvision</a></p>	Kensington MicroSaver Cable Lock	73P2582	Kensington Twin Head Cable Lock	45K1620	Lenovo Security Cable Lock	57Y4303
Kensington MicroSaver Cable Lock	73P2582						
Kensington Twin Head Cable Lock	45K1620						
Lenovo Security Cable Lock	57Y4303						



# ThinkVision® S22e-19

## DISPLAY

### Panel Size

21.5 inch

### Screen Dimensions (H x V) (mm)

476.06 (H) × 267.79 (V)

### Panel Type

VA

### Backlight

WLED

### Aspect Ratio

16:9

### Resolution

1920 x 1080

### Pixel Pitch (H x V) (mm)

0.2480 × 0.2480

### Viewing Angle (H x V)

178°/178°

### Response Time (gray to gray)

4 ms (extreme mode)  
6 ms (normal mode)

### Contrast Ratio (typical)

3000:1

### Dynamic Contrast Ratio (typical)

3M:1

### Color Gamut NTSC (CIE 1931)

72%

### Color Support (typical)

16.7M

## CONNECTIVITY

### Video Input Signals

VGA + HDMI1.4

### Video Cable Length

1.8 m

### Audio Out

Yes (3.5 mm)

## MULTI-MEDIA

### Optional Soundbar Support

Yes

## DIMENSIONS

### Size Packed (D x H x W) (mm/inch)

120 x 350 x 582 mm / 4.7 x 13.7 x 22.9 inch

### Size Unpacked w/stand (D x H x W) (mm/inch) (Lowest Position)

200.0 x 373.8 x 489.3 mm / 7.87 x 14.71 x 19.26 inch

### Size Unpacked w/stand (D x H x W) (mm/inch) (Highest Position)

200.0 x 373.8 x 489.3 mm / 7.87 x 14.71 x 19.26 inch

### Size Unpacked w/o stand (D x H x W) (mm/inch) (Head Only)

41.5 x 296.8 x 489.3 mm / 1.63 x 11.68 x 19.26 inch

### Weight Packed (kg/lbs.)

4.07kg / 8.97 lbs.

### Weight Unpacked (kg/lbs.)

2.75kg / 6.06 lbs.

### Weight (Monitor Head Only) (kg/lbs.)

2.46kg / 5.42 lbs.

## SPECIAL FEATURES

### Anti-Glare

Yes

### Thin Client Support (Tiny)

Yes (by VESA mount PN:4XF0N03161)

## MECHANICAL

### Tilt Angle (front / back)

-5°/22°

### VESA Mount

Yes (100 mm)

### Kensington™ Lock Slot

Yes

### Cable Management

Yes

### Bezel Color

Raven Black

### Bezel Width (side)

2.0 mm

### Bezel Width (top / bottom)

2.0 mm / 21.2 mm

## WHAT'S IN THE BOX

Monitor with stand

1 x HDMI Cable

1 x Power Cable

Quick setup guide

## CERTIFICATIONS

### ENERGY STAR Rating

7.0

### CCC

Yes

### TCO

TCO 7.0/TCO Edge 2.0

### EPEAT™

Gold

### RoHS

Yes

### Windows Certification

Windows 7, Windows 10

### China Energy Efficiency Standard

Tier 2

### Ambient Operating Temperature

0°C to 40°C

### Low Blue Light

Yes



© 2018 Lenovo. All rights reserved. These products are available while supplies last. Prices shown are subject to change without notice. For any questions concerning price, please contact your Lenovo Account Executive. Lenovo is not responsible for photographic or typographic errors. Warranty: For a copy of applicable warranties, write to: Warranty Information, 500 Park Offices Drive, RTP, NC 27709, Attn: Dept. ZPYA/B600. Lenovo makes no representation or warranty regarding third-party products or services. Trademarks: Lenovo, the Lenovo logo, Rescue and Recovery, ThinkPad, ThinkCentre, ThinkStation, ThinkVantage, and ThinkVision are trademarks or registered trademarks of Lenovo. Microsoft, Windows, and Vista are registered trademarks of Microsoft Corporation. Intel, the Intel logo, Intel Inside, Intel Core, and Core Inside are trademarks of Intel Corporation in the U.S. and/or other countries. Other company, product, and service names may be trademarks or service marks of others.

Specifications may vary depending upon region.

Lenovo™



# ThinkVision® S24e-10

## DISPLAY

### Panel Size

23.8"

### Screen Dimensions (H x V) (mm)

527.04 (H) × 296.46 (V)

### Panel Type

VA

### Backlight

WLED

### Aspect Ratio

16:9

### Resolution

1920 × 1080

### Pixel Pitch (H x V) (mm)

0.2745 × 0.2745

### Viewing Angle (H x V)

178°/178°

### Response Time (gray to gray)

4 ms (extreme mode)  
6 ms (normal mode)

### Contrast Ratio (typical)

3000:1

### Dynamic Contrast Ratio (typical)

3M:1

### Color Gamut NTSC (CIE 1931)

72%

### Color Support

16.7M

## CONNECTIVITY

### Video Input Signals

VGA + HDMI 1.4

### Video Cable Length

1.8 m

### Audio Out

Yes (3.5 mm)

## MULTI-MEDIA

### Optional Soundbar Support

Yes

## DIMENSIONS

### Size Packed (D x H x W) (mm/inch)

122 × 405 × 639 mm / 4.80 × 15.94 × 25.16 inch

### Size Unpacked w/stand (D x H x W) (mm/inch) (Lowest Position)

200.0 × 402.7 × 539.5 mm / 7.87 × 15.85 × 21.24 inch

### Size Unpacked w/stand (D x H x W) (mm/inch) (Highest Position)

200.0 × 402.7 × 539.5 mm / 7.87 × 15.85 × 21.24 inch

### Size Unpacked w/o stand (D x H x W) (mm/inch) (Head Only)

41.5 × 325.7 × 539.5 mm / 1.63 × 12.82 × 21.24 inch

### Weight Packed (kg/lbs.)

4.84kg / 10.67 lbs.

### Weight Unpacked (kg/lbs.)

3.36kg / 7.41 lbs.

### Weight (Monitor Head Only) (kg/lbs.)

3.07kg / 6.77 lbs.

## SPECIAL FEATURES

### Anti-Glare

Yes

### Thin Client Support (Tiny)

Yes (by VESA mount PN:4XFON03161)

## MECHANICAL

### Tilt Angle (front/back)

-5° / 22°

### VESA Mount

Yes (100 mm)

### Kensington™ Lock Slot

Yes

### Cable Management

Yes

### Bezel Color

Raven Black

### Bezel Width (Side)

2.0 mm

### Bezel Width (top / bottom)

2.0 mm / 22 mm

## WHAT'S IN THE BOX

Monitor with stand

1 x HDMI Cable

1 x Power Cable

Quick setup guide

## CERTIFICATIONS

### ENERGY STAR Rating

7.0

### CCC

Yes

### EPEAT™

Gold

### ULE

Gold

### RoHS

Yes

### Windows Certification

Windows 7, Windows 10

### China Energy Efficiency Standard

Tier 2

### Ambient Operating Temperature

0 to 40°C

### Low Blue Light

Yes



© 2018 Lenovo. All rights reserved. These products are available while supplies last. Prices shown are subject to change without notice. For any questions concerning price, please contact your Lenovo Account Executive. Lenovo is not responsible for photographic or typographic errors. Warranty: For a copy of applicable warranties, write to: Warranty Information, 500 Park Offices Drive, RTP, NC 27709, Attn: Dept. ZPYA/B600. Lenovo makes no representation or warranty regarding third-party products or services. Trademarks: Lenovo, the Lenovo logo, Rescue and Recovery, ThinkPad, ThinkCentre, ThinkStation, ThinkVantage, and ThinkVision are trademarks or registered trademarks of Lenovo. Microsoft, Windows, and Vista are registered trademarks of Microsoft Corporation. Intel, the Intel logo, Intel Inside, Intel Core, and Core Inside are trademarks of Intel Corporation in the U.S. and/or other countries. Other company, product, and service names may be trademarks or service marks of others.

Specifications may vary depending upon region.

Lenovo™





<p>Name <b>T2224d Wide Flat Panel Monitor</b>                  Bezel color <b>Black</b>                  Type-model <b>61B1JAR1US / 61B1JAT1EU</b>                  Panel TFT-LCD, In-Plane Switching (IPS), White LED backlight                  Viewable image size <b>21.5" (546mm) diagonal</b>                  Max view area (W x H) <b>18.74" x 10.54" (476.1mm x 267.8mm)</b>                  Native resolution <b>1920x1080</b>                  Aspect ratio 16:9                  Pixel pitch (mm) 0.248 x 0.248 mm                  Dot/Pixel per Inch 102 dpi                  Brightness 250 nits or cd/m<sup>2</sup> (typical)                  Contrast ratio 1000:1 (typical)                  Pixel response time 7ms (typical); 4ms (extreme mode)                  Color gamut 72%                  Viewing angle at 10:1 CR 178° (+/- 89°) horizontal, 178° (+/- 89°) vertical                  Stand Tilt stand                  Bezel width <i>Sides:</i> 0.69" (17.6mm)                  Dimensions (HxWxD) 15.02" H x 20.19" W x 8.06" D;                  381.4mm H x 512.9mm W x 204.9mm D                  Power supply 20 watts typical,                  25 watts maximum                  &lt;0.5 watts standby/suspend, universal, integrated (no external brick-like power supply)                  Weight 6.48 lb; 2.94 kg                  Limited warranty <b>3 year</b> (includes backlight)                  Available date March 2017</p>	<p style="text-align: center;"><b>Features</b></p> <ul style="list-style-type: none"> <li>• Widescreen 21.5-inch monitor</li> <li>• Supports 1920x1080 resolution</li> <li>• Supports optional soundbar</li> <li>• Supports ThinkCentre Tiny via VESA back mount</li> <li>• Includes dual input connection for attachment to two systems concurrently (analog and digital)</li> <li>• EPEAT Gold certified</li> <li>• Microsoft® Windows® 7 certified</li> <li>• Microsoft Windows 10 certified</li> </ul>				
<p>VESA-compliant VESA DDC2B/CI                  Power management ENERGY STAR® qualified                  Ergonomics ISO 9241-307                  Emission standards FCC Class B                  Environmental TCO Displays 7.0, TCO Certified Edge 2.0, WEEE, RoHS, <b>EPEAT™ Silver rating</b></p>	<div style="text-align: center;">  <p><b>ThinkVision T2224d Wide Monitor</b></p> </div>				
<p>Preset resolutions                  VGA: 640x350, 640x480, 720x400                  SVGA: 800x600                  XGA: 1024x768, 1152x864                  SXGA: 1280x1024                  WXGA: 1280x768, 1280x800, 1366x768                  WXGA+: 1440x900                  WSXGA+: 1680x1050                  Full HD: 1920x1080                  Presets / user settings Standard presets: 22; user settings: 22</p>					
<p>Viewing adjustments <i>Tilt:</i> 22° back, -5° forward                  Rotating screen None                  On screen display On screen display with digital user controls (8 languages)                  Control features Direct access (buttons on front) for automatic image setup, dual input and brightness                  USB hub None                  Multiple input Dual input (two different PCs attach to two different connectors; one PC shows image; select via button)                  Monitor connectors (1) VGA 15-pin D-shell, analog, blue                  (2) DisplayPort, digital, black, <b>HDCP-compliant</b>                  Signal cables (1) detachable, VGA 15-pin D-shell at each end, analog, 1.8 meter                  (2) detachable, DisplayPort at each end, digital, 1.8 meter                  Mounting features Wall or desk mounting using the Extend Arm or third-party accessories, 100mm x 100mm mount                  Security Security keyhole for attachment of optional cable lock (Kensington® lock-compatible)</p>					
<p>Ship group Monitor with stand, Safety and Warranty Information, 1.8 meter analog signal cable, 1.8 meter DP signal cable, 1.8 meter black power cord</p>					
<p style="text-align: center;"><b>Limited Warranty</b></p> <p>See details at <a href="http://support.lenovo.com/en_US/guides-and-manuals/detail.page?DocID=UM008281">http://support.lenovo.com/en_US/guides-and-manuals/detail.page?DocID=UM008281</a></p>	<p style="text-align: center;"><b>Accessories</b></p> <table border="0" style="width: 100%;"> <tr> <td>Kensington MicroSaver Cable Lock</td> <td style="text-align: right;">73P2582</td> </tr> <tr> <td>Kensington Twin Head Cable Lock</td> <td style="text-align: right;">45K1620</td> </tr> </table> <p>See details at <a href="http://www.lenovo.com/support/monitoraccessories">www.lenovo.com/support/monitoraccessories</a></p> <p>See all monitors at <a href="http://www.lenovo.com/thinkvision">www.lenovo.com/thinkvision</a></p>	Kensington MicroSaver Cable Lock	73P2582	Kensington Twin Head Cable Lock	45K1620
Kensington MicroSaver Cable Lock	73P2582				
Kensington Twin Head Cable Lock	45K1620				



<p>Name <b>T2254 Wide Flat Panel Monitor</b>                  Bezel color <b>Raven black</b>                  Type-model <b>60F6HAR1EU</b>                  Panel <b>TFT-LCD, twisted nematic (TN), White LED backlight</b>                  Viewable image size <b>22.0" (559mm) diagonal</b>                  Max view area (W x H) <b>18.70" x 11.70" (473.8mm x 296.1mm)</b>                  Native resolution <b>1680x1050</b>                  Aspect ratio <b>16:10</b>                  Pixel pitch (mm) <b>0.282 x 0.282 mm</b>                  Dot/Pixel per Inch <b>90 dpi</b>                  Brightness <b>250 nits or cd/m<sup>2</sup> (typical)</b>                  Contrast ratio <b>1000:1 (typical)</b>                  Pixel response time <b>5ms (typical)</b>                  Color gamut <b>72%</b>                  Viewing angle at 10:1 CR <b>170° (+/- 85°) horizontal, 160° (+/- 80°) vertical</b>                  Stand <b>Tilt and height adjustable stand</b>                  Bezel width <b>Sides: 0.67" (17mm)</b>                  Dimensions (HxWxD) <b>14.97" H x 20.05" W x 9.61" D;                  380.2mm H x 509.3mm W x 244.2mm D</b>                  Power supply <b>16 watts typical,                  22 watts maximum,                  &lt;0.5 watts standby/suspend, universal,                  integrated (no external brick-like power supply)</b>                  Weight <b>10.38 lb; 4.71 kg</b>                  Limited warranty <b>3 year (includes backlight)</b>                  Available date <b>March 2015</b></p>	<p style="text-align: center;"><b>Features</b></p> <ul style="list-style-type: none"> <li>• Widescreen 22.0-inch monitor</li> <li>• Supports 1680x1050 resolution</li> <li>• Supports ThinkCentre Tiny Clamp Bracket</li> <li>• Includes dual input connection for attachment to two systems concurrently (analog and digital)</li> <li>• EPEAT Gold certified</li> <li>• Supports optional soundbar</li> <li>• Microsoft® Windows® 7 certified</li> <li>• Microsoft Windows 8 / Windows 8.1 certified</li> <li>• Microsoft Windows 10 certified</li> </ul>				
<p>VESA-compliant <b>VESA DDC2B/CI</b>                  Power management <b>ENERGY STAR® qualified</b>                  Ergonomics <b>ISO 9241-307</b>                  Emission standards <b>None</b>                  Environmental <b>TCO Displays 7.0, TCO Certified Edge 2.0, WEEE, RoHS, <b>EPEAT™ Gold rating</b></b></p>	<div style="text-align: center;">  <p><b>ThinkVision T2254 Wide Monitor</b></p> </div>				
<p>Preset resolutions <b>VGA: 640x350, 640x480, 720x400                  SVGA: 800x600                  XGA: 1024x768, 1152x864                  SXGA: 1280x1024                  WXGA: 1280x768, 1280x800, 1366x768                  WXGA+: 1440x900                  WSXGA+: 1600x900, 1680x1050</b></p> <p>Presets / user settings <b>Standard presets: 26;                  user settings: 20</b></p>					
<p>Viewing adjustments <b>Tilt: 30° back, -5° forward; lift: 4.3" (110mm)</b>                  Rotating screen <b>None</b>                  On screen display <b>On screen display with digital user controls (8 languages)</b>                  Control features <b>Direct access (buttons on front) for automatic image setup, dual input and brightness</b>                  USB hub <b>None</b>                  Multiple input <b>Dual input (two different PCs attach to two different connectors; one PC shows image; select via button)</b>                  Monitor connectors <b>(1) VGA 15-pin D-shell, analog, blue                  (2) Digital Visual Interface (DVI-D), digital, white, <b>HDCP-compliant</b></b>                  Signal cables <b>(1) detachable, VGA 15-pin D-shell at each end, analog, 1.8 meter                  (2) detachable, DVI-D at each end, digital, 1.8 meter</b>                  Mounting features <b>Wall or desk mounting using the Extend Arm or third-party accessories, 100mm x 100mm mount</b>                  Security <b>Security keyhole for attachment of optional cable lock (Kensington® lock-compatible)</b></p>					
<p>Ship group <b>Monitor with stand, Safety and Warranty Information, 1.8 meter analog signal cable, 1.8 meter DVI-D cable, 1.8 meter black power cord</b></p>	<p style="text-align: center;"><b>Limited Warranty</b></p> <p>See details at <a href="http://support.lenovo.com/en_US/guides-and-manuals/detail.page?DocID=UM008281">http://support.lenovo.com/en_US/guides-and-manuals/detail.page?DocID=UM008281</a></p> <p style="text-align: center;"><b>Accessories</b></p> <table border="0" style="width: 100%;"> <tr> <td>Kensington MicroSaver Cable Lock</td> <td style="text-align: right;">73P2582</td> </tr> <tr> <td>Kensington Twin Head Cable Lock</td> <td style="text-align: right;">45K1620</td> </tr> </table> <p>See details at <a href="http://www.lenovo.com/support/monitoraccessories">www.lenovo.com/support/monitoraccessories</a></p> <p>See all monitors at <a href="http://www.lenovo.com/thinkvision">www.lenovo.com/thinkvision</a></p>	Kensington MicroSaver Cable Lock	73P2582	Kensington Twin Head Cable Lock	45K1620
Kensington MicroSaver Cable Lock	73P2582				
Kensington Twin Head Cable Lock	45K1620				



<p>Name <b>T2254p Wide Flat Panel Monitor</b>                  Bezel color <b>Raven black</b>                  Type-model <b>61BAMAR2US / 60E1MAR2US / 60CCMAR2US / 60CCMAT2EU / 61BAMAT2EU</b>                  Panel TFT-LCD, twisted nematic (TN), White LED backlight                  Viewable image size <b>22.0" (559mm) diagonal</b>                  Max view area (W x H) <b>18.70" x 11.70" (473.8mm x 296.1mm)</b>                  Native resolution <b>1680x1050</b>                  Aspect ratio 16:10                  Pixel pitch (mm) 0.282 x 0.282 mm                  Dot/Pixel per Inch 90 dpi                  Brightness 250 nits or cd/m<sup>2</sup> (typical)                  Contrast ratio 1000:1 (typical)                  Pixel response time 5ms (typical)                  Color gamut 72%                  Viewing angle at 10:1 CR 170° (+/- 85°) horizontal, 160° (+/- 80°) vertical                  Stand Tilt, swivel, pivot, and height adjustable                  Bezel width <b>Sides: 0.67" (17.1mm)</b>                  Dimensions (HxWxD) <b>14.63" H x 20.01" W x 9.55" D;</b>  <b>371.7mm H x 509.3mm W x 242.7mm D</b>                  Power supply 20 watts typical,                  25 watts maximum,                  &lt;0.5 watts standby/suspend, universal,                  integrated (no external brick-like power supply)                  Weight 10.14 lb; 4.60 kg                  Limited warranty <b>3 year</b> (includes backlight)                  Available date March 2015</p>	<p style="text-align: center;"><b>Features</b></p> <ul style="list-style-type: none"> <li>• Widescreen 22.0-inch monitor</li> <li>• Supports 1680x1050 resolution</li> <li>• Supports ThinkCentre Tiny Clamp Bracket</li> <li>• Supports optional soundbar</li> <li>• Includes dual input connection for attachment to two systems concurrently (analog and digital)</li> <li>• EPEAT Gold certified</li> <li>• Microsoft® Windows® 7 certified</li> <li>• Microsoft Windows 8 / Windows 8.1 certified</li> <li>• Microsoft Windows 10 certified</li> </ul>				
<p>VESA-compliant VESA DDC2B/CI                  Power management ENERGY STAR® qualified                  Ergonomics ISO 9241-307                  Emission standards FCC Class B                  Environmental TCO Displays 7.0, TCO Certified Edge 2.0, WEEE, RoHS, <b>EPEAT™ Gold rating</b></p>	<div style="text-align: center;">  <p><b>ThinkVision T2254p Wide Monitor</b></p> </div>				
<p>Preset resolutions                  VGA: 640x350, 640x480, 720x400                  SVGA: 800x600                  XGA: 1024x768, 1152x864                  SXGA: 1280x1024                  WXGA: 1280x768, 1280x800, 1366x768                  WXGA+: 1440x900                  WSXGA+: 1600x900, 1680x1050                  Presets / user settings Standard presets: 28;                  user settings: 20</p>					
<p>Viewing adjustments <i>Tilt:</i> 30° back, -5° forward; <i>lift:</i> 4.3" (110mm); <i>swivel:</i> +/-45°; detachable stand                  Rotating screen Screen pivots 90 degrees from landscape to portrait                  On screen display On screen display with digital user controls (8 languages)                  Control features Direct access (buttons on front) for automatic image setup, dual input and brightness                  USB hub None                  Multiple input Dual input (two different PCs attach to two different connectors; one PC shows image; select via button)                  Monitor connectors (1) VGA 15-pin D-shell, analog, blue                  (2) HDMI (1.4), digital, <b>HDCP-compliant</b>                  (3) DisplayPort, digital, black, <b>HDCP-compliant</b>                  Signal cables (1) detachable, VGA 15-pin D-shell at each end, analog, 1.8 meter                  (2) detachable, DisplayPort at each end, digital, 1.8 meter                  Mounting features Wall or desk mounting using the Extend Arm or third-party accessories, 100mm x 100mm mount                  Security Security keyhole for attachment of optional cable lock (Kensington® lock-compatible)</p>					
<p>Ship group Monitor with stand, Safety and Warranty Information, 1.8 meter analog signal cable, 1.8 meter DP signal cable, 1.8 meter black power cord</p>					
<p style="text-align: center;"><b>Limited Warranty</b></p> <p>See details at <a href="http://support.lenovo.com/en_US/guides-and-manuals/detail.page?DocID=UM008281">http://support.lenovo.com/en_US/guides-and-manuals/detail.page?DocID=UM008281</a></p>	<p style="text-align: center;"><b>Accessories</b></p> <table border="0"> <tr> <td>Kensington MicroSaver Cable Lock</td> <td style="text-align: right;">73P2582</td> </tr> <tr> <td>Kensington Twin Head Cable Lock</td> <td style="text-align: right;">45K1620</td> </tr> </table> <p>See details at <a href="http://www.lenovo.com/support/monitoraccessories">www.lenovo.com/support/monitoraccessories</a></p> <p>See all monitors at <a href="http://www.lenovo.com/thinkvision">www.lenovo.com/thinkvision</a></p>	Kensington MicroSaver Cable Lock	73P2582	Kensington Twin Head Cable Lock	45K1620
Kensington MicroSaver Cable Lock	73P2582				
Kensington Twin Head Cable Lock	45K1620				









<p>Name <b>T22i Wide Flat Panel Monitor</b>                  Bezel color <b>Black</b>                  Type-model <b>61A9MAR1US / 61A9MAT1EU</b>                  Panel TFT-LCD, In-Plane Switching (IPS), White LED backlight                  Viewable image size <b>21.5" (546mm) diagonal</b>                  Max view area (W x H) <b>18.74" x 10.54" (476.1mm x 267.8mm)</b>                  Native resolution <b>1920x1080</b>                  Aspect ratio 16:9                  Pixel pitch (mm) 0.248 x 0.248 mm                  Dot/Pixel per Inch 102 dpi                  Brightness 250 nits or cd/m<sup>2</sup> (typical)                  Contrast ratio 1000:1 (typical)                  Pixel response time 6ms (typical); 4ms (extreme mode)                  Color gamut 72%                  Viewing angle at 10:1 CR 178° (+/- 89°) horizontal, 178° (+/- 89°) vertical                  Stand Tilt, swivel, pivot, and height adjustable stand                  Bezel width <i>Sides:</i> 0.08" (2.0mm)                  Dimensions (HxWxD) 14.08" H x 19.28" W x 9.92" D;                  357.6mm H x 489.7mm W x 251.9mm D                  Power supply 16.5 watts typical,                  55 watts maximum (with USB 3.0 hub),                  &lt;0.5 watts standby/suspend, universal,                  integrated (no external brick-like power supply)                  Weight 10.85 lb; 4.92 kg                  Limited warranty <b>3 year</b> (includes backlight)                  Available date April 2017</p>	<p style="text-align: center;"><b>Features</b></p> <ul style="list-style-type: none"> <li>• Widescreen 21.5-inch monitor</li> <li>• Supports 1920x1080 resolution</li> <li>• Supports optional soundbar</li> <li>• Supports ThinkCentre Tiny via VESA back mount</li> <li>• Includes dual input connection for attachment to two systems concurrently</li> <li>• EPEAT Gold certified</li> <li>• Microsoft® Windows® 7 certified</li> <li>• Microsoft Windows 10 certified</li> </ul>				
<p>VESA-compliant VESA DDC2B/CI                  Power management ENERGY STAR® qualified                  Ergonomics ISO 9241-307                  Emission standards FCC Class B                  Environmental TCO Displays 7.0, TCO Certified Edge 2.0, WEEE, RoHS, <b>EPEAT™ Silver rating</b></p>	<div style="text-align: center;">  <p><b>ThinkVision T22i Wide Monitor</b></p> </div>				
<p>Preset resolutions                  VGA: 640x350, 640x480, 720x400                  SVGA: 800x600                  XGA: 1024x768, 1152x864                  SXGA: 1280x1024                  WXGA: 1280x768, 1366x768                  WXGA+: 1440x900, 1680x900                  WSXGA+: 1680x1050                  Full HD: 1920x1080                  Presets display modes HDMI: 17; DP: 17</p>					
<p>Viewing adjustments <i>Tilt:</i> 30° back, -5° forward; <i>lift:</i> 4.3" (110mm); <i>swivel:</i> +/-45°; detachable stand                  Rotating screen Screen pivots 90 degrees from landscape to portrait                  On screen display On screen display with digital user controls (8 languages)                  Control features Direct access (buttons on front) for power, menu, input source select and brightness                  USB hub USB 3.0 Hub: 1 port into PC (USB 3.0); 4 ports for accessories (4 USB 3.0)                  Multiple input Dual input (two different PCs attach to two different connectors; one PC shows image; select via button)                  Monitor connectors (1) VGA 15-pin D-shell, analog, blue                  (2) HDMI (1.4), digital, <b>HDCP-compliant</b>                  (3) DisplayPort, digital, black, <b>HDCP-compliant</b>                  Signal cables (1) detachable, VGA 15-pin D-shell at each end, analog, 1.8 meter                  (2) detachable, DisplayPort at each end, digital, 1.8 meter                  Mounting features Wall or desk mounting using the Extend Arm or third-party accessories, 100mm x 100mm mount                  Security Security keyhole for attachment of optional cable lock (Kensington® lock-compatible)</p>					
<p>Ship group Monitor with stand, Safety and Warranty Information, 1.8 meter analog signal cable, 1.8 meter DP signal cable, 1.8 meter USB signal cable, 1.8 meter black power cord</p>					
<p style="text-align: center;"><b>Limited Warranty</b></p> <p>See details at <a href="http://support.lenovo.com/en_US/guides-and-manuals/detail.page?DocID=UM008281">http://support.lenovo.com/en_US/guides-and-manuals/detail.page?DocID=UM008281</a></p>	<p style="text-align: center;"><b>Accessories</b></p> <table border="0"> <tr> <td>Kensington MicroSaver Cable Lock</td> <td style="text-align: right;">73P2582</td> </tr> <tr> <td>Kensington Twin Head Cable Lock</td> <td style="text-align: right;">45K1620</td> </tr> </table> <p>See details at <a href="http://www.lenovo.com/support/monitoraccessories">www.lenovo.com/support/monitoraccessories</a></p> <p>See all monitors at <a href="http://www.lenovo.com/thinkvision">www.lenovo.com/thinkvision</a></p>	Kensington MicroSaver Cable Lock	73P2582	Kensington Twin Head Cable Lock	45K1620
Kensington MicroSaver Cable Lock	73P2582				
Kensington Twin Head Cable Lock	45K1620				

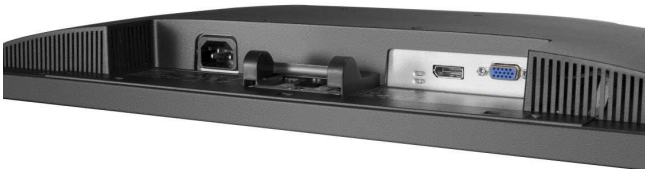

<p>Name <b>T22v Wide Flat Panel Monitor</b>                  Bezel color <b>Black</b>                  Type-model <b>61BBMAR6US / 61BBMAT6EU</b>                  Panel TFT-LCD, In-Plane Switching (IPS), White LED backlight                  Viewable image size <b>21.5" (546mm) diagonal</b>                  Max view area (W x H) <b>18.74" x 10.54" (476.1mm x 267.8mm)</b>                  Native resolution <b>1920x1080</b>                  Aspect ratio 16:9                  Pixel pitch (mm) 0.248 x 0.248 mm                  Dot/Pixel per Inch 102 dpi                  Brightness 250 nits or cd/m<sup>2</sup> (typical)                  Contrast ratio 1000:1 (typical)                  Pixel response time 6ms (typical); 4ms (extreme mode)                  Color gamut 72%                  Viewing angle at 10:1 CR 178° (+/- 89°) horizontal, 178° (+/- 89°) vertical                  Stand Tilt, swivel, pivot, and height adjustable stand                  Bezel width <i>Sides:</i> 0.08" (2.0mm)                  Dimensions (HxWxD) 19.14" H x 19.28" W x 9.92" D;                  485.8mm H x 489.7mm W x 251.9mm D                  Power supply 18 watts typical,                  43 watts maximum (with USB 3.0 hub),                  &lt;0.5 watts standby/suspend, universal,                  integrated (no external brick-like power supply)                  Weight 10.16 lb; 4.61 kg                  Limited warranty <b>3 year</b> (includes backlight)                  Available date October 2017</p>	<p style="text-align: center;"><b>Features</b></p> <ul style="list-style-type: none"> <li>• Widescreen 21.5-inch monitor</li> <li>• Supports 1920x1080 resolution</li> <li>• Supports optional soundbar</li> <li>• Supports ThinkCentre Tiny via VESA back mount</li> <li>• EPEAT Gold certified</li> <li>• Microsoft® Windows® 7 certified</li> <li>• Microsoft Windows 10 certified</li> </ul>
<p>VESA-compliant VESA DDC2B/CI                  Power management ENERGY STAR® qualified                  Ergonomics ISO 9241-307                  Emission standards FCC Class B                  Environmental TCO Displays 7.0, TCO Certified Edge 2.0, WEEE, RoHS, <b>EPEAT™ Silver rating</b></p>	<div style="text-align: center;">  <p><b>ThinkVision T22v Wide Monitor</b></p> </div>
<p>Preset resolutions                  VGA: 640x480, 720x400                  SVGA: 800x600, 832x624                  XGA: 1024x768, 1152x864                  SXGA: 1280x1024                  WXGA+: 1440x900, 1600x900                  WSXGA+: 1680x1050                  Full HD: 1920x1080                  Presets display modes Presets: 24; user modes: 20</p>	
<p>Viewing adjustments <i>Tilt:</i> 30° back, -5° forward; <i>lift:</i> 4.3" (110mm); <i>swivel:</i> +/-45°; detachable stand                  Rotating screen Screen pivots 90 degrees from landscape to portrait                  On screen display On screen display with digital user controls (8 languages)                  Control features Direct access for power, menu, input source select, volume up / down, speaker mute and microphone mute                  USB hub USB 3.0 Hub: 1 port into PC (USB 3.0); 2 ports for accessories (2 USB 3.0)                  Multimedia Integrated speakers, dual-array microphone, audio-in and Audio-out, optional sound bar supported                  Camera Integrated FHD camera with IR                  Multiple input Support HDMI, DisplayPort, VGA                  Monitor connectors (1) VGA 15-pin D-shell, analog, blue                  (2) HDMI (1.4), digital, <b>HDCP-compliant</b>                  (3) DisplayPort, digital, black, <b>HDCP-compliant</b>                  Signal cables (1) detachable, VGA 15-pin D-shell at each end, analog, 1.8 meter                  (2) detachable, DisplayPort at each end, digital, 1.8 meter                  Mounting features Wall or desk mounting using the Extend Arm or third-party accessories, 100mm x 100mm mount                  Security Security keyhole for attachment of optional cable lock (Kensington® lock-compatible)</p>	
<p>Ship group Monitor with stand, Safety and Warranty Information, 1.8 meter analog signal cable, 1.8 meter DP signal cable, 1.8 meter USB signal cable, 1.8 meter black power cord, 1.8 meter HDMI signal cable (Row)</p>	

<p style="text-align: center;"><b>Limited Warranty</b></p> <p>See details at <a href="http://support.lenovo.com/en_US/guides-and-manuals/detail.page?DocID=UM008281">http://support.lenovo.com/en_US/guides-and-manuals/detail.page?DocID=UM008281</a></p>	<p style="text-align: center;"><b>Accessories</b></p> <table border="0"> <tr> <td>Kensington MicroSaver Cable Lock</td> <td style="text-align: right;">73P2582</td> </tr> <tr> <td>Kensington Twin Head Cable Lock</td> <td style="text-align: right;">45K1620</td> </tr> </table> <p>See details at <a href="http://www.lenovo.com/support/monitoraccessories">www.lenovo.com/support/monitoraccessories</a></p> <p>See all monitors at <a href="http://www.lenovo.com/thinkvision">www.lenovo.com/thinkvision</a></p>	Kensington MicroSaver Cable Lock	73P2582	Kensington Twin Head Cable Lock	45K1620
Kensington MicroSaver Cable Lock	73P2582				
Kensington Twin Head Cable Lock	45K1620				



<p>Name <b>T2324d Wide Flat Panel Monitor</b>                  Bezel color <b>Black</b>                  Type-model <b>60F3JAR2US / 60F3JAT2EU</b>                  Panel <b>TFT-LCD, twisted nematic (TN), White LED backlight</b>                  Viewable image size <b>23.0" (584mm) diagonal</b>                  Max view area (W x H) <b>20.07" x 11.29" (509.8mm x 286.7mm)</b>                  Native resolution <b>1920x1080</b>                  Aspect ratio <b>16:9</b>                  Pixel pitch (mm) <b>0.2655 x 0.2655 mm</b>                  Dot/Pixel per Inch <b>96 dpi</b>                  Brightness <b>250 nits or cd/m<sup>2</sup> (typical)</b>                  Contrast ratio <b>1000:1 (typical)</b>                  Pixel response time <b>5ms (typical)</b>                  Color gamut <b>72%</b>                  Viewing angle at 10:1 CR <b>170° (+/- 85°) horizontal, 160° (+/- 80°) vertical</b>                  Stand <b>Tilt stand</b>                  Bezel width <b>Sides: 0.68" (17.3mm)</b>                  Dimensions (HxWxD) <b>15.75" H x 21.48" W x 8.06" D;                  400.3mm H x 545.8mm W x 204.9mm D</b>                  Power supply <b>20 watts typical,                  27 watts maximum                  &lt;0.3 watts standby/suspend, universal,                  integrated (no external brick-like power supply)</b>                  Weight <b>7.06 lb; 3.20 kg</b>                  Limited warranty <b>3 year (includes backlight)</b>                  Available date <b>June 2016</b></p>	<p style="text-align: center;"><b>Features</b></p> <ul style="list-style-type: none"> <li>• Widescreen 23.0-inch monitor</li> <li>• Supports 1920x1080 resolution</li> <li>• Supports optional soundbar</li> <li>• Supports ThinkCentre Tiny via VESA back mount</li> <li>• Includes dual input connection for attachment to two systems concurrently (analog and digital)</li> <li>• EPEAT Gold certified</li> <li>• Microsoft® Windows® 7 certified</li> <li>• Microsoft Windows 10 certified</li> </ul>				
<p>VESA-compliant <b>VESA DDC2B/CI</b>                  Power management <b>ENERGY STAR® qualified</b>                  Ergonomics <b>ISO 9241-307</b>                  Emission standards <b>FCC Class B</b>                  Environmental <b>TCO Displays 7.0, TCO Certified Edge 2.0, WEEE,                  RoHS, EPEAT™ Gold rating</b></p>	<div style="text-align: center;">  <p><b>ThinkVision T2324d Wide Monitor</b></p> </div>				
<p>Preset resolutions <b>VGA: 640x350, 640x480, 720x400                  SVGA: 800x600                  XGA: 1024x768, 1152x864                  SXGA: 1280x1024                  WXGA: 1280x768, 1280x800, 1366x768                  WXGA+: 1440x900                  WSXGA+: 1680x1050                  Full HD: 1920x1080</b></p> <p>Presets / user settings <b>Standard presets: 26; user settings: 16</b></p>					
<p>Viewing adjustments <b>Tilt: 22° back, -5°</b>                  Rotating screen <b>None</b>                  On screen display <b>On screen display with digital user controls (8 languages)</b>                  Control features <b>Direct access (buttons on front) for automatic image setup, dual input and brightness</b>                  USB hub <b>None</b>                  Multiple input <b>Dual input (two different PCs attach to two different connectors; one PC shows image; select via button)</b>                  Monitor connectors <b>(1) VGA 15-pin D-shell, analog, blue                  (2) DisplayPort, digital, black, <b>HDCP-compliant</b></b>                  Signal cables <b>(1) detachable, VGA 15-pin D-shell at each end, analog, 1.8 meter                  (2) detachable, DisplayPort at each end, digital, 1.8 meter</b>                  Mounting features <b>Wall or desk mounting using the Extend Arm or third-party accessories, 100mm x 100mm mount</b>                  Security <b>Security keyhole for attachment of optional cable lock (Kensington® lock-compatible)</b></p>					
<p>Ship group <b>Monitor with stand, Safety and Warranty Information, 1.8 meter analog signal cable, 1.8 meter DP signal cable, 1.8 meter black power cord</b></p>	<p style="text-align: center;"><b>Limited Warranty</b></p> <p>See details at <a href="http://support.lenovo.com/en_US/guides-and-manuals/detail.page?DocID=UM008281">http://support.lenovo.com/en_US/guides-and-manuals/detail.page?DocID=UM008281</a></p> <p style="text-align: center;"><b>Accessories</b></p> <table border="0" style="width: 100%;"> <tr> <td>Kensington MicroSaver Cable Lock</td> <td style="text-align: right;">73P2582</td> </tr> <tr> <td>Kensington Twin Head Cable Lock</td> <td style="text-align: right;">45K1620</td> </tr> </table> <p>See details at <a href="http://www.lenovo.com/support/monitoraccessories">www.lenovo.com/support/monitoraccessories</a></p> <p>See all monitors at <a href="http://www.lenovo.com/thinkvision">www.lenovo.com/thinkvision</a></p>	Kensington MicroSaver Cable Lock	73P2582	Kensington Twin Head Cable Lock	45K1620
Kensington MicroSaver Cable Lock	73P2582				
Kensington Twin Head Cable Lock	45K1620				







<p>Name <b>T23d-10 Wide Flat Panel Monitor</b>                  Bezel color <b>Black</b>                  Type-model <b>61C3MAR6US / 61C3MAT6EU</b>                  Panel TFT-LCD, In-Plane Switching (IPS), White LED backlight</p> <p>Viewable image size <b>22.5" (571.5mm) diagonal</b>                  Max view area (W x H) <b>19.5" x 12.4" (496.2mm x 313.9mm)</b>                  Native resolution <b>1920x1200</b>                  Aspect ratio <b>16:10</b>                  Pixel pitch (mm) <b>0.25 x 0.25 mm</b>                  Dot/Pixel per Inch <b>100.6 dpi</b>                  Brightness <b>250 nits or cd/m<sup>2</sup> (typical)</b>                  Contrast ratio <b>1000:1 (typical)</b>                  Pixel response time <b>6ms (typical)</b>                  Color gamut <b>72%</b>                  Viewing angle at 10:1 CR <b>178° (+/- 89°) horizontal, 178° (+/- 89°) vertical</b>                  Stand <b>Tilt, swivel, pivot, and height adjustable stand</b>                  Bezel width <b>Sides: 0.09" (2.3mm)</b>                  Dimensions (HxWxD) <b>19.37" H x 19.73" W x 9.9" D; 491.9mm H x 501.2mm W x 251.9mm D</b></p> <p>Power supply <b>15 watts typical, 18 watts maximum, &lt;0.3 watts standby/suspend, universal, integrated (no external brick-like power supply)</b></p> <p>Weight <b>10.67 lb; 4.85 kg</b>                  Limited warranty <b>3 year (includes backlight)</b>                  Available date <b>June 2018</b></p>	<p style="text-align: center;"><b>Features</b></p> <ul style="list-style-type: none"> <li>• Widescreen 22.5-inch monitor</li> <li>• Supports 1920x1200 resolution</li> <li>• Supports ThinkCentre Tiny Clamp Bracket</li> <li>• Supports optional soundbar</li> <li>• Includes dual input connection for attachment to two systems concurrently</li> <li>• EPEAT Gold certified</li> <li>• Microsoft® Windows® 7 certified</li> <li>• Microsoft Windows 10 certified</li> </ul>																	
<p>VESA-compliant <b>VESA DDC2B/CI</b>                  Power management <b>ENERGY STAR® qualified</b>                  Ergonomics <b>ISO 9241-307</b>                  Emission standards <b>FCC Class B</b>                  Environmental <b>TCO Displays 7.0, TCO Certified Edge 2.0, WEEE, RoHS, EPEAT™ Silver rating</b></p>	<div style="text-align: center;">  <p><b>ThinkVision T23d-10 Wide Monitor</b></p> </div>																	
<p>Preset resolutions</p> <table border="0"> <tr><td>VGA:</td><td>640x480, 720x400</td></tr> <tr><td>SVGA:</td><td>800x600</td></tr> <tr><td>XGA:</td><td>1024x768</td></tr> <tr><td>SXGA:</td><td>1280x1024</td></tr> <tr><td>WXGA:</td><td>1366x768</td></tr> <tr><td>WXGA+:</td><td>1440x900</td></tr> <tr><td>WSXGA+:</td><td>1680x1050</td></tr> <tr><td>Full HD:</td><td>1920x1080</td></tr> <tr><td>WUXGA:</td><td>1920x1200</td></tr> </table> <p>Presets display modes <b>Standard presets: 27; user settings: 20</b></p>		VGA:	640x480, 720x400	SVGA:	800x600	XGA:	1024x768	SXGA:	1280x1024	WXGA:	1366x768	WXGA+:	1440x900	WSXGA+:	1680x1050	Full HD:	1920x1080	WUXGA:
VGA:	640x480, 720x400																	
SVGA:	800x600																	
XGA:	1024x768																	
SXGA:	1280x1024																	
WXGA:	1366x768																	
WXGA+:	1440x900																	
WSXGA+:	1680x1050																	
Full HD:	1920x1080																	
WUXGA:	1920x1200																	
<p>Viewing adjustments <b>Tilt: 30° back, -5° forward; lift: 4.3" (110mm); swivel: +/-45°; detachable stand</b>                  Rotating screen <b>Screen pivots 90 degrees from landscape to portrait</b>                  On screen display <b>On screen display with digital user controls (8 languages)</b>                  Control features <b>Direct access (buttons on front) for power, menu, input source select and brightness</b>                  USB hub <b>None</b>                  Multiple input <b>Dual input (two different PCs attach to two different connectors; one PC shows image; select via button)</b>                  Monitor connectors <b>(1) VGA 15-pin D-shell, analog, blue                  (2) HDMI (1.4), digital, <b>HDCP-compliant</b>                  (3) DisplayPort, digital, black, <b>HDCP-compliant</b></b>                  Signal cables <b>(1) detachable, VGA 15-pin D-shell at each end, analog, 1.8 meter                  (2) detachable, DisplayPort at each end, digital, 1.8 meter</b>                  Mounting features <b>Wall or desk mounting using the Extend Arm or third-party accessories, 100mm x 100mm mount</b>                  Security <b>Security keyhole for attachment of optional cable lock (Kensington® lock-compatible)</b></p>	<p>Ship group <b>Monitor with stand, Safety and Warranty Information, 1.8 meter analog signal cable, 1.8 meter DP signal cable, 1.8 meter black power cord, 1.8 meter HDMI signal cable (NA only)</b></p>																	
<p style="text-align: center;"><b>Limited Warranty</b></p> <p>See details at <a href="http://support.lenovo.com/en_US/guides-and-manuals/detail.page?DocID=UM008281">http://support.lenovo.com/en_US/guides-and-manuals/detail.page?DocID=UM008281</a></p>	<p style="text-align: center;"><b>Accessories</b></p> <table border="0"> <tr> <td>Kensington MicroSaver Cable Lock</td> <td style="text-align: right;">73P2582</td> </tr> <tr> <td>Kensington Twin Head Cable Lock</td> <td style="text-align: right;">45K1620</td> </tr> </table> <p>See details at <a href="http://www.lenovo.com/support/monitoraccessories">www.lenovo.com/support/monitoraccessories</a></p> <p>See all monitors at <a href="http://www.lenovo.com/thinkvision">www.lenovo.com/thinkvision</a></p>	Kensington MicroSaver Cable Lock	73P2582	Kensington Twin Head Cable Lock	45K1620													
Kensington MicroSaver Cable Lock	73P2582																	
Kensington Twin Head Cable Lock	45K1620																	

Note: The specifications above may not be available in all regions.



<p>Name <b>T23i Wide Flat Panel Monitor</b>                  Bezel color <b>Black</b>                  Type-model <b>61ABMAR1US / 61ABMAT1EU</b>                  Panel TFT-LCD, In-Plane Switching (IPS), White LED backlight                  Viewable image size <b>23" (584.2mm) diagonal</b>                  Max view area (W x H) <b>20.36" x 11.92" (517.2mm x 302.8mm)</b>                  Native resolution <b>1920x1080</b>                  Aspect ratio <b>16:9</b>                  Pixel pitch (mm) <b>0.2652 x 0.2652 mm</b>                  Dot/Pixel per Inch <b>95.8 dpi</b>                  Brightness <b>250 nits or cd/m<sup>2</sup> (typical)</b>                  Contrast ratio <b>1000:1 (typical)</b>                  Pixel response time <b>6ms (typical)</b>                  Color gamut <b>72%</b>                  Viewing angle at 10:1 CR <b>178° (+/- 89°) horizontal, 178° (+/- 89°) vertical</b>                  Stand <b>Tilt, swivel, pivot, and height adjustable stand</b>                  Bezel width <b>Sides: 0.08" (2.0mm)</b>                  Dimensions (HxWxD) <b>13.3" H x 20.56" W x 10.4" D; 337.7mm H x 522.2mm W x 264.2mm D</b>                  Power supply <b>16 watts typical, 45 watts maximum (with USB 3.0 hub), &lt;0.5 watts standby/suspend, universal, integrated (no external brick-like power supply)</b>                  Weight <b>10.85 lb; 4.92 kg</b>                  Limited warranty <b>3 year (includes backlight)</b>                  Available date <b>April 2017</b></p>	<p style="text-align: center;"><b>Features</b></p> <ul style="list-style-type: none"> <li>• Widescreen 23-inch monitor</li> <li>• Supports 1920x1080 resolution</li> <li>• Supports ThinkCentre Tiny Clamp Bracket</li> <li>• Includes dual input connection for attachment to two systems concurrently</li> <li>• EPEAT Gold certified</li> <li>• Microsoft® Windows® 7 certified</li> <li>• Microsoft Windows 10 certified</li> </ul>				
<p>VESA-compliant <b>VESA DDC2B/CI</b>                  Power management <b>ENERGY STAR® qualified</b>                  Ergonomics <b>ISO 9241-307</b>                  Emission standards <b>FCC Class B</b>                  Environmental <b>TCO Displays 7.0, TCO Certified Edge 2.0, WEEE, RoHS, EPEAT™ Silver rating</b></p>	<div style="text-align: center;">  <p><b>ThinkVision T23i Wide Monitor</b></p> </div>				
<p>Preset resolutions <b>VGA: 640x480, 720x400                  SVGA: 800x600                  XGA: 1024x768, 1152x864                  SXGA: 1280x1024                  WXGA+: 1440x900                  WSXGA+: 1680x1050                  Full HD: 1920x1080</b></p> <p>Presets display modes <b>HDMI: 18; DP: 18</b></p>					
<p>Viewing adjustments <b>Tilt: 30° back, -5° forward; lift: 4.3" (110mm); swivel: +/-45°; detachable stand</b>                  Rotating screen <b>Screen pivots 90 degrees from landscape to portrait</b>                  On screen display <b>On screen display with digital user controls (8 languages)</b>                  Control features <b>Direct access (buttons on front) for power, menu, input source select and brightness and automatic image setup</b>                  USB hub <b>USB 3.0 Hub: 1 port into PC (USB 3.0); 4 ports for accessories (4 USB 3.0)</b>                  Multiple input <b>Dual input (two different PCs attach to two different connectors; one PC shows image; select via button)</b>                  Monitor connectors <b>(1) VGA 15-pin D-shell, analog, blue                  (2) HDMI (1.4), digital, <b>HDCP-compliant</b>                  (3) DisplayPort, digital, black, <b>HDCP-compliant</b></b>                  Signal cables <b>(1) detachable, VGA 15-pin D-shell at each end, analog, 1.8 meter                  (2) detachable, DisplayPort at each end, digital, 1.8 meter</b>                  Mounting features <b>Wall or desk mounting using the Extend Arm or third-party accessories, 100mm x 100mm mount</b>                  Security <b>Security keyhole for attachment of optional cable lock (Kensington® lock-compatible)</b></p>	<p>Viewing adjustments <b>Tilt: 30° back, -5° forward; lift: 4.3" (110mm); swivel: +/-45°; detachable stand</b>                  Rotating screen <b>Screen pivots 90 degrees from landscape to portrait</b>                  On screen display <b>On screen display with digital user controls (8 languages)</b>                  Control features <b>Direct access (buttons on front) for power, menu, input source select and brightness and automatic image setup</b>                  USB hub <b>USB 3.0 Hub: 1 port into PC (USB 3.0); 4 ports for accessories (4 USB 3.0)</b>                  Multiple input <b>Dual input (two different PCs attach to two different connectors; one PC shows image; select via button)</b>                  Monitor connectors <b>(1) VGA 15-pin D-shell, analog, blue                  (2) HDMI (1.4), digital, <b>HDCP-compliant</b>                  (3) DisplayPort, digital, black, <b>HDCP-compliant</b></b>                  Signal cables <b>(1) detachable, VGA 15-pin D-shell at each end, analog, 1.8 meter                  (2) detachable, DisplayPort at each end, digital, 1.8 meter</b>                  Mounting features <b>Wall or desk mounting using the Extend Arm or third-party accessories, 100mm x 100mm mount</b>                  Security <b>Security keyhole for attachment of optional cable lock (Kensington® lock-compatible)</b></p>				
<p>Ship group <b>Monitor with stand, Safety and Warranty Information, 1.8 meter analog signal cable, 1.8 meter DP signal cable, 1.8 meter USB signal cable, 1.8 meter black power cord</b></p>					
<p style="text-align: center;"><b>Limited Warranty</b></p> <p>See details at <a href="http://support.lenovo.com/en_US/guides-and-manuals/detail.page?DocID=UM008281">http://support.lenovo.com/en_US/guides-and-manuals/detail.page?DocID=UM008281</a></p>	<p style="text-align: center;"><b>Accessories</b></p> <table border="0"> <tr> <td>Kensington MicroSaver Cable Lock</td> <td style="text-align: right;">73P2582</td> </tr> <tr> <td>Kensington Twin Head Cable Lock</td> <td style="text-align: right;">45K1620</td> </tr> </table> <p>See details at <a href="http://www.lenovo.com/support/monitoraccessories">www.lenovo.com/support/monitoraccessories</a></p> <p>See all monitors at <a href="http://www.lenovo.com/thinkvision">www.lenovo.com/thinkvision</a></p>	Kensington MicroSaver Cable Lock	73P2582	Kensington Twin Head Cable Lock	45K1620
Kensington MicroSaver Cable Lock	73P2582				
Kensington Twin Head Cable Lock	45K1620				



<p>Name <b>T2454p Wide Flat Panel Monitor</b>                  Bezel color <b>Raven black</b>                  Type-model <b>60F9MAR1US / 60F9MAT1EU</b>                  Panel TFT-LCD, In-Plane Switching (IPS), White LED backlight</p> <p>Viewable image size <b>24.0" (609.6mm) diagonal</b>                  Max view area (W x H) <b>20.41" x 12.76" (518.4mm x 324.0mm)</b>                  Native resolution <b>1920x1200</b>                  Aspect ratio <b>16:10</b>                  Pixel pitch (mm) <b>0.270 x 0.270 mm</b>                  Dot/Pixel per Inch <b>94 dpi</b>                  Brightness <b>300 nits or cd/m<sup>2</sup> (typical)</b>                  Contrast ratio <b>1000:1 (typical)</b>                  Pixel response time <b>7ms (typical)</b>                  Color gamut <b>77.4%</b>                  Viewing angle at 10:1 CR <b>178° (+/- 89°) horizontal, 178° (+/- 89°) vertical</b>                  Stand <b>Tilt, swivel, pivot, and height adjustable stand</b>                  Bezel width <b>Sides: 0.74" (18.8mm)</b>                  Dimensions (HxWxD) <b>15.85" H x 21.94" W x 10.39" D; 402.5mm H x 557.4mm W x 264.2mm D</b></p> <p>Power supply <b>24 watts typical, 27 watts maximum (without USB 3.0 hub), 54 watts maximum (with USB 3.0 hub), &lt;0.5 watts standby/suspend, universal, integrated (no external brick-like power supply)</b></p> <p>Weight <b>13.60 lb; 6.15 kg</b>                  Limited warranty <b>3 year (includes backlight)</b>                  Available date <b>March 2015</b></p>	<p style="text-align: center;"><b>Features</b></p> <ul style="list-style-type: none"> <li>• Widescreen 24.0-inch monitor</li> <li>• Supports 1920x1200 resolution</li> <li>• Supports ThinkCentre Tiny Clamp Bracket</li> <li>• Supports optional soundbar</li> <li>• Includes dual input connection for attachment to two systems concurrently (analog and digital)</li> <li>• EPEAT Gold certified</li> <li>• Microsoft® Windows® 7 certified</li> <li>• Microsoft Windows 8 / Windows 8.1 certified</li> <li>• Microsoft Windows 10 certified</li> </ul>				
<p>VESA-compliant <b>VESA DDC2B/CI</b>                  Power management <b>ENERGY STAR® qualified</b>                  Ergonomics <b>ISO 9241-307</b>                  Emission standards <b>FCC Class B</b>                  Environmental <b>TCO Displays 7.0, TCO Certified Edge 2.0, WEEE, RoHS, EPEAT™ Gold rating</b></p> <p>Preset resolutions <b>VGA: 640x350, 640x480, 720x400</b>  <b>SVGA: 800x600</b>  <b>XGA: 1024x768</b>  <b>SXGA: 1280x1024</b>  <b>WXGA: 1280x720, 1280x768, 1280x800</b>  <b>WXGA+: 1440x900</b>  <b>WSXGA+: 1680x1050, 1600x1200</b>  <b>Full HD: 1920x1080, 1920x1200</b></p> <p>Presets / user settings <b>Standard presets: 21; user settings: 20</b></p>	<div style="text-align: center;">  <p><b>ThinkVision T2454p Wide Monitor</b></p> </div>				
<p>Viewing adjustments <b>Tilt: 30° back, -5° forward; lift: 4.3" (110mm); swivel: +/-45°; detachable stand</b>                  Rotating screen <b>Screen pivots 90 degrees from landscape to portrait</b>                  On screen display <b>On screen display with digital user controls (8 languages)</b>                  Control features <b>Direct access (buttons on front) for automatic image setup, dual input and brightness</b>                  USB hub <b>USB 3.0 Hub: 1 port into PC (USB 3.0); 4 ports for accessories (4 USB 3.0)</b>                  Multiple input <b>Dual input (two different PCs attach to two different connectors; one PC shows image; select via button)</b>                  Monitor connectors <b>(1) VGA 15-pin D-shell, analog, blue</b>  <b>(2) HDMI (1.4), digital, <b>HDCP-compliant</b></b>  <b>(3) DisplayPort, digital, black, <b>HDCP-compliant</b></b></p> <p>Signal cables <b>(1) detachable, VGA 15-pin D-shell at each end, analog, 1.8 meter</b>  <b>(2) detachable, DisplayPort at each end, digital, 1.8 meter</b></p> <p>Mounting features <b>Wall or desk mounting using the Extend Arm or third-party accessories, 100mm x 100mm mount</b>                  Security <b>Security keyhole for attachment of optional cable lock (Kensington® lock-compatible)</b></p>					
<p>Ship group <b>Monitor with stand, Safety and Warranty Information, 1.8 meter analog signal cable, 1.8 meter DisplayPort cable, 1.8 meter USB signal cable, 1.8 meter black power cord</b></p>					
<p style="text-align: center;"><b>Limited Warranty</b></p> <p>See details at <a href="http://support.lenovo.com/en_US/guides-and-manuals/detail.page?DocID=UM008281">http://support.lenovo.com/en_US/guides-and-manuals/detail.page?DocID=UM008281</a></p>	<p style="text-align: center;"><b>Accessories</b></p> <table border="0" style="width: 100%;"> <tr> <td>Kensington MicroSaver Cable Lock</td> <td style="text-align: right;">73P2582</td> </tr> <tr> <td>Kensington Twin Head Cable Lock</td> <td style="text-align: right;">45K1620</td> </tr> </table> <p>See details at <a href="http://www.lenovo.com/support/monitoraccessories">www.lenovo.com/support/monitoraccessories</a></p> <p>See all monitors at <a href="http://www.lenovo.com/thinkvision">www.lenovo.com/thinkvision</a></p>	Kensington MicroSaver Cable Lock	73P2582	Kensington Twin Head Cable Lock	45K1620
Kensington MicroSaver Cable Lock	73P2582				
Kensington Twin Head Cable Lock	45K1620				







<p>Name <b>T24d Wide Flat Panel Monitor</b>                  Bezel color <b>Black</b>                  Type-model <b>61B4MAR1US / 61B4MAT1EU</b>                  Panel TFT-LCD, In-Plane Switching (IPS), White LED backlight</p> <p>Viewable image size <b>24" (609.6mm) diagonal</b>                  Max view area (W x H) <b>20.41" x 12.75" (518.4mm x 324mm)</b>                  Native resolution <b>1920x1200</b>                  Aspect ratio <b>16:10</b>                  Pixel pitch (mm) <b>0.27 x 0.27 mm</b>                  Dot/Pixel per Inch <b>94 dpi</b>                  Brightness <b>300 nits or cd/m<sup>2</sup> (typical)</b>                  Contrast ratio <b>1000:1 (typical)</b>                  Pixel response time <b>7ms (typical)</b>                  Color gamut <b>99%</b>                  Viewing angle at 10:1 CR <b>178° (+/- 89°) horizontal, 178° (+/- 89°) vertical</b>                  Stand <b>Tilt, swivel, pivot, and height adjustable stand</b>                  Bezel width <b>Sides: 0.08" (2.0mm)</b>                  Dimensions (HxWxD) <b>19.58" H x 20.99" W x 10.25" D; 497.4mm H x 533.2mm W x 260.4mm D</b></p> <p>Power supply <b>22 watts typical, 64 watts maximum (with USB 3.0 hub), &lt;0.3 watts standby/suspend, universal, integrated (no external brick-like power supply)</b></p> <p>Weight <b>12.41 lb; 5.63 kg</b>                  Limited warranty <b>3 year (includes backlight)</b>                  Available date <b>June 2017</b></p>	<p style="text-align: center;"><b>Features</b></p> <ul style="list-style-type: none"> <li>• Widescreen 24-inch monitor</li> <li>• Supports 1920x1200 resolution</li> <li>• Supports ThinkCentre Tiny Clamp Bracket</li> <li>• Supports optional soundbar</li> <li>• Includes dual input connection for attachment to two systems concurrently</li> <li>• EPEAT Gold certified</li> <li>• Microsoft® Windows® 7 certified</li> <li>• Microsoft Windows 10 certified</li> </ul>				
<p>VESA-compliant <b>VESA DDC2B/CI</b>                  Power management <b>ENERGY STAR® qualified</b>                  Ergonomics <b>ISO 9241-307</b>                  Emission standards <b>FCC Class B</b>                  Environmental <b>TCO Displays 7.0, TCO Certified Edge 2.0, WEEE, RoHS, EPEAT™ Silver rating</b></p> <p>Preset resolutions <b>VGA: 640x480, 720x400                  SVGA: 800x600                  XGA: 1024x768                  SXGA: 1280x1024                  WXGA: 1366x768                  WXGA+: 1440x900                  WSXGA+: 1680x1050                  Full HD: 1920x1080                  WUXGA: 1920x1200</b></p> <p>Presets display modes <b>Standard presets: 22; user settings: 20</b></p>	<div style="text-align: center;">  <p><b>ThinkVision T24d Wide Monitor</b></p> </div>				
<p>Viewing adjustments <b>Tilt: 30° back, -5° forward; lift: 4.3" (110mm); swivel: +/-45°; detachable stand</b>                  Rotating screen <b>Screen pivots 90 degrees from landscape to portrait</b>                  On screen display <b>On screen display with digital user controls (8 languages)</b>                  Control features <b>Direct access (buttons on front) for power, menu, input source select and brightness</b>                  USB hub <b>USB 3.0 Hub: 1 port into PC (USB 3.0); 4 ports for accessories (4 USB 3.0)</b>                  Multiple input <b>Dual input (two different PCs attach to two different connectors; one PC shows image; select via button)</b>                  Monitor connectors <b>(1) VGA 15-pin D-shell, analog, blue                  (2) HDMI (1.4), digital, <b>HDCP-compliant</b>                  (3) DisplayPort, digital, black, <b>HDCP-compliant</b></b></p> <p>Signal cables <b>(1) detachable, VGA 15-pin D-shell at each end, analog, 1.8 meter                  (2) detachable, DisplayPort at each end, digital, 1.8 meter</b></p> <p>Mounting features <b>Wall or desk mounting using the Extend Arm or third-party accessories, 100mm x 100mm mount</b>                  Security <b>Security keyhole for attachment of optional cable lock (Kensington® lock-compatible)</b></p>	<p>Ship group <b>Monitor with stand, Safety and Warranty Information, 1.8 meter analog signal cable, 1.8 meter DP signal cable, 1.8 meter USB signal cable, 1.8 meter black power cord, 1.8 meter HDMI signal cable (NA only)</b></p>				
<p style="text-align: center;"><b>Limited Warranty</b></p> <p>See details at <a href="http://support.lenovo.com/en_US/guides-and-manuals/detail.page?DocID=UM008281">http://support.lenovo.com/en_US/guides-and-manuals/detail.page?DocID=UM008281</a></p>	<p style="text-align: center;"><b>Accessories</b></p> <table border="0"> <tr> <td>Kensington MicroSaver Cable Lock</td> <td style="text-align: right;">73P2582</td> </tr> <tr> <td>Kensington Twin Head Cable Lock</td> <td style="text-align: right;">45K1620</td> </tr> </table> <p>See details at <a href="http://www.lenovo.com/support/monitoraccessories">www.lenovo.com/support/monitoraccessories</a></p> <p>See all monitors at <a href="http://www.lenovo.com/thinkvision">www.lenovo.com/thinkvision</a></p>	Kensington MicroSaver Cable Lock	73P2582	Kensington Twin Head Cable Lock	45K1620
Kensington MicroSaver Cable Lock	73P2582				
Kensington Twin Head Cable Lock	45K1620				



# ThinkVision T24i-10 MONITOR



## SPECIFICATIONS

DISPLAY		DIMENSIONS (W x D x H)	
Panel Size	23.8" Wide	Size Packed	422 x 622 x 190
Panel Type	In-Plane Switchng	(mm)	16.61" x 24.48" x 7.48"
Backlight	WLED	(inches)	
Resolution (H x V)	1920 x 1080	Size Unpacked with Stand	
Aspect Ratio	16:9	Lowest Position	
Anti-Glare	Yes	(mm)	540.2 x 261.75 x 373.4
Near Edgeless Screen	Yes	(inches)	21.26" x 10.3" x 14.7"
Screen Dimensions (W x H)		Highest Position	
(mm)	527.04 x 296.46	(mm)	540.2 x 261.75 x 483.4
(inches)	20.75" x 11.67"	(inches)	21.26" x 10.3" x 19"
Maximum Brightness (Typical)	250 cd/m <sup>2</sup>	Size Unpacked without Stand	
Viewing Angle (H/V at CR 10:1)	178°/178°	(Monitor Head Only)	
Contrast Ratio (Typical)	1000:1	(mm)	540.2 x 46.45 x 325.98
Dynamic Contrast Ratio	3M:1	(inches)	21.26" x 1.82" x 12.83"
Pixel Pitch (mm)	0.2745 x 0.2745	Stand Base Footprint Area	
Color Gamut (CIE 1931)	72% NTSC	(mm)	250 x 250
Color Support (Typical)	16.7 Million	(inches)	9.84" x 9.84"
Response Time (gray to gray)	4 ms (Extreme mode)	Weight	
OSD Controls	6 ms (Normal mode)	Packed	Starting at 16.39 lbs (7.45 kg)
Buttons	5	Unpacked	Starting at 11.33 lbs (5.15 kg)
Languages	English, French, German, Spanish, Italian, Japanese, Simplified Chinese, Russian	Monitor Head Only	Starting at 7.26 lbs (3.3 kg)
		Full Container Load	1140 / 540 Units
		(40' STD / 20' STD)	
CONNECTIVITY		POWER CONSUMPTION	
Video Input Signals	VGA + HDMI™ 1.4 + DisplayPort™ 1.2	Typical	16.5 W
Video Cables Supplied (Length)	1.8 m	Maximum	55 W
USB Hub	1 x USB 3.0 <sup>1</sup> (Upstream) 4 x USB 3.0 <sup>1</sup> (Downstream, Incl. 1 BC)	Sleep-Mode	<0.5 W
Audio Out	Yes (3.5 mm)	Switch Off-Mode	<0.3 W
		Power Supply	Internal
		Power Voltage	90 VAC - 264 VAC
MECHANICAL		WHAT'S IN THE BOX	
Tilt Angle (Front / Back)	-5° / 30°	Monitor with Stand	
Swivel Angle (Left / Right)	+/-45°	1 x Power Cable	
Lift Range (mm)	110	1 x VGA Cable	
Pivot	+/-90°	1 x DisplayPort™ - DisplayPort™ Cable	
Cable Management	Yes	1 x HDMI™ Cable (NA Only)	
Kensington® Lock	Yes	Quick Setup Guide	
VESA® Mount (mm x mm)	Yes (100 X 100)		
Bezel Color	Raven Black	CERTIFICATIONS	
Bezel Width		EPEAT™	Gold
Top (mm / inches)	2 / 0.08"	ENERGY STAR® Rating	7.1
Sides (mm / inches)	2 / 0.08"	TCO®	7.0
		TCO Edge	2.0
		RoHS (EU 2002/95/EC)	Yes
		China Energy Efficiency Standard	Tier 2
		Windows Certification	Windows 7 / Windows 10
		TüV Eye Comfort Certification	Yes

<sup>1</sup> Depending on many factors such as the processing capability of peripheral devices, file attributes, and other factors related to system configuration and operating environments, the actual transfer rate using the various USB connectors on this device will vary and is typically slower than the data rates as defined by the respective USB specifications: - 5 Gbit/s for USB 3.1 Gen 1; 10 Gbit/s for USB 3.1 Gen 2 & 20 Gbit/s for USB 3.2.



WWW.LENOVO.COM

Lenovo™



# ThinkVision T24i-19 MONITOR



## SPECIFICATIONS

DISPLAY		DIMENSIONS (W x D)	
Panel Size	23.8" Wide	Size Packed (mm)	422 x 622 x 190
Panel Type	In-Plane-Switching	Size Packed (inches)	16.61" x 24.48" x 7.48"
Backlight	WLED	Size Unpacked with Stand Lowest Position (mm)	540.2 x 261.75 x 373.4
Resolution	FHD (1920 x 1080)	Size Unpacked with Stand Highest Position (mm)	540.2 x 261.75 x 483.4
Aspect Ratio	16:9	Size Unpacked without Stand (Monitor Head Only) (mm)	540.2 x 46.45 x 325.98
Anti-Glare	Yes	Size Unpacked without Stand (Monitor Head Only) (inches)	21.26" x 1.82" x 12.83"
Near Edgeless Screen	Yes	Stand Base Footprint Area (mm)	250 x 250
Screen Dimensions (W x H) (mm)	527.04 x 296.46	Stand Base Footprint Area (inches)	9.84" x 9.84"
Screen Dimensions (W x H) (inches)	20.75" x 11.67"	Weight Packed	Starting at 16.39 lbs (7.45 kg)
Brightness	250 nits	Weight Unpacked	Starting at 11.33 lbs (5.15 kg)
Viewing Angle (H/V at CR 10:1)	178°/178°	Weight Monitor Head Only	Starting at 7.26 lbs (3.3 kg)
Contrast Ratio (Typical)	1000:1	Full Container Load (40' STD / 20' STD)	1140 / 540 Units
Dynamic Contrast Ratio	3M:1		
Speakers	2 x 2W		
Pixel Pitch (mm)	0.2745 x 0.2745		
Color Gamut (CIE 1931)	72% NTSC		
Color Depth	8 bit		
Color Support (Typical)	16.7 Million		
Response Time (GtG) Extreme / Normal	4 ms / 6 ms		
OSD Controls Buttons	5		
OSD Controls Languages	English, French, German, Spanish, Italian, Japanese, Simplified Chinese, Russian		
CONNECTIVITY		POWER CONSUMPTION	
Video Input Signals	VGA + HDMI™ + DisplayPort™	Typical	16.5 W
Video Cables Supplied	VGA, DisplayPort™, USB, Power, HDMI™ (for NA only)	Maximum	59 W
USB Hub	USB 3.0 (4 x down, 1 x BC)	Sleep-Mode	<0.5 W
Audio Out	Yes (3.5 mm)	Switch Off-Mode	<0.3 W
Power	Internal	Power Supply	Internal
		Power Voltage	90 VAC - 264 VAC
		ENERGY STAR® (P <sub>on</sub> )	13.67 W
		ENERGY STAR® (E <sub>TEC</sub> )	43.51 kWh
MECHANICAL		WHAT'S IN THE BOX	
Tilt Angle (Front / Back)	-5° / 30°	Monitor with Stand	
Swivel Angle (Left / Right)	+/-45°	1 x Power Cable	
Lift Range (mm)	110	1 x VGA Cable	
Pivot	+/-90°	1 x DisplayPort™ - DisplayPort™ Cable	
Stand	LTPS	1 x HDMI Cable (NA Only)	
Cable Management	Yes	Quick Setup Guide	
Kensington® Lock	Yes	CERTIFICATIONS	
VESA® Mount (mm x mm)	Yes (100 X 100)	EPEAT™	Gold
Bezel Color	Raven Black	ENERGY STAR® Rating	7.1
Bezel Width		TCO	7.0
Top (mm / inches)	2 / 0.08"	TCO Edge	2.0
Sides (mm / inches)	2 / 0.08"	ULE	Yes
		RoHS (EU 2002/95/EC)	Yes
		China Energy Efficiency Standard	Tier 2
		Windows Certification	Windows 7 / Windows 10
		TüV Eye Comfort Certification	Yes
		TINY Support	Yes
		Soundbar Support*	Yes
		Package	EPS Cushion

\* Optional.



WWW.LENOVO.COM

Lenovo reserves the right to alter product offerings and specifications at any time, without notice. Lenovo makes every effort to ensure accuracy of all information but is not liable or responsible for any editorial, photographic or typographic errors. All images are for illustration purposes only. For full Lenovo product, service and warranty specifications visit [www.lenovo.com](http://www.lenovo.com). Lenovo makes no representations or warranties regarding third party products or services. **Trademarks:** The following are trademarks or registered trademarks of Lenovo: Lenovo, the Lenovo logo, Rescue and Recovery, ThinkPad, ThinkCentre, ThinkStation, ThinkServer, ThinkVantage and ThinkVision. Microsoft, Windows and Vista are registered trademarks of Microsoft Corporation. Ultrabook, Celeron, Celeron Inside, Core Inside, Intel, Intel Logo, Intel Atom, Intel Atom Inside, Intel Core, Intel Inside, Intel Inside Logo, Intel vPro, Itanium, Itanium Inside, Pentium, Pentium Inside, vPro Inside, Xeon, Xeon Phi, and Xeon Inside are trademarks of Intel Corporation in the U.S. and/or other countries. Other company, product and service names may be trademarks or service marks of others. Battery life (and recharge times) will vary based on many factors including system settings and usage. Visit [www.lenovo.com/lenovo/us/en/safecomp/](http://www.lenovo.com/lenovo/us/en/safecomp/) periodically for the latest information on safe and effective computing. ©2019 Lenovo. All rights reserved.

Lenovo™

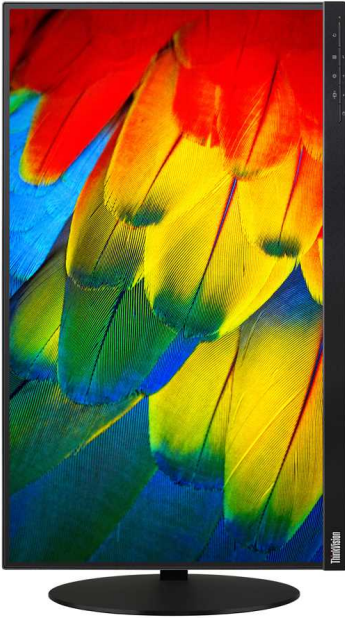



<p>Name <b>T24m Wide Flat Panel Monitor</b>                  Bezel color <b>Black</b>                  Type-model <b>61B8RAR3US / 61B8RAT3EU</b>                  Panel TFT-LCD, In-Plane Switching (IPS), White LED backlight                  Viewable image size <b>23.8" (604.7mm)</b> diagonal                  Max view area (W x H) <b>20.75" x 11.67"</b> (527.04mm x 296.46mm)                  Native resolution <b>1920x1080</b>                  Aspect ratio 16:9                  Pixel pitch (mm) 0.2745 x 0.2745 mm                  Dot/Pixel per Inch 92 dpi                  Brightness 250 nits or cd/m<sup>2</sup> (typical)                  Contrast ratio 1000:1 (typical)                  Pixel response time 6ms (typical)                  Color gamut 99% sRGB                  Viewing angle at 10:1 CR 178° (+/- 89°) horizontal, 178° (+/- 89°) vertical                  Stand Tilt, swivel, pivot, and height adjustable                  Bezel width <i>Sides:</i> 0.08" (2.0mm)                  Dimensions (HxWxD) 19.03" H x 21.26" W x 10.3" D;                  483.4mm H x 540.2mm W x 261.75mm D                  Power supply 17 watts typical,                  110 watts maximum (with USB 3.0 hub),                  &lt;0.5 watts standby/suspend, universal,                  integrated (no external brick-like power supply)                  Weight 12.34 lb; 5.6 kg                  Limited warranty <b>3 year</b> (includes backlight)                  Available date August 2017</p>	<p style="text-align: center;"><b>Features</b></p> <ul style="list-style-type: none"> <li>• Widescreen 23.8-inch monitor</li> <li>• Supports 1920x1080 resolution</li> <li>• Supports ThinkCentre Tiny Clamp Bracket</li> <li>• Supports optional soundbar</li> <li>• EPEAT Gold certified</li> <li>• Microsoft® Windows® 7 certified</li> <li>• Microsoft Windows 10 certified</li> </ul>				
<p>VESA-compliant VESA DDC2B/CI                  Power management ENERGY STAR® qualified                  Ergonomics ISO 9241-307                  Emission standards FCC Class B                  Environmental TCO Displays 7.0, TCO Certified Edge 2.0, WEEE, RoHS, <b>EPEAT™ Silver rating</b></p>	<div style="text-align: center;">  <p><b>ThinkVision T24m Wide Monitor</b></p> </div>				
<p>Preset resolutions                  VGA: 640x480                  SVGA: 800x600                  XGA: 1024x768                  SXGA: 1280x1024                  WXGA: 1366x768                  WXGA+: 1440x900, 1600x900                  WSXGA+: 1680x1050                  Full HD: 1920x1080, 1920x1200                  HDMI: 19; DP: 11</p>					
<p>Viewing adjustments <i>Tilt:</i> 30° back, -5° forward; <i>lift:</i> 4.3" (110mm); <i>swivel:</i> +/-45°; detachable stand                  Rotating screen Screen pivots 90 degrees from landscape to portrait                  On screen display On screen display with digital user controls (8 languages)                  Control features Direct access (buttons on front) for power, menu, input source select and brightness                  USB hub USB 3.0 Hub: 1 port into PC (USB 3.0); 4 ports for accessories (4 USB 3.0)                  Multimedia Audio-out, optional sound bar supported                  Multiple input Support HDMI, DisplayPort, USB 3.1 Type-C                  Monitor connectors (1) HDMI (1.4), digital, <b>HDCP-compliant</b>                  (2) DisplayPort (1.2), digital, <b>HDCP-compliant</b>                  (3) USB 3.1 Type-C                  Signal cables (1) 1.8 meter USB Type-C to USB Type-C cable                  Mounting features Wall or desk mounting using the Extend Arm or third-party accessories, 100mm x 100mm mount                  Security Security keyhole for attachment of optional cable lock (Kensington® lock-compatible)</p>					
<p>Ship group Monitor with stand, Safety and Warranty Information, 1.8 meter USB Type-C to USB Type-C cable, 1.8 meter black power cord</p>					
<p style="text-align: center;"><b>Limited Warranty</b></p> <p>See details at <a href="http://support.lenovo.com/en_US/guides-and-manuals/detail.page?DocID=UM008281">http://support.lenovo.com/en_US/guides-and-manuals/detail.page?DocID=UM008281</a></p>	<p style="text-align: center;"><b>Accessories</b></p> <table border="0"> <tr> <td>Kensington MicroSaver Cable Lock</td> <td style="text-align: right;">73P2582</td> </tr> <tr> <td>Kensington Twin Head Cable Lock</td> <td style="text-align: right;">45K1620</td> </tr> </table> <p>See details at <a href="http://www.lenovo.com/support/monitoraccessories">www.lenovo.com/support/monitoraccessories</a></p> <p>See all monitors at <a href="http://www.lenovo.com/thinkvision">www.lenovo.com/thinkvision</a></p>	Kensington MicroSaver Cable Lock	73P2582	Kensington Twin Head Cable Lock	45K1620
Kensington MicroSaver Cable Lock	73P2582				
Kensington Twin Head Cable Lock	45K1620				



<p>Name <b>T24v Wide Flat Panel Monitor</b>                  Bezel color <b>Black</b>                  Type-model <b>61BCMAR6US / 61BCMATEU</b>                  Panel TFT-LCD, In-Plane Switching (IPS), White LED backlight                  Viewable image size <b>23.8" (604.5mm)</b> diagonal                  Max view area (W x H) <b>20.75" x 11.67"</b> (527.04mm x 296.46mm)                  Native resolution <b>1920x1080</b>                  Aspect ratio 16:9                  Pixel pitch (mm) 0.2745 x 0.2745 mm                  Dot/Pixel per Inch 92 dpi                  Brightness 250 nits or cd/m<sup>2</sup> (typical)                  Contrast ratio 1000:1 (typical)                  Pixel response time 6ms (typical); 4ms (extreme mode)                  Color gamut 72%                  Viewing angle at 10:1 CR 178° (+/- 89°) horizontal, 178° (+/- 89°) vertical                  Stand Tilt, swivel, pivot, and height adjustable stand                  Bezel width <i>Sides:</i> 0.08" (2.0mm)                  Dimensions (HxWxD) 19.72" H x 21.28" W x 10.32" D;                  500.5mm H x 540.2mm W x 261.9mm D                  Power supply 20 watts typical,                  45 watts maximum (with USB 3.0 hub),                  &lt;0.5 watts standby/suspend, universal,                  integrated (no external brick-like power supply)                  Weight 11.18 lb; 5.07 kg                  Limited warranty <b>3 year</b> (includes backlight)                  Available date October 2017</p>	<p style="text-align: center;"><b>Features</b></p> <ul style="list-style-type: none"> <li>• Widescreen 23.8-inch monitor</li> <li>• Supports 1920x1080 resolution</li> <li>• Supports ThinkCentre Tiny Clamp Bracket</li> <li>• Supports optional soundbar</li> <li>• EPEAT Gold certified</li> <li>• Microsoft® Windows® 7 certified</li> <li>• Microsoft Windows 10 certified</li> </ul>				
<p>VESA-compliant VESA DDC2B/C1                  Power management ENERGY STAR® qualified                  Ergonomics ISO 9241-307                  Emission standards FCC Class B                  Environmental TCO Displays 7.0, TCO Certified Edge 2.0, WEEE, RoHS, <b>EPEAT™ Silver rating</b></p> <p>Preset resolutions                  VGA: 640x480, 720x400                  SVGA: 800x600, 832x624                  XGA: 1024x768, 1152x864                  SXGA: 1280x1024                  WXGA+: 1440x900, 1600x900                  WSXGA+: 1680x1050                  Full HD: 1920x1080</p> <p>Presets display modes Presets: 24; user modes: 20</p>	 <p style="text-align: center;"><b>ThinkVision T24v Wide Monitor</b></p>				
<p>Viewing adjustments <i>Tilt:</i> 30° back, -5° forward; <i>lift:</i> 4.3" (110mm); <i>swivel:</i> +/-45°; detachable stand                  Rotating screen Screen pivots 90 degrees from landscape to portrait                  On screen display On screen display with digital user controls (8 languages)                  Control features Direct access for power, menu, input source select, volume up / down, speaker mute and microphone mute                  USB hub USB 3.0 Hub: 1 port into PC (USB 3.0); 2 ports for accessories (2 USB 3.0)                  Multimedia Integrated speakers, dual-array microphone, audio-in and Audio-out, optional sound bar supported                  Camera Integrated FHD camera with IR                  Multiple input Support HDMI, DisplayPort, VGA                  Monitor connectors (1) VGA 15-pin D-shell, analog, blue                  (2) HDMI (1.4), digital, <b>HDCP-compliant</b>                  (3) DisplayPort, digital, black, <b>HDCP-compliant</b>                  Signal cables (1) detachable, VGA 15-pin D-shell at each end, analog, 1.8 meter                  (2) detachable, HDMI at each end, digital, 1.8 meter                  Mounting features Wall or desk mounting using the Extend Arm or third-party accessories, 100mm x 100mm mount                  Security Security keyhole for attachment of optional cable lock (Kensington® lock-compatible)</p>	<p>Viewing adjustments <i>Tilt:</i> 30° back, -5° forward; <i>lift:</i> 4.3" (110mm); <i>swivel:</i> +/-45°; detachable stand                  Rotating screen Screen pivots 90 degrees from landscape to portrait                  On screen display On screen display with digital user controls (8 languages)                  Control features Direct access for power, menu, input source select, volume up / down, speaker mute and microphone mute                  USB hub USB 3.0 Hub: 1 port into PC (USB 3.0); 2 ports for accessories (2 USB 3.0)                  Multimedia Integrated speakers, dual-array microphone, audio-in and Audio-out, optional sound bar supported                  Camera Integrated FHD camera with IR                  Multiple input Support HDMI, DisplayPort, VGA                  Monitor connectors (1) VGA 15-pin D-shell, analog, blue                  (2) HDMI (1.4), digital, <b>HDCP-compliant</b>                  (3) DisplayPort, digital, black, <b>HDCP-compliant</b>                  Signal cables (1) detachable, VGA 15-pin D-shell at each end, analog, 1.8 meter                  (2) detachable, HDMI at each end, digital, 1.8 meter                  Mounting features Wall or desk mounting using the Extend Arm or third-party accessories, 100mm x 100mm mount                  Security Security keyhole for attachment of optional cable lock (Kensington® lock-compatible)</p>				
<p>Ship group Monitor with stand, Safety and Warranty Information, 1.8 meter analog signal cable, 1.8 meter DP signal cable, 1.8 meter USB signal cable, 1.8 meter black power cord, 1.8 meter HDMI signal cable (Row)</p>					
<p style="text-align: center;"><b>Limited Warranty</b></p> <p>See details at <a href="http://support.lenovo.com/en_US/guides-and-manuals/detail.page?DocID=UM008281">http://support.lenovo.com/en_US/guides-and-manuals/detail.page?DocID=UM008281</a></p>	<p style="text-align: center;"><b>Accessories</b></p> <table border="0"> <tr> <td>Kensington MicroSaver Cable Lock</td> <td style="text-align: right;">73P2582</td> </tr> <tr> <td>Kensington Twin Head Cable Lock</td> <td style="text-align: right;">45K1620</td> </tr> </table> <p>See details at <a href="http://www.lenovo.com/support/monitoraccessories">www.lenovo.com/support/monitoraccessories</a></p> <p>See all monitors at <a href="http://www.lenovo.com/thinkvision">www.lenovo.com/thinkvision</a></p>	Kensington MicroSaver Cable Lock	73P2582	Kensington Twin Head Cable Lock	45K1620
Kensington MicroSaver Cable Lock	73P2582				
Kensington Twin Head Cable Lock	45K1620				



<p>Name <b>X24 Pro Wide Flat Panel Monitor</b>                  Bezel color <b>Black</b>                  Type-model <b>60E4ECR1US / 60E4ECT1US / 60E4ECT1EU</b>                  Panel TFT-LCD, AH-IPS (In-Plane Switching), White LED backlight                  Viewable image size <b>23.8" (604.5mm)</b> diagonal                  Max view area (W x H) <b>20.75" x 11.67"</b> (527.0mm x 296.5mm)                  Native resolution <b>1920x1080</b>                  Aspect ratio 16:9                  Pixel pitch (mm) 0.2745 x 0.2745 mm                  Dot/Pixel per Inch 92 dpi                  Brightness 250 nits or cd/m<sup>2</sup> (typical)                  Contrast ratio 1000:1 (typical)                  Pixel response time 7ms (typical)                  Color gamut 72%                  Viewing angle at 10:1 CR <b>178° (+/- 89°) horizontal, 178° (+/- 89°) vertical</b>                  Stand Tilt stand                  Bezel width <i>Sides:</i> 0.09" (2.3mm)                  Dimensions (HxWxD) 17.61" H x 21.30" W x 9.39" D;                  447.4mm H x 540.9mm W x 238.4mm D                  Power supply 20 watts typical,                  90 watts maximum,                  &lt;0.5 watts standby/suspend, universal, external power supply                  Weight 9.26 lb; 4.20 kg                  Limited warranty <b>1 year</b> (includes backlight)                  Available date July 2016</p>	<p style="text-align: center;"><b>Features</b></p> <ul style="list-style-type: none"> <li>• Widescreen 23.8-inch monitor</li> <li>• Supports 1920x1080 resolution</li> <li>• Includes dual input connection for attachment to two systems concurrently</li> <li>• EPEAT Silver certified</li> <li>• Intel RealSense 3D camera</li> <li>• Stereo speakers 3 watts x 2</li> <li>• One cable docking through USB 3.1 Type C with power delivery</li> <li>• Windows Hello certified</li> <li>• Microsoft® Windows® 10 certified</li> </ul>				
<p>Power management ENERGY STAR® qualified                  Ergonomics ISO 9241-307                  Emission standards FCC Class B                  Environmental TCO Displays 6.0, WEEE, RoHS, <b>EPEAT™ Silver rating</b></p> <p>Preset resolutions                  VGA: 640x350, 640x480, 720x400                  SVGA: 800x600                  XGA: 1024x768                  SXGA: 1280x1024                  WXGA: 1366x768                  WXGA+: 1440x900, 1600x900                  WSXGA+: 1680x1050                  Full HD: 1920x1080</p> <p>Presets / user settings                  Standard presets: 16;                  user settings: 20</p>	<div style="text-align: center;">  <p><b>ThinkVision X24 Pro Wide Monitor</b></p> </div>				
<p>Viewing adjustments <i>Tilt:</i> 22° back, -5° forward                  Rotating screen None                  On screen display On screen display with digital user controls                  Control features Direct access (buttons on side bezel) for dual input and brightness                  USB hub USB Hub: two USB 3.1 Type-C and one micro USB 3.0 ports                  Multimedia Integrated stereo speakers (3 watts x 2), built-in microphone                  Camera RealSense 3D camera SR300                  Multiple input Dual input (two different PCs attach to two different connectors; one PC shows image; select via button)                  Monitor connectors (1) mDP, Mini DisplayPort, digital, <b>HDCP-compliant</b>                  (2) USB Type-C, digital                  Signal cables (1) detachable, mDP to DP, digital, 2.0 meter                  (2) DP to mDP adapter                  (3) Micro USB 3.0 cable                  Mounting features None                  Security Security keyhole for attachment of optional cable lock (Kensington® lock-compatible)</p>					
<p>Ship group Monitor with stand, Safety and Warranty Information, ThinkPad 90W Square tip power adaptor, 2.0 meter Mini DisplayPort to DisplayPort signal cable (with DP to mDP adapter), Micro USB 3.0 cable (for using camera)</p>					
<p style="text-align: center;"><b>Limited Warranty</b></p> <p>See details at <a href="http://support.lenovo.com/en_US/guides-and-manuals/detail.page?DocID=UM008281">http://support.lenovo.com/en_US/guides-and-manuals/detail.page?DocID=UM008281</a></p>	<p style="text-align: center;"><b>Accessories</b></p> <table border="0"> <tr> <td>Kensington MicroSaver Cable Lock</td> <td style="text-align: right;">73P2582</td> </tr> <tr> <td>Kensington Twin Head Cable Lock</td> <td style="text-align: right;">45K1620</td> </tr> </table> <p>See details at <a href="http://www.lenovo.com/support/monitoraccessories">www.lenovo.com/support/monitoraccessories</a></p> <p>See all monitors at <a href="http://www.lenovo.com/thinkvision">www.lenovo.com/thinkvision</a></p>	Kensington MicroSaver Cable Lock	73P2582	Kensington Twin Head Cable Lock	45K1620
Kensington MicroSaver Cable Lock	73P2582				
Kensington Twin Head Cable Lock	45K1620				

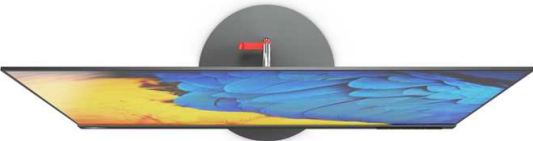



<p>Name <b>X24-20 Flat Panel Monitor</b>                  Bezel color <b>Raven black</b>                  Type-model <b>61BDGAR3US / 61BDGAT3EU</b>                  Panel TFT-LCD, IPS (In-Plane Switching), White LED backlight                  Viewable image size <b>23.8" (604.5mm)</b> diagonal                  Max view area (W x H) <b>20.75" x 11.67"</b> (527.0mm x 296.5mm)                  Native resolution <b>1920x1080</b>                  Aspect ratio 16:9                  Pixel pitch (mm) 0.2745 x 0.2745 mm                  Dot/Pixel per Inch 92 dpi                  Brightness 250 nits or cd/m<sup>2</sup> (typical)                  Contrast ratio 1000:1 (typical)                  Pixel response time 6ms (typical)                  Color gamut 72% (NTSC)                  Viewing angle at 10:1 CR <b>178° (+/- 89°) horizontal, 178° (+/- 89°) vertical</b>                  Stand Tilt stand                  Bezel width <i>Sides:</i> 0.04" (1.1mm)                  Dimensions (HxWxD) 12.85" H x 21.16" W x 8.66" D;                  326.4mm H x 537.4mm W x 220mm D                  Power supply 20 watts typical,                  25 watts maximum,                  &lt;0.5 watts standby/suspend, universal,                  external power supply                  Weight 7.3 lb; 3.3 kg                  Limited warranty <b>3 year</b> (includes backlight)                  Available date December 2017</p>	<p style="text-align: center;"><b>Features</b></p> <ul style="list-style-type: none"> <li>• Widescreen 23.8-inch monitor</li> <li>• Supports 1920x1080 resolution</li> <li>• Includes dual input connection for attachment to two systems concurrently</li> <li>• EPEAT Silver certified</li> <li>• Microsoft® Windows® 7 certified</li> <li>• Microsoft Windows 10 certified</li> </ul>				
<p>Power management ENERGY STAR® qualified                  Ergonomics ISO 9241-307                  Emission standards FCC Class B                  Environmental TCO Displays 7.0, TCO Certified Edge 2.0, WEEE, RoHS, <b>EPEAT™ Silver rating</b></p>	<div style="text-align: center;">  <p><b>ThinkVision X24-20 Monitor</b></p> </div>				
<p>Preset resolutions                  VGA: 640x350, 640x480, 720x400                  SVGA: 800x600                  XGA: 1024x768                  SXGA: 1280x1024                  WXGA: 1366x768                  WXGA+: 1440x900, 1600x900                  WSXGA+: 1680x1050                  Full HD: 1920x1080                  Presets / user settings Standard presets: 18;                  user settings: 0</p>					
<p>Viewing adjustments <i>Tilt:</i> 30° back, -5° forward                  Rotating screen None                  On screen display On screen display with digital user controls (8 languages)                  Control features Direct access (buttons on side bezel) for power, dual input and brightness                  USB hub None                  Multiple input Dual input (two different PCs attach to two different connectors; one PC shows image; select via button)                  Monitor connectors (1) HDMI (1.4a), digital, <b>HDCP-compliant</b>                  (2) DisplayPort, digital, black, <b>HDCP-compliant</b>                  Signal cables (1) detachable, HDMI at each end, digital, 1.8 meter                  Mounting features None                  Security Security keyhole for attachment of optional cable lock (Kensington® lock-compatible)</p>					
<p>Ship group Monitor with stand, Safety and Warranty Information, 1.8 meter HDMI signal cable,                  1.8 meter black power cord</p>	<p style="text-align: center;"><b>Accessories</b></p> <table border="0" style="width: 100%;"> <tr> <td>Kensington MicroSaver Cable Lock</td> <td style="text-align: right;">73P2582</td> </tr> <tr> <td>Kensington Twin Head Cable Lock</td> <td style="text-align: right;">45K1620</td> </tr> </table> <p>See details at <a href="http://www.lenovo.com/support/monitoraccessories">www.lenovo.com/support/monitoraccessories</a></p> <p>See all monitors at <a href="http://www.lenovo.com/thinkvision">www.lenovo.com/thinkvision</a></p>	Kensington MicroSaver Cable Lock	73P2582	Kensington Twin Head Cable Lock	45K1620
Kensington MicroSaver Cable Lock	73P2582				
Kensington Twin Head Cable Lock	45K1620				
<p style="text-align: center;"><b>Limited Warranty</b></p> <p>See details at <a href="http://support.lenovo.com/en_US/guides-and-manuals/detail.page?DocID=UM008281">http://support.lenovo.com/en_US/guides-and-manuals/detail.page?DocID=UM008281</a></p>					



<p>Name <b>P27h Wide Flat Panel Monitor</b>                  Case color <b>Black</b>                  Type-model <b>61AFGAR1US / 61AFGAT1EU</b>                  Panel TFT-LCD, IPS (In-Plane Switching), White LED backlight                  Viewable image size <b>27" (685.8mm)</b> diagonal                  Max view area (W x H) <b>23.49" x 13.21"</b> (596.7mm x 335.7mm)                  Optimum resolution <b>2560x1440</b>                  Max pixel rate <b>300MHz</b>                  Aspect ratio <b>16:9</b>                  Pixel pitch (mm) <b>0.2331 x 0.2331mm</b>                  Dot/Pixel per Inch <b>109 dpi</b>                  Brightness <b>350 nits or cd/m<sup>2</sup> (typical)</b>                  Contrast ratio <b>1000:1 (typical)</b>                  Pixel response time <b>4ms (extreme) / 6ms (typical)</b>                  Color gamut <b>99% sRGB</b>                  Viewing angle at 10:1 CR <b>178° horizontal, 178° vertical</b>                  Stand <b>Tilt, swivel, pivot, and height adjustable stand</b>                  Bezel width <b>Sides: 0.08" (2mm)</b>                  Dimensions <b>20.21" H x 24.08" W x 10.62" D;</b>                  (HxWxD, including stand) <b>513mm H x 611.6mm W x 269.8mm D</b>                  Power supply <b>38 watts typical, 140 watts maximum (with USB), &lt;0.5 watts sleep/off; &lt;0.5 watts switch off integrated (no external brick-like power supply)</b>                  Weight <b>15.43 lb; 7.0kg (including stand)</b>                  Limited warranty <b>3 year</b>                  Available date <b>April 2017</b></p>	<p><b>Features</b></p> <ul style="list-style-type: none"> <li>• 27-inch IPS LED backlight monitor</li> <li>• Supports 2560x1440 resolution</li> <li>• 5-Ports USB hub, support USB 3.0</li> <li>• Supports optional soundbar</li> <li>• Support ThinkCentre Tiny</li> <li>• Microsoft® Windows® 7 certified</li> <li>• Microsoft Windows 10 certified</li> </ul>						
<p>VESA-compliant <b>VESA DDC2B/CI</b>                  Power management <b>ENERGY STAR® 7.0</b>                  Ergonomics <b>ISO 9241-307</b>                  Emission standards <b>FCC Class B</b>                  Environmental <b>TCO Displays 7.0, RoHS, EPEAT™ Silver rating, ULE Gold</b></p>	<div data-bbox="987 659 1451 1024" data-label="Image"> </div> <p data-bbox="1094 1159 1360 1184" style="text-align: center;"><b>ThinkVision P27h Monitor</b></p>						
<p>Preset resolutions                  VGA: 640x480, 720x400                  SVGA: 800x600                  XGA: 1024x768                  SXGA: 1280x1024                  WXGA: 1366x768                  WXGA+: 1440x900, 1680x900                  WSXGA+: 1680x1050                  Full HD: 1920x1080, 1920x1200                  QHD: 2560x1440</p>							
<p>Presets display modes <b>HDMI: 22; DP: 14</b></p>							
<p>Viewing adjustments <b>Tilt: 30° back, -5° forward; lift: 4.33" (110mm); swivel: +/-45°</b>                  Rotating screen <b>Screen pivots 90 degrees from landscape to portrait</b>                  On screen display <b>On screen display with digital user controls (8 languages)</b>                  Control features <b>Direct access (buttons on front) for power, menu, input source select and brightness</b>                  USB hub <b>USB Hub: one USB 3.1 Type-C upstream port, four USB 3.0 Type-A downstream ports</b>                  Multimedia <b>Audio-out, optional sound bar supported</b>                  Camera <b>None</b>                  Multiple input <b>Support HDMI, DisplayPort, USB 3.1 Type-C, DisplayPort-out</b>                  Monitor connectors <b>(1) 2*HDMI (1.4), digital, HDCP-compliant                  (2) DisplayPort (1.2), digital, HDCP-compliant                  (3) DisplayPort-out, digital                  (4) USB 3.1 Type-C</b>                  Signal cables <b>(1) USB 3.1 Type-C cable, 1.8 meter</b>                  Mounting features <b>Wall or desk mounting using the Extend Arm or third-party accessories meeting the VESA FPMPI® (100mm mount)</b>                  Security <b>Security keyhole for attachment of optional cable lock (Kensington® lock-compatible)</b></p>							
<p>Ship group <b>Monitor, detachable stand, Quick start and safety poster, 1.8 meter USB 3.1 Type-C cable, 1.8 meter black power cord</b></p>							
<p style="text-align: center;"><b>Limited Warranty</b></p> <p>See details at <a href="http://support.lenovo.com/en_US/guides-and-manuals/detail.page?DocID=UM008281">http://support.lenovo.com/en_US/guides-and-manuals/detail.page?DocID=UM008281</a></p>	<p style="text-align: center;"><b>Accessories</b></p> <table border="0"> <tr> <td>Kensington MicroSaver Cable Lock</td> <td style="text-align: right;">73P2582</td> </tr> <tr> <td>Kensington Twin Head Cable Lock</td> <td style="text-align: right;">45K1620</td> </tr> <tr> <td>Lenovo Security Cable Lock</td> <td style="text-align: right;">57Y4303</td> </tr> </table> <p>See details at <a href="http://www.lenovo.com/support/monitoraccessories">www.lenovo.com/support/monitoraccessories</a></p> <p>See all monitors at <a href="http://www.lenovo.com/thinkvision">www.lenovo.com/thinkvision</a></p>	Kensington MicroSaver Cable Lock	73P2582	Kensington Twin Head Cable Lock	45K1620	Lenovo Security Cable Lock	57Y4303
Kensington MicroSaver Cable Lock	73P2582						
Kensington Twin Head Cable Lock	45K1620						
Lenovo Security Cable Lock	57Y4303						



<p>Name <b>P27q Wide Flat Panel Monitor</b>                  Case color <b>Black</b>                  Type-model <b>61A8GAT1EU</b>                  Panel TFT-LCD, IPS (In-Plane Switching), White LED backlight                  Viewable image size <b>27" (685.8mm)</b> diagonal                  Max view area (W x H) <b>23.49" x 13.21"</b> (596.7mm x 335.7mm)                  Optimum resolution <b>2560x1440</b>                  Max pixel rate 300MHz                  Aspect ratio 16:9                  Pixel pitch (mm) 0.2331 x 0.2331mm                  Dot/Pixel per Inch 109 dpi                  Brightness 350 nits or cd/m<sup>2</sup> (typical)                  Contrast ratio 1000:1 (typical)                  Pixel response time 4ms                  Color gamut 99% sRGB                  Viewing angle at 10:1 CR 178° horizontal, 178° vertical                  Stand Tilt, swivel, pivot, and height adjustable stand                  Bezel width <i>Sides:</i> 0.08" (2mm)                  Dimensions (HxWxD, including stand) 513mm H x 614mm W x 269.8mm D                  Power supply 38 watts typical, 75 watts maximum (with USB), &lt;0.5 watts sleep/off; &lt;0.3 watts switch off integrated (no external brick-like power supply)                  Weight 15.43 lb; 7.0kg (including stand)                  Limited warranty <b>3 year</b>                  Available date January 2017</p>	<p><b>Features</b></p> <ul style="list-style-type: none"> <li>• 27-inch IPS LED backlight monitor</li> <li>• Supports 2560x1440 resolution</li> <li>• 5-Ports USB hub, support USB 3.0</li> <li>• Support ThinkCentre Tiny</li> <li>• Supports optional soundbar</li> <li>• Microsoft® Windows® 7 certified</li> <li>• Microsoft Windows 10 certified</li> </ul>						
<p>VESA-compliant VESA DDC2B/CI                  Power management ENERGY STAR® 7.0                  Ergonomics ISO 9241-307                  Emission standards FCC Class B                  Environmental TCO Displays 7.0, RoHS, <b>EPEAT™ Silver rating</b>, ULE Gold</p>	 <p><b>ThinkVision P27q Monitor</b></p>						
<p>Preset resolutions                  VGA: 640x480, 720x400                  SVGA: 800x600                  XGA: 1024x768                  SXGA: 1280x1024                  WXGA: 1366x768                  WXGA+: 1440x900, 1600x900                  WSXGA+: 1680x1050                  Full HD: 1920x1080, 1920x1200                  QHD: 2560x1440</p> <p>Presets / user settings Standard presets: 20; user settings: 24</p>							
<p>Viewing adjustments <i>Tilt:</i> 30° back, -5° forward; <i>lift:</i> 4.33" (110mm); <i>swivel:</i> +/-45°                  Rotating screen <b>Screen pivots 90 degrees from landscape to portrait</b>                  On screen display On screen display with digital user controls (8 languages)                  Control features Direct access for menu, source switch, and brightness                  USB hub USB Hub: one USB 3.0 upstream port, four USB 3.0 downstream ports                  Multimedia Audio-out, optional sound bar supported                  Camera None                  Multiple input Support HDMI, DisplayPort, mini DisplayPort, DisplayPort-out                  Monitor connectors (1) 2*HDMI (1.4), digital, <b>HDCP-compliant</b>                  (2) DisplayPort (1.2), digital, <b>HDCP-compliant</b>                  (3) Mini DisplayPort, digital, <b>HDCP-compliant</b>                  Signal cables (1) detachable, mini DisplayPort to DisplayPort, digital, 1.8 meter                  Mounting features Wall or desk mounting using the Extend Arm or third-party accessories meeting the VESA FPMPI® (100mm mount)                  Security Security keyhole for attachment of optional cable lock (Kensington® lock-compatible)</p>							
<p>Ship group Monitor, detachable stand, Quick start and safety poster, 1.8 meter USB 3.0 cable, 1.8 meter mini DP to DP cable, 1.8 meter black power cord</p>	<p><b>Limited Warranty</b></p> <p>See details at <a href="http://support.lenovo.com/en_US/guides-and-manuals/detail.page?DocID=UM008281">http://support.lenovo.com/en_US/guides-and-manuals/detail.page?DocID=UM008281</a></p> <p><b>Accessories</b></p> <table border="0"> <tr> <td>Kensington MicroSaver Cable Lock</td> <td>73P2582</td> </tr> <tr> <td>Kensington Twin Head Cable Lock</td> <td>45K1620</td> </tr> <tr> <td>Lenovo Security Cable Lock</td> <td>57Y4303</td> </tr> </table> <p>See details at <a href="http://www.lenovo.com/support/monitoraccessories">www.lenovo.com/support/monitoraccessories</a></p> <p>See all monitors at <a href="http://www.lenovo.com/thinkvision">www.lenovo.com/thinkvision</a></p>	Kensington MicroSaver Cable Lock	73P2582	Kensington Twin Head Cable Lock	45K1620	Lenovo Security Cable Lock	57Y4303
Kensington MicroSaver Cable Lock	73P2582						
Kensington Twin Head Cable Lock	45K1620						
Lenovo Security Cable Lock	57Y4303						





<p>Name <b>P27u Wide Flat Panel Monitor</b>                  Case color <b>Black</b>                  Type-model <b>61CBGAR1US / 61CBGAT1EU / 61CBGAR1EU / 61B0GAR1US / 61B0GAT1EU</b>                  Panel TFT-LCD, IPS (In-Plane Switching), White LED backlight                  Viewable image size <b>27" (684.7mm)</b> diagonal                  Max view area (W x H) <b>23.49" x 13.21"</b> (596.74mm x 335.66mm)                  Optimum resolution <b>3840x2160</b>                  Max pixel rate <b>600MHz</b>                  Aspect ratio <b>16:9</b>                  Pixel pitch (mm) <b>0.1554 x 0.1554mm</b>                  Dot/Pixel per Inch <b>163 dpi</b>                  Brightness <b>350 nits or cd/m<sup>2</sup> (typical)</b>                  Contrast ratio <b>1000:1 (typical)</b>                  Pixel response time <b>6ms (typical)</b>                  Color gamut <b>1.457 sRGB</b>                  Viewing angle at 10:1 CR <b>178° horizontal, 178° vertical</b>                  Stand <b>Tilt, swivel, pivot, and height adjustable stand</b>                  Bezel width <b>Sides: 0.08" (2mm)</b>                  Dimensions (HxWxD, including stand) <b>20.21" H x 24.08" W x 10.62" D; 513.3mm H x 611.6mm W x 269.8mm D</b>                  Power supply <b>50 watts typical, 160 watts maximum (with USB), &lt;0.5 watts sleep/off; &lt;0.3 watts switch off integrated (no external brick-like power supply)</b>                  Weight <b>15.32 lb; 6.95kg (including stand)</b>                  Limited warranty <b>3 year</b>                  Available date <b>August 2017</b></p>	<p><b>Features</b></p> <ul style="list-style-type: none"> <li>• 27-inch IPS LED backlight monitor</li> <li>• Supports 3840x2160 resolution</li> <li>• 5-Ports USB hub, support USB 3.0</li> <li>• Support ThinkCentre Tiny</li> <li>• Supports optional soundbar</li> <li>• Microsoft® Windows® 7 certified</li> <li>• Microsoft Windows 10 certified</li> </ul>						
<p>VESA-compliant <b>VESA DDC2B/CI</b>                  Power management <b>ENERGY STAR® 7.0</b>                  Ergonomics <b>ISO 9241-307</b>                  Emission standards <b>FCC Class B</b>                  Environmental <b>TCO Displays 7.0, TCO Certified Edge 2.0, WEEE, RoHS, EPEAT™ Silver rating, ULE Gold</b></p>	 <p><b>ThinkVision P27u Monitor</b></p>						
<p>Preset resolutions <b>VGA: 640x480, 720x400, 720x480, 720x576</b>  <b>SVGA: 800x600</b>  <b>XGA: 1024x768</b>  <b>SXGA: 1280x720, 1280x800, 1280x1024</b>  <b>WXGA+: 1440x900, 1600x900</b>  <b>WSXGA+: 1680x1050</b>  <b>Full HD: 1920x1080, 1920x1200</b>  <b>QHD: 2560x1440</b>  <b>UHD: 3840x2160</b></p> <p>Presets / user settings <b>Standard presets: 27; user settings: 20</b></p>							
<p>Viewing adjustments <b>Tilt: 30° back, -5° forward; lift: 4.33" (110mm); swivel: +/-45°</b>                  Rotating screen <b>Screen pivots 90 degrees from landscape to portrait</b>                  On screen display <b>On screen display with digital user controls (8 languages)</b>                  Control features <b>Direct access (buttons on front) for power, menu, input source select and brightness</b>                  USB hub <b>USB Hub: one USB 3.1 Type-C port, four USB 3.0 Type-A downstream ports</b>                  Multimedia <b>Audio-out, optional sound bar supported</b>                  Camera <b>None</b>                  Multiple input <b>Support HDMI, DisplayPort, USB 3.1 Type-C</b>                  Monitor connectors <b>(1) 2*HDMI (2.0), digital, HDCP-compliant</b>  <b>(2) DisplayPort (1.2), digital, HDCP-compliant</b>  <b>(3) USB 3.1 Type-C</b>                  Signal cables <b>(1) detachable, DisplayPort to DisplayPort, digital, 1.8 meter</b>                  Mounting features <b>Wall or desk mounting using the Extend Arm or third-party accessories meeting the VESA FPMPI® (100mm mount)</b>                  Security <b>Security keyhole for attachment of optional cable lock (Kensington® lock-compatible)</b></p>							
<p>Ship group <b>Monitor, detachable stand, Quick start and safety poster, 1.8 meter USB Type-C to USB Type-C cable, 1.8 meter DP to DP cable, 1.8 meter HDMI to HDMI cable (NA only), 1.8 meter black power cord, 1.8 meter USB Type-C to USB Type-A cable</b></p>							
<p><b>Limited Warranty</b></p> <p>See details at <a href="http://support.lenovo.com/en_US/guides-and-manuals/detail.page?DocID=UM008281">http://support.lenovo.com/en_US/guides-and-manuals/detail.page?DocID=UM008281</a></p>	<p><b>Accessories</b></p> <table border="0"> <tr> <td>Kensington MicroSaver Cable Lock</td> <td>73P2582</td> </tr> <tr> <td>Kensington Twin Head Cable Lock</td> <td>45K1620</td> </tr> <tr> <td>Lenovo Security Cable Lock</td> <td>57Y4303</td> </tr> </table> <p>See details at <a href="http://www.lenovo.com/support/monitoraccessories">www.lenovo.com/support/monitoraccessories</a></p> <p>See all monitors at <a href="http://www.lenovo.com/thinkvision">www.lenovo.com/thinkvision</a></p>	Kensington MicroSaver Cable Lock	73P2582	Kensington Twin Head Cable Lock	45K1620	Lenovo Security Cable Lock	57Y4303
Kensington MicroSaver Cable Lock	73P2582						
Kensington Twin Head Cable Lock	45K1620						
Lenovo Security Cable Lock	57Y4303						



# ThinkVision P32u-10 MONITOR



## SPECIFICATIONS

DISPLAY		ENVIRONMENTAL	
Panel Size	32"	Temperature	
Panel Type	In-Plane Switching	Operating	0°C – 40°C
Backlight	WLED	Non-Operating	-20°C – 60°C
Resolution	3840 x 2160	Humidity	
Aspect Ratio	16:9	Operating	8% – 80%
Anti-Glare	Yes	Non-Operating	5% – 95%
Screen Dimensions (W x H) (mm)	708.48 (H) x 398.52 (V)	Altitude	
Maximum Brightness (Typical)	300 cd/m <sup>2</sup>	Operating	0 ft – 5000 ft
Viewing Angle (H/V at CR 10:1)	178°/178°	Non-Operating	0 ft – 40,000 ft
Contrast Ratio (Typical)	1000:1	Arsenic-Free Glass	Yes
Dynamic Contrast Ratio	3M:1	PVC-Free	Yes
Pixel Pitch (W x H) (mm)	0.1845 (H) x 0.1845 (V)	Mercury-Free	Yes
Dot/Pixel Per Inch (DP/PPI)	137	PCC % of Plastic Resins	85% with >25 g Plastic Parts
Color Gamut (1931)	99.5% AdobeRGB		
Response Time (Typical)	6 ms		
POWER CONSUMPTION		DIMENSIONS (W x D x H)	
Typical	70 W	Size Packed	
Maximum	200 W	(mm)	844 x 228 x 528
Sleep-Mode	≤0.5 W	(inches)	33.23" x 8.98" x 20.79"
Switch Off-Mode	≤0.5 W	Size Unpacked with Stand	
Power Supply	External	Lowest Position	
Power Voltage	90 VAC – 264 VAC	(mm)	726.7 x 350 x 497.8
Voltage Dynamic Frequency	47 Hz – 63 Hz	(inches)	28.61" x 13.78" x 19.6"
		Highest Position	
		(mm)	726.7 x 350 x 606.8
		(inches)	28.61" x 13.78" x 23.89"
		Size Unpacked without Stand	
		(Monitor Head Only)	
		(mm)	726.7 x 63.3 x 431.5
		(inches)	28.61" x 2.49" x 16.99"
		Distance from Table to Panel	
		Lowest Pixel at Bottom of Screen	
		(mm / inches)	90.9 / 3.58"
		Highest Pixel at Top of Screen	
		(mm / inches)	489.4 / 19.27"
		Stand Base Footprint Area	
		(mm / inches)	350 x 350 / 13.78" x 13.78"
		Weight	
		Packed	Starting at 29.32 lbs (13.3 kg)
		Unpacked	Starting at 22.05 lbs (10 kg)
		Monitor Head Only	Starting at 15.21 lbs (6.9 kg)
SIGNAL INPUT		COMPLIANCE	
Video Input Signals	2 x HDMI™ 2.0 + DisplayPort™ 1.2 + Thunderbolt™ 3.0-In + Thunderbolt™ 3.0-Out	EPEAT™	Gold
Video Cables Supplied	HDMI™, DisplayPort™, Thunderbolt™ 3.0	ENERGY STAR® Rating	7.0
Video Cable Length	2 m for Thunderbolt™, 1.8 m for HDMI™ and DisplayPort™	TCO	TCO 7.0 / TCO Edge 2.0
USB Hub	Yes (4 x Downstream, 1 x BC)	Windows Certification	Windows 7 / Windows 10
USB Cable Supplied	Yes (USB Type-A to Type-B)	China Energy Efficiency Standard	Tier 2
Audio-Out	Yes (3.5 mm)		
SIGNAL INTERFACE / PERFORMANCE		WARRANTY AND AVAILABILITY	
Horizontal Frequency	30 kHz – 160 kHz	Warranty	3 Years
Vertical Frequency	23 Hz – 80 Hz	Geography Availability	WW
Native Resolution	3840 x 2160		
Maximum Pixel Clock Speed / Bandwidth	HDMI™ : 600 MHz Display Port™: 5.4 Gbps Thunderbolt™: 10 Gbps		
Preset / User	28 / 20		
OSD Buttons	5 Buttons		
OSD Languages	English, French, German, Spanish, Italian, Japanese, Simplified Chinese, Russian		
MECHANICAL			
Tilt Angle (Front / Back)	-5° / 22°		
Swivel Angle (Left / Right)	45° / 45°		
Lift (mm)	110		
(CW / CCW)	90° / 90°		
VESA® Mount (mm)	100 x 100		
Kensington® Lock Slot	Yes		
Cable Management	Yes		
Bezel Color	Raven Black		
Bezel Width			
Top (mm / inches)	2 / 0.08"		
Bottom (mm / inches)	23.8 / 0.94"		
Sides (mm / inches)	2 / 0.08"		





## ThinkVision P44w-10

# Specifications

### DISPLAY

#### Panel Size

43.4 inches

#### Screen Dimensions (H x V)

1052.3 x 328.8mm  
41.4 x 12.9 inches

#### Panel Type

VA NearEdgeless,  
anti-glare

#### Curvature

1800R

#### Backlight

WLED

#### Aspect Ratio

32:10

#### Resolution

3840 x 1200

#### HDR

VESA Certified DisplayHDR™ 400

#### Pixel Pitch (H x V)

0.2740 x 0.2740mm

#### Viewing Angle (H x V)

178°/178°

#### Response Time (gray to gray)

4/6ms (extreme/typical)

#### Refresh Rate

Max. 144Hz

#### Contrast Ratio (typical)

3000:1

#### Dynamic Contrast Ratio (typical)

3M:1

#### Color Support (typical)

1.07B

#### Color Gamut

sRGB: 99.5%  
BT.709: 99.5%  
DCI-P3: 90%

#### Brightness

380 nits (typical)  
450 nits (peak)

### CONNECTIVITY

#### Video Input Signals

2 x HDMI 2.0  
1 x DP1.4  
1 x USB Type-C Gen1 (DP1.2 Alt Mode)  
1 x USB Type-C Gen2 (DP1.4 Alt Mode)

#### Video Cable Length

1.5m for USB Type-C Gen2  
1.8m for others

#### Audio Out

Yes (3.5mm)

#### USB Hub

Yes

#### USB Upstream

2 x USB 3.1 (1 x USB Type-C Gen1,

1 x USB Type-C Gen2)

#### USB Downstream

4 x USB 3.1 Gen1 (1 BC)

#### Power

Internal

#### Power Consumption

Typical/Max: 70W/250W  
Switch-off Mode: <0.5W  
Sleep/Off Mode: <0.5W

### DIMENSIONS

#### Size Packed (D x H x W)

1219 x 500 x 376mm  
47.99 x 19.68 x 14.80 inches

#### Size Unpacked w/stand (D x H x W) (Lowest Position)

269.8 x 461.1 x 1058.3mm  
10.62 x 18.15 x 41.67 inches

#### Size Unpacked w/stand (D x H x W) (Highest Position)

269.8 x 591.1 x 1058.3mm  
10.62 x 23.27 x 41.67 inches

#### Size Unpacked w/o stand (D x H x W) (Head Only)

137.2 x 366.1 x 1058.3mm  
5.40 x 14.21 x 41.67 inches

#### Weight Packed

18.59kg/40.98lbs.

#### Weight Unpacked

13.45kg/29.65lbs.

#### Weight (Monitor Head Only)

9.35kg/20.61lbs.

### SPECIAL FEATURES

#### Anti-Glare

Yes

#### PIP/PBP

Yes

#### Software

Yes (ThinkColor)

#### Speaker

Supports optional Harman  
Kardon certified speaker

### MECHANICAL

#### Tilt Angle (front/back)

-5°/22°

#### Swivel Angle (left/right)

±30°

#### Lift (Max. range)

Yes (130mm)

#### VESA Mount Capability

Yes (100 x 100mm)

#### Kensington™ Lock Slot

Yes

### Cable Management

Yes

### Bezel Color

Raven Black

### Bezel Width (side)

2.4mm

### Bezel Width (top/bottom)

2.4/25.6mm

### WHAT'S IN THE BOX

Monitor with stand  
1 x Power cable  
1 x HDMI cable  
1 x DP cable  
1 x USB Type-C Gen2 cable  
1 x USB Type-C to Type-A cable  
Quick setup guide

### CERTIFICATIONS

#### ENERGY STAR® Rating

71

#### CCC

Yes

#### RoHS

Yes

#### ULE

Gold

#### TCO

8.0

#### Windows Certification

Windows 7, Windows 10

#### China Energy Efficiency Standard

Tier 2

#### Ambient Operating Temperature

0°C to 45°C

#### TÜV Eye Comfort

Yes

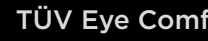
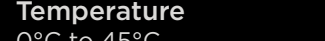

\*with FreeSync support graphic cards

© 2019 Lenovo. All rights reserved. Depending on many factors such as the processing capability of peripheral devices, file attributes, and other factors related to system configuration and operating environments, the actual transfer rate using the various USB connectors on this device will vary and is typically slower than the data rates as defined by the respective USB specifications: 5 Gbit/s for USB 3.1 Gen1, 10 Gbit/s for USB 3.1 Gen2 & 20 Gbit/s for USB 3.2. These products are available while supplies last. Prices shown are subject to change without notice. For any questions concerning price, please contact your Lenovo Account Executive. Lenovo is not responsible for photographic or typographic errors. Warranty: For a copy of applicable warranties, write to: Warranty Information, 500 Park Offices Drive, RTP, NC 27709, Attn: Dept. ZPYA/B600. Lenovo makes no representation or warranty regarding third-party products or services. Trademarks: Lenovo, the Lenovo logo, Rescue and Recovery, ThinkPad, ThinkCentre, ThinkStation, ThinkVantage, and ThinkVision are trademarks or registered trademarks of Lenovo. Microsoft, Windows, and Vista are registered trademarks of Microsoft Corporation. Intel, the Intel logo, Intel Inside, Intel Core, and Core Inside are trademarks of Intel Corporation in the U.S. and/or other countries. Other company, product, and service names may be trademarks or service marks of others.





# ThinkVision® S27i-10

## DISPLAY

### Panel Size

27 inch

### Screen Dimensions (H x V) (mm)

597.89 (H) × 336.31 (V)

### Panel Type

In-Plane Switching

### Backlight

WLED

### Aspect Ratio

16:9

### Resolution

1920 x 1080

### Pixel Pitch (H x V) (mm)

0.3110 × 0.3110

### Viewing angle (H x V)

178° / 178°

### Response Time (gray to gray)

4 ms (extreme mode)

6 ms (normal mode)

### Contrast Ratio (typical)

1000:1

### Dynamic Contrast Ratio (typical)

3M:1

### Color Gamut NTSC (CIE 1931)

72%

### Color Support

16.7M

## CONNECTIVITY

### Video Input Signals

VGA + HDMI 1.4

### Video Cable Length

1.8 m

### Audio Out

Yes (3.5 mm)

## MULTI-MEDIA

### Optional Soundbar Support

Yes

## DIMENSIONS

### Size Packed (D x H x W) (mm/inch)

132 x 455 x 715 mm / 5.20 x 17.91 x 28.15 inch

### Size Unpacked w/stand (D x H x W) (mm/inch) (Lowest Position)

220.0 x 443.5 x 611.9 mm / 8.66 x 17.46 x 24.10 inch

### Size Unpacked w/stand (D x H x W) (mm/inch) (Highest Position)

220.0 x 443.5 x 611.9 mm / 8.66 x 17.46 x 24.10 inch

### Size Unpacked w/o stand (D x H x W) (mm/inch) (Head Only)

46.2 x 366.5 x 611.9 mm / 1.82 x 14.43 x 24.10 inch

### Weight Packed (kg/lbs.)

6.80kg / 14.99 lbs.

### Weight Unpacked (kg/lbs.)

4.76kg / 10.49 lbs.

### Weight (Monitor Head Only) (kg/lbs.)

4.22kg / 9.30 lbs.

## SPECIAL FEATURES

### Anti-Glare

Yes

### Thin Client Support (Tiny)

Yes

(by VESA mount PN:4XFON03161)

## MECHANICAL

### Tilt Angle (front/back)

-5° / 22°

### VESA Mount

Yes (100 mm)

### Kensington™ Lock Slot

Yes

### Cable Management

Yes

### Bezel Color

Raven Black

### Bezel Width (Side)

2.0 mm

### Bezel Width (top / bottom)

2.0 mm / 21.68 mm

## WHAT'S IN THE BOX

Monitor with stand

1 x HDMI Cable

1 x VGA Cable (AP, EMEA only)

1 x Power Cable

Quick setup guide

## CERTIFICATIONS

### ENERGY STAR Rating

7.0

### TCO

7.0

### EPEAT™

Gold

### ULE

Gold

### RoHS

Yes

### Windows Certification

Windows 7, Windows 10

### China Energy Efficiency Standard

Tier 2

### Ambient Operating Temperature

0°C to 40°C

### TÜV Eye Confort Certification

Yes



© 2018 Lenovo. All rights reserved. These products are available while supplies last. Prices shown are subject to change without notice. For any questions concerning price, please contact your Lenovo Account Executive. Lenovo is not responsible for photographic or typographic errors. Warranty: For a copy of applicable warranties, write to: Warranty Information, 500 Park Offices Drive, RTP, NC 27709, Attn: Dept. ZPYA/B600. Lenovo makes no representation or warranty regarding third-party products or services. Trademarks: Lenovo, the Lenovo logo, Rescue and Recovery, ThinkPad, ThinkCentre, ThinkStation, ThinkVantage, and ThinkVision are trademarks or registered trademarks of Lenovo. Microsoft, Windows, and Vista are registered trademarks of Microsoft Corporation. Intel, the Intel logo, Intel Inside, Intel Core, and Core Inside are trademarks of Intel Corporation in the U.S. and/or other countries. Other company, product, and service names may be trademarks or service marks of others.

Specifications may vary depending upon region.

Lenovo™



# ThinkVision T25d-10

## DISPLAY

**Panel Size**  
25.0 inches

**Screen Dimensions (H x V)**  
533.45 x 338.76mm

**Panel Type**  
In-Plane Switching

**Backlight**  
WLED

**Aspect Ratio**  
16:10

**Resolution**  
1920 x 1200 pixels

**Refresh Rate**  
60Hz

**Pixel Pitch (H x V)**  
0.2789 x 0.2823mm

**Viewing Angle (H x V)**  
178°/178°

**Response Time (gray to gray)**  
4ms (extreme mode)  
6ms (normal mode)

**Contrast Ratio (typical)**  
1000:1

**Dynamic Contrast Ratio (typical)**  
3M:1

**Brightness (typical)**  
300 cd/m<sup>2</sup>

**Color Gamut sRGB (CIE 1931)**  
99%

**Color Support**  
16.7M

## CONNECTIVITY

**Video Input Signals**  
HDMI 1.4 + DP 1.2 + VGA

**Video Cables Supplied**  
DP + HDMI\*

**Video Cable Length**  
1.8m

**USB Hub**  
Yes

**USB Upstream**  
1 x USB 3.1 Gen1

**USB Downstream**  
4 x USB 3.1 Gen1 (with 1 BC)

**Audio Out**  
Yes (3.5mm)

## POWER

**Power Consumption (Typical/Max)**  
25W/66W

**Power Consumption Sleep/Off Mode**  
<0.5W

**Power Consumption Switch Off-Mode**  
<0.3W

**Power Supply**  
Internal

**ENERGY STAR® (P<sub>on</sub>)**  
16.54W

**ENERGY STAR® (E<sub>rec</sub>)**  
52.06kWh

**Voltage Required**  
100-240VAC (50/60Hz)

## DIMENSIONS

**Size Packed (D x H x W)**  
706 x 450 x 160mm/  
27.79 x 17.72 x 6.30 inches

**Size Unpacked w/stand (D x H x W)(mm/inch) (Lowest position)**  
260.4 x 399.5 x 548.7mm/  
10.25 x 15.73 x 21.60 inches

**Size Unpacked w/stand (D x H x W)(mm/inch) (Highest position)**  
260.4 x 509.5 x 548.7mm/  
10.25 x 20.06 x 21.60 inches

**Size Unpacked w/o stand (D x H x W)(mm/inch) (Head Only)**  
43.0 x 369.1 x 548.7mm/  
1.69 x 14.53 x 21.60 inches

**Weight Packed**  
7.8kg/17.20lbs.

**Weight Unpacked**  
5.5kg/12.13lbs.

**Weight (Monitor Head Only)**  
3.58kg/7.89lbs.

## SPECIAL FEATURES

**Anti-glare**  
Yes

**Optional Soundbar Support**  
Yes

**ThinkCentre Tiny Support**  
Yes

## MECHANICAL

**Tilt Angle (front/back)**  
-5°/30°

**Swivel Angle (left/right)**  
+/-45°

**Lift**  
Yes (110mm)

**Pivot**  
+/-90°

**VESA Mount Capability**  
Yes (100 x 100mm)

**Kensington™ Lock Slot**  
Yes

**Bezel Width (Side)**  
2.0mm

**Bezel Width (top/bottom)**  
2.0/22.2mm

## WHAT'S IN THE BOX

Monitor with stand  
1 x Power Cable  
1 x USB 3.1 Gen1 Cable  
1 x HDMI™ Cable\*  
1 x DP Cable  
Quick Setup Guide

## CERTIFICATIONS

**ENERGY STAR® Rating**  
7.1

**EU RoHS**  
Yes

**CCC**  
Yes

**TCO**  
TCO 8.0/TCO Edge 2.0

**Windows Certification**  
Windows 7, Windows 10

**China Energy Efficiency Standard**  
Tier 2

**TÜV Eye Comfort**  
Yes

**ULE**  
Gold



\*For NA and LA only

Depending on many factors such as the processing capability of peripheral devices, file attributes, and other factors related to system configuration and operating environments, the actual transfer rate using the various USB connectors on this device will vary and is typically slower than the data rates as defined by the respective USB specifications: - 5 Gbit/s for USB 3.1 Gen1; 10 Gbit/s for USB 3.1 Gen2 & 20 Gbit/s for USB 3.2.

© 2019 Lenovo. All rights reserved. These products are available while supplies last. Prices shown are subject to change without notice. For any questions concerning price, please contact your Lenovo Account Executive. Lenovo is not responsible for photographic or typographic errors. Warranty: For a copy of applicable warranties, write to: Warranty Information, 500 Park Offices Drive, RTP, NC 27709, Attn: Dept. ZPYA/B600. Lenovo makes no representation or warranty regarding third-party products or services. Trademarks: Lenovo, the Lenovo logo, Rescue and Recovery, ThinkPad, ThinkCentre, ThinkStation, ThinkVantage, and ThinkVision are trademarks or registered trademarks of Lenovo. Microsoft, Windows, and Vista are registered trademarks of Microsoft Corporation. Intel, the Intel logo, Intel Inside, Intel Core, and Core Inside are trademarks of Intel Corporation in the U.S. and/or other countries. Other company, product, and service names may be trademarks or service marks of others.

Specifications may vary depending upon region.

Lenovo



# ThinkVision T25m-10

## DISPLAY

**Panel Size**  
25.0 inches

**Screen Dimensions (H x V)**  
535.45 x 338.76mm

**Panel Type**  
In-Plane Switching

**Backlight**  
WLED

**Aspect Ratio**  
16:10

**Resolution**  
1920 x 1200 pixels

**Pixel Pitch (H x V)**  
0.2789 x 0.2823mm

**Viewing Angle (H x V)**  
178°/178°

**Response Time (gray to gray)**  
4ms (extreme mode)  
6ms (normal mode)

**Contrast Ratio (typical)**  
1000:1

**Dynamic Contrast Ratio (typical)**  
3M:1

**Brightness (typical)**  
300 cd/m<sup>2</sup>

**Color Gamut sRGB (CIE 1931)**  
99%

**Color Support**  
16.7M

## CONNECTIVITY

**Video Input Signals**  
HDMI 1.4 + DP 1.2 + USB 3.1 Type-C™  
(DP 1.2 Alt Mode)

**Video Cables Supplied**  
USB 3.1 Type-C™

**Video Cable Length**  
1.8m

**USB Hub**  
Yes

**USB Upstream**  
1 x USB 3.1 Gen1 (by USB Type-C™)

**USB Downstream**  
4 x USB 3.1 Gen1 (with 1 BC)

**Audio Out**  
Yes (3.5mm)

## POWER

**Power Consumption (Typical/Max)**  
30W/150W

**Power Consumption Sleep/Off Mode**  
<0.5W

**Power Consumption Switch Off-Mode**  
<0.3W

**Power Supply**  
Internal

**ENERGY STAR® (P<sub>on</sub>)**  
17.05W

**ENERGY STAR® (E<sub>TEC</sub>)**  
63.12kWh

**Power Voltage**  
100-240VAC (50/60Hz)

## DIMENSIONS

**Size Packed (D x H x W)**  
706 x 450 x 160mm/  
27.79 x 17.72 x 6.30 inches

**Size Unpacked w/stand (D x H x W) (mm/inch) (Lowest position)**  
260.4 x 399.5 x 548.7mm/  
10.25 x 15.73 x 21.60 inches

**Size Unpacked w/stand (D x H x W) (mm/inch) (Highest position)**  
260.4 x 509.5 x 548.7mm/  
10.25 x 20.06 x 21.60 inches

**Size Unpacked w/o stand (D x H x W) (mm/inch) (Head Only)**  
43.0 x 369.1 x 548.7mm/  
1.69 x 14.53 x 21.60 inches

**Weight Packed**  
7.8kg/17.20lbs.

**Weight Unpacked**  
5.5kg/12.13lbs.

**Weight (Monitor Head Only)**  
3.58kg/7.89lbs.

## SPECIAL FEATURES

**Anti-glare**  
Yes

**Smart Power\***  
Yes

**ThinkCentre Tiny Support**  
Yes

**Optional Soundbar Support**  
Yes

**Internal Speakers**  
Yes (3W x 2)

## MECHANICAL

**Tilt Angle (front/back)**  
-5°/30°

**Swivel Angle (left/right)**  
+/-45°

**Lift**  
Yes (110mm)

**Pivot**  
+/-90°

**VESA Mount Capability**  
Yes (100 x 100mm)

**Kensington™ Lock Slot**  
Yes

**Bezel Width (Side)**  
2.0mm

**Bezel Width (top/bottom)**  
2.0/22.2mm

## WHAT'S IN THE BOX

Monitor with stand  
1 x Power Cable  
1 x USB Type-C™ to Type-C™ cable  
Quick Setup Guide

## CERTIFICATIONS

**ENERGY STAR® Rating**  
7.1

**EU RoHS**  
Yes

**CCC**  
Yes

**TCO**  
TCO 8.0/TCO Edge 2.0

**Windows Certification**  
Windows 7, Windows 10

**China Energy Efficiency Standard**  
Tier 2

**TÜV Eye Comfort**  
Yes

**ULE**  
Gold



\*The Smart Power function intelligently detects overall power consumption and dynamically manages the power delivery to other devices. 75W power delivery by USB Type-C can be achieved when downstream USB ports are not connected and OSD brightness setting is <31.

Depending on many factors such as the processing capability of peripheral devices, file attributes, and other factors related to system configuration and operating environments, the actual transfer rate using the various USB connectors on this device will vary and is typically slower than the data rates as defined by the respective USB specifications: - 5 Gbit/s for USB 3.1 Gen1; 10 Gbit/s for USB 3.1 Gen2 & 20 Gbit/s for USB 3.2.

© 2019 Lenovo. All rights reserved. These products are available while supplies last. Prices shown are subject to change without notice. For any questions concerning price, please contact your Lenovo Account Executive. Lenovo is not responsible for photographic or typographic errors. Warranty: For a copy of applicable warranties, write to: Warranty Information, 500 Park Offices Drive, RTP, NC 27709, Attn: Dept. ZPYA/B600. Lenovo makes no representation or warranty regarding third-party products or services. Trademarks: Lenovo, the Lenovo logo, Rescue and Recovery, ThinkPad, ThinkCentre, ThinkStation, ThinkVantage, and ThinkVision are trademarks or registered trademarks of Lenovo. Microsoft, Windows, and Vista are registered trademarks of Microsoft Corporation. Intel, the Intel logo, Intel Inside, Intel Core, and Core Inside are trademarks of Intel Corporation in the U.S. and/or other countries. Other company, product, and service names may be trademarks or service marks of others.

Specifications may vary depending upon region.





# ThinkVision® T27i-10

## DISPLAY

### Panel Size

27 inch

### Screen Dimensions (H x V) (mm)

597.89 (H) × 336.31 (V)

### Panel Type

In-Plane Switching

### Backlight

WLED

### Aspect Ratio

16:9

### Resolution

1920 x 1080

### Pixel Pitch (H x V) (mm)

0.3110 × 0.3110

### Viewing angle (H x V)

178° / 178°

### Response Time (gray to gray)

4 ms (extreme mode)

6 ms (normal mode)

### Contrast Ratio (typical)

1000:1

### Dynamic Contrast Ratio (typical)

3M:1

### Color Gamut NTSC (CIE 1931)

72%

### Color Support

16.7M

## CONNECTIVITY

### Video Input Signals

VGA + HDMI 1.4 + DP 1.2

## USB Hub

Yes

1 x USB 3.0 (Upstream)

4 x USB 3.0 (Downstream, incl. 1BC)

### Cable Length

1.8 m

### Audio Out

Yes (3.5 mm)

### Power Consumption

22W (Typical) / 58W (max) at On mode;

<0.5W at Sleep mode; <0.3W at Switch off mode

## MULTI-MEDIA

### Optional Soundbar Support

Yes

## DIMENSIONS

### Size Packed (D x H x W) (mm/inch)

187 x 455 x 715 mm / 7.362 x 17.913 x 28.15 inch

### Size Unpacked w/stand (D x H x W) (mm/inch) (Lowest Position)

269.8 x 403.3 x 611.9 mm / 10.62 x 15.88 x 24.09 inch

### Size Unpacked w/stand (D x H x W) (mm/inch) (Highest Position)

269.8 x 513.3 x 611.9 mm / 10.62 x 20.21 x 24.09 inch

### Size Unpacked w/o stand (D x H x W) (mm/inch) (Head Only)

49.9 x 366.5 x 611.9 mm / 1.96 x 14.43 x 24.09 inch

### Weight Packed (kg/lbs.)

9.32kg / 20.55 lbs.

### Weight Unpacked (kg/lbs.)

6.55kg / 14.44 lbs.

### Weight (Monitor Head Only) (kg/lbs.)

4.60kg / 10.14 lbs.

## SPECIAL FEATURES

### Anti-Glare

Yes

### Thin Client Support (Tiny)

Yes

(by Tiny Clamp Bracket Kit+VESA

mount PN:4XFON82412+

PN:4XFON03161)

## MECHANICAL

### Tilt Angle (front/back)

-5°/30°

### Swivel Angle (left/right)

-45°/+45°

### Lift (Max range)

110 mm

### Pivot

-90°/90°

### VESA Mount

Yes (100 mm)

### Kensington™ Lock Slot

Yes

### Cable Management

Yes

### Bezel Color

Raven Black

### Bezel Width (Side)

2.0 mm

## WHAT'S IN THE BOX

Monitor with stand

1 x Power cable

1 x DP-DP cable

1 x HDMI cable (NA only)

1 x USB 3.0 cable

Quick setup guide

## CERTIFICATIONS

### ENERGY STAR Rating

7.0

### CCC

Yes

### TCO

7.0

### EPEAT™

Gold

### ULE

Gold

### Windows Certification

Windows 7, Windows 10

### China Energy Efficiency Standard

Tier 2

### Ambient Operating Temperature

0°C to 40°C

### Eye Comfort Certification

Yes



Lenovo™

© 2018 Lenovo. All rights reserved. These products are available while supplies last. Prices shown are subject to change without notice. For any questions concerning price, please contact your Lenovo Account Executive. Lenovo is not responsible for photographic or typographic errors. Warranty: For a copy of applicable warranties, write to: Warranty Information, 500 Park Offices Drive, RTP, NC 27709, Attn: Dept. ZPYA/B600. Lenovo makes no representation or warranty regarding third-party products or services. Trademarks: Lenovo, the Lenovo logo, Rescue and Recovery, ThinkPad, ThinkCentre, ThinkStation, ThinkVantage, and ThinkVision are trademarks or registered trademarks of Lenovo. Microsoft, Windows, and Vista are registered trademarks of Microsoft Corporation. Intel, the Intel logo, Intel Inside, Intel Core, and Core Inside are trademarks of Intel Corporation in the U.S. and/or other countries. Other company, product, and service names may be trademarks or service marks of others.

Specifications may vary depending upon region.



# ThinkVision T27p-10

## DISPLAY

**Panel Size**  
27.0 inches

**Screen Dimensions (H x V)**  
596.74 x 335.66mm

**Panel Type**  
In-Plane Switching

**Backlight**  
WLED

**Aspect Ratio**  
16:9

**Resolution**  
3840 x 2160 pixels

**Pixel Pitch (H x V)**  
0.1554 x 0.1554mm

**Viewing Angle (H x V)**  
178°/178°

**Response Time (gray to gray)**  
4ms (extreme mode)  
6ms (normal mode)

**Refresh Rate**  
60Hz

**Contrast Ratio (typical)**  
1000:1

**Dynamic Contrast Ratio (typical)**  
3M:1

**Brightness (typical)**  
350 cd/m<sup>2</sup>

**Color Gamut sRGB (CIE 1931)**  
99%

**Color Support**  
1.07 Billion

## POWER

**Power Consumption (Typical/Max)**  
50W/140W

**Power Consumption Sleep/Off Mode**  
<0.5W

**Power Consumption Switch Off-Mode**  
<0.3W

**Power Supply**  
Internal

**ENERGY STAR® (P<sub>on</sub>)**  
23.40W

**ENERGY STAR® (E<sub>TEC</sub>)**  
101.94kWh

**Voltage Required**  
100-240VAC (50/60Hz)

## CONNECTIVITY

**Video Input Signals**  
HDMI 2.0 + DP 1.2 + USB 3.1 Type-C™  
(DP 1.2 Alt Mode)

**Video Cables Supplied**  
USB 3.1 Type-C™ + HDMI

**Video Cable Length**  
1.8m

**USB Hub**  
Yes

**USB Upstream**  
1 x USB 3.1 Gen1 (by USB Type-C™)

**USB Downstream**  
4 x USB 3.1 Gen1 (with 1 BC)

## Audio Out

Yes (3.5mm)

## DIMENSIONS

**Size Packed (D x H x W)**  
732 x 210 x 453mm/  
28.82 x 8.27 x 17.83 inches

**Size Unpacked w/stand (D x H x W) (mm/inch)**  
269.8 x 403.3 x 611.6mm/  
10.62 x 15.88 x 24.08 inches

**Size Unpacked w/o stand (D x H x W) (mm/inch) (Head Only)**  
45.5 x 368.4 x 611.6mm/  
1.79 x 14.5 x 24.08 inches

**Weight Packed**  
11.00kg/24.25lbs.

**Weight Unpacked**  
6.95kg/15.32lbs.

**Weight (Monitor Head Only)**  
5.0kg/11.02lbs.

## SPECIAL FEATURES

**Smart Power\***  
Yes

**Anti-glare**  
Yes

**ThinkCentre Tiny Support**  
Yes

**Optional Soundbar Support**  
Yes

## MECHANICAL

**Tilt Angle (front/back)**  
-5°/30°

**Swivel Angle (left/right)**  
+/-45°

**Lift**  
Yes (110mm)

**Pivot**  
+/-90°

**VESA Mount Capability**  
Yes (100 x 100mm)

**Kensington™ Lock Slot**  
Yes

**Bezel Width (Side)**  
2.0mm

**Bezel Width (top/bottom)**  
2.0/24.5mm

## WHAT'S IN THE BOX

Monitor with stand  
1 x Power Cable  
1 x HDMI Cable  
1 x USB Type-C™ to Type-C™ cable  
Quick Setup Guide

## CERTIFICATIONS

**ENERGY STAR® Rating**  
7.1

**EU RoHS**  
Yes

**CCC**  
Yes

**Windows Certification**  
Windows 7, Windows 10

**China Energy Efficiency Standard**  
Tier 2

**TÜV Eye Comfort**  
Yes

**TCO**  
TCO 8.0/TCO Edge 2.0

**ULE**  
Gold



\*The Smart Power function intelligently detects overall power consumption and dynamically manages the power delivery to each device. 75W power delivery can be achieved when downstream USB ports are not connected and OSD brightness setting is <61.

Depending on many factors such as the processing capability of peripheral devices, file attributes, and other factors related to system configuration and operating environments, the actual transfer rate using the various USB connectors on this device will vary and is typically slower than the data rates as defined by the respective USB specifications: - 5 Gbit/s for USB 3.1 Gen1; 10 Gbit/s for USB 3.1 Gen2 & 20 Gbit/s for USB 3.2.

© 2019 Lenovo. All rights reserved. These products are available while supplies last. Prices shown are subject to change without notice. For any questions concerning price, please contact your Lenovo Account Executive. Lenovo is not responsible for photographic or typographic errors. Warranty: For a copy of applicable warranties, write to: Warranty Information, 500 Park Offices Drive, RTP, NC 27709, Attn: Dept. ZPYA/B600. Lenovo makes no representation or warranty regarding third-party products or services. Trademarks: Lenovo, the Lenovo logo, Rescue and Recovery, ThinkPad, ThinkCentre, ThinkStation, ThinkVantage, and ThinkVision are trademarks or registered trademarks of Lenovo. Microsoft, Windows, and Vista are registered trademarks of Microsoft Corporation. Intel, the Intel logo, Intel Inside, Intel Core, and Core Inside are trademarks of Intel Corporation in the U.S. and/or other countries. Other company, product, and service names may be trademarks or service marks of others.

Specifications may vary depending upon region.



<p>Name <b>X1 Wide Flat Panel Monitor</b>                  Case color <b>Black</b>                  Type-model <b>60E2GAR1US / 60E2GAT1US / 60E2GAT1EU</b>                  Panel TFT-LCD, IPS (In-Plane Switching), White LED backlight                  Viewable image size <b>27" (684.7mm) diagonal</b>                  Max view area (W x H) <b>23.49" x 13.21" (596.7mm x 335.7mm)</b>                  Optimum resolution <b>3840x2160</b>                  Max pixel rate <b>600MHz</b>                  Aspect ratio <b>16:9</b>                  Pixel pitch (mm) <b>0.16 x 0.16mm</b>                  Dot/Pixel per Inch <b>163 dpi</b>                  Brightness <b>300 nits or cd/m<sup>2</sup> (typical)</b>                  Contrast ratio <b>1300:1 (typical)</b>                  Pixel response time <b>6ms</b>                  Color gamut <b>99%</b>                  Viewing angle at 10:1 CR <b>178° horizontal, 178° vertical</b>                  Stand <b>Tilt stand</b>                  Bezel width <b>Sides: 0.088" (2.23mm)</b>                  Dimensions (HxWxD, including stand) <b>19.35" H x 24.19" W x 10.63" D; 491.4mm H x 614.5mm W x 270.0mm D</b>                  Power supply <b>40 watts typical, 130 watts maximum (with USB), &lt;0.5 watts sleep/off; &lt;0.5 watts switch off</b>                  Weight <b>14.11 lb; 6.40kg (including stand)</b>                  Limited warranty<sup>4</sup> <b>3 year</b>                  Available date <b>March 2016</b></p>	<p><b>Features</b></p> <ul style="list-style-type: none"> <li>• 27-inch IPS LED backlight monitor with speaker</li> <li>• Supports 3840x2160 resolution</li> <li>• 5-Ports USB hub, support USB Type-C</li> <li>• 3watts x 2 stereo speakers</li> <li>• Microsoft® Windows® 7 certified</li> <li>• Microsoft Windows 10 certified</li> </ul>						
<p>VESA-compliant<sup>2</sup> <b>VESA DDC2B/CI</b>                  Power management <b>ENERGY STAR® 7.0</b>                  Ergonomics <b>ISO 9241-307</b>                  Emission standards <b>FCC Class B</b>                  Environmental <b>TCO Displays 7.0, RoHS, EPEAT™ Silver rating, ULE Gold</b></p>	 <p style="text-align: center;"><b>ThinkVision X1 Monitor</b></p>						
<p>Preset resolutions                  VGA: 640x350, 640x480, 720x400                  SVGA: 800x600                  XGA: 1024x768, 1152x864                  SXGA: 1280x1024                  WXGA: 1280x720, 1280x768, 1280x800, 1360x768                  WXGA+: 1440x900, 1600x900                  WSXGA+: 1680x1050                  Full HD: 1920x1080, 1920x1200                  UHD: 3840x2160</p> <p>Presets / user settings Standard presets: 20; user settings: 20</p>							
<p>Viewing adjustments <i>Tilt: 22° back, -5° forward;</i>                  Rotating screen <b>None</b>                  On screen display <b>On screen display with digital user controls (8 languages)</b>                  Control features <b>Direct access (touch buttons on front) for menu, mute, volume up/down, and brightness</b>                  USB hub <b>USB Hub: one USB 3.1 Type-C upstream port, four USB 3.0 Type-A downstream ports</b>                  Multimedia <b>Integrated stereo speakers (3 watts x 2), built-in microphone</b>                  Camera <b>Full HD camera with LED light</b>                  Multiple input <b>Support HDMI, DisplayPort</b>                  Monitor connectors <b>(1) HDMI (1.4), digital, <b>HDCP-compliant</b></b>  <b>(2) DisplayPort (1.2), digital, <b>HDCP-compliant</b></b>                  Signal cables <b>(1) detachable, HDMI at each end, digital, 1.8 meter</b>  <b>(2) detachable, DisplayPort at each end, digital, 1.8 meter</b>                  Mounting features <b>Wall or desk mounting using the Extend Arm or third-party accessories meeting the VESA FPMPI® (100mm mount)</b>                  Security <b>Security keyhole for attachment of optional cable lock (Kensington® lock-compatible)</b></p>							
<p>Ship group <b>Monitor, detachable stand, Quick start and safety poster, 1.8 meter DisplayPort cable, 1.8 meter HDMI cable, 1.8 meter USB Type-C cable, 1.8 meter USB Type-C to Type-A cable, 1.8 meter black power cord, mini DP to DP adapter, power adapter (135W)</b></p>	<p style="text-align: center;"><b>Limited Warranty</b></p> <p>See details at <a href="http://support.lenovo.com/en_US/guides-and-manuals/detail.page?DocID=UM008281">http://support.lenovo.com/en_US/guides-and-manuals/detail.page?DocID=UM008281</a></p> <p style="text-align: center;"><b>Accessories</b></p> <table border="0"> <tr> <td>Kensington MicroSaver Cable Lock</td> <td style="text-align: right;">73P2582</td> </tr> <tr> <td>Kensington Twin Head Cable Lock</td> <td style="text-align: right;">45K1620</td> </tr> <tr> <td>Lenovo Security Cable Lock</td> <td style="text-align: right;">57Y4303</td> </tr> </table> <p>See details at <a href="http://www.lenovo.com/support/monitoraccessories">www.lenovo.com/support/monitoraccessories</a></p> <p>See all monitors at <a href="http://www.lenovo.com/thinkvision">www.lenovo.com/thinkvision</a></p>	Kensington MicroSaver Cable Lock	73P2582	Kensington Twin Head Cable Lock	45K1620	Lenovo Security Cable Lock	57Y4303
Kensington MicroSaver Cable Lock	73P2582						
Kensington Twin Head Cable Lock	45K1620						
Lenovo Security Cable Lock	57Y4303						

See footnotes for important warranty information





# ThinkVision X1 (2nd GEN) MONITOR

EXTREME STYLISH, EXTREME FOREFRONT.



THE MILESTONE OF X-SERIES, 27" FULL-SCREEN, 4K, THUNDERBOLT™ 3 MONITOR.

Pushing the limit of screen share ratio with innovative technology, the 27" Lenovo™ ThinkVision® X1 (2nd GEN) display brings full-screen and ultra-slim appearance in elegant design. With 4K resolution and >99% sRGB color gamut, you will be assured of excellent watching experience and Thunderbolt™ 3 interface will bring the best user experience. "Motor" camera is first used on monitor, which will move up and down automatically and with it you will own standard VoIP system.

## WHY YOU SHOULD BUY THE LENOVO THINKVISION X1 (2nd GEN) MONITOR



### Full-screen appearance

With world's slimmest (4.7 mm) 27" 4K TBT monitor you will experience full-screen 4-side Near-Edgeless display with the screen ratio of approximately 93%. The monitor also comes with a metal stand and a base.



### Brilliant performance

The 4K UHD IPS screen displays 3840 x 2160 resolution at 60 Hz, 99% sRGB color gamut, 10-bit depth, with 1.07 billion color support assures you stunning visuals and superb color experience.



### Convenient user experience

Total versatility with Thunderbolt™ 3 interface supporting 4K + USB 3.0 & 45W PD + motor-camera with dual-array microphone. A Think RedDot tracking button is integrated in the back cover.

## THE LENOVO THINKVISION X1 (2nd GEN) MONITOR IS BEST SUITED FOR

1

The Executives and CXO of company.

2

SOHO and Gold Collars with high income.

3

Trendsetters who pursue an extreme and forefront monitor.



# ThinkVision X1 (2nd GEN) MONITOR



## SPECIFICATIONS

DISPLAY		ENVIRONMENTAL	
Panel Size	27"	Temperature Operating	0°C - 45°C
Panel Type	IPS	Temperature Non-Operating	-20°C - 60°C
Backlight	WLED	Humidity Operating	8% - 80%
Resolution	3840 (H) x 2160 (V)	Humidity Non-Operating	5% - 95%
Aspect Ratio	16:9	Altitude Operating	16,000 ft
Anti-Glare	Yes	Altitude Non-Operating	40,000 ft
Screen Dimensions (W x H) (mm)	596.7 (H) x 335.7 (V)	Arsenic-Free Glass	Yes
Maximum Brightness (Typical)	350 cd/m <sup>2</sup>	PVC-Free	Yes (W/O cable)
Viewing Angle (H/V at CR 10:1)	178°/178°	Mercury-Free	Yes
Contrast Ratio (Typical)	1000:1	PCC % of Plastic Resins	25%
Dynamic Contrast Ratio	3M:1		
Pixel Pitch (W x H) (mm)	0.1554 x 0.1554	DIMENSIONS (W x D x H)	
Dot/Pixel Per Inch (DP/PPI)	163	Size Packed (mm)	718 x 140 x 470
Color Gamut (CIE 1931)	99% sRGB	Size Packed (inches)	28.27" x 5.51" x 18.5"
Response Time (Extreme/Typical/Off)	4/6/14 ms (G-to-G)	Size Unpacked with Stand (mm)	609.74 x 234.81 x 474.76
		Size Unpacked with Stand (inches)	24" x 9.24" x 18.69"
POWER CONSUMPTION		Size Unpacked without Stand (Monitor Head Only) (mm)	609.74 x 32.7 x 351.71
Typical	65 W	Size Unpacked without Stand (Monitor Head Only) (inches)	24" x 1.29" x 13.85"
Maximum	135 W	Distance from Table to Panel Lowest Pixel at Bottom of Screen (mm / inches)	134 / 5.276"
Sleep-Mode	0.5 W	Distance from Table to Panel Highest Pixel at Top of Screen (mm / inches)	450 / 17.717"
Switch Off-Mode	0.5 W	Stand Base Footprint Area (mm)	234.81 x 234.81
Power Supply	External	Stand Base Footprint Area (inches)	9.24" x 9.24"
Power Voltage	100 VAC - 240 VAC	Weight Packed	Starting at 18.45 lbs (8.37 kg)
Voltage Dynamic Frequency	50 Hz - 60 Hz	Weight Unpacked	Starting at 12.21 lbs (5.54 kg)
		Weight Monitor Head Only	Starting at 9.46 lbs (4.29 kg)
SIGNAL INPUT			
Video Input Signals	DisplayPort™ 1.2 + HDMI™ 2.0 + Thunderbolt™ 3	COMPLIANCE	
Video Cables Supplied	HDMI™ + Thunderbolt™ 3	EPEAT™	Silver
Video Cable Length	1.8 m	ENERGY STAR® Rating	7.0
USB Hub	Yes (4 x USB 3.0)	ULE	Silver
USB Cable Supplied	N/A	TCO®	7.0
Audio-Jack	Yes	RoHS	Yes
		Windows Certification	Windows 10
SIGNAL INTERFACE / PERFORMANCE		China Energy Label	Grade 2
Horizontal Frequency	30 kHz - 136 kHz	WARRANTY AND AVAILABILITY	
Vertical Frequency	30 Hz - 60 Hz	Warranty	3 Years
Native Resolution	3840 x 2160	Geography Availability	WW
Maximum Pixel Clock Speed/Bandwidth	20 Gbps		
Default Color Temperature	6500K		
Preset Modes	24		
OSD Buttons	2 Buttons + Tracking Point		
OSD Languages	English, French, Italian, German, Spanish, Japanese, Chinese, Russian		
MECHANICAL			
Tilt Angle (Front / Back)	-5° / 30°		
Swivel Angle (Left / Right)	N/A		
Lift (mm)	N/A		
Pivot	N/A		
VESA® Mount (mm)	N/A		
Kensington® Lock Slot	Yes		
Cable Management	Yes		
Bezel Color	N/A		
Bezel Width			
Top (mm / inches)	1.2 / 0.05"		
Bottom (mm / inches)	1.2 / 0.05"		
Sides (mm / inches)	1.2 / 0.05"		



WWW.LENOVO.COM

Lenovo reserves the right to alter product offerings and specifications at any time, without notice. Lenovo makes every effort to ensure accuracy of all information but is not liable or responsible for any editorial, photographic or typographic errors. All images are for illustration purposes only. For full Lenovo product, service and warranty specifications visit [www.lenovo.com](http://www.lenovo.com). Lenovo makes no representations or warranties regarding third party products or services. **Trademarks:** The following are trademarks or registered trademarks of Lenovo: Lenovo, the Lenovo logo, Rescue and Recovery, ThinkPad, ThinkCentre, ThinkStation, ThinkServer, ThinkVantage and ThinkVision. Microsoft, Windows and Vista are registered trademarks of Microsoft Corporation. Ultrabook, Celeron, Celeron Inside, Core Inside, Intel, Intel Logo, Intel Atom, Intel Atom Inside, Intel Core, Intel Inside, Intel Inside Logo, Intel vPro, Itanium, Itanium Inside, Pentium, Pentium Inside, vPro Inside, Xeon, Xeon Phi, and Xeon Inside are trademarks of Intel Corporation in the U.S. and/or other countries. Other company, product and service names may be trademarks or service marks of others. Battery life (and recharge times) will vary based on many factors including system settings and usage. Visit [www.lenovo.com/lenovo/us/en/safecom/](http://www.lenovo.com/lenovo/us/en/safecom/) periodically for the latest information on safe and effective computing. ©2018 Lenovo. All rights reserved.

This publication was developed for products and services offered in the United States and E.M.E.A countries. Lenovo may not offer the products, services or features discussed in this document in other countries. Lenovo may withdraw an offering at any time. Information is subject to change without notice. Consult your local representative for information on offerings available in your area.

Lenovo reserves the right to change specifications or other product information without notice. Lenovo is not responsible for photographic or typographical errors.

LENOVO PROVIDES THIS PUBLICATION "AS IS," WITHOUT WARRANTY OF ANY KIND, EITHER EXPRESS OR IMPLIED, INCLUDING THE IMPLIED WARRANTIES OF MERCHANTABILITY OR FITNESS FOR A PARTICULAR PURPOSE.

Some jurisdictions do not allow disclaimer of express or implied warranties in certain transactions, therefore this disclaimer may not apply to you.

**Availability:** All offers subject to availability. Lenovo reserves the right to alter product offerings and specifications at any time, without notice. Lenovo is not responsible for photographic or typographic errors.

**General:** Review key information provided by Microsoft that may apply to your system purchase, including details on Windows 10, Windows 8, Windows 7, and potential upgrades/downgrades. Lenovo makes no representation or warranty regarding third-party products or services.

**Trademarks:** Lenovo, ThinkPad, ThinkCentre, ThinkStation and the Lenovo logo are trademarks of Lenovo. Microsoft, Windows, Windows NT, and the Windows logo are trademarks of Microsoft Corporation. Ultrabook, Celeron, Celeron Inside, Core Inside, Intel, Intel Logo, Intel Atom, Intel Atom Inside, Intel Core, Intel Inside, Intel Inside Logo, Intel vPro, Itanium, Itanium Inside, Pentium, Pentium Inside, vPro Inside, Xeon, Xeon Phi, and Xeon Inside are trademarks of Intel Corporation in the U.S. and/or other countries. Other company, product or service names may be trademarks or service marks of others.

**Warranty:** For a copy of applicable warranties, write to: Lenovo Warranty Information, 1009 Think Place, Morrisville, NC, 27560. Lenovo makes no representation or warranty regarding third party products or services. The Lenovo Limited Warranty applies only to Lenovo hardware products purchased for your own use, and does not transfer upon resale.

**Limited warranty:** Support unrelated to a warranty issue may be subject to additional charges.

#### **Lenovo Services:**

**Carry-in or Mail-in Service:** Parts and labor repair coverage where the customer is responsible for shipping (including packaging) or delivery to authorized warranty provider or repair center.

**Depot or Courier Service:** Parts and labor repair coverage where shipping (including packaging) or delivery to the repair center is paid for by Lenovo.

**Expedited Depot:** Parts and labor coverage with expedited turnaround. Shipping (including packaging) or delivery to the repair center is paid for by Lenovo.

**Onsite / In-home Service:** Parts and labor repair coverage where labor is provided onsite at your place of business.

If Lenovo determines your product problem is covered by the product warranty and cannot be resolved over the telephone, a technician will be dispatched to arrive onsite, typically the next day.

**International Warranty Service (IWS):** PC repair coverage for customers who require a critical warranty repair while travelling internationally. Visit [www.lenovo.com/internationalwarranty](http://www.lenovo.com/internationalwarranty) for details. Visit [www.lenovo.com/warranty](http://www.lenovo.com/warranty) for Lenovo Warranty Services terms and conditions for complete details and restrictions.

**Included software:** may differ from its retail version (if available), and may not include user manuals or all program functionality. Software license agreements may apply.

**Battery life:** Battery life (and recharge times) will vary based on many factors including screen brightness, applications, features, power management, battery conditioning, and other customer preferences.

Visit <http://psref.lenovo.com/> for the latest version of Product Specifications Reference.

© Lenovo, 2018. All rights reserved.  
Lenovo 1009 Think Place Morrisville, NC 27560 U.S.A.