

Lenovo™ **Think**Products

PSREF



Product Specifications Reference

Version 552, December 2019

Visit <http://psref.lenovo.com> for the latest version

Lenovo ThinkPad Laptops

PSREF



Product Specifications Reference

Version 552, December 2019

Visit <http://psref.lenovo.com> for the latest version

Contents

Cover		33
Contents		
Summary Of Change		
11e Series		
ThinkPad 11e (5th Gen)		
ThinkPad 11e (5th Gen) Platform Specifications		
A Series		
ThinkPad A275		
ThinkPad A275 Platform Specifications		
ThinkPad A285		
ThinkPad A285 Platform Specifications		
ThinkPad A475		
ThinkPad A475 Platform Specifications		
ThinkPad A485		
ThinkPad A485 Platform Specifications		
E Series		
ThinkPad E14		
ThinkPad E14 Platform Specifications		
ThinkPad E15		
ThinkPad E15 Platform Specifications		
ThinkPad E480		
ThinkPad E480 Platform Specifications		
ThinkPad E490		
ThinkPad E490 Platform Specifications		
ThinkPad E490s		
ThinkPad E490s Platform Specifications		
ThinkPad E495		
ThinkPad E495 Platform Specifications		
ThinkPad E580		
ThinkPad E580 Platform Specifications		
ThinkPad E590		
ThinkPad E590 Platform Specifications		
ThinkPad E595		
ThinkPad E595 Platform Specifications		
L Series		
1 ThinkPad L13		33
2 ThinkPad L13 Platform Specifications		34
4 ThinkPad L380		35
5 ThinkPad L380 Platform Specifications		36
5 ThinkPad L390		37
6 ThinkPad L390 Platform Specifications		38
7 ThinkPad L480		39
7 ThinkPad L480 Platform Specifications		40
8 ThinkPad L490		41
9 ThinkPad L490 Platform Specifications		42
10 ThinkPad L570		43
11 ThinkPad L570 Platform Specifications		44
12 ThinkPad L580		45
13 ThinkPad L580 Platform Specifications		46
14 ThinkPad L590		47
15 ThinkPad L590 Platform Specifications		48
15 P Series		49
16 ThinkPad P1		49
17 ThinkPad P1 Platform Specifications		50
18 ThinkPad P1 (2nd Gen)		51
19 ThinkPad P1 (2nd Gen) Platform Specifications		52
20 ThinkPad P43s		53
21 ThinkPad P43s Platform Specifications		54
22 ThinkPad P51		55
23 ThinkPad P51 Platform Specifications		56
24 ThinkPad P52		57
25 ThinkPad P52 Platform Specifications		58
26 ThinkPad P52s		59
27 ThinkPad P52s Platform Specifications		60
28 ThinkPad P53		61
29 ThinkPad P53 Platform Specifications		62
30 ThinkPad P53s		63
31 ThinkPad P53s Platform Specifications		64
32 ThinkPad P72		65
33 ThinkPad P72 Platform Specifications		66

Contents

ThinkPad P73	67	ThinkPad X1 Yoga (4th Gen) Platform Specifications	100
ThinkPad P73 Platform Specifications	68	ThinkPad X380 Yoga	101
T Series	69	ThinkPad X380 Yoga Platform Specifications	102
ThinkPad T470	69	ThinkPad X390 Yoga	103
ThinkPad T470 Platform Specifications	70	ThinkPad X390 Yoga Platform Specifications	104
ThinkPad T470s	71	ThinkPad Yoga 11e (5th Gen)	105
ThinkPad T470s Platform Specifications	72	ThinkPad Yoga 11e (5th Gen) Platform Specifications	106
ThinkPad T480	73	X Series	107
ThinkPad T480 Platform Specifications	74	ThinkPad X1 Carbon (6th Gen)	107
ThinkPad T480s	75	ThinkPad X1 Carbon (6th Gen) Platform Specifications	108
ThinkPad T480s Platform Specifications	76	ThinkPad X1 Carbon (7th Gen)	109
ThinkPad T490	77	ThinkPad X1 Carbon (7th Gen) Platform Specifications	110
ThinkPad T490 Platform Specifications	78	ThinkPad X1 Extreme	111
ThinkPad T490 Secure Access / Healthcare Edition	79	ThinkPad X1 Extreme Platform Specifications	112
ThinkPad T490 Secure Access / Healthcare Edition Platform Specifications	80	ThinkPad X1 Extreme (2nd Gen)	113
ThinkPad T490s	81	ThinkPad X1 Extreme (2nd Gen) Platform Specifications	114
ThinkPad T490s Platform Specifications	82	ThinkPad X270	115
ThinkPad T495	83	ThinkPad X270 Platform Specifications	116
ThinkPad T495 Platform Specifications	84	ThinkPad X280	117
ThinkPad T495s	85	ThinkPad X280 Platform Specifications	118
ThinkPad T495s Platform Specifications	86	ThinkPad X390	119
ThinkPad T580	87	ThinkPad X390 Platform Specifications	120
ThinkPad T580 Platform Specifications	88	ThinkPad X395	121
ThinkPad T590	89	ThinkPad X395 Platform Specifications	122
ThinkPad T590 Platform Specifications	90	Legal Information	123
ThinkPad Yoga	91		
ThinkPad L13 Yoga	91		
ThinkPad L13 Yoga Platform Specifications	92		
ThinkPad L380 Yoga	93		
ThinkPad L380 Yoga Platform Specifications	94		
ThinkPad L390 Yoga	95		
ThinkPad L390 Yoga Platform Specifications	96		
ThinkPad X1 Yoga (3rd Gen)	97		
ThinkPad X1 Yoga (3rd Gen) Platform Specifications	98		
ThinkPad X1 Yoga (4th Gen)	99		

Summary of Changes

This section describes the technical changes made in this edition.

This edition might also include minor corrections and editorial changes which are not identified.

December 11, 2019 - Version 552

Additions in this update

▶ **New product(s)**

None

▶ **Others**

ThinkPad E14 - spec updated

ThinkPad E495 - spec updated

Withdrawals in this update

▶ **Withdrawn product(s)**

None



ThinkPad 11e (5th Gen) Platform Specifications

Product Specifications Reference (PSREF)

Processor	7th Generation Intel® Core™ m / i5 Processor, Intel Celeron® processor, or Intel Pentium® Silver processor								Dimensions Weight		WxDxH: 11.81" x 8.27" x 0.86"; 300mm x 210mm x 21.9mm Starting at 2.99 lb / 1.36 kg	
	Processor Number	# of Cores	# of Threads	Base Frequency	Burst Frequency	Cache	Memory Types	Processor Graphics	Case color	Black		
	m3-7Y30	2	4	1.0 GHz	2.6 GHz	4MB	LPDDR3-1866	Intel HD Graphics 615	Case material	Display cover: PC/ABS+GF; Bottom: PC/ABS plastic		
	i5-7Y54			1.2 GHz	3.2 GHz	4MB		Intel UHD Graphics 600	Smart card reader Media reader Ports	None MicroSD card reader Two USB 3.1 Gen 1, one USB 3.1 Type-C Gen 1 (with the function of Power Delivery and DisplayPort), HDMI 1.4b, Ethernet (RJ-45), headphone / microphone combo jack, microSD card reader, security keyhole * Depending on many factors, actual data transfer speed may be lower than theoretical speed		
	Celeron N4100	4	4	1.1 GHz	2.4 GHz	4MB	DDR4-2400	Intel UHD Graphics 600				
	Pentium Silver N5000			1.1 GHz	2.7 GHz	4MB		Intel UHD Graphics 605				
Graphics	Intel HD Graphics 615, Intel UHD Graphics 600 or 605 in processor, supports external digital monitor via HDMI or USB Type-C; supports dual independent display; Max resolution: 3840x2160@60Hz (USB Type-C); 4096x2160@30Hz (HDMI)								Camera	HD720p camera, fixed focus		
Chipset	Intel SoC (System on Chip) platform 4GB or 8GB / 1866MHz LPDDR3 or 2400MHz DDR4 / soldered to systemboard, no sockets								Audio support	HD Audio, Realtek® ALC3287 codec, stereo speakers, 2W x 2, Dolby® Audio™, mono digital microphone, combo audio/microphone jack		
Memory									Keyboard	6-row, spill-resistant, multimedia Fn keys		
Display	Size	Resolution	Type	Surface	Brightness	Aspect Ratio	Contrast Ratio	Color Gamut	Viewing Angle	Touchpad	Buttonless Mylar surface touchpad below keyboard, multi-touch	
	11.6"	HD (1366x768)	TN	Anti-glare	250 nits	16:9	400:1 or 500:1	45%	90°	Security	Power-on password, supervisor password, security keyhole	
	11.6"	HD (1366x768)	IPS	Anti-glare	250 nits	16:9	800:1	45%	170°	Security chip	Discrete TPM 2.0, TCG Certified	
Multi-touch (opt)	Capacitive-type multi-touch, supports 10-finger gesture (HD IPS only)								System Mgt	None		
Storage	eMMC flash memory on board or M.2 SSD / PCIe NVMe, PCIe 3.0 x 2, 16Gb/s								Fingerprint reader	None		
Optical	None								NFC	None		
Ethernet	Realtek RTL8111GUS Gigabit Network Connection								Battery	Integrated Li-ion 42Wh battery		
WLAN + Bluetooth™	One of the following, configurable by model: • Intel Wireless-AC 9260, Wi-Fi 2x2 802.11ac + Bluetooth 5.0, M.2 card • Intel Wireless-AC 9560, Wi-Fi 2x2 802.11ac + Bluetooth 5.0, M.2 card (US only)								Max battery life	MobileMark® 2014: 13.9 hr * Battery life varies significantly with settings, usage, & other factors		
WWAN	None								AC adapter	45W or 65W slim tip AC adapter, 45W or 65W USB Type-C AC adapter		
									Operating system (optional)	One of the following, configurable by model: • Windows® 10 Home 64 • Windows 10 Pro 64 • Windows 10 Pro in S mode • No OS		
									Limited warranty	One of the following, configurable by model: • 1-year depot repair service • 3-year/1-yr battery depot repair service		
									Mil-Spec test	MIL-STD-810G military testing		
									Environment	EPEAT™ Silver; ENERGY STAR® 6.1; RoHS-compliant		

Note: The specifications above may not be available in all regions.

Lenovo
August 2019



ThinkPad A275 Platform Specifications

Product Specifications Reference (PSREF)

Processor	AMD PRO A-Series APUs								Smart card reader Media reader Ports Monitor cable (optional) Camera (optional) Audio support	Optional: Smart card reader 4-in-1 reader (MMC, SD, SDHC, SDXC) Two USB 3.1 Gen 1 (USB 3.0, one Always On), USB 3.1 Type-C Gen 1 (with the function of Power Delivery and DisplayPort), HDMI 1.4b, Ethernet (RJ-45) <i>* Depending on many factors, actual data transfer speed may be lower than theoretical speed</i> HDMI to VGA: Lenovo HDMI to VGA Monitor Adapter USB-C to VGA: Lenovo USB-C to VGA Adapter USB-C to DP: Lenovo USB-C to DisplayPort Adapter HD720p resolution, fixed focus HD Audio, Realtek ALC3268 codec / stereo speakers, 1.5W x 2 / dual array microphone, combo audio/microphone jack								
	Processor Number	# of Cores	# of Threads	Base Frequency	Max Turbo Frequency	Cache	Memory Types	Processor Graphics										
	PRO A10-8730B	4	4	2.4 GHz	3.3 GHz	2MB	DDR4-1866	AMD Radeon™ R5 Graphics										
	PRO A12-8830B			2.5 GHz	3.4 GHz			AMD Radeon R7 Graphics										
	PRO A10-9700B			2.5 GHz	3.4 GHz													
PRO A12-9800B	2.7 GHz			3.6 GHz														
<i>* Windows 7 is only supported by PRO A10-8730B and PRO A12-8830B</i>																		
Graphics	AMD Radeon R5 or R7 Graphics in processor only; supports external digital monitor via HDMI or USB Type-C; supports three independent displays; Max resolution: 4096x2160@60Hz (USB Type-C); 4096x2160@30Hz (HDMI)								Keyboard UltraNav™	6-row, spill-resistant, multimedia Fn keys, optional LED backlight TrackPoint® pointing device and buttonless Mylar surface multi-touch touchpad								
Chipset Memory	AMD SoC (System on Chip) platform 16GB max / 1866MHz DDR4, one DDR4 SO-DIMM socket								Security Security chip	Power-on password, hard disk password, supervisor password, security keyhole <i>dTPM 1.2:</i> discrete TPM 1.2, TCG Certified <i>dTPM 2.0:</i> discrete TPM 2.0, TCG Certified								
Display	<i>Some:</i> 12.5" (317.5mm) HD (1366x768), anti-glare, LED backlight, 220 nits, 16:9 aspect ratio, 500:1 contrast ratio <i>Some:</i> 12.5" (317.5mm) FHD (1920x1080), anti-glare, LED backlight, IPS, 300 nits, 16:9 aspect ratio, 700:1 contrast ratio, 170° viewing angle								Fingerprint reader NFC	Optional: Touch style match on chip fingerprint reader on the palm rest None								
Multi-touch (opt)	On-cell touch, supports 10-finger gesture (FHD only, US only)								Internal battery External battery Max battery life (MobileMark® 2014)	Optional: Integrated Li-ion or Li-Polymer 3-cell (23Wh) Li-ion 3-cell (23Wh) or 6-cell (48Wh)								
Storage	<i>System has one HDD slot or one M.2 slot exclusively for storage</i> <i>Some:</i> HDD / SATA 6.0Gb/s, 2.5" wide, 7mm high, Active Protection System™ <i>Some:</i> SSD / SATA 6.0Gb/s, 2.5" wide, 7mm high (e.g. xxxGB SSD) <i>Some:</i> M.2 SSD / PCIe NVMe, PCIe 3.0 x 2, 16Gb/s								<table border="1"> <thead> <tr> <th>Models</th> <th>No + 3-cell</th> <th>3-cell + 3-cell</th> <th>3-cell + 6-cell 48Wh</th> </tr> </thead> <tbody> <tr> <td>Max battery life</td> <td>5.05 hr</td> <td>10.1 hr</td> <td>15.6 hr</td> </tr> </tbody> </table>		Models	No + 3-cell	3-cell + 3-cell	3-cell + 6-cell 48Wh	Max battery life	5.05 hr	10.1 hr	15.6 hr
Models	No + 3-cell	3-cell + 3-cell	3-cell + 6-cell 48Wh															
Max battery life	5.05 hr	10.1 hr	15.6 hr															
Optical	None								AC adapter	45W slim tip AC adapter or 45W USB Type-C AC adapter								
Ethernet	Realtek® RTL8111EPV Gigabit Ethernet connection								Operating system	One of the following, configurable by model: • Windows® 7 Professional 64 preinstalled through downgrade rights in Windows 10 Pro 64 • Windows 10 Home 64 • Windows 10 Pro 64								
WLAN Bluetooth™	Realtek RTL8822BE, Wi-Fi 2x2 802.11ac + BT4.1, M.2 card Bluetooth 4.1 wireless, integrated in Wi-Fi + Bluetooth combo adapter								Limited warranty	One of the following, configurable by model: • 1-year depot repair service • 3-year/1-yr battery depot repair service • 3-year/1-yr battery limited onsite service								
WWAN (optional)	One of the following, configurable by model: • Wireless WAN upgradable • Integrated Mobile Broadband 4G LTE-A, Qualcomm® Snapdragon™ X7 LTE-A (Sierra Wireless EM7455) <i>* For non-WWAN model, it means the model is NOT WWAN upgradable</i>								Mil-Spec test	MIL-STD-810G military testing								
SIM card (opt)	Micro-SIM card slot, opt Verizon LTE (US) SIM card								Environment	EEPEAT™ Gold (US only); ENERGY STAR® 6.1; RoHS-compliant								
Dimensions Weight	<i>WxDxH:</i> 12.03" x 8.21" x 0.80"; 305.5mm x 208.5mm x 20.3mm																	
	Models		No + 3-cell		3-cell + 3-cell		3 + 6-cell											
	Weight		2.79 lb / 1.27 kg		2.98 lb / 1.36 kg		3.33 lb / 1.52 kg											
Case color	Black																	
Case material	Glass-Fiber Reinforced Plastic																	

Note: The specifications above may not be available in all regions.

Lenovo
August 2019



ThinkPad A285 Platform Specifications

Product Specifications Reference (PSREF)

Processor	AMD Ryzen™ PRO Mobile Processors with Radeon™ Vega Graphics	Smart card reader Media reader Ports	Optional: Smart card reader MicroSD card reader, in the combo slot with nano-SIM card One USB 3.1 Gen 1 (Always On), one USB 3.1 Gen 2, two USB 3.1 Type-C Gen 2 (with the function of Power Delivery and DisplayPort), HDMI 2.0, Ethernet extension connector, combo slot of nano-SIM card (WWAN models) and microSD card reader, headphone / microphone combo jack, optional smart card reader, side docking connector, security keyhole <i>* Depending on many factors, actual data transfer speed may be lower than theoretical speed</i>																										
	<table border="1"> <thead> <tr> <th>Processor Number</th> <th># of Cores</th> <th># of Threads</th> <th>Base Frequency</th> <th>Max Turbo Frequency</th> <th>Cache</th> <th>Memory Types</th> <th>Processor Graphics</th> </tr> </thead> <tbody> <tr> <td>Ryzen 3 PRO 2300U</td> <td rowspan="3">4</td> <td>4</td> <td>2.0 GHz</td> <td>3.4 GHz</td> <td rowspan="3">2MB L2 / 4MB L3</td> <td rowspan="3">DDR4-2400</td> <td>Radeon Vega 6 Graphics</td> </tr> <tr> <td>Ryzen 5 PRO 2500U</td> <td>8</td> <td>2.0 GHz</td> <td>3.6 GHz</td> <td>Radeon Vega 8 Graphics</td> </tr> <tr> <td>Ryzen 7 PRO 2700U</td> <td>8</td> <td>2.2 GHz</td> <td>3.8 GHz</td> <td>Radeon Vega 10 Graphics</td> </tr> </tbody> </table>	Processor Number	# of Cores	# of Threads	Base Frequency	Max Turbo Frequency	Cache	Memory Types	Processor Graphics	Ryzen 3 PRO 2300U	4	4	2.0 GHz	3.4 GHz	2MB L2 / 4MB L3	DDR4-2400	Radeon Vega 6 Graphics	Ryzen 5 PRO 2500U	8	2.0 GHz	3.6 GHz	Radeon Vega 8 Graphics	Ryzen 7 PRO 2700U	8	2.2 GHz	3.8 GHz	Radeon Vega 10 Graphics	Monitor cable (optional) Bundled Accy	HDMI to VGA: Lenovo HDMI to VGA Monitor Adapter USB-C to VGA: Lenovo USB-C to VGA Adapter USB-C to DP: Lenovo USB-C to DisplayPort Adapter Optional: ThinkPad Ethernet Extension Adapter Gen 2
Processor Number	# of Cores	# of Threads	Base Frequency	Max Turbo Frequency	Cache	Memory Types	Processor Graphics																						
Ryzen 3 PRO 2300U	4	4	2.0 GHz	3.4 GHz	2MB L2 / 4MB L3	DDR4-2400	Radeon Vega 6 Graphics																						
Ryzen 5 PRO 2500U		8	2.0 GHz	3.6 GHz			Radeon Vega 8 Graphics																						
Ryzen 7 PRO 2700U		8	2.2 GHz	3.8 GHz			Radeon Vega 10 Graphics																						
Graphics	AMD Radeon Vega 6, Vega 8, or Vega 10 Graphics in processor only; supports external digital monitor via HDMI or USB Type-C; supports four independent displays; Max resolution: 5120x2880@60Hz (USB Type-C); 4096x2160@60Hz (HDMI)	Camera (optional)	One of the following, configurable by model: • HD720p camera with ThinkShutter camera privacy, fixed focus • IR camera and HD720p camera, fixed focus																										
Chipset	AMD SoC (System on Chip) platform	Audio support	HD Audio, Realtek ALC3287 codec / stereo speakers, 2W x 2, Dolby® Audio™ Premium / dual array microphone, headphone / microphone combo jack																										
Memory	8GB or 16GB / 2400MHz DDR4, soldered to systemboard, no sockets	Keyboard	6-row, spill-resistant, multimedia Fn keys, optional LED backlight																										
Display	Some: 12.5" (317.5mm) HD (1366x768), anti-glare, LED backlight, 220 nits, 16:9 aspect ratio, 400:1 contrast ratio Some: 12.5" (317.5mm) FHD (1920x1080), anti-glare, LED backlight, IPS, 300 nits, 16:9 aspect ratio, 800:1 contrast ratio, 170° viewing angle	UltraNav™	TrackPoint® pointing device and buttonless Mylar surface multi-touch touchpad																										
Multi-touch (opt)	On-cell touch, supports 10-finger gesture (FHD only)	Security	Power-on password, hard disk password, supervisor password, security keyhole																										
Storage	One of the following, configurable by model: • M.2 SSD / SATA 6.0Gb/s • M.2 SSD / PCIe NVMe, PCIe 3.0 x 4, 32Gb/s	Security chip	Discrete TPM 2.0, TCG Certified																										
Optical	None	System Mgt	DASH Management																										
Ethernet	Gigabit Ethernet connection via bundled or optional ThinkPad Ethernet Extension Adapter Gen 2	Fingerprint reader	Optional: Touch style match on chip fingerprint reader on the palm rest																										
WLAN	Realtek® RTL8822BE, Wi-Fi 2x2 802.11ac + Bluetooth 4.2, M.2 card	NFC	None																										
Bluetooth™	Bluetooth 4.2 wireless, integrated in Wi-Fi + Bluetooth combo adapter	Battery	Integrated Li-ion 48Wh battery, supports Rapid Charge (charge up to 80% in 1hr) with 65W AC adapter																										
WWAN (optional)	Integrated Mobile Broadband 4G LTE-A, Intel XMM™ 7360 (Fibocom L850-GL), M.2 card <i>* For non-WWAN model, it means the model is NOT WWAN upgradable</i>	Max battery life	MobileMark® 2014: 10.55 hr <i>* Battery life varies significantly with settings, usage, & other factors</i>																										
SIM card (opt)	Nano-SIM card slot, in the combo slot with microSD card reader, optional Verizon LTE (US) SIM card	AC adapter	45W or 65W USB Type-C AC adapter																										
Dimensions	WxDxH (HD & FHD multi-touch): 12.11" x 8.26" x 0.69"; 307.7mm x 209.8mm x 17.4mm WxDxH (FHD non-touch): 12.11" x 8.26" x 0.70"; 307.7mm x 209.8mm x 17.8mm	Operating system	Windows® 10 Home 64 or Windows 10 Pro 64																										
Weight	FHD non-touch model: 2.49 lb / 1.13 kg; HD non-touch model: 2.78 lb / 1.26 kg; FHD multi-touch model: 2.79 lb / 1.27 kg	Limited warranty	One of the following, configurable by model: • 1-year depot repair service • 3-year/1-yr battery depot repair service • 3-year/1-yr battery limited onsite service																										
Case color	Black	Mil-Spec test	MIL-STD-810G military testing																										
Case material	Display cover: Carbon Fiber (FHD non-touch model) or PPS (HD & FHD multi-touch model); Bottom: Magnesium/Aluminum	Environment	EPeAT™ Gold (US only); ENERGY STAR® 6.1; RoHS-compliant																										

Note: The specifications above may not be available in all regions.

Lenovo
April 2019



ThinkPad A475 Platform Specifications

Product Specifications Reference (PSREF)

Processor	AMD PRO A-Series APUs							Dimensions Weight	WxDxH: 13.25" x 9.15" x 0.79"; 336.6mm x 232.5mm x 19.95mm				
	Processor Number	# of Cores	# of Threads	Base Frequency	Max Turbo Frequency	Cache	Memory Types		Processor Graphics	Models	3-cell or 3 + 3-cell	6-cell or 3 + 6-cell	
	PRO A10-8730B	4	4	2.4 GHz	3.3 GHz	2MB	DDR4-1866		AMD Radeon™ R5 Graphics	Magnesium	3.49 lb / 1.58 kg	3.92 lb / 1.78 kg	
	PRO A12-8830B			2.5 GHz	3.4 GHz				AMD	PPS	3.63 lb / 1.65 kg	4.35 lb / 1.85 kg	
	PRO A10-9700B			2.5 GHz	3.4 GHz				Radeon				
PRO A12-9800B	2.7 GHz			3.6 GHz	R7 Graphics								
* Windows 7 is only supported by PRO A10-8730B and PRO A12-8830B							Case color	Black					
Graphics	AMD Radeon R5 or R7 Graphics in processor only; supports external digital monitor via HDMI or USB Type-C; supports three independent displays; Max resolution: 4096x2160@60Hz (USB Type-C); 4096x2160@30Hz (HDMI)							Case material	Display cover: Magnesium Hybrid or PPS (Magnesium Hybrid for US only); Bottom: Glass-Fiber Reinforced Plastic				
	Chipset	AMD SoC (System on Chip) platform							Smart card reader	Optional: Smart card reader			
Memory	32GB max / 1866MHz DDR4, dual-channel capable, two DDR4 SO-DIMM sockets							Media reader	4-in-1 reader (MMC, SD, SDHC, SDXC), supports SD 3.0, UHS-I				
Display	Some: 14.0" (355mm) HD (1366x768), anti-glare, LED backlight, 220 nits, 16:9 aspect ratio, 350:1 contrast ratio Some: 14.0" (355mm) FHD (1920x1080), anti-glare, LED backlight, IPS, 250 nits, 16:9 aspect ratio, 700:1 contrast ratio, 170° viewing angle							Ports	Three USB 3.1 Gen 1 (USB 3.0, one Always On), USB 3.1 Type-C Gen 2 (with the function of Power Delivery and DisplayPort), HDMI 1.4b, Ethernet (RJ-45), Dock connector * Depending on many factors, actual data transfer speed may be lower than theoretical speed Optional: Lenovo USB-C to VGA Adapter				
Multi-touch (opt)	On-cell touch, supports 10-finger gesture (FHD only, US only)							Monitor cable	Optional: Lenovo USB-C to VGA Adapter				
Storage	System has one HDD slot or one M.2 2280 slot exclusively for storage Some: HDD / SATA 6.0Gb/s, 2.5" wide, 7mm high, Active Protection System™ Some: SSD / SATA 6.0Gb/s, 2.5" wide, 7mm high (e.g. xxxGB SSD) Some: M.2 SSD / PCIe NVMe, PCIe 3.0 x 2, 16Gb/s * Installed M.2 SSD is PCIe 3.0 x 4 but run at PCIe 3.0 x 2 due to M.2 SSD adapter limitation							Camera (optional)	HD720p resolution, fixed focus				
Optical	None							Audio support	HD Audio, Realtek ALC3268 codec / stereo speakers, 2W x 2 / dual array microphone, combo audio/microphone jack				
Ethernet	Realtek® RTL8111EPV Gigabit Ethernet connection							Keyboard	6-row, spill-resistant, multimedia Fn keys, optional LED backlight UltraNav™ TrackPoint® pointing device and buttonless Mylar surface multi-touch touchpad				
WLAN	Realtek RTL8822BE, Wi-Fi 2x2 802.11ac + BT4.1, M.2 card							Security	Power-on password, hard disk password, supervisor password, security keyhole				
Bluetooth™	Bluetooth 4.1 wireless, integrated in Wi-Fi + Bluetooth combo adapter							Security chip	dTPM 1.2: discrete TPM 1.2, TCG Certified dTPM 2.0: discrete TPM 2.0, TCG Certified				
WWAN (optional)	One of the following, configurable by model: • Wireless WAN upgradable • Integrated Mobile Broadband 4G LTE-A, Qualcomm® Snapdragon™ X7 LTE-A (Sierra Wireless EM7455) * For non-WWAN model, it means the model is NOT WWAN upgradable							Fingerprint reader	Optional: Touch style match on chip fingerprint reader on the keyboard bezel				
SIM card (opt)	Micro-SIM card slot, opt Verizon LTE (US) SIM card							NFC	None				
							Internal battery	Optional: Integrated Li-Polymer 3-cell (24Wh)					
							External battery	Li-Polymer 3-cell (24Wh) or Li-ion 6-cell (48Wh)					
							Max battery life (MobileMark® 2014)	Models	3-cell	3 + 3-cell	6-cell 48Wh	3 + 6-cell 48Wh	
								Max battery life	5.13 hr	10.26 hr	10.26 hr	15.4 hr	
									* Battery life varies significantly with settings, usage, & other factors				
							AC adapter	45W or 65W slim tip AC adapter, 45W or 65W USB Type-C AC adapter					
							Operating system	One of the following, configurable by model: • Windows® 7 Professional 64 preinstalled through downgrade rights in Windows 10 Pro 64 • Windows 10 Home 64 • Windows 10 Pro 64					
							Limited warranty	One of the following, configurable by model: • 1-year depot repair service • 3-year/1-yr battery depot repair service • 3-year/1-yr battery limited onsite service					
							Mil-Spec test	MIL-STD-810G military testing					
							Environment	EPEAT™ Gold (US only); ENERGY STAR® 6.1; RoHS-compliant					

Note: The specifications above may not be available in all regions.

Lenovo
August 2019



ThinkPad A485 Platform Specifications

Product Specifications Reference (PSREF)

Processor	AMD Ryzen™ PRO Mobile Processors with Radeon™ Vega Graphics	Smart card reader Media reader Ports	<i>Optional:</i> Smart card reader 4-in-1 reader (MMC, SD, SDHC, SDXC), supports SD 3.0, UHS-I One USB 3.1 Gen 1 (Always On), one USB 3.1 Gen 2, two USB 3.1 Type-C Gen 2 (with the function of Power Delivery and DisplayPort), HDMI 2.0, Ethernet (RJ-45), nano-SIM card slot (WWAN models), headphone / microphone combo jack, optional smart card reader, 4-in-1 media reader (MMC, SD, SDHC, SDXC), side docking connector, security keyhole * Depending on many factors, actual data transfer speed may be lower than theoretical speed																									
	<table border="1"> <thead> <tr> <th>Processor Number</th> <th># of Cores</th> <th># of Threads</th> <th>Base Frequency</th> <th>Max Turbo Frequency</th> <th>Cache</th> <th>Memory Types</th> <th>Processor Graphics</th> </tr> </thead> <tbody> <tr> <td>Ryzen 3 PRO 2300U</td> <td rowspan="3">4</td> <td>4</td> <td>2.0 GHz</td> <td>3.4 GHz</td> <td rowspan="3">2MB L2 / 4MB L3</td> <td rowspan="3">DDR4-2400</td> <td>Radeon Vega 6 Graphics</td> </tr> <tr> <td>Ryzen 5 PRO 2500U</td> <td>8</td> <td>2.0 GHz</td> <td>3.6 GHz</td> <td>Radeon Vega 8 Graphics</td> </tr> <tr> <td>Ryzen 7 PRO 2700U</td> <td>8</td> <td>2.2 GHz</td> <td>3.8 GHz</td> <td>Radeon Vega 10 Graphics</td> </tr> </tbody> </table>	Processor Number	# of Cores	# of Threads	Base Frequency	Max Turbo Frequency	Cache	Memory Types	Processor Graphics	Ryzen 3 PRO 2300U	4	4	2.0 GHz	3.4 GHz	2MB L2 / 4MB L3	DDR4-2400	Radeon Vega 6 Graphics	Ryzen 5 PRO 2500U	8	2.0 GHz	3.6 GHz	Radeon Vega 8 Graphics	Ryzen 7 PRO 2700U	8	2.2 GHz	3.8 GHz	Radeon Vega 10 Graphics	HDMI to VGA: Lenovo HDMI to VGA Monitor Adapter USB-C to DP: Lenovo USB-C to DisplayPort Adapter
Processor Number	# of Cores	# of Threads	Base Frequency	Max Turbo Frequency	Cache	Memory Types	Processor Graphics																					
Ryzen 3 PRO 2300U	4	4	2.0 GHz	3.4 GHz	2MB L2 / 4MB L3	DDR4-2400	Radeon Vega 6 Graphics																					
Ryzen 5 PRO 2500U		8	2.0 GHz	3.6 GHz			Radeon Vega 8 Graphics																					
Ryzen 7 PRO 2700U		8	2.2 GHz	3.8 GHz			Radeon Vega 10 Graphics																					
Graphics	AMD Radeon Vega 6, Vega 8, or Vega 10 Graphics in processor only; supports external digital monitor via HDMI or USB Type-C; supports four independent displays; Max resolution: 5120x2880@60Hz (USB Type-C); 4096x2160@60Hz (HDMI)	Bundled Accy	None																									
Chipset	AMD SoC (System on Chip) platform	Camera (optional)	One of the following, configurable by model:																									
Memory	32GB max / 2400MHz DDR4, dual-channel capable, two DDR4 SO-DIMM sockets * Installed DIMMs are actually 2666MHz but run at 2400MHz due to AMD limitation	Audio support	• HD720p camera with ThinkShutter camera privacy, fixed focus • IR camera and HD720p camera, fixed focus HD Audio, Realtek® ALC3287 codec / stereo speakers, 2W x 2, Dolby® Audio™ Premium / dual array microphone, headphone / microphone combo jack																									
Display	Some: 14.0" (355mm) HD (1366x768), anti-glare, LED backlight, 220 nits, 16:9 aspect ratio, 400:1 contrast ratio Some: 14.0" (355mm) FHD (1920x1080), anti-glare, LED backlight, IPS, 250 nits, 16:9 aspect ratio, 700:1 contrast ratio, 170° viewing angle	Keyboard	6-row, spill-resistant, multimedia Fn keys, optional LED backlight UltraNav™ TrackPoint® pointing device and buttonless Mylar surface multi-touch touchpad																									
Multi-touch (opt)	On-cell touch, supports 10-finger gesture (FHD only)	Security	Power-on password, hard disk password, supervisor password, security keyhole																									
Storage	System has one HDD slot or one M.2 2280 slot exclusively for storage Some: HDD / SATA 6.0Gb/s, 2.5" wide, 7mm high, Active Protection System™ Some: SSD / SATA 6.0Gb/s, 2.5" wide, 7mm high Some: M.2 SSD / PCIe NVMe, PCIe 3.0 x 4 Some: 128GB M.2 SSD / PCIe NVMe, PCIe 3.0 x 2, in WWAN slot as 2nd Storage, mutually exclusive with WWAN * Installed M.2 SSD is PCIe 3.0 x 4 but run at PCIe 3.0 x 2 due to M.2 SSD adapter limitation	Security chip	Discrete TPM 2.0, TCG Certified																									
Optical	None	System Mgt	DASH Management																									
Ethernet	Realtek® RTL8111GUL Gigabit Ethernet connection	Fingerprint reader	<i>Optional:</i> Touch style match on chip fingerprint reader on the keyboard bezel																									
WLAN	Realtek RTL8822BE, Wi-Fi 2x2 802.11ac + Bluetooth 4.1, M.2 card	NFC	None																									
Bluetooth™	Bluetooth 4.1 wireless, integrated in Wi-Fi + Bluetooth combo adapter	Battery	Integrated Li-ion 24Wh battery and external Li-ion 24Wh, 48Wh, or 72Wh battery																									
WWAN (optional)	Integrated Mobile Broadband 4G LTE-A, Intel XMM™ 7360 (Fibocom L850-GL), M.2 card * For non-WWAN model, it means the model is NOT WWAN upgradable	Max battery life (MobileMark® 2014)	Models	24Wh	48Wh	72Wh	24Wh + 24Wh	24Wh + 48Wh	24Wh + 72Wh																			
SIM card (opt)	Nano-SIM card slot, optional Verizon LTE (US) SIM card	AC adapter	Max battery life	5.37 hr	10.76 hr	16.4 hr	10.76 hr	16.4 hr	22.15 hr																			
Dimensions	WxDxH: 13.25" x 9.15" x 0.79"; 336.6mm x 232.5mm x 19.95mm	Operating system	* Battery life varies significantly with settings, usage, & other factors																									
Weight	<table border="1"> <thead> <tr> <th>Models</th> <th>24Wh or 24Wh + 24Wh</th> <th>48Wh, 72Wh, or 24Wh + 48Wh / 72Wh</th> </tr> </thead> <tbody> <tr> <td>Magnesium</td> <td>3.49 lb / 1.58 kg</td> <td>3.92 lb / 1.78 kg</td> </tr> <tr> <td>PPS</td> <td>3.63 lb / 1.65 kg</td> <td>4.08 lb / 1.85 kg</td> </tr> </tbody> </table>	Models	24Wh or 24Wh + 24Wh	48Wh, 72Wh, or 24Wh + 48Wh / 72Wh	Magnesium	3.49 lb / 1.58 kg	3.92 lb / 1.78 kg	PPS	3.63 lb / 1.65 kg	4.08 lb / 1.85 kg	Limited warranty	One of the following, configurable by model:																
Models	24Wh or 24Wh + 24Wh	48Wh, 72Wh, or 24Wh + 48Wh / 72Wh																										
Magnesium	3.49 lb / 1.58 kg	3.92 lb / 1.78 kg																										
PPS	3.63 lb / 1.65 kg	4.08 lb / 1.85 kg																										
Case color	Black	Mil-Spec test	MIL-STD-810G military testing																									
Case material	Display cover: Magnesium Hybrid or PPS; Bottom: Glass-Fiber Reinforced Plastic	Environment	EPEAT™ Gold (US only); ENERGY STAR® 6.1; RoHS-compliant																									

Note: The specifications above may not be available in all regions.

Lenovo
May 2019



ThinkPad E14 Platform Specifications

Product Specifications Reference (PSREF)

Processor	10th Generation Intel® Core™ i3 / i5 / i7 Processor								Dimensions	Case Material		Dimensions (WxDxH)	
	Processor Number	# of Cores	# of Threads	Base Frequency	Max Turbo Frequency	Cache	Memory Types	Processor Graphics		Aluminum	12.80" x 9.13" x 0.70"; 325mm x 232mm x 17.9mm		
	i3-10110U	2	4	2.1 GHz	4.1 GHz	4MB	DDR4-2666	Intel UHD Graphics		PC/ABS	12.80" x 9.13" x 0.81"; 325mm x 232mm x 20.5mm		
	i5-10210U	4	8	1.6 GHz	4.2 GHz	6MB				Aluminum Display cover + PC/ABS Bottom	12.80" x 9.13" x 0.74"; 325mm x 232mm x 18.9mm		
	i7-10510U			1.8 GHz	4.9 GHz	8MB							
i7-10710U	6	12	1.1 GHz	4.7 GHz	12MB								
Graphics	Intel UHD Graphics in processor only or Intel UHD Graphics in processor and AMD Radeon RX 640 Graphics, 2GB GDDR5 memory; supports external digital monitor via HDMI or USB Type-C; supports three independent displays; Max resolution: 3840x2160@60Hz (USB Type-C); 3840x2160@30Hz (HDMI)								Weight	Case Material		Weight	
										Aluminum	starting at 3.81 lb / 1.73 kg		
Chipset Memory	Intel SoC (System on Chip) platform 16GB max / 2666MHz DDR4, one DDR4 SO-DIMM socket								Case color Case material	PC/ABS		starting at 3.90 lb / 1.77 kg	
										Aluminum Display cover + PC/ABS Bottom	starting at 3.74 lb / 1.69 kg		
Display									Smart card reader	None			
	Size	Resolution	Type	Surface	Brightness	Aspect Ratio	Contrast Ratio	Viewing Angle		Media reader	None		
Multi-touch	None								Ports	One USB 2.0, two USB 3.1 Gen 1 (one Always On), one USB 3.1 Type-C Gen 1 (with the function of Power Delivery and DisplayPort), HDMI 1.4b, Ethernet (RJ-45), headphone / microphone combo jack, security keyhole * Depending on many factors, actual data transfer speed may be lower than theoretical speed			
										Monitor cable	None		
Storage	Up to two drives (one M.2 SSD and one HDD) • HDD / SATA 6.0Gb/s, 2.5" wide, 7mm high, Active Protection System™ • M.2 2280 SSD / SATA 6.0Gb/s • M.2 2242 SSD / PCIe NVMe, PCIe 3.0 x 2 or PCIe 3.0 x 4 • M.2 2280 SSD / PCIe NVMe, PCIe 3.0 x 4 • Intel Optane™ Memory H10 with Solid State Storage, M.2 2280, PCIe NVMe 3.0 x 4								Bundled Accy	None			
										Camera	HD720p camera with optional ThinkShutter camera privacy, fixed focus		
Optical	None								Audio support	HD Audio, Synaptic® CX11880 codec / stereo speakers, 2W x 2, Dolby® Advanced Audio / dual array microphone, headphone / microphone combo jack			
										Keyboard	6-row, spill-resistant, multimedia Fn keys, optional LED backlight		
Ethernet	Gigabit Ethernet Connection, Realtek R8111GUS								UltraNav™	TrackPoint® pointing device and buttonless Mylar surface multi-touch touchpad			
										Security	Power-on password, hard disk password, supervisor password, security keyhole		
WLAN + Bluetooth™	One of the following, configurable by model: • Realtek® RTL8822CE, Wi-Fi 2x2 802.11ac + Bluetooth 5.0, M.2 card • Intel Wireless-AC 9560, Wi-Fi 2x2 802.11ac + Bluetooth 5.0, M.2 card • Intel Wi-Fi 6 AX201, Wi-Fi 2x2 802.11ax + Bluetooth 5.0, M.2 card								Security chip	Integrated model: discrete TPM 2.0, TCG Certified Discrete model: firmware TPM 2.0 integrated in chipset			
										System Mgt	None		
WWAN SIM card	None								Fingerprint reader	Optional: Touch style fingerprint reader on power button			
										NFC	None		
Battery	Integrated Li-ion 45Wh battery, supports Rapid Charge (charge up to 80% in 1hr) with 65W AC adapter								Max battery life	MobileMark® 2014: 12.8 hr * Battery life varies significantly with settings, usage, & other factors			
										AC adapter	45W or 65W USB Type-C AC adapter		
Operating system (optional)	One of the following, configurable by model: • Windows® 10 Home 64 • Windows 10 Pro 64 • Windows 10 Pro in S mode • No OS								Limited warranty (optional)	• 1-year mail-in repair service • 1-year depot repair service • 1-year depot with 2-year system board repair service • 1-year limited onsite service			
										Mil-Spec test	MIL-STD-810G military testing (by the end of Dec. 2019)		
Environment									Environment	EPEAT™ Silver; ENERGY STAR® 7.1; RoHS-compliant			

Note: The specifications above may not be available in all regions.



ThinkPad E15 Platform Specifications

Product Specifications Reference (PSREF)

Processor	10th Generation Intel® Core™ i3 / i5 / i7 Processor								Dimensions	<i>WxDxH:</i> 14.49" x 9.65" x 0.74"; 368mm x 245mm x 18.9mm
	Processor Number	# of Cores	# of Threads	Base Frequency	Max Turbo Frequency	Cache	Memory Types	Processor Graphics	Weight	Starting at 4.3 lb / 1.9 kg
	i3-10110U	2	4	2.1 GHz	4.1 GHz	4MB	DDR4-2666	Intel UHD Graphics	Case color	Black or silver
	i5-10210U	4	8	1.6 GHz	4.2 GHz	6MB			Case material	<i>Display cover:</i> Aluminum; <i>Bottom:</i> PC/ABS plastic
	i7-10510U			1.8 GHz	4.9 GHz	8MB			Smart card reader	None
	i7-10710U	6	12	1.1 GHz	4.7 GHz	12MB			Media reader	None
Graphics	Intel UHD Graphics in processor only or Intel UHD Graphics in processor and AMD Radeon RX 640 Graphics, 2GB GDDR5 memory; supports external digital monitor via HDMI or USB Type-C; supports three independent displays; Max resolution: 3840x2160@60Hz (USB Type-C); 3840x2160@30Hz (HDMI)								Ports	One USB 2.0, two USB 3.1 Gen 1 (one Always On), one USB 3.1 Type-C Gen 1 (with the function of Power Delivery and DisplayPort), HDMI 1.4b, Ethernet (RJ-45), headphone / microphone combo jack, security keyhole <i>* Depending on many factors, actual data transfer speed may be lower than theoretical speed</i>
Chipset	Intel SoC (System on Chip) platform								Monitor cable	None
Memory	16GB max / 2666MHz DDR4, one DDR4 SO-DIMM socket								Bundled Accy	None
Display	Size	Resolution	Type	Surface	Brightness	Aspect Ratio	Contrast Ratio	Viewing Angle	Camera	HD720p camera with optional ThinkShutter camera privacy, fixed focus
	15.6" FHD (1920x1080)		TN	Anti-glare	220 nits	16:9	400:1	90°	Audio support	HD Audio, Synaptic® CX11880 codec / stereo speakers, 2W x 2, Dolby® Advanced Audio / dual array microphone, headphone / microphone combo jack
	15.6" FHD (1920x1080)		IPS	Anti-glare	250 nits	16:9	700:1	170°	Keyboard	6-row, spill-resistant, multimedia Fn keys, numeric keypad, optional LED backlight
Multi-touch	None								UltraNav™	TrackPoint® pointing device and buttonless Mylar surface multi-touch touchpad
Storage	Up to two drives (one M.2 SSD and one HDD) • HDD / SATA 6.0Gb/s, 2.5" wide, 7mm high, Active Protection System™ • M.2 2280 SSD / SATA 6.0Gb/s • M.2 2242 SSD / PCIe NVMe, PCIe 3.0 x 2 or PCIe 3.0 x 4 • M.2 2280 SSD / PCIe NVMe, PCIe 3.0 x 4 • Intel Optane™ Memory H10 with Solid State Storage, M.2 2280, PCIe NVMe 3.0 x 4								Security	Power-on password, hard disk password, supervisor password, security keyhole
Optical	None								Security chip	<i>Integrated model:</i> discrete TPM 2.0, TCG Certified <i>Discrete model:</i> firmware TPM 2.0 integrated in chipset
Ethernet	Gigabit Ethernet Connection, Realtek R8111GUS								System Mgt	None
WLAN + Bluetooth™	One of the following, configurable by model: • Realtek® RTL8822CE, Wi-Fi 2x2 802.11ac + Bluetooth 5.0, M.2 card • Intel Wi-Fi 6 AX201, Wi-Fi 2x2 802.11ax + Bluetooth 5.0, M.2 card								Fingerprint reader	<i>Optional:</i> Touch style fingerprint reader on power button
WWAN	None								NFC	None
SIM card	None								Battery	Integrated Li-ion 45Wh battery, supports Rapid Charge (charge up to 80% in 1hr) with 65W AC adapter
									Max battery life	<i>MobileMark® 2014:</i> 12.2 hr <i>* Battery life varies significantly with settings, usage, & other factors</i>
									AC adapter	45W or 65W USB Type-C AC adapter
									Operating system (optional)	• Windows® 10 Home 64 • Windows 10 Pro 64 • Windows 10 Pro in S mode
									Limited warranty (optional)	• 1-year mail-in repair service • 1-year depot repair service • 1-year depot with 2-year system board repair service
									Mil-Spec test	MIL-STD-810G military testing (by the end of Jan. 2020)
									Environment	EPEAT™ Silver; ENERGY STAR® 7.1; RoHS-compliant

Note: The specifications above may not be available in all regions.

Lenovo
November 2019



ThinkPad E480 Platform Specifications

Product Specifications Reference (PSREF)

Processor	7th Generation Intel® Core™ i3 / i5 Processor (i3-7130U is NOT available in US and EMEA) or							Dimensions	Aluminum (WxDxH): 12.96" x 9.53" x 0.78"; 329mm x 242mm x 19.9mm PC/ABS (WxDxH): 12.96" x 9.53" x 0.83"; 329mm x 242mm x 21.9mm	
	Processor Number	# of Cores	# of Threads	Base Frequency	Max Turbo Frequency	Cache	Memory Types	Processor Graphics	Weight	
	i3-7020U	2	4	2.3 GHz	-	3MB	DDR4-2133	Intel HD Graphics 620	Starting at 3.87 lb / 1.75kg	
	i3-7130U			2.7 GHz	-	3MB			Case color	Black or silver
	i5-7200U			2.5 GHz	3.1 GHz	3MB			Case material	Display cover: Aluminum or PC/ABS plastic; Bottom: PC/ABS plastic
	8th Generation Intel Core i3 / i5 / i7 Processor							Smart card reader	None	
	Processor Number	# of Cores	# of Threads	Base Frequency	Max Turbo Frequency	Cache	Memory Types	Processor Graphics	Media reader	
	i3-8130U	2	4	2.2 GHz	3.4 GHz	4MB	DDR4-2400	Intel UHD Graphics 620	MicroSD card reader	
	i5-8250U	4	8	1.6 GHz	3.4 GHz	6MB			Ports	One USB 2.0, two USB 3.1 Gen 1 (one Always On), one USB 3.1 Type-C Gen 2 (with the function of Power Delivery and DisplayPort), HDMI 1.4b, Ethernet (RJ-45), headphone / microphone combo jack, microSD card reader, security keyhole * Depending on many factors, actual data transfer speed may be lower than theoretical speed
	i7-8550U			1.8 GHz	4.0 GHz	8MB			Camera	HD720p camera, fixed focus
Graphics	Intel HD Graphics 620 or Intel UHD Graphics 620 in processor only or Intel HD Graphics 620 or Intel UHD Graphics 620 in processor and AMD Radeon RX 550 Graphics, 2GB GDDR5 memory; supports external digital monitor via HDMI or USB Type-C; supports dual independent display; Max resolution: 1920x1080 (HDMI) @60Hz							Audio support	HD Audio, Synaptic® CX11852 codec / stereo speakers, 1.5W x 2, Dolby® Advanced Audio / dual array microphone, headphone / microphone combo jack	
Chipset	Intel SoC (System on Chip) platform							Keyboard	6-row, spill-resistant, multimedia Fn keys, optional LED backlight	
Memory	32GB max / 2400MHz DDR4, dual-channel capable, two DDR4 SO-DIMM sockets * System clocks down for processors with lower memory controller							UltraNav™	TrackPoint® pointing device and buttonless Mylar surface multi-touch touchpad	
Display	Some: 14.0" (355mm) HD (1366x768), anti-glare, LED backlight, 220 nits, 16:9 aspect ratio, 400:1 contrast ratio Some: 14.0" (355mm) FHD (1920x1080), anti-glare, LED backlight, IPS, 250 nits, 16:9 aspect ratio, 400:1 contrast ratio							Security	Power-on password, hard disk password, supervisor password, security keyhole	
Multi-touch	None							Security chip (opt)	Firmware TPM 2.0 integrated in chipset or discrete TPM 2.0 TCG Certified	
Storage	Up to 2 drives (one M.2 SSD and one HDD) Some: HDD / SATA 6.0Gb/s, 2.5" wide, removable, upgradable, Active Protection System™ Some: M.2 SSD / PCIe NVMe							vPro	None	
Optane™ memory	Optional: Intel Optane memory, PCIe NVMe, PCIe 3.0 x 2							Fingerprint reader	Optional: Touch style fingerprint reader on the palm rest	
Optical	None							NFC	None	
Ethernet	Gigabit Ethernet Connection, Realtek R8111GUS							Battery	Integrated Li-ion 45Wh battery, supports Rapid Charge (charge up to 80% in 1hr) with 65W AC adapter	
WLAN + Bluetooth™	One of the following, configurable by model: • Realtek® RTL8821CE, Wi-Fi 1x1 802.11ac + Bluetooth 4.1, M.2 card • Realtek RTL8822BE, Wi-Fi 2x2 802.11ac + Bluetooth 4.1, M.2 card • Intel Dual Band Wireless-AC 3165, 1x1, Wi-Fi + Bluetooth 4.1, M.2 Card * Intel 3165ac card supports BT4.2 but is limited to BT4.1 by Windows OS							Max battery life	MobileMark® 2014: 13.51 hr * Battery life varies significantly with settings, usage, & other factors	
WWAN	None							AC adapter	45W or 65W USB Type-C AC adapter	
SIM card	None							Operating system	Optional: Windows® 10 Home 64 or Windows 10 Pro 64	
								Limited warranty	One of the following, configurable by model: • 1-year mail-in repair service • 1-year depot repair service	
								Mil-Spec test	MIL-STD-810G military testing	
								Environment	EPEAT™ Gold (US only); ENERGY STAR® 6.1; RoHS-compliant	

Note: The specifications above may not be available in all regions.

Lenovo
August 2019



ThinkPad E490 Platform Specifications

Product Specifications Reference (PSREF)

Processor	8th Generation Intel® Core™ i3 / i5 / i7 Processor								Dimensions	Aluminum (WxDxH): 12.96" x 9.53" x 0.78"; 329mm x 242mm x 19.9mm PC/ABS (WxDxH): 12.96" x 9.53" x 0.83"; 329mm x 242mm x 21.9mm
	Processor Number	# of Cores	# of Threads	Base Frequency	Max Turbo Frequency	Cache	Memory Types	Processor Graphics	Weight	Starting at 3.87 lb / 1.75 kg
	i3-8145U	2	4	2.1 GHz	3.9 GHz	4MB	DDR4-2400	Intel UHD Graphics 620	Case color	Black or silver
	i5-8265U	4	8	1.6 GHz	3.9 GHz	6MB			Case material	Display cover: Aluminum or PC/ABS plastic; Bottom: PC/ABS plastic
	i5-8365U			1.6 GHz	4.1 GHz	6MB			Smart card reader	None
	i7-8565U			1.8 GHz	4.6 GHz	8MB			Media reader	MicroSD card reader
* i5-8365U is for special bid only										
Graphics	Intel UHD Graphics 620 in processor only or Intel UHD Graphics 620 in processor and AMD Radeon RX 550X Graphics, 2GB GDDR5 memory; supports external digital monitor via HDMI or USB Type-C; supports dual independent display; Max resolution: 4096x2304@60Hz (USB Type-C); 4096x2160@24Hz (HDMI)								Ports	One USB 2.0, two USB 3.1 Gen 1 (one Always On), one USB 3.1 Type-C Gen 2 (with the function of Power Delivery and DisplayPort), HDMI 1.4b, Ethernet (RJ-45), headphone / microphone combo jack, microSD card reader, security keyhole * Depending on many factors, actual data transfer speed may be lower than theoretical speed
Chipset Memory	Intel SoC (System on Chip) platform 32GB max / 2400MHz DDR4, dual-channel capable, two DDR4 SO-DIMM sockets * Installed memory is actually 2666MHz but run at 2400MHz due to Intel limitation								Camera	HD720p camera, fixed focus
Display	Size / Resolution	Surface	Type	Brightness	Aspect Ratio	Contrast Ratio	Viewing Angle	Multi-touch	Audio support	HD Audio, Synaptic® CX11880 codec / stereo speakers, 1.5W x 2, Dolby® Advanced Audio / dual array microphone, headphone / microphone combo jack
	14.0" HD (1366x768)	Anti-glare	TN	220 nits	16:9	400:1	90°	Non-touch	Keyboard	6-row, spill-resistant, multimedia Fn keys, optional LED backlight
	14.0" FHD (1920x1080)	Anti-glare	TN	220 nits	16:9	400:1	90°	Non-touch	UltraNav™	TrackPoint® pointing device and buttonless Mylar surface multi-touch touchpad
	14.0" FHD (1920x1080)	Anti-glare	IPS	250 nits	16:9	600:1	170°	Non-touch	Security	Power-on password, hard disk password, supervisor password, security keyhole
Multi-touch	None								Security chip	Integrated model: discrete TPM 2.0, TCG Certified Discrete model: firmware TPM 2.0 integrated in chipset
Storage	Up to two drives (one M.2 SSD and one HDD) • HDD / SATA 6.0Gb/s, 2.5" wide, 7mm high, Active Protection System™ • M.2 2280 SSD / SATA 6.0Gb/s • M.2 2242 SSD / PCIe NVMe, PCIe 3.0 x 2 • M.2 2280 SSD / PCIe NVMe, PCIe 3.0 x 4 * Installed M.2 2280 SSD is PCIe 3x4 but run at PCIe 3x2 due to M.2 SSD adapter limitation								System Mgt	None
Optane™ memory	Optional: Intel Optane memory, PCIe NVMe, PCIe 3.0 x 2								Fingerprint reader	Optional: Touch style fingerprint reader on the palm rest
Optical	None								NFC	None
Ethernet	Gigabit Ethernet Connection, Realtek R8111GUS								Battery	Integrated Li-ion 45Wh battery, supports Rapid Charge (charge up to 80% in 1hr) with 65W AC adapter
WLAN + Bluetooth™	One of the following, configurable by model: • Realtek® RTL8822BE, Wi-Fi 2x2 802.11ac + Bluetooth 4.2, M.2 card • Intel Wireless-AC 9260, Wi-Fi 2x2 802.11ac + Bluetooth 5.0, M.2 card								Max battery life	MobileMark® 2014: 13 hr * Battery life varies significantly with settings, usage, & other factors
WWAN SIM card	None								AC adapter	45W or 65W USB Type-C AC adapter
									Operating system	Optional: Windows® 10 Home 64 or Windows 10 Pro 64
									Limited warranty	One of the following, configurable by model: • 1-year mail-in repair service • 1-year depot repair service
									Mil-Spec test	MIL-STD-810G military testing
									Environment	EPEAT™ Silver; ENERGY STAR® 7.1; RoHS-compliant

Note: The specifications above may not be available in all regions.

Lenovo
December 2019



ThinkPad E490s Platform Specifications

Product Specifications Reference (PSREF)

Processor	8th Generation Intel® Core™ i5 / i7 Processor								Dimensions	<i>WxDxH:</i> 12.96" x 9.13" x 0.70"; 329mm x 232mm x 17.9mm																								
	Processor Number	# of Cores	# of Threads	Base Frequency	Max Turbo Frequency	Cache	Memory Types	Processor Graphics	Weight	Starting at 3.68 lb / 1.67 kg																								
	i5-8265U i7-8565U	4	8	1.6 GHz 1.8 GHz	3.9 GHz 4.5 GHz	6MB 8MB	DDR4-2400	Intel UHD Graphics 620	Case color	Black or silver																								
Graphics	Intel UHD Graphics 620 in processor only or Intel UHD Graphics 620 in processor and AMD Radeon RX 540X Graphics, 2GB GDDR5 memory; supports external digital monitor via HDMI or USB Type-C; supports three independent display; Max resolution: 4096x2304@60Hz (USB Type-C); 4096x2160@24Hz (HDMI)								Case material	Aluminum																								
									Smart card reader	None																								
Chipset	Intel SoC (System on Chip) platform								Media reader	MicroSD card reader																								
Memory	32GB max / 2400MHz DDR4, dual-channel capable, two DDR4 SO-DIMM sockets <i>* Installed memory is actually 2666MHz but run at 2400MHz due to Intel limitation</i>								Ports	One USB 2.0, two USB 3.1 Gen 1 (one Always On), one USB 3.1 Type-C Gen 2 (with the function of Power Delivery and DisplayPort), HDMI 1.4b, Ethernet (RJ-45), headphone / microphone combo jack, microSD card reader, security keyhole <i>* Depending on many factors, actual data transfer speed may be lower than theoretical speed</i>																								
Display	<table border="1"> <thead> <tr> <th>Size / Resolution</th> <th>Surface</th> <th>Type</th> <th>Brightness</th> <th>Aspect Ratio</th> <th>Contrast Ratio</th> <th>Viewing Angle</th> <th>Multi-touch</th> </tr> </thead> <tbody> <tr> <td>14.0" FHD (1920x1080)</td> <td>Anti-glare</td> <td>TN</td> <td>220 nits</td> <td>16:9</td> <td>400:1</td> <td>90°</td> <td>Non-touch</td> </tr> <tr> <td>14.0" FHD (1920x1080)</td> <td>Anti-glare</td> <td>IPS</td> <td>250 nits</td> <td>16:9</td> <td>600:1</td> <td>170°</td> <td>Non-touch</td> </tr> </tbody> </table>								Size / Resolution	Surface	Type	Brightness	Aspect Ratio	Contrast Ratio	Viewing Angle	Multi-touch	14.0" FHD (1920x1080)	Anti-glare	TN	220 nits	16:9	400:1	90°	Non-touch	14.0" FHD (1920x1080)	Anti-glare	IPS	250 nits	16:9	600:1	170°	Non-touch	Monitor cable	None
									Size / Resolution	Surface	Type	Brightness	Aspect Ratio	Contrast Ratio	Viewing Angle	Multi-touch																		
									14.0" FHD (1920x1080)	Anti-glare	TN	220 nits	16:9	400:1	90°	Non-touch																		
14.0" FHD (1920x1080)	Anti-glare	IPS	250 nits	16:9	600:1	170°	Non-touch																											
Bundled Accy	None																																	
Camera	HD720p camera, fixed focus								Audio support	HD Audio, Synaptic® CX11880 codec / stereo speakers, 2W x 2, Dolby® Audio™ Premium / dual array microphone, headphone / microphone combo jack																								
Keyboard	6-row, spill-resistant, multimedia Fn keys, optional LED backlight								UltraNav™	TrackPoint® pointing device and buttonless Mylar surface multi-touch touchpad																								
Multi-touch	None								Security	Power-on password, hard disk password, supervisor password, security keyhole																								
Storage	<i>One of the following, configurable by model:</i> <ul style="list-style-type: none"> M.2 2280 SSD / SATA 6.0Gb/s M.2 2242 SSD / PCIe NVMe, PCIe 3.0 x 2 M.2 2280 SSD / PCIe NVMe, PCIe 3.0 x 4 <i>* Installed M.2 2280 SSD is PCIe 3x4 but run at PCIe 3x2 due to M.2 SSD adapter limitation</i>								Security chip	<i>Integrated model:</i> discrete TPM 2.0, TCG Certified <i>Discrete model:</i> firmware TPM 2.0 integrated in chipset																								
									System Mgt	None																								
Optical	None								Fingerprint reader	Touch style fingerprint reader on the palm rest																								
Ethernet	Gigabit Ethernet Connection, Realtek R8111GUS								NFC	None																								
WLAN + Bluetooth™	<i>One of the following, configurable by model:</i> <ul style="list-style-type: none"> Realtek® RTL8822BE, Wi-Fi 2x2 802.11ac + Bluetooth 4.2, M.2 card Intel Wireless-AC 9260, Wi-Fi 2x2 802.11ac + Bluetooth 5.0, M.2 card 								Battery	Integrated Li-ion 42Wh battery, supports Rapid Charge (charge up to 80% in 1hr) with 65W AC adapter																								
WWAN	None								Max battery life	<i>MobileMark® 2014:</i> 11.5 hr <i>* Battery life varies significantly with settings, usage, & other factors</i>																								
SIM card	None								AC adapter	45W or 65W USB Type-C AC adapter																								
									Operating system	<i>Optional:</i> Windows® 10 Home 64 or Windows 10 Pro 64																								
									Limited warranty	1-year depot repair service																								
									Mil-Spec test	MIL-STD-810G military testing																								
									Environment	EPEAT™ Silver; ENERGY STAR® 7.1; RoHS-compliant																								

Note: The specifications above may not be available in all regions.

Lenovo
September 2019



ThinkPad E495 Platform Specifications

Product Specifications Reference (PSREF)

Processor	AMD Ryzen™ Mobile Processors with Radeon™ Vega Graphics								Dimensions <i>Aluminum (WxDxH):</i> 12.96" x 9.53" x 0.78"; 329mm x 242mm x 19.9mm <i>PC/ABS (WxDxH):</i> 12.96" x 9.53" x 0.83"; 329mm x 242mm x 21.9mm																							
	Processor Number	# of Cores	# of Threads	Base Frequency	Max Turbo Frequency	Cache	Memory Controller	Processor Graphics		Weight Starting at 3.87 lb / 1.75 kg Case color Black Case material <i>Display cover:</i> Aluminum or PC/ABS plastic; <i>Bottom:</i> PC/ABS plastic																						
	Ryzen 3 3200U	2	4	2.6 GHz	3.5 GHz	1MB L2 / 4MB L3	DDR4-2400	Radeon Vega 3 Graphics																								
	Ryzen 5 3500U	4	8	2.1 GHz	3.7 GHz	2MB L2 / 4MB L3		Radeon Vega 8 Graphics																								
Ryzen 7 3700U	2.3 GHz			4.0 GHz	2MB L2 / 4MB L3	Radeon RX Vega 10 Graphics																										
Graphics	AMD Radeon Vega 3, Vega 8, or RX Vega 10 Graphics in processor; supports external digital monitor via HDMI or USB Type-C; supports dual independent display; Max resolution: 3840x2160@60Hz (USB Type-C); 3840x2160@30Hz (HDMI)								Smart card reader None Media reader MicroSD card reader Ports One USB 2.0, two USB 3.1 Gen 1 (one Always On), one USB 3.1 Type-C Gen 1 (with the function of Power Delivery and DisplayPort), HDMI 1.4b, Ethernet (RJ-45), headphone / microphone combo jack, microSD card reader, security keyhole <i>* Depending on many factors, actual data transfer speed may be lower than theoretical speed</i> Monitor cable None Bundled Accy None Camera HD720p camera, fixed focus Audio support HD Audio, Synaptic® CX11880 codec / stereo speakers, 1.5W x 2, Dolby® Advanced Audio / dual array microphone, headphone / microphone combo jack																							
Chipset	AMD SoC (System on Chip) platform																															
Memory	32GB max / 2400MHz DDR4, dual-channel capable, two DDR4 SO-DIMM sockets <i>* Installed memory is actually 2666MHz but run at 2400MHz due to AMD limitation</i>																															
Display	<table border="1"> <thead> <tr> <th>Size / Resolution</th> <th>Surface</th> <th>Type</th> <th>Brightness</th> <th>Aspect Ratio</th> <th>Contrast Ratio</th> <th>Viewing Angle</th> <th>Multi-touch</th> </tr> </thead> <tbody> <tr> <td>14.0" HD (1366x768)</td> <td>Anti-glare</td> <td>TN</td> <td>220 nits</td> <td>16:9</td> <td>400:1</td> <td>90°</td> <td>Non-touch</td> </tr> <tr> <td>14.0" FHD (1920x1080)</td> <td>Anti-glare</td> <td>IPS</td> <td>250 nits</td> <td>16:9</td> <td>600:1</td> <td>170°</td> <td>Non-touch</td> </tr> </tbody> </table>									Size / Resolution	Surface	Type	Brightness	Aspect Ratio	Contrast Ratio	Viewing Angle	Multi-touch	14.0" HD (1366x768)	Anti-glare	TN	220 nits	16:9	400:1	90°	Non-touch	14.0" FHD (1920x1080)	Anti-glare	IPS	250 nits	16:9	600:1	170°
Size / Resolution	Surface	Type	Brightness	Aspect Ratio	Contrast Ratio	Viewing Angle	Multi-touch																									
14.0" HD (1366x768)	Anti-glare	TN	220 nits	16:9	400:1	90°	Non-touch																									
14.0" FHD (1920x1080)	Anti-glare	IPS	250 nits	16:9	600:1	170°	Non-touch																									
Multi-touch	None								Keyboard 6-row, spill-resistant, multimedia Fn keys UltraNav™ TrackPoint® pointing device and buttonless Mylar surface multi-touch touchpad Security Power-on password, hard disk password, supervisor password, security keyhole Security chip Discrete TPM 2.0, TCG Certified Fingerprint reader None NFC None Battery Integrated Li-ion 45Wh battery, supports Rapid Charge (charge up to 80% in 1hr) with 65W AC adapter Max battery life <i>MobileMark® 2014:</i> 11 hr <i>* Battery life varies significantly with settings, usage, & other factors</i> AC adapter 45W or 65W USB Type-C AC adapter Operating system <i>Optional:</i> Windows® 10 Home 64 or Windows 10 Pro 64 Limited warranty 1-year mail-in or 1-year depot repair service Mil-Spec test MIL-STD-810G military testing Environment EPEAT™ Silver; ENERGY STAR® 7.1; RoHS-compliant																							
Storage	Up to two drives (one M.2 SSD and one HDD) • HDD / SATA 6.0Gb/s, 2.5" wide, 7mm high, Active Protection System™ • M.2 2242 SSD / PCIe NVMe, PCIe 3.0 x 2 or PCIe 3.0 x 4 • M.2 2280 SSD / PCIe NVMe, PCIe 3.0 x 4																															
Optical	None																															
Ethernet	Gigabit Ethernet Connection, Realtek R8111GUS																															
WLAN + Bluetooth™	One of the following, configurable by model: • Realtek® RTL8822BE, Wi-Fi 2x2 802.11ac + Bluetooth 4.2, M.2 card • Intel Wireless-AC 9260, Wi-Fi 2x2 802.11ac + Bluetooth 5.0, M.2 card																															
WWAN SIM card	None																															

Note: The specifications above may not be available in all regions.

Lenovo
December 2019



ThinkPad E580 Platform Specifications

Product Specifications Reference (PSREF)

Processor	7th Generation Intel® Core™ i3 / i5 Processor or								WLAN + Bluetooth™ <i>One of the following, configurable by model:</i> <ul style="list-style-type: none"> • Realtek® RTL8821CE, Wi-Fi 1x1 802.11ac + Bluetooth 4.1, M.2 card • Realtek RTL8822BE, Wi-Fi 2x2 802.11ac + Bluetooth 4.1, M.2 card • Intel Dual Band Wireless-AC 3165, 1x1, Wi-Fi + Bluetooth 4.1, M.2 Card * Intel 3165ac card supports BT4.2 but is limited to BT4.1 by Windows OS
	Processor Number	# of Cores	# of Threads	Base Frequency	Max Turbo Frequency	Cache	Memory Types	Processor Graphics	
	i3-7020U	2	4	2.3 GHz	-	3MB	DDR4-2133	Intel HD Graphics 620	
	i3-7130U			2.7 GHz	-	3MB			
i5-7200U	2.5 GHz			3.1 GHz	3MB				
Processor	8th Generation Intel Core i3 / i5 / i7 Processor								WLAN + Bluetooth™ <i>One of the following, configurable by model:</i> <ul style="list-style-type: none"> • Realtek® RTL8821CE, Wi-Fi 1x1 802.11ac + Bluetooth 4.1, M.2 card • Realtek RTL8822BE, Wi-Fi 2x2 802.11ac + Bluetooth 4.1, M.2 card • Intel Dual Band Wireless-AC 3165, 1x1, Wi-Fi + Bluetooth 4.1, M.2 Card * Intel 3165ac card supports BT4.2 but is limited to BT4.1 by Windows OS
	Processor Number	# of Cores	# of Threads	Base Frequency	Max Turbo Frequency	Cache	Memory Types	Processor Graphics	
	i3-8130U	2	4	2.2 GHz	3.4 GHz	4MB	DDR4-2400	Intel UHD Graphics 620	
	i5-8250U			1.6 GHz	3.4 GHz	6MB			
i7-8550U	1.8 GHz			4.0 GHz	8MB				
* i3-7130U is NOT available in US and EMEA									
Graphics	Intel HD Graphics 620 or Intel UHD Graphics 620 in processor only or Intel HD Graphics 620 or Intel UHD Graphics 620 in processor and AMD Radeon RX 550 Graphics, 2GB GDDR5 memory; supports external digital monitor via HDMI or USB Type-C; supports dual independent display; Max resolution: 1920x1080 (HDMI) @60Hz								Dimensions WxDxH: 14.53" x 9.92" x 0.78"; 369mm x 252mm x 19.95mm Weight Starting at 4.7 lb / 2.1kg Case color Black or silver Case material Display cover: Aluminum; Bottom: PC/ABS plastic
	Chipset	Intel SoC (System on Chip) platform 32GB max / 2400MHz DDR4, dual-channel capable, two DDR4 SO-DIMM sockets * System clocks down for processors with lower memory controller							
Memory	Intel HD Graphics 620 or Intel UHD Graphics 620 in processor only or Intel HD Graphics 620 or Intel UHD Graphics 620 in processor and AMD Radeon RX 550 Graphics, 2GB GDDR5 memory; supports external digital monitor via HDMI or USB Type-C; supports dual independent display; Max resolution: 1920x1080 (HDMI) @60Hz								Media reader None Ports One USB 2.0, two USB 3.1 Gen 1 (one Always On), one USB 3.1 Type-C Gen 2 (with the function of Power Delivery and DisplayPort), HDMI 1.4b, Ethernet (RJ-45), headphone / microphone combo jack, microSD card reader, security keyhole * Depending on many factors, actual data transfer speed may be lower than theoretical speed
	Display	Some: 15.6" (396mm) HD (1366x768), anti-glare, LED backlight, 220 nits, 16:9 aspect ratio, 400:1 contrast ratio Some: 15.6" (396mm) FHD (1920x1080), anti-glare, LED backlight, IPS, 250 nits, 16:9 aspect ratio, 600:1 contrast ratio							
Multi-touch	None								Camera HD720p camera, fixed focus
Storage	Up to 2 drives (one M.2 SSD and one HDD) Some: HDD / SATA 6.0Gb/s, 2.5" wide, removable, upgradable, Active Protection System™ Some: M.2 SSD / PCIe NVMe								Audio support HD Audio, Synaptic® CX11852 codec / stereo speakers, 2W x 2, Dolby® Advanced Audio / dual array microphone, headphone / microphone combo jack
	Optane™ memory	Optional: Intel Optane memory, PCIe NVMe, PCIe 3.0 x 2							
Optical	None								Security Power-on password, hard disk password, supervisor password, security keyhole Security chip (opt) vPro Firmware TPM 2.0 integrated in chipset or discrete TPM 2.0 TCG Certified
Ethernet	Gigabit Ethernet Connection, Realtek R8111GUS								Fingerprint reader Optional: Touch style fingerprint reader on the palm rest
									NFC None
								Battery Integrated Li-ion 45Wh battery, supports Rapid Charge (charge up to 80% in 1hr) with 65W AC adapter	
								Max battery life MobileMark® 2014: 12.23 hr * Battery life varies significantly with settings, usage, & other factors	
								AC adapter 45W or 65W USB Type-C AC adapter	
								Operating system Optional: Windows® 10 Home 64 or Windows 10 Pro 64	
								Limited warranty One of the following, configurable by model: <ul style="list-style-type: none"> • 1-year mail-in repair service • 1-year depot repair service 	
								Mil-Spec test MIL-STD-810G military testing	
								Environment EPEAT™ Gold (US only); ENERGY STAR® 6.1; RoHS-compliant	

Note: The specifications above may not be available in all regions.

Lenovo
August 2019



ThinkPad E590 Platform Specifications

Product Specifications Reference (PSREF)

Processor	8th Generation Intel® Core™ i3 / i5 / i7 Processor								Dimensions	<i>WxDxH:</i> 14.53" x 9.94" x 0.78"; 369mm x 252.5mm x 19.9mm
	Processor Number	# of Cores	# of Threads	Base Frequency	Max Turbo Frequency	Cache	Memory Types	Processor Graphics	Weight	Starting at 4.68 lb / 2.12 kg
	i3-8145U	2	4	2.1 GHz	3.9 GHz	4MB	DDR4-2400	Intel UHD Graphics 620	Case color	Black or silver
	i5-8265U	4	8	1.6 GHz	3.9 GHz	6MB			Case material	<i>Display cover:</i> Aluminum; <i>Bottom:</i> PC/ABS plastic
i7-8565U	1.8 GHz			4.6 GHz	8MB	Smart card reader			None	
Graphics	Intel UHD Graphics 620 in processor only or Intel UHD Graphics 620 in processor and AMD Radeon RX 550X Graphics, 2GB GDDR5 memory; supports external digital monitor via HDMI or USB Type-C; supports dual independent display; Max resolution: 4096x2304@60Hz (USB Type-C); 4096x2160@24Hz (HDMI)								Media reader	MicroSD card reader
Chipset	Intel SoC (System on Chip) platform								Ports	One USB 2.0, two USB 3.1 Gen 1 (one Always On), one USB 3.1 Type-C Gen 2 (with the function of Power Delivery and DisplayPort), HDMI 1.4b, Ethernet (RJ-45), headphone / microphone combo jack, microSD card reader, security keyhole <i>* Depending on many factors, actual data transfer speed may be lower than theoretical speed</i>
Memory	32GB max / 2400MHz DDR4, dual-channel capable, two DDR4 SO-DIMM sockets <i>* Installed memory is actually 2666MHz but run at 2400MHz due to Intel limitation</i>								Monitor cable	None
Display	Size / Resolution	Surface	Type	Brightness	Aspect Ratio	Contrast Ratio	Viewing Angle	Multi-touch	Bundled Accy	None
	15.6" HD (1366x768)	Anti-glare	TN	220 nits	16:9	400:1	90°	Non-touch	Camera	HD720p camera, fixed focus
	15.6" FHD (1920x1080)	Anti-glare	IPS	250 nits	16:9	600:1	170°	Non-touch	Audio support	HD Audio, Synaptic® CX11880 codec / stereo speakers, 2W x 2, Dolby® Advanced Audio / dual array microphone, headphone / microphone combo jack
Multi-touch	None								Keyboard	6-row, spill-resistant, multimedia Fn keys, numeric keypad, optional LED backlight
Storage	Up to two drives (one M.2 SSD and one HDD) <ul style="list-style-type: none"> HDD / SATA 6.0Gb/s, 2.5" wide, 7mm high, Active Protection System™ M.2 2280 SSD / SATA 6.0Gb/s M.2 2242 SSD / PCIe NVMe, PCIe 3.0 x 2 M.2 2280 SSD / PCIe NVMe, PCIe 3.0 x 4 <i>* Installed M.2 2280 SSD is PCIe 3x4 but run at PCIe 3x2 due to M.2 SSD adapter limitation</i>								UltraNav™	TrackPoint® pointing device and buttonless Mylar surface multi-touch touchpad
Optane™ memory	Optional: Intel Optane memory, PCIe NVMe, PCIe 3.0 x 2								Security	Power-on password, hard disk password, supervisor password, security keyhole
Optical	None								Security chip	<i>Integrated model:</i> discrete TPM 2.0, TCG Certified <i>Discrete model:</i> firmware TPM 2.0 integrated in chipset
Ethernet	Gigabit Ethernet Connection, Realtek R8111GUS								System Mgt	None
WLAN + Bluetooth™	One of the following, configurable by model: <ul style="list-style-type: none"> Realtek® RTL8822BE, Wi-Fi 2x2 802.11ac + Bluetooth 4.2, M.2 card Intel Wireless-AC 9260, Wi-Fi 2x2 802.11ac + Bluetooth 5.0, M.2 card 								Fingerprint reader	<i>Optional:</i> Touch style fingerprint reader on the palm rest
WWAN	None								NFC	None
SIM card	None								Battery	Integrated Li-ion 45Wh battery, supports Rapid Charge (charge up to 80% in 1hr) with 65W AC adapter
									Max battery life	<i>MobileMark® 2014:</i> 11 hr <i>* Battery life varies significantly with settings, usage, & other factors</i>
									AC adapter	45W or 65W USB Type-C AC adapter
									Operating system	<i>Optional:</i> Windows® 10 Home 64 or Windows 10 Pro 64
									Limited warranty	One of the following, configurable by model: <ul style="list-style-type: none"> 1-year mail-in repair service 1-year depot repair service
									Mil-Spec test	MIL-STD-810G military testing
									Environment	EPEAT™ Silver; ENERGY STAR® 7.1; RoHS-compliant

Note: The specifications above may not be available in all regions.

Lenovo
August 2019



ThinkPad E595 Platform Specifications

Product Specifications Reference (PSREF)

Processor	AMD Ryzen™ Mobile Processors with Radeon™ Vega Graphics								Dimensions	<i>WxDxH:</i> 14.53" x 9.92" x 0.78"; 369mm x 252mm x 19.9mm
	Processor Number	# of Cores	# of Threads	Base Frequency	Max Turbo Frequency	Cache	Memory Controller	Processor Graphics	Weight	Starting at 4.7 lb / 2.1 kg
	Ryzen 3 3200U	2	4	2.6 GHz	3.5 GHz	1MB L2 / 4MB L3	DDR4-2400	Radeon Vega 3 Graphics	Case color	Black
	Ryzen 5 3500U	4	8	2.1 GHz	3.7 GHz	2MB L2 / 4MB L3		Radeon Vega 8 Graphics	Case material	<i>Display cover:</i> Aluminum; <i>Bottom:</i> PC/ABS plastic
Ryzen 7 3700U	2.3 GHz			4.0 GHz	2MB L2 / 4MB L3	Radeon RX Vega 10 Graphics		Smart card reader	None	
Graphics	AMD Radeon Vega 3, Vega 8, or RX Vega 10 Graphics in processor; supports external digital monitor via HDMI or USB Type-C; supports dual independent display; Max resolution: 3840x2160@60Hz (USB Type-C); 3840x2160@30Hz (HDMI)								Media reader	MicroSD card reader
Chipset	AMD SoC (System on Chip) platform								Ports	One USB 2.0, two USB 3.1 Gen 1 (one Always On), one USB 3.1 Type-C Gen 1 (with the function of Power Delivery and DisplayPort), HDMI 1.4b, Ethernet (RJ-45), headphone / microphone combo jack, microSD card reader, security keyhole <i>* Depending on many factors, actual data transfer speed may be lower than theoretical speed</i>
Memory	32GB max / 2400MHz DDR4, dual-channel capable, two DDR4 SO-DIMM sockets <i>* Installed memory is actually 2666MHz but run at 2400MHz due to AMD limitation</i>								Monitor cable	None
Display	Size / Resolution	Surface	Type	Brightness	Aspect Ratio	Contrast Ratio	Viewing Angle	Multi-touch	Bundled Accy	None
	15.6" HD (1366x768)	Anti-glare	TN	220 nits	16:9	400:1	90°	Non-touch	Camera	HD720p camera, fixed focus
	15.6" FHD (1920x1080)	Anti-glare	IPS	250 nits	16:9	600:1	170°	Non-touch	Audio support	HD Audio, Synaptic® CX11880 codec / stereo speakers, 2W x 2, Dolby® Advanced Audio / dual array microphone, headphone / microphone combo jack
Multi-touch	None								Keyboard	6-row, spill-resistant, multimedia Fn keys
Storage	Up to two drives (one M.2 SSD and one HDD) • HDD / SATA 6.0Gb/s, 2.5" wide, 7mm high, Active Protection System™ • M.2 2242 SSD / PCIe NVMe, PCIe 3.0 x 2 or PCIe 3.0 x 4 • M.2 2280 SSD / PCIe NVMe, PCIe 3.0 x 4								UltraNav™	TrackPoint® pointing device and buttonless Mylar surface multi-touch touchpad
Optical	None								Security	Power-on password, hard disk password, supervisor password, security keyhole
Ethernet	Gigabit Ethernet Connection, Realtek R8111GUS								Security chip	Discrete TPM 2.0, TCG Certified
WLAN + Bluetooth™	One of the following, configurable by model: • Realtek® RTL8822BE, Wi-Fi 2x2 802.11ac + Bluetooth 4.2, M.2 card • Intel Wireless-AC 9260, Wi-Fi 2x2 802.11ac + Bluetooth 5.0, M.2 card								Fingerprint reader	None
WWAN	None								NFC	None
SIM card	None								Battery	Integrated Li-ion 45Wh battery, supports Rapid Charge (charge up to 80% in 1hr) with 65W AC adapter
									Max battery life	<i>MobileMark® 2014:</i> 10.3 hr <i>* Battery life varies significantly with settings, usage, & other factors</i>
									AC adapter	45W or 65W USB Type-C AC adapter
									Operating system	<i>Optional:</i> Windows® 10 Home 64 or Windows 10 Pro 64
									Limited warranty	<i>One of the following, configurable by model:</i> • 1-year mail-in repair service • 1-year depot repair service
									Mil-Spec test	MIL-STD-810G military testing
									Environment	EPPEAT™ Silver; ENERGY STAR® 7.1; RoHS-compliant

Note: The specifications above may not be available in all regions.

Lenovo
November 2019



ThinkPad L13 Platform Specifications

Product Specifications Reference (PSREF)

Processor	10th Generation Intel® Core™ i3 / i5 / i7 Processor								Smart card reader Media reader Ports	<i>Optional:</i> Smart card reader MicroSD card reader Two USB 3.1 Gen 1 (one Always On), two USB 3.1 Type-C Gen 1 (with the function of Power Delivery and DisplayPort), HDMI 1.4b, headphone / microphone combo jack, microSD card reader, side docking connector, security keyhole * Depending on many factors, actual data transfer speed may be lower than theoretical speed
	Processor Number	# of Cores	# of Threads	Base Frequency	Max Turbo Frequency	Cache	Memory Types	Processor Graphics		
	i3-10110U	2	4	2.1 GHz	4.1 GHz	4MB	DDR4-2666	Intel UHD Graphics		
	i5-10210U	4	8	1.6 GHz	4.2 GHz	6MB				
i7-10510U	1.8 GHz			4.9 GHz	8MB					
Graphics	Intel UHD Graphics in processor; supports external digital monitor via HDMI or USB Type-C; supports three independent displays; Max resolution: 4096x2304@60Hz (USB Type-C); 4096x2160@30Hz (HDMI)								Monitor cable (optional)	<ul style="list-style-type: none"> Lenovo USB-C to VGA Adapter Lenovo USB-C to HDMI Adapter Lenovo USB-C to DisplayPort Adapter Lenovo HDMI to VGA Monitor Adapter Lenovo USB-C to Ethernet Adapter Lenovo USB-C to USB-A Adapter Lenovo USB-C to USB-C Cable 2m
Chipset	Intel SoC (System on Chip) platform								Bundled Accessories (optional)	Camera
Memory	4GB, 8GB, or 16GB / 2666MHz DDR4 / soldered to systemboard, no sockets									
Display	Size	Resolution	Surface	Type	Brightness	Aspect Ratio	Contrast Ratio	Viewing Angle	One of the following, configurable by model: • HD720p camera with ThinkShutter camera privacy, fixed focus • IR camera and HD720p camera with ThinkShutter camera privacy, fixed focus HD Audio, Synaptic® CX11880 codec / stereo speakers, 2W x 2, Dolby® Audio™ Premium / dual array microphone, headphone / microphone combo jack	
	13.3"	HD (1366x768)	Anti-glare	TN	250 nits	16:9	500:1	90°		
	13.3"	FHD (1920x1080)	Anti-glare	IPS	250 nits (non-touch) 300 nits (multi-touch)	16:9	800:1 (non-touch) 700:1 (multi-touch)	170°		
Multi-touch (opt)	On-cell touch, supports 10-finger gesture (FHD only)								Keyboard UltraNav™	6-row, spill-resistant, multimedia Fn keys, optional LED backlight TrackPoint® pointing device and buttonless Mylar surface touchpad, multi-touch
Storage	<i>One of the following, configurable by model:</i> • M.2 2242 SSD / PCIe NVMe, PCIe 3.0 x 2 • M.2 2280 SSD / PCIe NVMe, PCIe 3.0 x 4 • Intel Optane™ Memory H10 with Solid State Storage, M.2 2280, PCIe NVMe 3.0 x 4								Security Security chip	Power-on password, hard disk password, supervisor password, security keyhole Discrete TPM 2.0, TCG Certified
Optical	None								System Mgt (opt)	Intel vPro Technology
Ethernet	Native Intel Ethernet Connection I219-V (Non-vPro) or I219-LM (vPro) via optional Lenovo USB-C to Ethernet Adapter								Fingerprint reader	<i>Optional:</i> Touch style fingerprint reader on the palm rest
WLAN + Bluetooth™	<i>One of the following, configurable by model:</i> • Intel Wireless-AC 9560, Wi-Fi 2x2 802.11ac + Bluetooth 5.0, M.2 card • Intel Wi-Fi 6 AX201, Wi-Fi 2x2 802.11ax + Bluetooth 5.0, M.2 card								NFC	None
WWAN SIM card	None None								Battery	Integrated Li-ion 46Wh battery, supports Rapid Charge (charge up to 80% in 1hr) with 65W AC adapter
Dimensions	WxDxH: 12.26" x 8.62" x 0.69"; 311.5mm x 219mm x 17.6mm								Max battery life	MobileMark® 2014: 14.1 hr * Battery life varies significantly with settings, usage, & other factors
Weight	Starting at 3.06 lb / 1.38 kg								AC adapter	45W, 65W, or 65W slim USB-C AC adapter
Case color	Black or Silver								Operating system	<i>Optional:</i> Windows® 10 Home 64 or Windows 10 Pro 64
Case material	Display cover: Aluminum Bottom: GFRP								Limited warranty	<i>One of the following, configurable by model:</i> • 1-year depot repair service • 1-year depot with 2-year system board repair service • 1-year battery limited onsite service • 3-year/1-yr battery depot repair service • 3-year/1-yr battery limited onsite service
									Mil-Spec test	MIL-STD-810G military testing
									Environment	EPeAT™ Silver; ENERGY STAR® 7.1; RoHS-compliant

Note: The specifications above may not be available in all regions.

Lenovo
October 2019



ThinkPad L380 Platform Specifications

Product Specifications Reference (PSREF)

Processor	Intel® Celeron® Processor, 7th Generation Intel Core™ i3 / i5 Processor or							Dimensions	<i>WxDxH:</i> 12.67" x 8.83" x 0.74"; 321.8mm x 224.2mm x 18.8mm	
	Processor Number	# of Cores	# of Threads	Base Frequency	Max Turbo Frequency	Cache	Memory Types	Processor Graphics	Weight	Starting at 3.22 lb / 1.46 kg
	Cel 3965U	2	2	2.2 GHz	-	2MB	DDR4-2133	Intel HD Graphics 610	Case color	Black or Silver
	i3-7020U			2.3 GHz	-	3MB		Intel HD Graphics 620		
	i3-7130U			2.7 GHz	-	3MB				
	i5-7200U			2.5 GHz	3.1 GHz	3MB				
	8th Generation Intel Core i5 / i7 Processor							Smart card reader	None	
	Processor Number	# of Cores	# of Threads	Base Frequency	Max Turbo Frequency	Cache	Memory Types	Processor Graphics	Media reader	MicroSD card reader
	i3-8130U	2	4	2.2 GHz	3.4 GHz	4MB	DDR4-2400	Intel UHD Graphics 620	Ports	Two USB 3.1 Gen 1 (one Always On), two USB 3.1 Type-C Gen 1 (with the function of Power Delivery and DisplayPort), HDMI 1.4b, Ethernet extension connector, headphone / microphone combo jack, microSD card reader, security keyhole
	i5-8250U			1.6 GHz	3.4 GHz	6MB				
i5-8350U	1.7 GHz			3.6 GHz	6MB					
i7-8550U	1.8 GHz			4.0 GHz	8MB					
Graphics	Intel HD Graphics 610, 620 or Intel UHD Graphics 620 in processor; supports external digital monitor via HDMI or USB Type-C; supports three independent displays; Max resolution: 4096x2304@60Hz (USB Type-C); 4096x2160@30Hz (HDMI)							Monitor cable (optional)	HDMI to VGA: Lenovo HDMI to VGA Monitor Adapter USB-C to VGA: Lenovo USB-C to VGA Adapter USB-C to DP: Lenovo USB-C to DisplayPort Adapter	
Chipset	Intel SoC (System on Chip) platform							Bundled Accy	Optional: ThinkPad Ethernet Extension Cable	
Memory	32GB max / 2400MHz DDR4, dual-channel capable, two DDR4 SO-DIMM sockets <i>* System clocks down for processors with lower memory controller</i>							Camera	HD720p camera, fixed focus	
Display	<i>Some:</i> 13.3" (338mm) HD (1366x768), anti-glare, LED backlight, 250 nits, 16:9 aspect ratio, 500:1 contrast ratio <i>Some:</i> 13.3" (338mm) FHD (1920x1080), anti-glare, LED backlight, IPS, 250 nits, 16:9 aspect ratio, 700:1 contrast ratio, 170° viewing angle							Audio support	HD Audio, Realtek ALC3287 codec / stereo speakers, 2W x 2, Dolby® Audio™ / dual array microphone, headphone / microphone combo jack	
Multi-touch (opt)	on-cell touch, supports 10-finger gesture							Keyboard	6-row, spill-resistant, multimedia Fn keys, optional LED backlight	
Storage	<i>One of the following, configurable by model:</i> • M.2 SSD / SATA 6.0Gb/s (e.g. xxxGB SSD M.2) • M.2 SSD / PCIe NVMe, PCIe 3.0 x 4, 32Gb/s (e.g. xxxGB SSD M.2 PCIe NVMe)							UltraNav™	TrackPoint® pointing device and buttonless Mylar surface touchpad, multi-touch	
Optical	None							Security	Power-on password, hard disk password, supervisor password, security keyhole	
Ethernet	Native Intel Ethernet Connection I219-V (Non-vPro) or I219-LM (vPro) via optional ThinkPad Ethernet Extension Cable							Security chip	Discrete TPM 2.0, TCG Certified	
WLAN + Bluetooth™	Intel Dual Band Wireless-AC 8265, Wi-Fi 2x2 802.11ac + Bluetooth 4.1, M.2 card <i>* Intel 8265ac card supports BT4.2 but is limited to BT4.1 by Windows OS</i>							vPro (optional)	Intel vPro Technology	
WWAN	None							Fingerprint reader	Optional: Touch style fingerprint reader on the keyboard bezel, anti-spoofing technology	
SIM card	None							NFC (optional)	Near Field Communication	
								Battery	Integrated Li-ion 45Wh battery, supports Rapid Charge (charge up to 80% in 1hr) with 65W AC adapter	
								Max battery life	MobileMark® 2014: 16.1 hr <i>* Battery life varies significantly with settings, usage, & other factors</i>	
								AC adapter	45W or 65W USB Type-C AC adapter	
								Operating system	Optional: Windows® 10 Home 64 or Windows 10 Pro 64	
								Limited warranty	<i>One of the following, configurable by model:</i> • 1-year depot repair service • 3-year/1-yr battery depot repair service • 3-year/1-yr battery limited onsite service	
								Mil-Spec test	MIL-STD-810G military testing	
								Environment	EPEAT™ Gold (US only); ENERGY STAR® 6.1; RoHS-compliant	

Note: The specifications above may not be available in all regions.

Lenovo
August 2019



ThinkPad L390 Platform Specifications

Product Specifications Reference (PSREF)

Processor	8th Generation Intel® Core™ i3 / i5 / i7 Processor								Smart card reader	None
	Processor Number	# of Cores	# of Threads	Base Frequency	Max Turbo Frequency	Cache	Memory Types	Processor Graphics	Media reader	MicroSD card reader
	i3-8145U	2	4	2.1 GHz	3.9 GHz	4MB	DDR4-2400	Intel UHD Graphics 620	Ports	Two USB 3.1 Gen 1 (one Always On), two USB 3.1 Type-C Gen 1 (with the function of Power Delivery and DisplayPort), HDMI 1.4b, Ethernet extension connector, headphone / microphone combo jack, microSD card reader, security keyhole
	i5-8265U	4	8	1.6 GHz	3.9 GHz	6MB				
	i5-8365U			1.6 GHz	4.1 GHz	6MB				
i7-8565U	1.8 GHz			4.6 GHz	8MB					
Graphics	Intel UHD Graphics 620 in processor; supports external digital monitor via HDMI or USB Type-C; supports three independent displays; Max resolution: 4096x2304@60Hz (USB Type-C); 4096x2160@30Hz (HDMI)								Monitor cable (optional)	<ul style="list-style-type: none"> USB-C to VGA Adapter: Lenovo USB-C to VGA Adapter USB-C to VGA (plus Power) Adapter: Lenovo USB-C to VGA plus Power Adapter USB-C to HDMI Adapter: Lenovo USB-C to HDMI Adapter USB-C to HDMI (plus Power) Adapter: Lenovo USB-C to HDMI plus Power Adapter USB-C to DisplayPort Adapter: Lenovo USB-C to DisplayPort Adapter USB-C to Ethernet Adapter: Lenovo USB-C to Ethernet Adapter
Chipset Memory	Intel SoC (System on Chip) platform 32GB max / 2400MHz DDR4, dual-channel capable, two DDR4 SO-DIMM sockets * Installed memory is actually 2666MHz but run at 2400MHz due to Intel limitation								Bundled Accessories (optional)	<ul style="list-style-type: none"> USB-C to USB-A Adapter: Lenovo USB-C to USB-A Adapter USB-C to USB-C Cable 2m: Lenovo USB-C to USB-C Cable 2m
Display	Size	Resolution	Surface	Type	Brightness	Aspect Ratio	Contrast Ratio	Viewing Angle	Camera	HD720p camera, fixed focus
	13.3"	HD (1366x768)	Anti-glare	TN	250 nits	16:9	500:1	90°	Audio support	HD Audio, Realtek ALC3287 codec / stereo speakers, 2W x 2, Dolby® Audio™ Premium / dual array microphone, headphone / microphone combo jack
	13.3"	FHD (1920x1080)	Anti-glare	IPS	250 nits	16:9	700:1 (non-touch) 800:1 (multi-touch)	170°	Keyboard	6-row, spill-resistant, multimedia Fn keys, optional LED backlight
Multi-touch (opt)	On-cell touch, supports 10-finger gesture (FHD only)								UltraNav™	TrackPoint® pointing device and buttonless Mylar surface touchpad, multi-touch
Storage	<i>One of the following, configurable by model:</i> <ul style="list-style-type: none"> M.2 2280 SSD / SATA 6.0Gb/s M.2 2242 SSD / PCIe NVMe, PCIe 3.0 x 2 M.2 2280 SSD / PCIe NVMe, PCIe 3.0 x 4 Intel Optane™ Memory H10 with Solid State Storage, M.2 2280, PCIe NVMe 3.0 x 4 								Security	Power-on password, hard disk password, supervisor password, security keyhole
Optical	None								Security chip	Discrete TPM 2.0, TCG Certified
Ethernet	Native Intel Ethernet Connection I219-V (Non-vPro) or I219-LM (vPro) via optional ThinkPad Ethernet Extension Cable or Lenovo USB-C to Ethernet Adapter								System Mgt (opt)	Intel vPro Technology
WLAN	Intel Wireless-AC 9560, Wi-Fi 2x2 802.11ac + Bluetooth 5.0, M.2 card								Fingerprint reader	Optional: Touch style fingerprint reader on the palm rest
Bluetooth™	Bluetooth 5.0 wireless, integrated in Wi-Fi + Bluetooth combo adapter								NFC (optional)	Near Field Communication
WWAN	None								Battery	Integrated Li-ion 45Wh battery, supports Rapid Charge (charge up to 80% in 1hr) with 65W AC adapter
SIM card	None								Max battery life	MobileMark® 2014: 14.61 hr * Battery life varies significantly with settings, usage, & other factors
Dimensions	WxDxH: 12.67" x 8.83" x 0.74"; 321.8mm x 224.2mm x 18.8mm								AC adapter	45W or 65W USB Type-C AC adapter
Weight	Starting at 3.22 lb / 1.46 kg								Operating system	Optional: Windows® 10 Home 64 or Windows 10 Pro 64
Case color	Black or Silver								Limited warranty	<i>One of the following, configurable by model:</i> <ul style="list-style-type: none"> 1-year depot repair service 1-year depot with 2-year system board repair service 3-year/1-yr battery depot repair service 3-year/1-yr battery limited onsite service
Case material	Display cover: Aluminum Bottom: GFRP								Mil-Spec test	MIL-STD-810G military testing
									Environment	EPEAT™ Silver; ENERGY STAR® 7.1; RoHS-compliant

Note: The specifications above may not be available in all regions.

Lenovo
August 2019



ThinkPad L480 Platform Specifications

Product Specifications Reference (PSREF)

Processor	7th Generation Intel® Core™ i3 / i5 Processor or								WWAN (optional) <i>One of the following, configurable by model:</i> <ul style="list-style-type: none"> Integrated Mobile Broadband 4G LTE, Intel XMM™ 7262 (Fibocom L830-EB), M.2 card (EMEA only) Integrated Mobile Broadband 4G LTE-A, Intel XMM™ 7360 (Fibocom L850-GL), M.2 card <i>* For non-WWAN model, it means the model is NOT WWAN upgradable</i> SIM card (opt) Nano-SIM card slot, optional Verizon LTE (US) SIM card
	Processor Number	# of Cores	# of Threads	Base Frequency	Max Turbo Frequency	Cache	Memory Types	Processor Graphics	
	i3-7020U	2	4	2.3 GHz	-	3MB	DDR4-2133	Intel HD Graphics 620	
	i3-7130U			2.7 GHz	-	3MB			
	i5-7200U			2.5 GHz	3.1 GHz	3MB			
	i5-7300U			2.6 GHz	3.5 GHz	3MB			
	8th Generation Intel Core i3 / i5 / i7 Processor								
	Processor Number	# of Cores	# of Threads	Base Frequency	Max Turbo Frequency	Cache	Memory Types	Processor Graphics	
	i3-8130U	2	4	2.2 GHz	3.4 GHz	4MB	DDR4-2400	Intel UHD Graphics 620	
	i5-8250U	4	8	1.6 GHz	3.4 GHz	6MB			
	i5-8350U			1.7 GHz	3.6 GHz	6MB			
	i7-8550U			1.8 GHz	4.0 GHz	8MB			
	<i>* i3-7130U is NOT available in US and EMEA</i>								
Graphics	Intel HD Graphics 620 or Intel UHD Graphics 620 in processor only or Intel HD Graphics 620 or Intel UHD Graphics 620 in processor and AMD Radeon 530, 2GB GDDR5 memory (discrete models are NOT available in EMEA); supports external digital monitor via HDMI or USB Type-C; supports three independent displays; Max resolution: 4096x2304@60Hz (USB Type-C); 4096x2160@30Hz (HDMI)								
Chipset	Intel SoC (System on Chip) platform								
Memory	32GB max / 2400MHz DDR4, dual-channel capable, two DDR4 SO-DIMM sockets <i>* System clocks down for processors with lower memory controller</i>								
Display	<i>Some:</i> 14.0" (355mm) HD (1366x768), anti-glare, LED backlight, 220 nits, 16:9 aspect ratio, 500:1 contrast ratio <i>Some:</i> 14.0" (355mm) FHD (1920x1080), anti-glare, LED backlight, IPS, 250 nits, 16:9 aspect ratio, 800:1 contrast ratio, 170° viewing angle								
Multi-touch (opt)	On-cell touch, supports 10-finger gesture (FHD only)								
Storage	<i>System has one HDD slot or one M.2 2280 slot exclusively for storage</i> <i>Some:</i> HDD / SATA 6.0Gb/s, 2.5" wide, 7mm high, Active Protection System™ <i>Some:</i> SSD / SATA 6.0Gb/s, 2.5" wide, 7mm high (e.g. xxxGB SSD) <i>Some:</i> M.2 SSD / PCIe NVMe, PCIe 3.0 x 2, 16Gb/s <i>Some:</i> 128GB M.2 SSD / PCIe NVMe, PCIe 3.0 x 2, 16Gb/s, in WWAN slot as 2nd Storage, mutually exclusive with WWAN								
Optical	None								
Ethernet	<i>Non-vPro model:</i> Intel Ethernet Connection I219-V (Jacksonville) <i>vPro model:</i> Intel Ethernet Connection I219-LM (Jacksonville)								
WLAN + Bluetooth™ (optional)	<i>One of the following, configurable by model:</i> <ul style="list-style-type: none"> Realtek® RTL8822BE, Wi-Fi 2x2 802.11ac + Bluetooth 4.1, M.2 card (US only) Intel Dual Band Wireless-AC 8265, Wi-Fi 2x2 802.11ac + Bluetooth 4.1, M.2 card <i>* Intel 8265ac card supports BT4.2 but is limited to BT4.1 by Windows OS</i>								
	Dimensions	WxDxH: 13.19" x 9.25" x 0.89"; 335mm x 235mm x 22.5mm							
	Weight	Starting at 3.71 lb / 1.68 kg							
	Case color	Black							
	Case material	PC/ABS plastic							
	Smart card reader	<i>Optional:</i> Smart card reader							
	Media reader	MicroSD card reader							
	Ports	Two USB 3.1 Gen 1 (one Always On), two USB 3.1 Type-C Gen 1 (with the function of Power Delivery and DisplayPort), HDMI 1.4b, Ethernet (RJ-45), nano-SIM card slot (WWAN models), headphone / microphone combo jack, optional smart card reader, microSD card reader, side docking connector, security keyhole <i>* Depending on many factors, actual data transfer speed may be lower than theoretical speed</i>							
	Monitor cable (optional)	<i>HDMI to VGA:</i> Lenovo HDMI to VGA Monitor Adapter <i>USB-C to VGA:</i> Lenovo USB-C to VGA Adapter							
	Camera (optional)	<i>One of the following, configurable by model:</i> <ul style="list-style-type: none"> HD720p camera, fixed focus IR camera and HD720p camera, fixed focus 							
	Audio support	HD Audio, Realtek ALC3287 codec / stereo speakers, 2W x 2, Dolby® Audio™ / dual array microphone, headphone / microphone combo jack							
	Keyboard	6-row, spill-resistant, multimedia Fn keys, optional LED backlight							
	UltraNav™	TrackPoint® pointing device and buttonless Mylar surface multi-touch touchpad							
	Security	Power-on password, hard disk password, supervisor password, security keyhole							
	Security chip	Discrete TPM 2.0, TCG Certified							
	vPro (optional)	Intel vPro Technology							
	Fingerprint reader	<i>Optional:</i> Touch style match on chip fingerprint reader on the keyboard bezel, anti-spoofing technology							
	NFC (optional)	Near Field Communication							
	Battery	Integrated Li-ion 45Wh battery, supports Rapid Charge (charge up to 80% in 1hr) with 65W AC adapter							
	Max battery life	<i>MobileMark® 2014:</i> 12.2 hr <i>* Battery life varies significantly with settings, usage, & other factors</i>							
	AC adapter	45W or 65W USB Type-C AC adapter							
	Operating system	<i>Optional:</i> Windows® 10 Home 64 or Windows 10 Pro 64							
	Limited warranty	<i>One of the following, configurable by model:</i> <ul style="list-style-type: none"> 1-year depot repair service 3-year/1-yr battery depot repair service 3-year/1-yr battery limited onsite service 							
	Mil-Spec test	MIL-STD-810G military testing							
	Environment	EPEAT™ Gold (US only); ENERGY STAR® 6.1; RoHS-compliant							

Note: The specifications above may not be available in all regions.

Lenovo
August 2019



ThinkPad L490 Platform Specifications

Product Specifications Reference (PSREF)

Processor	Intel® Celeron® Processor or 8th Generation Intel Core™ i3 / i5 / i7 Processor									Dimensions	<i>WxDxH:</i> 13.19" x 9.25" x 0.89"; 335mm x 235mm x 22.5mm
	Processor Number	# of Cores	# of Threads	Base Frequency	Max Turbo Frequency	Cache	Memory Types	Processor Graphics	Weight	Starting at 3.72 lb / 1.69 kg	
	Cel 4305U	2	2	2.2 GHz	-	2MB	DDR4-2133	Intel UHD Graphics 610	Case color	Black	
	i3-8145U	2	4	2.1 GHz	3.9 GHz	4MB	DDR4-2400	Intel UHD Graphics 620	Case material	PC/ABS plastic	
	i5-8265U	4	8	1.6 GHz	3.9 GHz	6MB			Smart card reader	<i>Optional:</i> Smart card reader	
	i5-8365U	4	8	1.6 GHz	4.1 GHz	6MB			Media reader	MicroSD card reader	
i7-8565U	4	8	1.8 GHz	4.6 GHz	8MB	Ports			Two USB 3.1 Gen 1 (one Always On), one USB 3.1 Type-C Gen 1 (with the function of Power Delivery and DisplayPort), one USB 3.1 Type-C Gen 2 (with the function of Power Delivery and DisplayPort), HDMI 1.4b, Ethernet (RJ-45), nano-SIM card slot (WWAN models), headphone / microphone combo jack, optional smart card reader, microSD card reader, side docking connector, security keyhole		
i7-8665U	4	8	1.9 GHz	4.8 GHz	8MB			* Depending on many factors, actual data transfer speed may be lower than theoretical speed			
Graphics	Intel UHD Graphics 610 or 620 in processor only or Intel UHD Graphics 620 in processor and AMD Radeon 535, 2GB GDDR5 memory (discrete models are NOT available in EMEA); supports external digital monitor via HDMI or USB Type-C; supports three independent displays; Max resolution: 4096x2304@60Hz (USB Type-C); 4096x2160@24Hz (HDMI)									Monitor cable (<i>optional</i>)	HDMI to VGA: Lenovo HDMI to VGA Monitor Adapter USB-C to VGA: Lenovo USB-C to VGA Adapter USB-C to DP: Lenovo USB-C to DisplayPort Adapter
Chipset	Intel SoC (System on Chip) platform									Camera (<i>optional</i>)	<i>One of the following, configurable by model:</i>
Memory	64GB max / 2400MHz DDR4, dual-channel capable, two DDR4 SO-DIMM sockets * Installed memory is actually 2666MHz but run at 2133MHz or 2400MHz due to Intel limitation									Audio support	• HD720p camera with ThinkShutter camera privacy, fixed focus • IR camera and HD720p camera with ThinkShutter camera privacy, fixed focus
Display	Size	Resolution	Type	Surface	Brightness	Aspect Ratio	Contrast Ratio	Color Gamut	Viewing Angle	Keyboard	6-row, spill-resistant, multimedia Fn keys, optional LED backlight UltraNav™ TrackPoint® pointing device and buttonless Mylar surface multi-touch touchpad
	14.0"	HD (1366x768)	TN	Anti-glare	220 nits	16:9	500:1	45%	90°		
	14.0"	FHD (1920x1080)	IPS	Anti-glare	250 nits	16:9	800:1	45%	170°	Security	Power-on password, hard disk password, supervisor password, security keyhole
Multi-touch (<i>opt</i>)	On-cell touch, supports 10-finger gesture (FHD only)									Security chip	Discrete TPM 2.0, TCG Certified
Storage	<ul style="list-style-type: none"> HDD / SATA 6.0Gb/s, 2.5" wide, 7mm high, Active Protection System™ SSD / SATA 6.0Gb/s, 2.5" wide, 7mm high M.2 2280 SSD / PCIe NVMe, PCIe 3.0 x 4 M.2 2242 SSD / PCIe NVMe, PCIe 3.0 x 2 * Installed M.2 2280 SSD is PCIe 3x4 but run at PCIe 3x2 due to M.2 SSD adapter limitation									System Mgt (<i>opt</i>)	Intel vPro Technology
Optane™ memory	<i>Optional:</i> Intel Optane memory, PCIe NVMe, PCIe 3.0 x 2									Fingerprint reader	<i>Optional:</i> Touch style fingerprint reader on the palm rest
Optical	None									NFC (<i>optional</i>)	Near Field Communication
Ethernet	<i>Non-vPro model:</i> Intel Ethernet Connection I219-V (Jacksonville) <i>vPro model:</i> Intel Ethernet Connection I219-LM (Jacksonville)									Battery	Integrated Li-ion 45Wh battery, supports Rapid Charge (charge up to 80% in 1hr) with 65W AC adapter
WLAN + Bluetooth™ (<i>optional</i>)	<i>One of the following, configurable by model:</i> <ul style="list-style-type: none"> Realtek® RTL8822BE, Wi-Fi 2x2 802.11ac + Bluetooth 4.2, M.2 card (NOT available in EMEA) Intel Wireless-AC 9260, Wi-Fi 2x2 802.11ac + Bluetooth 5.0 Intel Wi-Fi 6 AX200, Wi-Fi 2x2 802.11ax + Bluetooth 5.0 									Max battery life	<i>MobileMark® 2014:</i> 12 hr * Battery life varies significantly with settings, usage, & other factors
WWAN (<i>optional</i>)	<i>One of the following, configurable by model:</i> <ul style="list-style-type: none"> Wireless WAN upgradable (special bid only in EMEA) Integrated Mobile Broadband 4G LTE, Fibocom L830-EB, M.2 card (EMEA only) Integrated Mobile Broadband 4G LTE-A, Fibocom L850-GL, M.2 card * For non-WWAN model, it means the model is NOT WWAN upgradable									AC adapter	45W, 65W, or 65W slim USB-C AC adapter
SIM card	None									Operating system	<i>Optional:</i> Windows® 10 Home 64 or Windows 10 Pro 64
										Limited warranty	<i>One of the following, configurable by model:</i> <ul style="list-style-type: none"> 1-year depot repair service 3-year/1-yr battery depot repair service
										Mil-Spec test	MIL-STD-810G military testing
										Environment	EPEAT™ Silver; ENERGY STAR® 7.1; RoHS-compliant

Note: The specifications above may not be available in all regions.

Lenovo
October 2019



ThinkPad L570 Platform Specifications

Product Specifications Reference (PSREF)

Processor	6th Generation Intel® Core™ i3 / i5 / i7 Processor or							WWAN (optional) <i>One of the following, configurable by model:</i> <ul style="list-style-type: none"> Wireless WAN upgradable Integrated Mobile Broadband 4G LTE-A, Qualcomm® Snapdragon™ X7 LTE-A (Sierra Wireless EM7455), M.2 card Integrated Mobile Broadband 4G LTE, Intel XMM™ 7160 (Fibocom L831-EAU), M.2 card (EMEA only) SIM card (opt) Micro-SIM card slot, opt Verizon LTE (US) or Lenovo® Connect (EMEA) SIM card
	Processor Number	# of Cores	# of Threads	Base Frequency	Max Turbo Frequency	Cache	Memory Types	
	i3-6006U	2	4	2.0 GHz	-	3MB	DDR4-2133	Intel HD Graphics 520
	i3-6100U			2.3 GHz	-	3MB		
	i5-6200U			2.3 GHz	2.8 GHz	3MB		
	i5-6300U			2.4 GHz	3.0 GHz	3MB		
	i7-6500U			2.5 GHz	3.1 GHz	4MB		
	i7-6600U			2.6 GHz	3.4 GHz	4MB		
	Intel Celeron® Processor or 7th Generation Intel Core i3 / i5 / i7 Processor							
	Processor Number	# of Cores	# of Threads	Base Frequency	Max Turbo Frequency	Cache	Memory Types	Processor Graphics
	Cel 3965U	2	4	2.2 GHz	-	2MB	DDR4-2133	Intel HD Graphics 610
	i3-7100U			2.4 GHz	-	3MB		Intel HD Graphics 620
	i5-7200U			2.5 GHz	3.1 GHz	3MB		
	i5-7300U			2.6 GHz	3.5 GHz	3MB		
	i7-7500U			2.7 GHz	3.5 GHz	4MB		
	i7-7600U			2.8 GHz	3.9 GHz	4MB		
	* i7 processor is NOT available in EMEA							
Graphics	Intel HD Graphics 520, 610, or 620 in processor only; supports external analog monitor via VGA and digital monitor via Mini DisplayPort; supports three independent displays; Max resolution: 3840x2160@60Hz (DP via mDP cable); 1920x1200@60Hz (VGA)							
Chipset	Intel SoC (System on Chip) platform							
Memory	32GB max / 2400MHz DDR4, dual-channel capable, two DDR4 SO-DIMM sockets * System clocks down for processors with lower memory controller							
Display	Some: 15.6" (396mm) HD (1366x768), anti-glare, LED backlight, 220 nits, 16:9 aspect ratio, 350:1 contrast ratio Some: 15.6" (396mm) FHD (1920x1080), anti-glare, LED backlight, 220 nits, 16:9 aspect ratio, 400:1 or 500:1 contrast ratio Some: 15.6" (396mm) FHD (1920x1080), anti-glare, LED backlight, IPS, 250 nits, 16:9 aspect ratio, 600:1 contrast ratio, 160° viewing angle							
Multi-touch	None							
Storage	Some: HDD / SATA 6.0Gb/s, 2.5" wide, 7mm high, Active Protection System™ Some: SSD / SATA 6.0Gb/s, 2.5" wide, 7mm high (e.g. xxxGB SSD) Some: M.2 SSD / PCIe NVMe, PCIe 3.0 x 2, 16Gb/s Some: 128GB M.2 SSD / SATA 6.0Gb/s, in WWAN slot as 2nd Storage, mutually exclusive with WWAN							
Optical (optional)	DVD-ROM or DVD burner, 9mm high, fixed, not removable, tray-in							
Ethernet	Non-vPro model: Intel Ethernet Connection I219-V (Jacksonville) vPro model: Intel Ethernet Connection I219-LM (Jacksonville)							
WLAN	One of the following, configurable by model: <ul style="list-style-type: none"> Realtek® RTL8822BE, Wi-Fi 2x2 802.11ac + BT4.1, M.2 card (US only) Intel Dual Band Wireless-AC 8260, Wi-Fi 2x2 802.11ac + BT4.1, M.2 card Intel Dual Band Wireless-AC 8265, Wi-Fi 2x2 802.11ac + BT4.1, M.2 card Bluetooth™ 4.1 wireless, integrated in Wi-Fi + Bluetooth combo adapter * Intel 8260ac / 8265ac card support BT4.2 but is limited to BT4.1 by Windows OS							
Battery	Li-ion 6-cell (48Wh)							
Max battery life	MobileMark® 2014: 14.8 hr * Battery life varies significantly with settings, usage, & other factors							
AC adapter	45W slim tip AC adapter							
Operating system	One of the following, configurable by model: <ul style="list-style-type: none"> Windows® 7 Professional 64 preinstalled through downgrade rights in Windows 10 Pro 64 Windows 10 Home 64 Windows 10 Pro 64 							
Limited warranty	One of the following, configurable by model: <ul style="list-style-type: none"> 1-year depot repair service 3-year/1-yr battery depot repair service 3-year/1-yr battery limited onsite service 							
Mil-Spec test	MIL-STD-810G military testing							
Environment	EPEAT™ Gold (US only); ENERGY STAR® 6.1; RoHS-compliant							

Note: The specifications above may not be available in all regions.

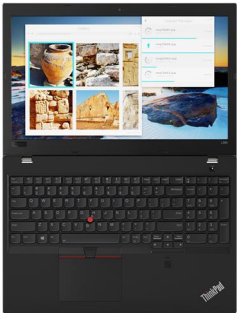

ThinkPad L580 Platform Specifications

Product Specifications Reference (PSREF)

Processor	Intel® Celeron® Processor, 7th Generation Intel Core™ i3 / i5 Processor or							WWAN (optional) <i>One of the following, configurable by model:</i> <ul style="list-style-type: none"> Integrated Mobile Broadband 4G LTE, Intel XMM™ 7262 (Fibocom L830-EB), M.2 card (EMEA only) Integrated Mobile Broadband 4G LTE-A, Intel XMM™ 7360 (Fibocom L850-GL), M.2 card * For non-WWAN model, it means the model is NOT WWAN upgradable Nano-SIM card slot, optional Verizon LTE (US) SIM card	
	Processor Number	# of Cores	# of Threads	Base Frequency	Max Turbo Frequency	Cache	Memory Types		Processor Graphics
	Cel 3965U	2	4	2.2 GHz	-	2MB	DDR4-2133	Intel HD Graphics 610	
	i3-7020U			2.3 GHz	-	3MB		Intel HD Graphics 620	
	i3-7130U			2.7 GHz	-	3MB			
	i5-7200U			2.5 GHz	3.1 GHz	3MB			
	i5-7300U			2.6 GHz	3.5 GHz	3MB			
	8th Generation Intel Core i3 / i5 / i7 Processor								
	Processor Number	# of Cores	# of Threads	Base Frequency	Max Turbo Frequency	Cache	Memory Types	Processor Graphics	
	i3-8130U	2	4	2.2 GHz	3.4 GHz	4MB	DDR4-2400	Intel UHD Graphics 620	
	i5-8250U	4	8	1.6 GHz	3.4 GHz	6MB			
	i5-8350U			1.7 GHz	3.6 GHz	6MB			
	i7-8550U			1.8 GHz	4.0 GHz	8MB			
	* i3-7130U is NOT available in US and EMEA								
Graphics	Intel HD Graphics 610, 620 or Intel UHD Graphics 620 in processor only or Intel HD Graphics 620 or Intel UHD Graphics 620 in processor and AMD Radeon 530, 2GB GDDR5 memory (discrete models are NOT available in EMEA); supports external digital monitor via HDMI or USB Type-C; supports three independent displays; Max resolution: 4096x2304@60Hz (USB Type-C); 4096x2160@30Hz (HDMI)							ExpressCard None Smart card reader <i>Optional:</i> Smart card reader Media reader MicroSD card reader Ports Two USB 3.1 Gen 1 (one Always On), two USB 3.1 Type-C Gen 1 (with the function of Power Delivery and DisplayPort), HDMI 1.4b, Ethernet (RJ-45), nano-SIM card slot (WWAN models), headphone / microphone combo jack, optional smart card reader, microSD card reader, side docking connector, security keyhole * Depending on many factors, actual data transfer speed may be lower than theoretical speed	
Chipset	Intel SoC (System on Chip) platform							Monitor cable (optional)	HDMI to VGA: Lenovo HDMI to VGA Monitor Adapter USB-C to VGA: Lenovo USB-C to VGA Adapter
Memory	32GB max / 2400MHz DDR4, dual-channel capable, two DDR4 SO-DIMM sockets * System clocks down for processors with lower memory controller							Camera (optional)	HD720p camera, fixed focus
Display	Some: 15.6" (396mm) HD (1366x768), anti-glare, LED backlight, 220 nits, 16:9 aspect ratio, 500:1 contrast ratio Some: 15.6" (396mm) FHD (1920x1080), anti-glare, LED backlight, IPS, 250 nits, 16:9 aspect ratio, 800:1 contrast ratio, 170° viewing angle							Audio support	HD Audio, Realtek ALC3287 codec / stereo speakers, 2W x 2, Dolby® Audio™ / dual array microphone, headphone / microphone combo jack
Multi-touch	None							Keyboard	6-row, spill-resistant, multimedia Fn keys, numeric keypad, optional LED backlight
Storage	System has one HDD slot or one M.2 2280 slot exclusively for storage Some: HDD / SATA 6.0Gb/s, 2.5" wide, 7mm high, Active Protection System™ Some: SSD / SATA 6.0Gb/s, 2.5" wide, 7mm high (e.g. xxxGB SSD) Some: M.2 SSD / PCIe NVMe, PCIe 3.0 x 2, 16Gb/s Some: 128GB M.2 SSD / PCIe NVMe, PCIe 3.0 x 2, 16Gb/s, in WWAN slot as 2nd Storage, mutually exclusive with WWAN							UltraNav™	TrackPoint® pointing device and buttonless Mylar surface multi-touch touchpad
Optical	None							Security	Power-on password, hard disk password, supervisor password, security keyhole
Ethernet	Non-vPro model: Intel Ethernet Connection I219-V (Jacksonville) vPro model: Intel Ethernet Connection I219-LM (Jacksonville)							Security chip	Discrete TPM 2.0, TCG Certified
WLAN + Bluetooth™ (optional)	One of the following, configurable by model: • Realtek® RTL8822BE, Wi-Fi 2x2 802.11ac + Bluetooth 4.1, M.2 card (US only) • Intel Dual Band Wireless-AC 8265, Wi-Fi 2x2 802.11ac + Bluetooth 4.1, M.2 card * Intel 8265ac card supports BT4.2 but is limited to BT4.1 by Windows OS							vPro (optional)	Intel vPro Technology
								Fingerprint reader	<i>Optional:</i> Touch style match on chip fingerprint reader on the palm rest, anti-spoofing technology
								NFC (optional)	Near Field Communication
								Battery	Integrated Li-ion 45Wh battery, supports Rapid Charge (charge up to 80% in 1hr) with 65W AC adapter
								Max battery life	MobileMark® 2014: 12 hr * Battery life varies significantly with settings, usage, & other factors
								AC adapter	45W or 65W USB Type-C AC adapter
								Operating system	<i>Optional:</i> Windows® 10 Home 64 or Windows 10 Pro 64
								Limited warranty	One of the following, configurable by model: • 1-year depot repair service • 3-year/1-yr battery depot repair service • 3-year/1-yr battery limited onsite service
								Mil-Spec test	MIL-STD-810G military testing
								Environment	EPEAT™ Gold (US only); ENERGY STAR® 6.1; RoHS-compliant

Note: The specifications above may not be available in all regions.

Lenovo
August 2019

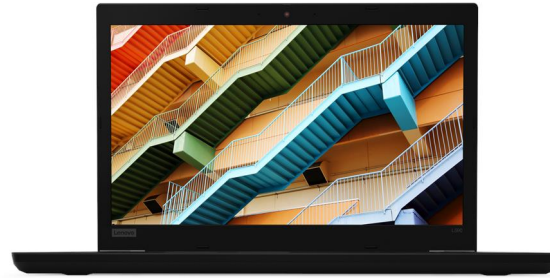

ThinkPad L590 Platform Specifications

Product Specifications Reference (PSREF)

Processor	Intel® Celeron® Processor or 8th Generation Intel Core™ i3 / i5 / i7 Processor									Dimensions	<i>WxDxH:</i> 14.82" x 10.02" x 0.90"; 376.5mm x 254.5mm x 22.95mm
	Processor Number	# of Cores	# of Threads	Base Frequency	Max Turbo Frequency	Cache	Memory Types	Processor Graphics	Weight	Starting at 4.48 lb / 2.0 kg	
	Cel 4305U	2	2	2.2 GHz	-	2MB	DDR4-2133	Intel UHD Graphics 610	Case color	Black	
	i3-8145U	2	4	2.1 GHz	3.9 GHz	4MB	DDR4-2400	Intel UHD Graphics 620	Case material	PC/ABS plastic	
	i5-8265U	4	8	1.6 GHz	3.9 GHz	6MB			Smart card reader	<i>Optional:</i> Smart card reader	
	i5-8365U	4	8	1.6 GHz	4.1 GHz	6MB			Media reader	MicroSD card reader	
i7-8565U	4	8	1.8 GHz	4.6 GHz	8MB	Ports			Two USB 3.1 Gen 1 (one Always On), one USB 3.1 Type-C Gen 1 (with the function of Power Delivery and DisplayPort), one USB 3.1 Type-C Gen 2 (with the function of Power Delivery and DisplayPort), HDMI 1.4b, Ethernet (RJ-45), nano-SIM card slot (WWAN models), headphone / microphone combo jack, optional smart card reader, microSD card reader, side docking connector, security keyhole		
i7-8665U	4	8	1.9 GHz	4.8 GHz	8MB			* Depending on many factors, actual data transfer speed may be lower than theoretical speed			
Graphics	Intel UHD Graphics 610 or 620 in processor only or Intel UHD Graphics 620 in processor and AMD Radeon 535, 2GB GDDR5 memory (discrete models are NOT available in EMEA); supports external digital monitor via HDMI or USB Type-C; supports three independent displays; Max resolution: 4096x2304@60Hz (USB Type-C); 4096x2160@24Hz (HDMI)									Monitor cable (<i>optional</i>)	HDMI to VGA: Lenovo HDMI to VGA Monitor Adapter USB-C to VGA: Lenovo USB-C to VGA Adapter USB-C to DP: Lenovo USB-C to DisplayPort Adapter
Chipset	Intel SoC (System on Chip) platform									Camera (<i>optional</i>)	<i>One of the following, configurable by model:</i>
Memory	64GB max / 2400MHz DDR4, dual-channel capable, two DDR4 SO-DIMM sockets * Installed memory is actually 2666MHz but run at 2133MHz or 2400MHz due to Intel limitation									Audio support	• HD720p camera with ThinkShutter camera privacy, fixed focus • IR camera and HD720p camera with ThinkShutter camera privacy, fixed focus HD Audio, Realtek ALC3287 codec / stereo speakers, 2W x 2, Dolby® Advanced Audio / dual array microphone, headphone / microphone combo jack
Display	Size	Resolution	Type	Surface	Brightness	Aspect Ratio	Contrast Ratio	Color Gamut	Viewing Angle	Keyboard UltraNav™	6-row, spill-resistant, multimedia Fn keys, numeric keypad, optional LED backlight TrackPoint® pointing device and buttonless Mylar surface multi-touch touchpad
	15.6"	HD (1366x768)	TN	Anti-glare	220 nits	16:9	500:1	45%	90°		
	15.6"	FHD (1920x1080)	IPS	Anti-glare	250 nits	16:9	800:1	45%	170°	Security	Power-on password, hard disk password, supervisor password, security keyhole
Multi-touch	None									Security chip	Discrete TPM 2.0, TCG Certified
Storage	<ul style="list-style-type: none"> HDD / SATA 6.0Gb/s, 2.5" wide, 7mm high, Active Protection System™ SSD / SATA 6.0Gb/s, 2.5" wide, 7mm high M.2 2280 SSD / PCIe NVMe, PCIe 3.0 x 4 M.2 2242 SSD / PCIe NVMe, PCIe 3.0 x 2 * Installed M.2 2280 SSD is PCIe 3x4 but run at PCIe 3x2 due to M.2 SSD adapter limitation									System Mgt (<i>opt</i>)	Intel vPro Technology
Optane™ memory	<i>Optional:</i> Intel Optane memory, PCIe NVMe, PCIe 3.0 x 2									Fingerprint reader	<i>Optional:</i> Touch style fingerprint reader on the palm rest
Optical	None									NFC (<i>optional</i>)	Near Field Communication
Ethernet	<i>Non-vPro model:</i> Intel Ethernet Connection I219-V (Jacksonville) <i>vPro model:</i> Intel Ethernet Connection I219-LM (Jacksonville)									Battery	Integrated Li-ion 45Wh battery, supports Rapid Charge (charge up to 80% in 1hr) with 65W AC adapter
WLAN + Bluetooth™ (<i>optional</i>)	<i>One of the following, configurable by model:</i> <ul style="list-style-type: none"> Realtek® RTL8822BE, Wi-Fi 2x2 802.11ac + Bluetooth 4.2, M.2 card (NOT available in EMEA) Intel Wireless-AC 9260, Wi-Fi 2x2 802.11ac + Bluetooth 5.0 Intel Wi-Fi 6 AX200, Wi-Fi 2x2 802.11ax + Bluetooth 5.0 									Max battery life	<i>MobileMark® 2014:</i> 12 hr * Battery life varies significantly with settings, usage, & other factors
WWAN (<i>optional</i>)	<i>One of the following, configurable by model:</i> <ul style="list-style-type: none"> Wireless WAN upgradable (special bid only in EMEA) Integrated Mobile Broadband 4G LTE, Fibocom L830-EB, M.2 card (EMEA only) Integrated Mobile Broadband 4G LTE-A, Fibocom L850-GL, M.2 card * For non-WWAN model, it means the model is NOT WWAN upgradable									AC adapter	45W, 65W, or 65W slim USB-C AC adapter
SIM card	None									Operating system	<i>Optional:</i> Windows® 10 Home 64 or Windows 10 Pro 64
										Limited warranty	<i>One of the following, configurable by model:</i> <ul style="list-style-type: none"> 1-year depot repair service 3-year/1-yr battery depot repair service
										Mil-Spec test	MIL-STD-810G military testing
										Environment	EPEAT™ Silver; ENERGY STAR® 7.1; RoHS-compliant

Note: The specifications above may not be available in all regions.

Lenovo
October 2019



ThinkPad P1 Platform Specifications

Product Specifications Reference (PSREF)

Processor	8th Generation Intel® Core™ i5 / i7 Processor or Intel Xeon® E Processor								Smart card reader	<i>Optional</i> : Smart card reader
	Processor Number	# of Cores	# of Threads	Base Frequency	Max Turbo Frequency	Cache	Memory Types	Processor Graphics	ExpressCard	None
	i5-8400H	4	8	2.5 GHz	4.2 GHz	8MB	DDR4-2666	Intel UHD Graphics 630	Media reader	SD Card reader (SD, SDHC, SDXC), supports UHS-II SD card
	i7-8750H	6	12	2.2 GHz	4.1 GHz	9MB			Ports	Two USB 3.1 Gen 1 (one Always On), two USB Type-C / Thunderbolt 3 (with the function of Power Delivery and DP), HDMI 2.0, Ethernet extension connector, headphone / microphone combo jack, optional smart card reader, SD card reader, security keyhole
	i7-8850H			2.6 GHz	4.3 GHz	9MB			* <i>Power Delivery only supports power-out for charging peripherals</i> * <i>Depending on many factors, actual data transfer speed may be lower than theoretical speed</i>	
	E-2176M			2.7 GHz	4.4 GHz	12MB		Intel UHD Graphics P630	Monitor cable (<i>optional</i>)	HDMI to VGA: Lenovo HDMI to VGA Monitor Adapter USB-C to DP: Lenovo USB-C to DisplayPort Adapter
Graphics	Intel UHD Graphics 630 or P630 in processor and NVIDIA® Quadro® P1000 or P2000, 4GB GDDR5 memory; supports external digital monitor via HDMI or Thunderbolt™; supports four independent displays; Max resolution: 5K@60Hz (Thunderbolt); 4K@60Hz (HDMI)								Bundled Accy	<i>Optional</i> : ThinkPad Ethernet Extension Cable
Chipset	Mobile Intel CM246 Chipset								Camera (<i>optional</i>)	<i>One of the following, configurable by model:</i>
Memory	64GB max / 2666MHz DDR4, ECC or non-ECC (ECC function supported only on Xeon processor), dual-channel capable, two DDR4 SO-DIMM sockets								Audio support	<ul style="list-style-type: none"> • HD720p camera with ThinkShutter camera privacy, fixed focus • IR camera and HD720p camera, fixed focus HD Audio, Realtek® ALC3286 codec / stereo speakers, 2W x 2, Dolby™ Audio™ Premium / dual array microphone, headphone / microphone combo jack, Dolby Atmos® headphone
Display	<i>Some</i> : 15.6" (396mm) FHD (1920x1080), anti-glare, LED backlight, IPS, 300 nits, 16:9 aspect ratio, 700:1 contrast ratio, 72% gamut, 170° viewing angle <i>Some</i> : 15.6" (396mm) UHD (3840x2160), anti-reflection, LED backlight, IPS, 400 nits, 16:9 aspect ratio, 1200:1 contrast ratio, 100% gamut, 170° viewing angle, multi-touch								Keyboard	6-row, spill-resistant, multimedia Fn keys, LED backlight
Multi-touch (<i>opt</i>)	Capacitive-type multi-touch, supports 10-finger gesture (4K only)								UltraNav™	TrackPoint® pointing device and buttonless glass surface multi-touch touchpad
Pen (<i>optional</i>)	Lenovo Pen Pro								Security	Power-on password, hard disk password, supervisor password, security keyhole
Storage	<i>Up to two M.2 SSD, supports single sided M.2 2280 drives only</i> M.2 SSD / PCIe NVMe, PCIe 3.0 x 4, 32Gb/s								Security chip	Discrete TPM 2.0, TCG Certified
RAID (<i>optional</i>)	RAID 0/1 support								vPro (<i>optional</i>)	Intel vPro Technology
Optical	None								Fingerprint reader	Touch style match on chip fingerprint reader on the keyboard bezel
Ethernet	Native Intel Ethernet Connection I219-V (<i>Non-vPro</i>) or I219-LM (<i>vPro</i>) via bundled or optional ThinkPad Ethernet Extension Cable								Color calibration	None
WLAN	Intel Wireless-AC 9560, Wi-Fi 2x2 802.11ac + Bluetooth 5.0, M.2 card								NFC	None
Bluetooth™	Bluetooth 5.0 wireless, integrated in Wi-Fi + Bluetooth combo adapter								Battery	Integrated Li-ion 80Wh battery, supports Rapid Charge (charge up to 80% in 1hr)
WWAN	None								Max battery life (<i>MobileMark 2014</i>)	<i>Discrete mode</i> : 7.36 hr; <i>Hybrid mode</i> : 13.87 hr * <i>Battery life varies significantly with settings, usage, & other factors</i>
SIM card	None								AC adapter	135W slim tip AC adapter
Dimensions	<i>WxDxH (non-touch)</i> : 14.24" x 9.67" x 0.72"; 361.8mm x 245.7mm x 18.4mm <i>WxDxH (multi-touch)</i> : 14.24" x 9.67" x 0.74"; 361.8mm x 245.7mm x 18.7mm								Operating system	<i>One of the following, configurable by model:</i>
Weight	<i>Non-touch model</i> : starting at 3.76 lb / 1.7 kg; <i>Multi-touch model</i> : starting at 4.06 lb / 1.8 kg								Limited warranty	<i>One of the following, configurable by model:</i>
Case color	Black									<ul style="list-style-type: none"> • 1-year depot repair service • 1-year depot with 2-year system board repair service • 3-year/1-yr battery depot repair service • 3-year/1-yr battery limited onsite service
Case material	<i>Display cover</i> : CFRP/GFRP hybrid; <i>Bottom</i> : Aluminum alloy								Mil-Spec test	MIL-STD-810G military testing
									Environment	EPPEAT™ Gold (US only); ENERGY STAR® 6.1; RoHS-compliant

Note: The specifications above may not be available in all regions.

Lenovo
November 2019

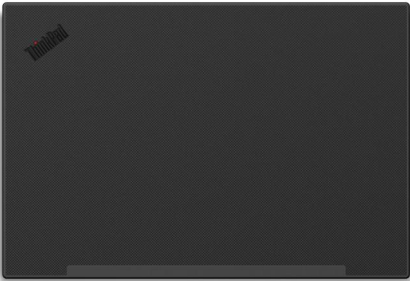

ThinkPad P1 (2nd Gen) Platform Specifications

Product Specifications Reference (PSREF)

Processor	9th Generation Intel® Core™ i5 / i7 / i9 Processor or Intel Xeon® E Processor									Dimensions	<i>WxDxH (non-touch):</i> 14.24" x 9.67" x 0.72"; 361.8mm x 245.7mm x 18.4mm <i>WxDxH (multi-touch):</i> 14.24" x 9.67" x 0.74"; 361.8mm x 245.7mm x 18.7mm		
	Processor Number	# of Cores	# of Threads	Base Frequency	Max Turbo Frequency	Cache	Memory Types	Processor Graphics		Weight	<i>Non-touch model:</i> starting at 3.75 lb / 1.7 kg; <i>Multi-touch model:</i> starting at 4.0 lb / 1.81 kg		
	i5-9400H	4	8	2.5 GHz	4.3 GHz	8MB	DDR4-2666	Intel UHD Graphics 630		Case color	Black paint (FHD model) or black weave (UHD model)		
	i7-9750H	6	12	2.6 GHz	4.5 GHz	12MB		Intel UHD Graphics 630		Case material	<i>Display cover:</i> CFRP/GFRP hybrid; <i>Bottom:</i> Aluminum alloy		
	i7-9850H	6	12	2.6 GHz	4.6 GHz	12MB		Intel UHD Graphics 630		Smart card reader	<i>Optional:</i> Smart card reader		
	i9-9880H	8	16	2.3 GHz	4.8 GHz	16MB		Intel UHD Graphics P630		Media reader	SD Card reader (SD, SDHC, SDXC), supports UHS-II SD card		
Graphics	Intel UHD Graphics 630 in processor only or Intel UHD Graphics 630 or P630 in processor and NVIDIA® Quadro® T1000 or T2000, 4GB GDDR5 memory; supports external digital monitor via HDMI or Thunderbolt™; supports four independent displays; Max resolution: 5K@60Hz (Thunderbolt); 4K@60Hz (HDMI)									Ports	Two USB 3.1 Gen 1 (one Always On), two USB 3.1 Type-C Gen 2 / Thunderbolt 3 (with the function of Power Delivery and DisplayPort), HDMI 2.0, Ethernet extension connector, headphone / microphone combo jack, optional smart card reader, SD card reader, security keyhole <i>* Power Delivery only supports power-out for charging peripherals</i> <i>* Depending on many factors, actual data transfer speed may be lower than theoretical speed</i>		
Chipset	Mobile Intel CM246 Chipset									Monitor cable (optional)	<i>HDMI to VGA:</i> Lenovo HDMI to VGA Monitor Adapter <i>USB-C to VGA:</i> Lenovo USB-C to VGA Adapter <i>USB-C to DP:</i> Lenovo USB-C to DisplayPort Adapter		
Memory	64GB max / 2666MHz DDR4, ECC or non-ECC (ECC function supported only on Xeon processor), dual-channel capable, two DDR4 SO-DIMM sockets									Bundled Accy	<i>Optional:</i> ThinkPad Ethernet Extension Cable		
Display	Size	Resolution	Type	Surface	Brightness	Aspect Ratio	Contrast Ratio	Color Gamut	Viewing Angle	Camera (optional)	<i>One of the following, configurable by model:</i> • HD720p camera with ThinkShutter camera privacy, fixed focus • IR camera and HD720p camera with ThinkShutter camera privacy, fixed focus		
	15.6"	FHD (1920x1080)	IPS	Anti-glare	300 nits	16:9	700:1	72% NTSC	170°	Audio support	HD Audio, Synaptic® CX11880 codec / stereo speakers, 2W x 2, Dolby® Audio™ Premium / optional dual array far-field microphone, headphone / microphone combo jack, Dolby Atmos® sound system		
	15.6"	FHD (1920x1080) Dolby Vision™ HDR	IPS	Anti-glare	500 nits	16:9	1200:1	72% NTSC	170°	Keyboard	6-row, spill-resistant, multimedia Fn keys, LED backlight UltraNav™ TrackPoint® pointing device and buttonless glass surface multi-touch touchpad		
	15.6"	UHD (3840x2160) Dolby Vision HDR	IPS	Anti-glare	500 nits	16:9	1200:1	100% Adobe	170°	Security	Power-on password, hard disk password, supervisor password, security keyhole		
	15.6"	UHD (3840x2160) Dolby Vision HDR, Multi-touch	OLED	Anti-reflection / Anti-smudge	SDR 400nit, HDR 500nit (peak)	16:9	100000:1	100% DCI-P3	170°	Security chip	Discrete TPM 2.0, TCG Certified		
Multi-touch (opt)	Capacitive-type multi-touch, supports 10-finger gesture (UHD OLED only), AR (anti-reflection) / AS (anti-smudge) coating									System Mgt (opt)	Intel vPro Technology		
Pen (optional)	Lenovo Pen Pro (special bid only)									Fingerprint reader	Touch style match on chip fingerprint reader on the keyboard bezel		
Storage	Up to two M.2 SSD, supports single sided M.2 2280 drives only M.2 2280 SSD / PCIe NVMe 3.0 x 4									Color calibration	<i>Optional:</i> X-Rite Pantone factory color calibration (UHD model only)		
RAID (optional)	RAID 0/1 support									NFC	None		
Optical	None									Battery	Integrated Li-ion 80Wh battery, supports Rapid Charge (charge up to 80% in 1hr)		
Ethernet	Native Intel Ethernet Connection I219-V (Non-vPro) or I219-LM (vPro) via bundled or optional ThinkPad Ethernet Extension Cable									Max battery life	<i>MobileMark® 2014:</i> 13.8 hr <i>* Battery life varies significantly with settings, usage, & other factors</i>		
WLAN (optional)	Intel Wi-Fi 6 AX200, Wi-Fi 2x2 802.11ax + Bluetooth 5.0									AC adapter	135W slim tip AC adapter		
Bluetooth™ (opt)	Bluetooth 5.0 wireless, integrated in Wi-Fi + Bluetooth combo adapter									Operating system	<i>One of the following, configurable by model:</i> • Windows® 10 Home 64 • Windows 10 Pro 64 • Windows 10 Pro 64 for Workstations		
WWAN	None									Limited warranty	<i>One of the following, configurable by model:</i> • 1-year depot repair service • 1-year depot with 2-year system board repair service • 3-year/1-yr battery depot repair service • 3-year/1-yr battery limited onsite service		
SIM card	None									Mil-Spec test	MIL-STD-810G military testing		
										Environment	EPEAT™ Silver; ENERGY STAR® 7.1; RoHS-compliant		

Note: The specifications above may not be available in all regions.

Lenovo
November 2019

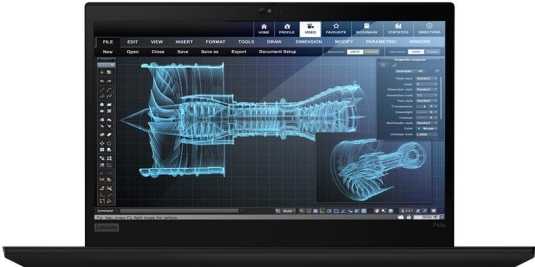

ThinkPad P43s Platform Specifications

Product Specifications Reference (PSREF)

Processor	8th Generation Intel® Core™ i7 Processor								Dimensions Weight	<i>WxDxH:</i> 12.95" x 8.94" x 0.70"; 329mm x 227mm x 17.9mm			
	Processor Number	# of Cores	# of Threads	Base Frequency	Max Turbo Frequency	Cache	Memory Types	Processor Graphics		Models	FHD	FHD Low Power	WQHD
Graphics	i5-8365U	4	8	1.6 GHz	4.1 GHz	6MB	DDR4-2400	Intel UHD Graphics 620	Case color: Black				
	i7-8565U			1.8 GHz	4.6 GHz	8MB			Case material: <i>Display cover:</i> PPS / 50% GF; <i>Bottom:</i> PA / 50% GF				
	i7-8665U			1.9 GHz	4.8 GHz	8MB			Smart card reader: <i>Optional:</i> Smart card reader				
Chipset	Intel SoC (System on Chip) platform								Media reader	MicroSD card reader			
Memory	48GB max / 2400MHz DDR4, dual-channel capable, 8GB or 16GB memory soldered to systemboard, one DDR4 SO-DIMM socket <i>* Installed memory is actually 2666MHz but run at 2400MHz due to Intel limitation</i>								Ports	Two USB 3.1 Gen 1 (one Always On), one USB 3.1 Type-C Gen 1 (with the function of Power Delivery and DisplayPort), one USB 3.1 Type-C Gen 2 / Thunderbolt 3 (with the function of PD and DP), HDMI 1.4b, Ethernet (RJ-45), nano-SIM card slot (WWAN models), headphone / microphone combo jack, optional smart card reader, microSD card reader, side docking connector, security keyhole <i>* Depending on many factors, actual data transfer speed may be lower than theoretical speed</i>			
Display	Size	Resolution	Type	Surface	Brightness	Aspect Ratio	Contrast Ratio	Color Gamut	Viewing Angle	Monitor cable (optional)	<i>HDMI to VGA:</i> Lenovo HDMI to VGA Monitor Adapter <i>USB-C to VGA:</i> Lenovo USB-C to VGA Adapter <i>USB-C to HDMI:</i> Lenovo USB-C to HDMI Adapter <i>USB-C to DP:</i> Lenovo USB-C to DisplayPort Adapter		
	14.0"	FHD (1920x1080)	IPS	Anti-glare	250 nits (non-touch) 300 nits (multi-touch)	16:9	700:1	45%	170°	Bundled Accy	None		
	14.0"	FHD (1920x1080) Low Power	IPS	Anti-glare	400 nits	16:9	800:1	72%	170°	Camera (optional)	<i>One of the following, configurable by model:</i> • HD720p camera with ThinkShutter camera privacy, fixed focus • IR camera and HD720p camera with ThinkShutter camera privacy, fixed focus		
	14.0"	FHD (1920x1080) ThinkPad Privacy Guard	IPS	Anti-glare	400 nits	16:9	1000:1	72%	170°	Audio support	HD Audio, Realtek® ALC3287 codec / stereo speakers, 2W x 2, Dolby® Audio™ Premium / optional dual array far-field microphone, headphone / microphone combo jack		
	14.0"	WQHD (2560x1440) Dolby Vision™ HDR	IPS	Glossy	500 nits	16:9	1500:1	100% Adobe	170°	Keyboard UltraNav™	6-row, spill-resistant, multimedia Fn keys, LED backlight TrackPoint® pointing device and buttonless Mylar surface multi-touch touchpad		
Multi-touch (opt)	On-cell touch, supports 10-finger gesture (FHD only)								Security	Power-on password, hard disk password, supervisor password, security keyhole			
Pen	None								Security chip	Discrete TPM 2.0, TCG Certified			
Storage	<i>Supports single sided M.2 2280 drives only</i> • M.2 2280 SSD / SATA 6.0Gb/s • M.2 2280 SSD / PCIe NVMe, PCIe 3.0 x 4 • M.2 2242 SSD / PCIe NVMe, PCIe 3.0 x 2 • Intel Optane™ Memory H10 with Solid State Storage, M.2 2280, PCIe NVMe 3.0 x 4								System Mgt (opt)	Intel vPro Technology			
	Optical	None								Fingerprint reader	<i>Optional:</i> Touch style match on chip fingerprint reader on the palm rest		
Ethernet	<i>Non-vPro model:</i> Intel Ethernet Connection I219-V (Jacksonville) <i>vPro model:</i> Intel Ethernet Connection I219-LM (Jacksonville)								NFC (optional)	Near Field Communication			
WLAN	Intel Wireless-AC 9560, Wi-Fi 2x2 802.11ac + Bluetooth 5.0								Battery	Integrated Li-ion 50Wh battery, supports Rapid Charge (charge up to 80% in 1hr)			
Bluetooth™	Bluetooth 5.0 wireless, integrated in Wi-Fi + Bluetooth combo adapter								Max battery life	<i>MobileMark® 2014:</i> 14.7 hr <i>* Battery life varies significantly with settings, usage, & other factors</i>			
WWAN (optional)	<i>One of the following, configurable by model:</i> • Wireless WAN upgradable (special bid only in EMEA) • Integrated Mobile Broadband 4G LTE, Fibocom L830-EB, M.2 card (EMEA only) • Integrated Mobile Broadband 4G LTE-A, Fibocom L850-GL, M.2 card <i>* For non-WWAN model, it means the model is NOT WWAN upgradable</i>								AC adapter	65W or 65W slim USB Type-C AC adapter			
SIM card (opt)	Nano-SIM card slot, optional Verizon LTE (US) SIM card								Operating system	Windows® 10 Home 64 or Windows 10 Pro 64			
Note: The specifications above may not be available in all regions.									Limited warranty	<i>One of the following, configurable by model:</i> • 1-year depot repair service • 3-year/1-yr battery depot repair service • 3-year/1-yr battery limited onsite service			
									Mil-Spec test	MIL-STD-810G military testing			
									Environment	EPEAT™ Silver; ENERGY STAR® 7.1; RoHS-compliant			

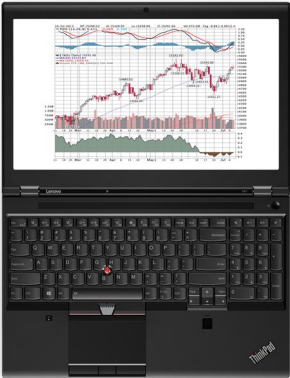

ThinkPad P51 Platform Specifications

Product Specifications Reference (PSREF)

Processor	6th or 7th Generation Intel® Core™ i7 Processor or Intel Xeon® Processor E3 v5 or v6 Family							Dimensions	<i>WxDxH:</i> 14.86" x 9.93" x 0.96-1.16"; 377.4mm x 252.3mm x 24.5-29.4mm <i>WxDxH(Touch):</i> 14.86" x 9.93" x 1.02-1.21"; 377.4mm x 252.3mm x 25.8-30.7mm				
	Processor Number	# of Cores	# of Threads	Base Frequency	Max Turbo Frequency	Cache	Memory Types	Processor Graphics	Weight	<i>Models</i>	<i>4-cell</i>	<i>6-cell</i>	
	i7-6820HQ	4	8	2.7 GHz	3.6 GHz	8MB	DDR4-2133	Intel HD Graphics 530		<i>Non-touch</i>	5.6 lb / 2.55kg	5.9 lb / 2.67kg	
	E3-1505M v5			2.8 GHz	3.7 GHz			Intel HD Graphics P530	<i>Multi-touch</i>	6.2 lb / 2.82kg	6.4 lb / 2.90kg		
	i7-7700HQ			2.8 GHz	3.8 GHz	6MB	DDR4-2400	Intel HD Graphics 630	Case color Case material	Black <i>Display cover:</i> Glass-Fiber Reinforced Plastic; <i>Bottom:</i> Magnesium/Aluminum			
	i7-7820HQ			2.9 GHz	3.9 GHz			Intel HD Graphics P630		Smart card reader ExpressCard Media reader Ports	<i>Optional:</i> Smart card reader One slot (ExpressCard/34) 4-in-1 reader (MMC, SD, SDHC, SDXC), supports UHS-II SD card Four USB 3.1 Gen 1 (USB 3.0, one Always On), USB Type-C / Thunderbolt 3, Mini DisplayPort 1.2a, HDMI 1.4b, Ethernet (RJ-45), Dock connector <i>* Depending on many factors, actual data transfer speed may be lower than theoretical speed</i>		
	E3-1505M v6			3.0 GHz	4.0 GHz	8MB	DDR4-2400	Intel HD Graphics P630	Camera (<i>optional</i>) Audio support		HD720p resolution, fixed focus HD Audio, Realtek® ALC3268 codec / stereo speakers, 2W x 2 / dual array microphone, combo audio/microphone jack		
	E3-1535M v6			3.1 GHz	4.2 GHz			Intel HD Graphics P630			Keyboard UltraNav™	6-row, spill-resistant, multimedia Fn keys, numeric keypad, optional LED backlight 3-button TrackPoint® pointing device and 3-button Mylar surface multi-touch touchpad	
Graphics	Intel HD Graphics 530, 630, P530, or P630 in processor and NVIDIA Quadro® M1200 or M2200, 4GB memory; supports external digital monitor via HDMI, Mini DisplayPort, or Thunderbolt™; supports four independent displays; Max resolution: 3840x2160@60Hz (DisplayPort via Mini DisplayPort cable); 3840x2160@60Hz (Thunderbolt); 4096x2160@24Hz (HDMI)							Security	Power-on password, hard disk password, supervisor password, security keyhole Discrete TPM 2.0, TCG Certified				
Chipset	Mobile Intel CM238 Chipset							vPro (<i>optional</i>)	Intel vPro Technology				
Memory	64GB max / 2400MHz DDR4, ECC or non-ECC (ECC function supported only on Xeon processor), dual-channel capable, four DDR4 SO-DIMM sockets <i>* System clocks down for processors with lower memory controller</i>							Fingerprint reader	Touch style match on chip fingerprint reader on the palm rest				
Display	<i>Some:</i> 15.6" (396mm) FHD (1920x1080), anti-glare, LED backlight, IPS, 250 nits, 16:9 aspect ratio, 700:1 contrast ratio, 160° viewing angle <i>Some:</i> 15.6" (396mm) 4K (3840x2160), anti-glare, LED backlight, IPS, 300 nits, 16:9 aspect ratio, 1000:1 contrast ratio, 100% gamut, 170° viewing angle							Color calibration	<i>Optional:</i> Pantone® color calibrator by X-Rite® color calibration sensor in palm rest				
Multi-touch (<i>opt</i>) Pen (<i>optional</i>)	Capacitive-type multi-touch, supports 10-finger gesture, 220 nits (FHD only) ThinkPad Pen Pro, active pen for multi-touch display							NFC	None				
Storage	<i>Up to 3 drives (two M.2 SSD and one HDD), supports single sided M.2 2280 drives only</i> <i>Some:</i> HDD / SATA 6.0Gb/s, 2.5" wide, 7mm high, Active Protection System™ <i>Some:</i> M.2 SSD / PCIe NVMe, PCIe 3.0 x 4, 32Gb/s							Battery	Lithium Polymer 4-cell (66Wh) or 6-cell (90Wh)				
RAID (<i>optional</i>) Optical	RAID 0/1 support None							Max battery life ¹⁰ (<i>MobileMark® 2014</i>)	<i>Model</i>	<i>4-cell</i>	<i>6-cell</i>		
Ethernet	<i>Non-vPro model:</i> Intel Ethernet Connection I219-V (Jacksonville) <i>vPro model:</i> Intel Ethernet Connection I219-LM (Jacksonville)							AC adapter	170W slim tip AC adapter				
WLAN	<i>One of the following, configurable by model:</i> • Intel Dual Band Wireless-AC 8260, Wi-Fi 2x2 802.11ac + BT4.1, M.2 card • Intel Dual Band Wireless-AC 8265, Wi-Fi 2x2 802.11ac + BT4.1, M.2 card							Operating system	<i>One of the following, configurable by model:</i> • Windows® 7 Professional 64 preinstalled through downgrade rights in Windows 10 Pro 64 • Windows® 10 Home 64 • Windows 10 Pro 64 • Windows 10 Pro 64 for Workstations				
Bluetooth™	Bluetooth 4.1 wireless, integrated in Wi-Fi + Bluetooth combo adapter <i>* Intel 8260ac / 8265ac card support BT4.2 but is limited to BT4.1 by Windows OS</i>							Limited warranty	<i>One of the following, configurable by model:</i> • 1-year depot repair service • 3-year/1-yr battery depot repair service • 3-year/1-yr battery limited onsite service				
WWAN (<i>optional</i>)	<i>One of the following, configurable by model:</i> • Wireless WAN upgradable • Integrated Mobile Broadband 4G LTE-A, Qualcomm® Snapdragon™ X7 LTE-A (Sierra Wireless EM7455), M.2 card							Mil-Spec test	MIL-STD-810G military testing				
SIM card (<i>opt</i>)	Micro-SIM card slot, opt Verizon LTE (US) or Lenovo® Connect (EMEA) SIM card							Environment	EPEAT™ Gold (US only); ENERGY STAR® 6.1; RoHS-compliant				

Note: The specifications above may not be available in all regions.

Lenovo
November 2019



ThinkPad P52 Platform Specifications

Product Specifications Reference (PSREF)

Processor	8th Generation Intel® Core™ i7 / i9 Processor or Intel Xeon® E Processor								Dimensions	<i>WxDxH:</i> 14.86" x 9.93" x 0.96-1.16"; 377.4mm x 252.3mm x 24.5-29.4mm <i>WxDxH(Touch):</i> 14.86" x 9.93" x 1.02-1.21"; 377.4mm x 252.3mm x 25.8-30.7mm <i>Non-touch model:</i> starting at 5.4 lb / 2.45kg; <i>Multi-touch model:</i> starting at 6.4 lb / 2.9kg
	Processor Number	# of Cores	# of Threads	Base Frequency	Max Turbo Frequency	Cache	Memory Types	Processor Graphics	Weight	Black <i>Display cover:</i> Glass-Fiber Reinforced Plastic; <i>Bottom:</i> Magnesium/Aluminum
	i7-8750H	6	12	2.2 GHz	4.1 GHz	9MB	DDR4-2400	Intel UHD Graphics 630	Case color	Black
	i7-8850H			2.6 GHz	4.3 GHz	9MB			Case material	<i>Display cover:</i> Glass-Fiber Reinforced Plastic; <i>Bottom:</i> Magnesium/Aluminum
	i9-8950HK			2.9 GHz	4.8 GHz	12MB		Smart card reader	<i>Optional:</i> Smart card reader	
E-2176M	2.7 GHz			4.4 GHz	12MB	ExpressCard		None		
Graphics	Intel UHD Graphics 630 or P630 in processor and NVIDIA Quadro® P1000 (4GB memory), P2000 (4GB memory), or P3200 (6GB memory, VR ready); supports external digital monitor via HDMI, Mini DisplayPort, or Thunderbolt™; supports four independent displays; Max resolution: 3840x2160@60Hz (DisplayPort via Mini DisplayPort cable); 5120x2880@30Hz (Thunderbolt); 4096x2160@60Hz (HDMI)								Media reader	4-in-1 reader (MMC, SD, SDHC, SDXC), supports UHS-II SD card
Chipset	Mobile Intel CM246 Chipset								Ports	Three USB 3.1 Gen 1 (one Always On), two USB Type-C / Thunderbolt 3 (with the function of Power Delivery and DP), Mini DisplayPort 1.4, HDMI 2.0, Ethernet (RJ-45), nano-SIM card slot (WWAN models), headphone / microphone combo jack, optional smart card reader, 4-in-1 reader (MMC, SD, SDHC, SDXC), security keyhole <i>* Power Delivery only supports power-out for charging peripherals</i> <i>* Depending on many factors, actual data transfer speed may be lower than theoretical speed</i>
Memory	128GB non-ECC or 64GB ECC max / 2400MHz DDR4 (ECC function supported only on Xeon processor), dual-channel capable, four DDR4 SO-DIMM sockets <i>* Installed DIMMs are actually 2666MHz but run at 2400MHz due to Intel limitation</i> <i>* 128GB non-ECC memory for special bid only</i>								Camera (optional)	<i>One of the following, configurable by model:</i> • HD720p camera with ThinkShutter camera privacy, fixed focus • IR camera and HD720p camera, fixed focus
Display	<i>Some:</i> 15.6" (396mm) FHD (1920x1080), anti-glare, LED backlight, IPS, 300 nits, 16:9 aspect ratio, 700:1 contrast ratio, 72% gamut, 160° viewing angle <i>Some:</i> 15.6" (396mm) UHD (3840x2160), anti-glare, LED backlight, IPS, 400 nits, 16:9 aspect ratio, 1000:1 contrast ratio, 100% gamut, 170° viewing angle, multi-touch								Audio support	HD Audio, Realtek® ALC3286 codec / stereo speakers, 2W x 2, Dolby® Audio™ Premium / optional dual array microphone, headphone / microphone combo jack, Dolby Atmos® headphone
Multi-touch (opt)	Capacitive-type multi-touch, supports 10-finger gesture (4K only)								Keyboard	6-row, spill-resistant, multimedia Fn keys, numeric keypad, LED backlight
Pen	Supports pen accessory, please see the accessory compatibility for details								UltraNav™	3-button TrackPoint® pointing device and 3-button Mylar surface multi-touch touchpad
Storage	<i>Up to 3 drives (two M.2 SSD and one HDD), supports single sided M.2 2280 drives only</i> <i>Some:</i> HDD / SATA 6.0Gb/s, 2.5" wide, 7mm high, Active Protection System™ <i>Some:</i> M.2 SSD / PCIe NVMe, PCIe 3.0 x 4, 32Gb/s								Security	Power-on password, hard disk password, supervisor password, security keyhole
Optane™ memory	<i>Optional:</i> Intel Optane memory, PCIe NVMe, PCIe 3.0 x 2								Security chip	Discrete TPM 2.0, TCG Certified
RAID (optional)	RAID 0/1 support								vPro (optional)	Intel vPro Technology
Optical	None								Fingerprint reader	Touch style match on chip fingerprint reader on the palm rest
Ethernet	<i>Non-vPro model:</i> Intel Ethernet Connection I219-V (Jacksonville) <i>vPro model:</i> Intel Ethernet Connection I219-LM (Jacksonville)								Color calibration	None
WLAN	Intel Wireless-AC 9560, Wi-Fi 2x2 802.11ac + Bluetooth 5.0, M.2 card								NFC (optional)	Near Field Communication
Bluetooth™	Bluetooth 5.0 wireless, integrated in Wi-Fi + Bluetooth combo adapter								Battery	Swappable Li-ion 90Wh battery
WWAN (optional)	<i>One of the following, configurable by model:</i> • Wireless WAN upgradable • Integrated Mobile Broadband 4G LTE-A, Intel XMM™ 7360 (Fibocom L850-GL), M.2 card								Max battery life	<i>Discrete mode:</i> 6.1 hr; <i>Hybrid mode:</i> 8.9 hr <i>(MobileMark® 2014)</i> <i>* Battery life varies significantly with settings, usage, & other factors</i>
SIM card (opt)	Nano-SIM card slot, optional Verizon LTE (US) SIM card								AC adapter	170W slim tip AC adapter
									Operating system	<i>One of the following, configurable by model:</i> • Windows® 10 Home 64 • Windows 10 Pro 64 • Windows 10 Pro 64 for Workstations
									Limited warranty (optional)	<i>One of the following, configurable by model:</i> • 1-year depot repair service • 3-year/1-yr battery depot repair service • 3-year/1-yr battery limited onsite service
									Mil-Spec test	MIL-STD-810G military testing
									Environment	EPEAT™ Silver; ENERGY STAR® 6.1; RoHS-compliant

Note: The specifications above may not be available in all regions.

Lenovo
November 2019



ThinkPad P52s Platform Specifications

Product Specifications Reference (PSREF)

Processor	8th Generation Intel® Core™ i5 / i7 Processor								Dimensions Weight Case color Case material	<i>WxDxH:</i> 14.40" x 9.95" x 0.79-0.80"; 365.8mm x 252.8mm x 19.95-20.2mm starting at 4.39 lb / 1.99 kg Black <i>Display cover:</i> GFRP + PPS; <i>Bottom:</i> GFRP												
	Processor Number	# of Cores	# of Threads	Base Frequency	Max Turbo Frequency	Cache	Memory Types	Processor Graphics														
	i5-8350U	4	8	1.7 GHz	3.6 GHz	6MB	DDR4-2400	Intel UHD Graphics 620														
	i7-8550U			1.8 GHz	4.0 GHz	8MB																
i7-8650U	1.9 GHz			4.2 GHz	8MB																	
Graphics	Intel UHD Graphics 620 in processor and NVIDIA Quadro® P500, 2GB GDDR5 memory; supports external digital monitor via HDMI or USB Type-C; supports three independent displays; Max resolution: 4096x2304@60Hz (USB Type-C); 4096x2160@30Hz (HDMI)								Smart card reader Media reader Ports Monitor cable (optional) Camera (optional) Audio support Keyboard UltraNav™ Security Security chip vPro (optional) Fingerprint reader NFC (optional) Battery Max battery life (MobileMark® 2014) AC adapter Operating system Limited warranty Mil-Spec test Environment	<i>Optional:</i> Smart card reader 4-in-1 reader (MMC, SD, SDHC, SDXC) Two USB 3.1 Gen 1 (one Always On), one USB 3.1 Type-C Gen 1 (with the function of Power Delivery and DisplayPort), one USB 3.1 Type-C Gen 2 / Thunderbolt 3 (with the function of PD and DP), HDMI 1.4b, Ethernet (RJ-45), nano-SIM card slot (WWAN models), headphone / microphone combo jack, optional smart card reader, 4-in-1 reader (MMC, SD, SDHC, SDXC), side docking connector, security keyhole <i>* Depending on many factors, actual data transfer speed may be lower than theoretical speed</i> <i>HDMI to VGA:</i> Lenovo HDMI to VGA Monitor Adapter <i>USB-C to DP:</i> Lenovo USB-C to DisplayPort Adapter <i>One of the following, configurable by model:</i> • HD720p camera with ThinkShutter camera privacy, fixed focus • IR camera and HD720p camera, fixed focus HD Audio, Realtek® ALC3287 codec / stereo speakers, 2W x 2, Dolby® Audio™ Premium / optional dual array microphone, headphone / microphone combo jack 6-row, spill-resistant, multimedia Fn keys, numeric keypad, optional LED backlight TrackPoint® pointing device and buttonless Mylar surface multi-touch touchpad Power-on password, hard disk password, supervisor password, security keyhole Discrete TPM 2.0, TCG Certified Intel vPro Technology <i>Optional:</i> Touch style match on chip fingerprint reader on the palm rest anti-spoofing technology Near Field Communication Optional integrated Li-ion 32Wh battery and swappable Li-ion 24Wh, 48Wh, or 72Wh battery <table border="1"> <thead> <tr> <th>Models</th> <th>48Wh</th> <th>72Wh</th> <th>32Wh + 24Wh</th> <th>32Wh + 48Wh</th> <th>32Wh + 72Wh</th> </tr> </thead> <tbody> <tr> <td><i>Max battery life</i></td> <td>12.2 hr</td> <td>18.5 hr</td> <td>13.5 hr</td> <td>20.1 hr</td> <td>26.3 hr</td> </tr> </tbody> </table> <i>* Battery life varies significantly with settings, usage, & other factors</i> 65W USB Type-C AC adapter Windows® 10 Home 64 or Windows 10 Pro 64 <i>One of the following, configurable by model:</i> • 1-year depot repair service • 1-year depot with 2-year system board repair service • 3-year/1-yr battery depot repair service • 3-year/1-yr battery limited onsite service • 3-year (including battery) limited onsite service MIL-STD-810G military testing EPEAT™ Silver; ENERGY STAR® 6.1; RoHS-compliant	Models	48Wh	72Wh	32Wh + 24Wh	32Wh + 48Wh	32Wh + 72Wh	<i>Max battery life</i>	12.2 hr	18.5 hr	13.5 hr	20.1 hr	26.3 hr
Models	48Wh	72Wh	32Wh + 24Wh	32Wh + 48Wh	32Wh + 72Wh																	
<i>Max battery life</i>	12.2 hr	18.5 hr	13.5 hr	20.1 hr	26.3 hr																	
Chipset	Intel SoC (System on Chip) platform																					
Memory	32GB max / 2400MHz DDR4, dual-channel capable, two DDR4 SO-DIMM sockets <i>* System clocks down for processors with lower memory controller</i>																					
Display	<i>Some:</i> 15.6" (396mm) FHD (1920x1080), anti-glare, LED backlight, IPS, 250 nits, 16:9 aspect ratio, 700:1 contrast ratio, 45% gamut, 170° viewing angle <i>Some:</i> 15.6" (396mm) UHD (3840x2160), anti-glare, LED backlight, IPS, 300 nits, 16:9 aspect ratio, 1000:1 contrast ratio, 72% gamut, 170° viewing angle																					
Multi-touch (opt) Pen	On-cell touch, supports 10-finger gesture (FHD only) None																					
Storage	System has one HDD slot or one M.2 2280 slot exclusively for storage, and supports single sided M.2 2280 drives only <i>Some:</i> HDD / SATA 6.0Gb/s, 2.5" wide, 7mm high, Active Protection System™ <i>Some:</i> SSD / SATA 6.0Gb/s, 2.5" wide, 7mm high (e.g. xxxGB SSD) <i>Some:</i> M.2 SSD / PCIe NVMe, PCIe 3.0 x 2, 16Gb/s <i>Some:</i> 128GB M.2 SSD / PCIe NVMe, PCIe 3.0 x 2, 16Gb/s, in WWAN slot as 2nd Storage, mutually exclusive with WWAN																					
Optane™ memory Optical	<i>Optional:</i> Intel Optane memory, PCIe NVMe, PCIe 3.0 x 2 None																					
Ethernet	<i>Non-vPro model:</i> Intel Ethernet Connection I219-V (Jacksonville) <i>vPro model:</i> Intel Ethernet Connection I219-LM (Jacksonville)																					
WLAN + Bluetooth™	Intel Dual Band Wireless-AC 8265, Wi-Fi 2x2 802.11ac + Bluetooth 4.1, M.2 card <i>* Intel 8265ac card supports BT4.2 but is limited to BT4.1 by Windows OS</i>																					
WWAN (optional)	<i>One of the following, configurable by model:</i> • Wireless WAN upgradable • Integrated Mobile Broadband 4G LTE, Intel XMM™ 7262 (Fibocom L830-EB), M.2 card (EMEA only) • Integrated Mobile Broadband 4G LTE-A, Intel XMM™ 7360 (Fibocom L850-GL), M.2 card <i>* For non-WWAN model, it means the model is NOT WWAN upgradable</i>																					
SIM card (opt)	Nano-SIM card slot, optional Verizon LTE (US) SIM card																					

Note: The specifications above may not be available in all regions.

Lenovo
November 2019



ThinkPad P53 Platform Specifications

Product Specifications Reference (PSREF)

Processor	9th Generation Intel® Core™ i5 / i7 / i9 Processor or Intel Xeon® E Processor								Dimensions	<i>WxDxH (non-touch):</i> 14.86" x 9.93" x 0.96-1.16"; 377.4mm x 252.3mm x 24.5-29.4mm <i>WxDxH (multi-touch):</i> 14.86" x 9.93" x 1.02-1.21"; 377.4mm x 252.3mm x 25.8-30.7mm								
	Processor Number	# of Cores	# of Threads	Base Frequency	Max Turbo Frequency	Cache	Memory Types	Processor Graphics	Weight	<i>Non-touch model:</i> starting at 5.51 lb / 2.5 kg; <i>Multi-touch model:</i> starting at 6.4 lb / 2.9 kg								
	i5-9400H	4	8	2.5 GHz	4.3 GHz	8MB	DDR4-2666	Intel UHD Graphics 630	Case color	Black								
	i7-9750H	6	12	2.6 GHz	4.5 GHz	12MB			Case material	<i>Display cover:</i> Glass-Fiber Reinforced Plastic; <i>Bottom:</i> Magnesium/Aluminum								
	i7-9850H	6	12	2.6 GHz	4.6 GHz	12MB			Smart card reader	<i>Optional:</i> Smart card reader								
	i9-9880H	8	16	2.3 GHz	4.8 GHz	16MB			ExpressCard	None								
	E-2276M	6	12	2.8 GHz	4.7 GHz	12MB			Media reader	4-in-1 reader (MMC, SD, SDHC, SDXC), supports UHS-II SD card								
Graphics	Intel UHD Graphics 630 or P630 in processor and NVIDIA® Quadro® T1000 (4GB GDDR5), T2000 (4GB GDDR5), RTX 3000 (6GB GDDR6, VR ready), RTX 4000 (8GB GDDR6, VR ready), or RTX 5000 (16GB GDDR6, VR ready); supports external digital monitor via HDMI, Mini DisplayPort, or Thunderbolt™; supports five independent displays; Max resolution: 5K@60Hz (Thunderbolt); 4K@60Hz (USB-C or HDMI)								Ports	Two USB 3.1 Gen 1 (one Always On), one USB 3.1 Type-C Gen 1 (with the function of Power Delivery and DisplayPort), two USB 3.1 Type-C Gen 2 / Thunderbolt 3 (with the function of PD and DP), HDMI 2.0, Ethernet (RJ-45), nano-SIM card slot (WWAN models), headphone / microphone combo jack, optional smart card reader, 4-in-1 reader (MMC, SD, SDHC, SDXC), security keyhole <i>* Power Delivery only supports power-out for charging peripherals</i> <i>* USB-C Dock is not supported in right-side USB-C port</i> <i>* Depending on many factors, actual data transfer speed may be lower than theoretical speed</i>								
Chipset	Mobile Intel CM246 Chipset								Monitor cable (optional)	<i>HDMI to VGA:</i> Lenovo HDMI to VGA Monitor Adapter <i>USB-C to VGA:</i> Lenovo USB-C to VGA Adapter <i>USB-C to DP:</i> Lenovo USB-C to DisplayPort Adapter								
Memory	128GB max / 2666MHz DDR4 (ECC function supported only on Xeon processor), dual-channel capable, four DDR4 SO-DIMM sockets								Bundled Accy	None								
Display	Size	Resolution	Type	Surface	Brightness	Aspect Ratio	Contrast Ratio	Color Gamut	Viewing Angle	Camera (optional)	<i>One of the following, configurable by model:</i> • HD720p camera with ThinkShutter camera privacy, fixed focus • IR camera and HD720p camera with ThinkShutter camera privacy, fixed focus							
	15.6"	FHD (1920x1080)	IPS	Anti-glare	300 nits	16:9	700:1	72%	160°	Audio support	HD Audio, Synaptic® CX11880 codec / stereo speakers, 2W x 2 / optional dual array far-field microphone, headphone / microphone combo jack, Dolby Atmos® sound system							
	15.6"	FHD (1920x1080) Dolby Vision™ HDR	IPS	Anti-glare	500 nits	16:9	1200:1	72%	160°	Keyboard	6-row, spill-resistant, multimedia Fn keys, numeric keypad, LED backlight							
	15.6"	UHD (3840x2160) Dolby Vision HDR	IPS	Anti-glare	500 nits	16:9	1200:1	100%	170°	UltraNav™	3-button TrackPoint® pointing device and 3-button Mylar surface multi-touch touchpad							
	15.6"	UHD (3840x2160) Dolby Vision HDR, Multi-touch	OLED	Anti-reflection / Anti-smudge	SDR 400nit, HDR 500nit (peak)	16:9	100000:1	100% DCI-P3	170°	Security	Power-on password, hard disk password, supervisor password, security keyhole							
Multi-touch (opt)	Capacitive-type multi-touch, supports 10-finger gesture (UHD only), anti-reflection (AR), anti-smudge (AS) coating								Security chip	Discrete TPM 2.0, TCG Certified								
Pen (optional)	Lenovo Pen Pro (special bid only)								vPro (optional)	Intel vPro Technology								
Storage	Up to 3 drives (3x M.2 SSD or 1x HDD + 2x M.2 SSD), supports single sided M.2 2280 drives only • HDD / SATA 6.0Gb/s, 2.5" wide, 7mm high, Active Protection System™ • M.2 2280 SSD / PCIe NVMe, PCIe 3.0 x 4 <i>* HDD is only available for T1000 and T2000 graphics model</i>								Fingerprint reader	Touch style match on chip fingerprint reader on the palm rest								
Optane™ memory	<i>Optional:</i> Intel Optane memory, PCIe NVMe, PCIe 3.0 x 2								Color calibration	<i>Optional:</i> X-Rite Pantone factory color calibration (UHD model only)								
RAID (optional)	RAID 0/1/5 support								NFC (optional)	Near Field Communication								
Optical	None								Battery	Integrated Li-ion 90Wh battery, supports Rapid Charge (charge up to 80% in 1hr)								
Ethernet	<i>Non-vPro model:</i> Intel Ethernet Connection I219-V (Jacksonville) <i>vPro model:</i> Intel Ethernet Connection I219-LM (Jacksonville)								Max battery life	<i>Discrete mode:</i> 8 hr; <i>Hybrid mode:</i> 13 hr <i>(MobileMark® 2014)</i> <i>* Battery life varies significantly with settings, usage, & other factors</i>								
WLAN (optional)	Intel Wi-Fi 6 AX200, Wi-Fi 2x2 802.11ax + Bluetooth 5.0								AC adapter	170W or 230W slim tip AC adapter								
Bluetooth™ (opt)	Bluetooth 5.0 wireless, integrated in Wi-Fi + Bluetooth combo adapter								Operating system	<i>One of the following, configurable by model:</i> • Windows® 10 Home 64 • Windows 10 Pro 64 • Windows 10 Pro 64 for Workstations								
WWAN (optional)	<i>One of the following, configurable by model:</i> • Wireless WAN upgradable (special bid only in EMEA) • Integrated Mobile Broadband 4G LTE-A, Fibocom L850-GL, M.2 card <i>* For non-WWAN model, it means the model is NOT WWAN upgradable</i>								Limited warranty	<i>One of the following, configurable by model:</i> • 1-year depot repair service • 3-year/1-yr battery depot repair service • 3-year/1-yr battery limited onsite service								
SIM card (opt)	Nano-SIM card slot, optional Verizon LTE (US) SIM card								Mil-Spec test	MIL-STD-810G military testing								
									Environment	EPEAT™ Silver; ENERGY STAR® 7.1; RoHS-compliant								

Note: The specifications above may not be available in all regions.

Lenovo
November 2019



ThinkPad P53s Platform Specifications

Product Specifications Reference (PSREF)

Processor	8th Generation Intel® Core™ i7 Processor									Dimensions	<i>WxDxH:</i> 14.40" x 9.76" x 0.75"; 365.8mm x 248mm x 19.1mm		
	Processor Number	# of Cores	# of Threads	Base Frequency	Max Turbo Frequency	Cache	Memory Types	Processor Graphics		Weight	starting at 3.87 lb / 1.75 kg		
	i7-8565U	4	8	1.8 GHz	4.6 GHz	8MB	DDR4-2400	Intel UHD Graphics 620		Case color	Black		
	i7-8665U			1.9 GHz	4.8 GHz	8MB				Case material	<i>Display cover:</i> PPS / 50% GF; <i>Bottom:</i> PA / 50% GF		
Graphics	Intel UHD Graphics 620 in processor and NVIDIA Quadro® P520, 2GB GDDR5 memory; supports external digital monitor via HDMI or USB Type-C; supports three independent displays; Max resolution: 3840x2160@60Hz (USB-C); 3840x2160@30Hz (HDMI)									Smart card reader	Optional: Smart card reader		
Chipset	Intel SoC (System on Chip) platform 48GB max / 2400MHz DDR4, dual-channel capable, 8GB or 16GB memory soldered to systemboard, one DDR4 SO-DIMM socket <i>* Installed memory is actually 2666MHz but run at 2400MHz due to Intel limitation</i>									Media reader	MicroSD card reader		
Memory										Ports	Two USB 3.1 Gen 1 (one Always On), one USB 3.1 Type-C Gen 1 (with the function of Power Delivery and DisplayPort), one USB 3.1 Type-C Gen 2 / Thunderbolt 3 (with the function of PD and DP), HDMI 1.4b, Ethernet (RJ-45), nano-SIM card slot (WWAN models), headphone / microphone combo jack, optional smart card reader, microSD card reader, side docking connector, security keyhole <i>* Depending on many factors, actual data transfer speed may be lower than theoretical speed</i>		
Display	Size	Resolution	Type	Surface	Brightness	Aspect Ratio	Contrast Ratio	Color Gamut	Viewing Angle	Monitor cable (optional)	<i>HDMI to VGA:</i> Lenovo HDMI to VGA Monitor Adapter <i>USB-C to VGA:</i> Lenovo USB-C to VGA Adapter <i>USB-C to DP:</i> Lenovo USB-C to DisplayPort Adapter		
	15.6"	FHD (1920x1080)	IPS	Anti-glare	250 nits	16:9	700:1	45%	170°	Bundled Accy	None		
	15.6"	UHD (3840x2160) Dolby Vision™ HDR	IPS	Anti-glare	500 nits	16:9	1200:1	100% Adobe	170°	Camera (optional)	<i>One of the following, configurable by model:</i> • HD720p camera with ThinkShutter camera privacy, fixed focus • IR camera and HD720p camera with ThinkShutter camera privacy, fixed focus		
Multi-touch (opt)	On-cell touch, supports 10-finger gesture (FHD only)									Audio support	HD Audio, Realtek® ALC3287 codec / stereo speakers, 2W x 2, Dolby® Audio™ Premium / dual array far-field microphone, headphone / microphone combo jack		
Pen	None									Keyboard	6-row, spill-resistant, multimedia Fn keys, numeric keypad, optional LED backlight		
Storage	Supports single sided M.2 2280 drives only • M.2 2280 SSD / SATA 6.0Gb/s • M.2 2280 SSD / PCIe NVMe, PCIe 3.0 x 4 • M.2 2242 SSD / PCIe NVMe, PCIe 3.0 x 2 • Intel Optane™ Memory H10 with Solid State Storage, M.2 2280, PCIe NVMe 3.0 x 4									UltraNav™	TrackPoint® pointing device and buttonless Mylar surface multi-touch touchpad		
Optical	None									Security	Power-on password, hard disk password, supervisor password, security keyhole		
Ethernet	<i>Non-vPro model:</i> Intel Ethernet Connection I219-V (Jacksonville) <i>vPro model:</i> Intel Ethernet Connection I219-LM (Jacksonville)									Security chip	Discrete TPM 2.0, TCG Certified		
WLAN	Intel Wireless-AC 9560, Wi-Fi 2x2 802.11ac + Bluetooth 5.0									System Mgt (opt)	Intel vPro Technology		
Bluetooth™	Bluetooth 5.0 wireless, integrated in Wi-Fi + Bluetooth combo adapter									Fingerprint reader	Optional: Touch style match on chip fingerprint reader on the palm rest		
WWAN (optional)	<i>One of the following, configurable by model:</i> • Wireless WAN upgradable (special bid only in EMEA) • Integrated Mobile Broadband 4G LTE, Fibocom L830-EB, M.2 card (EMEA only) • Integrated Mobile Broadband 4G LTE-A, Fibocom L850-GL, M.2 card <i>* For non-WWAN model, it means the model is NOT WWAN upgradable</i>									NFC (optional)	Near Field Communication		
SIM card (opt)	Nano-SIM card slot, optional Verizon LTE (US) SIM card									Battery	Integrated Li-ion 57Wh battery, supports Rapid Charge (charge up to 80% in 1hr)		
										Max battery life	<i>MobileMark® 2014:</i> 15 hr (FHD model) / 10 hr (UHD model) <i>* Battery life varies significantly with settings, usage, & other factors</i>		
										AC adapter	65W USB Type-C AC adapter		
										Operating system	Windows® 10 Home 64 or Windows 10 Pro 64		
										Limited warranty	<i>One of the following, configurable by model:</i> • 1-year depot repair service • 3-year/1-yr battery depot repair service • 3-year/1-yr battery limited onsite service		
										Mil-Spec test	MIL-STD-810G military testing		
										Environment	EPEAT™ Silver; ENERGY STAR® 7.1; RoHS-compliant		

Note: The specifications above may not be available in all regions.

Lenovo
November 2019

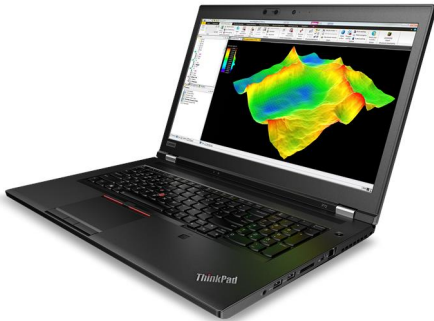

ThinkPad P72 Platform Specifications

Product Specifications Reference (PSREF)

Processor	8th Generation Intel® Core™ i7 Processor or Intel Xeon® E Processor								Dimensions	<i>WxDxH:</i> 16.38" x 11.06" x 0.96-1.16"; 416mm x 281mm x 24.5-29.4mm
	Processor Number	# of Cores	# of Threads	Base Frequency	Max Turbo Frequency	Cache	Memory Types	Processor Graphics	Weight	Starting at 7.5 lb / 3.4kg
	i7-8750H	6	12	2.2 GHz	4.1 GHz	9MB	DDR4-2400	Intel UHD Graphics 630	Case color	Black
	i7-8850H			2.6 GHz	4.3 GHz	9MB		Intel UHD Graphics P630	Case material	<i>Display cover:</i> GFRP + PPS; <i>Bottom:</i> Magnesium/Aluminum
	E-2176M			2.7 GHz	4.4 GHz	12MB		Intel UHD Graphics P630	Smart card reader	<i>Optional:</i> Smart card reader
E-2186M	2.9 GHz			4.8 GHz	12MB	ExpressCard		None		
Graphics	Intel UHD Graphics 630 or P630 in processor and NVIDIA Quadro® P600 (4GB memory), P2000 (4GB memory), P3200 (6GB memory), P4200 (8GB memory), or P5200 (16GB memory); supports external digital monitor via HDMI, Mini DisplayPort, or Thunderbolt™; supports four independent displays; Max resolution: 3840X2160@60Hz (DisplayPort via Mini DisplayPort cable); 5120X2880@30Hz (Thunderbolt); 4096x2160@60Hz (HDMI)								Media reader	4-in-1 reader (MMC, SD, SDHC, SDXC), supports UHS-II SD card
Chipset	Mobile Intel CM246 Chipset								Ports	Four USB 3.1 Gen 1 (one Always On), two USB Type-C / Thunderbolt 3 (with the function of Power Delivery and DP), Mini DisplayPort 1.4, HDMI 2.0, Ethernet (RJ-45), headphone / microphone combo jack, optional smart card reader, 4-in-1 reader (MMC, SD, SDHC, SDXC), security keyhole <i>* Power Delivery only supports power-out for charging peripherals</i> <i>* Depending on many factors, actual data transfer speed may be lower than theoretical speed</i>
Memory	128GB non-ECC or 64GB ECC max / 2400MHz DDR4 (ECC function supported only on Xeon processor), dual-channel capable, four DDR4 SO-DIMM sockets <i>* Installed DIMMs are actually 2666MHz but run at 2400MHz due to Intel limitation</i>								Monitor cable	<i>Optional:</i> Lenovo Mini-DisplayPort to DisplayPort Monitor Cable
Display	<i>Some:</i> 17.3" (439mm) FHD (1920x1080), anti-glare, LED backlight, IPS, 300 nits, 16:9 aspect ratio, 800:1 contrast ratio, 72% gamut, 170° viewing angle <i>Some:</i> 17.3" (439mm) UHD (3840x2160), anti-glare, LED backlight, IPS, 400 nits, 16:9 aspect ratio, 1000:1 contrast ratio, 100% Adobe gamut, 170° viewing angle								Camera (<i>optional</i>)	IR camera and HD720p camera, fixed focus
Multi-touch Pen	None Supports pen accessory, please see the accessory compatibility for details								Audio support	HD Audio, Realtek® ALC3286 codec / stereo speakers, 2W x 2, Dolby® Audio™ Premium / dual array microphone, headphone / microphone combo jack, Dolby Atmos® headphone
Storage	<i>Up to 3 drives (two M.2 SSD and one HDD), supports single sided M.2 2280 drives only</i> <i>Some:</i> HDD / SATA 6.0Gb/s, 2.5" wide, 7mm high, Active Protection System™ <i>Some:</i> M.2 SSD / PCIe NVMe, PCIe 3.0 x 4, 32Gb/s								Keyboard	6-row, spill-resistant, multimedia Fn keys, numeric keypad, LED backlight
Optane™ memory	<i>Optional:</i> Intel Optane memory, PCIe NVMe, PCIe 3.0 x 2								UltraNav™	3-button TrackPoint® pointing device and 3-button Mylar surface multi-touch touchpad
RAID (<i>optional</i>)	RAID 0/1 support								Security	Power-on password, hard disk password, supervisor password, security keyhole
Optical	None								Security chip	Discrete TPM 2.0, TCG Certified
Ethernet	<i>Non-vPro model:</i> Intel Ethernet Connection I219-V (Jacksonville) <i>vPro model:</i> Intel Ethernet Connection I219-LM (Jacksonville)								vPro (<i>optional</i>)	Intel vPro Technology
WLAN	Intel Wireless-AC 9560, Wi-Fi 2x2 802.11ac + Bluetooth 5.0, M.2 card								Fingerprint reader	Touch style match on chip fingerprint reader on the palm rest
Bluetooth™	Bluetooth 5.0 wireless, integrated in Wi-Fi + Bluetooth combo adapter								Color calibration	None
WWAN	None								NFC (<i>optional</i>)	Near Field Communication
SIM card	None								Battery	Li-ion 99Wh battery, supports Rapid Charge (charge up to 80% in 1hr)
									Max battery life	<i>MobileMark® 2014:</i> 16 hr <i>* Battery life varies significantly with settings, usage, & other factors</i>
									AC adapter	230W slim tip AC adapter
									Operating system (<i>optional</i>)	<i>One of the following, configurable by model:</i> • Windows® 10 Home 64 • Windows 10 Pro 64 • Windows 10 Pro 64 for Workstations
									Limited warranty	<i>One of the following, configurable by model:</i> • 1-year depot repair service • 3-year/1-yr battery depot repair service • 3-year/1-yr battery limited onsite service
									Mil-Spec test	MIL-STD-810G military testing
									Environment	EPPEAT™ Gold (US only); ENERGY STAR® 7.0; RoHS-compliant

Note: The specifications above may not be available in all regions.

Lenovo
November 2019



ThinkPad P73 Platform Specifications

Product Specifications Reference (PSREF)

Processor	9th Generation Intel® Core™ i5 / i7 / i9 Processor or Intel Xeon® E Processor									Dimensions WxDxH: 16.38" x 11.06" x 1.02-1.22"; 416mm x 281mm x 25.9-31mm Weight Starting at 7.5 lb (3.4kg) Case color Black Case material Display cover: GFRP + PPS; Bottom: Magnesium/Aluminum
	Processor Number	# of Cores	# of Threads	Base Frequency	Max Turbo Frequency	Cache	Memory Types	Processor Graphics		
	i5-9400H	4	8	2.5 GHz	4.3 GHz	8MB	DDR4-2666	Intel UHD Graphics 630		
	i7-9750H	6	12	2.6 GHz	4.5 GHz	12MB		Intel UHD Graphics 630		
	i7-9850H	6	12	2.6 GHz	4.6 GHz	12MB		Intel UHD Graphics 630		
	i9-9880H	8	16	2.3 GHz	4.8 GHz	16MB		Intel UHD Graphics 630		
E-2276M	6	12	2.8 GHz	4.7 GHz	12MB	Intel UHD Graphics P630				
Graphics	Intel UHD Graphics 630 or P630 in processor and NVIDIA Quadro® P620 (4GB GDDR5), T2000 (4GB GDDR5), RTX 3000 (6GB GDDR6, VR ready), RTX 4000 Max-Q (8GB GDDR6, VR ready), or RTX 5000 Max-Q (16GB GDDR6, VR ready); supports external digital monitor via HDMI or Thunderbolt™; supports five independent displays; Max resolution: 5K@60Hz (Thunderbolt); 4K@60Hz (USB-C or HDMI)									Smart card reader Optional: Smart card reader ExpressCard None Media reader 4-in-1 reader (MMC, SD, SDHC, SDXC), supports UHS-II SD card Ports Three USB 3.1 Gen 1 (one Always On), one USB 3.1 Type-C Gen 1 (with the function of Power Delivery and DisplayPort), two USB 3.1 Type-C Gen 2 / Thunderbolt 3 (with the function of PD and DP), HDMI 2.0, Ethernet (RJ-45), headphone / microphone combo jack, optional smart card reader, 4-in-1 reader (MMC, SD, SDHC, SDXC), security keyhole * Power Delivery only supports power-out for charging peripherals * Depending on many factors, actual data transfer speed may be lower than theoretical speed Monitor cable (optional) HDMI to VGA: Lenovo HDMI to VGA Monitor Adapter USB-C to VGA: Lenovo USB-C to VGA Adapter USB-C to DP: Lenovo USB-C to DisplayPort Adapter Bundled Accy None Camera (optional) IR camera and HD720p camera with ThinkShutter camera privacy, fixed focus Audio support HD Audio, Synaptic® CX11880 codec / stereo speakers, 2W x 2 / dual array far-field microphone, headphone / microphone combo jack, Dolby Atmos® sound system Keyboard 6-row, spill-resistant, multimedia Fn keys, numeric keypad, LED backlight UltraNav™ 3-button TrackPoint® pointing device and 3-button Mylar surface multi-touch touchpad Security Power-on password, hard disk password, supervisor password, security keyhole Security chip Discrete TPM 2.0, TCG Certified vPro (optional) Intel vPro Technology Fingerprint reader Touch style match on chip fingerprint reader on the palm rest Color calibration Optional: X-Rite Pantone factory color calibration (UHD model only) NFC (optional) Near Field Communication Battery Integrated Li-ion 99Wh battery, supports Rapid Charge (charge up to 80% in 1hr) Max battery life MobileMark® 2014: 17.2 hr * Battery life varies significantly with settings, usage, & other factors AC adapter 170W or 230W slim tip AC adapter Operating system One of the following, configurable by model: • Windows® 10 Home 64 • Windows 10 Pro 64 • Windows 10 Pro 64 for Workstations Limited warranty One of the following, configurable by model: • 1-year depot repair service • 3-year/1-yr battery depot repair service • 3-year/1-yr battery limited onsite service Mil-Spec test MIL-STD-810G military testing Environment EPEAT™ Silver; ENERGY STAR® 7.1; RoHS-compliant
Chipset	Mobile Intel CM246 Chipset									
Memory	128GB max / 2666MHz DDR4 (ECC function supported only on Xeon processor), dual-channel capable, four DDR4 SO-DIMM sockets									
Display	Size	Resolution	Type	Surface	Brightness	Aspect Ratio	Contrast Ratio	Color Gamut	Viewing Angle	
	17.3"	FHD (1920x1080)	IPS	Anti-glare	300 nits	16:9	700:1	72%	160°	
	17.3"	UHD (3840x2160) Dolby Vision™ HDR	IPS	Anti-glare	400 nits	16:9	1000:1	100%	170°	
Multi-touch	None									
Pen	None									
Storage	Up to 3 drives (two M.2 SSD and one HDD), supports single sided M.2 2280 drives only • HDD / SATA 6.0Gb/s, 2.5" wide, 7mm high, Active Protection System™ • M.2 2280 SSD / PCIe NVMe, PCIe 3.0 x 4									
Optane™ memory	Optional: Intel Optane memory, PCIe NVMe, PCIe 3.0 x 2									
RAID (optional)	RAID 0/1 support									
Optical	None									
Ethernet	Non-vPro model: Intel Ethernet Connection I219-V (Jacksonville) vPro model: Intel Ethernet Connection I219-LM (Jacksonville)									
WLAN (optional)	Intel Wi-Fi 6 AX200, Wi-Fi 2x2 802.11ax + Bluetooth 5.0									
Bluetooth™ (opt)	Bluetooth 5.0 wireless, integrated in Wi-Fi + Bluetooth combo adapter									
WWAN	None									
SIM card	None									

Note: The specifications above may not be available in all regions.

Lenovo
November 2019



ThinkPad T470 Platform Specifications

Product Specifications Reference (PSREF)

Processor	6th Generation Intel® Core™ i5 / i7 Processor or								WWAN (optional) <i>One of the following, configurable by model (WWAN can coexist with WiGig):</i> <ul style="list-style-type: none"> Wireless WAN upgradable Integrated Mobile Broadband 4G LTE-A, Qualcomm® Snapdragon™ X7 LTE-A (Sierra Wireless EM7455), M.2 card Integrated Mobile Broadband 4G LTE, Intel XMM™ 7160 (Fibocom L831-EAU), M.2 card (EMEA only) SIM card (opt) Micro-SIM card slot, opt Verizon LTE (US) or Lenovo® Connect (EMEA) SIM card								
	Processor Number	# of Cores	# of Threads	Base Frequency	Max Turbo Frequency	Cache	Memory Types	Processor Graphics									
	i5-6200U	2	4	2.3 GHz	2.8 GHz	3MB	DDR4-2133	Intel HD Graphics 520									
	i5-6300U			2.4 GHz	3.0 GHz	3MB											
	i7-6500U			2.5 GHz	3.1 GHz	4MB											
	i7-6600U			2.6 GHz	3.4 GHz	4MB											
	7th Generation Intel Core i3 / i5 / i7 Processor																
	Processor Number	# of Cores	# of Threads	Base Frequency	Max Turbo Frequency	Cache	Memory Types	Processor Graphics									
	i3-7100U	2	4	2.4 GHz	-	3MB	DDR4-2133	Intel HD Graphics 620									
	i5-7200U			2.5 GHz	3.1 GHz	3MB											
	i5-7300U			2.6 GHz	3.5 GHz	3MB											
	i7-7500U			2.7 GHz	3.5 GHz	4MB											
	i7-7600U			2.8 GHz	3.9 GHz	4MB											
	* i7-6500U is NOT available in EMEA																
Graphics	Intel HD Graphics 520 or 620 in processor only, or Intel HD Graphics 620 in processor and NVIDIA GeForce® 940MX, 2GB 2.5GHz GDDR5 memory (discrete models are NOT available in EMEA); supports external digital monitor via HDMI or USB Type-C; supports three independent displays; Max resolution: 4096x2304@60Hz (USB Type-C); 4096x2160@24Hz (HDMI)																
Chipset	Intel SoC (System on Chip) platform																
Memory	32GB max / 2400MHz DDR4, dual-channel capable, two DDR4 SO-DIMM sockets * System clocks down for processors with lower memory controller																
Display	<i>Some:</i> 14.0" (355mm) HD (1366x768), anti-glare, LED backlight, 220 nits, 16:9 aspect ratio, 400:1 contrast ratio <i>Some:</i> 14.0" (355mm) FHD (1920x1080), anti-glare, LED backlight, 220 nits, 16:9 aspect ratio, 400:1 or 500:1 contrast ratio <i>Some:</i> 14.0" (355mm) FHD (1920x1080), anti-glare, LED backlight, IPS, 250 nits, 16:9 aspect ratio, 700:1 contrast ratio, 170° viewing angle																
Multi-touch (opt)	On-cell touch, supports 10-finger gesture (FHD IPS panel with PPS cover only)																
Storage	<i>System has one HDD slot or one M.2 2280 slot exclusively for storage</i> <i>Some:</i> HDD / SATA 6.0Gb/s, 2.5" wide, 7mm high, Active Protection System™ <i>Some:</i> SSD / SATA 6.0Gb/s, 2.5" wide, 7mm high (e.g. xxxGB SSD) <i>Some:</i> M.2 SSD / PCIe NVMe, PCIe 3.0 x 2, 16Gb/s <i>Some:</i> 128GB M.2 SSD / SATA 6.0Gb/s, in WWAN slot as 2nd Storage, mutually exclusive with WWAN and WiGig																
Optical	None																
Ethernet	<i>Non-vPro model:</i> Intel Ethernet Connection I219-V (Jacksonville) <i>vPro model:</i> Intel Ethernet Connection I219-LM (Jacksonville)																
WLAN	<i>One of the following, configurable by model (WiGig can coexist with WWAN):</i> <ul style="list-style-type: none"> Realtek® RTL8822BE, Wi-Fi 2x2 802.11ac + BT4.1, M.2 card Intel Dual Band Wireless-AC 8260, Wi-Fi 2x2 802.11ac + BT4.1, M.2 card Intel Dual Band Wireless-AC 8265, Wi-Fi 2x2 802.11ac + BT4.1, M.2 card Intel Tri-Band Wireless-AC 18265, WiGig 802.11ad + Wi-Fi 2x2 802.11ac + BT4.1, M.2 card 																
Bluetooth™	Bluetooth 4.1 wireless, integrated in Wi-Fi + Bluetooth combo adapter * Intel 8265ac / 18265ac card support BT4.2 but is limited to BT4.1 by Windows OS																
Dimensions	WxDxH: 13.25" x 9.15" x 0.79"; 336.6mm x 232.5mm x 19.95mm Weight <table border="1"> <tr> <td>Models</td> <td>3-cell or 3 + 3-cell</td> <td>6-cell or 3 + 6-cell</td> </tr> <tr> <td>Magnesium</td> <td>3.49 lb / 1.58 kg</td> <td>3.92 lb / 1.78 kg</td> </tr> <tr> <td>PPS</td> <td>3.63 lb / 1.65 kg</td> <td>4.35 lb / 1.85 kg</td> </tr> </table>								Models	3-cell or 3 + 3-cell	6-cell or 3 + 6-cell	Magnesium	3.49 lb / 1.58 kg	3.92 lb / 1.78 kg	PPS	3.63 lb / 1.65 kg	4.35 lb / 1.85 kg
Models	3-cell or 3 + 3-cell	6-cell or 3 + 6-cell															
Magnesium	3.49 lb / 1.58 kg	3.92 lb / 1.78 kg															
PPS	3.63 lb / 1.65 kg	4.35 lb / 1.85 kg															
Case color	Black																
Case material	Display cover: Magnesium Hybrid or PPS; Bottom: Glass-Fiber Reinforced Plastic																
Smart card reader	Optional: Smart card reader																
Media reader	4-in-1 reader (MMC, SD, SDHC, SDXC), supports SD 3.0, UHS-I																
Ports	Three USB 3.1 Gen 1 (USB 3.0, one Always On), USB 3.1 Type-C Gen 2 / Thunderbolt 3 (w/ the function of Power Delivery and DP), HDMI 1.4b, Ethernet (RJ-45), Dock connector * Depending on many factors, actual data transfer speed may be lower than theoretical speed																
WiGig dock (opt)	ThinkPad WiGig dock																
Monitor cable	Optional: Lenovo USB-C to VGA Adapter																
Camera (optional)	720p: HD720p resolution, fixed focus IR & 720p: IR camera and HD720p camera (mutually exclusive with WiGig)																
Audio support	HD Audio, Realtek ALC3268 codec / stereo speakers, 2W x 2 / dual array microphone, combo audio/microphone jack																
Keyboard	6-row, spill-resistant, multimedia Fn keys, optional LED backlight																
UltraNav™	TrackPoint® pointing device and buttonless Mylar surface multi-touch touchpad																
Security	Power-on password, hard disk password, supervisor password, security keyhole																
Security chip	Discrete TPM 2.0, TCG Certified																
vPro (optional)	Intel vPro Technology																
Fingerprint reader	Optional: Touch style match on chip fingerprint reader on the keyboard bezel																
NFC (optional)	Near Field Communication																
Internal battery	Optional: Integrated Li-Polymer 3-cell (24Wh)																
External battery	Li-Polymer 3-cell (24Wh) or Li-ion 6-cell (48Wh or 72Wh)																
Max battery life (MobileMark® 2014)	Models	3-cell	3 + 3-cell	6-cell 48Wh	6-cell 72Wh	3 + 6-cell 48Wh	3 + 6-cell 72Wh										
	Integrated	6.9 hr	13.9 hr	13.9 hr	20.9 hr	20.9 hr	27.1 hr										
	Discrete	6.9 hr	13.9 hr	14.3 hr	21.6 hr	21.2 hr	28.6 hr										
	* Battery life varies significantly with settings, usage, & other factors																
AC adapter	45W or 65W slim tip AC adapter, 45W or 65W USB Type-C AC adapter																
Operating system	One of the following, configurable by model: <ul style="list-style-type: none"> Windows® 7 Professional 64 preinstalled through downgrade rights in Windows 10 Pro 64 Windows 10 Home 64 Windows 10 Pro 64 																
Limited warranty	One of the following, configurable by model: <ul style="list-style-type: none"> 1-year depot repair service 3-year/1-yr battery depot repair service 3-year/1-yr battery limited onsite service 																
Mil-Spec test	MIL-STD-810G military testing																
Environment	EPEAT™ Gold (US only); ENERGY STAR® 6.1; RoHS-compliant																

Note: The specifications above may not be available in all regions.

Lenovo
September 2018



ThinkPad T470s Platform Specifications

Product Specifications Reference (PSREF)

Processor	6th Generation Intel® Core™ i5 / i7 Processor								Dimensions Weight Case color Case material	<i>WxDxH:</i> 13.03" x 8.93" x 0.67-0.74"; 331mm x 226.8mm x 16.9-18.8mm Starting at 2.9 lb / 1.32 kg Black or Silver <i>Display cover:</i> CFRP Hybrid; <i>Bottom:</i> Magnesium
	Processor Number	# of Cores	# of Threads	Base Frequency	Max Turbo Frequency	Cache	Memory Types	Processor Graphics		
	i5-6200U	2	4	2.3 GHz	2.8 GHz	3MB	DDR4-2133	Intel HD Graphics 520	Smart card reader Media reader Ports	<i>Optional:</i> Smart card reader 4-in-1 reader (MMC, SD, SDHC, SDXC) Three USB 3.1 Gen 1 (USB 3.0, one Always On), USB 3.1 Type-C Gen 2 / Thunderbolt 3 (w/ the function of Power Delivery and DP), HDMI 1.4b, Ethernet (RJ-45), Dock connector <i>* Depending on many factors, actual data transfer speed may be lower than theoretical speed</i>
	i5-6300U			2.4 GHz	3.0 GHz	3MB				
	i7-6600U			2.6 GHz	3.4 GHz	4MB				
	or 7th Generation Intel Core i5 / i7 Processor								WiGig dock (opt) Monitor cable (optional) Camera (optional)	ThinkPad WiGig dock, mutually exclusive with WWAN <i>HDMI to VGA:</i> Lenovo HDMI to VGA Monitor Adapter <i>USB-C to VGA:</i> Lenovo USB-C to VGA Adapter HD720p resolution, fixed focus (models without camera are NOT available in EMEA)
	Processor Number	# of Cores	# of Threads	Base Frequency	Max Turbo Frequency	Cache	Memory Types	Processor Graphics		
	i5-7200U	2	4	2.5 GHz	3.1 GHz	3MB	DDR4-2133	Intel HD Graphics 620	HD Audio, Realtek® ALC3268 codec / stereo speakers, 1W x 2 / dual array microphone, combo audio/microphone jack 6-row, spill-resistant, multimedia Fn keys, optional LED backlight TrackPoint® pointing device and buttonless Mylar surface multi-touch touchpad Power-on password, hard disk password, supervisor password, security keyhole Discrete TPM 2.0, TCG Certified Intel vPro Technology <i>Optional:</i> Touch style match on chip fingerprint reader on the palm rest Near Field Communication Front Li-Polymer 3-cell (23Wh) and rear Li-ion 3-cell (26Wh), both Integrated MobileMark® 2014: up to 10.5 hr <i>* Battery life varies significantly with settings, usage, & other factors</i> 45W slim tip AC adapter, 45W or 65W USB Type-C AC adapter One of the following, configurable by model: • Windows® 7 Professional 64 preinstalled through downgrade rights in Windows 10 Pro 64 • Windows 10 Home 64 • Windows 10 Pro 64	
	i5-7300U			2.6 GHz	3.5 GHz	3MB				
	i7-7500U			2.7 GHz	3.5 GHz	4MB				
	i7-7600U			2.8 GHz	3.9 GHz	4MB				
Graphics	Intel HD Graphics 520 or 620 in processor; supports external digital monitor via HDMI or USB Type-C; supports three independent displays; Max resolution: 4096x2304@60Hz (USB Type-C); 4096x2160@24Hz (HDMI)								Audio support	
Chipset	Intel SoC (System on Chip) platform								Keyboard	
Memory	20GB or 24GB max ⁷ / 2400MHz DDR4, dual-channel capable, 4GB or 8GB memory soldered to systemboard, one DDR4 SO-DIMM socket <i>* System clocks down for processors with lower memory controller</i>								UltraNav™	
Display	<i>Some:</i> 14.0" (355mm) FHD (1920x1080), anti-glare, LED backlight, IPS, 250 nits, 16:9 aspect ratio, 700:1 contrast ratio, 160° viewing angle <i>Some:</i> 14.0" (355mm) WQHD (2560x1440), anti-glare, LED backlight, IPS, 300 nits, 16:9 aspect ratio, 700:1 contrast ratio, 160° viewing angle								Security	
Multi-touch (opt)	On-cell touch, supports 10-finger gesture, 250 nits (FHD only)								Security chip	
Storage	<i>One of the following, configurable by model:</i> • M.2 SSD / SATA 6.0Gb/s (e.g. xxxGB SSD M.2) • M.2 SSD / PCIe NVMe, PCIe 3.0 x 4, 32Gb/s (e.g. xxxGB SSD M.2 PCIe NVMe)								vPro (optional)	
Optical	None								Fingerprint reader	
Ethernet	<i>Non-vPro model:</i> Intel Ethernet Connection I219-V (Jacksonville) <i>vPro model:</i> Intel Ethernet Connection I219-LM (Jacksonville)								NFC (optional)	
WLAN	<i>One of the following, configurable by model (WiGig is mutually exclusive with WWAN):</i> • Intel Dual Band Wireless-AC 8260, Wi-Fi 2x2 802.11ac + BT4.1, M.2 card • Intel Dual Band Wireless-AC 8265, Wi-Fi 2x2 802.11ac + BT4.1, M.2 card • Intel Tri-Band Wireless-AC 18265, WiGig 802.11ad + Wi-Fi 2x2 802.11ac + BT4.1, M.2 card								Internal battery	
Bluetooth™	Bluetooth 4.1 wireless, integrated in Wi-Fi + Bluetooth combo adapter <i>* Intel 8265ac / 18265ac card support BT4.2 but is limited to BT4.1 by Windows OS</i>								Max battery life	
WWAN (optional)	<i>One of the following, configurable by model (mutually exclusive with WiGig):</i> • Wireless WAN upgradable • Integrated Mobile Broadband 4G LTE-A, Qualcomm® Snapdragon™ X7 LTE-A (Sierra Wireless EM7455), M.2 card • Micro-SIM card slot, opt Verizon LTE (US) or Lenovo® Connect (EMEA) SIM card								AC adapter	
SIM card (opt)									Operating system	
									Limited warranty	
									Mil-Spec test	
									Environment	



ThinkPad T480 Platform Specifications

Product Specifications Reference (PSREF)

Processor	7th Generation Intel® Core™ i5 Processor							Dimensions Weight	WxDxH: 13.25" x 9.15" x 0.79"; 336.6mm x 232.5mm x 19.95mm						
	Processor Number	# of Cores	# of Threads	Base Frequency	Max Turbo Frequency	Cache	Memory Types		Processor Graphics	Models	24Wh or 24Wh + 24Wh	48Wh, 72Wh, or 24Wh + 48Wh / 72Wh			
	i5-7200U	2	4	2.5 GHz	3.1 GHz	3MB	DDR4-2133	Intel HD Graphics 620	Integrated Magnesium	3.49 lb / 1.58 kg	3.92 lb / 1.78 kg				
	i5-7300U			2.6 GHz	3.5 GHz	3MB			Integrated PPS	3.63 lb / 1.65 kg	4.08 lb / 1.85 kg				
	or 8th Generation Intel Core i3 / i5 / i7 Processor							Case color Case material	Black Display cover: Magnesium Hybrid or PPS; Bottom: Glass-Fiber Reinforced Plastic						
	Processor Number	# of Cores	# of Threads	Base Frequency	Max Turbo Frequency	Cache	Memory Types		Processor Graphics	Smart card reader	Optional: Smart card reader				
	i3-8130U	4	8	2.2 GHz	3.4 GHz	4MB	DDR4-2400	Intel UHD Graphics 620	Media reader	4-in-1 reader (MMC, SD, SDHC, SDXC)					
	i5-8250U			1.6 GHz	3.4 GHz	6MB			Ports	Two USB 3.1 Gen 1 (one Always On), one USB 3.1 Type-C Gen 1 (with the function of Power Delivery and DisplayPort), one USB 3.1 Type-C Gen 2 / Thunderbolt 3 (with the function of PD and DP), HDMI 1.4b, Ethernet (RJ-45), nano-SIM card slot (WWAN models), headphone / microphone combo jack, optional smart card reader, 4-in-1 media reader (MMC, SD, SDHC, SDXC), side docking connector, security keyhole					
	i5-8350U			1.7 GHz	3.6 GHz	6MB				* Depending on many factors, actual data transfer speed may be lower than theoretical speed					
	i7-8550U			1.8 GHz	4.0 GHz	8MB				HDMI to VGA: Lenovo HDMI to VGA Monitor Adapter					
	i7-8650U			1.9 GHz	4.2 GHz	8MB				USB-C to DP: Lenovo USB-C to DisplayPort Adapter					
Graphics	Intel HD Graphics 620 or Intel UHD Graphics 620 in processor only or Intel HD Graphics 620 or Intel UHD Graphics 620 in processor and NVIDIA® GeForce® MX150, 2GB GDDR5 memory (discrete graphics is available only on i7 models in EMEA); supports external digital monitor via HDMI or USB Type-C; supports three independent displays; Max resolution: 4096x2304@60Hz (USB Type-C); 4096x2160@30Hz (HDMI)							Monitor cable (optional)	HDMI to VGA: Lenovo HDMI to VGA Monitor Adapter USB-C to DP: Lenovo USB-C to DisplayPort Adapter						
Chipset	Intel SoC (System on Chip) platform							Camera (optional)	One of the following, configurable by model: • HD720p camera with ThinkShutter camera privacy, fixed focus • IR camera and HD720p camera, fixed focus						
Memory	32GB max / 2400MHz DDR4, dual-channel capable, two DDR4 SO-DIMM sockets * System clocks down for processors with lower memory controller							Audio support	HD Audio, Realtek® ALC3287 codec / stereo speakers, 2W x 2, Dolby® Audio™ Premium / dual array microphone, headphone / microphone combo jack						
Display	Some:	14.0" (355mm) HD (1366x768), anti-glare, LED backlight, 220 nits, 16:9 aspect ratio, 400:1 contrast ratio					Keyboard UltraNav™	6-row, spill-resistant, multimedia Fn keys, optional LED backlight TrackPoint® pointing device and buttonless Mylar surface multi-touch touchpad							
	Some:	14.0" (355mm) FHD (1920x1080), anti-glare, LED backlight, IPS, 250 nits, 16:9 aspect ratio, 700:1 contrast ratio, 170° viewing angle						Security	Power-on password, hard disk password, supervisor password, security keyhole						
	Some:	14.0" (355mm) WQHD (2560x1440), anti-glare, LED backlight, IPS, 300 nits, 16:9 aspect ratio, 700:1 contrast ratio, 72% gamut, 170° viewing angle						Security chip	Discrete TPM 2.0, TCG Certified						
Multi-touch (opt)	On-cell touch, supports 10-finger gesture (FHD only)							vPro (optional)	Intel vPro Technology						
Storage	System has one HDD slot or one M.2 2280 slot exclusively for storage Some: HDD / SATA 6.0Gb/s, 2.5" wide, 7mm high, Active Protection System™ Some: SSD / SATA 6.0Gb/s, 2.5" wide, 7mm high (e.g. xxxGB SSD) Some: M.2 SSD / PCIe NVMe, PCIe 3.0 x 4 Some: 128GB M.2 SSD / PCIe NVMe, PCIe 3.0 x 2, in WWAN slot as 2nd Storage, mutually exclusive with WWAN * Installed M.2 SSD is PCIe 3.0 x 4 but run at PCIe 3.0 x 2 due to M.2 SSD adapter limitation							Fingerprint reader	Optional: Touch style match on chip fingerprint reader on the keyboard bezel, anti-spoofing technology						
Optane™ memory	Intel Optane memory, PCIe NVMe, PCIe 3.0 x 2							NFC (optional)	Near Field Communication						
Optical	None							Battery	Optional integrated Li-ion 24Wh battery and external Li-ion 24Wh, 48Wh, or 72Wh battery						
Ethernet	Non-vPro model: Intel Ethernet Connection I219-V (Jacksonville) vPro model: Intel Ethernet Connection I219-LM (Jacksonville)							Max battery life (MobileMark® 2014)	Models	24Wh	48Wh	72Wh	24Wh + 24Wh	24Wh + 48Wh	24Wh + 72Wh
WLAN + Bluetooth™ (opt)	Intel Dual Band Wireless-AC 8265, Wi-Fi 2x2 802.11ac + Bluetooth 4.1, M.2 card * Intel 8265ac card supports BT4.2 but is limited to BT4.1 by Windows OS							AC adapter	45W or 65W USB Type-C AC adapter						
WWAN (optional)	One of the following, configurable by model (mutually exclusive with Intel Optane memory): • Wireless WAN upgradable • Integrated Mobile Broadband 4G LTE, Intel XMM™ 7262 (Fibocom L830-EB), M.2 card (EMEA only) • Integrated Mobile Broadband 4G LTE-A, Intel XMM™ 7360 (Fibocom L850-GL), M.2 card							Operating system	Optional: Windows® 10 Home 64 or Windows 10 Pro 64						
SIM card (opt)	* For non-WWAN model, it means the model is NOT WWAN upgradable Nano-SIM card slot, optional Verizon LTE (US) SIM card							Limited warranty (optional)	One of the following, configurable by model: • 1-year depot repair service • 1-year depot with 2-year system board repair service • 3-year/1-yr battery depot repair service • 3-year/1-yr battery limited onsite service						
								Mil-Spec test	MIL-STD-810G military testing						
								Environment	EPEAT™ Gold (US only); ENERGY STAR® 6.1; RoHS-compliant						

Note: The specifications above may not be available in all regions.

Lenovo
August 2019



ThinkPad T480s Platform Specifications

Product Specifications Reference (PSREF)

Processor	7th Generation Intel® Core™ i5 Processor							Dimensions	<i>WxDxH:</i> 13.03" x 8.93" x 0.73"; 331mm x 226.8mm x 18.45mm
	Processor Number	# of Cores	# of Threads	Base Frequency	Max Turbo Frequency	Cache	Memory Types	Processor Graphics	Weight Starting at 2.9 lb / 1.32 kg
	i5-7200U	2	4	2.5 GHz	3.1 GHz	3MB	DDR4-2133	Intel HD Graphics 620	Case color Black or Silver
	i5-7300U			2.6 GHz	3.5 GHz	3MB			Case material <i>Display cover:</i> CFRP Hybrid; <i>Bottom:</i> Magnesium
	or 8th Generation Intel Core i5 / i7 Processor							Smart card reader	<i>Optional:</i> Smart card reader
	Processor Number	# of Cores	# of Threads	Base Frequency	Max Turbo Frequency	Cache	Memory Types	Processor Graphics	Media reader 4-in-1 reader (MMC, SD, SDHC, SDXC)
	i5-8250U	4	8	1.6 GHz	3.4 GHz	6MB	DDR4-2400	Intel UHD Graphics 620	Ports Two USB 3.1 Gen 1 (one Always On), one USB 3.1 Type-C Gen 1 (with the function of Power Delivery and DisplayPort), one USB 3.1 Type-C Gen 2 / Thunderbolt 3 (with the function of PD and DP), HDMI 1.4b, Ethernet (RJ-45), nano-SIM card slot (WWAN models), headphone / microphone combo jack, optional smart card reader,
	i5-8350U			1.7 GHz	3.6 GHz	6MB			
	i7-8550U			1.8 GHz	4.0 GHz	8MB			
	i7-8650U			1.9 GHz	4.2 GHz	8MB			
Graphics	Intel HD Graphics 620 or Intel UHD Graphics 620 in processor only or Intel UHD Graphics 620 in processor and NVIDIA® GeForce® MX150, 2GB GDDR5 memory (discrete models are NOT available in EMEA); supports external digital monitor via HDMI or USB Type-C; supports three independent displays; Max resolution: 4096x2304@60Hz (USB Type-C); 4096x2160@30Hz (HDMI)							Monitor cable <i>(optional)</i>	<i>USB-C to VGA:</i> Lenovo USB-C to VGA Adapter <i>USB-C to DP:</i> Lenovo USB-C to DisplayPort Adapter
Chipset	Intel SoC (System on Chip) platform							Camera	<i>One of the following, configurable by model:</i> • HD720p camera with ThinkShutter camera privacy, fixed focus • IR camera and HD720p camera, fixed focus
Memory	20GB or 24GB max / 2400MHz DDR4, dual-channel capable, 4GB or 8GB memory soldered to systemboard, one DDR4 SO-DIMM socket <i>* System clocks down for processors with lower memory controller</i>							Audio support	HD Audio, Realtek® ALC3287 codec / stereo speakers, 1W x 2, Dolby® Audio™ Premium / dual array microphone, headphone / microphone combo jack
Display	<i>Some:</i> 14.0" (355mm) FHD (1920x1080), anti-glare, LED backlight, IPS, 250 nits, 16:9 aspect ratio, 700:1 contrast ratio, 170° viewing angle, supports ThinkPad Privacy Guard on some models <i>Some:</i> 14.0" (355mm) WQHD (2560x1440), anti-glare, LED backlight, IPS, 300 nits, 16:9 aspect ratio, 700:1 contrast ratio, 72% gamut, 170° viewing angle							Keyboard	6-row, spill-resistant, multimedia Fn keys, optional LED backlight
Multi-touch <i>(opt)</i>	On-cell touch, supports 10-finger gesture, 250 nits (FHD only)							UltraNav™	TrackPoint® pointing device and buttonless Mylar surface multi-touch touchpad
Storage	<i>One of the following, configurable by model:</i> • M.2 SSD / SATA 6.0Gb/s • M.2 SSD / PCIe NVMe, PCIe 3.0 x 4, 32Gb/s							Security	Power-on password, hard disk password, supervisor password, security keyhole
Optical	None							Security chip	Discrete TPM 2.0, TCG Certified
Ethernet	<i>Non-vPro model:</i> Intel Ethernet Connection I219-V (Jacksonville) <i>vPro model:</i> Intel Ethernet Connection I219-LM (Jacksonville)							vPro <i>(optional)</i>	Intel vPro Technology
WLAN + Bluetooth™	Intel Dual Band Wireless-AC 8265, Wi-Fi 2x2 802.11ac + Bluetooth 4.1, M.2 card <i>* Intel 8265ac card supports BT4.2 but is limited to BT4.1 by Windows OS</i>							Fingerprint reader	<i>Optional:</i> Touch style match on chip fingerprint reader on the palm rest, anti-spoofing technology
WWAN <i>(optional)</i>	<i>One of the following, configurable by model:</i> • Wireless WAN upgradable • Integrated Mobile Broadband 4G LTE, Intel XMM™ 7262 (Fibocom L830-EB), M.2 card (EMEA only) • Integrated Mobile Broadband 4G LTE-A, Intel XMM™ 7360 (Fibocom L850-GL), M.2 card							NFC <i>(optional)</i>	Near Field Communication
SIM card <i>(opt)</i>	Nano-SIM card slot, optional Verizon LTE (US) SIM card							Battery	Integrated Li-ion 57Wh battery, supports Rapid Charge (0-80% in 60 mins) with 65W USB Type-C AC adapter
								Max battery life	<i>MobileMark® 2014:</i> 15.6 hr <i>* Battery life varies significantly with settings, usage, & other factors</i>
								AC adapter	45W or 65W USB Type-C AC adapter
								Operating system	<i>Optional:</i> Windows® 10 Home 64 or Windows 10 Pro 64
								Limited warranty	<i>One of the following, configurable by model:</i> • 1-year depot repair service • 1-year depot with 2-year system board repair service • 3-year/1-yr battery depot repair service • 3-year/1-yr battery limited onsite service
								Mil-Spec test	MIL-STD-810G military testing
								Environment	EPPEAT™ Silver; ENERGY STAR® 6.1; RoHS-compliant

Note: The specifications above may not be available in all regions.

Lenovo
August 2019

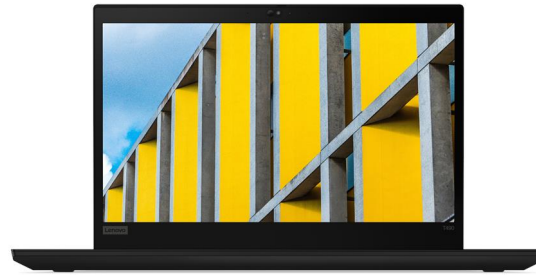

ThinkPad T490 Platform Specifications

Product Specifications Reference (PSREF)

Processor	8th Generation Intel® Core™ i5 / i7 Processor								Dimensions	<i>WxDxH:</i> 12.95" x 8.94" x 0.70"; 329mm x 227mm x 17.9mm				
	Processor Number	# of Cores	# of Threads	Base Frequency	Max Turbo Frequency	Cache	Memory Types	Processor Graphics	Weight	Models	HD	FHD	FHD Low Power / WQHD	Privacy Guard
	i5-8265U	4	8	1.6 GHz	3.9 GHz	6MB	DDR4-2400	Intel UHD Graphics 620	Case color Case material	Black				
	i5-8365U			1.6 GHz	4.1 GHz	6MB				<i>Display cover:</i> PPS / 50% GF;				
	i7-8565U			1.8 GHz	4.6 GHz	8MB				<i>Bottom:</i> PA / 50% GF				
	i7-8665U			1.9 GHz	4.8 GHz	8MB				Smart card reader <i>Optional:</i> Smart card reader				
	or 10th Generation Intel Core i5 / i7 Processor (NOT available in EMEA)								Media reader	MicroSD card reader				
	Processor Number	# of Cores	# of Threads	Base Frequency	Max Turbo Frequency	Cache	Memory Types	Processor Graphics	Ports	Two USB 3.1 Gen 1 (one Always On), one USB 3.1 Type-C Gen 1 (with the function of Power Delivery and DisplayPort), one USB 3.1 Type-C Gen 2 / Thunderbolt 3 (with the function of PD and DP), HDMI 1.4b, Ethernet (RJ-45), nano-SIM card slot (WWAN models), headphone / microphone combo jack, optional smart card reader, microUSB card reader, side docking connector, security keyhole				
	i5-10210U	4	8	1.6 GHz	4.2 GHz	6MB	DDR4-2400	Intel UHD Graphics	<i>* Depending on many factors, actual data transfer speed may be lower than theoretical speed</i>					
	i7-10510U			1.8 GHz	4.9 GHz	8MB			<i>HDMI to VGA:</i> Lenovo HDMI to VGA Monitor Adapter <i>USB-C to VGA:</i> Lenovo USB-C to VGA Adapter <i>USB-C to HDMI:</i> Lenovo USB-C to HDMI Adapter <i>USB-C to DP:</i> Lenovo USB-C to DisplayPort Adapter					
Graphics	Intel UHD Graphics 620 or Intel UHD Graphics in processor only or Intel UHD Graphics 620 or Intel UHD Graphics in processor and NVIDIA® GeForce® MX250, 2GB GDDR5 memory; supports external digital monitor via HDMI or Thunderbolt; supports three independent displays; Max resolution: 4096x2304@60Hz (Thunderbolt); 4096x2160@24Hz (HDMI)								Monitor cable (optional)	<i>HDMI to VGA:</i> Lenovo HDMI to VGA Monitor Adapter <i>USB-C to VGA:</i> Lenovo USB-C to VGA Adapter <i>USB-C to HDMI:</i> Lenovo USB-C to HDMI Adapter <i>USB-C to DP:</i> Lenovo USB-C to DisplayPort Adapter				
Chipset Memory	Intel SoC (System on Chip) platform 48GB max / 2400MHz DDR4, dual-channel capable, 8GB or 16GB memory soldered to systemboard, one DDR4 SO-DIMM socket <i>* Installed memory is actually 2666MHz but run at 2400MHz due to Intel limitation</i>								Camera (optional)	<i>One of the following, configurable by model:</i> • HD720p camera with ThinkShutter camera privacy, fixed focus • IR camera and HD720p camera with ThinkShutter camera privacy, fixed focus				
Display	Size	Resolution	Type	Surface	Brightness	Aspect Ratio	Contrast Ratio	Color Gamut	Viewing Angle	Audio support	HD Audio, Realtek® ALC3287 codec / stereo speakers, 2W x 2, Dolby® Audio™ Premium / optional dual array far-field microphone, headphone / microphone combo jack			
	14.0"	HD (1366x768)	TN	Anti-glare	220 nits	16:9	400:1	45%	90°	Keyboard	6-row, spill-resistant, multimedia Fn keys, optional LED backlight			
	14.0"	FHD (1920x1080)	IPS	Anti-glare	250 nits (non-touch) 300 nits (multi-touch)	16:9	700:1	45%	170°	UltraNav™	TrackPoint® pointing device and buttonless Mylar surface multi-touch touchpad			
	14.0"	FHD (1920x1080) Low Power	IPS	Anti-glare	400 nits	16:9	800:1	72%	170°	Security	Power-on password, hard disk password, supervisor password, security keyhole			
	14.0"	FHD (1920x1080) ThinkPad Privacy Guard	IPS	Anti-glare	400 nits	16:9	1000:1	72%	170°	Security chip	Discrete TPM 2.0, TCG Certified			
	14.0"	WQHD (2560x1440) HDR, Dolby Vision™	IPS	Glossy	500 nits	16:9	1500:1	100% Adobe	170°	System Mgt (opt)	Intel vPro Technology			
	<i>Multi-touch (opt)</i> On-cell touch, supports 10-finger gesture (FHD only)								Fingerprint reader	<i>Optional:</i> Touch style match on chip fingerprint reader on the palm rest				
	<i>Storage</i> • M.2 2280 SSD / SATA 6.0Gb/s (NOT available in EMEA) • M.2 2280 SSD / PCIe NVMe, PCIe 3.0 x 4 • M.2 2242 SSD / PCIe NVMe, PCIe 3.0 x 2 • Intel Optane™ Memory H10 with Solid State Storage, M.2 2280, PCIe NVMe 3.0 x 4								NFC (optional)	Near Field Communication				
	<i>Optical</i> None								Battery	Integrated Li-ion 50Wh battery, supports Rapid Charge (charge up to 80% in 1hr) with 65W AC adapter				
	<i>Ethernet</i> <i>Non-vPro model:</i> Intel Ethernet Connection I219-V (Jacksonville) <i>vPro model:</i> Intel Ethernet Connection I219-LM (Jacksonville)								Max battery life	<i>MobileMark® 2014:</i> 16.11 hr <i>* Battery life varies significantly with settings, usage, & other factors</i>				
	<i>WLAN + Bluetooth™ (optional)</i> • Intel Wireless-AC 9560, Wi-Fi 2x2 802.11ac + Bluetooth 5.0 • Intel Wi-Fi 6 AX201, Wi-Fi 2x2 802.11ax + Bluetooth 5.0 (AX201 for 10th Gen processor only)								AC adapter	45W, 65W, or 65W slim USB-C AC adapter				
	<i>WWAN (optional)</i> <i>One of the following, configurable by model:</i> • Wireless WAN upgradable (special bid only in EMEA) • Integrated Mobile Broadband 4G LTE, Fibocom L830-EB, M.2 card (EMEA only) • Integrated Mobile Broadband 4G LTE-A, Fibocom L850-GL, M.2 card • Integrated Mobile Broadband 4G LTE-A, Fibocom L860-GL, MIMO 4x4, M.2 card <i>* For non-WWAN model, it means the model is NOT WWAN upgradable</i>								Operating system (optional)	• Windows® 10 Home 64 • Windows 10 Pro 64 • Windows 10 Pro in S mode				
	<i>SIM card (opt)</i> Nano-SIM card slot, optional Verizon LTE (US) SIM card								Limited warranty (optional)	<i>One of the following, configurable by model:</i> • 1-year depot repair service • 1-year depot with 2-year system board repair service • 3-year/1-yr battery depot repair service • 1-year + 2-year/1-yr battery limited onsite service • 3-year/1-yr battery limited onsite service				
	<i>Mii-Spec test</i> MIL-STD-810G military testing								Environment	EPEAT™ Silver; ENERGY STAR® 7.1; RoHS-compliant				

Note: The specifications above may not be available in all regions.

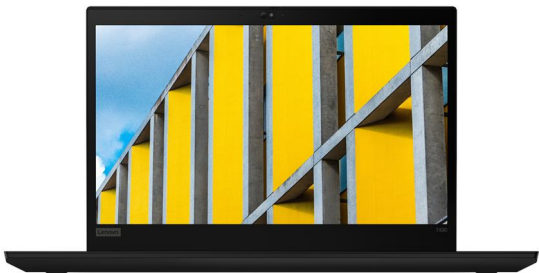

ThinkPad T490 Secure Access / Healthcare Edition Platform Specifications

Product Specifications Reference (PSREF)

Processor	8th Generation Intel® Core™ i5 / i7 Processor								Dimensions WxDxH: 12.95" x 8.94" x 0.70"; 329mm x 227mm x 17.9mm		
	Processor Number	# of Cores	# of Threads	Base Frequency	Max Turbo Frequency	Cache	Memory Types	Processor Graphics		Models	FHD
Graphics	i5-8265U	4	8	1.6 GHz	3.9 GHz	6MB	DDR4-2400	Intel UHD Graphics 620	Weight	3.41 lb / 1.55 kg	
	i5-8365U			1.6 GHz	4.1 GHz	6MB			Case color	Black	
	i7-8565U			1.8 GHz	4.6 GHz	8MB			Case material	Display cover: PPS / 50% GF; Keyboard cover: PC/ABS + Magnesium alloy (with ISO 22196 compliant anti-microbial surface treatment); Bottom: PA / 50% GF	
	i7-8665U			1.9 GHz	4.8 GHz	8MB			Smart card reader	None	
Chipset	Intel SoC (System on Chip) platform								RFID reader	RFID reader supporting RFID / NFC	
Memory	48GB max / 2400MHz DDR4, dual-channel capable, 8GB or 16GB memory soldered to systemboard, one DDR4 SO-DIMM socket * Installed memory is actually 2666MHz but run at 2400MHz due to Intel limitation								Media reader	MicroSD card reader	
Display	Size	Resolution	Type	Surface	Brightness	Aspect Ratio	Contrast Ratio	Color Gamut	Ports	Two USB 3.1 Gen 1 (one Always On), one USB 3.1 Type-C Gen 1 (with the function of Power Delivery and DisplayPort), one USB 3.1 Type-C Gen 2 / Thunderbolt 3 (with the function of PD and DP), HDMI 1.4b, Ethernet (RJ-45), nano-SIM card slot (WWAN model), headphone / microphone combo jack, optional smart card reader, microSD card reader, side docking connector, security keyhole * Depending on many factors, actual data transfer speed may be lower than theoretical speed	
	14.0"	FHD (1920x1080)	IPS	Anti-glare	250 nits (non-touch) 300 nits (multi-touch)	16:9	700:1	45%	170°	Monitor cable (optional)	HDMI to VGA: Lenovo HDMI to VGA Monitor Adapter USB-C to VGA: Lenovo USB-C to VGA Adapter USB-C to HDMI: Lenovo USB-C to HDMI Adapter USB-C to DP: Lenovo USB-C to DisplayPort Adapter
Multi-touch (opt)	On-cell touch, supports 10-finger gesture (FHD only)								Bundled Accy	None	
Storage	<ul style="list-style-type: none"> M.2 2280 SSD / SATA 6.0Gb/s M.2 2280 SSD / PCIe NVMe, PCIe 3.0 x 4 M.2 2242 SSD / PCIe NVMe, PCIe 3.0 x 2 Intel Optane™ Memory H10 with Solid State Storage, M.2 2280, PCIe NVMe 3.0 x 4 								Camera (optional)	One of the following, configurable by model: <ul style="list-style-type: none"> HD720p camera with ThinkShutter camera privacy, fixed focus IR camera and HD720p camera with ThinkShutter camera privacy, fixed focus 	
Optical	None								Audio support	HD Audio, Realtek® ALC3287 codec / stereo speakers, 2W x 2, Dolby® Audio™ Premium / dual array far-field microphone, headphone / microphone combo jack	
Ethernet	Non-vPro model: Intel Ethernet Connection I219-V (Jacksonville) vPro model: Intel Ethernet Connection I219-LM (Jacksonville)								Keyboard	6-row, spill-resistant, multimedia Fn keys, optional LED backlight	
WLAN (optional)	Intel Wireless-AC 9560, Wi-Fi 2x2 802.11ac + Bluetooth 5.0								UltraNav™	TrackPoint® pointing device and buttonless Mylar surface multi-touch touchpad	
Bluetooth™ (opt)	Bluetooth 5.0 wireless, integrated in Wi-Fi + Bluetooth combo adapter								Security	Power-on password, hard disk password, supervisor password, security keyhole	
WWAN (optional)	Wireless WAN upgradable (special bid only in EMEA) * For non-WWAN model, it means the model is NOT WWAN upgradable								Security chip	Discrete TPM 2.0, TCG Certified	
SIM card (opt)	None								System Mgt (opt)	Intel vPro Technology	
									Fingerprint reader	FIPS 201 fingerprint reader on palm rest	
									NFC	NFC support via RFID reader	
									Battery	Integrated Li-ion 50Wh battery, supports Rapid Charge (charge up to 80% in 1hr)	
									Max battery life	MobileMark® 2014: 16.11 hr * Battery life varies significantly with settings, usage, & other factors	
									AC adapter	45W, 65W, or 65W slim USB-C AC adapter	
									Operating system	Optional: Windows® 10 Pro 64	
									Limited warranty	One of the following, configurable by model: <ul style="list-style-type: none"> 1-year depot repair service 3-year/1-yr battery depot repair service 3-year/1-yr battery limited onsite service 	
									Mil-Spec test	MIL-STD-810G military testing	
									Environment	EPEAT™ Silver; ENERGY STAR® 7.1; RoHS-compliant	

Note: The specifications above may not be available in all regions.

Lenovo
September 2019



ThinkPad T490s Platform Specifications

Product Specifications Reference (PSREF)

<p>Processor 8th Generation Intel® Core™ i5 / i7 Processor</p> <table border="1"> <thead> <tr> <th>Processor Number</th> <th># of Cores</th> <th># of Threads</th> <th>Base Frequency</th> <th>Max Turbo Frequency</th> <th>Cache</th> <th>Memory Types</th> <th>Processor Graphics</th> </tr> </thead> <tbody> <tr> <td>i5-8265U</td> <td rowspan="4">4</td> <td rowspan="4">8</td> <td>1.6 GHz</td> <td>3.9 GHz</td> <td>6MB</td> <td rowspan="4">DDR4-2400</td> <td rowspan="4">Intel UHD Graphics 620</td> </tr> <tr> <td>i5-8365U</td> <td>1.6 GHz</td> <td>4.1 GHz</td> <td>6MB</td> </tr> <tr> <td>i7-8565U</td> <td>1.8 GHz</td> <td>4.6 GHz</td> <td>8MB</td> </tr> <tr> <td>i7-8665U</td> <td>1.9 GHz</td> <td>4.8 GHz</td> <td>8MB</td> </tr> </tbody> </table>	Processor Number	# of Cores	# of Threads	Base Frequency	Max Turbo Frequency	Cache	Memory Types	Processor Graphics	i5-8265U	4	8	1.6 GHz	3.9 GHz	6MB	DDR4-2400	Intel UHD Graphics 620	i5-8365U	1.6 GHz	4.1 GHz	6MB	i7-8565U	1.8 GHz	4.6 GHz	8MB	i7-8665U	1.9 GHz	4.8 GHz	8MB	<p>Dimensions <i>WxDxH (black with FHD / Privacy Guard):</i> 12.95" x 8.90" x 0.66"; 329.0mm x 226.15mm x 16.7mm <i>WxDxH (black with FHD Low Power / WQHD):</i> 12.94" x 8.89" x 0.63"; 328.8mm x 225.8mm x 16.1mm <i>WxDxH (silver):</i> 12.96" x 8.92" x 0.68"; 329.15mm x 226.45mm x 17.2mm</p> <p>Weight</p> <table border="1"> <thead> <tr> <th>Models</th> <th>Black with FHD</th> <th>Black with FHD Low Power / WQHD / Privacy Guard</th> <th>Silver</th> </tr> </thead> <tbody> <tr> <td>Weight</td> <td>2.98 lb / 1.35 kg</td> <td>2.81 lb / 1.27 kg</td> <td>3.29 lb / 1.49 kg</td> </tr> </tbody> </table>	Models	Black with FHD	Black with FHD Low Power / WQHD / Privacy Guard	Silver	Weight	2.98 lb / 1.35 kg	2.81 lb / 1.27 kg	3.29 lb / 1.49 kg									
Processor Number	# of Cores	# of Threads	Base Frequency	Max Turbo Frequency	Cache	Memory Types	Processor Graphics																																							
i5-8265U	4	8	1.6 GHz	3.9 GHz	6MB	DDR4-2400	Intel UHD Graphics 620																																							
i5-8365U			1.6 GHz	4.1 GHz	6MB																																									
i7-8565U			1.8 GHz	4.6 GHz	8MB																																									
i7-8665U			1.9 GHz	4.8 GHz	8MB																																									
Models	Black with FHD	Black with FHD Low Power / WQHD / Privacy Guard	Silver																																											
Weight	2.98 lb / 1.35 kg	2.81 lb / 1.27 kg	3.29 lb / 1.49 kg																																											
<p>Graphics Intel UHD Graphics 620 in processor; supports external digital monitor via HDMI or Thunderbolt; supports three independent displays; Max resolution: 4096x2304@60Hz (Thunderbolt); 4096x2160@24Hz (HDMI)</p>	<p>Case color Black or Silver Case material <i>Display cover:</i> CFRP Hybrid (black) or Aluminum (silver); <i>Bottom:</i> Magnesium</p>																																													
<p>Chipset Intel SoC (System on Chip) platform Memory 8GB, 16GB or 32GB / 2400MHz DDR4 / soldered to systemboard, no sockets <i>* Installed memory is actually 2666MHz but run at 2400MHz due to Intel limitation</i></p>	<p>Smart card reader <i>Optional:</i> Smart card reader Media reader MicroSD card reader Ports Two USB 3.1 Gen 1 (one Always On), one USB 3.1 Type-C Gen 1 (with the function of Power Delivery and DisplayPort), one USB 3.1 Type-C Gen 2 / Thunderbolt 3 (with the function of PD and DP), HDMI 1.4b, Ethernet extension connector, nano-SIM card slot (WWAN models), headphone / microphone combo jack, optional smart card reader, microSD card reader, side docking connector, security keyhole <i>* Depending on many factors, actual data transfer speed may be lower than theoretical speed</i></p>																																													
<p>Display</p> <table border="1"> <thead> <tr> <th>Size</th> <th>Resolution</th> <th>Type</th> <th>Surface</th> <th>Brightness</th> <th>Aspect Ratio</th> <th>Contrast Ratio</th> <th>Color Gamut</th> <th>Viewing Angle</th> </tr> </thead> <tbody> <tr> <td>14.0"</td> <td>FHD (1920x1080)</td> <td>IPS</td> <td>Anti-glare</td> <td>250 nits (non-touch) 300 nits (multi-touch)</td> <td>16:9</td> <td>700:1</td> <td>45%</td> <td>170°</td> </tr> <tr> <td>14.0"</td> <td>FHD (1920x1080) Low Power</td> <td>IPS</td> <td>Anti-glare</td> <td>400 nits</td> <td>16:9</td> <td>800:1</td> <td>72%</td> <td>170°</td> </tr> <tr> <td>14.0"</td> <td>FHD (1920x1080) ThinkPad Privacy Guard</td> <td>IPS</td> <td>Anti-glare</td> <td>400 nits</td> <td>16:9</td> <td>1000:1</td> <td>72%</td> <td>170°</td> </tr> <tr> <td>14.0"</td> <td>WQHD (2560x1440) HDR, Dolby Vision™</td> <td>IPS</td> <td>Glossy</td> <td>500 nits</td> <td>16:9</td> <td>1500:1</td> <td>100% Adobe</td> <td>170°</td> </tr> </tbody> </table>	Size	Resolution	Type	Surface	Brightness	Aspect Ratio	Contrast Ratio	Color Gamut	Viewing Angle	14.0"	FHD (1920x1080)	IPS	Anti-glare	250 nits (non-touch) 300 nits (multi-touch)	16:9	700:1	45%	170°	14.0"	FHD (1920x1080) Low Power	IPS	Anti-glare	400 nits	16:9	800:1	72%	170°	14.0"	FHD (1920x1080) ThinkPad Privacy Guard	IPS	Anti-glare	400 nits	16:9	1000:1	72%	170°	14.0"	WQHD (2560x1440) HDR, Dolby Vision™	IPS	Glossy	500 nits	16:9	1500:1	100% Adobe	170°	<p>Monitor cable (optional) <i>HDMI to VGA:</i> Lenovo HDMI to VGA Monitor Adapter <i>USB-C to VGA:</i> Lenovo USB-C to VGA Adapter <i>USB-C to DP:</i> Lenovo USB-C to DisplayPort Adapter Bundled Accy <i>Optional:</i> ThinkPad Ethernet Extension Adapter Gen 2</p> <p>Camera <i>One of the following, configurable by model:</i> • HD720p camera with ThinkShutter camera privacy, fixed focus • IR camera and HD720p camera with ThinkShutter camera privacy, fixed focus</p> <p>Audio support HD Audio, Realtek® ALC3287 codec / stereo speakers, 1W x 2, Dolby® Audio™ Premium / optional dual array far-field microphone, headphone / microphone combo jack</p>
Size	Resolution	Type	Surface	Brightness	Aspect Ratio	Contrast Ratio	Color Gamut	Viewing Angle																																						
14.0"	FHD (1920x1080)	IPS	Anti-glare	250 nits (non-touch) 300 nits (multi-touch)	16:9	700:1	45%	170°																																						
14.0"	FHD (1920x1080) Low Power	IPS	Anti-glare	400 nits	16:9	800:1	72%	170°																																						
14.0"	FHD (1920x1080) ThinkPad Privacy Guard	IPS	Anti-glare	400 nits	16:9	1000:1	72%	170°																																						
14.0"	WQHD (2560x1440) HDR, Dolby Vision™	IPS	Glossy	500 nits	16:9	1500:1	100% Adobe	170°																																						
<p>Multi-touch (opt) On-cell touch, supports 10-finger gesture (FHD only)</p>																																														
<p>Storage</p> <ul style="list-style-type: none"> • M.2 2280 SSD / SATA 6.0Gb/s • M.2 2280 SSD / PCIe NVMe, PCIe 3.0 x 4 • M.2 2242 SSD / PCIe NVMe, PCIe 3.0 x 2 • Intel Optane™ Memory H10 with Solid State Storage, M.2 2280, PCIe NVMe 3.0 x 4 <p>Optical None</p>	<p>Keyboard 6-row, spill-resistant, multimedia Fn keys, optional LED backlight UltraNav™ TrackPoint® pointing device and buttonless Mylar surface multi-touch touchpad</p> <p>Security Power-on password, hard disk password, supervisor password, security keyhole Security chip Discrete TPM 2.0, TCG Certified System Mgt (opt) Intel vPro Technology Fingerprint reader <i>Optional:</i> Touch style match on chip fingerprint reader on the palm rest NFC (optional) Near Field Communication</p>																																													
<p>Ethernet Native Intel Ethernet Connection I219-V (<i>Non-vPro</i>) or I219-LM (<i>vPro</i>) via bundled or optional ThinkPad Ethernet Extension Adapter Gen 2</p>																																														
<p>WLAN + Bluetooth™ (optional) <i>One of the following, configurable by model:</i> • Intel Wireless-AC 9560, Wi-Fi 2x2 802.11ac + Bluetooth 5.0 • Intel Wi-Fi 6 AX200, Wi-Fi 2x2 802.11ax + Bluetooth 5.0</p>	<p>Battery Integrated Li-ion 57Wh battery, supports Rapid Charge (charge up to 80% in 1hr) with 65W AC adapter Max battery life <i>MobileMark® 2014:</i> 20 hr <i>* Battery life varies significantly with settings, usage, & other factors</i></p> <p>AC adapter 45W, 65W, or 65W slim USB-C AC adapter</p>																																													
<p>WWAN (optional) <i>One of the following, configurable by model:</i> • Wireless WAN upgradable • Integrated Mobile Broadband 4G LTE, Fibocom L830-EB, M.2 card (EMEA only) • Integrated Mobile Broadband 4G LTE-A, Fibocom L850-GL, M.2 card <i>* For non-WWAN model, it means the model is NOT WWAN upgradable</i></p>	<p>Operating system <i>Optional:</i> Windows® 10 Home 64 or Windows 10 Pro 64</p>																																													
<p>SIM card (opt) Nano-SIM card slot, optional Verizon LTE (US) SIM card</p>	<p>Limited warranty <i>One of the following, configurable by model:</i> • 1-year depot repair service • 1-year depot with 2-year system board repair service • 3-year/1-yr battery depot repair service • 3-year/1-yr battery limited onsite service</p> <p>Mil-Spec test MIL-STD-810G military testing</p> <p>Environment EPEAT™ Gold; ENERGY STAR® 7.1; RoHS-compliant</p>																																													

Note: The specifications above may not be available in all regions.

Lenovo
October 2019



AMD



AMD



AMD



AMD



AMD



AMD

ThinkPad T495 Platform Specifications

Product Specifications Reference (PSREF)

Processor	AMD Ryzen™ PRO Mobile Processors with Radeon™ Vega Graphics									Dimensions WxDxH: 12.95" x 8.94" x 0.70"; 329mm x 227mm x 17.9mm
	Processor Number	# of Cores	# of Threads	Base Frequency	Max Turbo Frequency	Cache	Memory Controller	Processor Graphics		
	Ryzen 3 Pro 3300U	4	4	2.1 GHz	3.5 GHz	2MB L2 / 4MB L3	DDR4-2400	Radeon Vega 6 Graphics		
	Ryzen 5 Pro 3500U	4	8	2.1 GHz	3.7 GHz	2MB L2 / 4MB L3		Radeon Vega 8 Graphics		
Ryzen 7 Pro 3700U	4	8	2.3 GHz	4.0 GHz	2MB L2 / 4MB L3	Radeon Vega 10 Graphics				
Graphics	AMD Radeon Vega 6, Vega 8, or Vega 10 Graphics in processor; supports external digital monitor via USB-C or HDMI; supports four independent displays; Max resolution: 4096x2304@60Hz (USB-C); 4096x2160@60Hz (HDMI)									Case color Black Case material Display cover: PPS / 50% GF; Bottom: PA / 50% GF
Chipset	AMD SoC (System on Chip) platform									
Memory	32GB max / 2400MHz DDR4, dual-channel capable, 8GB or 16GB memory soldered to systemboard, one DDR4 SO-DIMM socket * Installed memory is actually 2666MHz but run at 2400MHz due to AMD limitation									
Display	32GB max / 2400MHz DDR4, dual-channel capable, 8GB or 16GB memory soldered to systemboard, one DDR4 SO-DIMM socket * Installed memory is actually 2666MHz but run at 2400MHz due to AMD limitation									
Display	Size	Resolution	Type	Surface	Brightness	Aspect Ratio	Contrast Ratio	Color Gamut	Viewing Angle	Camera (optional) One of the following, configurable by model: • HD720p camera with ThinkShutter camera privacy, fixed focus • IR camera and HD720p camera with ThinkShutter camera privacy, fixed focus
	14.0"	HD (1366x768)	TN	Anti-glare	220 nits	16:9	400:1	45%	90°	
	14.0"	FHD (1920x1080)	IPS	Anti-glare	250 nits (non-touch) 300 nits (multi-touch)	16:9	700:1	45%	170°	
14.0"	FHD (1920x1080) Low Power	IPS	Anti-glare	400 nits	16:9	800:1	72%	170°	Audio support HD Audio, Realtek® ALC3287 codec / stereo speakers, 2W x 2, Dolby® Audio™ Premium / optional dual array far-field microphone, headphone / microphone combo jack	
Multi-touch (opt)	On-cell touch, supports 10-finger gesture (FHD only)									
Storage	<ul style="list-style-type: none"> • M.2 2280 SSD / SATA 6.0Gb/s • M.2 2280 SSD / PCIe NVMe, PCIe 3.0 x 4 • M.2 2242 SSD / PCIe NVMe, PCIe 3.0 x 2 									
Optical	None									Keyboard UltraNav™ 6-row, spill-resistant, multimedia Fn keys, optional LED backlight TrackPoint® pointing device and buttonless Mylar surface multi-touch touchpad
Ethernet	Realtek® RTL8111 Gigabit Ethernet connection									
WLAN	One of the following, configurable by model: • Realtek® RTL8822BE, Wi-Fi 2x2 802.11ac + Bluetooth 4.2, M.2 card • Intel Wireless-AC 9260, Wi-Fi 2x2 802.11ac + Bluetooth 5.0									
Bluetooth™	Bluetooth 4.2 or 5.0 wireless, integrated in Wi-Fi + Bluetooth combo adapter									Security Power-on password, hard disk password, supervisor password, security keyhole Discrete TPM 2.0, TCG Certified System Mgt DASH Management Fingerprint reader Optional: Touch style match on chip fingerprint reader on the palm rest NFC None
WWAN (optional)	One of the following, configurable by model: • Wireless WAN upgradable • Integrated Mobile Broadband 4G LTE-A, Fibocom L850-GL, M.2 card * For non-WWAN model, it means the model is NOT WWAN upgradable									
SIM card (opt)	Nano-SIM card slot, optional Verizon LTE (US) SIM card									
Battery	Integrated Li-ion 50Wh battery, supports Rapid Charge (charge up to 80% in 1hr) with 65W AC adapter									Max battery life MobileMark® 2014: 13.4 hr * Battery life varies significantly with settings, usage, & other factors
AC adapter	45W or 65W USB Type-C AC adapter									
Operating system	Windows® 10 Home 64 or Windows 10 Pro 64									
Limited warranty	One of the following, configurable by model: • 1-year depot repair service • 3-year/1-yr battery depot repair service									Mil-Spec test MIL-STD-810G military testing
Environment	EPEAT™ Silver; ENERGY STAR® 7.1; RoHS-compliant									

Note: The specifications above may not be available in all regions.

Lenovo
December 2019



AMD



AMD



AMD



AMD



AMD



AMD

ThinkPad T495s Platform Specifications

Product Specifications Reference (PSREF)

Processor	AMD Ryzen™ PRO Mobile Processors with Radeon™ Vega Graphics									Dimensions	<i>WxDxH (FHD / Privacy Guard):</i> 12.95" x 8.90" x 0.66"; 329.0mm x 226.15mm x 16.7mm			
	Processor Number	# of Cores	# of Threads	Base Frequency	Max Turbo Frequency	Cache	Memory Controller	Processor Graphics			Weight	<i>WxDxH (Low Power):</i> 12.94" x 8.89" x 0.63"; 328.8mm x 225.8mm x 16.1mm		
Graphics	Ryzen 5 Pro 3500U	4	8	2.1 GHz	3.7 GHz	2MB L2 / 4MB L3	DDR4-2400	Radeon Vega 8 Graphics		Case color		Black		
	Ryzen 7 Pro 3700U	4	8	2.3 GHz	4.0 GHz	2MB L2 / 4MB L3		Radeon Vega 10 Graphics			Case material	<i>Display cover:</i> CFRP Hybrid; <i>Bottom:</i> Magnesium/Aluminum		
Chipset	AMD SoC (System on Chip) platform									Smart card reader		Optional: Smart card reader		
Memory	8GB or 16GB / 2400MHz DDR4 / soldered to systemboard, no sockets <i>* Installed memory is actually 2666MHz but run at 2400MHz due to AMD limitation</i>									Media reader	MicroSD card reader			
Display	Size	Resolution	Type	Surface	Brightness	Aspect Ratio	Contrast Ratio	Color Gamut	Viewing Angle	Ports	One USB 3.1 Gen 1 (Always On), one USB 3.1 Gen 2, two USB 3.1 Type-C Gen 2 (with the function of Power Delivery and DisplayPort), HDMI 2.0, Ethernet extension connector, nano-SIM card slot (WWAN models), headphone / microphone combo jack, optional smart card reader, microSD card reader, side docking connector, security keyhole <i>* Depending on many factors, actual data transfer speed may be lower than theoretical speed</i>			
	14.0"	FHD (1920x1080)	IPS	Anti-glare	250 nits (non-touch) 300 nits (multi-touch)	16:9	700:1	45%	170°		Monitor cable (optional)	HDMI to VGA: Lenovo HDMI to VGA Monitor Adapter		
	14.0"	FHD (1920x1080) Low Power	IPS	Anti-glare	400 nits	16:9	800:1	72%	170°		Bundled Accy	USB-C to VGA: Lenovo USB-C to VGA Adapter Optional: ThinkPad Ethernet Extension Adapter Gen 2		
	14.0"	FHD (1920x1080) ThinkPad Privacy Guard	IPS	Anti-glare	400 nits	16:9	1000:1	72%	170°		Camera	<i>One of the following, configurable by model:</i> • HD720p camera with ThinkShutter camera privacy, fixed focus • IR camera and HD720p camera with ThinkShutter camera privacy, fixed focus		
Multi-touch (opt)	On-cell touch, supports 10-finger gesture (FHD only)									Audio support	HD Audio, Realtek® ALC3287 codec / stereo speakers, 1W x 2, Dolby® Audio™ Premium / dual array far-field microphone, headphone / microphone combo jack			
Storage	M.2 2280 SSD / PCIe NVMe, PCIe 3.0 x 4									Keyboard	6-row, spill-resistant, multimedia Fn keys, optional LED backlight			
Optical	None									UltraNav™	TrackPoint® pointing device and buttonless Mylar surface multi-touch touchpad			
Ethernet	Realtek® RTL8111EPV Gigabit Ethernet connection									Security	Power-on password, hard disk password, supervisor password, security keyhole			
WLAN (optional)	Intel Wireless-AC 9260, Wi-Fi 2x2 802.11ac + Bluetooth 5.0									Security chip	Discrete TPM 2.0, TCG Certified			
Bluetooth™	Bluetooth 5.0 wireless, integrated in Wi-Fi + Bluetooth combo adapter									System Mgt	DASH Management			
WWAN (optional)	<i>One of the following, configurable by model:</i> • Wireless WAN upgradable • Integrated Mobile Broadband 4G LTE-A, Fibocom L850-GL, M.2 card <i>* For non-WWAN model, it means the model is NOT WWAN upgradable</i>									Fingerprint reader	Optional: Touch style match on chip fingerprint reader on the palm rest			
SIM card (opt)	Nano-SIM card slot, optional Verizon LTE (US) SIM card									NFC	None			
										Battery	Integrated Li-ion 57Wh battery, supports Rapid Charge (charge up to 80% in 1hr) with 65W AC adapter			
										Max battery life	MobileMark® 2014: 16.4 hr <i>* Battery life varies significantly with settings, usage, & other factors</i>			
										AC adapter	45W or 65W USB Type-C AC adapter			
										Operating system	Optional: Windows® 10 Home 64 or Windows 10 Pro 64			
										Limited warranty	<i>One of the following, configurable by model:</i> • 1-year depot repair service • 3-year/1-yr battery depot repair service			
										Mil-Spec test	MIL-STD-810G military testing			
										Environment	EPEAT™ Silver; ENERGY STAR® 7.1; RoHS-compliant			

Note: The specifications above may not be available in all regions.

Lenovo
October 2019



ThinkPad T580 Platform Specifications

Product Specifications Reference (PSREF)

Processor	7th Generation Intel® Core™ i5 Processor							Dimensions Weight	<i>WxDxH:</i> 14.40" x 9.95" x 0.79-0.80"; 365.8mm x 252.8mm x 19.95-20.2mm <i>Integrated model:</i> starting at 4.29 lb / 1.95 kg; <i>Discrete model:</i> starting at 4.39 lb / 1.99 kg																			
	Processor Number	# of Cores	# of Threads	Base Frequency	Max Turbo Frequency	Cache	Memory Types		Processor Graphics	Case color	Black																	
	i5-7200U	2	4	2.5 GHz	3.1 GHz	3MB	DDR4-2133	Intel HD Graphics 620	Case material	<i>Display cover:</i> GFRP + PPS; <i>Bottom:</i> GFRP																		
	i5-7300U			2.6 GHz	3.5 GHz	3MB																						
	or 8th Generation Intel Core i5 / i7 Processor							Smart card reader	<i>Optional:</i> Smart card reader																			
	Processor Number	# of Cores	# of Threads	Base Frequency	Max Turbo Frequency	Cache	Memory Types	Processor Graphics	Media reader	4-in-1 reader (MMC, SD, SDHC, SDXC)																		
	i5-8250U	4	8	1.6 GHz	3.4 GHz	6MB	DDR4-2400	Intel UHD Graphics 620	Ports	Two USB 3.1 Gen 1 (one Always On), one USB 3.1 Type-C Gen 1 (with the function of Power Delivery and DisplayPort), one USB 3.1 Type-C Gen 2 / Thunderbolt 3 (with the function of PD and DP), HDMI 1.4b, Ethernet (RJ-45), nano-SIM card slot (WWAN models), headphone / microphone combo jack, optional smart card reader, 4-in-1 reader (MMC, SD, SDHC, SDXC), side docking connector, security keyhole <i>* Depending on many factors, actual data transfer speed may be lower than theoretical speed</i>																		
	i5-8350U			1.7 GHz	3.6 GHz	6MB																						
	i7-8550U			1.8 GHz	4.0 GHz	8MB																						
	i7-8650U			1.9 GHz	4.2 GHz	8MB																						
Graphics	Intel HD Graphics 620 or Intel UHD Graphics 620 in processor only or Intel HD Graphics 620 or Intel UHD Graphics 620 in processor and NVIDIA® GeForce® MX150, 2GB GDDR5 memory; supports external digital monitor via HDMI or USB Type-C; supports three independent displays; Max resolution: 4096x2304@60Hz (USB Type-C); 4096x2160@30Hz (HDMI)							Monitor cable <i>(optional)</i>	<i>HDMI to VGA:</i> Lenovo HDMI to VGA Monitor Adapter <i>USB-C to DP:</i> Lenovo USB-C to DisplayPort Adapter																			
Chipset	Intel SoC (System on Chip) platform							Camera <i>(optional)</i>	<i>One of the following, configurable by model:</i> • HD720p camera with ThinkShutter camera privacy, fixed focus • IR camera and HD720p camera, fixed focus																			
Memory	32Gb max / 2400MHz DDR4, dual-channel capable, two DDR4 SO-DIMM sockets <i>* System clocks down for processors with lower memory controller</i>							Audio support	HD Audio, Realtek® ALC3287 codec / stereo speakers, 2W x 2, Dolby® Audio™ Premium / dual array microphone, headphone / microphone combo jack																			
Display	<i>Some:</i> 15.6" (396mm) FHD (1920x1080), anti-glare, LED backlight, IPS, 250 nits, 16:9 aspect ratio, 700:1 contrast ratio, 170° viewing angle <i>Some:</i> 15.6" (396mm) UHD (3840x2160), anti-glare, LED backlight, IPS, 300 nits, 16:9 aspect ratio, 1000:1 contrast ratio, 72% gamut, 170° viewing angle							Keyboard	6-row, spill-resistant, multimedia Fn keys, numeric keypad, optional LED backlight UltraNav™ TrackPoint® pointing device and buttonless Mylar surface multi-touch touchpad																			
Multi-touch <i>(opt)</i>	On-cell touch, supports 10-finger gesture (FHD only)							Security	Power-on password, hard disk password, supervisor password, security keyhole																			
Storage	<i>System has one HDD slot or one M.2 2280 slot exclusively for storage</i> <i>Some:</i> HDD / SATA 6.0Gb/s, 2.5" wide, 7mm high, Active Protection System™ <i>Some:</i> SSD / SATA 6.0Gb/s, 2.5" wide, 7mm high (e.g. xxxGB SSD) <i>Some:</i> M.2 SSD / PCIe NVMe, PCIe 3.0 x 2, 16Gb/s <i>Some:</i> 128GB M.2 SSD / PCIe NVMe, PCIe 3.0 x 2, 16Gb/s, in WWAN slot as 2nd Storage, mutually exclusive with WWAN							Security chip <i>vPro (optional)</i>	Discrete TPM 2.0, TCG Certified Intel vPro Technology																			
Optane™ memory	<i>Optional:</i> Intel Optane memory, PCIe NVMe, PCIe 3.0 x 2							Fingerprint reader	<i>Optional:</i> Touch style match on chip fingerprint reader on the palm rest, anti-spoofing technology																			
Optical	None							NFC <i>(optional)</i>	Near Field Communication																			
Ethernet	<i>Non-vPro model:</i> Intel Ethernet Connection I219-V (Jacksonville) <i>vPro model:</i> Intel Ethernet Connection I219-LM (Jacksonville)							Battery	Optional integrated Li-ion 32Wh battery and external Li-ion 24Wh, 48Wh, or 72Wh battery																			
WLAN + Bluetooth™	Intel Dual Band Wireless-AC 8265, Wi-Fi 2x2 802.11ac + Bluetooth 4.1, M.2 card <i>* Intel 8265ac card supports BT4.2 but is limited to BT4.1 by Windows OS</i>							Max battery life <i>(MobileMark® 2014)</i>	<table border="1"> <thead> <tr> <th>Models</th> <th>24Wh</th> <th>48Wh</th> <th>72Wh</th> <th>32Wh + 24Wh</th> <th>32Wh + 48Wh</th> <th>32Wh + 72Wh</th> </tr> </thead> <tbody> <tr> <td><i>Max battery life</i></td> <td>5.8 hr</td> <td>12.5 hr</td> <td>18.1 hr</td> <td>13.8 hr</td> <td>20.3 hr</td> <td>26.1 hr</td> </tr> </tbody> </table>						Models	24Wh	48Wh	72Wh	32Wh + 24Wh	32Wh + 48Wh	32Wh + 72Wh	<i>Max battery life</i>	5.8 hr	12.5 hr	18.1 hr	13.8 hr	20.3 hr	26.1 hr
Models	24Wh	48Wh	72Wh	32Wh + 24Wh	32Wh + 48Wh	32Wh + 72Wh																						
<i>Max battery life</i>	5.8 hr	12.5 hr	18.1 hr	13.8 hr	20.3 hr	26.1 hr																						
WWAN <i>(optional)</i>	<i>One of the following, configurable by model:</i> • Integrated Mobile Broadband 4G LTE, Intel XMM™ 7262 (Fibocom L830-EB), M.2 card (EMEA only) • Integrated Mobile Broadband 4G LTE-A, Intel XMM™ 7360 (Fibocom L850-GL), M.2 card <i>* For non-WWAN model, it means the model is NOT WWAN upgradable</i>							AC adapter	45W or 65W USB Type-C AC adapter																			
SIM card <i>(opt)</i>	Nano-SIM card slot, optional Verizon LTE (US) SIM card							Operating system	<i>Optional:</i> Windows® 10 Home 64 or Windows 10 Pro 64																			
								Limited warranty <i>(optional)</i>	<i>One of the following, configurable by model:</i> • 1-year depot repair service • 1-year depot with 2-year system board repair service • 3-year/1-yr battery depot repair service • 3-year/1-yr battery limited onsite service																			
								Mil-Spec test	MIL-STD-810G military testing																			
								Environment	EPEAT™ Silver; ENERGY STAR® 6.1; RoHS-compliant																			

Note: The specifications above may not be available in all regions.

Lenovo
August 2019



ThinkPad T590 Platform Specifications

Product Specifications Reference (PSREF)

Processor	8th Generation Intel® Core™ i5 / i7 Processor									Dimensions	<i>WxDxH:</i> 14.40" x 9.76" x 0.75"; 365.8mm x 248mm x 19.1mm
	Processor Number	# of Cores	# of Threads	Base Frequency	Max Turbo Frequency	Cache	Memory Types	Processor Graphics	Weight	<i>FHD model:</i> 3.87 lb / 1.75 kg; <i>UHD model:</i> 3.86 lb / 1.75 kg	
	i5-8265U	4	8	1.6 GHz	3.9 GHz	6MB	DDR4-2400	Intel UHD Graphics 620	Case color	Black	
	i5-8365U			1.6 GHz	4.1 GHz	6MB			Case material	<i>Display cover:</i> PPS / 50% GF; <i>Bottom:</i> PA / 50% GF	
	i7-8565U			1.8 GHz	4.6 GHz	8MB			Smart card reader	<i>Optional:</i> Smart card reader	
i7-8665U	1.9 GHz			4.8 GHz	8MB	Media reader			MicroSD card reader		
Graphics	Intel UHD Graphics 620 in processor only or Intel UHD Graphics 620 in processor and NVIDIA® GeForce® MX250, 2GB GDDR5 memory; supports external digital monitor via HDMI or Thunderbolt; supports three independent displays; Max resolution: 4096x2304@60Hz (Thunderbolt); 4096x2160@24Hz (HDMI)									Ports	Two USB 3.1 Gen 1 (one Always On), one USB 3.1 Type-C Gen 1 (with the function of Power Delivery and DisplayPort), one USB 3.1 Type-C Gen 2 / Thunderbolt 3 (with the function of PD and DP), HDMI 1.4b, Ethernet (RJ-45), nano-SIM card slot (WWAN models), headphone / microphone combo jack, optional smart card reader, microSD card reader, side docking connector, security keyhole <i>* Depending on many factors, actual data transfer speed may be lower than theoretical speed</i>
Chipset	Intel SoC (System on Chip) platform									Monitor cable (optional)	<i>HDMI to VGA:</i> Lenovo HDMI to VGA Monitor Adapter <i>USB-C to VGA:</i> Lenovo USB-C to VGA Adapter (NOT available in EMEA) <i>USB-C to DP:</i> Lenovo USB-C to DisplayPort Adapter (NOT available in EMEA)
Memory	48GB max / 2400MHz DDR4, dual-channel capable, 8GB or 16GB memory soldered to systemboard, one DDR4 SO-DIMM socket <i>* Installed memory is actually 2666MHz but run at 2400MHz due to Intel limitation</i>									Bundled Accy	None
Display	Size	Resolution	Type	Surface	Brightness	Aspect Ratio	Contrast Ratio	Color Gamut	Viewing Angle	Camera (optional)	<i>One of the following, configurable by model:</i> • HD720p camera with ThinkShutter camera privacy, fixed focus • IR camera and HD720p camera with ThinkShutter camera privacy, fixed focus
	15.6"	FHD (1920x1080)	IPS	Anti-glare	250 nits	16:9	700:1	45%	170°	Audio support	HD Audio, Realtek® ALC3287 codec / stereo speakers, 2W x 2, Dolby® Audio™ Premium / optional dual array far-field microphone, headphone / microphone combo jack
	15.6"	UHD (3840x2160) HDR, Dolby Vision™	IPS	Anti-glare	500 nits	16:9	1200:1	100% Adobe	170°	Keyboard	6-row, spill-resistant, multimedia Fn keys, numeric keypad, optional LED backlight
Multi-touch (opt)	On-cell touch, supports 10-finger gesture (FHD only)									UltraNav™	TrackPoint® pointing device and buttonless Mylar surface multi-touch touchpad
Storage	<ul style="list-style-type: none"> M.2 2280 SSD / SATA 6.0Gb/s M.2 2280 SSD / PCIe NVMe, PCIe 3.0 x 4 M.2 2242 SSD / PCIe NVMe, PCIe 3.0 x 2 Intel Optane™ Memory H10 with Solid State Storage, M.2 2280, PCIe NVMe 3.0 x 4 									Security	Power-on password, hard disk password, supervisor password, security keyhole
Optical	None									Security chip	Discrete TPM 2.0, TCG Certified
Ethernet	<i>Non-vPro model:</i> Intel Ethernet Connection I219-V (Jacksonville) <i>vPro model:</i> Intel Ethernet Connection I219-LM (Jacksonville)									System Mgt (opt)	Intel vPro Technology
WLAN (optional)	Intel Wireless-AC 9560, Wi-Fi 2x2 802.11ac + Bluetooth 5.0									Fingerprint reader	<i>Optional:</i> Touch style match on chip fingerprint reader on the palm rest
Bluetooth™	Bluetooth 5.0 wireless, integrated in Wi-Fi + Bluetooth combo adapter									NFC (optional)	Near Field Communication
WWAN (optional)	<i>One of the following, configurable by model:</i> • Wireless WAN upgradable (special bid only in EMEA) • Integrated Mobile Broadband 4G LTE, Fibocom L830-EB, M.2 card (EMEA only) • Integrated Mobile Broadband 4G LTE-A, Fibocom L850-GL, M.2 card <i>* For non-WWAN model, it means the model is NOT WWAN upgradable</i>									Battery	Integrated Li-ion 57Wh battery, supports Rapid Charge (charge up to 80% in 1hr) with 65W AC adapter
SIM card	Nano-SIM card slot, optional Verizon LTE (US) SIM card									Max battery life	<i>MobileMark® 2014:</i> 14.98 hr (9.5 hr for UHD model with discrete graphics) <i>* Battery life varies significantly with settings, usage, & other factors</i>
										AC adapter	45W or 65W USB Type-C AC adapter
										Operating system	<i>Optional:</i> Windows® 10 Home 64 or Windows 10 Pro 64
										Limited warranty	<i>One of the following, configurable by model:</i> • 1-year depot repair service • 1-year depot with 2-year system board repair service • 3-year/1-yr battery depot repair service • 3-year/1-yr battery limited onsite service
										Mil-Spec test	MIL-STD-810G military testing
										Environment	EPPEATM Silver; ENERGY STAR® 7.1; RoHS-compliant

Note: The specifications above may not be available in all regions.

Lenovo
August 2019



ThinkPad L13 Yoga Platform Specifications

Product Specifications Reference (PSREF)

Processor	10th Generation Intel® Core™ i3 / i5 / i7 Processor								Camera <i>One of the following, configurable by model:</i> <ul style="list-style-type: none"> • HD720p camera, with ThinkShutter™ camera privacy, fixed focus • IR camera and HD720p camera, with ThinkShutter camera privacy, fixed focus • World facing camera, 5MP resolution, auto focus (Fingerprint model only)
	Processor Number	# of Cores	# of Threads	Base Frequency	Max Turbo Frequency	Cache	Memory Types	Processor Graphics	
	i3-10110U	2	4	2.1 GHz	4.1 GHz	4MB	DDR4-2666	Intel UHD	
	i5-10210U i7-10510U	4	8	1.6 GHz 1.8 GHz	4.2 GHz 4.9 GHz	6MB 8MB			
Graphics	Intel UHD Graphics in processor only; supports external digital monitor via HDMI or USB Type-C; supports three independent displays; Max resolution: 4096x2304 @60Hz (USB Type-C); 4096x2160 @30Hz (HDMI)								Audio support HD Audio, Synaptics® CX11880-11Z / stereo speakers, 2W x 2, Dolby® Audio™ Premium / dual array microphone, headphone / microphone combo jack
Chipset	Intel SoC (System on Chip) platform								Keyboard UltraNav™
Memory	4GB, 8GB or 16GB / 2400MHz DDR4 / soldered to systemboard, no sockets								Security Power-on password, hard disk password, supervisor password, system management password, security keyhole
Display	13.3" (337.8mm) FHD (1920x1080), LED backlight, IPS, 300 nits, 16:9 aspect ratio, 800:1 contrast ratio, Color Gamut 72%, 170° viewing angle, AR (anti-reflection)								Security chip Discrete TPM 2.0 TCG Certified
Multi-touch	capacitive-type multi-touch, supports 10-finger gesture, could reduce the brightness by up to 10%								System Mgt None
Hinge	Yoga hinge, 360 degree								Fingerprint reader <i>Optional:</i> Touch style match on host fingerprint reader on the palm rest
Convert-mode	Laptop, tent, stand and tablet								NFC None
Pen	ThinkPad Pen Pro, active pen for multi-touch display, on-board rechargeable								Battery Integrated Li-ion 46Wh battery, supports Rapid Charge (charge up to 80% in 1hr) with 65W USB Type-C AC adapter
Storage	<i>One of the following, configurable by model:</i> <ul style="list-style-type: none"> • M.2 2280 SSD / PCIe NVMe, PCIe 3.0 x 4 • M.2 2242 SSD / PCIe NVMe, PCIe 3.0 x 2 								Max battery life <i>MobileMark® 2014:</i> 12.23 hrs <i>* Battery life varies significantly with settings, usage, & other factors</i>
Optical	None								AC adapter 45W USB Type-C, 65W USB Type-C or 65W Slim USB Type-C AC adapter
Ethernet	Gigabit Ethernet via USB-C to Ethernet Adapter Dongle or Mechanical Dock								Light sensor None
WLAN + Bluetooth™	<i>One of the following, configurable by model:</i> <ul style="list-style-type: none"> • Intel Wireless-AC 9560, Wi-Fi 2x2 802.11ac + Bluetooth 5.0 • Intel Wi-Fi 6 AX201, Wi-Fi 2x2 802.11ax + Bluetooth 5.0, M.2 card 								G-sensor Yes
WWAN	None								Gyroscope None
Dimensions	<i>WxDxH:</i> 12.26" x 8.62" x 0.69"; 311.5mm x 219mm x 17.6mm								Preload Windows® 10 Pro 64 or Windows 10 Pro in S mode
Weight	Starting at 3.17lb / 1.43kg								Limited warranty <i>One of the following, configurable by model:</i> <ul style="list-style-type: none"> • 1-year depot repair service • 1-year depot with 2-year system board service • 3-year depot repair service
Case color	Black or silver								Mil-Spec test MIL-STD-810G military testing
Case Material	<i>Display cover:</i> Magnesium + Aluminum <i>Bottom:</i> GFRP (Glass Fiber Reinforced Polymer)								Environment EPEAT™ Silver; ENERGY STAR® 7.1; RoHS-compliant
Smart card reader	<i>Optional:</i> Smart card reader								
Media reader	MicroSD card reader								
Ports	Two USB 3.1 Type-A Gen 1 (one Always On), two USB 3.1 Type-C Gen 1 (with the function of Power Delivery and Display Port), HDMI 1.4b, microSD card reader, headphone / microphone combo jack, optional smart card reader, side docking connector, security keyhole <i>* Depending on many factors, actual data transfer speed may be lower than theoretical speed</i>								
Monitor cable <i>(optional)</i>	<i>USB-C to VGA:</i> Lenovo USB-C to VGA Adapter <i>USB-C to HDMI:</i> Lenovo USB-C to HDMI Adapter <i>USB-C to DP:</i> Lenovo USB-C to DisplayPort Adapter								
Bundled Accy <i>(optional)</i>	<i>USB-C to RJ45:</i> Lenovo USB-C to Ethernet Adapter <i>USB-C to USB-A:</i> Lenovo USB-C to USB-A Adapter <i>USB-C to USB-C:</i> Lenovo USB-C to USB-C Cable 2M								

Note: The specifications above may not be available in all regions.

Lenovo
November 2019



ThinkPad L380 Yoga Platform Specifications

Product Specifications Reference (PSREF)

Processor	7th Generation Intel® Core™ i3 / i5 Processor								Dimensions Weight Case color Case material	WxDxH: 12.67" x 8.82" x 0.74"; 322mm x 224.2mm x 18.8mm Starting at 3.44 lb / 1.56 kg Black or Silver Display cover: Aluminum Bottom: GFRP
	Processor Number	# of Cores	# of Threads	Base Frequency	Max Turbo Frequency	Cache	Memory Types	Processor Graphics		
Processor	8th Generation Intel Core i3 / i5 / i7 Processor								Smart card reader Media reader Ports	None MicroSD card reader Two USB 3.1 Gen 1 (one Always On), two USB 3.1 Type-C Gen 1 (with the function of Power Delivery and DisplayPort), HDMI 1.4b, Ethernet extension connector, headphone / microphone combo jack, microSD card reader, security keyhole <i>* Depending on many factors, actual data transfer speed may be lower than theoretical speed</i> Monitor cable (optional) HDMI to VGA: Lenovo HDMI to VGA Monitor Adapter USB-C to VGA: Lenovo USB-C to VGA Adapter USB-C to DP: Lenovo USB-C to DisplayPort Adapter
	Processor Number	# of Cores	# of Threads	Base Frequency	Max Turbo Frequency	Cache	Memory Types	Processor Graphics		
Graphics	Intel HD Graphics 620 or Intel UHD Graphics 620 in processor; supports external digital monitor via HDMI or USB Type-C; supports three independent displays; Max resolution: 4096x2304@60Hz (USB Type-C); 4096x2160@30Hz (HDMI)								Camera	720p: HD720p resolution, low light sensitive, fixed focus IR & 720p: IR camera and HD720p camera, fixed focus World facing: Rear camera, 5MP resolution, auto focus
Chipset	Intel SoC (System on Chip) platform								Audio support	HD Audio, Realtek ALC3287 codec, Dolby® Advance / stereo speakers, 2W x 2 / dual array microphone, headphone / microphone combo jack
Memory	Up to 32GB max / 2400MHz DDR4, dual-channel capable, two DDR4 SO-DIMM sockets <i>* System clocks down for processors with lower memory controller</i>								Keyboard	6-row, multimedia Fn keys, optional LED backlight
Display	13.3" (338mm) FHD (1920x1080), LED backlight, IPS, 300 nits, 16:9 aspect ratio, 800:1 contrast ratio, 170° viewing angle, AR (anti-reflection)								UltraNav™	TrackPoint® pointing device and buttonless Mylar surface touchpad, multi-touch
Multi-touch (opt)	Capacitive-type multi-touch, AR (anti-reflection), supports 10-finger gesture								Security	Power-on password, hard disk password, supervisor password, security keyhole
Hinge	Yoga hinge, 360 degree								Security chip	Discrete TPM 2.0, TCG Certified
Convert-mode	Laptop, tent, stand, yoga and tablet								System Mgt (opt)	Intel vPro Technology
Pen	ThinkPad Pen Pro, active pen for multi-touch display, on-board garage								Fingerprint reader	<i>Optional:</i> Touch style fingerprint reader on the keyboard bezel, anti-spoofing technology
Storage	<i>One of the following, configurable by model:</i> • M.2 SSD / SATA 6.0Gb/s (e.g. xxxGB SSD M.2) • M.2 SSD / PCIe NVMe, PCIe 3.0 x 4, 32Gb/s (e.g. xxxGB SSD M.2 PCIe NVMe)								NFC (optional)	Near Field Communication (mutually exclusive with smart card reader)
Optical	None								Battery	Integrated Li-Ion 45Wh battery, supports Rapid Charge (charge up to 80% in 1hr) with 65W USB Type-C AC adapter
Ethernet	Native Intel Ethernet Connection I219-V (Non-vPro) or I219-LM (vPro) via optional ThinkPad Ethernet Extension Cable Gen 2								Max battery life	<i>MobileMark® 2014:</i> 12.85 hrs <i>* Battery life varies significantly with settings, usage, & other factors</i>
WLAN + Bluetooth™	Intel Dual Band Wireless-AC 8265, Wi-Fi 2x2 802.11ac + Bluetooth 4.1, M.2 card <i>* Wireless card supports BT4.2 but is limited to BT4.1 by Windows OS</i>								AC adapter	45W or 65W USB Type-C AC adapter
WWAN	None								Preload	Windows® 10 Home 64 or Windows 10 Pro 64
SIM card	None								Limited warranty	<i>One of the following, configurable by model:</i> • 1-year depot repair service • 1-year depot with 2-year system board service • 3-year/1-yr battery depot repair service • 3-year/1-yr battery limited onsite service
									Mil-Spec test	MIL-STD-810G military testing
									Environment	EPEAT™ Gold; ENERGY STAR® 6.1; RoHS-compliant



ThinkPad L390 Yoga Platform Specifications

Product Specifications Reference (PSREF)

Processor	8th Generation Intel® Core™ i3 / i5 / i7 Processor	Smart card reader	None																																		
	<table border="1"> <thead> <tr> <th>Processor Number</th> <th># of Cores</th> <th># of Threads</th> <th>Base Frequency</th> <th>Max Turbo Frequency</th> <th>Cache</th> <th>Memory Types</th> <th>Processor Graphics</th> </tr> </thead> <tbody> <tr> <td>i3-8145U</td> <td>2</td> <td>4</td> <td>2.1 GHz</td> <td>3.9 GHz</td> <td>4MB</td> <td rowspan="4">DDR4-2400</td> <td rowspan="4">Intel UHD Graphics 620</td> </tr> <tr> <td>i5-8265U</td> <td>4</td> <td>8</td> <td>1.6 GHz</td> <td>3.9 GHz</td> <td>6MB</td> </tr> <tr> <td>i5-8365U</td> <td>4</td> <td>8</td> <td>1.6 GHz</td> <td>4.1 GHz</td> <td>6MB</td> </tr> <tr> <td>i7-8565U</td> <td>4</td> <td>8</td> <td>1.8 GHz</td> <td>4.6 GHz</td> <td>8MB</td> </tr> </tbody> </table>	Processor Number	# of Cores	# of Threads	Base Frequency	Max Turbo Frequency	Cache	Memory Types	Processor Graphics	i3-8145U	2	4	2.1 GHz	3.9 GHz	4MB	DDR4-2400	Intel UHD Graphics 620	i5-8265U	4	8	1.6 GHz	3.9 GHz	6MB	i5-8365U	4	8	1.6 GHz	4.1 GHz	6MB	i7-8565U	4	8	1.8 GHz	4.6 GHz	8MB	Media reader	MicroSD card reader
Processor Number	# of Cores	# of Threads	Base Frequency	Max Turbo Frequency	Cache	Memory Types	Processor Graphics																														
i3-8145U	2	4	2.1 GHz	3.9 GHz	4MB	DDR4-2400	Intel UHD Graphics 620																														
i5-8265U	4	8	1.6 GHz	3.9 GHz	6MB																																
i5-8365U	4	8	1.6 GHz	4.1 GHz	6MB																																
i7-8565U	4	8	1.8 GHz	4.6 GHz	8MB																																
Graphics	Intel UHD Graphics 620 in processor; supports external digital monitor via HDMI or USB Type-C; supports three independent displays; Max resolution: 4096x2304@60Hz (USB Type-C); 4096x2160@30Hz (HDMI)	Ports	Two USB 3.1 Gen 1 (one Always On), two USB 3.1 Type-C Gen 1 (with the function of Power Delivery and DisplayPort), HDMI 1.4b, Ethernet extension connector, headphone / microphone combo jack, microSD card reader, security keyhole <i>* Depending on many factors, actual data transfer speed may be lower than theoretical speed</i>																																		
Chipset	Intel SoC (System on Chip) platform	Monitor cable (optional)	<ul style="list-style-type: none"> USB-C to VGA: Lenovo USB-C to VGA Adapter USB-C to VGA + Power Adapter: Lenovo USB-C to VGA plus Power Adapter USB-C to HDMI: Lenovo USB-C to HDMI Adapter USB-C to HDMI + Power Adapter: Lenovo USB-C to HDMI plus Power Adapter USB-C to DP: Lenovo USB-C to DisplayPort Adapter USB-C to RJ45: Lenovo USB-C to Ethernet Adapter 																																		
Memory	32GB max / 2400MHz DDR4, dual-channel capable, two DDR4 SO-DIMM sockets	Bundled Accessories (optional)	<ul style="list-style-type: none"> USB-C to USB-A: Lenovo USB-C to USB-A Adapter USB-C to USB-C: Lenovo USB-C to USB-C Cable 2M 																																		
Display	13.3" (338mm) FHD (1920x1080), LED backlight, IPS, 300 nits, 16:9 aspect ratio, 800:1 contrast ratio, 72% gamut, 170° viewing angle, AR (anti-reflection)	Camera	<ul style="list-style-type: none"> 720p: HD720p resolution, low light sensitive, fixed focus IR & 720p: IR camera and HD720p camera, fixed focus (black model only) World facing: 5MP resolution, auto focus (mutually exclusive with fingerprint reader) 																																		
Multi-touch	Capacitive-type multi-touch, AR (anti-reflection), supports 10-finger gesture, could reduce the brightness by up to 10%	Audio support	HD Audio, Realtek ALC3287 codec, Dolby® Audio™ Premium / stereo speakers, 2W x 2 / dual array microphone, headphone / microphone combo jack																																		
Hinge	Yoga hinge, 360 degree	Keyboard	6-row, spill-resistant, multimedia Fn keys, optional LED backlight																																		
Multi-mode Pen (optional)	Notebook, stand, tent, tablet ThinkPad Pen Pro, active pen for multi-touch display, on-board garage	UltraNav™	TrackPoint® pointing device and buttonless Mylar surface touchpad, multi-touch																																		
Storage	One of the following, configurable by model: <ul style="list-style-type: none"> M.2 SSD / SATA 6.0Gb/s M.2 2242 SSD / PCIe NVMe, PCIe 3.0 x 2 M.2 2280 SSD / PCIe NVMe, PCIe 3.0 x 4 Intel Optane™ Memory H10 with Solid State Storage, M.2 2280, PCIe NVMe 3.0 x 4 	Security	Power-on password, supervisor password, system management password, hard disk password, security keyhole																																		
Optical	None	Security chip	Discrete TPM 2.0, TCG Certified																																		
Storage	One of the following, configurable by model: <ul style="list-style-type: none"> M.2 SSD / SATA 6.0Gb/s (e.g. xxxGB SSD M.2) M.2 SSD / PCIe NVMe, PCIe 3.0 x 4, 32Gb/s (e.g. xxxGB SSD M.2 PCIe NVMe) 	System Mgt (opt)	Intel vPro Technology																																		
Optical	None	Fingerprint reader	Optional: Touch style fingerprint reader on the palm rest (mutually exclusive with World facing camera)																																		
Ethernet	Native Intel Ethernet Connection I219-V (Non-vPro) or I219-LM (vPro) via optional ThinkPad Ethernet Extension Cable or Lenovo USB-C to Ethernet Adapter	NFC (optional)	Near Field Communication																																		
WLAN	Intel Wireless-AC 9560, Wi-Fi 2x2 802.11ac + Bluetooth 5.0, M.2 card	Battery	Integrated Li-Ion 45Wh battery, supports Rapid Charge (charge up to 80% in 1hr) with 65W USB Type-C AC adapter																																		
Bluetooth™	Bluetooth 5.0 wireless, integrated in Wi-Fi + Bluetooth combo adapter	Max battery life	MobileMark® 2014: 12.17 hrs <i>* Battery life varies significantly with settings, usage, & other factors</i>																																		
WWAN	None	AC adapter	45W or 65W USB Type-C AC adapter																																		
Dimensions	WxDxH: 12.67" x 8.82" x 0.74"; 321.8mm x 224.2mm x 18.8mm	Preload	Windows® 10 Home 64 or Windows 10 Pro 64																																		
Weight	Starting at 3.44 lbs / 1.56 kg	Limited warranty	One of the following, configurable by model: <ul style="list-style-type: none"> 1-year depot repair service 1-year depot with 2-year system board service 3-year/1-yr battery depot repair service 3-year/1-yr battery limited onsite service 																																		
Case color	Black or Silver	Mil-Spec test	MIL-STD-810G military testing																																		
Case material	Display cover: Magnesium / Aluminum Bottom: GFRP	Environment	EPEAT™ Silver; ENERGY STAR® 7.1; RoHS-compliant																																		



ThinkPad X1 Yoga (3rd Gen) Platform Specifications

Product Specifications Reference (PSREF)

Processor	7th Generation Intel® Core™ i5 Processor <table border="1"> <thead> <tr> <th>Processor Number</th> <th># of Cores</th> <th># of Threads</th> <th>Base Frequency</th> <th>Max Turbo Frequency</th> <th>Cache</th> <th>Memory Types</th> <th>Processor Graphics</th> </tr> </thead> <tbody> <tr> <td>i5-7300U</td> <td>2</td> <td>4</td> <td>2.6 GHz</td> <td>3.5 GHz</td> <td>3MB</td> <td>LPDDR3-1866</td> <td>Intel HD Graphics 620</td> </tr> </tbody> </table> 8th Generation Intel Core i5 / i7 Processor <table border="1"> <thead> <tr> <th>Processor Number</th> <th># of Cores</th> <th># of Threads</th> <th>Base Frequency</th> <th>Max Turbo Frequency</th> <th>Cache</th> <th>Memory Types</th> <th>Processor Graphics</th> </tr> </thead> <tbody> <tr> <td>i5-8250U</td> <td rowspan="4">4</td> <td rowspan="4">8</td> <td>1.6 GHz</td> <td>3.4 GHz</td> <td>6MB</td> <td rowspan="4">LPDDR3-2133</td> <td rowspan="4">Intel UHD Graphics 620</td> </tr> <tr> <td>i5-8350U</td> <td>1.7 GHz</td> <td>3.6 GHz</td> <td>6MB</td> </tr> <tr> <td>i7-8550U</td> <td>1.8 GHz</td> <td>4.0 GHz</td> <td>8MB</td> </tr> <tr> <td>i7-8650U</td> <td>1.9 GHz</td> <td>4.2 GHz</td> <td>8MB</td> </tr> </tbody> </table>	Processor Number	# of Cores	# of Threads	Base Frequency	Max Turbo Frequency	Cache	Memory Types	Processor Graphics	i5-7300U	2	4	2.6 GHz	3.5 GHz	3MB	LPDDR3-1866	Intel HD Graphics 620	Processor Number	# of Cores	# of Threads	Base Frequency	Max Turbo Frequency	Cache	Memory Types	Processor Graphics	i5-8250U	4	8	1.6 GHz	3.4 GHz	6MB	LPDDR3-2133	Intel UHD Graphics 620	i5-8350U	1.7 GHz	3.6 GHz	6MB	i7-8550U	1.8 GHz	4.0 GHz	8MB	i7-8650U	1.9 GHz	4.2 GHz	8MB	Smart card reader None Media reader MicroSD card reader, supports UHS-II Ports Two USB 3.1 Gen 1 (one Always On), two USB 3.1 Type-C Gen 2 / Thunderbolt 3 (Power Delivery, DisplayPort, Data transfer), HDMI 1.4, Ethernet extension connector, nano-SIM card slot (WWAN models), headphone / microphone combo jack, microSD card reader <i>* Depending on many factors, actual data transfer speed may be lower than theoretical speed</i> WiGig dock None Monitor cable (optional) HDMI to VGA: Lenovo HDMI to VGA Monitor Adapter USB-C to VGA: Lenovo USB-C to VGA Adapter USB-C to DP: Lenovo USB-C to DisplayPort Adapter Camera (optional) <i>One of the following, configurable by model:</i> 720p: HD720p camera with ThinkShutter camera privacy, fixed focus IR & 720p: IR camera and HD720p camera, fixed focus <i>* WWAN models and HDR panel models can not support IR camera</i> Audio support HD Audio, Realtek® ALC3286 codec, Dolby® Audio™ Premium / stereo speakers, 1W x 2 /, 360° Noise-cancelling Dual Array Far Field, headphone / microphone combo jack
Processor Number	# of Cores	# of Threads	Base Frequency	Max Turbo Frequency	Cache	Memory Types	Processor Graphics																																							
i5-7300U	2	4	2.6 GHz	3.5 GHz	3MB	LPDDR3-1866	Intel HD Graphics 620																																							
Processor Number	# of Cores	# of Threads	Base Frequency	Max Turbo Frequency	Cache	Memory Types	Processor Graphics																																							
i5-8250U	4	8	1.6 GHz	3.4 GHz	6MB	LPDDR3-2133	Intel UHD Graphics 620																																							
i5-8350U			1.7 GHz	3.6 GHz	6MB																																									
i7-8550U			1.8 GHz	4.0 GHz	8MB																																									
i7-8650U			1.9 GHz	4.2 GHz	8MB																																									
Graphics	Intel HD Graphics 620 or Intel UHD Graphics 620 in processor; supports external digital monitor via HDMI or USB Type-C; supports three independent displays; Max resolution: 5120x2880@60Hz (USB Type-C); 4096x2160@30Hz (HDMI)	Keyboard 6-row wave keyboard (rise & fall), spill-resistant, multimedia Fn keys, LED backlit UltraNav™ TrackPoint® pointing device and 3+2 buttons multi-touch clickpad																																												
Chipset	Intel SoC (System on Chip) platform	Security Power-on password, hard disk password, supervisor password, security keyhole Security chip Discrete TPM 2.0 TCG Certified System Mgt (opt) Intel vPro Technology Fingerprint reader Touch style match on chip fingerprint reader on the palm rest NFC (optional) Near Field Communication																																												
Memory	8GB or 16GB / 2133MHz LPDDR3 / soldered to systemboard, no sockets	Battery Integrated Li-Ion 54Wh battery, supports Rapid Charge (charge up to 80% in 1hr) Max battery life <i>MobileMark® 2014: 15.4 hrs</i> <i>* Battery life varies significantly with settings, usage, & other factors</i>																																												
Display	<i>Some:</i> 14.0" (355mm) FHD (1920x1080), LED backlight, 300 nits, 16:9 aspect ratio, 700:1 contrast ratio, 72% gamut, 170° viewing angle, IPS, AR (anti-reflection) <i>Some:</i> 14.0" (355mm) WQHD (2560x1440), LED backlight, 300 nits, 16:9 aspect ratio, 700:1 contrast ratio, 72% gamut, 170° viewing angle, IPS, AR (anti-reflection) <i>Some:</i> 14.0" (355mm) HDR WQHD (2560x1440) with Dolby Vision™, LED backlight, 500 nits, 16:9 aspect ratio, 1500:1 contrast ratio, 100% gamut, 170° viewing angle, IPS, AR (anti-reflection)	AC adapter 45W or 65W USB Type-C AC adapter																																												
Multi-touch	Capacitive-type multi-touch, AR (anti-reflection), AS (anti-smudge), supports 10-finger gesture, reduces overall display brightness by 10%	Light sensor Ambient Light Sensor G-sensor 3D accelerometer Gyroscope 3D gyrometer GPS GPS function is integrated into WWAN module																																												
Hinge	Yoga hinge, 360 degree	Preload Windows® 10 Pro 64																																												
Convert-mode	Laptop, tent, stand, and tablet	Limited warranty <i>One of the following, configurable by model:</i> <ul style="list-style-type: none"> • 1-year depot repair service • 1-year depot with 2-year system board service • 3-year/1-yr battery depot repair service 																																												
Pen (optional)	ThinkPad Pen Pro, active pen for multi-touch display, on-board rechargeable	Mil-Spec test MIL-STD-810G military testing																																												
Storage	<i>Some:</i> M.2 SSD / SATA 6.0Gb/s (e.g. xxxG SSD) <i>Some:</i> M.2 SSD / PCIe NVMe, PCIe 3.0 x 4, 32Gb/s (e.g. xxxG SSD PCIe NVMe)	Environment EPEAT™ Silver; ENERGY STAR®; RoHS-compliant																																												
Optical	None																																													
Ethernet	Native Intel Ethernet Connection WGI219-LM (vPro) via optional ThinkPad Ethernet Extension Cable																																													
WLAN	Intel Dual Band Wireless-AC 8265, Wi-Fi 2x2 802.11ac + Bluetooth 4.2, M.2 card																																													
Bluetooth™	Bluetooth 4.2 wireless, integrated in Wi-Fi + Bluetooth combo adapter																																													
WWAN (optional)	Integrated Mobile Broadband 4G LTE-A, Intel XMM™ 7360 (Fibocom L850-GL), M.2 card																																													
SIM card (opt)	Nano-SIM card slot, optional Verizon LTE (US) SIM card																																													
Dimensions	<i>WxDxH:</i> 13.11" x 9.02" x 0.67"; 333mm x 229mm x 17.05mm																																													
Weight	Starting at 3.08 lb / 1.4kg																																													
Case color	Black or silver																																													
Case material	<i>Display cover:</i> Carbon-Fiber and Glass-Fiber hybrid; <i>Bottom:</i> magnesium-PPS hybrid																																													



ThinkPad X1 Yoga (4th Gen) Platform Specifications

Product Specifications Reference (PSREF)

Processor	8th Generation Intel® Core™ i5 / i7 Processor or 10th Generation Intel® Core™ i5 / i7 Processor (Not available in EMEA)									Dimensions	<i>WxDxH (Privacy Guard):</i> 12.71" x 8.58" x 0.63"; 323mm x 218mm x 15.95mm <i>WxDxH (Other model):</i> 12.71" x 8.58" x 0.61"; 323mm x 218mm x 15.5mm								
	Processor Number	# of Cores	# of Threads	Base Frequency	Max Turbo Frequency	Cache	Memory Types	Processor Graphics		Weight	<i>Privacy Guard model:</i> starting at 3.24lb / 1.47kg <i>Other model:</i> starting at 2.99lb / 1.36kg								
	i5-8265U	4	8	1.6 GHz	3.9 GHz	6MB	LPDDR3-2133	Intel UHD Graphics 620		Case color	Iron Grey								
	i5-8365U			1.6 GHz	4.1 GHz	6MB		Intel UHD Graphics 620		Case material	<i>Display cover:</i> Aluminium; <i>Bottom:</i> Magnesium								
	i7-8565U			1.8 GHz	4.6 GHz	8MB				Smart card reader	None								
	i7-8665U			1.9 GHz	4.8 GHz	8MB				Media reader	None								
	i5-10210U			1.6 GHz	4.2 GHz	6MB				Ports	Two USB 3.1 Gen 1 (one Always On), two USB 3.1 Type-C Gen 2 / Thunderbolt 3 (with the function of Power Delivery and DisplayPort), HDMI 1.4b, Ethernet extension connector, nano-SIM card slot (WWAN models), headphone / microphone combo jack, side docking connector, security keyhole <i>* Depending on many factors, actual data transfer speed may be lower than theoretical speed</i>								
	i7-10510U	6	12	1.8 GHz	4.9 GHz	8MB			Monitor cable	<i>Optional:</i> Lenovo HDMI to VGA Monitor Adapter									
	i7-10710U			1.1 GHz	4.7 GHz	12MB			Bundled Accy	<i>Optional:</i> ThinkPad Ethernet Extension Adapter Gen 2									
Graphics	Intel UHD Graphics 620 or Intel UHD Graphics in processor; supports external digital monitor via HDMI or USB Type-C™ / Thunderbolt; supports three independent displays; Max resolution: 5120x2880@60Hz (USB Type-C); 4096x2160@24Hz (HDMI)									Camera (optional)	<i>One of the following, configurable by model:</i> • HD720p camera with ThinkShutter camera privacy, fixed focus • IR camera and HD720p camera with ThinkShutter camera privacy, fixed focus								
Chipset	Intel SoC (System on Chip) platform									Audio support	HD Audio, Realtek® ALC1012L codec, Stereo speakers, 2W x 2, 0.8W x 2, Dolby® Audio™ Atmos / 4 array 360-degree far-field microphones, headphone / microphone combo jack								
Memory	8GB or 16GB / 2133MHz LPDDR3 / soldered to systemboard, no sockets									Keyboard	6-row, spill-resistant, multimedia Fn keys, LED backlight UltraNav™ TrackPoint® pointing device and buttonless Glass surface multi-touch touchpad								
Display	Size	Resolution	Type	Surface	Brightness	Aspect Ratio	Contrast Ratio	Color Gamut	Viewing Angle	Security	Power-on password, supervisor password, system management password, hard disk password								
	14.0"	FHD (1920x1080) Low Power	IPS	AR (anti-reflection) / AS (anti-smudge)	400 nits	16:9	800:1	72%	170°	Security chip	Discrete TPM 2.0 TCG Certified								
	14.0"	FHD (1920x1080) ThinkPad Privacy Guard	IPS	AR (anti-reflection) / AS (anti-smudge)	400 nits	16:9	1000:1	72%	170°	System Mgt	<i>Optional:</i> Intel vPro Technology								
	14.0"	WQHD (2560x1440)	IPS	AR (anti-reflection) / AS (anti-smudge)	300 nits	16:9	800:1	72%	170°	Fingerprint reader	Touch style match on chip fingerprint reader on the palm rest								
	14.0"	UHD (3840x2160) Dolby Vision™ HDR400	IPS	AR (anti-reflection) / AS (anti-smudge)	500 nits	16:9	1400:1	90%	170°	NFC	<i>Optional:</i> Near Field Communication								
Multi-touch	Capacitive-type multi-touch, AR (anti-reflection), AS (anti-smudge), supports 10-finger gesture, could reduce the brightness by up to 10%									Battery	Integrated Li-Ion 51Wh battery, supports Rapid Charge (charge up to 80% in 1hr) with 65W USB Type-C AC adapter								
Hinge	Yoga hinge, 360 degree									Max battery life	<i>MobileMark® 2014:</i> 18.1 hrs <i>* Battery life varies significantly with settings, usage, & other factors</i>								
Convert-mode	Laptop, tent, stand, and tablet									AC adapter	45W USB Type-C, 65W USB Type-C or 65W Slim USB Type-C AC adapter								
Pen	ThinkPad Pen Pro, active pen for multi-touch display, on-board rechargeable									G-sensor	3D accelerometer								
Storage	<i>One of the following, configurable by model:</i> • M.2 2280 SSD / SATA 6.0Gb/s • M.2 2280 SSD / PCIe NVMe, PCIe 3.0 x 4 • Intel Optane™ Memory H10 with Solid State Storage, M.2 2280, PCIe NVMe 3.0 x 4									Gyroscope	3D gyrometer								
Optical	None									GPS	GPS function is integrated into WWAN module								
Ethernet	Native Intel Ethernet Connection I1219-LM (vPro) or I1219-V (Non-vPro) via bundled or optional ThinkPad Ethernet Extension Adapter Gen 2									Preload	<i>One of the following, configurable by model:</i> • Windows® 10 Pro 64 • Windows 10 Home 64								
WLAN	Intel Wireless-AC 9560, Wi-Fi 2x2 802.11ac + Bluetooth 5.0, M.2 card									Limited warranty	<i>One of the following, configurable by model:</i> • 1-year depot repair service • 1-year depot with 2-year system board service • 3-year/1-yr battery depot repair service								
Bluetooth™	Bluetooth 5.0 wireless, integrated in Wi-Fi + Bluetooth combo adapter									Mil-Spec test	MIL-STD-810G military testing								
WWAN (optional)	<i>One of the following, configurable by model:</i> • Integrated Mobile Broadband 4G LTE-A, Fibocom L850-GL, M.2 card • Integrated Mobile Broadband 4G LTE-A, Fibocom L860-GL, MIMO 2x2, M.2 card									Environment	EPEAT™ Gold; ENERGY STAR® 7.1; RoHS-compliant								
SIM card (opt)	Nano-SIM card slot, optional Verizon LTE (US) SIM card																		



ThinkPad X380 Yoga Platform Specifications

Product Specifications Reference (PSREF)

Processor	8th Generation Intel® Core™ i3 / i5 / i7 Processor								Smart card reader Media reader Ports WiGig dock Monitor cable (optional) Camera Audio support Keyboard UltraNav™ Security Security chip System Mgt (opt) Fingerprint reader NFC (optional) Battery Max battery life AC adapter Light sensor G-sensor/ eCompass Gyroscope Preload Limited warranty Mil-Spec test Environment
	Processor Number	# of Cores	# of Threads	Base Frequency	Max Turbo Frequency	Cache	Memory Types	Processor Graphics	
	i3-8130U	2	4	2.2 GHz	3.4 GHz	4MB	DDR4-2400	Intel UHD Graphics 620	
	i5-8250U	4	8	1.6 GHz	3.4 GHz	6MB			
	i5-8350U			1.7 GHz	3.6 GHz	6MB			
	i7-8550U			1.8 GHz	4.0 GHz	8MB			
i7-8650U	1.9 GHz			4.2 GHz	8MB				
Graphics	Intel UHD Graphics 620 in processor only; supports external digital monitor via HDMI or USB Type-C; supports three independent displays; Max resolution: 4096x2304@60Hz (USB Type-C); 4096x2160@30Hz (HDMI)								
Chipset	Intel SoC (System on Chip) platform								
Memory	8GB or 16GB / 2400MHz DDR4 / soldered to systemboard, no sockets * System clocks down for processors with lower memory controller								
Display	13.3" (337.8mm) FHD (1920x1080), LED backlight, IPS 300 nits, 16:9 aspect ratio, 800:1 contrast ratio, 170° viewing angle, AR (anti-reflection)								
Multi-touch	Capacitive-type multi-touch, AR (anti-reflection), AS (anti-smudge), supports 10-finger gesture								
Hinge	Yoga hinge, 360 degree								
Convert-mode	Laptop, tent, stand, yoga and tablet								
Pen	ThinkPad Pen Pro, active pen for multi-touch display, on-board rechargeable								
Storage	Some: M.2 SSD / SATA 6.0Gb/s (e.g. xxxG SSD) Some: M.2 SSD / PCIe NVMe, PCIe 3.0 x 4, 32Gb/s (e.g. xxxG SSD PCIe NVMe)								
Optical	None								
Ethernet	Native Intel Ethernet Connection I219-V (Non-vPro) or I219-LM (vPro) via optional ThinkPad Ethernet Extension Cable								
WLAN	Intel Dual Band Wireless-AC 8265, Wi-Fi 2x2 802.11ac + Bluetooth 4.2, M.2 card								
Bluetooth™	Bluetooth 4.2 wireless, integrated in Wi-Fi + Bluetooth combo adapter								
WWAN (optional)	One of the following, configurable by model: • Integrated Mobile Broadband 4G LTE, Fibocom L830-EB, M.2 card (EMEA only) • Integrated Mobile Broadband 4G LTE-A, Fibocom L850-GL, M.2 card								
SIM card (opt)	Nano-SIM card slot								
Dimensions	WxDxH: 12.34" x 8.75" x 0.72"; 313.5mm x 222.2mm x 18.2mm								
Weight	Starting at 3.17 lb / 1.43kg								
Case color	Black or silver								
Case Material	Carbon-Fiber Hybrid								
Optional: Smart card reader (mutually exclusive with NFC) One microSD card slot (microSD, microSDHC, microSDXC), UHS-I Two USB 3.1 Gen 1 (one Always On), Ethernet extension connector, one USB 3.1 Type-C Gen 2 / Thunderbolt 3 (Power Delivery, DisplayPort, Data transfer), HDMI 1.4b, microSD card reader, nano-SIM card slot (WWAN models), headphone / microphone combo jack * Depending on many factors, actual data transfer speed may be lower than theoretical speed None USB-C to VGA: Lenovo USB-C to VGA Plus Power Adapter USB-C to DP: Lenovo USB-C to DisplayPort Adapter HDMI to VGA: Lenovo HDMI to VGA Monitor Adapter One of the following, configurable by model: 720p: HD720p camera, fixed focus IR & 720p: IR camera and HD720p camera, fixed focus HD Audio, Conexant® CX11771 codec / stereo speakers, 2W x 2 / optional dual array microphone, headphone / microphone combo jack 6-row, spill-resistant, multimedia Fn keys, LED backlight TrackPoint® pointing device and 3+2 buttons Mylar surface multi-touch click pad Power-on password, hard disk password, supervisor password, security keyhole Discrete TPM 2.0 TCG Certified Intel vPro Technology Optional: Touch style match on chip fingerprint reader on the palm rest Near Field Communication (mutually exclusive with smart card reader) Li-Ion 51Wh battery MobileMark® 2014: 13.6 hrs * Battery life varies significantly with settings, usage, & other factors 45W or 65W AC adapter (slim tip), 45W or 65W USB Type-C AC adapter Ambient Light Sensor 3D accelerometer and 3D magnetometer 3D compass 3D gyrometer Some: Windows® 10 Home 64 Some: Windows 10 Pro 64 One of the following, configurable by model: • 1-year depot repair service • 1-year depot with 2-year system board service • 3-year/1-yr battery depot repair service MIL-STD-810G military testing EPEAT™ Gold; ENERGY STAR®; RoHS-compliant									



ThinkPad X390 Yoga Platform Specifications

Product Specifications Reference (PSREF)

Processor	8th Generation Intel® Core™ i5 / i7 Processor								Smart card reader Media reader Ports	<i>Optional:</i> Smart card reader MicroSD card reader, in the combo slot with nano-SIM card Two USB 3.1 Gen 1 (one Always On), one USB 3.1 Type-C Gen 1 (with the function of Power Delivery and Display Port), one USB 3.1 Type-C Gen 2 / Thunderbolt 3 (with the function of PD and DP), HDMI 1.4b, Ethernet extension connector, combo slot of nano-SIM card (WWAN models) and microSD card reader, headphone / microphone combo jack, optional smart card reader, side docking connector, security keyhole * Depending on many factors, actual data transfer speed may be lower than theoretical speed <i>USB-C to HDMI:</i> Lenovo USB-C to HDMI Adapter <i>USB-C to VGA:</i> Lenovo USB-C to VGA Adapter <i>USB-C to DP:</i> Lenovo USB-C to DisplayPort Adapter <i>Optional:</i> ThinkPad Ethernet Extension Adapter Gen 2
	Processor Number	# of Cores	# of Threads	Base Frequency	Max Turbo Frequency	Cache	Memory Types	Processor Graphics		
	i5-8265U	4	8	1.6 GHz	3.9 GHz	6MB	DDR4-2400	Intel UHD Graphics 620		
	i5-8365U	4	8	1.6 GHz	4.1 GHz	6MB				
	i7-8565U	4	8	1.8 GHz	4.6 GHz	8MB				
i7-8665U	4	8	1.9 GHz	4.8 GHz	8MB					
Graphics	Intel UHD Graphics 620 in processor only; supports external digital monitor via HDMI or USB Type-C; supports three independent displays; Max resolution: 4096x2304@60Hz (USB Type-C); 4096x2160@24Hz (HDMI)								Monitor cable (optional)	* Depending on many factors, actual data transfer speed may be lower than theoretical speed <i>USB-C to HDMI:</i> Lenovo USB-C to HDMI Adapter <i>USB-C to VGA:</i> Lenovo USB-C to VGA Adapter <i>USB-C to DP:</i> Lenovo USB-C to DisplayPort Adapter
Chipset Memory	Intel SoC (System on Chip) platform 8GB or 16GB / 2400MHz DDR4 / soldered to systemboard, no sockets * Installed memory is actually 2666MHz but run at 2400MHz due to Intel limitation								Bundled Accy	<i>Optional:</i> ThinkPad Ethernet Extension Adapter Gen 2
Display	13.3" (337.8mm) FHD (1920x1080), LED backlight, IPS, 300 nits, 16:9 aspect ratio, 800:1 contrast ratio, Color Gamut 72%, 170° viewing angle, AR (anti-reflection)								Camera	One of the following, configurable by model: • HD720p camera, with ThinkShutter camera privacy, fixed focus • IR camera and HD720p camera, with ThinkShutter camera privacy, fixed focus
Multi-touch	capacitive-type multi-touch, AR (anti-reflection), AS (anti-smudge), supports 10-finger gesture, could reduce brightness by up to 10%								Audio support	HD Audio, Realtek® ALC3287 codec / stereo speakers, 2W x 2, Dolby® Audio™ Premium, dual array far-field microphones, headphone / microphone combo jack
Hinge	Yoga hinge, 360 degree								Keyboard	6-row, spill-resistant, multimedia Fn keys, LED backlight
Convert-mode	Laptop, tent, stand and tablet								UltraNav™	TrackPoint® pointing device and buttonless Mylar surface multi-touch touchpad
Pen	ThinkPad Pen Pro, active pen for multi-touch display, on-board rechargeable								Security	Power-on password, supervisor password, system management password, hard disk password, security keyhole
Storage	<ul style="list-style-type: none"> M.2 2280 SSD / SATA 6.0Gb/s M.2 2280 SSD / PCIe NVMe, PCIe 3.0 x 4 M.2 2242 SSD / PCIe NVMe, PCIe 3.0 x 2 Intel Optane™ Memory H10 with Solid State Storage, M.2 2280, PCIe NVMe 3.0 x 4 								Security chip	Discrete TPM 2.0 TCG Certified
Optical	None								System Mgt (opt)	Intel vPro Technology
Ethernet	Native Intel Ethernet Connection I219-V (Non-vPro) or I219-LM (vPro) via bundled or optional ThinkPad Ethernet Extension Adapter Gen 2								Fingerprint reader	Touch style match on chip fingerprint reader on the palm rest
WLAN	One of the following, configurable by model: • Intel Wireless-AC 9560, Wi-Fi 2x2 802.11ac + Bluetooth 5.0 • Intel Wi-Fi 6 AX200, Wi-Fi 2x2 802.11ax + Bluetooth 5.0								NFC (optional)	Near Field Communication
Bluetooth™	Bluetooth 5.0 wireless, integrated in Wi-Fi + Bluetooth combo adapter								Battery	Integrated Li-ion 50Wh battery, supports Rapid Charge (charge up to 80% in 1hr) with 65W USB Type-C AC adapter
WWAN (optional)	One of the following, configurable by model: • Integrated Mobile Broadband 4G LTE, Fibocom L830-EB, M.2 card (EMEA only) • Integrated Mobile Broadband 4G LTE-A, Fibocom L850-GL, M.2 card * For non-WWAN model, it means the model is NOT WWAN upgradable								Max battery life	MobileMark® 2014: 14.5 hrs * Battery life varies significantly with settings, usage, & other factors 45W USB Type-C, 65W USB Type-C or 65W Slim USB Type-C AC adapter
Dimensions	WxDxH: 12.22" x 8.62" x 0.63"; 310.4mm x 219mm x 15.95mm								AC adapter	45W USB Type-C, 65W USB Type-C or 65W Slim USB Type-C AC adapter
Weight	Starting at 2.85 lb /1.29kg								Light sensor	None
Case color	Black or silver (Silver is not available in EMEA)								G-sensor	3D accelerometer
Case Material	Display cover: Carbon-Fiber Hybrid Bottom: Carbon-Fiber Hybrid								Gyroscope	3D gyrometer
									Preload	Windows® 10 Home 64 or Windows 10 Pro 64
									Limited warranty	One of the following, configurable by model: • 1-year depot repair service • 1-year depot with 2-year system board service • 3-year/1-yr battery depot repair service • 3-year/1-yr battery limited onsite service
									Mil-Spec test	MIL-STD-810G military testing
									Environment	EPEAT™ Silver; ENERGY STAR® 7.1; RoHS-compliant



ThinkPad Yoga 11e (5th Gen) Platform Specifications

Product Specifications Reference (PSREF)

Processor	7th Generation Intel® Core™ m / i5 Processor, Intel Celeron® processor, or Intel Pentium® Silver processor							Dimensions	<i>WxDxH:</i> 11.81" x 8.27" x 0.89"; 300mm x 210mm x 22.5mm
								Weight	From 3.4 lb / 1.54kg
								Case color	Black
								Case material	<i>Display cover:</i> PC/ABS+GF; <i>Bottom:</i> PC/ABS plastic
								Media reader	MicroSD card reader
							Ports	Two USB 3.1 Gen 1, one USB 3.1 Type-C Gen 1 (with the function of Power Delivery and DisplayPort), HDMI1.4, Ethernet (RJ-45), headphone / microphone combo jack, microSD card reader, security keyhole <i>* Depending on many factors, actual data transfer speed may be lower than theoretical speed</i>	
							Control buttons	Power button, volume control button	
Graphics	Intel HD Graphics 615, Intel UHD Graphics 600 or 605 in processor, supports external digital monitor via HDMI or USB Type-C; supports dual independent display; Max resolution: 3840x2160@60Hz (USB Type-C); 4096x2160@30Hz (HDMI)							Camera	<i>One of the following, configurable by model:</i> <i>720p:</i> HD720p resolution, low light sensitive, fixed focus <i>World facing:</i> Rear camera, 5MP resolution, auto focuss
Chipset	Intel SoC (System on Chip) platform							Audio support	HD Audio, Realtek® ALC3287 codec Dolby Audio™ / stereo speakers, 2W x 2 / monaural microphone, headphone / microphone combo jack
Memory	4GB or 8GB / 1866MHz LPDDR3 or 2400MHz DDR4 / soldered to systemboard, no sockets							Keyboard	6-row, multimedia Fn keys
Display	11.6" (295mm) HD (1366x768), anti-glare, LED backlight, IPS, 250 nits, 16:9 aspect ratio, 800:1 contrast ratio, 170° viewing angle, Corning® Gorilla® Glass							UltraNav™	Two buttons click pad below keyboard, multi-touch
MultiTouch	Capacitive-type multi-touch, supports 10 fingers							Security	Power-on password, hard disk password, supervisor password, security keyhole
Hinge	Yoga hinge, 360 degree							Security chip	Discrete TPM 2.0, TCG Certified
Convertible mode	Laptop, tent, stand and tablet							System Mgt (opt)	None
Pen	<i>Optional:</i> ThinkPad Pen Pro, batteries required, on-board garage							Fingerprint reader	None
Storage	eMMC flash memory on board or M.2 SSD / PCIe NVMe, PCIe 3.0 x 2, 16Gb/s							Battery	Integrated Li-Ion 42Wh battery
Optical	None							Max battery life	<i>MobileMark® 2014:</i> 12 hrs <i>* Battery life varies significantly with settings, usage, & other factors</i>
Ethernet	Realtek RTL8111GUS-CG Gigabit Network Connection							AC adapter	45W or 65W slim tip AC adapter or USB Type-C AC adapter
WLAN	<i>One of the following, configurable by model:</i> • Intel Wireless-AC 9260, Wi-Fi 2x2 802.11ac + Bluetooth 5.0, M.2 card • Intel Wireless-AC 9560, Wi-Fi 2x2 802.11ac + Bluetooth 5.0, M.2 card							Preload	<i>Some:</i> Windows® 10 Home 64 <i>Some:</i> Windows 10 Pro 64
Bluetooth™	Bluetooth wireless, integrated in Wi-Fi + Bluetooth combo adapter							Limited warranty	<i>One of the following, configurable by model:</i> • 1-year depot repair service • 3-year depot repair service
WWAN	None							Mil-Spec test	MIL-STD-810G military testing
							Environment	EPEAT™ Gold; ENERGY STAR® 6.1; RoHS-compliant	



ThinkPad X1 Carbon (6th Gen) Platform Specifications

Product Specifications Reference (PSREF)

Processor	7th Generation Intel® Core™ i5 Processor								Dimensions	<i>WxDxH:</i> 12.74" x 8.55" x 0.63"; 323.5mm x 217.1mm x 15.95mm
	Processor Number	# of Cores	# of Threads	Base Frequency	Max Turbo Frequency	Cache	Memory Types	Processor Graphics	Weight	Starting at 2.49 lb / 1.13 kg
	i5-7300U	2	4	2.6 GHz	3.5 GHz	3MB	LPDDR3-1866	Intel HD Graphics 620	Case color	Black or Silver (silver case is NOT available in EMEA)
	or 8th Generation Intel Core i5 / i7 Processor								Case material	<i>Display cover:</i> CFRP/GFRP hybrid; <i>Bottom:</i> magnesium alloy / PPS hybrid
	Processor Number	# of Cores	# of Threads	Base Frequency	Max Turbo Frequency	Cache	Memory Types	Processor Graphics	Smart card reader	None
	i5-8250U	4	8	1.6 GHz	3.4 GHz	6MB	LPDDR3-2133	Intel UHD Graphics 620	Media reader	MicroSD card reader, supports UHS-II
	i5-8350U			1.7 GHz	3.6 GHz	6MB			Ports	Two USB 3.1 Gen 1 (one Always On), two USB 3.1 Type-C Gen 2 / Thunderbolt 3 (with the function of Power Delivery and DisplayPort), HDMI 1.4b, Ethernet extension connector, nano-SIM card slot (WWAN models), headphone / microphone combo jack, microSD card reader, side docking connector, security keyhole
	i7-8550U			1.8 GHz	4.0 GHz	8MB			Monitor cable	<i>HDMI to VGA:</i> Lenovo HDMI to VGA Monitor Adapter
	i7-8650U			1.9 GHz	4.2 GHz	8MB			<i>(optional)</i>	<i>USB-C to VGA:</i> Lenovo USB-C to VGA Adapter
Graphics	Intel HD Graphics 620 or Intel UHD Graphics 620 in processor; supports external digital monitor via HDMI or USB Type-C; supports three independent displays; Max resolution: 5120x2880@60Hz (USB Type-C); 4096x2160@30Hz (HDMI)								Bundled Accy	<i>Optional:</i> ThinkPad Ethernet Extension Adapter Gen 2
Chipset	Intel SoC (System on Chip) platform								Camera	<i>(optional)</i> One of the following, configurable by model:
Memory	8GB or 16GB / 2133MHz LPDDR3 / soldered to systemboard, no sockets <i>* System clocks down for processors with lower memory controller</i>								Audio support	<ul style="list-style-type: none"> HD720p camera with ThinkShutter camera privacy, fixed focus IR camera and HD720p camera, fixed focus
Display	<i>One of the following, configurable by model:</i> <ul style="list-style-type: none"> 14.0" (355mm) FHD (1920x1080), anti-glare, LED backlight, IPS, 300 nits, 16:9 aspect ratio, 700:1 contrast ratio, 72% gamut, 170° viewing angle 14.0" (355mm) WQHD (2560x1440), anti-glare, LED backlight, IPS, 300 nits, 16:9 aspect ratio, 700:1 contrast ratio, 72% gamut, 170° viewing angle 14.0" (355mm) HDR WQHD (2560x1440) with Dolby Vision™, glossy, LED backlight, IPS, 500 nits, 16:9 aspect ratio, 1500:1 contrast ratio, 100% gamut, 170° viewing angle 								Keyboard	6-row, spill-resistant, multimedia Fn keys, LED backlight
Multi-touch (opt)	On-cell touch, supports 10-finger gesture (FHD only)								UltraNav™	TrackPoint® pointing device and buttonless glass surface multi-touch touchpad
Storage	<i>One of the following, configurable by model:</i> <ul style="list-style-type: none"> M.2 SSD / SATA 6.0Gb/s (e.g. xxxGB SSD M.2) M.2 SSD / PCIe NVMe, PCIe 3.0 x 4, 32Gb/s (e.g. xxxGB SSD M.2 PCIe NVMe) 								Security chip	Power-on password, hard disk password, supervisor password, security keyhole
Optical	None								vPro (optional)	Intel vPro Technology
Ethernet	Native Intel Ethernet Connection I219-V (Non-vPro) or I219-LM (vPro) via bundled or optional ThinkPad Ethernet Extension Adapter Gen 2								Fingerprint reader	Touch style match on chip fingerprint reader on the palm rest, anti-spoofing technology
WLAN + Bluetooth™	Intel Dual Band Wireless-AC 8265, Wi-Fi 2x2 802.11ac + Bluetooth 4.1, M.2 card <i>* Intel 8265ac card supports BT4.2 but is limited to BT4.1 by Windows OS</i>								NFC (optional)	Near Field Communication
WWAN (optional)	Integrated Mobile Broadband 4G LTE-A, Intel XMM™ 7360 (Fibocom L850-GL), M.2 card <i>* For non-WWAN model, it means the model is NOT WWAN upgradable</i>								Battery	Integrated Li-ion 57Wh battery, supports Rapid Charge (charge up to 80% in 1hr) with 65W AC adapter
SIM card (opt)	Nano-SIM card slot, optional Verizon LTE (US) SIM card								Max battery life	<i>MobileMark® 2014:</i> 19.3 hr <i>* Battery life varies significantly with settings, usage, & other factors</i>
									AC adapter	45W, 65W, or 65W Low Halogen USB-C AC adapter
									Operating system	<i>Optional:</i> Windows® 10 Home 64 or Windows 10 Pro 64
									Limited warranty	<i>One of the following, configurable by model:</i> <ul style="list-style-type: none"> 1-year depot repair service 1-year depot with 2-year system board repair service 3-year/1-yr battery depot repair service 3-year/1-yr battery limited onsite service
									Mil-Spec test	MIL-STD-810G military testing
									Environment	EPEAT™ Gold (US only); ENERGY STAR® 6.1; RoHS-compliant



ThinkPad X1 Carbon (7th Gen) Platform Specifications

Product Specifications Reference (PSREF)

Processor	8th Generation Intel® Core™ i5 / i7 Processor									WWAN (optional) <i>One of the following, configurable by model:</i>	
	Processor Number	# of Cores	# of Threads	Base Frequency	Max Turbo Frequency	Cache	Memory Types	Processor Graphics			
	i5-8265U	4	8	1.6 GHz	3.9 GHz	6MB	LPDDR3-2133	Intel UHD Graphics 620	• Integrated Mobile Broadband 4G LTE-A, Fibocom L850-GL, M.2 card		
	i5-8365U			1.6 GHz	4.1 GHz	6MB			• Integrated Mobile Broadband 4G LTE-A, Fibocom L860-GL, MIMO 2x2, M.2 card		
	i7-8565U			1.8 GHz	4.6 GHz	8MB			* For non-WWAN model, it means the model is NOT WWAN upgradable		
	i7-8665U			1.9 GHz	4.8 GHz	8MB			Nano-SIM card slot, optional Verizon LTE (US) SIM card		
	or 10th Generation Intel Core i5 / i7 Processor (NOT available in EMEA)									SIM card (opt)	
	Processor Number	# of Cores	# of Threads	Base Frequency	Max Turbo Frequency	Cache	Memory Types	Processor Graphics	Dimensions		
	i5-10210U	4	8	1.6 GHz	4.2 GHz	6MB	LPDDR3-2133	Intel UHD Graphics	<i>WxDxH (Privacy Guard):</i> 12.72" x 8.54" x 0.61"; 323mm x 217mm x 15.4mm		
	i7-10510U			1.8 GHz	4.9 GHz	8MB			<i>WxDxH (other model):</i> 12.72" x 8.54" x 0.59"; 323mm x 217mm x 14.95mm		
	i7-10710U	6	12	1.1 GHz	4.7 GHz	12MB			Weight		
Graphics	Intel UHD Graphics 620 or Intel UHD Graphics in processor; supports external digital monitor via HDMI or USB Type-C / Thunderbolt; supports three independent displays; Max resolution: 5K@60Hz (Thunderbolt); 4K@24Hz (HDMI)									Case color Case material	
Chipset	Intel SoC (System on Chip) platform									Smart card reader	
Memory	8GB or 16GB / 2133MHz LPDDR3 / soldered to systemboard, no sockets									Media reader	
Display	Size	Resolution	Type	Surface	Brightness	Aspect Ratio	Contrast Ratio	Color Gamut	Viewing Angle	Ports	
	14.0"	FHD (1920x1080) Multi-touch	IPS	Anti-reflection Anti-smudge	300 nits	16:9	700:1	72%	170°	Two USB 3.1 Gen 1 (one Always On), two USB 3.1 Type-C Gen 2 / Thunderbolt 3 (with the function of Power Delivery and DisplayPort), HDMI 1.4b, Ethernet extension connector, nano-SIM card slot (WWAN models), headphone / microphone combo jack, side docking connector, security keyhole <i>* Depending on many factors, actual data transfer speed may be lower than theoretical speed</i>	
	14.0"	FHD (1920x1080) Low Power	IPS	Anti-glare	400 nits	16:9	800:1	72%	170°	Monitor cable Bundled Accy	
	14.0"	FHD (1920x1080) ThinkPad Privacy Guard	IPS	Anti-glare	400 nits	16:9	1000:1	72%	170°	Camera (optional) <i>One of the following, configurable by model:</i>	
	14.0"	WQHD (2560x1440)	IPS	Anti-glare	300 nits	16:9	700:1	72%	170°	• HD720p camera with ThinkShutter camera privacy, fixed focus	
	14.0"	UHD (3840x2160) HDR 400, Dolby Vision™	IPS	Glossy	500 nits	16:9	1400:1	90%	170°	• IR camera and HD720p camera with ThinkShutter camera privacy, fixed focus	
Multi-touch (opt)	Capacitive-type multi-touch, supports 10-finger gesture (FHD only), anti-reflection (AR) / anti-smudge (AS) coating									Audio support	
Storage	<i>One of the following, configurable by model:</i>									Keyboard	
	• M.2 2280 SSD / SATA 6.0Gb/s									UltraNav™	
	• M.2 2280 SSD / PCIe NVMe 3.0 x 4									TrackPoint® pointing device and buttonless glass surface multi-touch touchpad	
	• Intel Optane™ Memory H10 with Solid State Storage, M.2 2280, PCIe NVMe 3.0 x 4									Security	
Optical	None									Security chip	
Ethernet	Native Intel Ethernet Connection I219-V (Non-vPro) or I219-LM (vPro) via optional ThinkPad Ethernet Extension Adapter Gen 2									System Mgt (opt)	
WLAN + Bluetooth™	<i>One of the following, configurable by model:</i>									Fingerprint reader	
	• Intel Wireless-AC 9560, Wi-Fi 2x2 802.11ac + Bluetooth 5.0									Touch style match on chip fingerprint reader on the palm rest	
	• Intel Wi-Fi 6 AX201, Wi-Fi 2x2 802.11ax + Bluetooth 5.0 (AX201 for 10th Gen processor only)									NFC (optional)	
										Near Field Communication	
										Battery	
										Integrated Li-ion 51Wh battery, supports Rapid Charge (charge up to 80% in 1hr) with 65W AC adapter	
										Max battery life	
										<i>MobileMark® 2014:</i> 18.3 hr <i>* Battery life varies significantly with settings, usage, & other factors</i>	
										AC adapter	
										45W, 65W, or 65W slim USB-C AC adapter	
										Operating system	
										<i>Optional:</i> Windows® 10 Home 64 or Windows 10 Pro 64	
										Limited warranty	
										<i>One of the following, configurable by model:</i>	
										• 1-year depot repair service	
										• 1-year depot with 2-year system board repair service	
										• 3-year/1-yr battery depot repair service	
										• 3-year/1-yr battery limited onsite service	
										MIL-Spec test	
										MIL-STD-810G military testing	
										Environment	
										EPEAT™ Gold; ENERGY STAR® 7.1; RoHS-compliant	

Note: The specifications above may not be available in all regions.

Lenovo
October 2019



ThinkPad X1 Extreme Platform Specifications

Product Specifications Reference (PSREF)

Processor	8th Generation Intel® Core™ i5 / i7 Processor								Smart card reader	Optional: Smart card reader	
	Processor Number	# of Cores	# of Threads	Base Frequency	Max Turbo Frequency	Cache	Memory Types	Processor Graphics	Media reader	SD Card reader (SD, SDHC, SDXC), supports UHS-II SD card	
	i5-8300H	4	8	2.3 GHz	4.0 GHz	8MB	DDR4-2666	Intel UHD Graphics 630	Ports	Two USB 3.1 Gen 1 (one Always On), two USB 3.1 Type-C Gen 2 / Thunderbolt 3 (with the function of Power Delivery and DisplayPort), HDMI 2.0, Ethernet extension connector, headphone / microphone combo jack, optional smart card reader, SD card reader, security keyhole	
	i5-8400H			2.5 GHz	4.2 GHz				9MB	2.2 GHz	4.1 GHz
	i7-8750H	2.2 GHz	4.1 GHz	9MB	2.6 GHz	4.3 GHz					
	i7-8850H	2.6 GHz	4.3 GHz						9MB	2.6 GHz	4.3 GHz
Graphics	Intel UHD Graphics 630 in processor and NVIDIA® GeForce® GTX 1050 Ti, 4GB GDDR5 memory; supports external digital monitor via HDMI or Thunderbolt™; supports four independent displays; Max resolution: 5K@60Hz (Thunderbolt); 4K@60Hz (HDMI)										
Chipset	Mobile Intel CM246 Chipset								Camera (optional)	One of the following, configurable by model:	
Memory	64GB max / 2666MHz DDR4, dual-channel capable, two DDR4 SO-DIMM sockets								Audio support	<ul style="list-style-type: none"> • HD720p camera with ThinkShutter camera privacy, fixed focus • IR camera and HD720p camera, fixed focus 	
Display	<i>Some:</i> 15.6" (396mm) FHD (1920x1080), anti-glare, LED backlight, IPS, 300 nits, 16:9 aspect ratio, 700:1 contrast ratio, 72% gamut, 170° viewing angle <i>Some:</i> 15.6" (396mm) HDR UHD (3840x2160) with Dolby Vision™, LED backlight, IPS, 400 nits, 16:9 aspect ratio, 1200:1 contrast ratio, 100% gamut, 170° viewing angle, multi-touch, anti-reflection (AR)								Keyboard	6-row, spill-resistant, multimedia Fn keys, LED backlight	
Multi-touch (opt)	Capacitive-type multi-touch, supports 10-finger gesture (4K only)								UltraNav™	TrackPoint® pointing device and buttonless glass surface multi-touch touchpad	
Pen (optional)	Lenovo Pen Pro (special bid only)								Security	Power-on password, hard disk password, supervisor password, security keyhole	
Storage	<i>Up to 2 drives (two M.2 SSD)</i> <ul style="list-style-type: none"> • M.2 SSD / SATA 6.0Gb/s (e.g. xxxGB SSD M.2) • M.2 SSD / PCIe NVMe, PCIe 3.0 x 4, 32Gb/s (e.g. xxxGB SSD M.2 PCIe NVMe) 								Security chip	Discrete TPM 2.0, TCG Certified	
RAID (optional)	RAID 0/1 support								vPro (optional)	Intel vPro Technology	
Optical	None								Fingerprint reader	Touch style match on chip fingerprint reader on the keyboard bezel	
Ethernet	Native Intel Ethernet Connection I219-V (Non-vPro) or I219-LM (vPro) via bundled or optional ThinkPad Ethernet Extension Cable								Color calibration	None	
WLAN	Intel Wireless-AC 9560, Wi-Fi 2x2 802.11ac + Bluetooth 5.0, M.2 card								NFC	None	
Bluetooth™	Bluetooth 5.0 wireless, integrated in Wi-Fi + Bluetooth combo adapter								Battery	Integrated Li-ion 80Wh battery, supports Rapid Charge (charge up to 80% in 1hr)	
WWAN	None								Max battery life	<i>Discrete mode:</i> 9.5 hr; <i>Hybrid mode:</i> 14.9 hr	
SIM card	None								(MobileMark 2014)	* Battery life varies significantly with settings, usage, & other factors	
Dimensions	<i>WxDxH (non-touch):</i> 14.24" x 9.67" x 0.72"; 361.8mm x 245.7mm x 18.4mm <i>WxDxH (multi-ouch):</i> 14.24" x 9.67" x 0.74"; 361.8mm x 245.7mm x 18.7mm <i>Non-touch model:</i> starting at 3.76 lb / 1.7 kg; <i>Multi-touch model:</i> starting at 4.06 lb / 1.8 kg								AC adapter	135W slim tip AC adapter	
Weight									Operating system	Optional: Windows® 10 Home 64 or Windows 10 Pro 64	
Case color	Black								Limited warranty (optional)	One of the following, configurable by model:	
Case material	<i>Display cover:</i> CFRP/GFRP hybrid; <i>Bottom:</i> Aluminum alloy									<ul style="list-style-type: none"> • 1-year depot repair service • 3-year/1-yr battery depot repair service • 3-year/1-yr battery limited onsite service 	
									Mil-Spec test	MIL-STD-810G military testing	
									Environment	EPPEAT™ Gold (US only); ENERGY STAR® 7.0; RoHS-compliant	

Note: The specifications above may not be available in all regions.

Lenovo
August 2019

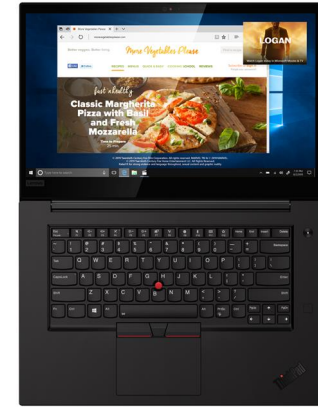

ThinkPad X1 Extreme (2nd Gen) Platform Specifications

Product Specifications Reference (PSREF)

Processor	9th Generation Intel® Core™ i5 / i7 / i9 Processor									Dimensions	<i>WxDxH (non-touch):</i> 14.24" x 9.67" x 0.72"; 361.8mm x 245.7mm x 18.4mm <i>WxDxH (multi-touch):</i> 14.24" x 9.67" x 0.74"; 361.8mm x 245.7mm x 18.7mm			
	Processor Number	# of Cores	# of Threads	Base Frequency	Max Turbo Frequency	Cache	Memory Types	Processor Graphics		Weight	<i>Non-touch model:</i> starting at 3.75 lb / 1.7 kg; <i>Multi-touch model:</i> starting at 4.0 lb / 1.81 kg			
	i5-9300H	4	8	2.4 GHz	4.1 GHz	8MB	DDR4-2666	Intel UHD Graphics 630		Case color	Black paint (FHD model) or black weave (UHD model)			
	i5-9400H	4	8	2.5 GHz	4.3 GHz	8MB				Case material	<i>Display cover:</i> CFRP/GFRP hybrid; <i>Bottom:</i> Aluminum alloy			
	i7-9750H	6	12	2.6 GHz	4.5 GHz	12MB				Smart card reader	<i>Optional:</i> Smart card reader			
	i7-9850H	6	12	2.6 GHz	4.6 GHz	12MB				Media reader	SD Card reader (SD, SDHC, SDXC), supports UHS-II SD card			
	i9-9880H	8	16	2.3 GHz	4.8 GHz	16MB				Ports	Two USB 3.1 Gen 1 (one Always On), two USB 3.1 Type-C Gen 2 / Thunderbolt 3 (with the function of Power Delivery and DisplayPort), HDMI 2.0, Ethernet extension connector, headphone / microphone combo jack, optional smart card reader, SD card reader, security keyhole, slim tip AC adapter <i>* Power Delivery only supports power-out for charging peripherals</i> <i>* Depending on many factors, actual data transfer speed may be lower than theoretical speed</i>			
Graphics	Intel UHD Graphics 630 in processor and NVIDIA® GeForce® GTX 1650, 4GB GDDR5 memory; supports external digital monitor via HDMI or Thunderbolt™; supports four independent displays; Max resolution: 5K@60Hz (Thunderbolt); 4K@60Hz (HDMI)									Monitor cable (optional)	<i>HDMI to VGA:</i> Lenovo HDMI to VGA Monitor Adapter <i>USB-C to VGA:</i> Lenovo USB-C to VGA Adapter <i>USB-C to DP:</i> Lenovo USB-C to DisplayPort Adapter			
Chipset	Mobile Intel CM246 Chipset									Bundled Accy	<i>Optional:</i> ThinkPad Ethernet Extension Cable			
Memory	64GB max / 2666MHz DDR4, dual-channel capable, two DDR4 SO-DIMM sockets									Camera (optional)	<i>One of the following, configurable by model:</i> • HD720p camera with ThinkShutter camera privacy, fixed focus • IR camera and HD720p camera with ThinkShutter camera privacy, fixed focus			
Display	Size	Resolution	Type	Surface	Brightness	Aspect Ratio	Contrast Ratio	Color Gamut	Viewing Angle	Audio support	HD Audio, Synaptic® CX11880 codec / stereo speakers, 2W x 2, Dolby® Audio™ Premium / dual 360° far-field microphone, headphone / microphone combo jack, Dolby Atmos® sound system			
	15.6"	FHD (1920x1080)	IPS	Anti-glare	300 nits	16:9	700:1	72% NTSC	170°	Keyboard UltraNav™	6-row, spill-resistant, multimedia Fn keys, LED backlight TrackPoint® pointing device and buttonless glass surface multi-touch touchpad			
	15.6"	FHD (1920x1080) Dolby Vision™ HDR	IPS	Anti-glare	500 nits	16:9	1200:1	72% NTSC	170°		Security	Power-on password, hard disk password, supervisor password, security keyhole		
	15.6"	UHD (3840x2160) Dolby Vision HDR	IPS	Anti-glare	500 nits	16:9	1200:1	100% Adobe	170°		Security chip	Discrete TPM 2.0, TCG Certified		
	15.6"	UHD (3840x2160) Dolby Vision HDR, Multi-touch	OLED	Anti-reflection Anti-smudge	SDR 400nit, HDR 500nit (peak)	16:9	100000:1	100% DCI-P3	170°		System Mgt (opt)	Intel vPro Technology		
Multi-touch (opt)	Capacitive-type multi-touch, supports 10-finger gesture (UHD OLED only), anti-reflection (AR), anti-smudge (AS) coating									Fingerprint reader	Touch style match on chip fingerprint reader on the keyboard bezel			
Pen	Supports pen accessory, please see the accessory compatibility for details									Color calibration	<i>Optional:</i> X-Rite Pantone factory color calibration (UHD model only)			
Storage	<i>Up to two M.2 SSD</i> M.2 2280 SSD / PCIe NVMe 3.0 x 4									NFC	None			
RAID (optional)	RAID 0/1 support									Battery	Integrated Li-ion 80Wh battery, supports Rapid Charge (charge up to 80% in 1hr)			
Optical	None									Max battery life	<i>MobileMark® 2014:</i> 14 hr <i>* Battery life varies significantly with settings, usage, & other factors</i>			
Ethernet	Native Intel Ethernet Connection I219-V (Non-vPro) or I219-LM (vPro) via bundled or optional ThinkPad Ethernet Extension Cable									AC adapter	135W slim tip AC adapter			
WLAN (optional)	Intel Wi-Fi 6 AX200, Wi-Fi 2x2 802.11ax + Bluetooth 5.0									Operating system	Windows® 10 Home 64 or Windows 10 Pro 64			
Bluetooth™	Bluetooth 5.0 wireless, integrated in Wi-Fi + Bluetooth combo adapter									Limited warranty	<i>One of the following, configurable by model:</i> • 1-year depot repair service • 3-year/1-yr battery depot repair service • 3-year/1-yr battery limited onsite service			
WWAN	None									Mil-Spec test	MIL-STD-810G military testing			
SIM card	None									Environment	EPEAT™ Silver; ENERGY STAR® 7.1; RoHS-compliant			

Note: The specifications above may not be available in all regions.

Lenovo
September 2019



ThinkPad X270 Platform Specifications

Product Specifications Reference (PSREF)

Processor	6th Generation Intel® Core™ i3 / i5 / i7 Processor							Dimensions WxDxH: 12.03" x 8.21" x 0.80"; 305.5mm x 208.5mm x 20.3mm	Weight			
	Processor Number	# of Cores	# of Threads	Base Frequency	Max Turbo Frequency	Cache	Memory Types		Processor Graphics	Models	No + 3-cell	3-cell + 3-cell
	i3-6006U	2	4	2.0 GHz	-	3MB	DDR4-2133	Intel HD Graphics 520	Weight			
	i3-6100U			2.3 GHz	-	3MB			2.79 lb / 1.27 kg	2.98 lb / 1.36 kg	3.33 lb / 1.52 kg	
	i5-6200U			2.3 GHz	2.8 GHz	3MB			Case color: Black			
	i5-6300U			2.4 GHz	3.0 GHz	3MB			Case material: Display cover: Glass-Fiber Reinforced Plastic; Bottom: Glass-Fiber Reinforced Plastic			
	i7-6500U			2.5 GHz	3.1 GHz	4MB			Smart card reader: Optional: Smart card reader			
	i7-6600U			2.6 GHz	3.4 GHz	4MB			Media reader: 4-in-1 reader (MMC, SD, SDHC, SDXC)			
	or 7th Generation Intel Core i3 / i5 / i7 Processor							Ports: Two USB 3.1 Gen 1 (USB 3.0, one Always On), USB 3.1 Type-C Gen 1 (with the function of Power Delivery and DisplayPort), HDMI 1.4b, Ethernet (RJ-45), Dock connector				
	Processor Number	# of Cores	# of Threads	Base Frequency	Max Turbo Frequency	Cache	Memory Types	Processor Graphics	* Depending on many factors, actual data transfer speed may be lower than theoretical speed			
	i3-7100U	2	4	2.4 GHz	-	3MB	DDR4-2133	Intel HD Graphics 620	WiGig dock (opt): ThinkPad WiGig dock, mutually exclusive with WWAN (US only)			
	i5-7200U			2.5 GHz	3.1 GHz	3MB			Monitor cable (optional): HDMI to VGA: Lenovo HDMI to VGA Monitor Adapter			
	i5-7300U			2.6 GHz	3.5 GHz	3MB			USB-C to VGA: Lenovo USB-C to VGA Adapter			
	i7-7500U			2.7 GHz	3.5 GHz	4MB			USB-C to DP: Lenovo USB-C to DisplayPort Adapter			
	i7-7600U			2.8 GHz	3.9 GHz	4MB			Camera (optional): HD720p resolution, fixed focus			
Graphics	Intel HD Graphics 520 or 620 in processor; supports external digital monitor via HDMI or USB Type-C; supports three independent displays; Max resolution: 4096x2160@60Hz (USB Type-C); 4096x2160@24Hz (HDMI)							Keyboard: 6-row, spill-resistant, multimedia Fn keys, optional LED backlight				
Chipset	Intel SoC (System on Chip) platform							UltraNav™: TrackPoint® pointing device and buttonless Mylar surface multi-touch touchpad				
Memory	16GB max / 2400MHz DDR4, one DDR4 SO-DIMM socket * System clocks down for processors with lower memory controller							Security: Power-on password, hard disk password, supervisor password, security keyhole				
Display	Some: 12.5" (317.5mm) HD (1366x768), anti-glare, LED backlight, 220 nits, 16:9 aspect ratio, 500:1 contrast ratio							Security chip: Discrete TPM 2.0, TCG Certified				
	Some: 12.5" (317.5mm) HD (1366x768), anti-glare, LED backlight, IPS, 300 nits, 16:9 aspect ratio, 800:1 contrast ratio, 170° viewing angle							vPro (optional): Intel vPro Technology				
	Some: 12.5" (317.5mm) FHD (1920x1080), anti-glare, LED backlight, IPS, 300 nits, 16:9 aspect ratio, 700:1 contrast ratio, 170° viewing angle							Fingerprint reader (optional): Touch style match on chip fingerprint reader on the palm rest				
Multi-touch (opt)	On-cell touch, supports 10-finger gesture (FHD only)							NFC (optional): Near Field Communication				
Storage	System has one HDD slot or one M.2 2280 slot exclusively for storage							Internal battery: Optional: Integrated Li-ion or Li-Polymer 3-cell (23Wh)				
	Some: HDD / SATA 6.0Gb/s, 2.5" wide, 7mm high, Active Protection System™							External battery: Li-ion 3-cell (23Wh) or 6-cell (48Wh or 72Wh)				
	Some: SSD / SATA 6.0Gb/s, 2.5" wide, 7mm high (e.g. xxxGB SSD)							Max battery life (MobileMark® 2014)				
	Some: M.2 SSD / PCIe NVMe, PCIe 3.0 x 2, 16Gb/s							Models				
	Some: 128GB M.2 SSD / SATA 6.0Gb/s, in WWAN slot as 2nd Storage, mutually exclusive with WWAN and WiGig							No + 3-cell				
								3-cell + 3-cell				
								3-cell + 6-cell 48Wh				
								3-cell + 6-cell 72Wh				
								Max battery life				
								6.52 hr				
								13.04 hr				
								20.1 hr				
								26.9 hr				
								* Battery life varies significantly with settings, usage, & other factors				
								AC adapter: 45W slim tip AC adapter or 45W USB Type-C AC adapter				
Operating system	One of the following, configurable by model:							• Windows® 7 Professional 64 preinstalled through downgrade rights in Windows 10 Pro 64				
								• Windows 10 Home 64				
								• Windows 10 Pro 64				
Limited warranty	One of the following, configurable by model:							• 1-year depot repair service				
								• 3-year/1-yr battery depot repair service				
								• 3-year/1-yr battery limited onsite service				
Mil-Spec test	MIL-STD-810G military testing											
Environment	EPEAT™ Gold (US only); ENERGY STAR® 6.1; RoHS-compliant											
WLAN	One of the following, configurable by model (WiGig is mutually exclusive with WWAN):											
	• Realtek® RTL8822BE, Wi-Fi 2x2 802.11ac + BT4.1											
	• Intel Dual Band Wireless-AC 8260, Wi-Fi 2x2 802.11ac + BT4.1											
	• Intel Dual Band Wireless-AC 8265, Wi-Fi 2x2 802.11ac + BT4.1											
	• Intel Tri-Band Wireless-AC 18265, WiGig 802.11ad + Wi-Fi 2x2 802.11ac + BT4.1 (US only)											
Bluetooth™	Bluetooth 4.1 wireless, integrated in Wi-Fi + Bluetooth combo adapter											
	* Intel 8265ac / 18265ac card support BT4.2 but is limited to BT4.1 by Windows OS											
WWAN (optional)	One of the following, configurable by model (mutually exclusive with WiGig):											
	• Wireless WAN upgradable											
	• Integrated Mobile Broadband 4G LTE-A, Qualcomm® Snapdragon™ X7 LTE-A (Sierra Wireless EM7455)											
	• Integrated Mobile Broadband 4G LTE, Intel XMM™ 7160 (Fibocom L831-EAU) (EMEA only)											
SIM card (opt)	Micro-SIM card slot, opt Verizon LTE (US) or Lenovo® Connect (EMEA) SIM card											



ThinkPad X280 Platform Specifications

Product Specifications Reference (PSREF)

Processor	7th Generation Intel® Core™ i3 / i5 Processor * i3-7130U is NOT available in US and EMEA; i5-7200U is NOT available in US							Dimensions	WxDxH: 12.11" x 8.26" x 0.69-0.70"; 307.7mm x 209.8mm x 17.4-17.8mm	
	Processor Number	# of Cores	# of Threads	Base Frequency	Max Turbo Frequency	Cache	Memory Types	Processor Graphics	Weight	FHD non-touch model: 2.49 lb / 1.13 kg; HD non-touch model: 2.78 lb / 1.26 kg; FHD multi-touch model: 2.79 lb / 1.27 kg
	i3-7020U	2	4	2.3 GHz	-	3MB	DDR4-2133	Intel HD Graphics 620	Case color	Black
	i3-7130U			2.7 GHz	-	3MB			Case material	Display cover: Carbon Fiber (FHD non-touch model) or Glass Fiber (HD & FHD multi-touch model); Bottom: Magnesium/Aluminum
	i5-7200U			2.5 GHz	3.1 GHz	3MB				
	i5-7300U			2.6 GHz	3.5 GHz	3MB				
	or 8th Generation Intel Core i3 / i5 / i7 Processor							Smart card reader	Optional: Smart card reader	
	Processor Number	# of Cores	# of Threads	Base Frequency	Max Turbo Frequency	Cache	Memory Types	Processor Graphics	Media reader	MicroSD card reader, in the combo slot with nano-SIM card
	i3-8130U	2	4	2.2 GHz	3.4 GHz	4MB	DDR4-2400	Intel UHD Graphics 620	Ports	Two USB 3.1 Gen 1 (one Always On), one USB 3.1 Type-C Gen 1 (with the function of Power Delivery and DisplayPort), one USB 3.1 Type-C Gen 2 / Thunderbolt 3 (with the function of PD and DP), HDMI 1.4b, Ethernet extension connector, combo slot of nano-SIM card (WWAN models) and microSD card reader, headphone / microphone combo jack, optional smart card reader, side docking connector, security keyhole * Depending on many factors, actual data transfer speed may be lower than theoretical speed
	i5-8250U	4	8	1.6 GHz	3.4 GHz	6MB				
	i5-8350U			1.7 GHz	3.6 GHz	6MB				
	i7-8550U			1.8 GHz	4.0 GHz	8MB				
	i7-8650U			1.9 GHz	4.2 GHz	8MB				
Graphics	Intel HD Graphics 620 or Intel UHD Graphics 620 in processor; supports external digital monitor via HDMI or USB Type-C; supports three independent displays; Max resolution: 4096x2304@60Hz (USB Type-C); 4096x2160@30Hz (HDMI)							Monitor cable (optional)	HDMI to VGA: Lenovo HDMI to VGA Monitor Adapter USB-C to VGA: Lenovo USB-C to VGA Adapter USB-C to DP: Lenovo USB-C to DisplayPort Adapter	
Chipset	Intel SoC (System on Chip) platform 4GB, 8GB, or 16GB / 2400MHz DDR4 / soldered to systemboard, no sockets * 4GB memory is NOT available in US and EMEA * System clocks down for processors with lower memory controller							Bundled Accy	Optional: ThinkPad Ethernet Extension Adapter Gen 2	
Memory	Intel SoC (System on Chip) platform 4GB, 8GB, or 16GB / 2400MHz DDR4 / soldered to systemboard, no sockets * 4GB memory is NOT available in US and EMEA * System clocks down for processors with lower memory controller							Camera (optional)	One of the following, configurable by model: • HD720p camera with ThinkShutter camera privacy, fixed focus • IR camera and HD720p camera, fixed focus	
Display	Some: 12.5" (317.5mm) HD (1366x768), anti-glare, LED backlight, 220 nits, 16:9 aspect ratio, 400:1 contrast ratio Some: 12.5" (317.5mm) FHD (1920x1080), anti-glare, LED backlight, IPS, 300 nits, 16:9 aspect ratio, 700:1 contrast ratio, 170° viewing angle							Audio support	HD Audio, Realtek® ALC3287 codec / stereo speakers, 2W x 2, Dolby® Audio™ Premium / dual array microphone, headphone / microphone combo jack	
Multi-touch (opt)	On-cell touch, supports 10-finger gesture (FHD only) * FHD non-touch model is NOT available in US							Keyboard	6-row, spill-resistant, multimedia Fn keys, optional LED backlight UltraNav™ TrackPoint® pointing device and buttonless Mylar surface multi-touch touchpad	
Storage	One of the following, configurable by model: • M.2 SSD / SATA 6.0Gb/s (e.g. xxxGB SSD M.2) • M.2 SSD / PCIe NVMe, PCIe 3.0 x 4, 32Gb/s (e.g. xxxGB SSD M.2 PCIe NVMe) None							Security	Power-on password, hard disk password, supervisor password, security keyhole	
Optical	None							Security chip	Discrete TPM 2.0, TCG Certified	
Ethernet	Native Intel Ethernet Connection I219-V (Non-vPro) or I219-LM (vPro) via bundled or optional ThinkPad Ethernet Extension Adapter Gen 2							vPro (optional)	Intel vPro Technology	
WLAN + Bluetooth™	Intel Dual Band Wireless-AC 8265, Wi-Fi 2x2 802.11ac + Bluetooth 4.1, M.2 card * Intel 8265ac card supports BT4.2 but is limited to BT4.1 by Windows OS							Fingerprint reader	Optional: Touch style match on chip fingerprint reader on the palm rest, anti-spoofing technology	
WWAN (optional)	One of the following, configurable by model: • Integrated Mobile Broadband 4G LTE, Intel XMM™ 7262 (Fibocom L830-EB), M.2 card (EMEA only) • Integrated Mobile Broadband 4G LTE-A, Intel XMM™ 7360 (Fibocom L850-GL), M.2 card * For non-WWAN model, it means the model is NOT WWAN upgradable							NFC (optional)	Near Field Communication	
SIM card (opt)	Nano-SIM card slot, in the combo slot with microSD card reader, optional Verizon LTE (US) SIM card							Battery	Integrated Li-ion 48Wh battery, supports Rapid Charge (charge up to 80% in 1hr) with 65W AC adapter	
								Max battery life	MobileMark® 2014: 16.6 hr * Battery life varies significantly with settings, usage, & other factors	
								AC adapter	45W or 65W USB-C AC adapter	
								Operating system	Optional: Windows® 10 Home 64 or Windows 10 Pro 64	
								Limited warranty	One of the following, configurable by model: • 1-year depot repair service • 1-year depot with 2-year system board repair service • 3-year/1-yr battery depot repair service • 3-year/1-yr battery limited onsite service	
								Mil-Spec test	MIL-STD-810G military testing	
								Environment	EPEAT™ Gold (US only); ENERGY STAR® 6.1; RoHS-compliant	

Note: The specifications above may not be available in all regions.

Lenovo
September 2019



ThinkPad X390 Platform Specifications

Product Specifications Reference (PSREF)

Processor	8th Generation Intel® Core™ i3 / i5 / i7 Processor								Dimensions	Models	FHD Non-touch	HD / FHD Multi-touch	
	Processor Number	# of Cores	# of Threads	Base Frequency	Max Turbo Frequency	Cache	Memory Types	Processor Graphics		Carbon Fiber	311.9mm x 217.0mm x 16.5mm 12.28" x 8.54" x 0.65"	-	
Processor	or 10th Generation Intel Core i5 / i7 Processor (NOT available in EMEA)								Weight	PPS	312.0mm x 217.2mm x 16.9mm 12.28" x 8.55" x 0.67"	312mm x 217.2mm x 16.9mm 12.28" x 8.55" x 0.67"	
	Processor Number	# of Cores	# of Threads	Base Frequency	Max Turbo Frequency	Cache	Memory Types	Processor Graphics		Models	FHD Non-touch	HD	FHD Multi-touch
Processor	or 10th Generation Intel Core i5 / i7 Processor (NOT available in EMEA)								Case color	Black			
	Processor Number	# of Cores	# of Threads	Base Frequency	Max Turbo Frequency	Cache	Memory Types	Processor Graphics		Case material	<i>Display cover:</i> Carbon Fiber (FHD non-touch only) or PPS; <i>Bottom:</i> Magnesium/Aluminum		
Processor	or 10th Generation Intel Core i5 / i7 Processor (NOT available in EMEA)								Smart card reader	Optional: Smart card reader			
	Processor Number	# of Cores	# of Threads	Base Frequency	Max Turbo Frequency	Cache	Memory Types	Processor Graphics		Media reader	MicroSD card reader, in the combo slot with nano-SIM card		
Graphics	Intel UHD Graphics 620 or Intel UHD Graphics in processor; supports external digital monitor via HDMI or USB Type-C; supports three independent displays; Max resolution: 4096x2304@60Hz (Thunderbolt); 4096x2160@24Hz (HDMI)								Ports	Two USB 3.1 Gen 1 (one Always On), one USB 3.1 Type-C Gen 1 (with the function of Power Delivery and DisplayPort), one USB 3.1 Type-C Gen 2 / Thunderbolt 3 (with the function of PD and DP), HDMI 1.4b, Ethernet extension connector, combo slot of nano-SIM card (WWAN models) and microSD card reader, headphone / microphone combo jack, optional smart card reader, side docking connector, security keyhole			
Chipset	Intel SoC (System on Chip) platform									Monitor cable (optional)	* Depending on many factors, actual data transfer speed may be lower than theoretical speed		
Memory	4GB, 8GB, 16GB or 32GB / 2400MHz DDR4 / soldered to systemboard, no sockets * 32GB memory is NOT available for models with 10th Gen processor * Installed memory is actually 2666MHz but run at 2400MHz due to Intel limitation								Bundled Accy		HDMI to VGA: Lenovo HDMI to VGA Monitor Adapter USB-C to VGA: Lenovo USB-C to VGA Adapter USB-C to DP: Lenovo USB-C to DisplayPort Adapter		
Display	Size	Resolution	Type	Surface	Brightness	Aspect Ratio	Contrast Ratio	Color Gamut		Viewing Angle	Optional: ThinkPad Ethernet Extension Adapter Gen 2		
	13.3"	HD (1366x768)	TN	Anti-glare	250 nits	16:9	500:1	45%	90°	Camera (optional) One of the following, configurable by model:			
	13.3"	FHD (1920x1080)	IPS	Anti-glare	300 nits	16:9	800:1 (non-touch) 700:1 (multi-touch)	72%	170°	• HD720p camera with ThinkShutter camera privacy, fixed focus • IR camera and HD720p camera with ThinkShutter camera privacy, fixed focus			
Multi-touch (opt)	On-cell touch, supports 10-finger gesture (FHD only)								Audio support	HD Audio, Realtek® ALC3287 codec / stereo speakers, 1W x 2, Dolby® Audio™ Premium / optional dual array far-field microphone, headphone / microphone combo jack			
	Storage	• M.2 2280 SSD / SATA 6.0Gb/s • M.2 2280 SSD / PCIe NVMe, PCIe 3.0 x 4 • M.2 2242 SSD / PCIe NVMe, PCIe 3.0 x 2 • Intel Optane™ Memory H10 with Solid State Storage, M.2 2280, PCIe NVMe 3.0 x 4								Keyboard	6-row, spill-resistant, multimedia Fn keys, optional LED backlight		
Optical		None									UltraNav™	TrackPoint® pointing device and buttonless Mylar surface multi-touch touchpad	
	Ethernet	Native Intel Ethernet Connection I219-V (Non-vPro) or I219-LM (vPro) via bundled or optional ThinkPad Ethernet Extension Adapter Gen 2								Security		Power-on password, hard disk password, supervisor password, security keyhole	
WLAN (optional)		One of the following, configurable by model: • Intel Wireless-AC 9560, Wi-Fi 2x2 802.11ac + Bluetooth 5.0 • Intel Wi-Fi 6 AX200, Wi-Fi 2x2 802.11ax + Bluetooth 5.0									Security chip	Discrete TPM 2.0, TCG Certified	
	Bluetooth™	Bluetooth 5.0 wireless, integrated in Wi-Fi + Bluetooth combo adapter								System Mgt (opt)		Intel vPro Technology	
WWAN (optional)		One of the following, configurable by model: • Wireless WAN upgradable (special bid only in EMEA) • Integrated Mobile Broadband 4G LTE, Fibocom L830-EB, M.2 card (EMEA only) • Integrated Mobile Broadband 4G LTE-A, Fibocom L850-GL, M.2 card * For non-WWAN model, it means the model is NOT WWAN upgradable									Fingerprint reader	Optional: Touch style match on chip fingerprint reader on the palm rest	
	Battery	Integrated Li-ion 48Wh battery, supports Rapid Charge (charge up to 80% in 1hr) with 65W AC adapter								NFC (optional)		Near Field Communication	
Max battery life		MobileMark® 2014: 17.6 hr * Battery life varies significantly with settings, usage, & other factors									AC adapter	45W, 65W, or 65W slim USB-C AC adapter	
	Operating system	Optional: Windows® 10 Home 64 or Windows 10 Pro 64								Limited warranty (optional)		One of the following, configurable by model: • 1-year depot repair service • 1-year depot with 2-year system board repair service • 1-year limited onsite service • 3-year/1-yr battery depot repair service • 3-year/1-yr battery limited onsite service	
Mil-Spec test		MIL-STD-810G military testing									Environment	EPEAT™ Gold; ENERGY STAR® 7.1; RoHS-compliant	

Note: The specifications above may not be available in all regions.

Lenovo
November 2019



AMD

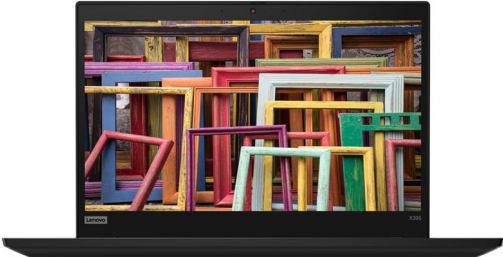

AMD



AMD



AMD



AMD



AMD

ThinkPad X395 Platform Specifications

Product Specifications Reference (PSREF)

Processor	AMD Ryzen™ PRO Mobile Processors with Radeon™ Vega Graphics								Dimensions WxDxH: 12.28" x 8.55" x 0.67"; 311.9mm x 217.2mm x 16.9mm	Weight	<table border="1"> <tr> <th>Models</th> <th>HD / FHD multi-touch</th> <th>FHD non-touch</th> <th>FHD Privacy Guard</th> </tr> <tr> <td></td> <td>2.91 lb / 1.32 kg</td> <td>2.82 lb / 1.28 kg</td> <td>3.01 lb / 1.37 kg</td> </tr> </table>				Models	HD / FHD multi-touch	FHD non-touch	FHD Privacy Guard		2.91 lb / 1.32 kg	2.82 lb / 1.28 kg	3.01 lb / 1.37 kg
	Models	HD / FHD multi-touch	FHD non-touch	FHD Privacy Guard																		
		2.91 lb / 1.32 kg	2.82 lb / 1.28 kg	3.01 lb / 1.37 kg																		
	Processor Number	# of Cores	# of Threads	Base Frequency	Max Turbo Frequency	Cache	Memory Controller	Processor Graphics			Case color Black Case material Display cover: PPS/GF; Bottom: Magnesium/Aluminum											
Ryzen 3 Pro 3300U	4	4	2.1 GHz	3.5 GHz	2MB L2 / 4MB L3	DDR4-2400	Radeon Vega 6 Graphics															
Ryzen 5 Pro 3500U	4	8	2.1 GHz	3.7 GHz	2MB L2 / 4MB L3		Radeon Vega 8 Graphics															
Ryzen 7 Pro 3700U	4	8	2.3 GHz	4.0 GHz	2MB L2 / 4MB L3		Radeon Vega 10 Graphics															
Graphics	AMD Radeon Vega 6, Vega 8, or Vega 10 Graphics in processor; supports external digital monitor via USB-C or HDMI; supports three independent displays; Max resolution: 4096x2304@60Hz (USB-C); 4096x2160@24Hz (HDMI)								Smart card reader	Optional: Smart card reader												
Chipset	AMD SoC (System on Chip) platform								Media reader	MicroSD card reader, in the combo slot with nano-SIM card												
Memory	8GB or 16GB / 2400MHz DDR4 / soldered to systemboard, no sockets * Installed memory is actually 2666MHz but run at 2400MHz due to AMD limitation								Ports	One USB 3.1 Gen 1 (Always On), one USB 3.1 Gen 2, two USB 3.1 Type-C Gen 2 (with the function of Power Delivery and DisplayPort), HDMI 2.0, Ethernet extension connector, combo slot of nano-SIM card (WWAN models) and microSD card reader, headphone / microphone combo jack, optional smart card reader, side docking connector, security keyhole * Depending on many factors, actual data transfer speed may be lower than theoretical speed												
Display	Size	Resolution	Type	Surface	Brightness	Aspect Ratio	Contrast Ratio	Color Gamut	Viewing Angle	Monitor cable (optional)	HDMI to VGA: Lenovo HDMI to VGA Monitor Adapter											
	13.3"	HD (1366x768)	TN	Anti-glare	250 nits	16:9	300:1	45%	90°	Bundled Accy	Optional: ThinkPad Ethernet Extension Adapter Gen 2											
	13.3"	FHD (1920x1080)	IPS	Anti-glare	300 nits	16:9	800:1 (non-touch) 700:1 (multi-touch)	72%	170°	Camera (optional)	One of the following, configurable by model: • HD720p camera with ThinkShutter camera privacy, fixed focus • IR camera and HD720p camera with ThinkShutter camera privacy, fixed focus											
	13.3"	FHD (1920x1080) ThinkPad Privacy Guard	IPS	Anti-glare	400 nits	16:9	1000:1	72%	178°	Audio support	HD Audio, Realtek ALC3287 codec / stereo speakers, 1W x 2, Dolby® Audio™ Premium / dual array far-field microphone, headphone / microphone combo jack											
Multi-touch (opt)	On-cell touch, supports 10-finger gesture (FHD only)								Keyboard	6-row, spill-resistant, multimedia Fn keys, optional LED backlight												
Storage	<ul style="list-style-type: none"> M.2 2280 SSD / SATA 6.0Gb/s M.2 2280 SSD / PCIe NVMe, PCIe 3.0 x 4 								UltraNav™	TrackPoint® pointing device and buttonless Mylar surface multi-touch touchpad												
Optical	None								Security	Power-on password, hard disk password, supervisor password, security keyhole												
Ethernet	Native Realtek® RTL8153 Gigabit Ethernet connection via bundled or optional ThinkPad Ethernet Extension Adapter Gen 2								Security chip	Discrete TPM 2.0, TCG Certified												
WLAN (optional)	Intel Wireless-AC 9260, Wi-Fi 2x2 802.11ac + Bluetooth 5.0								System Mgt	DASH Management												
Bluetooth™	Bluetooth 5.0 wireless, integrated in Wi-Fi + Bluetooth combo adapter								Fingerprint reader	Optional: Touch style match on chip fingerprint reader on the palm rest												
WWAN (optional)	One of the following, configurable by model: • Wireless WAN upgradable • Integrated Mobile Broadband 4G LTE-A, Fibocom L850-GL, M.2 card * For non-WWAN model, it means the model is NOT WWAN upgradable								NFC	None												
SIM card (opt)	Nano-SIM card slot, optional Verizon LTE (US) SIM card								Battery	Integrated Li-ion 48Wh battery, supports Rapid Charge (charge up to 80% in 1hr) with 65W AC adapter												
									Max battery life	MobileMark® 2014: 14.5 hr * Battery life varies significantly with settings, usage, & other factors												
									AC adapter	45W or 65W USB Type-C AC adapter												
									Operating system	Windows® 10 Home 64 or Windows 10 Pro 64												
									Limited warranty	One of the following, configurable by model: • 1-year depot repair service • 3-year/1-yr battery depot repair service												
									Mil-Spec test	MIL-STD-810G military testing												
									Environment	EPEAT™ Silver; ENERGY STAR® 7.1; RoHS-compliant												

Note: The specifications above may not be available in all regions.

Lenovo
July 2019

This publication was developed for products and services offered in the North America, E.M.E.A and Asia & Pacific countries. Lenovo may not offer the products, services or features discussed in this document in other countries. Lenovo may withdraw an offering at any time. Information is subject to change without notice. Consult your local representative for information on offerings available in your area.

Lenovo reserves the right to change specifications or other product information without notice. Lenovo is not responsible for photographic or typographical errors.

LENOVO PROVIDES THIS PUBLICATION "AS IS," WITHOUT WARRANTY OF ANY KIND, EITHER EXPRESS OR IMPLIED, INCLUDING THE IMPLIED WARRANTIES OF MERCHANTABILITY OR FITNESS FOR A PARTICULAR PURPOSE.

Some jurisdictions do not allow disclaimer of express or implied warranties in certain transactions, therefore this disclaimer may not apply to you.

Availability: All offers subject to availability. Lenovo reserves the right to alter product offerings and specifications at any time, without notice. Lenovo is not responsible for photographic or typographic errors.

General: Review key information provided by Microsoft that may apply to your system purchase, including details on Windows 10, Windows 8, Windows 7, and potential upgrades/downgrades. Lenovo makes no representation or warranty regarding third-party products or services.

Trademarks: Lenovo, ThinkPad, ThinkBook, ThinkCentre, ThinkStation, ThinkVision and the Lenovo logo are trademarks of Lenovo. Microsoft, Windows, Windows NT, and the Windows logo are trademarks of Microsoft Corporation. Ultrabook, Celeron, Celeron Inside, Core Inside, Intel, Intel Logo, Intel Atom, Intel Atom Inside, Intel Core, Intel Inside, Intel Inside Logo, Intel vPro, Itanium, Itanium Inside, Pentium, Pentium Inside, vPro Inside, Xeon, Xeon Phi, and Xeon Inside are trademarks of Intel Corporation in the U.S. and/or other countries. Other company, product or service names may be trademarks or service marks of others.

Warranty: For a copy of applicable warranties, write to: Lenovo Warranty Information, 1009 Think Place, Morrisville, NC, 27560. Lenovo makes no representation or warranty regarding third party products or services. The Lenovo Limited Warranty applies only to Lenovo hardware products purchased for your own use, and does not transfer upon resale.

Limited warranty: Support unrelated to a warranty issue may be subject to additional charges.

Lenovo Services:

Carry-in or Mail-in Service: Parts and labor repair coverage where the customer is responsible for shipping (including packaging) or delivery to authorized warranty provider or repair center.

Depot or Courier Service: Parts and labor repair coverage where shipping (including packaging) or delivery to the repair center is paid for by Lenovo.

Expedited Depot: Parts and labor coverage with expedited turnaround. Shipping (including packaging) or delivery to the repair center is paid for by Lenovo.

Onsite / In-home Service: Parts and labor repair coverage where labor is provided onsite at your place of business.

If Lenovo determines your product problem is covered by the product warranty and cannot be resolved over the telephone, a technician will be dispatched to arrive onsite, typically the next day.

International Warranty Service (IWS): PC repair coverage for customers who require a critical warranty repair while travelling internationally. Visit www.lenovo.com/internationalwarranty for details. Visit www.lenovo.com/warranty for Lenovo Warranty Services terms and conditions for complete details and restrictions.

Included software: may differ from its retail version (if available), and may not include user manuals or all program functionality. Software license agreements may apply.

Battery life: Battery life (and recharge times) will vary based on many factors including screen brightness, applications, features, power management, battery conditioning, and other customer preferences.

Visit <http://psref.lenovo.com/> for the latest version of Product Specifications Reference.

© Lenovo, 2019. All rights reserved.
Lenovo 1009 Think Place Morrisville, NC 27560 U.S.A.

Lenovo **ThinkPad** Tablets

PSREF



Product Specifications Reference

Version 550, October 2019

Visit <http://psref.lenovo.com> for the latest version

Contents

Cover	1
Contents	2
Summary Of Change	3
ThinkPad Tablets	4
ThinkPad X1 Tablet (3rd Gen)	4
ThinkPad X1 Tablet (3rd Gen) Platform Specifications	5
Legal Information	6

Summary of Changes

This section describes the technical changes made in this edition.

This edition might also include minor corrections and editorial changes which are not identified.

October 30, 2019 - Version 550

Additions in this update

▶ **New product(s)**

None

▶ **New model(s)**

None

▶ **Others**

ThinkPad X1 Tablet (3rd Gen) - Spec updated

Withdrawals in this update

▶ **Withdrawn product(s)**

None



ThinkPad X1 Tablet (3rd Gen) Platform Specifications

Product Specifications Reference (PSREF)

Processor	8th Generation Intel® Core™ i5 / i7 Processor								Control buttons Dock (<i>Optional</i>)	Power button, volume control button, reset switch • Thin Keyboard (Magnetic Detachable) • USB-C Dock Gen 2
	Processor Number	# of Cores	# of Threads	Base Frequency	Max Turbo Frequency	Cache	Memory Types	Processor Graphics		
	i5-8250U	4	8	1.6 GHz	3.4 GHz	6MB	LPDDR3-2133	Intel UHD Graphics 620		
	i5-8350U			1.7 GHz	3.6 GHz	6MB				
	i7-8550U			1.8 GHz	4.0 GHz	8MB				
i7-8650U	1.9 GHz			4.2 GHz	8MB					
Graphics	Intel UHD Graphics 620 in processor, supports external digital monitor via USB Type-C								Monitor cable Bundled Accy (<i>optional</i>)	None <i>USB-C to RJ45:</i> Lenovo USB-C to Ethernet Adapter <i>USB-C to VGA:</i> Lenovo USB C to VGA Plus Power Adapter <i>USB-C to HDMI:</i> Lenovo USB-C to HDMI Plus Power Adapter
Chipset	Intel SoC (System on Chip) platform								Camera	<i>Front camera:</i> 2.0-megapixel, fixed focus <i>Rear camera:</i> 8.0-megapixel, auto focus <i>Optional:</i> IR camera, fixed focus (mutually exclusive with NFC)
Memory	8GB or 16GB / 2133MHz LPDDR3, soldered to systemboard, no sockets								IR Camera	<i>Optional:</i> IR camera, fixed focus (mutually exclusive with NFC)
Display	13.0" (330mm) QHD+ (3000x2000), glossy, LED backlight, IPS, anti-fingerprint display with Corning® Gorilla® Glass, WideView (160° viewing), 400 nits, 3:2 aspect ratio, 1200:1 contrast ratio								Audio support	Realtek® ALC3278 codec / stereo speakers, 1W x 2 / dual array microphones, combo audio/microphone jack
Multi-touch Pen (<i>optional</i>)	Capacitive touch panel, supports ten-finger gesture								Pogo keyboard	Magnetic attached thin keyboard, with TrackPoint® pointing device and buttonless Mylar surface touchpad, multi-touch, backlit
Kick stand	Lenovo Pen Pro or Lenovo Active Pen (ThinkPad Pen Pro)								Keyboard color	Black
Storage	<i>One of the following, configurable by model:</i> • M.2 2280 SSD / SATA 6.0Gb/s • M.2 2280 SSD / PCIe NVMe, PCIe 3.0 x 4, 32Gb/s								Security	Kensington lock slot
Optical	None								Security chip	Discrete TPM 2.0 TCG Certified
Storage extension	One microSD card reader, in the combo slot with nano-SIM card, support USH-I, microSDHC, microSDXC								System Mgt (<i>opt</i>)	Intel vPro Technology
Ethernet	None								Fingerprint reader	<i>Optional:</i> Touch style Fingerprint reader
WLAN	Intel Dual Band Wireless-AC 8265, Wi-Fi 2x2 802.11ac + Bluetooth 4.2, M.2 card								NFC (<i>optional</i>)	Near Field Communication (mutually exclusive with IR camera)
Bluetooth™	Bluetooth 4.2 wireless, integrated in Wi-Fi + Bluetooth combo adapter								Battery	Integrated Li-Ion 42Wh battery
WWAN (<i>optional</i>)	Integrated Mobile Broadband 4G LTE-A, Qualcomm® Snapdragon™ X7 LTE-A (Sierra Wireless EM7455)								Max battery life	<i>MobileMark® 2014:</i> 9.5 hrs <i>* Battery life varies significantly with settings, usage, & other factors</i>
SIM card (<i>opt</i>)	Nano-SIM card slot, in the combo slot with microSD card reader								AC adapter	45W or 65W USB Type-C AC adapter
Dimensions	<i>Tablet only:</i> 11.97" x 8.9" x 0.35"; 304.1mm x 226mm x 8.9mm <i>Tablet + keyboard:</i> 11.97" x 8.9" x 0.57"; 304.1mm x 226mm x 14.4mm								Light sensor	Ambient Light Sensor
Weight	<i>Tablet only:</i> starting at 1.96 lb / 0.89kg <i>Tablet+ keyboard:</i> starting at 2.8 lb / 1.27kg								G-sensor	3D accelerometer
Case color	Black								Gyroscope	3D gyrometer
Case material	Magnesium/Aluminum								GPS (<i>optional</i>)	GPS function is integrated into WWAN module
Ports	Two USB 3.1 Type-C Gen 1 ((with the function of Power Delivery and DisplayPort), one Pogo keyboard connector, one Pen holder slot, headphone / microphone combo jack, combo slot of nano-SIM card (WWAN models) and microSD card reader <i>* Depending on many factors, actual data transfer speed may be lower than theoretical speed</i>								Preload	<i>One of the following, configurable by model:</i> • Windows® 10 Pro 64 • Windows 10 Home 64
									Limited warranty	<i>One of the following, configurable by model:</i> • 1-year depot repair service • 1-year depot with 2-year system board service • 3-year/1-yr battery depot repair service • 3-year/1-yr battery limited onsite service
									Mil-Spec test	MIL-STD-810G military testing
									Environment	EPEAT™ Silver, GREENGUARD, Low Halogen, RoHS

This publication was developed for products and services offered in the North America, E.M.E.A and Asia & Pacific countries. Lenovo may not offer the products, services or features discussed in this document in other countries. Lenovo may withdraw an offering at any time. Information is subject to change without notice. Consult your local representative for information on offerings available in your area.

Lenovo reserves the right to change specifications or other product information without notice. Lenovo is not responsible for photographic or typographical errors.

LENOVO PROVIDES THIS PUBLICATION "AS IS," WITHOUT WARRANTY OF ANY KIND, EITHER EXPRESS OR IMPLIED, INCLUDING THE IMPLIED WARRANTIES OF MERCHANTABILITY OR FITNESS FOR A PARTICULAR PURPOSE.

Some jurisdictions do not allow disclaimer of express or implied warranties in certain transactions, therefore this disclaimer may not apply to you.

Availability: All offers subject to availability. Lenovo reserves the right to alter product offerings and specifications at any time, without notice. Lenovo is not responsible for photographic or typographic errors.

General: Review key information provided by Microsoft that may apply to your system purchase, including details on Windows 10, Windows 8, Windows 7, and potential upgrades/downgrades. Lenovo makes no representation or warranty regarding third-party products or services.

Trademarks: Lenovo, ThinkPad, ThinkBook, ThinkCentre, ThinkStation, ThinkVision and the Lenovo logo are trademarks of Lenovo. Microsoft, Windows, Windows NT, and the Windows logo are trademarks of Microsoft Corporation. Ultrabook, Celeron, Celeron Inside, Core Inside, Intel, Intel Logo, Intel Atom, Intel Atom Inside, Intel Core, Intel Inside, Intel Inside Logo, Intel vPro, Itanium, Itanium Inside, Pentium, Pentium Inside, vPro Inside, Xeon, Xeon Phi, and Xeon Inside are trademarks of Intel Corporation in the U.S. and/or other countries. Other company, product or service names may be trademarks or service marks of others.

Warranty: For a copy of applicable warranties, write to: Lenovo Warranty Information, 1009 Think Place, Morrisville, NC, 27560. Lenovo makes no representation or warranty regarding third party products or services. The Lenovo Limited Warranty applies only to Lenovo hardware products purchased for your own use, and does not transfer upon resale.

Limited warranty: Support unrelated to a warranty issue may be subject to additional charges.

Lenovo Services:

Carry-in or Mail-in Service: Parts and labor repair coverage where the customer is responsible for shipping (including packaging) or delivery to authorized warranty provider or repair center.

Depot or Courier Service: Parts and labor repair coverage where shipping (including packaging) or delivery to the repair center is paid for by Lenovo.

Expedited Depot: Parts and labor coverage with expedited turnaround. Shipping (including packaging) or delivery to the repair center is paid for by Lenovo.

Onsite / In-home Service: Parts and labor repair coverage where labor is provided onsite at your place of business.

If Lenovo determines your product problem is covered by the product warranty and cannot be resolved over the telephone, a technician will be dispatched to arrive onsite, typically the next day.

International Warranty Service (IWS): PC repair coverage for customers who require a critical warranty repair while travelling internationally. Visit www.lenovo.com/internationalwarranty for details. Visit www.lenovo.com/warranty for Lenovo Warranty Services terms and conditions for complete details and restrictions.

Included software: may differ from its retail version (if available), and may not include user manuals or all program functionality. Software license agreements may apply.

Battery life: Battery life (and recharge times) will vary based on many factors including screen brightness, applications, features, power management, battery conditioning, and other customer preferences.

Visit <http://psref.lenovo.com/> for the latest version of Product Specifications Reference.

© Lenovo, 2019. All rights reserved.
Lenovo 1009 Think Place Morrisville, NC 27560 U.S.A.

Lenovo™ **ThinkCentre**®

PSREF



Product Specifications Reference

Version 551, November 2019

Visit <http://psref.lenovo.com> for the latest version

Contents

Cover		
Contents		
Summary Of Change		
All-In-One		
ThinkCentre M810z AIO		
ThinkCentre M810z AIO Platform Specifications		
ThinkCentre M820z AIO		
ThinkCentre M820z AIO Platform Specifications		
ThinkCentre M910z AIO		
ThinkCentre M910z AIO Platform Specifications		
ThinkCentre M920z AIO		
ThinkCentre M920z AIO Platform Specifications		
Nano Desktops		
ThinkCentre M90n-1 Nano		
ThinkCentre M90n-1 Nano Platform Specifications		
ThinkCentre M90n-1 Nano IoT		
ThinkCentre M90n-1 Nano IoT Platform Specifications		
SFF Desktops		
ThinkCentre M710 SFF		
ThinkCentre M710 SFF Platform Specifications		
ThinkCentre M710e SFF		
ThinkCentre M710e SFF Platform Specifications		
ThinkCentre M715 SFF		
ThinkCentre M715 SFF Platform Specifications		
ThinkCentre M720 SFF		
ThinkCentre M720 SFF Platform Specifications		
ThinkCentre M720e SFF		
ThinkCentre M720e SFF Platform Specifications		
ThinkCentre M725 SFF		
ThinkCentre M725 SFF Platform Specifications		
ThinkCentre M75s SFF		
ThinkCentre M75s SFF Platform Specifications		
ThinkCentre M910 SFF		
ThinkCentre M910 SFF Platform Specifications		
ThinkCentre M920 SFF		
ThinkCentre M920 SFF Platform Specifications		
1 ThinkCentre M920 SFF Platform Specifications	35	
2 Tiny Desktops	36	
4 ThinkCentre M600 Tiny	36	
ThinkCentre M600 Tiny Platform Specifications	37	
6 ThinkCentre M600 Tiny Thin Client	38	
ThinkCentre M600 Tiny Thin Client Platform Specifications	39	
8 ThinkCentre M625 Tiny	40	
ThinkCentre M625 Tiny Platform Specifications	41	
10 ThinkCentre M625 Tiny Thin Client	42	
ThinkCentre M625 Tiny Thin Client Platform Specifications	43	
12 ThinkCentre M630e Tiny	44	
ThinkCentre M630e Tiny Platform Specifications	45	
14 ThinkCentre M710 Tiny	46	
ThinkCentre M710 Tiny Platform Specifications	47	
15 ThinkCentre M715 Tiny (2nd Gen)	48	
ThinkCentre M715 Tiny (2nd Gen) Platform Specifications	49	
17 ThinkCentre M715 Tiny Thin Client	50	
ThinkCentre M715 Tiny Thin Client Platform Specifications	51	
18 ThinkCentre M715 Tiny Thin Client (2nd Gen)	52	
ThinkCentre M715 Tiny Thin Client (2nd Gen) Platform Specifications	53	
20 ThinkCentre M720 Tiny	54	
ThinkCentre M720 Tiny Platform Specifications	55	
22 ThinkCentre M75q Tiny	56	
ThinkCentre M75q Tiny Platform Specifications	57	
24 ThinkCentre M910 Tiny	58	
ThinkCentre M910 Tiny Platform Specifications	59	
26 ThinkCentre M920 Tiny	60	
ThinkCentre M920 Tiny Platform Specifications	61	
28 ThinkCentre M920x Tiny	62	
ThinkCentre M920x Tiny Platform Specifications	63	
30 Tiny-In-One	64	
31 ThinkCentre Tiny-In-One 22 Gen3	64	
ThinkCentre Tiny-In-One 22 Gen3 Platform Specifications	65	
33 ThinkCentre Tiny-In-One 24 Gen3	66	
ThinkCentre Tiny-In-One 24 Gen3 Platform Specifications	67	

Contents

ThinkCentre Tiny-In-One 27	68
ThinkCentre Tiny-In-One 27 Platform Specifications	69
Tower Desktops	70
ThinkCentre M710 Tower	70
ThinkCentre M710 Tower Platform Specifications	71
ThinkCentre M715 Tower	72
ThinkCentre M715 Tower Platform Specifications	73
ThinkCentre M720 Tower	74
ThinkCentre M720 Tower Platform Specifications	75
ThinkCentre M910 Tower	76
ThinkCentre M910 Tower Platform Specifications	77
ThinkCentre M920 Tower	78
ThinkCentre M920 Tower Platform Specifications	79
Legal Information	80

Contents

Summary of Changes	1	ThinkCentre M800z (10EW) - TopSeller	70
ThinkCentre Chromebox	2	ThinkCentre M800z (10ET) - TopSeller	71
ThinkCentre Chromebox Platform Specifications	3	ThinkCentre M800z (10EW)	72
ThinkCentre Chromebox (10H8) - TIO	4	ThinkCentre M800z (10EV)	73
ThinkCentre Chromebox (10H9) - TIO (TopSeller)	5	ThinkCentre M900 Tiny	74
ThinkCentre Chromebox (10H6) - TIO	6	ThinkCentre M900 Tiny Platform Specifications	75
ThinkCentre Chromebox (10H2)	7	ThinkCentre M900 Tiny (10FM) - TopSeller	76
ThinkCentre Chromebox (10H3) - TopSeller	8	ThinkCentre M900 Tiny (10FM) - TopSeller - II	77
ThinkCentre Chromebox (10H4)	9	ThinkCentre M900 Tiny (10NE) - TopSeller	78
ThinkCentre Chromebox (10H5) - TopSeller	10	ThinkCentre M900 Tiny (10NE) - TopSeller - II	79
ThinkCentre Tiny-in-One 22	11	ThinkCentre M900 Tiny (10FL)	80
ThinkCentre Tiny-in-One (TIO) 22	12	ThinkCentre M900 SFF	81
ThinkCentre Tiny-in-One 23	13	ThinkCentre M900 SFF Platform Specifications	82
ThinkCentre Tiny-in-One (TIO) 23	14	ThinkCentre M900 SFF (10FH) - TopSeller	83
ThinkCentre Tiny-in-One 24	15	ThinkCentre M900 SFF (10FG)	84
ThinkCentre Tiny-in-One (TIO) 24	16	ThinkCentre M900 Tower	85
ThinkCentre M600 Tiny	17	ThinkCentre M900 Tower Platform Specifications	86
ThinkCentre M600 Tiny Platform Specifications	18	ThinkCentre M900 Tower (10FD) - TopSeller	87
ThinkCentre M600 Tiny (10G9) - TopSeller	19	ThinkCentre M900 Tower (10FD) - TopSeller - II	88
ThinkCentre M600 Tiny (10KH) - Thin Client (TopSeller)	20	ThinkCentre M900 Tower (10FC)	89
ThinkCentre M600 Tiny (10GK) - Thin Client (TopSeller)	21	ThinkCentre M900z All-In-One	90
ThinkCentre M600 Tiny (10KK) - TIO (Thin Client) - TopSeller	22	ThinkCentre M900z Platform Specifications	91
ThinkCentre M600 Tiny (10GA) - OID	23	ThinkCentre M900z (10F3) - TopSeller	92
ThinkCentre M600 Tiny (10G8) - OID	24	ThinkCentre M900z (10F2) - TopSeller	93
ThinkCentre M600 Tiny (10GE) - TIO (OID)	25	ThinkCentre M900z (10F5)	94
ThinkCentre M600 Tiny (10GC) - TIO (OID)	26	ThinkCentre M900z (10F4)	95
ThinkCentre M600 Tiny (10KG) - Thin Client	27	ThinkCentre X1	96
ThinkCentre M600 Tiny (10GJ) - Thin Client	28	ThinkCentre X1 Platform Specifications	97
ThinkCentre M600 Tiny (10KJ) - TIO (Thin Client)	29	ThinkCentre X1 (10JX) - TopSeller	98
ThinkCentre M700 Tiny	30	ThinkCentre X1 (10KE) - TopSeller	99
ThinkCentre M700 Tiny Platform Specifications	31	ThinkCentre X1 (10KF)	100
ThinkCentre M700 Tiny (10HY) - TopSeller	32	ThinkCentre X1 (10HU)	101
ThinkCentre M700 Tiny (10HY) - TopSeller - II	33	ThinkCentre X1 (10K0) - TopSeller	102
ThinkCentre M700 Tiny (10J0)	34	ThinkCentre E63z All-In-One	103
ThinkCentre M700 SFF	35	ThinkCentre E63z Platform Specifications	104
ThinkCentre M700 SFF Platform Specifications	36	ThinkCentre E63z (10D4) - TopSeller	105
ThinkCentre M700 SFF (10GT) - TopSeller	37	ThinkCentre E63z (10D6) - Multi-touch (TopSeller)	106
ThinkCentre M700 SFF (10GT) - TopSeller - II	38	ThinkCentre E63z (10EK)	107
ThinkCentre M700 SFF (10GS)	39	ThinkCentre E63z (10E0) - TopSeller	108
ThinkCentre M700 Tower	40	ThinkCentre E63z (10EL) - TopSeller	109
ThinkCentre M700 Tower Platform Specifications	41	ThinkCentre E63z (10E1)	110
ThinkCentre M700 Tower (10GR) - TopSeller	42	ThinkCentre E63z (10E1) - Win10	111
ThinkCentre M700 Tower (10GQ)	43	ThinkCentre E63z (10EM)	112
ThinkCentre M700z All-In-One	44	ThinkCentre E63z (10E2) - Multi-touch (TopSeller)	113
ThinkCentre M700z Platform Specifications	45	ThinkCentre E63z (10E2) - Multi-touch (TopSeller) - Win10	114
ThinkCentre M700z (10EY) - TopSeller	46	ThinkCentre E63z (10E3) - Multi-touch	115
ThinkCentre M700z (10F1)	47	ThinkCentre E73 SFF and Tower	116
ThinkCentre M79 SFF and Tower	48	ThinkCentre E73 SFF (10AU) - TopSeller	117
ThinkCentre M79 SFF Platform Specifications	49	ThinkCentre E73 SFF (10AU) - TopSeller - II	118
ThinkCentre M79 Tower Platform Specifications	50	ThinkCentre E73 SFF (10AU) - TopSeller - III	119
ThinkCentre M79 SFF (10CU) - TopSeller	51	ThinkCentre E73 SFF (10AW) - ES 6.0 (TopSeller)	120
ThinkCentre M79 SFF (10JB) - TopSeller	52	ThinkCentre E73 SFF (10AW) - ES 6.0 (TopSeller) - II	121
ThinkCentre M79 SFF (10CT)	53	ThinkCentre E73 SFF (10AW) - ES 6.0 (TopSeller) - III	122
ThinkCentre M79 SFF (10JA)	54	ThinkCentre E73 SFF (10DU) - ES 6.0 (TopSeller)	123
ThinkCentre M79 Tower (10CR) - TopSeller	55	ThinkCentre E73 SFF (10DU) - ES 6.0 (TopSeller) - II	124
ThinkCentre M79 Tower (10J7) - TopSeller	56	ThinkCentre E73 SFF (10DU) - ES 6.0 (TopSeller) - III	125
ThinkCentre M79 Tower (10CQ)	57	ThinkCentre E73 SFF (10DU) - ES 6.0 (Win10) - TopSeller	126
ThinkCentre M79 Tower (10J6)	58	Withdrawn Product Books	127
ThinkCentre M800 SFF	59	Legal Information and Trademarks	128
ThinkCentre M800 SFF Platform Specifications	60		
ThinkCentre M800 SFF (10FY) - TopSeller	61		
ThinkCentre M800 SFF (10FX)	62		
ThinkCentre M800 Tower	63		
ThinkCentre M800 Tower Platform Specifications	64		
ThinkCentre M800 Tower (10FW) - TopSeller	65		
ThinkCentre M800 Tower (10FV)	66		
ThinkCentre M800z All-In-One	67		
ThinkCentre M800z Platform Specifications	68		
ThinkCentre M800z (10EU) - TopSeller	69		

Summary of Changes

This section describes the technical changes made in this edition.

This edition might also include minor corrections and editorial changes which are not identified.

September 2019 - Version 549

Additions in this update

- ▶ **New product(s)**
 - ThinkCentre M75s SFF
 - ThinkCentre M720e SFF
- ▶ **New model(s)**
 - None
- ▶ **Others**
 - None

Withdrawals in this update

- ▶ **Withdrawn product(s)**
 - None
- ▶ **Withdrawn model(s)**
 - None



ThinkCentre M810z Platform Specifications

Product Specifications Reference (PSREF)

Processor	Intel® Celeron®, Intel Pentium®, or 6th / 7th Gen Intel Core™ i3 / i5 / i7 Processor						Security features	<ul style="list-style-type: none"> Security slot (in rear for attachment of optional Kensington® MicroSaver® cable; Kensington lock also locks chassis) Smart USB protection, allows keyboard/mouse only, blocks all storage devices Optional cable lock to physically lock keyboard and mouse 	<ul style="list-style-type: none"> Power-on, admin, hard disk password Boot sequence control Boot without keyboard and mouse Individual USB port disablement Optional Chassis intrusion switch
	Processor	Cores / Threads	Frequency Base/Max(GHz)	Cache	Memory Support (Up to)	Integrated Graphics			
	Pentium G4400	2 / 2	3.3G	3 MB	DDR4-2133	HD 510			
	Pentium G4560	2 / 4	3.5G	3 MB	DDR4-2400	HD 610			
	Pentium G4600	2 / 4	3.6G	3 MB	DDR4-2400	HD 630			
	Core i3-6100	2 / 4	3.7G	3 MB	DDR4-2133	HD 530			
	Core i5-6500	4 / 4	3.2G / 3.6G	6 MB	DDR4-2133	HD 530			
	Core i7-6700	4 / 8	3.4G / 4.0G	8 MB	DDR4-2133	HD 530			
	Core i3-7100	2 / 4	3.9G	3 MB	DDR4-2400	HD 630			
	Core i5-7400	4 / 4	3.0G / 3.5G	6 MB	DDR4-2400	HD 630			
Core i5-7500	4 / 4	3.4G / 3.8G	6 MB	DDR4-2400	HD 630				
Core i5-7600	4 / 4	3.5G / 4.1G	6 MB	DDR4-2400	HD 630				
Core i7-7700	4 / 8	3.6G / 4.2G	8 MB	DDR4-2400	HD 630				
Memory	32GB max, DDR4-2400*, two 260-pin SO-DIMM sockets, dual-channel capable * System clocks down for the processors with lower memory controller						Keyboard	<i>Some:</i> Lenovo Calliope Keyboard (USB connector), black <i>Some:</i> Lenovo Traditional Keyboard (USB connector), black <i>Some:</i> Lenovo Calliope Wireless Keyboard (2.4GHz via USB receiver), black <i>Some:</i> Lenovo Calliope Mouse (USB connector), black <i>Some:</i> Lenovo Calliope Wireless Mouse (2.4GHz via USB receiver), black	Mouse <ul style="list-style-type: none"> Business black color Toolless stand Support VESA mount (100mm)
Storage	<i>Some:</i> Hard Drive / SATA 6.0Gb/s, 2.5", 5400 rpm or 7200 rpm <i>Some:</i> Solid State Drive (SSD) / SATA 6.0Gb/s, 2.5" <i>Some:</i> M.2 Solid State Drive (SSD) / PCIe NVMe, PCIe 3.0 x 4, 32Gb/s <i>Some:</i> Intel Optane™ Memory (models with 7th gen Core processor), M.2 <i>Some:</i> DVD-ROM SATA 1.5Gb/s Drive, slim (9.5mm) <i>Some:</i> DVD Burner (DVD±RW), SATA 1.5Gb/s Drive, slim (9.5mm)								
Optical	Optional 9-in-1 media card reader								
Media reader	Optional 9-in-1 media card reader								
Graphics	Intel HD Graphics 510/530/610/630 in processor, uses main memory, DirectX® 12, external monitor support via DisplayPort™; <i>Max resolution:</i> 4096x2304 (DP)@60Hz, 1920x1080 (Panel)@60Hz 21.5" (546.1mm) Full HD 1080p (1920x1080) TFT color , MVA panel, wide viewing angle (+/- 89°), LED backlight, 250 nits, 16:9 aspect ratio, 1000:1 contrast ratio, anti-glare, support Low Blue Light Mode								
Display	Optional Projected Capacitive Touch (PCT) technology, supports 10-point touch Optional 1080p camera, fixed focus, with dual microphone, LED indicator, physical switch on/off								
Multi-touch	Physical buttons for Microphone mute, brightness up/down, and power on/off								
Camera	Physical buttons for Microphone mute, brightness up/down, and power on/off								
Controls	Physical buttons for Microphone mute, brightness up/down, and power on/off								
Chipset	Intel B250 Chipset								
Rear ports*	Four USB 3.1 Gen1, ethernet (RJ-45), DisplayPort, optional serial (9-pin), Two USB 3.1 Gen1 (one is Always On and fast charge), optional card reader, one headphone / microphone combo jack (3.5mm)								
Side ports*	* Depending on many factors, actual data transfer speed may be lower than theoretical speed								
M.2 card slot	Two M.2 Card slots (one for WLAN, one for SSD/Optane)								
Audio support	High Definition (HD) Audio, Realtek ALC233 / two internal speakers (2W x 2), Dolby® Audio™ certified								
WLAN ¹³	<i>Some:</i> 11ac wireless, M.2 Card, Qualcomm Atheros QCA9377A (dual band), Wi-Fi + Bluetooth 4.1 combo adapter, 1x1 <i>Some:</i> 11ac wireless, M.2 Card, Qualcomm Atheros QCA6174A (dual band), Wi-Fi + Bluetooth 4.1 combo adapter, 2x2 <i>Some:</i> 11ac wireless, M.2 Card, Intel Dual Band Wireless-AC 3165, Wi-Fi + Bluetooth 4.1 combo adapter, 1x1 <i>Some:</i> 11ac wireless, M.2 Card, Intel Dual Band Wireless-AC 8265, Wi-Fi + Bluetooth 4.1 combo adapter, 2x2								
Bluetooth™	<i>Some:</i> Bluetooth 4.1 wireless, integrated in Wi-Fi + Bluetooth combo adapter								
Ethernet	Gigabit ethernet, Realtek RTL8111G, Wake on LAN®								
Manageability	None								
Security chip	TPM (Trusted Platform Module) 2.0, TCG Certified * Downgrade to TPM1.2 for the models with Win10 DG Win7 32 OS								
Power supply	150 watts, autosensing, 85% PSU								
Limited warranty ³	<i>Some:</i> 1-year or 3-year, depot repair service / service upgrades available <i>Some:</i> 1-year or 3-year, limited onsite service / service upgrades available								
Preload	Preloaded operating system <i>Some:</i> Windows® 7 Professional 32/64 preinstalled through downgrade rights in Windows 10 Pro 64-bit <i>Some:</i> Windows 10 Pro 64-bit <i>Some:</i> Windows 10 Home 64-bit								
Environment	Preloaded applications (only some listed) <ul style="list-style-type: none"> Microsoft Office preloaded; purchase a product key to activate - Only for Window 10 Lenovo Companion - Only for Window 7 Lenovo Solution Center Lenovo ThinkVantage Tools ThinkVantage System Update Create Recovery Media Adobe® Reader® Cyberlink PowerDVD Create (DVD±RW) 								
Environment	EPEAT™ Gold rating (North America); ENERGY STAR® 6.1; TCO AIO Computer Certified; ErP Lot 3; GREENGUARD® certified; RoHS-compliant								
MIL-SPEC test	MIL-STD-810G military certification (Low Pressure [Altitude], High Temperature, Low Temperature, Temperature Shock, Humidity, Sand and Dust, Vibration, Shock)								
Accessories	For compatible accessories, please go to http://www.lenovoquickpick.com								

See footnotes for more detailed information



ThinkCentre M820z Platform Specifications

Product Specifications Reference (PSREF)

Processor	Intel® Celeron®, Intel Pentium®, or 8th / 9th Gen Intel Core™ i3 / i5 / i7 / i9 series						WLAN <i>Some:</i> 11ac wireless, M.2 Card, Realtek RTL8821CE (dual band), Wi-Fi + Bluetooth 4.2 combo adapter, 1x1 <i>Some:</i> 11ac wireless, M.2 Card, Realtek RTL8822BE (dual band), Wi-Fi + Bluetooth 4.2 combo adapter, 2x2 <i>Some:</i> 11ac wireless, M.2 Card, Intel Dual Band Wireless-AC 3165, Wi-Fi + Bluetooth 4.2 combo adapter, 1x1 <i>Some:</i> 11ac wireless, M.2 Card, Intel Dual Band Wireless-AC 8265, Wi-Fi + Bluetooth 4.2 combo adapter, 2x2 Bluetooth™ Ethernet <i>Some:</i> Bluetooth 4.2 wireless, integrated in Wi-Fi + BT combo adapter Gigabit ethernet, Realtek RTL8111G, Wake on LAN®
	Processor	Cores / Threads	Frequency Base/Max(GHz)	Cache	Memory Support (Up to)	Integrated Graphics	
	Celeron G4900	2 / 2	3.1G	2 MB	DDR4-2400	UHD 610	
	Celeron G4920	2 / 2	3.2G	2 MB	DDR4-2400	UHD 610	
	Celeron G4930	2 / 2	3.2G	2 MB	DDR4-2400	UHD 610	
	Celeron G4950	2 / 2	3.3G	2 MB	DDR4-2400	UHD 610	
	Pentium Gold G5400	2 / 4	3.7G	4 MB	DDR4-2400	UHD 610	
	Pentium Gold G5420	2 / 4	3.8G	4 MB	DDR4-2400	UHD 610	
	Pentium Gold G5500	2 / 4	3.8G	4 MB	DDR4-2400	UHD 630	
	Pentium Gold G5600	2 / 4	3.9G	4 MB	DDR4-2400	UHD 630	
	Pentium Gold G5620	2 / 4	4.0G	4 MB	DDR4-2400	UHD 630	
	Core i3-8100	4 / 4	3.6G	6 MB	DDR4-2400	UHD 630	
	Core i3-8300	4 / 4	3.7G	8 MB	DDR4-2400	UHD 630	
	Core i5-8400	6 / 6	2.8G / 4.0G	9 MB	DDR4-2666	UHD 630	
	Core i5-8500	6 / 6	3.0G / 4.1G	9 MB	DDR4-2666	UHD 630	
	Core i5-8600	6 / 6	3.1G / 4.3G	9 MB	DDR4-2666	UHD 630	
	Core i7-8700	6 / 12	3.2G / 4.6G	12 MB	DDR4-2666	UHD 630	
	Core i3-9100	4 / 4	3.6G / 4.2G	6 MB	DDR4-2400	UHD 630	
	Core i3-9300	4 / 4	3.7G / 4.3G	8 MB	DDR4-2400	UHD 630	
	Core i5-9400	6 / 6	2.9G / 4.1G	9 MB	DDR4-2666	UHD 630	
Core i5-9500	6 / 6	3.0G / 4.4G	9 MB	DDR4-2666	UHD 630		
Core i5-9600	6 / 6	3.1G / 4.6G	9 MB	DDR4-2666	UHD 630		
Core i7-9700	8 / 8	3.0G / 4.7G	12 MB	DDR4-2666	UHD 630		
Core i9-9900	8 / 16	3.1G / 5.0G	16 MB	DDR4-2666	UHD 630		
Memory	32GB max (16GB SO-DIMM only available via special bid models), DDR4-2666*, two 260-pin SO-DIMM sockets, dual-channel capable * System clocks down for the processors with lower memory controller						
Storage	<i>Some:</i> Hard Drive / SATA 6.0Gb/s, 2.5", 5400 rpm or 7200 rpm <i>Some:</i> Solid State Drive (SSD) / SATA 6.0Gb/s, 2.5" <i>Some:</i> M.2 SSD (2242 / 2280) / PCIe NVMe, PCIe 3.0 x2 or PCIe 3.0 x4 <i>Some:</i> Intel Optane™ Memory (not support Celeron / Pentium Processor), M.2 <i>Some:</i> DVD-ROM SATA 1.5Gb/s Drive, slim (9.0mm) <i>Some:</i> DVD Burner (DVD±RW), SATA 1.5Gb/s Drive, slim (9.0mm)						
Optical	<i>Some:</i> DVD Burner (DVD±RW), SATA 1.5Gb/s Drive, slim (9.0mm)						
Media reader	Optional 3-in-1 media card reader						
Graphics	Intel HD Graphics 610/630 in processor, uses main memory, DirectX® 12, external monitor support via DisplayPort™; <i>Max resolution:</i> 4096x2304 (DP) @60Hz, 1920x1080 (Panel) @60Hz						
Display	21.5" (546.1mm) Full HD 1080p (1920x1080) TFT color , Borderless design, TFT-LCD, In-Plane Switching technology (In-Plane Switching may refer to IPS, PLS, ADS, AHVA, and AA), wide viewing angle (+/- 89°), LED backlight, 250 nits, 16:9 aspect ratio, 1000:1 contrast ratio, anti-glare, support Low Blue Light Mode Optional multi-touch, supports 10-point, AIT (Advanced In-cell Touch) technology Optional 1080p camera, with dual microphone, LED indicator, physical switch on/off, supports multi-degree rotation (horizontal 0° to 180°, vertical -25° to 25°)						
Multi-touch							
Camera							
Controls	Physical buttons on side for microphone mute and power on/off						
Chipset	Intel B360 Chipset						
Rear ports*	Four USB 3.1 Gen1 (one supports Smart Power On), one ethernet (RJ-45), one DisplayPort, one optional serial (9-pin),						
Side ports*	one USB 3.1 Gen2 (one is Always On and fast charge), one USB 3.1 Type-C Gen 1, one optional card reader, one headphone / microphone combo jack (3.5mm) * Depending on many factors, actual data transfer speed may be lower than theoretical speed						
M.2 card slot	Two M.2 Card slots (one for WLAN, one for SSD/Optane)						
Audio support	High Definition (HD) Audio, Realtek ALC233 / two internal speakers (2W x 2), Dolby® Audio™ Premium						
Power supply	150 watts, autosensing, 90% PSU						
Limited warranty ³	<i>Some:</i> 1-year or 3-year, depot repair service / service upgrades available <i>Some:</i> 1-year or 3-year, limited onsite service / service upgrades available						
Preload	Preloaded operating system <i>Some:</i> Windows 10 Pro 64-bit <i>Some:</i> Windows 10 Home 64-bit Preloaded applications (only some listed) • Lenovo Vantage • Microsoft Office preloaded; purchase a product key to activate • Cyberlink PowerDVD (only for models with DVD / DVD±RW) • Cyberlink Power2GO (only for models with DVD±RW) • LinkedIn						
Environment	ENERGY STAR® 7.0*, EPEAT™ Silver rating* (*not for non-OS models), ErP Lot 3, TCO AIO Computer certified, GREENGUARD® certified, TUV Eye comfort certified (for Full Function Monitor Stand only), TUV Low Blue Light certified, TUV Ultra Low Noise certified (on some models), RoHS-compliant						
MIL-SPEC test	MIL-STD-810G military certification (Low Pressure [Altitude], High Temperature, Low Temperature, Temperature Shock, Humidity, Sand and Dust, Vibration, Shock, Fungus)						
Accessories	For compatible accessories, please go to http://smartfind.lenovo.com						

Note: The specifications above may not be available in all regions.

Lenovo, June 2019



ThinkCentre M910z Platform Specifications

Product Specifications Reference (PSREF)

Processor	Intel® Celeron®, Intel Pentium®, or 6th / 7th Gen Intel Core™ i3 / i5 / i7 Processor	Security chip	TPM (Trusted Platform Module) 2.0, TCG Certified * Downgrade to TPM1.2 for the models with Win10 DG Win7 32 OS																																																						
	<table border="1"> <thead> <tr> <th>Processor</th> <th>Cores / Threads</th> <th>Frequency Base/Max(GHz)</th> <th>Cache</th> <th>Memory Support (Up to)</th> <th>Integrated Graphics</th> </tr> </thead> <tbody> <tr> <td>Core i3-6100</td> <td>2 / 4</td> <td>3.7G</td> <td>3 MB</td> <td>DDR4-2133</td> <td>HD 530</td> </tr> <tr> <td>Core i5-6500</td> <td>4 / 4</td> <td>3.2G / 3.6G</td> <td>6 MB</td> <td>DDR4-2133</td> <td>HD 530</td> </tr> <tr> <td>Core i7-6700</td> <td>4 / 8</td> <td>3.4G / 4.0G</td> <td>8 MB</td> <td>DDR4-2133</td> <td>HD 530</td> </tr> <tr> <td>Core i3-7100</td> <td>2 / 4</td> <td>3.9G</td> <td>3 MB</td> <td>DDR4-2400</td> <td>HD 630</td> </tr> <tr> <td>Core i5-7400</td> <td>4 / 4</td> <td>3.0G / 3.5G</td> <td>6 MB</td> <td>DDR4-2400</td> <td>HD 630</td> </tr> <tr> <td>Core i5-7500</td> <td>4 / 4</td> <td>3.4G / 3.8G</td> <td>6 MB</td> <td>DDR4-2400</td> <td>HD 630</td> </tr> <tr> <td>Core i5-7600</td> <td>4 / 4</td> <td>3.5G / 4.1G</td> <td>6 MB</td> <td>DDR4-2400</td> <td>HD 630</td> </tr> <tr> <td>Core i7-7700</td> <td>4 / 8</td> <td>3.6G / 4.2G</td> <td>8 MB</td> <td>DDR4-2400</td> <td>HD 630</td> </tr> </tbody> </table>	Processor	Cores / Threads	Frequency Base/Max(GHz)	Cache	Memory Support (Up to)	Integrated Graphics	Core i3-6100	2 / 4	3.7G	3 MB	DDR4-2133	HD 530	Core i5-6500	4 / 4	3.2G / 3.6G	6 MB	DDR4-2133	HD 530	Core i7-6700	4 / 8	3.4G / 4.0G	8 MB	DDR4-2133	HD 530	Core i3-7100	2 / 4	3.9G	3 MB	DDR4-2400	HD 630	Core i5-7400	4 / 4	3.0G / 3.5G	6 MB	DDR4-2400	HD 630	Core i5-7500	4 / 4	3.4G / 3.8G	6 MB	DDR4-2400	HD 630	Core i5-7600	4 / 4	3.5G / 4.1G	6 MB	DDR4-2400	HD 630	Core i7-7700	4 / 8	3.6G / 4.2G	8 MB	DDR4-2400	HD 630	Security features	<ul style="list-style-type: none"> Security slot (in rear for attachment of optional Kensington® MicroSaver® cable; Kensington lock also locks chassis) Smart USB protection, allows keyboard/mouse only, blocks all storage devices Optional cable lock to physically lock keyboard and mouse Power-on, admin, hard disk password Boot sequence control Boot without keyboard and mouse Individual USB port disablement Optional Chassis intrusion switch
Processor	Cores / Threads	Frequency Base/Max(GHz)	Cache	Memory Support (Up to)	Integrated Graphics																																																				
Core i3-6100	2 / 4	3.7G	3 MB	DDR4-2133	HD 530																																																				
Core i5-6500	4 / 4	3.2G / 3.6G	6 MB	DDR4-2133	HD 530																																																				
Core i7-6700	4 / 8	3.4G / 4.0G	8 MB	DDR4-2133	HD 530																																																				
Core i3-7100	2 / 4	3.9G	3 MB	DDR4-2400	HD 630																																																				
Core i5-7400	4 / 4	3.0G / 3.5G	6 MB	DDR4-2400	HD 630																																																				
Core i5-7500	4 / 4	3.4G / 3.8G	6 MB	DDR4-2400	HD 630																																																				
Core i5-7600	4 / 4	3.5G / 4.1G	6 MB	DDR4-2400	HD 630																																																				
Core i7-7700	4 / 8	3.6G / 4.2G	8 MB	DDR4-2400	HD 630																																																				
Memory	32GB max, DDR4-2400*, two 260-pin SO-DIMM sockets, dual-channel capable * System clocks down for the processors with lower memory controller	Keyboard	<i>Some:</i> Lenovo Calliope Keyboard (USB connector), black <i>Some:</i> Lenovo Traditional Keyboard (USB connector), black <i>Some:</i> Lenovo Calliope Wireless Keyboard (2.4GHz via USB receiver), black <i>Some:</i> Lenovo Calliope Mouse (USB connector), black <i>Some:</i> Lenovo Calliope Wireless Mouse (2.4GHz via USB receiver), black																																																						
Storage	<i>Some:</i> Hard Drive / SATA 6.0Gb/s, 2.5", 5400 rpm or 7200 rpm <i>Some:</i> Solid State Drive (SSD) / SATA 6.0Gb/s, 2.5" <i>Some:</i> M.2 Solid State Drive (SSD) / PCIe NVMe, PCIe 3.0 x 4, 32Gb/s <i>Some:</i> Intel Optane™ Memory (models with 7th gen Core processor), M.2 <i>Some:</i> DVD-ROM SATA 1.5Gb/s Drive, slim (9.5mm) <i>Some:</i> DVD Burner (DVD±RW), SATA 1.5Gb/s Drive, slim (9.5mm)	Mouse																																																							
Optical	Optional 9-in-1 media card reader	Mechanical	<ul style="list-style-type: none"> Business black color Toolless back cover, stand, disk, memory removal Support VESA mount (100mm) <table border="1"> <thead> <tr> <th></th> <th>Dimensions (WxDxH)</th> <th>Max weight (lb / kg)</th> <th>Adjustments</th> </tr> </thead> <tbody> <tr> <td>Without stand:</td> <td>23.0 X 1.8 X 15.4 (inch); 584 X 45 X 390 (mm)</td> <td>(Touch) 17.2 / 7.8 (Non-touch) 15.0 / 6.8</td> <td>N/A</td> </tr> <tr> <td>With Basic Monitor stand:</td> <td>23.0 X 9.6 X 18.0 (inch); 584 X 245 X 458 (mm)</td> <td>(Non-touch) 19.4 / 8.8</td> <td>Tilt: 45° back, -5° forward</td> </tr> <tr> <td>With UltraFlex II stand:</td> <td>23.0X 10.0 X 19.9 (inch); 584 X 253 X 505 (mm)</td> <td>(Touch) 22.7 / 10.3 (Non-touch) 20.7 / 9.4</td> <td>Tilt: 61° back, -5° forward; Lift: 110mm; Swivel: +/-45°</td> </tr> </tbody> </table>		Dimensions (WxDxH)	Max weight (lb / kg)	Adjustments	Without stand:	23.0 X 1.8 X 15.4 (inch); 584 X 45 X 390 (mm)	(Touch) 17.2 / 7.8 (Non-touch) 15.0 / 6.8	N/A	With Basic Monitor stand:	23.0 X 9.6 X 18.0 (inch); 584 X 245 X 458 (mm)	(Non-touch) 19.4 / 8.8	Tilt: 45° back, -5° forward	With UltraFlex II stand:	23.0X 10.0 X 19.9 (inch); 584 X 253 X 505 (mm)	(Touch) 22.7 / 10.3 (Non-touch) 20.7 / 9.4	Tilt: 61° back, -5° forward; Lift: 110mm; Swivel: +/-45°																																						
	Dimensions (WxDxH)	Max weight (lb / kg)	Adjustments																																																						
Without stand:	23.0 X 1.8 X 15.4 (inch); 584 X 45 X 390 (mm)	(Touch) 17.2 / 7.8 (Non-touch) 15.0 / 6.8	N/A																																																						
With Basic Monitor stand:	23.0 X 9.6 X 18.0 (inch); 584 X 245 X 458 (mm)	(Non-touch) 19.4 / 8.8	Tilt: 45° back, -5° forward																																																						
With UltraFlex II stand:	23.0X 10.0 X 19.9 (inch); 584 X 253 X 505 (mm)	(Touch) 22.7 / 10.3 (Non-touch) 20.7 / 9.4	Tilt: 61° back, -5° forward; Lift: 110mm; Swivel: +/-45°																																																						
Media reader	Optional 9-in-1 media card reader	Power supply	150 watts, autosensing, 85% PSU																																																						
Graphics	Intel HD Graphics 530/630 in processor, uses main memory, DirectX® 12, external monitor support via DisplayPort™; Max resolution: 4096x2304 (DP)@60Hz, 1920x1080 (Panel)@60Hz	Limited warranty ³	<i>Some:</i> 1-year or 3-year, depot repair service / service upgrades available <i>Some:</i> 1-year or 3-year, limited onsite service / service upgrades available																																																						
Display	23.8" (604.5mm) Full HD 1080p (1920x1080) TFT color, WVA panel, wide viewing angle (+/- 89°), LED backlight, 250 nits, 16:9 aspect ratio, 1000:1 contrast ratio, anti-glare, support Low Blue Light Mode, work as standalone monitor via DisplayPort (DP in / out combo)	Preload	Preloaded operating system <i>Some:</i> Windows® 7 Professional 32/64 preinstalled through downgrade rights in Windows 10 Pro 64-bit <i>Some:</i> Windows 10 Pro 64-bit <i>Some:</i> Windows 10 Home 64-bit Preloaded applications (only some listed) <ul style="list-style-type: none"> Microsoft Office preloaded; purchase a product key to activate Only for Window 10 Lenovo Companion Only for Window 7 Lenovo Solution Center Lenovo ThinkVantage Tools ThinkVantage System Update Create Recovery Media Adobe® Reader® Cyberlink PowerDVD Create (DVD±RW) 																																																						
Multi-touch	Optional Projected Capacitive Touch (PCT) technology, supports 10-point touch	Environment	EPEAT™ Gold rating (North America); ENERGY STAR® 6.1; TCO AIO Computer Certified; ULE Gold; ErP Lot 3; GREENGUARD® certified; RoHS-compliant																																																						
Camera	Optional 1080p camera, fixed focus, with dual microphone, LED indicator, physical switch on/off	MIL-SPEC test	MIL-STD-810G military certification (Low Pressure [Altitude], High Temperature, Low Temperature, Temperature Shock, Humidity, Sand and Dust, Vibration, Shock)																																																						
Controls	Physical buttons for Microphone mute, monitor mode switch, brightness up/down, and power on/off	Accessories	For compatible accessories, please go to http://www.lenovoquickpick.com																																																						
Chipset	Intel Q270 Chipset																																																								
Rear ports*	Four USB 3.1 Gen1, ethernet (RJ-45), DisplayPort in/out combo port, optional serial (9-pin)																																																								
Side ports*	Two USB 3.1 Gen1 (one is Always On and fast charge), optional card reader, one headphone / microphone combo jack (3.5mm), optional USB 3.1 Type-C Gen1																																																								
M.2 card slot	* Depending on many factors, actual data transfer speed may be lower than theoretical speed Two M.2 Card slots (one for WLAN, one for SSD/Optane)																																																								
Audio support	High Definition (HD) Audio, Realtek ALC233 / two internal speakers (3W x 2), Dolby® Audio™ certified																																																								
WLAN ¹³	<i>Some:</i> 11ac wireless, M.2 Card, Qualcomm Atheros QCA9377A (dual band), Wi-Fi + Bluetooth 4.1 combo adapter, 1x1 <i>Some:</i> 11ac wireless, M.2 Card, Qualcomm Atheros QCA6174A (dual band), Wi-Fi + Bluetooth 4.1 combo adapter, 2x2 <i>Some:</i> 11ac wireless, M.2 Card, Intel Dual Band Wireless-AC 3165, Wi-Fi + Bluetooth 4.1 combo adapter, 1x1 <i>Some:</i> 11ac wireless, M.2 Card, Intel Dual Band Wireless-AC 8265, Wi-Fi + Bluetooth 4.1 combo adapter, 2x2 <i>Some:</i> 11ac wireless, M.2 Card, Intel Dual Band Wireless-AC 8265, Wi-Fi + Bluetooth 4.1 combo adapter, Intel vPro technology support, 2x2																																																								
Bluetooth™	<i>Some:</i> Bluetooth 4.1 wireless, integrated in Wi-Fi + Bluetooth combo adapter																																																								
Ethernet	Gigabit ethernet, Intel Ethernet Connection I219-LM (Jacksonville), Wake on LAN®																																																								
Manageability	Intel Active Management Technology 11.0 (Intel AMT 11.0); Intel vPro technology on some models (require choosing a vPro-support Wi-Fi adapter to enable vPro function through wireless connection)																																																								

See footnotes for more detailed information



ThinkCentre M920z Platform Specifications

Product Specifications Reference (PSREF)

Processor	Intel® Celeron®, Intel Pentium®, or 8th / 9th Gen Intel Core™ i3 / i5 / i7 / i9 series						Audio support	High Definition (HD) Audio, Realtek ALC233 / two internal speakers (3W x 2), Dolby® Audio™ Premium																							
	Processor	Cores / Threads	Frequency Base/Max(GHz)	Cache	Memory Support (Up to)	Integrated Graphics	WLAN	<i>Some:</i> 11ac Wi-Fi + BT 4.2, M.2 Card, Realtek RTL8821CE (dual band), 1x1 <i>Some:</i> 11ac Wi-Fi + BT 4.2, M.2 Card, Realtek RTL8822BE (dual band), 2x2 <i>Some:</i> 11ac Wi-Fi + BT 4.2, M.2 Card, Intel Dual Band Wireless-AC 3165, 1x1 <i>Some:</i> 11ac Wi-Fi + BT 4.2, M.2 Card, Intel Dual Band Wireless-AC 8265,, 2x2 <i>Some:</i> 11ac Wi-Fi + BT 5.0, M.2 Card, Intel Wireless-AC 9560 (dual band), Intel vPro technology support, 2x2																							
	Celeron G4900	2 / 2	3.1G	2 MB	DDR4-2400	UHD 610	Bluetooth™ Ethernet	<i>Some:</i> Bluetooth 4.2/5.0 wireless, integrated in Wi-Fi + BT combo adapter Gigabit ethernet, Intel Ethernet Connection I219-LM (Jacksonville), Wake on LAN®																							
	Celeron G4920	2 / 2	3.2G	2 MB	DDR4-2400	UHD 610		Manageability	Intel Active Management Technology 12.0 (Intel AMT 12.0); Intel vPro technology on some models (require choosing a vPro-support Wi-Fi adapter to enable vPro function through wireless connection)																						
	Celeron G4930	2 / 2	3.2G	2 MB	DDR4-2400	UHD 610	Security chip	Discrete TPM 2.0, TCG Certified																							
	Celeron G4950	2 / 2	3.3G	2 MB	DDR4-2400	UHD 610		Security features	<ul style="list-style-type: none"> Security slot (in rear for attachment of optional Kensington® MicroSaver® cable; Kensington lock also locks chassis) Smart USB protection, allows keyboard/ mouse only, blocks all storage devices Power-on, admin, hard disk password Boot sequence control Boot without keyboard and mouse Individual USB port disablement Optional Chassis intrusion switch 																						
	Pentium Gold G5400	2 / 4	3.7G	4 MB	DDR4-2400	UHD 610	Keyboard		<i>Some:</i> Lenovo Calliope Keyboard (USB connector), black <i>Some:</i> Lenovo Traditional Keyboard (USB connector), black <i>Some:</i> Lenovo Calliope Wireless Keyboard (2.4GHz via USB receiver), black																						
	Pentium Gold G5420	2 / 4	3.8G	4 MB	DDR4-2400	UHD 610		Mouse	<i>Some:</i> Lenovo Calliope Mouse (USB connector), black <i>Some:</i> Lenovo Fingerprint Mouse (USB connector), Windows Hello support, black <i>Some:</i> Lenovo Calliope Wireless Mouse (2.4GHz via USB receiver), black																						
	Pentium Gold G5500	2 / 4	3.8G	4 MB	DDR4-2400	UHD 630	Mechanical		<ul style="list-style-type: none"> Business black color Toolless back cover, stand, disk, memory removal Support VESA mount (100mm) 																						
	Pentium Gold G5600	2 / 4	3.9G	4 MB	DDR4-2400	UHD 630		Memory	<table border="1"> <thead> <tr> <th>Dimensions (WxDxH)</th> <th>Max weight (lb / kg)</th> <th>Adjustments</th> </tr> </thead> <tbody> <tr> <td colspan="3">Without stand (No camera):</td> </tr> <tr> <td>21.3 X 1.8 X 13.7 (inch) 542 X 46 X 349 (mm)</td> <td>(Touch) 14.0 / 6.34 (Non-touch) 13.5 / 6.13</td> <td>N/A</td> </tr> <tr> <td colspan="3">With Full Function Monitor stand (No camera):</td> </tr> <tr> <td>21.3 X 9.9 X 15.9 to 20.2 (inch) 542 X 252 X 405 to 514 (mm)</td> <td>(Non-touch) 18.2 / 8.26</td> <td>Tilt: 45° back, -5° forward; Lift: 110mm; Swivel: +/-45°</td> </tr> <tr> <td colspan="3">With UltraFlex III stand (No camera):</td> </tr> <tr> <td>21.3 X 9.9 X 14.3 to 17.5 (inch) 542 X 252 X 363 to 444 (mm)</td> <td>(Touch) 19.7 / 8.94 (Non-touch) 19.2 / 8.73</td> <td>Tilt: 70° back, -5° forward; Lift: up to 136mm (flat mode) / up to 81mm (vertical mode); Swivel: +/-45°</td> </tr> </tbody> </table>			Dimensions (WxDxH)	Max weight (lb / kg)	Adjustments	Without stand (No camera):			21.3 X 1.8 X 13.7 (inch) 542 X 46 X 349 (mm)	(Touch) 14.0 / 6.34 (Non-touch) 13.5 / 6.13	N/A	With Full Function Monitor stand (No camera):			21.3 X 9.9 X 15.9 to 20.2 (inch) 542 X 252 X 405 to 514 (mm)	(Non-touch) 18.2 / 8.26	Tilt: 45° back, -5° forward; Lift: 110mm; Swivel: +/-45°	With UltraFlex III stand (No camera):			21.3 X 9.9 X 14.3 to 17.5 (inch) 542 X 252 X 363 to 444 (mm)	(Touch) 19.7 / 8.94 (Non-touch) 19.2 / 8.73
	Dimensions (WxDxH)	Max weight (lb / kg)	Adjustments																												
	Without stand (No camera):																														
	21.3 X 1.8 X 13.7 (inch) 542 X 46 X 349 (mm)	(Touch) 14.0 / 6.34 (Non-touch) 13.5 / 6.13	N/A																												
	With Full Function Monitor stand (No camera):																														
	21.3 X 9.9 X 15.9 to 20.2 (inch) 542 X 252 X 405 to 514 (mm)	(Non-touch) 18.2 / 8.26	Tilt: 45° back, -5° forward; Lift: 110mm; Swivel: +/-45°																												
	With UltraFlex III stand (No camera):																														
	21.3 X 9.9 X 14.3 to 17.5 (inch) 542 X 252 X 363 to 444 (mm)	(Touch) 19.7 / 8.94 (Non-touch) 19.2 / 8.73	Tilt: 70° back, -5° forward; Lift: up to 136mm (flat mode) / up to 81mm (vertical mode); Swivel: +/-45°																												
	Pentium Gold G5620	2 / 4	4.0G	4 MB	DDR4-2400	UHD 630	Storage	32GB max (16GB SO-DIMM only available via special bid models), DDR4-2666*, two 260-pin SO-DIMM sockets, dual-channel capable * System clocks down for the processors with lower memory controller																							
	Core i3-8100	4 / 4	3.6G	6 MB	DDR4-2400	UHD 630		Optical	<i>Some:</i> Hard Drive / SATA 6.0Gb/s, 2.5", 5400 rpm or 7200 rpm, supports up to two HDDs (2nd HDD occupies ODD bay), RAID0/1 support (RAID preset only available via special bid model) <i>Some:</i> Solid State Drive (SSD) / SATA 6.0Gb/s, 2.5" <i>Some:</i> M.2 SSD (2242 / 2280) / PCIe NVMe, PCIe 3.0 x2 or PCIe 3.0 x4 <i>Some:</i> Intel Optane™ Memory (not support Celeron / Pentium Processor), M.2 <i>Some:</i> DVD-ROM SATA 1.5Gb/s Drive, slim (9.0mm) <i>Some:</i> DVD Burner (DVD±RW), SATA 1.5Gb/s Drive, slim (9.0mm)																						
	Core i3-8300	4 / 4	3.7G	8 MB	DDR4-2400	UHD 630	Media reader		Optional 3-in-1 media card reader																						
Core i5-8400	6 / 6	2.8G / 4.0G	9 MB	DDR4-2666	UHD 630	Graphics		Intel HD Graphics 610/630 in processor, uses main memory, DirectX® 12, external monitor support via DisplayPort™; <i>Max resolution:</i> 4096x2304 (DP)@60Hz, 1920x1080 (Panel)@60Hz 23.8" (604.5mm) Full HD 1080p (1920x1080) TFT color , Borderless design, In-Plane Switching technology (In-Plane Switching may refer to IPS, PLS, ADS, AHVA, and AA), wide viewing angle (+/- 89°), LED backlight, 250 nits, 16:9 aspect ratio, 1000:1 contrast ratio, anti-glare, support Low Blue Light Mode, work as stand-alone monitor via DisplayPort (DP in / out combo)																							
Core i5-8500	6 / 6	3.0G / 4.1G	9 MB	DDR4-2666	UHD 630		Display	Optional multi-touch, supports 10-point, AIT (Advanced In-cell Touch) technology <i>Some:</i> 1080p camera, with dual microphone, LED indicator, physical switch on/off, supports multi-degree rotation (horizontal 0° to 180°, vertical -25° to 25°) <i>Some:</i> RGBIR camera, 1080p, with dual microphone, physical switch on/off, supports multi-degree rotation (horizontal 0° to 180°, vertical -25° to 25°) Windows Hello support, only available via special bid models																							
Core i5-8600	6 / 6	3.1G / 4.3G	9 MB	DDR4-2666	UHD 630	Multi-touch Camera		Physical buttons on side for microphone mute and power on/off																							
Core i7-8700	6 / 12	3.2G / 4.6G	12 MB	DDR4-2666	UHD 630		Controls	Intel Q370 Chipset																							
Core i3-9100	4 / 4	3.6G / 4.2G	6 MB	DDR4-2400	UHD 630	Chipset		Four USB 3.1 Gen1 (one supports Smart Power On), one ethernet (RJ-45), one DisplayPort in/out combo port, one optional serial (9-pin)																							
Core i3-9300	4 / 4	3.7G / 4.3G	8 MB	DDR4-2400	UHD 630		Rear ports*	one USB 3.1 Gen2 (one is Always On and fast charge), one USB 3.1 Gen1, one USB 3.1 Type-C Gen 1, one optional card reader, one headphone / microphone combo jack (3.5mm)																							
Core i5-9400	6 / 6	2.9G / 4.1G	9 MB	DDR4-2666	UHD 630	Side ports*		* Depending on many factors, actual data transfer speed may be lower than theoretical speed Two M.2 Card slots (one for WLAN, one for SSD/Optane)																							
Core i5-9500	6 / 6	3.0G / 4.4G	9 MB	DDR4-2666	UHD 630		M.2 card slot																								
Core i5-9600	6 / 6	3.1G / 4.6G	9 MB	DDR4-2666	UHD 630																										
Core i7-9700	8 / 8	3.0G / 4.7G	12 MB	DDR4-2666	UHD 630																										
Core i9-9900	8 / 16	3.1G / 5.0G	16 MB	DDR4-2666	UHD 630																										
							Power supply	150 watts, autosensing, 90% PSU																							
							Limited warranty ³	<i>Some:</i> 1-year or 3-year, depot repair service / service upgrades available <i>Some:</i> 1-year or 3-year, limited onsite service / service upgrades available																							
							Preload	Preloaded operating system <i>Some:</i> Windows 10 Pro 64-bit <i>Some:</i> Windows 10 Home 64-bit Preloaded applications (only some listed) <ul style="list-style-type: none"> Lenovo Vantage Microsoft Office preloaded; purchase a product key to activate Cyberlink PowerDVD (only for models with DVD / DVD±RW) Cyberlink Power2GO (only for models with DVD±RW) LinkedIn 																							
							Environment	ENERGY STAR® 7.0*, EPEAT™ Silver rating* (*not for non-OS models), ErP Lot 3, TCO AIO Computer certified, GREENGUARD® certified, TUV Eye comfort certified, TUV Low Blue Light certified, TUV Ultra Low Noise certified (on some models), RoHS-compliant																							
							MIL-SPEC test	MIL-STD-810G military certification (Low Pressure [Altitude], High Temperature, Low Temperature, Temperature Shock, Humidity, Sand and Dust, Vibration, Shock, Fungus)																							
							Accessories	For compatible accessories, please go to http://smartfind.lenovo.com																							

Note: The specifications above may not be available in all regions.

Lenovo, June 2019

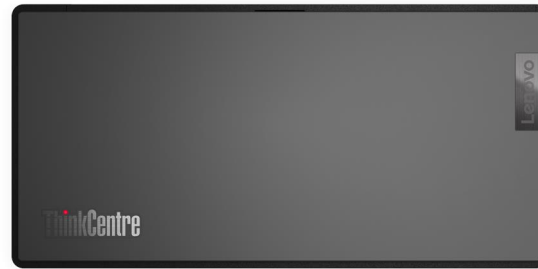

ThinkCentre M90n-1 Nano Platform Specifications

Product Specifications Reference (PSREF)

Processor	Intel® 8th Generation Intel Core™ i3 / i5 / i7 Processor						Manageability Intel vPro technology on some models (require choosing a vPro-support Wi-Fi adapter to enable vPro function through wireless connection)						
	Processor	Cores / Threads	Frequency Base/Max(GHz)	Cache	Memory Support (Up to)	Integrated Graphics		Security chip Discrete TPM 2.0, TCG Certified Security features <ul style="list-style-type: none"> • Security slot (in rear for optional Kensington® MicroSaver® cable) • Chassis intrusion switch • Power-on password • Administrator password • Hard disk password • Boot sequence control • Boot without keyboard and mouse • Individual USB port disablement • Smart USB protection, allows keyboard/mouse only, blocks all storage devices 					
	Core i3-8145U	2 / 4	2.1G / 3.9G	4 MB	DDR4-2400	UHD 620							
	Core i5-8265U	4 / 8	1.6G / 3.9G	6 MB	DDR4-2400	UHD 620							
	Core i5-8365U	4 / 8	1.6G / 4.1G	6 MB	DDR4-2400	UHD 620							
Core i7-8665U	4 / 8	1.9G / 4.8G	8 MB	DDR4-2400	UHD 620								
Memory	8GB or 16GB / DDR4-2666* / soldered to systemboard, no sockets, non-ECC * System automatically clocks down for the processors with lower memory controller						Keyboard <i>Some:</i> Lenovo Calliope Keyboard (USB connector), black <i>Some:</i> Lenovo Traditional Keyboard (USB connector), black <i>Some:</i> Lenovo Calliope Wireless Keyboard (2.4GHz via USB receiver), black Mouse <i>Some:</i> Lenovo Calliope Mouse (USB connector), black <i>Some:</i> Lenovo Fingerprint Mouse (USB connector), Windows Hello support, black <i>Some:</i> Lenovo Calliope Wireless Mouse (2.4GHz via USB receiver), black						
Storage	Support up to two M.2 SSD <i>Some:</i> M.2 2280 SSD / PCIe NVMe, PCIe 3.0 x 4* <i>Some:</i> M.2 2242 SSD / PCIe NVMe, PCIe 3.0 x 2 <i>Some:</i> Intel Optane™ Memory H10 with Solid State Storage, M.2 2280, PCIe NVMe 3.0 x 4 (not support Celeron) * M.2 SSD / Optane with SSD in PCIe 3.0 x 2 M.2 slot can only run at PCIe 3.0 x2												
RAID	RAID 0/1 support (RAID preset only available via special bid model)						Mechanical Nano (0.35L), black color; metal case Three M.2 slots: two for M.2 SSD (one PCIe 3.0 x4 and one PCIe 3.0 x2) and one for WLAN						
Optical	None												
Graphics	Intel UHD Graphics 620 in processor, uses main memory, DirectX® 12, one DisplayPort™, one USB 3.1 Type-C Gen2 with display function, up to 2 independent displays; <i>Max resolution:</i> 4096x2304 (DP) @60Hz; 4096x2304 (Type-C)@60Hz;						<table border="1"> <thead> <tr> <th></th> <th>Dimensions (WxDxH)</th> <th>Weight (Approx.)</th> </tr> </thead> <tbody> <tr> <td>M90n-1 Nano (with fan, 0.35L)</td> <td>7.05" X 3.46" X 0.87" 179mm X 88mm X 22mm</td> <td>1.11 lb (0.505 kg), vary by config</td> </tr> </tbody> </table>		Dimensions (WxDxH)	Weight (Approx.)	M90n-1 Nano (with fan, 0.35L)	7.05" X 3.46" X 0.87" 179mm X 88mm X 22mm	1.11 lb (0.505 kg), vary by config
	Dimensions (WxDxH)	Weight (Approx.)											
M90n-1 Nano (with fan, 0.35L)	7.05" X 3.46" X 0.87" 179mm X 88mm X 22mm	1.11 lb (0.505 kg), vary by config											
Monitor cable	Optional DP to VGA dongle, DP to HDMI dongle, Type-C to VGA dongle, Type-C to HDMI dongle, Type-C to DP dongle												
Chipset	Intel SoC (System on Chip) platform						Mounting <i>Some:</i> VESA mount bracket kit, supports VESA 75mm <i>Some:</i> VESA mount bracket kit with adapter holder, supports VESA 75mm <i>Some:</i> DIN rail mount bracket kit						
Front ports (Std.)*	2x USB 3.1 Gen2, 1x USB 3.1 Type-C Gen 2, one headphone / microphone combo jack (3.5mm)						Floor Stand None						
Rear ports (Std.)*	2x USB 3.1 Gen2, 1x USB 3.1 Type-C Gen 2 (with display function, support power-in [20V and >45W]), 1x ethernet (RJ-45), 1x DisplayPort * Depending on many factors, actual data transfer speed may be lower than theoretical speed						Power supply 65 watts AC/DC adapter, autosensing, 88% PSU (Not for TIO models)						
Audio support	Realtek ALC233VB / internal speaker (1 watt)						Limited warranty <i>Some:</i> 1-year, limited onsite service / service upgrades available <i>Some:</i> 3-year, limited onsite service / service upgrades available						
WLAN	<i>Some:</i> 11ac wireless, M.2 Card, Realtek RTL8822CE (dual band), Wi-Fi + Bluetooth 5.0 combo adapter, 1x1 <i>Some:</i> 11ac wireless, M.2 Card, Realtek RTL8822CE (dual band), Wi-Fi + Bluetooth 5.0 combo adapter, 2x2 <i>Some:</i> 11ac wireless, M.2 Card, Intel Wireless-AC 9462 (dual band), Wi-Fi + Bluetooth 5.0 combo adapter, 1x1 <i>Some:</i> 11ac wireless, M.2 Card, Intel Wireless-AC 9560 (dual band), Wi-Fi + Bluetooth 5.0 combo adapter, 2x2 <i>Some:</i> 11ac wireless, M.2 Card, Intel Wireless-AC 9560 (dual band), Wi-Fi + Bluetooth 5.0 combo adapter, Intel vPro technology support, 2x2						Preload Preloaded operating system <i>Some:</i> Windows® 10 Pro 64-bit <i>Some:</i> Windows 10 Home 64-bit						
Bluetooth	<i>Some:</i> Bluetooth 5.0 wireless, integrated in Wi-Fi + BT combo adapter						Environment ENERGY STAR® 7.1, EPEAT™ Silver rating (North America), ErP Lot 3, TCO 8.0, TUV ultra low noise verified (on some models), RoHS, WEEE, REACH						
Ethernet	Gigabit ethernet, Intel Ethernet Connection I219-LM(Jacksonville), Wake on LAN®						MIL-SPEC test MIL-STD-810H (Low Pressure [Altitude], High Temperature, Low Temperature, Temperature Shock, Humidity, Sand and Dust, Vibration, Shock, Solar Radiation)						
							Accessories For compatible accessories, please go to http://smartfind.lenovo.com						

Note: The specifications above may not be available in all regions.

Lenovo, July 2019



ThinkCentre M90n-1 Nano IoT Platform Specifications

Product Specifications Reference (PSREF)

Processor	Intel® Celeron® or 8th Generation Intel Core™ i3 Processor						Manageability Security chip Security features	None Discrete TPM 2.0, TCG Certified ● Security slot (in rear for optional Kensington® MicroSaver® cable) ● Chassis intrusion switch ● Power-on password ● Administrator password ● Hard disk password ● Boot sequence control ● Boot without keyboard and mouse ● Individual USB port disablement
	Processor	Cores / Threads	Frequency Base/Max(GHz)	Cache	Memory Support (Up to)	Integrated Graphics		
	Celeron 4205U	2 / 2	1.8G	2 MB	DDR4-2133	UHD 610		
	Core i3-8145U	2 / 4	2.1G / 3.9G	4 MB	DDR4-2400	UHD 620		
Memory	4GB / DDR4-2666* / soldered to systemboard, no sockets, non-ECC * System automatically clocks down for the processors with lower memory controller							
Storage	Support up to two M.2 SSD <i>Some:</i> M.2 2280 SSD / PCIe NVMe, PCIe 3.0 x 4* <i>Some:</i> M.2 2242 SSD / PCIe NVMe, PCIe 3.0 x 2 <i>Some:</i> Intel Optane™ Memory H10 with Solid State Storage, M.2 2280, PCIe NVMe 3.0 x 4 (not support Celeron) * M.2 SSD / Optane with SSD in PCIe 3.0 x 2 M.2 slot can only run at PCIe 3.0 x2						Keyboard	<i>Some:</i> Lenovo Calliope Keyboard (USB connector), black <i>Some:</i> Lenovo Traditional Keyboard (USB connector), black <i>Some:</i> Lenovo Calliope Wireless Keyboard (2.4GHz via USB receiver), black
RAID Optical	RAID 0/1 support (RAID preset only available via special bid model) None						Mouse	<i>Some:</i> Lenovo Calliope Mouse (USB connector), black <i>Some:</i> Lenovo Fingerprint Mouse (USB connector), Windows Hello support, black <i>Some:</i> Lenovo Calliope Wireless Mouse (2.4GHz via USB receiver), black
Graphics	Intel UHD Graphics 610/620 in processor, uses main memory, DirectX® 12, one DisplayPort™, one USB 3.1 Type-C Gen2 with display function, up to 2 independent displays; <i>Max resolution:</i> 4096x2304 (DP)@60Hz; 4096x2304 (Type-C)@60Hz;						Mechanical	Nano (fanless 0.55L), black color; metal case Four M.2 slots: two for M.2 SSD (one PCIe 3.0 x4 and one PCIe 3.0 x2), one for WLAN, and one for WWAN
Monitor cable	Optional DP to VGA dongle, DP to HDMI dongle, Type-C to VGA dongle, Type-C to HDMI dongle, Type-C to DP dongle							
Chipset	Intel SoC (System on Chip) platform							
Front ports (Std.)	2x USB 3.1 Gen2, 1x USB 3.1 Type-C Gen 2, one headphone / microphone combo jack (3.5mm), 2x serial							
Rear ports (Std.)	* <i>With Celeron:</i> 1x USB 2.0, 1x USB 3.1 Type-C Gen 2 (with display function, support power-in [20V, > 45W]), 1x ethernet (RJ-45), 1x DisplayPort <i>With Core i3:</i> 1x USB 3.1 Gen2, 1x USB 3.1 Type-C Gen 2 (with display function, support power-in [20V, > 45W]), 2x ethernet (RJ-45), 1x DisplayPort * Depending on many factors, actual data transfer speed may be lower than theoretical speed						Mounting	<i>Some:</i> VESA mount bracket kit, supports VESA 75mm <i>Some:</i> VESA mount bracket kit with adapter holder, supports VESA 75mm <i>Some:</i> DIN rail mount bracket kit
Audio support	Realtek ALC233VB / internal speaker (1watt)						Floor Stand	None
WLAN	<i>Some:</i> 11ac wireless, M.2 Card, Realtek RTL8822CE (dual band), Wi-Fi + Bluetooth 5.0 combo adapter, 1x1 <i>Some:</i> 11ac wireless, M.2 Card, Realtek RTL8822CE (dual band), Wi-Fi + Bluetooth 5.0 combo adapter, 2x2 <i>Some:</i> 11ac wireless, M.2 Card, Intel Wireless-AC 9462 (dual band), Wi-Fi + Bluetooth 5.0 combo adapter, 1x1 <i>Some:</i> 11ac wireless, M.2 Card, Intel Wireless-AC 9560 (dual band), Wi-Fi + Bluetooth 5.0 combo adapter, 2x2 <i>Some:</i> 11ac wireless, M.2 Card, Intel Wireless-AC 9560 (dual band), Wi-Fi + Bluetooth 5.0 combo adapter, Intel vPro technology support, 2x2						Power supply	<i>Some:</i> 65 watts AC/DC adapter, autosensing, 88% PSU <i>Some:</i> 65 watts AC/DC adapter (wide temperature), autosensing, 88% PSU (only for Machine Type 11AS)
Bluetooth	<i>Some:</i> Bluetooth 5.0 wireless, integrated in Wi-Fi + BT combo adapter						Limited warranty	<i>Some:</i> 1-year, limited onsite service / service upgrades available <i>Some:</i> 3-year, limited onsite service / service upgrades available
Ethernet	<i>With Celeron:</i> Gigabit ethernet, Realtek RTL8111K, 1x RJ-45, Wake on LAN® <i>With Core i3:</i> Two gigabit ethernet, Realtek RTL8111K and RTL8111HN, 2x RJ-45 Wake on LAN®						Preload	Preloaded operating system <i>Some:</i> Windows® 10 Pro 64-bit <i>Some:</i> Windows 10 Home 64-bit <i>Some:</i> Windows 10 IoT Enterprise (only available via special bid model)
							Environment	ENERGY STAR® 7.1, EPEAT™ Silver rating (North America), ErP Lot 3, TCO 8.0, TUV ultra low noise verified (on some models), RoHS, WEEE, REACH
							MIL-SPEC test	MIL-STD-810H (Low Pressure [Altitude], High Temperature, Low Temperature, Temperature Shock, Humidity, Sand and Dust, Vibration, Shock, Solar Radiation)
							Accessories	For compatible accessories, please go to http://smartfind.lenovo.com

Note: The specifications above may not be available in all regions.

Lenovo, July 2019

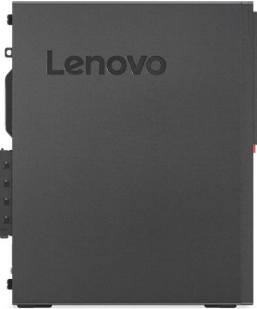
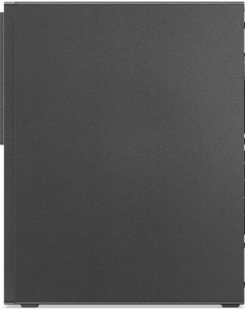
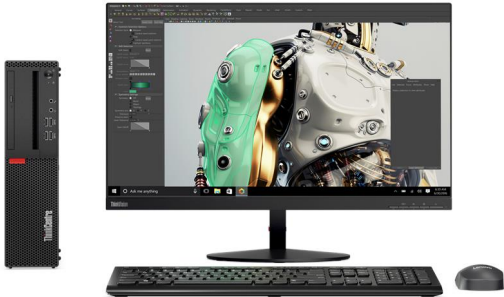

ThinkCentre M710 SFF Platform Specifications

Product Specifications Reference (PSREF)

Processor	Intel® Celeron®, Intel Pentium®, or 6/7th Generation Intel Core™ i3 / i5 / i7 Processor	Security features	<ul style="list-style-type: none"> Security slot (in rear for optional Kensington® MicroSaver® cable) Padlock loop Smart USB protection, allows keyboard/mouse only, blocks all storage devices Optional cable lock to physically lock both keyboard and mouse Power-on password Administrator password Hard disk password Boot sequence control Boot without keyboard and mouse Individual USB port disablement Optional chassis intrusion switch 																																																																								
	<table border="1"> <thead> <tr> <th>Processor</th> <th>Cores / Threads</th> <th>Frequency Base/Max(GHz)</th> <th>Cache</th> <th>Memory Support (Up to)</th> <th>Integrated Graphics</th> </tr> </thead> <tbody> <tr> <td>Pentium G4400</td> <td>2 / 2</td> <td>3.3G</td> <td>3 MB</td> <td>DDR4-2133</td> <td>HD 510</td> </tr> <tr> <td>Pentium G4560</td> <td>2 / 4</td> <td>3.5G</td> <td>3 MB</td> <td>DDR4-2400</td> <td>HD 610</td> </tr> <tr> <td>Pentium G4600</td> <td>2 / 4</td> <td>3.6G</td> <td>3 MB</td> <td>DDR4-2400</td> <td>HD 630</td> </tr> <tr> <td>Core i3-6100</td> <td>2 / 4</td> <td>3.7G</td> <td>3 MB</td> <td>DDR4-2133</td> <td>HD 530</td> </tr> <tr> <td>Core i5-6500</td> <td>4 / 4</td> <td>3.2G / 3.6G</td> <td>6 MB</td> <td>DDR4-2133</td> <td>HD 530</td> </tr> <tr> <td>Core i7-6700</td> <td>4 / 8</td> <td>3.4G / 4.0G</td> <td>8 MB</td> <td>DDR4-2133</td> <td>HD 530</td> </tr> <tr> <td>Core i3-7100</td> <td>2 / 4</td> <td>3.9G</td> <td>3 MB</td> <td>DDR4-2400</td> <td>HD 630</td> </tr> <tr> <td>Core i5-7400</td> <td>4 / 4</td> <td>3.0G / 3.5G</td> <td>6 MB</td> <td>DDR4-2400</td> <td>HD 630</td> </tr> <tr> <td>Core i5-7500</td> <td>4 / 4</td> <td>3.4G / 3.8G</td> <td>6 MB</td> <td>DDR4-2400</td> <td>HD 630</td> </tr> <tr> <td>Core i5-7600</td> <td>4 / 4</td> <td>3.5G / 4.1G</td> <td>6 MB</td> <td>DDR4-2400</td> <td>HD 630</td> </tr> <tr> <td>Core i7-7700</td> <td>4 / 8</td> <td>3.6G / 4.2G</td> <td>8 MB</td> <td>DDR4-2400</td> <td>HD 630</td> </tr> </tbody> </table>	Processor	Cores / Threads	Frequency Base/Max(GHz)	Cache	Memory Support (Up to)	Integrated Graphics	Pentium G4400	2 / 2	3.3G	3 MB	DDR4-2133	HD 510	Pentium G4560	2 / 4	3.5G	3 MB	DDR4-2400	HD 610	Pentium G4600	2 / 4	3.6G	3 MB	DDR4-2400	HD 630	Core i3-6100	2 / 4	3.7G	3 MB	DDR4-2133	HD 530	Core i5-6500	4 / 4	3.2G / 3.6G	6 MB	DDR4-2133	HD 530	Core i7-6700	4 / 8	3.4G / 4.0G	8 MB	DDR4-2133	HD 530	Core i3-7100	2 / 4	3.9G	3 MB	DDR4-2400	HD 630	Core i5-7400	4 / 4	3.0G / 3.5G	6 MB	DDR4-2400	HD 630	Core i5-7500	4 / 4	3.4G / 3.8G	6 MB	DDR4-2400	HD 630	Core i5-7600	4 / 4	3.5G / 4.1G	6 MB	DDR4-2400	HD 630	Core i7-7700	4 / 8	3.6G / 4.2G	8 MB	DDR4-2400	HD 630	Keyboard	<i>Some:</i> Lenovo Calliope Keyboard (USB connector), black <i>Some:</i> Lenovo Traditional Keyboard (USB connector), black <i>Some:</i> Lenovo Calliope Wireless Keyboard (2.4GHz via USB receiver), black <i>Some:</i> Lenovo Calliope Mouse (USB connector), black <i>Some:</i> Lenovo Calliope Wireless Mouse (2.4GHz via USB receiver), black
Processor	Cores / Threads	Frequency Base/Max(GHz)	Cache	Memory Support (Up to)	Integrated Graphics																																																																						
Pentium G4400	2 / 2	3.3G	3 MB	DDR4-2133	HD 510																																																																						
Pentium G4560	2 / 4	3.5G	3 MB	DDR4-2400	HD 610																																																																						
Pentium G4600	2 / 4	3.6G	3 MB	DDR4-2400	HD 630																																																																						
Core i3-6100	2 / 4	3.7G	3 MB	DDR4-2133	HD 530																																																																						
Core i5-6500	4 / 4	3.2G / 3.6G	6 MB	DDR4-2133	HD 530																																																																						
Core i7-6700	4 / 8	3.4G / 4.0G	8 MB	DDR4-2133	HD 530																																																																						
Core i3-7100	2 / 4	3.9G	3 MB	DDR4-2400	HD 630																																																																						
Core i5-7400	4 / 4	3.0G / 3.5G	6 MB	DDR4-2400	HD 630																																																																						
Core i5-7500	4 / 4	3.4G / 3.8G	6 MB	DDR4-2400	HD 630																																																																						
Core i5-7600	4 / 4	3.5G / 4.1G	6 MB	DDR4-2400	HD 630																																																																						
Core i7-7700	4 / 8	3.6G / 4.2G	8 MB	DDR4-2400	HD 630																																																																						
Memory	64GB max, UDIMM, DDR4-2400, four 288-pin DIMM sockets, non-ECC, dual-channel capable* * System automatically clocks down for the processors with lower memory controller	Mouse																																																																									
Storage	<i>Some:</i> Hard Drive / SATA 6.0Gb/s, 2.5" or 3.5", 5400 rpm or 7200 rpm <i>Some:</i> Solid State Drive (SSD) / SATA 6.0Gb/s, 2.5" <i>Some:</i> M.2 Solid State Drive (SSD) / PCIe NVMe, PCIe 3.0 x 4, 32Gb/s <i>Some:</i> Intel Optane™ Memory (models with 7th gen Core processor), M.2 <i>Some:</i> DVD-ROM SATA 1.5Gb/s Drive, slim (9.0mm) <i>Some:</i> DVD Burner (DVD±RW), SATA 1.5Gb/s Drive, slim (9.0mm)	Mechanical	<ul style="list-style-type: none"> SFF (8.4L), black color; metal case (WxDxH) 3.6" X 11.4" X 13.5"; 92.5mm X 290.5mm X 343.5mm Approx. 13.2 lb (6.0 kg), weight may vary by configuration Toolless cover, disk, optical removal Optional dust filter Bay 1: Slim external ODD bay Bay 2: 3.5", 1" high, internal, HDD/SSD Bay 3: 2.5", internal, HDD/SSD (optional bay) Slot 1: low-profile (length < 150mm, height < 68mm), PCIe 3.0 x16* Slot 2: low-profile (length < 150mm, height < 68mm), PCIe 3.0 x1* Slot 3: low-profile (length < 150mm, height < 68mm), PCIe 3.0 x1* Slot 4: no slot, only bracket for optional port extension* M.2 card slots: Two (one for WLAN, one for SSD/Optane) * Optional 2 front USB3.1 Type-C ports module occupies PCIe x16 slot (x4 card), optional rear 2x USB2.0 / parallel / 2nd serial occupies one expansion slot 																																																																								
Optical	Three onboard SATA 6.0Gb/s connectors Optional 7-in-1 media reader	Floor Stand	Optional system floor stand for vertical orientation																																																																								
Onboard SATA Media reader		Power supply	<i>Some:</i> 180 watts, autosensing, 85% PSU <i>Some:</i> 210 watts, autosensing, 85% PSU <i>Some:</i> 210 watts, autosensing, 92% PSU (only available via special bid)																																																																								
Graphics	Intel HD Graphics 510/530/610/630 in processor, uses main memory, DirectX® 12, one VGA, two DisplayPort™, supports 3 independent displays, works along with discrete graphics to support more displays; Max resolution: 4096x2304 (DP) @60Hz; 2048x1536 (VGA) @50Hz <i>Some:</i> NVIDIA GeForce® GT 730, DirectX 12, 2GB, PCIe 2.0 x8 adapter, two DisplayPort, 35 watts; Max resolution: 3840x2160 (DisplayPort) @60Hz;	Limited warranty ³	<i>Some:</i> 1-year or 3-year, depot service / service upgrades available <i>Some:</i> 1-year or 3-year, limited onsite service / service upgrades available																																																																								
Monitor cable	Optional DP to VGA, DP to DVI-D (single link), DP to dual DP, or DP to HDMI 1.4	Preload	Preloaded operating system <i>Some:</i> Windows® 7 Professional 32/64 preinstalled through downgrade rights in Windows 10 Pro 64-bit (not available with 7th Gen Intel processor) <i>Some:</i> Windows 10 Pro 64-bit <i>Some:</i> Windows 10 Home 64-bit Preloaded applications (only some listed) <ul style="list-style-type: none"> Microsoft Office preloaded; purchase a product key to activate - Only for Window 10 Lenovo Companion - Only for Window 7 Lenovo Solution Center Lenovo ThinkVantage Tools Create Recovery Media Adobe® Reader® Cyberlink PowerDVD Create (DVD±RW) 																																																																								
Chipset	Intel B250 Chipset	Environment	ENERGY STAR® 6.1, EPEAT™ Gold rating (North America), ErP Lot 3, GREENGUARD®, RoHS-compliant, TUV low noise verified (on some models)																																																																								
Front ports*	Four USB 3.1 Gen1, optional two USB 3.1 Type-C Gen 2 (only available via special bid), microphone (3.5mm), headphone (3.5mm)	Accessories	For compatible accessories, please go to http://www.lenovoquickpick.com																																																																								
Rear ports*	Two USB 3.1 Gen1, two USB 2.0, optional two USB 2.0, serial (9-pin), optional 2nd serial (9-pin), optional parallel (25-pin), ethernet (RJ-45), one VGA, two DisplayPort, two PS/2 ports (keyboard/mouse); additional DisplayPort on optional graphics on some models																																																																										
Rear audio ports* IEEE 1394*	Line-in (3.5mm), line-out (3.5mm), microphone-in (3.5mm) None * Depending on many factors, actual data transfer speed may be lower than theoretical speed																																																																										
Audio support	High Definition (HD) Audio, Realtek ALC662 / optional internal speaker (1.5 watt)																																																																										
WLAN ¹³	<i>Some:</i> 11ac wireless, M.2 Card, Qualcomm Atheros QCA9377A (dual band), Wi-Fi + Bluetooth 4.1 combo adapter, 1x1 <i>Some:</i> 11ac wireless, M.2 Card, Qualcomm Atheros QCA6174A (dual band), Wi-Fi + Bluetooth 4.1 combo adapter, 2x2 <i>Some:</i> 11ac wireless, M.2 Card, Intel Dual Band Wireless-AC 3165, Wi-Fi + Bluetooth 4.1 combo adapter, 1x1 <i>Some:</i> 11ac wireless, M.2 Card, Intel Dual Band Wireless-AC 8265, Wi-Fi + Bluetooth 4.1 combo adapter, 2x2																																																																										
Bluetooth™ Ethernet Modem	<i>Some:</i> Bluetooth 4.1 wireless, integrated in Wi-Fi + BT combo adapter Gigabit ethernet, Realtek RTL8111GN, Wake on LAN® None																																																																										
Manageability Security chip	None TPM (Trusted Platform Module) 2.0, TCG Certified * Downgrade to TPM1.2 for the models with Win10 DG Win7 32 OS																																																																										

Note: The specifications above may not be available in all regions.

Lenovo, June 2017

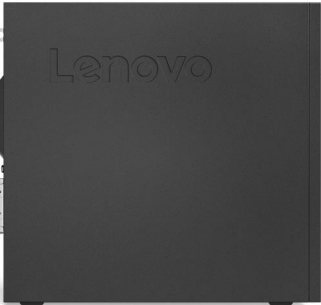

ThinkCentre M710e SFF Platform Specifications

Product Specifications Reference (PSREF)

Processor	Intel® Celeron®, Intel Pentium®, or 6/7th Generation Intel Core™ i3 / i5 / i7 Processor						<p>Security features</p> <ul style="list-style-type: none"> Security slot (in rear for optional Kensington® MicroSaver® cable) Padlock loop Smart USB protection, allows keyboard/mouse only, blocks all storage devices Optional smart cable clip to physically lock both keyboard and mouse Power-on password Administrator password Hard disk password Boot sequence control Boot without keyboard and mouse Individual USB port disablement Optional chassis intrusion switch <p>Keyboard</p> <p><i>Some:</i> Lenovo Calliope Keyboard (USB connector), black <i>Some:</i> Lenovo Traditional Keyboard (USB connector), black</p> <p>Mouse</p> <p><i>Some:</i> Lenovo Calliope Mouse (USB connector), black <i>Some:</i> Lenovo Fingerprint Mouse (USB connector), Windows Hello support, black</p> <p>Mechanical</p> <ul style="list-style-type: none"> SFF (7.4L), black color, metal case (WxDxH) 3.9" X 11.9" X 10.8"; 100mm X 303.5mm X 273.5mm Approx. 9.37 lb (4.25 kg), weight may vary by configuration Bay 1: Slim external ODD bay Bay 2: 3.5", 1" high, internal, supports 2.5" or 3.5" HDD/SSD (2.5 to 3.5 bracket comes with disk) Slot 1: low-profile (length < 152mm, height < 64mm), PCIe 3.0 x16* Slot 2: low-profile (length < 152mm, height < 64mm), PCIe 3.0 x1* M.2 card slots: one for SSD *Optional rear 2x USB2.0 / parallel occupies one expansion slot <p>Floor Stand</p> <p>Optional system floor stand for vertical orientation</p>
	Processor	Cores / Threads	Frequency Base/Max(GHz)	Cache	Memory Support (Up to)	Integrated Graphics	
	Celeron G3900	2 / 2	2.8G	2 MB	DDR4-2133	HD 510	
	Celeron G3930	2 / 2	2.9G	3 MB	DDR4-2133	HD 610	
	Pentium G4400	2 / 2	3.3G	3 MB	DDR4-2133	HD 510	
	Pentium G4500	2 / 2	3.5G	3 MB	DDR4-2133	HD 530	
	Pentium G4560	2 / 4	3.5G	3 MB	DDR4-2400	HD 610	
	Pentium G4600	2 / 4	3.6G	3 MB	DDR4-2400	HD 630	
	Core i3-6100	2 / 4	3.7G	3 MB	DDR4-2133	HD 530	
	Core i5-6400	4 / 4	2.7G / 3.3G	6 MB	DDR4-2133	HD 530	
	Core i5-6500	4 / 4	3.2G / 3.6G	6 MB	DDR4-2133	HD 530	
	Core i7-6700	4 / 8	3.4G / 4.0G	8 MB	DDR4-2133	HD 530	
	Core i3-7100	2 / 4	3.9G	3 MB	DDR4-2400	HD 630	
	Core i3-7300	2 / 4	4.0G	4 MB	DDR4-2400	HD 630	
	Core i5-7400	4 / 4	3.0G / 3.5G	6 MB	DDR4-2400	HD 630	
	Core i5-7500	4 / 4	3.4G / 3.8G	6 MB	DDR4-2400	HD 630	
	Core i5-7600	4 / 4	3.5G / 4.1G	6 MB	DDR4-2400	HD 630	
Core i7-7700	4 / 8	3.6G / 4.2G	8 MB	DDR4-2400	HD 630		
Memory	32GB max, UDIMM, DDR4-2400*, two 288-pin DIMM sockets, non-ECC, dual-channel capable *System automatically clocks down for the processors with lower memory controller						
Storage	<i>Some:</i> Hard Drive / SATA 6.0Gb/s, 2.5" or 3.5", 5400 rpm or 7200 rpm <i>Some:</i> Solid State Drive (SSD) / SATA 6.0Gb/s, 2.5" <i>Some:</i> M.2 Solid State Drive (SSD) / PCIe NVMe, PCIe 3.0 x 4, 32Gb/s						
Optical	<i>Some:</i> DVD-ROM SATA 1.5Gb/s Drive, slim (9.0mm) <i>Some:</i> DVD Burner (DVD±RW), SATA 1.5Gb/s Drive, slim (9.0mm)						
Onboard SATA	Two onboard SATA 6.0Gb/s connectors						
Media reader	Optional 7-in-1 media reader						
Graphics	Intel HD Graphics 510/530/610/630 in processor, uses main memory, DirectX® 12, one VGA, one DisplayPort™, supports 2 independent displays, works along with discrete graphics to support more displays; <i>Max resolution:</i> 4096x2160 (DP)@60Hz; 1920x1200 (VGA)@60Hz <i>Some:</i> NVIDIA GeForce® GT 730 , DirectX 12, 2GB, PCIe 2.0 x8 adapter, two DisplayPort, 35 watts; <i>Max resolution:</i> 3840x2160 (DisplayPort)@60Hz;						
Monitor cable	Optional DP to VGA, DP to DVI-D (single link), DP to dual DP, or DP to HDMI 1.4						
Chipset	Intel B250 Chipset						
Front ports*	Two USB 3.1 Gen1, microphone (3.5mm), one headphone / microphone combo jack (3.5mm)						
Rear ports*	Two USB 3.1 Gen1, two USB 2.0, optional two USB 2.0, serial (9-pin), optional 2nd serial (9-pin), optional parallel (25-pin), ethernet (RJ-45), one VGA, one DisplayPort, optional external USB to PS/2 ports cable (for PS/2 keyboard / mouse); additional DisplayPort on optional graphics on some models						
Rear audio ports*	Line-out jack (3.5mm)						
IEEE 1394*	None * Depending on many factors, actual data transfer speed may be lower than theoretical speed						
Audio support	High Definition (HD) Audio, Realtek ALC233 / internal speaker (1.5 watt)						
WLAN ¹³	None						
Bluetooth™	None						
Ethernet	Gigabit ethernet, Realtek RTL8111HN, Wake on LAN®						
Modem	None						
Manageability	None						
Security chip	TPM (Trusted Platform Module) 2.0, TCG Certified * Downgrade to TPM1.2 for the models with Win10 DG Win7 32 OS						
Packaging	<ul style="list-style-type: none"> (WxDxH) 7.7" X 15.4" X 19.7"; 195mm X 390mm X 500mm Cross weight (approx.) 14.22 lb (6.45 kg) 						
Power supply	<i>Some:</i> 180 watts, autosensing, 85% PSU						
Limited warranty ³	<i>Some:</i> 1-year or 3-year, depot service / service upgrades available <i>Some:</i> 1-year or 3-year, limited onsite service / service upgrades available						
Preload	<p>Preloaded operating system</p> <p><i>Some:</i> Windows® 10 Pro 64-bit <i>Some:</i> Windows 10 Home 64-bit <i>Some:</i> Windows 7 Professional 32/64 preinstalled through downgrade rights in Windows 10 Pro 64-bit(not available with 7th Gen Intel processor)</p> <p>Preloaded applications (only some listed)</p> <ul style="list-style-type: none"> Microsoft Office preloaded; purchase a product key to activate Cyberlink PowerDVD (DVD, DVD±RW) Cyberlink PowerDVD Create (DVD±RW) - Only for Window 10 Lenovo Companion - Only for Window 7 Lenovo Solution Center Lenovo System Update Create Recovery Media Adobe® Reader® 						
Environment	ENERGY STAR® 6.1, EPEAT™ Silver rating (North America), ErP Lot 3, RoHS-compliant, WEEE						
Accessories	For compatible accessories, please go to http://www.lenovoquickpick.com						

Note: The specifications above may not be available in all regions.

Lenovo, January 2018

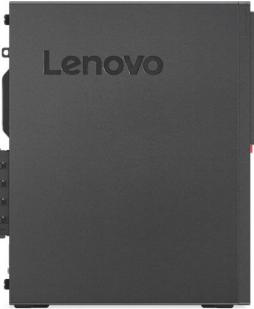
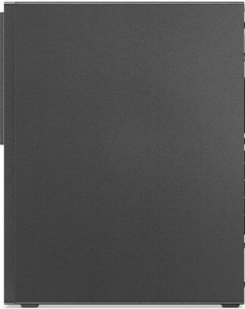
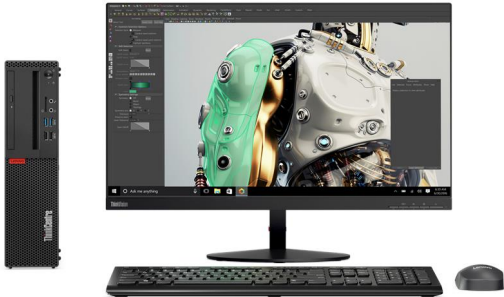

ThinkCentre M715 SFF Platform Specifications

Product Specifications Reference (PSREF)

Processor	AMD A6 / A8 / A10 / A12 series APU and Ryzen 3 / 5 / 7 series processor	Security features	<ul style="list-style-type: none"> Security slot (in rear for optional Kensington® MicroSaver® cable) Padlock loop Smart USB protection, allows keyboard/ mouse only, blocks all storage devices Optional cable lock to physically lock both keyboard and mouse Power-on password Administrator password Hard disk password Boot sequence control Boot without keyboard and mouse Individual USB port disablement Optional chassis intrusion switch 																																																												
	<table border="1"> <thead> <tr> <th>APU / processor</th> <th>Cores / Threads</th> <th>Frequency (Base/Max)</th> <th>L2 Cache</th> <th>Integrated Graphics</th> </tr> </thead> <tbody> <tr> <td>Ryzen 3 PRO 1200</td> <td>4 / 4</td> <td>3.1 / 3.4</td> <td>2MB</td> <td>None</td> </tr> <tr> <td>Ryzen 3 PRO 1300</td> <td>4 / 4</td> <td>3.5 / 3.7</td> <td>2MB</td> <td>None</td> </tr> <tr> <td>Ryzen 5 PRO 1500</td> <td>4 / 8</td> <td>3.5 / 3.7</td> <td>2MB</td> <td>None</td> </tr> <tr> <td>Ryzen 7 PRO 1700</td> <td>8 / 16</td> <td>3.0 / 3.7</td> <td>4MB</td> <td>None</td> </tr> <tr> <td>PRO A6-8570</td> <td>2 / 2</td> <td>3.5 / 3.8</td> <td>1MB</td> <td>Radeon R5 Series</td> </tr> <tr> <td>PRO A10-8770</td> <td>4 / 4</td> <td>3.5 / 3.8</td> <td>2MB</td> <td>Radeon R7 Series</td> </tr> <tr> <td>PRO A12-8870</td> <td>4 / 4</td> <td>3.7 / 4.2</td> <td>2MB</td> <td>Radeon R7 Series</td> </tr> <tr> <td>PRO A6-9500</td> <td>2 / 2</td> <td>3.5 / 3.8</td> <td>1MB</td> <td>Radeon R5 Series</td> </tr> <tr> <td>PRO A8-9600</td> <td>4 / 4</td> <td>3.1 / 3.4</td> <td>2MB</td> <td>Radeon R7 Series</td> </tr> <tr> <td>PRO A10-9700</td> <td>4 / 4</td> <td>3.5 / 3.8</td> <td>2MB</td> <td>Radeon R7 Series</td> </tr> <tr> <td>PRO A12-9800</td> <td>4 / 4</td> <td>3.8 / 4.2</td> <td>2MB</td> <td>Radeon R7 Series</td> </tr> </tbody> </table>	APU / processor	Cores / Threads	Frequency (Base/Max)	L2 Cache	Integrated Graphics	Ryzen 3 PRO 1200	4 / 4	3.1 / 3.4	2MB	None	Ryzen 3 PRO 1300	4 / 4	3.5 / 3.7	2MB	None	Ryzen 5 PRO 1500	4 / 8	3.5 / 3.7	2MB	None	Ryzen 7 PRO 1700	8 / 16	3.0 / 3.7	4MB	None	PRO A6-8570	2 / 2	3.5 / 3.8	1MB	Radeon R5 Series	PRO A10-8770	4 / 4	3.5 / 3.8	2MB	Radeon R7 Series	PRO A12-8870	4 / 4	3.7 / 4.2	2MB	Radeon R7 Series	PRO A6-9500	2 / 2	3.5 / 3.8	1MB	Radeon R5 Series	PRO A8-9600	4 / 4	3.1 / 3.4	2MB	Radeon R7 Series	PRO A10-9700	4 / 4	3.5 / 3.8	2MB	Radeon R7 Series	PRO A12-9800	4 / 4	3.8 / 4.2	2MB	Radeon R7 Series	Keyboard	<i>Some:</i> Lenovo Calliope Keyboard (USB connector), black <i>Some:</i> Lenovo Traditional Keyboard (USB connector), black <i>Some:</i> Lenovo Calliope Wireless Keyboard (2.4GHz via USB receiver), black
APU / processor	Cores / Threads	Frequency (Base/Max)	L2 Cache	Integrated Graphics																																																											
Ryzen 3 PRO 1200	4 / 4	3.1 / 3.4	2MB	None																																																											
Ryzen 3 PRO 1300	4 / 4	3.5 / 3.7	2MB	None																																																											
Ryzen 5 PRO 1500	4 / 8	3.5 / 3.7	2MB	None																																																											
Ryzen 7 PRO 1700	8 / 16	3.0 / 3.7	4MB	None																																																											
PRO A6-8570	2 / 2	3.5 / 3.8	1MB	Radeon R5 Series																																																											
PRO A10-8770	4 / 4	3.5 / 3.8	2MB	Radeon R7 Series																																																											
PRO A12-8870	4 / 4	3.7 / 4.2	2MB	Radeon R7 Series																																																											
PRO A6-9500	2 / 2	3.5 / 3.8	1MB	Radeon R5 Series																																																											
PRO A8-9600	4 / 4	3.1 / 3.4	2MB	Radeon R7 Series																																																											
PRO A10-9700	4 / 4	3.5 / 3.8	2MB	Radeon R7 Series																																																											
PRO A12-9800	4 / 4	3.8 / 4.2	2MB	Radeon R7 Series																																																											
		Mouse	<i>Some:</i> Lenovo Calliope Mouse (USB connector), black <i>Some:</i> Lenovo Calliope Wireless Mouse (2.4GHz via USB receiver), black <i>Some:</i> Lenovo Fingerprint Mouse (USB connector), Windows Hello support, black																																																												
Memory	64GB max, UDIMM, DDR4-2400, four 288-pin DIMM sockets, non-ECC, dual-channel capable* * System automatically clocks down for the processors with lower memory controller	Mechanical	<ul style="list-style-type: none"> SFF (8.4L), black color; metal case (WxDxH) 3.6" X 11.4" X 13.5"; 92.5mm X 290.5mm X 343.5mm Approx. 13.2 lb (6.0 kg), weight may vary by configuration Toolless cover, disk, optical removal Optional dust filter Bay 1: Slim external ODD bay Bay 2: 3.5", internal, HDD/SSD Bay 3: 2.5", internal, HDD/SSD (bay only comes with 2.5" 2nd disk) Slot 1: low-profile (length < 150mm, height < 68mm), PCIe 3.0 x16* Slot 2: low-profile (length < 150mm, height < 68mm), PCIe 2.0 x1* Slot 3: low-profile (length < 150mm, height < 68mm), PCIe 2.0 x1* Slot 4: no slot, only bracket for optional port extension* M.2 card slots: two (one for WLAN, one for SSD) * Optional front USB3.1 Type-C x2 module occupies PCIe x16 slot (x4 card), optional rear 2x USB2.0 / parallel / 2nd serial occupies one expansion slot 																																																												
Storage	<i>Some:</i> Hard Drive / SATA 6.0Gb/s, 2.5" or 3.5", 5400 rpm or 7200 rpm <i>Some:</i> Solid State Drive (SSD) / SATA 6.0Gb/s, 2.5" <i>Some:</i> M.2 Solid State Drive (SSD) / PCIe NVMe, PCIe 3.0 x 4, 32Gb/s	Floor Stand	Optional system floor stand for vertical orientation																																																												
Optical	<i>Some:</i> DVD-ROM SATA 1.5Gb/s Drive, slim (9.0mm) <i>Some:</i> DVD Burner (DVD±RW), SATA 1.5Gb/s Drive, slim (9.0mm)	Power supply	<i>Some:</i> 180 watts, autosensing, 85% PSU <i>Some:</i> 210 watts, autosensing, 85% PSU <i>Some:</i> 210 watts, autosensing, 92% PSU (only available via special bid)																																																												
Onboard SATA Media reader	Three onboard SATA 6.0Gb/s connectors Optional 7-in-1 media reader	Limited warranty	<i>Some:</i> 1-year or 3-year, depot service / service upgrades available <i>Some:</i> 1-year or 3-year, limited onsite service / service upgrades available																																																												
Graphics	AMD Radeon™ Graphics in processor (not for AMD Ryzen processor), uses main memory, DirectX® 12, one VGA, two DisplayPort™ (Onboard VGA and DP ports are invalid on the models with AMD Ryzen processor), supports 3 independent displays, works along with AMD discrete graphics to support more displays; <i>Max resolution:</i> 4096x2160 (DP)@60Hz; 1920x1200 (VGA)@60Hz <i>Some:</i> NVIDIA GeForce® GT 730 , DirectX 12, 2GB, PCIe 2.0 x8 adapter, two DisplayPort, 35 watts; <i>Max resolution:</i> 3840x2160 (DisplayPort)@60Hz;	Preload	Preloaded operating system <i>Some:</i> Windows® 7 Professional 32/64 preinstalled through downgrade rights in Windows 10 Pro 64-bit (Only available with Pro A6/A10/A12-8xxx APUs) <i>Some:</i> Windows 10 Pro 64-bit <i>Some:</i> Windows 10 Home 64-bit Preloaded applications (only some listed) <ul style="list-style-type: none"> Microsoft Office preloaded; purchase a product key to activate Only for Window 10 Lenovo Companion Only for Window 7 Lenovo Solution Center Lenovo ThinkVantage Tools Create Recovery Media Adobe® Reader® Cyberlink Power2Go Create (DVD±RW) 																																																												
Monitor cable	Optional DP to VGA, DP to DVI-D (single link), DP to dual DP, or DP to HDMI 1.4	Environment	ENERGY STAR® 6.1, EPEAT™ Gold rating (North America), ErP Lot 3, GREENGUARD®, RoHS-compliant																																																												
Chipset	AMD B350 Chipset	Accessories	For compatible accessories, please go to http://www.lenovoquickpick.com																																																												
Front ports*	Two USB 3.1 Gen2, two USB 3.1 Gen1, optional two USB 3.1 Type-C Gen 2 (only available via special bid), microphone (3.5mm), headphone (3.5mm)																																																														
Rear ports*	Two USB 3.1 Gen1, two USB 2.0, optional two USB 2.0, serial (9-pin), optional 2nd serial (9-pin), optional parallel (25-pin), ethernet (RJ-45), one VGA and two DisplayPort (not available on models with AMD Ryzen processor), two PS/2 ports (keyboard / mouse); additional DisplayPort on optional graphics on some models																																																														
Rear audio ports* IEEE 1394*	Line-in (3.5mm), line-out (3.5mm), microphone-in (3.5mm) None * Depending on many factors, actual data transfer speed may be lower than theoretical speed																																																														
Audio support	High Definition (HD) Audio, Realtek ALC662 / optional internal speaker (1.5 watt)																																																														
WLAN	<i>Some:</i> 11ac wireless, M.2 Card, Realtek RTL8821AE (dual band), Wi-Fi + Bluetooth 4.0 combo adapter, 1x1 <i>Some:</i> 11ac wireless, M.2 Card, Qualcomm Atheros QCA6174A (dual band), Wi-Fi + Bluetooth 4.1 combo adapter, 2x2 <i>Some:</i> 11ac wireless, M.2 Card, Qualcomm Atheros QCA9377 (dual band), Wi-Fi + Bluetooth 4.1 combo adapter, 1x1																																																														
Bluetooth™ Ethernet Modem	<i>Some:</i> Bluetooth 4.0 or 4.1 wireless, integrated in Wi-Fi + BT combo adapter Gigabit ethernet, Realtek RTL8111EPV, Wake on LAN® None																																																														
Manageability Security chip	DASH TPM (Trusted Platform Module) 2.0, TCG Certified * Downgrade to TPM1.2 for the models with Win10 DG Win7 32 OS																																																														

Note: The specifications above may not be available in all regions.

Lenovo, July 2017



ThinkCentre M720 SFF Platform Specifications

Product Specifications Reference (PSREF)

Processor	Intel® Celeron®, Intel Pentium®, or 8th / 9th Gen Intel Core™ i3 / i5 / i7 / i9 Processor	<p><i>Some:</i> 11ac wireless, M.2 Card, Realtek RTL8822BE (dual band), Wi-Fi + Bluetooth 4.2 combo adapter, 2x2</p> <p><i>Some:</i> 11ac wireless, M.2 Card, Intel Dual Band Wireless-AC 3165, Wi-Fi + Bluetooth 4.2 combo adapter, 1x1</p> <p><i>Some:</i> 11ac wireless, M.2 Card, Intel Dual Band Wireless-AC 8265, Wi-Fi + Bluetooth 4.2 combo adapter, 2x2</p> <p><i>Some:</i> Bluetooth 4.2 wireless, integrated in Wi-Fi + BT combo adapter</p>																																																																																																																								
	<table border="1"> <thead> <tr> <th>Processor</th> <th>Cores / Threads</th> <th>Frequency Base/Max(GHz)</th> <th>Cache</th> <th>Memory Support (Up to)</th> <th>Integrated Graphics</th> </tr> </thead> <tbody> <tr><td>Celeron G4900</td><td>2 / 2</td><td>3.1G</td><td>2 MB</td><td>DDR4-2400</td><td>UHD 610</td></tr> <tr><td>Celeron G4920</td><td>2 / 2</td><td>3.2G</td><td>2 MB</td><td>DDR4-2400</td><td>UHD 610</td></tr> <tr><td>Pentium Gold G5400</td><td>2 / 4</td><td>3.7G</td><td>4 MB</td><td>DDR4-2400</td><td>UHD 610</td></tr> <tr><td>Pentium Gold G5500</td><td>2 / 4</td><td>3.8G</td><td>4 MB</td><td>DDR4-2400</td><td>UHD 630</td></tr> <tr><td>Pentium Gold G5600</td><td>2 / 4</td><td>3.9G</td><td>4 MB</td><td>DDR4-2400</td><td>UHD 630</td></tr> <tr><td>Core i3-8100</td><td>4 / 4</td><td>3.6G</td><td>6 MB</td><td>DDR4-2400</td><td>UHD 630</td></tr> <tr><td>Core i3-8300</td><td>4 / 4</td><td>3.7G</td><td>8 MB</td><td>DDR4-2400</td><td>UHD 630</td></tr> <tr><td>Core i5-8400</td><td>6 / 6</td><td>2.8G / 4.0G</td><td>9 MB</td><td>DDR4-2666</td><td>UHD 630</td></tr> <tr><td>Core i5-8500</td><td>6 / 6</td><td>3.0G / 4.1G</td><td>9 MB</td><td>DDR4-2666</td><td>UHD 630</td></tr> <tr><td>Core i5-8600</td><td>6 / 6</td><td>3.1G / 4.3G</td><td>9 MB</td><td>DDR4-2666</td><td>UHD 630</td></tr> <tr><td>Core i7-8700</td><td>6 / 12</td><td>3.2G / 4.6G</td><td>12 MB</td><td>DDR4-2666</td><td>UHD 630</td></tr> <tr><td>Core i3-9100</td><td>4 / 4</td><td>3.6G / 4.2G</td><td>6 MB</td><td>DDR4-2400</td><td>UHD 630</td></tr> <tr><td>Core i3-9300</td><td>4 / 4</td><td>3.7G / 4.3G</td><td>8 MB</td><td>DDR4-2400</td><td>UHD 630</td></tr> <tr><td>Core i3-9320</td><td>4 / 4</td><td>3.7G / 4.4G</td><td>8 MB</td><td>DDR4-2400</td><td>UHD 630</td></tr> <tr><td>Core i5-9400</td><td>6 / 6</td><td>2.9G / 4.1G</td><td>9 MB</td><td>DDR4-2666</td><td>UHD 630</td></tr> <tr><td>Core i5-9500</td><td>6 / 6</td><td>3.0G / 4.4G</td><td>9 MB</td><td>DDR4-2666</td><td>UHD 630</td></tr> <tr><td>Core i5-9600</td><td>6 / 6</td><td>3.1G / 4.6G</td><td>9 MB</td><td>DDR4-2666</td><td>UHD 630</td></tr> <tr><td>Core i7-9700</td><td>8 / 8</td><td>3.0G / 4.7G</td><td>12 MB</td><td>DDR4-2666</td><td>UHD 630</td></tr> <tr><td>Core i9-9900</td><td>8 / 16</td><td>3.1G / 5.0G</td><td>16 MB</td><td>DDR4-2666</td><td>UHD 630</td></tr> </tbody> </table>	Processor	Cores / Threads	Frequency Base/Max(GHz)	Cache	Memory Support (Up to)	Integrated Graphics	Celeron G4900	2 / 2	3.1G	2 MB	DDR4-2400	UHD 610	Celeron G4920	2 / 2	3.2G	2 MB	DDR4-2400	UHD 610	Pentium Gold G5400	2 / 4	3.7G	4 MB	DDR4-2400	UHD 610	Pentium Gold G5500	2 / 4	3.8G	4 MB	DDR4-2400	UHD 630	Pentium Gold G5600	2 / 4	3.9G	4 MB	DDR4-2400	UHD 630	Core i3-8100	4 / 4	3.6G	6 MB	DDR4-2400	UHD 630	Core i3-8300	4 / 4	3.7G	8 MB	DDR4-2400	UHD 630	Core i5-8400	6 / 6	2.8G / 4.0G	9 MB	DDR4-2666	UHD 630	Core i5-8500	6 / 6	3.0G / 4.1G	9 MB	DDR4-2666	UHD 630	Core i5-8600	6 / 6	3.1G / 4.3G	9 MB	DDR4-2666	UHD 630	Core i7-8700	6 / 12	3.2G / 4.6G	12 MB	DDR4-2666	UHD 630	Core i3-9100	4 / 4	3.6G / 4.2G	6 MB	DDR4-2400	UHD 630	Core i3-9300	4 / 4	3.7G / 4.3G	8 MB	DDR4-2400	UHD 630	Core i3-9320	4 / 4	3.7G / 4.4G	8 MB	DDR4-2400	UHD 630	Core i5-9400	6 / 6	2.9G / 4.1G	9 MB	DDR4-2666	UHD 630	Core i5-9500	6 / 6	3.0G / 4.4G	9 MB	DDR4-2666	UHD 630	Core i5-9600	6 / 6	3.1G / 4.6G	9 MB	DDR4-2666	UHD 630	Core i7-9700	8 / 8	3.0G / 4.7G	12 MB	DDR4-2666	UHD 630	Core i9-9900	8 / 16	3.1G / 5.0G	16 MB	DDR4-2666	UHD 630	<p><i>Some:</i> Gigabit ethernet, Intel Ethernet Connection I219-V (Jacksonville), Wake on LAN®</p> <p><i>Some:</i> Intel Ethernet Server Adapter I350-T4*, gigabit ethernet, 4x RJ-45, PCIe x4</p> <p><i>Some:</i> Bitland BN8E88*, gigabit ethernet, PCIe x1 (only available via special bid)</p> <p>* Choose either I350-T4 or BN8E88</p>
Processor	Cores / Threads	Frequency Base/Max(GHz)	Cache	Memory Support (Up to)	Integrated Graphics																																																																																																																					
Celeron G4900	2 / 2	3.1G	2 MB	DDR4-2400	UHD 610																																																																																																																					
Celeron G4920	2 / 2	3.2G	2 MB	DDR4-2400	UHD 610																																																																																																																					
Pentium Gold G5400	2 / 4	3.7G	4 MB	DDR4-2400	UHD 610																																																																																																																					
Pentium Gold G5500	2 / 4	3.8G	4 MB	DDR4-2400	UHD 630																																																																																																																					
Pentium Gold G5600	2 / 4	3.9G	4 MB	DDR4-2400	UHD 630																																																																																																																					
Core i3-8100	4 / 4	3.6G	6 MB	DDR4-2400	UHD 630																																																																																																																					
Core i3-8300	4 / 4	3.7G	8 MB	DDR4-2400	UHD 630																																																																																																																					
Core i5-8400	6 / 6	2.8G / 4.0G	9 MB	DDR4-2666	UHD 630																																																																																																																					
Core i5-8500	6 / 6	3.0G / 4.1G	9 MB	DDR4-2666	UHD 630																																																																																																																					
Core i5-8600	6 / 6	3.1G / 4.3G	9 MB	DDR4-2666	UHD 630																																																																																																																					
Core i7-8700	6 / 12	3.2G / 4.6G	12 MB	DDR4-2666	UHD 630																																																																																																																					
Core i3-9100	4 / 4	3.6G / 4.2G	6 MB	DDR4-2400	UHD 630																																																																																																																					
Core i3-9300	4 / 4	3.7G / 4.3G	8 MB	DDR4-2400	UHD 630																																																																																																																					
Core i3-9320	4 / 4	3.7G / 4.4G	8 MB	DDR4-2400	UHD 630																																																																																																																					
Core i5-9400	6 / 6	2.9G / 4.1G	9 MB	DDR4-2666	UHD 630																																																																																																																					
Core i5-9500	6 / 6	3.0G / 4.4G	9 MB	DDR4-2666	UHD 630																																																																																																																					
Core i5-9600	6 / 6	3.1G / 4.6G	9 MB	DDR4-2666	UHD 630																																																																																																																					
Core i7-9700	8 / 8	3.0G / 4.7G	12 MB	DDR4-2666	UHD 630																																																																																																																					
Core i9-9900	8 / 16	3.1G / 5.0G	16 MB	DDR4-2666	UHD 630																																																																																																																					
		<p>None</p> <p>Discrete TPM 2.0, TCG Certified</p> <p>Security chip</p> <p>Security features</p> <ul style="list-style-type: none"> Security slot (in rear for optional Kensington® MicroSaver® cable) Padlock loop Optional cable lock to physically lock both keyboard and mouse Optional chassis intrusion switch Optional chassis E-Lock (special bid) Power-on password Administrator password Hard disk password Boot sequence control Boot without keyboard and mouse Individual USB port disablement Smart USB protection, allows keyboard/mouse only, blocks all storage devices 																																																																																																																								
		<p>Keyboard</p> <p><i>Some:</i> Lenovo Calliope Keyboard (USB connector), black</p> <p><i>Some:</i> Lenovo Traditional Keyboard (USB connector), black</p> <p><i>Some:</i> Lenovo Calliope Wireless Keyboard (2.4GHz via USB receiver), black</p> <p><i>Some:</i> Lenovo Keyboard (PS/2 connector), black (only available via special bid)</p> <p><i>Some:</i> Lenovo Calliope Mouse (USB connector), black</p> <p><i>Some:</i> Lenovo Fingerprint Mouse (USB connector), Windows Hello support, black</p> <p><i>Some:</i> Lenovo Calliope Wireless Mouse (2.4GHz via USB receiver), black</p> <p><i>Some:</i> Lenovo Mouse (PS/2 connector), black (only available via special bid)</p>																																																																																																																								
Memory	64GB max, UDIMM, DDR4-2666, four 288-pin DIMM sockets, non-ECC, dual-channel capable* * System automatically clocks down for the processors with lower memory controller																																																																																																																									
Storage	<p><i>Some:</i> Hard Drive / SATA 6.0Gb/s, 2.5" or 3.5", 5400 rpm or 7200 rpm</p> <p><i>Some:</i> Solid State Drive (SSD) / SATA 6.0Gb/s, 2.5"</p> <p><i>Some:</i> M.2 Solid State Drive (SSD) / PCIe NVMe, PCIe 3.0 x 4*, 32Gb/s</p> <p>* M.2 SSD (2242) PCIe NVMe only supports PCIe 3.0 x 2, 16Gb/s</p> <p><i>Some:</i> Intel Optane™ Memory (not support Celeron / Pentium Processor), M.2</p>																																																																																																																									
Optical	<p><i>Some:</i> DVD-ROM SATA 1.5Gb/s Drive, slim (9.0mm)</p> <p><i>Some:</i> DVD Burner (DVD±RW), SATA 1.5Gb/s Drive, slim (9.0mm)</p>																																																																																																																									
Onboard SATA Media reader	Three onboard SATA 6.0Gb/s connectors Optional 7-in-1 media reader																																																																																																																									
Graphics	<p>Intel UHD Graphics 610/630 in processor, uses main memory, DirectX® 12, one VGA, two DisplayPort™, supports 3 independent displays, works along with discrete graphics to support more displays;</p> <p><i>Max resolution:</i> 4096x2304 (DP)@60Hz; 2048x1536 (VGA)@50Hz</p> <p><i>Some:</i> NVIDIA GeForce® GT 730, DirectX 12, 2GB, PCIe 2.0 x16 adapter, two DisplayPort, 35 watts;</p> <p><i>Max resolution:</i> 3840x2160 (DisplayPort)@60Hz;</p>																																																																																																																									
Monitor cable	Optional DP to VGA dongle, DP to DVI-D dongle, DP to dual DP dongle (for Collage Display with intel integrated graphics), or DP to HDMI 1.4 dongle																																																																																																																									
Chipset	Intel B360 Chipset																																																																																																																									
Front ports* (Std.)	2x USB 3.1 Gen2, 2x USB 3.1 Gen1, 1x USB 3.1 Type-C Gen1 (15W charging), 1x microphone (3.5mm), 1x headphone / microphone combo jack (3.5mm)																																																																																																																									
Front ports* (Opt.)	Optional: 1x media reader																																																																																																																									
Rear ports* (Std.)	4x USB 2.0, 1x serial (9-pin), 1x ethernet (RJ-45), 1x VGA, 2x DisplayPort, 1x line-out (3.5mm)																																																																																																																									
Rear ports* (Opt.)	Optional: 2x USB 3.1 Gen1 via PCI2 x1**, 2x USB 3.1 Type-C Gen2 via PCIe x4** (special bid only), 1x 2nd serial (9-pin), 4x serial (9-pin) via PCIe x1, 1x parallel (25-pin), 2x PS/2 ports (keyboard/mouse), additional RJ-45 and video ports available on optional graphics or ethernet card																																																																																																																									
	* Depending on many factors, actual data transfer speed may be lower than theoretical speed																																																																																																																									
	** Choose either 2x USB 3.1 Gen1 or 2x USB 3.1 Type-C Gen2																																																																																																																									
Audio support	High Definition (HD) Audio, Realtek ALC233VB2 / internal speaker (2 watt)																																																																																																																									
WLAN	<i>Some:</i> 11ac wireless, M.2 Card, Realtek RTL8821CE (dual band), Wi-Fi + Bluetooth 4.2 combo adapter, 1x1																																																																																																																									
Mechanical	<ul style="list-style-type: none"> SFF (8.4L), black color; metal case (WxDxH) 3.64" X 11.44" X 13.52"; 92.5mm X 290.5mm X 343.5mm Approx. 13.24 lb (6.0 kg), weight may vary by configuration Toolless cover, disk, optical, and extension card removal Optional dust filter <p>Bay 1: Slim external ODD bay Bay 2: 3.5", 1" high, internal, HDD/SSD Bay 3: 2.5", internal, HDD/SSD (optional bay) Slot 1: low-profile (length < 147mm, height < 68.9mm), PCIe 3.0 x16 Slot 2: low-profile (length < 147mm, height < 68.9mm), PCIe 3.0 x1 Slot 3: low-profile (length < 147mm, height < 68.9mm), PCIe 3.0 x1 Slot 4: no slot, only bracket for optional port extension M.2 card slots: Two (one for WLAN, one for SSD/Optane)</p>																																																																																																																									
Floor Stand	Optional system floor stand for vertical orientation																																																																																																																									
Power supply	<p><i>Some:</i> 180 watts, autosensing, 85% PSU</p> <p><i>Some:</i> 210 watts, autosensing, 85% PSU</p> <p><i>Some:</i> 260 watts, autosensing, 92% PSU (only available via special bid)</p>																																																																																																																									
Limited warranty ³	<p><i>Some:</i> 1-year or 3-year, depot service / service upgrades available</p> <p><i>Some:</i> 1-year or 3-year, limited onsite service / service upgrades available</p>																																																																																																																									
Preload	<p>Preloaded operating system</p> <p><i>Some:</i> Windows® 10 Pro 64-bit</p> <p><i>Some:</i> Windows 10 Home 64-bit</p> <p>Preloaded applications (only some listed)</p> <ul style="list-style-type: none"> Lenovo Vantage Microsoft Office preloaded; purchase a product key to activate Cyberlink PowerDVD (only for models with DVD / DVD±RW) Cyberlink Power2GO (only for models with DVD±RW) LinkedIn 																																																																																																																									
Environment	ENERGY STAR® 6.1, EPEAT™ Silver rating (North America), ErP Lot 3, TCO, TUV low noise verified (coming soon, on some models), RoHS-compliant																																																																																																																									
Accessories	For compatible accessories, please go to http://smartfind.lenovo.com																																																																																																																									

Note: The specifications above may not be available in all regions.

Lenovo, June 2019



ThinkCentre M720e SFF Platform Specifications

Product Specifications Reference (PSREF)

Processor	Intel® Celeron®, Intel Pentium®, or 8th / 9th Gen Intel Core™ i3 / i5 / i7 / i9 Processor						Manageability	None																																																																																																																								
	<table border="1"> <thead> <tr> <th>Processor</th> <th>Cores / Threads</th> <th>Frequency Base/Max(GHz)</th> <th>Cache</th> <th>Memory Support (Up to)</th> <th>Integrated Graphics</th> </tr> </thead> <tbody> <tr><td>Celeron G4900</td><td>2 / 2</td><td>3.1G</td><td>2 MB</td><td>DDR4-2400</td><td>UHD 610</td></tr> <tr><td>Celeron G4920</td><td>2 / 2</td><td>3.2G</td><td>2 MB</td><td>DDR4-2400</td><td>UHD 610</td></tr> <tr><td>Celeron G4930</td><td>2 / 2</td><td>3.2G</td><td>2 MB</td><td>DDR4-2400</td><td>UHD 610</td></tr> <tr><td>Celeron G4950</td><td>2 / 2</td><td>3.3G</td><td>2 MB</td><td>DDR4-2400</td><td>UHD 610</td></tr> <tr><td>Pentium Gold G5500</td><td>2 / 4</td><td>3.8G</td><td>4 MB</td><td>DDR4-2400</td><td>UHD 630</td></tr> <tr><td>Pentium Gold G5600</td><td>2 / 4</td><td>3.9G</td><td>4 MB</td><td>DDR4-2400</td><td>UHD 630</td></tr> <tr><td>Pentium Gold G5420</td><td>2 / 4</td><td>3.8G</td><td>4 MB</td><td>DDR4-2400</td><td>UHD 610</td></tr> <tr><td>Pentium Gold G5620</td><td>2 / 4</td><td>4.0G</td><td>4 MB</td><td>DDR4-2400</td><td>UHD 630</td></tr> <tr><td>Core i3-8100</td><td>4 / 4</td><td>3.6G</td><td>6 MB</td><td>DDR4-2400</td><td>UHD 630</td></tr> <tr><td>Core i5-8400</td><td>6 / 6</td><td>2.8G / 4.0G</td><td>9 MB</td><td>DDR4-2666</td><td>UHD 630</td></tr> <tr><td>Core i5-8500</td><td>6 / 6</td><td>3.0G / 4.1G</td><td>9 MB</td><td>DDR4-2666</td><td>UHD 630</td></tr> <tr><td>Core i7-8700</td><td>6 / 12</td><td>3.2G / 4.6G</td><td>12 MB</td><td>DDR4-2666</td><td>UHD 630</td></tr> <tr><td>Core i3-9100</td><td>4 / 4</td><td>3.6G / 4.2G</td><td>6 MB</td><td>DDR4-2400</td><td>UHD 630</td></tr> <tr><td>Core i3-9300</td><td>4 / 4</td><td>3.7G / 4.3G</td><td>8 MB</td><td>DDR4-2400</td><td>UHD 630</td></tr> <tr><td>Core i5-9400</td><td>6 / 6</td><td>2.9G / 4.1G</td><td>9 MB</td><td>DDR4-2666</td><td>UHD 630</td></tr> <tr><td>Core i5-9500</td><td>6 / 6</td><td>3.0G / 4.4G</td><td>9 MB</td><td>DDR4-2666</td><td>UHD 630</td></tr> <tr><td>Core i5-9600</td><td>6 / 6</td><td>3.1G / 4.6G</td><td>9 MB</td><td>DDR4-2666</td><td>UHD 630</td></tr> <tr><td>Core i7-9700</td><td>8 / 8</td><td>3.0G / 4.7G</td><td>12 MB</td><td>DDR4-2666</td><td>UHD 630</td></tr> <tr><td>Core i9-9900</td><td>8 / 16</td><td>3.1G / 5.0G</td><td>16 MB</td><td>DDR4-2666</td><td>UHD 630</td></tr> </tbody> </table>						Processor	Cores / Threads	Frequency Base/Max(GHz)	Cache	Memory Support (Up to)	Integrated Graphics	Celeron G4900	2 / 2	3.1G	2 MB	DDR4-2400	UHD 610	Celeron G4920	2 / 2	3.2G	2 MB	DDR4-2400	UHD 610	Celeron G4930	2 / 2	3.2G	2 MB	DDR4-2400	UHD 610	Celeron G4950	2 / 2	3.3G	2 MB	DDR4-2400	UHD 610	Pentium Gold G5500	2 / 4	3.8G	4 MB	DDR4-2400	UHD 630	Pentium Gold G5600	2 / 4	3.9G	4 MB	DDR4-2400	UHD 630	Pentium Gold G5420	2 / 4	3.8G	4 MB	DDR4-2400	UHD 610	Pentium Gold G5620	2 / 4	4.0G	4 MB	DDR4-2400	UHD 630	Core i3-8100	4 / 4	3.6G	6 MB	DDR4-2400	UHD 630	Core i5-8400	6 / 6	2.8G / 4.0G	9 MB	DDR4-2666	UHD 630	Core i5-8500	6 / 6	3.0G / 4.1G	9 MB	DDR4-2666	UHD 630	Core i7-8700	6 / 12	3.2G / 4.6G	12 MB	DDR4-2666	UHD 630	Core i3-9100	4 / 4	3.6G / 4.2G	6 MB	DDR4-2400	UHD 630	Core i3-9300	4 / 4	3.7G / 4.3G	8 MB	DDR4-2400	UHD 630	Core i5-9400	6 / 6	2.9G / 4.1G	9 MB	DDR4-2666	UHD 630	Core i5-9500	6 / 6	3.0G / 4.4G	9 MB	DDR4-2666	UHD 630	Core i5-9600	6 / 6	3.1G / 4.6G	9 MB	DDR4-2666	UHD 630	Core i7-9700	8 / 8	3.0G / 4.7G	12 MB	DDR4-2666	UHD 630	Core i9-9900	8 / 16	3.1G / 5.0G	16 MB	DDR4-2666	UHD 630	Security chip	Discrete TPM 2.0, TCG Certified
	Processor	Cores / Threads	Frequency Base/Max(GHz)	Cache	Memory Support (Up to)	Integrated Graphics																																																																																																																										
	Celeron G4900	2 / 2	3.1G	2 MB	DDR4-2400	UHD 610																																																																																																																										
	Celeron G4920	2 / 2	3.2G	2 MB	DDR4-2400	UHD 610																																																																																																																										
	Celeron G4930	2 / 2	3.2G	2 MB	DDR4-2400	UHD 610																																																																																																																										
	Celeron G4950	2 / 2	3.3G	2 MB	DDR4-2400	UHD 610																																																																																																																										
	Pentium Gold G5500	2 / 4	3.8G	4 MB	DDR4-2400	UHD 630																																																																																																																										
	Pentium Gold G5600	2 / 4	3.9G	4 MB	DDR4-2400	UHD 630																																																																																																																										
	Pentium Gold G5420	2 / 4	3.8G	4 MB	DDR4-2400	UHD 610																																																																																																																										
	Pentium Gold G5620	2 / 4	4.0G	4 MB	DDR4-2400	UHD 630																																																																																																																										
	Core i3-8100	4 / 4	3.6G	6 MB	DDR4-2400	UHD 630																																																																																																																										
	Core i5-8400	6 / 6	2.8G / 4.0G	9 MB	DDR4-2666	UHD 630																																																																																																																										
	Core i5-8500	6 / 6	3.0G / 4.1G	9 MB	DDR4-2666	UHD 630																																																																																																																										
	Core i7-8700	6 / 12	3.2G / 4.6G	12 MB	DDR4-2666	UHD 630																																																																																																																										
	Core i3-9100	4 / 4	3.6G / 4.2G	6 MB	DDR4-2400	UHD 630																																																																																																																										
	Core i3-9300	4 / 4	3.7G / 4.3G	8 MB	DDR4-2400	UHD 630																																																																																																																										
	Core i5-9400	6 / 6	2.9G / 4.1G	9 MB	DDR4-2666	UHD 630																																																																																																																										
	Core i5-9500	6 / 6	3.0G / 4.4G	9 MB	DDR4-2666	UHD 630																																																																																																																										
	Core i5-9600	6 / 6	3.1G / 4.6G	9 MB	DDR4-2666	UHD 630																																																																																																																										
Core i7-9700	8 / 8	3.0G / 4.7G	12 MB	DDR4-2666	UHD 630																																																																																																																											
Core i9-9900	8 / 16	3.1G / 5.0G	16 MB	DDR4-2666	UHD 630																																																																																																																											
						Security features	<ul style="list-style-type: none"> Security slot (in rear for optional Kensington® MicroSaver® cable) Padlock loop Smart USB protection, allows keyboard/ mouse only, blocks all storage devices Optional smart cable clip to physically lock both keyboard and mouse 																																																																																																																									
						Keyboard	Some: Lenovo Calliope Keyboard (USB connector), black																																																																																																																									
						Mouse	Some: Lenovo Traditional Keyboard (USB connector), black Some: Lenovo Calliope Mouse (USB connector), black Some: Lenovo Fingerprint Mouse (USB connector), Windows Hello support, black																																																																																																																									
						Mechanical	<ul style="list-style-type: none"> SFF (7.4L), black color, metal case (WxDxH) 3.9" X 11.9" X 10.8"; 100mm X 303.5mm X 274.8mm Approx. 9.37 lb (4.25 kg), weight may vary by configuration Bay 1: Slim ODD bay Bay 2: 3.5" disk bay, supports 2.5" HDD (2.5 to 3.5 bracket comes with 2.5" disk) Slot 1: low-profile (length < 152mm, height < 64mm), PCIe 3.0 x16* Slot 2: low-profile (length < 152mm, height < 64mm), PCIe 3.0 x1* M.2 card slot: one for SSD *Optional rear 2x USB2.0 / parallel occupies one expansion slot 																																																																																																																									
						Floor Stand	Optional system floor stand for vertical orientation																																																																																																																									
						Packaging	<ul style="list-style-type: none"> (WxDxH) 7.7" X 15.4" X 19.7"; 195mm X 390mm X 500mm Cross weight (approx.) 14.48 lb (6.57 kg) 																																																																																																																									
Memory	32GB max, UDIMM, DDR4-2666*, two 288-pin DIMM sockets, non-ECC, dual-channel capable * Memory may be underclocked to DDR4-2400 for the lower memory controller in processor						Power supply	180 watts, autosensing, 85% PSU																																																																																																																								
Storage	Some: Hard Drive / SATA 6.0Gb/s, 2.5" or 3.5", 5400 rpm or 7200 rpm Some: M.2 Solid State Drive (SSD) / PCIe NVMe, PCIe 3.0 x2 or PCIe 3.0 x4						Limited warranty ³	Some: 1-year or 3-year, depot service / service upgrades available Some: 1-year or 3-year, limited onsite service / service upgrades available																																																																																																																								
Optane memory	Some: Intel Optane™ Memory, M.2 2280, PCIe NVMe, PCIe 3.0 x 2						Preload	Preloaded operating system Some: Windows® 10 Pro 64-bit Some: Windows 10 Home 64-bit Some: Linux Ubuntu																																																																																																																								
Optical	Some: DVD-ROM SATA 1.5Gb/s Drive, slim (9.0mm) Some: DVD Burner (DVD±RW), SATA 1.5Gb/s Drive, slim (9.0mm)						Environment	ENERGY STAR® 7, EPEAT™ Silver rating (North America), ErP Lot 3, RoHS-compliant, WEEE																																																																																																																								
Onboard SATA	Two onboard SATA 6.0Gb/s connectors						Accessories	For compatible accessories, please go to http://www.lenovoquickpick.com																																																																																																																								
Media reader	Optional 7-in-1 media reader																																																																																																																															
Graphics	Intel HD Graphics 610/630 in processor, uses main memory, DirectX® 12, one VGA, one DisplayPort™, supports 2 independent displays, works along with discrete graphics to support more displays; Max resolution: 4096x2304 (DP)@60Hz; 2048x1536 (VGA)@50Hz Some: AMD Radeon™ 520, DirectX 12, 2GB GDDR5, PCIe 3.0 x8 adapter, one VGA, one HDMI, 30 watts (Max); Max resolution: 3840x2160 (HDMI)@30Hz; 2048x1536 (VGA)@85Hz																																																																																																																															
Monitor cable	Optional DP to VGA, DP to DVI-D (single link), DP to dual DP, or DP to HDMI 1.4																																																																																																																															
Chipset	Intel B365 Chipset																																																																																																																															
Front ports* (Std.)	Two USB 3.1 Gen1, microphone (3.5mm), one headphone / microphone combo jack (3.5mm)																																																																																																																															
Front ports* (Opt.)	None																																																																																																																															
Rear ports* (Std.)	Two USB 3.1 Gen1, two USB 2.0, serial (9-pin), ethernet (RJ-45), one VGA, one DisplayPort, Line-out jack (3.5mm)																																																																																																																															
Rear ports* (Opt.)	optional two USB 2.0, optional 2nd serial (9-pin), optional parallel (25-pin), optional external USB to PS/2 ports cable (for PS/2 keyboard / mouse); additional video ports or RJ-45 on optional graphics / ethernet card on some models * Depending on many factors, actual data transfer speed may be lower than theoretical speed																																																																																																																															
Audio support	High Definition (HD) Audio, Realtek ALC623 / internal speaker (2 watt)																																																																																																																															
WLAN ¹³	None																																																																																																																															
Bluetooth™	None																																																																																																																															
Ethernet	Gigabit ethernet, Realtek RTL8111HN, Wake on LAN®																																																																																																																															
Ethernet (Opt.)	Some: Bitland BN8E88*, gigabit ethernet, PCIe x1																																																																																																																															
Modem	None																																																																																																																															

Note: The specifications above may not be available in all regions.

Lenovo, September 2019

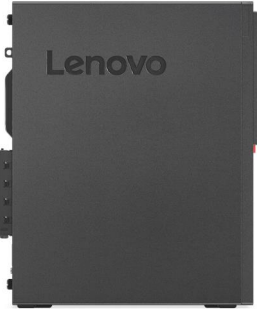
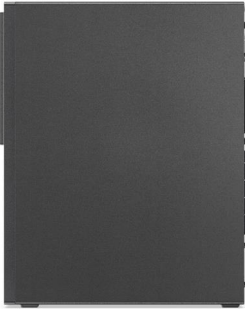

ThinkCentre M725 SFF Platform Specifications

Product Specifications Reference (PSREF)

Processor	AMD A6 / A8 / A10 / A12 and Ryzen 3 / 5 / 7 series processor					Ethernet	Gigabit ethernet, Realtek RTL8111EPV, Wake on LAN®																																																																		
	<table border="1"> <thead> <tr> <th>Processor</th> <th>Cores / Threads</th> <th>Frequency (Base/Max)</th> <th>L2 / L3 Cache</th> <th>Memory Support (Up to)</th> <th>Integrated Graphics</th> </tr> </thead> <tbody> <tr> <td>PRO A6-9500</td> <td>2 / 2</td> <td>3.5 / 3.8</td> <td>1MB</td> <td>DDR4-2400</td> <td>Radeon R5</td> </tr> <tr> <td>PRO A8-9600</td> <td>4 / 4</td> <td>3.1 / 3.4</td> <td>2MB</td> <td>DDR4-2400</td> <td>Radeon R7</td> </tr> <tr> <td>PRO A10-9700</td> <td>4 / 4</td> <td>3.5 / 3.8</td> <td>2MB</td> <td>DDR4-2400</td> <td>Radeon R7</td> </tr> <tr> <td>PRO A12-9800</td> <td>4 / 4</td> <td>3.8 / 4.2</td> <td>2MB</td> <td>DDR4-2400</td> <td>Radeon R7</td> </tr> <tr> <td>Ryzen 3 2300X</td> <td>4 / 4</td> <td>3.5 / 4.0</td> <td>2MB / 8MB</td> <td>DDR4-2933</td> <td>None</td> </tr> <tr> <td>Ryzen 5 2500X</td> <td>4 / 8</td> <td>3.6 / 4.0</td> <td>2MB / 8MB</td> <td>DDR4-2933</td> <td>None</td> </tr> <tr> <td>Ryzen 3 PRO 2200G</td> <td>4 / 4</td> <td>3.5 / 3.6</td> <td>2MB / 4MB</td> <td>DDR4-2933</td> <td>Radeon Vega 8</td> </tr> <tr> <td>Ryzen 5 PRO 2400G</td> <td>4 / 8</td> <td>3.6 / 3.8</td> <td>2MB / 4MB</td> <td>DDR4-2933</td> <td>Radeon RX Vega 11</td> </tr> <tr> <td>Ryzen 5 PRO 2600</td> <td>6 / 12</td> <td>3.4 / 3.9</td> <td>3MB / 16MB</td> <td>DDR4-2933</td> <td>None</td> </tr> <tr> <td>Ryzen 7 PRO 2700</td> <td>8 / 16</td> <td>3.2 / 4.1</td> <td>4MB / 16MB</td> <td>DDR4-2933</td> <td>None</td> </tr> </tbody> </table>					Processor	Cores / Threads	Frequency (Base/Max)	L2 / L3 Cache	Memory Support (Up to)	Integrated Graphics	PRO A6-9500	2 / 2	3.5 / 3.8	1MB	DDR4-2400	Radeon R5	PRO A8-9600	4 / 4	3.1 / 3.4	2MB	DDR4-2400	Radeon R7	PRO A10-9700	4 / 4	3.5 / 3.8	2MB	DDR4-2400	Radeon R7	PRO A12-9800	4 / 4	3.8 / 4.2	2MB	DDR4-2400	Radeon R7	Ryzen 3 2300X	4 / 4	3.5 / 4.0	2MB / 8MB	DDR4-2933	None	Ryzen 5 2500X	4 / 8	3.6 / 4.0	2MB / 8MB	DDR4-2933	None	Ryzen 3 PRO 2200G	4 / 4	3.5 / 3.6	2MB / 4MB	DDR4-2933	Radeon Vega 8	Ryzen 5 PRO 2400G	4 / 8	3.6 / 3.8	2MB / 4MB	DDR4-2933	Radeon RX Vega 11	Ryzen 5 PRO 2600	6 / 12	3.4 / 3.9	3MB / 16MB	DDR4-2933	None	Ryzen 7 PRO 2700	8 / 16	3.2 / 4.1	4MB / 16MB	DDR4-2933	None	Ethernet (Opt.)	Some: Bitland BN8E88, gigabit ethernet, 1x RJ-45, PCIe x1 (special bid only)
	Processor	Cores / Threads	Frequency (Base/Max)	L2 / L3 Cache	Memory Support (Up to)	Integrated Graphics																																																																			
	PRO A6-9500	2 / 2	3.5 / 3.8	1MB	DDR4-2400	Radeon R5																																																																			
	PRO A8-9600	4 / 4	3.1 / 3.4	2MB	DDR4-2400	Radeon R7																																																																			
	PRO A10-9700	4 / 4	3.5 / 3.8	2MB	DDR4-2400	Radeon R7																																																																			
	PRO A12-9800	4 / 4	3.8 / 4.2	2MB	DDR4-2400	Radeon R7																																																																			
	Ryzen 3 2300X	4 / 4	3.5 / 4.0	2MB / 8MB	DDR4-2933	None																																																																			
	Ryzen 5 2500X	4 / 8	3.6 / 4.0	2MB / 8MB	DDR4-2933	None																																																																			
	Ryzen 3 PRO 2200G	4 / 4	3.5 / 3.6	2MB / 4MB	DDR4-2933	Radeon Vega 8																																																																			
Ryzen 5 PRO 2400G	4 / 8	3.6 / 3.8	2MB / 4MB	DDR4-2933	Radeon RX Vega 11																																																																				
Ryzen 5 PRO 2600	6 / 12	3.4 / 3.9	3MB / 16MB	DDR4-2933	None																																																																				
Ryzen 7 PRO 2700	8 / 16	3.2 / 4.1	4MB / 16MB	DDR4-2933	None																																																																				
Manageability	DASH 10/1.1					Security chip	Discrete TPM 2.0, TCG Certified																																																																		
Security features	<ul style="list-style-type: none"> Security slot (in rear for optional Kensington® MicroSaver® cable) Padlock loop Smart USB protection, allows keyboard/ mouse only, blocks all storage devices Optional cable lock to physically lock both keyboard and mouse 					<ul style="list-style-type: none"> Power-on password Administrator password Hard disk password Boot sequence control Boot without keyboard and mouse Individual USB port disablement Optional chassis intrusion switch 																																																																			
Keyboard	<i>Some:</i> Lenovo Calliope Keyboard (USB connector), black <i>Some:</i> Lenovo Traditional Keyboard (USB connector), black <i>Some:</i> Lenovo Calliope Wireless Keyboard (2.4GHz via USB receiver), black <i>Some:</i> Lenovo Keyboard (PS/2 connector), black (only available via special bid)					Mouse	<i>Some:</i> Lenovo Calliope Mouse (USB connector), black <i>Some:</i> Lenovo Fingerprint Mouse (USB connector), Windows Hello support, black <i>Some:</i> Lenovo Calliope Wireless Mouse (2.4GHz via USB receiver), black <i>Some:</i> Lenovo Mouse (PS/2 connector), black (only available via special bid)																																																																		
Memory	64GB max, UDIMM, DDR4-2666*, four 288-pin DIMM sockets, non-ECC, dual-channel capable * Systemboard supports up to DDR4-2666, memory frequency may automatically clocks down for the lower capability of memory controller in processor					Mechanical	<ul style="list-style-type: none"> SFF (8.4L), black color; metal case (WxDxH) 3.6" X 11.4" X 13.5"; 92.5mm X 290.5mm X 343.5mm Approx. 13.2 lb (6.0 kg), weight may vary by configuration Toolless cover, disk, optical removal Optional dust filter 																																																																		
Storage	<i>Some:</i> Hard Drive / SATA 6.0Gb/s, 2.5" or 3.5", 5400 rpm or 7200 rpm <i>Some:</i> Solid State Drive (SSD) / SATA 6.0Gb/s, 2.5" <i>Some:</i> M.2 SSD / PCIe NVMe, PCIe 3.0 x 4*, 32Gb/s * 128GB SSD M.2 (2242) PCIe NVMe and AMD A6 / A8 / A10 / A12 processor only supports PCIe 3.0 x 2, 16Gb/s					Bay 1	Slim external ODD bay																																																																		
Optical	<i>Some:</i> DVD-ROM SATA 1.5Gb/s Drive, slim (9.0mm) <i>Some:</i> DVD Burner (DVD±RW), SATA 1.5Gb/s Drive, slim (9.0mm)					Bay 2	3.5", internal, HDD/SSD																																																																		
Onboard SATA	Three onboard SATA 6.0Gb/s connectors, RAID 0/1 support (RAID preset only available via special bid model)					Bay 3	2.5", internal, HDD/SSD (bay only comes with 2.5" 2nd disk)																																																																		
Media reader	Optional 7-in-1 media reader					Slot 1	low-profile (length < 150mm, height < 68mm), PCIe 3.0 x16																																																																		
Graphics	AMD Radeon™ Graphics in processor (only for some processors), uses main memory, DirectX® 12, one VGA, two DisplayPort™ (Onboard VGA and DP ports are only available on the models with integrated graphics), supports 3 independent displays, works along with AMD discrete graphics to support more displays; <i>Max resolution:</i> 4096x2160 (DP) @60Hz; 1920x1200 (VGA) @60Hz <i>Some:</i> NVIDIA GeForce® GT 730 , DirectX 12, 2GB GDDR5, PCIe 2.0 x16 (x8 elec.) adapter, two DisplayPort, 35 watts; <i>Max resolution:</i> 3840x2160 (DisplayPort) @60Hz					Slot 2	low-profile (length < 150mm, height < 68mm), PCIe 2.0 x1																																																																		
Monitor cable	Optional DP to VGA dongle, DP to DVI-D dongle, DP to dual DP dongle, or DP to HDMI 1.4 dongle					Slot 3	low-profile (length < 150mm, height < 68mm), PCIe 2.0 x1																																																																		
Chipset	AMD B450 Chipset					Slot 4	low-profile (length < 150mm, height < 68mm), PCI 3.0																																																																		
Front ports* (Std.)	2x USB 3.1 Gen2, 2x USB 3.1 Gen1, 1x microphone (3.5mm), 1x headphone (3.5mm)					M.2 card slots	two (one for WLAN, one for SSD)																																																																		
Front ports* (Opt.)	Optional: 1x media reader, 2x USB 3.1 Type-C Gen2 via PCIe card (special bid only)					Floor Stand	Optional system floor stand for vertical orientation																																																																		
Rear ports* (Std.)	2x USB 3.1 Gen1, 2x USB 2.0, 1x serial (9-pin), 1x ethernet (RJ-45), 1x VGA**, 2x DisplayPort**, 2x PS/2 ports (keyboard / mouse); 1x line-in (3.5mm), 1x line-out (3.5mm), 1x microphone (3.5mm)					Power supply	<i>Some:</i> 180 watts, autosensing, 85% PSU <i>Some:</i> 210 watts, autosensing, 85% PSU <i>Some:</i> 260 watts, autosensing, 92% PSU (only available via special bid)																																																																		
Rear ports* (Opt.)	Optional: 2x USB 2.0, 1x 2nd serial (9-pin), 1x parallel (25-pin), additional RJ-45 and video ports available on optional graphics or ethernet card					Limited warranty	1-year or 3-year, limited onsite service / service upgrades available																																																																		
	* Depending on many factors, actual data transfer speed may be lower than theoretical speed ** only available on the models with integrated graphics					Preload	Preloaded operating system <i>Some:</i> Windows 10 Pro 64-bit <i>Some:</i> Windows 10 Home 64-bit Preloaded applications (only some listed) <ul style="list-style-type: none"> Lenovo Vantage Microsoft Office preloaded; purchase a product key to activate Cyberlink PowerDVD (only for models with DVD / DVD±RW) Cyberlink Power2GO (only for models with DVD±RW) LinkedIn 																																																																		
Audio support	High Definition (HD) Audio, Realtek ALC662 / optional internal speaker (1 watt)					Environment	ENERGY STAR® 7.0*, EPEAT™ Silver rating* (*not for non-OS models); ERP Lot 3; RoHS-compliant																																																																		
WLAN	<i>Some:</i> 11ac wireless, M.2 Card, Realtek RTL8821CE (dual band), Wi-Fi + Bluetooth 4.2 combo adapter, 1x1 <i>Some:</i> 11ac wireless, M.2 Card, Qualcomm Atheros QCA9377A (dual band), Wi-Fi + Bluetooth 4.2* combo adapter, 1x1 <i>Some:</i> 11ac wireless, M.2 Card, Realtek RTL8822BE (dual band), Wi-Fi + Bluetooth 4.2* combo adapter, 2x2 <i>Some:</i> 11ac wireless, M.2 Card, Qualcomm Atheros QCA6174A (dual band), Wi-Fi + Bluetooth 4.2* combo adapter, 2x2					Accessories	For compatible accessories, please go to http://smartfind.lenovo.com																																																																		
Bluetooth™	<i>Some:</i> Bluetooth 4.2* wireless, integrated in Wi-Fi + BT combo adapter * Hardware supports BT 4.2, but Win10 RS3 and earlier only supports BT 4.1																																																																								

Note: The specifications above may not be available in all regions.

Lenovo, July 2018

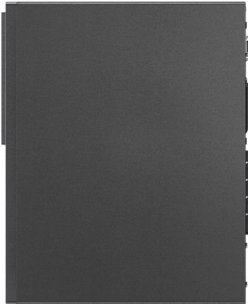

ThinkCentre M75s-1 SFF Platform Specifications

Product Specifications Reference (PSREF)

Processor	AMD Athlon PRO and Ryzen 3 / 5 / 7 PRO series processor						Ethernet	Gigabit ethernet, Realtek RTL8111EPV, Wake on LAN®																																										
	<table border="1"> <thead> <tr> <th>Processor</th> <th>Cores / Threads</th> <th>Frequency (Base/Max)</th> <th>L2 / L3 Cache</th> <th>Memory Support (Up to)</th> <th>Integrated Graphics</th> </tr> </thead> <tbody> <tr> <td>Athlon PRO 300GE</td> <td>2 / 4</td> <td>3.4 / 3.4</td> <td>1MB / 4MB</td> <td>DDR4-2666</td> <td>Radeon Vega 3</td> </tr> <tr> <td>Ryzen 3 PRO 3200G</td> <td>4 / 4</td> <td>3.6 / 4.0</td> <td>2MB / 4MB</td> <td>DDR4-2933</td> <td>Radeon Vega 8</td> </tr> <tr> <td>Ryzen 5 PRO 3400G</td> <td>4 / 8</td> <td>3.7 / 4.2</td> <td>2MB / 4MB</td> <td>DDR4-2933</td> <td>Radeon Vega 11</td> </tr> <tr> <td>Ryzen 5 PRO 3600</td> <td>6 / 12</td> <td>3.6 / 4.2</td> <td>3MB / 32MB</td> <td>DDR4-3200</td> <td>None</td> </tr> <tr> <td>Ryzen 7 PRO 3700</td> <td>8 / 16</td> <td>3.6 / 4.4</td> <td>4MB / 32MB</td> <td>DDR4-3200</td> <td>None</td> </tr> <tr> <td>Ryzen 9 PRO 3900</td> <td>12 / 24</td> <td>3.1 / 4.3</td> <td>6MB / 64MB</td> <td>DDR4-3200</td> <td>None</td> </tr> </tbody> </table>						Processor	Cores / Threads	Frequency (Base/Max)	L2 / L3 Cache	Memory Support (Up to)	Integrated Graphics	Athlon PRO 300GE	2 / 4	3.4 / 3.4	1MB / 4MB	DDR4-2666	Radeon Vega 3	Ryzen 3 PRO 3200G	4 / 4	3.6 / 4.0	2MB / 4MB	DDR4-2933	Radeon Vega 8	Ryzen 5 PRO 3400G	4 / 8	3.7 / 4.2	2MB / 4MB	DDR4-2933	Radeon Vega 11	Ryzen 5 PRO 3600	6 / 12	3.6 / 4.2	3MB / 32MB	DDR4-3200	None	Ryzen 7 PRO 3700	8 / 16	3.6 / 4.4	4MB / 32MB	DDR4-3200	None	Ryzen 9 PRO 3900	12 / 24	3.1 / 4.3	6MB / 64MB	DDR4-3200	None	Ethernet (Opt.)	None
	Processor	Cores / Threads	Frequency (Base/Max)	L2 / L3 Cache	Memory Support (Up to)	Integrated Graphics																																												
	Athlon PRO 300GE	2 / 4	3.4 / 3.4	1MB / 4MB	DDR4-2666	Radeon Vega 3																																												
	Ryzen 3 PRO 3200G	4 / 4	3.6 / 4.0	2MB / 4MB	DDR4-2933	Radeon Vega 8																																												
	Ryzen 5 PRO 3400G	4 / 8	3.7 / 4.2	2MB / 4MB	DDR4-2933	Radeon Vega 11																																												
	Ryzen 5 PRO 3600	6 / 12	3.6 / 4.2	3MB / 32MB	DDR4-3200	None																																												
Ryzen 7 PRO 3700	8 / 16	3.6 / 4.4	4MB / 32MB	DDR4-3200	None																																													
Ryzen 9 PRO 3900	12 / 24	3.1 / 4.3	6MB / 64MB	DDR4-3200	None																																													
Manageability							DASH 10/1.1																																											
Security chip							Discrete TPM 2.0, TCG Certified																																											
Security features							<ul style="list-style-type: none"> Security slot (in rear for optional Kensington® MicroSaver® cable) Padlock loop Smart USB protection, allows keyboard/ mouse only, blocks all storage devices Optional smart cable clip to physically lock both keyboard and mouse 																																											
							<ul style="list-style-type: none"> Power-on password Administrator password Hard disk password Boot sequence control Boot without keyboard and mouse Individual USB port disablement Optional chassis intrusion switch 																																											
Memory	64GB max, UDIMM, DDR4-2666*, four 288-pin DIMM sockets, non-ECC, dual-channel capable * Memory may be underclocked to DDR4 -1866, DDR4-2133, or DDR4-2400 for the lower capability of memory controller in processor						Keyboard	<i>Some:</i> Lenovo Traditional Keyboard (USB connector), black <i>Some:</i> Lenovo Calliope Wireless Keyboard (2.4GHz via USB receiver), black <i>Some:</i> Lenovo Keyboard (PS/2 connector), black (only available via special bid)																																										
Storage	<i>Some:</i> Hard Drive / SATA 6.0Gb/s, 2.5" or 3.5", 5400 rpm or 7200 rpm <i>Some:</i> M.2 SSD (2242 / 2280) / PCIe NVMe, PCIe 3.0 x2 or PCIe 3.0 x4						Mouse	<i>Some:</i> Lenovo Calliope Mouse (USB connector), black <i>Some:</i> Lenovo Fingerprint Mouse (USB connector), Windows Hello support, black <i>Some:</i> Lenovo Calliope Wireless Mouse (2.4GHz via USB receiver), black <i>Some:</i> Lenovo Mouse (PS/2 connector), black (only available via special bid)																																										
Optical	<i>Some:</i> DVD-ROM SATA 1.5Gb/s Drive, slim (9.0mm) <i>Some:</i> DVD Burner (DVD±RW), SATA 1.5Gb/s Drive, slim (9.0mm)						Mechanical	<ul style="list-style-type: none"> SFF (8.4L), black color; metal case (WxDxH) 3.6" X 11.4" X 13.5"; 92.5mm X 290.5mm X 343.5mm Approx. 13.2 lb (6.0 kg), weight may vary by configuration Toolless cover, disk, optical, and extension card removal Optional dust filter 																																										
Onboard SATA	Three onboard SATA 6.0Gb/s connectors, RAID 0/1 support (RAID preset only available via special bid model)							Bay 1: Slim external ODD bay Bay 2: 3.5", internal, HDD/SSD Bay 3: 2.5", internal, HDD/SSD (bay only comes with 2.5" 2nd disk) Slot 1: low-profile (length < 150mm, height < 68mm), PCIe 3.0 x16 Slot 2: low-profile (length < 150mm, height < 68mm), PCIe 2.0 x1 Slot 3: low-profile (length < 150mm, height < 68mm), PCIe 2.0 x1 Slot 4: low-profile (length < 150mm, height < 68mm), PCI 3.0 M.2 card slots: two (one for WLAN, one for SSD)																																										
Media reader	Optional 7-in-1 media reader						Floor Stand	Optional system floor stand for vertical orientation																																										
Graphics	AMD Radeon™ Graphics in processor (only for some processors), uses main memory, DirectX® 12, one VGA, two DisplayPort™ (Onboard VGA and DP ports are only available on the models with integrated graphics), supports 3 independent displays, works along with AMD discrete graphics to support more displays; <i>Max resolution:</i> 4096x2160 (DP) @60Hz; <i>Some:</i> AMD Radeon™ 520 , DirectX 12, 2GB GDDR5, PCIe 3.0 x8 adapter, two DisplayPort, 30 watts (Max); <i>Max resolution:</i> 4096x2160 (DP) @60Hz						Power supply	<i>Some:</i> 180 watts, autosensing, 85% PSU <i>Some:</i> 210 watts, autosensing, 85% PSU <i>Some:</i> 260 watts, autosensing, 92% PSU (only available via special bid)																																										
Monitor cable	Optional DP to VGA, DP to DVI-D (single link), DP to dual DP, or DP to HDMI 1.4						Limited warranty	1-year or 3-year, limited onsite service / service upgrades available																																										
Chipset	AMD PRO 560 FCH						Preload	Preloaded operating system <i>Some:</i> Windows 10 Pro 64-bit <i>Some:</i> Windows 10 Home 64-bit <i>Some:</i> Windows 10 IoT Enterprise <i>Some:</i> Linux Ubuntu																																										
Front ports* (Std.)	2x USB 3.1 Gen2, 2x USB 3.1 Gen1, 1x microphone (3.5mm), 1x headphone (3.5mm)						Environment	ENERGY STAR® 7.0*, EPEAT™ Silver rating* (*not for non-OS models); ErP Lot 3; RoHS-compliant, WEEE																																										
Front ports* (Opt.)	<i>Optional:</i> 1x media reader						Accessories	For compatible accessories, please go to http://smartfind.lenovo.com																																										
Rear ports* (Std.)	2x USB 3.1 Gen1 (one support Smart Power-On), 2x USB 2.0, 1x serial (9-pin), 1x ethernet (RJ-45), 1x VGA**, 2x DisplayPort**, 2x PS/2 ports (keyboard / mouse); 1x line-in (3.5mm), 1x line-out (3.5mm), 1x microphone (3.5mm)																																																	
Rear ports* (Opt.)	<i>Optional:</i> 2x USB 2.0, 1x parallel (25-pin), additional video ports available on optional graphics card * Depending on many factors, actual data transfer speed may be lower than theoretical speed ** only available on the models with integrated graphics																																																	
Audio support	High Definition (HD) Audio, Realtek ALC662 / optional internal speaker (1 watt)																																																	
WLAN	<i>Some:</i> 11ac wireless, M.2 Card, Realtek RTL8822CE (dual band), Wi-Fi + Bluetooth 5.0 combo adapter, 2x2 <i>Some:</i> 11ac wireless, M.2 Card, Qualcomm Atheros QCA6174A (dual band), Wi-Fi + Bluetooth 4.2 combo adapter, 2x2 <i>Some:</i> 11ac wireless, M.2 Card, Intel Wireless-AC 9260 (dual band), Wi-Fi + Bluetooth 5.0 combo adapter, 2x2																																																	
Bluetooth™	<i>Some:</i> Bluetooth 4.2 / 5.0 wireless, integrated in Wi-Fi + BT combo adapter																																																	

Note: The specifications above may not be available in all regions.

Lenovo, September 2019

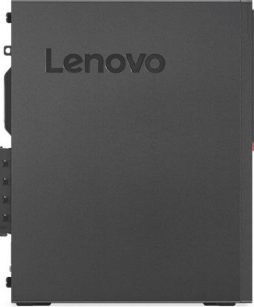
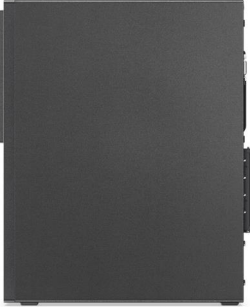

ThinkCentre M910 SFF Platform Specifications

Product Specifications Reference (PSREF)

Processor	Intel® Celeron®, Intel Pentium®, or 6/7th Generation Intel Core™ i3 / i5 / i7 Processor	Security features	<ul style="list-style-type: none"> Security slot (in rear for optional Kensington® MicroSaver® cable) Padlock loop Smart USB protection, allows keyboard/mouse only, blocks all storage devices Optional cable lock to physically lock both keyboard and mouse Power-on password Administrator password Hard disk password Boot sequence control Boot without keyboard and mouse Individual USB port disablement Optional chassis intrusion switch 																																																
	<table border="1"> <thead> <tr> <th>Processor</th> <th>Cores / Threads</th> <th>Frequency Base/Max(GHz)</th> <th>Cache</th> <th>Memory Support (Up to)</th> <th>Integrated Graphics</th> </tr> </thead> <tbody> <tr> <td>Core i5-6500</td> <td>4 / 4</td> <td>3.2G / 3.6G</td> <td>6 MB</td> <td>DDR4-2133</td> <td>HD 530</td> </tr> <tr> <td>Core i7-6700</td> <td>4 / 8</td> <td>3.4G / 4.0G</td> <td>8 MB</td> <td>DDR4-2133</td> <td>HD 530</td> </tr> <tr> <td>Core i3-7300</td> <td>2 / 4</td> <td>4.0G / --</td> <td>4 MB</td> <td>DDR4-2400</td> <td>HD 630</td> </tr> <tr> <td>Core i5-7400</td> <td>4 / 4</td> <td>3.0G / 3.5G</td> <td>6 MB</td> <td>DDR4-2400</td> <td>HD 630</td> </tr> <tr> <td>Core i5-7500</td> <td>4 / 4</td> <td>3.4G / 3.8G</td> <td>6 MB</td> <td>DDR4-2400</td> <td>HD 630</td> </tr> <tr> <td>Core i5-7600</td> <td>4 / 4</td> <td>3.5G / 4.1G</td> <td>6 MB</td> <td>DDR4-2400</td> <td>HD 630</td> </tr> <tr> <td>Core i7-7700</td> <td>4 / 8</td> <td>3.6G / 4.2G</td> <td>8 MB</td> <td>DDR4-2400</td> <td>HD 630</td> </tr> </tbody> </table>	Processor	Cores / Threads	Frequency Base/Max(GHz)	Cache	Memory Support (Up to)	Integrated Graphics	Core i5-6500	4 / 4	3.2G / 3.6G	6 MB	DDR4-2133	HD 530	Core i7-6700	4 / 8	3.4G / 4.0G	8 MB	DDR4-2133	HD 530	Core i3-7300	2 / 4	4.0G / --	4 MB	DDR4-2400	HD 630	Core i5-7400	4 / 4	3.0G / 3.5G	6 MB	DDR4-2400	HD 630	Core i5-7500	4 / 4	3.4G / 3.8G	6 MB	DDR4-2400	HD 630	Core i5-7600	4 / 4	3.5G / 4.1G	6 MB	DDR4-2400	HD 630	Core i7-7700	4 / 8	3.6G / 4.2G	8 MB	DDR4-2400	HD 630	Keyboard	<i>Some:</i> Lenovo Calliope Keyboard (USB connector), black <i>Some:</i> Lenovo Traditional Keyboard (USB connector), black <i>Some:</i> Lenovo Calliope Wireless Keyboard (2.4GHz via USB receiver), black
Processor	Cores / Threads	Frequency Base/Max(GHz)	Cache	Memory Support (Up to)	Integrated Graphics																																														
Core i5-6500	4 / 4	3.2G / 3.6G	6 MB	DDR4-2133	HD 530																																														
Core i7-6700	4 / 8	3.4G / 4.0G	8 MB	DDR4-2133	HD 530																																														
Core i3-7300	2 / 4	4.0G / --	4 MB	DDR4-2400	HD 630																																														
Core i5-7400	4 / 4	3.0G / 3.5G	6 MB	DDR4-2400	HD 630																																														
Core i5-7500	4 / 4	3.4G / 3.8G	6 MB	DDR4-2400	HD 630																																														
Core i5-7600	4 / 4	3.5G / 4.1G	6 MB	DDR4-2400	HD 630																																														
Core i7-7700	4 / 8	3.6G / 4.2G	8 MB	DDR4-2400	HD 630																																														
		Mouse	<i>Some:</i> Lenovo Calliope Mouse (USB connector), black <i>Some:</i> Lenovo Calliope Wireless Mouse (2.4GHz via USB receiver), black																																																
Memory	64GB max, UDIMM, DDR4-2400*, four 288-pin DIMM sockets, non-ECC, dual-channel capable * System automatically clocks down for the processors with lower memory controller	Mechanical	<ul style="list-style-type: none"> SFF (8.4L), black color, metal case (WxDxH) 3.6" X 11.4" X 13.5"; 92.5mm X 290.5mm X 343.5mm Approx. 11.92 lb (5.4 kg), weight may vary by configuration Toolless cover, disk, optical, graphic card removal Optional dust filter Bay 1: Slim external ODD bay Bay 2: 3.5", 1" high, internal, HDD/SSD Bay 3: 2.5", internal, HDD/SSD (optional bay) Slot 1: low-profile (length < 150mm, height < 68mm), PCIe 3.0 x16* Slot 2: low-profile (length < 150mm, height < 68mm), PCIe 3.0 x1* Slot 3: low-profile (length < 150mm, height < 68mm), PCIe 3.0 x16 (x4 signal)* Slot 4: no slot, only bracket for optional port extension* M.2 card slots: Two (one for WLAN, one for SSD/Optane) * Optional 2 front USB3.1 Type-C ports module occupies PCIe x16 (x4 signal) slot, optional rear 2x USB2.0 / parallel / 2nd serial / cable lock / Wi-Fi antenna occupies one expansion slot 																																																
Storage	<i>Some:</i> Hard Drive / SATA 6.0Gb/s, 2.5" or 3.5", 5400 rpm or 7200 rpm <i>Some:</i> Solid State Drive (SSD) / SATA 6.0Gb/s, 2.5" <i>Some:</i> M.2 Solid State Drive (SSD) / PCIe NVMe, PCIe 3.0 x 4, 32Gb/s <i>Some:</i> Intel Optane™ Memory (models with 7th gen Core processor), M.2 <i>Some:</i> DVD-ROM SATA 1.5Gb/s Drive, slim (9.0mm) <i>Some:</i> DVD Burner (DVD±RW), SATA 1.5Gb/s Drive, slim (9.0mm)	Floor Stand	Optional system floor stand for vertical orientation																																																
Optical	Four onboard SATA 6.0Gb/s connectors, RAID 0/1 support (RAID preset only available via special bid model)	Power supply	<i>Some:</i> 180 watts, autosensing, 85% PSU <i>Some:</i> 210 watts, autosensing, 85% PSU <i>Some:</i> 210 watts, autosensing, 92% PSU (only available via special bid)																																																
Onboard SATA	Optional 7-in-1 media reader	Limited warranty ³	<i>Some:</i> 1-year or 3-year, depot service / service upgrades available <i>Some:</i> 1-year or 3-year, limited onsite service / service upgrades available																																																
Media reader	Optional 7-in-1 media reader	Preload	Preloaded operating system <i>Some:</i> Windows® 7 Professional 32/64 preinstalled through downgrade rights in Windows 10 Pro 64-bit (not available with 7th Gen Intel processor) <i>Some:</i> Windows 10 Pro 64-bit <i>Some:</i> Windows 10 Home 64-bit																																																
Graphics	Intel HD Graphics 510/530/610/630 in processor, uses main memory, DirectX® 12, one VGA, two DisplayPort™, supports 3 independent displays, works along with discrete graphics to support more displays; Max resolution: 4096x2304 (DP)@60Hz; 2048x1536 (VGA)@50Hz <i>Some:</i> NVIDIA GeForce® GT 730, DirectX 12, 2GB, PCIe 2.0 x8 adapter, two DisplayPort, 35 watts; Max resolution: 3840x2160 (DisplayPort)@60Hz;	Preloaded applications (only some listed)	<ul style="list-style-type: none"> Microsoft Office preloaded; purchase a product key to activate Only for Window 10 Lenovo Companion Only for Window 7 Lenovo Solution Center Lenovo ThinkVantage Tools Create Recovery Media Adobe® Reader® Cyberlink PowerDVD Create (DVD±RW) 																																																
Monitor cable	Optional DP to VGA, DP to DVI-D (single link), DP to dual DP, or DP to HDMI 1.4	Environment	ENERGY STAR® 6.1, EPEAT™ Gold rating (North America), ErP Lot 3, GREENGUARD®, RoHS-compliant, TUV low noise verified (on some models)																																																
Chipset	Intel Q270 Chipset	Accessories	For compatible accessories, please go to http://www.lenovoquickpick.com																																																
Front ports*	Four USB 3.1 Gen1, optional two USB 3.1 Type-C Gen 2 (only available via special bid), microphone (3.5mm), headphone (3.5mm)	Bluetooth™	<i>Some:</i> Bluetooth 4.1 wireless, integrated in Wi-Fi + BT combo adapter																																																
Rear ports*	Four USB 3.1 Gen1, optional two USB 2.0, serial (9-pin), optional 2nd serial (9-pin), optional parallel (25-pin), ethernet (RJ-45), one VGA, two DisplayPort, optional two PS/2 ports (keyboard/mouse); additional DisplayPort on optional graphics on some models	Ethernet	Gigabit ethernet, Intel Ethernet Connection I219-LM(Jacksonville), Wake on LAN®																																																
Rear audio ports*	Line-in (3.5mm), line-out (3.5mm), microphone-in (3.5mm)	Modem	None																																																
IEEE 1394*	None * Depending on many factors, actual data transfer speed may be lower than theoretical speed	Manageability	Intel Active Management Technology 11.0 (Intel AMT 11.0); Intel vPro technology on some models (require choosing a vPro-support Wi-Fi adapter to enable vPro function through wireless connection)																																																
Audio support	High Definition (HD) Audio, Realtek ALC662 / optional internal speaker (1.5 watt)	Security chip	TPM (Trusted Platform Module) 2.0, TCG Certified * Downgrade to TPM1.2 for the models with Win10 DG Win7 32 OS																																																

Note: The specifications above may not be available in all regions.

Lenovo, August 2017



ThinkCentre M920 SFF Platform Specifications

Product Specifications Reference (PSREF)

Processor	Intel® Celeron®, Intel Pentium®, or 8th / 9th Gen Intel Core™ i3 / i5 / i7 / i9 Processor	Audio support	High Definition (HD) Audio, Realtek ALC233VB2 / internal speaker (2 watt)																																																																																																																																															
	<table border="1"> <thead> <tr> <th>Processor</th> <th>Cores / Threads</th> <th>Frequency Base/Max(GHz)</th> <th>Cache</th> <th>Memory Support (Up to)</th> <th>Integrated Graphics</th> </tr> </thead> <tbody> <tr><td>Celeron G4900</td><td>2 / 2</td><td>3.1G</td><td>2 MB</td><td>DDR4-2400</td><td>UHD 610</td></tr> <tr><td>Celeron G4920</td><td>2 / 2</td><td>3.2G</td><td>2 MB</td><td>DDR4-2400</td><td>UHD 610</td></tr> <tr><td>Celeron G4930</td><td>2 / 2</td><td>3.2G</td><td>2 MB</td><td>DDR4-2400</td><td>UHD 610</td></tr> <tr><td>Celeron G4950</td><td>2 / 2</td><td>3.3G</td><td>2 MB</td><td>DDR4-2400</td><td>UHD 610</td></tr> <tr><td>Pentium Gold G5400</td><td>2 / 4</td><td>3.7G</td><td>4 MB</td><td>DDR4-2400</td><td>UHD 610</td></tr> <tr><td>Pentium Gold G5500</td><td>2 / 4</td><td>3.8G</td><td>4 MB</td><td>DDR4-2400</td><td>UHD 630</td></tr> <tr><td>Pentium Gold G5600</td><td>2 / 4</td><td>3.9G</td><td>4 MB</td><td>DDR4-2400</td><td>UHD 630</td></tr> <tr><td>Pentium Gold G5420</td><td>2 / 4</td><td>3.8G</td><td>4 MB</td><td>DDR4-2400</td><td>UHD 610</td></tr> <tr><td>Pentium Gold G5620</td><td>2 / 4</td><td>4.0G</td><td>4 MB</td><td>DDR4-2400</td><td>UHD 630</td></tr> <tr><td>Core i3-8100</td><td>4 / 4</td><td>3.6G</td><td>6 MB</td><td>DDR4-2400</td><td>UHD 630</td></tr> <tr><td>Core i3-8300</td><td>4 / 4</td><td>3.7G</td><td>8 MB</td><td>DDR4-2400</td><td>UHD 630</td></tr> <tr><td>Core i5-8400</td><td>6 / 6</td><td>2.8G / 4.0G</td><td>9 MB</td><td>DDR4-2666</td><td>UHD 630</td></tr> <tr><td>Core i5-8500</td><td>6 / 6</td><td>3.0G / 4.1G</td><td>9 MB</td><td>DDR4-2666</td><td>UHD 630</td></tr> <tr><td>Core i5-8600</td><td>6 / 6</td><td>3.1G / 4.3G</td><td>9 MB</td><td>DDR4-2666</td><td>UHD 630</td></tr> <tr><td>Core i7-8700</td><td>6 / 12</td><td>3.2G / 4.6G</td><td>12 MB</td><td>DDR4-2666</td><td>UHD 630</td></tr> <tr><td>Core i3-9100</td><td>4 / 4</td><td>3.6G / 4.2G</td><td>6 MB</td><td>DDR4-2400</td><td>UHD 630</td></tr> <tr><td>Core i3-9300</td><td>4 / 4</td><td>3.7G / 4.3G</td><td>8 MB</td><td>DDR4-2400</td><td>UHD 630</td></tr> <tr><td>Core i3-9320</td><td>4 / 4</td><td>3.7G / 4.4G</td><td>8 MB</td><td>DDR4-2400</td><td>UHD 630</td></tr> <tr><td>Core i5-9400</td><td>6 / 6</td><td>2.9G / 4.1G</td><td>9 MB</td><td>DDR4-2666</td><td>UHD 630</td></tr> <tr><td>Core i5-9500</td><td>6 / 6</td><td>3.0G / 4.4G</td><td>9 MB</td><td>DDR4-2666</td><td>UHD 630</td></tr> <tr><td>Core i5-9600</td><td>6 / 6</td><td>3.1G / 4.6G</td><td>9 MB</td><td>DDR4-2666</td><td>UHD 630</td></tr> <tr><td>Core i7-9700</td><td>8 / 8</td><td>3.0G / 4.7G</td><td>12 MB</td><td>DDR4-2666</td><td>UHD 630</td></tr> <tr><td>Core i9-9900</td><td>8 / 16</td><td>3.1G / 5.0G</td><td>16 MB</td><td>DDR4-2666</td><td>UHD 630</td></tr> </tbody> </table>	Processor	Cores / Threads	Frequency Base/Max(GHz)	Cache	Memory Support (Up to)	Integrated Graphics	Celeron G4900	2 / 2	3.1G	2 MB	DDR4-2400	UHD 610	Celeron G4920	2 / 2	3.2G	2 MB	DDR4-2400	UHD 610	Celeron G4930	2 / 2	3.2G	2 MB	DDR4-2400	UHD 610	Celeron G4950	2 / 2	3.3G	2 MB	DDR4-2400	UHD 610	Pentium Gold G5400	2 / 4	3.7G	4 MB	DDR4-2400	UHD 610	Pentium Gold G5500	2 / 4	3.8G	4 MB	DDR4-2400	UHD 630	Pentium Gold G5600	2 / 4	3.9G	4 MB	DDR4-2400	UHD 630	Pentium Gold G5420	2 / 4	3.8G	4 MB	DDR4-2400	UHD 610	Pentium Gold G5620	2 / 4	4.0G	4 MB	DDR4-2400	UHD 630	Core i3-8100	4 / 4	3.6G	6 MB	DDR4-2400	UHD 630	Core i3-8300	4 / 4	3.7G	8 MB	DDR4-2400	UHD 630	Core i5-8400	6 / 6	2.8G / 4.0G	9 MB	DDR4-2666	UHD 630	Core i5-8500	6 / 6	3.0G / 4.1G	9 MB	DDR4-2666	UHD 630	Core i5-8600	6 / 6	3.1G / 4.3G	9 MB	DDR4-2666	UHD 630	Core i7-8700	6 / 12	3.2G / 4.6G	12 MB	DDR4-2666	UHD 630	Core i3-9100	4 / 4	3.6G / 4.2G	6 MB	DDR4-2400	UHD 630	Core i3-9300	4 / 4	3.7G / 4.3G	8 MB	DDR4-2400	UHD 630	Core i3-9320	4 / 4	3.7G / 4.4G	8 MB	DDR4-2400	UHD 630	Core i5-9400	6 / 6	2.9G / 4.1G	9 MB	DDR4-2666	UHD 630	Core i5-9500	6 / 6	3.0G / 4.4G	9 MB	DDR4-2666	UHD 630	Core i5-9600	6 / 6	3.1G / 4.6G	9 MB	DDR4-2666	UHD 630	Core i7-9700	8 / 8	3.0G / 4.7G	12 MB	DDR4-2666	UHD 630	Core i9-9900	8 / 16	3.1G / 5.0G	16 MB	DDR4-2666	UHD 630	<p>WLAN</p> <p><i>Some:</i> 11ac wireless, M.2 Card, Realtek RTL8821CE (dual band), Wi-Fi + Bluetooth 4.2 combo adapter, 1x1</p> <p><i>Some:</i> 11ac wireless, M.2 Card, Realtek RTL8822BE (dual band), Wi-Fi + Bluetooth 4.2 combo adapter, 2x2</p> <p><i>Some:</i> 11ac wireless, M.2 Card, Intel Dual Band Wireless-AC 3165, Wi-Fi + Bluetooth 4.2 combo adapter, 1x1</p> <p><i>Some:</i> 11ac wireless, M.2 Card, Intel Dual Band Wireless-AC 8265, Wi-Fi + Bluetooth 4.2 combo adapter, 2x2</p> <p><i>Some:</i> 11ac wireless, M.2 Card, Intel Wireless-AC 9560 (dual band), Wi-Fi + Bluetooth 5.0 combo adapter, Intel vPro technology support, 2x2</p> <p>Bluetooth</p> <p>Ethernet</p> <p>Ethernet (Opt.)</p> <p><i>Some:</i> Bluetooth 4.2/5.0 wireless, integrated in Wi-Fi + BT combo adapter</p> <p><i>Some:</i> Gigabit ethernet, Intel Ethernet Connection I219-LM(Jacksonville), Wake on LAN®</p> <p><i>Some:</i> Intel Ethernet Server Adapter I350-T4, gigabit ethernet, 4x RJ-45, PCIe x4</p> <p><i>Some:</i> Bitland BN8E88, gigabit ethernet, 1x RJ-45, PCIe x1 (special bid only)</p> <p>Manageability</p> <p>Intel Active Management Technology 12 (Intel AMT 12); Intel vPro technology on some models (require choosing a vPro-support Wi-Fi adapter to enable vPro function through wireless connection)</p> <p>Security chip</p> <p>Discrete TPM 2.0, TCG Certified</p> <p>Security features</p> <ul style="list-style-type: none"> • Security slot (in rear for optional Kensington® MicroSaver® cable) • Padlock loop • Optional cable lock to physically lock both keyboard and mouse • Optional chassis intrusion switch • Optional chassis E-Lock (special bid) • Power-on password • Administrator password • Hard disk password • Boot sequence control • Boot without keyboard and mouse • Individual USB port disablement • Smart USB protection, allows keyboard/mouse only, blocks all storage devices <p>Keyboard</p> <p><i>Some:</i> Lenovo Calliope Keyboard (USB connector), black</p> <p><i>Some:</i> Lenovo Traditional Keyboard (USB connector), black</p> <p><i>Some:</i> Lenovo Calliope Wireless Keyboard (2.4GHz via USB receiver), black</p> <p><i>Some:</i> Lenovo Keyboard (PS/2 connector), black (only available via special bid)</p> <p><i>Some:</i> Lenovo Calliope Mouse (USB connector), black</p> <p><i>Some:</i> Lenovo Fingerprint Mouse (USB connector), Windows Hello support, black</p> <p><i>Some:</i> Lenovo Calliope Wireless Mouse (2.4GHz via USB receiver), black</p> <p><i>Some:</i> Lenovo Mouse (PS/2 connector), black (only available via special bid)</p> <p>Mouse</p> <p>Mechanical</p> <ul style="list-style-type: none"> • SFF (8.4L), black color, metal case • (WxDxH) 3.6" X 11.4" X 13.5"; 92.5mm X 290.5mm X 343.5mm • Approx. 13.23 lb (6 kg), weight may vary by configuration • Toolless cover, disk, optical, extension card removal • Optional dust filter <p>Bay 1: Slim external ODD bay</p> <p>Bay 2: 3.5", 1" high, internal, HDD/SSD</p> <p>Bay 3: 2.5", internal, HDD/SSD (optional bay)</p> <p>Slot 1: low-profile (length < 150mm, height < 68mm), PCIe 3.0 x16</p> <p>Slot 2: low-profile (length < 150mm, height < 68mm), PCIe 3.0 x1</p> <p>Slot 3: low-profile (length < 150mm, height < 68mm), PCIe 3.0 x16 (x4 signal)</p> <p>Slot 4: no slot, only bracket for optional port extension</p> <p>M.2 card slots: Two (one for WLAN, one for SSD/Optane)</p> <p>Floor Stand</p> <p>Optional system floor stand for vertical orientation</p> <p>Power supply</p> <p><i>Some:</i> 180 watts, autosensing, 85% PSU</p> <p><i>Some:</i> 210 watts, autosensing, 85% PSU</p> <p><i>Some:</i> 260 watts, autosensing, 92% PSU (only available via special bid)</p> <p>Limited warranty</p> <p><i>Some:</i> 1-year or 3-year, depot service / service upgrades available</p> <p><i>Some:</i> 1-year or 3-year, limited onsite service / service upgrades available</p> <p>Preload</p> <p><i>Some:</i> Windows® 10 Pro 64-bit</p> <p><i>Some:</i> Windows 10 Home 64-bit</p> <p>Environment</p> <p>ENERGY STAR® 6.1, EPEAT™ Silver rating (North America), ErP Lot 3, TCO, TUV low noise verified (coming soon, on some models), RoHS-compliant</p> <p>Accessories</p> <p>For compatible accessories, please go to http://smartfind.lenovo.com</p>
Processor	Cores / Threads	Frequency Base/Max(GHz)	Cache	Memory Support (Up to)	Integrated Graphics																																																																																																																																													
Celeron G4900	2 / 2	3.1G	2 MB	DDR4-2400	UHD 610																																																																																																																																													
Celeron G4920	2 / 2	3.2G	2 MB	DDR4-2400	UHD 610																																																																																																																																													
Celeron G4930	2 / 2	3.2G	2 MB	DDR4-2400	UHD 610																																																																																																																																													
Celeron G4950	2 / 2	3.3G	2 MB	DDR4-2400	UHD 610																																																																																																																																													
Pentium Gold G5400	2 / 4	3.7G	4 MB	DDR4-2400	UHD 610																																																																																																																																													
Pentium Gold G5500	2 / 4	3.8G	4 MB	DDR4-2400	UHD 630																																																																																																																																													
Pentium Gold G5600	2 / 4	3.9G	4 MB	DDR4-2400	UHD 630																																																																																																																																													
Pentium Gold G5420	2 / 4	3.8G	4 MB	DDR4-2400	UHD 610																																																																																																																																													
Pentium Gold G5620	2 / 4	4.0G	4 MB	DDR4-2400	UHD 630																																																																																																																																													
Core i3-8100	4 / 4	3.6G	6 MB	DDR4-2400	UHD 630																																																																																																																																													
Core i3-8300	4 / 4	3.7G	8 MB	DDR4-2400	UHD 630																																																																																																																																													
Core i5-8400	6 / 6	2.8G / 4.0G	9 MB	DDR4-2666	UHD 630																																																																																																																																													
Core i5-8500	6 / 6	3.0G / 4.1G	9 MB	DDR4-2666	UHD 630																																																																																																																																													
Core i5-8600	6 / 6	3.1G / 4.3G	9 MB	DDR4-2666	UHD 630																																																																																																																																													
Core i7-8700	6 / 12	3.2G / 4.6G	12 MB	DDR4-2666	UHD 630																																																																																																																																													
Core i3-9100	4 / 4	3.6G / 4.2G	6 MB	DDR4-2400	UHD 630																																																																																																																																													
Core i3-9300	4 / 4	3.7G / 4.3G	8 MB	DDR4-2400	UHD 630																																																																																																																																													
Core i3-9320	4 / 4	3.7G / 4.4G	8 MB	DDR4-2400	UHD 630																																																																																																																																													
Core i5-9400	6 / 6	2.9G / 4.1G	9 MB	DDR4-2666	UHD 630																																																																																																																																													
Core i5-9500	6 / 6	3.0G / 4.4G	9 MB	DDR4-2666	UHD 630																																																																																																																																													
Core i5-9600	6 / 6	3.1G / 4.6G	9 MB	DDR4-2666	UHD 630																																																																																																																																													
Core i7-9700	8 / 8	3.0G / 4.7G	12 MB	DDR4-2666	UHD 630																																																																																																																																													
Core i9-9900	8 / 16	3.1G / 5.0G	16 MB	DDR4-2666	UHD 630																																																																																																																																													
Memory	64GB max, DDR4-2666*, four 288-pin DIMM sockets, dual-channel capable * System automatically clocks down for the processors with lower memory controller																																																																																																																																																	
Storage	<i>Some:</i> Hard Drive / SATA 6.0Gb/s, 2.5" or 3.5", 5400 rpm or 7200 rpm <i>Some:</i> Solid State Drive (SSD) / SATA 6.0Gb/s, 2.5" <i>Some:</i> M.2 Solid State Drive (SSD) / PCIe NVMe, PCIe 3.0 x 4*, 32Gb/s * 128GB SSD M.2 (2242) PCIe NVMe only supports PCIe 3.0 x 2, 16Gb/s <i>Some:</i> Intel Optane™ Memory (not support Celeron / Pentium Processor), M.2 <i>Some:</i> DVD-ROM, SATA 1.5Gb/s Drive, slim (9.0mm) <i>Some:</i> DVD Burner (DVD±RW), SATA 1.5Gb/s Drive, slim (9.0mm)																																																																																																																																																	
Optical	Four onboard SATA 6.0Gb/s connectors, RAID 0/1 support (RAID preset only available via special bid model)																																																																																																																																																	
Onboard SATA	Optional 7-in-1 media reader																																																																																																																																																	
Media reader																																																																																																																																																		
Graphics	Intel UHD Graphics 610/630 in processor, uses main memory, DirectX® 12, one VGA, two DisplayPort™, supports 3 independent displays, works along with discrete graphics to support more displays: <i>Max resolution:</i> 4096x2304 (DP)@60Hz; 2048x1536 (VGA)@50Hz <i>Some:</i> NVIDIA GeForce® GT 730 , DirectX 12, 2GB, PCIe 2.0 x16 adapter, two DisplayPort, 35 watts; <i>Max resolution:</i> 3840x2160 (DisplayPort)@60Hz;																																																																																																																																																	
Monitor cable	Optional DP to VGA dongle, DP to DVI-D dongle, DP to dual DP dongle (for Collage Display with intel integrated graphics), or DP to HDMI 1.4 dongle																																																																																																																																																	
Chipset	Intel Q370 Chipset																																																																																																																																																	
Front ports* (Std.)	2x USB 3.1 Gen2, 2x USB 3.1 Gen1, 1x USB 3.1 Type-C Gen1 (15W charging), 1x microphone (3.5mm), 1x headphone / microphone combo jack (3.5mm)																																																																																																																																																	
Front ports* (Opt.)	<i>Optional:</i> 1x media reader																																																																																																																																																	
Rear ports* (Std.)	4x USB 3.1 Gen1, 1x serial (9-pin), 1x ethernet (RJ-45), 1x VGA, 2x DisplayPort, 1x line-out (3.5mm)																																																																																																																																																	
Rear ports* (Opt.)	<i>Optional:</i> 2x USB 2.0, 2x USB 3.1 Gen1 via PCIe x1, 2x USB 3.1 Type-C Gen2 via PCIe x4 (special bid only), 1x 2nd serial (9-pin), 4x serial (9-pin) via PCIe x1, 1x parallel (25-pin), 2x PS/2 ports (keyboard/mouse), 1x Thunderbolt 3 (combo USB3.1 Type-C Gen 2 / DisplayPort) via PCIe x4 (available on 09/30/2018), additional RJ-45 and video ports available on optional graphics or ethernet card * Depending on many factors, actual data transfer speed may be lower than theoretical speed																																																																																																																																																	

Note: The specifications above may not be available in all regions.

Lenovo, June 2019

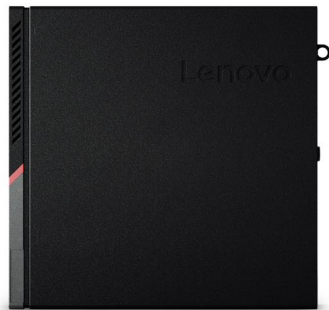

ThinkCentre M600 Tiny Platform Specifications

Product Specifications Reference (PSREF)

Processor	Intel® Celeron® Processor N3000 Series or Intel Pentium® Processor N3000 Series						Keyboard <i>Some:</i> Preferred Pro USB Keyboard (USB connector), Lenovo logo <i>Some:</i> Lenovo USB Fingerprint Keyboard (USB connector) <i>Some:</i> Ultralim Plus Wireless Keyboard (2.4GHz via USB receiver), black <i>Some:</i> Enhanced Optical USB Mouse, black, Lenovo logo <i>Some:</i> Ultralim Plus Wireless Mouse (2.4GHz via USB receiver), black												
	Processor	Cores / Threads	Frequency (Base/Max)	Cache	Memory Types	Integrated Graphics													
	Celeron N3050	2 / 2	1.6 / 2.16 GHz	2MB	DDR3L-1600	Intel HD													
	Celeron J3060	2 / 2	1.6 / 2.48 GHz	2MB	DDR3L-1600	Intel HD 400													
	Pentium N3700	4 / 4	1.6 / 2.4 GHz	2MB	DDR3L-1600	Intel HD													
	Pentium J3710	4 / 4	1.6 / 2.64 GHz	2MB	DDR3L-1600	Intel HD 405													
Chipset	Intel Architecture (IA) SoC that integrates Intel processor core, graphics, memory controller, and I/O interfaces into a single system-on-chip solution						<table border="1"> <thead> <tr> <th></th> <th>Dimensions (WxDxH)</th> <th>Max weight (lb / kg)</th> </tr> </thead> <tbody> <tr> <td>M600 Tiny only (1L)</td> <td>7.05" X 7.20" X 1.36" 179mm X 182.9mm X 34.5mm</td> <td>2.9 lb (1.3 kg)</td> </tr> <tr> <td>M600 Tiny (1L) with VESA mount & ODD box</td> <td>7.42" X 7.30" X 2.48" 188.4mm X 185.38mm X 63mm</td> <td>4.12 lb (1.87 kg)</td> </tr> <tr> <td>M600 Tiny (1L) with VESA mount & I/O box</td> <td>7.42" X 7.30" X 2.62" 188.4mm X 185.38mm X 66.6mm</td> <td>3.53 lb (1.6 kg)</td> </tr> </tbody> </table>		Dimensions (WxDxH)	Max weight (lb / kg)	M600 Tiny only (1L)	7.05" X 7.20" X 1.36" 179mm X 182.9mm X 34.5mm	2.9 lb (1.3 kg)	M600 Tiny (1L) with VESA mount & ODD box	7.42" X 7.30" X 2.48" 188.4mm X 185.38mm X 63mm	4.12 lb (1.87 kg)	M600 Tiny (1L) with VESA mount & I/O box	7.42" X 7.30" X 2.62" 188.4mm X 185.38mm X 66.6mm	3.53 lb (1.6 kg)
	Dimensions (WxDxH)	Max weight (lb / kg)																	
M600 Tiny only (1L)	7.05" X 7.20" X 1.36" 179mm X 182.9mm X 34.5mm	2.9 lb (1.3 kg)																	
M600 Tiny (1L) with VESA mount & ODD box	7.42" X 7.30" X 2.48" 188.4mm X 185.38mm X 63mm	4.12 lb (1.87 kg)																	
M600 Tiny (1L) with VESA mount & I/O box	7.42" X 7.30" X 2.62" 188.4mm X 185.38mm X 66.6mm	3.53 lb (1.6 kg)																	
Graphics	Intel HD Graphics in processor, uses main memory, DirectX® 11.1, twoDisplayPort™, one optional 3rd DP (not support DP to HDMI dongle) or VGA, supports triple independent display; Maximum resolution: 3840x2160(DP)@30Hz; 1920x1200(optional VGA)@60Hz; 1920x1080(DP to VGA dongle)@60Hz; 1920x1080(DP to DVI dongle)@60Hz; 3840x2160(DP to HDMI dongle)@30Hz																		
Monitor cable	Optional DP to VGA, DP to DVI-D (single link), or DP to HDMI 1.4 dongle																		
Memory	8GB max / DDR3 Low Voltage, DDR3L-1600, non-parity, one 204-pin SO-DIMM socket																		
Storage	<i>Some:</i> hard disk, 5400 or 7200 rpm, SATA 6.0Gb/s, 2.5" Wide <i>Some:</i> 500GB (5400 rpm) Solid State Hybrid Drive (SSHD) / with 8GB MLC NAND flash memory, SATA 6.0Gb/s, 2.5" wide																		
Optical	<i>Some:</i> Solid State Drive (SSD) / SATA 6.0Gb/s, 2.5" Wide <i>Some:</i> external ODD box with DVD-ROM, 9.5mm high, via USB <i>Some:</i> external ODD box with DVD±RW, 9.5mm high, via USB <i>Some:</i> external ODD box (for TIO) with DVD-ROM, 9.5mm high, via USB <i>Some:</i> external ODD box (for TIO) with DVD±RW, 9.5mm high, via USB																		
Onboard SATA Media reader	SATA 6.0Gb/s controller, one connectors on planar None																		
Front ports*	Two USB 3.0 (one is Always On and fast charge), one microphone (stereo, 3.5mm), one headphone / microphone combo jack (stereo, 3.5mm)																		
Rear ports*	Two USB 2.0, two USB 3.0 (optional external optical box or I/O box occupies one or two specific USB on some models), ethernet (RJ-45), two DisplayPort, one optional port (VGA, 3rd DP, or serial on some models), one headphone																		
I/O box*	Optional external I/O box, extends two USB 2.0, two USB 3.0, and one serial on rear, two USB 2.0 on front, via USB (occupy two specific USB 3.0 of M600 Tiny) * Depending on many factors, actual data transfer speed may be lower than theoretical speed																		
Audio support	High Definition (HD) Audio, Realtek ALC223 / optional internal speaker (1 watt)																		
WLAN ¹³	<i>Some:</i> 11ac wireless, M.2 Card, Realtek RTL8821AE (dual band), Wi-Fi + Bluetooth 4.0 combo adapter, 1x1 <i>Some:</i> 11ac wireless, M.2 Card, Qualcomm Atheros QCA9377 (dual band), Wi-Fi + Bluetooth 4.1 combo adapter, 1x1 <i>Some:</i> 11ac wireless, M.2 Card, Qualcomm Atheros QCA6174 (dual band), Wi-Fi + Bluetooth 4.1 combo adapter, 2x2 <i>Some:</i> 11ac wireless, M.2 Card, Intel Dual Band Wireless-AC 3165, Wi-Fi + Bluetooth 4.0 combo adapter, 1x1 <i>Some:</i> 11ac wireless, M.2 Card, Intel Dual Band Wireless-AC 8260, Wi-Fi + Bluetooth 4.1 combo adapter, 2x2																		
Bluetooth™	<i>Some:</i> Bluetooth 4.0 or 4.1 wireless, integrated in Wi-Fi + BT combo adapter																		
Ethernet	One gigabit ethernet port, Realtek RTL8111GN, Wake on LAN®																		
Modem	None																		
Manageability	None																		
Security chip	Trusted Platform Module, TCG 1.2-compliant																		
Security features	<ul style="list-style-type: none"> • Security slot (in rear for optional Kensington® MicroSaver® cable) • Padlock loop • Smart USB protection, allows keyboard/mouse only, blocks all storage devices • Power-on password • Administrator password • Hard disk password • Boot sequence control • Boot without keyboard and mouse • Individual USB port disablement • Chassis intrusion switch 																		
Environment	ENERGY STAR® 6.0*, EPEAT™ Gold rating* (*not for non-OS models); GREENGUARD®; RoHS-compliant; Cisco EnergyWise compatible; ErP Lot 3																		
Accessories	For compatible accessories, please go to TC-AQP sheet																		

See footnotes for more detailed information

Lenovo, November 2017

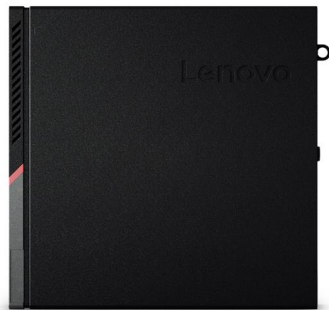

ThinkCentre M600 Tiny Thin Client Platform Specifications

Product Specifications Reference (PSREF)

Processor	Intel® Celeron® Processor N3000 Series or Intel Pentium® Processor N3000 Series						Keyboard <i>Some:</i> PS/2 Keyboard (PS/2 connector), Lenovo logo (for 2L models) <i>Some:</i> Preferred Pro USB Keyboard (USB connector), Lenovo logo <i>Some:</i> Ultralim Plus Wireless Keyboard (2.4GHz via USB receiver), black <i>Some:</i> PS/2 Optical Wheel Mouse, black, Lenovo logo (for 2L models) <i>Some:</i> Enhanced Optical USB Mouse, black, Lenovo logo <i>Some:</i> Ultralim Plus Wireless Mouse (2.4GHz via USB receiver), black									
	Processor	Cores / Threads	Frequency (Base/Max)	Cache	Memory Types	Integrated Graphics										
	Celeron N3000	2 / 2	1.04 / 2.08 GHz	2MB	DDR3L-1600	Intel HD										
	Celeron N3010	2 / 2	1.04 / 2.24 GHz	2MB	DDR3L-1600	Intel HD 400										
Chipset	Intel Architecture (IA) SoC that integrates Intel processor core, graphics, memory controller, and I/O interfaces into a single system-on-chip solution						Mechanical • Tiny (1L or 2L), black color, metal case <table border="1"> <thead> <tr> <th></th> <th>Dimensions (WxDxH)</th> <th>Max weight (lb / kg)</th> </tr> </thead> <tbody> <tr> <td>M600 Tiny only (1L)</td> <td>7.05" X 7.20" X 1.36" 179mm X 182.9mm X 34.5mm</td> <td>2.9 lb (1.3 kg)</td> </tr> <tr> <td>M600 Tiny only (2L)</td> <td>7.05" X 7.20" X 3.15" 179mm X 182.9mm X 80mm</td> <td>4.2 lb (1.9 kg)</td> </tr> </tbody> </table>		Dimensions (WxDxH)	Max weight (lb / kg)	M600 Tiny only (1L)	7.05" X 7.20" X 1.36" 179mm X 182.9mm X 34.5mm	2.9 lb (1.3 kg)	M600 Tiny only (2L)	7.05" X 7.20" X 3.15" 179mm X 182.9mm X 80mm	4.2 lb (1.9 kg)
	Dimensions (WxDxH)	Max weight (lb / kg)														
M600 Tiny only (1L)	7.05" X 7.20" X 1.36" 179mm X 182.9mm X 34.5mm	2.9 lb (1.3 kg)														
M600 Tiny only (2L)	7.05" X 7.20" X 3.15" 179mm X 182.9mm X 80mm	4.2 lb (1.9 kg)														
Graphics	Intel HD Graphics in processor, uses main memory, DirectX® 11.1, twoDisplayPort™, one optional 3rd DP (not support DP to HDMI dongle) or VGA, supports triple independent display; Maximum resolution: 3840x2160(DP)@30Hz; 1920x1200(optional VGA)@60Hz; 1920x1080(DP to VGA dongle)@60Hz; 1920x1080(DP to DVI dongle)@60Hz; 3840x2160(DP to HDMI dongle)@30Hz															
Monitor cable	Optional DP to VGA, DP to DVI-D (single link), or DP to HDMI 1.4 dongle															
Memory	8GB max / DDR3 Low Voltage, DDR3L-1600, non-parity, one 204-pin SO-DIMM socket						VESA mount Optional VESA mount bracket kit, supports VESA 75mm and 100mm Floor Stand Optional system floor stand for vertical orientation									
Storage	16GB, 32GB, or 128GB M.2 Solid State Drive (SSD), SATA interface						Power supply 65 watts AC/DC adapter, autosensing, 88% PSU (not included for TIO models)									
Optical	None						Limited warranty ³ <i>Some:</i> 1-year or 3-year, depot service / service upgrades available <i>Some:</i> 1-year or 3-year, limited onsite service / service upgrades available <i>Some:</i> 3-year, limited onsite service, OID (Onsite International Delivery) / service upgrades available <i>For Lenovo service upgrade options, please go to S-TC sheet</i>									
Onboard SATA	SATA 6.0Gb/s controller, one connectors on planar															
Media reader	None															
Front ports*	Two USB 3.0 (one is Always On and fast charge), one microphone (stereo, 3.5mm), one headphone / microphone combo jack (stereo, 3.5mm)						Preload <i>Some:</i> Windows Embedded Standard 7 (WES 7) <i>Some:</i> Windows Embedded Standard 7 V2 (WES 7 V2) <i>Some:</i> Windows 10 IoT Enterprise <i>Some:</i> LeTOS (Lenovo Terminal Operating System, Linux-based) <i>Some:</i> LeTOS V2 (Lenovo Terminal Operating System, Linux-based)									
Rear ports*	Two USB 2.0, two USB 3.0, ethernet (RJ-45), two DisplayPort, one optional port (VGA, 3rd DP, or serial on some models), one headphone; additional four serial (9-pin), one parallel (25-pin), and two PS/2 ports on 2L models															
I/O box	None															
Audio support	High Definition (HD) Audio, Realtek ALC223 / optional internal speaker (1 watt)						Environment ENERGY STAR® 6.0*, EPEAT™ Gold rating* (*not for non-OS models); GREENGUARD®; RoHS-compliant; Cisco EnergyWise compatible; ErP Lot 3									
WLAN ¹³	<i>Some:</i> 11ac wireless, M.2 Card, Realtek RTL8821AE (dual band), Wi-Fi + Bluetooth 4.0 combo adapter, 1x1 <i>Some:</i> 11ac wireless, M.2 Card, Qualcomm Atheros QCA9377 (dual band), Wi-Fi + Bluetooth 4.1 combo adapter, 1x1 <i>Some:</i> 11ac wireless, M.2 Card, Qualcomm Atheros QCA6174 (dual band), Wi-Fi + Bluetooth 4.1 combo adapter, 2x2 <i>Some:</i> 11ac wireless, M.2 Card, Intel Dual Band Wireless-AC 3165, Wi-Fi + Bluetooth 4.0 combo adapter, 1x1 (only for 1L models)						Accessories For compatible accessories, please go to TC-AQP sheet									
Bluetooth™	<i>Some:</i> Bluetooth 4.0 or 4.1 wireless, integrated in Wi-Fi + BT combo adapter															
Ethernet	One gigabit ethernet port, Realtek RTL8111GN, Wake on LAN®															
Modem	None															
Manageability	None															
Security chip	Trusted Platform Module, TCG 1.2-compliant															
Security features	<ul style="list-style-type: none"> • Security slot (in rear for optional Kensington® MicroSaver® cable) • Padlock loop • Smart USB protection, allows keyboard/mouse only, blocks all storage devices • Power-on password • Administrator password • Hard disk password • Boot sequence control • Boot without keyboard and mouse • Individual USB port disablement • Chassis intrusion switch 															

Note: The specifications above may not be available in all regions.

Lenovo, November 2017

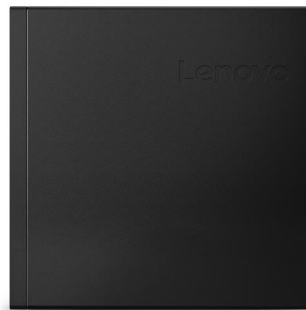

ThinkCentre M625 Tiny Platform Specifications

Product Specifications Reference (PSREF)

Processor	AMD A9 series APU						Keyboard Mouse	Some: Fullsize USB Keyboard (USB connector), black, Lenovo logo Some: USB Optical Wheel Mouse, black, Lenovo logo	
	APU	Cores	Frequency Base/Max	L2 Cache	Memory Support (Up to)	Integrated Graphics		Mechanical	Tiny (1L), black color; metal case • Toolless chassis open (for models with optional toolless chassis screw) • Toolless HDD, SSD, memory, Wi-Fi removal • Optional dust filter M625 Tiny only: 7.05" W X 7.20" D X 1.36" H 179mm W X 182.9mm D X 34.5mm H 2.9 lb (1.3 kg), weight may vary by configuration VESA mount Optional VESA mount bracket kit, supports VESA 75mm and 100mm Floor Stand Optional system floor stand for vertical orientation
Memory	8GB max, DDR4-2666, one 260-pin SO-DIMM socket * System frequency automatically clocks down for the lower capability of memory controller in processor						Power supply		65 watts AC/DC adapter, autosensing, 88% PSU (not included for TIO models)
Disk	Some: SATA 6.0Gb/s, 2.5" Wide, 5400 rpm or 7200 rpm Some: 128GB M.2 Solid State Drive (SSD) / PCIe NVMe interface Some: 256GB M.2 Solid State Drive (SSD) / PCIe NVMe interface							Limited warranty ³	Some: 1-year, depot service / service upgrades available Some: 1-year, limited onsite service / service upgrades available
Optical	None						Preload		Preloaded operating system Some: Windows [®] 10 Pro 64-bit Some: Windows 7 Professional 64 preinstalled through downgrade rights in Windows 10 Pro 64-bit
Onboard SATA	one SATA 6.0Gb/s connector on planar							Chipset	Preloaded applications (only some listed) - Windows 10 only • Lenovo Vantage • LinkedIn • Microsoft Office preloaded; purchase a product key to activate - Windows 7 only • Lenovo Solution Center • Lenovo System Update • Factory Recovery • User Guide Viewer • Microsoft Office preloaded; purchase a product key to activate • Adobe [®] Reader [®]
Media reader	None						Front ports*		
Graphics	AMD Radeon™ Graphics in processor, uses main memory, DirectX [®] 12, two DisplayPort™, one optional port (VGA or USB 2.0 Type-C with DisplayPort Alternate Mode), supports up to 2 independent displays; Max resolution: 3840x2160 (DP)@60Hz; 2048x1280 (VGA)@60Hz; 3840x2160 (USB 2.0 Type-C)@60Hz							Rear ports*	
Monitor cable	Optional DP to VGA, DP to DVI-D (single link), or DP to HDMI 1.4 dongle						I/O box		
Chipset	AMD SoC platform							Audio support	High Definition (HD) Audio, Realtek ALC233-VB2-CG/ internal speaker (1.5 watt)
Front ports*	Two USB 3.1 Gen1 (one is Always On and fast charge), one microphone (3.5mm), one headphone / microphone combo jack (3.5mm)						WLAN ¹³		Some: 11ac wireless, M.2 Card, Realtek RTL8822BE (dual band), Wi-Fi + Bluetooth 4.2* combo adapter, 2x2 Some: 11ac wireless, M.2 Card, Qualcomm Atheros QCA6174A (dual band), Wi-Fi + Bluetooth 4.2* combo adapter, 2x2
Rear ports*	One USB 3.1 Gen1, three USB 2.0, ethernet (RJ-45), two DisplayPort, two optional ports (Port 1 for VGA / serial / USB 2.0 Type-C (with DisplayPort Alternate Mode), Port 2 for serial) * Depending on many factors, actual data transfer speed may be lower than theoretical speed							Bluetooth™	Some: Bluetooth 4.2* wireless, integrated in Wi-Fi + BT combo adapter * Win 10 RS3 and Win10 earlier version only support Bluetooth 4.1
I/O box	None						Ethernet Modem		Gigabit ethernet, Realtek RTL8111HN, Wake on LAN [®]
Audio support	High Definition (HD) Audio, Realtek ALC233-VB2-CG/ internal speaker (1.5 watt)							Manageability	None
WLAN ¹³	Some: 11ac wireless, M.2 Card, Realtek RTL8822BE (dual band), Wi-Fi + Bluetooth 4.2* combo adapter, 2x2 Some: 11ac wireless, M.2 Card, Qualcomm Atheros QCA6174A (dual band), Wi-Fi + Bluetooth 4.2* combo adapter, 2x2						Security chip		Discrete TPM 2.0, TCG Certified
Bluetooth™	Some: Bluetooth 4.2* wireless, integrated in Wi-Fi + BT combo adapter * Win 10 RS3 and Win10 earlier version only support Bluetooth 4.1							Security features	<ul style="list-style-type: none"> Security slot (in rear for optional Kensington[®] MicroSaver[®] cable) Smart USB protection, allows keyboard/mouse only, blocks all storage devices Power-on password Administrator password Hard disk password Boot sequence control Boot without keyboard and mouse Individual USB port disablement Chassis intrusion switch
Ethernet Modem	None						Environment		ENERGY STAR [®] 6.1*, EPEAT™ Silver rating* (*Not for non-OS models), ErP Lot 3, RoHS-compliant, WEEE, TCO
Manageability	None							MIL-SPEC test	MIL-STD-810G military certification (Low Pressure [Altitude], High Temperature, Low Temperature, Temperature Shock, Humidity, Sand and Dust, Vibration, Shock, Fungus, Solar Radiation)
Security chip	Discrete TPM 2.0, TCG Certified						Accessories		For compatible accessories, please go to http://smartfind.lenovo.com
Security features	<ul style="list-style-type: none"> Security slot (in rear for optional Kensington[®] MicroSaver[®] cable) Smart USB protection, allows keyboard/mouse only, blocks all storage devices Power-on password Administrator password Hard disk password Boot sequence control Boot without keyboard and mouse Individual USB port disablement Chassis intrusion switch 								



ThinkCentre M625 Tiny Thin Client Platform Specifications

Product Specifications Reference (PSREF)

Processor	AMD E2 series APU						Keyboard Mouse	<i>Some:</i> Fullsize USB Keyboard (USB connector), black, Lenovo logo <i>Some:</i> USB Optical Wheel Mouse, black, Lenovo logo
	APU	Cores	Frequency Base/Max	L2 Cache	Memory Support (Up to)	Integrated Graphics	Mechanical	Tiny (1L), fan-less design, black color, metal case <ul style="list-style-type: none"> • Toolless chassis open (for models with optional toolless chassis screw) • Toolless SSD, memory, Wi-Fi removal M625 Tiny Thin Client only: 7.05" W X 7.20" D X 1.36" H 179mm W X 182.9mm D X 34.5mm H 2.9 lb (1.3 kg), weight may vary by configuration Optional VESA mount bracket kit, supports VESA 75mm and 100mm Optional system floor stand for vertical orientation
Memory	8GB max, DDR4-2666, one 260-pin SO-DIMM socket * System frequency automatically clocks down for the lower capability of memory controller in processor						VESA mount Floor Stand	
Disk	<i>Some:</i> 32GB M.2 Solid State Drive (SSD) / SATA interface <i>Some:</i> 128GB M.2 Solid State Drive (SSD) / PCIe NVMe interface						Power supply	65 watts AC/DC adapter, autosensing, 88% PSU (not included for TIO models)
Optical Onboard SATA Media reader	None one SATA 6.0Gb/s connector on planar None						Limited warranty ³	<i>Some:</i> 1-year, depot service / service upgrades available <i>Some:</i> 1-year, limited onsite service / service upgrades available
Graphics	AMD Radeon™ Graphics in processor, uses main memory, DirectX® 12, two DisplayPort™, one optional port (VGA or USB 2.0 Type-C with DisplayPort Alternate Mode), supports up to 2 independent displays; <i>Max resolution:</i> 3840x2160 (DP) @60Hz; 2048x1280 (VGA) @60Hz; 3840x2160 (USB 2.0 Type-C) @60Hz						Preload	Preloaded operating system <i>Some:</i> Windows Embedded Standard 7 V2 (WES 7 V2) <i>Some:</i> Windows 10 IoT Enterprise <i>Some:</i> LeTOS V2 (Lenovo Terminal Operating System, Linux-based)
Monitor cable	Optional DP to VGA, DP to DVI-D (single link), or DP to HDMI 1.4 dongle						Environment	ENERGY STAR® 6.1*, EPEAT™ Silver rating* (*Not for non-OS models), ErP Lot 3, RoHS-compliant, WEEE, TCO
Chipset	AMD SoC platform						MIL-SPEC test	MIL-STD-810G military certification (Low Pressure [Altitude], High Temperature, Low Temperature, Temperature Shock, Humidity, Sand and Dust, Vibration, Shock, Fungus, Solar Radiation)
Front ports*	Two USB 3.1 Gen1 (one is Always On and fast charge), one microphone (3.5mm), one headphone / microphone combo jack (3.5mm)						Accessories	For compatible accessories, please go to http://smartfind.lenovo.com
Rear ports*	One USB 3.1 Gen1, three USB 2.0, ethernet (RJ-45), two DisplayPort, two optional ports (Port 1 for VGA / serial / USB 2.0 Type-C (with DisplayPort Alternate Mode), Port 2 for serial) * Depending on many factors, actual data transfer speed may be lower than theoretical speed							
I/O box	None							
Audio support	High Definition (HD) Audio, Realtek ALC233-VB2-CG / internal speaker (1.5 watt)							
WLAN ¹³	<i>Some:</i> 11ac wireless, M.2 Card, Realtek RTL8821CE (dual band), Wi-Fi + Bluetooth 4.2* combo adapter, 1x1 <i>Some:</i> 11ac wireless, M.2 Card, Qualcomm Atheros QCA9377 (dual band), Wi-Fi + Bluetooth 4.2* combo adapter, 1x1 <i>Some:</i> 11ac wireless, M.2 Card, Realtek RTL8822BE (dual band), Wi-Fi + Bluetooth 4.2* combo adapter, 2x2 <i>Some:</i> 11ac wireless, M.2 Card, Qualcomm Atheros QCA6174A (dual band), Wi-Fi + Bluetooth 4.2* combo adapter, 2x2							
Bluetooth™	<i>Some:</i> Bluetooth 4.2* wireless, integrated in Wi-Fi + BT combo adapter * Win 10 RS3 and Win10 earlier version only support Bluetooth 4.1							
Ethernet Modem	Gigabit ethernet, Realtek RTL8111HN, Wake on LAN®							
Manageability Security chip Security features	None Discrete TPM 2.0, TCG Certified <ul style="list-style-type: none"> • Security slot (in rear for optional Kensington® MicroSaver® cable) • Smart USB protection, allows keyboard/mouse only, blocks all storage devices • Power-on password • Administrator password • Hard disk password • Boot sequence control • Boot without keyboard and mouse • Individual USB port disablement • Chassis intrusion switch 							



ThinkCentre M630e Tiny Platform Specifications

Product Specifications Reference (PSREF)

Processor	Intel® Pentium®, or 8th Generation Intel Core™ i3 / i5 Processor						Manageability Security chip Security features	None Firmware TPM 2.0, integrated in chipset <ul style="list-style-type: none"> Security slot (in rear for optional Kensington® MicroSaver® cable) Chassis intrusion switch Power-on password Administrator password Hard disk password <ul style="list-style-type: none"> Boot sequence control Boot without keyboard and mouse Individual USB port disablement Smart USB protection, allows keyboard/mouse only, blocks all storage devices 						
	Processor	Cores / Threads	Frequency Base/Max(GHz)	Cache	Memory Support (Up to)	Integrated Graphics								
	Pentium Gold 5405U	2 / 4	2.3G	2 MB	DDR4-2133	UHD 610								
	Core i3-8145U	2 / 4	2.1G / 3.9G	4 MB	DDR4-2400	UHD 620								
	Core i5-8265U	4 / 8	1.6G / 3.9G	6 MB	DDR4-2400	UHD 620								
Memory	16GB max, DDR4-2666*, one 260-pin SO-DIMM sockets, non-ECC * System automatically clocks down for the processors with lower memory controller						Keyboard Mouse	Some: Lenovo Calliope Keyboard (USB connector), black Some: Lenovo Calliope Mouse (USB connector), black						
Storage	Some: Hard Drive / SATA 6.0Gb/s, 2.5", 5400 rpm or 7200 rpm Some: Solid State Drive (SSD) / SATA 6.0Gb/s, 2.5" Some: M.2 SSD (2280) / PCIe NVMe, PCIe 3.0 x 4, 32Gb/s Some: M.2 SSD (2242) / PCIe NVMe, PCIe 3.0 x 2, 16Gb/s						Mechanical	Tiny (1L), black color; metal case <ul style="list-style-type: none"> Optional dust filter One 2.5" bay for HDD/SSD, two M.2 slots (one for WLAN, one for M.2 SSD) <table border="1"> <thead> <tr> <th></th> <th>Dimensions (WxDxH)</th> <th>Weight (Approx.)</th> </tr> </thead> <tbody> <tr> <td>Tiny only</td> <td>7.05" X 7.20" X 1.36" 179mm X 182.9mm X 34.5mm</td> <td>2.91 lb (1.32 kg), vary by config</td> </tr> </tbody> </table>		Dimensions (WxDxH)	Weight (Approx.)	Tiny only	7.05" X 7.20" X 1.36" 179mm X 182.9mm X 34.5mm	2.91 lb (1.32 kg), vary by config
	Dimensions (WxDxH)	Weight (Approx.)												
Tiny only	7.05" X 7.20" X 1.36" 179mm X 182.9mm X 34.5mm	2.91 lb (1.32 kg), vary by config												
Onboard SATA	One onboard SATA 6.0Gb/s connector						VESA mount Floor Stand	Optional VESA mount bracket kit, supports VESA 75mm and 100mm Optional system floor stand for vertical orientation						
Graphics	Intel HD Graphics 610/620 in processor, uses main memory, DirectX® 12, one DisplayPort™, one HDMI, up to 2 independent displays; Max resolution: 4096x2304 (DP) @60Hz; 4096x2304 (HDMI) @24Hz													
Monitor cable	Optional DP to VGA dongle or DP to HDMI 1.4 dongle													
Chipset	Intel SoC (System on Chip) platform													
Front ports* (Std.)	One USB 3.1 Gen1, one USB 3.1 Type-C Gen 1, one microphone (3.5mm), one headphone / microphone combo jack (3.5mm)						Power supply	Some: 65 watts adapter, autosensing, 88% PSU						
Rear ports* (Std.)	Two USB 3.1 Gen1, two USB 2.0, one ethernet (RJ-45), one DisplayPort, one HDMI						Limited warranty	Some: 1-year, depot service / service upgrades available Some: 1-year, limited onsite service / service upgrades available						
Rear ports* (Opt.)	None * Depending on many factors, actual data transfer speed may be lower than theoretical speed						Preload	Preloaded operating system Some: Windows® 10 Pro 64-bit Some: Windows 10 Home 64-bit Preloaded applications (only some listed) <ul style="list-style-type: none"> Lenovo Vantage Microsoft Office preloaded; purchase a product key to activate LinkedIn 						
Audio support	Realtek ALC233VB / internal speaker (1.5 watt)						Environment	ENERGY STAR® 7.0, EPEAT™ Silver rating, ErP Lot 3, TCO, RoHS-compliant, WEEE, REACH						
WLAN	Some: 11ac wireless, M.2 Card, Realtek RTL8821CE (dual band), Wi-Fi + Bluetooth 4.2 combo adapter, 1x1 Some: 11ac wireless, M.2 Card, Realtek RTL8822BE (dual band), Wi-Fi + Bluetooth 4.2 combo adapter, 2x2 Some: 11ac wireless, M.2 Card, Intel Dual Band Wireless-AC 3165, Wi-Fi + Bluetooth 4.2 combo adapter, 1x1 Some: 11ac wireless, M.2 Card, Intel Dual Band Wireless-AC 8265, Wi-Fi + Bluetooth 4.2 combo adapter, 2x2						MIL-SPEC test	Coming soon						
Bluetooth	Some: Bluetooth 4.2 wireless, integrated in Wi-Fi + BT combo adapter						Accessories	For compatible accessories, please go to http://smartfind.lenovo.com						
Ethernet	Gigabit ethernet, Realtek RTL8111HN-CG													
Ethernet (Opt.)	None													

Note: The specifications above may not be available in all regions.

Lenovo, October 2019



ThinkCentre M710 Tiny Platform Specifications

Product Specifications Reference (PSREF)

Processor	Intel® Celeron®, Intel Pentium®, or 6/7th Generation Intel Core™ i3 / i5 / i7 Processor						Security features <ul style="list-style-type: none"> Security slot (in rear for optional Kensington® MicroSaver® cable) Smart USB protection, allows keyboard/mouse only, blocks all storage devices Power-on password Administrator password Hard disk password Boot sequence control Boot without keyboard and mouse Individual USB port disablement Chassis intrusion switch
	Processor	Cores / Threads	Frequency Base/Max(GHz)	Cache	Memory Support (Up to)	Integrated Graphics	
	Pentium G4400T	2 / 2	2.9G	3 MB	DDR4-2133	HD 510	
	Pentium G4560T	2 / 4	2.9G	3 MB	DDR4-2400	HD 610	
	Pentium G4600T	2 / 4	3.0G	3 MB	DDR4-2400	HD 630	
	Core i3-6100T	2 / 4	3.2G	3 MB	DDR4-2133	HD 530	
	Core i5-6500T	4 / 4	2.5G / 3.1G	6 MB	DDR4-2133	HD 530	
	Core i7-6700T	4 / 8	2.8G / 3.6G	8 MB	DDR4-2133	HD 530	
	Core i3-7100T	2 / 4	3.4G	3 MB	DDR4-2400	HD 630	
	Core i5-7400T	4 / 4	2.4G / 3.0G	6 MB	DDR4-2400	HD 630	
	Core i5-7500T	4 / 4	2.7G / 3.3G	6 MB	DDR4-2400	HD 630	
Core i5-7600T	4 / 4	2.8G / 3.7G	6 MB	DDR4-2400	HD 630		
Core i7-7700T	4 / 8	2.9G / 3.8G	8 MB	DDR4-2400	HD 630		
Memory	32GB max, DDR4-2400*, two 260-pin SO-DIMM sockets, non-ECC, dual-channel capable * System automatically clocks down for the processors with lower memory controller						
Storage	<i>Some:</i> Hard Drive / SATA 6.0Gb/s, 2.5", 5400 rpm or 7200 rpm <i>Some:</i> Solid State Drive (SSD) / SATA 6.0Gb/s, 2.5" <i>Some:</i> M.2 Solid State Drive (SSD) / PCIe NVMe, PCIe 3.0 x 4, 32Gb/s <i>Some:</i> Intel Optane™ Memory (models with 7th gen Core processor), M.2 <i>Some:</i> DVD-ROM, slim (9.0mm), via USB external ODD box <i>Some:</i> DVD Burner (DVD±RW), slim (9.0mm), via USB external ODD box						
Optical	None						
Onboard SATA Media reader	One onboard SATA 6.0Gb/s connector						
Graphics	Intel HD Graphics 510/530/610/630 in processor, uses main memory, DirectX® 12, two DisplayPort™, one optional video port (HDMI, VGA, 3rd DP, or USB 3.1 Type-C with DisplayPort Alternate Mode), up to 3 independent displays; <i>Max resolution:</i> 4096x2304 (DP) @60Hz; 4096x2304 (Type-C) @60Hz; 4096x2160 (HDMI) @24Hz; 1920x1200 (VGA) @60Hz						
Monitor cable	Optional DP to VGA, DP to DVI-D (single link), DP to dual DP, or DP to HDMI 1.4						
Chipset	Intel B250 Chipset						
Front ports*	Two USB 3.1 Gen1 (one is Always On and fast charge), one microphone (3.5mm), one headphone / microphone combo jack (3.5mm)						
Rear ports*	Four USB 3.1 Gen1 (optional external optical box or external I/O box occupies one or two specific USB 3.1 Gen1 on some models), ethernet (RJ-45), two DisplayPort, two optional ports (Port 1 for VGA / 3rd DP / HDMI / serial / USB 3.1 Type-C Gen 1 (with DisplayPort Alternate Mode), Port 2 for serial)						
I/O box*	Optional external I/O box, extends two USB 2.0, two USB 3.1 Gen1, and one serial on rear, two USB 2.0 on front, via USB cable (occupy two specific USB 3.1 Gen1 of Tiny) * Depending on many factors, actual data transfer speed may be lower than theoretical speed						
Audio support	High Definition (HD) Audio, Realtek ALC294 / optional internal speaker (1w or 2w)						
WLAN ¹³	<i>Some:</i> 11ac wireless, M.2 Card, Qualcomm Atheros QCA9377A (dual band), Wi-Fi + Bluetooth 4.1 combo adapter, 1x1 <i>Some:</i> 11ac wireless, M.2 Card, Qualcomm Atheros QCA6174A (dual band), Wi-Fi + Bluetooth 4.1 combo adapter, 2x2 <i>Some:</i> 11ac wireless, M.2 Card, Intel Dual Band Wireless-AC 3165, Wi-Fi + Bluetooth 4.1 combo adapter, 1x1 <i>Some:</i> 11ac wireless, M.2 Card, Intel Dual Band Wireless-AC 8265, Wi-Fi + Bluetooth 4.1 combo adapter, 2x2						
Bluetooth™ Ethernet Modem	<i>Some:</i> Bluetooth 4.1 wireless, integrated in Wi-Fi + BT combo adapter Gigabit ethernet, Intel Ethernet Connection I219-V (Jacksonville), Wake on LAN® None						
Manageability Security chip	None TPM (Trusted Platform Module) 2.0*, TCG Certified * Downgrade to TPM1.2 for the models with Win10 DG Win7 32 OS						
VESA mount Floor Stand	Optional VESA mount bracket kit, supports VESA 75mm and 100mm Optional system floor stand for vertical orientation						
Power supply	65 watts AC/DC adapter, autosensing, 88% PSU (not included for TIO models) 90 watts AC/DC adapter, autosensing, 88% PSU (only for models with I/O box)						
Limited warranty ³	<i>Some:</i> 1-year or 3-year, depot service / service upgrades available <i>Some:</i> 1-year or 3-year, limited onsite service / service upgrades available						
Preload	<i>Some:</i> Windows® 7 Professional 32/64 preinstalled through downgrade rights in Windows 10 Pro 64-bit (not available with 7th Gen Intel processor) <i>Some:</i> Windows 10 Pro 64-bit <i>Some:</i> Windows 10 Home 64-bit Preloaded applications (only some listed) <ul style="list-style-type: none"> Microsoft Office preloaded; purchase a product key to activate - Only for Window 10 Lenovo Companion - Only for Window 7 Lenovo Solution Center Lenovo ThinkVantage Tools Create Recovery Media Adobe® Reader® Cyberlink PowerDVD Create (DVD±RW) 						
Environment	ENERGY STAR® 6.1, EPEAT™ Gold rating (North America), ErP Lot 3, GREENGUARD®, RoHS-compliant, TUV low noise verified (on some models)						
MIL-SPEC test	MIL-STD-810G military certification (Low Pressure [Altitude], High Temperature, Low Temperature, Temperature Shock, Humidity, Sand and Dust, Vibration, Shock, Fungus, Solar Radiation)						
Accessories	For compatible accessories, please go to http://www.lenovoquickpick.com						

See footnotes for more detailed information

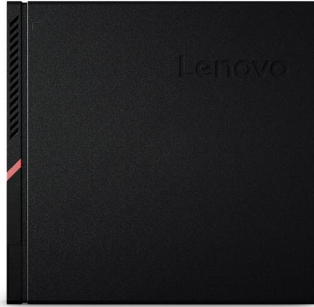

ThinkCentre M715 Tiny (2nd Gen) Platform Specifications

Product Specifications Reference (PSREF)

Processor	AMD Athlon, A6, A10, A12, or Ryzen processor	Security features	<ul style="list-style-type: none"> Security slot (in rear for optional Kensington® MicroSaver® cable) Administrator password Padlock loop Hard disk password Smart USB protection, allows keyboard/ mouse only, blocks all storage devices Boot sequence control Power-on password Boot without keyboard and mouse Individual USB port disablement Chassis intrusion switch 																																																																								
	<table border="1"> <thead> <tr> <th>Processor</th> <th>Cores / Threads</th> <th>Frequency Base/Max</th> <th>L2 / L3 Cache</th> <th>Memory Support (Up to)</th> <th>Integrated Graphics</th> </tr> </thead> <tbody> <tr> <td>Athlon 200GE</td> <td>2 / 4</td> <td>3.2 GHz</td> <td>1 MB / 4MB</td> <td>DDR4-2666</td> <td>Radeon Vega 3</td> </tr> <tr> <td>Athlon PRO 200GE</td> <td>2 / 4</td> <td>3.2 GHz</td> <td>1 MB / 4MB</td> <td>DDR4-2666</td> <td>Radeon Vega 3</td> </tr> <tr> <td>PRO A6-8570E</td> <td>2 / 2</td> <td>3.0 / 3.4 GHz</td> <td>1 MB / -</td> <td>DDR4-2400</td> <td>Radeon R5</td> </tr> <tr> <td>PRO A10-8770E</td> <td>4 / 4</td> <td>2.8 / 3.5 GHz</td> <td>2 MB / -</td> <td>DDR4-2400</td> <td>Radeon R7</td> </tr> <tr> <td>PRO A6-9500E</td> <td>2 / 2</td> <td>3.0 / 3.4 GHz</td> <td>1 MB / -</td> <td>DDR4-2400</td> <td>Radeon R5</td> </tr> <tr> <td>PRO A10-9700E</td> <td>4 / 4</td> <td>3.0 / 3.5 GHz</td> <td>2 MB / -</td> <td>DDR4-2400</td> <td>Radeon R7</td> </tr> <tr> <td>PRO A12-9800E</td> <td>4 / 4</td> <td>3.1 / 3.8 GHz</td> <td>2 MB / -</td> <td>DDR4-2400</td> <td>Radeon R7</td> </tr> <tr> <td>Ryzen 3 2200GE</td> <td>4 / 4</td> <td>3.2 / 3.6 GHz</td> <td>2 MB / 4MB</td> <td>DDR4-2933</td> <td>Radeon Vega 8</td> </tr> <tr> <td>Ryzen 3 PRO 2200GE</td> <td>4 / 4</td> <td>3.2 / 3.6 GHz</td> <td>2 MB / 4MB</td> <td>DDR4-2933</td> <td>Radeon Vega 8</td> </tr> <tr> <td>Ryzen 5 2400GE</td> <td>4 / 8</td> <td>3.2 / 3.8 GHz</td> <td>2 MB / 4MB</td> <td>DDR4-2933</td> <td>Radeon RX Vega 11</td> </tr> <tr> <td>Ryzen 5 PRO 2400GE</td> <td>4 / 8</td> <td>3.2 / 3.8 GHz</td> <td>2 MB / 4MB</td> <td>DDR4-2933</td> <td>Radeon RX Vega 11</td> </tr> </tbody> </table>	Processor	Cores / Threads	Frequency Base/Max	L2 / L3 Cache	Memory Support (Up to)	Integrated Graphics	Athlon 200GE	2 / 4	3.2 GHz	1 MB / 4MB	DDR4-2666	Radeon Vega 3	Athlon PRO 200GE	2 / 4	3.2 GHz	1 MB / 4MB	DDR4-2666	Radeon Vega 3	PRO A6-8570E	2 / 2	3.0 / 3.4 GHz	1 MB / -	DDR4-2400	Radeon R5	PRO A10-8770E	4 / 4	2.8 / 3.5 GHz	2 MB / -	DDR4-2400	Radeon R7	PRO A6-9500E	2 / 2	3.0 / 3.4 GHz	1 MB / -	DDR4-2400	Radeon R5	PRO A10-9700E	4 / 4	3.0 / 3.5 GHz	2 MB / -	DDR4-2400	Radeon R7	PRO A12-9800E	4 / 4	3.1 / 3.8 GHz	2 MB / -	DDR4-2400	Radeon R7	Ryzen 3 2200GE	4 / 4	3.2 / 3.6 GHz	2 MB / 4MB	DDR4-2933	Radeon Vega 8	Ryzen 3 PRO 2200GE	4 / 4	3.2 / 3.6 GHz	2 MB / 4MB	DDR4-2933	Radeon Vega 8	Ryzen 5 2400GE	4 / 8	3.2 / 3.8 GHz	2 MB / 4MB	DDR4-2933	Radeon RX Vega 11	Ryzen 5 PRO 2400GE	4 / 8	3.2 / 3.8 GHz	2 MB / 4MB	DDR4-2933	Radeon RX Vega 11	Keyboard	<ul style="list-style-type: none"> <i>Some:</i> Lenovo Calliope Keyboard (USB connector), black <i>Some:</i> Lenovo Traditional Keyboard (USB connector), black <i>Some:</i> Lenovo Calliope Wireless Keyboard (2.4GHz via USB receiver), black
Processor	Cores / Threads	Frequency Base/Max	L2 / L3 Cache	Memory Support (Up to)	Integrated Graphics																																																																						
Athlon 200GE	2 / 4	3.2 GHz	1 MB / 4MB	DDR4-2666	Radeon Vega 3																																																																						
Athlon PRO 200GE	2 / 4	3.2 GHz	1 MB / 4MB	DDR4-2666	Radeon Vega 3																																																																						
PRO A6-8570E	2 / 2	3.0 / 3.4 GHz	1 MB / -	DDR4-2400	Radeon R5																																																																						
PRO A10-8770E	4 / 4	2.8 / 3.5 GHz	2 MB / -	DDR4-2400	Radeon R7																																																																						
PRO A6-9500E	2 / 2	3.0 / 3.4 GHz	1 MB / -	DDR4-2400	Radeon R5																																																																						
PRO A10-9700E	4 / 4	3.0 / 3.5 GHz	2 MB / -	DDR4-2400	Radeon R7																																																																						
PRO A12-9800E	4 / 4	3.1 / 3.8 GHz	2 MB / -	DDR4-2400	Radeon R7																																																																						
Ryzen 3 2200GE	4 / 4	3.2 / 3.6 GHz	2 MB / 4MB	DDR4-2933	Radeon Vega 8																																																																						
Ryzen 3 PRO 2200GE	4 / 4	3.2 / 3.6 GHz	2 MB / 4MB	DDR4-2933	Radeon Vega 8																																																																						
Ryzen 5 2400GE	4 / 8	3.2 / 3.8 GHz	2 MB / 4MB	DDR4-2933	Radeon RX Vega 11																																																																						
Ryzen 5 PRO 2400GE	4 / 8	3.2 / 3.8 GHz	2 MB / 4MB	DDR4-2933	Radeon RX Vega 11																																																																						
		Mouse	<ul style="list-style-type: none"> <i>Some:</i> Lenovo Calliope Mouse (USB connector), black <i>Some:</i> Lenovo Fingerprint Mouse (USB connector), Windows Hello support, black <i>Some:</i> Lenovo Calliope Wireless Mouse (2.4GHz via USB receiver), black 																																																																								
Memory	32GB max, DDR4 2666*, two 260-pin SO-DIMM sockets, dual-channel capable * System automatically clocks down for the lower memory controller	Mechanical	<ul style="list-style-type: none"> Tiny (1L), black color; metal case Toolless chassis open (need optional toolless chassis screw) Optional dust filter <p>M715 Gen2 Tiny only: 7.05" W X 7.20" D X 1.36" H 179mm W X 182.9mm D X 34.5mm H 2.91 lb (1.32 kg), weight may vary by configuration</p> <p>With VESA mount & ODD box: 7.42" W X 7.30" D X 2.48" H 188.4mm W X 185.38mm D X 63mm H 3.66 lb (1.66 kg), weight may vary by configuration</p>																																																																								
Disk	<ul style="list-style-type: none"> <i>Some:</i> Hard Drive / SATA 6.0Gb/s, 2.5", 5400 rpm or 7200 rpm <i>Some:</i> Solid State Drive (SSD) / SATA 6.0Gb/s, 2.5" <i>Some:</i> M.2 SSD / PCIe NVMe, PCIe 3.0 x 4*, 32Gb/s 	VESA mount Floor Stand	Optional VESA mount bracket kit, supports VESA 75mm and 100mm Optional system floor stand for vertical orientation																																																																								
Optical	<ul style="list-style-type: none"> <i>Some:</i> DVD-ROM, 9.0mm high, via USB external ODD box <i>Some:</i> DVD±RW, 9.0mm high, via USB external ODD box 	Power supply	65 watts AC/DC adapter, autosensing, 88% PSU (not included for TIO models)																																																																								
Onboard SATA	One SATA cable (1-drop to device), one SATA 6.0Gb/s connector on planar	Limited warranty	1-year or 3-year, limited onsite service / service upgrades available																																																																								
Graphics	AMD Radeon™ Graphics in processor, uses main memory, DirectX® 12, two DisplayPort™, one optional port (HDMI, VGA, or 3rd DP), supports 3 independent displays (supports maximum of 2 concurrent HDMI/DVI displays when using HDMI port or DP to DVI/HDMI dongles, and Athlon / Athlon PRO only support 2 displays); Max resolution: 4096x2160 (DP) @60Hz; 4096x2160 (HDMI) @30Hz; 1920x1200 (VGA) @60Hz	Preload	<p>Preloaded operating system</p> <ul style="list-style-type: none"> <i>Some:</i> Windows® 10 Pro 64-bit <i>Some:</i> Windows 10 Home 64-bit <i>Some:</i> Windows 7 Professional 64 preinstalled through downgrade rights in Windows 10 Pro 64-bit <p>Preloaded applications (only some listed)</p> <ul style="list-style-type: none"> - Windows 10 only • Lenovo Vantage • Microsoft Office preloaded; purchase a product key to activate • Cyberlink PowerDVD (only for models with DVD / DVD±RW) • Cyberlink Power2GO (only for models with DVD±RW) • LinkedIn - Windows 7 only • Lenovo Solution Center • ThinkVantage System Update • Create Recovery Media • Microsoft Office preloaded; purchase a product key to activate • Adobe® Reader® 																																																																								
Monitor cable	Optional DP to VGA dongle, DP to DVI-D dongle, or DP to HDMI 1.4 dongle	Environment	ENERGY STAR® 7.0*, EPEAT™ Silver rating* (*Not for non-OS models); ErP Lot 3; ; RoHS-compliant																																																																								
Chipset	AMD B300 Chipset	MIL-SPEC test	MIL-STD-810G military certification (Low Pressure [Altitude], High Temperature, Low Temperature, Temperature Shock, Humidity, Sand and Dust, Vibration, Shock)																																																																								
Front ports* (Std.)	Two USB 3.1 Gen1 (one is Always On and fast charge), one microphone (stereo, 3.5mm), one headphone / microphone combo jack (stereo, 3.5mm)	Accessories	For compatible accessories, please go to http://smartfind.lenovo.com																																																																								
Rear ports* (Std.)	One USB 3.1 Gen1 and three USB 2.0, ethernet (RJ-45), two DisplayPort, one headphone																																																																										
Rear ports* (Opt.)	One optional port (VGA**, 3rd DP**, HDMI**, or serial on some models) * Depending on many factors, actual data transfer speed may be lower than theoretical speed ** Not support VGA, 3rd DP, HDMI for the models with Athlon / Athlon PRO																																																																										
Audio support	High Definition (HD) Audio, Realtek ALC233-VB2 / internal speaker (1.5 watt)																																																																										
WLAN	<ul style="list-style-type: none"> <i>Some:</i> 11ac wireless, M.2 Card, Realtek RTL8821CE (dual band), Wi-Fi + Bluetooth 4.2* combo adapter, 1x1 <i>Some:</i> 11ac wireless, M.2 Card, Qualcomm Atheros QCA9377 (dual band), Wi-Fi + Bluetooth 4.2* combo adapter, 1x1 <i>Some:</i> 11ac wireless, M.2 Card, Realtek RTL8822BE (dual band), Wi-Fi + Bluetooth 4.2* combo adapter, 2x2 <i>Some:</i> 11ac wireless, M.2 Card, Qualcomm Atheros QCA6174A (dual band), Wi-Fi + Bluetooth 4.2* combo adapter, 2x2 <i>Some:</i> Bluetooth 4.2* wireless, integrated in Wi-Fi + BT combo adapter 																																																																										
Bluetooth	* Hardware supports BT 4.2, but Win10 RS3 and earlier only supports BT 4.1																																																																										
Ethernet	Gigabit ethernet, Realtek RTL8111EPV, Wake on LAN®																																																																										
Manageability	DASH 1.0/1.1																																																																										
Security chip	Discrete TPM 2.0, TCG Certified																																																																										

Note: The specifications above may not be available in all regions.

Lenovo, July 2018

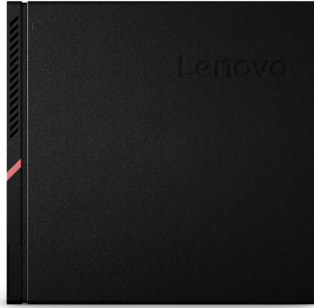

ThinkCentre M715 Tiny Thin Client Platform Specifications

Product Specifications Reference (PSREF)

Processor	AMD A6, A10, or A12 series APUs						Keyboard	<i>Some:</i> Fullsize USB Keyboard (USB connector), Lenovo logo
	APU	Cores	Frequency Base/Max	L2 Cache	Memory Types	Integrated Graphics	Mouse	<i>Some:</i> USB Optical Wheel Mouse, black, Lenovo logo
	PRO A6-8570E	2	3.0 / 3.4 GHz	1 MB	DDR4-2400	Radeon R5 Series	Mechanical	Tiny (1L), black color; metal case M715 Tiny only: 7.05" W X 7.20" D X 1.36" H 179mm W X 182.9mm D X 34.5mm H 2.9 lb (1.3 kg), weight may vary by configuration Optional VESA mount bracket kit, supports VESA 75mm and 100mm Optional system floor stand for vertical orientation
	PRO A10-8770E	4	2.8 / 3.5 GHz	2 MB	DDR4-2400	Radeon R7 Series		
PRO A12-8870E*	4	2.9 / 3.8 GHz	2 MB	DDR4-2400	Radeon R7 Series			
*PRO A12-8870E (support Windows 10 IOT only) is only available via special bid models								
Memory	4GB max, DDR4 2400, two 260-pin SO-DIMM sockets						VESA mount	Optional VESA mount bracket kit, supports VESA 75mm and 100mm Optional system floor stand for vertical orientation
Disk	<i>Some:</i> 256GB Solid State Drive (SSD) / SATA 6.0Gb/s, 2.5"* *256GB SATA (support Windows 10 IOT only) is only available via special bid models <i>Some:</i> 32GB M.2 Solid State Drive (SSD) / SATA interface <i>Some:</i> 128GB M.2 Solid State Drive (SSD) / PCIe NVMe interface						Floor Stand	
Optical	None						Power supply	65 watts AC/DC adapter, autosensing, 88% PSU (not included for TIO models)
Onboard SATA	One SATA cable (1-drop to device), one SATA 6.0Gb/s connector on planar						Limited warranty ³	<i>Some:</i> 1-year or 3-year, depot service / service upgrades available <i>Some:</i> 1-year or 3-year, limited onsite service / service upgrades available
Media reader	None						Preload	Preloaded operating system <i>Some:</i> Windows Embedded Standard 7 V2 (WES 7 V2) <i>Some:</i> Windows 10 IoT Enterprise <i>Some:</i> LeTOS V2 (Lenovo Terminal Operating System, Linux-based)
Graphics	AMD Radeon™ Graphics in processor, uses main memory, DirectX® 12, two DisplayPort™, one optional port (HDMI, VGA, or 3rd DP), supports 3 independent displays (supports maximum of 2 concurrent HDMI/DVI displays when using HDMI port or DP to DVI/HDMI dongles); <i>Max resolution:</i> 4096x2160 (DP) @60Hz; 4096x2160 (HDMI) @30Hz; 1920x1200 (VGA) @60Hz						Environment	ENERGY STAR® 6.1*, EPEAT™ Gold rating* (*not for non-OS models); ErP Lot 3; GREENGUARD®; RoHS-compliant
DP cable	Optional DP to VGA, DP to DVI-D (single link), or DP to HDMI 1.4 dongle						Accessories	For compatible accessories, please go to http://www.lenovoquickpick.com
Chipset	AMD B300 Chipset							
Front ports*	Two USB 3.0 (one is Always On and fast charge), one microphone (stereo, 3.5mm), one headphone / microphone combo jack (stereo, 3.5mm)							
Rear ports*	One USB 3.0 and three USB 2.0 (optional external optical box or I/O box occupies one specific USB 2.0 on some models), ethernet (RJ-45), two DisplayPort, one optional port (VGA, 3rd DP, HDMI, or serial on some models), one headphone * Depending on many factors, actual data transfer speed may be lower than theoretical speed							
I/O box	None							
Audio support	High Definition (HD) Audio, Realtek ALC233-CG / internal speaker (1.5 watt)							
WLAN ¹³	<i>Some:</i> 11ac wireless, M.2 Card, Realtek RTL8821AE (dual band), Wi-Fi + Bluetooth 4.0 combo adapter, 1x1							
Bluetooth™	<i>Some:</i> Bluetooth 4.0 or 4.1 wireless, integrated in Wi-Fi + BT combo adapter							
Ethernet	Gigabit ethernet, Realtek RTL8111EPV, Wake on LAN®							
Modem	None							
Manageability	DASH 1.0/1.1							
Security chip	Discrete TPM 2.0, TCG Certified							
Security features	<ul style="list-style-type: none"> ● Security slot (in rear for optional Kensington® MicroSaver® cable) ● Padlock loop ● Smart USB protection, allows keyboard/mouse only, blocks all storage devices ● Power-on password ● Administrator password ● Hard disk password ● Boot sequence control ● Boot without keyboard and mouse ● Individual USB port disablement ● Chassis intrusion switch 							

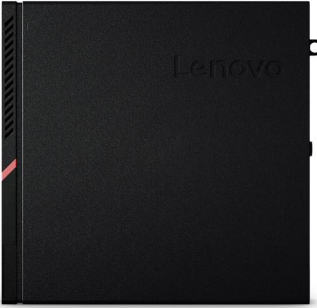

ThinkCentre M715 Tiny Thin Client (2nd Gen) Platform Specifications

Product Specifications Reference (PSREF)

Processor	AMD Athlon, A6, A10, or Ryzen processor						Keyboard	<i>Some:</i> Lenovo Calliope Keyboard (USB connector), black <i>Some:</i> Lenovo Traditional Keyboard (USB connector), black <i>Some:</i> Lenovo Calliope Wireless Keyboard (2.4GHz via USB receiver), black <i>Some:</i> Lenovo Calliope Mouse (USB connector), black <i>Some:</i> Lenovo Fingerprint Mouse (USB connector), Windows Hello support, black <i>Some:</i> Lenovo Calliope Wireless Mouse (2.4GHz via USB receiver), black
	APU	Cores / Threads	Frequency Base/Max	L2 / L3 Cache	Memory Sup-port (Up to)	Integrated Graphics	Mouse	
	Athlon PRO 200GE	2 / 4	3.2 GHz	1 MB / 4MB	DDR4-2666	Radeon Vega 3		
	PRO A6-8570E	2 / 2	3.0 / 3.4 GHz	1 MB / -	DDR4-2400	Radeon R5		
	PRO A10-8770E	4 / 4	2.8 / 3.5 GHz	2 MB / -	DDR4-2400	Radeon R7		
	Ryzen 3 PRO 2200GE	4 / 4	3.2 / 3.6 GHz	2 MB / 4MB	DDR4-2933	Radeon Vega 8		
Memory	8GB max, DDR4 2666*, two 260-pin SO-DIMM sockets, dual-channel capable * System automatically clocks down for the lower memory controller						Mechanical	Tiny (1L), black color; metal case • Toolless chassis open (need optional toolless chassis screw) • Optional dust filter M715 Gen2 Tiny only: 7.05" W X 7.20" D X 1.36" H 179mm W X 182.9mm D X 34.5mm H 2.91 lb (1.32 kg), weight may vary by configuration VESA mount Optional VESA mount bracket kit, supports VESA 75mm and 100mm Floor Stand Optional system floor stand for vertical orientation
Disk	<i>Some:</i> 32GB M.2 Solid State Drive (SSD) / SATA interface <i>Some:</i> 128GB M.2 Solid State Drive (SSD) / PCIe NVMe, PCIe 3.0 x 2						Power supply	65 watts AC/DC adapter, autosensing, 88% PSU (not included for TIO models)
Optical	None						Limited warranty	1-year or 3-year, limited onsite service / service upgrades available
Onboard SATA	One SATA cable (1-drop to device), one SATA 6.0Gb/s connector on planar						Preload	Preloaded operating system <i>Some:</i> Windows Embedded Standard 7 V2 (WES 7 V2) <i>Some:</i> Windows 10 IoT Enterprise <i>Some:</i> LeTOS V2 (Lenovo Terminal Operating System, Linux-based)
Graphics	AMD Radeon™ Graphics in processor, uses main memory, DirectX® 12, two DisplayPort™, one optional port (HDMI, VGA, or 3rd DP), supports 3 independent displays (supports maximum of 2 concurrent HDMI/DVI displays when using HDMI port or DP to DVI/HDMI dongles, and Athlon / Athlon PRO only support 2 displays); <i>Max resolution:</i> 4096x2160 (DP) @60Hz; 4096x2160 (HDMI) @30Hz; 1920x1200 (VGA) @60Hz						Environment	ENERGY STAR® 6.1*, EPEAT™ Silver rating* (*not for non-OS models); ErP Lot 3; RoHS-compliant
Monitor cable	Optional DP to VGA dongle, DP to DVI-D dongle, or DP to HDMI 1.4 dongle						MIL-SPEC test	MIL-STD-810G military certification (Low Pressure [Altitude], High Temperature, Low Temperature, Temperature Shock, Humidity, Sand and Dust, Vibration, Shock)
Chipset	AMD B300 Chipset						Accessories	For compatible accessories, please go to http://smartfind.lenovo.com
Front ports* (Std.)	Two USB 3.1 Gen1 (one is Always On and fast charge), one microphone (stereo, 3.5mm), one headphone / microphone combo jack (stereo, 3.5mm)							
Rear ports* (Std.)	One USB 3.1 Gen1 and three USB 2.0, ethernet (RJ-45), two DisplayPort, one headphone							
Rear ports* (Opt.)	One optional port (VGA**, 3rd DP**, HDMI**, or serial on some models) * Depending on many factors, actual data transfer speed may be lower than theoretical speed ** Not support VGA, 3rd DP, HDMI for the models with Athlon / Athlon PRO							
Audio support	High Definition (HD) Audio, Realtek ALC233-VB2 / internal speaker (1.5 watt)							
WLAN	<i>Some:</i> 11ac wireless, M.2 Card, Realtek RTL8821CE (dual band), Wi-Fi + Bluetooth 4.2* combo adapter, 1x1 <i>Some:</i> 11ac wireless, M.2 Card, Qualcomm Atheros QCA9377 (dual band), Wi-Fi + Bluetooth 4.2* combo adapter, 1x1 <i>Some:</i> 11ac wireless, M.2 Card, Realtek RTL8822BE (dual band), Wi-Fi + Bluetooth 4.2* combo adapter, 2x2 <i>Some:</i> 11ac wireless, M.2 Card, Qualcomm Atheros QCA6174A (dual band), Wi-Fi + Bluetooth 4.2* combo adapter, 2x2 <i>Some:</i> Bluetooth 4.2* wireless, integrated in Wi-Fi + BT combo adapter							
Bluetooth	* Hardware supports BT 4.2, but Win10 RS3 and earlier only supports BT 4.1							
Ethernet	Gigabit ethernet, Realtek RTL8111EPV, Wake on LAN®							
Manageability	DASH 1.0/1.1							
Security chip	Discrete TPM 2.0, TCG Certified							
Security features	<ul style="list-style-type: none"> • Security slot (in rear for optional Kensington® MicroSaver® cable) • Padlock loop • Smart USB protection, allows keyboard/mouse only, blocks all storage devices • Power-on password • Administrator password • Hard disk password • Boot sequence control • Boot without keyboard and mouse • Individual USB port disablement • Chassis intrusion switch 							

Note: The specifications above may not be available in all regions.

Lenovo, July 2018



ThinkCentre M720 Tiny Platform Specifications

Product Specifications Reference (PSREF)

Processor	Intel® Celeron®, Intel Pentium®, or 8th / 9th Gen Intel Core™ i3 / i5 / i7 / i9 Processor						Manageability None Security chip Discrete TPM 2.0, TCG Certified Security features <ul style="list-style-type: none"> Security slot (in rear for optional Kensington® MicroSaver® cable) Chassis intrusion switch Power-on password Administrator password Hard disk password <ul style="list-style-type: none"> Boot sequence control Boot without keyboard and mouse Individual USB port disablement Smart USB protection, allows keyboard/mouse only, blocks all storage devices
	Processor	Cores / Threads	Frequency Base/Max(GHz)	Cache	Memory Support (Up to)	Integrated Graphics	
	Celeron G4900T	2 / 2	2.9G	2 MB	DDR4-2400	UHD 610	
	Pentium Gold G5400T	2 / 4	3.1G	4 MB	DDR4-2400	UHD 610	
	Pentium Gold G5500T	2 / 4	3.2G	4 MB	DDR4-2400	UHD 630	
	Core i3-8100T	4 / 4	3.1G	6 MB	DDR4-2400	UHD 630	
	Core i3-8300T	4 / 4	3.2G	8 MB	DDR4-2400	UHD 630	
	Core i5-8400T	6 / 6	1.7G / 3.3G	9 MB	DDR4-2666	UHD 630	
	Core i5-8500T	6 / 6	2.1G / 3.5G	9 MB	DDR4-2666	UHD 630	
	Core i5-8600T	6 / 6	2.3G / 3.7G	9 MB	DDR4-2666	UHD 630	
	Core i7-8700T	6 / 12	2.4G / 4.0G	12 MB	DDR4-2666	UHD 630	
	Core i3-9100T	4 / 4	3.1G / 3.7G	6 MB	DDR4-2400	UHD 630	
	Core i3-9300T	4 / 4	3.2G / 3.8G	8 MB	DDR4-2400	UHD 630	
	Core i5-9400T	6 / 6	1.8G / 3.4G	9 MB	DDR4-2666	UHD 630	
	Core i5-9500T	6 / 6	2.2G / 3.7G	9 MB	DDR4-2666	UHD 630	
	Core i5-9600T	6 / 6	2.3G / 3.9G	9 MB	DDR4-2666	UHD 630	
	Core i7-9700T	8 / 8	2.0G / 4.3G	12 MB	DDR4-2666	UHD 630	
Core i9-9900T	8 / 16	2.1G / 4.4G	16 MB	DDR4-2666	UHD 630		
Memory	32GB max, DDR4-2666*, two 260-pin SO-DIMM sockets, non-ECC, dual-channel capable * System automatically clocks down for the processors with lower memory controller						
Storage	<i>Some:</i> Hard Drive / SATA 6.0Gb/s, 2.5", 5400 rpm or 7200 rpm <i>Some:</i> Solid State Drive (SSD) / SATA 6.0Gb/s, 2.5" <i>Some:</i> M.2 SSD / PCIe NVMe, PCIe 3.0 x 4*, 32Gb/s * 128GB SSD M.2 (2242) PCIe NVMe only supports PCIe 3.0 x 2, 16Gb/s <i>Some:</i> Intel Optane™ Memory (not support Celeron / Pentium Processor), M.2 <i>Some:</i> DVD-ROM, slim (9.0mm), via USB external ODD box <i>Some:</i> DVD Burner (DVD±RW), slim (9.0mm), via USB external ODD box One onboard SATA 6.0Gb/s connector						
Optical							
Onboard SATA							
Graphics	Intel HD Graphics 610/630 in processor, uses main memory, DirectX® 12, one DisplayPort™, one HDMI, one optional video port (2nd HDMI, VGA, 2nd DP, or USB 3.1 Type-C Gen1 with DisplayPort function), up to 3 independent displays; <i>Max resolution:</i> 4096x2304 (DP) @60Hz; 4096x2304 (Type-C) @60Hz; 4096x2160 (onboard HDMI) @24Hz; 2048x1536 (VGA) @50Hz Optional DP to VGA dongle, DP to DVI-D dongle, DP to dual DP dongle (for Collage Display with intel integrated graphics), or DP to HDMI 1.4 dongle						
Monitor cable							
Chipset	Intel B360 Chipset						
Front ports* (Std.)	one USB 3.1 Gen1 (Always On and fast charge), one USB 3.1 Type-C Gen 1, one microphone (3.5mm), one headphone / microphone combo jack (3.5mm)						
Rear ports* (Std.)	2x USB 3.1 Gen2, 2x USB 3.1 Gen1, 1x ethernet (RJ-45), 1x DisplayPort, 1x HDMI						
Rear ports* (Opt.)	Two optional ports (mutually exclusive with PCIe card): Port 1 for VGA / 2nd DP / 2nd HDMI / serial / USB 3.1 Type-C Gen 1 with DP function); Port 2 for serial; Optional ports via PCIe card: 2x USB 3.1 Gen1 via PCIe x1, 4x serial (9-pin) via PCIe x1 * Depending on many factors, actual data transfer speed may be lower than theoretical speed						
Audio support	Realtek ALC233VB2 / optional internal speaker (1.5 watt or 2 watt)						
WLAN	<i>Some:</i> 11ac wireless, M.2 Card, Realtek RTL8821CE (dual band), Wi-Fi + Bluetooth 4.2 combo adapter, 1x1 <i>Some:</i> 11ac wireless, M.2 Card, Realtek RTL8822BE (dual band), Wi-Fi + Bluetooth 4.2 combo adapter, 2x2 <i>Some:</i> 11ac wireless, M.2 Card, Intel Dual Band Wireless-AC 3165, Wi-Fi + Bluetooth 4.2 combo adapter, 1x1 <i>Some:</i> 11ac wireless, M.2 Card, Intel Dual Band Wireless-AC 8265, Wi-Fi + Bluetooth 4.2 combo adapter, 2x2						
Bluetooth	<i>Some:</i> Bluetooth 4.2 wireless, integrated in Wi-Fi + BT combo adapter						
Ethernet	Gigabit ethernet, Intel Ethernet Connection I219-V (Jacksonville), Wake on LAN®						
Ethernet (Opt.)	<i>Some:</i> Intel Ethernet Server Adapter I350-T4, gigabit ethernet, 4x RJ-45, PCIe x4						
			Dimensions (WxDxH) Tiny only 7.05" X 7.20" X 1.36" 179mm X 182.9mm X 34.5mm With VESA mount & ODD box 7.42" X 7.30" X 2.48" 188.4mm X 185.38mm X 63mm		Weight (Approx.) Tiny only 2.91 lb (1.32 kg), vary by config With VESA mount & ODD box 3.66 lb (1.66 kg), vary by config		
VESA mount	Optional VESA mount bracket kit, supports VESA 75mm and 100mm						
Floor Stand	Optional system floor stand for vertical orientation						
Power supply	<i>Some:</i> 65 watts AC/DC adapter, autosensing, 88% PSU <i>Some:</i> 90 watts AC/DC adapter, autosensing, 88% PSU <i>Some:</i> 135 watts AC/DC adapter, autosensing, 88% PSU						
Limited warranty	<i>Some:</i> 1-year or 3-year, depot service / service upgrades available <i>Some:</i> 1-year or 3-year, limited onsite service / service upgrades available						
Preload	Preloaded operating system <i>Some:</i> Windows® 10 Pro 64-bit <i>Some:</i> Windows 10 Home 64-bit Preloaded applications (only some listed) <ul style="list-style-type: none"> Lenovo Vantage Microsoft Office preloaded; purchase a product key to activate Cyberlink Power2GO (only for models with DVD / DVD±RW) Cyberlink Power2GO (only for models with DVD±RW) LinkedIn 						
Environment	ENERGY STAR® 7.0, EPEAT™ Gold rating (North America), ErP Lot 3, TCO, TUV ultra low noise verified (coming soon, on some models), RoHS-compliant						
MIL-SPEC test	MIL-STD-810G military certification (Low Pressure [Altitude], High Temperature, Low Temperature, Temperature Shock, Humidity, Sand and Dust, Vibration, Shock, Fungus, Solar Radiation)						
Accessories	For compatible accessories, please go to http://smartfind.lenovo.com						

Note: The specifications above may not be available in all regions.

Lenovo, June 2019



ThinkCentre M75q-1 Tiny Platform Specifications

Product Specifications Reference (PSREF)

Processor	AMD Athlon PRO or Ryzen 3 / 5 PRO series processor	Security features	<ul style="list-style-type: none"> Security slot (in rear for optional Kensington® MicroSaver® cable) Smart USB protection, allows keyboard/mouse only, blocks all storage devices Power-on password Administrator password Hard disk password Boot sequence control Boot without keyboard and mouse Individual USB port disablement Chassis intrusion switch 																																										
	<table border="1"> <thead> <tr> <th>Processor</th> <th>Cores / Threads</th> <th>Frequency Base/Max</th> <th>L2 / L3 Cache</th> <th>Memory Support (Up to)</th> <th>Integrated Graphics</th> </tr> </thead> <tbody> <tr> <td>Athlon PRO 200GE</td> <td>2 / 4</td> <td>3.2 GHz</td> <td>1 MB / 4MB</td> <td>DDR4-2666</td> <td>Radeon Vega 3</td> </tr> <tr> <td>Athlon PRO 300GE</td> <td>2 / 4</td> <td>3.4 GHz</td> <td>1 MB / 4MB</td> <td>DDR4-2666</td> <td>Radeon Vega 3</td> </tr> <tr> <td>Ryzen 3 PRO 2200GE</td> <td>4 / 4</td> <td>3.2 / 3.6 GHz</td> <td>2 MB / 4MB</td> <td>DDR4-2933</td> <td>Radeon Vega 8</td> </tr> <tr> <td>Ryzen 5 PRO 2400GE</td> <td>4 / 8</td> <td>3.2 / 3.8 GHz</td> <td>2 MB / 4MB</td> <td>DDR4-2933</td> <td>Radeon Vega 11</td> </tr> <tr> <td>Ryzen 3 PRO 3200GE</td> <td>4 / 4</td> <td>3.3 / 3.8 GHz</td> <td>2 MB / 4MB</td> <td>DDR4-2933</td> <td>Radeon Vega 8</td> </tr> <tr> <td>Ryzen 5 PRO 3400GE</td> <td>4 / 8</td> <td>3.3 / 4.0 GHz</td> <td>2 MB / 4MB</td> <td>DDR4-2933</td> <td>Radeon Vega 11</td> </tr> </tbody> </table>	Processor	Cores / Threads	Frequency Base/Max	L2 / L3 Cache	Memory Support (Up to)	Integrated Graphics	Athlon PRO 200GE	2 / 4	3.2 GHz	1 MB / 4MB	DDR4-2666	Radeon Vega 3	Athlon PRO 300GE	2 / 4	3.4 GHz	1 MB / 4MB	DDR4-2666	Radeon Vega 3	Ryzen 3 PRO 2200GE	4 / 4	3.2 / 3.6 GHz	2 MB / 4MB	DDR4-2933	Radeon Vega 8	Ryzen 5 PRO 2400GE	4 / 8	3.2 / 3.8 GHz	2 MB / 4MB	DDR4-2933	Radeon Vega 11	Ryzen 3 PRO 3200GE	4 / 4	3.3 / 3.8 GHz	2 MB / 4MB	DDR4-2933	Radeon Vega 8	Ryzen 5 PRO 3400GE	4 / 8	3.3 / 4.0 GHz	2 MB / 4MB	DDR4-2933	Radeon Vega 11	Keyboard	<i>Some:</i> Lenovo Traditional Keyboard (USB connector), black <i>Some:</i> Lenovo Calliope Wireless Keyboard (2.4GHz via USB receiver), black <i>Some:</i> Lenovo Calliope Mouse (USB connector), black <i>Some:</i> Lenovo Fingerprint Mouse (USB connector), Windows Hello support, black (only available via special bid models) <i>Some:</i> Lenovo Calliope Wireless Mouse (2.4GHz via USB receiver), black
Processor	Cores / Threads	Frequency Base/Max	L2 / L3 Cache	Memory Support (Up to)	Integrated Graphics																																								
Athlon PRO 200GE	2 / 4	3.2 GHz	1 MB / 4MB	DDR4-2666	Radeon Vega 3																																								
Athlon PRO 300GE	2 / 4	3.4 GHz	1 MB / 4MB	DDR4-2666	Radeon Vega 3																																								
Ryzen 3 PRO 2200GE	4 / 4	3.2 / 3.6 GHz	2 MB / 4MB	DDR4-2933	Radeon Vega 8																																								
Ryzen 5 PRO 2400GE	4 / 8	3.2 / 3.8 GHz	2 MB / 4MB	DDR4-2933	Radeon Vega 11																																								
Ryzen 3 PRO 3200GE	4 / 4	3.3 / 3.8 GHz	2 MB / 4MB	DDR4-2933	Radeon Vega 8																																								
Ryzen 5 PRO 3400GE	4 / 8	3.3 / 4.0 GHz	2 MB / 4MB	DDR4-2933	Radeon Vega 11																																								
Memory	32GB max, DDR4-2666*, two 260-pin SO-DIMM sockets, dual-channel capable * System automatically clocks down for the lower memory controller	Mechanical	Tiny (1L), black color; metal case <ul style="list-style-type: none"> Toolless chassis open (need optional toolless chassis screw) Toolless HDD, SSD, memory removal Optional dust filter M75q Tiny only: 7.05" W X 7.20" D X 1.36" H 179mm W X 182.9mm D X 34.5mm H 2.91 lb (1.32 kg), weight may vary by configuration With VESA mount & ODD box: 7.42" W X 7.30" D X 2.48" H 188.4mm W X 185.38mm D X 63mm H 3.66 lb (1.66 kg), weight may vary by configuration Optional VESA mount bracket kit, supports VESA 75mm and 100mm Optional system floor stand for vertical orientation																																										
Disk	<i>Some:</i> Hard Drive / SATA 6.0Gb/s, 2.5", 5400 rpm or 7200 rpm <i>Some:</i> M.2 SSD (2242 / 2280) / PCIe NVMe, PCIe 3.0 x2 or PCIe 3.0 x4	VESA mount	Optional VESA mount bracket kit, supports VESA 75mm and 100mm																																										
Optical	<i>Some:</i> DVD-ROM, 9.0mm high, via USB external ODD box <i>Some:</i> DVD±RW, 9.0mm high, via USB external ODD box	Floor Stand	Optional system floor stand for vertical orientation																																										
Onboard SATA	One SATA 6.0Gb/s connector on system board	Power supply	<i>Some:</i> 65 watts adapter, autosensing, 88% PSU (not included for TIO models) <i>Some:</i> 135 watts adapter, autosensing, 88% PSU (not included for TIO models)																																										
Graphics	AMD Radeon™ Graphics in processor, uses main memory, DirectX® 12, one DisplayPort™, one HDMI, one optional port (VGA, 2nd DP, or 2nd HDMI), supports 3 independent displays (supports maximum of 2 concurrent HDMI/DVI displays when using HDMI port or DP to DVI/HDMI dongles, and Athlon / Athlon PRO only support 2 displays); <i>Max resolution:</i> 4096x2160 (DP)@60Hz; 4096x2160 (HDMI)@30Hz; 1920x1200 (VGA)@60Hz	Limited warranty	1-year or 3-year, limited onsite service / service upgrades available																																										
Monitor cable	Optional DP to VGA dongle, DP to DVI-D dongle, DP to dual DP dongle, or DP to HDMI 1.4 dongle	Preload	Preloaded operating system <i>Some:</i> Windows® 10 Pro 64-bit <i>Some:</i> Windows 10 Home 64-bit <i>Some:</i> Windows 10 IoT Enterprise <i>Some:</i> Linux Ubuntu																																										
Chipset	AMD B300 Chipset	Environment	ENERGY STAR® 7.1*, EPEAT™ Silver rating* (*Not for non-OS models); ErP Lot 3; RoHS-compliant; TUV low noise verified																																										
Front ports* (Std.)	one USB 3.1 Gen1 (Always On and fast charge), one USB 3.1 Type-C Gen 1, one microphone (3.5mm), one headphone / microphone combo jack (3.5mm)	MIL-SPEC test	MIL-STD-810H military certification (Low Pressure [Altitude], High Temperature, Low Temperature, Temperature Shock, Humidity, Sand and Dust, Vibration, Shock, Fungus, Solar Radiation)																																										
Rear ports* (Std.)	1x USB 3.1 Gen1, 3x USB 2.0, 1x ethernet (RJ-45), 1x DisplayPort, 1x HDMI	Accessories	For compatible accessories, please go to http://smartfind.lenovo.com																																										
Rear ports* (Opt.)	Two optional ports: Port 1 for VGA / 2nd DP / 2nd HDMI / serial; Port 2 for serial; * Depending on many factors, actual data transfer speed may be lower than theoretical speed																																												
Audio support	High Definition (HD) Audio, Realtek ALC222CG / internal speaker (1.5 watt)																																												
WLAN	<i>Some:</i> 11ac wireless, M.2 Card, Realtek RTL8822CE (dual band), Wi-Fi + Bluetooth 5.0 combo adapter, 2x2 <i>Some:</i> 11ac wireless, M.2 Card, Qualcomm Atheros QCA6174A (dual band), Wi-Fi + Bluetooth 4.2 combo adapter, 2x2 <i>Some:</i> 11ac wireless, M.2 Card, Intel Wireless-AC 9260 (dual band), Wi-Fi + Bluetooth 5.0 combo adapter, 2x2																																												
Bluetooth	<i>Some:</i> Bluetooth 4.2 / 5.0 wireless, integrated in Wi-Fi + BT combo adapter																																												
Ethernet	Gigabit ethernet, Realtek RTL8111EPV-CG, Wake on LAN®																																												
Manageability	DASH 1.0/1.1																																												
Security chip	Discrete TPM 2.0, TCG Certified																																												

Note: The specifications above may not be available in all regions.

Lenovo, October 2019

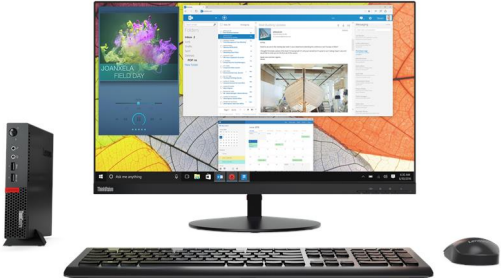

ThinkCentre M910 Tiny Platform Specifications

Product Specifications Reference (PSREF)

Processor	Intel® Celeron®, Intel Pentium®, or 6/7th Generation Intel Core™ i3 / i5 / i7 Processor						Security features <ul style="list-style-type: none"> Security slot (in rear for optional Kensington® MicroSaver® cable) Smart USB protection, allows keyboard/mouse only, blocks all storage devices Power-on password Administrator password Hard disk password Boot sequence control Boot without keyboard and mouse Individual USB port disablement Chassis intrusion switch
	Processor	Cores / Threads	Frequency Base/Max(GHz)	Cache	Memory Support (Up to)	Integrated Graphics	
	Core i5-6500T	4 / 4	2.5G / 3.1G	6 MB	DDR4-2133	HD 530	
	Core i7-6700T	4 / 8	2.8G / 3.6G	8 MB	DDR4-2133	HD 530	
	Core i5-7500T	4 / 4	2.7G / 3.3G	6 MB	DDR4-2400	HD 630	
	Core i5-7600T	4 / 4	2.8G / 3.7G	6 MB	DDR4-2400	HD 630	
Core i7-7700T	4 / 8	2.9G / 3.8G	8 MB	DDR4-2400	HD 630		
Memory	32GB max, DDR4-2400*, two 260-pin SO-DIMM sockets, non-ECC, dual-channel capable * System automatically clocks down for the processors with lower memory controller						
Storage	<i>Some:</i> Hard Drive / SATA 6.0Gb/s, 2.5", 5400 rpm or 7200 rpm, APS <i>Some:</i> Solid State Drive (SSD) / SATA 6.0Gb/s, 2.5" <i>Some:</i> M.2 Solid State Drive (SSD) / PCIe NVMe, PCIe 3.0 x 4, 32Gb/s <i>Some:</i> Intel Optane™ Memory (models with 7th gen Core processor), M.2 <i>Some:</i> DVD-ROM, slim (9.0mm), via USB external ODD box <i>Some:</i> DVD Burner (DVD±RW), slim (9.0mm), via USB external ODD box						
Optical	One onboard SATA 6.0Gb/s connector None						
Onboard SATA Media reader	None						
Graphics	Intel HD Graphics 510/530/610/630 in processor, uses main memory, DirectX® 12, two DisplayPort™, one optional video port (HDMI, VGA, 3rd DP, or USB 3.1 Type-C with DisplayPort Alternate Mode), up to 3 independent displays; <i>Max resolution:</i> 4096x2304 (DP)@60Hz; 4096x2304 (Type-C)@60Hz; 4096x2160 (HDMI)@24Hz; 1920x1200 (VGA)@60Hz						
Monitor cable	Optional DP to VGA, DP to DVI-D (single link), DP to dual DP, or DP to HDMI 1.4						
Chipset	Intel Q270 Chipset						
Front ports*	Two USB 3.1 Gen1 (one is Always On and fast charge), one microphone (3.5mm), one headphone / microphone combo jack (3.5mm)						
Rear ports*	Four USB 3.1 Gen1 (optional external optical box or external I/O box occupies one or two specific USB 3.1 Gen1 on some models), ethernet (RJ-45), two DisplayPort, two optional ports (Port 1 for VGA / 3rd DP / HDMI / serial / USB 3.1 Type-C Gen 1 (with DisplayPort Alternate Mode), Port 2 for serial)						
I/O box*	Optional external I/O box, extends two USB 2.0, two USB 3.1 Gen1, and one serial on rear, two USB 2.0 on front, via USB cable (occupy two specific USB 3.1 Gen1 of Tiny) * Depending on many factors, actual data transfer speed may be lower than theoretical speed						
Audio support	High Definition (HD) Audio, Realtek ALC294 / optional internal speaker (1w or 2w)						
WLAN ¹³	<i>Some:</i> 11ac wireless, M.2 Card, Qualcomm Atheros QCA9377A (dual band), Wi-Fi + Bluetooth 4.2 combo adapter, 1x1 <i>Some:</i> 11ac wireless, M.2 Card, Qualcomm Atheros QCA6174A (dual band), Wi-Fi + Bluetooth 4.2 combo adapter, 2x2 <i>Some:</i> 11ac wireless, M.2 Card, Intel Dual Band Wireless-AC 3165, Wi-Fi + Bluetooth 4.2 combo adapter, 1x1 <i>Some:</i> 11ac wireless, M.2 Card, Intel Dual Band Wireless-AC 8265, Wi-Fi + Bluetooth 4.2 combo adapter, 2x2 <i>Some:</i> 11ac wireless, M.2 Card, Intel Dual Band Wireless-AC 8265, Wi-Fi + Bluetooth 4.2 combo adapter, Intel vPro technology support, 2x2						
Bluetooth™	<i>Some:</i> Bluetooth 4.2 wireless, integrated in Wi-Fi + BT combo adapter * Hardware supports BT 4.2, but Win10 RS3 and earlier only supports BT 4.1						
Ethernet	Gigabit ethernet, Intel Ethernet Connection I219-LM(Jacksonville), Wake on LAN®						
Manageability	Intel Active Management Technology 11.0 (Intel AMT 11.0); Intel vPro technology on some models (require choosing a vPro-support Wi-Fi adapter to enable vPro function through wireless connection)						
Security chip	TPM (Trusted Platform Module) 2.0*, TCG Certified * Downgrade to TPM1.2 for the models with Win10 DG Win7 32 OS						
VESA mount Floor Stand	Optional VESA mount bracket kit, supports VESA 75mm and 100mm Optional system floor stand for vertical orientation						
Power supply	65 watts AC/DC adapter, autosensing, 88% PSU (not included for TIO models) 90 watts AC/DC adapter, autosensing, 88% PSU (only for models with I/O box)						
Limited warranty ³	<i>Some:</i> 1-year or 3-year, depot service / service upgrades available <i>Some:</i> 1-year or 3-year, limited onsite service / service upgrades available						
Preload	<i>Some:</i> Windows® 7 Professional 32/64 preinstalled through downgrade rights in Windows 10 Pro 64-bit (not available with 7th Gen Intel processor) <i>Some:</i> Windows 10 Pro 64-bit <i>Some:</i> Windows 10 Home 64-bit						
Environment	ENERGY STAR® 6.1, EPEAT™ Gold rating (North America), ErP Lot 3, GREENGUARD®, RoHS-compliant, TUV low noise verified (on some models)						
MIL-SPEC test	MIL-STD-810G military certification (Low Pressure [Altitude], High Temperature, Low Temperature, Temperature Shock, Humidity, Sand and Dust, Vibration, Shock, Fungus, Solar Radiation)						
Accessories	For compatible accessories, please go to http://www.lenovoquickpick.com						

See footnotes for more detailed information

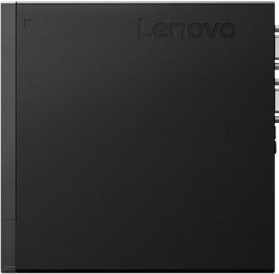

ThinkCentre M920 Tiny Platform Specifications

Product Specifications Reference (PSREF)

Processor	Intel® Celeron®, Intel Pentium®, or 8th / 9th Gen Intel Core™ i3 / i5 / i7 / i9 Processor						Bluetooth Ethernet (Opt.)	Some: Bluetooth 4.2/5.0 wireless, integrated in Wi-Fi + BT combo adapter Gigabit ethernet, Intel Ethernet Connection I219-LM(Jacksonville), Wake on LAN® Some: Intel Ethernet Server Adapter I350-T4, gigabit ethernet, 4x RJ-45, PCIe x4										
	Processor	Cores / Threads	Frequency Base/Max(GHz)	Cache	Memory Support (Up to)	Integrated Graphics	Manageability	Intel Active Management Technology 12 (Intel AMT 12); Intel vPro technology on some models (require choosing a vPro-support Wi-Fi adapter to enable vPro function through wireless connection)										
	Celeron G4900T	2 / 2	2.9G	2 MB	DDR4-2400	UHD 610	Security chip Security features	Discrete TPM 2.0, TCG Certified										
	Celeron G4930T	2 / 2	3.0G	2 MB	DDR4-2400	UHD 610		<ul style="list-style-type: none"> Security slot (in rear for optional Kensington® MicroSaver® cable) Chassis intrusion switch Power-on password Administrator password Hard disk password 										
	Pentium Gold G5400T	2 / 4	3.1G	4 MB	DDR4-2400	UHD 610	Keyboard	Some: Lenovo Calliope Keyboard (USB connector), black										
	Pentium Gold G5500T	2 / 4	3.2G	4 MB	DDR4-2400	UHD 630		Some: Lenovo Traditional Keyboard (USB connector), black										
	Pentium Gold G5600T	2 / 4	3.3G	4 MB	DDR4-2400	UHD 630	Mouse	Some: Lenovo Calliope Wireless Keyboard (2.4GHz via USB receiver), black										
	Pentium Gold G5420T	2 / 4	3.2G	4 MB	DDR4-2400	UHD 610		Some: Lenovo Calliope Mouse (USB connector), black										
	Core i3-8100T	4 / 4	3.1G	6 MB	DDR4-2400	UHD 630	Mechanical	Some: Lenovo Fingerprint Mouse (USB connector), Windows Hello support, black										
	Core i3-8300T	4 / 4	3.2G	8 MB	DDR4-2400	UHD 630		Some: Lenovo Calliope Wireless Mouse (2.4GHz via USB receiver), black										
	Core i5-8400T	6 / 6	1.7G / 3.3G	9 MB	DDR4-2666	UHD 630	Memory	Tiny (1L), black color; metal case										
	Core i5-8500T	6 / 6	2.1G / 3.5G	9 MB	DDR4-2666	UHD 630		<ul style="list-style-type: none"> Toolless chassis open (need optional toolless chassis screw) Toolless HDD, SSD, memory removal Optional dust filter 										
	Core i5-8600T	6 / 6	2.3G / 3.7G	9 MB	DDR4-2666	UHD 630		one 2.5" bay for HDD/SSD, one PCIe 3.0 x8 slot (low-profile), two M.2 slots (one for WLAN, one for M.2 SSD), 2.5" HDD/SSD and PCIe card are mutually exclusive										
	Core i7-8700T	6 / 12	2.4G / 4.0G	12 MB	DDR4-2666	UHD 630												
	Core i3-9100T	4 / 4	3.1G / 3.7G	6 MB	DDR4-2400	UHD 630												
	Core i3-9300T	4 / 4	3.2G / 3.8G	8 MB	DDR4-2400	UHD 630												
	Core i5-9400T	6 / 6	1.8G / 3.4G	9 MB	DDR4-2666	UHD 630												
	Core i5-9500T	6 / 6	2.2G / 3.7G	9 MB	DDR4-2666	UHD 630												
	Core i5-9600T	6 / 6	2.3G / 3.9G	9 MB	DDR4-2666	UHD 630												
	Core i7-9700T	8 / 8	2.0G / 4.3G	12 MB	DDR4-2666	UHD 630												
Core i9-9900T	8 / 16	2.1G / 4.4G	16 MB	DDR4-2666	UHD 630													
Storage	32GB max, DDR4-2666*, two 260-pin SO-DIMM sockets, dual-channel capable * System automatically clocks down for the processors with lower memory controller							<table border="1"> <thead> <tr> <th></th> <th>Dimensions (WxDxH)</th> <th>Weight (Approx.)</th> </tr> </thead> <tbody> <tr> <td>Tiny only</td> <td>7.05" X 7.20" X 1.36" 179mm X 182.9mm X 34.5mm</td> <td>2.91 lb (1.32 kg), vary by config</td> </tr> <tr> <td>With VESA mount & ODD box</td> <td>7.42" X 7.30" X 2.48" 188.4mm X 185.38mm X 63mm</td> <td>3.66 lb (1.66 kg), vary by config</td> </tr> </tbody> </table>				Dimensions (WxDxH)	Weight (Approx.)	Tiny only	7.05" X 7.20" X 1.36" 179mm X 182.9mm X 34.5mm	2.91 lb (1.32 kg), vary by config	With VESA mount & ODD box	7.42" X 7.30" X 2.48" 188.4mm X 185.38mm X 63mm
	Dimensions (WxDxH)	Weight (Approx.)																
Tiny only	7.05" X 7.20" X 1.36" 179mm X 182.9mm X 34.5mm	2.91 lb (1.32 kg), vary by config																
With VESA mount & ODD box	7.42" X 7.30" X 2.48" 188.4mm X 185.38mm X 63mm	3.66 lb (1.66 kg), vary by config																
Storage	Some: Hard Drive / SATA 6.0Gb/s, 2.5", 5400 rpm or 7200 rpm Some: Solid State Drive (SSD) / SATA 6.0Gb/s, 2.5" Some: M.2 SSD / PCIe NVMe, PCIe 3.0 x 4*, 32Gb/s * 128GB SSD M.2 (2242) PCIe NVMe only supports PCIe 3.0 x 2, 16Gb/s Some: Intel Optane™ Memory (not support Celeron / Pentium Processor), M.2						Optional VESA mount bracket kit, supports VESA 75mm and 100mm Optional system floor stand for vertical orientation											
Optical	Some: DVD-ROM, slim (9.0mm), via USB external ODD box Some: DVD Burner (DVD±RW), slim (9.0mm), via USB external ODD box						Power supply											
Onboard SATA	One onboard SATA 6.0Gb/s connector						Some: 65 watts AC/DC adapter, autosensing, 88% PSU Some: 90 watts AC/DC adapter, autosensing, 88% PSU Some: 135 watts AC/DC adapter, autosensing, 88% PSU											
Graphics	Intel HD Graphics 610/630 in processor, uses main memory, DirectX® 12, one DisplayPort™, one HDMI, one optional video port (2nd HDMI, VGA, 2nd DP, or USB 3.1 Type-C Gen1 with DisplayPort function), up to 3 independent displays; Max resolution: 4096x2304 (DP)@60Hz; 4096x2304 (Type-C)@60Hz; 4096x2160 (onboard HDMI)@24Hz; 2048x1536 (VGA)@50Hz						Limited warranty											
Monitor cable	Optional DP to VGA dongle, DP to DVI-D dongle, DP to dual DP dongle (for Collage Display with intel integrated graphics), or DP to HDMI 1.4 dongle						Some: 1-year or 3-year, depot service / service upgrades available Some: 1-year or 3-year, limited onsite service / service upgrades available											
Chipset	Intel Q370 Chipset						Preload											
Front ports (Std.)*	one USB 3.1 Gen1 (Always On and fast charge), one USB 3.1 Type-C Gen 1, one microphone (3.5mm), one headphone / microphone combo jack (3.5mm)						Preloaded operating system Some: Windows® 10 Pro 64-bit Some: Windows 10 Home 64-bit Preloaded applications (only some listed) <ul style="list-style-type: none"> Lenovo Vantage Microsoft Office preloaded; purchase a product key to activate Cyberlink PowerDVD (only for models with DVD / DVD±RW) Cyberlink Power2GO (only for models with DVD±RW) LinkedIn Intel Unite (Machine Type 10V8 models only) 											
Rear ports (Std.)*	2x USB 3.1 Gen2, 2x USB 3.1 Gen1, 1x ethernet (RJ-45), 1x DisplayPort, 1x HDMI						Environment											
Rear ports (Opt.)*	Two optional ports (mutually exclusive with PCIe card): Port 1 for VGA / 2nd DP / 2nd HDMI / serial / USB 3.1 Type-C Gen 1 with DP function); Port 2 for serial; Optional ports via PCIe card: 2x USB 3.1 Gen1 via PCIe x1, 4x serial (9-pin) via PCIe x1, 1x Thunderbolt 3 (combo USB3.1 Type-C Gen 2 / DisplayPort) via PCIe x4 * Depending on many factors, actual data transfer speed may be lower than theoretical speed						ENERGY STAR® 7.0, EPEAT™ Gold rating (North America), ErP Lot 3, TCO, TUV ultra low noise verified (coming soon, on some models), RoHS-compliant											
Audio support	Realtek ALC233VB2 / optional internal speaker (1.5 watt or 2 watt)						MIL-SPEC test											
WLAN	Some: 11ac wireless, M.2 Card, Realtek RTL8821CE (dual band), Wi-Fi + Bluetooth 4.2 combo adapter, 1x1 Some: 11ac wireless, M.2 Card, Realtek RTL8822BE (dual band), Wi-Fi + Bluetooth 4.2 combo adapter, 2x2 Some: 11ac wireless, M.2 Card, Intel Dual Band Wireless-AC 3165, Wi-Fi + Bluetooth 4.2 combo adapter, 1x1 Some: 11ac wireless, M.2 Card, Intel Dual Band Wireless-AC 8265, Wi-Fi + Bluetooth 4.2 combo adapter, 2x2 Some: 11ac wireless, M.2 Card, Intel Wireless-AC 9560 (dual band), Wi-Fi + Bluetooth 5.0 combo adapter, Intel vPro technology support, 2x2						Accessories											
							For compatible accessories, please go to http://smartfind.lenovo.com											

Note: The specifications above may not be available in all regions.

Lenovo, June 2019



ThinkCentre M920x Tiny Platform Specifications

Product Specifications Reference (PSREF)

Processor		Intel® Celeron®, Intel Pentium®, or 8th / 9th Gen Intel Core™ i3 / i5 / i7 / i9 Processor				
Processor	Cores / Threads	Frequency Base/Max(GHz)	Cache	Memory Support (Up to)	Integrated Graphics	
Celeron G4900	2 / 2	3.1G	2 MB	DDR4-2400	UHD 610	
Celeron G4920	2 / 2	3.2G	2 MB	DDR4-2400	UHD 610	
Celeron G4930	2 / 2	3.2G	2 MB	DDR4-2400	UHD 610	
Celeron G4950	2 / 2	3.3G	2 MB	DDR4-2400	UHD 610	
Pentium Gold G5400	2 / 4	3.7G	4 MB	DDR4-2400	UHD 610	
Pentium Gold G5500	2 / 4	3.8G	4 MB	DDR4-2400	UHD 630	
Pentium Gold G5600	2 / 4	3.9G	4 MB	DDR4-2400	UHD 630	
Pentium Gold G5420	2 / 4	3.8G	4 MB	DDR4-2400	UHD 610	
Pentium Gold G5620	2 / 4	4.0G	4 MB	DDR4-2400	UHD 630	
Core i3-8100	4 / 4	3.6G	6 MB	DDR4-2400	UHD 630	
Core i3-8300	4 / 4	3.7G	8 MB	DDR4-2400	UHD 630	
Core i5-8400	6 / 6	2.8G / 4.0G	9 MB	DDR4-2666	UHD 630	
Core i5-8500	6 / 6	3.0G / 4.1G	9 MB	DDR4-2666	UHD 630	
Core i5-8600	6 / 6	3.1G / 4.3G	9 MB	DDR4-2666	UHD 630	
Core i7-8700	6 / 12	3.2G / 4.6G	12 MB	DDR4-2666	UHD 630	
Core i3-9100	4 / 4	3.6G / 4.2G	6 MB	DDR4-2400	UHD 630	
Core i3-9300	4 / 4	3.7G / 4.3G	8 MB	DDR4-2400	UHD 630	
Core i3-9320	4 / 4	3.7G / 4.4G	8 MB	DDR4-2400	UHD 630	
Core i5-9400	6 / 6	2.9G / 4.1G	9 MB	DDR4-2666	UHD 630	
Core i5-9500	6 / 6	3.0G / 4.4G	9 MB	DDR4-2666	UHD 630	
Core i5-9600	6 / 6	3.1G / 4.6G	9 MB	DDR4-2666	UHD 630	
Celeron G4900T	2 / 2	2.9G	2 MB	DDR4-2400	UHD 610	
Celeron G4930T	2 / 2	3.0G	2 MB	DDR4-2400	UHD 610	
Pentium Gold G5400T	2 / 4	3.1G	4 MB	DDR4-2400	UHD 610	
Pentium Gold G5500T	2 / 4	3.2G	4 MB	DDR4-2400	UHD 630	
Pentium Gold G5600T	2 / 4	3.3G	4 MB	DDR4-2400	UHD 630	
Pentium Gold G5420T	2 / 4	3.2G	4 MB	DDR4-2400	UHD 610	
Core i3-8100T	4 / 4	3.1G	6 MB	DDR4-2400	UHD 630	
Core i3-8300T	4 / 4	3.2G	8 MB	DDR4-2400	UHD 630	
Core i5-8400T	6 / 6	1.7G / 3.3G	9 MB	DDR4-2666	UHD 630	
Core i5-8500T	6 / 6	2.1G / 3.5G	9 MB	DDR4-2666	UHD 630	
Core i5-8600T	6 / 6	2.3G / 3.7G	9 MB	DDR4-2666	UHD 630	
Core i7-8700T	6 / 12	2.4G / 4.0G	12 MB	DDR4-2666	UHD 630	
Core i3-9100T	4 / 4	3.1G / 3.7G	6 MB	DDR4-2400	UHD 630	
Core i3-9300T	4 / 4	3.2G / 3.8G	8 MB	DDR4-2400	UHD 630	
Core i5-9400T	6 / 6	1.8G / 3.4G	9 MB	DDR4-2666	UHD 630	
Core i5-9500T	6 / 6	2.2G / 3.7G	9 MB	DDR4-2666	UHD 630	
Core i5-9600T	6 / 6	2.3G / 3.9G	9 MB	DDR4-2666	UHD 630	
Core i7-9700T	8 / 8	2.0G / 4.3G	12 MB	DDR4-2666	UHD 630	
Core i9-9900T	8 / 16	2.1G / 4.4G	16 MB	DDR4-2666	UHD 630	

Processor	4x Mini DisplayPort, up to 4 independent displays, works along with onboard DP and HDMI to support up to 6 independent displays; <i>Max resolution:</i> 5120x2880@60Hz ((up to 2 Mini DisplayPort); 4096x2160@60Hz ((up to 4 Mini DisplayPort)									
Monitor cable	Optional DP to VGA dongle, DP to DVI-D dongle, DP to dual DP dongle (for Collage Display with Intel integrated graphics), or DP to HDMI 1.4 dongle, Mini DP to DP									
Chipset	Intel Q370 Chipset									
Front ports (Std.)*	one USB 3.1 Gen1 (Always On and fast charge), one USB 3.1 Type-C Gen 1, one microphone (3.5mm), one headphone / microphone combo jack (3.5mm)									
Rear ports (Std.)*	2x USB 3.1 Gen2, 2x USB 3.1 Gen1, 1x ethernet (RJ-45), 1x DP, 1x HDMI									
Rear ports (Opt.)*	Two optional ports (mutually exclusive with PCIe card): Port 1 for VGA / 2nd DP / 2nd HDMI / serial / USB 3.1 Type-C Gen 1 with DP function); Port 2 for serial; Optional ports via PCIe card: 2x USB 3.1 Gen1 via PCIe x1, 4x serial (9-pin) via PCIe x1, 1x Thunderbolt 3 (combo USB3.1 Type-C Gen 2 / DP) via PCIe x4 * Depending on many factors, actual data transfer speed may be lower than theoretical speed									
Audio support	Realtek ALC233VB2 / optional internal speaker (1.5 watt or 2 watt)									
WLAN	<i>Some:</i> 11ac Wi-Fi + BT 4.2, M.2 Card, Realtek RTL8821CE (dual band), 1x1 <i>Some:</i> 11ac Wi-Fi + BT 4.2, M.2 Card, Realtek RTL8822BE (dual band), 2x2 <i>Some:</i> 11ac Wi-Fi + BT 4.2, M.2 Card, Intel Dual Band Wireless-AC 3165, 1x1 <i>Some:</i> 11ac Wi-Fi + BT 4.2, M.2 Card, Intel Dual Band Wireless-AC 8265, 2x2 <i>Some:</i> 11ac Wi-Fi + BT 5.0, M.2 Card, Intel Wireless-AC 9560 (dual band), Intel vPro technology support, 2x2									
Bluetooth	<i>Some:</i> Bluetooth 4.2/5.0 wireless, integrated in Wi-Fi + BT combo adapter									
Ethernet	Gigabit ethernet, Intel Ethernet Connection I219-LM(Jacksonville), Wake on LAN®									
Ethernet (Opt.)	<i>Some:</i> Intel Ethernet Server Adapter I350-T4, gigabit ethernet, 4x RJ-45, PCIe x4									
Manageability	Intel Active Management Technology 12 (Intel AMT 12); Intel vPro technology on some models (require choosing a vPro-support Wi-Fi adapter to enable vPro function through wireless connection)									
Security chip	Discrete TPM 2.0, TCG Certified									
Security features	<ul style="list-style-type: none"> Security slot (in rear for optional Kensington® MicroSaver® cable) Chassis intrusion switch Power-on password Administrator password Hard disk password <ul style="list-style-type: none"> Boot sequence control Boot without keyboard and mouse Individual USB port disablement Smart USB protection, allows keyboard/mouse only, blocks all storage devices 									
Keyboard	<i>Some:</i> Lenovo Calliope Keyboard (USB connector), black <i>Some:</i> Lenovo Traditional Keyboard (USB connector), black <i>Some:</i> Lenovo Calliope Wireless Keyboard (2.4GHz via USB receiver), black									
Mouse	<i>Some:</i> Lenovo Calliope Mouse (USB connector), black <i>Some:</i> Lenovo Fingerprint Mouse (USB connector), Windows Hello support, black <i>Some:</i> Lenovo Calliope Wireless Mouse (2.4GHz via USB receiver), black									
Mechanical	Tiny (1L), black color; metal case <ul style="list-style-type: none"> Toolless chassis open (need optional toolless chassis screw) Toolless HDD, SSD, memory removal Optional dust filter one 2.5" bay for HDD/SSD, one PCIe 3.0 x8 slot (low-profile), three M.2 slots (one for WLAN, two for M.2 SSD), 2.5" HDD/SSD and PCIe card are mutually exclusive <table border="1" style="margin-left: 20px;"> <thead> <tr> <th></th> <th>Dimensions (WxDxH)</th> <th>Weight (Approx.)</th> </tr> </thead> <tbody> <tr> <td>Tiny only</td> <td>7.05" X 7.20" X 1.36" 179mm X 182.9mm X 34.5mm</td> <td>2.91 lb (1.32 kg), vary by config</td> </tr> <tr> <td>With VESA mount & ODD box</td> <td>7.42" X 7.30" X 2.48" 188.4mm X 185.38mm X 63mm</td> <td>3.66 lb (1.66 kg), vary by config</td> </tr> </tbody> </table>		Dimensions (WxDxH)	Weight (Approx.)	Tiny only	7.05" X 7.20" X 1.36" 179mm X 182.9mm X 34.5mm	2.91 lb (1.32 kg), vary by config	With VESA mount & ODD box	7.42" X 7.30" X 2.48" 188.4mm X 185.38mm X 63mm	3.66 lb (1.66 kg), vary by config
	Dimensions (WxDxH)	Weight (Approx.)								
Tiny only	7.05" X 7.20" X 1.36" 179mm X 182.9mm X 34.5mm	2.91 lb (1.32 kg), vary by config								
With VESA mount & ODD box	7.42" X 7.30" X 2.48" 188.4mm X 185.38mm X 63mm	3.66 lb (1.66 kg), vary by config								
Memory	32GB max, DDR4-2666*, two 260-pin SO-DIMM sockets, dual-channel capable * System automatically clocks down for the processors with lower memory controller									
Storage	<i>Some:</i> Hard Drive / SATA 6.0Gb/s, 2.5", 5400 rpm or 7200 rpm <i>Some:</i> Solid State Drive (SSD) / SATA 6.0Gb/s, 2.5" <i>Some:</i> M.2 SSD (support up to two M.2 SSD) / PCIe NVMe, PCIe 3.0 x 4", 32Gb/s, RAID 0/1 support (RAID preset only available via special bid model) * 128GB SSD M.2 (2242) PCIe NVMe only supports PCIe 3.0 x 2, 16Gb/s <i>Some:</i> Intel Optane™ Memory (not support Celeron / Pentium Processor), M.2									
Optical	<i>Some:</i> DVD-ROM, slim (9.0mm), via USB external ODD box <i>Some:</i> DVD Burner (DVD±RW), slim (9.0mm), via USB external ODD box									
Onboard SATA	One onboard SATA 6.0Gb/s connector									
Graphics	Intel HD Graphics 610/630 in processor, uses main memory, DirectX® 12, one DisplayPort™, one HDMI, one optional video port (2nd HDMI, VGA, 2nd DP, or USB 3.1 Type-C Gen1 with DisplayPort function), up to 3 independent displays; <i>Max resolution:</i> c4096x2304 (DP) @60Hz; 4096x2304 (Type-C) @60Hz; 4096x2160 (onboard HDMI) @24Hz; 2048x1536 (VGA) @50Hz <i>Some:</i> AMD Radeon™ RX 560 , DirectX 12, 4GB GDDR5, PCIe 3.0 x8 adapter,									
VESA mount	Optional VESA mount bracket kit, supports VESA 75mm and 100mm									
Floor Stand	Optional system floor stand for vertical orientation									
Power supply	135 watts AC/DC adapter, autosensing, 88% PSU									
Limited warranty	<i>Some:</i> 1-year or 3-year, depot service / service upgrades available <i>Some:</i> 1-year or 3-year, limited onsite service / service upgrades available									
Preload	<i>Some:</i> Windows® 10 Pro 64-bit <i>Some:</i> Windows 10 Home 64-bit									
Environment	ENERGY STAR® 7.0, EPEAT™ Gold rating (North America), ErP Lot 3, TCO, TUV ultra low noise verified (coming soon, on some models), RoHS-compliant									
MIL-SPEC test	MIL-STD-810G military certification (Low Pressure [Altitude], High Temperature, Low Temperature, Temperature Shock, Humidity, Sand and Dust, Vibration, Shock, Fungus, Solar Radiation)									
Accessories	For compatible accessories, please go to http://smartfind.lenovo.com									

Note: The specifications above may not be available in all regions.

Lenovo, June 2019



ThinkCentre Tiny-in-One (TIO) 22 Gen3

Product Specifications Reference (PSREF)

Model	<i>Non-touch model:</i> 10R1PAR1++/10R1PAT1++; <i>Touch model:</i> 10R0PAR1++/10R0PAT1++			Mounting features	Wall or desk mounting using the extend arm or third-party accessories meeting the VESA FPMPI® (100mm mount)
Form factor	Tiny-in-One, offers a full All-In-One experience when optional Tiny slots into the back of TIO, clean cabling and effortless setup			Adjustable stand	<i>Tilt:</i> 30° back, -5° forward; <i>lift:</i> 4.3" (110mm); <i>swivel:</i> +/-45°; <i>Pivot:</i> clockwise 0° to 90°
Compatible Tiny:	P330 / P320 / M920(x) / M720 / M910(x) / M710 / M900(x) / M700 / M630e / M625 / M600 / M75q / M715 / M93/p* / M83 / M73* / M53 / Chromebox Tiny * Non-TIO models can't be turned on by pressing power button of TIO			Power supply	90 watts AC/DC adapter, 88% PSU, universal
Panel	TFT-LCD, In-Plane Switching technology**, White LED backlight <i>Notes:</i> In-Plane Switching may refer to VA, PLS, and IPS panels			Power consumption	19 watts typical, 32 watts maximum, <0.5 watts standby / suspend
Viewable image size	21.5" (546.1mm) diagonal			Limited warranty	3-years , Customer Carry-In or Mail-In via Rapid Replacement Service
Max view area (W x H)	18.74" x 10.54" / 476.1mm x 267.8mm			VESA-compliant	VESA DDC2B/CI, VESA DPMS-compliant
Bezel Width	Top / Side: 2mm, Bottom: 22.1mm			Ergonomics	ISO 9241-307, TUV Eye Comfort certified
Native resolution	1920x1080			Emission standards	FCC Class B
Multi-touch	Optional 10-point multi-touch, supports Wake on Touch			Environmental	TCO 7.0, TCO Edge 2.0, WEEE, RoHS, ENERGY STAR® 7.0, EPEAT™ Silver rating, ULE Gold, TUV, VOC
Aspect ratio	16:9			Windows certifications	Windows 7 and Windows 10 certified
Pixel pitch (mm)	0.24795mm			Ship group	TIO (Monitor), detachable stand, AC/DC power adapter, power cord, user's guide and driver CD, quick start and safety poster
Dot/Pixel per Inch	102.4 dpi			Accessories	For compatible accessories, please go to http://www.lenovoquickpick.com
Brightness	250 nits or cd/m² (typical)				
Contrast ratio	1000:1 (typical)				
Pixel response time	14ms (default), over drive to 4ms, 6ms				
Color gamut	72%				
Anti-reflective	Anti-glare				
Viewing angle at 10:1 CR	178° (+/- 89°) horizontal, 178° (+/- 89°) vertical				
Preset resolutions	640x350 @ 70Hz 640x480 @ 60Hz, 66Hz, 72Hz, 75Hz 720x400 @ 70Hz 800x600 @ 60Hz, 72Hz, 75Hz 1024x768 @ 60Hz, 70Hz, 75Hz 1152x864 @ 75Hz 1280x800 @ 60Hz 1280x1024 @ 60Hz, 72Hz, 75Hz 1366x768 @ 60Hz 1440x900 @ 60Hz, 75Hz 1600x1200 @ 60Hz, 70Hz, 75Hz 1680x1050 @ 60Hz 1920x1080 @ 60Hz				
Presets / user settings	Presets: 25; user settings: 25				
On screen display	On screen display with digital user controls (8 languages)				
Control features	<i>Font:</i> Exit button, Left / Mode-switching button (TIO / monitor mode), Right / Brightness button, Enter / Menu button, Power button <i>Bottom:</i> Volume up button, Volume down button				
Tiny-in-One Power On	Pressing Alt + P on keyboard or pressing Power button positioned on TIO can turn on both TIO and Tiny (only some Tiny support, see compatible list)				
Side ports (TIO)	One USB 3.1 Gen1 / USB 2.0 (when M73 or M53 installed or USB 2.0 connected via USB upstream port) <i>Notes:</i> The USB port is only available when a Tiny is installed or a PC is connected via USB upstream port				
Side ports (Tiny)	Side ports offered by installed Tiny (optional)				
Rear ports	One DisplayPort in port, one USB upstream port, one power connector				
3-in-1 Cable	Undetachable 3-in-1 cable (Power connector, USB [supports USB 3.1 Gen1 / USB 2.0], DisplayPort), only for connecting to Tiny installed (optional)				
Camera	720p camera with dual microphone for VOIP, LED indicator				
Internal Speaker	2 watt x2				
Security	Security keyhole for attachment of optional cable lock (Kensington® lock compatible), locks optional Tiny with TIO together, more security features offered by Tiny installed (optional)				
Mechanical					
	Dimensions	TIO without stand	TIO with stand		
	W x D x H (inch)	19.26 x 2.85 x 13.35	19.26 x 10.76 x 14.59 - 18.93		
	W x D x H (mm)	489.3 x 72.5 x 339	489.3 x 273.3 x 370.7 - 480.7		
	Weight (Approx.)	7.01 lb / 3.19 kg	11.77 lb / 5.34 kg		

ThinkCentre Tiny-in-One 22 Gen3 Compatible list			
Model	P330 / P320 / M920(x) / M720 / M910(x) / M710 / M900(x) / M700 / M630e / M625 / M600 / M75q / M715 / M83 / M53 Tiny M90n Nano (with TIO kit)	M93/p Tiny, M73 Tiny	Chromebox
Turn on TIO and Tiny together via Alt + P on USB KB	All models	All models	Not support
Turn on TIO and Tiny together via TIO Power Button	All models	TIO models	All models



ThinkCentre Tiny-in-One (TIO) 24 Gen3

Product Specifications Reference (PSREF)

Model	<i>Non-touch model:</i> 10QYPAR1++/10QYPAT1++; <i>Touch model:</i> 10QXPAR1++/10QXPAT1++			Mounting features	Wall or desk mounting using the extend arm or third-party accessories meeting the VESA FPMPI® (100mm mount)																
Form factor	Tiny-in-One, offers a full All-In-One experience when optional Tiny slots into the back of TIO, clean cabling and effortless setup			Adjustable stand	<i>Tilt:</i> 30° back, -5° forward; <i>lift:</i> 4.3" (110mm); <i>swivel:</i> +/-45°; <i>Pivot:</i> clockwise 0° to 90°																
Compatible Tiny:	P330 / P320 / M920(x) / M720 / M910(x) / M710 / M900(x) / M700 / M630e / M625 / M600 / M75q / M715 / M93/p* / M83 / M73* / M53 / Chromebox Tiny * Non-TIO models can't be turned on by pressing power button of TIO			Power supply	90 watts AC/DC adapter, 88% PSU, universal																
Panel	TFT-LCD, In-Plane Switching technology**, White LED backlight <i>Notes:</i> In-Plane Switching may refer to VA, PLS, and IPS panels			Power consumption	19 watts typical, 32 watts maximum, <0.5 watts standby / suspend																
Viewable image size	23.8" (604.7mm) diagonal			Limited warranty	3-years , Customer Carry-In or Mail-In via Rapid Replacement Service																
Max view area (W x H)	21.06" x 12.32" / 535.0mm x 313.0mm			VESA-compliant	VESA DDC2B/CI, VESA DPMS-compliant																
Bezel Width	Top / Side: 2mm, Bottom: 22.1mm			Ergonomics	ISO 9241-307, TUV Eye Comfort certified																
Native resolution	1920x1080			Emission standards	FCC Class B																
Multi-touch	Optional 10-point multi-touch, supports Wake on Touch			Environmental	TCO 7.0, TCO Edge 2.0, WEEE, RoHS, ENERGY STAR® 7.0, EPEAT™ Silver rating, ULE Gold, TUV, VOC																
Aspect ratio	16:9			Windows certifications	Windows 7 and Windows 10 certified																
Pixel pitch (mm)	0.2745mm			Ship group	TIO 24 (Monitor), detachable stand, AC/DC power adapter, power cord, user's guide and driver CD, quick start and safety poster																
Dot/Pixel per Inch	92.6 dpi			Accessories	For compatible accessories, please go to http://www.lenovoquickpick.com																
Brightness	250 nits or cd/m² (typical)			<table border="1"> <thead> <tr> <th colspan="4">ThinkCentre Tiny-in-One 24 Gen3 Compatible list</th> </tr> </thead> <tbody> <tr> <td>Model</td> <td>P330 / P320 / M920(x) / M720 / M910(x) / M710 / M900(x) / M700 / M630e / M625 / M600 / M75q / M715 / M83 / M53 Tiny M90n Nano (with TIO kit)</td> <td>M93/p Tiny, M73 Tiny</td> <td>Chromebox</td> </tr> <tr> <td>Turn on TIO and Tiny together via Alt + P on USB KB</td> <td>All models</td> <td>All models</td> <td>Not support</td> </tr> <tr> <td>Turn on TIO and Tiny together via TIO Power Button</td> <td>All models</td> <td>TIO models</td> <td>All models</td> </tr> </tbody> </table>		ThinkCentre Tiny-in-One 24 Gen3 Compatible list				Model	P330 / P320 / M920(x) / M720 / M910(x) / M710 / M900(x) / M700 / M630e / M625 / M600 / M75q / M715 / M83 / M53 Tiny M90n Nano (with TIO kit)	M93/p Tiny, M73 Tiny	Chromebox	Turn on TIO and Tiny together via Alt + P on USB KB	All models	All models	Not support	Turn on TIO and Tiny together via TIO Power Button	All models	TIO models	All models
ThinkCentre Tiny-in-One 24 Gen3 Compatible list																					
Model	P330 / P320 / M920(x) / M720 / M910(x) / M710 / M900(x) / M700 / M630e / M625 / M600 / M75q / M715 / M83 / M53 Tiny M90n Nano (with TIO kit)	M93/p Tiny, M73 Tiny	Chromebox																		
Turn on TIO and Tiny together via Alt + P on USB KB	All models	All models	Not support																		
Turn on TIO and Tiny together via TIO Power Button	All models	TIO models	All models																		
Contrast ratio	1000:1 (typical)																				
Pixel response time	14ms (default), over drive to 4ms, 6ms																				
Color gamut	72%																				
Anti-reflective	Anti-glare																				
Viewing angle at 10:1 CR	178° (+/- 89°) horizontal, 178° (+/- 89°) vertical																				
Preset resolutions	640x350 @ 70Hz 640x480 @ 60Hz, 67Hz, 72Hz, 75Hz 720x400 @ 70Hz 800x600 @ 60Hz, 72Hz, 75Hz 1024x768 @ 60Hz, 70Hz, 75Hz 1152x864 @ 75Hz 1280x800 @ 60Hz 1280x1024 @ 60Hz, 72Hz, 75Hz 1366x768 @ 60Hz 1440x900 @ 60Hz, 75Hz 1600x1200 @ 60Hz, 70Hz, 75Hz 1680x1050 @ 60Hz 1920x1080 @ 60Hz																				
Presets / user settings	Presets: 25; user settings: 25																				
On screen display	On screen display with digital user controls (8 languages)																				
Control features	Font: Exit button, Left / Mode-switching button (TIO / monitor mode), Right / Brightness button, Enter / Menu button, Power button Bottom: Volume up button, Volume down button																				
Tiny-in-One Power On	Pressing Alt + P on keyboard or pressing Power button positioned on TIO can turn on both TIO and Tiny (only some Tiny support, see compatible list)																				
Side ports (TIO)	One USB 3.1 Gen1 / USB 2.0 (when M73 or M53 installed or USB 2.0 connected via USB upstream port) <i>Notes:</i> The USB port is only available when a Tiny is installed or a PC is connected via USB upstream port																				
Side ports (Tiny)	Side ports offered by installed Tiny (optional)																				
Rear ports	One DisplayPort in port, one USB upstream port, one power connector																				
3-in-1 Cable	Undetachable 3-in-1 cable (Power connector, USB [supports USB 3.1 Gen1 / USB 2.0], DisplayPort), only for connecting to Tiny installed (optional)																				
Camera	1080p camera with dual microphone for VOIP, LED indicator																				
Internal Speaker	2 watt x2																				
Security	Security keyhole for attachment of optional cable lock (Kensington® lock compatible), locks optional Tiny with TIO together, more security features offered by Tiny installed (optional)																				
Mechanical	<table border="1"> <thead> <tr> <th>Dimensions</th> <th>TIO without stand</th> <th>TIO with stand</th> </tr> </thead> <tbody> <tr> <td>W x D x H (inch)</td> <td>21.25 x 2.85 x 14.47</td> <td>21.25 x 11.11 x 15.72 - 20.06</td> </tr> <tr> <td>W x D x H (mm)</td> <td>539.8 x 72.5 x 367.6</td> <td>539.8 x 282.3 x 399.4 - 509.4</td> </tr> <tr> <td>Weight (Approx.)</td> <td>7.96 lb /3.61 kg</td> <td>12.92 lb /5.86 kg</td> </tr> </tbody> </table>			Dimensions	TIO without stand	TIO with stand	W x D x H (inch)	21.25 x 2.85 x 14.47	21.25 x 11.11 x 15.72 - 20.06	W x D x H (mm)	539.8 x 72.5 x 367.6	539.8 x 282.3 x 399.4 - 509.4	Weight (Approx.)	7.96 lb /3.61 kg	12.92 lb /5.86 kg						
Dimensions	TIO without stand	TIO with stand																			
W x D x H (inch)	21.25 x 2.85 x 14.47	21.25 x 11.11 x 15.72 - 20.06																			
W x D x H (mm)	539.8 x 72.5 x 367.6	539.8 x 282.3 x 399.4 - 509.4																			
Weight (Approx.)	7.96 lb /3.61 kg	12.92 lb /5.86 kg																			



ThinkCentre Tiny-in-One (TIO) 27

Product Specifications Reference (PSREF)

Form factor	Tiny-in-One, offers a full All-In-One experience when optional Tiny slots into the back of TIO, clean cabling and effortless setup	Mechanical	<table border="1"> <tr> <td></td> <td>TIO without stand</td> <td>TIO with stand</td> </tr> <tr> <td>Dimensions (W x D x H mm / inch)</td> <td>614.0 x 73.89 x 413.1 / 24.17 x 2.91 x 16.26</td> <td>614.0 x 329.0 x 444.25 - 554.25 / 24.17 x 12.95 x 17.49 - 21.82</td> </tr> <tr> <td>Weight (Approx.)</td> <td>4.91 kg / 10.82 lb</td> <td>7.95 kg / 17.53 lb</td> </tr> </table>			TIO without stand	TIO with stand	Dimensions (W x D x H mm / inch)	614.0 x 73.89 x 413.1 / 24.17 x 2.91 x 16.26	614.0 x 329.0 x 444.25 - 554.25 / 24.17 x 12.95 x 17.49 - 21.82	Weight (Approx.)	4.91 kg / 10.82 lb	7.95 kg / 17.53 lb							
	TIO without stand	TIO with stand																		
Dimensions (W x D x H mm / inch)	614.0 x 73.89 x 413.1 / 24.17 x 2.91 x 16.26	614.0 x 329.0 x 444.25 - 554.25 / 24.17 x 12.95 x 17.49 - 21.82																		
Weight (Approx.)	4.91 kg / 10.82 lb	7.95 kg / 17.53 lb																		
Compatible Tiny:	ThinkCentre Tiny, ThinkCentre Nano, and ThinkStation Tiny	Mounting features	Wall or desk mounting using the extend arm or third-party accessories meeting the VESA FPMPI® (100mm mount)																	
Panel	TFT-LCD, In-Plane Switching technology**, White LED backlight **Notes: In-Plane Switching may refer to IPS, PLS, ADS, AHVA, and AA	Adjustable stand	<i>Tilt:</i> 35° back, -5° forward; <i>lift:</i> 4.3" (110mm); <i>swivel:</i> +/-45°; <i>Pivot:</i> clockwise -5° to 90°																	
Viewable image size	27" (685.8mm) diagonal	Power supply	170 watts adapter, 88% PSU, universal																	
Max view area (W x H)	23.49" x 13.22" / 596.7mm x 335.7mm	Power consumption	37 watts typical, 57 watts maximum, <0.5 watts standby / suspend																	
Bezel Width	Top / Side: 2mm, Bottom: 23.3mm	Limited warranty	3-years , Product Exchange Service (US and EMEA) or Customer Carry-In Service (EMEA)																	
Native resolution	2560x1440	VESA-compliant	VESA DDC/CI, VESA DPMS-compliant																	
Multi-touch	None	Ergonomics	ISO 9241-307, TUV Eye Comfort certified																	
Aspect ratio	16:9	Emission standards	FCC Class B																	
Pixel pitch (mm)	0.2331mm	Environmental	TCO 8.0, TCO Edge 2.0, WEEE, RoHS, ENERGY STAR® 7.0, EPEAT™ Silver rating, ULE Gold, TUV, VOC																	
Dot/Pixel per Inch	109 dpi	Windows certifications	Windows 7 and Windows 10 certified																	
Brightness	350 nits or cd/m² (typical)	Ship group	TIO 27 (Monitor), detachable stand, power adapter, power cord, reference and driver CD																	
Contrast ratio	1000:1 (typical)	Accessories	For compatible accessories, please go to http://smartfind.lenovo.com																	
Pixel response time	14ms (default), over drive to 4ms, 6ms	<table border="1"> <thead> <tr> <th colspan="4">ThinkCentre Tiny-in-One 27 Compatible Matrix</th> </tr> </thead> <tbody> <tr> <td>Model</td> <td>P330 / P320 / M920(x) / M720 / M910(x) / M710 / M900(x) / M700 / M630e / M625 / M600 / M75q / M715 / M83 / M53 Tiny M90n Nano (with TIO kit)</td> <td>M93/p Tiny, M73 Tiny</td> <td>Chromebox</td> </tr> <tr> <td>Turn on TIO and Tiny together via Alt + P on USB KB</td> <td>All models</td> <td>All models</td> <td>Not support</td> </tr> <tr> <td>Turn on TIO and Tiny together via TIO Power Button</td> <td>All models</td> <td>TIO models</td> <td>All models</td> </tr> </tbody> </table>			ThinkCentre Tiny-in-One 27 Compatible Matrix				Model	P330 / P320 / M920(x) / M720 / M910(x) / M710 / M900(x) / M700 / M630e / M625 / M600 / M75q / M715 / M83 / M53 Tiny M90n Nano (with TIO kit)	M93/p Tiny, M73 Tiny	Chromebox	Turn on TIO and Tiny together via Alt + P on USB KB	All models	All models	Not support	Turn on TIO and Tiny together via TIO Power Button	All models	TIO models	All models
ThinkCentre Tiny-in-One 27 Compatible Matrix																				
Model	P330 / P320 / M920(x) / M720 / M910(x) / M710 / M900(x) / M700 / M630e / M625 / M600 / M75q / M715 / M83 / M53 Tiny M90n Nano (with TIO kit)	M93/p Tiny, M73 Tiny	Chromebox																	
Turn on TIO and Tiny together via Alt + P on USB KB	All models	All models	Not support																	
Turn on TIO and Tiny together via TIO Power Button	All models	TIO models	All models																	
Color gamut	99% sRGB																			
Anti-glare	Yes (25%)																			
Viewing angle at 10:1 CR	178° (+/- 89°) horizontal, 178° (+/- 89°) vertical																			
Preset resolutions	640x350 @ 70Hz 640x480 @ 60Hz, 66Hz, 72Hz, 75Hz 720x400 @ 70Hz 800x600 @ 60Hz, 72Hz, 75Hz 1024x768 @ 60Hz, 70Hz, 75Hz 1152x864 @ 75Hz 1280x768 @ 60Hz 1280x800 @ 60Hz 1280x1024 @ 60Hz, 72Hz, 75Hz 1366x768 @ 60Hz 1440x900 @ 60Hz, 75Hz 1600x1200 @ 60Hz, 70Hz, 75Hz 1680x1050 @ 60Hz 1920x1080 @ 60Hz 2560x1440 @ 60Hz																			
Presets / user settings	Presets: 27; user settings: 25																			
On screen display	On screen display with digital user controls (8 languages)																			
Control features	Font: Exit button, Left / Mode-switching button (TIO / monitor mode), Right / Brightness button, Enter / Menu button, Power button Bottom: Volume up button, Volume down button																			
Tiny-in-One Power On	Pressing Alt + P on keyboard or pressing Power button positioned on TIO can turn on both TIO and Tiny (only some support, see Compatible Matrix)																			
Side ports (TIO)	Two USB 3.1 Gen1 (downgrade to USB 2.0 when installing M73 or M53 or connecting USB 2.0 via USB upstream port), one headphone / microphone combo jack <i>Notes:</i> The USB ports are enabled by installing a Tiny or connecting USB upstream port; the audio port is enabled by installing a Tiny or connecting USB upstream, DisplayPort(in), or HDMI(in) port																			
Side ports (Tiny)	Side ports offered by the installed Tiny (optional)																			
Rear ports	One DisplayPort(in) port, one HDMI(in) port, one USB (Type-B) upstream port, one power connector																			
3-in-1 Cable	Undetachable 3-in-1 cable, connecting to the power connector, one USB, and one DisplayPort of the installed Tiny (optional)																			
Camera	RGBIR camera with dual microphone, supports Window Hello and Facial Recognition, Think Shutter for Privacy Security, LED indicator																			
Internal Speaker	2 watt x2																			
Security	Security keyhole for attachment of optional cable lock (Kensington® lock compatible), locks optional Tiny with TIO together, more security features offered by Tiny installed (optional)																			

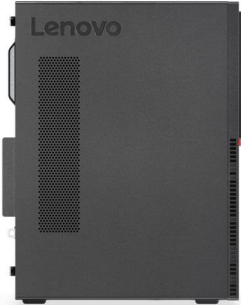
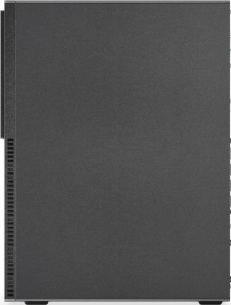

ThinkCentre M710 Tower Platform Specifications

Product Specifications Reference (PSREF)

Processor	Intel® Celeron®, Intel Pentium®, or 6/7th Generation Intel Core™ i3 / i5 / i7 Processor						Manageability None Security chip TPM (Trusted Platform Module) 2.0, TCG Certified * Downgrade to TPM1.2 for the models with Win10 DG Win7 32 OS Security features • Security slot (in rear for optional Kensington® MicroSaver® cable) • Padlock loop • Smart USB protection, allows keyboard/mouse only, blocks all storage devices • Optional cable lock to physically lock both keyboard and mouse • Power-on password • Administrator password • Hard disk password • Boot sequence control • Boot without keyboard and mouse • Individual USB port disablement • Optional chassis intrusion switch
	Processor	Cores / Threads	Frequency Base/Max(GHz)	Cache	Memory Support (Up to)	Integrated Graphics	
	Pentium G4400	2 / 2	3.3G	3 MB	DDR4-2133	HD 510	
	Pentium G4560	2 / 4	3.5G	3 MB	DDR4-2400	HD 610	
	Pentium G4600	2 / 4	3.6G	3 MB	DDR4-2400	HD 630	
	Core i3-6100	2 / 4	3.7G	3 MB	DDR4-2133	HD 530	
	Core i5-6500	4 / 4	3.2G / 3.6G	6 MB	DDR4-2133	HD 530	
	Core i7-6700	4 / 8	3.4G / 4.0G	8 MB	DDR4-2133	HD 530	
	Core i3-7100	2 / 4	3.9G	3 MB	DDR4-2400	HD 630	
	Core i5-7400	4 / 4	3.0G / 3.5G	6 MB	DDR4-2400	HD 630	
	Core i5-7500	4 / 4	3.4G / 3.8G	6 MB	DDR4-2400	HD 630	
	Core i5-7600	4 / 4	3.5G / 4.1G	6 MB	DDR4-2400	HD 630	
Core i7-7700	4 / 8	3.6G / 4.2G	8 MB	DDR4-2400	HD 630		
Memory	64GB max, UDIMM, DDR4-2400*, four 288-pin DIMM sockets, non-ECC, dual-channel capable * System automatically clocks down for the processors with lower memory controller						Mechanical • Tower (15L), black color, metal case • (WxDxH) 5.7" X 11.5" X 14.4"; 145mm X 292.7mm X 366mm • Approx. 14.3 lb (6.5 kg), weight may vary by configuration • Optional dust filter Bay 1: Slim external ODD bay Bay 2: 3.5", 1" high, internal, HDD/SSD Bay 3: 3.5", 1" high, internal, HDD/SSD Slot 1: half-length full-height (length < 189mm, height < 104mm), PCIe 3.0 x16* Slot 2: half-length full-height (length < 189mm, height < 104mm), PCIe 3.0 x1* Slot 3: half-length full-height (length < 189mm, height < 104mm), PCIe 3.0 x1* Slot 4: no slot, only bracket for optional port extension* M.2 card slots: Two (one for WLAN, one for SSD/Optane) * Optional 2 front USB3.1 Type-C ports module occupies PCIe x16 slot (x4 card), optional rear 2x USB2.0 / parallel occupies one expansion slot Power supply <i>Some:</i> 180 watts, autosensing, 85% PSU <i>Some:</i> 210 watts, autosensing, 85% PSU <i>Some:</i> 210 watts, autosensing, 92% PSU (only available via special bid) Limited warranty ³ <i>Some:</i> 1-year or 3-year, depot service / service upgrades available <i>Some:</i> 1-year or 3-year, limited onsite service / service upgrades available Preload Preloaded operating system <i>Some:</i> Windows® 7 Professional 32/64 preinstalled through downgrade rights in Windows 10 Pro 64-bit (not available with 7th Gen Intel processor) <i>Some:</i> Windows 10 Pro 64-bit <i>Some:</i> Windows 10 Home 64-bit Preloaded applications (only some listed) • Microsoft Office preloaded; purchase a product key to activate - Only for Window 10 • Lenovo Companion - Only for Window 7 • Lenovo Solution Center • Lenovo ThinkVantage Tools • Create Recovery Media • Adobe® Reader® • Cyberlink PowerDVD Create (DVD±RW) Environment ENERGY STAR® 6.1, EPEAT™ Gold rating (North America), ErP Lot 3, GREENGUARD®, RoHS-compliant, TUV low noise verified (on some models) Accessories For compatible accessories, please go to http://www.lenovoquickpick.com
Storage	<i>Some:</i> Hard Drive / SATA 6.0Gb/s, 2.5" or 3.5", 5400 rpm or 7200 rpm <i>Some:</i> Solid State Drive (SSD) / SATA 6.0Gb/s, 2.5" <i>Some:</i> M.2 Solid State Drive (SSD) / PCIe NVMe, PCIe 3.0 x 4, 32Gb/s <i>Some:</i> Intel Optane™ Memory (models with 7th gen Core processor), M.2 <i>Some:</i> DVD-ROM SATA 1.5Gb/s Drive, slim (9.0mm) <i>Some:</i> DVD Burner (DVD±RW), SATA 1.5Gb/s Drive, slim (9.0mm)						
Optical	<i>Some:</i> DVD Burner (DVD±RW), SATA 1.5Gb/s Drive, slim (9.0mm)						
Onboard SATA Media reader	Three onboard SATA 6.0Gb/s connectors Optional 7-in-1 media reader						
Graphics	Intel HD Graphics 510/530/610/630 in processor, uses main memory, DirectX® 12, one VGA, two DisplayPort™, supports 3 independent displays, works along with discrete graphics to support more displays; <i>Max resolution:</i> 4096x2304 (DP) @60Hz; 2048x1536 (VGA) @50Hz <i>Some:</i> NVIDIA GeForce® GT 730 , DirectX 12, 2GB, PCIe 2.0 x8 adapter, two DisplayPort, 35 watts; <i>Max resolution:</i> 3840x2160 (DisplayPort) @60Hz; <i>Some:</i> AMD Radeon™ R7 350 , DirectX 11, 2GB, PCIe 3.0 x8 adapter, one VGA, one HDMI, 75 watts, occupies two slots; <i>Max resolution:</i> 4096x2160 (HDMI) @24Hz; 2048x1536 (VGA) @85Hz						
Monitor Cable	Optional DP to VGA, DP to DVI-D (single link), DP to dual DP, or DP to HDMI 1.4						
Chipset	Intel B250 Chipset						
Front ports*	Four USB 3.1 Gen1, optional two USB 3.1 Type-C Gen 2 (only available via special bid), microphone (3.5mm), headphone (3.5mm)						
Rear ports*	Two USB 3.1 Gen1, two USB 2.0, optional two USB 2.0, serial (9-pin), optional 2nd serial (9-pin), optional parallel (25-pin), ethernet (RJ-45), one VGA, two DisplayPort, two PS/2 ports (keyboard/mouse); additional VGA, DisplayPort, or HDMI on optional graphics on some models						
Rear audio ports* IEEE 1394*	Line-in (3.5mm), line-out (3.5mm), microphone-in (3.5mm) None * Depending on many factors, actual data transfer speed may be lower than theoretical speed						
Audio support	High Definition (HD) Audio, Realtek ALC662 / optional internal speaker (1.5 watt)						
WLAN ¹³	<i>Some:</i> 11ac wireless, M.2 Card, Qualcomm Atheros QCA9377A (dual band), Wi-Fi + Bluetooth 4.1 combo adapter, 1x1 <i>Some:</i> 11ac wireless, M.2 Card, Qualcomm Atheros QCA6174A (dual band), Wi-Fi + Bluetooth 4.1 combo adapter, 2x2 <i>Some:</i> 11ac wireless, M.2 Card, Intel Dual Band Wireless-AC 3165, Wi-Fi + Bluetooth 4.1 combo adapter, 1x1 <i>Some:</i> 11ac wireless, M.2 Card, Intel Dual Band Wireless-AC 8265, Wi-Fi + Bluetooth 4.1 combo adapter, 2x2						
Bluetooth™	<i>Some:</i> Bluetooth 4.1 wireless, integrated in Wi-Fi + BT combo adapter						
Ethernet	Gigabit ethernet, Realtek RTL8111GN, Wake on LAN®						
Modem	None						

Note: The specifications above may not be available in all regions.

Lenovo, June 2017

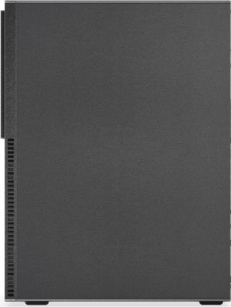
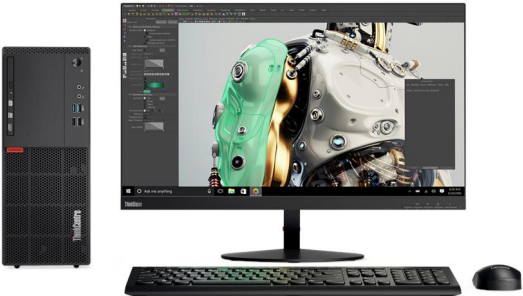

ThinkCentre M715 Tower Platform Specifications

Product Specifications Reference (PSREF)

Processor	AMD A6 / A8 / A10 / A12 series APU and Ryzen 3 / 5 / 7 series processor	Manageability	DASH																																																												
	<table border="1"> <thead> <tr> <th>APU / processor</th> <th>Cores / Threads</th> <th>Frequency (Base/Max)</th> <th>L2 Cache</th> <th>Integrated Graphics</th> </tr> </thead> <tbody> <tr> <td>Ryzen 3 PRO 1200</td> <td>4 / 4</td> <td>3.1 / 3.4</td> <td>2MB</td> <td>None</td> </tr> <tr> <td>Ryzen 3 PRO 1300</td> <td>4 / 4</td> <td>3.5 / 3.7</td> <td>2MB</td> <td>None</td> </tr> <tr> <td>Ryzen 5 PRO 1500</td> <td>4 / 8</td> <td>3.5 / 3.7</td> <td>2MB</td> <td>None</td> </tr> <tr> <td>Ryzen 7 PRO 1700</td> <td>8 / 16</td> <td>3.0 / 3.7</td> <td>4MB</td> <td>None</td> </tr> <tr> <td>PRO A6-8570</td> <td>2 / 2</td> <td>3.5 / 3.8</td> <td>1MB</td> <td>Radeon R5 Series</td> </tr> <tr> <td>PRO A10-8770</td> <td>4 / 4</td> <td>3.5 / 3.8</td> <td>2MB</td> <td>Radeon R7 Series</td> </tr> <tr> <td>PRO A12-8870</td> <td>4 / 4</td> <td>3.7 / 4.2</td> <td>2MB</td> <td>Radeon R7 Series</td> </tr> <tr> <td>PRO A6-9500</td> <td>2 / 2</td> <td>3.5 / 3.8</td> <td>1MB</td> <td>Radeon R5 Series</td> </tr> <tr> <td>PRO A8-9600</td> <td>4 / 4</td> <td>3.1 / 3.4</td> <td>2MB</td> <td>Radeon R7 Series</td> </tr> <tr> <td>PRO A10-9700</td> <td>4 / 4</td> <td>3.5 / 3.8</td> <td>2MB</td> <td>Radeon R7 Series</td> </tr> <tr> <td>PRO A12-9800</td> <td>4 / 4</td> <td>3.8 / 4.2</td> <td>2MB</td> <td>Radeon R7 Series</td> </tr> </tbody> </table>	APU / processor	Cores / Threads	Frequency (Base/Max)	L2 Cache	Integrated Graphics	Ryzen 3 PRO 1200	4 / 4	3.1 / 3.4	2MB	None	Ryzen 3 PRO 1300	4 / 4	3.5 / 3.7	2MB	None	Ryzen 5 PRO 1500	4 / 8	3.5 / 3.7	2MB	None	Ryzen 7 PRO 1700	8 / 16	3.0 / 3.7	4MB	None	PRO A6-8570	2 / 2	3.5 / 3.8	1MB	Radeon R5 Series	PRO A10-8770	4 / 4	3.5 / 3.8	2MB	Radeon R7 Series	PRO A12-8870	4 / 4	3.7 / 4.2	2MB	Radeon R7 Series	PRO A6-9500	2 / 2	3.5 / 3.8	1MB	Radeon R5 Series	PRO A8-9600	4 / 4	3.1 / 3.4	2MB	Radeon R7 Series	PRO A10-9700	4 / 4	3.5 / 3.8	2MB	Radeon R7 Series	PRO A12-9800	4 / 4	3.8 / 4.2	2MB	Radeon R7 Series	Security chip	TPM (Trusted Platform Module) 2.0, TCG Certified * Downgrade to TPM1.2 for the models with Win10 DG Win7 32 OS
APU / processor	Cores / Threads	Frequency (Base/Max)	L2 Cache	Integrated Graphics																																																											
Ryzen 3 PRO 1200	4 / 4	3.1 / 3.4	2MB	None																																																											
Ryzen 3 PRO 1300	4 / 4	3.5 / 3.7	2MB	None																																																											
Ryzen 5 PRO 1500	4 / 8	3.5 / 3.7	2MB	None																																																											
Ryzen 7 PRO 1700	8 / 16	3.0 / 3.7	4MB	None																																																											
PRO A6-8570	2 / 2	3.5 / 3.8	1MB	Radeon R5 Series																																																											
PRO A10-8770	4 / 4	3.5 / 3.8	2MB	Radeon R7 Series																																																											
PRO A12-8870	4 / 4	3.7 / 4.2	2MB	Radeon R7 Series																																																											
PRO A6-9500	2 / 2	3.5 / 3.8	1MB	Radeon R5 Series																																																											
PRO A8-9600	4 / 4	3.1 / 3.4	2MB	Radeon R7 Series																																																											
PRO A10-9700	4 / 4	3.5 / 3.8	2MB	Radeon R7 Series																																																											
PRO A12-9800	4 / 4	3.8 / 4.2	2MB	Radeon R7 Series																																																											
		Security features	<ul style="list-style-type: none"> Security slot (in rear for optional Kensington® MicroSaver® cable) Padlock loop Smart USB protection, allows keyboard/mouse only, blocks all storage devices Optional cable lock to physically lock both keyboard and mouse Power-on password Administrator password Hard disk password Boot sequence control Boot without keyboard and mouse Individual USB port disablement Optional chassis intrusion switch 																																																												
		Keyboard	<i>Some:</i> Lenovo Calliope Keyboard (USB connector), black <i>Some:</i> Lenovo Traditional Keyboard (USB connector), black <i>Some:</i> Lenovo Calliope Wireless Keyboard (2.4GHz via USB receiver), black <i>Some:</i> Lenovo Calliope Mouse (USB connector), black <i>Some:</i> Lenovo Calliope Wireless Mouse (2.4GHz via USB receiver), black <i>Some:</i> Lenovo Fingerprint Mouse (USB connector), Windows Hello support, black																																																												
		Mouse	<i>Some:</i> Lenovo Calliope Mouse (USB connector), black <i>Some:</i> Lenovo Calliope Wireless Mouse (2.4GHz via USB receiver), black <i>Some:</i> Lenovo Fingerprint Mouse (USB connector), Windows Hello support, black																																																												
Memory	64GB max, UDIMM, DDR4-2400*, four 288-pin DIMM sockets, non-ECC, dual-channel capable * System automatically clocks down for the processors with lower memory controller	Mechanical	<ul style="list-style-type: none"> Tower (15L), black color, metal case (WxDxH) 5.7" X 11.5" X 14.4"; 145mm X 292.7mm X 366mm Approx. 14.3 lb (6.5 kg), weight may vary by configuration Optional dust filter Bay 1: Slim external ODD bay Bay 2: 3.5", internal, HDD/SSD Bay 3: 2.5", internal, HDD/SSD Slot 1: half-length full-height (length < 189mm, height < 104mm), PCIe 3.0 x16* Slot 2: half-length full-height (length < 189mm, height < 104mm), PCIe 2.0 x1* Slot 3: half-length full-height (length < 189mm, height < 104mm), PCIe 2.0 x1* Slot 4: no slot, only bracket for optional port extension* M.2 card slots: two (one for WLAN, one for SSD) * Optional front USB3.1 Type-C x2 module occupies PCIe x16 slot (x4 card), optional rear 2x USB2.0 / parallel / 2nd serial occupies one expansion slot 																																																												
Storage	<i>Some:</i> Hard Drive / SATA 6.0Gb/s, 2.5" or 3.5", 5400 rpm or 7200 rpm <i>Some:</i> Solid State Drive (SSD) / SATA 6.0Gb/s, 2.5" <i>Some:</i> M.2 Solid State Drive (SSD) / PCIe NVMe, PCIe 3.0 x 4, 32Gb/s	Power supply	<i>Some:</i> 180 watts, autosensing, 85% PSU <i>Some:</i> 210 watts, autosensing, 85% PSU <i>Some:</i> 210 watts, autosensing, 92% PSU (only available via special bid)																																																												
Optical	<i>Some:</i> DVD-ROM SATA 1.5Gb/s Drive, slim (9.0mm) <i>Some:</i> DVD Burner (DVD±RW), SATA 1.5Gb/s Drive, slim (9.0mm)	Limited warranty	<i>Some:</i> 1-year or 3-year, depot service / service upgrades available <i>Some:</i> 1-year or 3-year, limited onsite service / service upgrades available																																																												
Onboard SATA Media reader	Three onboard SATA 6.0Gb/s connectors Optional 7-in-1 media reader	Preload	Preloaded operating system <i>Some:</i> Windows® 7 Professional 32/64 preinstalled through downgrade rights in Windows 10 Pro 64-bit (Only available with Pro A6/A10/A12-8xxx APUs) <i>Some:</i> Windows 10 Pro 64-bit <i>Some:</i> Windows 10 Home 64-bit Preloaded applications (only some listed) <ul style="list-style-type: none"> Microsoft Office preloaded; purchase a product key to activate Only for Window 10 Lenovo Companion Only for Window 7 Lenovo Solution Center Lenovo ThinkVantage Tools Create Recovery Media Adobe® Reader® Cyberlink PowerDVD Create (DVD±RW) 																																																												
Graphics	AMD Radeon™ Graphics in processor (not for AMD Ryzen processor), uses main memory, DirectX® 12, one VGA, two DisplayPort™ (Onboard VGA and DP ports are invalid on the models with AMD Ryzen processor), supports 3 independent displays, works along with AMD discrete graphics to support more displays; <i>Max resolution:</i> 4096x2160 (DP)@60Hz; 1920x1200 (VGA)@60Hz <i>Some:</i> NVIDIA GeForce® GT 730 , DirectX 12, 2GB, PCIe 2.0 x8 adapter, two DisplayPort, 35 watts; <i>Max resolution:</i> 3840x2160 (DisplayPort)@60Hz; <i>Some:</i> AMD Radeon™ RX 550 , DirectX 12, 2GB, PCIe 3.0 x8 adapter, one VGA, one HDMI, one DisplayPort, 50 watts, occupies two slots; <i>Max resolution:</i> 4096x2160 (HDMI)@60Hz; 2048x1536 (VGA)@60Hz; 5120x2880 (DP)@60Hz	Monitor Cable	Optional DP to VGA, DP to DVI-D (single link), DP to dual DP, or DP to HDMI 1.4																																																												
Chipset	AMD B350 Chipset	Front ports*	Two USB 3.1 Gen2, two USB 3.1 Gen1, optional two USB 3.1 Type-C Gen 2 (only available via special bid), microphone (3.5mm), headphone (3.5mm)																																																												
Front ports*		Rear ports*	Two USB 3.1 Gen1, two USB 2.0, optional two USB 2.0, serial (9-pin), optional 2nd serial (9-pin), optional parallel (25-pin), ethernet (RJ-45), one VGA and two DisplayPort (not available on models with AMD Ryzen processor), two PS/2 ports (keyboard / mouse); additional VGA, DisplayPort, or HDMI on optional graphics on some models																																																												
Rear audio ports* IEEE 1394*	Line-in (3.5mm), line-out (3.5mm), microphone-in (3.5mm) None * Depending on many factors, actual data transfer speed may be lower than theoretical speed	Audio support	High Definition (HD) Audio, Realtek ALC662 / optional internal speaker (1.5 watt)																																																												
WLAN	<i>Some:</i> 11ac wireless, M.2 Card, Realtek RTL8821AE (dual band), Wi-Fi + Bluetooth 4.0 combo adapter, 1x1 <i>Some:</i> 11ac wireless, M.2 Card, Qualcomm Atheros QCA6174A (dual band), Wi-Fi + Bluetooth 4.1 combo adapter, 2x2 <i>Some:</i> 11ac wireless, M.2 Card, Qualcomm Atheros QCA9377 (dual band), Wi-Fi + Bluetooth 4.1 combo adapter, 1x1	Environment	ENERGY STAR® 6.1, EPEAT™ Gold rating (North America), ErP Lot 3, GREENGUARD®, RoHS-compliant																																																												
Bluetooth™ Ethernet Modem	<i>Some:</i> Bluetooth 4.0 or 4.1 wireless, integrated in Wi-Fi + BT combo adapter Gigabit ethernet, Realtek RTL8111EPV, Wake on LAN® None	Accessories	For compatible accessories, please go to http://www.lenovoquickpick.com																																																												

Note: The specifications above may not be available in all regions.

Lenovo, July 2017



ThinkCentre M720 Tower Platform Specifications

Product Specifications Reference (PSREF)

Processor	Intel® Celeron®, Intel Pentium®, or 8th / 9th Gen Intel Core™ i3 / i5 / i7 / i9 Processor	WLAN ¹³	<p><i>Some:</i> 11ac wireless, M.2 Card, Realtek RTL8821CE (dual band), Wi-Fi + Bluetooth 4.2 combo adapter, 1x1</p> <p><i>Some:</i> 11ac wireless, M.2 Card, Realtek RTL8822BE (dual band), Wi-Fi + Bluetooth 4.2 combo adapter, 2x2</p> <p><i>Some:</i> 11ac wireless, M.2 Card, Intel Dual Band Wireless-AC 3165, Wi-Fi + Bluetooth 4.2 combo adapter, 1x1</p> <p><i>Some:</i> 11ac wireless, M.2 Card, Intel Dual Band Wireless-AC 8265, Wi-Fi + Bluetooth 4.2 combo adapter, 2x2</p> <p><i>Some:</i> Bluetooth 4.2 wireless, integrated in Wi-Fi + BT combo adapter</p>																																																																																																																								
	<table border="1"> <thead> <tr> <th>Processor</th> <th>Cores / Threads</th> <th>Frequency Base/Max(GHz)</th> <th>Cache</th> <th>Memory Support (Up to)</th> <th>Integrated Graphics</th> </tr> </thead> <tbody> <tr><td>Celeron G4900</td><td>2 / 2</td><td>3.1G</td><td>2 MB</td><td>DDR4-2400</td><td>UHD 610</td></tr> <tr><td>Celeron G4920</td><td>2 / 2</td><td>3.2G</td><td>2 MB</td><td>DDR4-2400</td><td>UHD 610</td></tr> <tr><td>Pentium Gold G5400</td><td>2 / 4</td><td>3.7G</td><td>4 MB</td><td>DDR4-2400</td><td>UHD 610</td></tr> <tr><td>Pentium Gold G5500</td><td>2 / 4</td><td>3.8G</td><td>4 MB</td><td>DDR4-2400</td><td>UHD 630</td></tr> <tr><td>Pentium Gold G5600</td><td>2 / 4</td><td>3.9G</td><td>4 MB</td><td>DDR4-2400</td><td>UHD 630</td></tr> <tr><td>Core i3-8100</td><td>4 / 4</td><td>3.6G</td><td>6 MB</td><td>DDR4-2400</td><td>UHD 630</td></tr> <tr><td>Core i3-8300</td><td>4 / 4</td><td>3.7G</td><td>8 MB</td><td>DDR4-2400</td><td>UHD 630</td></tr> <tr><td>Core i5-8400</td><td>6 / 6</td><td>2.8G / 4.0G</td><td>9 MB</td><td>DDR4-2666</td><td>UHD 630</td></tr> <tr><td>Core i5-8500</td><td>6 / 6</td><td>3.0G / 4.1G</td><td>9 MB</td><td>DDR4-2666</td><td>UHD 630</td></tr> <tr><td>Core i5-8600</td><td>6 / 6</td><td>3.1G / 4.3G</td><td>9 MB</td><td>DDR4-2666</td><td>UHD 630</td></tr> <tr><td>Core i7-8700</td><td>6 / 12</td><td>3.2G / 4.6G</td><td>12 MB</td><td>DDR4-2666</td><td>UHD 630</td></tr> <tr><td>Core i3-9100</td><td>4 / 4</td><td>3.6G / 4.2G</td><td>6 MB</td><td>DDR4-2400</td><td>UHD 630</td></tr> <tr><td>Core i3-9300</td><td>4 / 4</td><td>3.7G / 4.3G</td><td>8 MB</td><td>DDR4-2400</td><td>UHD 630</td></tr> <tr><td>Core i3-9320</td><td>4 / 4</td><td>3.7G / 4.4G</td><td>8 MB</td><td>DDR4-2400</td><td>UHD 630</td></tr> <tr><td>Core i5-9400</td><td>6 / 6</td><td>2.9G / 4.1G</td><td>9 MB</td><td>DDR4-2666</td><td>UHD 630</td></tr> <tr><td>Core i5-9500</td><td>6 / 6</td><td>3.0G / 4.4G</td><td>9 MB</td><td>DDR4-2666</td><td>UHD 630</td></tr> <tr><td>Core i5-9600</td><td>6 / 6</td><td>3.1G / 4.6G</td><td>9 MB</td><td>DDR4-2666</td><td>UHD 630</td></tr> <tr><td>Core i7-9700</td><td>8 / 8</td><td>3.0G / 4.7G</td><td>12 MB</td><td>DDR4-2666</td><td>UHD 630</td></tr> <tr><td>Core i9-9900</td><td>8 / 16</td><td>3.1G / 5.0G</td><td>16 MB</td><td>DDR4-2666</td><td>UHD 630</td></tr> </tbody> </table>	Processor	Cores / Threads	Frequency Base/Max(GHz)	Cache	Memory Support (Up to)	Integrated Graphics	Celeron G4900	2 / 2	3.1G	2 MB	DDR4-2400	UHD 610	Celeron G4920	2 / 2	3.2G	2 MB	DDR4-2400	UHD 610	Pentium Gold G5400	2 / 4	3.7G	4 MB	DDR4-2400	UHD 610	Pentium Gold G5500	2 / 4	3.8G	4 MB	DDR4-2400	UHD 630	Pentium Gold G5600	2 / 4	3.9G	4 MB	DDR4-2400	UHD 630	Core i3-8100	4 / 4	3.6G	6 MB	DDR4-2400	UHD 630	Core i3-8300	4 / 4	3.7G	8 MB	DDR4-2400	UHD 630	Core i5-8400	6 / 6	2.8G / 4.0G	9 MB	DDR4-2666	UHD 630	Core i5-8500	6 / 6	3.0G / 4.1G	9 MB	DDR4-2666	UHD 630	Core i5-8600	6 / 6	3.1G / 4.3G	9 MB	DDR4-2666	UHD 630	Core i7-8700	6 / 12	3.2G / 4.6G	12 MB	DDR4-2666	UHD 630	Core i3-9100	4 / 4	3.6G / 4.2G	6 MB	DDR4-2400	UHD 630	Core i3-9300	4 / 4	3.7G / 4.3G	8 MB	DDR4-2400	UHD 630	Core i3-9320	4 / 4	3.7G / 4.4G	8 MB	DDR4-2400	UHD 630	Core i5-9400	6 / 6	2.9G / 4.1G	9 MB	DDR4-2666	UHD 630	Core i5-9500	6 / 6	3.0G / 4.4G	9 MB	DDR4-2666	UHD 630	Core i5-9600	6 / 6	3.1G / 4.6G	9 MB	DDR4-2666	UHD 630	Core i7-9700	8 / 8	3.0G / 4.7G	12 MB	DDR4-2666	UHD 630	Core i9-9900	8 / 16	3.1G / 5.0G	16 MB	DDR4-2666	UHD 630	Ethernet Ethernet (Opt.)	<p>Gigabit ethernet, Intel Ethernet Connection I219-V (Jacksonville), Wake on LAN®</p> <p><i>Some:</i> Intel Ethernet Server Adapter I350-T4*, gigabit ethernet, 4x RJ-45, PCIe x4</p> <p><i>Some:</i> Bitland BN8E88*, gigabit ethernet, 1x RJ-45, PCIe x1 (special bid only)</p> <p>* Choose either I350-T4 or BN8E88</p>
Processor	Cores / Threads	Frequency Base/Max(GHz)	Cache	Memory Support (Up to)	Integrated Graphics																																																																																																																						
Celeron G4900	2 / 2	3.1G	2 MB	DDR4-2400	UHD 610																																																																																																																						
Celeron G4920	2 / 2	3.2G	2 MB	DDR4-2400	UHD 610																																																																																																																						
Pentium Gold G5400	2 / 4	3.7G	4 MB	DDR4-2400	UHD 610																																																																																																																						
Pentium Gold G5500	2 / 4	3.8G	4 MB	DDR4-2400	UHD 630																																																																																																																						
Pentium Gold G5600	2 / 4	3.9G	4 MB	DDR4-2400	UHD 630																																																																																																																						
Core i3-8100	4 / 4	3.6G	6 MB	DDR4-2400	UHD 630																																																																																																																						
Core i3-8300	4 / 4	3.7G	8 MB	DDR4-2400	UHD 630																																																																																																																						
Core i5-8400	6 / 6	2.8G / 4.0G	9 MB	DDR4-2666	UHD 630																																																																																																																						
Core i5-8500	6 / 6	3.0G / 4.1G	9 MB	DDR4-2666	UHD 630																																																																																																																						
Core i5-8600	6 / 6	3.1G / 4.3G	9 MB	DDR4-2666	UHD 630																																																																																																																						
Core i7-8700	6 / 12	3.2G / 4.6G	12 MB	DDR4-2666	UHD 630																																																																																																																						
Core i3-9100	4 / 4	3.6G / 4.2G	6 MB	DDR4-2400	UHD 630																																																																																																																						
Core i3-9300	4 / 4	3.7G / 4.3G	8 MB	DDR4-2400	UHD 630																																																																																																																						
Core i3-9320	4 / 4	3.7G / 4.4G	8 MB	DDR4-2400	UHD 630																																																																																																																						
Core i5-9400	6 / 6	2.9G / 4.1G	9 MB	DDR4-2666	UHD 630																																																																																																																						
Core i5-9500	6 / 6	3.0G / 4.4G	9 MB	DDR4-2666	UHD 630																																																																																																																						
Core i5-9600	6 / 6	3.1G / 4.6G	9 MB	DDR4-2666	UHD 630																																																																																																																						
Core i7-9700	8 / 8	3.0G / 4.7G	12 MB	DDR4-2666	UHD 630																																																																																																																						
Core i9-9900	8 / 16	3.1G / 5.0G	16 MB	DDR4-2666	UHD 630																																																																																																																						
		Manageability	None																																																																																																																								
		Security chip	Discrete TPM 2.0, TCG Certified																																																																																																																								
		Security features	<ul style="list-style-type: none"> • Security slot (in rear for optional Kensington® MicroSaver® cable) • Padlock loop • Optional cable lock to physically lock both keyboard and mouse • Optional chassis intrusion switch • Optional chassis E-Lock (special bid) • Power-on password • Administrator password • Hard disk password • Boot sequence control • Boot without keyboard and mouse • Individual USB port disablement • Smart USB protection, allows keyboard/mouse only, blocks all storage devices 																																																																																																																								
		Keyboard	<p><i>Some:</i> Lenovo Calliope Keyboard (USB connector), black</p> <p><i>Some:</i> Lenovo Traditional Keyboard (USB connector), black</p> <p><i>Some:</i> Lenovo Calliope Wireless Keyboard (2.4GHz via USB receiver), black</p> <p><i>Some:</i> Lenovo Keyboard (PS/2 connector), black (only available via special bid)</p> <p><i>Some:</i> Lenovo Calliope Mouse (USB connector), black</p> <p><i>Some:</i> Lenovo Fingerprint Mouse (USB connector), Windows Hello support, black</p> <p><i>Some:</i> Lenovo Calliope Wireless Mouse (2.4GHz via USB receiver), black</p> <p><i>Some:</i> Lenovo Mouse (PS/2 connector), black (only available via special bid)</p>																																																																																																																								
Memory	64GB max, UDIMM, DDR4-2666*, four 288-pin DIMM sockets, non-ECC, dual-channel capable * System automatically clocks down for the processors with lower memory controller	Mouse	<p><i>Some:</i> Lenovo Calliope Mouse (USB connector), black</p> <p><i>Some:</i> Lenovo Fingerprint Mouse (USB connector), Windows Hello support, black</p> <p><i>Some:</i> Lenovo Calliope Wireless Mouse (2.4GHz via USB receiver), black</p> <p><i>Some:</i> Lenovo Mouse (PS/2 connector), black (only available via special bid)</p>																																																																																																																								
Storage	<p><i>Some:</i> Hard Drive / SATA 6.0Gb/s, 2.5" or 3.5", 5400 rpm or 7200 rpm</p> <p><i>Some:</i> Solid State Drive (SSD) / SATA 6.0Gb/s, 2.5"</p> <p><i>Some:</i> M.2 SSD (2242 / 2280) / PCIe NVMe, PCIe 3.0 x2 or PCIe 3.0 x4</p> <p><i>Some:</i> Intel Optane™ Memory (not support Celeron / Pentium Processor), M.2</p>	Mechanical	<ul style="list-style-type: none"> • Tower (15L), black color, metal case • (WxDxH) 5.91" X 10.65" X 14.17"; 150mm X 270.5mm X 360mm • Approx. 15.21 lb (6.9 kg), weight may vary by configuration • Optional dust filter • Bay 1: Slim external ODD bay • Bay 2: 3.5", 1" high, internal, HDD/SSD • Bay 3: 3.5", 1" high, internal, HDD/SSD (optional bay) • Slot 1: half-length full-height (length < 189mm, height < 104mm), PCIe 3.0 x16 • Slot 2: half-length full-height (length < 189mm, height < 104mm), PCIe 3.0 x1 • Slot 3: half-length full-height (length < 189mm, height < 104mm), PCIe 3.0 x1 • Slot 4: no slot, only bracket for optional port extension • M.2 card slots: Two (one for WLAN, one for SSD/Optane) 																																																																																																																								
Optical	<p><i>Some:</i> DVD-ROM SATA 1.5Gb/s Drive, slim (9.0mm)</p> <p><i>Some:</i> DVD Burner (DVD±RW), SATA 1.5Gb/s Drive, slim (9.0mm)</p>	Power supply	<p><i>Some:</i> 180 watts, autosensing, 85% PSU</p> <p><i>Some:</i> 210 watts, autosensing, 85% PSU</p> <p><i>Some:</i> 260 watts, autosensing, 92% PSU (only available via special bid)</p>																																																																																																																								
Onboard SATA Media reader	Three onboard SATA 6.0Gb/s connectors Optional 7-in-1 media reader	Limited warranty ³	<p><i>Some:</i> 1-year or 3-year, depot service / service upgrades available</p> <p><i>Some:</i> 1-year or 3-year, limited onsite service / service upgrades available</p>																																																																																																																								
Graphics	<p>Intel UHD Graphics 610/630 in processor, uses main memory, DirectX® 12, one VGA (up to 2048x1536@50Hz), two DisplayPort™ (up to 4096x2304@60Hz), supports 3 independent displays, more displays support via discrete graphics</p> <p><i>Some:</i> NVIDIA GeForce® GT 730 (End Of Life), DirectX 12, 2GB, PCIe 2.0 x16, 35 watts, two DisplayPort (up to 3840x2160@60Hz)</p> <p><i>Some:</i> AMD Radeon™ 520, DirectX 12, 2GB GDDR5, PCIe 3.0 x8, 30 watts, two DisplayPort (up to 4096x2160@60Hz)</p> <p><i>Some:</i> AMD Radeon RX 550X, DirectX 12, 4GB GDDR5, PCIe 3.0 x8, 50 watts, one DisplayPort (up to 3840x2160@60Hz), one HDMI (up to 4096x2160@60Hz), one VGA (up to 2048x1536@85Hz)</p>	Preload	<p>Preloaded operating system</p> <p><i>Some:</i> Windows® 10 Pro 64-bit</p> <p><i>Some:</i> Windows 10 Home 64-bit</p> <p>Preloaded applications (only some listed)</p> <ul style="list-style-type: none"> • Lenovo Vantage • Microsoft Office preloaded; purchase a product key to activate • Cyberlink PowerDVD (only for models with DVD / DVD±RW) • Cyberlink Power2GO (only for models with DVD±RW) • LinkedIn 																																																																																																																								
Monitor Cable	Optional DP to VGA dongle, DP to DVI-D dongle, DP to dual DP dongle (for Collage Display with intel integrated graphics), or DP to HDMI 1.4 dongle	Environment	ENERGY STAR® 6.1, EPEAT™ Silver rating (North America), ErP Lot 3, TCO, TUV low noise verified (coming soon, on some models), RoHS-compliant																																																																																																																								
Chipset	Intel B360 Chipset	Accessories	For compatible accessories, please go to http://smartfind.lenovo.com																																																																																																																								
Front ports* (Std.)	2x USB 3.1 Gen2, 2x USB 3.1 Gen1, 1x USB 3.1 Type-C Gen1 (15W charging), 1x microphone (3.5mm), 1x headphone / microphone combo jack (3.5mm)																																																																																																																										
Front ports* (Opt.)	<i>Optional:</i> 1x media reader																																																																																																																										
Rear ports* (Std.)	4x USB 2.0, 1x serial (9-pin), 1x ethernet (RJ-45), 1x VGA, 2x DisplayPort, 1x line-out (3.5mm)																																																																																																																										
Rear ports* (Opt.)	<i>Optional:</i> 2x USB 3.1 Gen1 via PCIe x1**, 2x USB 3.1 Type-C Gen2 via PCIe x4** (special bid only), 1x 2nd serial (9-pin), 4x serial (9-pin) via PCIe x1, 1x parallel (25-pin), 2x PS/2 ports (keyboard/mouse), additional RJ-45 and video ports available on optional graphics or ethernet card																																																																																																																										
	* Depending on many factors, actual data transfer speed may be lower than theoretical speed ** Choose either 2x USB 3.1 Gen1 or 2x USB 3.1 Type-C Gen2																																																																																																																										
Audio support	High Definition (HD) Audio, Realtek ALC233VB2 / internal speaker (2 watt)																																																																																																																										

Note: The specifications above may not be available in all regions.

Lenovo, November 2019

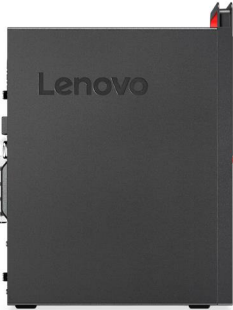
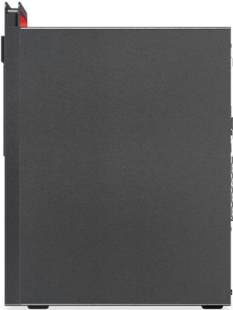

ThinkCentre M910 Tower Platform Specifications

Product Specifications Reference (PSREF)

Processor	Intel® Celeron®, Intel Pentium®, or 6/7th Generation Intel Core™ i3 / i5 / i7 Processor						Ethernet Modem	Gigabit ethernet, Intel Ethernet Connection I219-LM(Jacksonville), Wake on LAN® None
	Processor	Cores / Threads	Frequency Base/Max(GHz)	Cache	Memory Support (Up to)	Integrated Graphics	Manageability	Intel Active Management Technology 11.0 (Intel AMT 11.0); Intel vPro technology on some models (require choosing a vPro-support Wi-Fi adapter to enable vPro function through wireless connection)
	Core i5-6500	4 / 4	3.2G / 3.6G	6 MB	DDR4-2133	HD 530	Security chip	TPM (Trusted Platform Module) 2.0, TCG Certified * Downgrade to TPM1.2 for the models with Win10 DG Win7 32 OS
	Core i7-6700	4 / 8	3.4G / 4.0G	8 MB	DDR4-2133	HD 530	Security features	<ul style="list-style-type: none"> Security slot (in rear for optional Kensington® MicroSaver® cable) Power-on password Administrator password Padlock loop Hard disk password Smart USB protection, allows keyboard/ mouse only, blocks all storage devices Boot sequence control Boot without keyboard and mouse Optional cable lock to physically lock both keyboard and mouse Individual USB port disablement Optional chassis intrusion switch
	Core i3-7300	2 / 4	4.0G / --	4 MB	DDR4-2400	HD 630		
	Core i5-7400	4 / 4	3.0G / 3.5G	6 MB	DDR4-2400	HD 630		
	Core i5-7500	4 / 4	3.4G / 3.8G	6 MB	DDR4-2400	HD 630		
	Core i5-7600	4 / 4	3.5G / 4.1G	6 MB	DDR4-2400	HD 630		
Core i7-7700	4 / 8	3.6G / 4.2G	8 MB	DDR4-2400	HD 630			
Memory	64GB max, UDIMM, DDR4-2400*, four 288-pin DIMM sockets, non-ECC, dual-channel capable * System automatically clocks down for the processors with lower memory controller						Keyboard	Some: Lenovo Calliope Keyboard (USB connector), black Some: Lenovo Traditional Keyboard (USB connector), black
Storage	Some: Hard Drive / SATA 6.0Gb/s, 2.5" or 3.5", 5400 rpm or 7200 rpm Some: Solid State Drive (SSD) / SATA 6.0Gb/s, 2.5" Some: M.2 Solid State Drive (SSD) / PCIe NVMe, PCIe 3.0 x 4, 32Gb/s Some: Intel Optane™ Memory (models with 7th gen Core processor), M.2 Some: Front accessible and removable HDD, 3.5", lockable via physical key						Mouse	Some: Lenovo Calliope Wireless Keyboard (2.4GHz via USB receiver), black Some: Lenovo Calliope Mouse (USB connector), black Some: Lenovo Calliope Wireless Mouse (2.4GHz via USB receiver), black
Optical	Some: DVD-ROM, SATA 1.5Gb/s, 5.25" or slim (9.0mm) Some: DVD Burner (DVD±RW), SATA 1.5Gb/s, 5.25" or slim (9.0mm)						Mechanical	<ul style="list-style-type: none"> Tower (18L), black color, metal case (WxDxH) 6.5" X 12.65" X 16.15"; 165mm X 321.35mm X 410.25mm Approx. 15.45 lb (7 kg), weight may vary by configuration Toolless cover, disk, optical, graphic card removal Optional carry handle, dust filter Bay 1: Slim external ODD bay Bay 2: 5.25", 1.6" high, external, ODD / optional front access HDD Bay 3: 3.5", 1" high, internal, HDD/SSD Bay 4: 3.5", 1" high, internal, HDD/SSD (optional bay, bay comes with disk) Bay 5: 2.5", internal, HDD/SSD (optional bay) Notes: M910 Tower supports up to 3 SATA devices (ODD/HDD/SSD) and 1 eSATA device (front access HDD) Slot 1: full-length full-height (length < 268mm, height < 112mm), PCIe 3.0 x16* Slot 2: full-length full-height (length < 268mm, height < 112mm), PCIe 3.0 x1* Slot 3: full-length full-height (length < 268mm, height < 112mm), PCIe 3.0 x16 (x4 signal)* Slot 4: no slot, only bracket for optional port extension* M.2 card slots: Two (one for WLAN, one for SSD/Optane) * Optional 2 front USB3.1 Type-C ports module occupies PCIe x16 (x4 signal) slot, optional rear 2x USB2.0 / parallel / 2nd serial occupies one expansion slot
Onboard SATA	Four onboard SATA 6.0Gb/s connectors (1x eSATA and 3x SATA), RAID 0/1 support (RAID preset only available via special bid model)						Power supply	Some: 180 watts, autosensing, 85% PSU Some: 250 watts, autosensing, 85% PSU Some: 400 watts, autosensing, 92% PSU (only available via special bid)
Media reader	Optional 7-in-1 media reader						Limited warranty	Some: 1-year or 3-year, depot service / service upgrades available Some: 1-year or 3-year, limited onsite service / service upgrades available
Graphics	Intel HD Graphics 510/530/610/630 in processor, uses main memory, DirectX® 12, one VGA, two DisplayPort™, supports 3 independent displays, works along with discrete graphics to support more displays; Max resolution: 4096x2304 (DP) @60Hz; 2048x1536 (VGA) @50Hz Some: NVIDIA GeForce® GT 730, DirectX 12, 2GB, PCIe 2.0 x8 adapter, two DisplayPort, 35 watts; Max resolution: 3840x2160 (DisplayPort) @60Hz; Some: AMD Radeon™ R7 350, DirectX 11, 2GB, PCIe 3.0 x8 adapter, one VGA, one HDMI, 75 watts, occupies two slots; Max resolution: 4096x2160 (HDMI) @24Hz; 2048x1536 (VGA) @85Hz Some: NVIDIA GeForce GTX™ 1080 (only available via special bid model), DirectX 12, 8GB, PCIe 3.0 x16 adapter, one DVI-D, one HDMI, three DisplayPort, 180 watts, occupies two slots; Max resolution: 2560x1600 (DVI-D) @60Hz; 4096x2160 (HDMI) @60Hz 7680x4320 (with Single DP) @60Hz						Preload	Preloaded operating system Some: Windows® 7 Professional 32/64 preinstalled through downgrade rights in Windows 10 Pro 64-bit (not available with 7th Gen Intel processor) Some: Windows 10 Pro 64-bit Some: Windows 10 Home 64-bit Preloaded applications (only some listed) <ul style="list-style-type: none"> Microsoft Office preloaded; purchase a product key to activate Only for Window 10 Lenovo Companion Only for Window 7 Lenovo Solution Center Lenovo ThinkVantage Tools Create Recovery Media Adobe® Reader® Cyberlink PowerDVD Create (DVD±RW)
Monitor Cable	Optional DP to VGA, DP to DVI-D (single link), DP to dual DP, or DP to HDMI 1.4						Environment	ENERGY STAR® 6.1, EPEAT™ Gold rating (North America), ErP Lot 3, GREENGUARD®, RoHS-compliant, TUV low noise verified (on some models)
Chipset	Intel Q270 Chipset						Accessories	For compatible accessories, please go to http://www.lenovoquickpick.com
Front ports*	Four USB 3.1 Gen1, optional two USB 3.1 Type-C Gen 2 (only available via special bid), microphone (3.5mm), headphone (3.5mm)							
Rear ports*	Four USB 3.1 Gen1, optional two USB 2.0, serial (9-pin), optional 2nd serial (9-pin), optional parallel (25-pin), ethernet (RJ-45), one VGA, two DisplayPort, optional two PS/2 ports (keyboard/mouse); additional VGA, DisplayPort, DVI-D, or HDMI on optional graphics on some models							
Rear audio ports* IEEE 1394*	Line-in (3.5mm), line-out (3.5mm), microphone-in (3.5mm) None * Depending on many factors, actual data transfer speed may be lower than theoretical speed							
Audio support	High Definition (HD) Audio, Realtek ALC662 / optional internal speaker (1.5 watt)							
WLAN	Some: 11ac wireless, M.2 Card, Qualcomm Atheros QCA9377A (dual band), Wi-Fi + Bluetooth 4.1 combo adapter, 1x1 Some: 11ac wireless, M.2 Card, Qualcomm Atheros QCA6174A (dual band), Wi-Fi + Bluetooth 4.1 combo adapter, 2x2 Some: 11ac wireless, M.2 Card, Intel Dual Band Wireless-AC 3165, Wi-Fi + Bluetooth 4.1 combo adapter, 1x1 Some: 11ac wireless, M.2 Card, Intel Dual Band Wireless-AC 8265, Wi-Fi + Bluetooth 4.1 combo adapter, 2x2 Some: 11ac wireless, M.2 Card, Intel Dual Band Wireless-AC 8265, Wi-Fi + Bluetooth 4.1 combo adapter, Intel vPro technology support, 2x2							
Bluetooth™	Some: Bluetooth 4.1 wireless, integrated in Wi-Fi + BT combo adapter							

Note: The specifications above may not be available in all regions.

Lenovo, August 2017



ThinkCentre M920 Tower Platform Specifications

Product Specifications Reference (PSREF)

Processor	Intel® Celeron®, Intel Pentium®, or 8th /9th Gen Intel Core™ i3 / i5 / i7 / i9 Processor	USB3.1 Type-C Gen 2 / DisplayPort) via PCIe x4 (available on 09/30/2018), additional RJ-45 and video ports available on optional graphics or ethernet card * Depending on many factors, actual data transfer speed may be lower than theoretical speed																																																																																																																																																
	<table border="1"> <thead> <tr> <th>Processor</th> <th>Cores / Threads</th> <th>Frequency Base/Max(GHz)</th> <th>Cache</th> <th>Memory Support (Up to)</th> <th>Integrated Graphics</th> </tr> </thead> <tbody> <tr><td>Celeron G4900</td><td>2 / 2</td><td>3.1G</td><td>2 MB</td><td>DDR4-2400</td><td>UHD 610</td></tr> <tr><td>Celeron G4920</td><td>2 / 2</td><td>3.2G</td><td>2 MB</td><td>DDR4-2400</td><td>UHD 610</td></tr> <tr><td>Celeron G4930</td><td>2 / 2</td><td>3.2G</td><td>2 MB</td><td>DDR4-2400</td><td>UHD 610</td></tr> <tr><td>Celeron G4950</td><td>2 / 2</td><td>3.3G</td><td>2 MB</td><td>DDR4-2400</td><td>UHD 610</td></tr> <tr><td>Pentium Gold G5400</td><td>2 / 4</td><td>3.7G</td><td>4 MB</td><td>DDR4-2400</td><td>UHD 610</td></tr> <tr><td>Pentium Gold G5500</td><td>2 / 4</td><td>3.8G</td><td>4 MB</td><td>DDR4-2400</td><td>UHD 630</td></tr> <tr><td>Pentium Gold G5600</td><td>2 / 4</td><td>3.9G</td><td>4 MB</td><td>DDR4-2400</td><td>UHD 630</td></tr> <tr><td>Pentium Gold G5420</td><td>2 / 4</td><td>3.8G</td><td>4 MB</td><td>DDR4-2400</td><td>UHD 610</td></tr> <tr><td>Pentium Gold G5620</td><td>2 / 4</td><td>4.0G</td><td>4 MB</td><td>DDR4-2400</td><td>UHD 630</td></tr> <tr><td>Core i3-8100</td><td>4 / 4</td><td>3.6G</td><td>6 MB</td><td>DDR4-2400</td><td>UHD 630</td></tr> <tr><td>Core i3-8300</td><td>4 / 4</td><td>3.7G</td><td>8 MB</td><td>DDR4-2400</td><td>UHD 630</td></tr> <tr><td>Core i5-8400</td><td>6 / 6</td><td>2.8G / 4.0G</td><td>9 MB</td><td>DDR4-2666</td><td>UHD 630</td></tr> <tr><td>Core i5-8500</td><td>6 / 6</td><td>3.0G / 4.1G</td><td>9 MB</td><td>DDR4-2666</td><td>UHD 630</td></tr> <tr><td>Core i5-8600</td><td>6 / 6</td><td>3.1G / 4.3G</td><td>9 MB</td><td>DDR4-2666</td><td>UHD 630</td></tr> <tr><td>Core i7-8700</td><td>6 / 12</td><td>3.2G / 4.6G</td><td>12 MB</td><td>DDR4-2666</td><td>UHD 630</td></tr> <tr><td>Core i3-9100</td><td>4 / 4</td><td>3.6G / 4.2G</td><td>6 MB</td><td>DDR4-2400</td><td>UHD 630</td></tr> <tr><td>Core i3-9300</td><td>4 / 4</td><td>3.7G / 4.3G</td><td>8 MB</td><td>DDR4-2400</td><td>UHD 630</td></tr> <tr><td>Core i3-9320</td><td>4 / 4</td><td>3.7G / 4.4G</td><td>8 MB</td><td>DDR4-2400</td><td>UHD 630</td></tr> <tr><td>Core i5-9400</td><td>6 / 6</td><td>2.9G / 4.1G</td><td>9 MB</td><td>DDR4-2666</td><td>UHD 630</td></tr> <tr><td>Core i5-9500</td><td>6 / 6</td><td>3.0G / 4.4G</td><td>9 MB</td><td>DDR4-2666</td><td>UHD 630</td></tr> <tr><td>Core i5-9600</td><td>6 / 6</td><td>3.1G / 4.6G</td><td>9 MB</td><td>DDR4-2666</td><td>UHD 630</td></tr> <tr><td>Core i7-9700</td><td>8 / 8</td><td>3.0G / 4.7G</td><td>12 MB</td><td>DDR4-2666</td><td>UHD 630</td></tr> <tr><td>Core i9-9900</td><td>8 / 16</td><td>3.1G / 5.0G</td><td>16 MB</td><td>DDR4-2666</td><td>UHD 630</td></tr> </tbody> </table>	Processor	Cores / Threads	Frequency Base/Max(GHz)	Cache	Memory Support (Up to)	Integrated Graphics	Celeron G4900	2 / 2	3.1G	2 MB	DDR4-2400	UHD 610	Celeron G4920	2 / 2	3.2G	2 MB	DDR4-2400	UHD 610	Celeron G4930	2 / 2	3.2G	2 MB	DDR4-2400	UHD 610	Celeron G4950	2 / 2	3.3G	2 MB	DDR4-2400	UHD 610	Pentium Gold G5400	2 / 4	3.7G	4 MB	DDR4-2400	UHD 610	Pentium Gold G5500	2 / 4	3.8G	4 MB	DDR4-2400	UHD 630	Pentium Gold G5600	2 / 4	3.9G	4 MB	DDR4-2400	UHD 630	Pentium Gold G5420	2 / 4	3.8G	4 MB	DDR4-2400	UHD 610	Pentium Gold G5620	2 / 4	4.0G	4 MB	DDR4-2400	UHD 630	Core i3-8100	4 / 4	3.6G	6 MB	DDR4-2400	UHD 630	Core i3-8300	4 / 4	3.7G	8 MB	DDR4-2400	UHD 630	Core i5-8400	6 / 6	2.8G / 4.0G	9 MB	DDR4-2666	UHD 630	Core i5-8500	6 / 6	3.0G / 4.1G	9 MB	DDR4-2666	UHD 630	Core i5-8600	6 / 6	3.1G / 4.3G	9 MB	DDR4-2666	UHD 630	Core i7-8700	6 / 12	3.2G / 4.6G	12 MB	DDR4-2666	UHD 630	Core i3-9100	4 / 4	3.6G / 4.2G	6 MB	DDR4-2400	UHD 630	Core i3-9300	4 / 4	3.7G / 4.3G	8 MB	DDR4-2400	UHD 630	Core i3-9320	4 / 4	3.7G / 4.4G	8 MB	DDR4-2400	UHD 630	Core i5-9400	6 / 6	2.9G / 4.1G	9 MB	DDR4-2666	UHD 630	Core i5-9500	6 / 6	3.0G / 4.4G	9 MB	DDR4-2666	UHD 630	Core i5-9600	6 / 6	3.1G / 4.6G	9 MB	DDR4-2666	UHD 630	Core i7-9700	8 / 8	3.0G / 4.7G	12 MB	DDR4-2666	UHD 630	Core i9-9900	8 / 16	3.1G / 5.0G	16 MB	DDR4-2666	UHD 630	<p>Audio support High Definition (HD) Audio, Realtek ALC233VB2 / internal speaker (2 watt)</p> <p>WLAN <i>Some:</i> 11ac Wi-Fi + BT 4.2, M.2 Card, Realtek RTL8821CE (dual band), 1x1 <i>Some:</i> 11ac Wi-Fi + BT 4.2, M.2 Card, Realtek RTL8822BE (dual band), 2x2 <i>Some:</i> 11ac Wi-Fi + BT 4.2, M.2 Card, Intel Dual Band Wireless-AC 3165, 1x1 <i>Some:</i> 11ac wireless, M.2 Card, Intel Dual Band Wireless-AC 8265, 2x2 <i>Some:</i> 11ac Wi-Fi + BT 5.0, M.2 Card, Intel Wireless-AC 9560 (dual band), Intel vPro technology support, 2x2</p> <p>Bluetooth™ Ethernet Ethernet (Opt.) <i>Some:</i> Bluetooth 4.2/5.0 wireless, integrated in Wi-Fi + BT combo adapter Gigabit ethernet, Intel Ethernet Connection I219-LM(Jacksonville), Wake on LAN® <i>Some:</i> Intel Ethernet Server Adapter I350-T4, gigabit ethernet, 4x RJ-45, PCIe x4 <i>Some:</i> Bitland BN8E88, gigabit ethernet, 1x RJ-45, PCIe x1 (special bid only)</p> <p>Manageability Intel Active Management Technology 12 (Intel AMT 12); Intel vPro technology on some models (require choosing a vPro-support Wi-Fi adapter to enable vPro function through wireless connection)</p> <p>Security chip Discrete TPM 2.0, TCG Certified</p> <p>Security features</p> <ul style="list-style-type: none"> • Security slot (in rear for optional Kensington® MicroSaver® cable) • Padlock loop • Optional cable lock to physically lock both keyboard and mouse • Optional chassis intrusion switch • Optional chassis E-Lock (special bid) • Power-on password • Administrator password • Hard disk password • Boot sequence control • Boot without keyboard and mouse • Individual USB port disablement • Smart USB protection, allows keyboard/mouse only, blocks all storage devices <p>Keyboard <i>Some:</i> Lenovo Calliope Keyboard (USB connector), black <i>Some:</i> Lenovo Traditional Keyboard (USB connector), black <i>Some:</i> Lenovo Calliope Wireless Keyboard (2.4GHz via USB receiver), black <i>Some:</i> Lenovo Keyboard (PS/2 connector), black (only available via special bid)</p> <p>Mouse <i>Some:</i> Lenovo Calliope Mouse (USB connector), black <i>Some:</i> Lenovo Fingerprint Mouse (USB connector), Windows Hello support, black <i>Some:</i> Lenovo Calliope Wireless Mouse (2.4GHz via USB receiver), black <i>Some:</i> Lenovo Mouse (PS/2 connector), black (only available via special bid)</p> <p>Mechanical</p> <ul style="list-style-type: none"> • Tower (18L), black color, metal case • (WxDxH) 6.5" X 12.65" X 16.15"; 165mm X 321.35mm X 410.25mm • Approx. 15.45 lb (7 kg), weight may vary by configuration • Toolless cover, disk, optical, extension card removal • Optional carry handle, dust filter <p>Bay 1: Slim external ODD bay Bay 2: 5.25", 1.6" high, external, ODD / optional front access HDD Bay 3: 3.5", 1" high, internal, HDD/SSD Bay 4: 3.5", 1" high, internal, HDD/SSD (optional bay, bay comes with disk) Bay 5: 2.5", internal, HDD/SSD (optional bay) <i>Notes:</i> M920 Tower supports up to 3 SATA devices (ODD/HDD/SSD) and 1 eSATA device (front access HDD) Slot 1: full-length (< 268mm) full-height (< 112mm), PCIe 3.0 x16 Slot 2: full-length (< 268mm) full-height (< 112mm), PCIe 3.0 x1 Slot 3: full-length (< 268mm) full-height (< 112mm), PCIe 3.0 x16 (x4 signal) Slot 4: no slot, only bracket for optional port extension M.2 card slots: Two (one for WLAN, one for SSD/Optane)</p> <p>Power supply <i>Some:</i> 180 watts, autosensing, 85% PSU <i>Some:</i> 250 watts, autosensing, 85% PSU <i>Some:</i> 400 watts, autosensing, 92% PSU (only available via special bid)</p> <p>Limited warranty <i>Some:</i> 1-year or 3-year, depot service / service upgrades available <i>Some:</i> 1-year or 3-year, limited onsite service / service upgrades available</p> <p>Preload <i>Some:</i> Windows® 10 Pro 64-bit <i>Some:</i> Windows 10 Home 64-bit</p> <p>Environment ENERGY STAR® 6.1, EPEAT™ Silver rating (North America), ErP Lot 3, TCO, TUV low noise verified (coming soon, on some models), RoHS-compliant</p> <p>Accessories For compatible accessories, please go to http://smartfind.lenovo.com</p>
Processor	Cores / Threads	Frequency Base/Max(GHz)	Cache	Memory Support (Up to)	Integrated Graphics																																																																																																																																													
Celeron G4900	2 / 2	3.1G	2 MB	DDR4-2400	UHD 610																																																																																																																																													
Celeron G4920	2 / 2	3.2G	2 MB	DDR4-2400	UHD 610																																																																																																																																													
Celeron G4930	2 / 2	3.2G	2 MB	DDR4-2400	UHD 610																																																																																																																																													
Celeron G4950	2 / 2	3.3G	2 MB	DDR4-2400	UHD 610																																																																																																																																													
Pentium Gold G5400	2 / 4	3.7G	4 MB	DDR4-2400	UHD 610																																																																																																																																													
Pentium Gold G5500	2 / 4	3.8G	4 MB	DDR4-2400	UHD 630																																																																																																																																													
Pentium Gold G5600	2 / 4	3.9G	4 MB	DDR4-2400	UHD 630																																																																																																																																													
Pentium Gold G5420	2 / 4	3.8G	4 MB	DDR4-2400	UHD 610																																																																																																																																													
Pentium Gold G5620	2 / 4	4.0G	4 MB	DDR4-2400	UHD 630																																																																																																																																													
Core i3-8100	4 / 4	3.6G	6 MB	DDR4-2400	UHD 630																																																																																																																																													
Core i3-8300	4 / 4	3.7G	8 MB	DDR4-2400	UHD 630																																																																																																																																													
Core i5-8400	6 / 6	2.8G / 4.0G	9 MB	DDR4-2666	UHD 630																																																																																																																																													
Core i5-8500	6 / 6	3.0G / 4.1G	9 MB	DDR4-2666	UHD 630																																																																																																																																													
Core i5-8600	6 / 6	3.1G / 4.3G	9 MB	DDR4-2666	UHD 630																																																																																																																																													
Core i7-8700	6 / 12	3.2G / 4.6G	12 MB	DDR4-2666	UHD 630																																																																																																																																													
Core i3-9100	4 / 4	3.6G / 4.2G	6 MB	DDR4-2400	UHD 630																																																																																																																																													
Core i3-9300	4 / 4	3.7G / 4.3G	8 MB	DDR4-2400	UHD 630																																																																																																																																													
Core i3-9320	4 / 4	3.7G / 4.4G	8 MB	DDR4-2400	UHD 630																																																																																																																																													
Core i5-9400	6 / 6	2.9G / 4.1G	9 MB	DDR4-2666	UHD 630																																																																																																																																													
Core i5-9500	6 / 6	3.0G / 4.4G	9 MB	DDR4-2666	UHD 630																																																																																																																																													
Core i5-9600	6 / 6	3.1G / 4.6G	9 MB	DDR4-2666	UHD 630																																																																																																																																													
Core i7-9700	8 / 8	3.0G / 4.7G	12 MB	DDR4-2666	UHD 630																																																																																																																																													
Core i9-9900	8 / 16	3.1G / 5.0G	16 MB	DDR4-2666	UHD 630																																																																																																																																													
Memory	64GB max, DDR4-2666*, four 288-pin DIMM sockets, dual-channel capable * System automatically clocks down for the processors with lower memory controller																																																																																																																																																	
Storage	<i>Some:</i> Hard Drive / SATA 6.0Gb/s, 2.5" or 3.5", 5400 rpm or 7200 rpm <i>Some:</i> Solid State Drive (SSD) / SATA 6.0Gb/s, 2.5" <i>Some:</i> M.2 SSD (2242 / 2280) / PCIe NVMe, PCIe 3.0 x2 or PCIe 3.0 x4 <i>Some:</i> Intel Optane™ Memory (not support Celeron / Pentium Processor), M.2																																																																																																																																																	
Optical	Optional DVD-ROM or DVD Burner (DVD±RW), SATA 1.5Gb/s Drive, slim (9.0mm)																																																																																																																																																	
Onboard SATA	Four onboard SATA 6.0Gb/s connectors, RAID 0/1 support (RAID preset only available via special bid model)																																																																																																																																																	
Media reader	Optional 7-in-1 media reader																																																																																																																																																	
Graphics	Intel UHD Graphics 610/630 in processor, uses main memory, DirectX® 12, one VGA (up to 2048x1536@50Hz), two DisplayPort™ (up to 4096x2304@60Hz), supports 3 independent displays, more displays support via discrete graphics <i>Some:</i> NVIDIA GeForce® GT 730 (End Of Life), DirectX 12, 2GB GDDR5, PCIe 2.0 x16, 35 watts, two DisplayPort (up to 3840x2160@60Hz) <i>Some:</i> AMD Radeon™ 520 , DirectX 12, 2GB GDDR5, PCIe 3.0 x8, 30 watts, two DisplayPort (up to 4096x2160@60Hz) <i>Some:</i> AMD Radeon RX 550X , DirectX 12, 4GB GDDR5, PCIe 3.0 x8, 50 watts, one DisplayPort (up to 3840x2160@60Hz), one HDMI (up to 4096x2160@60Hz), one VGA (up to 2048*1536@85Hz) <i>Some:</i> NVIDIA GeForce GTX 1060 (special bid only), DirectX 12, 6GB GDDR5, PCIe 3.0 x16, 120 watts, 1x DVI-D (up to 2560x1600@60Hz), 1x HDMI (up to 4096x2160@60Hz), 3x DP (up to 5120x3200@60Hz), occupies two slots																																																																																																																																																	
Monitor Cable	Optional DP to VGA dongle, DP to DVI-D dongle, DP to dual DP dongle (for Collage Display with intel integrated graphics), or DP to HDMI 1.4 dongle																																																																																																																																																	
Chipset	Intel Q370 Chipset																																																																																																																																																	
Front ports* (Std.)	2x USB 3.1 Gen2, 2x USB 3.1 Gen1, 1x USB 3.1 Type-C Gen1 (15W charging), 1x microphone (3.5mm), 1x headphone / microphone combo jack (3.5mm)																																																																																																																																																	
Front ports* (Opt.)	<i>Optional:</i> 1x media reader																																																																																																																																																	
Rear ports* (Std.)	4x USB 3.1 Gen1, 1x serial (9-pin), 1x ethernet (RJ-45), 1x VGA, 2x DisplayPort, 1x line-out (3.5mm)																																																																																																																																																	
Rear ports* (Opt.)	<i>Optional:</i> 2x USB 2.0, 2x USB 3.1 Gen1 via PCIe x1, 2x USB 3.1 Type-C Gen2 via PCIe x4 (special bid only), 1x 2nd serial (9-pin), 4x serial (9-pin) via PCIe x1, 1x parallel (25-pin), 2x PS/2 ports (keyboard/mouse), 1x Thunderbolt 3 (combo)																																																																																																																																																	

Note: The specifications above may not be available in all regions.

Lenovo, November 2019

This publication was developed for products and services offered in the United States and E.M.E.A countries. Lenovo may not offer the products, services or features discussed in this document in other countries. Lenovo may withdraw an offering at any time. Information is subject to change without notice. Consult your local representative for information on offerings available in your area.

Lenovo reserves the right to change specifications or other product information without notice. Lenovo is not responsible for photographic or typographical errors.

LENOVO PROVIDES THIS PUBLICATION "AS IS," WITHOUT WARRANTY OF ANY KIND, EITHER EXPRESS OR IMPLIED, INCLUDING THE IMPLIED WARRANTIES OF MERCHANTABILITY OR FITNESS FOR A PARTICULAR PURPOSE.

Some jurisdictions do not allow disclaimer of express or implied warranties in certain transactions, therefore this disclaimer may not apply to you.

Availability: All offers subject to availability. Lenovo reserves the right to alter product offerings and specifications at any time, without notice. Lenovo is not responsible for photographic or typographic errors.

General: Review key information provided by Microsoft that may apply to your system purchase, including details on Windows 10, Windows 8, Windows 7, and potential upgrades/downgrades. Lenovo makes no representation or warranty regarding third-party products or services.

Trademarks: Lenovo, ThinkPad, ThinkCentre, ThinkStation and the Lenovo logo are trademarks of Lenovo. Microsoft, Windows, Windows NT, and the Windows logo are trademarks of Microsoft Corporation. Ultrabook, Celeron, Celeron Inside, Core Inside, Intel, Intel Logo, Intel Atom, Intel Atom Inside, Intel Core, Intel Inside, Intel Inside Logo, Intel vPro, Itanium, Itanium Inside, Pentium, Pentium Inside, vPro Inside, Xeon, Xeon Phi, and Xeon Inside are trademarks of Intel Corporation in the U.S. and/or other countries. Other company, product or service names may be trademarks or service marks of others.

Warranty: For a copy of applicable warranties, write to: Lenovo Warranty Information, 1009 Think Place, Morrisville, NC, 27560. Lenovo makes no representation or warranty regarding third party products or services. The Lenovo Limited Warranty applies only to Lenovo hardware products purchased for your own use, and does not transfer upon resale.

Limited warranty: Support unrelated to a warranty issue may be subject to additional charges.

Lenovo Services:

Carry-in or Mail-in Service: Parts and labor repair coverage where the customer is responsible for shipping (including packaging) or delivery to authorized warranty provider or repair center.

Depot or Courier Service: Parts and labor repair coverage where shipping (including packaging) or delivery to the repair center is paid for by Lenovo.

Expedited Depot: Parts and labor coverage with expedited turnaround. Shipping (including packaging) or delivery to the repair center is paid for by Lenovo.

Onsite / In-home Service: Parts and labor repair coverage where labor is provided onsite at your place of business.

If Lenovo determines your product problem is covered by the product warranty and cannot be resolved over the telephone, a technician will be dispatched to arrive onsite, typically the next day.

International Warranty Service (IWS): PC repair coverage for customers who require a critical warranty repair while travelling internationally. Visit www.lenovo.com/internationalwarranty for details. Visit www.lenovo.com/warranty for Lenovo Warranty Services terms and conditions for complete details and restrictions.

Included software: may differ from its retail version (if available), and may not include user manuals or all program functionality. Software license agreements may apply.

Battery life: Battery life (and recharge times) will vary based on many factors including screen brightness, applications, features, power management, battery conditioning, and other customer preferences.

Visit <http://psref.lenovo.com/> for the latest version of Product Specifications Reference.

© Lenovo, 2019. All rights reserved.
Lenovo 1009 Think Place Morrisville, NC 27560 U.S.A.

Lenovo ThinkStation.

PSREF



Product Specifications Reference

Version 552, December 2019

U.S.

EMEA

Visit <http://psref.lenovo.com> for the latest version

Summary of Changes

This section describes the changes made in this version of ThinkStation PSREF and in previous version. This edition might also include minor corrections and editorial changes which are not identified.

December 11, 2019 - Version 552

- ▶ Add Xeon Gold 6226 and 6244 on ThinkStation P920 and P720

August 7, 2019 - Version 546

- ▶ Update processor information on ThinkStation P330 Tiny

July 17, 2019 - Version 545

- ▶ Update EPEAT rating to Silver on most ThinkStation

June 26, 2019 - Version 544

- ▶ Add ThinkStation P330 Tower Gen 2/P330 SFF Gen 2 CPU Async update

May 15, 2019 - Version 542

- ▶ New ThinkStation P330 Tower Gen 2/P330 SFF Gen 2 announced on April 2019
- ▶ Update ThinkStation P920/P720/P520 specifications, add Quadro RTX 8000, DDR4-2933, Xeon Scalable Gen 2

March 13, 2019 - Version 539

- ▶ Add Intel vPro information on ThinkStation P330 Tower/P330 SFF/P520c/P520/P720/P920

February 20, 2019 - Version 538

- ▶ New ThinkStation P330 Tower models announced on February 2019
- ▶ Update ThinkStation P920/P720/P520/P520c specifications, add Quadro RTX4000/5000/6000

August 22, 2018 - Version 529

- ▶ New ThinkStation P330 Tower/SFF/Tiny models announced on August 2018
- ▶ Update ThinkStation P920/P720 specifications, update flex bay and graphics adapter section

August 1, 2018 - Version 528

- ▶ New product ThinkStation P330 Tower/SFF/Tiny announced on July 2018
- ▶ Update ThinkStation P920/P720/P520/P520c, add Refresh 2.0 information
- ▶ Remove all MTM PNs from PDF version

June 20, 2018 - Version 526

- ▶ New ThinkStation P320 Tower models announced on June 2018
- ▶ Update ThinkStation P720 and P920 models, remove EOL models for US
- ▶ Update Windows 10 Pro 64 for Workstations for some ThinkStation P720/P920 models

May 30, 2018 - Version 525

- ▶ Added ThinkStation P720/P920 EMEA May 2018 models

April 18, 2018 - Version 523

- ▶ New ThinkStation P320 Tower/ P320 SFF/P520c/P520/P720/P920 models announced on April 2018

March 28, 2018 - Version 522

- ▶ New ThinkStation P320 Tower/ P320 SFF/P520c/P520/P920 announced on March 2018

March 7, 2018 - Version 521

- ▶ New ThinkStation P320 Tower/ P320 SFF/P720/P920 announced on February 2018

January 30, 2018 - Version 519

- ▶ New ThinkStation P520c and P520 announced on January 2018
- ▶ New ThinkStation P320 Tower/P320 SFF announced on January 2018

December 20, 2017 - Version 517

- ▶ New ThinkStation P920 models announced on December 2017
- ▶ Add Optional Ports on ThinkStation P320 Tiny

September 29, 2017 - Version 513

- ▶ New ThinkStation P920 and P720 announced on September 2017
- ▶ New ThinkStation P320 Tower/P320 SFF/P410/P510/P710/P910 announced on September 2017

September 12, 2017 - Version 512

- ▶ New ThinkStation P320 Tower and P320 SFF models announced on August 2017

August 23, 2017 - Version 511

- ▶ New ThinkStation P320 Tiny models announced on August 2017

August 2, 2017 - Version 510

- ▶ New ThinkStation P320 Tiny/P320 Tower/ P320 SFF/P410/P510 models announced on July 2017

June 21, 2017 - Version 508

- ▶ New ThinkStation P320 Tiny announced on June 2017

May 26, 2017 - Version 507

- ▶ Add ThinkStation P410/P510/P710/P910 Refresh 3.0 Wave 1 models and update platform specifications

April 19, 2017 - Version 505

- ▶ New ThinkStation P320 Tower announced on April 2017
- ▶ New ThinkStation P320 SFF announced on April 2017

March 29, 2017 - Version 504

- ▶ Added ThinkStation P310 Tower and SFF models announced on March 2017
- ▶ Added ThinkStation P410 models announced on March 2017

January 25, 2017 - Version 501

- ▶ Update quantity of PCIe SSD adapter in ThinkStation P510/P910

January 4, 2017 - Version 500

- ▶ Added ThinkStation P310 models announced on December 2016

December 14, 2016 - Version 499

- ▶ Added ThinkStation P410/P510/P710/P910 EMEA models
- ▶ Added 1TB M.2 PCIe SSD, Quadro P5000, Quadro P6000 support on ThinkStation P510/P710/P910
- ▶ Added Quadro P5000 support on ThinkStation P410
- ▶ Added 6TB 7.2K SATA6Gbs HDD support on ThinkStation P410/P510/P710/P910
- ▶ Added ThinkStation P410/P510/P710/P910 models announced on December 2016

November 23, 2016 - Version 498

- ▶ Removed ThinkStation P500/P900 due to EOL
- ▶ Added ThinkStation P310 Tower and SFF models announced on November 2016

October 12, 2016 - Version 496

- ▶ Removed flash option on ThinkStation P510/P710/P910
- ▶ Added ThinkStation P310/P410/P510/P710/P910 models announced on September 2016

August 3, 2016 - Version 493

- ▶ Removed ThinkStation P500/P700/P900 Windows 7 DG from Win8.1 U.S. models
- ▶ Added keyboard and mouse features on all ThinkStation

July 13, 2016 - Version 492

- ▶ Added ThinkStation P500, P700, and P900 Windows 10 downgrade to Windows 7 models
- ▶ Updated Maximum configuration weight of ThinkStation P410
- ▶ Added ThinkStation P710 and P910 models announced on on July 2016
- ▶ Added "Maximum drives in 3.5" bay" feature on ThinkStation P500/P510/P700/P710/P900/P910

June 22, 2016 - Version 491

- ▶ Added new product ThinkStation P410/P510
- ▶ Added NVIDIA Quadro M2000 on ThinkStation P310 Tower
- ▶ Added keyboard and mouse information on ThinkStation P710/P910
- ▶ Added internal USB information on ThinkStation P710/P910

June 2, 2016 - Version 490

- ▶ Added ThinkStation P710/P910 US models
- ▶ Updated ThinkStation P710/P910 processor information

May 19, 2016 - Version 489

- ▶ Added NVIDIA Quadro M2000 on compatible product
- ▶ Updated maximum weight on ThinkStation P710
- ▶ Removed 30AT000BUS

April 27, 2016 - Version 488

- ▶ Added ThinkStation P710 and P910 models for EMEA, announced on April 2016
- ▶ Updated Energy star information on ThinkStation P500/P700/P710/P900/P910

April 6, 2016 - Version 487

- ▶ New ThinkStation P710 and P910, announced April 5, 2016 (specification only)

March 23, 2016 - Version 486

- ▶ Added processors specifications for P310/P500/P700/P900

February 24, 2016 - Version 485

- ▶ Added ThinkStation P310 and P700 models for US, announced on February 2016
- ▶ Added ThinkStation P700 and P900 models for EMEA, announced on February 2016

December 9, 2015 - Version 482

- ▶ New ThinkStation P310 Tower and SFF, announced November 24, 2015

November 18, 2015 - Version 481

- ▶ Combines ThinkStation PSREF United States version and Western Europe version.
- ▶ Extends the supported GEO into Europe, Middle East and Africa.
- ▶ Covers all TopSeller and Relationship models for US and all focus models for EMEA



ThinkStation P320 SFF Platform Specifications

Product Specifications Reference (PSREF)

Components	Specification																																			
Chipset	Intel C236 Chipset																																			
Intel AMT	Intel Active Management Technology 11 on Xeon models, Intel Standard Manageability on other models																																			
Processor	One Intel "KabyLake" or "Skylake" processor as listed: "Kaby Lake"																																			
	<table border="1"> <tbody> <tr><td>Xeon E3-1280 v6</td><td>4C/3.9GHz/8MB/72W/DDR4-2400</td></tr> <tr><td>Xeon E3-1275 v6</td><td>4C/3.8GHz/8MB/73W/DDR4-2400</td></tr> <tr><td>Xeon E3-1270 v6</td><td>4C/3.8GHz/8MB/72W/DDR4-2400</td></tr> <tr><td>Xeon E3-1245 v6</td><td>4C/3.7GHz/8MB/73W/DDR4-2400</td></tr> <tr><td>Xeon E3-1240 v6</td><td>4C/3.7GHz/8MB/72W/DDR4-2400</td></tr> <tr><td>Xeon E3-1230 v6</td><td>4C/3.5GHz/8MB/72W/DDR4-2400</td></tr> <tr><td>Xeon E3-1225 v6</td><td>4C/3.3GHz/8MB/73W/DDR4-2400</td></tr> <tr><td>Xeon E3-1220 v6</td><td>4C/3GHz/8MB/72W/DDR4-2400</td></tr> <tr><td>Core i7-7700</td><td>4C/3.6GHz/8MB/65W/DDR4-2400</td></tr> <tr><td>Core i5-7600</td><td>4C/3.5GHz/6MB/65W/DDR4-2400</td></tr> <tr><td>Core i5-7500</td><td>4C/3.4GHz/6MB/65W/DDR4-2400</td></tr> <tr><td>Core i5-7400</td><td>4C/3GHz/6MB/65W/DDR4-2400</td></tr> <tr><td>Core i3-7300</td><td>2C/4GHz/4MB/51W/DDR4-2400</td></tr> <tr><td>Core i3-7100</td><td>2C/3.9GHz/3MB/51W/DDR4-2400</td></tr> </tbody> </table>	Xeon E3-1280 v6	4C/3.9GHz/8MB/72W/DDR4-2400	Xeon E3-1275 v6	4C/3.8GHz/8MB/73W/DDR4-2400	Xeon E3-1270 v6	4C/3.8GHz/8MB/72W/DDR4-2400	Xeon E3-1245 v6	4C/3.7GHz/8MB/73W/DDR4-2400	Xeon E3-1240 v6	4C/3.7GHz/8MB/72W/DDR4-2400	Xeon E3-1230 v6	4C/3.5GHz/8MB/72W/DDR4-2400	Xeon E3-1225 v6	4C/3.3GHz/8MB/73W/DDR4-2400	Xeon E3-1220 v6	4C/3GHz/8MB/72W/DDR4-2400	Core i7-7700	4C/3.6GHz/8MB/65W/DDR4-2400	Core i5-7600	4C/3.5GHz/6MB/65W/DDR4-2400	Core i5-7500	4C/3.4GHz/6MB/65W/DDR4-2400	Core i5-7400	4C/3GHz/6MB/65W/DDR4-2400	Core i3-7300	2C/4GHz/4MB/51W/DDR4-2400	Core i3-7100	2C/3.9GHz/3MB/51W/DDR4-2400							
	Xeon E3-1280 v6	4C/3.9GHz/8MB/72W/DDR4-2400																																		
	Xeon E3-1275 v6	4C/3.8GHz/8MB/73W/DDR4-2400																																		
	Xeon E3-1270 v6	4C/3.8GHz/8MB/72W/DDR4-2400																																		
	Xeon E3-1245 v6	4C/3.7GHz/8MB/73W/DDR4-2400																																		
	Xeon E3-1240 v6	4C/3.7GHz/8MB/72W/DDR4-2400																																		
	Xeon E3-1230 v6	4C/3.5GHz/8MB/72W/DDR4-2400																																		
	Xeon E3-1225 v6	4C/3.3GHz/8MB/73W/DDR4-2400																																		
	Xeon E3-1220 v6	4C/3GHz/8MB/72W/DDR4-2400																																		
	Core i7-7700	4C/3.6GHz/8MB/65W/DDR4-2400																																		
	Core i5-7600	4C/3.5GHz/6MB/65W/DDR4-2400																																		
	Core i5-7500	4C/3.4GHz/6MB/65W/DDR4-2400																																		
	Core i5-7400	4C/3GHz/6MB/65W/DDR4-2400																																		
	Core i3-7300	2C/4GHz/4MB/51W/DDR4-2400																																		
	Core i3-7100	2C/3.9GHz/3MB/51W/DDR4-2400																																		
	"Skylake"	<table border="1"> <tbody> <tr><td>Xeon E3-1275 v5</td><td>4C/3.6GHz/8MB/80W/DDR4-2133</td></tr> <tr><td>Xeon E3-1245 v5</td><td>4C/3.5GHz/8MB/80W/DDR4-2133</td></tr> <tr><td>Xeon E3-1240 v5</td><td>4C/3.5GHz/8MB/80W/DDR4-2133</td></tr> <tr><td>Xeon E3-1230 v5</td><td>4C/3.4GHz/8MB/80W/DDR4-2133</td></tr> <tr><td>Xeon E3-1225 v5</td><td>4C/3.3GHz/8MB/80W/DDR4-2133</td></tr> <tr><td>Xeon E3-1220 v5</td><td>4C/3GHz/8MB/80W/DDR4-2133</td></tr> <tr><td>Core i7-6700</td><td>4C/3.4GHz/8MB/65W/DDR4-2133</td></tr> <tr><td>Core i5-6500</td><td>4C/3.2GHz/6MB/65W/DDR4-2133</td></tr> <tr><td>Core i5-6400</td><td>4C/2.7GHz/6MB/65W/DDR4-2133</td></tr> <tr><td>Core i3-6100</td><td>2C/3.7GHz/3MB/51W/DDR4-2133</td></tr> </tbody> </table>	Xeon E3-1275 v5	4C/3.6GHz/8MB/80W/DDR4-2133	Xeon E3-1245 v5	4C/3.5GHz/8MB/80W/DDR4-2133	Xeon E3-1240 v5	4C/3.5GHz/8MB/80W/DDR4-2133	Xeon E3-1230 v5	4C/3.4GHz/8MB/80W/DDR4-2133	Xeon E3-1225 v5	4C/3.3GHz/8MB/80W/DDR4-2133	Xeon E3-1220 v5	4C/3GHz/8MB/80W/DDR4-2133	Core i7-6700	4C/3.4GHz/8MB/65W/DDR4-2133	Core i5-6500	4C/3.2GHz/6MB/65W/DDR4-2133	Core i5-6400	4C/2.7GHz/6MB/65W/DDR4-2133	Core i3-6100	2C/3.7GHz/3MB/51W/DDR4-2133														
		Xeon E3-1275 v5	4C/3.6GHz/8MB/80W/DDR4-2133																																	
		Xeon E3-1245 v5	4C/3.5GHz/8MB/80W/DDR4-2133																																	
		Xeon E3-1240 v5	4C/3.5GHz/8MB/80W/DDR4-2133																																	
Xeon E3-1230 v5		4C/3.4GHz/8MB/80W/DDR4-2133																																		
Xeon E3-1225 v5		4C/3.3GHz/8MB/80W/DDR4-2133																																		
Xeon E3-1220 v5		4C/3GHz/8MB/80W/DDR4-2133																																		
Core i7-6700		4C/3.4GHz/8MB/65W/DDR4-2133																																		
Core i5-6500		4C/3.2GHz/6MB/65W/DDR4-2133																																		
Core i5-6400		4C/2.7GHz/6MB/65W/DDR4-2133																																		
Core i3-6100	2C/3.7GHz/3MB/51W/DDR4-2133																																			
Memory DIMM slots	4 DIMM slots, 2-channel (integrated memory controller in processor)																																			
Memory type/capacity	Up to 64GB ECC/non-ECC (4 x 16GB), DDR4-2400. UDIMM. "Skylake" processor supports up to DDR4-2133. Core i7 and i5 processors cannot support ECC.																																			
Intel HD Graphics in processor	Integrated Intel HD P530 in Xeon E3-12x5 v5 processors, or Intel HD P630 in Xeon E3-12x5 v6 processors, or Intel HD 530 in Core i7, i5, or i3 6000 processors. or Intel HD 630 in Core i7, i5, or i3 7000 processors. Works along with discrete graphics to support multi-display, enables three display connectors (2 DP, 1 VGA) on rear.																																			
Discrete graphics	Two PCI Express 3.0 x16 slots for graphics adapters. Up to two NVIDIA Quadro P1000. Supports the following NVIDIA graphic adapters:																																			
	<table border="1"> <thead> <tr> <th>Adapter</th> <th>Cores</th> <th>Memory</th> <th>Power</th> <th>Connector</th> </tr> </thead> <tbody> <tr> <td>NVS 310</td> <td>48</td> <td>1GB</td> <td>19.5W</td> <td>2xDP</td> </tr> <tr> <td>NVS 315</td> <td>48</td> <td>1GB</td> <td>19.5W</td> <td>2xDVI-I SL/2xDP</td> </tr> <tr> <td>NVS 510</td> <td>192</td> <td>2GB</td> <td>33.4W</td> <td>4xmini DP</td> </tr> <tr> <td>Quadro P400</td> <td>256</td> <td>2GB</td> <td>30W</td> <td>3xminiDP</td> </tr> <tr> <td>Quadro P600</td> <td>384</td> <td>2GB</td> <td>40W</td> <td>4xminiDP</td> </tr> <tr> <td>Quadro P1000</td> <td>640</td> <td>4GB</td> <td>47W</td> <td>4xminiDP</td> </tr> </tbody> </table>	Adapter	Cores	Memory	Power	Connector	NVS 310	48	1GB	19.5W	2xDP	NVS 315	48	1GB	19.5W	2xDVI-I SL/2xDP	NVS 510	192	2GB	33.4W	4xmini DP	Quadro P400	256	2GB	30W	3xminiDP	Quadro P600	384	2GB	40W	4xminiDP	Quadro P1000	640	4GB	47W	4xminiDP
	Adapter	Cores	Memory	Power	Connector																															
	NVS 310	48	1GB	19.5W	2xDP																															
	NVS 315	48	1GB	19.5W	2xDVI-I SL/2xDP																															
	NVS 510	192	2GB	33.4W	4xmini DP																															
Quadro P400	256	2GB	30W	3xminiDP																																
Quadro P600	384	2GB	40W	4xminiDP																																
Quadro P1000	640	4GB	47W	4xminiDP																																
Onboard drive controller	Five onboard SATA 6.0Gb/s connectors for optical and disk drives plus one SATA connector for optional eSATA. RAID 0, 1, 5* support <i>* RAID 5 needs three 2.5" SSD drives.</i>																																			
Drive Bays	One external 5.25" bay, one internal 3.5" bay (see right). Up to one 9mm optical + 2 x 3.5" disk drive bays + 1 x 2.5" disk drive bay + two M.2 NVMe SSD																																			
Supporting disk drives	<table border="1"> <tbody> <tr> <td>3.5" SATA HDD (7.2K 6Gbs)</td> <td>1TB/2TB/4TB/1TB hybrid/2TB hybrid</td> </tr> <tr> <td>2.5" SATA SSD (6Gbs)</td> <td>256GB Opal/512GB/512GB Opal/1TB Opal/2TB opal</td> </tr> <tr> <td>M.2 NVMe SSD, via PCIe adapter</td> <td>256GB Opal/512GB Opal/1TB Opal, via PCIe 3.0 x4 adapter, up to 2; or 16GB Intel Optane Memory, PCIe 3.0 x2</td> </tr> </tbody> </table>	3.5" SATA HDD (7.2K 6Gbs)	1TB/2TB/4TB/1TB hybrid/2TB hybrid	2.5" SATA SSD (6Gbs)	256GB Opal/512GB/512GB Opal/1TB Opal/2TB opal	M.2 NVMe SSD, via PCIe adapter	256GB Opal/512GB Opal/1TB Opal, via PCIe 3.0 x4 adapter, up to 2; or 16GB Intel Optane Memory, PCIe 3.0 x2																													
	3.5" SATA HDD (7.2K 6Gbs)	1TB/2TB/4TB/1TB hybrid/2TB hybrid																																		
2.5" SATA SSD (6Gbs)	256GB Opal/512GB/512GB Opal/1TB Opal/2TB opal																																			
M.2 NVMe SSD, via PCIe adapter	256GB Opal/512GB Opal/1TB Opal, via PCIe 3.0 x4 adapter, up to 2; or 16GB Intel Optane Memory, PCIe 3.0 x2																																			
Max internal storage	10TB (2 x 4TB 3.5" HDDs + 1 x 2TB 2.5" SSD) plus two 1TB M.2 NVMe SSD																																			
Media reader	9-in-1 card reader. Optional 29-in-1 card reader on selected models																																			
Power supply	One 210 watts with variable speed fan, autosensing, Climate Savers Computing Bronze, 80 PLUS Bronze qualified. Or one 210 watts with variable speed fan, autosensing, Climate Savers Computing Platinum, 80 PLUS Platinum qualified																																			
Onboard Ethernet	One onboard gigabit ethernet, Intel I219LM, supports Wake-on-LAN																																			

Components	Specification
HD Audio	Realtek ALC662 codec
TPM	Standard, TCG 2.0-compliant
Front ports	Two USB 3.1 Gen 1, microphone (3.5mm), headphone (3.5mm)
Rear ports	1 VGA and 2 DisplayPort (for Intel HD Graphics models only), two USB 2.0, four USB 3.1 Gen 1, one serial (9-pin), one ethernet (RJ-45), three analog audio ports (line-in, line-out, mic-in)
Mechanical	<ul style="list-style-type: none"> Raven black color; metal case 4.02"W x 15.53"D x 13.31"H 102mm W x 394.5mm D x 338mm H 17.2 lb (7.9kg) max configuration 12.9-liter
Environmental certifications	GREENGUARD certified/RoHS-compliant/EPEAT Gold rating/ENERGY STAR 6.1 qualified
Limited warranty	1 or 3-year limited onsite service with 9x5/NBD. Some parts are Customer Replaceable Units.
ISV certifications	Please visit www.thinkworkstations.com/isv-certifications/

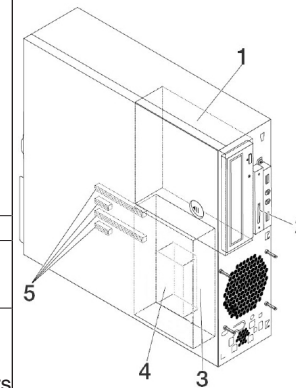

Drive Bays and PCIe Slots

Bay 1	5.25", supports one of the following: HH optical/flex module***/9mm optical+3.5" HDD bay/ 3.5" HDD bay/Front Access Storage Enclosure *** Flex module supports one or more of the following: 9mm optical/ 29-in-1 reader/front IEEE 1394/front eSATA. Up to one flex module is supported per system.
Bay 2	Optional 9-in-1 single slot reader
Bay 3	Standard 3.5" HDD bay
Bay 4	Optional 2.5" HDD bay (under Bay 3)
5 - Slots	Four PCIe slots (top-down): Slot 1: Low Profile, PCIe 3.0 x16 (near CPU) Slot 2: Low Profile, PCIe 3.0 x1 Slot 3: Low Profile, PCIe 3.0 x16 (x4 elec) Slot 4: Low Profile, PCIe 3.0 x1



ThinkStation P320 Tower Platform Specifications

Product Specifications Reference (PSREF)

Components	Specification																																																	
Chipset	Intel C236 Chipset																																																	
Intel AMT	Intel Active Management Technology 11 on Xeon models, Intel Standard Manageability on other models																																																	
Processor	One Intel "Kaby Lake" or "Skylake" processor as listed: "Kaby Lake"																																																	
	<table border="1"> <tbody> <tr><td>Xeon E3-1280 v6</td><td>4C/3.9GHz/8MB/72W/DDR4-2400</td></tr> <tr><td>Xeon E3-1275 v6</td><td>4C/3.8GHz/8MB/73W/DDR4-2400</td></tr> <tr><td>Xeon E3-1270 v6</td><td>4C/3.8GHz/8MB/72W/DDR4-2400</td></tr> <tr><td>Xeon E3-1245 v6</td><td>4C/3.7GHz/8MB/73W/DDR4-2400</td></tr> <tr><td>Xeon E3-1240 v6</td><td>4C/3.7GHz/8MB/72W/DDR4-2400</td></tr> <tr><td>Xeon E3-1230 v6</td><td>4C/3.5GHz/8MB/72W/DDR4-2400</td></tr> <tr><td>Xeon E3-1225 v6</td><td>4C/3.3GHz/8MB/73W/DDR4-2400</td></tr> <tr><td>Xeon E3-1220 v6</td><td>4C/3GHz/8MB/72W/DDR4-2400</td></tr> <tr><td>Core i7-7700K</td><td>4C/4.2GHz/8MB/91W/DDR4-2400</td></tr> <tr><td>Core i7-7700</td><td>4C/3.6GHz/8MB/65W/DDR4-2400</td></tr> <tr><td>Core i5-7600</td><td>4C/3.5GHz/6MB/65W/DDR4-2400</td></tr> <tr><td>Core i5-7500</td><td>4C/3.4GHz/6MB/65W/DDR4-2400</td></tr> <tr><td>Core i5-7400</td><td>4C/3GHz/6MB/65W/DDR4-2400</td></tr> <tr><td>Core i3-7300</td><td>2C/4GHz/4MB/51W/DDR4-2400</td></tr> <tr><td>Core i3-7100</td><td>2C/3.9GHz/3MB/51W/DDR4-2400</td></tr> </tbody> </table> "Skylake" <table border="1"> <tbody> <tr><td>Xeon E3-1275 v5</td><td>4C/3.6GHz/8MB/80W/DDR4-2133</td></tr> <tr><td>Xeon E3-1245 v5</td><td>4C/3.5GHz/8MB/80W/DDR4-2133</td></tr> <tr><td>Xeon E3-1240 v5</td><td>4C/3.5GHz/8MB/80W/DDR4-2133</td></tr> <tr><td>Xeon E3-1230 v5</td><td>4C/3.4GHz/8MB/80W/DDR4-2133</td></tr> <tr><td>Xeon E3-1225 v5</td><td>4C/3.3GHz/8MB/80W/DDR4-2133</td></tr> <tr><td>Xeon E3-1220 v5</td><td>4C/3GHz/8MB/80W/DDR4-2133</td></tr> <tr><td>Core i7-6700</td><td>4C/3.4GHz/8MB/65W/DDR4-2133</td></tr> <tr><td>Core i5-6500</td><td>4C/3.2GHz/6MB/65W/DDR4-2133</td></tr> <tr><td>Core i5-6400</td><td>4C/2.7GHz/6MB/65W/DDR4-2133</td></tr> <tr><td>Core i3-6100</td><td>2C/3.7GHz/3MB/51W/DDR4-2133</td></tr> </tbody> </table>	Xeon E3-1280 v6	4C/3.9GHz/8MB/72W/DDR4-2400	Xeon E3-1275 v6	4C/3.8GHz/8MB/73W/DDR4-2400	Xeon E3-1270 v6	4C/3.8GHz/8MB/72W/DDR4-2400	Xeon E3-1245 v6	4C/3.7GHz/8MB/73W/DDR4-2400	Xeon E3-1240 v6	4C/3.7GHz/8MB/72W/DDR4-2400	Xeon E3-1230 v6	4C/3.5GHz/8MB/72W/DDR4-2400	Xeon E3-1225 v6	4C/3.3GHz/8MB/73W/DDR4-2400	Xeon E3-1220 v6	4C/3GHz/8MB/72W/DDR4-2400	Core i7-7700K	4C/4.2GHz/8MB/91W/DDR4-2400	Core i7-7700	4C/3.6GHz/8MB/65W/DDR4-2400	Core i5-7600	4C/3.5GHz/6MB/65W/DDR4-2400	Core i5-7500	4C/3.4GHz/6MB/65W/DDR4-2400	Core i5-7400	4C/3GHz/6MB/65W/DDR4-2400	Core i3-7300	2C/4GHz/4MB/51W/DDR4-2400	Core i3-7100	2C/3.9GHz/3MB/51W/DDR4-2400	Xeon E3-1275 v5	4C/3.6GHz/8MB/80W/DDR4-2133	Xeon E3-1245 v5	4C/3.5GHz/8MB/80W/DDR4-2133	Xeon E3-1240 v5	4C/3.5GHz/8MB/80W/DDR4-2133	Xeon E3-1230 v5	4C/3.4GHz/8MB/80W/DDR4-2133	Xeon E3-1225 v5	4C/3.3GHz/8MB/80W/DDR4-2133	Xeon E3-1220 v5	4C/3GHz/8MB/80W/DDR4-2133	Core i7-6700	4C/3.4GHz/8MB/65W/DDR4-2133	Core i5-6500	4C/3.2GHz/6MB/65W/DDR4-2133	Core i5-6400	4C/2.7GHz/6MB/65W/DDR4-2133	Core i3-6100
Xeon E3-1280 v6	4C/3.9GHz/8MB/72W/DDR4-2400																																																	
Xeon E3-1275 v6	4C/3.8GHz/8MB/73W/DDR4-2400																																																	
Xeon E3-1270 v6	4C/3.8GHz/8MB/72W/DDR4-2400																																																	
Xeon E3-1245 v6	4C/3.7GHz/8MB/73W/DDR4-2400																																																	
Xeon E3-1240 v6	4C/3.7GHz/8MB/72W/DDR4-2400																																																	
Xeon E3-1230 v6	4C/3.5GHz/8MB/72W/DDR4-2400																																																	
Xeon E3-1225 v6	4C/3.3GHz/8MB/73W/DDR4-2400																																																	
Xeon E3-1220 v6	4C/3GHz/8MB/72W/DDR4-2400																																																	
Core i7-7700K	4C/4.2GHz/8MB/91W/DDR4-2400																																																	
Core i7-7700	4C/3.6GHz/8MB/65W/DDR4-2400																																																	
Core i5-7600	4C/3.5GHz/6MB/65W/DDR4-2400																																																	
Core i5-7500	4C/3.4GHz/6MB/65W/DDR4-2400																																																	
Core i5-7400	4C/3GHz/6MB/65W/DDR4-2400																																																	
Core i3-7300	2C/4GHz/4MB/51W/DDR4-2400																																																	
Core i3-7100	2C/3.9GHz/3MB/51W/DDR4-2400																																																	
Xeon E3-1275 v5	4C/3.6GHz/8MB/80W/DDR4-2133																																																	
Xeon E3-1245 v5	4C/3.5GHz/8MB/80W/DDR4-2133																																																	
Xeon E3-1240 v5	4C/3.5GHz/8MB/80W/DDR4-2133																																																	
Xeon E3-1230 v5	4C/3.4GHz/8MB/80W/DDR4-2133																																																	
Xeon E3-1225 v5	4C/3.3GHz/8MB/80W/DDR4-2133																																																	
Xeon E3-1220 v5	4C/3GHz/8MB/80W/DDR4-2133																																																	
Core i7-6700	4C/3.4GHz/8MB/65W/DDR4-2133																																																	
Core i5-6500	4C/3.2GHz/6MB/65W/DDR4-2133																																																	
Core i5-6400	4C/2.7GHz/6MB/65W/DDR4-2133																																																	
Core i3-6100	2C/3.7GHz/3MB/51W/DDR4-2133																																																	
Memory DIMM slots	4 DIMM slots, 2-channel (integrated memory controller in processor)																																																	
Memory type/capacity	Up to 64GB ECC/non-ECC (4 x 16GB), DDR4-2400. UDIMM. "Skylake" processor supports up to DDR4-2133. Core i7 and i5 processors cannot support ECC.																																																	
Intel HD Graphics in processor	Integrated Intel HD P530 in Xeon E3-12x5 v5 processors, or Intel HD P630 in Xeon E3-12x5 v6 processors, or Intel HD 530 in Core i7, i5, or i3 6000 processors, or Intel HD 630 in Core i7, i5, or i3 7000 processors. Works along with discrete graphics to support multi-display, enables three display connectors (2 DP, 1 VGA) on rear.																																																	
Discrete graphics	Two PCI Express 3.0 x16 slots for graphics adapters. Up to two Quadro P1000 on 250 watts models. Or up to two Quadro P2000, or up to one Quadro P4000 on 400 watts models. Supports the following NVIDIA graphics adapters:																																																	
	<table border="1"> <thead> <tr> <th>Adapter</th> <th>Cores</th> <th>Memory</th> <th>Power</th> <th>Connector</th> </tr> </thead> <tbody> <tr><td>NVS 310</td><td>48</td><td>1GB</td><td>19.5W</td><td>2xDP</td></tr> <tr><td>NVS 315</td><td>48</td><td>1GB</td><td>19.5W</td><td>2xDVI-I SL/2xDP</td></tr> <tr><td>NVS 510</td><td>192</td><td>2GB</td><td>33.4W</td><td>4xmini DP</td></tr> <tr><td>NVS 810</td><td>1024</td><td>4GB</td><td>68W</td><td>8xmini DP</td></tr> <tr><td>Quadro P400</td><td>256</td><td>2GB</td><td>30W</td><td>3xminiDP</td></tr> <tr><td>Quadro P600</td><td>384</td><td>2GB</td><td>40W</td><td>4xminiDP</td></tr> <tr><td>Quadro P1000</td><td>640</td><td>4GB</td><td>47W</td><td>4xminiDP</td></tr> <tr><td>Quadro P2000</td><td>1024</td><td>5GB</td><td>75W</td><td>4xDP</td></tr> <tr><td>Quadro P4000</td><td>1792</td><td>8GB</td><td>105W</td><td>4xDP</td></tr> </tbody> </table>	Adapter	Cores	Memory	Power	Connector	NVS 310	48	1GB	19.5W	2xDP	NVS 315	48	1GB	19.5W	2xDVI-I SL/2xDP	NVS 510	192	2GB	33.4W	4xmini DP	NVS 810	1024	4GB	68W	8xmini DP	Quadro P400	256	2GB	30W	3xminiDP	Quadro P600	384	2GB	40W	4xminiDP	Quadro P1000	640	4GB	47W	4xminiDP	Quadro P2000	1024	5GB	75W	4xDP	Quadro P4000	1792	8GB	105W
Adapter	Cores	Memory	Power	Connector																																														
NVS 310	48	1GB	19.5W	2xDP																																														
NVS 315	48	1GB	19.5W	2xDVI-I SL/2xDP																																														
NVS 510	192	2GB	33.4W	4xmini DP																																														
NVS 810	1024	4GB	68W	8xmini DP																																														
Quadro P400	256	2GB	30W	3xminiDP																																														
Quadro P600	384	2GB	40W	4xminiDP																																														
Quadro P1000	640	4GB	47W	4xminiDP																																														
Quadro P2000	1024	5GB	75W	4xDP																																														
Quadro P4000	1792	8GB	105W	4xDP																																														
Onboard drive controller	Five onboard SATA 6.0Gb/s connectors for optical and disk drives plus one SATA connector for optional eSATA. RAID 0, 1, 5, 10 support																																																	
Drive Bays	Two external 5.25" bays, two internal 3.5" bays (see right). Up to one 9mm optical plus 4 x 3.5" disk drive bays plus two M.2 NVMe SSD																																																	
Supporting disk drives	<table border="1"> <tbody> <tr><td>3.5" SATA HDD (7.2K 6Gbs)</td><td>1TB/2TB/4TB/1TB hybrid/2TB hybrid</td></tr> <tr><td>2.5" SATA SSD (6Gbs)</td><td>256GB Opal/512GB/512GB Opal/1TB Opal/2TB opal</td></tr> <tr><td>M.2 NVMe SSD, via PCIe adapter</td><td>256GB Opal/512GB Opal/1TB Opal, PCIe 3.0 x4, up to 2; or 16GB Intel Optane Memory. PCIe 3.0 x2</td></tr> </tbody> </table>	3.5" SATA HDD (7.2K 6Gbs)	1TB/2TB/4TB/1TB hybrid/2TB hybrid	2.5" SATA SSD (6Gbs)	256GB Opal/512GB/512GB Opal/1TB Opal/2TB opal	M.2 NVMe SSD, via PCIe adapter	256GB Opal/512GB Opal/1TB Opal, PCIe 3.0 x4, up to 2; or 16GB Intel Optane Memory. PCIe 3.0 x2																																											
3.5" SATA HDD (7.2K 6Gbs)	1TB/2TB/4TB/1TB hybrid/2TB hybrid																																																	
2.5" SATA SSD (6Gbs)	256GB Opal/512GB/512GB Opal/1TB Opal/2TB opal																																																	
M.2 NVMe SSD, via PCIe adapter	256GB Opal/512GB Opal/1TB Opal, PCIe 3.0 x4, up to 2; or 16GB Intel Optane Memory. PCIe 3.0 x2																																																	
Max internal storage	16TB (4 x 4TB 3.5" HDDs) plus 2TB (2 x 1TB) M.2 NVMe SSD																																																	
Media reader	9-in-1 card reader. Optional 29-in-1 card reader on selected models																																																	

Components	Specification
Power supply	One 250 watts with variable speed fan, autosensing, Climate Savers Computing Bronze, 80 PLUS Bronze qualified. Or one 400 watts with variable speed fan, autosensing, Climate Savers Computing Platinum, 80 PLUS Platinum qualified.
Onboard Ethernet	One onboard gigabit ethernet, Intel I219LM, supports Wake-on-LAN
HD Audio	Realtek ALC662 codec
TPM	Standard, TCG 2.0-compliant
Front ports	Two USB 3.1 Gen 1, microphone (3.5mm), headphone (3.5mm)
Rear ports	1 VGA and 2 DisplayPort (for Intel HD Graphics models only), two USB 2.0, four USB 3.1 Gen 1, one serial (9-pin), one ethernet (RJ-45), three analog audio ports (line-in, line-out, mic-in)
Mechanical	<ul style="list-style-type: none"> Raven black color; metal case 6.89"W x 16.77"D x 14.8"H 175mm W x 426mm D x 376mm H 28.66 lb (13kg) max configuration 25-liter
Environmental certifications	GREENGUARD certified/RoHS-compliant/EPEAT Gold rating/ENERGY STAR 6.1 qualified
Limited warranty	1 or 3-year limited onsite service with 9x5/NBD. Some parts are Customer Replaceable Units.
ISV certifications	Please visit www.thinkworkstations.com/isv-certifications/

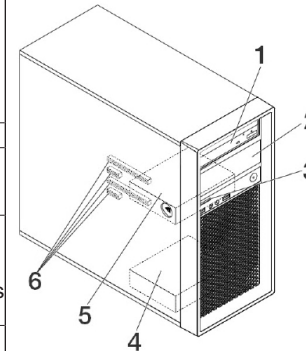

Drive Bays and PCIe Slots

Bay 1 and Bay 2	5.25", support one of the following: HH optical/flex module/9mm optical+3.5" HDD bay/ 3.5" HDD bay/Front Access Storage Enclosure (FASE) <i>Note:</i> 1. Flex module supports one or more of the following: 9mm optical/ 29-in-1 reader/front IEEE 1394/front eSATA. 2. Up to one flex module/FASE per system.
Bay 3	Optional 9-in-1 single slot reader
Bay 4	Standard 3.5" HDD bay
Bay 5	Standard 3.5" HDD bay
6 -Slots	Four PCIe slots (top-down): Slot 1: Half length, full height, PCIe 3.0 x16 (near CPU) Slot 2: Half length, full height, PCIe 3.0 x1 Slot 3: Half length, full height, PCIe 3.0 x16 (x4 elec) Slot 4: Half length, full height, PCIe 3.0 x1 <i>Note:</i> 1. Both discrete graphics adapter and M.2 NVMe SSD should be installed on slot 1 or slot 3, the maximum quantity of discrete graphics adapter and M.2 NVMe SSD is 2. 2. When two discrete graphics adapters are used, no other PCIe card can be used.



ThinkStation P330 SFF Gen 2 (30D1 and 30D2) Platform Specifications

Product Specifications Reference (PSREF)

Components	Specification																														
Form factor	8.4L mini-tower																														
Dimensions	Height: 343.5 mm (13.5 in). Width: 92.5 mm (3.6 in). Depth: 305.6 mm (12 in)																														
Weight	Maximum configuration: 13.23 lb (6.0kg) Supports one of the following processor:																														
Processor	Xeon E-2278G 8C/16T/3.4GHz/16MB/80W/DDR4-2666 (260W PSU needed)																														
	Xeon E-2276G 6C/12T/3.8GHz/12MB/80W/DDR4-2666																														
	Xeon E-2274G 4C/8T/4.0GHz/8MB/83W/DDR4-2666																														
	Xeon E-2246G 6C/12T/3.6GHz/12MB/80W/DDR4-2666																														
	Xeon E-2244G 4C/8T/3.8GHz/8MB/71W/DDR4-2666																														
	Xeon E-2236 6C/12T/3.4GHz/12MB/80W/DDR4-2666																														
	Xeon E-2234 4C/8T/3.6GHz/8MB/71W/DDR4-2666																														
	Xeon E-2226G 6C/6T/3.4GHz/12MB/80W/DDR4-2666																														
	Xeon E-2224G 4C/4T/3.5GHz/8MB/71W/DDR4-2666																														
	Xeon E-2224 4C/4T/3.4GHz/8MB/71W/DDR4-2666																														
	Xeon E-2174G 4C/8T/3.8GHz/8MB/71W/DDR4-2666																														
	Core i9-9900 8C/16T/3.1GHz/16MB/65W/DDR4-2666																														
	Core i7-9700 8C/8T/3.0GHz/12MB/65W/DDR4-2666																														
	Core i7-8700 6C/12T/3.2GHz/12MB/65W/DDR4-2666																														
	Core i5-9600 6C/6T/3.1GHz/9MB/65W/DDR4-2666																														
	Core i5-9500 6C/6T/3.0GHz/9MB/65W/DDR4-2666																														
	Core i5-9400 6C/6T/2.9GHz/9MB/65W/DDR4-2666																														
	Core i5-8500 6C/6T/3.0GHz/9MB/65W/DDR4-2666																														
	Core i3-9300 4C/4T/3.7GHz/8MB/62W/DDR4-2400																														
	Core i3-9100 4C/4T/3.6GHz/6MB/65W/DDR4-2400																														
	Core i3-8300 4C/4T/3.7GHz/8MB/62W/DDR4-2400																														
Core i3-8100 4C/4T/3.6GHz/6MB/65W/DDR4-2400																															
Pentium Gold G5620 2C/4T/4.0GHz/4MB/54W/DDR4-2400																															
Chipset	Intel C246 Chipset																														
Memory Sockets	4 DIMM sockets with 2 channels																														
Memory Types	8GB/16GB DDR4-2666 UDIMM ECC or 4GB/8GB/16GB/32GB DDR4-2666 UDIMM non-ECC																														
Memory Capacity	64GB with 4 x 16GB for UDIMM ECC or 128GB with 4 x 32GB UDIMM non-ECC																														
Memory Protection	ECC on models with UDIMM ECC memory																														
Expansion slots	Three PCIe 3.0 slots as following:																														
	Slot 1 PCIe 3.0 x16, low profile, links to CPU																														
	Slot 2 PCIe 3.0 x1, low profile, links to PCH																														
Processor graphics	Slot 3 PCIe 3.0 x16 (negotiable link width x4), low profile, links to PCH																														
	Integrated Intel UHD Graphics P630 in -G suffix Xeon processors, or Intel UHD Graphics 630 in Core i5 or i3 processors.																														
	Works along with discrete graphics to support multi-display, enables three rear display connectors (2 DP standard, 1 DP or HDMI optional)																														
Discrete graphics card	Up to two PCIe 3.0 x16 slots for discrete graphics adapter (Slot 1 and 3). Supports the following graphics adapters:																														
	<table border="1"> <thead> <tr> <th>Adapter</th> <th>Cores</th> <th>Memory</th> <th>Power</th> <th>Connectors</th> <th>Max qty</th> </tr> </thead> <tbody> <tr> <td>Quadro P400</td> <td>256</td> <td>2GB GDDR5</td> <td>30W</td> <td>3x miniDP</td> <td>2</td> </tr> <tr> <td>Quadro P620</td> <td>512</td> <td>2GB GDDR5</td> <td>40W</td> <td>4x miniDP</td> <td>2</td> </tr> <tr> <td>Quadro P1000</td> <td>640</td> <td>4GB GDDR5</td> <td>47W</td> <td>4x miniDP</td> <td>2</td> </tr> </tbody> </table>	Adapter	Cores	Memory	Power	Connectors	Max qty	Quadro P400	256	2GB GDDR5	30W	3x miniDP	2	Quadro P620	512	2GB GDDR5	40W	4x miniDP	2	Quadro P1000	640	4GB GDDR5	47W	4x miniDP	2						
	Adapter	Cores	Memory	Power	Connectors	Max qty																									
	Quadro P400	256	2GB GDDR5	30W	3x miniDP	2																									
Quadro P620	512	2GB GDDR5	40W	4x miniDP	2																										
Quadro P1000	640	4GB GDDR5	47W	4x miniDP	2																										
Storage Controller	<table border="1"> <thead> <tr> <th>Storage Controller</th> <th>Type</th> <th>Interface</th> <th>Disk Type</th> <th>RAID</th> </tr> </thead> <tbody> <tr> <td>Onboard Intel RST SATA RAID</td> <td>Std</td> <td>SATA 6Gb/s</td> <td>HDD or SSD</td> <td>0/1</td> </tr> <tr> <td>Onboard Intel RST PCIe RAID</td> <td>Std</td> <td>PCIe NVMe</td> <td>M.2 PCIe SSD</td> <td>0/1</td> </tr> </tbody> </table>	Storage Controller	Type	Interface	Disk Type	RAID	Onboard Intel RST SATA RAID	Std	SATA 6Gb/s	HDD or SSD	0/1	Onboard Intel RST PCIe RAID	Std	PCIe NVMe	M.2 PCIe SSD	0/1															
Storage Controller	Type	Interface	Disk Type	RAID																											
Onboard Intel RST SATA RAID	Std	SATA 6Gb/s	HDD or SSD	0/1																											
Onboard Intel RST PCIe RAID	Std	PCIe NVMe	M.2 PCIe SSD	0/1																											
Storage Support	Notes: M.2 SSD support is limited, please see Storage bay section for more information																														
	<table border="1"> <thead> <tr> <th>Disk Type</th> <th>Interface</th> <th>RPM</th> <th>Offering</th> <th>Max Qty</th> </tr> </thead> <tbody> <tr> <td>3.5" SATA HDD</td> <td>SATA 6Gb/s</td> <td>7.2K</td> <td>1TB/2TB/4TB</td> <td>1</td> </tr> <tr> <td>2.5" SATA HDD</td> <td>SATA 6Gb/s</td> <td>7.2K</td> <td>500GB FIPS</td> <td>2</td> </tr> <tr> <td>2.5" SATA SSD</td> <td>SATA 6Gb/s</td> <td></td> <td>256GB/512GB/1TB</td> <td>2</td> </tr> <tr> <td>Optane Memory</td> <td>PCIe NVMe</td> <td></td> <td>32GB</td> <td>1, used with HDD/SSD</td> </tr> <tr> <td>M.2 PCIe SSD</td> <td>PCIe NVMe</td> <td></td> <td>256GB/512GB/1TB</td> <td>3</td> </tr> </tbody> </table>	Disk Type	Interface	RPM	Offering	Max Qty	3.5" SATA HDD	SATA 6Gb/s	7.2K	1TB/2TB/4TB	1	2.5" SATA HDD	SATA 6Gb/s	7.2K	500GB FIPS	2	2.5" SATA SSD	SATA 6Gb/s		256GB/512GB/1TB	2	Optane Memory	PCIe NVMe		32GB	1, used with HDD/SSD	M.2 PCIe SSD	PCIe NVMe		256GB/512GB/1TB	3
	Disk Type	Interface	RPM	Offering	Max Qty																										
	3.5" SATA HDD	SATA 6Gb/s	7.2K	1TB/2TB/4TB	1																										
	2.5" SATA HDD	SATA 6Gb/s	7.2K	500GB FIPS	2																										
2.5" SATA SSD	SATA 6Gb/s		256GB/512GB/1TB	2																											
Optane Memory	PCIe NVMe		32GB	1, used with HDD/SSD																											
M.2 PCIe SSD	PCIe NVMe		256GB/512GB/1TB	3																											

Components	Specification
Storage bay	Up to 3 bays with two disk bays and one slim optical bay:
	Bay 1 Primary 3.5" SATA bay
	Bay 2 2.5" SATA bay (Optional)
	Bay 3 9mm Slim ODD bay
M.2	3x M.2 SSD (1 onboard, 2 via PCIe to M.2 adapter) Notes: Support 1x M.2 SSD at present, 3x M.2 SSD support is pending availability
M.2 slot for Wi-Fi and Bluetooth	One dedicated onboard M.2 slot for optional Intel Wireless-AC 9560, 2x2, 2.4GHz/5GHz (160MHz channels), 802.11ac, Bluetooth 5, up to 1.73Gbps
Media reader	Optional SD card reader on most models
Network interfaces	One onboard GbE port via integrated gigabit ethernet Intel i219LM, supports Wake-on-LAN. Optional PCIe ethernet adapters are available
Security features	Power-on and admin password. Trusted Platform Module, TCG 2.0 compliant. Optional chassis intrusion switch, cable lock, Kensington lock, and pad lock
Intel vPro	Supports Intel vPro on Xeon models. vPro also requires Wireless-AC 9560 if Wi-Fi is needed
Intel AMT	Intel Active Management Technology 12 on Xeon models, Intel Standard Manageability on other models
Base warranty	US models comes with 3-year limited onsite service with 9x5/NBD. 1 or 3-year limited onsite service with 9x5/NBD in EMEA or other GEOs
HD Audio	Intel HD Audio interface with Realtek ALC233 Codec
Front ports	2x USB 3.1 Gen 1 Type A. 2x USB 3.1 Gen 2 Type A. 1x USB 3.1 Gen 1 Type-C. 1x Mic-in. 1x Combo jack
Rear ports	2x USB 3.1 Gen 1 Type A. 2x USB 2.0 Type-A. 1x RJ-45. 1x COM. 2x DP. 1x Audio line-out Notes: DP needs Core, Pentium, or -G suffix Xeon processor
Optional rear ports	Supports the following via cable: 1x COM. 1x Parallel. 2x PS/2. 1x DP or 1x HDMI. 2x USB 2.0
	Supports the following via PCIe adapter: 4x COM. 2x USB 3.1 Type-C. 2x USB 3.1 Gen 1. 1x Thunderbolt. Notes: DP or HDMI needs Core, Pentium, or -G suffix Xeon processor
Temperature	Operating: 50 °F to 95 °F (10 °C to 35 °C) Non operating (no package): 14 °F to 140 °F (-10 °C to 60 °C) Non operating (with package): -40 °F to 140 °F (-40 °C to 60 °C)
Altitude	Operating: -15.2 m (-50 ft) to 3048 m (10 000 ft). Storage: -15.2 m (-50 ft) to 10, 668 m (35 000 ft)
Humidity	Operating: 30%~90%, non-condensing Storage (with package): 20%~90%, non-condensing
Environmental certification	RoHS-compliant. GREENGUARD. EPEAT Silver rating and ENERGY STAR 7 qualified
Power supply	Supports one 210W or 260W power supply. 210W is 100V - 240V, 85% PSU, Climate Savers Computing Bronze and 80 PLUS Bronze qualified. 260W is 100V - 240V, 92% PSU, Climate Savers Computing Platinum and 80 PLUS Platinum qualified
ISV certifications	Please visit www.thinkworkstations.com/isv-certifications/

Note:
1. Depending on many factors, actual data transfer speed mentioned on this page may be lower than theoretical speed.
2. Any questions or advice on ThinkStation PSREF, please contact [ThinkStation PSREF developer](mailto:ThinkStation_PSREF_developer@lenovo.com)

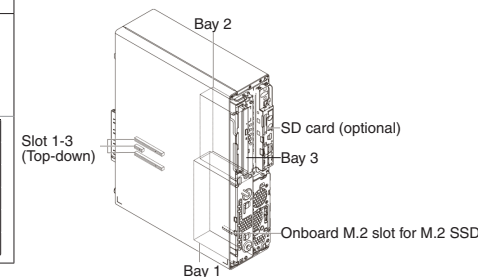



ThinkStation P330 Tiny Platform Specifications - I of II

Components	Specification	Components	Specification															
Form factor	1L. Optional VESA mount bracket kit, supports VESA 75mm and 100mm. Optional floor stand for vertical orientation. Optional tool-less chassis open. Optional dust filter	Expansion slots	One PCIe slot via specific riser card: PCIe 3.0 x16 (negotiable link width x8) and low profile for discrete graphics card; PCIe 3.0 x4 and low profile for i350-T4 adapter and quad COM ports adapter															
Dimensions	Height: 179 mm (7.0 in). Width: 36.5 mm (1.437 in). Depth: 182.9 mm (7.2 in)	Graphics	65W or 62W processor models supports processor graphics only. 35W processor models come with processor graphics plus a discrete graphics adapter															
Weight	Maximum configuration: 3.08 lb (1.4kg)	Graphics - Processor graphics	Integrated Intel UHD Graphics 630. Works along with discrete graphics to support multi-display															
Recommended monitors	Lenovo recommends ThinkVision P series monitors for best display performance and productivity	Graphics - Discrete graphics card	One of the following discrete graphics cards on 35W processor models: <table border="1"> <thead> <tr> <th>Adapter</th> <th>Cores</th> <th>Memory</th> <th>Power</th> <th>Connectors</th> </tr> </thead> <tbody> <tr> <td>Quadro P620</td> <td>512</td> <td>2GB GDDR5</td> <td>40W</td> <td>4x miniDP</td> </tr> <tr> <td>Quadro P1000</td> <td>640</td> <td>4GB GDDR5</td> <td>47W</td> <td>4x miniDP</td> </tr> </tbody> </table>	Adapter	Cores	Memory	Power	Connectors	Quadro P620	512	2GB GDDR5	40W	4x miniDP	Quadro P1000	640	4GB GDDR5	47W	4x miniDP
Adapter	Cores	Memory	Power	Connectors														
Quadro P620	512	2GB GDDR5	40W	4x miniDP														
Quadro P1000	640	4GB GDDR5	47W	4x miniDP														
Processor	Supports one of the following:								Storage controllers	Integrated Intel SATA AHCI controller in chipset, 6Gbps SATA, one onboard SATA port for 2.5" HDD								
	Processor Number	Cores	Threads	Base Frequency	Cache	TDP	Memory Types	Processor Graphics	Internal storage bay	Up to one 2.5" HDD on models without discrete graphics card								
	Core i9-9900T	8	16	2.1GHz	16MB	35W	DDR4-2666	Intel UHD Graphics 630	Disks	2.5" HDD supports up to 1TB, 6Gbps SATA, 7.2K or 5.4K								
	Core i7-9700T	8	8	2.0GHz	12MB	35W	DDR4-2666	Intel UHD Graphics 630	M.2 slot for SSD	Two onboard M.2 slots for M.2 SSD, one for M.2 2280 SSD, one for M.2 2280 or 2242 SSD								
	Core i5-9600T	6	6	2.3GHz	9MB	35W	DDR4-2666	Intel UHD Graphics 630	M.2 SSD	M.2 2280 SSD supports up to 1TB each, PCIe 3.0 x4, NVMe, optional Opal. M.2 2242 SSD supports up to 128GB, PCIe 3.0 x2, NVMe								
	Core i5-9600	6	6	3.1GHz	9MB	65W	DDR4-2666	Intel UHD Graphics 630	Optane memory	Up to one 16GB Optane memory per system. Optane memory must work with a 2.5" HDD								
	Core i5-9500T	6	6	2.2GHz	9MB	35W	DDR4-2666	Intel UHD Graphics 630	M.2 slot for Wi-Fi and Bluetooth	One dedicated M.2 2230 slot for optional Wi-Fi card, supports one of the following: Intel Wireless-AC 9560, 2x2, 2.4GHz/5GHz (160MHz channels), 802.11ac, Bluetooth 5, up to 1.73Gbps. Intel Wireless-AC 8265, 2x2, 2.4GHz/5GHz, 802.11ac, Bluetooth 4.2, up to 867Mbps. <i>Note: Wi-Fi card, or specific functions of Wi-Fi card may not be supported in some countries</i>								
	Core i5-9500	6	6	3.0GHz	9MB	65W	DDR4-2666	Intel UHD Graphics 630	Wi-Fi antenna	Optional Tiny 2.4GHz/5GHz SMA antenna kit								
	Core i5-9400T	6	6	1.8GHz	9MB	35W	DDR4-2666	Intel UHD Graphics 630	Optical	Optional one 9.0mm optical drive via optical drive kit, DVD-ROM or DVD±RW. VESA mount is required								
	Core i5-9400	6	6	2.9GHz	9MB	65W	DDR4-2666	Intel UHD Graphics 630	Media reader	None. Using USB adapter								
	Core i3-9320	4	4	3.7GHz	8MB	62W	DDR4-2400	Intel UHD Graphics 630	Network interfaces	One onboard GbE port via integrated gigabit ethernet Intel i219LM, supports Wake-on-LAN. Optional Intel i350-T4 for 4x GbE ports, using PCIe slot								
	Core i3-9300T	4	4	3.2GHz	8MB	35W	DDR4-2400	Intel UHD Graphics 630	Security features	Power-on and admin password. Trusted Platform Module, TCG 2.0 compliant. Chassis intrusion switch. Optional Kensington lock								
	Core i3-9300	4	4	3.7GHz	8MB	62W	DDR4-2400	Intel UHD Graphics 630	Intel vPro Technology	Supports vPro on models with the following processors: Core i7-8700T, Core i7-8700, Core i5-8600T, Core i5-8600, Core i5-8500T, Core i5-8500. vPro also requires Wireless-AC 9560 if Wi-Fi is needed								
	Core i3-9100T	4	4	3.1GHz	6MB	35W	DDR4-2400	Intel UHD Graphics 630	Systems management	Intel Active Management Technology 12 on vPro models, Intel Standard Manageability on other models								
	Core i3-9100	4	4	3.6GHz	6MB	65W	DDR4-2400	Intel UHD Graphics 630	Base warranty	US models comes with 3-year limited onsite service with 9x5/NBD. 1 or 3-year limited onsite service with 9x5/NBD in EMEA or other GEOs								
	Core i7-8700T	6	12	2.4GHz	12MB	35W	DDR4-2666	Intel UHD Graphics 630	HD Audio	Intel HD Audio interface with Realtek ALC233 Codec								
	Core i7-8700	6	12	3.2GHz	12MB	65W	DDR4-2666	Intel UHD Graphics 630	Front standard ports	1x USB 3.1 Gen 1 Type A (charging). 1x USB 3.1 Gen 1 Type-C. 1x Mic-in. 1x Combo jack								
	Core i5-8600T	6	6	2.3GHz	9MB	35W	DDR4-2666	Intel UHD Graphics 630	Rear standard ports	2x USB 3.1 Gen 2 Type A. 2x USB 3.1 Gen 1 Type-A. 1x RJ-45. 1x DP. 1x HDMI								
	Core i5-8600	6	6	3.1GHz	9MB	65W	DDR4-2666	Intel UHD Graphics 630	Optional rear ports - via punch out cable	Up to two optional rear ports via punch out cable. Port 1 supports one of the following: 1x USB 3.1 Gen 1 Type-C, also supports DP function. 1x COM. 1x VGA. 1x DP. 1x HDMI. Port 2 supports one COM								
	Core i5-8500T	6	6	2.1GHz	9MB	35W	DDR4-2666	Intel UHD Graphics 630										
	Core i5-8500	6	6	3.0GHz	9MB	65W	DDR4-2666	Intel UHD Graphics 630										
	Core i5-8400T	6	6	1.7GHz	9MB	35W	DDR4-2666	Intel UHD Graphics 630										
	Core i5-8400	6	6	2.8GHz	9MB	65W	DDR4-2666	Intel UHD Graphics 630										
	Core i3-8300T	4	4	3.2GHz	8MB	35W	DDR4-2400	Intel UHD Graphics 630										
	Core i3-8300	4	4	3.7GHz	8MB	62W	DDR4-2400	Intel UHD Graphics 630										
	Core i3-8100T	4	4	3.1GHz	6MB	35W	DDR4-2400	Intel UHD Graphics 630										
	Core i3-8100	4	4	3.6GHz	6MB	65W	DDR4-2400	Intel UHD Graphics 630										
	Chipset	Intel Q370 Chipset																
Memory	2 DIMM sockets. DDR4-2666. SoDIMM. Non-ECC																	
Memory Capacity	64GB (2x 32GB)																	

ThinkStation P330 Tiny Platform Specifications - II of II

Product Specifications Reference (PSREF)

Components	Specification
Optional rear ports - via PCIe adapter	Supports one of the following: 4x miniDP with Quadro P620 or P1000, 35W processor models only 2x USB 3.1 Gen 1. 4x RJ-45 GbE with Intel I350-T4. 4x COM <i>Note: Punch out cable and PCIe adapter are mutually exclusive</i>
Temperature	Operating: 50 °F to 95 °F (10 °C to 35 °C) Non operating (with package): -40 °F to 140 °F (-40 °C to 60 °C)
Altitude	Operating: -15.2 m (-50 ft) to 3048 m (10 000 ft). Storage: -15.2 m (-50 ft) to 10, 668 m (35 000 ft)
Humidity	Operating: 20%~80%, non-condensing Storage (with package): 20%~90%, non-condensing
MIL-SPEC	Certified
Environmental certification	RoHS-compliant. GREENGUARD. EPEAT Silver rating and ENERGY STAR 7 qualified
Power supply	Supports one 135W power adapter, 100V - 240V, 88% PSU
ISV certifications	Please visit www.thinkworkstations.com/isv-certifications/



ThinkStation P330 Tower Gen 2 (30CY and 30D0) Platform Specifications - I of II

Product Specifications Reference (PSREF)

Components	Specification																																																																																																																
Form factor	18L Tower																																																																																																																
Dimensions	Height: 376 mm (14.8 in). Width: 165 mm (6.5 in). Depth: 328 mm (12.9 in)																																																																																																																
Weight	Maximum configuration: 28.22 lb (12.8kg)																																																																																																																
Processor	Supports one of the following processors:																																																																																																																
	<table border="1"> <thead> <tr> <th>Processor</th> <th>Cache</th> <th>Power</th> <th>PSU</th> </tr> </thead> <tbody> <tr><td>Xeon E-2286G</td><td>6C/12T/4.0GHz/12MB/95W/DDR4-2666</td><td>400W PSU needed</td><td></td></tr> <tr><td>Xeon E-2278G</td><td>8C/16T/3.4GHz/16MB/80W/DDR4-2666</td><td>400W PSU needed</td><td></td></tr> <tr><td>Xeon E-2276G</td><td>6C/12T/3.8GHz/12MB/80W/DDR4-2666</td><td></td><td></td></tr> <tr><td>Xeon E-2274G</td><td>4C/8T/4.0GHz/8MB/83W/DDR4-2666</td><td></td><td></td></tr> <tr><td>Xeon E-2246G</td><td>6C/12T/3.6GHz/12MB/80W/DDR4-2666</td><td></td><td></td></tr> <tr><td>Xeon E-2244G</td><td>4C/8T/3.8GHz/8MB/71W/DDR4-2666</td><td></td><td></td></tr> <tr><td>Xeon E-2236</td><td>6C/12T/3.4GHz/12MB/80W/DDR4-2666</td><td></td><td></td></tr> <tr><td>Xeon E-2234</td><td>4C/8T/3.6GHz/8MB/71W/DDR4-2666</td><td></td><td></td></tr> <tr><td>Xeon E-2226G</td><td>6C/6T/3.4GHz/12MB/80W/DDR4-2666</td><td></td><td></td></tr> <tr><td>Xeon E-2224G</td><td>4C/4T/3.5GHz/8MB/71W/DDR4-2666</td><td></td><td></td></tr> <tr><td>Xeon E-2224</td><td>4C/4T/3.4GHz/8MB/71W/DDR4-2666</td><td></td><td></td></tr> <tr><td>Xeon E-2186G</td><td>6C/12T/3.8GHz/12MB/95W/DDR4-2666</td><td>400W PSU needed</td><td></td></tr> <tr><td>Xeon E-2174G</td><td>4C/8T/3.8GHz/8MB/71W/DDR4-2666</td><td></td><td></td></tr> <tr><td>Core i9-9900K</td><td>8C/16T/3.6GHz/16MB/95W/DDR4-2666</td><td>400W PSU needed</td><td></td></tr> <tr><td>Core i9-9900</td><td>8C/16T/3.1GHz/16MB/65W/DDR4-2666</td><td></td><td></td></tr> <tr><td>Core i7-9700K</td><td>8C/8T/3.6GHz/12MB/95W/DDR4-2666</td><td>400W PSU needed</td><td></td></tr> <tr><td>Core i7-9700</td><td>8C/8T/3.0GHz/12MB/65W/DDR4-2666</td><td></td><td></td></tr> <tr><td>Core i7-8700</td><td>6C/12T/3.2GHz/12MB/65W/DDR4-2666</td><td></td><td></td></tr> <tr><td>Core i5-9600K</td><td>6C/6T/3.7GHz/9MB/95W/DDR4-2666</td><td>400W PSU needed</td><td></td></tr> <tr><td>Core i5-9600</td><td>6C/6T/3.1GHz/9MB/65W/DDR4-2666</td><td></td><td></td></tr> <tr><td>Core i5-9500</td><td>6C/6T/3.0GHz/9MB/65W/DDR4-2666</td><td></td><td></td></tr> <tr><td>Core i5-9400</td><td>6C/6T/2.9GHz/9MB/65W/DDR4-2666</td><td></td><td></td></tr> <tr><td>Core i5-8500</td><td>6C/6T/3.0GHz/9MB/65W/DDR4-2666</td><td></td><td></td></tr> <tr><td>Core i3-9300</td><td>4C/4T/3.7GHz/8MB/62W/DDR4-2400</td><td></td><td></td></tr> <tr><td>Core i3-9100</td><td>4C/4T/3.6GHz/6MB/65W/DDR4-2400</td><td></td><td></td></tr> <tr><td>Core i3-8300</td><td>4C/4T/3.7GHz/8MB/62W/DDR4-2400</td><td></td><td></td></tr> <tr><td>Core i3-8100</td><td>4C/4T/3.6GHz/6MB/65W/DDR4-2400</td><td></td><td></td></tr> </tbody> </table>	Processor	Cache	Power	PSU	Xeon E-2286G	6C/12T/4.0GHz/12MB/95W/DDR4-2666	400W PSU needed		Xeon E-2278G	8C/16T/3.4GHz/16MB/80W/DDR4-2666	400W PSU needed		Xeon E-2276G	6C/12T/3.8GHz/12MB/80W/DDR4-2666			Xeon E-2274G	4C/8T/4.0GHz/8MB/83W/DDR4-2666			Xeon E-2246G	6C/12T/3.6GHz/12MB/80W/DDR4-2666			Xeon E-2244G	4C/8T/3.8GHz/8MB/71W/DDR4-2666			Xeon E-2236	6C/12T/3.4GHz/12MB/80W/DDR4-2666			Xeon E-2234	4C/8T/3.6GHz/8MB/71W/DDR4-2666			Xeon E-2226G	6C/6T/3.4GHz/12MB/80W/DDR4-2666			Xeon E-2224G	4C/4T/3.5GHz/8MB/71W/DDR4-2666			Xeon E-2224	4C/4T/3.4GHz/8MB/71W/DDR4-2666			Xeon E-2186G	6C/12T/3.8GHz/12MB/95W/DDR4-2666	400W PSU needed		Xeon E-2174G	4C/8T/3.8GHz/8MB/71W/DDR4-2666			Core i9-9900K	8C/16T/3.6GHz/16MB/95W/DDR4-2666	400W PSU needed		Core i9-9900	8C/16T/3.1GHz/16MB/65W/DDR4-2666			Core i7-9700K	8C/8T/3.6GHz/12MB/95W/DDR4-2666	400W PSU needed		Core i7-9700	8C/8T/3.0GHz/12MB/65W/DDR4-2666			Core i7-8700	6C/12T/3.2GHz/12MB/65W/DDR4-2666			Core i5-9600K	6C/6T/3.7GHz/9MB/95W/DDR4-2666	400W PSU needed		Core i5-9600	6C/6T/3.1GHz/9MB/65W/DDR4-2666			Core i5-9500	6C/6T/3.0GHz/9MB/65W/DDR4-2666			Core i5-9400	6C/6T/2.9GHz/9MB/65W/DDR4-2666			Core i5-8500	6C/6T/3.0GHz/9MB/65W/DDR4-2666			Core i3-9300	4C/4T/3.7GHz/8MB/62W/DDR4-2400			Core i3-9100	4C/4T/3.6GHz/6MB/65W/DDR4-2400			Core i3-8300	4C/4T/3.7GHz/8MB/62W/DDR4-2400			Core i3-8100	4C/4T/3.6GHz/6MB/65W/DDR4-2400		
	Processor	Cache	Power	PSU																																																																																																													
	Xeon E-2286G	6C/12T/4.0GHz/12MB/95W/DDR4-2666	400W PSU needed																																																																																																														
	Xeon E-2278G	8C/16T/3.4GHz/16MB/80W/DDR4-2666	400W PSU needed																																																																																																														
	Xeon E-2276G	6C/12T/3.8GHz/12MB/80W/DDR4-2666																																																																																																															
	Xeon E-2274G	4C/8T/4.0GHz/8MB/83W/DDR4-2666																																																																																																															
	Xeon E-2246G	6C/12T/3.6GHz/12MB/80W/DDR4-2666																																																																																																															
	Xeon E-2244G	4C/8T/3.8GHz/8MB/71W/DDR4-2666																																																																																																															
	Xeon E-2236	6C/12T/3.4GHz/12MB/80W/DDR4-2666																																																																																																															
	Xeon E-2234	4C/8T/3.6GHz/8MB/71W/DDR4-2666																																																																																																															
	Xeon E-2226G	6C/6T/3.4GHz/12MB/80W/DDR4-2666																																																																																																															
	Xeon E-2224G	4C/4T/3.5GHz/8MB/71W/DDR4-2666																																																																																																															
	Xeon E-2224	4C/4T/3.4GHz/8MB/71W/DDR4-2666																																																																																																															
	Xeon E-2186G	6C/12T/3.8GHz/12MB/95W/DDR4-2666	400W PSU needed																																																																																																														
	Xeon E-2174G	4C/8T/3.8GHz/8MB/71W/DDR4-2666																																																																																																															
	Core i9-9900K	8C/16T/3.6GHz/16MB/95W/DDR4-2666	400W PSU needed																																																																																																														
	Core i9-9900	8C/16T/3.1GHz/16MB/65W/DDR4-2666																																																																																																															
	Core i7-9700K	8C/8T/3.6GHz/12MB/95W/DDR4-2666	400W PSU needed																																																																																																														
	Core i7-9700	8C/8T/3.0GHz/12MB/65W/DDR4-2666																																																																																																															
	Core i7-8700	6C/12T/3.2GHz/12MB/65W/DDR4-2666																																																																																																															
	Core i5-9600K	6C/6T/3.7GHz/9MB/95W/DDR4-2666	400W PSU needed																																																																																																														
	Core i5-9600	6C/6T/3.1GHz/9MB/65W/DDR4-2666																																																																																																															
	Core i5-9500	6C/6T/3.0GHz/9MB/65W/DDR4-2666																																																																																																															
	Core i5-9400	6C/6T/2.9GHz/9MB/65W/DDR4-2666																																																																																																															
	Core i5-8500	6C/6T/3.0GHz/9MB/65W/DDR4-2666																																																																																																															
	Core i3-9300	4C/4T/3.7GHz/8MB/62W/DDR4-2400																																																																																																															
Core i3-9100	4C/4T/3.6GHz/6MB/65W/DDR4-2400																																																																																																																
Core i3-8300	4C/4T/3.7GHz/8MB/62W/DDR4-2400																																																																																																																
Core i3-8100	4C/4T/3.6GHz/6MB/65W/DDR4-2400																																																																																																																
Chipset	Intel C246 Chipset																																																																																																																
Memory Sockets	4 DIMM sockets with 2 channels																																																																																																																
Memory Types	8GB/16GB DDR4-2666 UDIMM ECC or 4GB/8GB/16GB/32GB DDR4-2666 UDIMM non-ECC																																																																																																																
Memory Capacity	64GB with 4 x 16GB for UDIMM ECC or 128GB with 4 x 32GB UDIMM non-ECC																																																																																																																
Memory Protection	ECC on models with UDIMM ECC memory																																																																																																																
Expansion slots	Three PCIe 3.0 slots as following:																																																																																																																
	Slot 1 PCIe 3.0 x16, full height, half length, links to CPU																																																																																																																
	Slot 2 PCIe 3.0 x1, full height, full length, links to PCH																																																																																																																
	Slot 3 PCIe 3.0 x16 (negotiable link width x4), full height, half length, links to PCH																																																																																																																
Processor graphics	Integrated Intel UHD Graphics P630 in -G suffix Xeon processors, or Intel UHD Graphics 630 in Core i7, i5, i3, or Pentium processors. Works along with discrete graphics to support multi-display, enables three rear display connectors (2 DP standard, 1 DP or HDMI optional)																																																																																																																
Discrete Graphics Offering	Up to two PCIe 3.0 x16 slots for discrete graphics card (Slot 1 and 3). Supports the following graphics adapters:																																																																																																																
	<table border="1"> <thead> <tr> <th>Graphics</th> <th>Memory</th> <th>Power</th> <th>Connector</th> <th>Max Qty</th> </tr> </thead> <tbody> <tr><td>Quadro P400</td><td>2GB GDDR5</td><td>30W</td><td>3x miniDP</td><td>2</td></tr> <tr><td>Quadro P620</td><td>2GB GDDR5</td><td>40W</td><td>4x miniDP</td><td>2</td></tr> <tr><td>Quadro P1000</td><td>4GB GDDR5</td><td>50W</td><td>4x miniDP</td><td>2</td></tr> <tr><td>Quadro P2000</td><td>5GB GDDR5</td><td>75W</td><td>4x DP</td><td>2</td></tr> <tr><td>Quadro P2200</td><td>5GB GDDR5X</td><td>75W</td><td>4x DP</td><td>2</td></tr> <tr><td>Quadro P4000</td><td>8GB GDDR5</td><td>105W</td><td>4x DP</td><td>1</td></tr> <tr><td>Quadro P5000</td><td>16GB GDDR5X</td><td>180W</td><td>DVI-D DL + 4x DP</td><td>1</td></tr> <tr><td>Quadro RTX 4000</td><td>8GB GDDR6</td><td>160W</td><td>3x DP, 1x VirtualLink</td><td>1</td></tr> </tbody> </table>	Graphics	Memory	Power	Connector	Max Qty	Quadro P400	2GB GDDR5	30W	3x miniDP	2	Quadro P620	2GB GDDR5	40W	4x miniDP	2	Quadro P1000	4GB GDDR5	50W	4x miniDP	2	Quadro P2000	5GB GDDR5	75W	4x DP	2	Quadro P2200	5GB GDDR5X	75W	4x DP	2	Quadro P4000	8GB GDDR5	105W	4x DP	1	Quadro P5000	16GB GDDR5X	180W	DVI-D DL + 4x DP	1	Quadro RTX 4000	8GB GDDR6	160W	3x DP, 1x VirtualLink	1																																																																			
	Graphics	Memory	Power	Connector	Max Qty																																																																																																												
	Quadro P400	2GB GDDR5	30W	3x miniDP	2																																																																																																												
	Quadro P620	2GB GDDR5	40W	4x miniDP	2																																																																																																												
	Quadro P1000	4GB GDDR5	50W	4x miniDP	2																																																																																																												
	Quadro P2000	5GB GDDR5	75W	4x DP	2																																																																																																												
	Quadro P2200	5GB GDDR5X	75W	4x DP	2																																																																																																												
	Quadro P4000	8GB GDDR5	105W	4x DP	1																																																																																																												
	Quadro P5000	16GB GDDR5X	180W	DVI-D DL + 4x DP	1																																																																																																												
Quadro RTX 4000	8GB GDDR6	160W	3x DP, 1x VirtualLink	1																																																																																																													
<i>Note: 2x Quadro P2000, Quadro P4000, Quadro P5000, or Quadro RTX 4000 needs 400W PSU</i>																																																																																																																	

Components	Specification																														
Storage Controller	Storage Controller																														
	Onboard Intel RST SATA RAID																														
	Onboard Intel RST PCIe RAID																														
Storage Support	<table border="1"> <thead> <tr> <th>Disk Type</th> <th>Interface</th> <th>RPM</th> <th>Offering</th> <th>Max Qty</th> </tr> </thead> <tbody> <tr><td>3.5" SATA HDD</td><td>SATA 6Gb/s</td><td>7.2K</td><td>1TB/2TB/4TB</td><td>3</td></tr> <tr><td>2.5" SATA HDD</td><td>SATA 6Gb/s</td><td>7.2K</td><td>500GB FIPS</td><td>4</td></tr> <tr><td>2.5" SATA SSD</td><td>SATA 6Gb/s</td><td></td><td>256GB/512GB/1TB</td><td>4</td></tr> <tr><td>Optane Memory</td><td>PCIe NVMe</td><td></td><td>32GB</td><td>1, used with HDD/SSD</td></tr> <tr><td>M.2 PCIe SSD</td><td>PCIe NVMe</td><td></td><td>256GB/512GB/1TB</td><td>3</td></tr> </tbody> </table>	Disk Type	Interface	RPM	Offering	Max Qty	3.5" SATA HDD	SATA 6Gb/s	7.2K	1TB/2TB/4TB	3	2.5" SATA HDD	SATA 6Gb/s	7.2K	500GB FIPS	4	2.5" SATA SSD	SATA 6Gb/s		256GB/512GB/1TB	4	Optane Memory	PCIe NVMe		32GB	1, used with HDD/SSD	M.2 PCIe SSD	PCIe NVMe		256GB/512GB/1TB	3
	Disk Type	Interface	RPM	Offering	Max Qty																										
	3.5" SATA HDD	SATA 6Gb/s	7.2K	1TB/2TB/4TB	3																										
	2.5" SATA HDD	SATA 6Gb/s	7.2K	500GB FIPS	4																										
	2.5" SATA SSD	SATA 6Gb/s		256GB/512GB/1TB	4																										
	Optane Memory	PCIe NVMe		32GB	1, used with HDD/SSD																										
M.2 PCIe SSD	PCIe NVMe		256GB/512GB/1TB	3																											
Storage Bays	Up to five bays with four disk bays plus one slim optical bay, supports up to 3x 3.5" HDD plus 1x 2.5" SSD, or 4x 2.5" HDD/SSD																														
	Bay 1 Primary disk bay, 3.5" or 2.5"																														
	Bay 2 2.5" SATA bay, cannot be available when 2nd Quadro P2000 is used																														
	Bay 3 Secondary disk bay, 3.5" or 2.5"																														
	Bay 4 5.25" Flex bay, supports one of the following: <ul style="list-style-type: none"> Flex module for optional front eSATA/Thunderbolt/IEEE1394 3rd disk bay, 3.5" or 2.5", removable, via Front Access Storage Enclosure, using SATA 4 connector as eSATA mode 3rd disk bay, 3.5" or 2.5", via 5.25" to 3.5" HDD Kit 																														
	Bay 5 9mm Slim ODD bay																														
M.2 3x M.2 SSD (1 onboard, 2 via PCIe to M.2 adapter)																															
Media reader	Optional SD card reader on most models																														
Network interfaces	One onboard GbE port via integrated gigabit ethernet Intel i219LM, supports Wake-on-LAN. Optional PCIe ethernet adapters are available																														
WLAN + Bluetooth	One dedicated onboard M.2 slot for optional Intel Wireless-AC 9560, 2x2, 2.4GHz/5GHz (160MHz channels), 802.11ac, Bluetooth 5, up to 1.73Gbps																														
Security features	Power-on and admin password. Trusted Platform Module, TCG 2.0 compliant. Optional chassis intrusion switch, e-lock, cable lock, Kensington lock, and pad lock																														
Intel vPro	Supports Intel vPro on Xeon models. vPro also requires Wireless-AC 9560 if Wi-Fi is needed																														
Intel AMT	Intel Active Management Technology 12 on Xeon models, Intel Standard Manageability on other models																														
Base warranty	US models comes with 3-year limited onsite service with 9x5/NBD. 1 or 3-year limited onsite service with 9x5/NBD in EMEA or other GEOs																														
HD Audio	Intel HD Audio interface with Realtek ALC233 Codec																														
Front ports	2x USB 3.1 Gen 1 Type A. 2x USB 3.1 Gen 2 Type A. 1x USB 3.1 Gen 1 Type-C. 1x Mic-in. 1x Combo jack																														
Rear ports	2x USB 3.1 Gen 1 Type A. 2x USB 2.0 Type-A. 1x RJ-45. 1x COM. 2x DP. 1x Audio line-out <i>Notes: DP needs Core, Pentium, or -G suffix Xeon processor</i>																														
Optional front ports (on flex module)	2x Thunderbolt (USB Type-C), one of two ports supports video-out. 1x eSATA. 1x IEEE1394																														
Optional rear ports	Supports the following via cable: 1x COM. 1x Parallel. 2x PS/2. 1x DP or 1x HDMI. 2x USB 2.0 Supports the following via PCIe adapter: 4x COM. 2x USB 3.1 Type-C. 2x USB 3.1 Gen 1. 1x Thunderbolt. <i>Notes: DP or HDMI needs Core, Pentium, or -G suffix Xeon processor</i>																														
Temperature	Operating: 50 °F to 95 °F (10 °C to 35 °C) Non operating (no package): 14 °F to 140 °F (-10 °C to 60 °C) Non operating (with package): -40 °F to 140 °F (-40 °C to 60 °C)																														

Components	Specification
Altitude	Operating: -15.2 m (-50 ft) to 3048 m (10 000 ft). Storage: -15.2 m (-50 ft) to 10, 668 m (35 000 ft)
Humidity	Operating: 30%~90%, non-condensing Storage (with package): 20%~90%, non-condensing
Environmental certification	RoHS-compliant. GREENGUARD. EPEAT Silver rating and ENERGY STAR 7 qualified
Power supply	Supports one 250W or 400W power supply, 100V - 240V, 92% PSU. Climate Savers Computing Platinum and 80 PLUS Platinum qualified. 400W PSU supports one 6+2-pin aux power connector.
ISV certifications	Please visit www.thinkworkstations.com/isv-certifications/

Note:

1. Depending on many factors, actual data transfer speed mentioned on this page may be lower than theoretical speed.
2. Any questions or advice on ThinkStation PSREF, please contact [ThinkStation PSREF developer](#)

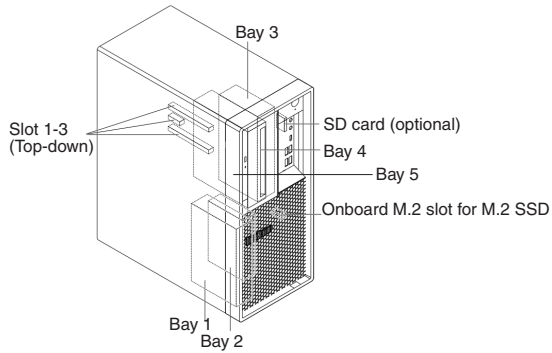



ThinkStation P520 Platform Specifications

Form factor	33L Tower						
Dimensions	165mm/6.5" W x 460mm/18.1" D x 440mm/17.3" H (with feet)						
Weight	Maximum configuration: 52.91 lb (24kg)						
Processor Support	Processor	# of Cores	# of Threads	Base Frequency	Cache	TDP	Memory Types
	Xeon W-2195	18	36	2.3GHz	24.75MB	140W	DDR4-2666
	Xeon W-2175	14	28	2.5GHz	19MB	140W	DDR4-2666
	Xeon W-2155	10	20	3.3GHz	13.75MB	140W	DDR4-2666
	Xeon W-2145	8	16	3.7GHz	11MB	140W	DDR4-2666
	Xeon W-2135	6	12	3.7GHz	8.25MB	140W	DDR4-2666
	Xeon W-2133	6	12	3.6GHz	8.25MB	140W	DDR4-2666
	Xeon W-2125	4	8	4.0GHz	8.25MB	120W	DDR4-2666
	Xeon W-2123	4	8	3.6GHz	8.25MB	120W	DDR4-2666
	Xeon W-2104	4	4	3.2GHz	8.25MB	120W	DDR4-2400
Xeon W-2102	4	4	2.9GHz	8.25MB	120W	DDR4-2400	

Processor Sockets	1x FCLGA2066
Chipset	Intel C422 Chipset
Memory Sockets	8 DIMM sockets with 4 channels
Memory Types	DDR4-2666 RDIMM
Memory Capacity	256GB with 8 x 32GB RDIMMs
Memory Protection	ECC

Expansion slots	Slot 1 (CPU)	PCIe 3.0 x8, full height, full length, 25W, open ended
	Slot 2 (CPU)	PCIe 3.0 x16, full height, full length, 75W, double-width
	Slot 3 (PCH)	PCIe 3.0 x4, full height, half length, 25W, open ended
	Slot 4 (CPU)	PCIe 3.0 x16, full height, full length, 75W, double-width
	Slot 5	PCI, full height, full length, 25W
	Slot 6 (PCH)	PCIe 3.0 x4, full height, half length, 25W, open ended

Discrete Graphics Offering	Graphics	Memory	Power	Connector	SLI / NV-link	Max Qty
	NVS 810	4GB DDR3	68W	8xmini DP		2
Quadro P400	2GB GDDR5	30W	3xminiDP		2	
Quadro P600	2GB GDDR5	45W	4xminiDP		2	
Quadro P620	2GB GDDR5	40W	4xminiDP		2	
Quadro P1000	4GB GDDR5	50W	4xminiDP		2	
Quadro P2000	5GB GDDR5	75W	4xDP		2	
Quadro P4000	8GB GDDR5	120W	4xDP		2	
Quadro P5000	16GB GDDR5X	180W	DVI-D DL+4xDP	SLI	2	
Quadro P6000	24GB GDDR5X	250W	DVI-D DL+4xDP		1	
Quadro RTX 4000	8GB GDDR6	160W	3xDP, 1xVirtualLink		2	
Quadro RTX 5000	16GB GDDR6	265W	4xDP, 1xVirtualLink		1	
Quadro RTX 6000	24GB GDDR6	295W	4xDP, 1xVirtualLink		1	
Quadro RTX 8000	48GB GDDR6	295W	4xDP, 1xVirtualLink		1	
Quadro GP100	16GB HBM2	235W	1xDVI-D DL, 4xDP	NVLink	2	
Quadro GV100	32GB HBM2	250W	4xDP		1	

Storage Controller	Storage Controller	Type	Interface	RAID	Cache
	Onboard Intel RSTe	Std	SATA 6Gb/s	0/1/10/5	
	9440-8i PCIe	Opt	SAS 12Gb/s, SATA 6Gb/s	0/1/10/5	
	9460-16i PCIe	Opt	SAS 12Gb/s, SATA 6Gb/s	0/1/10/5/6	4GB DDR4, SuperCap
	NVMe Basic	Opt	PCIe NVMe	0/1/10	
	NVMe Premium	Opt	PCIe NVMe	0/1/10/5	
NVMe for Intel SSD	Opt	PCIe NVMe	0/1/10/5		

Storage Support	Disk Type	Interface	RPM	Offering	Max Qty
	3.5" SATA HDD	SATA 6Gb/s	7.2K	1TB/2TB/4TB/6TB	6
	2.5" SATA HDD	SATA 6Gb/s	7.2K	500GB/500GB FIPS	6
	2.5" SATA SSD	SATA 6Gb/s		256GB/512GB/1TB/2TB	6
	M.2 PCIe SSD	PCIe NVMe		256GB/512GB/1TB/2TB	9
	PCIe AIC SSD	PCIe NVMe		480GB	2 (1 when quad M.2 adapter used)

Storage Bays	Bay Type	Maximum Drives Qty
	M.2 slot	9x M.2 SSD (2 onboard, 7 via PCIe to M.2 adapter)
Flex Bay		2 flex bays. Supports the following: <ul style="list-style-type: none"> • 2x half-height optical drives • 2x 5.25" 9.0mm optical drives • 1x 5.25" 9.0mm optical drive + 2x 3.5"/2.5" SATA SSD/HDD • 1x 3.5"/2.5" SATA SSD/HDD with Front Access Storage Enclosure • 1x flex module for the following options: <ul style="list-style-type: none"> • Tray 1: 9.0mm optical • Tray 2: 15-in-1 USB 3.1 Gen 1 reader, 2x Thunderbolt, or 4-digit diagnostic display • Port 1 and 2: Front USB 3.1 Gen 1 Type-C or eSATA • 2x M.2 SSD with 2x Front Removable Drive Enclosures
	Disk bay	Up to 4x 3.5" or 2.5" disks with 4 disk bays (2 bays standard, 2 bays optional)

Max Storage	Supports up to 9x M.2 SSD + 6x 3.5" HDD/6x 2.5" SATA disks/4x 2.5" SAS HDD + 1x PCIe AIC SSD. All HDD: 36TB using 6x 3.5" HDD All SSD: 30.48TB using 6x 2.5" SATA SSD, 9x M.2 SSD, and 1x PCIe AIC SSD
-------------	--------------------------------------------------------------------------------------------------------------------------------------------------------------------------------------------------------------

Power supply	Supports one of the following: <ul style="list-style-type: none"> • One fixed 690W, autosensing, 92%, 80 PLUS Platinum qualified • One fixed 900W, autosensing, 92%, 80 PLUS Platinum qualified
--------------	-------------------------------------------------------------------------------------------------------------------------------------------------------------------------------------------------------------------------

Media reader	SD USB 2.0 card reader on most models. Optional UHS-II 15-in-1 USB 3.1 Gen 1 reader on flex module
--------------	----------------------------------------------------------------------------------------------------

Network interfaces	Integrated one gigabit ethernet (Intel i219LM), supports Wake-on-LAN. Optional PCIe ethernet or wireless adapters are available
--------------------	---------------------------------------------------------------------------------------------------------------------------------

WLAN + Bluetooth	Optional Intel Wireless-AC 8265, 2x2, 2.4GHz/5GHz, 802.11ac, Bluetooth 4.2, up to 867Mbps
------------------	-------------------------------------------------------------------------------------------

Security features	Power-on and admin password. Trusted Platform Module, TCG 2.0 compliant, switch to 1.2 via UEFI setting. Optional access panel lock, Kensington lock, and pad lock
-------------------	--------------------------------------------------------------------------------------------------------------------------------------------------------------------

Intel vPro	Intel vPro technology supported. vPro requires Wireless-AC 8265 if Wi-Fi is needed
------------	------------------------------------------------------------------------------------

Intel AMT	Intel Active Management Technology 11
-----------	---------------------------------------

Diagnostic	Front panel warning LED. ThinkStation Diagnostics for Windows. Photo-audio transfer with Lenovo PC Diag-nostics for Android and iOS. Optional front 4-digit diagnostic display on flex module
------------	-----------------------------------------------------------------------------------------------------------------------------------------------------------------------------------------------

Base warranty	1 or 3-year limited onsite service with 9x5/NBD
---------------	-------------------------------------------------

HD Audio	Realtek ALC662 codec
----------	----------------------

Front ports	4x USB 3.1 Gen 1 (includes one 11W charging), 1x combo audio/microphone jack (3.5mm)
-------------	--------------------------------------------------------------------------------------

Rear ports	2x USB 2.0, 4x USB 3.1 Gen 1, 1x RJ-45, 3x analog audio ports (line-in, line-out, mic-in), 2x PS/2
------------	----------------------------------------------------------------------------------------------------

Optional ports	Front:	<ul style="list-style-type: none"> • 2x Thunderbolt ports (USB Type-C) on flex module, one of two ports supports video-out • 1x eSATA on flex module • 1x USB Type-C on flex module, USB 3.1 gen 1 	
	Rear:	<ul style="list-style-type: none"> • 1x COM port • 2x USB Type-C ports via PCIe adapter, USB 3.1 gen 2. One 15W, one 5W 	
	Internal:	<ul style="list-style-type: none"> • 1x internal USB 3.1 Gen 1 port 	

Environmental specification	Temperature - operating	50 °F to 95 °F (10 °C to 35 °C)
	Temperature - storage (no package)	14 °F to 140 °F (-10 °C to 60 °C)
	Temperature - storage (with package)	-40 °F to 140 °F (-40 °C to 60 °C)
	Altitude - operating	(Unpressurized): -50ft-10000ft (-15.2m-3048m)
	Humidity - operating	10%~80%, non-condensing
	Humidity - storage (with package)	10%~90%, non-condensing

Environmental Certifications	RoHS-compliant. GREENGUARD. EPEAT Silver rating. ENERGY STAR 6.1 qualified on model 30BE0008US and 30BE0009US
------------------------------	---------------------------------------------------------------------------------------------------------------

ISV certifications	Please visit www.thinkworkstations.com/isv-certifications/
--------------------	-------------------------------------------------------------------------------------------------------------------------------

Note:
 1. Depending on many factors, actual data transfer speed mentioned on this page may be lower than theoretical speed.
 2. To support the maximum expandability, 900W power supply may be needed.
 3. Any questions or advice on ThinkStation PSREF, please contact [ThinkStation PSREF developer](mailto:ThinkStation_PSREF_developer)



ThinkStation P520c Platform Specifications

Product Specifications Reference (PSREF)

Form factor	25L Tower						
Dimensions	175mm/6.89" W x 426mm/16.77" D x 376mm/14.8" H (with feet)						
Weight	Maximum configuration: 31.97 lb (14.5kg)						
Processor Support	Processor	# of Cores	# of Threads	Base Frequency	Cache	TDP	Memory Types
	Xeon W-2195	18	36	2.3GHz	24.75MB	140W	DDR4-2666
	Xeon W-2175	14	28	2.5GHz	19MB	140W	DDR4-2666
	Xeon W-2155	10	20	3.3GHz	13.75MB	140W	DDR4-2666
	Xeon W-2145	8	16	3.7GHz	11MB	140W	DDR4-2666
	Xeon W-2135	6	12	3.7GHz	8.25MB	140W	DDR4-2666
	Xeon W-2133	6	12	3.6GHz	8.25MB	140W	DDR4-2666
	Xeon W-2125	4	8	4.0GHz	8.25MB	120W	DDR4-2666
	Xeon W-2123	4	8	3.6GHz	8.25MB	120W	DDR4-2666
	Xeon W-2104	4	4	3.2GHz	8.25MB	120W	DDR4-2400
Xeon W-2102	4	4	2.9GHz	8.25MB	120W	DDR4-2400	
Processor Sockets	1x FCLGA2066						
Chipset	Intel C422 Chipset						
Memory Sockets	4 DIMM sockets with 4 channels						
Memory Types	DDR4-2666 RDIMM						
Memory Capacity	128GB with 4 x 32GB RDIMMs						
Memory Protection	ECC						
Expansion slots	Slot 1 (CPU)	PCIe 3.0 x16, full height, full length, 75W,					
	Slot 2 (CPU)	PCIe 3.0 x8, full height, full length, 25W, open ended					
	Slot 3 (CPU)	PCIe 3.0 x16, full height, full length, 75W					
	Slot 4 (PCH)	PCIe 3.0 x4, full height, half length, 25W, open ended					
Discrete Graphics Offering	Graphics	Memory	Power	Connector	SLI / NV-link	Max Qty	
	NVS 810	4GB DDR3	68W	8xmini DP		1	
	Quadro P400	2GB GDDR5	30W	3xminiDP		2	
	Quadro P600	2GB GDDR5	45W	4xminiDP		2	
	Quadro P620	2GB GDDR5	40W	4x miniDP		2	
	Quadro P1000	4GB GDDR5	50W	4xminiDP		2	
	Quadro P2000	5GB GDDR5	75W	4xDP		2	
	Quadro P4000	8GB GDDR5	120W	4xDP		2	
	Quadro P5000	16GB GDDR5X	180W	DVI-D DL+4xDP		1	
	Quadro RTX 4000	8GB GDDR6	160W	3xDP, 1xVirtualLink		1	
Storage Controller	Storage Controller	Type	Interface		RAID	Cache	
	Onboard Intel RSTe	Std	SATA 6Gb/s		0/1/10/5	-	
	9440-8i PCIe	Opt	SAS 12Gb/s, SATA 6Gb/s		0/1/10/5	-	
	NVMe Basic	Opt	PCIe NVMe		0/1/10	-	
	NVMe for Intel SSD	Opt	PCIe NVMe		0/1/10/5	-	
Storage Support	Disk Type	Interface	RPM	Offering		Max Qty	
	3.5" SATA HDD	SATA 6Gb/s	7.2K	1TB/2TB/4TB/6TB		4	
	2.5" SATA HDD	SATA 6Gb/s	7.2K	500GB/500GB FIPS		4	
	2.5" SATA SSD	SATA 6Gb/s		256GB/512GB/1TB/2TB		4	
	M.2 PCIe SSD	PCIe NVMe		256GB/512GB/1TB/2TB		5	
Storage Bays	Bay Type	Maximum Drives Qty					
	M.2 slot	5x M.2 SSD (2 onboard, 3 via PCIe to M.2 adapter)					
	Flex Bay	2 flex bays. Supports the following: <ul style="list-style-type: none"> 2x half-height optical drives 2x 5.25" 9.0mm optical drives 1x 5.25" 9.0mm optical drive + 2x 3.5"/2.5" SATA SSD/HDD 1x 3.5"/2.5" SATA SSD/HDD with Front Access Storage Enclosure 1x flex module for the following options: Tray 1: 9.0mm optical Tray 2: 15-in-1 USB 3.1 Gen 1 reader, 2x Thunderbolt, or 4-digit diagnostic display Port 1 and 2: Front USB 3.1 Gen 1 Type-C or eSATA <ul style="list-style-type: none"> 2x M.2 SSD with 2x Front Removable Drive Enclosures 					
	Disk bay	Up to 2x 3.5"/2.5" disks with 2 disk bays					

Max Storage	Supports up to 5x M.2 SSD + 4x 3.5" HDD/4x 2.5" SSD/4x 2.5" HDD All HDD: 24TB using 4x 3.5" HDD All SSD: 18TB using 4x 2.5" SATA SSD and 5x M.2 SSD												
Power supply	One fixed 500W, autosensing, 92%, 80 PLUS Platinum qualified												
Media reader	SD USB 2.0 card reader on most models. Optional UHS-II 15-in-1 USB 3.1 Gen 1 reader on flex module												
Network interfaces	Integrated one gigabit ethernet (Intel i219LM), supports Wake-on-LAN. Optional PCIe ethernet or wireless adapters are available												
WLAN + Bluetooth	Optional Intel Wireless-AC 8265, 2x2, 2.4GHz/5GHz, 802.11ac, Bluetooth 4.2, up to 867Mbps												
Security features	Power-on and admin password. Trusted Platform Module, TCG 2.0 compliant, switch to 1.2 via UEFI setting. Optional access panel lock, Kensington lock, and pad lock												
Intel vPro	Intel vPro technology supported. vPro requires Wireless-AC 8265 if Wi-Fi is needed												
Intel AMT	Intel Active Management Technology 11												
Diagnostic	ThinkStation Diagnostics for Windows. Optional front 4-digit diagnostic display on flex module												
Base warranty	1 or 3-year limited onsite service with 9x5/NBD												
HD Audio	Realtek ALC662 codec												
Front ports	2x USB 3.1 Gen 1, microphone (3.5mm), headphone (3.5mm)												
Rear ports	2x USB 2.0, 4x USB 3.1 Gen 1, 1x RJ-45, 3x analog audio ports (line-in, line-out, mic-in), 2x PS/2												
Optional ports	Supports the following optional ports: Front: <ul style="list-style-type: none"> 2x Thunderbolt ports (USB Type-C) on flex module, one of two ports supports video-out 1x eSATA on flex module 1x USB Type-C on flex module, USB 3.1 gen 1 Rear: <ul style="list-style-type: none"> 1x COM port 2x USB Type-C ports via PCIe adapter, USB 3.1 gen 2. One 15W, one 5W Internal: <ul style="list-style-type: none"> 1x internal USB 3.1 Gen 1 port 												
	Environmental specification	<table border="1"> <tr> <td>Temperature - operating</td> <td>50 °F to 95 °F (10 °C to 35 °C)</td> </tr> <tr> <td>Temperature - storage (no package)</td> <td>14 °F to 140 °F (-10 °C to 60 °C)</td> </tr> <tr> <td>Temperature - storage (with package)</td> <td>-40 °F to 140 °F (-40 °C to 60 °C)</td> </tr> <tr> <td>Altitude - operating</td> <td>(Unpressurized): -50ft-10000ft (-15.2m-3048m)</td> </tr> <tr> <td>Humidity - operating</td> <td>10%~80%, non-condensing</td> </tr> <tr> <td>Humidity - storage (with package)</td> <td>10%~90%, non-condensing</td> </tr> </table>	Temperature - operating	50 °F to 95 °F (10 °C to 35 °C)	Temperature - storage (no package)	14 °F to 140 °F (-10 °C to 60 °C)	Temperature - storage (with package)	-40 °F to 140 °F (-40 °C to 60 °C)	Altitude - operating	(Unpressurized): -50ft-10000ft (-15.2m-3048m)	Humidity - operating	10%~80%, non-condensing	Humidity - storage (with package)
Temperature - operating	50 °F to 95 °F (10 °C to 35 °C)												
Temperature - storage (no package)	14 °F to 140 °F (-10 °C to 60 °C)												
Temperature - storage (with package)	-40 °F to 140 °F (-40 °C to 60 °C)												
Altitude - operating	(Unpressurized): -50ft-10000ft (-15.2m-3048m)												
Humidity - operating	10%~80%, non-condensing												
Humidity - storage (with package)	10%~90%, non-condensing												
Environmental Certifications	RoHS-compliant. GREENGUARD. EPEAT Silver rating. ENERGY STAR 6.1 qualified on model 30BX0008US and 30BX0009US												
ISV certifications	Please visit www.thinkworkstations.com/isv-certifications/												

Note:
 1. Depending on many factors, actual data transfer speed mentioned on this page may be lower than theoretical speed.
 2. Any questions or advice on ThinkStation PSREF, please contact [ThinkStation PSREF developer](mailto:ThinkStation_PSREF_developer)



Expansion slots	
Slot 1 (CPU2)	PCIe 3.0 x16, full height, full length, 75W
Slot 2 (CPU1)	PCIe 3.0 x16, full height, full length, 75W, double-width
Slot 3 (CPU1)	PCIe 3.0 x8, full height, full length, 25W, open ended
Slot 4 (CPU1)	PCIe 3.0 x16, full height, full length, 75W, double-width
Slot 5	PCI, full height, full length, 25W
Slot 6 (PCH)	PCIe 3.0 x4, full height, half length, 25W, open ended

900W PSU supports two 6+2-pin aux power connectors.
690W PSU supports one 6+2-pin aux power connector.

Note: All expansion cards are optional

ThinkStation P720 Platform Specifications

Product Specifications Reference (PSREF)

Form factor	36L Tower
Dimensions	175mm/6.89" W x 485mm/19.1" D x 446mm/17.6" H (with feet)
Weight	Maximum configuration: 52.25 lb (23.7kg)
Processor Sockets	2x FCLGA3647
Processor Support	Up to two 150 W Gen 1 or Gen 2 Intel Xeon Scalable family processors, Bronze, Silver, Gold, or Platinum

	Processor	# of Cores	# of Threads	Base Frequency	Cache	TDP	Memory Types
	Xeon Gold 6244	8	16	3.6GHz	25MB	150W	DDR4-2933
	Xeon Gold 6242	16	32	2.8GHz	22MB	150W	DDR4-2933
	Xeon Gold 6238T	22	44	1.9GHz	30MB	125W	DDR4-2933
	Xeon Gold 6234	8	16	3.3GHz	25MB	130W	DDR4-2933
	Xeon Gold 6230	20	40	2.1GHz	28MB	125W	DDR4-2933
	Xeon Gold 6226	12	24	2.7GHz	19MB	125W	DDR4-2933
	Xeon Gold 5222	4	8	3.8GHz	17MB	105W	DDR4-2933
	Xeon Gold 5218	16	32	2.3GHz	22MB	125W	DDR4-2666
	Xeon Gold 5217	8	16	3.0GHz	11MB	115W	DDR4-2666
	Xeon Gold 5215	10	20	2.5GHz	13.75MB	85W	DDR4-2666
	Xeon Silver 4216	16	32	2.1GHz	22MB	100W	DDR4-2400
	Xeon Silver 4215	8	16	2.5GHz	11MB	85W	DDR4-2400
	Xeon Silver 4214	12	24	2.2GHz	17MB	85W	DDR4-2400
	Xeon Silver 4210	10	20	2.2GHz	14MB	85W	DDR4-2400
	Xeon Silver 4209T	8	16	2.2GHz	11MB	70W	DDR4-2400
	Xeon Silver 4208	8	16	2.1GHz	11MB	85W	DDR4-2400
	Xeon Bronze 3204	6	6	1.9GHz	8.25MB	85W	DDR4-2133
	Xeon Platinum 8160T	24	48	2.1GHz	33MB	150W	DDR4-2666
	Xeon Gold 6142	16	32	2.6GHz	22MB	150W	DDR4-2666
	Xeon Gold 6136	12	24	3.0GHz	24.75MB	150W	DDR4-2666
	Xeon Gold 6134	8	16	3.2GHz	24.75MB	130W	DDR4-2666
	Xeon Gold 6128	6	12	3.4GHz	19.25MB	115W	DDR4-2666
	Xeon Gold 5122	4	8	3.6GHz	16.5MB	105W	DDR4-2666
	Xeon Gold 5120T	14	28	2.2GHz	19.25MB	105W	DDR4-2400
	Xeon Gold 5118	12	24	2.3GHz	16.5MB	105W	DDR4-2400
	Xeon Gold 5115	10	20	2.4GHz	13.75MB	85W	DDR4-2400
	Xeon Silver 4116	12	24	2.1GHz	16.5MB	85W	DDR4-2400
	Xeon Silver 4114T	10	20	2.2GHz	13.75MB	85W	DDR4-2400
	Xeon Silver 4114	10	20	2.2GHz	13.75MB	85W	DDR4-2400
	Xeon Silver 4112	4	8	2.6GHz	8.25MB	85W	DDR4-2400
	Xeon Silver 4110	8	16	2.1GHz	11MB	85W	DDR4-2400
	Xeon Silver 4109T	8	16	2.0GHz	11MB	70W	DDR4-2400
	Xeon Silver 4108	8	16	1.8GHz	11MB	85W	DDR4-2400

Chipset	Intel C621 Chipset
Memory Sockets	12 DIMM sockets with 12 channels. 6 DIMM sockets with 6 channels per processor
Memory Types	DDR4-2666 RDIMM
Memory Capacity	768GB (DDR4-2933 RDIMM) or 384GB (DDR4-2666 RDIMM)
Memory Protection	ECC

Expansion slots	Slot 1 (CPU2)	PCIe 3.0 x16, full height, full length, 75W
	Slot 2 (CPU1)	PCIe 3.0 x16, full height, full length, 75W, double-width
	Slot 3 (CPU1)	PCIe 3.0 x8, full height, full length, 25W, open ended
	Slot 4 (CPU1)	PCIe 3.0 x16, full height, full length, 75W, double-width
	Slot 5	PCI, full height, full length, 25W
	Slot 6 (PCH)	PCIe 3.0 x4, full height, half length, 25W, open ended

	Graphics	Memory	Pow-er	Connector	SLI / NVlink	Max Qty
	NVS 810	4GB DDR3	68W	8xmini DP		2
	Quadro P400	2GB GDDR5	30W	3xminiDP		3
	Quadro P600	2GB GDDR5	45W	4xminiDP		3
	Quadro P620	2GB GDDR5	40W	4xminiDP		3
	Quadro P1000	4GB GDDR5	50W	4xminiDP		3
	Quadro P2000	5GB GDDR5	75W	4xDP		3
	Quadro P4000	8GB GDDR5	120W	4xDP		2
	Quadro P5000	16GB GDDR5X	180W	DVI-D DL+4xDP	SLI	2
	Quadro P6000	24GB GDDR5X	250W	DVI-D DL+4xDP		1

	Graphics	Memory	Pow-er	Connector	SLI / NVlink	Max Qty
	Quadro RTX 4000	8GB GDDR6	160W	3xDP, 1xVirtualLink		2
	Quadro RTX 5000	16GB GDDR6	265W	4xDP, 1xVirtualLink		1
	Quadro RTX 6000	24GB GDDR6	295W	4xDP, 1xVirtualLink		1
	Quadro RTX 8000	48GB GDDR6	295W	4xDP, 1xVirtualLink		1
	Quadro GP100	16GB HBM2	235W	1xDVI-D DL, 4xDP		1
	Quadro GV100	32GB HBM2	250W	4xDP		1

Storage Controller	Storage Controller	Type	Interface	RAID	Cache
	Onboard Intel RSTe	Std	SATA 6Gb/s	0/1/10/5	
	9440-8i PCIe	Opt	SAS 12Gb/s, SATA 6Gb/s	0/1/10/5	
	9460-16i PCIe	Opt	SAS 12Gb/s, SATA 6Gb/s	0/1/10/5/6	4GB DDR4, SuperCap
	NVMe Basic	Opt	PCIe NVMe	0/1/10	
	NVMe Premium	Opt	PCIe NVMe	0/1/10/5	
	NVMe for Intel SSD	Opt	PCIe NVMe	0/1/10/5	

Storage Support	Disk Type	Interface	RPM	Offering	Max Qty (Blind connection + 9460 used)
	3.5" SATA HDD	SATA 6Gb/s	7.2K	1TB/2TB/4TB/6TB	6 (Also supports additional 4x 2.5" SATA SSD/HDD)
2.5" SATA HDD	SATA 6Gb/s	7.2K	500GB/500GB FIPS	10	
2.5" SAS HDD	SAS 12Gb/s	10K	300GB/600GB	8	
2.5" SATA SSD	SATA 6Gb/s		256GB/512GB/1TB/2TB	10	
2.5" PCIe SSD	PCIe NVMe		1.5TB	2	
M.2 PCIe SSD	PCIe NVMe		256GB/512GB/1TB/2TB	9	
PCIe AIC SSD	PCIe NVMe		480GB	2	

Storage Bays	Bay Type	Maximum Drives Qty
	M.2 slot	9x M.2 SSD (2 onboard, 7 via PCIe to M.2 adapter)
Flex Bay	2 flex bays. Supports the following:	
	<ul style="list-style-type: none"> • 2x half-height optical drives • 2x 5.25" 9.0mm optical drives • 1x 5.25" 9.0mm optical drive + 1x 3.5"/2.5" SATA SSD/HDD • 1x 3.5"/2.5" SATA SSD/HDD with Front Access Storage Enclosure • 1x flex module for the following options: <ul style="list-style-type: none"> Tray 1: 9.0mm optical Tray 2: 15-in-1 USB 3.1 Gen 1 reader or 2x Thunderbolt Port 1 and 2: Front USB 3.1 Gen 1 Type-C or eSATA • 2x M.2 SSD with 2x Front Removable Drive Enclosures 	
Disk bay	4 disk bays (2 bays standard, 2 bays optional). Supports one of the following configurations:	
	<ul style="list-style-type: none"> • 4x 3.5" SATA HDD • 4x 3.5" SATA HDD + 4x 2.5" SATA SSD/HDD (Blind connection needed) • 8x 2.5" SATA SSD/HDD or 8x 2.5" SAS HDD (Blind connection needed) • 2x 2.5" PCIe SSD + 2x 3.5"/2.5" disks (Blind connection needed) 	

Max Storage	Supports up to 9x M.2 SSD + 6x 3.5" HDD/10x 2.5" SSD/10x 2.5" HDD + 2x PCIe AIC SSD. All HDD: 36TB using 6x 3.5" HDD All SSD: 38.96TB using 10x 2.5" SATA SSD, 9x M.2 SSD, and 2x PCIe AIC SSD
-------------	------------------------------------------------------------------------------------------------------------------------------------------------------------------------------------------------------

ThinkStation P720 Platform Specifications

Power supply	Supports one of the following: <ul style="list-style-type: none"> • One fixed 690W, autosensing, 92%, 80 PLUS Platinum qualified • One fixed 900W, autosensing, 92%, 80 PLUS Platinum qualified 	
Media reader	SD USB 2.0 card reader on most models. Optional UHS-II 15-in-1 USB 3.1 Gen 1 reader on flex module	
Network interfaces	Integrated two-port gigabit ethernet (Intel i219LM and i210AT), supports Wake-on-LAN on both two ports. Optional PCIe ethernet are available	
WLAN + Bluetooth	Optional Intel Wireless-AC 8265, 2x2, 2.4GHz/5GHz, 802.11ac, Bluetooth 4.2, up to 867Mbps	
Security features	Power-on and admin password. Trusted Platform Module, TCG 2.0 compliant, switch to 1.2 via UEFI setting. Chassis intrusion switch. Optional access panel lock, Kensington lock, and pad lock	
Intel vPro	Intel vPro technology supported. vPro requires Wireless-AC 8265 if Wi-Fi is needed	
Intel AMT	Intel Active Management Technology 11	
Diagnostic	Front panel warning LED. ThinkStation Diagnostics for Windows. Photo-audio transfer with Lenovo PC Diagnostics for Android and iOS. Optional front 4-digit diagnostic display on flex module	
Base warranty	1 or 3-year limited onsite service with 9x5/NBD	
HD Audio	Realtek ALC662 codec	
Front ports	4x USB 3.1 Gen 1 (includes one 11W charging), 1x combo audio/microphone jack (3.5mm)	
Rear ports	2x USB 2.0, 4x USB 3.1 Gen 1, 2x RJ-45, 3x analog audio ports (line-in, line-out, mic-in), 2x PS/2	
Optional ports	Supports the following optional ports: Front: <ul style="list-style-type: none"> • 2x Thunderbolt ports (USB Type-C) on flex module, one of two ports supports video-out • 1x eSATA on flex module • 1x USB Type-C on flex module, USB 3.1 gen 1 Rear: <ul style="list-style-type: none"> • 1x COM port • 2x USB Type-C ports via PCIe adapter, USB 3.1 gen 2. One 15W, one 5W Internal: <ul style="list-style-type: none"> • 1x internal USB 3.1 Gen 1 port 	
Environmental specification	Temperature - operating	50 °F to 95 °F (10 °C to 35 °C)
	Temperature - storage (no package)	14 °F to 140 °F (-10 °C to 60 °C)
	Temperature - storage (with package)	-40 °F to 140 °F (-40 °C to 60 °C)
	Altitude - operating	(Unpressurized): 0-10000ft (0-3048m)
	Humidity - operating	10%~80%, non-condensing
	Humidity - storage (with package)	10%~90%, non-condensing
Environmental Certifications	RoHS-compliant. GREENGUARD. EPEAT Silver rating. ENERGY STAR 6.1 qualified on model 30BA0007US and 30BA0008US	
ISV certifications	Please visit www.thinkworkstations.com/isv-certifications/	

Note:

1. Depending on many factors, actual data transfer speed mentioned on this page may be lower than theoretical speed.
2. To support the maximum expandability, 900W power supply may be needed.
3. Any questions or advice on ThinkStation PSREF, please contact [ThinkStation PSREF developer](#)



ThinkStation P920 Platform Specifications

Form factor	55L Tower						
Dimensions	200mm/7.87" W x 620mm/24.4" D x 446mm/17.56" H (with feet)						
Weight	Maximum configuration: 71.3 lb (32.3kg)						
Processor Sockets	2x FCLGA3647						
Processor Support	Up to two 205 W Gen 1 or Gen 2 Intel Xeon Scalable family processors, Bronze, Silver, Gold, or Platinum						
Processor Offering	Processor	# of Cores	# of Threads	Base Frequency	Cache	TDP	Memory Types
	Xeon Platinum 8280	28	56	2.7GHz	39MB	205W	DDR4-2933
	Xeon Gold 6254	18	36	3.1GHz	25MB	200W	DDR4-2933
	Xeon Gold 6244	8	16	3.6GHz	25MB	150W	DDR4-2933
	Xeon Gold 6242	16	32	2.8GHz	22MB	150W	DDR4-2933
	Xeon Gold 6238T	22	44	1.9GHz	30MB	125W	DDR4-2933
	Xeon Gold 6234	8	16	3.3GHz	25MB	130W	DDR4-2933
	Xeon Gold 6230	20	40	2.1GHz	28MB	125W	DDR4-2933
	Xeon Gold 6226	12	24	2.7GHz	19MB	125W	DDR4-2933
	Xeon Gold 5222	4	8	3.8GHz	17MB	105W	DDR4-2933
	Xeon Gold 5218	16	32	2.3GHz	22MB	125W	DDR4-2666
	Xeon Gold 5217	8	16	3.0GHz	11MB	115W	DDR4-2666
	Xeon Gold 5215	10	20	2.5GHz	13.75MB	85W	DDR4-2666
	Xeon Silver 4216	16	32	2.1GHz	22MB	100W	DDR4-2400
	Xeon Silver 4215	8	16	2.5GHz	11MB	85W	DDR4-2400
	Xeon Silver 4214	12	24	2.2GHz	17MB	85W	DDR4-2400
	Xeon Silver 4210	10	20	2.2GHz	14MB	85W	DDR4-2400
	Xeon Silver 4209T	8	16	2.2GHz	11MB	70W	DDR4-2400
	Xeon Silver 4208	8	16	2.1GHz	11MB	85W	DDR4-2400
	Xeon Bronze 3204	6	6	1.9GHz	8.25MB	85W	DDR4-2133
	Xeon Platinum 8160T	24	48	2.1GHz	33MB	150W	DDR4-2666
	Xeon Gold 6154	18	36	3.0GHz	24.75MB	200W	DDR4-2666
	Xeon Gold 6142	16	32	2.6GHz	22MB	150W	DDR4-2666
	Xeon Gold 6136	12	24	3.0GHz	24.75MB	150W	DDR4-2666
	Xeon Gold 6134	8	16	3.2GHz	24.75MB	130W	DDR4-2666
	Xeon Gold 6128	6	12	3.4GHz	19.25MB	115W	DDR4-2666
	Xeon Gold 5122	4	8	3.6GHz	16.5MB	105W	DDR4-2666
	Xeon Gold 5120T	14	28	2.2GHz	19.25MB	105W	DDR4-2400
	Xeon Gold 5118	12	24	2.3GHz	16.5MB	105W	DDR4-2400
	Xeon Gold 5115	10	20	2.4GHz	13.75MB	85W	DDR4-2400
	Xeon Silver 4116	12	24	2.1GHz	16.5MB	85W	DDR4-2400
	Xeon Silver 4114T	10	20	2.2GHz	13.75MB	85W	DDR4-2400
	Xeon Silver 4114	10	20	2.2GHz	13.75MB	85W	DDR4-2400
Xeon Silver 4112	4	8	2.6GHz	8.25MB	85W	DDR4-2400	
Xeon Silver 4110	8	16	2.1GHz	11MB	85W	DDR4-2400	
Xeon Silver 4109T	8	16	2.0GHz	11MB	70W	DDR4-2400	
Xeon Silver 4108	8	16	1.8GHz	11MB	85W	DDR4-2400	
Chipset	Intel C621 Chipset						
Memory Sockets	16 DIMM sockets with 12 channels. 8 DIMM sockets with 6 channels per processor						
Memory Types	DDR4-2666 RDIMM, DDR4-2666 LRDIMM, or DDR4-2933 RDIMM						
Memory Capacity	1TB (DDR4-2666 LRDIMM or DDR4-2933 RDIMM) or 512GB (DDR4-2666 RDIMM)						
Memory Protection	ECC						
Expansion slots	Slot 1 (CPU1)	PCIe 3.0 x16, full height, full length, 75W, double-width					
	Slot 2 (CPU1)	PCIe 3.0 x4, full height, full length, 25W, open ended					
	Slot 3 (CPU1)	PCIe 3.0 x16, full height, full length, 75W, double-width					
	Slot 4 (CPU1)	PCIe 3.0 x4, full height, full length, 25W, open ended					
	Slot 5 (PCH)	PCIe 3.0 x4, full height, half length, 25W, open ended					
	Slot 6 (CPU2)	PCIe 3.0 x16, full height, half length, 75W					
	Slot 7 (CPU2)	PCIe 3.0 x16, full height, full length, 75W, double-width					
	Slot 8 (CPU2)	PCIe 3.0 x16, full height, full length, 75W					

Discrete Graphics Offering	Graphics	Memory	Power	Connector	SLI / NVLink	Max Qty
	NVS 810	4GB DDR3	68W	8xmini DP		2
	Quadro P400	2GB GDDR5	30W	3xminiDP		5
	Quadro P600	2GB GDDR5	45W	4xminiDP		4
	Quadro P620	2GB GDDR5	40W	4xminiDP		4
	Quadro P1000	4GB GDDR5	50W	4xminiDP		4
	Quadro P2000	5GB GDDR5	75W	4xDP		4
	Quadro P4000	8GB GDDR5	120W	4xDP		4
	Quadro P5000	16GB GDDR5X	180W	DVI-D DL+4xDP	SLI	3
	Quadro P6000	24GB GDDR5X	250W	DVI-D DL+4xDP	SLI	3
	Quadro RTX 4000	8GB GDDR6	160W	3xDP, 1xVirtualLink		3
	Quadro RTX 5000	16GB GDDR6	265W	4xDP, 1xVirtualLink	NVLink	3
	Quadro RTX 6000	24GB GDDR6	295W	4xDP, 1xVirtualLink	NVLink	2
	Quadro RTX 8000	48GB GDDR6	295W	4xDP, 1xVirtualLink	NVLink	2
	Quadro GP100	16GB HBM2	235W	1xDVI-D DL, 4xDP	NVLink	3
Quadro GV100	32GB HBM2	250W	4xDP	NVLink	3	
Storage Controller	Storage Controller	Type	Interface	RAID	Cache	
	Onboard Intel RSTe	Std	SATA 6Gb/s	0/1/10/5		
	9440-8i PCIe	Opt	SAS 12Gb/s, SATA 6Gb/s	0/1/10/5		
	9460-16i PCIe	Opt	SAS 12Gb/s, SATA 6Gb/s	0/1/10/5/6		4GB DDR4, SuperCap
	NVMe Basic	Opt	PCIe NVMe	0/1/10		
	NVMe Premium	Opt	PCIe NVMe	0/1/10/5		
	NVMe for Intel SSD	Opt	PCIe NVMe	0/1/10/5		
Storage Support	Disk Type	Interface	RPM	Offering	Max Qty (9460 used)	
	3.5" SATA HDD	SATA 6Gb/s	7.2K	1TB/2TB/4TB/6TB	6 (Also supports additional 4x 2.5" SATA SSD/HDD)	
	2.5" SATA HDD	SATA 6Gb/s	7.2K	500GB/500GB FIPS	10	
	2.5" SAS HDD	SAS 12Gb/s	10K	300GB/600GB	8	
	2.5" SATA SSD	SATA 6Gb/s		256GB/512GB/1TB/2TB	10	
	2.5" PCIe SSD	PCIe NVMe		1.5TB	4	
	M.2 PCIe SSD	PCIe NVMe		256GB/512GB/1TB/2TB	9	
	PCIe AIC SSD	PCIe NVMe		480GB	2	
Storage Bays	Bay Type	Maximum Drives Qty				
	M.2 slot	9x M.2 SSD (2 onboard, 7 via PCIe to M.2 adapter)				
	Flex Bay	2x 3.5" or 2.5" disks. Supports the following: <ul style="list-style-type: none"> 3x half-height optical drives 2x 5.25" 9.0mm optical drives 1x 5.25" 9.0mm optical drive + 1x 3.5"/2.5" SATA SSD/HDD 1x 3.5"/2.5" SATA SSD/HDD with Front Access Storage Enclosure 1x flex module for the following options: Tray 1: 9.0mm optical Tray 2: 15-in-1 USB 3.1 Gen 1 reader or 2x Thunderbolt Port 1 and 2: Front USB 3.1 Gen 1 Type-C or eSATA <ul style="list-style-type: none"> 3x M.2 SSD with 3x Front Removable Drive Enclosures 				
	Disk bay	8 disk drives with 4 bays (2 bays standard, 2 bays optional). Supports one of the following configurations: <ul style="list-style-type: none"> 4x 3.5" SATA HDD 4x 3.5" SATA HDD + 4x 2.5" SATA SSD/HDD 8x 2.5" SATA SSD/HDD or 8x 2.5" SAS HDD 				

ThinkStation P920 Platform Specifications

Max Storage	Supports up to 9x M.2 SSD + 6x 3.5" HDD/10x 2.5" SSD/10x 2.5" HDD + 2x PCIe AIC SSD. All HDD: 36TB using 6x 3.5" HDD All SSD: 38.96TB using 10x 2.5" SATA SSD, 9x M.2 SSD, and 2x PCIe AIC SSD	
Power supply	One fixed 1400 watts, autosensing, 92% PSU, 80 PLUS Platinum qualified. Countries with input voltage under 115V, output power limited to 1125 watts	
Media reader	SD USB 2.0 card reader on most models. Optional UHS-II 15-in-1 USB 3.1 Gen 1 reader on flex module	
Network interfaces	Integrated two-port gigabit ethernet (Intel i219LM and i210AT), supports Wake-on-LAN on both two ports. Optional PCIe ethernet are available	
WLAN + Bluetooth	Optional Intel Wireless-AC 8265, 2x2, 2.4GHz/5GHz, 802.11ac, Bluetooth 4.2, up to 867Mbps	
Security features	Power-on and admin password. Trusted Platform Module, TCG 2.0 compliant, switch to 1.2 via UEFI setting. Chassis intrusion switch. Optional access panel lock, Kensington lock, and pad lock	
Intel vPro	Intel vPro technology supported. vPro requires Wireless-AC 8265 if Wi-Fi is needed	
Intel AMT	Intel Active Management Technology 11	
Diagnostic	Front 4-digit diagnostic display. ThinkStation Diagnostics for Windows. Photo-audio transfer with Lenovo PC Diagnostics for Android and iOS	
Base warranty	1 or 3-year limited onsite service with 9x5/NBD	
HD Audio	Realtek ALC662 codec	
Front ports	4x USB 3.1 Gen 1 (includes one 11W charging), 1x combo audio/microphone jack (3.5mm)	
Rear ports	2x USB 2.0, 4x USB 3.1 Gen 1, 2x RJ-45, 3x analog audio ports (line-in, line-out, mic-in), 2x PS/2	
Optional ports	Supports the following optional ports: Front: <ul style="list-style-type: none"> • 2x Thunderbolt ports (USB Type-C) on flex module, one of two ports supports video-out • 1x eSATA on flex module • 1x USB Type-C on flex module, USB 3.1 gen 1 Rear: <ul style="list-style-type: none"> • 1x COM port • 2x USB Type-C ports via PCIe adapter, USB 3.1 gen 2. One 15W, one 5W Internal: <ul style="list-style-type: none"> • 1x internal USB 3.1 Gen 1 port 	
Environmental specification	Temperature - operating	50 °F to 95 °F (10 °C to 35 °C)
	Temperature - storage (no package)	14 °F to 140 °F (-10 °C to 60 °C)
	Temperature - storage (with package)	-40 °F to 140 °F (-40 °C to 60 °C)
	Altitude - operating	(Unpressurized): 0-10000ft (0-3048m)
	Humidity - operating	10%~80%, non-condensing
	Humidity - storage (with package)	10%~90%, non-condensing
Environmental Certifications	RoHS-compliant. GREENGUARD. EPEAT Silver rating. ENERGY STAR 6.1 qualified on model 30BC0008US and 30BC0009US	
ISV certifications	Please visit www.thinkworkstations.com/isv-certifications/	

Note:

1. Depending on many factors, actual data transfer speed mentioned on this page may be lower than theoretical speed.
2. Any questions or advice on ThinkStation PSREF, please contact [ThinkStation PSREF developer \(houyf@lenovo.com\)](mailto:houyf@lenovo.com)

This publication was developed for products and services offered in the United States and E.M.E.A countries. Lenovo may not offer the products, services or features discussed in this document in other countries. Lenovo may withdraw an offering at any time. Information is subject to change without notice. Consult your local representative for information on offerings available in your area.

Lenovo reserves the right to change specifications or other product information without notice. Lenovo is not responsible for photographic or typographical errors.

LENOVO PROVIDES THIS PUBLICATION "AS IS," WITHOUT WARRANTY OF ANY KIND, EITHER EXPRESS OR IMPLIED, INCLUDING THE IMPLIED WARRANTIES OF MERCHANTABILITY OR FITNESS FOR A PARTICULAR PURPOSE.

Some jurisdictions do not allow disclaimer of express or implied warranties in certain transactions, therefore this disclaimer may not apply to you.

Availability: All offers subject to availability. Lenovo reserves the right to alter product offerings and specifications at any time, without notice. Lenovo is not responsible for photographic or typographic errors.

General: Review key information provided by Microsoft that may apply to your system purchase, including details on Windows 10, Windows 8, Windows 7, and potential upgrades/downgrades. Lenovo makes no representation or warranty regarding third-party products or services.

Trademarks: Lenovo, ThinkPad, ThinkCentre, ThinkStation and the Lenovo logo are trademarks of Lenovo. Microsoft, Windows, Windows NT, and the Windows logo are trademarks of Microsoft Corporation. Ultrabook, Celeron, Celeron Inside, Core Inside, Intel, Intel Logo, Intel Atom, Intel Atom Inside, Intel Core, Intel Inside, Intel Inside Logo, Intel vPro, Itanium, Itanium Inside, Pentium, Pentium Inside, vPro Inside, Xeon, Xeon Phi, and Xeon Inside are trademarks of Intel Corporation in the U.S. and/or other countries. Other company, product or service names may be trademarks or service marks of others.

Warranty: For a copy of applicable warranties, write to: Lenovo Warranty Information, 1009 Think Place, Morrisville, NC, 27560. Lenovo makes no representation or warranty regarding third party products or services. The Lenovo Limited Warranty applies only to Lenovo hardware products purchased for your own use, and does not transfer upon resale.

Limited warranty: Support unrelated to a warranty issue may be subject to additional charges.

Lenovo Services:

Carry-in or Mail-in Service: Parts and labor repair coverage where the customer is responsible for shipping (including packaging) or delivery to authorized warranty provider or repair center.

Depot or Courier Service: Parts and labor repair coverage where shipping (including packaging) or delivery to the repair center is paid for by Lenovo.

Expedited Depot: Parts and labor coverage with expedited turnaround. Shipping (including packaging) or delivery to the repair center is paid for by Lenovo.

Onsite / In-home Service: Parts and labor repair coverage where labor is provided onsite at your place of business.

If Lenovo determines your product problem is covered by the product warranty and cannot be resolved over the telephone, a technician will be dispatched to arrive onsite, typically the next day.

International Warranty Service (IWS): PC repair coverage for customers who require a critical warranty repair while travelling internationally. Visit www.lenovo.com/internationalwarranty for details. Visit www.lenovo.com/warranty for Lenovo Warranty Services terms and conditions for complete details and restrictions.

Included software: may differ from its retail version (if available), and may not include user manuals or all program functionality. Software license agreements may apply.

Battery life: Battery life (and recharge times) will vary based on many factors including screen brightness, applications, features, power management, battery conditioning, and other customer preferences.

Visit <http://psref.lenovo.com/> for the latest version of Product Specifications Reference.

© Lenovo, 2018. All rights reserved.
Lenovo 1009 Think Place Morrisville, NC 27560 U.S.A.

Lenovo™ **ThinkVision**

PSREF



Product Specifications Reference

Version 552, December 2019

Visit <http://psref.lenovo.com> for the latest version

Contents

Cover		
Contents		
Summary Of Change		
13 Inch - 16 Inch		
ThinkVision M14		
ThinkVision M14 Platform Specifications		
17 Inch - 20 Inch		
ThinkVision E1922s		
ThinkVision E1922s Platform Specifications		
ThinkVision E2054		
ThinkVision E2054 Platform Specifications		
ThinkVision LT1913p Square		
ThinkVision LT1913p Square Platform Specifications		
ThinkVision T1714		
ThinkVision T1714 Platform Specifications		
ThinkVision T1714p		
ThinkVision T1714p Platform Specifications		
ThinkVision T2054p		
ThinkVision T2054p Platform Specifications		
21 Inch - 24 Inch		
ThinkVision E21		
ThinkVision E21 Platform Specifications		
ThinkVision E24		
ThinkVision E24 Platform Specifications		
ThinkVision P24h		
ThinkVision P24h Platform Specifications		
ThinkVision P24q		
ThinkVision P24q Platform Specifications		
ThinkVision S22e		
ThinkVision S22e Platform Specifications		
ThinkVision S24e		
ThinkVision S24e Platform Specifications		
ThinkVision S24q-10		
ThinkVision S24q-10 Platform Specifications		
ThinkVision T2224d		
1 ThinkVision T2224d Platform Specifications		34
2 ThinkVision T2254		35
4 ThinkVision T2254 Platform Specifications		36
5 ThinkVision T2254p		37
5 ThinkVision T2254p Platform Specifications		38
6 ThinkVision T22i		39
7 ThinkVision T22i Platform Specifications		40
7 ThinkVision T22v		41
8 ThinkVision T22v Platform Specifications		42
9 ThinkVision T2324d		43
10 ThinkVision T2324d Platform Specifications		44
11 ThinkVision T23d		45
12 ThinkVision T23d Platform Specifications		46
13 ThinkVision T23i		47
14 ThinkVision T23i Platform Specifications		48
15 ThinkVision T2454p		49
16 ThinkVision T2454p Platform Specifications		50
17 ThinkVision T24d		51
18 ThinkVision T24d Platform Specifications		52
19 ThinkVision T24i-10		53
19 ThinkVision T24i-10 Platform Specifications		54
20 ThinkVision T24i-19		55
21 ThinkVision T24i-19 Platform Specifications		56
22 ThinkVision T24m		57
23 ThinkVision T24m Platform Specifications		58
24 ThinkVision T24v		59
25 ThinkVision T24v Platform Specifications		60
26 ThinkVision X24 Pro		61
27 ThinkVision X24 Pro Platform Specifications		62
28 ThinkVision X24-20		63
29 ThinkVision X24-20 Platform Specifications		64
30 Above 25 Inch		65
31 ThinkVision P27h		65
32 ThinkVision P27h Platform Specifications		66
33 ThinkVision P27q		67

Contents

ThinkVision P27q Platform Specifications	68
ThinkVision P27u	69
ThinkVision P27u Platform Specifications	70
ThinkVision P32u	71
ThinkVision P32u Platform Specifications	72
ThinkVision P44w-10	73
ThinkVision P44w-10 Platform Specifications	74
ThinkVision S27i	75
ThinkVision S27i Platform Specifications	76
ThinkVision S27q-10	77
ThinkVision S27q-10 Platform Specifications	78
ThinkVision T25d-10	79
ThinkVision T25d-10 Platform Specifications	80
ThinkVision T25m-10	81
ThinkVision T25m-10 Platform Specifications	82
ThinkVision T27i	83
ThinkVision T27i Platform Specifications	84
ThinkVision T27p-10	85
ThinkVision T27p-10 Platform Specifications	86
ThinkVision X1	87
ThinkVision X1 Platform Specifications	88
ThinkVision X1 (2nd Gen)	89
ThinkVision X1 (2nd Gen) Platform Specifications	90
Legal Information	92

Summary of Changes

This section describes the technical changes made in this edition.

This edition might also include minor corrections and editorial changes which are not identified.

December, 2019 - Version 552

Additions in this update

▶ **New product(s)**

ThinkVision S27q-10

ThinkVision S24q-10

▶ **New model(s)**

None

▶ **Others**

None

Withdrawals in this update

▶ **Withdrawn product(s)**

None

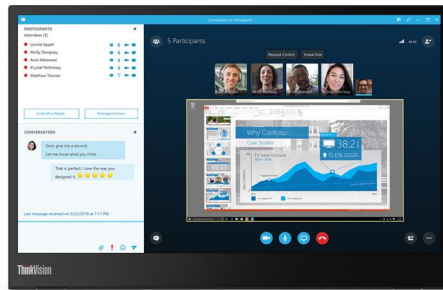



PORTABLE USB-C MONITOR CRAFTED FOR IMPROVED PRODUCTIVITY

The ThinkVision M14 is an ultraslim and ultralight mobile monitor. Its 14-inch screen helps you extend your workspace comfortably no matter where work takes you. Compatible with notebooks of any screen size that come with an advanced USB Type-C port*, the ThinkVision M14 can either extend or duplicate your notebook display with one plug. The USB Type-C ports on either side allow both left- and right-handed users to work efficiently, and the ergonomic design enhances user experience. Packed with impressive portability, connectivity, and flexibility features, the ThinkVision M14 is ideal for mobile productivity.



Extreme Portability



Superior Connectivity



Remarkable Flexibility

ACHIEVE TARGETS ON THE GO

The ThinkVision M14 boosts productivity with its thin and light form factor. Weighing 570g, this 4.4mm sleek mobile monitor enables easy portability. The stylish design with a Full HD, IPS display provides vivid lifelike visuals, ensuring you never miss out on any detail. With a brightness of 300 nits, the ThinkVision M14 offers a stunning visual experience while consuming content online.



4.4mm sleek: approximately as thin as two USD \$1 coins



Weight
570g



Screen Size
14 inches



Brightness
300 nits (Typical)



EXPERIENCE ADVANCED CONNECTIVITY

Two innovative USB Type-C ports on either side of the monitor make connectivity effortless. These ports support both power and video delivery simultaneously from a single port. The ThinkVision M14 also offers a 'power pass through' design that powers the mobile monitor by an adapter and charges the notebook at the same time. This feature is suitable for smartphones or notebooks with one USB Type-C port*. The ambidextrous design of this monitor enhances user comfort.



USB Ports
2 x USB Type-C



Cable
USB Type-C to C

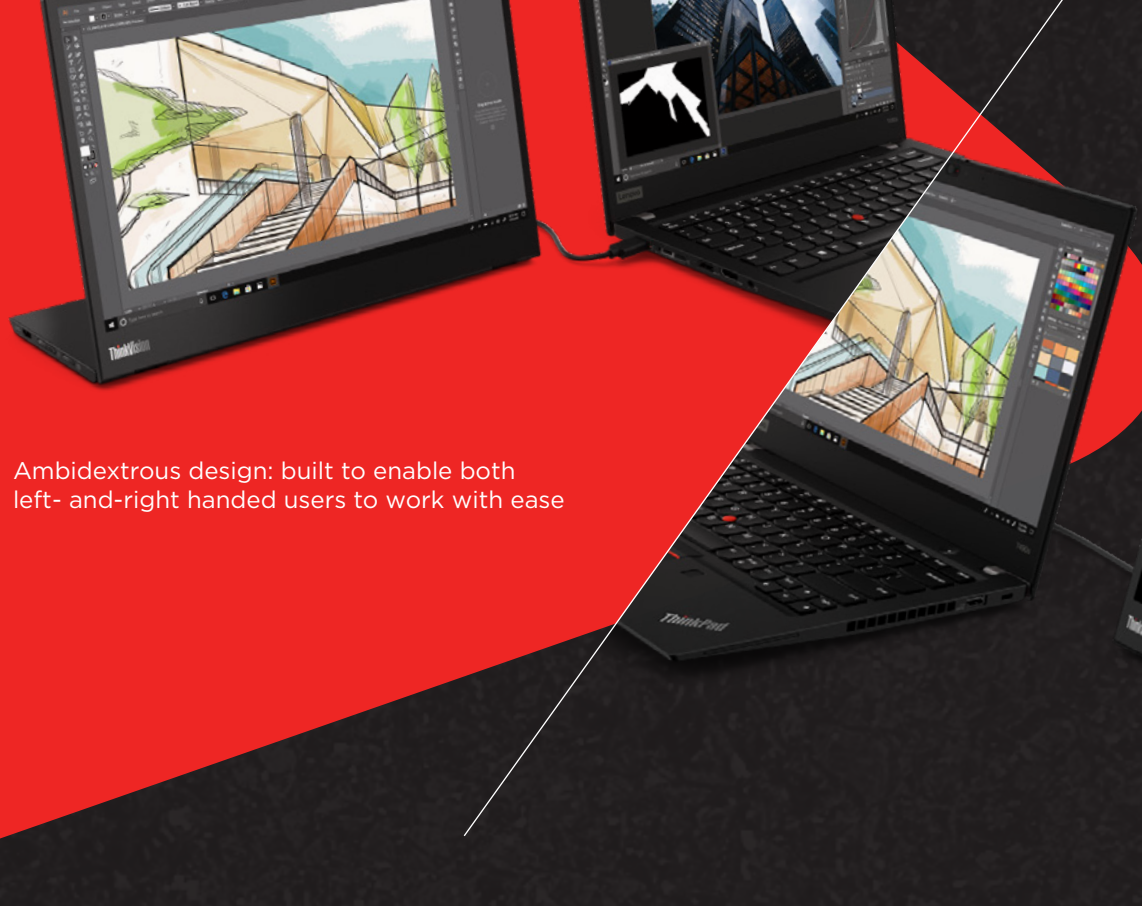

Ambidextrous design: built to enable both left- and right-handed users to work with ease

WORK THE WAY YOU LIKE

The ThinkVision M14 with its admirable flexibility is built for varied job roles. With a tilt angle of -5°-90°, you can position your monitor in a way that suits your style. Compare content with ease even as you use laptops of different screen sizes with the ergonomic height adjustable foot. Also, you can wall mount your monitor effortlessly with mounting support for a hands-free viewing experience. The advanced low blue light technology minimizes eye strain, making extended working hours easy.



Height Adjustable Foot
Tilt 0°-90°

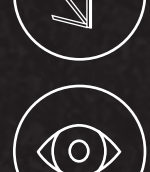

Monitor Stand
Tilt -5°-90°



Eye-care Technology
Low blue light

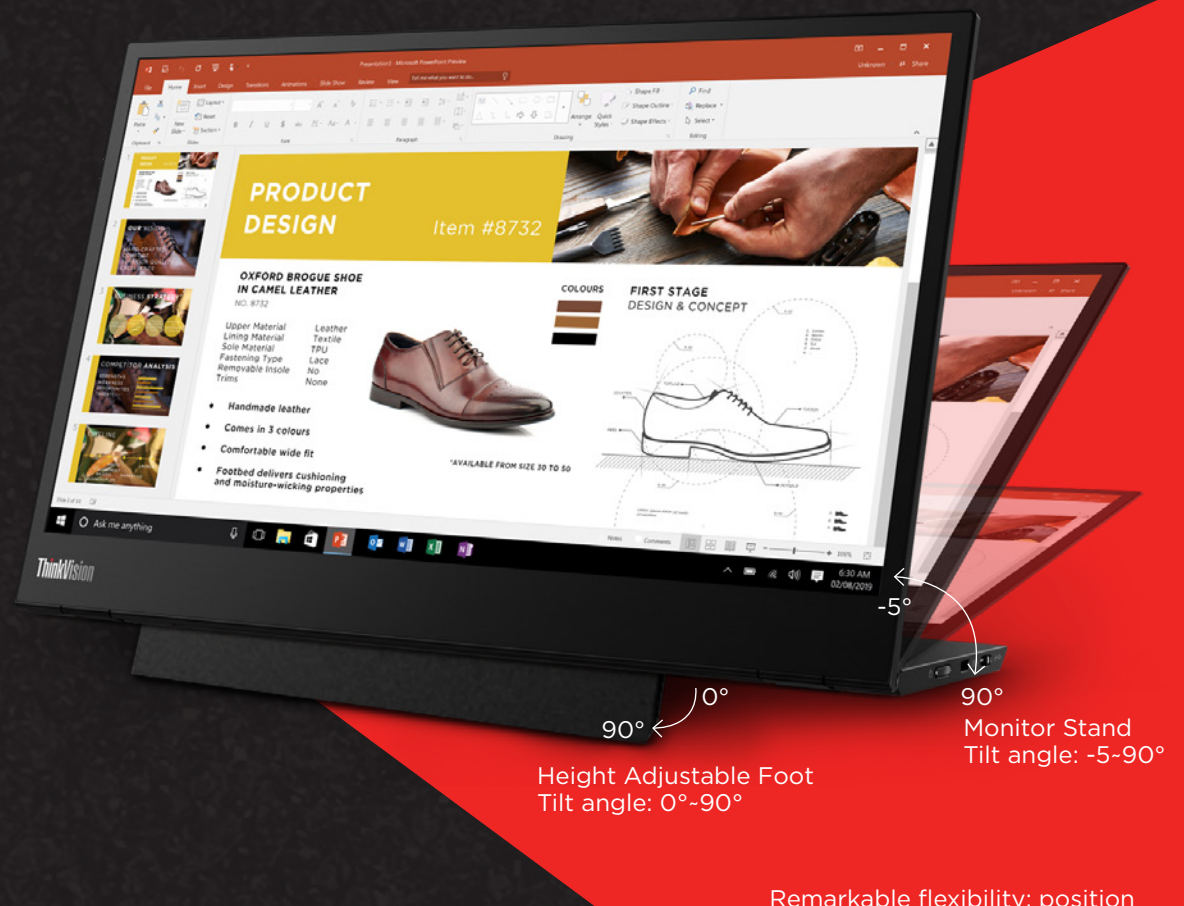

Height Adjustable Foot
Tilt angle: 0°-90°

Monitor Stand
Tilt angle: -5°-90°

Remarkable flexibility: position the monitor in the way that suits your style

*For charging usage, a Lenovo branded 65W adapter (Part No.: SA10E75874) is recommended

TECH SPECS

LCD PANEL

- Panel Size: 14-inch
- Screen Dimensions (W x H, mm): 309.31 x 173.99 mm
- Panel Type: In-Plane Switching
- Backlight: WLED
- Aspect Ratio: 16:9
- Resolution: 1920 x 1080
- Pixel Pitch (H x V, mm): 0.1611 x 0.1611 mm
- Dot/Pixel Per Inch (DPI/PPI): 157
- Viewing angle (H x V @ CR 10:1): 178° / 178°
- Response Time (typical): 6ms with OD
- Refresh Rate: 60 Hz
- Brightness (typical): 300 cd/m²
- Contrast Ratio (typical): 700:1
- Dynamic Contrast Ratio (typical): 3M:1
- Colour Gamut NTSC (CIE 1931): 72%
- Color Support (typical): 16.7 Million
- Color Depth: 8bit (6bit + FRC)
- Anti-Glare: Yes

CONNECTIVITY

- Video Input Signals: 2 x USB 3.1 Type-C (DPI.2 Alt Mode)

POWER

- Power Consumption (Typ./Max): 6 W / 7.5 W (Without USB Type-C output)
- ENERGY STAR® Power Consumption (P_{on}): 4.88 W
- ENERGY STAR® Power Consumption (E_{TEC}): 15.53 kWh
- Power Consumption Sleep/Off Mode: < 0.3 W

Power Consumption Switch-Off Mode

- < 0.3 W
- USB Type-C/Power Delivery: Up to 65 W
- Power Supply: External (no adapter bundle)
- Voltage Required: DC 5 V to 20 V

MECHANICAL

- Tilt Angle (front/back): -5° / 90°
- Mounting Support: Yes (100 mm)
- Kensington™ Lock Slot: Yes
- Cable Management: Yes
- Bezel Color: Raven Black
- Bezel Width (Side): 5.48mm
- Bezel Width (top / bottom): 5.47 mm / 23.87 mm

DIMENSIONS

- Size Packed (D x H x W) (mm / inch): 276 x 61 x 402 mm / 10.87 x 2.40 x 15.83 inches
- Size Unpacked w/stand (D x H x W) (mm / inch) (Lowest position): 96.54 x 209.03 x 323.37 mm / 3.8 x 8.23 x 12.73 inches
- Size Unpacked w/stand (D x H x W) (mm / inch) (Highest position): 96.54 x 220.03 x 323.37 mm / 3.8 x 8.66 x 12.73 inches
- Stand base footprint area (mm²): 260.87 x 69.55 mm / 10.27 x 2.74 inches
- Weight Packed (kg / lbs.): 1.67 kg / 3.67 lbs.
- Weight Unpacked (kg / lbs.): 0.57 kg / 1.26 lbs.

WHATS IN THE BOX

- 1 x Monitor with stand
- 1 x ThinkVision M14 sleeve
- 1 x USB Type-C cable (1 m)
- 1 x QSG
- 1 x Pair of clips

ENVIRONMENTAL

- Temperature - Operating: 0° to 40°C
- Temperature - Non-operating: -20° to 60°C
- Humidity - Operating: 30 to 80%
- Humidity - Non-operating: 30 to 90%
- Altitude - Operating: 0 to 5000 m
- Altitude - Non-operating: 0 to 40,000 ft
- Arsenic-free Glass: Yes
- PVC free: Yes
- Mercury free: Yes
- PCC % of plastic resins: 85%

WARRANTY

- Geography Availability: WW
- Warranty: 3 Years

CERTIFICATIONS

- ENERGY STAR® Rating: 7,1
- CCC: Yes
- EPEAT: Bronze
- RoHS (EU 2002/95/EC): Yes (Arsenic free / Pb free / Mercury free)
- Windows Certification: Windows 7 / 10
- Image Quality Capability: ISO 9241-307
- China Energy Efficiency Standard: Tier 2
- Low Blue Light / Eye Comfort: Yes (Low BlueLight)

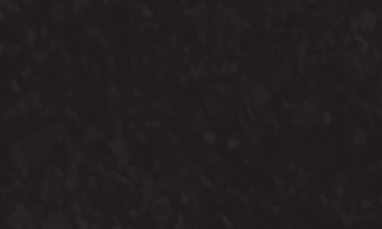



<p>Name E1922s Wide Flat Panel Monitor Case color Black Type-model 60G2AAR6US / 60G2AAT6EU Panel TFT-LCD, twisted nematic (TN), White LED backlight Viewable image size 18.5" (470mm) diagonal Max view area (W x H) 16.1" x 9.1" / 409.8mm x 230.4mm Native resolution 1366x768 Aspect ratio 16:9 Pixel pitch (mm) 0.3mm Dot/Pixel per Inch 85 dpi Brightness 200 nits or cd/m² (typical) Contrast ratio 600:1 (typical) Pixel response time 5ms (typical) Color gamut 72% Viewing angle at 10:1 CR 180° (+/- 90°) horizontal, 100° (+/- 50°) vertical Stand Tilt adjustable stand Bezel width Sides: 0.73" (18.5mm) Dimensions (HxWxD) 13.44" H x 17.65" W x 6.58" D; 341.5mm H x 448.4mm W x 167.2mm D Power supply 13.7 watts typical, 17 watts maximum, <0.5 watts standby/suspend, universal, integrated (no external brick-like power supply) Weight 6.03 lb; 2.74 kg Limited warranty⁴ 3 year (includes backlight) Available date March 2014</p>	<p style="text-align: center;">Features</p> <ul style="list-style-type: none"> • Widescreen 18.5-inch monitor • Supports HD 1366x768 resolution • Supports VESA mount (100mm) • Mercury free panel and arsenic free glass • Kensington lock slot ready for enhanced security • Support Lenovo Tiny PC via VESA mount • Supports optional soundbar • Microsoft® Windows® 7 certified • Microsoft Windows 8 / Windows 8.1 certified 				
<p>VESA-compliant² VESA DPMS-compliant Power management ENERGY STAR® 7.0 Ergonomics ISO 9241-307 Emission standards FCC Class B Environmental TCO (TCO Displays 7.0), WEEE, RoHS, EPEAT™ Silver rating</p>	<div style="text-align: center;">  <p>ThinkVision E1922s Wide Monitor</p> </div>				
<p>Preset resolutions VGA: 640x350, 640x480, 720x400 SVGA: 800x600, 832x624 XGA: 1024x768, 1152x864 SXGA: 1280x1024 WXGA: 1366x768</p> <p>Presets / user settings Standard presets: 15 user settings: 16</p>					
<p>Viewing adjustments Tilt: 20° backward, -5° forward Rotating screen None On screen display On screen display with digital user controls (8 languages) Control features Direct access (control buttons on front) for automatic image setup and adjustment for brightness Multiple input None Monitor connectors VGA 15-pin D-shell, analog, blue Signal cables detachable, VGA 15-pin D-shell at each end, analog, 1.8 meter Mounting features Wall or desk mounting using the Extend Arm or third-party accessories meeting the VESA FPMPI® (100mm mount) Security Security keyhole for attachment of optional cable lock (Kensington® lock-compatible)</p>					
<p>Ship group Monitor with stand, 1.8 meter analog signal cable, 1.8 meter black power cord</p>					
<p style="text-align: center;">Limited Warranty</p> <p>See details at http://support.lenovo.com/en_US/guides-and-manuals/detail.page?DocID=UM008281</p>	<p style="text-align: center;">Accessories</p> <table border="0"> <tr> <td>Kensington MicroSaver Cable Lock</td> <td style="text-align: right;">73P2582</td> </tr> <tr> <td>Kensington Twin Head Cable Lock</td> <td style="text-align: right;">45K1620</td> </tr> </table> <p>See details at www.lenovo.com/support/monitoraccessories</p> <p>See all monitors at www.lenovo.com/thinkvision</p>	Kensington MicroSaver Cable Lock	73P2582	Kensington Twin Head Cable Lock	45K1620
Kensington MicroSaver Cable Lock	73P2582				
Kensington Twin Head Cable Lock	45K1620				



<p>Name E2054 Wide Flat Panel Monitor Case color Raven black Type-model 60DFAAR1US / 60DFAAT1EU Panel TFT-LCD, In-Plane Switching (IPS), LED backlight Viewable image size 19.5" (494mm) diagonal Max view area (W x H) 16.48" x 10.33" / 418.6mm x 262.4mm Native resolution 1440x900 Aspect ratio 16:10 Pixel pitch (mm) 0.097mm x 0.292mm Dot/Pixel per Inch 87 dpi Brightness 250 nits or cd/m² (typical) Contrast ratio 1000:1 (typical) Pixel response time 7ms (typical) Color gamut 72% Viewing angle at 10:1 CR 178° (+/- 89°) horizontal, 178° (+/- 89°) vertical Stand Tilt adjustable stand Bezel width Top: 0.71" (18.0mm) Bottom: 0.70" (17.9mm) Sides: 1.02" (26.0mm) Dimensions (HxWxD) 14.65" H x 17.95" W x 7.41" D; 372.0mm H x 456.0mm W x 188.3mm D Power supply 16 watts typical, 20 watts maximum, <0.5 watts standby/suspend, universal, integrated (no external brick-like power supply) Weight 6.17 lb; 2.8 kg Limited warranty 3 year (includes backlight) Available date November 2015</p>	<p style="text-align: center;">Features</p> <ul style="list-style-type: none"> • Widescreen 19.5-inch monitor • Supports HD 1440x900 resolution • Supports VESA mount (100mm) • Mercury free panel and arsenic free glass • Kensington lock slot ready for enhanced security • Support Lenovo Tiny PC via VESA mount • Microsoft® Windows® 7 certified • Microsoft Windows 8 / Windows 8.1 certified • Microsoft Windows 10 certified
<p>VESA-compliant VESA DPMS-compliant Power management ENERGY STAR® 6.0 Ergonomics ISO 9241-307 Emission standards FCC Class B Environmental TCO (TCO Displays 6.0), WEEE, RoHS, EPEAT™ Silver rating</p>	<div style="text-align: center;">  <p>ThinkVision E2054 Wide Monitor</p> </div>
<p>Preset resolutions VGA: 640x480, 720x400 SVGA: 800x600 XGA: 1024x768 SXGA: 1280x768, 1280x1024 WXGA: 1366x768 WXGA+: 1440x900</p> <p>Presets / user settings Standard presets: 18 user settings: 10</p>	
<p>Viewing adjustments Tilt: 22° backward, -5° forward Rotating screen None On screen display On screen display with digital user controls (8 languages) Control features Direct access (control buttons on front) for automatic image setup and adjustment for brightness Multiple input None Monitor connectors VGA 15-pin D-shell, analog, blue Signal cables detachable, VGA 15-pin D-shell at each end, analog, 1.8 meter Mounting features Wall or desk mounting using the Extend Arm or third-party accessories meeting the VESA FPMPI® (100mm mount) Security Security keyhole for attachment of optional cable lock (Kensington® lock-compatible)</p>	
<p>Ship group Monitor with stand, 1.8 meter analog signal cable, 1.8 meter black power cord</p>	

<p style="text-align: center;">Limited Warranty</p> <p>See details at http://support.lenovo.com/en_US/guides-and-manuals/detail.page?DocID=UM008281</p>	<p style="text-align: center;">Accessories</p> <table border="0"> <tr> <td>Kensington MicroSaver Cable Lock</td> <td style="text-align: right;">73P2582</td> </tr> <tr> <td>Kensington Twin Head Cable Lock</td> <td style="text-align: right;">45K1620</td> </tr> </table> <p>See details at www.lenovo.com/support/monitoraccessories</p> <p>See all monitors at www.lenovo.com/thinkvision</p>	Kensington MicroSaver Cable Lock	73P2582	Kensington Twin Head Cable Lock	45K1620
Kensington MicroSaver Cable Lock	73P2582				
Kensington Twin Head Cable Lock	45K1620				



<p>Name LT1913p Square Flat Panel Monitor Case color Black Type-model 60FBHAR1US / 60FBHAT1EU Panel TFT-LCD, In-Plane Switching (IPS), White LED backlight Viewable image size 19.0" (480.0mm) diagonal Max view area (W x H) 14.76" x 11.80" (374.7mm x 299.8mm) Optimum resolution 1280x1024 Max pixel rate 205MHz (VGA), 165MHz (DVI) Aspect ratio 5:4 Pixel pitch (mm) 0.0976 (H) x 0.2928 (V) mm Dot/Pixel per Inch 86.8 dpi Brightness 250 nits or cd/m² (typical) Contrast ratio 1000:1 (typical) Pixel response time 7ms (typical) Color gamut 72% Viewing angle at 10:1 CR 178° horizontal, 178° vertical Stand Tilt, swivel, pivot, and height adjustable stand Bezel width Sides: 0.68" (17.4mm); top: 0.68" (17.4mm); bottom: 0.68" (17.4mm) Dimensions (HxWxD) 14.63" H x 16.18" W x 10.40" D; 371.5mm H x 411.0mm W x 264.2mm D Power supply 24 watts typical, 27 watts maximum, <0.5 watts standby/suspend, universal, integrated (no external brick-like power supply) Weight 10.69 lb; 4.85kg Limited warranty⁴ 3 year (includes backlight) Available date April 2015</p>	<p>Features</p> <ul style="list-style-type: none"> • 19-inch Square IPS LED backlight panel • Supports 1280x1024 resolution • Supports ThinkCentre Tiny Clamp Bracket • Mercury and arsenic free glass • Low Halogen • Recycled content in plastic material • Supports optional soundbar • Microsoft® Windows® 7 certified • Microsoft Windows 8 / Windows 8.1 certified • Microsoft Windows 10 certified 								
<p>VESA-compliant² VESA DDC2B/C1, EDID 1.3 Power management ENERGY STAR® 7.0 Ergonomics ISO 9241-307 Emission standards FCC Class B Environmental TCO Displays 7.0, TCO Certified Edge 1.1, WEEE, RoHS, EPEAT™ Silver rating, ULE Gold</p> <p>Preset resolutions VGA: 640x350, 640x480, 720x400 SVGA: 800x600, 823x624 XGA: 1024x768, 1152x864, 1152x900 SXGA: 1280x1024</p> <p>Presets / user settings Standard presets: 20; user settings: 20</p>	 <p>ThinkVision LT1913p Square Monitor</p>								
<p>Viewing adjustments Tilt: 30° back, -5° forward; lift: 4.3" (110mm); swivel: +/- 45° Rotating screen Screen pivots 90 degrees from landscape to portrait On screen display On screen display with digital user controls (8 languages) Control features Direct access (buttons on front) for automatic image setup, input switch, and brightness Multiple input Dual input (two different PCs attach to two different connectors; one PC shows image; select via button) Monitor connectors (1) VGA 15-pin D-shell, analog, blue (2) Digital Visual Interface (DVI-D), digital, white, HDCP-compliant Signal cables (1) detachable, VGA 15-pin D-shell at each end, analog, 1.8 meter (2) detachable, DVI-D at each end, digital, 1.8 meter Mounting features Wall or desk mounting using the Extend Arm or third-party accessories meeting the VESA FPMPI® (100mm mount) Security Security keyhole for attachment of optional cable lock (Kensington® lock-compatible)</p> <p>Ship group Monitor, attached stand, Setup poster, Safety and Warranty Information, 1.8 meter analog signal cable, 1.8 meter DVI-D cable, 1.8 meter black power cord</p>									
<p>Limited Warranty</p> <p>See details at http://support.lenovo.com/en_US/guides-and-manuals/detail.page?DocID=UM008281</p>	<p>Accessories</p> <table border="0"> <tr> <td>Kensington MicroSaver Cable Lock</td> <td>73P2582</td> </tr> <tr> <td>Kensington Twin Head Cable Lock</td> <td>45K1620</td> </tr> <tr> <td>Lenovo Security Cable Lock</td> <td>57Y4303</td> </tr> <tr> <td>Lenovo Easy Reach Monitor Stand</td> <td>55Y9258</td> </tr> </table> <p>See details at www.lenovo.com/support/monitoraccessories</p> <p>See all monitors at www.lenovo.com/thinkvision</p>	Kensington MicroSaver Cable Lock	73P2582	Kensington Twin Head Cable Lock	45K1620	Lenovo Security Cable Lock	57Y4303	Lenovo Easy Reach Monitor Stand	55Y9258
Kensington MicroSaver Cable Lock	73P2582								
Kensington Twin Head Cable Lock	45K1620								
Lenovo Security Cable Lock	57Y4303								
Lenovo Easy Reach Monitor Stand	55Y9258								



<p>Name T1714 Square Flat Panel Monitor Case color Black Type-model 60FDHAR1US / 60FDHAT1EU Panel TFT-LCD, twisted nematic (TN), White LED backlight Viewable image size 17.0" (432mm) diagonal Max view area (W x H) 13.3" x 10.6" (337.9mm x 270.3mm) Optimum resolution 1280x1024 Aspect ratio 5:4 Pixel pitch (mm) 0.264mm Dot/Pixel per Inch 96 dpi Brightness 250 nits or cd/m² (typical) Contrast ratio 1000:1 (typical) Pixel response time 5ms (typical) Color gamut 72% Viewing angle at 10:1 CR 170° (+/- 85°) horizontal, 160° (+/- 80°) vertical Stand Tilt stand Bezel width Sides: 0.69" (17.5mm) Dimensions 14.72" H x 14.74" W x 7.87" D; (HxWxD, including stand) 373.9mm H x 374.5mm W x 200mm D Power supply 14.0 watts typical, 18.0 watts maximum, <0.5 watts standby/suspend, universal, integrated (no external brick-like power supply) Weight 5.75 lb; 2.61kg Limited warranty 3 year (includes backlight) Available date September 2015</p>	<p>Features</p> <ul style="list-style-type: none"> • 17-inch Square LCD monitor • Supports SXGA 1280x1024 resolution • Includes dual input connection for attachment to two systems concurrently (analog and digital) • Mercury Arsenic free glass • Supports optional soundbar • Microsoft® Windows® 7 certified • Microsoft Windows 8 certified • Microsoft Windows 8.1 certified • Microsoft Windows 10 certified 						
<p>VESA-compliant VESA DDC2B/CI Power management ENERGY STAR® 7.0 Ergonomics ISO 9241-307 Emission standards FCC Class B Environmental TCO Displays 7.0, TCO Certified Edge 2.0, WEEE, RoHS, EPEAT™ Silver rating</p>	<div style="text-align: center;">  <p>ThinkVision T1714 Monitor</p> </div>						
<p>Preset resolutions VGA: 640x350, 640x480, 720x400 SVGA: 800x600 XGA: 1024x768, 1152x864, SXGA: 1280x800, 1280x1024 Presets / user settings Standard presets: 17; user settings: 17</p>							
<p>Viewing adjustments Tilt: 22° back, -5° forward Rotating screen None On screen display On screen display with digital user controls (8 languages) Control features Direct access (buttons on front) for automatic image setup and brightness Multiple input Dual input (two different PCs attach to two different connectors; one PC shows image; select via button) Monitor connectors (1) VGA 15-pin D-shell, analog, blue (2) Digital Visual Interface (DVI-D), digital, white, HDCP-compliant Signal cables (1) detachable, VGA 15-pin D-shell at each end, analog, 1.8 meter (2) detachable, DVI-D at each end, digital, 1.8 meter Mounting features Wall or desk mounting using the Extend Arm or third-party accessories meeting the VESA FPMPI® (100mm mount) Security Security keyhole for attachment of optional cable lock (Kensington® lock-compatible)</p>							
<p>Ship group Monitor and stand, Setup poster, Safety and Warranty Information, 1.8 meter analog signal cable, 1.8 meter DVI-D cable, 1.8 meter black power cord</p>							
<p style="text-align: center;">Limited Warranty</p> <p>See details at http://support.lenovo.com/en_US/guides-and-manuals/detail.page?DocID=UM008281</p>	<p style="text-align: center;">Accessories</p> <table border="0"> <tr> <td>Kensington MicroSaver Cable Lock</td> <td style="text-align: right;">73P2582</td> </tr> <tr> <td>Kensington Twin Head Cable Lock</td> <td style="text-align: right;">45K1620</td> </tr> <tr> <td>Lenovo Easy Reach Monitor Stand</td> <td style="text-align: right;">55Y9258</td> </tr> </table> <p>See details at www.lenovo.com/support/monitoraccessories</p> <p>See all monitors at www.lenovo.com/thinkvision</p>	Kensington MicroSaver Cable Lock	73P2582	Kensington Twin Head Cable Lock	45K1620	Lenovo Easy Reach Monitor Stand	55Y9258
Kensington MicroSaver Cable Lock	73P2582						
Kensington Twin Head Cable Lock	45K1620						
Lenovo Easy Reach Monitor Stand	55Y9258						



<p>Name T1714p Square Flat Panel Monitor Case color Black Type-model 60FELAR1US / 60FELAT1EU Panel TFT-LCD, twisted nematic (TN), White LED backlight Viewable image size 17.0" (432mm) diagonal Max view area (W x H) 13.3" x 10.6" (337.9mm x 270.3mm) Optimum resolution 1280x1024 Aspect ratio 5:4 Pixel pitch (mm) 0.264mm Dot/Pixel per Inch 96 dpi Brightness 250 nits or cd/m² (typical) Contrast ratio 1000:1 (typical) Pixel response time 5ms (typical) Color gamut 72% Viewing angle at 10:1 CR 170° (+/- 85°) horizontal, 160° (+/- 80°) vertical Stand Tilt height adjustable stand Bezel width Sides: 0.69" (17.5mm) Dimensions 17.63" H x 14.74" W x 9.61" D; (HxWxD, including stand) 447.9mm H x 374.5mm W x 244.2mm D Power supply 14.0 watts typical, 18.0 watts maximum, <0.5 watts standby/suspend, universal, integrated (no external brick-like power supply) Weight 8.71 lb; 3.95kg Limited warranty 3 year (includes backlight) Available date September 2015</p>	<p>Features</p> <ul style="list-style-type: none"> • 17-inch Square LCD monitor • Supports SXGA 1280x1024 resolution • Includes dual input connection for attachment to two systems concurrently (analog and digital) • Mercury Arsenic free glass • Supports Lenovo Tiny PC and 3rd party thin client via optional Lenovo bracket • Supports optional soundbar • Microsoft® Windows® 7 certified • Microsoft Windows 8 certified • Microsoft Windows 8.1 certified • Microsoft Windows 10 certified 						
<p>VESA-compliant VESA DDC2B/CI Power management ENERGY STAR® 7.0 Ergonomics ISO 9241-307 Emission standards FCC Class B Environmental TCO Displays 7.0, TCO Certified Edge 2.0, WEEE, RoHS, EPEAT™ Silver rating</p>	<div style="text-align: center;">  <p>ThinkVision T1714p Monitor</p> </div>						
<p>Preset resolutions VGA: 640x350, 640x480, 720x400 SVGA: 800x600 XGA: 1024x768, 1152x864, SXGA: 1280x800, 1280x1024 Presets / user settings Standard presets: 22; user settings: 22</p>							
<p>Viewing adjustments <i>Tilt: 22° back, -5° forward; lift: 4.3" (110mm)</i> Rotating screen None On screen display On screen display with digital user controls (8 languages) Control features Direct access (buttons on front) for automatic image setup and brightness Multiple input Dual input (two different PCs attach to two different connectors; one PC shows image; select via button) Monitor connectors (1) VGA 15-pin D-shell, analog, blue (2) Digital Visual Interface (DVI-D), digital, white, HDCP-compliant (3) DisplayPort, digital, black, HDCP-compliant Signal cables (1) detachable, VGA 15-pin D-shell at each end, analog, 1.8 meter (2) detachable, DVI-D at each end, digital, 1.8 meter Mounting features Wall or desk mounting using the Extend Arm or third-party accessories meeting the VESA FPMPI® (100mm mount) Security Security keyhole for attachment of optional cable lock (Kensington® lock-compatible)</p>							
<p>Ship group Monitor and stand, Setup poster, Safety and Warranty Information, 1.8 meter analog signal cable, 1.8 meter DVI-D cable, 1.8 meter black power cord</p>	<p>Limited Warranty</p> <p>See details at http://support.lenovo.com/en_US/guides-and-manuals/detail.page?DocID=UM008281</p> <p>Accessories</p> <table border="0"> <tr> <td>Kensington MicroSaver Cable Lock</td> <td>73P2582</td> </tr> <tr> <td>Kensington Twin Head Cable Lock</td> <td>45K1620</td> </tr> <tr> <td>Lenovo Easy Reach Monitor Stand</td> <td>55Y9258</td> </tr> </table> <p>See details at www.lenovo.com/support/monitoraccessories</p> <p>See all monitors at www.lenovo.com/thinkvision</p>	Kensington MicroSaver Cable Lock	73P2582	Kensington Twin Head Cable Lock	45K1620	Lenovo Easy Reach Monitor Stand	55Y9258
Kensington MicroSaver Cable Lock	73P2582						
Kensington Twin Head Cable Lock	45K1620						
Lenovo Easy Reach Monitor Stand	55Y9258						



Lenovo™ ThinkVision® T2054p Monitor

SPECIFICATIONS

DISPLAY		MECHANICAL	
Panel Size	19.45"	Tilt Angle (Front / Back)	-5° - 22°
Panel Type	IPS	Swivel Angle (Left / Right)	-45° - 45°
Backlit	WLED	Lift (mm)	110
Viewable Area (Diagonal)	19.45"	Pivot	No
Screen Dimensions (W x H) (mm)	262.35 x 418.61	VESA [®] Mount (mm)	100 x 100
Resolution	1440 x 900	Kensington [®] Lock Slot	Yes
Aspect Ratio	16:10	Cable Management	Yes
Viewing Angle (H/V at CR 10:1)	178° / 178°	Ambient Light Sensor	No
Maximum Brightness (Typical)	250 cd/m ²	Control Buttons	Yes
Contrast Ratio (Typical)	1000:1	Bezel Color	Raven Black
Pixel Pitch (W x H) (mm)	0.0969 x 0.2915	Bezel Width (Side) (mm / inches)	17 / 0.67"
Dot/Pixel Per Inch (DP / PPI)	87.3	Bezel Width (Top / Bottom) (mm / inches)	17 / 0.67"
Color Gamut (CIE 1931)	72%		
Number of Colors	16.7 M		
Response Time	7 ms		
Anti-Glare	Yes		
SIGNAL INPUT		SIGNAL INTERFACE / PERFORMANCE	
Video Input Signals	VGA, HDMI™, DisplayPort™	Horizontal Frequency	30 kHz - 81 kHz
Video Cables Supplied	VGA	Vertical Frequency	50 Hz - 75 Hz
Video Cable Length	1.8 m	Native Resolution	1440 x 900
USB Hub	No	Maximum Pixel Clock Speed / Bandwidth	VGA : 150 MHz HDMI™ : 150 MHz DisplayPort™: 150 MHz
USB Cable Supplied	No	Default Color Temperature	7200K
		Preset Display Modes	22
		User-defined Display Modes	16
		OSD Buttons	5
		OSD Languages	8
POWER CONSUMPTION		COMPLIANCE	
Power Consumption		EPEAT™	Silver
Typical	14.5 W	ENERGY STAR® Rating	6.0
Max. without USB Hub	21 W	ULE	Gold
Max. with USB Hub	N/A	TCO*	6.0
Sleep-Mode	0.3 W	TCO* Edge	2.0
Off-Mode	0.3 W	TUV	Yes
Heat Dissipation		GREENGUARD [®]	No
Typical	49.45 Btu/h	RoHS (EU 2002/95/EC)	Yes
Max.	71.61 Btu/h	Windows Certification	Windows 7, Windows 8, Windows 8.1, Windows 10
Power Supply	Internal	China Energy Efficiency Standard	Tier 1
Power Voltage	90 - 264 VAC, 1.5 A		
Voltage Dynamic Frequency	47 - 63 Hz		
DIMENSIONS (W X D X H)		ENVIRONMENTAL	
Size Packed		Temperature	
(mm)	509 x 176 x 368	Operating	0 °C - 45 °C
(inches)	20.04" x 6.93" x 14.49"	Non-operating	-20 °C - 60 °C (non-condensing)
Size Unpacked with Stand		Humidity	
(mm)	454.2 x 242.6 x 345.9 - 455.9	Operating	10% - 80%
(inches)	17.88" x 9.55" x 13.62" - 17.95"	Non-operating	5% - 95% (non-condensing)
Size Unpacked without Stand (Head Only)		Altitude	
(mm)	454.2 x 53 x 297.9	Operating	8,000 ft
(inches)	17.88" x 2.09" x 11.73"	Non-operating	40,000 ft
Distance from Table to Panel	(mm / inches)	Arsenic-free Glass	Yes
Lowest Pixel at Bottom of Screen	65.8 / 2.59"	PVC Free	Yes
Highest Pixel at Top of Screen	328.2 / 12.92"	Mercury Free	Yes
Stand Base Footprint Area		PCC % of Plastic Resins	85%
(mm / inches)	Diameter 240 / 9.45"	Low Halogen	No
Weight		WARRANTY AND AVAILABILITY	
Packed	Starting at 10.8 lbs (4.9 kg)	Warranty	3 Years
Unpacked	Starting at 8.15 lbs (3.7 kg)	Geography Availability	World Wide
Monitor Head	Starting at 4.85 lbs (2.2 kg)	ThinkVision [®] Logo	Yes
		Global Model	Yes



WWW.LENOVO.COM

©2019 Lenovo. All rights reserved. Availability: Offers, prices, specifications and availability may change without notice. Lenovo is not responsible for photographic or typographic errors. Warranty: For a copy of applicable warranties, write to: Warranty Information, 500 Park Offices Drive, RTP, NC, 27709, Attn: Dept. ZPYA/B600. Lenovo makes no representation or warranty regarding third-party products or services. Trademarks: Lenovo, the Lenovo logo, Rescue and Recovery, ThinkPad, ThinkCentre, ThinkStation, ThinkServer, ThinkVantage and ThinkVision are trademarks or registered trademarks of Lenovo. Microsoft, Windows and Vista are registered trademarks of Microsoft Corporation. Intel, the Intel logo, Intel Inside logo, Intel Atom and Intel Atom Inside are trademarks of Intel Corporation in the U.S. and/or other countries. Other company, product and service names may be trademarks or service marks of others. Visit Lenovo.com/safecomputing periodically for the latest information on safe and effective computing.



<p>Name E21 Wide Flat Panel Monitor Bezel color Black Type-model 61B9JAR1US / 61B9JAT1EU Panel TFT-LCD, twisted nematic (TN), White LED backlight Viewable image size 20.7" (525.78mm) diagonal Max view area (W x H) 18.03" x 10.14" (457.92mm x 257.58mm) Native resolution 1920x1080 Aspect ratio 16:9 Pixel pitch (mm) 0.2385 x 0.2385 mm Dot/Pixel per Inch 106 dpi Brightness 250 nits or cd/m² (typical) Contrast ratio 1000:1 (typical) Pixel response time 5ms (typical) Color gamut 72% Viewing angle at 10:1 CR 170° (+/- 85°) horizontal, 160° (+/- 80°) vertical Stand Tilt adjustable stand Bezel width Sides: 0.6" (15.3mm) Dimensions (HxWxD) 14.6" H x 19.31" W x 8.07" D; 370.9mm H x 490.5mm W x 204.9mm D Power supply 18 watts typical, 23 watts maximum, <0.3 watts standby/suspend, universal, integrated (no external brick-like power supply) Weight 5.82 lb; 2.64 kg Limited warranty 3 year (includes backlight) Available date August 2017</p>	<p style="text-align: center;">Features</p> <ul style="list-style-type: none"> • Widescreen 20.7-inch monitor • Supports 1920x1080 resolution • Supports ThinkCentre Tiny Clamp Bracket • Supports optional soundbar • EPEAT Gold certified • Low Blue Light certification • Microsoft® Windows® 7 certified • Microsoft Windows 10 certified 				
<p>VESA-compliant VESA DDC2B/CI Power management ENERGY STAR® qualified Ergonomics ISO 9241-307 Emission standards FCC Class B Environmental TCO Displays 7.0, TCO Certified Edge 2.0, WEEE, RoHS, EPEAT™ Silver rating</p>	<div style="text-align: center;">  <p>ThinkVision E21 Wide Monitor</p> </div>				
<p>Preset resolutions VGA: 640x350, 640x480, 720x400 SVGA: 800x600, 832x624 XGA: 1024x768, 1152x864 SXGA: 1280x1024 WXGA+: 1440x900 WSXGA+: 1680x1050 Full HD: 1920x1080</p> <p>Presets display modes Standard presets: 22</p>					
<p>Viewing adjustments Tilt: 22° back, -5° forward Rotating screen None On screen display On screen display with digital user controls (8 languages) Control features Direct access (buttons on front) for power, menu, input source select and brightness USB hub None Multiple input Dual input (two different PCs attach to two different connectors; one PC shows image; select via button) Monitor connectors (1) VGA 15-pin D-shell, analog, blue (2) DisplayPort (1.2), digital, black, HDCP-compliant Signal cables (1) detachable, VGA 15-pin D-shell at each end, analog, 1.8 meter Mounting features Wall or desk mounting using the Extend Arm or third-party accessories, 100mm x 100mm mount Security Security keyhole for attachment of optional cable lock (Kensington® lock-compatible)</p>					
<p>Ship group Monitor with stand, Safety and Warranty Information, 1.8 meter analog signal cable, 1.8 meter black power cord</p>	<p style="text-align: center;">Accessories</p> <table border="0"> <tr> <td>Kensington MicroSaver Cable Lock</td> <td style="text-align: right;">73P2582</td> </tr> <tr> <td>Kensington Twin Head Cable Lock</td> <td style="text-align: right;">45K1620</td> </tr> </table> <p>See details at www.lenovo.com/support/monitoraccessories</p> <p>See all monitors at www.lenovo.com/thinkvision</p>	Kensington MicroSaver Cable Lock	73P2582	Kensington Twin Head Cable Lock	45K1620
Kensington MicroSaver Cable Lock	73P2582				
Kensington Twin Head Cable Lock	45K1620				



<p>Name E24 Wide Flat Panel Monitor Bezel color Black Type-model 61B7JAR6US / 61B7JAT6EU Panel TFT-LCD, In-Plane Switching (IPS), White LED backlight Viewable image size 23.8" (604.7mm) diagonal Max view area (W x H) 20.75" x 11.67" (527.04mm x 296.46mm) Native resolution 1920x1080 Aspect ratio 16:9 Pixel pitch (mm) 0.2745 x 0.2745 mm Dot/Pixel per Inch 92.5 dpi Brightness 250 nits or cd/m² (typical) Contrast ratio 1000:1 (typical) Pixel response time 6ms (typical) Color gamut 72% Viewing angle at 10:1 CR 178° (+/- 89°) horizontal, 178° (+/- 89°) vertical Stand Tilt adjustable stand Bezel width <i>Sides:</i> 0.51" (13mm) Dimensions (HxWxD) 15.9" H x 21.81" W x 8.07" D; 403.8mm H x 554mm W x 204.9mm D Power supply 18 watts typical, 23 watts maximum, <0.3 watts standby/suspend, universal, integrated (no external brick-like power supply) Weight 8.2 lb; 3.7 kg Limited warranty 3 year (includes backlight) Available date August 2017</p>	<p style="text-align: center;">Features</p> <ul style="list-style-type: none"> • Widescreen 23.8-inch monitor • Supports 1920x1080 resolution • Supports ThinkCentre Tiny VESA mount • Supports optional soundbar • Includes dual input connection for attachment to two systems concurrently • EPEAT Gold certified • Microsoft® Windows® 7 certified • Microsoft Windows 10 certified 				
<p>VESA-compliant VESA DDC2B/CI Power management ENERGY STAR® qualified Ergonomics ISO 9241-307 Emission standards FCC Class B Environmental TCO Displays 7.0, TCO Certified Edge 2.0, WEEE, RoHS, EPEAT™ Silver rating</p>	<div style="text-align: center;">  <p>ThinkVision E24 Wide Monitor</p> </div>				
<p>Preset resolutions VGA: 640x350, 640x480, 720x400 SVGA: 800x600, 832x624 XGA: 1024x768, 1152x864 SXGA: 1280x1024 WXGA: 1366x768 WXGA+: 1440x900, 1600x900 WSXGA+: 1680x1050 Full HD: 1920x1080</p> <p>Presets display modes Standard presets: 24; user settings: 20</p>					
<p>Viewing adjustments <i>Tilt:</i> 22° back, -5° forward Rotating screen None On screen display On screen display with digital user controls (8 languages) Control features Direct access (buttons on front) for power, menu, input source select and brightness USB hub None Multiple input Dual input (two different PCs attach to two different connectors; one PC shows image; select via button) Monitor connectors (1) VGA 15-pin D-shell, analog, blue (2) DisplayPort, digital, black, HDCP-compliant Signal cables (1) detachable, VGA 15-pin D-shell at each end, analog, 1.8 meter (2) detachable, DisplayPort at each end, digital, 1.8 meter Mounting features Wall or desk mounting using the Extend Arm or third-party accessories, 100mm x 100mm mount Security Security keyhole for attachment of optional cable lock (Kensington® lock-compatible)</p>					
<p>Ship group Monitor with stand, Safety and Warranty Information, 1.8 meter analog signal cable, 1.8 meter DP signal cable, 1.8 meter black power cord</p>	<p style="text-align: center;">Accessories</p> <table border="0" style="width: 100%;"> <tr> <td>Kensington MicroSaver Cable Lock</td> <td style="text-align: right;">73P2582</td> </tr> <tr> <td>Kensington Twin Head Cable Lock</td> <td style="text-align: right;">45K1620</td> </tr> </table> <p>See details at www.lenovo.com/support/monitoraccessories</p> <p>See all monitors at www.lenovo.com/thinkvision</p>	Kensington MicroSaver Cable Lock	73P2582	Kensington Twin Head Cable Lock	45K1620
Kensington MicroSaver Cable Lock	73P2582				
Kensington Twin Head Cable Lock	45K1620				
<p style="text-align: center;">Limited Warranty</p> <p>See details at http://support.lenovo.com/en_US/guides-and-manuals/detail.page?DocID=UM008281</p>					



<p>Name P24h Wide Flat Panel Monitor Bezel color Black Type-model 61AEGAR3US / 61AEGAT3EU Panel TFT-LCD, In-Plane Switching (IPS), White LED backlight Viewable image size 23.8" (604.7mm) diagonal Max view area (W x H) 20.74" x 11.67" (526.9mm x 296.4mm) Native resolution 2560x1440 Aspect ratio 16:9 Pixel pitch (mm) 0.2058x 0.2058 mm Dot/Pixel per Inch 124 dpi Brightness 300 nits or cd/m² (typical) Contrast ratio 1000:1 (typical) Pixel response time 4ms (extreme) / 6ms (typical) Color gamut 99% sRGB Viewing angle at 10:1 CR 178° (+/- 89°) horizontal, 178° (+/- 89°) vertical Stand Tilt, swivel, pivot, and height adjustable stand Bezel width <i>Sides:</i> 0.08" (2.0mm) Dimensions (HxWxD) 14.7" H x 21.26" W x 10.3" D; 373.4mm H x 540.2mm W x 261.75mm D Power supply 24 watts typical, 120 watts maximum (with USB 3.0 hub), <0.5 watts standby/suspend, universal, integrated (no external brick-like power supply) Weight 12.54 lb; 5.69 kg Limited warranty 3 year (includes backlight) Available date April 2017</p>	<p style="text-align: center;">Features</p> <ul style="list-style-type: none"> • Widescreen 23.8-inch monitor • Supports 2560x1440 resolution • Supports optional soundbar • Supports ThinkCentre Tiny Clamp Bracket • Includes dual input connection for attachment to two systems concurrently • EPEAT Gold certified • Microsoft® Windows® 7 certified • Microsoft Windows 10 certified 				
<p>VESA-compliant VESA DDC2B/CI Power management ENERGY STAR® qualified Ergonomics ISO 9241-307 Emission standards FCC Class B Environmental TCO Displays 7.0, TCO Certified Edge 2.0, WEEE, RoHS, EPEAT™ Silver rating</p>	<div style="text-align: center;">  <p>ThinkVision P24h Wide Monitor</p> </div>				
<p>Preset resolutions VGA: 640x480, 720x400 SVGA: 800x600 XGA: 1024x768 SXGA: 1280x1024 WXGA: 1366x768 WXGA+: 1440x900, 1680x900 WSXGA+: 1680x1050 Full HD: 1920x1080, 1920x1200 QHD: 2560x1440 Presets display modes HDMI: 22; DP: 14</p>					
<p>Viewing adjustments <i>Tilt:</i> 30° back, -5° forward; <i>lift:</i> 4.3" (110mm); <i>swivel:</i> +/-45°; detachable stand Rotating screen Screen pivots 90 degrees from landscape to portrait On screen display On screen display with digital user controls (8 languages) Control features Direct access (buttons on front) for power, menu, input source select and brightness USB hub USB Hub: one USB 3.1 Type-C upstream port, four USB 3.0 Type-A downstream ports Multimedia Audio-out, optional sound bar supported Camera None Multiple input Support HDMI, DisplayPort, USB 3.1 Type-C, DisplayPort-out Monitor connectors (1) 2*HDMI (1.4), digital, HDCP-compliant (2) DisplayPort (1.2), digital, HDCP-compliant (3) DisplayPort-out, digital (4) USB 3.1 Type-C Signal cables (1) USB 3.1 Type-C cable, 1.8 meter Mounting features Wall or desk mounting using the Extend Arm or third-party accessories, 100mm x 100mm mount Security Security keyhole for attachment of optional cable lock (Kensington® lock-compatible)</p>					
<p>Ship group Monitor with stand, Safety and Warranty Information, 1.8 meter USB 3.1 Type-C cable, 1.8 meter black power cord</p>	<p style="text-align: center;">Accessories</p> <table border="0" style="width: 100%;"> <tr> <td>Kensington MicroSaver Cable Lock</td> <td style="text-align: right;">73P2582</td> </tr> <tr> <td>Kensington Twin Head Cable Lock</td> <td style="text-align: right;">45K1620</td> </tr> </table> <p>See details at www.lenovo.com/support/monitoraccessories</p> <p>See all monitors at www.lenovo.com/thinkvision</p>	Kensington MicroSaver Cable Lock	73P2582	Kensington Twin Head Cable Lock	45K1620
Kensington MicroSaver Cable Lock	73P2582				
Kensington Twin Head Cable Lock	45K1620				
<p style="text-align: center;">Limited Warranty</p> <p>See details at http://support.lenovo.com/en_US/guides-and-manuals/detail.page?DocID=UM008281</p>					



<p>Name P24q Wide Flat Panel Monitor Case color Black Type-model 61A5GAR3US / 61A5GAT3EU Panel TFT-LCD, IPS (In-Plane Switching), White LED backlight Viewable image size 23.8" (604.5mm) diagonal Max view area (W x H) 20.74" x 11.67" (526.85mm x 296.35mm) Optimum resolution 2560x1440 Max pixel rate 300MHz Aspect ratio 16:9 Pixel pitch (mm) 0.2058 x 0.2058mm Dot/Pixel per Inch 123 dpi Brightness 300 nits or cd/m² (typical) Contrast ratio 1000:1 (typical) Pixel response time 4ms Color gamut 99% sRGB Viewing angle at 10:1 CR 178° horizontal, 178° vertical Stand Tilt, swivel, pivot, and height adjustable stand Bezel width Sides: 0.08" (2mm) Dimensions (HxWxD, including stand) 373.4mm H x 540.2mm W x 261.75mm D Power supply 24 watts typical, 67 watts maximum (with USB), <0.5 watts sleep/off; <0.5 watts switch off integrated (no external brick-like power supply) Weight 12.35 lb; 5.6kg (including stand) Limited warranty 3 year Available date January 2017</p>	<p>Features</p> <ul style="list-style-type: none"> • 23.8-inch IPS LED backlight monitor • Supports 2560x1440 resolution • 5-Ports USB hub, support USB 3.0 • Support ThinkCentre Tiny • Supports optional soundbar • Microsoft® Windows® 7 certified • Microsoft Windows 10 certified 						
<p>VESA-compliant VESA DDC2B/CI Power management ENERGY STAR® 7.0 Ergonomics ISO 9241-307 Emission standards FCC Class B Environmental TCO Displays 7.0, RoHS, EPEAT™ Silver rating, ULE Gold</p>	<div style="text-align: center;">  <p>ThinkVision P24q Monitor</p> </div>						
<p>Preset resolutions VGA: 640x480, 720x400 SVGA: 800x600 XGA: 1024x768 SXGA: 1280x1024 WXGA: 1366x768 WXGA+: 1440x900, 1600x900 WSXGA+: 1680x1050 Full HD: 1920x1080, 1920x1200 QHD: 2560x1440</p> <p>Presets / user settings Standard presets: 20; user settings: 24</p>							
<p>Viewing adjustments Tilt: 30° back, -5° forward; lift: 4.33" (110mm); swivel: +/-45° Rotating screen Screen pivots 90 degrees from landscape to portrait On screen display On screen display with digital user controls (8 languages) Control features Direct access for menu, source switch, and brightness USB hub USB Hub: one USB 3.0 upstream port, four USB 3.0 downstream ports Multimedia Audio-out, optional sound bar supported Camera None Multiple input Support HDMI, DisplayPort, mini DisplayPort, DisplayPort-out Monitor connectors (1) 2*HDMI (1.4), digital, HDCP-compliant (2) DisplayPort (1.2), digital, HDCP-compliant (3) Mini DisplayPort, digital, HDCP-compliant Signal cables (1) detachable, mini DisplayPort to DisplayPort, digital, 1.8 meter Mounting features Wall or desk mounting using the Extend Arm or third-party accessories meeting the VESA FPMPI® (100mm mount) Security Security keyhole for attachment of optional cable lock (Kensington® lock-compatible)</p>							
<p>Ship group Monitor, detachable stand, Quick start and safety poster, 1.8 meter USB 3.0 cable, 1.8 meter mini DP to DP cable, 1.8 meter black power cord</p>	<p>Limited Warranty</p> <p>See details at http://support.lenovo.com/en_US/guides-and-manuals/detail.page?DocID=UM008281</p> <p>Accessories</p> <table border="0"> <tr> <td>Kensington MicroSaver Cable Lock</td> <td>73P2582</td> </tr> <tr> <td>Kensington Twin Head Cable Lock</td> <td>45K1620</td> </tr> <tr> <td>Lenovo Security Cable Lock</td> <td>57Y4303</td> </tr> </table> <p>See details at www.lenovo.com/support/monitoraccessories</p> <p>See all monitors at www.lenovo.com/thinkvision</p>	Kensington MicroSaver Cable Lock	73P2582	Kensington Twin Head Cable Lock	45K1620	Lenovo Security Cable Lock	57Y4303
Kensington MicroSaver Cable Lock	73P2582						
Kensington Twin Head Cable Lock	45K1620						
Lenovo Security Cable Lock	57Y4303						



ThinkVision® S22e-19

DISPLAY

Panel Size

21.5 inch

Screen Dimensions (H x V) (mm)

476.06 (H) × 267.79 (V)

Panel Type

VA

Backlight

WLED

Aspect Ratio

16:9

Resolution

1920 x 1080

Pixel Pitch (H x V) (mm)

0.2480 × 0.2480

Viewing Angle (H x V)

178°/178°

Response Time (gray to gray)

4 ms (extreme mode)
6 ms (normal mode)

Contrast Ratio (typical)

3000:1

Dynamic Contrast Ratio (typical)

3M:1

Color Gamut NTSC (CIE 1931)

72%

Color Support (typical)

16.7M

CONNECTIVITY

Video Input Signals

VGA + HDMI1.4

Video Cable Length

1.8 m

Audio Out

Yes (3.5 mm)

MULTI-MEDIA

Optional Soundbar Support

Yes

DIMENSIONS

Size Packed (D x H x W) (mm/inch)

120 x 350 x 582 mm / 4.7 x 13.7 x 22.9 inch

Size Unpacked w/stand (D x H x W) (mm/inch) (Lowest Position)

200.0 x 373.8 x 489.3 mm / 7.87 x 14.71 x 19.26 inch

Size Unpacked w/stand (D x H x W) (mm/inch) (Highest Position)

200.0 x 373.8 x 489.3 mm / 7.87 x 14.71 x 19.26 inch

Size Unpacked w/o stand (D x H x W) (mm/inch) (Head Only)

41.5 x 296.8 x 489.3 mm / 1.63 x 11.68 x 19.26 inch

Weight Packed (kg/lbs.)

4.07kg / 8.97 lbs.

Weight Unpacked (kg/lbs.)

2.75kg / 6.06 lbs.

Weight (Monitor Head Only) (kg/lbs.)

2.46kg / 5.42 lbs.

SPECIAL FEATURES

Anti-Glare

Yes

Thin Client Support (Tiny)

Yes (by VESA mount PN:4XF0N03161)

MECHANICAL

Tilt Angle (front / back)

-5°/22°

VESA Mount

Yes (100 mm)

Kensington™ Lock Slot

Yes

Cable Management

Yes

Bezel Color

Raven Black

Bezel Width (side)

2.0 mm

Bezel Width (top / bottom)

2.0 mm / 21.2 mm

WHAT'S IN THE BOX

Monitor with stand

1 x HDMI Cable

1 x Power Cable

Quick setup guide

CERTIFICATIONS

ENERGY STAR Rating

7.0

CCC

Yes

TCO

TCO 7.0/TCO Edge 2.0

EPEAT™

Gold

RoHS

Yes

Windows Certification

Windows 7, Windows 10

China Energy Efficiency Standard

Tier 2

Ambient Operating Temperature

0°C to 40°C

Low Blue Light

Yes



© 2018 Lenovo. All rights reserved. These products are available while supplies last. Prices shown are subject to change without notice. For any questions concerning price, please contact your Lenovo Account Executive. Lenovo is not responsible for photographic or typographic errors. Warranty: For a copy of applicable warranties, write to: Warranty Information, 500 Park Offices Drive, RTP, NC 27709, Attn: Dept. ZPYA/B600. Lenovo makes no representation or warranty regarding third-party products or services. Trademarks: Lenovo, the Lenovo logo, Rescue and Recovery, ThinkPad, ThinkCentre, ThinkStation, ThinkVantage, and ThinkVision are trademarks or registered trademarks of Lenovo. Microsoft, Windows, and Vista are registered trademarks of Microsoft Corporation. Intel, the Intel logo, Intel Inside, Intel Core, and Core Inside are trademarks of Intel Corporation in the U.S. and/or other countries. Other company, product, and service names may be trademarks or service marks of others.

Specifications may vary depending upon region.

Lenovo™



ThinkVision® S24e-10

DISPLAY

Panel Size
23.8-inch

Screen Dimensions (H x V)
527.04 x 296.46 mm

Panel Type
3-side NearEdgeless, VA

Backlight
WLED

Aspect Ratio
16:9

Resolution
1920 x 1080

Pixel Pitch (H x V)
0.2745 x 0.2745 mm

Dot/Pixel Per Inch (DPI/PPI)
92

Viewing Angle (H x V @ CR 10:1)
178°/178°

Response Time (gray to gray)
4 ms (Extreme Mode)
6 ms (Normal Mode)

Refresh Rate
60 Hz

Brightness (typical)
250 cd/m²

Contrast Ratio (typical)
3000:1

Dynamic Contrast Ratio (typical)
3M:1

Color Gamut NTSC (CIE 1931)
72% NTSC

Color Support
16.7 Million

Anti-glare
Yes

CONNECTIVITY

Video Signal
1 x VGA
1 x HDMI 1.4

Video Cable Length
1.8 m

Audio Signal
1 x Audio Out (3.5 mm)

MULTI-MEDIA

Optional Speakers Support
Yes

SPECIAL FEATURES

Sync Technology
FreeSync™

Thin Client Support (Tiny)
Yes (by VESA mount PN:4XF0N03161)

POWER

Power Consumption (Typ./Max)
24W / 31W

Power Consumption Sleep/Off Mode
< 0.3W

Power Consumption Switch-Off Mode
< 0.3W

Power Supply
Internal

Voltage Required
AC 100 to 240 V (47/63 Hz)

MECHANICAL

Tilt Angle (front/back)
-5° / 22°

VESA Mount
Yes (100 mm)

Kensington™ Lock Slot
Yes

Cable Management
Yes

Bezel Color
Raven Black

Bezel Width (Side)
2.0 mm

Bezel Width (top / bottom)
2.0 mm / 22 mm

DIMENSION

Size Packed (D x H x W) (mm/inch)
122 x 405 x 639 mm /
4.80 x 15.94 x 25.16 inches

Size Unpacked w/stand (D x H x W) (mm/inch) (Lowest Position)
200.0 x 402.7 x 539.5 mm /
7.87 x 15.85 x 21.24 inches

Size Unpacked w/stand (D x H x W) (mm/inch) (Highest Position)
200.0 x 402.7 x 539.5 mm /
7.87 x 15.85 x 21.24 inches

Size Unpacked w/o stand (D x H x W) (mm/inch) (Head Only)
41.5 x 325.7 x 539.5 mm /
1.63 x 12.82 x 21.24 inches

Min. Distance from Table to Panel (lowest pixel at bottom of screen, mm)
99.0 mm

Max. Distance from Table to Panel (highest pixel at top of screen, mm)
399.9 mm

Weight Packed (kg/lbs.)
4.84kg / 10.67 lbs.

Weight Unpacked (kg/lbs.)
3.36kg / 7.41 lbs.

Weight (Monitor Head Only) (kg/lbs.)
3.07kg / 6.77 lbs.

Full Container Load (40' STD / 20' STD)
1660 / 800 Units

WHAT'S IN THE BOX

Monitor with stand
1 x HDMI Cable
1 x Power Cable (1.8m)
Quick setup guide

CERTIFICATIONS

ENERGY STAR Rating
7.1

CCC
Yes

EPEAT™
Silver

ULE
Gold

RoHS (EU 2002/95/EC)
Yes(2011/65/EU)

Windows Certification
Windows 7, Windows 10

China Energy Efficiency Standard
Tier 2

Low Blue Light
Yes



© 2018 Lenovo. All rights reserved. These products are available while supplies last. Prices shown are subject to change without notice. For any questions concerning price, please contact your Lenovo Account Executive. Lenovo is not responsible for photographic or typographic errors. Warranty: For a copy of applicable warranties, write to: Warranty Information, 500 Park Offices Drive, RTP, NC 27709, Attn: Dept. ZPYA/B600. Lenovo makes no representation or warranty regarding third-party products or services. Trademarks: Lenovo, the Lenovo logo, Rescue and Recovery, ThinkPad, ThinkCentre, ThinkStation, ThinkVantage, and ThinkVision are trademarks or registered trademarks of Lenovo. Microsoft, Windows, and Vista are registered trademarks of Microsoft Corporation. Intel, the Intel logo, Intel Inside, Intel Core, and Core Inside are trademarks of Intel Corporation in the U.S. and/or other countries. Other company, product, and service names may be trademarks or service marks of others.

Specifications may vary depending upon region.

Lenovo™



ThinkVision S24q-10

DISPLAY

Panel Size

23.8-inch

Screen Dimensions

526.85 mm x 296.35 mm

Panel Type

3-side NearEdgeless
In-Plane Switching

Backlight

WLED

Aspect Ratio

16:9

Resolution

2560 x 1440

Pixel Pitch

0.2058 x 0.2058 mm

Dot/Pixel Per Inch (DPI/PPI)

124

Viewing Angle (H x V @ CR 10:1)

178° / 178°

Response Time

4ms (extreme mode)

Refresh Rate

60 Hz

Brightness (typical)

240 cd/m²

Brightness (peak)

300 cd/m²

Contrast Ratio (typical)

1000:1

Dynamic Contrast Ratio (typical)

3M:1

Color Gamut

> 99% sRGB

Color Support (typical)

16.7 Million

Anti-glare

Yes

CONNECTIVITY

Video Signal

1 x HDMI 1.4
1 x DP 1.2

Audio Signal

1 x Audio Out (3.5 mm)

SPECIAL FEATURES

Tiny Support

Yes

POWER

Power Consumption (typical/max)

20W / 31W

Power Consumption Sleep/Off Mode

< 0.5W

Power Consumption Switch-off Mode

< 0.3W

Power Supply

Internal

Energystar Power Consumption (P_{on}/E_{TEC})

16.76 W / 52.75 kWh

Voltage Required

AC 100 to 240 V (47/63 Hz)

MECHANICAL

Tilt Angle (front/back)

-5° / 22°

VESA Mount Capability

Yes (100 x 100 mm)

Kensington™ Lock Slot

Yes

Cable Management

Yes

Bezel Color

Raven Black

Bezel Width (side)

2 mm

Bezel Width (top/bottom)

2 / 21.4 mm

DIMENSION

Size Packed (D x H x W, mm/inch)

122 x 405 x 639 mm /
4.80 x 15.94 x 25.16 inches

Size Unpacked w/stand (D x H x W, mm/inch) (lowest position)

200 x 402.7 x 539.8 mm /
7.87 x 15.85 x 21.25 inches

Size Unpacked w/stand (D x H x W, mm/inch) (highest position)

200 x 402.7 x 539.8 mm /
7.87 x 15.85 x 21.25 inches

Size Unpacked w/o Stand (D x H x W, mm/inch) (head only)

42 x 325.7 x 539.8 mm /
1.65 x 12.82 x 21.25 inches

Min. Distance from Table to Panel (lowest pixel at bottom of screen, mm)

98.4 mm

Max. Distance from Table to Panel (highest pixel at top of screen, mm)

399.9 mm

Weight Packed (kg/lb)

5.10 kg / 11.24 lbs.

Weight Unpacked (kg/lb)

3.50 kg / 7.72 lbs.

Weight (monitor head only) (kg/lb)

3.21 kg / 7.08 lbs.

Full Container Load (40' STD / 20' STD)

1660 / 800 units

WHAT'S IN THE BOX

Monitor with stand
1 x Power cable (1.8 m)
1 x HDMI cable (1.8 m)
Quick setup guide

CERTIFICATION

ENERGY STAR® Rating

8.0

CCC

Yes

TCO

8.0

TCO Edge

2.0

EPEAT™

Silver

RoHS (EU 2002/95/EC)

Yes

Windows Certification

Windows 7, Windows 10

China Energy Efficiency Standard

Tier 1

TÜV Eye Comfort

Yes



Depending on many factors such as the processing capability of peripheral devices, file attributes, and other factors related to system configuration and operating environments, the actual transfer rate using the various USB connectors on this device will vary and is typically slower than the data rates as defined by the respective USB specifications: - 5 Gbit/s for USB 3.1 Gen1; 10 Gbit/s for USB 3.1 Gen2 & 20 Gbit/s for USB 3.2.

© 2019 Lenovo. All rights reserved. These products are available while supplies last. Prices shown are subject to change without notice. For any questions concerning price, please contact your Lenovo Account Executive. Lenovo is not responsible for photographic or typographic errors. Warranty: For a copy of applicable warranties, write to: Warranty Information, 500 Park Offices Drive, RTP, NC 27709, Attn: Dept. ZPYA/B600. Lenovo makes no representation or warranty regarding third-party products or services. Trademarks: Lenovo, the Lenovo logo, Rescue and Recovery, ThinkPad, ThinkCentre, ThinkStation, ThinkVantage, and ThinkVision are trademarks or registered trademarks of Lenovo. Microsoft, Windows, and Vista are registered trademarks of Microsoft Corporation. Intel, the Intel logo, Intel Inside, Intel Core, and Core Inside are trademarks of Intel Corporation in the U.S. and/or other countries. Other company, product, and service names may be trademarks or service marks of others.

Specifications may vary depending upon region.



<p>Name T2224d Wide Flat Panel Monitor Bezel color Black Type-model 60EBJAR1US / 60EBJAT1EU Panel TFT-LCD, Vertical Alignment panel (VA), White LED backlight Viewable image size 21.5" (546mm) diagonal Max view area (W x H) 18.74" x 10.54" (476.1mm x 267.8mm) Native resolution 1920x1080 Aspect ratio 16:9 Pixel pitch (mm) 0.248 x 0.248 mm Dot/Pixel per Inch 102 dpi Brightness 250 nits or cd/m² (typical) Contrast ratio 3000:1 (typical) Pixel response time 7ms (typical); 4ms (extreme mode) Color gamut 72% Viewing angle at 10:1 CR 178° (+/- 89°) horizontal, 178° (+/- 89°) vertical Stand Tilt stand Bezel width <i>Sides:</i> 0.69" (17.6mm) Dimensions (HxWxD) 15.02" H x 20.19" W x 8.06" D; 381.4mm H x 512.9mm W x 204.9mm D Power supply 20 watts typical, 25 watts maximum <0.5 watts standby/suspend, universal, integrated (no external brick-like power supply) Weight 6.48 lb; 2.94 kg Limited warranty 3 year (includes backlight) Available date July 2016</p>	<p style="text-align: center;">Features</p> <ul style="list-style-type: none"> • Widescreen 21.5-inch monitor • Supports 1920x1080 resolution • Supports optional soundbar • Supports ThinkCentre Tiny via VESA back mount • Includes dual input connection for attachment to two systems concurrently (analog and digital) • EPEAT Silver certified • Microsoft® Windows® 7 certified • Microsoft Windows 10 certified 				
<p>VESA-compliant VESA DDC2B/CI Power management ENERGY STAR® qualified Ergonomics ISO 9241-307 Emission standards FCC Class B Environmental TCO Displays 7.0, TCO Certified Edge 2.0, WEEE, RoHS, EPEAT™ SILVER rating</p>	<div style="text-align: center;">  <p>ThinkVision T2224d Wide Monitor</p> </div>				
<p>Preset resolutions VGA: 640x350, 640x480, 720x400 SVGA: 800x600, 832x624 XGA: 1024x768, 1152x864 SXGA: 1280x1024 WXGA: 1280x768, 1280x800 WXGA+: 1440x900 WSXGA+: 1680x1050 Full HD: 1920x1080 Presets / user settings Standard presets: 22; user settings: 22</p>					
<p>Viewing adjustments <i>Tilt:</i> 22° back, -5° forward Rotating screen None On screen display On screen display with digital user controls (8 languages) Control features Direct access (buttons on front) for automatic image setup, dual input and brightness USB hub None Multiple input Dual input (two different PCs attach to two different connectors; one PC shows image; select via button) Monitor connectors (1) VGA 15-pin D-shell, analog, blue (2) DisplayPort, digital, black, HDCP-compliant Signal cables (1) detachable, VGA 15-pin D-shell at each end, analog, 1.8 meter (2) detachable, DisplayPort at each end, digital, 1.8 meter Mounting features Wall or desk mounting using the Extend Arm or third-party accessories, 100mm x 100mm mount Security Security keyhole for attachment of optional cable lock (Kensington® lock-compatible)</p>					
<p>Ship group Monitor with stand, Safety and Warranty Information, 1.8 meter analog signal cable, 1.8 meter DP signal cable, 1.8 meter black power cord</p>	<p style="text-align: center;">Accessories</p> <table border="0" style="width: 100%;"> <tr> <td>Kensington MicroSaver Cable Lock</td> <td style="text-align: right;">73P2582</td> </tr> <tr> <td>Kensington Twin Head Cable Lock</td> <td style="text-align: right;">45K1620</td> </tr> </table> <p>See details at www.lenovo.com/support/monitoraccessories</p> <p>See all monitors at www.lenovo.com/thinkvision</p>	Kensington MicroSaver Cable Lock	73P2582	Kensington Twin Head Cable Lock	45K1620
Kensington MicroSaver Cable Lock	73P2582				
Kensington Twin Head Cable Lock	45K1620				
<p style="text-align: center;">Limited Warranty</p> <p>See details at http://support.lenovo.com/en_US/guides-and-manuals/detail.page?DocID=UM008281</p>					



<p>Name T2254 Wide Flat Panel Monitor Bezel color Raven black Type-model 60F6HAR1EU Panel TFT-LCD, twisted nematic (TN), White LED backlight Viewable image size 22.0" (559mm) diagonal Max view area (W x H) 18.70" x 11.70" (473.8mm x 296.1mm) Native resolution 1680x1050 Aspect ratio 16:10 Pixel pitch (mm) 0.282 x 0.282 mm Dot/Pixel per Inch 90 dpi Brightness 250 nits or cd/m² (typical) Contrast ratio 1000:1 (typical) Pixel response time 5ms (typical) Color gamut 72% Viewing angle at 10:1 CR 170° (+/- 85°) horizontal, 160° (+/- 80°) vertical Stand Tilt and height adjustable stand Bezel width Sides: 0.67" (17mm) Dimensions (HxWxD) 14.97" H x 20.05" W x 9.61" D; 380.2mm H x 509.3mm W x 244.2mm D Power supply 16 watts typical, 22 watts maximum, <0.5 watts standby/suspend, universal, integrated (no external brick-like power supply) Weight 10.38 lb; 4.71 kg Limited warranty 3 year (includes backlight) Available date March 2015</p>	<p style="text-align: center;">Features</p> <ul style="list-style-type: none"> • Widescreen 22.0-inch monitor • Supports 1680x1050 resolution • Supports ThinkCentre Tiny Clamp Bracket • Includes dual input connection for attachment to two systems concurrently (analog and digital) • EPEAT Gold certified • Supports optional soundbar • Microsoft® Windows® 7 certified • Microsoft Windows 8 / Windows 8.1 certified • Microsoft Windows 10 certified 				
<p>VESA-compliant VESA DDC2B/CI Power management ENERGY STAR® qualified Ergonomics ISO 9241-307 Emission standards None Environmental TCO Displays 7.0, TCO Certified Edge 2.0, WEEE, RoHS, EPEAT™ Gold rating</p>	<div style="text-align: center;">  <p>ThinkVision T2254 Wide Monitor</p> </div>				
<p>Preset resolutions VGA: 640x350, 640x480, 720x400 SVGA: 800x600 XGA: 1024x768, 1152x864 SXGA: 1280x1024 WXGA: 1280x768, 1280x800, 1366x768 WXGA+: 1440x900 WSXGA+: 1600x900, 1680x1050</p> <p>Presets / user settings Standard presets: 26; user settings: 20</p>					
<p>Viewing adjustments Tilt: 30° back, -5° forward; lift: 4.3" (110mm) Rotating screen None On screen display On screen display with digital user controls (8 languages) Control features Direct access (buttons on front) for automatic image setup, dual input and brightness USB hub None Multiple input Dual input (two different PCs attach to two different connectors; one PC shows image; select via button) Monitor connectors (1) VGA 15-pin D-shell, analog, blue (2) Digital Visual Interface (DVI-D), digital, white, HDCP-compliant Signal cables (1) detachable, VGA 15-pin D-shell at each end, analog, 1.8 meter (2) detachable, DVI-D at each end, digital, 1.8 meter Mounting features Wall or desk mounting using the Extend Arm or third-party accessories, 100mm x 100mm mount Security Security keyhole for attachment of optional cable lock (Kensington® lock-compatible)</p>					
<p>Ship group Monitor with stand, Safety and Warranty Information, 1.8 meter analog signal cable, 1.8 meter DVI-D cable, 1.8 meter black power cord</p>	<p style="text-align: center;">Limited Warranty</p> <p>See details at http://support.lenovo.com/en_US/guides-and-manuals/detail.page?DocID=UM008281</p> <p style="text-align: center;">Accessories</p> <table border="0" style="width: 100%;"> <tr> <td>Kensington MicroSaver Cable Lock</td> <td style="text-align: right;">73P2582</td> </tr> <tr> <td>Kensington Twin Head Cable Lock</td> <td style="text-align: right;">45K1620</td> </tr> </table> <p>See details at www.lenovo.com/support/monitoraccessories</p> <p>See all monitors at www.lenovo.com/thinkvision</p>	Kensington MicroSaver Cable Lock	73P2582	Kensington Twin Head Cable Lock	45K1620
Kensington MicroSaver Cable Lock	73P2582				
Kensington Twin Head Cable Lock	45K1620				



<p>Name T2254p Wide Flat Panel Monitor Bezel color Raven black Type-model 61BAMAR2US / 60E1MAR2US / 60CCMAR2US / 60CCMAT2EU / 61BAMAT2EU Panel TFT-LCD, twisted nematic (TN), White LED backlight Viewable image size 22.0" (559mm) diagonal Max view area (W x H) 18.70" x 11.70" (473.8mm x 296.1mm) Native resolution 1680x1050 Aspect ratio 16:10 Pixel pitch (mm) 0.282 x 0.282 mm Dot/Pixel per Inch 90 dpi Brightness 250 nits or cd/m² (typical) Contrast ratio 1000:1 (typical) Pixel response time 5ms (typical) Color gamut 72% Viewing angle at 10:1 CR 170° (+/- 85°) horizontal, 160° (+/- 80°) vertical Stand Tilt, swivel, pivot, and height adjustable Bezel width Sides: 0.67" (17.1mm) Dimensions (HxWxD) 14.63" H x 20.01" W x 9.55" D; 371.7mm H x 509.3mm W x 242.7mm D Power supply 20 watts typical, 25 watts maximum, <0.5 watts standby/suspend, universal, integrated (no external brick-like power supply) Weight 10.14 lb; 4.60 kg Limited warranty 3 year (includes backlight) Available date March 2015</p>	<p style="text-align: center;">Features</p> <ul style="list-style-type: none"> • Widescreen 22.0-inch monitor • Supports 1680x1050 resolution • Supports ThinkCentre Tiny Clamp Bracket • Supports optional soundbar • Includes dual input connection for attachment to two systems concurrently (analog and digital) • EPEAT Gold certified • Microsoft® Windows® 7 certified • Microsoft Windows 8 / Windows 8.1 certified • Microsoft Windows 10 certified 				
<p>VESA-compliant VESA DDC2B/CI Power management ENERGY STAR® qualified Ergonomics ISO 9241-307 Emission standards FCC Class B Environmental TCO Displays 7.0, TCO Certified Edge 2.0, WEEE, RoHS, EPEAT™ Gold rating</p>	<div style="text-align: center;">  <p>ThinkVision T2254p Wide Monitor</p> </div>				
<p>Preset resolutions VGA: 640x350, 640x480, 720x400 SVGA: 800x600 XGA: 1024x768, 1152x864 SXGA: 1280x1024 WXGA: 1280x768, 1280x800, 1366x768 WXGA+: 1440x900 WSXGA+: 1600x900, 1680x1050 Presets / user settings Standard presets: 28; user settings: 20</p>					
<p>Viewing adjustments <i>Tilt:</i> 30° back, -5° forward; <i>lift:</i> 4.3" (110mm); <i>swivel:</i> +/-45°; detachable stand Rotating screen Screen pivots 90 degrees from landscape to portrait On screen display On screen display with digital user controls (8 languages) Control features Direct access (buttons on front) for automatic image setup, dual input and brightness USB hub None Multiple input Dual input (two different PCs attach to two different connectors; one PC shows image; select via button) Monitor connectors (1) VGA 15-pin D-shell, analog, blue (2) HDMI (1.4), digital, HDCP-compliant (3) DisplayPort, digital, black, HDCP-compliant Signal cables (1) detachable, VGA 15-pin D-shell at each end, analog, 1.8 meter (2) detachable, DisplayPort at each end, digital, 1.8 meter Mounting features Wall or desk mounting using the Extend Arm or third-party accessories, 100mm x 100mm mount Security Security keyhole for attachment of optional cable lock (Kensington® lock-compatible)</p>					
<p>Ship group Monitor with stand, Safety and Warranty Information, 1.8 meter analog signal cable, 1.8 meter DP signal cable, 1.8 meter black power cord</p>					
<p style="text-align: center;">Limited Warranty</p> <p>See details at http://support.lenovo.com/en_US/guides-and-manuals/detail.page?DocID=UM008281</p>	<p style="text-align: center;">Accessories</p> <table border="0"> <tr> <td>Kensington MicroSaver Cable Lock</td> <td style="text-align: right;">73P2582</td> </tr> <tr> <td>Kensington Twin Head Cable Lock</td> <td style="text-align: right;">45K1620</td> </tr> </table> <p>See details at www.lenovo.com/support/monitoraccessories</p> <p>See all monitors at www.lenovo.com/thinkvision</p>	Kensington MicroSaver Cable Lock	73P2582	Kensington Twin Head Cable Lock	45K1620
Kensington MicroSaver Cable Lock	73P2582				
Kensington Twin Head Cable Lock	45K1620				



ThinkVision T22i-10 MONITOR



SPECIFICATIONS

DISPLAY		DIMENSIONS (W x D x H)	
Panel Size	21.5" Wide	Size Packed (mm)	577 x 378 x 191
Panel Type	IPS	(inches)	22.7" x 14.9" x 7.5"
Backlight	WLED	Size Unpacked with Stand (mm)	489.7 x 251.9 x 357.6
Resolution (H x V)	1920 x 1080	(inches)	19.28" x 9.92" x 14.08"
Aspect Ratio	16:9	Size Monitor Head Only (mm)	489.7 x 43.5 x 297
Anti-Glare	Yes	(inches)	19.28" x 1.71" x 11.69"
Borderless Screen	Yes	Stand Base Footprint Area (mm)	240 x 240
Screen Dimensions (W x H) (mm)	476.064 x 267.786	(inches)	9.45" x 9.45"
(inches)	18.74" x 10.54"	Weight	
Maximum Brightness (Typical)	250 cd/m ²	Packed	Starting at 16.36 lbs (7.42 kg)
Viewing Angle (H/V at CR 10:1)	178°/178°	Unpacked	Starting at 10.85 lbs (4.92 kg)
Contrast Ratio (Typical)	1000:1	Monitor Head Only	Starting at 6.94 lbs (3.15 kg)
Dynamic Contrast Ratio	3M:1		
Pixel Pitch (mm)	0.248 x 0.248		
Color Gamut NTSC (CIE 1931)	72%		
Color Support (Typical)	16.7 Million		
Response Time	4/6/14 ms		
CONNECTIVITY		POWER CONSUMPTION	
Video Input Signals	VGA + HDMI™ 1.4 + DisplayPort™ 1.2	Typical	20 W
Video Cables Supplied (Length)	1.8 m	Maximum	55 W
Audio	Audio-Out	Sleep-Mode	<0.5 W
OSD Languages	English, French, German, Spanish, Italian, Japanese, Simplified Chinese, Russian	Switch Off-Mode	<0.5 W
		Power Supply	Internal
		Power Voltage	100 VAC - 240 VAC
MECHANICAL		COMPLIANCE	
Tilt Angle (Front / Back)	-5° / 30°	Arsenic-Free Glass	Yes
Swivel Angle (Left / Right)	+/-45°	PVC-Free	Yes; Without Cable
Lift (mm / inches)	110 / 4.33"	Mercury-Free	Yes
Pivot	-90° / 90°	EPEAT™	Silver
Cable Management	Yes	ENERGY STAR® Rating	7.0
Kensington® Lock	Yes	TCO®	7.0
VESA® Mounting	Yes (100 mm)	TCO Edge	2.0
Bezel Color	Raven Black	RoHS (EU 2002/95/EC)	Yes
Bezel Width		China Energy Efficiency Standard	Tier 2
Top (mm / inches)	2 / 0.08"	Windows Certification	Windows 7 / Windows 10
Bottom (mm / inches)	21.4 / 0.84"		
Sides (mm / inches)	2 / 0.08"		

Lenovo™



WWW.LENOVO.COM

Lenovo reserves the right to alter product offerings and specifications at any time, without notice. Lenovo makes every effort to ensure accuracy of all information but is not liable or responsible for any editorial, photographic or typographic errors. All images are for illustration purposes only. For full Lenovo product, service and warranty specifications visit www.lenovo.com. Lenovo makes no representations or warranties regarding third party products or services. **Trademarks:** The following are trademarks or registered trademarks of Lenovo: Lenovo, the Lenovo logo, Rescue and Recovery, ThinkPad, ThinkCentre, ThinkStation, ThinkServer, ThinkVantage and ThinkVision. Microsoft, Windows and Vista are registered trademarks of Microsoft Corporation. Ultrabook, Celeron, Celeron Inside, Core Inside, Intel, Intel Logo, Intel Atom, Intel Atom Inside, Intel Core, Intel Inside, Intel Inside Logo, Intel vPro, Itanium, Itanium Inside, Pentium, Pentium Inside, vPro Inside, Xeon, Xeon Phi, and Xeon Inside are trademarks of Intel Corporation in the U.S. and/or other countries. Other company, product and service names may be trademarks or service marks of others. Battery life (and recharge times) will vary based on many factors including system settings and usage. Visit www.lenovo.com/lenovo/us/en/safecomp/ periodically for the latest information on safe and effective computing. ©2019 Lenovo. All rights reserved.



ThinkVision T22v-10 MONITOR

SPECIFICATIONS

DISPLAY		ENVIRONMENTAL	
Panel Size	21.5"	Temperature	
Panel Type	In-Plane Switching	Operating	0°C – 40°C
Backlight	WLED	Non-Operating	-20°C – 60°C
Resolution	1920 x 1080	Humidity	
Aspect Ratio	16:9	Operating	10% – 80%
Anti-Glare	Yes	Non-Operating	5% – 95%
Screen Dimensions (W x H) (mm)	476.06 x 267.79	Altitude	
Maximum Brightness (Typical)	250 cd/m ²	Operating	0 m – 8000 m
Viewing Angle (H/V at CR 10:1)	178°/178°	Non-Operating	0 ft – 40,000 ft
Contrast Ratio (Typical)	1000:1	Arsenic-Free Glass	Yes
Dynamic Contrast Ratio	3M:1	PVC-Free	Yes
Pixel Pitch (W x H) (mm)	0.25 x 0.25	Mercury-Free	Yes
Dot/Pixel Per Inch (DP/PPI)	102	PCC % of Plastic Resins	>85%
Color Gamut (CIE 1931)	72% sRGB		
Response Time (Extreme/Typical/Off)	4/6/14 ms (G-to-G)		
POWER CONSUMPTION		DIMENSIONS (W x D x H)	
Typical	18 W	Size Packed	
Maximum	43 W	(mm)	554 x 365 x 187
Sleep-Mode	<0.5 W	(inches)	21.81" x 14.37" x 7.36"
Switch Off-Mode	<0.3 W	Size Unpacked with Stand	
Power Supply	Internal	Lowest Position	
Power Voltage	90 VAC – 264 VAC	(mm)	489.7 x 251.9 x 375.8
Voltage Dynamic Frequency	47 Hz – 63 Hz	(inches)	19.28" x 9.92" x 14.79"
		Highest Position	
		(mm)	489.7 x 251.9 x 485.8
		(inches)	19.28" x 9.92" x 19.13"
		Size Unpacked without Stand	
		(Monitor Head Only)	
		(mm)	489.7 x 43.5 x 315.1
		(inches)	19.28" x 1.71" x 12.41"
		Distance from Table to Panel	
		Lowest Pixel at Bottom of Screen	
		(mm / inches)	82.1 / 3.23"
		Highest Pixel at Top of Screen	
		(mm / inches)	192.1 / 7.56"
		Stand Base Footprint Area	
		(mm / inches)	232 x 203.6 / 9.13" x 8.02"
		Weight	
		Packed	Starting at 14.46 lbs (6.56 kg)
		Unpacked	Starting at 10.16 lbs (4.61 kg)
		Monitor Head Only	Starting at 6.48 lbs (2.94 kg)
SIGNAL INPUT		COMPLIANCE	
Video Input Signals	HDMI™ 1.4 + DisplayPort™ 1.2 + VGA	EPEAT™	Silver
Video Cables Supplied	HDMI™ (ROW) + DisplayPort™ + VGA + USB 3.0 ¹	ENERGY STAR® Rating	7.0
Video Cable Length	1.8 m	ULE	Gold
USB Hub	Yes	TCO	TCO Display 7.0 / TCO Edge 2.0
USB Cable Supplied	Yes	RoHS (EU 2002/95/EC)	Yes
Audio-Out	Yes (3.5 mm)	Windows Certification	Windows 7 / Windows 10
		China Energy Efficiency Standard	Grade 2
		TÜV Eye Comfort	Yes
SIGNAL INTERFACE / PERFORMANCE		WARRANTY AND AVAILABILITY	
Horizontal Frequency	30 kHz – 81 kHz	Warranty	
Vertical Frequency	50 Hz – 75 Hz	ROW	3 Years
Native Resolution	1920 x 1080	PRC	18 Months
Maximum Pixel Clock Speed/ Bandwidth	VGA : 205 MHz HDMI™ : 165 MHz DisplayPort™ : 165 MHz	Geography Availability	WW
Default Color Temperature	6500K		
Preset/User Modes	24/20		
OSD Buttons	5+2 Buttons		
OSD Languages	English, French, German, Spanish, Italian, Japanese, Simplified Chinese, Russian		
MECHANICAL			
Tilt Angle (Front / Back)	-5° / 30°		
Swivel Angle (Left / Right)	+/-45°		
Lift (mm)	Yes (110)		
Pivot	+/-90°		
VESA® Mount (mm)	Yes (100 x 100)		
Kensington® Lock Slot	Yes		
Cable Management	Yes		
Bezel Color	Raven Black		
Bezel Width			
Top (mm / inches)	2 / 0.08"		
Bottom (mm / inches)	21.4 / 0.84"		
Sides (mm / inches)	2 / 0.08"		



WWW.LENOVO.COM

¹ Depending on many factors such as the processing capability of peripheral devices, file attributes, and other factors related to system configuration and operating environments, the actual transfer rate using the various USB connectors on this device will vary and is typically slower than the data rates as defined by the respective USB specifications: - 5 Gbit/s for USB 3.1 Gen 1; 10 Gbit/s for USB 3.1 Gen 2 & 20 Gbit/s for USB 3.2.



<p>Name T2324d Wide Flat Panel Monitor Bezel color Black Type-model 60F3JAR2US / 60F3JAT2EU Panel TFT-LCD, twisted nematic (TN), White LED backlight Viewable image size 23.0" (584mm) diagonal Max view area (W x H) 20.07" x 11.29" (509.8mm x 286.7mm) Native resolution 1920x1080 Aspect ratio 16:9 Pixel pitch (mm) 0.2655 x 0.2655 mm Dot/Pixel per Inch 96 dpi Brightness 250 nits or cd/m² (typical) Contrast ratio 1000:1 (typical) Pixel response time 5ms (typical) Color gamut 72% Viewing angle at 10:1 CR 170° (+/- 85°) horizontal, 160° (+/- 80°) vertical Stand Tilt stand Bezel width Sides: 0.68" (17.3mm) Dimensions (HxWxD) 15.75" H x 21.48" W x 8.06" D; 400.3mm H x 545.8mm W x 204.9mm D Power supply 20 watts typical, 27 watts maximum <0.3 watts standby/suspend, universal, integrated (no external brick-like power supply) Weight 7.06 lb; 3.20 kg Limited warranty 3 year (includes backlight) Available date June 2016</p>	<p style="text-align: center;">Features</p> <ul style="list-style-type: none"> • Widescreen 23.0-inch monitor • Supports 1920x1080 resolution • Supports optional soundbar • Supports ThinkCentre Tiny via VESA back mount • Includes dual input connection for attachment to two systems concurrently (analog and digital) • EPEAT Gold certified • Microsoft® Windows® 7 certified • Microsoft Windows 10 certified 				
<p>VESA-compliant VESA DDC2B/CI Power management ENERGY STAR® qualified Ergonomics ISO 9241-307 Emission standards FCC Class B Environmental TCO Displays 7.0, TCO Certified Edge 2.0, WEEE, RoHS, EPEAT™ Gold rating</p>	<div style="text-align: center;">  <p>ThinkVision T2324d Wide Monitor</p> </div>				
<p>Preset resolutions VGA: 640x350, 640x480, 720x400 SVGA: 800x600 XGA: 1024x768, 1152x864 SXGA: 1280x1024 WXGA: 1280x768, 1280x800, 1366x768 WXGA+: 1440x900 WSXGA+: 1680x1050 Full HD: 1920x1080</p> <p>Presets / user settings Standard presets: 26; user settings: 16</p>					
<p>Viewing adjustments Tilt: 22° back, -5° Rotating screen None On screen display On screen display with digital user controls (8 languages) Control features Direct access (buttons on front) for automatic image setup, dual input and brightness USB hub None Multiple input Dual input (two different PCs attach to two different connectors; one PC shows image; select via button) Monitor connectors (1) VGA 15-pin D-shell, analog, blue (2) DisplayPort, digital, black, HDCP-compliant Signal cables (1) detachable, VGA 15-pin D-shell at each end, analog, 1.8 meter (2) detachable, DisplayPort at each end, digital, 1.8 meter Mounting features Wall or desk mounting using the Extend Arm or third-party accessories, 100mm x 100mm mount Security Security keyhole for attachment of optional cable lock (Kensington® lock-compatible)</p>					
<p>Ship group Monitor with stand, Safety and Warranty Information, 1.8 meter analog signal cable, 1.8 meter DP signal cable, 1.8 meter black power cord</p>	<p style="text-align: center;">Limited Warranty</p> <p>See details at http://support.lenovo.com/en_US/guides-and-manuals/detail.page?DocID=UM008281</p> <p style="text-align: center;">Accessories</p> <table border="0" style="width: 100%;"> <tr> <td>Kensington MicroSaver Cable Lock</td> <td style="text-align: right;">73P2582</td> </tr> <tr> <td>Kensington Twin Head Cable Lock</td> <td style="text-align: right;">45K1620</td> </tr> </table> <p>See details at www.lenovo.com/support/monitoraccessories</p> <p>See all monitors at www.lenovo.com/thinkvision</p>	Kensington MicroSaver Cable Lock	73P2582	Kensington Twin Head Cable Lock	45K1620
Kensington MicroSaver Cable Lock	73P2582				
Kensington Twin Head Cable Lock	45K1620				



<p>Name T23d-10 Wide Flat Panel Monitor Bezel color Black Type-model 61C3MAR6US / 61C3MAT6EU Panel TFT-LCD, In-Plane Switching (IPS), White LED backlight</p> <p>Viewable image size 22.5" (571.5mm) diagonal Max view area (W x H) 19.5" x 12.4" (496.2mm x 313.9mm) Native resolution 1920x1200 Aspect ratio 16:10 Pixel pitch (mm) 0.25 x 0.25 mm Dot/Pixel per Inch 100.6 dpi Brightness 250 nits or cd/m² (typical) Contrast ratio 1000:1 (typical) Pixel response time 6ms (typical) Color gamut 72% Viewing angle at 10:1 CR 178° (+/- 89°) horizontal, 178° (+/- 89°) vertical Stand Tilt, swivel, pivot, and height adjustable stand Bezel width Sides: 0.09" (2.3mm) Dimensions (HxWxD) 19.37" H x 19.73" W x 9.9" D; 491.9mm H x 501.2mm W x 251.9mm D</p> <p>Power supply 15 watts typical, 18 watts maximum, <0.3 watts standby/suspend, universal, integrated (no external brick-like power supply)</p> <p>Weight 10.67 lb; 4.85 kg Limited warranty 3 year (includes backlight) Available date June 2018</p>	<p style="text-align: center;">Features</p> <ul style="list-style-type: none"> • Widescreen 22.5-inch monitor • Supports 1920x1200 resolution • Supports ThinkCentre Tiny Clamp Bracket • Supports optional soundbar • Includes dual input connection for attachment to two systems concurrently • EPEAT Gold certified • Microsoft® Windows® 7 certified • Microsoft Windows 10 certified 																	
<p>VESA-compliant VESA DDC2B/CI Power management ENERGY STAR® qualified Ergonomics ISO 9241-307 Emission standards FCC Class B Environmental TCO Displays 7.0, TCO Certified Edge 2.0, WEEE, RoHS, EPEAT™ Silver rating</p>	<div style="text-align: center;">  <p>ThinkVision T23d-10 Wide Monitor</p> </div>																	
<p>Preset resolutions</p> <table border="0"> <tr><td>VGA:</td><td>640x480, 720x400</td></tr> <tr><td>SVGA:</td><td>800x600</td></tr> <tr><td>XGA:</td><td>1024x768</td></tr> <tr><td>SXGA:</td><td>1280x1024</td></tr> <tr><td>WXGA:</td><td>1366x768</td></tr> <tr><td>WXGA+:</td><td>1440x900</td></tr> <tr><td>WSXGA+:</td><td>1680x1050</td></tr> <tr><td>Full HD:</td><td>1920x1080</td></tr> <tr><td>WUXGA:</td><td>1920x1200</td></tr> </table> <p>Presets display modes Standard presets: 27; user settings: 20</p>		VGA:	640x480, 720x400	SVGA:	800x600	XGA:	1024x768	SXGA:	1280x1024	WXGA:	1366x768	WXGA+:	1440x900	WSXGA+:	1680x1050	Full HD:	1920x1080	WUXGA:
VGA:	640x480, 720x400																	
SVGA:	800x600																	
XGA:	1024x768																	
SXGA:	1280x1024																	
WXGA:	1366x768																	
WXGA+:	1440x900																	
WSXGA+:	1680x1050																	
Full HD:	1920x1080																	
WUXGA:	1920x1200																	
<p>Viewing adjustments Tilt: 30° back, -5° forward; lift: 4.3" (110mm); swivel: +/-45°; detachable stand Rotating screen Screen pivots 90 degrees from landscape to portrait On screen display On screen display with digital user controls (8 languages) Control features Direct access (buttons on front) for power, menu, input source select and brightness USB hub None Multiple input Dual input (two different PCs attach to two different connectors; one PC shows image; select via button) Monitor connectors (1) VGA 15-pin D-shell, analog, blue (2) HDMI (1.4), digital, HDCP-compliant (3) DisplayPort, digital, black, HDCP-compliant Signal cables (1) detachable, VGA 15-pin D-shell at each end, analog, 1.8 meter (2) detachable, DisplayPort at each end, digital, 1.8 meter Mounting features Wall or desk mounting using the Extend Arm or third-party accessories, 100mm x 100mm mount Security Security keyhole for attachment of optional cable lock (Kensington® lock-compatible)</p>																		
<p>Ship group Monitor with stand, Safety and Warranty Information, 1.8 meter analog signal cable, 1.8 meter DP signal cable, 1.8 meter black power cord, 1.8 meter HDMI signal cable (NA only)</p>																		
<p style="text-align: center;">Limited Warranty</p> <p>See details at http://support.lenovo.com/en_US/guides-and-manuals/detail.page?DocID=UM008281</p>	<p style="text-align: center;">Accessories</p> <table border="0"> <tr> <td>Kensington MicroSaver Cable Lock</td> <td style="text-align: right;">73P2582</td> </tr> <tr> <td>Kensington Twin Head Cable Lock</td> <td style="text-align: right;">45K1620</td> </tr> </table> <p>See details at www.lenovo.com/support/monitoraccessories</p> <p>See all monitors at www.lenovo.com/thinkvision</p>	Kensington MicroSaver Cable Lock	73P2582	Kensington Twin Head Cable Lock	45K1620													
Kensington MicroSaver Cable Lock	73P2582																	
Kensington Twin Head Cable Lock	45K1620																	

Note: The specifications above may not be available in all regions.



<p>Name T23i Wide Flat Panel Monitor Bezel color Black Type-model 61ABMAR1US / 61ABMAT1EU Panel TFT-LCD, In-Plane Switching (IPS), White LED backlight Viewable image size 23" (584.2mm) diagonal Max view area (W x H) 20.36" x 11.92" (517.2mm x 302.8mm) Native resolution 1920x1080 Aspect ratio 16:9 Pixel pitch (mm) 0.2652 x 0.2652 mm Dot/Pixel per Inch 95.8 dpi Brightness 250 nits or cd/m² (typical) Contrast ratio 1000:1 (typical) Pixel response time 6ms (typical) Color gamut 72% Viewing angle at 10:1 CR 178° (+/- 89°) horizontal, 178° (+/- 89°) vertical Stand Tilt, swivel, pivot, and height adjustable stand Bezel width Sides: 0.08" (2.0mm) Dimensions (HxWxD) 13.3" H x 20.56" W x 10.4" D; 337.7mm H x 522.2mm W x 264.2mm D Power supply 16 watts typical, 45 watts maximum (with USB 3.0 hub), <0.5 watts standby/suspend, universal, integrated (no external brick-like power supply) Weight 10.85 lb; 4.92 kg Limited warranty 3 year (includes backlight) Available date April 2017</p>	<p style="text-align: center;">Features</p> <ul style="list-style-type: none"> • Widescreen 23-inch monitor • Supports 1920x1080 resolution • Supports ThinkCentre Tiny Clamp Bracket • Includes dual input connection for attachment to two systems concurrently • EPEAT Silver certified • Microsoft® Windows® 7 certified • Microsoft Windows 10 certified 				
<p>VESA-compliant VESA DDC2B/CI Power management ENERGY STAR® qualified Ergonomics ISO 9241-307 Emission standards FCC Class B Environmental TCO Displays 7.0, TCO Certified Edge 2.0, WEEE, RoHS, EPEAT™ SILVER rating</p>	<div style="text-align: center;">  <p>ThinkVision T23i Wide Monitor</p> </div>				
<p>Preset resolutions VGA: 640x480, 720x400 SVGA: 800x600 XGA: 1024x768, 1152x864 SXGA: 1280x1024 WXGA+: 1440x900 WSXGA+: 1680x1050 Full HD: 1920x1080</p> <p>Presets display modes HDMI: 18; DP: 18</p>					
<p>Viewing adjustments Tilt: 30° back, -5° forward; lift: 4.3" (110mm); swivel: +/-45°; detachable stand Rotating screen Screen pivots 90 degrees from landscape to portrait On screen display On screen display with digital user controls (8 languages) Control features Direct access (buttons on front) for power, menu, input source select and brightness and automatic image setup USB hub USB 3.0 Hub: 1 port into PC (USB 3.0); 4 ports for accessories (4 USB 3.0) Multiple input Dual input (two different PCs attach to two different connectors; one PC shows image; select via button) Monitor connectors (1) VGA 15-pin D-shell, analog, blue (2) HDMI (1.4), digital, HDCP-compliant (3) DisplayPort, digital, black, HDCP-compliant</p>	<p>Signal cables (1) detachable, VGA 15-pin D-shell at each end, analog, 1.8 meter (2) detachable, DisplayPort at each end, digital, 1.8 meter (3) detachable, HDMI at each end, digital, 1.8 meter (NA)</p>				
<p>Mounting features Wall or desk mounting using the Extend Arm or third-party accessories, 100mm x 100mm mount Security Security keyhole for attachment of optional cable lock (Kensington® lock-compatible) Ship group Monitor with stand, Safety and Warranty Information, 1.8 meter analog signal cable, 1.8 meter DP signal cable, 1.8 meter HDMI signal cable(NA), 1.8 meter USB signal cable, 1.8 meter black power cord</p>					
<p style="text-align: center;">Limited Warranty</p> <p>See details at http://support.lenovo.com/en_US/guides-and-manuals/detail.page?DocID=UM008281</p>	<p style="text-align: center;">Accessories</p> <table border="0" style="width: 100%;"> <tr> <td>Kensington MicroSaver Cable Lock</td> <td style="text-align: right;">73P2582</td> </tr> <tr> <td>Kensington Twin Head Cable Lock</td> <td style="text-align: right;">45K1620</td> </tr> </table> <p>See details at www.lenovo.com/support/monitoraccessories</p> <p>See all monitors at www.lenovo.com/thinkvision</p>	Kensington MicroSaver Cable Lock	73P2582	Kensington Twin Head Cable Lock	45K1620
Kensington MicroSaver Cable Lock	73P2582				
Kensington Twin Head Cable Lock	45K1620				



<p>Name T2454p Wide Flat Panel Monitor Bezel color Raven black Type-model 60F9MAR1US / 60F9MAT1EU Panel TFT-LCD, In-Plane Switching (IPS), White LED backlight</p> <p>Viewable image size 24.0" (609.6mm) diagonal Max view area (W x H) 20.41" x 12.76" (518.4mm x 324.0mm) Native resolution 1920x1200 Aspect ratio 16:10 Pixel pitch (mm) 0.270 x 0.270 mm Dot/Pixel per Inch 94 dpi Brightness 300 nits or cd/m² (typical) Contrast ratio 1000:1 (typical) Pixel response time 7ms (typical) Color gamut 77.4% Viewing angle at 10:1 CR 178° (+/- 89°) horizontal, 178° (+/- 89°) vertical Stand Tilt, swivel, pivot, and height adjustable stand Bezel width Sides: 0.74" (18.8mm) Dimensions (HxWxD) 15.85" H x 21.94" W x 10.39" D; 402.5mm H x 557.4mm W x 264.2mm D</p> <p>Power supply 24 watts typical, 27 watts maximum (without USB 3.0 hub), 54 watts maximum (with USB 3.0 hub), <0.5 watts standby/suspend, universal, integrated (no external brick-like power supply) Weight 13.60 lb; 6.15 kg Limited warranty 3 year (includes backlight) Available date March 2015</p>	<p style="text-align: center;">Features</p> <ul style="list-style-type: none"> • Widescreen 24.0-inch monitor • Supports 1920x1200 resolution • Supports ThinkCentre Tiny Clamp Bracket • Supports optional soundbar • Includes dual input connection for attachment to two systems concurrently (analog and digital) • EPEAT Gold certified • Microsoft® Windows® 7 certified • Microsoft Windows 8 / Windows 8.1 certified • Microsoft Windows 10 certified 				
<p>VESA-compliant VESA DDC2B/CI Power management ENERGY STAR® qualified Ergonomics ISO 9241-307 Emission standards FCC Class B Environmental TCO Displays 7.0, TCO Certified Edge 2.0, WEEE, RoHS, EPEAT™ Gold rating</p> <p>Preset resolutions VGA: 640x350, 640x480, 720x400 SVGA: 800x600 XGA: 1024x768 SXGA: 1280x1024 WXGA: 1280x720, 1280x768, 1280x800 WXGA+: 1440x900 WSXGA+: 1680x1050, 1600x1200 Full HD: 1920x1080, 1920x1200</p> <p>Presets / user settings Standard presets: 21; user settings: 20</p>	 <p style="text-align: center;">ThinkVision T2454p Wide Monitor</p>				
<p>Viewing adjustments Tilt: 30° back, -5° forward; lift: 4.3" (110mm); swivel: +/-45°; detachable stand Rotating screen Screen pivots 90 degrees from landscape to portrait On screen display On screen display with digital user controls (8 languages) Control features Direct access (buttons on front) for automatic image setup, dual input and brightness USB hub USB 3.0 Hub: 1 port into PC (USB 3.0); 4 ports for accessories (4 USB 3.0) Multiple input Dual input (two different PCs attach to two different connectors; one PC shows image; select via button) Monitor connectors (1) VGA 15-pin D-shell, analog, blue (2) HDMI (1.4), digital, HDCP-compliant (3) DisplayPort, digital, black, HDCP-compliant</p> <p>Signal cables (1) detachable, VGA 15-pin D-shell at each end, analog, 1.8 meter (2) detachable, DisplayPort at each end, digital, 1.8 meter</p> <p>Mounting features Wall or desk mounting using the Extend Arm or third-party accessories, 100mm x 100mm mount Security Security keyhole for attachment of optional cable lock (Kensington® lock-compatible)</p>	<p>Ship group Monitor with stand, Safety and Warranty Information, 1.8 meter analog signal cable, 1.8 meter DisplayPort cable, 1.8 meter USB signal cable, 1.8 meter black power cord</p>				
<p style="text-align: center;">Limited Warranty</p> <p>See details at http://support.lenovo.com/en_US/guides-and-manuals/detail.page?DocID=UM008281</p>	<p style="text-align: center;">Accessories</p> <table border="0"> <tr> <td>Kensington MicroSaver Cable Lock</td> <td style="text-align: right;">73P2582</td> </tr> <tr> <td>Kensington Twin Head Cable Lock</td> <td style="text-align: right;">45K1620</td> </tr> </table> <p>See details at www.lenovo.com/support/monitoraccessories</p> <p>See all monitors at www.lenovo.com/thinkvision</p>	Kensington MicroSaver Cable Lock	73P2582	Kensington Twin Head Cable Lock	45K1620
Kensington MicroSaver Cable Lock	73P2582				
Kensington Twin Head Cable Lock	45K1620				



ThinkVision T24d-10 MONITOR

SPECIFICATIONS

DISPLAY		DIMENSIONS (W x D x H)	
Panel Size	24"	Size Packed (mm)	160 x 655 x 422
Panel Type	In-Plane Switching	(inches)	6.3" x 25.79" x 16.61"
Resolution	1920 x 1200	Size Unpacked with Stand (mm)	533.2 x 260.4 x 497.4
Backlight	WLED	(inches)	20.99" x 10.25" x 19.58"
Aspect Ratio	16:10	Size Monitor Head Only (mm)	533.2 x 42.3 x 355.1
Pixel Pitch (W x H) (mm)	0.27 x 0.27	(inches)	20.99" x 1.67" x 13.98"
Dot/Pixel Per Inch (DPI/PPI)	94 PPI	Distance from Table to Panel (mm / inches)	Lowest Pixel at Bottom of Screen 56 / 2.2"
Anti-Glare	Yes	Highest Pixel at Top of Screen (mm / inches)	490 / 19.29"
Screen Dimensions (W x H) (mm)	518.4 x 324	Stand Base Footprint Area (mm)	250 x 250
(inches)	20.41" x 12.75"	(inches)	9.84" x 9.84"
Maximum Brightness (Typical)	300 cd/m ²	Weight Packed	Starting at 19.18 lbs (8.7 kg)
Viewing Angle (H/V at CR 10:1)	178°/178°	Unpacked	Starting at 12.41 lbs (5.63 kg)
Contrast Ratio (Typical)	1000:1	Monitor Head Only	Starting at 8.77 lbs (3.98 kg)
Dynamic Contrast Ratio	3M:1		
Color Gamut (CIE 1931)	99% sRGB		
Display Colors (Typical)	16.7 Million		
Response Time			
Extreme	4 ms		
Typical	7 ms		
Off	15 ms		
SIGNAL INPUT		POWER CONSUMPTION	
Video Input Signals	VGA + DisplayPort™ 1.2 + HDMI™ 1.4	Typical	22 W
Video Cables Supplied	VGA + DisplayPort™ + HDMI™*	Maximum	64 W
Video Cable Length	1.8 m	Sleep-Mode	<0.3 W
USB Hub	USB 3.0 ¹	Switch Off-Mode	<0.3 W
USB Cable Supplied	Yes	Power Supply	Internal
Audio-Out	Yes (3.5 mm)	Power Voltage	100 VAC - 240 VAC
		Voltage Dynamic Frequency	50 Hz - 60 Hz
SIGNAL INTERFACE / PERFORMANCE		ENVIRONMENTAL	
Horizontal Frequency	30 kHz - 83 KHz	Temperature Operating	0°C - 40°C
Vertical Frequency	50 Hz - 75 Hz	Non-Operating	-20°C - 60°C
Native Resolution	1920 x 1200	Humidity Operating	10% - 80%
Maximum Pixel Clock Speed/Bandwidth		Non-Operating	5% - 95%
VGA	205 MHz	Altitude Operating	0 m - 5000 m
HDMI™	165 MHz	Non-Operating	0 ft - 40,000 ft
DisplayPort™	165 MHz	Arsenic-Free Glass	Yes
Default Color Temperature	6500 K	PVC-Free	Yes
Preset Display Modes	20	Mercury-Free	Yes
OSD Buttons	5	PCC % of Plastic Resins	>85%
OSD Languages	English, French, German, Spanish, Italian, Japanese, Simplified Chinese, Russian		
MECHANICAL		COMPLIANCE	
Tilt Angle (Front / Back)	-5°/ 30°	EPEAT™	Silver
Swivel Angle (Left / Right)	+/-45°	ENERGY STAR® Rating	7.0
Lift (mm)	110	ULE	Gold
Pivot	+/-90°	TCO®	TCO Display 7.0 / TCO Edge 2.0
VESA® Mount (mm x mm)	100 x 100	RoHS (EU 2002/95/EC)	Yes
Cable Management	Yes	China Energy Efficiency Standard	Tier 2
Kensington® Lock	Yes	Windows Certification	Windows 7 / Windows 10
Bezel Color	Business Black		
Bezel Width			
Top (mm / inches)	2 / 0.08"		
Bottom (mm / inches)	22.7 / 0.89"		
Sides (mm / inches)	2 / 0.08"		
WARRANTY AND AVAILABILITY			
Warranty		3 Years	
Geography Availability		WW	

* NA only.

¹ Depending on many factors such as the processing capability of peripheral devices, file attributes, and other factors related to system configuration and operating environments, the actual transfer rate using the various USB connectors on this device will vary and is typically slower than the data rates as defined by the respective USB specifications: - 5 Gbit/s for USB 3.1 Gen 1; 10 Gbit/s for USB 3.1 Gen 2 & 20 Gbit/s for USB 3.2.



WWW.LENOVO.COM

Lenovo reserves the right to alter product offerings and specifications at any time, without notice. Lenovo makes every effort to ensure accuracy of all information but is not liable or responsible for any editorial, photographic or typographic errors. All images are for illustration purposes only. For full Lenovo product, service and warranty specifications visit www.lenovo.com. Lenovo makes no representations or warranties regarding third party products or services. **Trademarks:** The following are trademarks or registered trademarks of Lenovo: Lenovo, the Lenovo logo, Rescue and Recovery, ThinkPad, ThinkCentre, ThinkStation, ThinkServer, ThinkVantage and ThinkVision. Microsoft, Windows and Vista are registered trademarks of Microsoft Corporation. Ultrabook, Celeron, Celeron Inside, Core Inside, Intel, Intel Logo, Intel Atom, Intel Atom Inside, Intel Core, Intel Inside, Intel Inside Logo, Intel vPro, Itanium, Itanium Inside, Pentium, Pentium Inside, vPro Inside, Xeon, Xeon Phi, and Xeon Inside are trademarks of Intel Corporation in the U.S. and/or other countries. Other company, product and service names may be trademarks or service marks of others. Battery life (and recharge times) will vary based on many factors including system settings and usage. Visit www.lenovo.com/lenovo/us/en/safecomp/ periodically for the latest information on safe and effective computing. ©2019 Lenovo. All rights reserved.

Lenovo™



ThinkVision T24i-10 MONITOR



SPECIFICATIONS

DISPLAY		DIMENSIONS (W x D x H)	
Panel Size	23.8" Wide	Size Packed	422 x 622 x 190
Panel Type	In-Plane Switchng	(mm)	16.61" x 24.48" x 7.48"
Backlight	WLED	(inches)	
Resolution (H x V)	1920 x 1080	Size Unpacked with Stand	
Aspect Ratio	16:9	Lowest Position	
Anti-Glare	Yes	(mm)	540.2 x 261.75 x 373.4
Near Edgeless Screen	Yes	(inches)	21.26" x 10.3" x 14.7"
Screen Dimensions (W x H)		Highest Position	
(mm)	527.04 x 296.46	(mm)	540.2 x 261.75 x 483.4
(inches)	20.75" x 11.67"	(inches)	21.26" x 10.3" x 19"
Maximum Brightness (Typical)	250 cd/m ²	Size Unpacked without Stand	
Viewing Angle (H/V at CR 10:1)	178°/178°	(Monitor Head Only)	
Contrast Ratio (Typical)	1000:1	(mm)	540.2 x 46.45 x 325.98
Dynamic Contrast Ratio	3M:1	(inches)	21.26" x 1.82" x 12.83"
Pixel Pitch (mm)	0.2745 x 0.2745	Stand Base Footprint Area	
Color Gamut (CIE 1931)	72% NTSC	(mm)	250 x 250
Color Support (Typical)	16.7 Million	(inches)	9.84" x 9.84"
Response Time (gray to gray)	4 ms (Extreme mode)	Weight	
OSD Controls	6 ms (Normal mode)	Packed	Starting at 16.39 lbs (7.45 kg)
Buttons	5	Unpacked	Starting at 11.33 lbs (5.15 kg)
Languages	English, French, German, Spanish, Italian, Japanese, Simplified Chinese, Russian	Monitor Head Only	Starting at 7.26 lbs (3.3 kg)
		Full Container Load	1140 / 540 Units
		(40' STD / 20' STD)	
CONNECTIVITY		POWER CONSUMPTION	
Video Input Signals	VGA + HDMI™ 1.4 + DisplayPort™ 1.2	Typical	16.5 W
Video Cables Supplied (Length)	1.8 m	Maximum	55 W
USB Hub	1 x USB 3.0 ¹ (Upstream) 4 x USB 3.0 ¹ (Downstream, Incl. 1 BC)	Sleep-Mode	<0.5 W
Audio Out	Yes (3.5 mm)	Switch Off-Mode	<0.3 W
		Power Supply	Internal
		Power Voltage	90 VAC – 264 VAC
MECHANICAL		WHAT'S IN THE BOX	
Tilt Angle (Front / Back)	-5° / 30°	Monitor with Stand	
Swivel Angle (Left / Right)	+/-45°	1 x Power Cable	
Lift Range (mm)	110	1 x VGA Cable	
Pivot	+/-90°	1 x DisplayPort™ - DisplayPort™ Cable	
Cable Management	Yes	1 x HDMI™ Cable (NA Only)	
Kensington® Lock	Yes	Quick Setup Guide	
VESA® Mount (mm x mm)	Yes (100 X 100)		
Bezel Color	Raven Black	CERTIFICATIONS	
Bezel Width		EPEAT™	Silver
Top (mm / inches)	2 / 0.08"	ENERGY STAR® Rating	7.1
Sides (mm / inches)	2 / 0.08"	TCO®	7.0
		TCO Edge	2.0
		RoHS (EU 2002/95/EC)	Yes
		China Energy Efficiency Standard	Tier 2
		Windows Certification	Windows 7 / Windows 10
		TüV Eye Comfort Certification	Yes

¹ Depending on many factors such as the processing capability of peripheral devices, file attributes, and other factors related to system configuration and operating environments, the actual transfer rate using the various USB connectors on this device will vary and is typically slower than the data rates as defined by the respective USB specifications: - 5 Gbit/s for USB 3.1 Gen 1; 10 Gbit/s for USB 3.1 Gen 2 & 20 Gbit/s for USB 3.2.



WWW.LENOVO.COM

Lenovo™



ThinkVision T24i-19 MONITOR



SPECIFICATIONS

DISPLAY		DIMENSIONS (W x D)	
Panel Size	23.8" Wide	Size Packed (mm)	422 x 622 x 190
Panel Type	In-Plane-Switching	Size Packed (inches)	16.61" x 24.48" x 7.48"
Backlight	WLED	Size Unpacked with Stand Lowest Position (mm)	540.2 x 261.75 x 373.4
Resolution	FHD (1920 x 1080)	Size Unpacked with Stand Highest Position (mm)	540.2 x 261.75 x 483.4
Aspect Ratio	16:9	Size Unpacked without Stand (Monitor Head Only) (mm)	540.2 x 46.45 x 325.98
Anti-Glare	Yes	Size Unpacked without Stand (inches)	21.26" x 1.82" x 12.83"
Near Edgeless Screen	Yes	Stand Base Footprint Area (mm)	250 x 250
Screen Dimensions (W x H) (mm)	527.04 x 296.46	Stand Base Footprint Area (inches)	9.84" x 9.84"
Screen Dimensions (W x H) (inches)	20.75" x 11.67"	Weight Packed	Starting at 16.39 lbs (7.45 kg)
Brightness	250 nits	Weight Unpacked	Starting at 11.33 lbs (5.15 kg)
Viewing Angle (H/V at CR 10:1)	178°/178°	Weight Monitor Head Only	Starting at 7.26 lbs (3.3 kg)
Contrast Ratio (Typical)	1000:1	Full Container Load (40' STD / 20' STD)	1140 / 540 Units
Dynamic Contrast Ratio	3M:1		
Speakers	2 x 2W		
Pixel Pitch (mm)	0.2745 x 0.2745		
Color Gamut (CIE 1931)	72% NTSC		
Color Depth	8 bit		
Color Support (Typical)	16.7 Million		
Response Time (GtG) Extreme / Normal	4 ms / 6 ms		
OSD Controls Buttons	5		
OSD Controls Languages	English, French, German, Spanish, Italian, Japanese, Simplified Chinese, Russian		
CONNECTIVITY		POWER CONSUMPTION	
Video Input Signals	VGA + HDMI™ + DisplayPort™	Typical	16.5 W
Video Cables Supplied	VGA, DisplayPort™, USB, Power, HDMI™ (for NA only)	Maximum	59 W
USB Hub	USB 3.0 ¹ (4 x down, 1 x BC)	Sleep-Mode	<0.5 W
Audio Out	Yes (3.5 mm)	Switch Off-Mode	<0.3 W
Power	Internal	Power Supply	Internal
Soundbar Support*	Yes	Power Voltage	90 VAC – 264 VAC
		ENERGY STAR® (P _{on})	13.67 W
		ENERGY STAR® (E _{TEC})	43.51 kWh
MECHANICAL		WHAT'S IN THE BOX	
Tilt Angle (Front / Back)	-5° / 30°	Monitor with Stand	
Swivel Angle (Left / Right)	+/-45°	1 x Power Cable	
Lift Range (mm)	110	1 x VGA Cable	
Pivot	+/-90°	1 x DisplayPort™ - DisplayPort™ Cable	
Stand	LTPS	1 x HDMI™ Cable (NA Only)	
Cable Management	Yes	Quick Setup Guide	
Kensington® Lock	Yes	CERTIFICATIONS	
VESA® Mount (mm x mm)	Yes (100 X 100)	EPEAT™	Silver
Bezel Color	Raven Black	ENERGY STAR® Rating	7.1
Bezel Width		TCO®	7.0
Top (mm / inches)	2 / 0.08"	TCO Edge	2.0
Sides (mm / inches)	2 / 0.08"	ULE	Yes
		RoHS (EU 2002/95/EC)	Yes
		China Energy Efficiency Standard	Tier 2
		Windows Certification	Windows 7 / Windows 10
		TÜV Eye Comfort Certification	Yes
		TINY Support	Yes

* Optional.

¹ Depending on many factors such as the processing capability of peripheral devices, file attributes, and other factors related to system configuration and operating environments, the actual transfer rate using the various USB connectors on this device will vary and is typically slower than the data rates as defined by the respective USB specifications: ~ 5 Gbit/s for USB 3.1 Gen 1; 10 Gbit/s for USB 3.1 Gen 2 & 20 Gbit/s for USB 3.2.



WWW.LENOVO.COM

Lenovo reserves the right to alter product offerings and specifications at any time, without notice. Lenovo makes every effort to ensure accuracy of all information but is not liable or responsible for any editorial, photographic or typographic errors. All images are for illustration purposes only. For full Lenovo product, service and warranty specifications visit www.lenovo.com. Lenovo makes no representations or warranties regarding third party products or services. **Trademarks:** The following are trademarks or registered trademarks of Lenovo: Lenovo, the Lenovo logo, Rescue and Recovery, ThinkPad, ThinkCentre, ThinkStation, ThinkServer, ThinkVantage and ThinkVision. Microsoft, Windows and Vista are registered trademarks of Microsoft Corporation. Ultrabook, Celeron, Celeron Inside, Core Inside, Intel, Intel Logo, Intel Atom, Intel Atom Inside, Intel Core, Intel Inside, Intel Inside Logo, Intel vPro, Itanium, Itanium Inside, Pentium, Pentium Inside, vPro Inside, Xeon, Xeon Phi, and Xeon Inside are trademarks of Intel Corporation in the U.S. and/or other countries. Other company, product and service names may be trademarks or service marks of others. Battery life (and recharge times) will vary based on many factors including system settings and usage. Visit www.lenovo.com/lenovo/us/en/safecom/ periodically for the latest information on safe and effective computing. ©2019 Lenovo. All rights reserved.

Lenovo™

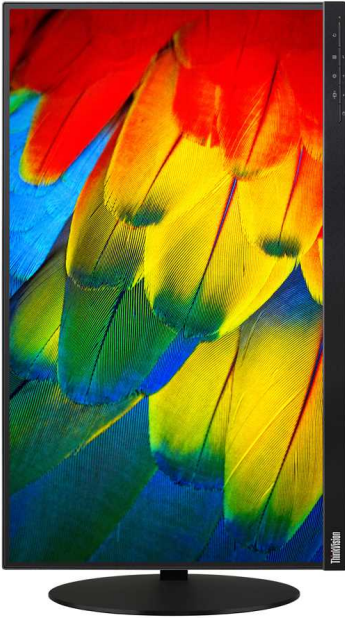

<p>Name T24m Wide Flat Panel Monitor Bezel color Black Type-model 61B8RAR3US / 61B8RAT3EU Panel TFT-LCD, In-Plane Switching (IPS), White LED backlight Viewable image size 23.8" (604.7mm) diagonal Max view area (W x H) 20.75" x 11.67" (527.04mm x 296.46mm) Native resolution 1920x1080 Aspect ratio 16:9 Pixel pitch (mm) 0.2745 x 0.2745 mm Dot/Pixel per Inch 92 dpi Brightness 250 nits or cd/m² (typical) Contrast ratio 1000:1 (typical) Pixel response time 6ms (typical) Color gamut 99% sRGB Viewing angle at 10:1 CR 178° (+/- 89°) horizontal, 178° (+/- 89°) vertical Stand Tilt, swivel, pivot, and height adjustable Bezel width <i>Sides:</i> 0.08" (2.0mm) Dimensions (HxWxD) 19.03" H x 21.26" W x 10.3" D; 483.4mm H x 540.2mm W x 261.75mm D Power supply 17 watts typical, 110 watts maximum (with USB 3.0 hub), <0.5 watts standby/suspend, universal, integrated (no external brick-like power supply) Weight 12.34 lb; 5.6 kg Limited warranty 3 year (includes backlight) Available date August 2017</p>	<p style="text-align: center;">Features</p> <ul style="list-style-type: none"> • Widescreen 23.8-inch monitor • Supports 1920x1080 resolution • Supports ThinkCentre Tiny Clamp Bracket • Supports optional soundbar • EPEAT Gold certified • Microsoft® Windows® 7 certified • Microsoft Windows 10 certified 				
<p>VESA-compliant VESA DDC2B/CI Power management ENERGY STAR® qualified Ergonomics ISO 9241-307 Emission standards FCC Class B Environmental TCO Displays 7.0, TCO Certified Edge 2.0, WEEE, RoHS, EPEAT™ Silver rating</p>	<div style="text-align: center;">  <p>ThinkVision T24m Wide Monitor</p> </div>				
<p>Preset resolutions VGA: 640x480 SVGA: 800x600 XGA: 1024x768 SXGA: 1280x1024 WXGA: 1366x768 WXGA+: 1440x900, 1600x900 WSXGA+: 1680x1050 Full HD: 1920x1080, 1920x1200 HDMI: 19; DP: 11</p>					
<p>Viewing adjustments <i>Tilt:</i> 30° back, -5° forward; <i>lift:</i> 4.3" (110mm); <i>swivel:</i> +/-45°; detachable stand Rotating screen Screen pivots 90 degrees from landscape to portrait On screen display On screen display with digital user controls (8 languages) Control features Direct access (buttons on front) for power, menu, input source select and brightness USB hub USB 3.0 Hub: 1 port into PC (USB 3.0); 4 ports for accessories (4 USB 3.0) Multimedia Audio-out, optional sound bar supported Multiple input Support HDMI, DisplayPort, USB 3.1 Type-C Monitor connectors (1) HDMI (1.4), digital, HDCP-compliant (2) DisplayPort (1.2), digital, HDCP-compliant (3) USB 3.1 Type-C Signal cables (1) 1.8 meter USB Type-C to USB Type-C cable Mounting features Wall or desk mounting using the Extend Arm or third-party accessories, 100mm x 100mm mount Security Security keyhole for attachment of optional cable lock (Kensington® lock-compatible)</p>					
<p>Ship group Monitor with stand, Safety and Warranty Information, 1.8 meter USB Type-C to USB Type-C cable, 1.8 meter black power cord</p>					
<p style="text-align: center;">Limited Warranty</p> <p>See details at http://support.lenovo.com/en_US/guides-and-manuals/detail.page?DocID=UM008281</p>	<p style="text-align: center;">Accessories</p> <table border="0"> <tr> <td>Kensington MicroSaver Cable Lock</td> <td style="text-align: right;">73P2582</td> </tr> <tr> <td>Kensington Twin Head Cable Lock</td> <td style="text-align: right;">45K1620</td> </tr> </table> <p>See details at www.lenovo.com/support/monitoraccessories</p> <p>See all monitors at www.lenovo.com/thinkvision</p>	Kensington MicroSaver Cable Lock	73P2582	Kensington Twin Head Cable Lock	45K1620
Kensington MicroSaver Cable Lock	73P2582				
Kensington Twin Head Cable Lock	45K1620				



ThinkVision T24v-10 MONITOR

SPECIFICATIONS

DISPLAY		ENVIRONMENTAL	
Panel Size	23.8"	Temperature	
Panel Type	In-Plane Switching	Operating	0°C – 40°C
Backlight	WLED	Non-Operating	-20°C – 60°C
Resolution	1920 x 1080	Humidity	
Aspect Ratio	16:9	Operating	10% – 80%
Anti-Glare	Yes	Non-Operating	5% – 95%
Screen Dimensions (W x H) (mm)	527.04 x 296.46	Altitude	
Maximum Brightness (Typical)	250 cd/m ²	Operating	0 m – 8000 m
Viewing Angle (H/V at CR 10:1)	178°/178°	Non-Operating	0 ft – 40,000 ft
Contrast Ratio (Typical)	1000:1	Arsenic-Free Glass	Yes
Dynamic Contrast Ratio	3M:1	PVC-Free	Yes
Pixel Pitch (W x H) (mm)	0.25 x 0.25	Mercury-Free	Yes
Dot/Pixel Per Inch (DP/PPI)	102	PCC % of Plastic Resins	>85%
Color Gamut (CIE 1931)	72% sRGB		
Response Time (Extreme/Typical/Off)	4/6/14 ms (G-to-G)		
POWER CONSUMPTION		DIMENSIONS (W x D x H)	
Typical	20 W	Size Packed	
Maximum	45 W	(mm)	608 x 395 x 187
Sleep-Mode	<0.5 W	(inches)	23.94" x 15.55" x 7.36"
Switch Off-Mode	<0.3 W	Size Unpacked with Stand	
Power Supply	Internal	Lowest Position	
Power Voltage	90 VAC – 264 VAC	(mm)	540.2 x 261.9 x 390.5
Voltage Dynamic Frequency	47 Hz – 63 Hz	(inches)	21.28" x 10.32" x 15.39"
		Highest Position	
		(mm)	540.2 x 261.9 x 500.5
		(inches)	21.28" x 10.32" x 19.72"
		Size Unpacked without Stand	
		(Monitor Head Only)	
		(mm)	540.2 x 43.8 x 343.7
		(inches)	21.27" x 1.72" x 13.53"
		Distance from Table to Panel	
		Lowest Pixel at Bottom of Screen	
		(mm / inches)	69.6 / 2.74"
		Highest Pixel at Top of Screen	
		(mm / inches)	69.6 / 2.74"
		Stand Base Footprint Area	
		(mm / inches)	242.5 x 212.8 / 9.55" x 8.38"
		Weight	
		Packed	Starting at 15.78 lbs (7.16 kg)
		Unpacked	Starting at 11.18 lbs (5.07 kg)
		Monitor Head Only	Starting at 7.3 lbs (3.31 kg)
SIGNAL INPUT		COMPLIANCE	
Video Input Signals	HDMI™ 1.4 + DisplayPort™ 1.2 + VGA	EPEAT™	Silver
Video Cables Supplied	HDMI™ (ROW) + DisplayPort™ + VGA + USB 3.0 ¹	ENERGY STAR® Rating	7.0
Video Cable Length	1.8 m	ULE	Gold
USB Hub	Yes	TCO®	TCO Display 7.0 / TCO Edge 2.0
USB Cable Supplied	Yes	RoHS (EU 2002/95/EC)	Yes
Audio-Out	Yes (3.5 mm)	Windows Certification	Windows 7 / Windows 10
		China Energy Efficiency Standard	Grade 2
		TÜV Eye Comfort	Yes
SIGNAL INTERFACE / PERFORMANCE		WARRANTY AND AVAILABILITY	
Horizontal Frequency	30 kHz – 81 kHz	Warranty	
Vertical Frequency	50 Hz – 75 Hz	ROW	3 Years
Native Resolution	1920 x 1080	PRC	18 Months
Maximum Pixel Clock Speed/ Bandwidth	VGA : 205 MHz HDMI™ : 165 MHz DisplayPort™ : 165 MHz	Geography Availability	WW
Default Color Temperature	6500K		
Preset/User Modes	27/21		
OSD Buttons	5+2 Buttons		
OSD Languages	English, French, German, Spanish, Italian, Japanese, Simplified Chinese, Russian		
MECHANICAL			
Tilt Angle (Front / Back)	-5° / 30°		
Swivel Angle (Left / Right)	+/-45°		
Lift (mm)	Yes (110)		
Pivot	+/-90°		
VESA® Mount (mm)	Yes (100 x 100)		
Kensington® Lock Slot	Yes		
Cable Management	Yes		
Bezel Color	Raven Black		
Bezel Width			
Top (mm / inches)	2 / 0.08"		
Bottom (mm / inches)	22 / 0.87"		
Sides (mm / inches)	2 / 0.08"		





WWW.LENOVO.COM

¹ Depending on many factors such as the processing capability of peripheral devices, file attributes, and other factors related to system configuration and operating environments, the actual transfer rate using the various USB connectors on this device will vary and is typically slower than the data rates as defined by the respective USB specifications: - 5 Gbit/s for USB 3.1 Gen 1; 10 Gbit/s for USB 3.1 Gen 2 & 20 Gbit/s for USB 3.2.

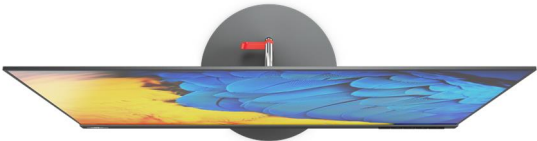

<p>Name X24 Pro Wide Flat Panel Monitor Bezel color Black Type-model 60E4ECR1US / 60E4ECT1US / 60E4ECT1EU Panel TFT-LCD, AH-IPS (In-Plane Switching), White LED backlight Viewable image size 23.8" (604.5mm) diagonal Max view area (W x H) 20.75" x 11.67" (527.0mm x 296.5mm) Native resolution 1920x1080 Aspect ratio 16:9 Pixel pitch (mm) 0.2745 x 0.2745 mm Dot/Pixel per Inch 92 dpi Brightness 250 nits or cd/m² (typical) Contrast ratio 1000:1 (typical) Pixel response time 7ms (typical) Color gamut 72% Viewing angle at 10:1 CR 178° (+/- 89°) horizontal, 178° (+/- 89°) vertical Stand Tilt stand Bezel width <i>Sides:</i> 0.09" (2.3mm) Dimensions (HxWxD) 17.61" H x 21.30" W x 9.39" D; 447.4mm H x 540.9mm W x 238.4mm D Power supply 20 watts typical, 90 watts maximum, <0.5 watts standby/suspend, universal, external power supply Weight 9.26 lb; 4.20 kg Limited warranty 1 year (includes backlight) Available date July 2016</p>	<p style="text-align: center;">Features</p> <ul style="list-style-type: none"> • Widescreen 23.8-inch monitor • Supports 1920x1080 resolution • Includes dual input connection for attachment to two systems concurrently • EPEAT Silver certified • Intel RealSense 3D camera • Stereo speakers 3 watts x 2 • One cable docking through USB 3.1 Type C with power delivery • Windows Hello certified • Microsoft® Windows® 10 certified 				
<p>Power management ENERGY STAR® qualified Ergonomics ISO 9241-307 Emission standards FCC Class B Environmental TCO Displays 6.0, WEEE, RoHS, EPEAT™ Silver rating</p> <p>Preset resolutions VGA: 640x350, 640x480, 720x400 SVGA: 800x600 XGA: 1024x768 SXGA: 1280x1024 WXGA: 1366x768 WXGA+: 1440x900, 1600x900 WSXGA+: 1680x1050 Full HD: 1920x1080</p> <p>Presets / user settings Standard presets: 16; user settings: 20</p>	<div style="text-align: center;">  <p>ThinkVision X24 Pro Wide Monitor</p> </div>				
<p>Viewing adjustments <i>Tilt:</i> 22° back, -5° forward Rotating screen None On screen display On screen display with digital user controls Control features Direct access (buttons on side bezel) for dual input and brightness USB hub USB Hub: two USB 3.1 Type-C and one micro USB 3.0 ports Multimedia Integrated stereo speakers (3 watts x 2), built-in microphone Camera RealSense 3D camera SR300 Multiple input Dual input (two different PCs attach to two different connectors; one PC shows image; select via button) Monitor connectors (1) mDP, Mini DisplayPort, digital, HDCP-compliant (2) USB Type-C, digital Signal cables (1) detachable, mDP to DP, digital, 2.0 meter (2) DP to mDP adapter (3) Micro USB 3.0 cable Mounting features None Security Security keyhole for attachment of optional cable lock (Kensington® lock-compatible)</p>					
<p>Ship group Monitor with stand, Safety and Warranty Information, ThinkPad 90W Square tip power adaptor, 2.0 meter Mini DisplayPort to DisplayPort signal cable (with DP to mDP adapter), Micro USB 3.0 cable (for using camera)</p>					
<p style="text-align: center;">Limited Warranty</p> <p>See details at http://support.lenovo.com/en_US/guides-and-manuals/detail.page?DocID=UM008281</p>	<p style="text-align: center;">Accessories</p> <table border="0"> <tr> <td>Kensington MicroSaver Cable Lock</td> <td style="text-align: right;">73P2582</td> </tr> <tr> <td>Kensington Twin Head Cable Lock</td> <td style="text-align: right;">45K1620</td> </tr> </table> <p>See details at www.lenovo.com/support/monitoraccessories</p> <p>See all monitors at www.lenovo.com/thinkvision</p>	Kensington MicroSaver Cable Lock	73P2582	Kensington Twin Head Cable Lock	45K1620
Kensington MicroSaver Cable Lock	73P2582				
Kensington Twin Head Cable Lock	45K1620				



<p>Name X24-20 Flat Panel Monitor Bezel color Raven black Type-model 61BDGAR3US / 61BDGAT3EU Panel TFT-LCD, IPS (In-Plane Switching), White LED backlight Viewable image size 23.8" (604.5mm) diagonal Max view area (W x H) 20.75" x 11.67" (527.0mm x 296.5mm) Native resolution 1920x1080 Aspect ratio 16:9 Pixel pitch (mm) 0.2745 x 0.2745 mm Dot/Pixel per Inch 92 dpi Brightness 250 nits or cd/m² (typical) Contrast ratio 1000:1 (typical) Pixel response time 6ms (typical) Color gamut 72% (NTSC) Viewing angle at 10:1 CR 178° (+/- 89°) horizontal, 178° (+/- 89°) vertical Stand Tilt stand Bezel width <i>Sides:</i> 0.04" (1.1mm) Dimensions (HxWxD) 12.85" H x 21.16" W x 8.66" D; 326.4mm H x 537.4mm W x 220mm D Power supply 20 watts typical, 25 watts maximum, <0.5 watts standby/suspend, universal, external power supply Weight 7.3 lb; 3.3 kg Limited warranty 3 year (includes backlight) Available date December 2017</p>	<p style="text-align: center;">Features</p> <ul style="list-style-type: none"> • Widescreen 23.8-inch monitor • Supports 1920x1080 resolution • Includes dual input connection for attachment to two systems concurrently • EPEAT Silver certified • Microsoft® Windows® 7 certified • Microsoft Windows 10 certified 				
<p>Power management ENERGY STAR® qualified Ergonomics ISO 9241-307 Emission standards FCC Class B Environmental TCO Displays 7.0, TCO Certified Edge 2.0, WEEE, RoHS, EPEAT™ Silver rating</p>	<div style="text-align: center;">  <p>ThinkVision X24-20 Monitor</p> </div>				
<p>Preset resolutions VGA: 640x350, 640x480, 720x400 SVGA: 800x600 XGA: 1024x768 SXGA: 1280x1024 WXGA: 1366x768 WXGA+: 1440x900, 1600x900 WSXGA+: 1680x1050 Full HD: 1920x1080 Presets / user settings Standard presets: 18; user settings: 0</p>					
<p>Viewing adjustments <i>Tilt:</i> 30° back, -5° forward Rotating screen None On screen display On screen display with digital user controls (8 languages) Control features Direct access (buttons on side bezel) for power, dual input and brightness USB hub None Multiple input Dual input (two different PCs attach to two different connectors; one PC shows image; select via button) Monitor connectors (1) HDMI (1.4a), digital, HDCP-compliant (2) DisplayPort, digital, black, HDCP-compliant Signal cables (1) detachable, HDMI at each end, digital, 1.8 meter Mounting features None Security Security keyhole for attachment of optional cable lock (Kensington® lock-compatible)</p>					
<p>Ship group Monitor with stand, Safety and Warranty Information, 1.8 meter HDMI signal cable, 1.8 meter black power cord</p>					
<p style="text-align: center;">Limited Warranty</p> <p>See details at http://support.lenovo.com/en_US/guides-and-manuals/detail.page?DocID=UM008281</p>	<p style="text-align: center;">Accessories</p> <table border="0" style="width: 100%;"> <tr> <td>Kensington MicroSaver Cable Lock</td> <td style="text-align: right;">73P2582</td> </tr> <tr> <td>Kensington Twin Head Cable Lock</td> <td style="text-align: right;">45K1620</td> </tr> </table> <p>See details at www.lenovo.com/support/monitoraccessories</p> <p>See all monitors at www.lenovo.com/thinkvision</p>	Kensington MicroSaver Cable Lock	73P2582	Kensington Twin Head Cable Lock	45K1620
Kensington MicroSaver Cable Lock	73P2582				
Kensington Twin Head Cable Lock	45K1620				



<p>Name P27h Wide Flat Panel Monitor Case color Black Type-model 61AFGAR1US / 61AFGAT1EU Panel TFT-LCD, IPS (In-Plane Switching), White LED backlight Viewable image size 27" (685.8mm) diagonal Max view area (W x H) 23.49" x 13.21" (596.7mm x 335.7mm) Optimum resolution 2560x1440 Max pixel rate 300MHz Aspect ratio 16:9 Pixel pitch (mm) 0.2331 x 0.2331mm Dot/Pixel per Inch 109 dpi Brightness 350 nits or cd/m² (typical) Contrast ratio 1000:1 (typical) Pixel response time 4ms (extreme) / 6ms (typical) Color gamut 99% sRGB Viewing angle at 10:1 CR 178° horizontal, 178° vertical Stand Tilt, swivel, pivot, and height adjustable stand Bezel width <i>Sides:</i> 0.08" (2mm) Dimensions 20.21" H x 24.08" W x 10.62" D; (HxWxD, including stand) 513mm H x 611.6mm W x 269.8mm D Power supply 38 watts typical, 140 watts maximum (with USB), <0.5 watts sleep/off; <0.5 watts switch off integrated (no external brick-like power supply) Weight 15.43 lb; 7.0kg (including stand) Limited warranty 3 year Available date April 2017</p>	<p style="text-align: center;">Features</p> <ul style="list-style-type: none"> • 27-inch IPS LED backlight monitor • Supports 2560x1440 resolution • 5-Ports USB hub, support USB 3.0 • Supports optional soundbar • Support ThinkCentre Tiny • Microsoft® Windows® 7 certified • Microsoft Windows 10 certified 						
<p>VESA-compliant VESA DDC2B/CI Power management ENERGY STAR® 7.0 Ergonomics ISO 9241-307 Emission standards FCC Class B Environmental TCO Displays 7.0, RoHS, EPEAT™ Silver rating, ULE Gold</p>	<div style="text-align: center;">  <p>ThinkVision P27h Monitor</p> </div>						
<p>Preset resolutions VGA: 640x480, 720x400 SVGA: 800x600 XGA: 1024x768 SXGA: 1280x1024 WXGA: 1366x768 WXGA+: 1440x900, 1680x900 WSXGA+: 1680x1050 Full HD: 1920x1080, 1920x1200 QHD: 2560x1440</p>							
<p>Presets display modes HDMI: 22; DP: 14</p>							
<p>Viewing adjustments <i>Tilt:</i> 30° back, -5° forward; <i>lift:</i> 4.33" (110mm); <i>swivel:</i> +/-45° Rotating screen Screen pivots 90 degrees from landscape to portrait On screen display On screen display with digital user controls (8 languages) Control features Direct access (buttons on front) for power, menu, input source select and brightness USB hub USB Hub: one USB 3.1 Type-C upstream port, four USB 3.0 Type-A downstream ports Multimedia Audio-out, optional sound bar supported Camera None Multiple input Support HDMI, DisplayPort, USB 3.1 Type-C, DisplayPort-out Monitor connectors (1) 2*HDMI (1.4), digital, HDCP-compliant (2) DisplayPort (1.2), digital, HDCP-compliant (3) DisplayPort-out, digital (4) USB 3.1 Type-C Signal cables (1) USB 3.1 Type-C cable, 1.8 meter Mounting features Wall or desk mounting using the Extend Arm or third-party accessories meeting the VESA FPMPI® (100mm mount) Security Security keyhole for attachment of optional cable lock (Kensington® lock-compatible)</p>							
<p>Ship group Monitor, detachable stand, Quick start and safety poster, 1.8 meter USB 3.1 Type-C cable, 1.8 meter black power cord</p>							
<p style="text-align: center;">Limited Warranty</p> <p>See details at http://support.lenovo.com/en_US/guides-and-manuals/detail.page?DocID=UM008281</p>	<p style="text-align: center;">Accessories</p> <table border="0"> <tr> <td>Kensington MicroSaver Cable Lock</td> <td style="text-align: right;">73P2582</td> </tr> <tr> <td>Kensington Twin Head Cable Lock</td> <td style="text-align: right;">45K1620</td> </tr> <tr> <td>Lenovo Security Cable Lock</td> <td style="text-align: right;">57Y4303</td> </tr> </table> <p>See details at www.lenovo.com/support/monitoraccessories See all monitors at www.lenovo.com/thinkvision</p>	Kensington MicroSaver Cable Lock	73P2582	Kensington Twin Head Cable Lock	45K1620	Lenovo Security Cable Lock	57Y4303
Kensington MicroSaver Cable Lock	73P2582						
Kensington Twin Head Cable Lock	45K1620						
Lenovo Security Cable Lock	57Y4303						



<p>Name P27q Wide Flat Panel Monitor Case color Black Type-model 61A8GAT1EU Panel TFT-LCD, IPS (In-Plane Switching), White LED backlight Viewable image size 27" (685.8mm) diagonal Max view area (W x H) 23.49" x 13.21" (596.7mm x 335.7mm) Optimum resolution 2560x1440 Max pixel rate 300MHz Aspect ratio 16:9 Pixel pitch (mm) 0.2331 x 0.2331mm Dot/Pixel per Inch 109 dpi Brightness 350 nits or cd/m² (typical) Contrast ratio 1000:1 (typical) Pixel response time 4ms Color gamut 99% sRGB Viewing angle at 10:1 CR 178° horizontal, 178° vertical Stand Tilt, swivel, pivot, and height adjustable stand Bezel width <i>Sides:</i> 0.08" (2mm) Dimensions 20.21" H x 24.17" W x 10.62" D; (HxWxD, including stand) 513mm H x 614mm W x 269.8mm D Power supply 38 watts typical, 75 watts maximum (with USB), <0.5 watts sleep/off; <0.3 watts switch off integrated (no external brick-like power supply) Weight 15.43 lb; 7.0kg (including stand) Limited warranty 3 year Available date January 2017</p>	<p>Features</p> <ul style="list-style-type: none"> • 27-inch IPS LED backlight monitor • Supports 2560x1440 resolution • 5-Ports USB hub, support USB 3.0 • Support ThinkCentre Tiny • Supports optional soundbar • Microsoft® Windows® 7 certified • Microsoft Windows 10 certified 						
<p>VESA-compliant VESA DDC2B/CI Power management ENERGY STAR® 7.0 Ergonomics ISO 9241-307 Emission standards FCC Class B Environmental TCO Displays 7.0, RoHS, EPEAT™ Silver rating, ULE Gold</p>	 <p>ThinkVision P27q Monitor</p>						
<p>Preset resolutions VGA: 640x480, 720x400 SVGA: 800x600 XGA: 1024x768 SXGA: 1280x1024 WXGA: 1366x768 WXGA+: 1440x900, 1600x900 WSXGA+: 1680x1050 Full HD: 1920x1080, 1920x1200 QHD: 2560x1440</p> <p>Presets / user settings Standard presets: 20; user settings: 24</p>							
<p>Viewing adjustments <i>Tilt:</i> 30° back, -5° forward; <i>lift:</i> 4.33" (110mm); <i>swivel:</i> +/-45° Rotating screen Screen pivots 90 degrees from landscape to portrait On screen display On screen display with digital user controls (8 languages) Control features Direct access for menu, source switch, and brightness USB hub USB Hub: one USB 3.0 upstream port, four USB 3.0 downstream ports Multimedia Audio-out, optional sound bar supported Camera None Multiple input Support HDMI, DisplayPort, mini DisplayPort, DisplayPort-out Monitor connectors (1) 2*HDMI (1.4), digital, HDCP-compliant (2) DisplayPort (1.2), digital, HDCP-compliant (3) Mini DisplayPort, digital, HDCP-compliant Signal cables (1) detachable, mini DisplayPort to DisplayPort, digital, 1.8 meter Mounting features Wall or desk mounting using the Extend Arm or third-party accessories meeting the VESA FPMPI® (100mm mount) Security Security keyhole for attachment of optional cable lock (Kensington® lock-compatible)</p>							
<p>Ship group Monitor, detachable stand, Quick start and safety poster, 1.8 meter USB 3.0 cable, 1.8 meter mini DP to DP cable, 1.8 meter black power cord</p>	<p>Limited Warranty</p> <p>See details at http://support.lenovo.com/en_US/guides-and-manuals/detail.page?DocID=UM008281</p> <p>Accessories</p> <table border="0"> <tr> <td>Kensington MicroSaver Cable Lock</td> <td>73P2582</td> </tr> <tr> <td>Kensington Twin Head Cable Lock</td> <td>45K1620</td> </tr> <tr> <td>Lenovo Security Cable Lock</td> <td>57Y4303</td> </tr> </table> <p>See details at www.lenovo.com/support/monitoraccessories</p> <p>See all monitors at www.lenovo.com/thinkvision</p>	Kensington MicroSaver Cable Lock	73P2582	Kensington Twin Head Cable Lock	45K1620	Lenovo Security Cable Lock	57Y4303
Kensington MicroSaver Cable Lock	73P2582						
Kensington Twin Head Cable Lock	45K1620						
Lenovo Security Cable Lock	57Y4303						



<p>Name P27u Wide Flat Panel Monitor Case color Black Type-model 61CBGAR1US / 61CBGAT1EU / 61CBGAR1EU / 61B0GAR1US / 61B0GAT1EU Panel TFT-LCD, IPS (In-Plane Switching), White LED backlight Viewable image size 27" (684.7mm) diagonal Max view area (W x H) 23.49" x 13.21" (596.74mm x 335.66mm) Optimum resolution 3840x2160 Max pixel rate 600MHz Aspect ratio 16:9 Pixel pitch (mm) 0.1554 x 0.1554mm Dot/Pixel per Inch 163 dpi Brightness 350 nits or cd/m² (typical) Contrast ratio 1000:1 (typical) Pixel response time 6ms (typical) Color gamut 1.457 sRGB Viewing angle at 10:1 CR 178° horizontal, 178° vertical Stand Tilt, swivel, pivot, and height adjustable stand Bezel width <i>Sides: 0.08" (2mm)</i> Dimensions (HxWxD, including stand) 20.21" H x 24.08" W x 10.62" D; 513.3mm H x 611.6mm W x 269.8mm D Power supply 50 watts typical, 160 watts maximum (with USB), <0.5 watts sleep/off; <0.3 watts switch off integrated (no external brick-like power supply) Weight 15.32 lb; 6.95kg (including stand) Limited warranty 3 year Available date August 2017</p>	<p>Features</p> <ul style="list-style-type: none"> • 27-inch IPS LED backlight monitor • Supports 3840x2160 resolution • 5-Ports USB hub, support USB 3.0 • Support ThinkCentre Tiny • Supports optional soundbar • Microsoft® Windows® 7 certified • Microsoft Windows 10 certified 						
<p>VESA-compliant VESA DDC2B/CI Power management ENERGY STAR® 7.0 Ergonomics ISO 9241-307 Emission standards FCC Class B Environmental TCO Displays 7.0, TCO Certified Edge 2.0, WEEE, RoHS, EPEAT™ Silver rating, ULE Gold</p>	 <p>ThinkVision P27u Monitor</p>						
<p>Preset resolutions VGA: 640x480, 720x400, 720x480, 720x576 SVGA: 800x600 XGA: 1024x768 SXGA: 1280x720, 1280x800, 1280x1024 WXGA+: 1440x900, 1600x900 WSXGA+: 1680x1050 Full HD: 1920x1080, 1920x1200 QHD: 2560x1440 UHD: 3840x2160</p> <p>Presets / user settings Standard presets: 27; user settings: 20</p>							
<p>Viewing adjustments <i>Tilt: 30° back, -5° forward; lift: 4.33" (110mm); swivel: +/-45°</i> Rotating screen Screen pivots 90 degrees from landscape to portrait On screen display On screen display with digital user controls (8 languages) Control features Direct access (buttons on front) for power, menu, input source select and brightness USB hub USB Hub: one USB 3.1 Type-C port, four USB 3.0 Type-A downstream ports Multimedia Audio-out, optional sound bar supported Camera None Multiple input Support HDMI, DisplayPort, USB 3.1 Type-C Monitor connectors (1) 2*HDMI (2.0), digital, HDCP-compliant (2) DisplayPort (1.2), digital, HDCP-compliant (3) USB 3.1 Type-C Signal cables (1) detachable, DisplayPort to DisplayPort, digital, 1.8 meter Mounting features Wall or desk mounting using the Extend Arm or third-party accessories meeting the VESA FPMPI® (100mm mount) Security Security keyhole for attachment of optional cable lock (Kensington® lock-compatible)</p>							
<p>Ship group Monitor, detachable stand, Quick start and safety poster, 1.8 meter USB Type-C to USB Type-C cable, 1.8 meter DP to DP cable, 1.8 meter HDMI to HDMI cable (NA only), 1.8 meter black power cord, 1.8 meter USB Type-C to USB Type-A cable</p>							
<p>Limited Warranty</p> <p>See details at http://support.lenovo.com/en_US/guides-and-manuals/detail.page?DocID=UM008281</p>	<p>Accessories</p> <table border="0"> <tr> <td>Kensington MicroSaver Cable Lock</td> <td>73P2582</td> </tr> <tr> <td>Kensington Twin Head Cable Lock</td> <td>45K1620</td> </tr> <tr> <td>Lenovo Security Cable Lock</td> <td>57Y4303</td> </tr> </table> <p>See details at www.lenovo.com/support/monitoraccessories</p> <p>See all monitors at www.lenovo.com/thinkvision</p>	Kensington MicroSaver Cable Lock	73P2582	Kensington Twin Head Cable Lock	45K1620	Lenovo Security Cable Lock	57Y4303
Kensington MicroSaver Cable Lock	73P2582						
Kensington Twin Head Cable Lock	45K1620						
Lenovo Security Cable Lock	57Y4303						



ThinkVision P32u-10 Monitor

Lenovo

BRINGING VISION TO LIFE

The ThinkVision P32u-10 monitor combines phenomenal visuals and effortless connectivity for powerful performance and precise viewing. From color-centric tasks such as graphic design and photo retouching to displaying detailed content for users like financial analysts, scientists, and researchers, this monitor delivers with utmost precision. What's more, with intuitive connectivity enabled by the Thunderbolt™ 3 port, it can daisy chain two 4K monitors for smooth multitasking and an unmatched viewing experience.

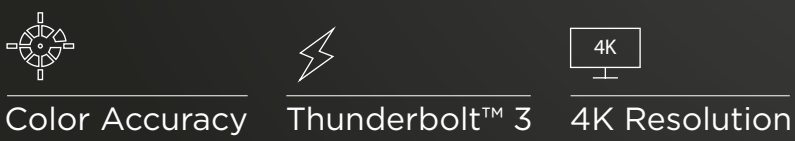

PROFESSIONAL-GRADE COLOR ACCURACY

Experience detailed and natural visuals as the 10-bit color depth offers over 1 billion colors with the 99.5% Adobe RGB color gamut. Also, the multiple color spaces on this monitor cater to the specific needs of various professionals. Colors are pre-calibrated from the factory, to an average of delta E<2. This feature helps industrial designers, graphic designers, and editors effectively work on color-critical tasks like video editing and color correction.

Additionally, with ThinkColor software, you can easily select and edit colors for various scenarios. You can also choose between multiple color spaces or tune the color with real-time preview.



CONNECTIVITY REDEFINED

Transferring data, watching videos, or charging devices on this monitor is as effortless as it could be. The intuitive Thunderbolt™ 3 port enables a one-cable connection to all the peripherals you need.

This port helps boost your productivity, and lets you explore more ways to work efficiently. Collaborate easily with lightning-fast data transfers, or daisy chain two independent 4K displays when you need to multitask.

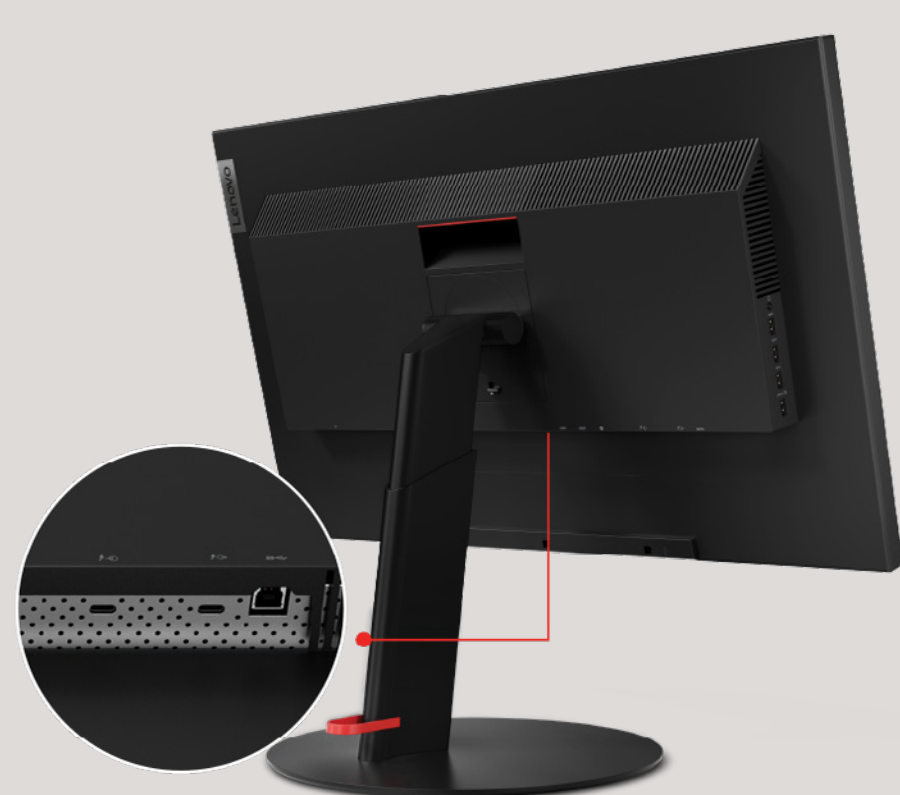
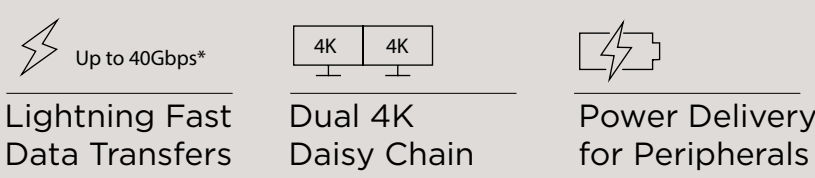

INCREDIBLE CLARITY FOR PRECISE VIEWING

This NearEdgeless 32-inch monitor is ideal for big data analysts and CAD designers who require bigger displays to view complex data or create highly detailed content. Also, for a great visual experience and consistent clarity from all angles, it features a 4K display that boasts a resolution of 3840 x 2160 pixels.

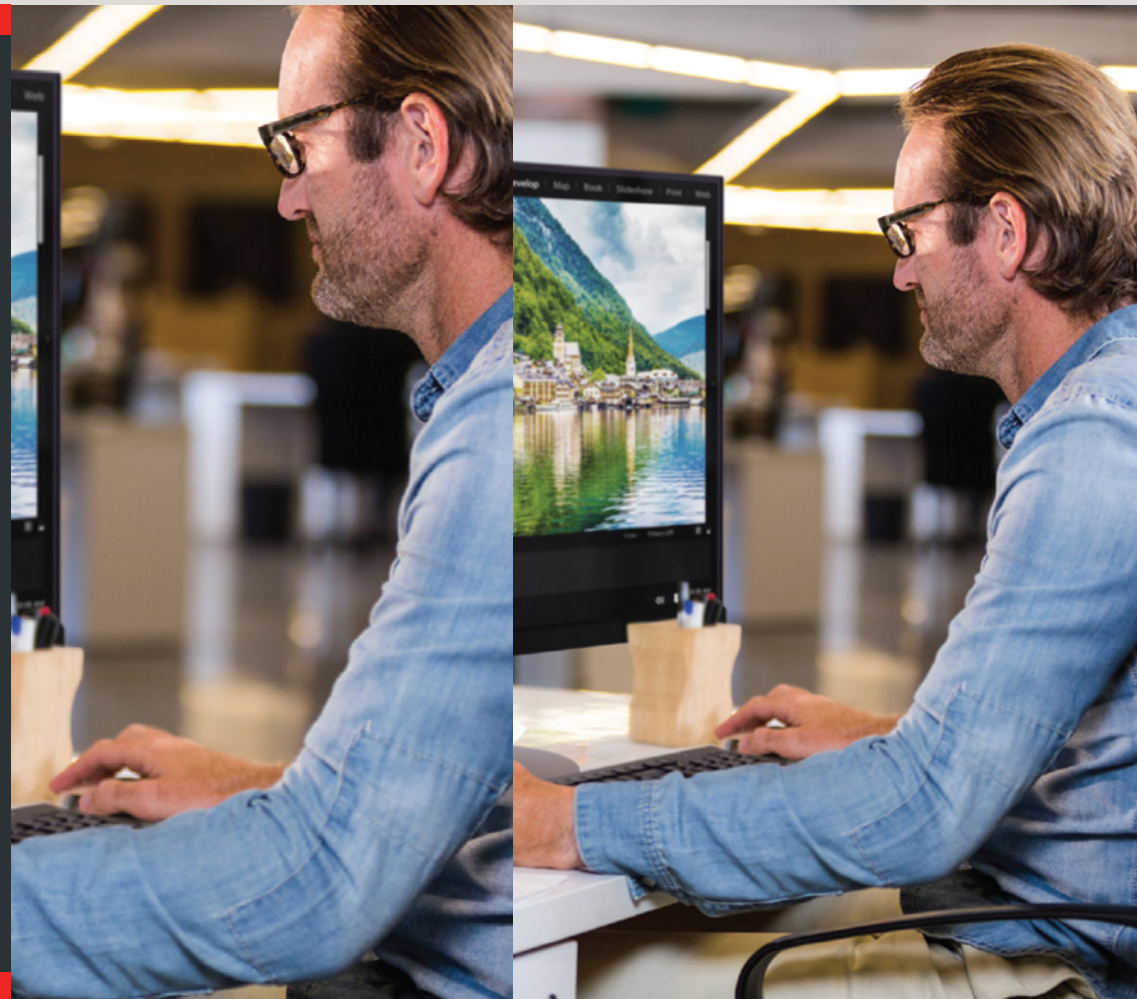

BRINGING COMFORT TO WORK

The ergonomic full-function stand allows you to position the monitor in any way that suits your working style or posture with lift, tilt, pivot, and swivel. Also, the anti-glare display allows you to work seamlessly even under glaring office lights. This feature is apt for video editors and designers who often spend long hours on their monitors.



ThinkVision® P32u-10 SPECIFICATIONS

DISPLAY

- Panel Size**
32 inches
- Screen Dimensions (H x V)**
708.48 x 398.52mm
- Panel Type**
In-Plane Switching
- Backlight**
WLED
- Aspect Ratio**
16:9
- Resolution**
3840 x 2160 pixels
- Pixel Pitch (H x V)**
0.1845 x 0.1845mm
- Viewing Angle (H x V)**
178°/178°
- Response Time (gray to gray)**
4ms (extreme mode)
6ms (normal mode)
- Contrast Ratio (typical)**
1000:1
- Dynamic Contrast Ratio (typical)**
3M:1
- Color Gamut**
99.5% Adobe RGB, 100% sRGB,
100% BT.709, 98.2% DCI-P3,
79.3% BT.2020
- Color Support**
1.07 Billion

CONNECTIVITY

- Video Input Signals**
2 HDMI 2.0 + DP 1.2 + Thunderbolt™ 3
In + Thunderbolt™ 3 Out
- Video Cable Length**
2m for Thunderbolt™
1.8m for HDMI & DP
- Audio Out**
Yes (3.5mm)
- USB Hub**
Yes
2 x USB 3.0 (Upstream,
1 by Thunderbolt™ 3)
4 x USB 3.0 (Downstream,
incl. 1BC)
- Power Consumption**
<57W (Typical) / <190W (Max)
<0.5W at Sleep mode
<0.3W at Switch off mode

DIMENSIONS

- Size Packed (D x H x W)**
844 x 228 x 528mm /
33.23 x 8.98 x 20.79 inches
- Size Unpacked w/stand (D x H x W) (Lowest Position)**
350.0 x 497.85 x 726.7mm /
13.78 x 19.6 x 28.61 inches
- Size Unpacked w/stand (D x H x W) (Highest Position)**
350.0 x 607.85 x 726.7mm /
13.78 x 23.93 x 28.61 inches
- Size Unpacked w/o stand (D x H x W) (Head Only)**
58.95 x 431.5 x 726.7mm /
2.32 x 16.99 x 28.61 inches

WEIGHT

- Weight Packed**
14.30kg/31.32lbs.
- Weight Unpacked**
10.97kg/24.18lbs.
- Weight (Monitor Head Only)**
6.97kg/15.37lbs.

SPECIAL FEATURES

- Factory Calibration**
Yes
- Anti-Glare**
Yes
- PIP/PBP**
Yes
- KVM switch**
Yes
- Software**
Yes (ThinkColor)

MECHANICAL

- Tilt Angle (front/back)**
-5°/30°
- Swivel Angle (left/right)**
-45°/+45°
- Lift (Max range)**
110mm
- Pivot**
-90°/90°
- VESA Mount Capability**
Yes (100 x 100mm)

Kensington™ Lock Slot

- Yes
- Cable Management**
Yes

- Bezel Color**
Raven Black
- Bezel Width (side)**
2mm
- Bezel Width (top/bottom)**
2.0/23.8mm

WHAT'S IN THE BOX

- Monitor with stand**
1 x Power cable
1 x DP-DP cable
1 x HDMI cable
1 x USB 3.0 cable
1 x Thunderbolt™ 3 cable (20Gbps)
1 x CD (ThinkColor)
Factory calibration report
Quick setup guide

CERTIFICATIONS

- ENERGY STAR® Rating**
71
- EPEAT™**
Silver
- CCC**
Yes
- RoHS**
Yes
- ULE**
Gold
- TCO**
7.0
- Windows Certification**
Windows 7, Windows 10
- China Energy Efficiency Standard**
Tier 2
- TÜV Eye Comfort**
Yes



© 2019 Lenovo. All rights reserved. Depending on many factors such as the processing capability of peripheral devices, file attributes, and other factors related to system configuration and operating environments, the actual transfer rate using the various USB connectors on this device will vary and is typically slower than the data rates as defined by the respective USB specifications: - 5 Gbit/s for USB 3.1 Gen1; 10 Gbit/s for USB 3.1 Gen2 & 20 Gbit/s for USB 3.2. These products are available while supplies last. Prices shown are subject to change without notice. For any questions concerning price, please contact your Lenovo Account Executive. Lenovo is not responsible for photographic or typographic errors. Warranty: For a copy of applicable warranties, write to: Warranty Information, 500 Park Offices Drive, RTP, NC 27709, Attn: Dept. ZFYA/B500. Lenovo makes no representation or warranty regarding third-party products or services. Trademarks: Lenovo, the Lenovo logo, Rescue and Recovery, ThinkPad, ThinkCentre, ThinkStation, ThinkVantage, and ThinkVision are trademarks or registered trademarks of Lenovo. Microsoft, Windows, and Vista are registered trademarks of Microsoft Corporation. Intel, the Intel logo, Intel Inside, Intel Core, and Core Inside are trademarks of Intel Corporation in the U.S. and/or other countries. Other company, product, and service names may be trademarks or service marks of others.

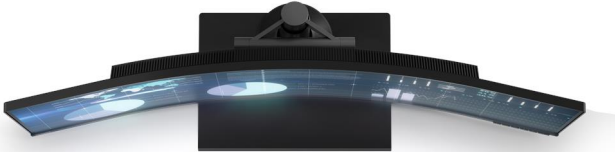

ThinkVision P44w-10

Specifications

DISPLAY

Panel Size
43.4 inches

Screen Dimensions (H x V)
1052.3 x 328.8mm
41.4 x 12.9 inches

Panel Type
VA NearEdgeless,
anti-glare

Curvature
1800R

Backlight
WLED

Aspect Ratio
32:10

Resolution
3840 x 1200

HDR
VESA Certified DisplayHDR™ 400

Pixel Pitch (H x V)
0.2740 x 0.2740mm

Viewing Angle (H x V)
178°/178°

Response Time (gray to gray)
4/6ms (extreme/typical)

Refresh Rate
Max. 144Hz

Contrast Ratio (typical)
3000:1

Dynamic Contrast Ratio (typical)
3M:1

Color Support (typical)
1.07B

Color Gamut
sRGB: 99.5%
BT.709: 99.5%
DCI-P3: 90%

Brightness
380 nits (typical)
450 nits (peak)

CONNECTIVITY

Video Input Signals
2 x HDMI 2.0
1 x DP1.4
1 x USB Type-C Gen1 (DP1.2 Alt Mode)
1 x USB Type-C Gen2 (DP1.4 Alt Mode)

Video Cable Length
1.5m for USB Type-C Gen2
1.8m for others

Audio Out
Yes (3.5mm)

USB Hub
Yes

USB Upstream
2 x USB 3.1 (1 x USB Type-C Gen1,

1 x USB Type-C Gen2)
USB Downstream
4 x USB 3.1 Gen1 (1 BC)

Power
Internal

Power Consumption
Typical/Max: 70W/250W
Switch-off Mode: <0.5W
Sleep/Off Mode: <0.5W

DIMENSIONS

Size Packed (D x H x W)
1219 x 500 x 376mm
47.99 x 19.68 x 14.80 inches

**Size Unpacked w/stand
(D x H x W) (Lowest Position)**
269.8 x 461.1 x 1058.3mm
10.62 x 18.15 x 41.67 inches

**Size Unpacked w/stand
(D x H x W) (Highest
Position)**
269.8 x 591.1 x 1058.3mm
10.62 x 23.27 x 41.67 inches

**Size Unpacked w/o stand
(D x H x W) (Head Only)**
137.2 x 366.1 x 1058.3mm
5.40 x 14.21 x 41.67 inches

Weight Packed
18.59kg/40.98lbs.

Weight Unpacked
13.45kg/29.65lbs.

Weight (Monitor Head Only)
9.35kg/20.61lbs.

SPECIAL FEATURES

Anti-Glare
Yes

PIP/PBP
Yes

Software
Yes (ThinkColor)

Speaker
Supports optional Harman
Kardon certified speaker

MECHANICAL

Tilt Angle (front/back)
-5°/22°

Swivel Angle (left/right)
±30°

Lift (Max. range)
Yes (130mm)

VESA Mount Capability
Yes (100 x 100mm)

Kensington™ Lock Slot
Yes

Cable Management
Yes

Bezel Color
Raven Black

Bezel Width (side)
2.4mm

Bezel Width (top/bottom)
2.4/25.6mm

WHAT'S IN THE BOX

Monitor with stand
1 x Power cable
1 x HDMI cable
1 x DP cable
1 x USB Type-C Gen2 cable
1 x USB Type-C to Type-A cable
Quick setup guide

CERTIFICATIONS

ENERGY STAR® Rating
7.1

CCC
Yes

RoHS
Yes

ULE
Gold

TCO
8.0

Windows Certification
Windows 7, Windows 10

**China Energy Efficiency
Standard**
Tier 2

**Ambient Operating
Temperature**
0°C to 45°C

TÜV Eye Comfort
Yes



*with FreeSync support graphic cards

© 2019 Lenovo. All rights reserved. Depending on many factors such as the processing capability of peripheral devices, file attributes, and other factors related to system configuration and operating environments, the actual transfer rate using the various USB connectors on this device will vary and is typically slower than the data rates as defined by the respective USB specifications: - 5 Gbit/s for USB 3.1 Gen1; 10 Gbit/s for USB 3.1 Gen2 & 20 Gbit/s for USB 3.2. These products are available while supplies last. Prices shown are subject to change without notice. For any questions concerning price, please contact your Lenovo Account Executive. Lenovo is not responsible for photographic or typographic errors. Warranty: For a copy of applicable warranties, write to: Warranty Information, 500 Park Offices Drive, RTP, NC 27709, Attn: Dept. ZPYA/B600. Lenovo makes no representation or warranty regarding third-party products or services. Trademarks: Lenovo, the Lenovo logo, Rescue and Recovery, ThinkPad, ThinkCentre, ThinkStation, ThinkVantage, and ThinkVision are trademarks or registered trademarks of Lenovo. Microsoft, Windows, and Vista are registered trademarks of Microsoft Corporation. Intel, the Intel logo, Intel Inside, Intel Core, and Core Inside are trademarks of Intel Corporation in the U.S. and/or other countries. Other company, product, and service names may be trademarks or service marks of others.



ThinkVision® S27i-10

DISPLAY

Panel Size

27 inch

Screen Dimensions (H x V) (mm)

597.89 (H) x 336.31 (V)

Panel Type

In-Plane Switching

Backlight

WLED

Aspect Ratio

16:9

Resolution

1920 x 1080

Pixel Pitch (H x V) (mm)

0.3110 x 0.3110

Viewing angle (H x V)

178° / 178°

Response Time (gray to gray)

4 ms (extreme mode)

6 ms (normal mode)

Contrast Ratio (typical)

1000:1

Dynamic Contrast Ratio (typical)

3M:1

Color Gamut NTSC (CIE 1931)

72%

Color Support

16.7M

CONNECTIVITY

Video Input Signals

VGA + HDMI 1.4

Video Cable Length

1.8 m

Audio Out

Yes (3.5 mm)

MULTI-MEDIA

Optional Soundbar Support

Yes

DIMENSIONS

Size Packed (D x H x W) (mm/inch)

132 x 455 x 715 mm / 5.20 x 17.91 x 28.15 inch

Size Unpacked w/stand (D x H x W) (mm/inch) (Lowest Position)

220.0 x 443.5 x 611.9 mm / 8.66 x 17.46 x 24.10 inch

Size Unpacked w/stand (D x H x W) (mm/inch) (Highest Position)

220.0 x 443.5 x 611.9 mm / 8.66 x 17.46 x 24.10 inch

Size Unpacked w/o stand (D x H x W) (mm/inch) (Head Only)

46.2 x 366.5 x 611.9 mm / 1.82 x 14.43 x 24.10 inch

Weight Packed (kg/lbs.)

6.80kg / 14.99 lbs.

Weight Unpacked (kg/lbs.)

4.76kg / 10.49 lbs.

Weight (Monitor Head Only) (kg/lbs.)

4.22kg / 9.30 lbs.

SPECIAL FEATURES

Anti-Glare

Yes

Thin Client Support (Tiny)

Yes

(by VESA mount PN:4XFON03161)

MECHANICAL

Tilt Angle (front/back)

-5° / 22°

VESA Mount

Yes (100 mm)

Kensington™ Lock Slot

Yes

Cable Management

Yes

Bezel Color

Raven Black

Bezel Width (Side)

2.0 mm

Bezel Width (top / bottom)

2.0 mm / 21.68 mm

WHAT'S IN THE BOX

Monitor with stand

1 x HDMI Cable

1 x VGA Cable (AP, EMEA only)

1 x Power Cable

Quick setup guide

CERTIFICATIONS

ENERGY STAR® Rating

7.0

TCO

7.0

EPEAT™

Silver

ULE

Gold

RoHS

Yes

Windows Certification

Windows 7, Windows 10

China Energy Efficiency Standard

Tier 2

Ambient Operating Temperature

0°C to 40°C

TÜV Eye Confort Certification

Yes



© 2018 Lenovo. All rights reserved. These products are available while supplies last. Prices shown are subject to change without notice. For any questions concerning price, please contact your Lenovo Account Executive. Lenovo is not responsible for photographic or typographic errors. Warranty: For a copy of applicable warranties, write to: Warranty Information, 500 Park Offices Drive, RTP, NC 27709, Attn: Dept. ZPYA/B600. Lenovo makes no representation or warranty regarding third-party products or services. Trademarks: Lenovo, the Lenovo logo, Rescue and Recovery, ThinkPad, ThinkCentre, ThinkStation, ThinkVantage, and ThinkVision are trademarks or registered trademarks of Lenovo. Microsoft, Windows, and Vista are registered trademarks of Microsoft Corporation. Intel, the Intel logo, Intel Inside, Intel Core, and Core Inside are trademarks of Intel Corporation in the U.S. and/or other countries. Other company, product, and service names may be trademarks or service marks of others.

Specifications may vary depending upon region.

Lenovo™



ThinkVision S27q-10

DISPLAY

Panel Size

27-inch

Screen Dimensions

596.74 mm x 335.66 mm

Panel Type

3-side NearEdgeless
In-Plane Switching

Backlight

WLED

Aspect Ratio

16:9

Resolution

2560 x 1440

Pixel Pitch

0.2331 x 0.2331 mm

Dot/Pixel Per Inch (DPI/PPI)

109

Viewing Angle (H x V @ CR 10:1)

178° / 178°

Response Time

4ms (extreme mode)

Refresh Rate

60 Hz

Brightness (typical)

280 cd/m²

Brightness (peak)

350 cd/m²

Contrast Ratio (typical)

1000:1

Dynamic Contrast Ratio (typical)

3M:1

Color Gamut

> 99% sRGB

Color Support (typical)

1.07 Billion

Anti-glare

Yes

CONNECTIVITY

Video Signal

1 x HDMI 1.4
1 x DP 1.2

Audio Signal

1 x Audio Port (3.5 mm)

SPECIAL FEATURES

Tiny Support

Yes

POWER

Power Consumption (typical/max)

35W / 45W

Power Consumption Sleep/Off Mode

< 0.5W

Power Consumption Switch-off Mode

< 0.3W

Power Supply

Internal

Energystar Power Consumption (P_{on}/E_{TEC})

19 W / 59.6 kWh

Voltage Required

AC 100 to 240 VAC (50/60 Hz)

MECHANICAL

Tilt Angle (front/back)

-5° / 22°

VESA Mount Capability

Yes (100 x 100 mm)

Kensington™ Lock Slot

Yes

Cable Management

Yes

Bezel Color

Raven Black

Bezel Width (side)

2 mm

Bezel Width (top/bottom)

2 / 22 mm

DIMENSION

Size Packed (D x H x W, mm/inch)

132 x 455 x 715 mm /
5.20 x 17.91 x 28.15 inches

Size Unpacked w/ Stand (D x H x W, mm/inch) (lowest position)

220 x 444.6 x 613.6 mm /
8.66 x 17.50 x 24.15 inches

Size Unpacked w/ Stand (D x H x W, mm/inch) (highest position)

220 x 444.6 x 613.6 mm /
8.66 x 17.50 x 24.15 inches

Size Unpacked w/o Stand (D x H x W, mm/inch) (head only)

42 x 367.6 x 613.6 mm /
1.65 x 14.47 x 24.15 inches

Min. Distance from Table to Panel (lowest pixel at bottom of screen, mm)

99 mm

Max. Distance from Table to Panel (highest pixel at top of screen, mm)

442.2 mm

Weight Packed (kg/lb)

6.36 kg / 14.02 lbs.

Weight Unpacked (kg/lb)

4.65 kg / 10.25 lbs.

Weight (monitor head only) (kg/lb)

4.10 kg / 9.04 lbs.

Full Container Load (40' STD / 20' STD)

1088 / 544 units

WHAT'S IN THE BOX

Monitor with stand
1 x Power cable (1.8 m)
1 x HDMI cable (1.8 m)
Quick setup guide

CERTIFICATION

ENERGY STAR® Rating

8.0

CCC

Yes

TCO

8.0

EPEAT™

Silver

RoHS (EU 2002/95/EC)

Yes

Windows Certification

Window 7, Window 10

China Energy Efficiency Standard

Tier 1

TÜV Eye Comfort

Yes



Depending on many factors such as the processing capability of peripheral devices, file attributes, and other factors related to system configuration and operating environments, the actual transfer rate using the various USB connectors on this device will vary and is typically slower than the data rates as defined by the respective USB specifications: - 5 Gbit/s for USB 3.1 Gen1; 10 Gbit/s for USB 3.1 Gen2 & 20 Gbit/s for USB 3.2.

© 2019 Lenovo. All rights reserved. These products are available while supplies last. Prices shown are subject to change without notice. For any questions concerning price, please contact your Lenovo Account Executive. Lenovo is not responsible for photographic or typographic errors. Warranty: For a copy of applicable warranties, write to: Warranty Information, 500 Park Offices Drive, RTP, NC 27709, Attn: Dept. ZPYA/B600. Lenovo makes no representation or warranty regarding third-party products or services. Trademarks: Lenovo, the Lenovo logo, Rescue and Recovery, ThinkPad, ThinkCentre, ThinkStation, ThinkVantage, and ThinkVision are trademarks or registered trademarks of Lenovo. Microsoft, Windows, and Vista are registered trademarks of Microsoft Corporation. Intel, the Intel logo, Intel Inside, Intel Core, and Core Inside are trademarks of Intel Corporation in the U.S. and/or other countries. Other company, product, and service names may be trademarks or service marks of others.

Specifications may vary depending upon region.



ThinkVision T25d-10

DISPLAY

Panel Size
25.0 inches

Screen Dimensions (H x V)
533.45 x 338.76mm

Panel Type
In-Plane Switching

Backlight
WLED

Aspect Ratio
16:10

Resolution
1920 x 1200 pixels

Refresh Rate
60Hz

Pixel Pitch (H x V)
0.2789 x 0.2823mm

Viewing Angle (H x V)
178°/178°

Response Time (gray to gray)
4ms (extreme mode)
6ms (normal mode)

Contrast Ratio (typical)
1000:1

Dynamic Contrast Ratio (typical)
3M:1

Brightness (typical)
300 cd/m²

Color Gamut sRGB (CIE 1931)
99%

Color Support
16.7M

CONNECTIVITY

Video Input Signals
HDMI 1.4 + DP 1.2 + VGA

Video Cables Supplied
DP + HDMI*

Video Cable Length
1.8m

USB Hub
Yes

USB Upstream
1 x USB 3.1 Gen1

USB Downstream
4 x USB 3.1 Gen1 (with 1 BC)

Audio Out
Yes (3.5mm)

POWER

Power Consumption (Typical/Max)
25W/66W

Power Consumption Sleep/Off Mode
<0.5W

Power Consumption Switch Off-Mode
<0.3W

Power Supply
Internal

ENERGY STAR® (P_{on})
16.54W

ENERGY STAR® (E_{rec})
52.06kWh

Voltage Required
100-240VAC (50/60Hz)

DIMENSIONS

Size Packed (D x H x W)
706 x 450 x 160mm/
27.79 x 17.72 x 6.30 inches

Size Unpacked w/stand (D x H x W)(mm/inch) (Lowest position)
260.4 x 399.5 x 548.7mm/
10.25 x 15.73 x 21.60 inches

Size Unpacked w/stand (D x H x W)(mm/inch) (Highest position)
260.4 x 509.5 x 548.7mm/
10.25 x 20.06 x 21.60 inches

Size Unpacked w/o stand (D x H x W)(mm/inch) (Head Only)
43.0 x 369.1 x 548.7mm/
1.69 x 14.53 x 21.60 inches

Weight Packed
7.8kg/17.20lbs.

Weight Unpacked
5.5kg/12.13lbs.

Weight (Monitor Head Only)
3.58kg/7.89lbs.

SPECIAL FEATURES

Anti-glare
Yes

Optional Soundbar Support
Yes

ThinkCentre Tiny Support
Yes

MECHANICAL

Tilt Angle (front/back)
-5°/30°

Swivel Angle (left/right)
+/-45°

Lift
Yes (110mm)

Pivot
+/-90°

VESA Mount Capability
Yes (100 x 100mm)

Kensington™ Lock Slot
Yes

Bezel Width (Side)
2.0mm

Bezel Width (top/bottom)
2.0/22.2mm

WHAT'S IN THE BOX

Monitor with stand
1 x Power Cable
1 x USB 3.1 Gen1 Cable
1 x HDMI™ Cable*
1 x DP Cable
Quick Setup Guide

CERTIFICATIONS

ENERGY STAR® Rating
7.1

EU RoHS
Yes

CCC
Yes

TCO
TCO 8.0/TCO Edge 2.0

Windows Certification
Windows 7, Windows 10

China Energy Efficiency Standard
Tier 2

TÜV Eye Comfort
Yes

ULE
Gold



*For NA and LA only

Depending on many factors such as the processing capability of peripheral devices, file attributes, and other factors related to system configuration and operating environments, the actual transfer rate using the various USB connectors on this device will vary and is typically slower than the data rates as defined by the respective USB specifications: - 5 Gbit/s for USB 3.1 Gen1; 10 Gbit/s for USB 3.1 Gen2 & 20 Gbit/s for USB 3.2.

© 2019 Lenovo. All rights reserved. These products are available while supplies last. Prices shown are subject to change without notice. For any questions concerning price, please contact your Lenovo Account Executive. Lenovo is not responsible for photographic or typographic errors. Warranty: For a copy of applicable warranties, write to: Warranty Information, 500 Park Offices Drive, RTP, NC 27709, Attn: Dept. ZPYA/B600. Lenovo makes no representation or warranty regarding third-party products or services. Trademarks: Lenovo, the Lenovo logo, Rescue and Recovery, ThinkPad, ThinkCentre, ThinkStation, ThinkVantage, and ThinkVision are trademarks or registered trademarks of Lenovo. Microsoft, Windows, and Vista are registered trademarks of Microsoft Corporation. Intel, the Intel logo, Intel Inside, Intel Core, and Core Inside are trademarks of Intel Corporation in the U.S. and/or other countries. Other company, product, and service names may be trademarks or service marks of others.

Specifications may vary depending upon region.

Lenovo



ThinkVision T25m-10

DISPLAY

Panel Size
25.0 inches

Screen Dimensions (H x V)
535.45 x 338.76mm

Panel Type
In-Plane Switching

Backlight
WLED

Aspect Ratio
16:10

Resolution
1920 x 1200 pixels

Pixel Pitch (H x V)
0.2789 x 0.2823mm

Viewing Angle (H x V)
178°/178°

Response Time (gray to gray)
4ms (extreme mode)
6ms (normal mode)

Contrast Ratio (typical)
1000:1

Dynamic Contrast Ratio (typical)
3M:1

Brightness (typical)
300 cd/m²

Color Gamut sRGB (CIE 1931)
99%

Color Support
16.7M

CONNECTIVITY

Video Input Signals
HDMI 1.4 + DP 1.2 + USB 3.1 Type-C™
(DP 1.2 Alt Mode)

Video Cables Supplied
USB 3.1 Type-C™

Video Cable Length
1.8m

USB Hub
Yes

USB Upstream
1 x USB 3.1 Gen1 (by USB Type-C™)

USB Downstream
4 x USB 3.1 Gen1 (with 1 BC)

Audio Out
Yes (3.5mm)

POWER

Power Consumption (Typical/Max)
30W/150W

Power Consumption Sleep/Off Mode
<0.5W

Power Consumption Switch Off-Mode
<0.3W

Power Supply
Internal

ENERGY STAR® (P_{on})
17.05W

ENERGY STAR® (E_{TEC})
63.12kWh

Power Voltage
100-240VAC (50/60Hz)

DIMENSIONS

Size Packed (D x H x W)
706 x 450 x 160mm/
27.79 x 17.72 x 6.30 inches

Size Unpacked w/stand (D x H x W) (mm/inch) (Lowest position)
260.4 x 399.5 x 548.7mm/
10.25 x 15.73 x 21.60 inches

Size Unpacked w/stand (D x H x W) (mm/inch) (Highest position)
260.4 x 509.5 x 548.7mm/
10.25 x 20.06 x 21.60 inches

Size Unpacked w/o stand (D x H x W) (mm/inch) (Head Only)
43.0 x 369.1 x 548.7mm/
1.69 x 14.53 x 21.60 inches

Weight Packed
7.8kg/17.20lbs.

Weight Unpacked
5.5kg/12.13lbs.

Weight (Monitor Head Only)
3.58kg/7.89lbs.

SPECIAL FEATURES

Anti-glare
Yes

Smart Power*
Yes

ThinkCentre Tiny Support
Yes

Optional Soundbar Support
Yes

Internal Speakers
Yes (3W x 2)

MECHANICAL

Tilt Angle (front/back)
-5°/30°

Swivel Angle (left/right)
+/-45°

Lift
Yes (110mm)

Pivot
+/-90°

VESA Mount Capability
Yes (100 x 100mm)

Kensington™ Lock Slot
Yes

Bezel Width (Side)
2.0mm

Bezel Width (top/bottom)
2.0/22.2mm

WHAT'S IN THE BOX

Monitor with stand
1 x Power Cable
1 x USB Type-C™ to Type-C™ cable
Quick Setup Guide

CERTIFICATIONS

ENERGY STAR® Rating
7.1

EU RoHS
Yes

CCC
Yes

TCO
TCO 8.0/TCO Edge 2.0

Windows Certification
Windows 7, Windows 10

China Energy Efficiency Standard
Tier 2

TÜV Eye Comfort
Yes

ULE
Gold

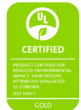

*The Smart Power function intelligently detects overall power consumption and dynamically manages the power delivery to other devices. 75W power delivery by USB Type-C can be achieved when downstream USB ports are not connected and OSD brightness setting is <31.

Depending on many factors such as the processing capability of peripheral devices, file attributes, and other factors related to system configuration and operating environments, the actual transfer rate using the various USB connectors on this device will vary and is typically slower than the data rates as defined by the respective USB specifications: - 5 Gbit/s for USB 3.1 Gen1; 10 Gbit/s for USB 3.1 Gen2 & 20 Gbit/s for USB 3.2.

© 2019 Lenovo. All rights reserved. These products are available while supplies last. Prices shown are subject to change without notice. For any questions concerning price, please contact your Lenovo Account Executive. Lenovo is not responsible for photographic or typographic errors. Warranty: For a copy of applicable warranties, write to: Warranty Information, 500 Park Offices Drive, RTP, NC 27709, Attn: Dept. ZPYA/B600. Lenovo makes no representation or warranty regarding third-party products or services. Trademarks: Lenovo, the Lenovo logo, Rescue and Recovery, ThinkPad, ThinkCentre, ThinkStation, ThinkVantage, and ThinkVision are trademarks or registered trademarks of Lenovo. Microsoft, Windows, and Vista are registered trademarks of Microsoft Corporation. Intel, the Intel logo, Intel Inside, Intel Core, and Core Inside are trademarks of Intel Corporation in the U.S. and/or other countries. Other company, product, and service names may be trademarks or service marks of others.

Specifications may vary depending upon region.

Lenovo



ThinkVision® T27i-10

DISPLAY

Panel Size

27 inch

Screen Dimensions (H x V) (mm)

597.89 (H) × 336.31 (V)

Panel Type

In-Plane Switching

Backlight

WLED

Aspect Ratio

16:9

Resolution

1920 × 1080

Pixel Pitch (H x V) (mm)

0.3110 × 0.3110

Viewing angle (H x V)

178° / 178°

Response Time (gray to gray)

4 ms (extreme mode)

6 ms (normal mode)

Contrast Ratio (typical)

1000:1

Dynamic Contrast Ratio (typical)

3M:1

Color Gamut NTSC (CIE 1931)

72%

Color Support

16.7M

CONNECTIVITY

Video Input Signals

VGA + HDMI 1.4 + DP 1.2

USB Hub

Yes

1 x USB 3.0 (Upstream)

4 x USB 3.0 (Downstream, incl. 1BC)

Cable Length

1.8 m

Audio Out

Yes (3.5 mm)

Power Consumption

22W (Typical) / 58W (max) at On mode;

<0.5W at Sleep mode; <0.3W at Switch off mode

MULTI-MEDIA

Optional Soundbar Support

Yes

DIMENSIONS

Size Packed (D x H x W) (mm/inch)

187 x 455 x 715 mm / 7.362 x 17.913 x 28.15 inch

Size Unpacked w/stand (D x H x W) (mm/inch) (Lowest Position)

269.8 x 403.3 x 611.9 mm / 10.62 x 15.88 x 24.09 inch

Size Unpacked w/stand (D x H x W) (mm/inch) (Highest Position)

269.8 x 513.3 x 611.9 mm / 10.62 x 20.21 x 24.09 inch

Size Unpacked w/o stand (D x H x W) (mm/inch) (Head Only)

49.9 x 366.5 x 611.9 mm / 1.96 x 14.43 x 24.09 inch

Weight Packed (kg/lbs.)

9.32kg / 20.55 lbs.

Weight Unpacked (kg/lbs.)

6.55kg / 14.44 lbs.

Weight (Monitor Head Only) (kg/lbs.)

4.60kg / 10.14 lbs.

SPECIAL FEATURES

Anti-Glare

Yes

Thin Client Support (Tiny)

Yes

(by Tiny Clamp Bracket Kit+VESA

mount PN:4XFON82412+

PN:4XFON03161)

MECHANICAL

Tilt Angle (front/back)

-5°/30°

Swivel Angle (left/right)

-45°/+45°

Lift (Max range)

110 mm

Pivot

-90°/90°

VESA Mount

Yes (100 mm)

Kensington™ Lock Slot

Yes

Cable Management

Yes

Bezel Color

Raven Black

Bezel Width (Side)

2.0 mm

WHAT'S IN THE BOX

Monitor with stand

1 x Power cable

1 x VGA cable

1 x DP-DP cable

1 x HDMI cable (NA only)

1 x USB 3.0 cable

Quick setup guide

CERTIFICATIONS

ENERGY STAR Rating

7.0

CCC

Yes

TCO

7.0

EPEAT™

Silver

ULE

Gold

Windows Certification

Windows 7, Windows 10

China Energy Efficiency Standard

Tier 2

Ambient Operating Temperature

0°C to 40°C

Eye Comfort Certification

Yes



© 2019 Lenovo. All rights reserved. Depending on many factors such as the processing capability of peripheral devices, file attributes, and other factors related to system configuration and operating environments, the actual transfer rate using the various USB connectors on this device will vary and is typically slower than the data rates as defined by the respective USB specifications: - 5 Gbit/s for USB 3.1 Gen1; 10 Gbit/s for USB 3.1 Gen2 & 20 Gbit/s for USB 3.2. These products are available while supplies last. Prices shown are subject to change without notice. For any questions concerning price, please contact your Lenovo Account Executive. Lenovo is not responsible for photographic or typographic errors. Warranty: For a copy of applicable warranties, write to: Warranty Information, 500 Park Offices Drive, RTP, NC 27709, Attn: Dept. ZPYA/B600. Lenovo makes no representation or warranty regarding third-party products or services. Trademarks: Lenovo, the Lenovo logo, Rescue and Recovery, ThinkPad, ThinkCentre, ThinkStation, ThinkVantage, and ThinkVision are trademarks or registered trademarks of Lenovo. Microsoft, Windows, and Vista are registered trademarks of Microsoft Corporation. Intel, the Intel logo, Intel Inside, Intel Core, and Core Inside are trademarks of Intel Corporation in the U.S. and/or other countries. Other company, product, and service names may be trademarks or service marks of others.

Specifications may vary depending upon region.

Lenovo



ThinkVision T27p-10

DISPLAY

Panel Size
27.0 inches

Screen Dimensions (H x V)
596.74 x 335.66mm

Panel Type
In-Plane Switching

Backlight
WLED

Aspect Ratio
16:9

Resolution
3840 x 2160 pixels

Pixel Pitch (H x V)
0.1554 x 0.1554mm

Viewing Angle (H x V)
178°/178°

Response Time (gray to gray)
4ms (extreme mode)
6ms (normal mode)

Refresh Rate
60Hz

Contrast Ratio (typical)
1000:1

Dynamic Contrast Ratio (typical)
3M:1

Brightness (typical)
350 cd/m²

Color Gamut sRGB (CIE 1931)
99%

Color Support
1.07 Billion

POWER

Power Consumption (Typical/Max)
50W/140W

Power Consumption Sleep/Off Mode
<0.5W

Power Consumption Switch Off-Mode
<0.3W

Power Supply
Internal

ENERGY STAR® (P_{on})
23.40W

ENERGY STAR® (E_{TEC})
101.94kWh

Voltage Required
100-240VAC (50/60Hz)

CONNECTIVITY

Video Input Signals
HDMI 2.0 + DP 1.2 + USB 3.1 Type-C™
(DP 1.2 Alt Mode)

Video Cables Supplied
USB 3.1 Type-C™ + HDMI

Video Cable Length
1.8m

USB Hub
Yes

USB Upstream
1 x USB 3.1 Gen1 (by USB Type-C™)

USB Downstream
4 x USB 3.1 Gen1 (with 1 BC)

Audio Out

Yes (3.5mm)

DIMENSIONS

Size Packed (D x H x W)
732 x 210 x 453mm/
28.82 x 8.27 x 17.83 inches

Size Unpacked w/stand (D x H x W) (mm/inch)
269.8 x 403.3 x 611.6mm/
10.62 x 15.88 x 24.08 inches

Size Unpacked w/o stand (D x H x W) (mm/inch) (Head Only)
45.5 x 368.4 x 611.6mm/
1.79 x 14.5 x 24.08 inches

Weight Packed
11.00kg/24.25lbs.

Weight Unpacked
6.95kg/15.32lbs.

Weight (Monitor Head Only)
5.0kg/11.02lbs.

SPECIAL FEATURES

Smart Power*
Yes

Anti-glare
Yes

ThinkCentre Tiny Support
Yes

Optional Soundbar Support
Yes

MECHANICAL

Tilt Angle (front/back)
-5°/30°

Swivel Angle (left/right)
+/-45°

Lift
Yes (110mm)

Pivot
+/-90°

VESA Mount Capability
Yes (100 x 100mm)

Kensington™ Lock Slot
Yes

Bezel Width (Side)
2.0mm

Bezel Width (top/bottom)
2.0/24.5mm

WHAT'S IN THE BOX

Monitor with stand
1 x Power Cable
1 x HDMI Cable
1 x USB Type-C™ to Type-C™ cable
Quick Setup Guide

CERTIFICATIONS

ENERGY STAR® Rating
7.1

EU RoHS
Yes

CCC
Yes

Windows Certification
Windows 7, Windows 10

China Energy Efficiency Standard
Tier 2

TÜV Eye Comfort
Yes

TCO
TCO 8.0/TCO Edge 2.0

ULE
Gold



*The Smart Power function intelligently detects overall power consumption and dynamically manages the power delivery to each device. 75W power delivery can be achieved when downstream USB ports are not connected and OSD brightness setting is <61.

Depending on many factors such as the processing capability of peripheral devices, file attributes, and other factors related to system configuration and operating environments, the actual transfer rate using the various USB connectors on this device will vary and is typically slower than the data rates as defined by the respective USB specifications: - 5 Gbit/s for USB 3.1 Gen1; 10 Gbit/s for USB 3.1 Gen2 & 20 Gbit/s for USB 3.2.

© 2019 Lenovo. All rights reserved. These products are available while supplies last. Prices shown are subject to change without notice. For any questions concerning price, please contact your Lenovo Account Executive. Lenovo is not responsible for photographic or typographic errors. Warranty: For a copy of applicable warranties, write to: Warranty Information, 500 Park Offices Drive, RTP, NC 27709, Attn: Dept. ZPYA/B600. Lenovo makes no representation or warranty regarding third-party products or services. Trademarks: Lenovo, the Lenovo logo, Rescue and Recovery, ThinkPad, ThinkCentre, ThinkStation, ThinkVantage, and ThinkVision are trademarks or registered trademarks of Lenovo. Microsoft, Windows, and Vista are registered trademarks of Microsoft Corporation. Intel, the Intel logo, Intel Inside, Intel Core, and Core Inside are trademarks of Intel Corporation in the U.S. and/or other countries. Other company, product, and service names may be trademarks or service marks of others.

Specifications may vary depending upon region.



<p>Name X1 Wide Flat Panel Monitor Case color Black Type-model 60E2GAR1US / 60E2GAT1US / 60E2GAT1EU Panel TFT-LCD, IPS (In-Plane Switching), White LED backlight Viewable image size 27" (684.7mm) diagonal Max view area (W x H) 23.49" x 13.21" (596.7mm x 335.7mm) Optimum resolution 3840x2160 Max pixel rate 600MHz Aspect ratio 16:9 Pixel pitch (mm) 0.16 x 0.16mm Dot/Pixel per Inch 163 dpi Brightness 300 nits or cd/m² (typical) Contrast ratio 1300:1 (typical) Pixel response time 6ms Color gamut 99% Viewing angle at 10:1 CR 178° horizontal, 178° vertical Stand Tilt stand Bezel width Sides: 0.088" (2.23mm) Dimensions (HxWxD, including stand) 19.35" H x 24.19" W x 10.63" D; 491.4mm H x 614.5mm W x 270.0mm D Power supply 40 watts typical, 130 watts maximum (with USB), <0.5 watts sleep/off; <0.5 watts switch off Weight 14.11 lb; 6.40kg (including stand) Limited warranty⁴ 3 year Available date March 2016</p>	<p>Features</p> <ul style="list-style-type: none"> • 27-inch IPS LED backlight monitor with speaker • Supports 3840x2160 resolution • 5-Ports USB hub, support USB Type-C • 3watts x 2 stereo speakers • Microsoft® Windows® 7 certified • Microsoft Windows 10 certified 						
<p>VESA-compliant² VESA DDC2B/CI Power management ENERGY STAR® 7.0 Ergonomics ISO 9241-307 Emission standards FCC Class B Environmental TCO Displays 7.0, RoHS, EPEAT™ Silver rating, ULE Gold</p>	 <p style="text-align: center;">ThinkVision X1 Monitor</p>						
<p>Preset resolutions VGA: 640x350, 640x480, 720x400 SVGA: 800x600 XGA: 1024x768, 1152x864 SXGA: 1280x1024 WXGA: 1280x720, 1280x768, 1280x800, 1360x768 WXGA+: 1440x900, 1600x900 WSXGA+: 1680x1050 Full HD: 1920x1080, 1920x1200 UHD: 3840x2160</p> <p>Presets / user settings Standard presets: 20; user settings: 20</p>							
<p>Viewing adjustments <i>Tilt: 22° back, -5° forward;</i> Rotating screen None On screen display On screen display with digital user controls (8 languages) Control features Direct access (touch buttons on front) for menu, mute, volume up/down, and brightness USB hub USB Hub: one USB 3.1 Type-C upstream port, four USB 3.0 Type-A downstream ports Multimedia Integrated stereo speakers (3 watts x 2), built-in microphone Camera Full HD camera with LED light Multiple input Support HDMI, DisplayPort Monitor connectors (1) HDMI (1.4), digital, HDCP-compliant (2) DisplayPort (1.2), digital, HDCP-compliant Signal cables (1) detachable, HDMI at each end, digital, 1.8 meter (2) detachable, DisplayPort at each end, digital, 1.8 meter Mounting features Wall or desk mounting using the Extend Arm or third-party accessories meeting the VESA FPMPI® (100mm mount) Security Security keyhole for attachment of optional cable lock (Kensington® lock-compatible)</p>							
<p>Ship group Monitor, detachable stand, Quick start and safety poster, 1.8 meter DisplayPort cable, 1.8 meter HDMI cable, 1.8 meter USB Type-C cable, 1.8 meter USB Type-C to Type-A cable, 1.8 meter black power cord, mini DP to DP adapter, power adapter (135W)</p>	<p style="text-align: center;">Limited Warranty</p> <p>See details at http://support.lenovo.com/en_US/guides-and-manuals/detail.page?DocID=UM008281</p> <p style="text-align: center;">Accessories</p> <table border="0"> <tr> <td>Kensington MicroSaver Cable Lock</td> <td style="text-align: right;">73P2582</td> </tr> <tr> <td>Kensington Twin Head Cable Lock</td> <td style="text-align: right;">45K1620</td> </tr> <tr> <td>Lenovo Security Cable Lock</td> <td style="text-align: right;">57Y4303</td> </tr> </table> <p>See details at www.lenovo.com/support/monitoraccessories</p> <p>See all monitors at www.lenovo.com/thinkvision</p>	Kensington MicroSaver Cable Lock	73P2582	Kensington Twin Head Cable Lock	45K1620	Lenovo Security Cable Lock	57Y4303
Kensington MicroSaver Cable Lock	73P2582						
Kensington Twin Head Cable Lock	45K1620						
Lenovo Security Cable Lock	57Y4303						

See footnotes for important warranty information

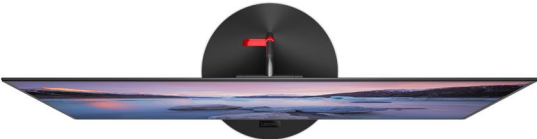

ThinkVision X1 (2nd GEN) MONITOR

EXTREME STYLISH, EXTREME FOREFRONT.



THE MILESTONE OF X-SERIES, 27" FULL-SCREEN, 4K, THUNDERBOLT™ 3 MONITOR.

Pushing the limit of screen share ratio with innovative technology, the 27" Lenovo™ ThinkVision® X1 (2nd GEN) display brings full-screen and ultra-slim appearance in elegant design. With 4K resolution and >99% sRGB color gamut, you will be assured of excellent watching experience and Thunderbolt™ 3 interface will bring the best user experience. "Motor" camera is first used on monitor, which will move up and down automatically and with it you will own standard VoIP system.

WHY YOU SHOULD BUY THE LENOVO THINKVISION X1 (2nd GEN) MONITOR



Full-screen appearance

With world's slimmest (4.7 mm) 27" 4K TBT monitor you will experience full-screen 4-side Near-Edgeless display with the screen ratio of approximately 93%. The monitor also comes with a metal stand and a base.



Brilliant performance

The 4K UHD IPS screen displays 3840 x 2160 resolution at 60 Hz, 99% sRGB color gamut, 10-bit depth, with 1.07 billion color support assures you stunning visuals and superb color experience.



Convenient user experience

Total versatility with Thunderbolt™ 3 interface supporting 4K + USB 3.0 & 45W PD + motor-camera with dual-array microphone. A Think RedDot tracking button is integrated in the back cover.

THE LENOVO THINKVISION X1 (2nd GEN) MONITOR IS BEST SUITED FOR

1

The Executives and CXO of company.

2

SOHO and Gold Collars with high income.

3

Trendsetters who pursue an extreme and forefront monitor.



ThinkVision X1 (2nd GEN) MONITOR



SPECIFICATIONS

DISPLAY		ENVIRONMENTAL	
Panel Size	27"	Temperature Operating	0°C - 45°C
Panel Type	IPS	Temperature Non-Operating	-20°C - 60°C
Backlight	WLED	Humidity Operating	8% - 80%
Resolution	3840 (H) x 2160 (V)	Humidity Non-Operating	5% - 95%
Aspect Ratio	16:9	Altitude Operating	16,000 ft
Anti-Glare	Yes	Altitude Non-Operating	40,000 ft
Screen Dimensions (W x H) (mm)	596.7 (H) x 335.7 (V)	Arsenic-Free Glass	Yes
Maximum Brightness (Typical)	350 cd/m ²	PVC-Free	Yes (W/O cable)
Viewing Angle (H/V at CR 10:1)	178°/178°	Mercury-Free	Yes
Contrast Ratio (Typical)	1000:1	PCC % of Plastic Resins	25%
Dynamic Contrast Ratio	3M:1		
Pixel Pitch (W x H) (mm)	0.1554 x 0.1554	DIMENSIONS (W x D x H)	
Dot/Pixel Per Inch (DP/PPI)	163	Size Packed (mm)	718 x 140 x 470
Color Gamut (CIE 1931)	99% sRGB	Size Packed (inches)	28.27" x 5.51" x 18.5"
Response Time (Extreme/Typical/Off)	4/6/14 ms (G-to-G)	Size Unpacked with Stand (mm)	609.74 x 234.81 x 474.76
		Size Unpacked with Stand (inches)	24" x 9.24" x 18.69"
POWER CONSUMPTION		Size Unpacked without Stand (Monitor Head Only) (mm)	609.74 x 32.7 x 351.71
Typical	65 W	Size Unpacked without Stand (Monitor Head Only) (inches)	24" x 1.29" x 13.85"
Maximum	135 W	Distance from Table to Panel Lowest Pixel at Bottom of Screen (mm / inches)	134 / 5.276"
Sleep-Mode	0.5 W	Distance from Table to Panel Highest Pixel at Top of Screen (mm / inches)	450 / 17.717"
Switch Off-Mode	0.5 W	Stand Base Footprint Area (mm)	234.81 x 234.81
Power Supply	External	Stand Base Footprint Area (inches)	9.24" x 9.24"
Power Voltage	100 VAC - 240 VAC	Weight Packed	Starting at 18.45 lbs (8.37 kg)
Voltage Dynamic Frequency	50 Hz - 60 Hz	Weight Unpacked	Starting at 12.21 lbs (5.54 kg)
		Weight Monitor Head Only	Starting at 9.46 lbs (4.29 kg)
SIGNAL INPUT			
Video Input Signals	DisplayPort™ 1.2 + HDMI™ 2.0 + Thunderbolt™ 3	COMPLIANCE	
Video Cables Supplied	HDMI™ + Thunderbolt™ 3	EPEAT™	Silver
Video Cable Length	1.8 m	ENERGY STAR® Rating	7.0
USB Hub	Yes (4 x USB 3.0)	ULE	Silver
USB Cable Supplied	N/A	TCO®	7.0
Audio-Jack	Yes	RoHS	Yes
		Windows Certification	Windows 10
SIGNAL INTERFACE / PERFORMANCE		China Energy Label	Grade 2
Horizontal Frequency	30 kHz - 136 kHz	WARRANTY AND AVAILABILITY	
Vertical Frequency	30 Hz - 60 Hz	Warranty	3 Years
Native Resolution	3840 x 2160	Geography Availability	WW
Maximum Pixel Clock Speed/Bandwidth	20 Gbps		
Default Color Temperature	6500K		
Preset Modes	24		
OSD Buttons	2 Buttons + Tracking Point		
OSD Languages	English, French, Italian, German, Spanish, Japanese, Chinese, Russian		
MECHANICAL			
Tilt Angle (Front / Back)	-5° / 30°		
Swivel Angle (Left / Right)	N/A		
Lift (mm)	N/A		
Pivot	N/A		
VESA® Mount (mm)	N/A		
Kensington® Lock Slot	Yes		
Cable Management	Yes		
Bezel Color	N/A		
Bezel Width Top (mm / inches)	1.2 / 0.05"		
Bezel Width Bottom (mm / inches)	1.2 / 0.05"		
Bezel Width Sides (mm / inches)	1.2 / 0.05"		



WWW.LENOVO.COM

Lenovo reserves the right to alter product offerings and specifications at any time, without notice. Lenovo makes every effort to ensure accuracy of all information but is not liable or responsible for any editorial, photographic or typographic errors. All images are for illustration purposes only. For full Lenovo product, service and warranty specifications visit www.lenovo.com. Lenovo makes no representations or warranties regarding third party products or services. **Trademarks:** The following are trademarks or registered trademarks of Lenovo: Lenovo, the Lenovo logo, Rescue and Recovery, ThinkPad, ThinkCentre, ThinkStation, ThinkServer, ThinkVantage and ThinkVision. Microsoft, Windows and Vista are registered trademarks of Microsoft Corporation. Ultrabook, Celeron, Celeron Inside, Core Inside, Intel, Intel Logo, Intel Atom, Intel Atom Inside, Intel Core, Intel Inside, Intel Inside Logo, Intel vPro, Itanium, Itanium Inside, Pentium, Pentium Inside, vPro Inside, Xeon, Xeon Phi, and Xeon Inside are trademarks of Intel Corporation in the U.S. and/or other countries. Other company, product and service names may be trademarks or service marks of others. Battery life (and recharge times) will vary based on many factors including system settings and usage. Visit www.lenovo.com/lenovo/us/en/safecom/ periodically for the latest information on safe and effective computing. ©2018 Lenovo. All rights reserved.

This publication was developed for products and services offered in the North America, E.M.E.A and Asia & Pacific countries. Lenovo may not offer the products, services or features discussed in this document in other countries. Lenovo may withdraw an offering at any time. Information is subject to change without notice. Consult your local representative for information on offerings available in your area.

Lenovo reserves the right to change specifications or other product information without notice. Lenovo is not responsible for photographic or typographical errors.

LENOVO PROVIDES THIS PUBLICATION "AS IS," WITHOUT WARRANTY OF ANY KIND, EITHER EXPRESS OR IMPLIED, INCLUDING THE IMPLIED WARRANTIES OF MERCHANTABILITY OR FITNESS FOR A PARTICULAR PURPOSE.

Some jurisdictions do not allow disclaimer of express or implied warranties in certain transactions, therefore this disclaimer may not apply to you.

Availability: All offers subject to availability. Lenovo reserves the right to alter product offerings and specifications at any time, without notice. Lenovo is not responsible for photographic or typographic errors.

General: Review key information provided by Microsoft that may apply to your system purchase, including details on Windows 10, Windows 8, Windows 7, and potential upgrades/downgrades. Lenovo makes no representation or warranty regarding third-party products or services.

Trademarks: Lenovo, ThinkPad, ThinkBook, ThinkCentre, ThinkStation, ThinkVision and the Lenovo logo are trademarks of Lenovo. Microsoft, Windows, Windows NT, and the Windows logo are trademarks of Microsoft Corporation. Ultrabook, Celeron, Celeron Inside, Core Inside, Intel, Intel Logo, Intel Atom, Intel Atom Inside, Intel Core, Intel Inside, Intel Inside Logo, Intel vPro, Itanium, Itanium Inside, Pentium, Pentium Inside, vPro Inside, Xeon, Xeon Phi, and Xeon Inside are trademarks of Intel Corporation in the U.S. and/or other countries. Other company, product or service names may be trademarks or service marks of others.

Warranty: For a copy of applicable warranties, write to: Lenovo Warranty Information, 1009 Think Place, Morrisville, NC, 27560. Lenovo makes no representation or warranty regarding third party products or services. The Lenovo Limited Warranty applies only to Lenovo hardware products purchased for your own use, and does not transfer upon resale.

Limited warranty: Support unrelated to a warranty issue may be subject to additional charges.

Lenovo Services:

Carry-in or Mail-in Service: Parts and labor repair coverage where the customer is responsible for shipping (including packaging) or delivery to authorized warranty provider or repair center.

Depot or Courier Service: Parts and labor repair coverage where shipping (including packaging) or delivery to the repair center is paid for by Lenovo.

Expedited Depot: Parts and labor coverage with expedited turnaround. Shipping (including packaging) or delivery to the repair center is paid for by Lenovo.

Onsite / In-home Service: Parts and labor repair coverage where labor is provided onsite at your place of business.

If Lenovo determines your product problem is covered by the product warranty and cannot be resolved over the telephone, a technician will be dispatched to arrive onsite, typically the next day.

International Warranty Service (IWS): PC repair coverage for customers who require a critical warranty repair while travelling internationally. Visit www.lenovo.com/internationalwarranty for details. Visit www.lenovo.com/warranty for Lenovo Warranty Services terms and conditions for complete details and restrictions.

Included software: may differ from its retail version (if available), and may not include user manuals or all program functionality. Software license agreements may apply.

Battery life: Battery life (and recharge times) will vary based on many factors including screen brightness, applications, features, power management, battery conditioning, and other customer preferences.

Visit <http://psref.lenovo.com/> for the latest version of Product Specifications Reference.

© Lenovo, 2019. All rights reserved.
Lenovo 1009 Think Place Morrisville, NC 27560 U.S.A.