

Order Hymenoptera, families Crabronidae and Sphecidae

Christian Schmid-Egger

INTRODUCTION

Sphecid wasps or digger wasps are large (30 mm) to minute (1.8 mm) wasps with a worldwide distribution and a focus in arid and semi arid areas. Females hunt other insects or spiders for larval nutrition, a few species develop as cleptoparasitoids of other sphecids. Around 300 of the 7000 worldwide species occur in the Arabian Peninsula (Ohl, in litt., own observation). Part of the genera of the Arabian fauna were revised by Guichard (1980–1994), other genera were dealt with in several revisions by Pulawski (1962–1995) and other authors. Consequently, knowledge about the sphecids from Arabia is quite extensive. Nevertheless, some important genera that occur in the Arabian Peninsula and southwest Asia have not been revised until now and therefore identification of a part of the collected species will remain doubtful or is impossible for the moment.

Sphecid wasps are mainly active during daylight and prefer high temperatures. They can be captured by hand-netting or by various kinds of traps. In desert areas, water traps are successful for sphecid collecting as well as Malaise traps. Collecting of the quick flying species of some genera, e.g. *Bembix*, *Stizus* or large *Sphex*-related species, is not easy and needs some experience and luck. Specimens can mainly be found on various flowers, but also on nesting places. Most Arabian species nests in the ground. Wood nesting species are rare because of lack of trees and larger shrubs in the deserts. The examined species occur in all important habitats of the UAE, from the costal dunes to the desert places (mainly in small oases or farms), as well as in the mountains.

The most important collecting methods in the present investigation have been various kinds of traps. Because of this, the results differ from those of earlier examinations of sphecids in Arabia, and there is a marked increase of species with small body size (less than 5.0 mm) such as *Solierella*, *Miscophus*, *Eremiasphecium*, *Belomicrus*-related species and others. These genera are mostly overlooked by traditional sampling methods with a net, caused by the inconspicuous behaviour of these minute species.

The former Hymenoptera family Sphecidae (s. lat., here called ‘sphecids’) is now divided into four families, forming the superfamily Apoidea together with the bees (Apidae). The present contribution covers most of the Crabronidae and Sphecidae s. str. The genera *Trypoxylon* Latreille, 1796, *Pseudomicroides* Antropov, 2001, and *Belomicroides* Kohl, 1899, will later be dealt with by Antropov, the genus *Tachysphex* by Straka & Schmid-Egger, and the genus *Nitela* Latreille, 1809, by Gayubo & Schmid-Egger. The genera *Diodontus* Curtis, 1834, *Larra* Fabricius, 1793, *Pseudoscolia* Radoszkowski, 1876, the subfamily Astatinae and some other single specimens could not yet be identified and will possibly be published later. The two remaining small families of sphecids consist of the Heterogynaeidae (1 species in the UAE; dealt with by Ohl, 2008), and the Ampulicidae (2 species in the UAE; M. Ohl, in this volume).

For the present contribution, 2665 specimens were examined, belonging to 128 species; 41 additional species are included from literature citations, consequently 169 species belonging to the fauna of the UAE are dealt with in the present paper. Eight species are described as new to science: *Bembix hauseri* (also occurring in Oman), *Crossocerus antropovi*, *Eremiasphecium pulawskii*; *Laphyragogus strakai*, *Miscophus paolorosai*, *Plenoculus vanharteni*, *Solierella jacobsi*, and *Synnevrus ohli*; 82 species are new for the

fauna of the UAE, and 34 species are new to the Arabian Peninsula. About 35–40 additional species can be expected from the material not yet identified, which gives an expected total number of about 210 species of ‘sphecids’ in the UAE.

MATERIALS AND METHODS

This chapter is based on material collected in the framework of the UAE Insect Project, Sharjah, by Antonius van Harten between 2005 and 2009; by Martin Hauser in March 2008, and by the author in March 2009; also on material collected by E. Sugden in 1984. Some other records of specimens collected by Oistein Berg, Oslo/Norway, Erwin Scheuchl, /Germany and Jan Batelka, Prague/Czech Republic have been added and a few additional specimens from the UAE were found in the Oberösterreichisches Landesmuseum, Linz/Austria. Antonius van Harten and E. Sugden collected their material in traps (water traps, light traps, Malaise traps) only, the material of Martin Hauser, Jan Batelka and the author was collected by hand netting. The author visited the country for a second time in January 2011, but includes here only paratype data of two new species. The remaining material will be published later.

The present checklist includes examined material as well as species mentioned in literature. The following information is given below: ‘specimens examined’: number of examined specimens, locations, and flight period. Only in types or in very rare specimens (up to 2 or 3 records), detailed information is given. The collector of most specimens is Antonius van Harten, he is not always mentioned separately. Longitude and latitude information is only given for type specimens, a full list of location data is given in the ‘Introduction’ to this volume.

The material is mainly deposited in following collections: Author’s collection (CSE), collection of Humboldt Museum, Berlin/Germany (Berlin), UAE Invertebrate Collection and the collection of Naturalis, Leiden/Netherlands. Types are deposited in Berlin, until otherwise stated. Specimens collected in the localities Dubai/al-Awir and Dubai/Nakhalai were collected by E. Sugden only, and are deposited in the California Department of Food & Agriculture, Sacramento, California/USA.

The systematic account follows that of Pulawski (internet database, 2010) with a few exceptions only. Genera and species are listed alphabetically within both families Sphecidae and Crabronidae. Literature citations for species identification are given, or identification keys and short diagnosis are included when necessary. Morphological terms follow that of Bohart & Menke (1976), and Pulawski & Prentice (2008). Antenna is divided into scape, pedicel and flagellomeres. Males have 11 flagellomeres (10 in some *Solierella*), females have 10 flagellomeres. In each plate, body length (= L) of the specimen is given.

Abbreviations used: AvH = A. van Harten; CSE = C. Schmid-Egger, ES = E. Sugden, MH = M. Hauser; NARC = National Avian Research Centre; OOL = ocellar ocular line; POL = posterior ocellar line.

SYSTEMATIC ACCOUNT

Family Crabronidae

Genus *Ammatomus* A. Costa, 1859

Identification: Pulawski, 1973.

Key to the species of *Ammatomus* from the Arabian Peninsula

- 1 Lateral carina of tergum I reaches end of tergum I. Hind tarsi yellow. In Arabia only in Oman: (Guichard, 1980) *Ammatomus asiaticus* Radoszkowski
 – Lateral carina of tergum I end in apical half or 2/3 of tergum I. At least hind tarsus V partly black, in some *mesostenus* completely yellow 2
- 2 Hind tarsal segments I–III apically with black spot, hind tarsus V black. Diameter of mesonotal punctures large, similar to punctures of mesopleuron
 *Ammatomus rufonodis* Radoszkowski
 – Hind tarsal segments I–III yellow, hind tarsus V in most specimens black in apical half. Mesonotal punctures very small, half as large as mesopleural punctures
 - *Ammatomus mesostenus* Handlirsch

Ammatomus mesostenus Handlirsch, 1888 Plates 1–2

Specimens examined: 42 specimens. Al-Ajban. Flight period: March–November.

Discussion: The specimens from the UAE differ from other specimens by colour. Tergum I and hindfemora are red, except for yellow tergal spots, and these parts are black in specimens from Egypt and Yemen. Mesonotal punctures much smaller and more scattered in specimens from the UAE (punctures 1–3 diameters apart), whereas punctures are large and punctuation is denser in specimens from other origins. It cannot be excluded that the specimens from the UAE represent a separate species, but more material from other Arabian countries is needed to make a final decision.

Distribution: North Africa, Yemen, Iran to Central Asia (Pulawski, 1973). Yemen: Al-Kadan, 17.ii.1998 (leg. A. van Harten, coll. Leiden). New to the UAE.

Ammatomus rufonodis Radoszkowski, 1877 Plate 3

Specimens examined: Wadi Madaq, 1♀, 19.iii.2009, leg. CSE.

Discussion: The species agrees with the subspec. *saharae* Handlirsch, 1895, as described by Pulawski (1973). Hind femora and basal 2/3 of tergum I are light reddish. The species is highly variable in colour, and *saharae* in my opinion has to be treated as a forma and not as a subspecies.

Distribution: North Africa, Iran to Central Asia (Pulawski, 1973). The subspec. *saharae* was described from southern Algeria. New to the UAE.

Genus *Ammoplanus* Giraud, 1869

Identification: Bouček, 2001.

Ammoplanus rhodesianus Arnold, 1924 Plates 4–5

Specimens examined: 19 specimens. Al-Ajban, North of Ajman, Dubai/Nakhalai, ar-Rafah, Sharjah Desert Park, Um al-Quwain, Wadi Madaq, Wadi Shawkah. Flight period: October–May.

Discussion: This species belongs to the subgenus *Ammoplanellus* Gussakovskij, 1931, and is well characterized by the form of the marginal cell of the forewing, which is anteriorly open; the enclosing vein is clearly not reaching the anterior margin of wing. Legs are dark reddish in both sexes, in contrast to *A. simplex*, which has yellowish-white legs.

Distribution: Africa, Spain and Portugal to Central Asia, UAE (Bouček, 2001).

Ammoplanus simplex Gussakovskij, 1852 Plate 6

Specimens examined: 18 specimens. Al-Ajban, Dubai/Nakhalai, Sharjah Desert Park, Wadi Madaq, Wadi Shawkah. Flight periods: October–December, April–May.



Plates 1–2. *Ammatomus mesostenus* Handlirsch. 1: Female, dorsal view, L = 8.2 mm; 2: Male, head.



Plate 3. *Ammatomus rufonodis* Radoszkowski, female, lateral view, L = 7.5 mm.

Discussion: The species belongs to the subgenus *Ammoplanellus* and is difficult to recognize with the key of Bouček (2001). Marginal cell is apically rounded. I have compared the present specimens with a female from Israel, identified by Z. Bouček. Both agree well, except some details in colour: legs, except black hindfemur, and clypeus are pale yellowish-white in the female from the UAE, whereas these parts are somewhat darker – clypeus basally black, apically reddish – in the female from Israel. *Ammoplanus simplex* can be distinguished from *rhodesianus* by yellowish-white legs, which are dark reddish in *rhodesianus*.

Distribution: Southern Europe, North Africa to India and Central Asia, UAE (Bouček, 2001).

Genus *Belomicrus* A. Costa, 1871

Discussion: The genus was revised and keyed by Guichard (1991a). Antropov (2007) described a new genus, *Guichardus*, and transferred *Belomicrus dromedarius* Guichard, 1991, to *Guichardus*. To enable the identification of the *Belomicrus* and *Guichardus* species from the Arabian Peninsula, I present a new key for those species. For more detailed studies, it is recommended to use the above mentioned literature, because further species also may occur in the UAE.

The present key is prepared for the identification of males and females of *Belomicrus* and *Guichardus* species of the Arabian Peninsula. Both genera are characterized by a mesonotal squama, similar to that of *Oxybelus*. In the latter genus, the squama is reduced to lateral parts, not connected medially, whereas the squama is connected in most *Belomicrus* (not in *Guichardus*). Also, mesonotum is markedly rugosely punctate in *Oxybelus*, and shiny with



Plates 4–5. *Ammoplanus rhodesianus* Arnold, female, L = 1.9 mm. 4: Dorsal view; 5: Lateral view.



Plate 6. *Ammoplanus simplex* Gussakovskij, female, lateral view, L = 2.0 mm.

sparse punctation in *Belomicrus* and *Guichardus*. The latter genera include minute species of 2.5 to 4.0 mm body length, whereas most *Oxybelus* are larger. The genus *Pseudomicroides* (most species originally described in *Belomicroides* Kohl, 1899) also belongs to the tribe Oxybelini and is characterized by lack of mesonotal squama. It will be treated in a separate contribution by A. Antropov.

Key to the species of *Belomicrus* and *Guichardus* from the Arabian Peninsula

- 1 Scutellum divided by a deep longitudinal furrow 2
- Scutellum flat, without furrow 3
- 2 Scape markedly emarginated below. Squama of metanotum reduced to narrow lateral spines, not connected basally, bearing long setae, directed inwards. Predominantly black species with the following parts pale: antenna, parts of legs, pronotal lobe, squama of metanotum. 2.5 mm. Female unknown
 *Guichardus dromedarius* Guichard (for description see further below)
- Scape evenly rounded. Squama of metanotum with large lateral triangular parts, basally largely connected, without setae. Markedly pale colored species with partly red abdomen in most specimens. 2.5–3.0 mm *Belomicrus dimorphus* Guichard
- 3 Emargination of metanotal squama triangular, shorter than remaining squama. Terga II (–IV) with triangular pale lateral spots, not connected medially. Mesonotum without pubescence *Belomicrus bimaculatus* Guichard

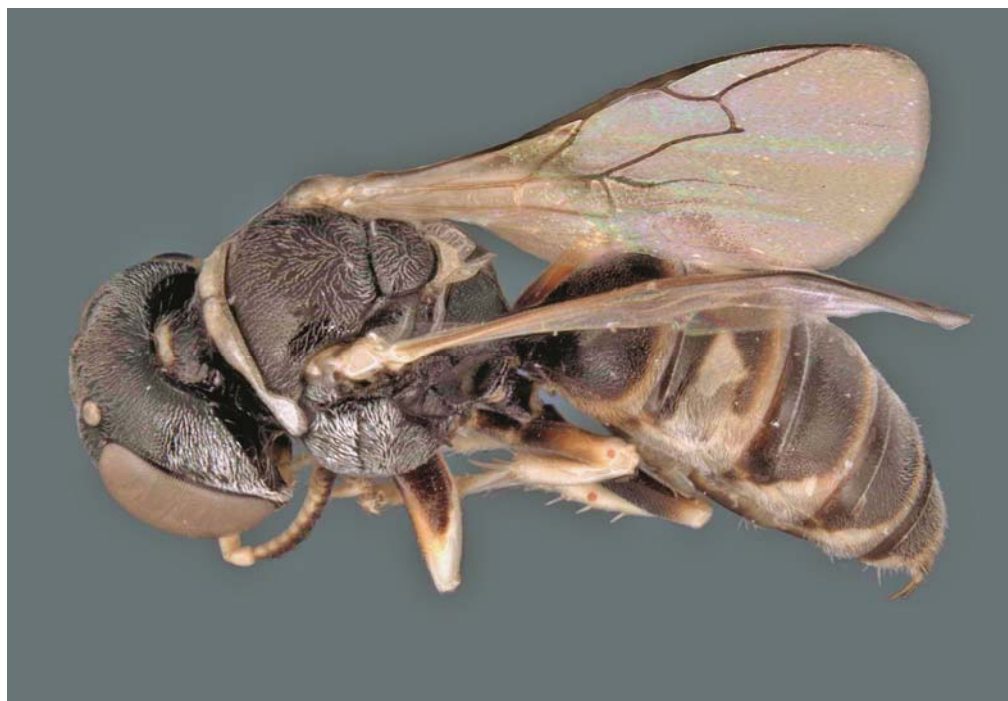

Plate 7. *Belomicrus bimaculatus* Guichard, female, laterodorsal view, L = 3.0 mm

- Emargination of metanomal squama rectangular, longer than remaining squama medially. Terga I–V with continuous pale basal bands, remaining terga in females reddish. Specimens from Saudi Arabia may be darker *Belomicrus schulthessi* Kohl

Belomicrus bimaculatus Guichard, 1991

Plate 7

Specimens examined: 96 specimens. Al-Ajban. Flight period: May, July.

Distribution: Oman, Egypt-Sinai (Guichard, 1991a). New to the UAE.

Belomicrus dimorphus Guichard, 1991

Plate 8

Specimens examined: 11 specimens. Al-Ajban; Dubai/Nakhalai, Sharjah Desert Park, Wadi Madaqa. Flight period: October, December, April.

Discussion: The identification was confirmed by A. Antropov.

Distribution: Arabia (Guichard, 1991a), Algeria (Leclerc, 1993). New to the UAE.

Belomicrus schulthessi Kohl, 1923

Plate 9

Specimens examined: Um al-Quwain, 1♂, 4♀, 19.iii.2009, leg. CSE.

Distribution: North Africa, Saudi Arabia, Central Asia (Guichard, 1991a). New to the UAE.

Genus ***Bembecinus*** Costa, 1859

Identification: Schmid-Egger, 2004.

Bembecinus acanthomerus (Morice, 1911)

Plate 10

Specimens examined: Wadi Madaqa, Um al-Quwain, 5♂, 19.iii.2009, leg. CSE.



Plates 8–9. 8: *Belomicrus dimorphus* Guichard, female, laterodorsal view, L = 2.8 mm; 9: *Belomicrus schulthessi* Kohl, female, laterodorsal view, L = 2.9 mm.

Distribution: West and North Africa, Israel to Central Asia, Oman (Schmid-Egger, 2004).
New to the UAE.

Bembecinus bytinskii de Beaumont, 1954

Plate 11

Specimens examined: 72 specimens. Al-Ajban, Dubai/al-Awir, Dubai/Nakhalai, Jebel Hafit/S of al-Ain, Sharjah Desert Park, Wadi Bih (dam), Wadi Hayl. Flight period: March–April, November.

Discussion: A female from al-Ajban has a full yellow band on tergum IV (normally it is completely black) and a yellow spot below clypeus.

Distribution: Arabian Peninsula to Israel, including the UAE (Schmid-Egger, 2004).

Bembecinus decoratus Guichard, 1980

Plates 12–13

Specimens examined: Sharjah, 15 km NE of ad-Dhaid, 1♂, 1♀, 19.iii.2007, leg. J. Batelka.

Distribution: Oman, UAE (Schmid-Egger, 2004).

Genus ***Bembix*** Fabricius, 1775

Identification: Guichard, 1989b.

Bembix chopardi Berland, 1950

Distribution: North Africa, Israel, Saudi Arabia, Oman, UAE (Guichard, 1989b).

Bembix chlorotica Spinola, 1838

Distribution: Egypt, Israel, Saudi Arabia, Oman, UAE (Guichard, 1989b).

Bembix dahlbomi Handlirsch, 1893

Discussion: It is possible that Guichard (1989b) confused this species with *B. hauseri* nov. spec.

Distribution: North Africa, Arabia, UAE (Guichard, 1989b).

Bembix freygessneri Morice, 1897

Plates 14–16

Specimens examined: 79 specimens. Abu Dhabi/Wazeel oasis, Near Mahafiz, N of Ajman, Ra's al-Khaimah, Sharjah Desert Park, Um al-Quwain, Wadi al-Helo/near tunnel; 20 km SW of Ra's al-Khaimah/Al Hamra Fort Hotel. Flight period: March (most specimens), November–December.

Distribution: North Africa, Israel, Arabia, UAE, a widespread and common species (Guichard, 1989b).

Bembix gazella Guichard, 1989

Distribution: Oman (Muscat), UAE (Guichard, 1989b).

Bembix hameri Guichard, 1989

Plates 17–19

Specimens examined: Mahafiz, 4♂, 1♀, 19.iii.2009, leg. CSE.

Distribution: UAE (Guichard, 1989b).

Bembix hauseri Schmid-Egger nov. spec.

Plates 20–22, Figures 1–7

Specimens examined: United Arab Emirates: 1♂, 2♀, desert farm, 25°08'N 55°45'E, 12.iii.2008, leg. MH. 1♂, Dubai/Lahbab env., 25.xi.2006, leg. J. Batelka & H. Pinda. 1♂, Abu Dhabi, Wazeel oasis, 25.xi.2006, leg. J. Batelka. 2♂, 4♀, Mahafiz, 19.iii.2009, leg. CSE; 1♂, 3♀, 10.i. 2011, leg. CSE. 1♂, 2♀, Sharjah Desert Park, 18.iii.2008, leg. MH; 4♂, 5♀, 19.iii.2009, leg. CSE; 2♂, 30.iv. 2009, leg. AvH; 1♂, 5♀, 10.i. 2011, leg. CSE. 1♀, 70 km S of Abu Dhabi, on Liwa road, 23,90°N 54,41°E, 10.i. 2011, leg. CSE. 7♂, 4♀, lake 17 km SW of al-Ain, 24,09°N 55,63°E, 10.i. 2011, leg. CSE. 1♀, Liwa



Plates 10–11. 10: *Bembecinus acanthomerus* (Morice), male, lateral view, L = 7.5 mm; 11: *Bembecinus bytinskii* de Beaumont, female, lateral view, L = 8.5 mm.



Plates 12–13. *Bembecinus decoratus* Guichard, 12: Male, dorsal view, L = 9.0 mm; 13: Female, dorsal view, L = 9.0 mm.



Plates 14–15. *Bembix freygessneri* Morice. 14: Male, lateral view, L = 15 mm; 15: Female, lateral view, L = 15 mm.



Plates 16–17. 16: *Bembix freygessneri* Morice, female, dorsal view, L = 15 mm; 17: *Bembix hameri* Guichard, male, dorsal view, L = 16 mm.



Plates 18–19. *Bembix hameri* Guichard. 18: Male, lateral view, L = 16 mm; 19: Female, lateral view, L = 9.0 mm.

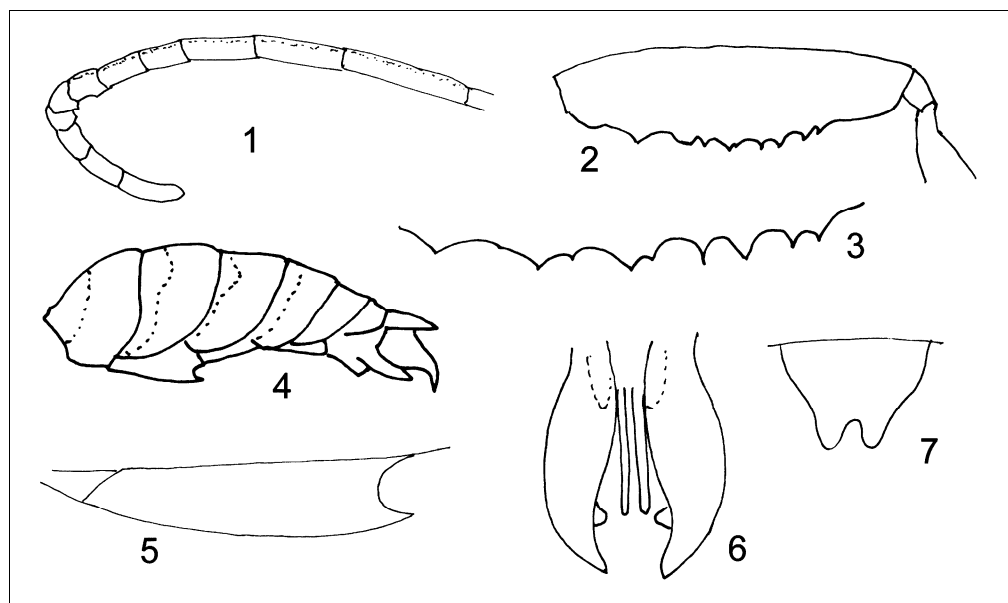

Figures 1–7. *Bembix hauseri* Schmid-Egger nov. spec., male. 1: Antenna; 2: Fore femur; 3: Teeth on fore femur; 4: Abdomen; 5: Sternum II; 6: Genitalia; 7: Tergum VII.

desert, 10 km S of Mezairaa, 23,05°N 53,77°E, 10.i. 2011, leg. CSE. 13♀, Liwa desert, 12 km S of Arada, 22,86°N 53,39°E, 10.i. 2011, leg. CSE. 9♀, Liwa desert, 8 km S Arada, 22,92°N 53,41°E, 10.i. 2011, leg. CSE. 15♀, Liwa Oasis, 4 km SE of Sabkha, 23,10°N 54,00°E, 10.i.2011, leg. CSE. 3♂, 8♀, Liwa Oasis, 5 km E Mezairaa, 23,12°N 53,84°E, 10.i. 2011 leg. CSE. 2♂, Liwa Oasis, Al Hama'im, 22,96°N 54,28°E, 10.i. 2011 leg. CSE. OMAN: 2♂, 2♀, 'J. Huwarrah, 24.iii.2000' (leg. M. Gillett, coll. OLL, location not identifiable, probably Jebel Wahrah, 23°12'N 56°44'E). 3♀, 25.iii.1995, 250 km S of Nizwa, 100 km SE of Ghaba Hotel (leg. Wittmann, CSE). A male from Sharjah Desert Park (19.iii.2009, leg. CSE) is chosen as holotype and deposited in the Museum für Naturkunde, Berlin/Germany, the other specimens are paratypes.

Discussion: Guichard (1989b) mentions that *dahlbomi* from eastern Arabia differs in colour (more grey) and in colour pattern (mesonotum black, terga with basal bands) from African *dahlbomi*. This colour form agrees with the colour pattern of *hauseri*. I could not examine true *dahlbomi* from the Arabian Peninsula and it is possible that Guichard (1989b) did not recognize *hauseri* and described it as 'dark' *dahlbomi*.

Diagnosis: The male of *hauseri* is characterized by a row of teeth on the fore femora. Among the *Bembix* species from the Palearctic region, it shares this special character only with *dahlbomi* from North Africa and Arabia and *admirabilis* Radoszkowski, 1893, from Central Asia. *Bembix admirabilis* was not examined, but the detailed redescription by Handlirsch (1893: 802) was compared and that species can be excluded. *Bembix hauseri* can be distinguished easily from both by a black meso- and metathorax. Mesonotum and propodeum are markedly yellow in other species, mesonotum with U-shaped spot in *dahlbomi* and four longitudinal stripes in *admirabilis*.

Tergum VII is laterally and apically deeply emarginated in *hauseri*, the emargination is rounded, whereas tergum VII is laterally triangular emarginated in *dahlbomi* and the apical



Plates 20–21. *Bembix hauseri* Schmid-Egger nov. spec. 20: Male, lateral view, L = 16 mm; 21: Female lateral view, L = 16 mm.



Plate 22. *Bembix hauseri* Schmid-Egger nov. spec., male, dorsal view, L = 16 mm.

emargination is lacking. *Bembix admirabilis* also has lateral rounded emarginations of tergum VII, with inner corners and a window-like patch. In the key of Guichard (1989b), the male of *hauseri* keys out to couplet 11 (*dahlbomi*) and can be recognized with this diagnosis.

The females key out to couplet 10. They can be distinguished from the remaining species by their colour pattern. The thorax is black except for the pronotum and pronotal lobes, labrum, clypeus and underside of scape are pale yellow (clypeus with two medial spots), terga have large, continuous bands, main colour is whitish-yellow with some olive. For other characters, see description.

Description of male: Body length 18 mm. Colour: Black, light yellow are labrum, mandible (with apical third dark red), clypeus, large band on inner eye margin, reaching ocellar region, connected basally, narrow horizontal band near front ocellus, narrow band along outer eye margin, scape (with black spot apico-dorsally). Flagellomeres black above, light brownish below. Pronotum with narrow apical band, laterally together with pronotal tubercles completely yellow. Mesonotum laterally with small band near tegula. Praecostal plate transparent with median yellow spot, tegula yellow with median black spot. Costal vein of forewing yellow, remaining venation dark with some reddish parts. Terga I–VI with large, pale olive-yellow bands, sterna II–V with small, lateral spots. Legs light yellow, with femora black above and partly black below, and tibiae with apico-dorsal black spot. Frons and thorax covered with long and dense silver pilosity, longest setae as long as flagellomere I. Morphology: Antennae as in Figure 1. Fore basitarsus with 6 thick and long spatulate spines, and each with a small short spine in between. Remaining legs without particularities. Sternum

II with keel, its tip markedly overhanging (Fig. 5), sternum VI with sharp keel. Sternum VII as in Figure 7. Genitalia as in Figure 6.

Description of female: Body length 16–17 mm. Colour, colour pattern and pubescence similar to male. Tergum VI and sternum V–VI black. Morphology: Fore basitarsus with 7 spatulate spines (basal spine shorter than remaining), and some smaller spines in between. Tergum VI in basal half densely and finely punctate, in apical half with large punctures, interspaces as large as punctures, shiny. Sternum II laterally with fine and dense punctures, medially with large punctures, interspaces partly larger than punctures, medially punctureless. Interspaces shiny. Remaining sterna finely and densely punctate, shiny. Tergum I basally with long, terga II–V with very short, but dense silver pubescence. Lateral pubescence of tergum IV–V partly black.

Distribution: The species is known from the desert zone in UAE, and from some places in northern Oman. During the trip in January 2011 it was the second most collected species next to *B. freydessneri*. Especially in the Liwa desert *Bembix hauseri* was common everywhere.

Ecology: The specimens from northern UAE (Mahafiz and Sharjah Desert Park) were found in two small farms. They were flying around near small flowering shrubs. The specimens from Liwa desert were collected in the Oasis or in the desert near *Zygophyllum* shrubs.

Derivatio nominis: The species is dedicated to Martin Hauser from Sacramento/California, a friend and specialist of Diptera. He found the first specimens of *Bembix hauseri*.

Bembix kohli Morice, 1897

Plates 23–25

Specimens examined: Mahafiz, Sharjah Desert Park, 3♂, 19.iii.2009, leg. CSE.

Distribution: Egypt, Iran/Baluchistan, UAE (Guichard, 1989b).

Bembix nilotica Priesner, 1958

Plates 26–29

Specimens examined: Al-Ajban, 6♀, 24.iv–22.v.2006, leg. AvH. Mahafiz, 1♂, 19.iii.2009, leg. CSE.

Distribution: Egypt, Israel, Arabia, UAE (Guichard, 1989b).

Bembix nigrispina Guichard, 1989

Distribution: UAE, Iran/Baluchistan (Guichard, 1989b).

Bembix oculata Latreille, 1805

Plates 30–33

Specimens examined: Wadi Shawkah, 1♂, 14.iii.2008, leg. MH. Wadi al-Helo/near tunnel, Wadi Wurayah, 3♂, 1♀, 19.iii.2009, leg. CSE.

Distribution: Europe, North Africa, western Asia, UAE (Guichard, 1989b).

Bembix priesneri de Beaumont, 1954

Plates 34–35

Specimens examined: Sharjah/Tawi as-Saman Oasis, 1♀, 16.iii.2007, leg. J. Batelka. Mahafiz, N of Ajman, 4♀, 19.iii.2009, leg. CSE.

Distribution: North Africa, Arabia, UAE (Guichard, 1989b).

Bembix radoszkowskyi Handlirsch, 1893

Distribution: North Africa, Israel, UAE (Guichard, 1989b).

Bembix rochei Guichard, 1989

Plates 36–37

Specimens examined: Jebel Hafit/S of al-Ain, 1♀, leg. M. Gillett.

Distribution: North Africa, UAE (Guichard, 1989b).



Plates 23–24. *Bembix kohli* Morice. 23: Dark male, lateral view, L = 15 mm. 24: Lighter male, lateral view, L = 15 mm.



Plates 25. *Bembix kohli* Morice, male, dorsal view, L = 15 mm.

Bembix rufiventris Priesner, 1958

Plates 38–40

Specimens examined: 55 specimens: Jebel Hafit/S of al-Ain, Wadi al-Helo/near tunnel, Wadi Hayl, Wadi Madha, Wadi Wurayah. Flight period: March.

Distribution: Egypt, Israel, Jordan, Saudi Arabia, Oman, UAE (Guichard, 1989b).

Bembix saadensis Guichard, 1989

Distribution: UAE (Guichard, 1989b).

Bembix tranquebarica Gmelin, 1790

Distribution: Baluchistan, India, UAE, Oman (Guichard, 1989b).

Genus ***Cerceris*** Latreille, 1802

Identification: Guichard, 1993; Schmidt, 2000; species from Arabia are partly included.

Cerceris alboatra Walker, 1871

Distribution: Egypt, Israel, Saudi Arabia, UAE (Guichard, 1993).

Cerceris albicincta Klug, 1845

Plate 41

Specimens examined: 21 specimens. Qurraya, Khor Fakkan, Dubai/al-Awir, Dubai/Nakhalai, Wadi Bih. Flight period April–May.

Distribution: North Africa, Israel, Arabian Peninsula including UAE; one of the commonest species in Arabia (Guichard, 1993).



Plates 26–27. *Bembix nilotica* Priesner. 26: Male, lateral view, L = 15 mm; 27: Female, lateral view, L = 15 mm.



Plates 28–29. *Bembix nilotica* Priesner. 28: Male, dorsal view, L = 15 mm; 29: Female, dorsal view, L = 15 mm.



Plates 30–31. *Bembix oculata* Latreille. 30: Male, lateral view, L = 16 mm; 31: Female, lateral view, L = 16 mm.



Plates 32–33. *Bembix oculata* Latreille. 32: Male, dorsal view, L = 16 mm; 33: Female, dorsal view, L = 16 mm.



Plates 34–35. *Bembix priesneri* de Beaumont, female, L = 14.5 mm. 24: Lateral view; 35: Dorsal view.



Plates 36–37. *Bembix rochei* Guichard, female, L = 16 mm. 36: Lateral view; 37: Dorsal view.



Plates 38–39. *Bembix rufiventris* Priesner. 38: Male, lateral view, L = 17 mm; 39: Female, lateral view, L = 17 mm.

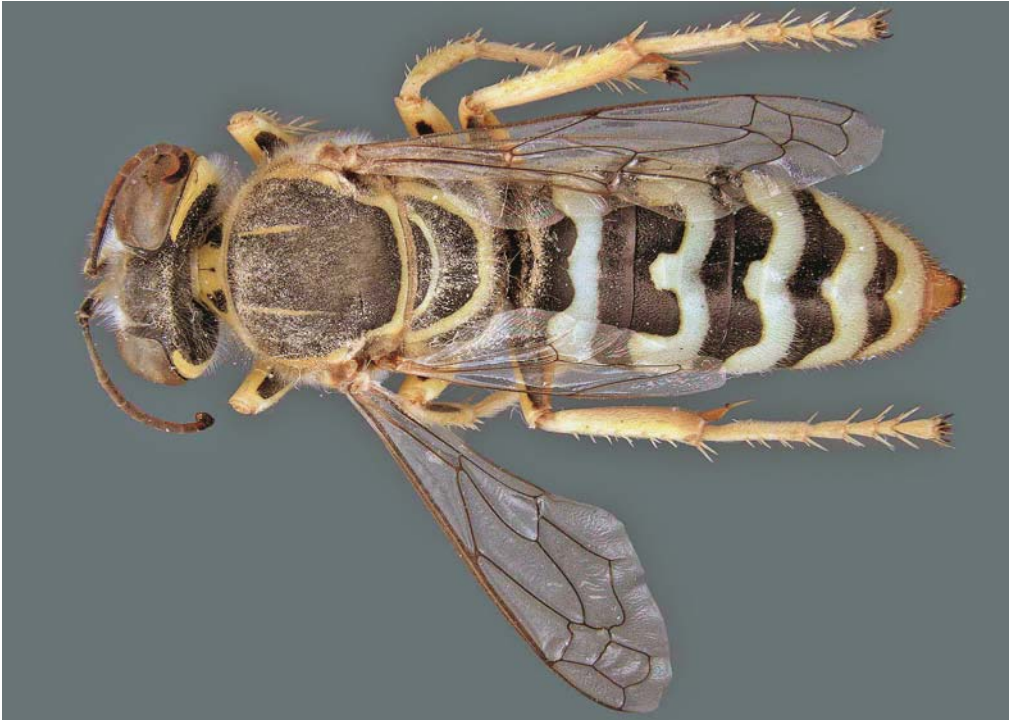

Plate 40. *Bembix rufiventris* Priesner, female, dorsal view, L = 17 mm.

Cerceris chromatica Schletterer, 1887

Distribution: North Africa, Israel, Saudi Arabia, UAE (Guichard, 1993).

Cerceris difficilis Guichard, 1993

Distribution: UAE (Guichard, 1993).

Cerceris hathor Pulawski, 1983

(= *eugenia* Schletterer, 1887, in Guichard, 1993)

Distribution: North Africa, Israel, Saudi Arabia, UAE (Guichard, 1993).

Cerceris fitzgeraldi Empey, 1973

Specimens examined: 33 specimens. Dubai/al-Awir, Dubai/Nakhalai, al-Ajban. Flight period: April–May.

Distribution: UAE, Oman (Guichard, 1990).

Plates 42–43

Cerceris hausa Arnold, 1931

Specimens examined: Um al-Quwain, 1♀, 18.iii.2008, leg. MH.

Distribution: Nigeria, Saudi Arabia (Guichard, 1993). New to the UAE.

Plate 44

Cerceris hameri Guichard, 1993

Distribution: UAE, only known from two females (Guichard, 1993).



Plate 41. *Cerceris albicincta* Klug, male, lateral view, L = 7.5 mm.

Cerceris nugax Arnold, 1931

Specimens examined: 10 km E of Ra's al-Khaimah Airport, 1♂, 17.iii.2009, leg. O. Berg.

Distribution: Nigeria, Mali, Saudi Arabia, UAE (Guichard, 1993).

Cerceris rufocincta Gerstäcker, 1858

Plate 45

Specimens examined: Wadi Hayl, 1♂, 15.iii.2008, leg. MH.

Distribution: Tropical Africa, Saudi Arabia (Guichard, 1990). New to the UAE.

Cerceris straminea Dufour, 1854

Plate 46

Specimens examined: Um al-Quwain, 1♀, 18.iii.2008, leg. MH. Wadi Bih, 1♂, 17.iii.2009, leg. O. Berg.

Distribution: North Africa to Baluchistan, Saudi Arabia, Oman, UAE (Guichard, 1990).

Cerceris tricolorata Spinola, 1838

Plate 47

Specimens examined: Dubai/al-Awir, 1♂, v.1984, leg. ES. Wadi Wurayah, 2♂, 20.iii.2009, leg. O. Berg.

Distribution: North Africa, Israel, Saudi Arabia, UAE (Guichard, 1993).

Cerceris vagans Radoszkowski, 1877

(= *turkestanica* Radoszkowski, 1893, in Guichard, 1993)

Distribution: Eastern Mediterranean, Central Asia, Iran, UAE



Plates 42–43. *Cerceris fitzgeraldi* Empey. 42: Male, lateral view, L = 11 mm; 44: Female, lateral view, L = 10 mm.



Plates 44–45. 44: *Cerceris hausa* Arnold, female, lateral view, L = 9.0 mm; 45: *Cerceris rufocincta* Gerstäcker, male, lateral view, L = 8.0 mm.



Plates 46–47. 46: *Cerceris straminea* Dufour, female, lateral view, L = 15 mm; 47: *Cerceris tricolorata* Spinola, male, lateral view, L = 9.0 mm.

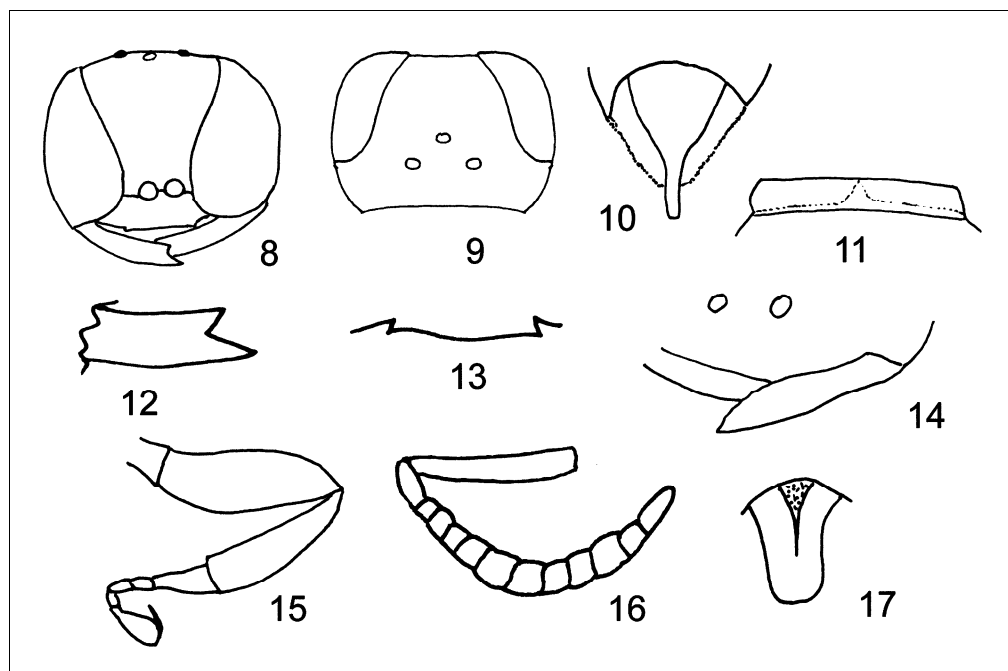

Figures 8–17. *Crossocerus antropovi* Schmid-Egger nov. spec. 8–13: Female. 8: Head frontal; 9: Head dorsal; 10: Tergum VI, pygidium; 11: Pronotum; 12: Mandible, 13: Clypeus lower margin; 14–18: Male. 14: Mandible; 15: Foreleg; 16: Antenna; 17: Tergum VII, pygidium.

***Cerceris vagula* Kohl, 1906**

Distribution: Yemen, Saudi Arabia, Oman, UAE (Guichard, 1993).

***Cerceris vittata eurypyga* Kohl, 1898**

Distribution: North Africa, Saudi Arabia, UAE (Guichard, 1993).

Genus ***Crossocerus*** Lepeletier & Brullé, 1835

***Crossocerus antropovi* Schmid-Egger nov. spec.**

Plate 48, Figures 8–17

Specimens examined: ♀ (holotype), 1♂, United Arab Emirates, Jebel Hafit, 24°04'N 55°45'E, 19.iii.2009, leg. C. Schmid-Egger (coll. CSE). The male is not designated as paratype, because its identity is not absolutely clear.

Discussion: The female of *Crossocerus antropovi* nov. spec. is not identifiable with the keys to the Mediterranean species or related areas. It keys out near *Crossocerus bulawayoensis* (Arnold, 1932), *C. minutulus* (Arnold, 1944) or *C. parcorum* Leclercq, 1958 (subgenus *Coelocrabro* Thomson, 1874) with the key to the African species (Leclercq, 1958), but differs in details. All mentioned species were described from southern and central Africa and Madagascar. Therefore, I describe the present species as new to science.

The male, collected together with the female, is more problematic. In the key to the African *Crossocerus* it keys out to *bulawayoensis*, but does not agree with the description. It was also compared with the key of Leclercq (1989) to *Lindenius* Lepeletier & Brullé, 1834, because of

its unidentate mandible. The latter is a generic character of *Lindenius*. It keys out to Nr. 28 (p. 431) in a group of species that cannot be identified without females.

It differs from the female by the following characters: Mandible apically truncate (mandible bidentate in female) and pronotum dark and larger (pronotum yellow and shorter in female). Otherwise it agrees with it in general aspects like punctuation, structure of propodeum, general form of mandible and antenna, and by the short and thick setae on head. Both male and female also have a prolonged and a reddish last tergum.

I describe the male here as the male of *antropovi* nov. spec., with the restriction that most *Crossocerus* must have a bi- or tridentate mandible, but will not designate it as a paratype.

Diagnosis: The female of *antropovi* nov. spec. is characterized by a special form of pygidial plate; markedly narrowed apically with a long apical stalk (Fig. 10), and by its colour pattern (see description). Mandible is bidentate apically, propodeal dorsum is very short, finely striate and without lateral or apical limitation. Male mandible is prolonged, slightly curved and apically truncate. Fore tarsus is shorter than fore tibia, propodeal dorsum is similar to female, and colour also characteristic (see description). Tergum VII is longer than wide, bulged, reddish and with median keel. Both sexes are very small with maximum 4.0 mm body length.

Description of female: Body length 4.0 mm. Colour. Black with the following parts pale yellow: mandible except dark reddish apical margin, scape, pedicel, flagellum below (brown below), pronotum, humeral tubercle, apical half of fore femora, apex of mid- and hind femora, tibiae, tarsi (last tarsomeres brownish). Tegula transparent with two yellow basal spots. Basal sclerite of forewing yellow with small median brown spot. Wings transparent, wing venation light brown. Stalk of pygidial area reddish. Morphology. Head, mandible, clypeus and pronotum as in Figures 8–13. Space between eye and hind ocellus without impression. Head, mesonotum, scutellum and postmetanotum shiny, with very fine and scattered punctures, punctures of head 2–4 diameters apart, much denser on apical part of mesonotum. Clypeus and along inner eye margin with silver appressed pubescence. Head above covered with erect setae, somewhat shorter than midocellar diameter. Pedicel $1.5 \times$ as long as wide, flagellomeres shorter than wide, last flagellomere $2 \times$ as long as wide. Mesonotum apically with short longitudinal striae. Scutellum along basal margin with narrow furrow, divided by small carinae. Mesopleuron with barely visible striation and some scattered punctures in lower half, without point in lower half. Horizontal part of propodeum short, as long as pronotum, with fine longitudinal striation and some larger striae, remaining propodeum with microsculpture. Terga shiny, with very sparse and small punctures, punctures of tergum V denser than on previous terga. Pygidial area with large punctures, 1–2 diameters apart, with long stalk. Terga laterally and sterna with long erect pale setae, as long or longer than midocellar diameter. Hind femora with about 9 erect spines, as long as midocellar diameter.

Description of male: 3.5 mm. Similar to female, except for the following: Colour. Pronotum dark, fore femora yellow with small basal spot on upper side, basal sclerite with large brown median spot, Tergum VII reddish with dark base. Morphology. Mandible apically pointed, point truncate, tergum VII roof-like, with median keel, longer than wide (Fig. 17).

Distribution and habitat: The species was found at the foot of Jebel Hafit, an isolated mountain in the eastern part of the UAE desert. The habitat was a stony area with a few scattered flowering plants of various species. The *Crossocerus* specimens were found on flowering *Ochradenus aucheri* (Resedaceae).

Derivatis nominis: The species is named in honour of Alexander Antropov from Moscow, Russia, a specialist of Crabronidae.



Plates 48–49. 48: *Crossocerus antropovi* Schmid-Egger nov. spec., female, dorsolateral view, L = 4.0 mm; 49: *Crossocerus emirorum* Leclercq, female, lateral view, L = 5.0 mm.



Plate 50. *Dasyproctus arabs* Kohl, female, lateral view, L = 9.0 mm.

***Crossocerus emiorum* Leclercq, 1998**

Plate 49

Specimens examined: 19 specimens. Sharjah Desert Park, Wadi Hayl, Wadi Madaq, Wadi Shawkah, Wadi Wurayah. Flight period: October–March.

Recognition: The species is easy to recognize on account of an elongate abdominal segment I (tergum I $4\times$ as long as apical width), a shiny body surface, and colour pattern: Clypeus, scape, pronotum, pronotal lobe, scutellum and metanotum, fore and mid legs are pale yellow. Female tergum VI is triangular, shiny, with some large punctures. With this combination of characters *emiorum* is unique among *Crossocerus* species from the Palaearctic region.

Distribution: UAE (Leclercq, 1998, described from Wadi Bih).

Genus *Dasyproctus* Lepelletier & Brullé, 1835

Identification: Leclercq, 1990.

***Dasyproctus arabs* Kohl, 1894**

Plate 50

Specimens examined: 31 specimens. Jebel Hafit/S Al Ain, Sharjah Desert Park, Sharjah, 15 km NE of ad-Dhaid, Wadi Bih (dam), Wadi Hayl, Wadi al-Helo/near tunnel, Wadi Madaq, Wadi Shawkah, Wadi Wurayah. Flight period: January–March.

Distribution: Egypt/Sinai, Algeria, Pakistan, Syria, Israel, Ethiopia (Leclercq, 1990; Pulawski Database), Oman (Guichard, 1980). New to the UAE.

Genus *Didineis* Wesmael, 1852

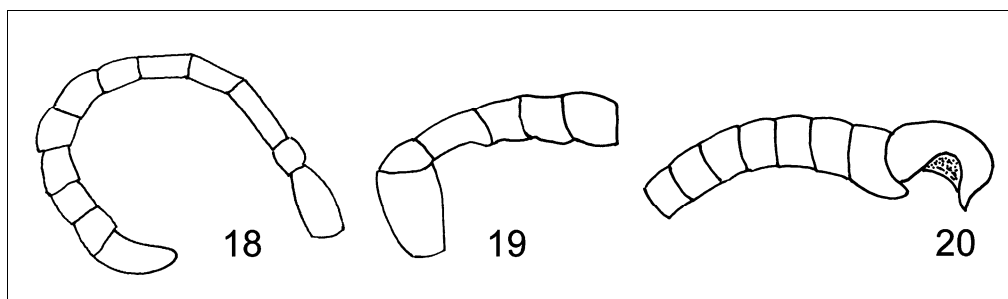

Figures 18–20: *Didineis bucharica* Gussakovskij. 18: Female antenna; 19: Male antennal base. 20: Male antennal apex.

Didineis bucharica Gussakovskij, 1937

Figures 18–20

Specimens examined: Al-Ajban, 1♀, 9.iv.2008, leg. AvH. Wadi Bih dam, 1♂, 1♀, 19.i–11.ii.2010, leg. AvH.

Discussion: The male keys out to *bucharica* in the key of Gussakovskij (1937) and agrees with the figures and description by the author. *Didineis barbieri* de Beaumont, 1968, from North Africa, and *D. latro* de Beaumont, 1967, from Turkey, can be excluded. Nevertheless, comparison with the types will be necessary for the final confirmation of the identification. The female is hitherto unknown to science. Both sexes will be described below:

Diagnosis: The male is characterized by short and thick flagellomeres, flagellomere I is emarginated below. Clypeus and inner eye margin are yellow. The emarginated flagellomere I is unique among the examined *Didineis* species. The female has also short and thick flagellomeres and shares this character with *D. crassicornis* Handlirsch, 1888, and *D. barbieri* de Beaumont 1968.

Description of male: Body length 6 mm. Colour: Black, yellow are: Basal 2/3 of mandible, clypeus, large band on inner eye margin, ending in upper 2/3, scape and flagellum below, flagellomere XI, humeral tubercle, basal spot on basal sclerite of forewing. Femora and tibiae reddish, tarsi partly reddish, mostly brown. Wing venation brown, wing surface greyish with some darker parts below pterostigma. Tergum I except base and tergum II laterally red, remaining terga black, last tergum apically somewhat reddish. Morphology: Apical clypeal margin slightly emarginate medially. Flagellum as in Figures 19 and 20. Frons, pronotum, mesonotum and upper half of mesopleuron finely punctate, 1–3 diameters apart, interspaces shiny. Punctuation of lower frons very dense. Lower mesopleuron rugulose punctate. Propodeal surface evenly striate, propodeal dorsum forming a triangular area, surrounded by fine keel. Propodeum laterally and on backside rugulose. Surface of terga II–VI divided: Basally shiny and punctureless, with fine microsculpture, apically punctate with shiny interspaces. Tergite VII densely punctate, apically truncate.

Description of female: Body length 8.0 mm. Colour. Black, yellow are basal 2/3 of mandible, clypeus except for basal and lateral margin, narrow band on lower half of inner eye margin, scape below, last tarsomeres. Red are fore tibia, outer side of midrib, terga and sterna I and II, tergum II with black apical margin, apex of tergum VI. Wings as in male. Morphology. Flagellum as in Figure 18. Punctuation of head and thorax similar to male, but in general much denser. Terga I and II shiny, without punctures, terga III–V similar as in males. Tergum VI in apical half surrounded by keel, forming a large pygidial area with dense punctuation in

apical half and with dense reddish setae. All femora below with long pale setae (2/3 as long as femoral diameter).

Distribution: Only known by the male holotype from Uzbekistan (Kashka Darya District, Guzar). New to the UAE and the Arabian Peninsula.

Genus *Dinetus* Panzer, 1806

Identification: Guichard, 1980 (key to species of *cereolus*-group, with *D. nabateus*); de Beaumont, 1960 (revision of species from the Mediterranean area).

Dinetus nabateus de Beaumont, 1960

Plates 51–52

Specimens examined: Dubai/Nakhalai, 2♀, 21.iv.1984, leg. ES. Um al-Quwain, 4♂, 19.iii.2009, leg. CSE.

Distribution: Egypt/Sinai, Oman (Guichard, 1980), Jordan (Guichard, 1991b), Israel (Schmid-Egger, unpubl.). New to the UAE.

Genus *Entomognathus* Dahlbom, 1844

Identification: Leclercq, 1997.

Entomognathus stevensoni Arnold, 1926

Plate 53

Specimens examined: N of Ajman, 1♂, 16.ix–12.x.2006, leg. AvH. Wadi Maidaq, 1♂, 14–25.i.2006, leg. AvH.

Discussion: The species is easy to recognize by the 4 rounded latero–apical indentations on mesonotum (“notali”; “sillon parapsidal” in Leclercq, 1997). The notauli are lacking in the male from Ajman and are replaced by a short carina. With the key of Leclercq (1997), the species keys out to *E. nanus* (Cameron, 1890) from India and Sri Lanka. However, it does not agree with the description of *nanus*, especially the colour pattern, and fits much better the original description of *stevensoni*.

Distribution: Botswana, Burkina Faso, Gabon, Gambia, Mali, Namibia, Nigeria, Senegal, South Africa, Togo, Zaire, and Zimbabwe (Leclercq, 1997). New to the UAE and the Arabian Peninsula.

Genus *Eremiasphecium* Kohl, 1897

Identification: Marshakow, 1976 (revision of Central Asian species); Pulawski, 1992 (review of species); Simon Thomas, 1994 (description of new species).

Key to the species of *Eremiasphecium* from the Arabian Peninsula

(Venation of fore wing is difficult to examine, because veins are extremely pale and barely contrasting with the wing itself in some specimens)

- 1 Fore wing with 2 submarginal cells (Fig. 22). (Whole insect pale yellow, or parts of propodeum and some spots on terga black. Flagellomeres longer than wide. Female: Process of fore metatarsus long, half as long as fore tarsus II (Fig. 23). Male: Flagellomere VI double as long as neighbouring flagellomeres, markedly emarginated, flagellum black in apical half) *Eremiasphecium harteni* Simon Thomas
- Fore wing with 3 submarginal cells (Fig. 21) **2**
- 2 Flagellomeres 1–6 shorter than wide. Female: Process of fore metatarsus short, approximately as long as diameter of fore basitarsus. (Colour variable, from wholly black to wholly pale yellow. Submarginal cell II petiolate, see Figure 21) *Eremiasphecium arabicum* Pulawski

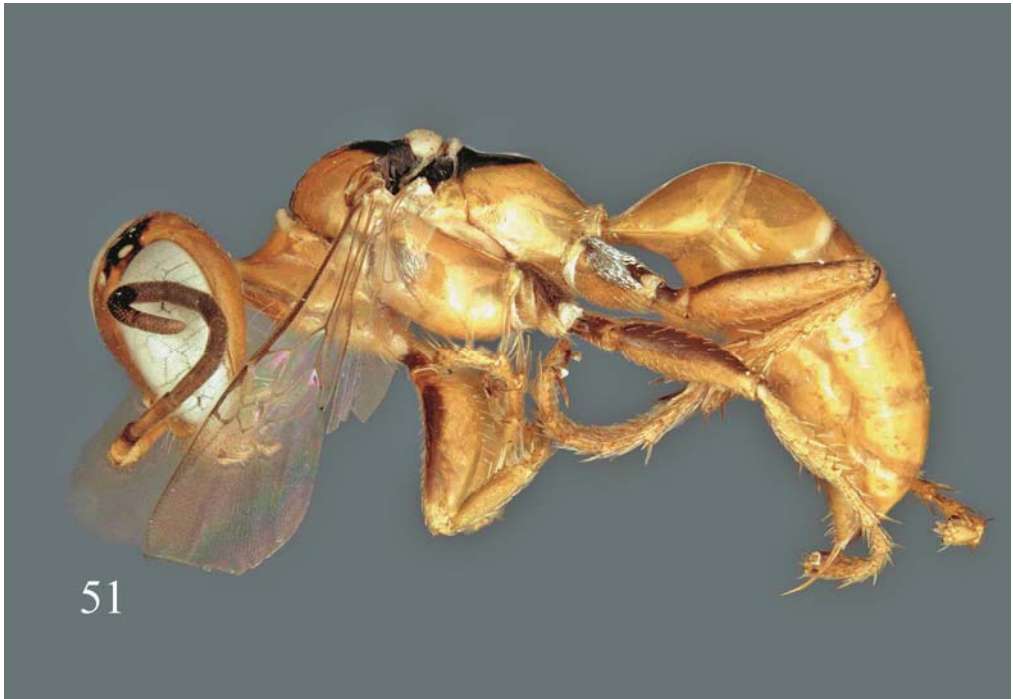

Plates 51–52. *Dinetus nabateus* de Beaumont, male, L = 4.8 mm. 51: Lateral view; 52: Dorsal view.



Plate 53. *Entomognathus stevensoni* Arnold, male, lateral view, L = 4.0 mm.

- Flagellomeres 1–6 longer than wide. Female: Process of fore metatarsus long, approximately 1.5–2 × as long as diameter of fore basitarsus (cf. Fig. 23) **3**
- 3** Insect completely pale. Submarginal cell II not or very short petiolate. POL smaller than OOL. Surface of head and mesosoma shiny *Eremiasphecium schmiedeknechti* Kohl
- Insect predominantly black. Submarginal cell II markedly petiolate (cf. Fig. 21). POL larger than OOL. Surface of head and mesosoma microsculptured. Male unknown
..... *Eremiasphecium pulawskii* Schmid-Egger nov. spec.

Eremiasphecium arabicum Pulawski, 1992

Plates 54–68, Figure 21

Specimens examined: Dubai/Nakhalai, 1♂, 21.iv.1984, leg. ES. Forma A, 1♀, al-Ajban, vi.2006, without head, leg. AvH. Forma B, 1♀, Um al-Quwain, 19.iii.2009, leg. CSE. Forma C, 1♀, Wadi Shawkah, 27.xi.2006, leg. AvH. Forma D, 1♀, N of Ajman, 30.vi.2008, leg. AvH. Wadi Shawkah, 2♀, March & December, leg. AvH.

Discussion: The species was only known from the female holotype, described from Saudi Arabia (El Rijadh, vi.1959). Four females from the UAE agree with the description of *arabicum* in morphology (see diagnosis), but each specimen differs markedly in colour. Two are similar in colour as described by Pulawski (1992), wholly black with mandibles, antenna, legs, tegulae pale yellow; one specimen has head and thorax black and gaster pale yellow; another specimen is wholly pale yellow without any black. Because of the similar



Plates 54–55. *Eremiasphecium arabicum* Pulawski, male, L = 2.0 mm. 54: Dorsal view; 55: Dorsal view of head.



Plates 56–57. *Eremiaspecium arabicum* Pulawski, female. 56: Forma B, dorsal view, L = 2.0 mm; 57: Forma C, dorsal view, L = 2.0 mm.



Plates 58. *Eremiasphecium arabicum* Pulawski, female, Forma D, dorsal view, L = 2.0 mm.

morphology, I treat them as conspecific. A male with similar morphology is most probably the hitherto unknown male of *arabicum*. It is wholly black, with the lower face white-yellowish.

Diagnosis: *Eremiasphecium arabicum* is characterized by a rounded head, seen in frontal view (in the other species it is wider than long), by short flagellomeres (flagellomeres I–V shorter than wide), in females by a short process of fore basitarsus and by the wing venation: 3 submarginal cells and 2 discoidal cells, submarginal cell II petiolated. For colour pattern, see description below.

Most other species of *Eremiasphecium* are completely pale yellow. Another black species is *E. budrysi* (Kazenas, 1991) from Kazakhstan, only known from the female holotype. Submarginal cells are similar to *arabicum*, but *budrysi* lacks recurrent vein II, so discoidal cell II is open. I have also examined an undescribed black species from southern Morocco with similar wing venation to *arabicum*. The female can be distinguished from *arabicum* by the form of the clypeus. Its apical clypeal margin has three teeth, lateral teeth are large and rounded, medial tooth is much smaller than lateral teeth, whereas apical clypeal margin of *arabicum* has many small irregular teeth. The male from Morocco has a black face but it is bicoloured in *arabicum*. Stigma of fore wing is pale in both sexes of the species from Morocco and dark brown in *arabicum*. Another predominantly black species is *pulawskii* nov. spec., described below.

Colour variation of *arabicum* females:

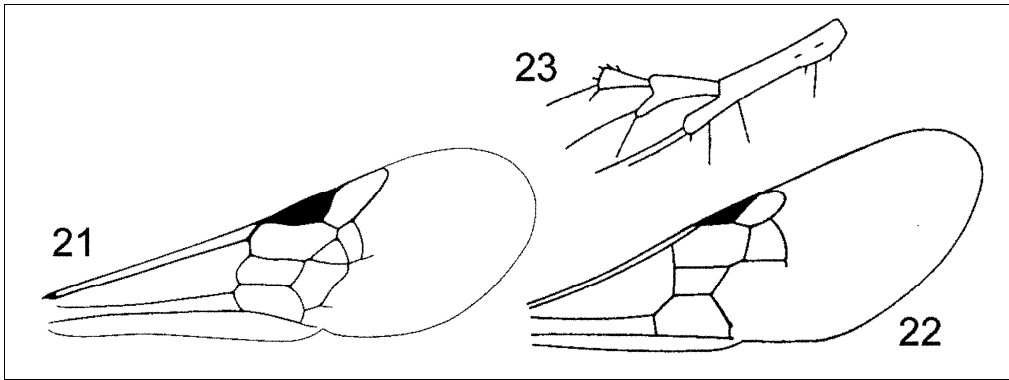

Figures 21–23. 21: *Eremiasphecium arabicum* Pulawski, female, fore wing (Figure from Pulawski, 1992); 22–23. *Eremiasphecium harteni* (Simon Thomas), female. 22: Fore wing; 23: Distal part of fore leg. (Figures 22 and 23 from Simon Thomas, 1994).

- **Forma A** (holotype from Saudi Arabia, sensu Pulawski, 1992). Black, with the following parts pale yellow: Clypeal lateral section, mandible, tegulae, humeral plate, (antenna brown dorsally), pale yellow ventrally, (scape largely dark brown), wing venation pale yellow basally, femora black and pale yellow apically, tibiae and tarsi pale yellow. A female from al-Ajban agrees with forma A, but lacks head.
- **Forma B**. Agrees with forma A, but all legs including femora are pale yellow.
- **Forma C**. Head and mesosoma are black, pale yellow are: Mandible except red tip, antenna including scape, tegulae, humeral tubercle, wing venation including pterostigma, legs including coxa and trochanter. Abdomen pale yellow with some darker marks on terga II–V baso-medially.
- **Forma D**. Whole specimen is pale ochre yellow, tip of mandible is dark red.

Description of *arabicum* male: Body length 2.0 mm. Colour. Black, pale ivory white are: Mandible (with tip reddish), lower half of face including clypeus (black colour begins above a horizontal line, crossing upper third of inner eye margin), scape, flagellum below, (dark above). tegula, humeral plate and basal parts of wing venation (pterostigma light brownish), legs (coxae and hind femora partly dark). Morphology. Body shiny, with a few scattered punctures. Propodeal dorsum uniformly microareolate. Venation of fore wing as in female (Fig. 2 in Pulawski, 1992). Flagellomeres I–V shorter than apical width, flagellomeres VI–VII as long as apical width, remaining flagellomeres longer than apical width, last flagellomere $2\times$ as long as apical width. Fore basitarsus with 4 long spines, apical spine as long as second tarsomere.

Distribution. Saudi Arabia (Pulawski, 1992). New to the UAE.

***Eremiasphecium harteni* Simon Thomas, 1994**

Plates 59–62, Figures 22–23

Specimens examined: 29 specimens. N of Ajman, Wadi Madaq. Flight period: July–November.

Discussion: *Eremiasphecium harteni* was described by a single female from Yemen and placed into the genus *Xanthosphecium* Simon Thomas, 1994, together with *X. sahelensis* Simon Thomas, 1994, from Senegal (Simon Thomas, 1994). The author later synonymised



Plates 59–60. *Eremiasphecium harteni* (Simon Thomas), male, L = 3.0 mm. 59: Ventral view; 60: Dorsal view.



Plates 61–62. *Eremiaspecium harteni* (Simon Thomas), females, dorsal view, showing variability, L = 3.0 and 3.8 mm.



Plate 63. *Eremiasphecium pulawskii* Schmid-Egger nov. spec., female, dorsolateral view, L = 3.5 mm.

the genus with *Eremiasphecium* (Simon Thomas, 1996). His erection of *Xanthosphecium* was based on the presence of only 2 submarginal cells (3 in *Eremiasphecium*). I could not examine the type, but the specimens from the UAE agree in description with *harteni*, despite a large variability in black colour. The male of *harteni* is described here for the first time. *Eremiasphecium sahelensis* (Simon Thomas, 1994), described from 2 females only, differs from *harteni* mostly by colour characters. As it can be seen in the examined females of *harteni*, the species presents a wide variety in colour with yellow, ochre, and translucent. So both may be conspecific, but only a type comparison can confirm the conspecificity.

Diagnosis: *Eremiasphecium harteni* differs from the other species by 2 submarginal cells only (3 in remaining species of the genus), combined with a very small marginal cell. The male is additionally characterized by a long flagellomere VII, what is markedly emarginated below (similar to some males of *Ectemnius* Dahlbom, 1845). In the male of *schmiedeknechti* Kohl, 1897, flagellomere VII is also emarginated, but less deep when compared with *harteni*. The species is completely yellow with propodeum partly black. Flagellomeres VI–X are dark in most females. Colour variation and additional description of female: Body length 3.8–4.0 mm. Females are ochre yellow with some variation in colour. Dark are parts of propodeal dorsum and terga, but also some longitudinal lines on mesonotum. Colour differs markedly in examined females, from mostly pale yellow to predominantly ochre yellow or brownish.

Description of male: Body length 2.8–4.0 mm. Colour. Whitish-yellow with the following parts dark brown: Apex of mandible, head behind ocelli, flagellomeres VII–XI, narrow line on lateral edge of mesonotum, propodeal dorsum. Colour of mesosoma variable, some specimens completely pale yellow without black, but most males with propodeal dorsum

black. Base of terga II–V with narrow reddish band or pale yellow. Wing venation pale, barely visible. Pterostigma in most specimens dark brownish, but may also be pale. Morphology. Apical clypeal margin medially with 3 very small, rounded teeth. Flagellomeres I–VI somewhat longer than wide; flagellomere VII $2.5\text{--}3.0\times$ as long as wide, with deep emargination below in whole length, deeper than half diameter of flagellomere; flagellomere VIII $1.5\times$ as long as wide, flagellomeres IX–XI $2.0\times$ as long as wide. Mesosoma. Surface of body shiny, without punctures, propodeal dorsum with dense punctures ('microareolate'), propodeal sides with 7–8 diagonal striae. Last terga, tibiae and tarsi with long, silver setae. Fore tarsi with long spines (apical spines longer than next tarsal segment), without process. Distribution. Yemen (Simon Thomas, 1994). New to the UAE.

***Eremiasphecium pulawskii* Schmid-Egger nov. spec.**

Plate 63

Specimens examined: Holotype ♀, United Arab Emirates, Um al-Quwain, $25^{\circ}32'N$ $55^{\circ}32'E$, 19.iii.2009, leg. CSE (coll. CSE). Paratype ♀, 15.vi.2006, Um al-Quwain, leg. AvH (coll. CSE).

Diagnosis: *Eremiasphecium pulawskii* is a predominantly black species with 3 submarginal cells and 2 discoidal cells, and submarginal cell II petiolate (cf. Fig 21). Therefore, it resembles the black forms of *arabicum*, but differs by a wider head, a wide emargination on apical clypeal margin, longer flagellomeres, a larger POL (POL larger than OOL in *pulawskii*, and POL smaller than OOL in *arabicum*) and by a larger process of fore basitarsus (cf. Fig. 23).

Description of female: Body length 3.5 mm. Colour. Black, whitish-yellow are: Apical third of femora, tibiae, tarsi, tegulae, humeral tubercle, wing venation (pterostigma mostly transparent), small band on scutellum apically, postmetanotum (laterally with small band only), medial band on terga I–III apically (as large as 2 ocellar diameters, not reaching tergal lateral edge). Flagellum including pedicel ochre, scape black. Mandible pale in basal half, reddish in apical half. Morphology. Head (in frontal view) $0.75\times$ as long as maximal width. Medial third of apical clypeal margin widely emarginated with small dentiform corner, remaining margin to eye straight. Antennal socket reaching clypeus. Flagellomeres I–VI slightly longer than wide, remaining flagellomeres $1.3\text{--}2.2\times$ as long as wide (becoming longer towards apex). POL slightly longer than OOL. Mesosoma. Collar short, as long as 1.5 ocellar diameters. Mesonotum basally with small median impression. Fore basitarsus with long process, reaching apical $2/3$ of fore tarsus II, fore tarsus II with short process, legs with long spinulation. Wing venation as in *arabicum*, marginal cell long, apically nearly pointed. Head and mesosoma finely microsculptured, propodeal dorsum microareolate, terga shiny.

Male unknown.

Derivatis nominis: The species is dedicated to Wojciech Pulawski, a leading specialist of sphecids from San Francisco/California, USA. He supported the author's work and revised the genus *Eremiasphecium* in 1992.

***Eremiasphecium schmiedeknechti* Kohl, 1897**

Plates 64–65

Specimens examined: N of Ajman, 2♂, 2♀, vi–vii.2008, leg. AvH.

Discussion: *Eremiasphecium schmiedeknechti* is the most widespread species of the genus. I have compared the present specimens with females from Israel. Those are dark lemon coloured, whereas the females from the UAE are more or less pale yellow. The males share an emarginated flagellomere VII with *harteni*, but it is less emarginated in *schmiedeknechti*.

Distribution: Egypt, Turkmenistan, Kazakhstan, Gran Canaria, Oman (Pulawski, 1992), Israel (2 females, Arava Valley, Hazeva, $36^{\circ}28'N$ $35^{\circ}09'E$, 3.iv.1995, coll. CSE). New to the UAE.



Plates 64–65. *Eremiasphecium schmiedeknehti* Kohl. 64: Male, dorsal view, L – 3.0 mm; 65: Female, dorsal view, L = 3.1 mm.

Genus *Gastrosericus* Spinola, 1839

Identification: Pulawski, 1995.

Gastrosericus electus Nurse, 1903

Specimens examined: 6 specimens. Al-Ajban. Flight period: July–August.

Plate 66

Distribution: West Africa, Arabia to Central Asia and India, UAE (Pulawski, 1995).

Gastrosericus eremicus Pulawski, 1995

Specimens examined: Al-Ajban, 1♀, 25.vii.2006, leg. AvH.

Distribution: West Africa, Arabia to India, UAE (Pulawski, 1995).

Gastrosericus funereus Gussakovskij, 1931

Plate 67

Specimens examined: Wadi al-Helo/near tunnel, 1♂, 7.vi.2006, leg. AvH.

Distribution: North Africa, Turkey, Arabia to Central Asia and India, UAE (Pulawski, 1995).

Gastrosericus moricei E. Saunders, 1910

Plates 68–69

Specimens examined: 235 specimens. Al-Ajban, N of Ajman, Um al-Quwain. Flight period: May–August, October.

Distribution: North and west Africa, Arabia to India, UAE (Pulawski, 1995).

Gastrosericus sabulosus Pulawski, 1995

Plate 70

Specimens examined: 43 specimens. Al-Ajban. Flight period: June–October.

Distribution: West Africa, Pakistan (Pulawski, 1995). New to the UAE and the Arabian Peninsula.

Gastrosericus sanctus Pulawski, 1973

Plate 71

Specimens examined: Wadi Shawkah, 1♂, 27.xi.2006, leg. AvH.

Discussion: The females are similar to *moricei* and not distinguishable with certainty. Among a large series of *moricei* females from the coastal areas northeast of Sharjah, are some specimens with an emarginated apical clypeal margin, which may belong to *sanctus*. Because of lack of unambiguous males from these locations, I will not treat them here.

Distribution: West and south Africa, Israel, Arabia, Iran, UAE (Pulawski, 1995).

Gastrosericus waltlii Spinola, 1839

Specimens examined: 54 specimens. Al Ajban, Al-Rafa, N of Ajman, Sharjah Desert Park, Wadi Wurayah. Flight period: January–December.

Distribution: Africa, Turkey, Arabia to India and Central Asia and Mongolia, UAE (Pulawski, 1995).

Genus *Guichardus* Antropov, 2007Identification: Guichard, 1991 (see also key for *Belomicrus* above).*Guichardus dromedarius* Guichard, 1991

Plate 72

Specimens examined: Wadi Madaq, 1♂, 29.iii–10.iv.2006, leg. AvH.

Discussion: The species was described in the genus *Belomicrus* and is included in the key of Guichard (1991). It was transferred to *Guichardus* by Antropov (2007). The examined male is the second finding of the species, the female is undescribed.

Distribution: Saudi Arabia (Guichard, 1991a). New to the UAE.



Plates 66–67. 66: *Gastrosericus electus* Nurse, male, lateral view, L = 4.5 mm; 67: *Gastrosericus funereus* Gussakovskij, male, lateral view, L = 4.5 mm.



Plates 68–69. *Gastrosericus moricei* E. Saunders. 68: Male, lateral view, L = 5.5 mm; 69: Female, lateral view, L = 7.0 mm.



Pates 70–71. 70: *Gastrosericus sabulosus* Pulawski, female, lateral view, L = 7.0 mm; 71: *Gastrosericus sanctus* Pulawski, male, dorsolateral view, L = 6.5 mm.



Plate 72. *Guichardus dromedarius* Guichard, male, lateral view, L = 2.0 mm.

Genus *Harpactus* Shuckard, 1837

Identification: The genus *Harpactus* is currently under revision by Tosko Ljubomirov.

Harpactus laevis aegyptiacus Schulz, 1904

Specimens examined: Sharjah Desert Park, 1♀, 6–28.xii.2006, leg. AvH. Wadi Maidaq, 1♂, 19.x–9.xi.2006, leg. AvH (det. T. Ljubomirov).

Distribution: North Africa, Israel, Senegal, Yemen (Ljubomirov, in litt). The records of “*Dienoplus* (= *Harpactus*) *formosus* Jurine, 1807” from Oman (Guichard, 1980) may also refer to this species.

Harpactus spec. aff. *quadrisignatus lugubris* de Beaumont, 1960

Specimens examined: Al-Ajban, 1♂, 17–24.iv.2006, Malaise trap, leg. AvH (det. T. Ljubomirov).

Discussion: The present specimen was examined by Ljubomirov and is probably *quadrisignatus lugubris* or a closely related undescribed species. The species can be distinguished from *laevis aegyptiacus* by the lack of red body colour, whereas the thorax is markedly red in *laevis aegyptiacus*. The records of “*Dienoplus* (= *Harpactus*) spec.” from Oman (Guichard, 1980) may also refer to this species.

Distribution: *Harpactus q. lugubris* was described from Libya.

Genus *Hoplisoides* Gribodo, 1884

Hoplisoides ferrugineus Spinola, 1839

Specimens examined: Wadi Wurayah 1♀, 13.iii.2009, leg. CSE.

Plate 73

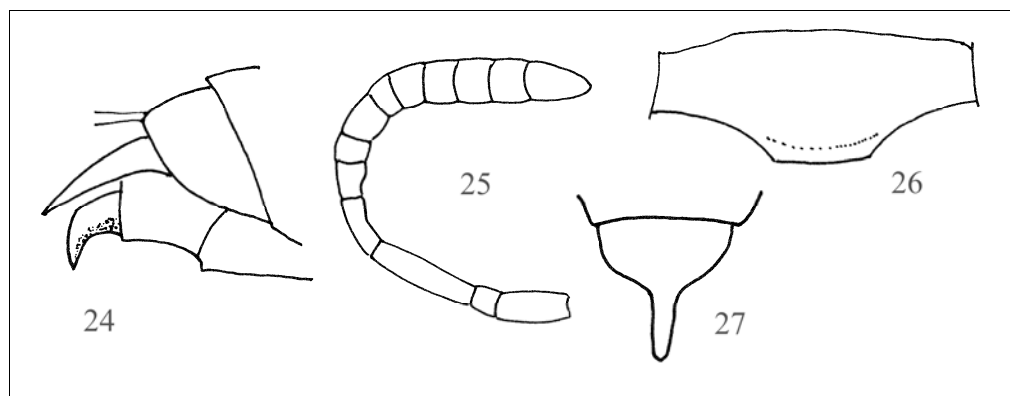

Figures 24–27. *Laphyragogus strakai* Schmid-Egger nov. spec., male. 24: Last abdominal terga; 25: Antenna; 26: Clypeus; 27: Tergum VII;

Distribution: Israel, Egypt, Libya, Morocco (Pulawski, internet database), Oman (Guichard, 1980). New to the UAE.

Genus *Laphyragogus* Kohl, 1889

***Laphyragogus strakai* Schmid-Egger nov. spec.**

Plate 74, Figures 24–27

Specimens examined: 2♂ (holotype and paratype), United Arab Emirates, Um al-Quwain, 25°32'N 55°32'E, 19.iii.2009, leg. CSE (coll. CSE).

Discussion: The genus *Laphyragogus* was partly revised by de Beaumont (1959). Unfortunately, the paper lacks a key and a full description of *Laphyragogus kohlii* Bingham, 1897, and the original description is not sufficient for a conclusive recognition of the species. *Laphyragogus kohlii* was recorded from northern Oman (Guichard, 1980), close to the present locality, and represents the only published record of a *Laphyragogus* in Arabia. All species described in detail by de Beaumont (1959) can be excluded for the present males, especially because of a different shape of the very special tergum VII and sternum VII. *Laphyragogus kohlii* can be excluded by colour, as *kohlii* has a marked yellow coloured head and thorax, whereas those are nearly completely black in the *strakai* male.

Diagnosis: The male of *strakai* is unique by the form of tergum VII. The apex is widely pointed, parallel-sided, apically truncate, and half as long as visible part of tergum. Apex is triangular or finely pointed in the other species. Sternum VII is markedly keeled; keel is tooth-like towards apex. Flagellomere III is weakly curved. Also, colour is characteristic: Head, flagellum and thorax are nearly completely black, whereas markedly yellow coloured in *kohli*. The female is unknown.

Description of male: Body length 7.5 mm. Colour. Black are antennae, head and thorax. Mandible pale yellow with black base and reddish-black apex. Metapostnotum, and clasp beside metapostnotum and scutellum each with narrow pale yellow band in holotype (metapostnotum black in paratype). Wings transparent, tegula, basal sclerite and wing venation whitish-yellow, apical wing venation somewhat darker. Legs pale to dark yellow, coxa, trochanter and femora black except apex. Terga and sterna dark yellowish with reddish-yellowish part (sterna and last terga darker than first terga). Head with long, dense and silver



Plates 73–74. 73: *Hoplisoides ferrugineus* Spinola, female, lateral view, L = 9.0 mm; 74: *Laphyragogus strakai* Schmid-Egger nov. spec., male, dorsal view, L = 7.5 mm.

pubescence, leaving apical half of clypeus uncovered. Setae in lower face appressed, in remaining parts erect, somewhat longer than scape. Thorax with less dense, erect long silver pubescence. Morphology. Clypeus, flagellomeres, sternum and tergum VII as in Figures 24–27. Clypeus densely punctate, medially with a few punctures only and large interspaces. Mesonotum and venter shiny, remaining surface of mesothorax (mesopleuron, propodeum) dull, microsculptured. Mesonotum and scutellum finely punctate, punctures 1–3 diameters apart. Propodeum microaereolate. Terga dull, densely punctate, no interspaces visible. Tergite VII shiny, with some large punctures. Sterna medially without setae or hairbrushes. Sternum apico-medially with two very small points. Sternum VII with tooth-like keel, keel apically as long as width of mid flagellomeres. Fore tarsomere with 9 long spines, apical spine as long as second tarsomeres. Remaining tarsomeres on fore-, mid- and hind legs also with long spines, all tarsomeres narrow.

Habitat: The males were found on sandy dunes at a beach site with scattered vegetation, by hand collecting.

Derivatis nominis: The species is dedicated to Jakub Straka, a specialist of *Crabronidae* from Prague/Czech Republic.

Laphyragogus spec.

Specimens examined: Sharjah Desert Park, 1♀, 1–30.xi.2008, pitfall traps, leg. AvH.

Discussion: The single recorded *Laphyragogus* female cannot be identified with the available descriptions. It may be the unknown female of *strakai* new species, as well as the female of *kohlii*. The certain association of males with conspecific females is difficult in *Laphyragogus*, because colour and morphology are markedly different in both sexes. Also, the present female was found in the desert zone of the UAE, and not together with the *strakai* male, which was found in coastal dunes. So, I hesitate to treat them as conspecific. The true identify of the present female can only be cleared up in a detailed revision of the genus and by type comparison. Nevertheless, I will describe it below to enable further identification.

Description of female: Body length 10 mm. Colour. Head lemon yellow, body pale yellow to drab. The following parts are black: Apical third of mandible, two large spots below ocelli, space between hind ocelli, band behind ocelli; mesonotum except two large oval yellow spots, small connected spot on mesopleuron and metapleuron; most of propodeal surface and propodeal backside. Flagellum dark brownish, with lighter underside. Scape, pedicel and flagellomere I yellow. Terga II–V with dark yellow basal band. Face and thorax covered with long, silvery adjacent pubescence. Morphology. Platform on sternum VI extremely large, as compared with other species. Sternum VI apically with triangular emargination.

Genus *Lindenius* Lepeletier & Brullé, 1835

Identification: Leclercq, 1989.

Lindenius aegyptius (Kohl, 1888)

Plate 75

Specimens examined: 94 specimens. Al-Ajban, N of Ajman, Wadi Safad. Flight period: February–November.

Recognition: The species is characterized by a horizontal furrow on lower mesonotum, and by marked lateral and medial teeth on apical clypeal margin.

Distribution: North Africa, Canary Islands, Pakistan and Kazakhstan (Leclercq, 1989). New to the UAE and the Arabian Peninsula.

Genus *Liris* Fabricius, 1804

Identification: de Beaumont, 1961b

Liris agilis Smith, 1856

Plate 76

Specimens examined: 10 specimens. Al-Ajban, Wadi Madaq, Wadi Wurayah. Flight period: January, March, July.

Distribution: West and North Africa (de Beaumont, 1961b). Oman (Guichard, 1980). New to the UAE.

Liris braueri Kohl, 1884

Plates 77–78

Specimens examined: 6 specimens. Wadi al-Helo/near tunnel, Wadi Madaq, Wadi Safad, Wadi Wurayah. Flight period: March, December.

Distribution: North Africa to Iran (de Beaumont, 1961b). Oman (Guichard, 1980). New to the UAE.

Liris cleopatra de Beaumont, 1961

Plate 79

Specimens examined: 9 specimens. N of Ajman, Um al-Quwain. Flight period: March.

Distribution: Egypt, Israel, Sudan (de Beaumont, 1961b). New to the UAE and the Arabian Peninsula.

Liris festinans praetertissimus Richards, 1928

Specimens examined: 15 specimens. Al-Ajban, Hatta, 10 km E of Ra's al-Khaimah Airport, Sharjah Desert Park. Flight period: March, April, August, December.

Distribution: Mediterranean area to Afghanistan (de Beaumont, 1961b). Oman (Guichard, 1980). New to the UAE.

Liris nigricans Walker, 1871

Specimens examined: 9 specimens. Al-Ajban, N of Ajman, Dubai/al-Awir, Dubai/Nakhalai, Hatta, Sharjah Desert Park. Flight period: October–May.

Distribution: Widespread in Africa, Central Asia (de Beaumont, 1961b). Oman (Guichard, 1980). New to the UAE.

Liris opalipennis Kohl, 1898

Plate 80–81

Specimens examined: 6 specimens. N of Ajman, Wadi Safad. Flight period: October, December.

Distribution: North Africa to Central Asia (de Beaumont, 1961b). New to the UAE and the Arabian Peninsula.

Liris subfasciatus Walker, 1871

Plate 82

Specimens examined: Al-Ajban 5♂, 9♀, 7.viii.2009, leg. AvH. Sharjah Desert Park, 1♂, 1.vii.2008, leg. AvH.

Distribution: Widespread in Africa, Central Asia (de Beaumont, 1961b). Oman (Guichard, 1980). New to the UAE.

Genus ***Miscophus*** Jurine, 1807

Identification: The genus is currently under revision by the author.

Key to the species of *Miscophus* from the Arabian Peninsula (females only)

A key for males is not possible, because some males are difficult or impossible to distinguish from each other by the lack of good characters on clypeus and spinulation of fore legs. They can be identified together with females from the same location and agree mainly in general sculpture and colour.

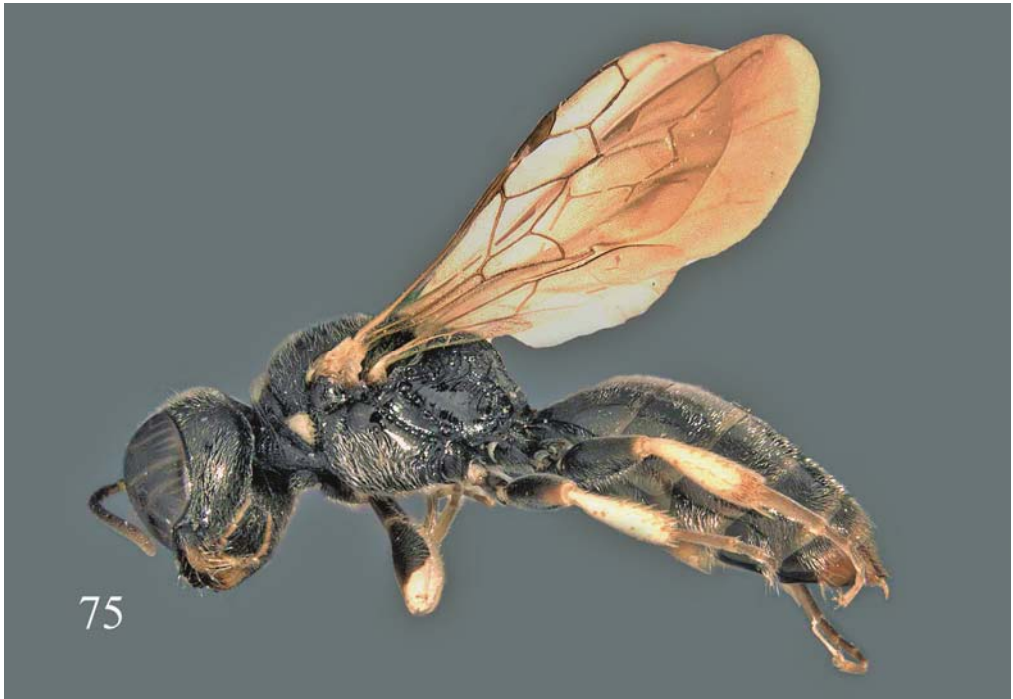

Plates 75–76. 75: *Linenius aegyptius* (Kohl), female, lateral view, L = 5.5 mm; 76: *Liris agilis* Smith, female, lateral view, L = 11 mm.



Plates 77–78. *Liris braueri* Kohl. 77: Male, lateral view, L = 13 mm; 78: Female, head in frontal view.



Plate 79. *Liris cleopatra* de Beaumont, male, lateral view, L = 8.1 mm.

- | | | |
|---|---|---|
| 1 | Anterior margin of clypeus continuous, without indentations | 2 |
| – | Anterior margin of clypeus divided into three parts | 3 |
| 2 | Mesopleuron below epimeron densely punctate, punctures large, interspaces as large as puncture diameter. Epimeron with a few, scattered punctures. Lower mesopleuron in some specimens with horizontal wrinkles | <i>Miscophus mimeticus</i> Honoré |
| – | Punctuation of mesopleuron less dense, interspaces larger than punctures. Epimeron without punctures, shiny, or with a few scattered punctures .. | <i>Miscophus affinis</i> Pulawski |
| 3 | Propodeal surface smooth and markedly shiny, at most with some barely visible transverse striae near median carina; without any pilosity. Mesonotum and frons shiny, with sparse punctation. Angle between surface and back of propodeum obtuse | <i>Miscophus paolorosai</i> Schmid-Egger nov. spec. |
| – | Propodeal surface dull with microsculpture or shiny with striation or honeycomb-like sculpture, in some species with pilosity. Mesonotum and frons in most species microsculptured or densely punctate (interspaces at most 2 diameters). Angle between surface and back of propodeum about 90–100 degrees (right angled) | 4 |
| 4 | Temples without (or with very short) pilosity. Female: Fore tarsal spines in most species less developed or absent. Males: Sternite VIII with four teeth. Smaller species, rarely longer than 6.0 mm | 5 |
| – | At least lower half of temples (behind eyes, seen in dorsal view) with erect whitish pilosity. Female: Fore tarsal spines well developed, last spine of fore metatarsus as long as or longer than second tarsal segment. Males: Sternite VIII bidentate. Larger species, mostly longer than 5.0 mm | 6 |



Plates 80–81. *Liris opalipennis* Kohl. 80: Male, lateral view, L = 8.2 mm; 81: Female, lateral view, L = 11 mm.



Plates 82. *Liris subfasciatus* Walker, male, lateral view, L = 9.5 mm.

- 5 Propodeal surface and sides markedly striate or honeycomb-like sculptured, with shiny interspaces. Scapus in most species black. Flagellomere I long, $2\times$ as long as pedicel *Miscophus pharaonis* Andrade
- Propodeal surface and sides grain-like microsculptured or punctate, dull, without shiny interspaces and without or only with a few ridges. Scape yellow below. Flagellomere I short, $1-1.5\times$ as long as pedicel. (Body length less than 4.0 mm)..... *Miscophus aenigma* Honoré
- 6 Spines of fore basitarsus long, thick, strongly spatulate apically. Apical spine of fore basitarsus at least as long as 2nd, 3rd and half of 4th tarsal segment together 7
- Spines of fore basitarsus not spatulate, but evenly pointed apically, in most specimens shorter than in *M. ctenopus* and *M. sericeus* 8
- 7 Tegula and praecostal plate yellow. Wing venation yellow. Apical dark part of forewing markedly contrasting to basal transparent part. Eye as large as half face. 5.0–6.0 mm *Miscophus sericeus* Radoszkowski
- Tegula and/or praecostal plate red, often with dark spot. Wing venation dark. Apical dark part of fore wing with greyish transition zone to basal transparent part. Eye larger than half face. 7.0–8.0 mm *Miscophus ctenopus* Kohl
- 8 Fore basitarsus with 4–5 spines (including a small basal spine) *Miscophus papyrus* Andrade
- Fore basitarsus with 3 spines *Miscophus helveticus* Kohl

Miscophus aenigma Honoré, 1944

Plate 83

Specimens examined: 24 specimens. Al-Ajban, N of Ajman. Flight period: May, September–October.

Distribution: Egypt, Israel (Schmid-Egger, in prep.). New for the UAE and the Arabian Peninsula.

Miscophus affinis Pulawski, 1964

Plate 84

Specimens examined: Ar-Rafah, 1♀, 19.iii.2009, leg. CSE.

Distribution: Morocco, Egypt, Israel, Turkmenistan (Schmid-Egger, in prep.). New to the UAE and the Arabian Peninsula.

Miscophus ctenopus Kohl, 1885

Plate 85

Specimens examined: 12 specimens. Bithnah, Sharjah Desert Park. Flight period: March, November–December.

Distribution: North Africa, Arabian Peninsula, Syria (Schmid-Egger, in prep.). New to the UAE.

Miscophus helveticus Kohl, 1883

Plate 86

Specimens examined: Wadi Madaqa, 1♀, 9.xi.2006, leg. AvH. Wadi Wurayah, 1♀, 4.xii.2006, leg. AvH.

Discussion: The specimens belong to a dark form (gaster and legs dark, with small dark red spots) with dense and long pilosity in face.

Distribution: Widely distributed in the Palaearctic region (Schmid-Egger, in prep.). New to the UAE and the Arabian Peninsula.

Miscophus mimeticus Honoré, 1944

Plates 87–88

Specimens examined: 68 specimens. Al-Ajban, Dubai/al-Awir, Dubai/Nakhalai, N of Ajman, Sharjah Desert Park, Wadi Siji. Flight period: April–May, August–October.

Distribution: North Africa to Central Asia, Arabian Peninsula (Schmid-Egger, in prep.). New to the UAE.

Miscophus paolorosai Schmid-Egger **nov. spec.**

Plates 89–90

Specimens examined: ♀ (holotype), 3♂ (paratypes), United Arab Emirates, Um al-Quwain, 25°32'N 55°32'E, 11–19.iii.2009, in water traps, leg. CSE (coll. CSE). 1♂, 3♀, N of Ajman, 17.ix.2008, in water traps, leg. AvH; 1♀, 27–30.iv.2008, in water traps, leg. AvH. 2♂, 3♀, ar-Rafah, 17.iii–30.iv.2008, in water traps, leg. AvH. 3♀, lake 17 km SW of al-Ain, 24,09°N 55,63°E, 10.i. 2011, leg. CSE. 1♂, Liwa desert, 12 km S of Arada, 22,86°N 53,39°E, 10.i. 2011 leg. CSE. Holotype in Berlin, paratypes in coll. CSE.

Discussion: *Miscophus paolorosai* cannot be assigned to any of the species groups defined by Andrade (1954). The species has some similarities to *Miscophus soikai* de Beaumont, 1952, from Central Sahara and to *Miscophus bytinskii* Verhoeff, 1955, from Israel.

Diagnosis: *Miscophus paolorosai* is unique on account of a shiny and polished body surface in combination with a black body colour and partly red legs. Microsculpture is barely visible and restricted to small areas only. This shiny overall impression is uncommon for a *Miscophus* species, because most species are markedly microsculptured or, when shiny, with weak punctures and rugulation. The angle between surface and vertical part (backside) of propodeum, seen in lateral view, is obtuse with approximately 125 degrees. In most other species it is more or less right-angled.

Description of female: Body length 4.0 mm. Colour. Body 'deep' black with the following parts light reddish: Basal half of mandible, scape, pedicel, flagellomere I below, all tibiae and tarsi, hind tarsi dark reddish. Foretarsal spines black. Wing transparent, wing venation light brownish, radius dark brown. Morphology. Medial part of apical clypeal margin triangular,



Plates 83–84. 83: *Miscophus aenigma* Honoré, female, dorsal view, L = 3.5 mm; 84: *Miscophus affinis* Pulawski, female, lateral view, L = 5.0 mm.



Plates 85–86. 85: *Miscophus ctenopus* Kohl, female, lateral view, L = 7.1 mm; 86: *Miscophus helveticus* Kohl, female, lateral view, L = 7.5 mm.



Plates 87–88. *Miscophus mimeticus* Honoré, female, L = 5.5 mm. 87: Lateral view; 88: Dorsal view.

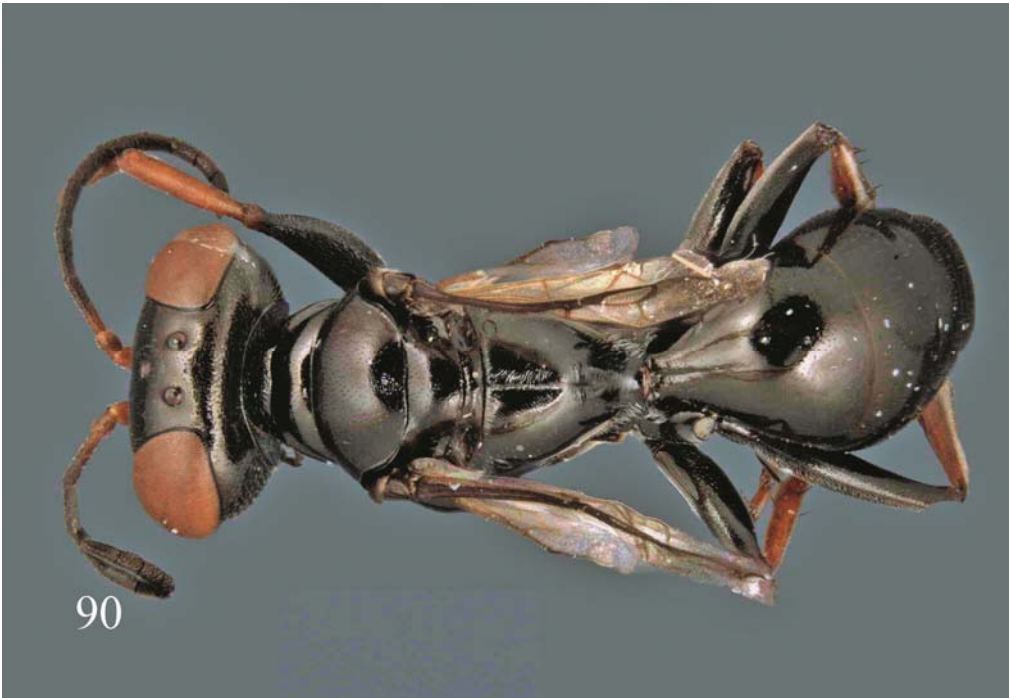

Plates 89–90. *Miscophus paolorosai* Schmid-Egger nov. spec., female, L = 4.0 mm. 89: Lateral view; 90: Dorsal view.

with obtuse angle. Lateral emargination weak. Flagellomere I as long as scape, about $3\times$ as long as pedicel. Pronotum, mesoscutum, propodeum laterally and terga with very weak and sparse punctation. Mesopleuron with weak and barely visible microsculpture. Propodeal dorsum (surface) shiny, with medial longitudinal carina and few very weak striae near carina. Overall impression shiny and polished. For shape of propodeum see Diagnosis, propodeum markedly narrowed to apex (dorsal view). Fore basistarsus with 3 long and thin spines, apical spine reaching middle of tarsomere III. Wing venation weak, but all cells visible. Cubital cell II small.

Description of male: Body length 3.0–3.5 mm. Agrees in colour and morphology with female. Fore basistarsus with apical spine only, as long as tarsomere II. Apical clypeal margin half rounded, and flagellomere I (and II) orange reddish.

Habitat: The species was found on a beach site with sand dunes and some sparse vegetation.

Derivatis nominis: The species is dedicated to Paolo Rosa from Milan/Italy, a friend and specialist of Chrysididae (Hymenoptera).

Miscophus papyrus Andrade, 1954

Plate 91

Specimens examined: 8 specimens. Al-Ajban, Dubai/al-Awir, Um al-Quwain, Wadi Bih (dam), Wadi Maidaq. Flight period: March–June.

Discussion: The species is variable in colour. Two females from the UAE differ markedly from each other: One has black femora and black flagellomeres, the other has all legs light red, flagellomeres I–II are yellow below. Nevertheless, the specimens agree in other characters with females from Egypt, the type area. Females of *papyrus* can be recognized by 4–5 forebasitarsal spines (both females from UAE have 4 spines), by a red abdomen, yellowish tegulae and an advanced medial part of apical clypeal margin. Recognition of males is not yet possible, because most males of the *helveticus* group lack valuable distinctive characters.

Distribution: North Africa, Arabian Peninsula (Schmid-Egger, in prep.). New to the UAE.

Miscophus pharaonis Andrade, 1940

Plate 92

Specimens examined: Wadi Wurayah, 1♂, 1♀, 28.i.2009, leg. AvH.

Discussion: The species is similar to *M. eatoni* Saunders, 1903, but can be distinguished by the polished and extreme shiny epimeron (upper part of mesopleuron). The epimeron is densely punctate in *eatoni*. *Miscophus pharaonis* is the only representative of the closer *eatoni* lineage from the Arabian Peninsula.

Distribution: Egypt, Israel, Oman, Yemen (Schmid-Egger, in prep.). New to the UAE.

Miscophus sericeus Radoszkowski, 1883

Plate 93

Specimens examined: N of Ajman, 3♀, 22.v.2008, 30.xi.2008, leg. AvH.

Discussion: The examined females are darker than females from Egypt, with terga II–VI and parts of femora black. Tergum I is partly or completely dark red. In females from Egypt all terga and legs are reddish.

Distribution: West and North Africa to Central Asia and Afghanistan (Schmid-Egger, in prep.). New to the UAE and the Arabian Peninsula.

Genus ***Oxybelus*** Latreille, 1796

Identification: Guichard, 1990. An additional key to the *Oxybelus lamellatus*-species group (species with enlarged mucron) in the Arabian Peninsula is given here:



Plates 91–92. 91: *Miscophus papyrus* Andrade, female, lateral view, L = 7.0 mm; 92: *Miscophus pharaonis* Andrade, female, lateral view, L = 4.5 mm.

Key to the Arabian species of the *Oxybelus lamellatus*-group (males and females)

- 1 Sternum II with dense punctation, punctures at most a diameter apart, in a few specimens medio-apically with some larger interspaces. Mucron in medial part with longitudinal dark spot. Metanotal squama pointed. Frons below ocelli with dense punctation *Oxybelus diphyllus* Costa
- Sternum II with large shiny interspaces, punctures 1–3 diameters apart, especially in medial half 2
- 2 Metanotal squama bifid. Frons between and below ocelli with dense punctation. Mucron medially large, brownish-reddish *Oxybelus lamellatus* Oliver
- Metanotal squama pointed. Frons between ocelli with shiny interspaces, punctures 1–2 diameters apart. Mucron in apical part transparent, with yellowish median spot *Oxybelus phyllophorus* Kohl

***Oxybelus alhumdalilleri* Guichard, 1990**

Discussions: The female is unknown.

Distribution: UAE, al-Futaisi Island (Guichard, 1990).

***Oxybelus arabicus* Guichard, 1990**

Plate 94

Specimens examined: 103 specimens. N of Ajman, Dubai/al-Awir, Dubai/Nakhalai, Jebel Hafit/S of al-Ain, Sharjah Desert Park, Wadi Bih (dam), Wadi Hayl, Wadi al-Helo/near tunnel, Wadi Maidaq, Wadi Shawkah, Wadi Wurayah. Flight period: December–July.

Discussion: In addition to the information in the key, the female is also characterized by a large pale yellow spot on sternum II that may be lacking in small specimens.

Distribution: Saudi Arabia, UAE; Oman, Yemen, Jordan, Israel (Guichard, 1990).

***Oxybelus collaris* Kohl, 1884**

Distribution: Arabia, Jordan, Egypt/Sinai, UAE (Guichard, 1990).

***Oxybelus lamellatus* Oliver, 1811**

Plates 95–96

Specimens examined: 153 specimens. Al-Ajban, Dubai/al-Awir, Dubai/Nakhalai, Jebel Hafit/S of al-Ain, Mahafiz, Sharjah Desert Park, Um al-Quwain, Wadi Bih (dam), Wadi Hayl, Wadi Shawkah, Wadi Wurayah. Flight period: November–July.

Distribution: From Southwest Europe and North Africa to Northwest India, southwards to Mali, Nigeria and Niger, UAE (“one of the commonest species throughout Arabia”, Guichard, 1990).

***Oxybelus phyllophorus* Kohl, 1898**

Plates 97–98

Specimens examined: 98 specimens. Al-Ajban, Dubai/al-Awir, Dubai/Nakhalai, Mahafiz. Flight period: March–May, August, December.

Discussion: Guichard (1990) includes only *Oxybelus diphyllus* Costa, 1882, in his key, known from Oman, North Africa and Sardinia, and not the closely related *O. phyllophorus*. Both species key out to *diphyllus* in his key (Guichard, 1990). *Oxybelus phyllophorus* is common in the UAE, whereas I could not examine any *diphyllus* from the UAE. The *lamellatus*-group (species with enlarged mucron) in the Arabian Peninsula can be identified with the key given above.

Distribution: Africa (Guichard, 1990), Morocco (Schmid-Egger, unpublished). New to the UAE and the Arabian Peninsula.



Plates 93-94. 93: *Miscophus sericeus* Radoszkowski, female, lateral view, L = 6.0 mm; 94: *Oxybelus arabicus* Guichard, female, lateral view, L = 7.2 mm.



Plates 95–96. *Oxybelus lamellatus* Oliver, female. 95: Lateral view, L = 7.2 mm; 96: Mesosoma in dorsal view.



Plates 97–98. *Oxybelus phyllophorus* Kohl, female, L = 6.0 mm. 97: Lateral view; 98: Mucron.

Oxybelus tinklyi Guichard, 1990

Plates 99–101

Specimens examined: 38 specimens. Al-Ajban, Dubai/al-Awir, Dubai/Nakhalai, Jebel Hafit/S of al-Ain, Sharjah, Sharjah Desert Park, Wadi al-Helo/near tunnel, Wadi Madaq. Flight period: December–August.

Distribution: Israel, Saudi Arabia, Oman, North Yemen, Mali (Guichard, 1990). New to the UAE.

Oxybelus verhoeffi de Beaumont, 1950

Plate 102

Specimens examined: Dubai/Nakhalai, 1♀, 15.iv.1984, leg. ES. Mahafiz, 1♀, 19.iii.2009, leg. CSE. Sharjah Desert Park, 1♀, 28.xii.2006, leg. AvH.

Distribution: North Africa, Arabia, UAE (Guichard, 1990).

Genus ***Palarus*** Latreille, 1802

Identification: Pulawski & Prentice, 2008; Guichard, 1988b.

Palarus bisignatus F. Morawitz, 1890

(= *P. rochei* in Guichard, 1988, synonymised with *bisignatus* by Pulawski & Prentice, 2008).

Distribution: Central Asia, UAE (Pulawski & Prentice, 2008).

Palarus comberi Nurse, 1911

Plate 103

Specimens examined: N. of Ajman, 6♀, 5–16.vii.2008, leg. AvH. Ar-Rafah, 2♂, 1♀, 22.v.2008, leg. AvH.

Distribution: India, Pakistan, Saudi Arabia (Pulawski & Prentice, 2008). New to the UAE.

Palarus dongalensis Klug, 1845

Distribution: North Africa, Iran, Saudi Arabia, Oman, UAE (Pulawski & Prentice, 2008; Guichard, 1988b)

Palarus fulviventris Latreille, 1812

(= *P. spinolae* Saussure, 1854, in Guichard, 1988b, synonymised with *fulviventris* by Pulawski & Prentice, 2008).

Distribution: North Africa, Iran, Saudi Arabia, UAE (Pulawski & Prentice, 2008; Guichard, 1988b)

Palarus histrio Spinola, 1838

Specimens examined: N of Ajman, 1♂, 13.iii.2009, leg. CSE.

Discussion: The male from UAE has a black head and thorax with the following parts dark orange reddish: Lower half of clypeus and pronotal lobe, and the following parts dark yellowish: Tegulae, narrow lateral band between scutellum and tegulae, continuous narrow band on metanotum. Red on thorax is reduced when compared with males from Morocco and wings are darker. The males from Morocco have a large and extended yellow pattern on head and thorax. Guichard (1988) described a large variation in colour in specimens from Saudi Arabia.

Distribution: North Africa to Arabia and Central Asia (Pulawski & Prentice, 2008; Guichard, 1988b). New to the UAE.

Palarus laetus Klug, 1845

Plates 104–105

Specimens examined: 12 specimens. Al Ajban, North of Ajman, Dubai/al-Awir. Jebel Hafit/S of al-Ain, Sharjah Desert Park, Um al-Quwain, Wadi Bih (dam). Flight period: March, June–July, September, November.



Plates 99–100. *Oxybelus tinklyi* Guichard, female, L = 3.5 mm. 99: Lateral view; 100: Dorsal view.



Plate 101. *Oxybelus tinklyi* Guichard, female. head.

Discussion: The examined males occur in two clearly separated colour forms. Forma A is markedly yellow with complete and large yellow bands on terga I–VII. Forma B (5 males from Jebel Hafit and Sharjah Desert Park) is in general smaller and has narrower bands on terga I–III, and small medial double spots on terga IV and V. Other terga are black. One male represents a transition form. It is remarkable in that such a colour variety does not exist in the 22 examined males from North Africa, which all belong to the lighter form A.

Distribution: North and West Africa, Oman, UAE (Pulawski & Prentice, 2008; Guichard, 1988b).

Genus *Parapiagetia* Kohl, 1897

Identification: Pulawski, 1977.

Parapiagetia erythropoda Cameron, 1889

Specimens examined: 60 males. Al-Ajban. Flight period: May to August.

Distribution: Whole of Africa, Pakistan and India (Pulawski, 1977). New to the UAE and the Arabian Peninsula.

Parapiagetia substriatula R. Turner, 1917

Plate 106

Specimens examined: Wadi Bih, 1♂, 1♀, 19.iii.2009, leg. CSE & E. Scheuchl.

Discussion: The species was described from 3 females. The male was hitherto unknown and is here described for the first time.

Diagnosis of male: The male keys out to *P. odontosoma* Kohl, 1897, in the key of Pulawski (1977). It differs by a marked pubescence on terga (without pubescence in *odontosoma* male),



Plates 102–103. 102: *Oxybelus verhoeffi* de Beaumont, female, lateral view, L = 6.0 mm; 103: *Palarus comberi* Nurse, female, lateral view, L = 13 mm.



Plates 104–105. *Palarus laetus* Klug. 104: Male, dorsal view, L = 7.5 mm; 105: Female, lateral view, L = 9.0 mm.



Plate 106. *Parapiagetia substriatula* R. Turner, male, lateral view, L = 5.0 mm.

by red terga VI–VII (black), by tergum VII without lateral carinae (with carinae), and by a broader lobe of clypeal margin (nearly triangular truncate).

Description of male: Body length 5.0 mm. Colour. Black. Mandible dark yellowish except dark apical third. Pale yellow are basal spot on tegulae (remaining part transparent), wing base including basal part of veins (remaining veins light brown), and apex of femora, tibiae, tarsi (tibiae reddish below). Apical half of tergum VI, tergum VII (pygidium), and sternum VII reddish. Morphology. Clypeal apical lobe broadly truncate (broader than in *P. genicularis* (F. Morawitz, 1890)). Flagellomere I as long as apical width. Mesonotum and scutellum with very fine and dense punctation, punctures 0.5–1 diameter apart. Mesopleuron medially with large, shiny area. Propodeum dorsally with some marked cross-striae. Vein M of forewing as long as cu–a (cf. Fig. 3 in Pulawski, 1970, page 613). Tergum I 1.5 × as long as apical width. Terga dull, with very fine microsculpture. Tergum VII (pygidium) shiny, with fine and dense punctation, laterally without carinae. Sternum VII with large triangular lateral teeth, and a very small point in between. Body covered with a more or less dense to scattered fine silver appressed pubescence. Setae on propodeum erect, as long as fore ocellar diameter. Appressed pubescence laterally and apically on terga I–V, leaving a large rectangular area without pubescence.

Distribution: Oman, Pakistan (Pulawski, 1977; Guichard, 1980). New to the UAE.

Genus *Philanthinus* de Beaumont, 1949

Identification: Guichard, 1990.

Philanthinus integer de Beaumont, 1949

Plates 107–108

Specimens examined: Wadi Hayl, 1♂, 19.iii.2009, leg. CSE. Wadi al-Helo/near tunnel, 1♂, 19.iii.2009, leg. CSE.

Discussion: Both males differ from examined males from Morocco. Nevertheless, I treat them as conspecific with *integer*. By the colour of terga, the specimens are similar to *P. quattuordecimpunctatus* (F. Morawitz, 1888), from Turkey and Central Asia, but the latter has longer setae on frons, a different shape of anterior clypeal margin, and a marked pale wing venation (dark brown in *integer*).

Diagnosis of males from UAE: The clypeus is completely black in one male and has very small yellow lateral and basal spots in the other male (yellow in specimens from Morocco), frons with scattered punctation (with dense punctation, punctures a diameter apart), propodeal dorsum shiny (with fine areolate microsculpture), and tergal bands I and II divided into 3 spots (continuous).

Distribution: North Africa, Israel (Guichard, 1990). New to the UAE and the Arabian Peninsula.

Genus ***Philanthus*** Fabricius, 1790

Identification: Guichard, 1990.

Philanthus coarctatus Spinola, 1838

Plates 109–110

Specimens examined: 178 specimens. Al-Ajban, 15 km NE of ad-Dhaid, Dubai/al-Awir, Dubai/Nakhalai, Jebel Hafit/S of al-Ain, Mahafiz, Sharjah Desert Park, Sharjah, Wadi Bih (dam), Wadi Hayl, Wadi Maidaq, Wadi Shawkah, Wadi Wurayah. Flight period: January–July.

Distribution: North and West Africa, West Asia, common in Arabia including the UAE (Guichard, 1994b).

Philanthus genalis Kohl, 1891

Distribution: North Africa, Jordan, UAE (Guichard, 1994b).

Philanthus minor Kohl, 1891

Specimens examined: N of Ajman, 1♀, 19.iii.2009, leg. CSE. Mahafiz, 1♀, 19.iii.2009, leg. CSE.

Distribution: North Africa, UAE (Guichard, 1994b).

Philanthus pallidus Klug, 1845

Plate 111

Specimens examined: N of Ajman, 1♂, 19.iii.2009, leg. CSE. Mahafiz, 3♀, 19.iii.2009, leg. CSE. Sharjah Desert Park, 2♂, 19.iii.2009, leg. CSE.

Distribution: North Africa, Arabia to Iran (Guichard, 1994b). New to the UAE.

Philanthus rutilus Spinola, 1838

Plate 112

Specimens examined: N of Ajman, 1♂, 21.iii.2007, leg. J. Batelka. Um al-Quwain, 3♂, 19.iii.2009, leg. CSE.

Distribution: North Africa, Yemen (Guichard, 1994b). New to the UAE.

Philanthus triangulum Fabricius, 1775

Plates 113–114

Specimens examined: 119 specimens. Al-Ajban, N of Ajman, Jebel Hafit/S of al-Ain, Mahafiz, Sharjah Desert Park, Um al-Quwain, Wadi al-Helo/near tunnel, Wadi Bih (dam), Wadi Hayl, Wadi Maidaq, Wadi Shawkah, Wadi Wurayah. Flight period: March–May.

Distribution: Europe, Africa, West Asia, Arabia (Guichard, 1994b). New to the UAE.



Plates 107–108. *Philanthinus integer* de Beaumont, male, L = 6.8 mm. 107: Dorsal view; 108: Head.



Plates 109–110. *Philanthus coarctatus* Spinola. 109: Male, lateral view, L = 8.5 mm; 110: Female, lateral view, L = 9.0 mm.



Plates 111–112. 111: *Philanthus pallidus* Klug, female, lateral view, L = 10 mm: 112: *Philanthus rutilus* Spinola, male, lateral view, L = 14 mm.



Plates 113–114. *Philanthus triangulum* Fabricius. 113: Male, lateral view, L = 11 mm; 114: Female, lateral view, L = 14 mm.

***Philanthus variegatus* Spinola, 1838**

Plates 115–116

Specimens examined: 5 males. Jebel Hafit/S of al-Ain, Wadi Bih (dam), Wadi Hayl, Wadi Shawkah. Flight Period: March, June.

Distribution: North Africa, Arabia to Central Asia, UAE (Guichard, 1994b).

Genus *Pison* Jurine, 1808

Identification: De Beaumont, 1961a (does not include *Pison allonymum*. The latter keys out to *atrum* Spinola).

***Pison allonymum* W. Schulz, 1906**

Plate 117

Specimens examined: Wadi Madaq, 1♂, 25.i.2006, leg. AvH. Wadi Safad, 1♀, 2.i.2006, leg. AvH.

Discussion: The species was identified by Alexander Antropov. It may be confused with *Pison atrum* Spinola, 1808, but differs from the latter by distinctly coarser punctures on mesoscutum and propodeal dorsum, denser and more delicate punctures on abdomen (particularly on terga II–VI–VII), and by the presence of an apically widened inner basal lobe of paramere; this lobe is very narrow and apically acute in *atrum* (Antropov, in litt.). Probably the finding of *atrum* in Oman (Guichard, 1980) also refers to *allonymum*.

Distribution: South Africa, Zimbabwe, Zaire, and Ethiopia (Pulawski, internet database). New to the UAE and the Arabian Peninsula.

***Pison carinatum* Turner, 1917**

Plates 118–119

Specimens examined: Fujairah, 2♀, 22.iv–20.v.2006, light trap, leg. AvH. Wadi Safad, 8♂, 6♀, 2.i.2006, leg. AvH..

Distribution: Tropical Africa to Israel and Cyprus (Pulawski, internet database), Oman (Guichard, 1980). New to the UAE.

Genus *Plenoculus* W. Fox, 1893

***Plenoculus vanharteni* Schmid-Egger nov. spec.**

Plates 120–122, Figures 28–33

Specimens examined: United Arab Emirates, 2♂, al-Ajban, 24°36'N 55°01'E, 17–24.vi.2006; 2♂, 2♀, 9.vi–2.v.2006; 1♂, 1♀, 12–19.vi.2006; in Malaise trap, leg. AvH (holotype ♂ from 17–24.iv.2006, others paratypes). 1♂, Dubai/Nakhalai, 25.iv.1984, in Malaise trap, leg. ES (paratype). Holotype deposited in Berlin, paratypes in coll. CSE.

Discussion: The genus *Plenoculus* is closely related to *Solierella* Spinola, 1851, and includes two rare species in the old World: *P. beaumonti* Andrade, 1957, from Portugal and Spain, and *P. murgabensis* Gussakovskij, 1928, from Central Asia. Other species occur in North America. I have examined a female from Turkmenistan (Repetek), that probable is *murgabensis*. It differs in some characters from the present females. The male of *murgabensis* agrees with the present species by its colour pattern, as given in the short description by Kazenas (1978), except for the lack of yellow tergal bands in *vanharteni*. The male of *P. beaumonti* has a black clypeus. So I can exclude that the new species from the UAE is identical with either *beaumonti* or *murgabensis*.

Diagnosis: *Plenoculus vanharteni* nov. spec. resembles at first glance a *Solierella* spec. It can be distinguished from *Solierella* species by the following characters: Fore tarsomeres with long apical spines in both sexes (without spines in most males), mandible with large emargination below (without emargination), Fore trochanter evenly rounded (with small basal emargination in most *Solierella* species). Male: Tergum VII with pygidial area laterally with small carinae (without lateral carinae). Female: Apical clypeal margin with large, triangular



Plates 115–116. *Philanthus variegatus* Spinola, males, in lateral view. 115: Darker specimen, L = 10 mm; 116: Lighter-coloured specimen, L = 14 mm.



Plate 117. *Pison allonymum* W. Schulz, female, lateral view, L = 8.5 mm.

Table 3. Differences between *Plenoculus vanharteni* nov. spec. and *Plenoculus murgabensis*.

Character	<i>Plenoculus vanharteni</i> female	<i>Plenoculus murgabensis</i> female (from Turkmenistan, Repetek, coll. CSE)
Body size	4.5–5.0 mm	6.0 mm
Colour of fore femora	With large, whitish spot on apex below	Completely black
Triangular clypeal emargination	Narrower than distance between inner margins of both scapes	As broad as distance between both scapes, measured from middle of scapes.
Triangular clypeal emargination	Margin as large as diameter of flagellomere I.	Margin half as large as diameter of flagellomere I.
Apical clypeal margin below outer margin of scape	Without teeth, but with rounded corner	With 3 small teeth, outer tooth larger than other.
Punctuation of mesonotum	Most interspaces larger than diameter, shiny	Interspaces smaller than diameter.
Pygidial dorsal area	Shorter than basal width; lateral parts of propodeal dorsum only with sparse pubescence	Longer than basal width; lateral parts of propodeal dorsum with marked and long pubescence.



Plates 118–119. *Pison carinatum* Turner. 118: Male, lateral view, L = 8.0 mm; 119: Female, lateral view, L = 8.5 mm.



Plates 120–121. *Plenoculus vanharteni* Schmid-Egger nov. spec., male, L = 4.0 mm. 120: Lateral view; 121: Dorsal view.



Plates 122. *Plenoculus vanharteni* Schmid-Egger nov. spec., male, head in frontal view.

emargination (*Solierella* without such emargination). These characters are autapomorphies for the genus *Plenoculus* (Bitsch et al., 2007). The present male also has a completely yellow clypeus, whereas it is black in all Palaearctic *Solierella* species. Description of male: Body length 3.0–4.0 mm. Colour. Pale yellow are mandible, except for reddish apex, clypeus, scape, tibiae, tarsi, apical 2/3 of fore femur, apical 1/3 of mid- and hind femora, large spots on fore coxa, small spots on mid coxa, pronotal lobe, tegula, fore- and hind wing venation. Flagellomeres ochre yellow, with first flagellomeres dark above. Head and mesosoma covered with dense, silver appressed pubescence. Apical tergal margin pale, with band-like dense silver pubescence. Tergum VII reddish. Morphology. Antenna with 12 flagellomeres, last flagellomere 1.5 × longer than flagellomere X. Head, mesosoma and terga shiny, with fine punctation, barely visible below dense pubescence. Propodeal dorsum and propodeal laterally without pubescence, propodeal dorsum finely microaereolate. Tergum VII shiny, with 5–10 large punctures, apically rounded, laterally with small carinae. Sterna shiny, with very fine and scattered punctation, apical margin paler than other parts of sterna. Fore basitarsus with 4 spines, as long as tarsal diameter, last spine somewhat longer. Legs in general with long spinulation.

Description of female. Body length 4.5–5.0 mm. Colour. Basal half of mandible yellow, except for black basal spot, flagellum brownish, darker above. Tegula transparent with basal white spot. Basal sclerite of wing and venation white, yellowish in apical part of wing. Fore femora with white large spot on apex below, tibiae and tarsi yellowish-white, tibiae dark above. Morphology. Mandible with marked tooth on basal third. Apical clypeal margin with triangular emargination. Margin of emargination shiny, large, without pubescence. Face

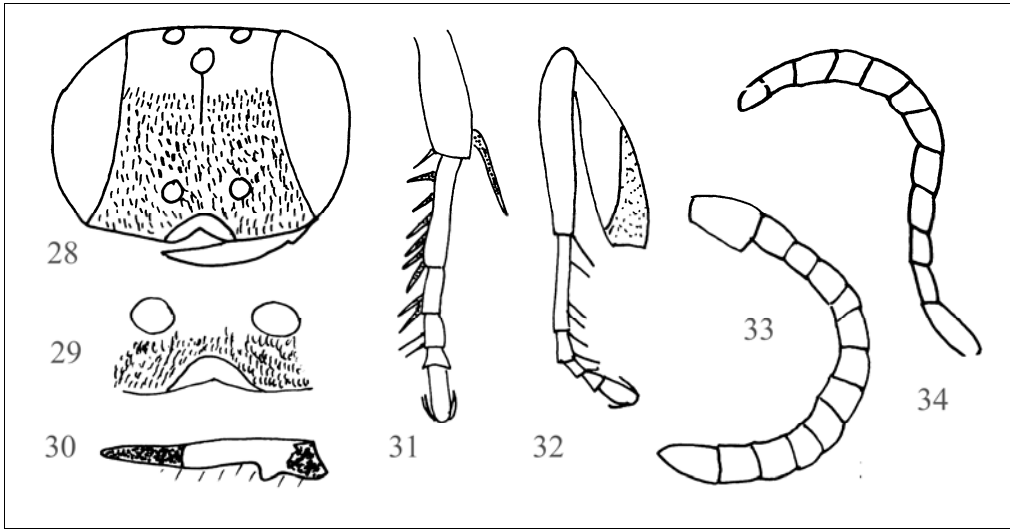

Figures 28–34. *Plenoculus vanharteni* Schmid-Egger nov. spec.; 28: Female head; 29: Female clypeus; 30: Female mandible; 31: Female, distal part of fore leg; 32: Male, distal part of fore leg; 33: Male antenna. 24: *Solierella jacobsi* Schmid-Egger nov. spec., male, antenna;

covered with silver pubescence, ending shortly below ocelli. Flagellomeres as long as wide, last flagellomere $1.3 \times$ as long as wide. Upper frons, mesonotum and scutellum shiny, with fine and dense punctation. Dorsal surface of propodeum with grain-like sculpture, apically with indistinct impression. Mesopleuron with dense silver pubescence. Terga I–III somewhat shiny, with very fine microsculpture. Other terga shinier, with scattered punctures. Tergum VI shiny, punctureless (except for 2–3 large basal punctures), laterally with fine edge, forming a pygidial area. Terga apically with depression that is somewhat lighter coloured than the rest of the terga. Fore basitarsus with 6 spines, as long as tarsal diameter, last spine $0.3 \times$ longer than other. Mid tibia and hind tibia with 3 rows each of 4 pale spines in apical half (all together 12–13 spines), mid basitarsus with 4 spines, hind basitarsus only with some apical spines.

Distribution: NE coast of the UAE, on sandy beach dunes.

Derivatis nominis: Named in honour of its collector, Tony van Harten, for his enormous contribution to the knowledge of Hymenoptera and other arthropods in the UAE.

Genus *Prosopigastra* A. Costa 1867

Identification: Pulawski, 1979.

Prosopigastra globiceps Morice, 1989

Plate 123

Specimens examined: N. of Ajman, 8♀, 16.vii.2008, leg. AvH.

Discussion: Colour of gaster varies in females from completely red to completely dark.

Distribution: Known from Mali, Sudan, Egypt and Israel to Central Asia and northwest China (Pulawski, 1979). New to the UAE and the Arabian Peninsula.

Prosopigastra menelaus Nurse, 1903

Plate 124

Specimens examined: N of Ajman, 5♂, 16.vii.2008, leg. AvH.



Plates 123–124. 123: *Prosopigastra globiceps* Morice, female, lateral view, L = 5.0 mm; 124: *Prosopigastra menelaus* Nurse, male, lateral view, L = 5.6 mm.

Distribution: Chad, Egypt, Central Asia to Pakistan (Pulawski, 1979), southern Israel (Schmid-Egger, unpubl.). New to the UAE and the Arabian Peninsula.

Genus *Solierella* Spinola, 1851

Identification: The genus is currently under revision by the author. It was previously unknown to the Arabian Peninsula. The male of one species has only 10 flagellomeres, which is unique among Arabian Crabronidae; usually, males have 11 flagellomeres.

Key to the species of *Solierella* from the UAE (males)

(If clypeus is yellow, compare with *Plenoculus vanharteni* Schmid-Egger nov. spec.)

- 1 Metanotum completely black (Antenna with 11 flagellomeres, last flagellomere as long as 5–6 previous flagellomeres) *Solierella nigradorsum* Pulawski
- Metanotum with yellowish band 2
- 2 Antenna with 10 flagellomeres. (Epimeron shiny) *Solierella jacobsi* Schmid-Egger nov. spec.
- Antenna with 11 flagellomeres 3
- 3 Last flagellomere shorter than previous one *Solierella insidiosa* de Beaumont
- Last flagellomere longer than previous one 4
- 4 Last flagellomere as long as previous 6–7 flagellomeres. Terga black *Solierella longicornis* Pulawski
- Last flagellomere as long as previous 2 flagellomeres. Terga red *Solierella dispar* Pulawski

Key to the species of *Solierella* from the UAE (females)

(If mandible and apical clypeal margin emarginated below, compare with *Plenoculus vanharteni* Schmid-Egger nov. spec.)

- 1 Metanotum completely black *Solierella nigradorsum* Pulawski
- Metanotum with yellowish band 2
- 2 Gaster mostly or completely red. Legs red and yellowish. Propodeal dorsum very finely sculptured, without carinae *Solierella dispar* Pulawski
- Gaster black. Legs without red colouration, partly black. Propodeum coarser sculptured 3
- 3 Epimeron (upper part of mesopleuron) shiny, with at most a few punctures in basal third. (All tibiae with full yellowish band on outer surface) *Solierella jacobsi* Schmid-Egger new species
- Epimeron fully punctate or finely microsculptured with only a small shiny area 4
- 4 Epimeron punctate, in apical half microsculptured or with a small shiny area. Fore- and mid tibiae with small yellow spot, hindtibia with yellowish band in basal half *Solierella insidiosa* de Beaumont
- Epimeron mostly punctate or with a very small microsculptured area. All tibiae with full yellowish band on outer surface *Solierella longicornis* Pulawski

Solierella dispar Pulawski, 1964

Plates 125–126

Specimens examined: 56 specimens. N of Ajman, Dubai/Nakhalai; Wadi Shawkah. Flight period: April–July.

Discussion. Females from the UAE differ in colour from specimens from North Africa and Israel. Abdomen is completely red, parts of thorax (propodeum, thorax laterally, pronotum)



Plates 125–126. *Solierella dispar* Pulawski. 125: Male, dorsal view, L = 2.8 mm; 126: Female, lateral view, L = 3.2 mm.

may be red. Colour of thorax is variable. In examined specimens from Israel and Morocco only terga I–II are red. Apart from colour, females and males can be recognized by the narrow, finely grain-like sculptured medial area of propodeum, and with fine silver pubescence on lateral parts of propodeal surface. Males have 11 flagellomeres (13 antennal segments), last flagellomere is thickened and somewhat longer than previous one.

Distribution: Egypt, Israel, Canary Island (Schmid-Egger, in prep.). New to the UAE and Arabia.

Solierella insidiosa de Beaumont, 1964

Specimens examined: Wadi Madaq, 1♀, 9.xi.2006; 2♂, 22.xii.2005, leg. AvH.

Discussion. The female from Wadi Madaq has reduced yellowish bands on tibiae, when compared with specimens from the Mediterranean area.

Distribution: Canary Islands, North Africa, South Europe, West Asia. (Schmid-Egger, in prep.). New to the UAE and the Arabian Peninsula.

Solierella jacobsi Schmid-Egger **nov. spec.**

Plates 127–128, Figure 34

Specimens examined: United Arab Emirates, 2♂, 2♀, Wadi Madaq, 26°19'N 56°08'E, 22.xii.2005–2.ii.2006, in water traps, leg. AvH. 1♂, 1♀, Wadi Wurayah, 5–30.xi.2008, in water traps, leg. AvH. 1♂, Wadi Wurayah farm, 1–8.iv.2009, in Malaise trap, leg. AvH. Female holotype in Berlin, paratypes in CSE. A male from Wadi Madaq, 22.xii.2005–2.i.2006, is the holotype.

Diagnosis: The female of *jacobsi* is characterized by the following character combination: Fore femora with a small yellowish spot, propodeal dorsum finely sculptured with some indistinct carinae only, and epimeron (upper part of mesopleuron) punctureless, shiny and polished. Especially the last character provides easy recognition of the species. In general view it is similar to the females of *longicornis* and *insidiosa* (see key above).

The male has a small yellowish spot on the fore femora and 10 flagellomeres (= 12 antennal segments) only. Therefore it is related to *S. verhoeffi* de Beaumont, 1964. and *S. pisonoides* (Saunders, 1873). It can be recognized by a finer sculptured propodeal dorsum (with marked carinae in *pisonoides*) that is limited by lateral carinae (without carinae in *verhoeffi*). The most obvious character is the shiny epimeron, as in female, that is punctate or microsculptured in most other species. The other Palaearctic *Solierella* species (males) with 10 flagellomeres are all smaller, finer sculptured and have larger pale bands on the femora.

Description of female: Body length 4.5–5.0 mm. Colour, Black with the following parts pale yellow: Mandible (base black, apex dark reddish); outer margin of pronotal lobe, two spots on pronotum, metanotum, small spot on apex of fore femora (twice as large as hindocellus), a band on outside of all tibiae, tarsi (tarsi are partly brownish), small spot on tegulae and basal sclerite of fore wing. Wing venation dark brown. Face in lower half with dense, silver pubescence, in towards frons V-shaped emarginated. Morphology. Clypeus with shiny triangular area near apex, medial part of apical margin somewhat rounded. Frons, mesonotum, scutellum and lower mesopleuron very shiny, with dense and fine punctation, that on mesopleuron more scattered than on rest. Epimeron shiny and polished, with some punctures in upper basal fourth. Propodeal dorsum surrounded by a fine keel, with fine, net-like striae, other parts of propodeum markedly and evenly horizontally striate. Terga finely and densely micropunctate, apical margin impressed, with band of fine silver pubescence. Fore leg without spines, except for a very short apical spine on each tarsomere.

Description of male: Body length 3.3 mm. Male agrees in colour and morphology with female, except for the following characters: Apical clypeal margin with narrow and short

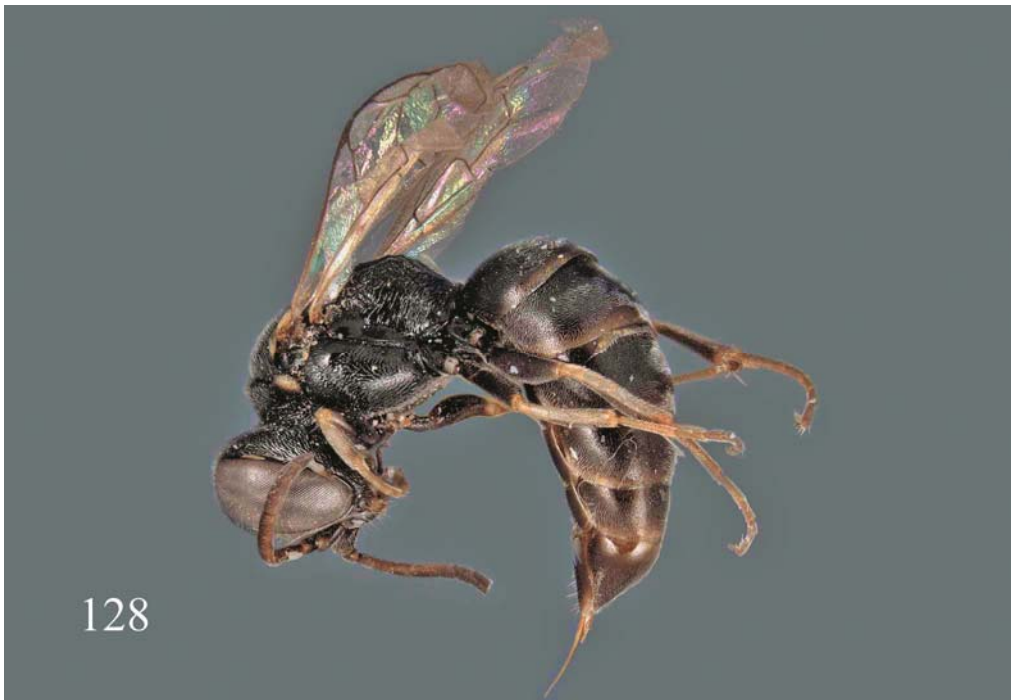

Plates 127–128. *Solierella jacobsi* Schmid-Egger nov. spec. 127: Male, lateral view, L = 3.3 mm; 128: Female, lateral view, L = 4.8 mm.

point, antenna with 10 flagellomeres, last flagellomere apically pointed, as long as previous one (Fig. 34).

Distribution: Only known from the Hajar Mountains in northeast UAE, near to the border with Oman.

Derivatis nominis: The species is dedicated to Hans-Joachim Jacobs from Ranzin, Germany, a friend and specialist of Crabronidae.

Solierella longicornis Pulawski, 1964

Plates 129–130

Specimens examined: 5 specimens. N of Ajman, Dubai/Nakhalai, Near Qurayyah/Khor Fakkan, Wadi Shawkah, Wadi Bih. Flight period: March–May.

Distribution: Described from Egypt, unpublished records from Tunisia and Jordan (Schmid-Egger, in prep.). New to the UAE and the Arabian Peninsula.

Solierella nigradorsum Pulawski, 1964

Plates 131–132

Specimens examined: 15 males and females. N of Ajman, Dubai/al-Awir, Dubai/Nakhalai, Sharjah Desert Park, Wadi Madaqa, Wadi Wurayah. Flight period: April–December.

Discussion: The male was hithero unknown and is described here for the first time.

Diagnosis: The species is unique among African and west Asian *Solierella* by having a black metanotum and partly yellowish legs (small apical spots on femora, band on outside of tibiae, tarsi). The male agrees in general with the female (detailed description in Pulawski, 1964). Male has 11 flagellomeres, last flagellomere is approximately as long as 5–6 previous ones, and therefore resembles *S. longicornis*. Apart from black metanotum and longer flagellomere XI, the male also resembles *S. antennalis* de Beaumont, 1956, described from Libya.

Description of male: Body length 3.0 mm. Colour. Black with the following pale yellow parts: Pronotal lobe, large apical spot on fore femur, very small apical spot on mid- and hind femora, outside of all tibiae and tarsi. Apical half of mandible ochre yellow. Body covered with fine silver pubescence, densely appressed on lower face, pronotum, lateral parts of metanotum and propodeal dorsum, mesopleuron. Morphology. Antenna with 11 flagellomeres (13 antennal segments), last flagellomere approximately as long as 5–6 previous ones. Frons, mesonotum and mesopleuron with indistinct, fine and dense punctation. Propodeal dorsum small, triangular, dull, with very fine net-like carinae.

Distribution: Egypt (Pulawski, 1964). New to the UAE and the Arabian Peninsula.

Genus ***Spilomena*** Shuckard, 1838

Identification: Dollfuss, 1986; Simon Thomas (1995) described two additional species from Yemen.

Spilomena mocsaryi Kohl, 1898

Plate 133

Specimens examined: Wadi Madaqa, 1♀, 25.i.2006, leg. AvH.

Discussion: The species agrees well with the description in Dollfuss (1986) and with examined females from my collection, except for the colour of the stigma. They are pale whitish-yellowish in the female from the UAE and brownish in the other females.

Distribution: Central and Southern Europe, Central Asia, Israel (Dollfuss, 1986). New to the UAE and the Arabian Peninsula.

Genus ***Stizoides*** Guérin-Méneville, 1844

Identification: Guichard, 1989; Ohl, 1999.



Plates 129–130. *Solierella longicornis* Pulawski, male, L = 3.8 mm. 129: Lateral view; 130: Dorsal view.



Plates 131–132. *Solierella nigradorsum* Pulawski, male, L = 3.0 mm. 131: Lateral view; 132: Dorsal view.



Plate 133. *Spilomena mocsaryi* Kohl, female, lateral view, L = 2.5 mm.

Stizoides abdominalis Dahlbom, 1845

Specimens examined: Sharjah Desert Park, 1♀, 25.i.–22.ii.2004, light trap, leg. AvH.

Distribution: Egypt (Ohl, 1999). New to the UAE and the Arabian Peninsula.

Stizoides assimilis Fabricius, 1787

Distribution: From Africa north of equator to Arabia, India and Central Asia (Ohl, 1999), UAE (Guichard, 1989).

Stizoides citrinus Klug, 1845

Distribution: West Africa to northwest India (Ohl, 1999), UAE (Guichard, 1989, as *S. poecilopterus* (Handlirsch, 1892)).

Stizoides klugii F. Smith, 1856

Specimens examined: Wadi Bih, 1♂, 23.iii.2007, leg. AvH.

Distribution: Algeria to Egypt, Chad, Israel, Saudi Arabia, Yemen (Ohl, 1999). New to the UAE.

Genus ***Stizus*** Latreille, 1802

Identification: Guichard, 1989a.

Stizus arabicus Guichard, 1989

Specimens examined: Al-Ajban, 1♂, 11.ix.2006, leg. AvH. Dubai/al-Awir, 1♀, 15.iv.1984, leg. ES.

Distribution: Oman, UAE (Guichard, 1989a).

Stizus bizonatus Spinola, 1839

Specimens examined: Dubai/al-Awir, 2♂, 5.v.1984, leg. ES.

Distribution: Egypt, Saudi Arabia, UAE (Guichard, 1989a).

Stizus fuscatus Morice, 1987

Distribution: North Africa, Saudi Arabia, UAE (Guichard, 1989a).

Stizus hyalipennis Handlirsch, 1892

Specimens examined: NARC, near Sweihan, 1♀, 11.v.2005, leg. AvH.

Distribution: North Africa, Israel, Saudi Arabia (Guichard, 1989a). New to the UAE.

Stizus niloticus Handlirsch, 1892

Specimens examined: Jebel Hafit/S of al-Ain, 1♂, 24.iii.2007, leg. J. Batelka. Wadi al-Helo/near tunnel, 1♂, 19.iii.2009, leg. CSE. Wadi Wurayah, 1♂, 20.iii.2009, leg. O. Berg.

Distribution: North Africa, Iran, Saudi Arabia (Guichard, 1989a). New to the UAE.

Stizus nadigi Roth, in Nadig 1933

Distribution: Known from North Africa and Mali to India, Saudi Arabia, UAE (Guichard, 1989a).

Stizus ruficornis Forster, 1771

Specimens examined: Sharjah Desert Park, 1♂, 31.v.2005, leg. AvH. NARC, near Sweihan, 1♂, 11.v.2005, leg. AvH.

Distribution: Western Palearctic region, Saudi Arabia, UAE (Guichard, 1989a).

Stizus savignyi Spinola, 1838

Distribution: North Africa, Eritrea, Saudi Arabia, UAE (Guichard, 1989a).

Genus ***Synnevrus*** Costa, 1859

Identification: Nemkov, 2001.

Discussion: Nemkov (2001) and Bitsch & Leclercq (1993) treat *Synnevrus* as a valid genus, but Pulawski (2009, internet database) synonymizes it with *Nysson* Latreille, 1796. I follow Nemkov (2001) and consider *Synnevrus* as a valid genus. It can be recognized by the double apical margin of tergum II, whereas that is simple in *Nysson*. Also, the sculpture of thorax is markedly coarser in *Synnevrus* as in *Nysson*.

Synnevrus barrei Radoszkowski, 1893

Plate 134

Specimens examined: Dubai/al-Awir, 1♀, 15–18.iv.1984; 1♂, 26–30.iv.1984; leg. ES.

Recognition: Within the genus *Synnevrus*, the female of *barrei* is unique on account of a red-coloured mesosoma. It is mostly or completely black in the other species. Edge of mesonotum is pointed laterally (dorsal view). Male mesosoma is partly red (pronotum, scutellum, parts of mesopleuron, metapleuron and propodeum laterally). Male tergum VII has long lateral teeth (somewhat longer than diameter of midocellus), without any tooth in-between. Last flagellomere is about 2 × as long as basal width and simple below. Body length 5.0–6.5 mm. The species can be distinguished from small species of *Nysson* with red body colour by the double apical margin of tergum II (generic character), by a marked occipital carina, forming a tooth on lower end, and by a coarse, honeycomb-like mesonotal punctation, which is markedly finer and with larger interspaces in most small *Nysson* species.



Plates 134–135. 134: *Synnevrus barrei* Radoszkowski, female, lateral view, L = 5.0 mm; 135: *Synnevrus ohli* Schmid-Egger nov. spec., male, dorsal view, L = 4.0 mm.

Distribution: Central Asia (Nemkov, 1991), Algeria (Pulawski, internet database). New to the UAE and the Arabian Peninsula.

***Synnevrus ohli* Schmid-Egger nov. spec.**

Plates 135–136

Specimen examined: United Arab Emirates, ♂ holotype, Dubai/al-Awir, 25°10'N 55°33'E, 22–26.iv.1984, Malaise trap, leg. ES (coll. Berlin).

Diagnosis: *Synnevrus ohli* keys out with the male of *barrei* in the key of Nemkov (2001). It is similar to *barrei* by having a laterally pointed edge of pronotum (laterally rounded in the other species), a marked occipital carina, a marked comb-like punctation on mesonotum and frons, and a lateral spine on mesoscutum. It can be distinguished from *barrei* by a shorter flagellomere XI, by a median small bulge between large lateral teeth on tergum VII (without such bulge in *barrei*), and by the lack of red colour on mesosoma (markedly red in *barrei*).

Description of male: Body length 4.0 mm. Colour. Head black, antenna reddish, with last flagellomeres dark above. Pronotum with large light yellow band, reaching pronotal lobes, the latter dark reddish. Scutellum with band in basal third. Tegulae and basal wing venation light reddish, remaining venation dark. Remaining mesosoma black. Tergum I reddish in basal half, laterally with pale yellow spots and large black space in between. Terga II and III with narrower lateral spots, remaining terga black. Tergum VI partly and tergum VII reddish. Sterna black with some reddish parts, sternum VII reddish. Legs including coxa reddish, all tibiae on outer side with narrow light yellow band over whole length. Head and mesosoma covered with silvery pilosity, densely appressed on lower face, on lower mesopleuron and laterally on pronotum. Morphology. Genae with marked edge below. Frons, mesonotum and mesoscutum with marked, comb-like punctation, punctures touching each other, deeply impressed. Punctures on mesonotum larger than on other parts. Pronotum, seen from above, forming an evenly and barely curved line, laterally with right-angled tooth. Metanotum laterally each with small spine. Propodeum apically with various edges, forming larger and smaller fields. Terga I–VI with marked and large, irregular punctures, 0.2–1 × diameters apart, other terga denser punctate. Basal third of terga less dense punctate than rest. Terga I–III laterally with double apical edge, barely visible on terga I and III. Tergum VII with apical narrow teeth, as long as midocellar diameter. Terga medially with small rounded bulge, as large as average diameter of a mesonotal puncture, and with a row of silver setae, as long as lateral teeth.

Female: unknown.

Derivatis nominis: The species is named in honour of Michael Ohl from Berlin, Germany, a specialist of sphecids.

Genus *Tachytes* Panzer, 1806

Identification: Guichard, 1994a. Pulawski's revision (1962) includes all Arabian species except *arabicus* Guichard, 1994, from Saudi Arabia.

***Tachytes argyreus* (F. Smith, 1856)**

Specimens examined: Al-Ajban, 7♂, 21.xii.2006, leg. AvH.

Distribution: North Africa, Arabia to Central Asia (Guichard, 1994a). New to the UAE.

***Tachytes archacophilus* Pulawski, 1962**

Distribution: Egypt, Jordan, Israel, Saudi Arabia, Oman, UAE (Guichard, 1994a).

***Tachytes cameronianus* Morice, 1897**

Specimens examined: Al-Ajban, 2♀, 21.xii.2006, leg. AvH.

Distribution: Egypt, Israel, Saudi Arabia, Oman (Guichard, 1994a). New to the UAE.

Tachytes comberi Turner, 1917

Plate 137

(= *patrizii* Guiglia, 1932, in Pulawski, 1962).

Specimens examined: Desert farm, 2♂, 12.iii.2008, leg. MH. Sharjah Desert Park, 1♂, 12.iii.2008, leg. MH. Sharjah/Tawi as-Saman oasis, 2♂, 19.iii.2007, leg. J. Batelka. Sharjah, 1♀, 20.vi.2005, leg. AvH.

Distribution: North Africa, Mauretania, Saudi Arabia, Oman, UAE (Guichard, 1994a).

Tachytes diversicornis Turner, 1918

Plates 138–139

Specimens examined: Al-Ajban, 1♀, 24.iv.2006, leg. AvH. Dubai/al-Awir, Dubai/Nakhalai, 4♂, 4♀, iv–v.1984, leg. ES.

Distribution: North Africa, Pakistan, Yemen, Oman, UAE (Guichard, 1994a).

Tachytes niloticus Turner, 1918

Plate 140

Specimens examined: 26 specimens. Al-Ajban, N of Ajman, Dubai/al-Awir, Dubai/Nakhalai. Flight period: April, May, August, October.

Distribution: North Africa, Tajikistan, Saudi Arabia, Oman (Guichard, 1994a). New to the UAE.

Tachytes priesneri Pulawski, 1962

Specimens examined: N of Ajman, 1♂, 17.xiii.2008, leg. AvH.

Distribution: Northern Sudan, Oman (Guichard, 1994a). New to the UAE.

Tachytes pygmaeus Kohl, 1888

Plate 141

Specimens examined: 26 males and 6 females. Dubai/al-Awir; Dubai/Nakhalai. Flight period: March–May.

Distribution: North Africa, northern India, Saudi Arabia, Oman, UAE (Guichard, 1994a).

Tachytes saharicus Pulawski, 1962

Distribution: North Africa, Saudi Arabia, UAE (Guichard, 1994a).

Tachytes serapis Pulawski, 1962

Specimens examined: Dubai/al-Awir, 1♀, 12.v.1984, leg. ES.

Distribution: North Africa, Saudi Arabia, UAE (Guichard, 1994a).

Tachytes trichopygus Pulawski, 1962

Distribution: Egypt (Sinai), Israel, UAE (Guichard, 1994a).

Family **Sphecidae** s. str.

Identification: Guichard, 1988a.

Genus ***Ammophila*** Kirby, 1798

Ammophila barbara Lepeletier, 1845

Plate 142

Specimens examined: Wadi Bih (dam), 3♂, 1♀, 19.iii.2009, leg. CSE.

Distribution: North Africa to Arabia, Turkey (Guichard, 1988a). New to the UAE.

Ammophila dolichodera Kohl, 1883

Plate 143

Specimens examined: 9 specimens. Wadi Bih (dam), Wadi al-Helo/near tunnel; Wadi Maidaq, Wadi Safad, Wadi Wurayah. Flight period: March.



Plates 136–137. 136: *Synnevrus ohli* Schmid-Egger nov. spec., male, lateral view, L = 4.0 mm; 137: *Tachytes comberi* Turner, male lateral view, L = 13 mm.



Plates 138–139. *Tachytes diversicornis* Turner, female, L = 9.5 mm. 138: Lateral view; 139: Head.



Plates 140–141. 140: *Tachytes niloticus* Turner, female, lateral view, L = 11 mm; 141: *Tachytes pygmaeus* Kohl, male, lateral view, L = 8.7 mm.



Plate 142. *Ammophila barbara* Lepeletier, male, lateral view, L = 15 mm.

Distribution: South Africa northwards to Mali and Niger, Arabian Peninsula (Guichard, 1988a). New to the UAE.

Ammophila erminea Kohl, 1901

Plate 144

Specimens examined: 6 specimens. Jebel Hafit/S of al-Ain, Sharjah/Tawi as-Saman oasis, Wadi Bih (dam), Wadi Wurayah. Flight period: March.

Distribution: North Africa, Israel, Jordan, Saudi Arabia, UAE (Guichard, 1988a).

Ammophila gracillima Taschenberg, 1869

Specimens examined: Al-Ajban, 1♂, 7–21.viii.2008, leg. AvH.

Distribution: North Africa, Israel and Arabia (Guichard, 1988a). New to the UAE.

Ammophila haimatosoma Kohl, 1883

Plate 145

Specimens examined: Dubai/Nakhalai, 2♂, 20.iv.1984, leg. ES.

Distribution: North Africa, Israel and Arabia (Guichard, 1988a). New to the UAE.

Ammophila insignis egregia Mocsary, 1881

Specimens examined: Wadi Wurayah, 1♂, 19.iii.2009, leg. CSE.

Distribution: Israel, Syria, Arabia (Guichard, 1988a); the nominate form in Africa south of Sahara. New to the UAE.



Plates 143–144. 143: *Ammophila dolichodera* Kohl, male, lateral view, L = 21 mm; 144: *Ammophila erminea* Kohl, male, lateral view, L = 21 mm.

Ammophila poecilocnemis Morice, 1900 Plate 146
 Specimens examined: 50 specimens. Jebel Hafit/S of al-Ain; Wadi Bih (dam), Wadi Hayl; Wadi al-Helo/near tunnel; Wadi Madaq, Wadi Shawkah, Wadi Wurayah. Flight period: November–March.
 Distribution: North Africa, Israel, Oman, Saudi Arabia, UAE (Guichard, 1988a).

Ammophila rubripes Spinola, 1838 Plate 147
 Specimens examined: 18 specimens. Al-Ajban. Flight period: April, July, November.
 Distribution: North Africa to Sahel, widespread and common in Arabia including the UAE (Guichard, 1988a).

Genus ***Chalybion*** Dahlbom, 1843

Chalybion flebile Lepeletier, 1845 Plate 148
 Specimens examined: Wadi Madaq, 2♀, 19.iii.2009, leg. CSE. Wadi Wurayah, 1♂, 20.iii.2009, leg. O. Berg.
 Distribution: Mediterranean area, Iran, Iraq, Arabia including the UAE (Guichard, 1988a).

Genus ***Chlorion*** Latreille, 1802

Chlorion semenowi occidentale de Beaumont, 1962
 Distribution: Egypt, Israel, Saudi Arabia, Oman, UAE (Guichard, 1988a).

Chlorion hirtum Kohl, 1885
 Distribution: Egypt, Israel, Jordan, Arabia, UAE (Guichard, 1988a).

Chlorion funereum Gribodo, 1879
 Distribution: North Africa, Jordan, Saudi Arabia, Yemen, UAE (Guichard, 1988a).

Genus ***Parapsammophila*** Taschenberg, 1869

Parapsammophila algira Kohl, 1901
 Specimens examined: Wadi al-Helo/near tunnel, 1♂, 19.iii.2009, leg. CSE.
 Distribution: North Africa, Saudi Arabia, Oman (Guichard, 1988a). New to the UAE.

Parapsammophila dolichostoma Kohl, 1901
 Specimens examined: 13 specimens. Jebel Hafit/S of al-Ain, Wadi Bih (dam), Wadi Hayl, Wadi al-Helo/near tunnel, Wadi Shawkah, Wadi Wurayah. Flight period: March.
 Distribution: Sahara, Egypt, Saudi Arabia, Yemen (Guichard, 1988a). New to the UAE.

Parapsammophila turanica Morawitz, 1890
 Specimens examined: Mahafiz, 1♀, 19.iii.2009, leg. CSE. Sharjah Desert Park, 2♀, 12.iii.2008, leg. MH. Wadi Wurayah, 1♀, 20.iii.2009, leg. O. Berg.
 Distribution: North Africa, southern Asia, Arabia including the UAE (Guichard, 1988a).

Genus ***Podalonia*** Fernald, 1927

Podalonia tydei Le Guillon, 1841 Plates 149–150
 Specimens examined: 14 specimens. Al-Ajban, Dubai/al-Awir; Ra's al-Khaimah Airport, Sharjah/15 km N of ad-Dhaid. Flight period: March–June.
 Distribution: Africa, southern Europe, Arabia including the UAE (Guichard, 1990).



Plates 145–146. 145: *Ammophila haimatosoma* Kohl, male, lateral view, L = 20 mm; 146: *Ammophila poecilocnemis* Morice, female, lateral view, L = 19 mm.



Plates 147–148. 147: *Ammophila rubripes* Spinola, male, lateral view, L = 20 mm; 148: *Chalybion flebile* Lepeletier, female, dorsal view, L = 18 mm.



Plates 149–150. *Podalonia tydei* Le Guillon. 149: Male, lateral view, L = 18 mm; 150: Female, lateral view, L = 20 mm.

Genus *Prionyx* Vander Linden, 1827

Prionyx crudelis F. Smith, 1856

Distribution: Africa, India, western Asia to Greece, Arabia including the UAE (Guichard, 1988a).

Prionyx kirbii Vander Linden, 1827

Plate 151

Specimens examined: Wadi Wurayah, 1♂, 19.iii.2009, leg. CSE.

Discussion: The species was mentioned as *Prionyx kirbii* subspec. *marginatus* F. Smith, 1856, by Guichard, 1988a). In my opinion *marginatus* is a colour form differing only by red petiole, occurring in the arid areas of Africa and Arabia.

Distribution: Africa, India, Arabia (Guichard, 1988a). New to the UAE.

Prionyx niveatus Dufour, 1863

Plate 152

Specimens examined: Um al-Quwain, 2♂, 28.vi.2008, leg. AvH.

Distribution: North Africa, western Asia, Arabia including the UAE (Guichard, 1988a).

Prionyx trichargyrus Spinola, 1838

Specimens examined: Sharjah Desert Park, 1♀, 28.xii.2006, leg. AvH.

Distribution: West and North Africa, Saudi Arabia (Guichard, 1988a). New to the UAE.

Prionyx viduatus (Christ, 1791)

Specimens examined: Near Qurayyah, 1♂, 7.viii.2008, leg. AvH.

Distribution: Africa, temperate Asia to China, Arabia including the UAE (Guichard, 1988a).

Genus *Sceliphron* Klug, 1801

Sceliphron madraspatanum pictum F. Smith, 1856

Plate 153

Specimens examined: 10 specimens. Al-Ajban, Dubai/al-Awir, Fujairah, Hatta, Wadi Hayl, Wadi Madaq, Wadi Wurayah. Flight period: April–September.

Discussion: *Sceliphron madraspatanum pictum* is a markedly yellow coloured form of *madraspatanum* and occurs in southwest and central Asia. Its taxonomical state as a subspecies is questionable. In my opinion it is a light colour form and not a subspecies. I have examined several specimens from Iraq and other places of origin, which partly represent intermediate forms between *pictum* and the Mediterranean subspec. *S. madraspatanum tubifex* Latreille, 1809. The latter consequently also has to be treated as forma.

Sceliphron rectum pulchellum Gussakovskij, 1933

(as *pulchellum rectum* Kohl, 1918, in Guichard, 1988a).

Distribution: Iran, India, Pakistan, UAE (Hensen, 1987)

Sceliphron spirifex Linnaeus, 1758

Distribution: Africa, southern Europe, Asia, widespread in Arabia, including the UAE (Guichard, 1988a).

Genus *Sphex* Linnaeus, 1758

Sphex argentatus Fabricius, 1787

Specimens examined: Dubai/al-Awir, 3♂, 5.v–30.vi.1984, leg. ES.

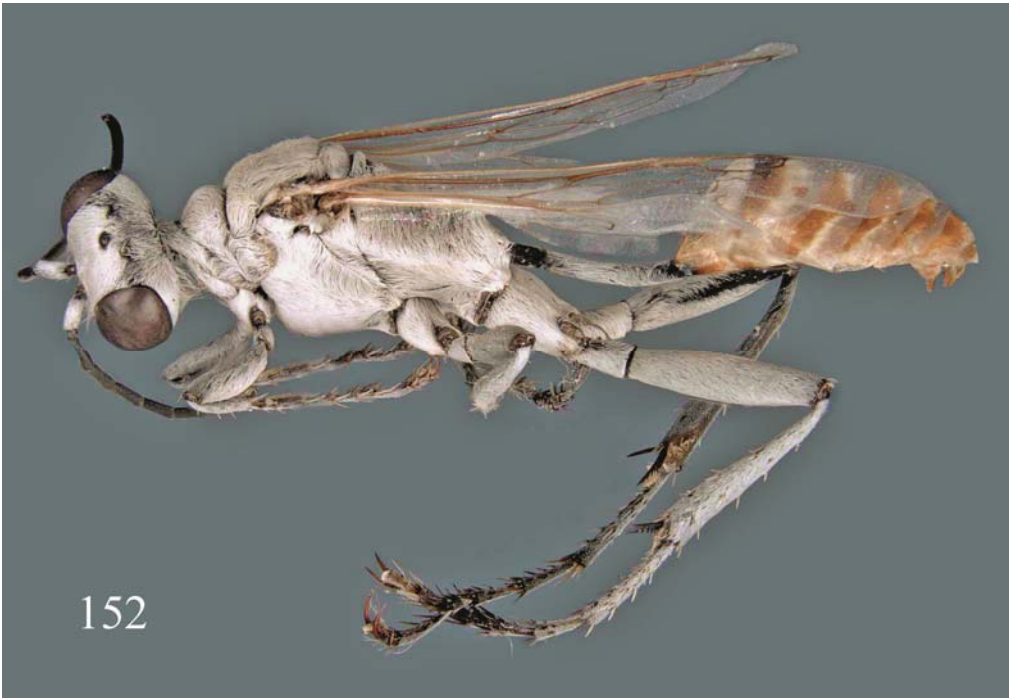

Plates 151–152. 151: *Prionyx kirbii* Vander Linden, male, lateral view, L = 15 mm; 152: *Prionyx niveatus* Dufour, male, lateral view, L = 13 mm.



Plate 153. *Sceliphron madraspatanum pictum* F. Smith, male, laterodorsal view, L = 18 mm.

Recognition: The species is not included in the key of Guichard (1988a) and might have been mixed with the following species by that author. The taxonomy of African and western Asian *Sphex* is not finally solved. I recognize *argentatus* by the following character combination within the genus *Sphex*: Gaster black, scutellum bituberculate, wings transparent, basally and apically darkened, face with black erect setae. *Sphex fumicatus* (in my sense) is similar but lacks black setae of face. Face is covered with long white setae only.

Distribution: Widespread in southern Asia and Africa (Pulawski, internet database). New to the UAE. Also, there is an unpublished record from Oman (male, Qurayat, 17.v.2004, leg. et coll. Schlaefle).

Sphex fumicatus Christ, 1791

Distribution: Widespread in southern Asia and Africa (Pulawski, internet database) “The most common and widespread *Sphex* species in Arabia” including Oman and the UAE (Guichard, 1988a). See also comments at *Sphex argentatus*. I have examined specimens from Egypt, Turkey and Oman.

Sphex pruinosus Germar, 1817

Distribution: Mediterranean area, Saudi Arabia, UAE (Guichard, 1988a).

Sphex flavipennis Fabricius, 1793

Distribution: Mediterranean area to Afghanistan, UAE (Guichard, 1988a).

ACKNOWLEDGEMENTS

I particularly thank Tony van Harten for sending the material and for his constant constructive and pleasant collaboration on the project. I also thank Dr. Michael Ohl and Volker Lohrmann from the Humboldt Museum, Berlin/Germany for their support in taking photos with the auto montage system of the Berlin Museum. Vladimir Kononenko from Vladivostok/Russia prepared the photos to their present brilliance. Martin Hauser from Sacramento/California, USA, Dr. Kees van Achterberg from Leiden/the Netherlands, Jan Batelka from Praha/Czech Republic, Oistein Berg from Oslo/Norway and Dr. Michael Ohl send specimens for further identification. Prof. Wojciech Pulawski, San Francisco/California, USA, Toshko Ljubomirov from Sofia/Bulgaria, and Alexander Antropov, Moscow/Russia supported the author by identifying various specimens. I also thank Margie Cochrane from the Cape Town Museum for searching for type material.

REFERENCES

- Antropov, A. (2007). *Guichardus* is a new Palaearctic genus of digger wasps of the tribe Oxybelini (Hymenoptera, Crabronidae). *Zoologicheskii Zhurnal*, 86: 211–220.
- Arnold, G. (1940). New species of African Hymenoptera No. 4. *Annals of the Transvaal Museum*, 20: 101–143.
- Bitsch, J., H. Dollfuss & Z. Bouček (2007): *Faune de France. France et régions limitrophes. 86. Hyménoptères Sphecidae d'Europe occidentale*. Volume 3. Fédération Française des Sociétés de Sciences Naturelles, Paris. 459 pp. 2nd Edition.
- Bohart, R.M. & A.S. Menke (1976): *Sphecid wasps of the world. A generic revision*. University of California Press, Berkeley, Los Angeles, London. 1 colour plate, IX + 695 pp.
- Bouček, Z. (2001): Palaearctic species of *Ammoplanus* (Hymenoptera: Sphecidae). *Journal of Natural History*, 35: 849–929.
- De Beaumont, J. (1937): Les Psenini (Hym. Sphecid.) de la région paléarctique. *Mitteilungen der Schweizerischen Entomologischen Gesellschaft*, 17: 33–93.
- De Beaumont J. (1959): Le genre *Laphyragogus* Kohl (Hym. Sphecid.). *Revue Suisse de Zoologie*, 66: 723–734.
- De Beaumont, J. (1960): Le genre *Dinetus* (Hym. Sphecid.). *Polskie Pismo Entomologiczne*, 30: 251–271.
- De Beaumont, J. (1961a): Les espèces méditerranéennes du genre *Pison* Jur. (Hym. Sphecid.). *Mitteilungen der Schweizerischen Entomologischen Gesellschaft*, 34: 53–56.
- De Beaumont, J. (1961b): Les *Liris* du bassin méditerranéen (Hym. Sphecid.). *Mitteilungen der Schweizerischen Entomologischen Gesellschaft*, 34:213–252.
- Dollfuss, H. (1986). Eine Revision der Gattung *Spilomena* Shuckard der westlichen und zentralen paläarktischen Region (Hymenoptera, Sphecidae). *Annalen des Naturhistorischen Museum in Wien*, 88–89: 481–510.
- Guichard, K.M. (1980): A preliminary account of the sphecid wasps of Oman (Hymenoptera, Sphecidae). *The Journal of Oman Studies*. Special Report No. 2: 223–232.
- Guichard, K.M. (1986): Hymenoptera: Fam. Sphecidae of Arabia. Key to the Arabian genera of hunting wasps. *Fauna of Saudi Arabia*, 8: 343–351.
- Guichard, K.M. (1988a): Hymenoptera: Sphecidae: Subfam. Sphecinae of the Arabian Peninsula. *Fauna of Saudi Arabia*, 9: 114–131.
- Guichard, K.M. (1988b): The genus *Palarus* (Hymenoptera: Sphecidae) in Arabia. *Fauna of Saudi Arabia*, 9: 132–137.

- Guichard, K.M. (1989a): The genera *Stizus* and *Stizoides* (Hymenoptera: Sphecidae) in Arabia. *Fauna of Saudi Arabia*, 10: 152–159.
- Guichard, K.M. (1989b): The genus *Bembix* (Hymenoptera: Sphecidae) in Arabia. *Fauna of Saudi Arabia*, 10: 134–151.
- Guichard, K.M. (1990): The genus *Oxybelus* (Hymenoptera: Sphecidae) in Arabia. *Fauna of Saudi Arabia*, 11: 277–285.
- Guichard, K.M. (1991a): Old World *Belomicrus* A. Costa, 1871. *Entomofauna*, 12: 353–369.
- Guichard, K.M. (1991b): Sphecidae (Hymenoptera) from Jordan including a new species of *Crabro*. *Linzer Biologische Beiträge*, 23: 337–343.
- Guichard, K.M. (1993): The genus *Cerceris* (Hymenoptera: Sphecidae) in Arabia. *Fauna of Saudi Arabia*, 13: 152–169.
- Guichard, K.M. (1994a): The genus *Tachytes* (Hymenoptera: Sphecidae) in Arabia. *Fauna of Saudi Arabia*, 14: 213–219.
- Guichard, K.M. (1994b): The genera *Philanthus* and *Philanthinus* (Hymenoptera: Sphecidae) in Arabia. *Fauna of Saudi Arabia*, 14: 207–212.
- Gussakovskij, V.V. (1937): Espèces paléarctiques des genres *Didineis* Wesm., *Pison* Latr. et *Psen* Latr. (Hymenoptera Sphecidea). *Trudy Zoologicheskogo Instituta Akademii Nauk SSSR*, 4: 599–698.
- Leclercq, J. (1958). Hymenoptera Sphecoidea (Sphecidae II. Subfam. Crabroninae) in: *Exploration du Parc National de l'Upemba. I. Mission G.F. de Witte en collaboration avec W. Adam, A. Janssens, L. van Meel & R. Verheyen (1946–1949), Fasc. 45: 1–114.*
- Leclercq, J. (1989). En vue d'une monographie du genre *Lindenius* Lepeletier & Brullé (Hymenoptera Sphecidae Crabroninae). *Bulletin de la Société Royale des Sciences de Liège*, 58: 419–444.
- Leclercq, J. (1990): Hyménoptères Sphécides Crabroniens du genre *Dasyproctus* Lepeletier & Brullé trouvés dans la Région Afrotropicale. *Bulletin de la Société Royale des Sciences de Liège*, 59: 219–257.
- Leclercq, J. (1997): Hyménoptères Sphécides Crabroniens du genre *Entomognathus* Dahlbom, 1844 d'Afrique et d'Asie. *Entomofauna*, 18: 113–134.
- Leclercq, J. (1998). *Crossocerus* (*Crossocerus*) *emirorum* sp. n., Crabronien nouveau des Emirats Arabes Unis (Hymenoptera: Sphecidae: Crabroninae). *Bulletin & Annales de la Société Royale Belge d'Entomologie*, 134: 235–238.
- Marshakov, V.B. (1976): Digger wasps of the genera *Eremiasphecium* Kohl, *Ammoplanus* Gir., *Ammoplanops* Guss. and *Anomiapteryx* Guss. (Hymenoptera, Sphecidae) of the fauna of the USSR and Mongolia. *Éntomologicheskoye Obozreniye*, 55: 668–682.
- Nemkov, P.G. (2001): Review of the digger wasps of the genus *Synnevrus* A. Costa (Hymenoptera, Crabronidae, Bembicinae) of Russia and neighboring countries. *Far Eastern Entomologist*, 98: 1–11.
- Ohl, M. (1999): A revision of *Stizoides* Guérin-Méneville, 1844: taxonomy, phylogenetic relationships, biogeography, and evolution (Hymenoptera: Apoidea: "Sphecidae"). *Mitteilungen aus dem Museum für Naturkunde in Berlin, Zoologische Reihe*, 75: 63–169.
- Ohl, M. (2008): Order Hymenoptera, family Heterogynaidae. *Arthropod fauna of the UAE*, 1: 403–406.
- Pulawski, W. (1962): Les *Tachytes* Panz. de la région paléarctique occidentale et centrale (Hym., Sphecidae). *Polskie Pismo Entomologiczne*, 32: 311–475.
- Pulawski, W. (1973): Les *Ammatomus* A. Costa (Hym., Sphecidae) de la région paléarctique occidentale et centrale. *Polskie Pismo Entomologiczne*, 43: 273–288.
- Pulawski, W. (1977): A revision of the Old World *Parapiagetia* Kohl (Hymenoptera, Sphecidae). *Polskie Pismo Entomologiczne*, 47: 601–669.

- Pulawski, W. (1979): A revision of the World *Prosopigastra* Costa (Hymenoptera, Sphecidae). *Polskie Pismo Entomologiczne*, 49: 3–134.
- Pulawski, W. (1992): A review of *Eremiasphecium* Kohl, 1897 (Hymenoptera: Sphecidae). *Entomofauna*, 13: 397–408.
- Pulawski, W. (1995): The wasp genus *Gastrosericus* Spinola, 1839 (Hymenoptera: Sphecidae). *Memoirs of the California Academy of Sciences*, 18: i–vi, 1–173.
- Pulawski, W.J. & M.A. Prentice: (2008): A revision of the wasp tribe Palarini Schrottky, 1909 (Hymenoptera: Apoidea: Crabronidae). *Proceedings of the California Academy of Sciences*, Series 4, 59: 307–479.
- Schmid-Egger, C. (2004): Revision of *Bembecinus* (Hymenoptera, Crabronidae) of the Palearctic Region. *Notes Fauniques de Gembloux*, 54: 3–69.
- Schmidt, K. (2000): Bestimmungstabelle der Gattung *Cerceris* Latreille, 1802 in Europa, dem Kaukasus, Kleinasien, Palästina und Nordafrika (Hymenoptera, Sphecidae, Philanthinae). *Stapfia*, 71: 1–325.
- Simon Thomas, R.T. (1994): Two new species of a new genus of Sphecidae from Senegal and Yemen (Hymenoptera). *Entomologische Berichten*, 54: 154–157.
- Simon Thomas, R.T. (1995): Two new species of *Spilomena* from Yemen (Hymenoptera: Sphecidae). *Entomologische Berichten*, 55: 68–71
- Simon Thomas, R.T. (1996): The status of the genus *Xanthosphecium* Simon Thomas (Hymenoptera: Sphecidae). *Entomologische Berichten*, 56: 196.