



National Products Inc.

2021 | ZEBRA MOUNTING SOLUTIONS



Field Service . Healthcare . Manufacturing . Retail . Transportation . Warehouse



SEEN IN THIS PHOTO:

RAM-HOL-ZE14U

RAM® Form-Fit Powered Dock
for Zebra TC21 & TC26

RAM-B-166U

RAM® Twist-Lock™ Suction Cup
Double Ball Mount

TABLE OF CONTENTS

HANDHELD PC



03 HANDHELD PC DOCKS



11 UNIVERSAL HOLDERS

SCANNERS



05 SCANNER HOLDERS

PRINTERS



06 PRINTER HOLDERS

TABLET PC



07 RUGGED TABLET DOCKS



11 UNIVERSAL HOLDERS

VEHICLE MOUNT COMPUTERS



09 VEHICLE MOUNT COMPUTER SOLUTIONS

POPULAR KITS

14



SEEN IN THIS PHOTO:

RAM-HOL-ZE7U

RAM® Form-Fit Powered Holder for Zebra TC70, 72, 75 & 77

RAM-316-HD-18-202U

RAM® Pod HD™ Vehicle Mount with 18" Aluminum Rod and Round Plate



HANDHELD PC DOCKS

RAM® Mounts offers a wide variety of ruggedized mounting solutions for Zebra mobile computers, printers, barcode scanners and more. Utilizing our form-fitting cradle design, securing your device wherever you need it has never been easier. The versatility of RAM® systems allow you to efficiently move your device between your car, desk, forklift, and much more. Allowing for near-infinite adjustability as well as vibration damping, the RAM® double ball and socket system provides maximum versatility and helps to extend the life of these devices.

HANDHELD PC SOLUTIONS

FORM-FIT POWERED HOLDERS FOR TC70, TC72, TC75 & TC77

RAM-HOL-ZE7U
Non-Locking

RAM-HOL-ZE7CLU
Combo-Locking

RAM-HOL-ZE7LU
Key-Locking

Compatible with the RAM-GDS-CHARGE-V10U for hardwire applications

RAM-HOL-ZE7-NPU
Non-Power

RAM-HOL-ZE6U
RAM® Form-Fit Powered Holder for TC51 & TC52

RAM-HOL-ZE14U
RAM® Form-Fit Powered Holder for Zebra TC21 & TC26

HANDHELD PC DOCKS					
PART NUMBER	DEVICE	NON-LOCKING	COMBO LOCKING	KEY LOCKING	POWER CONNECTOR
RAM-HOL-ZE6U	Zebra TC51, 52, 56 & 57	•			USB Type A
RAM-HOL-ZE7U	Zebra TC70, 72, 75 & 77	•			USB Type A & DC
RAM-HOL-ZE7LU	Zebra TC70, 72, 75 & 78			•	USB Type A & DC
RAM-HOL-ZE7CLU	Zebra TC70, 72, 75 & 79		•		USB Type A & DC
RAM-HOL-ZE7-NPU	Zebra TC70, 72, 75 & 80	•		•	Non-power
RAM-HOL-ZE14U	Zebra TC21 & TC26	•			USB Type A

SCANNER HOLDERS

Different types of scanner guns need different types of mounting solutions. Between the RAM® Quick-Draw™ and the RAM® Power-Grip™ we've effectively provided holders that cover a wide variety of scanner guns of different shapes and sizes. All RAM® Mounts Compatible™, these scanner gun holders have thoughtful design choices such as elastomeric fins that keep the scanner in place but are easy to remove when working fast.



RAM-HOL-ZE9U

RAM® Quick-Draw™ Holder for Zebra TC8000/8300

RAM® POWER-GRIP™

Features replaceable elastomeric fins for a secure fit

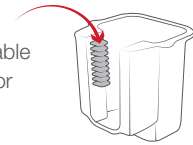

BEST SELLER



RAP-450U

RAM® Power-Grip™ XL Holder for Zebra MC9300

RAP-396U

RAM® Power-Grip™ Holder for Zebra 3600 Series

RAM® DROP-N-LOCK™



RAP-317U

RAM® Drop-N-Lock™ Scanner Gun Holder

RAM® QUICK-DRAW™



RAM-HOL-QD1U

RAM® Quick-Draw™ Spring Loaded Holder

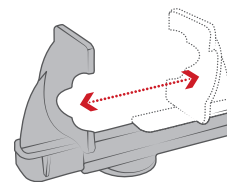

Adjustable side cups allow for supporting a wide variety of devices

SCANNER GUN COMPATIBILITY GUIDE

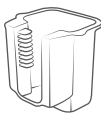
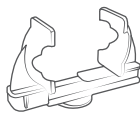
MODEL	 RAM® DROP-N-LOCK™	 RAM® POWER-GRIP™	 RAM® QUICK-DRAW™
3600 Series	-	RAP-396U	RAM-HOL-QD1U
DS8100 Series	RAP-317U	RAP-396U	-
DS4600 Series	RAP-317U	RAP-396U	-
DS2200 Series	RAP-317U	RAP-396U	-
LI2208	RAP-317U	RAP-396U	-
LI4278	RAP-317U	RAP-396U	-
LS1203	RAP-317U	RAP-396U	-
LS2208	RAP-317U	RAP-396U	-
MC2200 & 2700	RAP-317U	RAP-450U	RAM-HOL-QD1U
MC33XX Series	RAP-317U	RAP-450U	RAM-HOL-QD1U
MC3200	-	RAP-450U	RAM-HOL-QD1U
MC9200	-	RAP-450U	RAM-HOL-QD1U
MC9300	-	RAP-450U	RAM-HOL-QD1U
MT2000	-	RAP-396U	RAM-HOL-QD1U
TC8000/8300	-	-	RAM-HOL-ZE9U

SEEN IN THIS PHOTO:

RAM-VPR-104
 RAM® Quick-Draw™ Jr. Universal Small Printer Holder

RAM-101U-247-4
 RAM® 4" Square Post Clamp Mount with Round AMPS Plate

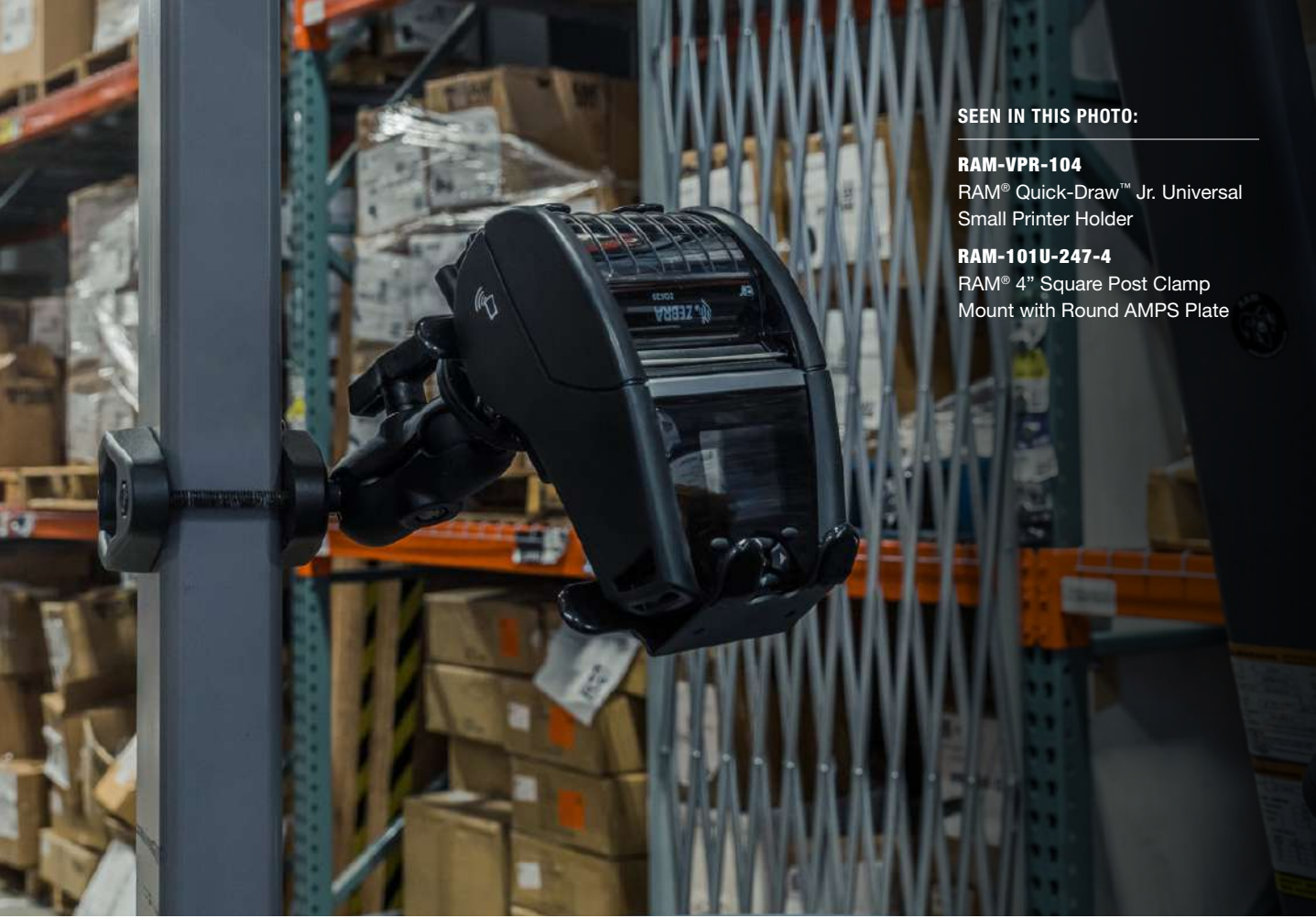

PRINTER HOLDERS

RAM® Mounts always doubles down on universal mounting solutions, and Zebra printers provide a convenient shape to house such mounting solutions. Our RAM® Quick-Draw™ Jr. holders utilize spring-loaded grips that extend to fit nearly any size of Zebra printers. Pair these holders with any B or C size RAM® mounting components for the ideal kit in the field service and material handling spaces.

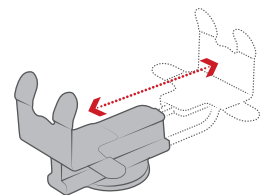

Spring-loaded universal holders offer convenient insertion and removal



RAM-VPR-105
 RAM® Quick-Draw™ Jr. Universal Printer Holder



RAM-VPR-104
 RAM® Quick-Draw™ Jr. Universal Small Printer Holder

MODEL	PART ID
QLN Series	RAM-VPR-104
ZQ300 Series	RAM-VPR-104
ZQ500 Series	RAM-VPR-104
ZQ600 Series	RAM-VPR-104

RUGGED TABLET DOCKS

To conquer everyday tasks in the warehouse, in the field, or on the front lines, RAM® Mounts rugged mounting solutions enable Zebra's versatile tablets to make the ideal pairing. Explore the new GDS® Power + Data docks for the Zebra ET5x 8.3", 8.4" and 10.1" rugged tablets with many different options to keep your device connected to power and have the ability to add peripherals such as scanners, printers, speakers and more.



RAM-HOL-ZE10PD2CLU
GDS® Combo Locking Power + Dual USB Dock for Zebra ET5x 8.3" & 8.4"



Optional accessory bracket allows you to connect RAM® 2-hole diamond bases for device mounting and features a cable management system for charge cords or additional peripherals

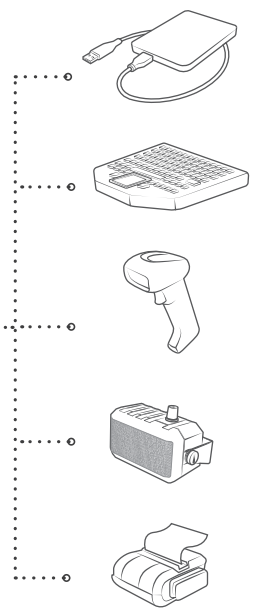
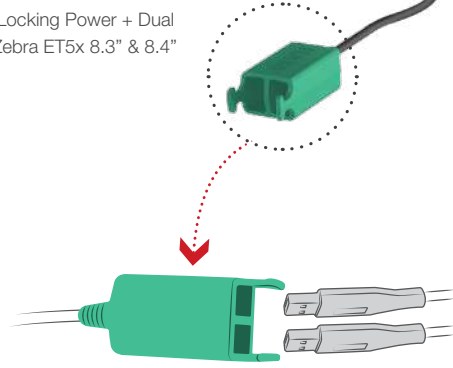

KITS



RAM-D-101U-C-247-4
RAM® 4" Square Post Clamp Mount with Round AMPS Plate



RAM-DIS-103-2U
RAM® Standard Accessory/Display Bracket



SEEN IN THIS PHOTO:





RAM-HOL-ZE10PD2CLU
 GDS® Combo Locking
 Power + Dual USB Dock
 for Zebra ET5x 8.3" & 8.4"

RAM-D-101U-C-247-4
 RAM® 4" Square Post
 Clamp Mount with Round
 AMPS Plate





RAM-DIS-103-2U
 RAM® Standard
 Accessory/Display Bracket

RAM-KB2-USB
 GDS® Keyboard™
 with Track Pad

ZEBRA ET5X 8.3" & 8.4"

PART NUMBER	 COMBO LOCKING	 KEY LOCKING	 POWERED	 SINGLE USB PERIPHERAL PORTS	 DUAL USB PERIPHERAL PORTS
RAM-HOL-ZE10U					
RAM-HOL-ZE10CLU	•				
RAM-HOL-ZE10KLU		•			
RAM-HOL-ZE10PU			•		
RAM-HOL-ZE10PCLU	•		•		
RAM-HOL-ZE10PKLU		•	•		
RAM-HOL-ZE10PDU			•	•	
RAM-HOL-ZE10PDCLU	•		•	•	
RAM-HOL-ZE10PDKLU		•	•	•	
RAM-HOL-ZE10PD2U			•		•
RAM-HOL-ZE10PD2CLU	•		•		•
RAM-HOL-ZE10PD2KLU		•	•		•

ZEBRA ET5X 10.1"

PART NUMBER	 COMBO LOCKING	 KEY LOCKING	 POWERED	 SINGLE USB PERIPHERAL PORTS	 DUAL USB PERIPHERAL PORTS
RAM-HOL-ZE11U					
RAM-HOL-ZE11CLU	•				
RAM-HOL-ZE11KLU		•			
RAM-HOL-ZE11PU			•		
RAM-HOL-ZE11PCLU	•		•		
RAM-HOL-ZE11PKLU		•	•		
RAM-HOL-ZE11PDU			•	•	
RAM-HOL-ZE11PDCLU	•		•	•	
RAM-HOL-ZE11PDKLU		•	•	•	
RAM-HOL-ZE11PD2U			•		•
RAM-HOL-ZE11PD2CLU	•		•		•
RAM-HOL-ZE11PD2KLU		•	•		•



SEEN IN THIS PHOTO:

- RAM-D-202U-CR01**
Crown Work Assist Adapter with 2.25" Ball
- RAM-D-201U-C**
Short Socket Arm with 2.25" Ball
- RAM-D-202U-23**
Device Adapter with 2.25" Ball
- RAM-KNOB9HU**
RAM® Hi-Torg™ Wrench for 2.25" Ball

VEHICLE MOUNT COMPUTER SOLUTIONS

When it comes to heavy duty equipment, RAM® Mounts is the most trusted brand for keeping these devices mounted without fault. For large Zebra vehicle computers, take advantage of the ultra-rugged forklift and vehicle mounts with VESA ball adapters designed to install directly into the back of the computer.

1

CHOOSE A BALL ADAPTER

RAM® offers a wide selection of ball adapters and cradles for your specific device.

2

CHOOSE A SOCKET ARM

Select a socket arm based on your desired length and placement.

3

CHOOSE A BASE

Select from a variety of bases to help secure your device where you need it.



This wrench provides the extra leverage needed to tighten the mount in cold weather or in small spaces.



Vibration damping

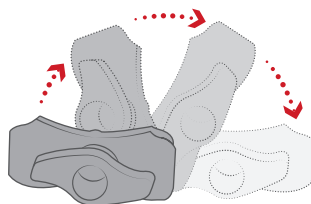

Double ball and socket technology allows for near-infinite adjustability of your RAM® mounting system

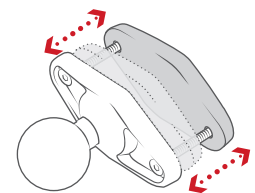

Easily adjustable

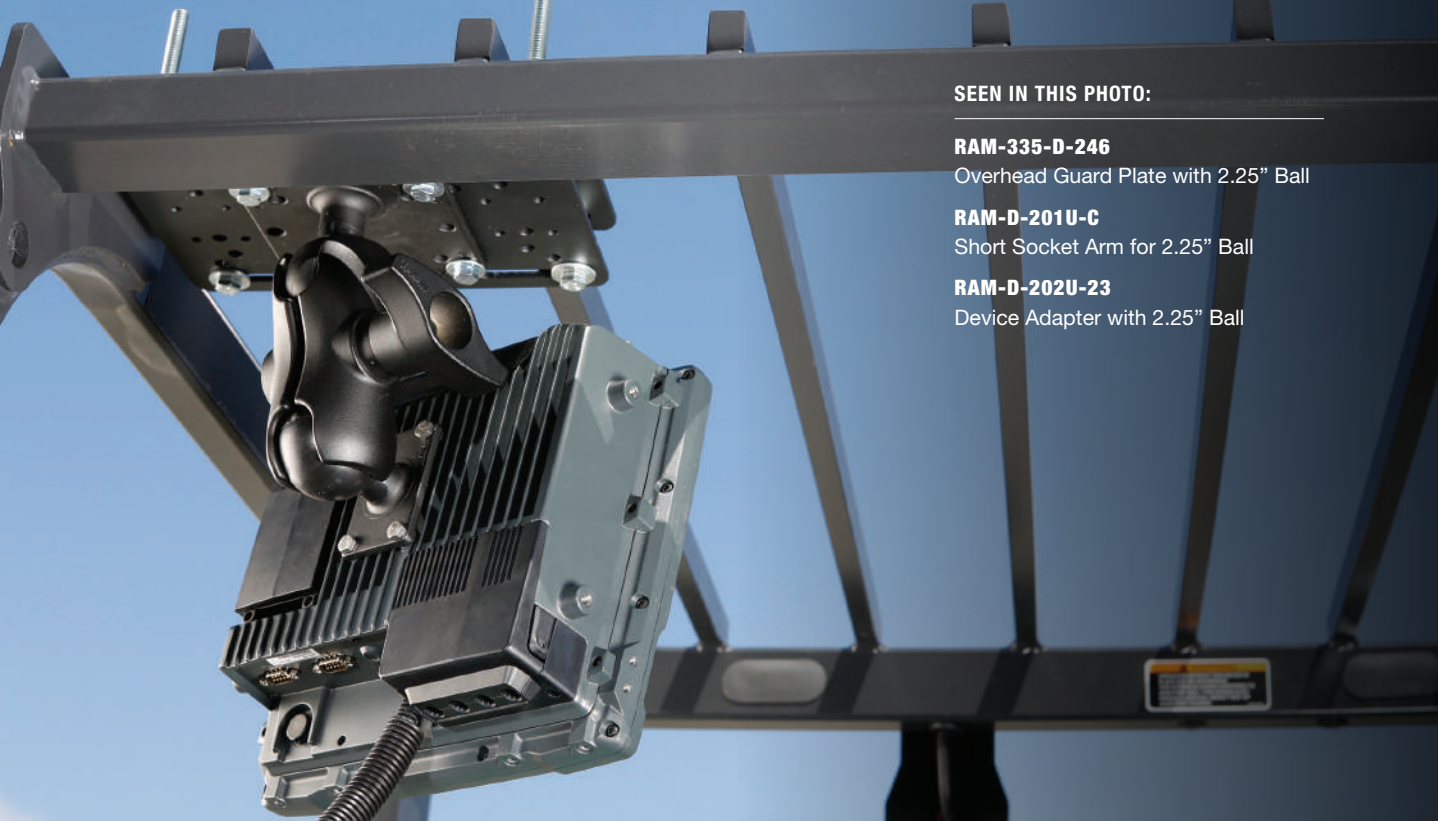

SEEN IN THIS PHOTO:

- RAM-335-D-246**
Overhead Guard Plate with 2.25" Ball
- RAM-D-201U-C**
Short Socket Arm for 2.25" Ball
- RAM-D-202U-23**
Device Adapter with 2.25" Ball

1 BALL ADAPTERS



RAM-D-2461U
75 x 75mm VESA Pattern
Zebra VC70N0



RAM-D-202U-23
1.5" x 2.5" Hole Pattern
Zebra VC8300
Zebra VC80
Zebra VH10 / VH10F

2 SOCKET ARMS



RAM-D-201U-C
Short Socket Arm



RAM-D-201U-C-MI1
Short Socket Arm with Jam Nut



RAM-D-201U
Medium Socket Arm



RAM-D-201U-MI1
Medium Socket Arm with Jam Nut

2 BASES



RAM-D-247U-4-IN1
4" Square Clamp Forklift Base



RAM-D-202U-IN1
Drill-Down Base



RAM-D-202U-CR01
Crown Work Assist Ball Base

UNIVERSAL HOLDERS

Using a tablet for in-vehicle navigation and mobile work is on the rise. The RAM® X-Grip® for Tablets holds all the benefits and design features of the standard X-Grip® with added arm support for a variety of different size Zebra tablets with, or without a rugged case. Additional grip handles provide side support for portrait, or landscape orientation, and are completely removable. Protect your investment with the highly rugged X-Grip® and be sure these holders stand the test of time in the harshest environments.



**BEST
SELLER**

RAM-HOL-UN9U
RAM® X-Grip® Universal Holder
for 9"-10" Tablets

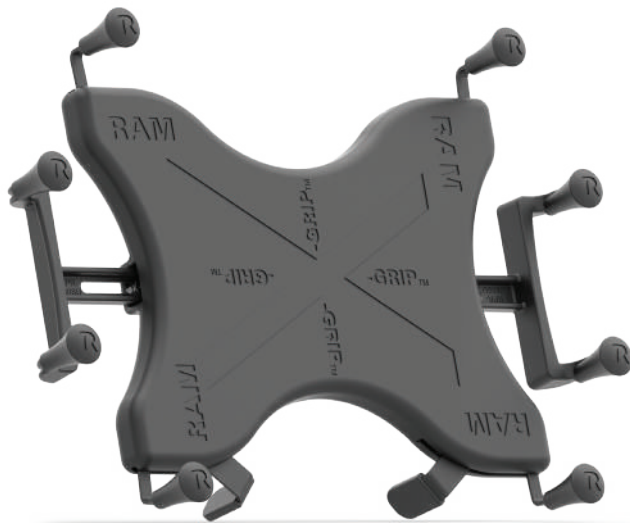

RAM-HOL-UN11U
For Zebra XSLATE R12

FEATURES

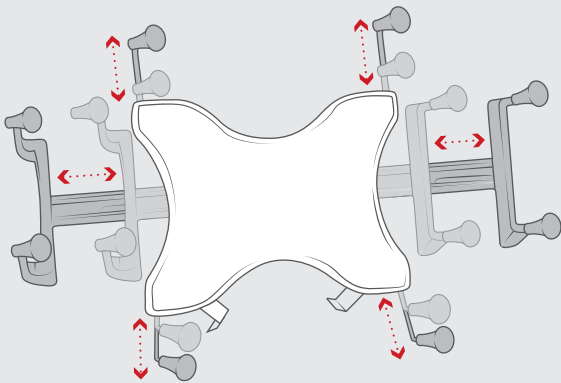

Additional grip handles for convenient insertion and removal

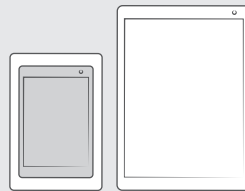

Fits all tablets 7" - 12" with or without a case

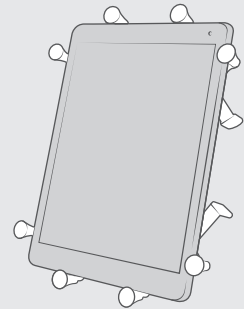

Steel spring-loaded arms keep tablets secure



RAM-HOL-UN4U
RAM® Finger-Grip™ for Zebra EC30, EC50 & EC55



RAM-HOL-TABL19U
RAM® Tab-Lock™ Tablet Holder for Zebra L10 Series (Locking)

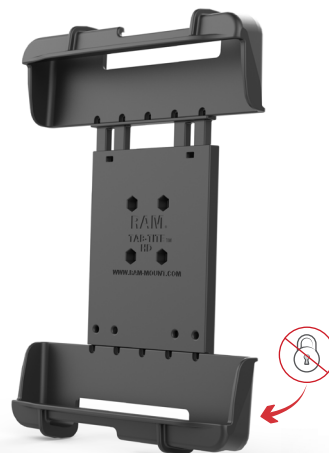

RAM-HOL-TAB19U
RAM® Tab-Tite™ Tablet Holder for Zebra L10 Series (Non-Locking)

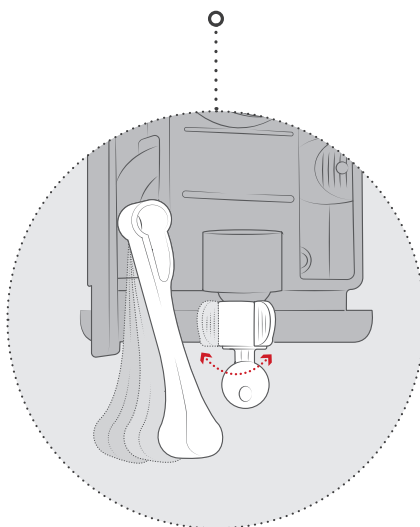

Locking mechanism for theft deterrence

FEATURES

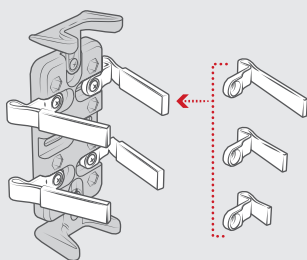

Different finger sizes to accommodate different device thicknesses

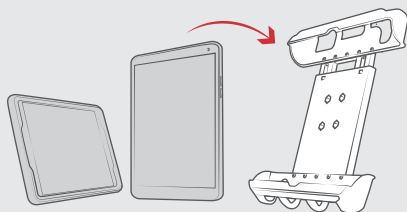

Supports tablets in portrait and landscape mode



Made of high-strength composites for durability and reliability in the most demanding environments

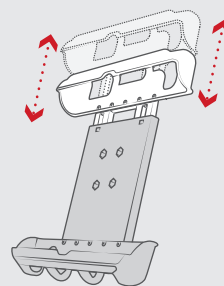

Adjustable to secure all tablets

SEEN IN THIS PHOTO:

RAM-VPR-104-1

RAM® Quick-Draw™ Jr.
with Double U-Bolt Base
for Small Printers



POPULAR KITS



RAM-101U-ZE1
 RAM® Flat Surface Mount for Zebra Printer Docks



RAM-B-138-UN4
 RAM® Finger-Grip™ Universal Mount with Drill-Down Base



RAM-B-108-UN4
 RAM® Finger-Grip™ Universal Mount with Strap Hose Clamp Base



RAM-B-247-3-UN4
 RAM® Finger-Grip™ Universal Holder with 3" Square Post Clamp Mount



RAM-101-ZE9U
 RAM® Quick-Draw™ Drill-Down Mount for Zebra TC8000/8300



RAM-101-235-1-ZE9U
 RAM® Quick-Draw™ Mount for Zebra TC8000/8300 with Double U-Bolt Base



RAM-101-400-ZE9U
 RAM® Quick-Draw™ Mount for Zebra TC8000/8300 with RAM® Tough-Claw™



RAM-101-247-4-ZE9U
 RAM® Quick-Draw™ Mount for Zebra TC8000/8300 with 4" Square Post Clamp



RAM-VPR-105-1
 RAM® Quick-Draw™ Jr. with Double U-Bolt Base for Printers



RAM-VPR-104-1
 RAM® Quick-Draw™ Jr. with Double U-Bolt Base for Small Printers

FEATURES

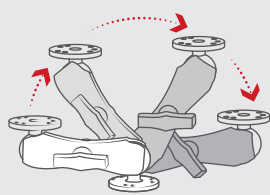

Double ball and socket technology allows for near-infinite adjustability of your RAM® mounting system

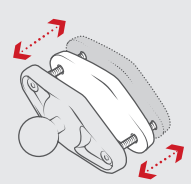

Clamping base ideal for square posts up to 4" in width; adjustable and easily removable

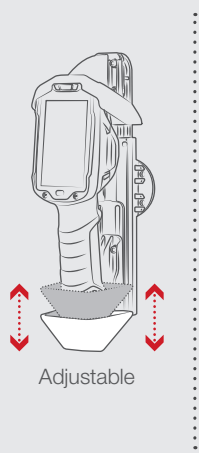

Adjustable

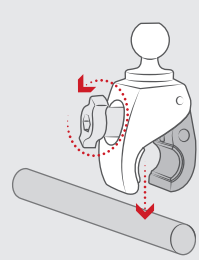

Convenient installation, transfer and removal of base



Mount Anything, Anywhere



rammount.com
1.800.497.7479
sales@rammount.com



GDS®, IntelliSkin®, GDS® Tech®, GDS® Technology®, GDS® Green® and GDS® Compatible® are trademarks or registered trademarks of National Products Inc. The distinctive D Shape® of the GDS® connector is a trademark of National Products Inc.

PATENTS AND TRADEMARKS
WWW.ZEBRAMOUNT.COM/ID



RAM® double socket arms with their distinctive Hourglass Shape are recognized globally as a symbol of the reliability, quality and durability of this line of products. The Hourglass Shape is a registered trademark of National Products Inc.



The distinctive RAM® "X-Grip®" product shape is a trademark of National Products Inc.