

István Balajti<sup>1</sup>

## General Overview on the Radar Conference in Boston 2019

### A bostoni 2019-es radarkonferencia általános áttekintése

Nowadays, 70–85% of the cost of modern warfare equipment is software-based solutions and services. These software modules define the quality and efficiency of the signal and data processing of the information of different sensors types. They are playing key roles in the artificial intelligence supported cognitive data processing and the effectiveness of the soldiers/decision-making commanders. The modernisation of the Hungarian Army, and the success of the Zrínyi 2026, basically depend on the understanding and professional service of the new technologies.

**Keywords:** radar, electronic attack/electronic protection, passive radar systems, bi- and multistatic radar systems, cognitive radar, Spectrum Sharing Technique, weather radar

Napjainkban a modern haditechnikai eszközök költségeinek 70–85%-át szoftver-alapú megoldások, szolgáltatások teszik ki. Ezek a szoftvermodulok határozzák meg a különböző típusú érzékelők jel-, és adatfeldolgozásának hatékonyságát és minőségét. Kulcsfontosságú a katonák-/döntést hozó parancsnokok feladata a mesterséges intelligencia által támogatott kognitív adatértékelés megvalósításában. A Magyar Honvédség modernizálása, a Zrínyi 2026 sikere, alapvetően az új technológiák megértésén és professzionális szintű kiszolgálásán múlik.

**Kulcsszavak:** rádiólokátor, aktív zavarás és zavarvédelem, passzívradar-rendszerek, bi- és multistatikus radarrendszerek, kognitív rádiólokátor, spektrumfelosztási technológiák, időjárásradar

<sup>1</sup> National University of Public Service, Faculty of Military Sciences and Officer Training, e-mail: [balajti.istvan@uni-nke.hu](mailto:balajti.istvan@uni-nke.hu), ORCID: <https://orcid.org/0000-0003-3566-2904>

## Introduction

The USA hosted the International Radar Conference held in Boston at the end of April 2019. The invitation of the Conference pointed out the following fact: "A radar revolution is underway, made possible by the rapid evolution of digital electronics, and powered by new innovative architectures, advanced components, novel waveforms and sophisticated processing techniques" [1].

The author's findings in this article are subjective and focused on the main topics, which may interest the Hungarian and Eastern-European readers.

The focal points of the conference were:

- Radar system related education such as Radar Systems Prototyping and Radar Summer School – Built-A-Radar at MIT
- Spectrum Sharing Techniques between radars and communication systems
- Passive radar systems
- Bistatic and Multistatic radar
- Electronic Attack (ECM)/Electronic Protection (ECCM)
- Weather radar
- Machine Learning Technology and Cognitive Radar
- Emerging technologies

All information on the conference is available at the link: [www.radarconf19.org/](http://www.radarconf19.org/)

## Technical Matters of the Conference

### *Tutorials*

The most powerful and compact part of the radar conferences are usually the Tutorial sections. This time, sixteen Tutorials were presented with titles that covered all relevant subjects, such as: Convex Optimization for Adaptive Radar; Over-the-Horizon Radar; Machine Learning Techniques for Radar ATR; Adaptive Arrays: Principles and Applications; Introduction to Synthetic Aperture Radar; Radar Systems Prototyping; Inverse Synthetic Aperture Radar Satellite Imaging; Radar Tracking State Estimation and Association; Phased Arrays for MIMO Radar; Passive Radar – From Target Detection to Imaging; Ultra-Wide Band Surveillance Radar; Bistatic and Multistatic Radar Imaging; Advanced Radar Processing Techniques; Communications and Radar Spectrum Sharing; Detection, Performance, and CFAR Techniques; Signal Processing for Passive Radar.

Two Tutorials were visited, which were the followings:

## Radar Systems Prototyping and Radar System Related Education

Dr. Lorenzo Lo Monte – Chief Scientist at Telephonics: Radar Systems Prototyping [2]

It is essential for radar engineers and managers to be aware of the radar performance design/upgrade feasibility or applicability of the new concept to the already existing radar. This tutorial refreshed the critical points of radar developments and demonstrated how could a radar prototype in the lowest and fastest way be built. These types of topics are essential for students, researchers and new requirement characterisations, because even the “old fashioned” radar subsystem obsolescence engineering requires proper analyses and feasibility study preparation. The reviewed solutions are characterised by much of the engineering requirements with the cost reduction realisations.

The key messages of the presentation are as follows: The design based on the KISS principle states that most systems work best, if they are kept simple rather than made complicated. See Figure 1.



Figure 1.

*The radar design required application of the KISS principle (The author's modification based on [2])*

Then the presenter went through all the steps of rapid radar design issues starting with the RF connector selection, attenuators/amplifiers mixers, etc. The selection ended at the Close/In and Broadband Phase Noise characterisation. The main part of the tutorial focused on the “Back End Design” critical factors. It started with the observation that Modern Radars perform Digital Signal Processing (DSP) using I/Q Data. Note: These are outdated methods and nowadays we use Direct Digital Demodulation techniques, where the signal sample rate is about 2.5 times of the signal Bandwidth and the unwanted signal filtering is solved by polyphase filters.

The chain of the modern radar receiver is structured as shown in Figure 2.

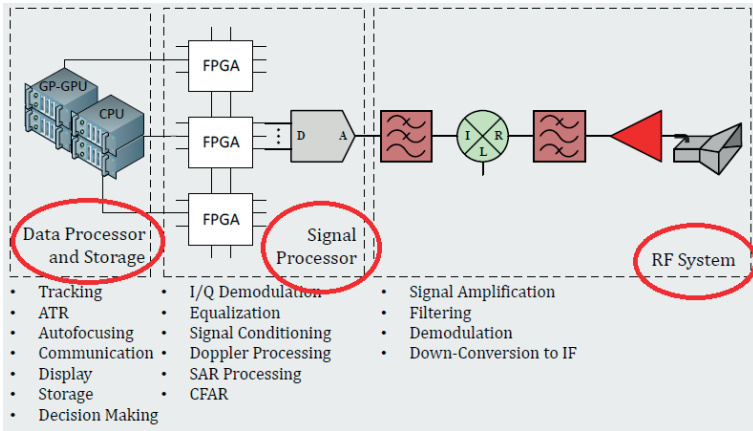

Figure 2.

Main tasks of the chain of the modern radar receiver (The author's modification based on [2])

The "RF system" is usually based on the "Superheterodyne Baseband Sampling" principle. The Signal Processor contains Analog Digital Converters (ADC), and Digital Analog Converters (DAC) for exciter, transmitter and for stable reference RF signals, Digital Signal Processors and FPGA, while for the Data Processor and Storage the most popular solutions are based on Graphical Modules and fast commercial workstations.

After the task clarification, the survey of available resources, devices, test equipment and know-how shall be accomplished. The radar equation is used for the determination of the subsystem design characteristics and performance specification of the radar subsystems. Figure 3 and 4 show the ADC selection of the "RF system".

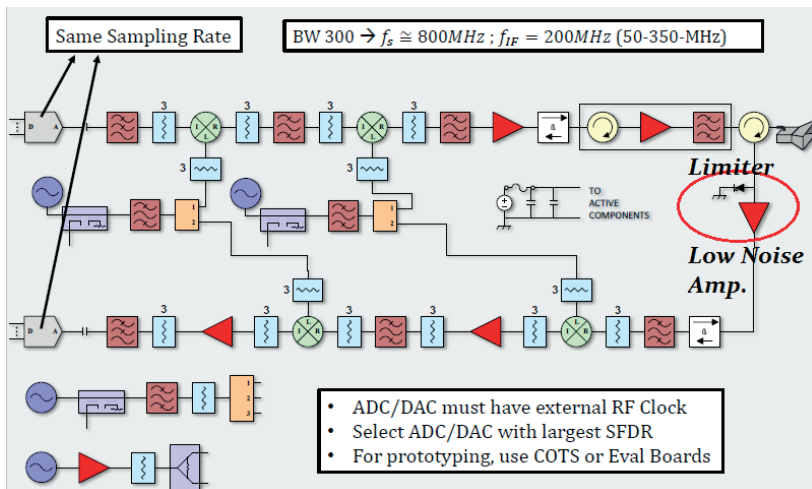

Figure 3.

The ADC selection requirements for the "RF subsystem" (The author's modification based on [2])

The weak signal must be amplified so that it can be measured well at the ADC

- Too little amplification will reduce SNR
- Too high amplification won't change SNR but will reduce dynamic range
- We need to find the right value

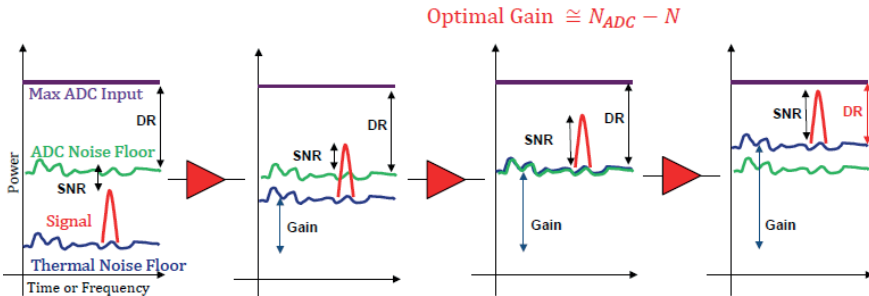

Figure 4.

The ADC dynamic range step up to the "RF subsystem" thermal noise [2]

Mitigation mismatching, unwanted spurious signal filtering and maximising linearity are the core requirements as the example in Figure 5 shows.

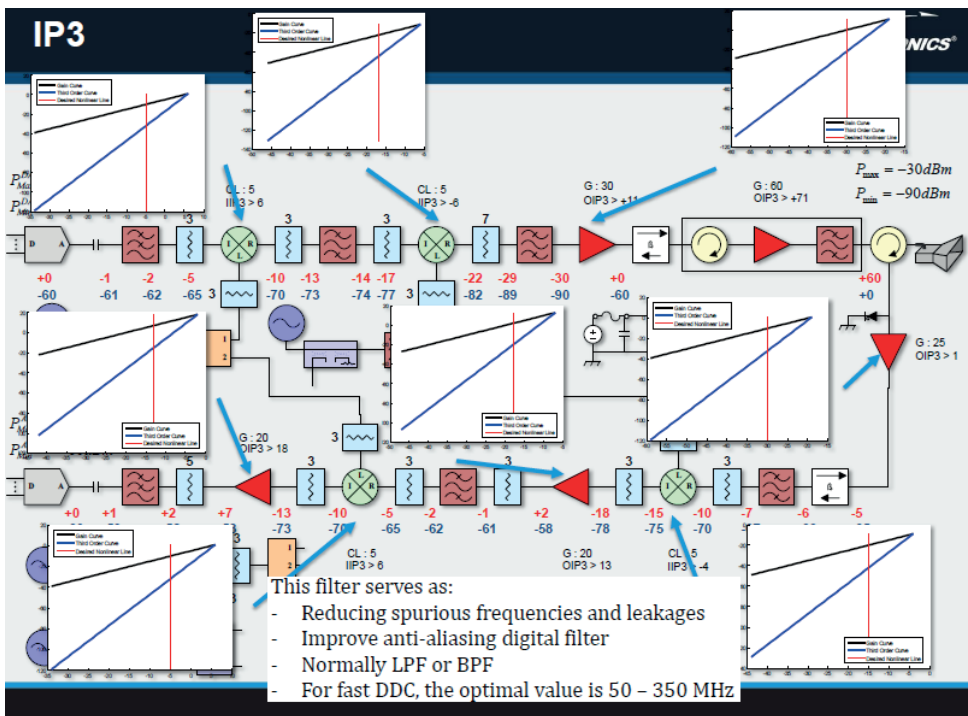

Figure 5.

Example for the linearity requirements of the RF components (The author's modification based on [2])

The presentation ended with emphasising the importance of further research as Figure 6 summarises.

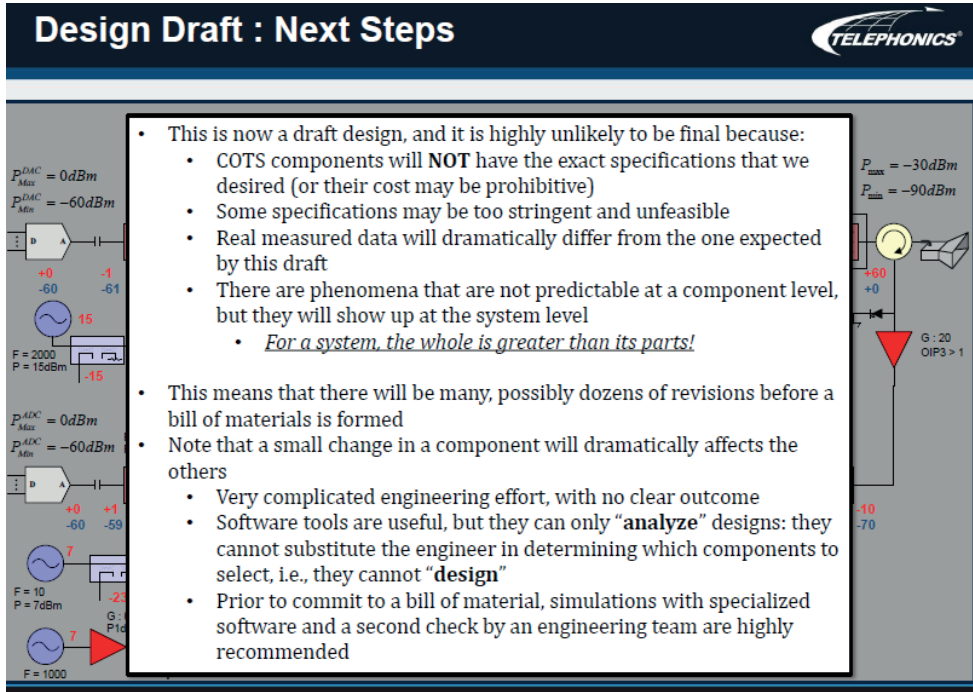

Figure 6.

*The reasons why the prototype of the radar is not the final solution [2]*

### Radar Summer School – Built-A-Radar at MIT

The presentations and the two days of “Summer School – Built-A-Radar at MIT” are managed by Kenneth E. Kolodziej, Patrick J. Bell, Alan J. Fenn, Elizabeth Kowalski, John W. Meklenburg, William F. Moulder, Julia S. Mullen and Bradley T. Perry. The presentation of these authors entitled *Build-a-Radar Self-Paced Massive Open Online Course* (MOOC) gives a quick overview of the subject offered possibilities [3]. The success of the courses highlights that Electromagnetic Education can be greatly enhanced by providing students with a practical hands-on project that helps illustrate the different theoretical concepts covered.

Figure 7 shows the radar which could be built by enthusiastic students or teams demonstrating the beauty, possibilities and importance of the radar related topics.

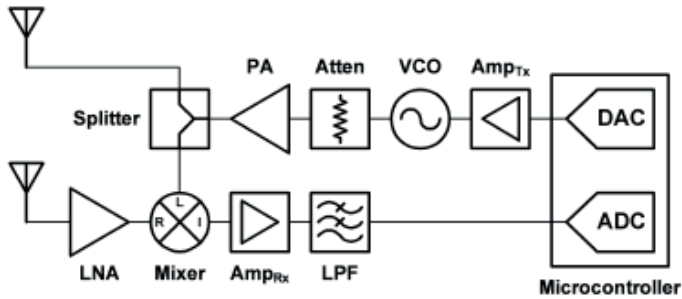

Figure 7.

Block diagram of the radar highlighting the connection of the microcontroller to the RF components and two antennas [3]

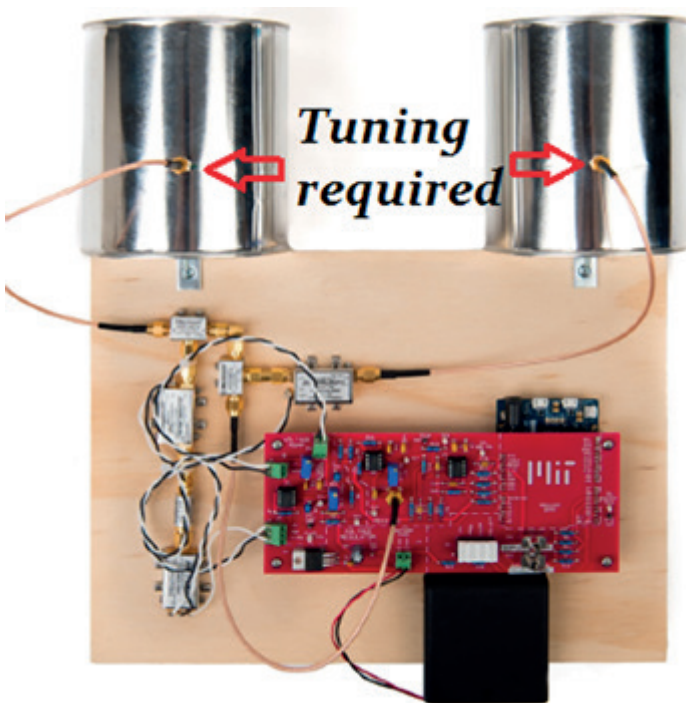

Figure 8.

Completely assembled build-a-radar system capable of Doppler, ranging and synthetic aperture imaging modes (The author's modification based on [3])

The course also contains a detailed set of instructions to guide students through the radar construction using a hardware kit that is also available online from 250 to 600 USD. Together, these combined offerings present a novel teaching tool for all students interested in radar and electromagnetics as a whole. The build-a-radar course site is free and open to everyone at <https://llx.mit.edu> after creating a simple



personal account that is used to track your progress. This online material addresses the second challenge mentioned, and offers video-recorded lectures, step-by-step built instructions and knowledge questions to serve as a tool for both students and other teachers. Further details are available at: [www.radarconf19.org/index.php/radar-summer-school/](http://www.radarconf19.org/index.php/radar-summer-school/).

### *Ultra-Wideband Surveillance Radar and Spectrum Sharing*

*Mark Davis: Ultra-Wideband Surveillance Radar [4]*

The Ultra-Wideband (UWB) Surveillance Radar is an emerging technology for detecting and characterising targets and cultural features for military and geosciences applications.

This Tutorial is divided into five parts such as:

1. Early history of battlefield surveillance radar
2. UWB Phased Array Antenna: Electronically scanned antennas and Wideband Waveforms
3. UWB Synthetic Aperture Radar (SAR) image and fixed object detection capability
4. UWB Ground Moving Target Indication/Space Time Adaptive Processing (STAP) and UWB Radar Spectrum Compliance
5. New research in Multi-mode Ultra-Wideband Radar, with the design of both SAR and moving target indication (MTI) FOPEN systems

The summary of the first part indicates that:

- UWB Radar Systems have been in development for over 40 Years – Primarily for military applications
- Commercial and Personal Communications are Ubiquitous:
  - eCommerce is the major source of many Businesses
  - Digital Communications is important for Security
- The regulations and frequency allocation process has changed significantly in the past 15 years:
  - UWB Standards in IEEE and NTIA/CEPT
  - Compliance Standards are Conservative and Inflexible
- The International Radar Community needs to adapt and develop new technologies – Analogous to Cognitive Radio

Further key arguments for UWB radars applications are as follows:

- Modern radar systems demand more bandwidth
  - Enable improved resolution of targets
  - Provide better obstacle detection and tracking
- Impediment: international regulations on frequency allocation:
  - Creates a "barrier for entry" for many new radar applications
- Important reasons for uwb operation of radars for commercial and military system applications:



- Humanitarian and natural disaster monitoring operations
- Characterisation of biomass for global warming research
- Foliage penetration for detecting objects under dense canopy
- Discriminating obscured objects in close proximity
- Radar require long wavelength and modest power within VHF to L-band to "see" objects under foliage and terrain cover
  - Recent focus of Earth Resources Monitoring Community
- Resolutions less than 0.5 m are needed for object discrimination
  - This qualifies as Ultra-Wide Band (UWB) – 25 percent bandwidth
- UWB characterisation immediately causes more intense spectrum regulations, compliance and testing

Figure 9 depicts the differences between the photographic picture and radar images of the UWB. The UWB "VHF" ("m" wavelength) radar image has the highest target detection capabilities with relatively low resolution. The combination of different types, frequency bands, SAR images gives the required performances.

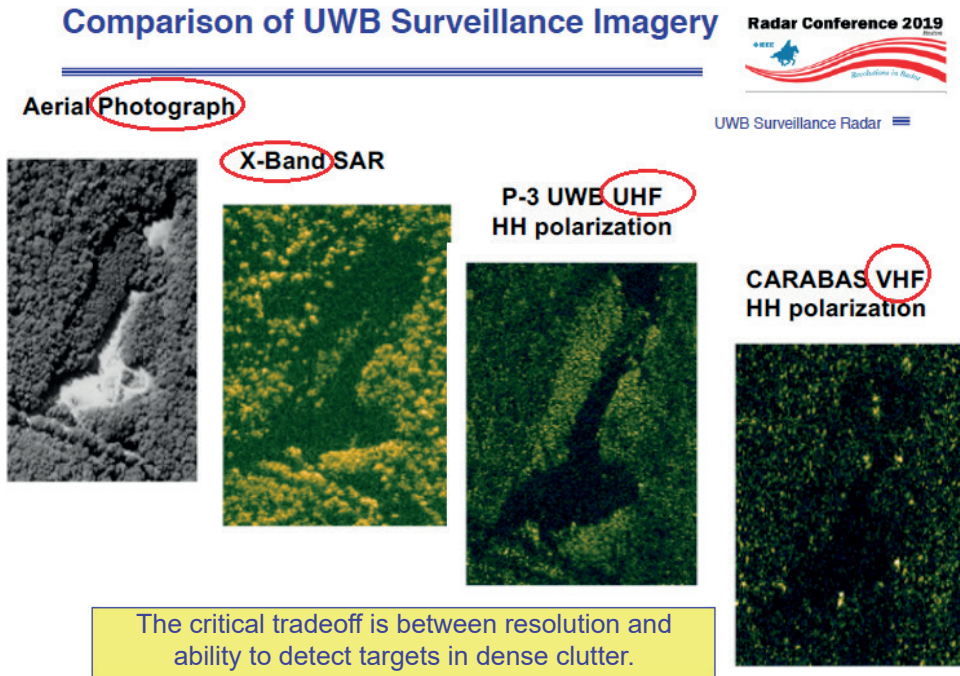

Figure 9.

*UWB radar targets detection performances are increasing in radar of "dm", "m" wavelength (The author's modification based on [4])*

Figure 10 summarises the requirements of the UWB radar waveforms, which are radar with very short or very complex sub-pulse modulation.

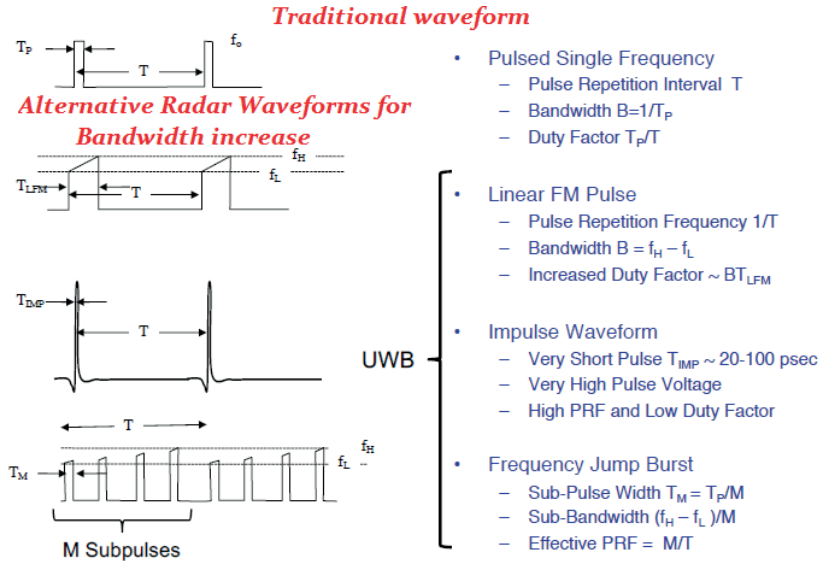

Figure 10.

Main parameters of the traditional and UWB radar waveforms [4]

Figure 11 shows one of the first UWB phased array antenna structure.

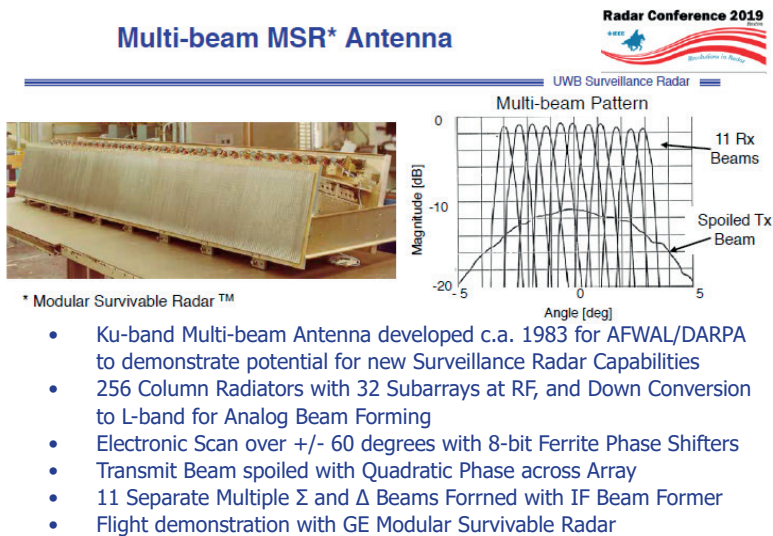

Figure 11.

UWB phased array with different type Receive and Transmit diagrams [4]

The UWB Radar Spectrum Compliance is the most challenging task to be solved and it is a good example for Spectrum Sharing requirement managements of other radar systems such as automobile radar and its communication systems.

Radio Frequency Interference has an impact on Radar Imaging as shown in Figure 12, where the received data streams are corrupted heavily.

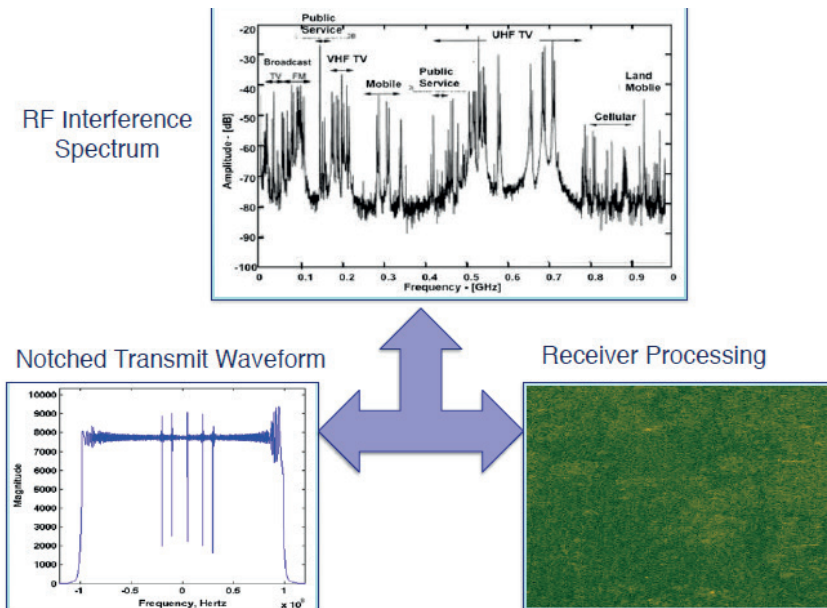

Figure 12.

*Heavily corrupted SAR image due to local interference (The author's modification based on [4])*

The tasks are connected to interference spectrum reduction or UWB Spectrum Sharing which are an emerging task for radar users that requires some preliminary studies. The National Telecommunications and Information Administration (NTIA) is an agency of the United States Department of Commerce and it is the governing body for any system that transmits. We have similar definitions and regulations in Europe. Restricted Bands are a Potential Interference to Sensitive Radio Communications such as Aircraft Radio Navigation, Radio Astronomy and Search and Rescue Operations. Figure 13 summarises the key requirements.

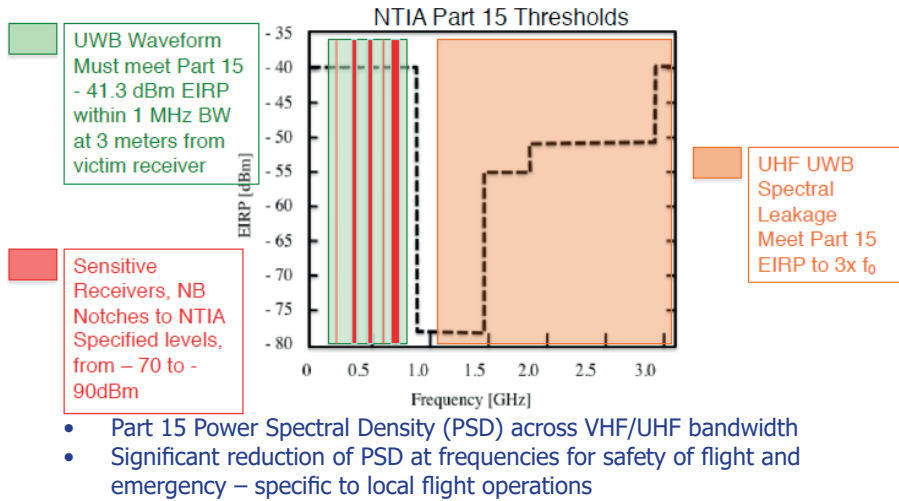

Figure 13.

*The NTIA Requirements of the U.S. on UWB Waveforms* (The author's modification based on [4])

Selling off of radar spectrum is a significant issue, which requires much more attention and inter-service coordination, than in the past, among radar service providers and governing bodies. The Radio Frequency Interference Removal could be solved or reduced significantly at the radar side by the Adaptive Transversal Filter and Adaptive LMS Processing.

Dr. Mark E. Davis's Tutorial ended with the following conclusion:

- Moving Target Indication (MTI) exploits Target DOPPLER to separate from:
  - Main beam clutter spread
  - Fast radar platform or low frequency complicates GMTI detection
- STAP technology demonstrated for moderate bandwidth GMTI:
  - Target motion through range and DOPPLER cells makes adaptive
  - Weights less effective
  - Wideband operation for high resolution moving target imaging
  - Requires multiple parallel STAP cancellation processes
- Along track interferometry enables detection and geolocation of:
  - Slow moving targets
  - ATI phase enables repositioning of moving targets in SAR image
  - Phase centre baseline creates DOPPLER ambiguities
- Continued research in simultaneous SAR and GMTI needed

### *Radar and Communication Systems Spectrum Sharing [5]*

The importance of the subject is highlighted by the fact that one tutorial and four sections have been focused on it such as: Daniel W. Bliss, Arizona State University, had a Tutorial on: RF Convergence – Joint Communications and Radar Spectrum/

Communications and Radar Spectrum Sharing RF Convergence. Special Session on Dynamic Spectrum Interactions between Radar and Communication systems; Spectrum Sharing and Automotive and Commercial Radar.

Professor Bliss pointed out in his tutorial that there are potential performance advantages availed by joint operations such as both logistical benefits of RF system reuse, and some interesting system benefits by having access to more sophisticated RF topologies. It is likely to be a significant growth in commercial interest in these joint systems, because of the quickly falling costs of RF systems and a growing range of non-traditional applications. Figure 14 indicates the challenges of the Spectrum Sharing.

- Don't give it to them
  - Fighting powerful economic forces
  - U.S. does not control world's spectrum

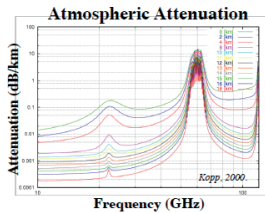
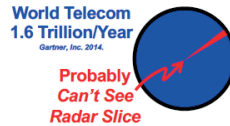

- Push radars to X-band and above
  - Many radars are already there
  - Transmit power (complicated trade)
  - Some loss in long range propagation
  - Getting chased by comms again

- Explore radar and radio coexistence
  - DARPA SSPARC efforts
  - ONR



Figure 14.

Potential solutions from traditional radar perspective [5]

Figure 15 is an example for optimizing joint radar and communications operation.

**Approach**

- Control RF resources for radar and communications users using reinforcement learning algorithms
- Adapt network operation according to changes in the environment with greater efficiency

**Challenges**

- Jointly optimize performance
- High dimensional action and state space
- Decision complexity grows with network size

**Applications**  
General Spectrum Sharing  
Mobile Sensing Networks

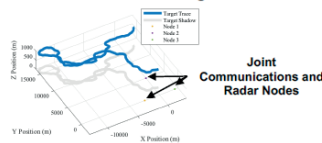

**Adaptive Water Filling Approach**

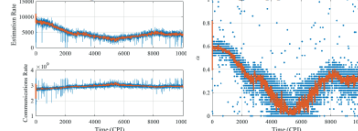

Jointly attempt to meet 80% of maximum possible rates

Adjust bandwidth split between mixed use and comms exclusive channel



O. Ma, A. Chiriyath, A. Herschfeld, and D. W. Bliss, "Cooperative Radar and Communications Coexistence Using Reinforcement Learning," IEEE Asilomar Conference on Signals, Systems, and Computers, Oct., 2018.



Figure 15.

Reinforcement learning of spectrum sharing [5]

The joint communications and radar systems may be the first examples of truly cognitive RF networks which have been illustrated in Figure 16 by Professor Bliss.

- **Employ RF energy to maximize overall system benefit**
- **Intelligently adapt to system's goals, resources, and environment**
- **Compensate for limited or stale knowledge of distributed system**

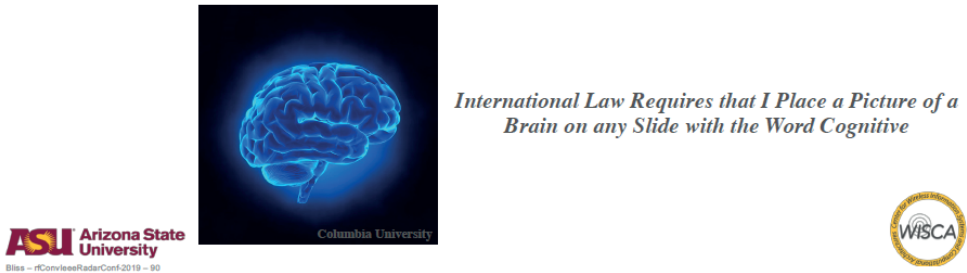

Figure 16.

*The "Real" Cognitive RF System [5]*

The paper of Mate Toth, Paul Meissner, Alexander Melzer and Klaus Witrissal entitled *Performance Comparison of Mutual Automotive Radar Interference Mitigation Algorithms* gives a comprehensive framework for the comparative analysis of automotive radar interference mitigation algorithms. A simulation methodology is developed with the general performance measures which are suitable for a statistical performance analysis. The paper concludes that "ramp filtering performs very well in terms of interference suppression, but strongly alters the RD map and the object peak value in the process, which is not the case for time domain methods" [6].

The article of Cenk Sahin, Patrick M. McCormick, Justin G. Metcalfy and Shannon D. Blunt entitled *Power-Efficient Multi-Beam Phase-Attached Radar/Communications* is important because it shows that the introduced combined approach is capable of transmitting independent data streams in multiple spatial directions (up to the number of antenna elements) simultaneously, including in the radar mainbeam, achieving a rate on the order of the time-bandwidth product times the PRF (Pulse Repetition Frequency) per stream [7].

PhD students from the University of Luxemburg, Sayed Hossein Dokhanchi, M. R. Bhavani Shankar, Kumar Vijay Mishra, Thomas Stifter and Bjorn Ottersten got the student paper prize for Performance Analysis of mmWave Bi-static PMCW-based Automotive Joint Radar-Communications System. They propose a millimetre-wave joint radar-communications (JRC) system that employs a single waveform for its constituent bi-static automotive radar and vehicle-to-vehicle communications. The suggested radar and communications multiplexing strategies are to improve the parameter identifiability with limited set of measurements. The introduced super-resolution algorithm in conjunction with unique multiplexing methods offers a low-complexity receiver processing with enhanced performance that is imperative to any JRC system [8]. This paper proves also that the quality of the radar related



university studies could be increased with permanent effort and smart, enthusiastic students and professors.

## Presentations which were in the scope of our interest at the conference

Three plenary speakers started the Technical Programs. The first speakers were Professor David McLaughlin, University of Massachusetts and Michael Dubois from Raytheon with their contribution entitled *Dense Networks of Short-Range Radars*. Their opinion that introduce the potential for using dense networks of small, low power, collaborative short range (tens of kilometres) X-band radars as a supplement – or perhaps as an alternative – to today's long-range radars has been studied over the past decade and has gained some support in the audience [9]. However, a few experts' opinion is that the combined passive radar networks with the combination of the automotive radar and communication potentials will be the future of dense radar systems solutions.

The second Plenary Speaker was Mark Markel from Waymo with his contribution entitled *Self-Driving Vehicles, and Radar Opportunities*. He emphasised the concept that the self-driving cars could be a potential solution to improve the quality and safety of our mobility. The concept offers an attractive option of other sensors in weather. The findings of the Google's Self Driving Car Project (now Waymo) were introduced [10].

The next Plenary Speaker was Dr. Jian Wang, his contribution entitled *Project Soli: Pico-Radar System for Ubiquitous Gesture Sensing* also dedicated to Google. The team developed the physical radar, including circuitry and antennas, to a single chip, while robustly tracking and recognising complex and fine gestures at close range with sub-millimetre accuracy. The SWaP-C of the chip is optimised to be readily adopted by most consumer electronics such as watch. Most of the audience accepted the speaker's opinion that: "The success of Project Soli will not only revolutionize the way we interact with electronic devices, but also create a brand-new market for radar technology and give it new life in consumer world – a new era for radar" [11].

## Findings on Passive Radar systems

The most active nation in this topic was Poland. Professor Mateusz Malanowski, Piotr Samczyński and Professor Krzysztof S. Kulpa, Warsaw University of Technology, had a tutorial entitled *Passive Radar – From Detection to Imaging* [12] and several presentations. The main message of their presentation was that the universities and economy of Poland has reached that level in the field of Passive Radar technology when their experts are able to design, fabricate and implement multistatic passive radar for target detection and imaging with various possible illuminators of opportunity (e.g. FM radio, digital television, cellular telephony), and features of different signals from the point of view of radar detection. The most advanced radar network concept of Deployable Multiband Passive/Active Radar was presented, in which a combination of active and passive radars is used. Figure 17 shows one Passive Radar Unit of Poland under construction.





Figure 17.  
*Passive Radar Unit of Poland* [12]

Martin Ummenhofer, Michael Kohler, Jochen Schell and Daniel O'Hagan: *Direction of Arrival Estimation Techniques for Passive Radar Based 3D Target Localization*, Fraunhoferstraße, Germany [13]. It presents a comparative analysis of direction of arrival (DOA) estimation techniques for the application in a linear antenna array of a Passive Bistatic Radar (PBR). The viability is demonstrated with experimental data obtained from a field trial with a PBR that exploits illuminations by the digital transmissions standard DVB-T2. This in conjunction with the system's DOA capability allows to accurately estimate 3D positions of air targets within the controlled traffic region.

The paper proves that the low TDOA estimations based on the illumination by network of transmitters in conjunction with the direction-finding capability of the linear array can be exploited for target localisation in 3D Cartesian coordinates. Further studies are required, because the low altitude of 3D measurement is problematic not only for long range 3D surveillance radars but for passive radar systems, too. The topic has got some attention to investigate further the beam position caused elevation angle measurement degradation.

Clément Berthillot, Agnès Santori, Olivier Rabaste, Dominique Poullin and Marc Lesturgie from France published the results on: *DVB-T Airborne passive radar: Clutter Analysis and Experimental Results* [14]. In this context, the difference between airborne and ground passive radar is reviewed by the authors. The first difference lies in the aeronautical channel, which requires the reference signal reconstruction from decoding the transmitted DVB-T signal. The receiver mobility emphasises the necessity of Doppler mask oversampling to mitigate rejection artefacts due to multipath Doppler

mismatch with the analysis grid. Figure 18 shows the RIVERA (airborne passive RADar) passive radar on the BUSARD plane with the RIVERA receiver configuration.

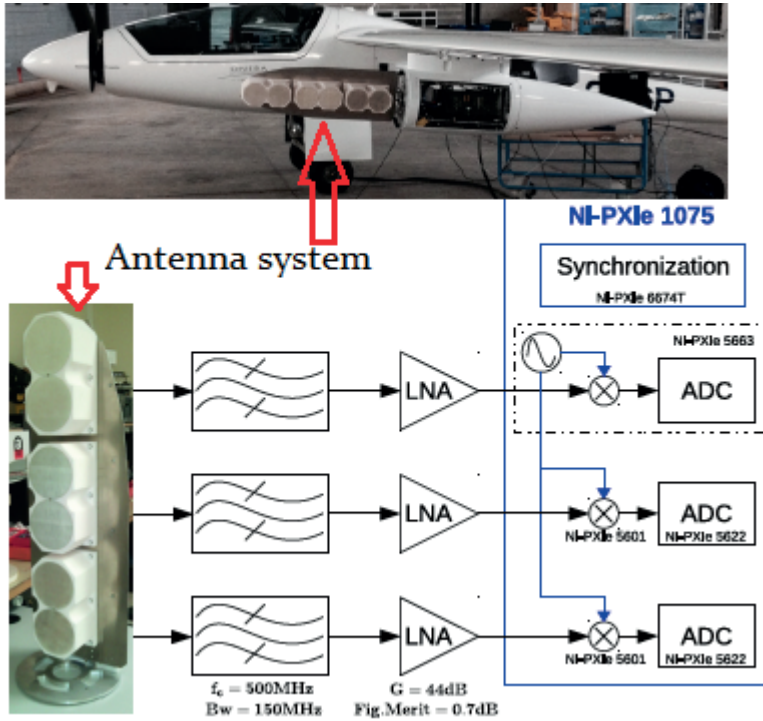

Figure 18.

*RIVERA radar and its receiver configuration* (The author's modification based on [14])

RIVERA radar has been developed and qualified, which gives a solid basis for meaningful experimental data collection, to understand the impact of the propagation channel on the reference signal and to strengthen the understanding of the clutter spread. The next challenging step to further enhance detection capacities of airborne passive radars is the mitigation of the significant clutter power which is largely spread in the Doppler dimension and along the range axis.

Brent H. Gessel and James R. Lievsay: *Three-Dimensional Emitter Selection Optimization*, Air Force Institute of Technology [15]. The paper introduces the primary concepts in passive radar and STAP that directly impact the performance of three-dimensional emitter selection optimisation for Passive GMTI. It is important, because ground moving target indication (GMTI) from an airborne platform and emitter selection requires more than just distance calculations to achieve optimal performance. The authors highlight the importance of bistatic angles, target and clutter characteristics, and emitter waveform properties as tuneable parameters that can change the course of emitter selection. The final result of the genetic algorithm tool is shown in Figure 19. The receiver's (red diamonds) position is optimised

against a target (first value next to the diamond) with the optimised tower to pair with (second number next to the diamond). The targets, yellow circles, are labelled 1–25. The transmitters, green stars, are randomly placed and labelled 1–7.

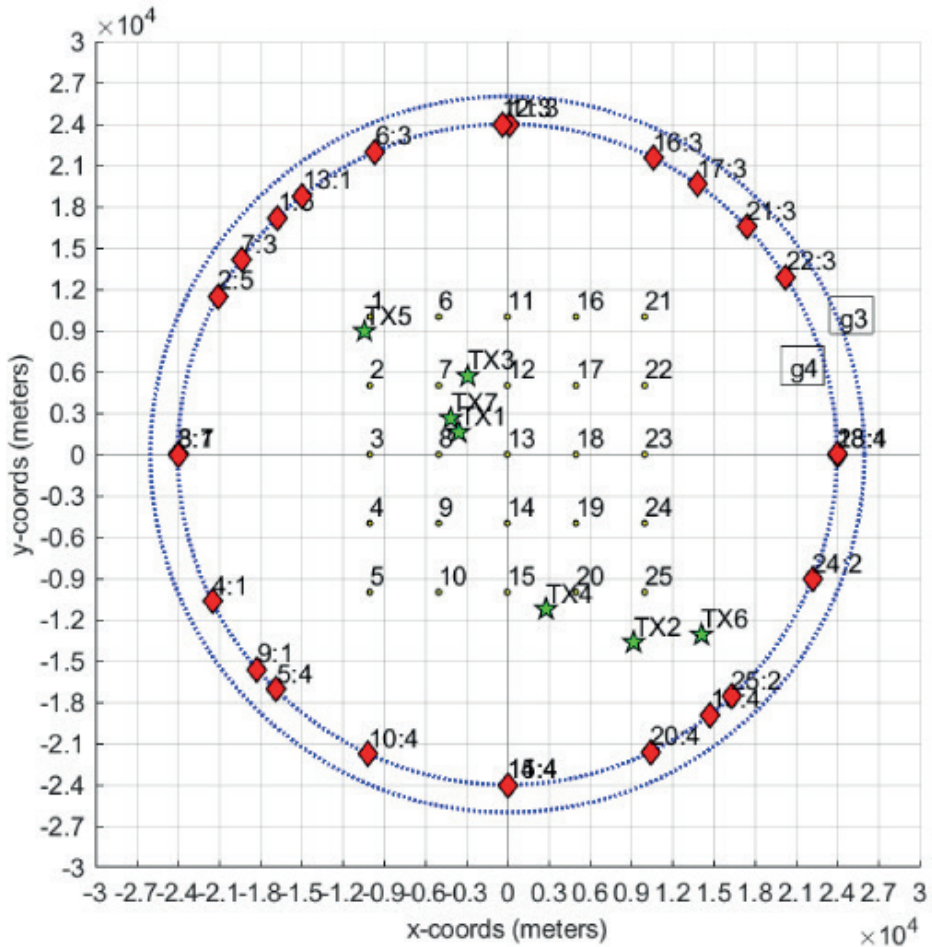

Figure 19.

*The graphic displays the final result of the study [15]*

Volker Winkler, Dietrich Fränken, Christian Erhart, Oliver Zeeb and Steffen Lutz: *Multistatic Multiband Passive Radar – Architecture and Sensor Cluster Results*, Hensoldt Sensors. The system architecture and relevant system components like the antenna, the receiver and the multi-hypothesis tracking system are introduced [21]. Figure 20 indicates the target tracking of a helicopter (marked blue) and some airliner targets (marked green) of opportunity. False targets due to the rotor blade echoes (red) are suppressed by an algorithm in the tracking system. A sensor cluster on various frequency bands offers a tremendous passive radar performance, which

will address new applications and fulfilment of customer demands for military surveillance, support of Ground Based Air Defence and civil ATC. The applied multi hypothesis tracking offers a tracking performance which is comparable to active radars, feasible of handling more than 100 targets in a single tracker. In multistatic cluster configurations, the system is feasible to handle up to 4 sensors in a cluster integrated in a multi hypothesis tracking system. In such a configuration, the coverage of large areas would be possible and the system will be able to support nationwide air surveillance programs like the U.S. Sensor program.

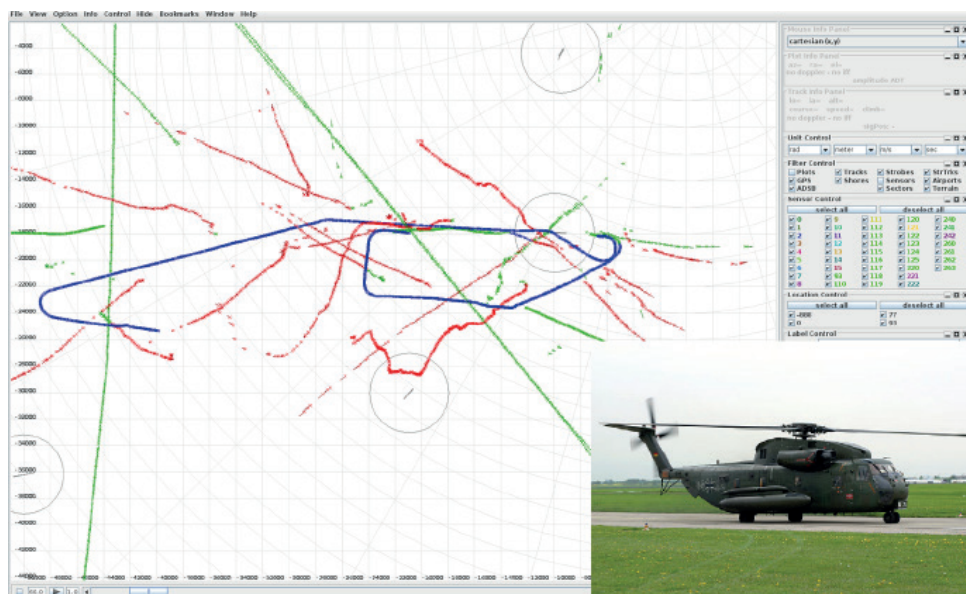

Figure 20.

*Target tracking of a helicopter [21]*

### *Findings on bistatic and multistatic radar*

De-ping Xia, Liang Zhang, Tao Wu and Xiang-dong Meng: *A Mainlobe Interference Suppression Algorithm Based on Bistatic Airborne Radar Cooperation*, China. The approach based on a bistatic radar system and mainlobe interference is suppressed through the cooperation of the two radars. A functional block diagram of the cooperated bistatic radar system is shown in Figure 21 [16].

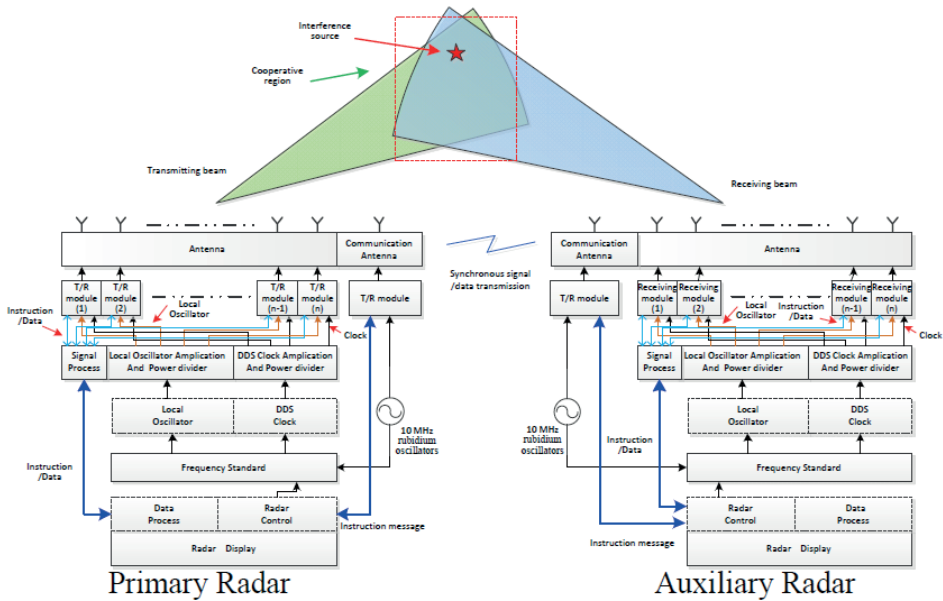

Figure 21.

Mainlobe interference suppression based on bistatic radar cooperation [16]

The radar at left acts as the primary radar, playing the role of transmitter and receiver, while the other acts as the auxiliary radar, acting as a receiver. A pair of 10 MHz rubidium clock oscillators provides stable phase and reference signals for the local oscillator and pulse timing signals within the major transmitter and the second receiver system, as shown. Synchronisation and data transmission of the two radars is realised through broadband communication links. The red pentagram indicates the region of interference. The system specifications for this radar are summarised in Table 1.

Table 1.

Bistatic airborne radar specification [16]

Characteristics	Primary Radar Specification	Auxiliary Radar Specification
Carrier frequency	1.25 GHz	1.25 GHz
Pulse Repetition Frequency	1,000–8,000 Hz	1,000–8,000 Hz
Pulse-width	12–100 $\mu$ s	
Peak output power	1 kW	
Transmitter/Receiver number	48	48
Signal bandwidth	5 MHz	
Antenna Beamwidth Tx.	2.9 deg.	
IF bandwidth		130 MHz
IF sample frequency		100 MHz
Noise figure		3 dB



Characteristics	Primary Radar Specification	Auxiliary Radar Specification
Antenna Beamwidth Rx.		3.4 deg.
Polarisation	Horizontal	Horizontal

The simulation is based on MUSIC estimation algorithm. Numerical examples show that the mainlobe interference is effectively restrained, and clear improvements in the Signal Interference Noise Ratio (SINR) are demonstrated.

John Summerfield and Dayalan Kasilingam: *Narrowband Bistatic Synthetic Aperture Radar Ambiguity Function Analysis and Design using Angular Harmonics* [17]. In order to develop new BSAR applications, new tools are needed to describe imaging performance for any bistatic collection geometry. The point spread function (PSF) and the associated ambiguity function (AF) fully describe coherent imaging performance but they are nonlinear and spatially variant that makes them difficult to use as a design tool. To overcome this spatially variant limitation and nonlinearity, a convolutional back projection kernel (CBPK) technique is used. The CBPK was transformed into a Fourier series domain in order to decouple the waveform spectrum from the collection geometry such as the pseudo monostatic geometry. Figure 22 shows the Bistatic Range Signature correction principle. Further research is required in the field of multi-static simultaneous transmit and receive system for finalising the work.

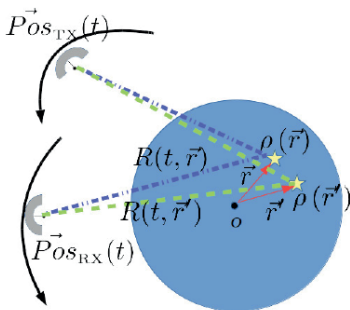

Fig. a. A graphical representation is shown of the bistatic range signature  $R(t, \vec{r})$  defined as the instantaneous path length from the transmitters position  $Pos_{Tx}(t)$  to position  $\vec{r}$  to the receivers position  $Pos_{Rx}(t)$ .

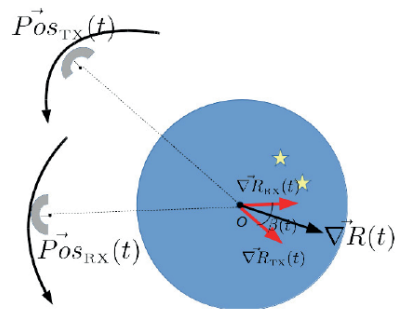

Fig. b. A graphical representation is shown of the bistatic range gradient  $\nabla R(t)$  defined as the vector sum of the transmitter line of sight vector  $\nabla R_{Tx}(t)$  with the receiver line of sight vector  $\nabla R_{Rx}(t)$ . The length of the bistatic range gradient depends on the bistatic angle  $\beta(t)$ , the angle between the platform line of sight vectors  $\nabla R_{Tx}(t)$  and  $\nabla R_{Rx}(t)$ .

Figure 22.

*Bistatic Range Signature correction principle* [17]

## Findings on Electronic Attack (ECM)/Electronic Protection (ECCM)

Taniza Roy, Neha Agarwal, Lgm Prakasam: *Digital Implementation of Electronic Counter Counter Measure Features in Radar Transmitter*, India [18]. The digital implementation of Electronic Counter Counter Measure (ECCM) techniques are employed as part of radar transmitters. Digital implementation of realisation measures such as Pulse Repetition Frequency jitter, waveform coding, frequency diversity, least jammed frequency computation and different modes have been explained. Design methodology of each

module has been explained and hardware realisation presented. Figure 23 shows the timing diagram of the Directional Jamming Analysis module. The design has been used in ground-based radar systems and the performance in field has been found satisfactory as per radar requirement.

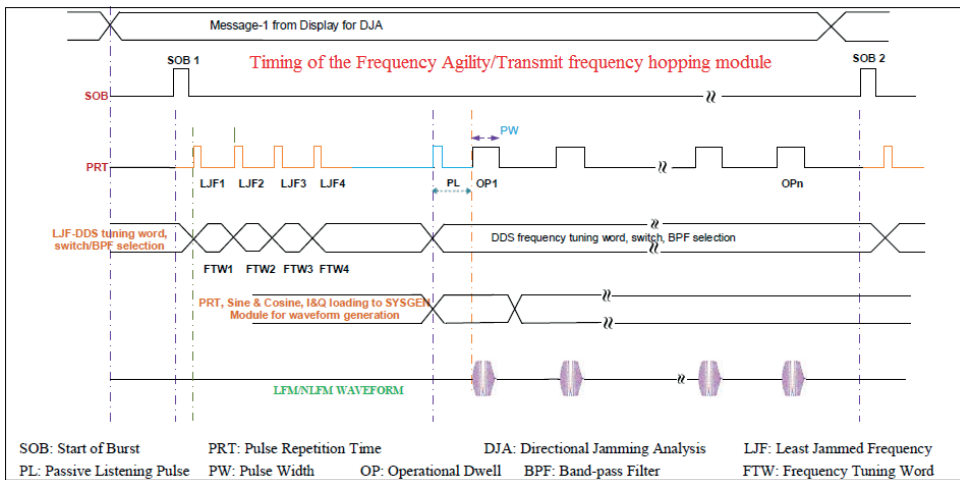

Figure 23.

*Timing of the Directional Jamming Analysis/Frequency Agility module [18]*

Robert Achatz: *Method for Evaluating Solid State Marine Radar Interference in Magnetron Marine Radars*, Institute for Telecommunication Sciences, National Telecommunications and Information Administration, USA [19]. The goal of the paper is to support the development of the interference protection criteria (IPC) and the corresponding minimum separation distance (MSD) for a specific frequency separation between radars which are operating in the same region with Solid State and Magnetron type transmitters. The simulation method was developed with in-situ field measurement data collection. Both results analyses were completed for combinations of short, medium, and long-range operation, filter settings, 55 and 135 MHz frequency separation between the Magnetron and Solid State type radars. Replicating the field test results was successful when the researchers set the Magnetron operating in short range or operating in medium-range with the short-range detection filter bandwidth. More comprehensive comparisons between method and field test results are needed to fully understand the method's predictive efficacy.

John Kota, Charles Topliff, Ravi Prasanth, Greg Ushomirsky and Stephen Kogon: *Radar Waveform Design Using Lagrangian Dynamics for Co-Channel Interference Mitigation*, Systems and Technology Research, Sensors and Signal Processing Group, USA [20]. A novel radar waveform phase function design is presented that constructs a radar waveform that spectrally manoeuvres around in-band co-channel interference (CCI) from active communications users that are co-channel with the radar system. The suggested design approach treats the CCI problem as the physical interpretable problem of optical refraction where the Time–Frequency (TF) signature of the radar



waveform is made to be analogous to a light ray propagating from a start time and position (frequency) to an end time and position (frequency). The radar waveform design will generally result in a nonlinear-frequency modulated (NLFM) waveform that provides improved SINR. Figure 24 plots plot of interference Power Spectral Density PSD (blue) for two interference sources, radar Instantaneous Bandwidth (IBW) (dotted yellow), and GMM refraction model (green). The interference consists of two OFDM model users occupying approximately 8.37% of the radar IBW and a single narrowband tone.

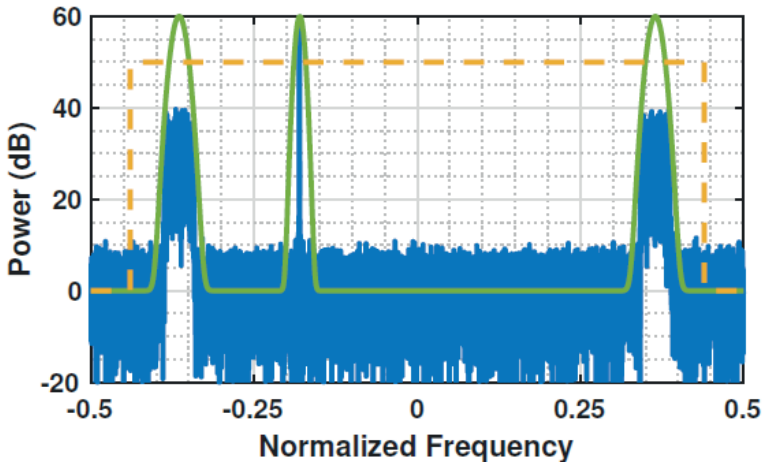

Figure 24.

*Power Spectral Density of the interference [20]*

Figure 25 compares the radar waveforms: (left) ideal TF signature for LFM and designed NLFM waveforms, (right) radar waveform power spectral density.

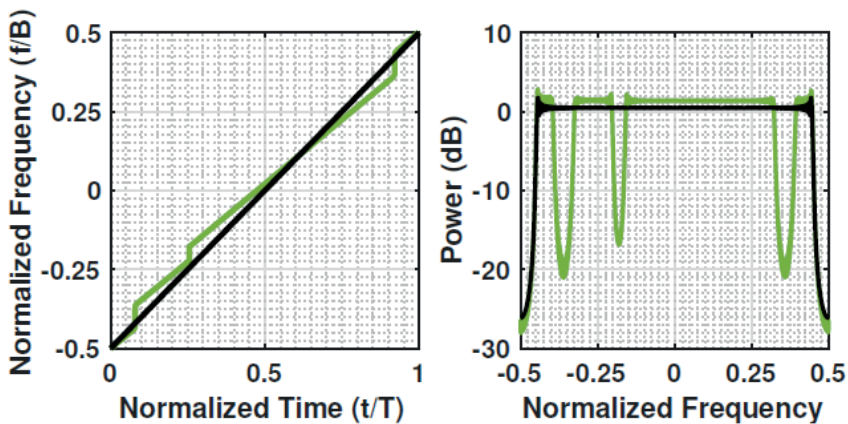

Figure 25.

*Comparison of the radar waveforms [20]*

A future work is planned for designing a cooperative CCI reduced communications spectral location. For achieving this, a joint radar and communications design that enables simultaneous sharing the RF spectrum will be presented.

## Conclusion

The paper presents a selective review of the most remarkable radar topics, papers of the conference, all which captured the attention of this paper's author. He would like to kindly draw the reader's attention to the fact that radar technology is growing fast from the monostatic radar solutions to the radio signal fuzed network centric solutions. This happens, because the radar measurement's degree of freedom has to be extended in space, frequency and polarisation, due to new customer needs such as automobile radar, civilian air traffic control, the growth of safety requirement and advanced military requirements.

The fast-growing computer and IT technology, the Spectrum Sharing Techniques between radars and communication systems, are essential parts of the modern Bistatic and Multistatic radar, Passive radar systems, Weather radar with Emerging Quantum and photonics-based radar solutions. The radar system-related Electronic Warfare techniques and tactics are advancing from the achievements of the current, above-mentioned state of the art technologies, while the radar performance measures could be supported and maintained for life-time cycle of the sensors, and they shall be part of the modern radar networks.

## References

- [1] 2019 IEEE Radar Conference Program, Boston, 22–26 April 2019, Proceedings of Revolution in Radar and Tutorial Material. [Online]. Available: [www.radarconf19.org](http://www.radarconf19.org) [Accessed Aug. 21, 2019].
- [2] L. Lo Monte, "Radar Systems Prototyping," Tutorial, Telephonics Co. USA, Proceedings of Revolution in Radar and Tutorial Material.
- [3] K. E. Kolodziej, P. J. Bell, A. J. Fenn, E. Kowalski, J. W. Meklenburg, W. F. Moulder, J. S. Mullen and B. T. Perry, "Radar Summer School: Built-A-Radar at MIT," USA, Proceedings of Revolution in Radar and Tutorial Material.
- [4] M. Davis, "Ultra-Wideband Surveillance Radar," In Proc. of 2019 IEEE Radar Conference (RadarConf), Boston, USA, 2019. DOI: <https://doi.org/10.1109/RADAR.2019.8835510>
- [5] D. W. Bliss, "Communications and Radar Spectrum Sharing RF Convergence," In Proc. of 2019 IEEE Radar Conference (RadarConf), Boston, USA, 2019. DOI: <https://doi.org/10.1109/RADAR.2019.8835827>
- [6] M. Tóth, P. Meissner, A. Melzer and K. Witrals, "Performance Comparison of Mutual Automotive Radar Interference Mitigation Algorithms," In Proc. of 2019 IEEE Radar Conference (RadarConf), Boston, USA, 2019. DOI: <https://doi.org/10.1109/RADAR.2019.8835681>

- [7] C. Sahin, P. M. McCormick, J. G. Metcalfe and S. D. Blunt, "Power-Efficient Multi-Beam Phase-Attached Radar/Communications," In Proc. of 2019 IEEE Radar Conference (RadarConf), Boston, USA, 2019. DOI: <https://doi.org/10.1109/RADAR.2019.8835583>
- [8] S. H. Dokhanchi, M. R. B. Shankar, K. V. Mishra, T. Stifter and B. Ottersten, "Performance Analysis of mmWave Bi-static PMCW-based Automotive Joint Radar-Communications System," In Proc. of 2019 IEEE Radar Conference (RadarConf), Boston, USA, 2019. DOI: <https://doi.org/10.1109/RADAR.2019.8835577>
- [9] D. McLaughlin and M. Dubois, "Dense Networks of Short-Range Radars," Plenary Speaker, University of Massachusetts, Raytheon Co., USA, Proceedings of Revolution in Radar and Tutorial Material.
- [10] M. Markel, "Self-Driving Vehicles, and Radar Opportunities," Waymo Co., USA, Proceedings of Revolution in Radar and Tutorial Material.
- [11] J. Wang, "Project Soli: Pico-Radar System for Ubiquitous Gesture Sensing," USA, Proceedings of Revolution in Radar and Tutorial Material.
- [12] M. Malanowski, P. Samczyński and K. S. Kulpa, "Passive Radar – From Detection to Imaging," In Proc. of 2019 IEEE Radar Conference (RadarConf), Boston, USA, 2019. DOI: <https://doi.org/10.1109/RADAR.2019.8835658>
- [13] M. Ummenhofer, M. Kohler, J. Schell and D. O'Hagan, "Direction of Arrival Estimation Techniques for Passive Radar Based 3D Target Localization," In Proc. of 2019 IEEE Radar Conference (RadarConf), Boston, USA, 2019. DOI: <https://doi.org/10.1109/RADAR.2019.8835841>
- [14] C. Berthillot, A. Santori, O. Rabaste, D. Poullin and M. Lesturgie, "DVB-T Airborne passive radar, Clutter Analysis and Experimental Results," In Proc. of 2019 IEEE Radar Conference (RadarConf), Boston, USA, 2019. DOI: <https://doi.org/10.1109/RADAR.2019.8835763>
- [15] B. H. Gessel and J. R. Lievsay, "Three-Dimensional Emitter Selection Optimization," In Proc. of 2019 IEEE Radar Conference (RadarConf), Boston, USA, 2019. DOI: <https://doi.org/10.1109/RADAR.2019.8835715>
- [16] D. Xia, L. Zhang, T. Wu and Xiang-dong Meng, "A Mainlobe Interference Suppression Algorithm Based on Bistatic Airborne Radar Cooperation," China, Proceedings of Revolution in Radar and Tutorial Material. DOI: <https://doi.org/10.1109/RADAR.2019.8835562>
- [17] J. Summerfield and D. Kasilingam, "Narrowband Bistatic Synthetic Aperture Radar Ambiguity Function Analysis and Design using Angular Harmonics," In Proc. of 2019 IEEE Radar Conference (RadarConf), Boston, USA, 2019. DOI: <https://doi.org/10.1109/RADAR.2019.8835524>
- [18] T. Roy, N. Agarwal and L. Prakasam, "Digital Implementation of Electronic Counter Counter Measure Features in Radar Transmitter," In Proc. of 2019 IEEE Radar Conference (RadarConf), Boston, USA, 2019. DOI: <https://doi.org/10.1109/RADAR.2019.8835698>
- [19] R. Achatz, "Method for Evaluating Solid State Marine Radar Interference in Magnetron Marine Radars," In Proc. of 2019 IEEE Radar Conference (RadarConf), Boston, USA, 2019. DOI: <https://doi.org/10.1109/RADAR.2019.8835684>

- [20] J. Kota, C. Topliff, R. Prasanth, G. Ushomirsky and S. Kogon, "Radar Waveform Design Using Lagrangian Dynamics for Co-Channel Interference Mitigation," In Proc. of 2019 IEEE Radar Conference (RadarConf), Boston, USA, 2019. DOI: <https://doi.org/10.1109/RADAR.2019.8835710>
- [21] V. Winkler, D. Fränken, C. Erhart, O. Zeeb and Steffen Lutz, "Multistatic Multiband Passive Radar – Architecture and Sensor Cluster Results," In Proc. of 2019 IEEE Radar Conference (RadarConf), Boston, USA, 2019. DOI: <https://doi.org/10.1109/RADAR.2019.8835688>