

Rothamsted Repository Download

A - Papers appearing in refereed journals

Clark, W. C. 1960. New Zealand Mononchidae (Enoplida, Nematoda) I
The genera *Mononchus* Bastian and *Prionchulus* Cobb. *Nematologica*. 5,
pp. 199-214.

The output can be accessed at: <https://repository.rothamsted.ac.uk/item/96yy4/new-zealand-mononchidae-enoplida-nematoda-i-the-genera-mononchus-bastian-and-prionchulus-cobb>.

© Please contact library@rothamsted.ac.uk for copyright queries.

SYSTEMATIC AND MORPHOLOGICAL STUDIES ON SOME
ENOPLIDA (NEMATODA) WITH SPECIAL REFERENCE TO
THE SOIL FAUNA OF NEW ZEALAND

by

W. C. CLARK, M.Sc. Hons. (N.Z.), D.I.C.

A
THESIS
PRESENTED FOR THE
DEGREE
OF
DOCTOR OF PHILOSOPHY

in the
Faculty of Science of the University of London

April 1961

Department of Nematology,
Rothamsted Experimental Station, Harpenden, Herts.

ABSTRACT

This study falls in two parts, systematics and morphology.

Systematics. The classification of the order Enoplida (Nematoda) is revised. At the subordinal level the classification is primarily based on the nature, number and position of the oesophageal glands and their ducts. Five suborders are recognised; Enoplina, Alaimina, Dorylaimina, Trichosyringina and Diectophymatina. The new features of the classification are:- Alaimina established for the Alaimoidea and the Diphtherophoroidea on the oesophageal and male sexual characters. The similarities between the Diphtherophoroidea and the Dorylaimoidea are considered to be due to convergent evolution. On oesophageal characters the Mononchidae are removed from the Tripyloidea and together with the Bathyodontidae form the Mononchoidea within the Dorylaimina. The Bathyodontidae is formed of genera previously placed in the Nygolaimidae which possess a cylindroid oesophagus, adhesive organs and a mononchoid stoma. The definitions and constitutions of the families Nygolaimidae and Belonidiridae are modified to make these families more homogeneous. The Mermithidae are placed with the Trichuroidea in Ward's Trichosyringina thus uniting all the families with the Oesophageal glands in the form of stichocytes.

The probable course of evolution in the soil dwelling

enoplids in general, and the Mononchidae in particular is described.

Morphology. The monorchic male reproductive system of the Alaimidae, and the two types of oesophago-intestinal junctions in the Mononchidae are described for the first time.

New species in the genera Amphidelus, Mononchus, Iotonchus, Cobbonchus, Mylonchulus, Pungentus, Longidorus, Sectomema, Dorylaimellus and Actinolaimus are described. A new leptonchid genus is erected, and its type species described. Existing species of the genera Cryptonchus, Mononchus, Prionchulus, Iotonchus and Cobbonchus are re-described.

CONTENTS

- I. Introduction
- II. Material and Methods
 - 1. Materials
 - 2. Sampling Technique and Procedure
 - 3. Storage of Samples
 - 4. Extraction of samples
 - 5. Fixation
 - 6. Mounting
 - 7. Examination
 - 8. Measurements
- III. Higher Taxonomy
 - 1. A Revised Classification of the Order Enoplida (printed)
 - 2. The Relationships of the Soil Dwelling Enoplids
- IV. Suborder Enoplina ; Family Ironidae
- V. Suborder Alaimina
 - 1. Description of Amphidelus spiralis n. sp.
 - 2. The Male Reproductive System in the Alaimoidea
- VI. Suborder Dorylaimina ; Family Mononchidae
 - 1. Introduction
 - 2. The Mononchidae and Biological Control
 - 3. The Oesophago-Intestinal Junction in the Mononchidae (Enoplida, Nematoda) (printed)
 - 4. Re-descriptions of Mononchus truncatus Bastian, M. papillatus Bastian and Prionchulus muscorum (Dujardin) (Enoplida, Nematoda). (printed)

5. The New Zealand Mononchidae (Enoplida, Nematoda)
 - I. The genera Mononchus Bastian and Prionchulus Cobb. (printed)
6. The Mononchidae (Enoplida, Nematoda) of New Zealand
 - II. The genus Iotonchus (Cobb, 1916) Altherr, 1950. (printed)
7. The Mononchidae (Enoplida, Nematoda) of New Zealand
 - III. A Review of the genus Cobbonchus Andrassy, 1958 with descriptions of new species. (printed)
8. The Mononchidae (Enoplida, Nematoda) of New Zealand
 - IV. The genus Mylonchulus (Cobb, 1916) Pennak, 1953 (printed)
9. Evolution within the Mononchidae

VII. Superfamily Dorylaimoidea

1. Dorylaiminae; Description of Pungentus maorum n.sp.
2. Actinolaiminae; Description of Actinolaimus zealandicus n. sp.
3. Tylencholaiminae; Description of Longidorus taniwha n. sp.
4. Nygolaimidae; Description of Sectomena taiaha n.sp.
5. Belonidiridae; Description of Dorylaimellus monticolus n. sp.
6. Leptonchidae; Description of Amphorostomum saccatum n. gen. et sp.

VIII. Conclusion

References

Appendix I: Enoplid genera recognised in New Zealand samples

ACKNOWLEDGMENTS

I thank Professor B. G. Peters and Dr C. Potter for acting as my supervisors and for discussions and encouragement.

I am grateful to the staff of the Department of Nematology, Rothamsted Experimental Station, for their kindness during my stay at that Institution. Especial thanks are due to Mr F. G. W. Jones for his encouragement, and to Dr J. B. Goodey for much help, advice, and free access to his excellent library.

Finally, I thank the New Zealand Department of Scientific and Industrial Research for financial support.

NOTE

References to figures, tables etc. are numbered consecutively in the type-written part, but each of the printed sections has its own series of figure numbers and so on. References to publications follow the same scheme; all papers cited in the typewritten sections are listed in the section "References" at the end of the thesis. Papers cited in the printed parts will be found at the end of the relevant section.

Section I

INTRODUCTION

When this study was first considered the idea was to investigate the species composition of nematode faunas and the abundance of different species in soil and litter of a variety of New Zealand soils. Further, it was intended to investigate the effect of different vegetation regimes on the nematode fauna of the same soil types. It was also thought that it might prove instructive to examine the nematode faunas which have developed in the soils in the central part of the North Island of New Zealand. These soils are largely derived from showers of volcanic ash, the time of deposition of which has been recorded in recent times, or accurately determined by other workers using radio-active carbon dating techniques. These ash-showers may have caused cataclysmic destruction of the fauna when and where they occurred, and have influenced its composition since. They may also have acted as barriers to migration for a considerable time. Lee (1959) has shown that the distribution of Megascolecine earthworms was influenced in this way. Given (pers. comm.) found a similar influence in the distribution of the Melolonthid beetles, and Forster (1954) recorded a similar discontinuity in the distribution of the harvest spiders of the suborder Laniatores.

No attempt was made whilst in New Zealand to identify

any of the material collected. The collecting programme was worked out using Taylor's (1948) "Soil Map of New Zealand" and the genetic classification of New Zealand soils included in it and in Taylor and Cox (1956).

In practice the original aims proved unattainable because of the dearth of knowledge of the free-living nematodes of New Zealand. The diversity of species encountered is illustrated by three samples taken from Wharekohe Silt Loam (a mature podzol derived from silicified claystones under Agathis australia Salisb. forest in a warm humid climate). The samples were taken under natural heath-type vegetation, from an 18-year old Paspalum dominant pasture, and from a two-year old ryegrass-white clover pasture. Each sample yielded eighteen to twenty fairly common species, but only two or three species were common to any pair of samples, and none common to all. Only one species of the species examined was referable to a known species. In view of the diversity of species and the indications that the vast majority of them appeared to be new, and in some cases, required the erection of new genera and possibly new families, it became necessary to turn to identification and description of species rather than to continue with predominantly ecological studies as planned.

Once the systematic study of the New Zealand species, and where necessary the European ones, was well in hand it

became apparent that the existing accepted arrangement of genera and species in some groups had become inadequate over the years. Much time, therefore, had to be spent incorporating new information, re-examining many accepted concepts and modifying the taxonomy to fit.

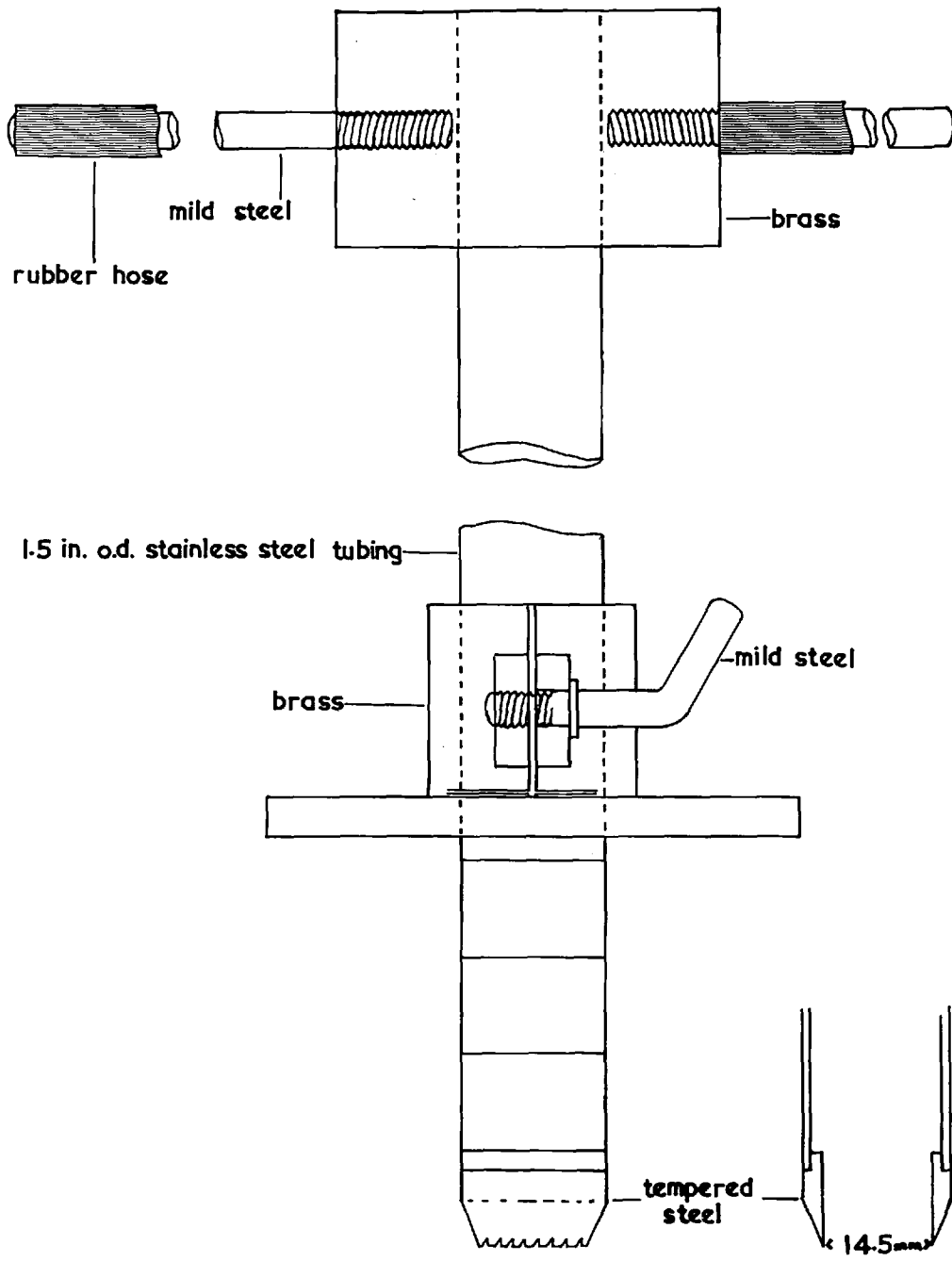

Fig. 1. Construction of the soil sampler.

Section II

MATERIALS AND METHODS

1. Materials

All the New Zealand material examined was collected by the author during the period January to May 1958. Of the material from sites outside New Zealand, some was collected by the author, but much had been collected by other workers; most of it was already in the slide collection of the Department of Nematology, Rothamsted Experimental Station. A few specimens were borrowed from workers outside Britain.

2. Sampling Technique and Procedure

As pointed out in the introduction, one of the original purposes of the study was to compare the abundance and species composition of nematode faunas under different conditions of soil type and vegetation. Therefore, an attempt was made to take samples of comparable size. A tubular soil sampler (fig. 1) was constructed of stainless steel because of the ease with which this material may be kept clean and the risks of cross contamination of samples reduced. The sampler was thrust into the soil to a depth of six inches, rotated, bent over at an angle to break the soil column, and withdrawn. The cutting edge was purposely made narrower than the internal diameter of the sampler body to reduce compaction of the soil core. It also served to grip the core and facilitate its removal from the ground. After

withdrawal from the soil, the sampler was inverted, and held at an angle. When the soil core was lightly prodded it slid down the tube and was usually recovered intact. The core was then cut with a knife into 0-3 and 3-6 inch lengths. The sampling procedure was repeated so that three cores were taken at each depth. Each core had a volume of approximately 50 ml., the three cores for each level giving a total sample volume of 150 ml. The samples from the different levels were placed in separate polythene bags, and if extraction would not take place within the next few days, the bags were sealed in a match flame. An embossed metal "Talabel" tag was included in each bag to provide a permanent **label** unaffected by moisture or abrasion.

The field record of site information included:-

1. Date of sampling.
2. Name of locality.
3. Map reference to the New Zealand 1 in. to the mile topographic sheets, with a brief description of site, noting:-
 - (a) Elevation.
 - (b) Aspect.
 - (c) Angle of slope, and whether convex or concave.
 - (d) Water logging etc.
4. A list of the dominant plant species present.
5. The soil type, after comparing with the descriptions

given in the relevant New Zealand Soil Bureau Bulletin, or if such a Bulletin had not been published, a description of the soil profile down to 2 ft. so that the soil type could be determined later. (Often pedologists accompanied me to ensure that the samples were taken on typical sites and to provide local information about the history of the area and the whereabouts of different classes of vegetation.)

6. The sample numbers and the depths to which taken.
7. Any other information which might prove useful later (e.g., fertilizer history, pH.).

Where samples could not be taken with a core sampler, a fern trowel was used to give a sample of the same volume.

Litter, moss and liverwort samples were only approximately 150 ml. in volume as it was not possible to easily standardise the sample size of this material. The great variation in water content made weight impracticable as a measure and the degree of compaction and type of litter influenced the amount of material in a given volume.

3. Storage of Samples

At the outset it was realized that the time which would elapse between sampling and extraction might well cause much variation in the results. To investigate this 18 0-3 inch cores were taken from an apparently uniform patch of grass-

land and each bagged and sealed separately. On returning to the laboratory, six of the cores were separately rubbed through a coarse sieve, the grasses teased out, the whole sample set up in a Baerman funnel in the usual way (see 4 below) and allowed to stand for 24 hours. Then the total number of nematodes emerging was counted and the types present noted. The samples not extracted immediately were placed in a refrigerator and kept at $4^{\circ}\text{C.} \pm 1^{\circ}$. At weekly intervals three samples were removed and extracted as before. When, four weeks later, the last samples had been extracted, the results showed that the number and, as far as could be determined, the species extracted did not vary over this period any more than the samples extracted immediately after sampling varied among themselves. These results are in accord with those obtained by Overgaard Nielsen (1949) and Oostenbrink (1960).

4. Extraction of Samples

The extraction procedure used was as follows:-

1. Rub sample through coarse sieve, tease out roots, pick out stones (the three cores being mixed in the process).
2. Transfer sample to two, six-inch funnels with fine cotton gauze supported on wire gauze. The metal label always accompanied the sample. The level of water in the funnel was adjusted so that it came

well up into the sample.

3. Thoroughly clean sieve. Discard original sample bag.
4. After 22 hours the nematodes were run off into Petri dishes.
5. The cotton gauze and the soil were discarded, and the funnel and wire gauze support washed in cold water before they could dry, possibly leaving some nematodes adhering to them. The apparatus was then washed in boiling water plus detergent, and then thoroughly rinsed in cold water. Thorough washing being regarded as an important precaution against cross-contamination of samples.

Because the mesh of the gauze was not fine enough for some soils this procedure did not give as clean samples as is desirable. Toilet tissues would have been much better and cheaper.

5. Fixation

After running off the nematodes in a little water into Petri dishes, these were examined under the binocular microscope for nematodes. The dish was then gently heated on a hot plate and frequently examined to check the condition of the nematodes, as soon as they were "relaxed" heating was stopped. The contents of the dish were then transferred to a 3 x 1 in. tube via a small clean funnel. When the contents of the tube

had settled, the volume of water was reduced with a pipette. An equal volume of double strength F.A. 4:10 (Goodey, 1957) added, a label inserted, the tube corked and shaken.

Enoplids fixed in this way remained in excellent condition for 3 years, but in the Tylenchida the spears had mostly dissolved, or at least become invisible long before this period of time had elapsed. The problem of the disappearance of spears in the orthodox acidic fixatives might be overcome by fixing in these solutions for a short period only, say 24 - 48 hours, and then transferring to a non-acidic preservative such as a 1% aqueous solution of propylene phenoxetol (Owen 1955, Owen and Steedman 1956).

6. Mounting

Before mounting the nematodes were transferred to glycerine according to Baker's (1953) method. It was found advantageous to add a little methylene blue to the first solution and to vary the time in this solution according to the degree of staining required, and the facility with which the different species took up the stain. Usually nematodes remained overnight in the pure glycerine in the oven as this resulted in better preparations. Whole mounts were made according to the method in Goodey (1957). Preparations of parts of nematodes for en face view of the lip region, transverse sections for examining the thickenings of the oesophageal lumen and the type of incisures etc., were also

made as described by Goodey, but it was found that better results were obtained from specimens which had been transferred to glycerine by Baker's method, rather than using the quick lactophenol-cotton-blue method.

7. Examination

Manipulations requiring only moderate magnifications were done under a Leitz stereoscopic microscope with a traversing head. When higher magnifications were needed, examinations were made under a Leitz Ortholux microscope using Achromatic objectives. Incident illumination was used in addition to transmitted light. Drawings were made with the assistance of a reflex prism made specially for the Ortholux microscope.

8. Measurements

Measurements were made in different ways for different purposes to keep the margin of error of the same magnitude throughout. Length measurements were made as described in Goodey (1957) always using a magnification of 125-200 diameters. Measurements of body width were made using a Leitz screw micrometer eyepiece and a magnification of 600 diameters. Measurements of stoma length and cuticle thickness were made with the same apparatus but at a magnification of 1,350 diameters.

Measurements are given according to the de Man formula which is almost universally used in descriptions of plant

parasitic and free-living nematodes. The de Man formula has largely superseded the Cobb formula, probably because it requires fewer measurements (a dubious advantage) and because **of the simpler type-setting** in publications than required by the Cobb formula at its simplest.

2. The Relationships of the Soil Dwelling Enoplida

In the previous section the systematics of the Enoplida as a whole were treated in an orthodox fashion. Here it is proposed to discuss the relationships of the soil dwelling groups in more detail. Because of the use of the "type method" in systematics, the type taxon is always discussed first in any sequence of taxa as if it were necessarily typical of the group or the most primitive. Such procedures often serve to obscure relationships rather than to clarify them.

In figure 2 the deduced phylogeny of the soil-dwelling enoplids is set out. In the construction of this scheme considerable importance has been placed upon the form of the oesophagus, the number and position of the oesophageal glands and their ducts, the stomatal armature, the adhesive organs (= caudal glands) and the male reproductive system. From this information it is possible to set out what appears to be the probable phylogeny of most groups, though the positions of the Diphtherophoroidea and the Campydoridae remain doubtful. I have considerable reservations about the validity of the Opailaimidae.

The enoploid stock probably branched to give rise to the Alaimina-Dorylaimina and Tripyloidea stems. The Tripyloidea retained the enoploid facies to the greatest extent, retaining the adhesive organs throughout and

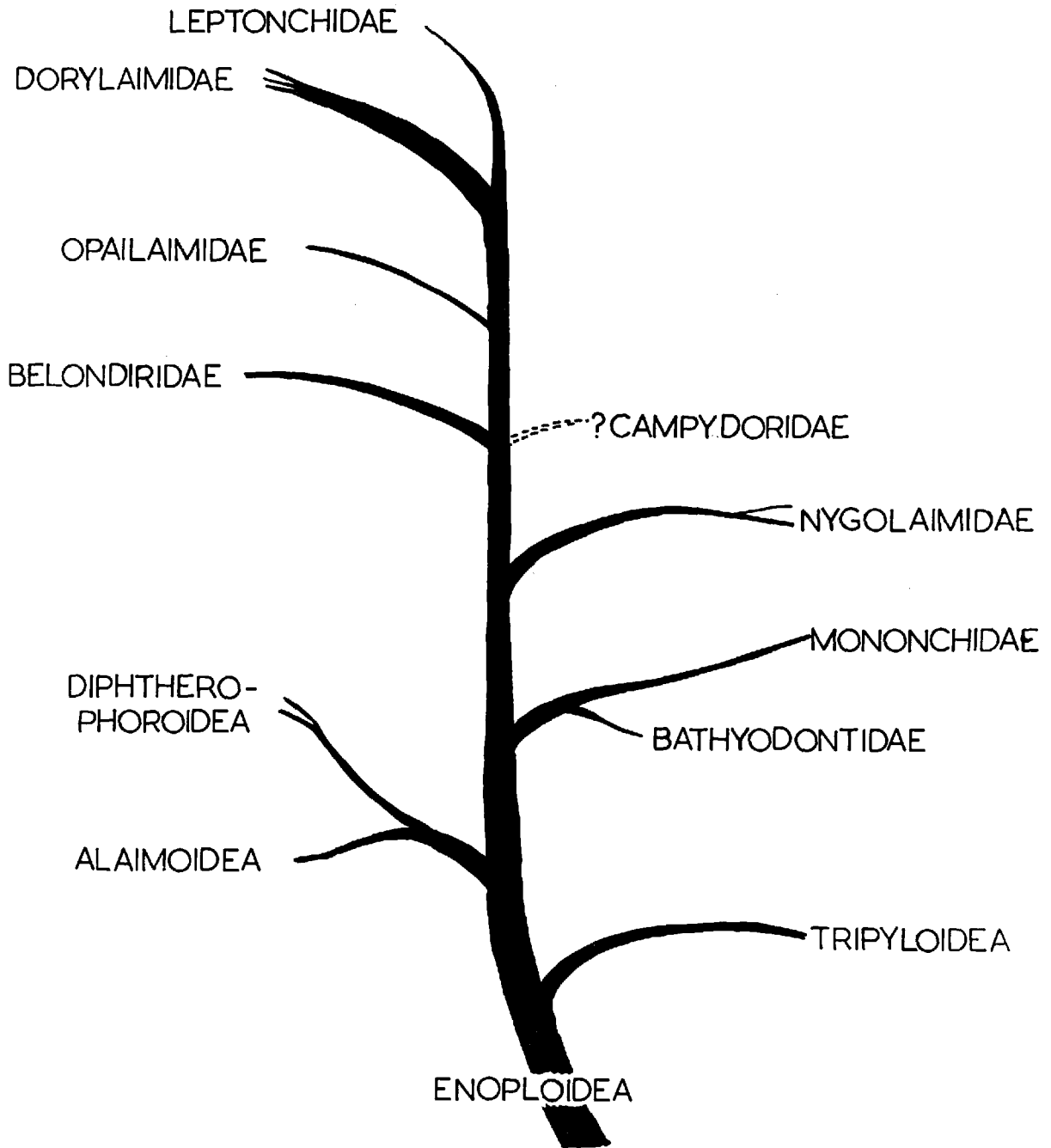
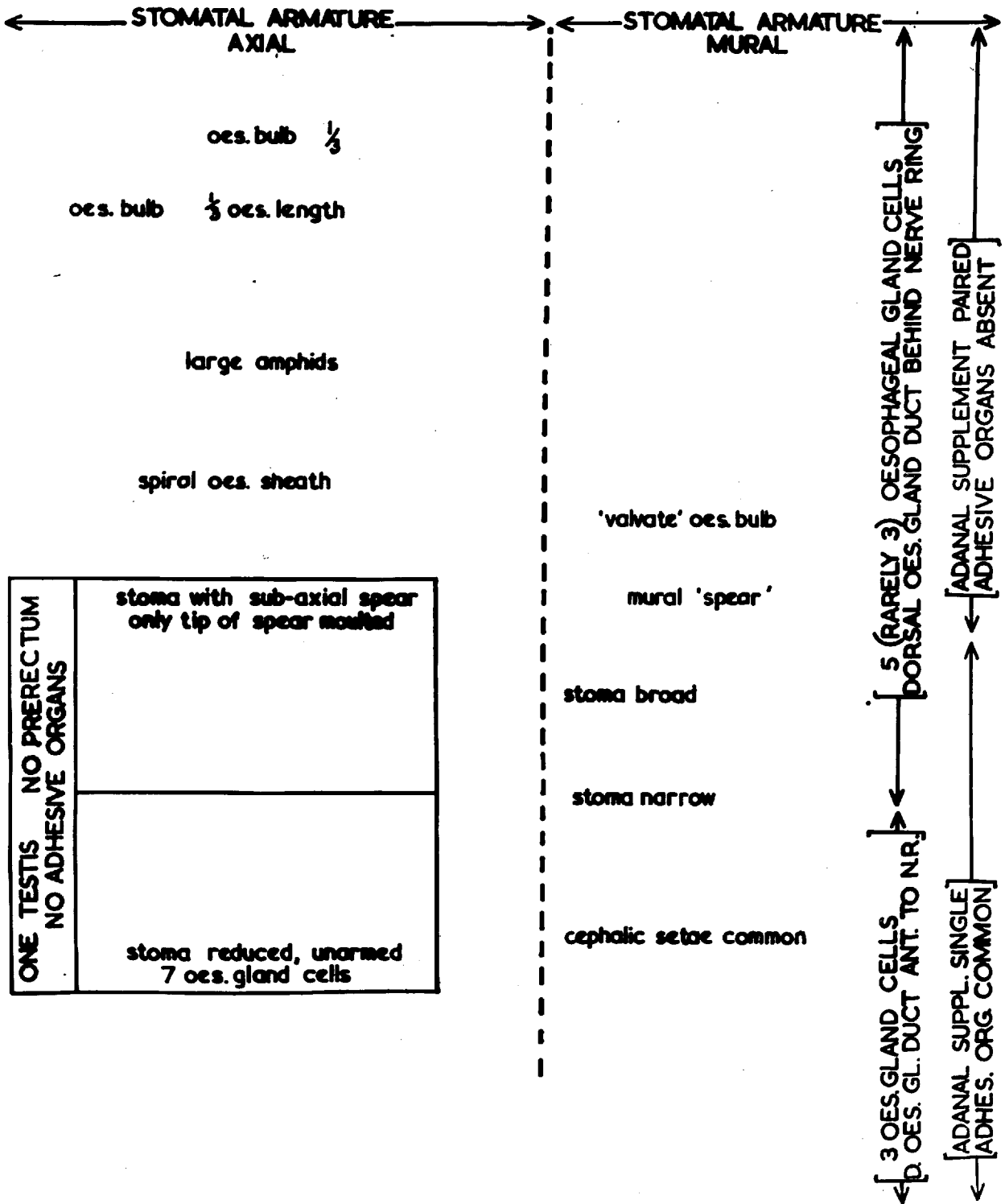

Fig. 2. Phyletic arrangement of the soil-dwelling Enoplida, with the morphological features shown on an overlay.



commonly possessing cephalic setae. The dorsal oesophageal gland duct opens into the oesophageal lumen anterior to the nerve ring. On the main branch of the phylogenetic tree the first important change was the increase in the number of oesophageal gland cells from three to five, and the posterior movement of the dorsal gland duct so that it came to open behind the nerve ring. The cephalic setae were probably lost about this stage. About here the Alaimina stock diverged in a different direction from either of the others, and appears soon to have reduced the number of testes to one, and to have lost the muscular ejaculatory duct and the adhesive organs. The excretory pore which was generally lost in the dorylaimoid line, was retained as was the tripyloid type of spicule. The Alaimina failed to develop a prerectum. It then diverged in two directions, one giving rise to the Alaimoidea and the other to the Diphtherophoroidea. In the alaim line the chief modifications were the total loss of the gubernaculum in the males and a great reduction of the cephalic structures so that the stoma became minute and the armature disappeared entirely. An additional pair of oesophageal gland cells arose. In the other branch which gave rise to the Diphtherophoroidea the chief change was in the stomatal armature, and the development of a complex non-axial spear which is analogous to, but not necessarily homologous with that of the dorylaims, the chief differences

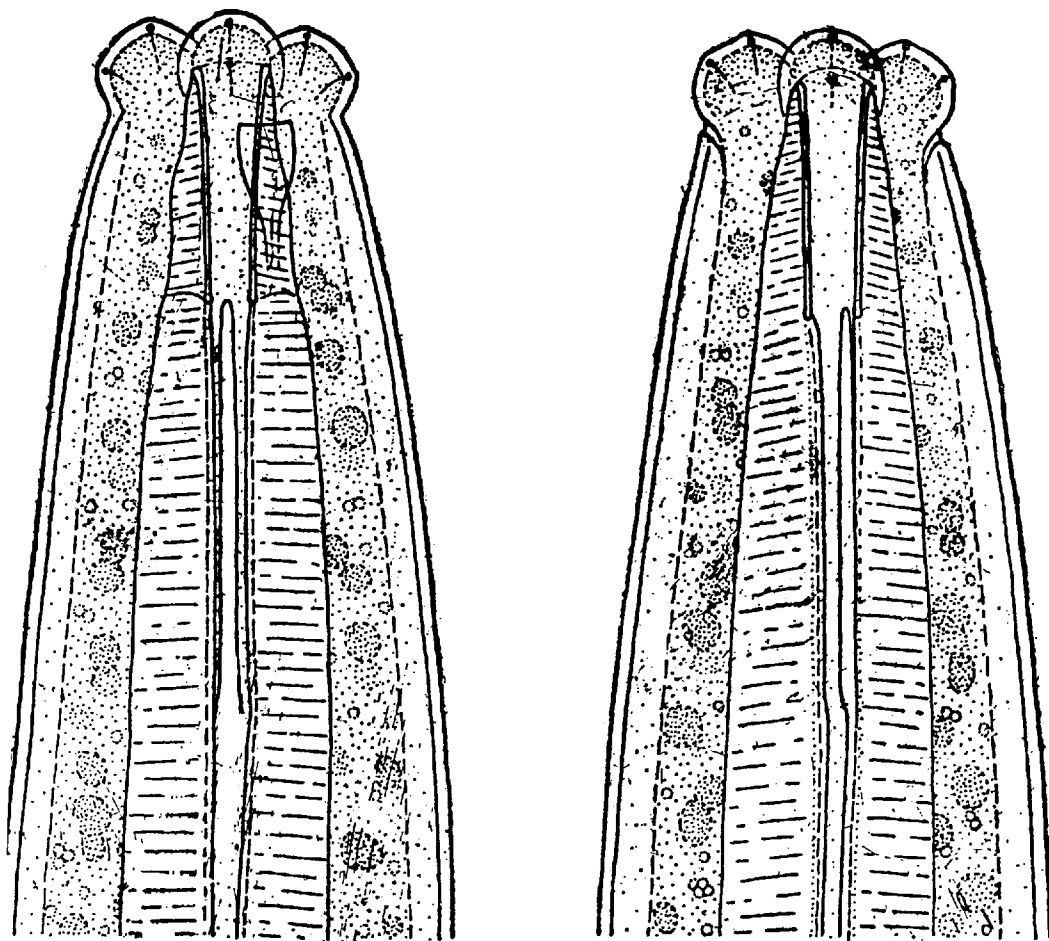
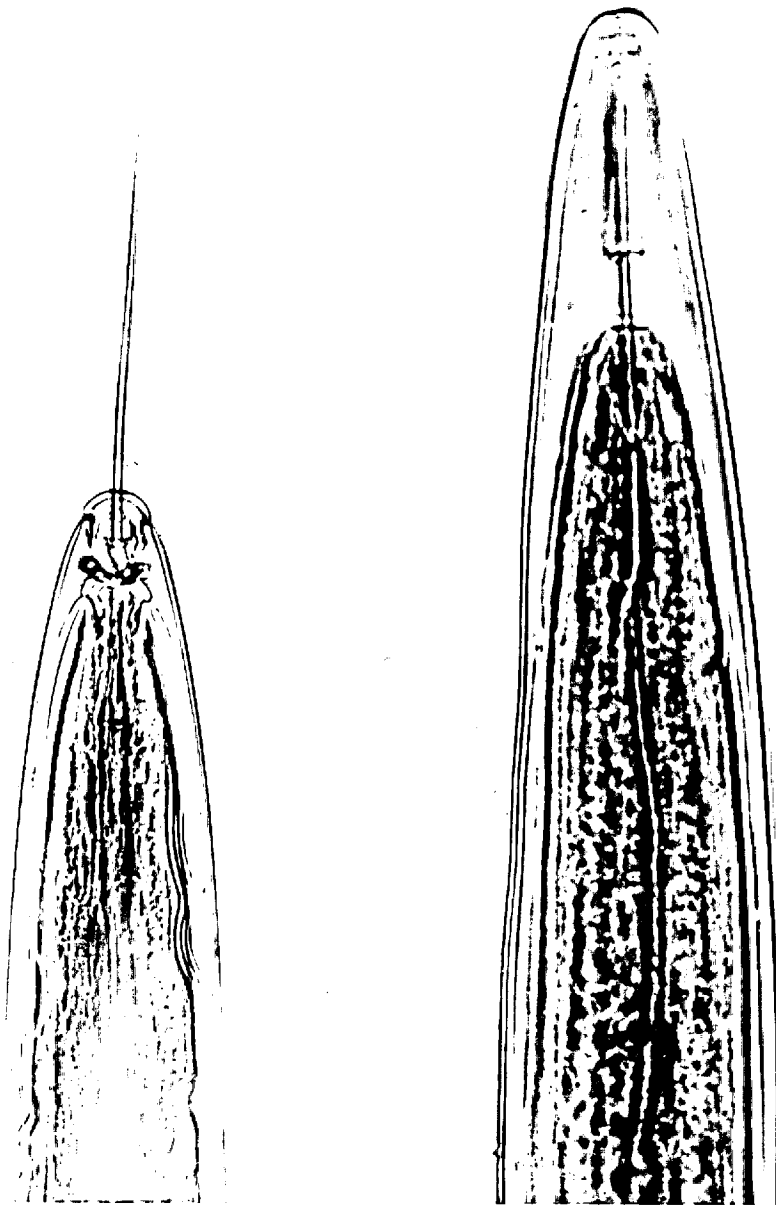

Fig. 3. Mirolaimus mirus Andrassy (After Andrassy, 1956)

being that it is not hollow and only the tip is shed at each moult.

On the main line, shortly after the Alaimina stock diverged, another line appeared in which the cylindroid oesophagus of the tribyloids was retained. This gave rise to the Mononchoidea; probably firstly to the Bathyodontidae and later by widening and elaboration of the stoma to the Mononchidae. It is noteworthy that the Bathyodontid stoma (especially Mirolaimus fig. 3) shows signs of an incipient mural spear or tooth. By the time the Nygolaimidae diverged this had become a mural tooth inserted on the wall of an eversible stoma. During the intervening period the adanal supplement had become paired, lateral accessory pieces became the rule amongst the males, and the adhesive glands were lost entirely. The loss of adhesive glands may be because the group had now become predominantly terrestrial and they were no longer needed. At the same time, the oesophagus became more slender anteriorly and the nygolaim oesophagus may be regarded as transitional between the cylindroid oesophagus of the Mononchoidea and the "dorylaimoid oesophagus" of the later groups. In the Nygolaimidae the gubernaculum makes its last appearance as a universal male character, appearing but sporadically in later groups.

The position of Campydoridae is uncertain; Campydora itself with a dorsal mural tooth is a stumbling block and as



A.

B.

Fig. 4. Moulting specimens of Longidorus taniwha n. sp., note the coiled, moulted spear extensions in A, and the moulted stomatal lining in both specimens.

remarked earlier (III, 1) the group is characterised chiefly by the possession of a valvate oesophageal bulb.

The Belondiridae are undoubtedly close to the Nygolaimidae as the spiral oesophageal sheath which, together with an axial spear characterises the Belondiridae, is also found in the Nygolaimid genus Nygellus. The most important new feature to appear in the step from the nygolaimids to the belondirids is the axial spear. The Opailaimidae are poorly characterised; the two genera Opailaimus and Ootolaimus having little in common. Opailaimus is reputed to possess an oesophageal sheath (it is not known whether this is spiral or not), and very large amphids. Both these characters are found in some belondirids, e.g., Dorylaimellus.

The Dorylaimidae have carried the suppression of the gubernaculum further than most groups, but it still appears sporadically. The enlarged posterior region of the oesophagus is always more than a third, and usually half or more of the total oesophageal length. Because Goodey (1961) has shown that the guiding ring is essentially of the same nature throughout the Dorylaimoidea (including the Nygolaimidae) no distinctions can be made on the basis of this character.

The last family to be considered, the Leptonchidae, are rather heterogeneous, especially in the form of the spear, but the oesophageal bulb is always less than one third of the oesophageal length. The number of supplements is often

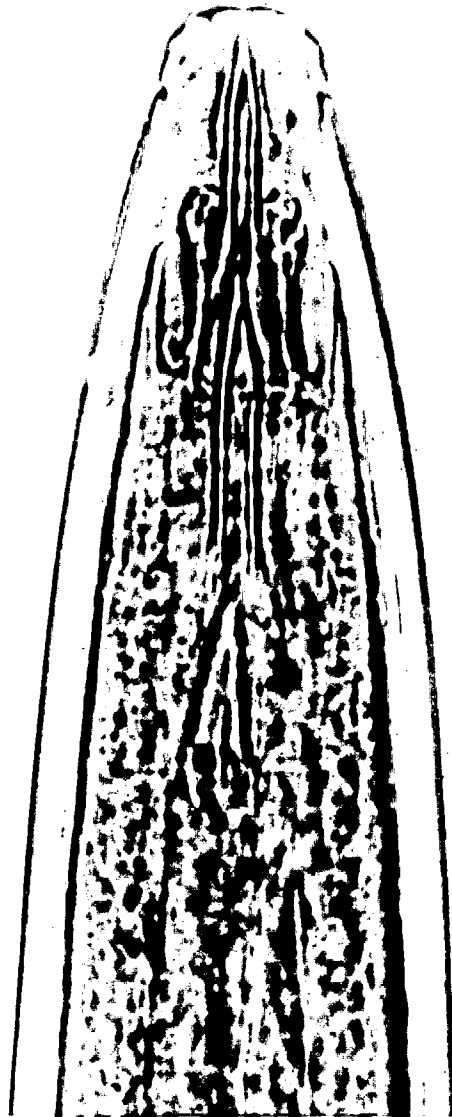

Fig. 5. A moulting Dorylaimus sp. showing the old spear being shed, the new spear in the definitive position, and a third spear forming in the oesophageal wall.

very small, but small numbers also occur in the Tylencholaiminae.

The superficial similarity between the Dorylaimoidea and the Diphtherophoroidea is considered to result from convergent evolution rather than an immediate common ancestry.

The phyletic scheme outlined above rests mainly upon the implied homology between the mural teeth of less evolved groups and the hollow, tubular axial spear of the higher groups. This may appear unjustified, but the idea is not new. Chitwood and Chitwood (1937) p. 9 state "A tooth may be transformed into a stylet in which case this structure may be termed an onchiostyle." Chitwood later (1938) again discussed the matter briefly. In the Dorylaimidae the spear (or onchiostyle) is a hollow cylinder with an oblique terminal aperture. The whole of the spear, guiding ring, spear extensions, and stomatal lining as well as the exo-cuticle are shed at each moult (fig. 4). The new spear is formed according to Thorne and Swanger (1936) in a single cell in the left submedian wall of the oesophagus and later migrates anteriorly and at the moult moves into its final position and establishes connections with the new guiding ring, and spear extensions (fig. 5). Because the guiding ring is continuous with the stomatal lining (Goodey, 1961) all food passes through the lumen of the spear. Exactly the same processes are involved in the replacement of the mural tooth



Fig. 6. A moulting larva of Iotonchus maragnus Clark with a new stomatal lining forming around the old lining which is being shed.

of the Nygolaimidae at each moult. Thorne (1930) shows this in his figures of Nygolaimus pachydermatus. In Nygolaimus the tooth is hollow, but has no terminal aperture. All food passes from the stoma into the oesophagus through the unobstructed passage between the tooth and the stomal wall. In Sectonema spp. the tooth appears to be solid. The significance of the Nygolaimidae in the evolution of the dorylaimoid spear was first noted by Cobb (1922) when he stated that Nygolaimus "may possibly be regarded as a transitional form".

In the Mononchidae the whole stoma and oesophageal lining is cast out at each moult, and a new stomatal capsule is formed behind the old one before it is shed (fig. 6). The developing stoma is surrounded by ectodermal tissue as is the developing dorylaimoid spear. The Mononchidae are, however, a specialised group, and the form of the stoma militates against its being formed more posteriorly in the oesophagus and then migrating into the definitive position. Unfortunately nothing is known of the behaviour of Mirolaimus during moulting or the origin of the "tooth". What happens in Ironus ignavus is illuminating. Here the stoma is surrounded at the anterior end by three inwardly projecting teeth. Again, the teeth, stomatal and oesophageal linings are shed at each moult (fig. 7). The new teeth already in existence before the moult are formed behind the old teeth in the



Fig. 7. A moulting larva of *Ironus ignavus* Bastian showing the moulting cuticle and oesophageal lining. The moulting teeth are not visible at this level of focus.

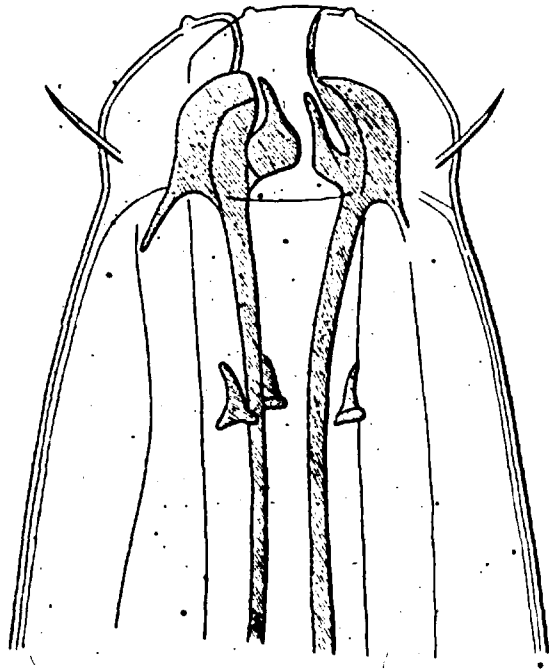

Fig. 8. Ironus ignavus (Bastian) larva showing the developing teeth. (After de Man, 1884).

tissue of the oesophagus (fig. 8) and migrate forward in a manner which, as de Man (1884) noted, is exactly comparable with the spear of the dorylaims. The chief differences between the movements of the teeth in Ironus and the spears of dorylaims are that, in the former, three elements are involved instead of one and that all the migration takes place through the oesophageal tissue rather than partly at least through the oesophageal lumen.

Section IV

Suborder ENOPLINA

Family IRONIDAE

Subfamily IRONINAE

Ironus ignavus Bastian, 1865

(for literature see Micoletzky, 1925, p.108).

Reefton, New Zealand.

4 $\frac{00}{++}$ s . L = 1.76 mm (range 1.65-1.89), a = 44-48;

b = 4.55-5.09, c = 3.44-3.91, V = 39.4-43.7

I have compared these specimens with material collected near Falmouth, England (type locality of I. ignavus) and can find no differences between the two populations. The New Zealand material comes from a sphagnum bog near Reefton in the Buller district. In fixed specimens from both populations I have been unable to detect the glandular structure in the oesophageal region figured by Cobb (1918).

Subfamily CRYPTONCHINAE Chitw. & Chitw., 1937

Cryptonchus Cobb, 1913

Ironidae, Cryptonchinae. Cuticle with very fine transverse striae. Amphids pocket-like, apertures transverse slits about as wide as stoma. Lip region not offset, consisting of six inconspicuous lips each bearing a single small papilla. No cephalic setae. Stoma long, tubular, composed of three abutting, longitudinal, sclerotized plates and bearing two small dorsal teeth at the posterior end. Oesophagus

cylindroid without a terminal bulb, but bearing a rather rounded, glandular sphincter at the oesophago-intestinal junction. Intestine simple. Vulva near middle of body, ovary single, anterior, reflexed. Eggs large (length about four times body width), only one in uterus at a time. Cuticular lining of rectum prominent. Tail tapering, caudal glands present, terminal duct seen only in tape species. Males unknown.

Type species: Cryptonchus nudus Cobb, 1913

Cobb (1913) founded the genus Cryptonchus for the reception of a species which he named nudus which he had found in two localities in the United States. Ditlevsen (1911) described the same species from Denmark under the name Cylindroclaimus tristis. The synonymy of this species is given below.

Cryptonchus tristis (Ditlevsen, 1911)

Cylindroclaimus tristis Ditlevsen, 1911

Cryptonchus nudus Cobb, 1913

Cylindrolaimus tristis W. Schneider, 1922

Ditlevsenia tristis Micoletzky, 1925

Cryptonchus tristis Filipjev, 1936

Cryptonchus nudus Goodey, 1951

This species has been recorded from two localities in the United States and from Denmark, Southern Sweden, Poland and Germany, from freshwater habitats about the roots of

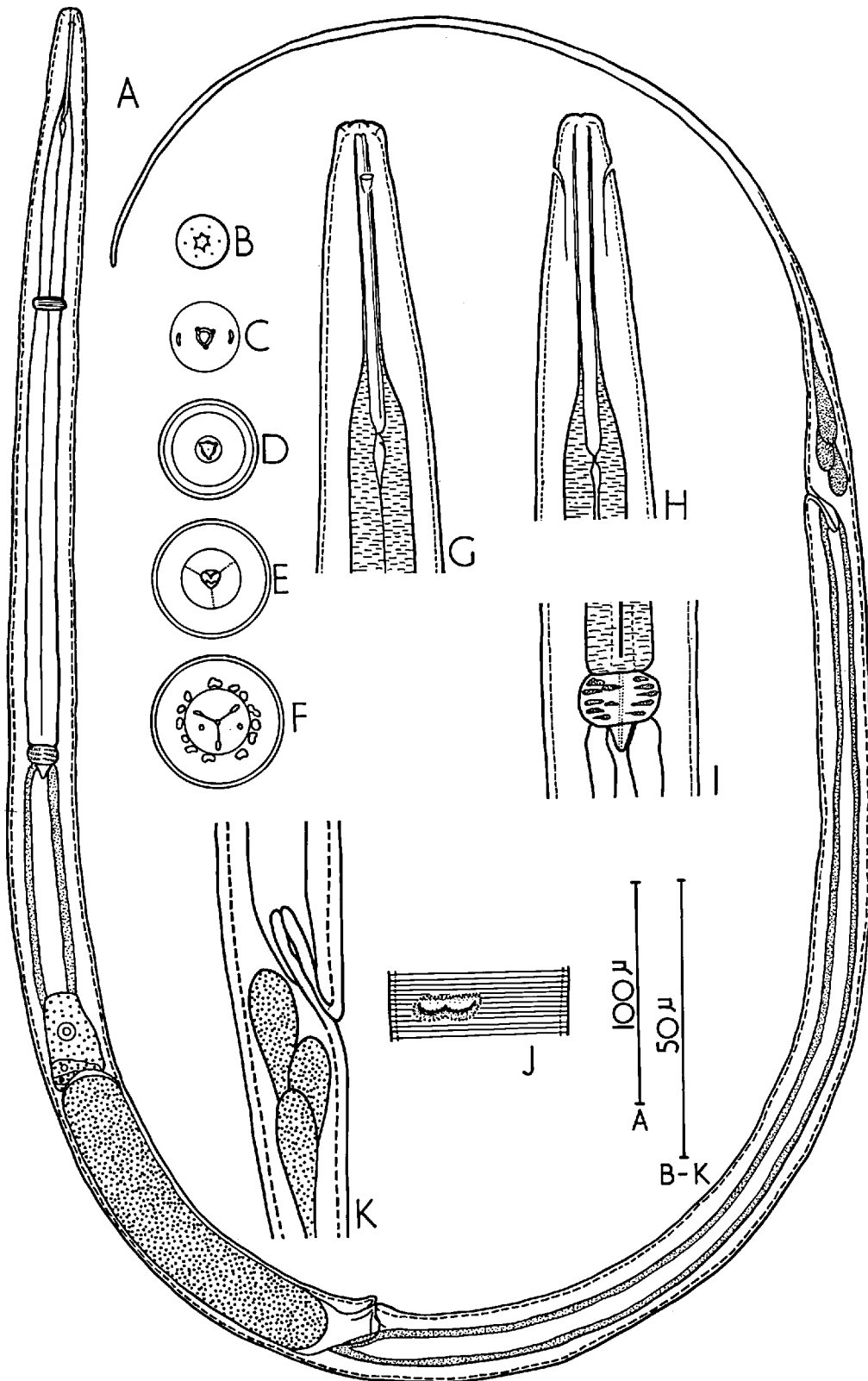

Fig. 9. *Cryptonchus abnormis* (Allgen). A female; B en face view of head; C ditto at level of amphids; D section through mid-region of stoma; E section through base of stoma showing tooth; F section through oesophagus; G & H head in lateral and dorsal views; I oesophago-intestinal junction; J ventral view of vulva; K anal region of female.

plants.

Cryptonchus abnormis (Allgen, 1933) Schuur-Stekh., 1951

Fig. 9 A-K

Cylindrolaimus abnormis Allgen, 1933

Gymnolaimus exilis T. Goodey, 1951 nec Cobb

Cryptonchus abnormis Schuurmans Stekhoven, 1951

Gymnolaimus exilis, Andrassy, 1956 nec Cobb

Measurements

Reefton, New Zealand. $\overset{\circ\circ}{++}$ n = 20. L = 1.756 mm (s = \pm 0.057 mm)
(range 1.62-1.85 mm; a = 46-70; b = 4.35-5.13; c = 3.26-3.72;
V = 40.3-45.3.

Cuticle and subcuticle 1 μ thick; cuticle with very numerous annulations, not resolvable into rows of dots. No lateral fields. Lip region not offset, but head region constricted slightly about one head-width behind lip region. Lips six, inconspicuous each with a single papilla. No cephalic setae. In en face view (fig. 9 B) oral aperture is hexagonal. Amphids situated one and a half head-widths behind lips, pouch-like with transverse slit-like apertures a little wider than stoma, appearing crescentic in en face view (fig. 9 C). Stoma about 6 times as long as width of lip region, tubular, of uniform diameter anterior to teeth, consisting of three sclerotized abutting plates, lumen somewhat triangular in cross section (fig. 9 D) reminiscent of the Mononchoidea. Stoma lumen constricted near posterior

end by a ventral thickening of the stoma wall and an opposing dorsal tooth. In lateral view there is a second smaller dorsal or sub-dorsal tooth a little posterior to the larger one but this was not visible in hand cut transverse sections. A short distance behind the teeth the lumen narrows and becomes the oesophagus proper. The whole of the stoma is embedded in oesophageal tissue which forms a thin sheath anteriorly but which thickens a little anterior to the teeth, and then remains the same width throughout its length. Nerve ring indistinct, occurring at 38 per cent of oesophageal length.

Oesophago-intestinal junction with a large, rather globular, glandular sphincter muscle with a small oesophago-intestinal valve projecting from its posterior face into the lumen of the intestine. Intestine simple.

Vulva a bi-crescentic, transverse slit, with slightly thickened, usually protuberant lips. Vagina somewhat muscular extending across almost a half body-width. Ovary reflexed through a short distance usually consisting of less than five oocytes, nuclei prominent. Uterus completely filled by a single egg. Egg length equal to four times body-width.

No prerectum. Rectum straight, length equal to anal body width, with a prominent cuticular lining. Anus a transverse slit. Tail long, slender, tapering uniformly to

filiform tip. Three caudal glands present but no terminal duct seen. Caudal cuticular pores not seen. Larvae resemble female. Males unknown.

Material from sphagnum swamp, Reefton, New Zealand.

Remarks. I have examined the slide bearing the specimens recorded by T. Goodey (1951) from Java and have compared these with the original description of Gymnolaimus exilis (Cobb, 1893) Cobb, 1913, and find that the material is definitely not referable to Gymnolaimus, because of the toothed nature of the stoma and the uniformly cylindroid posterior part of the oesophagus. Andrassy's use of G. exilis for this species appears to be based on Goodey's misidentification.

Most of my specimens have a large number of small oval bodies in the coelom, possibly Sporozoa, apparently similar to those recorded by Andrassy.

Distribution.

This species has an unusual distribution, being known only from the Lower Congo; Ivory Coast; Buitenzorg, Java and New Zealand. This discontinuity is probably explainable in terms of collection failure.

The two species of Cryptonchus are readily separated on the basis of tail length; in C. tristis $c = 11-14.3$, but in C. abnormis $c = 2.9-3.7$.

Section V

Suborder ALAIMINA

Family ALAIMIDAE

1. Description of Amphidelus spiralis n. sp.

Amphidelus spiralis n.sp.

Figs. 10 A - F.

Holotype ♀ L. = 1.21 mm. a = 50; b = 3.61; c = 17.5; V²² 70

Allotype ♂ L. = 1.21 mm. a = 65; b = 3.84; c = 17.3; T 52

Paratypes ♂♂ (n = 6) L = 1.26 mm. (range 1.13 - 1.43 mm)

a = 45 - 59; b = 3.61 - 4.00; c = 16.9 - 18.6;

V¹³⁻²² 66-71

♂♂ (n = 5) L = 1.225 mm. (range 1.16 - 1.32)

a = 62 - 66; b = 3.64 - 3.94 mm; c = 17.3 - 21.1;

T 51-57

Slender nematodes which taper gently from near the middle towards both ends. When killed with gentle heat they lie in a plane spiral. Cuticle and subcuticle 1.5 μ thick, smooth. No cuticular pores observed on any part of the body. Lip region somewhat angular, narrowing anterior to the outer circle of ten cephalic papillae. Inner ring of cephalic papillae not seen. Lips equal, almost fused. Aperture of stoma triangular in en face view. Amphid apertures large, oval, placed well back on neck region; amphids pocket-like and communicating posteriorly with sensillae which are situated about one body-width anterior

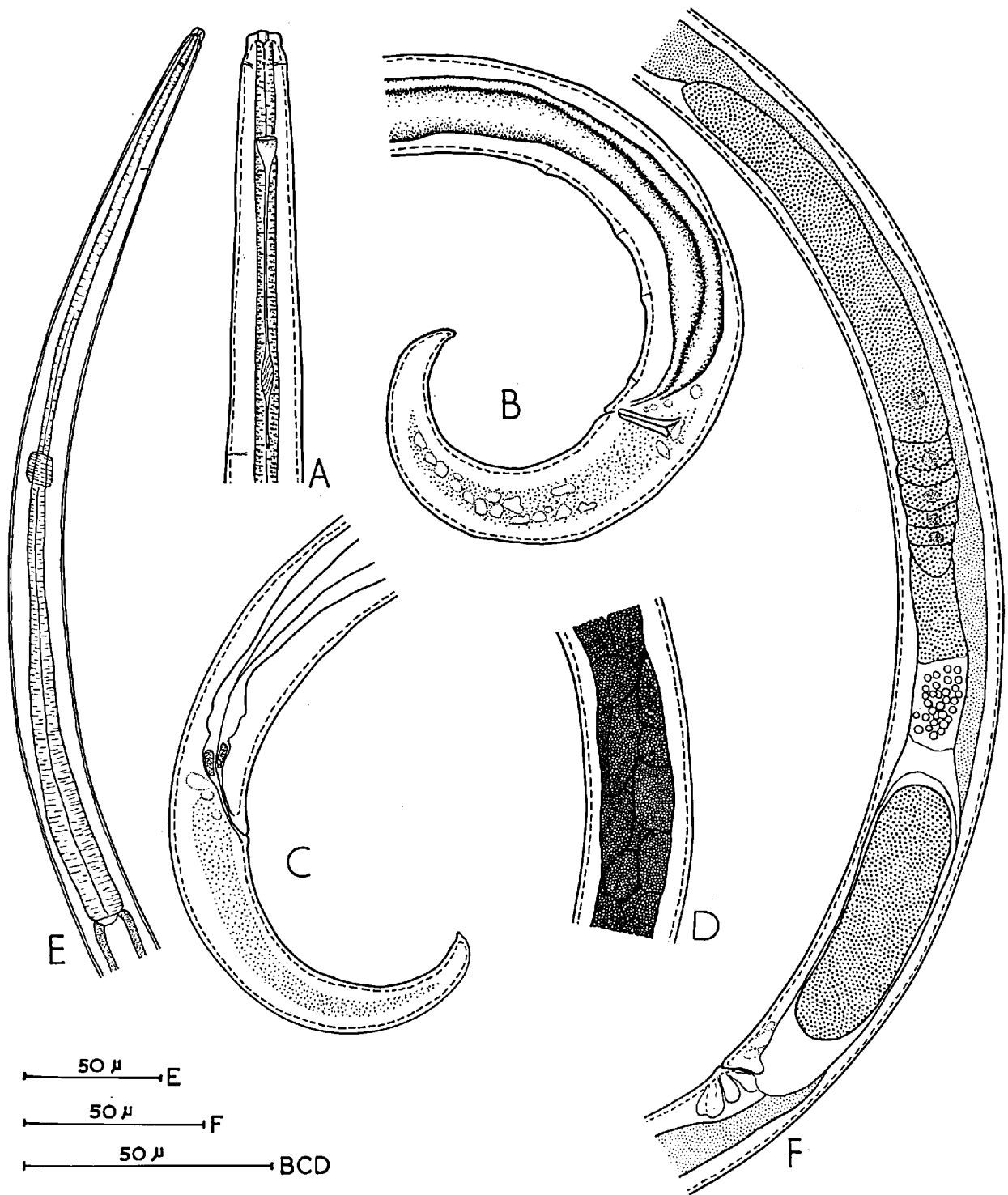

Fig. 10. *Amphidelus spiralis* n. sp. A lateral view of head, B male tail, C female tail, D spermatozoa within "packets" in vas deferens, E oesophageal region, F reproductive tract of female.

to the excretory pore. Stoma short, small, lying wholly anterior to the oesophagus. Oesophagus slender anteriorly, widening gradually posterior to the nerve ring (which occurs at about half its length) to form a rather pyriform posterior bulb. Oesophageal gland cells apparently seven in number. Oesophago-intestinal valve short and broad.

Intestine passes to the right of the reproductive tract. No definite prerectum in either sex, but in the female the intestine narrows slightly a short distance anterior to the rectal sphincter (fig. 10D).

Female Vulva a transverse slit; vagina directed slightly anteriorly and extending across less than half the body width. Uterus, oviduct and ovary single, and anterior. Uterus and oviduct outstretched. Ovary reflexed half-way back to the vulva. Only one egg in the uterus at a time. Eggs $73 \times 20.5 \mu$. Rectum straight, length slightly more than anal-body-width. Tail conoid with a short mucro on tip.

Male Testis single, outstretched, about one quarter as long as vas deferens. Spermatozoa arranged in a single or double row within anterior part of testis. Posterior part of testis filled with randomly arranged fusiform spermatozoa. Vas deferens set off from the testis by a slight constriction where the walls of the tube appear slightly thickened. In the vas deferens the spermatozoa appear to be enclosed in small packets (fig. 10E); the membrane about

them may be the cell wall of the primary spermatocyte. Generally the vas deferens is wider than the testis (half to two-thirds of the body width); no ejaculatory duct is present, only a very slight narrowing of the vas deferens near the spicules. Spicules paired, free, equal, straight with the dorsal ends flaring out slightly. Spicules set almost at right angles to the body axis. Ventral tips of spicules closer together than the dorsal ends. Supplements four, low-mammiform, ventro-median, approximately equidistant. Adanal member unpaired. Tail similar to female ventrally curved, conoid with a terminal mucro in most specimens.

Specific differentiation. Amphidelus spiralis n. sp. is readily distinguished from all other described species in the genus by the single unpaired anterior ovary and the complete absence of the posterior branch of the reproductive tract. The reduction in head width anterior to the outer ring of cephalic papillae and the mucronate tail also serve to distinguish this species from most others.

Type slides. Holotype, allotype and paratypes in the nematode collection, Entomology Division, D.S.I.R., Nelson, New Zealand. A paratype male and female in the slide collection, Nematology Department, Rothamsted Experimental Station, Harpenden, England (slide No. 193/2/1).

Type Locality. Waitaanga Saddle, N.Z.M.S.L., N 100, 453170, 520 m., in liverworts and mosses in Knightia excelsa R. Br. -

Weinmannia racemosa Linn.f. - Brachyglottis repanda Forst.
forest.

Remarks. The single prodelphic gonad in the female is unique in this genus. Spermatozoa within the uteri of the females all appeared much larger than the spermatozoa enclosed in packets within the vas deferens in the males. All males examined had spermatozoa in the vas deferens and some females had an egg in the uterus: material collected in April.

2. The Male Reproductive System in the Alaimoidea

Chitwood & Chitwood (1940 & 1950) discussed the male reproductive systems found in the Nematoda. However, as they state that in the Enoplida all males except those in the Trichuroidea and Dioctophymatoidea have paired testes, and that ejaculatory ducts, usually prominent, are found in all known forms other than the monorchic groups mentioned above, they evidently did not consider the Diphterophoroidea or the Alaimoidea. As far as can be ascertained all males in these two groups are monorchic, with the testis outstretched anteriorly, and without conspicuous ejaculatory ducts.

No accounts of monorchic reproductive tracts of soil dwelling enoplids have been found, and in an attempt to make good this deficiency, the system as found in representatives of the Alaimidae is described here. This account is based on

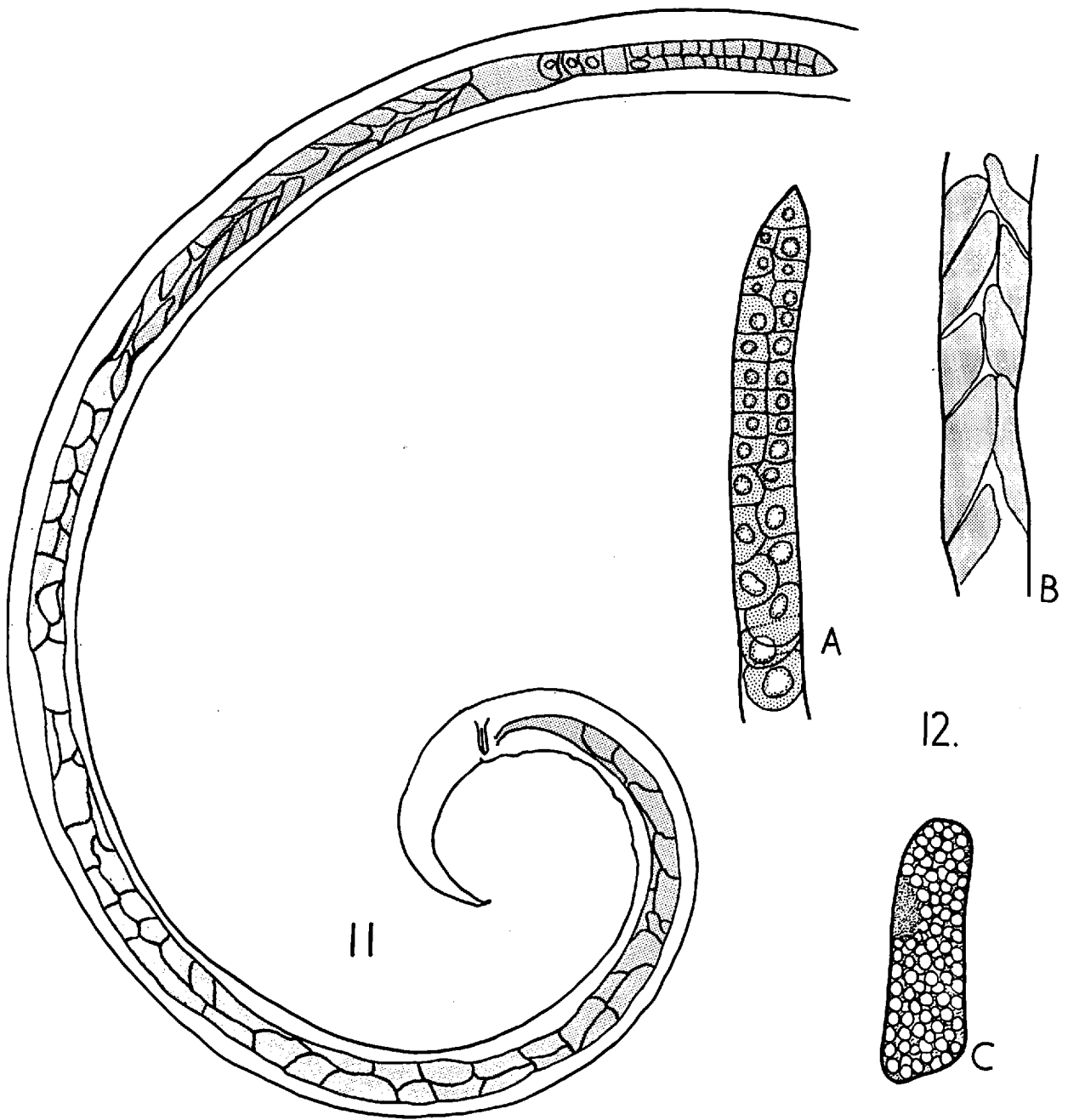

Figs. 11 & 12. Amphidelus spiralis n. sp. Fig. 11. Schematic representation of the male reproductive system. Fig. 12. A anterior end of testis showing spermatogonium and spermatocytes; B spermatocytes in posterior part of testis; C one packet of spermatozoa.

males of Alaimus glissus Thorne, 1939, Amphidelus spiralis n. sp. and males of four other undescribed species of Amphidelus from New Zealand.

(a) The Reproductive Tract

The main features of the alaimid male reproductive system are shown in figure 11. The single testis is outstretched anteriorly, and divisible into two distinct regions; the anterior germinal region where the spermatocytes are produced, and the posterior often wider region (the "seminal vesicle" of the Chitwoods) where the spermatocytes change their form. The "seminal vesicle" is marked off from the vas deferens by a slight constriction and a sphincter muscle, the degree of development of which varies from species to species. The vas deferens is very long and shows no sign of an ejaculatory duct. In most enoplids the vas deferens is constricted near the first supplement and behind this has rather thicker walls, but in the alaims there is only a gradual decrease in width a short distance anterior to the spicules.

The course of spermatogenesis has not been studied in detail in this group, but it appears to differ from the usual sequence of events and appears to be rather similar to that described by Cobb (1928) for Spirina parasitifera (Bastian). Chitwood (1940) has said that this account is based in part upon a misinterpretation. In the germinal

region of the testis the most anterior cell (spermatogonium?) is always single and apical. Behind this lies a series of spermatocytes. In young males these are arranged in a single row (primary spermatocytes ?) but in more mature specimens they lie in two rows (secondary spermatocytes ?) (fig. 12A). As they enlarge in the posterior part of the germinal region they once more lie in single file. In the germinal region the germ cells all have large nuclei with small darkly pigmented bodies, probably chromatin, and granular cytoplasm. In the seminal vesicle the spermatocytes become fusiform, the length : breadth ratio of the spermatocytes varies from species to species; the nuclei become invisible and the cytoplasm non-granular (fig. 12B). In the anterior part of the vas deferens the spermatocytes undergo repeated divisions to form a large number of small spherical cells (primary spermatids ?) which gradually increase in size as they pass down the vas deferens. The spermatids (?) are enclosed within membranes or packets (figs. 10E and 12C). The membranes appear to be the old cell wall of the secondary spermatocytes. About halfway down the vas deferens the spermatids suddenly become much smaller and more numerous within the packets but as they move further down the vas deferens, their former size is restored. These spherical bodies are the spermatozoa.

Chitwood (1940) claimed that the small bodies reported by Cobb (1928) which appear to have been similar to the ones

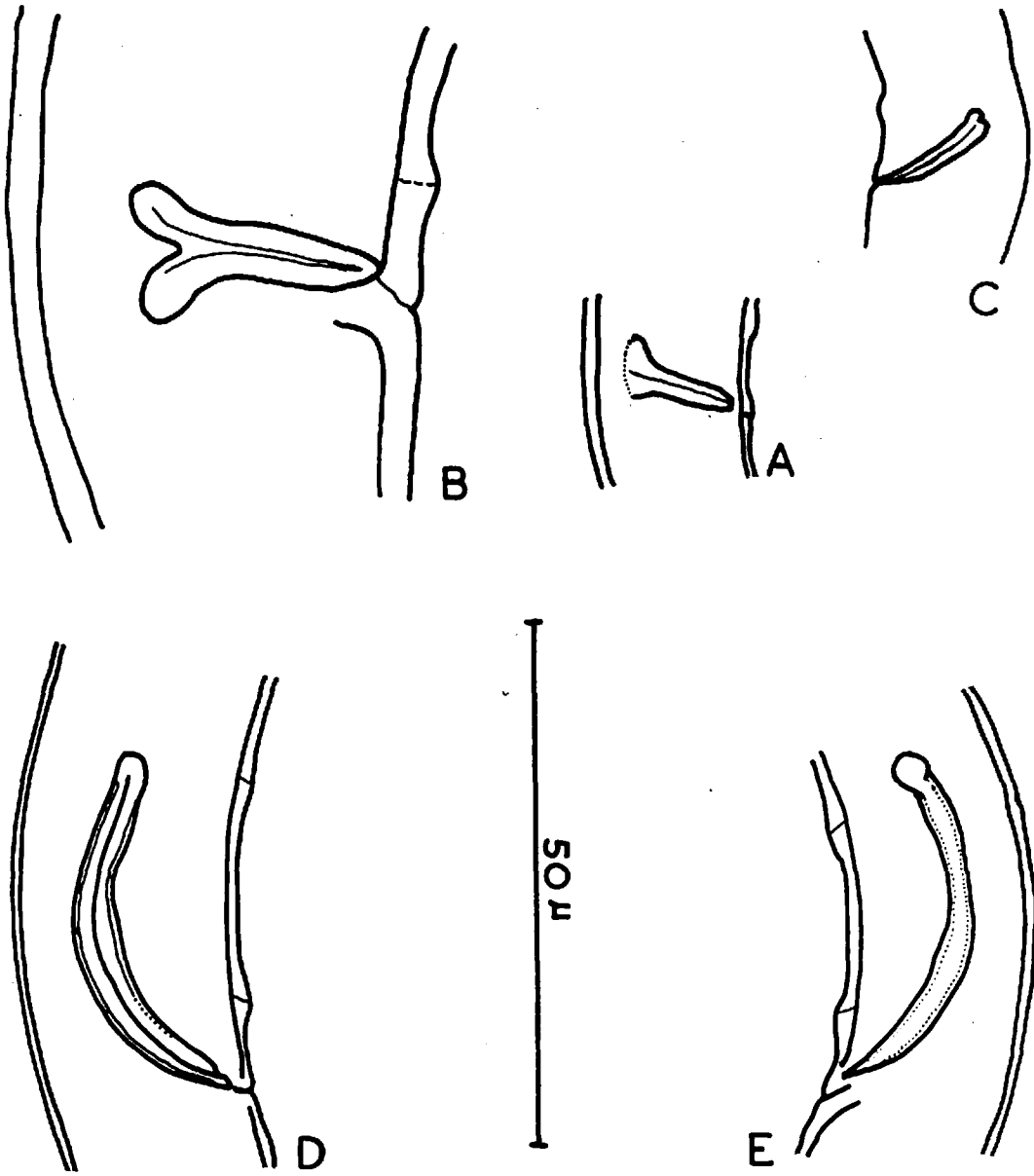

Fig. 13. Diversity of spicule form in the Alaimoidea.
 A Amphidelus spiralis n. sp., B Amphidelus sp. ex Lake Mahinapua, C Amphidelus sp. ex Waitaanga Saddle, D Amphidelus sp. ex Wharekohe, E. Amphidelus sp. ex Barrytown.

under discussion were not spermatozoa but secretion globules in the walls of the vas deferens. In the present case the whole lumen of the vas deferens is filled by these bodies. In a number of packets there is a darker area but as far as can be determined these darker patches indicate a local absence of spermatozoa.

In that there appear to be too many divisions between the production of the spermatocytes and the definitive spermatozoa, this description conflicts with the normal notion of spermatogenesis, but will serve for the gross morphology of the system. The course of spermatogenesis requires further investigation with more suitably stained material.

(b) The spicules

Up to the present, apart from Alaimus filiformis Daday which Thorne (1939) regarded as a species inquirenda, the spicule shape has been remarkably uniform in all described males of Alaimus and Amphidelus. All species have straight spicules with slightly enlarged or flaring heads (figs. 13 A-C) similar to those of Amphidelus spiralis. The New Zealand material of the genus displays a diversity of spicule form hitherto unknown. At least two species have curved spicules with rather rounded slightly inflated heads (figs. 13 D-E). In all other characters these specimens agree with the rest of the genus Amphidelus. This diversity of spicule form is

another way in which the Alaimina converge towards the Diphtherophoroidea, the other monorchic group with curved and straight spicules. The Alaimina, however, show no sign of a gubernaculum.

Section VI

Suborder DORYLAIMINA

Family MONONCHIDAE

1. Introduction

The mononchs were amongst the first free-living nematodes to be described when the study of free-living nematodes was in its infancy about the middle of the last century. The first mononch, Oncholaimus muscorum was described by Dujardin in 1845; this was followed by several more species described by Bastian in 1865 which he placed in his new genus Mononchus. He also transferred Dujardin's species to this genus. In the years that followed many of Bastian's species were recorded from the various parts of Europe and several new species added to the list. Most of the European species were all referable to the genus Mononchus as at present constituted. The outstanding exceptions being Anatonchus tridentatus (de Man) and Mylonchulus brachyuris (Butschli). About the turn of the century Cobb described a number of species which are now referable to genera other than Mononchus and Prionchulus.

The landmarks in the systematics of the group are Cobb's 1916 and 1917 papers where he first erected a number of subgenera within the genus. These were based on the different types of stomatal armature found in the group. Cobb was more concerned with the arrangement of the teeth

within the stoma rather than the shape of the stoma itself. Over the years Cobb's arrangement met with general, but not universal acceptance. Micoletzky (1922) accented the subgenera, but relegated many of Cobb's species to synonymy. Since Micoletzky's time a number of new species have been described, but the status of many species has long been in doubt. Andrassy (1958) revised the whole group and elevated all of Cobb's subgenera to generic rank and provided five new genera to accommodate species which did not fit Cobb's subgenera. At the generic level there is little criticism to offer on this arrangement. At the specific level, however, much of his synonymisation appears arbitrary. Most of the work was done from the literature and not from specimens, and displays an over-eagerness to "tidy up" by naming species which the original authors hesitated to name, or by synonymising and not giving any reasons. For instance, the discussion of the variability of Mononchus truncatus would have been more valuable if accompanied by a description and figures of the variation encountered. On the whole the paper was a considerable advance, even if it did omit the fact that all of Cobb's genera had been given generic rank by Pennak (1953), and that some, notably Prionchulus, Ahatonchus and Iotonchus had been accorded this rank even earlier (Chitwood & Chitwood, 1937, de Conninck 1939, Altherr 1950). The systematic position of the Mononchidae was discussed in

Section III.

Cobb (1917) discussed the biology and morphology of the group fully. The Mononchidae are a very widespread family occurring in soil, freshwater, cryptograms and forest litter. The odd records of them from marine environments, e.g., Wieser 1953, are readily accounted for as a result of having been washed out of their normal habitats by streams. Geographically, they have been found wherever they have been sought. They occur in high latitudes in the northern hemisphere, through the tropics and on the Antarctic continent itself. Whilst the family is widespread, not all genera are ubiquitous. Distribution at the generic level is discussed in subsection 9.

Cobb considered the mononchs to be mainly syngonic, but this seems to vary considerably from genus to genus. The New Zealand iotonchids mostly have males, and males are known in all New Zealand species of Mononchus. There seems to be no generalization of universal application to cover even a single genus in this respect.

Ditlevsen (1911) observed that mononchids very frequently float when soil is placed in water. I have confirmed this observation many times, and consider that it may be an important factor resulting in low estimates of soil populations where this possibility is not guarded against.

2. The Mononchidae and Biological Control

Since Cobb's 1917 paper there has been scarcely a paper dealing with the Mononchidae which has not mentioned that some of them at least are nemativorous. The nemativorous habit has been much discussed and probably over-emphasised. One result of this was the two American studies of predation by mononchids. Steiner and Heinly (1922) investigated the biology of Mononchus papillatus and were able to devise culture methods for this species. They fed M. papillatus exclusively on nematodes (Rhabditis, Turbatrix and Heterodera larvae), but to obtain satisfactory cultures they had to include a small amount of soil which suggests that other micro-organisms form an essential part of the diet. Large numbers of nematodes were eaten by this species under laboratory conditions, but apart from the Protozoa and bacteria which may have been present in the soil, no other food was offered, so a preference for nematodes as food was not established. My attempts to rear M. papillatus and Prionchulus muscorum in sterile silver sand using washed nematodes (Rhabditis, Aphelenchus, Aphelenchoides and Ditylenchus spp.) as food were unsuccessful. Hesling (pers. comm.) has succeeded in keeping a culture of a Prionchulus sp. (possibly punctatus Cobb) for over a month feeding them nematodes only.

Thorne (1927) studied the use of naturally occurring



Fig. 14. Part of an Iotonchus percivali Clark showing an itonchid stoma, a tylenchid, and a pair of dorylaimoid spicules in the gut.

mononchids to control Heterodera schachtii infestations in sugar beet. He was concerned with Mononchus papillatus, Mylonchulus sigmaturus and Myl. brachyuris. His data indicate a much higher proportion of mononchids to other nematodes than in Great Britain but frequently most of the population was composed of members of the genus Mylonchulus which rarely attack other nematodes. In fact, of the three species investigated by Thorne, only M. papillatus appeared to be nemativorous to any extent; the remaining species feeding mainly on rotifers and protozoans. I think the nemativorous habit has been exaggerated by the use of the Baerman funnel for extraction. In this apparatus high densities of nematodes are built up, often for long periods in a small volume of water at the bottom of the funnel. The chances of other nematodes being attacked under these circumstances are probably much greater than in soil. In my experience Anatonchus tridentatus is the most actively nemativorous of the British species. In New Zealand soils the Iotonchus spp. are active carnivores and are commonly found (fig. 14) with nematode remains, and rotifer masticies in their guts.

Even if the mononchs possessed all the features attributed to them it is unlikely that they could exert any great effect on Heterodera schachtii populations because the H. schachtii larvae are only exposed to the predators for a



Fig. 15. Part of a leptonchid showing a dense population of sporozoan oocysts.

relatively short period in the spring and early summer. Further, the life history of Mononchids, if M. papillatus is at all representative, is of too long duration for them to be able to utilize the periodically available larval heteroderas effectively as a food source. Then too, because the two groups of nematodes had been living together for a long period, the two populations may be assumed to have reached some sort of balance, and the mononchs would have increased naturally if the conditions over the whole spectrum of their requirements were being met.

If an especially nemativorous mononchid species could be found which would thrive in agricultural soils, then it might be useful when introduced into a new environment. A limiting factor may be the susceptibility of mononchs (and leptonchids) to sporozoan infections (Thorne, 1927 and p.204 sub-section 5 (fig. 15)). If such an attempt is to be made it would be more realistic to try them against migratory root parasites, rather than the more sedentary Heterodera and Meloidogyne spp. which are unavailable as food for long periods during the growing season.

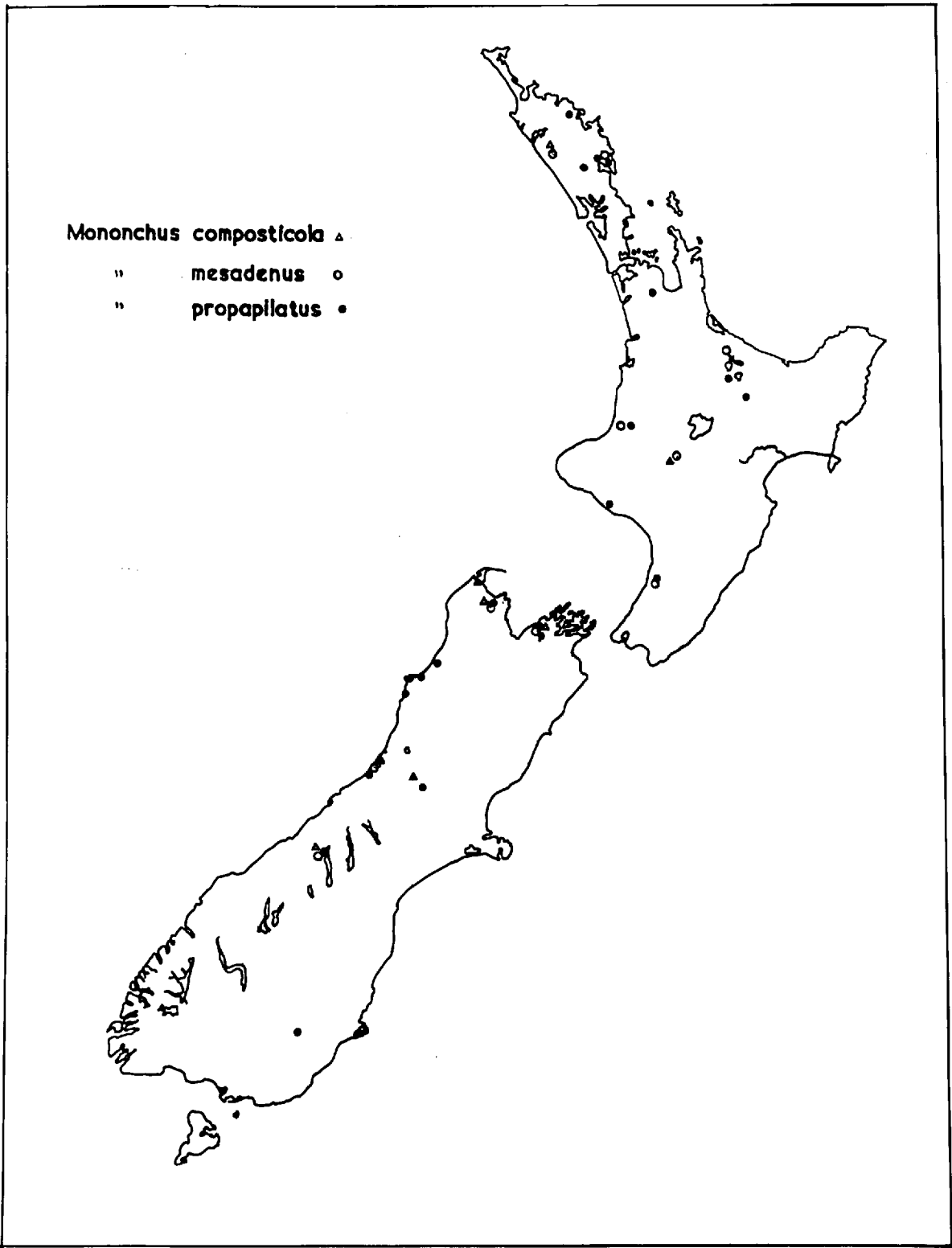

Fig. 16. Map showing the distribution of Mononchus spp. in New Zealand.

Distribution of New Zealand Mononchus spp.

The known distribution pattern of the New Zealand species of Mononchus (fig. 16) indicates that M. composticola and M. masadenus are forest inhabiting species. M. composticola is commonly found in forest litter, and M. masadenus is most commonly associated with mosses and liverworts. Where the two habitats are distinct as at Tutamoe these differences are clear cut. In the Tutamoe samples composticola was extracted from forest floor litter, and masadenus was recovered from mosses and liverworts scraped off tree trunks. Often a certain amount of moss and liverwort are found with the forest litter, and under these circumstances the two species occur together. Restriction of these species to either habitat does not appear to be absolute.

M. propaxillatus, however, shows no marked habitat preferences. It has been found in subalpine forests where frosts are common and where snow lies for several weeks every year, and in areas where snow or frost never occur. It is common in the litter of indigenous forest and amongst the fallen needles of exotic Pinus radiata De Don forests. The pine needle fauna of Kaiangaroa Forest was interesting because here M. propaxillatus was the dominant species, far outnumbering all the other species. A second male specimen was found at this locality. The litter of

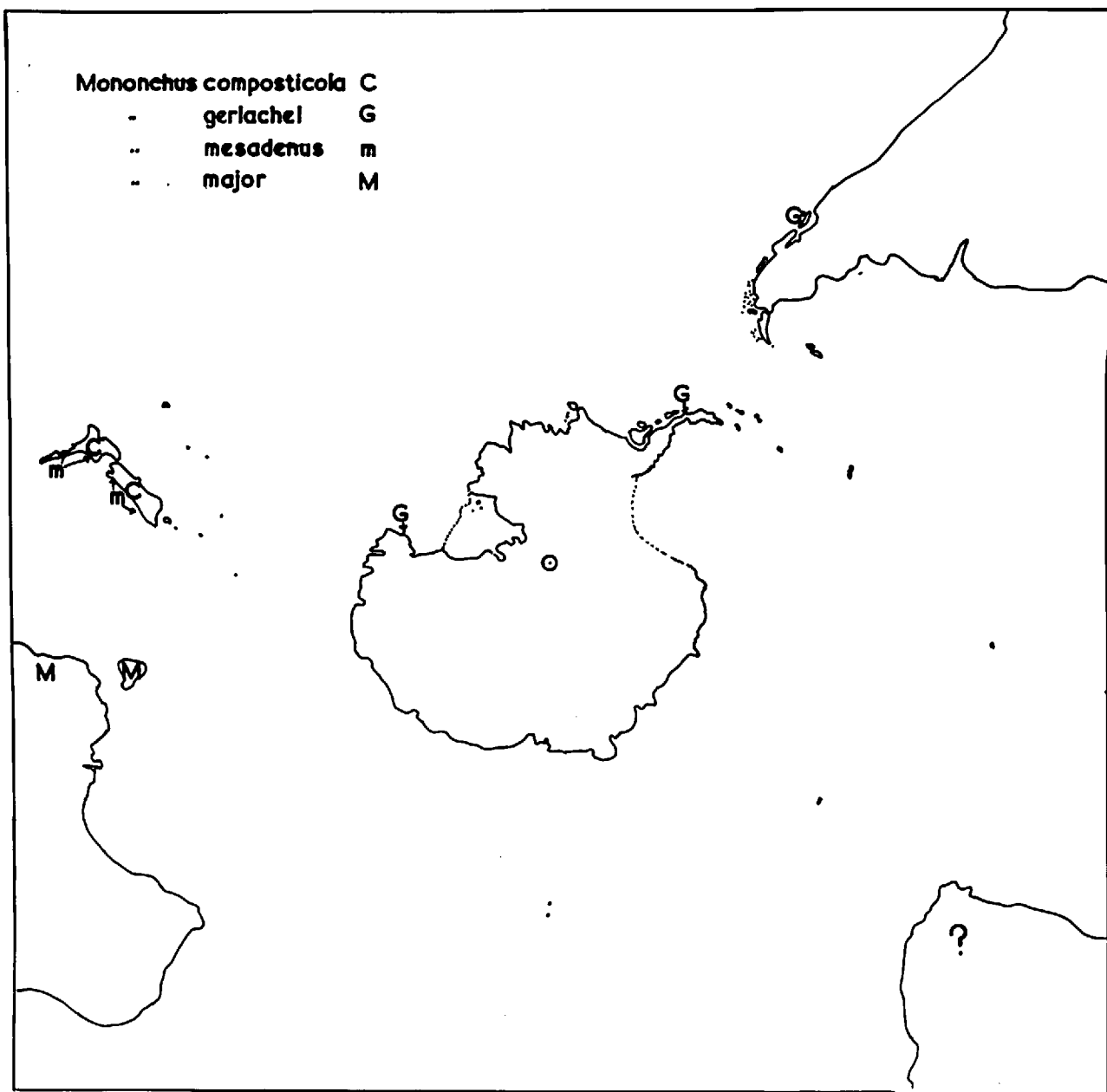

Fig. 17. Map showing the circum-south-polar distribution of four species of Mononchus.

Pinus forests may be regarded as a "new habitat" in New Zealand.

The circum-south polar distribution of the "Mononchus major - gerlachii group" is shown in figure 17. The four species comprising this group are closely related from a morphological point of view. Now that the probable existence of a circum-south polar group of terrestrial nematode species has been established it would be of great interest from a zoogeographical point of view to examine material from subantarctic islands such as Kerguelen, Macquarrie, Aucklands, Campbell, South Georgia and Gough.

Addendum The Legerella species mentioned on p. 204 of the previous subsection has been described by Canning (1961) under the name Legerella helminthorum.

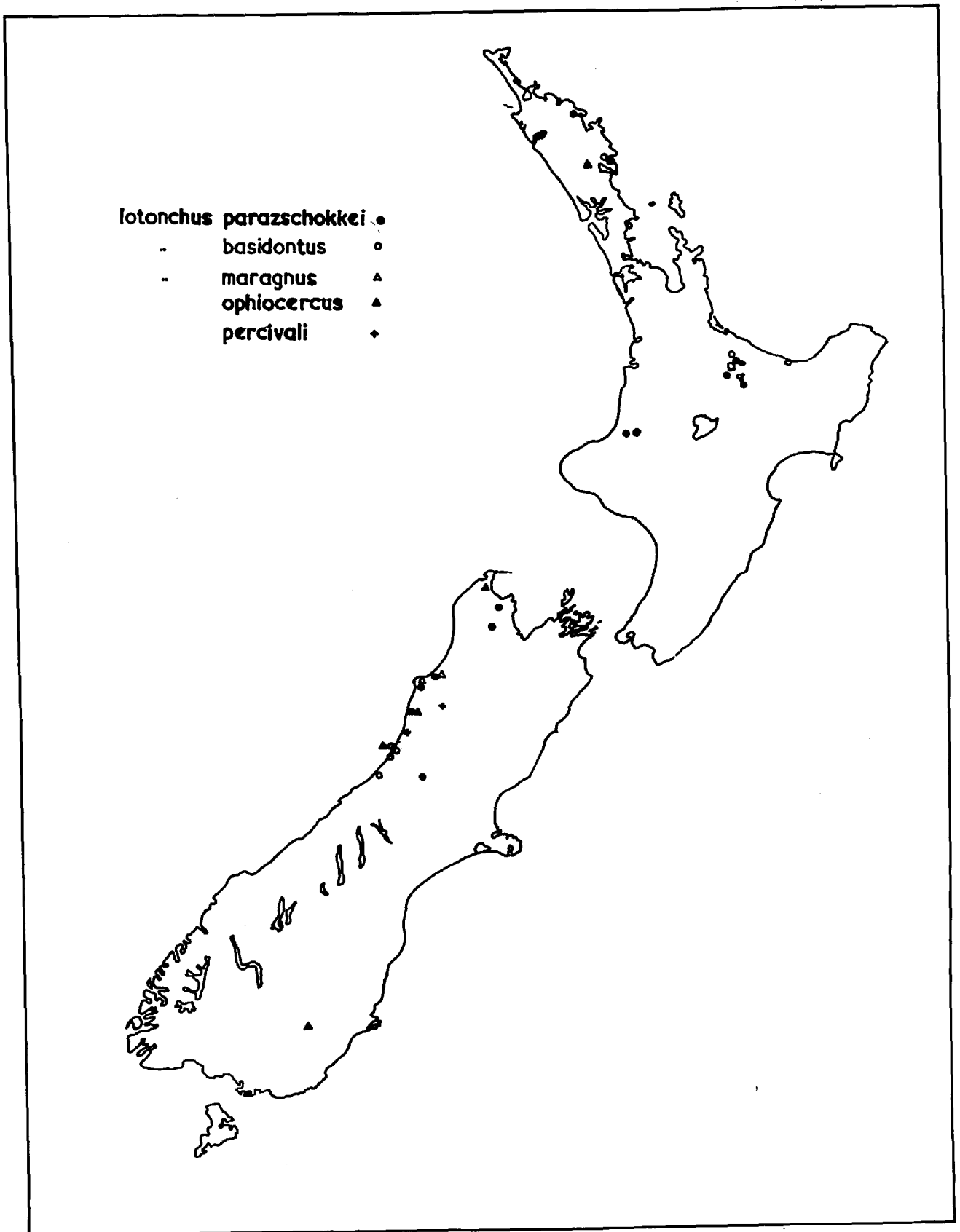

Fig. 18. Map showing the distribution of Iotonchus spp. in New Zealand.

Distribution of New Zealand Iotonchus spp.

The distribution of the New Zealand species of Iotonchus is shown in figure 13. It is noteworthy that apart from I. parazschokkei which is primarily a forest litter and secondarily a soil dwelling species, all the other species have been found in podzolic soils. In most instances these have been gley podzols (the Wharekohe locality is the exception). The immediate difficulty is to decide whether the factor which limits the distribution of these species is simply the water relations of the soils (all sites were rather wet), or if distribution is related to some other pedological feature such as pH.

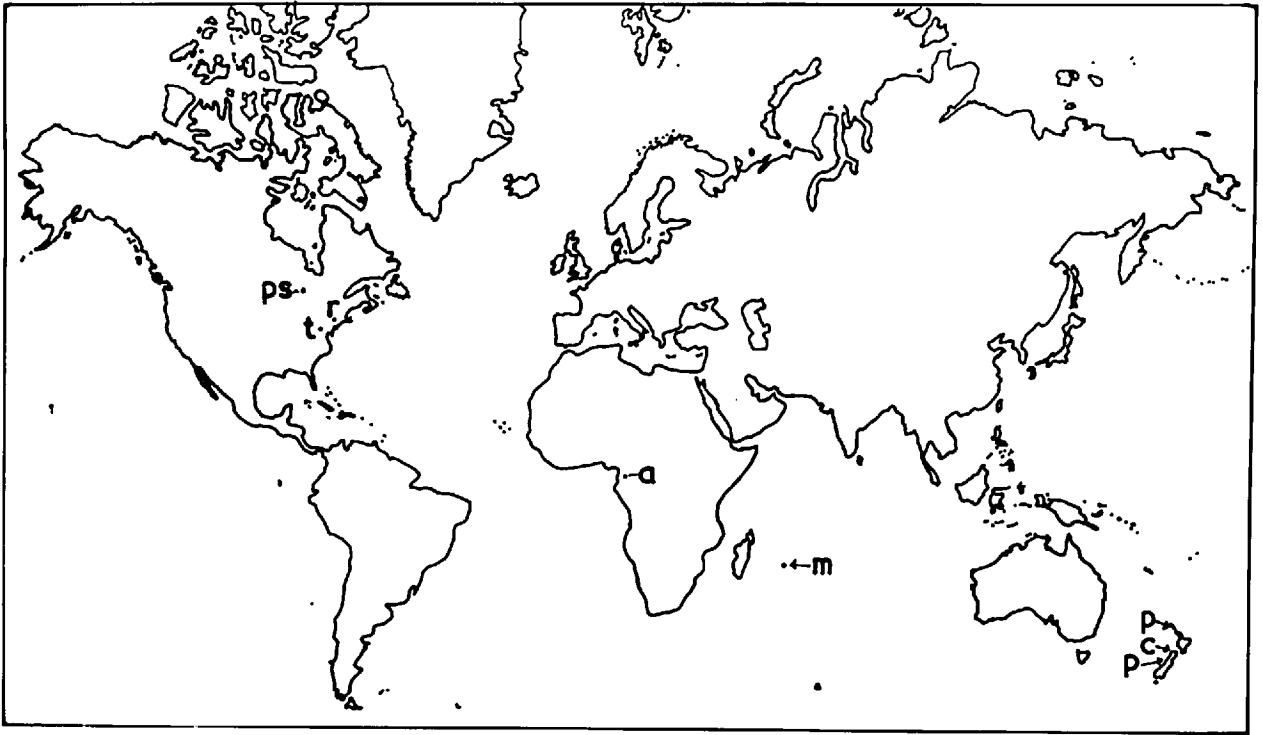

Fig. 19. World distribution of the genus Cobbonchus Andrassy.
a. abrupticaudatus (Altherr) ; c. chauliodus Clark ; m. mauritanus
(Williams) ; p. pounamua Clark ; ps. palustris (Cobb) ; r. radiatus
(Cobb) ; t. teres (Cobb).

Addendum on the genus Cobbonchus

Since the foregoing was written Altherr, 1960 has described Mononchus abrupticaudatus (= Cobbonchus abrupticaudatus) from the French Cameroons. Although Altherr remarked that his species is very similar to C. palustris (Cobb), it appears to me to be even closer to C. mauritianus (Williams), from which I am unable to differentiate it. The record of this species helps to fill one of the gaps in the distribution of this genus. It is significant that all known species are associated with very wet soils or sphagnum swamps ; not areas which have been much examined for nematodes. For this reason it is likely that the distribution as recorded in figure 19 reflects collection failure rather than a truly discontinuous distribution.

9. Evolution within the Mononchoidea

The natural consequence of a systematic study of group of organisms is the synthetic stage of the study where an attempt is made to weld the fragments of information available into a coherent whole. In this study an attempt is made to relate the mononchid genera to each other in a way which may indicate the general trends of evolution within the group. In the present study this process is beset with two main difficulties which must be clearly stated at the outset.

1. All evidence must be derived from neontology as nematodes have left no useful paleontological record. Because of this the time element cannot be considered.

2. Vast areas of the earth's surface have not been examined even cursorily for mononchids, so that evidence from distribution patterns is of unknown reliability, and further genera, as yet unrecorded may have to be incorporated at some future date.

Although I have earlier (Section III) included the Mononchoidea in the Dorylaimina there is no reason to believe that the ancestral mononchids were dorylaimoid. On morphological grounds it appears probable that the

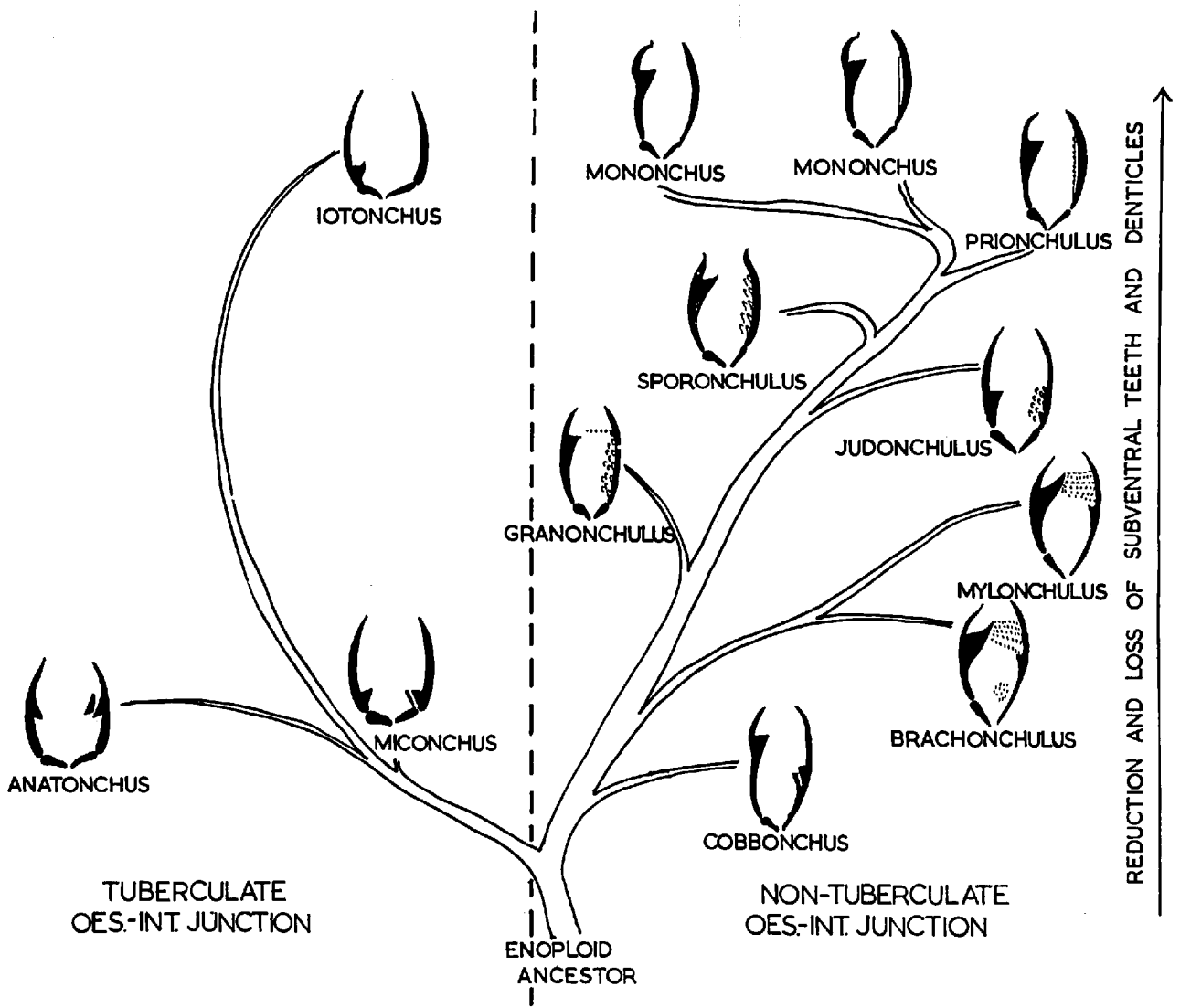

Fig. 20. Deduced phylogeny of the Mononchidae (see text)

immediate ancestral form resembled the modern Bathyodontidae more than any other group. The ancestral mononchid probably differed from the present day Bathyodontidae in possessing a tooth on each of the three stomatal sclerites. This situation is commonly seen in the Enoploidea and Tripyloidea. The reduction in the number of teeth appears to be the derived, rather than the primitive condition in the Enoplina. The elaboration of the oesophago-intestinal valve structures and the form of the stoma appear to be later and strictly mononchid developments.

The pro-mononchid ancestral form appears to have given rise to two distinct groups characterised by the presence of tuberculate or non-tuberculate oesophago-intestinal junctions (Clark, 1960 a). Parallelling this dichotomy is the shape of the stoma base which is broad and flattish in the tuberculate forms and pointed in the non-tuberculate genera (fig. 20). (The rare exceptions to this, Mononchus monhystera Cobb, and M. vorax Cobb, nec Rahm, may not really belong in the genus to which they have been assigned, but no material is available to check this point).

Niconchus is placed near the base of the tuberculate line of development. This genus has all the appearances of being primitive, and has a very wide distribution



A

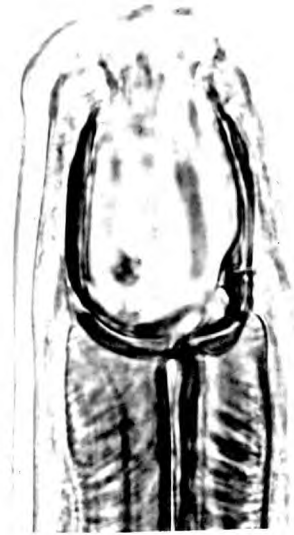

B

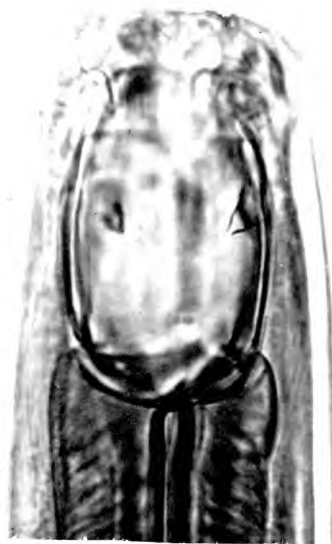

C

Fig. 21. Anatonchus tridentatus (de Man). A and B larvae, showing the anteriorly directed tooth in A, and the posteriorly directed tooth in B. C. Adult showing the anterior position of the reversed teeth at this stage of the life history.

(Europe, Africa, Australia, New Zealand, Fiji, North and South America). From Miconchus, Anatonchus may be readily derived by the reversal of the direction of the teeth and the acquisition of an ontogenetic anterior migration of the teeth. Reversal of the direction of the teeth does in fact occur at the first moult in Anatonchus tridentatus de Man, and in this same species the teeth move anteriorly at each successive moult (figs. 21 ABC). R.H. Mulvey (pers. comm) has a paper in the press describing three new North American species in this genus. If these are taken into account Anatonchus contains seven good species, three European and four North American. An eighth species A. kreissi Meyl is based on A. tridentatus of Kreis not de Man. The material on which this species is based consisted of one female and one juvenile. Kreis did not discuss the morphology of the juvenile which by analogy with other species in the genus would be expected to differ in stomatal characters from the adults. If the species is found again it would merit the erection of a new genus characterised by the presence of three reversed teeth as in Anatonchus, but with the dorsal tooth placed anteriorly to the subventral ones.

Iotonchus may also be derived from Miconchus by the

loss of the subventral teeth. The tooth apex may occur anywhere between about 10 - 56% of the height of the stoma calculated from the base. The only records of this fairly large genus from Europe are I. zschokkei (Menzel), I. bathybius (Micol) and I. simmenensis (Kreis), all inadequately known species of which zschokkei and simmenensis may be synonyms. The species of the genus are distributed as follows :- Austria 1, Australia 2, Brazil 4, East Indies 2, New Zealand 5, Switzerland 1, and U.S.A. 4. In all of the tuberculate genera the tail length varies considerably between species from 2% of the total length in Miconchus exilis (Cobb) to 43% in Iotonchus maragnus Clark.

Amongst the more numerous non-tuberculate genera the starting point is similar in that Cobbonchus has a stoma armed with three teeth; the subventral teeth may be much smaller than the dorsal one (C. chauliodus Clark) or about the same size (C. terres (Cobb)). From a Cobbonchus-like form the two closely allied genera Brachonchulus and Mylonchulus may be derived by reduction in the size of the subventral teeth and the appearance of subventral denticles arranged in transverse rows.

Brachonchulus is distinguished from Mylonchulus by the presence of an additional posterior patch of denticles. Granonchulus may be derived from the main line either before or after the emergence of Mylonchulus and Brachonchulus. The main feature here is the total loss of the subventral teeth, and the transverse rows of denticles which are a conspicuous feature of Brachonchulus and Mylonchulus are reduced to a single row and a ventral patch of irregularly arranged denticles. Jugonchulus appears to be a small side branch in which the dorsal tooth moved into the posterior half of the stoma, and the subventral denticles became reduced to a small patch, and the transverse rows of denticles disappeared entirely. Sporonchulus on the other hand appears to be much closer to the main line of evolution and here there is a marked trend for the subventral denticles to become arranged into longitudinal rows. This is more obvious in species like S. soutoi (Carvalho) than in the type species. Sporonchulus appears to have given rise through approximation of the rows of denticles into two median ventral denticulate ridges to Prionchulus. The genus Mononchus for the purposes of this discussion is best divided into two groups;

the "papillatus group" (papillatus Bastian and propapillatus Clark) which has a single low, non-denticulate ventral ridge; and the truncatus group containing the remainder of the genus which have no such ridge. The former appears to be more primitive in stomatal characters and the ventral ridge is apparently derived by fusion and reduction from the double ridge of Prionchulus. In the truncatus group the ventral ridge has disappeared entirely.

The fact that the genus Mononchus falls into two distinct groups may be taken as evidence that the present distinction between the genera Prionchulus and Mononchus is unnecessarily arbitrary and it might be wiser to regard M. papillatus and M. propapillatus as members of the genus Prionchulus which would then include species with a ventral ridge or ridges with or without denticulations. Or, in order to preserve the homogeneity of the classification which is based primarily on stomatal characters the "papillatus" group of species could be given generic status. No formal change is proposed here.

In the non-tuberculate line of development from Cobbonchus to Sporonchutus the tails are all short, often rather digitate, and usually less than 5% of the total length. In the genera Prionchulus and Mononchus caudal diversity makes its appearance, and the tails tend to be proportionately longer.

The distribution of some genera is noteworthy:
Sporonchulus is restricted to Brazil, Brachonchulus is known only from the East Indies (Sumatra and Surinam) and Granonchulus and Judonchulus are known only from Continental Europe and Florida. Mononchus, Frionchulus and Mylonchulus are cosmopolitan.

Section VII

The superfamily DORYLAIMOIDEA

1. Description of Pungentus maorum n.sp.

Family DORYLAIMIDAE

Subfamily DORYLAIMINAE

Pungentus maorum n.sp.

Figs. 22 A - G.

Holotype ♀ L. 1.64 mm; a = 31; b = 4.04; c = 57.3; V = 41.7

ll spear 32 μ

Paratypes ♀♀ (n = 24) L. = 1.645; (range 1.46 - 1.80),

(s = \pm 0.078mm); a = 34 - 42; b = 3.18 - 4.28;

c = 50.3 - 56.1 V = 40.1 - 45.5 10^{-18} .

spear 30 - 35 μ

Tikipunga ♀♀ (n = 24) L. = 1.619 mm (range 1.42 - 1.96 mm)

(s = \pm 0.107 mm); a = 31 - 41; b = 3.51 - 4.56;

c = 58.1 - 73.1; V = 40.0 - 45.1 10^{-18} spear

30 - 35 μ

Porutawhao ♀♀ (n = 5) L. = 1.694 mm (range 1.61 - 1.78)

a = 38 - 41; b = 3.89 - 4.03; c = 68.4 - 70.1;

V = 42.2 - 44.4 spear 32 - 33 μ

Males unknown.

Cuticle 1 μ thick with moderate transverse annulations.
Subcuticle 1 μ thick in oesophageal region, but much thicker
on tail where it has a vertically laminated appearance as in

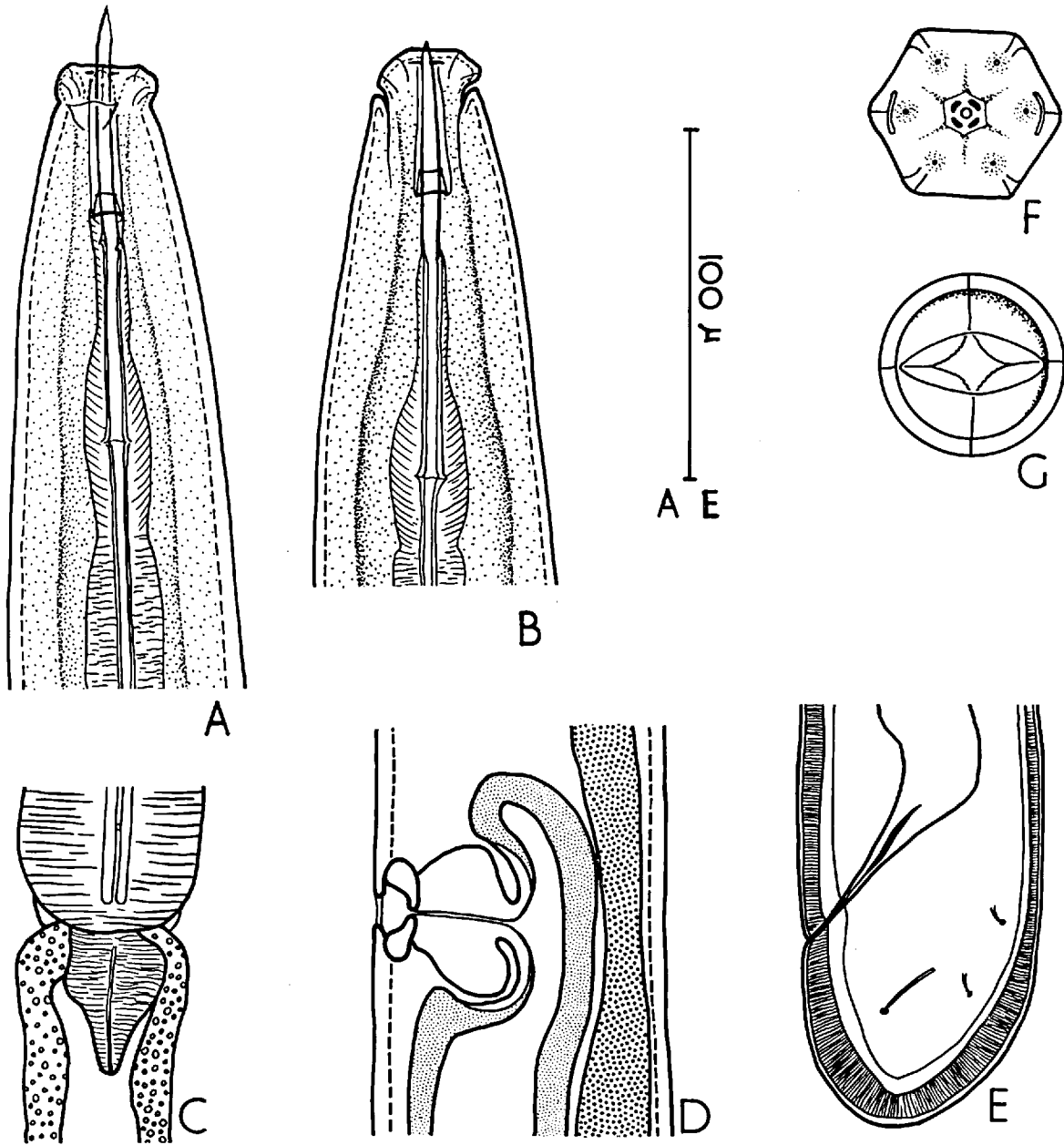

Fig. 22. Pungentus maorum n. sp. A & B lateral and dorsal views of female head; C oesophago-intestinal junction; D vulva in lateral view; E female tail; F en face view of lip region; G ventral view of vulva showing sclerite and slit in cuticle.

Longidorus spp.. No lateral fields. A ventro-median series of fine cuticular pores similar to that described by Goodey (1943) is present. It is best developed in the post-vulval region. Three caudal cuticular pores present as shown in fig. 22.

Lip region offset, head region tapers anteriorly. Lips six, equal, symmetrical; cephalic papillae in the usual rings of six and ten. The four small sclerites about the mouth characteristic of the genus are arranged dorso-laterally and ventro-laterally as figured by Goodey for P. thornei, and not as figured by Thorne and Swanger 1936 for P. pungens. Amphid apertures appear as crescentic slits in en face view, and as bow-shaped lines in lateral view. Spear 30 - 34 μ long, length equal to two and a half times width of lip region, slightly arcuate. Spear extensions almost as long as spear. Extensions unite with oesophageal lining in a distinct muscular bulb at the anterior end of the oesophagus. Oesophagus dorylaimoid, expanded part equal to half of oesophagus length. Oesophageal gland ducts occur at 54, 75 and 93 percent of oesophagus length. Oesophago-intestinal junction simple with a moderately short, stout oesophago-intestinal valve projecting into the intestinal lumen. Intestine simple, passes dorsally to gonad. Prerectum indistinct, equal to

one and a half anal-body-widths in length. Rectum straight, slender, almost equal to anal-body-width in length.

Vulva pre-equatorial, Vulva with four sclerotized plates, rather similar to those found in P. thornei but less angular centrally. The inner margins of the plates may be crenulate. The cuticle extends over the vulval sclerites, and makes the vulval aperture transverse and rather slit-like (fig. 20 G). Vagina extending across half body-width, very thick and solid. Anterior uterus represented by a short pre-vulval sac. Posterior uterus and oviduct outstretched; ovary singly reflexed through up to 85 percent of the total extent of the posterior reproductive structures. None of the specimens available (collected January - April) had sperms in the reproductive tract, and only one female had an egg in the uterus. This measured 85 x 31 μ .

Tail short, length equal to 0.8 anal-body-widths, hemispherical in shape.

Specific differentiation. Of the long speared species of Pungentus (those where the spear is about twice as long as the width of the lip region, or longer) with a single ovary P. maorum n. sp. is distinguished from P. sparsus Thorne by the hemispherical tail, and from P. monohystera Thorne and Swanger in having a more clearly offset lip region, and a proportionately longer spear. Differentiation from the

unfigured P. ichthyuris (Cobb) is more difficult, but Cobb's species is smaller (0.86 mm long) and apparently lacks the transverse annulations on the cuticle.

Type Slides. Holotype and paratypes in the nematode collection, Entomology Division, D.S.I.R., Nelson, N.Z. Paratypes (slide Nos. 155/3/1-3) have also been deposited in the slide collection, Nematology Department, Rothamsted Experimental Station, Harpenden, Herts., England.

Type locality. Granity, N.Z.M.S.1. 23/24, 311863, in rough pasture of Agrostis stolonifera L., Holcus lanatus L., Hypochoeris radicata L., and Juncus sp. Soil a. podzolic sandy loam.

Other localities. Porutawhao, in Lolium perrene L. - Trifolium repens pasture, Soil Omanuka peaty silt loam. Tikipunga in Paspalum dilatatum Poir dominant pasture with Lotus hispidus Desf., Plantago lanceolata L., and Hypochoeris radicata L. Soil: Hukerenui Silt Loam (a podzolized yellow-brown earth).

2. Description of Actinolaimus zealandicus n. sp.

Subfamily Actinolaiminae

Actinolaimus zealandicus n.sp.

figs. 23 A - J

Holotype ♀ L = 2.58 mm; a = 50; b = 4.56; c = 16.5; $14^{50.7}17$
Spear 21 μ

Allotype ♂ L = 2.65 mm; a = 46; b = 4.6; c = 98; T = 27.
spear 22 μ

For paratypes see table 1.

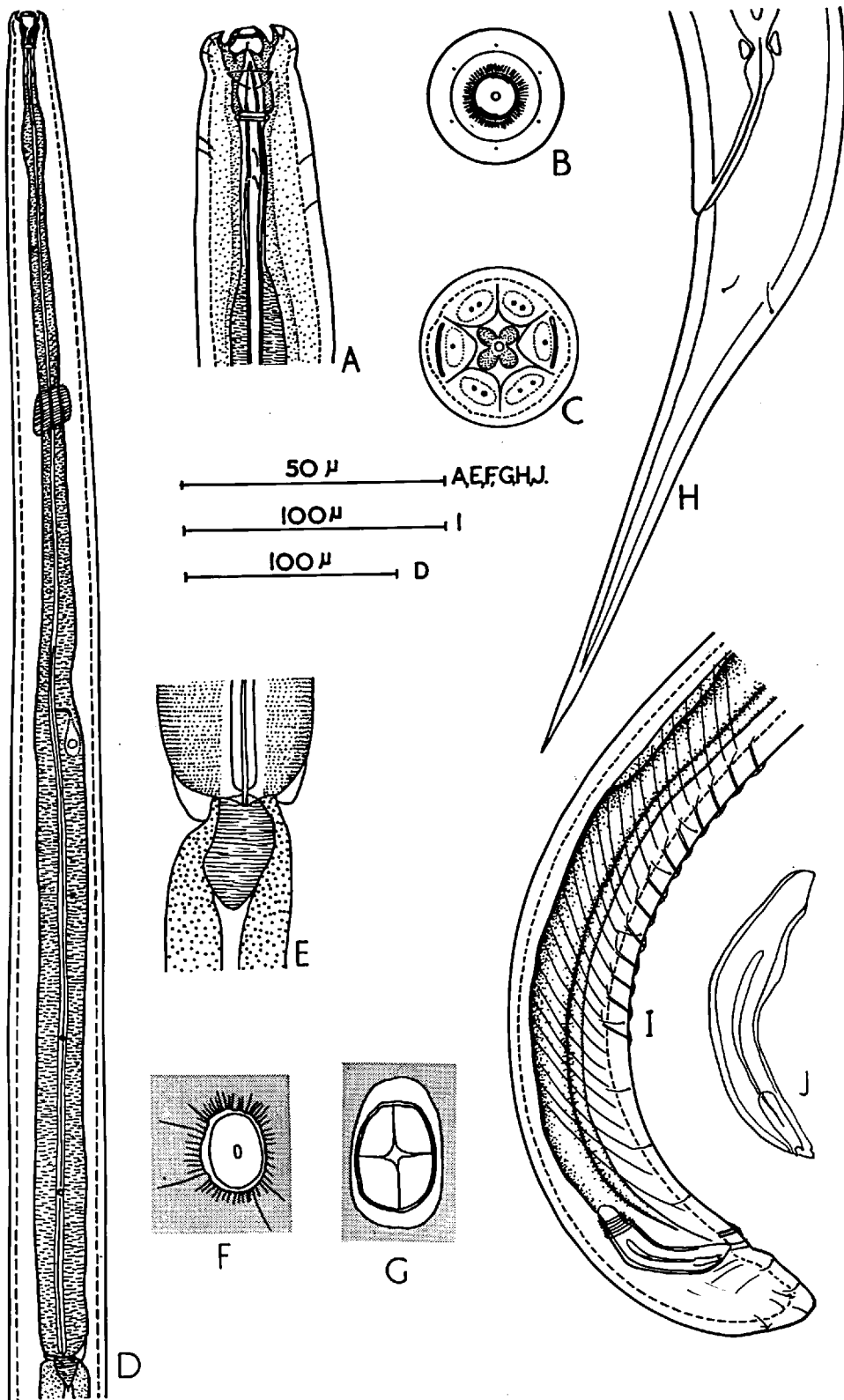

Fig. 23. *Actinolaimus zealandicus* n. sp. A lateral view of head; B en face view of head; C ditto at level of amphids; D oesophageal region; E oesophago-intestinal junction; F ventral view of vulva; G optical section through vagina; H female tail; I male tail; J spicule.

Cuticle 2 μ thick, with very fine transverse annulations only visible under oil immersion. Subcuticle 2 μ thick. Cuticular pores present in head regions as a dorsal and ventral pair and a short latero-median series. Lip region offset by a moderate constriction. Lip region about one third as wide as body at base of oesophagus. Head in en face view circular, with six papillae in the inner ring near the inner edges of the lips. Within the inner edges of the lips is seen the sclerotized annulus with many fine radiating ribs; the spear passes through the central hole. At a lower level of focus the ten outer papillae are visible; those of each lip are set in a rather granular area. Although posterior to the annulus, this region is subdivided into portions which are strikingly similar to the lips of other enoplids. The lateral "lips" are rather larger and more pointed centripetally than are the submedian "lips". The submedian "lips" are not at all pointed on their inner edges. The amphid apertures appear in this view as large crescentic slits. Arranged about the spear axis are four onchis, which in this view appear as a cross with each arm arranged at 45° from the perpendicular and horizontal axes.

In lateral view the sclerotized onchis extend from the anterior limit of the head to the anterior face of the double guiding ring. Anteriorly, processes arising from the

onchia support the annulus with radiating ribs. Often the annulus gives the appearance of being double. Spear strong, 20 - 23 μ long; spear aperture two-fifths of spear length. Spear extension terminating in a small swollen bulb of the oesophagus. Termination of spear extension not clearly demarcated.

Amphids cup shaped; aperture about one third as wide as head at this point.

Oesophagus with a short muscular bulb about the base of the spear extensions, then narrowing only to gradually widen again posteriorly, attaining and maintaining a maximum and uniform diameter in the posterior half. Nerve ring encircles the oesophagus at 29 percent of its length and the oesophageal gland ducts occur at 51, 76, and 88 percent. Oesophago-intestinal valve variable in shape; conical, length usual half to three-quarters of the maximum width of the oesophagus.

Intestine a simple tube passing dorsally and to the right of both ovaries and testes.

Female. Vulva equatorial, an elongate pore (fig. 23F). Vagina with a cruciform lumen; extends across half of the body width. Ovaries paired, reflexed through their entire length, which is equal to up to two-thirds of the length of the oviduct and uterus. Commonly it is the terminal part of the oviduct which is reflexed, so that

strictly the ovary is outstretched, but in the opposite direction to the genital ducts.

Prerectum 4 - 5 times the anal-body-width. Rectum slightly arcuate, one and a half times the anal-body-diameter. Tail dorsally convex concid at first, then filiform, with a pair of subdorsal and a pair of lateral cuticular pores.

Male. Testes paired, opposed, outstretched. Testicular range equal to half of length of vas deferens. Vas deferens constricted a little anterior to the first supplement to form the ejaculatory duct which may widen near the middle of the range of supplements. Supplements, an adanal pair plus 9 - 18 ventro-median ones, (13 and 15 are the most common numbers in the ventro-median series). The main series is contiguous and lies about one and a half spicule lengths anterior to the adanal pair. Spicules paired, free, heavy, arcuate, with a median groove in the central part. Spicule length equal to one and a quarter anal-body-widths (55 - 60 μ chord). The lateral guiding pieces appear bifid at the tip and somewhat rolled distally. Male prerectum of variable length, commencing a little anterior to the supplements or near the middle of the ventro-median series of supplements, or between these two points. Tail short, length about three quarters of the anal-body-width, dorsally convex, somewhat straightened

ventrally, tip rounded. Caudal cuticular pores as in figure 23 I.

Larvae all have female type tails.

Specific differentiation.

Actinolaimus zealandicus n. sp. is distinguished from all other species in possessing a clearly offset lip region, an almost smooth cuticle, amphid apertures one-third as wide as the head and lacking denticles in the stomatal region. The pore-like vulva may not be significant as this is not recorded in most descriptions. Similar lack of information makes one hesitate to place much weight of the form of the lateral guiding pieces in the male.

A. zealandicus is apparently rather similar to A. macrolaimus de Man and A. elaboratus Cobb, but differs in the absence of ribs in the stoma, and in the relative length of the spear aperture.

Type slides. Holotype, allotype, and paratypes in the nematode collection, Entomology Division, D.S.I.R., Nelson N.Z. Paratypes (slide 159/4/1) also in slide collection, Nematology Department, Rothamsted Experimental Station, Harpenden, Herts. England.

Type locality. Tutamoe, N.Z.M.S.I. N.18, 196072, 570 m. liverworts and mosses in Bailechnieidia tawa Benth. & Hook. f. - Dacrydium cupressinum Soland. forest.

Other localities. Collingwood, from leaf mould in axil of

Nikau Palm (Rhopalostylis sapida Wendl. & Drude), Lake Mahinapua Forest Reserve, from liverwort Lepidocolea scolopendra on Dacrydium cupressinum Soland., and also from Quintinnia acutifolia T. Kirk -- Weinmannia racemosa Linn. f. forest litter. Whangamoia Hill in Pittosporum eugenioides A. Cunn. - Nothopanax Colensoi Steem. - Aristotelia racemosa Hook.fil. forest litter. Mt. Cook, Governors Bush in Nothofagus Menziesii Oerst. Phyllocladus alpinus Hook. fil. - Podocarpus Hallii T. Kirk forest litter. Mt. Messenger in Clea Cunninghamii Hook. fil. - Vitex lucens T. Kirk - Shawia paniculata Forst. forest litter. Waitaanga Saddle from liverworts and mosses in Weinmannia racemosa Linn. f. - Brachyglottis repanda Forst.- tree fern forest. Hongi's Track in Beilschmiedia Tawa Benth. & Hook. f. - Knightia excelsa R. Br. - Podocarpus Totara D. Don forest litter.

Remarks. During moulting in this species the whole lining of the stoma, the spear and extensions together with the guiding ring as well as the exo-cuticle is shed. Extrication from the old cuticle appears to be achieved by rupturing the old cuticle about ten head widths behind the head.

The measurements and de Man formulae of this species show considerable variation, but there appears to be only one species involved. Thorne (1939) noted similar variations

Table 1

Measurements of female Actinolaimus zealandicus n.sp.

| | Tutamoe | Waitaanga | Mt. Messenger | Hongi's Track | L. Mahinapua | Hermitage | Collingwood |
|-------------|------------|------------|---------------|---------------|--------------|-----------|-------------|
| n | 4 | 3 | 6 | 2 | 3 | 2 | 1 |
| L (mean) | 2.65 | 1.83 | 2.52 | - | 2.58 | - | 2.83 |
| range | 2.58-2.70 | 1.78-1.9 | 2.13-2.75 | 1.78-2.08 | 2.38-2.84 | 2.88-3.03 | - |
| a | 38 - 50 | 40 - 51 | 39 - 49 | 44 - 45 | 49 - 51 | 47 | 50 |
| b | 4.4 - 4.56 | 3.4 - 4.44 | 3.6 - 4.57 | 3.78-3.88 | 3.92-4.39 | 4.38-4.4 | 4.52 |
| c | 16.5-23.9 | 10.8-19.3 | 11.5-16.3 | 11.3-14.6 | 14.4-16.7 | 18.8 | 18.5 |
| a.o. | 13 - 16 | 11 - 13 | 11 - 15 | 13 - 15 | 11 - 12 | 14 - 18 | 13 |
| V | 48.5-51 | 48.7-50.3 | 45.8-49.7 | 49.5-49.7 | 46.7-50.5 | 47.4-47.7 | 52 |
| p.o. | 12 - 17 | 8 - 16 | 10 - 18 | 8 - 15 | 13 - 14 | 14 - 15 | 14 |

Table 2

Measurements of male Actinolaimus zealandicus n.sp.

| | Titirangi | Waitaanga | Mt. Messenger | Hongi's Track | L. Mahinapua | Hermitage | Whangamoa |
|-------------|-----------|-----------|---------------|---------------|--------------|-----------|-----------|
| n | 6 | 9 | 4 | 2 | 7 | 2 | 1 |
| L (mean) | 2.36 | 2.13 | 2.45 | - | 2.37 | - | 2.86 |
| range | 1.66-2.65 | 1.75-2.64 | 2.11-2.60 | 1.73 - 2.18 | 1.91-2.74 | 2.69-2.74 | - |
| a | 45 - 56 | 45 - 54 | 41 - 55 | 45 - 49 | 42 - 53 | 50 - 55 | 52 |
| b | 3.61-4.6 | 3.52-4.71 | 3.92-4.44 | 3.5 - 3.95 | 3.44-4.52 | 4.35-4.37 | 4.31 |
| c | 69 - 107 | 70 - 109 | 78 - 95 | 62 - 90 | 79 - 94 | 85 - 109 | 87 |
| T | 24 - 34 | 26 - 37 | 25 - 42 | 33 - 34 | 23 - 32 | 24 - 29 | 35 |

in the reported measurements of A. macrolaimus de Man.

3. Description of Longidorus taniwaha n. sp.

Subfamily Tylencholaiminae

(including Longidorinae)

The Tylencholaiminae which now incorporates Thorne's Longidorinae (Chitwood, 1957) shares with the Diphtherophovoidea the rare distinction in the Enoplida, of including several plant parasitic species. The other agriculturally important feature of the biology of the group concerns the ability of several species of Longidorus and Xiphinema to act as vectors for several strains of plant viruses which have polygonal shaped particles. Virus transmission by Trichodorus primitivus and T. pachydermus involves short rod-shaped virus particles (tobacco rattle virus).

Subfamily Tylencholaiminae Filipjev, 1934.

Longidorus taniwaha n. sp.

Figs. 24 A - I

Barrytown.
Holotype ♀ L. = 4.66 mm. a = 54; b = 9.3; c = 151; $V = \sqrt[16]{51.5^{19}}$
spear 116 μ .

Allotype ♂ L. = 4.12 mm. a = 53; b = 7.7; c = 134; T = 32
spear 112 μ .

Paratypes ♀♀ (n = 4) L. (mean) = 4.64 mm. range = 4.12 - 5.0mm;
a = 50-56; b = 7.79 - 9.72; c = 149 - 163; $V = \sqrt[16]{-20}$
49.5 - 53.8 $\sqrt[10]{-19}$. spear 111 - 117 μ .

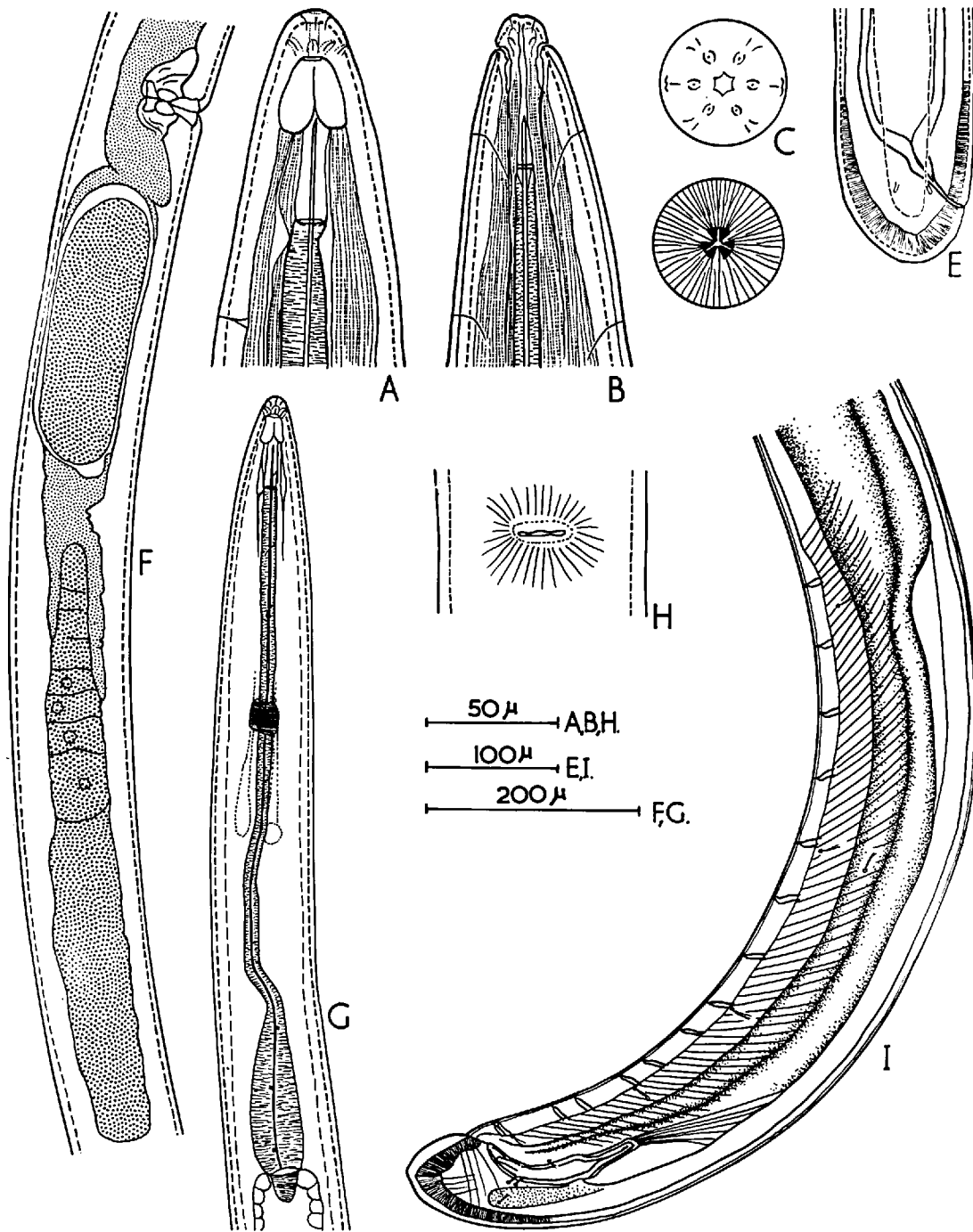

Fig. 24. Longidorus taniwha n. sp. A & B lateral and dorsal views of head; C en face view of head; D section through oesophagus; E female tail; F posterior branch of female reproductive system; G oesophageal region; H ventral view of vulva; I male tail.

Runanga
Paratype ♀ L. = 3.82 mm. a = 55; b = 7.15; c = 117; V=¹⁰ 49¹¹

Cuticle 3 μ thick with obsolescent, very fine transverse striae. Subcuticle 2 μ thick in cephalic region, but immensely thickened, and showing cross striations in the caudal region. The whole of the cuticle with well marked diagonal, somewhat anastomosing longitudinal striations which originate anteriorly on the dorsal and ventral mid-lines and converge posteriorly onto the "lateral fields". Lateral chord shows as a line anteriorly, but widens posteriorly, until posterior to the oesophagus it may be one-sixth as wide as the body.

Cuticular pores of head region usually only two lateral pairs, but a dorsal pore may be present. Usually only two pairs of caudal cuticular pores present on the female (fig. 24E), but occasionally a preanal pair is present. Cuticular caudal pores of male as in fig. 24I.

Lip region not offset in lateral view, rather rounded. Papillae in two rings of six and ten each. Amphid apertures very obscure, appear as faint crescentic slits. Amphids large, bilobed, lobes roughly symmetrical and extend half way back to guiding ring; apparently connected posteriorly to sensillae at about the level of the spear guiding ring. These sensillae in turn appear to be obscurely connected to a pair of saccate structures lying about the middle of the oesophagus. In en face view the lips

appear to be fused; the inner papillae are set on slight eminences and the outer ring arc lateral rather than apical in position. Amphid apertures appear as small bi-crescentic slits.

Spear 111 to 117 microns long, uniformly slender with a minute dorsal aperture; spear base flaring slightly at junction with spear extension. Spear extension slender, about half as long as spear, without knobs or other expansions except for a very slight expansion at the posterior end. Guiding ring simple, united with the cuticular lining of the stoma.

Nerve ring occurs at 38 percent of oesophageal length. No excretory pore seen.

Oesophagus typical of the genus; anterior three-quarters very slender with the posterior quarter enlarged to form the "bulb". Slender part often looped anterior to bulb. Bulb apparently containing the normal oesophageal glands whose ducts occur at 83, 90 and 98 percent of the oesophageal length (fig. 24G) Oesophageal lining sclerotized, appears thick in lateral view, but in transverse section (fig. 24D) the thickening is seen to consist of six triangular sclerotized strands united by thin zones. The whole forms a thin tube with a lumen of variable diameter. Oesophago-intestinal junction with a moderate but very variable oesophago-intestinal valve

("cardia" of authors). Intestine wider than posterior part of oesophagus, a simple tube, often with abundant oil droplets. Prerectum of female equal to seven anal-body-widths. Rectum straight, narrow, length equal to two anal-body-widths.

Female. Vulva at 49 - 54 percent of body length, a transverse slit, almost one-fifth as wide as body. Vagina extending across half the body width. Ovaries paired, opposed, singly reflexed through more than half the length of the oviduct and uterus, tapering towards tip and containing a number of oöcytes in a single row. A conspicuous sphincter muscle is present at the oviduct-uterus junction. Egg 202 x 65 μ .

Male. Testes paired, opposed, outstretched; testes seven tenths as long as vas ~~deferens~~ and ejaculatory duct. Intestine and vas deferens slightly constricted. opposite the first and second supplements, and beyond this point become the prerectum and ejaculatory duct respectively. Supplements not pailloid, 15, not equidistant; the first 13 are arranged alternately to the left and right of the ventral midline. The adanal pair as usual. Spicules paired, free, arcuate, pointed towards the tips. Lateral guiding pieces present, but in the only specimen available details of the tips are obscured.

Tail short, (length about one and a half anal-body-widths) rounded in females and larvae, slightly more pointed in the male.

Specific differentiation. L. taniwha n. sp. is readily distinguished from other species in the genus by the regularly hemispherical tail and the regularly tapering, non-offset head. In head shape L. taniwha most closely approaches L. goodeyi Hooper, (in press), but the tail is much more rounded than in that species, and the animal is generally smaller.

Type slides. Holotype, allotype and paratype slides are in nematode collection, Entomology Division, D.S.I.R., Nelson, N.Z. One paratype female (slide No. 168/8/1) in slide collection, Nematology Department, Rothamsted Experimental Station, Harpenden, Herts., England.

Type locality. Johnson's Scenic Reserve, Barrytown, N.Z.M.S.L. S.37, 347223, 15 metres, in Weinmannia racemosa Linn. f. - tree-fern dominated forest. Soil: Ikamatua sandy loam (an immature podzolic soil).

Other locality. Runanga in very wet Holcus lanatus L. - Agrostis tenuis Sibth. pasture with Juncus sp., Ranunculus acer L. and Lotus uliginosus Schkuhr.

Remarks. A moulting larva of this species (fig. 4A) proved interesting firstly for the light it sheds on the amount of cuticle cast off at each ecdysis, and secondly for the

information it gives on the spear. As may be seen in the figure, the old spear, the lining of the stoma, including the guiding ring and the spear extension is shed. It may also be noted that the anterior part of the lining of the amphids is also shed. At the posterior end of the oesophagus, part of the oesophageal lining was seen projecting into the lumen of the intestine. Whether this is to be interpreted as an indication that the posterior part of the oesophageal lining is normally shed via the alimentary canal at each moult, or merely as a fixation artefact is not clear. This specimen is also remarkable for its possession of three spears, one being moulted, one moving into the operating position, and a third still lying in the oesophagus wall.

The specific epithet is the Maori name for a legendary non-marine serpent.

A single female, apparently belonging to a further new species in this genus was found in the soil in a patch of regenerating forest between Awatuna and Stafford. This species is characterised by the possession of amphids with extra-ordinarily large apertures, a spear of 218μ , and a tail which is absolutely and relatively longer than in L. taniwha. Head and tail shape are rather similar. The de Man formula for this specimen is $L. 617 \text{ mm}; a = 47.5; b = 7.47 \text{ c} = 73; V = 53.$

4. Description of Sectonema taiaha n. sp.

Family NYGOLAIMIDAE

Subfamily Nygolaimineae

As discussed in section III I have somewhat changed the constitution of the family Nygolaimidae and made the family more uniform in respect of spear type. All genera referred to it are characterised by the presence of a mural tooth, with, or without a sheath of spiral connective tissue about the enlarged part of the oesophagus.

It may be noted that of the genera comprising this subfamily only Nygolaimus possesses the three "Cardiac glands" of Thorne at the oesophago-intestinal junction. Thorne (1939) regarded them as a diagnostic feature.

Thorne, 1930 has contributed all that is known of the biology of this group. He discussed the carnivorous habit of all the species he described, and stated that in his experience they were predacious upon enchytraeids (Oligochaeta), rather than upon nematodes. Sectomena ventralis was more voracious than any of the Nygolaimus spp. he examined. When attacking enchytraeids the tooth is everted and the prey is slit by a dorsal to ventral slash of the tooth. In smaller Nygolaimus spp. (e.g. N. vulgaris Thorne) the fluid or granular contents are sucked out, but in larger species it appears from the common occurrence of enchytraeid setae in the intestine that the whole oligochaet

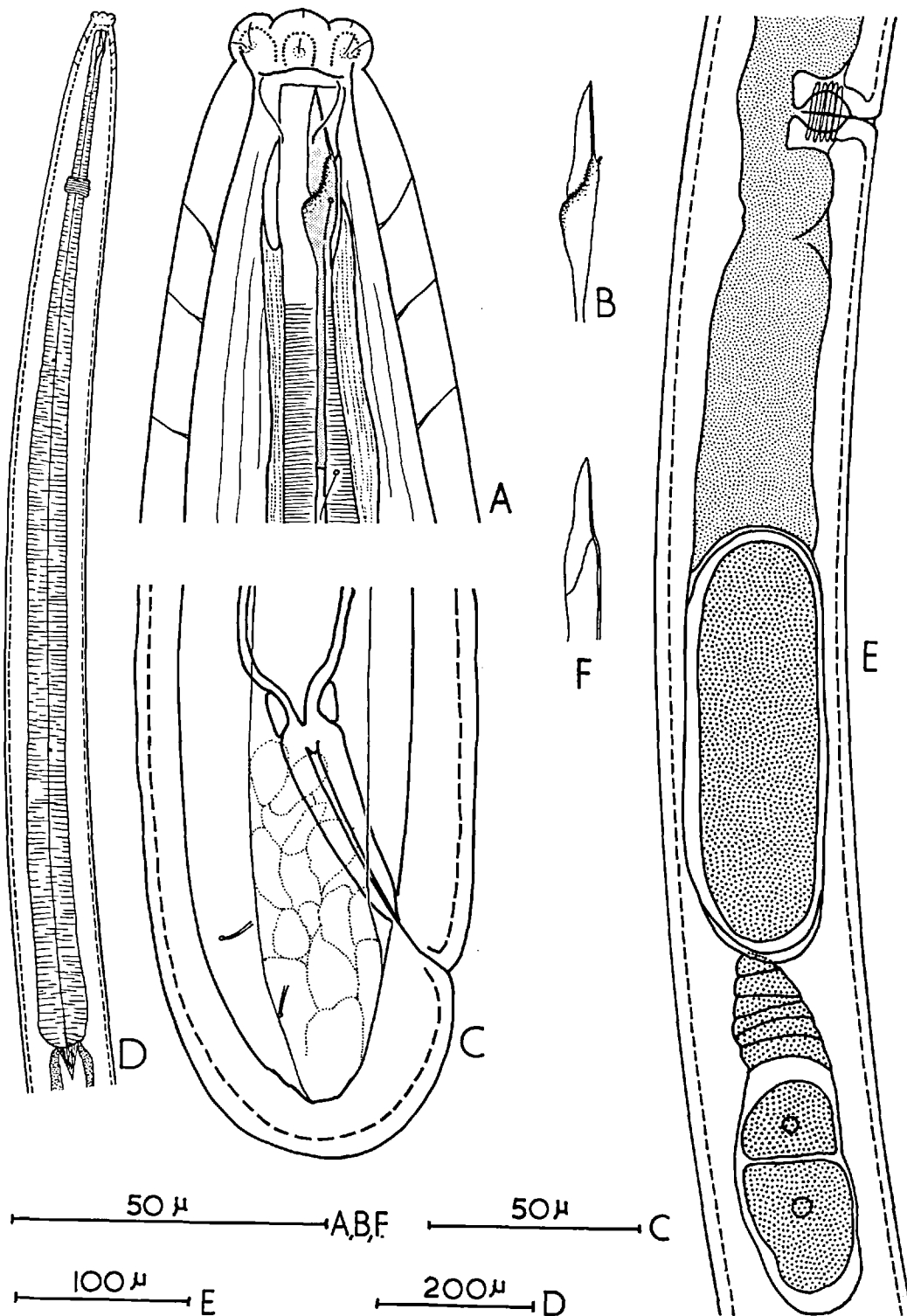

Fig. 26. *Sectonema taiaha* n. sp. A lateral view of head; B mural tooth; C female tail; D oesophageal region; E posterior branch of reproductive tract; F mural tooth of *Sectonema rotundicauda* Goodey.

is devoured.

Sectonema taiaha n. sp.

Figs. 25 A - E.

Holotype ♀ L = 5.37 mm; a = 29; b = 4.11; c = 100 V⁹ 40 13
tooth blade (tip to shoulder) 18 μ

Cuticle 3 μ thick with very faint obsolescent transverse striae; subcuticle 2 μ thick (measurements taken at posterior end of oesophagus). Cuticles much thicker just behind lip region. Lateral chords very narrow anteriorly, one-sixth as wide as the body in the middle region.

Cephalic cuticular pores four dorsal and four ventral; a lateral series is also present. Caudal cuticular pores represented by two post-anal pairs. (fig. 25C)

Lip region clearly offset, lips distinct, rounded; papillae in two rings of six and ten each. Amphids stirrup-shaped; half as wide as head at this point. Amphid apertures appear as bow-shaped slits in lateral view.

Stoma with a broad eversible vestibule on whose left ventro-submedian wall is attached a large mural tooth. Tooth complex, consisting of a slender rod posteriorly (= spear base ?) which at the level of the third ventral cuticular pore is distinctly marked off from a more posterior part (= spear extension ?). Anteriorly the spear base swells and forms a solid rounded base for the tooth from

which arises a thin, pointed blade with a thickened rib along the ventral edge.

Oesophagus long, gradually widening through the anterior third, and thereafter remaining about half as wide as the body. Nerve ring encircles the oesophagus at 18 percent of its length. Dorsal oesophageal gland duct occurs at 34 percent of the oesophageal length and the anterior subventral gland duct at 72 percent. Posterior subventral gland duct not seen.

The "cardiac glands" of Thorne are not present at the oesophago-intestinal junction. A slender pointed oesophago-intestinal valve projects into the lumen of the intestine. Intestine a simple tube which passes to the left of the anterior ovary and to the right of the posterior one.

Reproductive structures paired, ovaries singly reflexed through half to one-third of the length of the oviduct and uterus. Vagina thick-walled, extending across half the body width. Ovum length equal to twice body width.

Length of prerectum almost equal to four anal-body-widths. Rectum straight, length equal to one anal body width. Tail short, rounded, length equal to two-thirds of anal body width.

Specific differentiation. S. taiaha is readily distinguished from S. ventralis Thorne by the more rounded tail and the

paucity of the caudal cuticular pores. It differs from S. rotundicauda Goodey (known only from a single male) in the shape of the spear (c.f. figs 25 B & F). Goodey's species has a single caudal pore.

Type slides. Holotype in nematode collection, Entomology Division, D.S.I.R., N.Z.

Type locality. Westport pakihi, N.Z.M.S.I., 085674 in pakihi vegetation (Gleichenia circinate Schwartz, stunted Leptospermum scoparium Forst., Drosera spatulata Labill., Thelymitra spp.)

Soil: Gorge fine sandy loam (a podzolic soil).

Remarks. The specific epithet is the Maori name for a short, broad-based spear-like weapon used in hand-to-hand fighting.

5. Description of *Dorlaimellus monticolus* n. sp.

Family BELONDIRIDAE

This family appears to be well represented in New Zealand soils; the genera Belondira Thorne, Axonchium Cobb, and Dorylaimellus Cobb have all been recognised. Dorylaimellus is especially abundant, being represented by at least four species in the sample from which D. monticolus n. sp. is described, and a further five or six species from other localities await description.

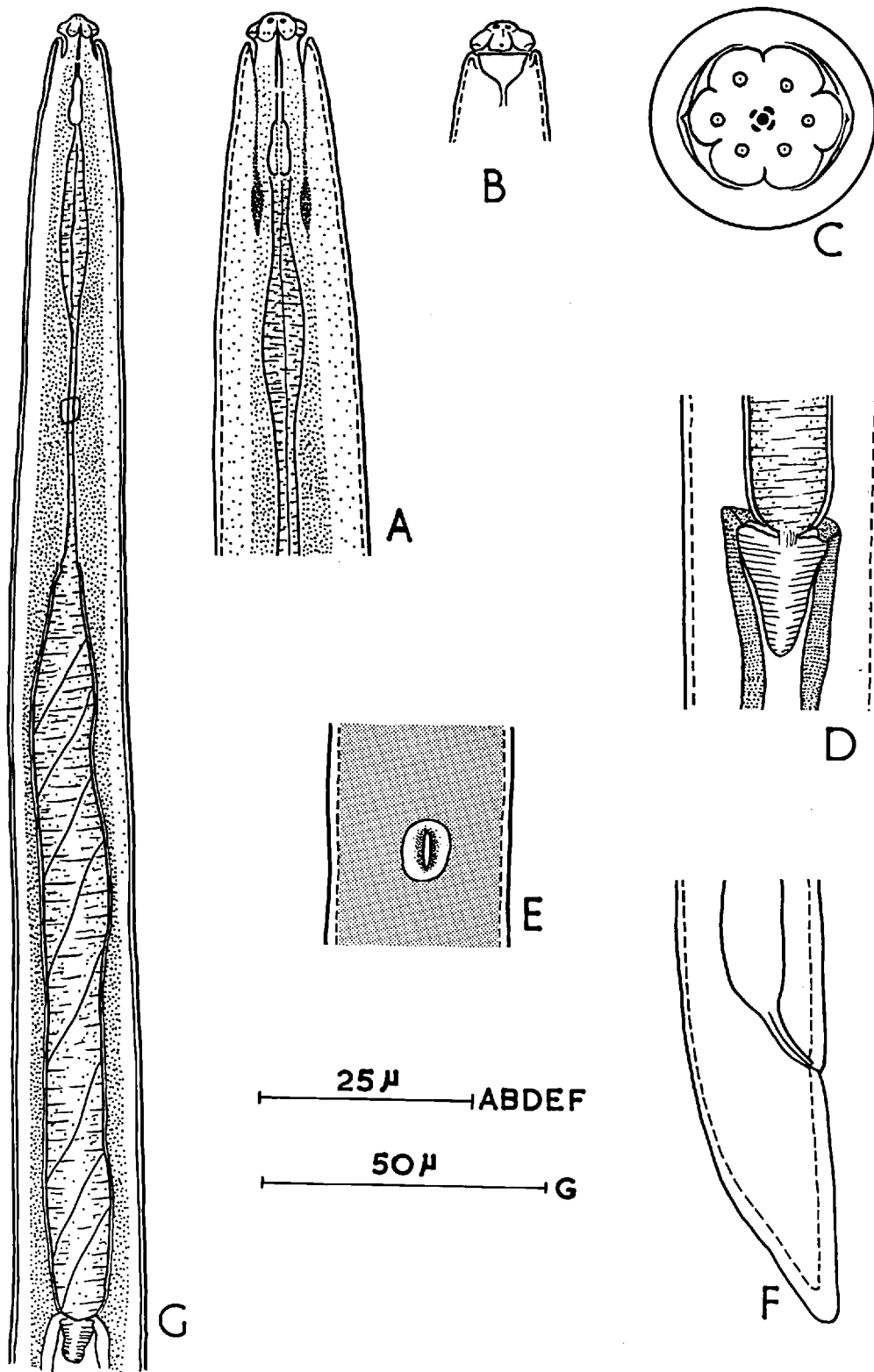

Fig. 26. Dorylaimellus monticolus n. sp. A dorsal view of head region, B lateral view of head to show amphid, C en face view of head, D oesophago-intestinal junction, E ventral view of vulva, F female tail, G oesophageal region.

Dorylaimellus monticolus n. sp.

Figs. 26 A - G

Holotype ♀ L = 0.76 mm; a = 34; b = 3.06; c = 32;
V = $8 \ 64^{10}$

Paratype ♀♀ (n = 2) L = 0.74 - 0.77mm; a = 32 - 35;
b = 2.88 - 3.18; c = 24.9 - 32.0; V = $7-8 \ 55-58^{8-10}$

Cuticle smooth, subcuticle with well marked annulations; cuticles 1μ thick. Lateral chords conspicuous in some specimens, but not in others. No cuticular pores seen on any part of the body.

Lip region offset by a marked constriction which is reinforced by the very large amphids. In en face view lip region hexagonal, lips equal, outer edge of each lip rounded. Cephalic papillae in the usual rings of six and ten, the outer ring being lateral in position.

In lateral view the lip region is bi-convex and the outer ring of papillae are more easily seen in this view than in en face. Four small sclerotized plates arranged as in figure 26 are clearly visible near the anterior limit of the stoma. Amphids pocket-shaped, apertures almost encircling the head. Posteriorly the amphids communicate with sensillae. Spear 7.5μ long, dorylaimoid; spear extensions of two regions, a short tube-like anterior part and a larger posterior part consisting of three solid radiating flanges. Extensions one and a quarter times as

long as spear.

Oesophagus expanding to form a small bulb just behind the flanged spear extensions, then narrowing again, and continuing as a narrow tube to 40 percent of its length where it expands to form the large broad posterior part. Posterior part of oesophagus with a spirally marked sheath. Oesophago-intestinal valve broad or conoid with a rounded tip. The lumen of the oesophagus is apparently without any greatly thickened lining, and through the greater part of the oesophagus the lumen is not visible. No sclerotized lining of the lumen was detected in hand-cut transverse sections of the oesophageal bulb. Dorsal oesophageal gland duct near the anterior limit of the broad posterior region of the oesophagus. Subventral glands or their ducts not seen. Nerve ring encircles oesophagus near the middle of the narrow region.

Intestine composed of small cells with dark granular contents. Intestine passes to the left of the anterior ovary, and to the right of the posterior one. Prerectum three and a half times the anal-body-width. Rectum slightly arcuate, length equal to three-quarters of anal-body-width.

Vulva slightly post-equatorial, and is situated at the bottom of a shallow, circular depression. Vulval aperture a short longitudinal slit. Vagina short; uteri and oviducts paired, opposed, outstretched; ovaries reflexed

through three-fifths of the distance back to the vulva.

Tail moderately short, length equal to twice anal-body-width; dorsally convex, ventral side almost straight, tail tip sub-digitate, rounded.

Specific differentiation. D. monticolus n. sp. is similar to D. striatus Thorne, 1939 which is stated to have transverse striae on the cuticle, but differs markedly from it in tail shape. It also bears a superficial resemblance to the much larger D. virginianus Cobb, but D. monticolus has a shorter digitate caudal region; further, the shape of the anterior oesophageal bulb and the oesophago-intestinal valve differ in both species.

Type slides. Holotype and paratype slides in nematode collection, Entomology Division, D.S.I.R., Nelson, N.Z.

Type locality. Summit of Lindis Pass, N.Z., 1000 metres in a skeletal yellow brown earth. Vegetation: Danthonia flavescens Hook. f. - Poa Colensoi Hook.f. sub-alpine grassland with Celmisia gracilentata Hook. f., Leucopogon fraseri A. Cunn., Raoulia Hook.f. spp. and Festuca novaezelandiae Cockayne.

6. Description of Amphorostomum saccatum n. gen. et sp.

Family LEPTONCHIDAE

As mentioned earlier (Section III) the Leptonchidae do not form a very coherent group. The addition of the new genus described below does not affect this situation in any

way. Whilst no other genus in the family contains species with sclerotizations about the stoma, this does not appear to be a character of more than generic significance.

Stomatal sclerotizations occur in Fungentus in the Dorylaiminae, in varying degrees in all the Actinolaiminae and in Dorylaimellus in the Belonidiridae.

Amphorostomum n. g.

Leptonchidae; moderate sized nematodes, with a flask-shaped sclerotized stomatal lining extending posteriorly to the anterior limit of the spear guiding ring and through which the spear runs. Amphids large with sinuous apertures. Oesophagus very slender in anterior three-quarters; basal bulb short, marked off by a distinct constriction. In the only known species only the anterior ovary is present, posterior genital tract forms a large post-vulval sac. Males testas dorylaimoid; spicules heavy, arcuate, paired, free. Lateral guiding pieces present. Supplements, an adanal pair plus five ventro-median ones. Tail similar in both sexes, short, rounded, with a terminal invagination of tail hypodermis.

Type species: Amphorostomum saccatum n. sp.

Remarks. On the basis of the offset, short posterior oesophageal bulb Amphorostomum appears to lie close to Doryllium Cobb and Tylencholaimellus Cobb, but differs from both these genera in the possession of a very slender,

uniformly tapering spear with simple extensions which lack both knobs and flanges. The most important single character is the possession of a flask-shaped sclerotized lining to the stoma. The name is derived from amphoreus = a flask, and stoma = a mouth.

Amphorostomum saccatum n. sp.

Figs. 27 A - G

Holotype ♀ L = 1.56 mm; a = 32; b = 6.21; c = 96.5;
v 17 52 13.5

Allotype ♂ L = 1.65 mm; a = 34; b = 6.8 c = 85.5; T = 38

Paratype ♀ L = 1.68 mm; a = 35; b = 7.06; c = 96; v=15⁵⁴ 13.5

Paratype ♂ L = 1.67 mm; a = 35; b = 6.37; c = 69; T = 35

Cuticle 1.5 u thick with an abundance of irregularly placed raised dots visible under oil immersion. Sub fig. 27C. cuticle 1.5 u thick, with fine transverse annulations. Lip region in en face view rather hexagonal, lips equal, inner ring of 6 papillae within the lip region; outer ring of ten papillae placed on the sides of the lips, and appear outside the lip region (fig. c). Amphid apertures large, slit-like, but somewhat dilated at each end. At lower levels of focus the sclerotized lining of the stoma is seen in optical section as a complete ring.

In lateral view the lip region appears slightly offset. Amphid apertures somewhat bi-crescentic in this view, and are easily confused with the depression which offsets the

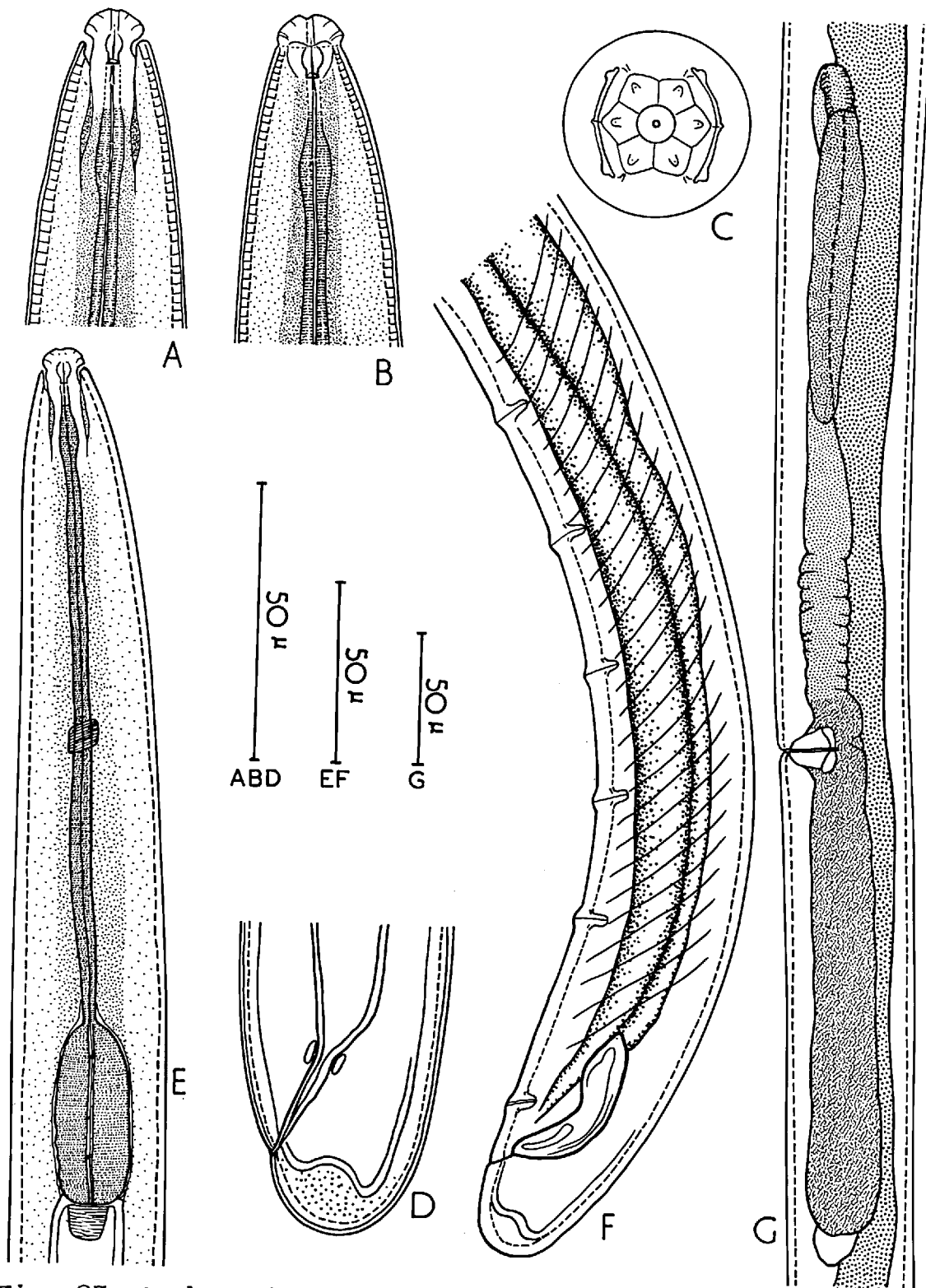

Fig. 27. Amphorostomum saccatum n. gen. et sp. A & B dorsal and lateral views of head; C en face view of head; D female tail; E oesophageal region; F male tail; G female reproductive system.

lip region. Amphids pocket-like, connecting posteriorly with sensillae. Stoma lined in the posterior half with a flask-shaped sclerotized lining which is cylindrical in the posterior third, and inflated at the centre of the anterior two-thirds, and narrows anteriorly and posteriorly from this point.

Spear 9.5μ long, slender, tapering uniformly to a fine tip. Spear aperture not seen. Extensions simple, without flanges etc., about equal to spear in length, posterior part in a slight expansion of the anterior end of the oesophagus.

Anterior three-quarters of oesophagus long and slender; posterior quarter half as wide as the body and sharply offset from the anterior part by a marked constriction. All oesophageal gland ducts discharge into the oesophageal lumen in the expanded posterior part. Nerve ring encircles the oesophagus slightly anterior to the mid-point. Oesophago-intestinal valve rather short, posterior part broad. Intestine a simple tube passing dorsally to the male and female reproductive organs. No distinct prerectum in female. Prerectum in male commences near the most anterior supplement.

Female. Vulva almost equatorial; a transverse slit. Vagina extending across half the body width. Posterior uterus present as a large post vulval sac filled with sperms

in both females, with a small cellular body (= the reduced ovary ?) attached to the distal extremity. Anterior uterus outstretched, but the oviduct reflexed a short distance from the tip. Ovary and terminal part of oviduct reflexed half-way back to the vulva. Tail short, length equal to two-thirds of anal-body-width, rounded. No caudal cuticular pores seen.

Male. Testes paired, outstretched. Vas deferens expanding a little anterior to the first supplement to form the ejaculatory duct. Supplements an adanal pair plus five ventro-median ones, all low, mammiform. Spicules paired, equal, free, heavy, arcuate. Lateral guiding pieces present, slightly arcuate, tips rounded. Male tail short, length equal to three-quarters of anal-body-width, tip rounded. No caudal cuticular pores seen.

Type slides Holotype, allotype and paratypes in nematode collection, Entomology Division, D.S.I.R., Nelson, N.Z.

Type locality. Westport Pakihi, N.Z.M.S.l., 085674, in soil with Gleichenia circinata Swartz, stunted Leptospermum scoparium Forst., and Drosera L., Thelymitra Forst. and Celmisia Cass. spp.. Soil: Gorge fine sandy loam (a gley podzol).

Remarks. The specimens examined were apparently preparing for the breeding season since both the females had abundant spermatozoa in their post-vulval sacs. No eggs were

present (material collected in February).

The specific name draws attention to the enormous post-vulval sac.

In some respects Amphorostomum saccatum appears to be allied to Tylencholaimus bryophilus Imamura, 1931. The similarity in the shape of the oesophagus is very striking, and apart from the presence of caudal pores the tails are somewhat similar. The exact nature of the stoma is not clear from the figures and not discussed in the text. Significant points of difference concern the spear which is stated to be trifurcated at the base, though no spear extensions are shown or mentioned. The adanal supplement is referred to in the singular and the prerectum is stated to be "always distinct". I do not feel justified in regarding all these differences as due to "faulty interpretation" as has happened so frequently in nematology. It appears unlikely from Imamura (1931) that type specimens were kept, so it is probably as well to wait until further information is available about this species before removing it again from the genus to which it was first assigned.

Section VIII

CONCLUSION

So far as any general remarks can be made about the free-living nematode fauna of New Zealand at this stage it appears to be characterised by a very high degree of endemism. The endemic status of many of the species can only be tentative at present because virtually nothing is known of the nematode faunas of the adjacent land masses of Australia, Tasmania, the Pacific or Sub-antarctic Islands, or even of Chile. If, however, one extrapolates from what is known of the rest of New Zealand's fauna a high degree of endemism is to be expected. This is no doubt due to a high degree of isolation from other land masses since Cretaceous times.

On the other hand, it is to be expected that when the faunas of arable land are studied it will be found that many European species have become established as is the case in the other terrestrial invertebrate groups, e.g., Insecta, Arachnida, Crustacea, Myriapoda, Oligochaeta and Mollusca.

At the present time it is clear that amongst the Enohlida very many species, a number of genera, and a family or two require description. Although the Tylenchida and Chromodorida have only been studied in a most cursory fashion it is evident that several new genera at least are required in these groups to accommodate as yet undescribed

species.

It is far too early in the study of the New Zealand fauna to consider inter-relationships between soil, vegetation and nematodes, except as mentioned earlier that most of the Iotonchus seem to be associated with podzolic soils.

Besides the erection of new species, this study of a few representatives of a single order of nematodes has served to show deficiencies in some of the currently accepted concepts in the taxonomy of the group. Attempts have been made to remedy these as far as possible but a considerable number of new problems have arisen. Some of these which are of more general interest and which require further study are:-

1. Re-examination of the number of oesophageal gland cells, and the positions of their ducts in Cryptonchus, the Diphtherophoroidea and Alaimoidea.
2. The extent of moulting in the Dorylaimoidea, i.e., is the whole of the oesophageal lining shed in all groups, and is this ever shed via the intestine.
3. The physiology of moulting in the Nematoda as a whole and a comparison with similar phenomena in the Arthropoda.
4. The nature of the tooth in the Bathyodontidae and its mode of origin at each moult.
5. A comparison of the formation and migration of teeth and spears in Ironus and the Dorylaimoidea.

6. Spermatogenesis in the Enoplida with special reference to the Alaimoidea.
7. The nature of the spiral sheath in the Belonidiridae.
8. The normal food habits of all groups.

APPENDIX I

A List of Enoelid Genera recognised in Soil Samples
from New Zealand

Oncholaimus Dujardin, 1845

Ironus Bastian, 1865

Cryptonchus Cobb, 1913

Tribyla Bastian, 1865

Tobrilus Andrassy, 1959 (several spp.)

new genus near Tobrilus

Alaimus de Man, 1880

Amphidelus Thorne, 1939 (6 or 7 spp.)

? new genus near Amphidelus

Mononchus Bastian, 1865 (4 spp.)

Prionchulus (Cobb, 1916), Chitw. & Chitw. 1937

Mylonchulus (Cobb, 1916) Pennak, 1953. (2.spp.)

Cobbonchus Andrassy, 1958 (3 or 4 spp.)

Iotonchus (Cobb, 1916) Altherr, 1950 (6 or 7 spp.)

Labronema Thorne 1939

Aporcelaimus Thorne and Swanger, 1936 (many spp.)

Dorylaimus Dujardin, 1845 (several spp.)

Eudorylaimus Andrassy, 1960 (several spp.)

Mesodorylaimus Andrassy, 1960

Discolaimus Cobb, 1913

Pungentus Thorne & Swanger, 1936

Tylencholaimus de Man, 1875. (several spp.)

Enchodelus Thorne, 1939 (several spp.)

Actinolaimus Cobb, 1913

Nygolaimus Cobb, 1913 (several spp.)

Sectonema Thorne, 1930

Longidorus Micol, 1922 (2 spp.)

? Longidorella Thorne, 1939

Belondira Thorne, 1939 (several spp.)

new genus near Belondira (2 or 3 spp.)

Axonchium Cobb, 1920

Dorylaimellus Cobb, 1913 (many spp.)

Dorylaimoides Thorne & Swanger 1936

? Doryllium Cobb, 1920

Tylencholaimellus Cobb, 1920 (several spp.)

new genus and family or subfamily between Leptonchidae
and Tylencholaiminae

new genus near Tyleptus Thorne, 1939

Amphorostomum n. gen.

a considerable variety of Leptonchid spp. which need
further study to determine generic position.

Aganomermis sp.

REFERENCES

- Allgen, C. 1933. Über einige frei lebende Nematoden aus dem Niederkongo. Zool. Anz. 20, 312 - 320.
- Altherr, E. 1950. Les nematodes de Parc National Suisse. Ergebn. wiss. Unters. schweiz Nat. Parks 3, I - 46.
- 1960. Results from the Danish Expedition to the French Cameroons (1949 - 1950) XXVIII - Nematodes limnicole. Bull. Inst. franc. Afr. noire, 22 ser. A. 770 - 787.
- Andrassy, I. 1956. Susswasser-Nematoden aus Fransösichest-West-Afrika. Opusc. zool. Univ. Bp., 1, 3 - 18.
- 1958. Über der System der Mononchiden (Mononchidae Chitwood, 1937; Nematoda). Ann. Hist.-nat. Mus. hung., n.s. 9, 151-174.
- Baker, A.D. 1953. Rapid method for mounting nematodes in glycerine. Canad. Ent. 85, 77 - 78.
- Canning, E.U. 1961. Legerella helminthorum n.sp., a coccidian parasitic in a nematode. Arch Protistk. (in press)
- Chitwood, B.G. 1957. A new species of Xiphinemella Loos, 1950 (Nematode) from Florida. Proc. Helm. Soc. Wash., 24, 53 - 56.
- Chitwood, B.G. & Chitwood, M.B. 1937. The histology of nemic oesophagi VIII. The oesophagus of representatives of the Enoplida. J. Wash. Acad. Sci. 27, 517 - 531.
- 1937. An Introduction to Nematology, Section I, Part I. Chitwood, Monumental Printing Co. Baltimore. pp. 1 - 53.
- 1938. ibid, Section I, Part II. Chitwood, Monumental Printing Co. Baltimore, pp. 55-123.
- 1940. ibid. Section I, Part III & Section II, Part I. Chitwood, Monumental Printing Co. Baltimore, pp. 125 - 242.
- An Introduction to Nematology, Part I (second edition) Chitwood, Baltimore, 213 pp.

- Clark, W.C. 1960. The oesophago-intestinal junction in the Mononchidae (Enoplida, Nematoda). Nematologica, 5, 178 - 183.
- Cobb, N.A. 1893. Nematodes, mostly Australian and Fijian. Macleay Memorial Volume. Linn. Soc. N.S.W., 1 - 59.
- 1913. New nematode genera found inhabiting fresh water and non-brackish soils. J. Wash. Acad. Sci. 3, 432 - 444.
- 1916. Notes on new genera and species of nematodes 4. "Subdivisions of Mononchus." J. Parasit., 2, 195 - 196.
- 1917. The Mononchs (Mononchus Bastian, 1865), a genus of free-living predatory nematodes. Soil Sci., 3, 431 - 486.
- 1918. Filter-bed nemas; Nematodes of the slow sand filter beds of American cities (Including new genera and species.) With notes on hermaphroditism and parthenogenesis. Contrib. Sci. Nematol. (7) 189 - 212.
- 1922. A new species of Nygolaimus, an outstanding genus of the Dorylaimidae. J. Wash. Acad. Sci. 12, 416 - 421.
- 1928. Nemaic Spermatogenesis, with a suggested discussion of simple organisms, -- Litobionts. J. Wash. Acad. Sci. 18, 375 - 387.
- de Conninck, L.A.P. 1939. Les nematodes libres de la grotte de Han (Han-sur-Losse, Belgique). Note de biospeleologie. Bull. Mus. Roy. Hist. Nat. Belg., 15, 1 - 40.
- Ditlevsen, H. A. 1911. Danish free-living nematodes. Vidensk. Medd. Dansk naturhist. For. Kbh. 63, 213 - 256.
- Forster, R.R. 1954. The New Zealand Harvestmen (suborder Laniatores), Canterbury [N. Z.] Mus. Bull. 2. 329 pp.
- Filinjev, I.N. 1936. Über Cryptonchus Cobb, 1913; Miscellanea Nematologica III. Zool. Anz. 114, 105 - 106.

- Goodey, J.B. 1957. Laboratory Methods for work with plant and soil nematodes. Tech. Bull. 2, Min. Agric. Fish. & Food. H.M.S.O. London. 47 pp.
- 1961. The Nature of the spear guiding apparatus in Dorylaimidae. J. Helm. (in press)
- Goodey, T. 1943. On Pungentus thornei n. sp., a new dorylaimid nematode from soil. J. Helm., 20, 6 - 9.
- 1951. Soil and Freshwater Nematodes. London, Methuen. 390 pp.
- Hooper, D.J. 1961. A redescription of Longidorus elongatus (de Man, 1876) Thorne & Swanger, 1936, (Nematoda, Dorylaimidae) and descriptions of five new species of Longidorus from Great Britain, Nematologica, 6 (in press).
- Imamura, S. 1931. Nematodes in the paddy field, with notes on their populations before and after irrigation. J. Coll. Agric. Tokyo, 11. 198 - 240.
- Lee, K.E. 1959. The earthworm fauna of New Zealand. Bull. N.Z. Dep. sci. industr. res. 130, 486 pp.
- de Man, J.G. 1884. Die frei in der reinen Erde und im süssen Wasser lebenden Nematoden der niederlandischen Fauna. Eine systematische-faunistische Monographie. Brill's, Leiden 206 pp.
- Meyl, A.H. [1960] Die Tierwelt Mitteleuropas Bd.1. lief 5a, Freilebende nematoden. Quelle & Meyer, Leipzig, 164 pp. + 54 pls.
- Micoletzky, H. 1921 & 1922. Die freilebenden Erd-Nematoden mit besonderer Berücksichtigung der Steirermark und der Bukowina, zugleich mit einer Revision sämtlicher nicht mariner, freilebender Nematoden in Form von Genus Beschreibungen und Bestimmungsschlüsseln. Arch. Naturg. Berlin, Abt. A. 87, 1 - 320, 321 - 650.
- 1925. Die freilebenden Süßwasser- und Moor-Nematoden Dänemarks. K. dansk vidensk. selsk., Afd. 8, 10, 57 - 310.

- Oostenbrink, M. 1960. Estimating nematode populations by some selected methods. pp 55 - 102 of Nematology, fundamentals and recent advances with emphasis on plant parasitic and soil forms edit. J.N. Sasser and W. R. Jenkins. Univ. of North Carolina Press, Chapel Hall, 480 pp.
- Overgaard Nielsen, C. 1949. Studies of the Soil Microfauna II. The soil inhabiting nematodes, Natura Jutlandica, 2, 1 - 131.
- Owen, G. & Steedman, H. F. 1956. Preservation of animal tissues, with a note on staining solutions. Quart. J. micr. Sci. 97, 319 - 321.
- Schnieder, W. 1922. Freilebende Süßwasser Nematoden aus ostholsteinischen Seen. Nebst Bemerkungen über die Nematodenfauna des Madü- und Schaalsees. Arch. Hydrobiol. 13, 696 - 753.
- Schuurmans Stekhoven, J.H. 1951. Nématodes saprozoaires et libres du Congo Belge. Mem. Inst. Sci. nat. Belg., 2, 1 - 79.
- Steiner, G. & Heinly, H. 1922. The possibility of control of Heterodera radicum and other plant-injurious nemas by means of predatory nemas, especially by Mononchus papillatus Bastian. J. Wash. Acad. Sci. 12, 367 - 386.
- Taylor, N. H. 1948. Soil Map of New Zealand. Soil Bureau, Wellington.
- & Cox, J.E. 1956. The soil pattern of New Zealand. N.Z. Inst. Agric. Sci. Proc. 1956, 28 - 44.
- Thorne, G. 1927. The life history, habits, and economic importance of some mononchs. J. Agric. Res. 34, 265 - 286.
- 1930. Predacious nemas of the genus Nygolaimus and a new genus Sectonema. J. Agric. Res. (Wash.), 49, 755 - 763.
- 1939. A monograph of the nematodes of the superfamily Dorylaimoidea. Capita Zoologica, 8, 1 - 261.

- & Swanger, H. 1936. A monograph of the
nematode genera Dorylaimus Dujardin, Aporcelaimus
n. g., Dorylaimoides n. g., and Pungentus n. g.,
Capita Zoologica, 6, 1 - 233.
- Wieser, W. 1953. Reports of the Lund University Chile
Expedition 1948 - 49.10 Free-living Marine
Nematodes. 1, Enoploidea, Acta Univ. lund.
n.s. 49, (6) 1 - 155.

6. The Mononchidae (Enoplida, Nematoda) of New Zealand. II. The genus Iotonchus (Cobb, 1916) Altherr, 1950.

THE MONONCHIDAE (ENOPLIDA, NEMATODA) OF NEW ZEALAND
II. THE GENUS *IOTONCHUS* (COBB, 1916) ALTHERR, 1950

BY

W. C. CLARK

Rothamsted Experimental Station, Harpenden, Herts, England 1)

COBB (1916) first erected *Iotonchus* as a subgenus of *Mononchus* Bastian, 1865 for large species with a small basal tooth or teeth, an elongated, three-ribbed stoma, a long slender tail, and single or paired reflexed ovaries and he designated *M. gymnolaimus* Cobb as the type species. ALTHERR (1950) and PENNAK (1953) first gave *Iotonchus* generic rank. Apparently unaware of this, ANDRÁSSY (1958) did the same, but placed the forms with subventral teeth in a new genus *Miconchus*. It is not possible to separate some species (e.g. *I. parazschokkei* (Allgén)) from *Mononchus* using the generic definitions of COBB (1916, 1917) or ANDRÁSSY (1958). In some species the dorsal tooth may lie partly in the anterior and partly in the posterior half of the stoma. The position of the tooth apex is not fixed and ranges over about ten per cent of the stoma length in most species. With the possible exception of *I. zschokkei* (Menzel) the stoma base is broad in *Iotonchus* and pointed in *Mononchus*. The different types of oesophago-intestinal junction in the two genera (CLARK, 1960) simplifies generic determination.

Iotonchus (Cobb, 1916) Altherr, 1950. Emend.

Mononchidae. Stoma large, barrel-shaped, with a broad base. Dorsal tooth anteriorly directed, moderate to small, often basal, but always within the posterior two thirds of stoma. Subventral teeth or denticles absent. Oesophago-intestinal junction tuberculate. Ovaries paired or single, reflexed. Testes paired opposed, outstretched. Spicules paired, free. Gubernaculum simple or with lateral processes. Lateral accessory pieces present or absent. Tail short, conoid, or long, conoid with a cylindroid end piece or filiform. Tail in both sexes similar or different.

Found in soil, mosses, liverworts, and forest litter.

Type species *Mononchus gymnolaimus* Cobb, 1893.

1) At present on study leave from Entomology Division, D.S.I.R., Nelson, New Zealand.

The known species of *Iotonchus* are:

- | | |
|--|--|
| <i>I. acutus</i> (Cobb, 1917) Andrásy, 1958 | <i>I. ophiocercus</i> n. sp. |
| <i>I. ambigonicus</i> (Thorne, 1924) Andrásy, 1958 | <i>I. pavazschokkei</i> (Allgén, 1929) Andrásy, 1958 |
| <i>I. basidontus</i> n. sp. | <i>I. percivali</i> n. sp. |
| <i>I. bathybius</i> (Micoletzky, 1913) Andrásy, 1958 | <i>I. piracicabae</i> (Lordello, 1953) Andrásy, 1958 |
| <i>I. brachylaimus</i> (Cobb, 1917) Andrásy, 1958 | <i>I. risoceiae</i> (Carvalho, 1955) Andrásy, 1958 |
| <i>I. consimilis</i> (Cobb, 1917) Andrásy, 1958 | <i>I. similis</i> (Cobb, 1893) Andrásy, 1958 |
| <i>I. gymnotaimus</i> (Cobb, 1893) Andrásy, 1958 | <i>I. simmenensis</i> (Kreis, 1924) Andrásy, 1958 |
| <i>I. jairi</i> (Lordello, 1958) n. comb. | <i>I. tenuicaudatus</i> (Kreis, 1924) n. comb. |
| <i>I. maragnus</i> n. sp. | <i>I. trichurus</i> (Cobb, 1917) Andrásy, 1958 |
| | <i>I. zschokkei</i> (Menzel, 1913) Andrásy, 1958 |

Iotonchus basidontus n. sp.

Figs. 1A-G

Ross

Holotype ♀ L = 1.81 mm; a = 30; b = 3.67; c = 6.82; V = ⁹ 59.8⁷

Allotype ♂ L = 1.95 mm; a = 30; b = 3.85; c = 8.60; T = 19.5

Paratype ♀ L = 1.68 mm; a = 32; b = 3.76; c = 7.16; V = ⁷ 58.1⁸

Awatuna-Stafford ♀ L = 1.82 mm; a = 28; b = 3.82; c = 6.85; V = ⁸ 56.4⁷

Awatuna ♀ L = 2.44 mm; a = 25; b = 4.32; c = 6.85; V = ¹¹ 55.2¹⁵

Hongi's Track ♀♀ (n = 2) L = 1.91-1.95 mm; a = 31; b = 4.03-4.08;
c = 6.45-6.66; V = ⁸⁻⁹ 58.1-59.7⁷⁻⁸

Cuticle 2 μ thick, with very faint obsolescent striae. No lateral fields. Subcuticle 3 μ thick, not striated. Head narrowing anteriorly, lip region scarcely offset. Lips and papillae not prominent in lateral view. Amphid situated one half head-width behind lateral lip, aperture oval. In *en face* view lip region is hexagonal, symmetrical; lips six, equal, inner edges rounded, outer edges angular. Papillae in two rings, inner one with six, outer with ring of ten papillae. Amphid apertures crescentic in this view. In lateral view stoma is barrel-shaped, width five-eighths of the height, base broad, somewhat rounded, anterior portion not greatly in-arched. Anterior aperture half as wide as the greatest width. Dorsal tooth low, at 75 per cent of the length of the stoma, and occurring on posterior limit of anterior dorsal element. Tooth apex sharp; anterior edge of tooth concave; posterior edge straight. Apart from the presence of the tooth, dorsal and subventral anterior stoma elements similar. Postero-dorsal element thicker than subventral members, but thins towards oesophageal lumen. Suture between anterior and posterior elements clearly marked. Anterior four-fifths of stoma within a thin muscular sheath; posterior fifth embedded in locally enlarged anterior end of oesophagus. Oesophagus narrows a little to nerve ring at one-third of its length, then increases slightly to occupy half the body-width. Dorsal oesophageal gland duct at half the oesophagus length; subventral glands discharge into posterior third of oesophagus. Oesophago-intestinal junction tuberculate (Fig. 1 C). Intestine with abundant oil droplets and dark granules.

Female Vulva transverse; vagina thick walled, extending across one-third of

body. Uteri and oviducts outstretched, a sphincter muscle present between uteri and oviducts; but the glandular region, observed in other species, not clearly visible. Ovaries reflexed through one third of length of oviduct and uterus. Ovaries half as wide as body. Oocytes in a single row. Intestine passes to the left of anterior and right of posterior ovary. Prerectum absent. Rectum straight, length two-thirds anal-body width. Anal lips slightly protuberant. Tail 15 per cent of total length;

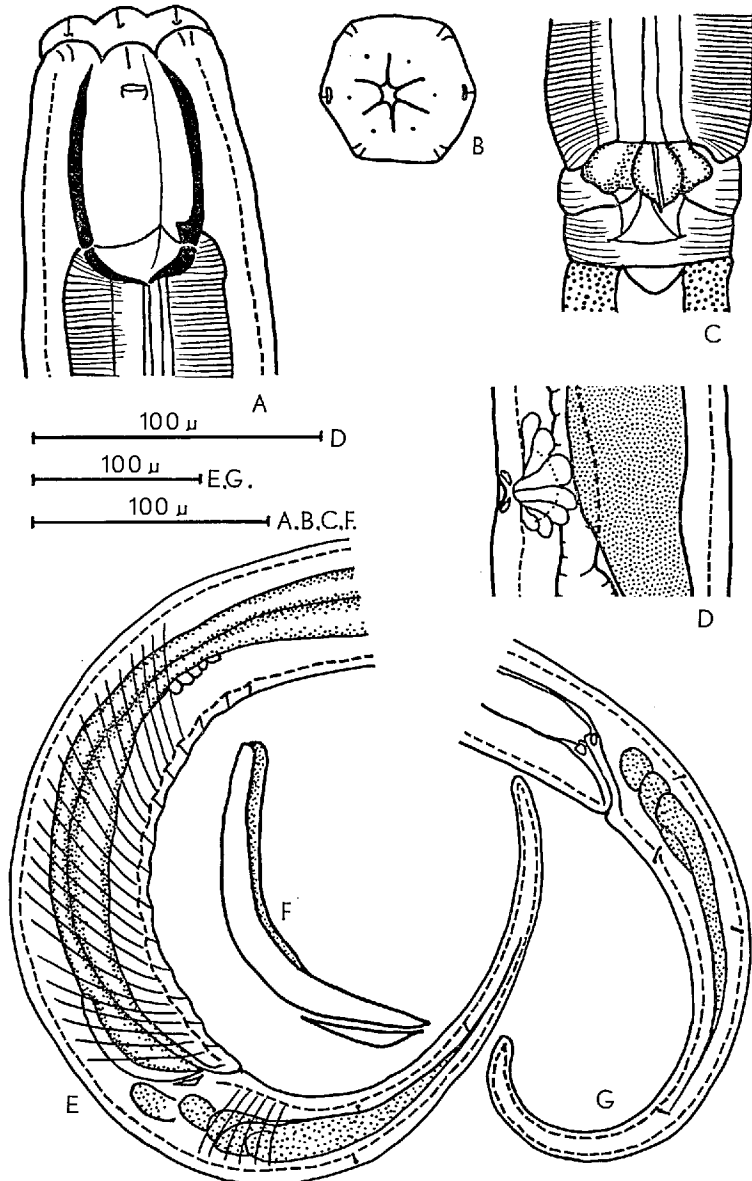

Fig. 1. *Ioronchus basidotus*. A. head region; B. *en face* view of lip region; C. oesophago-intestinal junction; D. lateral view of vulva; E. male tail; F. spicules and gubernaculum; G. female tail.

ventrally arcuate, conoid in proximal half, then cylindrical, tip rounded. Caudal glands and terminal duct present. Lateral cuticular pores as shown in fig. 1 G.

Male Testes paired, opposed, outstretched. Anterior testis five-sixths as long as posterior. Vas deferens equal to half testicular length. At a level between the second and third supplement the vas deferens swells to become the ejaculatory duct which opens into the cloaca. Prerectum equal to ejaculatory duct in length. Spicules paired, long, slender, free. Gubernaculum small, simple, without lateral processes. Lateral accessory pieces wanting. Supplements fourteen, small, papilliform, equidistant. Tail similar to female. Caudal glands with terminal duct present. Lateral cuticular pores as in fig. 1 E.

Specific differentiation. *I. basidontus* most closely resembles *I. gymnolaimus* (Cobb) and *I. consimilis* (Cobb); two species which need redescription. From these *I. basidontus* is distinguished by the presence of paired ovaries, the head which is not offset, the shape of the amphid (duplex in *I. consimilis*), the thickness of the stoma wall (thin in *I. gymnolaimus*) and the tail shape (tip swollen in *I. gymnolaimus*).

Type slides. In nematode collection, Entomology Division, D.S.I.R., Nelson, N.Z.

Type locality. Ross, Westland in *Lolium perenne* L.-*Trifolium repens* L.-*Anthoxanthum odoratum* L. pasture. Soil type: Hokitika fine sandy loam (a recent alluvial soil derived from schist).

Other localities. Kumara Beach, *Hydrocotyle* L. sp. — *Trifolium repens* L. turf; Awatuna, water-logged soil with *Ranunculus* L., *Hydrocotyle* L. and *Juncus* L.; Awatuna-Stafford, *Carpodetus serratus* Forst.-*Weinmannia racemosa* Linn. fil. scrub; Hokitika, mental hospital terrace, swampy land with sedges, *Juncus* L., and *Drosera* L. spp.; Hongi's Track, *Beilschmiedia Tawa* Benth. & Hook f.-*Knightsia excelsa* R. Br. forest litter; Kiripaka, *Beilschmiedia Tairāve* Benth. & Hook. f.-*Vitex lucens* T. Kirk forest litter.

Remarks Several specimens had rhabditids and tylenchids in the intestine. There appear to be no grounds for separating the Awatuna female from the others, though the measurements indicate a larger animal with a slightly shorter oesophagus.

Iotonchus maragnus n. sp.

Figs. 2 A-I

Sergeants Hill

Holotype ♀ L = 4.22 mm; a = 69; b = 7.14; c = 2.95; V = ⁶ 35.9⁷

Paratype 1 ♀ L = 3.64 mm; a = 59; b = 6.33; c = 2.31; V = ¹⁵ 38.9¹⁰

Westport Pakihi

Allotype ♂ L = 3.3 mm; a = 53; b = 6.24; c = 2.66; T = 24

Cuticle 1.5 μ thick with obsolescent fine annuli in caudal region. No lateral fields. Subcuticle 2.5 μ thick. Body tapers slightly anteriorly; lip region offset by slight constriction. In lateral view lips closely approximated. Amphids small, cup-

like, aperture a transverse slit. In *en face* view lip region almost circular; divided into six equal segments. Inner lip margins pointed, outer margins rounded. Papillae in two rings; inner ring of six and outer ring of ten (two papillae on each

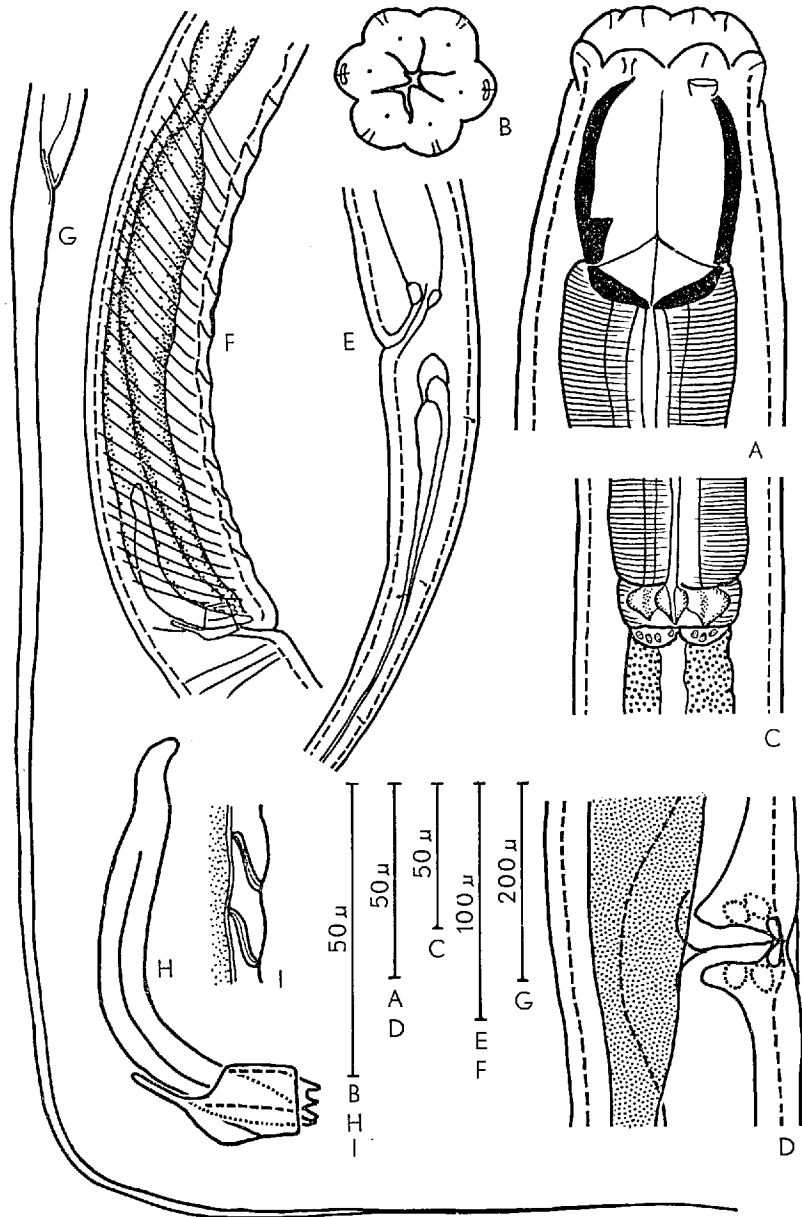

Fig. 2. *Iotonchus maragnus*. A. head region; B. *en face* view of lip region; C. oesophago-intestinal junction; D. lateral view of vulva; E. female tail; F. anal region of male; G. female tail; H. spicule, gubernaculum and lateral accessory piece; I. supplements.

of the submedian lips and one on each lateral). Amphid apertures crescentic in this view.

In lateral view stoma barrel-shaped, broad at base, three-quarters as wide as long, length equal to head width. Dorsal tooth apex at 59-61 per cent of stoma length. Anterior edge of tooth straight, horizontal; posterior edge intersects dorsal stoma wall at suture between anterior and posterior elements. Apart from dorsal tooth, ventral and dorsal stoma walls similar, in-arched anteriorly. Anterior stoma aperture two-fifths of greatest stoma width. Posterior elements similar. Outer surface of stoma with fine transverse striae. Anterior four-fifths of stoma within thin muscle sheath; posterior fifth embedded in expanded end of oesophagus.

Oesophagus narrows a little to nerve ring at one-third of its length where it occupies half body-width, then gradually expands to three-fifths body-width. Oesophageal gland ducts occur at 44, 63-67, and 93-96 per cent of the oesophageal length. Oesophago-intestinal junction tuberculate, funnel-shaped valve not seen. Posterior face of sphincter muscle with several large glandular (?) cells. Intestine as usual.

Female Vulva transverse. Vagina thick walled, extending across one third to half body-width. No radiating muscles seen. Uteri paired, opposed, outstretched, with conspicuous sphincter muscle and glandular region at uterus-oviduct junction. Ovary half as wide as body, reflexed through one sixth length of oviduct and uterus. No pre-rectum. Rectum straight, equal to anal-body-width. Tail extremely attenuated, filiform, approximately one-third of body length. Caudal glands present, terminal duct absent. Caudal cuticular pores as in fig. 2 E.

Male Testes paired, opposed, outstretched. Length of testes equal to length of vas deferens. Vas deferens enlarged posterior to second supplement where it becomes the ejaculatory duct. Ejaculatory duct and prerectum equal. Supplements twelve, small, low, almost equidistant. Spicules paired, free, slender, curved, with thickened median strand in distal three-quarters, tips bifid, head sigmoid. Paired, notched, lateral accessory pieces present. Gubernaculum large, thickened behind the spicules, lateral processes large, thin, partly enveloping the spicules and lateral accessory pieces. Tail similar to female.

Specific differentiation. The extremely long whip-like tail 34-43 per cent of the total length readily separates *I. maragnus* from all other species in the genus except *I. trichurus* Cobb and *I. percivali* n. sp. It is distinguished from *I. trichurus* by the paired ovaries and larger size and from *I. percivali* by the more anterior position of the vulva, the slightly longer tail and the smaller size. In the only males available there are twelve supplements in *I. maragnus* and eighteen in *I. percivali*.

Type slides. Entomology Division, D.I.S.R., Nelson, N.Z.

Type locality. Sergeant's Hill, Pakihi, N.Z.M.S.1. S23/24, 135724, 30 metres. Vegetation *Gleichenia circinata* Swartz, *Leptospermum scoparium* Forst., *Cladium teretifolium* R. Br., *Sphagnum falcatum* Bresch. Soil: Sergeant series (gley podsols).

Other locality. Westport Pakihi, vegetation as above.

Remarks A nemativorous species; food in the intestine includes larvae of its own species. Both localities with wet, mature gley podsol soils. The specific name alludes the whip-like tail (Greek $\mu\acute{\alpha}\rho\alpha\gamma\gamma\alpha$ = whip).

Iotonchus ophiocercus n. sp.

Figs. 3 A-H

| | |
|----------------------------|---|
| Holotype ♀ (Barrytown) | L = 4.03 mm; a = 41; b = 4.75; c = 4.88; V = 12 56.6 ¹⁰ |
| Allotype ♂ (Waimangaroa) | L = 3.82 mm; a = 46; b = 5.17; c = 5.76; T = 15 |
| Paratypes (Barrytown) 2 ♀♀ | L = 3.82 mm; a = 45-47; b = 4.81-4.85; c = 4.68; V = 9.10 53.9-61.9 ⁵⁻¹⁰ |
| (Kumara Beach) ♀ | L = 3.98; a = 44; b = 4.92; c = 5.21; V = 54.5 |
| ♂ | L = 3.75 mm; a = 38; b = 4.58; c = 10.5; T = 24.6 |

Cuticle 3 μ thick, with exceedingly fine annuli only visible under very favourable conditions, usually appearing smooth. No lateral fields. Subcuticle 2 μ thick. Lip region scarcely offset. Lips rather closely approximated. Amphids cup-shaped; aperture narrow, elliptical, situated at level of anterior limit of stoma walls. *En face* view (of larva) shows a rounded hexagonal lip region, lips equal, inner edges pointed. Papillae in two rings, inner ring of eighteen papillae, (three on each lip arranged in an obtuse triangle), outer ring of ten papillae. Abutting edges of the stomal elements slightly thickened on the inner side only. In lateral view stoma barrel-shaped, broadly rounded at base; anterior aperture four-fifths of maximum stoma width. Dorsal tooth apex at 54-60 per cent of stoma length. Tooth apex sharply pointed, anterior edge slightly convex, almost horizontal; lower edge slightly convex in middle and merging with lower stoma wall a short distance anterior to the suture between the anterior and posterior elements. Dorsal wall indented below tooth. Anterior parts of dorsal and ventral walls similar, incurved anteriorly, ventral wall appears slightly thicker due to thickening at abutting edges of subventral elements. Dorsal posterior element shorter and thicker than subventrals. Suture between anterior and posterior elements clearly marked. Outer surface of stoma with fine transverse striae. Anterior four-fifths of stoma enveloped in thin muscle sheath; posterior fifth embedded in locally expanded oesophagus.

Oesophagus narrows rapidly behind stoma base to about half body-width and remains this width to nerve ring at one-third of its length, then gradually expanding to half body-width in conformity with general body contour. Dorsal oesophageal gland opens into oesophagus near middle; subventral glands discharge into posterior third.

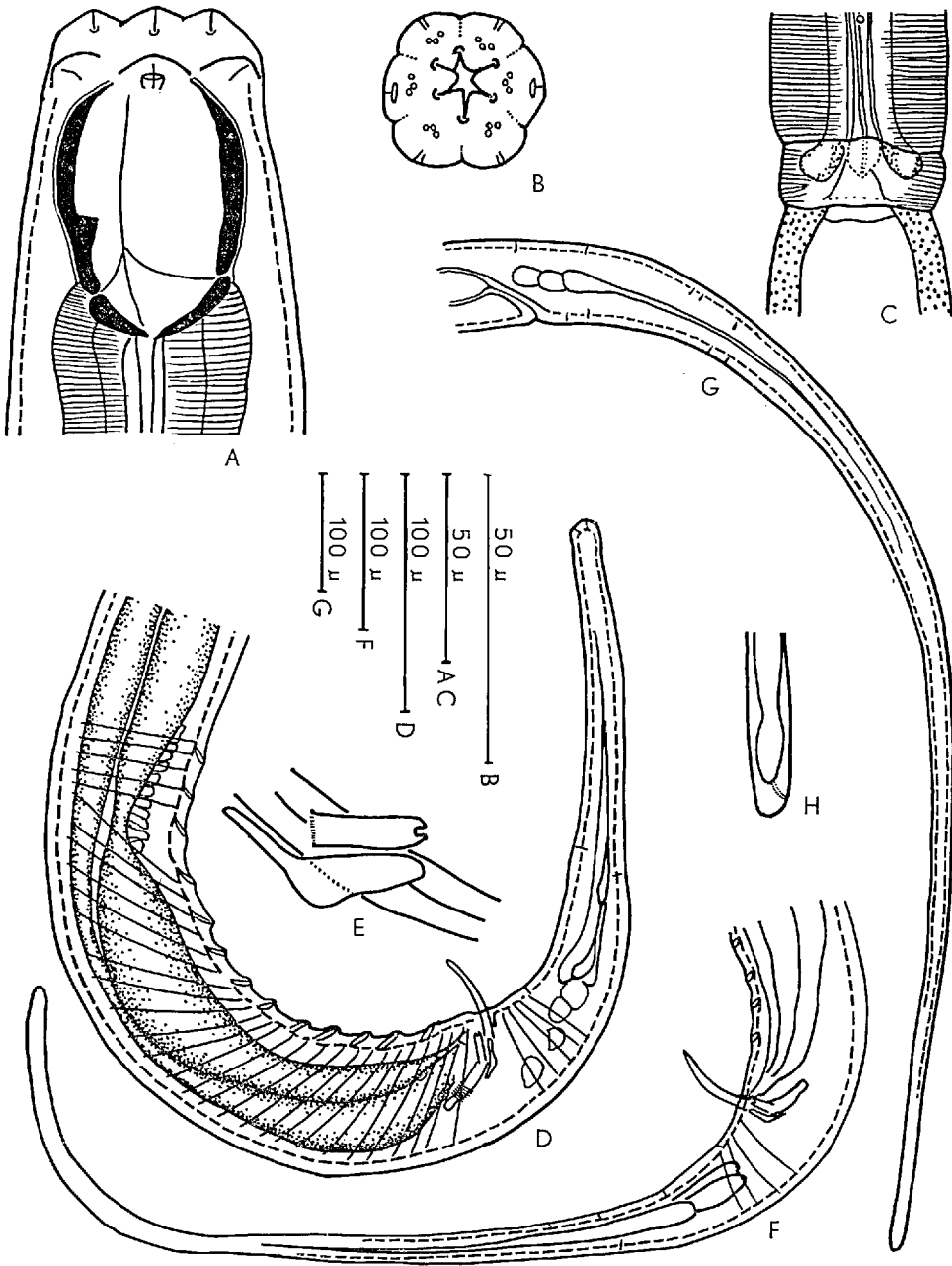

Fig. 3. *Iotonchus ophiocercus*. A. head region; B. *en face* view of lip region of larva; C. oesophago-intestinal junction; D. tail of paratype male; E. detail of gubernaculum, lateral accessory piece and spicule; F. tail of male allotype; G. female tail; H. tail tip.

Oesophago-intestinal junction tuberculate. Intestine a simple tube eight to twelve cells in diameter; cells packed with oil globules and dark granules.

Female Vulva transverse. Vagina with well developed musculature, extending half way across body. Uteri paired, opposed, outstretched, with a well developed sphincter muscle and glandular zone at the uterus-oviduct junction. Ovary reflexed through one-fifth of oviduct and uterus length. Ovary half as wide as body. A few cuticular pores sometimes present in the region of the vulva. Intestine passes to right of anterior ovary and to left of posterior one. Prerectum absent. Rectum straight, one anal-body-width long. Posterior anal lip slightly protuberant.

Tail very long, equal to one-fifth of the body length; tapering smoothly, ventrally arcuate, tip rounded. Caudal glands and sub-terminal duct present. Cuticular pores as shown in figure 3 G.

Male Testes paired, outstretched, opposed, sperms abundant; not arranged in any pattern. Vas deferens equal to testicular length; greatly dilated posterior to third supplement to become ejaculatory duct. Anterior half of ejaculatory duct much wider than posterior. Prerectum commences opposite fourth supplement. Spicules paired, free, slender, especially in distal half; heads knobbed; one and a quarter anal-body-widths long. Gubernaculum similar to that of *I. maragnus*. Lateral accessory pieces notched. Supplements eleven or thirteen, each with a low rounded papilla. Allotype male tail similar to female. Paratype male tail much shorter than other male or females. Caudal glands present; terminal duct not seen.

Specific differentiation. *I. ophiocercus* is unique in possessing a long tail ($c =$ about 5), and a tooth the apex of which lies near the middle of the stoma. Some species have a tail as long, or longer than *ophiocercus* (e.g. *trichurus*, *tenuidentatus*, *maragnus* and *percivali*), but all these have the tooth apex clearly in the posterior half of the stoma.

Type slides. All in Nematode Collection, Entomology Division, D.S.I.R., Nelson, N.Z.

Type locality. Johnson's Reserve, Barrytown, N.Z.M.S.1., S 37, 847223, 30 metres, in forest dominated by *Weinmannia racemosa* Linn. f. and tree ferns. Soil Ikamatua fine sandy loam (an immature podsol).

Other localities. Kumara Beach in *Hydrotyle* L.-*Trifolium repens* L. turf; Craigielachie, Otago in *Agrostis tenuis* L.-*Dactylis glomerata* L.-*Trifolium repens* L. pasture; Collingwood Pakihi, *Cladium teretifolium* R. Br., *Gleichenia circinata* Swartz, *Drosera pygmaea* DC.; Wharekohe, *Gleichenia circinata* Swartz, *Juncus* L. sp. *Leptospermum scoparium* Forst.

Remarks. This species has been collected from wet podsollic soils only.

Many specimens had nematode remains in the intestine; dorylaimoid spears and spicules as well as *I. ophiocercus* stomas have been seen.

The name is derived from the nature of the tail ($\delta\phi\iota\varsigma$ — a serpent, $\kappa\acute{\epsilon}\rho\alpha\varsigma$ — a tail).

Iotonchus parazschokkei (Allgén)

Figs. 4 A-F

Mononchus parazschokkei Allgén, 1929 p. 224 figs. 6a, b.*Mononchus (Iotonchus) parazschokkei* Goodey 1951 p. 272*Iotonchus parazschokkei* Andrásy 1958 p. 159

Males unknown. (For measurements of females see Table I).

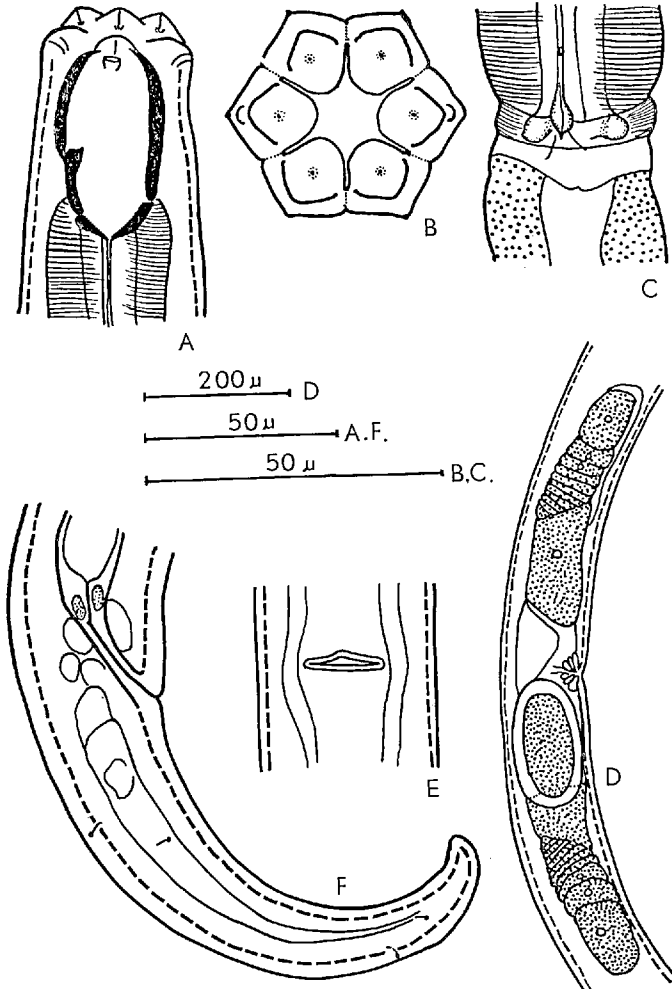

Fig. 4. *Iotonchus parazschokkei*. A. head region; B. *en face* view of lip region; C. oesophago-intestinal junction; D. female reproductive organs; E. ventral view of vulva; F. female tail.

Cuticle smooth, 3μ thick; no lateral fields. Subcuticle 1μ thick. Lip region scarcely offset. Amphids small, cup-like; aperture oval, situated posterior to outer lateral cephalic papilla. In *en face* view lip region hexagonal; lips equal and symmetrical, inner lips rounded, outer lips angular; inner ring with six papillae, outer

TABLE I
Measurements of Iotonchus parazschokkei females

| | <i>Kerikeri</i> | <i>Rerewhakaitu</i> | <i>Hongi's Track</i> | <i>Mt. Messenger</i> | <i>Arthur's Pass</i> | <i>Barrytown</i> | <i>Waitaanga Saddle</i> | <i>Lake Mahinapua</i> |
|-------------|-----------------|---------------------|--------------------------|--------------------------|--------------------------|------------------|-----------------------------|---------------------------|
| n | 4 | 10 | 2 | 1 | 18 | 2 | 10 | 11 |
| L (mm) mean | 1.28 | 1.50 | 1.57 | 1.79 | 1.90 | 2.20 | 2.34 | 2.37 |
| S.D. (mm) | ± 0.041 | ± 0.111 | -- | -- | ± 0.151 | -- | ± 0.207 | ± 0.183 |
| Range | 1.21-1.31 | 1.27-1.61 | 1.49-1.65 | 1.79 | 1.67-2.11 | 2.13-2.26 | 1.84-2.57 | 2.04-2.64 |
| a | 25-35 | 27-34 | 27-28 | 36 | 27-34 | 28-29 | 29-35 | 29-37 |
| b | 3.4-3.5 | 3.7-4.2 | 3.6 | 3.9 | 3.7-4.2 | 4.0-4.1 | 3.7-4.6 | 3.8-4.6 |
| c | 10.7-11.2 | 10.9-14.2 | 9.5-9.8 | 8.4 | 10.9-14.2 | 12.8-14.9 | 9.3-15.2 | 8.8-13.4 |
| a.o. 1) | 8-11 | 6-17 | 8-9 | 12 | 6-17 | 11-14 | 10-18 | 6-14 |
| V | 61-63 | 58-65 | 61-63 | 59.3 | 58-65 | 62-63 | 58-63 | 57-61 |
| p.o. 1) | 8-10 | 8-13 | 8-10 | 9 | 8-13 | 11-14 | 10-16 | 8-13 |

1) a.o. and p.o. anterior and posterior ovaries respectively.

ring with ten. Inner papillae situated on eminences near middle of each lip; outer papillae near the tips of the lips. Stoma circular in cross section.

In lateral view stoma heavily sclerotized, ovate, anterior end widest. Stoma widest at 47-55 per cent of its length. Dorsal tooth apex occurs at 46-56 per cent of the stoma length. Anterior edge of tooth straight or nearly so, sloping slightly posteriorly. Posterior edge of tooth slightly convex, quickly merging with general contour of posterior portion of stoma wall. Posterior to dorsal tooth outer surface of stoma is indented. Anterior to tooth dorsal wall is similar to, but thinner than the gently curving, anterior, ventral wall. The dorsal posterior element thicker and shorter than ventral ones. Posterior fifth of stoma embedded in slightly expanded end of oesophagus. Anterior four-fifths surrounded by a thin muscle sheath.

Oesophagus narrows a little to nerve ring, at one-third of its length, and then expands again, generally occupying half of body width. Oesophago-intestinal junction tuberculate with a well developed sphincter muscle. Intestine as usual. Vulva a transverse slit, one-third as wide as body, with thickened lips. Vagina thick walled, extending half way across body. Uteri paired, outstretched, opposed, and reflexed through half length of oviduct and uterus. Usually one or two eggs in the uteri at a time.

No prerectum. Rectum slightly arcuate, one to one and a quarter anal-body-widths long. Tail short, conoid, ventrally arcuate. Caudal glands present. No terminal duct. Three pairs of lateral cuticular pores present distributed as in fig. 4 F.

Specific differentiation. *I. parazschokkei* is similar to *I. amphigonius* (Thorne) and *I. zschokkei* (Menzel), but is distinguished by the longer tail.

Localities. Arthur's Pass and Takaka Hill in *Notbofagus* Blume forest litter; Lake Mahinapua in *Dacrydium cupressinum* Soland-*Quintinia acutifolia* T. Kirk forest litter; Barrytown in *Weinmannia racemosa* Linn. f.-tree fern litter; Four Mile River, Buller, and Sergeant's Hill from soil under *Gleichenia circinata* Swartz and *Sphagnum*; Iron Hill, Cobb River soil under *Cyperus alpina* R. Br.; Kerikeri soil under *Leptospermum scoparium* Forst. and *Hakea acicularis* R. Br.; Kiripaka *Beilschmiedia Tavaire* Benth. & Hook. f.-*Vitex lucens* T. Kirk forest litter; Hongi's Track *Beilschmiedia Tawa* Benth. & Hook. f.-*Knightsia excelsa* R. Br. forest litter; Rerewhakaitu soil under *Leptospermum scoparium* Forst. and *Poa caespitosa* Forst.; Waiotapu *Dacrydium cupressinum* Soland.-*Weinmannia racemosa* Linn. f. forest litter; Waitaanga Saddle in liverworts and mosses; Mt. Messenger *Olea Cunninghamhamii* Hook. f.-*Vitex lucens* T. Kirk forest litter.

Remarks. This species varies in length, but there are no conspicuous breaks in the series of measurements, or morphological differences between the largest and smallest specimens. It inhabits soil, moss and litter.

Iotonchus percivali n. sp.

Figs. 5 A-I

Holotype ♀ (Runanga) L = 5.94 mm; a = 71; b = 5.02; c = 3.79;
 $V = {}^{13} 51.5 {}^{13}$

Allotype ♂ (Reefton) L = 6.10; a = 74; b = 5.06; c = 4.15; T = 31

Cuticle 4 μ thick, smooth on body, annulated on tail. No lateral fields. Subcuticle 3 μ thick. Lip regions slightly offset, lips closely apposed, almost fused. Amphids cup-like; aperture narrow, situated near anterior end of sclerotized stoma. In *en face* view lip region circular, lateral lips smaller and more pointed on inner edge than sub-median lips. Outer edge of lips rounded. Papillae in two rings of six each. In lateral view sclerotized stoma is barrel-shaped, base broad; greatest width at one-quarter of its length where it occupies three-quarters of body-width. Dorsal tooth apex at 63 per cent of stoma length. Anterior edge of tooth straight, horizontal; apex rather blunt. Posterior edge of tooth intersects stoma wall at suture between anterior and posterior elements. Dorsal and ventral walls similar. Dorsal posterior element slightly thicker than subventrals. Suture between anterior and posterior elements distinct. Outer surface of stoma transversely striated. Subdorsal and sub-ventral cuticular pores near widest part of stoma. Muscular sheath about anterior part of stoma very thin. Anterior end of oesophagus expanded about stoma base, then narrowing to half body-width at nerve ring at one-fifth of oesophageal length, gently expanding beyond this to two-thirds body-width. Oesophago-intestinal junction tuberculate. Intestine with abundant oil droplets and dark granules.

Female Vulva transverse. Vagina thick walled, extending across half body-width. Uteri paired, outstretched, opposed, a strong sphincter and glandular region at uterus-oviduct junction. Upper part of uterus in holotype filled with sperm. Ovary half as wide as body, reflexed through one-third length of oviduct and uterus. Intestine passes to left of anterior ovary, and to right of posterior one. No pre-rectum; rectum slightly arcuate, length almost equal to anal-body-width. Tail ventrally flexed when fixed, long (26 per cent of body length), filiform, tip rounded. Caudal glands and terminal duct present. Cuticular pores few on proximal part of tail, more common on annulated distal two thirds.

Male Testes paired, opposed, outstretched, with abundant sperm randomly arranged. Vas deferens length equal to both testes. Opposite first supplement vas deferens expands to become ejaculatory duct, and the intestine narrows to form prerectum. Spicules paired, free, moderately heavy, knobbed on upper end with a thickened median rib on distal 85 per cent. Gubernaculum with thickened keel behind spicules and with lateral pieces which flank spicules. Parallel to and a little in front of lateral processes are notched, lateral accessory pieces. Supplements eighteen, low, papilliform, with rather sigmoid "cores". Tail similar to female.

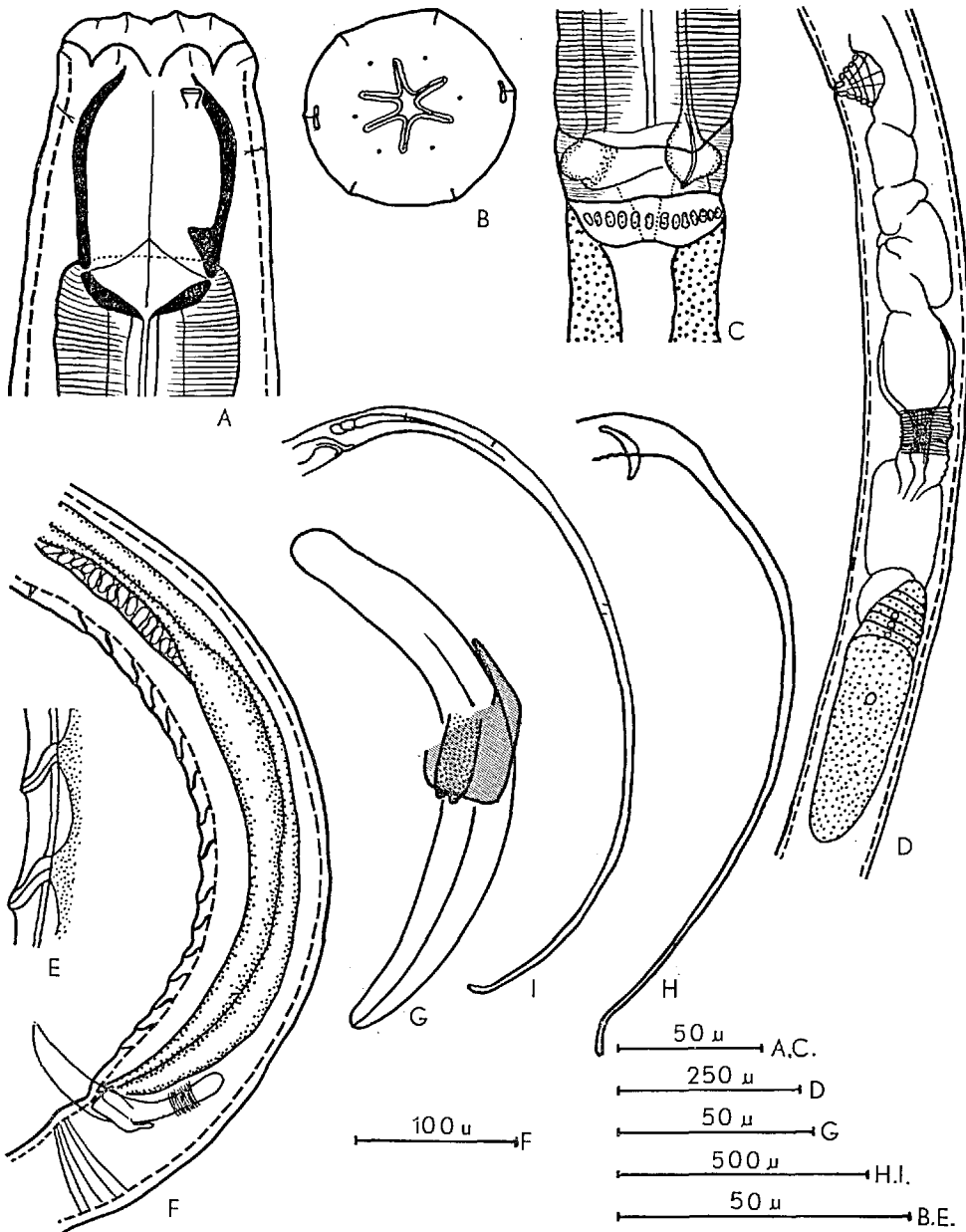

Fig. 5. *Iotonchus percivali*. A. head region; B. *en face* view of lip region; C. oesophago-intestinal junction; D. posterior limb of female reproductive system; E. male supplements; F. anal region of male; G. spicule, gubernaculum and lateral accessory piece; H. male tail; I. female tail.

Specific differentiation. Another species of the long-tailed group of *Iotonchus*; readily distinguished from all others by its large size, paired ovaries, median vulva and long tail.

Type slides. Entomology Division, D.S.I.R., Nelson, N.Z.

Type locality. Runanga, Westland, N.Z.M.S.1. S44, 774951, 20 metres. Very wet pasture, *Holcus lanatus* L., *Agrostis tenuis* L., *Juncus* L. sp., *Ranunculus repens* L.; soil: Karangarua fine sandy loam—a recent, poorly drained alluvial soil.

Other locality. Reefton in *Sphagnum* swamp.

Remarks. This species is named in honour of my teacher, the late Prof. E. Percival, of the University of Canterbury.

ZUSAMMENFASSUNG

Die Mononchiden (Enoplida, Nematoda) Neu-Seelands. 2. Die Gattung Iotonchus (Cobb, 1916) Altherr 1950.

Iotonchus (Cobb, 1916) Altherr 1950 wurde neu definiert. Die Gattung unterscheidet sich von *Mononchus* Bastian durch die tuberkulate Verbindung vom Oesophagus zum Darm, den Dorsalzahn, der ganz oder hauptsächlich in der hinteren Hälfte der Mundhöhle liegt, und durch die breite Basis der Mundhöhle. *I. jairi* (Lordello, 1959) n. comb. und *I. tenuidentatus* (Kreis 1924) n. comb. wurden aus der Gattung *Mononchus* in die Gattung *Iotonchus* überführt.

I. basidontus n. sp. unterscheidet sich von *I. gymnolaimus* und *I. constimilis* durch den Besitz von paarigen Ovarien. *I. maragnus* n. sp. ist durch den Besitz eines sehr langen fadenförmigen Schwanzes ($c = 2,3$ bis $2,9$) und die Lage der Vulva ($V = 36-39$) charakterisiert. *I. ophiocercus* n. sp. ist die einzige langgeschwänzte Art der Gattung mit der Zahnschuppe nahe der Mundhöhlenmitte. *I. percivali* n. sp. ist die grösste Art der Gattung ($L = 6$ mm). Sie hat einen langen Schwanz ($c = 3,8$ bis $4,1$), eine mittelständige Vulva und paarige Ovarien. *I. parazschokkei* (Allgén 1929) wurde neubeschrieben.

REFERENCES

- ALTHERR, E. (1950). Les nématodes de Parc National Suisse. *Ergebn. wiss. Unters. schweiz. Nat Parks* III 1-46.
- ANDRÁSSY, I. (1958). Über das System der Mononchiden (Mononchidae Chitwood, 1937; Nematoda). *Ann. Hist.-nat. Mus. hung.*, n.s. 9, 50, 151-171.
- CLARK, W. C., (1960). The oesophago-intestinal junction in the Mononchidae (Enoplida; Nematoda). *Nematologica*, 5, 178-183.
- COBB, N. A. (1916). Notes on new genera and species of nematodes. 4. Subdivisions of *Mononchus*. *J. Parasit.* 2, 195-196.
- (1917). The Mononchs (*Mononchus* Bastian, 1865) a genus of freeliving predatory nematodes, *Soil Sci.* 1, 431-486.
- PENNAK, R. W. (1953). *Freshwater Invertebrates of the United States*. New York, Ronald Press Co. 769 pp.

1. A REVISED CLASSIFICATION OF THE ORDER ENOPLIDA (NEMATODA)

By W. C. CLARK, Rothamsted Experimental Station, Harpenden, Herts,
England.*

(Received for publication, 5 December 1960)

Summary

The order Enoplida is re-classified into seven sub-orders mainly on the basis of the arrangement of the oesophageal glands and their ducts. The sub-orders recognised are Enoplina, Alaimina n. sub-order, Dorylaimina, Trichosyringina (composed of the Mermithoidea and Trichuroidea) and Diectophymatina. The Mononchidae are removed from the Tripyloidea and with the Bathyodontidae n. fam. (type genus *Bathyodontus* Fielding, 1950) comprise the Mononchoidea n. superfamily within the Dorylaimina. The Belondiridae and Nygolaimidae have been redefined, *Nygellus* Thorne, 1939 is transferred from the former to the latter and the Nygolaimellinae n. subfam. (type genus *Nygelolaimellus* Loos, 1949) erected. The Campydorinae are removed from the Leptonchidae and elevated to family rank. The Trichodorinae are given family rank, and with the Diphtherophoridae form the Diphtherophoroidea within the Dorylaimina. In the Trichuroidea four families and four subfamilies are recognised (Table 1). Skrjabin & Schikhobalova's 1954 proposal to unite the Trichuroidea with the Diectophymatina is rejected on the grounds of morphology and life history. It is considered that the life history of *Diectophyme renale* indicates a relationship between the Diectophymatina and the Gordiacea. The name *Octonchus* nom. nov. is proposed pro *Polydonus* Schultz, 1932 preocc., nec. *Polydonus* Blainville, 1826 a mollusc.

INTRODUCTION

Filipjev (1934) and Chitwood (1937) have rendered a signal service to nematology in leading the way towards a satisfactory classification of the Nematoda as a whole. Chitwood's (1937) classification was reprinted in expanded form in Chitwood and Chitwood's (1937) "*Introduction to Nematology*", and again with some modifications in the revised edition of 1950. T. Goodey (1951) in "*Soil and Freshwater Nematodes*" used the Chitwoods' 1937 classification for the most part, with modifications from Thorne (1939) in the Dorylaimoidea. The later works of the Chitwoods, T. Goodey, and Thorne have firmly established the main points of Chitwood's 1937 classification of the Enoplida for workers on soil and plant parasitic nematodes. Workers on marine nematodes use a slightly different classification; e.g. Wieser (1953a) regards all the subfamilies of the Enoplidae as families. The taxonomy of the Enoploidea needs extensive study; that proposed here will suffice in the interim. Because of the small number of animal parasitic genera contained within the Trichuroidea and the Diectophymatina animal parasitologists have, with the exception of Russian workers, been little concerned of late with the higher classification of this order. The exception is Skrjabin & Schikhobalova in Skrjabin, Schikhobalova, Sobolev, Paramonov & Svaarikov (1954) who have proposed a number of changes in the classification of these forms. The suggested changes include the removal of the Trichocephalata (suborder) Skrjabin &

*At present on study leave from Entomology Division, D.S.I.R., Nelson, New Zealand.

Shultz, 1928 (= Trichuroidea Railliet, 1916) from the Enoplida and uniting them with Diactophymata Skrjabin, 1927 (suborder) under the name Trichocephalida Spasski, 1954 in Skrjabin *et al.*, 1954. No reasons are given for these changes.

If the Trichuroidea are to be united with any other group at the ordinal or subordinal level their logical partners are the Mermithoidea with which they share many features, e.g. the oesophageal glands are represented by a stichosome outside the contour of the oesophagus, pore-like amphids, often a single spicule, and the presence of a stylet in the larval stage which, as Fülleborn (1923) pointed out, suggests an affinity between the two groups. The stylet occasionally persists in adults of both superfamilies. The Diactophymatina on the other hand are characterised by the presence of highly polynucleate oesophageal glands, which discharge anteriorly, contained within the contour of the oesophagus, and a conspicuous caudal sucker in the males – all features not found in the Trichuroidea. Woodhead (1950) has confirmed the observation of Lukasiak (1930) that the first stage larva of *Diactophyme renale* possesses a stylet. This may be regarded as indicative of an affinity between the diactophymatids, the trichurids, mermithids, and the dorylaimids, and would justify the retention of all these groups within the Enoplida. Primarily because of the differences in the arrangement of the oesophageal glands, and because of the occurrence of a *Gordius*-like stage in the life history I prefer to keep the Diactophymatina separate from the Trichuroidea, though admitting a degree of affinity on other grounds as suggested by Rauther (1918).

The great similarity of life history and of the morphology of larval stages of *Diactophyme renale* (Woodhead, 1950) and gordiids appears to indicate that these two groups may be much closer phylogenetically than has hitherto been supposed.

The presence of a dorylaimoid oesophagus in the Tetradonematidae, a dorylaimoid spear in all mermithid larvae, and of cyathiform amphids in some, as well as the pre-anal supplements in males point as Steiner (1917) and Filipjev (1934) have suggested, to an affinity between the Mermithidae and the Dorylaimoidea. In the work which follows Skrjabin *et al.*'s proposals are rejected.

Hyman (1951) gave a classification of the Nematoda into 17 orders without higher groups. The diagnoses are vague and insufficiently precise to be useable. The Chitwoods' (1937) division into two main groups Phasmidia or Sercenentea, and Aphasmidia or Adenophorea is retained as a matter of taxonomic expediency. The usefulness of these divisions in practical nematology is doubtful.

The present study arose out of the writer's work on the Mononchidae (Clark, 1960 a, b, c 1961 a, b, c) during the course of which it became apparent that the Mononchidae had very little in common with the rest of Chitwood's Triplyloidea, but much in common with the Dorylaimoidea. As it is now over twenty years since Chitwood's classification was erected and as much new knowledge has become available in the meantime the opportunity is taken to incorporate this into the existing framework and to make such changes as seem necessary.

TABLE 1—Proposed Classification of the Enoplida
Order ENOPLIDA

| Suborder | Superfamily | Family | Subfamily |
|----------------------|-------------------|---------------------------------------|---|
| ENOPLINA | ENOPLIOIDEA | ENOPLIDAE | { Enoplinae Leptosomatinae Phanodermatinae Oxystominae |
| | | LURATONEMATIDAE | |
| | TRIPYLOIDEA | ONCHOLAIMIDAE | { Oncholaiminae Eurystominae Enchilidiinae |
| | | TRIPYLIDAE | |
| | | IRONIDAE | { Ironinae Cryptonchinae |
| ALAIMINA | | ALAIMIDAE | |
| DORYLAIMINA | MONONCHOIDEA | MONONCHIDAE | |
| | | BATHYDONTIDAE | |
| | DORYLAIMOIDEA | DORYLAIMIDAE | { Dorylaiminae Actinolaiminae Tylencholaiminae |
| | | OPAILAIMIDAE | |
| | | BELONDIRIDAE | |
| | | NYGOLAIMIDAE | { Nygolaiminae Nygolaimellinae |
| | LEPTONCHIDAE | | |
| | CAMPYDORIDAE | | |
| | DIPHATHEROPHOIDEA | { DIPHATHEROPHORIDAE TRICHODORIDAE | |
| TRICHOSYRIN- GINA | MERMITHOIDEA | MERMITHIDAE | |
| | | TETRADONEMATIDAE | |
| | TRICHUROIDEA | TRICHURIDAE | { Trichurinae Capillariinae |
| | | TRICHOSOMOIDIDAE | { Trichosomoidinae Anatrichosomatinae |
| | TRICHNELLIDAE | | |
| | CYSTOOPSIDAE | | |
| DIOCTOPHY- MATINA | | DIOCTOPHYMATIDAE | { Dioctophymatinae Eustrongylidinae |
| | | SOBOLIPHYMATIDAE | |

PROPOSED CLASSIFICATION

Chitwood's classification into suborders is based in part on the nature of the oesophageal glands and their ducts. It is proposed to utilise this character more fully in the subdivision of the Enoplida. On this basis it is possible to divide the order into five readily definable suborders (see Table 1 and Fig. 1). The type and arrangement of the oesophageal glands and their ducts in the different suborders is shown schematically in Fig. 1. In the Enoplina the oesophageal glands are uni- or multi-nucleate and at least three of the glands discharge into the oesophageal lumen anterior to the nerve ring, commonly in the stomatal region. In the Alaimina n. suborder there appears to be seven uninucleate oesophageal glands which discharge anterior to the nerve ring. The Dorylaimina are characterised by having five (only three in *Leptonchus*) usually uninucleate oesophageal glands with all the ducts posterior to the nerve ring. In the Trichosyringina the oesophageal glands lie outside the contour of the oesophagus as a stichosome. Highly polynucleate, dichotomously branching oesophageal glands which lie within the contour of the oesophagus and which discharge anteriorly to the nerve ring characterise the Diectophymatina.

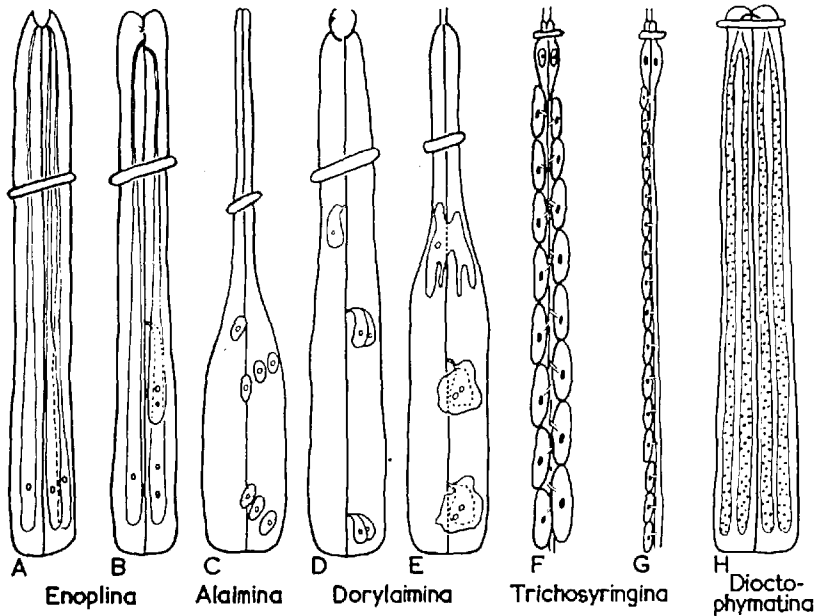

FIG. 1.—Diagrams illustrating the various arrangements of the oesophageal glands and their ducts in the Enoplida. A. Enoploidea, B. Tripyloidea, C. Alaimidae, D. Mononchoidea, E. Dorylaimoidea, F. Cystoospsidae, G. Mermithoidea and Trichuroidea excluding Cystoospsidae, H. Diectophymatina. (Partly after Chitwood & Chitwood.)

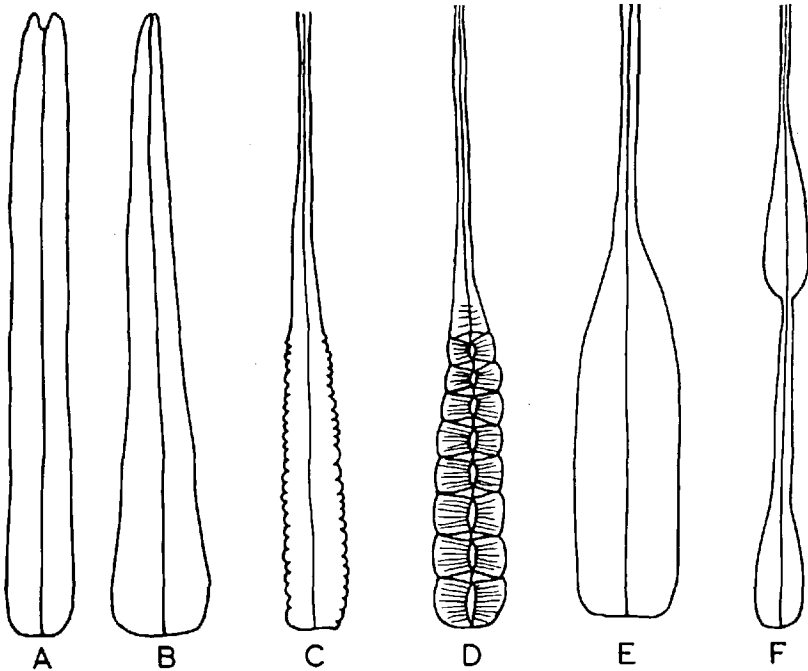

FIG. 2.—Diagrams to illustrate the terminology used to describe types of oesophagus. A. cylindroid, B. conoid, C. crenate, D. multibulbar, E. dorylaimoid, F. bi-bulbar.

At the level of superfamilies fewer changes have been made. The conception of the Tripyloidea has altered somewhat since 1937. Thorne (1939) removed the Alaimidae to the Dorylaimoidea. In 1950 the Chitwoods moved the Ironidae from the Enopliodea to the Tripyloidea, but retained the Alaimidae in the Tripyloidea. In the present scheme the Alaimidae are transferred to a newly created suborder Alaimina. The Alaimidae did not conform with the other members of the Tripyloidea, nor with other members of the Dorylaimoidea. The Alaimina possess a number of dorylaimoid and tripyloid characters as well as some special ones of their own. These characters are mentioned in Table 2. The greatly reduced stoma of the Alaimids is reminiscent of some Ironidae and male Enchilidiinae.

On balance it seems that the Alaimina may have an ancestry with much in common with the Tripyloidea and Dorylaimoidea, but have diverged along a different evolutionary line.

The Mononchidae have also been removed from the Tripyloidea, and in combination with the Bathyodontidae n. fam. form the Mononchoidea within the Dorylaimina. The Mononchidae have very little in common with the Tripyloidea, but share the following features with the Dorylaimoidea: similar arrangement of the oesophageal gland cells and their ducts; the absence of cephalic setae; a greatly reduced excretory system; the common occurrence of a sphincter muscle and glandular region at the junction of the

oviduct and uterus (T. Goodey, 1942, J. B. Goodey, Peacock and Pitcher 1960, Clark 1961 b, c); the large number of preanal supplements; the presence of cuticular caudal pores, and the occupation of the same general type of habitat.

TABLE 2—The Distribution of Certain Characters in the Alaimina, Dorylaimoidea, and Tripyloidea

| Character | ALAIMINA | DORYLAIMOIDEA | TRIPYLOIDEA |
|--|----------|---------------|-------------|
| Stoma unarmed, reduced | + | --- | — |
| seven oesophageal glands | + | — | — |
| testis single | + | — | — |
| oesophagus dorylaimoid | + | + | — |
| pair of adanal supplements present | — | + | — |
| prerectum present | — | + | — |
| spicules tripyloid | + | — | + |
| oesophageal gland ducts ant. to nerve ring | + | — | + |
| gubernaculum present | — | — | + |
| caudal glands present | — | — | + |
| cephalic setae present | — | — | + |

The Dorylaimoidea have been further restricted to exclude the Diphthero-phoridae (*sensu* Thorne, 1939) which have been raised to superfamily rank. The presence of the Diphthero-phoridae within the Dorylaimoidea has long been a matter of doubt, and because they differ from the rest of the Dorylaimoidea in so many characters e.g. a different type of spear, the presence of a gubernaculum, a distinct excretory pore, an unpaired testis, and the absence of a prerectum and adanal supplements it is considered advisable to remove them from the Dorylaimoidea. This action emphasises their distinctive characters and makes the Dorylaimoidea a more compact group. The Diphthero-phoroidea may have to be removed from the Dorylaimina in the future.

In the following section the changes which have been made in the families, subfamilies and the distribution of genera and species are noted after the diagnoses of the relevant groups.

DIAGNOSES

In the diagnoses information given in the higher categories is not mentioned again in the lower ones except to restrict the diagnoses of the lower category. In the lists of genera synonyms are not new unless marked as such.

Order ENOPLIDA

Adenophorea. Amphids pocket-like to pore-like or tuboid; caudal glands present or absent; subventral oesophageal glands opening either near anterior end of oesophagus or in posterior half; glands sometimes duplicate, rarely polynucleate; or outside the contour of the oesophagus as a stichosome; oesophagus cylindroid or conoid, rarely bi- or multi-bulbar, commonly with a narrow anterior part and a wider glandular posterior part, or greatly attenuated. Setae present or absent. Habitat - marine, freshwater, soil, parasitic in arthropods and vertebrates.

Suborder ENOPLINA

Enoplida. Head usually bearing 6 + 10, 10, or 6 + 4 setae (setae absent in a few scattered genera); amphids usually pocket-like; typical stylet absent; three or more oesophageal glands opening in the stomatal region, glands mostly uninucleate; oesophagus grossly cylindrical, conoid; or multibulbar; intestine functional; ovaries reflexed, female reproductive system simple; male with two spicules (very rarely none or one); muscular caudal sucker absent; caudal glands usually present; hypodermal glands commonly well developed; excretory system absent or consisting of one ventral cell. Polymyarian or meromyarian. Habitat - mainly marine or freshwater, some genera in moist soil.

Superfamily ENOPLIOIDEA Schuur.-Stekh. & de Coninck, 1933

Enoplina. Cuticle of head duplicate; males with 0, 1 or 2 supplements.

Family ENOPLIDAE Baird, 1853

Enoploidea. Stomatorhabdions poorly sclerotised; with or without mandibles; without a distinct stomatal capsule; stoma surrounded by oesophageal tissue. Type genus: *Enoplus* Dujardin, 1845.

Subfamily ENOPLINAE Micoletzky, 1922

Enoplidae. With three bifurcate mandibles; oesophagus cylindrical; amphids pocket like; males with one tuboid preanal supplement. Type genus: *Enoplus* Dujardin, 1845.

Other genera—

Enoploides Savaljav, 1912

Enoplolaimus de Man, 1893

Enoploneuma Kreis, 1934

Epacanthion Wieser, 1953

Hyalacanthion Wieser, 1959

Mesacanthion Filipjev, 1927

Mesacanthoides Wieser, 1953

Metenoploides Wieser, 1953

Oxyonchus Filipjev, 1927

Paramesacanthion Wieser, 1953

Parasavaljevia Wieser, 1953

Parenoplus Filipjev, 1927

Rhabdodemia Bayliss & Daubney,
1926

Savaljevia Filipjev, 1927

Trichenoplus Mawson, 1956

n. syn. *Filenoplus* Mawson 1956

Genera doubtfully included—

Chaetonema Filipjev, 1927*Fenestrolaimus* Filipjev, 1927*Donsinema* Allgén, 1949

Subfamily LEPTSOMATINAE Micoletzky, 1922

Enoplidae. Without mandibles; posterior part of oesophagus distinctly muscular; oesophagus usually cylindrical, rarely conoid, never vesiculate; subventral oesophageal glands may be multinucleate. Amphids pocket-like; males with one or two tuboid supplements (rarely absent, *Stenolaimus*). Type genus: *Leptosomatium* Bastian, 1865.

Other genera—

Anticoma Bastian, 1865*Paranticoma* Micol. & Kreis, 1930*Anticomopsis* Micol. & Kreis, 1930*Platycoma* Cobb, 1893*Antopus* Cobb, 1913*Platycomopsis* Ditlevsen, 1926*Barbonema* Filipjev, 1927(syn. *Dactylonema* Filipjev, 1927)*Cylicolaimus* de Man, 1890*Stenolaimus* Marion, 1870(?syn. *Nudolaimus* Allgén, 1929)*Synonchus* Cobb, 1893*Jägerskiöldia* Filipjev, 1916(syn. *Fiacra* Southern, 1914)*Leptosomatides* Filipjev, 1918*Thoracostoma* Marion, 1870*Leptosomatina* Allgén, 1951(syn. *Deontostoma* Filipjev, 1916)*Leptosomella* Filipjev, 1927*Triodontolaimus* de Man, 1893*Metacylicolaimus* Schuur.-Stekh.,
1946*Tubolaimella* Cobb, 1933

Genus doubtfully included—

Xennella Cobb, 1920

Subfamily PHANODERMATINAE Filipjev, 1927

Enoplidae. Amphids not elongate; mandibles absent; stoma rudimentary; oesophagus conoid, posterior part crenate in outline, muscles reduced; 10 cephalic setae; male with one or two tuboid supplements. Type genus: *Phanoderma* Bastian, 1865 (syn. *Cophonchus* Cobb, 1920 and *Heterocephalus* Marion, 1870).

Other genera—

Crenopharynx Filipjev, 1934*Phanodermatina* Allgén, 1939*Klugea* Filipjev, 1927*Phanodermella* Kreis, 1928(?syn. *Gullmarnia* Allgén, 1929)*Phanodermopsis* Ditlevsen, 1926*Micoletzki* Ditlevsen, 1926(syn. *Galeonema* Filipjev, 1927)*Nasimema* Filipjev, 1927

Subfamily OXYSTOMININAE Micol. 1924

Enopliidae. Stoma unarmed; oesophagus conoid with smooth outline; musculature weak; cephalic setae usually 6, post cephalic setae 4; amphids usually elongate, often tuboid internally. Males without preanal supplements. Type genus: *Oxystoma* Bütschli, 1874 with two subgenera *Oxystoma* s. str. (syn. *Oxystomatina* Filipjev, 1918; *Acoma* Steiner, 1916; *Schistodera* Cobb, 1920; and *Nemanemella* Filipjev, 1927) and *Nemanema* Cobb, 1920.

Other genera—

Augustinema Cobb, 1933

Halalaimoides Cobb, 1933

Halalaimus de Man, 1888

Porocoma Cobb, 1920

Thalassoalaimus de Man, 1893

Trefusia de Man, 1893

with subgenera—

Halalaimus s. str.

(syn. *Nuada* Southern, 1914)

Tynnodora Cobb, 1902

Pachydora Wieser, 1953

Doubtful genera—

Asymmetrica Kreis, 1929

Paroxystomatina Micol., 1922

Family LAURATONEMATIDAE Gerlach, 1954

Enoploidea. Stoma lightly to moderately sclerotised, unarmed; oesophagus cylindroid, 10 cephalic setae, ovary single, anterior; uterus discharges into cloaca, no externally opening vulva. Males with one testis, no supplements or gubernaculum; spicules straight or nearly so. Cuticle distinctly annulated. Type genus: *Lauratonema* Gerlach, 1954.

Family ONCHOLAIMIDAE Baylis & Daubney, 1926

Enoploidea. Stomatorhabdions heavily sclerotised; stoma somewhat capsuliform, only the posterior part surrounded by oesophageal tissue. Type genus: *Oncholaimus* Dujardin, 1845.

Subfamily ONCHOLAIMINAE Micol. 1922

Oncholaimidae. Oesophagus cylindroid, never crenate or multibulbar; supplement absent or pedunculate. Type genus: *Oncholaimus* Dujardin, 1845.

Other genera—

- | | |
|---|--|
| <i>Adoncholaimus</i> Filipjev, 1918 | <i>Octonchus</i> nom. nov. pro |
| <i>Anoncholaimus</i> Cobb, 1920 | <i>Polydontus</i> Schultz, 1932, see below |
| <i>Anoncholaimus</i> Schuur.-Stekh., 1950 | <i>Oncholaimellus</i> de Man, 1890 |
| <i>Anoplostoma</i> Bütschli, 1874 | <i>Oncholaimoides</i> Chitwood, 1937 |
| <i>Cacolaimus</i> Kreis, 1932 | <i>Oncholaimium</i> Cobb, 1930 |
| <i>Convexolaimus</i> Kreis, 1928 | <i>Pelagonema</i> Cobb, 1893 |
| <i>Dioncholaimus</i> Kreis, 1932 | (syn. <i>Cavilaimus</i> Wieser, 1952) |
| <i>Doryonchus</i> Kreis, 1932 | <i>Pelagonemella</i> Kreis, 1932 |
| <i>Filipjevina</i> Ditlevsen, 1928 | <i>Phaenoncholaimus</i> Kreis, 1932 |
| <i>Filoncholaimus</i> Filipjev, 1927 | <i>Pontonema</i> Leidy, 1856 |
| <i>Krampia</i> Ditlevsen, 1928 | (syn. <i>Paroncholaimus</i> Filip., 1916) |
| <i>Meroviscosia</i> Kreis, 1932 | <i>Prooncholaimus</i> Micol., 1924 |
| <i>Metaparoncholaimus</i> de Coninck & Schuur.-Stekh. 1933 | <i>Pseudopelagonema</i> Kreis, 1932 |
| <i>Metoncholaimoides</i> Wieser, 1953 | <i>Steineriella</i> Ditlevsen, 1928 |
| <i>Metoncholaimus</i> Filipjev, 1918 | <i>Trileptium</i> Cobb, 1933 nom. nov. |
| <i>Mononcholaimus</i> Kreis, 1924 | pro <i>Trilepta</i> Cobb, 1920 |
| <i>Mononchulus</i> Cobb, 1918 | <i>Vasculanema</i> Kreis, 1928 |
| | <i>Viscosia</i> de Man, 1890 |

Remarks. Wieser (1953) has already remarked that *Anoncholaimus* Schuur.-Stekh., 1950 is a homonym of *Anoncholaimus* Cobb, 1920. He also suggested that it may be synonymous with *Pelagonema* Cobb, 1893. In the meantime I prefer to leave this name to be dealt with by the next reviser who shall either confirm the synonymy or propose a new name. I propose the new name *Octonchus* for *Polydontus* Schultz, 1932 which is preoccupied by *Polydontus* Blainville, 1826 (a mollusc). *Polydontus marinus* Schultz, 1932 will become *Octonchus marinus* n. comb.

Subfamily EURYSTOMINAE Filipjev, 1934

Oncholaimidae. Oesophagus conoid, crenate, or multibulbar; stoma similar in both sexes, large, divided by one or more bands, rings or rows of denticles into two chambers. Large tooth broad with a large base. Spicules short, arcuate, gubernaculum usually with a dorsal apophysis; males with two (rarely one or none) cup-like sclerotised supplements. Amphid apertures transverse, oval or reniform. Type genus: *Eurystomina* Filipjev, 1918.

Other genera—

- | | |
|-------------------------------------|---|
| <i>Bolbella</i> Cobb, 1920 | <i>Megeurystomina</i> Luc & de Coninck, 1959 |
| <i>Ditlevsenella</i> Filipjev, 1927 | <i>Pareurystomina</i> Micol. & Kreis, 1930 |
| <i>Ledovitia</i> Filipjev, 1927 | <i>Thöonchus</i> Cobb, 1920 |

Subfamily ENCHILIDIINAE Micol., 1924

Oncholaimidae. Oesophagus conoid, sometimes crenate or multibulbar; showing sexual dimorphism in the stomatal region, males without a stoma, females and larvae generally with a stoma divided by a number of trans-

verse rings (sometimes faint and irregular giving the impression of two chambers in *Calyptronema*) into several chambers. Large tooth of female slender, spine-like with a narrow base. Amphid aperture roundish or longitudinal. Spicules elongated, gubernaculum without apophysis. Preanal supplements papilloid. Type genus: *Enchilidium* Nordman, 1840 (nom. nov. pro *Enchelidium* Ehrenb., 1836).

Other genera—

| | |
|---|--|
| <i>Calyptronema</i> Marion, 1870 | <i>Conistomella</i> Schuur-Stekh., 1942 |
| with two subgenera— | <i>Enchilidiella</i> Allgen, 1954 |
| <i>Calyptronema</i> s. str. | <i>Polygastrophora</i> de Man, 1922 |
| (syn. <i>Catalaimus</i> Cobb, 1920 | (syn. <i>Polygastrophorella</i> Schuur.- |
| <i>Rhinoplostoma</i> Allgen, 1929) | Stekh., 1935) |
| <i>Dilaimus</i> Filipjev, 1927 | <i>Symplocostoma</i> Bastian, 1865 |
| (syn. <i>Bradystoma</i> Schuur.-Stekh., | <i>Symplocostomella</i> Micol., & Kreis, |
| 1943) | 1930 |

Superfamily TRIPYLOIDEA Chitwood, 1937

Enoplina. Cuticle of head not duplicate; dorsal and at least two of the subventral oesophageal gland cells discharge anteriorly to the nerve ring (the situation in *Cryptonchus* is not clear). Supplements one or more, often papilloid. Habitat — marine, brackish, or freshwater, and soil. Type genus: *Tripyla* Bastian, 1865.

Family TRIPYLIDAE Oerly, 1880

Tripylloidea. Dorsal and two subventral glands opening in stomatal region. Stomatal walls not heavily sclerotised, stoma either funnel-shaped, or a slender tube with an inconspicuous median dorsal tooth; oesophago-intestinal valve large. Spicules almost straight, gubernaculum present; supplements three or more; caudal glands present. Type genus: *Tripyla* Bastian, 1865. (syn. *Trischistoma* Cobb, 1913).

Other genus: *Tobrilus* Andrásy, 1959 (nom. nov. pro *Trilobus* Bastian, 1865 preocc.).

Family IRONIDAE de Man, 1876

Tripylloidea. Dorsal and subventral glands open near stoma; stoma well developed, heavily sclerotised, cylindrical; with or without setae; amphids pocket-like; one preanal seta present in some males; gubernaculum present. Type genus: *Ironus* Bastian, 1865.

Subfamily IRONINAE Micol., 1922

Ironidae. With three or more teeth at anterior end of stoma; cephalic setae sometimes present; oesophago-intestinal valve small. Type genus: *Ironus* Bastian, 1865 (syn. *Cephalonema* Cobb, 1893).

Other genera—

Conilia Gerlach, 1954*Dolicholaimus* de Man, 1888*Ironella* Cobb, 1920*Parironus* Micol., 1930*Syringolaimus* de Man, 1889*Tbalassironus* de Man, 1889*Trissonchulus* Cobb, 1920

Subfamily CRYPTONCHINAE Chitwood, 1937

Ironidae. With one or two small teeth at the base of the stoma; no cephalic setae. Fresh water forms. Type genus: *Cryptonchus* Cobb, 1913 (syn. *Ditleusenina* Micol., 1925).

Suborder ALAIMINA n. suborder

Enoplida. Stoma vestigial, unarmed; amphids with crescentic apertures (*Amphidelus*), or minute, pore-like (*Alaimus*), commonly placed far back from lip region. Oesophagus dorylaimoid, enlarged only in terminal third. No definite prerectum. Testis single, adanal supplements absent, spicules triploid, no gubernaculum. Type genus: *Alaimus* de Man, 1880.

Family ALAIMIDAE Micol., 1922

Alaimina defined as above. Type genus: *Alaimus* de Man, 1880.

Other genus: *Amphidelus* Thorne, 1939

Doubtful genus: *Adorus* Thorne, 1939

Suborder DORYLAIMINA

Enoplida. Setae absent. All oesophageal gland duct orifices posterior to nerve ring; oesophageal glands uninucleate, contained within the wall of the oesophagus; oesophagus cylindroid (Mononchoidea), or basically consisting of a slender anterior part and an expanded posterior part, typically without valves, rarely bi-bulbar (Nygolaimellinae). Oesophagus never degenerate. Axial stylet or mural tooth or teeth present. Males with ventro-median supplements and two spicules. Caudal glands present in Mononchoidea only. Excretory pore generally absent or rudimentary except in Diphtherophoroidea. Mostly free-living in soil or fresh water, rarely marine (some Dorylaiminae) or plant parasitic (some Tylencholaiminae and Diphtherophoroidea).

Superfamily MONONCHOIDEA n. superfam.

Dorylaimina. Oesophagus cylindroid, widening slightly from anterior to posterior end, one dorsal and four subventral, uninucleate oesophageal gland cells. Stoma sclerotised bearing a mural tooth or teeth. Caudal glands typically present. Type genus: *Mononchus* Bastian, 1865.

Family MONONCHIDAE Chitwood, 1937

Mononchoidea. Stoma large, barrel- or cup-shaped, heavily sclerotised, bearing an immovable dorsal tooth with or without subventral teeth, and/or denticles. Amphids small, apertures slit-like. Gubernaculum present, complex lateral accessory pieces commonly present. Caudal glands usually present. Predacious nematodes free-living in soil or freshwater. Type genus: *Mononchus* Bastian, 1865.

Other genera—

| | |
|--|--|
| <i>Anatonchus</i> (Cobb, 1916) de Con- inck, 1939 | <i>Judonchulus</i> Andrásy, 1958 |
| <i>Brachonchulus</i> Andrásy, 1958 | <i>Mylonchulus</i> (Cobb, 1916) Pennak, 1953 |
| <i>Cobbonchus</i> Andrásy, 1958 | <i>Miconchus</i> Andrásy, 1958 |
| <i>Granonchulus</i> Andrásy, 1958 | <i>Prionchulus</i> (Cobb, 1916) Chitw. & Chitw., 1937 |
| <i>Iotonchus</i> (Cobb, 1916) Altherr, 1950 | <i>Sporonchulus</i> (Cobb, 1916) Pen- nak, 1953 |

Family BATHYODONTIDAE n. fam.

Mononchoidea. No setae. Stoma cylindrical, narrow, composed of anterior and posterior sets of three abutting plates (as in *Mononchus*), the anterior ones more heavily sclerotised than the posterior ones. The posterior elements, or the posterior limit of the anterior ones bearing a single tooth. Tooth left subventral in *Miraliamus* and *Bathyodontus*, and reputedly dorsal in *Oionchus*. Amphids cup-shaped, small. Ovaries single or paired, reflexed; tail short, rounded; caudal glands and terminal duct present. Only females known. Free-living in soil. Type genus: *Bathyodontus* Fielding, 1950.

Other genera—

| | |
|---------------------------------|----------------------------|
| <i>Mirolaimus</i> Andrásy, 1956 | <i>Oionchus</i> Cobb, 1913 |
|---------------------------------|----------------------------|

Remarks. This new family is erected for the reception of genera previously assigned to the Nygolaiminae. They differ from other genera in that subfamily in the form of the oesophagus and the presence of caudal glands and duct. Observations on living *Mirolaimus* confirm that the caudal gland acts as an adhesive organ. In *en face* view the similarity of *Mirolaimus* and the mononchids is remarkable. *Oionchus* alone possesses the glands at the oesophago-intestinal junction which are also found in the Nygolaims. There are indications that the Bathyodontidae may represent a transitional group between the Mononchoidea and the Dorylaimoidea, and that their kinship lies with the Nygolaimidae rather than with the Dorylaimidae. Knowledge of the males is desirable before this line of argument is pursued. *Enoplochilus* Kreis, 1932, once thought to be close to *Oionchus* is not placed in this classification. It may belong near the Eurystominae on the evidence of the reniform amphid, but it has nothing to do with the Dorylaimina.

Superfamily DORYLAIMOIDEA Thorne, 1934

Dorylaimina. Oesophagus basically consisting of a slender anterior part and an expanded posterior part; cephalic papillae in two rings, 6 in the inner and 10 in the outer; amphid apertures posterior to the cephalic papillae. Amphids stirrup-shaped or pouch-like with slit-like or ellipsoidal apertures. Stoma armed with an axial spear with a dorsal aperture, or a mural tooth. Lateral pores and prerectum present. Supplementis consisting of a ventro-median series and an adanal pair. Testes two. No caudal glands.

Family DORYLAIMIDAE de Man, 1876

Dorylaimoidea. Polymyarian. Amphids with obscure slit-like apertures. Stoma with an axial spear; oesophagus enlarged in posterior third or more, enlarged part not surrounded by a spiral sheath of connective tissue (a non-spiral sheath in *Drepanodorus striatus* (Krall, 1958)). Cuticle generally with minute transverse striae, sometimes with wing-like longitudinal striae over the whole body (certain species of *Dorylaimus* and *Actinolaimus*). Spicules with lateral guiding pieces; gubernaculum absent. Type genus: *Dorylaimus* Dujardin, 1845.

Subfamily DORYLAMINAE Filipjev, 1918

Dorylaimidae. Spear axial, spear or extensions not greatly elongated, without basal knobs, flanges, or tripartite extensions. Ovaries one or two. (Only species with sheath of connective tissue about enlarged part of oesophagus *Drepanodorus striatus* (Krall, 1958) which is characterised by also having the spear aperture longer than half the spear length.) Type genus: *Dorylaimus* Dujardin, 1845.

Other genera—

| | |
|--|---|
| <i>Amphidorylaimus</i> Andrassy, 1959 | <i>Lordellonema</i> Andrassy, 1960 |
| <i>Aporcelaimus</i> Thorne & Swanger, 1936 | <i>Mesodorylaimus</i> Andrassy, 1959 |
| <i>Chrysonema</i> Thorne, 1929 | <i>Meylonema</i> Andrassy, 1950 |
| <i>Discolaimium</i> Thorne, 1939 | <i>Prodorylaimus</i> Andrassy, 1959 |
| <i>Discolaimus</i> Cobb, 1919 | <i>Pungentus</i> Thorne & Swanger, 1936 |
| <i>Drepanodorus</i> Altherr, 1954 | <i>Thornia</i> Meyl, 1954 |
| (n. syn. <i>Paraxonchium</i> Krall, 1958) | <i>Thorneella</i> Andrassy, 1960 |
| <i>Eudorylaimus</i> Andrassy, 1959 | <i>Thornema</i> Andrassy, 1959 |
| <i>Labronema</i> Thorne, 1939 | <i>Wittoldinema</i> Brzeski, 1960 |

Remarks. The inclusion of *Paraxonchium striatum* Krall = *Drepanodorus striatus* (Krall, 1958) n. syn. in the Dorylaiminae is problematical. In conjunction with Dr J. B. Goodey it has been decided that because this species is so similar to other species referred to *Drepanodorus*, apart from the presence of the sheath about the expanded part of the oesophagus that it is best included here. Authors of the other species of *Drepanodorus* (Altherr, 1954 and Andrassy, 1956) did not record any such sheath.

Subfamily TYLENCHOLAIMINAE Filipjev, 1934

(including Longidorinae Thorne, 1935)

Dorylaimidae. Spear short with knobbed or flanged spear extensions, or greatly elongated with long, rod-like, or flanged extensions. Ovaries one or two. Tail similar in both sexes where known, except *Miranema*. Type genus: *Tylencholaimus* de Man, 1876.

Other genera—

Discomyctus Thorne, 1939*Enchodelus* Thorne, 1939*Longidorella* Thorne, 1939*Longidorus* Micol., 1922*Miranema* Thorne, 1939*Utabnema* Thorne, 1939*Xiphinema* Cobb, 1913*Xiphinemella* Loos, 1950(syn. *Taprobanus* Loos, 1949)

Remarks. *Tylencholaimus bryophilus* Imamura, 1931 was referred by Thorne, 1939 to *Doryllium* Cobb, 1920. It does not conform with Thorne's diagnosis of the genus because of its prodelphic ovary, and the large number of ventro-median supplements. The fine spear with its minute knobs contrasts strikingly with the other species referred to the genus. The shape of the oesophagus as figured by Imamura (1931) appears leptonchid, but may be interpreted as a further development of the type of oesophagus known in *Tylencholaimus nikkoensis* Kaburaki & Imamura, 1933 which was retained within the Tylencholaiminae by Thorne. Whilst the systematic position of *T. bryophilus* is difficult to determine I prefer on the basis of the spear, ovaries, and supplements to place this species once more in the genus *Tylencholaimus* de Man, 1876.

It may be noted that the original figures of *T. nikkoensis* and *T. kirifuri* Kaburaki & Imamura, 1933 differ in a number of important diagnostic features from the figures in Thorne, 1939.

Subfamily ACTINOLAIMINAE Thorne, 1939

Dorylaimidae. Walls of stoma partially or completely sclerotised, frequently bearing onchia or denticles. Supplements sometimes grouped into fascicles. Type genus: *Actinolaimus* Cobb, 1913, (= *Brasilaimus* Lordello & Zamith, 1957 n. syn.).

Other genera—

Actinolaimoides Meyl, 1957*Antholaimus* Cobb, 1913*Carcharolaimus* Thorne, 1939*Metactinolaimus* Meyl, 1957*Mylodiscus* Thorne, 1939*Paractinolaimus* Meyl, 1957*Trachypleurosum* Andrassy, 1959 nom.
nov. pro. *Trachypleura* Thorne,
1939, preocc.

Remarks. *Brasilaimus* Lordello & Zamith, 1957 is indistinguishable from *Actinolaimus* Cobb, 1913 on the basis of the information supplied in the generic diagnosis, or in the description and figures of the type species

B. subaquilus L. & Z., 1957. *Brasilaimus* is therefore synonymised with *Actinolaimus* Cobb, 1913. *B. subaquilus* becomes *Actinolaimus subaquilus* (Lordello & Zamith, 1957) n. comb.

Family OPAILAIMIDAE Kirjanova, 1951

Dorylaimoidea. Amphids and sensillae very large, expanded; posterior half of the oesophagus surrounded by a "cuticular" sheath. Spear long fine, delicate, unlike that of the Dorylaimidae. Type genus: *Opailamus* Kirjanova, 1951.

Other genus: *Ottolaimus* Kirjanova, 1951.

Remarks: The above diagnosis is a free paraphrasing of Kirjanova (1951). The exact status of this family is rather doubtful. Neither of the two species referred to it is adequately described or figured for species which reputedly possess so many outstanding characters. The arrangement of the spear, guiding ring, and amphid apertures of *Opailaimus* appears most unusual. *Ottolaimus* could well be based on a moulting specimen of *Discolaimus*. Both genera urgently need careful study.

Family BELONDIRIDAE Thorne, 1939

Dorylaimoidea. Polymyarian. Spear axial, small, often slightly arcuate in lateral view, dorsal aperture never distinctly longer than half spear length; spear extensions in two obscurely separated sections which bear broad flanges. Basal enlargement of oesophagus very variable in size, always surrounded by a sheath of spiral connective tissue. Ovaries paired or single; anterior ovary usually vestigial or absent. Supplements an adanal pair and a ventro-median series. Lateral guiding pieces present except in *Dorylaimellus*. Tails of both sexes similar where known. Type genus: *Belondira* Thorne, 1939.

Other genera—

Axonchium Cobb, 1920

Oxydirus Thorne, 1939

Dorylaimellus Cobb, 1913

Swangeria Thorne, 1939

(syn. *Pungentoides* Altherr, 1950)

Remarks. See under Nygolaimidae.

Family NYGOLAIMIDAE Thorne, 1939 n. grad.

Dorylaimoidea. Polymyarian. Spear a left subventral mural tooth set in an eversible stoma. Oesophagus usually expanded in basal half or more, rarely bi-bulbar (Nygolaimellinae); with or without a spiral sheath of connective tissue about expanded part. Three glandular bodies present at oesophago-intestinal junction. Ovaries paired or single, reflexed. Lateral guiding pieces and gubernaculum present in all known males. Type genus: *Nygolaimus* Cobb, 1913.

Remarks. I have somewhat changed the diagnoses of the families Belondiridae and Nygolaimidae, and the emphasis that Thorne placed on certain characters. The Nygolaimidae are characterised by the presence of a ventrolateral mural tooth, with or without a spiral oesophageal sheath, whereas the Belondiridae are characterised by the presence of an axial spear and the spiral sheath of connective tissue about the base of the oesophagus. It is largely on these grounds that I have removed the genera *Nygellus* and *Nygolaimellus* from the Belondiridae and assigned them to the Nygolaimidae. It should also be noted that both genera possess the three glandular bodies at the oesophago-intestinal junction, a feature found in the Nygolaimidae but not in the Belondiridae. Thorne may have been influenced in placing *Nygellus* with the Belondirids by the single posterior ovary in *N. clavatus* Thorne, but *N. symmetricus* Williams, 1958 shows that this character is not constant within the genus.

See also remarks on the Bathyodontidae.

Subfamily NYGOLAIMINAE Thorne, 1939

Nygolaimidae. Oesophagus unibulbar, with or without a spiral sheath about oesophagus base. Type genus: *Nygolaimus* Cobb, 1913.

Other genera—

Heterodoros Altherr, 1952

Sectonema Thorne, 1930

Nygellus Thorne, 1939

Subfamily NYGOLAIMELLINAE n. subfam.

Nygolaimidae. Oesophagus bibulbar, with a sheath about posterior part of oesophagus. Type genus: *Nygolaimellus* Loos, 1949.

Family LEPTONCHIDAE Thorne, 1935

Dorylaimoidea. Meromyarian. Spear axial, basal extensions well developed, or bearing basal knobs or flanges. Amphids large, stirrup shaped, aperture rather narrow in some *Tylencholaimellus* spp. Oesophagus slender with a short expanded basal region (rarely as much as one third of oesophageal length in some *Dorylaimoides*), which may be set off by a marked constriction. Lateral series of pores in two lines. Prerectum present. Males where known with lateral guiding pieces; no gubernaculum. Type genus: *Leptonchus* Cobb, 1920.

Other genera—

Dorylaimoides Thorne & Sw., 1936

Proleptonchus Lordello, 1953

Doryllium Cobb, 1920

Tylencholaimellus Cobb, 1915

Remarks. I am not convinced that the Leptonchidae form a coherent natural group, nor that these meromyarian types naturally belong within

the Dorylaimoidea which are essentially polymyarian. Opinion is divided on the value of this feature as a taxonomic criterion. When more forms are known it may be possible to define and subdivide the group with more certainty. In the meantime I have removed the Campydorinae from this family.

Family CAMPYDORIDAE Thorne, 1935 n. grad. Emend.

Dorylaimoidea. Meromyarian. Oesophagus slender in anterior four-fifths, small basal bulb, often set off by a marked constriction, with a triquetrous valvular chamber. Amphids stirrup-shaped; spear axial, with or without flanged basal extensions or a dorsal mural tooth. Ovary single, either pro- or opistho-delphic. Prerectum and excretory pore present or absent. Type genus: *Campydora* Cobb, 1920.

Other genera—

Aulolaimoides Micol., 1914

Tyleptus Thorne, 1939

Remarks. This family as it now stands is a "taxonomic expediency". Its chief purpose is to gather together the three genera that have a valve-like chamber in a small posterior oesophageal bulb, and which do not fit into any other family. As more species and genera with this character become known it will become necessary to subdivide it, a practice which has little to commend it at the present time.

Superfamily DIPHTHEROPHOROIDEA n. superfam.

Dorylaimina. Meromyarian. Spear short, stout, complex, or long, arcuate, attenuated, only tip moulted. Amphid apertures ellipsoidal. Anatomical details generally obscured by abundant granules. Oesophagus with a pyriform to elongate conoid basal bulb. Prerectum absent; testis one; ventro-median supplements present, adanal pair absent; gubernaculum present. Type genus: *Diphtherophora* de Man, 1880.

Family DIPHTHEROPHORIDAE Thorne, 1935 Emend

Diphtherophoroidea. Spear with basal knobs, stout, posteriorly of complex archlike structure in anterior part of dorsal sector, ventral sector apparently not fused to dorsal sector posteriorly. Guiding apparatus of spear a complicated structure of plates and rods of which an inverted V-shaped piece is often the most conspicuous. Supplements often reduced or vestigial. Type genus: *Diphtherophora* de Man, 1880.

Other genera—

Brachynemella Cobb, 1933 *Triplonchium* Cobb, 1920
 (syn. *Brachynema* Cobb, 1893 pre- *Tylolaimophorus* de Man, 1880
 occ.)

Family TRICHODORIDAE Thorne, 1935 n. grad.

Diphtherophoroidea. Spear strictly a dorsal tooth, long, attenuated, arcuate, without basal knobs (often described as tripartite in the middle region but this is a misinterpretation — see below). Ovaries paired or single, reflexed when paired; males with or without caudal alae; spicules straight or nearly so. Tail length not more than one anal-body-width. Type genus: *Trichodorus* Cobb, 1913.

Remarks. Allen (1957) has monographed this group and has figured the cross section of the "tripartite" part of the spear as U-shaped. He has informed me (in litt.) that the tripartite appearance is due to the greater passage of light through the centre of the spear when it is viewed laterally.

Suborder TRICHOSYRINGINA Ward, 1917

Enoplida. Setae absent; oesophageal glands forming a stichosome outside the contour of the oesophagus. Amphids pocket-like (some Mermithoidea) to pore-like. Parasitic at some stage of the life history in terrestrial or freshwater arthropods (Mermithoidea) or in vertebrates (Trichuroidea). Type genus: *Trichuris* Roederer, 1761.

Superfamily MERMITHOIDEA Wülker, 1924

Trichosyringina. Amphids modified pocket-like to pore-like; intestine extending anterior to base of oesophagus, usually without a lumen. Male with one or two spicules, usually two testes. Female reproductive system highly developed, usually with two ovaries and tubular vagina. Eggs modified, but not operculate. Bursa present in some *Eurynermis*. Type genus: *Mermis* Dujardin, 1842.

Family MERMITHIDAE Braun, 1883

Mermithoidea. Oesophagus not dorylaimoid in larval stages; larvae with an axial spear. Adults long slender worms with a smooth cuticle. Adult intestine replaced by trophosome or pseudo-intestine. Anus non functional. Larvae parasitic in freshwater and terrestrial arthropods. Adults free-living. Type genus: *Mermis* Dujardin, 1842.

The following genera have been erected—

| | |
|---|---|
| <i>Agameremis</i> Cobb, Steiner & Christie, 1923 | <i>Heydonius</i> Taylor, 1935 |
| <i>Agameremis</i> Stiles, 1903 | <i>Hydromeremis</i> Corti, 1902 |
| <i>Allomeremis</i> Steiner, 1924 | <i>Isomeremis</i> Coman, 1953 |
| <i>Amphidomeremis</i> Filipjev, 1934 | <i>Limnomeremis</i> Daday, 1911 |
| <i>Amphimeremis</i> Kaburaki & Imamura, 1932 | <i>Megalomeremis</i> Müller, 1931 |
| <i>Bathymeremis</i> Daday, 1911 | <i>Mesomeremis</i> Daday, 1911 |
| ? <i>Bolbinium</i> Cobb, 1920 | <i>Nanomeremis</i> Cobb, 1924 |
| <i>Complexomeremis</i> Filipjev, 1934 | <i>Neomeremis</i> Linstow, 1904 |
| <i>Eomeremis</i> Steiner, 1925 | (syn. <i>Octomeremis</i> Steiner, 1929) |
| <i>Eumeremis</i> Daday, 1911 | <i>Parameremis</i> Linstow, 1898 |
| <i>Eurymeremis</i> Müller, 1931 | <i>Phreatomeremis</i> Coman, 1953 |
| <i>Filipjevimeremis</i> Polozhentsev & Artukhovskiy, 1958 | <i>Psammomeremis</i> Polzhentsev, 1941 |
| <i>Gastromeremis</i> Micol., 1925 | <i>Pseudomeremis</i> de Man, 1903 |
| <i>Gordiomeremis</i> Heinze, 1934 | <i>Skrjabinomeremis</i> Polozhentsev, 1952 |
| <i>Hexameremis</i> Steiner, 1934 | <i>Tetrameremis</i> Steiner, 1925 |
| | <i>Tunicameremis</i> Schuur-Stekh., Mawson, & Couturier, 1955 |

Remarks. The above list of generic names was supplied by Dr H. E. Welch, who has in preparation a critical revision of the Mermithidae which may result in the synonymisation or rejection of some of the generic names listed above.

Family TETRADONEMATIDAE Cobb, 1919

Mermithoidea. Oesophagus dorylaimoid in larvae. All stages of life history may be found in insects; no rectum or anus in adults; males with one spicule, with or without supplements. Type genus: *Tetradonema* Cobb, 1919.

Other genera—

| | |
|---------------------------------|----------------------------------|
| <i>Aproctonema</i> Keilin, 1917 | <i>Mermithonema</i> Goodey, 1941 |
|---------------------------------|----------------------------------|

Superfamily TRICHUROIDEA Railliet, 1915

syn. Trichocephalata Skrjabin & Schultz, 1928

Trichosyringina. Amphids pore like; a spear present in larvae, rarely present in adults; intestine not extending anterior to base of oesophagus, lumen well developed, rarely terminating blindly (Cystoospsidae). Males with one testis and one or no spicules. Female with tubular vagina, one ovary; eggs typically operculate. Parasites of vertebrates in adult stages. Life history direct or indirect. Type genus: *Trichuris* Roederer, 1761.

Remarks. I have retained the more familiar name for this superfamily for the present. Although Leiper (1926) pointed out that *Trichuris* Roederer, 1761 is not available under the Rules, and that the correct name should be

Trichocephalus Goeze, 1882, most workers have been loath to adopt it. Under the Copenhagen Decisions on zoological nomenclature there is no longer any need to change family names which have been based on junior synonyms. The situation is not clear in this case as *Trichuris* is not strictly a synonym as it has never been legally available.

Family TRICHURIDAE Railliet, 1915

Trichuroidea. Oviparous, stichosome one row of stichocytes. Males with one spicule. Type genus: *Trichuris* Roederer, 1761.

Subfamily TRICHURINAE Ransom, 1911

Trichuridae. Posterior part of body distinctly wider than anterior part; oesophageal region much longer than rest of body. Type genus: *Trichuris* Roederer, 1761 (syn. *Trichocephalus* Goeze, 1882).

Subfamily CAPILLARIINAE Railliet, 1915

Trichuridae. Posterior part of body not distinctly wider than anterior part; oesophageal region not distinctly longer than rest of body. Type genus: *Capillaria* Zeder, 1800 (syn. *Aonchotbeca* Lopez-Neyra, 1947, *Capillostrongylodes* Freitas & Lent, 1935).

Other genera—

Eucoleus Dujardin, 1845

Hepaticola Hall, 1916

Skrjabinocapillaria Skarbilovitch, 1946

Thominx Dujardin, 1845

(syn. *Echinocoleus* Lopez-Neyra, 1947)

Family TRICHOSOMOIDIDAE York & Maplestone, 1926

Trichuroidea. Oesophageal region roughly equal to, or shorter than remainder of body; spear present or absent in adults. Males without spicules or copulatory sheath; either much smaller than female and parasitic within uterus or vagina, or non-parasitic and equal in size to female. Females oviparous or ovoviviparous. Type genus: *Trichosomoides* Railliet, 1895.

Subfamily TRICHOSOMOIDINAE Hall, 1916

Trichosomoididae. Oesophagus about equal to rest of body. Spear absent in adults. Males minute, parasitic within uterus of female. Type genus: *Trichosomoides* Railliet, 1895.

Other genus—

Trichuroides Ricci, 1949.

Subfamily ANATRICHOSOMATINAE Smith & Chitw., 1954

Trichosomoididae. Oesophagus one-third to one-sixth of body-length. Males not parasitic in female, size equal to or larger than females. Adults with spears. Parasites of monkeys. Type genus: *Anatrichosoma* Smith & Chitwood, 1957.

Family TRICHINELLIDAE Ward, 1907

Trichuroidea. Ovoviviparous; stichosome one row of stichocytes; males not degenerate; without spicules. Vulva in middle of oesophageal region. Oesophagus more than half body length in female, less than half body length in male. Type genus: *Trichinella* Railliet, 1895 (syn. *Trichina* Owen, 1835 nec Meigen, 1830).

Family CYSTOOPSIDAE Skrjabin, 1923

Trichuroidea. Oviparous. Stichosome two rows of stichocytes. Males with one spicule. Vulva in oesophageal region. (Only one species which is parasitic in the skin of the Volga sturgeon.) Type genus: *Cystoopsis* Wagner, 1867.

Suborder DIOCTOPHYMATINA

Enoplida. Setae absent, but long papillae may be present in larval stages. Oesophageal glands highly polynucleate, branching dichotomously within the contour of the oesophagus, ducts opening anterior to nerve ring. No lips; no spear in adults; oesophagus cylindroid, reproductive system single in both sexes. Males with one spicule in caudal sucker. Eggs operculate. Adults parasites of vertebrates.

Family DIOCTOPHYMATIDAE Railliet, 1915

Dioctophymatina. Muscular cephalic sucker absent. Type genus: *Dioctophyme* Collet-Meyret, 1802.

Subfamily DIOCTOPHYMATINAE Cast. & Chambers, 1910

Dioctophymatidae. Very large nematodes, females up to one metre long, males one-third of this. Vulva in anterior part of body. Adults parasitic in mammals. Type genus: *Dioctophyme* Collet-Meyret, 1802.

Other genus: *Mirandonema* Kreis, 1945.

Subfamily EUSTRONGYLINAE Chitw. & Chitw., 1937

Dioctophymatidae. Moderate to large size, cuticle coarsely striated towards extremities, with or without spines. Vulva near anus. Adults parasitic in birds. Type genus: *Eustrongylides* Jägerskiöld, 1909.

Other genus: *Hystrichis* Dujardin, 1845.

Family SOBOLIPHYMATIDAE Petrov, 1930

Dioctophymatina. With large muscular cephalic sucker. Females oviparous, with vulva near anus. Adults parasitic in carnivores and fish. Type genus: *Soboliphyme* Petrov, 1930.

KEY TO FAMILIES AND SUBFAMILIES OF THE ENOPLIDA

Taxonomic keys are attempts at finding short cuts, and like other short cuts they have their dangers. All identifications, at even the higher levels, must be checked against full descriptions and figures. In this key items in italics are spot characters, if they can be determined with certainty the remainder of the couplet may be ignored. References in brackets refer to published keys to genera.

- | | |
|---|--------------------|
| 1. Oesophageal glands within contour of oesophagus | 9 |
| Oesophageal glands present as a stichosome outside oesophageal contour | TRICHOSYRINGINA 2 |
| 2. Intestine extending anterior to base of oesophagus, usually without a lumen | MERMITHOIDEA 3 |
| Intestine not extending anterior to base of oesophagus, lumen well developed | TRICHUROIDEA 4 |
| 3. Oesophagus dorylaimoid in larval stages; adults and larvae found in insects. Males with one spicule | TETRADONEMATIDAE |
| Oesophagus not dorylaimoid in larval stages; only larvae parasitic in terrestrial and freshwater arthropods; males with one or two spicules | MERMITHIDAE |
| 4. Stichosome one row of stichocytes | 5 |
| Stichosome two rows of stichocytes | CYSTOOPSIDAE |
| 5. Males degenerate living within the uterus or vagina of the female, or <i>lacking spicules</i> and couplatory sheath | 6 |
| Males not degenerate, <i>with one spicule</i> | 8 |
| 6. <i>Males degenerate, living within female uterus</i> or vagina | TRICHOSOMOIDINAE |
| Males not degenerate, not living within female | 7 |
| 7. <i>Adults with spear</i> , vulva near oesophago-intestinal junction | ANATRICHOSOMATINAE |
| Adults without spear, vulva in middle of oesophageal region | TRICHINELLIDAE |
| 8. Oesophageal region extremely slender, longer than remainder of body | TRICHURINAE |
| Oesophageal region shorter than rest of body and not remarkably slender | CAPILLARIINAE |
| 9. Very large nematodes, adults parasitic in vertebrates; <i>males with caudal sucker</i> and one spicule; eggs operculate | DIOCTOPHYMATINA 10 |
| Not very large; not parasitic in vertebrates, males without caudal sucker; eggs not operculate | 12 |

| | | |
|--|--------------------------------------|----------|
| 10. With muscular cephalic sucker Without muscular cephalic sucker | SOBOLIPHYMATIDAE DIOCTOPHYMATIDAE | 11 |
| 11. Vulva in anterior part of body Vulva in posterior part of body | DIOCTOPHYMATINAE EUSTRONGYLIDINAE | |
| 12. Stoma vestigial, without spear or teeth, cephalic setae absent, oesophagus dorylaimoid, males without adanal supplements or gubernaculum (Thorne, 1939) Not as above | ALAIMIDAE | 13 |
| 13. <i>All oesophageal gland ducts posterior to nerve ring, no cephalic setae, oesophagus cylindroid, dorylaimoid or bi-bulbar; axial spear or mural tooth or teeth present, rarely marine – some Dorylaiminae. Caudal glands present in Mononchoidea only</i> | DORYLAIMINA | 14 |
| <i>Some or all oesophageal gland ducts anterior to nerve ring; usually with cephalic setae, oesophagus cylindroid, crenate, conoid or multibulbar. Caudal glands usually present</i> | ENOPLINA | 28 |
| 14. Oesophagus cylindroid Oesophagus dorylaimoid, conoid, or bi-bulbar | MONONCHOIDEA | 15 16 |
| 15. Stoma heavily sclerotised, cup- or barrel-shaped; armed with one or three teeth, tail conoid, arcuate, or filiform (Andrássy, 1958) Stoma moderately sclerotised; elongate, narrow; tail short, rounded, not conoid or filiform | MONONCHIDAE BATHYODONTIDAE | |
| 16. Spear short, stout with dorsal and ventral elements apparently separate posteriorly, or long, slender arcuate without dorsal aperture; prerectum, lateral pores, and <i>adanal supplements absent; one testis</i> ; excretory pore usually visible; anus often almost terminal Spear a hollow tube with an oblique dorsal aperture (aperture may be absent when spear is mural), often with variously developed spear extensions. <i>Testes two; adanal supplements, lateral pores, and usually prerectum present. Excretory pore absent or rudimentary</i> | DIPHITHEROPHOROIDEA DORYLAIMOIDEA | 17 18 |
| 17. Spear short, complex, with basal knobs; spear guiding apparatus of sclerotised plates and rods (Thorne, 1939) Spear long, arcuate, tapering towards ends, without basal knobs; obscure non-sclerotised guiding ring present (Allen, 1957) | DIPHITHEROPHORIDAE TRICHODORIDAE | |
| 18. Oesophageal bulb small, with a triquetrous valvular chamber Oesophageal bulb without a triquetrous valvular chamber | CAMPYDORIDAE | 19 |
| 19. Spear mural Spear axial | NYGOLAIMIDAE | 20 21 |
| 20. Oesophagus bi-bulbar Oesophagus mono-bulbar (dorylaimoid) | NYGOLAIMELLINAE NYGOLAIMINAE | |
| 21. Posterior part of oesophagus with a spiral sheath of connective tissue; anterior ovary usually vestigial or absent (if spear aperture is more than half spear length cf. <i>Drepanodoris</i> Dorylaiminae) Oesophagus without a spiral sheath | BELONDIRIDAE | 22 |

| | | |
|---|------------------|----|
| 22. Spear extensions bearing knobs | | 23 |
| Spear extensions not bearing knobs, but may bear flanges | | 24 |
| 23. Males with adanal and one ventromedian supplement, spear knobs moderate to large, spear with dorsal thickening. Females with posterior ovary only, anterior uterus greatly reduced or absent | LEPTONCHIDAE | |
| Males with adanal and three or more ventromedian supplements; spear knobs small, spear not thickened dorsally. Females with only anterior or paired ovaries (single and posterior only in <i>Tylencholaimus zee-landicus</i> de Man, 1876) | TYLENCHOLAIMINAE | |
| 24. Oesophagus enlarged in distal third or more | | 25 |
| Oesophagus enlarged in less than distal third; posterior bulb often pyriform or set off by marked constriction | LEPTONCHIDAE | |
| 25. Spear short and stout with oblique aperture, or if slender spear length greater than three times width of lip region. Spear often with flanges. Posterior half of oesophagus without cuticular sheath | DORYLAIMIDAE | 26 |
| Spear slender tapering uniformly to tip, length less than three times width of lip region; spear without knobs or flanges. With amphids very large, or with two anteriorly projecting "ears" on head. Posterior half of oesophagus surrounded by a "cuticular" sheath | OPAILAIMIDAE | |
| 26. Stomatal region heavily sclerotised, often dentate | ACTINOLAIMINAE | |
| Stomatal region not heavily sclerotised; never dentate | | 27 |
| 27. Spear and spear extension simple, short or of moderate length, never bearing flanges, etc (Andrássy, 1959) | DORYLAIMINAE | |
| Spear and or extensions greatly attenuated, or spear of moderate length with flanged extensions | TYLENCHOLAIMINAE | |
| 28. All oesophageal gland ducts opening in stomatal region anterior to nerve ring. Cuticle of head duplicate; supplements 0, 1, or 2 | ENOPIOIDEA | 28 |
| Dorsal and two subventral oesophageal glands opening anterior to nerve ring. Cuticle of head not duplicate; supplements one or more | TRIPYLOIDEA | 37 |
| 29. Vagina opening into cloaca, no external vulva | LAURATONEMATIDAE | |
| Vulva normal, external; vagina not discharging into cloaca | | 30 |
| 30. Stomatorhabdions poorly sclerotised; without distinct stomatal capsule, stoma surrounded by oesophageal tissue, or stoma absent | | 31 |
| Stomatorhabdions heavily sclerotised, stoma somewhat capsuliform; only posterior part surrounded by oesophageal tissue | ONCHOLAIMIDAE | 35 |
| 31. Stoma absent, supplement papilloid | ENCHILIDIINAE | |
| Stoma present supplement(s) tuboid or absent | ENOPLIDAE | 32 |
| 32. Stoma with three bifurcate mandibles | ENOPLINAE | |
| Stoma without three bifurcate mandibles | | 33 |
| 33. Posterior part of oesophagus crenate in outline, vesiculate, musculature reduced (Wieser, 1953a) | PHANODERMATINAE | |
| Posterior part of oesophagus not crenate in outline, never vesiculate | | 34 |

34. Supplements absent; oesophagus conoid, oesophageal musculature weak; 6 + 4 setae in external circle (Wieser, 1953a) OXYSTOMATINAE
Supplements one or two, tuboid; oesophagus usually cylindroid, rarely conoid; posterior oesophageal musculature well developed. Ten setae in external circle (Wieser, 1953b) LEPTOSOMATINAE
35. Oesophagus cylindroid, never crenate; supplements absent or pedunculate (Wieser, 1953a) ONCHOLAIMINAE
Oesophagus conoid, crenate or multibulbar; supplements papilloid, cup-like, or rarely absent 36
36. With sexual dimorphism of stoma; males without a stoma. Female stoma generally narrow, divided by a number of transverse rings into several chambers (sometimes rings faint giving the impression of two chambers in *Calyptronema*). Teeth slender, needle-like, base narrow. Spicules elongate, gubernaculum without apophysis; supplements papilloid (Wieser, 1953a) ENCHILIDIINAE
Without sexual dimorphism of stoma; stoma large, divided by one or more bands, rings, or rows of denticles into two chambers. Tooth broad with large base. Spicules short, arcuate, gubernaculum usually with a dorsal apophysis; supplements sclerotised, cup-like when present (Wieser, 1953a) EURYSTOMINAE
37. Stoma walls not heavily sclerotised; stoma either funnel-shaped or a very slender tube with an inconspicuous dorsal tooth. Tooth or teeth in median part of stoma. Spicules almost straight TRIPYLIDAE
Stoma walls strongly sclerotised, stoma elongate, teeth at anterior or posterior end of stoma. Spicules usually arcuate IRONIDAE 38
38. Teeth at anterior end of stoma, commonly with cephalic setae IRONINAE
Teeth at posterior end of stoma, never with cephalic setae CRYPTONCHINAE

ACKNOWLEDGMENTS

As is inevitable in a task such as this I have drawn heavily on the work of many other workers and I wish to acknowledge my indebtedness to them. I have sought advice from many workers especially Dr J. B. Goodey, Dr H. E. Welch, Prof. M. W. Allen, and Prof. R. T. Leiper. I wish to thank Dr Goodey and Prof. Leiper for reading the manuscript, but the responsibility for the conclusions, errors, and shortcomings of the proposed scheme is mine alone.

REFERENCES

- ALLEN, M. W. 1957: A Review of the Nematode Genus *Trichodorus* with Descriptions of Ten New Species. *Nematologica*, 2 (1): 32-62.
- ANDRASSY, I. 1958: Über das System der Mononchiden (Mononchidae, Chitwood, 1937; Nematoda) *Ann. hist.-nat. Mus. hung.* n.s. 9, 50: 151-71.
- 1959: Taxonomische Übersicht der Dorylaimen (Nematoda) 1, *Act. zool. Acad. Sci. hung.* 5: 191-240.

- CHITWOOD, B. G. 1937: A Revised Classification of the Nematoda, in "Papers in Helminthology, 30 Year Jubileum K. I. Skrjabin," Moscow, pp. 69-80.
- CHITWOOD, B. G.; CHITWOOD, M. B. 1937: "An Introduction to Nematology" Section 1, Part 1, Monumental Printing Co. Baltimore. 53 pp.
- 1950: "An Introduction to Nematology" (2nd edit.) Chitwood, Baltimore. 213 pp.
- CLARK, W. C. 1960a: The Oesophago-intestinal Junction in the Mononchidae (Enoplida, Nematoda), *Nematologica* 5, (3): 178-83.
- 1960b: Redescriptions of *Mononchus truncatus* Bastian, *M. papillatus* Bastian, and *Prionchulus muscorum* (Dujardin) (Enoplida: Nematoda), *Nematologica* 5, (3): 184-98.
- 1960c: The Mononchidae (Enoplida: Nematoda) of New Zealand. 1. The Genera *Mononchus* Bastian and *Prionchulus* Cobb. *Nematologica* 5, (3): 199-214.
- 1961a: The Mononchidae (Enoplida: Nematoda) of New Zealand. 2. The genus *Iotonchus* (Cobb, 1916) Altherr, 1950. *Nematologica* 5, (4): 260-74.
- 1961b: The Mononchidae (Enoplida: Nematoda) of New Zealand. 3. A review of the genus *Cobbonchus* Andrassy, 1958, with Descriptions of New Species. *Nematologica* 5, (4): 275-84.
- 1961c: The Mononchidae (Enoplida: Nematoda) of New Zealand. 4. The Genus *Mylonchulus* (Cobb, 1916) Pennak, 1953. *Nematologica* (in press).
- FILIPJEV, I. N. 1934: The Classification of the Free-living Nematodes and Their Relation to the Parasitic Nematodes. *Smithson. misc. Coll.*, 89 (6): 1-63.
- FULLEBORN, F. 1923: Über den "Mundstachel" der Trichotracheliden-Larven und Bemerkungen über die jüngsten Stadien von *Trichocephalus trichiurus*. *Arch. Schiffs. u. Tropen. Hyg.*, 27, (11): 413-20.
- GOODEY, T. 1942: Observations on *Mononchus tridentatus*, *M. brachyuris* and other Species of the Genus *Mononchus*. *J. Helminth.*, 20: 9-24.
- 1951: "Soil and Freshwater Nematodes", Methuen, London. 390 pp.
- GOODEY, J. B.; PEACOCK, F. C.; PITCHER, R. S. 1960: A Redescription of *Xiphinema diversicaudatum* (Micoletzky, 1923 & 1927) Thorne, 1939, and Observations on its Larval Stages. *Nematologica* 5, (2): 127-35.
- HYMAN, L. H. 1951: "The Invertebrates: Acanthocephala, Aschelminthes, and Entoprocta. The Pseudocoelomate Bilateria, (Vol. 3)", McGraw-Hill, New York, 573 pp.
- IMAMURA, S. 1931: Nematodes in the Paddy Field, with Notes on their Population before and after Irrigation. *J. Coll. Agric. Tokyo*, 11 (2): 198-240.
- KABURAKI, T.; IMAMURA, S. 1933: Descriptions of Two New Soil Nemas in the Nikko District. *Proc. imp. Acad. Japan*, 9, (3): 134-6.
- LEIPER, R. T. 1927: Discussion of the Validity of Certain Generic Names at Present in Use in Medical Helminthology. *Coll. Addr. Lond. Sch. Hyg.* 3: 484-91.
- LUKASIAK, J. 1930: Anatomische und Entwicklungsgeschichtliche Untersuchungen an *Dioctophyme renale* (Goeze, 1782) (*Eustrongylus gigas* Rud.). *Arch. Nauk. biol.* 3: 1-99.
- RAUTHER, M. 1918: Mitteilungen zur Nematodenkunde. *Zool. Jb.*, (Abt. 2), 40: 441-516.

- SKRJABIN, K. I.; SHIKHOBALOVA, N. P.; SOBOLEV, A. A.; PARAMONOV, A. A.; SUDARIKOV, V. E. 1954: "[Descriptive Catalogue of Parasitic Nematodes Vol. IV. Camallata, Rhabditata, Tylenchata, Trichocephalata, Dioctophymata and a Classification of Parasitic Nematodes under Hosts]". Izdatelstvo Akademii Nauk. S.S.S.R., Moscow, 927 pp.
- SKRJABIN, K. I.; SHIKHOBALOVA, N. P.; ORLOV, I. V. 1957: "[Principles of Nematology, edit. K. I. Skrjabin, Vol. VI. Trichocephalidae and Capillariidae of Animals and Man, and the Diseases caused by them]". Akademia Nauk., S.S.S.R., Moscow, 587 pp.
- STEINER, G. 1917: Über die Verwandtschaftsverhältnisse und die Systematische Stellung der Mermithiden. *Zool. Anz.*, 48: 263-7.
- THORNE, G. 1939: A Monograph of the Nematodes of the Superfamily Dorylaimoidea, *Capita zool.* 8, (5): 1-261.
- WIESER, W. 1953a: Reports of the Lund University Chile Expedition 1948-49. Free-living Marine Nematodes. I. Euploidea. *Acta Univ. lund.*, n.s. 49, (6): 1-155.
- 1953b: On the Morphology of the Head in the Family Leptosomatidae (Marine Free-living Nematodes). With a Key to all Described Genera. *Ark. Zool.* (ser. 2) 6 (3): 69-73.
- WOODHEAD, A. E. 1950: Life History Cycle of the Giant Kidney Worm, *Dioctophyme renale* (Nematoda), of Man and many other Mammals. *J. Parasit.*, 69: 21-46.

**3. THE OESOPHAGO-INTESTINAL JUNCTION
IN THE MONONCHIDAE (ENOPLIDA, NEMATODA)**

BY

W. C. CLARK

Rothamsted Experimental Station, Harpenden, Herts, England ¹⁾

¹⁾ At present on study leave from Entomology Division, D.S.I.R., Nelson, New Zealand.

While examining many species of the Mononchidae it became evident that the structure of the oesophago-intestinal junction in this family has been misinterpreted. The detailed structure of all the species examined differs from the published figures and descriptions because most workers have worked with fixed material, and also because the oesophago-intestinal junction has not been considered important. In specimens fixed in F.A. 4 : 10 or T.A.F. some of the valve structures described here are often obscure or invisible. For this reason the nematodes must be studied alive, narcotized, or *immediately* after "relaxing" with heat. The valve "funnel" (see later) may become obscure within 15-20 minutes of death. A 0.5 per cent aqueous solution of M.S. 222 Sandoz (a soluble salt of a meta-amino-benzoic acid ethyl ester) is a suitable narcotic for mononchs.

The oesophago-intestinal valves in the Mononchidae are of two types, for which the terms "tuberculate" and "non-tuberculate" are proposed. In this paper *Prionchulus muscorum* (Dujardin) exemplifies the non-tuberculate type, and *Anatonchus tridentatus* (de Man) the tuberculate type. The mononch oesophagus was first described by CHITWOOD & CHITWOOD (1937) and illustrated by further figures in 1950. Its lumen is tri-radiate and its lining sclerotized and greatly thickened locally (see figs. 1 B and 2 C). The thickenings are greatest in the centripetal half of each arm, and are linked with each other by thinner regions. The whole lumen can become circular in cross-section by contraction of the radial muscles to allow the passage of large food particles including whole nematodes. The appearance of this structure in lateral view is shown in figure 2 A, and in dorsal view in figure 2 B. Posterior to the end of the oesophagus there is often a zone of transparent tissue (t.z.), (varying in width in different species) that is usually flanked laterally by three (?) smaller transparent bodies. Behind this is found the sphincter muscle which bears on its posterior face a conical structure (c.o.) of very variable size which projects into the lumen of the intestine. (The sphincter muscle with or without the conical structure is the cardia of some authors. There is no constancy in the use of this term, borrowed from vertebrate anatomy where it refers to the opening of the stomach nearest the heart, and it is meaning-

less when applied to a nematode which has neither stomach nor heart). This conical body appears rather "structureless" and is not visible in all specimens. It may be obscured by the dense granules in the intestinal cells, by food in the intestine, or by contraction which brings it up close to the posterior face of the sphincter, or by a combination of these.

THE NON-TUBERCULATE VALVE

(Figs. 1 and 3)

In *Prionchulus muscorum* a cross section of the oesophageal lumen appears as shown in figure 1 B from the base of the stoma to a short distance behind the

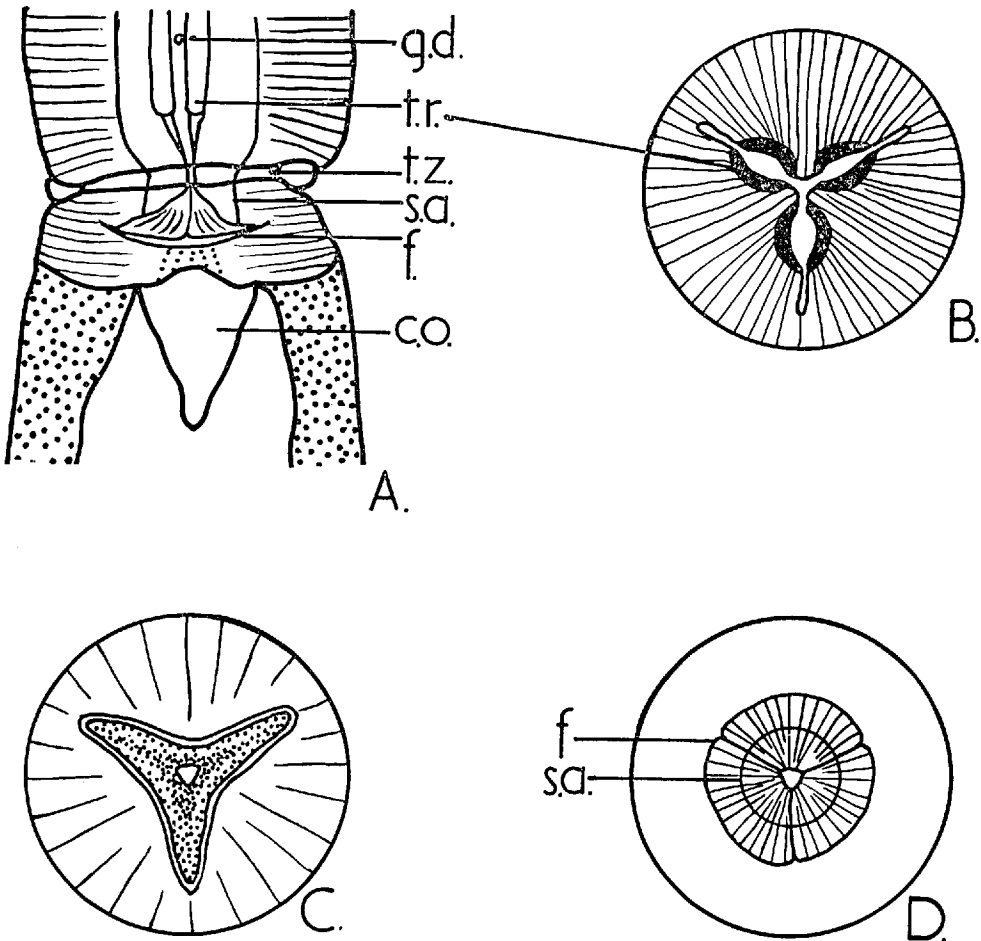

Fig. 1. *Prionchulus muscorum*. A. oesophago-intestinal junction; B. transverse section through oesophagus; C. transverse section through basal part of oesophagus showing the changed form of the sclerotized lining and the narrowing of the lumen; D. transverse section through the sphincter muscle showing the funnel-shaped valve from behind. c.o. conical organ; f. funnel-shaped valve; g.d. sub-ventral oesophageal gland duct; s.a. supporting annulus; t.r. thickened region of oesophageal lining; t.z. transparent zone.

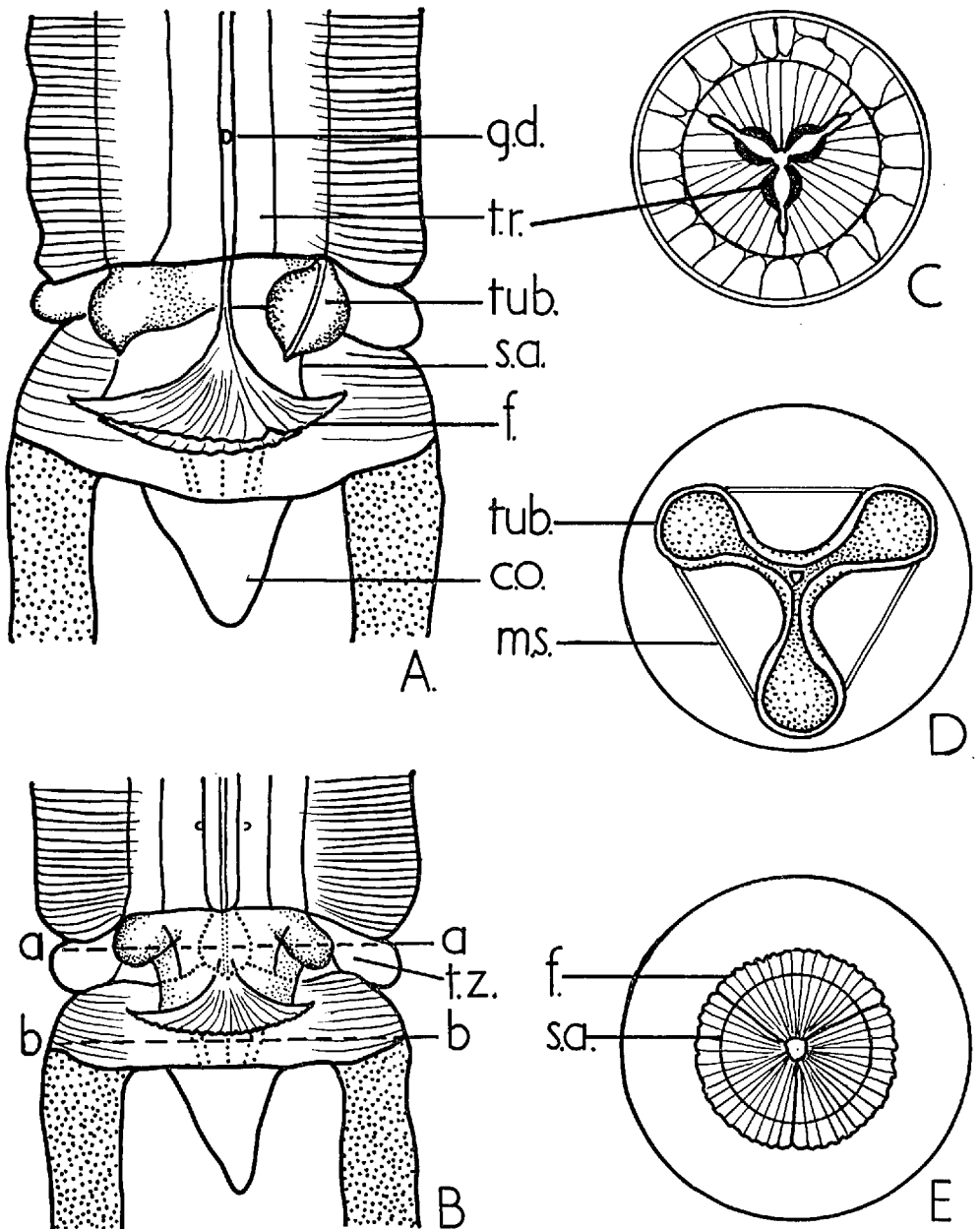

Fig. 2. *Anatonchus tridentatus*. A. oesophago-intestinal junction in lateral view; B. oesophago-intestinal junction in dorsal view; C. transverse section through the oesophageal region; D. section through oesophagus at level 'a' on fig. B. looking posteriorly showing the hollow tubercles uniting centrally; E. transverse section through the sphincter muscle at the level 'b' on fig. B. looking anteriorly showing the funnel-shaped valve. m.s. muscular (?) strand; tub. tubercles; other lettering as for figure 1.

W. C. CLARK: *The oesophago-intestinal junction in Mononchidae.*

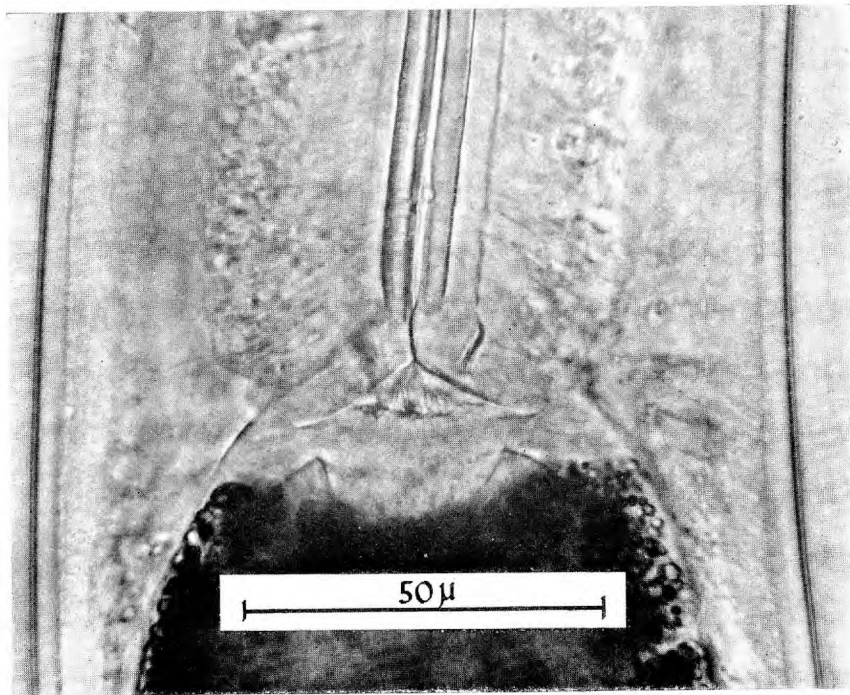

Fig. 3. Photomicrograph of oesophago-intestinal junction of *P. muscorum* (alive) showing the funnel shaped valve.

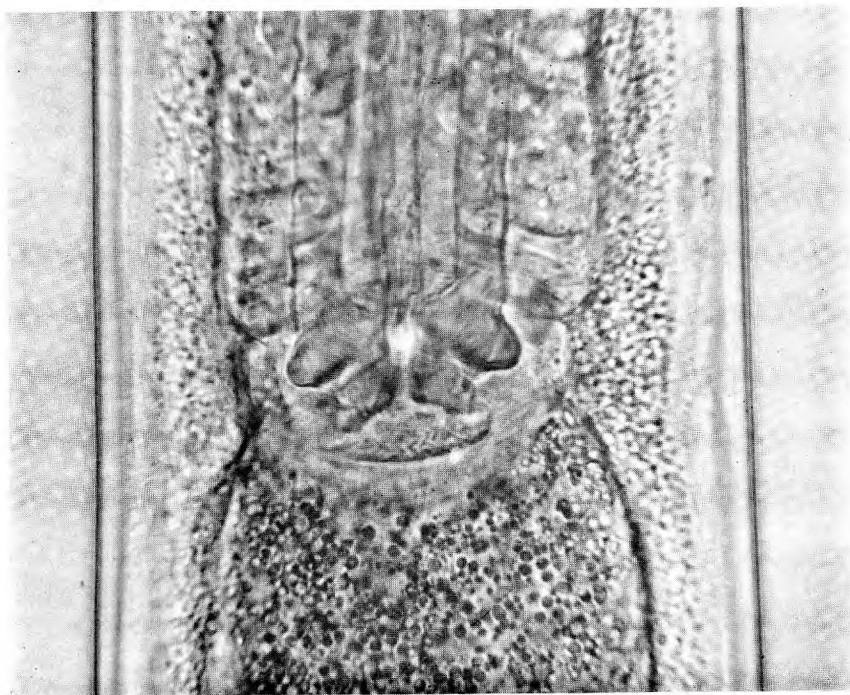

Fig. 4. Photomicrograph of oesophago-intestinal region of *A. tridentatus* showing the tubercles and the funnel shaped valve. (Scale applies to both figures).

Photos — C. C. Doncaster.

W. C. CLARK: *The oesophago-intestinal junction in Mononchidae.*

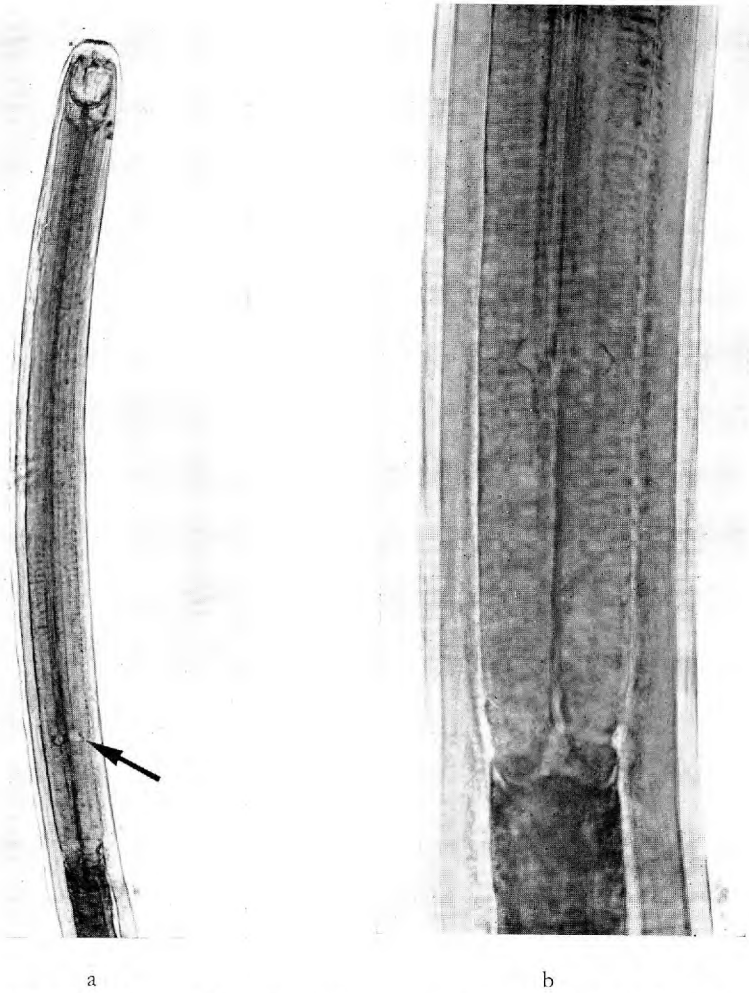

Fig. 5. Photomicrograph of a moulting larva of *Iotonchus* sp. showing the tubercles (arrow) part way up the oesophagus.

Both photos — C. C. Doncaster.

duct of the posterior subventral oesophageal gland. Here there is an abrupt change in shape as the thickenings disappear and, in cross section, this basal region now appears as in figure 1 C. The arms of the lumen become shorter, which in lateral view appears to narrow where it passes through the end of the oesophagus and the narrow transparent zone (t.z.) into the sphincter muscle. The lumen narrows here and the greater part of its width is made up of a "supporting annulus" (s.a.) which appears to be attached to the much plicated funnel-like structure (f) that forms the valve proper. The lumen expands greatly as it passes into the sphincter muscle, so becoming funnel-shaped. The exact shape varies somewhat with the state of contraction of the sphincter muscle fibres. There are indications that the "funnel" shares the tripartite nature of the stoma and oesophagus linings (Figure 1 D).

THE TUBERCULATE VALVE

(Figs. 2, 4, 5)

In *Anatonchus tridentatus* transverse sections through the oesophagus appear much the same as in *Prionchulus muscorum*. Behind the duct of the posterior sub-ventral oesophageal gland there is no marked change in the apparent width of the lumen as it passes into the transparent zone (t.z.). Within the transparent zone, or in the tissue of the sphincter muscle, or partly in both, the peripheral ends of the three arms of the sclerotized lining become inflated, and greatly thickened, forming fairly conspicuous, hollow tubercles or "knobs" (tub). The actual limits of these tubercles in relation to the transparent zone and the sphincter muscle vary somewhat from specimen to specimen. The cavities of the tubercles are connected in the centre of the oesophagus (see Fig. 2 D). From this point a narrow duct extends posteriorly, and forms the anterior part (or stem) of the tripartite, plicated funnel-shaped valve. The funnel-shaped valve is similar to that found in the non-tuberculate species, and has a similar supporting annulus which appears to be attached to the posterior part of the tubercles. In *A. tridentatus* the posterior rim of the funnel is crenulate, but in *P. muscorum* the rim tends to be smooth.

In moulting specimens of *A. tridentatus* and two undescribed species of *Iotonchus*, the tubercles have been observed part way up the oesophagus in the process of being shed with the rest of the sclerotized lining of the stoma and the oesophagus (Fig. 5).

DISTRIBUTION OF THE VALVE TYPES

The tubercles of the tuberculate type of valve were first reported by DITLEVSEN (1911) in *Anatonchus dolichurus* (Ditlevsen) and later by STEINER (1914) in *Miconchus studeri* (Steiner). MICOLETZKY (1922) did not see these structures in *A. dolichurus*, and regarded those recorded by Steiner as artefacts. Examination of many specimens and species of the Mononchidae has disclosed the following distribution of the two types of valve:

(a) non-tuberculate type present in:

Mononchus Bastian, 1865 (*M. truncatus* Bastian, *M. papillatus* Bastian, *M. kastrolli* Altherr, and three new species from New Zealand).

Prionchulus Cobb, 1916 (*P. muscorum* (Dujardin))

Mylonchulus Cobb, 1916 (*M. brachyurus* (Butschli) and two new species from New Zealand)

Cobbonchus Andrassy, 1958 (*C. mauritianus* (Williams) n. comb., and in three new species from New Zealand).

(b) tuberculate type valves are present in:

Anatonchus Cobb, 1916 (*A. tridentatus* (de Man), *A. dolichurus* (Ditlevsen), and in a new species from Rothamsted).

Iotonchus Cobb, 1916 (*I. acutus* Cobb, *I. brachylaimus* Cobb, *I. trichurus* Cobb, and *I. amphigonius* (Thorne), a new species from the Philippine Islands, a new species from the Cameroons, and in six new species, one of which may be synonymous with *I. parazschokkei* (Allgen) from New Zealand). *Miconchus* Andrassy, 1958 (*M. studeri* (Steiner)), and in a new species from Falmouth, England, though not seen in *M. trionchus* (Thorne). (These structures are often difficult to detect in specimens which have been mounted on slides for many years).

The type of valve found in the genera *Brachonchulus* Andrassy, 1958, *Granonchulus* Andrassy, 1958, *Judonchulus* Andrassy, 1958, and *Sporonchulus* Cobb, 1917 is not known as material of these genera was not available.

DISCUSSION

The tuberculate type of valve is found in genera in which the tooth or teeth lie in the posterior half of the stoma. Although the teeth in adults of *Anatonchus* spp. may be situated in the anterior half of the stoma, they are basally situated in the larvae. Further, the structure of the valve alone will serve to distinguish members of the genera *Mononchus* and *Iotonchus*, which have become inseparable as at present defined. The funnel-shaped valve, which is often a transient feature of fixed material, is not of systematic significance but the tubercles which show up well in fresh and preserved material appear to be useful.

I thank Mr. C. C. Doncaster for taking the photomicrographs, Prof. G. Thorne for reporting on *I. acutus*, *I. amphigonius*, *I. trichurus* and *M. trionchus*, and Mr. J. R. Williams for reporting on *I. brachylaimus* and for the gift of specimens.

ZUSAMMENFASSUNG

Die Verbindung von Oesophagus und Darm bei den Mononchiden (Enoplida, Nematoda)

Einige morphologische Merkmale der Verbindung von Oesophagus zum Darm verschwinden bei den Mononchiden oft bald nach der Fixierung, besonders die trichterförmige Klappe, die von dem Schliessmuskel umgeben ist. Veröffentlichungen über diesen Bereich stimmen mit der Morphologie der lebenden Nematoden nicht überein. Bei den Oesophagus-Darmklappen der Mononchiden unterscheidet man zwei Typen: 1. den tuberkular-Typ, der durch das Vorhandensein von drei deutlichen

hohlen Bläschen am Hinterende der Oesophagus nahe der trichterförmigen Klappe charakterisiert ist und 2. den nicht-tuberkular-Typ, bei dem die Bläschen fehlen und die Oesophagusführung nahe dem hinteren Ende enger wird. Der tubercular-Typ wurde bei *Anatonchus*, *Iotonchus* und *Miconchus* gefunden, der nicht-tuberkular-Typ trat bei *Mononchus*, *Prionchulus*, *Mylonchulus* und *Cobbonchus* auf.

Mononchus mauritiannus Williams 1958 wurde in die Gattung *Cobbonchus* Andrassy überführt.

LITERATURE

- ANDRÁSSY, I. (1958). Über das System der Mononchiden (Mononchidae Chitwood, 1937; Nematoda); *Ann. hist.-nat. Mus. hung.* n.s. 9, **50**, 151-171.
- CHITWOOD, B. G. & CHITWOOD, M. B. (1937). The histology of nemic oesophagi VIII. The oesophagus of representatives of the Enoplida, *J. Wash. Acad. Sci.*, **27**, 517-531.
- (1950). *An introduction to Nematology. Section 1, Anatomy*; revised edition, Baltimore, Chitwood.
- DITLEVSEN, H. (1911). Danish Free-living Nematodes, *Vidensk. Medd. dansk naturrb. Foren. Kbh.* **63**, 213-256.
- MICOLETZKY, H. (1922). Die freilebenden Erd-Nematoden, *Arch. Naturgesch.* **87**, Abt. A. (8 & 9) 1-650.
- STEINER, G. (1914). Freilebende Nematoden aus der Schweiz, *Arch. Hydrobiol. (Plankt.)* **9**, 259-276.

4. REDESCRIPTION OF *MONONCHUS TRUNCATUS* BASTIAN,
M. PAPILLATUS BASTIAN AND *PRIONCHULUS MUSCORUM*
(DUJARDIN) (ENOPLIDA, NEMATODA)

BY

W. C. CLARK

Rothamsted Experimental Station, Harpenden, Herts., England¹⁾

¹⁾ At present on study leave from Entomology Division, D.S.I.R., Nelson, New Zealand.

Three species of the Mononchidae are redescribed; *Mononchus truncatus* Bastian because it is the type species of *Mononchus*, and *M. papillatus* Bastian and *Prionchulus muscorum* (Dujardin) because of the confusion between them (ALTHERR, 1938). Both genera are redefined.

The nematodes examined were collected in England; *M. truncatus*, Falmouth (type locality) and Chippenham Fen; *M. papillatus*, Broadmoor Institution, Berks (type locality), Falmouth, and Woburn, Beds.; *P. muscorum*, Broadmoor Institution, Berks, Falmouth, Woburn, Beds., and Rothamsted. Moss from the Jardin des Plantes, Paris (type locality and habitat of *P. muscorum*) yielded no specimens. Measurements are of eelworms killed by heat, fixed in F.A. 4 : 10 and transferred to glycerine by Baker's method (GOODEY, 1957). The nematodes were examined alive or narcotized because details of the papillae and of the oesophago-intestinal junction become obscured after fixation (CLARK, 1960).

MONONCHIDAE Chitwood and Chitwood 1937 Emend.

Triploidea. Cuticle smooth or nearly so; lateral fields absent. Head broad, sub-rounded or truncated; not, or only slightly offset; with six lips and two rings of papillae, the inner ring with six or eighteen, the outer ring with six, ten, or fourteen papillae. Amphids level with the anterior half of the stoma, moderate to small size, pouch-like, with crescentic transverse apertures. Stoma large and wide, heavily sclerotized, tripartite and always armed with single immovable, dorsal tooth; subventral teeth present or absent, smaller or equal to the dorsal tooth. Teeth directed anteriorly or posteriorly. Subventral denticles absent or present in transverse or longitudinal rows, or scattered. Oesophagus very muscular, anteriorly enveloping the posterior end of the stoma, widening slightly posteriorly, always non-bulbar. Nerve ring encircles the oesophagus at one quarter to one third of its length. Dorsal oesophageal gland opens into oesophageal lumen behind nerve ring; one pair of subventral glands open near the posterior end of oesophagus, and the other pair between the other two ducts. Oesophageal lumen tri-

quetrous, lining sclerotized. Oesophago-intestinal junction with sphincter muscle and lightly sclerotized valve apparatus (usually not visible in fixed specimens). Intestine a simple tube, cells usually with granular contents. Pre-rectum in males only; rectum short, usually straight. Tail long or short, variously shaped, sexes similar or dissimilar; usually with three caudal glands which may or may not discharge through a terminal or subterminal orifice (= "spinneret" of Cobb). Tail usually with paired lateral cuticular pores. *Females* Genital organs mostly paired, opposed, but may be single, either pre- or post-vulvar; ovaries short, reflexed. Only a few eggs in the uteri at a time. *Males* Testes paired, opposed, outstretched. Spicules simple, paired and free. Gubernaculum present; often associated with complex lateral accessory pieces. Supplements in a single ventro-median series, sometimes echinulate, roughly equidistant.

In some species males are rare or unknown.

Found in soil, moss, liverworts, forest litter, and freshwater. Some show a distinct preference for wet soils.

Type genus: *Mononchus* Bastian, 1865.

Mononchus Bastian, 1865

Mononchidae. Stoma large, almost parallel sided, usually with pointed base; armed with a single, stout, anteriorly directed, dorsal tooth, its apex lying in the anterior half. A low, untoothed, ventral ridge may be present. Oesophago-intestinal junction of the non-tuberculate type (CLARK, 1960); i.e. with a stout sphincter muscle surrounding a lightly sclerotized, funnel-shaped extension of the oesophageal lining; never with sclerotized knobs or tubercles. Ovaries paired, rarely single (*M. monobystera* Cobb). Spicules simple, separate, arcuate. Gubernaculum simple, or enveloping the spicules laterally, or associated with complex accessory pieces. Tails mostly short, conoid; or long, conoid at first with a cylindrical end part. Found in freshwater, soil, leaf mould, mosses, and liverworts.

Type species: *Mononchus truncatus* Bastian, 1865.

Mononchus truncatus Bastian, 1865

Figures 1 A-I

Mononchus truncatus Bastian, 1865; p. 101, pl. IX, figs. 25, 26.

Mononchus macrostoma Bastian, 1865; p. 101-102, pl. IX, figs. 29, 30.

Mononchus longicaudatus Cobb, 1893; p. 12 fig. 2.

Mononchus microstoma Cobb, 1893; p. 13.

Mononchus (Mononchus) truncatus Cobb, 1916; p. 195.

Mononchus (Mononchus) macrostoma Cobb, 1916; p. 195.

Mononchus (Mononchus) longicaudatus Cobb, 1916; p. 195.

Mononchus macrostoma var. *filicaudatus* Schneider, 1937; p. 48, figs. 5a, b.

nec. *Mononchus macrostoma* var. *armatus* Daday, 1897; p. 108, fig. 14. (= *M. dadayi* Micoletzky, 1914 sp. *inquirenda*).

nec. *Mononchus longicaudatus* Schuurmans Stekhoven & Teunissen 1938; p. 85, figs. 44a, b, not of de Man nor of Cobb.

nec. *Mononchus macrostoma* Schuurmans Stekhoven & Teunissen 1938; p. 86, figs. 45a, b.

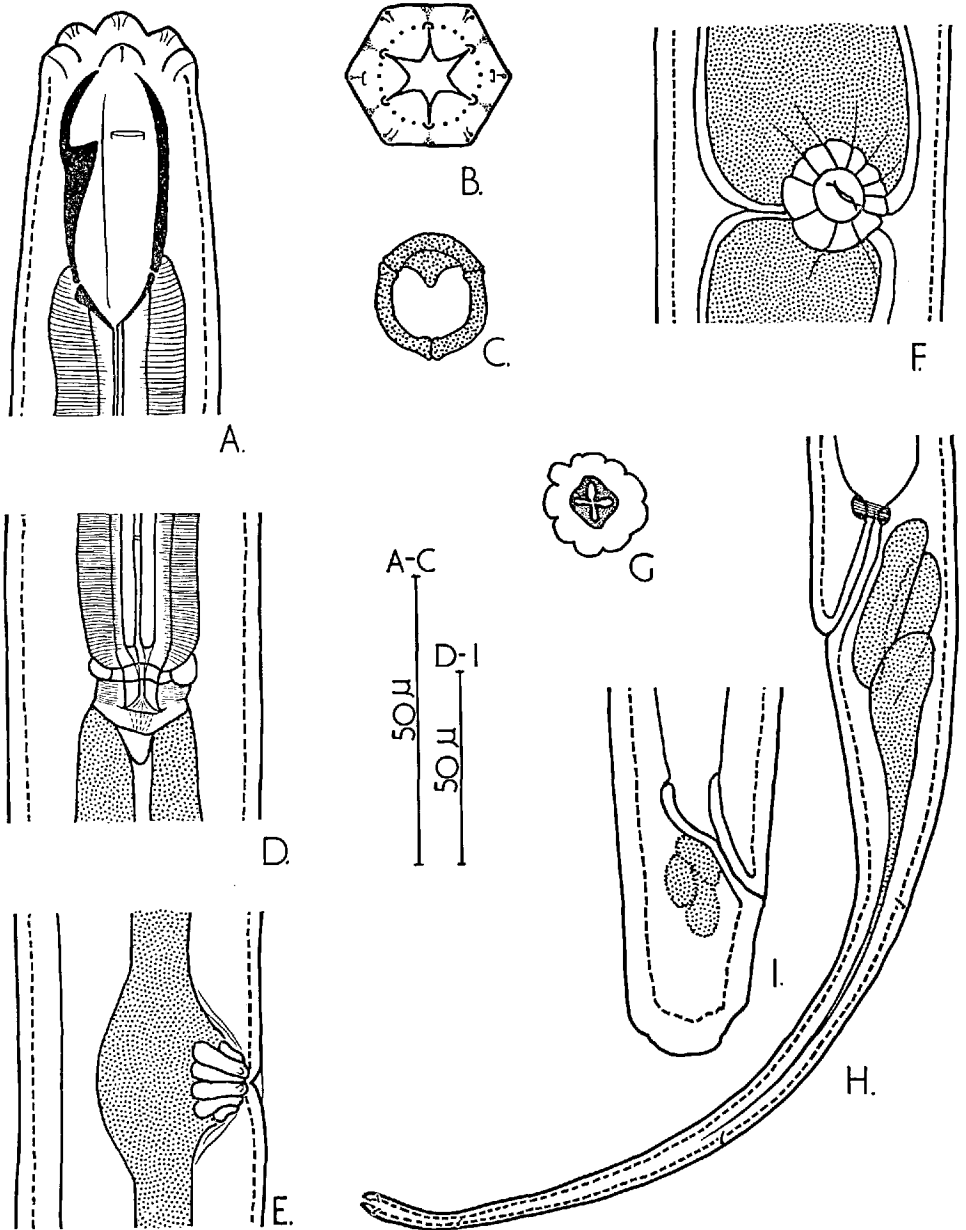

Figure 1. *Mononchus truncatus*. A. Head region; B. *en face* view of head; C. cross section of stoma at the level of the dorsal tooth; D. oesophago-intestinal junction; E. lateral view of the vulva; F. ventral view of vulva; G. sectional view of vagina; H. female tail; I. abnormal female tail.

Falmouth

Neotype ♀ L = 1.92 mm; a = 28; b = 3.9; c = 8; V = ¹⁴ 55.5 ¹³
 ♀♀ (n = 9) L = 1.86 mm; (s = ± 0.143 mm) (range 1.65-2.14 mm)
 a = 26-40; b = 3.4-4.3; c = 6.4-8.6;
 V = ¹⁰⁻²² 48.4-55.5 ¹⁰⁻¹⁵

Chippenham Fen

♀♀ (n = 2) L = 1.67-1.85 mm; a = 33-36; b = 3.6-3.8; c = 5.8-6.4;
 V = ⁹⁻¹¹ 53.4-54.3 ⁷⁻¹²

Neotype ♀ from moss at the edge of Swan Pool, Falmouth, England.

Slide no. 143/2/4 Nematology Dept., Rothamsted Experimental Station, Harpenden.

Cuticle smooth 2 μ thick, subcuticle 2 μ thick. No lateral fields. Head sub-rounded, not offset, lips rather small. Amphid apertures small transverse slits at the level of the dorsal tooth apex. In *en face* view the lip region as in figure 1B. Lips six, rounded on the inner edge, with two rings of papillae; inner ring of eighteen (three on each lip arranged in a short arc) and outer ring of ten (one at the peripheral apex of each lip, and one placed sub-laterally on each of the sub-median lips). In this view amphid apertures appear as crescentic slits. At level of dorsal tooth apex stoma deeper than wide, and the sclerotized elements are thickened where they abut.

In lateral view stoma almost three times as long as broad. Tooth apex at about 20-28 % of the stoma length. Anterior edge of the tooth straight, and sloping slightly posteriorly from apex. Posterior margin of tooth gently arcuate and merging imperceptibly with the stoma wall. Stoma wall with faint transverse striae, dorsal wall slightly indented below tooth apex. Stoma walls inarched above the tooth apex. Posterior elements not clearly marked off from anterior ones.

Oesophagus slightly expanded and surrounding basal third of stoma, then narrowing a little to the nerve ring at one quarter of the oesophageal length, then expanding again to occupy five-ninths of the body width. Dorsal oesophageal gland duct occurs at half the oesophageal length, duct of one pair of subventral oesophageal glands occurs at three-quarters of the oesophagus length, and the other duct at one oesophagus width from the end. Oesophago-intestinal junction with a narrow transparent zone interpolated between base of oesophagus and sphincter muscle, and flanked laterally by three (?) transparent bodies. Sphincter muscle solid, rather disc-like with an obtusely rounded conical structure projecting into intestinal lumen from the posterior face of the sphincter. Sclerotized lining of the oesophagus constricted near base of oesophagus and becomes less heavily sclerotized. After passing through the transparent zone and into the sphincter muscle the sclerotized lining fans out and becomes funnel-shaped. The walls of the "funnel" bear a number of plications. (The actual shape of this structure varies with the state of contraction of the muscle fibres). The lightly sclerotized "funnel" and the sphincter muscle form a valve between the oesophagus and the in-

testine (Figure 1D). Intestine a simple tube with abundant intra-cellular granules. In the female it passes to the right of the anterior and to the left of the posterior ovary. No pre-rectum in the female. Rectum straight, length equal to anal body width.

Vulva a transverse slit, one sixth body-width; lips oval, very feeble. Vagina feebly muscular, extending across less than one third of body-width; its lumen cruciform. Genital organs paired, opposed, ovaries reflexed through half the length of the uterus and oviduct. Up to four ova in the uteri at a time.

Tail conoid at first, then tapering more gradually to become almost cylindrical in the posterior two-thirds; tip rounded and slightly swollen. Three large caudal glands present, duct terminal. Paired lateral cuticular pores usually as shown in figure 1H.

Male (from DE MAN, 1884) "Schwanz des Männchens *von gleicher Gestalt* wie des Weibchens. Spicula *sehr schlank*, dünn, in eine sehr stumpfe Ecke gebogen, mit zentralem Verdickungsstreife, von zwei *ebenso schlanken*, aber viel kürzeren akzessorischen Stücken begleitet. Cuticula beim Männchen vor After schräg gestreift; 20 Papillen, nahe beieinander gelegen und kaum hervorragend, vor dem After und drei mediane ventrale wie auch einige laterale Papillen auf dem eigenlichen Schwanze." L = 1.9 mm.

REMARKS

M. truncatus and *M. macrostoma* are probably the same species. Apart from the supposed absence of cephalic papillae in *M. truncatus*, which is either an artifact or an oversight, the other differences mentioned by Bastian are unimportant. ANDRASSY (1958) has drawn attention to the variability of this species, with which he synonymised poorly known species such as *M. dadayi* Micoletzky, 1914, and *M. obtusus* Cobb, 1917. The six small tooth-like, cuticular, circum-oral spines mentioned by COBB (1917) in *M. dadayi* are the crudely drawn papillae. Daday's figures and descriptions are inadequate for identification. Butschli's figures of *M. obtusus* (copied by Cobb) are based on a partially distorted head which has been badly drawn. The stoma shown in these figures is of a different shape from that of *M. truncatus* and with the tooth apex at 39 per cent of the stoma length. The tail has a different shape, and the papillae are quite different. The status of Cobb's *M. longicaudatus* and *M. megalaimus* is not easily decided. *M. longicaudatus* is very similar to *M. truncatus*. These two species differ mainly in that males of the former have sixteen supplements compared with twenty in the latter, but as the range of variation of this character is not known, this criterion is of doubtful value for their separation. When Cobb erected *M. longicaudatus* in 1893 he does not appear to have seen *M. truncatus* (or *M. macrostoma*) from Europe. *M. longicaudatus* and *M. truncatus* are best regarded as synonyms until they can be compared. *M. megalaimus* is strikingly different from *M. truncatus* and *M. longicaudatus* in the feeble development of the lips and the close approximation of the anterior end of the stoma to the lips. Cobb's figure is not strictly lateral

so comparison of the teeth and stoma shape is not possible. *M. megalaimus* stands until the American mononchs are revised and its status determined. I regard *M. dadayi* Micol. and *M. obtusus* Cobb as *species inquirendae*.

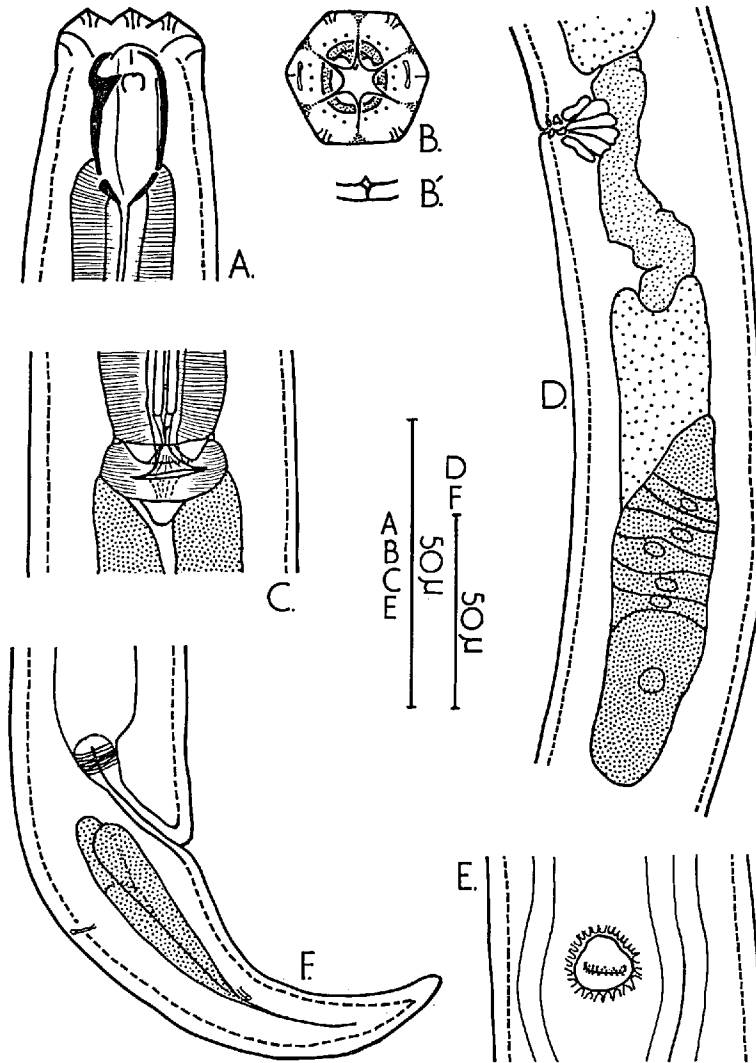

Figure 2. *Mononchus papillatus*. A. Head region; B. *en face* view of head (stoma cross section at the level of the dorsal tooth apex); B'. Enlarged view of ventral part of stoma showing ventral ridge in section; C. oesophago-intestinal junction; D. posterior half of female genital organs; E. ventral view of the vulva; F. female tail.

Mononchus papillatus Bastian

Figures 2A-F

Mononchus papillatus Bastian, 1865; p. 101, pl. IX, figs. 27, 28.

Mononchus (Mononchus) papillatus Cobb, 1916; p. 195.

Iotonchus papillatus Altherr, 1950; p. 4.

Prionchulus papillatus Altherr, 1952; p. 9.

Mononchus papillatus Andrassy, 1958; p. 1865.

nec Mononchus papillatus etc. in Butschli, 1873; Ditlevsen, 1911; Brakenhoff, 1914; Menzel, 1914; Hoffmann & Menzel, 1915; Micoletzky, 1922 (partim); Micoletzky, 1925; Allgén, 1929; Altherr, 1938; de Coninck, 1939; Schuurmans Stekhoven & Teunissen, 1938; Schuurmans Stekhoven & Mawson, 1954.

nec Mononchus bastiani de Man, 1876.

Broadmoor.

Neotype ♀ L = 1.29 mm; a = 29; b = 3.9; c = 19; V = $^{16} 62.2^{13}$

♀♀ (n = 9) L = 1.23 mm; (s = ± 0.292 mm) (range 1.01-1.30 mm);

a = 22-29; b = 3.6-3.9; c = 14-19; V = $^{8-16} 60-67.7^{9-14}$

Neotype ♀ from turf, Broadmoor Institution, Berks. England. (Type locality).

Slide no. 143/1/7 Nematology Dept., Rothamsted Experimental Station, Harpenden, England.

Males extremely rare; only description THORNE (1924).

Cuticle smooth 1.7 μ thick; subcuticle smooth 1.7 μ thick. No lateral fields. Lip region scarcely offset, cephalic lips and papillae conspicuous in fresh material, less so in preserved specimens. Lips six, equal, symmetrical, inner margin rounded, outer margin obtusely angular. In *en face* view the papillae are readily seen in two rings, the inner ring of eighteen (three on each lip arranged in an almost straight line across the lip,) and an outer ring of fourteen (one at the apex of each lip and a sub-lateral pair on each of the sub-median lips). The innervations of the three inner papillae are distinguishable in lateral view, but usually only one papilla in the outer ring on the sub-median lips is visible in this view. Amphid apertures appear as crescentic slits in *en face* view. Stoma squarish in cross section at level of dorsal tooth apex. In this view dorsal tooth appears triangular in cross section, spreading slightly onto the dorsal wall. Opposite the dorsal tooth apex the abutting edges of the anterior subventral components of the stoma are thickened on the inner face. (This thickening forms the ventral ridge seen in lateral view). In lateral view the amphid apertures are difficult to see, but are situated at the level of the dorsal tooth apex. Viewed laterally the sclerotized stoma is cup-shaped, half as wide as long, and half as wide as the head width. Dorsal tooth apex occurs at 15-21 % of the stoma length. Anterior margin of tooth straight, horizontal or nearly so; posterior edge merges smoothly into stoma wall without any re-entrant angle. Dorsal wall of stoma indented a little posterior to tooth apex. On the ventral wall the thickened, abutting edges of the antero-ventral elements of the stoma form a low, untoothed ridge extending from a point opposite the dorsal tooth apex to the posterior limit of the anterior elements. Anterior to the tooth apex and ventral ridge, the stoma walls arch inwardly and restrict the size of the anterior aperture to about a third of the greatest width of stoma. Suture between anterior and posterior elements obscure. Postero-dorsal element much thickened anteriorly, but thins rapidly towards oesophageal lumen. Anterior three-

quarters of stoma surrounded by thin connective tissue sheath; posterior quarter embedded in anterior part of oesophagus.

Oesophagus muscular and glandular, narrowing slightly from stoma base to nerve ring at a quarter of oesophageal length, then expanding with general body contour to occupy slightly more than half the body width. Dorsal oesophageal gland duct opens into oesophageal lumen at mid point; one sub-ventral gland duct opens at two-thirds of its length; remaining duct opens half an oesophagus-width from end. Oesophago-intestinal junction more complex than existing figures indicate. Base of the oesophagus sub-rounded; from its posterior face an annulus of transparent tissue is surrounded by the sphincter muscle. Sclerotized lining of oesophagus becomes much thinner near base of the oesophagus; constricted where it passes through posterior end and starts to expand again as it passes through the transparent annulus, becoming funnel-shaped within the sphincter muscle. Attached to the posterior face of sphincter is a small conical projection, the shape and size of which varies from specimen to specimen. On either side of the oesophagus base and anterior to the sphincter muscle are small discrete transparent bodies. In life the thin sclerotized funnel is constricted by the sphincter muscle, and the whole forms a valve. Food passes rapidly through this valve.

Intestine a simple tube with abundant dark granules in its cells, passing to the right of the anterior and to the left of the posterior ovary. No pre-rectum in the female; rectum straight, length almost equal to the anal body-width.

Vulva a transverse slit one fifth body-width, with slightly thickened oval lips. Vagina muscular, extending across one third of body-width, and uniting with paired uteri. Genital organs paired, opposed, ovary reflexed through half to two-thirds the length of oviduct and uterus. Ovary half as wide as body, oocytes in a single row. No sphincter muscle or glandular region observed at the oviduct-uterus junction. Usually only one mature egg in the uteri; occasionally one in each uterus.

Tail conoid, ventrally arcuate, short. Three caudal glands present but no terminal duct; two pairs of lateral cuticular pores seen.

Differential diagnosis

Mononchus papillatus Bastian is most frequently confused with *Prionchulus muscorum* (Dujardin). For differentiation of these two species see page 192.

REMARKS

Several species may be hidden under the name *M. papillatus*. It is almost certain that the larva assigned to this species by SCHUURMANS STEKHOVEN & MAWSON (1954) from Soltanbad, Iran ($L = 2.5$ mm) does not belong here. The *M. papillatus* recorded from New Zealand and the Campbell Islands by ALLGÉN (1929) are probably *P. muscorum* (Dujardin), though rather small ($L = 1.45$ mm). The smallest specimen of this species I have from New Zealand is 1.68 mm long. The size of Mononchids varies considerably from habitat to habitat and 1.45 mm may be written within the range of variation for Campbell Island populations. It

is uncertain whether Allgén's dimensions relate to a specimen from New Zealand or Campbell Island.

M. bastiani de Man, 1876 has often been synonymised with *M. papillatus* but according to P. A. A. LOOF (*in litt.*) de Man's specimen possesses the denticulate ridges of *P. muscorum* and is a synonym of that species.

M. cristatus Bastian, 1865 was synonymised with *M. papillatus* by ANDRÁSSY (1958). Bastian's description is brief and the figure (only specimen) has an obvious post-mortem artefact on the tail. The dimensions given are for an "immature female" for which $L = 1.1$ mm but FRANKLIN (1955) has shown that for *Aphelenchus* spp. Bastian's measurements are 25 per cent too large. This holds for at least some of his mononchs. The corrected length of *M. cristatus* is 0.82 mm which is very small for *papillatus*; the value ($c = 6$) for *cristatus* indicates a tail two to three times as long as that found in *papillatus*. *M. cristatus* has not been recorded since it was described, and could not be recognised from the data available. I therefore regard it as a *species inquirenda*.

Over the years the names *Mononchus papillatus* and *Prionchulus muscorum* have been used about equally for species with denticulate and non-denticulate ridges. The confusion is well known. Dujardin stated that denticulate ridges were present in *muscorum*, but Bastian stated of *papillatus* "tooth single," and did not figure any ridge on the ventral stoma wall. Dujardin gave the length of *muscorum* as 2.56 mm, and Bastian's *papillatus* was $\frac{1}{11}$ th in. (= 2.31 mm). Bastian's measurements are often 25 per cent too large (see above); this appears to hold for *M. macrostoma* and also appears likely for *M. papillatus*. If applicable, this reduces the length to 1.73 mm which is one fourth larger than any of my specimens from Broadmoor. This difference is not great for mononchids some of which (e.g. *Iotonchus parazschokkei* (Allgen), *M. propapillatus*, *Cobbonchus pounamua* n. spp. CLARK in press) vary by a factor greater than two. No definite conclusions can be drawn from measurements, nor from Bastian's figure of the head which is distorted. One can only speculate whether Bastian overlooked a denticulate or a non-denticulate ridge. We may note that he knew of Dujardin's species as he reproduced the description. In the absence of any type specimens it is impossible to prove synonymity, or that two distinct species are indicated. Because both names have long standing I prefer to restrict them as COBB, 1917 and T. GOODEY, 1942, 1951 have done, using *M. papillatus* for the species with a non-denticulate ridge, and *P. muscorum* for the species with two denticulate ventral ridges.

Prionchulus Cobb, 1916

Mononchidae. Stoma large, almost parallel sided, armed with a single, stout, anteriorly directed, dorsal tooth situated in the anterior half, and with two sub-ventral, denticulated, longitudinal, sclerotized ridges (only one visible in lateral view). Number of denticles variable, usually fewer and less well developed in larvae. Where the denticles are few they tend to be aggregated at the anterior

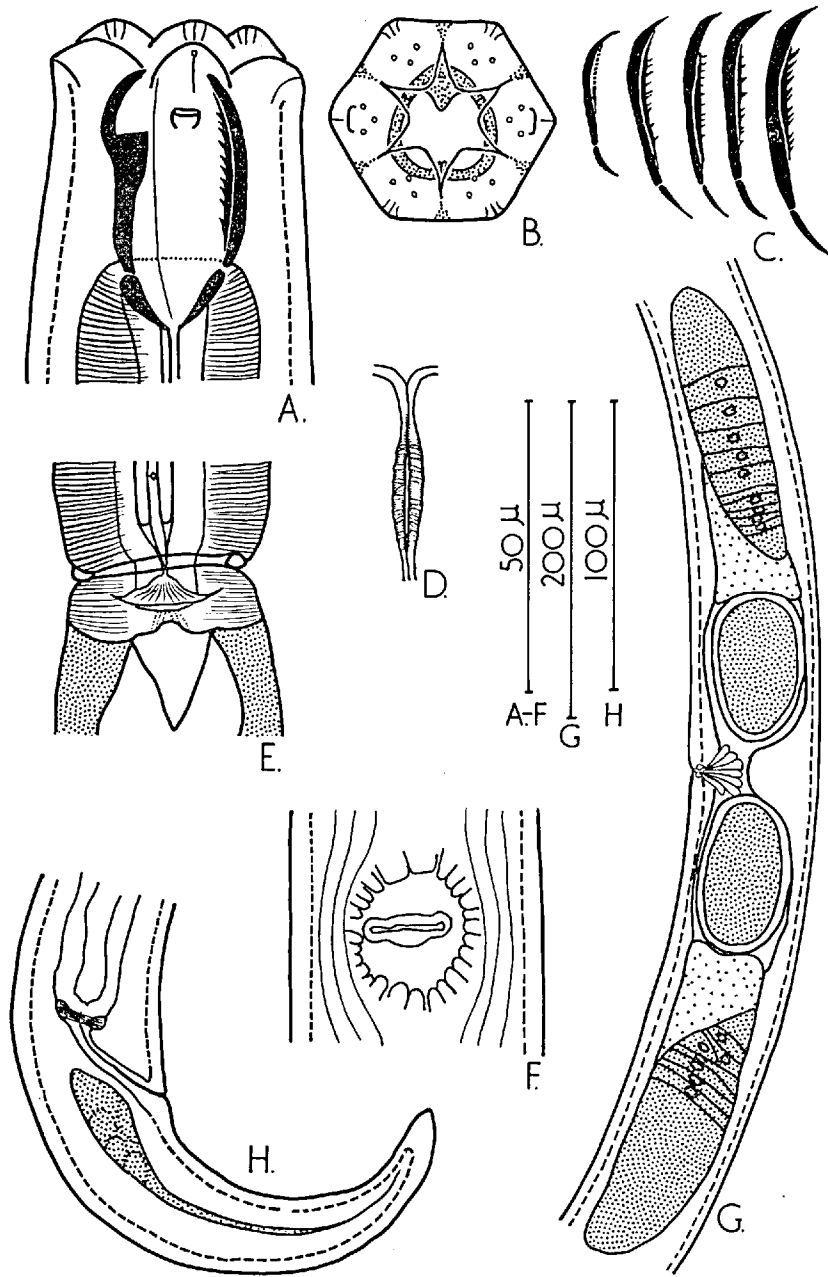

Figure 3. *Prionchulus muscorum*. A. Head region; B. *en face* view of head; cross section of stoma at the level of the dorsal tooth apex; C. lateral views of the denticulated ridges of some larvae showing variation in denticulation; D. ventral denticulated ridges viewed from the dorsal side; E. oesophago-intestinal junction; F. ventral view of the vulva; G. lateral view of female genital organs; H. female tail.

end of the ridges. Oesophago-intestinal valve non-tuberculate (CLARK, 1960); i.e. with stout sphincter muscle partially lined with lightly sclerotized, funnel-shaped extension of the oesophageal lining; never with sclerotized knobs or tubercles. Female genital organs paired, opposed, ovaries reflexed. Vulva 47-67 %. Spicules stout, arcuate; gubernaculum simple, but in all known males is associated with bifid lateral pieces. Tail usually short and conoid, rarely long and slender. Caudal glands present, no terminal duct. Paired lateral cuticular pores on tail (in males of *P. longus* Thorne these pores may be situated on papillae). Males rare or common. Found in soil, moss, leaf mould, and in sulphur springs (*P. thiocrenobius* Pax and Soós).

Type species: *Oncholaimus muscorum* Dujardin, 1845

Prionchulus muscorum (Dujardin, 1845) Chitw. & Chitw., 1937

Figures 3A-H

Oncholaimus muscorum Dujardin, 1845; p. 237.

Mononchus muscorum Bastian, 1865; p. 103.

Mononchus bastiani de Man, 1876; p. 184, pl. XIII, fig. 49a, b.

Mononchus (Prionchulus) muscorum Cobb, 1916; p. 195.

Mononchus (Prionchulus) muscorum macrolaimus Cobb, 1917; p. 163, fig. 38.

Prionchulus muscorum Chitwood and Chitwood 1937; p. 517.

Mononchus papillatus in Bütschli, 1873; Ditlevsen, 1911; Menzel, 1914; Hoffmänner & Menzel, 1915; Micoletzky, 1922 (partim); Micoletzky, 1925; Schneider, 1929 (partim); Allgén, 1929; de Coninck, 1939.

Broadmoor

♀♀ (n = 21) L = 2.12 mm; (s = ± 0.120 mm) (range = 1.91-2.32 mm)

a = 26-33; b = 3.3-4.4; c = 13-17;

V = ^{7.9}61.3-66.7 ^{7.22}

Cuticle smooth, 2.5 μ thick, subcuticle 1.5 μ thick. No lateral fields. Lip region not markedly offset. Lips and cephalic papillae readily distinguishable in lateral view (papillae less prominent in fixed material). Lip region hexagonal in *en face* view; lips six, equal, rounded on inner edge, obtusely angled on peripheral edge. Cephalic papillae in two rings, inner one of eighteen (three on each lip arranged in form of an inwardly directed obtuse triangle) and outer ring of fourteen (one placed at the apex of each lip, and a pair placed slightly laterally to this on each of the sub-median lips). Amphid apertures crescentic slits below the level of the lips. In this view the tripartite nature of the stoma is clearly seen. At the level of the dorsal tooth apex stoma rather triangular in cross section. Along the ventral suture the ventro-lateral elements are slightly invaginated and thickened on the inner surface where they abut. Transverse thickenings along these ridges form the denticulations characteristic of the genus. Dorsal tooth triangular in cross section spreading considerably onto the dorsal wall of the stoma.

In lateral view the inner ring of papillae is easily distinguished, but, of the outer ring, only the apical papillae are easily seen. In lateral view pouch-like amphids

are situated between the tooth apex and the anterior limit of the sclerotized stoma. Stoma twice as long as broad, cup-shaped with pointed base. Dorsal tooth strong, with apex at 25-30 % of stoma length. Anterior edge of the tooth straight, almost horizontal or sloping slightly posteriorly from the apex. Posterior or buttress edge merging imperceptibly with the dorsal stoma wall. On the ventral wall of the stoma lie the denticulate ridges bearing nine to fourteen denticles in the mature female. In larvae these denticles are irregular in development and number. Dorsal wall of stoma indented laterally to the tooth; both walls inarched above the tooth apex, and the anterior orifice of the stoma restricted to two-fifths of the greatest diameter of the stoma. Suture between the anterior and posterior stomal elements obscure. In lateral view the dorsal posterior element appears much thicker than the ventral ones, but becomes thinner towards the oesophageal lumen. Basal quarter of the stoma enveloped by the anterior end of the oesophagus. Oesophagus uniform in width to the nerve ring which occurs at a quarter of its length; then expanding a little with the general body contour and occupying three-fifths of the body width. Dorsal oesophageal gland duct opens into the oesophageal lumen at 60 per cent of the oesophagus length and the subventral gland ducts open at 80 and 95 per cent respectively.

Oesophago-intestinal junction with thin transparent zone interpolated between sphincter muscle and base of oesophagus. Flanked on either side by 3 (?) smaller transparent bodies. Sphincter stout and disc-like. A little before the end of the oesophagus its sclerotized lining becomes much thinner and is constricted as it passes through the oesophagus base and the transparent area. In the sphincter, this flares out again to form a shallow bell-like structure, much plicated in its mid-region. Its tripartite nature detectable only with difficulty. The shape of the sclerotized structure varies with the contraction of the sphincter muscle fibres. Posterior surface of sphincter bears a short conical structure the shape of which is rather variable, invisible in most specimens. Intestine a simple tube, cells with abundant dark granules. Intestine passes to the left of the anterior and to the right of the posterior ovary. No pre-rectum; rectum straight, equal to anal body-width.

Vulva a transverse slit, one-third as wide as the body, with broad, variable, slightly thickened lips. Vagina moderately muscular, extending inwards about a third of body width, and uniting with the uteri. Genital organs paired, opposed, ovaries reflexed through a third to half the length of oviducts and uteri. Oocytes arranged in a single row. No sphincter or glandular region between the oviducts and uteri. Length of the uteri varies with the number of mature eggs contained. Egg shells may be ridged. Often only one mature egg in each uterus, but there may be two in each.

Tail short, conoid, ventrally arcuate. Caudal glands present, but no spinneret. Two pairs of lateral cuticular pores as shown in figure 2F.

Male (after SCHNEIDER, 1923)

n = 2 L = 2.16-2.24 mm; a = 36-37; b = 4.0-4.14; c = 18-18.7.

Supplements sixteen evenly spaced, the first, three tail lengths from the anus. Spicules paired, large, arcuate. Gubernaculum small, partially enfolding the spicules. Notched lateral accessory pieces present. Tail similar to female.

REMARKS

One adult female *P. muscorum* from Broadmoor appeared to be undergoing an adult moult. The specimen had the normal, fully developed genital structures, a patent vulva in the cuticle that was being shed, and another lying beneath it in the newly formed cuticle. The stoma had two sclerotized linings; one in the process of being moulted. There were no mature eggs in the uteri, the oocytes in the ovaries were rather small, and the length of the eelworm was only 1.62 mm (smaller than any other females I have measured) and therefore probably precociously mature, rather than undergoing an additional moult.

P. muscorum appears to be a cosmopolitan species. Because the figures of *Mononchus muscorum* of SCHUURMANS STEKHOVEN & TEUNISSEN (1938) lie quite outside the range of variability encountered so far this species, the specimens from which these figures were drawn are believed to be a new and undescribed species. No measurements were given, and the males were not described or figured.

ANDRÁSSY (1958) provides a synonymy for *P. muscorum* but gives no reasons for including some of the forms. *M. papillatus* forma *macrodon* Fuchs is based on a specimen of *papillatus* with a partially collapsed stoma. There are no grounds for placing it in this genus as denticulate subventral ridges are neither figured nor mentioned. He has overlooked the echinulate eggs of *P. punctatus* Cobb, a feature unknown in *muscorum*. The status of *M. (P.) longicollis* Cobb is in doubt and as it appears to be based on a single larva I regard it as a *species inquirenda*. *M. (P.) muscorum macrolaimus* Cobb is of doubtful status; there appear to be some differences between the two forms but until specimens can be compared I agree with Andrásy and regard it as a synonym of *P. muscorum*. The single male of *P. spectabilis* (Ditlevsen) described by MEYL (1955) does not agree with the characters of *spectabilis*; there are far too many denticles on the ventral ridges and the length is only 1.52 mm whereas Ditlevsen's males measured 3.6 mm. Meyl's specimen may be a male of *P. muscorum*, but until similar specimens are found associated with females it is best to regard *P. spectabilis* Meyl, 1955 *nec* Ditlevsen, 1911 as a *species inquirenda*.

CONCLUSION

Adults of *M. papillatus* and *P. muscorum* are readily distinguishable. Most of the confusion between them has arisen from attempted determinations of larvae, and probably from the intrusion of a third species, *P. punctatus* Cobb, 1917 (= *M. muscorum* of BRAKENHOFF, 1914), a species characterised by poorly developed, rather short denticulate ridges in the stoma, and by the presence of echinulate eggs. Echinulate eggs are not found in *muscorum*, but have been re-

corded by BRAKENHOFF (1914), and ALTHERR (1938). The figures of these authors are not of typical *muscorum* or *papillatus*. *M. echinulatus* Altherr, 1938 appears to be a *lapsus* for *M. punctatus*. Specimens of *P. punctatus* were not available for consideration.

The described species of *Prionchulus* are chiefly to be recognised from the characters set in Table I. Most species are imperfectly known, the range of variation being quite unknown, and probably many more species await description.

TABLE I
Characters of the described species of *Prionchulus*

| species | ♀ | L. | c | tail | ♂ | L. | c | no. of denticle on ridges |
|------------------------------------|-------------------|----------|---------|-----------------------------------|---|-----------------|----|---------------------------------|
| <i>muscorum</i> (Dujardin) | | 1.9-3 mm | 12.5-17 | conoid short | | — | — | 9-14 |
| <i>longus</i> (Thorne) | | 2.14 mm | 20 | conoid short | | 2.0 mm | 27 | 20 |
| <i>punctatus</i> Cobb | | 1.7 mm | 14.3 | conoid short | | — | — | 12 (ridges short) |
| <i>spectabilis</i> (Ditl.) | (echinulate eggs) | 4.0 mm | 8 | conoid short | | 3.6 mm | ? | 7 |
| <i>thiocrenobius</i> Pax & Soos | | 1.6 mm | 5.5 | longish slender tip swollen | | — (V = 47 %) | — | 16-17 (?) (ridges short) |

M. papillatus and *P. muscorum* may be readily separated as follows:

M. papillatus

P. muscorum

Ventral ridge low, never denticulate

Ventral ridges prominent, always denticulate; denticulations variable in larvae.

Inner papillae on each lip arranged in a straight line

Inner papillae on each lip arranged in an obtuse triangle.

Stoma squarish in cross section at the level of dorsal tooth apex

Stoma rather triangular in cross section at level of dorsal tooth apex.

Ventral ridge terminates at level of tooth apex

Ventral ridges extend a little anterior to dorsal tooth apex.

Not more than two eggs in uteri at a time

Up to four eggs in uteri at a time.

L = 1.0-1.36 mm (British specimens)

L = 1.91-2.64 mm (British specimens).

A soil dwelling species

Predominantly a moss species.

ZUSAMMENFASSUNG

Neubeschreibung von Mononchus truncatus Bastian, M. papillatus Bastian und Prionchulus muscorum (Dujardin) (Enoplida, Nematoda)

Mononchus truncatus Bastian (= *M. macrostoma* Bastian) und *M. papillatus* Bastian werden aus topotypischem Material neubeschrieben und Enotypen bestimmt. *Prionchulus muscorum* (Dujardin 1845) Cobb 1916 wurde aus britischen Populationen neubeschrieben. Die Unterschiede von *M. papillatus* und *P. muscorum* sind folgende:

M. papillatus

Ventrale Leiste niedrig, nie gezähnt.

Innere Papillen an jeder Lippe in einer geraden Linie angeordnet.

Mund im Querschnitt fast quadratisch in Höhe der dorsalen Zahnspitze.

Ventrale Leiste endet auf der Höhe der dorsalen Zahnspitze.

Im Uterus nicht mehr als 2 Eier gleichzeitig.

L = 1,0-1,36 mm (Britische Proben).

Bodenbewohnende Art.

P. muscorum

Ventrale Leisten hervorstehend, stets gezähnt, Zähnelung unterschiedlich bei Larven.

Innere Papillen an jeder Lippe zu einem stumpfen Dreieck angeordnet.

Mund im Querschnitt mehr dreieckig in Höhe der dorsalen Zahnspitze.

Ventrale Leisten erstrecken sich ein wenig nach vorn zur dorsalen Zahnspitze.

Im Uterus bis zu 4 Eier gleichzeitig.

L = 1,91-2,64 mm (Britische Proben).

Vorwiegend eine moosbewohnende Art.

P. punctatus Cobb 1917 kann die Bestimmung beider Arten erschweren. *M. dadayi* Micoletzky 1914, *M. obtusus* Cobb 1917, *M. cristatus* Bastian 1865 und *P. longicollis* Cobb 1917 werden als species inquirendae angesehen. *Mononchus echinatus* Altherr 1938 ist ein Lapsus für *P. punctatus* Cobb.

REFERENCES

- ALLGÉN, C. (1929). Über einige freilebende Moosnematoden, *Nyt Mag. Naturv.* **67**, 211-230.
- ALTHERR, E. (1938). Le faune des mines des Bex, avec étude spéciale des Nématodes, *Rev. suisse Zool.*, **45**, 567-720.
- ANDRÁSSY, I. (1958). Über das System der Mononchiden (Mononchidae Chitwood, 1937; Nematoda), *Ann. Hist.-nat. Mus. hung. n.s.* **9**, **50**, 151-171.
- BASTIAN, H. C. (1865). Monograph on the Anguillulidae *Trans. Linn. Soc. Lond.* **25**, 73-84.
- BRAKENHOFF, H. (1914). Beiträge zur Kenntnis der Nematodenfauna des nordwestdeutschen Flachlandes, *Abhandl. Naturw. Verein, Bremen*; **22**, 267-311.
- CLARK, W. C. (1960). The oesophago-intestinal junction in the Mononchidae (Enoplida, Nematoda), *Nematologica*, **5**, 178-183.
- COBB, N. A. (1917). The Mononchs (*Mononchus* Bastian, 1865), a genus of freelifing predatory nematodes. *Soil Sci.*, **1**, 431-486.
- DITLEVSEN, H. (1911). Danish free-living nematodes, *Vidensk. Medd. dansk naturrb. Foren. Kbh.*, **63**, 213-256.
- FRANKLIN, M. T. (1955). A redescription of *Aphelenchoides parietinus* (Bastian, 1865) Steiner, 1932. *J. Helm.*, **29**, 65-76.
- GOODEY, J. B. (1957). *Laboratory methods for work with plant and soil nematodes*. *Tech. Bull. 2 Min. Ag. Fish. Food*, London, H.M.S.O. 47 pp.
- GOODEY, T. (1942). Observations on *Mononchus tridentatus*, *M. brachyuris* and other species of the genus *Mononchus*, *J. Helm.* **20**, 9-24.
- (1951). *Soil and Freshwater Nematodes*, London, Methuen, 390 pp.
- MEYL, A. (1955). Über einige an den deutschen Küsten vorkommende Arten des Nematodengattung *Mononchus* Bastian 1865, *Kieler Meeresforsch.*, **11**, 80-85.
- SCHNEIDER, W. (1923). Niederrheinische freilebende Nematoden, *Zool. Anz.*, **56**, 264-281.
- SCHUURMANS STEKHOVEN, J. H. & MAWSON, P. M. (1954). Freelifing Nematodes, mostly from Asia, *Ark. Zool.* **7**, 273-279.
- & TEUNISSEN, R. J. H. (1938). Nématodes libres terrestres, *Expl. du Parc National Albert Mission G. F. de Witte 1933-1935*, **22**, 1-229.
- THORNE, G. (1924). Utah nemas of the genus *Mononchus*. *Trans. Amer. micr. Soc.*, **43**, 157-171.

5. NEW ZEALAND MONONCHIDAE (ENOPLIDA, NEMATODA)
I THE GENERA *MONONCHUS* BASTIAN AND *PRIONCHULUS* COBB

BY

W. C. CLARK

Rothamsted Experimental Station, Harpenden, Herts, England¹⁾

Free-living nematodes of the New Zealand region have been little studied, the only important papers being those of COBB (1904), and ALLGÉN (1929). Cobb described *Miconchus rex* (Cobb, 1904) Andrassy, 1958 from 200-1200 feet in Lakes Manapouri and Wakatipu, and Allgén recorded "*Mononchus papillatus*" Bastian = *Prionchulus muscorum* (Dujardin) in moss from New Zealand and Campbell Island, and *Iotonchus trichurus* Cobb, *I. parazschokkei* (Allgén), and *Mononchus campbelli* Allgén in moss from Campbell Island. The determination of *I. trichurus* from a single larva is doubtful.

The material described in this and succeeding papers was collected by the author, killed by heat, fixed in F.A. 4 : 10, and transferred to glycerine by Baker's method.

Mononchus Bastian, 1865

Mononchus campbelli Allgén, 1929

Allgén's inadequate description is based on two poorly fixed distorted larvae from moss on Campbell Island. No precise locality is given, and no type specimens appear to have been kept. ANDRÁSSY (1958) synonymised *M. campbelli* with "*M. papillatus*" of SCHUURMANS STEKHOVEN & TEUNISSEN (1938) from the Belgian Congo, and tentatively with *M. allgéni* Meyl, 1957 from Lake Tanganyika. However, *c* for *M. campbelli* is 7.2 against 12.9 for *M. allgéni*. In "*M. papillatus*" *c* = 16 for larvae and 11.5 for adults, the dorsal tooth is situated more anteriorly in the stoma and the tail shape differs. Zoogeographically it is unlikely that the same species would occur in the Belgian Congo and on a subantarctic island. No useful purpose is served retaining this doubtful species and I regard *M. campbelli* as a *species inquirenda*.

Mononchus composticola n. sp.

Figs. 1A-J

Holotype ♀ L = 2.44 mm; a = 33; b = 4.67; c = 9.2; V ¹¹⁵⁰ 12

Allotype ♂ L = 3.42 mm; a = 39; b = 4.75; c = 21.5; T = 53.

For measurements of paratypes see Table I.

¹⁾ At present on study leave from Entomology Division, D.S.I.R., Nelson, New Zealand.

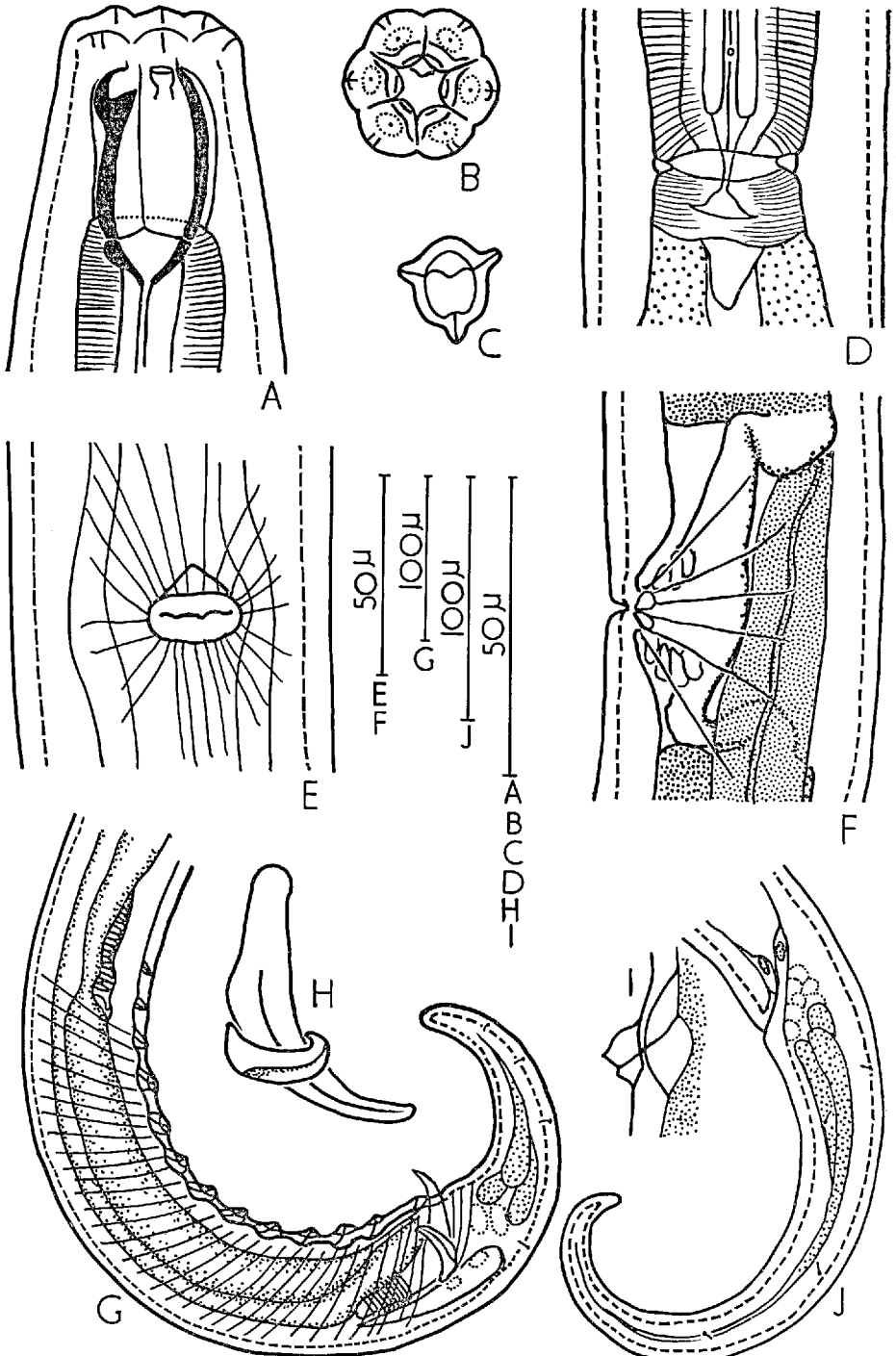

Fig. 1. *Mononchus composticola* n. sp. A. lateral view of head, B. en face view of lip region, C. stoma at level of tooth apex, D. oesophago-intestinal junction, E. ventral view of vulva, F. lateral view of vulva, G. male tail, H. spicules and gubernaculum, I. supplement, J. female tail.

TABLE I
Measurements of *Mononchus composticola* n. sp.

| | Mt. Cook | The Chateau | Tutamoe | Pelorus Br. | Waiotapu | Arthurs Pass (females) | Arthurs Pass (males) |
|----------------|-----------|-------------|-----------|-------------|-----------|------------------------|----------------------|
| n. | 7 | 10 | 12 | 1 | 7 | 36 | 3 |
| L. (mm) (mean) | 2.18 | 2.08 | 2.17 | 2.59 | 2.35 | 2.33 | 3.22 |
| S.D. mm | ± 0.323 | ± 0.124 | ± 0.169 | — | ± 0.192 | ± 0.166 | — |
| range | 1.76-2.66 | 1.88-2.29 | 1.91-2.44 | 2.59 | 2.11-2.60 | 1.83-2.70 | 3.04-3.51 |
| a | 27-38 | 25-38 | 33-42 | 31 | 30-35 | 27-36 | 35-38 |
| b | 4.21-5.25 | 3.9-4.5 | 3.68-5.05 | 5.18 | 4.6-5.0 | 3.76-4.95 | 4.5-4.7 |
| c | 7.5-10.9 | 7.2-8.4 | 7.4-9.8 | 11.0 | 8.5-10.7 | 7.2-9.9 | 17.8-22.0 |
| a.o. 1) | 7-9 | 10-13 | 9-14 | 8 | 8-11 | 7-9 | — |
| V | 45.4-54.2 | 50.8-54.7 | 48.5-54.7 | 47.7 | 44.8-48.9 | 48.3-52.0 | T. 52.4-57.9 |
| p.o. 1) | 7-13 | 8-12 | 10-13 | 12 | 7-10 | 5-13 | — |

1) Anterior and posterior ovaries respectively.

Measured specimens from Levin Bush, Hongi's Track, Takaka Hill, and Lake Mahinapua all fell within the range of measurements given above.

Cuticle 2.5μ thick, with fine, faint annulations only visible under oil immersion in favourable circumstances. No lateral fields. Subcuticle 2.0μ thick. Body outline tapering anteriorly; lip region not offset. Lips and papillae clearly visible in lateral view. Amphid apertures elliptical in lateral view, situated a little anterior to the apex of the dorsal tooth. Amphid constricted to two-thirds aperture width at a distance equal to aperture width, then expanding again.

In *en face* view lip region a rounded hexagon, symmetrical, all six lips rounded on both edges. Papillae in two rings; six in the inner ring and ten in the outer ring, (two on the sub-ventral lips and one on each lateral lip). Amphid apertures appear as crescentic slits in this view. The abutting edges of the anterior elements of the stoma skeleton elements appear thickened, project outwards, and are coincident with the clefts between the subdorsal and lateral lips, and between the subventral lips. At the level of tooth apex the tooth spreads onto the whole of the dorsal stoma wall. In lateral view the rather small stoma occupies half the body width, is attenuated oval in shape, more pointed posteriorly than anteriorly. Anterior aperture approximately half the greatest stoma width. Dorsal wall bears a single strong tooth the anterior edge of which is straight or slightly curved, and slopes slightly back from apex. Tooth apex at 6-17 per cent of stoma length. The posterior edge or buttress of the tooth is continuous with the contour of the posterior part of the wall. Whole tooth lies within anterior two-fifths of stoma. Anterior to the tooth the dorsal wall curves inwards. Outer surface of stoma wall indented in region of tooth. Anterior and posterior ventral elements curve smoothly throughout their length. Posterior dorsal element much thickened in anterior half, but thinning towards oesophageal lumen. Anterior two-thirds of stoma sur-

rounded by a thin muscle sheath; posterior third embedded in anterior end of the oesophagus.

Oesophagus slightly expanded anteriorly about stoma base; narrowing a little to nerve ring at one third of oesophageal length; expanding slightly beyond this in conformity with the body contour, and occupying half the body width.

Oesophago-intestinal junction non-tuberculate, (CLARK, 1960a) with a strong sphincter muscle enveloping the funnel-shaped valve. A fairly broad transparent zone is intercalated between oesophagus and sphincter muscle. A conical structure projects into intestinal lumen. Intestine is a simple tube; cells packed with fine granules.

Female. Vulva a transverse slit one quarter body-width, with thickened lips. Radiating muscle bands are conspicuous in ventral view. Vagina thick-walled and extending across half the body-width. Uterus bifid; size varies with stage of oögenesis. Ovaries paired, opposed, reflexed through two thirds of the length of the oviduct and uterus. Ovary occupying up to four-fifths of body width. Oöcytes in a single row. Usually one or two mature eggs at a time; rarely three. Intestine passes to the left of the anterior and to the right of the posterior ovary. Pre-rectum not demarcated in the female. Rectum straight, length almost equal to an anal-body-width.

Tail moderately elongate (five and a half to six times anal-body-width in length), conoid, ventrally arcuate, tip rounded. Caudal glands present; terminal duct absent. Four pairs of lateral cuticular pores distributed as shown in figure 1.

Male. Testes paired, opposed, outstretched. Relative development of anterior and posterior testes variable. Sperms numerous, not arranged in any definite pattern. Testes nine-tenths as long as vas deferens. Opposite the second supplement the vas deferens enlarges to become the ejaculatory duct, and continues as such to its junction with the cloaca. Pre-rectum as long as ejaculatory duct.

Spicules separate, stout, arcuate, more slender at tips. Upper portions of spicules embedded in a muscular sheath. Gubernaculum broad, U-shaped, strap-like, almost encircling the spicules. Each arm of the U with a thickened supporting ridge running laterally from the posterior face near the base of the U to near the anterior edge of the tips of the lateral processes. Midventral supplements 12, not echinulate, mostly mammiform, but the mammiform protuberances not well developed at the ends of the series. An adanal pore is present. Anterior to the supplements are a number of simple cuticular pores.

Tail short, two and a half times anal-body-width, conoid, ventrally arcuate, tip rounded. Caudal glands present, terminal duct absent. Caudal pores as shown in figure 1 G.

Specific differentiation. *M. composticola* forms with *M. major* Cobb, 1893, *M. mesadenus* n. sp., and *M. gerlachei* de Man, 1904 a closely related group of southern species. The only similar European species is *M. kastrolli* Altherr, 1958 which is readily separated from this species-group by the short tail ($c = 33$ or more), the presence of bifid spicules, and notched lateral accessory pieces in the

male. A new figure of the spicules etc. of *M. kastrolli* (drawn from paratypes supplied by Dr. Altherr) is provided (fig. 2). Of the New Zealand species, *M. composticola* is similar to *M. mesadenus* from which it is separated by the more slender female tail; *c* is usually within the range of 7-9.5 (*mesadenus* *c* = 10-16.5) and the presence of vulval gland ducts opening through the cuticle anterior and posterior to the vulva in *mesadenus*, but not in *composticola*. Males may be

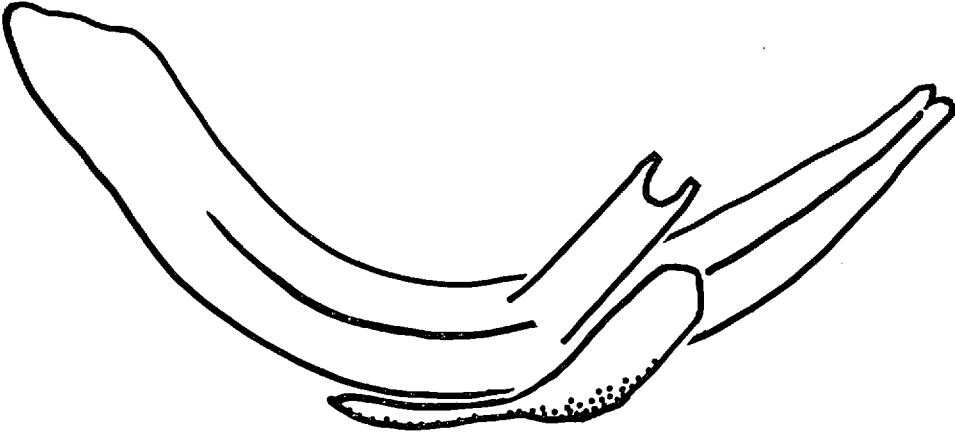

Fig. 2. *Mononchus kastrolli* Altherr, spicule, gubernaculum and lateral accessory piece.

distinguished by the supplements which number twelve in *composticola*; nine in *mesadenus*, and are echinulate only in the latter.

Mononchus composticola, *major*, *mesadenus* and *gerlachei* may be separated by the use of the following keys:

Key to males:

- | | |
|--|------------------------|
| 1. Lateral accessory pieces rounded at tip | <i>M. gerlachei</i> |
| Lateral accessory pieces absent | 2 |
| 2. Supplements echinulate | 3 |
| Supplements not echinulate, twelve | <i>M. composticola</i> |
| 3. Nine supplements; sixteen cephalic papillae | <i>M. mesadenus</i> |
| Twelve supplements; thirty-two cephalic papillae | <i>M. major</i> |

Key to females:

- | | |
|--|------------------------|
| 1. Glands present near vulva | 2 |
| Glands not present near vulva | <i>M. composticola</i> |
| 2. Terminal caudal gland duct present | 3 |
| Terminal caudal gland duct absent | <i>M. mesadenus</i> |
| 3. Sixteen cephalic papillae, (Danco Land and Possession Island, Antarctic region (de Man, 1904, Steiner, 1916)) | <i>M. gerlachei</i> |
| Thirty-two cephalic papillae (Australia & Tasmania (Cobb 1893, 1917)) | <i>M. major</i> |

Type slides. Holotype, allotype and paratype slides in nematode collection, Entomology Division, D.S.I.R., N.Z. Paratypes also at Nematology Dept. Rothamsted Experimental Station. Slide nos. 143/4/1-2.

Type locality. Rough Creek, Arthurs Pass, N.Z.; from leaf litter of *Nothofagus cliffortiodes* Oerst. forest with *Coprosma* Forst spp., *Nothopanax simplex* Seem., *Griselinia littoralis* Raoul, and *Blechnum pennamarina* Kuhn; altitude 765 metres; soil Haast fine sandy loam.

Other localities. (a) South Island; Takaka Hill in *Nothofagus fusca* Oerst. forest; Lake Mahinapua Forest Reserve in litter of *Quintinia acutifolia* T. Kirk — *Weinmannia racemosa* Linn. f. forest; Pelorus Bridge in litter of *Podocarpus spicatus* R. Br. — *Beilschmiedia Tawa* Benth. & Hook. f. forest; Governors Bush, Mt. Cook in *Nothofagus Menziesii* Oerst. forest litter. (b) North Island: Levin Bush in litter of *Knightia excelsa* R. Br. — *Beilschmiedia Tawa* Benth. & Hook. f. forest; Tongariro National Park, near Chateau, in *Nothofagus cliffortiodes* Oerst. — *Griselinia littoralis* Raoul forest litter; Tutamoe in litter of *Beilschmiedia Tawa* Benth. & Hook. f. — *Dacrydium cupressinum* Soland. forest.

Remarks. This species has been found only in the litter of indigenous forests in areas with a rainfall in excess of 40 in. per annum, though most localities approach more closely to 100 in. per annum. Neither the soil underlying the litter nor the species composition of the forest appear important in determining distribution. *M. composticola* may be equally abundant in small-leaved mor type, *Nothofagus* litter and in the broad-leaved, mull type *Beilschmiedia* forest. The association with forest litter suggested the specific epithet.

A parasitic sporozoan, *Legerella* sp. was found in a specimen from Arthurs Pass.

Mononchus mesadenus n. sp.

Figs. 3A-K.

Holotype ♀ L = 3.37 mm; a = 40; b = 4.45; c = 12.4; V = ¹¹ 54 ¹⁰

Allotype ♂ L = 3.26 mm; a = 40; b = 4.34; c = 20.5; T = 53.

For measurements of paratypes see Table II.

Cuticle 3.5 μ thick, smooth, very faint obsolescent transverse striae occasionally seen under oil immersion. Lateral fields not present. Subcuticle 2.5 μ thick, faintly annulated. Lip region not offset; lips and papillae clearly visible in lateral view. Amphid apertures appear circular in lateral view, are one sixth as wide as the lip region, and narrow rapidly. Amphids are situated near the anterior limit of the sclerotized stoma and immediately posterior to the lateral papilla. In *en face* view the lip region is bilaterally symmetrical, an elongate hexagon. Lips six, equal, inner edge bluntly rounded; outer edge slightly angled. Papillae in two rings, an inner ring of six and an outer ring of ten. Inner papillae flanked on either side by a rounded eminence. In this view the anterior edge of the stoma resembles that of *M. composticola*, but the dorsal tooth does not spread onto the stoma wall to the same extent. Laterally the stoma appears heavily sclerotized, twice as long as broad, oval in shape; fairly rounded posteriorly, and occupies just over half the body width. Anterior aperture half as wide as the greatest stoma width. Stoma walls with fine transverse striae. Dorsal tooth apex occurs at 7-16 % of the stoma length. Anterior edge of the tooth straight or slightly curved; sloping a little back

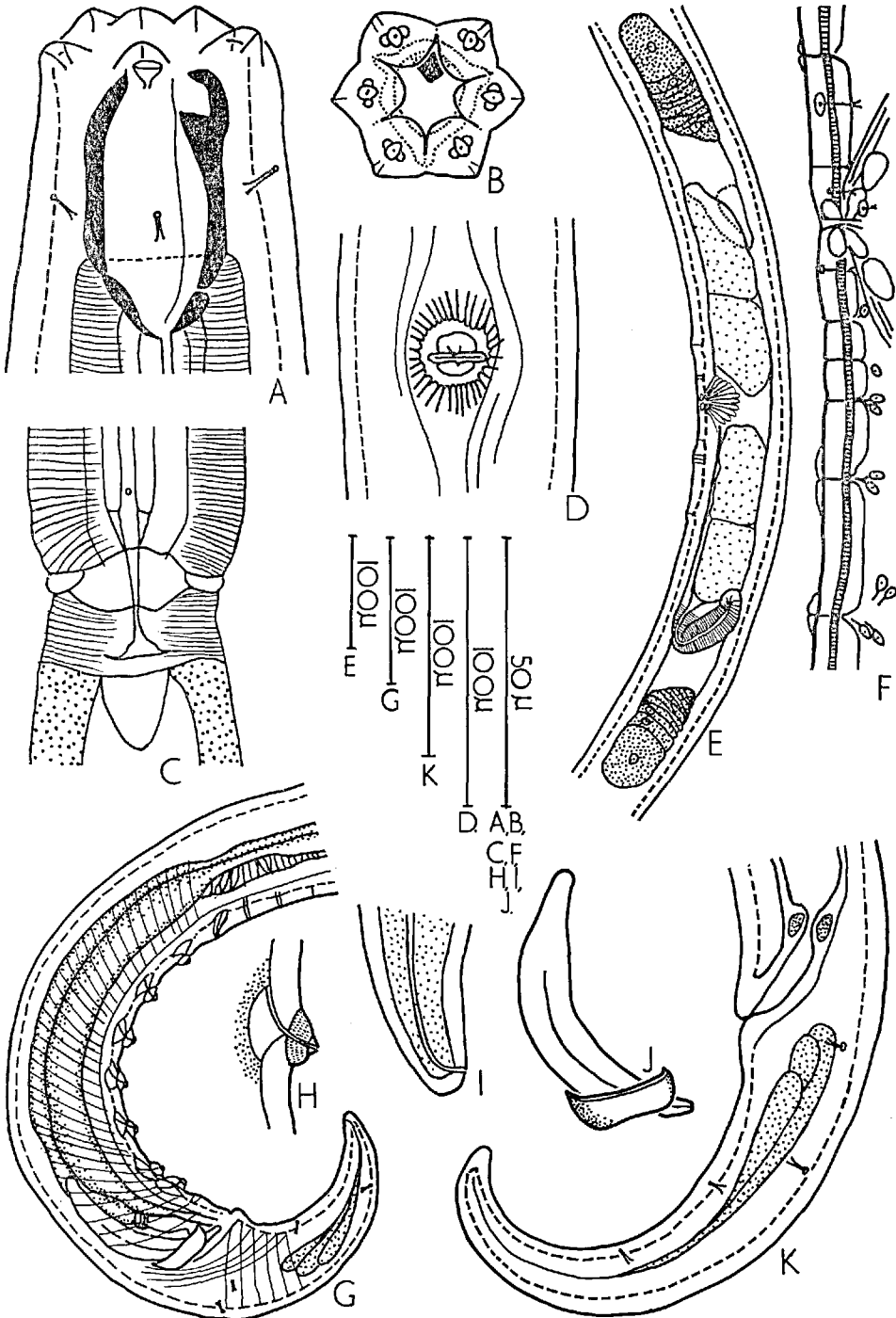

Fig. 3. *Mononchus mesadenus* n. sp. A. lateral view of head, B. *en face* view of lip region, C. oesophago-intestinal junction, D. ventral view of vulva, E. female reproductive organs, F. vulval region showing gland cells and ducts, G. male tail, H. supplement, I. tip of male tail, J. spicule and gubernaculum, K. female tail.

TABLE II
Measurements of *Mononchus mesadenus* n. sp.

| Females | Mt. | | | | | |
|------------------|-----------|-------------|-----------|-----------|-----------|---------------|
| | Messenger | The Chateau | Tutamoe | Kiripaka | Takaka | Hongi's Track |
| n | 9 | 6 | 6 | 2 | 2 | 1 |
| L (mm) (mean) | 3.17 | 3.35 | 3.09 | 3.78 | 3.32 | 2.49 |
| S.D. (mm) | ± 0.183 | ± 0.227 | ± 0.128 | — | — | — |
| range | 2.87-3.44 | 3.08-3.72 | 2.94-3.26 | 3.77-3.79 | 3.28-3.36 | 2.49 |
| a | 35-40 | 35-38 | 32-39 | 38 | 35-39 | 33 |
| b | 3.99-6.09 | 4.10-4.72 | 4.26-4.45 | 4.91-4.93 | 4.56-4.82 | 4.89 |
| c | 10.5-13.1 | 10.1-13.1 | 10.2-12.6 | 13.8-13.9 | 13.6-16.4 | 15.6 |
| a.o. | 9-15 | 7-15 | 8-15 | 11-13 | 9-11 | 7 |
| V | 47.2-56.0 | 51.0-53.5 | 51.3-55.3 | 51.5-52.2 | 54.4-55.8 | 51.8 |
| p.o. | 8-13 | 7-13 | 8-16 | 11 | 12 | 9 |
| Males | Mt. | | | | | |
| | Messenger | The Chateau | Tutamoe | Kiripaka | Rimu | Collingwood |
| n | 13 | 7 | 10 | 1 | 2 | 1 |
| L (mm) (mean) | 3.10 | 3.09 | 2.94 | 3.71 | 3.00 | 2.70 |
| S.D. (mm) | ± 0.185 | ± 0.225 | ± 0.177 | — | — | — |
| range | 2.61-3.35 | 2.94-3.62 | 2.65-3.20 | 3.71 | 2.78-3.23 | 2.70 |
| a | 31-40 | 35-40 | 34-41 | 39 | 32 | 36 |
| b | 4.15-4.55 | 3.96-4.26 | 3.99-4.45 | 4.71 | 4.02-4.03 | 3.88 |
| c | 16.0-20.8 | 15.0-18.1 | 14.6-20.1 | 22.3 | 17.0-18.3 | 22.3 |
| T | 53.1-57.2 | 41.4-62.4 | 38.8-48.2 | 58.7 | 40.1-54.8 | 53.2 |

from apex. Posterior edge slopes smoothly back and joins stoma wall without any re-entrant angle. Opposite the dorsal tooth the outer surface of the dorsal stoma wall is slightly indented. Anterior to the tooth the wall curves sharply inwards. Lower three-fifths of the ventral wall almost straight, anterior portion curving slightly inwards. Of the posterior elements the dorsal one is thickest anteriorly; both thin towards the oesophageal lumen. Anterior seven-tenths of stoma surrounded by a thin muscular sheath; posterior part embedded in anterior end of oesophagus. In the stomal region is a pair of subventral, subdorsal, and median cuticular pores.

Oesophagus narrows slightly to the nerve ring which occurs at one third of the oesophagus length, and thereafter swells a little generally occupying half the body width. Oesophago-intestinal junction non-tuberculate. Transparent zone between the oesophagus and sphincter muscle often wide (one-third as thick as sphincter muscle). Funnel-shaped valve obscure in all specimens. Intestine packed with dark granules.

Female. Vulva a transverse slit with thickened lips. Vagina with thick muscular walls, extending half way across the body. Uteri paired, outstretched. Interposed between uterus and oviduct is a thick-walled glandular structure and a sphincter muscle similar to that recorded by GOODEY (1942) in *Anatonchus tridentatus*

and *Mylonchulus brachyuris*. Ovaries paired, reflexed through up to one-third of the length of the oviduct and uterus. Ovaries occupying almost half the body width. One or two mature eggs in the uteri at once.

Near the vulva are a number of pores through the cuticle which appear to be connected with small gland cells. The largest of these have small cuticular mounds about the orifices of the ducts; the smaller ones do not. These structures tend to be arranged in ventro-median pairs, but exceptions are numerous. Some ducts are always present, but the number and position of both types of duct is variable. Simple body pores are present over the whole of the animal, but the papilliform pores are restricted to the vicinity of the vulva.

The intestine passes to the left of the anterior, and to the right of the posterior ovary. No pre-rectum. Rectum slightly arcuate, equal to anal-body-width.

Tail short, equal to four and a half times the anal-body-width; conoid, ventrally arcuate tip rounded. Caudal glands present; no terminal duct. Paired lateral cuticular pores present, often arranged as in figure 3 K, but there appears to be considerable variation.

Males. Testes paired, opposed, outstretched, sperms abundant, not arranged in any definite pattern. Vas deferens five-sixths of testicular length, dilating opposite the first supplement to become the ejaculatory duct and discharge into the cloaca. Also opposite the first supplement the intestine narrows to form the prerectum. Spicules separate, arcuate, thinning towards the tips with a median thickened rib in the distal two thirds. Total length of spicules equal to one and two-thirds anal-body-widths. Gubernaculum U-shaped, strap-like, almost encircling the spicules. Each arm of the U with a thickened anterior edge. Supplement nine, the middle seven mammiliform echinulate; first and anal supplements with low mounds rather than papillae. Anterior to the supplements is a series of body pores. In ventral view the basal echinulate portions of the supplements are seen to consist of two opposed crescentic swollen ridges.

Tail shorter than female; equal to two anal-body-widths, conoid, ventrally arcuate, with caudal glands and terminal duct. Paired lateral cuticular pores as shown in figure 3 G.

Specific differentiation. See under *M. composticola*.

Type material. Holotype, allotype, and paratype slides in the nematode collection of Entomology Division, D.S.I.R., N.Z. Paratypes also at Nematology Dept., Rothamsted Experimental Station. Slide nos. 143/5/1-2.

Type locality. Mt. Messenger, Taranaki, N.Z., N.Z.M.S. 1, N. 100, 146126, in *Olea Cunninghamii* Hook. f., *Vitex lucens* T. Kirk, *Shawia paniculata* Forst., *Brachyglottis repanda* Forst. forest litter; altitude 200 metres.

Other localities: (a) South Island: Collingwood from litter in a very damp spot in a *Rhopalostylis sapida* Wendl. & Drude grove; Takaka Hill, in litter of *Nothofagus fusca* Oerst. forest; Rimu State Forest (*Thuja plicata* Don. + regenerating natives) surface liverworts and mosses, (b) North Island: Tongariro National Park, near the Chateau in *Nothofagus cliffortioides* Oerst. — *Griselinia littoralis*

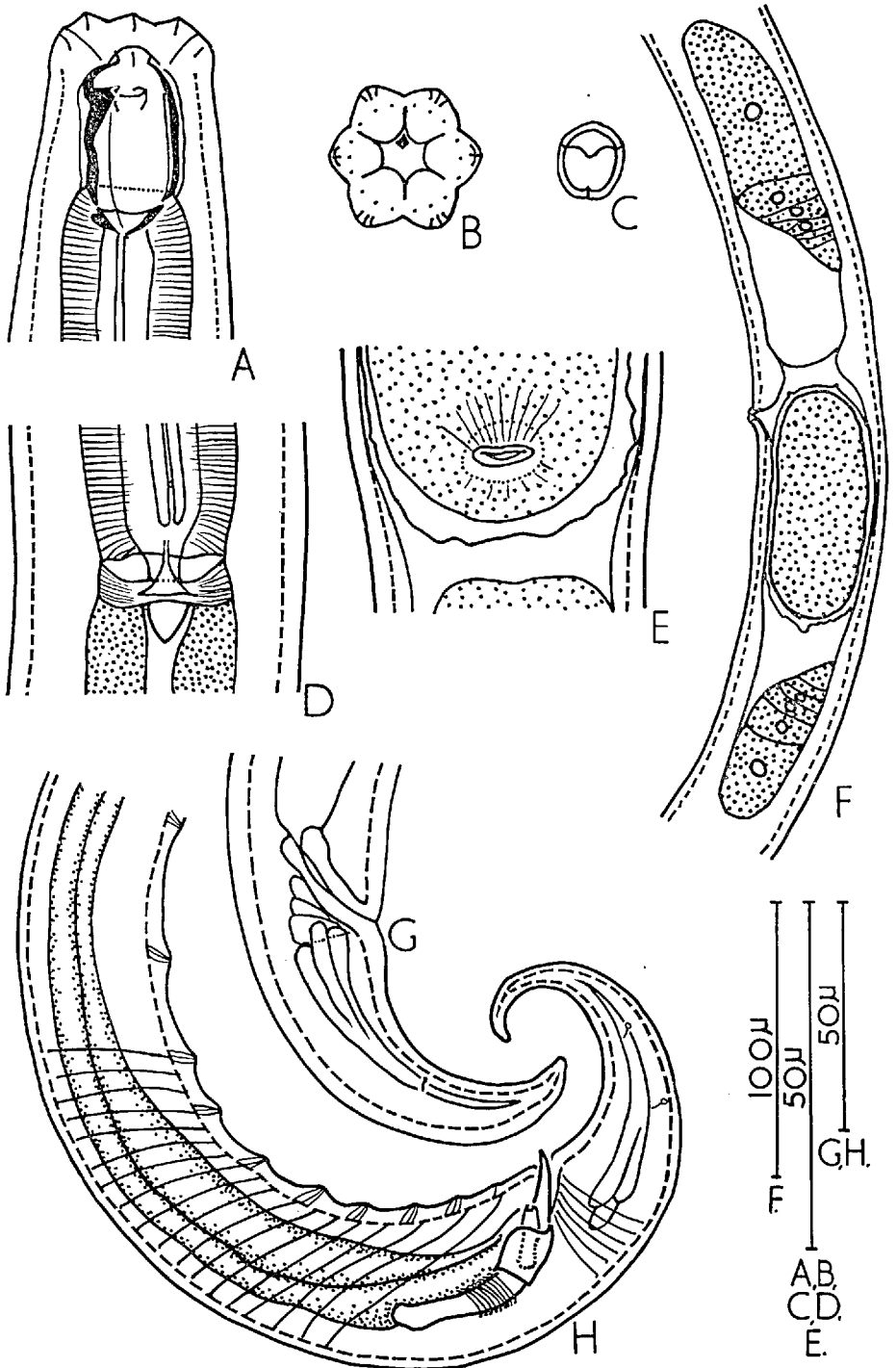

Fig. 4. *Mononchus propapillatus* n. sp. A. lateral view of head, B. en face view of lip region, C. stoma at level of tooth apex, D. oesophago-intestinal junction, E. ventral view of vulva, F. female reproductive structures, G. female tail, H. male tail.

Raoul forest litter; Hongi's Track, in litter of *Beilschmiedia Tawa* Benth. & Hook. f. — *Knighitia excelsa* R. Br. — *Podocarpus Totara* D. Don forest; Kirkpaka in litter of *Beilschmiedia Taraire* Benth. & Hook. f. — *Vitex lucens* T. Kirk — *Corynocarpus laevigata* Forst. forest; Tutamoe, from mosses and liverworts off tree trunks in *Beilschmiedia Tawa* Benth. & Hook. f. — *Dacrydium cupressinum* Soland. forest.

Remarks. This species, like *M. composticola* is found in native forests, but is associated with the cryptogamic flora as well as with the litter zone, and is more abundant in the North Island than in the South Island.

The specific name refers to the glands about the median vulva (mes = middle, adenus = a gland).

Females collected in April 1958 had spermatozoa in the uterus and oviduct.

Mononchus propapillatus n. sp.

Figs. 4A-H.

Holotype ♀ L = 1.16 mm; a = 22; b = 3.5; c = 12.6; V²⁴ 61.5¹⁴.

Allotype ♂ L = 1.10 mm; a = 32; b = 3.5; c = 11.5; T = 39.

For measurements of paratypes see Table III.

Cuticle smooth, without striations, 2 μ thick. Lateral fields not detected in either sex. Subcuticle 1.5 μ thick. Head offset by a moderate constriction, lips distinguishable in lateral view. Amphid opening slit-like, situated at the level of the dorsal tooth apex, and immediately posterior to the outer lateral papilla. Amphid narrowing to half aperture width at a distance equal to amphid width; amphid obscure beyond this point.

In *en face* view lip region hexagonal, symmetrical; all six lips similar, rounded on both edges. Papillae in two rings; an inner ring of eighteen, three on each lip arranged in a straight line across the lip, and an outer ring of fourteen, three on each of the submedian lips and one on each of the laterals. Amphid apertures crescentic in this view. Anterior rim of sclerotized stoma conspicuous; the sutures between the three parts coincide with the clefts between the subdorsal and lateral lips, and between the subventral lips. At the level of the dorsal tooth apex the stoma is rather oval in cross section, and is slightly indented ventrally. This indentation bears the ventral ridge seen in lateral view. Near its apex the tooth spreads over the whole of the dorsal wall of the stoma. In lateral view the heavily sclerotized stoma occupies half the body width, is roughly oval in shape, but rather blunter anteriorly than posteriorly. The anterior aperture is circular and approximately one third of the greatest stoma width. The dorsal wall bears the large, single tooth whose anterior edge is straight and which slopes slightly posteriorly from the apex. Posterior edge or buttress of the tooth joins the lateral wall slightly anterior to the mid point of this wall. In the region of the tooth the outer surface of the wall is slightly indented. Ventral wall curves smoothly throughout its length, and from the posterior limit of the anterior element to a point nearly

TABLE III
Measurements of *Mononchus propapillatus* n. sp. females

| | Mt. Cook | Waitaanga Saddle | Kumara Beach | Kiripaka | Waimangu | Mangatere | Kerikeri | Craigielachie | Takaka | Tikipunga | Levin Bush |
|------------------|-----------|---------------------|-----------------|-----------|-----------|-----------|-----------|---------------|-----------|-----------|---------------|
| n | 24 | 13 | 12 | 8 | 7 | 6 | 5 | 5 | 6 | 3 | 1 |
| L (mm) (mean) | 1.15 | 1.57 | 1.21 | 1.02 | 1.09 | 1.27 | 0.89 | 1.19 | 1.01 | 1.27 | 1.03 |
| S.D. (mm) | ± 0.060 | ± 0.132 | ± 0.058 | ± 0.057 | ± 0.078 | ± 0.089 | ± 0.037 | ± 0.024 | ± 0.051 | ± 0.041 | — |
| range | 1.01–1.71 | 1.39–1.78 | 1.12–1.32 | 0.93–1.11 | 0.95–1.18 | 1.21–1.38 | 0.84–0.93 | 1.14–1.21 | 0.93–1.07 | 1.08–1.38 | 1.03 |
| a | 23–33 | 27–34 | 24–36 | 25–31 | 27–28 | 24–29 | 26–29 | 25–30 | 24–28 | 29–30 | 21 |
| b | 3.24–3.81 | 3.4–3.98 | 3.30–3.71 | 3.21–3.45 | 3.00–3.44 | 3.52–3.89 | 3.18–3.23 | 3.34–3.47 | 2.95–3.41 | 3.48–3.87 | 3.62 |
| c | 11.9–16.5 | 10.1–12.8 | 13.2–18.9 | 10.7–13.3 | 11.2–13.3 | 13.8–15.7 | 10.3–11.6 | 14.8–17.4 | 12.1–13.8 | 12.8–15.0 | 10.7 |
| a.o. | 8–16 | 7–19 | 10–14 | 8–15 | 7–13 | 8–12 | 10–13 | 10–16 | 9–14 | 10–11 | 12 |
| V | 57.7–62.9 | 58.6–69.1 | 61.1–62.6 | 61.2–64.1 | 59.7–63.4 | 59.5–65.5 | 60.2–61.9 | 61.8–64.0 | 57.8–63.3 | 61.0–61.7 | 61.6 |
| p.o. | 10–16 | 8–16 | 8–12 | 9–12 | 7–12 | 7–20 | 8–13 | 9–15 | 10–15 | 10–11 | 18 |

opposite the tooth apex is a low untoothed ridge. The posterior elements make up the base of the stoma; the dorsal element is greatly thickened anteriorly, but the ventro-lateral elements are not. All three posterior elements are continuous with the cuticular lining of the oesophagus. Anterior three-quarters of stoma surrounded by a muscle sheath; posterior quarter embedded in the fore end of the oesophagus.

Oesophagus slightly expanded anteriorly, then narrowing a little to the nerve ring at one third its length; expanding slightly beyond this in conformity with the general body contour, and occupying half the body width.

Oesophago-intestinal junction typical of the genus, as shown in figure 4 D. Intestine a simple tube; cells packed with fine granules.

Female. Vulva a transverse slit with thickened lips which make it conspicuous even in lateral view. Vagina thick-walled and extending one third of the body-width. Uteri bifid, size very variable with the stage of development of the eggs. Ovaries paired, opposed and reflexed through three-quarters of their length. Ovaries almost three quarters as wide as the body, ova in a single row within each ovary. Usually only one mature egg at once, rarely two. (Material collection in February). Intestine passes to the left of the anterior and to the right of the posterior ovary. No prerectum in female. Rectum straight.

Tail conoid, ventrally arcuate, two and a half times anal body width in length, tip rounded. Caudal glands present, terminal duct absent. Caudal cuticular pores not seen.

Males. Testes paired, outstretched in opposite directions; anterior testis five-sixths as long as posterior testis; sperms numerous, not arranged in any definite pattern. Vas deferens seven-eighths of testicular length. From a point opposite the second supplement the vas deferens swells to become the ejaculatory duct which opens into the cloaca. Pre-rectum as long as ejaculatory duct.

Spicules long, arcuate, moderately slender, upper half embedded in a muscular sheath. Gubernaculum large, complex, consisting of a median dorsal portion from which arise two broad strap-like lateral processes which curve around the spicules. From the outer surface of each lateral process arises a ventrally directed accessory piece which is bifid at the tip. Supplements, nine papilliform, and one adanal without a papilla. The anterior three more widely spaced than the remainder.

Tail similar to female but tip more pointed. Caudal papillae, one dorsal pair at one-third of tail length and one lateral pair at three-fifths of tail length.

Differential diagnosis. *Mononchus propapillatus* differs from all other species in the genus, except *M. papillatus* Bastian in the possession of an untoothed ventral ridge. It is close to *M. papillatus* from which it is distinguished on male characters; viz. the presence of lateral accessory pieces; a gubernaculum with curved lateral processes which curve around the lateral accessory pieces and the spicules, and only ten supplements, of which the adanal member is not papilliform. *M. papillatus* has no lateral accessory pieces, the gubernaculum is simple, without lateral processes, and lies wholly above the spicules; the supplements are

twelve to sixteen in number and uniform in type. The lips of *propapillatus* are rounded, and the stoma oval in cross section, but in *papillatus* the lips are angular, and the stoma squarish.

The females of *M. propapillatus* are so similar to those of *M. papillatus* that I hesitate to erect a new species, but in view of the dissimilarity of the males there is no alternative as there is no doubt that they are correctly associated with the females. New Zealand has been isolated from other land masses since Cretaceous times and, on virgin sites, it is reasonable to expect slightly different forms. There is no reason why specific differentiation should not go further in one sex than in the other. There is no evidence of male dimorphism as found in the Acari (ANDRÉ, 1949) and the Opiliones (FORSTER, 1954) as only one type of male is known for each species.

Type slides. Holotype, allotype and paratypes are in the nematode collection, Entomology Division. Paratypes also at Nematology Department, Rothamsted Experimental Station; Slide nos. 143/6/1-1.

Type locality. Governor's Bush, Mount Cook, in *Nothofagus Menziesii* Oerst. forest with *Podocarpus Hallii* T. Kirk., *Phyllocladus alpinus* Hook. f. and *Coprosma* spp. Forst. from surface three inches of litter and soil. Soil type: Haast fine sandy loam (a semi-mature podzol derived from greywacke and schist). Height 810 metres.

Other localities. (a) South Island: Takaka Hill in *Nothofagus fusca* Oerst. forest; Whangamoia Hill in reverting grassland; Kumara Beach, *Trifolium repens* L. — *Hydrocotyle* sp. L. dominant grassland; Charleston Beach in *Lotus uliginosus* Schkuhr.; Ross in *Anthoxanthum odoratum* L. — *Trifolium repens* L. pasture; Cape Foulwind in *Agrostis stolonifera* L. — *Holcus lanatus* L. pasture; Utopia Road, Westport in *Anthoxanthum odoratum* L. — *Cynosurus cristatus* L. pasture; Granity in *Agrostis stolonifera* L. — *H. lanatus* L. pasture; Pelorus Bridge in *Podocarpus spicatus* R. Br. — *Beilschmiedia Tawa* Benth. & Hook. f. forest; Craigielachie, *Dactylis glomerata* L. — *Agrostis tenuis* Sibth. pasture; Cass in *Agrostis tenuis* Sibth. — *Anthoxanthum odoratum* L. grassland; Waikari — Culverden in *Festuca novaezealandiae* Cockayne — *Agropyrum scabrum* Beauv. grassland. (b) North Island: Levin Bush *Knightia excelsa* R. Br. — *Beilschmiedia Tawa* Benth. & Hook. f. forest; Waverly in *Lolium perenne* L. — *Trifolium repens* L. pasture; Waitaanga Saddle *Weinmannia racemosa* Linn. f. — *Brachyglottis repanda* Forst. — tree fern forest; Mangatere, *Paspalum dilatatum* Poir dominant pasture; Wharekohe, 2 year old *Lolium perenne* L. — *Trifolium repens* pasture (previously heathland type vegetation); Kiripaka in *Beilschmiedia Taraire* Benth. & Hook. f. — *Vitex lucens* T. Kirk forest; Tikipunga in *Paspalum dilatatum* Poir — *Lotus hispidus* Desf. — *Trifolium repens* L. pasture; Kerikeri in Low *Leptospermum scoparium* Forst. — *Hakea acicularis* R. Br. — *Cassinia fulvida* Hook. f. heath; Waimangu under *Pteridium esculentum* Hook. f., *Rubus* sp. L. (blackberry), *Festuca arundinacea* Schreb.

Remarks. This species is very widespread in New Zealand and its distribution

seems little influenced by factors such as soil type, vegetation cover, or climate. The specimens from Kerikeri, however, where the soil is particularly barren, are smaller than those from other localities. *Iotonchus parazschokkei* (Allgén) is also small at this site.

Prionchulus muscorum (Dujardin, 1845) Chitw. & Chitw., 1937

For synonymy see CLARK, 1960b.

| | | |
|--------------|-----|---|
| Arthurs Pass | 1 ♀ | L = 2.8 mm; a = 34; b = 4.25; c = 9.27; V ¹¹ 62.5 ¹² stoma 47 μ. |
| Mt. Cook | 1 ♀ | L = 1.715 mm; a = 32.73; b = 3.81; c = 16.52; V ¹² 62.1 ¹³ stoma 37 μ. |
| Waimungu | 1 ♀ | L = 1.95 mm; a = 30; b = 4.19; c = 15.9; V ¹¹ 65.1 ¹² stoma 38 μ. |
| Wharekohe | 1 ♀ | L = 1.68 mm; a = 35; b = 4.02; c = 17.3; V ⁹ 66.3 ⁷ stoma 36 μ. |

Remarks. The measurements given above lie for the most part within the limits of variation given for this species by CLARK (1960b) for British specimens. The most important divergence is that for tail length in the Arthurs Pass specimen where $c = 9.27$ which indicates a much longer tail than is usual in European specimens. I hesitate to separate this form on the basis of a single specimen. Otherwise it is indistinguishable from European specimens. In the specimens from the other localities in New Zealand the denticulations of the ventral ridges are less well developed than in British specimens.

Other locality. Nelson, Entomology Division compost heap, larvae only.

ZUSAMMENFASSUNG

Neu-Seeländische Mononchiden (Enoplida, Nematoda) I. Die Gattungen Mononchus Bastian und Prionchulus Cobb

Mononchus composticola, *M. mesadenus*, und *M. propapillatus* n. spp. werden beschrieben, *Prionchulus muscorum* (Dujardin) wird aus Neu-Seeland erwähnt. *M. campelli* Allgén 1929 ist als species inquirenda anzusehen. *M. composticola* und *M. mesadenus* werden mit *M. gerlachei* de Man 1904 und *M. major* Cobb 1893 vereinigt. Durch den angegebenen Schlüssel können sie voneinander getrennt werden.

REFERENCES

- ALLGÉN, C. (1929). Über einige freilebende Moosnematoden, *Nyt Mag. Naturv.* **67**, 211-230.
- ANDRÁSSY, I. (1958). Über das System der Mononchiden (Mononchidae Chitwood, 1937; Nematoda), *Ann. Hist.-nat. Mus. hung.* n.s. **9**, **50**, 151-171.
- ANDRÉ, A. (1949). Ordre des Acariens (*Acari* Nitsch, 1818) *Traité de Zoologie, Paris*, **6**, 794-892.
- CLARK, W. C. (1960a). The oesophago-intestinal junction in the Mononchidae (Enoplida, Nematoda), *Nematologica*, **5**, 178-183.
- (1960b). Redescription of *Mononchus truncatus* Bastian, *M. papillatus* Bastian, and *Prionchulus muscorum* (Dujardin) (Enoplida, Nematoda), *Nematologica*, **5**, 184-198.
- COBB, N. A. (1893). Nematodes, mostly Australian and Fijian, *Macleay Memorial Volume, Linn. Soc. N.S.W.*, 1-59.
- (1904). Free-living fresh-water New Zealand nematodes, *Proc. Camb. phil. Soc.*, **12**, 363-374.
- (1917). The Mononchs (*Mononchus* Bastian, 1865), a genus of freelifving predatory nematodes, *Soil Sci.*, **1**, 431-486.

- FORSTER, R. R. (1954). The New Zealand Harvestmen (sub-order Laniatores) *Canterbury* [N.Z.] *Mus. Bull.*, 2. 329 pp.
- GOODEY, T. (1942). Observations on *Mononchus tridentatus*, *M. brachyuris* and other species of the genus *Mononchus*, *J. Helm.* **20**, 9-24.
- DE MAN, J. G. (1904). Nematodes Libres, *Resultats du Voy. du S. Y. Belgica, 1897-99*, *Zoologie*, 1-55.
- SCHUURMANS STEKHOVEN, J. H. & TEUNISSEN, R. J. H. (1938). Nematodes libres terrestres, *Expl. du Parc National Albert Mission G. F. de Witte 1933-1935*, **22**, 1-229.
- STEINER, G. (1916). Beitrage zur geographischen Verbreitung freilebender Nematoden, *Zool. Anz.*, **46**, 311-347.

7.

THE MONONCHIDAE (ENOPLIDA, NEMATODA) OF NEW ZEALAND
 III. A REVIEW OF THE GENUS *COBBONCHUS* ANDRÁSSY, 1958
 WITH DESCRIPTIONS OF NEW SPECIES

BY

W. C. CLARK

Rothamsted Experimental Station, Harpenden, Herts., England¹⁾

ANDRÁSSY (1958) erected the genus *Cobbonchus* for three species, *M. palustris* Cobb, *M. radiatus* Cobb and *M. teres* Cobb, which COBB (1917) had referred to *Mononchus* Bastian. *Cobbonchus* is characterised by the possession of an anterior dorsal tooth and two posterior subventral teeth.

None of these species was fully described. *C. radiatus* and *C. teres* are based on "a single young specimen" and a "single more or less shrunken specimen" respectively. Cobb did not remark on the rounded head of *C. palustris* which is quite unlike that of any other mononchid.

Miss E. M. Buhner (*in litt.*) considers it unlikely that the holotypes of these species still exist. When Cobb based a species on a single specimen it was usually beheaded or sectioned. Many were mounted in glycerine jelly which later proved unsatisfactory. However, Miss Buhner has supplied photographs of Cobb's original drawings, including unpublished drawings of the tails which are reproduced here in figs. 1-3. From these figures and Cobb's description I have compiled the fuller descriptions given below.

Since Andrásy's work appeared, more information has become available about the genus *Cobbonchus*, which is redefined below.

Cobbonchus Andrásy, 1958 Emend.

Mononchidae. Lip region scarcely or not offset. Stoma moderately large, about twice as long as broad, with three anteriorly directed teeth. Dorsal tooth larger than, and anterior to subventral teeth. Amphids small to moderate, transverse, slit like. Ovaries paired or single. When single either the anterior or posterior ovary may be suppressed and represented by a uterine sac²⁾. Vulva post-median, vagina often muscular. Oesophago-intestinal junction non-tuberculate (CLARK, 1960). Testes paired, opposed, outstretched. Spicules simple, paired, free. Gubernaculum complex. Supplements simple, papilliform, equidistant. Tail in both sexes short,

¹⁾ At present on study leave from Entomology Division, D.S.I.R., Nelson, New Zealand.

²⁾ I have a single female of a new species from Stafford, N.Z., which has a posterior ovary and a pre-vulval uterine sac. As this is a most unusual feature, I await more material before describing it.

ventrally arcuate, conoid at first, becoming cylindroid distally. Caudal glands massive, often reaching beyond the anus; ampulla well developed, terminal duct in all known species. Cuticular pores not known in females, on papillae in only known males (*C. pounamua* n. sp.).

Found in wet soil or *Sphagnum* bogs.

Type species (by author's designation): *Mononchus palustris* Cobb, 1917.

The known species of the genus are:

C. chauliodus n. sp.

C. mauritianus (Williams, 1958) Clark, 1960

C. palustris (Cobb, 1917) Andr assy, 1958

C. pounamua n. sp.

C. radiatus (Cobb, 1917) Andr assy, 1958

C. teres (Cobb, 1917) Andr assy, 1958

Cobbonchus palustris (Cobb) Andr assy

Figs. 1 A-C

Mononchus (*Mononchus*) *palustris* Cobb, 1917, p. 154, fig. 18.

Mononchus palustris Schneider, 1937, p. 49, fig. 6a-b.

Cobbonchus palustris Andr assy, 1958, p. 161

Female (after Cobb) L 1.4 mm; a 37; b 3.33; c 33.3; V 62.

Lip region not offset, head rounded. Papillae in two rings of six each. Amphid aperture small, transverse, at level of dorsal tooth apex. Stoma large, almost twice as long as broad, parallel-sided. Stoma wall indented in region of teeth, base broad. Dorsal tooth apex at 32 per cent of stoma length; subventral tooth apices at 57 per

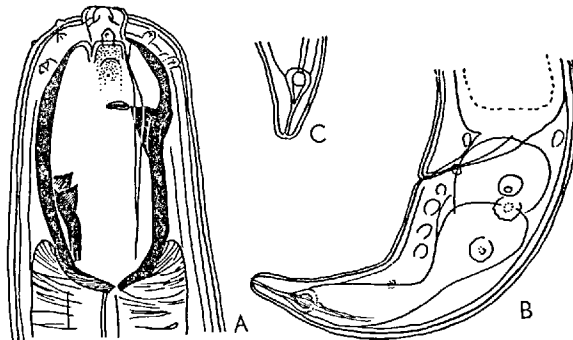

Fig. 1. *Cobbonchus palustris*. A. lateral view of head; B. female tail; C. tail tip. (All after Cobb).

cent, posterior fifth of stoma embedded in anterior end of oesophagus. Nerve ring at 8 per cent of body length. Intestine 12-15 cells in girth. Ovaries paired, rather small, tapering, eight to ten oocytes in each. Eggs elongated, twice as long as body width. Rectum straight, length equal to 0.7 of anal-body-width. Tail short, ventrally arcuate, rather conoid. Caudal glands broad, saccate; ampulla large, duct terminal.

Recorded by Cobb from a white cedar swamp, Jefferson County, Wisconsin, U.S.A.

Cobbonchus radiatus (Cobb) Andrassy

Figs. 2 A-B

Mononchus (*Mononchus*) *radiatus* Cobb, 1917, p. 154, fig. 17.*Cobbonchus radiatus* Andrassy, 1958, p. 161.

"Young specimen" (after Cobb) L 0.8 mm; a 35; b 3.33; c 20; V 74

Lip region offset by a broad shallow constriction. Papillae in two rings, an inner one of six and an outer one of ten. Amphid aperture a small crescentic slit at level of dorsal tooth apex. Stoma large, almost twice as long as broad (figured specimen appears a little distorted). Dorsal tooth apex at 24 per cent of stoma length; subventral tooth apices at 64 per cent. Cobb's figures show two unusual structures posterior to the stoma base which I am unable to explain. Nerve ring at 9 per cent of body length. Genital organs apparently paired and symmetrically

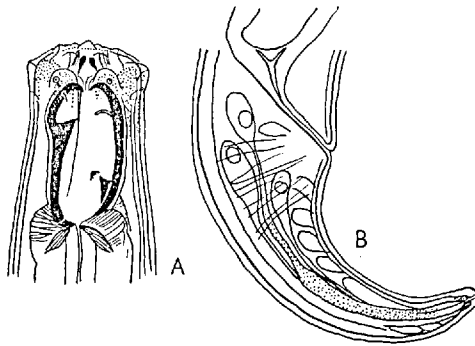

Fig. 2. *Cobbonchus radiatus*. A. lateral view of head; B. female tail. (Both after Cobb).

reflexed. Rectum almost straight, nearly equal to anal-body-width. Anal lips slightly protuberant. Tail short, ventrally arcuate, conoid. Caudal glands rather slender for the genus, ampulla present, duct terminal.

Specimen from "patch of wild cranberries with sphagnum", Cranberry Bog, New Lisbon, New Jersey, U.S.A.

Remarks. Cobb's sketches include an outline from which the measurements were taken. This shows the anterior and posterior limits of the reproductive system, indicating that the specimen may have been a young adult female.

Cobbonchus teres (Cobb) Andrassy

Figs. 3 A-B

Mononchus (*Mononchus*) *teres* Cobb, 1917, p. 155, fig. 19.*Cobbonchus teres* Andrassy, 1958, p. 161.

"Young specimen" (after Cobb) L 0.6 mm; a 26; b 2.86; c 16.5; V 60

Lip region not offset, head squarish. Papillae in two rings of six each. Amphid apertures small crescentic slits at level of dorsal tooth apex. Stoma large, broad, almost barrel-shaped. Dorsal tooth apex at 27 per cent of stoma length; subventral tooth apices at 65 per cent. Posterior fifth of stoma embedded in anterior end of oesophagus. Nerve ring at 8 per cent of body length. Rectum almost sigmoid,

length a little less than anal-body-width. Anal lips protuberant. Tail strongly arcuate, conoid. Caudal glands elongated, ampulla conspicuous, one fifth as long as tail, duct terminal.

Remarks. Cobb noted "description prepared from a single, more or less shrunken specimen found in the sphagnum of a pot in which blueberry plants were being cultivated".

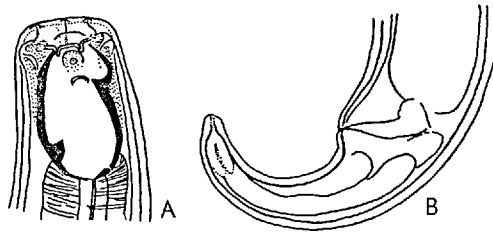

Fig. 3. *Cobbonchus teres*. A. lateral view of head; B. female tail. (Both after Cobb).

Cobbonchus mauritianus (Williams) Clark

Figs. 4 A-C

Mononchus mauritianus Williams, 1958, p. 5-6, figs 5 & 6.

Cobbonchus mauritianus Clark, 1960, p. 182.

Measurements ♀♀ (after Williams) L 1.1-1.3 mm; a 32; b 3.16; c 24.4; V 63.2

Cuticle 1 μ thick, smooth, no lateral fields; subcuticle 1 μ thick. Lip region truncate, slightly offset. Body tapering gradually towards head. Papillae in two rings, inner one of six, outer of ten papillae. Amphid aperture of moderate size,

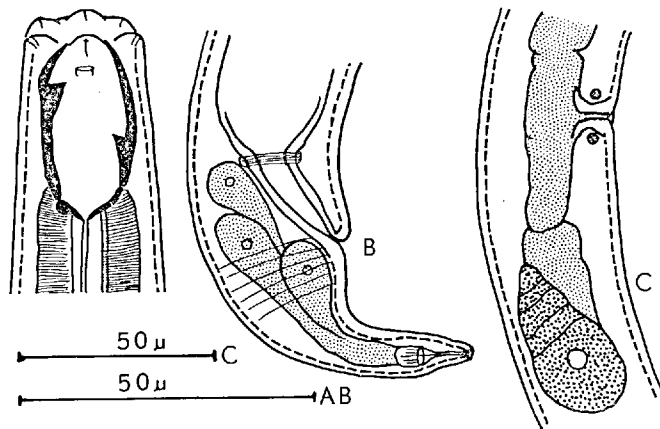

Fig. 4. *Cobbonchus mauritianus*. A. lateral view of head; B. female tail; C. posterior branch of female reproductive system.

a transverse slit situated a little anterior to dorsal tooth apex. Stoma parallel-sided, large, almost twice as long as wide. Dorsal tooth apex 23-24 per cent of stoma length; subventral tooth apices at 53-57 per cent. Posterior sixth of stoma embedded in anterior end of oesophagus. Oesophagus narrowing a little from stoma base to nerve ring at 23 per cent of its length, then expanding gently to three-

quarters body-width at the widest part. Oesophageal gland ducts occur at 39, 73 and 94 per cent of oesophageal length. Oesophago-intestinal junction non-tuberculate. Conical structure on posterior face of sphincter muscle prominent in my specimen. Vagina a thick walled tube with a sphincter muscle, but without radiating muscle fibres. Uteri and oviducts paired, outstretched; ovaries short reflexed through half length of oviduct and uterus. No prerectum. Rectum straight, almost equal to anal-body-width. Anal lips prominent. Tail short, ventrally flexed, conoid at first, then cylindroid. Caudal glands and ampulla large, prominent. Terminal duct slightly dorsal. No cuticular pores seen.

Remarks. The above description was prepared from a single paratype female kindly supplied by Mr. J. R. Williams. *C. mauritianus* differs from *C. palustris* (Cobb) in the shape of the head, the position of the teeth, and the bulbous anal region, but not in the shape of the tail as suggested by WILLIAMS (1958). Williams has informed me (*in litt.*) that the soil on Plaine Sophie, Mauritius where these specimens were collected is very wet, indicating that this species, like all others in the genus, has a preference for wet situations.

Cobbonchus chauliodus n. sp.

Figs. 5 A-D

Holotype ♀ L 3.28 mm; a 51; b 3.12; c 40.6; V¹⁹ 69.9

Cuticle 1.5 μ thick, smooth except on cylindroid part of tail where it is annulated, no lateral fields. Subcuticle 2 μ thick. Lip region slightly offset. Papillae in two rings; inner ring of six and outer ring of ten. Amphids cup-like, situated a little behind dorsal tooth apex; aperture slitlike. Stoma heavily sclerotized, widest anteriorly, narrowing towards the base. At widest part stoma occupies 70 per cent of body width. Walls inarched anteriorly. Dorsal posterior stoma element appears pyriform in optical section; subventrals appear lenticular, all elements thinning towards oesophageal lumen. Outer surface of stoma with fine transverse striae. Single dorsal tooth massive, apex at 16 per cent of stoma length and reaching almost to centre of stoma, anterior edge straight sloping posteriorly from apex, posterior edge merging with stoma wall near midpoint of stoma. Subventral teeth much smaller than dorsal tooth, apices at 39 per cent of stoma length, anterior edges concave, sloping posteriorly, posterior edges convex. Anterior four-fifths of stoma surrounded by a thin sheath, posterior fifth embedded in anterior end of oesophagus. Oesophagus of uniform diameter from stoma base to nerve ring at one sixth of its length, then expanding a little to occupy three-fifths of body-width. Oesophageal gland ducts occur at 45, 67, and 96 per cent of oesophageal length. Oesophago-intestinal junction non-tuberculate, details obscure, but appears essentially the same as *Prionchulus muscorum* (Dujardin). Intestine passes to left of reproductive organs. Vulva transverse. Vagina extending across one third of body width, broad. Vulva and vagina surrounded by massive musculature. Uterus prodelpic, doubly reflexed in distal part in holotype (fig. 5), posterior uterus represented by a long post-vulval sac. Sphincter muscle present at uterus-oviduct

junction. Ovary rather small, reflexed less than one fifth of the length of oviduct and uterus. Rectum straight, length equal to anal-body-width. Anterior anal lip lobar in form. Tail short, conoid at first with a ventral flexure, after which it is cylindroid with a terminal peg. Caudal glands very large occupying most of the post-anal space. Ampulla well developed, duct terminal. One cuticular pore near end of cylindroid part of tail.

Specific differentiation. The large size immediately separates *C. chauliodus* from all other species in the genus. Other distinguishing features are the massive dorsal tooth, and the single prodelphic ovary.

Type slides Holotype and paratype (larva) in nematode collection, Entomology Division, D.S.I.R., Nelson, N.Z.

Type locality. Collingwood Pakihi, Nelson, N.Z.M.S.1. S3, 086013, 30 metres, in a gley podsol soil with *Cladium teretifolium* R. Br., *Gleichenia circinata* Swartz, *Drosera pygmaea* DC. and *Celmisia gracilentia* Hook f.

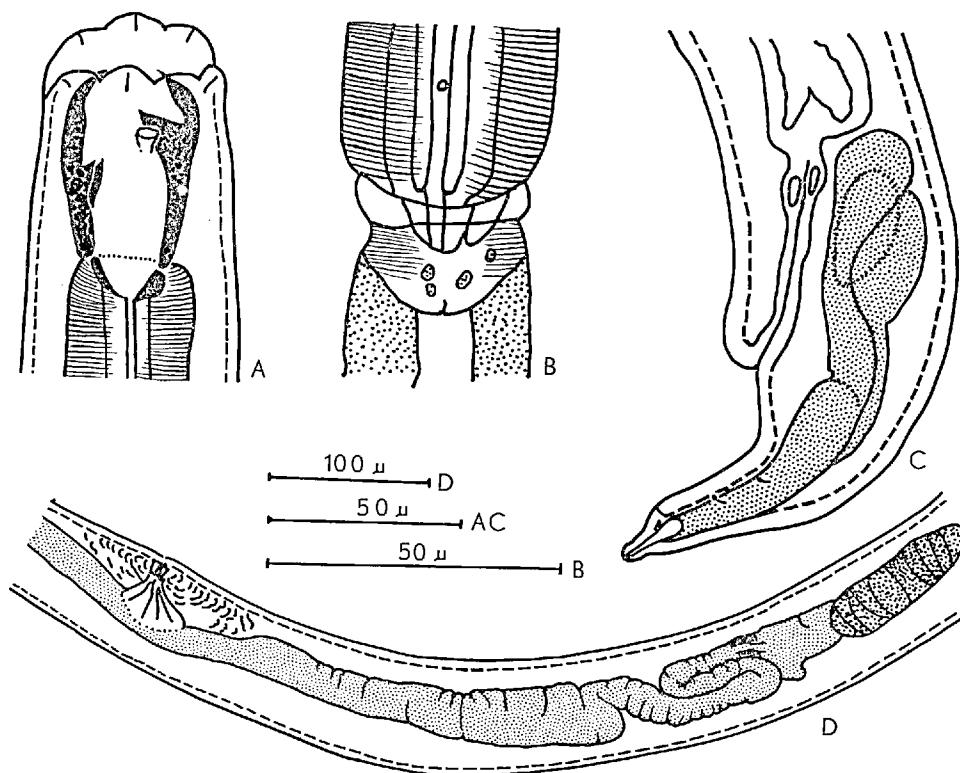

Fig. 5. *Cobbonchus chauliodus*. A. lateral view of head; B. oesophago-intestinal junction; C. female tail; D. female reproductive system.

Remarks. The name alludes to the large tooth ($\chi\alpha\upsilon\lambda\iota\omicron\delta\omicron\varsigma$ = having prominent teeth).

Cobbonchus pounamua n. sp.

Figs. 6 A-I

Holotype ♀ (Awatuna) L 2.87 mm; a 44; b 3.68; c 34.4 V²⁷ 68.9¹⁵

Allotype ♂ (Awatuna) L 2.87 mm; a 47; b 3.83; c 34.4 T 34.6

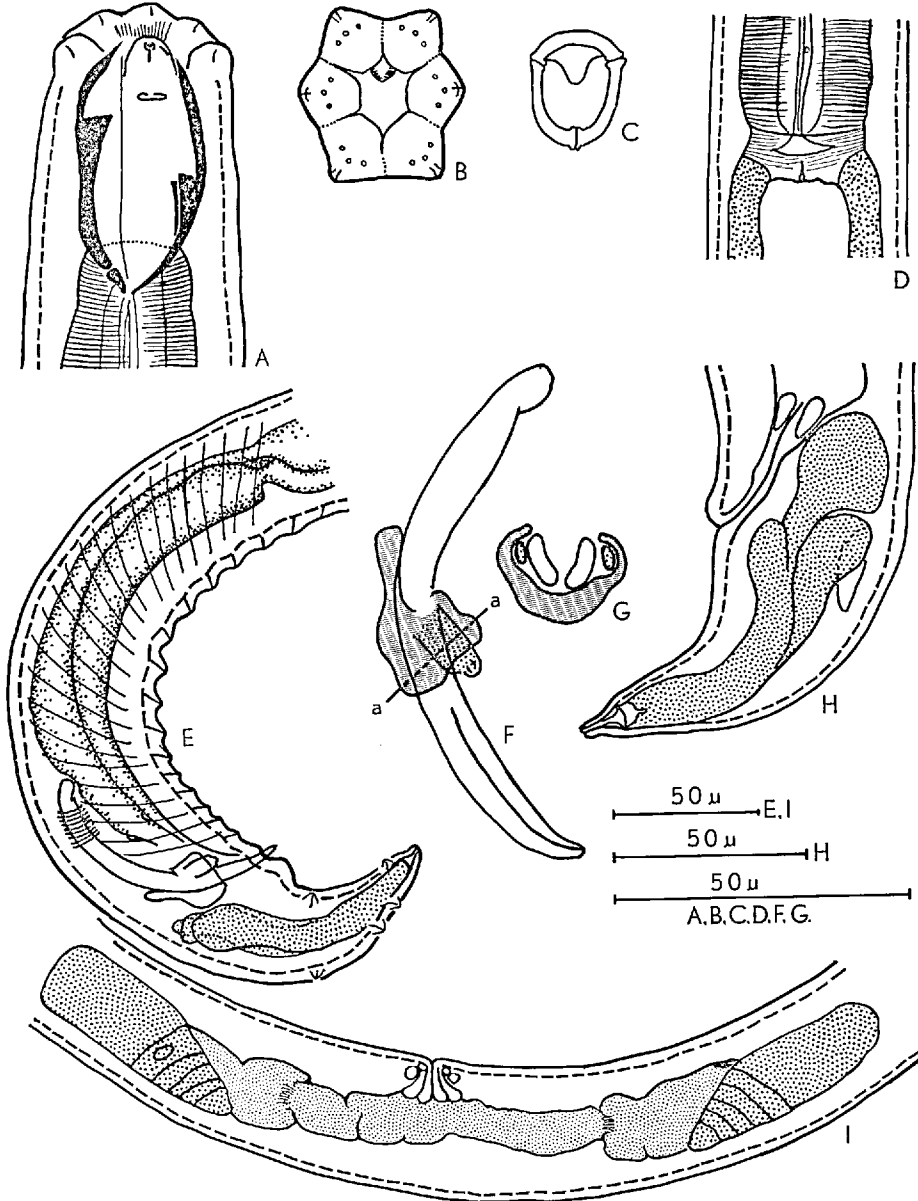

Fig. 6. *Cobbonchus pounamua*. A. lateral view of head; B. *en face* view of lip region; C. transverse section through stoma at level of dorsal tooth apex; D. oesophago-intestinal junction; E. male tail; F. spicule, lateral accessory piece and gubernaculum; G. optical section through a— a of fig. F; H. female tail; I. female reproductive system.

- Paratypes ♂ (Awatuna) L 2.72 mm; a 53; b 3.76; c 30.7 T 33.5
 ♂ (Hokitika) L 2.17 mm, a 46; b 3.46; c 26.8 T 37.8
 ♂ (Fairdown) L 2.68 mm; a 46; b 4.0; c 27.9 T 32.2
 ♀♀ (Reefton) n = 2; L 1.26-1.30 mm; a 38-39; b 2.89-2.90;
 c 26.1-27.3 V ⁷ 61.3-63.0 ⁹

Cuticle 1.5 μ thick with faint, obsolescent annulations sometimes visible under oil immersion. Subcuticle 1.5 μ thick. Lip region not offset; lateral lips more prominent than others. Amphid apertures slit-like, wide, situated a little in front of dorsal tooth apex. In *en face* view lip region hexagonal, elongated dorso-ventrally. Papillae in two rings, inner ring with eighteen papillae, three on each lip and outer ring of ten. Amphid apertures appear below outer lateral papillae as crescentic slits. At level of dorsal tooth apex the stoma is oval in cross section, with slight thickenings of the abutting edges of its skeletal elements. In lateral view stoma oval, twice as long as broad, in-arched anteriorly and pointed at base, dorsal wall thicker than ventral wall. Dorsal tooth medium sized, extending across less than a third of stoma width, apex at 31-33 per cent of stoma length, anterior edge almost straight and horizontal, posterior edge slightly concave. Subventral tooth apices at 50-55 per cent of stoma length, teeth similar to, but smaller than dorsal tooth. Posterior fifth of stoma embedded in anterior end of oesophagus. Oesophagus narrowing very slightly to nerve ring at a quarter of oesophageal length, then expanding a little to occupy three quarters body width. Oesophageal gland ducts at 52, 68-71, and 95-97 per cent of oesophageal length. Oesophago-intestinal junction non-tuberculate. Intestine, with large dark granules, passes to left of anterior ovary and to right of posterior one.

Female. Vulva a transverse slit. Vagina thick and muscular, extending across one-third body-width. Uteri paired, opposed, outstretched, short. Sphincter muscle present between uteri and oviducts. Ovaries reflexed through half length of uterus and oviduct, half as wide as body. No prerectum. Rectum straight, length equal to three-quarters anal-body-width. Tail conoid, ventrally flexed, tip with peg-like process. Annules fairly easily seen on posterior half of tail. Caudal glands massive, extending anteriorly beyond anus, ampulla conspicuous, duct terminal. A single cuticular pore near ampulla on ventral side.

Male. Testes paired, opposed, outstretched, sperm numerous. Vas deferens equal in length to testes. Opposite the second supplement vas deferens enlarges to become the ejaculatory duct, and prerectum is marked off from intestine. Spicules paired, free, slender, arcuate, and bluntly rounded at tips. Lateral accessory pieces present. Gubernaculum similar to some *Iotonchus* species; consisting of a solid dorsal part lying mostly behind the spicules from which arise a pair of lateral processes which extend forward on either side of the spicules and lateral accessory pieces and then turn inwards towards each other in front of the spicules. (Figs. 6 F & G). Supplements papilliform 16-18, largest near middle of series, decreasing in size towards either end. Tail short, conoid, ventrally arcuate, posterior

anal lip prominent. Caudal glands large, ampulla well developed, duct terminal. Cuticular pores prominent; open on tips of papilliform structures like those described in males of *Mylonchulus brachyuris* (Bütschli) by GOODEY (1942). The position of the papillae varies from specimen to specimen but is generally as in fig. 6 E.

Specific differentiation. Bears a general resemblance to *C. palustris* but differs from it in head shape, shape of stoma base, number of cephalic papillae and the orientation of the rectum.

Type slides. All type slides in nematode collection, Entomology Division, D.S.I.R., Nelson, N.Z.

Type locality. Awatuna, Westland, N.Z.M.S.1. S50/51 625672, *Ranunculus* sp. *Hydrocotyle* sp., *Juncus* sp. *Holcus lanatus* L.; soil, Mahinapua sands (wet podsolic sands).

Other localities. Reefton in sphagnum swamp; Hokitika in swampy pasture with *Juncus* L., *Drosera* L. etc.; Fairdown in swampy pasture, Westport pakihi, *Gleichenia circinata* Swartz, *Sphagnum* L., *Leptospermum scoparium* Forst. and *Drosera* L. sp.; Wharekohe *Cladium teretifolium* R. Br., *Leptospermum scoparium* Forst. and *Gleichenia circinata* Swartz. Swampy land in all cases.

Remarks. The similarity of the male tails of *C. pounamua* (the only known males in the genus) and those of *Mylonchulus brachyuris* point to a close affinity between the genera *Cobbonchus* and *Mylonchulus*. This suggested affinity is further supported by the form of the stoma with three anteriorly directed teeth set at two levels, the non-tuberculate oesophago-intestinal junction, and the similar female tails in both genera.

The specimens from Reefton are smaller than those from elsewhere and have a slightly longer oesophagus, but do not differ in other respects.

The specific name is derived from the Maori name for the region in which most specimens were collected.

I thank the Nematology Section U.S. Dept. of Agriculture, Beltsville, for permission to reproduce Cobb's drawings, and Mr. J. R. Williams for the gift of a paratype of *C. mauritianus*.

ZUSAMMENFASSUNG

Die Mononchiden (Enoplida, Nematoda) Neu-Seelands 3. Rückblick über die Gattung Cobbonchus Andrassy 1958 mit Beschreibungen neuer Arten

Die Gattung *Cobbonchus* Andrassy 1958 wurde neu definiert. Neue Beschreibungen von *C. palustris* (Cobb), *C. radiatus* (Cobb) und *C. teres* (Cobb) wurden aus COBB (1917) und einigen unveröffentlichten Abbildungen Cobbs zusammengestellt. *C. mauritianus* wird neu beschrieben. *C. chauliodus* n. sp. unterscheidet sich von anderen durch seine Grösse, den massiven Dorsalzahn und das einfache, prodelphische Ovar. *C. pounamua* n. sp. unterscheidet sich von *C. palustris* in der Kopfform, der spitzen Mundbasis und der grösseren Anzahl von Kopfpapillen.

REFERENCES

- ANDRÁSSY, I. (1958). Über das System der Mononchiden (Mononchidae Chitwood, 1937; Nematoda). *Ann. hist.-nat. Mus. hung.* n.s. 9, 50, 151-171.

- CLARK, W. C. (1960). The oesophago-intestinal junction in the Mononchidae (Enoplida: Nematoda). *Nematologica* **5**, 178-183.
- COBB, N. A. (1917). The Mononchs (*Mononchus* Bastian, 1865) a genus of freeliving predatory nematodes, *Soil Sci.*, **1**, 431-486.
- GOODEY, T. (1942). Observations on *Mononchus tridentatus*, *M. brachyuris* and other species of the genus *Mononchus*. *J. Helm.*, **20**, 9-24.
- WILLIAMS, J. R. (1958). Studies on the nematode soil fauna of sugar cane fields in Mauritius. 1. The genus *Mononchus* (Trilobidae, Enoplida), *Occas. Pap. (1) Mauritius Sugar Ind. Res. Inst.* 13 pp.

8.

THE MONONCHIDAE (ENOPLIDA: NEMATODA) OF NEW ZEALAND
IV. THE GENUS *MYLONCHULUS* (COBB, 1916) PENNAK, 1953

BY

W. C. CLARK

Rothamsted Experimental Station, Harpenden, Herts., England¹⁾

Two new species of *Mylonchulus* are described. *M. arenicolus* n. sp. is distinguished by its almost parallel-sided stoma, the arrangement of the subventral denticles and the tail shape. *M. ubis* n. sp. is marked off by the subterminal position of the caudal gland duct in conjunction with the regularly conoid tail and the arrangement of the subventral denticles.

The genus *Mylonchulus* appears to be cosmopolitan, having been recorded from most countries where free-living nematodes have been studied. Because Mulvey (pers. comm.) has a revision of the genus in the press, I am describing two new species without either reviewing the genus or commenting on the status of other species. A complete list of the Mononchidae recorded to date from the New Zealand region is appended. This is the last paper in this series (Clark 1960 a-d).

Mylonchulus arenicolus n. sp.

Figs. 1 A-D

Holotype ♀ L = 1.45 mm; a = 29; b = 3.59; c = 31.4; V 1264.7^{13}

Paratype ♀ L = 1.48 mm; a = 31; b = 3.44; c = 29.7; V 1462.7^{13}

Cuticle (head region) 1 μ thick, smooth; subcuticle 1 μ thick; cuticle much thicker on tail. No lateral fields. Lip region scarcely offset. Lips distinct, somewhat pointed; papillae six in inner ring and ten in outer ring. Amphid apertures appear as transverse slits in lateral view situated at the level of the dorsal tooth apex.

Stoma heavily sclerotized, almost parallel-sided anteriorly, pointed posteriorly, greatest width equal to three-fifths of stoma length, or half body width at this point. Dorsal stoma wall with a massive pointed dorsal tooth; anterior edge concave, sloping posteriorly from tooth apex; posterior edge convex, merging with stoma wall near middle of stoma. Tooth apex extending to middle of stoma and situated at 14—19 per cent of stoma length. Posterior dorsal stomal element rather triangular in optical section. Ventral wall similar to dorsal, but bearing 2 small subventral teeth and six rows of denticles arranged across the ventro-lateral stomal elements. Anterior and posterior ventral elements appear fused. Posterior quarter

¹⁾ on study leave from Entomology Division, D.S.I.R., Nelson, New Zealand.

of stoma with fine transverse striae. Posterior third of stoma embedded in slightly swollen anterior end of oesophagus. Oesophagus narrows a little to the nerve ring at one quarter of its length, then expands again, generally occupying two-thirds of the body width. Dorsal and subventral oesophageal gland ducts occur at 50, 63, and 94 per cent of oesophageal length. Oesophago-intestinal junction non-tuberculate, no transparent zone observed. Intestine usual for the family.

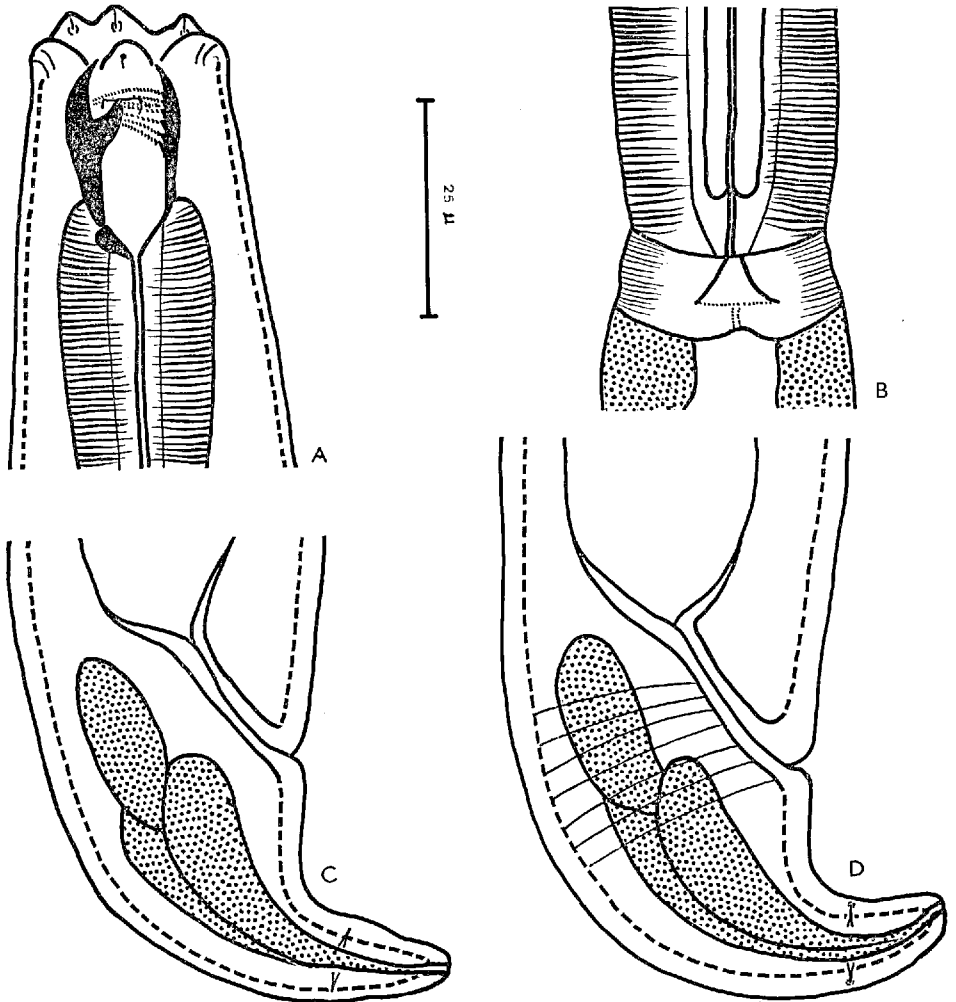

Fig. 1. *Mylonchulus arenicolus* n. sp. A. head region, B. oesophago-intestinal junction, C. tail of holotype, D. tail of paratype.

Ovaries paired, reflexed. Vulva a transverse slit at about two-thirds of body length. Vagina thick walled, extending across one-third of body width. Uteri outstretched with a well developed sphincter muscle at junction with each oviduct; spermatozoa occur abundantly on either side of the sphincter.

Tail short, conoid, ventrally arcuate, generally as in figure 1 C, but often as in fig. 1 D. Caudal glands well developed; duct terminal in position. Cuticular caudal pores as shown in figs. 1 C-D. Larvae similar to female.

Males unknown, but the abundance of sperm in the females (collected in February) indicates their probable existence.

Specific differentiation. Readily distinguished from the other New Zealand species by the terminal position of the caudal gland duct. *M. arenicolus* is distinguished from other species in the genus by its almost parallel-sided stoma, the arrangement of the sub-ventral denticles and the tail shape. It appears to be closest to *M. incurvus* (Cobb, 1917).

Type slides. Holotype and paratypes in Nematode collection, Entomology Division, D.S.I.R., N.Z.

Type locality. Kumara Beach, Westland, N.Z.M.S.I., S 50/51 741654 in unstabilized dune sand about the roots of *Desmoschoenus frondosus* Banks & Sol.

Mylonchulus ubis n. sp.

Figs. 2 A-E

Kumara Beach (Holotype) ♀ L = 1.24 mm; a = 29; b = 3.54; c = 23.1;
V = 8 60¹¹

(Paratypes) 2 ♀♀, L = 1.2-1.23 mm; a = 27-28; b = 3.36-3.49;
c = 24.0-24.7; V 6-7 59.5-60¹¹

Waitaanga Saddle 2 ♀♀ L = 1.07-1.09 mm; a = 30; b = 3.09-3.12;
c = 21.5-23.1; V = 63

Kiripaka ♀ L = 1.10 mm; a = 27; b = 3.31; c = 22.0; V = 13 63.5¹²

Reefton ♀ L = 1.22 mm; a = 27; b = 3.51; c = 24.3; V = 7 59¹¹

Ross ♀ L = 1.2 mm; a = 25; b = 3.49; c = 23; V = 19 60.7¹²

Wharekohe ♀ L = 1.31 mm; a = 32; b = 3.79; c = 26.2; V = 8 54⁶

Cuticle 1.3 μ thick, smooth, no lateral fields; subcuticle 1 μ thick. Lip region scarcely offset, lips well developed. "Inner lips" pointed, "outer lips" rounded. Papillae in two rings, six in the inner and ten in the outer ring. Amphid aperture a transverse slit situated slightly posterior to the dorsal tooth apex, one-fifth as wide as body at this level. Stoma goblet shaped, pointed posteriorly, half as wide as body in this region. Stoma dominated by the large anteriorly directed dorsal tooth whose apex reaches the centre of the stoma, and which occurs at 14-21 per cent of the length of the stoma. Anterior edge of tooth concave, posterior edge convex. Dorsal wall of stoma clearly divided into anterior and posterior elements, but subventral elements appear to be completely fused. Postero-dorsal element triangular on optical section, antero-dorsal element arcuate in outline. Subventral element straighter anteriorly than dorsal element. Subventral denticles in five to seven transverse rows. Posterior subventral denticles not conspicuously larger than the more anterior ones. Posterior part of stoma with fine transverse striae. Poste-

rior third of stoma embedded in locally expanded anterior end of oesophagus which narrows slightly to the nerve ring at a quarter of its length and then expands slightly in conformity with the body contour, generally occupying two-thirds of the body width. Dorsal and subventral oesophageal gland ducts discharge into the oesophageal lumen at 55, 68 and 93 per cent of the oesophageal length respectively.

Oesophago-intestinal junction non-tuberculate with a transparent zone intercalated between the posterior end of the oesophagus and the sphincter muscle. Intestine typical of the family.

Vulva at 54-63 per cent of body length. Ovaries paired, opposed, reflexed,

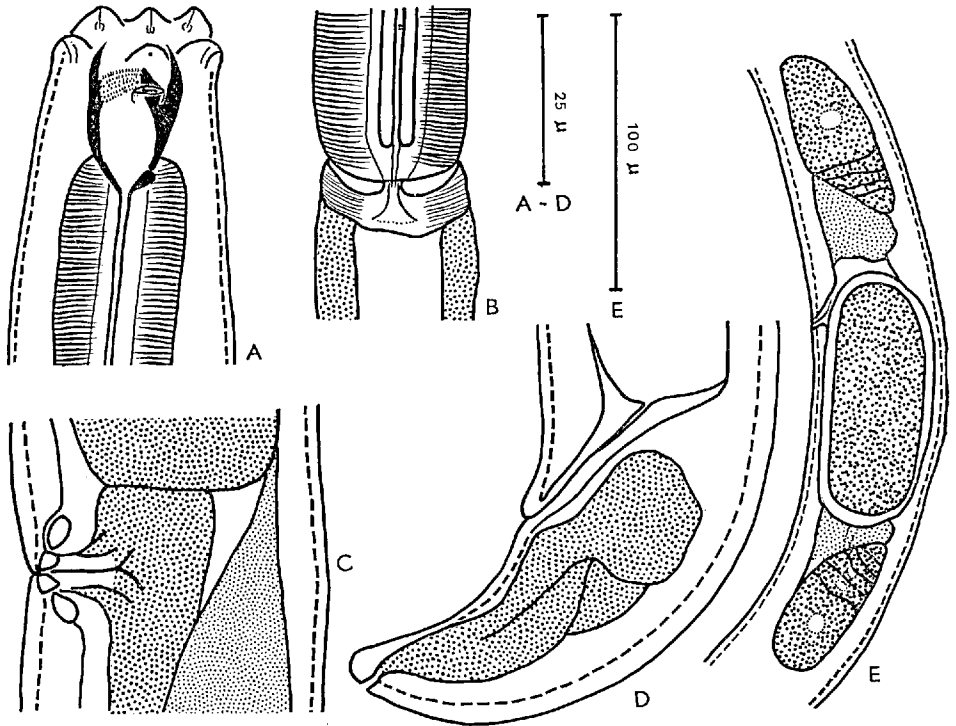

Fig. 2. *Mylonchulus ubis* n. sp. A. head region, B. oesophago-intestinal junction, C. vulva, D. female tail, E. reproductive organs.

occupying half body width. Oviducts and uteri short, with a sphincter muscle and glandular region at the oviduct-uterus junction. Only one mature ovum in the uterus at a time; there does not appear to be room for more in such a short reproductive tract. Egg length almost twice body width. Vagina with muscular walls extending across one-third of body width.

Prerectum absent, rectum straight, length equal to two-thirds anal-body-width.

Tail conoid, ventrally arcuate, tip rounded; caudal glands well developed, duct dorsally subterminal. Cuticular caudal pores apparently lacking.

Larvae resemble females.

Males unknown.

Specific differentiation. Readily distinguished from *M. arenicolus*, the only other known New Zealand species by the subterminal position of the caudal gland duct. The subterminal position of the caudal gland duct in conjunction with the regularly conoid tail, the regular arrangement of the subventral denticles and the absence of a pair of large, posterior subventral denticles, serve to distinguish this species from all others in the genus.

Type slides. Holotype and paratypes in nematode collection, Entomology Division, D.S.I.R., New Zealand. Paratype in slide collection, Nematology Department, Rothamsted Experimental Station, Harpenden, Herts., England, slide no. 147/4/1.

Type locality. Kumara Beach, Westland, N.Z.M.S.I. S 50/51 741656, in stabilized sand ridge with *Trifolium repens* L., *Hydrocotyle* sp., *Hypochoeris radicata* L., *Plantago* sp., and *Festuca novaeseelandiae* Cockayne. Soil: Mahinapua sands (imature podzolic loamy sands).

Other localities: Ross, Westland in *Trifolium repens* L. — *Anthoxanthum odoratum* L. — *Lolium perenne* L. pasture; Reefton in *Sphagnum* swamp with *Hypochoeris radicata* L.; Hongi's Track, in *Beilschmiedia Tawa* Benth. & Hook. f. — *Knightia excelsa* R. Br. forest litter; Waitaanga Saddle in liverworts and mosses in Tree-fern — *Brachyglottis repanda* Forst. — *Weinmannia racemosa* Linn. f. forest; Wharekohe, in 18 year-old *Paspalum dilatatum* Poir — *Lolium perenne* L. — *Trifolium repens* L. pasture; Kiripaka in *Beilschmiedia Taraire* Benth. & Hook. f. — *Vitex lucens* T. Kirk — *Dysoxylum spectabile* Hook. f. forest litter.

Remarks. All localities where this species has been found either are, or in historic time have been forested areas. This species has not been found in natural grasslands areas, but has been found in grasslands induced by man.

CHECKLIST OF NEW ZEALAND MONONCHIDAE

| | |
|--|--|
| <i>Mononchus composticola</i> Clark, 1960 | <i>Cobbonchus pounamua</i> Clark, 1960 |
| „ <i>mesadenus</i> Clark, 1960 | <i>Miconchus rex</i> (Cobb, 1904) Andrassy, 1958 |
| „ <i>propapillatus</i> Clark, 1960 | <i>Iotonchus basidontus</i> Clark, 1960 |
| <i>Prionchulus muscorum</i> (Dujardin, 1845) | „ <i>maragnus</i> Clark, 1960 |
| Chitw. & Chitw., 1937 | „ <i>ophiocercus</i> Clark, 1960 |
| <i>Mylonchulus ubis</i> n. sp. | „ <i>paraszokkei</i> (Allgen, 1929) |
| „ <i>arenicolus</i> n. sp. | Andrassy, 1958 |
| <i>Cobbonchus chauliodus</i> Clark, 1960 | „ <i>percivali</i> Clark, 1960 |

Allgen's (1929) record of *Iotonchus trichurus* (Cobb, 1917) Andrassy, 1958 from Campbell Island is considered doubtful.

ZUSAMMENFASSUNG

Die Mononchiden (Enoplida: Nematoda) Neu-Seelands
 4. Die Gattung *Mylonchulus* (Cobb, 1916) Pennak, 1953

Zwei neue Arten der Gattung *Mylonchulus* werden beschrieben. *Mylonchulus arenicolus* n. sp. ist unterschieden durch den Besitz einer fast parallel-seitigen Mundhöhle, fünf Reihen subventraler Zähnen, zwei kleiner subventraler Zähne und einem gebogenen fast konisch gefingerten Schwanz mit einer kaudalen Drüsengang. *M. ubis* n. sp. ist charakterisiert durch die Anwesenheit regulär angeordneter subventraler Zähnen und dem Fehlen subventraler Zähne. Der Schwanz ist in der Regel konisch gebogen mit einer dorsalen, subterminalen Drüsengang.

REFERENCE

- ALLGEN, C. (1929). Über einige freilebende Moos-Nematoden, *Nyt Mag. Naturvid.* **67**, 211-230.
 CLARK, W. C. (1960a). The oesophago-intestinal junction in the Mononchidae (Enoplida, Nematoda). *Nematologica* **5**, 178-183.
 — (1960b). The Mononchidae (Enoplida: Nematoda) of New Zealand 1. The genera *Mononchus* Bastian, and *Prionchulus* Cobb. *Nematologica*, **5**, 199-214.
 — (1960c). The Mononchidae (Enoplida: Nematoda) of New Zealand. 2. The genus *Iotonchus* (Cobb, 1916) Altherr, 1950. *Nematologica* **5**, 259-273.
 — (1960d). The Mononchidae (Enoplida: Nematoda) of New Zealand. 3. A review of the genus *Cobbonchus* Andrassy, 1958 with descriptions of new species, *Nematologica* **5**, 274-283.