

# Designs of Optical Instruments – Phenomena

Six different phenomena form the basics of Optical spectroscopic methods:

- 1. Absorption** – causes the promotion of a particle from its normal room temperature state to one or more higher energy excited states.
  - ✓ The process of absorption of quantized; i.e., for absorption to occur, the excitation energy must exactly match the energy difference between the ground state and one of the excited states.
  - ✓ For molecules, obtaining a radiant energy that match a transition is easy as there are several states (electronic, vibration, rotation). For atoms, this is a challenge because they contain only electronic states.
  - ✓ For molecules, there are several relaxation means by which the excited species can get rid of the excess energy (i) non-radiative, (ii) fluorescence, and (iii) phosphorescence
  - ✓ For molecular absorption, we need materials that allow only a part of the electromagnetic radiation to be exposed to the analyte depending on the information needed
- 2. Fluorescence -**
- 3. Phosphorescence -**
- 4. Scattering -** only interested in the small fraction of the scattered photons (approximately 1 in 10 million) that are scattered by an excitation, with the scattered photons having a frequency different from that of the incident photons
- 5. Emission –** release of radiant light by a substance resulting from heat
- 6. Luminescence -** emission of light by a substance not resulting from heat. E.g., Chemiluminescence: a result of a chemical reaction, Photoluminescence: a result of absorption of photons

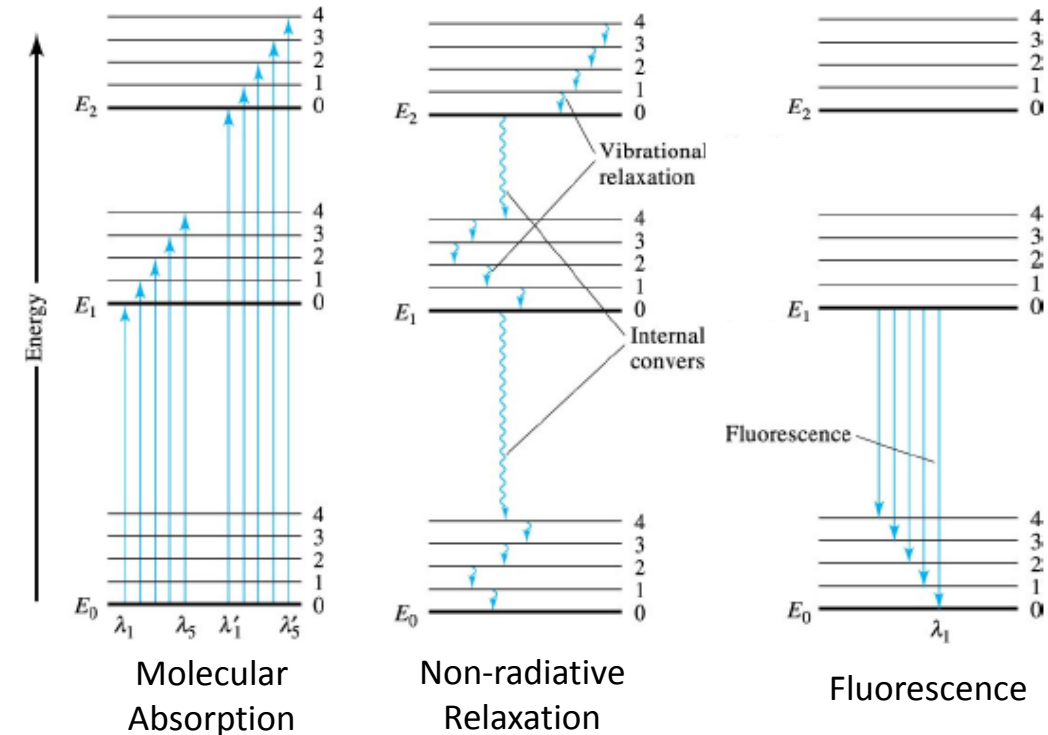

# Designs of Optical Instruments – Components

---

Although the required instrument components for measuring each phenomenon somewhat differ in configuration, most of their basic components are remarkably similar

Typical spectroscopic instrument contain five components:

1. Stable source for radiant energy
2. Transparent container for holding the sample
3. Device that isolates restricted region of the spectrum for measurement
4. A radiant detector that converts radiant energy to useable electrical signal
5. Signal processor and readout

# Designs of Optical Instruments – Basic Configurations

## 1. Absorption

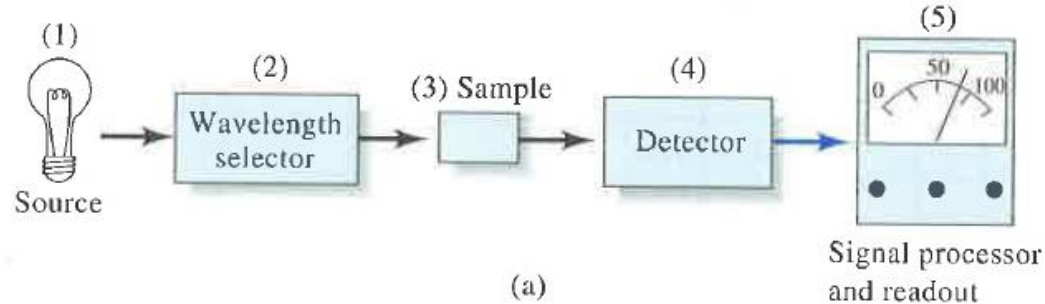

## 2. Fluorescence and Phosphorescence

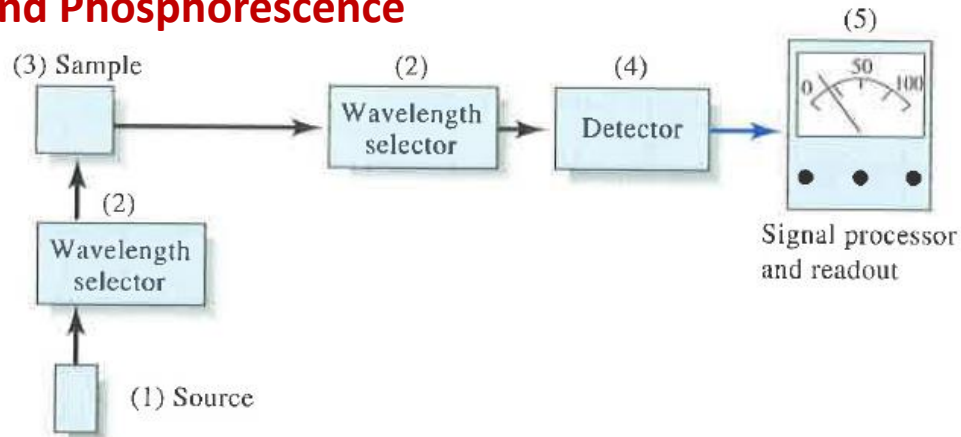

## 3. Emission or Luminescence

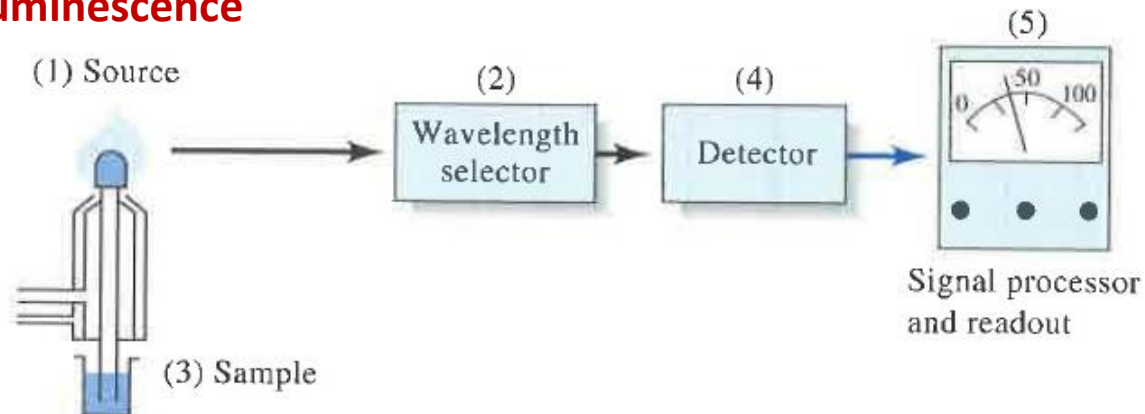

- Emission spectroscopy and Chemiluminescence spectroscopy differ from the others in that no external radiation source is required.
- The sample itself is the emitter
- Emission: sample container is a plasma, or flame that contains the analyte, and also causes it to emit radiant light
- Chemiluminescence: radiation source is a solution of the analyte plus reagents held in a transparent sample holder

# Sources of Radiation

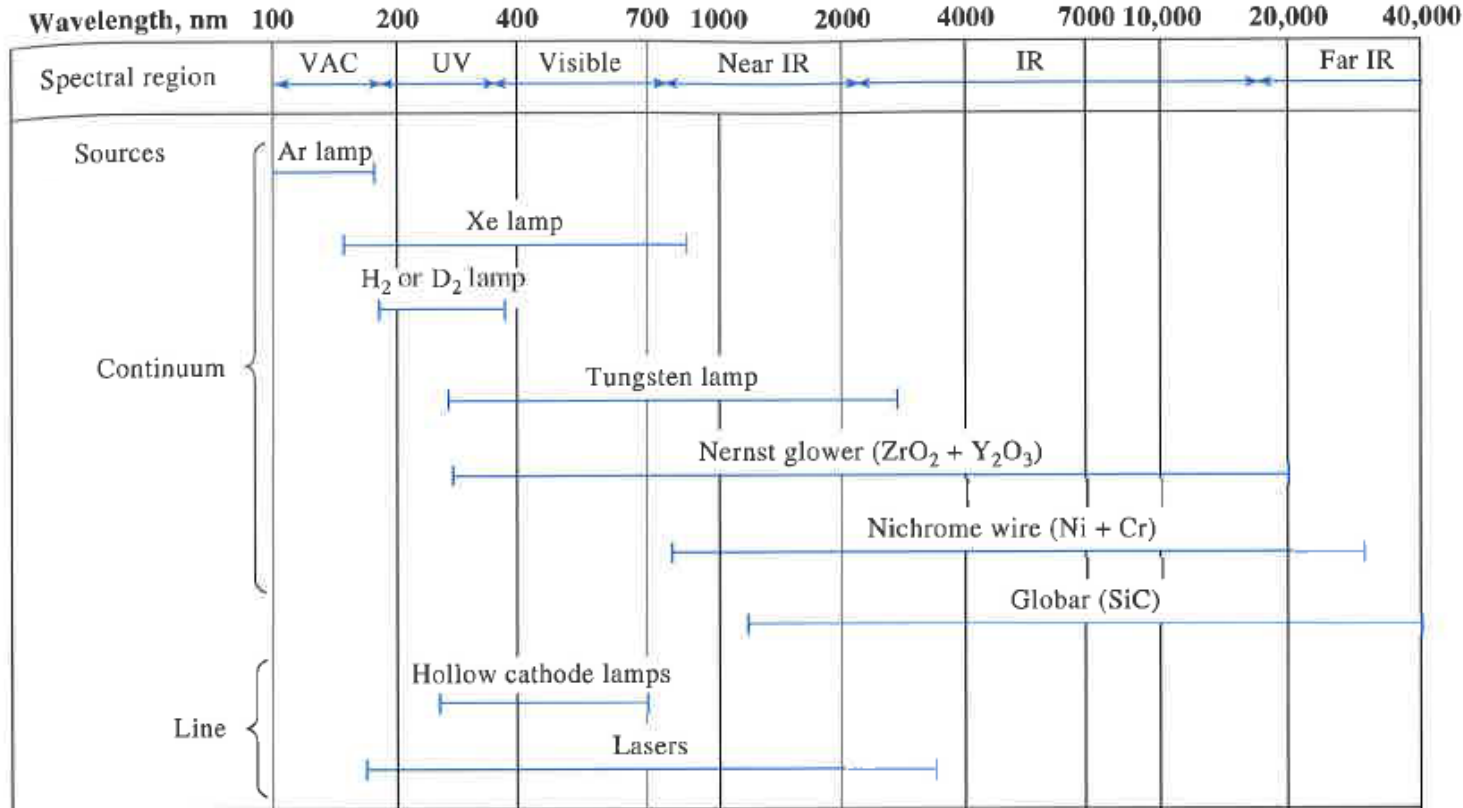

A suitable source is the one that is (1) stable and (2) generates sufficient radiant power for easy detection

## Continuum sources:

1. Emit radiation that changes only slowly as function of wavelength
2. Widely used in absorption and fluorescence spec

## Line sources:

1. Emit discrete of limited number of lines or bands of radiation, each of which spans a limited range of wavelengths
2. Widely used in atomic absorption spectroscopy, atomic and molecular fluorescence spectroscopy, and Raman spectroscopy



# Sources of Radiation

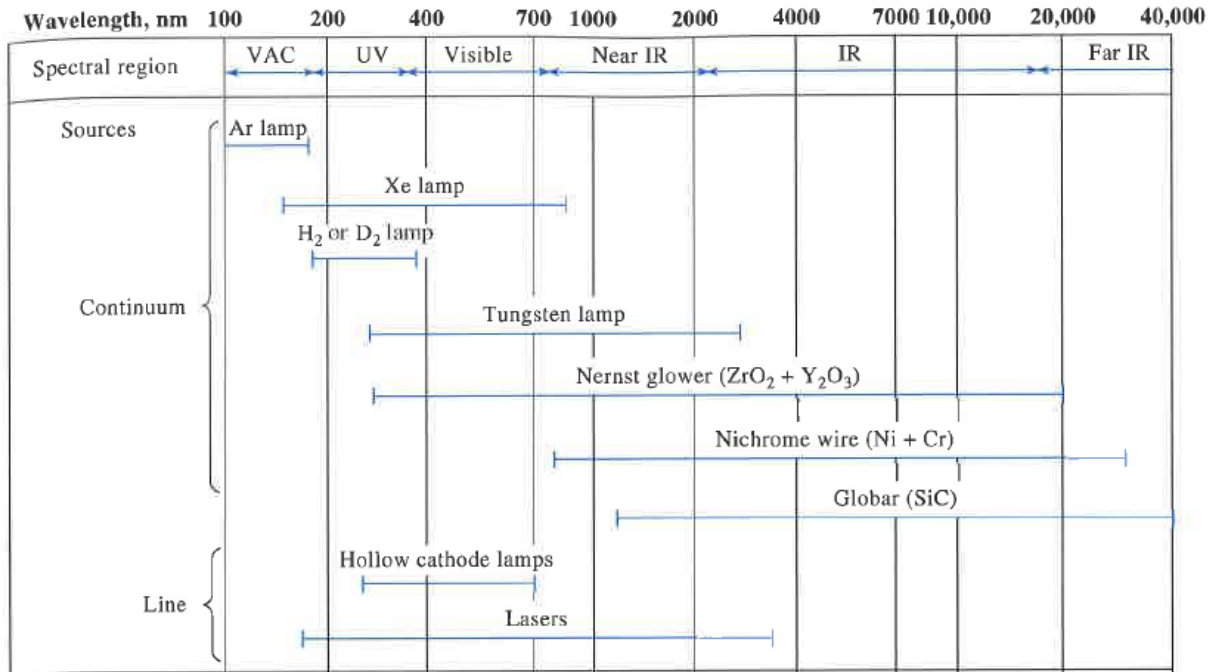

Most common continuum sources:

2. Visible Region – tungsten filament lamp or quartz-halogen lamps

Blackbody radiation:

- Temperature dependent
- Bulk of the radiation is emitted in the IR region during heating
- Absorption of radiation by glass case that houses the filament absorbs the IR radiations, and imposes the lower limit
- Quartz case allows higher temperatures (3500 K) to be used, which yields higher radiant intensities, and expands the range of the lamp to UV regions
- Tungsten-halogen lamp: contain iodine, which sublimates to react with tungsten vapor to form a volatile compound WI<sub>2</sub>. When molecules of this compound strikes the filament, decomposition occurs, which re-deposits tungsten and thus extending the lifetime of the lamp

3. Infrared region – inert solids heated to 1500 to 2000 K

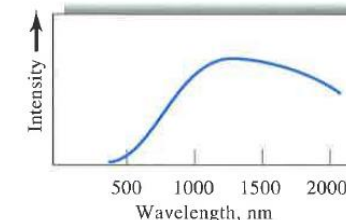
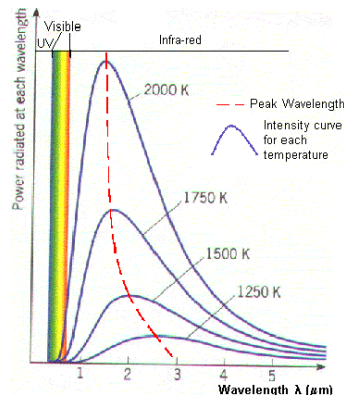

# Sources of Radiation

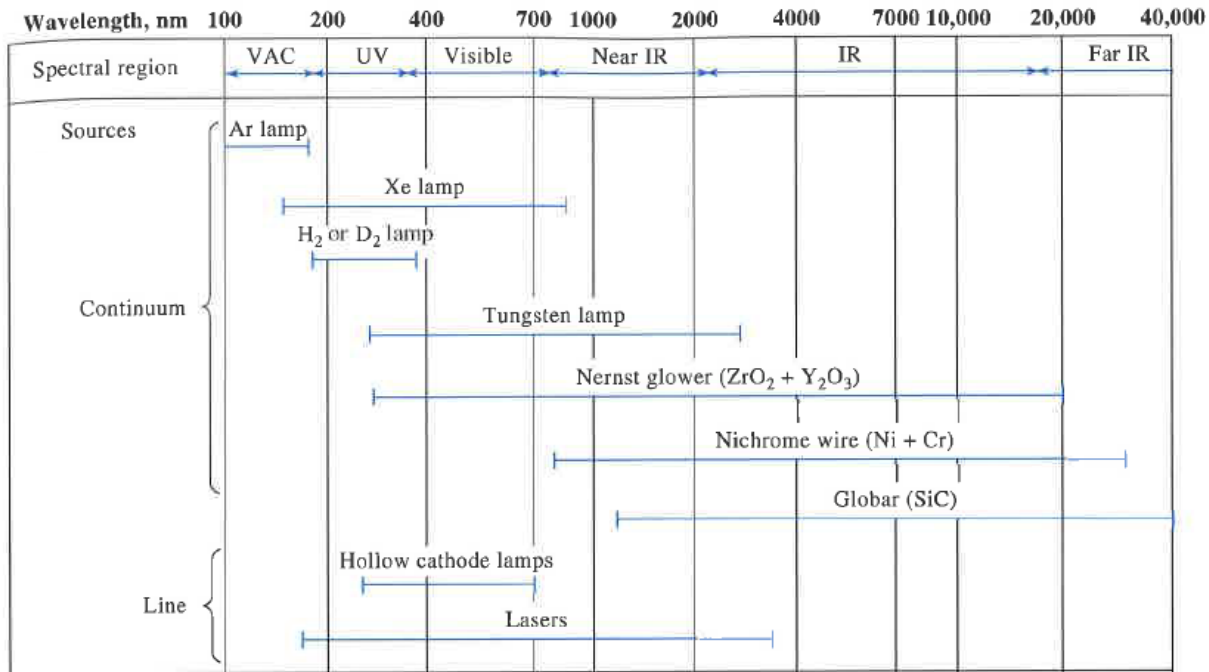

## Most common line sources:

### 1. Holo Cathode Lamps

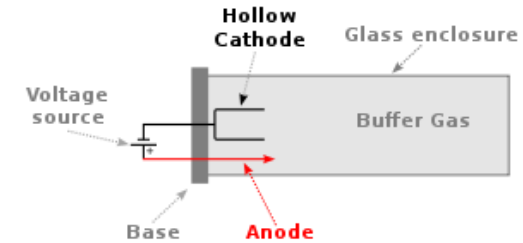

- High field between anode and cathode ionizes inert gas buffer inside the glass
- Ionized inert gases are accelerated to the cathode (negatively charged), which sputters atoms from the cathode
- Sputtered atoms are excited through collision with other atoms in the glass enclosure
- Photons are emitted as the excited atoms decay to the ground state. These photons are of discrete energies, and thus producing line spectrum

# Materials for Cell, Windows, lenses, and Prisms

Sample containers must be transparent to radiation in the spectra region of interest  
 Common materials and their useful regions are shown below

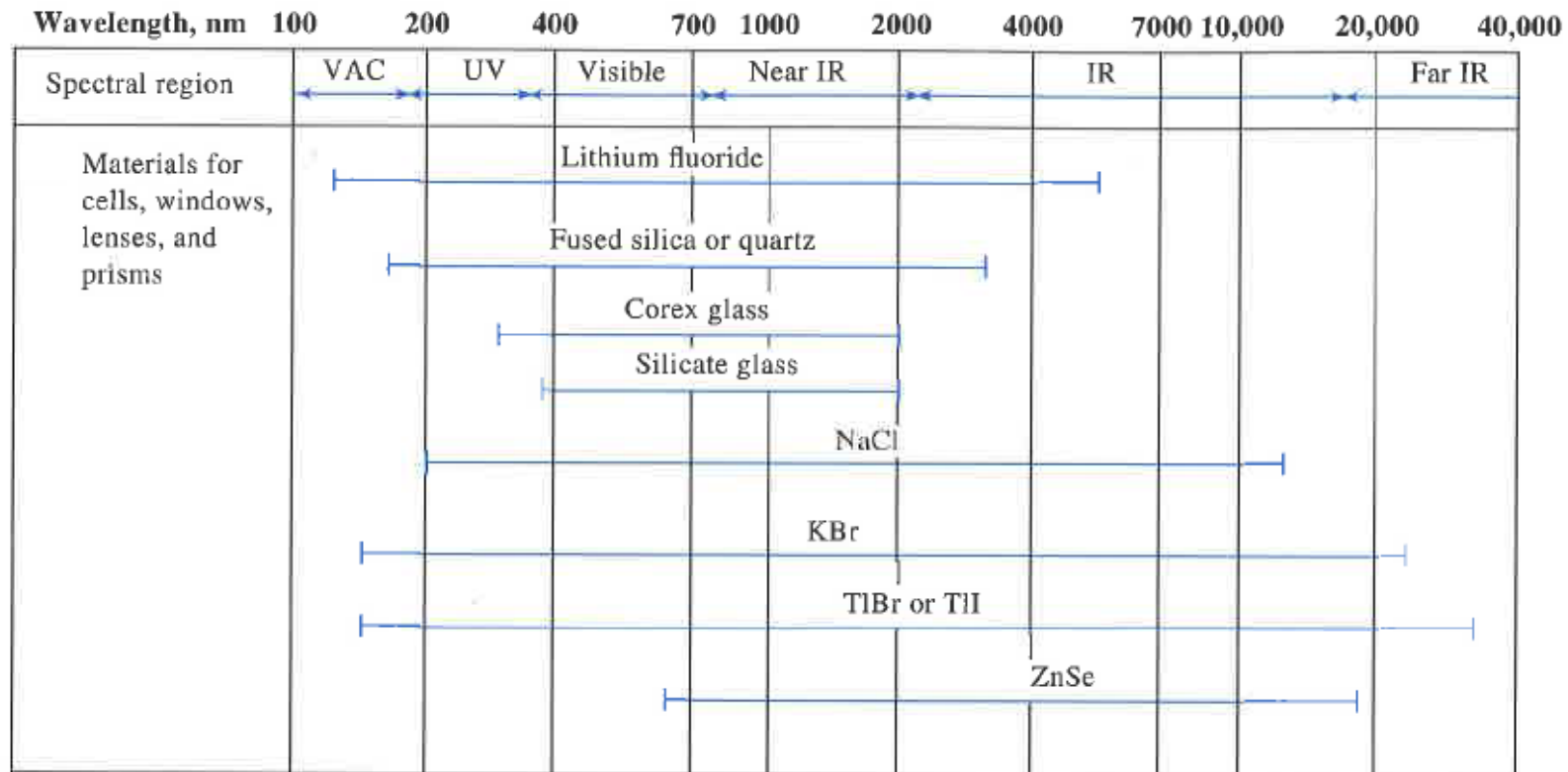



# Wavelength Selectors

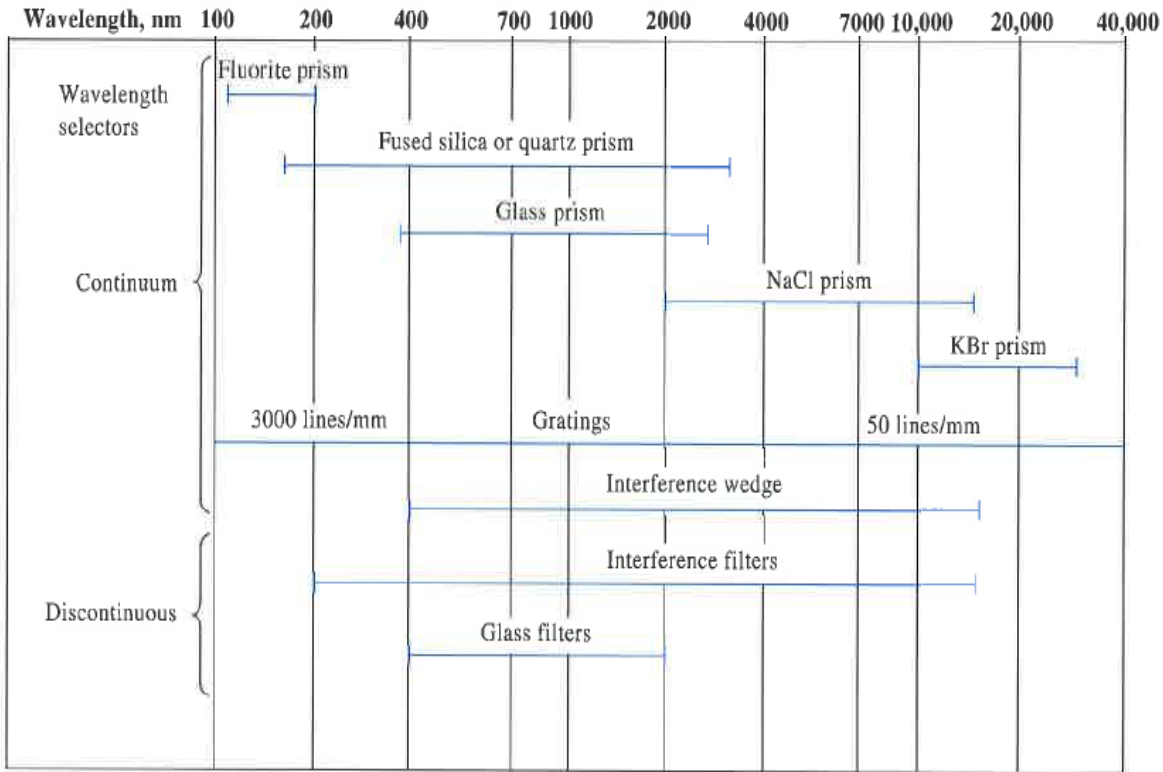

Two types of Wavelength Selectors:

1. Filters (allows a selected portion of radiation to pass)
  - a) Absorption Filters (only for visible region)
  - b) Interference Filters (for UV, Visible and IR regions)

2. Monochromators (for scanning)

- a) Prism Monochromators (for UV, Visible and IR regions)
  - i. Cornu type ( $60^\circ$ )
  - ii. Littrow type ( $30^\circ$ )
- b) Grating Monochromators (for UV, Visible and IR regions)
  - i. Echellette Grating
  - ii. Concave Gratings
  - iii. Holographic Gratings

# Wavelength Selectors – Absorption Filters

---

Less expensive compared with interference filters  
Widely used for band selection in visible region  
Bandwidth range: 30 – 250 nm available commercially

## Types:

Colored glass → thermally stable

Dye suspension in gelatin and sandwiched between glass

Cutoff filter → 100% transmittance over some portion, and then rapidly falls to zero over the remainder

Combine cutoff filter with a second filter to achieve a narrow spectra band

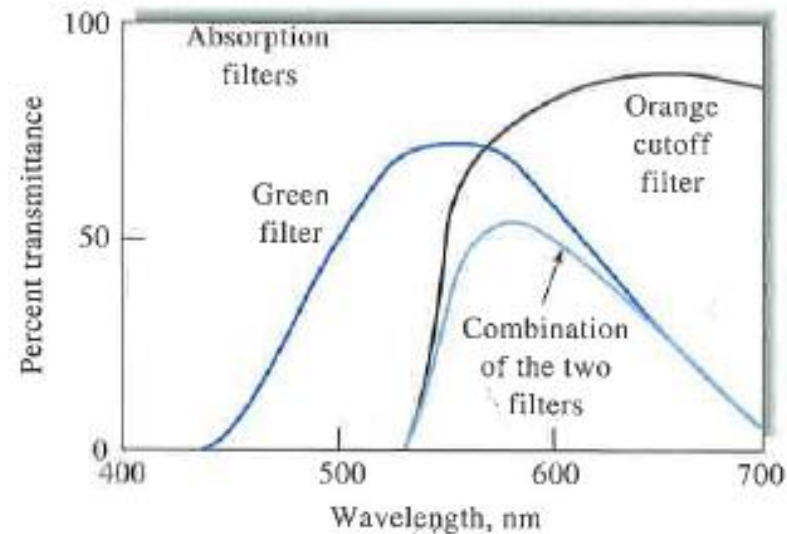

# Wavelength Selectors – Interference Filters

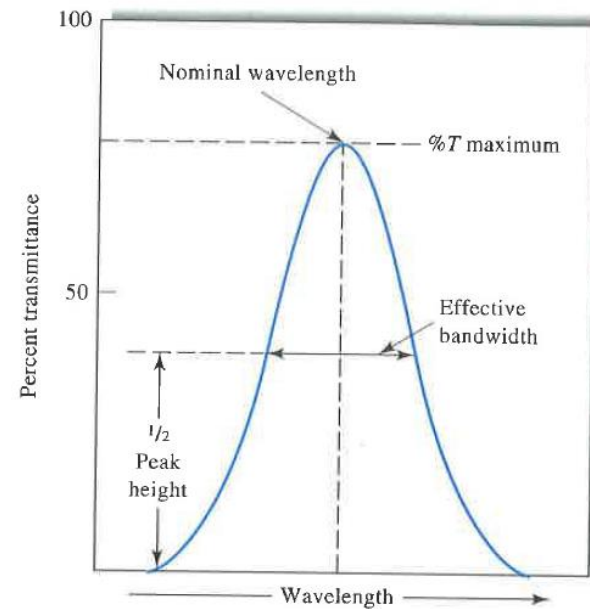
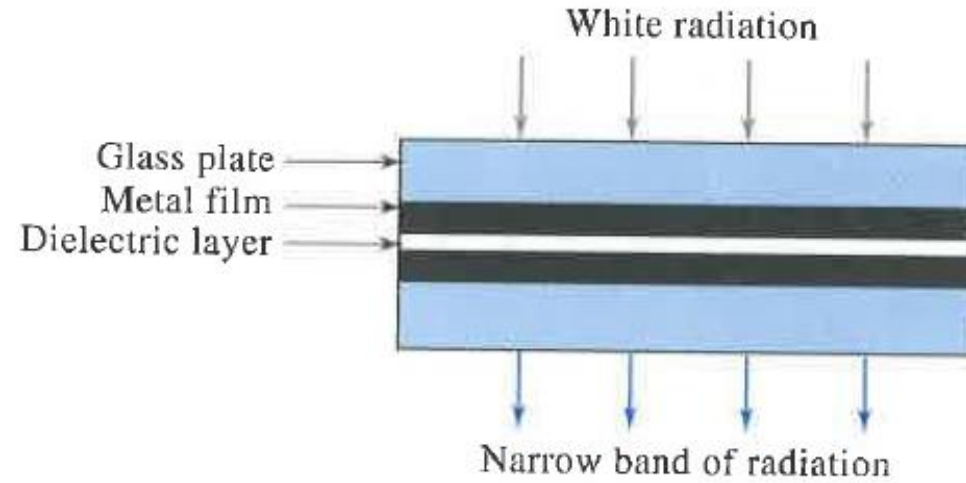

output of a typical filter-based wavelength selector

# Wavelength Selectors – Interference Filters

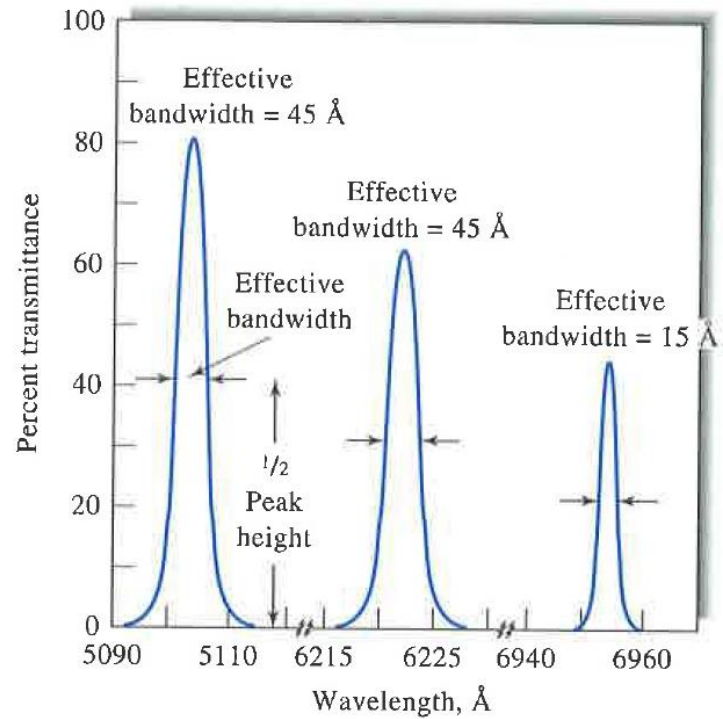

Decreased effective bandwidth comes at a cost of reduced percent transmittance

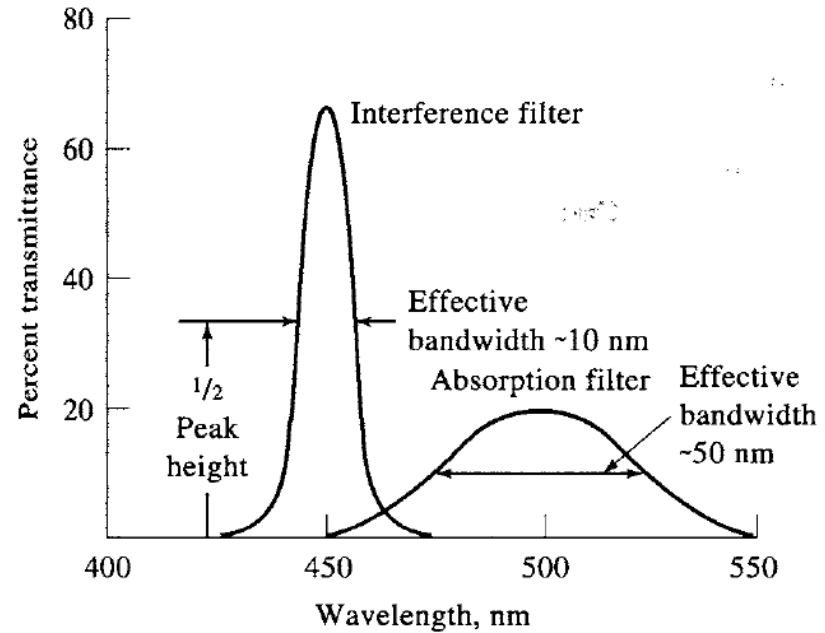

Effective bandwidth for three types of filters

# Wavelength Selectors – Monochromators

## 1. Prism Monochromator

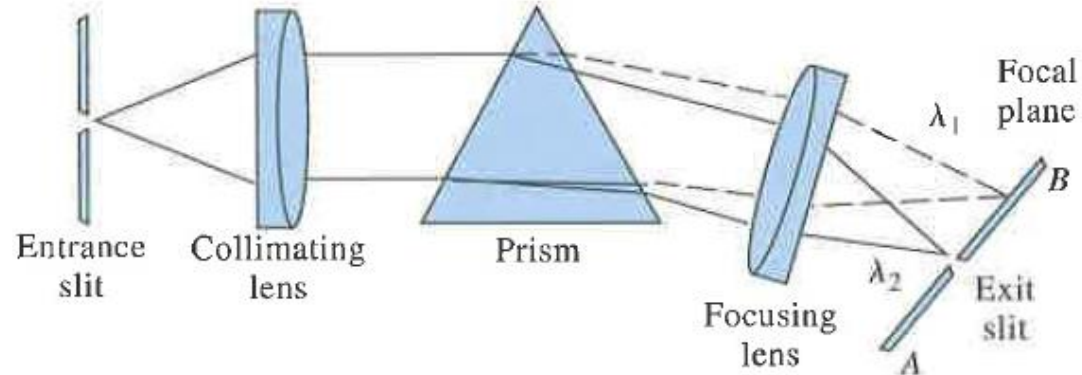

## 2. Grating Monochromator

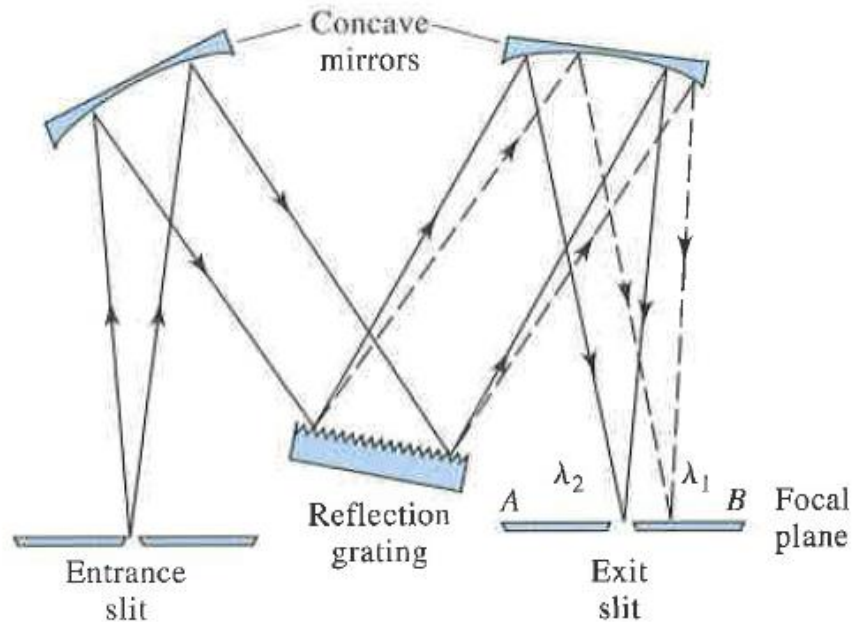

### Components of Monochromators

1. Entrance slit that provides a triangular optical image
2. Collimating lens that produces a parallel beam of radiation
3. A prism or grating that disperses the radiation into its component wavelengths
4. Focusing element that reform the image of the entrance slit, and focuses it on a focal plane
5. An exit slit in the focal plane that isolates the desired spectral band

Scan wavelength by rotating prism or grating

# Wavelength Selectors – Prism Monochromators

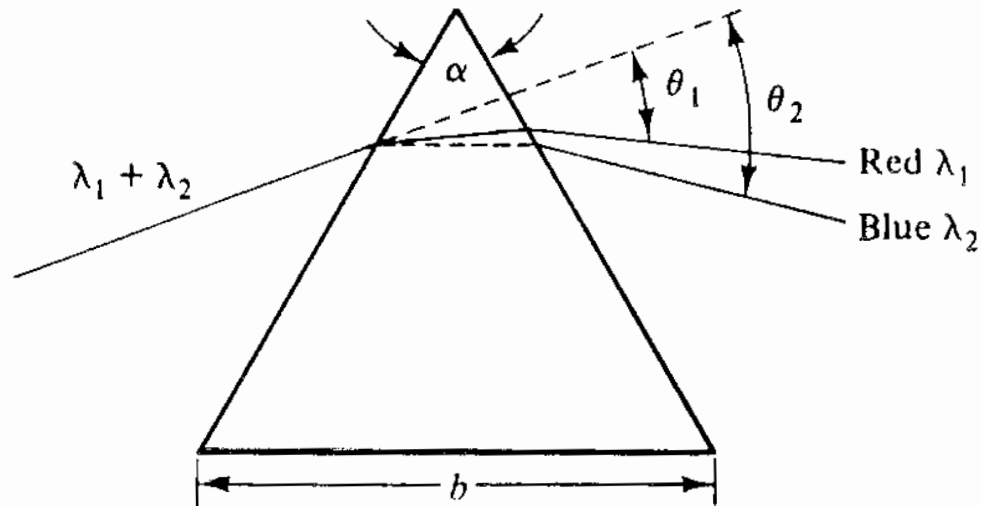

Dispersion of light of two wavelengths by a prism of refractive index  $n$ , apex  $\alpha$ , and baselength  $b$ . Collimated rays of wavelength  $\lambda_1$  (red) and  $\lambda_2$  (blue) are refracted upon entering the prism material and upon exiting it according to Snell's law. Normal prism materials show higher refractive indices at shorter wavelengths. Hence blue light of wavelength  $\lambda_2$  is more highly refracted than red light ( $\lambda_1$ )

Design types

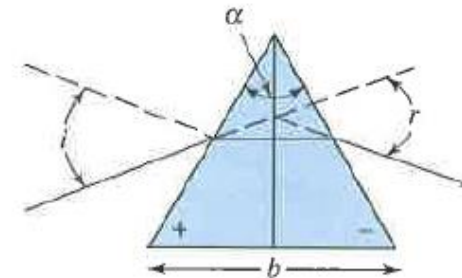

Cornu Type

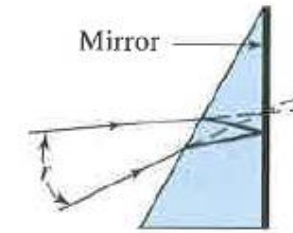

Littrow Type

# Wavelength Selectors – Prism Monochromators

By design ( $\alpha$ )

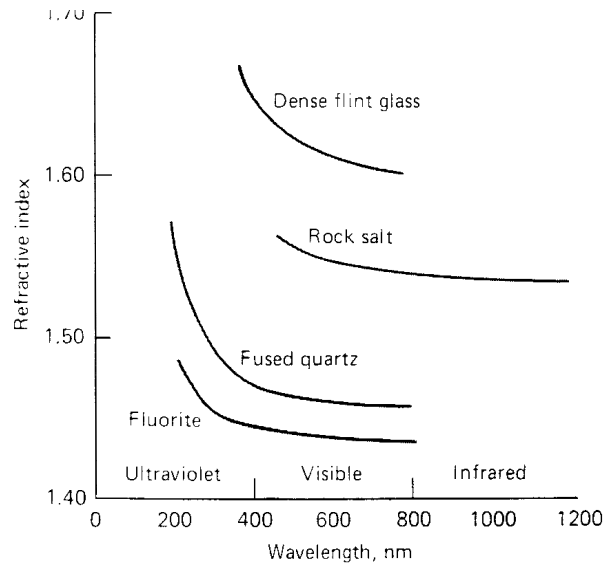
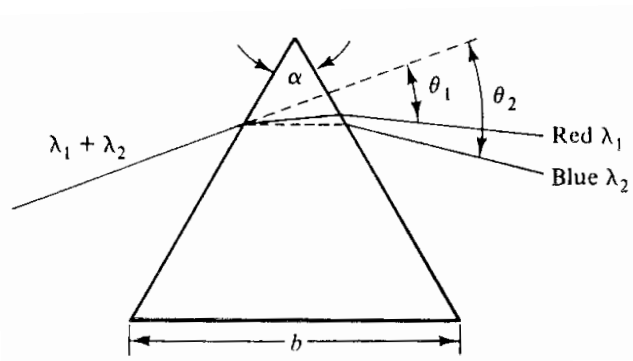

Dispersion of several optical materials

By material selection ( $n$ )

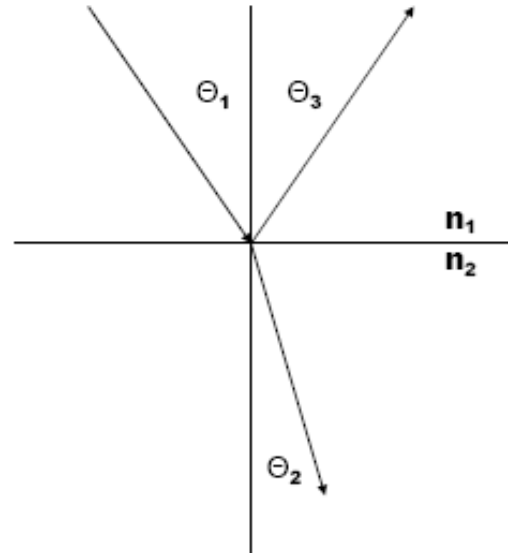

Snell's Law of Refraction

$$n_1 \sin \Theta_1 = n_2 \sin \Theta_2$$

Angular Dispersion (DA):

From Snell's law, the angle of refraction of light in a prism depends on the refractive index of the prism material. But, since that refractive index varies with wavelength, it follows that the angle that the light is refracted by will also vary with wavelength, causing an angular separation of the colors.

$$DA = \frac{d\Theta}{d\lambda} = \frac{dn}{d\lambda} \times \frac{d\Theta}{dn}$$

↑
↑

Determined by prism design (e.g.,  $\alpha$ )
Determined by prism material

$n$  = refractive index of the prism material

$\Theta$  = angle of refraction

$\lambda$  = wavelength of refracted ray

# Wavelength Selectors – Grating Monochromators

## Grating Monochromator

Wavelength selection device based on the constructive interference of light rays that have traveled different distances to reach the same point.

Work via two mechanism:

- (1) Transmission, or
- (2) Reflection (most common)

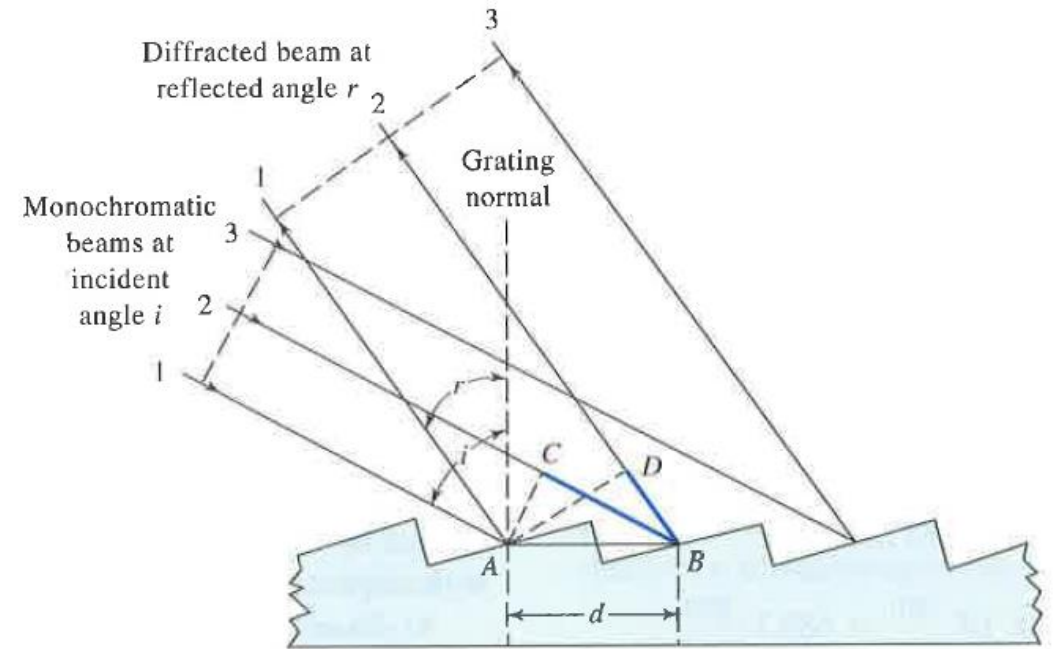
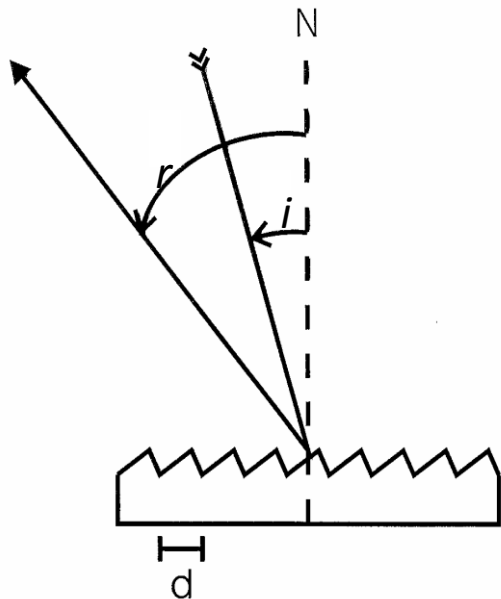

Beam 2 travels a greater distance than beam 1,  
**the extra distance =  $BC + DB$**

For constructive interference, this extra distance must be a multiple of the wavelength ( $n\lambda$ ) of the reflected beam

$$n\lambda = BC + DB$$

Since angle at  $CAB = i$ , and angle at  $DAB = r$ ,

$$CB = d \sin i, \text{ and } BD = d \sin r$$

$$n\lambda = d \sin i + d \sin r = d(\sin i + \sin r)$$



# Wavelength Selectors – Grating Monochromators

## Performance Characteristics

1. Spectra Purity
2. Dispersion
3. Resolving Power
4. Light-gathering Power

### 1. Spectra Purity:

The exiting beam is always observed to be contaminated with small amounts of wavelengths far from that of the instrumental setting. This is mainly due to the following reasons:

- a) Scattered radiation – caused by the presence of dust particulates inside the monochromator as well as on various optical surfaces. This drawback can be overcome by sealing the monochromator entrance and exit slits by suitable windows
- b) Stray radiation – radiation that exits the monochromator without passing through the dispersion element. This problem, including those related to spurious radiation, can be largely eliminated by painting the internal walls of the monochromator by a black paint
- c) Imperfections of monochromator components – e.g., broken or uneven blazes, uneven lens or mirror surfaces, etc., would lead to important problems regarding the quality of obtained wavelengths

### 2. Dispersion:

Angular dispersion ( $dr/d\lambda$ ): change in angle of reflection ( $r$ ) with respect to changes in wavelength ( $\lambda$ )

Differentiate  $n\lambda = d(\sin i + \sin r)$  at constant incidence angle

$$nd\lambda = d\cos r \cdot dr$$
$$\frac{dr}{d\lambda} = \frac{n}{d\cos r}$$

Linear dispersion (D) is the most appropriate, which represents variations in wavelength as a function of some distance ( $y$ ) on the focal plane

$$D = dy/d\lambda$$

If the focal length of the collimating mirror is  $F$ , then

$$dy = Fdr; \text{ hence } D = \frac{Fdr}{d\lambda}$$

$$\text{Reciprocal linear dispersion (D}^{-1}\text{)} = \frac{d\lambda}{dy} = \frac{1}{F} \frac{d\lambda}{dr} = \frac{d\cos r}{nF}$$

At small reflection angles ( $<20^\circ$ ),  $\cos r \approx 1$

$$\text{Hence, } D^{-1} = \frac{d}{nF} \text{ and } D = \frac{nF}{d}$$

# Wavelength Selectors – Grating Monochromators

---

$$D = \frac{nF}{d}$$

Implications for small angle of reflection usually used for grating operation

1. dispersion of a grating monochromator is linear and independent on wavelength
2. dispersion of a grating monochromator increases as the line spacing,  $d$ , is decreased
3. dispersion of gratings is linear meaning that all wavelengths are dispersed to the same extent, something that simplifies instrumental designs

# Wavelength Selectors – Grating Monochromators

## 3. Resolving Power ( $R$ ):

Ability of a grating monochromators to separate adjacent wavelengths, with very small difference

$$R = \lambda/\Delta\lambda$$

$\Delta\lambda$  = difference between the two adjacent wavelengths ( $\lambda_2 - \lambda_1$ )

$\lambda$  = average of the two wavelengths  $(\lambda_1 + \lambda_2)/2$

The resolving power can also be defined as:

$$R = nN$$

$n$  = diffraction order

$N$  = number of illuminated blazes

Hence, better resolving powers can be obtained with:

- Longer gratings
- Higher blaze density
- Higher order of diffraction (obtained using echelle gratings)

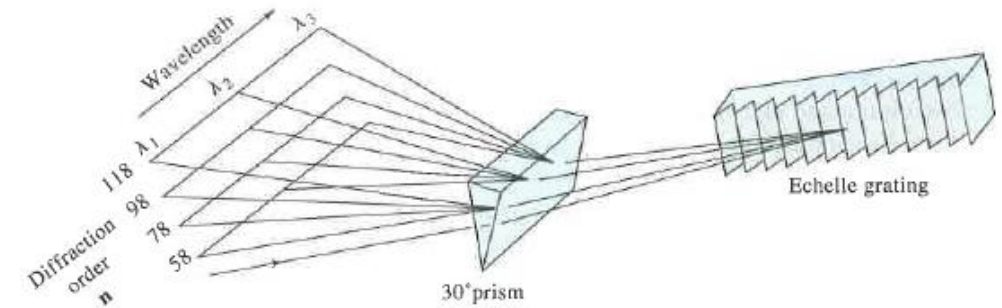

Echelle gratings: contains two dispersing elements

	Echellette	Echelle
Focal length	0.5 m	0.5 m
Groove density	1200/mm	79/mm
Diffraction angle, $\beta$	10°22'	63°26'
Order $n$ (at 300 nm)	1	75
Resolution (at 300 nm), $\lambda/\Delta\lambda$	62,400	763,000
Reciprocal linear dispersion, $D^{-1}$	16 Å/mm	1.5 Å/mm
Light-gathering power, $F$	$f/9.8$	$f/8.8$

# Wavelength Selectors – Grating Monochromators

---

## 4. *Light-gathering Power:*

The ability of a grating monochromator to collect incident radiation from the entrance slit is very important as only some of this radiation will reach the detector

$f$ /number (or  $f$ -number or speed) is a measure of the ability of the monochromator to collect incident radiation

$$f/\text{number} = F/d$$

F = focal length of the collimating mirror or lens

d = diameter of mirror

The light-gathering power of a grating monochromator increases as the inverse square of the  $f$ -number.

Thus:  $f/2$  mirror gathers 4 times more light than an  $f/4$

The  $f$ -number for most monochromators ranges from 1 to 10

# General Instrumentation for Spectrochemical Method

