

JCU ePrints

This file is part of the following reference:

Robbins, William D. (2006) *Abundance, demography and population structure of the grey reef shark (*Carcharhinus amblyrhynchos*) and the white tip reef shark (*Triaenodon obesus*) (Fam. Charcharhinidae).*
PhD thesis, James Cook University.

Access to this file is available from:

<http://eprints.jcu.edu.au/2096>

**ABUNDANCE, DEMOGRAPHY AND POPULATION STRUCTURE OF THE
GREY REEF SHARK (*CARCHARHINUS AMBLYRHYNCHOS*) AND THE
WHITETIP REEF SHARK (*TRIAENODON OBESUS*)
(FAM. CARCHARHINIDAE)**

Thesis submitted by
William David ROBBINS B.Sc (Hons)
April 2006

For the degree of Doctor of Philosophy in Marine Biology
School of Marine Biology and Aquaculture
James Cook University

STATEMENT OF ACCESS

I, the undersigned author of this work, understand that James Cook University will make this thesis available within the University Library, and via the Australian Digital Theses network, for use elsewhere. I declare that the electronic copy of this thesis provided to the James Cook University library is an accurate copy of the print thesis submitted, within the limits of the technology available.

I understand that, as an unpublished work, a thesis has significant protection under the Copyright Act and;

All users consulting this thesis must agree not to copy or closely paraphrase it in whole or in part without the written consent of the author; and to make proper public written acknowledgement for any assistance which they obtain from it. They must also agree to obtain prior written consent from the author before use or distribution of all or part of this thesis within 12 months of its award by James Cook University.

Beyond this, I do not wish to place any restrictions on access to this thesis.

Signature

Date

STATEMENT OF SOURCES

DECLARATION

I declare that this thesis is my own work and has not been submitted in any form for another degree or diploma at any university or other institution of tertiary education. Information derived from the published or unpublished work of others has been acknowledged in the text and a list of references is given.

Signature

Date

CONTRIBUTION OF OTHERS TO THIS THESIS

Corey Green (Primary Industries, Victoria):

- Photography of sectioned oxytetracyclined vertebrae (Chapter 3)

Ashley Williams (James Cook Uni):

- Excel growth model fit macro (Chapter 3)

Mizue Hisano & Sean Connolly (James Cook Uni):

- “R” code for maximum likelihood tests of reef/zone abundance data (Chapter 2)
- “R” code for fitting logistic bootstraps to maturity data (Chapter 4)
- “R” code for fitting saturation curves to *Carcharhinus amblyrhynchos* litter size (Chapter 4)

Sue Reilly (James Cook Uni):

- Histological expertise in preparing and sectioning shark gonads (Chapter 4)

Jenny Giles (CSIRO):

- *T. obesus* tissue samples from Bali (Chapter 7)

Richard Fitzpatrick and Andy Dunstan (MV *Undersea explorer*):

- *T. obesus* tissue samples from Osprey reef (Chapter 7)

I would also like the following granting bodies for their financial support of this project:

- Australian Academy of Science
- Australian Coral Reef Society (x3)
- Cooperative Research Centre (CRC) Reef (x5)
- Great Barrier Reef Marine Park Authority (x3)
- PADI Aware Asia Pacific (x2)
- School of Marine Biology and Aquaculture (James Cook University) (x3)
- Kate & Noel Monkman stipend support (James Cook University)

PUBLICATIONS ARISING FROM THIS THESIS

Published.

Robbins WD. 2006. Evaluation of two underwater biopsy probes for *in situ* collection of shark tissue samples. *Marine Ecology Progress Series* 310: 213-217.

Robbins WD and Choat JH. 2002. Age-based dynamics of tropical reef fishes. *Technical Manual. James Cook University. Townsville.* 39pp.

In review.

Robbins WD, Hisano M, Connolly S and Choat JH. *In review.* Ongoing collapse of coral reef shark populations. *Current Biology.*

In prep.

Robbins WD and Choat JH. *In prep.* Abundance of reef shark populations: Implications for conservation and management. *P. Roy. Soc. Lond. B. Bio.*

Robbins WD. *In prep.* Age and growth of two species of coral reef carcharhinids on the Great Barrier Reef (Australia). *J. Fish. Biol.*

Robbins WD. *In prep.* Reproductive biology of the grey reef shark *Carcharhinus amblyrhynchos*, and the whitetip reef shark *Triaenodon obesus* in tropical waters. *Mar. Biol.*

Robbins WD. *In prep.* Mortality and demography of two species of coral reef carcharhinids: evidence of populations in decline. *Coral Reefs.*

Robbins WD, Choat JH and Bowen B. *In prep.* Genetic stock structure of the whitetip reef shark *Triaenodon obesus* on the Great Barrier Reef (Australia) and across the Indo-Pacific. *Mar. Biol.*

ACKNOWLEDGEMENTS

I would like to thank my supervisor, Prof. J. Howard Choat for his input and faith in this project over the last 5 years. His knowledge of coral reef ecosystems has been a constant source of valuable information, and an inspiration to succeed. Thank you also to Assoc. Prof. Garry Russ for your assistance and co-supervision of this project.

To the many people who have helped me in the laboratory and the field. Thank you for your time, effort, and for many late nights covered in bait and shark bits. Especial thanks to Rachel Green, whose help was invaluable, and always given freely with a smile. Thanks also to Tony Ayling, Eddie Game, Tom Lisney, Chadd Chustz, Kendall Clements, David Raubenheimer, Stirling Peverell and Jess Burton. Also a big thank-you to Kurt Hammond, Brian Bartlam, Auslink commercial fisheries, Jenny Giles, Richard Fitzpatrick, Andy Dunstan and the crew of *Undersea explorer*, as well as the directors and staff of Lizard Island, One-Tree Island, Coconut Island and Criobe field stations.

Thank you to Terry Walker and Corey Green of Primary Industries Research, Victoria. Your assistance in the interpretation of growth rings and reproductive biology of elasmobranchs has improved both my knowledge and this thesis enormously. Thanks also to Jennifer Schultz, Lynne van Herwerden, Sean Connolly, Mizue Hisano, Selma Klanten, Sue Reilly, Alex Anderson, John Ackerman, Ashley Williams and Brian Bowen who have assisted me with the analysis and interpretation of results.

To the friends of mine who have helped me with feedback, assistance and for always being there when I needed it. To these people I say a very heartfelt thank-you. Especial thanks go (in no particular order) to Jo-anne Blinco, Kerrie Gorman, Elisabeth Laman-tripp, Rachel Green and Shane Askew. And to Ailsa Kerswell – thank you for being the best friend, partner and giant freddo provider a guy could have. You were always there with a smile, a coffee, and although usually not taken, more often than not good advice.

And finally to my parents, who have always been there for me, and always encouraged me to follow my goals. Without your support I would never have come this far. Words seem so inadequate, but thank you so much.

TABLE OF CONTENTS

Statement of access	i
Statement of sources	ii
Contribution of others	iii
Publications arising from thesis	iv
Acknowledgements	v
Table of contents	vi
List of tables	x
List of figures and plates	xii
Abstract	1
Chapter 1. General Introduction	4
1.1. Introduction	4
1.2. Thesis outline	9
Chapter 2. Abundance and habitat distribution of two coral reef carcharhinids	11
2.1. Introduction	11
2.2. Methods	14
2.2.1. Underwater visual censuses	14
2.2.1.1. Distribution of sharks across reef habitat	15
2.2.1.2. Shark abundance on local and regional scales	16
2.2.2. Underwater baited video	18
2.3. Results	19
2.3.1. Habitat associations of reef carcharhinids	19
2.3.2. Effects of fisheries management on reef carcharhinid abundance	20
2.3.2.1. Underwater visual censuses	20
2.3.2.2. Underwater baited video censuses	21
2.3.3. Regional scale patterns of reef carcharhinid abundance	22

2.4. Discussion.....	22
2.4.1. Effects of fisheries management on reef carcharhinid abundance.....	23
2.4.1.1. The Australian Great Barrier Reef.....	23
2.4.1.2. Region reef shark abundances	27
Chapter 3. Age and growth of two coral reef carcharhinids	42
3.1. Introduction.....	42
3.1.1. Studies of whitetip reef shark and grey reef shark age and growth	43
3.1.2. Background to shark ageing.....	44
3.1.2.1. Vertebral ageing techniques.....	44
3.1.2.2. Validation of shark ages.....	45
3.2. Methods	47
3.2.1 Collection of samples.....	47
3.2.1.1. Field collections.....	47
3.2.1.2. Commercial collections	48
3.2.2. Processing of animals.....	48
3.2.3. Ageing individuals	49
3.2.3.1. Vertebrae preparation.....	49
3.2.3.2. Centra sectioning	49
3.2.3.3. Vertebral ageing.....	50
3.2.3.4. Size-at-age relationships	51
3.2.4. Validation of ages	52
3.2.4.1. Oxytetracycline validation	52
3.2.4.2. Edge analysis	53
3.3. Results.....	54
3.3.1. Age and growth relationships	54
3.3.2. Length and weight relationships	57
3.3.3. Validation of growth rings	58
3.3.3.1. Oxytetracycline validation	58
3.3.3.2. Vertebral edge characterisation.....	59
3.4. Discussion.....	59

Chapter 4. Reproductive biology of two coral reef carcharhinids	76
4.1. Introduction.....	76
4.1.1. Elasmobranch embryonic development.....	76
4.1.2. Constraints of internal fertilisation	77
4.1.3. Variations in viviparous shark reproduction.....	78
4.1.3.1. Age and size of maturity.....	78
4.1.3.2. Litter size	79
4.1.4. Reproductive biology of reef carcharhinids.....	79
4.2. Methods	81
4.3. Results.....	83
4.3.1. Maturity of male reef sharks	83
4.3.2. Maturity of female reef sharks.....	84
4.3.3. Reproductive parameters of females.....	85
4.3.3.1. Oocyte growth.....	85
4.3.3.2. Litter sizes.....	85
4.3.3.3. Growth of pups	86
4.3.3.4. Gestation and breeding	87
4.4. Discussion.....	88
Chapter 5. Demography of two coral reef carcharhinids	103
5.1. Introduction.....	103
5.1.1. Population modelling.....	104
5.2. Methods	106
5.2.1. Mortality rates.....	106
5.2.2. Population dynamics.....	108
5.3. Results.....	109
5.3.1. Mortality estimation.....	109
5.3.2. Demographic modelling.....	110
5.4. Discussion.....	113
Chapter 6. Underwater biopsy probes for shark tissue collection.....	131
6.1. Introduction.....	131
6.2. Methods	133
6.3. Results.....	134

6.4. Discussion.....	135
Chapter 7. Genetic population structure of <i>Triaenodon obesus</i>.....	140
7.1. Introduction.....	140
7.1.1. Mitochondrial DNA analysis in sharks.....	141
7.2. Methods	143
7.2.1. Collection of tissues.....	143
7.2.2. Amplification and sequencing of DNA	144
7.2.3. Analysis of genetic structure.....	145
7.2.3.1. Phylogenetic analyses.....	145
7.2.3.2. Population structure	146
7.3. Results.....	147
7.3.1. Phylogenetic analyses	147
7.3.2. Population analyses.....	148
7.4. Discussion.....	149
Chapter 8. General discussion.....	160
8.1. Significant findings.....	160
8.2. Future directions	165
8.3. Summary.....	167
References.....	168
Appendix	195

LIST OF TABLES

- Table 2.1.** Summary of fishing activities allowed in the four Great Barrier Reef Marine Park zones most pertinent to coral reefs.
- Table 2.2.** Dates and number of surveys of underwater visual censuses on Great Barrier Reef.
- Table 3.1.** Residual sum of squares (rSS) for growth functions fitted to *Triaenodon obesus* and *Carcharhinus amblyrhynchos* size at age data.
- Table 3.2.** Von Bertalanffy growth parameters fitted to *Triaenodon obesus* and *Carcharhinus amblyrhynchos* from the Great Barrier Reef.
- Table 3.3.** Maximum likelihood ratio tests of *Triaenodon obesus* and *Carcharhinus amblyrhynchos* sex-specific von Bertalanffy growth parameters on the Great Barrier Reef.
- Table 3.4.** Growth and time at liberty of 3 oxytetracyclined *Carcharhinus amblyrhynchos* individuals recaptured during this study.
- Table 4.1.** Reproductive parameters used to macroscopically characterise the reproductive status of sharks investigated in this study.
- Table 4.2.** Number of *Triaenodon obesus* and *Carcharhinus amblyrhynchos* females found in each reproductive stage.
- Table 5.1.** Vital rate parameters derived in this thesis, and used to calculate age-based Leslie matrices.
- Table 5.2.** Instantaneous mortality rates calculated at the mid-point of each age class for total *Carcharhinus amblyrhynchos* catches.

- Table 5.3.** Leslie matrix of fished *Triaenodon obesus* populations on the Great Barrier Reef.
- Table 5.4.** Leslie matrix of fished *Carcharhinus amblyrhynchos* populations on the Great Barrier Reef.
- Table 5.5.** Dynamics of fished *Triaenodon obesus* and *Carcharhinus amblyrhynchos* populations on the Great Barrier Reef, estimated through age-based Leslie matrices.
- Table 5.6.** Effects of varying demographic parameters on *Triaenodon obesus* and *Carcharhinus amblyrhynchos* population dynamics.
- Table 5.7.** Indirect mortality techniques and resulting annual population growth of Great Barrier Reef *Triaenodon obesus* and *Carcharhinus amblyrhynchos*.
- Table 6.1.** Variation in the wet weight of tissue collected and % total and successful tissue retention with two biopsy probe types.
- Table 7.1.** Polymorphic nucleotide positions in the mtDNA control region of *Triaenodon obesus* from the Indo-Pacific.
- Table 7.2.** Haplotype frequencies and sequence divergence for *Triaenodon obesus* from locations with ≥ 10 individuals.
- Table 7.3.** Analysis of *Triaenodon obesus* molecular variance (AMOVA) among locations with ≥ 10 samples.
- Table 7.4.** Pairwise F_{ST} values among locations for *Triaenodon obesus* with ≥ 10 samples.

LIST OF FIGURES AND PLATES

- Plate 1.1.** Photographs of (a) the whitetip reef shark (*Triaenodon obesus*) and (b) the grey reef shark (*Carcharhinus amblyrhynchos*) taken by the author during this study.
- Figure 2.1.** Location of Great Barrier Reef underwater visual censuses.
- Figure 2.2.** Location of regional coral reef underwater visual shark surveys.
- Figure 2.3.** Abundance of three species of reef shark sighted during 8 000 m² censuses at the Cocos (Keeling) islands, separated by reef habitat.
- Figure 2.4.** Time which reef sharks were sighted on all underwater visual censuses at the Cocos (Keeling) islands, pooled across 2 minute intervals.
- Figure 2.5.** *Carcharhinus amblyrhynchos* abundances recorded from two observers using 8 000 m² underwater visual counts in three habitats at Cocos (Keeling) islands.
- Figure 2.6.** Effects of varying transect size on the mean abundance of three reef shark species at the Cocos (Keeling) Islands.
- Figure 2.7.** Mean abundance of (a) *Triaenodon obesus* and (b) *Carcharhinus amblyrhynchos* on coral reef crests in four levels of fishing management on the Great Barrier Reef.
- Figure 2.8.** Mean abundance of (a) *Triaenodon obesus* and (b) *Carcharhinus amblyrhynchos* from unbaited and baited underwater video recordings on the Great Barrier Reef reef crest.
- Figure 2.9.** Mean abundance of (a) *Triaenodon obesus* and (b) *Carcharhinus amblyrhynchos* on Indo-Pacific coral reef crests.

- Figure 3.1.** Locations of research sampling and commercial fishing bases in the northern and central Great Barrier Reef.
- Figure 3.2.** Thin sections of a (a) *Triaenodon obesus* and (b) *Carcharhinus amblyrhynchus* vertebrae viewed under transmitted and reflected light.
- Figure 3.3.** Size frequencies of all (a) *Triaenodon obesus* and (b) *Carcharhinus amblyrhynchus* commercial and research catches on the Great Barrier Reef.
- Figure 3.4.** Size at age for (a) *Triaenodon obesus* and (b) *Carcharhinus amblyrhynchus* separated by capture location and sex on the Great Barrier Reef.
- Figure 3.5.** Size at age for (a) *Triaenodon obesus* and (b) *Carcharhinus amblyrhynchus* separated by sex from combined locations on the Great Barrier Reef.
- Figure 3.6.** Relationship between vertebral centrum diameter and (a) age and (b) size for *Triaenodon obesus*, and (c) age and (d) size for *Carcharhinus amblyrhynchus* from the Great Barrier Reef.
- Figure 3.7.** Length-weight regressions for (a) *Triaenodon obesus* and (b) *Carcharhinus amblyrhynchus* from the Great Barrier Reef.
- Figure 3.8.** Thin section of an oxytetracycline injected *Carcharhinus amblyrhynchus* vertebrae from Cocos (Keeling) Islands viewed under (a) normal reflected light and (b) reflected UV light.
- Figure 3.9.** Proportion of *Triaenodon obesus* individuals with opaque vertebral edges separated by month.

- Figure 4.1.** Transverse section of (a) two maturing (stage m2) *Triaenodon obesus* seminiferous follicles and (b) a mature *T. obesus* anterior epididymis, with loose, mature sperm inside the ductus efferens.
- Figure 4.2.** Relationships between clasper length and adult size for (a) *Triaenodon obesus* and (b) *Carcharhinus amblyrhynchus* males.
- Figure 4.3.** Proportion of mature *Triaenodon obesus* males based on (a) total length and (b) age.
- Figure 4.4.** Proportion of mature *Carcharhinus amblyrhynchus* males based on (a) total length and (b) age.
- Figure 4.5.** Proportion of mature *Triaenodon obesus* females based on (a) total length and (b) age.
- Figure 4.6.** Proportion of mature *Carcharhinus amblyrhynchus* females based on (a) total length and (b) age.
- Figure 4.7.** Mean maximum oocyte diameter (MOD) in (a) *Triaenodon obesus* and (b) *Carcharhinus amblyrhynchus* with month of capture. Also indicated are uterine eggs without obvious pups attached.
- Figure 4.8.** Litter sizes of *Triaenodon obesus* with (a) age and (b) adult size. Also indicated are uterine egg numbers without visible pups.
- Figure 4.9.** Litter sizes of *Carcharhinus amblyrhynchus* with age. Also indicated are uterine egg numbers without visible pups.
- Figure 4.10.** Size at month for developing (a) *Triaenodon obesus* and (b) *Carcharhinus amblyrhynchus* pups.
- Plate 4.1.** Undeveloped 13 cm TL embryo found in the right uterus of a 135 cm TL *Triaenodon obesus*.

- Figure 5.1.** (a) Commercial and (b) research *Triaenodon obesus* catches from the central and northern Great Barrier Reef.
- Figure 5.2.** Ln (frequency + 1) of total *Triaenodon obesus* catches from the central and northern Great Barrier Reef.
- Figure 5.3.** (a) Commercial and (b) research line *Carcharhinus amblyrhynchos* catches from the central and northern Great Barrier Reef.
- Figure 5.4.** Ln (frequency + 1) of total *Carcharhinus amblyrhynchos* catches from the central and northern Great Barrier Reef.
- Figure 5.5.** Estimated percentage of stock remaining of *Triaenodon obesus* and *Carcharhinus amblyrhynchos* on the Great Barrier Reef at predicted decline rates.
- Figure 5.6.** Contribution of each age class to current and future reproductive output relative to the first (0+) age class for (a) *Triaenodon obesus* and (b) *Carcharhinus amblyrhynchos*.
- Figure 5.7.** Elasticity analyses of *Triaenodon obesus* and *Carcharhinus amblyrhynchos* on the Great Barrier Reef.
- Figure 6.1.** Underwater biopsy probe with Type I & Type II barrel inserts.
- Figure 6.2.** Mean wet weight (mg) of tissue retained from reef sharks using Type I and Type II biopsy probes.
- Figure 7.1.** Fixation indices used in genetic population analyses.
- Figure 7.2.** Location of *Triaenodon obesus* tissue collections.
- Figure 7.3.** Minimum spanning tree indicating the relationship and distribution among *Triaenodon obesus* haplotypes.

Figure 7.4. 50% Majority rule consensus tree of 98 maximum parsimony trees for *Triaenodon obesus* following heuristic iterations.

Figure 7.5. Relationship between pairwise F_{ST} values and minimum seaward geographic separation for *Triaenodon obesus* from locations with ≥ 10 samples.

Appendix 3.1. Further parameter estimates of *Triaenodon obesus* and *Carcharhinus amblyrhynchos* maximum likelihood ratio tests (Chapter 3; table 3.3).

Appendix 3.2. Size-at-age for (a) *Triaenodon obesus* and (b) *Carcharhinus amblyrhynchos* individuals with von Bertalanffy growth functions fitted, constrained to size-at-birth estimated from reproductive data.

Appendix 3.3. Size-at-age for (a) *Triaenodon obesus* and (b) *Carcharhinus amblyrhynchos* individuals combined by sex with Gompertz and logistic models fitted.

Thesis abstract.

Reef sharks (fam. Carcharhinidae) are high-order predators, found throughout the Indo-Pacific. I examined the abundance, growth, reproduction and demography of two species of reef carcharhinid; the grey reef shark (*Carcharhinus amblyrhynchos*) and the whitetip reef shark (*Triaenodon obesus*), and investigated the genetic stock structure of *T. obesus* across the Indo-Pacific.

Underwater visual census protocols were successfully developed, and provided real-time, fisheries-independent estimates of reef carcharhinid abundances. Visual censusing of a minimally-exploited reef system ascertained that reef crest was the preferred habitat of *T. obesus* and *C. amblyrhynchos*, while the blacktip reef shark (*C. melanopterus*) was more abundant in reef flat and lagoon habitats. Reef carcharhinid densities were low, and even in the most abundant habitat, did not exceed 3.5 sharks hectare⁻¹. Visual censuses across reef systems in the Indian and Pacific Oceans found consistently low numbers of reef sharks, with most regions having less than 0.5 sharks hectare⁻¹. Closer investigation of the Great Barrier Reef (Australia) revealed a significant effect of fishing management on reef shark abundance. All levels of fishing pressure impacted upon reef carcharhinid abundance, with reductions on fished reefs of up to 80% and 97% for *T. obesus* and *C. amblyrhynchos*, respectively. This suggests that reef shark populations are particularly vulnerable to population depletion. The inability of marine protected areas to provide refuge for reef carcharhinids was highlighted and discussed.

Age and growth characteristics of *T. obesus* and *C. amblyrhynchos* populations from the Great Barrier Reef were examined through vertebral thin sections. Both shark species

grew slowly, with longevities of 19 years. Females out-lived males in both species. Both sexes of *C. amblyrhynchos* grew at similar rates, while sexually-dimorphic growth rates were observed in older *T. obesus*. Age estimates were preliminarily validated through oxytetracyclined recaptures of *C. amblyrhynchos*, while characterisation of the vertebral edge provided strong evidence that *T. obesus* also lays annual growth bands.

Females matured 1-2 years later than males, at 8 and 11 years for *T. obesus* and *C. amblyrhynchos*, respectively. Mean litter sizes were comparable with smaller (<1 m) carcharhinids. Litter sizes initially increased with female body size in *C. amblyrhynchos*, reaching 3-4 pups per breeding for most of their reproductive life. Litter sizes ranged between 1-4 pups per breeding in *T. obesus*, with a mean of 2 pups per breeding, irrespective of female somatic size. Breeding occurs biennially in both species, with an offspring sex ratio of 1:1. For the longevities recorded, maximum reproductive output was estimated at 12 pups per female for both species.

Population dynamics of the two species were analysed using age-based (Leslie) matrices. Using two methods of mortality estimation, annual decline rates of 6.3-8.8% year⁻¹ and 10.3-15.2% year⁻¹ were found for *T. obesus* and *C. amblyrhynchos*, respectively. This suggests that reef carcharhinids are overfished on the Great Barrier Reef. Based on current (albeit exploited) demographic parameters, the natural rates of population growth were estimated at 3.4-5.7% year⁻¹ for *T. obesus*, and 0.8-3.5% year⁻¹ for *C. amblyrhynchos*. Elasticity analyses and reproductive values showed that juvenile survival is the most important component of each species lifespan. However, catch analyses revealed that a high proportion of juveniles are taken in both species (especially *C. amblyrhynchos*). At the current rates of decline, abundances of *T. obesus*

and *C. amblyrhynchos* are forecast to decline to 16-27% and 4-12% of current levels on fished reefs in the next 20 years, respectively.

Development of an *in-situ* underwater biopsy probe enabled non-lethal, minimally invasive, collection of reef carcharhinid tissues. High levels of genetic differentiation were found in *T. obesus* across the Indo-Pacific, as well as between two contiguous sites on the Great Barrier Reef. Genetic separation did not correlate with geographic separation, suggesting that *T. obesus* has a high degree of site fidelity on coral reefs, even when migrations are possible. On an evolutionary scale, it was found that the Indian Ocean was invaded first by *T. obesus*, with Pacific Ocean invasion occurring simultaneously with a second Indian Ocean invasion.

The unique combination of fisheries-independent abundance counts, population dynamics and investigation of genetic stock structure provides a comprehensive overview of the low abundance and slow population dynamics of coral reef carcharhinids. Findings from this PhD provide further evidence of the variety of age and reproductive strategies employed by the family Carcharhinidae, and a scientific basis for future decisions regarding reef carcharhinid management.

Chapter 1. General introduction.

1.1. INTRODUCTION

Sharks are historically a very successful group of fishes. Radiating in the late Silurian (400 MYA), the sharks, rays and chimaeras (ghost sharks) collectively form the cartilaginous fishes, class Chondrichthyes. Chondrichthyans can be divided into 2 subclasses: Elasmobranchii (sharks and rays) and Holocephali (chimaeras). The Elasmobranchii has eight orders, with 56% of all shark species found in the order Carcharhiniformes (ground sharks) (Compagno 1990). Carcharhiniformes comprise 8 families, with 48 genera and over extant 196 species (Compagno 2001). All carcharhiniformes are predatory, with most species found on continental shelves and slopes (Compagno 2001).

Requiem or whaler sharks (fam. Carcharhinidae) are prominent members of the order Carcharhiniformes, with 30 of the 49 recognised carcharhinid species found in Australia (Last & Stevens 1994). Members of this family are predominantly tropical, inhabiting a range of oceanic, coastal and reef environments (Compagno 1984, Last & Stevens 1994). The biology of a number of oceanic and coastal carcharhinids have been investigated (Branstetter 1987a, Simpfendorfer 1992b, Sminkey & Musick 1996, Lessa et al. 1999b, Wintner et al. 2002); yet while studies have investigated the behaviour and movements of reef carcharhinids (Johnson & Nelson 1973, McKibben & Nelson 1986, Economakis & Lobel 1998, Garla et al. 2006), equivalent biological studies on coral reef sharks have been less forthcoming (e.g. Wass (1971), Randall (1977), Radtke & Cailliet (1984)).

Shark life histories are usually characterised as having slow growth, late maturity, low fecundity and low mortality (Holden 1974, Hoenig & Gruber 1990, Pratt & Casey 1990, Bonfil 1994). Oceanic and coastal carcharhinids generally fit this pattern, and the limited data available suggests that the life histories of reef carcharhinids may be similar (Wass 1971, Randall 1977, De Crosta et al. 1984). The life histories of sharks often limit their ability to absorb additional mortality, such as fishing pressures. Although coral reef carcharhinids are distributed throughout the tropical Indo-Pacific (Last & Stevens 1994), an increasing body of circumstantial evidence suggests they may be highly susceptible to overfishing. However, to determine the degree of reef carcharhinid vulnerability to fishing, the demographically-important traits of age and reproduction need to be further quantified. This is one of the objectives of this thesis. To allow comparison of these traits with other species of the family, the variability inherent in the growth and reproduction of carcharhinids also needs to be understood.

Understanding the processes associated with reproduction are critical for successful shark management. A wide range of specialisations have been found in carcharhinid embryonic development, reproductive sizes, litter size and breeding periodicity. Age at maturity ranges from 1 year in the small Australian sharpnose shark (*Rhizoprionodon taylori*) (Simpfendorfer 1993), to over 18 years for larger carcharhinids, such as the bull shark (*Carcharhinus leucas*) (Branstetter & Stiles 1987). Many female carcharhinids mature later, and at a larger size than males (bimaturism) (Branstetter 1987a, Wintner & Cliff 1996, Driggers et al. 2004b). Yet an equivalent number of species also mature at similar sizes (Seki et al. 1998, Lessa et al. 1999b, Lucifora et al. 2005). The relationship between litter size and female somatic size is often variable before maximum adult size is reached (Joung & Chen 1995, Lessa et al. 1999a, Capape et al. 2003, Loefer &

Sedberry 2003), although once the maximum size is reached, larger carcharhinid species usually have larger litter sizes (Simpfendorfer 1992b). Smaller carcharhinid species generally breed annually (Simpfendorfer 1992b, Loefer & Sedberry 2003), while most other carcharhinids breed biennially (Branstetter, 1981). However, at least two medium-sized carcharhinids (*C. melanopterus* and *C. acronotus*) breed annually (Hazin et al. 2002, Porcher 2005), and there is evidence that the 2.7 m dusky shark (*C. obscurus*) breeds triennially (Clark & von Schmidt 1965). Embryonic diapause is also known to occur for one species of this family (*R. taylori*) (Simpfendorfer 1992b).

Growth and longevity also varies considerably among carcharhinid species. Maximum size ranges from 78 cm in *R. taylori*, to 6 m in the tiger shark (*Galeocerdo cuvier*) (Simpfendorfer 1993, Last & Stevens 1994). Meanwhile, the longevity of carcharhinids ranges from 4+ years in the blacknose shark (*C. acronotus*), up to 33+ years in the dusky shark (*C. obscurus*) (Natanson et al. 1995, Carlson et al. 1999). Differences in growth are well documented between sexes, with females commonly growing larger than males in most species (Cortés 2000). Growth rates within species also differs considerably between locations (Tanaka et al. 1990, Skomal & Natanson 2003, Lessa et al. 2004), as does longevity (Allen & Wintner 2002, Driggers et al. 2004a). The variability in carcharhinid growth dynamics is not always intuitive, and highlights the need to individually ascertain the growth dynamics of each species.

Although major declines in the status of coral reefs are occurring on an unprecedented, world-wide scale (Hughes et al. 2003, Pandolfi et al. 2003, Bellwood et al. 2004), the biology and population status of large coral reef predators (such as reef carcharhinids) remains largely unknown. Information to date is based on limited studies (e.g. Wass

1971, De Crosta et al. (1984), Radtke & Cailliet (1984)), or in the case of the whitetip reef shark (*Triaenodon obesus*), some parameters are little more than educated estimates (Randall 1977). Coral reefs are thought to support relatively high shark densities, when compared to other habitats. This is due largely to the habitat fidelity of reef sharks, together with the depth restrictions of coral reefs, and sharks in general (Garla et al. 2006, Priede et al. 2006). However, actual estimates of shark densities on coral reefs are unknown. Hence, population sizes cannot be estimated from reef area, nor can management plans account for shark abundances when determining reserve sizes, or fishing limits.

Although targeted fisheries for reef carcharhinids exist (Anderson & Waheed 1999, Nageon de Lestang 1999), they are mostly restricted to artesinal fisheries. The bulk of reef carcharhinid catches are a result of line and net fisheries by-catch (Ali et al. 1999, Swamy 1999, Rose et al. 2003). Since reef sharks do not form major commercial fisheries, little emphasis has been placed on determining the biology and demography of reef carcharhinids. This is despite their contribution to significant portions of fisheries by-catch (Swamy 1999). Management of reef carcharhinids is often non-existent, or where it does occur, is within a more general framework, relying on no-fishing areas to maintain stock numbers (Anderson & Waheed 1999, Nageon de Lestang 1999, Swamy 1999).

Few studies have modelled the recovery potential of reef carcharhinids to fishing pressure. Those that have, estimate reef sharks to be at medium risk to fishing depletion, when compared with other coastal and oceanic species (Smith et al. 1998, Stobutzki et al. in prep). However, these studies have used the limited life-history parameters from

the literature, without consideration of the data collection, or local variations in such parameters. For example, Great Barrier Reef (GBR) estimates of life history parameters are unknown for reef carcharhinids, as almost all information available is derived from studies undertaken in Hawaii (Wass 1971, De Crosta et al. 1984, Radtke & Cailliet 1984), central Northern Australia (Lyle 1987, Stevens & McLoughlin 1991) or central Pacific islands (Randall 1977). Stobutzki et al (in prep) estimated the recovery potential of GBR reef sharks using parameters obtained from these other locations. If life-history parameters vary between regions, this will result in false predictions of the ability of GBR reef sharks to resist fishing pressure. To date, none of these studies have tested the estimated recovery potential against quantitative data of abundance or demographics.

Sharks on coral reefs are easy to locate, and co-occur with a range of harvestable fish groups. Consequently, they have the potential to be highly susceptible to fishing pressures (Morgan & Burgess 2004). Anecdotal evidence from north Queensland reef researchers suggests that fishing may have a significant effect on reef carcharhinid populations, with a noticeable reduction in their quantity and frequency on the Great Barrier Reef in the last 10-15 years (J. H. Choat & T. Ayling, *pers. comm.*). During this time, commercial shark catches on the GBR have increased approximately 4-fold, reaching 1 250 tons in 2003 (Gribble et al. 2005). Reef carcharhinids contributed approximately 7% of this total in net fisheries (Rose et al. 2003), with an unknown contribution to the line catch. Since 1994, the catch per unit effort of sharks has not reduced (Gribble et al. 2005); however this may be a result of more efficient fishing gears and techniques rather than stable stock numbers. If the anecdotal declines in reef carcharhinid frequencies are representative of real declines in abundance, then reef

shark harvest on the Great Barrier Reef has been proceeding at an unsustainable rate. As such, an understanding of their demography is urgently required.

The broad objective of this thesis was to better understand the biology of two species of coral reef carcharhinids on the Great Barrier Reef. This was achieved through a multi-faceted approach investigating the ecology and population dynamics of the whitetip reef shark, *Triaenodon obesus* (Rüppell 1837) and the grey reef shark, *Carcharhinus amblyrhynchos* (Bleeker, 1856). Both species are medium sized (1-2 m) carcharhinids, and together with the blacktip reef shark (*C. melanopterus*), are the most common sharks on tropical coral reefs (Compagno 1984).

1.2. THESIS OUTLINE

Chapter 2 of this thesis provides a fisheries-independent, real-time approach to estimating reef shark densities across coral reef habitats. It investigates the effects of differential levels of fishing pressure on population densities, and obtains regional-scale estimates of reef carcharhinid abundances. Chapter 3 describes the growth and longevities of *Triaenodon obesus* and *Carcharhinus amblyrhynchos*. Chapter 4 investigates the reproductive biology of the two species, ascertaining the vital rate parameters required to investigate their respective demographies. Mortality estimates are derived from the age distribution and growth curve of each species in Chapter 5, and the findings of age-based (Leslie) matrix analyses presented for both populations. Chapter 6 demonstrates a minimally-invasive technique for obtaining *in situ* genetic samples of reef carcharhinids, which is used in Chapter 7 to investigate the genetic stock structure of the most sedentary reef shark, *T. obesus* on the Great Barrier Reef, and across the Indo-Pacific. Chapter 8 summarises the major findings of this thesis.

a. The whitetip reef shark, *Triaenodon obesus*.

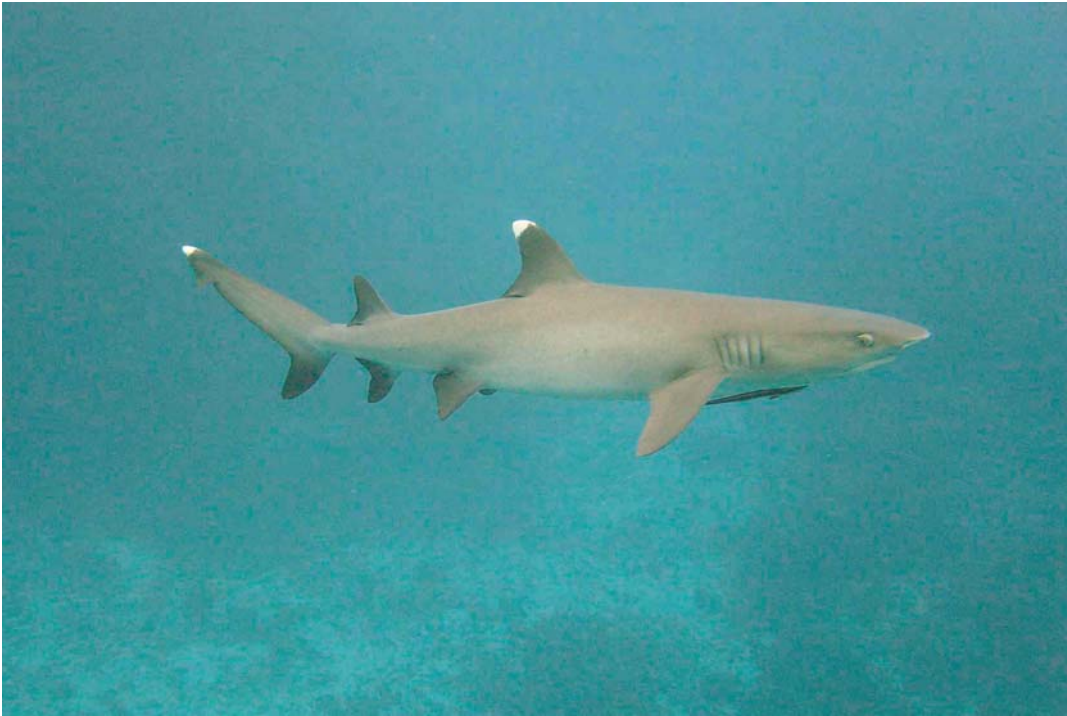

b. The grey reef shark, *Carcharhinus amblyrhynchos*.



Plate 1.1. Photographs of (a) the whitetip reef shark (*Triaenodon obesus*) and (b) the grey reef shark (*Carcharhinus amblyrhynchos*) taken by the author during this study.

Chapter 2. Abundance and habitat distribution of two coral reef carcharhinids

2.1. INTRODUCTION

Most sharks are highly mobile, apex predators (Compagno 1990). Reef carcharhinids are no exception, and are among the dominant predators on tropical coral reefs (Cortés 1999a, Friedlander & DeMartini 2002, Bascompte et al. 2005). Species such as the grey reef shark (*Carcharhinus amblyrhynchos*) are highly inquisitive, and have been often observed to investigate disturbances (Nelson & Johnson 1980, Nelson et al. 1986).

Unfortunately, this behaviour makes such species vulnerable to capture in both net and line reef fisheries. An increasingly large number of reef carcharhinids are captured in directed and bycatch reef fisheries (Nageon de Lestang 1999, Swamy 1999, Gribble et al. 2005); however, little is known about the baseline abundance of carcharhinids on coral reefs, nor the magnitude to which fishing decreases their numbers.

Due to their large size, relative rarity and often-extensive foraging ranges, it is usually difficult to obtain unbiased estimates of shark abundances. While an increasing amount of valuable demographic data is becoming available, it is mostly derived from fisheries catch data (Musick et al. 1993, Campana et al. 2002a, Ellis et al. 2005, Myers & Worm 2005). From the perspective of shark management, this information has the disadvantage of being retrospective. If shark populations decline rapidly in the face of fishing exploitation, this information may simply confirm what has come to pass (Brander 1981, Baum et al. 2003).

Real-time methods of visually estimating shark abundance have largely revolved around private and tourist boat reporting of shark sightings (Parrish & Goto 1997, Wilson et al.

2001, Southhall et al. 2005). Unfortunately this technique has been restricted to large, charismatic species, such as the whale shark (*Rhincodon typus*). However, recent developments have seen advances in shark censusing techniques using other methods. Acoustic attractants and remote videos have proven capable of providing real-time estimates of shark abundances, especially in deep (<100 m) waters (Cappo & Meekan 2004). Similarly, advances in acoustic telemetry and satellite tags have permitted investigation of shark movements, allowing estimates of dispersal and habitat utilisation (Chapman et al. 2005, Heupel & Simpfendorfer 2005, Garla et al. 2006, Wilson et al. 2006). For shallow coral reef environments, there is a further censusing technique which has the capacity to provide real-time, quantitative abundance estimates of shark species.

Where water depth and benthic habitat permit diver counts, underwater visual surveys may provide a viable alternative to estimate shark abundances. Shallow tropical reefs provide an appropriate environment for underwater visual censusing of reef fishes (Brock 1954, Mapstone & Ayling 1998, Graham et al. 2003, Samoilys & Carlos 2005). However, most reef censuses survey an area less than 200 m² (Thresher & Gunn 1986, Mapstone & Ayling 1998). Such surveys are too small to adequately census reef sharks, as they are considerably less abundant on coral reefs than most reef fishes, and capable of roaming kilometres each day (Nelson & Johnson 1980, McKibben & Nelson 1986). Visual surveys of reef sharks can give meaningful results, but only if the survey area adequately represents the abundance of sharks present. This will require considerably larger transects.

A number of carcharhinid species are strongly associated with coral reefs. The three most common of these species are the grey reef shark (*C. amblyrhynchos*), the blacktip reef shark (*C. melanopterus*) and the whitetip reef shark (*Triaenodon obesus*) (Compagno 1984). All three are medium-sized sharks (1.6-2.4 m) (Compagno 1984), and are noted to have distinctive, yet overlapping habitat associations within coral reefs (Nelson & Johnson 1980). *Carcharhinus amblyrhynchos* is characteristic of more oceanic outer reef locations including crests and passes, (McKibben & Nelson 1986, Wetherbee et al. 1997). *Triaenodon obesus* is found across a greater range of habitats; however, with a depth preference of 10-30 m, it is more abundant on reef fronts (Randall 1977, Nelson & Johnson 1980). *Carcharhinus melanopterus* is thought to prefer shallow reef flat and sheltered lagoon habitats (Nelson & Johnson 1980, Compagno 1984); however, unlike the other two species, *C. melanopterus* is also commonly encountered in non-reefal habitats such as mangroves and inshore waters. While the broad habitat distributions of these species have been noted in the literature, the densities in which these species can be found in each habitat are unknown.

The Great Barrier Reef Marine Park (GBRMP) is widely considered to be one of the least degraded reefs in the world (Hughes et al. 2003, Pandolfi et al. 2003, Bellwood et al. 2004). The GBRMP aims to balance conservation with sustainable use (Anon 2004), and is regulated through a hierarchical series of management zones ranging from no-entry marine protected areas (MPAs), to areas open to multidisciplinary fisheries. The status of shark populations in this system should provide a valuable insight into the efficacy of fisheries management to apex predators. Marine protected areas offer protection for some larger fish species (Russ 2002), and may also provide protection for aggregating shark species (Bonfil 1999). However, their efficacy for coral reef sharks

remains questionable (Chapman et al. 2005, Garla et al. 2006). If MPAs fail to provide adequate refuge for reef sharks, increasing fishing pressures on coral reefs may have devastating effects for population abundances.

The aim of this chapter was to develop a visual census protocol to estimate reef shark abundances, employing it to detect differences in reef shark populations associated with differential levels of fishing management. As each species is widely distributed (Compagno 1984, Last & Stevens 1994), the sampling protocol was extended to a multi-scale program covering two ocean basins. This allowed the comparison of reef systems historically exposed to heavy fishing pressure to those which have virtually no history of shark harvesting. To ensure quality control of the shark estimates, visual censusing techniques were compared between observers, and against the results of video censusing.

The specific aims of this chapter were:

1. To determine appropriate shark visual censusing techniques to quantify the distribution and abundance of sharks across coral reef habitats.
2. To investigate the effects of fishing management on the abundance of two species of reef carcharhinid in their preferred coral reef habitat.

2.2. METHODS

2.2.1. Underwater visual censuses

Underwater visual censuses (UVCs) were conducted on SCUBA. Surveys were conducted as belt transects, covering 400 m x 20 m, or 8 000 m² (0.8 hectare). This

distance permitted the surveying of large tracts of reef, while the 20 m transect width was sufficient to record roaming sharks. Divers swam at a constant rate of 20 m min⁻¹, swimming down current when possible to limit noise and movements. Transects were conducted as 20 min timed swims, with a GPS initially used to verify the transect length. Random transect lengths were verified with GPS throughout the study to ensure consistency of area surveyed. As *Triaenodon obesus* often rests on the sandy bottom next to reefs (Nelson & Johnson 1980), divers ensured they maintained visual contact with the substratum. Censuses were conducted during daylight hours, between 0750 and 1700 h. All censuses were conducted with a minimum visibility of 10 m.

2.2.1.1. Distribution of sharks across reef habitat

To quantify the abundance and habitat partitioning of reef sharks, underwater visual censuses were conducted at the southern atoll of the Cocos (Keeling) Islands (12°08'S, 96°52'E). This isolated Indian Ocean atoll was chosen as it has extensive reef and lagoonal areas, which provide crucial habitat for many juvenile and adult fish species. It is also thought to be one of the last pristine reefs in the world (Miller & Sweatman 2004). The atoll is sparsely populated, with approximately 600 Cocos-Malay and ex-mainland Australian inhabitants (Anon 2001). Since colonisation in 1826 (Bunce 1988), the island group has had no recorded history of commercial fishing. Moreover, field observations and discussions with the two ethnic groups on the atoll indicated that neither group considers shark an edible species, preferentially targeting bonefish (*Albula neoguinaica*), reef teleosts and pelagic fishes (Scombridae and Istiophoridae). Although sharks may be hooked during line fishing, they are usually returned to the water alive. Thus it was reasoned that the Cocos (Keeling) island group could be considered “minimally exploited” for shark. Abundance and distribution of sharks at

this location should therefore be representative of natural levels, with little anthropogenic interference.

Underwater visual censuses (UVCs) were conducted across three reef habitats at the Cocos (Keeling) Islands: reef crest (extending 10 m either side of the crest, including dropoff), reef flat (at least 50 m from the reef crest) and sandy lagoon. Precision of UVCs was investigated with a second diver (AM Ayling), who recorded *Carcharhinus amblyrhynchos* abundance in independent censuses in adjacent areas. *Carcharhinus amblyrhynchos* was chosen for comparison as it is often reactive to diver presence (Johnson & Nelson 1973, Nelson et al. 1986), and thus thought to be the most susceptible to differences in diver technique and behaviour. AM Ayling's extensive history with counting reef fishes (Choat & Ayling 1987, Mapstone & Ayling 1998, Williamson et al. 2004) allowed the opportunity to compare abundance estimates from divers with two contrasting levels of UVC experience.

The time at which sharks were sighted was recorded on all transects. The mean density of sharks sighted was re-calculated for the first 5, 10 and 15 minutes of each transect (each approximately corresponding to a further 100 m traversed). Comparisons of shark densities estimated during each time period effectively allowed comparisons of transects of approximately 2 000 m², 4 000 m² and 6 000 m², to determine optimal transect size.

2.2.1.2. Shark abundance on local and regional scales

An intensive sampling regime of UVCs was conducted on the Great Barrier Reef (GBR) to investigate the effects of fisheries management on reef shark abundance. Four levels

of reef management were surveyed, which collectively account for 95% of managed coral reef area in the marine park (table 2.1). These management zones represented a distinct gradient in fishing pressure: (1) no-entry (Preservation) zones, which are aerially-surveyed, strictly-enforced exclusion areas (1% of total reef area on the GBR); (2) no-take (Marine National Park) zones, where fishing is prohibited but fishing boats may be present (30% of total reef area). Moderate levels of illegal fishing have been documented in these zones (Davis et al. 2004); (3) limited-fishing (Conservation Park) zones, which have tight restrictions on the type and quantity of fishing gear permitted (4% of reef area); and (4) open-fishing zones, which have fewer gear restrictions on line fishing (60% of reef area). Restrictions exist on size and catch limits in limited- and open-fishing zones; however, these do not apply to reef sharks.

Underwater visual censuses were conducted in the reef crest habitat of northern and central outer and midshelf reefs (fig. 2.1). Current management zones of Bommie Bay, Crystal Beach, MacGillivray and Washing Machine reefs were implemented in 1983; all other listed northern reef zones have been in place since 1992. All listed central reef zones were implemented in 1987 (fig 2.1). As the Great Barrier Reef Marine Park underwent re-zonation in July 2004, only reefs which retained their previous management zone were included in subsequent surveys (table 2.2). The sampling protocol was expanded to encompass further locations in the Indian and Pacific Oceans (fig. 2.2). Each location had varying levels of historical and contemporary fishing effort. Similar to the GBR sampling, all UVCs were conducted in reef crest habitats.

Prior to statistical analyses, shark abundances at all locations were natural log transformed. Although statistical analyses such as analysis of variances (ANOVAs) are

often robust to violations in the assumptions of data normality and homoscedasticity of variance (Underwood 1981), the natural log transformations undertaken increased the normality of the data, as well as reducing or removing variance heteroscedasticity. All statistical analyses were performed on the natural log data.

To test for differences in shark abundance among reefs of the same management zone, the Great Barrier Reef data was initially analysed as a linear mixed effects model fitted through maximum likelihood. Management zone was a fixed effect, and reefs were a random effect nested within zone. The reef-zone interaction was not significant ($p > 0.9$ for both species), allowing pooling of transects across reefs within management zones. The data was subsequently analysed using one-way ANOVAs and Tukey HSD *post hoc* tests to test for significant differences among reef management zones. One-way ANOVAs (natural log transformed data) were also used to analyse the Cocos (Keeling) abundances, as the Cocos (Keeling) southern atoll was considered a single, continuous coral reef, rather than a series of discrete reefs (as is the case for the Great Barrier Reef).

2.2.2. Underwater baited video

The efficacy of replicated, baited underwater video camera surveys to estimate shark abundance on shallow coral reefs was also investigated at Lizard Island and outer reefs (northern GBR). Four Sony VX1000E video cameras in Amphibico VH1000 underwater housings were deployed between 2.1-6.2 m depth, facing out at approximately 300 m intervals along the reef crest. Time of day was randomly selected between 0815 and 1615 h. Cameras were either baited with 1 kg mix of pilchards and tuna oil in a 30 cm x 9 cm diameter PVC tube, or left unbaited. Bait tubes were tethered to the substratum 6 m from the camera, with 21 x 1 cm diameter holes to allow effusion

of the bait. Diver influence was removed by exiting the area once the cameras began recording.

2.3. RESULTS

2.3.1. Habitat associations of reef carcharhinids

Forty six transects were conducted at the Cocos (Keeling) islands, censusing an area of 368 000 m². Ninety sharks across 3 species of carcharhinid were recorded. Overall shark abundances were low, with approximately 2 individuals hectare⁻¹ recorded for the most abundant species (*Triaenodon obesus*) in its preferred habitat (fig. 2.3). Habitat preferences were apparent for 2 of the 3 species. Highest abundances of *T. obesus* and *Carcharhinus amblyrhynchos* were recorded in the reef crest habitat, with significantly lower abundances in the reef flat habitat (*T. obesus*: ANOVA; MS=0.97, F=3.44, p<0.05; *C. amblyrhynchos*: ANOVA; MS=0.69, F=4.95, p<0.05; fig. 2.3).

Carcharhinus amblyrhynchos abundance was also significantly lower in the lagoon habitat (fig. 2.3). *Carcharhinus melanopterus* abundance did not differ significantly among the 3 habitats (ANOVA; MS=0.20, F=0.96, p>0.05; fig. 2.3).

No pattern was evident in the time at which sharks were sighted along transects (fig. 2.4). This suggested the UVCs were not influenced by the sounds of the boat engines, or by the divers entering the water. Differences in the surveyor's experience in conducting UVCs also did not affect the results, with no differences revealed in between-observer *C. amblyrhynchos* estimates among the 3 reef habitats (ANOVA; MS=0.00, F=0.30, p>0.05; fig. 2.5). This also suggests that single-diver UVCs are appropriate to survey reef sharks. Division of transects into their first 5, 10 and 15 minute time periods

demonstrated that the mean density of each shark species did not significantly change with transect size in any habitat, although mean density of all species was highest in the smallest (5 min; ~2 000 m²) transects (fig. 2.6). The standard errors did however, decrease with increasing transect size. Transect lengths of 400 m (8 000m²) provided the most precise estimate of reef shark abundance, and were used in all subsequent underwater visual censuses.

The lack of fishing pressure to drive the habitat patterns found at the Cocos (Keeling) Islands suggests these observations reflect both the natural habitat preferences of the three reef shark species, together with an estimate of their natural densities. As this thesis will focus on *T. obesus* and *C. amblyrhynchos*, all subsequent censuses were conducted in the reef crest habitat, concentrating on the abundance of these species.

2.3.2. Effects of fisheries management on reef carcharhinid abundance

2.3.2.1. Underwater visual censuses

Eighty UVCs (totalling 640 000 m²) were conducted on 21 northern and central Great Barrier Reef (GBR) reefs. Abundances of *T. obesus* and *C. amblyrhynchos* were low, with both species markedly influenced by management zonation (fig. 2.7). The highest abundance of *T. obesus* was found in no-entry zones, which had similar densities to that of the minimally exploited Cocos (Keeling) reef crest habitat. All other management zones had significantly reduced levels of *T. obesus* abundance (one-way ANOVA; MS=1.25, F=7.98, p<0.005). Abundances in limited- and open-fishing zones were reduced by 76% and 80%, respectively. A Tukey's HSD test showed no significant difference in *T. obesus* abundance among no-take, limited-fishing and open-fishing zones (p>0.05).

A similar, but stronger pattern was evident for *C. amblyrhynchos* (fig. 2.7).

Carcharhinus amblyrhynchos abundance was significantly higher in no-entry zones than all other management zones (one-way ANOVA; MS=2.23, F=14.28, $p < 0.005$).

Abundance in nominally no-take zones was reduced by 91% when compared with no-entry zones. Abundances in limited- and open-fishing zones were reduced by 94% and 97%, respectively. Similar to *T. obesus*, no significant difference was found between limited-fishing, open-fishing and no-take reefs (Tukey's HSD test; $p > 0.05$).

These results indicate that reef shark populations are heavily depleted on fished reefs, as well as highlighting the dramatic difference in the effectiveness of no-entry zones and (nominally) no-take zones. For both species, levels of abundance comparable with the Cocos (Keeling) islands only occurred on no-entry reefs. No-take zones appear ineffectual at maintaining reef carcharhinid abundances. In addition to having the greatest densities of reef carcharhinids, no-entry zones also had the largest individuals sighted on the Great Barrier Reef. Maximum sizes estimated on these reefs were 170 cm total length (TL) for *T. obesus* and 200 cm TL for *C. amblyrhynchos*.

2.3.2.2. Underwater baited video censuses

Underwater video surveys produced poor correlations with the UVCs. Eight unbaited and 16 baited underwater video replicates were trialed, with 2 unbaited replicates discounted due to camera malfunction. Tapes ran on average for 62 minutes, with sharks sighted on 67% of unbaited replicates, and 56% of baited replicates. Underwater video counts were highly variable, with no clear pattern among reef management zones (fig. 2.8). Moreover, the limited field of view of the cameras failed to provide representative estimates of reef shark abundances, with greater numbers of sharks

sighted during camera retrieval than the tapes revealed (field obs.). For these reasons, video estimates of shark abundance were not used in this study.

2.3.3. Regional scale patterns of reef carcharhinid abundance

A further 46 transects (368 000 m²) were conducted in the reef crest habitat at the Seychelles, Christmas Island, Moorea and the Marquesas Islands (fig. 2.9). No obvious trends in abundance were visible across ocean basins. Densities of *T. obesus* ranged from zero sightings at the Seychelles, to 0.58 sharks hectare⁻¹ at the Marquesas Islands. *Carcharhinus amblyrhynchos* was recorded only at the Marquesas Islands, at a density of 0.10 sharks hectare⁻¹. The levels of abundance recorded for both species was equivalent to, or less than, the abundances recorded in the fished and nominally no-take zones from the Great Barrier Reef. Although it is possible that fishing pressures are responsible for this result, the limited sampling in these areas make it impossible to separate fishing effects from the influence of normal biogeographic variation at these locations.

2.4. DISCUSSION

The Cocos (Keeling) Islands are possibly one of the few reef environments with relatively undisturbed reef shark populations. Total shark numbers at the Cocos (Keeling) Islands were greatest in reef crest and outer slope habitats where *Carcharhinus amblyrhynchos* and *Triaenodon obesus* dominated. Differences in abundance with habitat across the three species confirmed the ability of underwater visual census protocols to determine abundance profiles and known habitat associations of reef sharks (Randall 1977, Nelson & Johnson 1980, Wetherbee et al. 1997). The

order and magnitude of *C. amblyrhynchos* habitat associations (reef crest > lagoon > reef flat) was retained when the results of an independent observer were included in the analysis, confirming that single-observer counts can precisely estimate shark abundances. Observer experience did not bias the data, nor did transect area (rescaled from larger transects) significantly alter the estimated reef shark densities. These findings highlight the robustness of this sampling technique for coral reef sharks. As 400 m (8 000 m²) transects provided the most precise estimates of reef shark abundances, this transect size was deemed the most appropriate for all underwater visual censuses of coral reef carcharhinids.

2.4.1. Effects of fisheries management on reef carcharhinid abundance

2.4.1.1. The Australian Great Barrier Reef

Densities of both *C. amblyrhynchos* and *T. obesus* in no-entry zones of the Great Barrier Reef Marine Park (Australia) were similar to those from the Cocos (Keeling) reef crest habitat. This suggests that even in undisturbed reef environments, the abundance of each species is low, and not expected to exceed ~2.0 sharks hectare⁻¹. Total shark abundance is not expected to exceed ~3.7 sharks hectare⁻¹. It also suggests that the high levels of abundance seen in GBR no-entry zones are unlikely to be an artefact of the more inquisitive behaviour of sharks unused to divers (Nelson & Johnson 1980). If this was the case, the GBR no-entry zones would be significantly greater than the Cocos (Keeling) Islands, which have appreciable levels of boat traffic, as well as the presence of diving activities.

Reefs with the fewest fishing restrictions (open fishing zones) were reduced by 80% for *T. obesus*, and 97% for *C. amblyrhynchos* when compared with no-entry reefs. Limited

fishing and open fishing zones are subject to differential levels of fishing management, yet both zones were undistinguishable in terms of reef shark abundance. This suggests that even limited levels of fishing pressure can significantly reduce reef shark numbers. This result was more pronounced for *C. amblyrhynchos*, whose abundance was decreased by an order of magnitude more than *T. obesus*. This difference probably reflects the more active and aggressive foraging mode of *C. amblyrhynchos* (Nelson & Johnson 1980).

There are two principle ways in which fishing pressure may produce the differences observed in shark abundance between no-entry and fished reefs: directly, through overfishing of sharks; and indirectly, through fishing of prey species, forcing sharks to seek prey on unfished reefs. However, it is unlikely that indirect fishing pressures are responsible for the patterns observed in these reef sharks. The preferred prey of both shark species includes benthic fishes (Scaridae and Acanthuridae), cephalopods and eels (Muraenidae) (Randall 1977, Wetherbee et al. 1997). With the exception of cephalopods, these species are neither commercially nor recreationally fished on the Great Barrier Reef. Predatory fishes such as coral trout (*Plectropomus*) sp. and red throat emperor (*Lethrinus miniatus*) are commonly targeted by fishers on coral reefs, yet such species do not form an important dietary component in reef sharks. Fisher-mediated reductions in predatory fish abundance in fished zones are unlikely to result in a depletion of food availability for reef sharks (which may force them to seek food resources on alternative reefs). Indeed, reductions of teleost predator abundance in fished zones may increase the density of prey species which are jointly targeted by reef sharks. Although I can offer no data on the effects of management zones on the abundance of sharks at depths over ~25 m, it is pertinent to note that the water depths

surveyed are often targeted by fishers seeking reef teleost predators. Yet sharks found in deeper water may still be vulnerable if vertical foraging patterns bring these animals into range of this fishing pressure. Telemetry data has shown that such vertical migrations occur daily in the whitetip reef shark (R. Fitzpatrick, unpubl. data).

The pervasive nature of illegal fishing was illustrated by the marked differences in shark abundance between no-entry and no-take zones. Both zones exclude fishing, differing primarily in that no-entry zones are closed to public entry and patrolled by aerial surveillance. Reef sharks are known to be inquisitive to non-feeding disturbances (Nelson & Johnson 1980), making it unlikely that boating and diving activities in no-take zones are responsible for the reduction in shark numbers. However illegal fishing activities have been recorded in up to 14% of fisheries enforcement patrols of inshore no-take zones on the central Great Barrier Reef (Davis et al. 2004). Thus it appears likely that this largely-undocumented source of illegal fishing is the most likely explanation for reduced shark numbers in this zone. This supports the conclusion that even limited fishing activities can significantly reduce shark abundances. The value of no-entry zones in preventing illegal fishing was also demonstrated in that the largest individuals of each species were sighted in these zones.

An alternative explanation for the marked difference in abundance between no-take and no-entry zones is that sharks move from no-take to fished zones (where they are caught) more frequently than they move from no-entry to fished zones. However, while movements of sharks may occur between reefs zoned for different fishing levels (Chapman et al. 2005), it is unlikely that reef sharks preferentially move out from areas of lower density (no-take zones) at greater rates than from areas of higher density (no-

entry zones). No-take and no-entry zones are often similar in size, and similarly interspersed among open-fishing and limited-fishing zones (fig. 2.1). Indeed, no-entry reefs may be found within 1-2 km of open-fishing reefs, yet higher abundance levels are maintained on no-entry zone reefs. Moreover, the movements of reef sharks such as the whitetip reef shark are limited (0-3 km) (Randall 1977), suggesting a high level of site fidelity. Consequently, the most likely explanation for the discrepancy between no-entry and no-take reefs remains that illegal fishing in no-take zones has a highly deleterious effect on reef shark abundances.

The Great Barrier Reef is by no means alone with infringements of no-fishing areas. Illegal fishing activities have been widely reported in marine park areas across the globe (Anderson & Waheed 1999, Nageon de Lestang 1999, Chiappone et al. 2004). Lost hook and line gear may be more prevalent in no-fishing zones than in fishable areas, forming the majority of marine debris (Chiappone et al. 2004). Coral reefs are especially open to fishing pressure as they are often easy to find, with a wide range of harvestable species (Morgan & Burgess 2004). Reef sharks therefore may be in the position where their habitat choice (coral reefs) affords them little protection from line fishing pressure, especially when non-compliance with fishing restrictions removes any managerial protection.

Video recordings using both baited and unbaited cameras did not show the clear pattern of differences in reef management zone revealed by visual counts. While it is possible that this may be a reflection of behavioural changes of individuals within marine reserves to novel structures and baits (Willis & Babcock 2000), it is more likely due to inadequacies in the field of view of the cameras. While aggressive interactions amongst

individual sharks at the baits were rare, individuals of *C. amblyrhynchos* were especially prone to dominate the bait for the full period of the recording. When this occurred, conspecifics maintained their distance outside the viewing areas of the cameras. While video census techniques are a critically important tool for estimating shark abundances in deeper water environments (Cappo & Meekan 2004), the results may be conservative with respect to the actual magnitude of differences among fished and unfished areas.

Both *T. obesus* and *C. amblyrhynchos* are known to have strong site fidelity in lagoonal areas (Randall 1977, Nelson & Johnson 1980), although *C. amblyrhynchos* may roam greater distances along reefs fronts (McKibben & Nelson 1986). The marked differences in reef crest shark abundance with fishing zonation suggest a high degree of site fidelity exists for GBR reef carcharhinid populations on individual reefs. Although increased nocturnal roaming has been recorded in nocturnally-feeding shark species (Gruber et al. 1988, Garla et al. 2006), it is likely high reef fidelity occurs for both *T. obesus* and *C. amblyrhynchos* during night foraging (Nelson & Johnson 1980, McKibben & Nelson 1986). The extent to which nocturnal roaming may occur in other reef species may be determined through future tagging or telemetry studies.

2.4.1.2. Region reef shark abundances

Regional differences in reef shark populations showed a greater variation within ocean basins, than between ocean basins. The major contrasts in the Indian Ocean were between the Cocos (Keeling) Islands and the Seychelles. Despite an extensive visual sampling program in the Seychelles no reef sharks were recorded in the formal counts. Moreover, only 4 sharks were observed during associated sampling activities (fish

spearing and line-fishing) at the same localities. Although a natural absence of sharks in the area cannot be discounted, the marked contrast with the Cocos (Keeling) Islands, and the popular descriptions of widespread and intensive shark fishing for dried meat and more recently shark fins over the last 60 years indicate that absence of the study species can be ascribed to over-fishing (Travis 1990, Nageon de Lestang 1998).

Due to a lack of fringing beach, and the associated problems of small boat access, line fishing is limited on much of the reef at Christmas Island. Hence, the limited number of sharks sighted at Christmas Island may be due to a different factor. The reefs at Christmas Island are limited in extent, being confined to narrow shelves and crests lacking reef flats and lagoon areas. Thus, habitat structure is likely to be the main restriction on the numbers of reef sharks at Christmas Island. In the Pacific, the islands of Moorea and the Marquesas group have artesinal line fisheries that may impact shark populations. Although there may be similar habitat limitations to Christmas Island which account for the reduction in shark abundance, the more general case for regional differences in abundance patterns is now comprehensively confounded by fishing activities.

Nevertheless, the regional results, together with the Great Barrier Reef data, strongly suggest that both historical and contemporary fishing activities can drastically reduce shark numbers over whole reef systems. In the absence of conservative management practices, extirpation of reef shark populations from entire reef areas is a very real possibility. However, there is some cause for optimism. High abundances on GBR no-entry reefs indicate that high levels of shark abundance can be sustained in reef systems that allow fishing elsewhere, provided that enforcement is effective. Crucially, the

apparent failure of no-take zones to protect sharks makes it clear that the mere legal prohibition of fishing in marine protected areas is inadequate; such prohibitions must be part of a regime that facilitates effective ongoing enforcement or community-based universal compliance from reef users (McClanahan et al. 2006).

Surrounding reef habitats also need to be accounted for when considering marine parks as potential shark reserves. Simulation of the efficiency of MPA networks shows that the effective protection offered by a single, large MPA (as opposed to a network of smaller MPAs), is much greater in the face of non-compliance for species with relatively limited dispersal (Kritzer 2004). This is due to a decreased perimeter-to-area effect as the MPA size increases, as illegal fishing is more likely to occur closer to the edge of an MPA (Gribble & Robertson 1998, Kritzer 2004). Although the GBR data suggests that both *T. obesus* and *C. amblyrhynchos* maintain a high degree of site-fidelity on coral reefs, other reef species such as the Caribbean reef shark (*C. perezi*) are capable of roaming at least 30 km between coral reefs (Chapman et al. 2005). To ensure the efficacy of marine reserves for a suite of shark species, sufficiently large areas will need to be considered. Nevertheless, MPAs may provide protection for some species of shark when they encompass areas of site fidelity or known aggregations (Bonfil 1999).

Underwater visual censuses provide an appropriate and cost-effective protocol for estimating the abundance of reef carcharhinids. Due to the clarity of water and shallow depths (<20 m) it is possible for divers to rapidly assess multiple locations, completing up to 3 replicate counts (24 000 m²) per dive. Underwater visual censuses were capable of estimating the density of both foraging and resting reef sharks (such as *T. obesus*); and allowed three main conclusions to be drawn: Firstly, sharks are rare members of the

reef fish assemblage, even in the absence of fishing. This is a reflection of their large size and trophic status as apex predators. Secondly, shark populations are highly sensitive to line fishing, with even low intensity fishing reducing numbers to levels characteristic of exploited reef environments. And finally, shark numbers vary over regional scales but the results are difficult to interpret due to confounding between natural patterns of biogeographical variation and fishing history.

The results presented in this chapter demonstrate a high vulnerability of at two species of reef carcharhinid to fisheries overexploitation. To determine the mechanisms behind this vulnerability, the demography of each species will need to be individually investigated. This will require the processing of a number of individuals from each species, and the analysis of both age and reproductive data. This will be focus of the following three chapters.

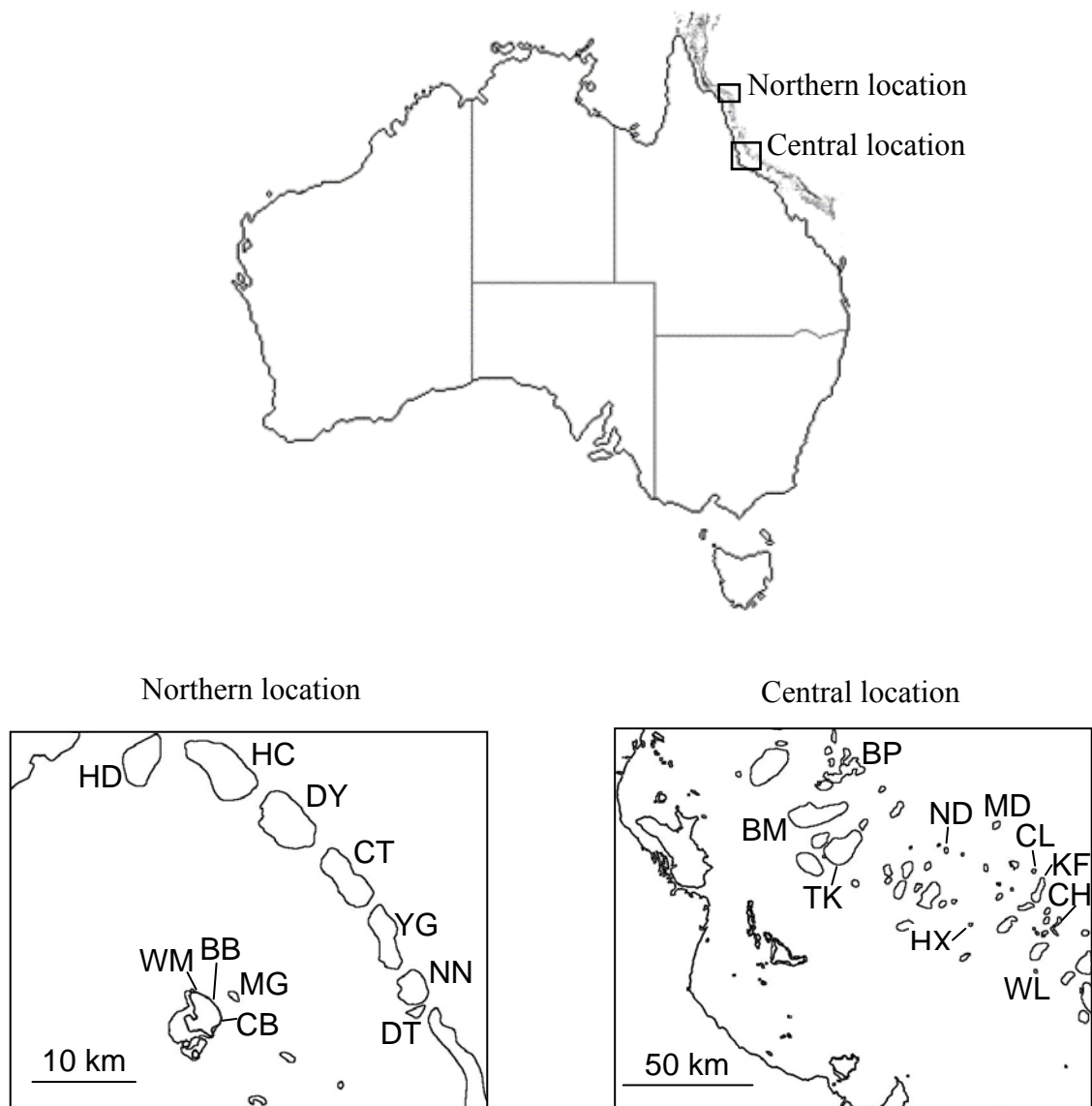

Figure 2.1. Location of Great Barrier Reef underwater visual censuses. No-entry zone reefs surveyed were Carter (CT) and Hilder (HD) reefs; no-take zone reefs were Barnett Patches (BP), Coil (CL), Detached (DT), MacGillivray (MG), No Name (NN) and Wheeler (WL) reefs; limited-fishing zone reefs were Bommie Bay (BB), Crystal Beach (CB), Myrmidon (MD), Needle (ND), Trunk (TK) and Washing Machine (WM) reefs; open-fishing zone reefs were Britomart (BM), Chicken (CH), Day (DY), Helix (HX), Hicks (HC), Knife (KF) and Yonge (YG) reefs. Current zonation of BB, CB, MG and WM reefs was implemented in 1983; other listed northern reef zones were implemented in 1992. All listed central reef zones were implemented in 1987.

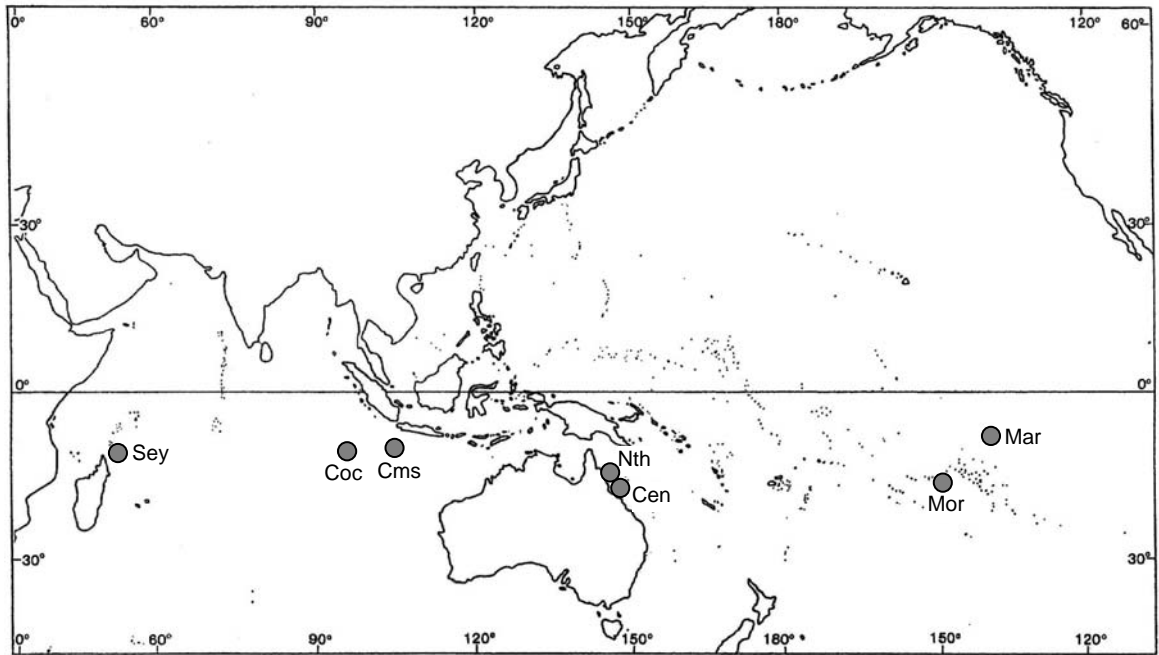

Figure 2.2. Location of regional coral reef underwater visual shark surveys. Sey: Seychelles (Farquhar Islands), Coc: Cocos (Keeling) Islands, Cms: Christmas Island, Nth: Northern GBR, Cen: central GBR, Mor: Moorea, Mar: Marquesas Islands.

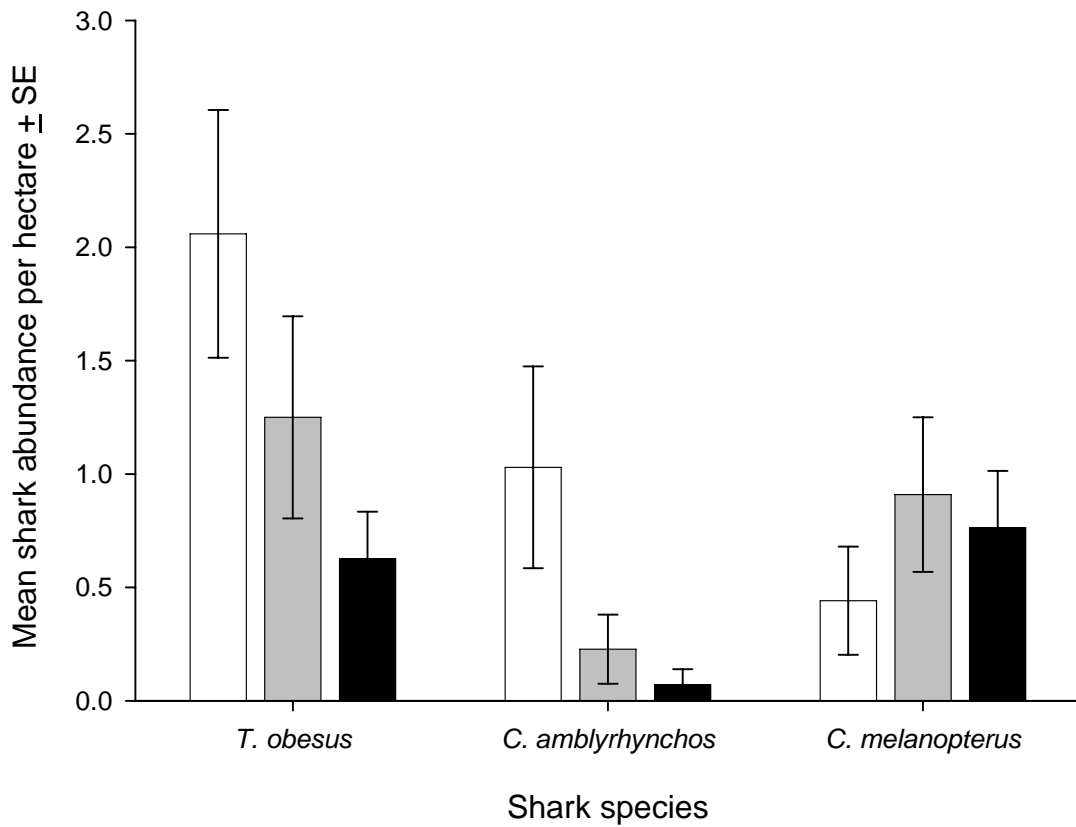

Figure 2.3. Abundance of three species of reef shark sighted during 8 000 m² censuses at the Cocos (Keeling) islands. Habitats surveyed included reef crest (open bar, n=17 transects); lagoon (grey bar, n=11 transects) and reef flat (closed bar, n=18 transects). Abundance estimates have been rescaled to 10 000 m².

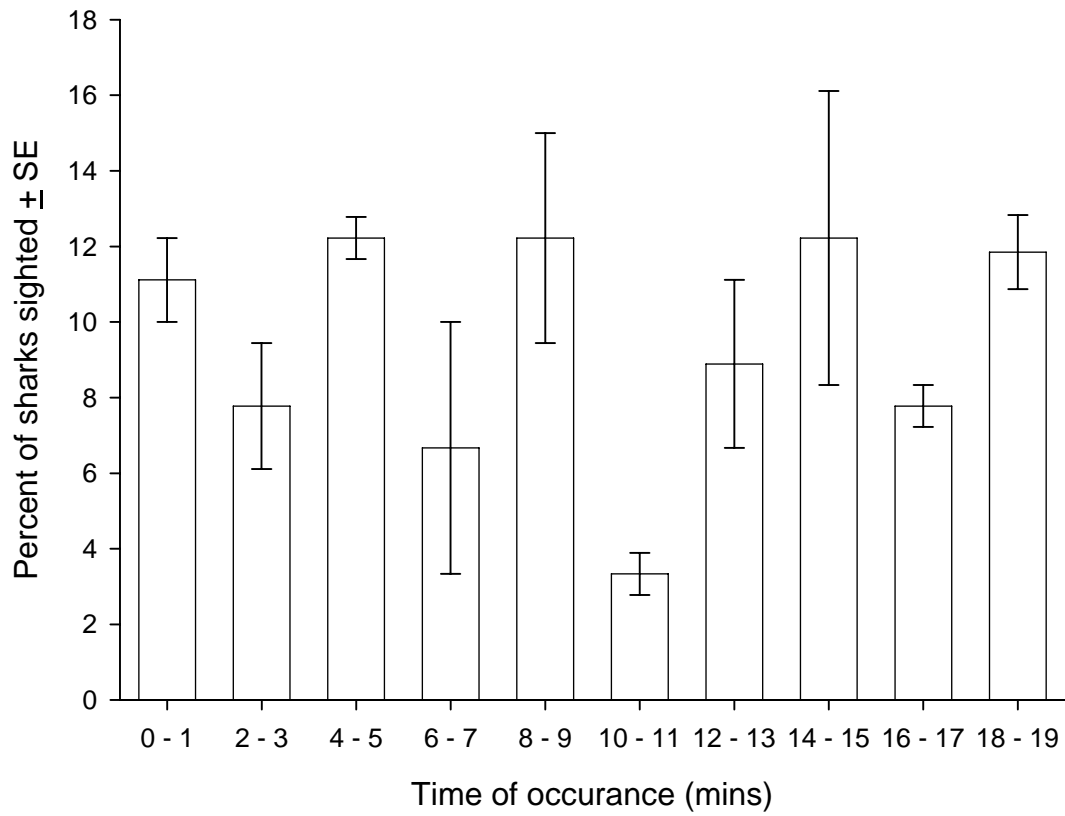

Figure 2.4. Time period when reef sharks were sighted on underwater visual censuses at the Cocos (Keeling) islands, pooled across 2 minute intervals. Number of transects with sharks=35, number of sharks=90.

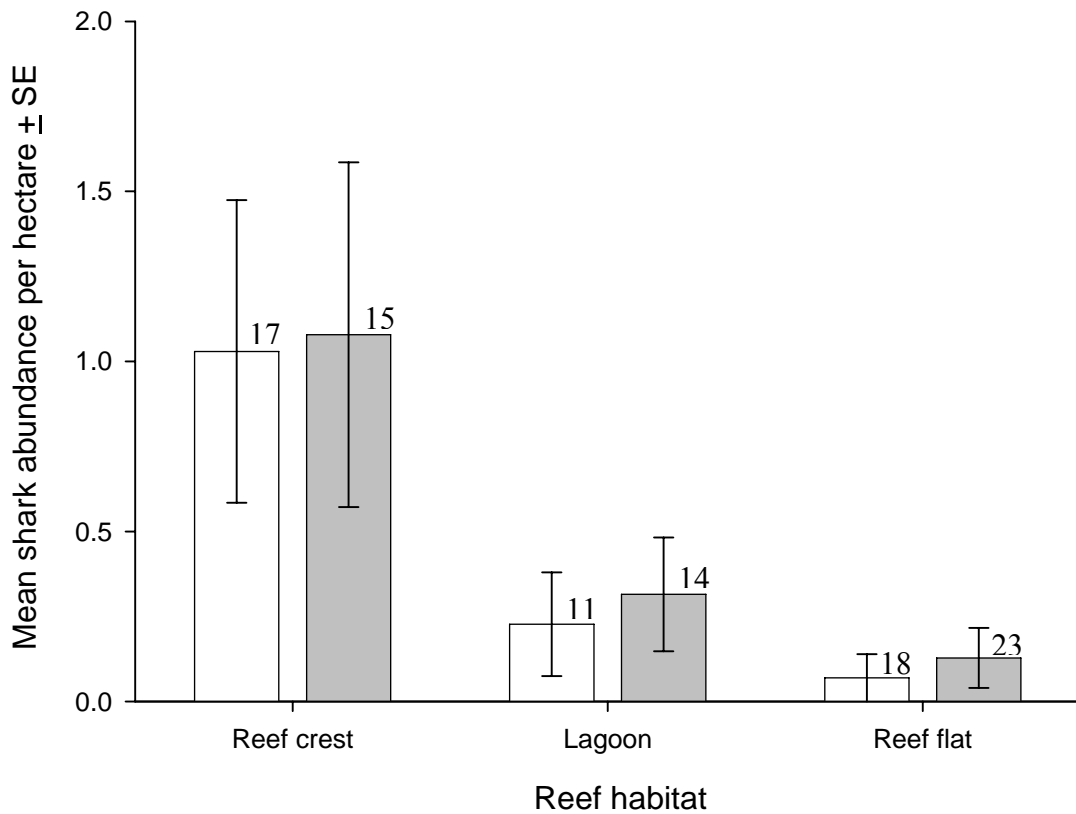

Figure 2.5. *Carcharhinus amblyrhynchus* abundances recorded from two observers using 8 000 m² underwater visual counts in three habitats at Cocos (Keeling) islands. Open bar indicates this author's counts; grey bars indicate the results of a second, independent surveyor (AM Ayling). Numbers indicate how many transects undertaken by each observer in each habitat. Abundances have been rescaled to 10 000 m².

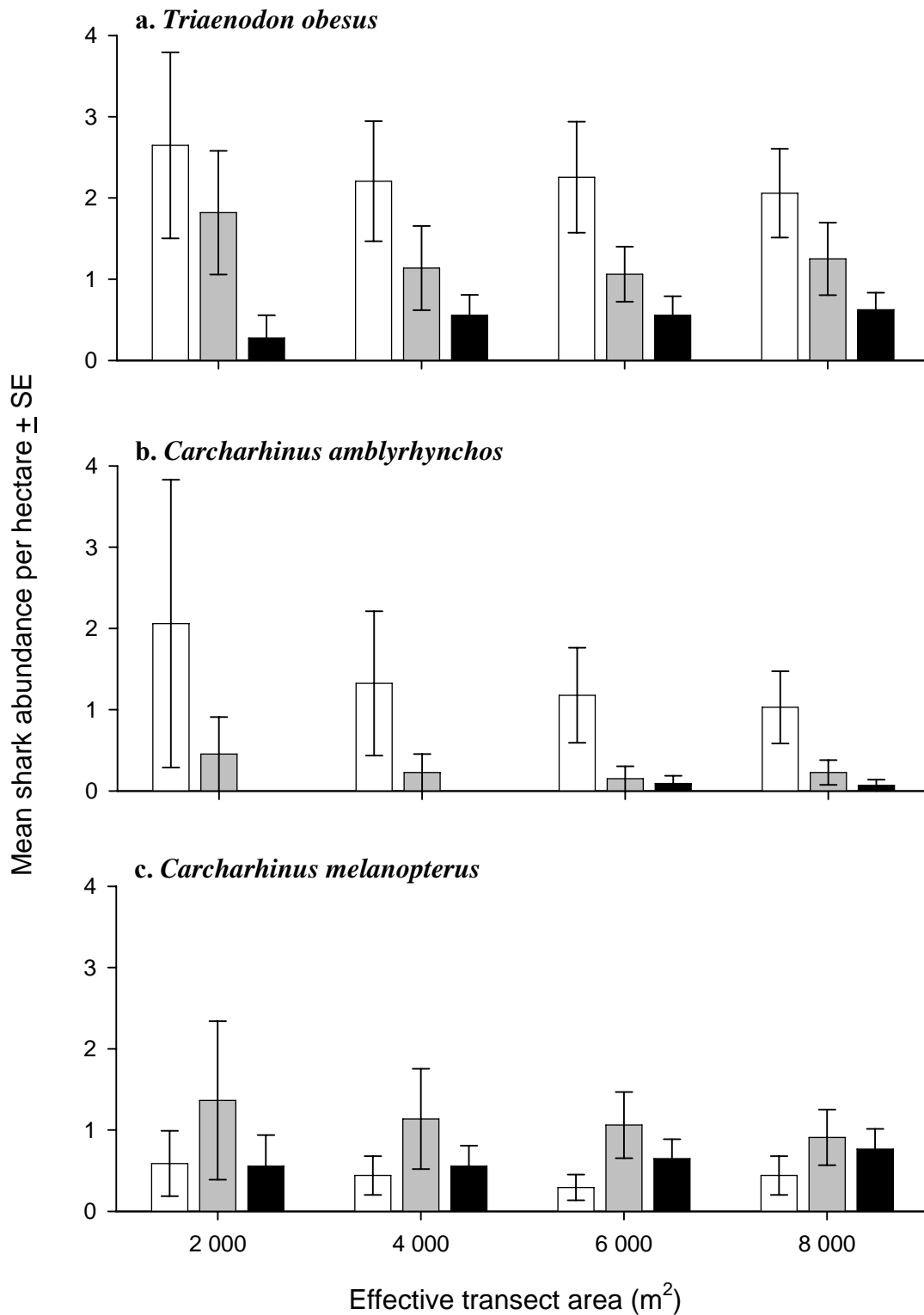

Figure 2.6. Effects of varying transect size on the mean abundance of reef sharks recorded in the reef crest (open bar, n=17 transects), lagoon (grey bar, n=11 transects) and reef flat (closed bar, n=18 transects) habitats of Cocos (Keeling Islands). All values are derived from 400 m (8 000m²) transects, and rescaled to 10 000 m².

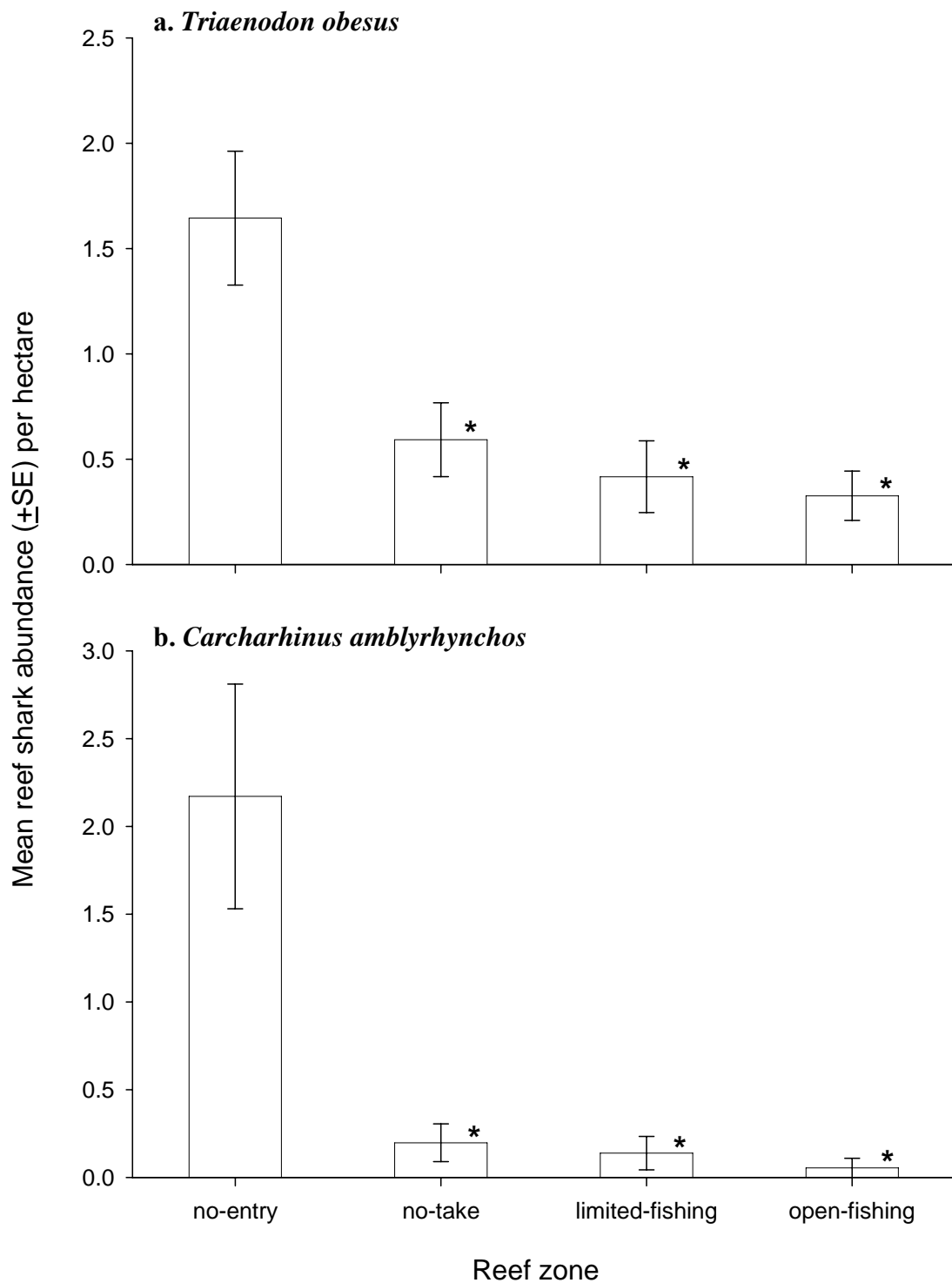

Figure 2.7. Mean abundance of (a) *Triaenodon obesus* and (b) *Carcharhinus amblyrhynchos* on coral reef crests in four levels of fishing management on the Great Barrier Reef. 23 surveys were undertaken in open-fishing zones; 19 surveys were undertaken in all other zones (table 2.2). Asterisks indicate management zones significantly different ($p < 0.005$) from no-entry (Preservation) zones (ANOVA using natural log transformed data). Abundances have been rescaled to 10 000 m².

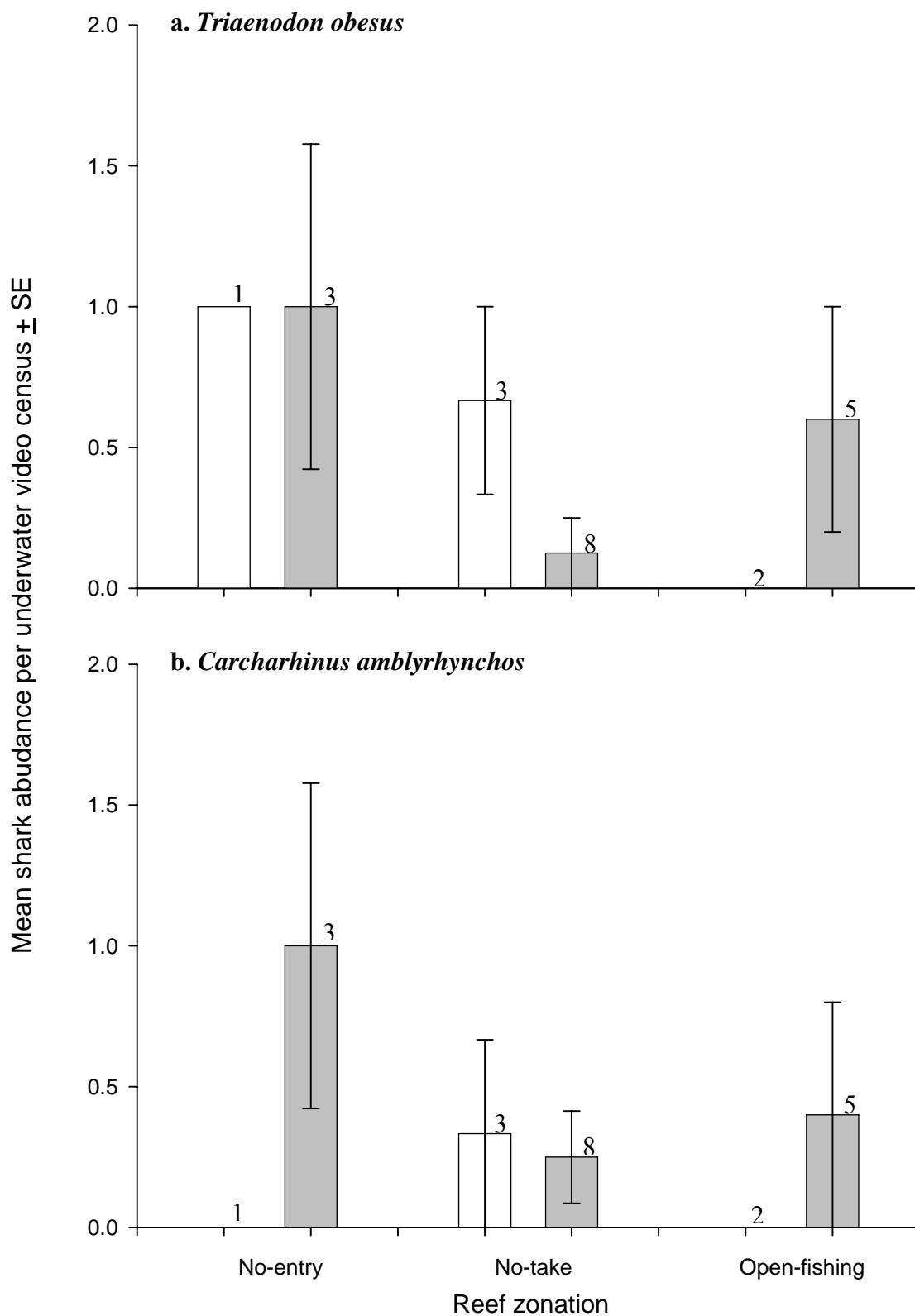

Figure 2.8. Mean abundance of (a) *Triaenodon obesus* and (b) *Carcharhinus amblyrhynchos* from unbaited (open bars) and baited (closed bars) underwater video recordings on the Great Barrier Reef. Numbers indicate how many recordings undertaken in each habitat.

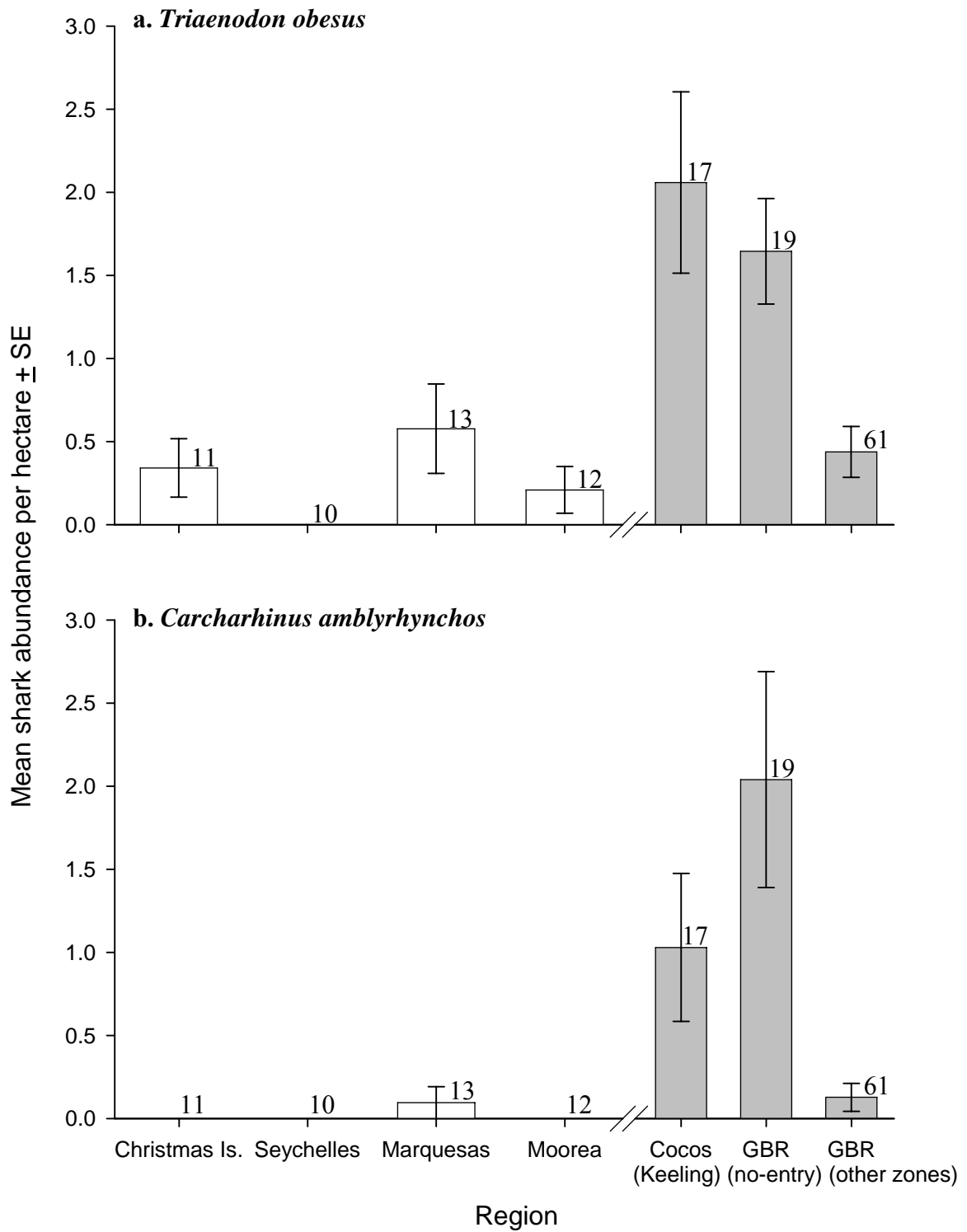

Figure 2.9. Mean abundance of (a) *Triaenodon obesus* and (b) *Carcharhinus amblyrhynchos* on Indo-Pacific coral reef crests. Abundances have been rescaled to 10 000 m². Data from figs. 2.3 & 2.7 (closed bars) included for comparison. Numbers indicate how many transects undertaken at each location.

Table 2.1. Summary of fishing activities allowed in the four Great Barrier Reef Marine Park zones most pertinent to coral reefs during most underwater visual surveys (prior to the 2004 rezonation. See table 2.2 for survey dates). Names in parentheses are used throughout the text. Species-specific size and take limits are not applicable to reef sharks. Since the 2004 rezonation, a limit of 3 lines per person, with a combined total of 6 hooks has been introduced in the Habitat Protection zone, and spearfishing is now permitted in Conservation Park zones. Trawling has not been permitted in any of the listed zones.

Management zone	Zone accessibility	Fishing permitted?	Fishing restrictions
Preservation (no-entry)	Emergency only	No	N/A
Marine National Park (no-take)	Yes	No	N/A
Conservation Park (limited-fishing)	Yes	Yes	1 hook per line; 1 line per person. Species-specific size and take limits
Habitat Protection (open-fishing)	Yes	Yes	Species-specific size and take limits. Maximum of 6 hooks per line. Spearfishing allowed

Table 2.2. Dates and number of surveys of underwater visual censuses on Great Barrier Reef reef crest habitat (see figure 2.1 for reef locations). All reefs surveyed after the July 2004 rezonation of the GBR (*) had retained their previous management zone.

Reef	Management zone	Location	Date(s) surveyed	No. surveys
Carter	No-entry	Northern	13.01.01 - 19.01.01	9
			24.11.04*	2
Hilder	No-entry	Northern	09.01.01 – 16.01.01	4
			25.11.04*	4
Barnett Patches	No-take	Central	17.10.01	3
Coil	No-take	Central	01.12.03	4
Detached	No-take	Northern	15.10.03 – 17.10.03	3
MacGillivray	No-take	Northern	12.01.01	1
			11.10.03	1
No-Name	No-take	Northern	11.01.01	1
			11.10.03 – 12.10.03	2
Wheeler	No-take	Central	04.12.03	4
Bommie Bay	Limited-fishing	Northern	18.10.03	1
			01.12.04*	2
Crystal Beach	Limited-fishing	Northern	12.01.01 – 15.01.01	2
			01.12.04*	2
Washing Machine	Limited-fishing	Northern	19.10.03 – 20.10.03	2
			01.12.04*	2
Myrmidon	Limited-fishing	Central	19.10.01	1
			30.11.03	3
Needle	Limited-fishing	Central	31.05.03	2
Trunk	Limited-fishing	Central	01.06.03	2
Britomart	Open-fishing	Central	16.10.01	3
Chicken	Open-fishing	Central	03.12.03	5
Day	Open-fishing	Northern	08.01.01	1
			20.10.03	2
Helix	Open-fishing	Central	30.05.03	2
			29.11.03	4
Hicks	Open-fishing	Northern	09.01.01 – 16.01.01	3
Knife	Open-fishing	Central	02.12.03	2
Yonge	Open-fishing	Northern	14.01.01	1

Chapter 3. Age and growth of two coral reef carcharhinids

3.1. INTRODUCTION

Age is arguably one of the most critical life history parameters in the demography of a species. Maximum age (longevity) limits the number of breeding cycles available to an individual, due to death or senescence. Meanwhile, increases in age before this time are often associated with an increase in somatic size. This results in increased reproductive output in many marine species, through higher fecundity and decreased predation (Simpfendorfer 1992b, Loefer & Sedberry 2003, Chatzisprou & Megalofonou 2005, Narimatsu et al. 2005, Rahman & Tachihara 2005). The form of an individual's size-at-age (growth) curve also has direct consequences on reproductive output. The apportioning of early growth energetics to maximise somatic size prior to reproductive development (rather than a combination of the two) results in an asymptotic form of growth, where age is decoupled from size (Choat & Axe 1996, Zekeria et al. 2006). Species with asymptotic growth reach sexual maturity much earlier than those which grow continuously throughout life (Choat & Robertson 2002). Early maturity provides an extended reproductive lifespan, and when longevity is equivalent, a decreased time between generations (Krebs 1994).

The growth rates of marine vertebrates invariably decrease with age (e.g. Branstetter & McEachran 1986, Choat & Axe 1996, Di Benedetto & Ramos 2004, Evans & Hindell 2004). This makes it increasingly difficult to distinguish between older age classes using length measurements. Incorrect ageing such as this can subsequently produce misleading results from demographic analyses, especially for long-lived species

(Hillborn & Walters 1992). Determination of individual ages, and form of growth curve, are therefore essential first steps in the demographic analysis of a species.

3.1.1. Studies of whitetip reef shark and grey reef shark age and growth

The first investigation of grey reef shark (*Carcharhinus amblyrhynchos*) growth was undertaken in Hawaiian waters (as *C. menisorrhah*), using length-frequency analysis (Tester 1969). One hundred and fifty eight individuals were captured, allowing a preliminary growth curve to be generated. A later attempt to verify these results through tag-recapture was unsuccessful, due to a lack of recaptured animals (Wass 1971). The first age-based growth curve of *C. amblyrhynchos* was constructed in 1984, again using animals collected from the Hawaiian Island group (De Crosta et al. 1984). This growth curve was similar to the original findings of Tester (1969), estimating longevity at 9 years. However, in the same year, Radtke and Cailliet (1984) used an experimental electron microprobe technique to age a further 59 Hawaiian *C. amblyrhynchos*. This technique produced higher ages for similar-sized animals, estimating longevity at 12 yrs (Radtke & Cailliet 1984). The authors did however, suggest that the longevity of *C. amblyrhynchos* may be much higher, as they lacked larger-sized animals in their dataset (Radtke & Cailliet 1984). This conclusion was supported by Compagno (1984), who suggested that *C. amblyrhynchos* may live at least twice as long (25 yrs).

To date, no quantitative estimates of longevity or growth are available for *T. obesus*. Field observations and tag-recapture of *T. obesus* have estimated its longevity at approximately 25 yrs (Randall 1977, Compagno 1984); however, many of the most basic age and size parameters of this species remain unresolved.

3.1.2. Background to shark ageing

3.1.2.1. Vertebral ageing techniques

Fish and shark ages can be determined by counting periodic checkmarks on their calcified structures. Structures used for ageing sharks and rays (elasmobranches) include dorsal spines (Machado & Figueiredo 2000, Clarke et al. 2002), caudal thorns (Gallagher & Nolan 1999), neural arches (McFarlane et al. 2002) and even the upper jaw bone of orectolobids (wobbegongs) (Tanaka 1990). However, vertebral centra are considered the best structure for elasmobranch ageing (Campana et al. 2002b). By 2004, vertebral centra had been used in approximately 70% of elasmobranch ageing studies (Cailliet & Goldman 2004).

Age estimates are derived from counts of the concentric opaque and translucent bands found on the vertebral centra. Environmental cues may promote the formation of opaque vertebral bands, through seasonal changes in temperature and light, or ambient phosphorus levels increasing the ability of elasmobranches to uptake minerals (Jones & Geen 1977, Casey et al. 1985, Officer et al. 1997). However, the actual mechanisms behind elasmobranch vertebral band formation remain unclear, as metabolic changes through stress, migration or mating events may also initiate band formation (Pratt & Casey 1983, Simpfendorfer 1993, Branstetter & Musick 1994).

The most common shark vertebrae pattern consists of concentric pairs of wide opaque and narrower translucent bands (Cailliet & Goldman 2004). Translucent bands usually form in winter, when somatic growth rates are reduced (Jones & Geen 1977, Branstetter 1987a, Parsons 1993a, Natanson et al. 1995, Wintner & Cliff 1996, Carlson et al. 1999, Wintner & Dudley 2000, Simpfendorfer et al. 2002, Cailliet & Goldman 2004).

However, these bands have been known to form as late as spring (Sminkey & Musick 1995, Lessa & Santana 1998) or even in summer (Simpfendorfer 1993, Loefer & Sedberry 2003). The narrower (usually translucent) winter bands are often referred to as annuli, and are generally counted to estimate shark ages (Cailliet & Goldman 2004). This differs from the ageing of teleost fishes, in which the opaque (usually summer) bands are counted (Choat & Axe 1996, Cappo et al. 2000, Williams et al. 2005).

The calcareous structure of shark vertebrae is more difficult to interpret than the bony otoliths of fishes, which are usually read without enhancement (Secor et al. 1995). Enhancement techniques such as staining or x-raying are commonly employed to assist in the interpretation of shark vertebrae bandings (Stevens 1975, Cailliet et al. 1983b, Francis & Mulligan 1998, Gelsleichter et al. 1998). There is no universal vertebral enhancement technique, as individual results vary widely between species. Subsequently, a suite of enhancement techniques must usually be trialled for each species.

3.1.2.2. Validation of shark ages

Validation is the process of confidently determining the temporal periodicity of band formation (Cailliet 1990). One of the best validation techniques available is the use of fluorochrome dyes, such as oxytetracycline (OTC), in wild or captive specimens (Campana 2001). When injected at 25 mg kg^{-1} , OTC is a harmless antibiotic which is incorporated into the growing vertebrae centra edge (Branstetter 1987b, Gelsleichter et al. 1997, Natanson et al. 1999). Oxytetracycline incorporated into the vertebrae is neither re-absorbed, nor degraded over time (e.g. Smith et al. 2003). Upon re-capture, analysis of vertebral growth between the OTC mark and the outer vertebrae edge allows

band periodicity to be compared against known time at liberty. Successful OTC validations have been made for sharks at liberty for up to 20 years (Smith et al. 2003). Oxytetracyclining does however have the disadvantage of requiring the re-capture of tagged individuals. These events are notoriously infrequent, with re-capture rates below 10% common in shark studies (Kohler & Turner 2001).

Alternative validation techniques include characterisation of vertebrae edge band formation (Kusher et al. 1992, Wintner et al. 2002), captive rearing (Branstetter 1987b, Tanaka 1990), identification of ^{14}C bomb radiocarbon peaks corresponding to 1960's atmospheric testing of atomic bombs (Campana et al. 2002b), size frequency analysis (Natanson et al. 1995, White et al. 2002) and tag-recapture analysis (Simpfendorfer 2000, Natanson et al. 2002). The relative merits of these techniques are beyond the scope of this chapter; however, good reviews can be found in Campana (2001) and Cailliet (1990 & 2004).

The majority of shark and ray validation studies have established annual periodicity of vertebral band formation (Branstetter & McEachran 1986, Branstetter 1987b, Campana et al. 2002b, Natanson et al. 2002, Simpfendorfer et al. 2002, Skomal & Natanson 2003, Smith et al. 2003, Cailliet & Goldman 2004). However, biennial band deposition has been found in the basking shark (*Cetorhinus maximus*) and the sand tiger (*Odontaspis taurus*) (Branstetter & Musick 1994, Parker and Stott (1965 in Castro et al. 1999)). Moreover, band deposition is dependant upon somatic growth in the Pacific angel shark, *Squatina californica*, with bands appearing more frequently in faster-growing, younger animals (Natanson & Cailliet 1990). Vertebral band formation is similarly difficult to predict in captive gummy sharks (*Mustelus antarcticus*), due to irregular periods of slow

vertebral growth (Officer et al. 1997). The mechanisms behind the differences in these species is not always obvious, however they serve to highlight the need to individually validate each species.

The understanding of reef shark demography is a key aim of this thesis. Therefore, it is critical to determine the age and growth of the species under investigation. Both the whitetip reef shark (*Triaenodon obesus*) and the grey reef shark (*Carcharhinus amblyrhynchos*) are medium-sized carcharhinids (Compagno 1984). Hence, it is also likely that size will have a significant influence on fecundity. The effects of age on size will therefore be explored for both species.

The specific aims of this chapter were:

1. To determine the size-at-age of *Triaenodon obesus* and *Carcharhinus amblyrhynchos* on the Great Barrier Reef.
2. To determine the longevities of *T. obesus* and *C. amblyrhynchos* on the Great Barrier Reef.
3. To validate the periodicity of vertebral band formation, using a combination of oxytetracycline injections and centrum edge analysis.

3.2. METHODS

3.2.1 Collection of samples

3.2.1.1. Field collections

Field collections were undertaken between February 2001 and April 2005, at northern and central locations on the Great Barrier Reef (fig. 3.1). The northern location

consisted of Lizard Island (14°42'S, 145°30'E) and its associated mid- and outer-shelf reefs. Central collections were taken from mid- and outer-shelf reefs within 100 nm of Townsville (19°16'S, 146°49'E). *Triaenodon obesus* and *Carcharhinus amblyrhynchos* were captured through hook and line fishing, with additional *T. obesus* captured through spearing on snorkel and SCUBA. Catches of both species were greatest at night, within the 10-day period around the full moon. Fishing took place from small runabouts or live-aboard charters, between 1530 and 0730 h. All animals kept for sacrifice were pithed immediately with a steel spike, as per James Cook University standards (ethics approval #A696), and processed as soon as practical.

3.2.1.2. Commercial collections

Both species of shark were obtained from commercial reef-line fisheries operating out of Townsville and Cairns (fig 3.1). Target reefs for commercial fisheries at both locations overlapped with those used for research field collections. Line fishing gear was comparable with that used in research collections (single 9/0 hook and monofilament line). All sizes of shark were retained by the fisheries, with individuals frozen following capture. Total lengths of all individuals were recorded, with large catches (such as neonate *C. amblyrhynchos*) sub-sampled for processing.

3.2.2. Processing of animals

Individual sexes were recorded, and precaudal length (PCL, taken from the tip of the snout to the posterior of the precaudal pit), fork length (FL) and “stretched” total length (TL, with the dorsal tail lobe bent parallel to the body axis) measured to the nearest mm. Sharks were weighed to the nearest gram with an electronic balance. After ventral dissection, the viscera were removed, and a section of vertebrae taken for ageing.

Sexual maturity was evaluated (Chapter 4), and a 1-2 cm² fin clipping taken from the trailing edge of the dorsal fin for genetic analysis (Chapter 7).

3.2.3. Ageing individuals

3.2.3.1. Vertebrae preparation

The 10 vertebral centra anterior to the first dorsal insertion (rear of dorsal fin) were taken from each shark. Vertebrae from this region are the largest, and usually provide more accurate age estimations than vertebrae from other regions (Officer et al. 1996). The anterior 5 vertebrae were removed of excess tissue and frozen until processing. Remaining vertebrae were frozen as spares. Processed vertebrae were defrosted, with individual centra separated with a scalpel. Remaining tissue was removed by soaking in a 4.2% sodium hypochlorite solution for 10-60 minutes, depending on vertebrae size. Centra were rinsed in running tap water for 10 minutes and stored in 70% LG EtOH to aid readability (Wintner & Cliff 1996).

3.2.3.2. Centra sectioning

Vertebral centra were cut horizontally (sagittally) on an Isomet™ low speed saw. The two centra halves were viewed under a dissecting microscope, with the half showing the best cut of the vertebrae origin retained. The cut face was polished with P400 grit wet emery paper, and mounted on a microscope slide with Crystalbond® thermoplastic glue. A second, parallel cut was made to the vertebra half, resulting in a “bow-tie” section approximately 500 µm thick. The second cut face was polished with P400 grit wet emery paper until the vertebral bands gave the optimum resolution. Finished vertebral sections ranged between 200-400 µm thick. Sectioned vertebrae were stored dry.

Initial exploration of haematoxylin, ninhydrin and cobolt nitrate stains were undertaken to enhance vertebral band interpretation. However none of these techniques produced a marked increase in band resolution. As such, vertebrae were read through thin sectioning without staining.

3.2.3.3. *Vertebral ageing*

Sectioned vertebra centra were viewed under both transmitted and reflected light using an Olympus SZ40 stereo dissecting microscope. Centrum diameters were measured to the nearest 0.02 mm with vernier callipers, and plotted against age and size. Ages were estimated through counts of translucent growth bands on the centra, without knowledge of the sex or size of the individual. Each individual was aged 3 times, with counts conducted on separate days to ensure independence. If 2 of the 3 counts were in agreement, with the third count varying by no more than 1 growth band, the consensus count was taken as the age. If any of the 3 counts differed by more than 1 growth band, the vertebrae was judged unreadable. In these cases, a different vertebral centrum from the same individual was processed, and the ageing process repeated.

The magnitude of error associated with age estimates was calculated on readable vertebrae through the index of average percent error (IAPE) (Beamish & Fournier 1981):

$$IAPE = \frac{100}{N} \sum_{j=1}^N \left(\frac{1}{R} \sum_{i=1}^R \frac{|X_{ij} - X_j|}{X_j} \right) \quad \text{equ. 3.1}$$

where N = number of sharks aged;

R = number of times sharks are aged;

X_{ij} = the i th age determination for the j th shark;

X_j = the average estimated age of the j th shark.

External confirmation of age estimates was undertaken at the Central Ageing Facility, Primary Industries Research (Victoria). This is an internationally-recognised government department specialising in the ageing of both teleost and chondrichthyan fishes. A random selection of 20 vertebral thin sections spanning all sizes of both species was aged without knowledge of size or sex of the species, under the supervision of the PIRVic Offshore Fisheries Program Leader, Mr Terry Walker. These estimates were not undertaken as a formal comparison, but as confirmation of my vertebral interpretations.

3.2.3.4. Size-at-age relationships

Size-at-age data was initially examined by location (northern and central GBR) to confirm consistent relationships between the two sampling areas. A lack of location-specific differences in size-at-age permitted subsequent pooling of locations. Pooled-location data were plotted by sex, with 11 different growth models fitted to the data. Von Bertalanffy (VB) growth functions (von Bertalanffy 1938) were chosen to model the size-at-age relationships:

$$L_t = L_\infty \cdot (1 - e^{-k(t-t_0)}) \quad \text{equ. 3.2}$$

where L_t = length at time t ;

L_∞ = mean theoretical maximum length;

k = growth coefficient (the rate at which L_{∞} is approached); and

t_0 = theoretical time when length equals zero.

Almost all ages of each species were represented in the data, negating the need to back-calculate age classes (Cailliet 1990). Sex-specific differences in growth rate were examined using maximum likelihood analysis of von Bertalanffy growth rates (Kimura 1980). This analysis is one of the most accurate ways to compare such growth curves (Cerrato 1990).

3.2.4. Validation of ages

3.2.4.1. Oxytetracycline validation

Oxytetracycline (OTC) validation of age estimates was undertaken for both species at Lizard Island, One Tree Island (23°28'S, 152°04'E) and the Cocos (Keeling) islands (12°08'S, 96°52'E). Sharks were line-fished with barbless 9/0 hooks to reduce injury. Individuals were landed using a tail rope or large landing net, and restrained by hand. Pre-caudal length was measured, with total weight calculated from the species' size-weight relationship. Pre-caudal length was used as it was more accurate to measure *in situ* than TL. Oxytetracycline was injected at 25 mg kg body weight⁻¹ intraperitoneally. A Hallprint PDA tag was inserted next to the first dorsal fin following Davies and Joubert (1966), and a 1 cm² fin clipping was taken for genetic analysis. Sharks were released following hook removal. All sharks returned to the water actively swam away.

Recaptured tagged animals were processed as per sections 3.2.2 & 3.2.3.

Oxytetracyclined vertebrae were illuminated with "D block" UV light source (excitation wavelength of 355-425 nm), and digital photographs of OTC-marked vertebrae taken

through a stereo dissector. Distances from the translucent band margins and OTC band to the edge of the vertebrae were measured using Visere image viewer 2.2.

Periodicity of growth band formation was estimated following the formulae of Cappo et al. (2000). These formulae calculate growth following the OTC mark as a proportion of the growth in the last complete year:

$$IF = (R_a - T) / (R_a - R_{a-1}) \quad \text{equ. 3.3a}$$

$$FF = (R - R_a) / (R_a - R_{a-1}) \quad \text{equ. 3.3b}$$

$$V = (IF + FF + N) / L \quad \text{equ. 3.3c}$$

where IF = initial fraction

FF = final fraction

V = band formation periodicity (number of cycles yr⁻¹)

R = distance from vertebral centre to vertebral edge

R_a = distance from vertebral centre to outside growth band

R_{a-1} = distance from vertebral centre to penultimate growth band

T = distance from vertebral centre to oxytetracycline band

N = number of complete cycles outside OTC band

L = time at liberty (yr⁻¹)

3.2.4.2. Edge analysis

Vertebral edge analysis was undertaken for *T. obesus*, based on Kusher et al (1992). The outmost band on the vertebral edge was identified, and characterised as translucent or opaque. Two characterisation readings were undertaken on each vertebrae, with any

ambiguous vertebrae characterised a third time. All vertebrae were characterised without knowledge of capture date. Individuals whose vertebrae edge remained ambiguous after three readings were removed from analysis. Proportion of individuals with opaque edges was plotted against capture month to identify the timing of vertebral band formation.

3.3. RESULTS

3.3.1. Age and growth relationships

A total of 134 *Triaenodon obesus* and 199 *Carcharhinus amblyrhynchos* individuals were captured. Of these, a subset of 126 *T. obesus* and 89 *C. amblyrhynchos* were aged through vertebral thin sections. Analysis of vertebral thin sections showed concentric opaque and translucent bands visible in the corpus calcareum, occasionally visible across the intermedalia (fig. 3.2). Opaque bands were broadest, with the narrower translucent bands used for age estimation. An opaque band corresponding to the change in angle of the intermedalia (birth band) was present in both species.

A wide size range of both species were captured (fig. 3.3). Commercial catches of *T. obesus* showed a higher proportion of smaller animals than the research line and spear catches. The reasons for this are not immediately apparent, as line-fishing techniques were comparable, and no differences were apparent between the size frequencies obtained through research fishing and spearing. It is possible that a time-of-day effect is occurring, as most research catches were caught during the night, while commercial catches occurred during the day. No difference was observed between commercial and research catches of *C. amblyrhynchos*.

No differences were found in the size at age of males and females between northern and central sampling locations (fig. 3.4). This allowed pooling of samples from both locations for all following analyses. *Triaenodon obesus* and *C. amblyrhynchos* display continuous growth throughout their lifespan (fig. 3.5), with both females reaching a maximum longevity of 19 years. Males of both species were shorter-lived, with the oldest male *T. obesus* being 14 years and the oldest male *C. amblyrhynchos* being 15 years (fig. 3.5). External age estimates (PIRVic) produced results within 1 yr of those estimated by this study across all age classes of both species.

Eleven growth models were fitted to the pooled size-at-age data (table 3.1), with regression sum of squares (rSS) used to determine each model's goodness-of-fit. A logistic curve fitted best for *T. obesus*, while a 4-parameter Schnute model (Schnute 1981) fitted best for *C. amblyrhynchos*. However, the rSS of the von Bertalanffy growth function was within 1% of the best-fitting model for both species (table 3.1). To allow comparisons between sexes, and among other species in the shark literature, the VB growth function was subsequently chosen to fit to both species (fig. 3.5; table 3.2). The size at birth for *T. obesus* and *C. amblyrhynchos* estimated using VB growth functions (74-78 cm for *T. obesus*; 73 cm for *C. amblyrhynchos*; fig. 3.5) was higher than that estimated through *in utero* pup growth (Chapter 4). However, the VB growth functions adequately described growth of all individuals for all other time periods.

Maximum likelihood ratio tests (Kimura 1980) were undertaken to examine sex-biased differences in growth rates. Female longevity was initially truncated to that of the males, to reduce potential biases in maximum size due to older longevities (Haddon 2001). Significant differences were found between male and female VB growth curves

for *T. obesus* (table 3.3; see appendix 3.1 for full parameter estimates). However closer examination showed no significant differences in any of the three VB growth parameters alone (table 3.3; appendix 3.1). The larger size of female *T. obesus* was due to the female growth rate being maintained after the male growth rate has reduced, rather than a higher intrinsic rate of growth (fig. 3.5a). No significant differences in growth rates were found between sexes in *C. amblyrhynchos* (table 3.3; fig. 3.5b). To ensure that the truncation of older females was not artificially influencing the results, analyses were re-ran for both species, with all female data points included. The magnitude and significance of the results remained unchanged.

Centrum diameter (CD) increased allometrically with both age and total length in each species (fig. 3.6; equ's. 3.4 - 3.7). Examination of equ's 3.4 & 3.6 residuals showed no consistent deviation along the regression, indicating the absence of reader bias with age. Centrum diameter regressions were found to increase at a similar rate for both sexes with age (*T. obesus*: ANCOVA; MS=0.60, F=1.75, p>0.05; *C. amblyrhynchos*: ANCOVA; MS=0.01, F=0.01, p>0.05).

$$T. obesus: \quad CD \text{ (mm)} = (\text{age} \cdot 0.457) + 6.93 \quad (r^2 = 0.88) \quad \text{equ. 3.4}$$

$$CD \text{ (mm)} = (\text{TL} \cdot 0.108) - 2.02 \quad (r^2 = 0.96) \quad \text{equ. 3.5}$$

$$C. amblyrhynchos: \quad CD \text{ (mm)} = (\text{age} \cdot 0.624) + 7.02 \quad (r^2 = 0.95) \quad \text{equ. 3.6}$$

$$CD \text{ (mm)} = (\text{TL} \cdot 0.119) - 2.40 \quad (r^2 = 0.99) \quad \text{equ. 3.7}$$

Count precision was reasonable for *T. obesus*, with an index of average percent error (IAPE) of 5.86%. The IAPE was much higher for *C. amblyrhynchos* (14.62%), however this reduced to 5.32% when the first-year (0+) cohort was excluded from calculations.

Exclusion of these *C. amblyrhynchos* individuals from IAPE calculations was deemed reasonable as IAPE estimates which include lower age classes are usually inflated due to a higher proportional error (e.g. Simpfendorfer 1993).

3.3.2. Length and weight relationships

Relationships between total length (TL) and other length measurements were calculated to allow comparisons with other studies. These relationships were described by the following equations:

$$T. obesus: \quad TL \text{ (cm)} = (1.183 \cdot PCL) + 10.74 \quad (r^2 = 0.999) \quad \text{equ. 3.8}$$

$$TL \text{ (cm)} = (1.119 \cdot FL) + 7.51 \quad (r^2 = 0.997) \quad \text{equ. 3.9}$$

$$C. amblyrhynchos: \quad TL \text{ (cm)} = (1.287 \cdot PCL) + 6.12 \quad (r^2 = 0.999) \quad \text{equ. 3.10}$$

$$TL \text{ (cm)} = (1.193 \cdot FL) + 4.19 \quad (r^2 = 0.999) \quad \text{equ. 3.11}$$

A positive exponential relationship was present between size and weight for both species (fig. 3.7). When weight increases proportional to length (allometric growth), b ($y = ax^b$), equals 3. However in both species, b was greater than 3, suggesting that weight increased at a faster rate than length. Sex-specific differences in weight with size were not present in either species, allowing the following combined curves to be fitted:

$$T. obesus: \quad \text{total weight} = 4.7 \times 10^{-7} \cdot TL^{3.49} \quad (r^2 = 0.96) \quad \text{equ. 3.12}$$

$$C. amblyrhynchos: \quad \text{total weight} = 1.55 \times 10^{-6} \cdot TL^{3.29} \quad (r^2 = 0.99) \quad \text{equ. 3.13}$$

3.3.3. Validation of growth rings

3.3.3.1. Oxytetracycline validation

In approximately 500 hrs fishing, 10 *T. obesus* and 30 *C. amblyrhynchos* individuals were oxytetracyclined, tagged and released. All other individuals of these species captured were retained for dissection. The decision to release or retain captured sharks was based primarily on size of the animal. Smaller individuals were usually released, especially if they appeared immature. Tagging was undertaken throughout the duration of the study, with the hope that recapture may still occur following thesis submission.

Three *C. amblyrhynchos* individuals were recaptured (10% recapture rate), while tagged *T. obesus* were neither resighted nor recaptured. Although none of the recaptured *C. amblyrhynchos* had been at liberty for more than 10 months, preliminary estimation of band formation periodicity was still possible. Calculated band formation in recaptured *C. amblyrhynchos* ranged from 0.83 years to 1.17 years (fig. 3.8; table 3.4), with an average band periodicity of 0.98 ± 0.10 years. Although a temporal scale of >1 yr at liberty is necessary to be certain of the band periodicity, the results are consistent with a hypothesis of annular deposition of opaque and translucent bands. Two of the recaptured *C. amblyrhynchos* showed growth consistent with annual band deposition, while the third *C. amblyrhynchos* had apparently shrunk by 5 cm while at liberty (table 3.4). This was likely to be due to an error in recording PCL during tagging, rather than an actual decrease in somatic size (table 3.4). All *C. amblyrhynchos* were recaptured within 50 m of their original tagging site.

3.3.3.2. Vertebral edge characterisation

Following the lack of recaptured individuals, edge analysis was undertaken on *T. obesus* to determine the seasonality of vertebral band formation. Of the 126 individuals aged, 33 (26%) were removed due to uncertainties in month of capture (due to commercial trips collecting across calendar months) or ambiguous edge characterisation. Although a small number of individuals were found with opaque vertebral edges throughout the year, a strong temporal pattern in opaque band deposition was evident. Over 66% of individuals with opaque vertebral edges were found between January and April (fig. 3.9). Opaque band deposition therefore appears to occur in the mid- to late Austral summer, with translucent annuli deposited in late winter. The sinusoidal cycle of opaque band deposition makes it highly likely that a single translucent and opaque band is laid down annually in *T. obesus*.

3.4. DISCUSSION

Analysis of vertebral thin sections allowed estimates of *Triaenodon obesus* and *Carcharhinus amblyrhynchos* growth and longevity. Both *T. obesus* and *C. amblyrhynchos* are medium sized carcharhinids, with captured animals not exceeding 156 cm and 170 cm TL, respectively. These values are lower than the commonly found maximum size of both species elsewhere (Compagno 1984), possibly due to truncation of older (larger) individuals through fishing exploitation. Both shark species were slow-growing, increasing by less than 1 m in approximately 20 years on the Great Barrier Reef. Differences in the size composition of commercial and research catches of *T. obesus* were apparent, however the combination of both sampling regimes allowed good representation of all size classes. Both sexes of *C. amblyrhynchos* grew at similar rates,

while extended female growth produced sexually-dimorphic growth patterns in older *T. obesus*. Continued female growth is well documented in other carcharhinids (Cortés 2000, Bishop et al. 2006), possibly as a mechanism to maximise reproductive output through increased litter sizes. The utilisation of this strategy by *T. obesus* will be discussed in the next chapter. As both populations sampled are from an exploited system, it is possible that they may be growing at a faster rate than an unexploited population would (e.g. through density compensation). Unfortunately, investigation of the occurrence or magnitude of such an effect is outside the scope of this study.

A number of growth models were found to fit the size-at-age data for both species. Unconstrained VB growth models (fig. 3.5) were chosen as they fitted well to all free-living age classes (including the *C. amblyrhynchos* 0+ age class as a whole), and allow comparison with other studies. First year (0+) *C. amblyrhynchos* showed the most variation in any age class (fig. 3.5), as their accelerated first year growth rates resulted in a wide size range, depending upon whether they were captured towards the start or the end of their first year. The VB growth models predicted a higher size-at-birth than suggested by the reproductive data (60+ cm for *T. obesus*; 56 cm for *C. amblyrhynchos*; Chapter 4); however, models were not constrained to the reproductive values as this often results in underestimation of the first few years of growth (e.g. Neer et al. 2005, Bishop et al. 2006; appendix 3.2). As the accurate assessment of the size-at-age relationship is crucial for non-aged individuals in Chapter 5, this was unacceptable in this study. Alternative growth models, such as Gompertz or logistic fits, have been argued to be more appropriate for elasmobranch data, as they may produce more biologically-realistic estimates of size-at-age and L_{∞} parameters (Mollet et al. 2002, Carlson & Baremore 2005, Neer et al. 2005). Both Gompertz and logistic models fitted

the data well, yet produced results which were almost identical to the un-constrained VB growth function (appendix 3.3).

Although some of the L_{∞} values estimated by the VB growth models (table 3.2) are much higher than the length of animals captured, this is common in species which maintain continuous growth throughout life (e.g. Choat & Robertson 2002). L_{∞} values which are similar to the maximum lengths obtained occur only in species with more asymptotic growth forms (Simpfendorfer 1993, Choat & Robertson 2002, Conrath et al. 2002). L_{∞} values should therefore never be used as a proxy for the expected maximum size of a species, nor should they be compared across studies without consideration of the shape of the growth curve. Von Bertalanffy growth models with larger-than-possible L_{∞} values are appropriate to use so long as the models accurately describe the size-at-age relationship over the lifespan of the population.

Both *T. obesus* and *C. amblyrhynchos* displayed relatively low initial growth rates; increasing by 38% and 40% of their estimated birth lengths (Chapter 4) in the first year, respectively. Initial growth rates such as these are similar to other medium-sized carcharhinids, such as the night shark (*C. signatus*), which grows 40 - 50% in the first year (Schwartz 1984, Santana & Lessa 2004). The large size at birth of both *T. obesus* and *C. amblyrhynchos* (relative to the size of most reef predators), together with a lack of conspecific predation (Randall 1977, De Crosta et al. 1984, Wetherbee et al. 1997) is likely to reduce the need of these species to grow more rapidly for predator avoidance.

Highly-accelerated initial growth rates are an anti-predation strategy in sharks, usually employed by both small and large shark species. Smaller shark species are inherently

more vulnerable to predation by other shark and fish species (Branstetter 1990). Rapid initial growth of neonate (newborn) pups of these species is therefore crucial to minimise predation losses. Species such as the small Australian sharpnose shark (*Rhizoprionodon taylori*) grow extremely rapidly, increasing by up to 140% of their birth length in the first 12 months (Simpfendorfer 1993). Large shark species such as the blue shark (*Prionace glauca*) and the tiger shark (*Galeocerdo cuvier*) also display rapid initial growth, doubling their length in the first year (Stevens 1975, Cailliet et al. 1983a, Branstetter et al. 1987, Natanson et al. 1999, Wintner & Dudley 2000). High predation levels may also explain the rapid neonate growth in these larger species; however, it is their large, highly-predatory conspecifics which may pose the greatest threat for these newborn individuals (Branstetter 1990).

Both *T. obesus* and *C. amblyrhynchos* increased in weight disproportionately faster than length. For its length, *C. amblyrhynchos* was a heavier and therefore larger shark (fig. 3.7). This species is known to engage in agonistic threat displays to discourage potential predators (Johnson & Nelson 1973, Nelson et al. 1986). It is possible that a larger size may make this species appear more imposing. *Triaenodon obesus* is not known to agonistically threaten other species. It does however, prey upon teleost fishes in reef microhabitats, foraging through crevices and cracks in the reef to prise them out (Randall 1977, Compagno 1990). In this case, a more streamlined morphology would aid fitting through the reef matrix.

Extended female longevities are common in carcharhinids (Lessa & Santana 1998, Lessa et al. 2000, Carlson & Baremore 2003, Santana & Lessa 2004). Reef carcharhinids follow the convention, with both *T. obesus* and *C. amblyrhynchos* females

outliving males. It is possible that *T. obesus* and *C. amblyrhynchos* longevities may exceed than those reported in this study, as the significant levels of fishing on the GBR (Samoilys et al. 2002, Gribble et al. 2005) may have truncated the older individuals from these populations. Larger individuals of both species were sighted on underwater visual transects in no-entry Preservation zones (Chapter 2), suggesting older individuals in the absence of fishing pressure. Unfortunately permit restrictions did not permit the collection of any larger individuals to determine the maximum longevities.

Extirpation of older individuals notwithstanding, the longevity of *C. amblyrhynchos* on the GBR was still markedly higher than that found in previous Hawaiian studies (De Crosta et al. 1984, Radtke & Cailliet 1984). Geographic variation in longevity of up to 8 yrs has been found in the starspotted dogfish (*Mustelus manazo*) in the Pacific Ocean (Yamaguchi et al. 1998), which is similar to the magnitude of difference between Hawaiian and GBR longevity estimates. Whether the differences in longevity between the Hawaiian studies and this study are due to sampling biases, mis-identification of ages, or real differences in the age structure of *C. amblyrhynchos* is unclear. None of the Hawaiian studies validated their findings with recognised techniques. As such it is possible that these studies have under-estimated individual ages. It is worth further investigation of *C. amblyrhynchos* longevity in Hawaii to ascertain the reason for this variation.

The preliminary validation of *C. amblyrhynchos* suggested the annual periodicity of vertebral increments. Similarly, the use of edge analysis strongly suggested annular deposition of bands in *T. obesus*. Like many sharks, *T. obesus* appears to deposit broader opaque bands in summer and narrower bands in winter (Natanson et al. 1995,

Carlson et al. 1999, Carlson & Baremore 2005, Neer & Thompson 2005). It is hoped that future opportunities will allow the re-capture of oxytetracyclined *T. obesus* and further *C. amblyrhynchos*, permitting confirmation of these findings.

The results of this chapter present the first age-based growth and longevity estimates for *T. obesus*. They also show a much greater longevity of *C. amblyrhynchos* than previously estimated. Although the actual longevity of both species may be greater in non-exploited reef systems, the growth curves produced show a good representation of the size-at-age of both species on the Great Barrier Reef. Exploited shark populations may show biases due to gear selectivity, or exhibit accelerated growth rates (Sminkey & Musick 1995); however this cannot be tested here due to the lack of unexploited sharks from this reef system. The index of average percent error for *T. obesus* and *C. amblyrhynchos* was comparable to other carcharhinid studies (Brown & Gruber 1988, Cailliet & Yudin 1990, Natanson & Kohler 1996, Wintner & Cliff 1996, Carlson et al. 1999, Wintner & Dudley 2000, Loefer & Sedberry 2003), suggesting that unstained vertebral thin sections were appropriate structures to estimate reef carcharhinid ages. Independent confirmation from external readers and good relationships between centrum diameter and age confirmed this. Periodicity of band formation was preliminarily validated in *C. amblyrhynchos*, and strongly suggested in *T. obesus*. These results allow the reproductive biology of both species to be investigated from both an age and size perspective. This will be the focus of the next chapter.

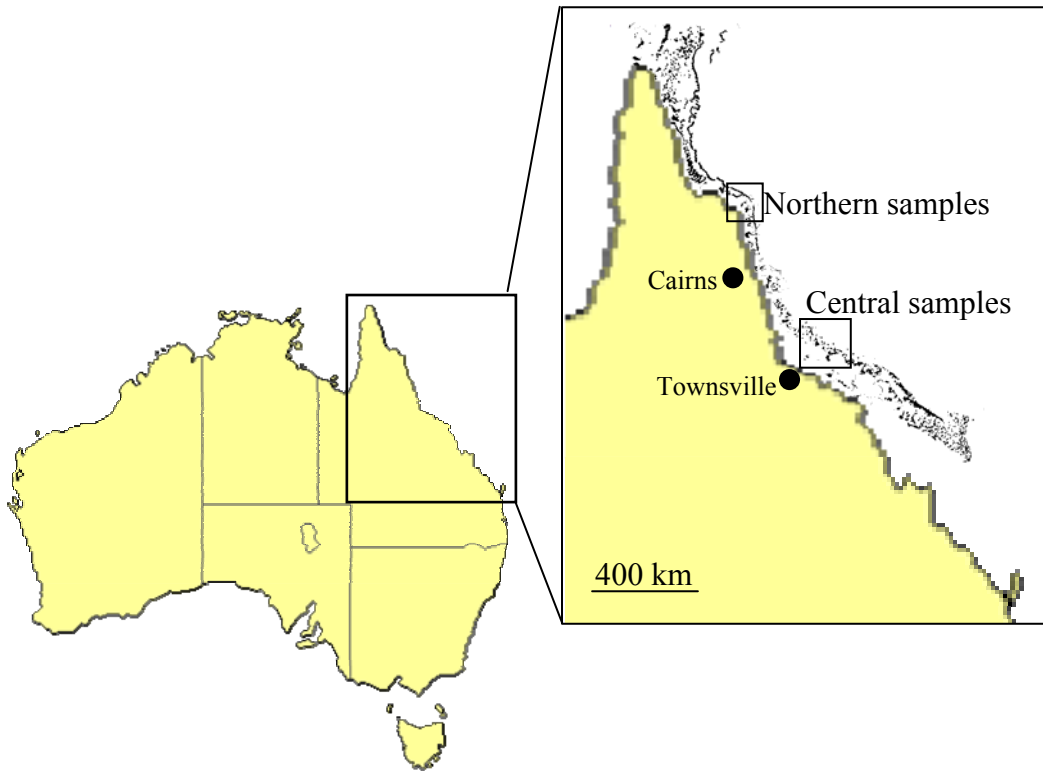

Figure 3.1. Locations of research sampling and commercial fishing bases in the northern and central Great Barrier Reef. Boxes delineate the northern and central sampling areas. Circles represent commercial fishing bases.

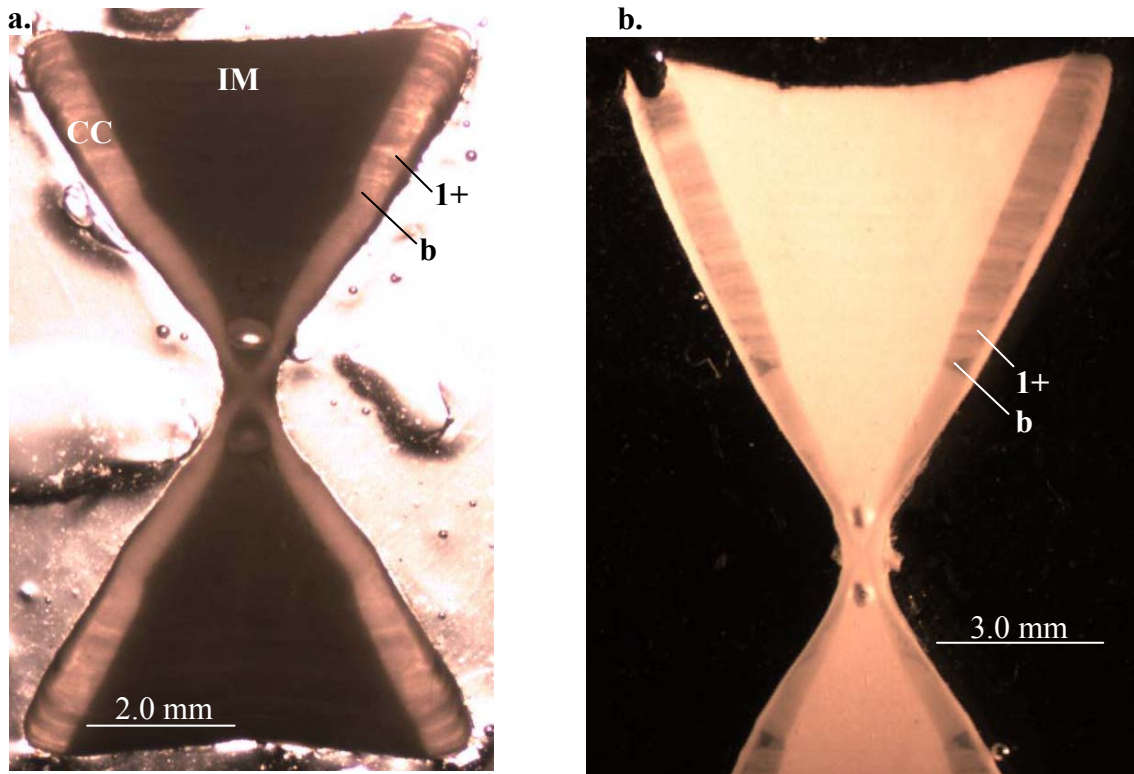

Figure 3.2. Thin sections of a (a) 7+ yr *Triaenodon obesus* and (b) 16+ yr *Carcharhinus amblyrhynchos* vertebrae viewed under transmitted and reflected light, respectively. Concentric broad (summer) and narrow (winter) bands are visible. The position of the first annual band is indicated (1+r), as is the birth ring (b), intermedalia (IM) and corpus calcareum (CC).

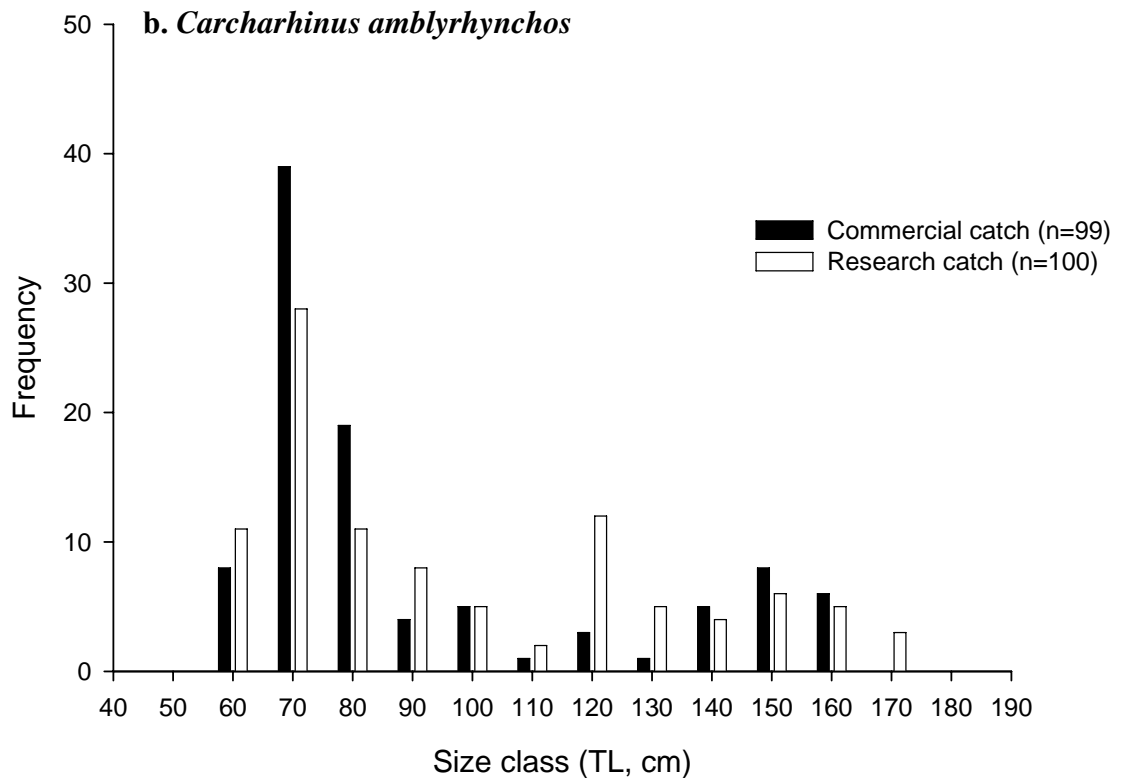
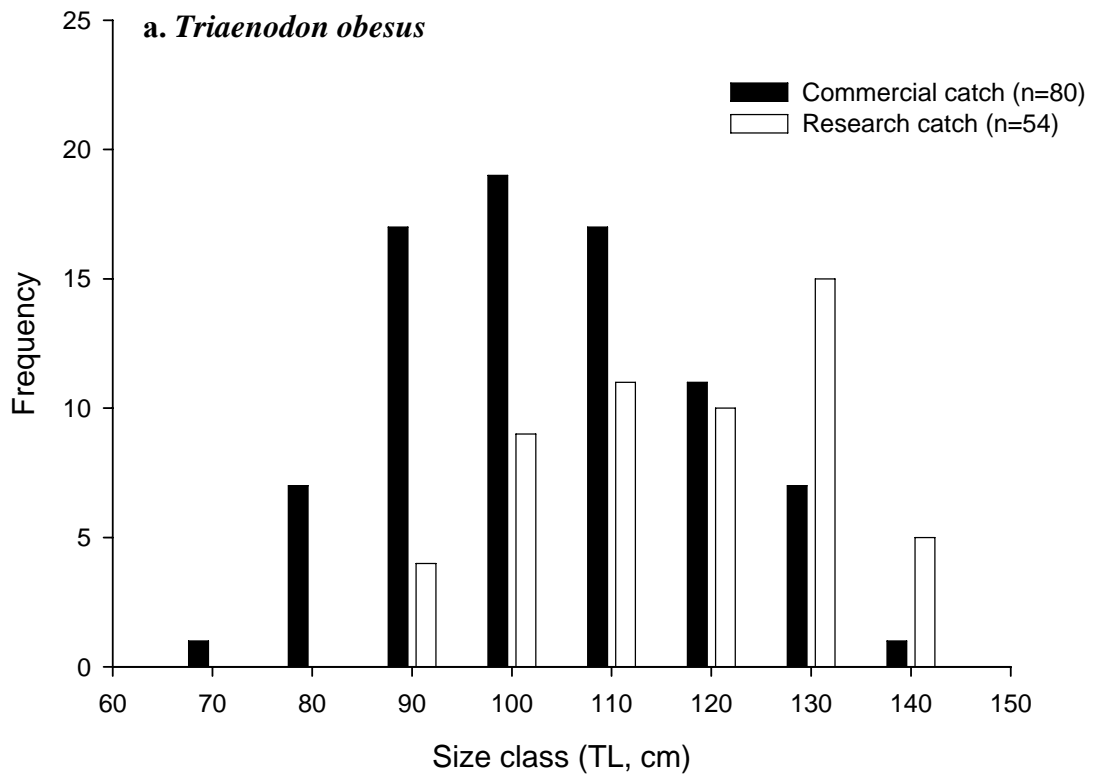

Figure 3.3. Size frequencies of (a) *Triaenodon obesus* and (b) *Carcharhinus amblyrhynchos* commercial and research catches on the Great Barrier Reef.

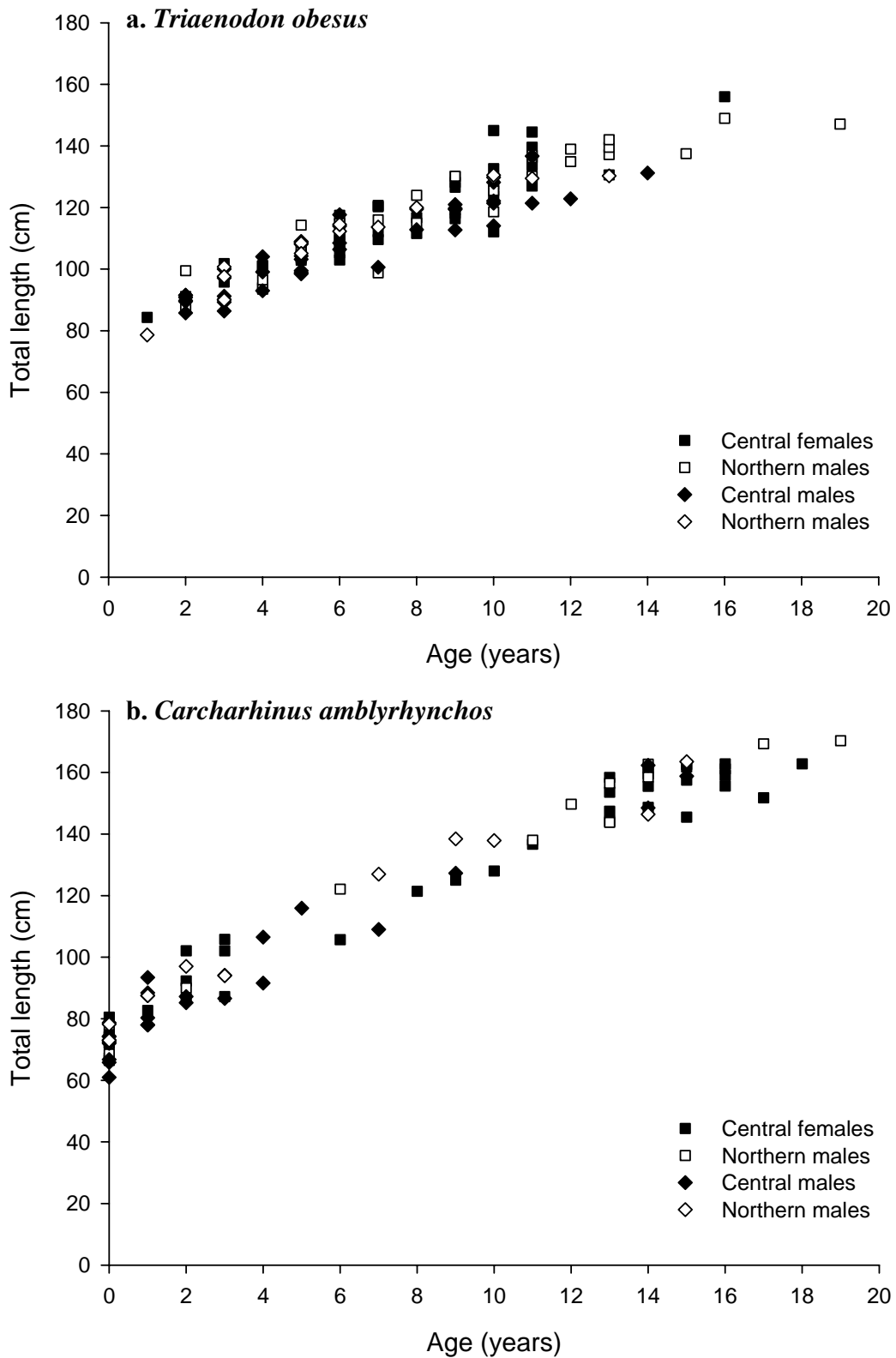

Figure 3.4. Size at age for (a) *Triaenodon obesus* and (b) *Carcharhinus amblyrhynchos* individuals by capture location and sex on the Great Barrier Reef. Two individuals with unknown sexual identity were obtained eviscerated from commercial sources, and are not shown here.

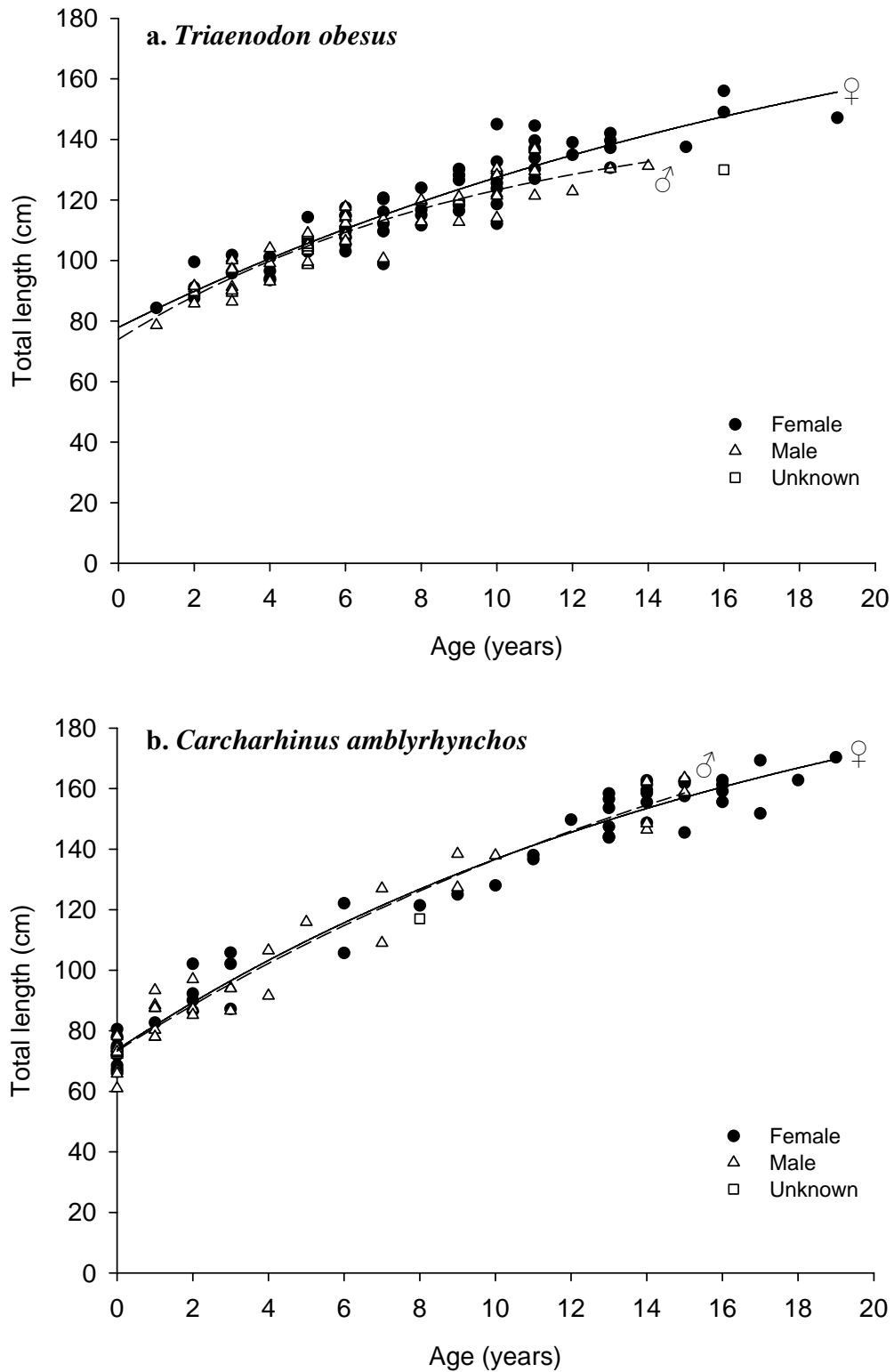

Figure 3.5. Size at age for (a) *Triaenodon obesus* (n=126) and (b) *Carcharhinus amblyrhynchos* (n=89) separated by sex from combined locations on the Great Barrier Reef. Regression lines indicate von Bertalanffy growth functions. Individuals with unknown sexual identity were not included in regressions.

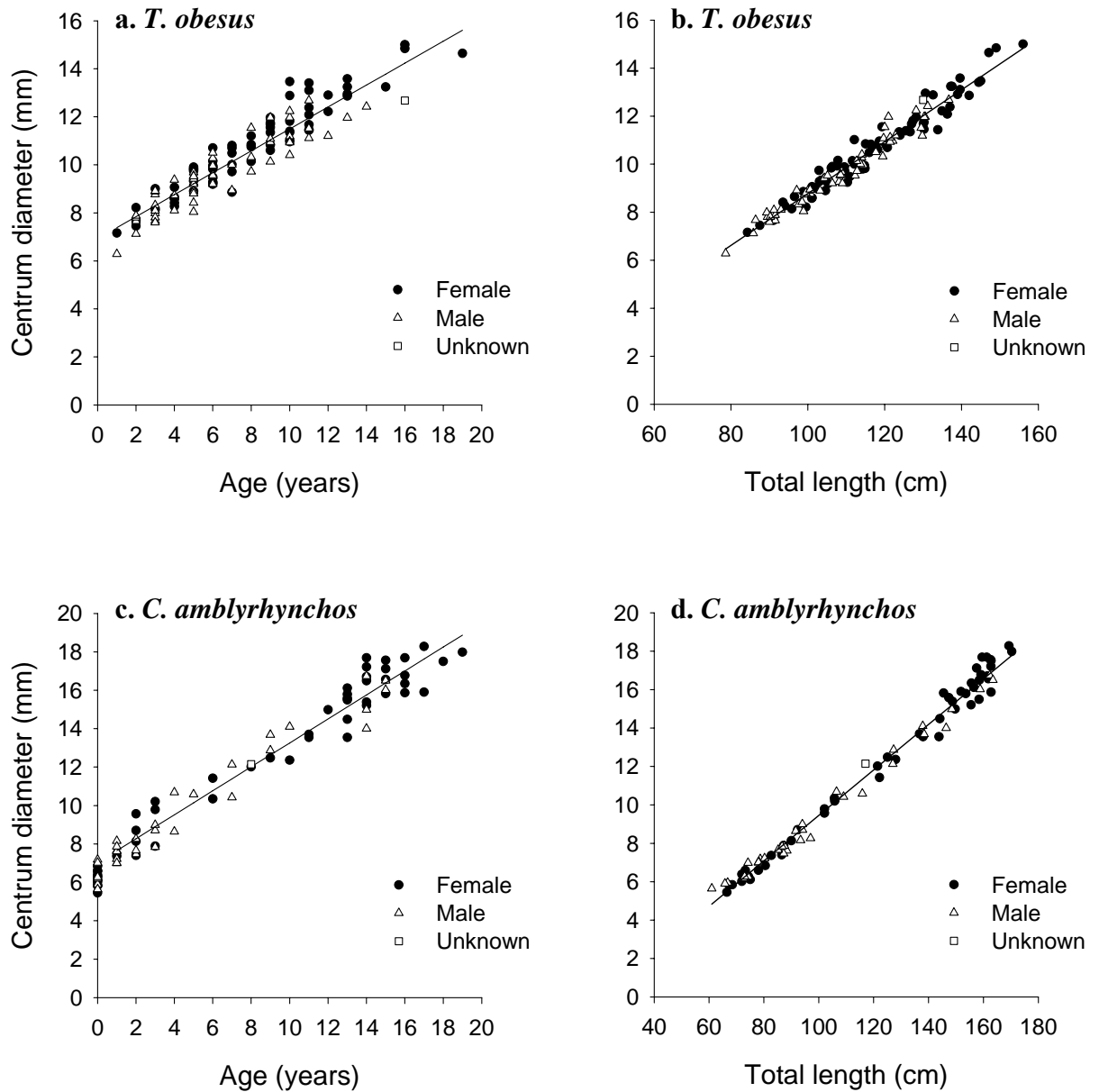

Figure 3.6. Relationship between vertebral centrum diameter and (a) age and (b) size for *Triaenodon obesus*, and (c) age and (d) size for *Carcharhinus amblyrhynchos* from the Great Barrier Reef. Age estimates taken from unstained sectioned vertebral readings. Linear regressions were not fitted to first-year (0+) individuals in plot (c), although all *C. amblyrhynchos* individuals were used in the regression of plot (d). Equ's 3.4 – 3.7 describe the linear regressions fitted.

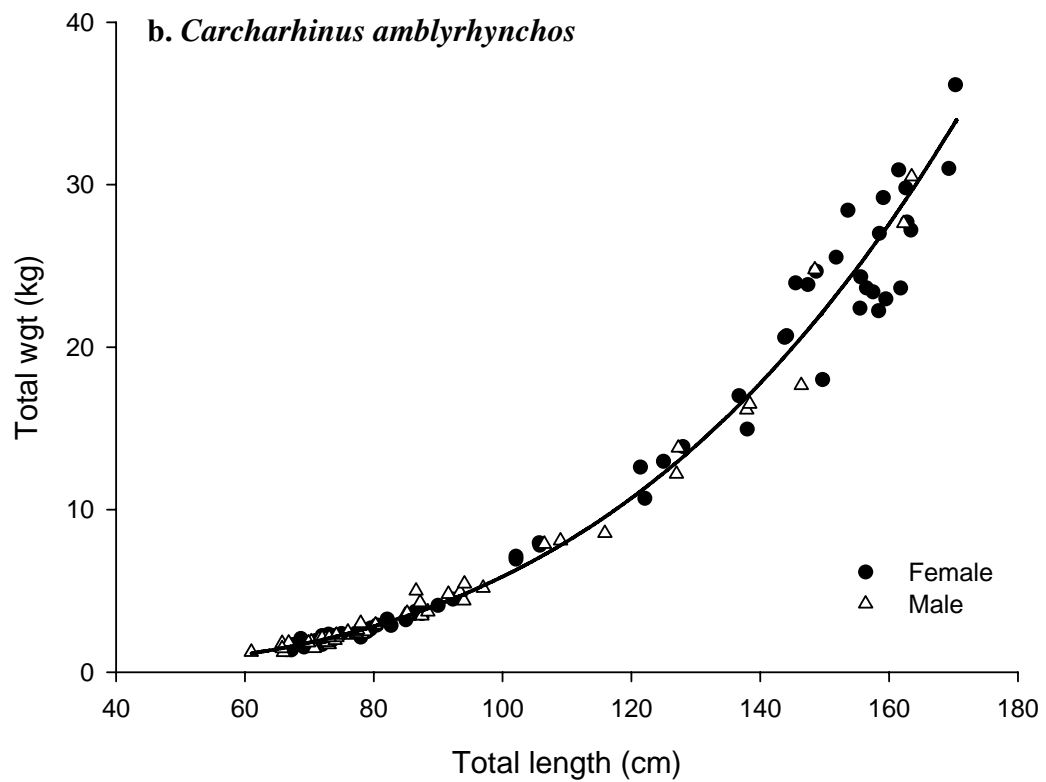
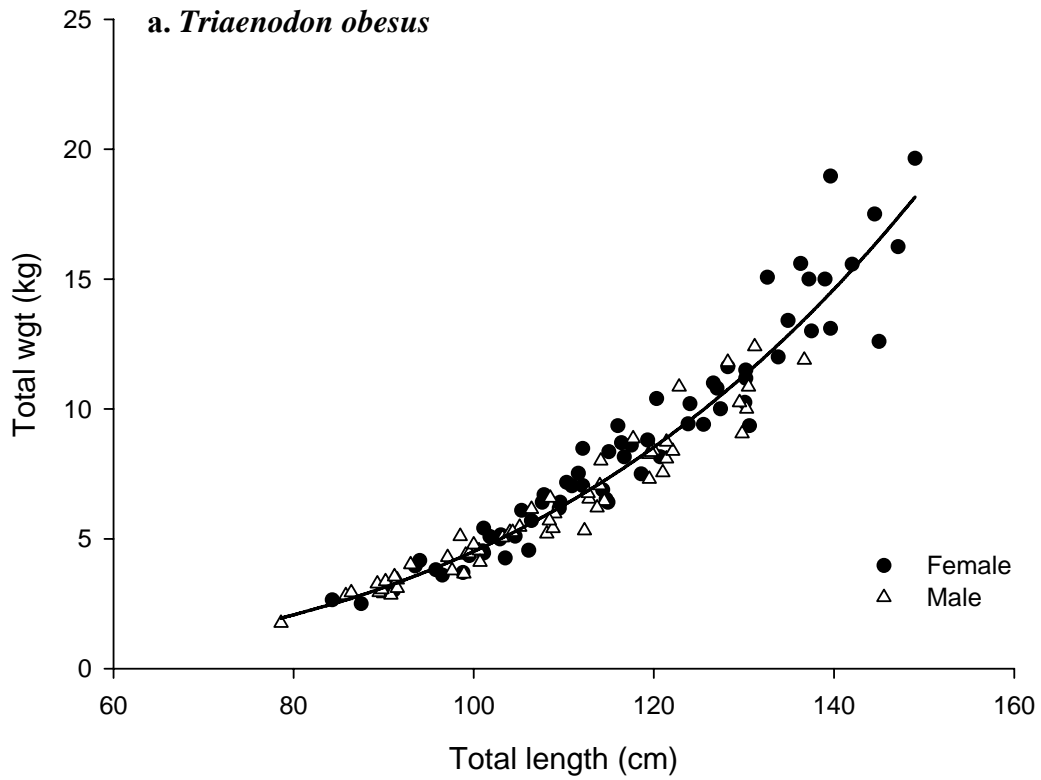

Figure 3.7. Length-weight regressions for (a) *Triaenodon obesus* and (b) *Carcharhinus amblyrhynchos* from the Great Barrier Reef. Individuals with unknown sexual identities not included. Equ's 3.12 and 3.13 describe the exponential curves fitted.

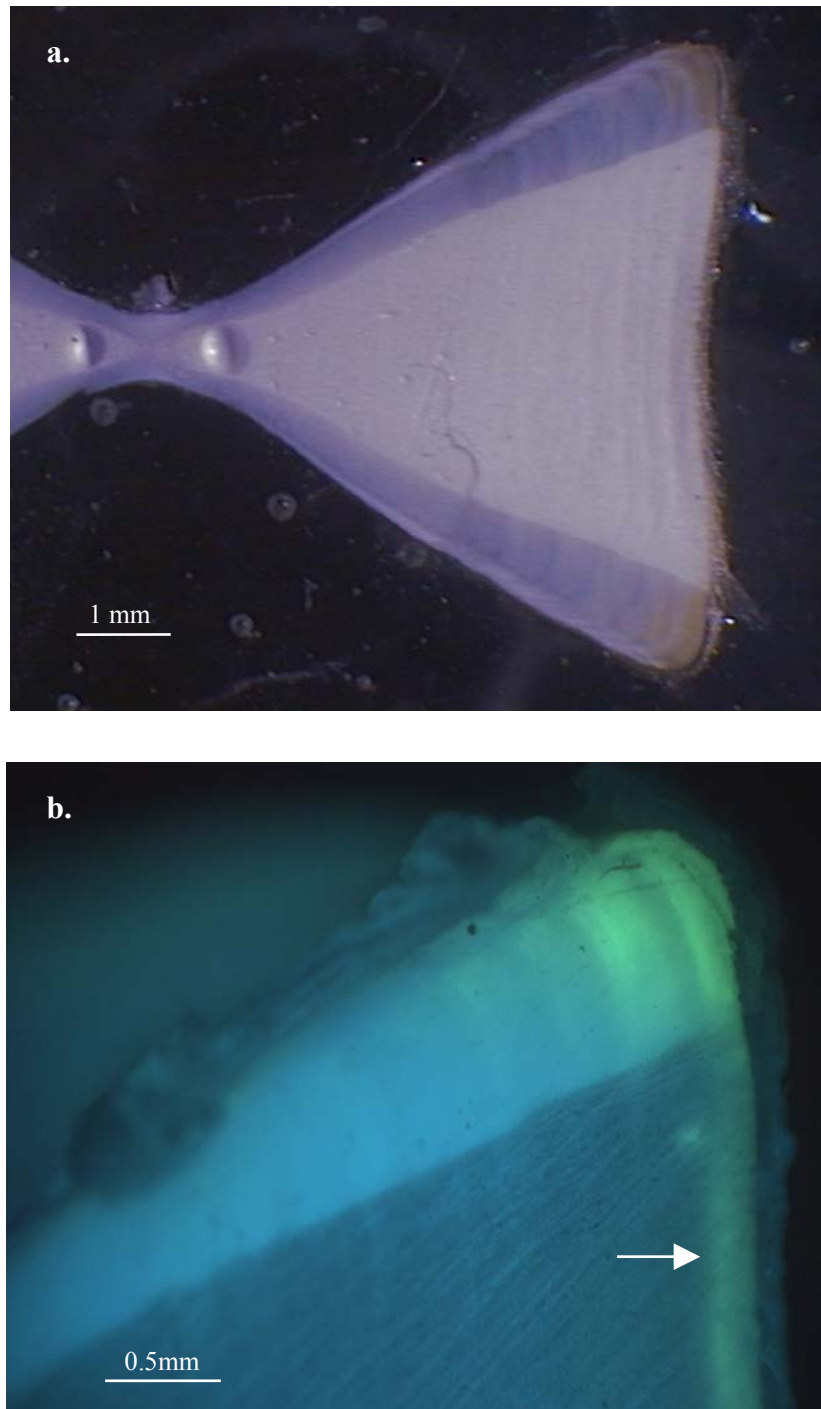

Figure 3.8. Thin section of an oxytetracycline injected *Carcharhinus amblyrhynchus* vertebrae from Cocos (Keeling) Islands viewed under (a) normal reflected light and (b) reflected UV light. Visible is the glowing OTC band (arrow) incorporated into the edge of the vertebrae. Multiple glowing bands appear on the edge due to refraction of light. Photographs courtesy of Corey Green, Primary Industries, Victoria.

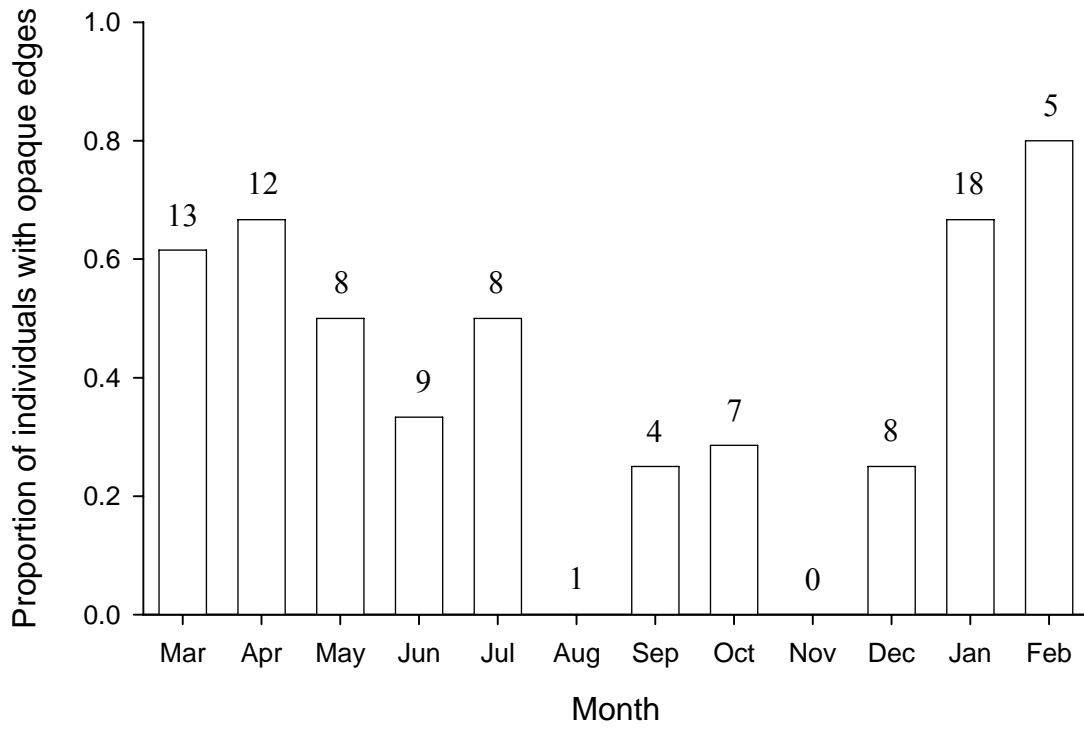

Figure 3.9. Proportion of *Triaenodon obesus* individuals with opaque vertebral edges separated by month. A strong seasonal pattern showing opaque deposition in the mid Austral summer is evident. Numbers indicate sample size per month.

Table 3.1. Residual sum of squares (rSS) for growth functions fitted to *Triaenodon obesus* and *Carcharhinus amblyrhynchos* size at age data. * indicates model with lowest rSS. For both species, the von Bertalanffy growth function (VBGF; equ. 3.2) are within 1% of the model with the lowest rSS.

Growth model	<i>T. obesus</i>	<i>C. amblyrhynchos</i>
VBGF	4338	3277
Logistic	4311*	3369
Schnute	32170	3267*
Exponential	33304	61776
Gompertz	4321	3314
Linear	4884	4257
Power	5723	6972
Power ²	4939	119891
Quadratic	5252	5385
Richards	4321	3314
VBGF (weight based)	4326	3299

Table 3.2. Von Bertalanffy growth parameters fitted to *Triaenodon obesus* and *Carcharhinus amblyrhynchos* from the Great Barrier Reef. L_{∞} in cm; t_0 in years.

Species	L_{∞}	K	t_0	r^2	N
<i>T. obesus</i> female	207.8	0.05	-9.8	0.87	69
<i>T. obesus</i> male	150.9	0.10	-6.6	0.89	56
<i>C. amblyrhynchos</i>	229.2	0.05	-7.51	0.97	89

Table 3.3. Maximum likelihood ratio tests of *Triaenodon obesus* and *Carcharhinus amblyrhynchos* sex-specific von Bertalanffy growth parameters on the Great Barrier Reef. Coincident curve indicates scenario where a single curve is fitted to both sexes; the 3 VB growth parameters indicate scenarios where a single value is shared by both sexes. * indicates significant results ($p < 0.05$). See appendix 3.1 for full parameter estimates. Individuals with unknown sex removed.

		Coincident	L_{∞}	K	t_0
<i>T. obesus</i>	rSS	395755.5	371604.9	369825.5	367630.2
	χ^2	10.31	2.63	2.04	1.32
	df	3	1	1	1
	p	0.02*	0.10	0.15	0.25
<i>C. amblyrhynchos</i>	rSS	292144.6	291783.6	291813.1	291931.3
	χ^2	0.18	0.08	0.09	0.12
	df	3	1	1	1
	p	0.98	0.78	0.77	0.73

Table 3.4. Growth and time at liberty of the three oxytetracyclined *Carcharhinus amblyrhynchos* individuals recaptured during this study. Length and growth in cm; time at liberty in days; calculated band formation in years. The reduction in PCL of the third individual was probably due to measurement error at time of tagging.

Location	Age at recapture	PCL at tagging	PCL at recapture	Growth	Expected growth	Time at liberty	Calculated band formation
Cocos (Keeling)	6	89.3	92.4	3.1	3.8	315	0.83
Lizard Is.	6	87.2	88.2	1.0	1.3	112	1.17
Lizard Is.	1	67.0	62.0	-5.0	2.1	105	0.94

Chapter 4. Reproductive biology of two coral reef carcharhinids

4.1. INTRODUCTION

Elasmobranchs have a reproductive mode characterised by the internal fertilisation of a limited number of large, yolky eggs. Internal fertilisation results in larger, well-developed offspring at birth, and ensures that maternal energy apportioned to reproduction is not wasted through egg predation (Goodwin et al. 2002, Carrier et al. 2004). Internal fertilisation also imposes many physical and metabolic constraints, which reduce reproductive output. Nevertheless, a surprising variety of reproductive specialisations exist among elasmobranchs (sharks and rays). A wide range of variations are found in embryonic development, reproductive size, litter size and breeding periodicity. Variability in these parameters directly impact on the population dynamics of elasmobranch species; hence it is important to understand these parameters.

4.1.1. Elasmobranch embryonic development

Elasmobranch reproduction can be divided into two broad categories, based on the retention or deposition of the egg from the uterus (Wourms 1977, Hamlett & Hysell 1998). Oviparity (external laying of fertilised eggs) is the primitive form of reproduction, and one usually employed by batoids (rays) (Hamlett 1999). Viviparity (the retention of developing eggs within the uterus) is a more modern reproductive strategy, and occurs in approximately 60% of modern shark species (Wourms & Demski 1993). Both reproductive modes result in the birth of fully developed offspring.

The viviparous reproductive mode has been recently redefined, and can now be subdivided into five categories, based on the nutrition source of the developing embryo

(Hamlett et al. 2005). Lecithotrophy is the deriving of embryonic nutrition from the yolk reserves of the egg sac alone, while the other four viviparous categories involve additional nutritional inputs by the mother (matrotrophy). These take the form of uterine secretions (histotrophy); yolky ova ovulated throughout gestation (ovatrophy); sacrificial siblings to be consumed *in utero* (adelphotrophy); and placental transfer (placentatroph), when a direct placental connection is formed with the mother where the yolk sac surface touches the uterine wall (Carrier et al. 2004, Hamlett et al. 2005). Placentatroph occurs predominantly in sharks of the order Carcharhiniformes, with almost every shark from the family Carcharhinidae displaying this trait (Hamlett et al. 2005). The only known exception is the lecithotrophic (and possibly histotrophic) tiger shark, *Galeocerdo cuvier* (Compagno 2001, Hamlett et al. 2005).

4.1.2. Constraints of internal fertilisation

The constraints of internal fertilisation are manifest in many aspects of elasmobranch reproductive biology. Maturity is delayed in both sexes of internally-fertilising species, as females must be much larger than externally-fertilising species; meanwhile males must be of appropriate somatic size to allow the physical act of mating to occur (Klimley 1987). The numbers of eggs most elasmobranchs produce are limited, as their larger size usually requires many months to develop (Carrier et al. 2004). Viviparous species are furthermore limited in the number of gestating pups they can accommodate, both in terms of available uterus volume, and maternal energetics budget. The variations in shark reproduction which occur in response to these constraints will be briefly reviewed here.

4.1.3. Variations in viviparous shark reproduction

4.1.3.1. Age and size of maturity

Most viviparous sharks mature relatively late, at between 60-90% of their maximum size (Holden 1974, Pratt & Casey 1990). Smaller shark species usually mature at a proportionally smaller size, and often produce smaller offspring (Pratt & Casey 1990). Carcharhinid maturity varies from 1 year in the small Australian sharpnose shark (*Rhizoprionodon taylori*) (Simpfendorfer 1993), to at least 20 years for larger carcharhinids such as the dusky shark (*Carcharhinus obscurus*) (Natanson et al. 1995, Simpfendorfer et al. 2002). Delayed maturity may be an adaptive mechanism to decrease the proportion of reproductive individuals lost to predation (Stevens & McLoughlin 1991). Delayed maturity also decreases neonate predation in shark species which produce larger offspring (Branstetter 1990).

Female sharks often mature later, and at a larger size than males (bimaturism) (Branstetter 1981). At least six species of carcharhinid shark display this trait (Branstetter 1987a, Wintner & Cliff 1996, Wintner & Dudley 2000, Driggers et al. 2004b), however an equivalent number also mature at similar sizes (Stevens & McLoughlin 1991, Simpfendorfer 1993, Lessa & Santana 1998, Seki et al. 1998, Lessa et al. 1999b, Lucifora et al. 2005). The variability between sex-specific sizes at maturity within this family highlights the importance of ascertaining the age and size of maturity for both sexes separately, rather than assuming their equality. Size at maturity also varies on a regional scale in many shark species (Branstetter 1987a, Parsons 1993b, Simpfendorfer 1993, Lombardi-Carlson et al. 2003). It is therefore just as important to ascertain the point of maturity in the local populations under investigation.

4.1.3.2. Litter size

Most viviparous sharks mate in discrete breeding seasons, with gestation periods ranging from less than six months up to two years (Compagno 1990, Hamlett 1999, Kajiura et al. 2000). With the exception of a few highly-fecund species, (such as the whale shark, *Rhincodon typus*, (Joung et al. 1996)), the relatively long gestation period, and the physical constraints of retaining young limits offspring production per season. Larger shark species often compensate for this by increasing litter sizes (Cortés 2000, Goodwin et al. 2002); however, this is not always the case. Larger species may instead opt to trade an increased litter size of smaller pups for smaller numbers of larger pups (Branstetter 1990, Pratt & Casey 1990, Compagno 2001).

A strong relationship exists between maximum adult size and maximum litter size in carcharhinid sharks (Simpfendorfer 1992b). Similarly, size-specific correlations with litter size are sometimes found in carcharhinid females reproducing below maximum size. Smaller sharpnose sharks such as *R. taylori* and *R. terraenovae*, as well as larger species such as the sandbar shark (*C. plumbeus*) increase litter size with increasing adult body size (Simpfendorfer 1992b, Joung & Chen 1995, Loefer & Sedberry 2003). However, larger species such as the spinner shark (*C. brevipinna*) and daggernose shark (*Isogomphodon oxyrinchus*) have similar litter sizes, irrespective of female body size (Lessa et al. 1999a, Capape et al. 2003).

4.1.4. Reproductive biology of reef carcharhinids

The reproductive biology of many coastal, pelagic and commercially-targeted carcharhinid species is well known (Stevens & McLoughlin 1991, Simpfendorfer 1992b, Seki et al. 1998, Driggers et al. 2004b, Lucifora et al. 2005). However, many

components of reef carcharhinid biology remain unresolved. For example, the grey reef shark (*C. amblyrhynchos*) is known to have between 2-6 pups, with a 9-12 month gestation period (Tester 1969, Stevens & McLoughlin 1991, Wetherbee et al. 1997). However, the relationship between fecundity and adult size is unknown. As with most carcharhinids (Branstetter 1981), *C. amblyrhynchos* is believed to breed biennially (Wetherbee et al. 1997), yet this has not been formally examined. Importantly, biennial breeding cannot be assumed, as similar-sized carcharhinids such as the blacktip reef shark (*C. melanopterus*) and blacknose shark (*C. acronotus*) breed annually (Schwartz 1984, Hazin et al. 2002, Porcher 2005). The age at maturity of *C. amblyrhynchos* is also unclear, with estimate ranging between 3 and 6-8 years (Compagno 1984, De Crosta et al. 1984, Fourmanoir 1976 (in Wetherbee et al. 1997)). The gestation period of the whitetip reef shark (*Triaenodon obesus*) is known to be at least 5 months (Randall 1977); however, the actual period and frequency of parturition is unknown. Further reproductive characteristics of *T. obesus* have not been investigated, or are based on limited observations (Randall 1977).

The large variability in reproductive traits displayed by the family Carcharhinidae means that the reproductive biology of reef carcharhinids cannot simply be inferred from related taxa. A comprehensive examination of *T. obesus* and *C. amblyrhynchos* reproduction is clearly overdue. With the ages of individuals already determined (Chapter 3), the reproductive characteristics of these two species can be examined from both an age and size perspective. Reproductive parameters which are variable in carcharhinids, yet are necessary for demographic analyses will be the focus of this chapter.

The specific aims of this chapter were:

1. To determine the age and size of *Triaenodon obesus* and *Carcharhinus amblyrhynchos* sexual maturity.
2. To determine the reproductive characteristics of litter size, sex ratio and breeding periodicity of *T. obesus* and *C. amblyrhynchos*.

4.2. METHODS

Reproductive parameters were available from 125 *Triaenodon obesus* and 139 *Carcharhinus amblyrhynchos*. Ages were available for 125 and 89 of these individuals, respectively (Chapter 3).

Male reproductive status was determined through examination of the male external intromittant organs (claspers), and testes development. Sharks were divided into three reproductive categories; immature, maturing and mature (table 4.1). Maturity was determined by measuring clasper length, the degree of calcification and the clasper's ability to freely rotate. To determine whether externally-mature males were capable of producing viable sperm, transverse sections of maturing and mature central testes were cut to 5 μm , and stained with haematoxylin and eosin. The presence of mature sperm was then visually determined using a 40x high power microscope. Transverse cuts were also made across the epididymis of mature male sharks to investigate the presence and seasonality of sperm production.

Female sharks were divided into six categories reproductive categories (table 4.1). Each category was based on uterine condition and oocyte follicle development (Walker 1983, Lenanton et al. 1990). Females were considered immature at stage f1, maturing at stage

f2 and mature at stage f3 or greater. Presence or absence of a vaginal membrane (hymen) was investigated to determine whether prior mating had occurred. Hymen presence was determined by passing a probe through the cloaca and into the posterior uterus.

Ovarian follicles greater than 5 mm diameter were measured to the nearest 0.02 mm with vernier calipers. Follicle condition (yolky (vitellogenic) or pale (non- vitellogenic)) was noted. Developing oocytes were found within follicles in the gonad, and were termed “ova” once ovulated and “eggs” once fertilised. The diameter of uterine eggs were measured similarly to ovarian follicles; however, as uterine eggs are often ovate from passing through the oviducal gland (Castro & Wourms 1993), 6 mm was added to their diameter to adjust for this distortion. This value was chosen by determining the diameter increase of three *T. obesus* uterine eggs when they were squashed spherical. Weight, total length (TL) and sex were recorded of developing embryos (pups) present in the uteri.

The percentage of mature individuals (maturity ogives) was estimated using a first-order logistic regression of maturity against TL and age for both species. Maturity was taken as 50% of the regression maximum. To quantify the uncertainty around the regression, 95% confidence limits were estimated from 10 000 random bootstraps (with replacement) fitted using the statistical package R (Team 2004). The first-order logistic regression used was:

$$p(x) = \left(\frac{1}{1 + e^{-\alpha(x - bx)}} \right) \quad \text{equ. 4.1}$$

where $p(x)$ = proportion of individuals mature at age (or TL) x ;

α = curvature coefficient; and

bx = age (years) or TL (cm) at 50% maturity (inflection point of curve).

No significant relationship was found between litter size and TL, and litter size and age for *T. obesus*. This allowed linear regressions to be fitted to these data. Variations in *C. amblyrhynchos* litter size with age and TL required a four-parameter saturation curve to be fitted to the data. The equation of this curve was:

$$L = 1 + \left(\frac{(c_1 - 1)}{1 + 10^{((c_2 - x) * c_3)}} \right) \quad \text{equ. 4.2}$$

where L = litter size of adult shark;

c_1 - c_3 = saturation indices; and

x = age (years).

4.3. RESULTS

4.3.1. Maturity of male reef sharks

The testes of *Triaenodon obesus* and *Carcharhinus amblyrhynchos* were associated with the anterior surface of the epigonal tissue, in a diametric arrangement typical of carcharhinids (Pratt 1988). Males showed no evidence of mature sperm in immature (stage m1) testes; however, mature sperm was present in the seminiferous follicles closest to the epigonal tissue in both stage late stage m2 and stage m3 individuals (fig. 4.1). Mature sperm was produced in both species while the external intromittant organs

(claspers) were still developing. Hence, it is clasper development rather than gonad development which is the best indication of maturity in these species.

The claspers of *T. obesus* began elongating at approximately 103 cm TL, and were fully elongated once adults reached 116 cm TL (fig. 4.2a). Logistic regressions showed that 50% male maturity was reached between 112-116 cm TL, or 7 yrs (fig. 4.3a-b). At this size, the claspers are approximately 12.4% of the shark's total length. Clasper elongation in *C. amblyrhynchos* males began at approximately 118 cm TL, with 50% male maturity reached at 132-138 cm TL, or 9 yrs (fig. 4.2b; fig. 4.4). The slope of the *C. amblyrhynchos* logistic regression was much steeper than that of *T. obesus*; however, this due in part to a lower sample size around maturity. Clasper length was proportionally smaller in *C. amblyrhynchos* than *T. obesus*, at approximately 8.8% TL. For both species, clasper calcification appeared insufficient to permit penetration until the claspers were fully elongated.

4.3.2. Maturity of female reef sharks

Sixty seven *T. obesus* females and 76 *C. amblyrhynchos* females were categorised according to table 4.1. The majority of females were immature in both species (table 4.2). The females of *T. obesus* and *C. amblyrhynchos* both mature later, and at marginally greater sizes than their male conspecifics. Fifty percent of *T. obesus* females were mature between 114-122 cm TL, or 8 years (fig. 4.5). Fifty percent of *C. amblyrhynchos* females were mature between 130-142 cm TL, or 11 years (fig. 4.6). Similar to the males, the slopes of the *C. amblyrhynchos* regressions were steeper due to a smaller sample of size maturing females. Sixty percent of maturing *T. obesus* females and all maturing *C. amblyrhynchos* females were virginal.

4.3.3. Reproductive parameters of females

4.3.3.1. Oocyte growth

Up to 11 (*T. obesus*) and 20 (*C. amblyrhynchos*) oocyte follicles >5 mm were found in the gonads of each species. Gonad fecundity was higher than uterine fecundity in both species, as not all oocytes were ovulated. No ova were found in transit between the ovary and the uteri, suggesting a rapid transit through the oviducal gland. The maximum diameter of vitellogenic oocytes >5 mm (MOD) revealed a seasonal pattern of growth for both *T. obesus* and *C. amblyrhynchos* (fig. 4.7). *Triaenodon obesus* follicles developed over 5-7 months, with ovulation occurring at approximately 28 mm diameter. *Carcharhinus amblyrhynchos* oocytes were ovulated at approximately 35 mm diameter, following a similar development period. Ovulation was protracted in both species, occurring between October and January in *T. obesus*, and from at least August to October in *C. amblyrhynchos*.

4.3.3.2. Litter sizes

Litter size (fecundity) of *T. obesus* ranged between 1-4 pups per pregnant female (fig. 4.8). *Triaenodon obesus* females produced an average of 2.07 pups per litter, with no significant variation with adult size ($F=0.08$, $p>0.05$) or age ($F=1.76$, $p>0.05$). This is an extremely low level of fecundity for a carcharhinid, and more consistent with species smaller under 1 m (Compagno 1984). A 4-parameter saturation curve gave the best fit to the litter size with size and age of *C. amblyrhynchos* (fig. 4.9). Litter size increased from 1-3 pups in young (13 yr) mature females, to 3-4 pups for all other mature females.

Uterine eggs without visible embryos (stage f4 females) were found in both species during the ovulation season. Additionally, on two occasions, a female *T. obesus* was found with a single pup in one uterus (15 cm and 25 cm TL, respectively), and an unfertilised ovum in the other uterus. This suggested non-fertilisation of the ova, rather than the presence of ovotrophy in this species. A third *T. obesus* female had a non-viable embryo, which had failed to develop past 13 cm TL when its sibling was 50 cm TL (plate 4.1). Incomplete fertilisation was not noted in *C. amblyrhynchos*, nor was any evidence of non-viable embryos.

4.3.3.3. Growth of pups

Embryos (pups) were found in both uteri in both species, with a strong seasonal pattern visible in total length (fig. 4.10). No pups <8 cm TL were identified, due to a lack of pregnant females during early embryonic development. The largest gestating pups found in each species were 60 cm TL (*T. obesus*) and 54 cm TL (*C. amblyrhynchos*), which were found in October. Free-swimming *C. amblyrhynchos* neonates of 61 cm TL were also captured in October. This suggests that size at birth for *C. amblyrhynchos* is 54-61 cm TL, which is similar to the size at birth (~ 63 cm TL), estimated from central northern Australia (Stevens & McLoughlin 1991). Size at birth for *T. obesus* was estimated at 60+ cm TL. Sibling pups were of comparative size for both species, indicating concurrent fertilisation of eggs. A Chi square test showed equal sex ratios of developing pups in both *T. obesus* ($\chi^2=0.03$; d.f=1; p=0.85) and *C. amblyrhynchos* ($\chi^2=0.62$; d.f=1; p=0.43).

4.3.3.4. Gestation and breeding

Triaenodon obesus ovulation occurred between October and early January (fig. 4.7a). No gestating pups were found after October (fig. 4.10a). Therefore, gestation in *T. obesus* was estimated to take place between October/January until the following October (10-12 months). Transverse cuts across the epididymis in male *T. obesus* confirmed the presence of sperm during the ovulation period only (fig. 4.1b). The gestation period of *T. obesus* was corroborated with an aquarium-based pregnancy at the Maui Ocean Center (MOC), Hawaii. Staff at the MOC witnessed a mating event in their tank in August 2002, with parturition of 5 pups occurring 11 months later (John Gorman, unpublished data). The mean size at birth of the MOC's pups (63.7 cm TL \pm 0.5 SE) was similar to that estimated in this study.

The gestation period of *C. amblyrhynchos* was estimated at 12-14 months, beginning in August/October, and continuing until parturition the following October (figs. 4.7b, 4.8b). Breeding seasonality could not be confirmed with male *C. amblyrhynchos*, as sperm was only found in the epididymis of one male captured in late July. This may have been due to difficulties with processing semi-frozen *C. amblyrhynchos* samples, as well as researcher inexperience. Insufficient samples of mature males were available to investigate gonadosomatic indices to determine breeding seasonality, due to degradation of the gonads in many of the male commercial samples. These appeared to be caused by delays between capture and freezing.

With the exception of ovulating (stage f4) females, vitellogenic follicles (>5 mm) were absent in pregnant or post-parturition females of either species. The lack of concurrent ovarian and gestation cycles indicates non-annular breeding in both *T. obesus* and *C.*

amblyrhynchos. Between May and October, all mature females of both species had either vitellogenic follicles or developing pups, indicating a lack of resting year(s) between parturition and successive ovarian cycles. Breeding in both *T. obesus* and *C. amblyrhynchos* is therefore biennial. This was corroborated with 55% of mature *T. obesus* females and 52% of mature *C. amblyrhynchos* females in maternal condition (capable of parturition in the following pupping season) (table 4.2).

4.4. DISCUSSION

Triaenodon obesus and *Carcharhinus amblyrhynchos* on the Great Barrier Reef both share a number of reproductive traits with other carcharhinid species. Bimaturism occurs in both species, as females mature later than their male conspecifics (1-2 yrs), and at slightly larger sizes. Sexual maturity is reached at ~74% and ~80% of maximum size for *T. obesus* and *C. amblyrhynchos*, respectively. This is commonly the case in similar viviparous sharks (Holden 1974, Pratt & Casey 1990). Distinct seasonality was present in the ovarian and gestation cycles of both species, while a lack of synchrony in ovarian and gestation cycles indicated biennial parturition in both species. Although annual breeding has been found in smaller, tropical carcharhinids, such as *Rhizoprionodon taylori* and *R. terraenovae* (Simpfendorfer 1992b, Loefer & Sedberry 2003), the biennial reproductive cycles seen here are more common in carcharhinids (Branstetter 1981, White et al. 2002).

The gestation periods of *T. obesus* and *C. amblyrhynchos* were similar to that of another reef carcharhinid, the blacktip reef shark (*C. melanopterus*) (Porcher 2005).

Carcharhinus melanopterus has a gestation period of 286–305 days, or 9.5-10 months,

however unlike the two study species, *C. melanopterus* appears to breed annually (Lyle 1987, Porcher 2005). *Carcharhinus melanopterus* is smaller than the two study species (Compagno 1984), and as such may not need a “resting” year between parturitions. The extended reproductive cycles of biennially-breeding elasmobranchs such as *T. obesus* and *C. amblyrhynchos* may therefore reflect a greater maternal investment by females in building up energy reserves for follicle production and gestation (Castro 1996). As with a number of shark species (Simpfendorfer 1992b, Jensen et al. 2002, Capape et al. 2004), the timing of *T. obesus* and *C. amblyrhynchos* mating results in parturition around the start of summer. This gives the newborn shark pups (neonates) the most advantageous timing with respect to food resources, allowing them the most rapid growth.

Litter sizes of both *C. amblyrhynchos* and *T. obesus* females were very low (≤ 4 pups), with both species employing different strategies to maximise reproductive output.

Carcharhinus amblyrhynchos females matured later than *T. obesus*, with greater litter sizes for all but the first breeding cycle. Although *T. obesus* females grew larger than their male counterparts (Chapter 3, fig. 3.4a), they maintained similar mean litter sizes (2 pups) throughout their entire reproductive life. However, as reproductive senescence is absent in sharks (Pratt & Casey 1990), the earlier maturity of *T. obesus* females (3 years) allows *T. obesus* an extra breeding season. Females of both species living to the maximum age found (19 years; Chapter 3, fig. 3.4) would therefore produce a similar number of pups over the course of their lifetime (~ 12). The differences in these strategies may exist due to the smaller, slimmer morphology of *T. obesus*, which may limit litter sizes more than the larger *C. amblyrhynchos*. Litter sizes of *C. amblyrhynchos* found in this study (1-4 pups) were comparable to Hawaiian populations

(3-6) (Wass 1971, Wetherbee et al. 1997), and those previously observed in northern Australian waters (2-3) (Stevens & McLoughlin 1991). The low levels of reproductive output for both species suggest the natural mortality rates must also be low.

Sex determination of offspring appeared to be randomly selected in both species. No significant differences were found in the sex ratios of developing embryos, which is commonly noted in carcharhinid sharks (Wass 1971, Joung & Chen 1995, Garayzar 1996, Capape et al. 2003). Although embryonic diapause has been cited for one carcharhinid species, *R. taylori* (Simpfendorfer 1992b), there was no evidence of this occurring in either study species.

Similar to other carcharhinid species (Branstetter 1987a, Hazin et al. 2000), gonad development preceded external reproductive development. Clasper length and calcification were therefore found to be the most accurate assessment of male reef shark maturity. Size at maturity of *C. amblyrhynchos* males was similar to previous estimates; however, females matured 13 cm TL larger in this study when compared to Hawaiian counterparts (Wetherbee et al. 1997). Subsequently, the age of female maturity (11 yrs) was also later than previous *C. amblyrhynchos* estimates (3-8 years; De Crosta et al. (1984), Fourmanoir 1976 (in Wetherbee et al. 1997)). Variations in age at maturity have been observed between locations for other shark species (Branstetter 1987a, Parsons 1993b, Simpfendorfer 1993, Lombardi-Carlson et al. 2003). The variations found here may be indicative of different growth and demographic rates between the Great Barrier Reef and Hawaii.

In both species, oocytes were ovulated from a single functional ovary into both uteri. The primitive elasmobranch condition is paired ovaries, while it is the right ovary which is functional in most *Carcharhinus* species (Dodd et al. 1983, Carrier et al. 2004). Interestingly, the functional ovary was on the right in *C. amblyrhynchos*; however, the left ovary was functional in *T. obesus*. The reason for this difference is not apparent from this study. Irrespective of the ovary used, ova were transferred to both uteri in both species.

The results from this chapter show that *T. obesus* and *C. amblyrhynchos* share reproductive characteristics such as gestation periodicity and biennial breeding. However, differences in litter size as well as size and age at maturity warrant their reproductive biology to be treated separately. The successful characterisation of each species' reproductive biology on the Great Barrier Reef will enable the demography of each population to be calculated. This will be the focus of the next chapter.

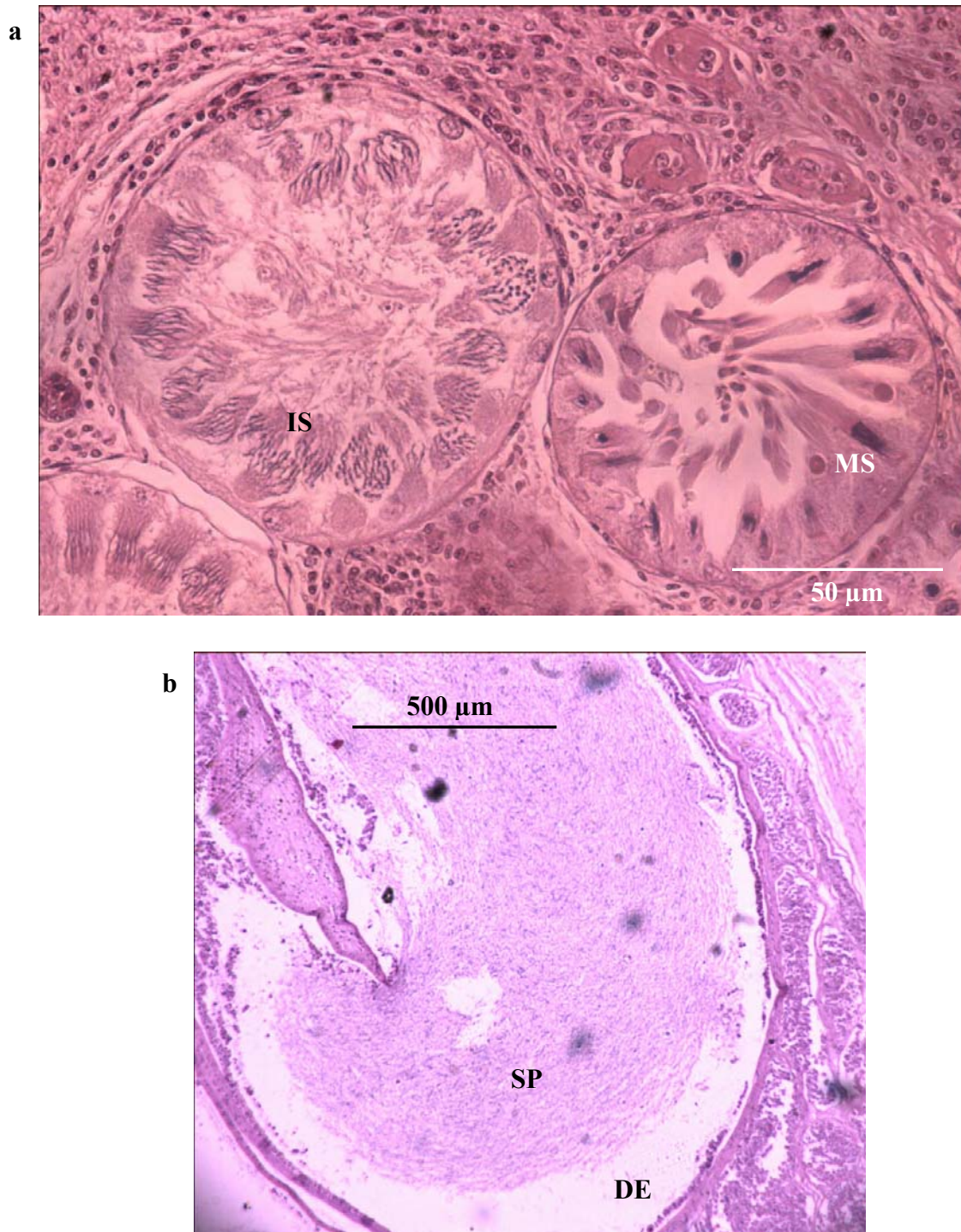

Figure 4.1. (a) Transverse section of two maturing (stage m2) *Triaenodon obesus* seminiferous follicles. Visible are both immature (IS) and mature (MS) spermatozoa arranged in bundles around the periphery of the follicle. (b) Transverse section of a mature *T. obesus* anterior epididymis, with loose, mature sperm (SP) inside the ductus efferens (DE).

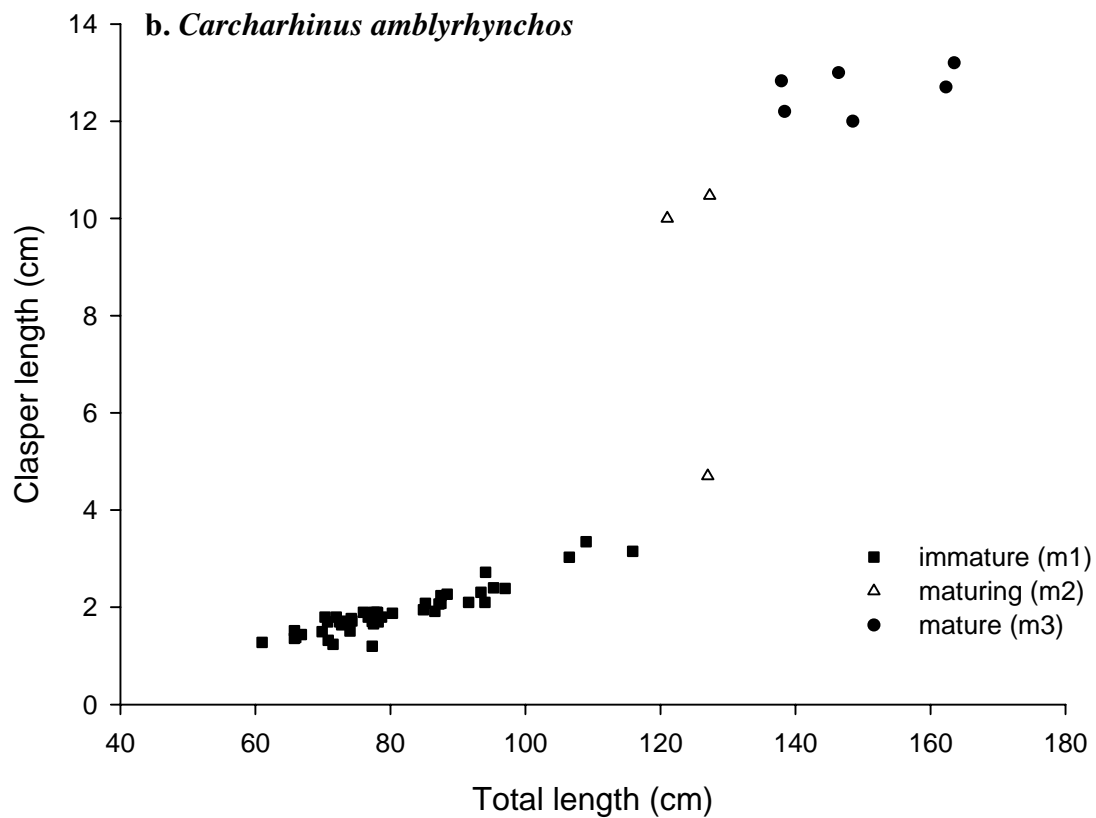
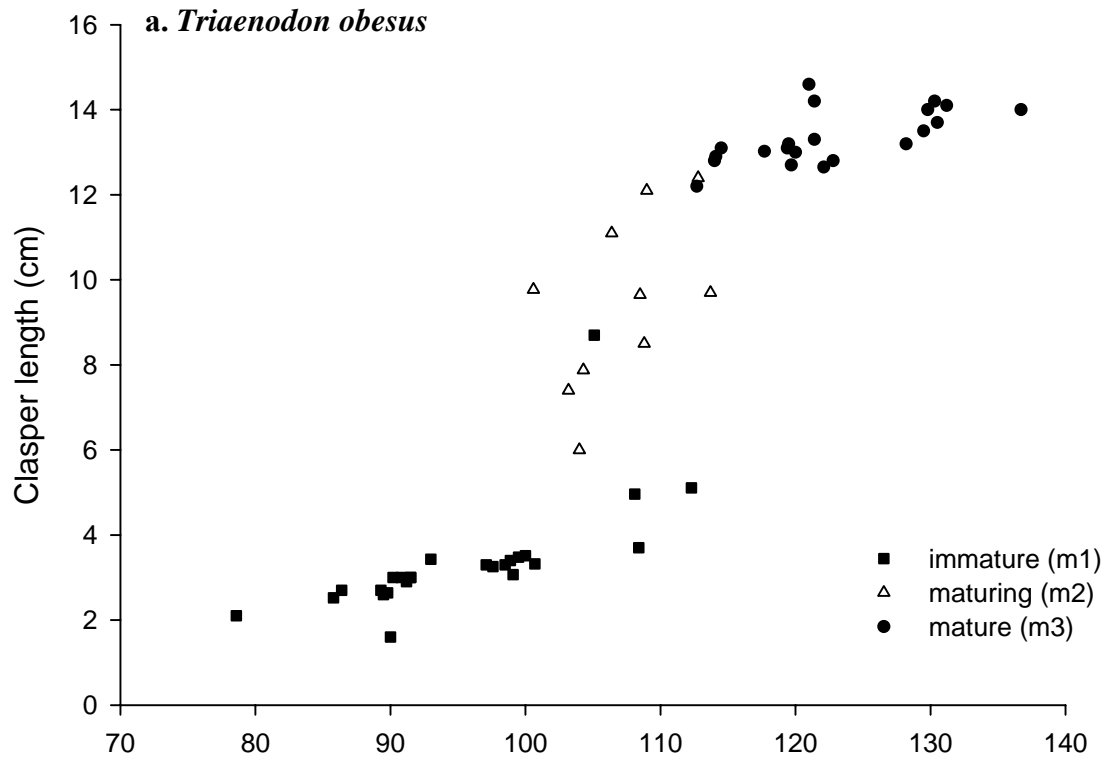

Figure 4.2. Relationships between clasper length and adult size for (a) *Triaenodon obesus* and (b) *Carcharhinus amblyrhynchos* males. Individuals have been grouped into three maturity stages (m1-m3).

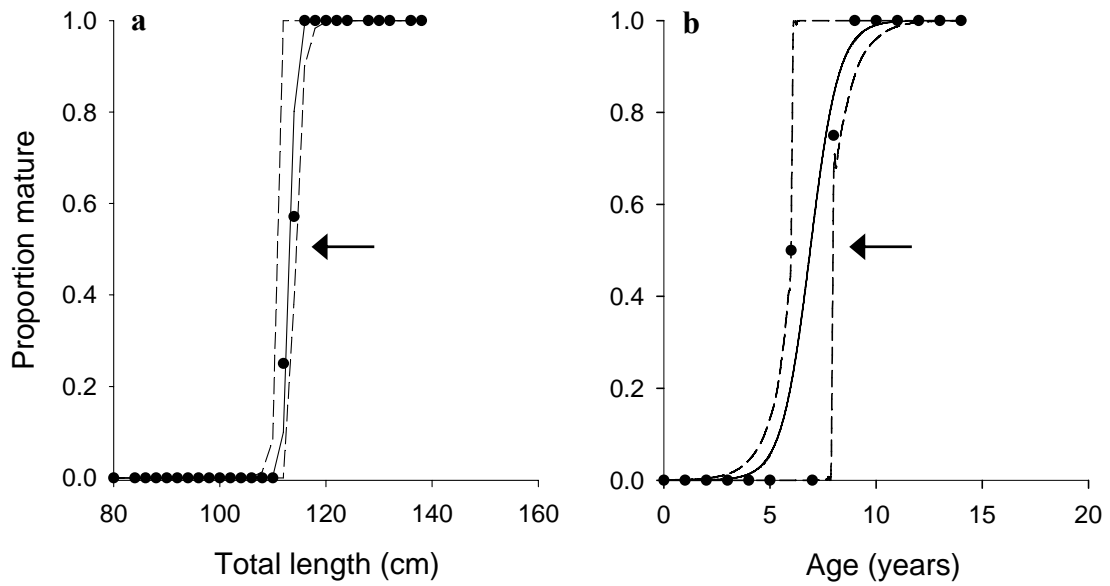

Figure 4.3. Proportion of mature *Triaenodon obesus* males based on (a) total length and (b) age. Solid line indicates logistic regression; dashed lines are 95% confidence limits. Arrows indicate 50% maturity.

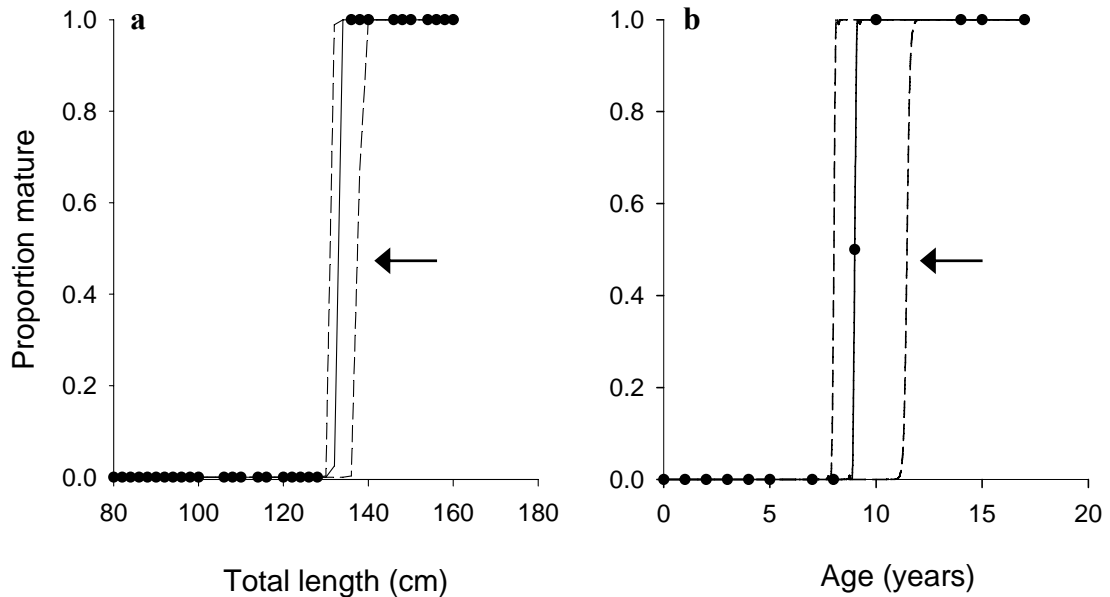

Figure 4.4. Proportion of mature *Carcharhinus amblyrhynchos* males based on (a) total length and (b) age. Solid line indicates logistic regression; dashed lines indicate 95% confidence limits. Arrows indicate 50% maturity.

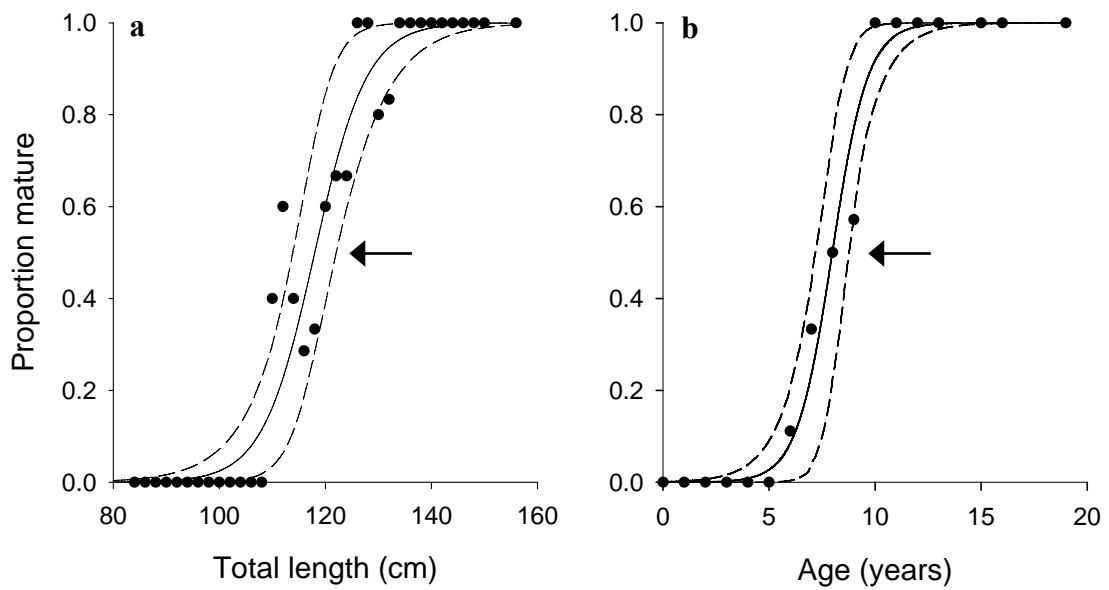

Figure 4.5. Proportion of mature *Triaenodon obesus* females based on (a) total length and (b) age. Solid line indicates logistic regression; dashed lines indicate 95% confidence limits. Arrows indicate 50% maturity.

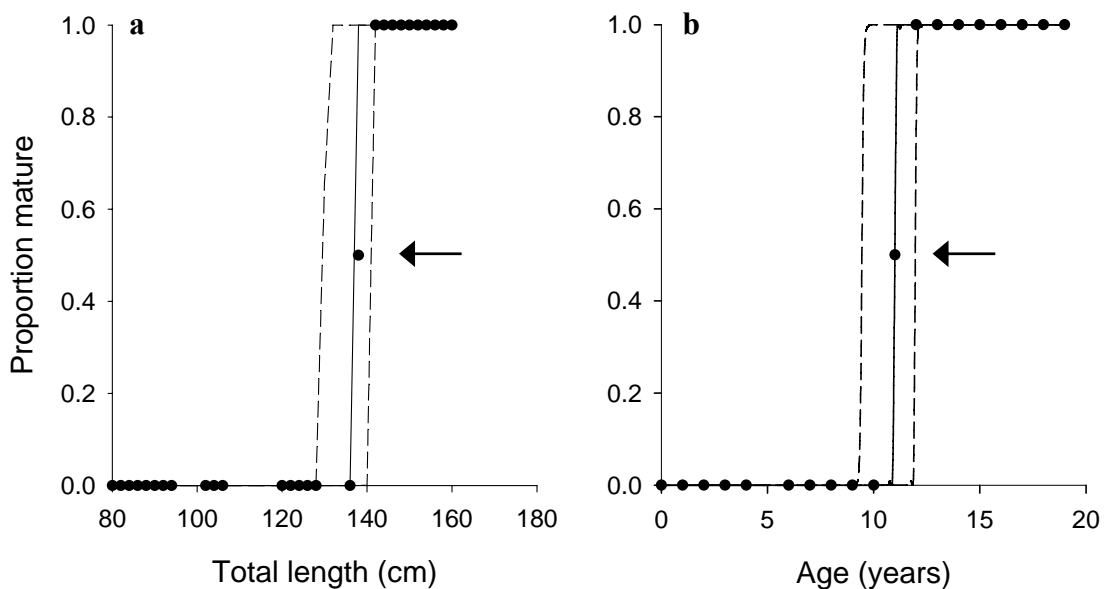

Figure 4.6. Proportion of mature *Carcharhinus amblyrhynchos* females based on (a) total length and (b) age. Solid line indicates logistic regression; dashed lines indicate 95% confidence limits. Arrows indicate 50% maturity.

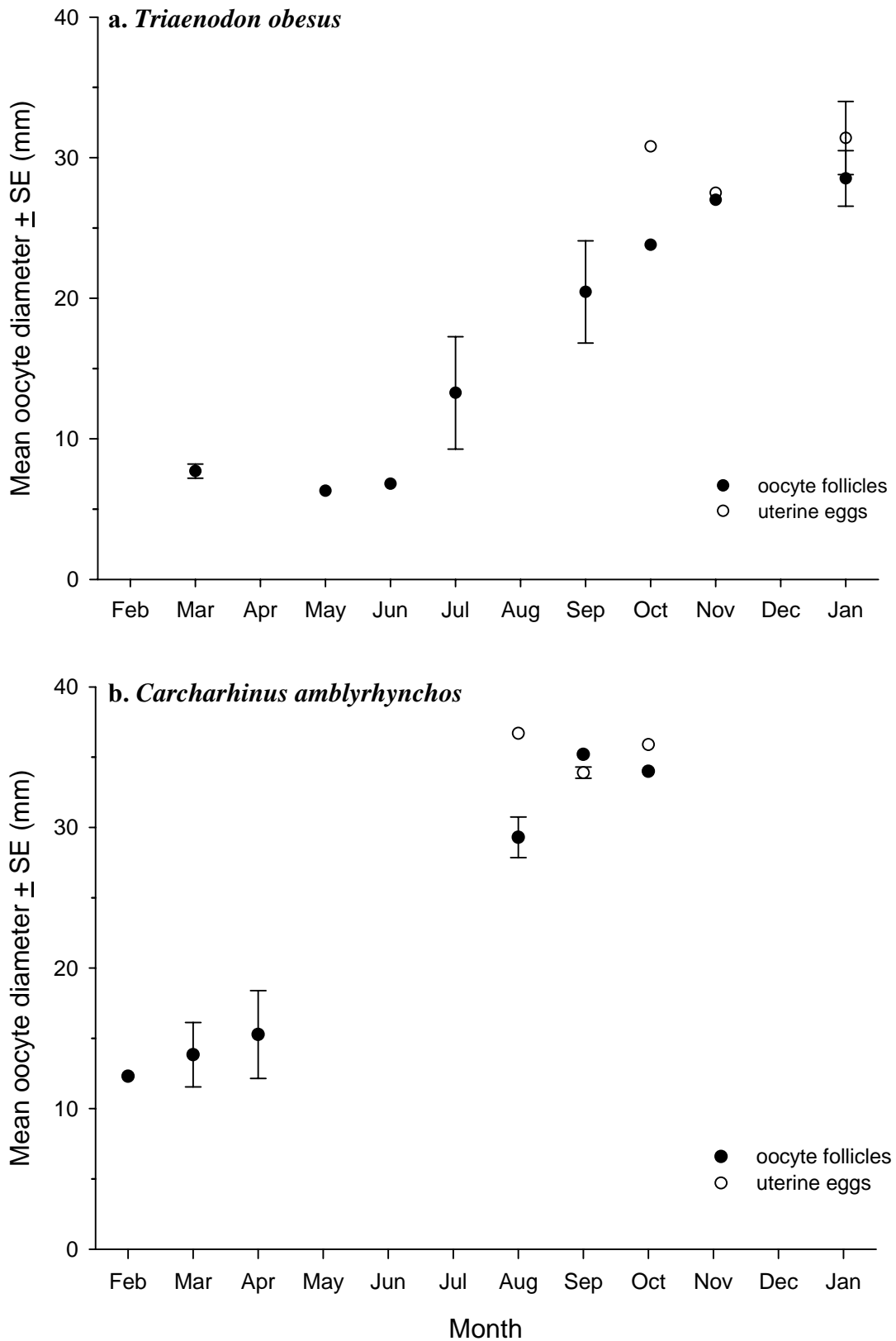

Figure 4.7. Mean maximum oocyte diameter (MOD) in (a) *Triaenodon obesus* and (b) *Carcharhinus amblyrhynchos* with month of capture (solid circles). Also indicated are uterine eggs without obvious pups attached (open circles). Months are offset for clarity.

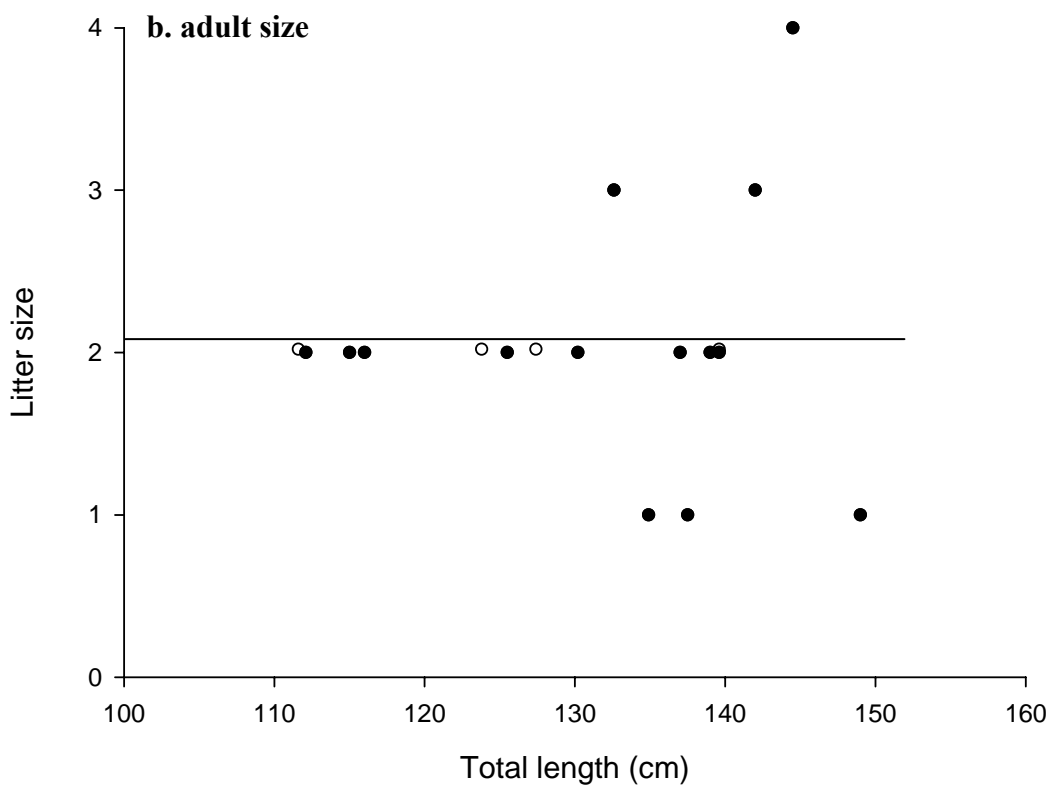
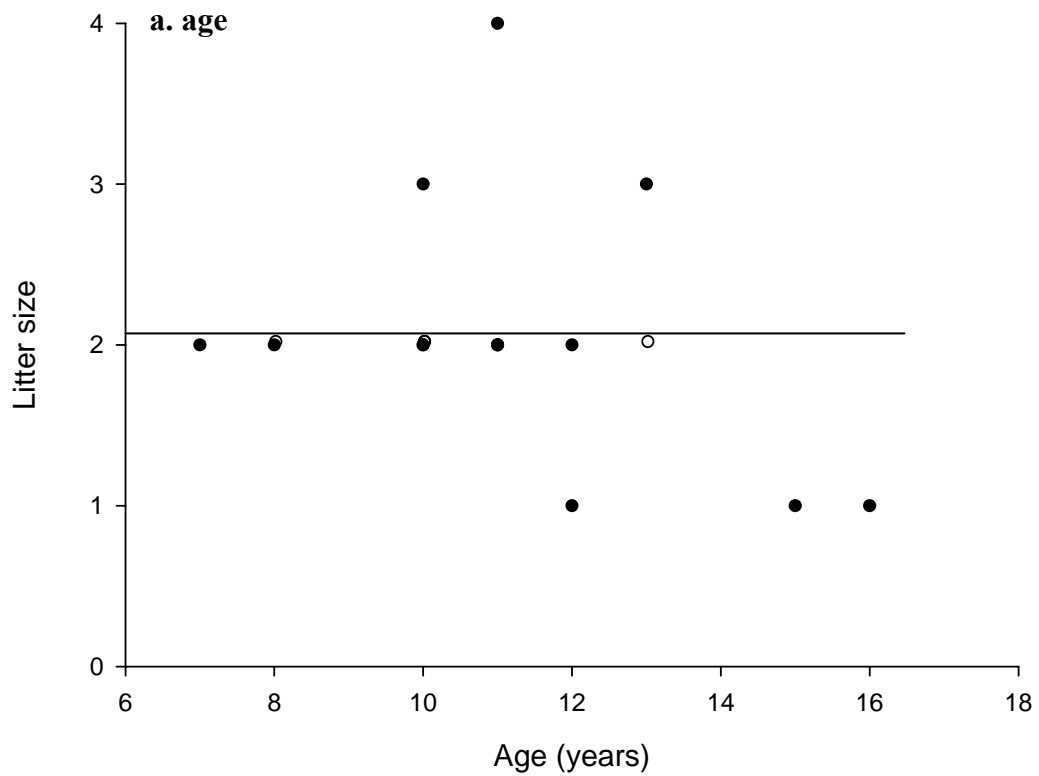

Figure 4.8. Litter sizes (closed circles) of *Triaenodon obesus* with (a) age and (b) adult size. Also indicated are uterine egg numbers without visible pups (open circles). Regression lines indicate average litter size (2.07), fitted to pup data only.

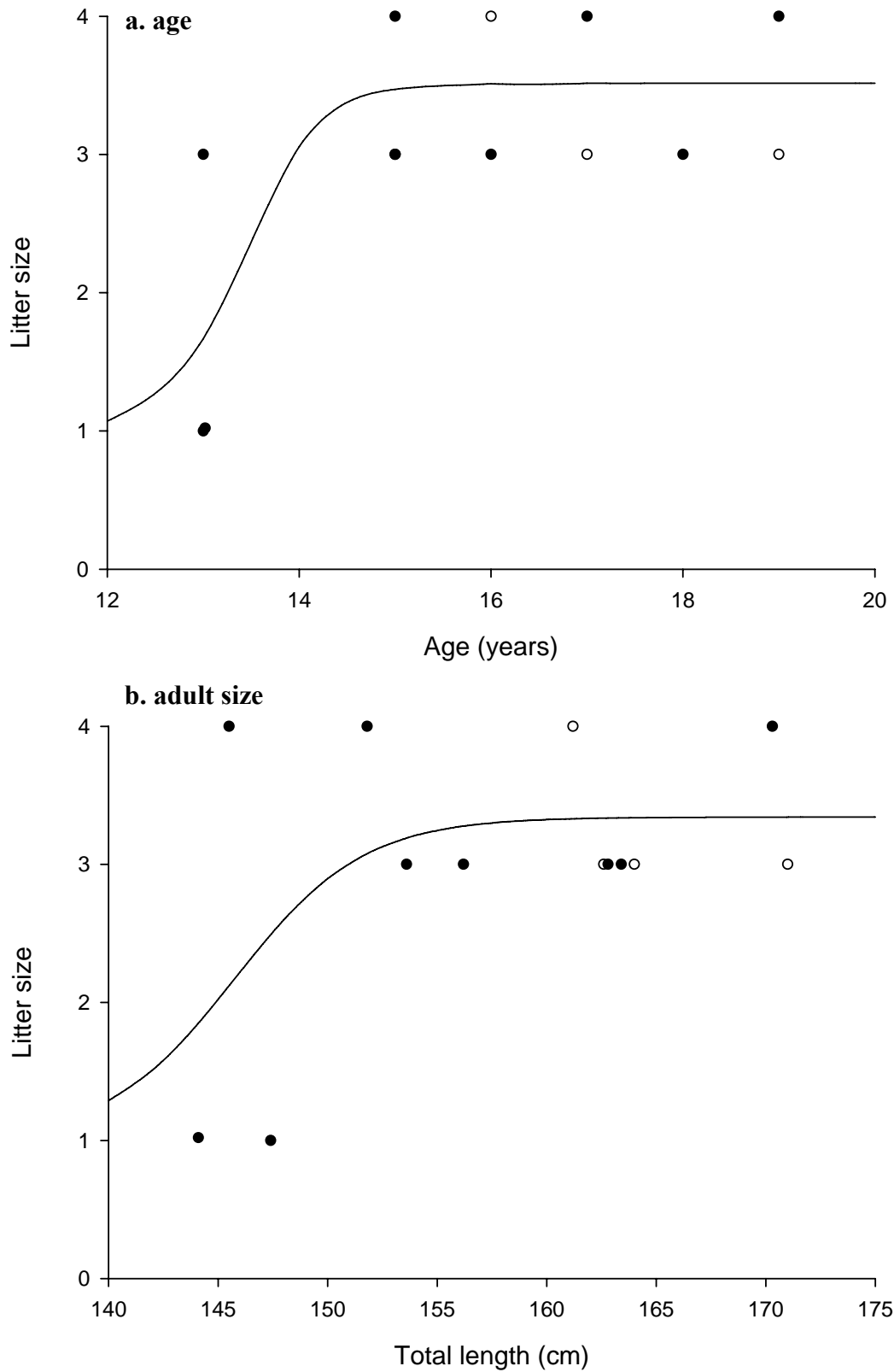

Figure 4.9. Litter sizes (closed circles) of *Carcharhinus amblyrhynchos* with (a) age and (b) adult size. Also indicated are uterine egg numbers without visible pups (open circles). Four-parameter saturation curves fitted to pup data only.

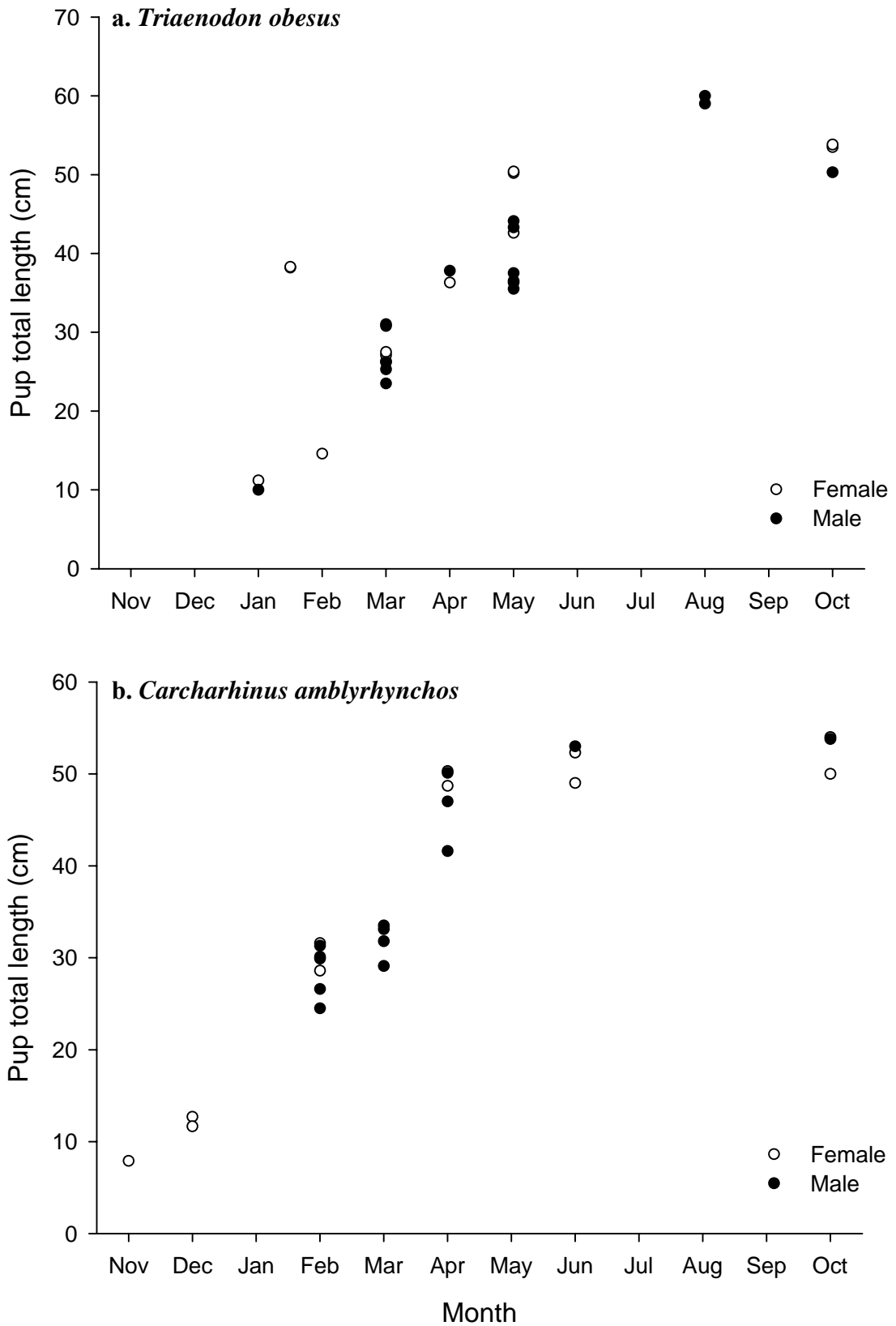

Figure 4.10. Size at month for developing (a) *Triaenodon obesus* and (b) *Carcharhinus amblyrhynchos* pups. Open circles indicate female pups, closed circles indicate male pups. Months are offset for clarity.

Table 4.1. Parameters used to macroscopically characterise the reproductive status of sharks investigated in this study. Female maturity was based on Walker (1983) and Lenanton et al. (1990). Male maturity was based on Francis & Maolagain (2000).

Sex	Reproductive stage	Maturity	Reproductive characteristics
Male	m1	Immature	Testes very thin along entire length. Claspers small and uncalcified.
	m2	Maturing	Testes thickening. Claspers elongated, but not fully calcified.
	m3	Mature	Testes thick along entire length. Claspers fully calcified and elongated. Claspers able to freely rotate.
Female	f1	Immature	Uterus thin along entire length. Uterus empty.
	f2	Maturing	Uterus enlarged posteriorly. Uterus empty. Ovarian follicles <5 mm diameter
	f3	Mature	Uterus enlarged along whole length. Uterus empty. Ovarian follicles >5 mm diameter may be present.
	f4	Mature	Uterus containing yolky eggs. No embryos visible on eggs.
	f5	Mature	Pregnant. Uterus with visible embryos.
	f6	Mature	Uterus large and flaccid. Post-partum.

Table 4.2. Number of *Triaenodon obesus* and *Carcharhinus amblyrhynchus* females found in each reproductive stage. Stages f1 and f2 are immature, f3-f6 are mature. Maternal individuals were defined as those capable of giving birth in the next parturition season.

Maturity stage	<i>Triaenodon obesus</i>	<i>Carcharhinus amblyrhynchus</i>
f1	19	45
f2	15	4
f3	15	13
f4	4	2
f5	14	9
f6	0	3
Total	67	76
% mature (f3-f6)	49.3%	35.5%
% maternal (f4-f6/f3-f6)	54.5%	51.9%



Plate 4.1. Undeveloped 13 cm TL embryo found in the right uterus of a 135 cm TL *Triaenodon obesus*. Its sibling was a normally-developed 50 cm TL male in the left uterus. Scale of tape measure in cm.

Chapter 5. Demography of two coral reef carcharhinids on the Great Barrier Reef

5.1. INTRODUCTION

Many aspects of shark biology contribute to their vulnerability to fishing mortality. The dominant demographic features of sharks include slow growth, late maturities, long gestation periods and low fecundities (Holden 1974, Hoenig & Gruber 1990, Pratt & Casey 1990, Musick 1999, Stevens et al. 2000). These features are a direct consequence of internal fertilisation, and place considerable constraints on reproductive output. Most shark species are also apex predators (Compagno 1984); and as such, are often relatively rare in marine ecosystems (Chapter 2). Furthermore, as predators with highly developed sensory systems (Myrberg 2001), sharks are also efficient at rapidly locating and consuming food items, including baited hooks.

Reef sharks are caught in large numbers through both commercial and recreational fisheries. Two thirds of the Queensland commercial shark catch (net and line) is taken from within the Great Barrier Reef (Gribble et al. 2005). Commercial net and line shark catches on the GBR totalled 1 250 tons in 2003; a 4-fold increase from 1994 (Gribble et al. 2005). Reef sharks may contribute around 7% of this total in net fisheries (Rose et al. 2003), with an unknown contribution to the line catch. Recreational shark catch also occurs in offshore waters throughout Australia (Henry & Lyle 2003). Many Queensland offshore areas include coral reef; and as anecdotal evidence suggests that few sharks recreationally caught are returned to the water alive, it is reasonable to assume that recreational line fishing also contributes significant levels of mortality to reef sharks. The significant effect which fishing pressure exerts on shark abundances (Chapter 2), coupled with the trend of increasing fishing pressure on coral reef shark species, and the

current ignorance of reef shark demography and population status (Nageon de Lestang 1999, Swamy 1999, Chin May 2005) suggests an assessment of reef shark population status is an urgent priority on the GBR.

5.1.1. Population modelling

Predation, senescence and disease are the primary causes of natural mortality in biological populations. Without the effects of hunting or fishing, it is this rate of mortality, together with the rates of birth, immigration and emigration, which dictates a population's growth (Krebs 1994). Although external mortality pressure such as fishing may indirectly decrease juvenile mortality rates (through removal of predatory adults) (Musick et al. 1993, Walker 1998), the most obvious effect of external mortality is to increase the total mortality within a population (Beverton & Holt 1965). This invariably leads to decreased population growth, or in severe cases, population decline.

Investigations of the demographic circumstances which lead to population declines are an urgent research priority for groups of fish with life histories which expose them to such risk (e.g. sharks).

Knowledge of how a fished population responds to additional mortality is crucial for the effective management of shark resources. Two groups of models available to investigate shark population status are dynamic fishery models, which rely on time series data such as fishing effort and catch rates to predict stock changes (Punt & Walker 1998); and demographic models, which are based on life history (vital rate) parameters (Krebs 1994). Most traditional fisheries models have been developed for teleost fishes, and often over-estimate the lower productivity of many shark species (Anderson 1990). Demographic models however, often provide a more appropriate choice to estimate

population response to fishing mortality in sharks (Musick 1999). This is because accurate long-term fishing data are often unavailable, vital rate parameters can be accurately derived from individual species, and population responses to harvesting are detectable more rapidly than in traditional surplus production models (Bonfil 1996, Musick 1999).

Three types of demographic models have been used in shark demography studies; life tables, age-based (Leslie) matrix models and stage-based matrix models. Life tables use the Euler-Lotka equation to make a static prediction of population growth based upon survivorship and reproductive schedules (Krebs 1994). Matrix models predict population growth by mathematically projecting vital rate parameters through time (Leslie 1945, Caswell 2001). Static matrix models are based on the assumption that these parameters will remain unchanged through time, resulting in life tables and static matrix models producing similar results (Simpfendorfer 2004). Stage-based matrix models partition the life history of a species into a number of discrete maturity stages. Provided the data is available, this can provide an accurate estimate of age-dependant parameters, rather than averaging parameters which vary over the entire life of the animal (Cortés 1999b, Brewster-Geisz & Miller 2000).

To predict the population dynamics of a species, basic demographic parameters such as age at maturity, mortality, fecundity and longevity must be known (Campana 2001, Cailliet & Goldman 2004). With the exception of mortality rates, these parameters have already been ascertained for the whitetip reef shark (*Triaenodon obesus*) and the grey reef shark (*Carcharhinus amblyrhynchos*) (Chapters 3 & 4). Following the calculation of population mortality rates, an age-based (Leslie) matrix approach was used to analyse

the population dynamics for both these species. This type of model has been widely used to calculate shark population dynamics (Hoenig & Gruber 1990, Cortés 2002, Mollet & Cailliet 2002, Carlson et al. 2003), and allows closer examination of the importance of individual age classes to population growth (Caswell 2001). Leslie matrices have also been argued to produce the most realistic estimates of demographic parameters for elasmobranches (Mollet & Cailliet 2002).

The specific aims of this chapter were:

1. To determine the current mortality rates of *Triaenodon obesus* and *Carcharhinus amblyrhynchos* on the Great Barrier Reef.
2. To determine the population growth rates of *T. obesus* and *C. amblyrhynchos*, through age-based Leslie matrices.

5.2. METHODS

5.2.1. Mortality rates

Triaenodon obesus individuals were obtained through commercial and research line fishing, as well as research spearing. *Carcharhinus amblyrhynchos* individuals were obtained from line fishing (commercial and research) only (Chapter 3). Instantaneous mortality rates were calculated from the pooled central and northern Great Barrier Reef catch curves of *T. obesus* and *C. amblyrhynchos*. As both species are under commercial and recreational fishing pressure, mortality rates represented total (Z), rather than natural (M) mortality. Ages of tagged and unprocessed individuals were estimated from growth curves (Chapter 3, fig. 3.5), and included in analyses. Kolmogorov-Smirnov

(KS) tests (Sokal & Rohlf 1995) in SPSS were used to compare age-frequency distributions from commercial and research catches.

Total mortality rate of *T. obesus* was estimated from the natural log-transformed frequency on age class. This technique assumes constant declines across the older age classes, due to mortality rather than emigration. The lack of apparent movement between reefs (Chapter 2) suggests this is a reasonable assumption. A linear regression was applied to the descending arm of the age-frequency distribution, with the absolute value of the regression slope equalling the instantaneous total mortality rate (Z) (Ricker 1975). Ricker (1975) suggested excluding the most abundant age class from analyses, however Simpfendorfer (1999) argued that the use of this point is appropriate if its inclusion does not produce a statistically-better curvilinear fit. The validity of including the most abundant age class was examined through an *F*-test of linear and quadratic regressions.

The prevalence of first-year (0+) *C. amblyrhynchos* did not allow linearization of the frequency age-data through logarithmic transformation. Instead, a 3-parameter, type III, logistic population model was fitted to the log-transformed frequency on age class data, following Beerkircher et al (2003):

$$\log(N_t) = \frac{K}{1 + \left(\frac{K}{N_0} - 1\right) * e^{-r*t}} \quad \text{equ. 5.1.}$$

where N = number of individuals at time *t*;

K = carrying capacity of the population;

N_0 = population size at time t ; and

r = intrinsic rate of population increase.

To account for deaths occurring throughout the year, each age class was plotted as the midpoint of the range it spanned (Leslie 1945). Instantaneous estimates of Z were calculated as the tangent of the regression at each age class mid-point.

5.2.2. Population dynamics

Population dynamics of *T. obesus* and *C. amblyrhynchos* were calculated with age-based Leslie matrices (Leslie 1945), using the PopTools add-in in MS Excel. Age and reproductive parameters were taken from chapters 3 & 4. As demographic models use female data only, natality estimates were multiplied by 0.25 to account for the 1:1 sex ratio, and biennial breeding (Chapter 4). Survivorship of individuals to each age class was calculated from the equation:

$$l_x = l_{x-1} (e^{-Z_x}) \quad \text{equ. 5.2.}$$

where l_x = proportion of population surviving to age x (equals 1 for first age class);

l_{x-1} = proportion of population surviving to previous age class; and

Z_x = total instantaneous mortality rate at age x . (Equals natural mortality in unfished populations).

Leslie matrices allow the mean generation length (G ; the mean time between parent birth and offspring birth, factoring in fecundity and survival), net reproductive rate (R_0 ; number of daughters born in successive generations as a proportion of the previous

generation), intrinsic capacity for population increase (r) and finite rate of population increase (λ) to be calculated for each species (Krebs 1994). Reproductive values (the contribution of each age class to current and future reproductive output) and elasticity analyses (proportional value of survival in each life stage to population growth) were also calculated for each species using PopTools.

The mortality rates of first-year individuals are sometimes doubled in demographic analyses to simulate higher juvenile natural mortality (e.g. Hoenig & Gruber 1990, Cailliet 1992, Cortés 1998). However, it was thought that the highly cryptic behaviour of first-year (0+) *T. obesus* juveniles probably reduced the mortality rates of the youngest age class. Moreover, the prevalence of first-year *C. amblyrhynchos* individuals produced an extremely high initial mortality rate, without any artificial increases. Consequently, first-year mortality rates were not increased for either species.

5.3. RESULTS

5.3.1. Mortality estimation

No significant difference was found between the age-frequency distributions of commercially line fished, and research caught (line fished and speared) *Triaenodon obesus* (KS test; $z=0.949$, $p>0.10$; fig. 5.1). This enabled catch data from both types of sampling to be pooled. A linear regression through the descending arm (5yrs onwards) of the log-transformed total frequency on age class produced an instantaneous total mortality rate (Z) of 0.193 yr^{-1} (fig. 5.2). This was almost identical to the estimate of Z derived from the total line-fished data alone (0.192 yr^{-1}), confirming the acceptability of combining both spearing and line-fishing data together. Fitting a quadratic curve did not

significantly improve the fit over a linear curve (F -test; $F=2.48$, $p>0.05$), permitting the first most abundant age class (5+ yrs) to be used in the linear regression.

Both commercial ($n=99$) and research ($n=100$) line-fished *Carcharhinus amblyrhynchos* catch curves showed similar age-frequency distributions (fig. 5.3). The highest recruitment into the line-based fishery occurred in the first-year (0+) cohort, (46% and 39% of the commercial line-fished and research line-fished catches respectively), rapidly declining in the following age classes. First-year individuals were obtained from multiple reefs. Open umbilical scars (indicating recent parturition) were present on first-year individuals captured during the summer months, confirming recent birth.

Kolmogorov-Smirnov analysis showed no significant difference between commercially-fished and research-fished *C. amblyrhynchos* age-frequency distributions (KS test; $z=1.107$, $p>0.05$), allowing catch data to be pooled. Age-frequencies of *C. amblyrhynchos* declined too rapidly to be described by a linear regression. Instead, a type III mortality curve produced total instantaneous mortality rates ranging between 2.444 yr^{-1} , and 0.002 yr^{-1} (fig. 5.4; table 5.2).

5.3.2. Demographic modelling

Leslie (age-based) matrices of fished *T. obesus* and *C. amblyrhynchos* populations (tables 5.3 and 5.4) produced long generation lengths (over a decade), with insufficient net reproductive rates (R_0) for population replacement throughout generations (table 5.5). The intrinsic rates of population increase (r) were negative for both *T. obesus* and *C. amblyrhynchos*, indicating population declines. The rates of population decline (λ) were calculated at 6.3% annually for *T. obesus*, and 15.2% annually for *C. amblyrhynchos* (table 5.5). If these rates of decline remain constant in the future,

numerical losses of 73% and 96% are forecast for *T. obesus* and *C. amblyrhynchos*, respectively, over the next 20 years (fig. 5.5). To reduce these declines to population equilibrium ($r = 0$), a reduction in total annual mortality of 32% is required across all age classes for *T. obesus*, and 43% across all age classes for *C. amblyrhynchos*.

Alternatively, an (unrealistic) annual reduction of 66% mortality in just the first two age classes would also produce *C. amblyrhynchos* population stability.

In order to assess the effects of stochastic variations in demographics parameters on the results of population analyses, as well as accounting for the possibility of fishing pressure truncating the maximum age reached by both species, Leslie matrices were re-ran with a variety of mortalities, ages at maturity and longevities examined for both species (table 5.6). Furthermore, to account for the possibility of the *C. amblyrhynchos* age-frequency distributions being influenced by gear selectivity or depth partitioning increasing the catch of young individuals, analyses were also conducted using the *T. obesus* survivorship schedule ($Z = 0.193 \text{ yr}^{-1}$; an optimistic assumption, since *C. amblyrhynchos* exhibits a greater response to fishing (fig. 5.3; Chapter 2, fig. 2.7), and is known to attack bait more aggressively than *T. obesus* (Hobson 1963)). Only 2 of the further 46 scenarios investigated produced a positive population increase (table 5.6).

A number of indirect mortality estimates were further derived for both populations, and used to calculate population growth using Leslie matrices (table 5.7). Of the seven techniques, only Hoenig (1983)'s technique attempts to calculate total mortality. The results of Hoenig (1983)'s technique showed similar population declines (8.8%) for *T. obesus*, while estimating a significant, but lower population decline (10.3%) for *C. amblyrhynchos*. Three of the techniques which estimated natural mortality were clearly

unsuitable, predicting large naturally-occurring population declines. The remaining three techniques produced population growth for both species. Based on current longevities and growth rates, it appears that the natural population growth rate of *T. obesus* is between 3.4-5.7% yr⁻¹, while the natural population growth rate of *C. amblyrhynchos* is between 0.8–3.5% yr⁻¹.

Analysis of reproductive values showed that the most important age classes (in terms of current and potential future reproductive output) were 8-9 years for *T. obesus*, and 3-4 years for *C. amblyrhynchos* (fig. 5.6). These values represent age classes which are taken in line fisheries, however the difference in age-frequency distributions between *T. obesus* and *C. amblyrhynchos* means a greater proportion of *C. amblyrhynchos* individuals are removed before the most reproductively-valuable age-classes are reached.

Elasticity analyses showed that survival of the juvenile component of both species contributed greatest to population growth (fig. 5.7). The ratios of adult and juvenile (excluding first-year) to first-year (0+) survival were calculated, to determine the degree to which first-year survival must increase to compensate for later mortality (Heppell et al. 1999). The adult:first-year elasticity ratio was 5:1 for *T. obesus*, and 6:1 for *C. amblyrhynchos*. The juvenile:first-year elasticity ratio was higher; at 7:1 for *T. obesus*, and 10:1 for *C. amblyrhynchos*. This means that a 10% decrease in adult survival of *C. amblyrhynchos* would require a 60% increase in fecundity or first-year (0+) survival to compensate. However, a similar 10% decrease in juvenile (1-10 yrs) survival would require a 100% increase in fecundity or first-year survival to compensate. With a greater proportion of juveniles being removed from the population, neither scenario is likely.

5.4. DISCUSSION

Demographic analysis of *Triacanthodes obesus* and *Carcharhinus amblyrhynchus* populations indicated current decline of both species on the Great Barrier Reef. The calculated rates of decline appear severe for both species, suggesting an immediate need to address this situation. To ensure the demographic calculations were as valid as possible, a number of procedures were applied. To remove the possibility of naturally-occurring geographic variations causing spurious results, all demographic parameters were estimated from local stocks. Furthermore, to prevent displaying the “worst case” scenario, matrix models (optimistically) assumed no increase in first-year (0+) mortality, and successful mating immediately following maturity.

To account for the possibility of gear selectivity truncating longevities or producing biased catch curves, a further 46 matrix models were ran with a variety of parameter changed (table 5.6). These analyses also accounted for possible variation in the age at maturity of each species. Of the additional 46 matrix models, only 2 produced positive population growth. In both cases, instantaneous mortality needed to be reduced by 50% to prevent declines. Even further analyses using an indirect method to calculate total mortality rates (Hoenig 1983), also predicted comparable declines for *T. obesus*, and lower, albeit still severe, declines for *C. amblyrhynchus* on the Great Barrier Reef. The results of these alternative scenarios suggest that although the parameter estimates used may have some level of inherent biases, or uncertainties through natural variations, even though the magnitude of population declines predicted may change, the overall conclusions for both species should not. Based on two different estimates of mortality, it appears that *T. obesus* is declining at between 6.3-8.8% year⁻¹, and *C. amblyrhynchus* at between 10.3-15.2% year⁻¹,

The vulnerability of most shark species to overfishing is usually attributed to their k -selected life history strategies of late maturity, long gestation periods and low fecundities (Holden 1974, Pratt & Casey 1990, Stevens et al. 2000, Cortés 2004). Both *T. obesus* and *C. amblyrhynchos* have low levels of fecundity, more similar to that of smaller species such as *Rhizoprionodon terraenovae* (Castro & Wourms 1993, Hazin et al. 2002), than of the larger carcharhinid species such as the spinner shark (*C. brevipinna*) and the Galapagos shark (*C. galapagensis*) (Wetherbee et al. 1996, Capape et al. 2003). However, many smaller shark species have annual parturition (Simpfendorfer 1992b, Castro & Wourms 1993), with higher intrinsic capacity for population increase (r) (Smith et al. 1998). The longer gestation periods, and non-synchronous ovarian and gestation cycles of *T. obesus* and *C. amblyrhynchos* prevent these species from breeding at the same rate as these smaller species. Together with the low fecundities, this reduces their natural population growth, and increases their susceptibility to fishing vulnerability.

Elasticity analyses of elasmobranch age-structured matrix models has commonly concluded that juvenile survival has the largest effect on population growth rate (Sminkey & Musick 1996, Cortés 2002, Otway et al. 2004). This finding was echoed in this study, and is indicative of the high proportion of immature individuals in both populations. The value of juvenile survival is greater in *C. amblyrhynchos*, as the more reproductively-valuable individuals are found in the younger age classes. Unfortunately, over half the *C. amblyrhynchos* individuals captured by line fisheries are taken from the first two age classes.

The static demographic models used here cannot account for density dependent changes in juvenile mortality. Such changes result from increased survival rates of juveniles through decreased adult predation (Sminkey & Musick 1995). As fishing exploitation preferentially removes larger individuals (Dulvy et al. 2004), the inability of static demographic models to account for such changes in natural mortality has been suggested to underestimate the estimates of population growth for fished stocks (Walker 1998). In the case of GBR reef sharks, such density compensations would result in lower population losses than currently predicted. These effects occur when there is a density-dependant effect between adult stock size and juvenile survival, and no relationship between juvenile density and survivorship (Gruber et al. 2001, Cortés 2004).

It is unlikely that reductions in the already-rare adult populations of reef sharks will have a significant effect on juvenile survival. Both *T. obesus* and *C. amblyrhynchos* preferentially target benthic fishes (Scaridae and Acanthuridae), cephalopods and eels (Muraenidae) (Randall 1977, Wetherbee et al. 1997); conspecifics do not form an acknowledged part of their diet. Predation of juveniles by adult conspecifics is likely to be even lower in highly cryptic species such as *T. obesus*, which forage and hide throughout the reef matrix (Randall 1977). Instead, the greatest predators of juvenile reef sharks are larger shark species, such as the tiger shark (*Galeocerdo cuvier*) and large groupers (fam. Serranidae) (Randall 1977, Lowe et al. 1996). Adult reef shark densities would not be expected to have a large impact on the density of either of these groups. Lower adult densities may however, result in a reduced probability of successfully breeding each season due to increased difficulties in finding mates (Allee effect) (Allee 1931).

The output of shark demographic models can be affected by differential gear selectively with age (Beerkircher et al. 2003). However, snorkeling and baited video camera field observations of both species (primarily *C. amblyrhynchos*; see Chapter 2) revealed no obvious relationship between shark size and time of arrival to bait on any of the surveyed reefs; nor any obvious differences in size/age structure among sampled reefs. Similarly, the use of lever-drag overhead fishing reels on research trips reduced the chance of larger individuals breaking the line. The lack of difference between the age-frequencies of commercial and research collections suggests that variations in fisher experience also had no influence on catch frequencies. It is possible that the catch curve of *C. amblyrhynchos* is being influenced by smaller individuals disproportionately taking baits over large individuals; however, severe population declines were maintained for this species when more traditional mortality schedules were fitted (tables 5.6 & 5.7). It is postulated that the higher capture rate of juvenile *C. amblyrhynchos* means the alternative mortality schedule (that of *T. obesus*) is probably a conservative estimate. This was supported by Hoenig (1983)'s indirect mortality rate, which produced a higher population decline for *C. amblyrhynchos* than the *T. obesus* catch curve (table 5.7). Based on current (albeit exploited) parameters, it also appears that "natural" rates of population growth may be between 3.4-5.7% year⁻¹ for *T. obesus*, and 0.8-3.5% year⁻¹ for *C. amblyrhynchos* (table 5.7). Both these rates appear realistic for shark populations.

These results indicate the need for an urgent response to promote the recovery of reef shark populations on the Great Barrier Reef. The population trajectories of rapid decline, coupled with the large reductions seen in reef shark abundances, indicate that extirpation of these species from fished GBR reefs is a realistic possibility. It has been

said that one of the biggest mistakes in fisheries management is not implementing appropriate management strategies before a population becomes imperiled (Morgan & Burgess 2004). It is clear from the findings of this chapter that this situation has already been reached, and a serious commitment to reef shark management will be required sooner, rather than later, to address this situation on the Great Barrier Reef.

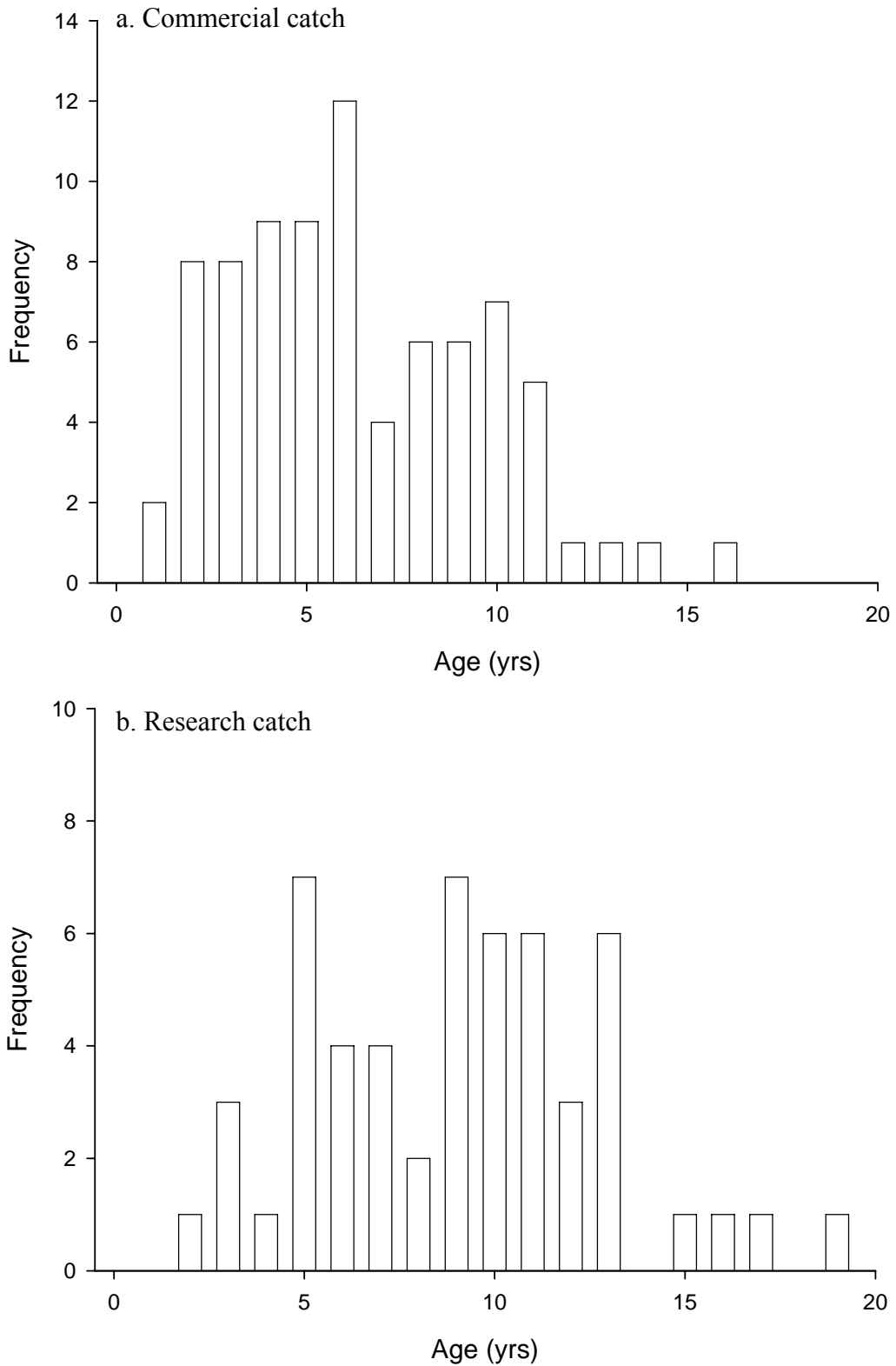

Figure 5.1. (a) Commercial (n=80) and (b) research *Triaenodon obesus* catches from the central and northern Great Barrier Reef. Research catches include line fished (n=19) and speared individuals (n=35). All commercial catches were line fished.

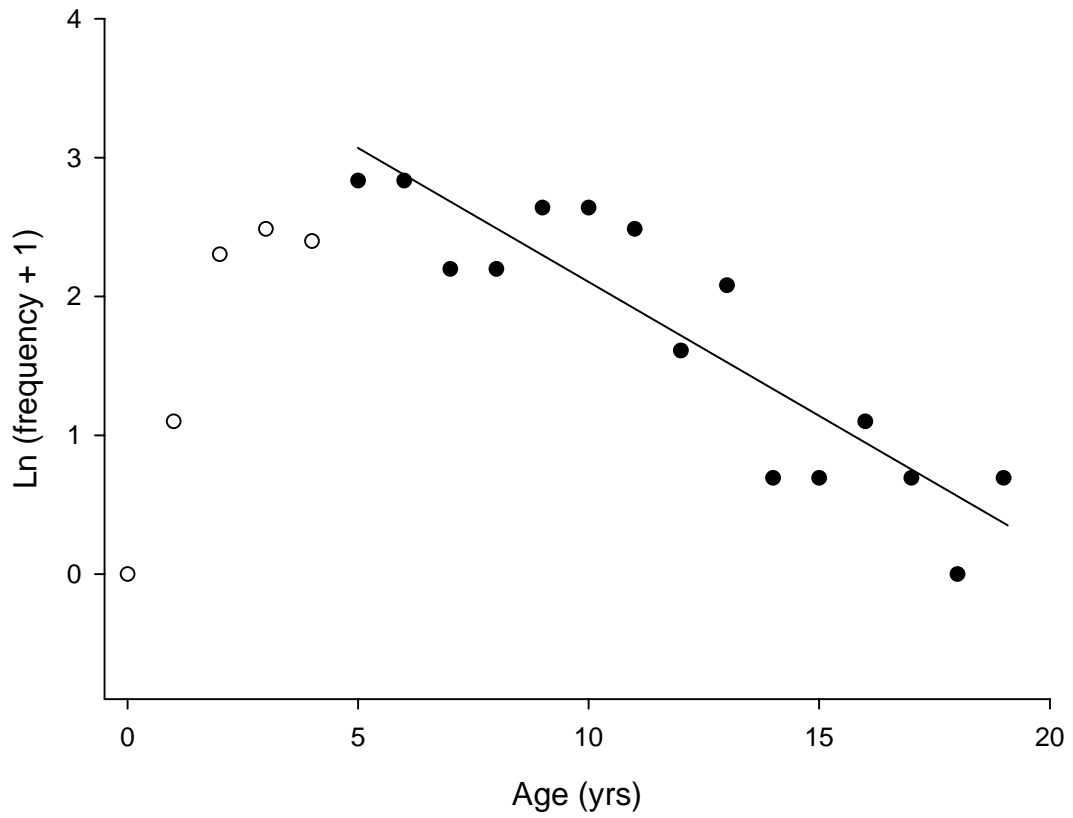

Figure 5.2. Ln (frequency + 1) of total *Triaenodon obesus* catches from the central and northern Great Barrier Reef. Regression line applied to age class 5+ and greater (closed data points). Regression slope (Z) = -0.193; $r^2 = 0.808$.

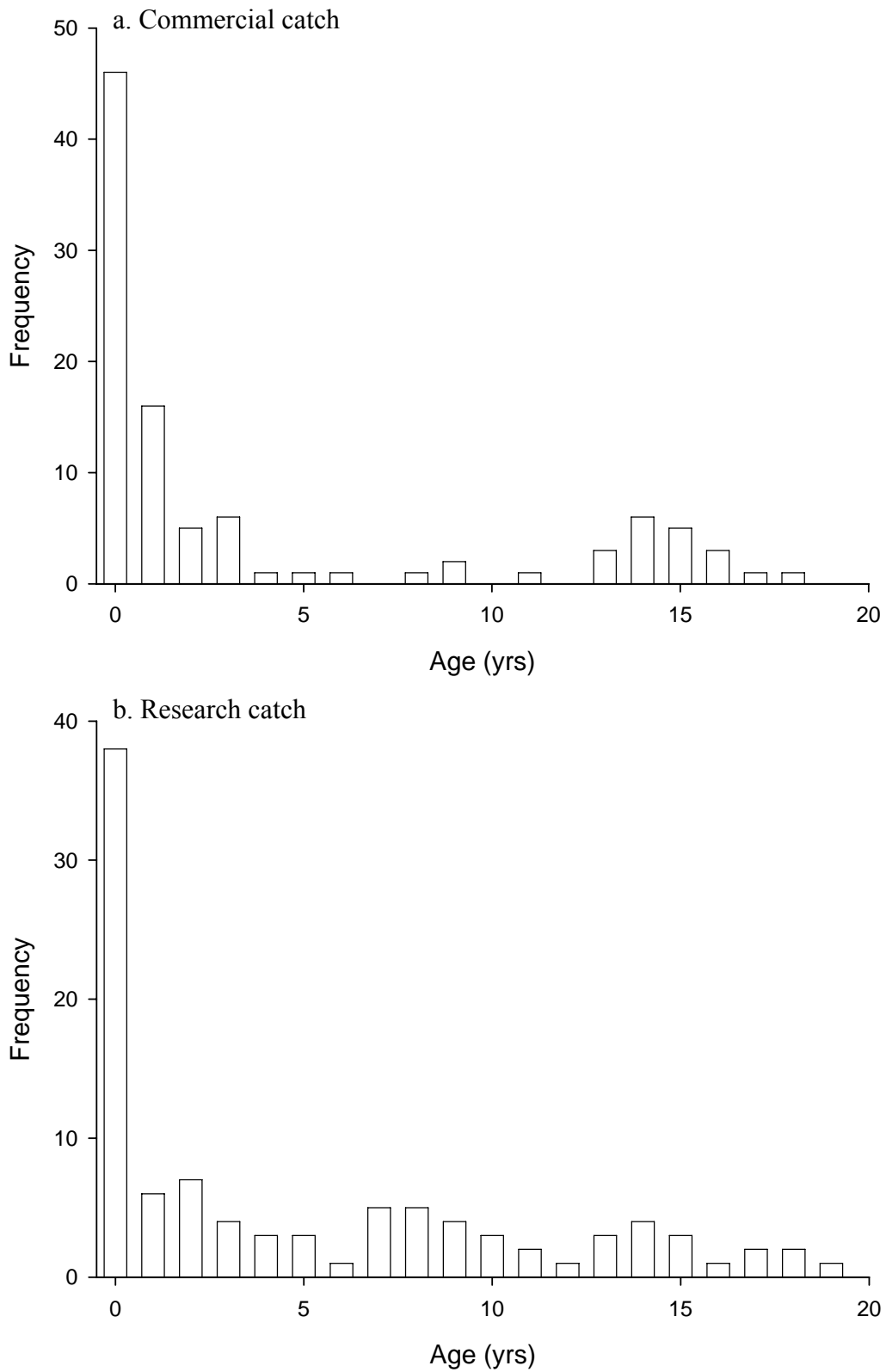

Figure 5.3. (a) Commercial and (b) research line *Carcharhinus amblyrhynchos* catches from the central and northern Great Barrier Reef. n = 99 (commercial catches) and 100 (research catches).

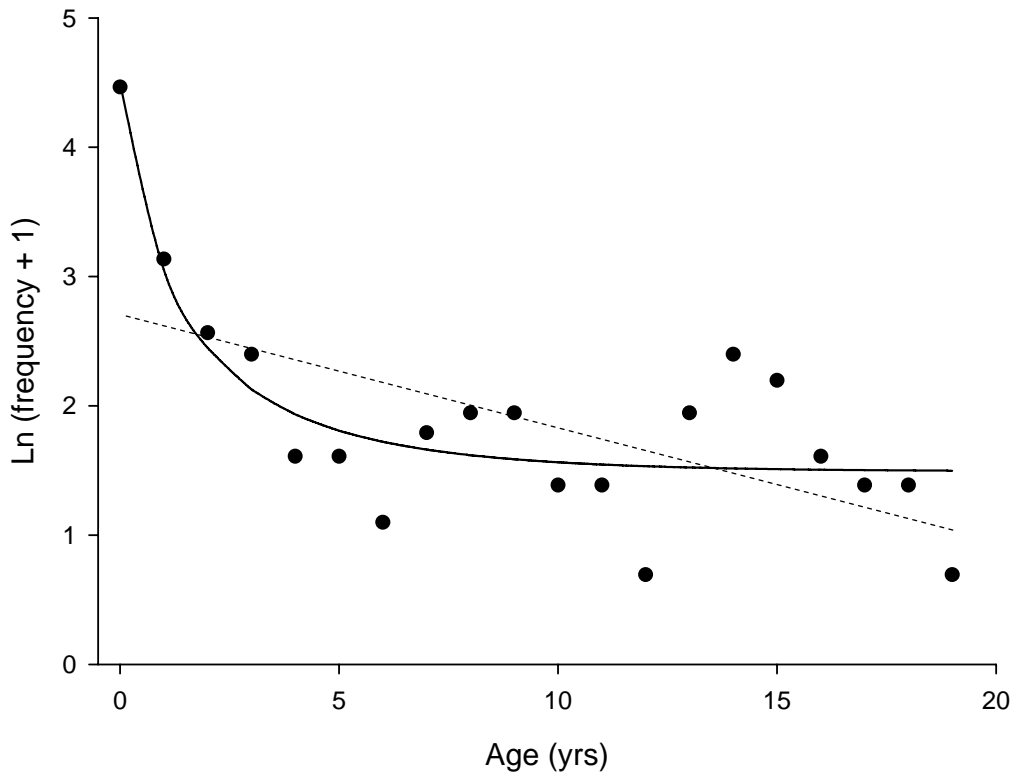

Figure 5.4. Ln (frequency + 1) of total *Carcharhinus amblyrhynchus* catches from the central and northern Great Barrier Reef. Dashed line indicates linear regression (adjusted $r^2 = 0.34$); solid line indicates a type III mortality, 3-parameter logistic curve (adjusted $r^2 = 0.70$). r^2 values have been adjusted following Moore & McCabe (1993), to account for the different number of parameters used in each regression.

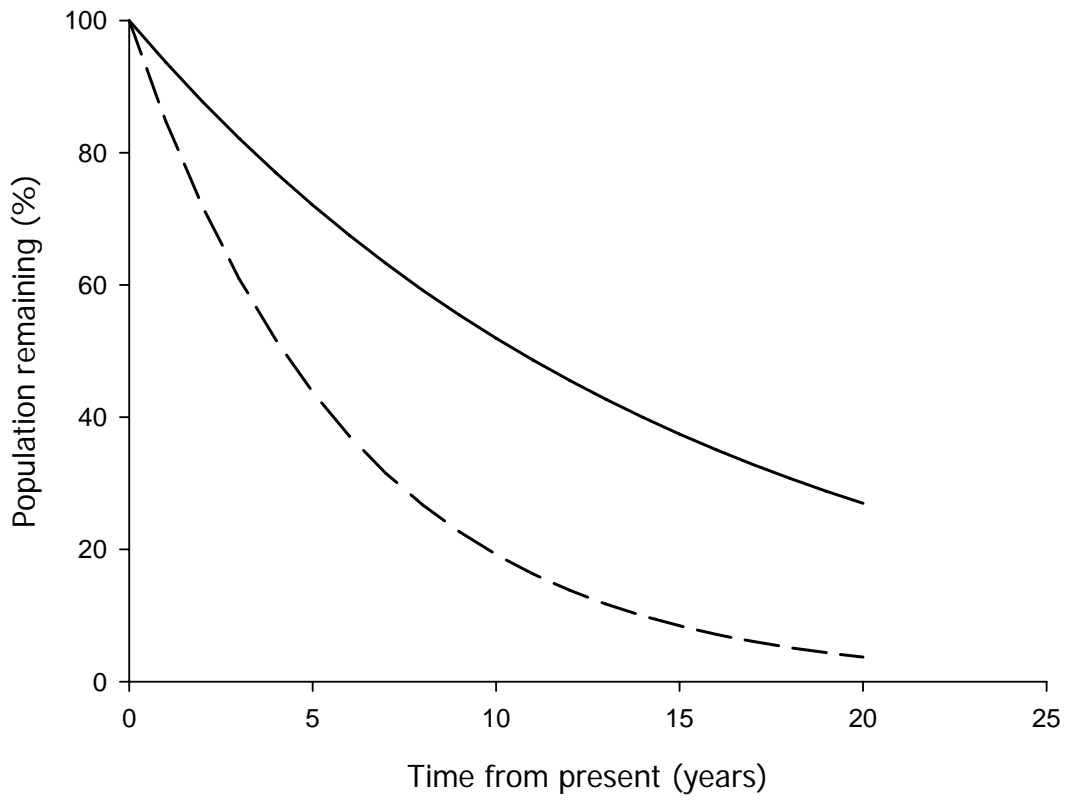

Figure 5.5. Estimated percentage of *Triaenodon obesus* (solid line) and *Carcharhinus amblyrhynchos* (dashed line) populations remaining on the Great Barrier Reef at predicted decline rates (catch curve mortality estimates used)..

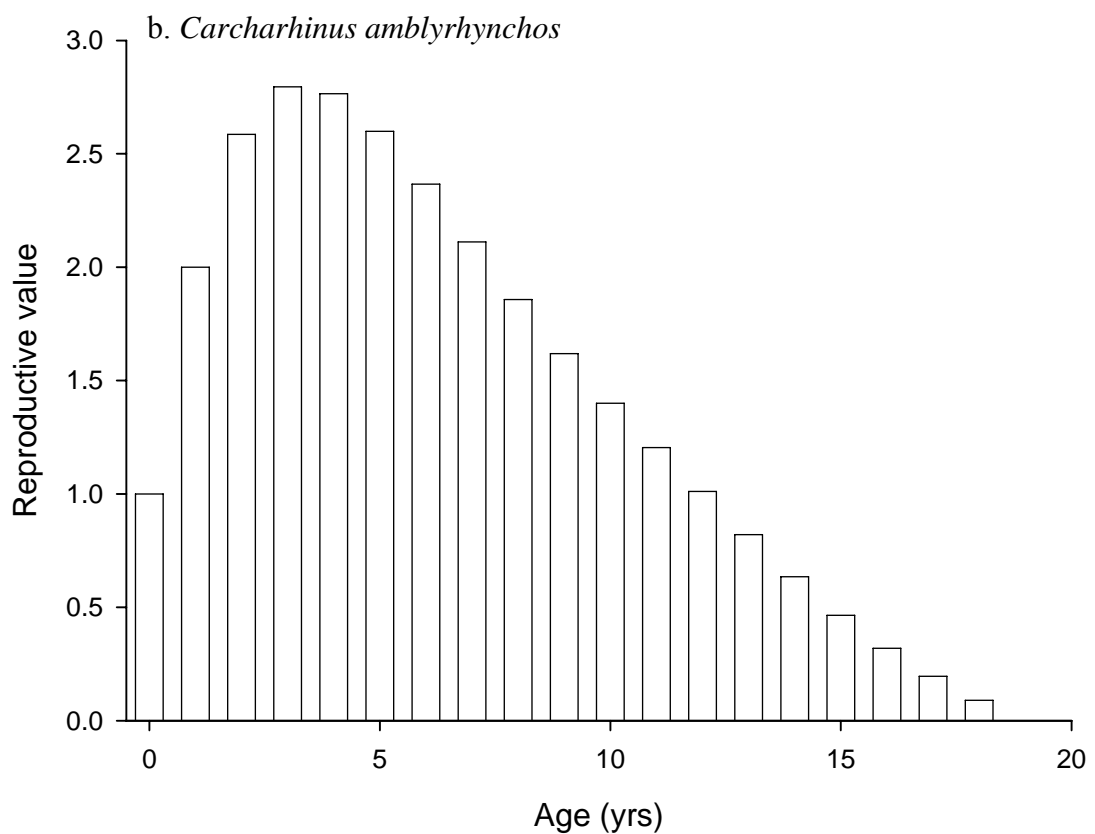

Figure 5.6. Contribution of each age class to current and future reproductive output relative to the first (0+) age class for (a) *Triaenodon obesus* and (b) *Carcharhinus amblyrhynchos*.

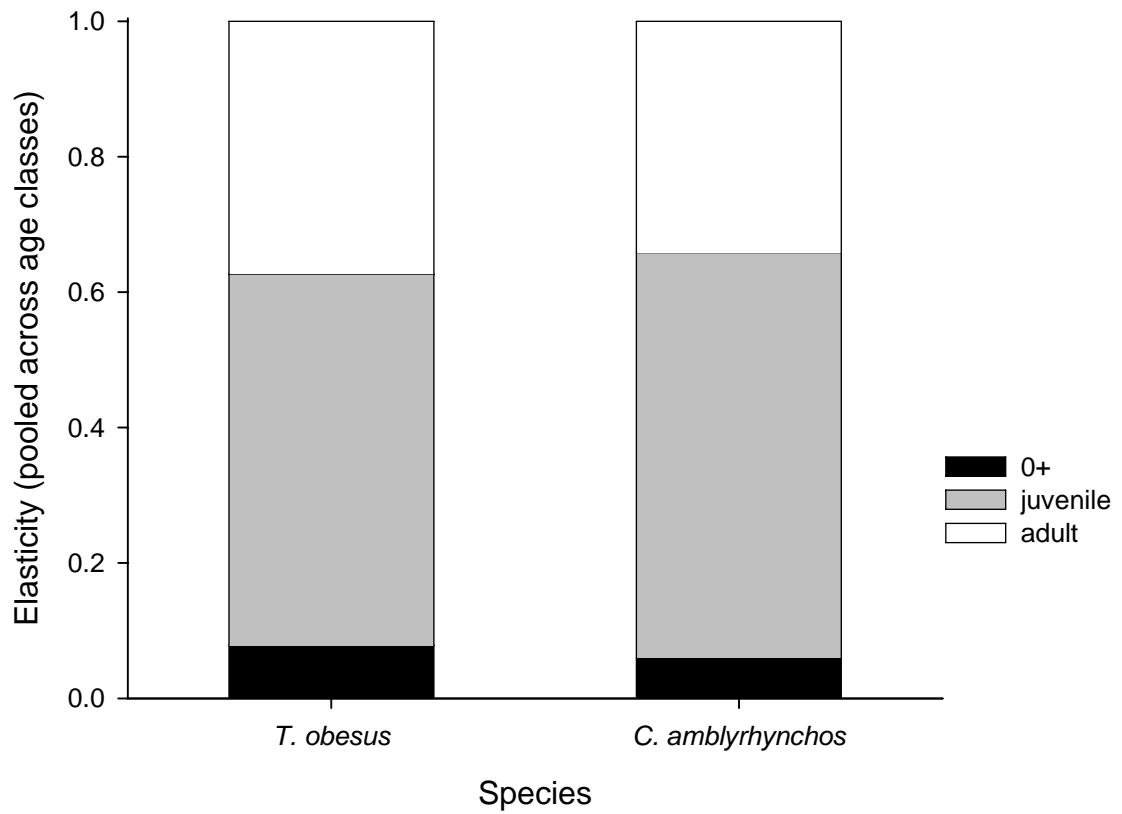

Figure 5.7. Elasticity analyses of *Triaenodon obesus* and *Carcharhinus amblyrhynchos* on the Great Barrier Reef. Bar sections represent the proportional value of survival in each life stage to population growth.

Table 5.1. Vital rate parameters derived in this thesis, and used to calculate age-based Leslie matrices.

Parameter	<i>Triaenodon obesus</i>	<i>Carcharhinus amblyrhynchos</i>
Maximum age	19	19
Age at first birth	9 years	12 years
Fecundity	2 pups	1 - 4 pups
Female-only natality	1 pup per breeding	0.5 – 2 pups per breeding
Breeding frequency	2 years	2 years
Instantaneous mortality	0.193	2.44 – 0.002

Table 5.2. Instantaneous mortality rates calculated at the mid-point of each age class for total *Carcharhinus amblyrhynchos* catches.

Age class	Z	Age class	Z
0+	2.444	10+	0.02
1+	0.858	11+	0.015
2+	0.422	12+	0.011
3+	0.243	13+	0.008
4+	0.154	14+	0.006
5+	0.103	15+	0.005
6+	0.071	16+	0.004
7+	0.051	17+	0.003
8+	0.037	18+	0.002
9+	0.027	19+	0.002

Table 5.3. Leslie matrix of fished *Triaenodon obesus* populations on the Great Barrier Reef. Top row represents effective age-specific fecundity; diagonal values represent probability of survival from one age class to the next.

0	0	0	0	0	0	0	0	0.412	0.412	0.412	0.412	0.412	0.412	0.412	0.412	0.412	0.412	0.412
0.824	0	0	0	0	0	0	0	0	0	0	0	0	0	0	0	0	0	0
0	0.824	0	0	0	0	0	0	0	0	0	0	0	0	0	0	0	0	0
0	0	0.824	0	0	0	0	0	0	0	0	0	0	0	0	0	0	0	0
0	0	0	0.824	0	0	0	0	0	0	0	0	0	0	0	0	0	0	0
0	0	0	0	0.824	0	0	0	0	0	0	0	0	0	0	0	0	0	0
0	0	0	0	0	0.824	0	0	0	0	0	0	0	0	0	0	0	0	0
0	0	0	0	0	0	0.824	0	0	0	0	0	0	0	0	0	0	0	0
0	0	0	0	0	0	0	0.824	0	0	0	0	0	0	0	0	0	0	0
0	0	0	0	0	0	0	0	0.824	0	0	0	0	0	0	0	0	0	0
0	0	0	0	0	0	0	0	0	0.824	0	0	0	0	0	0	0	0	0
0	0	0	0	0	0	0	0	0	0	0.824	0	0	0	0	0	0	0	0
0	0	0	0	0	0	0	0	0	0	0	0.824	0	0	0	0	0	0	0
0	0	0	0	0	0	0	0	0	0	0	0	0.824	0	0	0	0	0	0
0	0	0	0	0	0	0	0	0	0	0	0	0	0.824	0	0	0	0	0
0	0	0	0	0	0	0	0	0	0	0	0	0	0	0.824	0	0	0	0
0	0	0	0	0	0	0	0	0	0	0	0	0	0	0	0.824	0	0	0
0	0	0	0	0	0	0	0	0	0	0	0	0	0	0	0	0.824	0	0
0	0	0	0	0	0	0	0	0	0	0	0	0	0	0	0	0	0.824	0

Table 5.4. Leslie matrix of fished *Carcharhinus amblyrhynchos* populations on the Great Barrier Reef. Top row represents effective age-specific fecundity; diagonal values represent probability of survival from one age class to the next.

0	0	0	0	0	0	0	0	0	0	0	0.022	0.043	0.065	0.076	0.076	0.076	0.076	0.076
0.424	0	0	0	0	0	0	0	0	0	0	0	0	0	0	0	0	0	0
0	0.656	0	0	0	0	0	0	0	0	0	0	0	0	0	0	0	0	0
0	0	0.784	0	0	0	0	0	0	0	0	0	0	0	0	0	0	0	0
0	0	0	0.857	0	0	0	0	0	0	0	0	0	0	0	0	0	0	0
0	0	0	0	0.902	0	0	0	0	0	0	0	0	0	0	0	0	0	0
0	0	0	0	0	0.931	0	0	0	0	0	0	0	0	0	0	0	0	0
0	0	0	0	0	0	0.950	0	0	0	0	0	0	0	0	0	0	0	0
0	0	0	0	0	0	0	0.964	0	0	0	0	0	0	0	0	0	0	0
0	0	0	0	0	0	0	0	0.973	0	0	0	0	0	0	0	0	0	0
0	0	0	0	0	0	0	0	0	0.980	0	0	0	0	0	0	0	0	0
0	0	0	0	0	0	0	0	0	0	0.985	0	0	0	0	0	0	0	0
0	0	0	0	0	0	0	0	0	0	0	0.989	0	0	0	0	0	0	0
0	0	0	0	0	0	0	0	0	0	0	0	0.992	0	0	0	0	0	0
0	0	0	0	0	0	0	0	0	0	0	0	0	0.994	0	0	0	0	0
0	0	0	0	0	0	0	0	0	0	0	0	0	0	0.995	0	0	0	0
0	0	0	0	0	0	0	0	0	0	0	0	0	0	0	0.996	0	0	0
0	0	0	0	0	0	0	0	0	0	0	0	0	0	0	0	0.997	0	0
0	0	0	0	0	0	0	0	0	0	0	0	0	0	0	0	0	0.998	0

Table 5.5. Dynamics of fished *Triaenodon obesus* and *Carcharhinus amblyrhynchos* populations on the Great Barrier Reef, estimated through age-based Leslie matrices and catch-curve mortalities.

Parameter	<i>Triaenodon obesus</i>	<i>Carcharhinus amblyrhynchos</i>
Mean generation length (G)	12.5 years	16.4 years
Net reproductive rate (R_0)	0.441	0.067
Intrinsic capacity for population increase (r)	-0.0655	-0.1650
Finite rate of population increase (λ)	0.937	0.848
Annual population decline	6.34%	15.21%

Table 5.6. Effects of varying demographic parameters on *Triaenodon obesus* and *Carcharhinus amblyrhynchos* population dynamics. Results show finite rate of population increase (λ) and percent population declines. Values in bold show parameter changes which produced population increase. Changes in mortality refer to instantaneous mortality (Z).

Parameter changed	<i>Triaenodon obesus</i>		<i>Carcharhinus amblyrhynchos</i>		<i>C. amblyrhynchos</i> with <i>T. obesus</i> mortality	
	λ	% decline	λ	% decline	λ	% decline
No changes	0.937	6.34	0.848	15.21	0.922	7.79
Double 0+ mortality	0.923	7.74	0.734	26.59	0.911	8.92
mortality x 0.5	1.031	3.15 (increase)	0.972	2.85	1.015	1.55 (increase)
mortality x 0.75	0.983	1.71	0.907	9.29	0.968	3.23
mortality x 0.9	0.955	4.52	0.871	12.90	0.940	6.00
mortality x 1.1	0.919	8.13	0.826	17.44	0.904	9.55
mortality x 1.25	0.892	10.75	0.793	20.66	0.879	12.14
mortality x 1.5	0.850	14.96	0.743	25.71	0.837	16.27
Mature 2 yrs early	0.964	3.56	0.855	14.48	0.947	5.25
Mature 1 yr early	0.950	5.04	0.852	14.81	0.935	6.54
Mature 1 yr later	0.925	7.53	0.843	15.69	0.910	9.05
Mature 2 yrs later	0.914	8.64	0.837	16.29	0.896	10.36
Longevity x 0.8	0.917	8.31	0.774	22.57	0.877	12.26
Longevity x 1.2	0.945	5.50	0.887	11.32	0.937	6.27
Longevity x 1.4	0.949	5.10	0.912	8.80	0.944	5.60
Longevity x 1.5	0.950	4.98	0.922	7.85	0.946	5.41

Table 5.7. Indirect mortality techniques and resulting annual population growth of Great Barrier Reef *Triaenodon obesus* and *Carcharhinus amblyrhynchos*. *Triaenodon obesus* parameters derived from female data only. *Carcharhinus amblyrhynchos* parameters derived from female data for Hoenig (1983) and Jensen (1996) (growth #1). All other *C. amblyrhynchos* parameters from both sexes combined. Arrows indicate population growth (↑) and decline (↓). Positive population growth also in bold. Note that Hoenig (1983)'s technique estimated total mortality (Z). All other techniques estimated natural mortality (M).

Technique	<i>Triaenodon obesus</i>			<i>Carcharhinus amblyrhynchos</i>		
	M	λ	% change	M	λ	% change
Hoenig (1983) (Z)	0.220	0.912	8.84 (↓)	0.220	0.897	10.25 (↓)
Jensen (1996) (maturity)	0.206	0.924	7.57 (↓)	0.150	0.963	3.74 (↓)
Pauly (1980)	0.139	0.988	1.17 (↓)	0.142	0.971	2.94 (↓)
Peterson & Wroblewski (1984)	0.238- 0.436	0.816	18.37 (↓)	0.211- 0.422	0.834	16.59 (↓)
Chen & Watanabe (1989)	0.064- 0.128	1.034	3.41 (↑)	0.074- 0.160	1.008	0.78 (↑)
Jensen (1996) (growth #1)	0.072	1.057	5.69 (↑)	0.077	1.035	3.53 (↑)
Jensen (1996) (growth #2)	0.077	1.052	5.19 (↑)	0.082	1.030	3.00 (↑)

Chapter 6. Evaluation of two underwater biopsy probes for *in situ* collection of shark tissue samples

6.1. INTRODUCTION

The examination of a population's biology often requires knowledge of the geographical range of that population. This removes potential variation in results, which may arise from analysing multiple populations. Techniques to estimate population range include tagging studies, molecular analysis and use of biological tags such as parasites (Boje et al. 1997, Holland et al. 1999, Heist & Gold 2000, Pardini et al. 2001). The logistics and costs of tag-release studies, together with the large sample numbers required makes their use prohibitive in studies which cannot rely on continual commercial catches. Meanwhile, the use of parasitic indicators usually requires the sacrifice and dissection of the animal. Molecular analysis however, may be undertaken using tissue from sacrificed or live animals.

To date, the majority of shark and ray molecular analyses have been undertaken on visceral or muscle tissue (Heist et al. 1996a, Delarbre et al. 1998, Sandoval-Castillo et al. 2004). This has invariably involved the sacrifice of the study animals, either through commercial sources or research collections. Non-lethal collections of genetic material (such as fin clippings) are uncommon, and usually only carried out in conjunction with tag and release studies (Feldheim et al. 2001, Keeney et al. 2003). Unfortunately even tag and release techniques require the capture and surfacing of individuals, usually through netting or line fishing. This can result in stress and injury to the animal, or even death (Hoffmayer & Parsons 2001, Sundström & Gruber 2002). Net and line fishing

techniques also result in the capture of incidental or by-catch species (Francis et al. 2001, Notarbartolo-di-Sciara et al. 2003).

In situations which involve the sampling of rare or declining populations, it is important to minimising the impacts of data collection. With many exploited elasmobranch populations currently in decline (Casey & Myers 1998, Campana et al. 2002, Baum et al. 2003, Myers & Worm 2003; Chapter 5), or low in abundance (Graham et al. 2001, Baum & Myers 2004; Chapter 2), this is especially true for sharks. When sampling simply requires the collection of tissue samples for molecular analysis, sacrifice of the animal is often not necessary (Keeney et al. 2003).

Non-lethal tissue collections are commonly undertaken on wild cetaceans. This usually involves firing a stainless steel dart into the animal, retaining a plug of skin and blubber (Aguilar & Nadal 1984, Barrett-Lennard et al. 1996). Researchers approach the target animal on boats, firing the darts with crossbows (Hooker et al. 2001), above-water spearguns (Borrell et al. 2004) or modified rifles (Krützen et al. 2002). Equivalent underwater techniques do not appear to have been developed. For shark species found in shallow waters, underwater collection of tissue samples would allow divers to select specific animals to sample without the need for capture or restraint.

The aim of this chapter was:

1. To evaluate the design and practicality of two underwater biopsy probes to non-lethally collect tissue samples from reef sharks for molecular analysis.

6.2. METHODS

Two types of biopsy probe were machined from mild stainless steel. The two probes differed only in the structure of the penetrating barrel. Type I probes had a series of three 4 mm rearward-facing notches cut into the barrel to aid tissue retention (fig. 6.1a-c). In the second probe type, two *Kerr* 21 mm ISO4 barbed broaches (dental broaches) were twisted together and positioned inside the probe barrel (fig. 6.1d-e). The dental broaches had rearwards-facing serrated barbs running along their length, and were held in place by the barrel-retaining pin (fig. 6.1e). Two indents were made halfway down the Type II barrel to constrict the bore. Both types of barrel had a small (2.4 mm) hole at their base to allow effusion of water from the barrel as it pushed into the shark.

Biopsy probes were screwed to the end of an 1100 mm spear, and fired from a medium-pressured *Mares Cyrano 1100* pneumatic speargun.

Three species of reef carcharhinid were sampled at the Cocos (Keeling) southern atoll (12°08'S; 96°52'E) and the Marquesas Island group (08° 56'S; 140° 07'W). Sharks were targeted at an angle approximately 20° from perpendicular, with biopsy probes shot into the dorsal musculature below the first dorsal fin. Distance to sharks sampled ranged between 2 m and 5 m. Probe barrel assemblies were soaked in a 42 g l⁻¹ solution of sodium hypochlorite (household bleach) for 30 minutes between uses to remove any remaining traces of tissue before rinsing in fresh water.

Probed tissue wet weight was measured to 5 decimal places, and total genomic DNA extracted from the tissues. Extraction protocols were based on those of Sunnucks and Hales (1996), which are known to successfully extract shark DNA (Feldheim et al. 2001). Extracted DNA was selectively amplified using polymerase chain reaction (PCR;

Chapter 7). The standard weight of tissue required for DNA extraction was 3 mg. All biopsy probe samples retaining at least 3 mg of tissue were therefore considered successful.

6.3. RESULTS

Tissue samples were obtained from *Triaenodon obesus*, *Carcharhinus amblyrhynchos* and *C. melanopterus*. All sharks sampled were estimated at between 1.1-1.4 m TL. Total weights of *T. obesus* and *C. amblyrhynchos* were estimated at between 7-16 kg (Chapter 3; fig 3.7). Biopsy samples obtained usually consisted of a circular patch of skin, with muscle tissue attached. Probes penetrated no further than the retaining pin (approximately 25 mm), leaving a 5 mm diameter external lesion in the shark.

Tissues collected from the three species were pooled for analyses. Both probe types retained on average over 50 mg of tissue per use (fig. 6.2). The mean tissue retention rate did not differ significantly between the two probe types (*t*-test; $t=0.08$, $p>0.05$). The standard error of each probe type was similar, however this was a reflection of the greater sample size of type I probe data. For a 12 kg shark, the weight of tissue removed was approximately 0.0004% of its total body weight.

Although both probe types tested retained tissue, type II probes retained a higher proportion of analysable (>3 mg) tissue than type I probes (Table 1). The dental broaches were efficient at holding the tissue, while the indents in the barrel compressed the tissue slightly, allowing the broaches a better grip. However the increased efficiency of type II probes was balanced by the longer preparation time required before each use.

The dental broaches required individual alignment with tweezers prior to each use. This alignment took up to five minutes per probe. Probe type I required no such preparation.

6.4. DISCUSSION

The use of underwater biopsy probes allowed the collection of shark tissue for molecular analysis, without the capture or restraint of individuals. Once the diver was within spearing range of the shark, both probe types offered a rapid and simple technique for taking skin and muscle tissue samples from selected individuals. Both types of probe were easy to replace underwater, allowing rapid targeting of multiple sharks if required. Although the mean wet weight of tissue collected was similar for both probes, type II probes were found to deliver the most consistent results. In situations where rare species are under investigation, it is important to maximize the success rate of sampling. As such, it is worth the additional preparation time required for type II probes to obtain a higher proportion of successful tissue retentions.

The benefit of type I probes lay in their minimal preparation time. When the number of target individuals is not limited, their ease of preparation may outweigh the lower successful tissue retention rates. With advances in molecular extraction protocols, DNA can now be successfully extracted from tissue quantities as small as 1 mg (Kasajima et al. 2004). If protocols such as this can be used on shark tissues, the successful retention rate of type I probes will improve.

Female sharks are often seen with significantly greater injuries from mating, caused by the male biting during copulation (Pratt & Carrier 2001, Whitney et al. 2004). Female sharks and rays compensate for this mating behaviour by having dermal layers up to 50% thicker than males (Kajiura et al. 2000, Pratt & Carrier 2001). Male and female

Triaenodon obesus are also often sighted with dermal abrasions incurred through foraging through the reef matrix (field obs.). Differences in dermal thickness presented no problem for the biopsy probes as the protocol used extracted DNA from both muscle and skin samples. Probed individuals of both sexes were sighted up to 5 days after sampling, with no obvious distress or adverse behaviour.

Underwater tissue sampling has a number of practical advantages. It allows the user to actively select the target animals, preventing the catch of non-target individuals or species. Species vary in their predisposition to attractants such as baited hooks; both in terms of catch rates and catchability (Compagno 1984, Berkeley & Campos 1988). The ability to selectively target animals may increase cost-efficiency through reduced sampling time. Stress and injury risk in target animals are reduced, as capturing and surfacing with nets or lines is avoided. Fibronecrosis, luminal obstructions and bacterial infections associated with sharks ingesting and retaining hooks are also avoided (Borucinska et al. 2002).

While this chapter focused on coral reef carcharhinids, underwater biopsy probes are likely to be successful with other benthic or coastal sharks. Orectolobids (wobbegongs), ginglymostomatids (nurse sharks), other carcharhinids (such as *Negaprion* sp.) and heterodontids (horn sharks) are all possible candidates for sampling with this technique. Although not trialed, rare or endangered species of ray such as Mobulidae (devilrays) may also be sampled with biopsy probes. These animals are often found in shallow coral reef waters, and are approachable by divers. Biting of the female also occurs in this species during mating (Yano et al. 1999), hence these females would be familiar with dermal abrasions. Both types of biopsy probe have also been successfully used to

collect *in situ* samples of tissue from rare and endangered teleosts, such as the Maori wrasse (*Cheilinus undulatus*) and the black cod (*Epinephelus daemeli*) (Robbins, unpubl. data).

Obtaining tissue samples through minimally invasive sampling techniques benefits both the study species, as well as the researcher. When the sacrifice of animals is not necessary, these benefits make the use of biopsy probes highly desirable. The results from this chapter have demonstrated the feasibility of collecting *in situ* tissue samples from coral reef carcharhinids. Together with tissue samples collected from commercial and sacrificial research collections, the genetic stock structure of one of the study species, *Triaenodon obesus*, will be investigated in the next chapter.

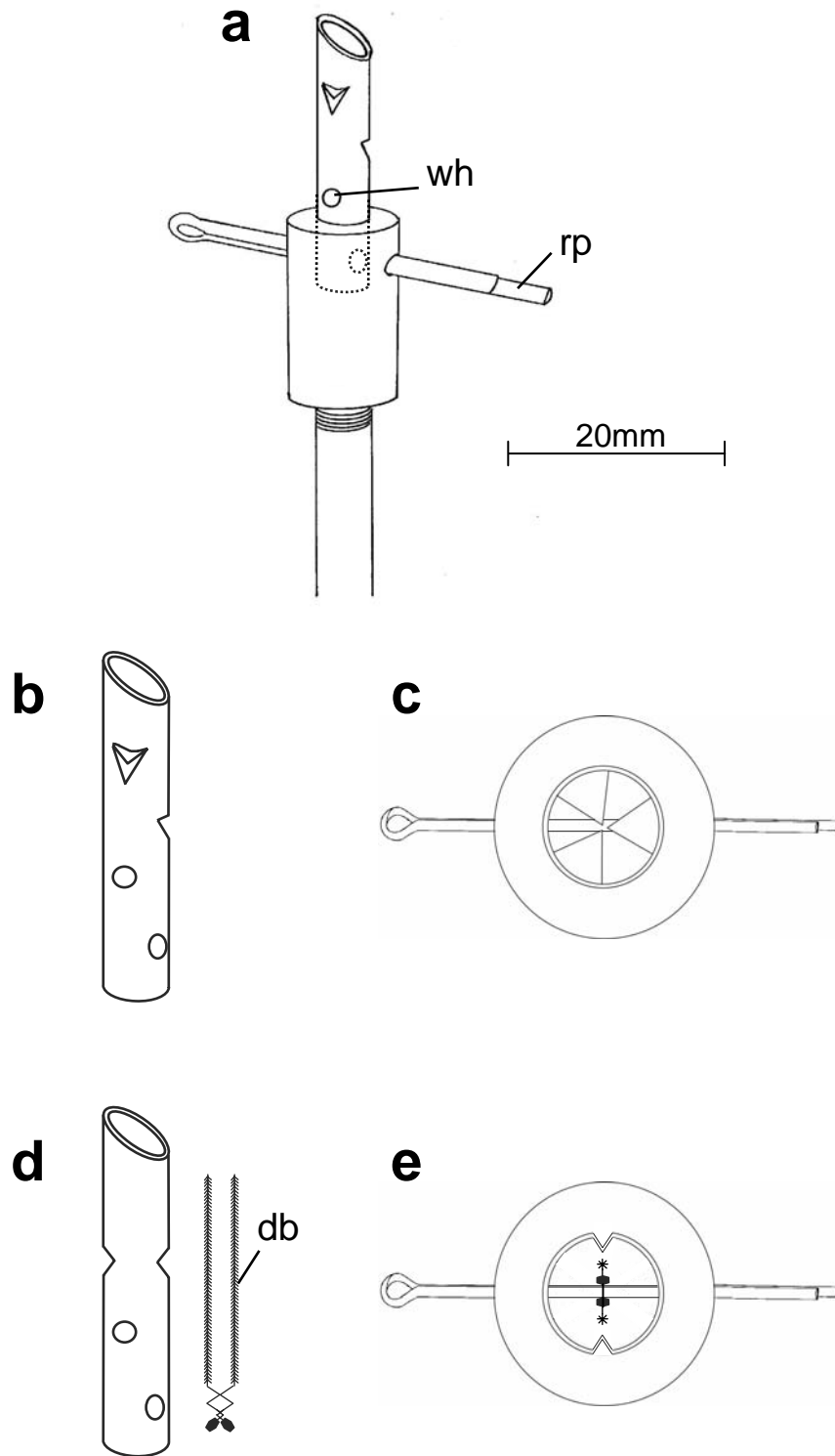

Figure 6.1. (a) Complete biopsy probe with Type I barrel insert. Dashed lines indicate extent of barrel inside the probe. (b, c) Lateral and aerial views of Type I barrel insert and (d, e) Type II barrel insert. wh: water effusion hole; rp: barrel retaining pin; db: dental broaches used with Type II barrel. Scale bar applicable to (a) only.

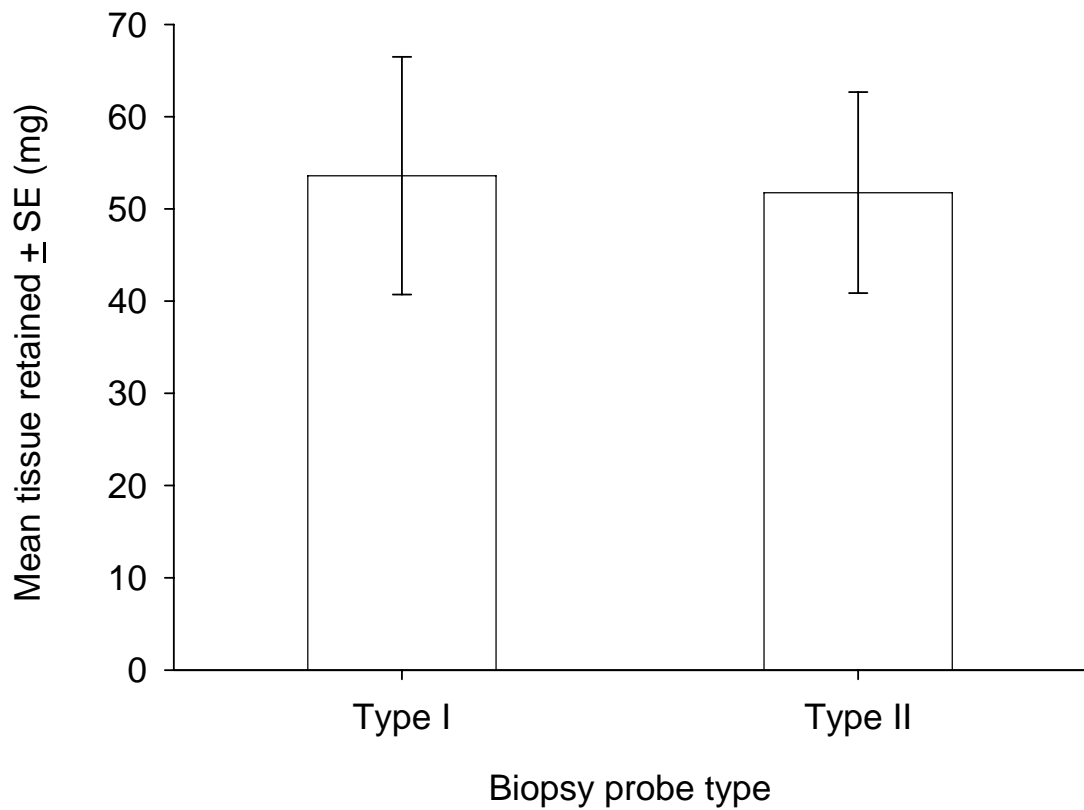

Figure 6.2. Mean wet weight (mg) of tissue retained from reef sharks using Type I and Type II biopsy probes.

Table 6.1. Variation in the wet weight of tissue collected and % total and successful tissue retention with two biopsy probe types. Successful tissue retention was defined as >3 mg.

Probe Type	Tissue retained (mg)		Tissue retention	Successful retention	Number of trials
	Minimum	Maximum			
Type I	0.5	384	87%	70%	37
Type II	6.6	122	91%	91%	11

7.1. INTRODUCTION

One of the potential issues hindering the management of sharks on the Great Barrier Reef is the uncertainty of their stock structure. It is unknown whether reef shark species exist as single panmictic populations, or as separate, reproductively-isolated sub-populations. Similar-sized carcharhinids have been found to move up to 880 km in under 10 months (Merson & Pratt 2001). However, philopatric behaviours may limit movements in species with high dispersal potential (Bowen et al. 1992). Strong site-fidelity has already been suggested for reef carcharhinids (Chapter 2). If reef sharks do exhibit such philopatric attributes, large-scale movements cannot be assumed on the GBR, despite its continuous reef habitat.

Techniques to determine genetic population structure have progressed markedly since their inception in the 1960s. Direct sequencing protocols may require as little as 1 mg tissue (Kasajima et al. 2004). This can now be obtained through minimally-invasive methods (Chapter 6). Both mitochondrial and nuclear genomes can be used to investigate population structure, however mitochondrial DNA (mtDNA) has many advantages over nuclear DNA. Mitochondrial DNA is a haploid genome, much smaller than nuclear DNA; it evolves at a faster rate than the nuclear genome, reaching fixation (identifiable genetic difference) four times faster than the nuclear genome. Furthermore, mtDNA has high levels of intraspecific variability in its non-coding region, and allows statistically more powerful analyses than nuclear DNA (especially at low migration rates) (Brown et al. 1979, Birky et al. 1983, Li & Graur 1991, Avise 2004, Ballard & Whitlock 2004). However, as mitochondria are maternally-inherited, their use can only

allow inference of female-mediated gene flow. This is not always representative of both sexes (Pardini et al. 2001).

7.1.1. Mitochondrial DNA analysis in sharks

There is little difference between the mtDNA genome of sharks and other vertebrates (Martin 1995). The shark mtDNA genome is well understood, having been mapped out for species such as the starspotted smooth-hound shark (*Mustelus manazo*) and the small-spotted catshark (*Scyliorhinus canicula*) (Cao et al. 1998, Delarbre et al. 1998). As with other vertebrates, the two most variable regions in the shark mtDNA genome are the control region (formally called “d-loop”) and the cytochrome *b* gene (Martin 1993, Kitamura et al. 1996b).

The control region is a non-coding (non protein-forming) section of mtDNA. It contains a hypervariable region, with increased levels of nucleotide substitutions. Multiple nucleotide substitutions within this region result in different nucleotide sequences (haplotypes) among individuals. The relative frequencies of these haplotypes can be compared using fixation indices (F or Φ -statistics; fig. 7.1). Unless the natural DNA mutation rate is extreme, the variance in haplotype frequencies between locations provides an estimate of their migration rates and reproductive isolation (Ward & Grewe 1994). The control region is the fastest evolving region of the mtDNA (Aquadro & Greenberg 1983, Cann et al. 1987), evolving around five times faster than the cytochrome *b* region in sharks (Palumbi 1996). Heist et al. (1996a) and Kitamura et al. (1996a) were first to advocate the use of the control region to investigate shark population structure. The slower-evolving cytochrome *b* region is generally more useful for determining phylogenetic relationships and species identification (Martin 1995,

Kitamura et al. 1996b, Heist & Gold 1999, Chan et al. 2003). The mtDNA control region was investigated in this study.

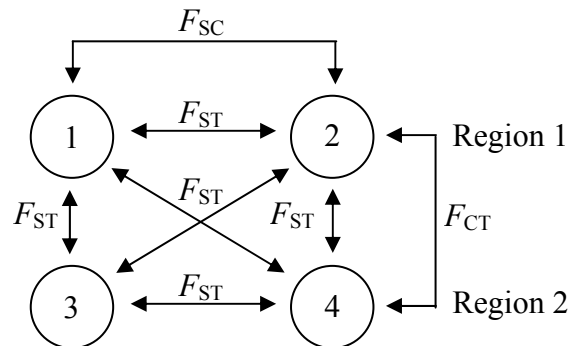

Figure 7.1. Fixation indices used in genetic population analyses. Numbers represent 4 hypothetical populations in 2 regions. F_{CT} : proportion of variance between regions relative to the total population; F_{SC} : proportion of variance between populations within regions; F_{ST} : proportion of variance among populations relative to the total population.

Molecular techniques have identified population structure in many shark families, including requiem (Carcharhinidae), mackerel (Lamnidae), hammerhead (Sphyrnidae) and angel sharks (Squatinae) (Martin 1993, Heist et al. 1995, Heist et al. 1996a, Gaida 1997, Feldheim et al. 2001, Keeney et al. 2003). Although sharks have naturally low rates of molecular evolution (Martin et al. 1992), both nuclear and mtDNA analyses have detected significant stock structure among shark populations at both ocean-basin (Martin 1993, Heist et al. 1996a, Pardini et al. 2001, Schrey & Heist 2003) and regional (Gaida 1997, Gardner & Ward 1998, Keeney et al. 2003, Keeney et al. 2005) spatial scales. Population structure in species such as the Pacific angel shark (*Squatina californica*) has been detected at resolutions as small as 100 km (Gaida 1995). Genetic population studies of sharks have focussed on coastal and oceanic species (Heist et al. 1996b, Pardini et al. 2001, Schrey & Heist 2003). As a result, species such

as the whitetip reef shark (*Triaenodon obesus*) and the grey reef shark (*Carcharhinus amblyrhynchos*) remain unexamined. While it would be useful to investigate the stock structure of both study species, limitations on time and funding only permitted one species to be investigated. *Triaenodon obesus* was examined as it is thought to be the least ephemeral of the two study species (Randall 1977, Nelson & Johnson 1980), and therefore the most likely to exhibit population fragmentation on the GBR. Confirmation of discrete population structure on the GBR would justify further investigation of *C. amblyrhynchos* population structure.

The specific aims of this chapter were:

1. To investigate the degree of genetic differentiation in *Triaenodon obesus* between two locations on the GBR, using mitochondrial control region sequences.
2. To compare the mitochondrial control region diversity of *T. obesus* on the GBR with other Indo-Pacific locations.

7.2. METHODS

7.2.1. Collection of tissues

Forty *Triaenodon obesus* and three *Carcharhinus amblyrhynchos* dorsal fin clips were randomly taken from northern and central GBR collections (fig. 7.2). Thirty two *T. obesus* skin and muscle samples were collected from the Cocos (Keeling) Islands and the Marquesas Islands using *in situ* underwater biopsy probes (cf. Chapter 6), and a further nine fin clips were obtained from Indonesia (Bali) and Osprey reef (Coral Sea;

13°54'S, 146°37'E) through external collaborations (fig. 7.2). All tissue samples were immediately placed in 80% EtOH, and stored at room temperature.

7.2.2. Amplification and sequencing of DNA

Total genomic DNA was extracted from each sample, following the protocol of Sunnucks and Hale (1996). Polymerase chain reaction (PCR) was used to selectively amplify the mitochondrial control region using an MJ Research PTC-200 thermocycler. Reactions were carried out in 25 µl aliquots, containing 1x *Taq* buffer (50 mM KCL, 10 mM Tris-HCL, 0.1% Triton X-100, pH 9.0), 1.5 mM MgCl₂, 130 µM each dNTP, 0.5 µM each primer, 1.5 units *Taq* DNA polymerase and approximately 20 ng template DNA. A negative control consisting of all reagents minus template DNA was included for each batch of reactions. Reaction conditions for each PCR used an initial denaturing step at 94°C for 2 min, followed by 30 cycles of 30 sec denaturing at 94°C, 30 sec annealing at 53°C, and 1 min extension at 72°C. A final 10 min extension was conducted at 72°C.

Light strand ProL2 (5'-CTG CCC TTG GCT CCC AAA GC-3') (Pardini et al. 2001) and heavy strand 282H (5'-AAG GCT AGG ACC AAA CCT-3') (Keeney et al. 2003) primers were used to amplify PCR products. Successful PCR products were visually identified on a 1.5% agarose gel, and purified using standard isopropanol precipitation. Single extension sequencing of cleaned PCR products was performed by *Macrogen* (www.macrogen.com), using BigDyeTM nucleotide terminators. Difficulties were encountered when sequencing the heavy mtDNA strand, due to variations in the number of adenosine bases in the 894-904 base pair region among the individual mitochondria in each *T. obesus* (heteroplasmy). This prevented the reverse (282H) primer from

sequencing upstream of the 894th base position. To overcome this, a third, internal light strand primer (Rf45: 5'- TAC GGT TTG TGG TAC ATT AC-3') was created. This primer attached to the *T. obesus* control region at the 355th base pair position, and allowed sequencing downstream to the 904th base pair position.

7.2.3. Analysis of genetic structure

Mitochondrial sequences were edited using Sequencher 4.5 (Gene Codes Corporation), automatically aligned with ClustalX (Thompson et al. 1997) and refined manually using Se-AI 2.0 (Rambaut 1996). Sequences were verified as carcharhinid through GenBank[®], to eliminate the possibility of mis-amplification or contamination. Two types of analyses were undertaken on the sequence data; a phylogeny to investigate the evolutionary distribution of *T. obesus*, and a phylogeographic analysis of the genetic structure of contemporary *T. obesus* populations. All individuals were used in the phylogenetic analyses. To ensure statistical integrity, locations with less than 10 individuals were excluded from population analyses.

7.2.3.1. Phylogenetic analyses

The minimum spanning tree (the most direct relationship between haplotypes) was analysed using Arlequin 3.0 (Schneider et al. 2000). Maximum parsimony analysis in PAUP* 4.10b (Swofford 1998) determined the most parsimonious consensus tree of all individuals, using the three *C. amblyrhynchos* samples as an out-group to root the tree. A chi-square homogeneity test independently investigated the distribution of individuals from different locations across clades identified in the consensus tree.

7.2.3.2. *Population structure*

Modeltest 3.06 (Posada & Crandall 1998) identified the Kimura (1981) K81uf+1 model to be the most appropriate substitution model for parametric tests. This model was not supported in parametric analyses (Arlequin 3.0); however, its similarity to the Tamura & Nei model (Tamura & Nei 1993) allowed use of the Tamura and Nei model in all such analyses. Gene flow among locations was inferred through hierarchical analysis of molecular variance (AMOVA) and fixation indices using Arlequin 3.0 (Excoffier et al. 1992). A permutation approach produced a haplotype correlation measure (Φ -statistic), allowing population structure to be statistically tested. The magnitude of haplotype dissimilarity among locations was measured using pairwise F_{ST} values (Wright 1951) implemented in Arlequin 3.0 (Schneider et al. 2000).

Minimum sea-travelling distance between locations was determined with a map, and the effect of geographic separation on population dissimilarity (pairwise F_{STs}) examined using 10 000 bootstrapped Mantel tests in IBD 1.52 (Bohonak 2002). Haplotype diversity (Nei 1987) and nucleotide diversity (Tajima 1983) were calculated manually or using Arlequin 3.0. These indices estimated the frequency of haplotypes among individuals (h), and the average-weighted sequence divergence between haplotypes (π) respectively.

7.3. RESULTS

7.3.1. Phylogenetic analyses

Sequence lengths of 1 065 base pairs were obtained from 81 *Triaenodon obesus* individuals, spanning the entire mitochondrial control region. Nucleotide composition of the control region was rich in adenine and thymine bases (36% thymine, 31% adenine), typical of marine fishes and sharks (McMillan & Palumbi 1995, Keeney & Heist 2003). Fifteen polymorphic nucleotide sites were found, 8 of which were sufficiently variable to allow comparisons between individuals (parsimony-informative). Twelve distinct haplotypes were found, 3 of which accounted for 80% of individuals (table 7.1). All locations had more than 1 haplotype, with the most common haplotype found at all locations (fig. 7.3).

Most parsimony-informative sites had undergone transition nucleotide substitutions (within the same chemical group; C↔T or A↔G) (table 7.1). Only one nucleotide site (#697) had haplotypes which had undertaken the more difficult transversion substitution across nucleotide chemical groups (A↔T). The overall ratio of transition to transversion substitutions was therefore extremely high (14:1). All transition sites had the same nucleotide base as the outgroup (*Carcharhinus amblyrhynchos*), suggesting saturation of the transition sites may be occurring. Saturations such as these add “noise” to the genetic signal, making population structure more difficult to detect.

A maximum parsimony (MP) analysis using heuristic searches produced 98 most parsimonious trees. The 50% majority rule consensus tree of all MP trees (fig. 7.4) is shown. Four distinct clades were evident, with all but the single-individual clade (clade III) comprised of individuals from multiple locations. Ocean-level structuring was

present ($\chi^2 = 9.73$; $df = 3$; $p < 0.05$), with clades I and II (excluding IIa) dominated by Pacific Ocean sharks, and clades IIa, IVa and IV dominated by Indian Ocean sharks (fig. 7.4).

Two distinct lineages of *T. obesus* were evident at the Cocos (Keeling) Islands. The oldest lineage was the basal group (clade IV and IVa), followed by a more recent lineage (clade IIa), which arose when Pacific Ocean populations of *T. obesus* first appeared (clades Ia and II) (fig. 7.4). Descendants of both Cocos (Keeling) Island invasions are extant today. The position of the single clade III individual from Bali may represent a lineage from the Indo-Australian Archipelago that contributed to the first invasion of the Cocos (Keeling) islands and the invasion of the Pacific Ocean. Based on the branch lengths (fig. 7.4), it appears that *T. obesus* originally invaded the Indian Ocean much earlier than the Pacific Ocean.

7.3.2. Population analyses

While it was useful to obtain as many samples as possible for phylogenetic analyses, the small sample sizes from Bali and Osprey reef may confound population structure analyses. Sample sizes of at least 10 individuals are usually required to detect differences in haplotype frequencies between populations (Tajima 1983). All locations with less than 10 individuals were therefore excluded from population genetic analyses.

The distribution of haplotypes across locations with $n \geq 10$ samples resulted in a relatively high haplotype diversity at the Cocos (Keeling) islands, northern GBR and Marquesas Islands (table 7.2). The central GBR population was dominated by haplotype

12, resulting in much lower haplotype diversity ($h=0.432$). The high degree of similarity between haplotypes resulted in low nucleotide diversity at all locations (table 7.2).

Analysis of molecular variance showed statistically significant variation in *T. obesus* haplotypes among locations (AMOVA, Φ_{st} $p<0.001$; table 7.3). Closer examination of pairwise F_{ST} values revealed that haplotype differences were high (>0.15) among all but the northern GBR and Marquesas Islands (table 7.4). All interactions except this were statistically significant. This suggests limited female-mediated gene flow among *T. obesus* populations, on both large and regional scales.

Pairwise F_{ST} values were not correlated with geographic separation (Mantel test, $p>0.05$; fig. 7.5). Nor were significant correlations ($p>0.05$) found in further Mantel analyses when both pairwise F_{ST} and distance matrices were \log_{10} transformed to adjust for differences in scale (Bohonak 2002). Isolation by distance effects (increased haplotype dissimilarity with distance) (Wright 1943) were not manifest in sampled *T. obesus* populations. However, to fully evaluate gene flow and isolation by distance effects among and within ocean basins, additional sites from throughout the distribution range (fig. 7.2) need to be sampled.

7.4. DISCUSSION

The whitetip reef shark (*Triaenodon obesus*) exhibits population separation on multiple geographic scales. With a lack of a pelagic dispersal phase, it is not surprising to find reproductively-isolated populations across the Indo-Pacific, which has large oceanic expanses devoid of reef structure. However, there are no obvious vicariant impediments

to latitudinal migrations of *T. obesus* along the Great Barrier Reef. Yet with migrations of less than 10 individuals required per generation to statistically homogenise genetic drift (Allendorf & Phelps 1981), the highly significant F_{ST} value between northern and central GBR populations ($p < 0.005$; table. 7.4) revealed an unexpectedly low degree of female-mediated gene flow.

Similar degrees of population separation have been recorded in female carcharhinids returning to nursery areas to parturate (Feldheim et al. 2002, Keeney et al. 2003, Keeney et al. 2005). However, the degree of population separation within the GBR indicates unprecedented site fidelity in carcharhinid sharks in a non-nursery, contiguous habitat. High levels of site fidelity in coral reef habitats increase both resource familiarity and foraging success (Bradshaw et al. 2004). The long-term ecological benefits of this may outweigh the advantages of dispersal and genetic heterogeneity provided by increased gene flow. The extent to which *T. obesus* is employing this strategy is worth further investigation, and will become clearer when the extent of the spatial scale at which genetically-different sub-populations exist can be determined.

Random gene flow usually results in distant locations receiving the least immigrants. This ultimately leads to fringe locations becoming more divergent genetically (isolation by distance) (Wright 1943). The degree of reproductive isolation (pairwise F_{ST} values) found in spatially-separated *T. obesus* populations was very high ($F_{ST} > 0.15$; Hartl & Clark (1997)); however, it did not increase with distance. The reproductive isolation seen between the two GBR locations was greater than the difference observed among the most distant locations (Marquesas Islands and the Cocos (Keeling) Islands). The lack of isolation by distance effects suggests that the degree of genetic separation in *T.*

obesus populations is not affected by the degree of spatial separation. Both regional and broad-scale movements of *T. obesus* appear to be similarly unlikely. These effects were strong enough to be detected in the presence of saturation of the transition sites.

The combination of high haplotype diversity and low nucleotide diversity seen in *T. obesus* (table 7.2) has been observed in widespread species of both carcharhinid and lamnid (mackerel) sharks (Heist et al. 1996a, Keeney et al. 2003). It is indicative of a small number of similar, prevalent haplotypes distributed throughout populations (Grant & Bowen 1998). Shared haplotypes may occur across reproductively-isolated locations through convergent haplotype evolution (identity by state), or as a result of locations being originally invaded by individuals who carried similar haplotypes (identity by descent or founder effect) (Mayr 1954, Tajima 1983). Both possibilities are feasible here. The high degree of similarity between common *T. obesus* haplotypes ($\pi=0.3\%$), together with the long generation times found in *T. obesus* (Chapter 5) will both contribute to the persistence of shared haplotypes across locations, even in the absence of gene flow.

Haplotype diversity (h) is usually proportional to population density (Avice 2004). The Cocos (Keeling) Islands was expected to have the highest haplotype diversity, as it had the highest density of *T. obesus* (Chapter 2), as well as evidence of a secondary invasion. However, the prevalence of haplotype 10 (fig 7.3) reduced the haplotype diversity to levels observed in other locations. All individuals with this haplotype originated from the secondary invasion of the Cocos (Keeling) Islands. The individuals from this invasion therefore appear to be more successful than those from the first invasion.

Although the Pacific Ocean was invaded at the same time as the secondary Indian Ocean invasion, there was little overlap between Pacific and Indian Ocean haplotypes (fig. 7.3). However, it is difficult to hypothesize the extent of ocean-level differences with only one Indian Ocean location. A study of the unicornfish (*Naso unicornis*) has found a biogeographic barrier exists between the central and east Indian Ocean (East Indian Ocean divide) (Klanten 2004). This divide causes greater genetic difference between the East and West Indian Ocean populations, than between the Pacific and Indian Oceans (Klanten 2004). Further studies of populations on the West and East Indian Oceans will determine the extent to which this barrier has influenced the distribution of reef carcharhinids.

The results presented here are indicative of female-mediated gene flow. There is no evidence to date to suggest *T. obesus* undertakes sexual segregations, although this behaviour has been observed in reef sharks such as *Carcharhinus amblyrhynchos* (Economakis & Lobel 1998). Sexual segregations occur in larger shark species, such as the scalloped hammerhead (*Sphyrna lewini*) and sand tiger sharks (*Carcharias taurus*), for feeding, mate selection and to maximise embryonic growth (Klimley 1987, Lucifora et al. 2002). Both sexes of large pelagic species such as the white shark (*Carcharodon carcharias*) may undertake trans-oceanic migrations; however, it is possible that mating behaviours may result in a distinct sex-bias in gene flow (Pardini et al. 2001, Bonfil et al. 2005). The presence of sexually-mediated gene flow in *T. obesus* can be investigated using the microsatellite regions of the nuclear genome. Until such time, the lack of movement inferred between adjacent coral reefs (Chapter 2), suggests it is not unreasonable to assume that both sexes of *T. obesus* have similar gene flow.

Knowledge of stock structure and population ranges are essential for effective management of reef carcharhinids. The grouping of individuals into discrete subpopulations may require their treatment as separate management units, defined by their population structure (Moritz 1994, Keeney & Heist 2003). This is especially important in exploited stocks, in which boundaries are needed to determine abundance and catch limits (Baker et al. 1999). The growth and reproductive characteristics of *T. obesus* were similar between the two reproductively-isolated populations on the GBR (Chapters 3 & 4). This allowed the pooling of their growth and demographic characteristics. However the issue of their management cannot be similarly pooled. Maintenance of stock numbers will need to be considered separately if migrations are not occurring within the GBR.

Future genetic studies of *T. obesus* on the GBR will need to focus on the determination of the populations' geographic ranges. This will involve analysis of genetic material sampled at smaller spatial scales, together with the use of additional markers (particularly nuclear) to determine both the scale of gene flow, and to detect whether male-mediated gene flow is similar to that of the females. These analyses, together with a similar investigation of grey reef shark (*C. amblyrhynchos*) and blacktip reef shark (*C. melanopterus*) population structure will build on the findings presented here. This will allow the full extent of reef carcharhinid population structure on the GBR to be determined.

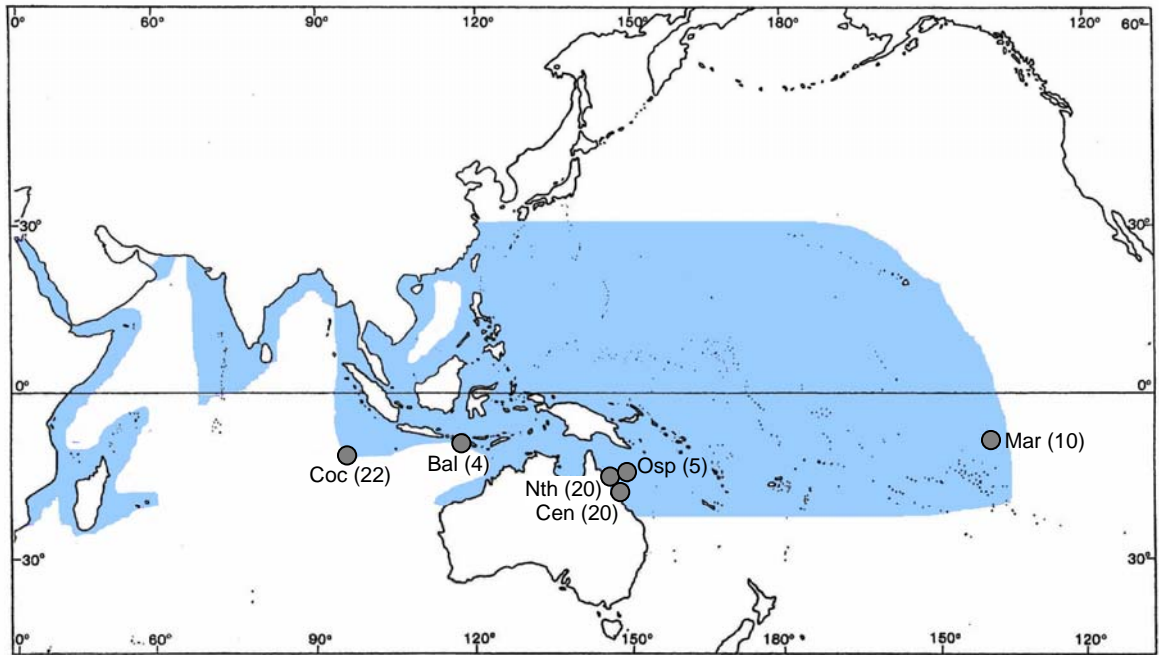

Figure 7.2. Location of *Triaenodon obesus* tissue collections. Coc: Cocos (Keeling) Islands, Bal: Bali, Nth: Northern GBR, Cen: central GBR, Osp: Osprey reef; Mar: Marquesas Islands. Numbers in parenthesis indicate sample sizes. Shaded areas indicate known *T. obesus* distribution (Last & Stevens 1994).

Table 7.1. Polymorphic nucleotide positions in the mtDNA control region of *Triaenodon obesus* from the Indo-Pacific. The nucleotides at each polymorphic position are given for haplotype 1. Haplotypes which share those nucleotides are indicated with a period or otherwise stated. Parsimony-informative sites are indicated by an *. A: adenine, C: cytosine, G: guanine and T: thymine. Insertion/deletion sites indicated by a dash (“-“), n: number of individuals per haplotype (total = 81 individuals).

Haplotype	120*	221	252	288*	367	412	416	697*	733*	748	752*	773*	774*	901	990*	n
1	G	T	A	T	T	A	T	A	T	T	T	A	C	A	C	1
2	G	-	1
3	.	.	.	C	C	.	G	T	.	.	1
4	.	.	G	.	C	1
5	T	.	T	1
6	-	.	1
7	.	C	1
8	T	4
9	A	T	5
10	.	.	.	C	C	.	C	.	T	.	.	14
11	C	.	C	.	T	.	.	21
12	T	.	.	.	G	T	.	.	30

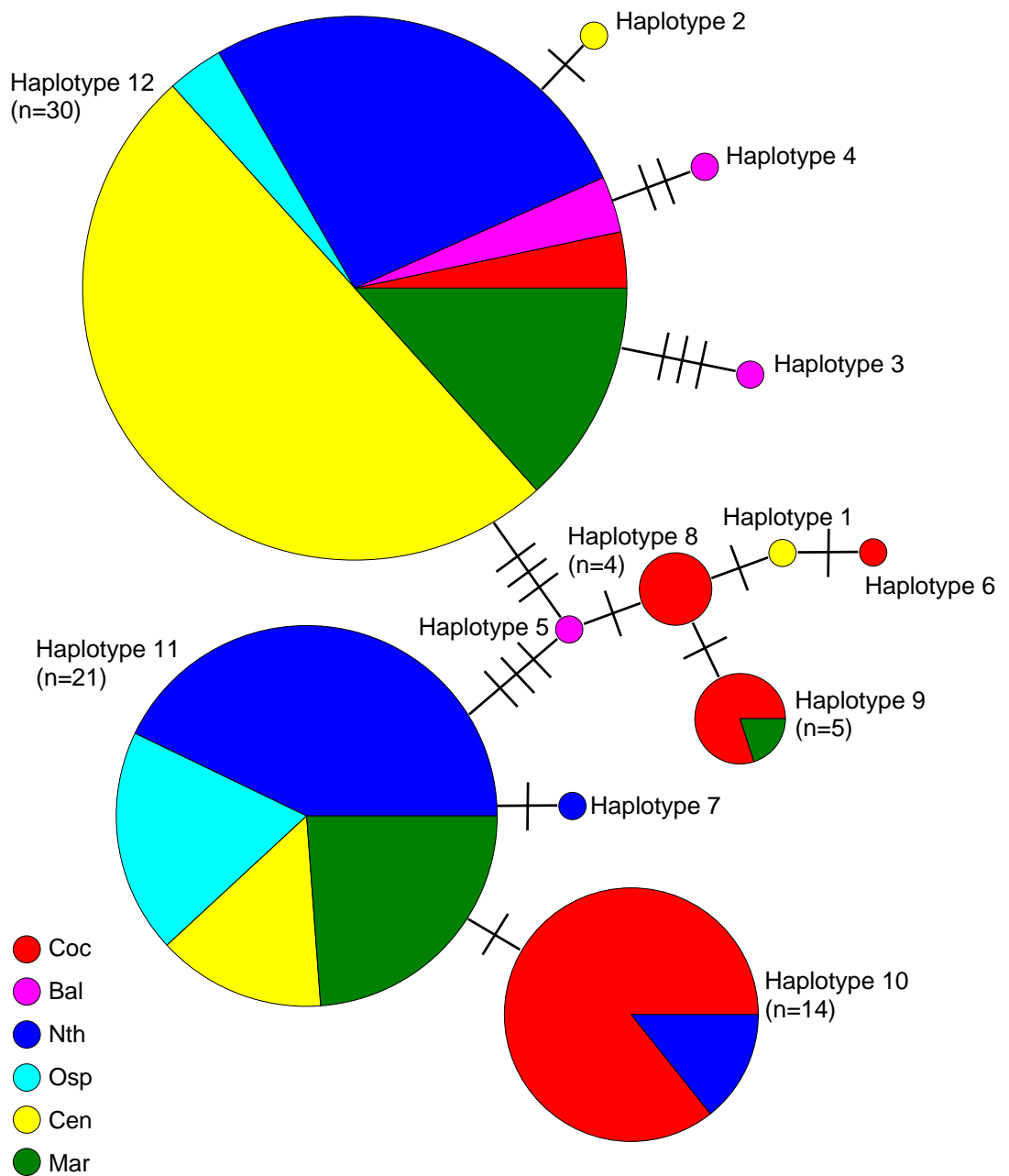

Figure 7.3. Minimum spanning tree indicating the relationship and distribution among *Triaenodon obesus* haplotypes. Circle sizes are proportional to sample size (see table 7.1). Cross-bars indicate single nucleotide substitutions. Haplotypes with sample sizes >1 indicated. Refer fig. 7.2 for location abbreviations.

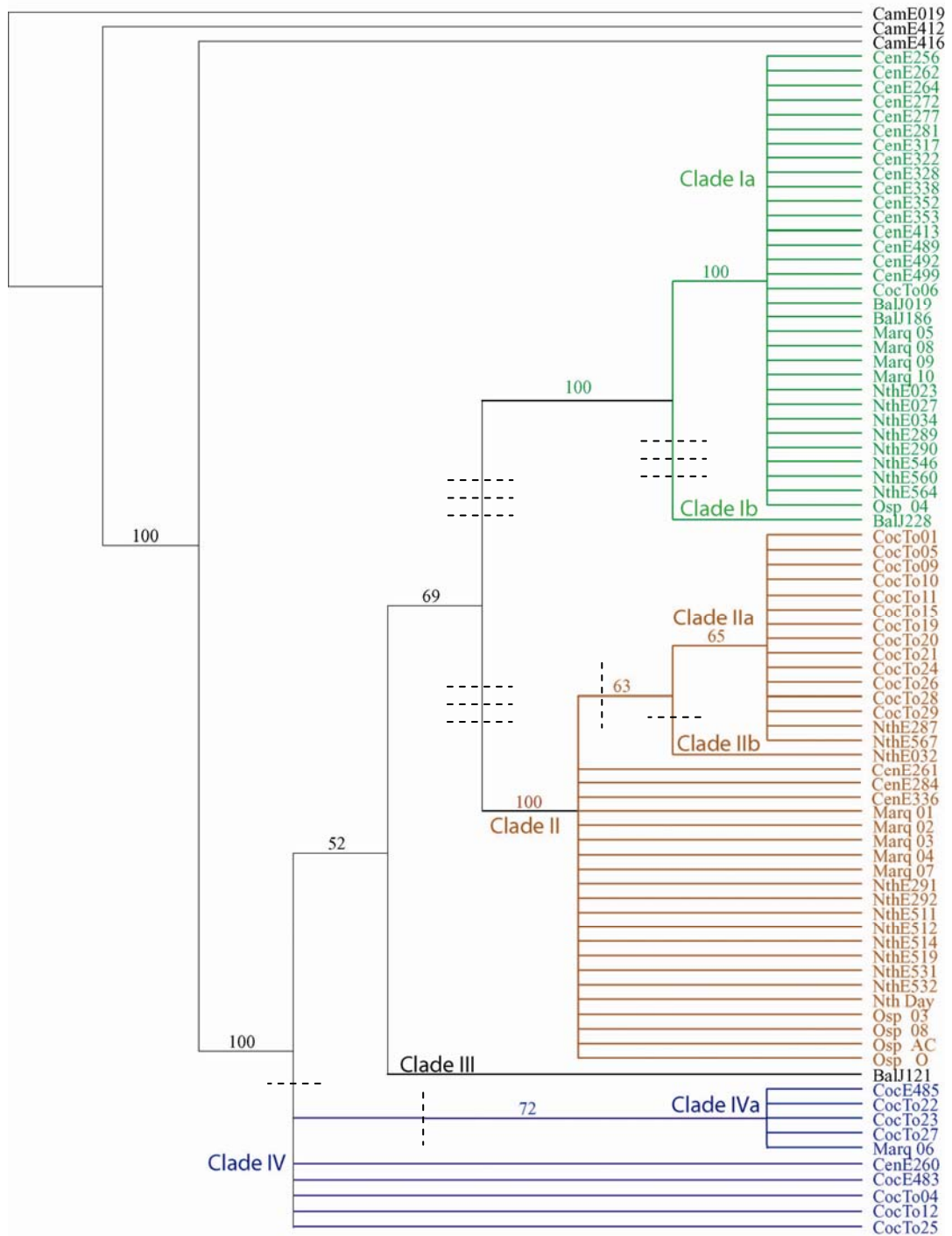

Figure 7.4. 50% Majority rule consensus tree of 98 maximum parsimony trees for 81 *Triaenodon obesus* following heuristic iterations. Sample numbers are prefixed with location (see fig. 7.2), outgroups prefixed by “Cam”. Majority rule consensus values indicated above branches. Clades indicated by colour. Dashed lines indicate number of nucleotide substitutions differentiating clades.

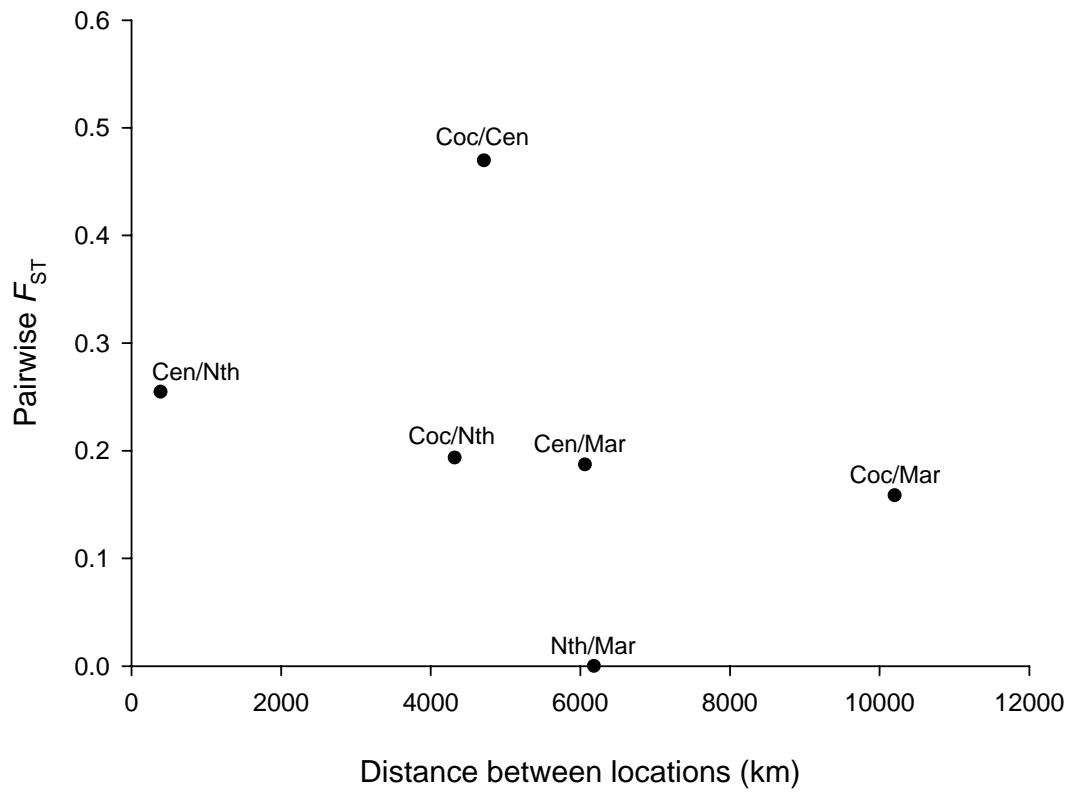

Figure 7.5. Relationship between pairwise F_{ST} values and minimum seaward geographic separation for *Triaenodon obesus* from locations with ≥ 10 samples. Refer fig. 7.2 for location abbreviations.

Table 7.2. Haplotype frequencies and sequence divergence for *Triaenodon obesus* from locations with ≥ 10 individuals. Refer fig 7.2 for location abbreviations.

Location	haplotype diversity (<i>h</i>)	nucleotide diversity ($\pi \times 100$)
Coc	0.662	0.283 \pm 0.172
Nth	0.658	0.218 \pm 0.139
Cen	0.432	0.147 \pm 0.102
Mar	0.644	0.266 \pm 0.173

Table 7.3. Analysis of molecular variance (AMOVA) among locations with ≥ 10 samples^a. df = degrees of freedom; SS = sum of squares. * indicates a significant value.

	df	SS	Variance components	Percent variation	Fixation indices	p-value
Among locations	3	26.36	0.43	26.6	$\Phi_{st} = 0.266$	0.000*
Within locations	68	81.03	1.19	73.4		
Total	71	107.39	1.62	100		

^aLocations sampled: Coc, Nth, Cen and Mar (refer fig. 7.2).

Table 7.4. Pairwise F_{ST} values among locations for *Triaenodon obesus* with ≥ 10 samples. Significant results in bold. * indicates $p < 0.05$; ** indicates $p < 0.005$. Refer fig. 7.2 for location abbreviations.

	Coc	Nth	Cen	Mar
Coc	--			
Nth	0.19**	--		
Cen	0.47**	0.25**	--	
Mar	0.16*	-0.05	0.19*	--

Chapter 8. General discussion.

8.1. SIGNIFICANT FINDINGS OF THIS STUDY

The analysis of the demographic characteristics of two coral reef carcharhinids revealed a consistent pattern of low reproductive output, and slow population turnover. The reproductive strategies of the whitetip reef shark (*Triaenodon obesus*), and the grey reef shark (*Carcharhinus amblyrhynchos*) were found to incorporate the more conservative traits of both smaller and larger members of their family, limiting their capability to absorb additional mortality. The fecundities of *T. obesus* and *C. amblyrhynchos* (2 and 3-4 pups, respectively) are considerably lower than the average litter sizes of larger carcharhinid species, which often have over twice the number of pups (Simpfendorfer 1992a, Wetherbee et al. 1996, Capape et al. 2003). However, both *T. obesus* and *C. amblyrhynchos* resemble larger species, in that they have a biennial breeding cycle (Branstetter 1981). Smaller carcharhinids, such as the sharpnose sharks (*Rhizoprionodon terraenovae* and *R. taylori*) have average litter sizes similar to the reef carcharhinids (~4 pups) (Simpfendorfer 1992b, Loefer & Sedberry 2003). However, in contrast to *T. obesus* and *C. amblyrhynchos*, they are capable of reproducing annually. Holden (1974) concluded that most elasmobranch populations produce only enough females to provide constant recruitment. With a total estimated output of just 6 female pups over a lifetime, reef carcharhinids appear to be employing this strategy. Such low levels of reproductive output suggest the natural mortality rates must also be low in these species.

Growth of *T. obesus* and *C. amblyrhynchos* is typical of many carcharhinid species. Both species exhibited faster initial growth, with decreasing, continuous growth

throughout the rest of their life. Sexually-dimorphic growth rates were apparent in *T. obesus*, while both sexes of *C. amblyrhynchos* grew at similar rates. Neither species exceeded the maximum expected size in captured samples (Compagno 1984); however, as both populations sampled are from an exploited system, it is possible that they may be growing faster than unexploited populations would (e.g. through density compensation), yet truncation of older individuals by fisheries exploitation may also be occurring. This point notwithstanding, large differences in *C. amblyrhynchos* growth and longevity became apparent when the results of this study were compared with studies conducted at other locations (De Crosta et al. 1984, Radtke & Cailliet 1984). Such variations are not uncommon in carcharhinids, with similar variations in growth dynamics apparent in species such as the blacknose shark (*C. acronotus*) and the blue shark (*Prionace glauca*) (Driggers et al. 2004a, Lessa et al. 2004). The occurrence of large variations in shark growth highlights the importance of individually estimating growth characteristics at different locations. Preliminary age validations through oxytetracycline recaptures and vertebral edge characterisations supported the age estimates derived in this study.

The combination of age, reproduction and mortality estimates permitted the demographics of exploited *T. obesus* and *C. amblyrhynchos* populations to be determined on the Great Barrier Reef (GBR). Previous studies have categorised both species of reef carcharhinid as being at “medium risk” of non-sustainability to fishing pressure (Smith et al. 1998, Stobutzki et al. in prep). However, the results of this thesis suggest that the vulnerability of reef carcharhinids is considerably greater. This discrepancy between findings occurs because of the different life history parameters (vital rates) used in calculations. Published estimates of *C. amblyrhynchos* life history

parameters have been mostly derived from a single region (Hawaii) (De Crosta et al. 1984, Radtke & Cailliet 1984), and differ in terms of longevity and litter size from the GBR. Moreover, previous studies have classed the life history parameters of species into broad categories. This has sometimes led to the grouping of parameters that vary by up to 400% (Stobutzki et al. in prep). This thesis was the first study to derive complete vital rate parameters for *T. obesus*, and the first to demographically model *T. obesus* and *C. amblyrhynchos* populations using parameter estimates specific to the location of collection. For this reason, the results presented here are proposed to be the most accurate for the two study species. Uncertainties or biases around the predicted population declines were investigated through alternative simulations and mortality estimates. Population declines for both species were forecast in almost every scenario investigated.

Predicted population declines on the GBR forecast numerical losses between 73-84% and 88-96% over the next 20 years for *T. obesus* and *C. amblyrhynchos*, respectively. At these rates, extirpation of these species from the GBR is a strong possibility. If losses of these magnitudes are realised, the chance of population recovery will be remote. Analysis of demographic elasticities revealed that juvenile survival has a higher impact on population growth than adult survival. Any change in the juvenile survival rates therefore affects a large proportion of the population (Heppell et al. 1999). Such findings are common in shark population dynamics (Sminkey & Musick 1996, Cortés 2002, Otway et al. 2004), as the delayed maturity found in many shark species causes a high proportion of immature individuals. Future management plans of reef carcharhinids will need to ensure that juvenile survival is a priority.

The magnitude to which fishing pressure affects coral reef carcharhinids was reflected in the reduced abundance of individuals in fished zones of the GBR. Gear restrictions have a negligible effect on reef carcharhinid abundance, with reductions of 76-80% observed for *T. obesus*, and 94-97% for *C. amblyrhynchos*, in the reef crest areas of limited and open fishing, respectively. These reductions are very similar to Hawaiian reef shark biomass reductions (>90%) seen as a result of fishing (Friedlander & DeMartini 2002). Similar reductions in abundance were seen in MPAs with known limited illegal fishing. These findings suggest that even the most limited levels of fishing pressure will severely deplete reef carcharhinid abundances. They also indicate that the “Marine National Park” MPAs, which comprise 30% of total reef area in the GBR Marine Park, are ineffectual in their protection of reef carcharhinids.

The ecological effects of extirpation of reef carcharhinids from the GBR are difficult to predict. ECOPATH modelling has predicted that removal of reef sharks from an unexploited reef system might have little impact on remaining reef species (Stevens et al. 2000). It is thought that the high degree of ecological redundancy inherent in coral reef ecosystems may allow other large predators (such as serranids) to fulfil the ecological role of reef sharks (Stevens et al. 2000). However, reef systems which lack such redundancies (such as exploited reefs, or the low-diversity Caribbean reefs), may behave differently. As apex predators, reef carcharhinids exert a “top down” influence upon reef trophodynamics (Bascompte et al. 2005). Modelling of their removal from this type of reef system causes trophic instability, resulting in trophic cascades and depletion of herbivorous fishes (Bascompte et al. 2005). It is difficult to isolate the impacts of shark depletions from contemporary coral reefs, as fishing pressure (which is usually responsible for shark reductions) often continues impacting down the food web

to the smaller species (Pauly et al. 1998, Myers & Worm 2003). A precautionary principle however, would conclude that the effects are likely to be significant and long-lasting, and should be avoided at all costs.

The development of an underwater visual census protocol was one of the few instances in which fisheries-independent estimates of shark abundance have been obtained.

Underwater visual censuses permitted rapid assessment of shark abundances on coral reef systems throughout the Indo-Pacific. From the perspective of shark management, this has the advantage of providing “real time” estimates of shark abundance on coral reefs, rather than relying on fishery catch data. The relative rarity of reef carcharhinids was highlighted on pristine reef systems, with maximum abundances of 3.7 sharks hectare⁻¹ in their preferred habitat. Most other regions surveyed had less than 0.5 sharks hectare⁻¹. Regional-scale biogeographic and habitat influence on abundance estimates could not be separated from fishing effects. Nevertheless, it is a worrying reflection of the global status of reef carcharhinids that the abundance levels seen at all non-pristine locations were equivalent to the depleted levels observed on fished GBR reefs.

Development of an *in-situ* underwater biopsy probe enabled the non-lethal, minimally invasive collection of reef carcharhinid tissues across Indo-Pacific locations. Genetic analysis of *T. obesus* populations found reproductively-isolated populations across the Indo-Pacific, and between two locations on the GBR. With a lack of a pelagic dispersal phase, it is not surprising to find reproductively-isolated populations across the Indo-Pacific, as these areas have large oceanic expanses devoid of reef structure. However, there are no obvious vicariant impediments to latitudinal migrations of *T. obesus* along the Great Barrier Reef. It therefore appears that *T. obesus* has a high degree of site

fidelity on coral reefs, even when migrations are possible. Knowledge of the stock structure and population ranges is essential for effective management of reef carcharhinids, as discrete subpopulations will require individual management (Moritz 1994). On an evolutionary scale, it was found that the Indian Ocean was invaded first by *T. obesus*, with Pacific Ocean invasion simultaneously occurring with a second Indian Ocean invasion. It is likely that the point of origin of both invasions was near the Indo-Australian Archipelago.

8.2. FUTURE DIRECTIONS

This thesis provides a robust overview of reef carcharhinid biology. It also identifies a number of future research avenues. Collection of oxytetracyclined *T. obesus* individuals needs to be completed, to confirm the results of validation through vertebral edge characterisation. It is anticipated that future fieldtrips will be undertaken to achieve this. Similarly, further collection of oxytetracyclined *C. amblyrhynchos* individuals at liberty >1 yr also need collection. The largest individuals of both *T. obesus* and *C. amblyrhynchos* sighted during this study were found in no-entry (no collection) Preservation zones. Sacrifice of a small number of the largest individuals from these zones will allow the maximum longevity on the GBR to be ascertained, and compared with individuals captured in fished zones.

The extent of the spatial scales in which *T. obesus* and other reef carcharhinids exhibit genetic structuring must be defined for their effective management. Knowledge of such genetic boundaries is especially important in contiguous locations, such as the GBR. Investigation of the frequency (or lack) of inter-reefal movements of sharks will provide

insights into the effectiveness of individually managing single reefs. Diel effects on inter-reefal movements of reef carcharhinids should also be further investigated, as many reef shark species are known to feed nocturnally (Randall 1977, McKibben & Nelson 1986), and may move greater distances at night (Nelson & Johnson 1980, Garla et al. 2006). Nocturnal distribution patterns of reef carcharhinids can be verified against daytime patterns through tagging and further genetic studies (such as nuclear markers).

Expansion of the underwater visual census program will allow rapid assessment of coral reef carcharhinids at many more locations. Such censuses can be used to estimate the standing abundances of sharks, as well as investigating the effectiveness of current MPA designs for reef shark protection. The efficacy of MPAs as a tool to protect reef sharks is currently questionable, as many MPAs may be too limited in size to accommodate the movement patterns of adult sharks (Chapman et al. 2005, Garla et al. 2006).

The role in which dive and tourist operators can assist in reef carcharhinid conservation should also be encouraged. In the Maldives, a single live *C. amblyrhynchos* has been estimated to generate up to US \$3 300 year⁻¹ alive in tourism income. Meanwhile, the same shark dead will bring a once-only price of US \$32 in the local fishery (Anderson & Ahmed 1993). Pressure from the Maldives tourism industry forced the government to prioritise reef shark conservation in 9 of the 15 MPAs declared in 1995 (Anderson & Waheed 1999). Sharks have recently been listed as the greatest dive attraction to the GBR (Miller & Sweatman 2004). With increasing levels of tourism on the GBR, raising the profile of reef sharks should lead to increasing support for their conservation. Moreover, the reporting of fishing infringements in MPAs by tourist operators may

provide some protection for reef sharks, supplementing the deficient levels of policing which are currently in place.

8.3. SUMMARY

Abundance estimates, demographic modeling and genetic analysis combined well to produce a comprehensive overview of reef carcharhinid biology. The abundance data from the Great Barrier Reef suggested decreased densities of reef sharks on fished reefs. This was supported by demographic predictions of population declines. The abundance data also suggested a high degree of site fidelity, which was supported by the conclusions of a broader-scale genetic examination of *T. obesus*. Examination of the age and reproductive data intuitively suggested low population turnovers, as was forecast by the demographic modelling. The limited fecundity of each species was in turn reflected by the low abundances seen of each species. While it is reassuring that the independently-collected aspects of this project were in agreement, it is cause for concern that all the project aspects suggest that reef carcharhinids such as *Triaenodon obesus* and *Carcharhinus amblyrhynchos* are highly vulnerable to population overexploitation. It is hoped that the contribution of this thesis to the understanding of reef carcharhinid biology will enable a scientific basis for the sustainable management of reef carcharhinids on tropical coral reefs.

REFERENCES

- Aguilar A, Nadal J (1984) Obtención de biopsias hipodérmicas de cetáceos en libertad. *Inv Pesq* 48:23-29
- Ali A, Ali R, Nasir M, Salleh I (1999) Management of shark fisheries in Malaysia. In: Shotten R (ed) Case studies of the management of elasmobranch fisheries. FAO Fisheries Technical Paper. Vol. 378 Part 1, p 402-424
- Allee WC (1931) Animal aggregations. A study in general sociology. University of Chicago Press Chicago
- Allen BR, Wintner SP (2002) Age and growth of the spinner shark *Carcharhinus brevipinna* (Muller and Henle, 1839) off the Kwazulu-Natal coast, South Africa. *S Afr J Marine Sci* 24:1-8
- Allendorf FW, Phelps SR (1981) Use of allelic frequencies to describe population structure. *Can J Fish Aquat Sci* 38:1507-1514
- Anderson ED (1990) Fishery models as applied to elasmobranch fisheries. In: Pratt HL, Gruber SH, Taniuchi T (eds) Elasmobranchs as living resources: Advances in the biology, ecology, systematics, and the status of the fisheries Proceedings of the second United States-Japan workshop, Honolulu, Hawaii., p 473-484
- Anderson RC, Ahmed H (1993) The shark fisheries of the Maldives. Ministry of Fisheries and Agriculture, Maldives and FAO, Rome, 73pp
- Anderson RC, Waheed Z (1999) Management of shark fisheries in the Maldives. In: Shotten R (ed) Case studies of the management of elasmobranch fisheries. FAO Fisheries Technical Paper. Vol. 378 Part 1, p 367-401
- Anon (2001) 2001 Census basic community profiles and snapshots. Territory of Cocos (Keeling) Islands. Australian Bureau of Statistics
- Anon (2004) Great Barrier Reef Marine Park zoning plan 2003. The Great Barrier Reef Marine Park Authority Townsville
- Aquadro CF, Greenberg BD (1983) Human mitochondrial DNA variation and evolution: Analysis of nucleotide sequences from seven individuals. *Genetics* 103:287-312
- Avise JC (2004) Molecular markers, natural history, and evolution. Second edition. Sinauer Associates, Inc. Sunderland, Massachusetts

- Baker CS, Patenaude NJ, Bannister JL, Robins J, Kato H (1999) Distribution and diversity of mtDNA lineages among southern right whales (*Eubalaena australis*) from Australia and New Zealand. *Mar Biol* 134:1-7
- Ballard JWO, Whitlock MC (2004) The incomplete natural history of mitochondria. *Mol Ecol* 13:729-744
- Barrett-Lennard LG, Smith TG, Ellis GM (1996) A cetacean biopsy system using lightweight pneumatic darts, and its effect on the behavior of killer whales. *Mar Mamm Sci* 12:14-27
- Bascompte J, Melian CJ, Sala E (2005) Interaction strength combinations and the overfishing of a marine food web. *Proc Natl Acad Sci* 102:5443–5447
- Baum JK, Myers RA (2004) Shifting baselines and the decline of pelagic sharks in the Gulf of Mexico. *Ecology Letters* 7:135-145
- Baum JK, Myers RA, Kehler DG, Worm B, Harley SJ, Doherty PA (2003) Collapse and conservation of shark populations in the northwest Atlantic. *Science* 299:389-392
- Beamish RJ, Fournier DA (1981) A method for comparing the precision of a set of age determinations. *Can J Fish Aquat Sci* 38:982-983
- Beerkircher L, Shivji M, Cortes E (2003) A Monte Carlo demographic analysis of the silky shark (*Carcharhinus falciformis*): implications of gear selectivity. *Fish Bull* 101:168-174
- Bellwood DR, Hughes TP, Folke C, Nystrom N (2004) Confronting the coral reef crisis. *Nature* 429:827-833
- Berkeley SA, Campos WL (1988) Relative abundance and fishery potential of pelagic sharks along Florida's east coast. *Marine Fisheries Review* 50:9-16
- Beverton RJH, Holt SJ (1965) On the dynamics of exploited fish populations. Ministry of Agriculture, Fisheries and Food. Fishery investigations. Series II, Volume XIX. Lowestoft
- Birky CWJ, Maruyama T, Fuerst P (1983) An approach to population and evolutionary genetic theory for genes in mitochondria and chloroplasts, and some results. *Genetics* 103:513–527
- Bishop SDH, Francis MP, Duffy C, Montgomery JC (2006) Age, growth, maturity, longevity and natural mortality of the shortfin mako shark (*Isurus oxyrinchus*) in New Zealand waters. *Mar Freshwater Res* 57:143-154

- Bohonak AJ (2002) IBD (Isolation By Distance): A program for analyses of isolation by distance. *Journal of Heredity* 93:153-154
- Boje J, Riget F, Koie M (1997) Helminth Parasites As Biological Tags in Population Studies of Greenland Halibut (*Reinhardtius hippoglossoides* (Walbaum)), in the North-West Atlantic. *ICES J Mar Sci* 54:886-895
- Bonfil R (1994) Overview of world elasmobranch fisheries. *FAO Fisheries Technical Paper* 341:1-119
- Bonfil R (1996) Pattern and trends in world shark fisheries. In: Gribble NA, McPherson G, Lane B (eds). *Shark management and conservation. Proceedings from the sharks and man workshop of the second world fisheries congress, Series QC98001*. Department of Primary Industries Queensland, Australia. p 3
- Bonfil R (1999) Marine Protected Areas as a shark fisheries management tool. In: Seret B, Sire JY (eds) *Proceedings of the 5th Indo-Pacific fish conference Noumea, 1997*. Societe Francaise d'Ichtyologie, Paris and Istitut de Recherche pour le Developement, Paris, p 217-230
- Bonfil R, Meyer M, Scholl MC, Johnson R, O'Brien S, Oosthuizen H, Swanson S, Kotze D, Paterson M (2005) Transoceanic migration, spatial dynamics, and population linkages of white sharks. *Science* 310:100-103
- Borrell A, Cantos G, Pastor T, Aguilar A (2004) Levels of organochlorine compounds in spotted dolphins from the Coiba archipelago, Panama. *Chemosphere* 54:669-677
- Borucinska J, Kohler N, Natanson L, Skomal G (2002) Pathology associated with retained fishing hooks in blue sharks, *Prionace glauca* (L.), with implications for their conservation. *J Fish Dis* 25:515-521
- Bowen B, Meylan AB, Ross J, Limpus CJ, Balazs G, Avise JC (1992) Global population structure and natural history of the green turtle (*Chelonia mydas*) in terms of matriarchal phylogeny. *Evolution* 46:865-881
- Bradshaw CJA, Hindell MA, Sumner MD, Michael KJ (2004) Loyalty pays: potential life history consequences of fidelity to marine foraging regions by southern elephant seals. *Animal Behaviour* 68:1349-1360
- Brander K (1981) Disappearance of common skate *Raia batis* from Irish Sea. *Nature* 290:49-49
- Branstetter S (1981) Biological notes on the sharks of the north central Gulf of Mexico. *Contrib Mar Sci* 24:13-34

- Branstetter S (1987a) Age and growth estimates for blacktip, *Carcharhinus limbatus*, and spinner, *C. brevipinna*, sharks from the northwestern Gulf of Mexico. *Copeia* 1987:964-974
- Branstetter S (1987b) Age and growth validation of newborn sharks held in laboratory aquaria, with comments on the life history of the Atlantic sharpnose shark, *Rhizoprionodon terraenovae*. *Copeia* 1987:291-300
- Branstetter S (1990) Early life-history implications of selected carcharhinoid and lamnoid sharks of the northwest Atlantic. In: Pratt HL, Gruber SH, Taniuchi T (eds) Elasmobranchs as living resources: Advances in the biology, ecology, systematics, and the status of the fisheries. Proceedings of the second United States-Japan workshop, Honolulu, Hawaii, p 17-28
- Branstetter S, McEachran JD (1986) Age and growth of four carcharhinid sharks common to the Gulf of Mexico: a summary paper. In: Uyeno T, Arai R, Taniuchi T, Matsuura K (eds) Indo-Pacific fish biology: proceedings of the second international conference on Indo-Pacific fishes. Ichthyological Society of Japan, Tokyo, Japan, p 361-371
- Branstetter S, Musick JA (1994) Age and growth estimates for the sand tiger in the northwestern Atlantic Ocean. *Trans Am Fish Soc* 123:242-254
- Branstetter S, Musick JA, Colvolcoresses JA (1987) A comparison of the age and growth of the tiger shark, *Galeocerdo cuvier*, from off Virginia and from the northwestern gulf of Mexico. *Fish Bull* 85:269-279
- Branstetter S, Stiles R (1987) Age and growth estimates of the bull shark, *Carcharhinus leucas*, from the northern Gulf of Mexico. *Env Biol Fish* 20:169-181
- Brewster-Geisz KK, Miller TJ (2000) Management of the sandbar shark, *Carcharhinus plumbeus*: implications of a stage-based model. *Fish Bull* 98:236-249
- Brock VE (1954) A preliminary report on a method of estimating reef fish populations. *J Wildl Manage* 18:297-308
- Brown CA, Gruber SH (1988) Age assessment of the lemon shark, *Negaprion brevirostris*, using tetracycline validated centra. *Copeia* 1988:747-753
- Brown WM, George MJ, Wilson AC (1979) Rapid isolation of animal mitochondrial DNA. *PROC NATL ACAD SCI* 76:1967-1971
- Bunce P (1988) The Cocos (Keeling) Islands. Australian atolls in the Indian Ocean. The Jacaranda Press Milton

- Cailliet GM (1990) Elasmobranch age determination and verification; an updated review. In: Pratt HL, Gruber SH, Taniuchi T (eds). Elasmobranchs as living resources: Advances in the biology, ecology, systematics, and the status of the fisheries. Proceedings of the second United States-Japan workshop, Honolulu, Hawaii, p 157-165
- Cailliet GM (1992) Demography of the central California population of the leopard shark (*Triakis semifasciata*). Aust J Mar Freshw Res 43:183-189
- Cailliet GM, Goldman KJ (2004) Age determination and validation in chondrichthyan fishes. In: Carrier JC, Musick JA, Heithaus MR (eds) Biology of sharks and their relatives. CRC Press, Florida, p 399-447
- Cailliet GM, Martin LK, Harvey JT, Kusher D, Weldon BA (1983a) Preliminary studies on the age and growth of blue, *Prionace glauca*, common thresher, *Alopias vulpinus*, and shortfin mako, *Isurus oxyrinchus*, sharks from California waters. In: E.D. Prince ED, Pulos LM (eds) Proceedings of the international workshop on age determination of oceanic pelagic fishes: tunas, billfishes, and sharks, p 179-188
- Cailliet GM, Martin LK, Kusher D, Wolf P, Weldon BA (1983b) Techniques for enhancing vertebral bands in age estimation of California elasmobranchs. In: E.D. Prince ED, Pulos LM (eds) Proceedings of the international workshop on age determination of oceanic pelagic fishes: tunas, billfishes, and sharks, p 157-165
- Cailliet GM, Yudin KG (1990) Growth characteristics of two populations of *Mustelus manazo* from Japan based upon cross-readings of vertebral bands. In: Pratt HL, Gruber SH, Taniuchi T (eds) Elasmobranchs as living resources: Advances in the biology, ecology, systematics, and the status of the fisheries. Proceedings of the second United States-Japan workshop, Honolulu, Hawaii, p 167-176
- Campana SE (2001) Accuracy, precision and quality control in age determination, including a review of the use and abuse of age validation methods. J Fish Biol 59:197-242
- Campana SE, Joyce W, Marks L, Natanson LJ, Kohler NE, Jensen CF, Mello JJ, Pratt HL, Myklevoll S (2002a) Population dynamics of the porbeagle in the northwest Atlantic Ocean. North Am J Fish Management 22:106-121
- Campana SE, Natanson LJ, Myklevoll S (2002b) Bomb dating and age determination of large pelagic sharks. Can J Fish Aquat Sci 59:450-455

- Cann RL, Stoneking M, Wilson AC (1987) Mitochondrial DNA and human evolution. *Nature* 325
- Cao Y, Waddell PJ, Okada N, Hasegawa M (1998) The complete mitochondrial DNA sequence of the shark *Mustelus manazo*: Evaluating rooting contradictions to living bony vertebrates. *Mol Biol Evol* 15:1637-1646
- Capape C, Hemida F, Seck AA, Diatta Y, Guelorget O, Zaouali J (2003) Distribution and reproductive biology of the spinner shark, *Carcharhinus brevipinna* (Muller and Henle, 1841) (Chondrichthyes: Carcharhinidae). *Isr J Zool* 49:269-286
- Capape C, Seck AA, Diatta Y, Reynaud C, Hemida F, Zaouali J (2004) Reproductive biology of the blacktip shark, *Carcharhinus limbatus* (Chondrichthyes: Carcharhinidae) off west and north African coasts. *Cybium* 28:275-284
- Cappo M, Eden P, Newman SJ, Robertson S (2000) A new approach to validation of periodicity and timing of opaque zone formation in the otoliths of eleven species of *Lutjanus* from the central Great Barrier Reef. *Fish Bull* 98:474-488
- Cappo M, Meekan M (2004) Traditional fishing puts the bite on sharks. *Australasian Science* November/December: 29-32
- Carlson JD, Cortés E, Bethea DM (2003) Life history and population dynamics of the finetooth shark (*Carcharhinus isodon*) in the northeastern Gulf of Mexico. *Fish Bull* 101:281-292
- Carlson JK, Baremore IE (2003) Changes in biological parameters of Atlantic sharpnose shark *Rhizoprionodon terraenovae* in the Gulf of Mexico: evidence for density-dependent growth and maturity? *Mar Freshwater Res* 54:227-234
- Carlson JK, Baremore IE (2005) Growth dynamics of the spinner shark (*Carcharhinus brevipinna*) off the United States southeast and Gulf of Mexico coasts: a comparison of methods. *Fish Bull* 103:280-291
- Carlson JK, Cortés E, Johnson AG (1999) Age and growth of the blacknose shark, *Carcharhinus acronotus*, in the eastern Gulf of Mexico. *Copeia* 1999:684-691
- Carrier JC, Pratt HL, Castro JI (2004) Reproductive biology of elasmobranchs. In: Carrier JC, Musick JA, Heithaus MR (eds) *Biology of sharks and their relatives*. CRC Press, Florida, p 269-286
- Casey JG, Pratt HL, Stillwell CE (1985) Age and growth of the sandbar shark, (*Carcharhinus plumbeus*), from the western North Atlantic. *Can J Fish Aquat Sci* 42:963-975

- Casey JM, Myers RA (1998) Near extinction of a large, widely distributed fish. *Science* 281:690-692
- Castro JI (1996) Biology of the blacktip shark, *Carcharhinus limbatus*, off the southeastern United States. *Bull Mar Sci* 59:508-522
- Castro JI, Woodley CM, Brudek RL (1999) A preliminary evaluation of the status of shark species. *FAO Fisheries Technical Paper* 380:72pp
- Castro JI, Wourms JP (1993) Reproduction, placentation, and embryonic development of the Atlantic sharpnose shark, *Rhizoprionodon terraenovae*. *J Morphol* 218:257-280
- Caswell H (2001) *Matrix population models: Construction, analysis and interpretation*. 2nd edition. Sinauer Associates Sunderland, MA. USA.
- Cerrato RM (1990) Interpretable statistical tests for growth comparisons using parameters in the von Bertalanffy equation. *Can J Fish Aquat Sci* 47:1416-1426
- Chan RWK, Dixon PI, Pepperell JG, Reid DD (2003) Application of DNA-based techniques for the identification of whaler sharks (*Carcharhinus* spp.) caught in protective beach meshing and by recreational fisheries off the coast of New South Wales. *Fish Bull* 101:910-914
- Chapman DD, Pikitch EK, Babcock EA, Shivji MS (2005) Marine reserve design and evaluation using automated acoustic telemetry: A case study involving coral-reef associated sharks in the Mesoamerican Caribbean. *Marine Technol Soc J* 39:42-56
- Chatzisprou A, Megalofonou P (2005) Sexual maturity, fecundity and embryonic development of the spiny dogfish, *Squalus acanthias*, in the eastern Mediterranean Sea. *J Mar Biol Assoc UK* 85:1155-1161
- Chen S, Watanabe S (1989) Age dependence of natural mortality coefficient in fish populations dynamics. *Nippon Suisan Gakkaishi* 55:205-208
- Chiappone M, Swanson DW, Miller SL, Dienes H (2004) Spatial distribution of lost fishing gear on fished and protected offshore reefs in the Florida Keys National Marine Sanctuary. *Carib J Sci* 40:312-326
- Chin A (May 2005) Sharks and rays. In Chin. A, State of the Great Barrier Reef On-line, Great Barrier Reef Marine Park Authority, Townsville. Viewed on 11/11/2005:http://www.gbrmpa.gov.au/corp_site/info_services/publications/sotr/sharks_rays/index.html.

- Choat JH, Axe LM (1996) Growth and longevity in acanthurid fishes; an analysis of otolith increments. *Mar Ecol Prog Ser* 134:15-26
- Choat JH, Ayling AM (1987) The relationship between habitat structure and fish faunas on New Zealand reefs. *J Exp Mar Biol Ecol* 110:257-284
- Choat JH, Robertson DRR (2002) Age-based studies. In: Sale PF (ed) *Coral reef fishes Dynamics and diversity in a complex ecosystem*. Elsevier Science (USA), San Diego, California, p 57-80
- Clark E, von Schmidt K (1965) Sharks of the Central Gulf Coast of Florida. *Bull Mar Sci* 15:13-83
- Clarke MW, Connolly PL, Bracken JJ (2002) Age estimation of the exploited deepwater shark *Centrophorus squamosus* from the continental slopes of the Rockall Trough and Porcupine Bank. *J Fish Biol* 60:501-514
- Compagno LJV (1984) FAO species catalogue. Vol. 4. Sharks of the world. An annotated and illustrated catalogue of shark species known to date. Part 2. Carcharhiniformes. FAO Fisheries Symposium 4. Pt 2:251-655
- Compagno LJV (1990) Alternative life-history styles of cartilaginous fishes in time and space. *Env Biol Fish* 28:33-75
- Compagno LJV (2001) *Sharks of the order Carcharhiniformes*. The Blackburn Press Caldwell, New Jersey.
- Conrath CL, Gelsleichter J, Musick JA (2002) Age and growth of the smooth dogfish (*Mustelus canis*) in the northwest Atlantic Ocean. *Fish Bull* 100:674-682
- Cortés E (1998) Demographic analysis as an aid in shark stock assessment and management. *Fish Res* 39:199-208
- Cortés E (1999a) Standardized diet compositions and trophic levels of sharks. *ICES J Mar Sci* 56:707-717
- Cortés E (1999b) A stochastic stage-based population model of the sandbar shark in the western North Atlantic. In: Musick JA (ed) *Life in the slow lane: Ecology and conservation of long lived marine animals*. American Fisheries Society Symposium 23, Bethesda, Maryland, p 115-136
- Cortés E (2000) Life history patterns and correlations in sharks. *Rev Fish Sci* 8:299-344
- Cortés E (2002) Incorporating uncertainty into demographic modelling: Application to shark populations and their conservation. *Conserv Biol* 16:1048-1062

- Cortés E (2004) Life history patterns, demography, and population dynamics. In: Carrier JC, Musick JA, Heithaus MR (eds) *Biology of sharks and their relatives*. CRC Press, Florida, p 449-470
- Davies DH, Joubert LS (1966) Tag evaluation and shark tagging in South African waters., Investigational report no. 12. The Oceanographic Research Institute. South African Association for Marine Biological Research, Durban
- Davis KLF, Russ GR, Williamson DH, Evans RD (2004) Surveillance and poaching on inshore reefs on the Great Barrier Reef Marine Park. *Coast Manage* 32:373-387
- De Crosta MA, Taylor LRJ, Parrish JD (1984) Age determination, growth, and energetics of three species of carcharhinid sharks in Hawaii. *Proceedings of the second symposium on resource investigations of the NW Hawaiian Islands*. University of Hawaii, Honolulu, p 75-95
- Delarbre C, Spruyt N, Delmarre C, Gallut C, Barriel V, Janvier P, Laudet V, Gachelin G (1998) The complete nucleotide sequence of the mitochondrial DNA of the dogfish, *Scyliorhinus canicula*. *Genetics* 150:331-344
- Di Benedetto APM, Ramos RMA (2004) Biology of the marine tucuxi dolphin (*Sotalia fluviatilis*) in south-eastern Brazil. *J Mar Biol Assoc UK* 84:1245-1250
- Dodd JM, Dodd HI, Buggan RT (1983) Control of reproduction in elasmobranch fishes. In: Rankin JC, Pitcher TJ, Duggan R (eds) *Control processes in fish physiology*. J. Wiley & sons, New York, p 221
- Driggers WB, Carlson JK, Cullum B, Dean JM, Oakley D, Ulrich G (2004a) Age and growth of the blacknose shark, *Carcharhinus acronotus*, in the western North Atlantic Ocean with comments on regional variation in growth rates. *Env Biol Fish* 71:171-178
- Driggers WB, Oakley DA, Ulrich G, Carlson JK, Cullum BJ, Dean JM (2004b) Reproductive biology of *Carcharhinus acronotus* in the coastal waters of South Carolina. *J Fish Biol* 64:1540-1551
- Dulvy NK, Polunin NVC, Mill AC, Graham NAJ (2004) Size structural change in lightly exploited coral reef fish communities: evidence for weak indirect effects. *Can J Fish Aquat Sci* 61:466-475
- Economakis AE, Lobel PS (1998) Aggregation behavior of the grey reef shark, *Carcharhinus amblyrhynchos*, at Johnston Atoll, central Pacific Ocean. *Env Biol Fish* 51:129-139

- Ellis JR, Dulvy NK, Jennings S, Parker-Humphreys JM, Rogers SI (2005) Assessing the status of demersal elasmobranchs in UK waters: a review. *J Mar Biol Assoc UK* 85:1025-1047
- Evans K, Hindell MA (2004) The age structure and growth of female sperm whales (*Physeter macrocephalus*) in southern Australian waters. *J Zool* 263:237-250
- Excoffier L, Smouse PE, Quattro JM (1992) Analysis of molecular variance inferred from metric distances among DNA haplotypes: Application to human mitochondrial DNA restriction data. *Genetics* 131:479-491
- Feldheim KA, Gruber SH, Ashley MV (2001) Population genetic structure of the lemon shark (*Negaprion brevirostris*) in the western Atlantic: DNA microsatellite variation. *Mol Ecol* 10:295-303
- Feldheim KA, Gruber SH, Ashley MV (2002) The breeding biology of lemon sharks at a tropical nursery lagoon. *P Roy Soc Lond B Bio* 269:1655-1661
- Francis MP, Griggs LH, Baird SJ (2001) Pelagic shark bycatch in the New Zealand tuna longline fishery. *Mar Freshwater Res* 52:165-178
- Francis MP, Maolagain C (2000) Age, growth and maturity of a New Zealand endemic shark (*Mustelus lenticulatus*) estimated from vertebral bands. *Mar Freshwater Res* 51:35-42
- Francis MP, Mulligan KP (1998) Age and growth of New Zealand school shark, *Galeorhinus galeus*. *New Zeal J Mar Fresh* 32:427-440
- Friedlander AM, DeMartini EE (2002) Contrasts in density, size, and biomass of reef fishes between the northwestern and the main Hawaiian islands: The effects of fishing down apex predators. *Mar Ecol Prog Ser* 230:253-265
- Gaida IH (1995) Evolutionary aspects of gene expression in the Pacific angel shark, *Squatina californica* (Squatiniiformes, Squatinidae). *Copeia* 1995:532-554
- Gaida IH (1997) Population structure of the Pacific angel shark, *Squatina californica* (Squatiniiformes, Squatinidae), around the California channel islands. *Copeia* 1997:738-744
- Gallagher M, Nolan CP (1999) A novel method for the estimation of age and growth in rajids using caudal thorns. *Can J Fish Aquat Sci* 56:1590-1599
- Garayzar CJV (1996) Reproduction of *Carcharhinus obscurus* (Pisces, Carcharhinidae) in the northeast Pacific. *Rev Biol Trop* 44:287-289

- Gardner MG, Ward RD (1998) Population structure of the Australian gummy shark (*Mustelus antarcticus* Günther) inferred from allozymes, mitochondrial DNA and vertebrae counts. *Mar Freshwater Res* 49:733-745
- Garla R, Chapman D, Wetherbee B, Shivji M (2006) Movement patterns of young Caribbean reef sharks, *Carcharhinus perezi*, at Fernando de Noronha Archipelago, Brazil: The potential of marine protected areas for conservation of a nursery ground. *Mar Biol* 149:189-199
- Gelsleichter J, Cortés E, Manire CA, Hueter RE, Musick JA (1997) Evaluation of toxicity of oxytetracycline on growth of captive nurse sharks, *Ginglymostoma cirratum*. *Fish Bull* 96:624-627
- Gelsleichter J, Piercy A, Musick JA (1998) Evaluation of copper, iron and lead substitution techniques in elasmobranch age determination. *J Fish Biol* 53:465-470
- Goodwin NB, Dulvy NK, Reynolds JD (2002) Life-history correlates of the evolution of live bearing in fishes. *Philos Trans R Soc Lond, Ser B, Biol Sci* 357:259-267
- Graham KJ, Andrew NL, Hodgson KE (2001) Changes in relative abundance of sharks and rays on Australian South East Fishery trawl grounds after twenty years of fishing. *Mar Freshwater Res* 52:549-561
- Graham NAJ, Evans RD, Russ GR (2003) The effects of marine reserve protection on the trophic relationships of reef fishes on the Great Barrier Reef. *Environ Conserv* 30:200-208
- Grant WS, Bowen BW (1998) Shallow population histories in deep evolutionary lineages of marine fishes: Insights from sardines and anchovies and lessons for conservation. *Journal of Heredity* 89:415-426
- Gribble NA, Robertson JWA (1998) Fishing effort in the far northern section cross shelf closure area of the Great Barrier Reef Marine Park - the effectiveness of area-closures. *J Environ Manage* 52:53-67
- Gribble NA, Whybird O, Williams L, Garrett R (2005) Fishery assessment update 1988-2003: Queensland east coast shark. Department of Primary Industries and Fisheries, Queensland. Report #QI04070. 25 pp
- Gruber SH, de Marignac JRC, Hoenig JM (2001) Survival of juvenile lemon sharks at Bimini, Bahamas, estimated by mark-depletion experiments. *Trans Am Fish Soc* 130:376-384

- Gruber SH, Nelson DR, Morrissey JF (1988) Patterns of activity and space utilization of lemon sharks, *Negaprion brevirostris*, in a shallow Bahamian lagoon. *Bull Mar Sci* 43:61-76
- Haddon M (2001) Modelling and quantitative methods in fisheries. Chapman and Hall, CRC Press Boca Raton, FL.
- Hamlett WC (1999) Female reproductive system. In: Hamlett WC (ed) Sharks, skates, and rays The biology of elasmobranch fishes. The Johns Hopkins University Press, Baltimore, Maryland, p 398-443
- Hamlett WC, Hysell M (1998) Uterine specializations in elasmobranchs. *J Exp Zool* 282:438-459
- Hamlett WC, Kormanik G, Storrie M, Stevens B, Walker TI (2005) Chondrichthyan parity, lecithotrophy and matrotrophy. In: Hamlett WC (ed) Reproductive biology and phylogeny of Chondrichthyes: Sharks, batoids and chimaeras. Science Publishers, Enfield, NH, USA. 562 pp
- Hartl DL, Clark AG (1997) Principles of population genetics. Sinauer Associates. Sunderland, MA.
- Hazin FHV, Lucena FM, Souza T, Boeckman CE, Broadhurst MK, Menni RC (2000) Maturation of the night shark, *Carcharhinus signatus*, in the southwestern equatorial Atlantic Ocean. *Bull Mar Sci* 66:173-185
- Hazin FHV, Oliveira PG, Broadhurst MK (2002) Reproduction of the blacknose shark (*Carcharhinus acronotus*) in coastal waters off northeastern Brazil. *Fish Bull* 100:143-148
- Heist EJ, Gold JR (1999) Genetic identification of sharks in the US Atlantic large coastal shark fishery. *Fish Bull* 97:53-61
- Heist EJ, Gold JR (2000) DNA microsatellite loci and genetic structure of red snapper in the Gulf of Mexico. *Trans Am Fish Soc* 129:469-475
- Heist EJ, Graves JE, Musick JA (1995) Population genetics of the sandbar shark (*Carcharhinus plumbeus*) in the Gulf of Mexico and mid-Atlantic Bight. *Copeia* 1995:555-562
- Heist EJ, Musick JA, Graves JE (1996a) Genetic population structure of the shortfin mako (*Isurus oxyrinchus*) inferred from restriction fragment length polymorphism analysis of mitochondrial DNA. *Can J Fish Aquat Sci* 53:583-588

- Heist EJ, Musick JA, Graves JE (1996b) Mitochondrial DNA Diversity and Divergence Among Sharpnose Sharks, *Rhizoprionodon terraenovae*, From the Gulf of Mexico and Mid-Atlantic Bight. *Fish Bull* 94:664-668
- Henry GW, Lyle JM (2003) The national recreational and indigenous fishing survey, Tasmanian Aquaculture and Fisheries Institute, Hobart
- Heppell SS, Crowder LB, Menzel TR (1999) Life table analysis of long-lived marine species with implications for conservation and management. In: Musick JA (ed) *Life in the slow lane: Ecology and conservation of long lived marine animals*. American Fisheries Society Symposium 23, Bethesda, Maryland, p 137-148
- Heupel MR, Simpfendorfer CA (2005) Using acoustic monitoring to evaluate MPAs for shark nursery areas: The importance of long-term data. *Marine Technol Soc J* 39:10-18
- Hillborn R, Walters CJ (1992) *Quantitative fisheries stock assessment. Choice, dynamics and uncertainty*. Chapman & Hall. New York.
- Hobson ES (1963) Feeding behavior in three species of sharks. *Pac Sci* 17:171-194
- Hoening JM (1983) Empirical use of longevity data to estimate mortality rates. *Fish Bull* 82:898-903
- Hoening JM, Gruber SH (1990) Life-history patterns in the elasmobranchs: Implications for fisheries management. In: Pratt HL, Gruber SH, Taniuchi T (eds) *Elasmobranchs as living resources: Advances in the biology, ecology, systematics, and the status of the fisheries* Proceedings of the second United States-Japan workshop, Honolulu, Hawaii, p 1-16
- Hoffmayer ER, Parsons GR (2001) The physiological response to capture and handling stress in the Atlantic sharpnose shark, *Rhizoprionodon terraenovae*. *Fish Physiol Biochem* 25:277-285
- Holden MJ (1974) Problems in the rational exploitation of elasmobranch populations and some suggested solutions. In: Harden FR (ed) *Sea fisheries research*. Paul Elek Ltd, London, p 117-137
- Holland KN, Wetherbee BM, Lowe CG, Meyer CG (1999) Movements of tiger sharks (*Galeocerdo cuvier*) in coastal Hawaiian waters. *Mar Biol* 134:665-673
- Hooker SK, Iverson SJ, Ostrom P, Smith SC (2001) Diet of northern bottlenose whales inferred from fatty-acid and stable-isotope analyses of biopsy samples. *Can J Zoo* 79:1442-1454

- Hughes TP, Baird AH, Bellwood DR, Card M, Connolly SR, Folke C, Grosberg R, Hoegh-Guldberg O, Jackson JBC, Kleypas J, Lough JM, Marshall P, Nystrom M, Palumbi SR, Pandolfi JM, Rosen B, Roughgarden J (2003) Climate change, human impacts, and the resilience of coral reefs. *Science* 301:929-933
- Jensen AL (1996) Beverton and Holt life history invariants result from optimal trade-off of reproduction and survival. *Can J Fish Aquat Sci* 53:820-822
- Jensen CF, Natanson LJ, Pratt HL, Kohler NE, Campana SE (2002) The reproductive biology of the porbeagle shark (*Lamna nasus*) in the western North Atlantic Ocean. *Fish Bull* 100:727-738
- Johnson RH, Nelson DR (1973) Agonistic display in the gray reef shark, *Carcharhinus menisorrah*, and its relationship to attacks on man. *Copeia* 1973:76-84
- Jones BC, Geen GH (1977) Age determination of an elasmobranch (*Squalis acanthias*) by X-ray spectrometry. *J Fish Res Board Can* 34:44-48
- Joung SJ, Chen CT (1995) Reproduction in the sandbar shark, *Carcharhinus plumbeus*, in the waters off northeastern Taiwan. *Copeia* 1995:659-665
- Joung SJ, Chen CT, Clark E, Uchida S, Huang WYP (1996) The whale shark, *Rhincodon typus*, is a livebearer - 300 embryos found in one megamamma supreme. *Env Biol Fish* 46:219-223
- Kajiura SM, Sebastian AP, Tricas TC (2000) Dermal bite wounds as indicators of reproductive seasonality and behaviour in the Atlantic stingray, *Dasyatis sabina*. *Env Biol Fish* 58:23-31
- Kasajima I, Ide Y, Ohkama-Ohtsu N, Hayashi H, Yoneyama T, Fujiwara T (2004) A protocol for rapid DNA extraction from *Arabidopsis thaliana* for PCR analysis. *Plant Molecular Biology Reporter* 22:49-52
- Keeney DB, Heist EJ (2003) Characterization of microsatellite loci isolated from the blacktip shark and their utility in requiem and hammerhead sharks. *Molecular Ecology Notes* 3:501-504
- Keeney DB, Heupel M, Hueter RE, Heist EJ (2003) Genetic heterogeneity among blacktip shark, *Carcharhinus limbatus*, continental nurseries along the U.S. Atlantic and Gulf of Mexico. *Mar Biol* 143:1039-1046
- Keeney DB, Heupel MR, Hueter RE, Heist EJ (2005) Microsatellite and mitochondrial DNA analyses of the genetic structure of blacktip shark (*Carcharhinus limbatus*) nurseries in the northwestern Atlantic, Gulf of Mexico, and Caribbean Sea. *Mol Ecol* 14:1911-1923

- Kimura DK (1980) Likelihood methods for the von Bertalanffy growth curve. *Fish Bull* 77:765-777
- Kimura M (1981) Estimation of evolutionary distances between homologous nucleotide sequences. *PROC NATL ACAD SCI* 78:454-458
- Kitamura T, Takemura A, Watabe S, Taniuchi T, Shimizu M (1996a) Mitochondrial DNA analysis for the cytochrome b gene and d-loop region from the bull shark *Carcharhinus leucas*. *Fisheries Sci* 62:21-27
- Kitamura T, Takemura A, Watabe S, Taniuchi T, Shimizu M (1996b) Molecular phylogeny of the sharks and rays of superorder Squalea based on mitochondrial cytochrome b gene. *Fisheries Sci* 62:340-343
- Klanten SO (2004) Molecular phylogeny, temporal patterns of lineage diversification and phylogeography of the surgeonfish genus *Naso* (Acanthuridae). PhD dissertation, James Cook University
- Klimley AP (1987) The determinants of sexual segregation in the scalloped hammerhead shark, *Sphyrna lewini*. *Env Biol Fish* 18:27-40
- Kohler NE, Turner PA (2001) Shark tagging: A review of conventional methods and studies. *Env Biol Fish* 60:191-223
- Krebs CJ (1994) *Ecology: The experimental analysis of distribution and abundance*. Harper Collins New York
- Kritzer JP (2004) Effects of noncompliance on the success of alternative designs of marine protected-area networks for conservation and fisheries management. *Conserv Biol* 18:1021-1031
- Krützen M, Barré LM, Möller LM, Heithaus MR, Simms C, Sherwin WB (2002) Biopsy system for small cetaceans: darting success and wound healing in *Tursiops* spp. *Mar Mamm Sci* 18:863–878
- Kusher DI, Smith SE, Cailliet GM (1992) Validated age and growth of the leopard shark, *Triakis semifasciata*, with comments on reproduction. *Env Biol Fish* 35:187-203
- Last PR, Stevens JD (1994) *Sharks and rays of Australia*. CSIRO Division of Fisheries. Australia
- Lenanton RCJ, Heald DI, Platell M, Cliff M, Shaw J (1990) Aspects of the reproductive biology of the gummy shark, *Mustelus antarcticus* Günther, from waters off the south coast of Western Australia. *Aust J Mar Freshw Res* 41:807-822

- Leslie PH (1945) On the use of matrices in certain population mathematics. *Biometrika* 33:183-212
- Lessa R, Batista V, Almeida Z (1999a) Occurrence and biology of the daggernose shark *Isogomphodon oxyrinchus* (Chondrichthyes: Carcharhinidae) off the Maranhao coast (Brazil). *Bull Mar Sci* 64:115-128
- Lessa R, Paglerani R, Santana FM (1999b) Biology and morphometry of the oceanic whitetip shark, *Carcharhinus longimanus* (Carcharhinidae), off north-eastern Brazil. *Cybiurn* 23:353-368
- Lessa R, Santana FA, Hazin FH (2004) Age and growth of the blue shark *Prionace glauca* (Linnaeus, 1758) off northeastern Brazil. *Fish Res* 66:19-30
- Lessa R, Santana FM (1998) Age determination and growth of the smalltail shark, *Carcharhinus porosus*, from northern Brazil. *Mar Freshwater Res* 49:705-711
- Lessa R, Santana FM, Batista V, Almeida Z (2000) Age and growth of the daggernose shark, *Isogomphodon oxyrinchus*, from northern Brazil. *Mar Freshwater Res* 51:339-347
- Li WH, Graur D (1991) *Fundamentals of molecular evolution*. Sinauer Associates. Sunderland, M. A.
- Loefer JK, Sedberry GR (2003) Life history of the Atlantic sharpnose shark (*Rhizoprionodon terraenovae*) (Richardson, 1836) off the southeastern United States. *Fish Bull* 101:75-88
- Lombardi-Carlson L, A., Cortés E, Parsons GR, Manire CA (2003) Latitudinal variation in life-history traits of bonnethead sharks, *Sphyrna tiburo*, (Carcharhiniformes: Sphyrnidae) from the eastern Gulf of Mexico. *Mar Freshwater Res* 54:875 - 883
- Lowe CG, Wetherbee BM, Crow GL, Tester AL (1996) Ontogenetic dietary shifts and feeding behavior of the tiger shark, *Galeocerdo cuvier*, in Hawaiian waters. *Env Biol Fish* 47:203-211
- Lucifora LO, Menni RC, Escalante AH (2002) Reproductive ecology and abundance of the sand tiger shark, *Carcharias taurus*, from the southwestern Atlantic. *ICES J Mar Sci* 59:553-561
- Lucifora LO, Menni RC, Escalante AH (2005) Reproduction and seasonal occurrence of the copper shark, *Carcharhinus brachyurus*, from north Patagonia, Argentina. *ICES J Mar Sci* 62:107-115

- Lyle JM (1987) Observations on the biology of *Carcharhinus cautus* (Whitley), *C. melanopterus* (Quoy & Gaimard) and *C. fitzroyensis* (Whitley) from northern Australia. *Aust J Mar Freshw Res* 38:701-710
- Machado PB, Figueiredo I (2000) A technique for ageing the birdbeak dogfish (*Deania calcea* Lowe, 1839) from dorsal spines. *Fish Res* 45:93-98
- Mapstone BD, Ayling AM (1998) An investigation of optimum methods and unit sizes for the visual estimation of abundances of some coral reef organisms. Report to the Great Barrier Reef Marine Park Authority, Townsville, Australia.
- Martin AP (1993) Application of mitochondrial DNA sequence analysis to the problem of species identification of sharks. In: Branstetter S (ed) Conservation biology of elasmobranchs. NOAA (National Oceanic and Atmospheric Administration) Technical Report NMFS (National Marine Fisheries Service). Tampa, Florida, p 53-59
- Martin AP (1995) Mitochondrial DNA sequence evolution in sharks: Rates, patterns, and phylogenetic inferences. *Mol Biol Evol* 12:1114-1123
- Martin AP, Naylor JP, Palumbi SR (1992) Rates of mitochondrial DNA evolution in sharks are slow compared with mammals. *Nature* 357:153-155
- Mayr E (1954) Change of genetic environment and evolution. In: Huxley J, Hardy AC, Ford EB (eds) Evolution as a process. Allan & Unwin, London, p 157-180
- McClanahan TR, Marnane MJ, Cinner JE, Kiene W (2006) A comparison of marine protected areas and alternative approaches to coral reef management. *Curr Biol* 16:1408-1413
- McFarlane GA, King JR, Saunders MW (2002) Preliminary study on the use of neural arches in the age determination of bluntnose sixgill sharks (*Hexanchus griseus*). *Fish Bull* 100:861-864
- McKibben JN, Nelson DR (1986) Patterns of movement and grouping of grey reef sharks, *Carcharhinus amblyrhynchos*, at Enewetak, Marshall Islands. *Bull Mar Sci* 38:89-110
- McMillan WO, Palumbi SR (1995) Concordant evolutionary patterns among Indo-West Pacific butterflyfishes. *P Roy Soc Lond B Bio* 260:229-236
- Merson RR, Pratt HL (2001) Distribution, movements and growth of young sandbar sharks, *Carcharhinus plumbeus*, in the nursery grounds of Delaware Bay. *Env Biol Fish* 61:13-24

- Miller I, Sweatman H (2004) Status of coral reefs in Australia and Papua New Guinea in 2004. In: Wilkinson C (ed) Status of coral reefs of the world: 2004. Australian Institute of Marine Science, Townsville, Australia, p 303-335
- Mollet HF, Cailliet GM (2002) Comparative population demography of elasmobranchs using life history tables, Leslie matrices and stage-based matrix models. *Mar Freshwater Res* 53:503-516
- Mollet HF, Ezcurra JM, O'Sullivan JB (2002) Captive biology of the pelagic stingray, *Dasyatis violacea* (Bonaparte, 1832). *Mar Freshwater Res* 53:531-541
- Moore D, McCabe G (1993) Introduction to the practice of statistics. W.H. Freeman and Co. New York
- Morgan AC, Burgess GH (2004) Fishery-dependant sampling: Total catch, effort and catch composition. In: Musick JA, Bonfil R (eds) Elasmobranch fisheries management techniques. APEC Fisheries Working Group, Singapore, p 241-264
- Moritz C (1994) Defining 'evolutionarily significant units' for conservation. *Trends Ecol Evol* 9:373-375
- Musick JA (1999) Ecology and conservation of long-lived marine animals. In: Musick JA (ed) Life in the slow lane: Ecology and conservation of long lived marine animals. American Fisheries Society Symposium 23, Bethesda, Maryland, p 1-10
- Musick JA, Branstetter S, A. CJ (1993) Trends in shark abundance from 1974 to 1991 for the Chesapeake Bight region of the U.S. mid-Atlantic coast. In: Branstetter S (ed) Conservation biology of elasmobranchs. NOAA (National Oceanic and Atmospheric Administration) Technical Report NMFS (National Marine Fisheries Service). Tampa, Florida, p 1-18
- Myers RA, Worm B (2003) Rapid worldwide depletion of predatory fish communities. *Nature* 423:280-283
- Myers RA, Worm B (2005) Extinction, survival or recovery of large predatory fishes. *P Roy Soc Lond B Bio* 360:13-20
- Myrberg AA (2001) The acoustical biology of elasmobranchs. *Env Biol Fish* 60:31-45
- Nageon de Lestang J (1998) Management of shark fisheries in Seychelles., Seychelles Fishing Authority
- Nageon de Lestang J (1999) Management of shark fisheries in Seychelles. In: Shotten R (ed) Case studies of the management of elasmobranch fisheries. FAO Fisheries Technical Paper. Vol. 378 Part 1, p 285-315

- Narimatsu Y, Kitagawa D, Hattori T, Onodera H (2005) Reproductive biology of female Rikuzen sole (*Dexistes rikuzenius*). *Fish Bull* 103:635-647
- Natanson LJ, Cailliet GM (1990) Vertebral growth zone deposition in Pacific angel sharks. *Copeia* 1990:1133-1145
- Natanson LJ, Casey JG, Kohler NE (1995) Age and growth estimates for the dusky shark, *Carcharhinus obscurus*, in the western North-Atlantic Ocean. *Fish Bull* 93:116-126
- Natanson LJ, Casey JG, Kohler NE, Colket T (1999) Growth of the tiger shark, *Galeocerdo cuvier*, in the western North Atlantic based on tag returns and length frequencies; and a note on the effects of tagging. *Fish Bull* 97:944-953
- Natanson LJ, Kohler NE (1996) A preliminary estimate of age and growth of the dusky shark *Carcharhinus obscurus* from the south-west Indian Ocean, with comparisons to the western north Atlantic population. *S Afr J Marine Sci* 17:217-224
- Natanson LJ, Mello JJ, Campana SE (2002) Validated age and growth of the porbeagle shark (*Lamna nasus*) in the western North Atlantic Ocean. *Fish Bull* 100:266-278
- Neer JA, Thompson BA (2005) Life history of the cownose ray, *Rhinoptera bonasus*, in the northern Gulf of Mexico, with comments on geographic variability in life history traits. *Env Biol Fish* 73:321-331
- Neer JA, Thompson BA, Carlson JK (2005) Age and growth of *Carcharhinus leucas* in the northern Gulf of Mexico: incorporating variability in size at birth. *J Fish Biol* 67:370-383
- Nei M (1987) *Molecular evolutionary genetics*. Columbia University Press. New York.
- Nelson DR, Johnson RH (1980) Behaviour of the reef sharks of Rangiroa, French Polynesia. *Natural Geographic Society Res Rep* 12:479-498
- Nelson DR, Johnson RH, McKibben JN, Pittenger GG (1986) Agonistic attacks on divers and submersibles by gray reef sharks, *Carcharhinus amblyrhynchos*: Antipredatory or competitive? *Bull Mar Sci* 28:68-88
- Notarbartolo-di-Sciara G, Zanardelli M, Jahoda M, Panigada S, Airoidi S (2003) The fin whale *Balaenoptera physalus* (L. 1758) in the Mediterranean Sea. *Mammal Review* 33:105-150

- Officer RA, Day RW, Clement JG, Brown LP (1997) Captive gummy sharks, *Mustelus antarcticus*, form hypermineralised bands in their vertebrae during winter. *Can J Fish Aquat Sci* 54:2677-2683
- Officer RA, Gason AS, Walker TI, Clement JG (1996) Sources of variation in counts of growth increments in vertebrae from gummy shark, *Mustelus antarcticus*, and school shark, *Galeorhinus galeus* - implications for age determination. *Can J Fish Aquat Sci* 53:1765-1777
- Otway NM, Bradshaw CJA, Harcourt RG (2004) Estimating the rate of quasi-extinction of the Australian grey nurse shark (*Carcharias taurus*) population using deterministic age- and stage-classified models. *Biol Conserv* 119:341-350
- Palumbi SR (1996) Nucleid Acids II: The polymerase chain reaction. In: Hillis DM, Moriz C, Mable BK (eds) *Molecular Systematics*. Sinauer, Sunderland, MA., p 205-247
- Pandolfi JM, Bradbury RH, Sala E, Hughes TP, Bjorndal KA, Cooke RG, McArdle D, McClenachan L, Newman MJH, Paredes G, Warner RR, Jackson JBC (2003) Global trajectories of the long-term decline of coral reef ecosystems. *Science* 301:955-958
- Pardini AT, Jones CS, Noble LR, Kreiser B, Stevens JD, Cliff G, Scholl MC, Francis M, Duffy CAJ, Martin AP (2001) Sex-biased dispersal of great white sharks. *Nature* 412:139-140
- Parrish FA, Goto RS (1997) Patterns of insular shark dynamics based on fishery bycatch and lifeguard surveillance at Oahu, Hawaii, 1983-1992. *Bull Mar Sci* 61:763-777
- Parsons GR (1993a) Age determination and growth of the bonnethead shark *Sphyrna tiburo*: A comparison of two populations. *Mar Biol* 117:23-31
- Parsons GR (1993b) Geographic variation in reproduction between two populations of the bonnethead shark, *Sphyrna tiburo*. *Env Biol Fish* 38:25-35
- Pauly D (1980) On the interrelationships between natural mortality, growth parameters, and mean environmental temperature in 175 fish stocks. *ICES J Mar Sci* 39:175-192
- Pauly D, Christensen V, Dalsgaard J, Froese R, Torres FJ (1998) Fishing down marine food webs. *Science* 279:860-863
- Peterson I, Wroblewski JS (1984) Mortality rate of fishes in the pelagic ecosystem. *Can J Fish Aquat Sci* 41:1117-1120

- Porcher IF (2005) On the gestation period of the blackfin reef shark, *Carcharhinus melanopterus*, in waters off Moorea, French Polynesia. *Mar Biol* 146:1207-1211
- Posada D, Crandall KA (1998) Modeltest: Testing the model of DNA substitution. *Bioinformatics* 14:817-818
- Pratt HL, Carrier JC (2001) A review of elasmobranch reproductive behaviour with a case study on the nurse shark, *Ginglymostoma cirratum*. *Env Biol Fish* 60:157-188
- Pratt HL, Casey JG (1983) Age and growth of the shortfin mako, *Isurus oxyrinchus*, using four methods. *Can J Fish Aquat Sci* 40:1944-1957
- Pratt HL, Casey JG (1990) Shark reproductive strategies as a limiting factor in directed fisheries, with a review of Holden's method of estimating growth parameters. In: Pratt HL, Gruber SH, Taniuchi T (eds) *Elasmobranchs as living resources: Advances in the biology, ecology, systematics, and the status of the fisheries. Proceedings of the second United States-Japan workshop*. Honolulu, Hawaii, p 97-109
- Pratt HLJ (1988) Elasmobranch gonad structure: A description and survey. *Copeia* 1988:719-729
- Priede IG, Froese R, Bailey DM, Bergstad OA, Collins MA, Dyb JE, Henriques C, Jones EG, King N (2006) The absence of sharks from abyssal regions of the world's oceans. *P Roy Soc Lond B Bio* doi:10.1098/rspb.2005.3461 online
- Punt AE, Walker TI (1998) Stock assessment and risk analysis for the school shark (*Galeorhinus galeus*) off southern Australia. *Mar Freshwater Res* 49:719-731
- Radtke RL, Cailliet GM (1984) Age estimation and growth of the gray reef shark *Carcharhinus amblyrhynchos* from the northwestern Hawaiian Islands. *Proceedings of the second symposium on resource investigations of the NW Hawaiian Islands*, University of Hawaii, Honolulu, p 121-127
- Rahman H, Tachihara K (2005) Reproductive biology of *Sillago aeolus* in Okinawa Island, Japan. *Fisheries Sci* 71:122-132
- Rambaut A (1996) Se-Al: Sequence alignment editor. <http://evolve.zoo.ox.ac.uk>.
- Randall JE (1977) Contribution to the biology of the whitetip reef shark (*Triaenodon obesus*). *Pac Sci* 31:143-164
- Ricker WE (1975) Computation and interpretation of biological statistics of fish populations. Department of the Environment Fisheries and Marine Service. Ottawa, Canada.

- Rose C, Williams L, Gribble NA, Garrett R, Stapley J (2003) Queensland east coast shark catch, report #Q103020. Queensland Department of Primary Industries
- Russ GR (2002) Yet another review of marine reserves as reef fishery management tools. In: Sale PF (ed) Coral reef fishes. Academic Press, San Diego, CA, p 421-443
- Samoilys M, Williams LE, Slade SJ (2002) Coral reef line fishery. In: Williams LE (ed) Queensland's fisheries resources Current conditions and recent trends 1988-2000. Queensland's fisheries resources. Current conditions and recent trends 1988-2000. Department of Primary Industries, Brisbane, p 66-74
- Samoilys MA, Carlos G (2005) Determining methods of underwater visual census for estimating the abundance of coral reef fishes. *Env Biol Fish* 57:289-304
- Sandoval-Castillo J, Rocha-Olivares A, Villavicencio-Garayzar C, Balart E (2004) Cryptic isolation of Gulf of California shovelnose guitarfish evidenced by mitochondrial DNA. *Mar Biol* 145:983-988
- Santana FM, Lessa R (2004) Age determination and growth of the night shark (*Carcharhinus signatus*) off the northeastern Brazilian coast. *Fish Bull* 102:156-167
- Schneider S, Roessli D, Excoffier L (2000) Arlequin ver. 2.000: A software for population genetic data analysis. Genetics and Biometry Laboratory, University of Geneva, Switzerland
- Schnute J (1981) A versatile growth model with statistically stable parameters. *Can J Fish Aquat Sci* 38:1128-1140
- Schrey AW, Heist EJ (2003) Microsatellite analysis of population structure in the shortfin mako (*Isurus oxyrinchus*). *Can J Fish Aquat Sci* 60:670-675
- Schwartz FJ (1984) Occurrence, abundance, and biology of the blacknose shark, *Carcharhinus acronotus*, in North Carolina. *Northeast Gulf Sci* 7:29-47
- Secor DH, Campana SE, Dean JM (1995) Recent developments in fish otolith research. Belle W Baruch Library in Marine Sciences Book No. 19. University of South Carolina Press. Columbia, South Carolina.
- Seki T, Taniuchi T, Nakano H, Shimizu M (1998) Age, growth and reproduction of the oceanic whitetip shark from the Pacific Ocean. *Fisheries Sci* 64:14-20
- Simpfendorfer CA (1992a) Biology of tiger sharks (*Galeocerdo cuvier*) caught by the Queensland shark meshing program off Townsville, Australia. *Aust J Mar Freshw Res* 43:33-43

- Simpfendorfer CA (1992b) Reproductive strategy of the Australian sharpnose shark, *Rhizoprionodon taylori* (Elasmobranchii: Carcharhinidae), from Cleveland Bay, northern Australia. *Aust J Mar Freshw Res* 43:67-75
- Simpfendorfer CA (1993) Age and growth of the Australian sharpnose shark, *Rhizoprionodon taylori*, from north Queensland, Australia. *Env Biol Fish* 36:233-241
- Simpfendorfer CA (1999) Mortality estimates and demographic analysis for the Australian sharpnose shark, *Rhizoprionodon taylori*, from northern Australia. *Fish Bull* 97:978-986
- Simpfendorfer CA (2000) Growth rates of juvenile dusky sharks, *Carcharhinus obscurus* (Lesueur, 1818), from southwestern Australia estimated from tag-recapture data. *Fish Bull* 98:811-822
- Simpfendorfer CA (2004) Demographic models: life tables, matrix models and rebound potential. In: Musick JA, Bonfil R (eds) *Elasmobranch fisheries management techniques*. APEC Fisheries Working Group, Singapore, p 187-204
- Simpfendorfer CA, McAuley RB, Chidlow J, Unsworth P (2002) Validated age and growth of the dusky shark, *Carcharhinus obscurus*, from Western Australian waters. *Mar Freshwater Res* 53:567-573
- Skomal GB, Natanson LJ (2003) Age and growth of the blue shark (*Prionace glauca*) in the North Atlantic Ocean. *Fish Bull* 101:627-639
- Sminkey TR, Musick JA (1995) Age and growth of the sandbar shark, *Carcharhinus plumbeus*, before and after population depletion. *Copeia* 1995:871-883
- Sminkey TR, Musick JA (1996) Demographic analysis of the sandbar shark, *Carcharhinus plumbeus* in the western North Atlantic. *Fish Bull* 94:341-347
- Smith SE, Au DW, Show C (1998) Intrinsic rebound potentials of 26 species of Pacific sharks. *Mar Freshwater Res* 49:663-678
- Smith SE, Mitchell RA, Fuller D (2003) Age-validation of a leopard shark (*Triakis semifasciata*) recaptured after 20 years. *Fish Bull* 101:194-198
- Sokal RR, Rohlf FJ (1995) *Biometry*. Freeman. New York
- Southhall EJ, Sims DW, Metcalfe JD, Doyle JI, Fanshawe S, Lacey C, Shrimpton J, Solandt JL, Spccdie CD (2005) Spatial distribution patterns of basking sharks on the European shelf: preliminary comparison of satellite-tag geolocation, survey and public sightings data. *J Mar Biol Assoc UK* 85:1083-1088

- Stevens JD (1975) Vertebral rings as a means of age determination in the blue shark (*Prionace glauca*). *J Mar Biol Assoc UK* 55:657-665
- Stevens JD, Bonfil R, Dulvy NK, Walker PA (2000) The effects of fishing on sharks, rays, and chimaeras (chondrichthyans), and the implications for marine ecosystems. *ICES J Mar Sci* 57:476-494
- Stevens JD, McLoughlin KJ (1991) Distribution, size and sex composition, reproductive biology and diet of sharks from northern Australia. *Aust J Mar Freshw Res* 42:151-199
- Stobutzki IC, Stevens J, Miller MJ, Deng R, Salini J, McAuley R, Buckworth R, Gribble N, McPherson G, McLoughlin K (in prep.) Assessing the regional impact of fishing on chondrichthyans in northern Australia: 148 species, 28 fisheries and limited data.
- Sundström LF, Gruber SH (2002) Effects of capture and transmitter attachments on the swimming speed of large juvenile lemon sharks in the wild. *J Fish Biol* 61:834-838
- Sunnucks P, Hales DF (1996) Numerous transposed sequences of mitochondrial cytochrome oxidase I-II in aphids of the genus *Sitobion* (Hemiptera: Aphididae). *Mol Biol Evol* 13:510-524
- Swamy K (1999) Shark fisheries in Fiji: Their management and issues of future concern. In: Shotten R (ed) Case studies of the management of elasmobranch fisheries. *FAO Fisheries Technical Paper*. Vol. 378 Part 2, p 580-607
- Swofford DL (1998) *PAUP* Phylogenetic Analysis Using Parsimony (* and other methods)*. Sinauer Associates Massachusetts
- Tajima F (1983) Evolutionary relationship of DNA sequences in finite populations. *Genetics* 105:437-460
- Tamura K, Nei M (1993) Estimation of the number of nucleotide substitutions in the control region of mitochondrial DNA in humans and chimpanzees. *Mol Biol Evol* 10:512-526
- Tanaka S (1990) Age and growth studies on the calcified structures of newborn sharks in laboratory aquaria using tetracycline. In: Pratt HL, Gruber SH, Taniuchi T (eds) *Elasmobranchs as living resources: Advances in the biology, ecology, systematics, and the status of the fisheries*. Proceedings of the second United States-Japan workshop, Honolulu, Hawaii, p 189-202

- Tanaka S, Cailliet GM, Yudin KG (1990) Differences in growth of the blueshark, *Prionace glauca*: technique or population? In: Pratt HL, Gruber SH, Taniuchi T (eds) Elasmobranchs as living resources: Advances in the biology, ecology, systematics, and the status of the fisheries. Proceedings of the second United States-Japan workshop, Honolulu, Hawaii, p 177-187.
- Team RDC (2004) R: A language and environment for statistical computing. R Foundation for Statistical Computing Vienna, Austria ISBN 3-900051-00-3, URL <http://www.R-project.org>
- Tester AL (1969) Cooperative shark research and control program; final report 1967-69., Department of zoology, University of Hawaii., Honolulu.
- Thompson JD, Gibson TJ, Plewniak FFJ, Higgins DG (1997) The ClustalX windows interface: Flexible strategies for multiple sequence alignment aided by quality analysis tools. *Nucleic Acids Research* 24:4876-4882
- Thresher RE, Gunn JS (1986) Comparative analysis of visual census techniques for highly mobile, reef-associated piscivores (Carangidae). *Env Biol Fish* 17:93-116
- Travis W (1990) Beyond the reefs. Calusa Bay Publications Mahé, Seychelles
- Underwood AJ (1981) Techniques of analysis of variance in experimental marine biology and ecology. *Ann Rev Ocean and Mar Bio* 19:513-605
- von Bertalanffy L (1938) A quantitative theory of organic growth (inquiries on growth laws. II). *Hum Biol* 10:181-213
- Walker TI (1983) Investigations of the gummy shark *Mustelus antarcticus* Gunther, from south-eastern Australian waters. Report to the Fishing Industry Research Committee, Victoria Fisheries and Wildlife Department
- Walker TI (1998) Can shark resources be harvested sustainably? A question revisited with a review of shark fisheries. *Mar Freshwater Res* 49:553-572
- Ward RD, Grewe PM (1994) Appraisal of molecular-genetic techniques in fisheries. *Rev Fish Biol Fish* 4:300-325
- Wass RC (1971) A comparative study of the life history, distribution and ecology of the sandbar shark and the gray reef shark in Hawaii. PhD dissertation, University of Hawaii
- Wetherbee BM, Crow GL, Lowe CG (1996) Biology of the Galapagos shark, *Carcharhinus galapagensis*, in Hawai'i. *Env Biol Fish* 45:299-310

- Wetherbee BM, Crow GL, Lowe CG (1997) Distribution, reproduction and diet of the gray reef shark *Carcharhinus amblyrhynchos* in Hawaii. *Mar Ecol Prog Ser* 151:181-189
- White WT, Hall NG, Potter IC (2002) Size and age compositions and reproductive biology of the nervous shark *Carcharhinus cautus* in a large subtropical embayment, including an analysis of growth during pre- and postnatal life. *Mar Biol* 141:1153 –1164
- Whitney NM, Pratt HL, Carrier JC (2004) Group courtship, mating behaviour and siphon sac function in the whitetip reef shark, *Triaenodon obesus*. *Animal Behaviour* 68:1435-1442
- Williams AJ, Davies CR, Mapstone BD (2005) Variation in the periodicity and timing of increment formation in red throat emperor (*Lethrinus miniatus*) otoliths. *Mar Freshwater Res* 56:529-538
- Williamson DH, Russ GR, Ayling AM (2004) No-take marine reserves increase abundance and biomass of reef fish on inshore fringing reefs of the Great Barrier Reef. *Environ Conserv* 31:149-159
- Willis TJ, Babcock RC (2000) A baited underwater video system for the determination of relative density of carnivorous reef fish. *Mar Freshwater Res* 51:755-763
- Wilson SG, Polovina JJ, Stewart BS, Meekan MG (2006) Movements of whale sharks (*Rhincodon typus*) tagged at Ningaloo Reef, Western Australia. *Mar Biol* 148:1157-1166
- Wilson SG, Taylor JG, Pearce AF (2001) The seasonal aggregation of whale sharks at Ningaloo reef, Western Australia: Currents, migrations and the *El Nino*/southern oscillation. *Env Biol Fish* 61:1-11
- Wintner SP, Cliff G (1996) Age and growth determination of the blacktip shark, *Carcharhinus limbatus*, from the east coast of South Africa. *Fish Bull* 94:135-144
- Wintner SP, Dudley SFJ (2000) Age and growth estimates for the tiger shark, *Galeocerdo cuvier*, from the east coast of South Africa. *Mar Freshwater Res* 51:43-53
- Wintner SP, Dudley SFJ, Kistnasamy N, Everett B (2002) Age and growth estimates for the Zambezi shark, *Carcharhinus leucas*, from the east coast of South Africa. *Mar Freshwater Res* 53:557-566

- Wourms JP (1977) Reproduction and development in chondrichthyan fishes. *Am Zool* 17:379-410
- Wourms JP, Demski LS (1993) The reproduction and development of sharks, skates, rays and ratfishes - introduction, history, overview, and future prospects. *Env Biol Fish* 38:7-21
- Wright S (1943) Isolation by distance. *Genetics* 28:114-138
- Wright S (1951) The genetical structure of populations. *Ann Eugen* 15:323-354
- Yamaguchi A, Taniuchi T, Shimizu M (1998) Geographic variation in growth of the starspotted dogfish *Mustelus manazo* from five localities in Japan and Taiwan. *Fisheries Sci* 64:732-739
- Yano K, Sato F, Takahashi T (1999) Observations of mating behavior of the manta ray, *Manta birostris*, at the Ogasawara Islands, Japan. *Ichthyol Res* 46:289-296
- Zekeria ZA, Weertman S, Samuel B, Kale-ab T, Videler JJ (2006) Growth of *Chaetodon larvatus* (Chaetodontidae : Pisces) in the southern Red Sea. *Mar Biol* 148:1113-1122

Appendices

Appendix 3.1. Parameter estimates of *Triaenodon obesus* and *Carcharhinus amblyrhynchos* maximum likelihood ratio tests (Chapter 3; table 3.3). Coincident curve indicates scenario where a single curve is fitted to both sexes; the 3 VB growth parameters indicate scenarios where a single value is shared by both sexes. Female longevities have been truncated to that of the males.

		Coincident	L_{∞}	K	t_0
<i>T. obesus</i>	L_{∞}	191.1	192.1	180.5	170.1
Male	k	0.06	0.05	0.06	0.07
	t_0	-9.2	-10.4	-9.7	-8.9
<i>T. obesus</i>	L_{∞}	191.0	192.1	191.7	196.2
Female	k	0.06	0.06	0.06	0.06
	t_0	-9.2	-8.8	-8.7	-8.9
<i>C. amblyrhynchos</i>	L_{∞}	251.4	251.5	252.0	253.2
Male	k	0.04	0.04	0.04	0.04
	t_0	-8.0	-7.9	-7.9	-8.0
<i>C. amblyrhynchos</i>	L_{∞}	251.4	251.5	250.9	249.2
Female	k	0.04	0.04	0.04	0.04
	t_0	-8.0	-8.1	-8.1	-8.0

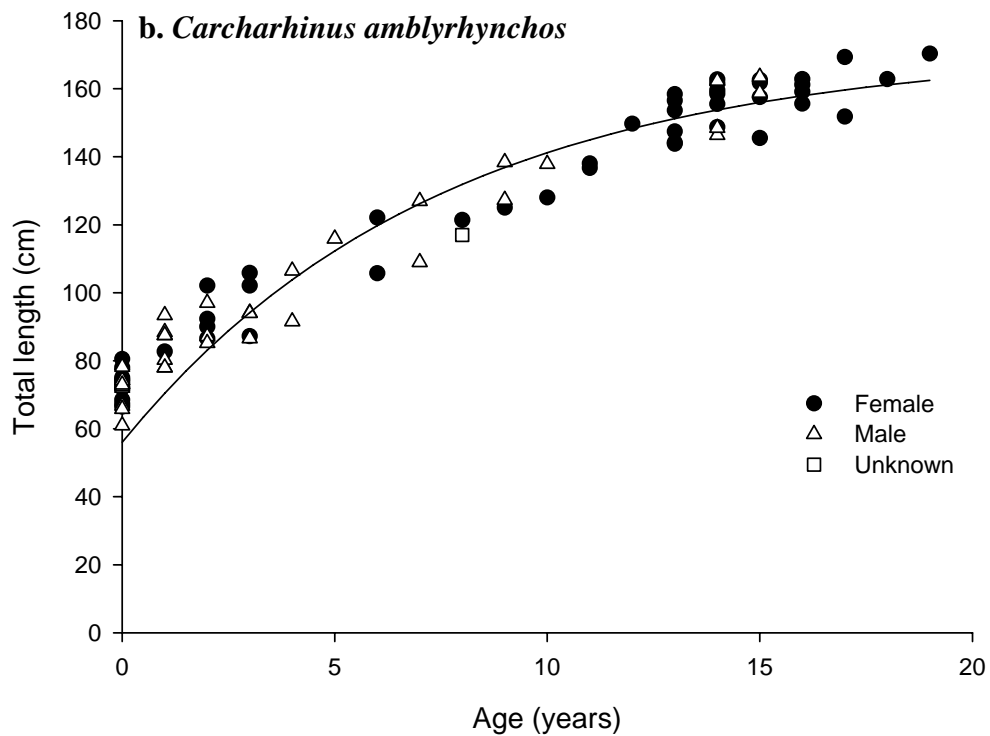
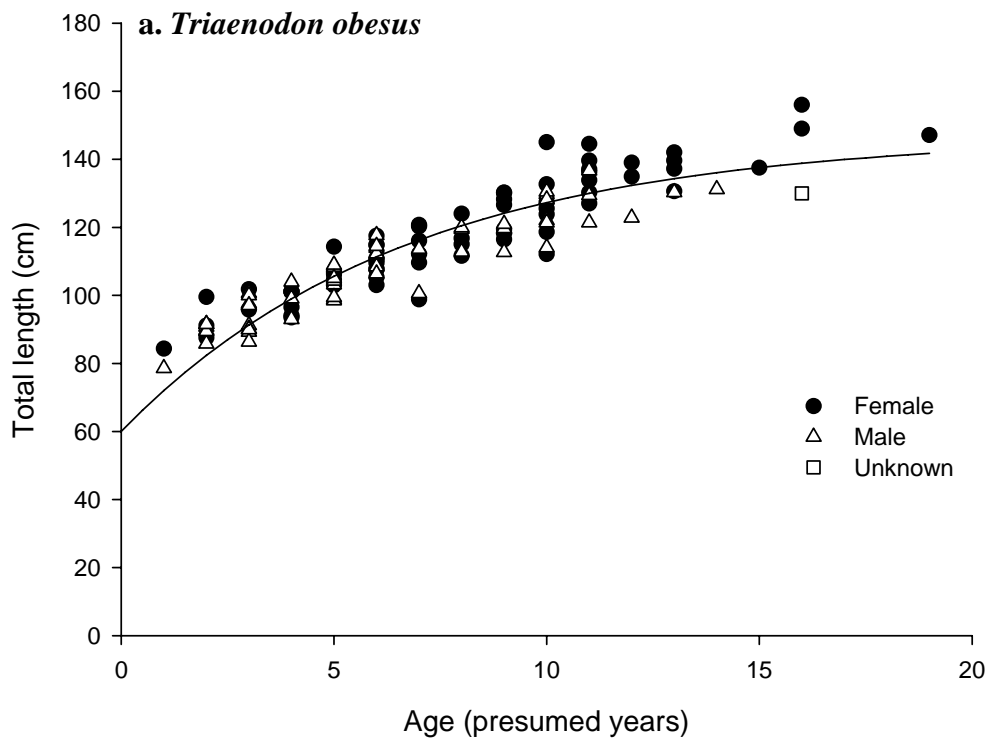

Appendix 3.2. Size-at-age for (a) *Triaenodon obesus* (n=126) and (b) *Carcharhinus amblyrhynchos* (n=89). Von Bertalanffy growth functions have been fitted, constrained to size-at-birth estimated from reproductive data (60 cm for *T. obesus*, 56 cm for *C. amblyrhynchos*; Chapter 4). This has underestimated the size of the first 2-3 age classes.

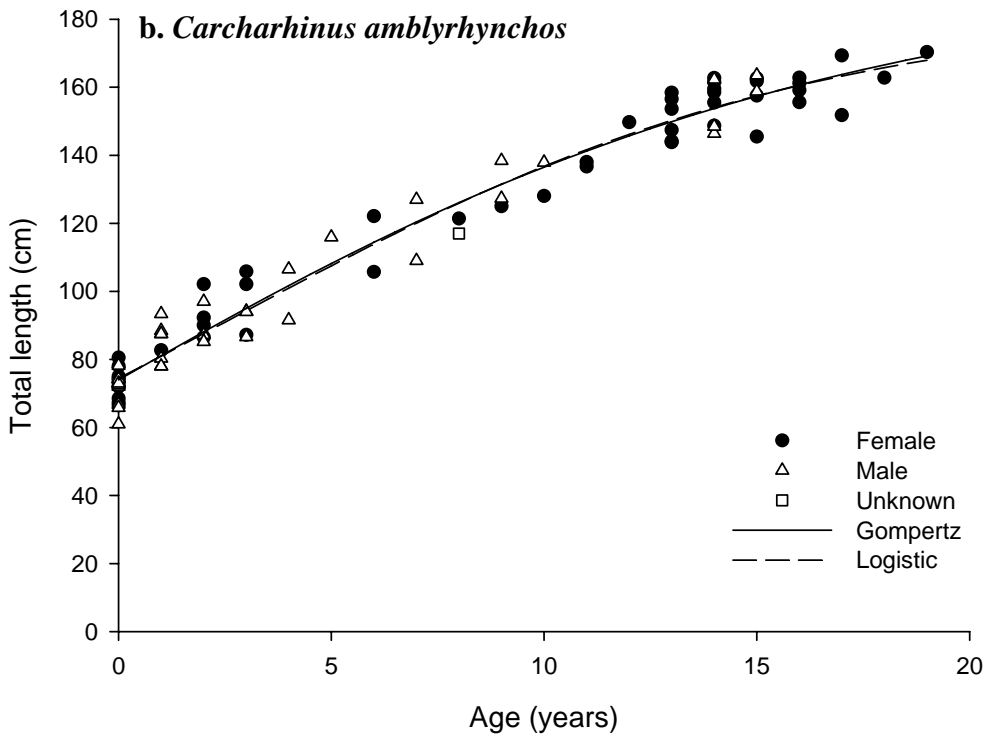
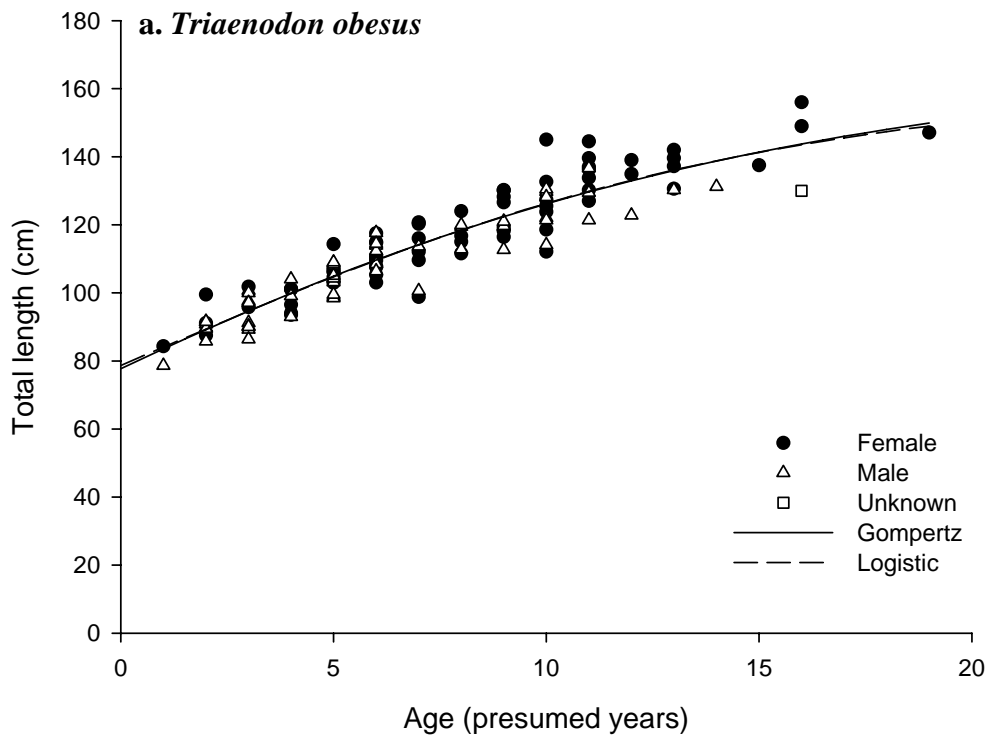

Appendix 3.3. Size-at-age for (a) *Triaenodon obesus* (n=126) and (b) *Carcharhinus amblyrhynchos* (n=89), combined by sex with Gompertz and logistic models fitted. Regression lines are almost identical to un-constrained von Bertalanffy growth functions (Chapter 3; fig 3.5).