

Solar inverters

Quick installation guide

PVI-3.0-3.6-3.8-4.2-TL-OUTD-S-US (-A)

PVI-5000-6000-TL-OUTD-US (-A)

EN



In addition to the information provided in this quick installation guide, the safety and installation guidelines provided in the technical manual must be read and followed. The technical documentation and the interface and management software for the product are available at www.abb.com/solarinverters.

Power and productivity
for a better world™



1. Label and warnings

IMPORTANT SAFETY INSTRUCTIONS SAVE THESE INSTRUCTIONS -- KEEP IN SAFE PLACE!

The installer must read this document in its entirety before installing or commissioning this equipment.

For more detailed information regarding proper installation and use of this product, refer to the product manual located at www.abb.com/solarinverters. The labels on the inverter carry the markings, main technical data and identification of the equipment and manufacturer. The technical data shown in this quick installation guide does not replace that shown on the labels attached to the equipment.

Symbols used in the guide and on the products







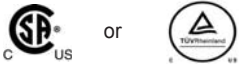

 <p>These are nationally recognized test laboratory marks showing certification to UL 1741; CSA-C22 No. 107.1-01, UL 1741: Supplement A (draft) where marked</p>	 <p>General warning - Important safety information</p>
 <p>Hazardous voltage</p>	 <p>Hot surfaces</p>
 <p>System earth conductor (main grounding protective earth, PE)</p>	 <p>Phase</p>
 <p>Grounding (earth)</p>	 <p>Direct and alternating currents, respectively</p>

Table 1

This inverter has been tested and found to comply with the limits for a Class B digital device, pursuant to Part 15 of the FCC Rules. These limits are designed to provide reasonable protection against harmful interference in a residential installation. This equipment generates, uses and can radiate radio frequency energy and, if not installed and used in accordance with the instructions, may cause harmful interference to radio communications. However, there is no guarantee that interference will not occur in a particular installation. If this equipment does cause harmful interference to radio or television reception, which can be determined by turning the equipment off and on, the user is encouraged to try to correct the interference by one or more of the following measures: a) Reorient or relocate the receiving antenna; b) Increase the separation between the equipment and receiver; c) Connect the equipment into an outlet on a circuit different from that to which the receiver is connected; d) Consult the dealer or an experienced radio/TV technician for help.

- The PV source conductors must be Listed PV wire per NEC 690.35. PV output conductors shall consist of sheathed (jacketed) multi-conductor cables or installed in an approved raceway and must be isolated from the enclosure and system grounding, as required by NEC 690.35, and is the responsibility of the installer.
- To reduce the risk of fire, connect only to a circuit provided with 15A, 20A, or 25A maximum branch circuit overcurrent protection in accordance with the NEC (ANSI/NFPA 70). The inverter must be connected only to a dedicated branch circuit provided with the maximum branch OCPD listed in the technical data sheet found at www.abb.com/solarinverters.
- All models listed in the technical data sheet have an integrated DC disconnect switch rated 600V/25A per contact.
- Maximum array DC voltage input to each MPPT circuit is 600 Vdc under any condition.

2. Installation location

Environmental checks

- Maximum operational ambient air temperature must be considered when choosing the installation location. Installing the inverter where operating temperatures exceed specifications will result in power derating. It is recommended the inverter be installed within the specified temperature range.
- Exposure to direct sunlight will increase the operational temperature of the inverter and may cause output power limiting. It is recommended to use a sun shade to minimize direct sunlight when ambient air temperature around the unit exceeds 104°F/40°C.
- Due to acoustical noise (about 50dBA at 1 m) from the inverters, do not install in rooms where prolonged presence of people or animals is expected.

Installation position

- Install on a wall or strong structure capable of bearing weight.
- Install vertically with a maximum incline of +/- 5° (see Figure 1).
- Maintain minimum clearance measurements shown (see Figure 1).
- Ensure sufficient working area in front of inverter for wiring box access.
- Choose a location that allows unobstructed airflow around inverter (see Figure 2).
- Position multiple inverters side-by-side, maintaining minimum clearances (see Figure 3).
- Multiple inverters can also be placed in a staggered arrangement (see Figure 3).
- Minimum clearances for staggered arrangements include width of inverter plus additional allowances for inverters arranged above or below (see Figure 3).

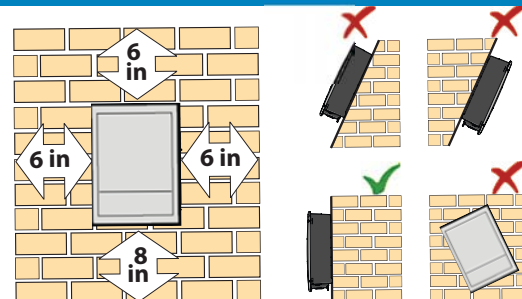

Figure 1

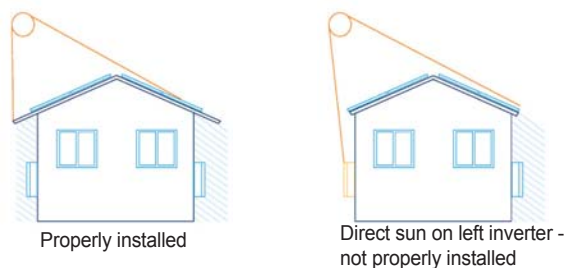

Figure 2

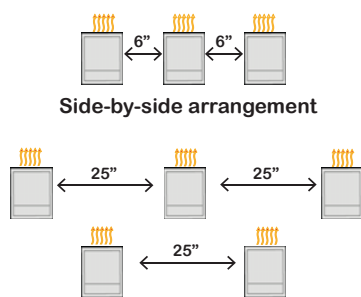

Figure 3

3. Wall mounting

The PVI-3.0/3.6/3.8/4.2 and PVI-5000/6000 string inverters can be wall or pole mounted using the included mounting bracket. The procedure to mount the inverter first involves installing the mounting bracket to the final installation location. Once the bracket is installed, the inverter is hung on the top bracket with the help of three screws which are pre-installed on the back of the inverter. A step-by-step procedure is described below.

Components included in mounting kit

- 1 - Wall bracket - XAB.V2C01.0
- 1 - Mounting bracket security bar - XAK.V2C03.0
- 2 - Red cable AWG10 - 9153G038600
- 2 - Black cable AWG10 - 9153G038700

- 1 - Hardware bag containing:
 - 5 - 6.3 x 70mm screws, washers, anchors
 - 3 - 4 x 10mm screws

- 1 - Terminal connector 82000006439-G

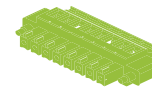

Step 1: Using four of the five 6.3 x 70mm screws provided, screw the bracket to the mounting surface using the recommended screw positions for each mounting scenario as shown in Figures 4, 5 and 6.

Step 2: Carefully lift the inverter onto the installed mounting bracket and hang the inverter so that the pre-installed mounting screws on the back side of inverter are securely placed into the three slots to mount (hang) the inverter as shown in Figure 7.

Step 3: Secure the inverter chassis bottom flange to the mounting surface using the fifth 6.3 x 70mm screw provided. Note that the bottom flange is not a load bearing component. See Figure 8.

Step 4: Install the mounting bracket security bar on top of the installed mounting bracket into the three pre-drilled screw holes using the three 4 x 10mm screws provided. See Figure 8.

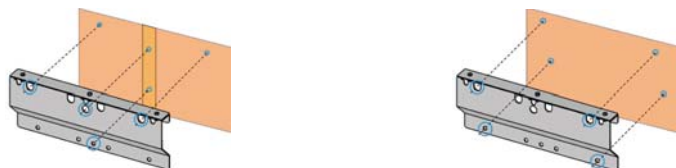

Figure 4 - wall mounting - wooden frame (center stud) Figure 5 - wall mounting on brick/concrete

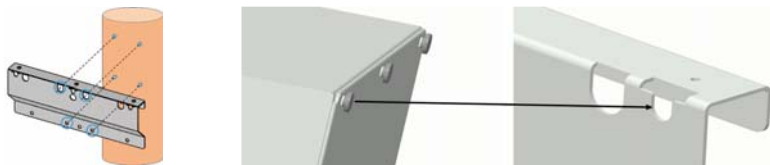

Figure 6 - pole mounting Figure 7 - hang inverter by pre-installed screws into bracket slots

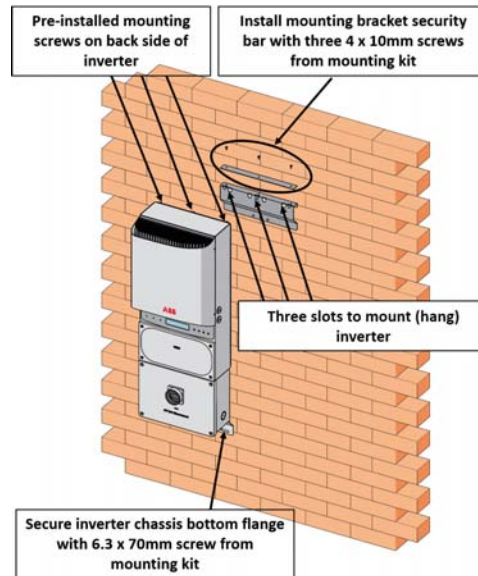

Figure 8 - install mounting bracket security bar and secure chassis bottom flange

4. Wiring box components

Switchbox external view

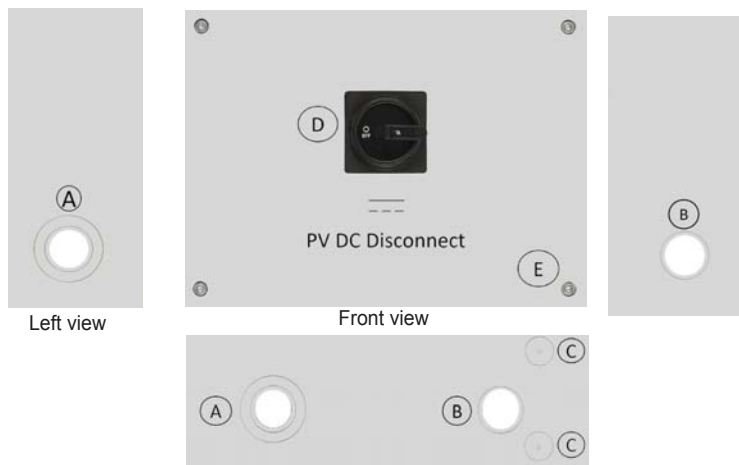

Figure 9

Switchbox internal view

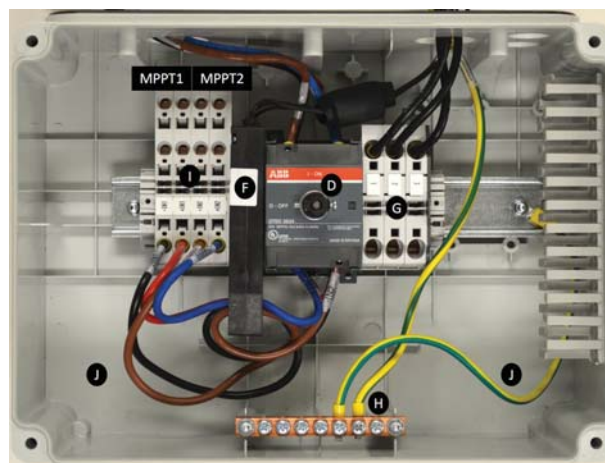

Figure 10

Refer to Figure 9 above		Refer to Figure 10 above	
A	DC conduit opening for 3/4", marking for 1" and 1-1/2" conduit	F	AFD board (-A only)
B	AC conduit opening for 3/4", marking for 1" conduit	G	AC grid output terminals, see NOTE 1 below
C	Communication conduit drill out entry (size 1/2")	H	Array PE ground, see NOTE 1 below
D	DC Disconnect Switch	I	DC input terminals
E	Cover screws (4)	J	Conduit drill out entry sizes 3/4", 1" (drill out markings on back side of switchbox - not visible from interior side)
MPPT1 and MPPT2 DC array input, see NOTE 1 below		IMPORTANT NOTE: Conduit must be attached using liquid tight fittings to maintain Type 4 enclosure integrity.	

NOTE 1: DC array wiring terminals are spring pressure type and accommodate a wire size range of 16-4 AWG. AC output terminals are spring pressure type and accommodate a wire size range of 14-4 AWG. **NOTE 2:** Grounding busbar has screw terminals and accepts 16-4 AWG solid wire or 16-4 stranded wire. **DC disconnect switch (C) disconnects the DC current from the PV panels in the "OFF" position. The inverter will stop producing power, but DOES NOT disconnect the AC from the grid. To prevent electrocution hazards, all the connection operations must be carried out with the external AC disconnect switch downstream of the inverter (grid side) open and locked out.**

5. DC input connections



The maximum allowable input short circuit current limit of the PV array for each MPPT input channel is 22A_{dc} for the 5.0kW, 6.0kW; 20A_{dc} for 3.6kW, 3.8kW and 4.2kW inverters; 12.5A_{dc} for the 3.0kW. Array equipment grounding must be installed per the requirements of the NEC and is the responsibility of the installer. A configuration program that can help to correctly size the photovoltaic system is available on at <http://www.stringsizer.abb.com>.

The transformerless design requires that the PV array to be floating with respect to ground per NEC 690.35.

Both the DC PV string wire and the AC output wire must be UL listed wire rated minimum 600V and the antennae wire and any communications wire must be secured inside the plastic conduit on the right side of the switchbox.

- The inverter can be configured with two independent maximum power point tracking (MPPT) channels or as a single channel with one MPPT by paralleling the two channels.
- Parallel two inputs when the current from PV array exceeds 22A_{dc} for the PVI-5000/6000; 20 A_{dc} for the PVI-3.6/3.8/4.2 or 12.5 A for the PVI-3.0, or array power exceeds the limit for single channel (refer to the technical data sheet at www.abb.com/solarinverters).
- For inverter FW version earlier than C.2.0.0, switch S1 located on the inverter connection board, is used to select parallel (PAR) or independent (IND) input mode. For inverter FW version C.2.0.0 or later, the input mode is set from the settings menu as shown in Figure 11.

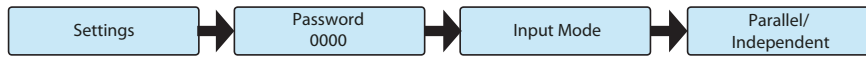

Figure 11

- The default position of switch S1 is set in the IND mode (DOWN) as shown in Figure 12.
- To access the switchbox wiring and Switch S1, loosen the four captive screws on the inverter cover and wiring box cover. The cover screws can be tightened or loosened using a torx 20 wrench (not included in kit). **Before removing front covers, DC switch must be in the OFF position.**
- **When complete**, reinstall the front covers and tighten the cover screws with at least 1.5Nm (13.2 in-lbs) torque.
- If using a 3/4" conduit, utilize one of the pre-drilled openings provided for the PV array connection. If installing a conduit larger than the provided openings, make a conduit hole using a punchout tool or hole saw for the PV array wiring connection.

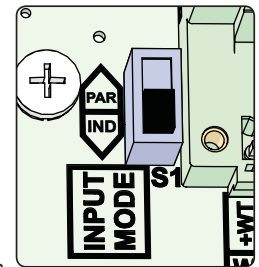

Figure 12

Independent mode configuration

- Connect array to String 1 and String 2 input positions shown in Figure 13, running separate wires for POS and NEG for each array.
- Up to four strings can be connected in the INDEPENDENT mode.
- To connect four strings, String 3 and String 4 are connected in addition to 1 and 2, running separate wires for POS and NEG for each array.
- Confirm that the input mode is set to IND (using switch S1 on units with FW version earlier than C.2.0.0; for units with FW version C.2.0.0 and later, the input mode is set using the LCD menu, described in Figure 11).
- If connecting a single array, it is recommended to configure the inverter to parallel input mode.

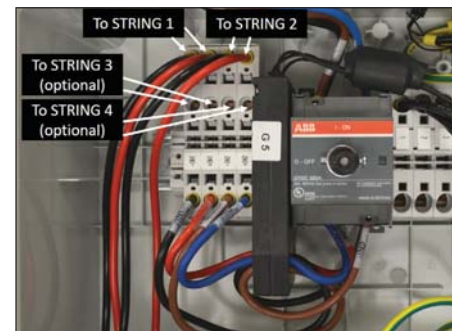

Figure 13

Parallel mode configuration

- For parallel mode operation, paralleling of input strings must be done in the switch box as well as on the main board inside the inverter.
- Connect array to String 1 and String 2 input positions shown in Figure 14, running separate wires for POS and NEG for each array.
- Parallel the two MPPT inputs of terminal -IN1/-IN2 and +IN1/+IN2 in the switch box, using the two #10 AWG jumper wires provided, 1 black and 1 red,
- Connect the input in the switch box as shown in Figure 14.
- Referring to Figure 15, parallel the two MPPT inputs of -IN1 and -IN2 and +IN1 and +IN2 in the inverter, using the two #10 AWG jumper wires provided, 1 black and 1 red. Connect the input as shown in Figure 15 and tighten with 13in-lbs torque.
- Confirm that the input mode is set to PAR (using switch S1 on units with FW version earlier than C.2.0.0; for units with FW C.2.0.0 and later, the input mode is set using the LCD menu, described in Figure 11).

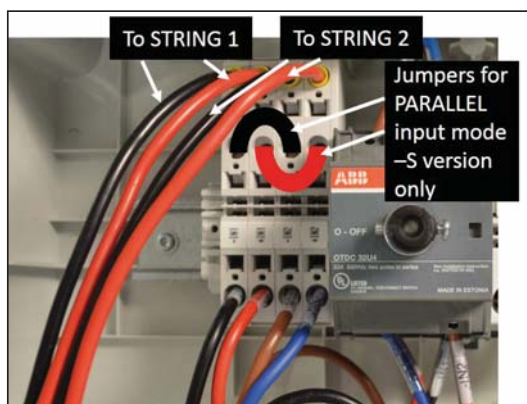

Figure 14

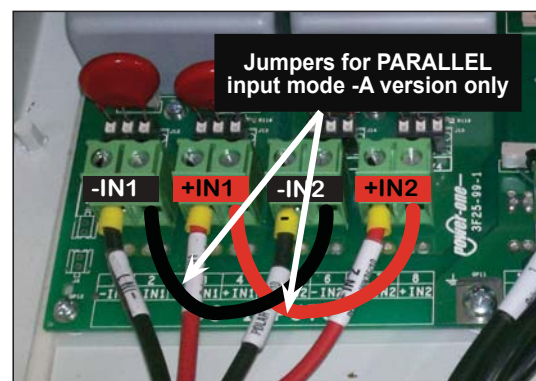

Figure 15

6. AC output connections



AC output overcurrent protection is not provided with the inverter; it is the responsibility of the end user to provide overcurrent protection for the AC output circuit.

To prevent electrocution hazards, all the connection operations must be carried out with the external AC disconnect switch downstream of the inverter (grid side) open and locked out.

Size conductors per NEC Article 310; Use 90°C copper wire only; terminal block accommodates 14-4 AWG wire size range. The AC grid wiring is connected through the inverter switchbox.

Both the DC PV string wire and the AC output wire must be UL listed wire rated minimum 600V and the antennae wire and any communications wire must be secured inside the plastic conduit on the right side of the switchbox.

- Run an approved raceway between inverter and external AC disconnect switch.
- If using a 3/4" conduit, utilize one of the pre-drilled openings provided for the AC wiring. If installing a conduit larger than the provided openings, make a conduit hole using a punchout tool or hole saw for the AC array wiring connection.
- Connect AC wiring to switch box terminal block **G** and the main AC ground cable to switchbox bus bar **H** shown in Figure 16.
- Table 2 shows AC wiring connections based on the AC grid type, (also found on a label in the switchbox).
- Connect wiring to the numbered terminals based on selected grid type.

Grid Standard	L1 L3 N L2 208V~ 3PH - Y			L1 L2 240V~ SPLIT-PHASE			L1 L3 N L2 277V~ 3PH - Y		
Terminal	1	2	3	1	2	3	1	2	3
Wire	L1	L2	--	L1	L2	N	N	L1	--
Wire Size	10-4 AWG								
Table 2									

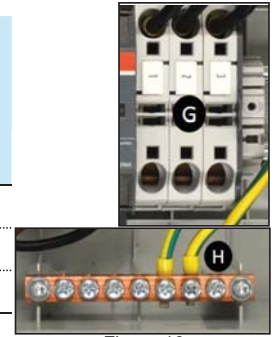

Figure 16

The default 240V-SPLIT-PHASE connection requires the grid Neutral to be connected for proper operation. Before connecting the inverter to the grid, the grid type must be selected if it differs from the default 240V-SPLIT-PHASE setting. See Sect. 10 for instructions to change the default. If several inverters are installed to a three-phase AC GRID, always distribute the inverters between the phases in order to reduce power imbalance between the phases.

7. Communications wiring

Wiring for the RS-485 communication system and hardwired control options are routed through the switchbox (section 4) and into the main inverter chassis for termination. Drill out conduit entry points for communication wiring are provided on the bottom of the switch box (refer to section 4). The conduit hole must be made using a punchout tool or hole saw. Alarm and monitoring connections are shown as items **Q** and **R** in Figure 17. Refer to the technical manual at www.abb.com/solarinverters for connections to **ALARM (Q)** and **Rem (remote control)**.



The **WIND** terminals (\pm WT) are not isolated and can have hazardous voltages present. These terminals must not be utilized for any purpose in a PV installation (use with wind models only).

To connect the communication wiring, it is necessary to open the inverter cover and access the communication connections located on the main board.

- To remove the front cover of the inverter compartment, loosen the four captive screws indicated. These screws can be loosened using a torx 20 wrench (not included in kit).
- When connection operations are complete, re-install the front covers and tighten the cover screws with at least 1.5Nm (13.2 in-lbs) torque to ensure proper waterproof sealing.

The RS-485 communication line connects the inverter to the monitoring devices and may be "daisy-chained" (in-out) among multiple inverters. The RS-485 connecting cables can use both the terminal connections **R**, as well as the RJ45 connectors **S**, to connect to the dedicated port.



If a daisy chain connection is required for AFD installed inverters (-A models), use standard multiconductor RS-485 cable and connect the three RS-485 leads (-RTN, +T/R, -T/R) **USING ONLY THE MATING CONNECTORS**.

Do not use RJ45 connectors with AFD installations.

RS-485 connectors (R)

- If terminal blocks are used, signals RTN, +T/R and -T/R have to be cabled.
- Use a cable designed for use with RS-485 communications.
- Locate mating connectors (provided in hardware bag) for the terminal block.
- Connect the three (-RTN, +T/R, -T/R) to the mating connector corresponding points.
- Attach mating connector to line up with correct signals on either upper or lower terminal rows (two parallel terminals rows are on the terminal block and two mating connectors are included).

Daisy chain connection (see figure 18)

- Recommended length of total communication cable line for all inverters in the system is 1,000 meters [1,094 yards] or less.
- Depending on type of computer used, cable line adaptor can be RS-485-RS232 or RS-485-USB.

Termination switch (S2)

- On the last inverter in a daisy chain, or on a single inverter, activate termination resistance by moving switch S2 down into the ON position.
- All other inverters in daisy chain will have the switch up in the OFF position.

Addressing each inverter

- Default setting for RS-485 address is 2 and termination switch in OFF position.
 - When multiple inverters are connected in a daisy chain, it is necessary to assign a different RS-485 address to each unit.
- See section 10 for instruction on using the display to configure settings.

Refer to the technical manual at www.abb.com/solarinverters for connection of alarm wiring (Q) and Rem (remote control).

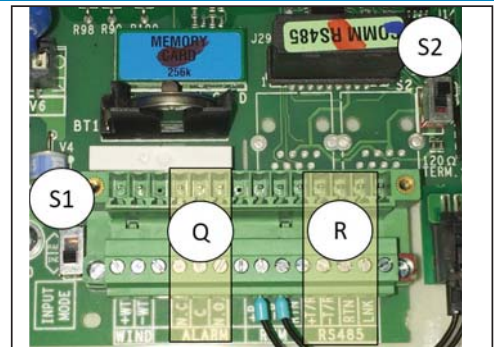

PVI-3.0/3.6/3.8/4.2

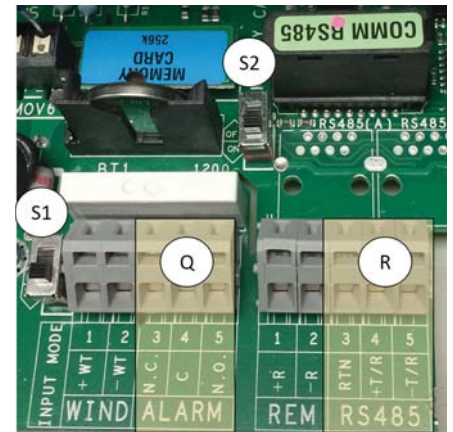

PVI-5000/6000

S1	Input Mode Selector Switch S1
S2	RS-485 Line Termination Resistor Switch S2
Q	External alarm Out Terminals
R	RS-485 Terminal Block*

*REM-Remote control not available for -A model; terminal +R is not accessible with AFD

Figure 17

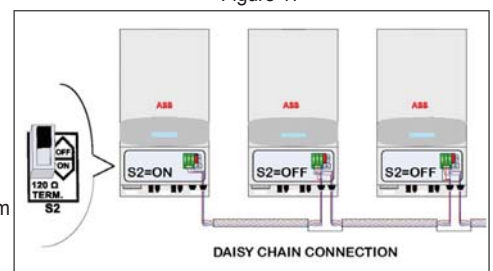

Figure 18

8. User interface

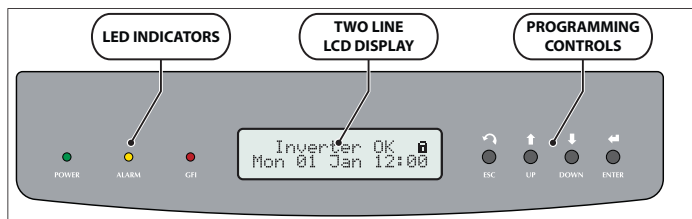

Figure 19

- LEDs indicate operating state of the inverter.
 - Operating parameters of the equipment are displayed in two lines on the LCD.
 - Controls on the keypad are used to review data on the LCD and access data logged internally.
- Text in LCD consists of 2 lines with 16 characters per line.
- Press the ENTER key to stop menu scrolling.
 - Press the ESC key to access the three MAIN MENUS:
STATISTICS - SETTINGS - INFO

Refer to Figure 19 above

POWER LED	GREEN: On if the inverter is working correctly. Flashes when checking the grid or if there is insufficient sunlight.
ALARM	YELLOW: The inverter has detected an anomaly. Anomaly is shown on the display
GFI	RED: Ground fault on the DC side of the PV array. Error is shown on the display.
ESC	Used to access the main menu, go back to the previous menu, or go back to the previous digit to be edited.
UP	Used to scroll up the menu options or shift the numerical scale in ascending order.
DOWN	Used to scroll down the menu options or shift the numerical scale in descending order.
ENTER	Used to confirm an action, access submenu for selected option (indicated by > arrow symbol) or switch to next digit to be edited.

The **Statistics**, **Settings** and **Info** menus can be accessed with just the PV array connected. Some parameters (e.g., current, voltage, power, partial energy, lifetime energy etc.) are available only after grid connection.

Based on individual installations, the following parameters may need to be configured **prior to initial grid connection**:

- The RS-485 bus address for daisy chain (see section 10),
- AC grid type if different from default (see section 10),
- Adjustments to default frequency and disconnection time (see section 9).

Complete descriptions of the data available on the display menus can be found in the product manual located at www.abb.com/solarinverters.

9. Response to abnormal conditions

Abnormal grid conditions: The inverter is programmed to respond to abnormal grid conditions as specified in Table 3.

Cond.	Utility source		Max. time (sec) ² at 60Hz before cessation of current
	Voltage (V)	Frequency (Hz)	
A	$< 0.50 V_{nom}^1$	Rated (60Hz)	Default setting ³ 0.16 (Adj. 0.16 to 1.5)
B	$0.50 V_{nom}^1 \leq V < 0.70$	Rated (60Hz)	Default setting ³ 2 (Adj. 0.16 to 30)
C	$0.70 V_{nom}^1 \leq V < 0.88$		
C	$1.10 V_{nom}^1 < (*)$	Rated (60Hz)	Default setting ³ 1 (Adj. 0.16 to 30)(*)
D	$1.20 V_{nom} \leq V (*)$	Rated (60Hz)	Default setting ³ 0.16 (Adj. 0.001 to 0.16 sec)
E	Rated	Default setting ³ $f > 60.5$ Hz (Adj. 60.1 to 64.0 Hz)	Default setting ³ 0.16 (Adj. 0.16 to 300 sec)
F	Rated	Default setting ³ $f < 59.3$ Hz (Adj. 56.0 to 59.9 Hz)	Default setting ³ 0.16 (Adj. 0.16 to 300 sec)
G	Rated	Default setting ³ $f < 57.0$ Hz (Adj. 50.0 to 56.0 Hz)	0.16 (Fixed)
H	Rated	Default setting ³ $f > 63.0$ Hz (Adj. 62.0 to 64.0 Hz)	0.16 (Fixed)

¹ Vnom is the nominal output voltage rating.

² Trip limit and trip time accuracy specification is as follows: Voltage: +/-2%, Frequency: +/- 0.10Hz, Time: 2 grid cycles (33ms @ 60Hz)

³ Default settings aligned with IEEE 1547-2003 requirements.

(*) Note: For model at 277V, the intermediate overvoltage parameter (U>) is fixed at 110% Vnom for threshold and 0.160 s for Trip Time, and the absolute over-voltage parameter (U>>) is fixed at 111.9%. Vnom for threshold and 0.002 s for Trip Time.

Table 3

To adjust frequency and disconnect times to meet local utility requirements, modifications are made using the inverter LCD display or Aurora Manager-TL software (version 3.32 or later).

- **Modification of parameters from LCD display:** The frequency and disconnect settings can be modified from the LCD display by accessing the Service submenu under SETTINGS. The Service menu is protected by a time-limited Service password, which can be obtained by calling ABB solar inverter technical support at 1-877-261-1374.
- **Modification of frequency and disconnect parameters from Aurora Manager TL software:** The Aurora Manager TL software, with instructions to download and install on a PC, can be found at www.abb.com/solarinverters. An RS485-USB adapter (not included) is required to modify settings using the Aurora Manager TL software. The USB driver files and instructions for installation can be found at user manual available online at www.abb.com/solarinverters.

Fault currents and durations: During a grid fault including a short circuit condition, the inverter may inject current into the grid as specified in Table 4.

Product family	Utility voltage (V)	Fault current RMS (A)	Fault current peak (A)	Total Duration (ms)
PVI-3.0/3.6/3.8/4.2	208	13.5	122.4	119
	240	14.7	164.4	120
	277	12.3	165.9	123
PVI-5000/6000	208	25.6	36.25	82
	240	25.8	36.50	107
	277	22.4	31.75	80

Table 4

Output power derating at high ambient temperature: Under high ambient temperatures, the inverter is designed to derate the output power. Detailed derating curves by model are provided in the main inverter manual found on www.abb.com/solarinverters.

10. Grid standard and RS-485 address

When multiple units have been connected in a daisy chain, the individual address will need to be assigned **prior to grid connection** using the display menu. The grid default type, 240V Split Phase, can also be changed **prior to grid connection** using the display menu.

With only the array connected, set the inverter's DC disconnect switch to ON. The GREEN POWER LED will flash and YELLOW ALARM LED will be steady. The LCD will read "Missing Grid". Press ESC to open the menus. Use the DOWN key to scroll to Settings, and press ENTER.

The Settings menu requires an access password.

0***

Upon selecting **SETTINGS**, the password screen will display; the default password is **0000**.

Pressing ENTER four times loads four zeroes on the display and opens the submenu.

The LCD has two visible text lines and the UP and DOWN control keys are used to scroll through the menu items. An arrow on the left side of the display highlights the current selection. Move the arrow UP or DOWN to the desired selection and press ENTER to access the associated submenu (see section 8). To return to the preceding menu, press the ESC key.

Date/Time setting: For proper operation of the inverter, the date and time must be set correctly. In the **SETTINGS** menu, scroll to **Time** and press ENTER to open the submenu. The time and date can be set by pressing the UP and DOWN keys and pressing ENTER to move through all fields on the display.

Time

Time XX:XX
Date DD MM YYYY

Address and Grid voltage setting are described below for use in installation. Complete descriptions of the submenus can be found in the full manual at www.abb.com/solarinverters.

Address: In the **SETTINGS** menu, scroll to **Address** and press ENTER to open the submenu. Address values are assigned manually using any value in the range 2 to 64. Press the UP and DOWN keys to scroll through numbers and ENTER to select. Auto address = 1 and can be used only once; default address is set at 2.

>Address
Display settings

Address
>2

This menu selection applies to FW version C.2.0.0 or later

Grid voltage setting: Depending on the firmware version of the inverter, the grid voltage can be set from the Settings menu. In inverter FW version earlier than C.2.0.0, this is done using the "Set Vgrid" menu. In inverter FW version C.2.0.0 or later, it is done through the "Nation" menu. To choose a grid connection different from the 240V Split-phase default, use the UP or DOWN key to move the arrow to the desired selection and press ENTER. A second display screen will open; press ENTER to confirm the selection or ESC to cancel. **Upon completion, turn the DC Disconnect switch OFF to save changes.**

Nation

Nation Select

No Nation / UL 240 Split/
& other choices

This menu selection applies to FW version earlier than C.2.0.0

Alarm Message
>Set Vgrid

240V Split Ph
Vnom = 240V

11. Commissioning

The procedure for START-UP is as follows:

- Set the inverter's DC disconnect switch to ON.
- Set the external AC disconnect switch to the inverter to ON.

Once both disconnects are closed, the inverter starts the grid connection sequence.

Initializing ...
Please wait

While the system checks for grid connection (Missing Grid) to be established, the ALARM LED turns steady YELLOW and the POWER LED flashes GREEN.

Missing Grid ...

When waiting for sunlight (Waiting Sun), the POWER LED turns steady GREEN. As soon as conditions are met, the inverter is connected to the grid.

Waiting Sun ...

For -A versions ONLY, the display shows the AFD board self-test running and results upon connection. If the self-test results are OK, the inverter will continue to Next connections.

Test Arc Sensor
OK

If a potential problem on the AFD board is detected, the self-test will result in error.

Refer to section 12 below to clear the error and restart the self-test.

Arc Self Test
E053

All versions will display the following screens during connection:

Next connections
2 secs

Vgrid 241.8V
In range

Fgrid 60.0Hz
In range

Time (seconds) remaining to complete the output voltage and frequency values check, and whether the values are within range.

Meas. RISO ...
In range

A final display screen confirms RISO measurement.

If all items described above test OK, the inverter is connected to the grid and displays the message, **"Inverter OK"**, along with the date and time. If there is not sufficient sunlight to connect to the grid, the unit will repeat the connection procedure until all the parameters controlling connection to the grid (voltage and frequency, confirmation of no ground fault) are within range. During this procedure, the green LED flashes ON and OFF.

Clock malfunctioning, or other non-function related faults that do not interfere with operation, may also be shown instead of the date and time.

Inverter OK 
Mon 03 Jan 11:00

12. AFD (arc fault detection)

An autotest circuit is included in the module design of the DC ARC FAULT CIRCUIT INTERRUPTER (AFCI) solution. The AFCI performs a self-test when the system is started, (i.e., every morning when sunlight is sufficient for connection). The inverter display area shows the results of the self-test:

- If the self-test results are OK, the inverter will continue to AC grid connection.
- If a potential problem on the AFD board is detected, the self-test will result in error.

Press the ESC key to clear the error and start the restart self-test. If self-test results are OK, the inverter will re-connect to the AC grid.

If the DC arc fault is still present, the self test will result in error E050.

Refer to the technical manual at www.abb.com/solarinverters for possible solutions.

- During normal operation, the input current is continually measured and analyzed.
- If a DC arc fault is detected, the inverter is disconnected from the AC grid and error E050 will be displayed.

Refer to the technical manual at www.abb.com/solarinverters for possible solutions.

The AF self-test can be manually started anytime using the following procedure:

1. Turn off the inverter (switching off both DC and AC switches) and,
2. Turn on both the DC and AC switches waiting for display communication of self-test result.

Test Arc Sensor
OK

Arc Self Test
E053

Arc Fault
E050

13. Grid support functions

Inverters with firmware version C.2.0.0 or later are equipped with advanced grid support functionality that is useful to support reactive loads and also assist in reliable operation of the utility grid in the presence of a large number of distributed energy generation sources.

The grid support functions that are equipped on this inverter are described in the following sections. Access to settings under the Service menu require a time-limited password, which can be obtained by calling ABB solar inverter technical support at 1-877-261-1374. This quick installation guide provides an overview of the available grid support functions. For complete details, refer to the technical manual at www.abb.com/solarinverters.

1. Voltage ride-through

This inverter provides parameters to respond to under-voltage and over-voltage events. The inverter is designed to operate normally within the specified operating range. If voltage excursions occur, the inverter is designed to continue operating normally or cease to export power for a specified delay. Beyond this programmed delay, the inverter disconnects from the grid in the event of an abnormal voltage condition. The parameters that control voltage ride-through can be accessed from the Service menu (see Figure 20).

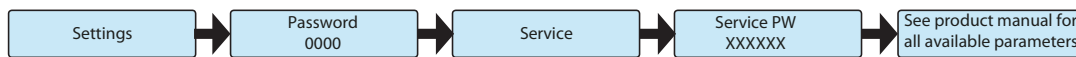

Figure 20

2. Frequency ride-through

This inverter provides parameters to respond to under-frequency and over-frequency events. If frequency excursions occur, the inverter is designed to continue operating normally for a specified delay. Beyond this programmed delay, the inverter disconnects from the grid in the event of an abnormal voltage condition. The frequency ride-through parameters can be modified by accessing the Service menu (see Figure 21).

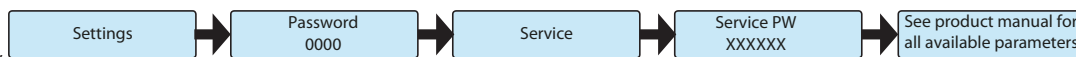

Figure 21

3. Reactive power modes

This inverter is designed to export active as well as reactive power into the utility grid. The inverter provides several modes of operation for reactive power control and are described below. The controls can be accessed from the Settings menu (see Figure 22).



Figure 22

- **Disable:** This is the default setting. Under this setting, the inverter exports a power factor of 1.0.
- **Fixed power factor control (Fixed cos-phi):** In this mode, the operator can set the output power factor to a fixed value. When enabled, Set percentage will appear on the display allowing you to set the value of Cos-Phi as a percentage from 0.1 to 100.
- **Power factor as function of output power (Std cosphi 0.9):** In this mode, the inverter reduces the output power as a function of the output power at a given operating point. The default curve can be modified using the Aurora Manager-TL (version 3.32 or later) software program, which can be downloaded from ABB's download center web page at <http://www.abb.com/abblibrary/DownloadCenter/>. Enter "Aurora Manager TL" in the search for box on this web page to locate the download link to the latest software version.
- **Dynamic Volt/VAR control (Std Q(U)):** Under this mode, the level of reactive power exported by the inverter is a function of the operating grid voltage, also known as a Volt/VAR curve. The default Volt/VAR curve can be modified using the Aurora Manager-TL (version 3.32 or later) software program.

4. Power reduction

This inverter offers two modes for active power reduction.

- **Fixed power reduction:** When enabled from the Settings menu (see Figure 23), this mode limits the active power that the inverter can export to the grid. The setting is specified as a percentage of the rated power of the inverter, from 0% to 100% in steps of 1%.
- **Frequency/Watt function (OF Derating):** Under this mode, the inverter limits the active power as a function of the grid frequency. The default frequency/watt can be modified using the Aurora Manager-TL (version 3.32 or later) software program. The frequency/watt function can be accessed from the menu as shown in Figure 24.



Figure 23



Figure 24

5. Ramp controls

The inverter is designed to control the rate at which output power is increased, either at startup, or after a temporary low power condition on the PV array (such as fast shading). The following ramp controls are provided on this inverter.

- **Normal ramp:** The normal ramp defines the maximum rate at which the inverter can increase the output power under normal operation. The normal ramp control limits the dramatic fluctuations in the output power in order to prevent instabilities on the utility grid. The normal ramp rate can be modified from the Aurora Manager TL software (version 3.32 or later).
- **Slow ramp:** The soft-start ramp defines the maximum rate at which the inverter can increase the output power when the inverter is first starting up. This startup may occur on a daily basis or when the inverter restarts after an abnormal grid event has ended. The soft start ramp settings can be accessed from the menu as shown in Figure 25.



Figure 25

Contact us

www.abb.com/solarinverters

BCM.00364.1AP, Rev. AA
© Copyright 2016 ABB. All Rights Reserved.
Specifications subject to change without notice.