

A BRITISH COMPANY SUPPORTING BRITISH CARS

## LAND ROVER & RANGE ROVER POPULAR PARTS

ORIGINAL, OEM & AFTERMARKET  
PARTS & ACCESSORIES

1948 TO PRESENT DAY



Service Kits

Filtration

Wipers

Drive Belts

Ignition

Brakes

Suspension

Steering

Clutch

Transmission

Cooling

Rotating Electrics

Engine Parts

Exhaust Parts

Engine Mountings

Fuel System

Cables

Wheel Nuts

**0% Interest**  
for 4 months from

**PayPal**  
**CREDIT**

on orders over £99

Please see our website for details

LINES OPEN 20/7: UK 01522 568000 - USA 1 855 746 2767

E-MAIL: [lrsales@rimmerbros.com](mailto:lrsales@rimmerbros.com)

**[www.rimmerbros.com](http://www.rimmerbros.com)**



# Welcome to our Land Rover Popular Parts Catalogue

This catalogue lists popular items for all Land Rover vehicles.

We also have more detailed catalogues available for Range Rover Classic & P38, Range Rover Sport, Discovery 1, 2 and 3, Defender and Freelander 1 – please request your free copy.

Details of all our other catalogues can be found on the inside rear cover.

We pride ourselves in being able to offer from stock, a vast array of genuine, OEM and Aftermarket parts at competitive prices and deliver them fast - worldwide. We have sophisticated systems to handle, process and track your order – delivering the service you expect from a name that has been in the parts business for nearly 35 years.

We identify parts so that you know what you are buying. When there are alternatives to the original Land Rover part, we use a simple numbering system so that you can select the part that best suits your needs and budget. This avoids any confusion when comparing quality and price:

- **Aftermarket (reproduction) part – will have a P suffix**
- **OEM (original equipment manufacturer) part – will have a P1 suffix**
- **Genuine (Land Rover boxed) part – will have a plain number**

We are also able to offer a full technical sales and customer service back-up to help select the parts you need and to ensure that everything you order meets expectations.



## Can't find what you're looking for?

Rimmer Bros is an authorised Land Rover Parts Distributor. We have access to the full range of genuine Land Rover parts - for every model direct from Land Rover. For parts not listed in this catalogue, please contact us quoting your full VIN number.



## HOW TO ORDER

Website: [www.rimmerbros.co.uk](http://www.rimmerbros.co.uk)  
Telephone: UK - **01522 568000**  
*UK office hours only* Overseas - **+44 1522 568000**  
From the USA - **1 855 7462767**  
*(UK office hours only)*

Email: [Irsales@rimmerbros.co.uk](mailto:Irsales@rimmerbros.co.uk)

Fax: UK - **01522 567600**  
Overseas - **+44 1522 567600**

Post: Triumph House, Sleaford Road,  
Bracebridge Heath, Lincoln LN4 2NA, England

Collect in Person: Our sales counter is open 8.30am-5.30pm  
Monday to Friday and 8.30am-1pm Saturday.  
We also offer a 'click and collect' service to save you time.





## PAYMENTS

We accept all major credit, debit and charge cards and also Paypal on orders where all items are in stock. Orders can also be pre-paid by bank transfer (in GBP/Euro/US Dollar-please add £7.00 to cover bank charges) or cheque (in GBP-please allow a few extra days for clearance). If you send cash or Rimmer Bros Vouchers, please use registered mail, as we cannot accept responsibility for any loss.

Our bank details for GBP are:- NAT WEST Bank, Account No. 05839874  
Sort Code 54-10-23 IBAN No GB74NWBK54102305839874 IBAN BIC NWBKGB2L

Our bank details for Euro are:- NAT WEST Bank, Account Prefix 550/00/  
Account No. 06848516 IBAN No GB25NWBK60720906848516 IBAN BIC NWBKGB2L

Our bank details for US Dollar are:- NAT WEST Bank, Account Prefix 140/00/  
Account No. 15012506 IBAN No GB16NWBK60730115012506 IBAN BIC NWBKGB2L

## PRICING

The prices in this Catalogue were correct at the time of printing but are subject to change without prior notice. Please confirm all prices when ordering.

Our website gives up-to-the minute information regarding availability and the price of any item. We show two prices in GBP, one excluding VAT (for worldwide, outside EU countries) and one including UK VAT at 20%. Orders shipped to certain EU countries will be charged EU VAT at that country's prevailing rate - please see 'VAT' below.

All orders will be invoiced and charged in GBP. All goods are sold subject to the price ruling at the time of invoicing.

## VAT

Residents of the UK and certain EU countries pay 20% UK VAT (Sales Tax) on parts and delivery. Due to EU legislation, where we exceed the export threshold to a country, we must VAT register and charge VAT at that country's prevailing rate. UK VAT is charged at 20% on EU shipped orders except in the following countries; Austria 20%, Belgium 21%, Denmark 25%, Finland 24%, France 20%, Germany 19%, Ireland 23%, Italy 22%, Netherlands 21%, Portugal 23%, Portugal Azores 18%, Portugal Madeira 22%, Spain 21%, Sweden 25%. Our EU VAT number will be shown on the invoice.

Note that books and manuals are generally zero rated for VAT purposes.

For EU businesses who are VAT registered, we require your VAT number and official order to export at VAT exempt prices.

For Worldwide (outside the EU) orders sent direct from our premises, VAT is not charged however, any local import duty, taxes or customs clearance are not included in our prices and must be paid for by you, usually at the time of delivery by the Carrier.

Visitors to our shop & sales counter from outside the EU can reclaim the VAT (when leaving the country) using a VAT407 Reclaim Form which we can provide upon request. This form cannot be used for Mail Order transactions.

## QUOTATIONS

If you require a written quotation for the part(s) and/or delivery charge(s) before ordering, please contact us.

## BACK ORDERS

Back-ordered parts are not charged for until despatch. Upon despatch we will charge the price (in GBP) quoted at the time of ordering. Prices will be unaffected by any subsequent price alterations unless advised in writing to you.

Please notify us in writing (letter, fax or email) if you wish to cancel any back ordered items. Back orders are automatically cancelled after 3 months. Back Ordered parts will be sent carriage free (some exclusions apply for export overseas). If you would prefer that your order is sent complete, please request this at the time of ordering.

## SPECIAL ORDERS

Certain items (coloured trim, carpets, one-off type parts, etc) are sometimes only available by special order. This means we have to order them for you specially from the manufacturer. For this reason, we require a 20% non-refundable deposit upon taking your order. The balance is payable when the goods are despatched.

Please note that special order items can take several weeks to be supplied and are non returnable.



**At Rimmer Bros, we opt to use the best carriers in the business to ensure your order is delivered safely, securely, and on time.**

Orders are despatched as soon as practically possible. If your parts are required urgently and you want an express delivery service, please tell us.

We use Royal Mail's first class post service or international standard (formerly air mail) service for small packages and DPD, UPS and Fedex for most of our domestic and the majority of our overseas parcels. Larger domestic orders are sent via DX Freight, and for customers in Europe we also utilise DPD (as an alternative to UPS) for a cost effective, economy delivery service by road.

These options provide our customers with a choice of the best services available.

Guide prices for shipping (including packaging and handling), are shown below.

Shipping charges for export of oversize parcels outside the UK may need to be quoted once the order is picked and packed. Please also see below for further details.

Once your order is shipped and providing we have your email address, we will email confirmation to you, including tracking information if applicable.

Please note that as a security measure, your first order with us must be delivered to the credit card holders registered address.



## United Kingdom

We utilise Royal Mail's first class post service, DPD or UPS Standard Service, depending upon size, weight and urgency. Larger domestic orders are sent via DX Freight or Pallet couriers.

We aim to despatch all UK orders within 24hrs, subject to stock availability and payment being received. Orders containing items which are advertised as "available to order", or are temporarily out of stock will take longer, depending on stock availability from our suppliers.

The majority of UK orders are delivered within 1-3 working days. Certain off-shore, remote, Scottish Highland and Northern Ireland destinations may take longer. Bulky and very heavy items may also take longer. If you require your parts urgently, a UK Mainland next working day express option is available for orders placed by 3pm except for oversize parcels where the order must be placed by 10am. You can also choose to have your order sent to an alternative work address or direct to your garage. A nominated delivery day option is also available, as is a same day service for very urgent items. All orders sent by carrier or Royal Mail Special Delivery / DPD pre Noon will require a signature on delivery. We will send you an order despatch confirmation email and tracking number providing we have your email address. Order tracking is not available for Royal Mail first class post deliveries, so please wait a full 3-5 working days for your order to arrive. Royal Mail will only accept claims for loss after 10 working days from due date on first class post and 5 working days on Special Delivery.

Shipping charges (including packaging & handling) are calculated on the weight of the consignment and the desired shipping method.

Please note that our minimum postage charge reflects our cost of processing, picking, packing and despatching your order and may sometimes appear disproportionate with an order of very low value. An order of £10 or less will usually attract the minimum postage charge, so we recommend you add some other items to increase the order value to make the postage charge more cost effective.

The UK chart on the opposite page is a guide to our shipping charges and transit times.

Supplements apply to out of area rural destinations including Highlands, Scottish Islands, Northern Ireland, Isle of Man, Isle of Wight, and the Channel Islands and for certain 'hazardous' products, such as aerosols, paints, fluids and chemicals. Please enquire for shipping to BFPO addresses. Any quoted delivery times are for 'working days' from despatch and exclude weekends and bank holidays. All delivery times are guides. Certain large or bulky items may incur an additional packing charge. Please note that the delivery driver may need assistance to unload large/heavy items - Please advise if special delivery arrangements are required.

## EU Countries

We utilise Royal Mail Airmail for small parcels and DPD Classic for an economy, larger parcel delivery service by road for most European destinations at a low, fixed price box rate up to 31.5Kg (not exceeding 175cm length and 300cm girth which is length cm + 2 x width cm + 2 x height cm) - meaning that it costs no more to include extra parts! We also use UPS Road and Air services. Large European orders are sent by air or road freight by alternate carriers, depending upon destination and speed of service required.

We aim to despatch all export orders within 48 hours of receipt, subject to stock availability and payment for goods and shipping charges being received. Orders containing items which are advertised as "available to order", or are temporarily out of stock will take longer depending on stock availability from our suppliers. To keep shipping charges as low as possible, we may hold orders until all stock is available to ship as one consignment.

Delivery times will be dependent on location and delivery method selected. See guide below for estimated times. Bulky and very heavy items may take longer. If you require your parts urgently, an Express option is available. A Next Day service is available for very urgent orders to certain European locations. All orders sent by Carrier will require a signature on delivery. You can choose to have your order sent to an alternative work address or direct to your garage. We will send you an order despatch confirmation email and tracking number providing we have your email address. Order tracking is not available for Royal Mail Air Mail deliveries and we cannot accept a claim for loss unless at least 20 working days have passed from the due delivery date.

Shipping charges (including packaging & handling) are based on weight and volume. Our order system automatically calculates the shipping charge based only on the weight of the goods.

For orders that include oversize, large / bulky parts (e.g. body panels), an additional shipping charge may be incurred, which may not be reflected at the time of ordering. This is because the charge is calculated on physical weight, rather than volumetric weight. This can not be calculated until the order is packed, measured and weighed. If the volumetric weight exceeds the physical weight, we will notify you by email prior to despatch if the estimated shipping charge is insufficient and inform you of the new shipping total, seeking your authorisation to proceed.

Certain large or bulky items may also incur an additional packing charge.

The EU chart on opposite page is a guide to our shipping charges and transit times for EU destinations

Any quoted delivery times are for 'working days' from despatch and exclude weekends and bank holidays. All delivery times are guides. Small orders are sent via Royal Mail Air Mail service and will usually arrive within 5-15 days depending on location. Large and bulky or heavy items and orders, will be sent using international freight services. We will contact you to advise on prices and service speeds available to your destination.

VAT at the ruling rate will be applied to the order if shipped within the EU. Please note that there may be shipping restrictions for overseas destinations for certain 'hazardous' products, such as aerosols, paints, fluids and chemicals. Please enquire for shipping to BFPO addresses. Orders can not be sent to American Forces Post Offices (APO's).

## OTHER THINGS TO NOTE

### Please check your parcels

When you sign for a parcel being delivered, please inspect it carefully. If it has suffered in transit, you can mark the delivery note 'Parcel Damaged', before signing, or even refuse delivery in serious cases. We do of course pack carefully to help avoid these problems! Some deliveries involve more than one parcel - please check that all have been received.

We must be advised within 48 hours of delivery of any shortages or damaged goods.

### Loss In Transit

If your parcel does not arrive, we have to establish our claim with the carriers concerned before we can send a replacement consignment. This can sometimes be a lengthy process, and if your part is needed urgently, a second order can be paid for to save time. We refund one of your orders as soon as the carriers clear our claim.



**Worldwide (Non EC Countries)**

We utilise Royal Mail Airmail and a combination of UPS and Fedex services. Larger overseas orders are sent by air or sea freight by alternate carriers, depending upon destination and speed of service required.

We aim to despatch all export orders within 48 hours of receipt, subject to stock availability and payment for goods and shipping charges being received. Orders containing items which are advertised as "available to order", or are temporarily out of stock will take longer depending on stock availability from our suppliers. To keep shipping charges as low as possible, we may hold orders until all stock is available to ship as one consignment.

Delivery times will be dependent on location and delivery method selected. See guide below for estimated times. Bulky and very heavy items may take longer. If you require your parts urgently, an Express option is available. All orders sent by Carrier will require a signature on delivery. You can choose to have your order sent to an alternative work address or direct to your garage. We will send you an order despatch confirmation email and tracking number providing we have your email address. Order tracking is not available for Royal Mail Air Mail deliveries and we cannot accept a claim for loss unless at least 25 working days have passed from the due delivery date.

Shipping charges (including packaging & handling) are based on weight and volume.

Our order system automatically calculates the shipping charge based only on the weight of the goods.

For orders that include oversize, large / bulky parts (e.g. body panels), an additional shipping charge may be incurred, which may not be reflected at the time of ordering. This is because the charge is calculated on physical weight, rather than volumetric weight. This can not be calculated until the order is packed, measured and weighed. If the volumetric weight exceeds the physical weight, we will notify you by email prior to despatch if the estimated shipping charge is insufficient and inform you of the new shipping total, seeking your authorisation to proceed.

Certain large or bulky items may also incur an additional packing charge.

The Worldwide chart opposite is a guide to our shipping charges and transit times for Worldwide (Non UK/EU) destinations

Any quoted delivery times are for 'working days' from despatch and exclude weekends and bank holidays. All delivery times are guides. Small orders are sent via Royal Mail Airmail service and will usually arrive within 5-15 days depending on location. Large and bulky or heavy items and orders, will be sent using international freight services. We will contact you to advise on prices and service speeds available to your destination.

We do not charge VAT on orders despatched directly outside the EU however, any local import duty, taxes or customs clearance are not included in our prices and must be paid for by you, usually at the time of delivery by the Carrier. Please note that there may be shipping restrictions for overseas destinations for certain 'hazardous' products, such as aerosols, paints, fluids and chemicals. Please enquire for shipping to BFPO addresses. Orders cannot be sent to American Forces Post Offices (APO's)

**UNITED KINGDOM SHIPPING CHARGES AND TRANSIT TIMES**

Service	Transit Times From Despatch*	Price ex VAT
Royal Mail First Class Post	Usually 1 - 3 working days - Excludes Hazardous Goods	From £2.50
Royal Mail Special Delivery / DPD Pre Noon	Order By 3pm Next working day from despatch Mon - Fri (not inc Saturday)	From £6.95
Standard Carrier Delivery	Usually 2 - 3 working days Mon- Fri	From £7.95
Next Day Express Carrier	Order by 3pm for Next working day Mon - Fri delivery from despatch	From £10.95
Pre-12 Carrier Delivery	Order by 3pm Before 12 o'clock the following day	From £18.95
Nominated Day Delivery	Any week day of your choice (minimum 48hr notice)	From £10.95
Saturday Delivery	Order by Phone by 3pm on Friday for Saturday delivery	From £9.75
Sunday Delivery	Order by Phone by 10am on Saturday for Sunday delivery	From £12.95
Collection in person from our Lincoln Showroom	Open weekdays 08:30 - 17:30, Saturday 08:30 - 13:00	FREE
Delivery to classic car shows and meetings	See which UK and international shows we are attending on our events page	FREE
Same-Day	Location restrictions apply Contact us - 01522 568000	

\*We aim to despatch all UK orders within 24hrs. Prices shown exclude VAT.

**EC SHIPPING CHARGES AND TRANSIT TIMES**

Area	STANDARD Delivery via DPD Up to 31.5kg Box		EXPRESS Delivery via UPS Express Saver Based on Weight / Size	
	Price ex VAT	Transit Time From Despatch* Approx	Price ex VAT From 1kg	Transit Time From Despatch* Approx
Austria	£14.95	3 days	£24.80	1 day
Belgium	£12.95	2 days	£22.46	1 day
Bulgaria	£24.95	4-6 days	£27.05	2-3 day
Croatia	UPS Only	UPS Only	£42.38	2-3 day
Czech Republic	£17.95	3-4 days	£26.95	1-2 day
Denmark	£14.95	3 days	£24.80	1 day
Estonia	£19.95	4-5 days	£27.05	1-2 day
Finland	£19.95	4-5 days	£24.80	1-2 day
France	£12.95 (Chronopost / Exapaq)	2 days	£22.81	1 day
Germany	£12.95	2 days	£22.81	1 day
Greece	From £14.35 (UPS Only)	6-10 days	£24.80	1-2 day
Hungary	£19.95	4-6 days	£26.95	2-3 day
Iceland	UPS Only	UPS Only	£42.38	2-3 day
Italy	£17.95 (BRT Corriere Espresso)	3-4 days	£24.80	1 day
Latvia	£24.95	4-6 days	£27.05	2-3 day
Lithuania	£24.95	4-6 days	£27.05	2-3 day
Luxembourg	£12.95	2 days	£22.46	1 day
Netherlands	£12.95	2 days	£22.46	1 day
Norway	From £20.28 (UPS Only)	4-6 days	£39.73	1-2 day
Poland	£19.95	4-5 days	£26.95	1-2 day
Portugal**	£19.95 (Chronopost)	4-5 days	£24.80	1-2 day
Republic of Ireland	£12.95	2 days	£22.46	1 day
Romania	£24.95	4-6 days	£27.05	2-3 day
Russia	Enquire	Enquire	Enquire	Enquire
Slovak Republic	£17.95	3-4 days	£26.95	1-2 day
Slovenia	£19.95	4-5 days	£26.95	1-2 day
Spain***	£17.95 (Seur)	3-4 days	£24.80	1 day
Sweden	£19.95	4-5 days	£24.80	1-2 day
Switzerland	From £20.28 (UPS Only)	4-6 days	£39.73	1-2 day

\*We aim to despatch all export orders within 48 hours. Prices shown exclude VAT.

\*\*Excludes Maderia and the Azores. \*\*\*Excludes Balaeric and Canary Islands

**WORLDWIDE (NON UK/EC) SHIPPING CHARGES AND TRANSIT TIMES**

Area	UPS Express Saver		FedEx Int Economy	
	Transit Time From Despatch* Approx	Prices From 1kg	Transit Time From Despatch* Approx	Prices From 1kg
Africa / Middle East	2-5 days	From £28.12	6-7 days	From £25.00
Asia	2-5 days	From £28.12	5-7 days	From £20.50
Australia	2-5 days	From £28.12	5-7 days	From £20.50
Canada	2 days	From £23.71	5-6 days	From £16.50
New Zealand	2-5 days	From £35.49	5-7 days	From £20.50
North America	2 days	From £23.71	5-6 days	From £15.00
South and Central America	3-4 days	From £53.74	5-7 days	From £25.00

\*We aim to despatch all export orders within 48 hours

## RETURNS & EXCHANGE OLD UNITS

All returns must be pre-authorised with a returns authorisation (RA) number. Returned products without an RA number will be subject to delay and possible return to sender. All returns are subject to a physical inspection.

We must have received and inspected the product before an exchange or credit can be issued (see also Warranty & Legal Info). Defective items are backed 100% and after 30 days can be returned for exchange only.

### Returns of Parts Not Required - within 14 days

All goods sold by Mail Order are covered by the Consumer Contracts Regulations, which allow for a fourteen day 'cooling off' period during which you may cancel your order (in writing) by sending us a letter, fax or e-mail at any time up to and including the fourteenth working day after the day on which you received your purchase.

If you exercise your statutory right to cancel you must immediately return to us (at your own cost), the item(s) that you do not wish to keep. Return carriage charges are non-refundable. We will acknowledge receipt of your written cancellation by issuing a 'Returns Authorisation Number' which should be quoted and accompanied by a proof of purchase or invoice when returning the goods.

Please ensure all goods are adequately packed to avoid damage, that you insure them accordingly with the carrier used and obtain a proof of shipment. Please note that all goods must be in the condition supplied at the point of sale and with their original, undamaged packaging. Returns are not permitted on parts specially ordered by Rimmer Bros on customer's behalf.

### Returns of parts not required - within 14 - 28 days

As an added benefit to Rimmer Bros customers and in addition to your statutory cancellation right (as detailed above), returns may be considered outside the 14 day cooling off period up to and including 28 days after you receive your purchase, subject to the following criteria. Please note that any offset, credit or refund will be at the sole discretion of Rimmer Bros Ltd.

A 'Returns Authorisation Number' must be applied for within the 14 to 28 day period. Where goods have been correctly supplied, it may be possible to offset the full value of the return against another order of the same or higher value. Alternatively, a credit note (for the full value) could be offered. Please note that any cash refund will be subject to a handling charge (typically 15% min £5) to cover administration and re-stocking costs. Return carriage charges are non-refundable.

All goods returned for a credit or exchange must be accompanied by our invoice quoting the 'Return Authorisation Number'. Please complete the form on the reverse side of the invoice. Goods must be adequately packed to avoid damage. You should insure them accordingly with the carrier and obtain a proof of shipment. No responsibility can be accepted for goods received by us, damaged. Goods must be in the condition supplied at the point of sale and with their original, undamaged packaging. Returns are not permitted on parts specially ordered by Rimmer Bros on customer's behalf.

### Returns of Parts Not Required - Outside 28 days

No returns will be considered after 28 days unless covered by the terms and conditions of our Warranty.

### Returns of Exchange 'Old Units'

There is no specific time limit for the return of exchange old units except for Genuine Land Rover parts, where old core must be returned within 80 days. Please contact us prior to returning the old unit for a 'Return Authorisation Number'. This speeds up the process of returning the surcharge refund. See reverse of invoice for full details of returns procedure.

Please note that old core must be complete and serviceable and drained of fluids where applicable. We reserve the right to retain all or part of the surcharge if the unit is irreparable, damaged or not identical to the type supplied.

Old core parts should NOT be disassembled for inspection purposes.

The core parts returned MUST be the same as the original part supplied and MUST be returned in the packaging used for the supply of the original part, AND must be safely fixed/fastened in that packaging – failure to comply may result in a charge being levied for any resulting or consequential costs incurred.

Returned core parts should NOT be cleaned by abrasive methods such as sandblasting or glass beading. If such cleaning methods have been used and damage has occurred the return core will be rejected and no credit will be issued.

### Other Returns

Other returns will be dealt with in accordance with your statutory rights, if applicable, or our warranty.

### Returns Processing

Please note that returns are processed as quickly as possible. During busy periods, especially in the Spring and Summer, returns may take up to 14 days to process. Your statutory rights remain unaffected.



## WARRANTY & LEGAL INFO

### Parts Warranty

All new and reconditioned parts are covered by a 12 month manufacturer's warranty unless specifically stated. You should notify us immediately if a potential warranty situation arises. We will then advise a course of action. Any suspected faulty part must be returned to us together with the original invoice or proof of purchase and with as much information relating to the problem as possible. **Please note that a defective part must be returned and received by us before it can be exchanged.** All warranty parts are subject to a physical inspection. This may involve returning the part to our supplier to verify the fault before it can be exchanged. Defective items are backed 100% and after 30 days can be returned for exchange only. For warranty claims please state vehicle chassis number, date fitted & mileage, date failed & mileage and exact nature of fault.

The warranty period commences from our invoice date not from the date of installation or first use. This warranty covers defects to the part when fitted and used correctly for normal, everyday vehicle use but does not apply to parts used for any extraordinary or unusual uses such as competition, racing, rallying or parts subsequently stripped down, altered, modified or adapted etc. in any way from their original design or intended use.

Although we are, by law, liable for death or personal injury caused by our proven negligence and by the Consumer Rights Act 2015, our warranty only covers the parts in question and not to any consequential loss or cost, eg garage labour, recovery, car hire, re-delivery, parking fines etc. No claim will be validated if the failure is caused by misuse, neglect, overheating, incorrect installation or failure of a related component.

Any part replaced or repaired under warranty, will only benefit from the balance of the cover remaining from the original purchase date. Warranties are not transferable. Acceptance of goods is deemed as acceptance of these terms. The warranties are in addition to, and do not affect your statutory consumer rights.

### Legal Info

Errors & Omissions Excepted. Please tell us if you think something is wrong in this Catalogue. All parts offered subject to availability.

All part numbers, illustrations and photographs used are intended for reference and identification purposes only and are not necessarily an exact representation of the goods supplied. Photographs of parts should be considered indicative of what we supply rather than an exact representation as sources of supply and manufacture can change.

Whilst we make every effort to ensure the accuracy of product descriptions, illustrations and photographs, they are based upon information supplied by the manufacturer or distributor at the time.

There may be occasions - due to circumstances beyond our control - when specifications are changed, or when goods become temporarily unavailable.

Certain part numbers may have been superseded to an alternative number when a later version or updated specification is offered.

**© Copyright Rimmer Bros Ltd. All rights reserved. No part of this publication may be copied, reproduced, stored in any retrieval system, communicated or transmitted in any form or by any means, including Photocopying, Electronic, Mechanical or otherwise, without prior written permission from Rimmer Bros Ltd.**





Insurance solutions\*  
for classics and more.



- CLASSIC + MODERN CAR
- CLASSIC + MODERN BIKE
- MULTI VEHICLE
- COLLECTORS
- KIT CAR
- COMPETITION CAR
- CLASSIC MOTOR TRADE
- MOTORSPORT SUPPORT VEHICLE



At FJ we understand every classic vehicle owner is different. With FJ+ you can build your classic vehicle policy from a range of cover options\* including **breakdown**, **agreed value**, **salvage retention** and **spare parts**.

Call our friendly UK team for a quote.

**0333 207 6256**

or visit:

**footmanjames.co.uk**



Part of the Towergate Group



\*All cover is subject to insurers terms and conditions, which is available upon request.

Footman James is a trading name of Towergate Underwriting Group Limited. Registered in England No. 4043759. Registered Address: Towergate House, Eclipse Park, Sittingbourne Road, Maidstone, Kent ME14 3EN. Authorised and regulated by the Financial Conduct Authority. Telephone calls may be monitored or recorded. Sign up to our newsletter at footmanjames.co.uk to receive updates on all the latest news, events, offers and competitions.FP ADGE674.9.16



**If you know what you want why wait until office hours?**

*Visit our website and order online anytime!*



HOME PAGE, WITH NAVIGATION MENU

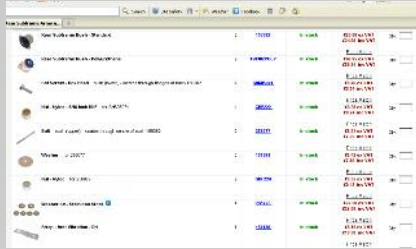

CURRENT PRICE AND AVAILABILITY IS DISPLAYED

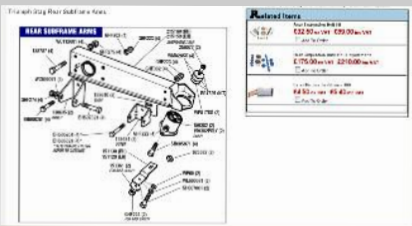

DETAILED PARTS INFORMATION MAKES SELECTION EASY



SIMPLY ENTER WHAT YOU WANT TO ORDER, AND PROCEED TO CHECK OUT FOR SECURE ORDERING!

Featuring:-

- 'Live' Catalogues for all models
- Stock Availability
- Current Prices
- Special Offers
- Clearance Bargains
- Competitors Price Match
- Live Chat Facility
- Wish List
- Multiple Currency Pricing
- Shipping Charges

*Ordering on-line is easy, secure, fast and efficient. Visit our website today.*

**SIGN UP ON OUR WEBSITE TODAY FOR THE LATEST NEWS AND OFFERS!**

Join our email list to ensure you don't miss out on new products and promotions, whether you own a Triumph, Land Rover, MG Rover, Jaguar '98 on or Mini!



# CLEARANCE BARGAINS

## HUGE SAVINGS

ITEMS ADDED DAILY! LIMITED SUPPLIES!

**Visit our website to pick up a bargain today on our heavily discounted Clearance Bargain parts.**

- First come first served.
- Limited quantities of product available.
- Parts will no longer be available once sold.
- Product selection changes regularly.
- Shipped anywhere worldwide.

**Click on this Clearance Bargains Banner on our home page to see some amazing bargains ...**





# 90 (1983-1989)

## 1983 to 1989 All Models

Listed below are the most popular parts required for the Land Rover 90.

We have access to the full range of parts for your vehicle. Please contact us if not listed here.



## SERVICE KITS

### 90 (1983-1989)

### Filter Kit

All 2.5L TD5 diesel models. Includes oil filter, air filter, rotor filter, fuel filter & sump plug washer.

Aftermarket	1	<b>LL1346P</b>	11.50	13.80
Genuine	1	<b>LL1346</b>	70.83	85.00

All 200 TDi diesel models. Includes oil filter, air filter, fuel filter & sump plug washer.

Aftermarket	1	<b>LL1344P</b>	9.58	11.50
Genuine	1	<b>LL1344</b>	42.50	51.00

All 300 TDi diesel models. Includes oil filter, air filter, fuel filter & sump plug washer

Aftermarket	1	<b>LL1345P</b>	9.79	11.75
Genuine	1	<b>LL1345</b>	40.00	48.00



LL1346

## FILTRATION

### 90 (1983-1989)

### Oil Filter - Cartridge

All models with 2.25L petrol engine	Aftermarket	1	<b>ERR3340P</b>	2.00	2.40
	OEM	1	<b>ERR3340P1</b>	3.33	4.00
	Genuine	1	<b>ERR3340</b>	10.82	12.98

All models with 2.5L normally aspirated diesel engine	Aftermarket	1	<b>ERR3340P</b>	2.00	2.40
	OEM	1	<b>ERR3340P1</b>	3.33	4.00
	Genuine	1	<b>ERR3340</b>	10.82	12.98

All models with 2.5L petrol engine	Aftermarket	1	<b>ERR3340P</b>	2.00	2.40
	OEM	1	<b>ERR3340P1</b>	3.33	4.00
	Genuine	1	<b>ERR3340</b>	10.82	12.98

All models with 2.5L turbo diesel engine	Aftermarket	1	<b>ERR3340P</b>	2.00	2.40
	OEM	1	<b>ERR3340P1</b>	3.33	4.00
	Genuine	1	<b>ERR3340</b>	10.82	12.98

All models with V8 petrol engine	Aftermarket	1	<b>ERR3340P</b>	2.00	2.40
	OEM	1	<b>ERR3340P1</b>	3.33	4.00
	Genuine	1	<b>ERR3340</b>	10.82	12.98

### Air Filter

All diesel models up to (VIN) FA375497	Aftermarket	1	<b>NRC9238P</b>	5.83	7.00
	OEM	1	<b>NRC9238P1</b>	7.08	8.50
	Genuine	1	<b>NRC9238</b>	17.46	20.95

All petrol models except V8 up to (VIN) FA375497	Aftermarket	1	<b>NRC9238P</b>	5.83	7.00
	OEM	1	<b>NRC9238P1</b>	7.08	8.50
	Genuine	1	<b>NRC9238</b>	17.46	20.95

All V8 petrol engine models	Aftermarket	1	<b>RTC3479P</b>	9.58	11.50
	Genuine	1	<b>RTC3479</b>	41.44	49.73

### Fuel Filter

All 2.25L diesel models. Element for in line filter assembly.	Aftermarket	1	<b>90517711P</b>	1.83	2.20
	Aftermarket	1	<b>GFE5296</b>	3.50	4.20
	Genuine	1	<b>90517711</b>	4.92	5.90

All 2.25L petrol models. Element for in line filter assembly.	Aftermarket	1	<b>JS660LP</b>	1.33	1.60
	Genuine	1	<b>JS660L</b>	3.06	3.67

All 2.5L normally aspirated diesel models. Element for in line filter assembly.	Aftermarket	1	<b>90517711P</b>	1.83	2.20
	Aftermarket	1	<b>GFE5296</b>	3.50	4.20
	Genuine	1	<b>90517711</b>	4.92	5.90

All 2.5L petrol models. Element for in line filter assembly.	Genuine	1	<b>JS660L</b>	3.06	3.67
--------------------------------------------------------------	---------	---	---------------	------	------

All 2.5L Turbo Diesel (not Tdi) models. Element for in line filter assembly.	Aftermarket	1	<b>90517711P</b>	1.83	2.20
	Aftermarket	1	<b>GFE5296</b>	3.50	4.20
	Genuine	1	<b>90517711</b>	4.92	5.90

All 3.5L V8 carb petrol models. Element for in line filter assembly.	Aftermarket	1	<b>JS660LP</b>	1.33	1.60
	Genuine	1	<b>JS660L</b>	3.06	3.67

### Fuel Filter Complete Assembly

All 2.25L petrol models	Aftermarket	1	<b>NRC9786P</b>	16.88	20.26
	Genuine	1	<b>NRC9786</b>	98.07	117.68

All 2.5L petrol models	Aftermarket	1	<b>NRC9786P</b>	16.88	20.26
	Genuine	1	<b>NRC9786</b>	98.07	117.68

All 3.5L V8 carb petrol models	Aftermarket	1	<b>NRC9786P</b>	16.88	20.26
	Genuine	1	<b>NRC9786</b>	98.07	117.68

All diesel engine models. Sedimentor type.	Aftermarket	1	<b>NRC9708P</b>	17.08	20.50
	OEM	1	<b>NRC9708P1</b>	26.67	32.00
	Genuine	1	<b>NRC9708</b>	76.51	91.81

### Fuel Filter Seal

All diesel engine models Bottom, for sedimentor filter	Aftermarket	1	<b>AAU9902P</b>	0.58	0.70
	Genuine	1	<b>AAU9902</b>	1.78	2.14

Top, for sedimentor filter	Aftermarket	1	<b>AAU9903P</b>	0.33	0.40
	Genuine	1	<b>AAU9903</b>	1.78	2.14

All diesel models	Genuine	1	<b>605011</b>	0.32	0.38
-------------------	---------	---	---------------	------	------



ERR3340

NRC9786P

GFE5296

RTC3058

## WIPER BLADES

### 90 (1983-1989)

### Wiper Blade

All models up to (VIN) EA452017 Front and rear, spigot fixing	Aftermarket	3	<b>LR079891P</b>	2.33	2.80
	OEM	3	<b>LR079891P1</b>	3.08	3.70
	Genuine	3	<b>LR079891</b>	9.31	11.17

All models from (VIN) FA452018 Front and rear, hook fitting	Aftermarket	3	<b>LR079891P</b>	2.33	2.80
	OEM	3	<b>LR079891P1</b>	3.08	3.70
	Genuine	3	<b>LR079891</b>	9.31	11.17



LR079891



## 90 (1983-1989)

## SCREEN/LAMP WASHER SYSTEMS

## Washer Jet

All models up to (VIN) AA270226					
Front screen	Aftermarket	2	<b>PRC2437P</b>	2.25	2.70
	Genuine	2	<b>PRC2437</b>	7.56	9.07
All models from (VIN) AA270227 on					
Front screen, twin jet type	Aftermarket	1	<b>LR061677P</b>	2.00	2.40
	Genuine	1	<b>LR061677</b>	7.80	9.36
All models with rear screen wash					
Rear screen	Aftermarket	1	<b>LR061678P</b>	2.25	2.70
	Genuine	1	<b>LR061678</b>	7.80	9.36
All models with rear wash/wipe up to (VIN) AA270226 (1986)					
Rear screen wash	Genuine	1	<b>EAM9332</b>	1.95	2.34

## Washer Jet Repair Kit

Front screen wash (twin nozzle jet - allows replacement of broken outer section without having to remove dash top to replace whole assembly. DNJ500290 adhesive also required).

All models	Genuine	1	<b>DNJ500270</b>	9.49	11.39
------------	---------	---	------------------	------	-------

## Windscreen Washer Pump

All models to (VIN) AA270226					
Front screen	Aftermarket	1	<b>GWW125</b>	9.38	11.26
All non air conditioning models with rear screen wash					
Rear screen	Aftermarket	1	<b>STC1453P</b>	4.00	4.80
All models from (VIN) AA270227 on with air conditioning					
Front or rear screen wash	Aftermarket	1	<b>GWW1194</b>	7.50	9.00
All models with air conditioning or with headlamp wash from (VIN) AA270227 on					
	Genuine	1	<b>DRC2713L</b>	40.97	49.16

## Windscreen Washer Pump Link Lead

All models without air conditioning or headlamp wash  
Fit with STC1453 pump as replacement for original windscreen washer pump.

	Aftermarket	1	<b>AMR3849P</b>	5.42	6.50
	Genuine	1	<b>AMR3849</b>	11.05	13.26

## Washer Hose

Per Metre. 4mm internal diameter (3mm also available). Front or rear screen wash

All models	Aftermarket	a/r	<b>GWW201M</b>	2.25	2.70
------------	-------------	-----	----------------	------	------

## Washer Reservoir

All models with rear screen wash/wipe with air conditioning					
Front & rear screen wash	Genuine	1	<b>PRC5765</b>	89.57	107.48
All models up to (VIN) AA270226 with headlamp wash without air conditioning					
Headlamp wash	Genuine	1	<b>PRC3300</b>	71.11	85.33
All models with air conditioning without headlamp wash up to (VIN) AA270226					
Front screen wash	Genuine	1	<b>PRC3786</b>	43.53	52.24
All models without air conditioning or headlamp wash from (VIN) AA270227 on					
Front screen wash	Genuine	1	<b>PRC5744</b>	33.26	39.91
All models with headlamp wash with air conditioning from (VIN) AA270227 on					
Front screen & headlamp wash	Genuine	1	<b>PRC5773</b>	94.77	113.72
All models with rear screen wash/wipe and headlamp wash without air conditioning from (VIN) AA270227 on					
Front & rear screen & headlamp wash	Genuine	1	<b>PRC5777</b>	42.63	51.16
All models with rear screen wash/wipe and headlamp wash (South Africa, Sweden) from (VIN) AA270227 on					
Rear screen & headlamp wash	Genuine	1	<b>PRC5773</b>	94.77	113.72
Front screen wash	Genuine	1	<b>PRC5744</b>	33.26	39.91

## Washer Reservoir Cap

All models with air conditioning or with headlamp wash					
45mm dia.	Genuine	1	<b>DMG10005L</b>	3.10	3.72

## Washer Reservoir &amp; Pump

All models with rear screen wash/wipe up to (VIN) AA270226					
Bag type reservoir, rear screen wash	Genuine	1	<b>STC3803</b>	118.18	141.82

## Windscreen Cleaning Paste

Prevents wiper blade judder/squeak by 'deep cleaning' the windscreen (ref: Land Rover Tech Bulletin LRA501-002)

All models	Genuine	a/r	<b>DNJ500340</b>	7.72	9.26
------------	---------	-----	------------------	------	------



PRC2437

STC3803



## 90 (1983-1989)

## DRIVE BELTS

## Timing Belt Kit

All 2.5L N/A diesel models	Britpart	1	<b>ETC7333BPK</b>	27.08	32.50
All 2.5L Turbo Diesel models	Britpart	1	<b>ETC7333BPK</b>	27.08	32.50

## Timing Belt

All models with 2.5L normally aspirated diesel engine					
	OEM	1	<b>ETC7333P1</b>	6.67	8.00
	Genuine	1	<b>ETC7333</b>	38.00	45.60
All models with 2.5L turbo diesel engine (not TDi)					
	OEM	1	<b>ETC7333P1</b>	6.67	8.00
	Genuine	1	<b>ETC7333</b>	38.00	45.60

## Alternator Drive Belt

All models with 2.5L normally aspirated diesel engine - Alternator					
	Aftermarket	1	<b>ETC7939P</b>	2.25	2.70
	OEM	1	<b>ETC7939P1</b>	3.83	4.60
	Genuine	1	<b>ETC7939</b>	15.73	18.88
All models with 2.5L turbo diesel engine - Alternator					
	Aftermarket	1	<b>ETC7939P</b>	2.25	2.70
	OEM	1	<b>ETC7939P1</b>	3.83	4.60
	Genuine	1	<b>ETC7939</b>	15.73	18.88
All models with V8 carb engine, without air conditioning - Alternator					
	Aftermarket	1	<b>ETC7394P</b>	2.50	3.00
	OEM	1	<b>ETC7394P1</b>	3.50	4.20
	Genuine	1	<b>ETC7394</b>	26.11	31.33
Models with V8 carb engine and air conditioning - Alternator					
	Aftermarket	1	<b>ERR2073P</b>	2.83	3.40
	Genuine	1	<b>ERR2073</b>	7.86	9.43
All V8 carb models with air conditioning up to Aug. 1986 - Alternator					
	Aftermarket	1	<b>ERC8852P</b>	1.67	2.00
	Genuine	1	<b>ERC8852</b>	10.46	12.55

## Fan Belt

Civilian models with 2.25L 4 cyl engines (not split charge)					
Fan	Aftermarket	1	<b>563132 L-RP</b>	1.25	1.50
2.25L 4 cyl petrol engine models with split charge					
	Aftermarket	1	<b>ERC8938P</b>	2.67	3.20
	Genuine	1	<b>ERC8938</b>	16.07	19.28
Civilian models with 2.5L 4 cyl petrol engines (not split charge) - Fan					
	Aftermarket	1	<b>563132 L-RP</b>	1.25	1.50
2.5L 4 cyl petrol engine models with air conditioning - Fan					
	Aftermarket	1	<b>ERC8938P</b>	2.67	3.20
	Genuine	1	<b>ERC8938</b>	16.07	19.28
Civilian models with 2.5L 4 cyl normally aspirated diesel engines (not split charge) - Fan					
	Aftermarket	1	<b>563132 L-RP</b>	1.25	1.50
V8 carb engine models without power steering or air conditioning - Fan					
	Aftermarket	1	<b>613602P</b>	2.33	2.80
	OEM	1	<b>613602P1</b>	3.83	4.60
All models with V8 carb engine					
	Aftermarket	1	<b>614670P</b>	1.50	1.80
	Genuine	1	<b>614670</b>	15.16	18.19

## PAS Belt

All models with 2.25L petrol engine					
Adwest power steering	Aftermarket	1	<b>ETC4272P</b>	2.25	2.70
Gemmer power steering	Aftermarket	1	<b>ETC5815P</b>	1.75	2.10
	OEM	1	<b>ETC5815P1</b>	2.50	3.00
	Genuine	1	<b>ETC5815</b>	20.62	24.74
Power steering	Aftermarket	1	<b>ERC5146P</b>	3.33	4.00
	Genuine	1	<b>ERC5146</b>	16.94	20.33
All models with 2.5L petrol engine					
Gemmer power steering	Aftermarket	1	<b>ETC5815P</b>	1.75	2.10
	OEM	1	<b>ETC5815P1</b>	2.50	3.00
	Genuine	1	<b>ETC5815</b>	20.62	24.74
Power steering	Aftermarket	1	<b>ERC5146P</b>	3.33	4.00
	Genuine	1	<b>ERC5146</b>	16.94	20.33
All models with 2.5L normally aspirated diesel engine					
Adwest power steering	Aftermarket	1	<b>ETC4272P</b>	2.25	2.70
Gemmer power steering	Aftermarket	1	<b>ETC5815P</b>	1.75	2.10
	OEM	1	<b>ETC5815P1</b>	2.50	3.00
	Genuine	1	<b>ETC5815</b>	20.62	24.74
Power steering	Aftermarket	1	<b>ERC5146P</b>	3.33	4.00
	Genuine	1	<b>ERC5146</b>	16.94	20.33
All models with V8 carb engine					
Power steering	Aftermarket	1	<b>ERC675P</b>	2.83	3.40
	OEM	1	<b>ERC675P1</b>	3.33	4.00
	Genuine	1	<b>ERC675</b>	21.28	25.54

## A/C Belt

All V8 carb models with air conditioning					
Air cond compressor	Aftermarket	1	<b>603713P</b>	2.67	3.20



ETC7333P1





# IGNITION SYSTEM

# 90 (1983-1989)

## Spark Plug

All 2.25L 8.0:1CR petrol models N12Y type	Aftermarket	4	<b>RTC3570P</b>	1.83	2.20	
	Genuine	4	<b>RTC3570X</b>	3.25	3.90	
All 2.5L petrol engine models RN9YC type	Aftermarket	4	<b>ERR743P</b>	1.75	2.10	
	Genuine	4	<b>ERR743</b>	4.03	4.84	
	N9YC type	Genuine	4	<b>RTC3812</b>	3.03	3.64
		Genuine	4	<b>RTC3812X</b>	2.59	3.11
RN11YC type	Aftermarket	4	<b>ERR3799P</b>	2.00	2.40	
	Genuine	4	<b>ERR3799</b>	4.19	5.03	
All V8 carb petrol models with 8.13:1 compression ratio, std performance 19mm reach	MG Rover	8	<b>GSP4382</b>	2.95	3.54	
	MG Rover	8	<b>GSP4382</b>	2.95	3.54	
All V8 carb petrol models with 9.35:1 compression ratio, high performance 19mm reach, double core	MG Rover	8	<b>GSP462</b>	2.95	3.54	
	MG Rover	8	<b>GSP462</b>	2.95	3.54	
All V8 carb petrol models with 9.35:1 compression ratio, std performance 19mm reach	MG Rover	8	<b>GSP4362</b>	2.95	3.54	
	MG Rover	8	<b>GSP4362</b>	2.95	3.54	
All V8 petrol engine models RN11YC type	Aftermarket	8	<b>ERR3799P</b>	2.00	2.40	
	Genuine	8	<b>ERR3799</b>	4.19	5.03	

## Glow Plug

All diesel engine models	Aftermarket	4	<b>ERC8450P</b>	2.25	2.70
	OEM	4	<b>ERC8450P1</b>	7.29	8.75
	Genuine	4	<b>ERC8450</b>	14.18	17.02

## Ignition Coil

All 2.25L petrol engine models	Aftermarket	1	<b>PRC9858P</b>	7.35	8.82
	OEM	1	<b>PRC9858P1</b>	12.92	15.50
	Genuine	1	<b>PRC9858</b>	77.61	93.13
All 2.5L petrol engine models	Aftermarket	1	<b>PRC9858P</b>	7.35	8.82
	OEM	1	<b>PRC9858P1</b>	12.92	15.50
	Genuine	1	<b>PRC9858</b>	77.61	93.13
V8 carb petrol engines up to 1986 Ballasted type	Aftermarket	1	<b>8510047P</b>	7.50	9.00
	Genuine	1	<b>8510047</b>	70.62	84.74
All V8 carb petrol engine models from (VIN) BA on Lucas type	Aftermarket	1	<b>RTC5628P</b>	9.58	11.50
	OEM	1	<b>RTC5628P1</b>	14.58	17.50
	Genuine	1	<b>RTC5628</b>	94.86	113.83
	Bosch type	Aftermarket	1	<b>PRC6574P</b>	15.83
	OEM	1	<b>PRC6574P1</b>	39.58	47.50
	Genuine	1	<b>PRC6574</b>	114.80	137.76

## Contact Set

All 4 cyl petrol models fitted with Lucas 59D type distributor Blue sliding contact type set	Aftermarket	1	<b>GCS261</b>	6.88	8.26	
	Aftermarket	1	<b>RTC6625P</b>	1.50	1.80	
All 2.25L and 2.5L petrol engine models Type 45D/59D distributor, fixed contact set (alternative to sliding contact set).	Aftermarket	1	<b>RTC3288P</b>	0.92	1.10	
	Genuine	1	<b>RTC3288</b>	1.70	2.04	
	Type 45D/59D distributor, sliding contact set (alternative to fixed contact set)	Aftermarket	1	<b>RTC6627P</b>	2.00	2.40
		Genuine	1	<b>RTC6627</b>	10.32	12.38
All V8 carb petrol models with points type distributors	Aftermarket	1	<b>GCS2117</b>	7.50	9.00	
	Aftermarket	1	<b>GCS2117P</b>	4.08	4.90	

## Adjustment Bush, Contact Set

All V8 petrol models with points type distributor. For sliding points type distributor	Genuine	1	<b>RTC5014</b>	1.33	1.60
----------------------------------------------------------------------------------------	---------	---	----------------	------	------

## Rotor Arm

2.25L and 2.5L petrol engine models with Lucas distributor Type 45D/59D distributor	Aftermarket	1	<b>RTC3614P</b>	1.00	1.20
	Aftermarket	1	<b>GRA114</b>	2.33	2.80
	Red, as original, for type 45D/59D distributor	Lucas	1	<b>GRA114RED</b>	7.50
2.25L petrol engine models with Ducellier distributor	Aftermarket	1	<b>RTC4933P</b>	1.00	1.20
	Genuine	1	<b>RTC4933</b>	3.77	4.52
All V8 carb petrol models with points type distributor	Aftermarket	1	<b>RTC3618P</b>	2.00	2.40
All V8 petrol engines with electronic ignition	Aftermarket	1	<b>STC1857P</b>	2.33	2.80
	OEM	1	<b>STC1857P1</b>	9.58	11.50
	Genuine	1	<b>STC1857</b>	15.18	18.22
	Red	OEM	1	<b>GRA117RED</b>	7.50



## Condenser

2.25L and 2.5L petrol engine models with Lucas distributor For type 45D/59D distributor	Aftermarket	1	<b>RTC6621P</b>	1.00	1.20
	Aftermarket	1	<b>GSC109</b>	2.33	2.80
	Aftermarket	1	<b>RTC3524P</b>	2.75	3.30
	Genuine	1	<b>RTC6621</b>	2.23	2.68
2.25L petrol engine models with Ducellier distributor	Aftermarket	1	<b>RTC4935P</b>	2.25	2.70
	Genuine	1	<b>RTC6620</b>	1.99	2.39
All V8 petrol models with Stromberg carbs (eng) 15G	Aftermarket	1	<b>RTC3472P</b>	1.25	1.50
	Aftermarket	1	<b>GSC111</b>	3.08	3.70
	Genuine	1	<b>RTC3472</b>	3.73	4.48
	Genuine	1	<b>RTC3472</b>	3.73	4.48

## Distributor Cap

2.25L and 2.5L petrol engine models with Lucas distributor - Type 45D/59D distributor	Aftermarket	1	<b>RTC3278P</b>	2.33	2.80
	OEM	1	<b>RTC3278P1</b>	3.50	4.20
	Genuine	1	<b>RTC3278</b>	16.53	19.84
2.25L petrol engine models with Ducellier distributor	Aftermarket	1	<b>RTC4932P</b>	3.75	4.50
	Aftermarket	1	<b>GDC117P</b>	5.00	6.00
All V8 petrol engine models	OEM	1	<b>GDC117P1</b>	16.04	19.25
	Aftermarket	1	<b>GDC117</b>	10.42	12.50
	Genuine	1	<b>GDC1170E</b>	32.94	39.53

## Amplifier Link Lead

V8 petrol engine with 2 pin integral amp type 35DLM8 distributor	Aftermarket	1	<b>STC1212P</b>	24.58	29.50
------------------------------------------------------------------	-------------	---	-----------------	-------	-------

## Amplifier Module & Link Lead.

V8 petrol engine with 2 pin integral amp type 35DLM8 distributor	Britpart	1	<b>STC1184KBP</b>	24.58	29.50
------------------------------------------------------------------	----------	---	-------------------	-------	-------

## Amplifier Module

V8 petrol engine with 3 pin integral amp type 35DLM8 distributor	Aftermarket	1	<b>STC1184P</b>	14.58	17.50
	Genuine	1	<b>STC1184</b>	136.26	163.51
	Genuine	1	<b>STC1184</b>	136.26	163.51

## Amplifier Plug

V8 petrol engine with 3 pin integral amp type 35DLM8 distributor -3 pin, for STC1184	OEM	1	<b>STC1184P1</b>	22.50	27.00
--------------------------------------------------------------------------------------	-----	---	------------------	-------	-------

## Pick Up & Baseplate, Distributor

All V8 carb petrol models with electronic ignition with 3 pin integral amplifier - Distributor	Aftermarket	1	<b>RTC5090P</b>	15.63	18.76
	OEM	1	<b>RTC5090P1</b>	67.50	81.00
	Genuine	1	<b>RTC5090</b>	130.55	156.66
	Genuine	1	<b>RTC5090</b>	130.55	156.66

## Vacuum Unit

V8 carb petrol engines (eng) 17G, 22G only - Distributor	Aftermarket	1	<b>608266P</b>	35.00	42.00
	Genuine	1	<b>608266</b>	97.18	116.62
	Genuine	1	<b>608266</b>	97.18	116.62
V8 carb petrol engines (eng) 20G, 24G only with 2 pin amp type distributor - Distributor	Aftermarket	1	<b>RTC3201P</b>	29.58	35.50
	Genuine	1	<b>RTC3201</b>	121.09	145.31

## Suppressor, Coil

All V8 carb petrol models with electronic ignition - Coil	Aftermarket	1	<b>ADU7242LP</b>	3.75	4.50
-----------------------------------------------------------	-------------	---	------------------	------	------

## Distributor Drive Gear

All V8 Carb petrol engine models - On camshaft	Aftermarket	1	<b>614188A</b>	22.50	27.00
------------------------------------------------	-------------	---	----------------	-------	-------

## Distributor Drive Gear and Coupling

All V8 Carb petrol engine models On distributor	Aftermarket	1	<b>ERC1353A</b>	27.50	33.00
----------------------------------------------------	-------------	---	-----------------	-------	-------

## O Ring Distributor

All V8 Carb petrol engine models	Aftermarket	1	<b>603446P</b>	2.50	3.00
	Genuine	1	<b>603446</b>	7.27	8.72

## Ignition Lead Set

2.25L petrol engine models	Aftermarket	1	<b>ERC3256P</b>	6.04	7.25	
	Genuine	1	<b>ERC3256</b>	51.30	61.56	
2.5L petrol engine models	Aftermarket	1	<b>ERC3256P</b>	6.04	7.25	
	Genuine	1	<b>ERC3256</b>	51.30	61.56	
All V8 carb petrol engine models - Silicone	Aftermarket	1	<b>RTC6551P</b>	11.67	14.00	
	OEM	1	<b>RTC6551P1</b>	19.58	23.50	
	Red	Aftermarket	1	<b>RTC6551PS</b>	16.67	20.00
		OEM	1	<b>RTC6551P1S</b>	32.50	39.00
	Black	Aftermarket	1	<b>GHT206S</b>	25.83	31.00
		Aftermarket	1	<b>GHT206S</b>	25.83	31.00



## 90 (1983-1989)

## BRAKING SYSTEM

## Brake Pad Set - Front Brakes

All models - Not Vented

Aftermarket	1	<b>SFP500160P</b>	10.63	12.76
EBC	1	<b>SFP500160ULTIMAX</b>	30.00	36.00
Brembo	1	<b>SFP500160BREMBO</b>	28.33	34.00
Genuine	1	<b>SFP500160</b>	57.52	69.02
Green Stuff	1	<b>SFP500160GS</b>	33.33	40.00
RHD up to (axle) 22L09654 and 22L10192 to 10271				
OEM	1	<b>STC2956P</b>	13.54	16.25
EBC	1	<b>STC2956ULTIMAX</b>	25.00	30.00
Brembo	1	<b>STC2956BREMBO</b>	23.75	28.50
EBC	1	<b>STC2956GS</b>	33.33	40.00
LHD up to (axle) 23L05967 and 23L05988 to 06059				
OEM	1	<b>STC2956P</b>	13.54	16.25
EBC	1	<b>STC2956ULTIMAX</b>	25.00	30.00
Brembo	1	<b>STC2956BREMBO</b>	23.75	28.50
EBC	1	<b>STC2956GS</b>	33.33	40.00
Green Stuff				

## Brake Shoe Set - Rear Brakes

All models	Aftermarket	1	<b>STC2796P</b>	9.38	11.26
	OEM	1	<b>STC2796P1</b>	27.08	32.50

## Spring and Pin Kit

All models - Front Brake Pads	Aftermarket	1	<b>RTC5001P</b>	3.33	4.00
	Genuine	1	<b>RTC5001</b>	12.33	14.80

## Anti Rattle Spring

All models - Front brake pads	Aftermarket	4	<b>606688P</b>	1.08	1.30
	Genuine	4	<b>606688</b>	1.72	2.06

## Brake Shoe Spring

All models - Rear Brakes	Aftermarket	2	<b>218983P</b>	0.58	0.70
	Genuine	2	<b>218983</b>	2.90	3.48

## Brake Adjuster Kit

All models - Rear Brake Shoes	Aftermarket	1	<b>RTC3176P</b>	10.83	13.00
	Genuine	1	<b>RTC3176</b>	109.72	131.66

## Brake Disc (each)

All models - Front, Not Vented	Aftermarket	2	<b>571762P</b>	14.38	17.26
	OEM	2	<b>571762P1</b>	19.79	23.75
	Aftermarket	2	<b>LR017951P</b>	13.75	16.50
	Genuine	2	<b>LR017951</b>	52.35	62.82

## Brake Disc (pair)

All models - Front, Not Vented	Brembo	1	<b>LR017951BREMBO</b>	50.00	60.00
--------------------------------	--------	---	-----------------------	-------	-------

## Performance Brake Disc (pair)

All models - Front, Not Vented, slotted & drilled	Britpart	1	<b>LR017951URBP</b>	39.58	47.50
---------------------------------------------------	----------	---	---------------------	-------	-------

## Brake Drum - Rear

All models - Rear	Aftermarket	2	<b>591039P</b>	13.13	15.76
	Genuine	2	<b>591039</b>	82.60	99.12

## Brake Caliper

All RHD from (axle) 22L09655 to 22L10191, 22L10272 to (VIN) HA701009					
Right Hand Front, Solid Disc Brakes	Aftermarket	1	<b>RTC4998P</b>	35.00	42.00
	Genuine	1	<b>RTC4998</b>	473.35	568.02
			<i>*Exchange Surcharge 54.00</i>		<i>64.80</i>
Left Hand Front, Solid Disc Brakes	Aftermarket	1	<b>RTC4999P</b>	35.00	42.00
	Genuine	1	<b>RTC4999</b>	473.35	568.02
			<i>*Exchange Surcharge 56.00</i>		<i>67.20</i>
All LHD from (axle) 23L05988 to 23L06059, 23L06079 to (VIN) HA701009					
Right Hand Front, Solid Disc Brakes	Aftermarket	1	<b>RTC4998P</b>	35.00	42.00
	Genuine	1	<b>RTC4998</b>	473.35	568.02
			<i>*Exchange Surcharge 55.00</i>		<i>66.00</i>
Left Hand Front, Solid Disc Brakes	Aftermarket	1	<b>RTC4999P</b>	35.00	42.00
	Genuine	1	<b>RTC4999</b>	473.35	568.02
			<i>*Exchange Surcharge 57.00</i>		<i>68.40</i>

## Dust Cap Bleed Screw

All models - Blue, front caliper bleed nipple	Genuine	2	<b>594091</b>	4.66	5.59
-----------------------------------------------	---------	---	---------------	------	------

## Bleed Nipple

All models - Front brake caliper	Aftermarket	2	<b>RTC1526P</b>	1.83	2.20
	Genuine	2	<b>RTC1526</b>	2.77	3.32

## Wheel Cylinder

All models					
Right Hand Rear	Aftermarket	1	<b>RTC3168P</b>	8.13	9.76
	OEM	1	<b>RTC3168P1</b>	14.79	17.75
	Genuine	1	<b>RTC3168</b>	157.31	188.77
Left Hand Rear	Aftermarket	1	<b>RTC3169P</b>	8.13	9.76
	OEM	1	<b>RTC3169P1</b>	14.79	17.75
	Genuine	1	<b>RTC3169</b>	89.47	107.36

## Wheel Cylinder Repair Kit

All models - Rear	Aftermarket	2	<b>RTC3170P</b>	2.92	3.50
-------------------	-------------	---	-----------------	------	------

## Brake Master Cylinder

All models - No reservoir	Aftermarket	1	<b>NRC9529P</b>	37.50	45.00
	OEM	1	<b>NRC9529P1</b>	55.00	66.00
	Genuine	1	<b>NRC9529</b>	185.42	222.50

## Master Cylinder Repair Kit

All models - Brake master cylinder	Aftermarket	1	<b>GRK1027P</b>	2.08	2.50
	Aftermarket	1	<b>RTC3387P</b>	5.63	6.76
	Genuine	1	<b>RTC3387</b>	33.84	40.61

## Bleed Screw

All models - Rear wheel cylinder	Genuine	2	<b>LR015523</b>	2.75	3.30
----------------------------------	---------	---	-----------------	------	------

## Caliper Repair Kit

All models - Front	Aftermarket	4	<b>AEU1547P</b>	2.00	2.40
	OEM	4	<b>AEU1547P1</b>	7.08	8.50
	Genuine	4	<b>AEU1547</b>	12.39	14.87

## Servo Repair Kit

All models with type 50 servo					
Type 50 servo (227mm dia servo)	Aftermarket	1	<b>18G8951A</b>	11.25	13.50
All models with type 80 servo					
Type 80 servo (276mm dia servo)	Aftermarket	1	<b>AEU2741P</b>	3.50	4.20
	Genuine	1	<b>AEU2741</b>	42.66	51.19
All models up to (VIN) HA701009					
Servo Non-Return Valve	Genuine	1	<b>RTC812</b>	25.83	31.00

## Brake Hose

All models - Rear, rubber	Aftermarket	1	<b>NRC9455P</b>	3.33	4.00
	Genuine	1	<b>NRC9455</b>	34.58	41.50

## Clutch Hose

All 4 cylinder models	Aftermarket	1	<b>RTC4425P</b>	2.50	3.00
	OEM	1	<b>RTC4425P1</b>	8.75	10.50
	Genuine	1	<b>RTC4425</b>	34.58	41.50

## Brake Pipe Clip

All models - Double type	Aftermarket	a/r	<b>625521A</b>	1.25	1.50
--------------------------	-------------	-----	----------------	------	------

## Brake/Clutch Pipe Clip

All models - Double	Genuine	a/r	<b>NTC1175</b>	0.58	0.70
---------------------	---------	-----	----------------	------	------

## T Piece Brake System

All models - Rear brake pipes	Aftermarket	a/r	<b>NRC4251P</b>	6.04	7.25
	Genuine	a/r	<b>NRC4251</b>	17.88	21.46

## Brake Shoe Set - Handbrake

All models - Handbrake, rod operated type	Aftermarket	1	<b>STC965P</b>	7.50	9.00
	OEM	1	<b>STC965P1</b>	22.50	27.00
	Genuine	1	<b>STC965</b>	80.87	97.04

## Brake Drum - Handbrake

All models - Handbrake	Aftermarket	1	<b>LR025177P</b>	20.42	24.50
	Genuine	1	<b>LR025177</b>	152.67	183.20

## Locking Plate Handbrake

All models	Aftermarket	1	<b>515467P</b>	1.33	1.60
	Genuine	1	<b>515467</b>	1.72	2.06

## Retaining Plate Handbrake

All models	Aftermarket	1	<b>515468P</b>	1.08	1.30
	Genuine	1	<b>515468</b>	2.30	2.76

## Dust Cover Expander Unit

All models with LT77 5 speed gearbox					
	OEM	1	<b>515466P1</b>	3.33	4.00
	Genuine	1	<b>515466</b>	4.49	5.39
All models with LT85 5 speed gearbox					
	OEM	1	<b>515466P1</b>	3.33	4.00
	Genuine	1	<b>515466</b>	4.49	5.39

## Expander Unit

All models with LT77 5 speed gearbox					
	Aftermarket	1	<b>AEU2734P</b>	17.29	20.75
	Genuine	1	<b>AEU2734</b>	330.80	396.96
All models with LT85 5 speed gearbox					
	Aftermarket	1	<b>AEU2734P</b>	17.29	20.75
	Genuine	1	<b>AEU2734</b>	330.80	396.96



571762P





# BRAKING SYSTEM

**90 (1983-1989)**

## Brake Adjuster Transmission

All models with LT230 transfer box - Early type expander

Aftermarket	1	<b>AEU2735P</b>	10.42	12.50
Genuine	1	<b>AEU2735</b>	237.59	285.11

## Handbrake Cable

RHD models

Aftermarket	1	<b>NRC5088P</b>	7.50	9.00
Genuine	1	<b>NRC5088</b>	34.58	41.50

## Handbrake Cable Clevis Pin

All models - 8 x 22mm, Handbrake cable to Handbrake lever

Genuine	1	<b>PC108291L</b>	3.45	4.14
---------	---	------------------	------	------

## Brake Pressure Switch

All models with dual brakes and PDWA valve up to (VIN) HA901219

Genuine	1	<b>AAU1700</b>	27.30	32.76
---------	---	----------------	-------	-------

## Brake Pedal Rubber

Optional fitment to (VIN) AA234187

Aftermarket	1	<b>NRC9224P</b>	2.08	2.50
Genuine	1	<b>NRC9224</b>	15.96	19.15

All models (VIN) AA234188 on - Brake and clutch

Aftermarket	2	<b>SKE500060P</b>	2.83	3.40
Genuine	2	<b>SKE500060</b>	8.92	10.70



AAU1700



NRC9224P

# SUSPENSION

**90 (1983-1989)**

## Bush Radius Arm

All models - Front suspension

chassis end, rubber	Aftermarket	4	<b>NRC4514P</b>	0.79	0.95
	Genuine	4	<b>NRC4514</b>	2.76	3.31
axle end, rubber	Aftermarket	4	<b>NTC7307P</b>	1.50	1.80
	Genuine	4	<b>NTC7307</b>	20.38	24.46
axle end, poly.	Aftermarket	2	<b>NTC7307POLY</b>	6.67	8.00
set of 4	Bearmach	1	<b>NTC7307BMPYC</b>	87.50	105.00
chassis end, poly.	Aftermarket	4	<b>NRC4514POLY</b>	3.00	3.60
	Polybush	1	<b>NRC4514POLYBUSH</b>	20.42	24.50

All models - Rear suspension

rubber	Aftermarket	2	<b>NTC1772P</b>	1.50	1.80
	OEM	2	<b>NTC1772P1</b>	3.00	3.60
	Genuine	2	<b>NTC1772</b>	9.29	11.15
poly.	Aftermarket	2	<b>NTC1772POLY</b>	4.38	5.26
poly. performance red (pair)	Polybush	1	<b>NTC1772POLYBUSH</b>	22.50	27.00

All models - Rear suspension, chassis end

rubber (pair)	Aftermarket	1	<b>STC618P</b>	6.67	8.00
	OEM	1	<b>STC618P1</b>	15.42	18.50
	Genuine	1	<b>STC618</b>	59.46	71.35
poly.	Aftermarket	2	<b>NTC9027POLY</b>	20.00	24.00
poly. performance red (pair)	Polybush	1	<b>NTC9027POLYBUSH</b>	39.58	47.50
poly. (pair)	Aftermarket	1	<b>STC618POLY</b>	25.83	31.00

## Bush Kit Radius Arm

All models - Front Suspension Kit, radius arm to chassis,

rubber	Britpart	1	<b>NRC4514BPKIT</b>	7.08	8.50
poly. yellow	Britpart	1	<b>NRC4514BPKPOLYEL</b>	9.58	11.50

## Bush Shock Absorber Mounting

All models - Front upper and lower, rear lower

rubber	Aftermarket	8	<b>552818P</b>	0.50	0.60
	Genuine	8	<b>552818</b>	1.38	1.66
poly. performance red	Polybush	1	<b>5528189PBR</b>	25.00	30.00
poly. comfort blue	Polybush	1	<b>552818PPBB</b>	25.00	30.00
poly. dynamic orange	Polybush	1	<b>5528189PBO</b>	25.00	30.00
poly.	Aftermarket	8	<b>552818POLY</b>	0.83	1.00

All models - Rear, upper

rubber	Aftermarket	2	<b>NRC5593P</b>	1.08	1.30
	Genuine	2	<b>NRC5593</b>	6.28	7.54
poly.	Aftermarket	2	<b>NRC5593POLY</b>	4.00	4.80
	Terrafrima	2	<b>NRC5593TFP</b>	13.13	15.76

## Bush Panhard Rod

All models - Front

rubber	Aftermarket	2	<b>ANR3410P</b>	0.75	0.90
	OEM	2	<b>ANR3410P1</b>	2.75	3.30
	Genuine	2	<b>ANR3410</b>	8.67	10.40
poly.	Aftermarket	2	<b>ANR3410POLY</b>	4.00	4.80

## Bush Panhard Rod Kit

All models - Front, poly.

Terrafrima	1	<b>ANR3410TFPK</b>	15.63	18.76
------------	---	--------------------	-------	-------

## Washer for Bush on Radius Arm

All models - Rear suspension, chassis end

Aftermarket	2	<b>STC618WASHER</b>	5.42	6.50
-------------	---	---------------------	------	------

## Bush Upper Link

All models - Rear suspension

rubber	Aftermarket	2	<b>NTC1773P</b>	1.58	1.90
	OEM	2	<b>NTC1773P1</b>	4.00	4.80
	Genuine	2	<b>NTC1773</b>	19.99	23.99
poly., performance red (pair)	Polybush	1	<b>NTC1773POLYBUSH</b>	23.75	28.50
poly., comfort blue (pair)	Polybush	1	<b>NTC1773POLYBUSHBLUE</b>	23.75	28.50
poly., (each)	Aftermarket	2	<b>NTC1773POLY</b>	4.38	5.26



NRC4514POLY

## Suspension Bush Kit

Bush kit 'D' - incl. bottom link mounting bushes, front radius arm to axle bushes, A frame bushes, Panhard rod bushes, upper and lower shock absorber bushes, radius arm to chassis bushes.

All models	Aftermarket	1	<b>RA1173EARLYP</b>	26.25	31.50
	Genuine	1	<b>RA1173EARLY</b>	300.00	360.00

## Suspension Bush Kit B

All models - poly.

Aftermarket	1	<b>RA1274ALTPOLY</b>	87.50	105.00
-------------	---	----------------------	-------	--------

All models up to (VIN) KA930455 - poly., blue

Britpart	1	<b>RA1274BPPOLYBLUE</b>	75.00	90.00
----------	---	-------------------------	-------	-------

## Bolt Kit for Bush Kits

All models

Aftermarket	1	<b>RA1177P</b>	40.42	48.50
Genuine	1	<b>RA1177</b>	71.67	86.00

## Shock Absorber Bush Kit

All models - Front shock absorber bush kit

comfort blue	Polybush	1	<b>LL1357B</b>	22.08	26.50
performance red	Polybush	1	<b>LL1357</b>	22.08	26.50

All models - Rear shock absorber bush kit

performance red	Polybush	1	<b>LL1356</b>	27.08	32.50
comfort blue	Polybush	1	<b>LL1356B</b>	27.08	32.50

## Anti Roll Bar Bush

All models fitted with anti roll bar

Front upper and lower, poly.	Aftermarket	4	<b>552819POLY</b>	1.08	1.30
Anti roll bar link, rubber	Aftermarket	4	<b>552819P</b>	0.19	0.23
	Genuine	4	<b>552819</b>	1.39	1.67

## Bush Anti Roll Bar Mounting

All models - Front anti roll bar, poly.

Aftermarket	2	<b>NTC6828POLY</b>	6.25	7.50
-------------	---	--------------------	------	------

All models - Front anti roll bar, poly. 25.4mm inside diameter, Uprated

Terrafrima	2	<b>NTC6828URTFPY</b>	23.33	28.00
------------	---	----------------------	-------	-------

## Anti Roll Bar Bush Kit

All models - Front anti roll bar bush kit

performance red	Polybush	1	<b>LL1359</b>	35.00	42.00
comfort blue	Polybush	1	<b>LL1359B</b>	35.00	42.00

## Anti Roll Bar - Front

All models with factory heavy duty suspension

Aftermarket	1	<b>LR033037P</b>	50.00	60.00
Genuine	1	<b>LR033037</b>	72.75	87.30

## Anti Roll Bar Link Ball Joint

All models - Front and rear

Aftermarket	2	<b>NTC1888P</b>	4.79	5.75
OEM	2	<b>NTC1888P1</b>	13.54	16.25
Genuine	2	<b>NTC1888</b>	41.58	49.90

## Mounting Bush, Anti Roll Bar

All models - Front anti roll bar

Aftermarket	2	<b>NTC6828P</b>	1.33	1.60
OEM	2	<b>NTC6828P1</b>	2.72	3.26
Genuine	2	<b>NTC6828</b>	6.99	8.39

## Clamp Bracket

All models - Anti roll bar mounting, front

Aftermarket	2	<b>NTC6776P</b>	3.75	4.50
Genuine	2	<b>NTC6776</b>	5.93	7.12

## Anti Roll Bar Upgraded

Front, uprated 25.4mm diameter

All models with factory heavy duty suspension

Terrafrima	1	<b>LR033037URTF</b>	245.83	295.00
------------	---	---------------------	--------	--------

## Link Kit (for uprated anti roll bars)

All models with factory heavy duty suspension - Fitting Kit

Terrafrima	1	<b>LR033037URTFK</b>	24.58	29.50
------------	---	----------------------	-------	-------



## 90 (1983-1989)

## SUSPENSION

**Spacer Kit (2 hole for anti roll bar)**

All models with factory heavy duty suspension

Terrafrima	1	<b>LR033037-8URTFSK2</b>	35.00	42.00
------------	---	--------------------------	-------	-------

**Spacer Kit (4 hole for anti roll bar)**

All models with factory heavy duty suspension

Terrafrima	1	<b>LR033037-8URTFSK4</b>	39.58	47.50
------------	---	--------------------------	-------	-------

**Shock Absorber - Front**

All models

Front, std.	Aftermarket	2	<b>STC3766P</b>	13.54	16.25
	OEM	2	<b>STC3766P1</b>	25.00	30.00
	Genuine	2	<b>STC3766</b>	62.74	75.29
Front, oil, std. height	Aftermarket	2	<b>RSC100050P</b>	13.54	16.25
	OEM	2	<b>RSC100050P1</b>	29.58	35.50
	Genuine	2	<b>RSC100050</b>	61.43	73.72
Front, gas, std. height (pair)	Bilstein	1	<b>RA1345BILSTEIN</b>	132.50	159.00
Front, gas, std. height	Terrafrima	2	<b>RA1345TFAT</b>	28.33	34.00
	Decarbon	2	<b>RA1345DECARBONEA</b>	63.33	76.00
Pro Sport	Terrafrima	2	<b>RA1345TFPS</b>	48.33	58.00
Heavy Duty, Front, heavy duty	Britpart	2	<b>STC3766BPHD</b>	16.67	20.00
Front, gas, std. height, Commercial heavy duty	Terrafrima	2	<b>RA1345TFCHD</b>	58.33	70.00

**Shock Mounting Retention Ring**

All models - Front suspension

Aftermarket	2	<b>RNJ500010P</b>	3.58	4.30
Genuine	2	<b>RNJ500010</b>	16.34	19.61

**Shock Absorber - Rear**

All models

Rear, oil, std. height	Aftermarket	2	<b>STC3771P</b>	13.96	16.75
	OEM	2	<b>STC3771P1</b>	24.58	29.50
	Genuine	2	<b>STC3771</b>	63.97	76.76
Rear, gas, std. height (pair)	Bilstein	1	<b>RA1346BILSTEIN</b>	132.50	159.00
	Pro-Comp	2	<b>RA1346BMPC</b>	38.33	46.00
	Terrafrima	2	<b>RA1346TFPS</b>	48.33	58.00
All Terrain	Terrafrima	2	<b>RA1346TFAT</b>	29.17	35.00
Heavy Duty, Rear, gas, heavy duty, std. height	Aftermarket	2	<b>STC3772P</b>	13.96	16.75
	OEM	2	<b>STC3772P1</b>	27.50	33.00
	Genuine	2	<b>STC3772</b>	64.26	77.11
Rear, gas, Commercial Heavy Duty, std. height	Terrafrima	2	<b>RA1346TFCHD</b>	58.33	70.00

**Coil Spring**

All models

Front, driver's side	Aftermarket	1	<b>NRC9446P</b>	13.13	15.76
	Genuine	1	<b>NRC9446</b>	62.65	75.18
Front, passenger's side	Aftermarket	1	<b>NRC9447P</b>	14.58	17.50
	Genuine	1	<b>NRC9447</b>	65.08	78.10
Rear, driver's side, standard	Aftermarket	1	<b>NRC9448P</b>	14.38	17.26
	Genuine	1	<b>NRC9448</b>	64.40	77.28
Rear driver's side, heavy duty, green/yellow/red stripe <i>All models with factory heavy duty fitment</i>	Aftermarket	1	<b>RKB101230P</b>	19.58	23.50
	Genuine	1	<b>RKB101230</b>	67.85	81.42
Rear, passenger's side, standard	Aftermarket	1	<b>NRC9449P</b>	16.04	19.25
	Genuine	1	<b>NRC9449</b>	63.84	76.61

**Mounting Bracket**

All models - Front spring, upper

Aftermarket	2	<b>NRC6372P</b>	13.13	15.76
Genuine	2	<b>NRC6372</b>	56.30	67.56

**Lower Seat, Coil Spring**

All models - Front suspension

Aftermarket	2	<b>NRC9700P</b>	3.00	3.60
Genuine	2	<b>NRC9700</b>	11.51	13.81

**Spring Seat Lower**

All models to (VIN) LA939975

Rear suspension	Aftermarket	2	<b>NRC9700P</b>	3.00	3.60
	Genuine	2	<b>NRC9700</b>	11.51	13.81

**Plate, Spring Retainer**

All models - Rear

Aftermarket	2	<b>NTC6106P</b>	1.75	2.10
Genuine	2	<b>NTC6106</b>	3.28	3.94

**Ball Joint Assembly**

All models - Rear upper link

Aftermarket	1	<b>RHF500110P</b>	7.08	8.50	
OEM	1	<b>RHF500110P1</b>	16.67	20.00	
	1	<b>RHF500110</b>	39.98	47.98	
Heavy Duty	Bearmach	1	<b>RHF500110URBM</b>	14.38	17.26

**Ball Joint Assembly & Fulcrum Bracket**

All models - Rear upper link &amp; fulcrum bracket

Britpart	1	<b>RHF500110BPASSY</b>	39.58	47.50
----------	---	------------------------	-------	-------

**Radius Arm Assembly**

All models - Front suspension

Aftermarket	2	<b>NTC2705P</b>	120.00	144.00
Genuine	2	<b>NTC2705</b>	302.34	362.81

**Panhard Rod Assembly**

All models - Front suspension, RHD or LHD

Aftermarket	1	<b>RBI500020P</b>	23.75	28.50
Genuine	1	<b>RBI500020</b>	136.98	164.38

**Tie Bar**

All RHD models - Steering box

Aftermarket	1	<b>LR041261P</b>	15.63	18.76
Genuine	1	<b>LR041261</b>	46.04	55.25

**Top Link Assembly**

All models

Rear suspension, RH	Aftermarket	1	<b>NTC2706P</b>	80.00	96.00
	Genuine	1	<b>NTC2706</b>	241.05	289.26
Rear suspension, LH	Genuine	1	<b>LR045324</b>	175.36	210.43

**Bump Stop**

All models

Front suspension, rubber	Aftermarket	2	<b>ANR4188P</b>	2.58	3.10
	OEM	2	<b>ANR4188P1</b>	6.04	7.25
	Genuine	2	<b>ANR4188</b>	24.38	29.26
Rear suspension, rubber	Aftermarket	2	<b>ANR4189P</b>	3.08	3.70
	OEM	2	<b>ANR4189P1</b>	8.13	9.76
	Genuine	2	<b>ANR4189</b>	18.20	21.84

All models - Front suspension, poly., red	Polybush	2	<b>ANR4188POLYBUSH</b>	19.17	23.00
	Britpart	2	<b>ANR4188BPPYBLK</b>	13.25	15.90
	Britpart	2	<b>ANR4188BPPYEL</b>	13.25	15.90
All models - Rear suspension, poly. black	Polybush	2	<b>ANR4189POLYBUSH</b>	17.08	20.50
	Britpart	2	<b>ANR4189BPPYBLK</b>	13.25	15.90
	Britpart	2	<b>ANR4189BPPYEL</b>	13.25	15.90

**Bump Stop Spacers**

All models - Front or rear

Terrafrima	a/r	<b>ANR4188-9TFSPACER</b>	29.58	35.50
------------	-----	--------------------------	-------	-------



STC3766P



NRC9447P



STC3772P



RBI500020P





# STEERING

# 90 (1983-1989)

## Drop Arm Lever

All RHD models with Adwest power steering - For steering box with 4 bolt top plate				
Aftermarket	1	<b>QFW000020P</b>	18.54	22.25
OEM	1	<b>QFW000020P1</b>	57.50	69.00
Genuine	1	<b>QFW000020</b>	112.70	135.24

## Drop Arm Repair Kit

All models with gaiter lip on steering arm - Steering drag link				
Aftermarket	1	<b>RBG000010P</b>	4.58	5.50
OEM	1	<b>RBG000010P1</b>	20.63	24.76
Genuine	1	<b>RBG000010</b>	55.33	66.40

## Steering Arm Lever

All RHD models with Gemmer power steering - For steering box with 6 bolt top plate				
Genuine	1	<b>RTC6398</b>	372.63	447.16
Genuine	1	<b>RTC6398</b>	372.63	447.16
All RHD models with manual steering				
All LHD models with Adwest power steering - For steering box with 4 bolt top plate				
Aftermarket	1	<b>QFW000030P</b>	16.67	20.00
OEM	1	<b>QFW000030P1</b>	57.50	69.00
Genuine	1	<b>QFW000030</b>	112.70	135.24
All LHD models with Gemmer power steering - For steering box with 6 bolt top plate				
Aftermarket	1	<b>RTC6399P</b>	14.58	17.50
Genuine	1	<b>RTC6399</b>	372.63	447.16
All LHD models with manual steering				
Aftermarket	1	<b>RTC6399P</b>	14.58	17.50
Genuine	1	<b>RTC6399</b>	372.63	447.16

## Ball Joint, Drop Arm

All models - RH				
Aftermarket	1	<b>RBG000010P</b>	4.58	5.50
OEM	1	<b>RBG000010P1</b>	20.63	24.76
Genuine	1	<b>RBG000010</b>	55.33	66.40

## Universal Joint

All models				
Upper				
Aftermarket	1	<b>NRC7387P</b>	8.54	10.25
OEM	1	<b>NRC7387P1</b>	27.50	33.00
Genuine	1	<b>NRC7387</b>	48.59	58.31
Lower				
Aftermarket	1	<b>NRC7704P</b>	8.54	10.25
OEM	1	<b>NRC7704P1</b>	27.50	33.00
Genuine	1	<b>NRC7704</b>	47.31	56.77

## Lower Shaft Assembly

All models - With joints				
Aftermarket	1	<b>RTC4738P</b>	39.58	47.50
OEM	1	<b>RTC4738P1</b>	115.00	138.00
Genuine	1	<b>RTC4738</b>	203.24	243.89

## Steering Column Upper

All models				
OEM	1	<b>QMB101620P1</b>	95.00	114.00
Genuine	1	<b>QMB101620</b>	298.67	358.40

## Steering Damper Assembly

All models				
Aftermarket	1	<b>RTC4472P</b>	11.50	13.80
Bilstein	1	<b>RTC4472UR</b>	65.00	78.00
Terraforma	1	<b>RTC4472TF</b>	33.75	40.50
Cellular Dynamic	1	<b>RTC4472UR-BPCEL</b>	29.58	35.50
Super Gaz	1	<b>RTC4472UR-BPSUP</b>	27.50	33.00
Genuine	1	<b>RTC4472</b>	66.07	79.28
All models - Return to centre' type; uprated damper with return assistance spring				
Terraforma	1	<b>RTC4472FRTC</b>	57.50	69.00

## Steering Damper Bush Set, Polyurethane

All models				
Polybush Dynamic Red	Polybush	1	<b>LL1358</b>	18.13 21.76
Polybush Comfort Blue	Polybush	1	<b>LL1358B</b>	18.13 21.76
Britpart Black	Britpart	1	<b>LL1358-BPPOLYBLK</b>	3.33 4.00
Britpart Yellow	Britpart	1	<b>LL1358-BPPOLYEL</b>	3.58 4.30

## Eye Bush, Steering Damper

All models				
Aftermarket	4	<b>NTC1775P</b>	1.08	1.30
Aftermarket	4	<b>NTC1775POLY</b>	2.75	3.30
Genuine	4	<b>QEM500020</b>	5.19	6.23
Performance Red	Polybush	1	<b>NTC1775PB</b>	19.79 23.75

## Track Rod Assembly

All models				
Aftermarket	1	<b>LR041267P</b>	16.67	20.00
OEM	1	<b>LR041267P1</b>	38.33	46.00
Genuine	1	<b>LR041267</b>	165.15	198.18

## Track Rod Tube

All models				
Aftermarket	1	<b>LR045730P</b>	9.58	11.50
OEM	1	<b>LR045730P1</b>	16.88	20.26
Genuine	1	<b>LR045730</b>	44.56	53.47

## Track Rod End

All models - Track rod end, non-greasable				
RH thread				
Aftermarket	1	<b>RTC5869P</b>	4.58	5.50
OEM	1	<b>RTC5869P1</b>	10.63	12.76
Genuine	1	<b>RTC5869</b>	35.73	42.88
LH thread				
Aftermarket	1	<b>RTC5870P</b>	4.58	5.50
OEM	1	<b>RTC5870P1</b>	10.63	12.76
Genuine	1	<b>RTC5870</b>	35.73	42.88

## Rubber Cap Track Rod End

All models				
Aftermarket	2	<b>214649P</b>	1.33	1.60
Genuine	2	<b>214649</b>	4.57	5.48
Rubber cap, large diameter	Genuine	2	<b>214685</b>	3.15 3.78

## Cross Rod Eye End

All RHD models				
Aftermarket	1	<b>ANR2858P</b>	50.00	60.00
Genuine	1	<b>ANR2858</b>	58.86	70.63
All LHD models				
Aftermarket	1	<b>ANR2859P</b>	42.50	51.00
Genuine	1	<b>ANR2859</b>	56.57	67.88

## Cross Rod Tube

All models - Must be fitted together with later type eye end ANR2858 (RHD) or ANR2859 (LHD)				
Aftermarket	1	<b>ANR2860P</b>	9.58	11.50
OEM	1	<b>ANR2860P1</b>	16.88	20.26
Genuine	1	<b>ANR2860</b>	37.75	45.30
All models - Original style tube, not for fitment with later type ANR2858 (RHD) or ANR2859 (LHD) eye ends				
Aftermarket	1	<b>NRC9741P</b>	11.88	14.26

## Seal Kit Steering Box

All models with Adwest power steering - For steering box with 4 bolt top plate				
Lower				
Aftermarket	1	<b>STC2848P</b>	3.75	4.50
OEM	1	<b>STC2848P1</b>	5.63	6.76
Genuine	1	<b>STC2848</b>	20.28	24.34
Upper				
Aftermarket	1	<b>STC2847P</b>	9.79	11.75
Genuine	1	<b>STC2847</b>	67.67	81.20
All RHD models with Gemmer power steering - For steering box with 6 bolt top plate				
Aftermarket	1	<b>RTC5071P</b>	13.75	16.50
Genuine	1	<b>RTC5071</b>	238.89	286.67

## Repair Kit Steering Box

All models with Adwest manual steering				
Aftermarket	1	<b>STC892P</b>	11.25	13.50
Genuine	1	<b>STC892</b>	39.20	47.04

## Seal Steering Box Shaft

All models with Gemmer manual steering box				
Aftermarket	1	<b>AEU4024P</b>	1.08	1.30
Genuine	1	<b>AEU4024</b>	11.54	13.85

## Seal Worm Shaft

All models with Gemmer manual steering box				
Genuine	1	<b>BAU4870</b>	5.68	6.82

## Pinion Seal Steering Box

All models with Adwest power steering				
Genuine	1	<b>608065</b>	7.28	8.74

## Seal Kit Input Shaft Steering Box

All models with Adwest power steering - For steering box with 4 bolt top plate				
Aftermarket	1	<b>STC889P</b>	5.63	6.76
Genuine	1	<b>STC889</b>	33.20	39.84

## Pad Adjuster Kit Steering Box

All models with Adwest power steering - For steering box with 4 bolt top plate				
Genuine	1	<b>STC4385</b>	124.00	148.80

## Shaft Assy Steering Box

All LHD models with Adwest power steering - For steering box with 4 bolt top plate				
Genuine	1	<b>RTC4399</b>	301.74	362.09

## Gasket Kit Power Steering Pump

All V8 petrol power steering models				
Aftermarket	1	<b>ABU7145P</b>	4.00	4.80
All V8 petrol models with 30 series steering pump				
Aftermarket	1	<b>ABU7145P</b>	4.00	4.80

## Seal, Power Steering Pump

All models with Gemmer or Hobourn Eaton power steering pump - Inlet union. Dowty washer type seal				
Aftermarket	1	<b>RTC5675P</b>	1.00	1.20
Genuine	1	<b>RTC5675</b>	3.39	4.07

## Seal Kit Steering Pump

All V8 petrol power steering models				
Aftermarket	1	<b>STC1633P</b>	1.50	1.80

## Power Steering Fluid

All models with power steering - 1 litre. Cold (standard) climates fluid				
Aftermarket	a/r	<b>STC50519P</b>	12.08	14.50
Genuine	a/r	<b>STC50519</b>	18.96	22.75

## Cap Steering Reservoir

All models up to (VIN) AA244022				
Genuine	1	<b>RTC3056</b>	27.02	32.42

## Cap, Power Steering Reservoir

All models with power steering				
Genuine	1	<b>NTC2723</b>	21.59	25.91

## Gasket - Swivel Housing

All models				
Aftermarket	2	<b>FTC3646P</b>	0.50	0.60
Genuine	2	<b>FTC3646</b>	2.14	2.57

## Gasket - Lower Swivel Pin

All models				
Aftermarket	2	<b>FTC3647P</b>	0.50	0.60
Genuine	2	<b>FTC3647</b>	2.46	2.95



## 90 (1983-1989)

## CLUTCH

## Clutch Kit

All 2.5L petrol models - Includes clutch cover, plate & release bearing				
	Aftermarket	1	<b>STC8359P</b>	58.33 70.00
	Genuine	1	<b>STC8359</b>	214.45 257.34
All 2.5L 4 cyl diesel models - Includes clutch plate, cover and release bearing				
	Britpart	1	<b>LR009366BP</b>	50.00 60.00
	Genuine	1	<b>GCK555AF</b>	125.83 151.00
Heavy duty	Britpart	1	<b>LR009366BPHD</b>	55.00 66.00
Heavy duty, OEM.	Britpart	1	<b>LR009366BPHDOEM</b>	95.00 114.00
Heavy duty. Includes clutch cover, plate, release bearing & fork				
	Britpart	1	<b>LR009366BPHDFORK</b>	90.83 109.00
All 3.5L V8 carb petrol models with 5 speed LT85 or LT77 gearbox - Includes clutch cover, plate & release bearing				
	Aftermarket	1	<b>STC8361P</b>	90.83 109.00
	Genuine	1	<b>STC8361</b>	345.00 414.00

## Clutch Plate &amp; Cover Assembly

All 2.5L 4 cyl diesel models				
	Aftermarket	1	<b>LR009366P</b>	57.50 69.00
	OEM	1	<b>LR009366P1</b>	70.00 84.00
	Genuine	1	<b>LR009366</b>	169.85 203.82
All 2.5L 4 cyl diesel models - Heavy duty				
	Britpart	1	<b>LR009366BPHDPARTIAL</b>	49.17 59.00

## Clutch Cover

All 4 cyl petrol models - 9.5" diameter, diaphragm type				
	Aftermarket	1	<b>576557P</b>	27.50 33.00
	OEM	1	<b>576557P1</b>	36.67 44.00
	Genuine	1	<b>576557</b>	116.97 140.36
All diesel models				
	Aftermarket	1	<b>URB100760P</b>	29.58 35.50
	OEM	1	<b>URB100760P1</b>	39.58 47.50
	Genuine	1	<b>URB100760</b>	91.30 109.56
All V8 petrol models				
	Aftermarket	1	<b>576476P</b>	39.58 47.50
	OEM	1	<b>576476P1</b>	60.00 72.00
	Genuine	1	<b>576476</b>	118.73 142.48

## Clutch Plate

All 4 cyl petrol models				
	Aftermarket	1	<b>8510307P</b>	22.50 27.00
	OEM	1	<b>8510307P1</b>	36.67 44.00
	Genuine	1	<b>8510307</b>	117.94 141.53
All 3.5L V8 carb petrol models with 5 speed gearbox				
	OEM	1	<b>8510308P1</b>	37.50 45.00
	Genuine	1	<b>8510308</b>	217.38 260.86
All diesel models				
	Aftermarket	1	<b>UQB500030P</b>	22.50 27.00
	OEM	1	<b>GCP242</b>	45.00 54.00
	Genuine	1	<b>UQB500030</b>	119.39 143.27

## Clutch Release Bearing

All models - With carrier				
	Aftermarket	1	<b>FTC5200P</b>	7.92 9.50
	OEM	1	<b>FTC5200P1</b>	12.50 15.00
	Genuine	1	<b>FTC5200</b>	37.38 44.86
Heavy Duty	Britpart	1	<b>FTC5200HDBP</b>	45.83 55.00
	Bearmach	1	<b>FTC5200HDBM</b>	80.00 96.00

## Clutch Fork

All 4 cyl petrol and diesel models				
	Aftermarket	1	<b>FTC2957P</b>	3.75 4.50
	OEM	1	<b>FTC2957P1</b>	10.83 13.00
	Genuine	1	<b>FTC2957</b>	23.33 28.00
Heavy Duty	Britpart	1	<b>FTC2957BPHD</b>	8.75 10.50
Heavy Duty - Includes release fork, slipper pads, bush, staple & clip				
	Britpart	1	<b>FTC2957BPHDKIT</b>	11.67 14.00
All V8 petrol models				
	Aftermarket	1	<b>576137P</b>	23.96 28.75
	OEM	1	<b>576137P1</b>	29.58 35.50
	Genuine	1	<b>576137</b>	63.81 76.57

## Clutch Fork Staple Retainer

All 4 cyl petrol and diesel models				
	Aftermarket	1	<b>FRC3416P</b>	0.58 0.70
	Genuine	1	<b>FRC3416</b>	2.35 2.82
All V8 petrol models				
	Aftermarket	1	<b>576203P</b>	0.25 0.30
	Genuine	1	<b>576203</b>	0.66 0.79

## Pivot Clutch Release Arm

All 4 cyl models with 5 speed LT77 gearbox				
	OEM	1	<b>FRC5180P1</b>	15.04 18.05
	Genuine	1	<b>FRC5180</b>	57.38 68.86

## Pad Clutch Release Lever

All 4 cyl models with 5 speed LT77 gearbox				
	Aftermarket	2	<b>FRC5255P</b>	0.50 0.60
	Genuine	2	<b>FRC5255</b>	1.53 1.84

## Clutch Sleeve Guide

All models				
	Genuine	1	<b>FRC4078</b>	3.10 3.72

## Clutch Pipe

All 4 cyl petrol and diesel models - Hose to slave cyl.				
	Aftermarket	1	<b>NRC9595P</b>	13.96 16.75
	Genuine	1	<b>NRC9595</b>	29.11 34.93
All RHD models - Master cyl to hose				
	Genuine	1	<b>NRC8330</b>	29.11 34.93
All LHD models - Master cyl to hose				
	Genuine	1	<b>NRC8329</b>	28.08 33.70

## Clutch Hose

All V8 petrol models				
	Aftermarket	1	<b>NRC2211P</b>	3.25 3.90
	Genuine	1	<b>NRC2211</b>	33.62 40.34

## Clutch Pipe Assembly

All V8 petrol models - From clutch hose to slave cylinder				
	OEM	1	<b>577643P1</b>	9.58 11.50
	Genuine	1	<b>577643</b>	12.26 14.71

## Clutch Slave Cylinder

All models except V8				
	Aftermarket	1	<b>591231P</b>	7.08 8.50
	OEM	1	<b>591231P1</b>	18.13 21.76
	Genuine	1	<b>591231</b>	78.39 94.07
All V8 petrol models				
	OEM	1	<b>UKC8677P1</b>	20.00 24.00
	Genuine	1	<b>UKC8677</b>	16.67 20.00

## Slave Cylinder Repair Kit

All models except V8				
	Aftermarket	1	<b>8G8600LP</b>	1.00 1.20
	OEM	1	<b>8G8600LP1</b>	4.38 5.26
	Genuine	1	<b>8G8600L</b>	8.51 10.21
All V8 petrol models				
	Genuine	1	<b>513390</b>	5.00 6.00

## Clutch Master Cylinder

All models				
	Aftermarket	1	<b>STC500100P</b>	9.58 11.50
	OEM	1	<b>STC500100P1</b>	19.79 23.75
	Genuine	1	<b>STC500100</b>	76.84 92.21

## Master Cylinder Repair Kit

All models - Clutch master cylinder				
	Aftermarket	1	<b>GRK1027P</b>	2.08 2.50
	OEM	1	<b>GRK1027</b>	5.63 6.76

## Push Rod Clip

All 4 cyl petrol and diesel models				
	Aftermarket	1	<b>FRC3327P</b>	0.75 0.90
	Genuine	1	<b>FRC3327</b>	3.23 3.88
All V8 petrol models				
	Aftermarket	1	<b>576723P</b>	0.38 0.46
	Genuine	1	<b>576723</b>	3.95 4.74

## Push Rod

All 4 cyl petrol & diesel models with 5 speed LT77 gearbox - Clutch slave cylinder				
	Aftermarket	1	<b>FRC3417P</b>	2.25 2.70
	Genuine	1	<b>FRC3417</b>	7.98 9.58
All V8 petrol models - Bleed Screw Clutch Slave Cylinder				
	Genuine	1	<b>606733A</b>	2.58 3.10

## Dowel Clutch Guide

All models with LT77 gearbox - 5 speed				
	Genuine	2	<b>FRC2481</b>	2.29 2.75

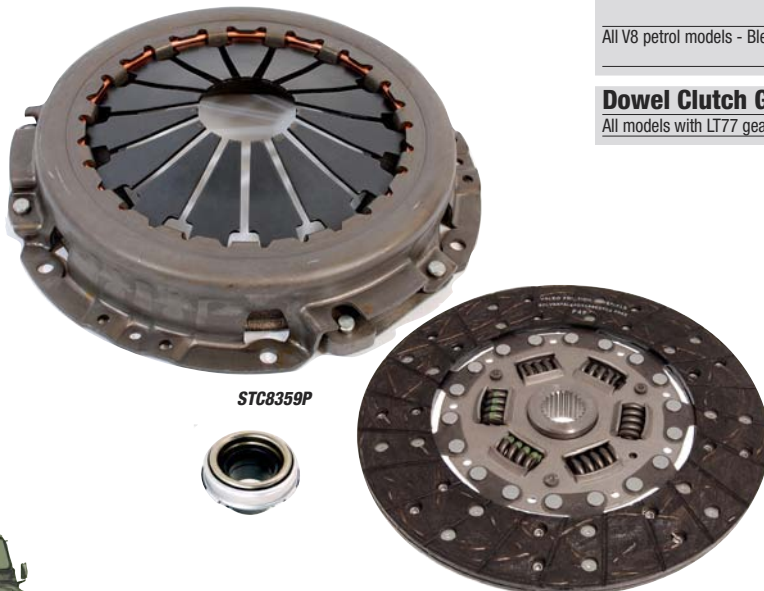

STC8359P





# TRANSMISSION

# 90 (1983-1989)

## Constant Velocity Joint

All models up to (axle) 22L27847 and 23L12092 - 23 spline				
	Aftermarket	2	<b>AEU2522P</b>	18.13 21.76
All models from (axle) 22L27848 and 23L12093 on - 33 spline				
	Aftermarket	2	<b>RTC6862P</b>	15.83 19.00
	Genuine	2	<b>RTC6862</b>	577.93 693.52

## Gaiter Propshaft c/w Clips

All models - Front				
	Aftermarket	1	<b>276484P</b>	2.33 2.80
	Genuine	1	<b>276484</b>	22.65 27.18

## Gaiter Propshaft

All models				
Front				
	Aftermarket	1	<b>TVE100000P</b>	2.58 3.10
	OEM	1	<b>TVE100000P1</b>	3.08 3.70
	Genuine	1	<b>TVE100000</b>	15.14 18.17
Rear				
	Aftermarket	1	<b>276483P</b>	3.00 3.60
	Genuine	1	<b>276483</b>	24.73 29.68

## Universal Joint

All 4 cyl models to (VIN) CA252578 - Propshaft				
	Aftermarket	2	<b>RTC3346P</b>	3.50 4.20
	OEM	2	<b>RTC3346P1</b>	8.13 9.76
	Genuine	2	<b>RTC3346</b>	49.81 59.77
All 4 cyl models (VIN) CA252579 on - Propshaft, sealed				
	Aftermarket	2	<b>RTC3458P</b>	4.08 4.90
	OEM	2	<b>RTC3458P1</b>	8.54 10.25
	Genuine	2	<b>RTC3458</b>	46.58 55.90
All V8 petrol models to (VIN) CA254406 - Propshaft				
	Aftermarket	2	<b>RTC3346P</b>	3.50 4.20
	OEM	2	<b>RTC3346P1</b>	8.13 9.76
	Genuine	2	<b>RTC3346</b>	49.81 59.77
All V8 petrol models (VIN) CA254407 on - Propshaft, sealed				
	Aftermarket	2	<b>RTC3458P</b>	4.08 4.90
	OEM	2	<b>RTC3458P1</b>	8.54 10.25
	Genuine	2	<b>RTC3458</b>	46.58 55.90

## Shaft Assembly

All models with LT230 transfer box - Front Output				
	Aftermarket	1	<b>FRC5449P</b>	38.75 46.50
	Genuine	1	<b>FRC5449</b>	190.22 228.26

## Front Output Shaft

All V8 carb petrol models with 4 speed LT95 gearbox				
	OEM	1	<b>594337P1</b>	53.33 64.00
	Genuine	1	<b>594337</b>	145.02 174.02

## Drive Flange, Transfer Box

All models with 43D transfer box - Front, heavy duty				
	Genuine	1	<b>IEC100020</b>	49.74 59.69

## Shaft Front Axle

All models (axle) 20L, 21L, 22L, 23L - RH				
	Genuine	1	<b>AEU2520</b>	317.01 380.41

## Spacer Front Drive Shaft

All models (axle) 20L, 21L, 22L, 23L				
	Aftermarket	2	<b>FTC254P</b>	2.83 3.40
	Genuine	2	<b>FTC254</b>	5.31 6.37

## Hub Assembly

All models				
Front				
	Aftermarket	2	<b>FRC6139P</b>	55.00 66.00
	Genuine	2	<b>FRC6139</b>	149.65 179.58
Rear				
	Aftermarket	2	<b>FRC6141P</b>	30.83 37.00
	Genuine	2	<b>FRC6141</b>	365.26 438.31
All models (axle) 22S08283B on - Rear				
	Aftermarket	2	<b>FRC8555P</b>	39.58 47.50
	Genuine	2	<b>FRC8555</b>	149.20 179.04

## Stub Axle

All models				
Front				
	Aftermarket	2	<b>FRC4320P</b>	20.63 24.76
	OEM	2	<b>FRC4320P1</b>	50.00 60.00
	Genuine	2	<b>FRC4320</b>	103.38 124.06
Rear				
	Aftermarket	2	<b>FRC3132P</b>	19.58 23.50
	OEM	2	<b>FRC3132P1</b>	39.58 47.50
	Genuine	2	<b>FRC3132</b>	167.46 200.95
All models (axle) 22S08283B on - Rear				
	Aftermarket	2	<b>FRC8540P</b>	16.04 19.25
	OEM	2	<b>FRC8540P1</b>	45.00 54.00
	Genuine	2	<b>FRC8540</b>	201.46 241.75

## Stub Axle Nut

All models				
	Aftermarket	4	<b>FRC8700P</b>	1.25 1.50
	Genuine	4	<b>FRC8700</b>	10.09 12.11

## Stub Axle Kit

All models - Front, includes stub axle, gasket, bolts, washers, bearing and seals				
	Britpart	2	<b>FRC4320BPK</b>	20.63 24.76
Up to (axle) 22S08283B - Rear, includes stub axle, gasket, bolts and nuts				
	Britpart	2	<b>FRC3132BPK</b>	45.83 55.00
From (axle) 22S08284B on - Rear, includes stub axle, gasket, bolts and nuts				
	Britpart	2	<b>FRC8540BPK</b>	17.50 21.00

## Driving Member

All models - 24 spline, front and rear				
	Aftermarket	2	<b>FRC5806P</b>	5.42 6.50
	Genuine	2	<b>FRC5806</b>	128.29 153.95

## Driving Member Heavy Duty

All models - 24 spline, front and rear				
	Britpart	2	<b>FRC5806HDBPDEF</b>	25.83 31.00
	Bearmach	2	<b>FRC5806HDBMDEF</b>	13.33 16.00
	Britpart	2	<b>FRC5806HDKBPDEF</b>	60.00 72.00
Kit (pair)				

## Dust Cap, Screw On

All models fitted with Bearmach heavy duty driving members - Heavy duty driving member				
	Bearmach	2	<b>RUC105200HDBMNUT</b>	3.33 4.00
All models fitted with Britpart heavy duty driving members - Heavy duty driving member				
	Britpart	2	<b>RUC105200HDBPCAP</b>	8.75 10.50

## Bolt Kit, Heavy Duty Driving Members

All models fitted with Britpart heavy duty driving members - Includes 10 bolts (one axle set)				
	Britpart	1	<b>RUC105200BPKBOLT</b>	10.00 12.00

## Hub and Sleeve Assy Trans Box

All 4 cyl models with LT77 gearbox and LT230 transfer box (gbox) 22D				
	OEM	1	<b>FTC382P1</b>	78.33 94.00
	Genuine	1	<b>FTC382</b>	341.90 410.28
All V8 carb petrol models with 5 speed LT77 gearbox and LT230 transfer box (gbox) 32D				
	OEM	1	<b>FTC382P1</b>	78.33 94.00
	Genuine	1	<b>FTC382</b>	341.90 410.28

## Spacer Hub

All models				
	Aftermarket	2	<b>FRC8227P</b>	1.75 2.10
	Genuine	2	<b>FRC8227</b>	29.89 35.87

## Bearing Swivel Pin Housing

All models				
	Aftermarket	2	<b>606666P</b>	3.33 4.00
	OEM	2	<b>606666P1</b>	10.42 12.50
	Genuine	2	<b>606666</b>	23.99 28.79

## Housing Swivel Pin Bearing

All models (axle) 20L, 21L, 22L, 23L - 7 hole type				
	Aftermarket	2	<b>FTC5105P</b>	60.00 72.00
	OEM	2	<b>FTC5105P1</b>	87.50 105.00
	Genuine	2	<b>FTC5105</b>	197.93 237.52

## Housing & Bush Swivel Pin

All models				
	Aftermarket	2	<b>8510267P</b>	6.04 7.25
	Genuine	2	<b>8510267</b>	31.21 37.45

## Housing, Swivel Pin

All RHD models - LH				
	Genuine	1	<b>FTC2529</b>	468.45 562.14
All LHD models				
	OEM	1	<b>FTC2530P1</b>	245.83 295.00
	Genuine	1	<b>FTC2530</b>	522.25 626.70
	OEM	1	<b>FTC2531P1</b>	233.33 280.00
	Genuine	1	<b>FTC2531</b>	502.76 603.31

## Swivel Pin

All models				
Upper				
	Aftermarket	2	<b>FRC3511P</b>	5.63 6.76
	Genuine	2	<b>FRC3511</b>	86.01 103.21
Lower				
	Aftermarket	2	<b>FRC2894P</b>	2.50 3.00
	Genuine	2	<b>FRC2894</b>	64.95 77.94

## Swivel Housing Grease

All models				
Sachet				
	OEM	a/r	<b>STC3435P1</b>	5.00 6.00
	Genuine	a/r	<b>STC3435</b>	7.69 9.23
370g bottle				
	Britpart	a/r	<b>STC3435BPBOTTLE</b>	4.79 5.75
370ml sachet				
	Britpart	a/r	<b>STC3435BPSACHET</b>	4.38 5.26

## Oil Seal Diff Unit

All models (axle) to 22S08283B				
	Aftermarket	1	<b>FRC4586P</b>	0.83 1.00
	OEM	1	<b>FRC4586P1</b>	3.50 4.20
	Genuine	1	<b>FRC4586</b>	11.66 13.99
All models (axle) 22S08284B on				
	Aftermarket	1	<b>FRC8220P</b>	1.50 1.80
	OEM	1	<b>FRC8220P1</b>	5.63 6.76
	Genuine	1	<b>FRC8220</b>	27.28 32.74

## Oil Seal Hub

All models				
	Aftermarket	2	<b>FRC8222P</b>	1.83 2.20
	OEM	2	<b>FRC8222P1</b>	5.63 6.76
	Genuine	2	<b>FRC8222</b>	21.24 25.49

## Oil Seal Stub Axle

All models - Twin lip type				
	Aftermarket	2	<b>RTC3511P</b>	1.33 1.60
	OEM	2	<b>RTC3511P1</b>	3.50 4.20
	Genuine	2	<b>RTC3511</b>	12.52 15.02



**90 (1983-1989)****TRANSMISSION****Seal Inner Stub Axle**

All models (axle) 20L, 21L, 22L, 23L, 22S, 24S

Aftermarket	2	<b>FTC4785P</b>	1.33	1.60
OEM	2	<b>FTC4785P1</b>	3.00	3.60
Genuine	2	<b>FTC4785</b>	4.34	5.21

**Seal Stub Axle**

All models

Aftermarket	2	<b>FRC3099P</b>	0.75	0.90
OEM	2	<b>FRC3099P1</b>	3.25	3.90
Genuine	2	<b>FRC3099</b>	8.09	9.71

**Oil Seal Output Shaft**

All V8 petrol models with LT95 4 speed gearbox

Aftermarket	1	<b>90622240P</b>	1.25	1.50
Genuine	1	<b>90622240</b>	3.81	4.57
Alternative to 90622240	1	<b>571175P</b>	0.63	0.76
Genuine	1	<b>571175</b>	3.69	4.43

**Oil Seal Front Cover**

All models with LT77 5 speed gearbox (gbox) suffix A to E

Aftermarket	1	<b>UKC1060P</b>	1.58	1.90
Aftermarket	1	<b>UKC1060</b>	5.63	6.76

**Oil Seal Clutch Sleeve Housing**

All V8 petrol models with LT95 4 speed gearbox

Aftermarket	1	<b>571059P</b>	0.63	0.76
Genuine	1	<b>571059</b>	7.87	9.44

**Oil Seal Transfer Box Input**

All models with LT230 transfer box

Aftermarket	1	<b>ICV100000P</b>	0.92	1.10
OEM	1	<b>ICV100000P1</b>	3.83	4.60
Genuine	1	<b>ICV100000</b>	6.99	8.39

**Oil Seal Transfer Box Output Flange**

All models with LT230 transfer box

Aftermarket	1	<b>FTC4939P</b>	2.00	2.40
OEM	1	<b>FTC4939P1</b>	5.00	6.00
Genuine	1	<b>FTC4939</b>	13.18	15.82

**Oil Seal Swivel**

All models - 9mm

Aftermarket	2	<b>LR059968P</b>	2.08	2.50
OEM	2	<b>LR059968P1</b>	5.83	7.00
Genuine	2	<b>LR059968</b>	9.89	11.87

**Oil Seal Swivel Pin Housing**

All models (axle) 20L, 21L, 22L, 23L

Aftermarket	2	<b>571718P</b>	1.17	1.40
OEM	2	<b>571718P1</b>	3.00	3.60
Genuine	2	<b>571718</b>	6.81	8.17

**Drain Plug Diff Unit**

All models

Aftermarket	1	<b>608246P</b>	2.33	2.80
Genuine	1	<b>608246</b>	9.63	11.56

**Sealing Washer Drain Plug**

All models with LT77 or R380 5 speed gearbox - Alternative to FRC7064A

Aftermarket	1	<b>FTC4112P</b>	0.79	0.95
Genuine	1	<b>FTC4112</b>	2.37	2.84

**Drain Plug Transfer Box**

All models with LT230 transfer box

Aftermarket	1	<b>599552P</b>	2.83	3.40
Genuine	1	<b>599552</b>	8.99	10.79

All V8 models with LT95 4 speed gearbox

Aftermarket	1	<b>599552P</b>	2.83	3.40
Genuine	1	<b>599552</b>	8.99	10.79

**Sealing Washer Drain Plug**

All models - Land Rover type axle

Aftermarket	1	<b>515599P</b>	0.33	0.40
Genuine	1	<b>515599</b>	1.17	1.40

All models with LT77 or R380 5 speed gearbox - Alternative to FTC4112

Aftermarket	1	<b>FRC7064A</b>	1.08	1.30
-------------	---	-----------------	------	------

**Gear Speedometer Drive**

All models with LT230 transfer box

Aftermarket	1	<b>FRC3162P</b>	20.63	24.76
OEM	1	<b>FRC3162P1</b>	23.75	28.50
Genuine	1	<b>FRC3162</b>	64.01	76.81

**Speedometer Drive Gear**

All models with blue coded 20 teeth speedometer drive pinion -

Pinion, blue, 20 teeth	Aftermarket	1	<b>FRC3310P</b>	8.54	10.25
	Genuine	1	<b>FRC3310</b>	16.89	20.27

All models with green coded 21 teeth speedometer drive pinion -

Pinion, green, 21 teeth	Genuine	1	<b>FRC3311</b>	21.56	25.87
-------------------------	---------	---	----------------	-------	-------

All models with yellow coded 22 teeth speedometer drive pinion (205 x 16" tyres) -

Pinion, yellow, 22 teeth	OEM	1	<b>FRC3312P1</b>	15.63	18.76
	Genuine	1	<b>FRC3312</b>	20.23	24.28

All models with red coded 23 teeth speedometer drive pinion (V8 carb models) -

Pinion, red, 23 teeth	OEM	1	<b>FRC3313P1</b>	15.63	18.76
	Genuine	1	<b>FRC3313</b>	20.53	24.64

All models V8 petrol with LT77 5 speed gearbox with 29D transfer box

Green, 21 teeth	Genuine	1	<b>FRC3311</b>	21.56	25.87
-----------------	---------	---	----------------	-------	-------

**Switch, Gearbox**

High/Low, with spade connectors - All models with LT230 transfer box

Aftermarket	1	<b>PRC2911P</b>	4.08	4.90
OEM	1	<b>PRC2911P1</b>	7.92	9.50
Genuine	1	<b>PRC2911</b>	35.18	42.22

**Taper Roller Bearing Diff Carrier**

All models (axle) 23S, 42S, 44S, 64L - Land Rover type axle

Aftermarket	2	<b>RTC3095P</b>	4.25	5.10
OEM	2	<b>RTC3095P1</b>	9.37	11.24
Genuine	2	<b>RTC3095</b>	52.69	63.23

**608246P****599522P****PRC2911P****FRC3310P****FRC3311****RTC3095**



# COOLING

# 90 (1983-1989)

## Expansion Bottle Cap

All 4 cyl petrol models up to (VIN) LA932798 - 9lb pressure	Aftermarket	1	<b>GRC118</b>	4.08	4.90
	Genuine	1	<b>GRC118</b>	4.08	4.90
All 4 cyl diesel models up to (VIN) LA932798 except 200 TDi - 9lb pressure	Aftermarket	1	<b>GRC118</b>	4.08	4.90
	Genuine	1	<b>GRC118</b>	4.08	4.90

## Radiator Cap

All 2.5L NA diesel models - Expansion tank	Aftermarket	1	<b>STC4735P</b>	1.50	1.80
	Genuine	1	<b>STC4735</b>	6.11	7.33

## Expansion Bottle Cap

All 2.5L normally aspirated diesel engine models	Aftermarket	1	<b>PCD100150P</b>	1.42	1.70
	Genuine	1	<b>PCD100150</b>	4.04	4.85
15lb pressure	Aftermarket	1	<b>GRC110</b>	4.38	5.26
All 2.5L turbo diesel engine models	Aftermarket	1	<b>PCD100160-P</b>	2.00	2.40
	Genuine	1	<b>PCD100160</b>	3.87	4.64
All V8 carb petrol engine models	Aftermarket	1	<b>PCD100150P</b>	1.42	1.70
	Genuine	1	<b>PCD100150</b>	4.04	4.85
15lb pressure	Aftermarket	1	<b>GRC110</b>	4.38	5.26

## Thermostat

All 2.25L petrol engine models	Aftermarket	1	<b>596225P</b>	2.75	3.30
82°C	Genuine	1	<b>596225</b>	35.56	42.67
All 4 cyl petrol and diesel engine models	Aftermarket	1	<b>602687P</b>	2.58	3.10
82°C	OEM	1	<b>602687P1</b>	3.58	4.30
	Genuine	1	<b>602687</b>	10.06	12.07
74°C	Aftermarket	1	<b>ETC4761P</b>	2.00	2.40
	OEM	1	<b>ETC4761P1</b>	3.50	4.20
	Genuine	1	<b>ETC4761</b>	12.25	14.70
74°C hot climates option	Aftermarket	1	<b>GTS102</b>	3.33	4.00
82°C, std fitment	Aftermarket	1	<b>GTS104</b>	3.58	4.30
88°C, cold climates option	Aftermarket	1	<b>GTS106</b>	3.58	4.30
All V8 carb petrol engine models	Aftermarket	1	<b>602687P</b>	2.58	3.10
82°C	OEM	1	<b>602687P1</b>	3.58	4.30
	Genuine	1	<b>602687</b>	10.06	12.07
All V8 petrol models	Aftermarket	1	<b>GTS102</b>	3.33	4.00
74°C, hot climates option	Aftermarket	1	<b>GTS104</b>	3.58	4.30
82°C, std fitment	Aftermarket	1	<b>GTS104</b>	3.58	4.30
88°C, cold climates option	Aftermarket	1	<b>GTS106</b>	3.58	4.30

## Thermostat Housing Gasket

All 4 cylinder models - Thermostat housing	Aftermarket	1	<b>ERR3682P</b>	0.33	0.40
	Genuine	1	<b>ERR3682</b>	2.04	2.45
All 2.5L NA and Turbo Diesel models - Lower	Aftermarket	1	<b>247874P</b>	0.15	0.18
	Genuine	1	<b>247874</b>	1.74	2.09
All V8 petrol engine models - Thermostat housing	Aftermarket	1	<b>ERR2429P</b>	0.67	0.80
	Genuine	1	<b>ERR2429</b>	1.75	2.10
All V8 petrol models with 4 barrel carb conversion	Aftermarket	1	<b>GTG116</b>	1.83	2.20

## Thermostat Housing

All 2.5L petrol models	Genuine	1	<b>ERC8758</b>	141.21	169.45
All V8 petrol models with air conditioning	Aftermarket	1	<b>ETC6135A</b>	29.58	35.50

## Thermostat Housing Adaptor

All 2.5L 4 cyl petrol and diesel models including Turbo Diesel - Heater pipe	Genuine	1	<b>624091</b>	7.82	9.38
------------------------------------------------------------------------------	---------	---	---------------	------	------



596225



STC636P



PRC3359P

## Water Pump

All 2.25L petrol engine models without air conditioning	Aftermarket	1	<b>STC636P</b>	34.58	41.50
	Genuine	1	<b>STC636</b>	242.88	291.46
All 2.5L petrol engine models without air conditioning	Aftermarket	1	<b>STC637P</b>	29.58	35.50
	OEM	1	<b>STC637P1</b>	50.00	60.00
	Genuine*	1	<b>STC637</b>	138.92	166.70
			*Exchange Surcharge	35.00	42.00
All 2.5L petrol engine models with air conditioning	Aftermarket	1	<b>STC635P</b>	26.67	32.00
	Genuine*	1	<b>STC635</b>	168.32	201.98
			*Exchange Surcharge	39.00	46.80
All 2.5L normally aspirated diesel models without air conditioning	Aftermarket	1	<b>STC637P</b>	29.58	35.50
	OEM	1	<b>STC637P1</b>	50.00	60.00
	Genuine*	1	<b>STC637</b>	138.92	166.70
			*Exchange Surcharge	36.00	43.20
All 2.5L normally aspirated diesel models with air conditioning	Aftermarket	1	<b>STC635P</b>	26.67	32.00
	Genuine*	1	<b>STC635</b>	168.32	201.98
			*Exchange Surcharge	39.00	46.80
All 2.5L turbo diesel models	Aftermarket	1	<b>STC635P</b>	26.67	32.00
	Genuine*	1	<b>STC635</b>	168.32	201.98
			*Exchange Surcharge	40.00	48.00
All military 2.5L petrol models	Genuine	1	<b>STC634</b>	234.13	280.96
All V8 carb petrol models without viscous coupling	Aftermarket	1	<b>STC1611P</b>	30.00	36.00
	Genuine*	1	<b>STC1611</b>	126.22	151.46
			*Exchange Surcharge	29.00	34.80
All V8 carb petrol engine models with viscous coupling with air conditioning	Aftermarket	1	<b>STC488P</b>	50.00	60.00
	Genuine*	1	<b>STC488</b>	182.33	218.80
			*Exchange Surcharge	41.00	49.20

## Water Pump Gasket

All 4 cylinder models - Water pump	Aftermarket	1	<b>ERC5655P</b>	0.38	0.46
	Genuine	1	<b>ERC5655</b>	5.04	6.05
All V8 carb engine models - Water pump	Aftermarket	1	<b>ERR2428P</b>	0.83	1.00
	OEM	1	<b>ERR2428P1</b>	4.00	4.80
	Genuine	1	<b>ERR2428</b>	8.47	10.16

## Water Pump Inlet Housing Gasket

All 4 cylinder models - Water pump inlet housing	Aftermarket	1	<b>ERR1607P</b>	0.25	0.30
	Genuine	1	<b>ERR1607</b>	1.67	2.00

## Temperature Sensor

4 cyl petrol models with air conditioning - Blue	Aftermarket	1	<b>PRC3366P</b>	4.38	5.26
	Genuine	1	<b>PRC3366</b>	33.89	40.67
All 4 cyl petrol and diesel engine models	Aftermarket	1	<b>PRC2505P</b>	2.00	2.40
	Genuine	1	<b>PRC2505</b>	23.66	28.39
All 2.5L petrol models with red temp sensor	Aftermarket	1	<b>PRC3541P</b>	10.42	12.50
	Genuine	1	<b>PRC3541</b>	33.89	40.67
All 2.5L N/A diesel models with red temp sensor	Aftermarket	1	<b>PRC3541P</b>	10.42	12.50
	Genuine	1	<b>PRC3541</b>	33.89	40.67
2.5L N/A diesel engine models - Blue	Aftermarket	1	<b>PRC3366P</b>	4.38	5.26
	Genuine	1	<b>PRC3366</b>	33.89	40.67
2.5L Turbo Diesel engine models	Aftermarket	1	<b>PRC3359P</b>	5.00	6.00
Green	OEM	1	<b>PRC3359P1</b>	27.08	32.50
	Genuine	1	<b>PRC3359</b>	39.35	47.22
	Aftermarket	1	<b>PRC3505A</b>	10.00	12.00
Yellow	Aftermarket	1	<b>PRC3505A</b>	10.00	12.00
All V8 carb petrol models	Aftermarket	1	<b>RTC4996P</b>	5.63	6.76
All V8 petrol models	Aftermarket	1	<b>PRC2506P</b>	5.63	6.76
	Genuine	1	<b>PRC2506</b>	23.66	28.39
V8 carb petrol models with air conditioning	Aftermarket	1	<b>PRC3359P</b>	5.00	6.00
Green	OEM	1	<b>PRC3359P1</b>	27.08	32.50
	Genuine	1	<b>PRC3359</b>	39.35	47.22
	Aftermarket	1	<b>PRC3505A</b>	10.00	12.00
Yellow	Aftermarket	1	<b>PRC3505A</b>	10.00	12.00



## 90 (1983-1989)

## ELECTRICAL - ROTATING ELECTRICS

## Alternator

All 4 cyl petrol models without air conditioning					
A127/45Amp - New, exchange	Genuine*	1	<b>STC229</b>	300.76	360.91
	*Exchange Surcharge			48.00	57.60
All 4 cyl petrol models with air conditioning					
A127/65Amp - New, outright	Aftermarket	1	<b>STC234P</b>	67.50	81.00
A133/65Amp - Recond'd, exchange	Aftermarket*	1	<b>RTC5218EP</b>	95.83	115.00
	*Exchange Surcharge			26.00	31.20
A133/65Amp - New, exchange	Genuine*	1	<b>RTC5218E</b>	131.77	158.12
	*Exchange Surcharge			33.00	39.60
All 2.5L petrol models without air conditioning with A127/45amp alternator					
New, outright	Aftermarket	1	<b>RTC5682P</b>	70.83	85.00
Reconditioned, exchange	Genuine*	1	<b>RTC5682E</b>	131.34	157.61
	*Exchange Surcharge			30.00	36.00
All 2.5L N/A diesel models without air conditioning with A127/45amp alternator					
New, outright	Aftermarket	1	<b>RTC5682P</b>	70.83	85.00
Reconditioned, exchange	Genuine*	1	<b>RTC5682E</b>	131.34	157.61
	*Exchange Surcharge			31.00	37.20
All 2.5L normally aspirated diesel models with air conditioning and 65Amp alternator					
A127/65Amp - New, outright	Aftermarket	1	<b>STC234P</b>	67.50	81.00
A133/65Amp - Recond'd, exchange	Aftermarket*	1	<b>RTC5218EP</b>	95.83	115.00
	*Exchange Surcharge			27.00	32.40
	Genuine*	1	<b>RTC5218E</b>	131.77	158.12
	*Exchange Surcharge			34.00	40.80
All 2.5L normally aspirated diesel models without air conditioning					
A127/45Amp - New, exchange	Genuine*	1	<b>STC229</b>	300.76	360.91
	*Exchange Surcharge			49.00	58.80
2.5L N/A diesel military models fitted for radio with 24V system (90amp alternator)					
New, outright	Genuine	1	<b>PRC5253</b>	4379.92	5255.90
All 2.5L Turbo Diesel models without air conditioning (A127/45amp alternator)					
New, outright	Aftermarket	1	<b>RTC5682P</b>	70.83	85.00
Reconditioned, exchange	Genuine*	1	<b>RTC5682E</b>	131.34	157.61
	*Exchange Surcharge			32.00	38.40
All 2.5L turbo diesel models without air conditioning					
A127/45Amp - New, exchange	Genuine*	1	<b>STC229</b>	300.76	360.91
	*Exchange Surcharge			50.00	60.00
All models with V8 carb petrol engine up to (engine) 17G00182 - A115-45Amp/18ACR					
Reconditioned, exchange	Aftermarket*	1	<b>RTC5086EP</b>	61.67	74.00
	*Exchange Surcharge			25.00	30.00
	Genuine*	1	<b>RTC5086E</b>	185.10	222.12
	*Exchange Surcharge			50.40	
All V8 carb petrol engine models with 45 Amp alternator - A127/45Amp					
New, outright	Aftermarket	1	<b>RTC5683EP</b>	82.50	99.00
Reconditioned, exchange	Genuine*	1	<b>RTC5683E</b>	160.78	192.94
	*Exchange Surcharge			37.00	44.40
All V8 carb petrol models with LH fixing high output A127/65amp alternator					
New, outright	Aftermarket	1	<b>STC233P</b>	55.00	66.00
All V8 carb petrol models with LH fixing ignition sensed std power alternator (A115/45amp, replaces 17ACR/36amp)					
Reconditioned, exchange	Genuine*	1	<b>RTC5085E</b>	119.76	143.71
	*Exchange Surcharge			28.00	33.60

## Starter Motor

All 2.5L petrol models up to (eng) 17H26367C - Lucas M78R type starter					
New, outright	Aftermarket	1	<b>PRC6613P</b>	75.00	90.00
Reconditioned, exchange	Genuine*	1	<b>PRC6613E</b>	268.19	321.83
	*Exchange Surcharge			47.00	56.40
New, exchange	Genuine*	1	<b>PRC6613N</b>	390.98	469.18
	*Exchange Surcharge			53.00	63.60
2.5L petrol engine models from (eng) 17H26368C on - Bosch type starter motor					
New, outright	Aftermarket	1	<b>NAD10040P</b>	60.00	72.00
Reconditioned, exchange	Genuine*	1	<b>NAD10040E</b>	233.12	279.74
	*Exchange Surcharge			43.00	51.60
New, exchange	Genuine*	1	<b>NAD10040</b>	487.94	585.53
	*Exchange Surcharge			58.00	69.60
All 2.5L normally aspirated diesel engine models with Lucas starter motor					
New, outright	Aftermarket	1	<b>RTC5249NP</b>	90.00	108.00
Lucas type M113, exchange	Genuine*	1	<b>RTC5249E</b>	252.89	303.47
	*Exchange Surcharge			46.00	55.20
Lucas type M113, new, exchange	Genuine*	1	<b>RTC5249N</b>	541.97	650.36
	*Exchange Surcharge			59.00	70.80
Hi Torque, uprated	Powerlite	1	<b>RTC5249UR</b>	145.00	174.00
All 2.5L N/A diesel models					
New, outright	Aftermarket	1	<b>NAD500210P</b>	82.50	99.00
	OEM	1	<b>NAD500210P1</b>	175.00	210.00
Reconditioned, exchange	Genuine*	1	<b>PRC5109E</b>	242.74	291.29
	*Exchange Surcharge			44.00	52.80
New, exchange	Genuine*	1	<b>NAD500210</b>	316.78	380.14
	*Exchange Surcharge			61.20	
All 2.5L Turbo Diesel models					
New, outright	Aftermarket	1	<b>NAD500210P</b>	82.50	99.00
	OEM	1	<b>NAD500210P1</b>	175.00	210.00
New, exchange	Genuine*	1	<b>NAD500210</b>	316.78	380.14
	*Exchange Surcharge			52.00	62.40
Reconditioned, exchange	Genuine*	1	<b>PRC5109E</b>	242.74	291.29
	*Exchange Surcharge			45.00	54.00
Military 2.5L petrol models, fitted for radio - 24V system					
New, exchange	Genuine*	1	<b>90501505</b>	3300.25	3960.30
	*Exchange Surcharge			60.00	72.00
All military 2.5L petrol models with 24V system - 24V system					
New, outright	Genuine	1	<b>ERR5693</b>	1022.38	1226.86



## 90 (1983-1989)

## ENGINE GASKETS

## Gasket Rocker Cover

All 2.5L petrol models - Self adhesive					
	Aftermarket	1	<b>ERR4933P</b>	1.00	1.20
	Genuine	1	<b>ERR4933</b>	11.78	14.14
All 2.5L N/A diesel models - Self adhesive					
	Aftermarket	1	<b>ETC6438P</b>	0.92	1.10
	Genuine	1	<b>ETC6438</b>	7.20	8.64
All V8 petrol models					
Rubber	OEM	2	<b>GEG436UPRATED</b>	2.65	3.18
Cork	OEM	2	<b>GEG436</b>	1.58	1.90

## Gasket Cylinder Head

2.5L petrol models					
	Aftermarket	1	<b>ERC6380P</b>	3.25	3.90
	OEM	1	<b>ERC6380P1</b>	12.95	15.54
	Genuine	1	<b>ERC6380</b>	25.12	30.14
2.5L N/A and Turbo Diesel models					
	Aftermarket	1	<b>ERR3618P</b>	3.00	3.60
	OEM	1	<b>ERR3618P1</b>	9.79	11.75
	Genuine	1	<b>ERR3618</b>	36.82	44.18
V8 petrol models - Original style tin head gasket					
	Aftermarket	2	<b>603796P</b>	1.92	2.30
	Genuine	2	<b>603796</b>	10.18	12.22
All 3.5L V8 petrol models					
Tin type gasket					
	Aftermarket	2	<b>GEG340</b>	5.00	6.00
	Aftermarket	2	<b>GEG340P</b>	2.08	2.50
Composite type gasket					
	Aftermarket	2	<b>GEG340COM</b>	15.42	18.50
	Aftermarket	2	<b>GEG340COMP</b>	6.04	7.25
	Genuine	2	<b>ERR4248</b>	35.01	42.01

## Gasket Oil Sump

2.5L petrol models					
	Aftermarket	1	<b>546841P</b>	1.00	1.20
	OEM	1	<b>546841P1</b>	2.42	2.90
	Genuine	1	<b>546841</b>	17.82	21.38
2.5L N/A diesel models					
	Aftermarket	1	<b>546841P</b>	1.00	1.20
	OEM	1	<b>546841P1</b>	2.42	2.90
	Genuine	1	<b>546841</b>	17.82	21.38
All V8 petrol models					
	Aftermarket	1	<b>AJM539P</b>	1.00	1.20
	Aftermarket	1	<b>AJM539</b>	4.08	4.90

## Gasket Decoke Set

2.5L petrol models					
	Aftermarket	1	<b>STC1640P</b>	8.54	10.25
	OEM	1	<b>STC1640P1</b>	21.67	26.00
	Genuine	1	<b>STC1640</b>	71.31	85.57
2.5L N/A diesel models					
	Aftermarket	1	<b>STC1562P</b>	9.79	11.75
	OEM	1	<b>STC1562P1</b>	24.58	29.50
	Genuine	1	<b>STC1562</b>	107.15	128.58
2.5L Turbo Diesel models					
	Aftermarket	1	<b>RTC5774P</b>	11.88	14.26
	OEM	1	<b>RTC5774P1</b>	45.00	54.00
	Genuine	1	<b>RTC5774</b>	118.92	142.70
V8 petrol models - Includes original fitment tin head gasket					
	Aftermarket	1	<b>STC1566P</b>	11.67	14.00
	Genuine	1	<b>STC1566</b>	133.80	160.56
All 3.5L V8 petrol models - Includes tin type head gasket					
	Aftermarket	1	<b>GUG1066HS</b>	20.42	24.50
	Aftermarket	1	<b>GUG1066HSCM</b>	19.79	23.75
Includes composite type head gasket					
	Aftermarket	1	<b>GUG1066HSCOM</b>	33.33	40.00

## Gasket Conversion Set

2.5L petrol models					
	Aftermarket	1	<b>STC1467P</b>	6.88	8.26
	OEM	1	<b>STC1467P1</b>	29.58	35.50
	Genuine	1	<b>STC1467</b>	127.06	152.47
All 2.5L N/A diesel models					
	Aftermarket	1	<b>STC1559P</b>	11.04	13.25
	Genuine	1	<b>STC1559</b>	93.01	111.61
	Genuine	1	<b>STC1560</b>	160.93	193.12
2.5L Turbo Diesel models					
	Aftermarket	1	<b>STC1558P</b>	10.63	12.76
All 3.5L V8 carb petrol models					
	Aftermarket	1	<b>GUG1538CS</b>	13.13	15.76
	Aftermarket	1	<b>GUG1538CSP</b>	10.83	13.00
V8 petrol models					
	Aftermarket	1	<b>STC1639P</b>	9.79	11.75
	OEM	1	<b>STC1639P1</b>	25.83	31.00
	Genuine	1	<b>STC1639</b>	60.34	72.41

## Silicone Sealant RTV

Numerous applications					
	Aftermarket	a/r	<b>RTC3254P</b>	5.00	6.00
	Genuine	a/r	<b>RTC3254</b>	21.04	25.25

## Sealant Instant Gasket

Numerous applications					
	Genuine	a/r	<b>STC50550</b>	13.10	15.72





# ENGINE SWITCHES

**90 (1983-1989)**

## Temperature Sensor Oil Pump

All V8 carb petrol engine models	Aftermarket	1	<b>PRC2236P</b>	3.50	4.20
----------------------------------	-------------	---	-----------------	------	------

**PRC2236P**

## Oil Pressure Switch

All 4 cyl models	Aftermarket	1	<b>PRC6387P</b>	1.83	2.20
	OEM	1	<b>PRC6387P1</b>	3.50	4.20
	Genuine	1	<b>PRC6387</b>	28.77	34.52
All V8 carb petrol engine models	Aftermarket	1	<b>DRC2479A</b>	29.58	35.50
All V8 petrol engine models	Aftermarket	1	<b>STC4104P</b>	3.00	3.60
	OEM	1	<b>STC4104P1</b>	12.50	15.00
	Genuine	1	<b>STC4104</b>	29.01	34.81

# DRAIN PLUGS

**90 (1983-1989)**

## Sump Plug Magnetic

All petrol and diesel models except V8	Genuine	1	<b>ETC5577</b>	3.53	4.24
----------------------------------------	---------	---	----------------	------	------

## Sump Plug

All V8 petrol models	Aftermarket	1	<b>603659A</b>	2.83	3.40
----------------------	-------------	---	----------------	------	------

## Sump Plug Washer

All petrol and diesel models	Aftermarket	1	<b>213961A</b>	1.25	1.50
------------------------------	-------------	---	----------------	------	------

## Washer Sump Plug

All 4 cyl petrol models	Aftermarket	1	<b>FRC4808P</b>	0.58	0.70
	Genuine	1	<b>FRC4808</b>	1.83	2.20
All 2.5L N/A and Turbo Diesel models	Aftermarket	1	<b>FRC4808P</b>	0.58	0.70
	Genuine	1	<b>FRC4808</b>	1.83	2.20
All models with LT230 transfer box	Aftermarket	1	<b>FRC4808P</b>	0.58	0.70
	Genuine	1	<b>FRC4808</b>	1.83	2.20

## Copper Sealing Washer

Numerous applications	Aftermarket	1	<b>ETC7398P</b>	0.75	0.90
	Genuine	1	<b>ETC7398</b>	1.55	1.86

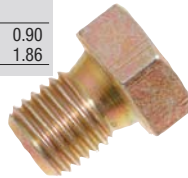
**ETC5577**

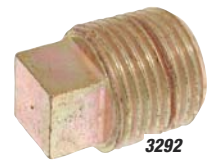
**603659A**

**3292**

# OIL SEALS ENGINE

**90 (1983-1989)**

## Oil Seal Crankshaft Front

All 4 cyl and 8 cyl models	Aftermarket	1	<b>ERR6490P</b>	3.00	3.60
	OEM	1	<b>ERR6490P1</b>	5.00	6.00
2.5L petrol models with twin lip seal	Aftermarket	1	<b>ETC5187P</b>	0.75	0.90
	OEM	1	<b>ETC5187P1</b>	3.83	4.60
	Genuine	1	<b>ETC5187</b>	11.33	13.60

## Oil Seal Front Cover

All 4cyl and 8 cyl models	Aftermarket	1	<b>ETC4154P</b>	1.08	1.30
	OEM	1	<b>ETC4154P1</b>	3.00	3.60
	Genuine	1	<b>ETC4154</b>	14.67	17.60

**ERR6490P**

**ERR2532P**

## Oil Seal Crankshaft Rear

2.5L petrol, 2.5L N/A and Turbo Diesel models	Aftermarket	1	<b>ERR2532P</b>	2.00	2.40
	OEM	1	<b>ERR2532P1</b>	5.83	7.00
	Genuine	1	<b>ERR2532</b>	21.00	25.20
All V8 petrol models - Lip type seal	Aftermarket	1	<b>ERR2640P</b>	3.00	3.60
	OEM	1	<b>ERR2640P1</b>	7.92	9.50
	Genuine	1	<b>ERR2640</b>	15.58	18.70

## Oil Seal Camshaft

2.5L N/A and Turbo Diesel models	Aftermarket	1	<b>ETC5064P</b>	2.08	2.50
	OEM	1	<b>ETC5064P1</b>	2.50	3.00
	Genuine	1	<b>ETC5064</b>	21.23	25.48

## O Ring Camshaft Small

All 2.5L N/A & Turbo Diesel models - Camshaft pulley retaining plate	Genuine	1	<b>ERC8849</b>	0.61	0.73
----------------------------------------------------------------------	---------	---	----------------	------	------

# ENGINE & GEARBOX MOUNTINGS

**90 (1983-1989)**

## Engine Mounting

All 4 cyl models - Engine and gearbox, M10 thread	Aftermarket	2	<b>ANR1808P</b>	2.33	2.80
	OEM	2	<b>ANR1808P1</b>	3.58	4.30
	Genuine	2	<b>ANR1808</b>	17.50	21.00
All V8 petrol models - With M12 metric threads	Aftermarket	4	<b>STC434P</b>	2.33	2.80
	OEM	4	<b>STC434P1</b>	9.38	11.26
	Genuine	4	<b>STC434</b>	23.83	28.60

## Bracket Engine Mounting

All 4 cyl models	RH	Genuine	1	<b>NRC5434</b>	103.48	124.18
	LH	Genuine	1	<b>NRC9557</b>	143.30	171.96

## Gearbox Mounting

All V8 petrol models - With M12 metric threads	Aftermarket	4	<b>STC434P</b>	2.33	2.80
	OEM	4	<b>STC434P1</b>	9.38	11.26
	Genuine	2	<b>STC434</b>	23.83	28.60

## Bracket Gearbox Mounting

All V8 petrol models - RH	Genuine	1	<b>ANR4657</b>	68.90	82.68
All V8 petrol models with 5 speed LT85 gearbox	Genuine	1	<b>NRC9501</b>	42.45	50.94

**ANR1808**

**STC434**

## 90 (1983-1989)

## CABLES

## Accelerator Cable

All RHD 2.5L petrol models	Aftermarket	1	<b>NRC8116P</b>	4.00	4.80
	Genuine	1	<b>NRC8116</b>	148.51	178.21
All RHD 2.5L petrol models up to (VIN) BA295722	Aftermarket	1	<b>NTC2086P</b>	3.75	4.50
	Genuine	1	<b>NTC2086</b>	22.07	26.48
All RHD 2.5L petrol models from (VIN) BA295723 on	Aftermarket	1	<b>NTC3460P</b>	7.50	9.00
	Genuine	1	<b>NTC3460</b>	74.35	89.22
All RHD diesel models with hand throttle to (VIN) AA267061					
Secondary (hand) throttle	Genuine	1	<b>NRC8502</b>	56.74	68.09
RHD 2.5L NA diesel models (VIN) AA267062 on	Aftermarket	1	<b>NTC2743P</b>	6.88	8.26
	Genuine	1	<b>NTC2743</b>	83.79	100.55
All RHD 2.5L Turbo Diesel models	Aftermarket	1	<b>NTC2743P</b>	6.88	8.26
	Genuine	1	<b>NTC2743</b>	83.79	100.55
All 4 cyl petrol models with hand throttle					
Secondary (hand) throttle	Genuine	1	<b>NRC8560</b>	245.88	295.06
All V8 carb petrol models	Aftermarket	1	<b>NRC5494P</b>	4.58	5.50
	Genuine	1	<b>NRC5494</b>	57.35	68.82
All RHD V8 carb petrol models with hand throttle					
Secondary (hand) throttle	Genuine	1	<b>NRC9284</b>	21.22	25.46
All LHD 2.5L petrol models up to (VIN) AA295722	Aftermarket	1	<b>NTC2087P</b>	4.00	4.80
	Genuine	1	<b>NTC2087</b>	68.10	81.72
LHD 2.5L petrol models from (VIN) BA295734 on	Aftermarket	1	<b>NTC3459P</b>	4.00	4.80
LHD 2.5L NA diesel models to (VIN) AA267061	Aftermarket	1	<b>NRC7606P</b>	2.75	3.30
	Genuine	1	<b>NRC7606</b>	48.41	58.09
LHD 2.5L NA diesel models with hand throttle from (VIN) AA267062 to HA456213					
Secondary (hand) throttle	Genuine	1	<b>NTC3483</b>	81.70	98.04
All LHD 2.5L normally aspirated diesel models from (VIN) AA267061 on	Aftermarket	1	<b>NTC3396P</b>	5.00	6.00
	Genuine	1	<b>NTC3396</b>	75.66	90.79
All LHD 2.5L turbo diesel models (not TDi)	Aftermarket	1	<b>NTC3396P</b>	5.00	6.00
	Genuine	1	<b>NTC3396</b>	75.66	90.79
All LHD diesel models with hand throttle to (VIN) AA267061					
Secondary (hand) throttle	Genuine	1	<b>NRC8503</b>	56.80	68.16
LHD 2.5L Turbo Diesel models with hand throttle from (VIN) AA267062 to HA456213					
Secondary (hand) throttle	Genuine	1	<b>NTC3483</b>	81.70	98.04
All LHD diesel models with hand throttle from (VIN) AA267062 to HA456213					
Secondary (hand) throttle	Genuine	1	<b>NTC3484</b>	127.86	153.43
All LHD V8 carb petrol models with hand throttle					
Secondary (hand) throttle	Genuine	1	<b>NRC9285</b>	81.70	98.04

## Bonnet Release Cable

All models	Aftermarket	1	<b>ALR9556P</b>	3.33	4.00
	Genuine	1	<b>ALR9556</b>	19.00	22.80

## Choke Cable

All RHD 4 cyl petrol models	Aftermarket	1	<b>NTC1384P</b>	11.67	14.00
	Genuine	1	<b>NTC1384</b>	44.09	52.91
All RHD 4 cyl petrol models up to (VIN) AA270139	Aftermarket	1	<b>NRC8626P</b>	8.96	10.75
All RHD V8 petrol models up to (VIN) AA268051	Aftermarket	1	<b>NRC7792P</b>	9.79	11.75
All RHD V8 carb petrol models from (VIN) AA268052 on	Aftermarket	1	<b>NTC3932P</b>	27.50	33.00
	Genuine	1	<b>NTC3932</b>	47.39	56.87
All LHD 4 cyl petrol models up to (VIN) AA270139	Genuine	1	<b>NRC8627</b>	35.16	42.19
All LHD 4 cyl petrol models from (VIN) AA270140 on	Aftermarket	1	<b>NTC1385P</b>	10.63	12.76
	Genuine	1	<b>NTC1385</b>	68.83	82.60
All LHD V8 petrol models up to (VIN) AA268051	Aftermarket	1	<b>NRC7791P</b>	16.67	20.00
All LHD V8 carb petrol models from (VIN) AA268052 on	Aftermarket	1	<b>NTC3933P</b>	25.00	30.00
	Genuine	1	<b>NTC3933</b>	43.03	51.64

## Speedometer Cable

All RHD 4 cyl models to (VIN) AA266613 - Two piece cable, upper end	Aftermarket	1	<b>PRC5567P</b>	2.50	3.00
	Genuine	1	<b>PRC5567</b>	48.60	58.32
All RHD 4 cyl petrol & diesel models from (VIN) AA267908 on except Police or overspeed warning fitted models - One piece cable	Aftermarket	1	<b>PRC6022P</b>	4.79	5.75
	Genuine	1	<b>PRC6022</b>	113.28	135.94
All RHD V8 models to (VIN) AA267907 - Two piece cable, upper end	Aftermarket	1	<b>PRC5567P</b>	2.50	3.00
	Genuine	1	<b>PRC5567</b>	48.60	58.32
Two piece cable, lower end	Aftermarket	1	<b>PRC5564P</b>	4.79	5.75
All RHD V8 models from (VIN) AA267908 on					
One piece cable	Aftermarket	1	<b>PRC6023P</b>	5.00	6.00
	Genuine	1	<b>PRC6023</b>	85.06	102.07
All LHD models to (VIN) AA267696					
Two piece cable, upper end	Aftermarket	1	<b>PRC5567P</b>	2.50	3.00
	Genuine	1	<b>PRC5567</b>	48.60	58.32



## 90 (1983-1989)

## WINDOW REGULATORS

## Window Regulator

All models					
Front RH	Aftermarket	1	<b>MUC3024P</b>	10.62	12.74
	Genuine	1	<b>MUC3024</b>	136.50	163.80
Front LH	Aftermarket	1	<b>MUC3025P</b>	12.08	14.50
	Genuine	1	<b>MUC3025</b>	109.40	131.28

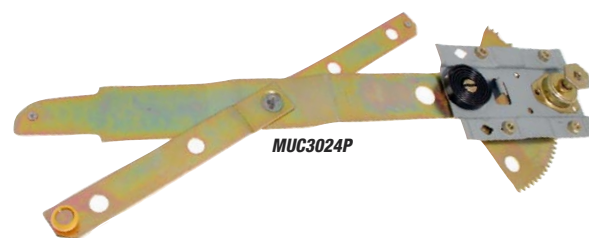

## 90 (1983-1989)

## WHEEL CENTRE CAP &amp; WHEEL NUTS

## Wheel Centre Cap

All models with Alpine White (NUC) 5 spoke steel wheels - Alpine White, features Land Rover Logo					
	Genuine	a/r	<b>ANR3861</b>	3.09	3.71

## Wheel Stud

All models - Front and rear hubs	Aftermarket	a/r	<b>FRC6137P</b>	0.46	0.55
	Genuine	a/r	<b>FRC6137</b>	4.25	5.10
All models - Extended, 60mm (original fitment for Defender Wolf/XD). Allows fitment of certain alternative wheels	OEM	a/r	<b>FRC7577P1</b>	5.83	7.00
	Genuine	a/r	<b>FRC7577</b>	19.36	23.23

## Wheel Nut

All models with alloy spare wheel - Alloy spare wheel only					
	Genuine	a/r	<b>ANR4914</b>	8.42	10.10
All models with alloy wheels - Without stainless steel cap	Aftermarket	a/r	<b>NRC7415P</b>	2.00	2.40
	OEM	a/r	<b>NRC7415P1</b>	2.75	3.30
	Genuine	a/r	<b>NRC7415</b>	2.97	3.56
All models with steel wheels	Aftermarket	a/r	<b>RRD500010P</b>	0.79	0.95
	Genuine	a/r	<b>RRD500010</b>	1.82	2.18





# 110 (1983-1989)

## 1983 to 1989 All Models

Listed below are the most popular parts required for the Land Rover 110.

We have access to the full range of parts for your vehicle. Please contact us if not listed here.



## SERVICE KITS

### Filter Kit

All 2.5L TD5 diesel models - Includes oil filter, air filter, rotor filter, fuel filter & sump plug washer				
Aftermarket	1	<b>LL1346P</b>	11.50	13.80
Genuine	1	<b>LL1346</b>	70.83	85.00
All 200 TDi diesel models - Includes oil filter, air filter, fuel filter & sump plug washer				
Aftermarket	1	<b>LL1344P</b>	9.58	11.50
Genuine	1	<b>LL1344</b>	42.50	51.00
All 300 TDi diesel models - Includes oil filter, air filter, fuel filter & sump plug washer				
Aftermarket	1	<b>LL1345P</b>	9.79	11.75
Genuine	1	<b>LL1345</b>	40.00	48.00



## 110 (1983-1989)

## FILTRATION

### Oil Filter - Cartridge

All models with 2.25L petrol engine				
Aftermarket	1	<b>ERR3340P</b>	2.00	2.40
OEM	1	<b>ERR3340P1</b>	3.33	4.00
Genuine	1	<b>ERR3340</b>	10.82	12.98
All models with 2.5L petrol engine				
Aftermarket	1	<b>ERR3340P</b>	2.00	2.40
OEM	1	<b>ERR3340P1</b>	3.33	4.00
Genuine	1	<b>ERR3340</b>	10.82	12.98
All models with 2.5L normally aspirated diesel engine				
Aftermarket	1	<b>ERR3340P</b>	2.00	2.40
OEM	1	<b>ERR3340P1</b>	3.33	4.00
Genuine	1	<b>ERR3340</b>	10.82	12.98
All models with 2.5L turbo diesel engine				
Aftermarket	1	<b>ERR3340P</b>	2.00	2.40
OEM	1	<b>ERR3340P1</b>	3.33	4.00
Genuine	1	<b>ERR3340</b>	10.82	12.98
All models with V8 petrol engine				
Aftermarket	1	<b>ERR3340P</b>	2.00	2.40
OEM	1	<b>ERR3340P1</b>	3.33	4.00
Genuine	1	<b>ERR3340</b>	10.82	12.98

### Air Filter

All petrol models except V8 up to (VIN) FA375497				
Aftermarket	1	<b>NRC9238P</b>	5.83	7.00
OEM	1	<b>NRC9238P1</b>	7.08	8.50
Genuine	1	<b>NRC9238</b>	17.46	20.95
All diesel models up to (VIN) FA375497				
Aftermarket	1	<b>NRC9238P</b>	5.83	7.00
OEM	1	<b>NRC9238P1</b>	7.08	8.50
Genuine	1	<b>NRC9238</b>	17.46	20.95
All V8 petrol engine models				
Aftermarket	1	<b>RTC3479P</b>	9.58	11.50
Genuine	1	<b>RTC3479</b>	41.44	49.73

### Fuel Filter

All 2.25L diesel models - Element for in line filter assembly				
Aftermarket	1	<b>90517711P</b>	1.83	2.20
Aftermarket	1	<b>GFE5296</b>	3.50	4.20
Genuine	1	<b>90517711</b>	4.92	5.90
All 2.25L petrol models - Element for in line filter assembly				
Aftermarket	1	<b>JS660LP</b>	1.33	1.60
Genuine	1	<b>JS660L</b>	3.06	3.67
All 2.5L normally aspirated diesel models - Element for in line filter assembly				
Aftermarket	1	<b>90517711P</b>	1.83	2.20
Aftermarket	1	<b>GFE5296</b>	3.50	4.20
Genuine	1	<b>90517711</b>	4.92	5.90
All 2.5L petrol models - Element for in line filter assembly				
Aftermarket	1	<b>JS660LP</b>	1.33	1.60
Genuine	1	<b>JS660L</b>	3.06	3.67
All 2.5L Turbo Diesel (not Tdi) models - Element for in line filter assembly				
Aftermarket	1	<b>90517711P</b>	1.83	2.20
Aftermarket	1	<b>GFE5296</b>	3.50	4.20
Genuine	1	<b>90517711</b>	4.92	5.90
All 3.5L V8 carb petrol models - Element for in line filter assembly				
Aftermarket	1	<b>JS660LP</b>	1.33	1.60
Genuine	1	<b>JS660L</b>	3.06	3.67

### Fuel Filter Complete Assembly

All 2.25L petrol models				
Aftermarket	1	<b>NRC9786P</b>	16.88	20.26
Genuine	1	<b>NRC9786</b>	98.07	117.68
All 2.5L petrol models				
Aftermarket	1	<b>NRC9786P</b>	16.88	20.26
Genuine	1	<b>NRC9786</b>	98.07	117.68
All 3.5L V8 carb petrol models				
Aftermarket	1	<b>NRC9786P</b>	16.88	20.26
Genuine	1	<b>NRC9786</b>	98.07	117.68
All diesel engine models - Sedimentor type				
Aftermarket	1	<b>NRC9708P</b>	17.08	20.50
OEM	1	<b>NRC9708P1</b>	26.67	32.00
Genuine	1	<b>NRC9708</b>	76.51	91.81

### Fuel Filter Seal

All diesel engine models				
Bottom, for sedimentor filter				
Aftermarket	1	<b>AAU9902P</b>	0.58	0.70
Genuine	1	<b>AAU9902</b>	1.78	2.14
Top, for sedimentor filter				
Aftermarket	1	<b>AAU9903P</b>	0.33	0.40
Genuine	1	<b>AAU9903</b>	1.78	2.14
All diesel models				
Aftermarket	1	<b>605011</b>	0.32	0.38
Genuine	1	<b>605011</b>	0.32	0.38



ERR3340



NRC9786P



GFE5296



RTC3058

## WIPER BLADES

### Wiper Blade

All models up to (VIN) EA452017				
Front and rear, spigot fixing				
Aftermarket	3	<b>LR079891P</b>	2.33	2.80
OEM	3	<b>LR079891P1</b>	3.08	3.70
Genuine	3	<b>LR079891</b>	9.31	11.17
All models from (VIN) FA452018				
Front and rear, hook fitting				
Aftermarket	3	<b>LR079891P</b>	2.33	2.80
OEM	3	<b>LR079891P1</b>	3.08	3.70
Genuine	3	<b>LR079891</b>	9.31	11.17



LR079891

## 110 (1983-1989)



## 110 (1983-1989)

## SCREEN/LAMP WASHER SYSTEMS

## Washer Jet

All models up to (VIN) AA270226 - Front screen				
	Aftermarket	2	<b>PRC2437P</b>	2.25 2.70
	Genuine	2	<b>PRC2437</b>	7.56 9.07
All models from (VIN) AA270227 on - Front screen, twin jet type				
	Aftermarket	1	<b>LR061677P</b>	2.00 2.40
	Genuine	1	<b>LR061677</b>	7.80 9.36
All models with rear screen wash - Rear screen				
	Aftermarket	1	<b>LR061678P</b>	2.25 2.70
	Genuine	1	<b>LR061678</b>	5.32 6.38
All models with rear wash/wipe up to (VIN) AA270226 (1986) - Rear screen wash				
	Genuine	1	<b>EAM9332</b>	1.95 2.34

## Washer Jet Repair Kit

All models				
Front screen wash (twin nozzle jet - allows replacement of broken outer section without having to remove dash top to replace whole assembly. DNJ500290 adhesive also required)				
	Genuine	1	<b>DNJ500270</b>	9.49 11.39

## Windscreen Washer Pump

All models to (VIN) AA270226				
	Aftermarket	1	<b>GWW125</b>	9.38 11.26
All non air conditioning models with rear screen wash				
	Aftermarket	1	<b>STC1453P</b>	4.00 4.80
All models from (VIN) AA270227 on with air conditioning				
	Aftermarket	1	<b>GWW1194</b>	7.50 9.00
All models with air conditioning or with headlamp wash from (VIN) AA270227 on				
	Genuine	1	<b>DRC2713L</b>	40.97 49.16



LR061677



GWW125

## Windscreen Washer Pump Link Lead

All models without air conditioning or headlamp wash				
Fit with STC1453 pump as replacement for original windscreen washer pump				
	Aftermarket	1	<b>AMR3849P</b>	5.42 6.50
	Genuine	1	<b>AMR3849</b>	11.05 13.26

## Washer Hose, Per Metre

All models - 4mm internal diameter (3mm also available)				
	Aftermarket	a/r	<b>GWW201M</b>	2.25 2.70

## Washer Reservoir

All models with rear screen wash/wipe with air conditioning				
	Genuine	1	<b>PRC5765</b>	89.57 107.48
All models up to (VIN) AA270226 with headlamp wash without air conditioning				
	Genuine	1	<b>PRC3300</b>	71.11 85.33
All models with air conditioning without headlamp wash up to (VIN) AA270226				
	Genuine	1	<b>PRC3786</b>	43.53 52.24
All models without air conditioning or headlamp wash from (VIN) AA270227 on				
	Genuine	1	<b>PRC5744</b>	33.26 39.91
	Genuine	1	<b>PRC5773</b>	94.77 113.72
All models with rear screen wash/wipe and headlamp wash without air conditioning from (VIN) AA270227 on				
	Genuine	1	<b>PRC5777</b>	42.63 51.16
All models with rear screen wash/wipe and headlamp wash (South Africa, Sweden) from (VIN) AA270227 on				
	Genuine	1	<b>PRC5773</b>	94.77 113.72
	Genuine	1	<b>PRC5744</b>	33.26 39.91

## Washer Reservoir Cap

All models with air conditioning or with headlamp wash - 45mm dia.				
	Genuine	1	<b>DMG10005L</b>	3.10 3.72

## Washer Reservoir &amp; Pump

All models with rear screen wash/wipe up to (VIN) AA270226				
	Genuine	1	<b>STC3803</b>	118.18 141.82

## Windscreen Cleaning Paste

All models - Prevents wiper blade judder/squeak by 'deep cleaning' the windscreen (ref: Land Rover Tech Bulletin LRA501-002)				
	Genuine	a/r	<b>DNJ500340</b>	7.72 9.26

## 110 (1983-1989)

## DRIVE BELTS

## Timing Belt Kit

All 2.5L N/A diesel models				
	Britpart	1	<b>ETC7333BPK</b>	27.08 32.50
All 2.5L Turbo Diesel models				
	Britpart	1	<b>ETC7333BPK</b>	27.08 32.50

## Timing Belt

All models with 2.5L normally aspirated diesel engine				
	OEM	1	<b>ETC7333P1</b>	6.67 8.00
	Genuine	1	<b>ETC7333</b>	38.00 45.60
All models with 2.5L turbo diesel engine (not TDi)				
	OEM	1	<b>ETC7333P1</b>	6.67 8.00
	Genuine	1	<b>ETC7333</b>	38.00 45.60

## Alternator Drive Belt

All models with 2.5L normally aspirated diesel engine				
	Aftermarket	1	<b>ETC7939P</b>	2.25 2.70
	OEM	1	<b>ETC7939P1</b>	3.83 4.60
	Genuine	1	<b>ETC7939</b>	15.73 18.88
All models with 2.5L turbo diesel engine				
	Aftermarket	1	<b>ETC7939P</b>	2.25 2.70
	OEM	1	<b>ETC7939P1</b>	3.83 4.60
	Genuine	1	<b>ETC7939</b>	15.73 18.88
All models with V8 carb engine, without air conditioning				
	Aftermarket	1	<b>ETC7394P</b>	2.50 3.00
	OEM	1	<b>ETC7394P1</b>	3.50 4.20
	Genuine	1	<b>ETC7394</b>	26.11 31.33
Models with V8 carb engine and air conditioning				
	Aftermarket	1	<b>ERR2073P</b>	2.83 3.40
	Genuine	1	<b>ERR2073</b>	7.86 9.43
All V8 carb models with air conditioning up to Aug. 1986				
	Aftermarket	1	<b>ERC8852P</b>	1.67 2.00
	Genuine	1	<b>ERC8852</b>	10.46 12.55



ETC7939P1

## Fan Belt

Civilian models with 2.25L 4 cyl engines (not split charge)				
	Aftermarket	1	<b>563132 L-RP</b>	1.25 1.50
2.25L 4 cyl petrol engine models with split charge				
	Aftermarket	1	<b>ERC8938P</b>	2.67 3.20
	Genuine	1	<b>ERC8938</b>	16.07 19.28
Civilian models with 2.5L 4 cyl petrol engines (not split charge)				
	Aftermarket	1	<b>563132 L-RP</b>	1.25 1.50
2.5L 4 cyl petrol engine models with air conditioning				
	Aftermarket	1	<b>ERC8938P</b>	2.67 3.20
	Genuine	1	<b>ERC8938</b>	16.07 19.28
Civilian models with 2.5L 4 cyl normally aspirated diesel engines (not split charge)				
	Aftermarket	1	<b>563132 L-RP</b>	1.25 1.50
V8 carb engine models without power steering or air conditioning				
	Aftermarket	1	<b>613602P</b>	2.33 2.80
	OEM	1	<b>613602P1</b>	3.83 4.60
All models with V8 carb engine				
	Aftermarket	1	<b>614670P</b>	1.50 1.80
	Genuine	1	<b>614670</b>	15.16 18.19

## PAS Belt

All models with 2.25L petrol engine				
	Aftermarket	1	<b>ETC4272P</b>	2.25 2.70
	Aftermarket	1	<b>ETC5815P</b>	1.75 2.10
	OEM	1	<b>ETC5815P1</b>	2.50 3.00
	Genuine	1	<b>ETC5815</b>	20.62 24.74
	Aftermarket	1	<b>ERC5146P</b>	3.33 4.00
	Genuine	1	<b>ERC5146</b>	16.94 20.33
All models with 2.5L petrol engine				
	Aftermarket	1	<b>ETC4272P</b>	2.25 2.70
	Aftermarket	1	<b>ETC5815P</b>	1.75 2.10
	OEM	1	<b>ETC5815P1</b>	2.50 3.00
	Genuine	1	<b>ETC5815</b>	20.62 24.74
	Aftermarket	1	<b>ERC5146P</b>	3.33 4.00
	Genuine	1	<b>ERC5146</b>	16.94 20.33
All models with 2.5L normally aspirated diesel engine				
	Aftermarket	1	<b>ETC4272P</b>	2.25 2.70
	Aftermarket	1	<b>ETC5815P</b>	1.75 2.10
	OEM	1	<b>ETC5815P1</b>	2.50 3.00
	Genuine	1	<b>ETC5815</b>	20.62 24.74
	Aftermarket	1	<b>ERC5146P</b>	3.33 4.00
	Genuine	1	<b>ERC5146</b>	16.94 20.33
All models with V8 carb engine				
	Aftermarket	1	<b>ERC675P</b>	2.83 3.40
	OEM	1	<b>ERC675P1</b>	3.33 4.00
	Genuine	1	<b>ERC675</b>	21.28 25.54

## A/C Belt

All V8 carb models with air conditioning - Air cond compressor				
	Aftermarket	1	<b>603713P</b>	2.67 3.20





# IGNITION SYSTEM

**110 (1983-1989)**

## Spark Plug

2.25L petrol models with 7:1 comp ratio	Aftermarket	4	<b>RTC3571P</b>	1.58	1.90
	OEM	4	<b>RTC3571P1</b>	1.50	1.80
All 2.5L petrol engine models					
RN9YC type	Aftermarket	4	<b>ERR743P</b>	1.75	2.10
	Genuine	4	<b>ERR743</b>	4.03	4.84
RN11YC type	Aftermarket	4	<b>ERR3799P</b>	2.00	2.40
	Genuine	4	<b>ERR3799</b>	4.19	5.03
N9YC type	Genuine	4	<b>RTC3812</b>	3.03	3.64
	Genuine	4	<b>RTC3812X</b>	2.59	3.11
All V8 carb petrol engine models					
N12Y type	Aftermarket	8	<b>RTC3570P</b>	1.83	2.20
	Genuine	8	<b>RTC3570X</b>	3.25	3.90
All V8 carb petrol models with 9.35:1 compression ratio, std performance					
19mm reach	MG Rover	8	<b>GSP4362</b>	2.95	3.54
All V8 carb petrol models with 8.13:1 compression ratio, std performance					
19mm reach	MG Rover	8	<b>GSP4382</b>	2.95	3.54
All V8 carb petrol models with 9.35:1 compression ratio, high performance					
19mm reach, double core	MG Rover	8	<b>GSP6462</b>	2.95	3.54
All V8 petrol engine models					
RN11YC type	Aftermarket	8	<b>ERR3799P</b>	2.00	2.40
	Genuine	8	<b>ERR3799</b>	4.19	5.03

## Glow Plug

All diesel engine models	Aftermarket	4	<b>ERC8450P</b>	2.25	2.70
	OEM	4	<b>ERC8450P1</b>	7.29	8.75
	Genuine	4	<b>ERC8450</b>	14.18	17.02

## Ignition Coil

All 2.25L petrol engine models	Aftermarket	1	<b>PRC9858P</b>	7.35	8.82
	OEM	1	<b>PRC9858P1</b>	12.92	15.50
	Genuine	1	<b>PRC9858</b>	77.61	93.13
All 2.5L petrol engine models	Aftermarket	1	<b>PRC9858P</b>	7.35	8.82
	OEM	1	<b>PRC9858P1</b>	12.92	15.50
	Genuine	1	<b>PRC9858</b>	77.61	93.13
V8 carb petrol engines up to 1986 - Ballasted type	Aftermarket	1	<b>8510047P</b>	7.50	9.00
	Genuine	1	<b>8510047</b>	70.62	84.74
All V8 carb petrol engine models from (VIN) BA on					
Lucas type	Aftermarket	1	<b>RTC5628P</b>	9.58	11.50
	OEM	1	<b>RTC5628P1</b>	14.58	17.50
	Genuine	1	<b>RTC5628</b>	94.86	113.83
Bosch type	Aftermarket	1	<b>PRC6574P</b>	15.83	19.00
	OEM	1	<b>PRC6574P1</b>	39.58	47.50
	Genuine	1	<b>PRC6574</b>	114.80	137.76

## Contact Set

All 4 cyl petrol models fitted with Lucas 59D type distributor - Blue sliding contact type set	Aftermarket	1	<b>GCS261</b>	6.88	8.26
2.25L petrol engine models with Ducellier distributor	Aftermarket	1	<b>RTC6625P</b>	1.50	1.80
All 2.25L and 2.5L petrol engine models - Type 45D/59D distributor, fixed contact set (alternative to sliding contact set)	Aftermarket	1	<b>RTC3288P</b>	0.92	1.10
	Genuine	1	<b>RTC3288</b>	1.70	2.04
sliding contact set (alternative to fixed contact set)	Aftermarket	1	<b>RTC6627P</b>	2.00	2.40
	Genuine	1	<b>RTC6627</b>	10.32	12.38
All V8 carb petrol models with points type distributors	Aftermarket	1	<b>GCS2117P</b>	4.08	4.90
	Aftermarket	1	<b>GCS2117</b>	7.50	9.00

## Adjustment Bush, Contact Set

All V8 petrol models with points type distributor - For sliding points type distributor	Genuine	1	<b>RTC5014</b>	1.33	1.60
-----------------------------------------------------------------------------------------	---------	---	----------------	------	------

## Rotor Arm

2.25L and 2.5L petrol engine models with Lucas distributor					
Type 45D/59D distributor	Aftermarket	1	<b>RTC3614P</b>	1.00	1.20
	Aftermarket	1	<b>GRA114</b>	2.33	2.80
Red, as original, for type 45D/59D distributor	Lucas	1	<b>GRA114RED</b>	7.50	9.00
2.25L petrol engine models with Ducellier distributor	Aftermarket	1	<b>RTC4933P</b>	1.00	1.20
	Genuine	1	<b>RTC4933</b>	3.77	4.52
All V8 carb petrol models with points type distributor	Aftermarket	1	<b>RTC3618P</b>	2.00	2.40
All V8 petrol engines with electronic ignition	Aftermarket	1	<b>STC1857P</b>	2.33	2.80
	OEM	1	<b>STC1857P1</b>	9.58	11.50
	Genuine	1	<b>STC1857</b>	15.18	18.22
Red	OEM	1	<b>GRA117RED</b>	7.50	9.00

## Condenser

2.25L and 2.5L petrol engine models with Lucas distributor - Type 45D/59D distributor	Aftermarket	1	<b>RTC6621P</b>	1.00	1.20
	Aftermarket	1	<b>GSC109</b>	2.33	2.80
	Aftermarket	1	<b>RTC3524P</b>	2.75	3.30
	Genuine	1	<b>RTC6621</b>	2.23	2.68
2.25L petrol engine models with Ducellier distributor	Aftermarket	1	<b>RTC4935P</b>	2.25	2.70
	Genuine	1	<b>RTC6620</b>	1.99	2.39
All V8 petrol models with Stromberg carbs (eng) 15G	Aftermarket	1	<b>RTC3472P</b>	1.25	1.50
	Aftermarket	1	<b>GSC111</b>	3.08	3.70
	Genuine	1	<b>RTC3472</b>	3.73	4.48

## Distributor Cap

2.25L and 2.5L petrol engine models with Lucas distributor - Type 45D/59D distributor	Aftermarket	1	<b>RTC3278P</b>	2.33	2.80
	OEM	1	<b>RTC3278P1</b>	3.50	4.20
	Genuine	1	<b>RTC3278</b>	16.53	19.84
2.25L petrol engine models with Ducellier distributor	Aftermarket	1	<b>RTC4932P</b>	3.75	4.50
All V8 petrol engine models	Aftermarket	1	<b>GDC117P</b>	5.00	6.00
	OEM	1	<b>GDC117P1</b>	16.04	19.25
	Aftermarket	1	<b>GDC117</b>	10.42	12.50
	Genuine	1	<b>GDC1170E</b>	32.94	39.53

## Amplifier Link Lead

V8 petrol engine with 2 pin integral amp type 35DLM8 distributor - Amplifier to coil, converts 3 pin to 2 pin	Aftermarket	1	<b>STC1212P</b>	24.58	29.50
---------------------------------------------------------------------------------------------------------------	-------------	---	-----------------	-------	-------

## Amplifier Module & Link Lead

V8 petrol engine with 2 pin integral amp type 35DLM8 distributor - Included link lead converts 3 pin to 2 pin	Britpart	1	<b>STC1184KBP</b>	24.58	29.50
---------------------------------------------------------------------------------------------------------------	----------	---	-------------------	-------	-------

## Amplifier Module

V8 petrol engine with 3 pin integral amp type 35DLM8 distributor	Aftermarket	1	<b>STC1184P</b>	14.58	17.50
V8 petrol engine with 3 pin integral amp type 35DLM8 distributor	Genuine	1	<b>STC1184</b>	136.26	163.51

## Amplifier Plug

V8 petrol engine with 3 pin integral amp type 35DLM8 distributor - 3 pin, for STC1184	OEM	1	<b>STC1184P1</b>	22.50	27.00
---------------------------------------------------------------------------------------	-----	---	------------------	-------	-------

## Pick Up & Baseplate, Distributor

All V8 carb petrol models with electronic ignition with 3 pin integral amplifier	Aftermarket	1	<b>RTC5090P</b>	15.63	18.76
	OEM	1	<b>RTC5090P1</b>	67.50	81.00
	Genuine	1	<b>RTC5090</b>	130.55	156.66

## Vacuum Unit, Distributor

V8 carb petrol engines (eng) 17G, 22G only	Aftermarket	1	<b>608266P</b>	35.00	42.00
	Genuine	1	<b>608266</b>	97.18	116.62
V8 carb petrol engines (eng) 20G, 24G only with 2 pin amp type distributor	Aftermarket	1	<b>RTC3201P</b>	29.58	35.50
	Genuine	1	<b>RTC3201</b>	121.09	145.31

## Suppressor, Coil

All V8 carb petrol models with electronic ignition	Aftermarket	1	<b>ADU7242LP</b>	3.75	4.50
----------------------------------------------------	-------------	---	------------------	------	------

## Distributor Drive Gear

All V8 Carb petrol engine models - On camshaft	Aftermarket	1	<b>614188A</b>	22.50	27.00
------------------------------------------------	-------------	---	----------------	-------	-------

## Distributor Drive Gear & Coupling

All V8 Carb petrol engine models - On distributor	Aftermarket	1	<b>ERC1353A</b>	27.50	33.00
---------------------------------------------------	-------------	---	-----------------	-------	-------

## O Ring Distributor

All V8 carb petrol models	Aftermarket	1	<b>603446P</b>	2.50	3.00
	Genuine	1	<b>603446</b>	7.27	8.72

## Ignition Lead Set

2.25L petrol engine models	Aftermarket	1	<b>ERC3256P</b>	6.04	7.25
	Genuine	1	<b>ERC3256</b>	51.30	61.56
2.5L petrol engine models	Aftermarket	1	<b>ERC3256P</b>	6.04	7.25
	Genuine	1	<b>ERC3256</b>	51.30	61.56
All V8 carb petrol engine models - Silicone	Aftermarket	1	<b>RTC6551P</b>	11.67	14.00
	OEM	1	<b>RTC6551P1</b>	19.58	23.50
Red	Aftermarket	1	<b>RTC6551PS</b>	16.67	20.00
	OEM	1	<b>RTC6551P1S</b>	32.50	39.00
Black	Aftermarket	1	<b>GHT206S</b>	25.83	31.00

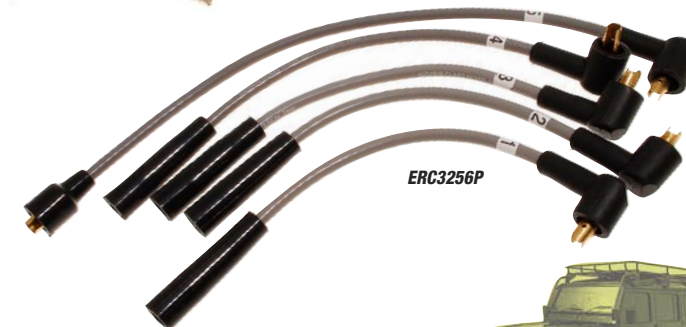
**GCS261**

**ERC3256P**

## 110 (1983-1989)

## BRAKING SYSTEM

## Brake Pad Set

All models - Front Brakes	Aftermarket	1	<b>STC2952P</b>	13.96	16.75
	OEM	1	<b>STC2952P1</b>	23.75	28.50
	Genuine	1	<b>STC2952</b>	59.49	71.39
Green Stuff	EBC	1	<b>STC2952GS</b>	32.50	39.00

## Brake Shoe Set

All models - Rear Brakes	Aftermarket	1	<b>STC2797P</b>	11.67	14.00
	OEM	1	<b>STC2797P1</b>	25.83	31.00
	Genuine	1	<b>STC2797</b>	191.25	229.50

## Brake Linings Set

All models - Set of 4, with rivets 11" dia brakes rear brakes	Aftermarket	1	<b>STC3944P</b>	12.50	15.00
	Aftermarket	1	<b>STC2795P</b>	3.50	4.20
	Genuine	1	<b>STC2795</b>	49.44	59.33

## Spring and Pin Kit

All models - Front Brake Pads	Aftermarket	1	<b>RTC5001P</b>	3.33	4.00
	Genuine	1	<b>RTC5001</b>	12.33	14.80

## Brake Adjuster Kit

All models - Rear Brake Shoes	Aftermarket	1	<b>RTC3176P</b>	10.83	13.00
	Genuine	1	<b>RTC3176</b>	109.72	131.66

## Brake Disc (each)

All models - Front, Not Vented	Aftermarket	2	<b>571762P</b>	14.38	17.26
	OEM	2	<b>571762P1</b>	19.79	23.75
	Aftermarket	2	<b>LR017951P</b>	13.75	16.50
Genuine	2	<b>LR017951</b>	52.35	62.82	

All models with non-vented rear disc brakes  
Rear, Not Vented

Rear, Not Vented	Aftermarket	2	<b>FTC3846P</b>	13.54	16.25
	OEM	2	<b>FTC3846P1</b>	20.83	25.00
	Genuine	2	<b>FTC3846</b>	43.03	51.64

## Brake Disc (pair)

All models - Front, Not Vented	Brembo	1	<b>LR017951BREMBO</b>	50.00	60.00
--------------------------------	--------	---	-----------------------	-------	-------

## Performance Brake Disc (pair)

All models - Front, Not Vented, slotted & drilled	Britpart	1	<b>LR017951URBP</b>	39.58	47.50
---------------------------------------------------	----------	---	---------------------	-------	-------

## Brake Drum - Rear

All models - Rear	Aftermarket	2	<b>576973P</b>	17.50	21.00
	Genuine	2	<b>576973</b>	90.40	108.48

## Brake Caliper

All RHD up to (axle) 20L21632B Right Hand Front, Solid Disc Brakes	Aftermarket	1	<b>AEU2537P</b>	35.00	42.00
	Genuine	1	<b>AEU2537</b>	298.37	358.04

Left Hand Front, Solid Disc Brakes

Aftermarket	1	<b>AEU2538P</b>	35.00	42.00
	Genuine	1	<b>AEU2538</b>	276.27

All LHD up to (axle) 21L18648B  
Right Hand Front, Solid Disc Brakes

Aftermarket	1	<b>AEU2537P</b>	35.00	42.00
	Genuine	1	<b>AEU2537</b>	298.37

Left Hand Front, Solid Disc Brakes

Aftermarket	1	<b>AEU2538P</b>	35.00	42.00
	Genuine	1	<b>AEU2538</b>	276.27

## Dust Cap Bleed Screw

All models - Blue, front caliper bleed nipple	Genuine	2	<b>594091</b>	4.66	5.59
-----------------------------------------------	---------	---	---------------	------	------

## Brake Master Cylinder

All models	Aftermarket	1	<b>NRC8690P</b>	26.67	32.00
	Genuine	1	<b>NRC8690</b>	162.68	195.22
	OEM	1	<b>NRC8690P1</b>	85.00	102.00

Does not include reservoir

## Master Cylinder Repair Kit

All models - Brake master cylinder	Aftermarket	1	<b>AEU3015P</b>	2.50	3.00
	Aftermarket	1	<b>GRK1027P</b>	2.08	2.50
	OEM	1	<b>AEU3015P1</b>	27.50	33.00
	Genuine	1	<b>AEU3015</b>	51.70	62.04

## Brake Fluid Reservoir

All models	Aftermarket	1	<b>AEU1045P</b>	21.67	26.00
------------	-------------	---	-----------------	-------	-------

## Servo Non-Return Valve

All models up to (VIN) HA701009	Genuine	1	<b>RTC812</b>	25.83	31.00
---------------------------------	---------	---	---------------	-------	-------

## Servo Repair Kit

All models with type 50 servo - Type 50 servo (227mm dia servo)	Aftermarket	1	<b>18G8951A</b>	11.25	13.50
	Genuine	1	<b>18G8951</b>	11.25	13.50
All models with type 80 servo - Type 80 servo (276mm dia servo)	Aftermarket	1	<b>AEU2741P</b>	3.50	4.20
	Aftermarket	1	<b>AEU2741</b>	42.66	51.19
	Genuine	1	<b>AEU2741</b>	42.66	51.19

## Wheel Cylinder

All models Right Hand Rear	Aftermarket	1	<b>RTC3626P</b>	6.88	8.26
	OEM	1	<b>RTC3626P1</b>	16.88	20.26
	Genuine	1	<b>RTC3626</b>	28.45	34.14
Left Hand Rear	Aftermarket	1	<b>RTC3627P</b>	6.88	8.26
	OEM	1	<b>RTC3627P1</b>	16.88	20.26
	Genuine	1	<b>RTC3627</b>	28.45	34.14

## Wheel Cylinder Repair Kit

All models - Rear	Aftermarket	2	<b>AEU2498P</b>	2.08	2.50
-------------------	-------------	---	-----------------	------	------

## Brake Hose

All 4 cylinder models - Clutch hose	Aftermarket	1	<b>RTC4425P</b>	2.50	3.00
	OEM	1	<b>RTC4425P1</b>	8.75	10.50
	Genuine	1	<b>RTC4425</b>	34.58	41.50

## Brake Pipe Clip

All models - Double type	Aftermarket	a/r	<b>625521A</b>	1.25	1.50
--------------------------	-------------	-----	----------------	------	------

## Brake/Clutch Pipe Clip

All models - Double	Genuine	a/r	<b>NTC1175</b>	0.58	0.70
---------------------	---------	-----	----------------	------	------

## T Piece Brake System

All models - Rear brake pipes	Aftermarket	a/r	<b>NRC4251P</b>	6.04	7.25
	Genuine	a/r	<b>NRC4251</b>	17.88	21.46

## Brake Shoe Set - Handbrake

All models - Handbrake, rod operated type	Aftermarket	1	<b>STC965P</b>	7.50	9.00
	OEM	1	<b>STC965P1</b>	22.50	27.00
	Genuine	1	<b>STC965</b>	80.87	97.04

## Brake Drum - Handbrake

All models - Handbrake	Aftermarket	1	<b>LR025177P</b>	20.42	24.50
	Genuine	1	<b>LR025177</b>	152.67	183.20

## Locking Plate Handbrake

All models	Aftermarket	1	<b>515467P</b>	1.33	1.60
	Genuine	1	<b>515467</b>	1.72	2.06

## Retaining Plate Handbrake

All models	Aftermarket	1	<b>515468P</b>	1.08	1.30
	Genuine	1	<b>515468</b>	2.30	2.76

## Dust Cover Expander Unit

All models with LT77 5 speed gearbox	OEM	1	<b>515466P1</b>	3.33	4.00
	Genuine	1	<b>515466</b>	4.49	5.39
All models with LT85 5 speed gearbox	OEM	1	<b>515466P1</b>	3.33	4.00
	Genuine	1	<b>515466</b>	4.49	5.39

## Expander Unit

All models with LT77 5 speed gearbox	Aftermarket	1	<b>AEU2734P</b>	17.29	20.75
	Genuine	1	<b>AEU2734</b>	330.80	396.96
All models with LT85 5 speed gearbox	Aftermarket	1	<b>AEU2734P</b>	17.29	20.75
	Genuine	1	<b>AEU2734</b>	330.80	396.96

## Brake Adjuster Transmission

All models with LT230 transfer box - Early type expander	Aftermarket	1	<b>AEU2735P</b>	10.42	12.50
	Genuine	1	<b>AEU2735</b>	237.59	285.11

## Handbrake Cable

RHD models	Aftermarket	1	<b>NRC5088P</b>	7.50	9.00
	Genuine	1	<b>NRC5088</b>	34.58	41.50

## Handbrake Cable Clevis Pin

All models - 8 x 22mm, Handbrake cable to Handbrake lever	Genuine	1	<b>PC108291L</b>	3.45	4.14
-----------------------------------------------------------	---------	---	------------------	------	------

## Brake Pedal Rubber

Optional fitment to (VIN) AA234187	Aftermarket	1	<b>NRC9224P</b>	2.08	2.50
	Genuine	1	<b>NRC9224</b>	15.96	19.15
All models (VIN) AA234188 on - Brake and Clutch	Aftermarket	2	<b>SKE500060P</b>	2.83	3.40
	Genuine	2	<b>SKE500060</b>	8.92	10.70



STC2952GS



# SUSPENSION

# 110 (1983-1989)

## Bush Radius Arm

All models - Front suspension chassis end, rubber				
	Aftermarket	4	<b>NRC4514P</b>	0.79 0.95
	Genuine	4	<b>NRC4514</b>	2.76 3.31
chassis end, poly.				
	Aftermarket	4	<b>NRC4514POLY</b>	3.00 3.60
	Polybush	1	<b>NRC4514POLYBUSH</b>	20.42 24.50
axle end, rubber				
	Aftermarket	4	<b>NTC7307P</b>	1.50 1.80
	Genuine	4	<b>NTC7307</b>	20.38 24.46
axle end, poly.				
	Aftermarket	2	<b>NTC7307POLY</b>	6.67 8.00
All models - Rear suspension rubber				
	Aftermarket	2	<b>NTC1772P</b>	1.50 1.80
	OEM	2	<b>NTC1772P1</b>	3.00 3.60
	Genuine	2	<b>NTC1772</b>	9.29 11.15
poly.				
	Aftermarket	2	<b>NTC1772POLY</b>	4.38 5.26
	Polybush	1	<b>NTC1772POLYBUSH</b>	22.50 27.00
chassis end, poly.				
	Aftermarket	2	<b>NTC9027POLY</b>	20.00 24.00
chassis end, rubber (pair)				
	Aftermarket	1	<b>STC618P</b>	6.67 8.00
	OEM	1	<b>STC618P1</b>	15.42 18.50
	Genuine	1	<b>STC618</b>	59.46 71.35
chassis end, poly (pair)				
	Aftermarket	1	<b>STC618POLY</b>	25.83 31.00

## Bush Kit Radius Arm

All models - Front suspension , Kit, radius arm to chassis rubber				
	Britpart	1	<b>NRC4514BPKIT</b>	7.08 8.50
	Britpart	1	<b>NRC4514BPKPOLYEL</b>	9.58 11.50
poly, yellow				
	Britpart	1	<b>NRC4514BPKPOLYEL</b>	9.58 11.50
axle end, poly., set of 4				
	Bearmach	1	<b>NTC7307BMPVC</b>	87.50 105.00
All models - Rear suspension chassis end, poly, performance red (pair)				
	Polybush	1	<b>NTC9027POLYBUSH</b>	39.58 47.50

## Bush Shock Absorber Mounting

All models - Front upper and lower, rear lower rubber				
	Aftermarket	8	<b>552818P</b>	0.50 0.60
	Genuine	8	<b>552818</b>	1.38 1.66
poly, performance red				
	Polybush	4	<b>5528189PBR</b>	25.00 30.00
poly, comfort blue				
	Polybush	4	<b>552818PPBB</b>	25.00 30.00
poly, dynamic orange				
	Polybush	4	<b>5528189PBO</b>	25.00 30.00
poly				
	Aftermarket	4	<b>552818POLY</b>	0.83 1.00
All models - Rear, upper rubber				
	Aftermarket	2	<b>NRC5593P</b>	1.08 1.30
	Genuine	2	<b>NRC5593</b>	6.28 7.54
poly.				
	Aftermarket	2	<b>NRC5593POLY</b>	4.00 4.80
	Terrafrima	2	<b>NRC5593TFP</b>	13.13 15.76

## Bush Panhard Rod

All models - Front rubber				
	Aftermarket	2	<b>ANR3410P</b>	0.75 0.90
	OEM	2	<b>ANR3410P1</b>	2.75 3.30
	Genuine	2	<b>ANR3410</b>	8.67 10.40
poly.				
	Aftermarket	2	<b>ANR3410POLY</b>	4.00 4.80

## Bush Panhard Rod Kit

All models - Front, poly.	Terrafrima	1	<b>ANR3410TFPK</b>	15.63 18.76
---------------------------	------------	---	--------------------	-------------

## Washer for Bush on Radius Arm

All models - Rear suspension, chassis end	Aftermarket	2	<b>STC618WASHER</b>	5.42 6.50
-------------------------------------------	-------------	---	---------------------	-----------

## Bush Upper Link

All models - Rear suspension rubber				
	Aftermarket	2	<b>NTC1773P</b>	1.58 1.90
	OEM	2	<b>NTC1773P1</b>	4.00 4.80
	Genuine	2	<b>NTC1773</b>	19.99 23.99
poly., performance red (pair)				
	Polybush	1	<b>NTC1773POLYBUSH</b>	23.75 28.50
poly., comfort blue (pair)				
	Polybush	1	<b>NTC1773POLYBUSHBLUE</b>	23.75 28.50
poly.				
	Aftermarket	2	<b>NTC1773POLY</b>	4.38 5.26

## Suspension Bush Kit

All models				
Bush kit 'D' - incl. bottom link mounting bushes, front radius arm to axle bushes, A frame bushes, Panhard rod bushes, upper and lower shock absorber bushes, radius arm to chassis bushes				
	Aftermarket	1	<b>RA1173EARLYP</b>	26.25 31.50
	Genuine	1	<b>RA1173EARLY</b>	300.00 360.00

## Suspension Bush Kit B

All models - poly.	Aftermarket	1	<b>RA1274ALTPOLY</b>	87.50 105.00
All models up to (VIN) KA930455 - poly., blue	Britpart	1	<b>RA1274BPPOLYBLUE</b>	75.00 90.00

## Bolt Kit for Bush Kits

All models	Aftermarket	1	<b>RA1177P</b>	40.42 48.50
	Genuine	1	<b>RA1177</b>	71.67 86.00

## Shock Absorber Bush Kit

All models - Front shock absorber bush kit				
comfort blue	Polybush	1	<b>LL1357B</b>	22.08 26.50
performance red	Polybush	1	<b>LL1357</b>	22.08 26.50
All models - Rear shock absorber bush kit				
performance red	Polybush	1	<b>LL1356</b>	27.08 32.50
comfort blue	Polybush	1	<b>LL1356B</b>	27.08 32.50

## Anti Roll Bar

All models with factory heavy duty Front	Aftermarket	1	<b>LR033037P</b>	50.00 60.00
	Genuine	1	<b>LR033037</b>	72.75 87.30
All models - Rear, standard size	Aftermarket	1	<b>LR033038P</b>	45.00 54.00
	Genuine	1	<b>LR033038</b>	78.73 94.48

## Bush Anti Roll Bar Mounting

All models - Front anti roll bar poly.	Aftermarket	2	<b>NTC6828POLY</b>	6.25 7.50
Upated 25.4mm inside diameter	Terrafrima	2	<b>NTC6828URTFPY</b>	23.33 28.00

## Anti Roll Bar Bush Kit

All models - Front anti roll bar bush kit performance red	Polybush	1	<b>LL1359</b>	35.00 42.00
comfort blue	Polybush	1	<b>LL1359B</b>	35.00 42.00
All models - Rear anti roll bar bush kit comfort blue	Polybush	1	<b>LL1360B</b>	33.75 40.50
performance red	Polybush	1	<b>LL1360</b>	33.75 40.50

## Anti Roll Bar Bush

All models fitted with anti roll bar Rear, lower, poly.	Aftermarket	4	<b>552819POLY</b>	1.08 1.30
Anti roll bar link, rubber	Aftermarket	4	<b>552819P</b>	0.19 0.23
	Genuine	4	<b>552819</b>	1.39 1.67

## Anti Roll Bar Link Ball Joint

All models - Front and rear	Aftermarket	2	<b>NTC1888P</b>	4.79 5.75
	OEM	2	<b>NTC1888P1</b>	13.54 16.25
	Genuine	2	<b>NTC1888</b>	41.58 49.90

## Mounting Bush, Anti Roll Bar

All models - Front anti roll bar	Aftermarket	2	<b>NTC6828P</b>	1.33 1.60
	OEM	2	<b>NTC6828P1</b>	2.72 3.26
	Genuine	2	<b>NTC6828</b>	6.99 8.39

## Clamp Bracket

All models - Anti roll bar mounting, front	Aftermarket	2	<b>NTC6776P</b>	3.75 4.50
	Genuine	2	<b>NTC6776</b>	5.93 7.12



RA1173EARLYP



RA1274ALTPOLY





**110 (1983-1989)****SUSPENSION****Anti Roll Bar Uprated**

All models with factory heavy duty Front, uprated 25.4mm diameter				
	Terrafirma	1	<b>LR033037URTF</b>	245.83 295.00
All model - Rear				
uprated standard diameter	Bearmach	1	<b>LR033038URBM</b>	170.00 204.00
uprated 25.4mm diameter	Terrafirma	1	<b>LR033038URTF254</b>	225.00 270.00
uprated 28.0mm diameter	Terrafirma	1	<b>LR033038URTF280</b>	241.67 290.00

**Link Kit (for uprated anti roll bars)**

All models with factory heavy duty Front Fitting Kit				
	Terrafirma	1	<b>LR033037URTFK</b>	24.58 29.50
All models - Rear Fitting Kit				
	Terrafirma	1	<b>LR033038URTFK</b>	39.58 47.50

**Spacer Kit (2 hole for anti roll bars)**

All models with factory heavy duty for anti roll bar				
	Terrafirma	1	<b>LR033037-8URTFK2</b>	35.00 42.00

**Spacer Kit (4 hole for anti roll bars)**

All models with factory heavy duty for anti roll bar				
	Terrafirma	1	<b>LR033037-8URTFK4</b>	39.58 47.50

**Shock Absorber**

All models - Front, oil, std. height				
	Aftermarket	2	<b>RSC100050P</b>	13.54 16.25
	OEM	2	<b>RSC100050P1</b>	29.58 35.50
	Genuine	2	<b>RSC100050</b>	61.43 73.7
All models - Front, gas, std. height				
	Bilstein (pair)	1	<b>RA1345BILSTEIN</b>	132.50 159.00
	Terrafirma	2	<b>RA1345TFAT</b>	28.33 34.00
	Decarbon	2	<b>RA1345DECARBONEA</b>	63.33 76.00
Pro Sport	Terrafirma	2	<b>RA1345TFPS</b>	48.33 58.00
Commercial heavy duty	Terrafirma	2	<b>RA1345TFCHD</b>	58.33 70.00

**Shock Mounting Retention Ring**

All models - Front				
	Aftermarket	2	<b>RNJ500010P</b>	3.58 4.30
	Genuine	2	<b>RNJ500010</b>	16.34 19.61

**Shock Absorber - Rear**

All models - Rear, oil, std. height				
	Aftermarket	2	<b>STC3771P</b>	13.96 16.75
	OEM	2	<b>STC3771P1</b>	24.58 29.50
	Genuine	2	<b>STC3771</b>	63.97 76.76
All models - Rear, gas, std. height				
	Bilstein (pair)	1	<b>RA1346BILSTEIN</b>	132.50 159.00
Pro Sport	Terrafirma	2	<b>RA1346TFPS</b>	48.33 58.00
	Pro-Comp	2	<b>RA1346BMPC</b>	38.33 46.00
All Terrain	Terrafirma	2	<b>RA1346TFAT</b>	29.17 35.00
Heavy Duty	Aftermarket	2	<b>STC3772P</b>	13.96 16.75
	OEM	2	<b>STC3772P1</b>	27.50 33.00
	Genuine	2	<b>STC3772</b>	64.26 77.11
Commercial Heavy Duty, std. height	Terrafirma	2	<b>RA1346TFCHD</b>	58.33 70.00
127 model, Military - Rear	Genuine	2	<b>RRC3817</b>	117.36 140.83

**Coil Spring - Front**

All models - Front, driver's side, standard				
	Aftermarket	1	<b>NRC8044P</b>	15.83 19.00
	Genuine	1	<b>NRC8044</b>	63.59 76.31
driver's side, heavy duty				
	Aftermarket	1	<b>NRC9448P</b>	14.38 17.26
	Genuine	1	<b>NRC9448</b>	64.40 77.28
passenger's side, standard				
	Aftermarket	1	<b>NRC8045P</b>	15.83 19.00
	Genuine	1	<b>NRC8045</b>	63.10 75.72
passenger's side, heavy duty				
	Aftermarket	1	<b>NRC9449P</b>	16.04 19.25
	Genuine	1	<b>NRC9449</b>	63.84 76.61

**Mounting Bracket**

All models - Front spring, upper				
	Aftermarket	2	<b>NRC6372P</b>	13.13 15.76
	Genuine	2	<b>NRC6372</b>	56.30 67.56

**Lower Seat, Coil Spring**

All models - Front				
	Aftermarket	2	<b>NRC9700P</b>	3.00 3.60
	Genuine	2	<b>NRC9700</b>	11.51 13.81

**Coil Spring - Rear**

All models without self levelling - Rear, driver's side				
	Aftermarket	1	<b>NRC6389P</b>	26.67 32.00
	Genuine	1	<b>NRC6389</b>	66.35 79.62
passenger's side				
	Aftermarket	1	<b>NRC6904P</b>	26.67 32.00
	Genuine	1	<b>NRC6904</b>	67.84 81.41
All models with self levelling - Rear, driver's side				
	Aftermarket	1	<b>NRC6388P</b>	17.50 21.00
	Genuine	1	<b>NRC6388</b>	66.35 79.62
passenger's side				
	Aftermarket	1	<b>NRC7000P</b>	17.50 21.00
	Genuine	1	<b>NRC7000</b>	63.20 75.84

**Coil Spring Helper**

All models with heavy duty Rear, both sides				
	Aftermarket	2	<b>RRC3266P</b>	8.96 10.75
	Genuine	2	<b>RRC3266</b>	60.47 72.56

**Retainer Ring Spring Upper**

All models with factory heavy duty Rear				
	Aftermarket	2	<b>RRC3352P</b>	9.58 11.50
	Genuine	2	<b>RRC3352</b>	41.84 50.21

**Retainer Ring Spring Lower**

All models with factory heavy duty - Rear				
Aftermarket	2	<b>LR018027P</b>	10.83	13.00
Genuine	2	<b>LR018027</b>	41.13	49.36

**Ball Joint Assembly**

All models - Rear upper link				
Aftermarket	1	<b>RHF500110P</b>	7.08	8.50
OEM	1	<b>RHF500110P1</b>	16.67	20.00
Genuine	1	<b>RHF500110</b>	39.98	47.98
Heavy Duty				
Bearmach	1	<b>RHF500110URBM</b>	14.38	17.26

**Ball Joint Assembly & Fulcrum Bracket**

All models - Rear upper link & fulcrum bracket				
Britpart	1	<b>RHF500110BPASSY</b>	39.58	47.50

**Ball Joint, Upper**

All models with self levelling Self levelling unit				
Aftermarket	2	<b>575882P</b>	4.58	5.50

**Gaiter Ball Joint**

All models with self levelling Lower, self levelling unit				
Aftermarket	1	<b>NRC6561P</b>	3.58	4.30
Genuine	1	<b>NRC6561</b>	18.38	22.06

**Radius Arm Assembly**

All models - Front				
Aftermarket	2	<b>NTC2705P</b>	120.00	144.00
Genuine	2	<b>NTC2705</b>	302.34	362.81

**Panhard Rod Assembly**

All models - Front suspension, RHD or LHD				
Aftermarket	1	<b>RBI500020P</b>	23.75	28.50
Genuine	1	<b>RBI500020</b>	136.98	164.38

**Tie Bar**

All RHD models - Steering box				
Aftermarket	1	<b>LR041261P</b>	15.63	18.76
Genuine	1	<b>LR041261</b>	46.04	55.25

**Top Link Assembly**

All models- Rear suspension				
RH				
Aftermarket	1	<b>NTC2706P</b>	80.00	96.00
Genuine	1	<b>NTC2706</b>	241.05	289.26
LH				
Genuine	1	<b>LR045324</b>	173.56	208.27

**Bump Stop**

All models- Front suspension, rubber				
Aftermarket	2	<b>ANR4188P</b>	2.58	3.10
OEM	2	<b>ANR4188P1</b>	6.04	7.25
Genuine	2	<b>ANR4188</b>	24.38	29.26
All models - Rear suspension, rubber				
Aftermarket	2	<b>ANR4189P</b>	3.08	3.70
OEM	2	<b>ANR4189P1</b>	8.13	9.76
Genuine	2	<b>ANR4189</b>	18.20	21.84

**Bump Stop**

All models - Front suspension, poly.				
red				
Polybush	2	<b>ANR4188PPOLYBUSH</b>	19.17	23.00
black				
Britpart	2	<b>ANR4188PPPYBLK</b>	13.25	15.90
yellow				
Britpart	2	<b>ANR4188PPPYEL</b>	13.25	15.90
All models - Rear suspension, poly.				
black				
Polybush	2	<b>ANR4189PPOLYBUSH</b>	17.08	20.50
black				
Britpart	2	<b>ANR4189PPPYBLK</b>	13.25	15.90
yellow				
Britpart	2	<b>ANR4189PPPYEL</b>	13.25	15.90

**Bump Stop Spacers**

All models- Front or rear				
Terrafirma	a/r	<b>ANR4188-9TFSPACER</b>	29.58	35.50



# STEERING

# 110 (1983-1989)

## Drop Arm Lever

All RHD models with Adwest power. For steering box with 4 bolt top plate				
Aftermarket	1	<b>QFW000020P</b>	18.54	22.25
OEM	1	<b>QFW000020P1</b>	57.50	69.00
Genuine	1	<b>QFW000020</b>	112.70	135.24

## Drop Arm Repair Kit

All models with gaiter lip on steering arm- Steering drag link				
Aftermarket	1	<b>RBG000010P</b>	4.58	5.50
OEM	1	<b>RBG000010P1</b>	20.63	24.76
Genuine	1	<b>RBG000010</b>	55.33	66.40

## Steering Arm Lever

All RHD models with Gemmer power. For steering box with 6 bolt top plate				
Genuine	1	<b>RTC6398</b>	372.63	447.16
All LHD models with Adwest power. For steering box with 4 bolt top plate				
Aftermarket	1	<b>QFW000030P</b>	16.67	20.00
OEM	1	<b>QFW000030P1</b>	57.50	69.00
Genuine	1	<b>QFW000030</b>	112.70	135.24
All LHD models with Gemmer power. For steering box with 6 bolt top plate				
Aftermarket	1	<b>RTC6399P</b>	14.58	17.50
Genuine	1	<b>RTC6399</b>	372.63	447.16
All LHD models with manual				
Aftermarket	1	<b>RTC6399P</b>	14.58	17.50
Genuine	1	<b>RTC6399</b>	372.63	447.16

## Ball Joint, Drop Arm

All models - RH				
Aftermarket	1	<b>RBG000010P</b>	4.58	5.50
OEM	1	<b>RBG000010P1</b>	20.63	24.76
Genuine	1	<b>RBG000010</b>	55.33	66.40

## Universal Joint

All models - Upper				
Aftermarket	1	<b>NRC7387P</b>	8.54	10.25
OEM	1	<b>NRC7387P1</b>	27.50	33.00
Genuine	1	<b>NRC7387</b>	48.59	58.31
All models - Lower				
Aftermarket	1	<b>NRC7704P</b>	8.54	10.25
OEM	1	<b>NRC7704P1</b>	27.50	33.00
Genuine	1	<b>NRC7704</b>	47.31	56.77

## Lower Shaft Assembly

All models - With joints				
Aftermarket	1	<b>RTC4738P</b>	39.58	47.50
OEM	1	<b>RTC4738P1</b>	115.00	138.00
Genuine	1	<b>RTC4738</b>	203.24	243.89

## Steering Column Upper

All models				
OEM	1	<b>QMB101620P1</b>	95.00	114.00
Genuine	1	<b>QMB101620</b>	298.67	358.40

## Steering Damper Assembly

All models				
Aftermarket	1	<b>RTC4472P</b>	11.50	13.80
Bilstein	1	<b>RTC4472UR</b>	65.00	78.00
Terraforma	1	<b>RTC4472TF</b>	33.75	40.50
Cellular Dynamic	1	<b>RTC4472UR-BPCEL</b>	29.58	35.50
Super Gaz	1	<b>RTC4472UR-BPSUP</b>	27.50	33.00
Genuine	1	<b>RTC4472</b>	66.07	79.28
'Return to centre' type; uprated damper with return assistance spring				
Terraforma	1	<b>RTC4472TFRTC</b>	57.50	69.00

## Steering Damper Bush Set, Polyurethane

All models				
Polybush Dynamic Red	Polybush	1	<b>LL1358</b>	18.13 21.76
Polybush Comfort Blue	Polybush	1	<b>LL1358B</b>	18.13 21.76
Britpart Black	Britpart	1	<b>LL1358-BPPOLYBLK</b>	3.33 4.00
Britpart Yellow	Britpart	1	<b>LL1358-BPPOLYEL</b>	3.58 4.30

## Eye Bush, Steering Damper

All models				
Aftermarket	4	<b>NTC1775P</b>	1.08	1.30
Genuine	4	<b>QEM500020</b>	5.19	6.23
Poly	Aftermarket	4	<b>NTC1775POLY</b>	2.75 3.30
Performance Red Kit	Polybush	1	<b>NTC1775PB</b>	19.79 23.75

## Track Rod Assembly

All models				
Aftermarket	1	<b>LR041267P</b>	16.67	20.00
OEM	1	<b>LR041267P1</b>	38.33	46.00
Genuine	1	<b>LR041267</b>	165.15	198.18

## Track Rod Tube

All models				
Aftermarket	1	<b>LR045730P</b>	9.58	11.50
OEM	1	<b>LR045730P1</b>	16.88	20.26
Genuine	1	<b>LR045730</b>	44.56	53.47

## Track Rod End

All models - Track rod end				
RH thread, non-greasable				
Aftermarket	1	<b>RTC5869P</b>	4.58	5.50
OEM	1	<b>RTC5869P1</b>	10.63	12.76
Genuine	1	<b>RTC5869</b>	35.73	42.88
LH thread, non-greasable				
Aftermarket	1	<b>RTC5870P</b>	4.58	5.50
OEM	1	<b>RTC5870P1</b>	10.63	12.76
Genuine	1	<b>RTC5870</b>	35.73	42.88

## Rubber Cap Track Rod End

All models				
Aftermarket	2	<b>214649P</b>	1.33	1.60
Genuine	2	<b>214649</b>	4.57	5.48
Rubber cap, large diameter	Genuine	2	<b>214685</b>	3.15 3.78

## Ball Joint Kit

All models with Gemmer manual steering box up to (VIN) 322575				
OEM	1	<b>AEU2761P1</b>	24.58	29.50
Genuine	1	<b>AEU2761</b>	85.12	102.14

## Track Rod End

All models - RH thread, non-greasable				
Aftermarket	1	<b>RTC5869P</b>	4.58	5.50
OEM	1	<b>RTC5869P1</b>	10.63	12.76
Genuine	1	<b>RTC5869</b>	35.73	42.88
All models - LH thread, non-greasable				
Aftermarket	1	<b>RTC5870P</b>	4.58	5.50
OEM	1	<b>RTC5870P1</b>	10.63	12.76
Genuine	1	<b>RTC5870</b>	35.73	42.88

## Cross Rod Eye End

All RHD models				
Aftermarket	1	<b>ANR2858P</b>	50.00	60.00
Genuine	1	<b>ANR2858</b>	58.86	70.63
All LHD models				
Aftermarket	1	<b>ANR2859P</b>	42.50	51.00
Genuine	1	<b>ANR2859</b>	56.57	67.88

## Cross Rod Tube

All models - Must be fitted together with later type eye end ANR2858 (RHD) or ANR2859 (LHD)				
Aftermarket	1	<b>ANR2860P</b>	9.58	11.50
OEM	1	<b>ANR2860P1</b>	16.88	20.26
Genuine	1	<b>ANR2860</b>	37.75	45.30
All models - Original style tube, not for fitment with later type ANR2858 (RHD) or ANR2859 (LHD) eye ends				
Aftermarket	1	<b>NRC9741P</b>	11.88	14.26

## Pinion Seal Steering Box

All models with Adwest power				
Genuine	1	<b>608065</b>	7.28	8.74

## Seal Kit Steering Box

All models with Adwest power. For steering box with 3 or 4 bolt top plate				
Aftermarket	1	<b>STC2848P</b>	3.75	4.50
OEM	1	<b>STC2848P1</b>	5.63	6.76
Genuine	1	<b>STC2848</b>	20.28	24.34
All models with Adwest lightweight power. For steering box with 4 bolt top plate				
Aftermarket	1	<b>STC2847P</b>	9.79	11.75
Genuine	1	<b>STC2847</b>	67.67	81.20
All models with Adwest heavyweight power. For steering box with 3 bolt top plate				
Aftermarket	1	<b>RTC308P</b>	8.96	10.75
Genuine	1	<b>RTC308</b>	103.71	124.45
All RHD models with Gemmer power. For steering box with 6 bolt top plate				
Aftermarket	1	<b>RTC5071P</b>	13.75	16.50
Genuine	1	<b>RTC5071</b>	238.89	286.67

## Repair Kit Steering Box

All models with Adwest manual steering				
Aftermarket	1	<b>STC892P</b>	11.25	13.50
Genuine	1	<b>STC892</b>	39.20	47.04

## Seal Steering Box Shaft

All models with Gemmer manual steering box				
Aftermarket	1	<b>AEU4024P</b>	1.08	1.30
Genuine	1	<b>AEU4024</b>	11.54	13.85

## Seal Worm Shaft

All models with Gemmer manual steering box				
Genuine	1	<b>BAU4870</b>	5.68	6.82

## Seal Kit Input Shaft Steering Box

All models with Adwest lightweight power. For steering box with 4 bolt top plate				
Aftermarket	1	<b>STC889P</b>	5.63	6.76
Genuine	1	<b>STC889</b>	33.20	39.84

## Pad Adjuster Kit Steering Box

All models with Adwest lightweight power. For steering box with 4 bolt top plate				
Genuine	1	<b>STC4385</b>	124.00	148.80

## Shaft Assembly Steering Box

All LHD models with Adwest lightweight power. For steering box with 4 bolt top plate				
Land Rover	1	<b>RTC4399</b>	301.74	362.09

## Seal Kit Steering Pump

All V8 petrol power steering models up to (VIN) AA244542				
Aftermarket	1	<b>ABU7142P</b>	5.00	6.00
Genuine	1	<b>ABU7142</b>	50.03	60.04

## Gasket Kit Steering Pump

All V8 petrol power steering models				
Aftermarket	1	<b>ABU7145P</b>	4.00	4.80
All V8 petrol models with 30 series steering pump				
Aftermarket	1	<b>ABU7145P</b>	4.00	4.80

## Seal, Power Steering Pump

All models with Gemmer or Hobourn Eaton power steering pump- Inlet union. Dowty washer type seal				
Aftermarket	1	<b>RTC5675P</b>	1.00	1.20
Genuine	1	<b>RTC5675</b>	3.39	4.07



## 110 (1983-1989)

## STEERING

## Seal Kit Steering Pump

All V8 petrol power steering models from (VIN) AA244543 on				
Aftermarket	1	<b>STC1633P</b>	1.50	1.80

## Power Steering Fluid

All models with power 1 litre. Cold (standard) climates fluid				
Aftermarket	a/r	<b>STC50519P</b>	12.08	14.50
Genuine	a/r	<b>STC50519</b>	18.96	22.75

## Cap Steering Reservoir

All models up to (VIN) AA244022	Genuine	1	<b>RTC3056</b>	27.02	32.42
All models with power steering	Genuine	1	<b>NTC2723</b>	21.59	25.91

## Gasket

All models - Swivel housing	Aftermarket	2	<b>FTC3646P</b>	0.50	0.60
	Genuine	2	<b>FTC3646</b>	2.14	2.57
All models - Lower swivel pin	Aftermarket	2	<b>FTC3647P</b>	0.50	0.60
	Genuine	2	<b>FTC3647</b>	2.46	2.95

## 110 (1983-1989)

## CLUTCH

## Clutch Kit

All 2.25L petrol models - Includes clutch cover, plate & release bearing				
Aftermarket	1	<b>STC8359P</b>	58.33	70.00
Genuine	1	<b>STC8359</b>	214.45	257.34

All 2.5L petrol models - Includes clutch cover, plate & release bearing				
Aftermarket	1	<b>STC8359P</b>	58.33	70.00
Genuine	1	<b>STC8359</b>	214.45	257.34

All 2.5L 4 cyl diesel models - Includes clutch plate, cover and release bearing				
Genuine	1	<b>GCK555AF</b>	125.83	151.00
Britpart	1	<b>LR009366BP</b>	50.00	60.00

All 2.5L 4 cyl diesel models - Heavy duty. Includes clutch cover, plate & release bearing				
Britpart	1	<b>LR009366BPHD</b>	55.00	66.00

Includes clutch cover, plate, release bearing & fork				
Britpart	1	<b>LR009366BPHDFORK</b>	90.83	109.00

OEM. Includes clutch cover, plate & release bearing				
Britpart	1	<b>LR009366BPHDOEM</b>	95.00	114.00

All V8 petrol models with 4 speed LT95 gearbox - Includes clutch plate, cover and release bearing				
Aftermarket	1	<b>GCK203P</b>	91.67	110.00

All 3.5L V8 carb petrol models with 5 speed LT85 or LT77 gearbox - Includes clutch cover, plate & release bearing				
Aftermarket	1	<b>STC8361P</b>	90.83	109.00
Genuine	1	<b>STC8361</b>	345.00	414.00

## Clutch Plate &amp; Cover Assembly

All 2.5L 4 cyl diesel models	OEM	1	<b>LR009366P1</b>	70.00	84.00
	Aftermarket	1	<b>LR009366P</b>	57.50	69.00
	Genuine	1	<b>LR009366</b>	169.85	203.82

All 2.5L 4 cyl diesel models - Heavy duty	Britpart	1	<b>LR009366BPHDPARTIAL</b>	49.17	59.00
-------------------------------------------	----------	---	----------------------------	-------	-------

## Clutch Cover

All 4 cyl petrol models- 9.5" diameter, diaphragm type				
Aftermarket	1	<b>576557P</b>	27.50	33.00
OEM	1	<b>576557P1</b>	36.67	44.00
Genuine	1	<b>576557</b>	116.97	140.36

All diesel models				
Aftermarket	1	<b>URB100760P</b>	29.58	35.50
OEM	1	<b>URB100760P1</b>	39.58	47.50
Genuine	1	<b>URB100760</b>	91.30	109.56

All V8 petrol models				
Aftermarket	1	<b>576476P</b>	39.58	47.50
OEM	1	<b>576476P1</b>	60.00	72.00
Genuine	1	<b>576476</b>	118.73	142.48

## Clutch Plate

All 4 cyl petrol models				
Aftermarket	1	<b>8510307P</b>	22.50	27.00
OEM	1	<b>8510307P1</b>	36.67	44.00
Genuine	1	<b>8510307</b>	117.94	141.53

All 3.5L V8 carb petrol models with 5 speed gearbox				
OEM	1	<b>8510308P1</b>	37.50	45.00
Genuine	1	<b>8510308</b>	217.38	260.86

All diesel models				
Aftermarket	1	<b>UQB500030P</b>	22.50	27.00
Genuine	1	<b>UQB500030</b>	119.39	143.27
OEM	1	<b>GCP242</b>	45.00	54.00

## Clutch Release Bearing

All models - With carrier				
Aftermarket	1	<b>FTC5200P</b>	7.92	9.50
OEM	1	<b>FTC5200P1</b>	12.50	15.00
Genuine	1	<b>FTC5200</b>	37.38	44.86
Heavy Duty				
Britpart	1	<b>FTC5200HDBP</b>	45.83	55.00
Bearmach	1	<b>FTC5200HDBM</b>	80.00	96.00

## Clutch Fork

All 4 cyl petrol and diesel models				
Aftermarket	1	<b>FTC2957P</b>	3.75	4.50
OEM	1	<b>FTC2957P1</b>	10.83	13.00
Genuine	1	<b>FTC2957</b>	23.33	28.00

Heavy Duty				
Britpart	1	<b>FTC2957BPHD</b>	8.75	10.50

Kit Heavy Duty- Includes release fork, slipper pads, bush, staple & clip				
Britpart	1	<b>FTC2957BPHDKIT</b>	11.67	14.00

All V8 petrol models				
Aftermarket	1	<b>576137P</b>	23.96	28.75
OEM	1	<b>576137P1</b>	29.58	35.50
Genuine	1	<b>576137</b>	63.81	76.57

## Clutch Fork Staple Retainer

All 4 cyl petrol and diesel models				
Aftermarket	1	<b>FRC3416P</b>	0.58	0.70
Genuine	1	<b>FRC3416</b>	2.35	2.82

All V8 petrol models				
Aftermarket	1	<b>576203P</b>	0.25	0.30
Genuine	1	<b>576203</b>	0.66	0.79

## Pivot Clutch Release Arm

All 4 cyl models with 5 speed LT77 gearbox	OEM	1	<b>FRC5180P1</b>	15.04	18.05
	Genuine	1	<b>FRC5180</b>	57.38	68.86

## Pad Clutch Release Lever

All 4 cyl models with 5 speed LT77 gearbox	Aftermarket	2	<b>FRC5255P</b>	0.50	0.60
	Genuine	2	<b>FRC5255</b>	1.53	1.84

## Clutch Sleeve Guide

All models	Genuine	1	<b>FRC4078</b>	3.10	3.72
------------	---------	---	----------------	------	------

## Clutch Pipe

All 4 cyl petrol and diesel models - Hose to slave cyl.				
Aftermarket	1	<b>NRC9595P</b>	13.96	16.75
Genuine	1	<b>NRC9595</b>	29.11	34.93

All RHD models - Master cyl to hose	Genuine	1	<b>NRC8330</b>	29.11	34.93
All LHD models - Master cyl to hose	Genuine	1	<b>NRC8329</b>	28.08	33.70

## Clutch Hose

All V8 petrol models	Aftermarket	1	<b>NRC2211P</b>	3.25	3.90
	Genuine	1	<b>NRC2211</b>	33.62	40.34

## Clutch Pipe Assembly

All V8 petrol models - From clutch hose to slave cylinder				
OEM	1	<b>577643P1</b>	9.58	11.50
Genuine	1	<b>577643</b>	12.26	14.71

## Slave Cylinder Repair Kit

All models except V8				
Aftermarket	1	<b>8G8600LP</b>	1.00	1.20
OEM	1	<b>8G8600LP1</b>	4.38	5.26
Genuine	1	<b>8G8600L</b>	8.51	10.21

All V8 petrol models	Genuine	1	<b>513390</b>	5.00	6.00
----------------------	---------	---	---------------	------	------

## Master Cylinder Repair Kit

All models - Clutch master cylinder				
Aftermarket	1	<b>GRK1027P</b>	2.08	2.50
OEM	1	<b>GRK1027</b>	5.63	6.76

## Clutch Master Cylinder

All models				
Aftermarket	1	<b>STC500100P</b>	9.58	11.50
OEM	1	<b>STC500100P1</b>	19.79	23.75
Genuine	1	<b>STC500100</b>	76.84	92.21

## Clutch Slave Cylinder

All models except V8				
Aftermarket	1	<b>591231P</b>	7.08	8.50
OEM	1	<b>591231P1</b>	18.13	21.76
Genuine	1	<b>591231</b>	78.39	94.07

All V8 petrol models				
OEM	1	<b>UKC8677P1</b>	20.00	24.00
Genuine	1	<b>UKC8677</b>	16.67	20.00

## Push Rod Clip

All 4 cyl petrol and diesel models				
Aftermarket	1	<b>FRC3327P</b>	0.75	0.90
Genuine	1	<b>FRC3327</b>	3.23	3.88

All V8 petrol models				
Aftermarket	1	<b>576723P</b>	0.38	0.46
Genuine	1	<b>576723</b>	3.95	4.74

## Push Rod

All 4 cyl petrol & diesel models with 5 speed LT77 gearbox - Clutch slave cylinder				
Aftermarket	1	<b>FRC3417P</b>	2.25	2.70
Genuine	1	<b>FRC3417</b>	7.98	9.58

## Bleed Screw Clutch Slave Cylinder

All V8 petrol models	Genuine	1	<b>606733A</b>	2.58	3.10
----------------------	---------	---	----------------	------	------

## Pedal Pad

All models up to (VIN) AA234187 - Clutch pedal only				
Aftermarket	2	<b>278166P</b>	1.83	2.20
Genuine	2	<b>278166</b>	6.94	8.33

## Dowel Clutch Guide

All models with LT77 gearbox - 5 speed	Genuine	2	<b>FRC2481</b>	2.29	2.75
----------------------------------------	---------	---	----------------	------	------





# TRANSMISSION

**110 (1983-1989)**

## Constant Velocity Joint

All models up to (axle) 20L48865 and 21L33355 - 23 spline				
	Aftermarket	2	<b>AEU2522P</b>	18.13 21.76
All models from (axle) 20L48866 and 21L33356 on - 33 spline				
	Aftermarket	2	<b>RTC6862P</b>	15.83 19.00
	Genuine	2	<b>RTC6862</b>	577.93 693.52

## Gaiter Propshaft c/w Clips

All models - Front				
	Aftermarket	1	<b>276484P</b>	2.33 2.80
	Genuine	1	<b>276484</b>	22.65 27.18

## Gaiter Propshaft

All models - Front				
	Aftermarket	1	<b>TVE100000P</b>	2.58 3.10
	OEM	1	<b>TVE100000P1</b>	3.08 3.70
	Genuine	1	<b>TVE100000</b>	15.14 18.17
All models - Rear				
	Aftermarket	1	<b>276483P</b>	3.00 3.60
	Genuine	1	<b>276483</b>	24.73 29.68

## Universal Joint

All 4 cyl models to (VIN) CA252578 - Propshaft				
	Aftermarket	2	<b>RTC3346P</b>	3.50 4.20
	OEM	2	<b>RTC3346P1</b>	8.13 9.76
	Genuine	2	<b>RTC3346</b>	49.81 59.77
All 4 cyl models from (VIN) CA252579 on - Propshaft, sealed				
	Aftermarket	2	<b>RTC3458P</b>	4.08 4.90
	OEM	2	<b>RTC3458P1</b>	8.54 10.25
	Genuine	2	<b>RTC3458</b>	46.58 55.90
All V8 petrol models to (VIN) CA254406 - Propshaft				
	Aftermarket	2	<b>RTC3346P</b>	3.50 4.20
	OEM	2	<b>RTC3346P1</b>	8.13 9.76
	Genuine	2	<b>RTC3346</b>	49.81 59.77
All V8 petrol models from (VIN) CA254407 on - Propshaft, sealed				
	Aftermarket	2	<b>RTC3458P</b>	4.08 4.90
	OEM	2	<b>RTC3458P1</b>	8.54 10.25
	Genuine	2	<b>RTC3458</b>	46.58 55.90

## Shaft Assembly Front Output

All models with LT230 transfer box				
	Aftermarket	1	<b>FRC5449P</b>	38.75 46.5
	Genuine	1	<b>FRC5449</b>	190.22 228.26

## Front Output Shaft

All V8 carb petrol models with 4 speed LT95 gearbox				
	OEM	1	<b>594337P1</b>	53.33 64.00
	Genuine	1	<b>594337</b>	145.02 174.02

## Drive Flange, Transfer Box

All models with 43D transfer box - Front, heavy duty				
	Genuine	1	<b>IEC100020</b>	49.74 59.69

## Shaft Front Axle

All models (axle) 20L, 21L, 22L, 23L - RH				
	Genuine	1	<b>AEU2520</b>	317.01 380.41

## Spacer Front Drive Shaft

All models (axle) 20L, 21L, 22L, 23L				
	Aftermarket	2	<b>FTC254P</b>	2.83 3.40
	Genuine	2	<b>FTC254</b>	5.31 6.37

## Stub Axle - Front

All models				
	Aftermarket	2	<b>FRC4320P</b>	20.63 24.76
	OEM	2	<b>FRC4320P1</b>	50.00 60.00
	Genuine	2	<b>FRC4320</b>	103.38 124.06

## Stub Axle Kit - Front

All models - Front. Includes stub axle, gasket, bolts, washers, bearing and seals				
	Britpart	2	<b>FRC4320BPK</b>	20.63 24.76

## Stub Axle - Rear

All models				
	Aftermarket	2	<b>FRC3132P</b>	19.58 23.50
	OEM	2	<b>FRC3132P1</b>	39.58 47.50
	Genuine	2	<b>FRC3132</b>	167.46 200.95
All models (axle) 22S08283B on				
	Aftermarket	2	<b>FRC8540P</b>	16.04 19.25
	OEM	2	<b>FRC8540P1</b>	45.00 54.00
	Genuine	2	<b>FRC8540</b>	201.46 241.75

## Stub Axle Kit - Rear

Up to (axle) 22S08283B - Rear, includes stub axle, gasket, bolts and nuts				
	Britpart	2	<b>FRC3132BPK</b>	45.83 55.00
From (axle) 22S08284B on - Rear, includes stub axle, gasket, bolts and nuts				
	Britpart	2	<b>FRC8540BPK</b>	17.50 21.00

## Stub Axle Nut

All models				
	Aftermarket	4	<b>FRC8700P</b>	1.25 1.50
	Genuine	4	<b>FRC8700</b>	10.09 12.11

## Hub Assembly Rear

All models (axle) 22S08283B on				
	Aftermarket	2	<b>FRC8555P</b>	39.58 47.50
	Genuine	2	<b>FRC8555</b>	149.20 179.04

## Driving Member

All models - 24 spline, front and rear				
	Aftermarket	2	<b>FRC5806P</b>	5.42 6.50
	Genuine	2	<b>FRC5806</b>	128.29 153.95
Heavy Duty				
	Bearmach	2	<b>FRC5806HDBMDEF</b>	13.33 16.00
	Britpart	2	<b>FRC5806HDBPDEF</b>	25.83 31.00

## Driving Member Kit

All models - Pair of 24 spline driving members					
	Heavy Duty	Britpart	2	<b>FRC5806HDKBPDF</b>	60.00 72.00

## Dust Cap, Screw On

All models fitted with Bearmach heavy duty driving members					
	Heavy duty driving member	Bearmach	2	<b>RUC105200HDBMNU</b>	3.33 4.00
All models fitted with Britpart heavy duty driving members					
	Heavy duty driving member	Britpart	2	<b>RUC105200HDBPCAP</b>	8.75 10.50

## Bolt Kit, Heavy Duty Driving Members

All models fitted with Britpart heavy duty driving members - Includes 10 bolts (one axle set)				
	Britpart	1	<b>RUC105200BPKBOLT</b>	10.00 12.00

## Hub and Sleeve Assembly Trans Box

All 4 cyl models with LT77 gearbox and LT230 transfer box (gbox) 22D				
	OEM	1	<b>FTC382P1</b>	78.33 94.00
	Genuine	1	<b>FTC382</b>	341.90 410.28
All V8 carb petrol models with 5 speed LT77 gearbox and LT230 transfer box (gbox) 32D				
	OEM	1	<b>FTC382P1</b>	78.33 94.00
	Genuine	1	<b>FTC382</b>	341.90 410.28

## Spacer Hub

All models				
	Aftermarket	2	<b>FRC8227P</b>	1.75 2.10
	Genuine	2	<b>FRC8227</b>	29.89 35.87

## Bearing Swivel Pin Housing

All models				
	Aftermarket	2	<b>606666P</b>	3.33 4.00
	OEM	2	<b>606666P1</b>	10.42 12.50
	Genuine	2	<b>606666</b>	23.99 28.79

## Housing Swivel Pin Bearing

All models (axle) 20L, 21L, 22L, 23L - 7 hole type				
	Aftermarket	2	<b>FTC5105P</b>	60.00 72.00
	OEM	2	<b>FTC5105P1</b>	87.50 105.00
	Genuine	2	<b>FTC5105</b>	197.93 237.52

## Housing and Bush Swivel Pin

All models				
	Aftermarket	2	<b>8510267P</b>	6.04 7.25
	Genuine	2	<b>8510267</b>	31.21 37.45



606666P1



AEU2522P



RTC3346P



FRC8540P



FRC5806HDKBPDF



**110 (1983-1989)****TRANSMISSION****Housing, Swivel Pin**

All RHD models				
LH	Genuine	1	<b>FTC2529</b>	468.45 562.14
RH	OEM	1	<b>FTC2530P1</b>	245.83 295.00
All LHD models				
RH	Genuine	1	<b>FTC2530</b>	522.25 626.70
LH	OEM	1	<b>FTC2531P1</b>	233.33 280.00
	Genuine	1	<b>FTC2531</b>	502.76 603.31

**Swivel Pin Upper**

All models				
	Aftermarket	2	<b>FRC3511P</b>	5.63 6.76
	Genuine	2	<b>FRC3511</b>	86.01 103.21

**Swivel Pin Lower**

All models				
	Aftermarket	2	<b>FRC2894P</b>	2.50 3.00
	Genuine	2	<b>FRC2894</b>	64.95 77.94

**Swivel Housing Grease**

All models - Sachet				
	OEM	a/r	<b>STC3435P1</b>	5.00 6.00
	Genuine	a/r	<b>STC3435</b>	7.69 9.23
All models - 370g bottle				
	Britpart	a/r	<b>STC3435BPBOTTLE</b>	4.79 5.75
All models - 370ml sachet				
	Britpart	a/r	<b>STC3435BPSACHET</b>	4.38 5.26

**Oil Seal Diff Unit**

All models (axle) to 22S08283B				
	Aftermarket	1	<b>FRC4586P</b>	0.83 1.00
	OEM	1	<b>FRC4586P1</b>	3.50 4.20
	Genuine	1	<b>FRC4586</b>	11.66 13.99
All models (axle) 22S08284B on				
	Aftermarket	1	<b>FRC8220P</b>	1.50 1.80
	OEM	1	<b>FRC8220P1</b>	5.63 6.76
	Genuine	1	<b>FRC8220</b>	27.28 32.74

**Oil Seal Diff Pinion**

All models rear axle only (axle) 14S to 17S				
	Aftermarket	1	<b>FTC4851P</b>	2.00 2.40
	OEM	1	<b>FTC4851P1</b>	5.00 6.00
	Genuine	1	<b>FTC4851</b>	17.42 20.90

**Oil Seal, Differential**

All Salisbury type axles - Pinion				
	Aftermarket	1	<b>AEU2515P</b>	2.83 3.40
	Genuine	1	<b>AEU2515</b>	35.42 42.50

**Oil Seal Rear Diff Pinion**

All models				
	Genuine	1	<b>AAU3381</b>	5.30 6.36

**Oil Seal Hub**

All models				
	Aftermarket	2	<b>FRC8222P</b>	1.83 2.20
	OEM	2	<b>FRC8222P1</b>	5.63 6.76
	Genuine	2	<b>FRC8222</b>	21.24 25.49

**Oil Seal Stub Axle**

All models - Twin lip type				
	Aftermarket	2	<b>RTC3511P</b>	1.33 1.60
	OEM	2	<b>RTC3511P1</b>	3.50 4.20
	Genuine	2	<b>RTC3511</b>	12.52 15.02

**Seal Inner Stub Axle**

All models (axle) 20L, 21L, 22L, 23L, 22S, 24S				
	Aftermarket	2	<b>FTC4785P</b>	1.33 1.60
	OEM	2	<b>FTC4785P1</b>	3.00 3.60
	Genuine	2	<b>FTC4785</b>	4.34 5.21

**Seal Stub Axle**

All models				
	Aftermarket	2	<b>FRC3099P</b>	0.75 0.90
	OEM	2	<b>FRC3099P1</b>	3.25 3.90
	Genuine	2	<b>FRC3099</b>	8.09 9.71

**Oil Seal Output Shaft**

All V8 petrol models with LT95 4 speed gearbox				
	Aftermarket	1	<b>90622240P</b>	1.25 1.50
	Genuine	1	<b>90622240</b>	3.81 4.57
Alternative to 90622240				
	Aftermarket	1	<b>571175P</b>	0.63 0.76
	Genuine	1	<b>571175</b>	3.69 4.43

**Oil Seal Front Cover**

All models with LT77 5 speed gearbox (gbox) suffix A to E				
	Aftermarket	1	<b>UKC1060P</b>	1.58 1.90
	Aftermarket	1	<b>UKC1060</b>	5.63 6.76

**Oil Seal Clutch Sleeve Housing**

All V8 petrol models with LT95 4 speed gearbox				
	Aftermarket	1	<b>571059P</b>	0.63 0.76
	Genuine	1	<b>571059</b>	7.87 9.44

**Oil Seal Transfer Box Input**

All models with LT230 transfer box				
	Aftermarket	1	<b>ICV100000P</b>	0.92 1.10
	OEM	1	<b>ICV100000P1</b>	3.83 4.60
	Genuine	1	<b>ICV100000</b>	6.99 8.39

**Oil Seal Transfer Box Output Flange**

All models with LT230 transfer box				
	Aftermarket	1	<b>FTC4939P</b>	2.00 2.40
	OEM	1	<b>FTC4939P1</b>	5.00 6.00
	Genuine	1	<b>FTC4939</b>	13.18 15.82

**Oil Seal Swivel**

All models - 9mm				
	Aftermarket	2	<b>LR059968P</b>	2.08 2.50
	OEM	2	<b>LR059968P1</b>	5.83 7.00
	Genuine	2	<b>LR059968</b>	9.89 11.87

**Oil Seal Swivel Pin Housing**

All models (axle) 20L, 21L, 22L, 23L				
	Aftermarket	2	<b>571718P</b>	1.17 1.40
	OEM	2	<b>571718P1</b>	3.00 3.60
	Genuine	2	<b>571718</b>	6.81 8.17

**Drain Plug Diff Unit**

All models				
	Aftermarket	1	<b>608246P</b>	2.33 2.80
	Genuine	1	<b>608246</b>	9.63 11.56

**Sealing Washer Drain Plug**

All models with LT77 or R380 5 speed gearbox - Alternative to FRC7064A				
	Aftermarket	1	<b>FTC4112P</b>	0.79 0.95
	Genuine	1	<b>FTC4112</b>	2.37 2.84

**Drain Plug Transfer Box**

All models with LT230 transfer box				
	Aftermarket	1	<b>599552P</b>	2.83 3.40
	Genuine	1	<b>599552</b>	8.99 10.79
All V8 models with LT95 4 speed gearbox				
	Aftermarket	1	<b>599552P</b>	2.83 3.40
	Genuine	1	<b>599552</b>	8.99 10.79

**Sealing Washer Drain Plug**

All models - Land Rover type axle				
	Aftermarket	1	<b>515599P</b>	0.33 0.40
	Genuine	1	<b>515599</b>	1.17 1.40
All models with LT77 or R380 5 speed gearbox - Alternative to FTC4112				
	Aftermarket	1	<b>FRC7064A</b>	1.08 1.30

**Gear Speedometer Drive**

All models with LT230 transfer box				
	Aftermarket	1	<b>FRC3162P</b>	20.63 24.76
	OEM	1	<b>FRC3162P1</b>	23.75 28.50
	Genuine	1	<b>FRC3162</b>	64.01 76.81

**Speedometer Drive Gear**

All models with blue coded 20 teeth speedometer drive pinion - Pinion, blue, 20 teeth				
	Aftermarket	1	<b>FRC3310P</b>	8.54 10.25
	Genuine	1	<b>FRC3310</b>	16.89 20.27

**Switch, Gearbox**

All models with LT230 transfer box - High/Low, with spade connectors				
	Aftermarket	1	<b>PRC2911P</b>	4.08 4.90
	OEM	1	<b>PRC2911P1</b>	7.92 9.50
	Genuine	1	<b>PRC2911</b>	35.18 42.22

**Taper Roller Bearing Diff Carrier**

All models (axle) 64L - Land Rover type axle				
	Aftermarket	2	<b>RTC3095P</b>	4.25 5.10
	OEM	2	<b>RTC3095P1</b>	9.37 11.24
	Genuine	2	<b>RTC3095</b>	52.69 63.23

FRC3511P



FRC2894P



FRC3162P



RTC3095P



# COOLING

**110 (1983-1989)**

## Expansion Bottle Cap

All 4 cyl petrol models up to (VIN) LA932798- 9lb pressure	Aftermarket	1	<b>GRC118</b>	4.08	4.90
All 4 cyl diesel models up to (VIN) LA932798 except 200 TDi - 9lb pressure	Aftermarket	1	<b>GRC118</b>	4.08	4.90
All 2.5L normally aspirated diesel engine models	Aftermarket	1	<b>PCD100150P</b>	1.42	1.70
	Genuine	1	<b>PCD100150</b>	4.04	4.85
15lb pressure	Aftermarket	1	<b>GRC110</b>	4.38	5.26
All 2.5L turbo diesel engine models	Aftermarket	1	<b>PCD100160-P</b>	2.00	2.40
	Genuine	1	<b>PCD100160</b>	3.87	4.64
All V8 carb petrol engine models	Aftermarket	1	<b>PCD100150P</b>	1.42	1.70
	Genuine	1	<b>PCD100150</b>	4.04	4.85
15lb pressure	Aftermarket	1	<b>GRC110</b>	4.38	5.26

## Radiator Cap

All 2.5L NA diesel models - Expansion tank	Aftermarket	1	<b>STC4735P</b>	1.50	1.80
	Genuine	1	<b>STC4735</b>	6.11	7.33

## Thermostat

All 2.25L petrol engine models - 82°C	Aftermarket	1	<b>596225P</b>	2.75	3.30
	Genuine	1	<b>596225</b>	35.56	42.67
All 4 cyl petrol and diesel engine models 82°C	Aftermarket	1	<b>602687P</b>	2.58	3.10
	OEM	1	<b>602687P1</b>	3.58	4.30
	Genuine	1	<b>602687</b>	10.06	12.07
74°C	Aftermarket	1	<b>ETC4761P</b>	2.00	2.40
	OEM	1	<b>ETC4761P1</b>	3.50	4.20
	Genuine	1	<b>ETC4761</b>	12.25	14.70
74°C, hot climates option	Aftermarket	1	<b>GTS102</b>	3.33	4.00
82°C, std fitment	Aftermarket	1	<b>GTS104</b>	3.58	4.30
88°C, cold climates option	Aftermarket	1	<b>GTS106</b>	3.58	4.30
All V8 carb petrol engine models 82°C	Aftermarket	1	<b>602687P</b>	2.58	3.10
	OEM	1	<b>602687P1</b>	3.58	4.30
	Genuine	1	<b>602687</b>	10.06	12.07
All V8 petrol models 74°C, hot climates option	Aftermarket	1	<b>GTS102</b>	3.33	4.00
82°C, std fitment	Aftermarket	1	<b>GTS104</b>	3.58	4.30
88°C, cold climates option	Aftermarket	1	<b>GTS106</b>	3.58	4.30

## Thermostat Housing Gasket

All 4 cylinder models- Thermostat housing	Aftermarket	1	<b>ERR3682P</b>	0.33	0.40
	Genuine	1	<b>ERR3682</b>	2.04	2.45
All 2.25L petrol and diesel models - Lower	Aftermarket	1	<b>247874P</b>	0.15	0.18
	Genuine	1	<b>247874</b>	1.74	2.09
All 2.5L NA and Turbo Diesel models - Lower	Aftermarket	1	<b>247874P</b>	0.15	0.18
	Genuine	1	<b>247874</b>	1.74	2.09
All V8 petrol engine models - Thermostat housing	Aftermarket	1	<b>ERR2429P</b>	0.67	0.80
	Genuine	1	<b>ERR2429</b>	1.75	2.10
All V8 petrol models with 4 barrel carb conversion	Aftermarket	1	<b>GTG116</b>	1.83	2.20

## Thermostat Housing

All 2.25L & 2.5L petrol models	Genuine	1	<b>ERC8758</b>	141.21	169.45
All 2.5L N/A & Turbo Diesel models	Genuine	1	<b>ERC8758</b>	141.21	169.45
All V8 petrol models with air conditioning	Aftermarket	1	<b>ETC6135A</b>	29.58	35.50

## Thermostat Housing Adaptor

All 2.25L and 2.5L 4 cyl petrol and diesel models including Turbo Diesel - Heater pipe	Genuine	1	<b>624091</b>	7.82	9.38
----------------------------------------------------------------------------------------	---------	---	---------------	------	------



GRC118



602687P



STC635P



RTC4996P

## Water Pump

All 2.25L petrol engine models without air conditioning	Aftermarket	1	<b>STC636P</b>	34.58	41.50
	Genuine	1	<b>STC636</b>	242.88	291.46
All 2.5L petrol engine models without air conditioning	Aftermarket	1	<b>STC637P</b>	29.58	35.50
	OEM	1	<b>STC637P1</b>	50.00	60.00
	Genuine*	1	<b>STC637</b>	138.92	166.70
			*Exchange Surcharge	40.00	48.00
All 2.5L petrol engine models with air conditioning	Aftermarket	1	<b>STC635P</b>	26.67	32.00
	Genuine*	1	<b>STC635</b>	168.32	201.98
			*Exchange Surcharge	70.00	84.00
All 2.5L normally aspirated diesel models without air conditioning	Aftermarket	1	<b>STC637P</b>	29.58	35.50
	OEM	1	<b>STC637P1</b>	50.00	60.00
	Genuine*	1	<b>STC637</b>	138.92	166.70
			*Exchange Surcharge	40.00	48.00
All 2.5L normally aspirated diesel models with air conditioning	Aftermarket	1	<b>STC635P</b>	26.67	32.00
	Genuine*	1	<b>STC635</b>	168.32	201.98
			*Exchange Surcharge	70.00	84.00
All 2.5L turbo diesel models	Aftermarket	1	<b>STC635P</b>	26.67	32.00
	Genuine*	1	<b>STC635</b>	168.32	201.98
			*Exchange Surcharge	70.00	84.00
All military 2.5L petrol models	Genuine	1	<b>STC634</b>	234.13	280.96
All V8 carb petrol models without viscous coupling	Aftermarket	1	<b>STC1611P</b>	30.00	36.00
	Genuine*	1	<b>STC1611</b>	126.22	151.46
			*Exchange Surcharge	40.00	48.00
All V8 carb petrol engine models with viscous coupling with air conditioning	Aftermarket	1	<b>STC488P</b>	50.00	60.00
	Genuine*	1	<b>STC488</b>	182.33	218.80
			*Exchange Surcharge	40.00	48.00

## Water Pump Gasket

All 4 cylinder models - Water pump	Aftermarket	1	<b>ERC5655P</b>	0.38	0.46
	Genuine	1	<b>ERC5655</b>	5.04	6.05
All V8 carb engine models - Water pump	Aftermarket	1	<b>ERR2428P</b>	0.83	1.00
	OEM	1	<b>ERR2428P1</b>	4.00	4.80
	Genuine	1	<b>ERR2428</b>	8.47	10.16

## Water Pump Inlet Housing Gasket

All 4 cylinder models - Water pump inlet housing	Aftermarket	1	<b>ERR1607P</b>	0.25	0.30
	Genuine	1	<b>ERR1607</b>	1.67	2.00

## Temperature Sensor

4 cyl petrol models with air conditioning - Blue	Aftermarket	1	<b>PRC3366P</b>	4.38	5.26
	Genuine	1	<b>PRC3366</b>	33.89	40.67
All 4 cyl petrol and diesel engine models	Aftermarket	1	<b>PRC2505P</b>	2.00	2.40
	Genuine	1	<b>PRC2505</b>	23.66	28.39
All 2.25L petrol models with red temp sensor	Aftermarket	1	<b>PRC3541P</b>	10.42	12.50
	Genuine	1	<b>PRC3541</b>	33.89	40.67
All 2.5L petrol models with red temp sensor	Aftermarket	1	<b>PRC3541P</b>	10.42	12.50
	Genuine	1	<b>PRC3541</b>	33.89	40.67
All 2.5L N/A diesel models with red temp sensor	Aftermarket	1	<b>PRC3541P</b>	10.42	12.50
	Genuine	1	<b>PRC3541</b>	33.89	40.67
2.5L N/A diesel engine models Blue	Aftermarket	1	<b>PRC3366P</b>	4.38	5.26
	Genuine	1	<b>PRC3366</b>	33.89	40.67
2.5L Turbo Diesel engine models Green	Aftermarket	1	<b>PRC3359P</b>	5.00	6.00
	OEM	1	<b>PRC3359P1</b>	27.08	32.50
	Genuine	1	<b>PRC3359</b>	39.35	47.22
Yellow	Aftermarket	1	<b>PRC3505A</b>	10.00	12.00
V8 carb petrol models with air conditioning Green	Aftermarket	1	<b>PRC3359P</b>	5.00	6.00
	OEM	1	<b>PRC3359P1</b>	27.08	32.50
	Genuine	1	<b>PRC3359</b>	39.35	47.22
All V8 carb petrol models	Aftermarket	1	<b>RTC4996P</b>	5.63	6.76
V8 carb petrol models with air conditioning Yellow	Aftermarket	1	<b>PRC3505A</b>	10.00	12.00
All V8 petrol models	Aftermarket	1	<b>PRC2506P</b>	5.63	6.76
	Genuine	1	<b>PRC2506</b>	23.66	28.39



## 110 (1983-1989)

## ELECTRICAL - ROTATING ELECTRICS

## Alternator

All 4 cyl petrol models without air conditioning - A127/45Amp				
New, exchange	Genuine*	1	<b>STC229</b>	300.76 360.91 70.00 84.00
All 4 cyl petrol models with air conditioning - A127/65Amp				
New, outright	Aftermarket	1	<b>STC234P</b>	67.50 81.00
All 4 cyl petrol models with air conditioning - A133/65Amp				
Reconditioned, exchange	Aftermarket*	1	<b>RTC5218EP</b>	95.83 115.00 100.00 120.00
New, exchange	Genuine	1	<b>RTC5218E</b>	131.77 158.12 80.00 96.00
All 2.5L petrol models without air conditioning with A127/45amp				
New, outright	Aftermarket	1	<b>RTC5682P</b>	70.83 85.00
Reconditioned, exchange	Genuine*	1	<b>RTC5682E</b>	131.34 157.61 80.00 96.00
All 2.5L Turbo Diesel models without air conditioning (A127/45amp alternator)				
New, outright	Aftermarket	1	<b>RTC5682P</b>	70.83 85.00
Reconditioned, exchange	Genuine*	1	<b>RTC5682E</b>	131.34 157.61 80.00 96.00
All 2.5L normally aspirated diesel models with air conditioning and 65Amp alternator - A133/65Amp				
Reconditioned, exchange	Aftermarket*	1	<b>RTC5218EP</b>	95.83 115.00 100.00 120.00
New, exchange	Genuine*	1	<b>RTC5218E</b>	131.77 158.12 80.00 96.00
All 2.5L normally aspirated diesel models with air conditioning and 65Amp alternator - A127/65Amp				
New, outright	Aftermarket	1	<b>STC234P</b>	67.50 81.00
All 2.5L normally aspirated diesel models without air conditioning				
A127/45Amp, New, exchange	Genuine*	1	<b>STC229</b>	300.76 360.91 70.00 84.00
2.5L N/A diesel military models fitted for radio with 24V system (90amp alternator)				
New, outright	Genuine	1	<b>PRC5253</b>	4379.92 5255.90
All 2.5L N/A diesel models without air conditioning with A127/45amp alternator				
New, outright	Aftermarket	1	<b>RTC5682P</b>	70.83 85.00
Reconditioned, exchange	Genuine*	1	<b>RTC5682E</b>	131.34 157.61 80.00 96.00
All 2.5L turbo diesel models without air conditioning - A127/45Amp				
New, exchange	Genuine*	1	<b>STC229</b>	300.76 360.91 70.00 84.00
All models with V8 carb petrol engine up to (engine) 17G00182 - A115-45Amp/18ACR				
Reconditioned, exchange	Aftermarket*	1	<b>RTC5086EP</b>	61.67 74.00 25.00 30.00
Reconditioned, exchange	Genuine*	1	<b>RTC5086E</b>	185.10 222.12 80.00 96.00
All V8 carb petrol engine models with 45 Amp alternator - A127/45Amp				
New, outright	Aftermarket	1	<b>RTC5683EP</b>	82.50 99.00
Reconditioned, exchange	Genuine*	1	<b>RTC5683E</b>	160.78 192.94 80.00 96.00
All V8 carb petrol models with LH fixing high output A127/65amp alternator				
New, outright	Aftermarket	1	<b>STC233P</b>	55.00 66.00
All V8 carb petrol models with LH fixing ignition sensed std power alternator (A115/45amp, replaces 17ACR/36amp)				
Reconditioned, exchange	Genuine*	1	<b>RTC5085E</b>	119.76 143.71 80.00 96.00

## Starter Motor

All 2.25L petrol models - Lucas M78R type starter				
New, outright	Aftermarket	1	<b>PRC6613P</b>	75.00 90.00
Reconditioned, exchange	Genuine*	1	<b>PRC6613E</b>	268.19 321.83 70.00 84.00
New, exchange	Genuine*	1	<b>PRC6613N</b>	390.98 469.18 70.00 84.00
All 2.5L petrol models up to (eng) 17H26367C - Lucas M78R type starter				
New, outright	Aftermarket	1	<b>PRC6613P</b>	75.00 90.00
Reconditioned, exchange	Genuine*	1	<b>PRC6613E</b>	268.19 321.83 70.00 84.00
New, exchange	Genuine*	1	<b>PRC6613N</b>	390.98 469.18 70.00 84.00
2.5L petrol engine models from (eng) 17H26368C on - Bosch type starter motor				
New, outright	Aftermarket	1	<b>NAD10040P</b>	60.00 72.00
Reconditioned, exchange	Genuine*	1	<b>NAD10040E</b>	233.12 279.74 70.00 84.00
New, exchange	Genuine*	1	<b>NAD10040</b>	487.94 585.53 70.00 84.00
All 2.5L normally aspirated diesel engine models with Lucas starter motor				
New, outright	Aftermarket	1	<b>RTC5249NP</b>	90.00 108.00
Lucas type M113 - Recon'd exchange	Genuine*	1	<b>RTC5249E</b>	252.89 303.47 100.00 120.00
Lucas type M113 - New, exchange	Genuine*	1	<b>RTC5249N</b>	541.97 650.36 70.00 84.00
All 2.5L normally aspirated diesel engine models with Lucas starter motor				
Hi Torque, uprated	Powerlite	1	<b>RTC5249UR</b>	145.00 174.00
All 2.5L N/A diesel models				
New, outright	Aftermarket	1	<b>NAD500210P</b>	82.50 99.00
Reconditioned, exchange	OEM	1	<b>NAD500210P1</b>	175.00 210.00
New, exchange	Genuine*	1	<b>PRC5109E</b>	242.74 291.29 100.00 120.00
New, exchange	Genuine*	1	<b>NAD500210</b>	316.78 380.14 100.00 120.00
All 2.5L Turbo Diesel models				
New, outright	Aftermarket	1	<b>NAD500210P</b>	82.50 99.00
New, exchange	OEM	1	<b>NAD500210P1</b>	175.00 210.00
Reconditioned, exchange	Genuine*	1	<b>NAD500210</b>	316.78 380.14 100.00 120.00
Reconditioned, exchange	Genuine*	1	<b>PRC5109E</b>	242.74 291.29 100.00 120.00
Military 2.25L petrol models, fitted for radio - 24V system				
New, exchange	Genuine*	1	<b>90501505</b>	3300.25 3960.30 70.00 84.00
All military 2.5L petrol models with 24V system - 24V system				
New, outright	Genuine	1	<b>ERR5693</b>	1022.38 1226.86

## 110 (1983-1989)

## ENGINE GASKETS

## Gasket Rocker Cover

All 2.25L and 2.5L petrol models				
Self adhesive	Aftermarket	1	<b>ERR4933P</b>	1.00 1.20
	Genuine	1	<b>ERR4933</b>	11.78 14.14
All 2.5L N/A diesel models				
Self adhesive	Aftermarket	1	<b>ETC6438P</b>	0.92 1.10
	Genuine	1	<b>ETC6438</b>	7.20 8.64
All V8 petrol models				
Rubber	OEM	2	<b>GEG436UPRATED</b>	2.65 3.18
Cork	OEM	2	<b>GEG436</b>	1.58 1.90

## Gasket Cylinder Head

2.25L and 2.5L petrol models				
	Aftermarket	1	<b>ERC6380P</b>	3.25 3.90
	OEM	1	<b>ERC6380P1</b>	12.95 15.54
	Genuine	1	<b>ERC6380</b>	25.12 30.14
2.5L N/A and Turbo Diesel models				
	Aftermarket	1	<b>ERR3618P</b>	3.00 3.60
	OEM	1	<b>ERR3618P1</b>	9.79 11.75
	Genuine	1	<b>ERR3618</b>	36.82 44.18
V8 petrol models - Original style tin head gasket				
	Aftermarket	2	<b>603796P</b>	1.92 2.30
	Genuine	2	<b>603796</b>	10.18 12.22
All 3.5L V8 petrol models				
Tin type gasket	Aftermarket	2	<b>GEG340</b>	5.00 6.00
	Aftermarket	2	<b>GEG340P</b>	2.08 2.50
Composite type gasket	Aftermarket	2	<b>GEG340COM</b>	15.42 18.50
	Aftermarket	2	<b>GEG340COMP</b>	6.04 7.25
	Genuine	2	<b>ERR4248</b>	35.01 42.01

## Gasket Oil Sump

2.25L and 2.5L petrol models				
	Aftermarket	1	<b>546841P</b>	1.00 1.20
	OEM	1	<b>546841P1</b>	2.42 2.90
	Genuine	1	<b>546841</b>	17.82 21.38
2.5L N/A diesel models				
	Aftermarket	1	<b>546841P</b>	1.00 1.20
	OEM	1	<b>546841P1</b>	2.42 2.90
	Genuine	1	<b>546841</b>	17.82 21.38
All V8 petrol models				
	Aftermarket	1	<b>AJM539P</b>	1.00 1.20
	Aftermarket	1	<b>AJM539</b>	4.08 4.90

## Gasket Decoke Set

2.25L and 2.5L petrol models				
	Aftermarket	1	<b>STC1640P</b>	8.54 10.25
	OEM	1	<b>STC1640P1</b>	21.67 26.00
	Genuine	1	<b>STC1640</b>	71.31 85.57
All 2.25L petrol models				
	Aftermarket	1	<b>STC1567P</b>	10.00 12.00
2.5L N/A diesel models				
	Aftermarket	1	<b>STC1562P</b>	9.79 11.75
	OEM	1	<b>STC1562P1</b>	24.58 29.50
	Genuine	1	<b>STC1562</b>	107.15 128.58
2.5L Turbo Diesel models				
	Aftermarket	1	<b>RTC5774P</b>	11.88 14.26
	OEM	1	<b>RTC5774P1</b>	45.00 54.00
	Genuine	1	<b>RTC5774</b>	118.92 142.70
V8 petrol models				
Includes original fitment tin head gasket	Aftermarket	1	<b>STC1566P</b>	11.67 14.00
Includes original style tin head gasket	Genuine	1	<b>STC1566</b>	133.80 160.56
All 3.5L V8 petrol models				
Includes tin type head gasket	Aftermarket	1	<b>GUG1066HS</b>	20.42 24.50
	Aftermarket	1	<b>GUG1066HSC</b>	19.79 23.75
Includes composite type head gasket	Aftermarket	1	<b>GUG1066HSCOM</b>	33.33 40.00

## Gasket Conversion Set

2.25L and 2.5L petrol models				
	Aftermarket	1	<b>STC1467P</b>	6.88 8.26
	OEM	1	<b>STC1467P1</b>	29.58 35.50
	Genuine	1	<b>STC1467</b>	127.06 152.47
All 2.25L diesel models				
	Aftermarket	1	<b>STC1561P</b>	5.00 6.00
	Genuine	1	<b>STC1561</b>	199.86 239.83
All 2.5L N/A diesel models				
	Aftermarket	1	<b>STC1559P</b>	11.04 13.25
	Genuine	1	<b>STC1559</b>	93.01 111.61
2.5L N/A diesel models				
	Genuine	1	<b>STC1560</b>	160.93 193.12
2.5L Turbo Diesel models				
	Aftermarket	1	<b>STC1558P</b>	10.63 12.76
All 3.5L V8 carb petrol models				
	Aftermarket	1	<b>GUG1538CS</b>	13.13 15.76
	Aftermarket	1	<b>GUG1538CSP</b>	10.83 13.00
V8 petrol models				
	Aftermarket	1	<b>STC1639P</b>	9.79 11.75
	OEM	1	<b>STC1639P1</b>	25.83 31.00
	Genuine	1	<b>STC1639</b>	60.34 72.41

## Silicone Sealant RTV

Numerous applications				
	Aftermarket	a/r	<b>RTC3254P</b>	5.00 6.00
	Genuine	a/r	<b>RTC3254</b>	21.04 25.25

## Sealant Instant Gasket

Numerous applications				
	Genuine	a/r	<b>STC50550</b>	13.10 15.72



## ENGINE SWITCHES

**110 (1983-1989)**

### Temperature Sensor Oil Pump

All V8 carb petrol engine models	Aftermarket	1	<b>PRC2236P</b>	3.50	4.20
----------------------------------	-------------	---	-----------------	------	------

**PRC2236P**

### Oil Pressure Switch

All 4 cyl models	Aftermarket	1	<b>PRC6387P</b>	1.83	2.20
	OEM	1	<b>PRC6387P1</b>	3.50	4.20
	Genuine	1	<b>PRC6387</b>	28.77	34.52
All V8 carb petrol engine models	Aftermarket	1	<b>DRC2479A</b>	29.58	35.50
All V8 petrol engine models	Aftermarket	1	<b>STC4104P</b>	3.00	3.60
	OEM	1	<b>STC4104P1</b>	12.50	15.00
	Genuine	1	<b>STC4104</b>	29.01	34.81

## DRAIN PLUGS

**110 (1983-1989)**

### Sump Plug Magnetic

All petrol and diesel models except V8	Genuine	1	<b>ETC5577</b>	3.53	4.24
----------------------------------------	---------	---	----------------	------	------

### Sump Plug

All V8 petrol models	Aftermarket	1	<b>603659A</b>	2.83	3.40
All 2.25L petrol models	Genuine	1	<b>536577</b>	1.91	2.29

### Sump Plug Washer

All petrol and diesel models	Aftermarket	1	<b>213961A</b>	1.25	1.50
All 4 cyl petrol models	Aftermarket	1	<b>FRC4808P</b>	0.58	0.70
	Genuine	1	<b>FRC4808</b>	1.83	2.20
2.25L petrol models	Aftermarket	1	<b>243959P</b>	0.38	0.46
	Genuine	1	<b>243959</b>	0.82	0.98
All 2.5L N/A and Turbo Diesel models	Aftermarket	1	<b>FRC4808P</b>	0.58	0.70
	Genuine	1	<b>FRC4808</b>	1.83	2.20
All models with LT230 transfer box	Aftermarket	1	<b>FRC4808P</b>	0.58	0.70
	Genuine	1	<b>FRC4808</b>	1.83	2.20

### Copper Sealing Washer

Numerous applications	Aftermarket	1	<b>ETC7398P</b>	0.75	0.90
	Genuine	1	<b>ETC7398</b>	1.55	1.86

### Filler Plug - Gearbox

All models with 5 speed LT77 gearbox - Gearbox	OEM	1	<b>3292P1</b>	1.33	1.60
	Genuine	1	<b>3292</b>	15.68	18.82
All V8 petrol models with 5 speed LT85 gearbox	OEM	1	<b>3292P1</b>	1.33	1.60
	Genuine	1	<b>3292</b>	15.68	18.82

### Drain Plug

All diesel models - Fuel filter/sedimentor	OEM	1	<b>37H7920P1</b>	7.08	8.50
	Genuine	1	<b>37H7920</b>	9.02	10.82

### Filler Plug - Steering Box

All models with Adwest manual steering box - Steering box	Genuine	1	<b>STC897</b>	31.33	37.60
	Genuine	1	<b>AEU4017</b>	3.57	4.28

**ETC5577**

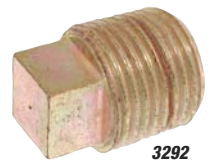
**603659A**

**3292**

## OIL SEALS ENGINE

**110 (1983-1989)**

### Oil Seal Crankshaft Front

All 4 cyl and 8 cyl models	Aftermarket	1	<b>ERR6490P</b>	3.00	3.60
	OEM	1	<b>ERR6490P1</b>	5.00	6.00
2.25L and 2.5L petrol models with twin lip seal	Aftermarket	1	<b>ETC5187P</b>	0.75	0.90
	OEM	1	<b>ETC5187P1</b>	3.83	4.60
	Genuine	1	<b>ETC5187</b>	11.33	13.60

### Oil Seal Front Cover

All 4cyl and 8 cyl models	Aftermarket	1	<b>ETC4154P</b>	1.08	1.30
	OEM	1	<b>ETC4154P1</b>	3.00	3.60
	Genuine	1	<b>ETC4154</b>	14.67	17.60

### Oil Seal Crankshaft Rear

2.25L and 2.5L petrol, 2.5L N/A and Turbo Diesel models	Aftermarket	1	<b>ERR2532P</b>	2.00	2.40
	OEM	1	<b>ERR2532P1</b>	5.83	7.00
	Genuine	1	<b>ERR2532</b>	21.00	25.20
	All V8 petrol models - Lip type seal	Aftermarket	1	<b>ERR2640P</b>	3.00
OEM		1	<b>ERR2640P1</b>	7.92	9.50
Genuine		1	<b>ERR2640</b>	15.58	18.70

### Oil Seal Camshaft

2.5L N/A and Turbo Diesel models	Aftermarket	1	<b>ETC5064P</b>	2.08	2.50
	OEM	1	<b>ETC5064P1</b>	2.50	3.00
	Genuine	1	<b>ETC5064</b>	21.23	25.48

### O Ring Camshaft Small

All 2.5L N/A & Turbo Diesel models - Camshaft pulley retaining plate	Genuine	1	<b>ERC8849</b>	0.61	0.73
----------------------------------------------------------------------	---------	---	----------------	------	------

**ERR6490P**

## ENGINE & GEARBOX MOUNTINGS

**110 (1983-1989)**

### Engine Mounting

All 4 cyl models - Engine and gearbox, M10 thread	Aftermarket	2	<b>ANR1808P</b>	2.33	2.80
	OEM	2	<b>ANR1808P1</b>	3.58	4.30
	Genuine	2	<b>ANR1808</b>	17.50	21.00
All V8 petrol models - With M12 metric threads	Aftermarket	4	<b>STC434P</b>	2.33	2.80
	OEM	4	<b>STC434P1</b>	9.38	11.26
	Genuine	4	<b>STC434</b>	23.83	28.60

### Bracket Engine Mounting

All 4 cyl models	RH	Genuine	1	<b>NRC5434</b>	103.48	124.18
	LH	Genuine	1	<b>NRC9557</b>	143.30	171.96

### Gearbox Mounting

All V8 petrol models - With M12 metric threads	Aftermarket	4	<b>STC434P</b>	2.33	2.80
	OEM	4	<b>STC434P1</b>	9.38	11.26
	Genuine	4	<b>STC434</b>	23.83	28.60

### Bracket Gearbox Mounting

All V8 petrol models - RH	Genuine	1	<b>ANR4657</b>	68.90	82.68
All V8 petrol models with 5 speed LT85 gearbox	Genuine	1	<b>NRC9501</b>	42.45	50.94

**ANR1808**

**STC434**

## 110 (1983-1989)

## CABLES

## Accelerator Cable

All RHD 2.25L petrol models	Aftermarket	1	<b>NRC8116P</b>	4.00	4.80	
	Genuine	1	<b>NRC8116</b>	148.51	178.21	
All RHD 2.5L petrol models up to (VIN) AA295722	Aftermarket	1	<b>NTC2086P</b>	3.75	4.50	
	Genuine	1	<b>NTC2086</b>	22.07	26.48	
All RHD 2.5L petrol models from (VIN) AA295723 on	Aftermarket	1	<b>NTC3460P</b>	7.50	9.00	
	Genuine	1	<b>NTC3460</b>	74.35	89.22	
All RHD diesel models with hand throttle to (VIN) AA267061 - Secondary (hand) throttle	Genuine	1	<b>NRC8502</b>	56.74	68.09	
All RHD 2.5L NA diesel models from (VIN) AA267062 on	Aftermarket	1	<b>NTC2743P</b>	6.88	8.26	
	Genuine	1	<b>NTC2743</b>	83.79	100.55	
All RHD 2.5L Turbo Diesel models	Aftermarket	1	<b>NTC2743P</b>	6.88	8.26	
	Genuine	1	<b>NTC2743</b>	83.79	100.55	
All 4 cyl petrol models with hand throttle - Secondary (hand) throttle	Genuine	1	<b>NRC8560</b>	245.88	295.06	
All V8 carb petrol models	Aftermarket	1	<b>NRC5494P</b>	4.58	5.50	
	Genuine	1	<b>NRC5494</b>	57.35	68.82	
All RHD V8 carb petrol models with hand throttle - Secondary (hand) throttle	Genuine	1	<b>NRC9284</b>	21.22	25.46	
All LHD 2.25L diesel models	Genuine	1	<b>NRC7607</b>	40.84	49.01	
All LHD 2.5L petrol models up to (VIN) BA295722	Aftermarket	1	<b>NTC2087P</b>	4.00	4.80	
	Genuine	1	<b>NTC2087</b>	68.10	81.72	
All LHD 2.25L petrol models up to (VIN) BA295722	Aftermarket	1	<b>NRC8117P</b>	4.79	5.75	
	Genuine	1	<b>NRC8117</b>	27.22	32.66	
LHD 2.5L petrol models (VIN) BA295734 on	Aftermarket	1	<b>NTC3459P</b>	4.00	4.80	
All LHD diesel models with hand throttle to (VIN) AA267061 - Secondary (hand) throttle	Genuine	1	<b>NRC8503</b>	56.80	68.16	
LHD 2.5L NA diesel models with hand throttle (VIN) AA267062 to HA456213	Secondary (hand) throttle	Genuine	1	<b>NTC3483</b>	81.70	98.04
LHD 2.5L NA diesel models to (VIN) AA267061	Aftermarket	1	<b>NRC7606P</b>	2.75	3.30	
	Genuine	1	<b>NRC7606</b>	48.41	58.09	
All LHD 2.5L normally aspirated diesel models from (VIN) AA267062 on	Aftermarket	1	<b>NTC3396P</b>	5.00	6.00	
	Genuine	1	<b>NTC3396</b>	75.66	90.79	
All LHD 2.5L turbo diesel models (not TDi)	Aftermarket	1	<b>NTC3396P</b>	5.00	6.00	
	Genuine	1	<b>NTC3396</b>	75.66	90.79	
LHD 2.5L Turbo Diesel models with hand throttle (VIN) AA267062 to HA456213	Secondary (hand) throttle	Genuine	1	<b>NTC3483</b>	81.70	98.04
All LHD diesel models with hand throttle from (VIN) AA267062 to HA456213 - Secondary (hand) throttle	Genuine	1	<b>NTC3484</b>	127.86	153.43	
All LHD V8 carb petrol models with hand throttle - Secondary (hand) throttle	Genuine	1	<b>NRC9285</b>	81.70	98.04	

## Bonnet Release Cable

All models	Aftermarket	1	<b>ALR9556P</b>	3.33	4.00
	Genuine	1	<b>ALR9556</b>	19.00	22.80

## Choke Cable

All RHD 4 cyl petrol models	Aftermarket	1	<b>NTC1384P</b>	11.67	14.00
	Genuine	1	<b>NTC1384</b>	44.09	52.91
All RHD 4 cyl petrol models up to (VIN) AA270139	Aftermarket	1	<b>NRC8626P</b>	8.96	10.75
All RHD V8 petrol models up to (VIN) AA268051	Aftermarket	1	<b>NRC7792P</b>	9.79	11.75
All RHD V8 carb petrol models from (VIN) AA268052 on	Aftermarket	1	<b>NTC3932P</b>	27.50	33.00
	Genuine	1	<b>NTC3932</b>	47.39	56.87
All LHD 4 cyl petrol models up to (VIN) AA270139	Genuine	1	<b>NRC8627</b>	35.16	42.19
All LHD 4 cyl petrol models from (VIN) AA270140 on	Aftermarket	1	<b>NTC1385P</b>	10.63	12.76
	Genuine	1	<b>NTC1385</b>	68.83	82.60
All LHD V8 petrol models up to (VIN) AA268051	Aftermarket	1	<b>NRC7791P</b>	16.67	20.00
All LHD V8 carb petrol models from (VIN) AA268052 on	Aftermarket	1	<b>NTC3933P</b>	25.00	30.00
	Genuine	1	<b>NTC3933</b>	43.03	51.64

## Speedometer Cable

All 4 cyl petrol & diesel models up to (VIN) AA268016 - Lower cable	Aftermarket	1	<b>PRC5663P</b>	13.38	16.06	
	Genuine	1	<b>PRC5663</b>	46.03	55.24	
All RHD 4 cyl models to (VIN) AA266613 - Two piece cable, upper end	Aftermarket	1	<b>PRC5567P</b>	2.50	3.00	
	Genuine	1	<b>PRC5567</b>	48.60	58.32	
All RHD 4 cyl petrol & diesel models from (VIN) AA267908 on except Police or overspeed warning fitted models - One piece cable	Aftermarket	1	<b>PRC6022P</b>	4.79	5.75	
	Genuine	1	<b>PRC6022</b>	113.28	135.94	
All RHD V8 models to (VIN) AA267907 - Two piece cable, upper end	Aftermarket	1	<b>PRC5567P</b>	2.50	3.00	
	Genuine	1	<b>PRC5567</b>	48.60	58.32	
All RHD V8 petrol models up to (VIN) AA268016 - Two piece cable, lower end	Aftermarket	1	<b>PRC5564P</b>	4.79	5.75	
	OEM	1	<b>PRC5664P1</b>	25.83	31.00	
All RHD V8 models from (VIN) AA267908 on - One piece cable	Aftermarket	1	<b>PRC6023P</b>	5.00	6.00	
	Genuine	1	<b>PRC6023</b>	85.06	102.07	
All LHD models to (VIN) AA267696 - Two piece cable, upper end	Aftermarket	1	<b>PRC5567P</b>	2.50	3.00	
	Genuine	1	<b>PRC5567</b>	48.60	58.32	
All LHD V8 petrol models up to (VIN) AA268016 - Lower cable	Aftermarket	1	<b>PRC5662P</b>	5.00	6.00	
	Genuine	1	<b>PRC5662</b>	49.50	59.40	
All models with overspeed audible warning up to (VIN) BA299084	Lower cable	Genuine	1	<b>PRC4282</b>	25.67	30.80
	Upper cable	Genuine	1	<b>PRC4298</b>	50.18	60.22
All models with overspeed audible warning from (VIN) BA299085 on	Lower cable	Genuine	1	<b>PRC6036</b>	62.50	75.00
	Upper cable	Genuine	1	<b>PRC6037</b>	99.46	119.35
All 4 cyl petrol & diesel police spec models with observer's speedometer - 70", gearbox to junction	Genuine	1	<b>ZXC9120</b>	106.68	128.02	
All V8 carb petrol police spec models with observer's speedometer - 80", gearbox to junction	Genuine	1	<b>ZXC9119</b>	115.68	138.82	
All police spec models with observer's speedometer	26", junction to main speedometer	Genuine	1	<b>ZXC9117</b>	70.50	84.60
	18.5", junction to observer's speedometer	Genuine	1	<b>ZXC9118</b>	70.50	84.60

## 110 (1983-1989)

## WINDOW REGULATORS

## Window Regulator

All models from (VIN) AA271215 on					
Front RH	Aftermarket	1	<b>MUC3024P</b>	10.62	12.74
	Genuine	1	<b>MUC3024</b>	136.50	163.80
Front LH	Aftermarket	1	<b>MUC3025P</b>	12.08	14.50
	Genuine	1	<b>MUC3025</b>	109.40	131.28
All station wagon and crew cab models from (VIN) AA267064					
Rear RH	Aftermarket	1	<b>MUC3026P</b>	16.87	20.24
	Genuine	1	<b>MUC3026</b>	94.38	113.26
Rear LH	Aftermarket	1	<b>MUC3027P</b>	13.12	15.74
	Genuine	1	<b>MUC3027</b>	94.38	113.26

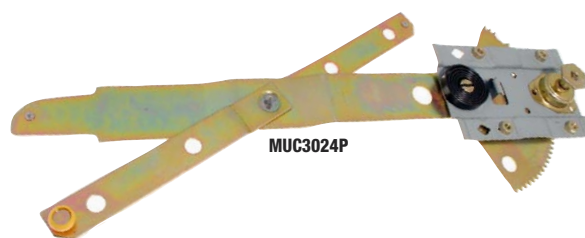

MUC3024P

## 110 (1983-1989)

## WHEEL STUDS &amp; WHEEL NUTS

## Wheel Nut

All models with alloy spare wheel - Alloy spare wheel only	Genuine	a/r	<b>ANR4914</b>	8.42	10.10
All models with alloy wheels - Without stainless steel cap	Aftermarket	a/r	<b>NRC7415P</b>	2.00	2.40
	OEM	a/r	<b>NRC7415P1</b>	2.75	3.30
	Genuine	a/r	<b>NRC7415</b>	2.97	3.56
All models with steel wheels	Aftermarket	a/r	<b>RRD500010P</b>	0.79	0.95
	Genuine	a/r	<b>RRD500010</b>	1.82	2.18

## Wheel Nut Set

All models with alloy wheels - Set of 20. Without stainless steel cap	Aftermarket	a/r	<b>NRC7415KP</b>	38.33	46.00
	Genuine	a/r	<b>NRC7415K</b>	58.50	70.20
All models with steel wheels - Set of 20	Aftermarket	a/r	<b>RRD500010KP</b>	11.04	13.25
	Genuine	a/r	<b>RRD500010K</b>	34.00	40.80

## Wheel Stud

All models - Front and rear hubs	Aftermarket	a/r	<b>FRC6137P</b>	0.46	0.55
	Genuine	a/r	<b>FRC6137</b>	4.25	5.10
All models - Extended, 60mm (original fitment for Defender Wolf/XD). Allows fitment of certain alternative wheels	OEM	a/r	<b>FRC7577P1</b>	5.83	7.00
	Genuine	a/r	<b>FRC7577</b>	19.36	23.23





# DEFENDER 90 (1989 on)

## 1989 on All Models

Listed below are the most popular parts required for the Land Rover Defender 90.

We have access to the full range of parts for your vehicle. Please contact us if not listed here.



## SERVICE KITS

## DEFENDER 90 (1989 on)

### Filter Kit

All 200 TDI diesel models - Includes oil filter, air filter, fuel filter & sump plug washer				
Aftermarket	1	<b>LL1344P</b>	9.58	11.50
Genuine	1	<b>LL1344</b>	42.50	51.00
All 300 TDI diesel models - Includes oil filter, air filter, fuel filter & sump plug washer				
Aftermarket	1	<b>LL1345P</b>	9.79	11.75
Genuine	1	<b>LL1345</b>	40.00	48.00
All 2.5L TD5 diesel models - Includes oil filter, air filter, rotor filter, fuel filter & sump plug washer				
Aftermarket	1	<b>LL1346P</b>	11.50	13.80
Genuine	1	<b>LL1346</b>	70.83	85.00

2.4L & 2.2L TDCi diesel models from (VIN) 7A000001 to DA444246 Includes oil filter, air filter, fuel filter & sump plug				
Bearmach	1	<b>LL1539BM</b>	19.17	23.00
Genuine	1	<b>LL1539</b>	77.50	93.00
2.2L TDCi diesel models from (VIN) DA444247 on Includes oil filter, air filter, fuel filter & sump plug				
Britpart	1	<b>LL1539BPLATE</b>	21.67	26.00

## FILTRATION

## DEFENDER 90 (1989 on)

### Oil Filter

All models with 200TDi diesel engine - Cartridge				
Aftermarket	1	<b>ERR3340P</b>	2.00	2.40
OEM	1	<b>ERR3340P1</b>	3.33	4.00
Genuine	1	<b>ERR3340</b>	10.82	12.98
All models with 300TDi diesel engine- Cartridge				
Aftermarket	1	<b>ERR3340P</b>	2.00	2.40
OEM	1	<b>ERR3340P1</b>	3.33	4.00
Genuine	1	<b>ERR3340</b>	10.82	12.98
All models with TD5 diesel engine up to (VIN) 6A999999 - Cartridge (stubby)				
Aftermarket	1	<b>LPX100590P</b>	2.83	3.40
OEM	1	<b>LPX100590P1</b>	4.00	4.80
Genuine	1	<b>LPX100590</b>	8.08	9.70
Britpart	1	<b>LPX100590BPSTUB</b>	1.83	2.20
All models with V8 petrol engine - Cartridge				
Aftermarket	1	<b>ERR3340P</b>	2.00	2.40
OEM	1	<b>ERR3340P1</b>	3.33	4.00
Genuine	1	<b>ERR3340</b>	10.82	12.98
All models with 2.2L Puma diesel engine (VIN) DA444247 on				
Aftermarket	1	<b>LR058104P</b>	7.50	9.00
Genuine	1	<b>LR058104</b>	12.26	14.71
All 2.4L Puma diesel models - Element				
Aftermarket	1	<b>LR030778P</b>	3.00	3.60
OEM	1	<b>LR030778P1</b>	4.00	4.80
Genuine	1	<b>LR030778</b>	9.80	11.76

### Air Filter

All 200TDi diesel models				
Aftermarket	1	<b>NTC6660P</b>	5.63	6.76
OEM	1	<b>NTC6660P1</b>	7.50	9.00
Genuine	1	<b>NTC6660</b>	21.38	25.66
All 300TDi diesel models				
Aftermarket	1	<b>ESR2623P</b>	5.63	6.76
OEM	1	<b>ESR2623P1</b>	9.38	11.26
Genuine	1	<b>ESR2623</b>	19.52	23.42
All TD5 diesel models up to (VIN) 6A999999				
Aftermarket	1	<b>LR027408P</b>	2.50	3.00
OEM	1	<b>LR027408P1</b>	4.58	5.50
Genuine	1	<b>LR027408</b>	12.57	15.08
All V8 EFI petrol models				
Aftermarket	1	<b>RTC4683P</b>	3.25	3.90
OEM	1	<b>RTC4683P1</b>	5.63	6.76
Genuine	1	<b>RTC4683</b>	8.30	9.96
All V8 carburettor models				
Aftermarket	1	<b>RTC3479P</b>	9.58	11.50
Genuine	1	<b>RTC3479</b>	41.44	49.73
All models from (VIN) 7A000001 on				
Aftermarket	1	<b>PHE500060P</b>	3.00	3.60
OEM	1	<b>PHE500060P1</b>	7.50	9.00
Genuine	1	<b>PHE500060</b>	32.36	38.83

### EGR Air Filter

All 2.5L TD5 diesel engine models up to (VIN) XA175541				
Genuine	1	<b>ESR4323</b>	2.93	3.52

### Mounting Rubber Air Cleaner

All 4.0L V8 EFI petrol models				
Genuine	1	<b>ESR1579</b>	13.98	16.78

### Fuel Filter Complete Assembly

All 200TDi diesel models				
Aftermarket	1	<b>WJN500180P1</b>	50.00	60.00
Genuine	1	<b>WJN500180</b>	98.37	118.04
All 300TDi diesel models				
Aftermarket	1	<b>WJN500180P1</b>	50.00	60.00
Genuine	1	<b>WJN500180</b>	98.37	118.04
All models with TD5 engine from (VIN) 5A705374				
Genuine	1	<b>WJN500150</b>	279.36	335.23
2.5L 5 cylinder Turbo (TD5) engine models				
OEM	1	<b>WJN000020P1</b>	115.00	138.00
Genuine	1	<b>WJN000020</b>	154.64	185.57
All 2.5L petrol models				
Aftermarket	1	<b>NRC9786P</b>	16.88	20.26
Genuine	1	<b>NRC9786</b>	98.07	117.68
All 2.0L Mpi petrol models up to (VIN) WA159806				
Aftermarket	1	<b>NRC9786P</b>	16.88	20.26
Genuine	1	<b>NRC9786</b>	98.07	117.68
All 3.5L V8 carb petrol models				
Aftermarket	1	<b>NRC9786P</b>	16.88	20.26
Genuine	1	<b>NRC9786</b>	98.07	117.68
All diesel engine models up to (VIN) 6A999999 - Sedimentor type				
Aftermarket	1	<b>NRC9708P</b>	17.08	20.50
OEM	1	<b>NRC9708P1</b>	26.67	32.00
Genuine	1	<b>NRC9708</b>	76.51	91.81

### Fuel Filter Assembly

All models with 2.4L or 2.2L Puma diesel engines - Cartridge and filter head				
Aftermarket	1	<b>WJN500190BPHSG</b>	24.58	29.50

### Fuel Filter

All 200TDi diesel models with unheated fuel filter - Includes sealing ring				
Aftermarket	1	<b>AEU2147LP</b>	3.00	3.60
OEM	1	<b>AEU2147LP1</b>	4.38	5.26
Genuine	1	<b>AEU2147L</b>	13.78	16.54
All cold climates 200TDi diesel models with heated fuel filter - Includes sealing ring				
OEM	1	<b>RTC5938P1</b>	5.00	6.00
Genuine	1	<b>RTC5938</b>	17.49	20.99
All 300TDi diesel models with unheated fuel filter - Includes sealing ring				
Aftermarket	1	<b>AEU2147LP</b>	3.00	3.60
OEM	1	<b>AEU2147LP1</b>	4.38	5.26
Genuine	1	<b>AEU2147L</b>	13.78	16.54
All cold climates 300TDi diesel models with heated fuel filter - Includes sealing ring				
OEM	1	<b>RTC5938P1</b>	5.00	6.00
Genuine	1	<b>RTC5938</b>	17.49	20.99
All TD5 diesel models up to (VIN) 6A999999				
Aftermarket	1	<b>ESR4686P</b>	5.00	6.00
OEM	1	<b>ESR4686P1</b>	12.50	15.00
Genuine	1	<b>ESR4686</b>	39.80	47.76
All 2.5L petrol models - Element for in line filter assembly				
Aftermarket	1	<b>JS660LP</b>	1.33	1.60
Genuine	1	<b>JS660L</b>	3.06	3.67
All 2.8L 6 cyl petrol models - Internal threaded unions				
Aftermarket	1	<b>ESR4065P</b>	3.00	3.60
OEM	1	<b>ESR4065P1</b>	4.58	5.50
Genuine	1	<b>ESR4065</b>	14.85	17.82
All 2.0L Mpi petrol models up to (VIN) WA159806 - Element for in line filter assembly				
Aftermarket	1	<b>JS660LP</b>	1.33	1.60
Genuine	1	<b>JS660L</b>	3.06	3.67
All 3.5L V8 carb petrol models Internal threaded unions				
Aftermarket	1	<b>ESR4065P</b>	3.00	3.60
OEM	1	<b>ESR4065P1</b>	4.58	5.50
Genuine	1	<b>ESR4065</b>	14.85	17.82
Element for in line filter assembly				
Aftermarket	1	<b>JS660LP</b>	1.33	1.60
Genuine	1	<b>JS660L</b>	3.06	3.67
All diesel models from (VIN) 7A000001 on				
Aftermarket	1	<b>WJ1500040P</b>	12.50	15.00
OEM	1	<b>WJ1500040P1</b>	15.83	19.00
Genuine	1	<b>WJ1500040</b>	36.72	44.06
All V8 Efi petrol models - Internal threaded unions				
Aftermarket	1	<b>ESR4065P</b>	3.00	3.60
OEM	1	<b>ESR4065P1</b>	4.58	5.50
Genuine	1	<b>ESR4065</b>	14.85	17.82

### Fuel Filter Seal

All diesel engine models up to (VIN) 6A999999				
Top, for sedimentor filter				
Aftermarket	1	<b>AAU9903P</b>	0.33	0.40
Genuine	1	<b>AAU9903</b>	1.78	2.14
Bottom, for sedimentor filter				
Aftermarket	1	<b>AAU9902P</b>	0.58	0.70
Genuine	1	<b>AAU9902</b>	1.78	2.14
All diesel models to (VIN) 6A999999				
Genuine	1	<b>605011</b>	0.32	0.38

### Air Bleed Valve Fuel Filter

2.5L TD5 diesel models				
Genuine	1	<b>WJN500110</b>	15.47	18.56

### Oil Strainer Transmission, Gearbox

All V8 EFI petrol models with auto gearbox				
Aftermarket	1	<b>RTC4653P</b>	5.21	6.25
OEM	1	<b>RTC4653P1</b>	9.37	11.24
Genuine	1	<b>RTC4653</b>	49.14	58.97



**DEFENDER 90 (1989 on)****WIPER BLADES****Wiper Blade**

All models - Front and rear, hook fitting	Aftermarket	3	LR079891P	2.33	2.80
	OEM	3	LR079891P1	3.08	3.70
	Genuine	3	LR079891	9.31	11.17



LR079891

**DEFENDER 90 (1989 on)****SCREEN/LAMP WASHER SYSTEMS****Washer Jet**

All models with rear screen wash	Aftermarket	1	LR061678P	2.25	2.70
Rear screen	Genuine	1	LR061678	5.32	6.38

All models from (VIN) AA270227 to WA159806	Aftermarket	1	LR061677P	2.00	2.40
Front screen, twin jet type	Genuine	1	LR061677	7.80	9.36

**Washer Jet Repair Kit**

All models - Front screen wash	Genuine	1	DNJ500270	9.49	11.39
<i>(Twin nozzle jet - allows replacement of broken outer section without having to remove dash top to replace whole assembly. DNJ500290 adhesive also required)</i>					

**Washer Pumps**

All non air conditioning models with rear screen wash up to (VIN) WA159806	Aftermarket	1	STC1453P	4.00	4.80
Rear screen	Genuine	1	STC1453		

All models up to (VIN) WA159806 with air conditioning	Aftermarket	1	GWV1194	7.50	9.00
Front or rear screen wash	Genuine	1	GWV1194		

All models with air conditioning or with headlamp wash up to (VIN) WA159806	Aftermarket	1	DRC2713L	40.97	49.16
Front screen	Genuine	1	DRC2713L		

All models from (VIN) XA159807 on	OEM	1	DMC100550P1	5.00	6.00
Front screen	Genuine	1	DMC100550	29.38	35.26

Rear screen	OEM	1	DMC100540P1	6.04	7.25
	Genuine	1	DMC100540	29.41	35.29

Military TD5 (Wolf/XD)	Aftermarket	1	PRC3615P	12.50	15.00
Front screen, 24V	Genuine	1	PRC3615	29.29	35.15

**Windscreen Washer Pump Link Lead**

All models without air conditioning or headlamp wash up to (VIN) WA159806	Aftermarket	1	AMR3849P	5.42	6.50
<i>Fit with STC1453 pump as replacement for original windscreen washer pump</i>					
	Genuine	1	AMR3849	11.05	13.26

**Washer Hose Non Return Valve**

All models from (VIN) XA159807 on - Fits in-line in 4mm dia. hose	Aftermarket	1	AMR6676P	1.42	1.70
	Genuine	1	AMR6676	3.26	3.91

**Pump to Valve Hose**

All models from (VIN) XA159807 on	Genuine	1	DNC101720	39.81	47.77
Front screen wash					

**Washer Hose, Per Metre**

All models - 4mm internal diameter (3mm also available).	Aftermarket	a/r	GWV201M	2.25	2.70
Front or rear screen wash					

**Washer Reservoir Cap**

All models with air conditioning or with headlamp wash up to (VIN) WA159806	Genuine	1	DMG10005L	3.10	3.72
45mm dia.					

All models from (VIN) XA159807 on	OEM	1	DMG10001LP1	4.79	5.75
Front & rear screen wash	Genuine	1	DMG10001L	5.73	6.88

**Washer Reservoir**

All models without air conditioning or headlamp wash up to (VIN) WA159806	Genuine	1	PRC5744	33.26	39.91
Front screen wash					

All models with rear screen wash/wipe and headlamp wash without air conditioning up to (VIN) WA159806	Genuine	1	PRC5777	42.63	51.16
Front & rear screen & headlamp wash					

All models with rear screen wash/wipe with air conditioning up to (VIN) WA159806	Genuine	1	PRC5765	89.57	107.48
Front & rear screen wash					

All models with headlamp wash with air conditioning up to (VIN) WA159806	Genuine	1	PRC5773	94.77	113.72
Front screen & headlamp wash					

All models without rear screen wash from (VIN) XA159807 on	Genuine	1	DMB500130	32.23	38.68
Front screen wash					

All models with rear screen wash from (VIN) XA159807 on	Genuine	1	DMB500120	51.38	61.66
Front & rear screen wash					

All models with rear screen wash/wipe and headlamp wash (South Africa, Sweden) up to (VIN) LA647644	Genuine	1	PRC5744	33.26	39.91
Front screen wash					

Rear screen & headlamp wash	Genuine	1	PRC5773	94.77	113.72

**Windscreen Cleaning Paste**

All models	Genuine	a/r	DNJ500340	7.72	9.26
<i>Prevents wiper blade judder/squeak by 'deep cleaning' the windscreen (ref: Land Rover Tech Bulletin LRA501-002)</i>					



LR061677P



GWV201M



DMC100550



DMG10001L



PRC5744



# DRIVE BELTS

**DEFENDER 90 (1989 on)**

## Timing Belt Kit Complete

All 300 TDi diesel models to (VIN) VA101257	Aftermarket	1	<b>STC4095LP</b>	155.83	187.00
<i>Includes belt plus all parts to convert to later 300 TDi belt alignment method</i>					

## Timing Belt Kit

All 200 TDi diesel models	Bearmach	1	<b>ETC8550KITBDEF</b>	32.50	39.00
All 300 TDi diesel models	Aftermarket	1	<b>STC4096LP</b>	47.50	57.00
	OEM	1	<b>STC4096LP1</b>	65.00	78.00
	Bearmach	1	<b>STC4096BM</b>	68.33	82.00
	Genuine	1	<b>STC4096L</b>	122.95	147.54

All 300 TDi diesel models up to (VIN) VA117353	Britpart	1	<b>ERR1092KITBPEARLY</b>	22.50	27.00
All 300 TDi diesel models from (VIN) VA117354 on	Britpart	1	<b>ERR1092KITBPLATE</b>	22.50	27.00

## Timing Belt

All models with 200TDi diesel engine	OEM	1	<b>ETC8550P1</b>	12.92	15.50
	Genuine	1	<b>ETC8550</b>	38.00	45.60
All models with 300TDi diesel engine	Aftermarket	1	<b>ERR1092P</b>	6.88	8.26
	OEM	1	<b>ERR1092P1</b>	10.63	12.76
	Genuine	1	<b>ERR1092</b>	38.02	45.62

## Fan Belt

All 300TDi diesel engines up to (engine) 16L25164 - Fan	Aftermarket	1	<b>ERR3287P</b>	5.83	7.00
	OEM	1	<b>ERR3287P1</b>	10.00	12.00
	Genuine	1	<b>ERR3287</b>	21.64	25.97

All 300TDi diesel engines from (engine) 16L25165 on - Fan	Aftermarket	1	<b>ERR5911P</b>	7.08	8.50
	OEM	1	<b>ERR5911P1</b>	10.63	12.76
	Genuine	1	<b>ERR5911</b>	19.60	23.52

All Australia 300 TDi diesel models up to (engine) 16L25164 - Fan	Genuine	1	<b>HYM895</b>	30.68	36.82
-------------------------------------------------------------------	---------	---	---------------	-------	-------

All Australia 300 TDi diesel models from (engine) 16L25165 on - Fan	Genuine	1	<b>HYM1174</b>	30.68	36.82
---------------------------------------------------------------------	---------	---	----------------	-------	-------

## Primary Drive Belt

Non-air conditioned models with 2.2L Puma diesel engine (VIN) CA000001 on - Primary	Genuine	1	<b>LR031361</b>	43.62	52.34
-------------------------------------------------------------------------------------	---------	---	-----------------	-------	-------

Air conditioned models with 2.2L Puma diesel engine (VIN) CA000001 on - Primary	Genuine	1	<b>LR031360</b>	43.62	52.34
---------------------------------------------------------------------------------	---------	---	-----------------	-------	-------

## PAS Drive Belt

All models with V8 carb engine - Power steering	Aftermarket	1	<b>ERC675P</b>	2.83	3.40
	OEM	1	<b>ERC675P1</b>	3.33	4.00
	Genuine	1	<b>ERC675</b>	21.28	25.54

## Alternator Drive Belt

All models with 200TDi diesel engine - Alternator	Aftermarket	1	<b>ETC7939P</b>	2.25	2.70
	OEM	1	<b>ETC7939P1</b>	3.83	4.60
	Genuine	1	<b>ETC7939</b>	15.73	18.88

All 300 TDi diesel models up to (VIN) MA169102 except Australia - Alternator with 61mm dia. pulley	Aftermarket	1	<b>PQS000030P</b>	4.00	4.80
	OEM	1	<b>PQS000030P1</b>	8.13	9.76
	Genuine	1	<b>PQS000030</b>	30.72	36.86

All 300 TDi diesel models from (VIN) TA169103 except Australia - Alternator with 49mm dia. pulley	Aftermarket	1	<b>PQS000040P</b>	4.79	5.75
	OEM	1	<b>PQS000040P1</b>	7.50	9.00
	Genuine	1	<b>PQS000040</b>	30.72	36.86

All models with TD5 diesel engine without air conditioning up to (VIN) 6A999999 - Alternator	Aftermarket	1	<b>PQS101490P</b>	6.67	8.00
	OEM	1	<b>PQS101490P1</b>	10.00	12.00
	Genuine	1	<b>PQS101490</b>	23.02	27.62

All models with TD5 diesel engine with air conditioning up to (VIN) 6A999999 - Alternator	Aftermarket	1	<b>PQS101500P</b>	6.04	7.25
	OEM	1	<b>PQS101500P1</b>	8.75	10.50
	Genuine	1	<b>PQS101500</b>	23.02	27.62

All models with V8 carb engine and air conditioning - Alternator	Aftermarket	1	<b>ERR2073P</b>	2.83	3.40
	Genuine	1	<b>ERR2073</b>	7.86	9.43

All models with V8 EFI engine with air conditioning - Alternator	Aftermarket	1	<b>ERR5579P</b>	5.63	6.76
	OEM	1	<b>ERR5579P1</b>	13.75	16.50
	Genuine	1	<b>ERR5579</b>	28.36	34.03

All models with 2.4L Puma diesel without air conditioning - Alternator	Genuine	1	<b>PQS500610</b>	34.24	41.09
------------------------------------------------------------------------	---------	---	------------------	-------	-------

2.4L TDCi Puma diesel models with air conditioning - Alternator	OEM	1	<b>PQS500600P1</b>	17.08	20.50
	Genuine	1	<b>PQS500600</b>	34.54	41.45

## A/C Drive Belt

All models with 300TDi diesel engine and air conditioning - Air cond compressor	Aftermarket	1	<b>ERR2215P</b>	3.50	4.20
	OEM	1	<b>ERR2215P1</b>	5.63	6.76
	Genuine	1	<b>ERR2215</b>	13.13	15.76

All Australia 300 TDi diesel models with air conditioning - Air cond compressor	Genuine	1	<b>HYM627</b>	30.68	36.82
---------------------------------------------------------------------------------	---------	---	---------------	-------	-------

All Australia 2.5L TD5 diesel models from (VIN) XA159807 to 2A999999 with Australia only accessory air conditioning kit	Air cond compressor	Genuine	<b>HYM1132</b>	26.48	31.78
-------------------------------------------------------------------------------------------------------------------------	---------------------	---------	----------------	-------	-------

All V8 carb models with air conditioning - Air cond compressor	Aftermarket	1	<b>603713P</b>	2.67	3.20
----------------------------------------------------------------	-------------	---	----------------	------	------





**DEFENDER 90 (1989 on)****IGNITION SYSTEM****Spark Plug**

All V8 carb petrol engine models - N12Y type

Aftermarket	8	<b>RTC3570P</b>	1.83	2.20
Genuine	8	<b>RTC3570X</b>	3.25	3.90

All V8 carb petrol models with 8.13:1 compression ratio, std performance - 19mm reach

MG Rover	8	<b>GSP4382</b>	2.95	3.54
----------	---	----------------	------	------

All V8 carb petrol models with 9.35:1 compression ratio, std performance - 19mm reach

MG Rover	8	<b>GSP4362</b>	2.95	3.54
----------	---	----------------	------	------

All V8 carb petrol models with 9.35:1 compression ratio, high performance 19mm reach, double core

MG Rover	8	<b>GSP6462</b>	2.95	3.54
----------	---	----------------	------	------

All V8 petrol engine models - RN11YC type

Aftermarket	8	<b>ERR3799P</b>	2.00	2.40
-------------	---	-----------------	------	------

Genuine	8	<b>ERR3799</b>	4.19	5.03
---------	---	----------------	------	------

All 4.0L V8 EFI petrol models up to (VIN) WA159806 - 9mm reach, double core

MG Rover	8	<b>GSP6462</b>	2.95	3.54
----------	---	----------------	------	------

**Glow Plug**

All 2.5L 200 TDi and 300 TDi diesel engine models

Aftermarket	4	<b>ETC8847P</b>	3.00	3.60
-------------	---	-----------------	------	------

OEM	4	<b>ETC8847P1</b>	8.75	10.50
-----	---	------------------	------	-------

Genuine	4	<b>ETC8847</b>	33.60	40.32
---------	---	----------------	-------	-------

All 2.5L TD5 diesel engine models

Aftermarket	5	<b>ERR6066P</b>	2.83	3.40
-------------	---	-----------------	------	------

OEM	5	<b>ERR6066P1</b>	8.54	10.25
-----	---	------------------	------	-------

All 2.2L TDCi Puma diesel engine models

Genuine	4	<b>LR029960</b>	10.72	12.86
---------	---	-----------------	-------	-------

All 2.4L TDCi Puma diesel engine models

Aftermarket	4	<b>LR004377P</b>	6.88	8.26
-------------	---	------------------	------	------

OEM	4	<b>LR004377P1</b>	10.00	12.00
-----	---	-------------------	-------	-------

Genuine	4	<b>LR004377</b>	15.47	18.56
---------	---	-----------------	-------	-------

Military models with 300 TDi diesel engine

Genuine	4	<b>ERR4084</b>	29.15	34.98
---------	---	----------------	-------	-------

Military XD/Wolf

Genuine	4	<b>STC7418</b>	224.42	269.30
---------	---	----------------	--------	--------

**Glow Plug Cable**

All 200 TDi and 300 TDi diesel engine models

Genuine	1	<b>AMR2425</b>	13.13	15.76
---------	---	----------------	-------	-------

**Ignition Coil**

All V8 carb petrol engine models

Lucas type

Aftermarket	1	<b>RTC5628P</b>	9.58	11.50
-------------	---	-----------------	------	-------

OEM	1	<b>RTC5628P1</b>	14.58	17.50
-----	---	------------------	-------	-------

Genuine	1	<b>RTC5628</b>	94.86	113.83
---------	---	----------------	-------	--------

Bosch type

Aftermarket	1	<b>PRC6574P</b>	15.83	19.00
-------------	---	-----------------	-------	-------

OEM	1	<b>PRC6574P1</b>	39.58	47.50
-----	---	------------------	-------	-------

Genuine	1	<b>PRC6574</b>	114.80	137.76
---------	---	----------------	--------	--------

All V8 EFI petrol engine models - GEMs system

Aftermarket	1	<b>ERR6269P</b>	59.17	71.00
-------------	---	-----------------	-------	-------

Genuine	1	<b>ERR6269</b>	459.47	551.36
---------	---	----------------	--------	--------

**Adjustment Bush, Contact Set**

All V8 petrol models with points type distributor - For sliding points type distributor

Genuine	1	<b>RTC5014</b>	1.33	1.60
---------	---	----------------	------	------

**Rotor Arm**

All V8 carb petrol models with points type distributor

Aftermarket	1	<b>RTC3618P</b>	2.00	2.40
-------------	---	-----------------	------	------

All V8 petrol engines with electronic ignition

Aftermarket	1	<b>STC1857P</b>	2.33	2.80
-------------	---	-----------------	------	------

OEM	1	<b>STC1857P1</b>	9.58	11.50
-----	---	------------------	------	-------

Genuine	1	<b>STC1857</b>	15.18	18.22
---------	---	----------------	-------	-------

Red

OEM	1	<b>GRA117RED</b>	7.50	9.00
-----	---	------------------	------	------

**Distributor Cap**

All V8 petrol engine models

Aftermarket	1	<b>GDC117P</b>	5.00	6.00
-------------	---	----------------	------	------

Aftermarket	1	<b>GDC117</b>	10.42	12.50
-------------	---	---------------	-------	-------

OEM	1	<b>GDC117P1</b>	16.04	19.25
-----	---	-----------------	-------	-------

Genuine	1	<b>GDC1170E</b>	32.94	39.53
---------	---	-----------------	-------	-------

**Amplifier Module & Link Lead**

V8 petrol engine with 2 pin integral amp type 35DLM8 distributor Included link lead converts 3 pin to 2 pin

Britpart	1	<b>STC1184KBP</b>	24.58	29.50
----------	---	-------------------	-------	-------

All 3.5L V8 petrol models with electronic ignition with 2 pin integral amplifier (2 pin plug)

Amplifier to coil, lead identified by 2 pin plug connector

OEM	1	<b>PRC6144P1</b>	36.25	43.50
-----	---	------------------	-------	-------

Genuine	1	<b>PRC6144</b>	40.55	48.66
---------	---	----------------	-------	-------

All 3.5L V8 petrol models with electronic ignition with 2 pin integral amplifier (2 pin plug)

Amplifier to coil, lead identified by 2 pin plug connector

OEM	1	<b>PRC6144P1</b>	36.25	43.50
-----	---	------------------	-------	-------

Genuine	1	<b>PRC6144</b>	40.55	48.66
---------	---	----------------	-------	-------

All 3.5L V8 petrol models with electronic ignition with 2 pin integral amplifier (2 pin plug)

Amplifier to coil, lead identified by 2 pin plug connector

OEM	1	<b>PRC6144P1</b>	36.25	43.50
-----	---	------------------	-------	-------

Genuine	1	<b>PRC6144</b>	40.55	48.66
---------	---	----------------	-------	-------

All 3.5L V8 petrol models with electronic ignition with 2 pin integral amplifier (2 pin plug)

Amplifier to coil, lead identified by 2 pin plug connector

OEM	1	<b>PRC6144P1</b>	36.25	43.50
-----	---	------------------	-------	-------

Genuine	1	<b>PRC6144</b>	40.55	48.66
---------	---	----------------	-------	-------

All 3.5L V8 petrol models with electronic ignition with 2 pin integral amplifier (2 pin plug)

Amplifier to coil, lead identified by 2 pin plug connector

OEM	1	<b>PRC6144P1</b>	36.25	43.50
-----	---	------------------	-------	-------

Genuine	1	<b>PRC6144</b>	40.55	48.66
---------	---	----------------	-------	-------

All 3.5L V8 petrol models with electronic ignition with 2 pin integral amplifier (2 pin plug)

Amplifier to coil, lead identified by 2 pin plug connector

OEM	1	<b>PRC6144P1</b>	36.25	43.50
-----	---	------------------	-------	-------

Genuine	1	<b>PRC6144</b>	40.55	48.66
---------	---	----------------	-------	-------

All 3.5L V8 petrol models with electronic ignition with 2 pin integral amplifier (2 pin plug)

Amplifier to coil, lead identified by 2 pin plug connector

OEM	1	<b>PRC6144P1</b>	36.25	43.50
-----	---	------------------	-------	-------

Genuine	1	<b>PRC6144</b>	40.55	48.66
---------	---	----------------	-------	-------

All 3.5L V8 petrol models with electronic ignition with 2 pin integral amplifier (2 pin plug)

Amplifier to coil, lead identified by 2 pin plug connector

OEM	1	<b>PRC6144P1</b>	36.25	43.50
-----	---	------------------	-------	-------

Genuine	1	<b>PRC6144</b>	40.55	48.66
---------	---	----------------	-------	-------

All 3.5L V8 petrol models with electronic ignition with 2 pin integral amplifier (2 pin plug)

Amplifier to coil, lead identified by 2 pin plug connector

Amplifier to coil, lead identified by 2 pin plug connector

Amplifier to coil, lead identified by 2 pin plug connector

Amplifier to coil, lead identified by 2 pin plug connector

Amplifier to coil, lead identified by 2 pin plug connector

Amplifier to coil, lead identified by 2 pin plug connector

Amplifier to coil, lead identified by 2 pin plug connector

Amplifier to coil, lead identified by 2 pin plug connector

Amplifier to coil, lead identified by 2 pin plug connector

Amplifier to coil, lead identified by 2 pin plug connector

Amplifier to coil, lead identified by 2 pin plug connector

Amplifier to coil, lead identified by 2 pin plug connector

Amplifier to coil, lead identified by 2 pin plug connector

Amplifier to coil, lead identified by 2 pin plug connector

Amplifier to coil, lead identified by 2 pin plug connector

Amplifier to coil, lead identified by 2 pin plug connector

Amplifier to coil, lead identified by 2 pin plug connector

Amplifier to coil, lead identified by 2 pin plug connector

Amplifier to coil, lead identified by 2 pin plug connector

Amplifier to coil, lead identified by 2 pin plug connector

Amplifier to coil, lead identified by 2 pin plug connector

Amplifier to coil, lead identified by 2 pin plug connector

Amplifier to coil, lead identified by 2 pin plug connector

Amplifier to coil, lead identified by 2 pin plug connector

Amplifier to coil, lead identified by 2 pin plug connector

Amplifier to coil, lead identified by 2 pin plug connector

Amplifier to coil, lead identified by 2 pin plug connector

Amplifier to coil, lead identified by 2 pin plug connector

Amplifier to coil, lead identified by 2 pin plug connector

Amplifier to coil, lead identified by 2 pin plug connector

Amplifier to coil, lead identified by 2 pin plug connector

Amplifier to coil, lead identified by 2 pin plug connector

Amplifier to coil, lead identified by 2 pin plug connector

Amplifier to coil, lead identified by 2 pin plug connector

Amplifier to coil, lead identified by 2 pin plug connector

Amplifier to coil, lead identified by 2 pin plug connector

Amplifier to coil, lead identified by 2 pin plug connector

Amplifier to coil, lead identified by 2 pin plug connector

Amplifier to coil, lead identified by 2 pin plug connector

Amplifier to coil, lead identified by 2 pin plug connector

Amplifier to coil, lead identified by 2 pin plug connector

Amplifier to coil, lead identified by 2 pin plug connector

Amplifier to coil, lead identified by 2 pin plug connector

Amplifier to coil, lead identified by 2 pin plug connector

Amplifier to coil, lead identified by 2 pin plug connector

Amplifier to coil, lead identified by 2 pin plug connector

Amplifier to coil, lead identified by 2 pin plug connector

Amplifier to coil, lead identified by 2 pin plug connector

Amplifier to coil, lead identified by 2 pin plug connector

Amplifier to coil, lead identified by 2 pin plug connector

Amplifier to coil, lead identified by 2 pin plug connector

Amplifier to coil, lead identified by 2 pin plug connector

Amplifier to coil, lead identified by 2 pin plug connector

Amplifier to coil, lead identified by 2 pin plug connector

Amplifier to coil, lead identified by 2 pin plug connector

Amplifier to coil, lead identified by 2 pin plug connector

Amplifier to coil, lead identified by 2 pin plug connector

Amplifier to coil, lead identified by 2 pin plug connector

Amplifier to coil, lead identified by 2 pin plug connector

Amplifier to coil, lead identified by 2 pin plug connector

Amplifier to coil, lead identified by 2 pin plug connector

Amplifier to coil, lead identified by 2 pin plug connector

Amplifier to coil, lead identified by 2 pin plug connector

Amplifier to coil, lead identified by 2 pin plug connector

Amplifier to coil, lead identified by 2 pin plug connector

Amplifier to coil, lead identified by 2 pin plug connector

Amplifier to coil, lead identified by 2 pin plug connector

Amplifier to coil, lead identified by 2 pin plug connector

Amplifier to coil, lead identified by 2 pin plug connector

Amplifier to coil, lead identified by 2 pin plug connector

Amplifier to coil, lead identified by 2 pin plug connector

Amplifier to coil, lead identified by 2 pin plug connector

Amplifier to coil, lead identified by 2 pin plug connector

Amplifier to coil, lead identified by 2 pin plug connector

Amplifier to coil, lead identified by 2 pin plug connector

Amplifier to coil, lead identified by 2 pin plug connector

Amplifier to coil, lead identified by 2 pin plug connector

Amplifier to coil, lead identified by 2 pin plug connector

Amplifier to coil, lead identified by 2 pin plug connector

Amplifier to coil, lead identified by 2 pin plug connector

Amplifier to coil, lead identified by 2 pin plug connector

Amplifier to coil, lead identified by 2 pin plug connector

Amplifier to coil, lead identified by 2 pin plug connector

Amplifier to coil, lead identified by 2 pin plug connector

Amplifier to coil, lead identified by 2 pin plug connector

Amplifier to coil, lead identified by 2 pin plug connector

Amplifier to coil, lead identified by 2 pin plug connector

Amplifier to coil, lead identified by 2 pin plug connector

Amplifier to coil, lead identified by 2 pin plug connector

Amplifier to coil, lead identified by 2 pin plug connector

Amplifier to coil, lead identified by 2 pin plug connector

Amplifier to coil, lead identified by 2 pin plug connector

Amplifier to coil, lead identified by 2 pin plug connector

Amplifier to coil, lead identified by 2 pin plug connector

Amplifier to coil, lead identified by 2 pin plug connector

Amplifier to coil, lead identified by 2 pin plug connector

Amplifier to coil, lead identified by 2 pin plug connector

Amplifier to coil, lead identified by 2 pin plug connector

Amplifier to coil, lead identified by 2 pin plug connector

Amplifier to coil, lead identified by 2 pin plug connector

Amplifier to coil, lead identified by 2 pin plug connector

Amplifier to coil, lead identified by 2

# BRAKING SYSTEM

# DEFENDER 90 (1989 on)

## Brake Pad Set

All models up to (VIN) KA930455				
Front Brakes, Not Vented				
Aftermarket	1	<b>SFP500160P</b>	10.63	12.76
Brembo	1	<b>SFP500160BREMBO</b>	28.33	34.00
EBC	1	<b>SFP500160ULTIMAX</b>	30.00	36.00
Genuine	1	<b>SFP500160</b>	57.52	69.02
Front Brakes, Not Vented - Green Stuff				
EBC	1	<b>SFP500160GS</b>	33.33	40.00
From axle no, 23L06078 LHD & up to (VIN) HA701009				
Front				
EBC	1	<b>RA1392GS</b>	34.58	41.50
Genuine	1	<b>STC3765</b>	72.26	86.71
All models from (VIN) HA701010 to KA930455				
Front Brakes				
Aftermarket	1	<b>STC2952P</b>	13.96	16.75
OEM	1	<b>STC2952P1</b>	23.75	28.50
Genuine	1	<b>STC2952</b>	59.49	71.39
Front Brakes- Green Stuff				
EBC	1	<b>STC2952GS</b>	32.50	39.00
All models from (VIN) LA930456 on				
Front Brakes				
Aftermarket	1	<b>SFP000260P</b>	13.54	16.25
Brembo	1	<b>SFP000260BREMBO</b>	32.65	39.18
Genuine	1	<b>SFP000260</b>	76.90	92.28
Rear Brakes				
Aftermarket	1	<b>LR032954P</b>	10.00	12.00
Brembo	1	<b>LR032954BREMBO</b>	23.33	28.00
OEM	1	<b>LR032954P1</b>	15.00	18.00
Genuine	1	<b>LR032954</b>	52.91	63.49

## Brake Shoe Set

All models up to (VIN) KA930455				
Rear Brakes				
Aftermarket	1	<b>STC2796P</b>	9.38	11.26
OEM	1	<b>STC2796P1</b>	27.08	32.50

## Brake Pad Fitting Kit

All models with vented discs from (VIN) LA930456 on				
Front Vented Disc Brakes				
Aftermarket	1	<b>STC8575P</b>	2.83	3.40
Genuine	1	<b>STC8575</b>	5.01	6.01

## Spring & Pin Kit

All models with non-vented front disc brakes				
Front brake pad retention				
Aftermarket	1	<b>RTC5001P</b>	3.33	4.00
Genuine	1	<b>RTC5001</b>	12.33	14.80

## Anti Rattle Spring

All models to (VIN) HA701009				
Front brake pads				
Aftermarket	4	<b>606688P</b>	1.08	1.30
Genuine	4	<b>606688</b>	1.72	2.06

## Brake Pad Fitting Kit

All models from (VIN) LA930456				
Rear Disc Brakes				
Aftermarket	1	<b>STC8574P</b>	3.33	4.00

## Brake Shoe Spring

All models up to (VIN) KA930455				
Rear Brakes				
Aftermarket	2	<b>218983P</b>	0.58	0.70
Genuine	2	<b>218983</b>	2.90	3.48

## Brake Shoe Retaining Spring

All models with rear drum brakes				
Genuine	1	<b>236993</b>	8.66	10.39

## Brake Adjuster Kit

All models with rear drum brakes				
Rear axle set				
Aftermarket	1	<b>RTC3176P</b>	10.83	13.00
Genuine	1	<b>RTC3176</b>	109.72	131.66

## Brake Disc

All models with non vented front disc brakes				
Front, Not Vented (each)				
Aftermarket	2	<b>LR017951P</b>	13.75	16.50
Genuine	2	<b>LR017951</b>	52.35	62.82
Front, Not Vented (pair)				
Brembo	1	<b>LR017951BREMBO</b>	50.00	60.00
Vented disc brake models from (VIN) LA930456 to 9A777776				
Front, Vented (each)				
Aftermarket	2	<b>LR017952P</b>	16.04	19.25
OEM	2	<b>LR017952P1</b>	25.00	30.00
Genuine	2	<b>LR017952</b>	58.71	70.45
Front, Vented (each)				
Brembo	1	<b>LR017952BREMBO</b>	72.50	87.00
All models with non-vented rear disc brakes up to (VIN) WA159806				
Rear, Not Vented (each)				
Aftermarket	2	<b>FTC3846P</b>	13.54	16.25
OEM	2	<b>FTC3846P1</b>	20.83	25.00
Genuine	2	<b>FTC3846</b>	43.03	51.64

## Performance Brake Disc (pair)

All models with non vented front disc brakes				
Front, Not Vented, slotted & drilled (pair) Britpart				
Britpart	1	<b>LR017951URBP</b>	39.58	47.50
Vented disc brake models from (VIN) LA930456 to 9A777776				
Front, Vented, slotted & drilled pair				
Britpart	1	<b>LR017952URBP</b>	50.00	60.00

## Mudshield Brake Disc

All models from (VIN) TA989187 on - Front				
RH				
Aftermarket	1	<b>FTC4838P</b>	10.00	12.00
Genuine	1	<b>FTC4838</b>	10.69	12.83
LH				
Aftermarket	1	<b>FTC4839P</b>	15.42	18.50
Genuine	1	<b>FTC4839</b>	16.82	20.18
All models with rear disc brakes - RH rear				
Genuine	1	<b>LR017960</b>	24.10	28.92
All models (VIN) LA930456 on - LH rear				
Genuine	1	<b>LR017961</b>	24.10	28.92

## Brake Drum

All models up to (VIN) KA930455				
Aftermarket	2	<b>591039P</b>	13.13	15.76
Genuine	2	<b>591039</b>	82.60	99.12

## Brake Caliper

Up to (axle) 22L09654 RHD				
Front RH				
Aftermarket	1	<b>RTC3380P</b>	115.00	138.00
Genuine*	1	<b>RTC3380</b>	430.98	517.18
*Exchange Surcharge 50.00 60.00				
Front LH				
Aftermarket	1	<b>RTC3381P</b>	115.00	138.00
Genuine*	1	<b>RTC3381</b>	430.98	517.18
*Exchange Surcharge 50.00 60.00				
Up to (axle) 23L05987 LHD				
Front RH				
Aftermarket	1	<b>RTC3380P</b>	115.00	138.00
Genuine*	1	<b>RTC3380</b>	430.98	517.18
*Exchange Surcharge 50.00 60.00				
Front LH				
Aftermarket	1	<b>RTC3381P</b>	115.00	138.00
Genuine*	1	<b>RTC3381</b>	430.98	517.18
*Exchange Surcharge 50.00 60.00				
All models to (VIN) HA701009				
Front, RH				
Genuine*	1	<b>LR017742</b>	315.56	378.67
*Exchange Surcharge 50.00 60.00				
Front, LH				
Genuine*	1	<b>LR017738</b>	315.56	378.67
*Exchange Surcharge 50.00 60.00				
(VIN) HA701010 to (VIN) KA930455				
Front RH				
Aftermarket	1	<b>RTC5572P</b>	48.33	58.00
Genuine*	1	<b>RTC5572</b>	446.84	536.21
*Exchange Surcharge 50.00 60.00				
Front LH				
Aftermarket	1	<b>RTC5573P</b>	48.33	58.00
Genuine*	1	<b>RTC5573</b>	446.84	536.21
*Exchange Surcharge 50.00 60.00				
All from (VIN) HA701010 to KA930455				
Right Hand Front, Solid Disc Brakes				
Aftermarket	1	<b>SEB500440P</b>	39.58	47.50
OEM	1	<b>SEB500440P1</b>	120.00	144.00
Genuine*	1	<b>SEB500440</b>	362.04	434.45
*Exchange Surcharge 50.00 60.00				
Left Hand Front, Solid Disc Brakes				
Aftermarket	1	<b>SEB500450P</b>	39.58	47.50
OEM	1	<b>SEB500450P1</b>	120.00	144.00
Genuine*	1	<b>SEB500450</b>	362.04	434.45
*Exchange Surcharge 50.00 60.00				
With vented disc brakes from (VIN) LA930456 on				
Right Hand Front, Vented Disc Brakes				
Aftermarket	1	<b>SEB500460P</b>	37.50	45.00
OEM	1	<b>SEB500460P1</b>	90.00	108.00
Genuine*	1	<b>SEB500460</b>	406.37	487.64
*Exchange Surcharge 50.00 60.00				
Left Hand Front, Vented Disc Brakes				
Aftermarket	1	<b>SEB500470P</b>	37.50	45.00
OEM	1	<b>SEB500470P1</b>	90.00	108.00
Genuine*	1	<b>SEB500470</b>	406.37	487.64
*Exchange Surcharge 50.00 60.00				
All models from (VIN) HA701010 to 6A713927				
Right Hand Rear, Metric				
Aftermarket	1	<b>SMC500110P</b>	28.75	34.50
Exchange*	1	<b>SMC500110R</b>	85.00	102.00
*Exchange Surcharge 40.00 48.00				
Genuine*	1	<b>SMC500110</b>	209.47	251.36
*Exchange Surcharge 50.00 60.00				
Left Hand Rear, Metric				
Aftermarket	1	<b>SMC500240P</b>	28.75	34.50
Exchange*	1	<b>SMC500240R</b>	85.00	102.00
*Exchange Surcharge 40.00 48.00				
Genuine*	1	<b>SMC500240</b>	209.47	251.36
*Exchange Surcharge 50.00 60.00				



LRO17951P



RTC5572P



**DEFENDER 90 (1989 on)****BRAKING SYSTEM****Brake Caliper Piston**

All models to (VIN) HA701009				
Front, Standard material	Aftermarket	4	<b>606683P</b>	3.25 3.90
	OEM	4	<b>606683P1</b>	5.00 6.00
	Genuine	4	<b>606683</b>	16.73 20.08
Front, Stainless Steel material	Aftermarket	4	<b>606683SS</b>	7.50 9.00
Front, Kit - Stainless Steel material	Aftermarket	1	<b>606683BPSSKIT</b>	50.00 60.00
All from (VIN) HA701010 to KA930455 - Vented Disc Brakes				
Front, Standard Material	Aftermarket	4	<b>STC201P</b>	3.00 3.60
	OEM	4	<b>STC201P1</b>	4.00 4.80
	Genuine	4	<b>STC201</b>	21.60 25.92
Front, Stainless Steel Material	Aftermarket	4	<b>STC201SS</b>	8.13 9.76
All models from (VIN) HA701010 on				
Rear, Standard material	Aftermarket	1	<b>SEE500130P</b>	9.38 11.26
	OEM	1	<b>SEE500130P1</b>	19.58 23.50
	Genuine	1	<b>SEE500130</b>	58.57 70.28

**Dust Cap Bleed Screw**

All models - Blue, front caliper bleed nipple	Genuine	2	<b>594091</b>	4.66 5.59
-----------------------------------------------	---------	---	---------------	-----------

**Bleed Nipple for Caliper**

All models - Front & rear	Aftermarket	2	<b>SMG000010P</b>	2.58 3.10
	Genuine	2	<b>SMG000010</b>	4.28 5.14

**Bleed Nipple**

All models to (VIN) KA930455				
Front brake caliper	Aftermarket	2	<b>RTC1526P</b>	1.83 2.20
	Genuine	2	<b>RTC1526</b>	2.77 3.32
All models (VIN) LA930456 to 1A622423				
Rear brake caliper	Aftermarket	2	<b>RTC1526P</b>	1.83 2.20
	Genuine	2	<b>RTC1526</b>	2.77 3.32

**Wheel Cylinder**

Up to (VIN) HA701009				
Right Hand Rear	Aftermarket	1	<b>RTC3168P</b>	8.13 9.76
	OEM	1	<b>RTC3168P1</b>	14.79 17.75
	Genuine	1	<b>RTC3168</b>	157.31 188.77
Left Hand Rear	Aftermarket	1	<b>RTC3169P</b>	8.13 9.76
	OEM	1	<b>RTC3169P1</b>	14.79 17.75
	Genuine	1	<b>RTC3169</b>	89.47 107.36
All models from (VIN) HA701010 to KA930455				
Right Hand Rear	Aftermarket	1	<b>STC468P</b>	8.54 10.25
	OEM	1	<b>STC468P1</b>	26.67 32.00
	Genuine	1	<b>STC468</b>	129.08 154.90
Left Hand Rear	Aftermarket	1	<b>STC467P</b>	7.92 9.50
	OEM	1	<b>STC467P1</b>	24.58 29.50
	Genuine	1	<b>STC467</b>	129.08 154.90

**Brake Master Cylinder**

Without ABS up to (VIN) HA701009 - No reservoir				
	Aftermarket	1	<b>NRC9529P</b>	37.50 45.00
	OEM	1	<b>NRC9529P1</b>	55.00 66.00
	Genuine	1	<b>NRC9529</b>	185.42 222.50
Without ABS, from (VIN) HA701010 to XA178473				
	Aftermarket	1	<b>LR013018P</b>	31.67 38.00
	OEM	1	<b>LR013018P1</b>	60.00 72.00
	Genuine	1	<b>LR013018</b>	183.55 220.26
All models with ABS				
	OEM	1	<b>LR013017P1</b>	135.00 162.00
	Genuine	1	<b>LR013017</b>	216.26 259.51

**Reservoir Brake Master Cylinder**

All models (VIN) HA701010 on	Genuine	1	<b>SJJ100351</b>	40.76 48.91
------------------------------	---------	---	------------------	-------------

**Brake Servo Assembly**

Without ABS up to (VIN) HA701009 - Type 80, 276mm dia, non-return valve at top left				
	Aftermarket	1	<b>NRC4772P</b>	45.00 54.00
	Genuine	1	<b>NRC4772</b>	351.11 421.33
	Aftermarket	1	<b>STC2878P</b>	55.00 66.00
	Genuine	1	<b>STC2878</b>	605.11 726.13
Without ABS, from (VIN) HA701010 to WA159806				
	Aftermarket	1	<b>LR013488P</b>	58.33 70.00
	OEM	1	<b>LR013488P1</b>	67.50 81.00
	Genuine	1	<b>LR013488</b>	184.40 221.28
Without ABS up to (VIN) HA701009 - 2 Port type				
	Aftermarket	1	<b>NRC4775P</b>	50.00 60.00
All models from (VIN) XA159807				
	Genuine	1	<b>SJG100240</b>	259.46 311.35

**Seal Brake Servo**

All models	Genuine	1	<b>SJ0100080</b>	3.47 4.16
------------	---------	---	------------------	-----------

**Servo Non-Return Valve**

All models from (VIN) HA701010 to WA159806	Genuine	1	<b>RTC812</b>	25.83 31.00
--------------------------------------------	---------	---	---------------	-------------

**Caliper Repair Kit**

All models to (VIN) HA701009 - Front				
	Aftermarket	2	<b>AEU1547P</b>	2.00 2.40
	OEM	2	<b>AEU1547P1</b>	7.08 8.50
	Genuine	2	<b>AEU1547</b>	12.39 14.87
All models (VIN) HA701010 on - Front				
	Aftermarket	2	<b>AEU2539P</b>	2.58 3.10
	OEM	2	<b>AEU2539P1</b>	8.13 9.76
	Genuine	2	<b>AEU2539</b>	10.01 12.01
All models from (VIN) HA701010				
Front caliper, kit includes pistons	Aftermarket	2	<b>STC1280P</b>	9.58 11.50
	OEM	2	<b>STC1280P1</b>	49.17 59.00
	Genuine	2	<b>STC1280</b>	83.56 100.27
All models - Rear				
	Aftermarket	2	<b>8G8587LP</b>	1.50 1.80
	Genuine	2	<b>8G8587L</b>	7.18 8.62
All models from (VIN) LA930456 to 6A999999				
Rear caliper, kit includes pistons	Aftermarket	2	<b>SEE500140P</b>	5.63 6.76
	OEM	2	<b>SEE500140P1</b>	29.50 35.40
	Genuine	2	<b>SEE500140</b>	54.78 65.74

**Master Cylinder Repair Kit**

All models to (VIN) 5A701192 - Brake master cylinder				
	Aftermarket	1	<b>GRK1027P</b>	2.08 2.50
All models to (VIN) HA701009 - Brake master cylinder				
	Aftermarket	1	<b>RTC3387P</b>	5.63 6.76
	Genuine	1	<b>RTC3387</b>	33.84 40.61
All models from (VIN) HA701010 to XA178473				
	Aftermarket	1	<b>STC491P</b>	12.08 14.50
	OEM	1	<b>STC491P1</b>	25.83 31.00

**Servo Repair Kit**

All models with type 50 servo to (VIN) HA701009 - Type 50 servo (227mm dia servo)				
	Aftermarket	1	<b>18G8951A</b>	11.25 13.50
All models with type 80 servo to (VIN) HA701009 - Type 80 servo (276mm dia servo)				
	Aftermarket	1	<b>AEU2741P</b>	3.50 4.20
	Genuine	1	<b>AEU2741</b>	42.66 51.19

**Wheel Cylinder Repair Kit**

All models to (VIN) HA701009 - Rear				
	Aftermarket	2	<b>RTC3170P</b>	2.92 3.50
All models (VIN) HA701010 to KA930455				
Rear	Aftermarket	2	<b>STC469P</b>	4.08 4.90
	OEM	2	<b>STC469P1</b>	13.13 15.76
	Genuine	2	<b>STC469</b>	16.01 19.21

**Brake Hose**

All models up to (VIN) 6A999999				
Front, rubber	Aftermarket	2	<b>NRC7874P</b>	3.00 3.60
	OEM	2	<b>NRC7874P1</b>	7.08 8.50
	Genuine	2	<b>NRC7874</b>	34.58 41.50
All models up to (VIN) WA159806				
Rear, rubber	Aftermarket	1	<b>NRC9455P</b>	3.33 4.00
	Genuine	1	<b>NRC9455</b>	34.58 41.50
ABS models from (VIN) XA159807 on				
Rear, RH, rubber	Aftermarket	1	<b>SHB101370P</b>	6.88 8.26
	Genuine	1	<b>SHB101370</b>	34.58 41.50
Rear, LH, rubber	Aftermarket	1	<b>SHB101430P</b>	5.63 6.76
	OEM	1	<b>SHB101430P1</b>	10.00 12.00
	Genuine	1	<b>SHB101430</b>	34.58 41.50
All models without ABS (VIN) 7A000001 on				
Rear	OEM	1	<b>SHB500220P1</b>	17.50 21.00
Non ABS models from (VIN) XA159807 on				
Rear, rubber	Aftermarket	1	<b>SHB101370P</b>	6.88 8.26
	Genuine	1	<b>SHB101370</b>	34.58 41.50
All models without ABS (VIN) 7A000001 on				
Rear	Genuine	1	<b>SHB500220</b>	32.94 39.53
All 4 cylinder models up to (VIN) LA930456 (200TDi)				
Clutch hose	Aftermarket	1	<b>RTC4425P</b>	2.50 3.00
	OEM	1	<b>RTC4425P1</b>	8.75 10.50
	Genuine	1	<b>RTC4425</b>	34.58 41.50

**Brake Pipe Clip**

All models - Double type				
Various applications	Aftermarket	a/r	<b>625521A</b>	1.25 1.50
	Genuine	a/r	<b>NTC1176</b>	0.71 0.85
	Genuine	a/r	<b>NTC9543L</b>	1.80 2.16

**Brake Pipe Clip Double**

All models with rear drum brakes less ABS to (VIN) HA701009				
	Genuine	a/r	<b>79125</b>	0.32 0.38

**Brake/Clutch Pipe Clip**

All models - Double	Genuine	a/r	<b>NTC1175</b>	0.58 0.70
---------------------	---------	-----	----------------	-----------

**Brake Pipe T Piece**

All non-ABS models (VIN) XA159807 on				
Rear axle	Aftermarket	a/r	<b>SGL100000P</b>	6.87 8.24
	Genuine	a/r	<b>SGL100000</b>	12.74 15.29

**2-way Brake Pipe Connector**

All models without ABS - Rear	Genuine	a/r	<b>BMK2466</b>	4.41 5.29
-------------------------------	---------	-----	----------------	-----------

**T Piece Brake System**

All non-ABS models - Rear brake pipes				
	Aftermarket	a/r	<b>NRC4251P</b>	6.04 7.25
	Genuine	a/r	<b>NRC4251</b>	17.88 21.46





# BRAKING SYSTEM

# DEFENDER 90 (1989 on)

## Brake Shoe Set - Handbrake

Up to (VIN) KA930456				
Handbrake, rod operated type	Aftermarket	1	<b>STC965P</b>	7.50 9.00
	OEM	1	<b>STC965P1</b>	22.50 27.00
	Genuine	1	<b>STC965</b>	80.87 97.04
From (VIN) LA 935630 on				
Handbrake, direct entry cable type	Aftermarket	1	<b>ICW500010P</b>	10.00 12.00
	OEM	1	<b>ICW500010P1</b>	25.00 30.00
	Genuine	1	<b>ICW500010</b>	65.52 78.62

## Brake Shoe Return Spring

All models with LT77S & LT85 Gearbox to (VIN) LA935629				
	Aftermarket	1	<b>STC246P</b>	4.83 5.80
	Genuine	1	<b>STC246</b>	5.74 6.89

## Brake Spring Kit

All models from (VIN) LA935630				
Handbrake Shoe Retention	Aftermarket	1	<b>ICW100050P</b>	3.83 4.60
	OEM	1	<b>ICW100050P1</b>	8.12 9.74
	Genuine	1	<b>ICW100050</b>	11.52 13.82

## Brake Drum - Handbrake

All models up to (VIN) AA796490				
Handbrake	Aftermarket	1	<b>LR025177P</b>	20.42 24.50
	Genuine	1	<b>LR025177</b>	152.67 183.20

## Backplate Handbrake

All models with LT77S & LT85 Gearbox to (VIN) LA935629				
	Genuine	1	<b>STC963</b>	343.70 412.44
From (VIN) LA935630 to XA175163 and 7A000001 on - Handbrake, direct entry cable type				
	Genuine	1	<b>STC1533</b>	46.67 56.00

## Locking Plate Handbrake

All models to (VIN) LA935629				
	Aftermarket	1	<b>515467P</b>	1.33 1.60
	Genuine	1	<b>515467</b>	1.72 2.06

## Retaining Plate Handbrake

All models to (VIN) LA935629				
	Aftermarket	1	<b>515468P</b>	1.08 1.30
	Genuine	1	<b>515468</b>	2.30 2.76

## Dust Cover Expander Unit

All models with LT77 5 speed gearbox				
	OEM	1	<b>515466P1</b>	3.33 4.00
	Genuine	1	<b>515466</b>	4.49 5.39

## Expander Unit

All models with LT77 5 speed gearbox				
	Aftermarket	1	<b>AEU2734P</b>	17.29 20.75
	Genuine	1	<b>AEU2734</b>	330.80 396.96

## Retaining Kit Expander

All models - Parking Brake				
	Aftermarket	1	<b>RA1109P</b>	3.00 3.60
	Genuine	1	<b>RA1109</b>	5.83 7.00

## Brake Shoe Adjuster Assembly

All models with LT77S & LT85 Gearbox to (VIN) LA935629				
	Aftermarket	1	<b>STC244P</b>	17.29 20.75
	Genuine	1	<b>STC244</b>	125.32 150.38
	Genuine	1	<b>STC245</b>	124.64 149.57

## Brake Adjuster Transmission

All models with LT230 transfer box to (VIN) LA935629 - Early type expander				
	Aftermarket	1	<b>AEU2735P</b>	10.42 12.50
	Genuine	1	<b>AEU2735</b>	237.59 285.11

## Transmission Brake Adjustment Kit

All models from (VIN) LA935630 on				
	Aftermarket	1	<b>ICW500020P</b>	9.37 11.24
	Genuine	1	<b>ICW500020</b>	13.81 16.57

## Brake Lever Kit

All models (VIN) XA159807 on - Handbrake				
	Genuine	1	<b>ICW100010</b>	15.27 18.32



STC965P

## Transmission Brake Connecting Rod

All models to (VIN) LA935629 - Fitted with LT77S & LT85 gearbox for old type expander assembly				
	Genuine	1	<b>STC964</b>	38.33 46.00

## Cross Shaft

All models from (VIN) 4A290431 on - Handbrake, Direct Entry Cable Type				
	Genuine	1	<b>ICF100000</b>	12.74 15.29

## Handbrake Switch

All models LHD				
	Aftermarket	1	<b>EEP191LP</b>	11.87 14.24
	Genuine	1	<b>EEP191L</b>	14.24 17.09

## Handbrake Cable

RHD models up to (VIN) LA935629				
	Aftermarket	1	<b>NRC5088P</b>	7.50 9.00
	Genuine	1	<b>NRC5088</b>	34.58 41.50
LHD models up to (VIN) LA935629				
	Aftermarket	1	<b>NRC5089P</b>	11.67 14.00
	Genuine	1	<b>NRC5089</b>	34.58 41.50
All models from (VIN) LA935630 to 6A999999				
	Aftermarket	1	<b>SPB500200P</b>	9.79 11.75
	OEM	1	<b>SPB500200P1</b>	20.42 24.50
	Genuine	1	<b>SPB500200</b>	72.61 87.13

## Handbrake Cable Clevis Pin

All models - 8 x 22mm, Handbrake cable to Handbrake lever				
	Genuine	1	<b>PC108291L</b>	3.45 4.14

## ABS Brake Sensor Kit

All models with ABS to (VIN) 5A683617				
Front brakes	OEM	2	<b>SSW100050P1</b>	160.00 192.00
	Genuine	2	<b>SSW100050</b>	334.23 401.08

## ABS Sensor Kit

ABS models from (VIN) XA159807 to 6A999999				
Front brakes	Aftermarket	2	<b>STC1749P</b>	28.75 34.50
	Genuine	2	<b>STC1749</b>	217.69 261.23
Rear brakes	Aftermarket	2	<b>STC1750P</b>	40.00 48.00
	Genuine	2	<b>STC1750</b>	278.01 333.61
All models with anti lock brakes to (VIN) 3A664199				
Rear, RH or LH	Aftermarket	2	<b>SSW100060P</b>	45.00 54.00
	OEM	2	<b>SSW100060P1</b>	165.00 198.00
	Genuine	2	<b>SSW100060</b>	172.09 206.51
All models with anti lock brakes (VIN) 3A664200 to AA798476				
Rear, RH or LH, Wabco type	Aftermarket	2	<b>SSW500080P</b>	105.00 126.00
	OEM	2	<b>SSW500080P1</b>	150.00 180.00
	Genuine	2	<b>SSW500080</b>	189.14 226.97

## ABS Sensor

All models from (VIN) 6A000001 - Front				
	OEM	2	<b>SSW500050P1</b>	70.00 84.00
	Genuine	2	<b>SSW500050</b>	171.14 205.37
All models with anti lock brakes from (VIN) 7A000001 to AA798476 -				
Front brakes	OEM	2	<b>SSW500090P1</b>	150.00 180.00
	Genuine	2	<b>SSW500090</b>	171.17 205.40
All models with ABS (VIN) AA798477 on				
Front, Bosch type	OEM	2	<b>LR023690P1</b>	19.95 23.94
	Genuine	2	<b>LR023690</b>	26.77 32.12
Rear, Bosch type	OEM	2	<b>LR023691P1</b>	24.95 29.94
	Genuine	2	<b>LR023691</b>	33.51 40.21
All models from (VIN) BA888888				
Front & rear	Genuine	2	<b>LR029522</b>	14.33 17.20

## ABS Sensor Oil Seal

All models with ABS - Front brakes				
	Aftermarket	1	<b>FTC1376P</b>	1.00 1.20
	OEM	1	<b>FTC1376P1</b>	2.50 3.00
	Genuine	1	<b>FTC1376</b>	9.10 10.92

## Bush ABS Sensor

All models with anti lock brakes to (VIN) BA888887				
Front and rear	Aftermarket	2	<b>FTC1374P</b>	4.58 5.50
	Genuine	2	<b>LR029522</b>	14.33 17.20

## Exciter Ring

All models with ABS - Rear				
	Genuine	2	<b>FTC1379</b>	253.57 304.28

## ABS Yaw Rate Sensor

All 2.2L TDCi Puma diesel models from (VIN) FA000001 on				
	Genuine	1	<b>LR011785</b>	287.53 345.04

## Brake Pedal Rubber

All models except V8 EFI - Brake and clutch				
	Aftermarket	2	<b>SKE500060P</b>	2.83 3.40
	Genuine	2	<b>SKE500060</b>	8.92 10.70

## Brake Pedal Pivot Bush

All models				
	Genuine	1	<b>564816</b>	11.27 13.52



**DEFENDER 90 (1989 on)****SUSPENSION****Bush Radius Arm**

All models up to (VIN) VA130784 - Front suspension				
chassis end, rubber	Aftermarket	4	<b>NRC4514P</b>	0.79 0.95
	Genuine	4	<b>NRC4514</b>	2.76 3.31
chassis end, poly.	Polybush	1	<b>NRC4514POLYBUSH</b>	20.42 24.50
	Aftermarket	4	<b>NRC4514POLY</b>	3.00 3.60
All models from (VIN) VA130785 on				
chassis end, rubber	Aftermarket	4	<b>ANR6971P</b>	0.79 0.95
	OEM	4	<b>ANR6971P1</b>	2.08 2.50
	Genuine	4	<b>ANR6971</b>	2.40 2.88
chassis end, poly.	Aftermarket	2	<b>ANR6971POLY</b>	3.83 4.60
All models up to (VIN) KA930455 - Front suspension				
axle end, rubber	Aftermarket	4	<b>NTC7307P</b>	1.50 1.80
	Genuine	4	<b>NTC7307</b>	20.38 24.46
axle end, poly.	Aftermarket	4	<b>NTC7307POLY</b>	6.67 8.00
axle end, poly. set of 4	Bearmach	1	<b>NTC7307BMPYC</b>	87.50 105.00
All models from (VIN) LA930456 on - Front suspension				
rubber	Aftermarket	4	<b>NTC6781P</b>	1.50 1.80
	OEM	4	<b>NTC6781P1</b>	4.08 4.90
	Genuine	4	<b>NTC6781</b>	14.96 17.95
poly.	Aftermarket	4	<b>NTC6781POLY</b>	5.00 6.00
	Britpart	1	<b>NTC6781BPPY</b>	16.88 20.26
	Bearmach	1	<b>NTC6781BMPYC</b>	85.00 102.00
All models - Rear suspension				
chassis end, rubber (pair)	Aftermarket	1	<b>STC618P</b>	6.67 8.00
	OEM	1	<b>STC618P1</b>	15.42 18.50
	Genuine	1	<b>STC618</b>	59.46 71.35
rubber	Aftermarket	2	<b>NTC1772P</b>	1.50 1.80
	OEM	2	<b>NTC1772P1</b>	3.00 3.60
	Genuine	2	<b>NTC1772</b>	9.29 11.15
chassis end, poly.	Aftermarket	2	<b>NTC9027POLY</b>	20.00 24.00
chassis end, poly. (pair)	Aftermarket	1	<b>STC618POLY</b>	25.83 31.00
poly.	Aftermarket	2	<b>NTC1772POLY</b>	4.38 5.26
poly. (pair) performance red	Polybush	1	<b>NTC1772POLYBUSH</b>	22.50 27.00

**Bush Kit Radius Arm**

All models up to (VIN) VA130784				
Front suspension Kit, radius arm to chassis				
rubber	Britpart	1	<b>NRC4514BPKIT</b>	7.08 8.50
poly. yellow	Britpart	1	<b>NRC4514BPKPOLYEL</b>	9.58 11.50
All models				
Rear suspension, chassis end, poly., performance red	Polybush	1	<b>NTC9027POLYBUSH</b>	39.58 47.50

**Shock Absorber Bush Kit**

All models to (VIN) WA159806				
Front & Rear	Aftermarket	1	<b>LL1095P</b>	5.83 7.00
	Genuine	1	<b>LL1095</b>	27.50 33.00
Front & Rear, poly.	Aftermarket	1	<b>LL1095POLY</b>	16.25 19.50
Rear				
performance red	Polybush	1	<b>LL1356</b>	27.08 32.50
comfort blue	Polybush	1	<b>LL1356B</b>	27.08 32.50
All models from (VIN) XA159807 on				
Front & Rear	Aftermarket	1	<b>LL1095L</b>	28.75 34.50
Front & rear, poly.	Aftermarket	1	<b>LL1095LPOLY</b>	22.50 27.00
All models				
Front				
performance red	Polybush	1	<b>LL1357</b>	22.08 26.50
comfort blue	Polybush	1	<b>LL1357B</b>	22.08 26.50

**Bush Shock Absorber Mounting**

All models				
Front upper and lower, rear lower				
rubber	Aftermarket	8	<b>552818P</b>	0.50 0.60
	Genuine	8	<b>552818</b>	1.38 1.66
poly, performance red	Polybush	1	<b>5528189PBR</b>	25.00 30.00
poly, comfort blue	Polybush	1	<b>552818PPBB</b>	25.00 30.00
poly, dynamic orange	Polybush	1	<b>5528189PBO</b>	25.00 30.00
	Aftermarket	8	<b>552818POLY</b>	0.83 1.00
Rear, upper, rubber	Aftermarket	2	<b>NRC5593P</b>	1.08 1.30
	Genuine	2	<b>NRC5593</b>	6.28 7.54
poly.	Aftermarket	2	<b>NRC5593POLY</b>	4.00 4
All models from (VIN) XA159807 on				
Rear, lower, poly.	Aftermarket	2	<b>RNF100090LPOLY</b>	2.25 2.70
Rear, lower, rubber	Aftermarket	4	<b>RNF100090LP</b>	0.54 0.65
	Genuine	4	<b>RNF100090</b>	1.09 1.31
	Genuine	4	<b>RNF100090L</b>	2.06 2.47
	Terrafrima	2	<b>NRC5593TFP</b>	13.13 15.76
Rear, Kit, poly., 8 piece set of 8	Aftermarket	1	<b>RNF100090LPB</b>	30.83 37.00

**Bush Panhard Rod**

All models up to (VIN) 2A626645				
Front, rubber	Aftermarket	2	<b>ANR3410P</b>	0.75 0.90
	OEM	2	<b>ANR3410P1</b>	2.75 3.30
	Genuine	2	<b>ANR3410</b>	8.67 10.40
Front, poly.	Aftermarket	2	<b>ANR3410POLY</b>	4.00 4.80
	Terrafrima	1	<b>ANR3410TFPK</b>	15.63 18.76
All models from (VIN) 2A626646 on				
Front suspension, rubber	Aftermarket	2	<b>RBX101340P</b>	1.75 2.10
	OEM	2	<b>RBX101340P1</b>	8.96 10.75
	Genuine	2	<b>RBX101340</b>	14.27 17.12
Front suspension, poly.	Aftermarket	2	<b>RBX101340POLY</b>	6.04 7.25

**Washer for Bush on Radius Arm**

All models - Rear suspension, chassis end	Aftermarket	2	<b>STC618WASHER</b>	5.42 6.50
-------------------------------------------	-------------	---	---------------------	-----------

**Bush Upper Link**

All models - Rear suspension				
rubber	Aftermarket	2	<b>NTC1773P</b>	1.58 1.90
	OEM	2	<b>NTC1773P1</b>	4.00 4.80
	Genuine	2	<b>NTC1773</b>	19.99 23.99
poly., performance red (pair)	Polybush	1	<b>NTC1773POLYBUSH</b>	23.75 28.50
poly., comfort blue (pair)	Polybush	1	<b>NTC1773POLYBUSHBLUE</b>	23.75 28.50
	Aftermarket	2	<b>NTC1773POLY</b>	4.38 5.26

**Suspension Bush Kit**

All models up to (VIN) KA930455				
<i>Bush kit 'D' - incl. bottom link mounting bushes, front radius arm to axle bushes, A frame bushes, Panhard rod bushes, upper and lower shock absorber bushes, radius arm to chassis bushes</i>				
	Aftermarket	1	<b>RA1173EARLYP</b>	26.25 31.50
	Genuine	1	<b>RA1173EARLY</b>	300.00 360.00

All models to (VIN) KA930455 - Complete vehicle set, poly.,				
black	Britpart	1	<b>LL1059BPPOLYBLK</b>	58.33 70.00
blue	Britpart	1	<b>LL1059BPPOLYBLUE</b>	60.83 73.00
yellow	Britpart	1	<b>LL1059BPPOLYEL</b>	80.83 97.00

All models to (VIN) KA930455 - Kit contains Radius Arms & Panhard Rod bushes, poly.,				
performance red	Polybush	1	<b>LL1059PBR</b>	130.00 156.00
comfort blue	Polybush	1	<b>LL1059PBB</b>	130.00 156.00
dynamic orange	Polybush	1	<b>LL1059PBO</b>	130.00 156.00

All models (VIN) LA930456 to 2A626645				
<i>Bush kit 'D' - incl. bottom link mounting bushes, front radius arm to axle bushes, A frame bushes, Panhard rod bushes, upper and lower shock absorber bushes, radius arm to chassis bushes</i>				
	Aftermarket	1	<b>RA1173LATEP</b>	26.25 31.50
	Genuine	1	<b>RA1173LATE</b>	280.00 336.00

All models to (VIN) AA267063 - Complete vehicle set				
poly., black	Aftermarket	1	<b>LL1059ALTPOLY</b>	124.17 149.00

All models from (VIN) BA267064 - Complete vehicle set, poly., black				
	Aftermarket	1	<b>LL1059ALTPOLYL</b>	110.83 133.00

**Suspension Bush Kit B**

All models up to (VIN) KA930455 - poly.				
	Aftermarket	1	<b>RA1274ALTPOLY</b>	87.50 105.00

All models (VIN) LA930456 on - poly., performance red				
	Polybush	1	<b>RA1274PBRED</b>	130.00 156.00

All models (VIN) LA930456 on - poly., comfort blue				
	Polybush	1	<b>RA1275POLYBUSH</b>	142.50 171.00
dynamic orange	Polybush	1	<b>RA1274PBORANGE</b>	130.00 156.00

All models (VIN) LA930456 to WA159806 - poly.,				
black	Britpart	1	<b>RA1274BPPYBLKDEF</b>	58.33 70.00
yellow	Britpart	1	<b>RA1274BPPYELDEF</b>	80.83 97.00

**Bolt Kit for Bush Kits**

All models				
	Aftermarket	1	<b>RA1177P</b>	40.42 48.50
	Genuine	1	<b>RA1177</b>	71.67 86.00

**Anti Roll Bar Bush Kit**

All models - Front anti roll bar bush kit				
performance red	Polybush	1	<b>LL1359</b>	35.00 42.00
comfort blue	Polybush	1	<b>LL1359B</b>	35.00 42.00

**Anti Roll Bar Bush**

All models fitted with anti roll bar				
Front upper and lower, poly.	Aftermarket	4	<b>552819POLY</b>	1.08 1.30
Anti roll bar link, rubber	Aftermarket	4	<b>552819P</b>	0.19 0.23
	Genuine	4	<b>552819</b>	1.39 1.67

**Bush Anti Roll Bar Mounting**

All models with factory heavy duty suspension to (VIN) 6A999999				
Front anti roll bar, poly.	Aftermarket	2	<b>NTC6828POLY</b>	6.25 7.50

All models (VIN) 7A000001 on				
Front anti roll bar, poly.	Aftermarket	2	<b>NTC6828POLY</b>	6.25 7.50
Front anti roll bar, poly. 25.4mm inside diameter				
Upated	Terrafrima	2	<b>NTC6828URTFPY</b>	23.33 28.00

All models with factory heavy duty suspension to (VIN) 6A999999				
Front anti roll bar, poly. 25.4mm inside diameter				
Upated	Terrafrima	2	<b>NTC6828URTFPY</b>	23.33 28.00



NRC4514BPKIT

# SUSPENSION

# DEFENDER 90 (1989 on)

## Bump Stop

All models					
Front suspension, rubber	Aftermarket	2	<b>ANR4188P</b>	2.58	3.10
	OEM	2	<b>ANR4188P1</b>	6.04	7.25
	Genuine	2	<b>ANR4188</b>	24.38	29.26
Front suspension, poly., red	Polybush	2	<b>ANR4188POLYBUSH</b>	19.17	23.00
	Britpart	2	<b>ANR4188BPPYBLK</b>	13.25	15.90
	Britpart	2	<b>ANR4188BPPYEL</b>	13.25	15.90
Rear suspension, rubber	Aftermarket	2	<b>ANR4189P</b>	3.08	3.70
	OEM	2	<b>ANR4189P1</b>	8.13	9.76
	Genuine	2	<b>ANR4189</b>	18.20	21.84
Rear suspension, poly. black	Polybush	2	<b>ANR4189POLYBUSH</b>	17.08	20.50
	Britpart	2	<b>ANR4189BPPYBLK</b>	13.25	15.90
	Britpart	2	<b>ANR4189BPPYEL</b>	13.25	15.90

## Bump Stop Spacers

All models - Front or rear	Terrafirma	a/r	<b>ANR4188-9TFSPACER</b>	29.58	35.50
----------------------------	------------	-----	--------------------------	-------	-------

## Anti Roll Bar Bush Kit

All models up to (VIN) WA159806					
Rear anti roll bar bush kit	Aftermarket	1	<b>LL1096</b>	15.83	19.00
All models from (VIN) WA159807 to 6A999999					
Rear anti roll bar bush kit	Aftermarket	1	<b>LL1097</b>	16.67	20.00
All models					
Rear, poly., performance red	Polybush	1	<b>LL1096PBR</b>	30.83	37.00
Rear, poly., comfort blue	Polybush	1	<b>LL1096PBB</b>	30.83	37.00

## Bush Anti Roll Bar Mounting

All models from (VIN) MA960430 to WA159806 except V8 EFI					
Rear, poly., for 16mm bar	Aftermarket	4	<b>NTC7394POLY</b>	6.25	7.50
All models from (VIN) XA159807 on					
Rear, standard poly.	Aftermarket	2	<b>EGP1889POLY</b>	6.04	7.25
All models from (VIN) XA159807 on					
Rear, 25.4mm inside diameter, poly.	Terrafirma	2	<b>EGP1889URTFPY254</b>	16.67	20.00
Rear, 28.0mm inside diameter, poly.	Terrafirma	2	<b>EGP1889URTFPY280</b>	15.42	18.50

## Bush Anti Roll Bar Mounting Upgraded

All models from (VIN) MA960430 to WA159806 except V8 EFI					
Rear, poly., 25.4mm inside diameter	Terrafirma	2	<b>NTC7394URTFPY254</b>	21.25	25.50
Rear, poly., 28.0mm inside diameter	Terrafirma	2	<b>NTC7394URTFPY280</b>	23.33	28.00

## Polyurethane Bush Kit

All models (VIN) 2A626646 on - Car set of suspension bushes,					
performance red	Polybush	1	<b>LL1479PBRED</b>	137.50	165.00
comfort blue	Polybush	1	<b>LL1479PBBBLUE</b>	148.33	178.00
All models (VIN) XA159807 to 6A999999 - Car set of suspension bushes,					
black	Britpart	1	<b>LL1479BPPOLYBLK</b>	58.33	70.00
yellow	Britpart	1	<b>LL1479BPPOLYEL</b>	70.83	85.00
All models (VIN) 7A000001 on - Car set of suspension bushes,					
black	Britpart	1	<b>LL1480BPPOLYBLK</b>	58.33	70.00
yellow	Britpart	1	<b>LL1480BPPOLYEL</b>	68.33	82.00

## Supplementary Bush Kit

All models up to (VIN) WA159806					
Supplementary kit - includes bushes for front and rear ARBs, A frames, shock absorbers and steering damper					
	Aftermarket	1	<b>LL1308</b>	63.33	76.00
All models from (VIN) WA159807 to 6A999999					
Supplementary kit - includes bushes for front and rear ARBs, A frames, shock absorbers and steering damper					
	Aftermarket	1	<b>LL1309</b>	63.33	76.00

## Mounting Bush, Anti Roll Bar

All models with factory heavy duty suspension to (VIN) 6A999999					
Front anti roll bar	Aftermarket	2	<b>NTC6828P</b>	1.33	1.60
	OEM	2	<b>NTC6828P1</b>	2.72	3.26
	Genuine	2	<b>NTC6828</b>	6.99	8.39
All models (VIN) 7A000001 on					
Front anti roll bar	Aftermarket	2	<b>NTC6828P</b>	1.33	1.60
	OEM	2	<b>NTC6828P1</b>	2.72	3.26
	Genuine	2	<b>NTC6828</b>	6.99	8.39
All models from (VIN) MA960430 to WA159806 except V8 EFI					
Rear, standard rubber, for 16mm bar	Aftermarket	2	<b>NTC7394P</b>	1.33	1.60
	OEM	2	<b>NTC7394P1</b>	3.00	3.60
	Genuine	2	<b>NTC7394</b>	4.53	5.44
All models from (VIN) XA159807 on					
Rear, standard rubber	Aftermarket	2	<b>EGP1889P</b>	2.00	2.40
	Aftermarket	2	<b>EGP1889A</b>	2.17	2.60
	Genuine	2	<b>EGP1889</b>	2.97	3.56

## Anti Roll Bar

All models with factory heavy duty suspension to (VIN) 6A999999					
Front	Aftermarket	1	<b>LR033037P</b>	50.00	60.00
	Genuine	1	<b>LR033037</b>	72.75	87.30
	All models (VIN) 7A000001 on - Front				
Aftermarket	1	<b>LR033037P</b>	50.00	60.00	
	Genuine	1	<b>LR033037</b>	72.75	87.30

## Anti Roll Bar Link Ball Joint

All models - Front and rear					
Aftermarket	2	<b>NTC1888P</b>	4.79	5.75	
OEM	2	<b>NTC1888P1</b>	13.54	16.25	
Genuine	2	<b>NTC1888</b>	41.58	49.90	

## Clamp Bracket

All models - Anti roll bar mounting, front					
Aftermarket	2	<b>NTC6776P</b>	3.75	4.50	
Genuine	2	<b>NTC6776</b>	5.93	7.12	

## Anti Roll Bar Upgraded

All models with factory heavy duty suspension to (VIN) 6A999999					
Front, upgraded 25.4mm diameter	Terrafirma	1	<b>LR033037URTF</b>	245.83	295.00
All models (VIN) 7A000001 on -					
Front, upgraded 25.4mm diameter	Terrafirma	1	<b>LR033037URTF</b>	245.83	295.00

## Link Kit for Upgraded Anti Roll Bars

All models with factory heavy duty suspension to (VIN) 6A999999 - Fitting Kit					
	Terrafirma	1	<b>LR033037URTFK</b>	24.58	29.50
All models (VIN) 7A000001 on - Fitting Kit					
	Terrafirma	1	<b>LR033037URTFK</b>	24.58	29.50

## Spacer Kit (2 hole for anti-roll bar)

All models with factory heavy duty suspension to (VIN) 6A999999 - for anti roll bar					
	Terrafirma	1	<b>LR033037-8URTFK2</b>	35.00	42.00
All models (VIN) 7A000001 on - for anti roll bar					
	Terrafirma	1	<b>LR033037-8URTFK2</b>	35.00	42.00

## Spacer Kit (4 hole for anti-roll bar)

All models with factory heavy duty suspension to (VIN) 6A999999 - for anti roll bar					
	Terrafirma	1	<b>LR033037-8URTFK4</b>	39.58	47.50
All models (VIN) 7A000001 on - for anti roll bar					
	Terrafirma	1	<b>LR033037-8URTFK4</b>	39.58	47.50

## Shock Absorber - Front

All models up to (VIN) WA159806					
Front, standard	Aftermarket	2	<b>STC3766P</b>	13.54	16.25
	OEM	2	<b>STC3766P1</b>	25.00	30.00
	Genuine	2	<b>STC3766</b>	62.74	75.29
Front, heavy duty	Britpart	2	<b>STC3766BPHD</b>	16.67	20.00
	All models from (VIN) XA159807				
Front	Aftermarket	2	<b>RSC100040P</b>	13.13	15.76
	OEM	2	<b>RSC100040P1</b>	29.58	35.50
	Genuine	2	<b>RSC100040</b>	60.88	73.06
Front (pair)	Bilstein	1	<b>RSC100040BILSTEIN</b>	152.50	183.00
	All models				
Front, oil, std. height	Aftermarket	2	<b>RSC100050P</b>	13.54	16.25
	OEM	2	<b>RSC100050P1</b>	29.58	35.50
	Genuine	2	<b>RSC100050</b>	61.43	73.72
Front, gas, std. height	Decarbon	2	<b>RA1345DECARBONEA</b>	63.33	76.00
	Super Gaz	2	<b>LL1481BPSUP</b>	33.33	40.00
	Cellular Dynamic	2	<b>LL1481BPCEL</b>	39.58	47.50
	Terrafirma	2	<b>RA1345TFAT</b>	28.33	34.00
	Bilstein	1	<b>RA1345BILSTEIN</b>	132.50	159.00
	Terrafirma	2	<b>RA1345TFPS</b>	48.33	58.00
Front, gas, std. height (pair)	Bilstein	1	<b>RA1345BILSTEIN</b>	132.50	159.00
	Terrafirma	2	<b>RA1345TFCHD</b>	58.33	70.00
All models from (VIN) 7A738816 on - Front					
Military (Wolf) - Front	Genuine	2	<b>RSC500290</b>	57.82	69.38
	Genuine	2	<b>RNB501380</b>	106.47	127.76

## Shock Absorber - Rear

All models up to (VIN) WA159806					
Rear	Aftermarket	2	<b>STC3767P</b>	13.54	16.25
	OEM	2	<b>STC3767P1</b>	27.50	33.00
	Genuine	2	<b>STC3767</b>	65.30	78.36
Rear, oil, std. height	Aftermarket	2	<b>STC3771P</b>	13.96	16.75
	OEM	2	<b>STC3771P1</b>	24.58	29.50
	Genuine	2	<b>STC3771</b>	63.97	76.76
All models up to (VIN) WA159806					
Rear, gas, heavy duty, std. height	Aftermarket	2	<b>STC3772P</b>	13.96	16.75
	OEM	2	<b>STC3772P1</b>	27.50	33.00
	Britpart	2	<b>STC3767BPHD</b>	16.67	20.00
	Genuine	2	<b>STC3772</b>	64.26	77.11
All models from (VIN) XA159807					
Rear	Aftermarket	2	<b>RPM100070P</b>	13.54	16.25
	OEM	2	<b>RPM100070P1</b>	35.00	42.00
	Genuine	2	<b>RPM100070</b>	63.61	76.33
Rear, oil, std. height	Aftermarket	2	<b>STC3704P</b>	14.58	17.50
	OEM	2	<b>STC3704P1</b>	26.67	32.00
	Genuine	2	<b>STC3704</b>	59.25	71.10
Rear, oil, std. height B6 Damper	Bilstein	2	<b>STC3704UPRATED</b>	80.00	96.00
	Bilstein	1	<b>RPM100070BILSTEIN</b>	152.50	183.00
All models					
Rear, gas, std. height	Pro-Comp	2	<b>RA1346BMPC</b>	38.33	46.00
	Super Gaz	2	<b>LL1482BPSUP</b>	33.33	40.00
	Cellular Dynamic	2	<b>LL1482BPCEL</b>	39.58	47.50
	Bilstein	1	<b>RA1346BILSTEIN</b>	132.50	159.00
Rear, gas, std. height (pair)	Terrafirma	2	<b>RA1346TFAT</b>	29.17	35.00
Rear, gas, std. height All Terrain	Terrafirma	2	<b>RA1346TFAT</b>	29.17	35.00
Rear, gas, std. height Pro Sport	Terrafirma	2	<b>RA1346TFPS</b>	48.33	58.00
Rear, gas, std. height Commercial Heavy Duty	Terrafirma	2	<b>RA1346TFCHD</b>	58.33	70.00

## Shock Mounting Retention Ring

All models - Front					
Aftermarket	2	<b>RNJ500010P</b>	3.58	4.30	
Genuine	2	<b>RNJ500010</b>	16.34	19.61	





**DEFENDER 90 (1989 on)****SUSPENSION****Coil Spring - Front**

All models up to (VIN) 6A999999 - Front, driver's side	Aftermarket	1	<b>NRC9446P</b>	13.13	15.76
	Genuine	1	<b>NRC9446</b>	62.65	75.18
passenger's side	Aftermarket	1	<b>NRC9447P</b>	14.58	17.50
	Genuine	1	<b>NRC9447</b>	65.08	78.10
All RHD and LHD models from (VIN) 7A000001 to AA798475 - Front, driver's side	Genuine	1	<b>REB500200</b>	75.85	91.02
	Genuine	1	<b>REB500220</b>	73.62	88.34
All RHD models from (VIN) AA798476 on - Front, both sides	Genuine	2	<b>REB500220</b>	73.62	88.34
	Genuine	2	<b>REB500200</b>	75.85	91.02
passenger's side	Genuine	1	<b>REB500220</b>	73.62	88.34

**Coil Spring - Rear**

All models up to (VIN) 6A999999 - Rear, standard driver's side	Aftermarket	1	<b>NRC9448P</b>	14.38	17.26
	Genuine	1	<b>NRC9448</b>	64.40	77.28
passenger's side	Aftermarket	1	<b>NRC9449P</b>	16.04	19.25
	Genuine	1	<b>NRC9449</b>	63.84	76.61
All station wagon models with standard springs from (VIN) 7A000001 to AA999999 - Rear, driver's side	Genuine	1	<b>RKB500280</b>	69.84	83.81
	Genuine	1	<b>RKB500290</b>	98.55	118.26
All models with heavy duty/2+2 seat suspension (VIN) 7A000001 to AA999999 - Rear, driver's side, white/green/pink	Genuine	1	<b>RKB500270</b>	88.70	106.44
	Genuine	1	<b>RKB500310</b>	75.82	90.98
All RHD 2 seat configuration models from (VIN) BA000001 on - Rear, both sides	Aftermarket	2	<b>RKB101230P</b>	19.58	23.50
	Genuine	2	<b>RKB101230</b>	67.85	81.42
All RHD models with 2+2 seat configuration from (VIN) BA000001 on - Rear, both sides	Genuine	2	<b>RKB500290</b>	98.55	118.26
	Genuine	2	<b>RKB500270</b>	88.70	106.44
All RHD models with heavy duty/2+2 seat suspension (VIN) BA000001 on - Rear, white/green/pink driver's & passenger's sides	Genuine	2	<b>RKB500270</b>	88.70	106.44
	Rear, standard				
All station wagon models to (VIN) AA999999 driver's side	Aftermarket	1	<b>RKB101230P</b>	19.58	23.50
	Genuine	1	<b>RKB101230</b>	67.85	81.42
passenger's side	Aftermarket	1	<b>RKB101240P</b>	19.38	23.26
	Genuine	1	<b>RKB101240</b>	68.11	81.73
All models with factory heavy duty fitment to (VIN) 6A999999 - heavy duty, green/yellow/red stripe driver's side	Aftermarket	1	<b>RKB101230P</b>	19.58	23.50
	Genuine	1	<b>RKB101230</b>	67.85	81.42
All models with heavy duty suspension from (VIN) XA159807 to AA999999 - Rear, driver's side, heavy duty	Aftermarket	1	<b>RKB101230P</b>	19.58	23.50
	Genuine	1	<b>RKB101230</b>	67.85	81.42
passenger's side, heavy duty	Aftermarket	1	<b>RKB101240P</b>	19.38	23.26
	Genuine	1	<b>RKB101240</b>	68.11	81.73
All LHD 2 seat configuration models from (VIN) BA000001 on - Rear, driver's side	Aftermarket	1	<b>RKB101230P</b>	19.58	23.50
	Genuine	1	<b>RKB101230</b>	67.85	81.42
passenger's side	Aftermarket	1	<b>RKB101240P</b>	19.38	23.26
	Genuine	1	<b>RKB101240</b>	68.11	81.73
All LHD models with 2+2 seat configuration from (VIN) BA000001 on - Rear, driver's side	Genuine	1	<b>RKB500280</b>	69.84	83.81
	Genuine	1	<b>RKB500290</b>	98.55	118.26
All LHD models with heavy duty/2+2 seat suspension (VIN) BA000001 on - Rear, driver's side, white/green/pink	Genuine	1	<b>RKB500270</b>	88.70	106.44
	Genuine	1	<b>RKB500310</b>	75.82	90.98
All 4.0L V8 EFI petrol models - Rear, heavy duty, green/yellow/red stripe driver's side	Genuine	1	<b>RKB101230P</b>	19.58	23.50
	Genuine	1	<b>RKB101230</b>	67.85	81.42
Military (Wolf) - Rear	Genuine	2	<b>RKB101060</b>	63.20	75.84

**Coil Spring Isolator**

All models from (VIN) XA159807 - Rear	Genuine	2	<b>ANR3060</b>	4.00	4.80
---------------------------------------	---------	---	----------------	------	------

**Lower Seat, Coil Spring**

All models - Front	Aftermarket	2	<b>NRC9700P</b>	3.00	3.60
	Genuine	2	<b>NRC9700</b>	11.51	13.81

**Mounting Bracket**

All models - Front spring, upper	Aftermarket	2	<b>NRC6372P</b>	13.13	15.76
	Genuine	2	<b>NRC6372</b>	56.30	67.56

**Plate, Spring Retainer**

All models - Rear	Aftermarket	2	<b>NTC6106P</b>	1.75	2.10
	Genuine	2	<b>NTC6106</b>	3.28	3.94

**Spring Seat Lower**

All models (VIN) MA939976 to 4A682694 - Rear spring	Aftermarket	2	<b>ANR3578P</b>	5.00	6.00
	Genuine	2	<b>ANR3578</b>	11.61	13.93
All models (VIN) 4A682695 to 6A999999 - Rear	Aftermarket	2	<b>NRC9700P</b>	3.00	3.60
	Genuine	2	<b>NRC9700</b>	11.51	13.81
All models (VIN) 7A000001 on - Rear spring	Aftermarket	2	<b>ANR3578P</b>	5.00	6.00
	Genuine	2	<b>ANR3578</b>	11.61	13.93

**Ball Joint Assembly & Fulcrum Bracket**

All models - Rear upper link & fulcrum bracket	Britpart	1	<b>RHF500110BPASSY</b>	39.58	47.50
------------------------------------------------	----------	---	------------------------	-------	-------

**Ball Joint Assembly**

All models - Rear upper link	Aftermarket	1	<b>RHF500110P</b>	7.08	8.50
	OEM	1	<b>RHF500110P1</b>	16.67	20.00
	Genuine	1	<b>RHF500110</b>	39.98	47.98
Heavy Duty	Bearmach	1	<b>RHF500110URBM</b>	14.38	17.26

**Drop Arm Repair Kit**

All models - Steering drag link	Aftermarket	1	<b>RBG000010P</b>	4.58	5.50
	OEM	1	<b>RBG000010P1</b>	20.63	24.76
	Genuine	1	<b>RBG000010</b>	55.33	66.40

**Dust Cover Ball Joint**

All models from (VIN) CA000001 to (VIN) EA329884	OEM	1	<b>572338P1</b>	3.58	4.30
	Genuine	1	<b>572338</b>	8.34	10.01

**Radius Arm Assembly**

All models up to (VIN) KA930455 - Front suspension	Aftermarket	2	<b>NTC2705P</b>	120.00	144.00
	Genuine	2	<b>NTC2705</b>	302.34	362.81
	All models from (VIN) LA930456 on - Front suspension	OEM	2	<b>LR041266P1</b>	135.00
Genuine		2	<b>LR041266</b>	316.61	379.93
All models from (VIN) HA470428 on - Rear suspension, fits earlier models if replaced in pairs	Aftermarket	2	<b>LR049068P</b>	29.58	35.50
	Genuine	2	<b>LR049068</b>	88.44	106.13

**Radius Arm Nut & Bolt Kit**

All models	Front	Britpart	1	<b>LL1679BP</b>	8.13	9.76
		Britpart	1	<b>LL1680BP</b>	6.67	8.00
	Rear					

**Panhard Rod Assembly**

All models up to (VIN) 2A626645 - Front, RHD or LHD	Aftermarket	1	<b>RBI500020P</b>	23.75	28.50
	Genuine	1	<b>RBI500020</b>	136.98	164.38
	All RHD models from (VIN) 2A626646 on - Front suspension	Aftermarket	1	<b>RBI100041P</b>	28.33
Genuine		1	<b>RBI100041</b>	122.24	146.69
All LHD models from (VIN) 2A626646 on - Front suspension	OEM	1	<b>RBI100031P1</b>	48.33	58.00
	Genuine	1	<b>RBI100031</b>	136.52	163.82

**Tie Bar**

All RHD models - Steering box	Aftermarket	1	<b>LR041261P</b>	15.63	18.76
	Genuine	1	<b>LR041261</b>	46.04	55.25

**Tie Bar Bracket**

All models - Rear	Britpart	1	<b>LL1507BP</b>	11.88	14.26
-------------------	----------	---	-----------------	-------	-------

**Top Link Assembly**

All models - Rear suspension	RH	Aftermarket	1	<b>NTC2706P</b>	80.00	96.00
		Genuine	1	<b>NTC2706</b>	241.05	289.26
		Genuine	1	<b>LR045324</b>	173.56	208.27
	LH					

**Upper Arm**

All models from (VIN) DA000001 - Rear	RH	Genuine	1	<b>LR045323</b>	173.56	208.27
		Genuine	1	<b>LR045324</b>	173.56	208.27

**Shock Absorber Kit**

All models to (VIN) WA159806 - Kit includes 2 front & 2 rear shock absorbers	Standard	Aftermarket	1	<b>LL1295P</b>	50.00	60.00
		Genuine	1	<b>LL1295</b>	241.67	290.00
		Upgraded - Heavy Duty Gas	Bilstein	1	<b>RA1344BILSTEIN</b>	262.50
All models from (VIN) XA159807 - Kit includes 2 front & 2 rear shock absorbers	Standard	Aftermarket	1	<b>LL1296P</b>	50.00	60.00
		Genuine	1	<b>LL1296</b>	233.33	280.00
		Upgraded - Heavy Duty Gas	Bilstein	1	<b>LL1112</b>	291.67

**Shock Absorber & Spring Kit**

All models to (VIN) WA159806 - Kit contains 4 shock absorbers & 4 coil springs	Aftermarket	1	<b>LL1098P</b>	103.33	124.00	
		Genuine	1	<b>LL1098</b>	455.00	546.00
		All models from (VIN) XA159807 - Kit contains 4 shock absorbers & 4 coil springs	Aftermarket	1	<b>LL1099P</b>	102.50
Genuine	1		<b>LL1099</b>	450.00	540.00	

**Shock Absorber & Spring Kit Upgraded**

All models to (VIN) WA159806 - Kit includes 2 front & 2 rear shock absorbers & 4 coil springs	Bilstein	1	<b>LL1113BILSTEINE</b>	354.17	425.00
		All models from (VIN) XA159807 - Kit includes 2 front & 2 rear shock absorbers & 4 coil springs	Bilstein	1	<b>LL1113BILSTEINL</b>

**Coil Spring Kit Standard**

All models to (VIN) WA159806 - Kit includes 2 front & 2 rear coil springs	Aftermarket	1	<b>LL1301P</b>	51.67	62.00	
		Genuine	1	<b>LL1301</b>	230.00	276.00
		All models from (VIN) XA159807 - Kit includes 2 front & 2 rear coil springs	Aftermarket	1	<b>LL1302P</b>	51.67
Genuine	1		<b>LL1302</b>	230.00	276.00	



# STEERING

## Drop Arm Lever

All RHD models with Adwest power steering - For steering box with 4 bolt top plate				
Aftermarket	1	<b>QFW000020P</b>	18.54	22.25
OEM	1	<b>QFW000020P1</b>	57.50	69.00
Genuine	1	<b>QFW000020</b>	112.70	135.24

## Steering Arm Lever

All RHD models with manual steering				
Genuine	1	<b>RTC6398</b>	372.63	447.16
All RHD models with Gemmer power steering - For steering box with 6 bolt top plate				
Genuine	1	<b>RTC6398</b>	372.63	447.16
All LHD models with manual steering				
Aftermarket	1	<b>RTC6399P</b>	14.58	17.50
Genuine	1	<b>RTC6399</b>	372.63	447.16
All LHD models with Adwest power steering - For steering box with 4 bolt top plate				
Aftermarket	1	<b>QFW000030P</b>	16.67	20.00
OEM	1	<b>QFW000030P1</b>	57.50	69.00
Genuine	1	<b>QFW000030</b>	112.70	135.24
All LHD models with Gemmer power steering - For steering box with 6 bolt top plate				
Aftermarket	1	<b>RTC6399P</b>	14.58	17.50
Genuine	1	<b>RTC6399</b>	372.63	447.16

## Ball Joint, Drop Arm

All models - RH				
Aftermarket	1	<b>RBG000010P</b>	4.58	5.50
OEM	1	<b>RBG000010P1</b>	20.63	24.76
Genuine	1	<b>RBG000010</b>	55.33	66.40

## Tube, Cross Rod

All models up to (VIN) LA939975 Original style tube, not for fitment with later type ANR2858 (RHD) or ANR2859 (LHD) eye ends				
Aftermarket	1	<b>NRC9741P</b>	11.88	14.26

## Universal Joint

All models up to (VIN) VA133508				
Upper				
Aftermarket	1	<b>NRC7387P</b>	8.54	10.25
OEM	1	<b>NRC7387P1</b>	27.50	33.00
Genuine	1	<b>NRC7387</b>	48.59	58.31
Lower				
Aftermarket	1	<b>NRC7704P</b>	8.54	10.25
OEM	1	<b>NRC7704P1</b>	27.50	33.00
Genuine	1	<b>NRC7704</b>	47.31	56.77

## Universal Joint Kit

All models from (VIN) 3A650904 on				
Lower				
Aftermarket	1	<b>QLE500020P</b>	8.13	9.76
OEM	1	<b>QLE500020P1</b>	16.67	20.00
Genuine	1	<b>QLE500020</b>	49.49	59.39

## Lower Shaft Assembly

All models up to (VIN) VA133508 - With joints				
Aftermarket	1	<b>RTC4738P</b>	39.58	47.50
OEM	1	<b>RTC4738P1</b>	115.00	138.00
Genuine	1	<b>RTC4738</b>	203.24	243.89
All models from (VIN) 3A650904 to 6A999999 - With joints				
Aftermarket	1	<b>QME500031P</b>	39.58	47.50
OEM	1	<b>QME500031P1</b>	80.00	96.00
Genuine	1	<b>QME500031</b>	192.42	230.90

## Steering Column Upper

All models up to (VIN) HA906579				
OEM	1	<b>QMB101620P1</b>	95.00	114.00
Genuine	1	<b>QMB101620</b>	298.67	358.40
All models from (VIN) JA906580 on with basic type steering wheel				
OEM	1	<b>NTC9068P1</b>	195.00	234.00
Genuine	1	<b>NTC9068</b>	294.30	353.16

## Steering Damper Assembly

All models				
Aftermarket	1	<b>RTC4472P</b>	11.50	13.80
Bilstein	1	<b>RTC4472UR</b>	65.00	78.00
Terrafrirma	1	<b>RTC4472TF</b>	33.75	40.50
Celluler Dynamic	1	<b>RTC4472UR-BPCEL</b>	29.58	35.50
Super Gaz	1	<b>RTC4472UR-BPSUP</b>	27.50	33.00
Genuine	1	<b>RTC4472</b>	66.07	79.28
All models - 'Return to centre' type; uprated damper with return assistance spring				
Terrafrirma	1	<b>RTC4472TFRTC</b>	57.50	69.00
Military (Wolf)	1	<b>STC3138</b>	63.74	76.49

## Bush Steering Damper

All models				
Genuine	1	<b>QEM500020</b>	5.19	6.23

## Steering Damper Bush Set, Polyurethane

All models - Polybush				
Dynamic Red	Polybush	1	<b>LL1358</b>	18.13 21.76
Comfort Blue	Polybush	1	<b>LL1358B</b>	18.13 21.76
All models - Britpart				
Black	Britpart	1	<b>LL1358-BPPOLYBLK</b>	3.33 4.00
Yellow	Britpart	1	<b>LL1358-BPPOLYEL</b>	3.58 4.30

## Eye Bush, Steering Damper

All models				
Aftermarket	1	<b>NTC1775P</b>	1.08	1.30
Aftermarket	1	<b>NTC1775POLY</b>	2.75	3.30
Performance Red	Polybush	1	<b>NTC1775PB</b>	19.79 23.75

## Track Rod Assembly

All models				
Aftermarket	1	<b>LR041267P</b>	16.67	20.00
OEM	1	<b>LR041267P1</b>	38.33	46.00
Genuine	1	<b>LR041267</b>	165.15	198.18

## Track Rod Tube

All models				
Aftermarket	1	<b>LR045730P</b>	9.58	11.50
OEM	1	<b>LR045730P1</b>	16.88	20.26
Genuine	1	<b>LR045730</b>	44.56	53.47

## Track Rod End

All models				
RH thread, non-greasable				
Aftermarket	1	<b>RTC5869P</b>	4.58	5.50
OEM	1	<b>RTC5869P1</b>	10.63	12.76
Genuine	1	<b>RTC5869</b>	35.73	42.88
LH thread, non-greasable				
Aftermarket	1	<b>RTC5870P</b>	4.58	5.50
OEM	1	<b>RTC5870P1</b>	10.63	12.76
Genuine	1	<b>RTC5870</b>	35.73	42.88

## Cross Rod Tube

All models - On vehicles up to (VIN) LA939975 must be fitted together with later type eye end ANR2858 (RHD) or ANR2859 (LHD)				
Aftermarket	1	<b>ANR2860P</b>	9.58	11.50
OEM	1	<b>ANR2860P1</b>	16.88	20.26
Genuine	1	<b>ANR2860</b>	37.75	45.30

## Cross Rod Eye End

All RHD models up to (VIN) DA439438				
Aftermarket	1	<b>ANR2858P</b>	50.00	60.00
Genuine	1	<b>ANR2858</b>	58.86	70.63
All LHD models up to (VIN) DA439438				
Aftermarket	1	<b>ANR2859P</b>	42.50	51.00
Genuine	1	<b>ANR2859</b>	56.57	67.88
All RHD models from (VIN) DA439439 on				
Genuine	1	<b>LR049447</b>	94.15	112.98
All LHD models from (VIN) DA439439 on				
Genuine	1	<b>LR049448</b>	55.43	66.52

## Seal Kit Steering Box

All models with Adwest power steering - For steering box with 4 bolt top plate				
Aftermarket	1	<b>STC2848P</b>	3.75	4.50
OEM	1	<b>STC2848P1</b>	5.63	6.76
Genuine	1	<b>STC2848</b>	20.28	24.34
Aftermarket	1	<b>STC2847P</b>	9.79	11.75
Genuine	1	<b>STC2847</b>	67.67	81.20
All RHD models with Gemmer power steering - For steering box with 6 bolt top plate				
Aftermarket	1	<b>RTC5071P</b>	13.75	16.50
Genuine	1	<b>RTC5071</b>	238.89	286.67

## Seal Steering Box Shaft

All models with Gemmer manual steering box				
Aftermarket	1	<b>AEU4024P</b>	1.08	1.30
Genuine	1	<b>AEU4024</b>	11.54	13.85

## Seal Worm Shaft

All models with Gemmer manual steering box				
Genuine	1	<b>BAU4870</b>	5.68	6.82

## Pinion Seal Steering Box

All models with Adwest power steering				
Genuine	1	<b>608065</b>	7.28	8.74

## Seal Kit Input Shaft Steering Box

All models with Adwest power steering - For steering box with 4 bolt top plate				
Aftermarket	1	<b>STC889P</b>	5.63	6.76
Genuine	1	<b>STC889</b>	33.20	39.84

## Pad Adjuster Kit Steering Box

All models with Adwest power steering - For steering box with 4 bolt top plate				
Genuine	1	<b>STC4385</b>	124.00	148.80

## Tie Bar, Mounting

All models from (VIN) MA940010 on - Steering box				
Aftermarket	1	<b>LR041261P</b>	15.63	18.76
Genuine	1	<b>LR041261</b>	46.04	55.25

## Shaft Assembly Steering Box

LHD models with Adwest power steering - For steering box with 4 bolt top plate				
Land Rover	1	<b>RTC4399</b>	301.74	362.09

## Gasket Kit Power Steering Pump

All V8 carb petrol power steering models				
Aftermarket	1	<b>ABU7145P</b>	4.00	4.80
All V8 petrol models with 30 series steering pump				
Aftermarket	1	<b>ABU7145P</b>	4.00	4.80

## Seal Kit Steering Pump

All V8 carb petrol power steering models				
Aftermarket	1	<b>STC1633P</b>	1.50	1.80

## Seal, Power Steering Pump

All models with Gemmer or Hobourn Eaton power steering pump/Inlet union - Dowty washer type seal				
Aftermarket	1	<b>RTC5675P</b>	1.00	1.20
Genuine	1	<b>RTC5675</b>	3.39	4.07



**DEFENDER 90 (1989 on)****STEERING****Power Steering Fluid**

All models 1 litre. Cold (standard) climates fluid

Aftermarket	a/r	<b>STC50519P</b>	12.08	14.50
Genuine	a/r	<b>STC50519</b>	18.96	22.75

**Cap, Power Steering Reservoir**

All models with power steering

Genuine	1	<b>NTC2723</b>	21.59	25.91
---------	---	----------------	-------	-------

**Gasket**

All models

Swivel housing	Aftermarket	2	<b>FTC3646P</b>	0.50	0.60
	Genuine	2	<b>FTC3646</b>	2.14	2.57
Lower swivel pin	Aftermarket	2	<b>FTC3647P</b>	0.50	0.60
	Genuine	2	<b>FTC3647</b>	2.46	2.95

**DEFENDER 90 (1989 on)****CLUTCH****Clutch Plate & Cover Assembly**

All 200 and 300 TDi diesel models	Aftermarket	1	<b>LR009366P</b>	57.50	69.00
	OEM	1	<b>LR009366P1</b>	70.00	84.00
	Genuine	1	<b>LR0093666</b>	169.85	203.82
Heavy duty	Britpart	1	<b>LR009366BPHDPARTIAL</b>	49.17	59.00
All 2.5L TD5 diesel models - Includes clutch plate & cover for heavy duty one piece flywheel	Britpart	1	<b>LL1082BPFWCLUTCH</b>	70.00	84.00
Late 3.5L V8 carb petrol models, from (eng) 24G14148B on	OEM	1	<b>STC50503P1</b>	89.17	107.00
	Genuine	1	<b>STC50503</b>	364.19	437.03
All 2.4L/2.2L Puma TDCi diesel models	Genuine	1	<b>LR047831</b>	285.80	342.96

**Clutch Kit**

All 200 and 300 TDi diesel models

Heavy duty. OEM. Includes clutch cover, plate &amp; release bearing

Britpart	1	<b>LR009366BPHDOEM</b>	95.00	114.00
----------	---	------------------------	-------	--------

Heavy duty. Includes clutch cover, plate &amp; release bearing

Britpart	1	<b>LR009366BPHD</b>	55.00	66.00
----------	---	---------------------	-------	-------

Heavy duty. Includes clutch cover, plate, release bearing &amp; fork

Britpart	1	<b>LR009366BPHDFORK</b>	90.83	109.00
----------	---	-------------------------	-------	--------

Standard. Includes clutch plate, cover and release bearing

Britpart	1	<b>LR009366BP</b>	50.00	60.00
Genuine	1	<b>GCK555AF</b>	125.83	151.00

All 2.5L TD5 diesel models

Aftermarket	1	<b>LL1082P</b>	68.33	82.00
OEM	1	<b>LL1082P1</b>	95.00	114.00
Genuine	1	<b>LL1082</b>	262.50	315.00

All 3.5L V8 carb petrol models with 5 speed LT77 or R380 gearbox

Includes clutch cover, plate &amp; release bearing

Aftermarket	1	<b>STC8361P</b>	90.83	109.00
Genuine	1	<b>STC8361</b>	345.00	414.00

**Dual Mass Flywheel & Clutch Kit**

All 2.5L TD5 diesel models - Includes clutch plate, cover, self centering bearing &amp; dual mass flywheel

Britpart	1	<b>LL1082BPFWD</b>	333.33	400.00
----------	---	--------------------	--------	--------

**One Piece Flywheel & Clutch Kit**

All 2.5L TD5 diesel models - Includes clutch plate, cover, self centering bearing &amp; heavy duty one piece flywheel

Britpart	1	<b>LL1082BPFWHD</b>	333.33	400.00
----------	---	---------------------	--------	--------

**Clutch Cover**

All 200 and 300TDi diesel models	Aftermarket	1	<b>URB100760P</b>	29.58	35.50
	OEM	1	<b>URB100760P1</b>	39.58	47.50
	Genuine	1	<b>URB100760</b>	91.30	109.56
All 2.5L TD5 diesel models	Aftermarket	1	<b>FTC4630P</b>	35.83	43.00
	Genuine	1	<b>FTC4630</b>	132.20	158.64
All V8 petrol models	Aftermarket	1	<b>576476P</b>	39.58	47.50
	OEM	1	<b>576476P1</b>	60.00	72.00
	Genuine	1	<b>576476</b>	118.73	142.48

**Clutch Plate**

All 4 cyl diesel models to (VIN) 6A999999 - Standard spec.

Aftermarket	1	<b>UQB500030P</b>	22.50	27.00
OEM	1	<b>GCP242</b>	45.00	54.00
Genuine	1	<b>UQB500030</b>	119.39	143.27

All 200 and 300TDi diesel models - Heavy duty

Genuine	1	<b>UQB000130</b>	139.32	167.18
---------	---	------------------	--------	--------

All 2.5L TD5 diesel models

Aftermarket	1	<b>UQB000120P</b>	31.67	38.00
OEM	1	<b>UQB000120P1</b>	60.00	72.00
Genuine	1	<b>UQB000120</b>	114.28	137.14

All 2.8L 6 cyl BMW M52 petrol models

OEM	1	<b>FTC2157P1</b>	125.00	150.00
Genuine	1	<b>FTC2157</b>	118.73	142.48

All 3.5L V8 carb petrol models

OEM	1	<b>8510308P1</b>	37.50	45.00
Genuine	1	<b>8510308</b>	217.38	260.86

**Drive Plate**

All 4.0L V8 EFI petrol automatic models

Aftermarket	1	<b>FTC4607P</b>	7.50	9.00
Genuine	1	<b>FTC4607</b>	31.41	37.69

**Clutch Release Bearing**

All models (except 2.5L petrol and N/A diesel with R380 g/box) up to (VIN) 6A999999 - With carrier

Aftermarket	1	<b>FTC5200P</b>	7.92	9.50
OEM	1	<b>FTC5200P1</b>	12.50	15.00
Genuine	1	<b>FTC5200</b>	37.38	44.86

All 2.5L TD5 diesel models - For heavy duty one piece flywheel

Genuine	1	<b>LL1082BPFWHDBRG</b>	46.67	56.00
---------	---	------------------------	-------	-------

All models (except 2.5L petrol and N/A diesel with R380 g/box) up to (VIN) 6A999999 - With carrier

Heavy Duty	Britpart	1	<b>FTC5200HDBP</b>	45.83	55.00
	Bearmach	1	<b>FTC5200HDBM</b>	80.00	96.00

**Clutch Release Bearing (old spec)**

2.5L petrol and N/A diesel with R380 gearbox

Aftermarket	1	<b>UTJ100210P</b>	10.63	12.76
OEM	1	<b>UTJ100210P1</b>	20.00	24.00
Genuine	1	<b>UTJ100210</b>	45.44	54.53

**Clutch Release Bearing Guide**

All 300TDi diesel models

Aftermarket	1	<b>FTC5218P</b>	21.67	26.00
OEM	1	<b>FTC5218P1</b>	39.58	47.50
Genuine	1	<b>FTC5218</b>	81.82	98.18

**Clutch Slave/Release Bearing**

All 2.4L and 2.2L TDCi Puma diesel models

Aftermarket	1	<b>LR068979P</b>	34.17	41.00
OEM	1	<b>LR068979P1</b>	49.17	59.00
Genuine	1	<b>LR068979</b>	59.99	71.99

**Clutch Release Bearing Guide**

All 2.8L 6 cyl BMW M52 petrol models with 5 speed R380 gearbox (gbox) suffix K or L

Genuine	1	<b>UTO100010</b>	69.03	82.84
---------	---	------------------	-------	-------

**Clutch Fork**

All 200 and 300TDi diesel models

Aftermarket	1	<b>FTC2957P</b>	3.75	4.50	
OEM	1	<b>FTC2957P1</b>	10.83	13.00	
Genuine	1	<b>FTC2957</b>	23.33	28.00	
Heavy Duty	Britpart	1	<b>FTC2957BPHD</b>	8.75	10.50

All 2.5L TD5 diesel models

Aftermarket	1	<b>576137P</b>	23.96	28.75
OEM	1	<b>576137P1</b>	29.58	35.50
Genuine	1	<b>576137</b>	63.81	76.57

All V8 petrol models

Aftermarket	1	<b>576137P</b>	23.96	28.75
OEM	1	<b>576137P1</b>	29.58	35.50
Genuine	1	<b>576137</b>	63.81	76.57

Wolf/XD military models

May be used as uprated clutch fork on civilian Defenders with R380 gearbox (features stronger socket for pivot ball)

Genuine	1	<b>UTD100000</b>	62.10	74.52
---------	---	------------------	-------	-------

**Clutch Fork Kit**

Heavy Duty - All 200 and 300TDi diesel models Includes release fork, slipper pads, bush, staple &amp; clip

Britpart	1	<b>FTC2957BPHDKIT</b>	11.67	14.00
----------	---	-----------------------	-------	-------

**Clutch Fork Staple Retainer**

All 200 and 300TDi diesel models

Aftermarket	1	<b>FRC3416P</b>	0.58	0.70
Genuine	1	<b>FRC3416</b>	2.35	2.82

All 2.5L TD5 diesel models

Aftermarket	1	<b>576203P</b>	0.25	0.30
Genuine	1	<b>576203</b>	0.66	0.79

All V8 petrol models

Aftermarket	1	<b>576203P</b>	0.25	0.30
Genuine	1	<b>576203</b>	0.66	0.79



FTC2957BPHDKIT



LR009366BPHDPARTIAL



# CLUTCH

# DEFENDER 90 (1989 on)

## Pad Clutch Release Lever

All 4 cyl models with 5 speed LT77 gearbox	Aftermarket	2	<b>FRC5255P</b>	0.50	0.60
	Genuine	2	<b>FRC5255</b>	1.53	1.84
All 4 cyl models with 5 speed R380 gearbox	Aftermarket	2	<b>FRC5255P</b>	0.50	0.60
	Genuine	2	<b>FRC5255</b>	1.53	1.84

## Pivot Clutch Release Arm

All 4 cyl models with 5 speed LT77 gearbox	OEM	1	<b>FRC5180P1</b>	15.04	18.05
	Genuine	1	<b>FRC5180</b>	57.38	68.86

## Clutch Sleeve Guide

All models up to (VIN) LA939975	Genuine	1	<b>FRC4078</b>	3.10	3.72
---------------------------------	---------	---	----------------	------	------

## Clutch Pipe

All 200 and 300TDi diesel models - Hose to slave cyl.	Aftermarket	1	<b>NRC9595P</b>	13.96	16.75
	Genuine	1	<b>NRC9595</b>	29.11	34.93
All RHD models up to (VIN) LA939975 - Master cyl to hose	Aftermarket	1	<b>NRC8330</b>	29.11	34.93
	Genuine	1	<b>NRC8330</b>	29.11	34.93
All LHD models up to (VIN) LA939975 - Master cyl to hose	Aftermarket	1	<b>NRC8329</b>	28.08	33.70
	Genuine	1	<b>NRC8329</b>	28.08	33.70

## Clutch Hose

All 300TDi diesel models	Aftermarket	1	<b>NTC9055P</b>	2.50	3.00
	OEM	1	<b>NTC9055P1</b>	10.00	12.00
	Genuine	1	<b>NTC9055</b>	42.06	50.47
All 2.5L TD5 diesel models	Aftermarket	1	<b>NRC2211P</b>	3.25	3.90
	Genuine	1	<b>NRC2211</b>	33.62	40.34
All V8 petrol models	Aftermarket	1	<b>NRC2211P</b>	3.25	3.90
	Genuine	1	<b>NRC2211</b>	33.62	40.34
All 2.4L & 2.2L TDCi Puma diesel models (VIN) 7A000001 on	OEM	1	<b>STH500060P1</b>	15.83	19.00
	Genuine	1	<b>STH500060</b>	35.75	42.90

## Clutch Pipe Assembly

All RHD 2.5L TD5 diesel models - Master cylinder to union	Aftermarket	1	<b>STG101100</b>	20.84	25.01
	Genuine	1	<b>STG101100</b>	20.84	25.01
All RHD models from (VIN) MA939976 to WA159806 except 2.8L 6 cyl BMW M52 petrol	Aftermarket	1	<b>ANR2162</b>	64.87	77.84
	Genuine	1	<b>ANR2162</b>	64.87	77.84
All 2.5L TD5 diesel models - From clutch hose to slave cylinder	Aftermarket	1	<b>ANR2183</b>	14.79	17.75
	Genuine	1	<b>ANR2183</b>	14.79	17.75
All V8 petrol manual models - From clutch hose to slave cylinder	Aftermarket	1	<b>577643P1</b>	9.58	11.50
	Genuine	1	<b>577643</b>	12.26	14.71
All RHD models from (VIN) 7A000001 on - Master cylinder to union	Aftermarket	1	<b>STG500230</b>	16.98	20.38
	Genuine	1	<b>STG500230</b>	16.98	20.38
All LHD models from (VIN) 7A000001 on - Master cylinder to union	Aftermarket	1	<b>STG500190</b>	11.51	13.81
	Genuine	1	<b>STG500190</b>	11.51	13.81

## Clutch Master Cylinder

All models	Aftermarket	1	<b>STC500100P</b>	9.58	11.50
	OEM	1	<b>STC500100P1</b>	19.79	23.75
	Genuine	1	<b>STC500100</b>	76.84	92.21
From (VIN) 7A000001 on	Aftermarket	1	<b>STC500100P</b>	9.58	11.50
	OEM	1	<b>STC500100P1</b>	19.79	23.75
	Genuine	1	<b>STC500100</b>	76.84	92.21

## Master Cylinder Repair Kit

All models - Clutch master cylinder	Aftermarket	1	<b>GRK1027P</b>	2.08	2.50
	OEM	1	<b>GRK1027</b>	5.63	6.76

## Clutch M/cyl Filler Cap Plastic

All models from (VIN) XA178603 to 6A999999	Genuine	1	<b>500201A</b>	6.04	7.25
--------------------------------------------	---------	---	----------------	------	------

## Clutch Slave Cylinder

All 2.5L TD5 diesel models	Aftermarket	1	<b>FTC5202P</b>	7.08	8.50
	OEM	1	<b>FTC5202P1</b>	11.04	13.25
	Genuine	1	<b>FTC5202</b>	62.08	74.50
All models from (VIN) MA939976 to (gbox) 56A0669086 - Early R380 gearbox	Aftermarket	1	<b>FTC5072P</b>	8.54	10.25
	OEM	1	<b>FTC5072P1</b>	14.58	17.50
	Genuine	1	<b>FTC5072</b>	65.51	78.61
All 2.5L 300TDi diesel models from (gbox) 56A0669087 on - Late R380 gearbox	Aftermarket	1	<b>FTC5202P</b>	7.08	8.50
	OEM	1	<b>FTC5202P1</b>	11.04	13.25
	Genuine	1	<b>FTC5202</b>	62.08	74.50
All models except V8 to (VIN) LA939975 - LT77 gearbox type	Aftermarket	1	<b>591231P</b>	7.08	8.50
	OEM	1	<b>591231P1</b>	18.13	21.76
	Genuine	1	<b>591231</b>	78.39	94.07
All 2.8L 6 cyl petrol models	Aftermarket	1	<b>ANR2967P</b>	12.92	15.50
	OEM	1	<b>ANR2967P1</b>	29.58	35.50
	Genuine	1	<b>ANR2967</b>	147.40	176.88
All V8 petrol models	OEM	1	<b>UKC8677P1</b>	20.00	24.00
	Genuine	1	<b>UKC8677</b>	16.67	20.00

## Slave Cylinder Repair Kit

All models except V8 to (VIN) LA939975 - LT77 gearbox type	Aftermarket	1	<b>8G8600LP</b>	1.00	1.20
	OEM	1	<b>8G8600LP1</b>	4.38	5.26
	Genuine	1	<b>8G8600L</b>	8.51	10.21
All models except V8 from (VIN) MA939976 to 6A999999R380 gearbox types	Aftermarket	1	<b>STC2818P</b>	1.25	1.50
	OEM	1	<b>STC2818P1</b>	4.00	4.80
	Genuine	1	<b>STC2818</b>	6.22	7.46
All V8 petrol models	Genuine	1	<b>513390</b>	5.00	6.00

## Clutch Slave Cylinder Adaptor

All 2.4L & 2.2L TDCi Puma diesel models (VIN) 7A000001 on	Genuine	1	<b>LR068981</b>	27.92	33.50
-----------------------------------------------------------	---------	---	-----------------	-------	-------

## Clutch Slave Cylinder Push Rod

All 2.8L 6 cyl BMW M52 petrol models	Genuine	1	<b>FTC2170</b>	19.44	23.33
--------------------------------------	---------	---	----------------	-------	-------

## Push Rod Clip

All 200 and 300TDi diesel models	Aftermarket	1	<b>FRC3327P</b>	0.75	0.90
	Genuine	1	<b>FRC3327</b>	3.23	3.88
All 2.5L TD5 diesel models	Aftermarket	1	<b>576723P</b>	0.38	0.46
	Genuine	1	<b>576723</b>	3.95	4.74
All V8 petrol models	Aftermarket	1	<b>576723P</b>	0.38	0.46
	Genuine	1	<b>576723</b>	3.95	4.74

## Push Rod

All 300TDi diesel models	Aftermarket	1	<b>FTC3912P</b>	8.33	10.00
	Genuine	1	<b>FTC3912</b>	16.78	20.14
All 4 cyl petrol & diesel models with 5 speed LT77 gearbox - Clutch slave cylinder	Aftermarket	1	<b>FRC3417P</b>	2.25	2.70
	Genuine	1	<b>FRC3417</b>	7.98	9.58
	Genuine	1	<b>FTC5199</b>	7.67	9.20
All 2.5L TD5 diesel models	Genuine	1	<b>FTC5199</b>	7.67	9.20
All 2.5L N/A diesel models with 5 speed R380 gearbox - Clutch slave cylinder	Aftermarket	1	<b>FTC4229</b>	44.12	52.94
	Genuine	1	<b>FTC4229</b>	44.12	52.94

## Bleed Screw Clutch Slave Cylinder

All 300TDi and 2.5L TD5 diesel models	Genuine	1	<b>606733A</b>	2.58	3.10
All V8 petrol models	Genuine	1	<b>606733A</b>	2.58	3.10

## Switch Clutch Master Cylinder

All 2.4L and 2.2L TDCi Puma diesel models - Electronic diesel control	Genuine	1	<b>MSK500020</b>	21.81	26.17
-----------------------------------------------------------------------	---------	---	------------------	-------	-------

## Dowel Clutch Guide

All models up to (VIN) 6A999999	Genuine	2	<b>FRC2481</b>	2.29	2.75
---------------------------------	---------	---	----------------	------	------



GRK1027



STC500100P

UKC8677P1



FTC3912P



**DEFENDER 90 (1989 on)****TRANSMISSION****Constant Velocity Joint**

All models up to (VIN) KA930455 - 33 spline	Aftermarket	2	<b>RTC6862P</b>	15.83	19.00
	Genuine	2	<b>RTC6862</b>	577.93	693.52
All models to (VIN) KA930455 (axle) 20L, 21L, 22L, 23L - 23 spline	Aftermarket	2	<b>AEU2522P</b>	18.13	21.76
	Aftermarket	1	<b>TDJ000010P</b>	20.63	24.76

**Gaiter Propshaft**

All models to (VIN) 6A999999 Rear	Aftermarket	1	<b>TVE100000P</b>	2.58	3.10
	OEM	1	<b>TVE100000P1</b>	3.08	3.70
	Genuine	1	<b>TVE100000</b>	15.14	18.17
Front	Aftermarket	1	<b>276483P</b>	3.00	3.60
	Genuine	1	<b>276483</b>	24.73	29.68

**Gaiter Propshaft c/w Clips**

All models to (VIN) 6A999999 - Front	Aftermarket	1	<b>276484P</b>	2.33	2.80
	Genuine	1	<b>276484</b>	22.65	27.18

**Universal Joint**

All models (VIN) 1A612405 to 6A999999 Front propshaft	Aftermarket	2	<b>STC4807P</b>	6.67	8.00
	OEM	2	<b>STC4807P1</b>	30.83	37.00
	Genuine	2	<b>STC4807</b>	48.23	57.88

All models (VIN) 7A000001 on Front propshaft	Aftermarket	2	<b>TVC500010P</b>	8.96	10.75
	OEM	2	<b>TVC500010P1</b>	22.50	27.00
	Genuine	2	<b>TVC500010</b>	49.59	59.51
Rear propshaft	Aftermarket	2	<b>TVC500010P</b>	8.96	10.75
	OEM	2	<b>TVC500010P1</b>	22.50	27.00
	Genuine	2	<b>TVC500010</b>	49.59	59.51

All models to (VIN) 6A999999 Propshaft, sealed	Aftermarket	2	<b>RTC3458P</b>	4.08	4.90
	OEM	2	<b>RTC3458P1</b>	8.54	10.25
	Genuine	2	<b>RTC3458</b>	46.58	55.90

**Shaft Front Axle**

All non-ABS models to (axle) 20L48865, 21L33355, 22L27847, 23L12092 RH	Aftermarket	1	<b>AEU2520</b>	317.01	380.41
	Genuine	1	<b>AEU2520</b>	317.01	380.41

All non-ABS models (axle) 20L48866 on, 21L33356 on, 22L27848 on, 23L12093 on RH	Aftermarket	1	<b>RTC6754P</b>	21.67	26.00
	Genuine	1	<b>RTC6754</b>	174.72	209.66
LH	Aftermarket	1	<b>RTC6755P</b>	27.50	33.00
	Genuine	1	<b>RTC6755</b>	269.69	323.63

All models (VIN) LA930456 on (axle) 61L, 61S, 63L, 64L, 10M to 17M RH	Aftermarket	1	<b>TDC000020P</b>	22.08	26.50
	OEM	1	<b>TDC000020P1</b>	45.00	54.00
	Genuine	1	<b>TDC000020</b>	242.38	290.86
LH	Aftermarket	1	<b>TDC000030P</b>	22.92	27.50
	OEM	1	<b>TDC000030P1</b>	48.33	58.00
	Genuine	1	<b>TDC000030</b>	290.18	348.22

All models (VIN) LA930456 on, (axle) 61L, 61S, 63L, 64L, 10M to 17M, plus (VIN) 7A000001 on RH, 24 spline	Aftermarket	1	<b>TDB500280P</b>	39.58	47.50
	OEM	1	<b>TDB500280P1</b>	170.83	205.00
	Genuine	1	<b>TDB500280</b>	235.57	282.68
LH, 24 spline	Aftermarket	1	<b>TDB500290P</b>	45.00	54.00
	OEM	1	<b>TDB500290P1</b>	170.83	205.00
	Genuine	1	<b>TDB500290</b>	199.50	239.40

**Shaft Rear Axle**

All models with 2 pin diff to (VIN) KA930455, to (axle) 22S64620E, not V8 RH, std strength for 2 pin diff	Aftermarket	1	<b>FRC7680P</b>	16.67	20.00
	OEM	1	<b>FRC7680P1</b>	28.33	34.00
	Genuine	1	<b>FRC7680</b>	131.02	157.22
LH, std strength for 2 pin diff	Aftermarket	1	<b>FRC7681P</b>	19.79	23.75
	OEM	1	<b>FRC7681P1</b>	29.58	35.50
	Genuine	1	<b>FRC7681</b>	131.02	157.22

All models with 4 pin diff to (VIN) KA930455 RH, heavy duty, for 4 pin diff	Genuine	1	<b>FRC8094</b>	173.74	208.49
	Genuine	1	<b>FRC8094</b>	173.74	208.49
All models (VIN) LA930456 to 4A671162 RH, 24 spline	Aftermarket	1	<b>FTC3270P</b>	35.83	43.00
	Genuine	1	<b>FTC3270</b>	210.33	252.40
LH, 24 spline	Aftermarket	1	<b>FTC3271P</b>	38.33	46.00
	Genuine	1	<b>FTC3271</b>	241.79	290.15

All models (VIN) 4A671163 on (axle) 14S to 17S RH	Aftermarket	1	<b>LR072976P</b>	22.50	27.00
	OEM	1	<b>LR072976P1</b>	53.33	64.00
	Genuine	1	<b>LR072976</b>	277.77	333.32
LH	Aftermarket	1	<b>T0B500030P</b>	25.00	30.00
	OEM	1	<b>T0B500030P1</b>	57.50	69.00
	Genuine	1	<b>T0B500030</b>	307.94	369.53

**Shaft Assembly Front Output**

All models with LT230 transfer box	Aftermarket	1	<b>FRC5449P</b>	38.75	46.50
	Genuine	1	<b>FRC5449</b>	190.22	228.26

**Drive Flange Kit, Transfer Box**

All models with 43D transfer box up to (VIN) 6A999999 - Front output shaft	Aftermarket	1	<b>LR055718P</b>	23.54	28.25
	Genuine	1	<b>LR055718</b>	144.19	173.03

**Drive Flange, Transfer Box**

All models with 43D transfer box - Front, heavy duty	Genuine	1	<b>IEC100020</b>	49.74	59.69
	Genuine	1	<b>IEC100020</b>	49.74	59.69

All models from (VIN) 7A000001 on - Front output shaft	Aftermarket	1	<b>LR055718P</b>	23.54	28.25
	Genuine	1	<b>LR055718</b>	144.19	173.03

**Spacer Front Drive Shaft**

All models to (VIN) KA930455 (axle) 20L, 21L, 22L, 23L	Aftermarket	2	<b>FTC254P</b>	2.83	3.40
	Genuine	2	<b>FTC254</b>	5.31	6.37

All models (VIN) LA930456 on (axle) 20L, 21L, 22L, 23L	Genuine	1	<b>TYF000010</b>	3.99	4.79
	Genuine	1	<b>TYF000010</b>	3.99	4.79

**Hub Assembly**

All models to (VIN) KA930455 Front	Aftermarket	2	<b>FRC6139P</b>	55.00	66.00
	Genuine	2	<b>FRC6139</b>	149.65	179.58
	Aftermarket	2	<b>FRC8555P</b>	39.58	47.50
Rear	Aftermarket	2	<b>FRC8555</b>	149.20	179.04
	Genuine	2	<b>FRC8555</b>	149.20	179.04

All models to (VIN) KA930455 (axle) 22S Rear	Aftermarket	2	<b>FRC6141P</b>	30.83	37.00
	Genuine	2	<b>FRC6141</b>	365.26	438.31

All models (VIN) LA930456 to 6A999999 (axle) 61L, 61S, 63L, 64L plus (VIN) 7A000001 on Rear	Aftermarket	2	<b>RUB500240P</b>	50.00	60.00
	Genuine	2	<b>RUB500240</b>	150.00	180.00

**Stub Axle**

All models to (VIN) KA930455 Front	Aftermarket	2	<b>FRC4320P</b>	20.63	24.76
	OEM	2	<b>FRC4320P1</b>	50.00	60.00
	Genuine	2	<b>FRC4320</b>	103.38	124.06

Rear	Aftermarket	2	<b>FRC3132P</b>	19.58	23.50
	OEM	2	<b>FRC3132P1</b>	39.58	47.50
	Genuine	2	<b>FRC3132</b>	167.46	200.95
All models (VIN) LA930456 on (axle) 22S Rear	Aftermarket	2	<b>FRC8540P</b>	16.04	19.25
	Genuine	2	<b>FRC8540P1</b>	45.00	54.00

All models (VIN) LA930456 on Front	Aftermarket	2	<b>FTC3154P</b>	16.04	19.25
	OEM	2	<b>FTC3154P1</b>	50.00	60.00
	Genuine	2	<b>FTC3154</b>	82.86	99.43

All models (VIN) LA930456 on (axle) 42S, 44S, 58S, 59S Rear	Aftermarket	2	<b>FTC3188P</b>	16.04	19.25
	OEM	2	<b>FTC3188P1</b>	45.00	54.00
	Genuine	2	<b>FTC3188</b>	83.71	100.45

**Stub Axle Nut**

All models to (VIN) KA930455	Aftermarket	4	<b>FRC8700P</b>	1.25	1.50
	Genuine	4	<b>FRC8700</b>	10.09	12.11

All models (VIN) LA930456 on (axle) 61L, 61S, 63L, 64L - Front	Aftermarket	4	<b>FRC8700P</b>	1.25	1.50
	Genuine	4	<b>FRC8700</b>	10.09	12.11

All models (VIN) LA930456 to WA159806 - Rear	Aftermarket	4	<b>FRC8700P</b>	1.25	1.50
	Genuine	4	<b>FRC8700</b>	10.09	12.11

**Stub Axle Kit**

All models to (VIN) KA930455 - Front, includes stub axle, gasket, bolts, washers, bearing and seals	Britpart	2	<b>FRC4320BPK</b>	20.63	24.76
	Genuine	2	<b>FRC4320BPK</b>	20.63	24.76

All models (VIN) LA930456 to 6A999999 - Front, includes stub axle, gasket, bolts, washers, bearing and seals	Britpart	2	<b>FTC3154DEFBPK</b>	25.83	31.00
	Genuine	2	<b>FTC3154DEFBPK</b>	25.83	31.00

All models (VIN) 7A000001 on - Front, includes stub axle, gasket, bolts, washers, bearing and seals	Britpart	2	<b>FTC3154PUMABPK</b>	25.83	31.00
	Genuine	2	<b>FTC3154PUMABPK</b>	25.83	31.00

Up to (axle) 22S08283B - Rear, includes stub axle, gasket, bolts and nuts	Britpart	2	<b>FRC3132BPK</b>	45.83	55.00
	Genuine	2	<b>FRC3132BPK</b>	45.83	55.00

From (axle) 22S08284B to (VIN) KA930455 - Rear, includes stub axle, gasket, bolts and nuts	Britpart	2	<b>FRC8540BPK</b>	17.50	21.00
	Genuine	2	<b>FRC8540BPK</b>	17.50	21.00

All models (VIN) LA930456 on (axle) 42S, 44S, 58S, 59S - Rear, includes stub axle, gasket, bolts and seal	Britpart	2	<b>FTC3188DEFBPK</b>	19.58	23.50
	Genuine	2	<b>FTC3188DEFBPK</b>	19.58	23.50



RTC6862P



FRC4320P

# TRANSMISSION

# DEFENDER 90 (1989 on)

## Retaining Nut

All models (axle) 10M-17M, (VIN) LA930456 on Front axle				
Aftermarket	4	<b>RFD10000P</b>	1.50	1.80
Genuine	4	<b>RFD100000</b>	5.06	6.07
All models (VIN) XA159807 on - Rear axle				
Aftermarket	4	<b>RFD10000P</b>	1.50	1.80
Genuine	4	<b>RFD100000</b>	5.06	6.07

## Driving Member

All models to (VIN) KA930455 - 24 spline, front and rear				
Aftermarket	2	<b>FRC5806P</b>	5.42	6.50
Genuine	2	<b>FRC5806</b>	128.29	153.95
Heavy Duty				
Britpart	2	<b>FRC5806HDBPDEF</b>	25.83	31.00
Bearmach	2	<b>FRC5806HDBMDEF</b>	13.33	16.00
All models (VIN) LA930456 on - 24 spline, front and rear				
Aftermarket	2	<b>RUC105200P</b>	4.58	5.50
OEM	2	<b>RUC105200P1</b>	12.50	15.00
Genuine	2	<b>RUC105200</b>	118.51	142.21
Heavy Duty				
Britpart	2	<b>RUC105200HDBP</b>	25.83	31.00
Terraforma	2	<b>RUC105200HDTF</b>	16.88	20.26
Bearmach	2	<b>RUC105200HDBM</b>	16.88	20.26

## Driving Member Kit

All models up to (VIN) KA930454 - Pair of 24 spline driving members				
Heavy Duty	2	<b>FRC5806HDKBDEF</b>	60.00	72.00
Britpart	2	<b>RUC105200HDKBP</b>	62.50	75.00

## Dust Cap, Screw On

All models fitted with Britpart heavy duty driving members - Heavy duty driving member				
Cap	2	<b>RUC105200HDBPCAP</b>	8.75	10.50
Nut	2	<b>RUC105200HDBMNU</b>	3.33	4.00

## Bolt Kit, Heavy Duty Driving Members

All models fitted with Britpart heavy duty driving members includes 10 bolts (one axle set)				
Britpart	1	<b>RUC105200BPKBOLT</b>	10.00	12.00

## Hub and Sleeve Assembly Trans Box

All 4 cyl models with LT77 gearbox and LT230 transfer box (gbox) 22D				
OEM	1	<b>FTC382P1</b>	78.33	94.00
Genuine	1	<b>FTC382</b>	341.90	410.28
All 300TDi diesel models with LT230 transfer box (gbox) 43D				
OEM	1	<b>FTC5099P1</b>	110.83	133.00
Genuine	1	<b>FTC5099</b>	271.78	326.14
All TD5 diesel models with LT230 transfer box (gbox) 43D				
OEM	1	<b>FTC5099P1</b>	110.83	133.00
Genuine	1	<b>FTC5099</b>	271.78	326.14
All V8 carb petrol models with 5 speed LT77 gearbox and LT230 transfer box (gbox) 32D				
OEM	1	<b>FTC382P1</b>	78.33	94.00
Genuine	1	<b>FTC382</b>	341.90	410.28
All 2.4L and 2.2L TDCi diesel models with LT230 transfer box from (VIN) 7A000001 on				
OEM	1	<b>FTC5099P1</b>	110.83	133.00
Genuine	1	<b>FTC5099</b>	271.78	326.14

## Spacer Hub

All models to (VIN) KA930455				
Aftermarket	2	<b>FRC8227P</b>	1.75	2.10
Genuine	2	<b>FRC8227</b>	29.89	35.87

## Bearing Stub Housing

All models (VIN) LA930456 on				
Aftermarket	2	<b>FTC861P</b>	5.63	6.76
OEM	2	<b>FTC861P1</b>	6.67	8.00
Genuine	2	<b>FTC861</b>	11.73	14.08

## Bearing Swivel Pin Housing

All models				
Aftermarket	2	<b>606666P</b>	3.33	4.00
OEM	2	<b>606666P1</b>	10.42	12.50
Genuine	2	<b>606666</b>	23.99	28.79

## Housing Swivel Pin Bearing

All models (axle) 20L, 21L, 22L, 23L to (VIN) WA159961 - 7 hole type				
Aftermarket	2	<b>FTC5105P</b>	60.00	72.00
OEM	2	<b>FTC5105P1</b>	87.50	105.00
Genuine	2	<b>FTC5105</b>	197.93	237.52
All models (VIN) LA930456 on, (axle) 61L, 61S, 63L, 63S, plus (VIN) 7A000001 on				
Aftermarket	2	<b>FTC5366P</b>	80.00	96.00
OEM	2	<b>FTC5366P1</b>	85.00	102.00
Genuine	2	<b>FTC5366</b>	161.99	194.39

## Housing and Bush Swivel Pin

All models to (VIN) KA930455				
Aftermarket	2	<b>8510267P</b>	6.04	7.25
Genuine	2	<b>8510267</b>	31.21	37.45

## Housing, Swivel Pin

All RHD models up to (VIN) KA930455 - LH				
Genuine	1	<b>FTC2529</b>	468.45	562.14
All LHD models up to (VIN) KA930455				
RH				
OEM	1	<b>FTC2530P1</b>	245.83	295.00
Genuine	1	<b>FTC2530</b>	522.25	626.70
LH				
OEM	1	<b>FTC2531P1</b>	233.33	280.00
Genuine	1	<b>FTC2531</b>	502.76	603.31

## Swivel Pin

UPPER All models to (VIN) KA930455				
Upper				
Aftermarket	2	<b>FRC3511P</b>	5.63	6.76
Genuine	2	<b>FRC3511</b>	86.01	103.21
All models (VIN) LA930456 to WA159806				
Upper				
Aftermarket	2	<b>FTC2882P</b>	5.00	6.00
Genuine	2	<b>FTC2882</b>	51.55	61.86
All models - Lower				
Aftermarket	2	<b>FRC2894P</b>	2.50	3.00
Genuine	2	<b>FRC2894</b>	64.95	77.94

## Swivel Pin Kit Upper

All non ABS models (VIN) XA159807 on				
Aftermarket	2	<b>TAR100040P</b>	13.13	15.76
Genuine	2	<b>TAR100040</b>	33.60	40.32
All ABS fitted models (VIN) XA159807 on				
Aftermarket	2	<b>TAR100050P</b>	13.75	16.50
Genuine	2	<b>TAR100050</b>	41.44	49.73

## Damper, Swivel Pin

50 LE model only - Front axle,				
RH				
Genuine	1	<b>FTC1616</b>	38.03	45.64
LH				
Genuine	1	<b>FTC1617</b>	38.03	45.64

## Swivel Housing Grease

All models				
Sachet				
OEM	a/r	<b>STC3435P1</b>	5.00	6.00
Genuine	a/r	<b>STC3435</b>	7.69	9.23
370g bottle				
Britpart	a/r	<b>STC3435BPBOTTLE</b>	4.79	5.75
370ml sachet				
Britpart	a/r	<b>STC3435BPSACHET</b>	4.38	5.26

## Gasket Oil Sump

ZF 4 speed automatic transmission				
Aftermarket	1	<b>RTC4268P</b>	2.50	3.00
OEM	1	<b>RTC4268P1</b>	4.00	4.80
Genuine	1	<b>RTC4268</b>	16.52	19.82

## Oil Seal Diff Unit

All models to (VIN) KA930455				
Front				
Aftermarket	1	<b>FRC8220P</b>	1.50	1.80
OEM	1	<b>FRC8220P1</b>	5.63	6.76
Genuine	1	<b>FRC8220</b>	27.28	32.74
Rear				
Aftermarket	1	<b>FRC4586P</b>	0.83	1.00
OEM	1	<b>FRC4586P1</b>	3.50	4.20
Genuine	1	<b>FRC4586</b>	11.66	13.99
All models (VIN) LA930456 to (axle) 62L12289A				
Front				
Aftermarket	1	<b>FRC8220P</b>	1.50	1.80
OEM	1	<b>FRC8220P1</b>	5.63	6.76
Genuine	1	<b>FRC8220</b>	27.28	32.74
All models (VIN) LA930456 to VA102732				
Rear				
Aftermarket	1	<b>FRC8220P</b>	1.50	1.80
OEM	1	<b>FRC8220P1</b>	5.63	6.76
Genuine	1	<b>FRC8220</b>	27.28	32.74

## Oil Seal Diff Pinion Front

All models (axle) 62L12290L on and (VIN) 7A000001 on				
Aftermarket	1	<b>FTC5258P</b>	1.50	1.80
OEM	1	<b>FTC5258P1</b>	4.08	4.90
Genuine	1	<b>FTC5258</b>	13.96	16.75

## Oil Seal Hub

All models to (VIN) KA930455				
Aftermarket	2	<b>FRC8222P</b>	1.83	2.20
OEM	2	<b>FRC8222P1</b>	5.63	6.76
Genuine	2	<b>FRC8222</b>	21.24	25.49

## Oil Seal Stub Axle

All models to (VIN) KA930455 - Twin lip type				
Aftermarket	2	<b>RTC3511P</b>	1.33	1.60
OEM	2	<b>RTC3511P1</b>	3.50	4.20
Genuine	2	<b>RTC3511</b>	12.52	15.02

## Seal Inner Stub Axle

All models (axle) 20L, 21L, 22L, 23L, 22S, 24S to (VIN) KA930455				
Aftermarket	2	<b>FTC4785P</b>	1.33	1.60
OEM	2	<b>FTC4785P1</b>	3.00	3.60
Genuine	2	<b>FTC4785</b>	4.34	5.21

## Seal Stub Axle

All models to (VIN) KA930455				
Aftermarket	2	<b>FRC3099P</b>	0.75	0.90
OEM	2	<b>FRC3099P1</b>	3.25	3.90
Genuine	2	<b>FRC3099</b>	8.09	9.71

## Seal Stub Axle Inner

All models (VIN) VA104815 on - Front				
Aftermarket	2	<b>FTC5268P</b>	0.92	1.10
Genuine	2	<b>FTC5268</b>	3.18	3.82
All models (VIN) LA930456 on (axle) 42S, 44S, 58S, 59S, plus (VIN) 7A000001 on - Rear				
Aftermarket	2	<b>FTC5268P</b>	0.92	1.10
Genuine	2	<b>FTC5268</b>	3.18	3.82

## Seal Stub Axle Outer

All models (VIN) LA930456 to (axle) 20L77036C				
Aftermarket	2	<b>FTC840P</b>	2.08	2.50
Genuine	2	<b>FTC840</b>	10.71	12.85





**DEFENDER 90 (1989 on)****TRANSMISSION****Seal Output Shaft**

All models with R380 5 speed gearbox	Aftermarket	1	<b>FTC500010P</b>	1.00	1.20
	Genuine	1	<b>FTC500010</b>	12.07	14.48

**Seal Drive Shaft**

All models (axle) 61L, 61S, 63S, 64L plus (VIN) 7A000001 on	Aftermarket	2	<b>FTC3276P</b>	1.00	1.20
	OEM	2	<b>FTC3276P1</b>	2.75	3.30
	Genuine	2	<b>FTC3276</b>	3.47	4.16

**Oil Seal Front Cover**

All models with LT77 5 speed gearbox (gbox) suffix A to E	Aftermarket	1	<b>UKC1060P</b>	1.58	1.90
	Aftermarket	1	<b>UKC1060</b>	5.63	6.76
All models with R380 5 speed gearbox (gbox) suffix J	Aftermarket	1	<b>UKC1060P</b>	1.58	1.90
	Aftermarket	1	<b>UKC1060</b>	5.63	6.76

**Oil Seal Oil Pump Housing**

All V8 EFI petrol models with auto gearbox	Aftermarket	1	<b>RTC5102P</b>	6.04	7.25
	Genuine	1	<b>RTC5102</b>	16.12	19.34

**Oil Seal Transfer Box Input**

All models with LT230 transfer box	Aftermarket	1	<b>ICV100000P</b>	0.92	1.10
	OEM	1	<b>ICV100000P1</b>	3.83	4.60
	Genuine	1	<b>ICV100000</b>	6.99	8.39

**Oil Seal Transfer Box Output Flange**

All models with LT230 transfer box	Aftermarket	1	<b>FTC4939P</b>	2.00	2.40
	OEM	1	<b>FTC4939P1</b>	5.00	6.00
	Genuine	1	<b>FTC4939</b>	13.18	15.82

**Oil Seal Swivel**

All models - 9mm	Aftermarket	2	<b>LR059968P</b>	2.08	2.50
	OEM	2	<b>LR059968P1</b>	5.83	7.00
	Genuine	2	<b>LR059968</b>	9.89	11.87

**Oil Seal Swivel Pin Housing**

All models (axle) 20L, 21L, 22L, 23L	Aftermarket	2	<b>571718P</b>	1.17	1.40
	OEM	2	<b>571718P1</b>	3.00	3.60
	Genuine	2	<b>571718</b>	6.81	8.17

**Drain Plug**

All models from (VIN) 7A000001 on - Magnetic, front axle	OEM	1	<b>TYB500120P1</b>	4.08	4.90
	Genuine	1	<b>TYB500120</b>	7.05	8.46

**Plug, Oil Filler & Drain**

All models (VIN) 7A000001 on - Front & rear axles, non-magnetic type	Genuine	1	<b>TGZ500070</b>	7.94	9.53
----------------------------------------------------------------------	---------	---	------------------	------	------

**Drain Plug Diff Unit**

All models	Aftermarket	1	<b>608246P</b>	2.33	2.80
	Genuine	1	<b>608246</b>	9.63	11.56

**Drain Plug Transfer Box**

All models with LT230 transfer box	Aftermarket	1	<b>599552P</b>	2.83	3.40
	Genuine	1	<b>599552</b>	8.99	10.79

**Sealing Washer Drain Plug**

All models with LT77 or R380 5 speed gearbox	Alternative to FRC7064A	Aftermarket	1	<b>FTC4112P</b>	0.79	0.95
		Genuine	1	<b>FTC4112</b>	2.37	2.84
Alternative to FTC4112	Aftermarket	1	<b>FRC7064A</b>	1.08	1.30	

**Speedometer Drive Gear**

All models with LT230 transfer box	Aftermarket	1	<b>FRC3162P</b>	20.63	24.76	
	OEM	1	<b>FRC3162P1</b>	23.75	28.50	
	Genuine	1	<b>FRC3162</b>	64.01	76.81	
All models with blue coded 20 teeth speedometer drive pinion, blue, 20 teeth	Aftermarket	1	<b>FRC3310P</b>	8.54	10.25	
	Genuine	1	<b>FRC3310</b>	16.89	20.27	
All models with green coded 21 teeth speedometer drive pinion, green, 21 teeth	Genuine	1	<b>FRC3311</b>	21.56	25.87	
All models with yellow coded 22 teeth speedometer drive pinion (205 x 16" tyres)	Pinion, yellow, 22 teeth	OEM	1	<b>FRC3312P1</b>	15.63	18.76
		Genuine	1	<b>FRC3312</b>	20.23	24.28
All models with red coded 23 teeth speedometer drive pinion (V8 carb models)	Pinion, red, 23 teeth	OEM	1	<b>FRC3313P1</b>	15.63	18.76
		Genuine	1	<b>FRC3313</b>	20.53	24.64

**Gear Speed Drive Spindle**

All models up to (VIN) 6A999999 except 50 LE and V8 petrol with LT77 5 speed gearbox with 29D transfer box - Green, 21 teeth	Genuine	1	<b>FRC3311</b>	21.56	25.87
All models (VIN) 7A000001 on - Blue, 20 teeth	Aftermarket	1	<b>FRC3310P</b>	8.54	10.25
	Genuine	1	<b>FRC3310</b>	16.89	20.27

**Switch, Gearbox**

All models up to (VIN) 2A642630 - High/Low, with spade connectors	Aftermarket	1	<b>PRC2911P</b>	4.08	4.90
	OEM	1	<b>PRC2911P1</b>	7.92	9.50
	Genuine	1	<b>PRC2911</b>	35.18	42.22

**Switch, Transfer Box**

All models from (VIN) 2A642631 on - High/Low, with harness and plug	Aftermarket	1	<b>IGM500011P</b>	10.62	12.74
	Genuine	1	<b>IGM500011</b>	25.94	31.13
All models with 43D transfer box - Low ratio detection	Genuine	1	<b>IGM100000</b>	42.77	51.32

**Taper Roller Bearing Diff Carrier**

All models (axle) 23S, 42S, 44S, 64L, plus all 2 and 4 pin diffs from (VIN) 7A000001 on Land Rover type axle	Aftermarket	2	<b>RTC3095P</b>	4.25	5.10
	OEM	2	<b>RTC3095P1</b>	9.37	11.24
	Genuine	2	<b>RTC3095</b>	52.69	63.23

**Transducer, Speed**

All models from (VIN) XA159807 on - Transfer box	Genuine	1	<b>YBE100530</b>	60.33	72.40
--------------------------------------------------	---------	---	------------------	-------	-------



# COOLING

# DEFENDER 90 (1989 on)

## Expansion Bottle Cap

All 2.5L 200 TDi and 300 TDi diesel models - 15lb pressure				
Aftermarket	1	<b>NTC7161P</b>	2.75	3.30
OEM	1	<b>NTC7161P1</b>	7.08	8.50
Genuine	1	<b>NTC7161</b>	10.44	12.53
All V8 carb petrol engine models				
Aftermarket	1	<b>PCD100150P</b>	1.42	1.70
Genuine	1	<b>PCD100150</b>	4.04	4.85
15lb pressure				
Aftermarket	1	<b>GRC110</b>	4.38	5.26
All 2.4L/2.2L Puma TDCi diesel engine models				
Aftermarket	1	<b>PCD100160-P</b>	2.00	2.40
Genuine	1	<b>PCD100160</b>	3.87	4.64

## Thermostat

All 2.5L 200 TDi diesel engine models - 88°C				
Aftermarket	1	<b>ERR2803P</b>	2.83	3.40
OEM	1	<b>ERR2803P1</b>	9.17	11.00
Genuine	1	<b>ERR2803</b>	11.50	13.80
All 2.5L 300 TDi diesel engine models				
Aftermarket	1	<b>ERR3291P</b>	2.75	3.30
OEM	1	<b>ERR3291P1</b>	5.21	6.25
Genuine	1	<b>ERR3291</b>	11.07	13.28
All V8 carb petrol engine models - 82°C				
Aftermarket	1	<b>602687P</b>	2.58	3.10
OEM	1	<b>602687P1</b>	3.58	4.30
Genuine	1	<b>602687</b>	10.06	12.07
All V8 petrol models				
74°C, hot climates option				
Aftermarket	1	<b>GTS102</b>	3.33	4.00
82°C, std fitment				
Aftermarket	1	<b>GTS104</b>	3.58	4.30
88°C, cold climates option				
Aftermarket	1	<b>GTS106</b>	3.58	4.30
All V8 EFI petrol engine models - 88°C				
Aftermarket	1	<b>ETC4765P</b>	2.50	3.00
OEM	1	<b>ETC4765P1</b>	3.08	3.70
Genuine	1	<b>ETC4765</b>	10.06	12.07
All 2.4L TDCi Puma diesel engine models				
OEM	1	<b>LR004618P1</b>	10.83	13.00
Genuine	1	<b>LR004618</b>	51.39	61.67

## Thermostat Gasket

All 300 TDi diesel engine models - Thermostat housing				
Aftermarket	1	<b>ERR3490P</b>	0.38	0.46
Genuine	1	<b>ERR3490</b>	2.20	2.64

## Thermostat Housing Gasket

All 200 TDi diesel models				
Thermostat housing				
Aftermarket	1	<b>ERR3682P</b>	0.33	0.40
Genuine	1	<b>ERR3682</b>	2.04	2.45
Lower				
Aftermarket	1	<b>ETC8007P</b>	0.42	0.50
Genuine	1	<b>ETC8007</b>	2.20	2.64
All V8 petrol engine models - Thermostat housing				
Aftermarket	1	<b>ERR2429P</b>	0.67	0.80
Genuine	1	<b>ERR2429</b>	1.75	2.10
All V8 petrol models with 4 barrel carb conversion				
Aftermarket	1	<b>GTG116</b>	1.83	2.20

## O Ring Thermostat Housing

All 300 TDi diesel models - Thermostat housing				
Aftermarket	1	<b>ERR4685P</b>	0.46	0.55
Genuine	1	<b>ERR4685</b>	2.15	2.58

## Thermostat Housing

All 200 TDi diesel models				
Genuine	1	<b>ERR1499</b>	201.38	241.66
Aftermarket	1	<b>ERR3479P</b>	57.50	69.00
Genuine	1	<b>ERR3479</b>	281.22	337.46
All 2.5L TD5 and 2.4L/2.2L TDCi Puma diesel engine models				
Aftermarket	1	<b>PEM100990P</b>	12.92	15.50
OEM	1	<b>PEM100990P1</b>	16.67	20.00
Genuine	1	<b>PEM100990</b>	29.47	35.36
All V8 petrol models with air conditioning				
Aftermarket	1	<b>ETC6135A</b>	29.58	35.50

## Thermostat Housing Adaptor

All 200 TDi and 300 TDi diesel models - Heater pipe				
Genuine	1	<b>624091</b>	7.82	9.38

## Plastic Plug

All 300 TDi diesel engine models - Thermostat housing filler				
Aftermarket	1	<b>ERR4686P</b>	0.92	1.10
Genuine	1	<b>ERR4686</b>	2.47	2.96

## Water Pump

All 200 TDi diesel models				
Aftermarket	1	<b>STC639P</b>	29.58	35.50
Genuine	1	<b>STC639</b>	200.37	240.44
All 2.5L 300 TDi diesel engine models				
Aftermarket	1	<b>PEB500090P</b>	14.58	17.50
OEM	1	<b>PEB500090P1</b>	19.58	23.50
Genuine	1	<b>PEB500090</b>	105.27	126.32
All 2.5L TD5 diesel engine models				
Aftermarket	1	<b>PEM500040P</b>	15.00	18.00
OEM	1	<b>PEM500040P1</b>	27.50	33.00
Genuine	1	<b>PEM500040</b>	116.96	140.35
All V8 carb petrol engine models with viscous coupling with air conditioning				
Aftermarket	1	<b>STC488P</b>	50.00	60.00
Genuine*	1	<b>STC488</b>	182.33	218.80
*Exchange Surcharge				
			40.00	48.00
All V8 EFI petrol engine models				
Aftermarket	1	<b>STC4378P</b>	28.75	34.50
OEM	1	<b>STC4378P1</b>	53.33	64.00
Genuine*	1	<b>STC4378</b>	128.66	154.39
*Exchange Surcharge				
			40.00	48.00
All 2.2L Puma diesel models to (VIN) FA458988				
Genuine	1	<b>LR071294</b>	130.00	156.00
All 2.4L TDCi Puma diesel engine models				
OEM	1	<b>LR079819P1</b>	60.00	72.00
Genuine	1	<b>LR083283</b>	245.89	295.07

## Water Pump Gasket

All 200 TDi diesel models - Water pump				
Aftermarket	1	<b>ERC5655P</b>	0.38	0.46
Genuine	1	<b>ERC5655</b>	5.04	6.05
All 300 TDi diesel engine models				
Water pump				
Aftermarket	1	<b>ERR3284P</b>	0.67	0.80
Genuine	1	<b>ERR3284</b>	5.04	6.05
Distance piece to block				
Aftermarket	1	<b>PET100790P</b>	0.92	1.10
Genuine	1	<b>PET100790</b>	4.80	5.76
All V8 carb engine models - Water pump				
Aftermarket	1	<b>ERR2428P</b>	0.83	1.00
OEM	1	<b>ERR2428P1</b>	4.00	4.80
Genuine	1	<b>ERR2428</b>	8.47	10.16
All V8 EFI petrol engine models - Water pump				
Aftermarket	1	<b>ERR4077P</b>	1.50	1.80
Genuine	1	<b>ERR4077</b>	8.44	10.13
All 2.4L Puma diesel models				
Genuine	1	<b>LR004389</b>	9.50	11.40

## Water Pump Inlet Housing Gasket

All 200 TDi diesel models - Water pump inlet housing				
Aftermarket	1	<b>ERR1607P</b>	0.25	0.30
Genuine	1	<b>ERR1607</b>	1.67	2.00

## Water Pump Seal

All 2.5L TD5 diesel models				
Aftermarket	1	<b>ERR6711P</b>	3.00	3.60
Genuine	1	<b>ERR6711</b>	5.04	6.05

## D Ring Set

All 2.5L TD5 diesel engine models - Water pump				
Aftermarket	1	<b>PFQ10001LP</b>	5.00	6.00
Genuine	1	<b>PFQ10001L</b>	8.01	9.61

## Intercooler Hose

All 2.5L 200 TDi diesel models				
Turbo to intercooler pipe				
Aftermarket	1	<b>ESR2934P</b>	5.63	6.76
OEM	1	<b>ESR2934P1</b>	16.67	20.00
Genuine	1	<b>ESR2934</b>	53.88	64.66
Upper				
Genuine	1	<b>ESR289</b>	7.27	8.72
All 200 TDi diesel models				
Lower, intercooler to pipe				
Aftermarket	1	<b>ESR2942P</b>	44.17	53.00
Genuine	1	<b>ESR2942</b>	75.63	90.76
All 2.5L 300 TDi diesel engine models				
Aftermarket	1	<b>ESR2309P</b>	4.58	5.50
Genuine	1	<b>ESR2309</b>	44.08	52.90
Intercooler end				
Aftermarket	1	<b>PNH102092P</b>	3.00	3.60
Genuine	1	<b>PNH102092</b>	22.46	26.95
Turbo end				
Aftermarket	1	<b>PNH102082P</b>	8.33	10.00
Genuine	1	<b>PNH102082</b>	45.67	54.80
All 2.5L TD5 diesel models				
LH, pipe to intercooler				
Aftermarket	1	<b>PNH102091P</b>	8.13	9.76
OEM	1	<b>PNH102091P1</b>	9.79	11.75
Genuine	1	<b>PNH102091</b>	45.86	55.03
LH, pipe to turbocharger				
OEM	1	<b>PNH102081P1</b>	8.13	9.76
Genuine	1	<b>PNH102081</b>	45.84	55.01
All models with 2.4L Puma diesel engine				
LH				
Aftermarket	1	<b>PNH500660P</b>	14.79	17.75
Genuine	1	<b>PNH500660</b>	35.56	42.67

## Temperature Sensor

All 200TDi diesel engine models				
Aftermarket	1	<b>PRC8593P</b>	8.33	10.00
Genuine	1	<b>PRC8593</b>	26.58	31.90
200TDi diesel engine models - Green				
Aftermarket	1	<b>PRC3359P</b>	5.00	6.00
OEM	1	<b>PRC3359P1</b>	27.08	32.50
Genuine	1	<b>PRC3359</b>	39.35	47.22
300TDi and TD5 diesel engine models				
Aftermarket	1	<b>ERR2081P</b>	3.25	3.90
OEM	1	<b>ERR2081P1</b>	9.79	11.75
Genuine	1	<b>ERR2081</b>	14.00	16.80
All 300TDi diesel engine models				
Aftermarket	1	<b>AMR3321P</b>	2.00	2.40
OEM	1	<b>AMR3321P1</b>	18.54	22.25
Genuine	1	<b>AMR3321</b>	21.94	26.33
All 300TDi diesel models				
Aftermarket	1	<b>AMR1425P</b>	2.75	3.30
Genuine	1	<b>AMR1425</b>	23.47	28.16
All V8 carb petrol models				
Aftermarket	1	<b>RTC4996P</b>	5.63	6.76
V8 carb petrol models with air conditioning - Green				
Aftermarket	1	<b>PRC3359P</b>	5.00	6.00
OEM	1	<b>PRC3359P1</b>	27.08	32.50
Genuine	1	<b>PRC3359</b>	39.35	47.22
V8 carb and EFI petrol models with air conditioning - Yellow				
Aftermarket	1	<b>PRC3505A</b>	10.00	12.00
All 4.0L V8 EFI petrol models - To gauge				
Aftermarket	1	<b>AMR1425P</b>	2.75	3.30
All V8 EFI petrol engine models - To gauge				
Genuine	1	<b>AMR1425</b>	23.47	28.16
All V8 EFI petrol engine models				
Aftermarket	1	<b>ETC8496A</b>	5.00	6.00

## Coolant Temperature Sensor

All V8 carb petrol models without air conditioning				
Aftermarket	1	<b>PRC2506P</b>	5.63	6.76
Genuine	1	<b>PRC2506</b>	23.66	28.39
All 2.2L TDCi Puma diesel models				
Genuine	1	<b>LR041442</b>	25.70	30.84





**DEFENDER 90 (1989 on)****ELECTRICAL - ROTATING ELECTRICS****Alternator**

All 200 TDi diesel models without air conditioning (A127/45amp alternator)			
New, outright	Aftermarket	1	<b>RTC5682P</b> 70.83 85.00
Reconditioned, exchange	Genuine*	1	<b>RTC5682E</b> 131.34 157.61 *Exchange Surcharge 80.00 96.00
All 200 TDi diesel models without air conditioning (originally fitted with A127/45amp alternator) Upgrades from 45amp to 100amp alternator. Includes 100amp alternator (new, outright), pulley, drive belt and uprated power cable			
Upgrade Kit	Britpart	1	<b>RTC5682PKUR</b> 100.00 120.00
All 200Tdi diesel models - A127/45Amp			
New, exchange	Genuine*	1	<b>STC229</b> 300.76 360.91 *Exchange Surcharge 70.00 84.00
All 300Tdi diesel models - A127-65Amp			
New, outright	Aftermarket	1	<b>AMR4249P</b> 68.33 82.00
New, exchange	Genuine*	1	<b>AMR4249</b> 290.29 348.35 *Exchange Surcharge 150.00 180.00
All TD5 diesel models up to (VIN) 6A999999 - A127-120Amp			
New, outright	Aftermarket	1	<b>ERR6999P</b> 150.83 181.00
	OEM	1	<b>ERR6999P1</b> 195.00 234.00
New, exchange	Genuine*	1	<b>ERR6999</b> 612.34 734.81 *Exchange Surcharge 70.00 84.00
All V8 carb petrol engine models with 45 Amp alternator - A127/45Amp			
New, outright	Aftermarket	1	<b>RTC5683EP</b> 82.50 99.00
Exchange	Genuine*	1	<b>RTC5683E</b> 160.78 192.94 *Exchange Surcharge 80.00 96.00
All V8 carb petrol models with LH fixing high output A127/65amp alternator			
New, outright	Aftermarket	1	<b>STC233P</b> 55.00 66.00
All V8 EFI petrol models - A127-100Amp			
New, outright	Aftermarket	1	<b>AMR4247P</b> 86.67 104.00
	OEM	1	<b>AMR4247P1</b> 125.00 150.00
Reconditioned, exchange	Genuine*	1	<b>AMR4247E</b> 296.08 355.30 *Exchange Surcharge 80.00 96.00
New, exchange	Genuine*	1	<b>AMR4247</b> 671.35 805.62 *Exchange Surcharge 80.00 96.00
All models with 2.2L Puma diesel engine			
New, outright	OEM	1	<b>LR065867P1</b> 216.67 260.00
New, exchange	Genuine*	1	<b>LR065867</b> 329.35 395.22 *Exchange Surcharge 100.00 120.00
All 2.4L TDCi Puma diesel engine models			
New, outright	Aftermarket	1	<b>YLE500310P</b> 129.17 155.00
	OEM	1	<b>YLE500310P1</b> 165.00 198.00
New, exchange	Genuine*	1	<b>YLE500310</b> 303.18 363.82 *Exchange Surcharge 70.00 84.00
2.5L N/A diesel military models fitted for radio with 24V system (90amp alternator)			
New, outright	Genuine	1	<b>PRC5253</b> 4379.92 5255.90
Military fitted for radio (FFR) models with A127/65amp alternator - 12V or 24V system, radio screened,			
New, outright	Genuine	1	<b>AMR3329</b> 803.00 963.60
Military Wolf 24V, 300Tdi engine (eng) 15L without exhaust gas recirculation			
New, outright	OEM	1	<b>RRC8642P1</b> 483.33 580.00
	Genuine	1	<b>RRC8642</b> 803.00 963.60
Military Wolf 24V, 300Tdi engine (eng) 25L with exhaust gas recirculation			
New, exchange	Genuine*	1	<b>RRC8761</b> 803.00 963.60 *Exchange Surcharge 80.00 96.00
Military Wolf/XD with 24V system, 50amp			
New, outright	Genuine	1	<b>RRC8560</b> 803.00 963.60
Military Wolf/XD with 24V system			
New, outright	Genuine	1	<b>8510176</b> 1605.98 1927.18

**Starter Motor**

All 200 TDi & 300 TDi diesel models			
New, outright	Aftermarket	1	<b>NAD500210P</b> 82.50 99.00
	OEM	1	<b>NAD500210P1</b> 175.00 210.00
New, exchange	Genuine*	1	<b>NAD500210</b> 316.78 380.14 *Exchange Surcharge 100.00 120.00
Reconditioned, exchange	Genuine*	1	<b>PRC5109E</b> 242.74 291.29 *Exchange Surcharge 100.00 120.00
All models with TD5 diesel engine			
New, outright	Aftermarket	1	<b>NAD101240P</b> 85.00 102.00
Reconditioned, exchange	Genuine*	1	<b>NAD101240E</b> 169.28 203.14 *Exchange Surcharge 70.00 84.00
New, exchange	Genuine*	1	<b>NAD101240</b> 275.36 330.43 *Exchange Surcharge 70.00 84.00
All models with V8 EFI petrol engine - Bosch type			
New, outright	Aftermarket	1	<b>NAD101490P</b> 70.00 84.00
	OEM	1	<b>NAD101490P1</b> 155.00 186.00
Reconditioned, exchange	Genuine*	1	<b>NAD101490E</b> 129.64 155.57 *Exchange Surcharge 70.00 84.00
New, exchange	Genuine*	1	<b>NAD101490</b> 208.17 249.80 *Exchange Surcharge 70.00 84.00
All 2.4L/2.2L Puma TDCi diesel engine models - new			
New, outright	Aftermarket	1	<b>LR025840P</b> 90.00 108.00
	OEM	1	<b>LR025840P1</b> 170.00 204.00
New, exchange	Genuine*	1	<b>LR025840</b> 265.57 318.68 *Exchange Surcharge 200.00 240.00
All military 2.5L petrol models with 24V system - 24V system, new, outright			
New, outright	Genuine	1	<b>ERR5693</b> 1022.38 1226.86
300 TDi Wolf/XD military - New, outright			
New, outright	OEM	1	<b>NAD500220P1</b> 500.00 600.00
	Genuine	1	<b>NAD500220</b> 640.32 768.38



RTC5682P



RTC5683EP



NAD500210P





# ENGINE GASKETS

# DEFENDER 90 (1989 on)

## Gasket Camshaft Cover

TD5 diesel models from (VIN) 2A622424 on	Aftermarket	1	<b>LVP000020P</b>	2.75	3.30
	OEM	1	<b>LVP000020P1</b>	8.13	9.76
	Genuine	1	<b>LVP000020</b>	28.37	34.04

## Gasket Rocker Cover

All 200TDi diesel models	Aftermarket	1	<b>ERR2393P</b>	2.00	2.40
	Genuine	1	<b>ERR2393</b>	11.47	13.76
All 300TDi diesel models	Aftermarket	1	<b>ERR2409P</b>	2.00	2.40
	OEM	1	<b>ERR2409P1</b>	3.58	4.30
	Genuine	1	<b>ERR2409</b>	10.74	12.89
All V8 petrol models Cork	OEM	2	<b>GEG436</b>	1.58	1.90
	Rubber	OEM	2	<b>GEG436UPRATED</b>	2.65
All 2.4L Puma diesel models	Genuine	1	<b>LR004440</b>	25.65	30.78

## Sealing Washer Rocker Cover

All 200TDi diesel models	Aftermarket	3	<b>ERR663P</b>	1.50	1.80
	Genuine	3	<b>ERR663</b>	7.92	9.50
All 300TDi diesel models	Aftermarket	3	<b>ERR3424P</b>	0.75	0.90
	Genuine	3	<b>ERR3424</b>	2.98	3.58

## Gasket Cylinder Head

200TDi and 300TDi diesel models					
1.30mm, one hole	Aftermarket	1	<b>LVB500200P</b>	5.42	6.50
	Genuine	1	<b>LVB500200</b>	51.39	61.67
1.30mm, one hole, MLS type	OEM	1	<b>LVB500200P1</b>	11.67	14.00
1.40mm, two holes	Aftermarket	1	<b>LVB500210</b>	48.48	58.18
	Genuine	1	<b>LVB500210P1</b>	11.67	14.00
1.40mm, two holes, MLS type	Aftermarket	1	<b>LVB500210P</b>	5.42	6.50
	OEM	1	<b>LVB500210P1</b>	11.67	14.00
1.50mm, three holes	Aftermarket	1	<b>LVB500220</b>	44.06	52.87
	Genuine	1	<b>LVB500220P1</b>	10.63	12.76
1.50mm, three holes, MLS type	Aftermarket	1	<b>LVB500220P</b>	13.75	16.50
	OEM	1	<b>LVB500220P1</b>	37.45	44.94
1.60mm	Aftermarket	1	<b>LVB500230P</b>	12.50	15.00
	OEM	1	<b>LVB500230P1</b>	18.13	21.76
2.5L TD5 diesel models					
1.20mm, two holes	Aftermarket	1	<b>LVB000240P</b>	12.50	15.00
	OEM	1	<b>LVB000240P1</b>	25.00	30.00
	Genuine	1	<b>LVB000240</b>	57.56	69.07
1.27mm, one hole	Aftermarket	1	<b>LVB000250P</b>	12.50	15.00
	OEM	1	<b>LVB000250P1</b>	25.00	30.00
	Genuine	1	<b>LVB000250</b>	38.40	46.08
1.35mm, three holes	Aftermarket	1	<b>LVB000260P</b>	12.50	15.00
	OEM	1	<b>LVB000260P1</b>	25.00	30.00
	Genuine	1	<b>LVB000260</b>	60.51	72.61
V8 carb petrol models up to (VIN) LA921745 - <i>Original style tin head gasket</i>					
Aftermarket	2	<b>603796P</b>	1.92	2.30	
	Genuine	2	<b>603796</b>	10.18	12.22
V8 carb petrol models from (VIN) MA921746 on - <i>Original style composite head gasket</i>					
Aftermarket	2	<b>ERR7218P</b>	7.50	9.00	
	OEM	2	<b>ERR7218P1</b>	21.67	26.00
Genuine	2	<b>ERR7218</b>	31.90	38.28	
	All 3.5L V8 petrol models				
Tin type gasket	Aftermarket	2	<b>GEG340P</b>	2.08	2.50
	Aftermarket	2	<b>GEG340</b>	5.00	6.00
Composite type gasket	Aftermarket	2	<b>GEG340COM</b>	15.42	18.50
	Aftermarket	2	<b>GEG340COMP</b>	6.04	7.25
	Genuine	2	<b>ERR4248</b>	35.01	42.01
4.0L V8 EFI petrol models - <i>Original style composite head gasket</i>					
Aftermarket	2	<b>LVB500030P</b>	4.58	5.50	
	OEM	2	<b>LVB500030P1</b>	8.13	9.76
Genuine	2	<b>LVB500030</b>	39.14	46.97	
	All 2.2L TDCi Puma diesel models				
1 identification tooth	Aftermarket	1	<b>LR040897P</b>	32.92	39.50
	Genuine	1	<b>LR040897</b>	49.58	59.50
2 identification teeth	Aftermarket	1	<b>LR040898P</b>	32.92	39.50
	Genuine	1	<b>LR040898</b>	48.52	58.22
3 identification teeth	Aftermarket	1	<b>LR040899P</b>	26.50	31.80
	Genuine	1	<b>LR040899</b>	53.14	63.77
2.4L Puma diesel models					
2 teeth	Aftermarket	1	<b>LR004419P</b>	23.75	28.50
	Genuine	1	<b>LR004419</b>	106.59	127.91
3 teeth	Aftermarket	1	<b>LR004420P</b>	23.75	28.50
	OEM	1	<b>LR004420P1</b>	30.00	36.00
	Genuine	1	<b>LR004420</b>	44.62	53.54

## Gasket Decoke Set

200TDi diesel models - <i>Without head gasket</i>					
Aftermarket	1	<b>STC1172P</b>	15.63	18.76	
	OEM	1	<b>STC1172P1</b>	50.00	60.00
	Genuine	1	<b>STC1172</b>	93.01	111.61
300TDi diesel models - <i>Without head gasket</i>					
Aftermarket	1	<b>STC2802P</b>	8.96	10.75	
	OEM	1	<b>STC2802P1</b>	32.50	39.00
	Genuine	1	<b>STC2802</b>	88.35	106.02
V8 carb petrol models up to (VIN) LA921745 - <i>Includes original fitment tin head gasket</i>					
Aftermarket	1	<b>STC1566P</b>	11.67	14.00	
	Genuine	1	<b>STC1566</b>	133.80	160.56
All 3.5L V8 petrol models					
Includes tin type head gasket	Aftermarket	1	<b>GUG1066HS</b>	20.42	24.50
	Aftermarket	1	<b>GUG1066HSK</b>	19.79	23.75
Includes composite type head gasket	Aftermarket	1	<b>GUG1066HSCOM</b>	33.33	40.00

## Gasket Oil Sump

2.5L TD5 diesel models					
Aftermarket	1	<b>LVF500040P</b>	8.54	10.25	
	Genuine	1	<b>LVF500040</b>	20.20	24.24
All V8 petrol models					
Aftermarket	1	<b>AJM539P</b>	1.00	1.20	
	Aftermarket	1	<b>AJM539</b>	4.08	4.90
All 2.2L TDCi Puma diesel models					
Genuine	1	<b>LR032154</b>	9.96	11.95	

## Gasket Conversion Set

All 200TDi diesel models					
Aftermarket	1	<b>STC1557P</b>	15.00	18.00	
	OEM	1	<b>STC1557P1</b>	45.00	54.00
	Genuine	1	<b>STC1557</b>	151.83	182.20
All 300TDi diesel models					
Aftermarket	1	<b>STC2801P</b>	13.96	16.75	
	OEM	1	<b>STC2801P1</b>	27.50	33.00
	Genuine	1	<b>STC2801</b>	90.31	108.37
V8 carb petrol models					
Aftermarket	1	<b>STC1639P</b>	9.79	11.75	
	OEM	1	<b>STC1639P1</b>	25.83	31.00
	Genuine	1	<b>STC1639</b>	60.34	72.41
All 3.5L V8 carb petrol models					
Aftermarket	1	<b>GUG1538CSP</b>	10.83	13.00	
	Aftermarket	1	<b>GUG1538CS</b>	13.13	15.76

## Sealant 70gm Tube

200TDi diesel models					
OEM	a/r	<b>STC611P1</b>	11.67	14.00	
	Genuine	a/r	<b>STC611</b>	31.80	38.16

## Silicone Sealant RTV

Numerous applications					
Aftermarket	a/r	<b>RTC3254P</b>	5.00	6.00	
	Genuine	a/r	<b>RTC3254</b>	21.04	25.25

## Sealant Instant Gasket

Numerous applications					
Genuine	a/r	<b>STC50550</b>	13.10	15.72	

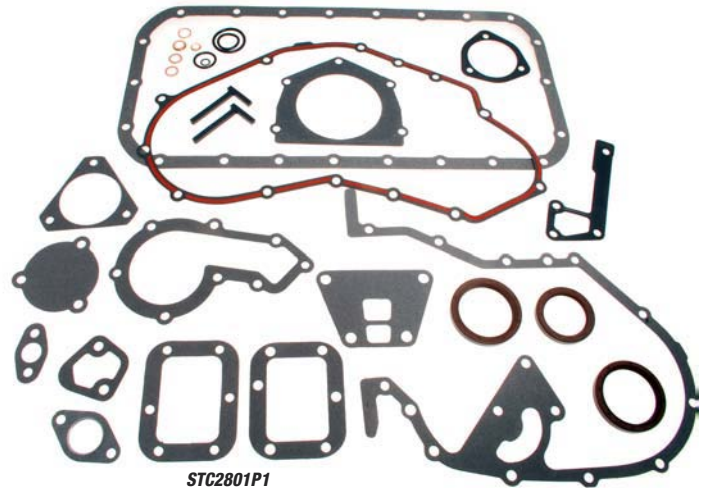

STC2801P1



LVP000020P



GEG340



ERR2393P



**DEFENDER 90 (1989 on)****ENGINE SWITCHES****Camshaft Position Sensor**

All 2.4L and 2.2L TDCi Puma diesel models	Aftermarket	1	<b>LR048186P</b>	11.67	14.00
	Genuine	1	<b>LR048186</b>	57.05	68.46
All 2.2L TDCi Puma diesel models	OEM	1	<b>LR056258P1</b>	45.00	54.00
	Genuine	1	<b>LR056258</b>	83.98	100.78

**Crankshaft Sensor Assembly**

All 2.5L TD5 diesel models	Aftermarket	1	<b>NSC100790P</b>	19.58	23.50
	Genuine	1	<b>NSC100790</b>	167.25	200.70

**Crankshaft Sensor**

All 4.0L V8 EFI petrol models - GEMS type	OEM	1	<b>ERR6119P1</b>	25.83	31.00
	Genuine	1	<b>ERR6119</b>	85.88	103.06
All 2.4L TDCi Puma diesel models	Aftermarket	1	<b>LR004396P</b>	14.58	17.50
	OEM	1	<b>LR004396P1</b>	29.58	35.50
	Genuine	1	<b>LR004396</b>	236.78	284.14

**Temperature Sensor Oil Pump**

All V8 carb petrol engine models	Aftermarket	1	<b>PRC2236P</b>	3.50	4.20
----------------------------------	-------------	---	-----------------	------	------

**Oil Temperature Switch**

2.8L 6 cyl BMW M52 petrol engine models	Aftermarket	1	<b>1703993P</b>	9.38	11.26
	Genuine	1	<b>1703993</b>	25.17	30.20

**Engine Knock Sensor**

All V8 EFI petrol models	Genuine	1	<b>LR023359P</b>	119.95	143.94
--------------------------	---------	---	------------------	--------	--------

**Oil Level Sensor**

All 2.4L & 2.2L TDCi Puma diesel models	Genuine	1	<b>LR005905</b>	22.35	26.82
-----------------------------------------	---------	---	-----------------	-------	-------



ERR6119P1

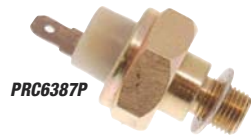

PRC6387P

**Oil Pressure Switch**

All 4 cyl models up to (VIN) 6A999999	Aftermarket	1	<b>PRC6387P</b>	1.83	2.20
	OEM	1	<b>PRC6387P1</b>	3.50	4.20
	Genuine	1	<b>PRC6387</b>	28.77	34.52

**2.5L TD5 diesel engine models**

Parallel thread (not tapered)	Aftermarket	1	<b>NUC000020P</b>	3.00	3.60
	Genuine	1	<b>NUC000020</b>	6.52	7.82
Tapered thread (not parallel)	Aftermarket	1	<b>NUC10003P</b>	3.25	3.90
	Genuine	1	<b>NUC10003</b>	6.94	8.33
All V8 carb petrol engine models	Aftermarket	1	<b>DRC2479A</b>	29.58	35.50
All V8 petrol engine models	Aftermarket	1	<b>STC4104P</b>	3.00	3.60
	OEM	1	<b>STC4104P1</b>	12.50	15.00
	Genuine	1	<b>STC4104</b>	29.01	34.81

**All 2.4L and 2.2L Puma diesel engine models**

All 2.4L and 2.2L Puma diesel engine models	Aftermarket	1	<b>LR004410P</b>	3.50	4.20
	OEM	1	<b>LR004410P1</b>	6.67	8.00
	Genuine	1	<b>LR004410</b>	23.19	27.83

**Air Inlet Temperature Sensor**

All 2.8L 6 cyl BMW M52 petrol models	Genuine	1	<b>1739510</b>	23.34	28.01
--------------------------------------	---------	---	----------------	-------	-------

**Manifold Pressure Sensor**

2.5L TD5 diesel engine models	Aftermarket	1	<b>MHK100640P</b>	16.55	19.86
	Genuine	1	<b>MHK100640</b>	98.86	118.63

**Manifold Absolute Pressure Sensor**

All 2.5L TD5 diesel models up to (VIN) 1A622305	MG Rover	1	<b>MHK100600</b>	151.82	182.18
	Genuine	1	<b>MHK100600L</b>	267.11	320.53
All 2.5L TD5 diesel models from (VIN) 1A622306 on	Genuine	1	<b>MHK100820L</b>	96.22	115.46
	Genuine	1	<b>LR022164</b>	116.15	139.38

**Oxygen Sensor**

4.0L V8 EFI petrol models	Aftermarket	1	<b>AMR6244P</b>	45.00	54.00
	Genuine	1	<b>AMR6244</b>	157.75	189.30
All 2.2L TDCi Puma diesel models - Pre-catalyst	Genuine	1	<b>LR030006</b>	117.36	140.83

**DEFENDER 90 (1989 on)****DRAIN PLUGS****Sump Plug Magnetic**

All 200TDi diesel models	Genuine	1	<b>ETC5577</b>	3.53	4.24
--------------------------	---------	---	----------------	------	------

**Sump Plug Washer**

All 200TDi and 300TDi diesel models	Aftermarket	1	<b>FRC4808P</b>	0.58	0.70
	Genuine	1	<b>FRC4808</b>	1.83	2.20
All 200TDi diesel models	Aftermarket	1	<b>213961A</b>	1.25	1.50
	Aftermarket	1	<b>CDU1001</b>	0.54	0.65
All V8 petrol models	Aftermarket	1	<b>213961A</b>	1.25	1.50
	Aftermarket	1	<b>UAM2857P</b>	0.58	0.70
All models with LT230 transfer box	Aftermarket	1	<b>FRC4808P</b>	0.58	0.70
	Genuine	1	<b>FRC4808</b>	1.83	2.20

**Sump Plug**

300TDi diesel models up to (eng) 16L88228A and 23L88228A	Aftermarket	1	<b>UAM2957P</b>	1.58	1.90
	Genuine	1	<b>UAM2957</b>	2.08	2.50
All 300 TDi diesel models (eng) 23L/16L88229A on	OEM	1	<b>LSF100040LP1</b>	1.50	1.80
	Genuine	1	<b>LSF100040L</b>	3.13	3.76
All V8 petrol models	Aftermarket	1	<b>603659A</b>	2.83	3.40

**Sealing Washer Sump Plug**

All 300TDi diesel models (eng) 16L88228A on, 23L88228A on	Aftermarket	1	<b>ALU1403LP</b>	0.54	0.65
	Genuine	1	<b>ALU1403L</b>	1.11	1.33
All models with LT230 transfer box (gbox) 43D on	Aftermarket	1	<b>ALU1403LP</b>	0.54	0.65
	Genuine	1	<b>ALU1403L</b>	1.11	1.33
All models with R380 5 speed gearbox	Aftermarket	1	<b>ALU1403LP</b>	0.54	0.65
	Genuine	1	<b>ALU1403L</b>	1.11	1.33

**Sump Plug & Washer**

All 2.4L and 2.2L Puma diesel models	Aftermarket	1	<b>1013938P</b>	1.50	1.80
	Genuine	1	<b>1013938</b>	3.19	3.83

**Oil Drain Valve Kit**

All 300 TDi diesel models (eng) 23L/16L88229A on	Aftermarket	1	<b>LSF100040LODV</b>	32.08	38.50
--------------------------------------------------	-------------	---	----------------------	-------	-------

**O Ring for Drain Plug**

2.5L N/A & 2.5L TD engine models	Genuine	1	<b>37H575P</b>	0.58	0.70
----------------------------------	---------	---	----------------	------	------

**Copper Sealing Washer**

Numerous applications	Aftermarket	1	<b>ETC7398P</b>	0.75	0.90
	Genuine	1	<b>ETC7398</b>	1.55	1.86

**Filler Plug**

All models with 5 speed LT77 gearbox - Gearbox	OEM	1	<b>3292P1</b>	1.33	1.60
	Genuine	1	<b>3292</b>	15.68	18.82
All models with 5 speed R380 gearbox - Gearbox	OEM	1	<b>FTC4056P1</b>	6.46	7.75
	Genuine	1	<b>FTC4056</b>	6.98	8.38
All models with Advest manual steering box - Steering box	Genuine	1	<b>STC897</b>	31.33	37.60
	Genuine	1	<b>AEU4017</b>	3.57	4.28
All models from (VIN) LA930456 on - Swivel housing	OEM	1	<b>3292P1</b>	1.33	1.60
	Genuine	1	<b>3292</b>	15.68	18.82

**Wading Plug**

All models with 5 speed R380 gearbox - Gearbox bellhousing. Alternative to 3290A	OEM	1	<b>FTC4056P1</b>	6.46	7.75
-------------------------------------------------------------------------------------	-----	---	------------------	------	------

**Drain Plug**

All V8 EFI petrol models with auto gearbox - Magnetic, gearbox	Genuine	1	<b>RTC4647</b>	7.86	9.43
----------------------------------------------------------------	---------	---	----------------	------	------

**O Ring Oil Screen**

All V8 EFI petrol models with auto gearbox	Aftermarket	1	<b>RTC4276P</b>	0.38	0.46
	Genuine	1	<b>RTC4276</b>	1.80	2.16

**Drain Plug**

All diesel models up to (VIN) 6A999999 except 2.5L TD5 diesel - Fuel filter/sedimentor	OEM	1	<b>37H7920P1</b>	7.08	8.50
	Genuine	1	<b>37H7920</b>	9.02	10.82
All 2.5L TD5 diesel models with fuel filter fitted with drain - Fuel filter/sedimentor	Genuine	1	<b>YXJ500060NAA</b>	2.99	3.59



LSF100040LODV



# OIL SEALS ENGINE

# DEFENDER 90 (1989 on)

## Oil Seal Crankshaft Front

200TDi diesel models	Aftermarket	1	<b>ERR6490P</b>	3.00	3.60
	OEM	1	<b>ERR6490P1</b>	5.00	6.00
300TDi diesel models - Inner	Aftermarket	1	<b>ERR4575P</b>	2.33	2.80
	OEM	1	<b>ERR4575P1</b>	5.63	6.76
	Genuine	1	<b>ERR4575</b>	14.76	17.71
300TDi diesel models up to (eng) 15L01620A - Outer	Aftermarket	1	<b>ERR4576P</b>	1.25	1.50
	Genuine	1	<b>ERR4576</b>	6.95	8.34
300TDi diesel models from (eng) 15L01621A on - Outer	Aftermarket	1	<b>ERR7143P</b>	4.58	5.50
	Genuine	1	<b>ERR7143</b>	32.31	38.77
2.5L TD5 diesel models	Aftermarket	1	<b>ERR5992P</b>	3.58	4.30
	Genuine	1	<b>ERR5992</b>	10.27	12.32
All V8 petrol models	Aftermarket	1	<b>ERR6490P</b>	3.00	3.60
	OEM	1	<b>ERR6490P1</b>	5.00	6.00
All 2.4L and 2.2L Puma diesel models	OEM	1	<b>LR077704P1</b>	9.58	11.50
	Genuine	1	<b>LR077704</b>	15.54	18.65

## Oil Seal Crankshaft Rear

200TDi diesel models	Aftermarket	1	<b>ERR2532P</b>	2.00	2.40
	OEM	1	<b>ERR2532P1</b>	5.83	7.00
	Genuine	1	<b>ERR2532</b>	21.00	25.20
300TDi diesel models	Aftermarket	1	<b>LUF100430P</b>	7.50	9.00
	OEM	1	<b>LUF100430P1</b>	9.58	11.50
	Genuine	1	<b>LUF100430</b>	26.79	32.15
2.5L TD5 diesel models	Aftermarket	1	<b>LUF100420P</b>	7.50	9.00
	OEM	1	<b>LUF100420P1</b>	9.79	11.75
	Genuine	1	<b>LUF100420</b>	21.82	26.18
All V8 petrol models - Lip type seal	Aftermarket	1	<b>ERR2640P</b>	3.00	3.60
	OEM	1	<b>ERR2640P1</b>	7.92	9.50
	Genuine	1	<b>ERR2640</b>	15.58	18.70
All 2.4L and 2.2L Puma diesel models	Aftermarket	1	<b>LR020610P</b>	14.79	17.75
	Genuine	1	<b>LR020610</b>	35.94	43.13

## Oil Seal Front Cover

V8 petrol models	Aftermarket	1	<b>ETC4154P</b>	1.08	1.30
	OEM	1	<b>ETC4154P1</b>	3.00	3.60
	Genuine	1	<b>ETC4154</b>	14.67	17.60
200TDi diesel models	Aftermarket	1	<b>ETC4154P</b>	1.08	1.30
	OEM	1	<b>ETC4154P1</b>	3.00	3.60
	Genuine	1	<b>ETC4154</b>	14.67	17.60

## Oil Seal Camshaft

200TDi diesel models	Aftermarket	1	<b>ETC5064P</b>	2.08	2.50	
	OEM	1	<b>ETC5064P1</b>	2.50	3.00	
	Genuine	1	<b>ETC5064</b>	21.23	25.48	
300TDi diesel models	Aftermarket	1	<b>ERR3356P</b>	0.58	0.70	
	OEM	1	<b>ERR3356P1</b>	2.50	3.00	
	Genuine	1	<b>ERR3356</b>	12.31	14.77	
TD5 diesel models	Front	Aftermarket	1	<b>LDI100030P</b>	4.00	4.80
		Genuine	1	<b>LDI100030</b>	16.82	20.18
Rear	Aftermarket	1	<b>ERR5369P</b>	1.33	1.60	
	OEM	1	<b>ERR5369P1</b>	1.58	1.90	
	Genuine	1	<b>ERR5369</b>	2.89	3.47	

## O Ring Camshaft Small

All 200TDi diesel models - Camshaft pulley retaining plate		Genuine	1	<b>ERC8849</b>	0.61	0.73



# EXHAUST GAS RECIRCULATION (EGR)

# DEFENDER 90 (1989

## EGR Valve

All models with 300 TDi diesel engine	Aftermarket	1	<b>WAV100330P</b>	40.00	48.00
	Genuine	1	<b>WAV100330</b>	259.67	311.60
All 2.5L TD5 diesel models	Genuine	1	<b>WAV100270</b>	141.36	169.63
	Genuine	2	<b>MSG100110</b>	59.46	71.35
	Genuine	1	<b>LR081121</b>	188.10	225.72
All 2.4L TDCi Puma diesel models	Aftermarket	1	<b>LR006650P</b>	95.00	114.00
All 2.4L TDCi Puma diesel models	Genuine	1	<b>LR006650</b>	136.26	163.51

## Solenoid EGR Valve

All 300 TDi diesel models without catalyst	Genuine	1	<b>ERR3314</b>	129.28	155.14
--------------------------------------------	---------	---	----------------	--------	--------

## EGR Blanking Kit

All 300 TDi diesel models - Includes blanking plate, insulator/gasket and screws					
	Britpart	1	<b>LL1473BP</b>	5.00	6.00
	Terrafirma	1	<b>LL1473TF</b>	4.75	5.70
	Bearmach	1	<b>LL1473BM</b>	5.83	7.00
All 2.5L TD5 diesel models - Includes blanking plate, bypass tube and gasket					
	Britpart	2	<b>LL1474BP</b>	29.58	35.50
	Terrafirma	2	<b>LL1474TF</b>	34.58	41.50
	Bearmach	2	<b>LL1474BM</b>	33.75	40.50

## Gasket EGR Valve to Pipe

All 200 TDi and 300 TDi diesel models	Aftermarket	1	<b>WAL500010LP</b>	2.00	2.40
	OEM	1	<b>WAL500010LP1</b>	3.58	4.30
	Genuine	1	<b>WAL500010L</b>	6.18	7.42
All 300 TDi diesel models	Aftermarket	1	<b>ERR3319P</b>	1.00	1.20
	Genuine	1	<b>ERR3319</b>	1.75	2.10
All 2.5L TD5 diesel models	Genuine	1	<b>WAL100240</b>	0.80	0.96

## Gasket

All 2.5L TD5 diesel engine models - Exhaust gas recirculation valve to pipe	Genuine	1	<b>ERR6620</b>	1.75	2.10
-----------------------------------------------------------------------------	---------	---	----------------	------	------

## Gasket EGR Valve to Manifold

All 2.4L and 2.2L Puma diesel models	OEM	1	<b>LR034076P1</b>	4.58	5.50
	Genuine	1	<b>LR034076</b>	7.95	9.54

## Gasket EGR Cooler Seating

All 2.2L TDCi Puma diesel models	Genuine	1	<b>LR030028</b>	9.95	11.94
----------------------------------	---------	---	-----------------	------	-------

## Gasket EGR Valve to Cooler

All 2.2L TDCi Puma diesel models	Genuine	1	<b>LR037955</b>	7.00	8.40
All 2.4L TDCi Puma diesel models	Genuine	1	<b>LR004476</b>	9.31	11.17

## Gasket EGR Cooler

All 2.4L TDCi Puma diesel models	Genuine	1	<b>LR004477</b>	11.36	13.63
----------------------------------	---------	---	-----------------	-------	-------

## Gasket EGR Valve

All 2.4L TDCi Puma diesel models	Genuine	1	<b>LR004477</b>	11.36	13.63
----------------------------------	---------	---	-----------------	-------	-------

## Y Pipe EGR Valve

All 300 TDi diesel models without catalyst	Genuine	1	<b>ERR3579</b>	188.44	226.13
--------------------------------------------	---------	---	----------------	--------	--------

## Pipe EGR Valve to Y Pipe

All 300 TDi diesel models without catalyst	Genuine	1	<b>ERR5732</b>	152.03	182.44
--------------------------------------------	---------	---	----------------	--------	--------

## EGR Pipe

All 300 TDi diesel models	Aftermarket	1	<b>ERR3581P</b>	3.25	3.90
	Genuine	1	<b>ERR3581</b>	45.30	54.36
300TDi diesel models	Aftermarket	1	<b>ERR3580P</b>	3.25	3.90
	Genuine	1	<b>ERR3580</b>	53.69	64.43

## Pipe EGR Valve to Filter

All 2.5L TD5 diesel models up to (VIN) XA175541					
	Genuine	1	<b>WAP100980</b>	4.12	4.94
All 2.5L TD5 diesel models from (VIN) XA175542 on					
	Genuine	1	<b>WAP101390</b>	16.03	19.24

## Pipe EGR Valve

All 2.5L TD5 diesel models	Genuine	1	<b>WAP101220</b>	141.93	170.32
----------------------------	---------	---	------------------	--------	--------

## EGR Cooler Hose

All 2.5L TD5 diesel engine models from (VIN) 2A622424 on					
	Genuine	1	<b>PEH000310</b>	9.56	11.47

## EGR Cooler Return Hose

All 2.5L TD5 diesel engine models from (VIN) 2A622424 on					
	Genuine	1	<b>PCH001370</b>	23.90	28.68

## Hose EGR Cooler Inlet

All 2.2L TDCi Puma diesel models	Genuine	1	<b>LR077774</b>	20.49	24.59
All 2.2L TDCi Puma diesel models up to (VIN) CA417102					
	Genuine	1	<b>LR030029</b>	10.44	12.53

## Pipe MAP Sensor/EGR Valve

All 2.4L TDCi Puma diesel models	Genuine	1	<b>LR010456</b>	320.66	384.79
----------------------------------	---------	---	-----------------	--------	--------



WAP100270





## DEFENDER 90 (1989 on)

## ENGINE &amp; GEARBOX MOUNTINGS

## Engine Mounting

All 200TDi diesel models - Engine and gearbox, M10 thread				
Aftermarket	2	<b>ANR1808P</b>	2.33	2.80
OEM	2	<b>ANR1808P1</b>	3.58	4.30
Genuine	2	<b>ANR1808</b>	17.50	21.00
All 300TDi diesel models - Engine				
Aftermarket	2	<b>NTC9416P</b>	9.17	11.00
Genuine	2	<b>NTC9416</b>	51.74	62.09
All TD5 diesel models - Engine				
Aftermarket	2	<b>KKB500750P</b>	25.00	30.00
Genuine	2	<b>KKB500750</b>	50.59	60.71
All V8 petrol models to (VIN) TA970049 - With M12 metric threads				
Aftermarket	4	<b>STC434P</b>	2.33	2.80
OEM	4	<b>STC434P1</b>	9.38	11.26
Genuine	4	<b>STC434</b>	23.83	28.60
4.0L V8 EFI petrol models - Engine, M12 thread				
Aftermarket	2	<b>KKB103120P</b>	1.67	2.00
Genuine	2	<b>KKB103120</b>	20.20	24.24

## Bracket Engine Mounting

All 4 cyl models up to (VIN) LA939975				
RH	Genuine	1	<b>NRC5434</b>	103.48 124.18
LH	Genuine	1	<b>NRC5557</b>	143.30 171.96
All 300TDi diesel models				
RH	Genuine	1	<b>ANR2868</b>	117.03 140.44
LH	Genuine	1	<b>NTC9415</b>	97.80 117.36
All 2.5L TD5 diesel models				
RH	Genuine	1	<b>KKU000740</b>	58.89 70.67
LH	Genuine	1	<b>ANR6623</b>	363.80 436.56
All 2.5L petrol models with later chassis - converts later chassis for 2.5L petrol model use				
RH	Genuine	1	<b>KVU100220</b>	96.37 115.64
LH	Genuine	1	<b>KVU100230</b>	87.33 104.80
All V8 carb petrol models with later chassis - converts later chassis for V8 carb petrol model use				
RH	Genuine	1	<b>KVU100240</b>	43.29 51.95
All 2.4L & 2.2L Puma diesel models				
RH	Genuine	1	<b>KKU500830</b>	33.96 40.75
LH	Genuine	1	<b>KKU500860</b>	63.69 76.43

## Gearbox Mounting

All 300TDi diesel models				
RH	Aftermarket	1	<b>ANR3200P</b>	2.50 3.00
	Genuine	1	<b>ANR3200</b>	23.26 27.91
LH	Aftermarket	1	<b>ANR3201P</b>	2.50 3.00
	OEM	1	<b>ANR3201P1</b>	4.58 5.50
	Genuine	1	<b>ANR3201</b>	23.26 27.91
All V8 petrol models to (VIN) TA970049 - With M12 metric threads				
	Aftermarket	4	<b>STC434P</b>	2.33 2.80
	OEM	4	<b>STC434P1</b>	9.38 11.26
	Genuine	2	<b>STC434</b>	23.83 28.60
4.0L V8 EFI petrol models - Engine, M12 thread				
	Genuine	2	<b>KKB103120</b>	20.20 24.24
All 2.4L and 2.2L TDCi diesel models				
RH	Aftermarket	1	<b>KQB500550P</b>	5.00 6.00
	Genuine	1	<b>KQB500550</b>	14.42 17.30
LH	Aftermarket	1	<b>KQB500560P</b>	6.88 8.26
	Genuine	1	<b>KQB500560</b>	17.61 21.13

## Bracket Gearbox Mounting

All 2.5L TD5 diesel models - RH	Genuine	1	<b>ANR5636</b>	17.16 20.59
All V8 petrol models - RH	Genuine	1	<b>ANR4657</b>	68.90 82.68
All 2.4L & 2.2L Puma diesel models - LH	Genuine	1	<b>KKU000710</b>	12.63 15.16



NTC9416P



ANR6623

## DEFENDER 90 (1989 on)

## FUEL SYSTEM SWITCHES

## Throttle Position Sensor

All 300 TDi diesel models with exhaust gas recirculation (EGR) and immobiliser				
	Genuine	1	<b>STC4389</b>	420.71 504.85
4.0 V8 EFI petrol models	Genuine	1	<b>ERR4278</b>	98.01 117.61

## Air Flow Sensor

2.5L TD5 diesel models	Aftermarket	1	<b>MHK100620P</b>	26.25 31.50
	OEM	1	<b>MHK100620P1</b>	60.00 72.00
	Genuine	1	<b>MHK100620</b>	123.84 148.61
2.4L Puma diesel models	OEM	1	<b>MHK501040P1</b>	50.00 60.00
	Genuine	1	<b>MHK501040</b>	107.33 128.80

## Air Flow Sensor Meter

4.0 V8 EFI petrol models (GEMS)	Aftermarket	1	<b>ERR5595P</b>	95.00 114.00
	Genuine*	1	<b>ERR5595</b>	818.10 981.72
			*Exchange Surcharge 200.00	240.00

## Air Inlet Sensor

4.0 V8 EFI petrol models	Genuine	1	<b>ERR2946</b>	95.73 114.88
--------------------------	---------	---	----------------	--------------

## Air Flow Meter

All 2.8L 6 cyl BMW M52 petrol models	Genuine	1	<b>1703275</b>	199.51 239.41
All 2.2L TDCi Puma diesel models	OEM	1	<b>LRO19830P1</b>	85.00 102.00
	Genuine	1	<b>LRO19830</b>	107.33 128.80

## Fuel Temperature Sensor

All 4.0L V8 EFI petrol models	Aftermarket	1	<b>ETC6661P</b>	40.00 48.00
-------------------------------	-------------	---	-----------------	-------------

## Water Sensor for Fuel Filter

2.5L TD5 diesel models	OEM	1	<b>WKW500060P1</b>	21.50 25.80
	Genuine	1	<b>WKW500060</b>	68.58 82.30

## DEFENDER 90 (1989 on)

## CABLES

## Accelerator Cable

All RHD 200 TDi diesel models	Aftermarket	1	<b>ANR1419P</b>	11.88 14.26
	Genuine	1	<b>ANR1419</b>	42.47 50.96
All RHD 300 TDi diesel models	Aftermarket	1	<b>NTC9360P</b>	6.88 8.26
	Genuine	1	<b>NTC9360</b>	56.06 67.27
All RHD 300 TDi diesel models - Secondary throttle	Aftermarket	1	<b>ANR1338P</b>	21.25 25.50
	Genuine	1	<b>ANR1338</b>	58.62 70.34
All RHD diesel models with hand throttle from (VIN) HA456214 to LA939975 - Secondary (hand) throttle	Genuine	1	<b>NTC8554</b>	32.64 39.17
All 4 cyl diesel models fitted with hand throttle from (VIN) MA939976 on - Secondary (hand) throttle	Genuine	1	<b>ANR1339</b>	61.76 74.11
All V8 carb petrol models	Aftermarket	1	<b>NRC5494P</b>	4.58 5.50
	Genuine	1	<b>NRC5494</b>	57.35 68.82
All RHD V8 carb petrol models with hand throttle - Secondary (hand) throttle	Genuine	1	<b>NRC9284</b>	21.22 25.46
All 4.0L V8 EFI petrol models	Aftermarket	1	<b>SBB104100P</b>	10.00 12.00
	Genuine	1	<b>SBB104100</b>	29.23 35.08
All LHD 200 TDi diesel models	OEM	1	<b>NTC4945P1</b>	11.67 14.00
	Genuine	1	<b>NTC4945</b>	37.19 44.63
All LHD 300 TDi diesel models	Aftermarket	1	<b>NTC9359P</b>	7.08 8.50
	OEM	1	<b>NTC9359P1</b>	16.67 20.00
	Genuine	1	<b>NTC9359</b>	62.86 75.43
All LHD diesel models with hand throttle from (VIN) HA456214 to LA939975 - Secondary (hand) throttle	Genuine	1	<b>NTC8553</b>	73.47 88.16
All LHD V8 carb petrol models with hand throttle - Secondary (hand) throttle	Genuine	1	<b>NRC9285</b>	81.70 98.04
All USA/CDN/Mex V8 EFI petrol models	Genuine	1	<b>NTC9163</b>	41.66 49.99

## Bonnet Release Cable

All models up to (VIN) TA977536	Aftermarket	1	<b>ALR9556P</b>	3.33 4.00
	Genuine	1	<b>ALR9556</b>	19.00 22.80
All models except 4.0L V8 EFI from (VIN) TA977537 to WA159806	Aftermarket	1	<b>ASR1457P</b>	3.92 4.70
	Genuine	1	<b>ASR1457</b>	13.27 15.92
All models from (VIN) 2A622424 to 6A999999	Genuine	1	<b>FSE000070</b>	6.50 7.80
All models from (VIN) XA159807 to 1A622423	Genuine	1	<b>FSE100460</b>	19.87 23.84
All 4.0L V8 EFI petrol models	Aftermarket	1	<b>ALR9555P</b>	5.63 6.76
	Genuine	1	<b>ALR9555</b>	17.00 20.40
All models from (VIN) 7A000001 on - Engine compartment end	Genuine	1	<b>FSE500080</b>	8.55 10.26

## Choke Cable

All RHD V8 carb petrol models	Aftermarket	1	<b>NTC3932P</b>	27.50 33.00
	Genuine	1	<b>NTC3932</b>	47.39 56.87
All LHD V8 carb petrol models	Aftermarket	1	<b>NTC3933P</b>	25.00 30.00
	Genuine	1	<b>NTC3933</b>	43.03 51.64

## Speedometer Cable

All RHD 4 cyl petrol & diesel models except Police or overspeed warning fitted models - One piece cable	Aftermarket	1	<b>PRC6022P</b>	4.79 5.75
	Genuine	1	<b>PRC6022</b>	113.28 135.94
All RHD V8 carb models - One piece cable	Aftermarket	1	<b>PRC6023P</b>	5.00 6.00
	Genuine	1	<b>PRC6023</b>	85.06 102.07



# WINDOW REGULATORS

**DEFENDER 90 (1989 on)**

## Window Regulator

All models up to (VIN) LA932528				
Front RH	Aftermarket	1	<b>MUC3024P</b>	10.62 12.74
	Genuine	1	<b>MUC3024</b>	136.50 163.80
Front LH	Aftermarket	1	<b>MUC3025P</b>	12.08 14.50
	Genuine	1	<b>MUC3025</b>	109.40 131.28
All models from (VIN) LA932529 to 1A622423				
Front RH	Aftermarket	1	<b>ALR4533P</b>	25.83 31.00
	Genuine	1	<b>ALR4533</b>	90.79 108.95
Front LH	Aftermarket	1	<b>ALR4532P</b>	25.83 31.00
	Genuine	1	<b>ALR4532</b>	90.79 108.95
All models with manual windows from (VIN) 2A622424 on				
Front RH	Aftermarket	1	<b>CUH000100P</b>	30.83 37.00
	Genuine	1	<b>CUH000100</b>	69.95 83.94
Front LH	Aftermarket	1	<b>CUH000111P</b>	37.08 44.50
	Genuine	1	<b>CUH000111</b>	50.51 60.61
All models with electric windows (VIN) 2A622424 on - Electric, includes motor				
Front RH	Aftermarket	1	<b>CUH000082P</b>	50.83 61.00
	Genuine	1	<b>CUH000082</b>	145.51 174.61



# WHEEL CENTRE CAPS & WHEEL NUTS

**DEFENDER 90 (1989 on)**

## Wheel Centre Cap

All models with polished shadow chrome alloy wheel centre caps with green/gold Land Rover badge				
Polished shadow chrome finish with Land Rover green/gold badge				
	Genuine	a/r	<b>RRJ500060MUZ</b>	8.42 10.10
All models with Silver Sparkle (MNH) colour alloy wheels				
Silver Sparkle, features Land Rover logo				
	Genuine	a/r	<b>ANR2391MNH</b>	7.13 8.56
All models with Quicksilver (MUE) colour alloy wheels				
Quicksilver, features Land Rover logo				
	Genuine	a/r	<b>ANR2391MUE</b>	5.13 6.16
All models with Alpine White (NUC) 5 spoke steel wheels				
Alpine White, features Land Rover logo				
	Genuine	a/r	<b>ANR3861</b>	3.09 3.71
All models up to (VIN) 5A999999 with Black colour alloy wheels				
Black, features Land Rover logo				
	Genuine	a/r	<b>STC7248</b>	10.06 12.07
Tomb Raider limited edition				
Pewter, features Land Rover logo				
	Genuine	a/r	<b>ANR2391LAL</b>	5.29 6.35
All models with 16" dual finish alloy wheels from (VIN) 7A000001 on				
Polished finish, Land Rover green/silver badge				
	Aftermarket	a/r	<b>LR023301P</b>	5.42 6.50
	Genuine	a/r	<b>LR023301</b>	6.64 7.97

## Wheel Stud

All models up to (VIN) KA930455				
Front and rear hubs				
	Aftermarket	a/r	<b>FRC6137P</b>	0.46 0.55
	Genuine	a/r	<b>FRC6137</b>	4.25 5.10
All models from (VIN) LA930456 on, will fit earlier models				
For alloy or steel wheels				
	Aftermarket	a/r	<b>RUF500010P</b>	1.33 1.60
	Genuine	a/r	<b>RUF500010</b>	2.09 2.51
All models - Extended, 60mm (original fitment for Defender Wolf/XD).				
Allows fitment of certain alternative wheels				
	OEM	a/r	<b>FRC7577P1</b>	5.83 7.00
	Genuine	a/r	<b>FRC7577</b>	19.36 23.23

## Wheel Nut

All models with steel wheels				
	Aftermarket	a/r	<b>RRD500010P</b>	0.79 0.95
	Genuine	a/r	<b>RRD500010</b>	1.82 2.18
All models with alloy wheels up to (VIN) 6A999999 except Tomb Raider				
Without stainless steel cap				
	Aftermarket	a/r	<b>NRC7415P</b>	2.00 2.40
	OEM	a/r	<b>NRC7415P1</b>	2.75 3.30
	Genuine	a/r	<b>NRC7415</b>	2.97 3.56
All models with alloy spare wheel up to (VIN) 4A999999				
Alloy spare wheel only				
	Genuine	a/r	<b>ANR4914</b>	8.42 10.10
All models with stainless capped wheel nuts for alloy wheels from (VIN) 7A000001 on -				
With stainless steel cap				
	Aftermarket	a/r	<b>RRD500560P</b>	2.33 2.80
	OEM	a/r	<b>RRD500560P1</b>	4.38 5.26
	Britpart	a/r	<b>RRD500560BP</b>	2.08 2.50
	Genuine	a/r	<b>RRD500560</b>	11.43 13.72
All models with alloy spare wheel from (VIN) 7A000001 on				
Alloy spare wheel only				
	Genuine	a/r	<b>RRD500520</b>	4.97 5.96

## Wheel Nut Set

All models with steel wheels - Set of 20				
	Aftermarket	a/r	<b>RRD500010KP</b>	11.04 13.25
	Genuine	a/r	<b>RRD500010K</b>	34.00 40.80
All models with alloy wheels up to (VIN) 6A999999 except Tomb Raider				
Set of 20. Without stainless steel cap				
	Aftermarket	a/r	<b>NRC7415KP</b>	38.33 46.00
	Genuine	a/r	<b>NRC7415K</b>	58.50 70.20
All models with stainless capped wheel nuts for alloy wheels from (VIN) 7A000001 on				
Set of 20. With stainless steel cap				
	Aftermarket	a/r	<b>RRD500560KP</b>	38.33 46.00
	OEM	a/r	<b>RRD500560KP1</b>	77.50 93.00
	Genuine	a/r	<b>RRD500560K</b>	215.00 258.00





# DEFENDER 110 (1989 on)

## 1989 on - All Models

Listed below are the most popular parts required for the Defender 110. We have access to the full range of parts for your vehicle. Please contact us if not listed here.

### DEFENDER 110 (1989 on)

## SERVICE KITS

### Filter Kit

All 200 TDi diesel models - Includes oil filter, air filter, fuel filter & sump plug washer				
Aftermarket	1	<b>LL1344P</b>	9.58	11.50
Genuine	1	<b>LL1344</b>	42.50	51.00
All 300 TDi diesel models - Includes oil filter, air filter, fuel filter & sump plug washer				
Aftermarket	1	<b>LL1345P</b>	9.79	11.75
Genuine	1	<b>LL1345</b>	40.00	48.00
All 2.5L TD5 diesel models - Includes oil filter, air filter, rotor filter, fuel filter & sump plug washer				
Aftermarket	1	<b>LL1346P</b>	11.50	13.80
Genuine	1	<b>LL1346</b>	70.83	85.00

2.4L & 2.2L TDCi diesel models from (VIN) 7A000001 to DA444246 -

Includes oil filter, air filter, fuel filter & sump plug				
Bearmach	1	<b>LL1539BM</b>	19.17	23.00
Genuine	1	<b>LL1539</b>	77.50	93.00

2.2L TDCi diesel models from (VIN) DA444247 on - Includes oil filter, air filter, fuel filter & sump plug				
Britpart	1	<b>LL1539BPLATE</b>	21.67	26.00

All 3.9L V8 EFI petrol models - Includes oil filter, air filter, fuel filter & sump plug washer. Does not include spark plugs				
Genuine	1	<b>RD1209</b>	27.50	33.00

### DEFENDER 110 (1989 on)

## FILTRATION

### Oil Filter

All models with 200TDi diesel engine - Cartridge				
Aftermarket	1	<b>ERR3340P</b>	2.00	2.40
OEM	1	<b>ERR3340P1</b>	3.33	4.00
Genuine	1	<b>ERR3340</b>	10.82	12.98
All models with 300TDi diesel engine - Cartridge				
Aftermarket	1	<b>ERR3340P</b>	2.00	2.40
OEM	1	<b>ERR3340P1</b>	3.33	4.00
Genuine	1	<b>ERR3340</b>	10.82	12.98
All models with TD5 diesel engine up to (VIN) 6A999999 - Cartridge				
Aftermarket	1	<b>LPX100590P</b>	2.83	3.40
OEM	1	<b>LPX100590P1</b>	3.33	4.00
Genuine	1	<b>LPX100590</b>	8.08	9.70
Stubby	1	<b>LPX100590BPSTUB</b>	1.83	2.20
All models with V8 petrol engine - Cartridge				
Aftermarket	1	<b>ERR3340P</b>	2.00	2.40
OEM	1	<b>ERR3340P1</b>	3.33	4.00
Genuine	1	<b>ERR3340</b>	10.82	12.98
All models with 2.2L Puma diesel engine (VIN) DA444247 on				
Aftermarket	1	<b>LR058104P</b>	7.50	9.00
Genuine	1	<b>LR058104</b>	12.26	14.71
All 2.4L Puma diesel models - Element				
Aftermarket	1	<b>LR030778P</b>	3.00	3.60
OEM	1	<b>LR030778P1</b>	4.00	4.80
Genuine	1	<b>LR030778</b>	9.80	11.76

### Air Filter

All 200TDi diesel models				
Aftermarket	1	<b>NTC6660P</b>	5.63	6.76
OEM	1	<b>NTC6660P1</b>	7.50	9.00
Genuine	1	<b>NTC6660</b>	21.38	25.66
All 300TDi diesel models				
Aftermarket	1	<b>ESR2623P</b>	5.63	6.76
OEM	1	<b>ESR2623P1</b>	9.38	11.26
Genuine	1	<b>ESR2623</b>	19.52	23.42
All TD5 diesel models up to (VIN) 6A999999				
Aftermarket	1	<b>LR027408P</b>	2.50	3.00
OEM	1	<b>LR027408P1</b>	4.58	5.50
Genuine	1	<b>LR027408</b>	12.57	15.08
All V8 EFI petrol models				
Aftermarket	1	<b>RTC4683P</b>	3.25	3.90
OEM	1	<b>RTC4683P1</b>	5.63	6.76
Genuine	1	<b>RTC4683</b>	8.30	9.96
All V8 carburettor models				
Aftermarket	1	<b>RTC3479P</b>	9.58	11.50
Genuine	1	<b>RTC3479</b>	41.44	49.73
All models from (VIN) 7A000001 on				
Aftermarket	1	<b>PHE500060P</b>	3.00	3.60
OEM	1	<b>PHE500060P1</b>	7.50	9.00
Genuine	1	<b>PHE500060</b>	32.36	38.83

### Fuel Filter

All 200TDi diesel models with unheated fuel filter - Includes sealing ring				
Aftermarket	1	<b>AEU2147LP</b>	3.00	3.60
OEM	1	<b>AEU2147LP1</b>	4.38	5.26
Genuine	1	<b>AEU2147L</b>	13.78	16.54
All cold climates 200TDi diesel models with heated fuel filter - Includes sealing ring				
OEM	1	<b>RTC5938P1</b>	5.00	6.00
Genuine	1	<b>RTC5938</b>	17.49	20.99
All 300TDi diesel models with unheated fuel filter - Includes sealing ring				
Aftermarket	1	<b>AEU2147LP</b>	3.00	3.60
OEM	1	<b>AEU2147LP1</b>	4.38	5.26
Genuine	1	<b>AEU2147L</b>	13.78	16.54
All cold climates 300TDi diesel models with heated fuel filter - Includes sealing ring				
OEM	1	<b>RTC5938P1</b>	5.00	6.00
Genuine	1	<b>RTC5938</b>	17.49	20.99
All TD5 diesel models up to (VIN) 6A999999				
Aftermarket	1	<b>ESR4686P</b>	5.00	6.00
OEM	1	<b>ESR4686P1</b>	12.50	15.00
Genuine	1	<b>ESR4686</b>	39.80	47.76
All 2.5L petrol models - Element for in line filter assembly				
Aftermarket	1	<b>JS660LP</b>	1.33	1.60
Genuine	1	<b>JS660L</b>	3.06	3.67

### Fuel Filter Cont'd

All 2.8L 6 cyl petrol models - Internal threaded unions				
Aftermarket	1	<b>ESR4065P</b>	3.00	3.60
OEM	1	<b>ESR4065P1</b>	4.58	5.50
Genuine	1	<b>ESR4065</b>	14.85	17.82
All 3.5L V8 carb petrol models - Internal threaded unions				
Aftermarket	1	<b>ESR4065P</b>	3.00	3.60
OEM	1	<b>ESR4065P1</b>	4.58	5.50
Genuine	1	<b>ESR4065</b>	14.85	17.82
All 3.5L V8 carb petrol models - Element for in line filter assembly				
Aftermarket	1	<b>JS660LP</b>	1.33	1.60
Genuine	1	<b>JS660L</b>	3.06	3.67
All diesel models from (VIN) 7A000001 on				
Aftermarket	1	<b>WJ1500040P</b>	12.50	15.00
OEM	1	<b>WJ1500040P1</b>	15.83	19.00
Genuine	1	<b>WJ1500040</b>	36.72	44.06
All V8 Efi petrol models - Internal threaded unions				
Aftermarket	1	<b>ESR4065P</b>	3.00	3.60
OEM	1	<b>ESR4065P1</b>	4.58	5.50
Genuine	1	<b>ESR4065</b>	14.85	17.82

### Fuel Filter Complete Assembly

All 200TDi diesel models				
Aftermarket	1	<b>WJN500180P1</b>	50.00	60.00
Genuine	1	<b>WJN500180</b>	98.37	118.04
All 300TDi diesel models				
Genuine	1	<b>WJN500180</b>	98.37	118.04
Aftermarket	1	<b>WJN500180P1</b>	50.00	60.00
All 2.5L petrol models				
Aftermarket	1	<b>NRC9786P</b>	16.88	20.26
Genuine	1	<b>NRC9786</b>	98.07	117.68
All 3.5L V8 carb petrol models				
Aftermarket	1	<b>NRC9786P</b>	16.88	20.26
Genuine	1	<b>NRC9786</b>	98.07	117.68
All diesel engine models up to (VIN) 6A999999 - Sedimentor type				
Aftermarket	1	<b>NRC9708P</b>	17.08	20.50
OEM	1	<b>NRC9708P1</b>	26.67	32.00
Genuine	1	<b>NRC9708</b>	76.51	91.81

### Fuel Filter Assembly

All models with 2.4L or 2.2L Puma diesel engines - Cartridge and filter head				
Aftermarket	1	<b>WJN500190BPHSG</b>	24.58	29.50

### Fuel Filter Seal

All diesel engine models up to (VIN) 6A999999 - Top, for sedimentor filter				
Aftermarket	1	<b>AAU9903P</b>	0.33	0.40
Genuine	1	<b>AAU9903</b>	1.78	2.14
All diesel engine models up to (VIN) 6A999999 - Bottom, for sedimentor filter				
Aftermarket	1	<b>AAU9902P</b>	0.58	0.70
Genuine	1	<b>AAU9902</b>	1.78	2.14
All diesel models to (VIN) 6A999999				
Genuine	1	<b>605011</b>	0.32	0.38

### Air Bleed Valve Fuel Filter

2.5L TD5 diesel models				
Genuine	1	<b>WJN500110</b>	15.47	18.56

### EGR Air Filter

All 2.5L TD5 diesel engine models up to (VIN) XA175541				
Genuine	1	<b>ESR4323</b>	2.93	3.52



ESR4065



RTC3479P

### DEFENDER 110 (1989 on)

## WIPER BLADES

### Wiper Blade

All models - Front and rear, hook fitting				
Aftermarket	3	<b>LR079891P</b>	2.33	2.80
OEM	3	<b>LR079891P1</b>	3.08	3.70
Genuine	3	<b>LR079891</b>	9.31	11.17





# SCREEN/LAMP WASHER SYSTEMS

# DEFENDER 110 (1989 on)

## Washer Jet

All models with rear screen wash				
Rear screen	Aftermarket	1	<b>LR061678P</b>	2.25 2.70
	Genuine	1	<b>LR061678</b>	5.32 6.38
All models from (VIN) AA270227 to WA159806				
Front screen, twin jet type	Aftermarket	1	<b>LR061677P</b>	2.00 2.40
	Genuine	1	<b>LR061677</b>	7.80 9.36

## Washer Jet Repair Kit

All models - Front screen wash				
	Genuine	1	<b>DNJ500270</b>	9.49 11.39
<i>Twin nozzle jet - allows replacement of broken outer section without having to remove dash top to replace whole assembly. DNJ500290 adhesive also required.</i>				

## Washer Pumps

All non air conditioning models with rear screen wash up to (VIN) WA159806				
Rear screen	Aftermarket	1	<b>STC1453P</b>	4.00 4.80
All models up to (VIN) WA159806 with air conditioning				
Front or rear screen wash	Aftermarket	1	<b>GWW1194</b>	7.50 9.00
All models with air conditioning or with headlamp wash up to (VIN) WA159806				
	Genuine	1	<b>DRC2713L</b>	40.97 49.16
All models from (VIN) XA159807 on				
Front screen	OEM	1	<b>DMC100550P1</b>	5.00 6.00
	Genuine	1	<b>DMC100550</b>	29.38 35.26
Rear screen	OEM	1	<b>DMC100540P1</b>	6.04 7.25
	Genuine	1	<b>DMC100540</b>	29.41 35.29
Military TD5 (Wolf/XD) - Front screen, 24V	Aftermarket	1	<b>PRC3615P</b>	12.50 15.00
	Genuine	1	<b>PRC3615</b>	29.29 35.15

## Windscreen Washer Pump Link Lead

All models without air conditioning or headlamp wash up to (VIN) WA159806				
<i>Fit with STC1453 pump as replacement for original windscreen washer pump</i>				
	Aftermarket	1	<b>AMR3849P</b>	5.42 6.50
	Genuine	1	<b>AMR3849</b>	11.05 13.26

## Washer Hose Non Return Valve

All models from (VIN) XA159807 on - Fits in-line in 4mm dia. hose				
	Aftermarket	1	<b>AMR6676P</b>	1.42 1.70
	Genuine	1	<b>AMR6676</b>	3.26 3.91

## Pump to Valve Hose

All models from (VIN) XA159807 on				
Front screen wash	Genuine	1	<b>DNC101720</b>	39.81 47.77

## Washer Hose, Per Metre

All models - 4mm internal diameter (3mm also available).				
Front or rear screen wash	Aftermarket	a/r	<b>GWW201M</b>	2.25 2.70

## Washer Reservoir Cap

All models with air conditioning or with headlamp wash up to (VIN) WA159806 - 45mm dia.				
	Genuine	1	<b>DMG10005L</b>	3.10 3.72
All models from (VIN) XA159807 on				
Front & rear screen wash	OEM	1	<b>DMG10001LP1</b>	4.79 5.75
	Genuine	1	<b>DMG10001L</b>	5.73 6.88

## Washer Reservoir

All models without air conditioning or headlamp wash up to (VIN) WA159806				
Front screen wash	Genuine	1	<b>PRC5744</b>	33.26 39.91
All models with rear screen wash/wipe and headlamp wash without air conditioning up to (VIN) WA159806				
Front & rear screen & headlamp wash	Genuine	1	<b>PRC5777</b>	42.63 51.16
All models with rear screen wash/wipe with air conditioning up to (VIN) WA159806				
Front & rear screen wash	Genuine	1	<b>PRC5765</b>	89.57 107.48
All models with headlamp wash with air conditioning up to (VIN) WA159806				
Front screen & headlamp wash	Genuine	1	<b>PRC5773</b>	94.77 113.72
All models without rear screen wash from (VIN) XA159807 on				
Front screen wash	Genuine	1	<b>DMB500130</b>	32.23 38.68
All models with rear screen wash from (VIN) XA159807 on				
Front & rear screen wash	Genuine	1	<b>DMB500120</b>	51.38 61.66
All models with rear screen wash/wipe and headlamp wash (South Africa, Sweden) up to (VIN) LA647644				
Front screen wash	Genuine	1	<b>PRC5744</b>	33.26 39.91
Rear screen & headlamp wash	Genuine	1	<b>PRC5773</b>	94.77 113.72

## Windscreen Cleaning Paste

All models - Prevents wiper blade judder/squeak by 'deep cleaning' the windscreen				
<i>(ref. Land Rover Tech Bulletin LRA501-002)</i>				
	Genuine	a/r	<b>DNJ500340</b>	7.72 9.26

# DRIVE BELTS

# DEFENDER 110 (1989 on)

## Timing Belt Kit Complete

All 300 TDi diesel models to (VIN) VA101257				
<i>Includes belt plus all parts to convert to later 300 TDi belt alignment method</i>				
	Aftermarket	1	<b>STC4095LP</b>	155.83 187.00

## Timing Belt Kit

All 200 TDi diesel models	Bearmach	1	<b>ETC8550KITBDEF</b>	32.50 39.00
All 300 TDi diesel models	Aftermarket	1	<b>STC4096LP</b>	47.50 57.00
	OEM	1	<b>STC4096LP1</b>	65.00 78.00
	Bearmach	1	<b>STC4096BM</b>	68.33 82.00
	Genuine	1	<b>STC4096L</b>	122.95 147.54
All 300 TDi diesel models up to (VIN) VA117353				
	Britpart	1	<b>ERR1092KITBPEARLY</b>	22.50 27.00
All 300 TDi diesel models from (VIN) VA117354 on				
	Britpart	1	<b>ERR1092KITBPLATE</b>	22.50 27.00

## Timing Belt

All models with 200TDi diesel engine	OEM	1	<b>ETC8550P1</b>	12.92 15.50
	Genuine	1	<b>ETC8550</b>	38.00 45.60
All models with 300TDi diesel engine	Aftermarket	1	<b>ERR1092P</b>	6.88 8.26
	OEM	1	<b>ERR1092P1</b>	10.63 12.76
	Genuine	1	<b>ERR1092</b>	38.02 45.62

## Primary Drive Belt

Non-air conditioned models with 2.2L Puma diesel engine (VIN) CA000001 on - Primary				
	Genuine	1	<b>LR031361</b>	43.62 52.34
Air conditioned models with 2.2L Puma diesel engine (VIN) CA000001 on - Primary				
	Genuine	1	<b>LR031360</b>	43.62 52.34

## PAS Drive Belt

All models with V8 carb engine - Power steering				
	Aftermarket	1	<b>ERC675P</b>	2.83 3.40
	OEM	1	<b>ERC675P1</b>	3.33 4.00
	Genuine	1	<b>ERC675</b>	21.28 25.54

## A/C Drive Belt

All models with 300TDi diesel engine and air conditioning - Air cond compressor				
	Aftermarket	1	<b>ERR2215P</b>	3.50 4.20
	OEM	1	<b>ERR2215P1</b>	5.63 6.76
	Genuine	1	<b>ERR2215</b>	13.13 15.76
All Australia 300 TDi diesel models with air conditioning - Air cond compressor				
	Genuine	1	<b>HYM627</b>	30.68 36.82
All Australia 2.5L TD5 diesel models from (VIN) XA159807 to 2A999999 with Australia only accessory air conditioning kit - Air cond compressor				
	Genuine	1	<b>HYM1132</b>	26.48 31.78
All V8 carb models with air conditioning - Air cond compressor				
	Aftermarket	1	<b>603713P</b>	2.67 3.20

## Alternator Drive Belt

All models with 200TDi diesel engine - Alternator				
	Aftermarket	1	<b>ETC7939P</b>	2.25 2.70
	OEM	1	<b>ETC7939P1</b>	3.83 4.60
	Genuine	1	<b>ETC7939</b>	15.73 18.88
All 300 TDi diesel models up to (VIN) MA169102 except Australia - Alternator with 61mm dia. pulley				
	Aftermarket	1	<b>PQS000030P</b>	4.00 4.80
	OEM	1	<b>PQS000030P1</b>	8.13 9.76
	Genuine	1	<b>PQS000030</b>	30.72 36.86
All 300 TDi diesel models from (VIN) TA169103 except Australia - Alternator with 49mm dia. pulley				
	Aftermarket	1	<b>PQS000040P</b>	4.79 5.75
	OEM	1	<b>PQS000040P1</b>	7.50 9.00
	Genuine	1	<b>PQS000040</b>	30.72 36.86
All models with TD5 diesel engine without air conditioning up to (VIN) 6A999999 - Alternator				
	Aftermarket	1	<b>PQS101490P</b>	6.67 8.00
	OEM	1	<b>PQS101490P1</b>	10.00 12.00
	Genuine	1	<b>PQS101490</b>	23.02 27.62
All models with TD5 diesel engine with air conditioning up to (VIN) 6A999999 - Alternator				
	Aftermarket	1	<b>PQS101500P</b>	6.04 7.25
	OEM	1	<b>PQS101500P1</b>	8.75 10.50
	Genuine	1	<b>PQS101500</b>	23.02 27.62
Models with V8 carb engine and air conditioning - Alternator				
	Aftermarket	1	<b>ERR2073P</b>	2.83 3.40
	Genuine	1	<b>ERR2073</b>	7.86 9.43
All models with V8 EFI engine with air conditioning - Alternator				
	Aftermarket	1	<b>ERR5579P</b>	5.63 6.76
	OEM	1	<b>ERR5579P1</b>	13.75 16.50
	Genuine	1	<b>ERR5579</b>	28.36 34.03
All models with 2.4L Puma diesel without air conditioning - Alternator				
	Genuine	1	<b>PQS500610</b>	34.24 41.09
2.4L TDCi Puma diesel models with air conditioning - Alternator				
	OEM	1	<b>PQS500600P1</b>	17.08 20.50
	Genuine	1	<b>PQS500600</b>	34.54 41.45
Military 24V models with 300TDi diesel engine - Alternator				
	Genuine	1	<b>ERR6005</b>	21.54 25.85

## Fan Belt

All 300TDi diesel engines up to (engine) 16L25164 - Fan				
	Aftermarket	1	<b>ERR3287P</b>	5.83 7.00
	OEM	1	<b>ERR3287P1</b>	10.00 12.00
	Genuine	1	<b>ERR3287</b>	21.64 25.97
All 300TDi diesel engines from (engine) 16L25165 on - Fan				
	Aftermarket	1	<b>ERR5911P</b>	7.08 8.50
	OEM	1	<b>ERR5911P1</b>	10.63 12.76
	Genuine	1	<b>ERR5911</b>	19.60 23.52
All Australia 300 TDi diesel models up to (engine) 16L25164 - Fan				
	Genuine	1	<b>HYM895</b>	30.68 36.82
All Australia 300 TDi diesel models from (engine) 16L25165 on - Fan				
	Genuine	1	<b>HYM1174</b>	30.68 36.82



**DEFENDER 110 (1989 on)****IGNITION SYSTEM****Spark Plug**

All V8 carb petrol engine models - N12Y type	Aftermarket	8	<b>RTC3570P</b>	1.83	2.20
	Genuine	8	<b>RTC3570X</b>	3.25	3.90
All V8 carb petrol models with 8.13:1 compression ratio, std performance 19mm reach	MG Rover	8	<b>GSP4382</b>	2.95	3.54
	MG Rover	8	<b>GSP4362</b>	2.95	3.54
All V8 carb petrol models with 9.35:1 compression ratio, std performance 19mm reach	MG Rover	8	<b>GSP4362</b>	2.95	3.54
	MG Rover	8	<b>GSP6462</b>	2.95	3.54
All V8 carb petrol models with 9.35:1 compression ratio, high performance 9mm reach, double core	MG Rover	8	<b>GSP6462</b>	2.95	3.54
	Aftermarket	8	<b>ERR3799P</b>	2.00	2.40
All V8 petrol engine models - RN11YC type	Aftermarket	8	<b>ERR3799P</b>	2.00	2.40
	Genuine	8	<b>ERR3799</b>	4.19	5.03

**Glow Plug**

All 2.5L 200 TDi and 300 TDi diesel models	Aftermarket	4	<b>ETC8847P</b>	3.00	3.60
	OEM	4	<b>ETC8847P1</b>	8.75	10.50
	Genuine	4	<b>ETC8847</b>	33.60	40.32
All 2.2L TDCi Puma diesel models	Genuine	4	<b>LR029960</b>	10.72	12.86
All 2.4L TDCi Puma diesel engine models	Aftermarket	4	<b>LR004377P</b>	6.88	8.26
	OEM	4	<b>LR004377P1</b>	10.00	12.00
	Genuine	4	<b>LR004377</b>	15.47	18.56
	Genuine	4	<b>ERR4084</b>	29.15	34.98
Military models with 300 TDi diesel engine	Genuine	4	<b>ERR4084</b>	29.15	34.98
Military XD/Wolf	Genuine	4	<b>STC7418</b>	224.42	269.30

**Glow Plug Cable**

All 200 TDi and 300 TDi diesel models	Genuine	4	<b>AMR2425</b>	13.13	15.76
---------------------------------------	---------	---	----------------	-------	-------

**Ignition Coil**

All V8 carb petrol engine models Lucas type	Aftermarket	1	<b>RTC5628P</b>	9.58	11.50
	OEM	1	<b>RTC5628P1</b>	14.58	17.50
	Genuine	1	<b>RTC5628</b>	94.86	113.83
Bosch type	Aftermarket	1	<b>PRC6574P</b>	15.83	19.00
	OEM	1	<b>PRC6574P1</b>	39.58	47.50
	Genuine	1	<b>PRC6574</b>	114.80	137.76
All V8 EFI petrol engine models - GEMs system	Aftermarket	1	<b>ERR6269P</b>	59.17	71.00
	Genuine	1	<b>ERR6269</b>	459.47	551.36

**Adjustment Bush, Contact Set**

All V8 petrol models with points type distributor - For sliding points type distributor	Genuine	1	<b>RTC5014</b>	1.33	1.60
-----------------------------------------------------------------------------------------	---------	---	----------------	------	------

**Rotor Arm**

All V8 carb petrol models with points type distributor	Aftermarket	1	<b>RTC3618P</b>	2.00	2.40
	Aftermarket	1	<b>STC1857P</b>	2.33	2.80
All V8 petrol engines with electronic ignition	OEM	1	<b>STC1857P1</b>	9.58	11.50
	Genuine	1	<b>STC1857</b>	15.18	18.22
	Red	OEM	1	<b>GRA117RED</b>	7.50

**Distributor Cap**

All V8 petrol engine models	Aftermarket	1	<b>GDC117P</b>	5.00	6.00
	Aftermarket	1	<b>GDC117</b>	10.42	12.50
	OEM	1	<b>GDC117P1</b>	16.04	19.25
	Genuine	1	<b>GDC1170E</b>	32.94	39.53

**Amplifier Link Lead**

V8 petrol engine with 2 pin integral amp type 35DLM8 distributor - Amplifier to coil, converts 3 pin to 2 pin	Aftermarket	1	<b>STC1212P</b>	24.58	29.50
	OEM	1	<b>PRC6144P1</b>	36.25	43.50
All 3.5L V8 petrol models with electronic ignition with 2 pin integral amplifier (2 pin plug) - Amplifier to coil, lead identified by 2 pin plug connector	OEM	1	<b>PRC6144</b>	40.55	48.66

**Amplifier Module & Link Lead**

V8 petrol engine with 2 pin integral amp type 35DLM8 distributor - Included link lead converts 3 pin to 2 pin	Britpart	1	<b>STC1184KBP</b>	24.58	29.50
---------------------------------------------------------------------------------------------------------------	----------	---	-------------------	-------	-------

**Amplifier Module**

V8 petrol engine with 3 pin integral amp type 35DLM8 distributor	Aftermarket	1	<b>STC1184P</b>	14.58	17.50
	Genuine	1	<b>STC1184</b>	136.26	163.51

**Amplifier Plug**

V8 petrol engine with 3 pin integral amp type 35DLM8 distributor - 3 pin, for STC1184	OEM	1	<b>STC1184P1</b>	22.50	27.00
---------------------------------------------------------------------------------------	-----	---	------------------	-------	-------

**Pick Up & Baseplate, Distributor**

All V8 carb petrol models with electronic ignition with 3 pin integral amplifier	Aftermarket	1	<b>RTC5090P</b>	15.63	18.76
	OEM	1	<b>RTC5090P1</b>	67.50	81.00
	Genuine	1	<b>RTC5090</b>	130.55	156.66
All USA/CDN/Mex 3.5L V8 EFI petrol models with with 3 pin integral amplifier	Aftermarket	1	<b>RTC5090P</b>	15.63	18.76
	OEM	1	<b>RTC5090P1</b>	67.50	81.00
	Genuine	1	<b>RTC5090</b>	130.55	156.66

**Vacuum Unit, Distributor**

V8 carb petrol engines (eng) 20G, 24G only with 2 pin amp type distributor	Aftermarket	1	<b>RTC3201P</b>	29.58	35.50
	Genuine	1	<b>RTC3201</b>	121.09	145.31
	Aftermarket	1	<b>608266P</b>	35.00	42.00
V8 carb petrol engines (eng) 17G, 22G only	Genuine	1	<b>608266</b>	97.18	116.62
	All detoxed V8 petrol models (eng) 20G/24G with 3 pin amplifier	Aftermarket	1	<b>RTC5092P</b>	33.33
Genuine		1	<b>RTC5092</b>	181.12	217.34

**Suppressor, Coil**

All V8 carb petrol models	Aftermarket	1	<b>ADU7242LP</b>	3.75	4.50
---------------------------	-------------	---	------------------	------	------

**Distributor Drive Gear & Coupling**

All V8 Carb petrol engine models - On distributor	Aftermarket	1	<b>ERC1353A</b>	27.50	33.00
---------------------------------------------------	-------------	---	-----------------	-------	-------

**Distributor Drive Gear**

All V8 Carb petrol engine models - On camshaft	Aftermarket	1	<b>614188A</b>	22.50	27.00
------------------------------------------------	-------------	---	----------------	-------	-------

**O Ring Distributor**

All V8 carb petrol models	Aftermarket	1	<b>603446P</b>	2.50	3.00
	Genuine	1	<b>603446</b>	7.27	8.72

**Ignition Lead Set**

All V8 carb petrol engine models - Silicone	Aftermarket	1	<b>RTC6551P</b>	11.67	14.00	
	OEM	1	<b>RTC6551P1</b>	19.58	23.50	
	Red	Aftermarket	1	<b>RTC6551PS</b>	16.67	20.00
	Black	Aftermarket	1	<b>GHT206S</b>	25.83	31.00
	Performance Red	OEM	1	<b>RTC6551P1S</b>	32.50	39.00



RTC3570P



ETC8847P



RTC5628P



STC1184KBP



RTC6551P1S



# BRAKING SYSTEM

## Brake Pad Set

All models up to (VIN) KA930455				
Front Brakes	Aftermarket	1	<b>STC2952P</b>	13.96 16.75
	OEM	1	<b>STC2952P1</b>	23.75 28.50
	Genuine	1	<b>STC2952</b>	59.49 71.39
Front Brakes, Green Stuff	EBC	1	<b>STC2952GS</b>	32.50 39.00
All models from (VIN) LA930456 on				
Front Brakes	Aftermarket	1	<b>SFP000260P</b>	13.54 16.25
	Brembo	1	<b>SFP000260BREMBO</b>	32.65 39.18
	Genuine	1	<b>SFP000260</b>	76.90 92.28
All models from (VIN) LA930456 to 1A614447				
Rear Brakes, Solid Discs,	Aftermarket	1	<b>SFP000280P</b>	8.96 10.75
	OEM	1	<b>SFP000280P1</b>	15.42 18.50
	Genuine	1	<b>SFP000280</b>	53.20 63.84
Rear Brakes, Solid Discs, Green Stuff	EBC	1	<b>SFP000280GS</b>	29.58 35.50
All models from (VIN) 1A614448 on				
Rear Brakes	Aftermarket	1	<b>SFP000250P</b>	11.04 13.25
	Mintex	1	<b>SFP000250P1</b>	16.88 20.26
	Genuine	1	<b>SFP000250</b>	50.18 60.22

## Brake Shoe Set

All models up to (VIN) KA930455				
Rear Brakes	Aftermarket	1	<b>STC2797P</b>	11.67 14.00
	OEM	1	<b>STC2797P1</b>	25.83 31.00
	Genuine	1	<b>STC2797</b>	191.25 229.50

## Brake Linings Set

All models with rear drum brakes - Set of 4, with rivets, rear brakes				
	Aftermarket	1	<b>STC2795P</b>	3.50 4.20
	Genuine	1	<b>STC2795</b>	49.44 59.33
All models up to (VIN) KA930455 - Set of 4, with rivets, 11" dia brakes				
	Aftermarket	1	<b>STC3944P</b>	12.50 15.00

## Brake Pad Fitting Kit

All models with vented discs from (VIN) LA930456 on				
Front Vented Disc Brakes	Aftermarket	1	<b>STC8575P</b>	2.83 3.40
	Genuine	1	<b>STC8575</b>	5.01 6.01
All models from (VIN) LA930456				
Rear Disc Brakes	Aftermarket	1	<b>STC8574P</b>	3.33 4.00
All models from (VIN) LA930456 to 1A614447				
Rear Brakes, Solid Discs	OEM	1	<b>SFP000280FKP1</b>	4.58 5.50

## Spring and Pin Kit

All models with non-vented front disc brakes				
Front brake pad retention	Aftermarket	1	<b>RTC5001P</b>	3.33 4.00
	Genuine	1	<b>RTC5001</b>	12.33 14.80

## Brake Shoe Retaining Spring

All models with rear drum brakes	Genuine	1	<b>236993</b>	8.66 10.39
----------------------------------	---------	---	---------------	------------

## Brake Adjuster Kit

All models with rear drum brakes				
Rear axle set	Aftermarket	1	<b>RTC3176P</b>	10.83 13.00
	Genuine	1	<b>RTC3176</b>	109.72 131.66

## Brake Disc (each)

All models with non-vented front disc brakes - Front,				
Not Vented	Aftermarket	2	<b>LR017951P</b>	13.75 16.50
	Genuine	2	<b>LR017951</b>	52.35 62.82
Not Vented (pair)	Brembo	1	<b>LR017951BREMBO</b>	50.00 60.00
Not Vented, slotted & drilled (pair)	Britpart	1	<b>LR017951URBP</b>	39.58 47.50
Vented disc brake models from (VIN) LA930456 to 9A777776 - Front,				
Vented	Aftermarket	2	<b>LR017952P</b>	16.04 19.25
	OEM	2	<b>LR017952P1</b>	25.00 30.00
	Genuine	2	<b>LR017952</b>	58.71 70.45
Vented (pair)	Brembo	1	<b>LR017952BREMBO</b>	72.50 87.00
Performance, Vented, slotted & drilled (pair)	Britpart	1	<b>LR017952URBP</b>	50.00 60.00
Vented disc brake models from (VIN) LA930456 to 9A777776 - Front				
All models with non-vented rear disc brakes up to (VIN) WA159806 - Rear				
Not Vented	Aftermarket	2	<b>FTC3846P</b>	13.54 16.25
	OEM	2	<b>FTC3846P1</b>	20.83 25.00
	Genuine	2	<b>FTC3846</b>	43.03 51.64

## Mudshield Brake Disc

All models from (VIN) TA989187 on				
Front RH	Aftermarket	1	<b>FTC4838P</b>	10.00 12.00
	Genuine	1	<b>FTC4838</b>	10.69 12.83
Front LH	Aftermarket	1	<b>FTC4839P</b>	15.42 18.50
	Genuine	1	<b>FTC4839</b>	16.82 20.18
All models with rear disc brakes - RH rear	Genuine	1	<b>LR017960</b>	24.10 28.92
All models (VIN) LA930456 on - LH rear	Genuine	1	<b>LR017961</b>	24.10 28.92

## Brake Drum

All models up to (VIN) KA930455 - Rear	Aftermarket	2	<b>576973P</b>	17.50 21.00
	Genuine	2	<b>576973</b>	90.40 108.48



SFP000260P



FTC4838P



STC2797P

## Brake Caliper

Up to (axle) 22L09654 RHD				
Right Hand Front	Aftermarket	1	<b>RTC3380P</b>	115.00 138.00
	Genuine*	1	<b>RTC3380</b>	430.98 517.18
			*Exchange Surcharge	50.00 60.00
Left Hand Front	Aftermarket	1	<b>RTC3381P</b>	115.00 138.00
	Genuine*	1	<b>RTC3381</b>	430.98 517.18
			*Exchange Surcharge	50.00 60.00
Up to (axle) 23L05987 LHD				
Right Hand Front	Aftermarket	1	<b>RTC3380P</b>	115.00 138.00
	Genuine*	1	<b>RTC3380</b>	430.98 517.18
			*Exchange Surcharge	50.00 60.00
Left Hand Front	Aftermarket	1	<b>RTC3381P</b>	115.00 138.00
	Genuine*	1	<b>RTC3381</b>	430.98 517.18
			*Exchange Surcharge	50.00 60.00
All RHD from (axle) 20L21633B to (VIN) KA930455 - Solid Disc Brakes				
Right Hand Front	Aftermarket	1	<b>SEB500440P</b>	39.58 47.50
	OEM	1	<b>SEB500440P1</b>	120.00 144.00
	Genuine*	1	<b>SEB500440</b>	362.04 434.45
			*Exchange Surcharge	50.00 60.00
Left Hand Front	Aftermarket	1	<b>SEB500450P</b>	39.58 47.50
	OEM	1	<b>SEB500450P1</b>	120.00 144.00
	Genuine*	1	<b>SEB500450</b>	362.04 434.45
			*Exchange Surcharge	50.00 60.00
All LHD from (axle) 21L18649B to (VIN) KA930455 - Solid Disc Brakes				
Right Hand Front	Aftermarket	1	<b>SEB500440P</b>	39.58 47.50
	OEM	1	<b>SEB500440P1</b>	120.00 144.00
	Genuine*	1	<b>SEB500440</b>	362.04 434.45
			*Exchange Surcharge	50.00 60.00
Left Hand Front	Aftermarket	1	<b>SEB500450P</b>	39.58 47.50
	OEM	1	<b>SEB500450P1</b>	120.00 144.00
	Genuine*	1	<b>SEB500450</b>	362.04 434.45
			*Exchange Surcharge	50.00 60.00
(VIN) HA701010 to (VIN) KA930455				
Right Hand Front	Aftermarket	1	<b>RTC5572P</b>	48.33 58.00
	Genuine*	1	<b>RTC5572</b>	446.84 536.21
			*Exchange Surcharge	50.00 60.00
Left Hand Front	Aftermarket	1	<b>RTC5573P</b>	48.33 58.00
	Genuine*	1	<b>RTC5573</b>	446.84 536.21
			*Exchange Surcharge	50.00 60.00
All models from (VIN) LA930456 on - Vented Disc Brakes				
Right Hand Front	Aftermarket	1	<b>SEB500460P</b>	37.50 45.00
	OEM	1	<b>SEB500460P1</b>	90.00 108.00
	Genuine*	1	<b>SEB500460</b>	406.37 487.64
			*Exchange Surcharge	50.00 60.00
Left Hand Front	Aftermarket	1	<b>SEB500470P</b>	37.50 45.00
	OEM	1	<b>SEB500470P1</b>	90.00 108.00
	Genuine*	1	<b>SEB500470</b>	406.37 487.64
			*Exchange Surcharge	50.00 60.00
All models from (VIN) BA to 1A614447 - Vented Disc Brakes				
Right Hand Rear	Aftermarket	1	<b>STC1268P</b>	29.58 35.50
	Genuine*	1	<b>STC1268</b>	125.04 150.05
			*Exchange Surcharge	50.00 60.00
Left Hand Rear	Aftermarket	1	<b>STC1269P</b>	29.58 35.50
	Genuine*	1	<b>STC1269</b>	125.04 150.05
			*Exchange Surcharge	50.00 60.00
All models from (VIN) 1A614448 on				
Right Hand Rear	Aftermarket	1	<b>SMC500270P</b>	60.00 72.00
	OEM	1	<b>SMC500270P1</b>	95.00 114.00
	Genuine*	1	<b>SMC500270</b>	256.03 307.24
			*Exchange Surcharge	50.00 60.00
Left Hand Rear	Aftermarket	1	<b>SMC500260P</b>	60.00 72.00
	OEM	1	<b>SMC500260P1</b>	95.00 114.00
	Genuine*	1	<b>SMC500260</b>	256.03 307.24
			*Exchange Surcharge	50.00 60.00

## Brake Caliper Piston

All RHD from (axle) 20L21633B to (VIN) KA930455 - Front, Vented Disc Brakes				
Standard Material	Aftermarket	4	<b>STC201P</b>	3.00 3.60
	OEM	4	<b>STC201P1</b>	4.00 4.80
	Genuine	4	<b>STC201</b>	21.60 25.92
Stainless Steel Material	Aftermarket	4	<b>STC201SS</b>	8.13 9.76
All LHD from (axle) 21L18649B to (VIN) KA930455 - Front, Vented Disc Brakes				
Standard Material	Aftermarket	4	<b>STC201P</b>	3.00 3.60
	OEM	4	<b>STC201P1</b>	4.00 4.80
	Genuine	4	<b>STC201</b>	21.60 25.92
Stainless Steel Material	Aftermarket	4	<b>STC201SS</b>	8.13 9.76





**DEFENDER 110 (1989 on)****BRAKING SYSTEM****Dust Cap Bleed Screw**

All models - Blue, front caliper bleed nipple	Genuine	2	<b>594091</b>	4.66	5.59
-----------------------------------------------	---------	---	---------------	------	------

**Bleed Nipple for Caliper**

All models - Front & rear	Aftermarket	2	<b>SMG000010P</b>	2.58	3.10
	Genuine	2	<b>SMG000010</b>	4.28	5.14

**Bleed Nipple**

All models (VIN) LA930456 to 1A622423 - Rear brake caliper	Aftermarket	2	<b>RTC1526P</b>	1.83	2.20
	Genuine	2	<b>RTC1526</b>	2.77	3.32

**Wheel Cylinder**

Up to (VIN) KA930545 Right Hand Rear	Aftermarket	1	<b>RTC3626P</b>	6.88	8.26
	OEM	1	<b>RTC3626P1</b>	16.88	20.26
	Genuine	1	<b>RTC3626</b>	28.45	34.14
Left Hand Rear	Aftermarket	1	<b>RTC3627P</b>	6.88	8.26
	OEM	1	<b>RTC3627P1</b>	16.88	20.26
	Genuine	1	<b>RTC3627</b>	28.45	34.14

**Wheel Cylinder Repair Kit**

All models to (VIN) KA930455 - Rear	Aftermarket	2	<b>AEU2498P</b>	2.08	2.50
-------------------------------------	-------------	---	-----------------	------	------

**Bleed Screw Wheel Cylinder**

All models - Rear	Genuine	2	<b>608400</b>	4.83	5.80
-------------------	---------	---	---------------	------	------

**Brake Master Cylinder**

Without ABS up to (VIN) HA901219 <i>Does not include reservoir</i>	Aftermarket	1	<b>NRC8690P</b>	26.67	32.00
	OEM	1	<b>NRC8690P1</b>	85.00	102.00
	Genuine	1	<b>NRC8690</b>	162.68	195.22
Without ABS, from (VIN) HA901220 to XA178473	Aftermarket	1	<b>LR013018P</b>	31.67	38.00
	OEM	1	<b>LR013018P1</b>	60.00	72.00
	Genuine	1	<b>LR013018</b>	183.55	220.26
All models with ABS	OEM	1	<b>LR013017P1</b>	135.00	162.00
	Genuine	1	<b>LR013017</b>	216.26	259.51

**Master Cylinder Repair Kit**

All models to (VIN) 5A701192 - Brake master cylinder	Aftermarket	1	<b>GRK1027P</b>	2.08	2.50
------------------------------------------------------	-------------	---	-----------------	------	------

All models to (VIN) HA901219 - Brake master cylinder	Aftermarket	1	<b>AEU3015P</b>	2.50	3.00
	OEM	1	<b>AEU3015P1</b>	27.50	33.00
	Genuine	1	<b>AEU3015</b>	51.70	62.04
All models from (VIN) HA901220 to XA178473	OEM	1	<b>STC491P1</b>	25.83	31.00
	Genuine	1	<b>STC491</b>	25.83	31.00
All models with type 50 servo to (VIN) HA701009 - Type 50 servo (227mm dia servo)	Aftermarket	1	<b>18G8951A</b>	11.25	13.50

**Reservoir Brake Master Cylinder**

All models (VIN) HA701010 on	Genuine	1	<b>SJJ100351</b>	40.76	48.91
------------------------------	---------	---	------------------	-------	-------

**Brake Fluid Reservoir**

All models to (VIN) HA901219	Aftermarket	1	<b>AEU1045P</b>	21.67	26.00
------------------------------	-------------	---	-----------------	-------	-------

**Brake Servo Assembly**

Without ABS up to (VIN) HA901219 - Type 80, 276mm dia, non-return valve at top left	Aftermarket	1	<b>NRC4772P</b>	45.00	54.00
	Genuine	1	<b>NRC4772</b>	351.11	421.33
	Aftermarket	1	<b>STC2878P</b>	55.00	66.00
	Genuine	1	<b>STC2878</b>	605.11	726.13
	Without ABS, from (VIN) HA901220 to WA159806	Aftermarket	1	<b>LR013488P</b>	58.33
OEM		1	<b>LR013488P1</b>	67.50	81.00
Genuine		1	<b>LR013488</b>	184.40	221.28
All models from (VIN) XA159807	Genuine	1	<b>SJG100240</b>	259.46	311.35
	Without ABS up to (VIN) HA901219 - 2 Port type	Aftermarket	1	<b>NRC4775P</b>	50.00

**Servo Repair Kit**

All models with type 80 servo to (VIN) HA701009 - Type 80 servo (276mm dia servo)	Aftermarket	1	<b>AEU2741P</b>	3.50	4.20
	Genuine	1	<b>AEU2741</b>	42.66	51.19

**Seal Brake Servo**

All models	Genuine	1	<b>SJO100080</b>	3.47	4.16
------------	---------	---	------------------	------	------

**Servo Non-Return Valve**

All models from (VIN) HA701010 to WA159806	Genuine	1	<b>RTC812</b>	25.83	31.00
--------------------------------------------	---------	---	---------------	-------	-------

**Caliper Repair Kit**

All RHD models from (axle) 20L21633B on Front caliper, kit includes pistons	Aftermarket	2	<b>STC1280P</b>	9.58	11.50
	OEM	2	<b>STC1280P1</b>	49.17	59.00
	Genuine	2	<b>STC1280</b>	83.56	100.27
All LHD models from (axle) 21L18649B on Front caliper, kit includes pistons	Aftermarket	2	<b>STC1280P</b>	9.58	11.50
	OEM	2	<b>STC1280P1</b>	49.17	59.00
	Genuine	2	<b>STC1280</b>	83.56	100.27
All models (VIN) HA701010 on - Front	Aftermarket	2	<b>AEU2539P</b>	2.58	3.10
	OEM	2	<b>AEU2539P1</b>	8.13	9.76
	Genuine	2	<b>AEU2539</b>	10.01	12.01
All models from (VIN) LA930456 to 1A614447 Rear caliper, kit does not include pistons	Aftermarket	2	<b>STC1270P</b>	2.08	2.50
	OEM	2	<b>STC1270P1</b>	3.50	4.20
	Genuine	2	<b>STC1270</b>	5.97	7.16
All models from (VIN) LA930456 to 1A614447 Rear caliper, kit includes pistons	Aftermarket	2	<b>STC1281P</b>	5.00	6.00
	OEM	2	<b>STC1281P1</b>	39.58	47.50
	Genuine	2	<b>STC1281</b>	54.91	65.89
All models (VIN) 1A614448 on - Rear	Aftermarket	2	<b>SMN000060P1</b>	2.83	3.40
	OEM	2	<b>SMN000060P</b>	6.04	7.25
	Genuine	2	<b>SMN000060</b>	7.18	8.62

**Brake Hose**

All models up to (VIN) 6A999999 Front, rubber	Aftermarket	2	<b>NRC7874P</b>	3.00	3.60
	OEM	2	<b>NRC7874P1</b>	7.08	8.50
	Genuine	2	<b>NRC7874</b>	34.58	41.50
All models from (VIN) LA930456 to WA159806 Rear hose, rubber	Aftermarket	1	<b>NRC9456P</b>	3.33	4.00
	Genuine	1	<b>NRC9456</b>	40.34	48.41
ABS models from (VIN) XA159807 on Rear, RH, rubber	Aftermarket	1	<b>SHB101370P</b>	6.88	8.26
	Genuine	1	<b>SHB101370</b>	34.58	41.50
	Rear, LH, rubber	Aftermarket	1	<b>SHB101430P</b>	5.63
OEM		1	<b>SHB101430P1</b>	10.00	12.00
Genuine		1	<b>SHB101430</b>	34.58	41.50
Non ABS models from (VIN) XA159807 on Rear, rubber	Aftermarket	1	<b>SHB101370P</b>	6.88	8.26
	Genuine	1	<b>SHB101370</b>	34.58	41.50
All models without ABS (VIN) 7A000001 on Rear	OEM	1	<b>SHB500220P1</b>	17.50	21.00
	Genuine	1	<b>SHB500220</b>	32.94	39.53
All 4 cylinder models up to (VIN) LA930456 (200TDI) Clutch hose	Aftermarket	1	<b>RTC4425P</b>	2.50	3.00
	OEM	1	<b>RTC4425P1</b>	8.75	10.50
	Genuine	1	<b>RTC4425</b>	34.58	41.50

**Brake Pipe Clip**

All models - Double type Various applications	Aftermarket	a/r	<b>625521A</b>	1.25	1.50
	Genuine	a/r	<b>NTC1176</b>	0.71	0.85
	Genuine	a/r	<b>NTC9543L</b>	1.80	2.16
All models with rear drum brakes less ABS to (VIN) HA701009 Double	Genuine	a/r	<b>79125</b>	0.32	0.38
	All models without ABS to (VIN) HA901219 Triple	Genuine	a/r	<b>AFU1217</b>	1.24

**Brake/Clutch Pipe Clip**

All models - Double	Genuine	a/r	<b>NTC1175</b>	0.58	0.70
---------------------	---------	-----	----------------	------	------

**Brake Pipe T Piece**

All non-ABS models (VIN) XA159807 on - Rear axle	Aftermarket	a/r	<b>SGL100000P</b>	6.87	8.24
	Genuine	a/r	<b>SGL100000</b>	12.74	15.29



RTC3626P



STC1280P



# BRAKING SYSTEM

## 2-way Brake Pipe Connector

All non ABS models with solid discs - Rear	Genuine	a/r	<b>BMK2466</b>	4.41	5.29
--------------------------------------------	---------	-----	----------------	------	------

## T Piece Brake System

All non-ABS models - Rear brake pipes	Aftermarket	a/r	<b>NRC4251P</b>	6.04	7.25
	Genuine	a/r	<b>NRC4251</b>	17.88	21.46

## Brake Shoe Return Spring

All models with LT77S & LT85 Gearbox to (VIN) LA935629	Aftermarket	1	<b>STC246P</b>	4.83	5.80
	Genuine	1	<b>STC246</b>	5.74	6.89

## Brake Shoe Set - Handbrake

Up to (VIN) KA930456 Handbrake, rod operated type	Aftermarket	1	<b>STC965P</b>	7.50	9.00
	OEM	1	<b>STC965P1</b>	22.50	27.00
	Genuine	1	<b>STC965</b>	80.87	97.04
From (VIN) LA 935630 on Handbrake, direct entry cable type	Aftermarket	1	<b>ICW500010P</b>	10.00	12.00
	OEM	1	<b>ICW500010P1</b>	25.00	30.00
	Genuine	1	<b>ICW500010</b>	65.52	78.62

## Brake Drum - Handbrake

All models up to (VIN) AA796490 Handbrake	Aftermarket	1	<b>LR025177P</b>	20.42	24.50
	Genuine	1	<b>LR025177</b>	152.67	183.20

## Brake Spring Kit

All models from (VIN) LA935630 - Handbrake Shoe Retention	Aftermarket	1	<b>ICW100050P</b>	3.83	4.60
	OEM	1	<b>ICW100050P1</b>	8.12	9.74
	Genuine	1	<b>ICW100050</b>	11.52	13.82

## Backplate Handbrake

All models with LT77S & LT85 Gearbox to (VIN) LA935629	Genuine	1	<b>STC963</b>	343.70	412.44
	From (VIN) LA935630 to XA175163 and 7A000001 on - Handbrake, direct entry cable type				
	Genuine	1	<b>STC1533</b>	46.67	56.00

## Locking Plate Handbrake

All models to (VIN) LA935629	Aftermarket	1	<b>515467P</b>	1.33	1.60
	Genuine	1	<b>515467</b>	1.72	2.06

## Retaining Plate Handbrake

All models to (VIN) LA935629	Aftermarket	1	<b>515468P</b>	1.08	1.30
	Genuine	1	<b>515468</b>	2.30	2.76

## Dust Cover Expander Unit

All models with LT77 5 speed gearbox	OEM	1	<b>515466P1</b>	3.33	4.00
	Genuine	1	<b>515466</b>	4.49	5.39

## Expander Unit

All models with LT77 5 speed gearbox	Aftermarket	1	<b>AEU2734P</b>	17.29	20.75
	Genuine	1	<b>AEU2734</b>	330.80	396.96

## Retaining Kit Expander

All models - Parking Brake	Aftermarket	1	<b>RA1109P</b>	3.00	3.60
	Genuine	1	<b>RA1109</b>	5.83	7.00

## Brake Shoe Adjuster Assembly

All models with LT77S & LT85 Gearbox to (VIN) LA935629	Aftermarket	1	<b>STC244P</b>	17.29	20.75
	Genuine	1	<b>STC244</b>	125.32	150.38
	Genuine	1	<b>STC245</b>	124.64	149.57

## Brake Adjuster Transmission

All models with LT230 transfer box to (VIN) LA935629 - Early type expander	Aftermarket	1	<b>AEU2735P</b>	10.42	12.50
	Genuine	1	<b>AEU2735</b>	237.59	285.11

## Transmission Brake Adjustment Kit

All models from (VIN) LA935630 on	Aftermarket	1	<b>ICW500020P</b>	9.37	11.24
	Genuine	1	<b>ICW500020</b>	13.81	16.57

## Brake Lever Kit

All models (VIN) XA159807 on - Handbrake	Genuine	1	<b>ICW100010</b>	15.27	18.32
------------------------------------------	---------	---	------------------	-------	-------

## Transmission Brake Connecting Rod

All models to (VIN) LA935629 - Fitted with LT77S & LT85 gearbox for old type expander assembly	Genuine	1	<b>STC964</b>	38.33	46.00
------------------------------------------------------------------------------------------------	---------	---	---------------	-------	-------

## Cross Shaft

All models from (VIN) 4A290431 on - Handbrake, Direct Entry Cable Type	Genuine	1	<b>ICF100000</b>	12.74	15.29
------------------------------------------------------------------------	---------	---	------------------	-------	-------

## Handbrake Switch

All models LHD	Aftermarket	1	<b>EEP191LP</b>	11.87	14.24
	Genuine	1	<b>EEP191L</b>	14.24	17.09

## Handbrake Cable

RHD models up to (VIN) LA935629	Aftermarket	1	<b>NRC5088P</b>	7.50	9.00
	Genuine	1	<b>NRC5088</b>	34.58	41.50
LHD models up to (VIN) LA935629	Aftermarket	1	<b>NRC5089P</b>	11.67	14.00
	Genuine	1	<b>NRC5089</b>	34.58	41.50
All models from (VIN) LA935630 to 6A999999	Aftermarket	1	<b>SPB500200P</b>	9.79	11.75
	OEM	1	<b>SPB500200P1</b>	20.42	24.50
	Genuine	1	<b>SPB500200</b>	72.61	87.13

## Handbrake Cable Clevis Pin

All models - 8 x 22mm, Handbrake cable to Handbrake lever	Genuine	1	<b>PC108291L</b>	3.45	4.14
-----------------------------------------------------------	---------	---	------------------	------	------

## ABS Sensor Kit

ABS models from (VIN) XA159807 to 6A999999 - Front brakes					
	Aftermarket	2	<b>STC1749P</b>	28.75	34.50
	Genuine	2	<b>STC1749</b>	217.69	261.23
ABS models from (VIN) XA159807 to 6A999999 - Rear brakes					
	Aftermarket	2	<b>STC1750P</b>	40.00	48.00
	Genuine	2	<b>STC1750</b>	278.01	333.61
All models with anti lock brakes to (VIN) 3A664199 - Rear, RH or LH					
	Aftermarket	2	<b>SSW100060P</b>	45.00	54.00
	OEM	2	<b>SSW100060P1</b>	165.00	198.00
	Genuine	2	<b>SSW100060</b>	172.09	206.51
	All models with anti lock brakes (VIN) 3A664200 to AA798476 - Rear, RH or LH, Wabco type				
	Aftermarket	2	<b>SSW500080P</b>	105.00	126.00
	OEM	2	<b>SSW500080P1</b>	150.00	180.00
	Genuine	2	<b>SSW500080</b>	189.14	226.97

## ABS Sensor

All models from (VIN) 6A000001					
Front	OEM	2	<b>SSW500050P1</b>	70.00	84.00
	Genuine	2	<b>SSW500050</b>	171.14	205.37
All models with anti lock brakes from (VIN) 7A000001 to AA798476					
Front brakes	OEM	2	<b>SSW500090P1</b>	150.00	180.00
	Genuine	2	<b>SSW500090</b>	171.17	205.40
All models with ABS (VIN) AA798477 on					
Front, Bosch type	OEM	2	<b>LR023690P1</b>	19.95	23.94
	Genuine	2	<b>LR023690</b>	26.77	32.12
Rear, Bosch type	OEM	2	<b>LR023691P1</b>	24.95	29.94
	Genuine	2	<b>LR023691</b>	33.51	40.21
All models from (VIN) BA888888					
Front & rear	Genuine	2	<b>LR029522</b>	14.33	17.20

## ABS Sensor Oil Seal

All models with ABS					
Front brakes	Aftermarket	1	<b>FTC1376P</b>	1.00	1.20
	OEM	1	<b>FTC1376P1</b>	2.50	3.00
	Genuine	1	<b>FTC1376</b>	9.10	10.92

## Bush ABS Sensor

All models with anti lock brakes to (VIN) BA888887					
Front and rear	Aftermarket	2	<b>FTC1374P</b>	4.58	5.50
	Genuine	2	<b>LR029522</b>	14.33	17.20

## Exciter Ring

All models with ABS - Rear	Genuine	2	<b>FTC1379</b>	253.57	304.28
----------------------------	---------	---	----------------	--------	--------

## ABS Yaw Rate Sensor

All 2.2L TDCI Puma diesel models from (VIN) FA000001 on					
	Genuine	1	<b>LR011785</b>	287.53	345.04

## Brake Pedal Rubber

All models - Brake and clutch	Aftermarket	2	<b>SKE500060P</b>	2.83	3.40
	Genuine	2	<b>SKE500060</b>	8.92	10.70

## Brake Pedal Pivot Bush

All models	Genuine	1	<b>564816</b>	11.27	13.52
------------	---------	---	---------------	-------	-------



STC1749P



## DEFENDER 110 (1989 on)

## SUSPENSION

## Bush Radius Arm

All models up to (VIN) VA130784

Front suspension, chassis end, rubber	Aftermarket	4	<b>NRC4514P</b>	0.79	0.95
	Genuine	4	<b>NRC4514</b>	2.76	3.31
Front suspension, chassis end, poly.	Polybush	1	<b>NRC4514POLYBUSH</b>	20.42	24.50
	Aftermarket	4	<b>NRC4514POLY</b>	3.00	3.60

All models from (VIN) VA130785 on

Front suspension, chassis end, rubber	Aftermarket	4	<b>ANR6971P</b>	0.79	0.95
	OEM	4	<b>ANR6971P1</b>	2.08	2.50
	Genuine	4	<b>ANR6971</b>	2.40	2.88
Front suspension, chassis end, poly.	Aftermarket	2	<b>ANR6971POLY</b>	3.83	4.60

All models up to (VIN) KA930455

Front suspension, axle end, rubber	Aftermarket	4	<b>NTC7307P</b>	1.50	1.80
	Genuine	4	<b>NTC7307</b>	20.38	24.46
Front suspension, axle end, poly.	Aftermarket	4	<b>NTC7307POLY</b>	6.67	8.00

All models from (VIN) LA930456 on

Front suspension, rubber	Aftermarket	4	<b>NTC6781P</b>	1.50	1.80
	OEM	4	<b>NTC6781P1</b>	4.08	4.90
	Genuine	4	<b>NTC6781</b>	14.96	17.95
Front suspension, poly.	Aftermarket	4	<b>NTC6781POLY</b>	5.00	6.00

All models

Rear suspension, rubber	Aftermarket	2	<b>NTC1772P</b>	1.50	1.80
	OEM	2	<b>NTC1772P1</b>	3.00	3.60
	Genuine	2	<b>NTC1772</b>	9.29	11.15
Rear suspension, chassis end, poly.	Aftermarket	2	<b>NTC9027POLY</b>	20.00	24.00
Rear suspension, poly.	Aftermarket	2	<b>NTC1772POLY</b>	4.38	5.26

Rear suspension, poly., performance red (pair)	Polybush	1	<b>NTC1772POLYBUSH</b>	22.50	27.00
------------------------------------------------	----------	---	------------------------	-------	-------

Rear suspension, chassis end, rubber (pair)	Aftermarket	1	<b>STC618P</b>	6.67	8.00
	OEM	1	<b>STC618P1</b>	15.42	18.50
	Genuine	1	<b>STC618</b>	59.46	71.35

Rear suspension, chassis end poly. (pair)	Aftermarket	1	<b>STC618POLY</b>	25.83	31.00
-------------------------------------------	-------------	---	-------------------	-------	-------

## Bush Kit Radius Arm

All models up to (VIN) VA130784

Front Suspension Kit, radius arm to chassis, rubber	Britpart	1	<b>NRC4514BPKIT</b>	7.08	8.50
Front Suspension Kit, radius arm to chassis, poly. yellow	Britpart	1	<b>NRC4514BPKPOLYEL</b>	9.58	11.50

All models from (VIN) KA930455

Front Suspension, axle end, poly., set of 4	Bearmach	1	<b>NTC7307BMPYC</b>	87.50	105.00
---------------------------------------------	----------	---	---------------------	-------	--------

All models from (VIN) LA930456 on

Front Suspension, poly.	Britpart	1	<b>NTC6781BPPY</b>	16.88	20.26
	Bearmach	1	<b>NTC6781BMPYC</b>	85.00	102.00

All models

Rear Suspension, chassis end, poly. performance red	Polybush	1	<b>NTC9027POLYBUSH</b>	39.58	47.50
-----------------------------------------------------	----------	---	------------------------	-------	-------

## Shock Absorber Bush Kit

All models to (VIN) WA159806 - Front &amp; Rear

	Aftermarket	1	<b>LL1095P</b>	5.83	7.00
	Genuine	1	<b>LL1095</b>	27.50	33.00

All models from (VIN) XA159807 on - Front &amp; Rear

	Aftermarket	1	<b>LL1095L</b>	28.75	34.50
--	-------------	---	----------------	-------	-------

All models - Front shock absorber bush kit,

performance red	Polybush	1	<b>LL1357</b>	22.08	26.50
comfort blue	Polybush	1	<b>LL1357B</b>	22.08	26.50

All models to (VIN) WA159806 - Front &amp; rear, poly.

	Aftermarket	1	<b>LL1095POLY</b>	16.25	19.50
--	-------------	---	-------------------	-------	-------

All models from (VIN) XA159807 on - Front &amp; rear, poly.

	Aftermarket	1	<b>LL1095LPOLY</b>	22.50	27.00
--	-------------	---	--------------------	-------	-------

## Bush Shock Absorber Mounting

All models

Front upper and lower, rear lower, rubber	Aftermarket	8	<b>552818P</b>	0.50	0.60
	Genuine	8	<b>552818</b>	1.38	1.66

Front upper and lower, rear lower, poly. performance red	Polybush	1	<b>5528189PBR</b>	25.00	30.00
comfort blue	Polybush	1	<b>552818PPBB</b>	25.00	30.00
dynamic orange	Polybush	1	<b>5528189PBO</b>	25.00	30.00
	Aftermarket	8	<b>552818POLY</b>	0.83	1.00

Rear, upper, rubber	Aftermarket	2	<b>NRC5593P</b>	1.08	1.30
	Genuine	2	<b>NRC5593</b>	6.28	7.54

Rear, upper, poly.	Aftermarket	2	<b>NRC5593POLY</b>	4.00	4.80
	Terrafrirma	2	<b>NRC5593TFP</b>	13.13	15.76

All models from (VIN) XA159807 on

Rear, lower, rubber	Aftermarket	4	<b>RNF100090LP</b>	0.54	0.65
	Genuine	4	<b>RNF100090</b>	1.09	1.31
	Genuine	4	<b>RNF100090L</b>	2.06	2.47

Rear, lower, poly.	Aftermarket	2	<b>RNF100090LPOLY</b>	2.25	2.70
--------------------	-------------	---	-----------------------	------	------

## Bush Panhard Rod

All models up to (VIN) 2A626645

Front, rubber	Aftermarket	2	<b>ANR3410P</b>	0.75	0.90
	OEM	2	<b>ANR3410P1</b>	2.75	3.30
	Genuine	2	<b>ANR3410</b>	8.67	10.40
Front, poly.	Aftermarket	2	<b>ANR3410POLY</b>	4.00	4.80

All models from (VIN) 2A626646 on

Front suspension, rubber	Aftermarket	2	<b>RBX101340P</b>	1.75	2.10
	OEM	2	<b>RBX101340P1</b>	8.96	10.75
	Genuine	2	<b>RBX101340</b>	14.27	17.12
Front suspension, poly.	Aftermarket	2	<b>RBX101340POLY</b>	6.04	7.25

## Bush Panhard Rod Kit

All models up to (VIN) 2A626645

Front, poly.	Terrafrirma	1	<b>ANR3410TFPK</b>	15.63	18.76
--------------	-------------	---	--------------------	-------	-------

## Washer for Bush on Radius Arm

All models - Rear suspension, chassis end

	Aftermarket	2	<b>STC618WASHER</b>	5.42	6.50
--	-------------	---	---------------------	------	------

## Bush Upper Link

All models

Rear suspension, rubber	Aftermarket	2	<b>NTC1773P</b>	1.58	1.90
	OEM	2	<b>NTC1773P1</b>	4.00	4.80
	Genuine	2	<b>NTC1773</b>	19.99	23.99
Rear suspension, poly.	Aftermarket	2	<b>NTC1773POLY</b>	4.38	5.26

## Bush Upper Link (pair)

All models - Rear suspension, poly.

performance red	Polybush	1	<b>NTC1773POLYBUSH</b>	23.75	28.50
comfort blue	Polybush	1	<b>NTC1773POLYBUSHBLUE</b>	23.75	28.50

## Suspension Bush Kit

All models up to (VIN) KA930455 - Bush kit 'D'

incl. bottom link mounting bushes, front radius arm to axle bushes, A frame bushes, Panhard rod bushes, upper and lower shock absorber bushes, radius arm to chassis bushes

	Aftermarket	1	<b>RA1173EARLYP</b>	26.25	31.50
	Genuine	1	<b>RA1173EARLY</b>	300.00	360.00

All models (VIN) LA930456 to 2A626645 - Bush kit 'D'

incl. bottom link mounting bushes, front radius arm to axle bushes, A frame bushes, Panhard rod bushes, upper and lower shock absorber bushes, radius arm to chassis bushes

	Aftermarket	1	<b>RA1173LATEP</b>	26.25	31.50
	Genuine	1	<b>RA1173LATE</b>	280.00	336.00

All models to (VIN) AA267063 - Complete vehicle set, poly., black

	Aftermarket	1	<b>LL1059ALTPOLY</b>	124.17	149.00
--	-------------	---	----------------------	--------	--------

All models from (VIN) BA267064 - Complete vehicle set, poly., black

	Aftermarket	1	<b>LL1059ALTPOLYL</b>	110.83	133.00
--	-------------	---	-----------------------	--------	--------

All models to (VIN) KA930455 - Complete vehicle set, poly., black

	Britpart	1	<b>LL1059BPPOLYBLK</b>	58.33	70.00
--	----------	---	------------------------	-------	-------

	Britpart	1	<b>LL1059BPPOLYBLUE</b>	60.83	73.00
--	----------	---	-------------------------	-------	-------

	Britpart	1	<b>LL1059BPPOLYEL</b>	80.83	97.00
--	----------	---	-----------------------	-------	-------

All models to (VIN) KA930455 - Kit contains Radius Arms &amp; Panhard Rod bushes, poly.,

performance red	Polybush	1	<b>LL1059PBR</b>	130.00	156.00
-----------------	----------	---	------------------	--------	--------

comfort blue	Polybush	1	<b>LL1059PBB</b>	130.00	156.00
--------------	----------	---	------------------	--------	--------

dynamic orange	Polybush	1	<b>LL1059PBO</b>	130.00	156.00
----------------	----------	---	------------------	--------	--------

## Suspension Bush Kit B

All models up to (VIN) KA930455 - poly.

	Aftermarket	1	<b>RA1274ALTPOLY</b>	87.50	105.00
--	-------------	---	----------------------	-------	--------

All models (VIN) LA930456 on - poly.

performance red	Polybush	1	<b>RA1274PBRED</b>	130.00	156.00
-----------------	----------	---	--------------------	--------	--------

comfort blue	Polybush	1	<b>RA1275POLYBUSH</b>	142.50	171.00
--------------	----------	---	-----------------------	--------	--------

dynamic orange	Polybush	1	<b>RA1274PBORANGE</b>	130.00	156.00
----------------	----------	---	-----------------------	--------	--------

All models (VIN) LA930456 to WA159806 - poly., black

	Britpart	1	<b>RA1274BPPYBLKDEF</b>	58.33	70.00
--	----------	---	-------------------------	-------	-------

yellow	Britpart	1	<b>RA1274BPPYELDEF</b>	80.83	97.00
--------	----------	---	------------------------	-------	-------

## Supplementary Bush Kit

All models up to (VIN) WA159806

Supplementary kit - includes bushes for front and rear ARBs, A frames, shock absorbers and steering damper

	Aftermarket	1	<b>LL1310</b>	65.83	79.00
--	-------------	---	---------------	-------	-------

All models from (VIN) WA159807 to 6A999999 -

Supplementary kit - includes bushes for front and rear ARBs, A frames, shock absorbers and steering damper

	Aftermarket	1	<b>LL1310L</b>	73.33	88.00
--	-------------	---	----------------	-------	-------

## Bolt Kit for Bush Kits

All models

	Aftermarket	1	<b>RA1177P</b>	40.42	48.50
--	-------------	---	----------------	-------	-------

	Genuine	1	<b>RA1177</b>	71.67	86.00
--	---------	---	---------------	-------	-------

## Anti Roll Bar Bush

All models fitted with anti roll bar

Rear, lower, poly.	Aftermarket	4	<b>552819POLY</b>	1.08	1.30
--------------------	-------------	---	-------------------	------	------

Anti roll bar link, rubber	Aftermarket	4	<b>552819P</b>	0.19	0.23
----------------------------	-------------	---	----------------	------	------

	Genuine	4	<b>552819</b>	1.39	1.67
--	---------	---	---------------	------	------

All models with rear anti roll bar - Rear

	Aftermarket	2	<b>NRC5674P</b>	1.08	1.30
--	-------------	---	-----------------	------	------

	Genuine	2	<b>NRC5674</b>	3.90	4.68
--	---------	---	----------------	------	------

## Bush Anti Roll Bar

All models with rear anti roll bar

Rear, poly.	Aftermarket	2	<b>NRC5674POLY</b>	6.25	7.50
-------------	-------------	---	--------------------	------	------

## Anti Roll Bar Bush Kit

All models

Front anti roll bar bush kit, performance red	Polybush	1	<b>LL1359</b>	35.00	42.00
-----------------------------------------------	----------	---	---------------	-------	-------

comfort blue	Polybush	1	<b>LL1359B</b>	35.00	42.00
--------------	----------	---	----------------	-------	-------

Rear anti roll bar bush kit, performance red	Polybush	1	<b>LL1360</b>	33.75	40.50
----------------------------------------------	----------	---	---------------	-------	-------

comfort blue	Polybush	1	<b>LL1360B</b>	33.75	40.50
--------------	----------	---	----------------	-------	-------



552818POLY





# SUSPENSION

## Bush Anti Roll Bar Mounting

All models with factory heavy duty suspension to (VIN) 6A999999				
Front anti roll bar, poly.	Aftermarket	2	<b>NTC6828POLY</b>	6.25 7.50
All models (VIN) 7A000001 on				
Front anti roll bar, poly.	Aftermarket	2	<b>NTC6828POLY</b>	6.25 7.50
All models from (VIN) MA960430 to WA159806 except V8 EFI				
Rear, poly., for 16mm bar	Aftermarket	2	<b>NTC7394POLY</b>	6.25 7.50

## Bush Anti Roll Bar Mounting Upated

All models (VIN) 7A000001 on - Front anti roll bar, poly. 25.4mm inside diameter				
	Terrafrima	2	<b>NTC6828URTFPY</b>	23.33 28.00
All models with factory heavy duty suspension to (VIN) 6A999999 - Front anti roll bar, poly. 25.4mm inside diameter				
	Terrafrima	2	<b>NTC6828URTFPY</b>	23.33 28.00
All models from (VIN) MA960430 to WA159806 except V8 EFI - Rear, poly., 25.4mm inside diameter				
	Terrafrima	2	<b>NTC7394URTFPY254</b>	21.25 25.50
28.0mm inside diameter				
	Terrafrima	2	<b>NTC7394URTFPY280</b>	23.33 28.00

## Bump Stop

All models				
Front suspension, poly., red				
	Polybush	2	<b>ANR4188POLYBUSH</b>	19.17 23.00
	Britpart	2	<b>ANR4188PPPYBLK</b>	13.25 15.90
	Britpart	2	<b>ANR4188BPPPYEL</b>	13.25 15.90
Rear suspension, poly.				
	Polybush	2	<b>ANR4189POLYBUSH</b>	17.08 20.50
	Britpart	2	<b>ANR4189BPPPYBLK</b>	13.25 15.90
	Britpart	2	<b>ANR4189BPPPYEL</b>	13.25 15.90
Front suspension, rubber				
	Aftermarket	2	<b>ANR4188P</b>	2.58 3.10
	OEM	2	<b>ANR4188P1</b>	6.04 7.25
	Genuine	2	<b>ANR4188</b>	24.38 29.26
Rear suspension, rubber				
	Aftermarket	2	<b>ANR4189P</b>	3.08 3.70
	OEM	2	<b>ANR4189P1</b>	8.13 9.76
	Genuine	2	<b>ANR4189</b>	18.20 21.84

## Bump Stop Spacers

All models - Front or rear	Terrafrima	a/r	<b>ANR4188-9TFSPACER</b>	29.58 35.50
----------------------------	------------	-----	--------------------------	-------------

## Bush Kit Shock Absorber Mounting (set of 8)

All models from (VIN) XA159807 on - Kit, poly., 8 piece	Aftermarket	1	<b>RNF100090LPB</b>	30.83 37.00
---------------------------------------------------------	-------------	---	---------------------	-------------

## Shock Absorber Bush Kit

All models up to (VIN) WA159806 - Rear shock absorber bush kit				
performance red	Polybush	1	<b>LL1356</b>	27.08 32.50
comfort blue	Polybush	1	<b>LL1356B</b>	27.08 32.50

## Polyurethane Bush Kit

All models (VIN) 2A626646 on - Car set of suspension bushes				
performance red	Polybush	1	<b>LL1479PBRED</b>	137.50 165.00
comfort blue	Polybush	1	<b>LL1479PBBLUE</b>	148.33 178.00
All models (VIN) XA159807 to 6A999999 - Car set of suspension bushes				
Britpart black	Britpart	1	<b>LL1479BPPPOLYBLK</b>	58.33 70.00
Britpart yellow	Britpart	1	<b>LL1479BPPPOLYEL</b>	70.83 85.00
All models (VIN) 7A000001 on - Car set of suspension bushes				
Britpart black	Britpart	1	<b>LL1480BPPPOLYBLK</b>	58.33 70.00
Britpart yellow	Britpart	1	<b>LL1480BPPPOLYEL</b>	68.33 82.00

## Mounting Bush, Anti Roll Bar

All models with factory heavy duty suspension to (VIN) 6A999999				
Front anti roll bar				
	Aftermarket	2	<b>NTC6828P</b>	1.33 1.60
	OEM	2	<b>NTC6828P1</b>	2.72 3.26
	Genuine	2	<b>NTC6828</b>	6.99 8.39
All models (VIN) 7A000001 on				
Front anti roll bar				
	Aftermarket	2	<b>NTC6828P</b>	1.33 1.60
	OEM	2	<b>NTC6828P1</b>	2.72 3.26
	Genuine	2	<b>NTC6828</b>	6.99 8.39
All models from (VIN) MA960430 to WA159806 except V8 EFI				
Rear, standard rubber, for 16mm bar				
	Aftermarket	2	<b>NTC7394P</b>	1.33 1.60
	OEM	2	<b>NTC7394P1</b>	3.00 3.60
	Genuine	2	<b>NTC7394</b>	4.53 5.44

## Anti Roll Bar

All models with factory heavy duty suspension to (VIN) 6A999999				
Front				
	Aftermarket	1	<b>LR033037P</b>	50.00 60.00
	Genuine	1	<b>LR033037</b>	72.75 87.30
All models (VIN) 7A000001 on - Front				
	Aftermarket	1	<b>LR033037P</b>	50.00 60.00
	Genuine	1	<b>LR033037</b>	72.75 87.30
All models				
Rear, standard size				
	Aftermarket	1	<b>LR033038P</b>	45.00 54.00
	Genuine	1	<b>LR033038</b>	78.73 94.48

## Anti Roll Bar Upated

All models with factory heavy duty suspension to (VIN) 6A999999				
Front, upated 25.4mm diameter	Terrafrima	1	<b>LR033037URTF</b>	245.83 295.00
All models (VIN) 7A000001 on				
Front, upated 25.4mm diameter	Terrafrima	1	<b>LR033037URTF</b>	245.83 295.00
All models				
Rear, upated standard diameter	Bearmach	1	<b>LR033038URBM</b>	170.00 204.00
Rear, upated 25.4mm diameter	Terrafrima	1	<b>LR033038URTF254</b>	225.00 270.00
Rear, upated 28.0mm diameter	Terrafrima	1	<b>LR033038URTF280</b>	241.67 290.00

## Bush Anti Roll Bar Upated

All models with rear anti roll bar - Rear, 25.4mm inside diameter, poly.				
	Terrafrima	2	<b>NRC5674URTFPY254</b>	20.63 24.76
28.0mm inside diameter, poly.				
	Terrafrima	2	<b>NRC5674URTFPY280</b>	23.33 28.00

## Anti Roll Bar Link Ball Joint

All models - Front and rear				
	Aftermarket	2	<b>NTC1888P</b>	4.79 5.75
	OEM	2	<b>NTC1888P1</b>	13.54 16.25
	Genuine	2	<b>NTC1888</b>	41.58 49.90

## Clamp Bracket

All models - Anti roll bar mounting, front				
	Aftermarket	2	<b>NTC6776P</b>	3.75 4.50
	Genuine	2	<b>NTC6776</b>	5.93 7.12

## Link Kit for upated anti roll bars

All models with factory heavy duty suspension to (VIN) 6A999999 - Fitting Kit				
	Terrafrima	1	<b>LR033037URTFK</b>	24.58 29.50
All models (VIN) 7A000001 on - Fitting Kit				
	Terrafrima	1	<b>LR033037URTFK</b>	24.58 29.50
All models - Fitting Kit				
	Terrafrima	1	<b>LR033038URTFK</b>	39.58 47.50

## Spacer Kit 2 hole

All models with factory heavy duty suspension to (VIN) 6A999999 - for anti roll bar				
	Terrafrima	1	<b>LR033037-8URTFK2</b>	35.00 42.00
	Terrafrima	1	<b>LR033037-8URTFK4</b>	39.58 47.50
All models (VIN) 7A000001 on - for anti roll bar				
	Terrafrima	1	<b>LR033037-8URTFK2</b>	35.00 42.00
	Terrafrima	1	<b>LR033037-8URTFK4</b>	39.58 47.50

## Shock Absorber - Front

All models up to (VIN) WA159806				
Front				
	Aftermarket	2	<b>STC3769P</b>	13.54 16.25
	OEM	2	<b>STC3769P1</b>	25.00 30.00
	Genuine	2	<b>STC3769</b>	54.19 65.03
All models				
Front, oil, std. height				
	Aftermarket	2	<b>RSC100050P</b>	13.54 16.25
	OEM	2	<b>RSC100050P1</b>	29.58 35.50
	Genuine	2	<b>RSC100050</b>	61.43 73.72
	Bilstein	1	<b>RA1345BILSTEIN</b>	132.50 159.00
	Decarbon	2	<b>RA1345DECARBONEA</b>	63.33 76.00
	Cellular Dynamic	2	<b>LL1481BPCEL</b>	39.58 47.50
	Super Gaz	2	<b>LL1481BPSUP</b>	33.33 40.00
	Terrafrima	2	<b>RA1345TFAT</b>	28.33 34.00
	Terrafrima	2	<b>RA1345TFPS</b>	48.33 58.00
All models - Front, gas, std. height, Commercial heavy duty				
	Terrafrima	2	<b>RA1345TFCHD</b>	58.33 70.00
130, All models				
Front, std. height				
	Super Gaz	2	<b>LL1481BPSUP</b>	33.33 40.00
	Cellular Dynamic	2	<b>LL1481BPCEL</b>	39.58 47.50
130, All models up to (VIN) WA159806				
Front				
	Aftermarket	2	<b>STC3769P</b>	13.54 16.25
	OEM	2	<b>STC3769P1</b>	25.00 30.00
	Genuine	2	<b>STC3769</b>	54.19 65.03
	Genuine	2	<b>RSC500290</b>	57.82 69.38
All models from (VIN) 7A000001 on - Front				
	Genuine	2	<b>RNB501380</b>	106.47 127.76

## Shock Absorber - Rear

All models up to (VIN) WA159806				
Rear, oil, std. height				
	Aftermarket	2	<b>STC3771P</b>	13.96 16.75
	OEM	2	<b>STC3771P1</b>	24.58 29.50
	Genuine	2	<b>STC3771</b>	63.97 76.76
Rear, Heavy Duty, gas, std. height				
	Aftermarket	2	<b>STC3772P</b>	13.96 16.75
	OEM	2	<b>STC3772P1</b>	27.50 33.00
	Genuine	2	<b>STC3772</b>	64.26 77.11
All models up to (VIN) WA159806 with self levelling suspension				
Rear				
	Aftermarket	2	<b>STC3770P</b>	16.50 19.80
	Genuine	2	<b>STC3770</b>	65.28 78.34
All models from (VIN) XA159807 on				
Rear, oil, std. height				
	Aftermarket	2	<b>STC3704P</b>	14.58 17.50
	OEM	2	<b>STC3704P1</b>	26.67 32.00
	Genuine	2	<b>STC3704</b>	59.25 71.10
Rear				
	Aftermarket	2	<b>RPM100080P</b>	14.58 17.50
	OEM	2	<b>RPM100080P1</b>	36.67 44.00
	Genuine	2	<b>RPM100080</b>	59.21 71.05
	Bilstein	2	<b>STC3704UPRATED</b>	80.00 96.00
	Pro-Comp	2	<b>RA1346BMPC</b>	38.33 46.00
All models				
Rear, gas, All Terrain, std. height				
	Terrafrima	2	<b>RA1346TFAT</b>	29.17 35.00
Rear, gas, Pro Sport, std. height				
	Terrafrima	2	<b>RA1346TFPS</b>	48.33 58.00
Rear, std. height				
	Super Gaz	2	<b>LL1482BPSUP</b>	33.33 40.00
	Cellular Dynamic	2	<b>LL1482BPCEL</b>	39.58 47.50
	Bilstein	1	<b>RA1346BILSTEIN</b>	132.50 159.00
Rear, gas, Commercial Heavy Duty, std. height				
	Terrafrima	2	<b>RA1346TFCHD</b>	58.33 70.00
130, All models				
Rear, std. height				
	Super Gaz	2	<b>LL1482BPSUP</b>	33.33 40.00
	Cellular Dynamic	2	<b>LL1482BPCEL</b>	39.58 47.50
130, All models from (VIN) XA159807				
Rear				
	Aftermarket	2	<b>RPM100080P</b>	14.58 17.50
	OEM	2	<b>RPM100080P1</b>	36.67 44.00
	Genuine	2	<b>RPM100080</b>	59.21 71.05
130, Military - Rear				
	Genuine	2	<b>RRC3817</b>	117.36 140.83

## Shock Mounting Retention Ring

All models - Front suspension				
	Aftermarket	2	<b>RNJ500010P</b>	3.58 4.30
	Genuine	2	<b>RNJ500010</b>	16.34 19.61



**DEFENDER 110 (1989 on)****SUSPENSION****Coil Spring**

All models up to (VIN) 6A999999				
Front, driver's side, standard	Aftermarket	1	<b>NRC8044P</b>	15.83 19.00
	Genuine	1	<b>NRC8044</b>	63.59 76.31
Front, passenger's side, standard	Aftermarket	1	<b>NRC8045P</b>	15.83 19.00
	Genuine	1	<b>NRC8045</b>	63.10 75.72
All RHD models from (VIN) 7A000001 on				
Front, both sides, standard	Aftermarket	2	<b>NRC8045P</b>	15.83 19.00
	Genuine	2	<b>NRC8045</b>	63.10 75.72
All LHD models from (VIN) 7A000001 on				
Front, driver's side, standard	Aftermarket	1	<b>NRC8044P</b>	15.83 19.00
	Genuine	1	<b>NRC8044</b>	63.59 76.31
Front, passenger's side, standard	Aftermarket	1	<b>NRC8045P</b>	15.83 19.00
	Genuine	1	<b>NRC8045</b>	63.10 75.72
All models without self levelling suspension up to (VIN) WA159806				
Rear, driver's side	Aftermarket	1	<b>NRC6389P</b>	26.67 32.00
	Genuine	1	<b>NRC6389</b>	66.35 79.62
Rear, passenger's side	Aftermarket	1	<b>NRC6904P</b>	26.67 32.00
	Genuine	1	<b>NRC6904</b>	67.84 81.41
All models with self levelling suspension up to (VIN) WA159806				
Rear, driver's side	Aftermarket	1	<b>NRC6388P</b>	17.50 21.00
	Genuine	1	<b>NRC6388</b>	66.35 79.62
Rear, passenger's side	Aftermarket	1	<b>NRC7000P</b>	17.50 21.00
	Genuine	1	<b>NRC7000</b>	63.20 75.84
All models from (VIN) 7A000001 on except station wagon				
Rear, both sides	Genuine	2	<b>RKB500300</b>	69.47 83.36
All models				
Front, driver's side, heavy duty	Aftermarket	1	<b>NRC9448P</b>	14.38 17.26
	Genuine	1	<b>NRC9448</b>	64.40 77.28
Front, passenger's side, heavy duty	Aftermarket	1	<b>NRC9449P</b>	16.04 19.25
	Genuine	1	<b>NRC9449</b>	63.84 76.61
130, All models				
Front, driver's side	Aftermarket	1	<b>NRC9448P</b>	14.38 17.26
	Genuine	1	<b>NRC9448</b>	64.40 77.28
Front, passenger's side	Aftermarket	1	<b>NRC9449P</b>	16.04 19.25
	Genuine	1	<b>NRC9449</b>	63.84 76.61
130, All models up to (VIN) WA159806				
Rear, driver's side	Aftermarket	1	<b>NRC6389P</b>	26.67 32.00
	Genuine	1	<b>NRC6389</b>	66.35 79.62
Rear, passenger's side	Aftermarket	1	<b>NRC6904P</b>	26.67 32.00
	Genuine	1	<b>NRC6904</b>	67.84 81.41
All models from (VIN) XA159807 to 6A999999				
Rear, both sides	Aftermarket	2	<b>RKB101111P</b>	28.33 34.00
	Genuine	2	<b>RKB101111</b>	69.37 83.24
All station wagon models with 5 seat configuration from (VIN) 7A000001 on				
Rear, both sides	Aftermarket	2	<b>RKB101111P</b>	28.33 34.00
	Genuine	2	<b>RKB101111</b>	69.37 83.24
Wolf Military - Rear	Genuine	2	<b>ANR3540</b>	74.02 88.82

**Coil Spring Helper**

All models with heavy duty suspension				
Rear, both sides	Aftermarket	2	<b>RRC3266P</b>	8.96 10.75
	Genuine	2	<b>RRC3266</b>	60.47 72.56
130, All models - Rear, both sides				
	Aftermarket	2	<b>RRC3266P</b>	8.96 10.75
	Genuine	2	<b>RRC3266</b>	60.47 72.56

**Coil Spring Isolator**

All models from (VIN) XA159807 - Rear	Genuine	2	<b>ANR3060</b>	4.00 4.80
130, All models from (VIN) XA159807 - Rear	Genuine	2	<b>ANR3060</b>	4.00 4.80

**Coil Spring Retainer**

All models - Rear				
	Aftermarket	2	<b>NRC4318P</b>	2.50 3.00
	Genuine	2	<b>NRC4318</b>	3.22 3.86
130, All models - Rear				
	Aftermarket	2	<b>NRC4318P</b>	2.50 3.00
	Genuine	2	<b>NRC4318</b>	3.22 3.86

**Coil Spring Seat**

All models - Rear lower				
	Aftermarket	2	<b>NRC4317P</b>	10.00 12.00
	Genuine	2	<b>NRC4317</b>	15.73 18.88
130, All models - Rear lower				
	Aftermarket	2	<b>NRC4317P</b>	10.00 12.00
	Genuine	2	<b>NRC4317</b>	15.73 18.88

**Lower Seat, Coil Spring**

All models - Front suspension				
	Aftermarket	2	<b>NRC9700P</b>	3.00 3.60
	Genuine	2	<b>NRC9700</b>	11.51 13.81

**Mounting Bracket**

All models - Front spring, upper				
	Aftermarket	2	<b>NRC6372P</b>	13.13 15.76
	Genuine	2	<b>NRC6372</b>	56.30 67.56

**Retainer Ring Spring Upper**

All models with factory heavy duty suspension				
Rear suspension	Aftermarket	2	<b>RRC3352P</b>	9.58 11.50
	Genuine	2	<b>RRC3352</b>	41.84 50.21
	Aftermarket	2	<b>LRO18027P</b>	10.83 13.00
	Genuine	2	<b>LRO18027</b>	41.13 49.36

**Ball Joint Assembly**

All models - Rear upper link				
	Aftermarket	1	<b>RHF500110P</b>	7.08 8.50
	OEM	1	<b>RHF500110P1</b>	16.67 20.00
	Genuine	1	<b>RHF500110</b>	39.98 47.98
Heavy Duty	Bearmach	1	<b>RHF500110URBM</b>	14.38 17.26

**Ball Joint Assembly & Fulcrum Bracket**

All models - Rear upper link & fulcrum bracket				
	Britpart	1	<b>RHF500110BPASSY</b>	39.58 47.50

**Drop Arm Repair Kit**

All models - Steering drag link				
	Aftermarket	1	<b>RBG000010P</b>	4.58 5.50
	OEM	1	<b>RBG000010P1</b>	20.63 24.76
	Genuine	1	<b>RBG000010</b>	55.33 66.40

**Dust Cover Ball Joint**

All models from (VIN) CA000001 to (VIN) EA329884				
	OEM	1	<b>572338P1</b>	3.58 4.30
	Genuine	1	<b>572338</b>	8.34 10.01

**Ball Joint, Upper**

All models with self levelling suspension - Self levelling unit				
	Aftermarket	2	<b>575882P</b>	4.58 5.50

**Ball Joint Self Levelling Unit**

All models - Top & bottom	Aftermarket	2	<b>575882P</b>	4.58 5.50
---------------------------	-------------	---	----------------	-----------

**Gaiter Ball Joint**

All models with self levelling suspension - Lower, self levelling unit				
	Aftermarket	1	<b>NRC6561P</b>	3.58 4.30
	Genuine	1	<b>NRC6561</b>	18.38 22.06

**Seal Lower Balljoint Self Levelling Unit**

All models - Lower	Genuine	1	<b>NRC8007</b>	2.32 2.78
--------------------	---------	---	----------------	-----------

**Radius Arm Assembly**

All models up to (VIN) KA930455				
Front suspension	Aftermarket	2	<b>NTC2705P</b>	120.00 144.00
	Genuine	2	<b>NTC2705</b>	302.34 362.81
All models from (VIN) LA930456 on				
Front suspension	OEM	2	<b>LR041266P1</b>	135.00 162.00
	Genuine	2	<b>LR041266</b>	316.61 379.93

**Radius Arm Nut & Bolt Kit**

All models				
Front	Britpart	1	<b>LL1679BP</b>	8.13 9.76
Rear	Britpart	1	<b>LL1680BP</b>	6.67 8.00

**Radius Arm Nut & Bolt Kit**

All models				
Front	Britpart	1	<b>LL1679BP</b>	8.13 9.76
Rear	Britpart	1	<b>LL1680BP</b>	6.67 8.00

**Panhard Rod Assembly**

All models up to (VIN) 2A626645				
Front suspension, RHD or LHD	Aftermarket	1	<b>RBI500020P</b>	23.75 28.50
	Genuine	1	<b>RBI500020</b>	136.98 164.38

All RHD models from (VIN) 2A626646 on				
Front suspension	Aftermarket	1	<b>RBI100041P</b>	28.33 34.00
	Genuine	1	<b>RBI100041</b>	122.24 146.69

All LHD models from (VIN) 2A626646 on				
Front suspension	OEM	1	<b>RBI100031P1</b>	48.33 58.00
	Genuine	1	<b>RBI100031</b>	136.52 163.82

**Tie Bar**

All RHD models - Steering box				
	Aftermarket	1	<b>LR041261P</b>	15.63 18.76
	Genuine	1	<b>LR041261</b>	46.04 55.25

**Tie Bar Bracket**

All models - Rear				
	Britpart	1	<b>LL1507BP</b>	11.88 14.26
130, All models - Rear				
	Britpart	1	<b>LL1507BP</b>	11.88 14.26

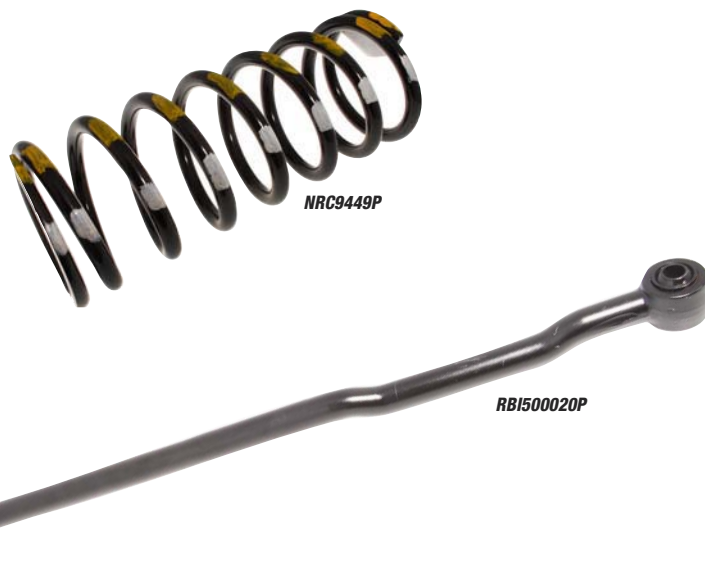

# SUSPENSION

# DEFENDER 110 (1989 on)

## Top Link Assembly

All models - Rear suspension

RH	Aftermarket	1	<b>NTC2706P</b>	80.00	96.00
	Genuine	1	<b>NTC2706</b>	241.05	289.26
LH	Genuine	1	<b>LR045324</b>	173.56	208.27

## Upper Arm

All models from (VIN) DA000001 - Rear

RH	Genuine	1	<b>LR045323</b>	173.56	208.27
LH	Genuine	1	<b>LR045324</b>	173.56	208.27

## Shock Absorber Kit Normal Duty

All models to (VIN) WA159806 unless fitted with self levelling suspension - Kit includes 2 front &amp; 2 rear shock absorbers

Aftermarket	1	<b>LL1297P</b>	52.50	63.00
Genuine	1	<b>LL1297</b>	217.50	261.00

130, All models to (VIN) WA159806 unless fitted with self levelling suspension - Kit includes 2 front &amp; 2 rear shock absorbers

Aftermarket	1	<b>LL1297P</b>	52.50	63.00
Genuine	1	<b>LL1297</b>	217.50	261.00

## Shock Absorber Kit Standard

All models from (VIN) XA159807 - Kit includes 2 front &amp; 2 rear shock absorbers

Aftermarket	1	<b>LL1300P</b>	48.33	58.00
Genuine	1	<b>LL1300</b>	229.17	275.00

130, All models from (VIN) XA159807 - Kit includes 2 front &amp; 2 rear shock absorbers

Aftermarket	1	<b>LL1300P</b>	48.33	58.00
Genuine	1	<b>LL1300</b>	229.17	275.00

## Shock Absorber Kit Self Levelling

All models to (VIN) WA159806 with self levelling suspension - Kit includes 2 front &amp; 2 rear shock absorbers

Aftermarket	1	<b>LL1299P</b>	55.00	66.00
Genuine	1	<b>LL1299</b>	229.17	275.00

## Shock Absorber Kit Self Levelling

130, All models to (VIN) WA159806 with self levelling suspension - Kit includes 2 front &amp; 2 rear shock absorbers

Aftermarket	1	<b>LL1299P</b>	55.00	66.00
Genuine	1	<b>LL1299</b>	229.17	275.00

## Shock Absorber Kit Upgraded

All models up to (VIN) WA159806 - Kit includes 2 front &amp; 2 rear shock absorbers, Heavy Duty Gas

Bilstein	1	<b>RA1344BILSTEIN</b>	262.50	315.00
----------	---	-----------------------	--------	--------

All models from (VIN) XA159807 on - Kit includes 2 front &amp; 2 rear shock absorbers, Heavy Duty Gas

Bilstein	1	<b>LL1112</b>	291.67	350.00
----------	---	---------------	--------	--------

130, All models up to (VIN) WA159806 - Kit includes 2 front &amp; 2 rear shock absorbers, Heavy Duty Gas

Bilstein	1	<b>RA1344BILSTEIN</b>	262.50	315.00
----------	---	-----------------------	--------	--------

## Shock Absorber Kit Heavy Duty

All models to (VIN) WA159806 unless fitted with self levelling suspension - Kit includes 2 front &amp; 2 rear shock absorbers

Aftermarket	1	<b>LL1298P</b>	52.50	63.00
Genuine	1	<b>LL1298</b>	215.00	258.00

130, All models to (VIN) WA159806 unless fitted with self levelling suspension - Kit includes 2 front &amp; 2 rear shock absorbers

Aftermarket	1	<b>LL1298P</b>	52.50	63.00
Genuine	1	<b>LL1298</b>	215.00	258.00

## Shock Absorber & Spring Kit

All models to (VIN) WA159806 with standard suspension - Kit contains 4 shock absorbers &amp; 4 coil springs

Aftermarket	1	<b>LL1100P</b>	125.00	150.00
Genuine	1	<b>LL1100</b>	450.00	540.00

All models from (VIN) XA159807 with standard suspension - Kit contains 4 shock absorbers &amp; 4 coil springs

Aftermarket	1	<b>LL1101P</b>	132.50	159.00
Genuine	1	<b>LL1101</b>	425.00	510.00

All models to (VIN) WA159806 with self levelling suspension - Kit contains 4 shock absorbers &amp; 4 coil springs

Aftermarket	1	<b>LL1102P</b>	107.50	129.00
Genuine	1	<b>LL1102</b>	450.00	540.00

All models from (VIN) XA159807 with self levelling suspension - Kit contains 4 shock absorbers &amp; 4 coil springs

Aftermarket	1	<b>LL1103P</b>	132.50	159.00
Genuine	1	<b>LL1103</b>	425.00	510.00

130, All models to (VIN) WA159806 with standard suspension - Kit contains 4 shock absorbers &amp; 4 coil springs

Aftermarket	1	<b>LL1104P</b>	121.67	146.00
Genuine	1	<b>LL1104</b>	433.33	520.00

130, All models from (VIN) XA159807 with standard suspension - Kit contains 4 shock absorbers &amp; 4 coil springs

Aftermarket	1	<b>LL1105P</b>	130.83	157.00
Genuine	1	<b>LL1105</b>	425.00	510.00

## Shock Absorber & Spring Kit Upgraded

All models to (VIN) WA159806 unless fitted with self levelling suspension - Kit includes 2 front &amp; 2 rear shock absorbers &amp; 4 coil springs

Bilstein	1	<b>LL1114BILSTEINE</b>	375.00	450.00
----------	---	------------------------	--------	--------

All models from (VIN) XA159807 unless fitted with self levelling suspension - Kit includes 2 front &amp; 2 rear shock absorbers &amp; 4 coil springs

Bilstein	1	<b>LL1114BILSTEINL</b>	425.00	510.00
----------	---	------------------------	--------	--------

130, All models to (VIN) WA159806 unless fitted with self levelling suspension - Kit includes 2 front &amp; 2 rear shock absorbers &amp; 4 coil springs

Bilstein	1	<b>LL1114BILSTEINE</b>	375.00	450.00
----------	---	------------------------	--------	--------

130, All models from (VIN) XA159807 unless fitted with self levelling suspension - Kit includes 2 front &amp; 2 rear shock absorbers &amp; 4 coil springs

Bilstein	1	<b>LL1114BILSTEINL</b>	425.00	510.00
----------	---	------------------------	--------	--------

## Coil Spring Kit Normal Duty

All models to (VIN) WA159806 unless fitted with self levelling suspension - Kit includes 2 front &amp; 2 rear coil springs

Aftermarket	1	<b>LL1303P</b>	71.67	86.00
Genuine	1	<b>LL1303</b>	233.33	280.00

## Coil Spring Kit Self Levelling

All models to (VIN) WA159806 with self levelling suspension - Kit includes 2 front &amp; 2 rear coil springs

Aftermarket	1	<b>LL1305P</b>	62.50	75.00
Genuine	1	<b>LL1305</b>	230.00	276.00

## Coil Spring Kit Normal Duty

All models from (VIN) XA159807 - Kit includes 2 front &amp; 2 rear coil springs

Aftermarket	1	<b>LL1304P</b>	85.00	102.00
Genuine	1	<b>LL1304</b>	225.00	270.00

## Coil Spring Kit Self Levelling

130, All models to (VIN) WA159806 - Kit includes 2 front &amp; 2 rear coil springs

Aftermarket	1	<b>LL1306P</b>	70.83	85.00
Genuine	1	<b>LL1306</b>	233.33	280.00

130, All models from (VIN) XA159807 - Kit includes 2 front &amp; 2 rear coil springs

Aftermarket	1	<b>LL1307P</b>	77.50	93.00
Genuine	1	<b>LL1307</b>	230.00	276.00





**DEFENDER 110 (1989 on)****STEERING****Drop Arm Lever**

All RHD models with Adwest power steering - For steering box with 4 bolt top plate				
Aftermarket	1	<b>QFW000020P</b>	18.54	22.25
OEM	1	<b>QFW000020P1</b>	57.50	69.00
Genuine	1	<b>QFW000020</b>	112.70	135.24

**Steering Arm Lever**

All RHD models with manual steering				
Genuine	1	<b>RTC6398</b>	372.63	447.16
All RHD models with Gemmer power steering - For steering box with 6 bolt top plate				
Genuine	1	<b>RTC6398</b>	372.63	447.16
All LHD models with manual steering				
Aftermarket	1	<b>RTC6399P</b>	14.58	17.50
Genuine	1	<b>RTC6399</b>	372.63	447.16
All LHD models with Adwest power steering - For steering box with 4 bolt top plate				
Aftermarket	1	<b>QFW000030P</b>	16.67	20.00
OEM	1	<b>QFW000030P1</b>	57.50	69.00
Genuine	1	<b>QFW000030</b>	112.70	135.24
All LHD models with Gemmer power steering - For steering box with 6 bolt top plate				
Aftermarket	1	<b>RTC6399P</b>	14.58	17.50
Genuine	1	<b>RTC6399</b>	372.63	447.16

**Ball Joint, Drop Arm**

All models - RH				
Aftermarket	1	<b>RBG000010P</b>	4.58	5.50
OEM	1	<b>RBG000010P1</b>	20.63	24.76
Genuine	1	<b>RBG000010</b>	55.33	66.40

**Tube, Cross Rod**

All models up to (VIN) LA939975 - Original style tube, not for fitment with later type ANR2858 (RHD) or ANR2859 (LHD) eye ends				
Aftermarket	1	<b>NRC9741P</b>	11.88	14.26

**Universal Joint**

All models up to (VIN) VA133508				
Upper				
Aftermarket	1	<b>NRC7387P</b>	8.54	10.25
OEM	1	<b>NRC7387P1</b>	27.50	33.00
Genuine	1	<b>NRC7387</b>	48.59	58.31
Lower				
Aftermarket	1	<b>NRC7704P</b>	8.54	10.25
OEM	1	<b>NRC7704P1</b>	27.50	33.00
Genuine	1	<b>NRC7704</b>	47.31	56.77

**Universal Joint Kit**

All models from (VIN) 3A650904 on - Lower				
Aftermarket	1	<b>QLE500020P</b>	8.13	9.76
OEM	1	<b>QLE500020P1</b>	16.67	20.00
Genuine	1	<b>QLE500020</b>	49.49	59.39

**Lower Shaft Assembly**

All models up to (VIN) VA133508 - With joints				
Aftermarket	1	<b>RTC4738P</b>	39.58	47.50
OEM	1	<b>RTC4738P1</b>	115.00	138.00
Genuine	1	<b>RTC4738</b>	203.24	243.89
All models from (VIN) 3A650904 to 6A999999 - With joints				
Aftermarket	1	<b>QME500031P</b>	39.58	47.50
OEM	1	<b>QME500031P1</b>	80.00	96.00
Genuine	1	<b>QME500031</b>	192.42	230.90

**Steering Column Upper**

All models up to (VIN) HA906579				
OEM	1	<b>QMB101620P1</b>	95.00	114.00
Genuine	1	<b>QMB101620</b>	298.67	358.40
All models from (VIN) JA906580 on with basic type steering wheel				
OEM	1	<b>NTC9068P1</b>	195.00	234.00
Genuine	1	<b>NTC9068</b>	294.30	353.16

**Steering Damper Assembly**

All models				
Aftermarket	1	<b>RTC4472P</b>	11.50	13.80
Bilstein	1	<b>RTC4472UR</b>	65.00	78.00
Terra Firma	1	<b>RTC4472TF</b>	33.75	40.50
Celluler Dynamic	1	<b>RTC4472UR-BPCEL</b>	29.58	35.50
Super Gaz	1	<b>RTC4472UR-BPSUP</b>	27.50	33.00
Genuine	1	<b>RTC4472</b>	66.07	79.28
All models - 'Return to centre' type; uprated damper with return assistance spring				
Terra Firma	1	<b>RTC4472TFRTC</b>	57.50	69.00
Military (Wolf)	1	<b>STC3138</b>	63.74	76.49

**Bush Steering Damper**

All models				
Genuine	1	<b>QEM500020</b>	5.19	6.23

**Steering Damper Bush Set, Polyurethane**

All models				
Polybush Dynamic Red	Polybush	1	<b>LL1358</b>	18.13 21.76
Polybush Comfort Blue	Polybush	1	<b>LL1358B</b>	18.13 21.76
Britpart Black	Britpart	1	<b>LL1358-BPPOLYBLK</b>	3.33 4.00
Britpart Yellow	Britpart	1	<b>LL1358-BPPOLYEL</b>	3.58 4.30

**Eye Bush, Steering Damper**

All models				
Aftermarket	1	<b>NTC1775P</b>	1.08	1.30
Aftermarket	1	<b>NTC1775POLY</b>	2.75	3.30

**Eye Bush Kit, Steering Damper**

All models - Performance Red				
Polybush	1	<b>NTC1775PB</b>	19.79	23.75

**Track Rod Assembly**

All models				
Aftermarket	1	<b>LR041267P</b>	16.67	20.00
OEM	1	<b>LR041267P1</b>	38.33	46.00
Genuine	1	<b>LR041267</b>	165.15	198.18

**Track Rod Tube**

All models				
Aftermarket	1	<b>LR045730P</b>	9.58	11.50
OEM	1	<b>LR045730P1</b>	16.88	20.26
Genuine	1	<b>LR045730</b>	44.56	53.47

**Track Rod End**

All models - Track rod end				
RH thread, non-greasable				
Aftermarket	1	<b>RTC5869P</b>	4.58	5.50
OEM	1	<b>RTC5869P1</b>	10.63	12.76
Genuine	1	<b>RTC5869</b>	35.73	42.88
LH thread, non-greasable				
Aftermarket	1	<b>RTC5870P</b>	4.58	5.50
OEM	1	<b>RTC5870P1</b>	10.63	12.76
Genuine	1	<b>RTC5870</b>	35.73	42.88
Military - Heavy duty				
RH thread				
Genuine	1	<b>RRC4222P1</b>	29.58	35.50
Genuine	1	<b>RRC4222</b>	72.31	86.77
LH thread				
Genuine	1	<b>RRC4221P1</b>	29.58	35.50
Genuine	1	<b>RRC4221</b>	72.31	86.77

**Cross Rod Tube**

All models				
On vehicles up to (VIN) LA939975 must be fitted together with later type eye end ANR2858 (RHD) or ANR2859 (LHD)				
Aftermarket	1	<b>ANR2860P</b>	9.58	11.50
OEM	1	<b>ANR2860P1</b>	16.88	20.26
Genuine	1	<b>ANR2860</b>	37.75	45.30

**Cross Rod Eye End**

All RHD models up to (VIN) DA439438				
Aftermarket	1	<b>ANR2858P</b>	50.00	60.00
Genuine	1	<b>ANR2858</b>	58.86	70.63
All RHD models from (VIN) DA439439 on				
Genuine	1	<b>LR049447</b>	94.15	112.98
All LHD models up to (VIN) DA439438				
Aftermarket	1	<b>ANR2859P</b>	42.50	51.00
Genuine	1	<b>ANR2859</b>	56.57	67.88
All LHD models from (VIN) DA439439 on				
Genuine	1	<b>LR049448</b>	55.43	66.52

**Seal Kit Steering Box**

All models with Adwest power steering - For steering box with 4 bolt top plate				
Aftermarket	1	<b>STC2848P</b>	3.75	4.50
OEM	1	<b>STC2848P1</b>	5.63	6.76
Genuine	1	<b>STC2848</b>	20.28	24.34
Aftermarket	1	<b>STC2847P</b>	9.79	11.75
Genuine	1	<b>STC2847</b>	67.67	81.20
All RHD models with Gemmer power steering - For steering box with 6 bolt top plate				
Aftermarket	1	<b>RTC5071P</b>	13.75	16.50
Genuine	1	<b>RTC5071</b>	238.89	286.67

**Seal Worm Shaft**

All models with Gemmer manual steering box				
Genuine	1	<b>BAU4870</b>	5.68	6.82

**Pinion Seal Steering Box**

All models with Adwest power steering				
Genuine	1	<b>608065</b>	7.28	8.74

**Seal Kit Input Shaft Steering Box**

All models with Adwest power steering - For steering box with 4 bolt top plate				
Aftermarket	1	<b>STC889P</b>	5.63	6.76
Genuine	1	<b>STC889</b>	33.20	39.84

**Pad Adjuster Kit Steering Box**

All models with Adwest power steering - For steering box with 4 bolt top plate				
Genuine	1	<b>STC4385</b>	124.00	148.80



NTC1775PB

# STEERING

## Tie Bar, Mounting

All models from (VIN) MA940010 on - Steering box

Aftermarket	1	<b>LR041261P</b>	15.63	18.76
Genuine	1	<b>LR041261</b>	46.04	55.25

## Shaft Assembly Steering Box

LHD models with Advest power steering - For steering box with 4 bolt top plate

Land Rover	1	<b>RTC4399</b>	301.74	362.09
------------	---	----------------	--------	--------

## Gasket Kit Power Steering Pump

All V8 carb petrol power steering models Aftermarket 1 **ABU7145P** 4.00 4.80

All V8 petrol models with 30 series steering pump

Aftermarket	1	<b>ABU7145P</b>	4.00	4.80
-------------	---	-----------------	------	------

## Seal Kit Steering Pump

All V8 carb petrol power steering models Aftermarket 1 **STC1633P** 1.50 1.80

## Seal, Power Steering Pump

All models with Gemmer or Hobourn Eaton power steering pump - Inlet union. Dowty washer type seal

Aftermarket	1	<b>RTC5675P</b>	1.00	1.20
Genuine	1	<b>RTC5675</b>	3.39	4.07

# CLUTCH

## Clutch Plate & Cover Assembly

All 200 and 300 TDi diesel models

Aftermarket	1	<b>LR009366P</b>	57.50	69.00
OEM	1	<b>LR009366P1</b>	70.00	84.00
Genuine	1	<b>LR009366</b>	169.85	203.82

Heavy duty Britpart 1 **LR009366BPHDPARTIAL** 49.17 59.00

All 2.5L TD5 diesel models - Includes clutch plate &amp; cover for heavy duty one piece flywheel

Britpart	1	<b>LL1082BPFWCLUTCH</b>	70.00	84.00
----------	---	-------------------------	-------	-------

Late 3.5L V8 carb petrol models, from (eng) 24G14148B on

OEM	1	<b>STC50503P1</b>	89.17	107.00
Genuine	1	<b>STC50503</b>	364.19	437.03

All 2.4L/2.2L Puma TDCi diesel models Genuine 1 **LR047831** 285.80 342.96

## Clutch Kit

All 200 and 300 TDi diesel models -

Includes clutch cover, plate &amp; release bearing

Britpart	1	<b>LR009366BP</b>	50.00	60.00
Genuine	1	<b>GCK555AF</b>	125.83	151.00

Includes clutch cover, plate &amp; release bearing

Heavy duty, OEM Britpart 1 **LR009366BPHDOEM** 95.00 114.00Heavy duty Britpart 1 **LR009366BPHD** 55.00 66.00

Includes clutch cover, plate, release bearing &amp; fork

Heavy duty Britpart 1 **LR009366BPHDFORK** 90.83 109.00

All 2.5L TD5 diesel models

Aftermarket	1	<b>LL1082P</b>	68.33	82.00
OEM	1	<b>LL1082P1</b>	95.00	114.00
Genuine	1	<b>LL1082</b>	262.50	315.00

All 3.5L V8 carb petrol models with 5 speed LT77 or R380 gearbox

Includes clutch cover, plate &amp; release bearing

Aftermarket	1	<b>STC8361P</b>	90.83	109.00
Genuine	1	<b>STC8361</b>	345.00	414.00

## Dual Mass Flywheel & Clutch Kit

All 2.5L TD5 diesel models - Includes clutch plate, cover, self centering bearing &amp; dual mass flywheel

Britpart	1	<b>LL1082BPFW</b>	333.33	400.00
----------	---	-------------------	--------	--------

## One Piece Flywheel & Clutch Kit

All 2.5L TD5 diesel models

Includes clutch plate, cover, self centering bearing &amp; heavy duty one piece flywheel

Britpart	1	<b>LL1082BPFWHD</b>	333.33	400.00
----------	---	---------------------	--------	--------

## Clutch Cover

All 200 and 300TDi diesel models

Aftermarket	1	<b>URB100760P</b>	29.58	35.50
OEM	1	<b>URB100760P1</b>	39.58	47.50
Genuine	1	<b>URB100760</b>	91.30	109.56

All 2.5L TD5 diesel models

Aftermarket	1	<b>FTC4630P</b>	35.83	43.00
Genuine	1	<b>FTC4630</b>	132.20	158.64

All V8 petrol models

Aftermarket	1	<b>576476P</b>	39.58	47.50
OEM	1	<b>576476P1</b>	60.00	72.00
Genuine	1	<b>576476</b>	118.73	142.48



LL1082BPFWCLUTCH

# DEFENDER 110 (1989 on)

## Power Steering Fluid

All models - 1 litre. Cold (standard) climates fluid

Aftermarket	a/r	<b>STC50519P</b>	12.08	14.50
Genuine	a/r	<b>STC50519</b>	18.96	22.75

## Cap, Power Steering Reservoir

All models with power steering

Genuine	1	<b>NTC2723</b>	21.59	25.91
---------	---	----------------	-------	-------

## Gasket

All models

Swivel housing

Aftermarket	2	<b>FTC3646P</b>	0.50	0.60
Genuine	2	<b>FTC3646</b>	2.14	2.57

Lower swivel pin

Aftermarket	2	<b>FTC3647P</b>	0.50	0.60
Genuine	2	<b>FTC3647</b>	2.46	2.95

## Clutch Plate

All 4 cyl diesel models to (VIN) 6A999999 - Standard spec.

Aftermarket	1	<b>UQB500030P</b>	22.50	27.00
OEM	1	<b>GCP242</b>	45.00	54.00
Genuine	1	<b>UQB500030</b>	119.39	143.27

All 200 and 300TDi diesel models - Heavy duty

Genuine	1	<b>UQB000130</b>	139.32	167.18
---------	---	------------------	--------	--------

All 2.5L TD5 diesel models

Aftermarket	1	<b>UQB000120P</b>	31.67	38.00
OEM	1	<b>UQB000120P1</b>	60.00	72.00
Genuine	1	<b>UQB000120</b>	114.28	137.14

All 2.8L 6 cyl BMW M52 petrol models

OEM	1	<b>FTC2157P1</b>	125.00	150.00
Genuine	1	<b>FTC2157</b>	118.73	142.48

All 3.5L V8 carb petrol models

OEM	1	<b>8510308P1</b>	37.50	45.00
Genuine	1	<b>8510308</b>	217.38	260.86

## Drive Plate

All 4.0L V8 EFI petrol automatic models

Aftermarket	1	<b>FTC4607P</b>	7.50	9.00
Genuine	1	<b>FTC4607</b>	31.41	37.69

## Clutch Release Bearing

All models (except 2.5L petrol and N/A diesel with R380 g/box) up to (VIN) 6A999999 - With carrier

Aftermarket	1	<b>FTC5200P</b>	7.92	9.50
OEM	1	<b>FTC5200P1</b>	12.50	15.00
Genuine	1	<b>FTC5200</b>	37.38	44.86

Heavy Duty

Britpart	1	<b>FTC5200HDBP</b>	45.83	55.00
Bearmach	1	<b>FTC5200HDBM</b>	80.00	96.00

All 2.5L TD5 diesel models - For heavy duty one piece flywheel

Genuine	1	<b>LL1082BPFWHDBRG</b>	46.67	56.00
---------	---	------------------------	-------	-------

2.5L petrol and N/A diesel with R380 gearbox (old spec)

Aftermarket	1	<b>UTJ100210P</b>	10.63	12.76
OEM	1	<b>UTJ100210P1</b>	20.00	24.00
Genuine	1	<b>UTJ100210</b>	45.44	54.53

## Clutch Release Bearing Guide

All 300TDi diesel models

Aftermarket	1	<b>FTC5218P</b>	21.67	26.00
OEM	1	<b>FTC5218P1</b>	39.58	47.50
Genuine	1	<b>FTC5218</b>	81.82	98.18

## Clutch Slave/Release Bearing

All 2.4L and 2.2L TDCi Puma diesel models

Aftermarket	1	<b>LR068979P</b>	34.17	41.00
OEM	1	<b>LR068979P1</b>	49.17	59.00
Genuine	1	<b>LR068979</b>	59.99	71.99

All 2.8L 6 cyl BMW M52 petrol models with 5 speed R380 gearbox (gbox) suffix K or L

Genuine	1	<b>UTO100010</b>	69.03	82.84
---------	---	------------------	-------	-------

## Clutch Fork

All 200 and 300TDi diesel models

Aftermarket	1	<b>FTC2957P</b>	3.75	4.50
OEM	1	<b>FTC2957P1</b>	10.83	13.00
Genuine	1	<b>FTC2957</b>	23.33	28.00

Heavy Duty

Britpart	1	<b>FTC2957BPHD</b>	8.75	10.50
----------	---	--------------------	------	-------

All 2.5L TD5 diesel models

Aftermarket	1	<b>576137P</b>	23.96	28.75
OEM	1	<b>576137P1</b>	29.58	35.50
Genuine	1	<b>576137</b>	63.81	76.57

All V8 petrol models

Aftermarket	1	<b>576137P</b>	23.96	28.75
OEM	1	<b>576137P1</b>	29.58	35.50
Genuine	1	<b>576137</b>	63.81	76.57

Wolf/XD military models

Genuine	1	<b>UTD100000</b>	62.10	74.52
---------	---	------------------	-------	-------

May be used as uprated clutch fork on civilian Defenders with R380 gearbox (features stronger socket for pivot ball)

## Clutch Fork Kit Heavy Duty

All 200 and 300TDi diesel models - Includes release fork, slipper pads, bush, staple &amp; clip

Britpart	1	<b>FTC2957BPHDKIT</b>	11.67	14.00
----------	---	-----------------------	-------	-------



**DEFENDER 110 (1989 on)****CLUTCH****Clutch Fork Staple Retainer**

All 200 and 300TDi diesel models	Aftermarket	1	<b>FRC3416P</b>	0.58	0.70
	Genuine	1	<b>FRC3416</b>	2.35	2.82
All 2.5L TD5 diesel models	Aftermarket	1	<b>576203P</b>	0.25	0.30
	Genuine	1	<b>576203</b>	0.66	0.79
All V8 petrol models	Aftermarket	1	<b>576203P</b>	0.25	0.30
	Genuine	1	<b>576203</b>	0.66	0.79

**Pad Clutch Release Lever**

All 4 cyl models with 5 speed LT77 gearbox	Aftermarket	2	<b>FRC5255P</b>	0.50	0.60
	Genuine	2	<b>FRC5255</b>	1.53	1.84
All 4 cyl models with 5 speed R380 gearbox	Aftermarket	2	<b>FRC5255P</b>	0.50	0.60
	Genuine	2	<b>FRC5255</b>	1.53	1.84

**Pivot Clutch Release Arm**

All 4 cyl models with 5 speed LT77 gearbox	OEM	1	<b>FRC5180P1</b>	15.04	18.05
	Genuine	1	<b>FRC5180</b>	57.38	68.86

**Clutch Sleeve Guide**

All models up to (VIN) LA939975	Genuine	1	<b>FRC4078</b>	3.10	3.72
---------------------------------	---------	---	----------------	------	------

**Clutch Pipe**

All 200 and 300TDi diesel models - Hose to slave cyl.	Aftermarket	1	<b>NRC9595P</b>	13.96	16.75
	Genuine	1	<b>NRC9595</b>	29.11	34.93
All RHD models up to (VIN) LA939975 - Master cyl to hose	Aftermarket	1	<b>NRC8330</b>	29.11	34.93
	Genuine	1	<b>NRC8330</b>	29.11	34.93
All LHD models up to (VIN) LA939975 - Master cyl to hose	Aftermarket	1	<b>NRC8329</b>	28.08	33.70
	Genuine	1	<b>NRC8329</b>	28.08	33.70

**Clutch Hose**

All 300TDi diesel models	Aftermarket	1	<b>NTC9055P</b>	2.50	3.00
	OEM	1	<b>NTC9055P1</b>	10.00	12.00
	Genuine	1	<b>NTC9055</b>	42.06	50.47
All 2.5L TD5 diesel models	Aftermarket	1	<b>NRC2211P</b>	3.25	3.90
	Genuine	1	<b>NRC2211</b>	33.62	40.34
All V8 petrol models	Aftermarket	1	<b>NRC2211P</b>	3.25	3.90
	Genuine	1	<b>NRC2211</b>	33.62	40.34
All 2.4L & 2.2L TDCi Puma diesel models (VIN) 7A000001 on	OEM	1	<b>STH500060P1</b>	15.83	19.00
	Genuine	1	<b>STH500060</b>	35.75	42.90

**Clutch Pipe Assembly**

All RHD 2.5L TD5 diesel models - Master cylinder to union	Aftermarket	1	<b>STG101100</b>	20.84	25.01
	Genuine	1	<b>STG101100</b>	20.84	25.01
All RHD 300 TDi diesel models from (VIN) XA159807 on - Master cylinder to union	Aftermarket	1	<b>STG101150</b>	29.11	34.93
	Genuine	1	<b>STG101150</b>	29.11	34.93
All RHD models from (VIN) MA939976 to WA159806 except 2.8L 6 cyl BMW M52 petrol - Master cylinder to union	Aftermarket	1	<b>ANR2162</b>	64.87	77.84
	Genuine	1	<b>ANR2162</b>	64.87	77.84
All 2.5L TD5 diesel models - From clutch hose to slave cylinder	Aftermarket	1	<b>ANR2183</b>	14.79	17.75
	Genuine	1	<b>ANR2183</b>	14.79	17.75
All V8 petrol models - From clutch hose to slave cylinder	OEM	1	<b>577643P1</b>	9.58	11.50
	Genuine	1	<b>577643</b>	12.26	14.71
All RHD models from (VIN) 7A000001 on - Master cylinder to union	Aftermarket	1	<b>STG500230</b>	16.98	20.38
	Genuine	1	<b>STG500230</b>	16.98	20.38
All LHD models from (VIN) 7A000001 on - Master cylinder to union	Aftermarket	1	<b>STG500190</b>	11.51	13.81
	Genuine	1	<b>STG500190</b>	11.51	13.81

**Clutch Master Cylinder**

All models	Aftermarket	1	<b>STC500100P</b>	9.58	11.50
	OEM	1	<b>STC500100P1</b>	19.79	23.75
	Genuine	1	<b>STC500100</b>	76.84	92.21
From (VIN) 7A000001 on	Aftermarket	1	<b>STC500100P</b>	9.58	11.50
	OEM	1	<b>STC500100P1</b>	19.79	23.75
	Genuine	1	<b>STC500100</b>	76.84	92.21

**Master Cylinder Repair Kit**

All models - Clutch master cylinder	Aftermarket	1	<b>GRK1027P</b>	2.08	2.50
	OEM	1	<b>GRK1027</b>	5.63	6.76

**Clutch M/cyl Filler Cap Plastic**

All models from (VIN) XA178603 to 6A999999	Aftermarket	1	<b>500201A</b>	6.04	7.25
	Genuine	1	<b>500201A</b>	6.04	7.25

**Clutch Slave Cylinder**

All 2.5L TD5 diesel models	Aftermarket	1	<b>FTC5202P</b>	7.08	8.50
	OEM	1	<b>FTC5202P1</b>	11.04	13.25
	Genuine	1	<b>FTC5202</b>	62.08	74.50
All models from (VIN) MA939976 to (gbox) 56A0669086 - Early R380 gearbox	Aftermarket	1	<b>FTC5072P</b>	8.54	10.25
	OEM	1	<b>FTC5072P1</b>	14.58	17.50
	Aftermarket	1	<b>FTC5072</b>	65.51	78.61
	Genuine	1	<b>FTC5072</b>	65.51	78.61
All 2.5L 300TDi diesel models from (gbox) 56A0669087 on - Late R380 gearbox	Aftermarket	1	<b>FTC5202P</b>	7.08	8.50
	OEM	1	<b>FTC5202P1</b>	11.04	13.25
	Aftermarket	1	<b>FTC5202</b>	62.08	74.50
	Genuine	1	<b>FTC5202</b>	62.08	74.50
All models except V8 to (VIN) LA939975 - LT77 gearbox type	Aftermarket	1	<b>591231P</b>	7.08	8.50
	OEM	1	<b>591231P1</b>	18.13	21.76
	Aftermarket	1	<b>591231</b>	78.39	94.07
	Genuine	1	<b>591231</b>	78.39	94.07
All 2.8L 6 cyl petrol models	Aftermarket	1	<b>ANR2967P</b>	12.92	15.50
	OEM	1	<b>ANR2967P1</b>	29.58	35.50
	Genuine	1	<b>ANR2967</b>	147.40	176.88
All V8 petrol models	OEM	1	<b>UKC8677P1</b>	20.00	24.00
	Genuine	1	<b>UKC8677</b>	16.67	20.00

**Slave Cylinder Repair Kit**

All models except V8 to (VIN) LA939975 - LT77 gearbox type	Aftermarket	1	<b>8G8600LP</b>	1.00	1.20
	OEM	1	<b>8G8600LP1</b>	4.38	5.26
	Genuine	1	<b>8G8600L</b>	8.51	10.21
All models except V8 from (VIN) MA939976 to 6A999999 - R380 gearbox types	Aftermarket	1	<b>STC2818P</b>	1.25	1.50
	OEM	1	<b>STC2818P1</b>	4.00	4.80
	Aftermarket	1	<b>STC2818</b>	6.22	7.46
	Genuine	1	<b>STC2818</b>	6.22	7.46
All V8 petrol models	Aftermarket	1	<b>513390</b>	5.00	6.00
	Genuine	1	<b>513390</b>	5.00	6.00

**Clutch Slave Cylinder Adaptor**

All 2.4L & 2.2L TDCi Puma diesel models (VIN) 7A000001 on	Aftermarket	1	<b>LR068981</b>	27.92	33.50
	Genuine	1	<b>LR068981</b>	27.92	33.50

**Push Rod Clip**

All 2.8L 6 cyl BMW M52 petrol models	Aftermarket	1	<b>FTC2170</b>	19.44	23.33
	Genuine	1	<b>FTC2170</b>	19.44	23.33
All 2.5L TD5 diesel models	Aftermarket	1	<b>576723P</b>	0.38	0.46
	Genuine	1	<b>576723</b>	3.95	4.74
All V8 petrol models	Aftermarket	1	<b>576723P</b>	0.38	0.46
	Genuine	1	<b>576723</b>	3.95	4.74

**Push Rod**

All 300TDi diesel models	Aftermarket	1	<b>FTC3912P</b>	8.33	10.00
	Genuine	1	<b>FTC3912</b>	16.78	20.14
All 4 cyl petrol & diesel models with 5 speed LT77 gearbox - Clutch slave cylinder	Aftermarket	1	<b>FRC3417P</b>	2.25	2.70
	OEM	1	<b>FRC3417</b>	7.98	9.58
	Genuine	1	<b>FRC3417</b>	7.98	9.58
All 2.5L TD5 diesel models	Aftermarket	1	<b>FTC5199</b>	7.67	9.20
	Genuine	1	<b>FTC5199</b>	7.67	9.20
All 2.5L N/A diesel models with 5 speed R380 gearbox - Clutch slave cylinder	Aftermarket	1	<b>FTC4229</b>	44.12	52.94
	Genuine	1	<b>FTC4229</b>	44.12	52.94

**Bleed Screw Clutch Slave Cylinder**

All 300TDi and 2.5L TD5 diesel models	Aftermarket	1	<b>606733A</b>	2.58	3.10
	Genuine	1	<b>606733A</b>	2.58	3.10

**Switch Clutch Master Cylinder**

All 2.4L and 2.2L TDCi Puma diesel models - Electronic diesel control	Aftermarket	1	<b>MSK500020</b>	21.81	26.17
	Genuine	1	<b>MSK500020</b>	21.81	26.17

**Dowel Clutch Guide**

All models up to (VIN) 6A999999	Genuine	2	<b>FRC2481</b>	2.29	2.75
---------------------------------	---------	---	----------------	------	------





# TRANSMISSION

## Constant Velocity Joint

All models up to (VIN) KA930455 - 33 spline

Aftermarket	2	<b>RTC6862P</b>	15.83	19.00
Genuine	2	<b>RTC6862</b>	577.93	693.52

All models to (VIN) KA930455 (axle) 20L, 21L, 22L, 23L - 23 spline

Aftermarket	2	<b>AEU2522P</b>	18.13	21.76
-------------	---	-----------------	-------	-------

All models (VIN) LA930456 to 6A999999 (axle) 61L, 62L, 63L, 64L, 11M to 17M - 24 spline

Aftermarket	1	<b>TDJ000010P</b>	20.63	24.76
-------------	---	-------------------	-------	-------

## Gaiter Propshaft

All models to (VIN) 6A999999

Front	Aftermarket	1	<b>TVE100000P</b>	2.58	3.10
	OEM	1	<b>TVE100000P1</b>	3.08	3.70
	Genuine	1	<b>TVE100000</b>	15.14	18.17
Rear	Aftermarket	1	<b>276483P</b>	3.00	3.60
	Genuine	1	<b>276483</b>	24.73	29.68

## Gaiter Propshaft c/w Clips

All models to (VIN) 6A999999 - Front	Aftermarket	1	<b>276484P</b>	2.33	2.80
	Genuine	1	<b>276484</b>	22.65	27.18

## Universal Joint

All models (VIN) 1A612405 to 6A999999

Front propshaft	Aftermarket	2	<b>STC4807P</b>	6.67	8.00
	OEM	2	<b>STC4807P1</b>	30.83	37.00
	Genuine	2	<b>STC4807</b>	48.23	57.88

All models to (VIN) 6A999999

Propshaft, sealed	Aftermarket	2	<b>RTC3458P</b>	4.08	4.90
	OEM	2	<b>RTC3458P1</b>	8.54	10.25
	Genuine	2	<b>RTC3458</b>	46.58	55.90

All models (VIN) 7A000001 on

Front propshaft	Aftermarket	2	<b>TVC500010P</b>	8.96	10.75
	OEM	2	<b>TVC500010P1</b>	22.50	27.00
	Genuine	2	<b>TVC500010</b>	49.59	59.51

Rear propshaft, sealed

Aftermarket	2	<b>RTC3458P</b>	4.08	4.90
OEM	2	<b>RTC3458P1</b>	8.54	10.25
Genuine	2	<b>RTC3458</b>	46.58	55.90

All 300TDi diesel models

Rear propshaft, heavy duty spec	Aftermarket	2	<b>TVC100010P</b>	6.67	8.00
	OEM	2	<b>TVC100010P1</b>	15.42	18.50
	Genuine	2	<b>TVC100010</b>	67.89	81.47

All 2.5L TD5 diesel models to (VIN) 2A638133

Rear propshaft, heavy duty spec	Aftermarket	2	<b>TVC100010P</b>	6.67	8.00
	OEM	2	<b>TVC100010P1</b>	15.42	18.50
	Genuine	2	<b>TVC100010</b>	67.89	81.47

All 2.5L TD5 diesel models (VIN) 2A638134 on

Rear propshaft, all specs	Aftermarket	2	<b>TVC100010P</b>	6.67	8.00
	OEM	2	<b>TVC100010P1</b>	15.42	18.50
	Genuine	2	<b>TVC100010</b>	67.89	81.47

All V8 petrol models (VIN) LA937640 on

Rear propshaft, heavy duty spec	Aftermarket	2	<b>TVC100010P</b>	6.67	8.00
	OEM	2	<b>TVC100010P1</b>	15.42	18.50
	Genuine	2	<b>TVC100010</b>	67.89	81.47

## Shaft Front Axle

All non-ABS models to (axle) 20L48865, 21L33355, 22L27847, 23L12092

RH	Genuine	1	<b>AEU2520</b>	317.01	380.41
----	---------	---	----------------	--------	--------

All non-ABS models(axle) 20L48866 on, 21L33356 on, 22L27848 on, 23L12093 on

RH	Aftermarket	1	<b>RTC6754P</b>	21.67	26.00
	Genuine	1	<b>RTC6754</b>	174.72	209.66
LH	Aftermarket	1	<b>RTC6755P</b>	27.50	33.00
	Genuine	1	<b>RTC6755</b>	269.69	323.63

All models (VIN) LA930456 on (axle) 61L, 61S, 63L, 64L, 10M to 17M -

RH	Aftermarket	1	<b>TDC000020P</b>	22.08	26.50
	OEM	1	<b>TDC000020P1</b>	45.00	54.00
	Genuine	1	<b>TDC000020</b>	242.38	290.86
LH	Aftermarket	1	<b>TDC000030P</b>	22.92	27.50
	OEM	1	<b>TDC000030P1</b>	48.33	58.00
	Genuine	1	<b>TDC000030</b>	290.18	348.22

All models (VIN) LA930456 on, (axle) 61L, 61S, 63L, 64L, 10M to 17M, plus (VIN) 7A000001 on

RH, 24 spline	Aftermarket	1	<b>TDB500280P</b>	39.58	47.50
	OEM	1	<b>TDB500280P1</b>	170.83	205.00
	Genuine	1	<b>TDB500280</b>	235.57	282.68
LH, 24 spline	Aftermarket	1	<b>TDB500290P</b>	45.00	54.00
	OEM	1	<b>TDB500290P1</b>	170.83	205.00
	Genuine	1	<b>TDB500290</b>	199.50	239.40

## Shaft Rear Axle

All models to (VIN) KA930455

RH	Genuine	1	<b>FRC2454</b>	271.35	325.62
LH	Genuine	1	<b>FRC2455</b>	271.35	325.62

All models (VIN) KA930456 to 2A638163

RH	Aftermarket	1	<b>FTC1724P</b>	17.50	21.00
	OEM	1	<b>FTC1724P1</b>	66.67	80.00
	Genuine	1	<b>FTC1724</b>	265.57	318.68
LH	Aftermarket	1	<b>FTC1725P</b>	18.54	22.25
	OEM	1	<b>FTC1725P1</b>	71.67	86.00
	Genuine	1	<b>FTC1725</b>	306.58	367.90

All models (VIN) 2A638165 on (axle) 14S to 17S

RH	Aftermarket	1	<b>LR072976P</b>	22.50	27.00
	OEM	1	<b>LR072976P1</b>	53.33	64.00
	Genuine	1	<b>LR072976</b>	277.77	333.32
LH	Aftermarket	1	<b>T0B500030P</b>	25.00	30.00
	OEM	1	<b>T0B500030P1</b>	57.50	69.00
	Genuine	1	<b>T0B500030</b>	307.94	369.53

## Shaft Assembly Front Output

All models with LT230 transfer box

Aftermarket	1	<b>FRC5449P</b>	38.75	46.50
Genuine	1	<b>FRC5449</b>	190.22	228.26

## Drive Flange Kit, Transfer Box

All models with 43D transfer box up to (VIN) 6A999999 - Front output shaft

Aftermarket	1	<b>LR055718P</b>	23.54	28.25
Genuine	1	<b>LR055718</b>	144.19	173.03

All models with 43D transfer box - Front, heavy duty

Genuine	1	<b>IEC100020</b>	49.74	59.69
---------	---	------------------	-------	-------

All models from (VIN) 7A000001 on - Front output shaft

Aftermarket	1	<b>LR055718P</b>	23.54	28.25
Genuine	1	<b>LR055718</b>	144.19	173.03

## Spacer Front Drive Shaft

All models to (VIN) KA930455 (axle) 20L, 21L, 22L, 23L

Aftermarket	2	<b>FTC254P</b>	2.83	3.40
Genuine	2	<b>FTC254</b>	5.31	6.37

All models (VIN) LA930456 on (axle) 20L, 21L, 22L, 23L

Genuine	1	<b>TYF000010</b>	3.99	4.79
---------	---	------------------	------	------

## Hub Assembly

All models to (VIN) KA930455

Front	Aftermarket	2	<b>FRC6139P</b>	55.00	66.00
	Genuine	2	<b>FRC6139</b>	149.65	179.58
Rear	Aftermarket	2	<b>FRC8555P</b>	39.58	47.50
	Genuine	2	<b>FRC8555</b>	149.20	179.04

All models (VIN) LA930456 to 6A999999 (axle) 61L, 61S, 63L, 64L plus (VIN) 7A000001 on

Aftermarket	2	<b>RUB500240P</b>	50.00	60.00
Genuine	2	<b>RUB500240</b>	150.00	180.00

## Stub Axle

All models to (VIN) KA930455

Front	Aftermarket	2	<b>FRC4320P</b>	20.63	24.76
	OEM	2	<b>FRC4320P1</b>	50.00	60.00
	Genuine	2	<b>FRC4320</b>	103.38	124.06
Rear	Aftermarket	2	<b>FRC3132P</b>	19.58	23.50
	OEM	2	<b>FRC3132P1</b>	39.58	47.50
	Genuine	2	<b>FRC3132</b>	167.46	200.95

All models (VIN) LA930456 on

Front	Aftermarket	2	<b>FTC3154P</b>	16.04	19.25
	OEM	2	<b>FTC3154P1</b>	50.00	60.00
	Genuine	2	<b>FTC3154</b>	82.86	99.43
Rear	Aftermarket	2	<b>FRC8540P</b>	16.04	19.25
	OEM	2	<b>FRC8540P1</b>	45.00	54.00
	Genuine	2	<b>FRC8540</b>	201.46	241.75

All models (VIN) LA930456 on (axle) 38S, 39S

Rear	Aftermarket	2	<b>FTC1740P</b>	14.79	17.75
	OEM	2	<b>FTC1740P1</b>	51.67	62.00
	Genuine	2	<b>FTC1740</b>	104.42	125.30

All models (VIN) WA769311 on (axle) 60S, 62L, 62S, 63S

Rear	Aftermarket	2	<b>FTC3188P</b>	16.04	19.25
	OEM	2	<b>FTC3188P1</b>	45.00	54.00
	Genuine	2	<b>FTC3188</b>	83.71	100.45

## Stub Axle Nut

All models to (VIN) KA930455

Aftermarket	4	<b>FRC8700P</b>	1.25	1.50
Genuine	4	<b>FRC8700</b>	10.09	12.11

All models (VIN) LA930456 on (axle) 61L, 61S, 63L, 64L

Front	Aftermarket	4	<b>FRC8700P</b>	1.25	1.50
	Genuine	4	<b>FRC8700</b>	10.09	12.11

All models (VIN) LA930456 to WA159806

Rear	Aftermarket	4	<b>FRC8700P</b>	1.25	1.50
	Genuine	4	<b>FRC8700</b>	10.09	12.11

## Stub Axle Kit

All models to (VIN) KA930455 - Front.

Includes stub axle, gasket, bolts, washers, bearing and seals		Britpart	2	<b>FRC4320BPK</b>	20.63	24.76

All models (VIN) LA930456 to 6A999999 - Front.

Includes stub axle, gasket, bolts, washers, bearing and seals		Britpart	2	<b>FTC3154DEFBPK</b>	25.83	31.00

All models (VIN) 7A000001 on - Front. Includes stub axle, gasket, bolts, washers, bearing and seals

		Britpart	2	<b>FTC3154PUMABPK</b>	25.83	31.00

Up to (axle) 22S08283B - Rear.

Includes stub axle, gasket, bolts and nuts		Britpart	2	<b>FRC3132BPK</b>	45.83	55.00

From (axle) 22S08284B to (VIN) KA930455 - Rear.

Includes stub axle, gasket, bolts and nuts		Britpart	2	<b>FRC8540BPK</b>	17.50	21.00

All models (VIN) WA769311 on (axle) 60S, 62L, 62S, 63S - Rear.

Includes stub axle, gasket, bolts and seal		Britpart	2	<b>FTC3188DEFBPK</b>	19.58	23.50

**DEFENDER 110 (1989 on)****TRANSMISSION****Hub Retaining Nut**

All models (axle) 10M-17M, (VIN) LA930456 on				
Front axle	Aftermarket	4	<b>RFD10000P</b>	1.50 1.80
	Genuine	4	<b>RFD100000</b>	5.06 6.07
All models (VIN) XA159807 on				
Rear axle	Aftermarket	4	<b>RFD10000P</b>	1.50 1.80
	Genuine	4	<b>RFD100000</b>	5.06 6.07

**Driving Member**

All models (VIN) LA930456 on - 24 spline, front and rear				
	Aftermarket	2	<b>RUC105200P</b>	4.58 5.50
	OEM	2	<b>RUC105200P1</b>	12.50 15.00
	Genuine	2	<b>RUC105200</b>	118.51 142.21
Heavy Duty				
	Britpart	2	<b>RUC105200HDBP</b>	25.83 31.00
	Terrafrima	2	<b>RUC105200HDTF</b>	16.88 20.26
	Bearmach	2	<b>RUC105200HDBM</b>	16.88 20.26

**Driving Member Kit, Heavy Duty**

All models (VIN) LA930456 on - Pair of 24 spline driving members				
	Britpart	2	<b>RUC105200HDKBP</b>	62.50 75.00

**Dust Cap, Screw On**

All models fitted with Britpart heavy duty driving members				
Cap	Bearmach	2	<b>RUC105200HDBPCAP</b>	8.75 10.50
Nut	Bearmach	2	<b>RUC105200HDBMNU</b>	3.33 4.00

**Bolt Kit, Heavy Duty Driving Members**

All models fitted with Britpart heavy duty driving members - Includes 10 bolts (one axle set)				
	Britpart	1	<b>RUC105200HPKBOLT</b>	10.00 12.00

**Hub & Sleeve Assembly Trans Box**

All 4 cyl models with LT77 gearbox and LT230 transfer box (gbox) 22D				
	OEM	1	<b>FTC382P1</b>	78.33 94.00
	Genuine	1	<b>FTC382</b>	341.90 410.28
All 300TDi diesel models with LT230 transfer box (gbox) 43D				
	OEM	1	<b>FTC5099P1</b>	110.83 133.00
	Genuine	1	<b>FTC5099</b>	271.78 326.14
All TD5 diesel models with LT230 transfer box (gbox) 43D				
	OEM	1	<b>FTC5099P1</b>	110.83 133.00
	Genuine	1	<b>FTC5099</b>	271.78 326.14
All V8 carb petrol models with 5 speed LT77 gearbox and LT230 transfer box (gbox) 32D				
	OEM	1	<b>FTC382P1</b>	78.33 94.00
	Genuine	1	<b>FTC382</b>	341.90 410.28
All 2.4L and 2.2L TDCi diesel models with LT230 transfer box from (VIN) 7A000001 on				
	OEM	1	<b>FTC5099P1</b>	110.83 133.00
	Genuine	1	<b>FTC5099</b>	271.78 326.14

**Spacer Hub**

All models to (VIN) KA930455				
	Aftermarket	2	<b>FRC8227P</b>	1.75 2.10
	Genuine	2	<b>FRC8227</b>	29.89 35.87

**Bearing Stub Housing**

All models (VIN) LA930456 on				
	Aftermarket	2	<b>FTC861P</b>	5.63 6.76
	OEM	2	<b>FTC861P1</b>	6.67 8.00
	Genuine	2	<b>FTC861</b>	11.73 14.08

**Bearing Swivel Pin Housing**

All models				
	Aftermarket	2	<b>606666P</b>	3.33 4.00
	OEM	2	<b>606666P1</b>	10.42 12.50
	Genuine	2	<b>606666</b>	23.99 28.79

**Housing Swivel Pin Bearing**

All models (axle) 20L, 21L, 22L, 23L to (VIN) WA159961 - 7 hole type				
	Aftermarket	2	<b>FTC5105P</b>	60.00 72.00
	OEM	2	<b>FTC5105P1</b>	87.50 105.00
	Genuine	2	<b>FTC5105</b>	197.93 237.52
All models (VIN) LA930456 on, (axle) 61L, 61S, 63L, 63S, plus (VIN) 7A000001 on				
	Aftermarket	2	<b>FTC5366P</b>	80.00 96.00
	OEM	2	<b>FTC5366P1</b>	85.00 102.00
	Genuine	2	<b>FTC5366</b>	161.99 194.39

**Housing & Bush Swivel Pin**

All models to (VIN) KA930455				
	Aftermarket	2	<b>8510267P</b>	6.04 7.25
	Genuine	2	<b>8510267</b>	31.21 37.45

**Housing, Swivel Pin**

All RHD models up to (VIN) KA930455				
LH	Genuine	1	<b>FTC2529</b>	468.45 562.14
All LHD models up to (VIN) KA930455				
RH	OEM	1	<b>FTC2530P1</b>	245.83 295.00
	Genuine	1	<b>FTC2530</b>	522.25 626.70
	OEM	1	<b>FTC2531P1</b>	233.33 280.00
LH	Genuine	1	<b>FTC2531</b>	502.76 603.31

**Swivel Pin Upper**

All models to (VIN) KA930455				
	Aftermarket	2	<b>FRC3511P</b>	5.63 6.76
	Genuine	2	<b>FRC3511</b>	86.01 103.21
All models (VIN) LA930456 to WA159806				
	Aftermarket	2	<b>FTC2882P</b>	5.00 6.00
	Genuine	2	<b>FTC2882</b>	51.55 61.86

**Swivel Pin Lower**

All models				
	Aftermarket	2	<b>FRC2894P</b>	2.50 3.00
	Genuine	2	<b>FRC2894</b>	64.95 77.94

**Swivel Pin Kit Upper**

All non ABS models (VIN) XA159807 on				
	Aftermarket	2	<b>TAR100040P</b>	13.13 15.76
	Genuine	2	<b>TAR100040</b>	33.60 40.32
All ABS fitted models (VIN) XA159807 on				
	Aftermarket	2	<b>TAR100050P</b>	13.75 16.50
	Genuine	2	<b>TAR100050</b>	41.44 49.73

**Swivel Housing Grease**

All models				
Sachet	OEM	a/r	<b>STC3435P1</b>	5.00 6.00
	Genuine	a/r	<b>STC3435</b>	7.69 9.23
370g bottle	Britpart	a/r	<b>STC3435BPBOTTLE</b>	4.79 5.75
370ml sachet	Britpart	a/r	<b>STC3435BPSACHET</b>	4.38 5.26

**Oil Seal Diff Unit**

All models to (VIN) KA930455				
	Aftermarket	1	<b>FRC8220P</b>	1.50 1.80
	OEM	1	<b>FRC8220P1</b>	5.63 6.76
	Genuine	1	<b>FRC8220</b>	27.28 32.74
All models front axle only to (VIN) KA930455				
	Aftermarket	1	<b>FRC4586P</b>	0.83 1.00
	OEM	1	<b>FRC4586P1</b>	3.50 4.20
	Genuine	1	<b>FRC4586</b>	11.66 13.99
All models (VIN) LA930456 to (axle) 62L12289A				
Front	Aftermarket	1	<b>FRC8220P</b>	1.50 1.80
	OEM	1	<b>FRC8220P1</b>	5.63 6.76
	Genuine	1	<b>FRC8220</b>	27.28 32.74
All models (VIN) LA930456 to VA102732				
Rear	Aftermarket	1	<b>FRC8220P</b>	1.50 1.80
	OEM	1	<b>FRC8220P1</b>	5.63 6.76
	Genuine	1	<b>FRC8220</b>	27.28 32.74
All Salisbury type axles - Pinion				
	Aftermarket	1	<b>AEU2515P</b>	2.83 3.40
	Genuine	1	<b>AEU2515</b>	35.42 42.50

**Oil Seal Diff Pinion Front**

All models (axle) 62L12290L on and (VIN) 7A000001 on				
	Aftermarket	1	<b>FTC5258P</b>	1.50 1.80
	OEM	1	<b>FTC5258P1</b>	4.08 4.90
	Genuine	1	<b>FTC5258</b>	13.96 16.75

**Oil Seal Diff Pinion**

All models rear axle only (axle) 14S to 17S, plus (VIN) 7A000001 on				
	Aftermarket	1	<b>FTC4851P</b>	2.00 2.40
	OEM	1	<b>FTC4851P1</b>	5.00 6.00
	Genuine	1	<b>FTC4851</b>	17.42 20.90

**Oil Seal Hub**

All models to (VIN) XA159806				
	Genuine	1	<b>AAU3381</b>	5.30 6.36
All models to (VIN) KA930455				
	Aftermarket	2	<b>FRC8222P</b>	1.83 2.20
	OEM	2	<b>FRC8222P1</b>	5.63 6.76
	Genuine	2	<b>FRC8222</b>	21.24 25.49

**Oil Seal Stub Axle**

All models to (VIN) KA930455 - Twin lip type				
	Aftermarket	2	<b>RTC3511P</b>	1.33 1.60
	OEM	2	<b>RTC3511P1</b>	3.50 4.20
	Genuine	2	<b>RTC3511</b>	12.52 15.02

**Seal Inner Stub Axle**

All models (axle) 20L, 21L, 22L, 23L, 22S, 24S to (VIN) KA930455				
	Aftermarket	2	<b>FTC4785P</b>	1.33 1.60
	OEM	2	<b>FTC4785P1</b>	3.00 3.60
	Genuine	2	<b>FTC4785</b>	4.34 5.21

**Seal Stub Axle**

All models to (VIN) KA930455				
	Aftermarket	2	<b>FRC3099P</b>	0.75 0.90
	OEM	2	<b>FRC3099P1</b>	3.25 3.90
	Genuine	2	<b>FRC3099</b>	8.09 9.71

**Seal Stub Axle Inner**

All models (VIN) VA104815 on				
Front	Aftermarket	2	<b>FTC5268P</b>	0.92 1.10
	Genuine	2	<b>FTC5268</b>	3.18 3.82
All models (VIN) LA930456 on (axle) 42S, 44S, 58S, 59S, plus (VIN) 7A000001 on -				
Rear	Aftermarket	2	<b>FTC5268P</b>	0.92 1.10
	Genuine	2	<b>FTC5268</b>	3.18 3.82

**Seal Stub Axle Outer**

All models (VIN) LA930456 to (axle) 20L77036C				
	Aftermarket	2	<b>FTC840P</b>	2.08 2.50
	Genuine	2	<b>FTC840</b>	10.71 12.85

**Seal Output Shaft**

All models with R380 5 speed gearbox				
	Aftermarket	1	<b>FTC500010P</b>	1.00 1.20
	Genuine	1	<b>FTC500010</b>	12.07 14.48



RUC105200P



# TRANSMISSION

# DEFENDER 110 (1989 on)

## Seal Rear Axle Diff Unit

All models (VIN) XA159807 on	Aftermarket	1	<b>STC4401P</b>	2.75	3.30
	OEM	1	<b>STC4401P1</b>	4.38	5.26
	Genuine	1	<b>STC4401</b>	42.98	51.58

## Seal Drive Shaft

All models (axle) 61L, 61S, 63S, 64L plus (VIN) 7A000001 on	Aftermarket	2	<b>FTC3276P</b>	1.00	1.20
	OEM	2	<b>FTC3276P1</b>	2.75	3.30
	Genuine	2	<b>FTC3276</b>	3.47	4.16

## Oil Seal Front Cover

All models with LT77 5 speed gearbox (gbox) suffix A to E	Aftermarket	1	<b>UKC1060P</b>	1.58	1.90
	Aftermarket	1	<b>UKC1060</b>	5.63	6.76
All models with R380 5 speed gearbox (gbox) suffix J	Aftermarket	1	<b>UKC1060P</b>	1.58	1.90
	Aftermarket	1	<b>UKC1060</b>	5.63	6.76

## Oil Seal Transfer Box Input

All models with LT230 transfer box	Aftermarket	1	<b>ICV100000P</b>	0.92	1.10
	OEM	1	<b>ICV100000P1</b>	3.83	4.60
	Genuine	1	<b>ICV100000</b>	6.99	8.39

## Oil Seal Transfer Box Output Flange

All models with LT230 transfer box	Aftermarket	1	<b>FTC4939P</b>	2.00	2.40
	OEM	1	<b>FTC4939P1</b>	5.00	6.00
	Genuine	1	<b>FTC4939</b>	13.18	15.82

## Oil Seal Swivel

All models - 9mm	Aftermarket	2	<b>LR059968P</b>	2.08	2.50
	OEM	2	<b>LR059968P1</b>	5.83	7.00
	Genuine	2	<b>LR059968</b>	9.89	11.87

## Oil Seal Swivel Pin Housing

All models (axle) 20L, 21L, 22L, 23L	Aftermarket	2	<b>571718P</b>	1.17	1.40
	OEM	2	<b>571718P1</b>	3.00	3.60
	Genuine	2	<b>571718</b>	6.81	8.17

## Drain Plug

All models from (VIN) 7A000001 on - Magnetic, front axle	OEM	1	<b>TYB500120P1</b>	4.08	4.90
	Genuine	1	<b>TYB500120</b>	7.05	8.46

## Plug, Oil Filler & Drain

All models (VIN) 7A000001 on - Front & rear axles, non-magnetic type	Genuine	1	<b>TGZ500070</b>	7.94	9.53
----------------------------------------------------------------------	---------	---	------------------	------	------

## Drain Plug Diff Unit

All models	Aftermarket	1	<b>608246P</b>	2.33	2.80
	Genuine	1	<b>608246</b>	9.63	11.56

## Drain Plug Transfer Box

All models with LT230 transfer box	Aftermarket	1	<b>599552P</b>	2.83	3.40
	Genuine	1	<b>599552</b>	8.99	10.79

## Sealing Washer Drain Plug

All models - Land Rover type axle	Aftermarket	1	<b>515599P</b>	0.33	0.40
	Genuine	1	<b>515599</b>	1.17	1.40
All models with LT77 or R380 5 speed gearbox					
Alternative to FRC7064A	Aftermarket	1	<b>FTC4112P</b>	0.79	0.95
	Genuine	1	<b>FTC4112</b>	2.37	2.84
Alternative to FTC4112	Aftermarket	1	<b>FRC7064A</b>	1.08	1.30
All models with R380 5 speed gearbox	Aftermarket	1	<b>FTC4112P</b>	0.79	0.95
	Genuine	1	<b>FTC4112</b>	2.37	2.84

## Speedometer Drive Gear

All models with LT230 transfer box	Aftermarket	1	<b>FRC3162P</b>	20.63	24.76
	OEM	1	<b>FRC3162P1</b>	23.75	28.50
	Genuine	1	<b>FRC3162</b>	64.01	76.81
All models with blue coded 20 teeth speedometer drive pinion - Pinion, blue, 20 teeth					
	Aftermarket	1	<b>FRC3310P</b>	8.54	10.25
	Genuine	1	<b>FRC3310</b>	16.89	20.27

## Gear Speedo Drive Spindle

All models (VIN) 7A000001 on - Blue, 20 teeth	Aftermarket	1	<b>FRC3310P</b>	8.54	10.25
	Genuine	1	<b>FRC3310</b>	16.89	20.27

## Switch, Gearbox

All models up to (VIN) 2A642630 - High/Low, with spade connectors	Aftermarket	1	<b>PRC2911P</b>	4.08	4.90
	OEM	1	<b>PRC2911P1</b>	7.92	9.50

## Switch, Transfer Box

All models up to (VIN) 2A642630 - High/Low, with spade connectors	Genuine	1	<b>PRC2911</b>	35.18	42.22
All models from (VIN) 2A642631 on - High/Low, with harness and plug					
	Aftermarket	1	<b>IGM500011P</b>	10.62	12.74
	Genuine	1	<b>IGM500011</b>	25.94	31.13
All models with 43D transfer box - Low ratio detection					
	Genuine	1	<b>IGM100000</b>	42.77	51.32

## Taper Roller Bearing Diff Carrier

All models (axle) 64L, plus all 2 and 4 pin diffs from (VIN) 7A000001 on - Land Rover type axle	Aftermarket	2	<b>RTC3095P</b>	4.25	5.10
	OEM	2	<b>RTC3095P1</b>	9.37	11.24
	Genuine	2	<b>RTC3095</b>	52.69	63.23

## Transducer, Speed

All models from (VIN) XA159807 on - Transfer box	Genuine	1	<b>YBE100530</b>	60.33	72.40
--------------------------------------------------	---------	---	------------------	-------	-------





## DEFENDER 110 (1989 on)

## COOLING

## Expansion Bottle Cap

All 2.5L 200 TDi and 300 TDi diesel models - 15lb pressure				
Aftermarket	1	<b>NTC7161P</b>	2.75	3.30
OEM		<b>NTC7161P1</b>	7.08	8.50
Genuine	1	<b>NTC7161</b>	10.44	12.53
All V8 carb petrol engine models				
Aftermarket	1	<b>PCD100150P</b>	1.42	1.70
Genuine	1	<b>PCD100150</b>	4.04	4.85
15lb pressure				
Aftermarket	1	<b>GRC110</b>	4.38	5.26
All 2.4L/2.2L Puma TDCi diesel engine models				
Aftermarket	1	<b>PCD100160-P</b>	2.00	2.40
Genuine	1	<b>PCD100160</b>	3.87	4.64

## Thermostat

All 2.5L 200 TDi diesel engine models - 88°C				
Aftermarket	1	<b>ERR2803P</b>	2.83	3.40
OEM	1	<b>ERR2803P1</b>	9.17	11.00
Genuine	1	<b>ERR2803</b>	11.50	13.80
All 2.5L 300 TDi diesel engine models				
Aftermarket	1	<b>ERR3291P</b>	2.75	3.30
OEM	1	<b>ERR3291P1</b>	5.21	6.25
Genuine	1	<b>ERR3291</b>	11.07	13.28
All V8 carb petrol engine models - 82°C				
Aftermarket	1	<b>602687P</b>	2.58	3.10
OEM	1	<b>602687P1</b>	3.58	4.30
Genuine	1	<b>602687</b>	10.06	12.07
All V8 petrol models				
74°C, hot climates option				
Aftermarket	1	<b>GTS102</b>	3.33	4.00
82°C, std fitment				
Aftermarket	1	<b>GTS104</b>	3.58	4.30
Aftermarket	1	<b>GTS106</b>	3.58	4.30
88°C, cold climates option				
Aftermarket	1	<b>ETC4765P</b>	2.50	3.00
OEM	1	<b>ETC4765P1</b>	3.08	3.70
Genuine	1	<b>ETC4765</b>	10.06	12.07
All 2.4L TDCi Puma diesel engine models				
OEM	1	<b>LR004618P1</b>	10.83	13.00
Genuine	1	<b>LR004618</b>	51.39	61.67

## Thermostat Gasket

All 300 TDi diesel engine models - Thermostat housing				
Aftermarket	1	<b>ERR3490P</b>	0.38	0.46
Genuine	1	<b>ERR3490</b>	2.20	2.64

## Thermostat Housing Gasket

All 200 TDi diesel models - Thermostat housing				
Aftermarket	1	<b>ERR3682P</b>	0.33	0.40
Genuine	1	<b>ERR3682</b>	2.04	2.45
All 200 TDi diesel models - Lower				
Aftermarket	1	<b>ETC8007P</b>	0.42	0.50
Genuine	1	<b>ETC8007</b>	2.20	2.64
All V8 petrol engine models - Thermostat housing				
Aftermarket	1	<b>ERR2429P</b>	0.67	0.80
Genuine	1	<b>ERR2429</b>	1.75	2.10
All V8 petrol models with 4 barrel carb conversion				
Aftermarket	1	<b>GTG116</b>	1.83	2.20

## O Ring Thermostat Housing

All 300 TDi diesel models - Thermostat housing				
Aftermarket	1	<b>ERR4685P</b>	0.46	0.55
Genuine	1	<b>ERR4685</b>	2.15	2.58

## Thermostat Housing

All 200 TDi diesel models				
Genuine	1	<b>ERR1499</b>	201.38	241.66
Aftermarket	1	<b>ERR3479P</b>	57.50	69.00
Genuine	1	<b>ERR3479</b>	281.22	337.46
All 2.5L TD5 and 2.4L/2.2L TDCi Puma diesel engine models				
Aftermarket	1	<b>PEM100990P</b>	12.92	15.50
OEM	1	<b>PEM100990P1</b>	16.67	20.00
Genuine	1	<b>PEM100990</b>	29.47	35.36
All V8 petrol models with air conditioning				
Aftermarket	1	<b>ETC6135A</b>	29.58	35.50

## Thermostat Housing Adaptor

All 200 TDi and 300 TDi diesel models - Heater pipe				
Genuine	1	<b>624091</b>	7.82	9.38

## Plastic Plug

All 300 TDi diesel engine models - Thermostat housing filler				
Aftermarket	1	<b>ERR4686P</b>	0.92	1.10
Genuine	1	<b>ERR4686</b>	2.47	2.96

## Water Pump

All 200 TDi diesel models				
Aftermarket	1	<b>STC639P</b>	29.58	35.50
Genuine	1	<b>STC639</b>	200.37	240.44
All 2.5L 300 TDi diesel engine models				
Aftermarket	1	<b>PEB500090P</b>	14.58	17.50
OEM	1	<b>PEB500090P1</b>	19.58	23.50
Genuine	1	<b>PEB500090</b>	105.27	126.32
All 2.5L TD5 diesel engine models				
Aftermarket	1	<b>PEM500040P</b>	15.00	18.00
OEM	1	<b>PEM500040P1</b>	27.50	33.00
Genuine	1	<b>PEM500040</b>	116.96	140.35
All V8 carb petrol engine models with viscous coupling with air conditioning				
Aftermarket	1	<b>STC488P</b>	50.00	60.00
Genuine*	1	<b>STC488</b>	182.33	218.80
*Exchange Surcharge				
			40.00	48.00
All V8 EFI petrol engine models				
Aftermarket	1	<b>STC4378P</b>	28.75	34.50
OEM	1	<b>STC4378P1</b>	53.33	64.00
Genuine*	1	<b>STC4378</b>	128.66	154.39
*Exchange Surcharge				
			40.00	48.00
All 2.2L Puma diesel models to (VIN) FA458988				
Genuine	1	<b>LR071294</b>	130.00	156.00
All 2.4L TDCi Puma diesel engine models				
OEM	1	<b>LR079819P1</b>	60.00	72.00
Genuine	1	<b>LR083283</b>	245.89	295.07

## Water Pump Gasket

All 200 TDi diesel models - Water pump				
Aftermarket	1	<b>ERC5655P</b>	0.38	0.46
Genuine	1	<b>ERC5655</b>	5.04	6.05
All 300 TDi diesel engine models - Water pump				
Aftermarket	1	<b>ERR3284P</b>	0.67	0.80
Genuine	1	<b>ERR3284</b>	5.04	6.05
All 300 TDi diesel engine models - Distance piece to block				
Aftermarket	1	<b>PET100790P</b>	0.92	1.10
Genuine	1	<b>PET100790</b>	4.80	5.76
All V8 carb engine models - Water pump				
Aftermarket	1	<b>ERR2428P</b>	0.83	1.00
OEM	1	<b>ERR2428P1</b>	4.00	4.80
Genuine	1	<b>ERR2428</b>	8.47	10.16
All V8 EFI petrol engine models - Water pump				
Aftermarket	1	<b>ERR4077P</b>	1.50	1.80
Genuine	1	<b>ERR4077</b>	8.44	10.13
All 2.4L Puma diesel models				
Genuine	1	<b>LR004389</b>	9.50	11.40

## Water Pump Inlet Housing Gasket

All 200 TDi diesel models - Water pump inlet housing				
Aftermarket	1	<b>ERR1607P</b>	0.25	0.30
Genuine	1	<b>ERR1607</b>	1.67	2.00

## Water Pump Seal

All 2.5L TD5 diesel models				
Aftermarket	1	<b>ERR6711P</b>	3.00	3.60
Genuine	1	<b>ERR6711</b>	5.04	6.05

## D Ring Set

All 2.5L TD5 diesel engine models - Water pump				
Aftermarket	1	<b>PFQ10001LP</b>	5.00	6.00
Genuine	1	<b>PFQ10001L</b>	8.01	9.61

## Intercooler Hose

All 2.5L 200 TDi diesel models - Turbo to intercooler pipe				
Aftermarket	1	<b>ESR2934P</b>	5.63	6.76
OEM	1	<b>ESR2934P1</b>	16.67	20.00
Genuine	1	<b>ESR2934</b>	53.88	64.66
All 2.5L 200 TDi diesel models - Upper, intercooler to pipe				
Genuine	1	<b>ESR289</b>	7.27	8.72
All 200 TDi diesel models - Lower, intercooler to pipe				
Aftermarket	1	<b>ESR2942P</b>	44.17	53.00
Genuine	1	<b>ESR2942</b>	75.63	90.76
All 2.5L 300 TDi diesel engine models				
Aftermarket	1	<b>ESR2309P</b>	4.58	5.50
Genuine	1	<b>ESR2309</b>	44.08	52.90
All 2.5L 300 TDi diesel engine models - Intercooler end				
Aftermarket	1	<b>PNH102092P</b>	3.00	3.60
Genuine	1	<b>PNH102092</b>	22.46	26.95
All 2.5L 300 TDi diesel engine models - Turbo end				
Aftermarket	1	<b>PNH102082P</b>	8.33	10.00
Genuine	1	<b>PNH102082</b>	45.67	54.80
All 2.5L TD5 diesel models - LH, pipe to intercooler				
Aftermarket	1	<b>PNH102091P</b>	8.13	9.76
OEM	1	<b>PNH102091P1</b>	9.79	11.75
Genuine	1	<b>PNH102091</b>	45.86	55.03
All 2.5L TD5 diesel models - LH, pipe to turbocharger				
Genuine	1	<b>PNH102081</b>	45.84	55.01
All models with 2.4L Puma diesel engine - LH				
Aftermarket	1	<b>PNH500660P</b>	14.79	17.75
Genuine	1	<b>PNH500660</b>	35.56	42.67

## Temperature Sensor

All 200TDi diesel engine models				
Aftermarket	1	<b>PRC8593P</b>	8.33	10.00
Genuine	1	<b>PRC8593</b>	26.58	31.90
200TDi diesel engine models - Green				
Aftermarket	1	<b>PRC3359P</b>	5.00	6.00
OEM	1	<b>PRC3359P1</b>	27.08	32.50
Genuine	1	<b>PRC3359</b>	39.35	47.22
300TDi and TD5 diesel engine models				
Aftermarket	1	<b>ERR2081P</b>	3.25	3.90
OEM	1	<b>ERR2081P1</b>	9.79	11.75
Genuine	1	<b>ERR2081</b>	14.00	16.80
All 300TDi diesel engine models				
Aftermarket	1	<b>AMR3321P</b>	2.00	2.40
OEM	1	<b>AMR3321P1</b>	18.54	22.25
Genuine	1	<b>AMR3321</b>	21.94	26.33
Aftermarket	1	<b>AMR1425P</b>	2.75	3.30
Genuine	1	<b>AMR1425</b>	23.47	28.16
All V8 carb petrol models				
Aftermarket	1	<b>RTC4996P</b>	5.63	6.76
V8 carb petrol models with air conditioning - Green				
Aftermarket	1	<b>PRC3359P</b>	5.00	6.00
OEM	1	<b>PRC3359P1</b>	27.08	32.50
Genuine	1	<b>PRC3359</b>	39.35	47.22

## Coolant Temperature Sensor

All V8 carb petrol models without air conditioning				
Aftermarket	1	<b>PRC2506P</b>	5.63	6.76
Genuine	1	<b>PRC2506</b>	23.66	28.39
All 2.2L TDCi Puma diesel models				
Genuine	1	<b>LR041442</b>	25.70	30.84



# ELECTRICAL - ROTATING ELECTRICS

# DEFENDER 110 (1989 on)

## Alternator

All 200 TDi diesel models without air conditioning (A127/45amp alternator)					
New, outright	Aftermarket	1	<b>RTC5682P</b>	70.83	85.00
Reconditioned, exchange	Genuine*	1	<b>RTC5682E</b>	131.34	157.61
			*Exchange Surcharge	80.00	96.00
All 200 TDi diesel models without air conditioning (originally fitted with A127/45amp alternator) Upgrades from 45amp to 100amp alternator. Includes 100amp alternator (new, outright), pulley, drive belt and uprated power cable					
Upgrade Kit	Britpart	1	<b>RTC5682PKUR</b>	100.00	120.00
All 200Tdi diesel models - A127/45Amp					
New, exchange	Genuine*	1	<b>STG229</b>	300.76	360.91
			*Exchange Surcharge	70.00	84.00
All 300Tdi diesel models - A127-65Amp					
New, outright	Aftermarket	1	<b>AMR4249P</b>	68.33	82.00
New, exchange	Genuine*	1	<b>AMR4249</b>	290.29	348.35
			*Exchange Surcharge	150.00	180.00
All TD5 diesel models up to (VIN) 6A999999 - A127-120Amp					
New, outright	Aftermarket	1	<b>ERR6999P</b>	150.83	181.00
	OEM	1	<b>ERR6999P1</b>	195.00	234.00
New, exchange	Genuine*	1	<b>ERR6999</b>	612.34	734.81
			*Exchange Surcharge	70.00	84.00
All V8 carb petrol engine models with 45 Amp alternator - A127/45Amp					
New, outright	Aftermarket	1	<b>RTC5683EP</b>	82.50	99.00
Exchange	Genuine*	1	<b>RTC5683E</b>	160.78	192.94
			*Exchange Surcharge	80.00	96.00
All V8 carb petrol models with LH fixing high output A127/65amp alternator					
New, outright	Aftermarket	1	<b>STG233P</b>	55.00	66.00
All V8 EFi petrol models - A127-100Amp					
New, outright	Aftermarket	1	<b>AMR4247P</b>	86.67	104.00
	OEM	1	<b>AMR4247P1</b>	125.00	150.00
Reconditioned, exchange	Genuine*	1	<b>AMR4247E</b>	296.08	355.30
			*Exchange Surcharge	80.00	96.00
New, exchange	Genuine*	1	<b>AMR4247</b>	671.35	805.62
			*Exchange Surcharge	80.00	96.00
All models with 2.2L Puma diesel engine					
New, outright	OEM	1	<b>LR065867P1</b>	216.67	260.00
New, exchange	Genuine*	1	<b>LR065867</b>	329.35	395.22
			*Exchange Surcharge	100.00	120.00
All 2.4L TDCi Puma diesel engine models					
New, outright	Aftermarket	1	<b>YLE500310P</b>	129.17	155.00
	OEM	1	<b>YLE500310P1</b>	165.00	198.00
New, exchange	Genuine*	1	<b>YLE500310</b>	303.18	363.82
			*Exchange Surcharge	70.00	84.00
2.5L N/A diesel military models fitted for radio with 24V system (90amp alternator)					
New, outright	Genuine	1	<b>PRC5253</b>	4379.92	5255.90
Military fitted for radio (FFR) models with A127/65amp alternator - 12V or 24V system, radio screened,					
New, outright	Genuine	1	<b>AMR3329</b>	803.00	963.60
Military Wolf 24V, 300TDi engine (eng) 15L without exhaust gas recirculation					
New, outright	OEM	1	<b>RRC8642P1</b>	483.33	580.00
	Genuine	1	<b>RRC8642</b>	803.00	963.60
Military Wolf 24V, 300TDi engine (eng) 25L with exhaust gas recirculation					
New, exchange	Genuine*	1	<b>RRC8761</b>	803.00	963.60
			*Exchange Surcharge	80.00	96.00
Military Wolf/XD with 24V system, 50amp					
New, outright	Genuine	1	<b>RRC8560</b>	803.00	963.60
Military Wolf/XD with 24V system					
New, outright	Genuine	1	<b>8510176</b>	1605.98	1927.18

## Starter Motor

All 200 TDi & 300 TDi diesel models					
New, outright	Aftermarket	1	<b>NAD500210P</b>	82.50	99.00
	OEM	1	<b>NAD500210P1</b>	175.00	210.00
New, exchange	Genuine*	1	<b>NAD500210</b>	316.78	380.14
			*Exchange Surcharge	100.00	120.00
Reconditioned, exchange	Genuine*	1	<b>PRC5109E</b>	242.74	291.29
			*Exchange Surcharge	100.00	120.00
All models with TD5 diesel engine					
New, outright	Aftermarket	1	<b>NAD101240P</b>	85.00	102.00
Reconditioned, exchange	Genuine*	1	<b>NAD101240E</b>	169.28	203.14
			*Exchange Surcharge	70.00	84.00
New, exchange	Genuine*	1	<b>NAD101240</b>	275.36	330.43
			*Exchange Surcharge	70.00	84.00
All models with V8 EFi petrol engine - Bosch type					
New, outright	Aftermarket	1	<b>NAD101490P</b>	70.00	84.00
	OEM	1	<b>NAD101490P1</b>	155.00	186.00
Reconditioned, exchange	Genuine*	1	<b>NAD101490E</b>	129.64	155.57
			*Exchange Surcharge	70.00	84.00
New, exchange	Genuine*	1	<b>NAD101490</b>	208.17	249.80
			*Exchange Surcharge	70.00	84.00
All 2.4L/2.2L Puma TDCi diesel engine models - new					
New, outright	Aftermarket	1	<b>LR025840P</b>	90.00	108.00
	OEM	1	<b>LR025840P1</b>	170.00	204.00
New, exchange	Genuine*	1	<b>LR025840</b>	265.57	318.68
			*Exchange Surcharge	200.00	240.00
All military 2.5L petrol models with 24V system - 24V system, new, outright					
New, outright	Genuine	1	<b>ERR5693</b>	1022.38	1226.86
300 TDi Wolf/XD military					
New, outright	OEM	1	<b>NAD500220P1</b>	500.00	600.00
	Genuine	1	<b>NAD500220</b>	640.32	768.38



RTC5682P



RTC5683EP



STG233P



AMR4247P1



NAD500210P



NAD101490P



LR025840





## DEFENDER 110 (1989 on)

## ENGINE GASKETS

## Gasket Camshaft Cover

TD5 diesel models up to (VIN) 1A622423	Aftermarket	1	<b>ERR7094P</b>	3.50	4.20
	OEM	1	<b>ERR7094P1</b>	8.54	10.25
	Genuine	1	<b>ERR7094</b>	27.07	32.48
TD5 diesel models from (VIN) 2A622424 on	Aftermarket	1	<b>LVP000020P</b>	2.75	3.30
	OEM	1	<b>LVP000020P1</b>	8.13	9.76
	Genuine	1	<b>LVP000020</b>	28.37	34.04

## Gasket Rocker Cover

All 200TDi diesel models	Aftermarket	1	<b>ERR2393P</b>	2.00	2.40
	Genuine	1	<b>ERR2393</b>	11.47	13.76
All 300TDi diesel models	Aftermarket	1	<b>ERR2409P</b>	2.00	2.40
	OEM	1	<b>ERR2409P1</b>	3.58	4.30
	Genuine	1	<b>ERR2409</b>	10.74	12.89
All V8 petrol models	OEM	2	<b>GEG436</b>	1.58	1.90
	Rubber	OEM	2	<b>GEG436UPRATED</b>	2.65
All 2.4L Puma diesel models	Genuine	1	<b>LR004440</b>	25.65	30.78

## Sealing Washer Rocker Cover

All 200TDi diesel models	Aftermarket	3	<b>ERR663P</b>	1.50	1.80
	Genuine	3	<b>ERR663</b>	7.92	9.50
All 300TDi diesel models	Aftermarket	3	<b>ERR3424P</b>	0.75	0.90
	Genuine	3	<b>ERR3424</b>	2.98	3.58

## Gasket Cylinder Head

200TDi and 300TDi diesel models	1.30mm, one hole	Aftermarket	1	<b>LVB500200P</b>	5.42	6.50
		Genuine	1	<b>LVB500200</b>	51.39	61.67
	1.30mm, one hole, MLS type	OEM	1	<b>LVB500200P1</b>	11.67	14.00
		Genuine	1	<b>LVB500210</b>	48.48	58.18
	1.40mm, two holes	Aftermarket	1	<b>LVB500210P</b>	5.42	6.50
		OEM	1	<b>LVB500210P1</b>	11.67	14.00
	1.40mm, two holes, MLS type	Genuine	1	<b>LVB500220</b>	44.06	52.87
		Aftermarket	1	<b>LVB500220P</b>	10.63	12.76
	1.50mm, three holes	OEM	1	<b>LVB500220P1</b>	13.75	16.50
		Genuine	1	<b>LVB500230</b>	37.45	44.94
	1.50mm, three holes, MLS type	Aftermarket	1	<b>LVB500230P</b>	12.50	15.00
		OEM	1	<b>LVB500230P1</b>	18.13	21.76
2.5L TD5 diesel models	1.20mm, two holes	Aftermarket	1	<b>LVB000240P</b>	12.50	15.00
		OEM	1	<b>LVB000240P1</b>	25.00	30.00
		Genuine	1	<b>LVB000240</b>	57.56	69.07
		Aftermarket	1	<b>LVB000250P</b>	12.50	15.00
	1.27mm, one hole	OEM	1	<b>LVB000250P1</b>	25.00	30.00
		Genuine	1	<b>LVB000250</b>	38.40	46.08
	1.35mm, three holes	Aftermarket	1	<b>LVB000260P</b>	12.50	15.00
		OEM	1	<b>LVB000260P1</b>	25.00	30.00
		Genuine	1	<b>LVB000260</b>	60.51	72.61
		V8 carb petrol models up to (VIN) LA921745 - <i>Original style tin head gasket</i>	Aftermarket	2	<b>603796P</b>	1.92
Genuine	2		<b>603796</b>	10.18	12.22	
Aftermarket	2		<b>ERR7218P</b>	7.50	9.00	
V8 carb petrol models from (VIN) MA921746 on - <i>Original style composite head gasket</i>	OEM	2	<b>ERR7218P1</b>	21.67	26.00	
	Genuine	2	<b>ERR7218</b>	31.90	38.28	
	All 3.5L V8 petrol models	Tin type gasket	Aftermarket	2	<b>GEG340P</b>	2.08
Aftermarket			2	<b>GEG340</b>	5.00	6.00
	Composite type gasket	Aftermarket	2	<b>GEG340COM</b>	15.42	18.50
		Aftermarket	2	<b>GEG340COMP</b>	6.04	7.25
		Genuine	2	<b>ERR4248</b>	35.01	42.01
		All 2.2L TDCi Puma diesel models	1 identification tooth	Aftermarket	1	<b>LR040897P</b>
Genuine	1			<b>LR040897</b>	49.58	59.50
	2 identification teeth	Aftermarket	1	<b>LR040898P</b>	32.92	39.50
		Genuine	1	<b>LR040898</b>	48.52	58.22
	3 identification teeth	Aftermarket	1	<b>LR040899P</b>	26.50	31.80
		Genuine	1	<b>LR040899</b>	53.14	63.77
2.4L Puma diesel models -	1 tooth	Aftermarket	1	<b>LR004418P</b>	23.75	28.50
		Genuine	1	<b>LR004418</b>	113.69	136.43
	2 teeth	Aftermarket	1	<b>LR004419P</b>	23.75	28.50
		Genuine	1	<b>LR004419</b>	106.59	127.91
	3 teeth	Aftermarket	1	<b>LR004420P</b>	23.75	28.50
		OEM	1	<b>LR004420P1</b>	30.00	36.00
		Genuine	1	<b>LR004420</b>	44.62	53.54

## Gasket Decoke Set

200TDi diesel models - <i>Without head gasket</i>	Aftermarket	1	<b>STC1172P</b>	15.63	18.76	
	OEM	1	<b>STC1172P1</b>	50.00	60.00	
	Genuine	1	<b>STC1172</b>	93.01	111.61	
300TDi diesel models - <i>Without head gasket</i>	Aftermarket	1	<b>STC2802P</b>	8.96	10.75	
	OEM	1	<b>STC2802P1</b>	32.50	39.00	
	Genuine	1	<b>STC2802</b>	88.35	106.02	
V8 carb petrol models up to (VIN) LA921745 - <i>Includes original fitment tin head gasket</i>	Aftermarket	1	<b>STC1566P</b>	11.67	14.00	
	Aftermarket	1	<b>STC1566</b>	133.80	160.56	
	All 3.5L V8 petrol models	Includes tin type head gasket	Aftermarket	1	<b>GUG1066HS</b>	20.42
Aftermarket			1	<b>GUG1066HSK</b>	19.79	23.75
	Includes composite type head gasket	Aftermarket	1	<b>GUG1066HSCOM</b>	33.33	40.00

## Gasket Oil Sump

2.5L TD5 diesel models	Aftermarket	1	<b>LVF500040P</b>	8.54	10.25
	Genuine	1	<b>LVF500040</b>	20.20	24.24
All V8 petrol models	Aftermarket	1	<b>AJM539P</b>	1.00	1.20
	Aftermarket	1	<b>AJM539</b>	4.08	4.90
All 2.2L TDCi Puma diesel models	Genuine	1	<b>LR032154</b>	9.96	11.95

## Gasket Conversion Set

All 200TDi diesel models	Aftermarket	1	<b>STC1557P</b>	15.00	18.00
	OEM	1	<b>STC1557P1</b>	45.00	54.00
	Genuine	1	<b>STC1557</b>	151.83	182.20
All 300TDi diesel models	Aftermarket	1	<b>STC2801P</b>	13.96	16.75
	OEM	1	<b>STC2801P1</b>	27.50	33.00
	Genuine	1	<b>STC2801</b>	90.31	108.37
V8 carb petrol models	Aftermarket	1	<b>STC1639P</b>	9.79	11.75
	OEM	1	<b>STC1639P1</b>	25.83	31.00
	Genuine	1	<b>STC1639</b>	60.34	72.41
All 3.5L V8 carb petrol models	Aftermarket	1	<b>GUG1538CSP</b>	10.83	13.00
	Aftermarket	1	<b>GUG1538CS</b>	13.13	15.76

## Sealant 70gm Tube

200TDi diesel models	OEM	a/r	<b>STC611P1</b>	11.67	14.00
	Genuine	a/r	<b>STC611</b>	31.80	38.16

## Silicone Sealant RTV

Numerous applications	Aftermarket	a/r	<b>RTC3254P</b>	5.00	6.00
	Genuine	a/r	<b>RTC3254</b>	21.04	25.25

## Sealant Instant Gasket

Numerous applications	Genuine	a/r	<b>STC50550</b>	13.10	15.72
-----------------------	---------	-----	-----------------	-------	-------

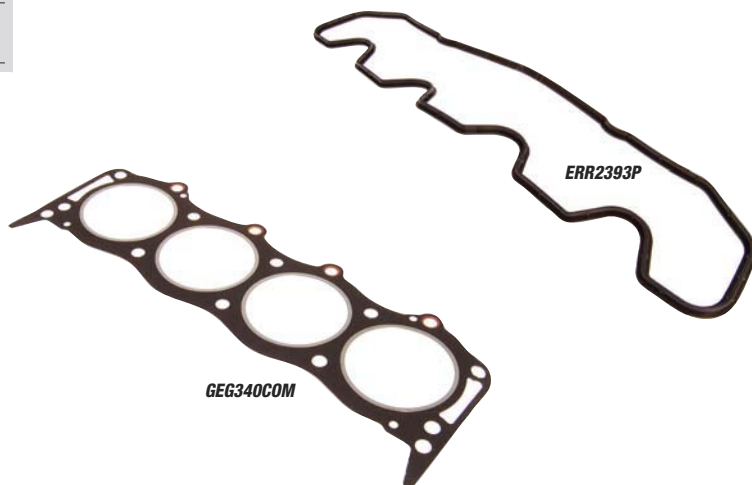
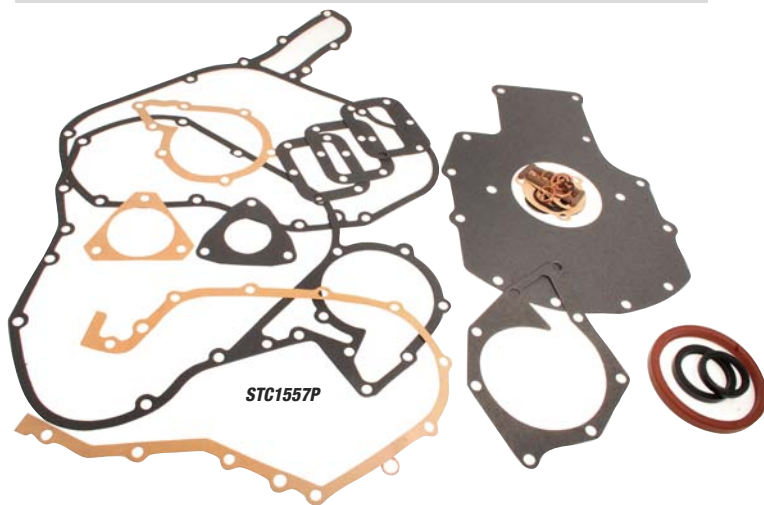



# ENGINE SWITCHES

## Camshaft Position Sensor

All 2.4L and 2.2L TDCi Puma diesel models	Aftermarket	1	<b>LR048186P</b>	11.67	14.00
	Genuine	1	<b>LR048186</b>	57.05	68.46
All 2.2L TDCi Puma diesel models	OEM	1	<b>LR056258P1</b>	45.00	54.00
	Genuine	1	<b>LR056258</b>	83.98	100.78

## Crankshaft Sensor Assembly

All 2.5L TD5 diesel models	Aftermarket	1	<b>NSC100790P</b>	19.58	23.50
	Genuine	1	<b>NSC100790</b>	167.25	200.70

## Crankshaft Sensor

All 2.4L TDCi Puma diesel models	Aftermarket	1	<b>LR004396P</b>	14.58	17.50
	OEM	1	<b>LR004396P1</b>	29.58	35.50
	Genuine	1	<b>LR004396</b>	236.78	284.14

## Temperature Sensor Oil Pump

All V8 carb petrol engine models	Aftermarket	1	<b>PRC2236P</b>	3.50	4.20
----------------------------------	-------------	---	-----------------	------	------

## Oil Temperature Switch

2.8L 6 cyl BMW M52 petrol engine models	Aftermarket	1	<b>1703993P</b>	9.38	11.26
	Genuine	1	<b>1703993</b>	25.17	30.20

## Oil Level Sensor

All 2.4L & 2.2L TDCi Puma diesel models	Genuine	1	<b>LR005905</b>	22.35	26.82
-----------------------------------------	---------	---	-----------------	-------	-------

## Oxygen Sensor

All 2.2L TDCi Puma diesel models - Pre-catalyst	Genuine	1	<b>LR030006</b>	117.36	140.83
-------------------------------------------------	---------	---	-----------------	--------	--------

## Oil Pressure Switch

All 4 cyl models up to (VIN) 6A999999	Aftermarket	1	<b>PRC6387P</b>	1.83	2.20
	OEM	1	<b>PRC6387P1</b>	3.50	4.20
	Genuine	1	<b>PRC6387</b>	28.77	34.52
2.5L TD5 diesel engine models Parallel thread (not tapered)	Aftermarket	1	<b>NUC000020P</b>	3.00	3.60
	Genuine	1	<b>NUC000020</b>	6.52	7.82
Tapered thread (not parallel)	Aftermarket	1	<b>NUC10003P</b>	3.25	3.90
	Genuine	1	<b>NUC10003</b>	6.94	8.33
All V8 carb petrol engine models	Aftermarket	1	<b>DRC2479A</b>	29.58	35.50
All V8 petrol engine models	Aftermarket	1	<b>STC4104P</b>	3.00	3.60
	OEM	1	<b>STC4104P1</b>	12.50	15.00
	Genuine	1	<b>STC4104</b>	29.01	34.81
All 2.4L and 2.2L Puma diesel engine models	Aftermarket	1	<b>LR004410P</b>	3.50	4.20
	OEM	1	<b>LR004410P1</b>	6.67	8.00
	Genuine	1	<b>LR004410</b>	23.19	27.83

## Air Inlet Temperature Sensor

All 2.8L 6 cyl BMW M52 petrol models	Genuine	1	<b>1739510</b>	23.34	28.01
--------------------------------------	---------	---	----------------	-------	-------

## Manifold Pressure Sensor

2.5L TD5 diesel engine models	Aftermarket	1	<b>MHK100640P</b>	16.55	19.86
	Genuine	1	<b>MHK100640</b>	98.86	118.63

## Manifold Absolute Pressure Sensor

All 2.5L TD5 diesel models up to (VIN) 1A622305	MG Rover	1	<b>MHK100600</b>	151.82	182.18
	Genuine	1	<b>MHK100600L</b>	267.11	320.53
All 2.5L TD5 diesel models from (VIN) 1A622306 on	Genuine	1	<b>MHK100820L</b>	96.22	115.46
	Genuine	1	<b>LR022164</b>	116.15	139.38

# DRAIN PLUGS

## Sump Plug Magnetic

All 200TDi diesel models	Genuine	1	<b>ETC5577</b>	3.53	4.24
--------------------------	---------	---	----------------	------	------

## Sump Plug Washer

All 200TDi and 300TDi diesel models	Aftermarket	1	<b>FRC4808P</b>	0.58	0.70
	Genuine	1	<b>FRC4808</b>	1.83	2.20
	Aftermarket	1	<b>213961A</b>	1.25	1.50
All 200TDi diesel models 300TDi diesel models up to (eng) 16L88228A and 23L88228A	Aftermarket	1	<b>UAM2857P</b>	0.58	0.70
	Aftermarket	1	<b>CDU1001</b>	0.54	0.65

## Sump Plug

300TDi diesel models up to (eng) 16L88228A and 23L88228A	Aftermarket	1	<b>UAM2957P</b>	1.58	1.90
	Genuine	1	<b>UAM2957</b>	2.08	2.50
All 300 TDi diesel models (eng) 23L/16L88229A on	OEM	1	<b>LSF100040LP1</b>	1.50	1.80
	Genuine	1	<b>LSF100040L</b>	3.13	3.76
All V8 petrol models	Aftermarket	1	<b>603659A</b>	2.83	3.40
	Aftermarket	1	<b>213961A</b>	1.25	1.50

## Sealing Washer Sump Plug

All 300TDi diesel models (eng) 16L88228A on, 23L88228A on	Aftermarket	1	<b>ALU1403LP</b>	0.54	0.65
	Genuine	1	<b>ALU1403L</b>	1.11	1.33
All models with LT230 transfer box (gbox) 43D on	Aftermarket	1	<b>ALU1403LP</b>	0.54	0.65
	Genuine	1	<b>ALU1403L</b>	1.11	1.33
All models with R380 5 speed gearbox	Aftermarket	1	<b>ALU1403LP</b>	0.54	0.65
	Genuine	1	<b>ALU1403L</b>	1.11	1.33

## Oil Drain Valve Kit

All 300 TDi diesel models (eng) 23L/16L88229A on	Aftermarket	1	<b>LSF100040LODV</b>	32.08	38.50
--------------------------------------------------	-------------	---	----------------------	-------	-------

## O Ring for Drain Plug

2.5L N/A & 2.5L TD engine models	Genuine	1	<b>37H575P</b>	0.58	0.70
----------------------------------	---------	---	----------------	------	------



LSF100040LODV

## Sump Plug & Washer

All 2.4L and 2.2L Puma diesel models	Aftermarket	1	<b>1013938P</b>	1.50	1.80
	Genuine	1	<b>1013938</b>	3.19	3.83

## Copper Sealing Washer

Numerous applications	Aftermarket	1	<b>ETC7398P</b>	0.75	0.90
	Genuine	1	<b>ETC7398</b>	1.55	1.86

## Filler Plug

All models with 5 speed LT77 gearbox - Gearbox	OEM	1	<b>3292P1</b>	1.33	1.60
	Genuine	1	<b>3292</b>	15.68	18.82
All models with 5 speed R380 gearbox - Gearbox	OEM	1	<b>FTC4056P1</b>	6.46	7.75
	Genuine	1	<b>FTC4056</b>	6.98	8.38
All models with Adwest manual steering box - Steering box	Genuine	1	<b>STC897</b>	31.33	37.60
All models with Gemmer manual steering box - Steering box	Genuine	1	<b>AEU4017</b>	3.57	4.28
	OEM	1	<b>3292P1</b>	1.33	1.60
All models from (VIN) LA930456 on - Swivel housing	Genuine	1	<b>3292</b>	15.68	18.82

## Wading Plug

All models with 5 speed R380 gearbox - Gearbox bellhousing. Alternative to 3290A	OEM	1	<b>FTC4056P1</b>	6.46	7.75
----------------------------------------------------------------------------------	-----	---	------------------	------	------

## Drain Plug

All diesel models up to (VIN) 6A999999 except 2.5L TD5 diesel - Fuel filter/sedimentor	OEM	1	<b>37H7920P1</b>	7.08	8.50
	Genuine	1	<b>37H7920</b>	9.02	10.82
All 2.5L TD5 diesel models with fuel filter fitted with drain - Fuel filter/sedimentor	Genuine	1	<b>YXJ500060NAA</b>	2.99	3.59

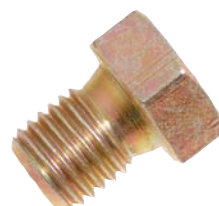

ETC5577



UAM2857P

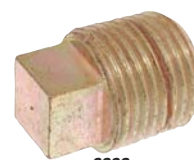

3292



**DEFENDER 110 (1989 on)****OIL SEALS ENGINE****Oil Seal Crankshaft Front**

200TDi diesel models	Aftermarket	1	<b>ERR6490P</b>	3.00	3.60
	OEM	1	<b>ERR6490P1</b>	5.00	6.00
300TDi diesel models - Inner	Aftermarket	1	<b>ERR4575P</b>	2.33	2.80
	OEM	1	<b>ERR4575P1</b>	5.63	6.76
	Genuine	1	<b>ERR4575</b>	14.76	17.71
300TDi diesel models up to (eng) 15L01620A - Outer	Aftermarket	1	<b>ERR4576P</b>	1.25	1.50
	Genuine	1	<b>ERR4576</b>	6.95	8.34
300TDi diesel models from (eng) 15L01621A on - Outer	Aftermarket	1	<b>ERR7143P</b>	4.58	5.50
	Genuine	1	<b>ERR7143</b>	32.31	38.77
2.5L TD5 diesel models	Aftermarket	1	<b>ERR5992P</b>	3.58	4.30
	Genuine	1	<b>ERR5992</b>	10.27	12.32
All V8 petrol models	Aftermarket	1	<b>ERR6490P</b>	3.00	3.60
	OEM	1	<b>ERR6490P1</b>	5.00	6.00
All 2.4L and 2.2L Puma diesel models	OEM	1	<b>LR077704P1</b>	9.58	11.50
	Genuine	1	<b>LR077704</b>	15.54	18.65

**Oil Seal Crankshaft Rear**

200TDi diesel models	Aftermarket	1	<b>ERR2532P</b>	2.00	2.40
	OEM	1	<b>ERR2532P1</b>	5.83	7.00
	Genuine	1	<b>ERR2532</b>	21.00	25.20
300TDi diesel models	Aftermarket	1	<b>LUF100430P</b>	7.50	9.00
	OEM	1	<b>LUF100430P1</b>	9.58	11.50
	Genuine	1	<b>LUF100430</b>	26.79	32.15
2.5L TD5 diesel models	Aftermarket	1	<b>LUF100420P</b>	7.50	9.00
	OEM	1	<b>LUF100420P1</b>	9.79	11.75
	Genuine	1	<b>LUF100420</b>	21.82	26.18
All V8 petrol models - Lip type seal	Aftermarket	1	<b>ERR2640P</b>	3.00	3.60
	OEM	1	<b>ERR2640P1</b>	7.92	9.50
	Genuine	1	<b>ERR2640</b>	15.58	18.70
All 2.4L and 2.2L Puma diesel models	Aftermarket	1	<b>LR020610P</b>	14.79	17.75
	Genuine	1	<b>LR020610</b>	35.94	43.13

**Oil Seal Front Cover**

V8 petrol models	Aftermarket	1	<b>ETC4154P</b>	1.08	1.30
	OEM	1	<b>ETC4154P1</b>	3.00	3.60
	Genuine	1	<b>ETC4154</b>	14.67	17.60
200TDi diesel models	Aftermarket	1	<b>ETC4154P</b>	1.08	1.30
	OEM	1	<b>ETC4154P1</b>	3.00	3.60
	Genuine	1	<b>ETC4154</b>	14.67	17.60

**Oil Seal Camshaft**

200TDi diesel models	Aftermarket	1	<b>ETC5064P</b>	2.08	2.50
	OEM	1	<b>ETC5064P1</b>	2.50	3.00
	Genuine	1	<b>ETC5064</b>	21.23	25.48
300TDi diesel models	Aftermarket	1	<b>ERR3356P</b>	0.58	0.70
	OEM	1	<b>ERR3356P1</b>	2.50	3.00
	Genuine	1	<b>ERR3356</b>	12.31	14.77
TD5 diesel models Front	Aftermarket	1	<b>LD1100030P</b>	4.00	4.80
	Genuine	1	<b>LD1100030</b>	16.82	20.18
Rear	Aftermarket	1	<b>ERR5369P</b>	1.33	1.60
	OEM	1	<b>ERR5369P1</b>	1.58	1.90
	Genuine	1	<b>ERR5369</b>	2.89	3.47

**O Ring Camshaft Small**

All 200TDi models - Camshaft pulley retaining plate		Genuine	1	<b>ERC8849</b>	0.61	0.73
-----------------------------------------------------	--	---------	---	----------------	------	------

**DEFENDER 110 (1989 on)****EXHAUST GAS RECIRCULATION (EGR)****EGR Valve**

All models with 300 TDi diesel engine	Aftermarket	1	<b>WAV100330P</b>	40.00	48.00
	Genuine	1	<b>WAV100330</b>	259.67	311.60
All 2.5L TD5 diesel models	Genuine	1	<b>WAV100270</b>	141.36	169.63
	Genuine	2	<b>MSG100110</b>	59.46	71.35
All 2.2L TDCi Puma diesel models	Genuine	1	<b>LR081121</b>	188.10	225.72
All 2.4L TDCi Puma diesel models	Aftermarket	1	<b>LR006650P</b>	95.00	114.00
	Genuine	1	<b>LR006650</b>	136.26	163.51

**Solenoid EGR Valve**

All 300 TDi diesel models without catalyst	Genuine	1	<b>ERR3314</b>	129.28	155.14
--------------------------------------------	---------	---	----------------	--------	--------

**EGR Blanking Kit**

All 300 TDi diesel models - Includes blanking plate, insulator/gasket and screws					
Britpart	1	<b>LL1473BP</b>	5.00	6.00	
Terrafirma	1	<b>LL1473TF</b>	4.75	5.70	
Bearmach	1	<b>LL1473BM</b>	5.83	7.00	
All 2.5L TD5 diesel models - Includes blanking plate, bypass tube and gasket					
Britpart	2	<b>LL1474BP</b>	29.58	35.50	
Terrafirma	2	<b>LL1474TF</b>	34.58	41.50	
Bearmach	2	<b>LL1474BM</b>	33.75	40.50	

**Gasket EGR Valve to Pipe**

All 200 TDi and 300 TDi diesel models	Aftermarket	1	<b>WAL500010LP</b>	2.00	2.40
	OEM	1	<b>WAL500010LP1</b>	3.58	4.30
	Genuine	1	<b>WAL500010L</b>	6.18	7.42
All 300 TDi diesel models	Aftermarket	1	<b>ERR3319P</b>	1.00	1.20
	Genuine	1	<b>ERR3319</b>	1.75	2.10
	Genuine	1	<b>WAL100240</b>	0.80	0.96

**Gasket**

All 2.5L TD5 diesel engine models - Exhaust gas recirculation valve to pipe	Genuine	1	<b>ERR6620</b>	1.75	2.10
-----------------------------------------------------------------------------	---------	---	----------------	------	------

**Gasket EGR Valve to Manifold**

All 2.4L and 2.2L Puma diesel models	OEM	1	<b>LR034076P1</b>	4.58	5.50
	Genuine	1	<b>LR034076</b>	7.95	9.54

**Gasket EGR Cooler Seating**

All 2.2L TDCi Puma diesel models	Genuine	1	<b>LR030028</b>	9.95	11.94
----------------------------------	---------	---	-----------------	------	-------

**Gasket EGR Valve to Cooler**

All 2.2L TDCi Puma diesel models	Genuine	1	<b>LR037955</b>	7.00	8.40
All 2.4L TDCi Puma diesel models	Genuine	1	<b>LR004476</b>	9.31	11.17

**Gasket EGR Cooler**

All 2.4L TDCi Puma diesel models	Genuine	1	<b>LR004477</b>	11.36	13.63
----------------------------------	---------	---	-----------------	-------	-------

**Gasket EGR Valve**

All 2.4L TDCi Puma diesel models	Genuine	1	<b>LR004477</b>	11.36	13.63
----------------------------------	---------	---	-----------------	-------	-------

**Y Pipe EGR Valve**

All 300 TDi diesel models without catalyst	Genuine	1	<b>ERR3579</b>	188.44	226.13
--------------------------------------------	---------	---	----------------	--------	--------

**Pipe EGR Valve to Y Pipe**

All 300 TDi diesel models without catalyst	Genuine	1	<b>ERR5732</b>	152.03	182.44
--------------------------------------------	---------	---	----------------	--------	--------

**EGR Pipe**

All 300 TDi diesel models	Aftermarket	1	<b>ERR3581P</b>	3.25	3.90
	Genuine	1	<b>ERR3581</b>	45.30	54.36
300TDi diesel models	Aftermarket	1	<b>ERR3580P</b>	3.25	3.90
	Genuine	1	<b>ERR3580</b>	53.69	64.43

**Pipe EGR Valve to Filter**

All 2.5L TD5 diesel models up to (VIN) XA175541					
	Genuine	1	<b>WAP100980</b>	4.12	4.94
All 2.5L TD5 diesel models from (VIN) XA175542 on					
	Genuine	1	<b>WAP101390</b>	16.03	19.24

**Pipe EGR Valve**

All 2.5L TD5 diesel models	Genuine	1	<b>WAP101220</b>	141.93	170.32
----------------------------	---------	---	------------------	--------	--------

**EGR Cooler Hose**

All 2.5L TD5 diesel engine models from (VIN) 2A622424 on					
	Genuine	1	<b>PEH000310</b>	9.56	11.47

**EGR Cooler Return Hose**

All 2.5L TD5 diesel engine models from (VIN) 2A622424 on					
	Genuine	1	<b>PCH001370</b>	23.90	28.68

**Hose EGR Cooler Inlet**

All 2.2L TDCi Puma diesel models	Genuine	1	<b>LR077774</b>	20.49	24.59
All 2.2L TDCi Puma diesel models up to (VIN) CA417102	Genuine	1	<b>LR030029</b>	10.44	12.53

**Pipe MAP Sensor/EGR Valve**

All 2.4L TDCi Puma diesel models	Genuine	1	<b>LR010456</b>	320.66	384.79
----------------------------------	---------	---	-----------------	--------	--------



WAV100270



LR034076

# ENGINE & GEARBOX MOUNTINGS

## Engine Mounting

All 200TDi diesel models - Engine and gearbox, M10 thread				
Aftermarket	2	<b>ANR1808P</b>	2.33	2.80
OEM	2	<b>ANR1808P1</b>	3.58	4.30
Genuine	2	<b>ANR1808</b>	17.50	21.00
All 300TDi diesel models - Engine				
Aftermarket	2	<b>NTC9416P</b>	9.17	11.00
Genuine	2	<b>NTC9416</b>	51.74	62.09
All TD5 diesel models - Engine				
Aftermarket	2	<b>KKB500750P</b>	25.00	30.00
Genuine	2	<b>KKB500750</b>	50.59	60.71
All V8 petrol models to (VIN) TA970049 - With M12 metric threads				
Aftermarket	4	<b>STC434P</b>	2.33	2.80
OEM	4	<b>STC434P1</b>	9.38	11.26
Genuine	4	<b>STC434</b>	23.83	28.60

## Bracket Engine Mounting

All 4 cyl models up to (VIN) LA939975				
RH	Genuine	1	<b>NRC5434</b>	103.48 124.18
LH	Genuine	1	<b>NRC9557</b>	143.30 171.96
All 300TDi diesel models				
RH	Genuine	1	<b>ANR2868</b>	117.03 140.44
LH	Genuine	1	<b>NTC9415</b>	97.80 117.36
All 2.5L TD5 diesel models				
RH	Genuine	1	<b>KKU000740</b>	58.89 70.67
LH	Genuine	1	<b>ANR6623</b>	363.80 436.56
All 2.5L petrol models with later chassis - converts later chassis for 2.5L petrol model use				
RH	Genuine	1	<b>KVU100220</b>	96.37 115.64
LH	Genuine	1	<b>KVU100230</b>	87.33 104.80
All V8 carb petrol models with later chassis - converts later chassis for V8 carb petrol model use				
RH	Genuine	1	<b>KVU100240</b>	43.29 51.95
All 2.4L & 2.2L Puma diesel models				
RH	Genuine	1	<b>KKU500830</b>	33.96 40.75
LH	Genuine	1	<b>KKU500860</b>	63.69 76.43

## Gearbox Mounting

All 300TDi diesel models				
RH	Aftermarket	1	<b>ANR3200P</b>	2.50 3.00
	Genuine	1	<b>ANR3200</b>	23.26 27.91
LH	Aftermarket	1	<b>ANR3201P</b>	2.50 3.00
	OEM	1	<b>ANR3201P1</b>	4.58 5.50
	Genuine	1	<b>ANR3201</b>	23.26 27.91
All V8 petrol models to (VIN) TA970049 - With M12 metric threads				
Aftermarket	2	<b>STC434P</b>	2.33	2.80
OEM	2	<b>STC434P1</b>	9.38	11.26
Genuine	2	<b>STC434</b>	23.83	28.60
All 2.4L and 2.2L TDCi diesel models				
RH	Aftermarket	1	<b>KQB500550P</b>	5.00 6.00
	Genuine	1	<b>KQB500550</b>	14.42 17.30
LH	Aftermarket	1	<b>KQB500560P</b>	6.88 8.26
	Genuine	1	<b>KQB500560</b>	17.61 21.13

## Bracket Gearbox Mounting

All 2.5L TD5 diesel models - RH	Genuine	1	<b>ANR5636</b>	17.16 20.59
All V8 petrol models - RH	Genuine	1	<b>ANR4657</b>	68.90 82.68
All 2.4L & 2.2L Puma diesel models - LH	Genuine	1	<b>KKU000710</b>	12.63 15.16



NTC9416P



ANR5636

# FUEL SYSTEM SWITCHES

## Throttle Position Sensor

All 300 TDi diesel models with exhaust gas recirculation (EGR) and immobiliser				
Genuine	1	<b>STC4389</b>	420.71	504.85

## Air Flow Sensor

2.5L TD5 diesel models				
Aftermarket	1	<b>MHK100620P</b>	26.25	31.50
OEM	1	<b>MHK100620P1</b>	60.00	72.00
Genuine	1	<b>MHK100620</b>	123.84	148.61
2.4L Puma diesel models				
OEM	1	<b>MHK501040P1</b>	50.00	60.00
Genuine	1	<b>MHK501040</b>	107.33	128.80

## Air Flow Meter

All 2.8L 6 cyl BMW M52 petrol models	Genuine	1	<b>1703275</b>	199.51 239.41
All 2.2L TDCi Puma diesel models	OEM	1	<b>LR019830P1</b>	85.00 102.00
	Genuine	1	<b>LR019830</b>	107.33 128.80

## Water Sensor for Fuel Filter

2.5L TD5 diesel models	OEM	1	<b>WKW500060P1</b>	21.50 25.80
	Genuine	1	<b>WKW500060</b>	68.58 82.30

# CABLES

## Accelerator Cable

All RHD 200 TDi diesel models				
Aftermarket	1	<b>ANR1419P</b>	11.88	14.26
Genuine	1	<b>ANR1419</b>	42.47	50.96
All RHD 300 TDi diesel models				
Aftermarket	1	<b>NTC9360P</b>	6.88	8.26
Genuine	1	<b>NTC9360</b>	56.06	67.27
All RHD 300 TDi diesel models - Secondary throttle				
Aftermarket	1	<b>ANR1338P</b>	21.25	25.50
Genuine	1	<b>ANR1338</b>	58.62	70.34
All RHD diesel models with hand throttle from (VIN) HA456214 to LA939975 - Secondary (hand) throttle				
Genuine	1	<b>NTC8554</b>	32.64	39.17
All 4 cyl diesel models fitted with hand throttle from (VIN) MA939976 on - Secondary (hand) throttle				
Genuine	1	<b>ANR1339</b>	61.76	74.11
All V8 carb petrol models				
Aftermarket	1	<b>NRC5494P</b>	4.58	5.50
Genuine	1	<b>NRC5494</b>	57.35	68.82
All RHD V8 carb petrol models with hand throttle - Secondary (hand) throttle				
Genuine	1	<b>NRC9284</b>	21.22	25.46
All LHD 200 TDi diesel models				
OEM	1	<b>NTC4945P1</b>	11.67	14.00
Genuine	1	<b>NTC4945</b>	37.19	44.63
All LHD 300 TDi diesel models				
Aftermarket	1	<b>NTC9359P</b>	7.08	8.50
OEM	1	<b>NTC9359P1</b>	16.67	20.00
Genuine	1	<b>NTC9359</b>	62.86	75.43
All LHD diesel models with hand throttle from (VIN) HA456214 to LA939975 - Secondary (hand) throttle				
Genuine	1	<b>NTC8553</b>	73.47	88.16
All LHD V8 carb petrol models with hand throttle - Secondary (hand) throttle				
Genuine	1	<b>NRC9285</b>	81.70	98.04
Genuine	1	<b>NTC9163</b>	41.66	49.99



ANR1419P

## Bonnet Release Cable

All models up to (VIN) TA977536				
Aftermarket	1	<b>ALR9556P</b>	3.33	4.00
Genuine	1	<b>ALR9556</b>	19.00	22.80
All models from (VIN) TA977537 to WA159806				
Aftermarket	1	<b>ASR1457P</b>	3.92	4.70
Genuine	1	<b>ASR1457</b>	13.27	15.92
All models from (VIN) 2A622424 to 6A999999				
Genuine	1	<b>FSE000070</b>	6.50	7.80
All models from (VIN) XA159807 to 1A622423				
Genuine	1	<b>FSE100460</b>	19.87	23.84
All models from (VIN) 7A000001 on - Engine compartment end				
Genuine	1	<b>FSE500080</b>	8.55	10.26

## Choke Cable

All RHD V8 carb petrol models				
Aftermarket	1	<b>NTC3932P</b>	27.50	33.00
Genuine	1	<b>NTC3932</b>	47.39	56.87
All LHD V8 carb petrol models				
Aftermarket	1	<b>NTC3933P</b>	25.00	30.00
Genuine	1	<b>NTC3933</b>	43.03	51.64

## Speedometer Cable

All RHD 4 cyl petrol & diesel models except Police or overspeed warning fitted models - One piece cable				
Aftermarket	1	<b>PRC6022P</b>	4.79	5.75
Genuine	1	<b>PRC6022</b>	113.28	135.94
All RHD V8 carb models - One piece cable				
Aftermarket	1	<b>PRC6023P</b>	5.00	6.00
Genuine	1	<b>PRC6023</b>	85.06	102.07



NTC3933





**DEFENDER 110 (1989 on)****WINDOW REGULATORS****Window Regulator**

All models up to (VIN) LA932528				
Front RH	Aftermarket	1	<b>MUC3024P</b>	10.62 12.74
	Genuine	1	<b>MUC3024</b>	136.50 163.80
Front LH	Aftermarket	1	<b>MUC3025P</b>	12.08 14.50
	Genuine	1	<b>MUC3025</b>	109.40 131.28
All models from (VIN) LA932529 to 1A622423				
Front RH	Aftermarket	1	<b>ALR4533P</b>	25.83 31.00
	Genuine	1	<b>ALR4533</b>	90.79 108.95
Front LH	Aftermarket	1	<b>ALR4532P</b>	25.83 31.00
	Genuine	1	<b>ALR4532</b>	90.79 108.95
All models with manual windows from (VIN) 2A622424 on				
Front RH	Aftermarket	1	<b>CUH000100P</b>	30.83 37.00
	Genuine	1	<b>CUH000100</b>	69.95 83.94
All models with electric windows (VIN) 2A622424 on - Electric, includes motor				
Front RH	Aftermarket	1	<b>CUH000092P</b>	50.83 61.00
	Genuine	1	<b>CUH000092</b>	129.29 155.15
All station wagon and crew cab models up to (VIN) LA932486				
Rear RH	Aftermarket	1	<b>MUC3026P</b>	16.87 20.24
	Genuine	1	<b>MUC3026</b>	94.38 113.26
Rear LH	Aftermarket	1	<b>MUC3027P</b>	13.12 15.74
	Genuine	1	<b>MUC3027</b>	94.38 113.26

**DEFENDER 110 (1989 on)****WHEEL CENTRE CAPS & WHEEL NUTS****Wheel Centre Cap**

All models with polished shadow chrome alloy wheel centre caps with green/gold Land Rover badge				
Polished shadow chrome finish with Land Rover green/gold badge				
	Genuine	a/r	<b>RRJ500060MUZ</b>	8.42 10.10
All models with Silver Sparkle (MNH) colour alloy wheels				
Silver Sparkle, features Land Rover logo				
	Genuine	a/r	<b>ANR2391MNH</b>	7.13 8.56
All models with Quicksilver (MUE) colour alloy wheels				
Quicksilver, features Land Rover logo				
	Genuine	a/r	<b>ANR2391MUE</b>	5.13 6.16
All models with Alpine White (NUC) 5 spoke steel wheels				
Alpine White, features Land Rover Logo				
	Genuine	a/r	<b>ANR3861</b>	3.09 3.71
All models up to (VIN) 5A999999 with Black colour alloy wheels				
Black, features Land Rover logo				
	Genuine	a/r	<b>STC7248</b>	10.06 12.07
Tomb Raider limited edition				
Pewter, features Land Rover logo				
	Genuine	a/r	<b>ANR2391LAL</b>	5.29 6.35
All models with 16" dual finish alloy wheels from (VIN) 7A000001 on				
Polished finish, Land Rover green/silver badge				
	Aftermarket	a/r	<b>LR023301P</b>	5.42 6.50
	Genuine	a/r	<b>LR023301</b>	6.64 7.97

**Wheel Stud**

All models up to (VIN) KA930455				
Front and rear hubs				
	Aftermarket	a/r	<b>FRC6137P</b>	0.46 0.55
	Genuine	a/r	<b>FRC6137</b>	4.25 5.10
All models from (VIN) LA930456 on, will fit earlier models				
For alloy or steel wheels				
	Aftermarket	a/r	<b>RUF500010P</b>	1.33 1.60
	Genuine	a/r	<b>RUF500010</b>	2.09 2.51
All models - Extended, 60mm (original fitment for Defender Wolfi/XD).				
Allows fitment of certain alternative wheels				
	OEM	a/r	<b>FRC7577P1</b>	5.83 7.00
	Genuine	a/r	<b>FRC7577</b>	19.36 23.23

**Wheel Nut**

All models with steel wheels				
	Aftermarket	a/r	<b>RRD500010P</b>	0.79 0.95
	Genuine	a/r	<b>RRD500010</b>	1.82 2.18
All models with alloy wheels up to (VIN) 6A999999 except Tomb Raider				
Without stainless steel cap				
	Aftermarket	a/r	<b>NRC7415P</b>	2.00 2.40
	OEM	a/r	<b>NRC7415P1</b>	2.75 3.30
	Genuine	a/r	<b>NRC7415</b>	2.97 3.56
All models with alloy spare wheel up to (VIN) 4A999999				
Alloy spare wheel only				
	Genuine	a/r	<b>ANR4914</b>	8.42 10.10
All models with stainless capped wheel nuts for alloy wheels from (VIN) 7A000001 on				
With stainless steel cap				
	Aftermarket	a/r	<b>RRD500560P</b>	2.33 2.80
	OEM	a/r	<b>RRD500560P1</b>	4.38 5.26
	Britpart	a/r	<b>RRD500560BP</b>	2.08 2.50
	Genuine	a/r	<b>RRD500560</b>	11.43 13.72
All models with alloy spare wheel from (VIN) 7A000001 on				
Alloy spare wheel only				
	Genuine	a/r	<b>RRD500520</b>	4.97 5.96

**Wheel Nut Set**

All models with steel wheels - Set of 20				
	Aftermarket	a/r	<b>RRD500010KP</b>	11.04 13.25
	Genuine	a/r	<b>RRD500010K</b>	34.00 40.80
All models with alloy wheels up to (VIN) 6A999999 except Tomb Raider				
Set of 20. Without stainless steel cap				
	Aftermarket	a/r	<b>NRC7415KP</b>	38.33 46.00
	Genuine	a/r	<b>NRC7415K</b>	58.50 70.20
All models with stainless capped wheel nuts for alloy wheels from (VIN) 7A000001 on				
Set of 20. With stainless steel cap				
	Aftermarket	a/r	<b>RRD500560KP</b>	38.33 46.00
	OEM	a/r	<b>RRD500560KP1</b>	77.50 93.00
	Genuine	a/r	<b>RRD500560K</b>	215.00 258.00



# DISCOVERY 1 (1989 to 1998)

## 1989 to 1998 - All Models

Listed below are the most popular parts required for the Discovery 1.

We have access to the full range of parts for your vehicle. Please contact us if not listed here.



## SERVICE KITS

### Service Kit

All 3.5L V8 EFI petrol models - Includes oil filter, air filter, fuel filter, spark plugs & sump plug washer			
Aftermarket	1	<b>RD1208P</b>	21.67 26.00
Genuine	1	<b>RD1208</b>	54.17 65.00



RD1208P

## FILTRATION

### Oil Filter

All models with 200TDi diesel engine - Cartridge			
Aftermarket	1	<b>ERR3340P</b>	2.00 2.40
OEM	1	<b>ERR3340P1</b>	3.33 4.00
Genuine	1	<b>ERR3340</b>	10.82 12.98
All models with 300TDi diesel engine - Cartridge			
Aftermarket	1	<b>ERR3340P</b>	2.00 2.40
OEM	1	<b>ERR3340P1</b>	3.33 4.00
Genuine	1	<b>ERR3340</b>	10.82 12.98
All models with V8 petrol engine - Cartridge			
Aftermarket	1	<b>ERR3340P</b>	2.00 2.40
OEM	1	<b>ERR3340P1</b>	3.33 4.00
Genuine	1	<b>ERR3340</b>	10.82 12.98
All models with 2.0L MPI petrol engine - Cartridge			
Aftermarket	1	<b>LPW100180LP</b>	2.33 2.80

### Air Filter

All 200TDi diesel models up to (VIN) JA018272			
Aftermarket	1	<b>NTC1435P</b>	6.88 8.26
OEM	1	<b>NTC1435P1</b>	7.50 9.00
Genuine	1	<b>NTC1435</b>	25.89 31.07
200TDi diesel from (VIN) JA018273 to LA081991			
Aftermarket	1	<b>ESR1049P</b>	5.63 6.76
OEM	1	<b>ESR1049P1</b>	10.63 12.76
All 300TDi diesel models			
Aftermarket	1	<b>ESR1445P</b>	2.08 2.50
OEM	1	<b>ESR1445P1</b>	3.58 4.30
Genuine	1	<b>ESR1445</b>	6.95 8.34
All 2.0 MPI petrol models			
Aftermarket	1	<b>ESR1445P</b>	2.08 2.50
OEM	1	<b>ESR1445P1</b>	3.58 4.30
Genuine	1	<b>ESR1445</b>	6.95 8.34
All V8 carburettor models			
Aftermarket	2	<b>605191P</b>	2.83 3.40
OEM	2	<b>605191P1</b>	4.38 5.26
Genuine	2	<b>GFE1117</b>	5.83 7.00
Genuine	2	<b>605191</b>	6.29 7.55
All V8 EFI petrol models up to (VIN) LA081991			
Aftermarket	1	<b>RTC4683P</b>	3.25 3.90
OEM	1	<b>RTC4683P1</b>	5.63 6.76
Genuine	1	<b>RTC4683</b>	8.30 9.96
All V8 Efi petrol models from (VIN) MA081992 on			
Aftermarket	1	<b>ESR1445P</b>	2.08 2.50
OEM	1	<b>ESR1445P1</b>	3.58 4.30
Genuine	1	<b>ESR1445</b>	6.95 8.34

### Mounting Rubber Air Cleaner

All 200 TDi diesel models (VIN) JA020995 on	Genuine	1	<b>ESR1579</b>	13.98 16.78
---------------------------------------------	---------	---	----------------	-------------

## WIPER BLADES

### Wiper Blade

All models up to (VIN) WA753922 - Front			
RHD models from (VIN) WA753923 on			
Front, driver's side, with spoiler			
Aftermarket	1	<b>AMR1805P</b>	2.42 2.90
OEM	1	<b>DKC100900P</b>	2.42 2.90
Genuine	1	<b>DKC100900P1</b>	3.50 4.20
Genuine	1	<b>DKC100900</b>	5.96 7.15
LHD models from (VIN) WA753923 on			
Front, driver's side, with spoiler			
Aftermarket	1	<b>DKC100910P</b>	1.58 1.90
OEM	1	<b>DKC100910P1</b>	4.38 5.26
Genuine	1	<b>DKC100910</b>	6.87 8.24
All models from (VIN) WA753923 on			
Front, passenger's side			
Aftermarket	1	<b>DKC100920P</b>	2.08 2.50
OEM	1	<b>DKC100920P1</b>	3.00 3.60
Genuine	1	<b>DKC100920</b>	5.96 7.15
Aftermarket	1	<b>RTC6787P</b>	2.83 3.40
OEM	1	<b>RTC6787P1</b>	5.42 6.50
All models from (VIN) MA081992 on - Rear			
Aftermarket	1	<b>AMR1806P</b>	1.75 2.10
OEM	1	<b>AMR1806P-OE</b>	3.50 4.20
Genuine	1	<b>AMR1806</b>	9.39 11.27



AMR1805P



DKC100920P

## DISCOVERY 1 (1989 to 1998)

### Filter Kit

200 TDi diesel models to (VIN) JA018272 - Includes oil filter, air filter, fuel filter & sump plug washer			
Aftermarket	1	<b>RD1207P</b>	8.96 10.75
Genuine	1	<b>RD1207</b>	45.83 55.00
200 TDi diesel models from (VIN) JA018273 on - Includes oil filter, air filter, fuel filter & sump plug washer			
Aftermarket	1	<b>RA1477P</b>	10.75 12.90
All 300 TDi diesel models - Includes oil filter, air filter, fuel filter & sump plug washer			
Aftermarket	1	<b>RA1478P</b>	7.25 8.70
Genuine	1	<b>RA1478</b>	26.67 32.00
All 3.9L V8 EFI petrol models - Includes oil filter, air filter, fuel filter & sump plug washer. Does not include spark plugs			
Aftermarket	1	<b>RD1209P</b>	5.95 7.14

### Fuel Filter

All 200TDi and 300TDi diesel models with unheated fuel filter - Includes sealing ring			
Aftermarket	1	<b>AEU2147LP</b>	3.00 3.60
OEM	1	<b>AEU2147LP1</b>	4.38 5.26
Genuine	1	<b>AEU2147L</b>	13.78 16.54
All cold climates 200TDi and 300TDi diesel models with heated fuel filter - Includes sealing ring			
OEM	1	<b>RTC5938P1</b>	5.00 6.00
Genuine	1	<b>RTC5938</b>	17.49 20.99
All 2.0L MPI petrol models - Internal threaded unions			
Aftermarket	1	<b>ESR4065P</b>	3.00 3.60
OEM	1	<b>ESR4065P1</b>	4.58 5.50
Genuine	1	<b>ESR4065</b>	14.85 17.82
All V8 carb petrol models - Element for in line filter assembly			
Aftermarket	1	<b>JS660LP</b>	1.33 1.60
Genuine	1	<b>JS660L</b>	3.06 3.67
All V8 Efi petrol models - Internal threaded unions			
Aftermarket	1	<b>ESR4065P</b>	3.00 3.60
OEM	1	<b>ESR4065P1</b>	4.58 5.50
Genuine	1	<b>ESR4065</b>	14.85 17.82

### Fuel Filter Complete Assembly

All diesel engine models - Sedimentor type			
Aftermarket	1	<b>NRC9708P</b>	17.08 20.50
OEM	1	<b>NRC9708P1</b>	26.67 32.00
Genuine	1	<b>NRC9708</b>	76.51 91.81
All diesel engine models			
Aftermarket	1	<b>WJN500180P1</b>	50.00 60.00
Genuine	1	<b>WJN500180</b>	98.37 118.04
All V8 carb petrol models			
Aftermarket	1	<b>NRC9786P</b>	16.88 20.26
Genuine	1	<b>NRC9786</b>	98.07 117.68

### Fuel Filter Seal

All diesel engine models			
Top, for sedimentor filter			
Aftermarket	1	<b>AAU9903P</b>	0.33 0.40
Genuine	1	<b>AAU9903</b>	1.78 2.14
Bottom, for sedimentor filter			
Aftermarket	1	<b>AAU9902P</b>	0.58 0.70
Genuine	1	<b>AAU9902</b>	1.78 2.14
All diesel models			
Genuine	1	<b>605011</b>	0.32 0.38

### Rocker Cover Filter

All models with Efi V8 petrol engine	Aftermarket	1	<b>ERC3209A</b>	2.08 2.50
--------------------------------------	-------------	---	-----------------	-----------

### Oil Strainer Transmission, Gearbox

All models with auto gearbox			
Aftermarket	1	<b>RTC4653P</b>	5.21 6.25
OEM	1	<b>RTC4653P1</b>	9.37 11.24
Genuine	1	<b>RTC4653</b>	49.14 58.97





## DISCOVERY 1 (1989 to 1998)

## SCREEN/LAMP WASHER SYSTEM

## Washer Jet

All models - Front screen	Aftermarket	2	<b>PRC7304P</b>	3.00	3.60
	Genuine	2	<b>PRC7304</b>	6.99	8.39
All models from (VIN) MA081992 on					
Rear screen	Aftermarket	1	<b>PRC6496P</b>	2.33	2.80
Headlamp	Aftermarket	2	<b>AMR1890P</b>	3.25	3.90
	Genuine	2	<b>AMR1890</b>	6.66	7.99
All models with headlamp wash up to (VIN) LA081991					
Headlamp	Aftermarket	2	<b>PRC4615P</b>	3.00	3.60

## Tee Piece Headlamp Wash

All models with headlamp power wash					
Front bumper hose	Aftermarket	1	<b>DCP6656P</b>	7.50	9.00
	Genuine	1	<b>DCP6656</b>	9.29	11.15

## Washer Pump

All models from (VIN) MA081992 on					
Headlamps	Genuine	1	<b>AMR3661</b>	52.15	62.58

## Washer Hose, Per Metre

All models - 4mm internal diameter (3mm also available).	Front or rear screen wash				
	Aftermarket	a/r	<b>GWV201M</b>	2.25	2.70

## Washer Reservoir

All models without headlamp wash from (VIN) MA081992 on - Front & rear screen wash					
	Genuine	1	<b>STC2934</b>	61.60	73.92
All models with headlamp wash from (VIN) MA081992 on - Front & rear screen & headlamp wash					
	Genuine	1	<b>STC2933</b>	28.71	34.45

## Windscreen Cleaning Paste

All models	Genuine	a/r	<b>DNJ500340</b>	7.72	9.26
Prevents wiper blade judder/squeak by 'deep cleaning' the windscreen (ref: Land Rover Tech Bulletin LRA501-002)					



## DISCOVERY 1 (1989 to 1998)

## DRIVE BELTS

## Timing Belt Kit Complete

All 300 TDi diesel models to (VIN) VA542370/711273					
Includes belt plus all parts to convert to later 300 TDi belt alignment method					
	Aftermarket	1	<b>STC4095LP</b>	155.83	187.00

## Timing Belt Kit

All 200 TDi diesel models	Bearmach	1	<b>ETC8550KITBMDIS</b>	52.50	63.00
All 300 TDi diesel models	Aftermarket	1	<b>STC4096LP</b>	47.50	57.00
	OEM	1	<b>STC4096LP1</b>	65.00	78.00
	Bearmach	1	<b>STC4096BM</b>	68.33	82.00
	Genuine	1	<b>STC4096L</b>	122.95	147.54
All 300 TDi diesel models up to (VIN) VA560897					
	Britpart	1	<b>ERR1092KITBPEARLY</b>	22.50	27.00
All 300 TDi diesel models from (VIN) VA560898 on					
	Britpart	1	<b>ERR1092KITBPLATE</b>	22.50	27.00

## Timing Belt

All models with 200TDi diesel engine	OEM	1	<b>ETC8550P1</b>	12.92	15.50
	Genuine	1	<b>ETC8550</b>	38.00	45.60
All models with 300TDi diesel engine	Aftermarket	1	<b>ERR1092P</b>	6.88	8.26
	OEM	1	<b>ERR1092P1</b>	10.63	12.76
	Genuine	1	<b>ERR1092</b>	38.02	45.62
All models with 2.0L MPI petrol engine	OEM	1	<b>LHN10016P1</b>	9.38	11.26
	Genuine	1	<b>LHN10016</b>	27.69	33.23

## Alternator Drive Belt

All models with 200TDi diesel engine - Alternator					
	Aftermarket	1	<b>ETC7469P</b>	1.75	2.10
	OEM	1	<b>ETC7469P1</b>	3.08	3.70
	Genuine	1	<b>ETC7469</b>	14.05	16.86
All 300 TDi diesel models up to (VIN) TA534103/TA703236 - Alternator with 61mm dia. pulley					
	Aftermarket	1	<b>PQS000030P</b>	4.00	4.80
	OEM	1	<b>PQS000030P1</b>	8.13	9.76
	Genuine	1	<b>PQS000030</b>	30.72	36.86
All 300 TDi diesel models from (VIN) VA534104/VA703237 on - Alternator with 49mm dia. pulley					
	Aftermarket	1	<b>PQS000040P</b>	4.79	5.75
	OEM	1	<b>PQS000040P1</b>	7.50	9.00
	Genuine	1	<b>PQS000040</b>	30.72	36.86
All models with 2.0L MPI petrol engine without air conditioning - Alternator					
	Aftermarket	1	<b>PQS100900P</b>	4.00	4.80
	OEM	1	<b>PQS100900P1</b>	7.50	9.00
	Genuine	1	<b>PQS100900</b>	32.04	38.45
All models with 2.0L MPI petrol engine and air conditioning - Alternator					
	Aftermarket	1	<b>PQS10061P</b>	5.42	6.50
	Genuine	1	<b>PQS10061</b>	27.12	32.54
Models with V8 carb engine and air conditioning - Alternator					
	Aftermarket	1	<b>ERR2073P</b>	2.83	3.40
	Genuine	1	<b>ERR2073</b>	7.86	9.43
All models with V8 EFI petrol engine - Alternator					
	Aftermarket	1	<b>ERR2678P</b>	2.50	3.00
	OEM	1	<b>ERR2678P1</b>	5.63	6.76
	Genuine	1	<b>ERR2678</b>	27.99	33.59
All models with V8 EFI engine without air conditioning from (engine) 36D50530 on - Alternator					
	Aftermarket	1	<b>ERR6191P</b>	10.63	12.76
	OEM	1	<b>ERR6191P1</b>	11.88	14.26
	Genuine	1	<b>ERR6191</b>	23.71	28.45
All models with V8 EFI engine with air conditioning from (engine) 36D50530 on - Alternator					
	Aftermarket	1	<b>ERR5579P</b>	5.63	6.76
	OEM	1	<b>ERR5579P1</b>	13.75	16.50
	Genuine	1	<b>ERR5579</b>	28.36	34.03
All models with V8 EFI engine without air conditioning from (VIN) MA081992 on - Alternator					
	Aftermarket	1	<b>ERR4461P</b>	6.88	8.26
	OEM	1	<b>ERR4461P1</b>	9.79	11.75
	Genuine	1	<b>ERR4461</b>	28.01	33.61

## Fan Belt

All models with 200TDi diesel engine - Fan	Aftermarket	1	<b>ERR810P</b>	2.58	3.10
	OEM	1	<b>ERR810P1</b>	3.33	4.00
	Genuine	1	<b>ERR810</b>	23.57	28.28
All 300TDi diesel engines up to (VIN) MA163103 - Fan					
	Aftermarket	1	<b>ERR3287P</b>	5.83	7.00
	OEM	1	<b>ERR3287P1</b>	10.00	12.00
	Genuine	1	<b>ERR3287</b>	21.64	25.97
All 300TDi diesel engines from (VIN) TA163104 on - Fan					
	Aftermarket	1	<b>ERR5911P</b>	7.08	8.50
	OEM	1	<b>ERR5911P1</b>	10.63	12.76
	Genuine	1	<b>ERR5911</b>	19.60	23.52

## PAS Belt

All models with V8 carb engine - Power steering					
	Aftermarket	1	<b>ERC675P</b>	2.83	3.40
	OEM	1	<b>ERC675P1</b>	3.33	4.00
	Genuine	1	<b>ERC675</b>	21.28	25.54

## A/C Belt

All models with 200TDi diesel engine and air conditioning - Air cond compressor					
	Aftermarket	1	<b>ETC9009P</b>	2.75	3.30
	OEM	1	<b>ETC9009P1</b>	4.00	4.80
	Genuine	1	<b>ETC9009</b>	31.11	37.33
All models with 300TDi diesel engine and air conditioning - Air cond compressor					
	Aftermarket	1	<b>ERR2215P</b>	3.50	4.20
	OEM	1	<b>ERR2215P1</b>	5.63	6.76
	Genuine	1	<b>ERR2215</b>	13.13	15.76
Models with V8 engine and air conditioning up to (VIN) LA081991 - Air cond compressor					
	Aftermarket	1	<b>611612P</b>	2.83	3.40
	OEM	1	<b>611612P1</b>	5.63	6.76
	Genuine	1	<b>611612</b>	15.12	18.14
All models with V8 EFI engine with air conditioning from (VIN) MA081992 to (engine) 36D50529 - Air cond compressor					
	Aftermarket	1	<b>ERR4623P</b>	6.88	8.26
	OEM	1	<b>ERR4623P1</b>	13.13	15.76
	Genuine	1	<b>ERR4623</b>	29.45	35.34



STC4095LP





# IGNITION SYSTEM

## Spark Plug

All 2.0L MPI petrol engine models	Aftermarket	4	<b>NLP10003P</b>	2.25	2.70
	Genuine	4	<b>NLP10003</b>	4.65	5.58
All 3.5L V8 petrol models with 8.13:1 compression ratio, std performance 19mm reach	MG Rover	8	<b>GSP4382</b>	2.95	3.54
	MG Rover	8	<b>GSP4362</b>	2.95	3.54
All 3.5L V8 petrol models with 9.35:1 compression ratio, std performance - 19mm reach high performance - 19mm reach, double core	MG Rover	8	<b>GSP6462</b>	2.95	3.54
	MG Rover	8	<b>GSP4382</b>	2.95	3.54
All 3.9L V8 petrol models with 8.13:1 compression ratio without catalyst, std performance 19mm reach	MG Rover	8	<b>GSP4382</b>	2.95	3.54
	MG Rover	8	<b>GSP4362</b>	2.95	3.54
All 3.9L V8 petrol models with 9.35:1 compression ratio without catalyst std performance - 19mm reach high performance - 19mm reach, double core	MG Rover	8	<b>GSP6462</b>	2.95	3.54
	MG Rover	8	<b>GSP4382</b>	2.95	3.54
All V8 carb petrol engine models RN11YC type	Aftermarket	8	<b>ERR3799P</b>	2.00	2.40
	Genuine	8	<b>ERR3799</b>	4.19	5.03
All V8 EFI petrol engine models RSN12YC type N9YC type	Genuine	8	<b>ETC7244</b>	4.21	5.05
	Genuine	8	<b>RTC3812X</b>	2.59	3.11
	Genuine	8	<b>RTC3812</b>	3.03	3.64
All USA/CDN/Mex 4.0L V8 EFI petrol models 19mm reach, double core	MG Rover	8	<b>GSP6462</b>	2.95	3.54

## Glow Plug

All 2.5L 200 TDI and 300 TDI diesel models	Aftermarket	4	<b>ETC8847P</b>	3.00	3.60
	OEM	4	<b>ETC8847P1</b>	8.75	10.50
	Genuine	4	<b>ETC8847</b>	33.60	40.32

## Glow Plug Cable

All 200 TDI and 300 TDI diesel models	Genuine	1	<b>AMR2425</b>	13.13	15.76
---------------------------------------	---------	---	----------------	-------	-------

## Ignition Coil

All 2.0L MPI petrol models - For 2 cylinders	Genuine	1	<b>NEC10047</b>	32.42	38.90
----------------------------------------------	---------	---	-----------------	-------	-------

## Ignition Coil & Bracket Assembly

All 2.0L MPI petrol models - Includes 2 coils (for 4 cylinders)	Genuine	1	<b>NEC10049</b>	230.46	276.55
-----------------------------------------------------------------	---------	---	-----------------	--------	--------

## Ignition Coil

All V8 carb petrol engine models Lucas type	Aftermarket	1	<b>RTC5628P</b>	9.58	11.50
	OEM	1	<b>RTC5628P1</b>	14.58	17.50
	Genuine	1	<b>RTC5628</b>	94.86	113.83
Bosch type	Aftermarket	1	<b>PRC6574P</b>	15.83	19.00
	OEM	1	<b>PRC6574P1</b>	39.58	47.50
	Genuine	1	<b>PRC6574</b>	114.80	137.76
All V8 EFI petrol engine models with distributor ignition Lucas type	Aftermarket	1	<b>RTC5628P</b>	9.58	11.50
	OEM	1	<b>RTC5628P1</b>	14.58	17.50
	Genuine	1	<b>RTC5628</b>	94.86	113.83
Bosch type	Aftermarket	1	<b>PRC6574P</b>	15.83	19.00
	OEM	1	<b>PRC6574P1</b>	39.58	47.50
	Genuine	1	<b>PRC6574</b>	114.80	137.76
GEMs system	Aftermarket	1	<b>ERR6269P</b>	59.17	71.00
	Genuine	1	<b>ERR6269</b>	459.47	551.36

## Rotor Arm

All V8 petrol engines with electronic ignition	Aftermarket	1	<b>STC1857P</b>	2.33	2.80
	OEM	1	<b>STC1857P1</b>	9.58	11.50
	Genuine	1	<b>STC1857</b>	15.18	18.22
Red	OEM	1	<b>GRA117RED</b>	7.50	9.00

## Distributor Cap

All V8 petrol engine models	Aftermarket	1	<b>GDC117P</b>	5.00	6.00
	Aftermarket	1	<b>GDC117</b>	10.42	12.50
	OEM	1	<b>GDC117P1</b>	16.04	19.25
	Genuine	1	<b>GDC117OE</b>	32.94	39.53

## Amplifier Link Lead

V8 petrol engine with 2 pin integral amp type 35DLM8 distributor - Amplifier to coil, converts 3 pin to 2 pin	Aftermarket	1	<b>STC1212P</b>	24.58	29.50
All 3.9L V8 petrol models with electronic ignition with 2 pin integral amplifier - Amplifier to coil, lead identified by 2 pin plug connector	OEM	1	<b>PRC6144P1</b>	36.25	43.50
	Genuine	1	<b>PRC6144</b>	40.55	48.66



STC1184KBP



STC1857P1

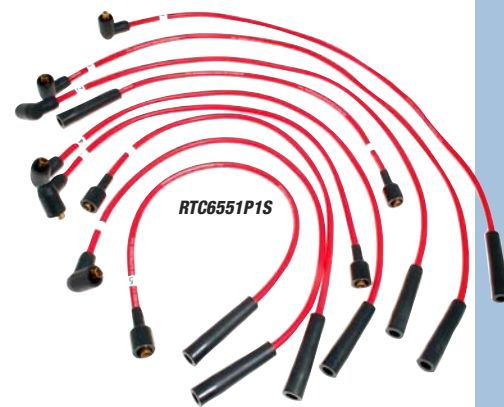

RTC6551P1S

# DISCOVERY 1 (1989 to 1998)

## Amplifier Module

All V8 petrol models with electronic ignition with 2 pin integral amplifier - Amplifier fitted to 35DLM8 distributor	Aftermarket	1	<b>NJL100060</b>	22.50	27.00
	V8 petrol engine with 3 pin integral amp type 35DLM8 distributor	Aftermarket	1	<b>STC1184P</b>	14.58
	Genuine	1	<b>STC1184</b>	136.26	163.51
All V8 EFI petrol models from (VIN) MA094073 on with remote amplifier	Aftermarket	1	<b>STC1856P</b>	55.00	66.00
	Genuine	1	<b>STC1856</b>	399.03	478.84

## Amplifier Module & Link Lead

V8 petrol engine with 2 pin integral amp type 35DLM8 distributor - Included link lead converts 3 pin to 2 pin	Britpart	1	<b>STC1184KBP</b>	24.58	29.50
------------------------------------------------------------------------------------------------------------------	----------	---	-------------------	-------	-------

## Amplifier Plug

V8 petrol engine with 3 pin integral amp type 35DLM8 distributor - 3 pin, for STC1184	OEM	1	<b>STC1184P1</b>	22.50	27.00
---------------------------------------------------------------------------------------	-----	---	------------------	-------	-------

## Pick Up & Baseplate, Distributor

All V8 carb petrol models with electronic ignition with 3 pin integral amplifier	Aftermarket	1	<b>RTC5090P</b>	15.63	18.76
	OEM	1	<b>RTC5090P1</b>	67.50	81.00
	Genuine	1	<b>RTC5090</b>	130.55	156.66
All V8 EFI petrol models with with 3 pin integral amplifier	Aftermarket	1	<b>RTC5090P</b>	15.63	18.76
	OEM	1	<b>RTC5090P1</b>	67.50	81.00
	Genuine	1	<b>RTC5090</b>	130.55	156.66
All V8 EFI petrol models from (VIN) MA094073 on with remote amplifier	OEM	1	<b>STC2898P1</b>	80.00	96.00
	Genuine	1	<b>STC2898</b>	139.69	167.63

## Vacuum Unit, Distributor

All V8 carb petrol engines	Aftermarket	1	<b>RTC5092P</b>	33.33	40.00
	Genuine	1	<b>RTC5092</b>	181.12	217.34
V8 EFI petrol engines with 2 pin amp type distributor	Aftermarket	1	<b>RTC3201P</b>	29.58	35.50
	Genuine	1	<b>RTC3201</b>	121.09	145.31
All V8 EFI petrol models with with 3 pin amplifier	OEM	1	<b>STC1186P1</b>	57.50	69.00
	Genuine	1	<b>STC1186</b>	100.22	120.26

## Distributor Drive Gear

All V8 Carb and EFI petrol engine models - On camshaft	Aftermarket	1	<b>614188A</b>	22.50	27.00
--------------------------------------------------------	-------------	---	----------------	-------	-------

## Distributor Drive Gear & Coupling

All V8 Carb and EFI petrol engine models - On distributor	Aftermarket	1	<b>ERC1353A</b>	27.50	33.00
-----------------------------------------------------------	-------------	---	-----------------	-------	-------

## O Ring Distributor

All V8 petrol models except 4.0L V8 USA/CDN/Mex	Aftermarket	1	<b>603446P</b>	2.50	3.00
	Genuine	1	<b>603446</b>	7.27	8.72

## Suppressor, Coil

All V8 petrol models	Aftermarket	1	<b>ADU7242LP</b>	3.75	4.50
----------------------	-------------	---	------------------	------	------

## Ignition Lead Set

All V8 carb petrol engine models - Silicone	Aftermarket	1	<b>RTC6551P</b>	11.67	14.00
	OEM	1	<b>RTC6551P1</b>	19.58	23.50
	Aftermarket	1	<b>RTC6551PS</b>	16.67	20.00
	OEM	1	<b>RTC6551P1S</b>	32.50	39.00
All V8 EFI petrol engine models with distributor ignition - Silicone	Aftermarket	1	<b>GHT206S</b>	25.83	31.00
	Aftermarket	1	<b>RTC6551P</b>	11.67	14.00
	OEM	1	<b>RTC6551P1</b>	19.58	23.50
	Aftermarket	1	<b>RTC6551PS</b>	16.67	20.00
Red	OEM	1	<b>RTC6551P1S</b>	32.50	39.00
	Aftermarket	1	<b>GHT206S</b>	25.83	31.00



## DISCOVERY 1 (1989 to 1998)

## BRAKING SYSTEM

## Brake Pad Set

All models without vented discs to (VIN) KA034313					
Front	OEM	1	<b>SFP500220P1</b>	24.17	29.00
	Genuine	1	<b>SFP500220</b>	48.72	58.46
Vented disc models from (VIN) KA034314 on Front Brakes, Vented					
	Aftermarket	1	<b>SFP500180P1</b>	18.13	21.76
	Genuine	1	<b>SFP500180</b>	35.98	43.18
All solid disc models to axle no. 38L03120B					
Front Brakes with split pin retaining pins	Aftermarket	1	<b>STC2956P</b>	13.54	16.25
	Brembo	1	<b>STC2956BREMBO</b>	23.75	28.50
	EBC	1	<b>STC2956ULTIMAX</b>	25.00	30.00
Green Stuff	EBC	1	<b>STC2956GS</b>	33.33	40.00
All non vented disc brake models					
Front Brakes, Not Vented	Aftermarket	1	<b>SFP500160P</b>	10.63	12.76
	Brembo	1	<b>SFP500160BREMBO</b>	28.33	34.00
	EBC	1	<b>SFP500160ULTIMAX</b>	30.00	36.00
	Genuine	1	<b>SFP500160</b>	57.52	69.02
Green Stuff	EBC	1	<b>SFP500160GS</b>	33.33	40.00
All non vented disc brake models					
Rear Brakes, Not Vented	OEM	1	<b>SFP500190P1</b>	11.67	14.00
All models					
Rear Brakes, Without Sensors	Aftermarket	1	<b>LR032954P</b>	10.00	12.00
	Brembo	1	<b>LR032954BREMBO</b>	23.33	28.00
	OEM	1	<b>LR032954P1</b>	15.00	18.00
	Genuine	1	<b>LR032954</b>	52.91	63.49
Rear Brakes, With Sensors	Aftermarket	1	<b>SFP500200P</b>	11.67	14.00
	Brembo	1	<b>SFP500200BREMBO</b>	23.75	28.50
	Genuine	1	<b>SFP500200</b>	60.06	72.07

## Brake Pad Fitting Kit

All models up to (VIN) KA034331					
Front Solid Disc Brakes	Aftermarket	1	<b>STC8573P</b>	2.58	3.10
All models with solid front discs					
Front Solid Disc Brakes	OEM	1	<b>STC8576P1</b>	1.83	2.20
	Genuine	1	<b>STC8576</b>	5.55	6.66
All models with vented disc brakes					
Front Vented Disc Brakes	Aftermarket	1	<b>STC8575P</b>	2.83	3.40
	Genuine	1	<b>STC8575</b>	5.01	6.01
All models - Rear Disc Brakes	Aftermarket	1	<b>STC8574P</b>	3.33	4.00

## Spring &amp; Pin Kit

All models - Front brake pad retention	Aftermarket	1	<b>RTC5001P</b>	3.33	4.00
	Genuine	1	<b>RTC5001</b>	12.33	14.80

## Brake Pad Retaining Kit

All models with solid discs - Front, split-pin type retaining pins					
	Aftermarket	1	<b>RA1396P</b>	6.25	7.50
	Genuine	1	<b>RA1396</b>	9.79	11.75

## Shim Brake Pads

All models					
Rear RH outer,	Aftermarket	1	<b>591629P</b>	2.08	2.50
Rear LH inner	Aftermarket	1	<b>591628P</b>	1.33	1.60

## Brake Disc

All non vented disc brake models - Front, Not Vented					
each	Aftermarket	2	<b>LR017951P</b>	13.75	16.50
	Genuine	2	<b>LR017951</b>	52.35	62.82
pair	Brembo	1	<b>LR017951BREMBO</b>	50.00	60.00
slotted & drilled, pair	Britpart	1	<b>LR017951URBP</b>	39.58	47.50
All vented disc brake models - Front, Vented					
each	Aftermarket	2	<b>LR017952P</b>	16.04	19.25
	OEM	2	<b>LR017952P1</b>	25.00	30.00
	Genuine	2	<b>LR017952</b>	58.71	70.45
pair	Brembo	1	<b>LR017952BREMBO</b>	72.50	87.00
slotted & drilled, pair	Britpart	1	<b>LR017952URBP</b>	50.00	60.00
All models - Rear, Not Vented, each					
	Aftermarket	2	<b>LR017953P</b>	13.75	16.50
	OEM	2	<b>LR017953P1</b>	19.58	23.50
	Genuine	2	<b>LR017953</b>	63.06	75.67
pair	Brembo	1	<b>LR017953BREMBO</b>	55.00	66.00
slotted & drilled, pair	Britpart	1	<b>LR017953URBP</b>	45.00	54.00

## Mudshield Brake Disc

All models - Front					
RH	Aftermarket	1	<b>FTC4838P</b>	10.00	12.00
	Genuine	1	<b>FTC4838</b>	10.69	12.83
LH	Aftermarket	1	<b>FTC4839P</b>	15.42	18.50
	Genuine	1	<b>FTC4839</b>	16.82	20.18

## Brake Drum

All models - Handbrake	Genuine	1	<b>LR025177</b>	152.67	183.20
------------------------	---------	---	-----------------	--------	--------

## Brake Caliper

All models up to (VIN) KA034313, Solid Disc Brakes					
Right Hand Front,	Aftermarket	1	<b>AEU1718P</b>	42.50	51.00
Left Hand Front	Aftermarket	1	<b>AEU1719P</b>	42.50	51.00
Solid disc brake models from (VIN) KA034314 to (VIN) LA081991 - Solid Disc Brakes					
Right Hand Front	Aftermarket	1	<b>STC1258P</b>	70.00	84.00
	OEM	1	<b>STC1258P1</b>	105.00	126.00
Left Hand Front	Aftermarket	1	<b>STC1259P</b>	70.00	84.00
	OEM	1	<b>STC1259P1</b>	105.00	126.00
	Genuine	1	<b>STC1259</b>	228.93	274.72
Solid disc brake models from (VIN) MA081992 - Solid Disc Brakes					
Right Hand Front	Aftermarket	1	<b>STC1962P</b>	39.58	47.50
	Genuine	1	<b>STC1962</b>	193.78	232.54
Left Hand Front	Aftermarket	1	<b>STC1963P</b>	39.58	47.50
	OEM	1	<b>STC1963P1</b>	115.00	138.00
	Genuine	1	<b>STC1963</b>	210.17	252.20
RHD Diesel with vented discs from (axle) 42L00001B to 42L00521B - Vented Disc Brakes					
Right Hand Front	Aftermarket	1	<b>RTC6776P</b>	45.00	54.00
	OEM	1	<b>RTC6776P1</b>	110.00	132.00
	Exchange*	1	<b>RTC6776R</b>	100.00	120.00
			<i>*Exchange Surcharge</i>	40.00	48.00
	Genuine*	1	<b>RTC6776</b>	262.57	315.08
			<i>*Exchange Surcharge</i>	50.00	60.00
Left Hand Front	Aftermarket	1	<b>RTC6777P</b>	48.33	58.00
	OEM	1	<b>RTC6777P1</b>	110.00	132.00
	Exchange*	1	<b>RTC6777R</b>	100.00	120.00
			<i>*Exchange Surcharge</i>	40.00	48.00
	Genuine*	1	<b>RTC6777</b>	262.57	315.08
			<i>*Exchange Surcharge</i>	50.00	60.00
RHD V8 with vented discs from (axle) 38L00001B to 38L03120B - Vented Disc Brakes					
Right Hand Front	Aftermarket	1	<b>RTC6776P</b>	45.00	54.00
	OEM	1	<b>RTC6776P1</b>	110.00	132.00
	Exchange*	1	<b>RTC6776R</b>	100.00	120.00
			<i>*Exchange Surcharge</i>	40.00	48.00
	Genuine*	1	<b>RTC6776</b>	262.57	315.08
			<i>*Exchange Surcharge</i>	50.00	60.00
Left Hand Front	Aftermarket	1	<b>RTC6777P</b>	48.33	58.00
	OEM	1	<b>RTC6777P1</b>	110.00	132.00
	Exchange*	1	<b>RTC6777R</b>	100.00	120.00
			<i>*Exchange Surcharge</i>	40.00	48.00
	Genuine*	1	<b>RTC6777</b>	262.57	315.08
			<i>*Exchange Surcharge</i>	50.00	60.00
LHD V8 with vented discs from (axle) 39L00001B to 39L05552B - Vented Disc Brakes					
Right Hand Front	Aftermarket	1	<b>RTC6776P</b>	45.00	54.00
	OEM	1	<b>RTC6776P1</b>	110.00	132.00
	Exchange*	1	<b>RTC6776R</b>	100.00	120.00
			<i>*Exchange Surcharge</i>	40.00	48.00
	Genuine*	1	<b>RTC6776</b>	262.57	315.08
			<i>*Exchange Surcharge</i>	50.00	60.00
Left Hand Front	Aftermarket	1	<b>RTC6777P</b>	48.33	58.00
	OEM	1	<b>RTC6777P1</b>	110.00	132.00
	Exchange*	1	<b>RTC6777R</b>	100.00	120.00
			<i>*Exchange Surcharge</i>	40.00	48.00
	Genuine*	1	<b>RTC6777</b>	262.57	315.08
			<i>*Exchange Surcharge</i>	50.00	60.00
LHD Diesel with vented discs from (axle) 43L00001B to 43L18579B - Vented Disc Brakes					
Right Hand Front	Aftermarket	1	<b>RTC6776P</b>	45.00	54.00
	OEM	1	<b>RTC6776P1</b>	110.00	132.00
	Exchange*	1	<b>RTC6776R</b>	100.00	120.00
			<i>*Exchange Surcharge</i>	40.00	48.00
	Genuine*	1	<b>RTC6776</b>	262.57	315.08
			<i>*Exchange Surcharge</i>	50.00	60.00
Left Hand Front	Aftermarket	1	<b>RTC6777P</b>	48.33	58.00
	OEM	1	<b>RTC6777P1</b>	110.00	132.00
	Exchange*	1	<b>RTC6777R</b>	100.00	120.00
			<i>*Exchange Surcharge</i>	40.00	48.00
	Genuine*	1	<b>RTC6777</b>	262.57	315.08
			<i>*Exchange Surcharge</i>	50.00	60.00
All without ABS up to (axle) 28S44171D and 32S2118B - Solid Disc Brakes, Imperial					
Right Hand Rear	Aftermarket	1	<b>RTC5889P</b>	27.50	33.00
	Exchange*	1	<b>RTC5889R</b>	56.58	67.90
			<i>*Exchange Surcharge</i>	40.00	48.00
	Genuine*	1	<b>RTC5889</b>	190.99	229.19
			<i>*Exchange Surcharge</i>	50.00	60.00
All up to (axle) 28S44171D and 32S2118B - Solid Disc Brakes, Imperial					
Left Hand Rear	Aftermarket	1	<b>RTC5890P</b>	27.50	33.00
	Exchange*	1	<b>RTC5890R</b>	56.58	67.90
			<i>*Exchange Surcharge</i>	40.00	48.00
	Genuine*	1	<b>RTC5890</b>	190.99	229.19
			<i>*Exchange Surcharge</i>	50.00	60.00
All from (axle) 28S44172D and 32S2119B					
Right Hand Rear, Metric	Aftermarket	1	<b>SMC500110P</b>	28.75	34.50
	Exchange*	1	<b>SMC500110R</b>	85.00	102.00
			<i>*Exchange Surcharge</i>	40.00	48.00
	Genuine*	1	<b>SMC500110</b>	209.47	251.36
			<i>*Exchange Surcharge</i>	50.00	60.00
Left Hand Rear, Metric	Aftermarket	1	<b>SMC500240P</b>	28.75	34.50
	Exchange*	1	<b>SMC500240R</b>	85.00	102.00
			<i>*Exchange Surcharge</i>	40.00	48.00
	Genuine*	1	<b>SMC500240</b>	209.47	251.36
			<i>*Exchange Surcharge</i>	50.00	60.00

## Brake Caliper Piston

All models - Front					
Standard material	Aftermarket	4	<b>606683P</b>	3.25	3.90
	OEM	4	<b>606683P1</b>	5.00	6.00
	Genuine	4	<b>606683</b>	16.73	20.08
Stainless Steel material	Aftermarket	4	<b>606683SS</b>	7.50	9.00
All models - Rear					
Standard material	Aftermarket	4	<b>606696P</b>	2.25	2.70
	OEM	4	<b>606696P1</b>	5.42	6.50
	Genuine	4	<b>606696</b>	19.99	23.99
Stainless Steel material	Aftermarket	4	<b>606696SS</b>	7.08	8.50



FTC4838P

# BRAKING SYSTEM

## Brake Caliper Piston Kit

All models				
Front, Stainless Steel material	Aftermarket	1	<b>606683BPSSKIT</b>	50.00 60.00
Rear, Stainless Steel material	Aftermarket	1	<b>606696BPSSKIT</b>	25.83 31.00

## Dust Cap Bleed Screw

All models up to (VIN) KA034313 - Blue, front caliper bleed nipple				
	Genuine	2	<b>594091</b>	4.66 5.59

## Bleed Nipple

All models - Front brake caliper				
	Aftermarket	2	<b>RTC1526P</b>	1.83 2.20
	Genuine	2	<b>RTC1526</b>	2.77 3.32

## Brake Master Cylinder

Without ABS up to (VIN) LA081991				
	Aftermarket	1	<b>NTC4991P</b>	67.50 81.00
	OEM	1	<b>NTC4991P1</b>	78.33 94.00
	Genuine	1	<b>NTC4991</b>	289.59 347.51
Without ABS, from (VIN) MA081992				
	Aftermarket	1	<b>STC1285P</b>	58.33 70.00
	Genuine	1	<b>STC1285</b>	276.77 332.12
All models with ABS				
	Aftermarket	1	<b>STC1284P</b>	86.67 104.00
	OEM	1	<b>STC1284P1</b>	120.00 144.00

## Master Cylinder Repair Kit

All models to (VIN) LA081991 - Brake master cylinder, excludes reservoir				
	Aftermarket	1	<b>RTC5834P</b>	18.54 22.25
	OEM	1	<b>RTC5834P1</b>	27.92 33.50
	Genuine	1	<b>RTC5834</b>	105.91 127.09
Non ABS models from (VIN) MA081992 on				
	Aftermarket	1	<b>STC2901P</b>	22.92 27.50
	Genuine	1	<b>STC2901</b>	85.36 102.43
All models with ABS				
	Genuine	1	<b>STC2904</b>	64.63 77.56

## Master Cyl Reservoir Kit

Non ABS models from (VIN) MA081992 on	Aftermarket	1	<b>STC2902P</b>	29.58 35.50
---------------------------------------	-------------	---	-----------------	-------------

## Brake Servo Assembly

All models from (VIN) MA081992				
	Aftermarket	1	<b>STC1286P</b>	72.50 87.00
	OEM	1	<b>STC1286P1</b>	109.17 131.00
	Genuine	1	<b>STC1286</b>	257.87 309.44

## Servo Repair Kit

All models	Genuine	1	<b>RTC5832</b>	34.58 41.50
------------	---------	---	----------------	-------------

## Caliper Repair Kit

All models - Front				
	Aftermarket	2	<b>AEU1547P</b>	2.00 2.40
	OEM	2	<b>AEU1547P1</b>	7.08 8.50
	Genuine	2	<b>AEU1547</b>	12.39 14.87
All models - Rear caliper, kit includes pistons				
	Aftermarket	2	<b>SEE500140P</b>	5.63 6.76
	OEM	2	<b>SEE500140P1</b>	29.50 35.40
	Genuine	2	<b>SEE500140</b>	54.78 65.74

## Brake Hose

All models up to (VIN) JA034313				
Front hose, metric system				
	Aftermarket	4	<b>NRC4401P</b>	3.00 3.60
	OEM	4	<b>NRC4401P1</b>	7.50 9.00
	Genuine	4	<b>NRC4401</b>	40.83 49.00
All models from (VIN) KA034313 on				
Front, rubber				
	Aftermarket	4	<b>ANR1765P</b>	3.50 4.20
	OEM	4	<b>ANR1765P1</b>	11.67 14.00
	Genuine	4	<b>ANR1765</b>	34.57 41.48
All models - Rear, rubber				
	Aftermarket	1	<b>NTC3458P</b>	2.50 3.00
	OEM	1	<b>NTC3458P1</b>	5.83 7.00
	Genuine	1	<b>NTC3458</b>	28.82 34.58

## Brake Pipe Kit Copper

All non ABS models to (VIN) JA0012332				
Complete vehicle kit (13 pipes & clips)				
	Automec	1	<b>RD106091-92</b>	102.50 123.00
All non ABS models from (VIN) JA0012333 to (VIN) LA081991				
Complete vehicle kit				
	Automec	1	<b>RD106093-94</b>	97.50 117.00
All non ABS models from (VIN) MA081992				
Complete vehicle kit				
	Automec	1	<b>RD106095-98</b>	95.83 115.00

## Brake Pipe Clip

All models - Double type				
	Aftermarket	a/r	<b>625521A</b>	1.25 1.50
All models				
	Aftermarket	a/r	<b>GHF1192</b>	0.92 1.10
All models with ABS from (VIN) MA081922				
	Genuine	a/r	<b>NTC1176</b>	0.71 0.85
Various applications				
	Genuine	a/r	<b>NTC9543L</b>	1.80 2.16

## Brake Pipe Clip Double

All models without ABS				
	Genuine	a/r	<b>79125</b>	0.32 0.38
Various applications				
	Genuine	a/r	<b>NTC9530</b>	0.86 1.03

## 2-way Brake Pipe Connector

All models without ABS - Rear	Genuine	a/r	<b>BMK2466</b>	4.41 5.29
-------------------------------	---------	-----	----------------	-----------

## Brake Pipe Clip Triple

All models with ABS from (VIN) MA081922	Genuine	a/r	<b>AFU1217</b>	1.24 1.49
-----------------------------------------	---------	-----	----------------	-----------

## T Piece Brake System

All non-ABS models - Rear brake pipes				
	Aftermarket	a/r	<b>NRC4251P</b>	6.04 7.25
	Genuine	a/r	<b>NRC4251</b>	17.88 21.46

# DISCOVERY 1 (1989 to 1998)

## Brake Shoe Return Spring - Handbrake

All models with 'GREEN, - (T)28D283204E				
	Aftermarket	1	<b>STC246P</b>	4.83 5.80
	Genuine	1	<b>STC246</b>	5.74 6.89

## Brake Spring Kit - Handbrake

All models from (transmission) 28D283205E on - Handbrake Shoe Retention				
	Aftermarket	1	<b>ICW100050P</b>	3.83 4.60
	OEM	1	<b>ICW100050P1</b>	8.12 9.74
	Genuine	1	<b>ICW100050</b>	11.52 13.82

## Brake Shoe Set - Handbrake

Up to (transmission) 28D283204E - Handbrake, rod operated type				
	Aftermarket	1	<b>STC965P</b>	7.50 9.00
	OEM	1	<b>STC965P1</b>	22.50 27.00
	Genuine	1	<b>STC965</b>	80.87 97.04
All models from (VIN) KA034314 on - Handbrake, direct entry cable type				
	Aftermarket	1	<b>ICW500010P</b>	10.00 12.00
	OEM	1	<b>ICW500010P1</b>	25.00 30.00
	Genuine	1	<b>ICW500010</b>	65.52 78.62

## Brake Drum - Handbrake

All models - Handbrake				
	Aftermarket	1	<b>LR025177P</b>	20.42 24.50
	Genuine	1	<b>LR025177</b>	152.67 183.20

## Backplate Handbrake

All models from (transmission) 28D283205E on - Handbrake, direct entry cable type				
	Genuine	1	<b>STC1533</b>	46.67 56.00
All models with horizontally mounted brake shoes				
	Genuine	1	<b>STC963</b>	343.70 412.44

## Retaining Plate Handbrake

All models to (VIN) LA081991				
	Aftermarket	1	<b>515468P</b>	1.08 1.30
	Genuine	1	<b>515468</b>	2.30 2.76

## Dust Cover Expander Unit

All models with LT77 5 speed gearbox				
	OEM	1	<b>515466P1</b>	3.33 4.00
	Genuine	1	<b>515466</b>	4.49 5.39

## Expander Unit

All models with LT77 5 speed gearbox				
	Aftermarket	1	<b>AEU2734P</b>	17.29 20.75
	Genuine	1	<b>AEU2734</b>	330.80 396.96

## Retaining Kit Expander

All models - Parking Brake				
	Aftermarket	1	<b>RA1109P</b>	3.00 3.60
	Genuine	1	<b>RA1109</b>	5.83 7.00

## Brake Shoe Adjuster Assembly

All models with GREEN, - (T)28D283204E				
	Aftermarket	1	<b>STC244P</b>	17.29 20.75
	Genuine	1	<b>STC244</b>	125.32 150.38
	Genuine	1	<b>STC245</b>	124.64 149.57

## Brake Adjuster Transmission

All models with LT230 transfer box - Early type expander				
	Aftermarket	1	<b>AEU2735P</b>	10.42 12.50
	Genuine	1	<b>AEU2735</b>	237.59 285.11

## Transmission Brake Adjustment Kit

All models with direct entry hand brake cable (gbox) T28D283205E on				
	Aftermarket	1	<b>ICW500020P</b>	9.37 11.24
	Genuine	1	<b>ICW500020</b>	13.81 16.57

## Clevis Pin Handbrake Lever

All models				
	Aftermarket	1	<b>FRC8547P</b>	2.08 2.50
	Genuine	1	<b>FRC8547</b>	3.30 3.96

## Transmission Brake Connecting Rod

All models	Genuine	1	<b>STC964</b>	38.33 46.00
------------	---------	---	---------------	-------------

## Handbrake Switch

All models except MPI and LTI engines	Genuine	1	<b>CLP8699L</b>	24.46 29.35
---------------------------------------	---------	---	-----------------	-------------

## Handbrake Adjusting Knob

All models	Genuine	1	<b>NTC5009</b>	1.72 2.06
------------	---------	---	----------------	-----------





## DISCOVERY 1 (1989 to 1998)

## BRAKING SYSTEM

## Handbrake Cable

Tdi diesel to (VIN) KA055568	Aftermarket	1	<b>NTC9400P</b>	8.96	10.75
	Genuine	1	<b>NTC9400</b>	58.36	70.03
Tdi diesel from (VIN) KA055569 to LA063967	Aftermarket	1	<b>NTC6125P</b>	12.50	15.00
	OEM	1	<b>NTC6125P1</b>	24.00	28.80
	Genuine	1	<b>NTC6125</b>	52.30	62.76
Tdi diesel from (VIN) LA063968 on	Aftermarket	1	<b>STC1528P</b>	10.00	12.00
	OEM	1	<b>STC1528P1</b>	15.63	18.76
	Genuine	1	<b>STC1528</b>	73.21	87.85
V8 petrol to (VIN) KA055568	Aftermarket	1	<b>NTC9400P</b>	8.96	10.75
	Genuine	1	<b>NTC9400</b>	58.36	70.03
V8 petrol from (VIN) KA055569 to LA063967	Aftermarket	1	<b>NTC6125P</b>	12.50	15.00
	OEM	1	<b>NTC6125P1</b>	24.00	28.80
	Genuine	1	<b>NTC6125</b>	52.30	62.76
V8 petrol from (VIN) LA063968 on	Aftermarket	1	<b>STC1528P</b>	10.00	12.00
	OEM	1	<b>STC1528P1</b>	15.63	18.76
	Genuine	1	<b>STC1528</b>	73.21	87.85

## ABS Sensor Kit

All ABS models					
Front brakes	Aftermarket	2	<b>STC1749P</b>	28.75	34.50
	Genuine	2	<b>STC1749</b>	217.69	261.23
Rear brakes	Aftermarket	2	<b>STC1750P</b>	40.00	48.00
	Genuine	2	<b>STC1750</b>	278.01	333.61

## ABS Sensor Oil Seal

All models with ABS from (VIN) JA032851 on - Front brakes					
	Aftermarket	1	<b>FTC1376P</b>	1.00	1.20
	OEM	1	<b>FTC1376P1</b>	2.50	3.00
	Genuine	1	<b>FTC1376</b>	9.10	10.92

## Bush ABS Sensor

All models with anti lock brakes - Front and rear					
	Aftermarket	2	<b>FTC1374P</b>	4.58	5.50
	Genuine	2	<b>LR029522</b>	14.33	17.20

## Exciter Ring

All models with ABS - Rear	Genuine	2	<b>FTC1379</b>	253.57	304.28
----------------------------	---------	---	----------------	--------	--------

## Brake Pedal Rubber

All manual models - Brake and clutch	Aftermarket	2	<b>575818P</b>	1.83	2.20
	Genuine	2	<b>575818</b>	6.79	8.15
All models with automatic transmission	Aftermarket	1	<b>ANR2941P</b>	7.92	9.50
	Genuine	1	<b>ANR2941</b>	11.53	13.84

## Bush Brake Pedal Pivot

All models to (VIN) LA081991	Genuine	1	<b>575806</b>	3.92	4.70
------------------------------	---------	---	---------------	------	------

## DISCOVERY 1 (1989 to 1998)

## SUSPENSION

## Bush Radius Arm

All models - Front suspension chassis end, rubber					
	Aftermarket	4	<b>NRC4514P</b>	0.79	0.95
	Genuine	4	<b>NRC4514</b>	2.76	3.31
rubber	Aftermarket	4	<b>NTC6781P</b>	1.50	1.80
	OEM	4	<b>NTC6781P1</b>	4.08	4.90
	Genuine	4	<b>NTC6781</b>	14.96	17.95
	Aftermarket	4	<b>NTC6860P</b>	2.00	2.40
	OEM	4	<b>NTC6860P1</b>	6.67	8.00
	Genuine	4	<b>NTC6860</b>	10.40	12.48
Kit, radius arm to chassis, rubber	Britpart	1	<b>NRC4514BPKIT</b>	7.08	8.50
All models - Rear suspension chassis end, rubber, pair					
	Aftermarket	1	<b>STC618P</b>	6.67	8.00
	OEM	1	<b>STC618P1</b>	15.42	18.50
	Genuine	1	<b>STC618</b>	59.46	71.35
rubber	Aftermarket	2	<b>NTC1772P</b>	1.50	1.80
	OEM	2	<b>NTC1772P1</b>	3.00	3.60
	Genuine	2	<b>NTC1772</b>	9.29	11.15

## Washer for Bush on Radius Arm

All models - Rear suspension, chassis end	Aftermarket	2	<b>STC618WASHER</b>	5.42	6.50
-------------------------------------------	-------------	---	---------------------	------	------

## Bush Shock Absorber Mounting

All models					
Front upper and lower, rubber	Aftermarket	8	<b>552818P</b>	0.50	0.60
	Genuine	8	<b>552818</b>	1.38	1.66
Rear, upper, rubber	Aftermarket	2	<b>NRC5593P</b>	1.08	1.30
	Genuine	2	<b>NRC5593</b>	6.28	7.54
All models up to (VIN) LA081991					
Rear, lower, rubber	Aftermarket	8	<b>552818P</b>	0.50	0.60
	Genuine	8	<b>552818</b>	1.38	1.66
All models from (VIN) MA081992 on					
Rear, lower, rubber	Aftermarket	4	<b>RNF100090LP</b>	0.54	0.65
	Genuine	4	<b>RNF100090L</b>	2.06	2.47
	Genuine	4	<b>RNF100090</b>	1.09	1.31

## Bush Panhard Rod

All models from (VIN) MA085513 on - Front rubber (each)					
	Aftermarket	2	<b>ANR3410P</b>	0.75	0.90
	OEM	2	<b>ANR3410P1</b>	2.75	3.30
	Genuine	2	<b>ANR3410</b>	8.67	10.40
poly. (each)	Aftermarket	2	<b>ANR3410POLY</b>	4.00	4.80
Kit poly.	Terrafirma	1	<b>ANR3410TFPK</b>	15.63	18.76

## Bush Upper Link

All models - Rear suspension, rubber					
	Aftermarket	2	<b>NTC1773P</b>	1.58	1.90
	OEM	2	<b>NTC1773P1</b>	4.00	4.80
	Genuine	2	<b>NTC1773</b>	19.99	23.99

## Suspension Bush Kit

All models to (VIN) JA021208 - Kit contains complete vehicle set					
	Aftermarket	1	<b>RD1053P</b>	30.42	36.50
	Genuine	1	<b>RD1053</b>	199.00	238.80
All models from (VIN) JA021209 to (VIN) MA085512 without anti roll bars - Kit contains complete vehicle set					
	Aftermarket	1	<b>RD1054P</b>	29.58	35.50
	Genuine	1	<b>RD1054</b>	257.50	309.00
	Aftermarket	1	<b>RD1055P</b>	33.33	40.00
	Genuine	1	<b>RD1055</b>	279.17	335.00
All models from (VIN) MA085513 on - Kit contains complete vehicle set					
	Aftermarket	1	<b>RD1055P</b>	33.33	40.00
	Genuine	1	<b>RD1055</b>	279.17	335.00

## Suspension Bush Kit B

All models - poly.					
	Aftermarket	1	<b>RA1274ALTPOLY</b>	87.50	105.00
performance red	Polybush	1	<b>RA1274PBRED</b>	130.00	156.00
dynamic orange	Polybush	1	<b>RA1274PBORANGE</b>	130.00	156.00
black	Britpart	1	<b>RA1274BPPYBLKDIS</b>	75.83	91.00
yellow	Britpart	1	<b>RA1274BPPYELDIS</b>	75.83	91.00
blue	Britpart	1	<b>RA1274BPPYBLUE</b>	75.00	90.00

## Bolt Kit for Suspension Bush Kit

All models to (VIN) JA021208 - Kit contains all the nuts & bolts required when renewing bushes					
	Aftermarket	1	<b>RD1056P</b>	43.33	52.00
	Genuine	1	<b>RD1056</b>	71.67	86.00
All models from (VIN) JA021209 to (VIN) MA085512 without anti roll bars - Kit contains all the nuts & bolts required when renewing bushes					
	Aftermarket	1	<b>RD1057P</b>	34.58	41.50
	Genuine	1	<b>RD1057</b>	70.83	85.00
All models from (VIN) JA021209 to (VIN) MA085512 with anti roll bars - Kit contains all the nuts & bolts required when renewing bushes					
	Aftermarket	1	<b>RD1056P</b>	43.33	52.00
	Genuine	1	<b>RD1056</b>	71.67	86.00
All models from (VIN) MA085513 on - Kit contains all the nuts & bolts required when renewing bushes					
	Aftermarket	1	<b>RD1057P</b>	34.58	41.50
	Genuine	1	<b>RD1057</b>	70.83	85.00

## Bush Kit Radius Arm

All models - Front suspension, poly. chassis end					
	Aftermarket	4	<b>NRC4514POLY</b>	3.00	3.60
	Polybush	4	<b>NRC4514POLYBUSH</b>	20.42	24.50
	Aftermarket	4	<b>NTC6781POLY</b>	5.00	6.00
	Aftermarket	4	<b>NTC6860POLY</b>	6.25	7.50
	Britpart	1	<b>NTC6781BPPY</b>	16.88	20.26
	Bearmach	1	<b>NTC6781BMPYC</b>	85.00	102.00
black	Britpart	1	<b>NTC6860PYKITBP</b>	22.92	27.50
yellow	Britpart	1	<b>NTC6860PYKITELBP</b>	22.92	27.50
red (set of 4)	Polybush	1	<b>NTC6860PBRED</b>	47.50	57.00
Kit, radius arm to chassis, yellow	Britpart	1	<b>NRC4514BPKPOLYEL</b>	9.58	11.50
All models - Rear suspension, poly.					
	Aftermarket	2	<b>NTC1772POLY</b>	4.38	5.26
performance red	Polybush	1	<b>NTC1772POLYBUSH</b>	22.50	27.00
chassis end	Aftermarket	2	<b>NTC9027POLY</b>	20.00	24.00
chassis end, pair	Aftermarket	1	<b>STC618POLY</b>	25.83	31.00
Kit, chassis end, performance red	Polybush	1	<b>NTC9027POLYBUSH</b>	39.58	47.50

## Bush Shock Absorber Mounting

All models - Front upper and lower, poly.					
	Aftermarket	8	<b>552818POLY</b>	0.83	1.00
performance red	Polybush	1	<b>5528189PBR</b>	25.00	30.00
comfort blue	Polybush	1	<b>552818PPBB</b>	25.00	30.00
dynamic orange	Polybush	1	<b>5528189PBO</b>	25.00	30.00
All models up to (VIN) LA081991 - Rear, lower, poly.					
	Aftermarket	4	<b>552818POLY</b>	0.83	1.00
performance red	Polybush	1	<b>5528189PBR</b>	25.00	30.00
comfort blue	Polybush	1	<b>552818PPBB</b>	25.00	30.00
dynamic orange	Polybush	1	<b>5528189PBO</b>	25.00	30.00
All models from (VIN) MA081992 on - Rear, lower, poly.					
	Aftermarket	4	<b>RNF100090LPOLY</b>	2.25	2.70
All models - Rear, upper, poly.	Aftermarket	2	<b>NRC5593POLY</b>	4.00	4.80
	Terrafirma	2	<b>NRC5593TFP</b>	13.13	15.76

## Shock Absorber Bush Kit

All models - Front shock absorber bush kit					
performance red	Polybush	1	<b>LL1357</b>	22.08	26.50
comfort blue	Polybush	1	<b>LL1357B</b>	22.08	26.50
All models up to (VIN) LA081991 - Rear shock absorber bush kit					
performance red	Polybush	1	<b>LL1356</b>	27.08	32.50
comfort blue	Polybush	1	<b>LL1356B</b>	27.08	32.50



# SUSPENSION

# DISCOVERY 1 (1989 to 1998)

## Bush Kit Shock Absorber Mounting (set of 8)

All models from (VIN) MA081992 on - Kit, poly., 8 piece				
Aftermarket	1	<b>RNF100090LPB</b>	30.83	37.00
All models with standard suspension - Kit contains all shock absorber bushes front & rear (14pc), poly.				
Aftermarket	1	<b>RD1061</b>	15.83	19.00

## Anti Roll Bar Bush

All models fitted with anti roll bar - Front upper and lower, rear lower, poly.				
Aftermarket	4	<b>552819POLY</b>	1.08	1.30
All models - Front anti roll bar bush kit				
performance red	Polybush	1	<b>LL1359</b>	35.00 42.00
comfort blue	Polybush	1	<b>LL1359B</b>	35.00 42.00

## Anti Roll Bar Bush Kit

All models with factory fitted anti roll bar - Front, kit contains mounting & link bushes (6pc), poly.				
Aftermarket	1	<b>RD1062</b>	15.83	19.00

## Bush Anti Roll Bar Mounting

All models - Front anti roll bar, poly.				
Aftermarket	2	<b>NTC6828POLY</b>	6.25	7.50
All models - Rear, poly.				
for 16mm bar				
Aftermarket	4	<b>NTC7394POLY</b>	6.25	7.50
Upgraded, 25.4mm inside diameter				
Terraforma	2	<b>NTC7394URTFPY254</b>	21.25	25.50
Upgraded, 28.0mm inside diameter				
Terraforma	2	<b>NTC7394URTFPY280</b>	23.33	28.00

## Anti Roll Bar Kit

All models not fitted with anti roll bars - Front & Rear (note brackets require welding to chassis), poly.				
Aftermarket	1	<b>STC8156AABPOLY</b>	139.17	167.00

## Bush Anti Roll Bar Mounting Upgraded

All models - Front anti roll bar, poly. 25.4mm inside diameter				
Terraforma	2	<b>NTC6828URTFPY</b>	23.33	28.00

## Anti Roll Bar Bush Kit

All models with factory fitted anti roll bar - Rear, kit contains mounting & link bushes (6pc), poly.				
Aftermarket	1	<b>RD1063</b>	14.58	17.50

## Bump Stop

All models to (VIN) MA113760 - Front suspension,				
poly., red	Polybush	2	<b>ANR4188POLYBUSH</b>	19.17 23.00
poly., black	Britpart	2	<b>ANR4188BPPYBLK</b>	13.25 15.90
poly., yellow	Britpart	2	<b>ANR4188BPPYYEL</b>	13.25 15.90
rubber	Aftermarket	2	<b>ANR4188P</b>	2.58 3.10
	OEM	2	<b>ANR4188P1</b>	6.04 7.25
	Genuine	2	<b>ANR4188</b>	24.38 29.26
All models from (VIN) MA113761 on - Front M16 x 100mm				
	Genuine	2	<b>ANR2420</b>	19.75 23.70
All models to (VIN) LA081991 - Rear suspension				
poly., red	Polybush	2	<b>ANR4189POLYBUSH</b>	17.08 20.50
poly., black	Britpart	2	<b>ANR4189BPPYBLK</b>	13.25 15.90
poly., yellow	Britpart	2	<b>ANR4189BPPYYEL</b>	13.25 15.90
rubber	Aftermarket	2	<b>ANR4189P</b>	3.08 3.70
	OEM	2	<b>ANR4189P1</b>	8.13 9.76
	Genuine	2	<b>ANR4189</b>	18.20 21.84
All models from (VIN) MA081992 on - Rear suspension				
rubber	Aftermarket	2	<b>ANR2991P</b>	2.83 3.40
	Genuine	2	<b>ANR2991</b>	11.22 13.46

## Bump Stop Spacers

All models to (VIN) MA113760 - Front or rear				
Terraforma	a/r	<b>ANR4188-9TFSPACER</b>	29.58	35.50

## Bush Upper Link

All models - Rear suspension, poly.				
Aftermarket	2	<b>NTC1773POLY</b>	4.38	5.26
All models - Rear suspension, poly.,				
performance red (pair)	Polybush	1	<b>NTC1773POLYBUSH</b>	23.75 28.50
comfort blue (pair)	Polybush	1	<b>NTC1773POLYBUSHBLUE</b>	23.75 28.50

## Supplementary Bush Kit

All models				
Aftermarket	1	<b>RD1112</b>	63.33	76.00
<i>Includes bushes not supplied in suspension bush kits, shock absorbers, anti roll bar, A frame &amp; steering damper, poly.</i>				

## Anti Roll Bar

All models to (VIN) LA081991 - Front				
Genuine	1	<b>NTC6836</b>	381.32	457.58
All models (VIN) MA081992 on - Front				
Aftermarket	1	<b>LR033037P</b>	50.00	60.00
Genuine	1	<b>LR033037</b>	72.75	87.30
All models - Rear, standard size				
Aftermarket	1	<b>LR033038P</b>	45.00	54.00
Genuine	1	<b>LR033038</b>	78.73	94.48

## Anti Roll Bar Upgraded

All models (VIN) MA081992 on - Front, upgraded 25.4mm diameter				
Terraforma	1	<b>LR033037URTF</b>	245.83	295.00
All models - Rear,				
upgraded standard diameter				
Bearmach	1	<b>LR033038URBM</b>	170.00	204.00
upgraded 25.4mm diameter				
Terraforma	1	<b>LR033038URTF254</b>	225.00	270.00
upgraded 28.0mm diameter				
Terraforma	1	<b>LR033038URTF280</b>	241.67	290.00

## Anti Roll Bar Bush

All models fitted with anti roll bar - Anti roll bar link, rubber				
Aftermarket	4	<b>552819P</b>	0.19	0.23
Genuine	4	<b>552819</b>	1.39	1.67

## Anti Roll Bar Link Ball Joint

All models - Front and rear				
Aftermarket	2	<b>NTC1888P</b>	4.79	5.75
OEM	2	<b>NTC1888P1</b>	13.54	16.25
Genuine	2	<b>NTC1888</b>	41.58	49.90

## Link Kit for uprated anti roll bars

All models - Fitting Kit				
Terraforma	1	<b>LR033038URTFK</b>	39.58	47.50
All models (VIN) MA081992 on - Fitting Kit				
Terraforma	1	<b>LR033037URTFK</b>	24.58	29.50

## Mounting Bush, Anti Roll Bar

All models - Front anti roll bar				
Aftermarket	2	<b>NTC6828P</b>	1.33	1.60
OEM	2	<b>NTC6828P1</b>	2.72	3.26
Genuine	2	<b>NTC6828</b>	6.99	8.39
All models - Rear, standard rubber, for 16mm bar				
Aftermarket	2	<b>NTC7394P</b>	1.33	1.60
OEM	2	<b>NTC7394P1</b>	3.00	3.60
Genuine	2	<b>NTC7394</b>	4.53	5.44

## Spare D Bush for Anti Roll Bar (Pair)

All models				
Front	Aftermarket	1	<b>RA1352DBUSH</b>	5.42 6.50
Rear	Aftermarket	1	<b>STC8156AADBUSH</b>	13.13 15.76

## Clamp Bracket

All models - Anti roll bar mounting, front				
Aftermarket	2	<b>NTC6776P</b>	3.75	4.50
Genuine	2	<b>NTC6776</b>	5.93	7.12

## Spacer Kit

All models (VIN) MA081992 on - for anti roll bar				
2 hole	Terraforma	1	<b>LR033037-8URTFK2</b>	35.00 42.00
4 hole	Terraforma	1	<b>LR033037-8URTFK4</b>	39.58 47.50

## Shock Absorber & Spring Kit

All RHD Tdi engine models from (VIN) HA472849 to (VIN) KA038877 without anti roll bar				
<i>Kit includes 2 front &amp; 2 rear shock absorbers &amp; 4 coil springs</i>				
Aftermarket	1	<b>RD1045P</b>	110.83	133.00
All Tdi engine models from (VIN) KA038878 to (VIN) LA081991 without anti roll bar				
<i>Kit includes 2 front &amp; 2 rear shock absorbers &amp; 4 coil springs</i>				
Aftermarket	1	<b>RD1048P</b>	110.00	132.00
Genuine	1	<b>RD1048</b>	379.17	455.00
All Tdi engine models to (VIN) LA081991 with anti roll bar				
<i>Kit includes 2 front &amp; 2 rear shock absorbers &amp; 4 coil springs</i>				
Aftermarket	1	<b>RD1048P</b>	110.00	132.00
Genuine	1	<b>RD1048</b>	379.17	455.00
All Tdi engine models from (VIN) MA081992 on - <i>Kit includes 2 front &amp; 2 rear shock absorbers &amp; 4 coil springs</i>				
Aftermarket	1	<b>RD1052P</b>	165.00	198.00
Genuine	1	<b>RD1052</b>	408.33	490.00
All Mpi engine models to (VIN) HA472849 without anti roll bar				
<i>Kit includes 2 front &amp; 2 rear shock absorbers &amp; 4 coil springs</i>				
Aftermarket	1	<b>RD1049P</b>	114.17	137.00
Genuine	1	<b>RD1049</b>	466.67	560.00
All RHD Mpi engine models from (VIN) HA472850 to (VIN) KA038877 without anti roll bar				
<i>Kit includes 2 front &amp; 2 rear shock absorbers &amp; 4 coil springs</i>				
Aftermarket	1	<b>RD1049P</b>	114.17	137.00
Genuine	1	<b>RD1049</b>	466.67	560.00
All Mpi engine models from (VIN) KA038878 to (VIN) LA081991 without anti roll bar				
<i>Kit includes 2 front &amp; 2 rear shock absorbers &amp; 4 coil springs</i>				
Aftermarket	1	<b>RD1044P</b>	113.33	136.00
Genuine	1	<b>RD1044</b>	404.17	485.00
All Mpi engine models to (VIN) LA081991 with anti roll bar				
<i>Kit includes 2 front &amp; 2 rear shock absorbers &amp; 4 coil springs</i>				
Aftermarket	1	<b>RD1044P</b>	113.33	136.00
Genuine	1	<b>RD1044</b>	404.17	485.00
All Mpi engine models from (VIN) MA081992 on - <i>Kit includes 2 front &amp; 2 rear shock absorbers &amp; 4 coil springs</i>				
Aftermarket	1	<b>RD1051P</b>	115.83	139.00
Genuine	1	<b>RD1051</b>	433.33	520.00
All RHD V8 engine models to (VIN) HA472849 without anti roll bar				
<i>Kit includes 2 front &amp; 2 rear shock absorbers &amp; 4 coil springs</i>				
Aftermarket	1	<b>RD1041P</b>	110.83	133.00
Genuine	1	<b>RD1041</b>	466.67	560.00
All RHD V8 engine models from (VIN) HA472850 to (VIN) KA038877 without anti roll bar				
<i>Kit includes 2 front &amp; 2 rear shock absorbers &amp; 4 coil springs</i>				
Aftermarket	1	<b>RD1041P</b>	110.83	133.00
Genuine	1	<b>RD1041</b>	466.67	560.00
All RHD V8 engine models from (VIN) LA081991 without anti roll bar				
<i>Kit includes 2 front &amp; 2 rear shock absorbers &amp; 4 coil springs</i>				
Aftermarket	1	<b>RD1043P</b>	110.83	133.00
Genuine	1	<b>RD1043</b>	404.17	485.00
All RHD V8 engine models to (VIN) LA081991 with anti roll bar				
<i>Kit includes 2 front &amp; 2 rear shock absorbers &amp; 4 coil springs</i>				
Aftermarket	1	<b>RD1043P</b>	110.83	133.00
Genuine	1	<b>RD1043</b>	404.17	485.00
All RHD V8 engine models from (VIN) MA081992 on				
<i>Kit includes 2 front &amp; 2 rear shock absorbers &amp; 4 coil springs</i>				
Aftermarket	1	<b>RD1050P</b>	115.00	138.00
Genuine	1	<b>RD1050</b>	433.33	520.00
All LHD V8 engine models from (VIN) KA038878 to (VIN) LA081991 without anti roll bar				
<i>Kit includes 2 front &amp; 2 rear shock absorbers &amp; 4 coil springs</i>				
Aftermarket	1	<b>RD1044P</b>	113.33	136.00
Genuine	1	<b>RD1044</b>	404.17	485.00
All LHD V8 engine models to (VIN) LA081991 with anti roll bar				
<i>Kit includes 2 front &amp; 2 rear shock absorbers &amp; 4 coil springs</i>				
Aftermarket	1	<b>RD1044P</b>	113.33	136.00
Genuine	1	<b>RD1044</b>	404.17	485.00
All LHD V8 engine models from (VIN) MA081992 on				
<i>Kit includes 2 front &amp; 2 rear shock absorbers &amp; 4 coil springs</i>				
Aftermarket	1	<b>RD1051P</b>	115.83	139.00
Genuine	1	<b>RD1051</b>	433.33	520.00



## DISCOVERY 1 (1989 to 1998)

## SUSPENSION

## Shock Absorber

All models except air suspension				
Front, gas, std. height	Decarbon	2	<b>RA1345DECARBONEA</b>	63.33 76.00
Front, gas, std. height (pair)	Bilstein	1	<b>RA1345BILSTEIN</b>	132.50 159.00
All models				
Front, gas, std. height				
All Terrain	Terrafrirma	2	<b>RA1345TFAT</b>	28.33 34.00
Pro Sport	Terrafrirma	2	<b>RA1345TFPS</b>	48.33 58.00
	Super Gaz	2	<b>LL1481BPSUP</b>	33.33 40.00
	Cellular Dynamic	2	<b>LL1481BPCEL</b>	39.58 47.50
Commercial heavy duty,	Terrafrirma	2	<b>RA1345TFCHD</b>	58.33 70.00
Rear, gas, std. height				
All Terrain,	Terrafrirma	2	<b>RA1346TFAT</b>	29.17 35.00
Pro Sport	Terrafrirma	2	<b>RA1346TFPS</b>	48.33 58.00
(pair)	Bilstein	1	<b>RA1346BILSTEIN</b>	132.50 159.00
	Super Gaz	2	<b>LL1482BPSUP</b>	33.33 40.00
	Cellular Dynamic	2	<b>LL1482BPCEL</b>	39.58 47.50
	Pro-Comp	2	<b>RA1346BMPC</b>	38.33 46.00
Commercial Heavy Duty	Terrafrirma	2	<b>RA1346TFCHD</b>	58.33 70.00
All models up to (VIN) LA081991				
Rear	Aftermarket	2	<b>STC3939P</b>	13.96 16.75
	OEM	2	<b>STC3939P1</b>	27.50 33.00
	Genuine	2	<b>STC3939</b>	55.19 66.23
	Genuine	2	<b>NTC8214</b>	93.88 112.66

## Shock Absorber Kit Standard

All models without anti roll bar - Kit includes 2 front & 2 rear shock absorbers				
	Aftermarket	1	<b>RD1039P</b>	54.17 65.00
	Genuine	1	<b>RD1039</b>	198.33 238.00
All models to (VIN) LA081991 with anti roll bar - Kit includes 2 front & 2 rear shock absorbers				
	Aftermarket	1	<b>RD1039P</b>	54.17 65.00
	Genuine	1	<b>RD1039</b>	198.33 238.00
All models from (VIN) MA081992 with anti roll bar - Kit includes 2 front & 2 rear shock absorbers				
	Aftermarket	1	<b>RD1040P</b>	53.33 64.00
	Genuine	1	<b>RD1040</b>	204.17 245.00
All models - Kit includes 2 front & 2 rear shock absorbers, Heavy Duty Gas				
	Bilstein	1	<b>RA1344BILSTEIN</b>	262.50 315.00

## Shock Mounting Retention Ring

All models - Front suspension				
	Aftermarket	2	<b>RNJ500010P</b>	3.58 4.30
	Genuine	2	<b>RNJ500010</b>	16.34 19.61

## Coil Spring

All RHD diesel models up to (VIN) HA475972				
Front, both sides, standard	Aftermarket	2	<b>NRC2119P</b>	12.92 15.50
RHD diesel models (VIN) HA475973 to KA038877				
Front, driver's and passenger's side	Aftermarket	2	<b>NTC8477P</b>	15.63 18.76
	Genuine	2	<b>NTC8477</b>	63.20 75.84
All diesel engine models from (VIN) KA038878 to MA116460				
Front, driver's side, standard	Aftermarket	1	<b>ANR1975P</b>	14.58 17.50
	Genuine	1	<b>ANR1975</b>	46.80 56.16
Front, passenger's side, standard	Aftermarket	1	<b>ANR1976P</b>	14.58 17.50
	Genuine	1	<b>ANR1976</b>	46.80 56.16
All diesel engine models from (VIN) MA116461 on -				
Front, drivers side	Aftermarket	1	<b>ANR4351P</b>	13.96 16.75
	Genuine	1	<b>ANR4351</b>	46.80 56.16
Front, passenger side	Aftermarket	1	<b>ANR4350P</b>	13.96 16.75
	Genuine	1	<b>ANR4350</b>	46.80 56.16
All diesel LHD models up to (VIN) HA475972				
Front RH, standard	Aftermarket	1	<b>NRC2119P</b>	12.92 15.50
Front LH, heavy duty	Aftermarket	1	<b>NRC4305P</b>	15.83 19.00
LHD diesel models (VIN) HA475973 to KA038877				
Front, driver's side	Genuine	1	<b>NTC8476</b>	63.20 75.84
Front, passenger's side	Aftermarket	1	<b>NTC8477P</b>	15.63 18.76
	Genuine	1	<b>NTC8477</b>	63.20 75.84
All 2.0L MPI petrol models				
Front driver's side, std, blue stripe	Aftermarket	1	<b>572315P</b>	13.33 16.00
	Genuine	1	<b>572315</b>	64.19 77.03
Front passenger's side, std, blue/white stripe	Aftermarket	1	<b>NRC4306P</b>	15.83 19.00
	Genuine	1	<b>NRC4306</b>	63.20 75.84
All LHD V8 petrol models				
Front LH, std, blue/white stripe	Aftermarket	1	<b>NRC4306P</b>	15.83 19.00
	Genuine	1	<b>NRC4306</b>	63.20 75.84
RHD diesel models (VIN) HA475973 to KA038877				
Rear, driver's and passenger's sides	Aftermarket	2	<b>NTC8572P</b>	17.50 21.00
	Genuine	2	<b>NTC8572</b>	75.33 90.40
All models from (VIN) KA038878 to LA081991				
Rear, both sides, standard	Aftermarket	2	<b>ANR3058P</b>	17.50 21.00
	Genuine	2	<b>ANR3058</b>	55.60 66.72
All models from (VIN) MA081992 on				
Rear, both sides, standard	Aftermarket	2	<b>ANR3477P</b>	21.50 25.80
	Genuine	2	<b>ANR3477</b>	67.88 81.46
LHD diesel models up to (VIN) KA038877				
Rear, passenger's side	Aftermarket	1	<b>NTC8572P</b>	17.50 21.00
	Genuine	1	<b>NTC8572</b>	75.33 90.40

## Coil Spring Kit (vehicle set)

All models - Kit includes 2 front & 2 rear springs, standard ride height				
	Aftermarket	1	<b>RD1059</b>	128.33 154.00

## Coil Spring Kit (pair)

All models - Kit includes 2 rear springs, standard ride height				
	Aftermarket	1	<b>RD1058</b>	68.33 82.00

## Lower Seat, Coil Spring

All models - Front and rear suspension				
	Aftermarket	2	<b>NRC9700P</b>	3.00 3.60
	Genuine	2	<b>NRC9700</b>	11.51 13.81

## Mounting Bracket

All models - Front spring, upper				
	Aftermarket	2	<b>NRC6372P</b>	13.13 15.76
	Genuine	2	<b>NRC6372</b>	56.30 67.56

## Coil Spring Isolator

All models - - Rear				
	Genuine	2	<b>ANR3060</b>	4.00 4.80

## Spring Isolator Upper

All models (VIN) MA081992 on - Rear spring				
	Aftermarket	2	<b>ANR2938P</b>	3.83 4.60
	OEM	2	<b>ANR2938P1</b>	4.58 5.50
	Genuine	2	<b>ANR2938</b>	9.40 11.28

## Plate, Spring Retainer

All models - Rear				
	Aftermarket	2	<b>NTC6106P</b>	1.75 2.10
	Genuine	2	<b>NTC6106</b>	3.28 3.94

## Ball Joint Assembly

All models - Rear upper link				
	Aftermarket	1	<b>RHF500110P</b>	7.08 8.50
	OEM	1	<b>RHF500110P1</b>	16.67 20.00
	Genuine	1	<b>RHF500110</b>	39.98 47.98
Heavy Duty	Bearmach	1	<b>RHF500110URBM</b>	14.38 17.26

## Ball Joint Assembly &amp; Fulcrum Bracket

All models - Rear upper link & fulcrum bracket				
	Britpart	1	<b>RHF500110BPASSY</b>	39.58 47.50

## Drop Arm Repair Kit

All models up to (VIN) JA019109 - Steering drag link				
	Aftermarket	1	<b>RBG000010P</b>	4.58 5.50
	OEM	1	<b>RBG000010P1</b>	20.63 24.76
	Genuine	1	<b>RBG000010</b>	55.33 66.40

## Radius Arm Assembly

All models				
Front suspension				
	Aftermarket	2	<b>NTC2694P</b>	105.00 126.00
	Genuine	2	<b>NTC2694</b>	309.34 371.21
Rear suspension				
	Aftermarket	2	<b>LR049068P</b>	29.58 35.50
	Genuine	2	<b>LR049068</b>	88.44 106.13

## Radius Arm Nut &amp; Bolt Kit

All models				
Front				
	Britpart	1	<b>LL1679BP</b>	8.13 9.76
Rear				
	Britpart	1	<b>LL1680BP</b>	6.67 8.00

## Panhard Rod Assembly

All models - Front suspension, RHD or LHD				
	Aftermarket	1	<b>RBI500020P</b>	23.75 28.50
	Genuine	1	<b>RBI500020</b>	136.98 164.38

## Tie Bar

All RHD models - Steering box				
	Aftermarket	1	<b>LR041261P</b>	15.63 18.76
	Genuine	1	<b>LR041261</b>	46.04 55.25

## Top Link Assembly

All models - Rear suspension				
RH				
	Aftermarket	1	<b>NTC2706P</b>	80.00 96.00
	Genuine	1	<b>NTC2706</b>	241.05 289.26
LH				
	Genuine	1	<b>LR045324</b>	173.56 208.27

## Drag Link End Piece

All models up to (VIN) JA018174 - Cranked				
	Aftermarket	1	<b>NRC1823P</b>	15.63 18.76
	Genuine	1	<b>NRC1823</b>	95.42 114.50

## Drag Link End Tube

All models up to (VIN) JA018174 - Cranked				
	Aftermarket	1	<b>NRC1824P</b>	14.58 17.50

## Drag Link Assembly

All models up to (VIN) JA018174				
	Aftermarket	1	<b>NRC3226P</b>	39.58 47.50
All models from (VIN) JA018175 on				
	Aftermarket	1	<b>NTC9607P</b>	39.58 47.50
	Genuine	1	<b>NTC9607</b>	105.59 126.71

## Drag Link Tube

All models (VIN) JA018175 on				
	Aftermarket	1	<b>NTC8390P</b>	11.67 14.00
	OEM	1	<b>NTC8390P1</b>	15.63 18.76
	Genuine	1	<b>NTC8390</b>	112.14 134.57

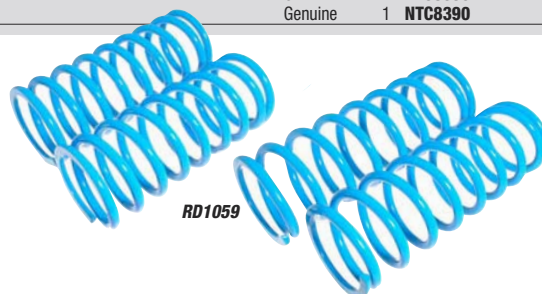



# STEERING

## Drop Arm Lever

All RHD models to (VIN) JA018109				
Aftermarket	1	<b>QFW000020P</b>	18.54	22.25
OEM	1	<b>QFW000020P1</b>	57.50	69.00
Genuine	1	<b>QFW000020</b>	112.70	135.24
All LHD models from (VIN) JA018110 on				
OEM	1	<b>NTC9235P1</b>	27.50	33.00
Genuine	1	<b>NTC9235</b>	102.05	122.46

## Drop Arm

All RHD models (VIN) JA018110 on - Steering box				
OEM	1	<b>NTC9236P1</b>	27.50	33.00
Genuine	1	<b>NTC9236</b>	114.41	137.29
All LHD models from (VIN) JA018110 on - Steering box				
OEM	1	<b>NTC9235P1</b>	27.50	33.00
Genuine	1	<b>NTC9235</b>	102.05	122.46

## Steering Arm Lever

All LHD models to (VIN) JA018109				
Aftermarket	1	<b>QFW000030P</b>	16.67	20.00
OEM	1	<b>QFW000030P1</b>	57.50	69.00
Genuine	1	<b>QFW000030</b>	112.70	135.24

## Heavy Duty Steering Arm Kit

All models up to (VIN) JA018174 - Includes cross rod and track rod (3 ball joints)				
Terrafirma	1	<b>RA2071TF</b>	95.00	114.00
Requires fitting kit RD125371BPFK				
Britpart	1	<b>RA2071BP</b>	93.33	112.00
All models from (VIN) JA018175 on - Includes cross rod and track rod (4 ball joints)				
Terrafirma	1	<b>RD1253TF</b>	93.33	112.00
Requires fitting kit RD125371BPFK				
Britpart	1	<b>RD1253BP</b>	90.00	108.00

## Fitting Kit, Heavy Duty Steering Arms

All models to be fitted with Britpart heavy duty steering arms				
Includes U bolts, nuts and damper bracket for RA2071BP or RD1253BP				
Britpart	1	<b>RD125371BPFK</b>	7.50	9.00

## Drag Link Assembly

All models up to (VIN) JA018174 - Includes ball joints				
Aftermarket	1	<b>NRC3226P</b>	39.58	47.50
All models from (VIN) JA018175 on - Includes ball joints				
Aftermarket	1	<b>NTC9607P</b>	39.58	47.50
Genuine	1	<b>NTC9607</b>	105.59	126.71

## Ball Joint, Drop Arm

All models up to (VIN) JA018109 - RH				
Aftermarket	1	<b>RBG000010P</b>	4.58	5.50
OEM	1	<b>RBG000010P1</b>	20.63	24.76
Genuine	1	<b>RBG000010</b>	55.33	66.40

## Adjustment Shaft

All models - Track rod				
Aftermarket	1	<b>NRC4700P</b>	4.17	5.00
OEM	1	<b>NRC4700P1</b>	11.88	14.26
Genuine	1	<b>NRC4700</b>	52.18	62.62

## Universal Joint

LHD models up to (VIN) HA002271 - Lower				
Aftermarket	1	<b>NRC7704P</b>	8.54	10.25
OEM	1	<b>NRC7704P1</b>	27.50	33.00
Genuine	1	<b>NRC7704</b>	47.31	56.77
All models from (VIN) HA002272 to LA081991 - Lower				
Aftermarket	1	<b>NRC7387P</b>	8.54	10.25
OEM	1	<b>NRC7387P1</b>	27.50	33.00
Genuine	1	<b>NRC7387</b>	48.59	58.31
All models from (VIN) MA081992 on - Lower				
Aftermarket	1	<b>STC2800P</b>	10.83	13.00

## Lower Shaft Assembly

All models up to (VIN) LA081991 - With joints				
Aftermarket	1	<b>NTC8478P</b>	27.50	33.00
All models from (VIN) MA081992 on - With universal joints				
Aftermarket	1	<b>QME500040P</b>	39.58	47.50
Genuine	1	<b>QME500040</b>	186.01	223.21

## Seal, Steering Column

All models up to (VIN) LA081991 - Steering column to bulkhead				
Genuine	1	<b>575733</b>	0.55	0.66

## Steering Damper Assembly

All models				
Aftermarket	1	<b>STC786P</b>	10.00	12.00
OEM	1	<b>STC786P1</b>	37.50	45.00
Bilstein	1	<b>STC786UR</b>	67.50	81.00
Terrafirma	1	<b>STC786TF</b>	33.75	40.50
Cellular Dynamic	1	<b>STC786UR-BPCEL</b>	29.58	35.50
Super Gaz	1	<b>STC786UR-BPSUP</b>	25.83	31.00
Genuine	1	<b>STC786</b>	65.72	78.86

## Fitting Kit, Steering Damper

All models - Allows Terrafirma Defender 'return to centre' damper or adjustable damper to be fitted				
Terrafirma	1	<b>STC786TFRTCFK</b>	53.33	64.00

## Bush Steering Damper

All models				
Aftermarket	4	<b>568858P</b>	0.38	0.46
Genuine	4	<b>568858</b>	4.92	5.90
Poly.				
Aftermarket	4	<b>568858POLY</b>	2.00	2.40

## Steering Damper Bush Kit

All models - Uprated polyurethane				
Aftermarket	1	<b>RD1065</b>	7.50	9.00

## Track Rod Assembly

All models				
Aftermarket	1	<b>RTC1799P</b>	39.58	47.50
OEM	1	<b>RTC1799P1</b>	60.00	72.00
Genuine	1	<b>RTC1799</b>	228.91	274.69

## Track Rod Tube

All models				
Aftermarket	1	<b>NRC145P</b>	14.58	17.50
Genuine	1	<b>NRC145</b>	116.62	139.94

## Track Rod End

All models - Track rod end, non-greasabl				
RH thread				
Aftermarket	2	<b>RTC5869P</b>	4.58	5.50
OEM	2	<b>RTC5869P1</b>	10.63	12.76
Genuine	2	<b>RTC5869</b>	35.73	42.88
LH thread				
Aftermarket	2	<b>RTC5870P</b>	4.58	5.50
OEM	2	<b>RTC5870P1</b>	10.63	12.76
Genuine	2	<b>RTC5870</b>	35.73	42.88

## Rubber Cap Track Rod End

All models				
Aftermarket	2	<b>214649P</b>	1.33	1.60
Genuine	2	<b>214649</b>	4.57	5.48

## Spring Ring Track Rod End

All models - Rubber cap, large diameter				
Genuine	2	<b>214685</b>	3.15	3.78

## Cross Rod Eye End

All models				
Aftermarket	1	<b>NRC1823P</b>	15.63	18.76
Genuine	1	<b>NRC1823</b>	95.42	114.50

## Cross Rod Tube

All models up to (VIN) JA018174				
Aftermarket	1	<b>NRC1824P</b>	14.58	17.50
All models from (VIN) JA018175 on				
Aftermarket	1	<b>NTC8390P</b>	11.67	14.00
OEM	1	<b>NTC8390P1</b>	15.63	18.76
Genuine	1	<b>NTC8390</b>	112.14	134.57

## Shaft Adjustable, Drag Link

All models				
Aftermarket	1	<b>NRC4700P</b>	4.17	5.00
OEM	1	<b>NRC4700P1</b>	11.88	14.26
Genuine	1	<b>NRC4700</b>	52.18	62.62

## Seal Kit Steering Box

All models - For steering box with 4 bolt top plate				
Aftermarket	1	<b>STC2848P</b>	3.75	4.50
OEM	1	<b>STC2848P1</b>	5.63	6.76
Genuine	1	<b>STC2848</b>	20.28	24.34
Aftermarket	1	<b>STC2847P</b>	9.79	11.75
Genuine	1	<b>STC2847</b>	67.67	81.20

## Pinion Seal Steering Box

All models				
Genuine	1	<b>608065</b>	7.28	8.74

## Seal Kit Input Shaft Steering Box

All models - For steering box with 4 bolt top plate				
Aftermarket	1	<b>STC889P</b>	5.63	6.76
Genuine	1	<b>STC889</b>	33.20	39.84

## Pad Adjuster Kit Steering Box

All models - For steering box with 4 bolt top plate				
Genuine	1	<b>STC4385</b>	124.00	148.80

## Shaft Assembly Steering Box

All LHD models				
Land Rover	1	<b>RTC4399</b>	301.74	362.09

## Tie Bar, Mounting

All models from (VIN) MA081992 on - Steering box				
Aftermarket	1	<b>LR041261P</b>	15.63	18.76
Genuine	1	<b>LR041261</b>	46.04	55.25

## Seal Kit Steering Pump

All V8 models up to (VIN) LA081991				
Aftermarket	1	<b>STC1633P</b>	1.50	1.80

## Power Steering Fluid

All models - 1 litre. Cold (standard) climates fluid				
Aftermarket	a/r	<b>STC50519P</b>	12.08	14.50
Genuine	a/r	<b>STC50519</b>	18.96	22.75

## Cap, Power Steering Reservoir

All models				
Genuine	1	<b>NTC2723</b>	21.59	25.91

## Gasket

All models				
Swivel housing				
Aftermarket	2	<b>FTC3646P</b>	0.50	0.60
Genuine	2	<b>FTC3646</b>	2.14	2.57
Lower swivel pin				
Aftermarket	2	<b>FTC3647P</b>	0.50	0.60
Genuine	2	<b>FTC3647</b>	2.46	2.95



**DISCOVERY 1 (1989 to 1998)****CLUTCH****Clutch Plate & Cover Assembly**

All 200 and 300 TDi diesel models	Aftermarket	1	<b>LR009366P</b>	57.50	69.00
	OEM	1	<b>LR009366P1</b>	70.00	84.00
	Genuine	1	<b>LR009366</b>	169.85	203.82
Heavy duty	Britpart	1	<b>LR009366BPHDPARTIAL</b>	49.17	59.00
All 3.9L V8 petrol engine models	Aftermarket	1	<b>8510310P</b>	95.41	114.49
	Genuine	1	<b>8510310</b>	318.10	381.72

**Clutch Kit**

All 200 and 300 TDi diesel models - Includes clutch plate, cover and release bearing					
Genuine	1	<b>GCK555AF</b>	125.83	151.00	
	1	<b>LR009366BP</b>	50.00	60.00	
Heavy duty. Includes clutch cover, plate & release bearing					
Britpart	1	<b>LR009366BPHD</b>	55.00	66.00	
	1	<b>LR009366BPHDFORK</b>	90.83	109.00	
	1	<b>LR009366BPHDOEM</b>	95.00	114.00	
All 2.0L MPI petrol manual models - Includes clutch cover, plate, release bearing & clip					
Aftermarket	1	<b>RD1036P</b>	88.33	106.00	
Genuine	1	<b>RD1036</b>	370.00	444.00	
All 3.5L V8 carb petrol models - Includes clutch cover, plate & release bearing					
Aftermarket	1	<b>STC8360P</b>	83.33	100.00	
Genuine	1	<b>STC8360</b>	255.00	306.00	
All 3.5L V8 EFI petrol models - Includes clutch cover, plate & release bearing					
Aftermarket	1	<b>STC8361P</b>	90.83	109.00	
Genuine	1	<b>STC8361</b>	345.00	414.00	
All 3.9L V8 EFI petrol manual models - Includes clutch cover, plate & release bearing					
OEM	1	<b>STC8362P1</b>	100.00	120.00	
Genuine	1	<b>STC8362</b>	233.00	279.60	

**Clutch Cover**

All diesel models	Aftermarket	1	<b>URB100760P</b>	29.58	35.50
	OEM	1	<b>URB100760P1</b>	39.58	47.50
	Genuine	1	<b>URB100760</b>	91.30	109.56
2.0L MPI petrol models - 9.5" diameter, diaphragm type					
Aftermarket	1	<b>576557P</b>	27.50	33.00	
OEM	1	<b>576557P1</b>	36.67	44.00	
Genuine	1	<b>576557</b>	116.97	140.36	
All 3.5L V8 carb petrol models					
OEM	1	<b>FTC813P1</b>	54.17	65.00	
Genuine	1	<b>FTC813</b>	118.73	142.48	
All V8 EFI petrol manual models					
OEM	1	<b>FTC2001P1</b>	55.00	66.00	
3.5L V8 EFI petrol models					
Aftermarket	1	<b>576476P</b>	39.58	47.50	
OEM	1	<b>576476P1</b>	60.00	72.00	
Genuine	1	<b>576476</b>	118.73	142.48	

**Clutch Plate**

All diesel models	Aftermarket	1	<b>UQB500030P</b>	22.50	27.00
	OEM	1	<b>GCP242</b>	45.00	54.00
	Genuine	1	<b>UQB500030</b>	119.39	143.27
All 2.0L MPI petrol models					
OEM	1	<b>8510306P1</b>	46.67	56.00	
Genuine	1	<b>8510306</b>	209.21	251.05	
All 3.5L V8 carb petrol models					
Aftermarket	1	<b>FTC814P</b>	32.50	39.00	
OEM	1	<b>FTC814P1</b>	46.67	56.00	
Genuine	1	<b>FTC814</b>	118.22	141.86	
All 3.5L V8 EFI petrol models					
OEM	1	<b>8510308P1</b>	37.50	45.00	
Genuine	1	<b>8510308</b>	217.38	260.86	
All V8 EFI petrol manual models					
OEM	1	<b>FTC2002P1</b>	47.50	57.00	

**Drive Plate**

Late US spec 4.0L V8 petrol automatic models					
Aftermarket	1	<b>FTC4607P</b>	7.50	9.00	
Genuine	1	<b>FTC4607</b>	31.41	37.69	

**Clutch Release Bearing**

All models except MPI - With carrier	Aftermarket	1	<b>FTC5200P</b>	7.92	9.50
	OEM	1	<b>FTC5200P1</b>	12.50	15.00
	Genuine	1	<b>FTC5200</b>	37.38	44.86
Heavy Duty					
Britpart	1	<b>FTC5200HDBP</b>	45.83	55.00	
Bearmach	1	<b>FTC5200HDBM</b>	80.00	96.00	
MPI petrol models - With carrier					
Aftermarket	1	<b>FTC2772P</b>	27.08	32.50	
Genuine	1	<b>FTC2772</b>	84.10	100.92	

**Clutch Release Bearing Guide**

All 300TDi diesel models	Aftermarket	1	<b>FTC5218P</b>	21.67	26.00
	OEM	1	<b>FTC5218P1</b>	39.58	47.50
	Genuine	1	<b>FTC5218</b>	81.82	98.18

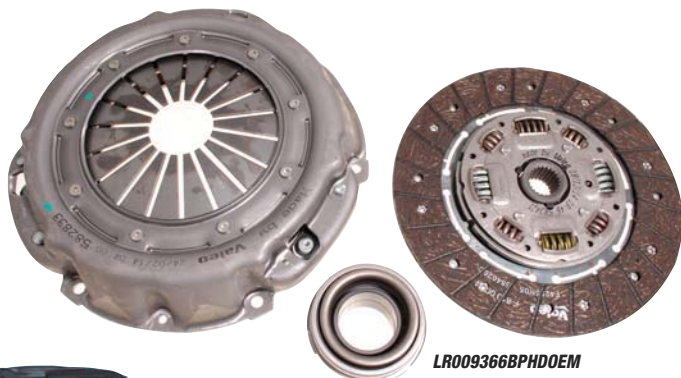

LR009366BPHDOEM

**Clutch Fork**

All 200TDi diesel models	Aftermarket	1	<b>576137P</b>	23.96	28.75
	OEM	1	<b>576137P1</b>	29.58	35.50
	Genuine	1	<b>576137</b>	63.81	76.57
All 300TDi diesel models	Aftermarket	1	<b>FTC2957P</b>	3.75	4.50
	OEM	1	<b>FTC2957P1</b>	10.83	13.00
	Genuine	1	<b>FTC2957</b>	23.33	28.00
Heavy Duty					
Britpart	1	<b>FTC2957BPHD</b>	8.75	10.50	
All 2.0L MPI petrol models					
Aftermarket	1	<b>FTC2957P</b>	3.75	4.50	
OEM	1	<b>FTC2957P1</b>	10.83	13.00	
Genuine	1	<b>FTC2957</b>	23.33	28.00	
Heavy Duty					
Britpart	1	<b>FTC2957BPHD</b>	8.75	10.50	
All V8 petrol models up to (VIN) KA045958 and from (VIN) MA on					
Aftermarket	1	<b>576137P</b>	23.96	28.75	
OEM	1	<b>576137P1</b>	29.58	35.50	
Genuine	1	<b>576137</b>	63.81	76.57	
All V8 petrol models from (VIN) KA045959 to LA081991					
Aftermarket	1	<b>FTC2957P</b>	3.75	4.50	
OEM	1	<b>FTC2957P1</b>	10.83	13.00	
Genuine	1	<b>FTC2957</b>	23.33	28.00	
Heavy Duty					
Britpart	1	<b>FTC2957BPHD</b>	8.75	10.50	

**Clutch Fork Kit Heavy Duty**

All 300TDi diesel models - Includes release fork, slipper pads, bush, staple & clip					
Britpart	1	<b>FTC2957BPHDKIT</b>	11.67	14.00	
All 2.0L MPI petrol models - Includes release fork, slipper pads, bush, staple & clip					
Britpart	1	<b>FTC2957BPHDKIT</b>	11.67	14.00	
All V8 petrol models from (VIN) KA045959 to LA081991 - Includes release fork, slipper pads, bush, staple & clip					
Britpart	1	<b>FTC2957BPHDKIT</b>	11.67	14.00	

**Clutch Fork Staple Retainer**

All 200TDi diesel models	Aftermarket	1	<b>576203P</b>	0.25	0.30
	Genuine	1	<b>576203</b>	0.66	0.79
All 300TDi diesel models	Aftermarket	1	<b>FRC3416P</b>	0.58	0.70
	Genuine	1	<b>FRC3416</b>	2.35	2.82
	Aftermarket	1	<b>FRC3416P</b>	0.58	0.70
All 2.0L MPI petrol models	Aftermarket	1	<b>FRC3416P</b>	0.58	0.70
	Genuine	1	<b>FRC3416</b>	2.35	2.82
All V8 petrol models up to (VIN) KA045958 and from (VIN) MA on					
Aftermarket	1	<b>576203P</b>	0.25	0.30	
Genuine	1	<b>576203</b>	0.66	0.79	
All V8 petrol models from (VIN) KA045959 to LA081991					
Aftermarket	1	<b>FRC3416P</b>	0.58	0.70	
Genuine	1	<b>FRC3416</b>	2.35	2.82	

**Pad Clutch Release Lever**

All 4 cyl models with 5 speed LT77 gearbox	Aftermarket	2	<b>FRC5255P</b>	0.50	0.60
	Genuine	2	<b>FRC5255</b>	1.53	1.84
All 4 cyl models with 5 speed R380 gearbox	Aftermarket	2	<b>FRC5255P</b>	0.50	0.60
	Genuine	2	<b>FRC5255</b>	1.53	1.84

**Clutch Hose**

All diesel models	Aftermarket	1	<b>NTC3400P</b>	5.83	7.00
	OEM	1	<b>NTC3400P1</b>	12.08	14.50
	Genuine	1	<b>NTC3400</b>	51.97	62.36
All V8 and 2.0L MPI petrol models					
Aftermarket	1	<b>NRC2211P</b>	3.25	3.90	
Genuine	1	<b>NRC2211</b>	33.62	40.34	

**Clutch Pipe Assembly**

All petrol manual models from (VIN) KA046333 on - From clutch hose to slave cylinder					
Genuine	1	<b>ANR2183</b>	14.79	17.75	

**Clutch Master Cylinder**

All 200TDi diesel models	Aftermarket	1	<b>AEU1714P</b>	14.79	17.75
	OEM	1	<b>AEU1714P1</b>	43.33	52.00
	Genuine	1	<b>AEU1714</b>	88.96	106.75
All 300TDi diesel models	Aftermarket	1	<b>ANR2651P</b>	29.58	35.50
	OEM	1	<b>ANR2651P1</b>	37.50	45.00
	Genuine	1	<b>ANR2651</b>	88.96	106.75
All 2.0L MPI petrol models	Aftermarket	1	<b>ANR2651P</b>	29.58	35.50
	OEM	1	<b>ANR2651P1</b>	37.50	45.00
	Genuine	1	<b>ANR2651</b>	88.96	106.75
All V8 petrol models up to (VIN) LA081991	Aftermarket	1	<b>AEU1714P</b>	14.79	17.75
	OEM	1	<b>AEU1714P1</b>	43.33	52.00
	Genuine	1	<b>AEU1714</b>	88.96	106.75
All V8 petrol models from (VIN) MA081992 on					
Aftermarket	1	<b>ANR2186P</b>	22.08	26.50	
OEM	1	<b>ANR2186P1</b>	33.75	40.50	
Genuine	1	<b>ANR2186</b>	99.89	119.87	

**Master Cylinder Repair Kit**

All models - Clutch master cylinder	Aftermarket	1	<b>STC1126P</b>	1.75	2.10
	OEM	1	<b>STC1126P1</b>	3.92	4.70
	Genuine	1	<b>STC1126</b>	8.39	10.07

**Master Cylinder Reservoir Cap**

All manual models up to (VIN) LA081991 except 2.0L MPI petrol - Clutch master cylinder					
Genuine	1	<b>513123A</b>	2.54	3.05	
All 2.0L MPI petrol manual models up to (VIN) LA081991 - Clutch master cylinder					
Genuine	1	<b>STC1646</b>	4.99	5.99	
All manual models from (VIN) MA081992 on - Clutch master cylinder					
Genuine	1	<b>STC1646</b>	4.99	5.99	

# CLUTCH

## Clutch Slave Cylinder

All models up to (VIN) KA045958 - Early LT77 gearbox				
Aftermarket	1	<b>TKC2786P</b>	5.21	6.25
OEM	1	<b>TKC2786LP1</b>	23.75	28.50
Genuine	1	<b>TKC2786L</b>	32.24	38.69
Genuine	1	<b>TKC2786</b>	19.17	23.00
All models from (VIN) KA045959 to LA081991 - Late LT77 gearbox				
Aftermarket	1	<b>FTC2498P</b>	8.75	10.50
OEM	1	<b>FTC2498P1</b>	21.67	26.00
Genuine	1	<b>FTC2498</b>	41.44	49.73
All models from (VIN) MA081992 on - R380 gearbox				
Aftermarket	1	<b>FTC5072P</b>	8.54	10.25
OEM	1	<b>FTC5072P1</b>	14.58	17.50
Genuine	1	<b>FTC5072</b>	65.51	78.61

## Slave Cylinder Repair Kit

All models up to (VIN) KA045958 - Early LT77 gearbox				
Aftermarket	1	<b>514244P</b>	2.50	3.00
Genuine	1	<b>514244</b>	8.12	9.74
All models from (VIN) MA081992 on - R380 gearbox type				
Aftermarket	1	<b>STC2818P</b>	1.25	1.50
OEM	1	<b>STC2818P1</b>	4.00	4.80
Genuine	1	<b>STC2818</b>	6.22	7.46



TKC2786P

## Push Rod Clip

All 200TDi diesel models				
Aftermarket	1	<b>576723P</b>	0.38	0.46
Genuine	1	<b>576723</b>	3.95	4.74
All 300TDi diesel models				
Aftermarket	1	<b>FRC3327P</b>	0.75	0.90
Genuine	1	<b>FRC3327</b>	3.23	3.88
All 2.0L MPI petrol models				
Aftermarket	1	<b>FRC3327P</b>	0.75	0.90
Genuine	1	<b>FRC3327</b>	3.23	3.88
All V8 petrol models up to (VIN) KA045958 and from (VIN) MA on				
Aftermarket	1	<b>576723P</b>	0.38	0.46
Genuine	1	<b>576723</b>	3.95	4.74

## Push Rod

All 4 cyl petrol & diesel models with 5 speed LT77 gearbox - Clutch slave cylinder				
Aftermarket	1	<b>FRC3417P</b>	2.25	2.70
Genuine	1	<b>FRC3417</b>	7.98	9.58
All 300TDi diesel models				
Aftermarket	1	<b>FTC3912P</b>	8.33	10.00
Genuine	1	<b>FTC3912</b>	16.78	20.14
All 2.0L MPI petrol models from (VIN) MA081992 on				
Aftermarket	1	<b>FTC3912P</b>	8.33	10.00
Genuine	1	<b>FTC3912</b>	16.78	20.14

## Bleed Screw Clutch Slave Cylinder

All models				
Genuine	1	<b>606733A</b>	2.58	3.10

## Clutch Damper Assembly

All diesel models				
Aftermarket	1	<b>STD10002P</b>	13.75	16.50
Genuine	1	<b>STD10002</b>	56.95	68.34

## Dowel Clutch Guide

All models				
Genuine	2	<b>FRC2481</b>	2.29	2.75

# TRANSMISSION

## Constant Velocity Joint

All non ABS models to (VIN) JA032850 - 10 spline				
Aftermarket	2	<b>RTC5843P</b>	17.08	20.50
All non ABS models (VIN) JA032851 on to (axle) 38L03120B, 39L05552B, 42L00521B, 43L18579B - 10 spline				
Aftermarket	2	<b>RTC6811P</b>	19.58	23.50
Genuine	2	<b>RTC6811</b>	493.19	591.83
All non ABS models (axle) 38L03121B on, 39L05553B on, 42L00522B on, 43L18580B on, 71L to 78L - 24 spline				
Aftermarket	2	<b>TDJ000010P</b>	20.63	24.76
All ABS fitted models - 24 spline				
Aftermarket	2	<b>TDJ000010P</b>	20.63	24.76

## Gaiter Propshaft c/w Clips

All models - Front				
Aftermarket	1	<b>276484P</b>	2.33	2.80
Genuine	1	<b>276484</b>	22.65	27.18

## Gaiter Propshaft

All models - Front				
Aftermarket	1	<b>276483P</b>	3.00	3.60
Genuine	1	<b>276483</b>	24.73	29.68
All models - Rear				
Aftermarket	1	<b>TVE100000P</b>	2.58	3.10
OEM	1	<b>TVE100000P1</b>	3.08	3.70
Genuine	1	<b>TVE100000</b>	15.14	18.17

## Propshaft Coupling

All models - Without fixings				
Aftermarket	1	<b>TVF100010P</b>	13.96	16.75
OEM	1	<b>TVF100010P1</b>	32.50	39.00
Genuine	1	<b>TVF100010</b>	69.22	83.06

## Bearing & Bolt Kit

All models - Rear propshaft coupling				
Aftermarket	1	<b>TVF100010PKIT</b>	6.88	8.26

## Universal Joint

All models - Propshaft, sealed				
Aftermarket	2	<b>RTC3458P</b>	4.08	4.90
OEM	2	<b>RTC3458P1</b>	8.54	10.25
Genuine	2	<b>RTC3458</b>	46.58	55.90



RTC3458P

## Shaft Front Axle

All non ABS models				
RH	Aftermarket	1	<b>RTC5840P</b>	27.50 33.00
LH	Aftermarket	1	<b>RTC5842P</b>	27.50 33.00
All non-ABS models to (axle) 38L03120B, 39L05552B, 42L00521B, 43L18579B				
RH	Aftermarket	1	<b>RTC6754P</b>	21.67 26.00
	Genuine	1	<b>RTC6754</b>	174.72 209.66
LH	Aftermarket	1	<b>RTC6755P</b>	27.50 33.00
	Genuine	1	<b>RTC6755</b>	269.69 323.63
All non-ABS models (axle) 38L03121B on, 39L05553B on, 42L00522B on, 43L18580B on, 71L to 78L				
RH	Aftermarket	1	<b>TDC000020P</b>	22.08 26.50
	OEM	1	<b>TDC000020P1</b>	45.00 54.00
	Genuine	1	<b>TDC000020</b>	242.38 290.86
LH	Aftermarket	1	<b>TDC000030P</b>	22.92 27.50
	OEM	1	<b>TDC000030P1</b>	48.33 58.00
	Genuine	1	<b>TDC000030</b>	290.18 348.22
All ABS fitted models				
RH	Aftermarket	1	<b>TDC000020P</b>	22.08 26.50
	OEM	1	<b>TDC000020P1</b>	45.00 54.00
	Genuine	1	<b>TDC000020</b>	242.38 290.86
LH	Aftermarket	1	<b>TDC000030P</b>	22.92 27.50
	OEM	1	<b>TDC000030P1</b>	48.33 58.00
	Genuine	1	<b>TDC000030</b>	290.18 348.22
All models (VIN) JA032851 on - 24 spline				
RH	Aftermarket	1	<b>TDB500280P</b>	39.58 47.50
	OEM	1	<b>TDB500280P1</b>	170.83 205.00
	Genuine	1	<b>TDB500280</b>	235.57 282.68
LH	Aftermarket	1	<b>TDB500290P</b>	45.00 54.00
	OEM	1	<b>TDB500290P1</b>	170.83 205.00
	Genuine	1	<b>TDB500290</b>	199.50 239.40

## Shaft Rear Axle

All models to (axle) 28S44171, 32S29121 - 10 spline				
RH	Aftermarket	1	<b>FTC3186P</b>	85.83 103.00
	Genuine	1	<b>FTC3186</b>	303.40 364.08
LH	Aftermarket	1	<b>FTC3187P</b>	85.00 102.00
	OEM	1	<b>FTC3187P1</b>	125.00 150.00
	Genuine	1	<b>FTC3187</b>	322.51 387.01
All models (axle) 28S44172 on, 32S29122 on - 24 spline				
RH	Aftermarket	1	<b>FTC3270P</b>	35.83 43.00
	Genuine	1	<b>FTC3270</b>	210.33 252.40
LH	Aftermarket	1	<b>FTC3271P</b>	38.33 46.00
	Genuine	1	<b>FTC3271</b>	241.79 290.15

## Spacer Front Drive Shaft

All models				
Genuine	1	<b>TYF000010</b>	3.99	4.79

## Shaft Assembly Front Output

All models with LT230 transfer box				
Aftermarket	1	<b>FRC5449P</b>	38.75	46.50
Genuine	1	<b>FRC5449</b>	190.22	228.26

## Half Shaft & CV Joint

All models up to (VIN) JA032850 - Front axle				
RH	OEM	1	<b>FRC9518P1</b>	175.00 210.00
LH	OEM	1	<b>FRC9519P1</b>	175.00 210.00





**DISCOVERY 1 (1989 to 1998)****TRANSMISSION****Half Shaft**

All models up to (VIN) JA032850 - Rear axle, RH, 10 spline type

Genuine	1	<b>571882</b>	280.18	336.22
---------	---	---------------	--------	--------

**Hub & Sleeve Assembly Trans Box**

All models with LT230 transfer box (gbox) suffix E to G

OEM	1	<b>FTC382P1</b>	78.33	94.00
Genuine	1	<b>FTC382</b>	341.90	410.28

**Hub Assembly**

All models (VIN) JA032851 on

Aftermarket	2	<b>RUB500240P</b>	50.00	60.00
Genuine	2	<b>RUB500240</b>	150.00	180.00

**Spacer Hub**

All models

Aftermarket	2	<b>FRC8227P</b>	1.75	2.10
Genuine	2	<b>FRC8227</b>	29.89	35.87

**Stub Axle Front**

All models (axle) 38L03121B on, 39L05553B on, 42L00522B on, 43L18580B on

Aftermarket	2	<b>FTC3154P</b>	16.04	19.25
OEM	2	<b>FTC3154P1</b>	50.00	60.00
Genuine	2	<b>FTC3154</b>	82.86	99.43

All models to (VIN) JA032850

Aftermarket	2	<b>FTC57P</b>	29.58	35.50
-------------	---	---------------	-------	-------

**Stub Axle Rear**

All models to (VIN) JA032850

Aftermarket	2	<b>FRC8005P</b>	45.00	54.00
Genuine	2	<b>FRC8005</b>	206.92	248.30

All models (VIN) JA032851 on

Aftermarket	2	<b>FTC3188P</b>	16.04	19.25
OEM	2	<b>FTC3188P1</b>	45.00	54.00
Genuine	2	<b>FTC3188</b>	83.71	100.45

**Stub Axle Nut**

All models

Aftermarket	4	<b>FRC8700P</b>	1.25	1.50
Genuine	4	<b>FRC8700</b>	10.09	12.11

**Stub Axle Kit**

All models (axle) 38L03121B on, 39L05553B on, 42L00522B on, 43L18580B on (VIN) JA032851 on - Front, includes stub axle, gasket, bolts, washers, bearing and seals

Britpart	2	<b>FTC3154DISCOBPK</b>	25.83	31.00
----------	---	------------------------	-------	-------

All models to (VIN) JA032850 - Rear, includes stub axle, gasket, bolts, washers, bearing and seals

Britpart	2	<b>FRC8005BPK</b>	44.17	53.00
----------	---	-------------------	-------	-------

All models (VIN) JA032851 on - Rear, includes stub axle, gasket, bolts and seal

Britpart	2	<b>FTC3188BPK</b>	19.58	23.50
----------	---	-------------------	-------	-------

**Bearing Stub Housing**

All models to (VIN) JA032850

Aftermarket	2	<b>FTC861P</b>	5.63	6.76
OEM	2	<b>FTC861P1</b>	6.67	8.00
Genuine	2	<b>FTC861</b>	11.73	14.08

All non ABS models (axle) 38L03121B on, 39L05553B on, 42L00522B on, 43L18580B on, 71L to 78L

Aftermarket	2	<b>FTC861P</b>	5.63	6.76
OEM	2	<b>FTC861P1</b>	6.67	8.00
Genuine	2	<b>FTC861</b>	11.73	14.08

**Driving Member**

All models (VIN) JA032851 on - 24 spline, front

Aftermarket	2	<b>RUC105200P</b>	4.58	5.50
OEM	2	<b>RUC105200P1</b>	12.50	15.00
Genuine	2	<b>RUC105200</b>	118.51	142.21

**Driving Member Heavy Duty**

All models (VIN) JA032851 on - 24 spline, front

Terraforma	2	<b>RUC105200HDTF</b>	16.88	20.26
Britpart	2	<b>RUC105200HDBP</b>	25.83	31.00
Bearmach	2	<b>RUC105200HDBM</b>	16.88	20.26

**Driving Member Kit, Heavy Duty**

All models (VIN) JA032851 on - Pair of 24 spline driving members

Britpart	2	<b>RUC105200HDKBP</b>	62.50	75.00
----------	---	-----------------------	-------	-------

**Bolt Kit, Heavy Duty Driving Members**

All models fitted with Britpart heavy duty driving members - Includes 10 bolts (one axle set)

Britpart	1	<b>RUC105200BPKBOLT</b>	10.00	12.00
----------	---	-------------------------	-------	-------

**Dust Cap, Screw On**

All models fitted with Britpart heavy duty driving members - Heavy duty driving member

Britpart	2	<b>RUC105200HDBPCAP</b>	8.75	10.50
----------	---	-------------------------	------	-------

All models fitted with Bearmach heavy duty driving members - Heavy duty driving member

Bearmach	2	<b>RUC105200HDBMNUT</b>	3.33	4.00
----------	---	-------------------------	------	------

**Bearing Swivel Pin Housing**

All models

Aftermarket	2	<b>606666P</b>	3.33	4.00
OEM	2	<b>606666P1</b>	10.42	12.50
Genuine	2	<b>606666</b>	23.99	28.79

**Housing Swivel Pin Bearing**

All non ABS models

Aftermarket	2	<b>FTC5366P</b>	80.00	96.00
OEM	2	<b>FTC5366P1</b>	85.00	102.00
Genuine	2	<b>FTC5366</b>	161.99	194.39

All ABS fitted models - 7 hole type

Aftermarket	2	<b>FTC5105P</b>	60.00	72.00
OEM	2	<b>FTC5105P1</b>	87.50	105.00
Genuine	2	<b>FTC5105</b>	197.93	237.52

**Housing & Bush, Swivel Pin**

All models without ABS up to (VIN) JA032850 - Upper, 'Railko bush'

Aftermarket	2	<b>FTC125P</b>	8.96	10.75
OEM	2	<b>FTC125P1</b>	10.83	13.00
Genuine	2	<b>FTC125</b>	53.42	64.10

**Swivel Pin Upper**

All models to (VIN) JA032849

Aftermarket	2	<b>571756P</b>	5.00	6.00
-------------	---	----------------	------	------

All models (VIN) JA032850 on

Aftermarket	2	<b>FRC2882P</b>	5.00	6.00
Genuine	2	<b>FRC2882</b>	51.55	61.86

**Swivel Pin Lower**

All models to (VIN) JA032849

Aftermarket	2	<b>571819P</b>	4.79	5.75
-------------	---	----------------	------	------

All models (VIN) JA032850 on

Aftermarket	2	<b>FRC2894P</b>	2.50	3.00
Genuine	2	<b>FRC2894</b>	64.95	77.94

**Swivel Pin Kit Upper**

All models (VIN) JA032850 on

Aftermarket	2	<b>STC226P</b>	19.79	23.75
OEM	2	<b>STC226P1</b>	22.50	27.00
Genuine	2	<b>STC226</b>	35.75	42.90

**Damper, Swivel Pin**

All models (VIN) JA032850 on - Front axle

RH	Genuine	1	<b>FTC1616</b>	38.03	45.64
LH	Genuine	1	<b>FTC1617</b>	38.03	45.64

**Thrust Bearing Swivel Pin**

All models (VIN) JA032850 on

Genuine	2	<b>FTC2065</b>	3.36	4.03
---------	---	----------------	------	------

**Swivel Housing Grease**

All models

Sachet	OEM	a/r	<b>STC3435P1</b>	5.00	6.00
	Genuine	a/r	<b>STC3435</b>	7.69	9.23
370g bottle	Britpart	a/r	<b>STC3435BPBOTTLE</b>	4.79	5.75
370ml sachet	Britpart	a/r	<b>STC3435BPSACHET</b>	4.38	5.26

**Gasket Oil Sump**

All models with auto gearbox

Aftermarket	1	<b>RTC4268P</b>	2.50	3.00
OEM	1	<b>RTC4268P1</b>	4.00	4.80
Genuine	1	<b>RTC4268</b>	16.52	19.82

**Oil Seal Diff Unit**

All models to (axle) 71L49101A, 72L34502A, 74L05336A, 75L17519A, 76L05465A, 77L11316A, 78L50959A

Aftermarket	1	<b>FRC8220P</b>	1.50	1.80
OEM	1	<b>FRC8220P1</b>	5.63	6.76
Genuine	1	<b>FRC8220</b>	27.28	32.74

**Oil Seal Diff Pinion Front**

All models (axle) 71L49102A on, 72L34502A on, 74L05337A on, 75L17520A on, 76L05466A on, 77L11317A on, 78L50960A on

Aftermarket	1	<b>FTC5258P</b>	1.50	1.80
OEM	1	<b>FTC5258P1</b>	4.08	4.90
Genuine	1	<b>FTC5258</b>	13.96	16.75

**Oil Seal Hub**

All models

Aftermarket	2	<b>FRC8222P</b>	1.83	2.20
OEM	2	<b>FRC8222P1</b>	5.63	6.76
Genuine	2	<b>FRC8222</b>	21.24	25.49

**Seal Stub Axle Outer**

All models to (VIN) JA032850

Aftermarket	2	<b>FTC840P</b>	2.08	2.50
Genuine	2	<b>FTC840</b>	10.71	12.85

**Seal Stub Axle Inner**

All models (axle) 38L03121B on, 39L05553B on, 42L00522B on, 43L18580B on - Front

Aftermarket	2	<b>FTC5268P</b>	0.92	1.10
Genuine	2	<b>FTC5268</b>	3.18	3.82

All models (VIN) JA 032851 on - Rear

Aftermarket	2	<b>FTC5268P</b>	0.92	1.10
Genuine	2	<b>FTC5268</b>	3.18	3.82

**Seal Output Shaft**

All models with R380 5 speed gearbox

Aftermarket	1	<b>FTC500010P</b>	1.00	1.20
Genuine	1	<b>FTC500010</b>	12.07	14.48

**Oil Seal Transfer Box Output Flange**

All models with LT230 transfer box

Aftermarket	1	<b>FTC4939P</b>	2.00	2.40
OEM	1	<b>FTC4939P1</b>	5.00	6.00
Genuine	1	<b>FTC4939</b>	13.18	15.82

**Oil Seal Transfer Box Input**

All models with LT230 transfer box

Aftermarket	1	<b>ICV100000P</b>	0.92	1.10
OEM	1	<b>ICV100000P1</b>	3.83	4.60
Genuine	1	<b>ICV100000</b>	6.99	8.39

**Seal Drive Shaft**

All non ABS models (axle) 38L03121B on, 39L05553B on, 42L00522B on, 43L18580B on, 71L to 78L

Aftermarket	2	<b>FTC3276P</b>	1.00	1.20
OEM	2	<b>FTC3276P1</b>	2.75	3.30
Genuine	2	<b>FTC3276</b>	3.47	4.16

All models with ABS

Aftermarket	2	<b>FTC3276P</b>	1.00	1.20
OEM	2	<b>FTC3276P1</b>	2.75	3.30
Genuine	2	<b>FTC3276</b>	3.47	4.16



# TRANSMISSION

## Seal Inner Stub Axle

All models	Aftermarket	2	<b>FTC4785P</b>	1.33	1.60
	OEM	2	<b>FTC4785P1</b>	3.00	3.60
	Genuine	2	<b>FTC4785</b>	4.34	5.21

## Oil Seal Front Cover

All models with LT77 5 speed gearbox (gbox) suffix G to H	Aftermarket	1	<b>UKC1060P</b>	1.58	1.90
	OEM	1	<b>UKC1060</b>	5.63	6.76
All models with R380 5 speed gearbox (gbox) suffix J to K	Aftermarket	1	<b>UKC1060P</b>	1.58	1.90
	OEM	1	<b>UKC1060</b>	5.63	6.76

## Oil Seal Oil Pump Housing

All models with 4 speed auto gearbox	Aftermarket	1	<b>RTC5102P</b>	6.04	7.25
	Genuine	1	<b>RTC5102</b>	16.12	19.34

## Oil Seal Swivel

All models - 9mm	Aftermarket	2	<b>LR059968P</b>	2.08	2.50
	OEM	2	<b>LR059968P1</b>	5.83	7.00
	Genuine	2	<b>LR059968</b>	9.89	11.87

## Oil Seal Swivel Pin Housing

All models to (VIN) JA032850 - 12.5mm	Aftermarket	2	<b>571890P</b>	2.00	2.40
All models to (axle) 38L03120B, 39L05552B, 42L00521B, 43L18579B	Aftermarket	2	<b>571718P</b>	1.17	1.40
	OEM	2	<b>571718P1</b>	3.00	3.60
	Genuine	2	<b>571718</b>	6.81	8.17

## Drain Plug Diff Unit

All models	Aftermarket	1	<b>608246P</b>	2.33	2.80
	Genuine	1	<b>608246</b>	9.63	11.56

## Drain Plug Transfer Box

All models with LT230 transfer box	Aftermarket	1	<b>599552P</b>	2.83	3.40
	Genuine	1	<b>599552</b>	8.99	10.79

## Sealing Washer, Drain Plug

All models with LT77 or R380 5 speed gearbox	Alternative to FTC4112	Aftermarket	1	<b>FRC7064A</b>	1.08	1.30
	Alternative to FRC7064A	Aftermarket	1	<b>FTC4112P</b>	0.79	0.95
		Genuine	1	<b>FTC4112</b>	2.37	2.84
All models - Land Rover type axle	Aftermarket	1	<b>515599P</b>	0.33	0.40	
	Genuine	1	<b>515599</b>	1.17	1.40	
All Land Rover type axles - Axle	Genuine	1	<b>FRC4809</b>	0.80	0.96	

## Speedometer Drive Gear

All models with LT230 transfer box	Aftermarket	1	<b>FRC3162P</b>	20.63	24.76
	OEM	1	<b>FRC3162P1</b>	23.75	28.50
	Genuine	1	<b>FRC3162</b>	64.01	76.81
All diesel manual models except Gulf States - Pinion, blue, 20 teeth	Aftermarket	1	<b>FRC3310P</b>	8.54	10.25
	Genuine	1	<b>FRC3310</b>	16.89	20.27
All V8 carb petrol models - Pinion, blue, 20 teeth	Aftermarket	1	<b>FRC3310P</b>	8.54	10.25
	Genuine	1	<b>FRC3310</b>	16.89	20.27
All diesel automatic models - Pinion, black, 23 teeth	Aftermarket	1	<b>FRC9339</b>	24.42	29.30
	Genuine	1	<b>FRC9339</b>	24.42	29.30
All V8 EFI petrol models - Pinion, black, 23 teeth	Aftermarket	1	<b>FRC9339</b>	24.42	29.30
	Genuine	1	<b>FRC9339</b>	24.42	29.30
All Gulf States diesel manual models - Pinion, black, 23 teeth	Aftermarket	1	<b>FRC9339</b>	24.42	29.30
	Genuine	1	<b>FRC9339</b>	24.42	29.30

## Gear Speedo Drive Spindle

Diesel models with auto gearbox except Gulf States - Blue, 20 teeth	Aftermarket	1	<b>FRC3310P</b>	8.54	10.25
	Genuine	1	<b>FRC3310</b>	16.89	20.27
All V8 carb petrol models - Blue, 20 teeth	Aftermarket	1	<b>FRC3310P</b>	8.54	10.25
	Genuine	1	<b>FRC3310</b>	16.89	20.27

## Taper Roller Bearing Diff Carrier

All models (axle) 38L03121B on, 39L05553B on, 42L00522B on, 43L18580B on, 71L to 78L - Land Rover type axle	Aftermarket	2	<b>RTC3095P</b>	4.25	5.10
	OEM	2	<b>RTC3095P1</b>	9.37	11.24
	Genuine	2	<b>RTC3095</b>	52.69	63.23

## Switch, Gearbox

All models High/Low, with spade connectors	Aftermarket	1	<b>PRC2911P</b>	4.08	4.90
	OEM	1	<b>PRC2911P1</b>	7.92	9.50
	Genuine	1	<b>PRC2911</b>	35.18	42.22

## Switch, Transfer Box

All models (VIN) MA081992 on Transfer box temperature	OEM	1	<b>PRC7984P1</b>	27.92	33.50
	Genuine	1	<b>PRC7984</b>	35.22	42.26

## Damper, Harmonic

All models up to (VIN) MA098422 - Front axle	Genuine	1	<b>FTC1499</b>	126.27	151.52
All diesel models from (VIN) MA098423 on - Front axle	Genuine	1	<b>FRC9693</b>	210.06	252.07
All petrol models from (VIN) MA098423 on - Front axle	Genuine	1	<b>FTC1499</b>	126.27	151.52





## DISCOVERY 1 (1989 to 1998)

## COOLING

## Expansion Bottle Cap

All 2.5L 200 TDi and 300 TDi diesel models - 15lb pressure				
Aftermarket	1	<b>NTC7161P</b>	2.75	3.30
OEM	1	<b>NTC7161P1</b>	7.08	8.50
Genuine	1	<b>NTC7161</b>	10.44	12.53
All 2.0L MPI petrol engine models - 15lb pressure				
Aftermarket	1	<b>NTC7161P</b>	2.75	3.30
OEM	1	<b>NTC7161P1</b>	7.08	8.50
Genuine	1	<b>NTC7161</b>	10.44	12.53
All V8 carb petrol engine models - 15lb pressure				
Aftermarket	1	<b>GRC110</b>	4.38	5.26
Aftermarket	1	<b>PCD100150P</b>	1.42	1.70
Genuine	1	<b>PCD100150</b>	4.04	4.85
All V8 EFI petrol engine models - 15lb pressure				
Aftermarket	1	<b>NTC7161P</b>	2.75	3.30
OEM	1	<b>NTC7161P1</b>	7.08	8.50
Genuine	1	<b>NTC7161</b>	10.44	12.53

## Thermostat

All 2.5L 200 TDi diesel engine models - 88°C					
Aftermarket	1	<b>ERR2803P</b>	2.83	3.40	
OEM	1	<b>ERR2803P1</b>	9.17	11.00	
Genuine	1	<b>ERR2803</b>	11.50	13.80	
All 2.5L 300 TDi diesel engine models					
Aftermarket	1	<b>ERR3291P</b>	2.75	3.30	
Aftermarket	1	<b>ERR3291P1</b>	5.21	6.25	
Genuine	1	<b>ERR3291</b>	11.07	13.28	
All 2.0L MPI petrol engine models - 88°C					
OEM	1	<b>PEL10017P1</b>	7.08	8.50	
Genuine	1	<b>PEL10017</b>	11.55	13.86	
All V8 petrol models					
74°C, hot climates option	Aftermarket	1	<b>GTS102</b>	3.33	4.00
82°C, std fitment	Aftermarket	1	<b>GTS104</b>	3.58	4.30
88°C, cold climates option	Aftermarket	1	<b>GTS106</b>	3.58	4.30
88°C	Aftermarket	1	<b>ETC4765P</b>	2.50	3.00
	OEM	1	<b>ETC4765P1</b>	3.08	3.70
	Genuine	1	<b>ETC4765</b>	10.06	12.07

## Thermostat Gasket

All 300 TDi diesel engine models - Thermostat housing				
Aftermarket	1	<b>ERR3490P</b>	0.38	0.46
Genuine	1	<b>ERR3490</b>	2.20	2.64

## Thermostat Housing Gasket

All 200 TDi diesel models					
Lower	Aftermarket	1	<b>ETC8007P</b>	0.42	0.50
	Genuine	1	<b>ETC8007</b>	2.20	2.64
Thermostat housing	Aftermarket	1	<b>ERR3682P</b>	0.33	0.40
	Genuine	1	<b>ERR3682</b>	2.04	2.45
All 2.0L MPI petrol engine models	Genuine	1	<b>PET10014</b>	2.04	2.45
All V8 petrol engine models - Thermostat housing					
	Aftermarket	1	<b>ERR2429P</b>	0.67	0.80
	Genuine	1	<b>ERR2429</b>	1.75	2.10
All V8 petrol models with 4 barrel carb conversion					
	Aftermarket	1	<b>GTG116</b>	1.83	2.20

## O Ring Thermostat Housing

All 300 TDi diesel models - Thermostat housing				
Aftermarket	1	<b>ERR4685P</b>	0.46	0.55
Genuine	1	<b>ERR4685</b>	2.15	2.58

## Thermostat Housing

All 300 TDi diesel models without air conditioning				
Aftermarket	1	<b>ERR3479P</b>	57.50	69.00
Genuine	1	<b>ERR3479</b>	281.22	337.46
All V8 petrol models with air conditioning				
Aftermarket	1	<b>ETC6135A</b>	29.58	35.50

## Thermostat Housing Adaptor

All 200 TDi and 300 TDi diesel models - Heater pipe				
Genuine	1	<b>624091</b>	7.82	9.38

## Plastic Plug

All 300 TDi diesel engine models - Thermostat housing filler				
Aftermarket	1	<b>ERR4686P</b>	0.92	1.10
Genuine	1	<b>ERR4686</b>	2.47	2.96

## Thermostat Switch

200 TDi diesel models Switzerland only				
Genuine	1	<b>ERR338</b>	47.86	57.43

## Water Pump

All 2.5L 200 TDi diesel engine models					
Aftermarket	1	<b>RTC6395P</b>	23.75	28.50	
OEM	1	<b>RTC6395P1</b>	45.83	55.00	
Genuine*	1	<b>RTC6395</b>	100.86	121.03	
			<i>*Exchange Surcharge</i>	40.00	48.00
All 2.5L 300 TDi diesel engine models					
Aftermarket	1	<b>PEB500090P</b>	14.58	17.50	
OEM	1	<b>PEB500090P1</b>	19.58	23.50	
Genuine	1	<b>PEB500090</b>	105.27	126.32	
All 2.0L MPI petrol engine models					
Aftermarket	1	<b>PEB102420LP</b>	12.50	15.00	
OEM	1	<b>PEB102420LP1</b>	28.75	34.50	
Genuine	1	<b>PEB102420L</b>	57.96	69.55	
All V8 petrol models up to (VIN) LA081991					
Aftermarket	1	<b>STC483P</b>	29.58	35.50	
OEM	1	<b>STC483P1</b>	55.00	66.00	
Genuine*	1	<b>STC483</b>	165.49	198.59	
			<i>*Exchange Surcharge</i>	40.00	48.00
All V8 EFI petrol engine models from (VIN) MA081992 on					
Aftermarket	1	<b>STC4378P</b>	28.75	34.50	
OEM	1	<b>STC4378P1</b>	53.33	64.00	
Genuine*	1	<b>STC4378</b>	128.66	154.39	
			<i>*Exchange Surcharge</i>	40.00	48.00

## Water Pump Gasket

All 200 TDi diesel models - Water pump				
Aftermarket	1	<b>ERR388P</b>	0.38	0.46
Genuine	1	<b>ERR388</b>	1.67	2.00
All 300 TDi diesel engine models - Water pump				
Aftermarket	1	<b>ERR3284P</b>	0.67	0.80
Genuine	1	<b>ERR3284</b>	5.04	6.05
All V8 carb engine models - Water pump				
Aftermarket	1	<b>ERR2428P</b>	0.83	1.00
OEM	1	<b>ERR2428P1</b>	4.00	4.80
Genuine	1	<b>ERR2428</b>	8.47	10.16
All V8 EFI engine models up to (VIN) LA081991 - Water pump				
Aftermarket	1	<b>ERR2428P</b>	0.83	1.00
OEM	1	<b>ERR2428P1</b>	4.00	4.80
Genuine	1	<b>ERR2428</b>	8.47	10.16
All V8 EFI models from (VIN) MA081992 on - Water pump				
Aftermarket	1	<b>ERR4077P</b>	1.50	1.80
Genuine	1	<b>ERR4077</b>	8.44	10.13

## Water Pump Inlet Housing Gasket

All 200 TDi diesel models - Water pump inlet housing				
Aftermarket	1	<b>ERR1607P</b>	0.25	0.30
Genuine	1	<b>ERR1607</b>	1.67	2.00

## D Ring Set

All 2.0L MPI petrol engine models - Water pump				
Aftermarket	1	<b>PFQ10001LP</b>	5.00	6.00
Genuine	1	<b>PFQ10001L</b>	8.01	9.61

## Intercooler Hose

All 200 TDi diesel models - LH front, short					
Aftermarket	1	<b>ESR2943P</b>	4.08	4.90	
All 2.5L 300 TDi diesel engine models					
Top	Aftermarket	1	<b>ESR3025P</b>	4.00	4.80
	Genuine	1	<b>ESR3025</b>	98.35	118.02
Bottom	Aftermarket	1	<b>ESR2913P</b>	2.25	2.70
	Genuine	1	<b>ESR2913</b>	55.00	66.00
All 2.5L 200 TDi diesel engine models					
Rear	Aftermarket	1	<b>ESR2932P</b>	4.08	4.90
	Aftermarket	1	<b>ESR2263P</b>	4.08	4.90

## Hose Turbocharger

All 300 TDi diesel models				
Aftermarket	1	<b>ESR2912P</b>	2.75	3.30
Genuine	1	<b>ESR2912</b>	57.20	68.64

## Intercooler Pipe &amp; Hose Kit

All 300 TDi diesel models - Includes lower pipe and two hoses				
Genuine	1	<b>ESR2910</b>	195.66	234.79

## Temperature Sensor

200TDi and 300TDi diesel engine models					
Green	Aftermarket	1	<b>PRC3359P</b>	5.00	6.00
	OEM	1	<b>PRC3359P1</b>	27.08	32.50
	Genuine	1	<b>PRC3359</b>	39.35	47.22
All 200TDi diesel engine models					
Orange	Aftermarket	1	<b>PRC8001P</b>	6.67	8.00
Green	Aftermarket	1	<b>PRC9917P</b>	4.08	4.90
300TDi diesel engine models					
	Aftermarket	1	<b>ERR2081P</b>	3.25	3.90
	OEM	1	<b>ERR2081P1</b>	9.79	11.75
	Genuine	1	<b>ERR2081</b>	14.00	16.80
Yellow	Aftermarket	1	<b>PRC3505A</b>	10.00	12.00
All 300TDi diesel models - To gauge					
	Aftermarket	1	<b>AMR1425P</b>	2.75	3.30
	Genuine	1	<b>AMR1425</b>	23.47	28.16
2.0L MPI petrol engine models - To gauge					
	Aftermarket	1	<b>AMR1425P</b>	2.75	3.30
	Genuine	1	<b>AMR1425</b>	23.47	28.16
2.0L MPI petrol engine models - Coolant					
	Aftermarket	1	<b>GTR185</b>	9.38	11.26
All V8 carb petrol engine models					
	Aftermarket	1	<b>PRC8003P</b>	3.50	4.20
Yellow	Aftermarket	1	<b>PRC3505A</b>	10.00	12.00
All V8 EFI petrol models - To gauge					
	Aftermarket	1	<b>AMR1425P</b>	2.75	3.30
	Genuine	1	<b>AMR1425</b>	23.47	28.16
All V8 EFI petrol engine models					
(USA/CDN/Mex only) Yellow	Aftermarket	1	<b>ETC8496A</b>	5.00	6.00
	Aftermarket	1	<b>PRC3505A</b>	10.00	12.00
All 4.0L V8 EFI petrol engine models (USA/CDN/Mex)					
	Aftermarket	1	<b>PRC8783P</b>	4.58	5.50



RTC6395P





# ELECTRICAL - ROTATING ELECTRICS

# DISCOVERY 1 (1989 to 1998)

## Alternator

All 200 TDi diesel models (A127/65amp alternator) -				
New, outright	Aftermarket	1	<b>STC233P</b>	55.00 66.00
All 300 TDi diesel models with A127/100amp alternator from (VIN) VA534104/703237 on				
Reconditioned, outright	Aftermarket	1	<b>AMR5425P</b>	88.33 106.00
New, exchange	Genuine*	1	<b>AMR5425</b>	400.02 480.02
			*Exchange Surcharge	80.00 96.00
All models with 300TDi diesel engine up to (engine) 21L36462 - A127 I-100Amp				
New, outright	Aftermarket	1	<b>YLE10113P</b>	90.00 108.00
	OEM	1	<b>YLE10113P1</b>	135.00 162.00
Reconditioned, exchange	Genuine*	1	<b>YLE10113E</b>	268.31 321.97
			*Exchange Surcharge	70.00 84.00
New, exchange	Genuine*	1	<b>YLE10113</b>	679.07 814.88
			*Exchange Surcharge	70.00 84.00
All 300TDi diesel models from (engine) 18L12424 on - A127 I-100Amp				
New, exchange	Genuine*	1	<b>AMR4248E</b>	379.61 455.53
			*Exchange Surcharge	70.00 84.00
All 2.0L MPI petrol models up to (VIN) MA163103 (A127/100amp alternator)				
New, outright	Aftermarket	1	<b>YLE10124P</b>	105.00 126.00
	OEM	1	<b>YLE10124P1</b>	155.00 186.00
New, exchange	Genuine*	1	<b>YLE10124</b>	416.08 499.30
			*Exchange Surcharge	70.00 84.00
All 2.0L MPI petrol models from (VIN) TA163104/TA501920 on (A127/100amp alternator)				
New, outright	OEM	1	<b>YLE101880P1</b>	155.00 186.00
Reconditioned, exchange	Genuine*	1	<b>YLE101880E</b>	267.47 320.96
			*Exchange Surcharge	70.00 84.00
New, exchange	Genuine*	1	<b>YLE101880</b>	412.01 494.41
			*Exchange Surcharge	70.00 84.00
All V8 carb petrol models - A127/65Amp				
New, outright	Aftermarket	1	<b>STC234P</b>	67.50 81.00
All V8 petrol models from (VIN) MA081992 to TA163436 - A127 I-100Amp				
New, outright	Aftermarket	1	<b>AMR3107P</b>	95.00 114.00
Reconditioned, exchange	Genuine*	1	<b>AMR3107E</b>	271.16 325.39
			*Exchange Surcharge	60.00 72.00
New, exchange	Genuine*	1	<b>AMR3107</b>	507.80 609.36
			*Exchange Surcharge	60.00 72.00
All V8 EFI petrol models - A133/80Amp				
New, outright	Aftermarket	1	<b>STC1753P</b>	95.00 114.00
Reconditioned, exchange	Genuine*	1	<b>STC1753E</b>	218.67 262.40
			*Exchange Surcharge	70.00 84.00
New, exchange	Genuine*	1	<b>STC1753</b>	271.53 325.84
			*Exchange Surcharge	70.00 84.00
All V8 EFI petrol models from (VIN) TA163437 on - A127-100Amp				
New, outright	Aftermarket	1	<b>AMR4247P</b>	86.67 104.00
	OEM	1	<b>AMR4247P1</b>	125.00 150.00
Reconditioned, exchange	Genuine*	1	<b>AMR4247E</b>	296.08 355.30
			*Exchange Surcharge	80.00 96.00
New, exchange	Genuine*	1	<b>AMR4247</b>	671.35 805.62
			*Exchange Surcharge	80.00 96.00
All V8 EFI petrol models from (VIN) KA034314 to LA081991 - A127/72Amp				
New, exchange	Aftermarket*	1	<b>YLE10088P</b>	65.83 79.00
			*Exchange Surcharge	40.00 48.00
	Genuine*	1	<b>YLE10088</b>	270.68 324.82
			*Exchange Surcharge	40.00 48.00
All V8 EFI petrol models to (VIN) LA081991 with 85 amp alternator - A127I-85 amp alternator type				
New, exchange	Genuine*	1	<b>YLE10099</b>	621.62 745.94
			*Exchange Surcharge	70.00 84.00
New, outright	Aftermarket	1	<b>YLE10099P</b>	100.00 120.00

## Alternator Upgrade Kit

All 200 TDi diesel models (originally fitted with A127/65amp alternator) - Upgrades from 45amp to 100amp alternator. Includes 100amp alternator (new, outright), pulley, drive belt and uprated power cable				
New, outright	Britpart	1	<b>STC233P-KUR</b>	100.00 120.00

## Starter Motor

All 200 TDi & 300 TDi diesel models				
New, outright	Aftermarket	1	<b>NAD500210P</b>	82.50 99.00
	OEM	1	<b>NAD500210P1</b>	175.00 210.00
New, exchange	Genuine*	1	<b>NAD500210</b>	316.78 380.14
			*Exchange Surcharge	100.00 120.00
Reconditioned, exchange	Genuine*	1	<b>PRC5109E</b>	242.74 291.29
			*Exchange Surcharge	100.00 120.00
All 2.0L MPI petrol models				
New, outright	Genuine	1	<b>NAD10048</b>	884.23 1061.08
All models with V8 EFI petrol engine from (VIN) KA045927 on on - Bosch type,				
New, outright	Aftermarket	1	<b>NAD101490P</b>	70.00 84.00
	OEM	1	<b>NAD101490P1</b>	155.00 186.00
New, exchange	Genuine*	1	<b>NAD101490E</b>	129.64 155.57
			*Exchange Surcharge	70.00 84.00
	Genuine*	1	<b>NAD101490</b>	208.17 249.80
			*Exchange Surcharge	70.00 84.00



STC233P



AMR5425P



YLE10113P



AMR4248E



YLE10124P



YLE101880P1



STC234P



AMR3107P



STC1753P



AMR4247P1



YLE10088P



YLE10099P



NAD500210P



NAD101490P1



## DISCOVERY 1 (1989 to 1998)

## ENGINE GASKETS

## Gasket Camshaft Cover

2.0L MPI petrol models from (VIN) KA038822 on - Exhaust				
Aftermarket	1	<b>LVP100170P</b>	3.83	4.60
OEM	1	<b>LVP100170P1</b>	5.63	6.76
Genuine	1	<b>LVP100170</b>	8.66	10.39
All 2.0L MPI petrol models up to (VIN) MA163103/501919 - Inlet cam				
Genuine	1	<b>LVP10006</b>	25.88	31.06
All 2.0L MPI petrol models from (VIN) TA163104/501920 on - Inlet cam				
Genuine	1	<b>LVP100320L</b>	16.32	19.58

## Gasket Rocker Cover

All 200TDi diesel models					
Aftermarket	1	<b>ERR2393P</b>	2.00	2.40	
Genuine	1	<b>ERR2393</b>	11.47	13.76	
All 300TDi diesel models					
Aftermarket	1	<b>ERR2409P</b>	2.00	2.40	
OEM	1	<b>ERR2409P1</b>	3.58	4.30	
Genuine	1	<b>ERR2409</b>	10.74	12.89	
All V8 petrol models					
Cork	OEM	2	<b>GEG436</b>	1.58	1.90
Rubber	OEM	2	<b>GEG436UPRATED</b>	2.65	3.18

## Sealing Washer Rocker Cover

All 200TDi diesel models				
Aftermarket	3	<b>ERR663P</b>	1.50	1.80
Genuine	3	<b>ERR663</b>	7.92	9.50
All 300TDi diesel models				
Aftermarket	3	<b>ERR3424P</b>	0.75	0.90
Genuine	3	<b>ERR3424</b>	2.98	3.58

## Gasket Cylinder Head

200TDi and 300TDi diesel models				
1.30mm, one hole				
Aftermarket	1	<b>LVB500200P</b>	5.42	6.50
Genuine	1	<b>LVB500200</b>	51.39	61.67
1.30mm, one hole, MLS type				
OEM	1	<b>LVB500200P1</b>	11.67	14.00
1.40mm, two holes, MLS type				
Aftermarket	1	<b>LVB500210P</b>	5.42	6.50
OEM	1	<b>LVB500210P1</b>	11.67	14.00
1.40mm, two holes				
Genuine	1	<b>LVB500210</b>	48.48	58.18
1.50mm, three holes, MLS type				
Aftermarket	1	<b>LVB500220P</b>	10.63	12.76
OEM	1	<b>LVB500220P1</b>	13.75	16.50
1.50mm, three holes				
Genuine	1	<b>LVB500220</b>	44.06	52.87
1.60mm, MLS type				
Aftermarket	1	<b>LVB500230P</b>	12.50	15.00
OEM	1	<b>LVB500230P1</b>	18.13	21.76
1.60mm				
Genuine	1	<b>LVB500230</b>	37.45	44.94
2.0L MPI petrol models				
Aftermarket	1	<b>LVB101000P</b>	21.67	26.00
Genuine	1	<b>LVB101000</b>	42.22	50.66
All 3.5L V8 petrol models				
Composite type gasket				
Aftermarket	2	<b>GEG340COM</b>	15.42	18.50
Aftermarket	2	<b>GEG340COMP</b>	6.04	7.25
Genuine	2	<b>ERR4248</b>	35.01	42.01
Tin type gasket				
Aftermarket	2	<b>GEG340P</b>	2.08	2.50
Aftermarket	2	<b>GEG340</b>	5.00	6.00
3.5L V8 petrol models up to (VIN) LA081991 - Original style tin head gasket				
Aftermarket	2	<b>603796P</b>	1.92	2.30
Genuine	2	<b>603796</b>	10.18	12.22
3.5L V8 EFI petrol models from (VIN) MA081992 on - Original style composite head gasket				
Aftermarket	2	<b>ERR7218P</b>	7.50	9.00
OEM	2	<b>ERR7218P1</b>	21.67	26.00
Genuine	2	<b>ERR7218</b>	31.90	38.28
3.9L and 4.0L V8 petrol with 2 rows of head bolts - Original style composite head gasket				
Aftermarket	2	<b>LVB500030P</b>	4.58	5.50
OEM	2	<b>LVB500030P1</b>	8.13	9.76
Genuine	2	<b>LVB500030</b>	39.14	46.97
3.9L V8 petrol with 3 rows of head bolts				
Upgrade type composite head gasket				
Aftermarket	2	<b>ETC7819P</b>	3.00	3.60
Original fitment tin head gasket				
Genuine	2	<b>ETC7819</b>	11.09	13.31

## Gasket Decoke Set

200TDi diesel models - Without head gasket				
Aftermarket	1	<b>STC1172P</b>	15.63	18.76
OEM	1	<b>STC1172P1</b>	50.00	60.00
Genuine	1	<b>STC1172</b>	93.01	111.61
300TDi diesel models - Without head gasket				
Aftermarket	1	<b>STC2802P</b>	8.96	10.75
OEM	1	<b>STC2802P1</b>	32.50	39.00
Genuine	1	<b>STC2802</b>	88.35	106.02
All 2.0L MPI petrol models from (eng) 101829 on				
Aftermarket	1	<b>STC3160P</b>	102.50	123.00
Genuine	1	<b>STC3160</b>	138.44	166.13
All 3.5L V8 petrol models - Includes tin type head gasket				
Aftermarket	1	<b>GUG1066HS</b>	20.42	24.50
Aftermarket	1	<b>GUG1066HSK</b>	19.79	23.75
All 3.5L V8 petrol models - Includes composite type head gasket				
Aftermarket	1	<b>GUG1066HSCOM</b>	33.33	40.00
V8 carb petrol models up to (VIN) LA081991 - Includes original fitment tin head gasket				
Aftermarket	1	<b>STC1566P</b>	11.67	14.00
Genuine	1	<b>STC1566</b>	133.80	160.56
3.5L V8 EFI petrol models up to (VIN) LA081991 - Includes original style tin head gasket				
Aftermarket	1	<b>STC1642P</b>	22.92	27.50
All V8 EFI petrol models (VIN) MA081992 on - Engines with 2 rows of head bolts (COMPOSITE)				
Aftermarket	1	<b>RA1233P</b>	57.50	69.00
Genuine	1	<b>RA1233</b>	90.83	109.00

## Gasket Oil Sump

All 2.0L MPI petrol models				
Aftermarket	1	<b>LVF10005P</b>	27.50	33.00
Genuine	1	<b>LVF10005</b>	32.66	39.19
All V8 petrol models except USA/CDN/Mex 4.0L V8 EFI				
Aftermarket	1	<b>AJM539P</b>	1.00	1.20
Aftermarket	1	<b>AJM539</b>	4.08	4.90

## Gasket Conversion Set

All 200TDi diesel models				
Aftermarket	1	<b>STC1557P</b>	15.00	18.00
OEM	1	<b>STC1557P1</b>	45.00	54.00
Genuine	1	<b>STC1557</b>	151.83	182.20
All 300TDi diesel models				
Aftermarket	1	<b>STC2801P</b>	13.96	16.75
OEM	1	<b>STC2801P1</b>	27.50	33.00
Genuine	1	<b>STC2801</b>	90.31	108.37
All 2.0L MPI petrol models				
Genuine	1	<b>STC848</b>	89.76	107.71
All 3.5L V8 carb petrol models				
Aftermarket	1	<b>GUG1538CS</b>	13.13	15.76
Aftermarket	1	<b>GUG1538CSP</b>	10.83	13.00
V8 petrol models up to (VIN) LA081991				
Aftermarket	1	<b>STC1639P</b>	9.79	11.75
OEM	1	<b>STC1639P1</b>	25.83	31.00
Genuine	1	<b>STC1639</b>	60.34	72.41
V8 petrol models from (VIN) MA081992 on				
Aftermarket	1	<b>STC2823P</b>	12.50	15.00
Genuine	1	<b>STC2823</b>	79.56	95.47

## Sealant 70gm Tube

200TDi diesel models				
OEM	a/r	<b>STC611P1</b>	11.67	14.00
Genuine	a/r	<b>STC611</b>	31.80	38.16

## Silicone Sealant RTV

Numerous applications				
Aftermarket	a/r	<b>RTC3254P</b>	5.00	6.00
Genuine	a/r	<b>RTC3254</b>	21.04	25.25

## Sealant Instant Gasket

Numerous applications				
Genuine	a/r	<b>STC50550</b>	13.10	15.72

## DISCOVERY 1 (1989 to 1998)

## ENGINE SWITCHES

## Camshaft Position Sensor

All USA/CDN/Mex V8 EFI petrol models from (VIN) TA501920 on				
Aftermarket	1	<b>NSC100840P</b>	115.00	138.00

## Crankshaft Sensor

All manual V8 EFI petrol models USA/CDN/Mex (VIN) TA163100/TA501920 to (eng) 50D09963A - GEMS type				
Aftermarket	1	<b>ERR3006P</b>	24.95	29.94
Genuine	1	<b>ERR3006</b>	106.67	128.00
All automatic V8 EFI petrol models USA/CDN/Mex (eng) 50D09964A on - GEMS type				
OEM	1	<b>ERR6119P1</b>	25.83	31.00
Genuine	1	<b>ERR6119</b>	85.88	103.06

## Crankshaft Position Sensor

All 300 TDi diesel automatic models				
OEM	1	<b>ERR2079P1</b>	13.13	15.76
Genuine	1	<b>ERR2079</b>	122.31	146.77

## Crankshaft Sensor Assembly

2.0L MPI petrol models up to (VIN) MA163103				
OEM	1	<b>ADU7340LP1</b>	26.67	32.00
Genuine	1	<b>ADU7340L</b>	83.47	100.16
All 2.0L MPI petrol models (VIN) TA163104/TA501921 on				
Aftermarket	1	<b>NSC100390LP</b>	15.00	18.00
OEM	1	<b>NSC100390LP1</b>	25.00	30.00
Genuine	1	<b>NSC100390L</b>	85.88	103.06

## Engine Knock Sensor

All 2.0L MPI petrol models				
Genuine	1	<b>ADU8229L</b>	73.34	88.01

## Oil Pressure Switch

All diesel engine models				
Aftermarket	1	<b>PRC6387P</b>	1.83	2.20
OEM	1	<b>PRC6387P1</b>	3.50	4.20
Genuine	1	<b>PRC6387</b>	28.77	34.52
2.0L MPI petrol engine models				
Aftermarket	1	<b>NUC10003P</b>	3.25	3.90
Genuine	1	<b>NUC10003</b>	6.94	8.33
All V8 petrol engine models				
Aftermarket	1	<b>STC4104P</b>	3.00	3.60
OEM	1	<b>STC4104P1</b>	12.50	15.00
Genuine	1	<b>STC4104</b>	29.01	34.81

## Air Inlet Temperature Sensor

All 300 TDi diesel automatic models				
Aftermarket	1	<b>ERR2082P</b>	5.83	7.00
Genuine	1	<b>ERR2082</b>	39.73	47.68
2.0L MPI petrol engine models				
OEM	1	<b>NNK10001LP1</b>	20.00	24.00
Genuine	1	<b>NNK10001L</b>	24.04	28.85

## Oxygen Sensor

All V8 EFI petrol models except USA/CDN/Mex				
Aftermarket	1	<b>ERR6729P</b>	39.58	47.50
OEM	1	<b>ERR6729P1</b>	66.67	80.00
V8 EFI petrol models USA/CDN/Mex up to (VIN) SA163099/SA501919				
Aftermarket	1	<b>ERR6729P</b>	39.58	47.50
OEM	1	<b>ERR6729P1</b>	66.67	80.00
V8 EFI petrol models USA/CDN/Mex from (VIN) TA163100/TA501920 on				
OEM	1	<b>ERR1834P1</b>	50.00	60.00
Genuine	1	<b>ERR1834</b>	186.25	223.50



## DRAIN PLUGS

### Sump Plug Magnetic

All 200TDi diesel models	Genuine	1	<b>ETC5577</b>	3.53	4.24
--------------------------	---------	---	----------------	------	------

### Sump Plug

300TDi diesel models	Aftermarket	1	<b>UAM2957P</b>	1.58	1.90
	Genuine	1	<b>UAM2957</b>	2.08	2.50
All 300 TDi diesel models (eng) 21L88229A on	OEM	1	<b>LSF100040LP1</b>	1.50	1.80
	Genuine	1	<b>LSF100040L</b>	3.13	3.76
2.0L MPI petrol models	Aftermarket	1	<b>UAM2957P</b>	1.58	1.90
	Genuine	1	<b>UAM2957</b>	2.08	2.50
All V8 petrol models	Aftermarket	1	<b>603659A</b>	2.83	3.40

### Sump Plug Washer

All 200TDi and 300TDi diesel models	Aftermarket	1	<b>FRC4808P</b>	0.58	0.70
	Genuine	1	<b>FRC4808</b>	1.83	2.20
All 200TDi diesel models	Aftermarket	1	<b>213961A</b>	1.25	1.50
300TDi diesel models	Aftermarket	1	<b>UAM2857P</b>	0.58	0.70
2.0L MPI petrol models	Aftermarket	1	<b>UAM2857P</b>	0.58	0.70
All V8 petrol models	Aftermarket	1	<b>213961A</b>	1.25	1.50

### Sealing Washer Sump Plug

All 300TDi diesel models (eng) 21L88228A on	Aftermarket	1	<b>ALU1403LP</b>	0.54	0.65
	Genuine	1	<b>ALU1403L</b>	1.11	1.33
All models with R380 5 speed gearbox to (VIN) MA109620	Aftermarket	1	<b>ALU1403LP</b>	0.54	0.65
	Genuine	1	<b>ALU1403L</b>	1.11	1.33

### Oil Drain Valve Kit

All 300TDi diesel models (eng) 21L88229A on	Aftermarket	1	<b>LSF100040LODV</b>	32.08	38.50
---------------------------------------------	-------------	---	----------------------	-------	-------

## OIL SEALS ENGINE

### Oil Seal Crankshaft - Front

200TDi diesel models	Aftermarket	1	<b>ERR6490P</b>	3.00	3.60
	OEM	1	<b>ERR6490P1</b>	5.00	6.00
300TDi diesel models - Inner	Aftermarket	1	<b>ERR4575P</b>	2.33	2.80
	OEM	1	<b>ERR4575P1</b>	5.63	6.76
	Genuine	1	<b>ERR4575</b>	14.76	17.71
300TDi diesel models up to (VIN) VA560897 - Outer	Aftermarket	1	<b>ERR4576P</b>	1.25	1.50
	Genuine	1	<b>ERR4576</b>	6.95	8.34
300TDi diesel models from (VIN) VA560898 on - Outer	Aftermarket	1	<b>ERR7143P</b>	4.58	5.50
	Genuine	1	<b>ERR7143</b>	32.31	38.77
All V8 petrol models	Aftermarket	1	<b>ERR6490P</b>	3.00	3.60
	OEM	1	<b>ERR6490P1</b>	5.00	6.00

### Oil Seal Crankshaft - Rear

200TDi diesel models	Aftermarket	1	<b>ERR2532P</b>	2.00	2.40
	OEM	1	<b>ERR2532P1</b>	5.83	7.00
	Genuine	1	<b>ERR2532</b>	21.00	25.20
300TDi diesel models	Aftermarket	1	<b>LUF100430P</b>	7.50	9.00
	OEM	1	<b>LUF100430P1</b>	9.58	11.50
	Genuine	1	<b>LUF100430</b>	26.79	32.15
All 2.0L MPI petrol models - With retainer	OEM	1	<b>LUL10007LP1</b>	27.50	33.00
	Genuine	1	<b>LUL10007L</b>	73.40	88.08
All V8 petrol models - Lip type seal	Aftermarket	1	<b>ERR2640P</b>	3.00	3.60
	OEM	1	<b>ERR2640P1</b>	7.92	9.50
	Genuine	1	<b>ERR2640</b>	15.58	18.70

## EXHAUST GAS RECIRCULATION (EGR)

### EGR Valve

All 200 TDi diesel manual models without catalyst	Genuine	2	<b>ERR355</b>	65.84	79.01
All 200 TDi diesel manual models with EGR	Genuine	1	<b>PRC9146</b>	43.33	52.00

### EGR Blanking Kit

All 300 TDi diesel models - Includes blanking plate, insulator/gasket and screws	Britpart	1	<b>LL1473BP</b>	5.00	6.00
	Terrafirma	1	<b>LL1473TF</b>	4.75	5.70
	Bearmach	1	<b>LL1473BM</b>	5.83	7.00

### Solenoid EGR Valve

All 300 TDi diesel models without catalyst	Genuine	1	<b>ERR3314</b>	129.28	155.14
--------------------------------------------	---------	---	----------------	--------	--------

### Cooler EGR Valve

300 TDi diesel models Japan only	Genuine	1	<b>ERR6723</b>	363.42	436.10
----------------------------------	---------	---	----------------	--------	--------

### Gasket EGR Valve to Pipe

All 200 TDi and 300 TDi diesel models	Aftermarket	1	<b>WAL500010LP</b>	2.00	2.40
	OEM	1	<b>WAL500010LP1</b>	3.58	4.30
	Genuine	1	<b>WAL500010L</b>	6.18	7.42
All 300 TDi diesel models	Aftermarket	1	<b>ERR3319P</b>	1.00	1.20
	Genuine	1	<b>ERR3319</b>	1.75	2.10

## DISCOVERY 1 (1989 to 1998)

### Copper Sealing Washer

Numerous applications	Aftermarket	1	<b>ETC7398P</b>	0.75	0.90
	Genuine	1	<b>ETC7398</b>	1.55	1.86

### Filler Plug

All models with 5 speed LT77 gearbox - Gearbox	OEM	1	<b>3292P1</b>	1.33	1.60
	Genuine	1	<b>3292</b>	15.68	18.82
All models with 5 speed R380 gearbox - Gearbox	OEM	1	<b>FTC4056P1</b>	6.46	7.75
	Genuine	1	<b>FTC4056</b>	6.98	8.38
All models - Swivel housing	OEM	1	<b>3292P1</b>	1.33	1.60
	Genuine	1	<b>3292</b>	15.68	18.82

### Wading Plug

All models with 5 speed R380 gearbox - Gearbox bellhousing. Alternative to 3290A	OEM	1	<b>FTC4056P1</b>	6.46	7.75
	Genuine	1	<b>FTC4056</b>	6.98	8.38

### Drain Plug

All models with 4 speed automatic transmission - Magnetic, gearbox	Genuine	1	<b>RTC4647</b>	7.86	9.43
All diesel models - Fuel filter/sedimentor	OEM	1	<b>37H7920P1</b>	7.08	8.50
	Genuine	1	<b>37H7920</b>	9.02	10.82

### O Ring Oil Screen

All models with 4 speed auto gearbox	Aftermarket	1	<b>RTC4276P</b>	0.38	0.46
	Genuine	1	<b>RTC4276</b>	1.80	2.16

## DISCOVERY 1 (1989 to 1998)

### Oil Seal Front Cover

200TDi diesel models	Aftermarket	1	<b>ETC4154P</b>	1.08	1.30
	OEM	1	<b>ETC4154P1</b>	3.00	3.60
	Genuine	1	<b>ETC4154</b>	14.67	17.60
V8 petrol models	Aftermarket	1	<b>ETC4154P</b>	1.08	1.30
	OEM	1	<b>ETC4154P1</b>	3.00	3.60
	Genuine	1	<b>ETC4154</b>	14.67	17.60

### Oil Seal Camshaft - Front

200TDi diesel models	Aftermarket	1	<b>ETC5064P</b>	2.08	2.50
	OEM	1	<b>ETC5064P1</b>	2.50	3.00
	Genuine	1	<b>ETC5064</b>	21.23	25.48
300TDi diesel models	Aftermarket	1	<b>ERR3356P</b>	0.58	0.70
	OEM	1	<b>ERR3356P1</b>	2.50	3.00
	Genuine	1	<b>ERR3356</b>	12.31	14.77
2.0L MPI petrol models - Front	Aftermarket	1	<b>LZB100271P</b>	1.25	1.50
	OEM	1	<b>LZB100271P1</b>	2.25	2.70
	Genuine	1	<b>LZB100271</b>	5.36	6.43

### Oil Seal Camshaft - Rear

All 2.0L MPI petrol models - Blanking plug type seal - Rear	Genuine	1	<b>LUC100120</b>	3.80	4.56
-------------------------------------------------------------	---------	---	------------------	------	------

### O Ring Camshaft Small

All 200TDi diesel models - Camshaft pulley retaining plate	Genuine	1	<b>ERC8849</b>	0.61	0.73
------------------------------------------------------------	---------	---	----------------	------	------

## DISCOVERY 1 (1989 to 1998)

### EGR Pipe

300TDi diesel models	Aftermarket	1	<b>ERR3580P</b>	3.25	3.90
	Genuine	1	<b>ERR3580</b>	53.69	64.43
All 300 TDi diesel models	Aftermarket	1	<b>ERR3581P</b>	3.25	3.90
	Genuine	1	<b>ERR3581</b>	45.30	54.36

### Y Pipe EGR Valve

All 300 TDi diesel models (eng) 15G except Japan	Genuine	1	<b>ERR3579</b>	188.44	226.13
300 TDi diesel models Japan only	Genuine	1	<b>ERR6721</b>	55.24	66.29

### Pipe EGR Valve to Solenoid

All 200 TDi diesel manual models without catalyst	Genuine	1	<b>ERR1986</b>	16.22	19.46
---------------------------------------------------	---------	---	----------------	-------	-------

### Hose EGR Cooler to Water Rail

300 TDi diesel models Japan only	Genuine	1	<b>ESR3993</b>	53.54	64.25
----------------------------------	---------	---	----------------	-------	-------





**DISCOVERY 1 (1989 to 1998)****ENGINE & GEARBOX MOUNTINGS****Engine Mounting**

All 200TDi diesel models - Engine	Aftermarket	2	<b>ANR2488P</b>	11.67	14.00
	Aftermarket	2	<b>NTC9416P</b>	9.17	11.00
	Genuine	2	<b>NTC9416</b>	51.74	62.09
2.0L MPI petrol models up to (VIN) LA081991 - Engine, M10 thread	Aftermarket	2	<b>ANR1808P</b>	2.33	2.80
	OEM	2	<b>ANR1808P1</b>	3.58	4.30
	Genuine	2	<b>ANR1808</b>	17.50	21.00
All 2.0L MPI petrol models up to (VIN) LA081991 - LH, M10 thread	Aftermarket	1	<b>ANR2471P</b>	2.83	3.40
	Genuine	1	<b>ANR2471</b>	43.29	51.95
All V8 petrol models - With M12 metric threads	Aftermarket	2	<b>STC434P</b>	2.33	2.80
	OEM	2	<b>STC434P1</b>	9.38	11.26
	Genuine	2	<b>STC434</b>	23.83	28.60
All V8 petrol models from (VIN) MA081992 on - Engine, M12 thread	Aftermarket	2	<b>KKB103120P</b>	1.67	2.00
	Genuine	2	<b>KKB103120</b>	20.20	24.24

**Bracket Engine Mounting**

All 200TDi diesel manual models	RH	Genuine	1	<b>NTC6281</b>	51.97	62.36
	LH	Genuine	1	<b>NTC6280</b>	51.97	62.36
All 300TDi diesel models	RH	Genuine	1	<b>ANR2868</b>	117.03	140.44
	LH	Genuine	1	<b>NTC9415</b>	97.80	117.36
All 2.0L MPI petrol models from (VIN) MA081992 on	RH	Genuine	1	<b>ANR3642</b>	51.97	62.36
	LH	Genuine	1	<b>ANR3641</b>	52.70	63.24

**Gearbox Mounting**

All 4 cyl models	RH	Aftermarket	1	<b>ANR3200P</b>	2.50	3.00
		Genuine	1	<b>ANR3200</b>	23.26	27.91
LH	Aftermarket	1	<b>ANR3201P</b>	2.50	3.00	
	OEM	1	<b>ANR3201P1</b>	4.58	5.50	
	Genuine	1	<b>ANR3201</b>	23.26	27.91	
All 200TDi diesel manual models - Rear	Genuine	1	<b>NTC6282</b>	135.84	163.01	
All V8 petrol models up to (VIN) LA081991	Aftermarket	2	<b>NTC5890P</b>	2.83	3.40	
	Genuine	2	<b>NTC5890</b>	28.49	34.19	
V8 petrol models up to (VIN) LA081991 - Gearbox, M10 thread	Aftermarket	2	<b>ANR1808P</b>	2.33	2.80	
	OEM	2	<b>ANR1808P1</b>	3.58	4.30	
	Genuine	2	<b>ANR1808</b>	17.50	21.00	
All V8 petrol models from (VIN) MA081992 on	Aftermarket	2	<b>ANR2805P</b>	2.42	2.90	
	Genuine	2	<b>ANR2805</b>	13.75	16.50	



NTC9416P



ANR3201P

**DISCOVERY 1 (1989 to 1998)****FUEL SYSTEM SWITCHES****Throttle Position Sensor**

All 300 TDi diesel models from (VIN) VA534104/703237 on	Genuine	1	<b>STC4389</b>	420.71	504.85
V8 petrol models USA/CDN/Mex from (VIN) TA163100/501920	Genuine	1	<b>ERR4278</b>	98.01	117.61

**Air Flow Sensor Meter**

V8 petrol models USA/CDN/Mex from (VIN) TA163100/501920 (GEMS)	Aftermarket	1	<b>ERR5595P</b>	95.00	114.00
	Genuine*	1	<b>ERR5595</b>	818.10	981.72
				200.00	240.00

**Oxygen Sensor**

All 2.0L MPI petrol models	Genuine	1	<b>MHK10004L</b>	126.70	152.04
----------------------------	---------	---	------------------	--------	--------

**Fuel Temperature Sensor**

All 2.0L MPI petrol models	Aftermarket	1	<b>MEK10002LP</b>	7.08	8.50
	Genuine	1	<b>MEK10002L</b>	23.42	28.10
All V8 EFI petrol models	Aftermarket	1	<b>ETC6661P</b>	40.00	48.00

**Turbo Boost Pressure Switch**

All 300 TDi diesel models	Genuine	1	<b>ERR2083</b>	467.68	561.22
---------------------------	---------	---	----------------	--------	--------

**Mass Airflow Sensor**

V8 EFI petrol models from (VIN) MA081992 on (not USA/CDN/Mex)	Aftermarket	1	<b>ERR5198P</b>	83.33	100.00
V8 EFI petrol models from (VIN) MA081992 to SA163099 USA/CDN/Mex	Aftermarket	1	<b>ERR5198P</b>	83.33	100.00

**DISCOVERY 1 (1989 to 1998)****CABLES****Accelerator Cable**

All RHD 200 TDi diesel models up to (VIN) JA031012	Aftermarket	1	<b>NTC7226P</b>	17.92	21.50
All RHD 300TDi diesel models without cruise control with Electronic Diesel Control (EDC) from (VIN) TA163104/TA501919 on	Aftermarket	1	<b>SBB104250P</b>	11.88	14.26
	Genuine	1	<b>SBB104250</b>	50.66	60.79
All 300 TDi diesel models	Aftermarket	1	<b>ANR3606P</b>	12.50	15.00
	Genuine	1	<b>ANR3606</b>	31.50	37.80
All RHD diesel models with cruise control without Electronic Diesel Control (EDC)	Genuine	1	<b>SBB104330</b>	30.12	36.14
All RHD V8 EFI petrol models	Aftermarket	1	<b>SBB104300P</b>	14.79	17.75
	Genuine	1	<b>SBB104300</b>	53.57	64.28
All LHD 200 TDi diesel models up to (VIN) JA031012	Aftermarket	1	<b>NTC7227P</b>	25.83	31.00
All LHD 300TDi diesel models without cruise control with Electronic Diesel Control (EDC) from (VIN) TA163104/TA501919 on	Aftermarket	1	<b>ANR4617P</b>	19.79	23.75
	Genuine	1	<b>ANR4617</b>	33.90	40.68
All LHD diesel models with cruise control without Electronic Diesel Control (EDC)	Genuine	1	<b>SBB104320</b>	44.48	53.38
All LHD 2.0L MPI petrol models	Genuine	1	<b>ANR2078</b>	42.98	51.58
All LHD V8 carb petrol models	Aftermarket	1	<b>NTC7535P</b>	22.50	27.00
	Genuine	1	<b>NTC7535</b>	29.87	35.84
All LHD V8 EFI petrol models	Aftermarket	1	<b>ANR5327P</b>	10.63	12.76
	Genuine	1	<b>ANR5327</b>	31.72	38.06

**Bonnet Release Cable**

All models from (VIN) MA117986 to TA164840	Aftermarket	1	<b>ALR7062P</b>	3.58	4.30
	Genuine	1	<b>ALR7062</b>	11.88	14.26
All models from (VIN) TA164840 on	Aftermarket	1	<b>ASR1405P</b>	13.75	16.50
	Genuine	1	<b>ASR1405</b>	19.41	23.29

**Choke Cable**

All V8 carb petrol models	OEM	1	<b>NTC7723P1</b>	15.63	18.76
	Genuine	1	<b>NTC7723</b>	26.60	31.92

**Speedometer Cable**

All RHD models except V8 EFI up to (VIN) LA081991 - One piece cable	Aftermarket	1	<b>PRC9872P</b>	8.96	10.75
All RHD V8 EFI up to (VIN) LA081991 - One piece cable	Aftermarket	1	<b>PRC8232P</b>	4.58	5.50
All V8 EFI petrol models up to (VIN) LA081991 - Transducer to instruments	Aftermarket	1	<b>PRC9871P</b>	5.63	6.76
All 3.5L V8 EFI up to (VIN) HA473731 - Gearbox to transducer	Aftermarket	1	<b>PRC6320P</b>	3.75	4.50
All V8 EFI from (VIN) HA473731 on - Gearbox to transducer	Aftermarket	1	<b>PRC7949P</b>	3.50	4.20
All LHD models up to (VIN) LA081991 except V8 EFI petrol - One piece cable	Aftermarket	1	<b>PRC9873P</b>	8.96	10.75

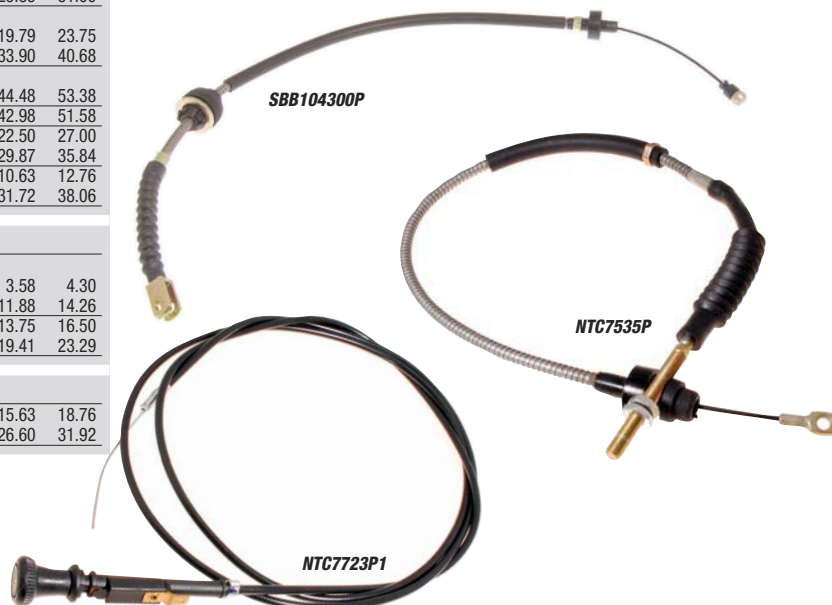

# WINDOW REGULATORS

**DISCOVERY 1 (1989 to 1998)**

## Window Regulator

All models with manual windows up to (VIN) LA081991 - Front				
RH	Aftermarket	1	<b>MUC2038P</b>	14.58 17.50
	Genuine	1	<b>MUC2038</b>	115.33 138.40
LH	Aftermarket	1	<b>MUC2039P</b>	18.96 22.75
	Genuine	1	<b>MUC2039</b>	116.40 139.68
All models with electric front windows (VIN) MA137190 on - Front				
RH	Aftermarket	1	<b>LR006373P</b>	17.29 20.75
	Genuine	1	<b>LR006373</b>	96.61 115.93
LH	Aftermarket	1	<b>LR006374P</b>	13.12 15.74
	Genuine	1	<b>LR006374</b>	96.61 115.93
All models with electric rear windows (VIN) MA137190 on - Rear				
RH	Aftermarket	1	<b>STC2884P</b>	22.08 26.50
	Genuine	1	<b>STC2884</b>	85.66 102.79
LH	Aftermarket	1	<b>STC2883P</b>	22.08 26.50
	Genuine	1	<b>STC2883</b>	85.66 102.79

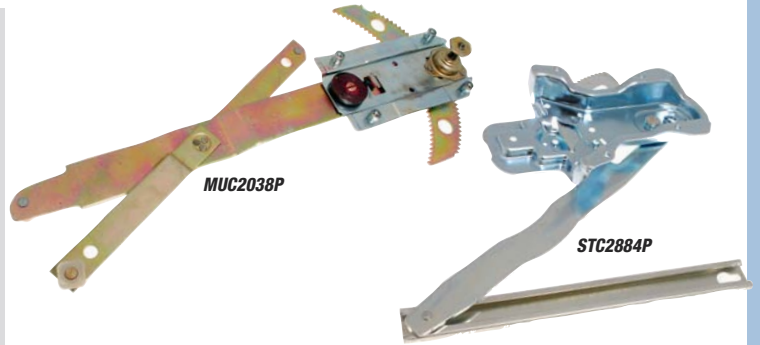

# WHEEL CENTRE CAPS & WHEEL NUTS

**DISCOVERY 1 (1989 to 1998)**

## Wheel Centre Cap

All models with Silver Sparkle (MNH) colour alloy wheels				
Silver Sparkle, features Land Rover logo	Genuine	a/r	<b>ANR2391MNH</b>	7.13 8.56
All models with Quicksilver (MUE) colour alloy wheels - Quicksilver, features Land Rover logo				
	Genuine	a/r	<b>ANR2391MUE</b>	5.13 6.16
All models fitted with 5 spoke Pewter colour (LAL) alloy wheels from (VIN) WA746542 on - Pewter, features Land Rover logo				
	Genuine	a/r	<b>ANR2391LAL</b>	5.29 6.35
All models with Black colour alloy wheels				
Black, features Land Rover logo	Genuine	a/r	<b>STC7248</b>	10.06 12.07

## Wheel Stud

All models with alloy wheels - For alloy or steel wheels				
	Aftermarket	a/r	<b>RUF500010P</b>	1.33 1.60
	Genuine	a/r	<b>RUF500010</b>	2.09 2.51
All models - Extended, 60mm (original fitment for Defender Wolf/XD). Allows fitment of certain alternative wheels				
	OEM	a/r	<b>FRC7577P1</b>	5.83 7.00
	Genuine	a/r	<b>FRC7577</b>	19.36 23.23

## Wheel Nut

All models with steel wheels				
	Aftermarket	a/r	<b>RRD500010P</b>	0.79 0.95
	Genuine	a/r	<b>RRD500010</b>	1.82 2.18
All models with alloy wheels up to (VIN) KA052252 - Without stainless steel cap				
	Aftermarket	a/r	<b>NRC7415P</b>	2.00 2.40
	OEM	a/r	<b>NRC7415P1</b>	2.75 3.30
	Genuine	a/r	<b>NRC7415</b>	2.97 3.56
All models with alloy spare wheel - Alloy spare wheel only				
	Genuine	a/r	<b>ANR4914</b>	8.42 10.10

## Wheel Nut Set

All models with steel wheels - Set of 20				
	Aftermarket	a/r	<b>RRD500010KP</b>	11.04 13.25
	Genuine	a/r	<b>RRD500010K</b>	34.00 40.80
All models with alloy wheels up to (VIN) KA052252 - Set of 20. Without stainless steel cap				
	Aftermarket	a/r	<b>NRC7415KP</b>	38.33 46.00
	Genuine	a/r	<b>NRC7415K</b>	58.50 70.20







# DISCOVERY 2 (1998 to 2004)

1998 to 2004 - All Models

Listed below are the most popular parts required for the Discovery 2.

We have access to the full range of parts for your vehicle. Please contact us if not listed here.

## DISCOVERY 2 (1998 to 2004)

### SERVICE KITS

#### Service Kit

All 2.5L TD5 diesel models	Aftermarket	1	<b>LL1346P</b>	11.50	13.80
	Genuine	1	<b>LL1346</b>	70.83	85.00
All V8 EFI petrol models - Includes oil filter, air filter, spark plugs & sump plug washer	Aftermarket	1	<b>RD1210P</b>	39.58	47.50
	Genuine	1	<b>RD1210</b>	87.50	105.00

#### Filter Kit

All 2.5L TD5 diesel models - Includes oil filter, air filter, rotor filter, fuel filter & sump plug washer					
	Aftermarket	1	<b>LL1346P</b>	11.50	13.80
	Genuine	1	<b>LL1346</b>	70.83	85.00



LL1346P



RD1210P

## DISCOVERY 2 (1998 to 2004)

### FILTRATION

#### Oil Filter

All models with TD5 diesel engine - Cartridge					
	Aftermarket	1	<b>LPX100590P</b>	2.83	3.40
	OEM	1	<b>LPX100590P1</b>	4.00	4.80
	Genuine	1	<b>LPX100590</b>	8.08	9.70
Stubby	Britpart	1	<b>LPX100590BPSTUB</b>	1.83	2.20
All models with V8 petrol engine - Cartridge					
	Aftermarket	1	<b>ERR3340P</b>	2.00	2.40
	OEM	1	<b>ERR3340P1</b>	3.33	4.00
	Genuine	1	<b>ERR3340</b>	10.82	12.98

#### Air Filter

All TD5 diesel models					
	Aftermarket	1	<b>LR027408P</b>	2.50	3.00
	OEM	1	<b>LR027408P1</b>	4.58	5.50
	Genuine	1	<b>LR027408</b>	12.57	15.08
All V8 EFI petrol models					
	Aftermarket	1	<b>LR027408P</b>	2.50	3.00
	OEM	1	<b>LR027408P1</b>	4.58	5.50
	Genuine	1	<b>LR027408</b>	12.57	15.08

#### EGR Air Filter

All 2.5L TD5 diesel engine models up to (VIN) XA222500					
	Genuine	1	<b>ESR4323</b>	2.93	3.52



ESR4323

#### Fuel Filter

All TD5 diesel models					
	Aftermarket	1	<b>ESR4686P</b>	5.00	6.00
	OEM	1	<b>ESR4686P1</b>	12.50	15.00
	Genuine	1	<b>ESR4686</b>	39.80	47.76

#### Fuel Filter Complete Assembly

All diesel engine models from (VIN)YA250945 to (VIN) 3A838203					
	OEM	1	<b>WJN000030P1</b>	90.00	108.00
	Genuine	1	<b>WJN000030</b>	130.74	156.89

#### Air Bleed Valve Fuel Filter

2.5L TD5 diesel models					
	Genuine	1	<b>WJN500110</b>	15.47	18.56

#### Oil Strainer Transmission, Gearbox

All models with 4 speed auto gearbox					
	Aftermarket	1	<b>RTC4653P</b>	5.21	6.25
	OEM	1	<b>RTC4653P1</b>	9.37	11.24
	Genuine	1	<b>RTC4653</b>	49.14	58.97



ESR4686P1



WJN000030

## DISCOVERY 2 (1998 to 2004)

### WIPER BLADES

#### Wiper Blade

All models					
Front	Aftermarket	2	<b>DKC100960P</b>	3.08	3.70
	OEM	2	<b>DKC100960P1</b>	7.08	8.50
	Genuine	2	<b>DKC100960</b>	15.18	18.22
Rear	Aftermarket	1	<b>DKC100890P</b>	2.92	3.50
	Genuine	1	<b>DKC100890</b>	9.64	11.57

#### Wiper Blades, Pair

All models - Winter, accessory fitment					
	Britpart	1	<b>DKC500010PMDBP</b>	20.63	24.76
	OEM	1	<b>DKC500010PMDP1</b>	19.79	23.75
	Genuine	1	<b>DKC500010PMD</b>	55.20	66.24

#### Aerofoil, Wiper Blade

All RHD models - Driver's side					
	Genuine	1	<b>DKS100030</b>	11.43	13.72



DKC500010PMDBP

DKS100030



# SCREEN/LAMP WASHER SYSTEM

# DISCOVERY 2 (1998 to 2004)

## Washer Jet

All models					
Front screen wash	Genuine	2	<b>DNJ500090</b>	15.16	18.19
Rear screen	OEM	1	<b>AWR2406P1</b>	5.83	7.00
	Genuine	1	<b>AWR2406</b>	7.26	8.71
All models from (VIN) 3A000001 on with headlamp wash					
RH, headlamp wash	Genuine	1	<b>DNH000060</b>	15.82	18.98
LH, headlamp wash	Genuine	1	<b>DNH000070</b>	15.82	18.98

## Washer Jet Retaining Clip

All models with headlamp wash - Headlamp jet to bumper					
	Genuine	2	<b>DYC000190</b>	1.80	2.16

## Washer Jet & Hose

All models to (VIN) 2A999999 - Headlamp					
	Aftermarket	2	<b>AMR5114P</b>	7.50	9.00
	Genuine	2	<b>AMR5114</b>	15.82	18.98

## Washer Pump

All models					
Front screen	OEM	1	<b>DMC100550P1</b>	5.00	6.00
	Genuine	1	<b>DMC100550</b>	29.38	35.26
Rear screen	OEM	1	<b>DMC100540P1</b>	6.04	7.25
	Genuine	1	<b>DMC100540</b>	29.41	35.29
All models with headlamp wash					
Headlamps	Genuine	1	<b>DMC100560</b>	32.83	39.40

## Washer Hose, Per Metre

All models - 4mm internal diameter (3mm also available).					
Front or rear screen wash	Aftermarket	a/r	<b>GWV201M</b>	2.25	2.70

## Washer Hose Assembly & Non Return Valve

All models - Front screen wash	Genuine	1	<b>DNH500020</b>	7.67	9.20
--------------------------------	---------	---	------------------	------	------

## Washer Hose Non Return Valve

All models - Fits in-line in 4mm dia. hose					
	Aftermarket	1	<b>AMR6676P</b>	1.42	1.70
	Genuine	1	<b>AMR6676</b>	3.26	3.91

## Washer Jet Elbow

All models - Front screen wash	Genuine	3	<b>DNG10001</b>	2.01	2.41
--------------------------------	---------	---	-----------------	------	------

## Washer Hose Straight Connector

All models	Genuine	1	<b>DNG10007L</b>	4.13	4.96
------------	---------	---	------------------	------	------

## Washer Hose Non Return Valve

All models - Headlamp wash	Genuine	1	<b>DNE100050</b>	6.16	7.39
----------------------------	---------	---	------------------	------	------

## Washer Hose & Non Return Valve

All models with headlamp wash - Headlamp wash					
	Genuine	1	<b>DNH000050</b>	57.99	69.59

## Washer Jet Fixing Screw Cap

All models with headlamp wash up to (VIN) 2A999999 - Headlamp wash					
	Genuine	1	<b>AWR6436</b>	5.73	6.88

## Washer Reservoir

All models up to (VIN) 2A999999 without headlamp wash - Front & rear screen wash.					
<i>Does not include pumps</i>					
	Genuine	1	<b>DMB102980</b>	102.30	122.76
All models up to (VIN) 2A999999 with headlamp wash - Front & rear screen & headlamp wash.					
<i>Does not include pumps</i>					
	Genuine	1	<b>DMB102970</b>	51.52	61.82

## Washer Reservoir & Pumps

All models from (VIN) 3A000001 on without headlamp wash - Front & rear screen wash					
	Genuine	1	<b>DMB500020</b>	94.87	113.84
All models from (VIN) 3A000001 on with headlamp wash - Front & rear screen & headlamp wash					
	Genuine	1	<b>DMB500010</b>	117.15	140.58

## Washer Reservoir Cap

All models - Front & rear screen & headlamp wash					
	OEM	1	<b>DMG10001LP1</b>	4.79	5.75
	Genuine	1	<b>DMG10001L</b>	5.73	6.88

## Windscreen Cleaning Paste

All models	Genuine	a/r	<b>DNJ500340</b>	7.72	9.26
<i>Prevents wiper blade judder/squeak by 'deep cleaning' the windscreen (ref: Land Rover Tech Bulletin LRA501-002)</i>					

# DRIVE BELTS

# DISCOVERY 2 (1998 to 2004)

## Alternator Drive Belt

All models with TD5 diesel engine without air conditioning or active cornering enhancement - Alternator					
	Aftermarket	1	<b>PQS101490P</b>	6.67	8.00
	OEM	1	<b>PQS101490P1</b>	10.00	12.00
	Genuine	1	<b>PQS101490</b>	23.02	27.62
All models with TD5 diesel engine without air conditioning, with active cornering enhancement - Alternator					
	Aftermarket	1	<b>PQS101520P</b>	6.88	8.26
	OEM	1	<b>PQS101520P1</b>	10.63	12.76
	Genuine	1	<b>PQS101520</b>	23.71	28.45
All models with TD5 diesel engine with air conditioning, without active cornering enhancement - Alternator					
	Aftermarket	1	<b>PQS101500P</b>	6.04	7.25
	OEM	1	<b>PQS101500P1</b>	8.75	10.50
	Genuine	1	<b>PQS101500</b>	23.02	27.62
All models with TD5 diesel engine with air conditioning and active cornering enhancement - Alternator					
	Aftermarket	1	<b>PQS101510P</b>	6.88	8.26
	OEM	1	<b>PQS101510P1</b>	10.63	12.76
	Genuine	1	<b>PQS101510</b>	25.64	30.77

All models with V8 petrol engine, without air conditioning, without active cornering enhancement - Alternator					
	Aftermarket	1	<b>ERR6899P</b>	5.63	6.76
	OEM	1	<b>ERR6899P1</b>	9.58	11.50
	Genuine	1	<b>ERR6899</b>	37.78	45.34
All models with V8 petrol engine, without air conditioning, with active cornering enhancement - Alternator					
	Aftermarket	1	<b>ERR6897P</b>	10.42	12.50
	OEM	1	<b>ERR6897P1</b>	14.38	17.26
	Genuine	1	<b>ERR6897</b>	36.55	43.86
All models with V8 petrol engine, with air conditioning, without active cornering enhancement - Alternator					
	Aftermarket	1	<b>ERR6898P</b>	5.63	6.76
	OEM	1	<b>ERR6898P1</b>	10.00	12.00
	Genuine	1	<b>ERR6898</b>	35.49	42.59
All models with V8 petrol engine, air conditioning and active cornering enhancement - Alternator					
	Aftermarket	1	<b>ERR6896P</b>	9.17	11.00
	OEM	1	<b>ERR6896P1</b>	13.33	16.00
	Genuine	1	<b>ERR6896</b>	35.64	42.77

# IGNITION SYSTEM

# DISCOVERY 2 (1998 to 2004)

## Spark Plug

All V8 petrol engine models					
	Aftermarket	8	<b>NLP100320P</b>	6.88	8.26
	Genuine	8	<b>NLP100320</b>	10.06	12.07

## Glow Plug

All 2.5L TD5 diesel engine models	Genuine	5	<b>ERR6066</b>	12.33	14.80
-----------------------------------	---------	---	----------------	-------	-------

## Ignition Coil

All V8 EFI petrol engine models - MEMs system					
	Aftermarket	2	<b>ERR6045P</b>	20.63	24.76
	OEM	2	<b>ERR6045P1</b>	23.33	28.00
	Genuine	2	<b>ERR6045</b>	40.84	49.01

## Ignition Coil & Bracket Assembly

All V8 EFI petrol engine models - MEMs system. Includes 4 coils (for 8 cylinders)					
	Aftermarket	1	<b>ERR6566P</b>	80.00	96.00
	Genuine	1	<b>ERR6566</b>	154.81	185.77

## Ignition Lead Set

All V8i petrol models					
	Aftermarket	1	<b>RA2001P</b>	14.79	17.75
	Genuine	1	<b>RA2001</b>	130.00	156.00
Performance, silicone RED	Aftermarket	1	<b>RA2001S</b>	25.83	31.00

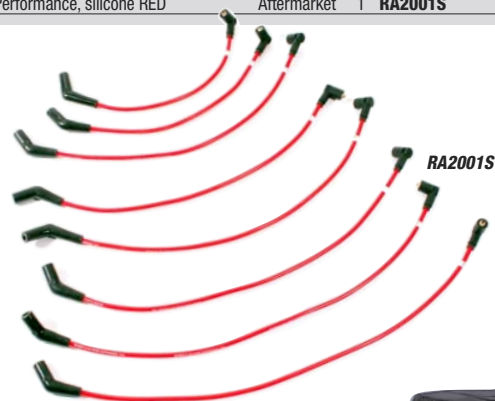

## DISCOVERY 2 (1998 to 2004)

## BRAKING SYSTEM

## Brake Pad Set

All models				
Front Brakes				
Aftermarket	1	<b>SFP500150P</b>	13.96	16.75
OEM	1	<b>SFP500150P1</b>	18.54	22.25
Genuine	1	<b>SFP500150</b>	45.45	54.54
Front Brakes, Green Stuff				
EBC	1	<b>SFP500150GS</b>	39.58	47.50
Rear Brakes				
Aftermarket	1	<b>SFP500130P</b>	11.67	14.00
OEM	1	<b>SFP500130P1</b>	18.13	21.76
EBC	1	<b>SFP500130ULTIMAX</b>	20.00	24.00
Genuine	1	<b>SFP500130</b>	67.42	80.90
Rear Brakes, Green Stuff				
EBC	1	<b>SFP500130GS</b>	32.08	38.50

## Brake Disc (each)

All models				
Front, Vented				
Aftermarket	2	<b>SDB000380P</b>	17.50	21.00
Brembo	2	<b>SDB000380BREMBO</b>	59.95	71.94
OEM	2	<b>SDB000380P1</b>	32.50	39.00
Genuine	2	<b>SDB000380</b>	60.72	72.86
Rear, Not Vented				
Aftermarket	2	<b>SDB000470P</b>	13.54	16.25
Genuine	2	<b>SDB000470</b>	58.00	69.60
Rear, Not Vented (pair)				
Brembo	1	<b>SDB000470BREMBO</b>	55.83	67.00

## Performance Brake Disc (pair)

All models				
Front, Vented, slotted & drilled				
Britpart	1	<b>SDB000380URBP</b>	58.33	70.00
Rear, Not Vented, slotted & drilled				
Britpart	1	<b>SDB000470URBP</b>	46.67	56.00

## Mudshield Brake Disc

All models				
Front RH				
Genuine	1	<b>FTC4908</b>	25.42	30.50
Front LH				
Genuine	1	<b>FTC4909</b>	25.42	30.50
All models fitted with non-vented discs				
Rear				
Genuine	2	<b>FTC4778</b>	37.45	44.94

## Brake Caliper

All models to (VIN) 2A999999 - Right Hand Front, Vented Disc Brakes				
New, outright				
Aftermarket	1	<b>STC1916P</b>	29.58	35.50
New, exchange				
OEM*	1	<b>STC1916P1</b>	85.83	103.00
*Exchange Surcharge				
50.00			60.00	
Reconditioned, exchange				
Exchange*	1	<b>STC1916E</b>	66.32	79.58
*Exchange Surcharge				
50.00			60.00	
New, exchange				
Genuine*	1	<b>STC1916</b>	185.24	222.29
*Exchange Surcharge				
50.00			60.00	
All models to (VIN) 2A999999 - Left Hand Front, Vented Disc Brakes				
New, outright				
Aftermarket	1	<b>STC1915P</b>	29.58	35.50
OEM	1	<b>STC1915P1</b>	110.00	132.00
Reconditioned, exchange				
Exchange*	1	<b>STC1915E</b>	66.32	79.58
*Exchange Surcharge				
50.00			60.00	
New, exchange				
Genuine*	1	<b>STC1915</b>	185.24	222.29
*Exchange Surcharge				
50.00			60.00	
All models from (VIN) 3A000000 - Right Hand Front				
New, outright				
Aftermarket	1	<b>SEG000030P</b>	65.00	78.00
New, exchange				
Genuine*	1	<b>SEG000030E</b>	106.10	127.32
*Exchange Surcharge				
90.00			108.00	
All models from (VIN) 3A000000 - Left Hand Front				
New, outright				
Aftermarket	1	<b>SEG000060P</b>	65.00	78.00
New, exchange				
Genuine*	1	<b>SEG000060E</b>	106.10	127.32
*Exchange Surcharge				
50.00			60.00	
All models - Right Hand Rear, Solid Disc Brakes				
New, outright				
Aftermarket	1	<b>STC1906P</b>	25.00	30.00
Reconditioned, exchange				
Exchange*	1	<b>STC1906E</b>	66.32	79.58
*Exchange Surcharge				
50.00			60.00	
New, exchange				
Genuine*	1	<b>STC1906</b>	110.73	132.88
*Exchange Surcharge				
50.00			60.00	
All models - Left Hand Rear, Solid Disc Brakes				
New, outright				
Aftermarket	1	<b>STC1905P</b>	25.00	30.00
Reconditioned, exchange				
Exchange*	1	<b>STC1905E</b>	66.32	79.58
*Exchange Surcharge				
50.00			60.00	
New, exchange				
Genuine*	1	<b>STC1905</b>	110.76	132.91
*Exchange Surcharge				
50.00			60.00	

## Brake Caliper Carrier

All models				
Front, Vented Disc Brakes				
OEM	2	<b>STC1917P1</b>	22.50	27.00
Genuine	2	<b>STC1917</b>	202.92	243.50
Rear, Solid Disc Brakes				
Aftermarket	2	<b>STC1907P</b>	16.67	20.00
OEM	2	<b>STC1907P1</b>	19.58	23.50
Genuine	2	<b>STC1907</b>	47.75	57.30

## Brake Caliper Piston

All models to (VIN) 2A999999				
Front, Vented Disc Brakes				
Aftermarket	4	<b>STC1918P</b>	4.38	5.26
OEM	4	<b>STC1918P1</b>	7.50	9.00
Genuine	4	<b>STC1918</b>	17.20	20.64
All models from (VIN) 3A000000				
Front				
Aftermarket	2	<b>SEK000020P</b>	9.58	11.50
Genuine	2	<b>SEK000020</b>	20.36	24.43
All models				
Rear, Solid Disc Brakes				
Aftermarket	1	<b>STC1908P</b>	4.08	4.90
Genuine	1	<b>STC1908</b>	18.49	22.19

## Dust Cap Bleed Screw

All models - Blue, clutch slave cylinder bleed nipple				
Genuine	2	<b>594091</b>	4.66	5.59

## Slider Pin Bolt

All models - Front and rear calipers				
Genuine	2	<b>STC1914</b>	1.10	1.32

## Caliper Guide Pin Kit

All models				
Front brakes				
Aftermarket	1	<b>STC1920P</b>	13.54	16.25
Genuine	1	<b>STC1920</b>	17.90	21.48
Rear brakes				
Aftermarket	1	<b>STC1910P</b>	12.29	14.75
Genuine	1	<b>STC1910</b>	16.11	19.33

## Brake Master Cylinder

RHD models from (VIN) 3A000000				
Aftermarket	1	<b>SJC000100P</b>	72.50	87.00
Genuine	1	<b>SJC000100</b>	216.26	259.51
LHD models from (VIN) XA232917 to 2A999999				
Aftermarket	1	<b>SJC100432P</b>	110.00	132.00
LHD models from (VIN) 3A000000				
Aftermarket	1	<b>SJC000110P</b>	72.50	87.00
OEM	1	<b>SJC000110P1</b>	130.00	156.00
Genuine	1	<b>SJC000110</b>	230.61	276.73

## Brake Servo Assembly

All RHD models from (VIN) YA284968 to (VIN) 2A999999				
OEM	1	<b>SJG000040P1</b>	225.00	270.00
Genuine	1	<b>SJG000040</b>	361.16	433.39
All LHD models from (VIN) YA284968 to (VIN) 2A999999				
Genuine	1	<b>SJG000050</b>	357.46	428.95
All RHD models from (VIN) 3A000000				
OEM	1	<b>SJG500020P1</b>	200.00	240.00
Genuine	1	<b>SJG500020</b>	286.82	344.18

## Filter for Brake Servo

All models				
Genuine	1	<b>SID100040</b>	4.00	4.80

## Seal Brake Servo

All models				
Genuine	1	<b>SJO100080</b>	3.47	4.16

## Cap &amp; Float Switch Reservoir

All models				
Genuine	1	<b>SJL000040</b>	33.17	39.80

## Caliper Repair Kit

All models up to (VIN) 2A999999 - Front caliper, kit does not include pistons				
Aftermarket	2	<b>STC1919P</b>	3.92	4.70
OEM	2	<b>STC1919P1</b>	10.83	13.00
Genuine	2	<b>STC1919</b>	21.49	25.79
All models from (VIN) 3A000000 - Front				
Genuine	2	<b>SEEO00130</b>	23.87	28.64
All models - Rear caliper, kit does not include pistons				
Aftermarket	2	<b>STC1909P</b>	3.50	4.20
Genuine	2	<b>STC1909</b>	10.73	12.88

## Master Cylinder Repair Kit

All models from (VIN) XA232917				
Genuine	1	<b>SJJ100362</b>	50.09	60.11

## Brake Hose

All models				
Front, RH, rubber				
Aftermarket	1	<b>SHB101190P</b>	12.50	15.00
Genuine	1	<b>SHB101190</b>	43.22	51.86
Front, LH, rubber				
Aftermarket	1	<b>SHB101180P</b>	12.50	15.00
OEM	1	<b>SHB101180P1</b>	15.00	18.00
Genuine	1	<b>SHB101180</b>	43.22	51.86
Rear, RH, rubber				
Aftermarket	1	<b>SHB101200P</b>	8.54	10.25
OEM	1	<b>SHB101200P1</b>	19.79	23.75
Genuine	1	<b>SHB101200</b>	42.80	51.36
Rear, LH, includes bracket and banjo				
Aftermarket	1	<b>SHB101170P</b>	10.63	12.76
OEM	1	<b>SHB101170P1</b>	15.63	18.76
Genuine	1	<b>SHB101170</b>	43.22	51.86

## Modulator pipe to underfloor pipe

All models				
Aftermarket	2	<b>SHB101350P</b>	7.08	8.50
OEM	2	<b>SHB101350P1</b>	10.00	12.00
Genuine	2	<b>SHB101350</b>	19.58	23.50

## Brake Pipe Kit

All models to (VIN) JA non ABS (1991 to 1992) - Complete vehicle set				
Automec	1	<b>RD106091-92</b>	102.50	123.00
All models to from (VIN) KA to (VIN) LA non ABS (1993 to 1994) - Complete vehicle set				
Automec	1	<b>RD106093-94</b>	97.50	117.00
All models to from (VIN) MA on non ABS (1195 to 1998) - Complete vehicle set				
Automec	1	<b>RD106095-98</b>	95.83	115.00

## Brake Shoe Set - Handbrake

All models - Handbrake, direct entry cable type				
Aftermarket	1	<b>ICW500010P</b>	10.00	12.00
OEM	1	<b>ICW500010P1</b>	25.00	30.00
Genuine	1	<b>ICW500010</b>	65.52	78.62



# BRAKING SYSTEM

## Brake Spring Kit - Handbrake

All models - Handbrake Shoe Retention	Aftermarket	1	<b>ICW100050P</b>	3.83	4.60
	OEM	1	<b>ICW100050P1</b>	8.12	9.74
	Genuine	1	<b>ICW100050</b>	11.52	13.82

## Brake Drum - Handbrake

All models - Handbrake	Aftermarket	1	<b>LR025177P</b>	20.42	24.50
	Genuine	1	<b>LR025177</b>	152.67	183.20

## Transmission Brake Adjustment Kit

All models	Aftermarket	1	<b>ICW500020P</b>	9.37	11.24
	Genuine	1	<b>ICW500020</b>	13.81	16.57

## Brake Lever Kit - Handbrake

All models - Handbrake	Genuine	1	<b>ICW100010</b>	15.27	18.32
------------------------	---------	---	------------------	-------	-------

## Cross Shaft

All models from (VIN) 4A828649 - Handbrake, Direct Entry Cable Type					
	Genuine	1	<b>ICF100000</b>	12.74	15.29

## Handbrake Switch

All models	Genuine	1	<b>CLP8699L</b>	24.46	29.35
------------	---------	---	-----------------	-------	-------

## Handbrake Adjusting Knob

All models	Genuine	1	<b>NTC5009</b>	1.72	2.06
------------	---------	---	----------------	------	------

## Handbrake Cable

All models to (VIN) XA224663	Aftermarket	1	<b>SPB101500P</b>	14.38	17.26
	Genuine	1	<b>SPB101500</b>	144.69	173.63
All models from (VIN) 1A710609	Aftermarket	1	<b>SPB000150P</b>	12.92	15.50
	OEM	1	<b>SPB000150P1</b>	28.33	34.00
	Genuine	1	<b>SPB000150</b>	94.17	113.00

## ABS Sensor

All models					
Front hubs	Aftermarket	1	<b>SSW500020P</b>	29.58	35.50
	OEM	1	<b>SSW500020P1</b>	85.00	102.00
	Genuine	1	<b>SSW500020</b>	100.76	120.91
Rear hubs	Aftermarket	1	<b>SSW500030P</b>	25.55	30.66
	OEM	1	<b>SSW500030P1</b>	70.00	84.00
	Genuine	1	<b>SSW500030</b>	130.99	157.19

## Repair Kit for ABS Modulator

All models with ABS - Repair kit for SRB101203 & SRB500570					
	OEM	1	<b>SW0500040P1</b>	350.00	420.00

## Brake Pedal Rubber

All manual models - Brake and clutch	Aftermarket	2	<b>575818P</b>	1.83	2.20
	Genuine	2	<b>575818</b>	6.79	8.15
All models with automatic transmission	Aftermarket	1	<b>ANR2941P</b>	7.92	9.50
	Genuine	1	<b>ANR2941</b>	11.53	13.84

# SUSPENSION

## Bush Radius Arm

All models - Front suspension axle end, rubber	Aftermarket	4	<b>RBX101680P</b>	5.63	6.76
	OEM	4	<b>RBX101680P1</b>	20.83	25.00
	Genuine	4	<b>RBX101680</b>	25.79	30.95
chassis end, rubber	Aftermarket	2	<b>RBX101730P</b>	5.21	6.25
	Genuine	2	<b>RBX101730</b>	27.92	33.50
axle end, poly.	Aftermarket	4	<b>RBX101680POLY</b>	10.63	12.76
	Aftermarket	2	<b>RBX101730POLY</b>	20.00	24.00
All models - Rear suspension axle end, rubber	Aftermarket	4	<b>ANR6947P</b>	5.63	6.76
	Genuine	4	<b>ANR6947</b>	25.41	30.49
	Aftermarket	4	<b>ANR6947POLY</b>	10.63	12.76

## Bush Shock Absorber

All models - Front suspension upper, rear suspension upper and lower rubber	Aftermarket	2	<b>ROA100050P</b>	2.00	2.40
	Genuine	2	<b>ROA100050</b>	9.49	11.39
	poly.	Aftermarket	2	<b>ROA100050POLY</b>	8.33
All models - Front suspension, lower rubber	Aftermarket	2	<b>ROA100040P</b>	4.00	4.80
	Genuine	2	<b>ROA100040</b>	22.09	26.51
	poly.	Aftermarket	2	<b>ROA100040POLY</b>	13.33

## Shock Absorber Bush Kit

All models - Front & rear rubber	Genuine	1	<b>RD1180</b>	91.67	110.00
	Aftermarket	1	<b>RD1180POLY</b>	65.83	79.00

## Bush Panhard Rod

All models - Front suspension rubber	Aftermarket	2	<b>RBX101340P</b>	1.75	2.10
	OEM	2	<b>RBX101340P1</b>	8.96	10.75
	Genuine	2	<b>RBX101340</b>	14.27	17.12
	poly.	Aftermarket	2	<b>RBX101340POLY</b>	6.04

## Bush Watts Linkage Bar

All models - Rear suspension rubber	Aftermarket	2	<b>RGX100960P</b>	19.79	23.75
	Genuine	2	<b>RGX100960</b>	44.25	53.10
	poly.	Aftermarket	2	<b>RGX100960POLY</b>	57.50

## Bush Kit Watts Linkage Bar

All models - Rear suspension, rubber kit	Britpart	1	<b>RGX100960BPK</b>	110.00	132.00
------------------------------------------	----------	---	---------------------	--------	--------

## Bush Transverse Link

All models - Rear suspension rubber	Aftermarket	2	<b>RGX100970P</b>	6.04	7.25
	Genuine	2	<b>RGX100970</b>	20.54	24.65
	poly.	Aftermarket	2	<b>RGX100970POLY</b>	8.75

# DISCOVERY 2 (1998 to 2004)

## Suspension Bush Kit

All models with coil Spring Suspension without ACE - Kit contains complete vehicle set					
	Genuine	1	<b>RD1187</b>	565.00	678.00
All models with air suspension without ACE - Kit contains complete vehicle set					
	Genuine	1	<b>RD1188</b>	545.00	654.00
All models with ACE - Kit contains complete vehicle set					
	Genuine	1	<b>RD1186</b>	625.00	750.00
All models Kit includes Fr & Rr Panhard bushes, Watts linkage & Fr & Rr radius arm bushes, poly., dynamic orange					
	Polybush	1	<b>RD1189POLYBUSH</b>	207.50	249.00
	Flo-Flex	1	<b>RD1189FLOFLEX</b>	136.67	164.00
black	Britpart	1	<b>RD1189BPPOLYBLK</b>	90.00	108.00
yellow	Britpart	1	<b>RD1189BPPOLYEL</b>	90.00	108.00
	Bearmach	1	<b>RD1189BMPOLY</b>	117.50	141.00

## Bolt Kit for Suspension Bush Kit

All models - Kit contains all nuts & bolts required when renewing the suspension bushes					
	Genuine	1	<b>RD1185</b>	132.50	159.00

## Bump Stop (set of 4)

All models - Front and rear suspension					
poly. black	Britpart	1	<b>RNV100060BPPYBLK</b>	39.58	47.50
poly. yellow	Britpart	1	<b>RNV100060BPPYEL</b>	60.00	72.00

## Bush Anti Roll Bar Mounting

All models - Front, poly.	Aftermarket	2	<b>RBX101690POLY</b>	6.04	7.25
All models with coil spring suspension without active cornering enhancement					
Rear, poly.	Aftermarket	2	<b>RBX101710POLY</b>	4.58	5.50

## Supplementary Bush Kit

All models with coil Spring Suspension with ACE Kit includes shock absorber bushes & steering damper bushes, poly.					
	Aftermarket	1	<b>RD1192POLY</b>	65.83	79.00
All models with coil Spring Suspension without ACE Kit includes shock absorber bushes, Fr anti roll bar bushes & steering damper bushes, poly.					
	Aftermarket	1	<b>RD1190POLY</b>	80.83	97.00



RD1189POLYBUSH





## DISCOVERY 2 (1998 to 2004)

## SUSPENSION

## Anti Roll Bar

All models without ACE				
Front	Genuine	1	<b>RBL101370</b>	173.90 208.68
All models with ACE suspension				
Front, anti roll bar only	Genuine	1	<b>ANR6550</b>	164.27 197.12
Rear, anti roll bar only	Genuine	1	<b>ANR6956</b>	167.60 201.12
All models with coil spring suspension without ACE				
Rear	Aftermarket	1	<b>RGB101320P</b>	100.00 120.00
	Genuine	1	<b>RGB101320</b>	224.17 269.00
All models with coil spring rear suspension and 7 seat configuration, without active roll bar system				
Rear	Genuine	1	<b>RGB000180</b>	153.77 184.52
All models with air suspension without ACE				
Rear	Aftermarket	1	<b>RGB101310P</b>	100.00 120.00
	Genuine	1	<b>RGB101310</b>	224.17 269.00

## Anti Roll Bar Assembly

All models with ACE suspension - includes anti roll bar, torsion bar, ACE actuator & bushes				
Front	Genuine	1	<b>RBL101121</b>	504.34 605.21
Rear	Genuine	1	<b>RGB101020</b>	527.64 633.17

## Anti Roll Bar Bush

All models with active cornering enhancement				
Front and rear suspension, rubber	Aftermarket	2	<b>ANR6551P</b>	6.67 8.00
	OEM	2	<b>ANR6551P1</b>	9.38 11.26
	Genuine	2	<b>ANR6551</b>	20.30 24.36
All models with ACE suspension				
Front & rear, actuator rod end	Aftermarket	2	<b>ANR6554P</b>	8.54 10.25
	OEM	2	<b>ANR6554P1</b>	13.75 16.50
	Genuine	2	<b>ANR6554</b>	20.19 24.23

## Anti Roll Bar Link

All models				
Front	Aftermarket	2	<b>RBM100223P</b>	5.83 7.00
	OEM	2	<b>RBM100223P1</b>	10.42 12.50
	Genuine	2	<b>RBM100223</b>	81.30 97.56
All models with air suspension with active cornering enhancement				
Rear	Aftermarket	2	<b>RGD100682P</b>	6.88 8.26
	OEM	2	<b>RGD100682P1</b>	15.83 19.00
	Genuine	2	<b>RGD100682</b>	86.19 103.43

## Mounting Bush, Anti Roll Bar

All models				
Front	Aftermarket	2	<b>RBX101690P</b>	1.50 1.80
	Genuine	2	<b>RBX101690</b>	2.68 3.22
All models with coil spring suspension without active cornering enhancement				
Rear, standard rubber	Aftermarket	2	<b>RBX101710P</b>	1.25 1.50
	Genuine	2	<b>RBX101710</b>	5.65 6.78
All models with air suspension without active cornering enhancement				
Rear, standard rubber	Aftermarket	2	<b>RBX101700P</b>	1.25 1.50
	Genuine	2	<b>RBX101700</b>	2.61 3.13
All models with active cornering enhancement				
Front and rear suspension, rubber	Aftermarket	2	<b>RBX101181P</b>	1.42 1.70
	Genuine	2	<b>RBX101181</b>	2.32 2.78

## Bracket, Mounting

All models - Front & rear anti roll bar				
	Aftermarket	2	<b>RBU100240P</b>	13.13 15.76
	Genuine	2	<b>RBU100240</b>	17.49 20.99

## Bush Actuator

All models with Active Cornering Enhancement				
Front anti roll bar	Aftermarket	2	<b>RBX101740P</b>	8.13 9.76
	OEM	2	<b>RBX101740P1</b>	65.00 78.00
	Genuine	2	<b>RBX101740</b>	120.03 144.04

## Actuator, Active Roll Bar System

All models with active cornering enhancement				
Front & rear	OEM	2	<b>RQK100000P1</b>	73.33 88.00
	Genuine	2	<b>RQK100000</b>	149.46 179.35

## Shock Absorber

All models without Active Cornering Enhancement up to (VIN) 2A999999				
Front, std.	Aftermarket	2	<b>RNB103533P</b>	19.79 23.75
	OEM	2	<b>RNB103533P1</b>	42.50 51.00
	Genuine	2	<b>RNB103533</b>	60.36 72.43
All models with coil springs without Active Cornering Enhancement up to (VIN) 2A999999				
Rear, std.	Aftermarket	2	<b>RPD102333P</b>	17.50 21.00
	OEM	2	<b>RPD102333P1</b>	39.58 47.50
	Genuine	2	<b>RPD102333</b>	60.36 72.43
All models with coil springs and Active Cornering Enhancement up to (VIN) 2A999999				
Front, std.	Aftermarket	2	<b>RNB103683P</b>	19.17 23.00
	OEM	2	<b>RNB103683P1</b>	45.00 54.00
	Terrafirma	2	<b>RNB103683TFAT</b>	33.33 40.00
	Old Man Emu	2	<b>RNB103683BMOME</b>	83.33 100.00
	Genuine	2	<b>RNB103683</b>	60.36 72.43
Front, std. (pair)	Bilstein	1	<b>RNB103683BILSTEIN</b>	157.50 189.00
Rear, std.	Aftermarket	2	<b>RPD102343P</b>	16.88 20.26
	OEM	2	<b>RPD102343P1</b>	45.83 55.00
	Terrafirma	2	<b>RPD102343TFAT</b>	33.33 40.00
	Old Man Emu	2	<b>RPD102343BMOME</b>	93.33 112.00
	Genuine	2	<b>RPD102343</b>	60.36 72.43
Rear, std. (pair)	Bilstein	1	<b>RPD102343BILSTEIN</b>	142.50 171.00
All models with air suspension without Active Cornering Enhancement up to (VIN) 2A999999				
Rear, std.	Aftermarket	2	<b>RPD102363P</b>	16.88 20.26
	OEM	2	<b>RPD102363P1</b>	43.33 52.00
	Genuine	2	<b>RPD102363</b>	60.36 72.43
All models (VIN) 3A000001 on				
Front	Aftermarket	2	<b>RNB000270P</b>	17.50 21.00
	Genuine	2	<b>RNB000270</b>	96.56 115.87
Rear	Genuine	2	<b>RPD000190</b>	96.56 115.87
All models with active roll control and levelled suspension				
Front	Aftermarket	2	<b>RNB103694P</b>	19.58 23.50
	Genuine	2	<b>RNB103694</b>	60.36 72.43
Rear	Aftermarket	2	<b>RPD102354P</b>	16.88 20.26
	Genuine	2	<b>RPD102354</b>	60.36 72.43
All models				
Front	Super Gaz	2	<b>RD1248BPSUP</b>	27.92 33.50
Rear	Cellular Dynamic	2	<b>RD1249BPCEL</b>	32.50 39.00
	Super Gaz	2	<b>RD1249BPSUP</b>	27.92 33.50

## Turret Shock Absorber

All models				
Front suspension	Aftermarket	2	<b>KVU101051P</b>	83.33 100.00
	Genuine	2	<b>KVU101051</b>	93.80 112.56
Front suspension (pair)	Terrafirma	1	<b>KVU101051TF</b>	103.33 124.00

## Coil Spring

All RHD petrol models to (VIN) 2A999999				
Front RH, std	Aftermarket	1	<b>REB101340P</b>	40.83 49.00
	Genuine	1	<b>REB101340</b>	61.51 73.81
All diesel RHD models to (VIN) 2A999999				
Front RH, std	Aftermarket	1	<b>REB101341P</b>	40.83 49.00
	Genuine	1	<b>REB101341</b>	68.26 81.91
Front LH, std	Aftermarket	1	<b>REB101340P</b>	40.83 49.00
	Genuine	1	<b>REB101340</b>	61.51 73.81
All V8 petrol RHD models to (VIN) 2A999999				
Front LH, std	Aftermarket	1	<b>REB101330P</b>	16.67 20.00
	Genuine	1	<b>REB101330</b>	91.03 109.24
RHD models without XD9000 winch (VIN) 3A000001 on				
Front, RH, grey/purple	Genuine	1	<b>REB000330</b>	61.71 74.05
Front, RH, yellow/orange	Genuine	1	<b>REB000350</b>	67.99 81.59
Front, RH, yellow/purple	Genuine	1	<b>REB000310</b>	88.47 106.16
Front, LH, blue/purple	Genuine	1	<b>REB000320</b>	88.47 106.16
Front, LH, green/orange	Genuine	1	<b>REB000360</b>	67.99 81.59
Front, LH, purple	Genuine	1	<b>REB000340</b>	88.47 106.16
All models with XD9000 winch (VIN) 3A000001 on				
Front, RH/LH, brown/pink	Genuine	2	<b>REB000490</b>	68.33 82.00
All diesel LHD models to (VIN) 2A999999				
Front, std	Aftermarket	2	<b>REB101340P</b>	40.83 49.00
	Genuine	2	<b>REB101340</b>	61.51 73.81
All V8 petrol LHD models to (VIN) 2A999999				
Front, RH/LH, std	Aftermarket	2	<b>REB101330P</b>	16.67 20.00
	Genuine	2	<b>REB101330</b>	91.03 109.24
LHD models without XD9000 winch (VIN) 3A000001 on				
Front, RH/LH, yellow/purple	Genuine	2	<b>REB000310</b>	88.47 106.16
Front, RH/LH, purple/red	Genuine	2	<b>REB000300</b>	71.03 85.24
Front, RH/LH, grey/purple	Genuine	2	<b>REB000330</b>	61.71 74.05
All RHD models without air suspension				
Rear RH	Aftermarket	1	<b>RKB101101P</b>	29.58 35.50
	Genuine	1	<b>RKB101101</b>	71.67 86.00
Rear LH	Aftermarket	1	<b>RKB101100P</b>	17.50 21.00
	Genuine	1	<b>RKB101100</b>	64.47 77.36
All RHD models without air suspension with 7 seat configuration (VIN) 2A737590 on				
Rear RH, green/grey	Genuine	1	<b>RKB000340</b>	84.26 101.11
Rear LH, grey/white	Genuine	1	<b>RKB000350</b>	84.26 101.11
All RHD models without air suspension (VIN) 3A000001 on				
Rear RH, grey/pink	Genuine	1	<b>RKB000380</b>	25.98 31.18
Rear RH, orange/grey	Genuine	1	<b>RKB000310</b>	84.26 101.11
Rear LH, brown/orange	Genuine	1	<b>RKB000300</b>	67.99 81.59
Rear LH, yellow/grey	Genuine	1	<b>RKB000320</b>	81.92 98.30
All LHD models without air suspension				
Rear RH & LH	Aftermarket	2	<b>RKB101100P</b>	17.50 21.00
	Genuine	2	<b>RKB101100</b>	64.47 77.36
All LHD models without air suspension with 7 seat configuration (VIN) 2A737590 on				
Rear RH/LH, blue/grey	Genuine	2	<b>RKB000330</b>	65.07 78.08
All LHD models without air suspension (VIN) 3A000001 on				
Rear RH/LH, brown/orange	Genuine	2	<b>RKB000300</b>	67.99 81.59
Rear RH/LH, orange/grey	Genuine	2	<b>RKB000310</b>	84.26 101.11

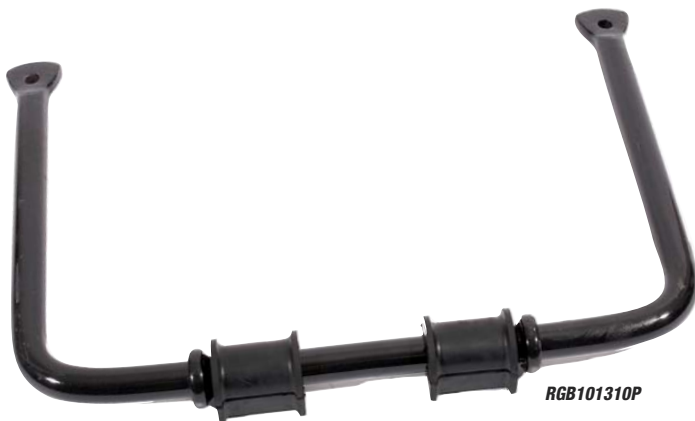

RGB101310P



# SUSPENSION

# DISCOVERY 2 (1998 to 2004)

## Coil Spring Conversion Kit

All models with air suspension - Rear, Kit includes 2 coil springs & fitting kit

standard	Britpart	1	<b>RD1206BP</b>	63.33	76.00
	Terrafirma	1	<b>RD1206TF</b>	60.00	72.00
standard	Bearmach	1	<b>RD1206BM</b>	87.50	105.00

## Lower Seat, Coil Spring

All models					
Front RH	Genuine	1	<b>REG000020</b>	38.04	45.65
Front LH	Genuine	1	<b>REG000030</b>	38.04	45.65

## Spring Isolator Upper

All models					
Front suspension	Aftermarket	2	<b>RBC100111P</b>	6.04	7.25
	Genuine	2	<b>RBC100111</b>	14.24	17.09

All models without air suspension					
Rear spring	Aftermarket	2	<b>ANR2938P</b>	3.83	4.60
	OEM	2	<b>ANR2938P1</b>	4.58	5.50
	Genuine	2	<b>ANR2938</b>	9.40	11.28

## Spring Seat Lower

All models without air suspension					
Rear spring	Aftermarket	2	<b>ANR3578P</b>	5.00	6.00
	Genuine	2	<b>ANR3578</b>	11.61	13.93

## Ball Joint

All models					
Front knuckle, upper	Aftermarket	2	<b>FTC3570P</b>	6.88	8.26
	OEM	2	<b>FTC3570P1</b>	15.00	18.00
	Genuine	2	<b>FTC3570</b>	26.73	32.08
Front knuckle, lower	Aftermarket	2	<b>FTC3571P</b>	6.88	8.26
	OEM	2	<b>FTC3571P1</b>	15.00	18.00
	Genuine	2	<b>FTC3571</b>	26.73	32.08

## Ball Joint Assembly

All models					
Swivel, upper	Aftermarket	2	<b>FTC3570P</b>	6.88	8.26
	OEM	2	<b>FTC3570P1</b>	15.00	18.00
	Genuine	2	<b>FTC3570</b>	26.73	32.08
Swivel, lower	Aftermarket	2	<b>FTC3571P</b>	6.88	8.26
	OEM	2	<b>FTC3571P1</b>	15.00	18.00
	Genuine	2	<b>FTC3571</b>	26.73	32.08

## Radius Arm Assembly

All models					
Front	Genuine	2	<b>RBJ102353</b>	568.01	681.61
Rear	Genuine	2	<b>RGG104862</b>	557.94	669.53

## Panhard Rod

All RHD models (VIN) 3A000001 on					
Front suspension	OEM	1	<b>RB1000090P1</b>	55.83	67.00
	Genuine	1	<b>RB1000090</b>	122.22	146.66

## Panhard Rod Assembly

All LHD models up to (VIN) 2A999999					
Front suspension	Genuine	1	<b>RB1100050</b>	69.26	83.11

## Panhard Rod

All LHD models (VIN) 3A000001 on					
Front suspension	Genuine	1	<b>RB1000100</b>	140.78	168.94

## Drag Link Assembly

All RHD models	Aftermarket	1	<b>QH000040P</b>	21.67	26.00
	OEM	1	<b>QH000040P1</b>	50.00	60.00
	Genuine	1	<b>QH000040</b>	88.62	106.34
All LHD models	Aftermarket	1	<b>QH000050P</b>	25.83	31.00
	OEM	1	<b>QH000050P1</b>	52.50	63.00
	Genuine	1	<b>QH000050</b>	92.27	110.72

## Knuckle, Without Hub

All models					
Front axle, RH	OEM	1	<b>TAX000040P1</b>	125.00	150.00
	Genuine	1	<b>TAX000040</b>	203.06	243.67
Front axle, LH	OEM	1	<b>TAX000050P1</b>	125.00	150.00
	Genuine	1	<b>TAX000050</b>	203.06	243.67

## Watts Linkage Centre (includes bushes)

All models - Rear, centre pivot link & bushes	Britpart	1	<b>RGD100550BPCTR</b>	130.00	156.00
-----------------------------------------------	----------	---	-----------------------	--------	--------

## Watts Linkage Arm

All models - Rear, complete with bush	Genuine	1	<b>RGD100450</b>	252.95	303.54
---------------------------------------	---------	---	------------------	--------	--------

## Watts Linkage Assembly

All models - Rear, complete with arms, centre pivot link & bushes	Genuine	1	<b>RGD100550</b>	486.57	583.88
-------------------------------------------------------------------	---------	---	------------------	--------	--------

## Vibration Damper

All models - Watts linkage, rear	Genuine	1	<b>RHE000010</b>	4.64	5.57
----------------------------------	---------	---	------------------	------	------

## Bump Stop

All models					
Front and rear suspension	Aftermarket	4	<b>RNV100060P</b>	3.33	4.00
	OEM	4	<b>RNV100060P1</b>	6.87	8.24
	Genuine	4	<b>RNV100060</b>	21.72	26.06

## Height Sensor

All models					
Rear suspension, RH and LH	Aftermarket	2	<b>RQH100030P</b>	28.33	34.00
	OEM	2	<b>RQH100030P1</b>	34.58	41.50
	Genuine	2	<b>RQH100030</b>	44.97	53.96

## Air Suspension Compressor

All models with air suspension	OEM	1	<b>RQG100041P1</b>	279.17	335.00
	Genuine	1	<b>RQG100041</b>	390.78	468.94

## Air Suspension Spring

All models with air suspension					
Rear	OEM	2	<b>RKB101200P1</b>	75.83	91.00
	Genuine	2	<b>RKB101200</b>	239.86	287.83

## Filter & Plug

All models with Active Cornering Enhancement - Active Cornering Enhancement valve block					
	OEM	1	<b>RVJ100010P1</b>	22.29	26.75
	Genuine	1	<b>RVJ100010</b>	68.68	82.42

## O Ring Seal Kit

All models with Active Cornering Enhancement to (VIN) 3A778134 - Air suspension valve block					
	OEM	1	<b>RVW100010P1</b>	14.37	17.24
	Genuine	1	<b>RVW100010</b>	22.91	27.49

## Valve Block

All models with rear air suspension - Rear air spring control					
	Genuine	1	<b>ANR4869</b>	284.00	340.80

## Shock Absorber Kit Standard

All models with standard suspension without ACE - Kit includes 2 front & 2 rear shock absorbers					
	Aftermarket	1	<b>RD1182P</b>	65.83	79.00
	Genuine	1	<b>RD1182</b>	229.17	275.00

All models with standard suspension with ACE - Kit includes 2 front & 2 rear shock absorbers					
	Aftermarket	1	<b>RD1181P</b>	60.00	72.00
	Genuine	1	<b>RD1181</b>	229.17	275.00

All models with active ride suspension without ACE - Kit includes 2 front & 2 rear shock absorbers					
	Aftermarket	1	<b>RD1184P</b>	66.67	80.00
	Genuine	1	<b>RD1184</b>	229.17	275.00

All models with active ride suspension with ACE - Kit includes 2 front & 2 rear shock absorbers					
	Aftermarket	1	<b>RD1183P</b>	62.50	75.00
	Genuine	1	<b>RD1183</b>	229.17	275.00

## Shock Absorber Kit Upated

All models - Kit includes 2 front & 2 rear shock absorbers					
Heavy Duty Gas	Bilstein	1	<b>RD1200BILSTEIN</b>	287.50	345.00

## Torsion Bar

All models with ACE suspension					
Front	Genuine	1	<b>RBL101400</b>	464.71	557.65
Rear	Genuine	1	<b>RGB101330</b>	440.58	528.70

## Roller Bearing Watts Linkage

All models					
Rear suspension	Aftermarket	1	<b>RGW100020P</b>	31.25	37.50
	Genuine	1	<b>RGW100020</b>	47.53	57.04



RD1200BILSTEIN



## DISCOVERY 2 (1998 to 2004)

## STEERING

## Drop Arm Lever

All RHD models up to (VIN) 2A999999 - Steering box							
			OEM	1	<b>QJF100140P1</b>	32.50	39.00
			Genuine	1	<b>QJF100140</b>	86.14	103.37

## Drop Arm

All RHD models (VIN) 3A000001 on - Steering box							
			Genuine	1	<b>QJF000020</b>	74.20	89.04

## Heavy Duty Steering Arm Kit

All models - Includes cross rod and track rod (4 ball joints).							
			Terrafirma	1	<b>RD1254TF</b>	99.00	118.80
			Britpart	1	<b>RD1254BP</b>	90.00	108.00
			Bearmach	1	<b>RD1254BM</b>	85.83	103.00

*Does not require steering damper*

## Drag Link Assembly

All RHD models							
			Aftermarket	1	<b>QH000040P</b>	21.67	26.00
			OEM	1	<b>QH000040P1</b>	50.00	60.00
			Genuine	1	<b>QH000040</b>	88.62	106.34
All LHD models							
			Aftermarket	1	<b>QH000050P</b>	25.83	31.00
			OEM	1	<b>QH000050P1</b>	52.50	63.00
			Genuine	1	<b>QH000050</b>	92.27	110.72

## Drag Link Clamp

All models								
			Large	Genuine	1	<b>QJK100000</b>	7.53	9.04
			Small	Aftermarket	1	<b>QJK100010P</b>	1.58	1.90
				Genuine	1	<b>QJK100010</b>	7.53	9.04

## Tube, Drag Link

All RHD models							
			Aftermarket	1	<b>QEK000020P</b>	27.08	32.50
			Genuine	1	<b>QEK000020</b>	90.15	108.18
All LHD models							
			Aftermarket	1	<b>QEK000030</b>	90.18	108.22

## Track Rod End &amp; Tube

All models - Long joint							
			Genuine	1	<b>QFS000040</b>	93.74	112.49

## Universal Joint Kit

All models from (VIN) 3A802784 on - Lower							
			Genuine	1	<b>QLE500010</b>	61.08	73.30

## Steering Damper Assembly

All models							
			Aftermarket	1	<b>QHH100001P</b>	16.67	20.00
			Bilstein	1	<b>QHH100001UR</b>	65.00	78.00
			Terrafirma	1	<b>QHH100001TF</b>	33.75	40.50
			Cellular Dynamic	1	<b>QHH100001URBPCEL</b>	33.33	40.00
			Genuine	1	<b>QHH100001</b>	66.03	79.24

## Track Rod End

All models							
Short joint, for cross rod & track rod							
			Aftermarket	1	<b>QFS000010P</b>	5.63	6.76
			OEM	1	<b>QFS000010P1</b>	13.75	16.50
			Genuine	1	<b>QFS000010</b>	36.07	43.28
Long arm track rod							
			Aftermarket	1	<b>QFS000040P</b>	30.00	36.00
			Genuine	1	<b>QFS000040</b>	93.74	112.49

## Track Rod Assembly

All models							
			Aftermarket	1	<b>TIQ000010P</b>	22.92	27.50
			OEM	1	<b>TIQ000010P1</b>	50.00	60.00
			Genuine	1	<b>TIQ000010</b>	92.35	110.82

## Repair Kit Steering Box

All models							
Main kit							
			Aftermarket	1	<b>QFW100140P</b>	37.50	45.00
			OEM	1	<b>QFW100140P1</b>	48.33	58.00
			Genuine	1	<b>QFW100140</b>	95.75	114.90
Input kit							
			Aftermarket	1	<b>QFW100150P</b>	3.00	3.60
			Genuine	1	<b>QFW100150</b>	27.28	32.74
Output kit							
			Aftermarket	1	<b>QFW100180P</b>	12.08	14.50
			Genuine	1	<b>QFW100180</b>	25.47	30.56
Secondary kit							
			OEM	1	<b>QFW100190P1</b>	10.00	12.00
			Genuine	1	<b>QFW100190</b>	22.48	26.98

## Power Steering Fluid

All models - 1 litre. Cold (standard) climates fluid							
			Aftermarket	a/r	<b>STC50519P</b>	12.08	14.50
			Genuine	a/r	<b>STC50519</b>	18.96	22.75

## DISCOVERY 2 (1998 to 2004)

## CLUTCH

## Clutch Kit

All 2.5L TD5 diesel manual models							
			Aftermarket	1	<b>LL1082P</b>	68.33	82.00
			OEM	1	<b>LL1082P1</b>	95.00	114.00
			Genuine	1	<b>LL1082</b>	262.50	315.00
All V8 petrol manual models <i>Includes clutch cover, plate, release bearing &amp; clip</i>							
			Aftermarket	1	<b>RD1193P</b>	105.00	126.00
			Genuine	1	<b>RD1193</b>	310.00	372.00

## Clutch Plate &amp; Cover Assembly

All 2.5L TD5 diesel manual models							
			Britpart	1	<b>LL1082BPFWCLUTCH</b>	70.00	84.00

*Includes clutch plate & cover for heavy duty one piece flywheel*

## Dual Mass Flywheel &amp; Clutch Kit

All 2.5L TD5 diesel manual models							
			Britpart	1	<b>LL1082BPFW</b>	333.33	400.00

*Includes clutch plate, cover, self centering bearing & dual mass flywheel*

## One Piece Flywheel &amp; Clutch Kit

All 2.5L TD5 diesel manual models							
			Britpart	1	<b>LL1082BPFWHD</b>	333.33	400.00

*Includes clutch plate, cover, self centering bearing & heavy duty one piece flywheel*

## Clutch Cover

All 2.5L TD5 diesel models							
			Aftermarket	1	<b>FTC4630P</b>	35.83	43.00
			Genuine	1	<b>FTC4630</b>	132.20	158.64
All V8 petrol models							
			OEM	1	<b>FTC5301P1</b>	52.50	63.00
			Genuine	1	<b>FTC5301</b>	147.06	176.47

## Clutch Plate

All 2.5L TD5 diesel models							
			Aftermarket	1	<b>QUB000120P</b>	31.67	38.00
			OEM	1	<b>QUB000120P1</b>	60.00	72.00
			Genuine	1	<b>QUB000120</b>	114.28	137.14
All V8 petrol models							
			Aftermarket	1	<b>8510309P</b>	37.50	45.00
			OEM	1	<b>8510309P1</b>	47.50	57.00
			Genuine	1	<b>8510309</b>	147.06	176.47

## Drive Plate

All V8 petrol models							
			Aftermarket	1	<b>FTC4607P</b>	7.50	9.00
			Genuine	1	<b>FTC4607</b>	31.41	37.69

## Clutch Release Bearing

All models - With carrier							
			Aftermarket	1	<b>FTC5200P</b>	7.92	9.50
			OEM	1	<b>FTC5200P1</b>	12.50	15.00
			Genuine	1	<b>FTC5200</b>	37.38	44.86
Heavy Duty							
			Britpart	1	<b>FTC5200HDBP</b>	45.83	55.00
			Bearmach	1	<b>FTC5200HDBM</b>	80.00	96.00
All 2.5L TD5 diesel manual models - For heavy duty one piece flywheel							
			Genuine	1	<b>LL1082BPFWHD BRG</b>	46.67	56.00

## Clutch Hose &amp; Pipe Assembly

All 2.5L TD5 diesel manual models - To slave cylinder							
			Genuine	1	<b>STG101032</b>	81.77	98.12
All V8 petrol manual models - To master cylinder							
			Genuine	1	<b>STG101062</b>	48.00	57.60

## Clutch Pipe Assembly

All RHD 2.5L TD5 diesel manual models up to (VIN) 2A999999								
			Master cylinder to union	Genuine	1	<b>STG101160</b>	30.73	36.88
			Union to hose	Genuine	1	<b>STG101170</b>	30.73	36.88
All RHD 2.5L TD5 diesel manual models from (VIN) 3A000001 on								
			Master cylinder to union	Genuine	1	<b>STG500040</b>	30.73	36.88
All LHD 2.5L TD5 diesel manual models up to (VIN) 2A999999								
			Master cylinder to union	Genuine	1	<b>STG101180</b>	31.20	37.44
			Union to hose	Genuine	1	<b>STG101190</b>	30.73	36.88
All LHD 2.5L TD5 diesel manual models from (VIN) 3A000001 on								
			Master cylinder to union	Genuine	1	<b>STG500040</b>	30.73	36.88
All manual models								
			Reservoir to master cylinder	Genuine	1	<b>STH100180</b>	4.94	5.93

## Slave Cylinder Repair Kit

All models							
			Aftermarket	1	<b>STC2818P</b>	1.25	1.50
			OEM	1	<b>STC2818P1</b>	4.00	4.80
			Genuine	1	<b>STC2818</b>	6.22	7.46

## Clutch Master Cylinder

All 2.5L TD5 diesel models							
			OEM	1	<b>STC000280P1</b>	60.83	73.00
			Genuine	1	<b>STC000280</b>	154.36	185.23
All V8 petrol models up to (VIN) 2A999999							
			OEM	1	<b>STC100390P1</b>	29.58	35.50
			Genuine	1	<b>STC100390</b>	164.32	197.18
All V8 petrol models from (VIN) 3A000001 on							
			OEM	1	<b>STC000220P1</b>	50.00	60.00
			Genuine	1	<b>STC000220</b>	127.25	152.70

## Clutch Slave Cylinder

All models							
			Aftermarket	1	<b>FTC5202P</b>	7.08	8.50
			OEM	1	<b>FTC5202P1</b>	11.04	13.25
			Genuine	1	<b>FTC5202</b>	62.08	74.50

## Push Rod Clip

All models							
			Aftermarket	1	<b>576723P</b>	0.38	0.46
			Genuine	1	<b>576723</b>	3.95	4.74

## Push Rod

All models							
			Genuine	1	<b>FTC5199</b>	7.67	9.20

## Bleed Screw Clutch Slave Cylinder

All models							
			Genuine	1	<b>606733A</b>	2.58	3.10

## Dowel Clutch Guide

All models							
			Genuine	2	<b>FRC2481</b>	2.29	2.75





# TRANSMISSION

# DISCOVERY 2 (1998 to 2004)

## Constant Velocity Joint

All models	Aftermarket	2	<b>TDR100790P</b>	27.50	33.00
	OEM	2	<b>TDR100790P1</b>	125.00	150.00
	Genuine	2	<b>TDR100790</b>	245.31	294.37

## Gaiter Propshaft

All models - Rear	Aftermarket	1	<b>TVE100000P</b>	2.58	3.10
	OEM	1	<b>TVE100000P1</b>	3.08	3.70
	Genuine	1	<b>TVE100000</b>	15.14	18.17

## Propshaft Coupling

All models - Without fixings	Aftermarket	1	<b>TVF100010P</b>	13.96	16.75
	OEM	1	<b>TVF100010P1</b>	32.50	39.00
	Genuine	1	<b>TVF100010</b>	69.22	83.06

## Bearing & Bolt Kit

All models - Rear propshaft coupling	Aftermarket	1	<b>TVF100010PKIT</b>	6.88	8.26
--------------------------------------	-------------	---	----------------------	------	------

## Shaft Front Axle

All models RH	OEM	1	<b>TDB500250P1</b>	145.83	175.00
	Genuine	1	<b>TDB500250</b>	506.94	608.33
LH	OEM	1	<b>TDB500240P1</b>	145.00	174.00
	Genuine	1	<b>TDB500240</b>	557.64	669.17

## Shaft Assembly Front Output

All models with LT230 transfer box	Aftermarket	1	<b>FRC5449P</b>	38.75	46.50
	Genuine	1	<b>FRC5449</b>	190.22	228.26

## Half Shaft

All models - Rear axle	Genuine	1	<b>TOD100020</b>	357.77	429.32
		1	<b>TOD100030P1</b>	115.00	138.00
		1	<b>TOD100030</b>	307.73	369.28

## Half Shaft Set, Heavy Duty

All models - Pair of heavy duty half shafts with CV joints	Bearmach	1	<b>TDB500240-50BMHD</b>	783.33	940.00
------------------------------------------------------------	----------	---	-------------------------	--------	--------

## Drive Flange & Seal Kit

All models - Transfer box, front output shaft	OEM	1	<b>STC4379P</b>	32.50	39.00
	Genuine	1	<b>STC4379</b>	154.80	185.76

## Gaiter Kit Front Drive Shaft

All models	Aftermarket	2	<b>TDR100780P</b>	3.58	4.30
	OEM	2	<b>TDR100780P1</b>	9.79	11.75
	Genuine	2	<b>TDR100780</b>	24.73	29.68

## Hub & Bearing Assembly

All models Front	Aftermarket	1	<b>TAY100060P</b>	65.00	78.00
	OEM	1	<b>TAY100060P1</b>	125.00	150.00
	Genuine	1	<b>TAY100060</b>	343.26	411.91
Rear	Aftermarket	2	<b>TAY100050P</b>	75.00	90.00
	OEM	2	<b>TAY100050P1</b>	141.67	170.00
	Genuine	2	<b>TAY100050</b>	321.64	385.97

## Hub & Sleeve Assembly Trans Box

All models with LT230 transfer box	OEM	1	<b>FTC5099P1</b>	110.83	133.00
	Genuine	1	<b>FTC5099</b>	271.78	326.14

## Gasket Gearbox Sump

All models with auto gearbox	Aftermarket	1	<b>RTC4268P</b>	2.50	3.00
	OEM	1	<b>RTC4268P1</b>	4.00	4.80
	Genuine	1	<b>RTC4268</b>	16.52	19.82

## Oil Seal Diff Pinion Front

All models - Front and rear axle	Aftermarket	1	<b>FTC5258P</b>	1.50	1.80
	OEM	1	<b>FTC5258P1</b>	4.08	4.90
	Genuine	1	<b>FTC5258</b>	13.96	16.75

## Seal Drive Shaft Front

All models	Aftermarket	2	<b>FTC4822P</b>	3.33	4.00
	Genuine	2	<b>FTC4822</b>	14.67	17.60

## Seal Output Shaft

All models with R380 5 speed gearbox	Aftermarket	1	<b>FTC500010P</b>	1.00	1.20
	Genuine	1	<b>FTC500010</b>	12.07	14.48

## Oil Seal Transfer Box Output Flange

All models with LT230 transfer box	Aftermarket	1	<b>FTC4939P</b>	2.00	2.40
	OEM	1	<b>FTC4939P1</b>	5.00	6.00
	Genuine	1	<b>FTC4939</b>	13.18	15.82

## Oil Seal Transfer Box Input

All models with LT230 transfer box	Aftermarket	1	<b>ICV100000P</b>	0.92	1.10
	OEM	1	<b>ICV100000P1</b>	3.83	4.60
	Genuine	1	<b>ICV100000</b>	6.99	8.39

## Oil Seal Front Cover

All models with R380 5 speed gearbox	Aftermarket	1	<b>UKC1060P</b>	1.58	1.90
	Aftermarket	1	<b>UKC1060</b>	5.63	6.76

## Oil Seal Oil Pump Housing

All models with 4 speed auto gearbox	Aftermarket	1	<b>RTC5102P</b>	6.04	7.25
	Genuine	1	<b>RTC5102</b>	16.12	19.34

## Drain Plug Diff Unit

All models	Aftermarket	1	<b>608246P</b>	2.33	2.80
	Genuine	1	<b>608246</b>	9.63	11.56

## Drain Plug Transfer Box

All models with LT230 transfer box	Aftermarket	1	<b>599552P</b>	2.83	3.40
	Genuine	1	<b>599552</b>	8.99	10.79

## Plug, Oil Filler & Level

All models - Front & rear axles	Aftermarket	1	<b>FTC5403P</b>	1.75	2.10
	Genuine	1	<b>FTC5403</b>	2.60	3.12

## Sealing Washer Drain Plug

All models with R380 5 speed gearbox	Alternative to FRC7064A	Aftermarket	1	<b>FTC4112P</b>	0.79	0.95
		Genuine	1	<b>FTC4112</b>	2.37	2.84
		Aftermarket	1	<b>FRC7064A</b>	1.08	1.30

## Switch, Gearbox

All models up to (VIN) 2A999999 - High/Low, with spade connectors					
All models up to (VIN) 2A999999 - High/Low, with spade connectors	Aftermarket	1	<b>PRC2911P</b>	4.08	4.90
	OEM	1	<b>PRC2911P1</b>	7.92	9.50
	Genuine	1	<b>PRC2911</b>	35.18	42.22

## Switch, Transfer Box

All models - Low ratio detection	Genuine	1	<b>IGM100000</b>	42.77	51.32
All models from (VIN) 3A771055 on - High/Low, with harness and plug	Aftermarket	1	<b>IGM500011P</b>	10.62	12.74
	Genuine	1	<b>IGM500011</b>	25.94	31.13

All V8 petrol models - Transfer box temperature					
All V8 petrol models - Transfer box temperature	OEM	1	<b>PRC7984P1</b>	27.92	33.50
	Genuine	1	<b>PRC7984</b>	35.22	42.26

## Damper, Vibration

All models - Rear axle	Genuine	2	<b>TVG100000</b>	125.78	150.94
------------------------	---------	---	------------------	--------	--------



TDB500240-50BMHD

TAY100050P



TVG100000



## DISCOVERY 2 (1998 to 2004)

## COOLING

## Expansion Bottle Cap

All models	Aftermarket	1	PCD000070P	3.42	4.10
	OEM	1	PCD000070P1	7.08	8.50
	Genuine	1	PCD000070A	11.91	14.29
	Genuine	1	PCD000070	9.02	10.82

## Thermostat Housing

All 2.5L TD5 diesel models up to (VIN) 5A476242					
	Aftermarket	1	PEM100990P	12.92	15.50
	OEM	1	PEM100990P1	16.67	20.00
	Genuine	1	PEM100990	29.47	35.36
All 2.5L TD5 diesel engine models from (VIN) 5A476243 on					
	OEM	1	PEL500110P1	24.58	29.50
	Genuine	1	PEL500110	40.55	48.66

## Water Pump

All 2.5L TD5 diesel engine models					
	Aftermarket	1	PEM500040P	15.00	18.00
	OEM	1	PEM500040P1	27.50	33.00
	Genuine	1	PEM500040	116.96	140.35
All V8 petrol engine models					
	Aftermarket	1	STC4378P	28.75	34.50
	OEM	1	STC4378P1	53.33	64.00
	Genuine*	1	STC4378	128.66	154.39
			*Exchange Surcharge	40.00	48.00

## D Ring Set

All 2.5L TD5 diesel engine models - Water pump					
	Aftermarket	1	PFQ10001LP	5.00	6.00
	Genuine	1	PFQ10001L	8.01	9.61

## Water Pump Seal

All 2.5L TD5 diesel models					
	Aftermarket	1	ERR6711P	3.00	3.60
	Genuine	1	ERR6711	5.04	6.05

## Water Pump Gasket

All petrol engine models - Water pump					
	Aftermarket	1	ERR4077P	1.50	1.80
	Genuine	1	ERR4077	8.44	10.13

## Intercooler Hose

All 2.5L TD5 diesel engine models					
	Aftermarket	1	ESR4640P	7.50	9.00
	Genuine	1	ESR4640	36.30	43.56

## Intercooler Pipe &amp; Hose Kit

All 2.5L TD5 diesel models - LH, intercooler to turbocharger					
	Genuine	1	PNH102101	102.06	122.47

## Intercooler Hose

All 2.5L TD5 diesel models					
LH rear, short	Genuine	1	PNH102111	24.06	28.87
LH, intercooler to pipe	Genuine	1	PNH102121	25.31	30.37

## Temperature Sensor

TD5 diesel engine models					
	Aftermarket	1	ERR2081P	3.25	3.90
	OEM	1	ERR2081P1	9.79	11.75
	Genuine	1	ERR2081	14.00	16.80
V8 petrol engine models to (VIN) 3A818214					
	OEM	1	MEK100160P1	10.00	12.00
	Genuine	1	MEK100160	24.04	28.85

## Coolant Temperature Sensor

All V8 EFI petrol models from (VIN) 3A818215 on					
	Aftermarket	1	MEK500130P	5.42	6.50
	Genuine	1	MEK500130	15.29	18.35

## DISCOVERY 2 (1998 to 2004)

## ELECTRICS - ROTATING ELECTRICS

## Alternator

All TD5 diesel models - A127-120Amp					
New, outright	Aftermarket	1	ERR6999P	150.83	181.00
	OEM	1	ERR6999P1	195.00	234.00
New, exchange	Genuine*	1	ERR6999	612.34	734.81
			*Exchange Surcharge	70.00	84.00
All V8 petrol models up to (VIN) 3A239591					
New, outright	Aftermarket	1	ERR6413P	96.67	116.00
New, exchange	Genuine*	1	ERR6413	462.32	554.78
			*Exchange Surcharge	70.00	84.00
All V8 petrol models from (VIN) 3A239592 on					
New, outright	Aftermarket	1	YLE500090P	145.00	174.00
Reconditioned, exchange	Genuine*	1	YLE500090E	297.56	357.07
			*Exchange Surcharge	70.00	84.00
New, exchange	Genuine*	1	YLE500090	476.19	571.43
			*Exchange Surcharge	150.00	180.00

## Starter Motor

All models with TD5 diesel engine					
New, outright	Aftermarket	1	NAD101240P	85.00	102.00
Reconditioned, exchange	Genuine*	1	NAD101240E	169.28	203.14
			*Exchange Surcharge	70.00	84.00
New, exchange	Genuine*	1	NAD101240	275.36	330.43
			*Exchange Surcharge	70.00	84.00
All models with V8 EFI petrol engine - Bosch type					
New, outright	Aftermarket	1	NAD101490P	70.00	84.00
	OEM	1	NAD101490P1	155.00	186.00
Reconditioned, exchange	Genuine*	1	NAD101490E	129.64	155.57
			*Exchange Surcharge	70.00	84.00
New, exchange	Genuine*	1	NAD101490	208.17	249.80
			*Exchange Surcharge	70.00	84.00

## DISCOVERY 2 (1998 to 2004)

## ENGINE GASKETS

## Gasket Camshaft Cover

TD5 diesel models up to (VIN) 1A736339					
	Aftermarket	1	ERR7094P	3.50	4.20
	OEM	1	ERR7094P1	8.54	10.25
	Genuine	1	ERR7094	27.07	32.48
TD5 diesel models from (VIN) 2A736340 on					
	Aftermarket	1	LVP000020P	2.75	3.30
	OEM	1	LVP000020P1	8.13	9.76
	Genuine	1	LVP000020	28.37	34.04

## Gasket Rocker Cover

All V8 petrol models					
Cork	OEM	2	GEG436	1.58	1.90
Rubber	OEM	2	GEG436UPRATED	2.65	3.18

## Gasket Cylinder Head

2.5L TD5 diesel models					
1.20mm, two holes					
	Aftermarket	1	LVB000240P	12.50	15.00
	OEM	1	LVB000240P1	25.00	30.00
	Genuine	1	LVB000240	57.56	69.07
1.27mm, one hole					
	Aftermarket	1	LVB000250P	12.50	15.00
	OEM	1	LVB000250P1	25.00	30.00
	Genuine	1	LVB000250	38.40	46.08
1.35mm, three holes					
	Aftermarket	1	LVB000260P	12.50	15.00
	OEM	1	LVB000260P1	25.00	30.00
	Genuine	1	LVB000260	60.51	72.61

## Original Style Composite Head Gasket

4.0L and 4.6L V8 petrol with 2 rows of head bolts					
	Aftermarket	2	LVB500030P	4.58	5.50
	OEM	2	LVB500030P1	8.13	9.76
	Genuine	2	LVB500030	39.14	46.97

## Gasket Decoke Set

All V8 EFI petrol models - Engines with 2 rows of head bolts (COMPOSITE)					
	Aftermarket	1	RA1233P	57.50	69.00
	Genuine	1	RA1233	90.83	109.00

## Gasket Oil Sump

2.5L TD5 diesel models					
	Aftermarket	1	LVF500040P	8.54	10.25
	Genuine	1	LVF500040	20.20	24.24

## Gasket Conversion Set

All V8 petrol models					
	Aftermarket	1	STC1639P38	15.63	18.76

## Silicone Sealant RTV

Numerous applications					
	Aftermarket	a/r	RTC3254P	5.00	6.00
	Genuine	a/r	RTC3254	21.04	25.25

## Sealant Instant Gasket

Numerous applications					
	Genuine	a/r	STC50550	13.10	15.72



LVB000240P

# ENGINE SWITCHES

## Camshaft Sensor

V8 petrol models	OEM	1	<b>ERR6169P1</b>	100.00	120.00
	Genuine	1	<b>ERR6169</b>	151.58	181.90

## Crankshaft Sensor Assembly

All 2.5L TD5 diesel models	Aftermarket	1	<b>NSC100790P</b>	19.58	23.50
	Genuine	1	<b>NSC100790</b>	167.25	200.70

## Crankshaft Position Sensor

All V8 EFI petrol manual models	Aftermarket	1	<b>ERR7352P</b>	65.00	78.00
	Genuine	1	<b>ERR7352</b>	86.27	103.52
All V8 EFI petrol automatic models	Aftermarket	1	<b>ERR7354P</b>	30.00	36.00
	OEM	1	<b>ERR7354P1</b>	47.50	57.00
	Genuine	1	<b>ERR7354</b>	68.41	82.09

## Oil Temperature Switch

All 2.5L TD5 diesel models up to (VIN) 4A869986 - Gearbox oil cooler	Aftermarket	1	<b>UB1100030P</b>	39.58	47.50
	Genuine	1	<b>UB1100030</b>	88.98	106.78
All V8 petrol models up to (VIN) 3A836443 - Gearbox oil cooler	Aftermarket	1	<b>UB1100030P</b>	39.58	47.50
	Genuine	1	<b>UB1100030</b>	88.98	106.78

## Engine Knock Sensor

All V8 EFI petrol models	Aftermarket	1	<b>NSC100650P</b>	19.58	23.50
	Genuine	1	<b>NSC100650</b>	58.77	70.52

## Manifold Absolute Pressure Sensor

All 2.5L TD5 diesel models up to (VIN) YA711530	MG Rover	1	<b>MHK100600</b>	151.82	182.18
	Genuine	1	<b>MHK100600L</b>	267.11	320.53
All 2.5L TD5 diesel models from (VIN) YA711531 on	Genuine	1	<b>MHK100820L</b>	96.22	115.46

## Manifold Pressure Sensor

2.5L TD5 diesel engine models	Aftermarket	1	<b>MHK100640P</b>	16.55	19.86
	Genuine	1	<b>MHK100640</b>	98.86	118.63

## Oil Pressure Switch

2.5L TD5 diesel engine models Parallel thread (not tapered)	Aftermarket	1	<b>NUC000020P</b>	3.00	3.60
	Genuine	1	<b>NUC000020</b>	6.52	7.82
Tapered thread (not parallel)	Aftermarket	1	<b>NUC10003P</b>	3.25	3.90
	Genuine	1	<b>NUC10003</b>	6.94	8.33
All V8 petrol engine models up to (VIN) XA231750	Aftermarket	1	<b>STC4104P</b>	3.00	3.60
	OEM	1	<b>STC4104P1</b>	12.50	15.00
	Genuine	1	<b>STC4104</b>	29.01	34.81
V8 petrol engine models from (VIN) XA231751 on	Aftermarket	1	<b>LR058003P</b>	2.50	3.00
	OEM	1	<b>LR058003P1</b>	3.00	3.60
	Genuine	1	<b>LR058003</b>	15.35	18.42
All V8 EFI petrol models from (VIN) XA231751 on - Fits timing cover, parallel thread	Aftermarket	1	<b>NUC100280LP</b>	3.00	3.60
	Genuine	1	<b>NUC100280L</b>	13.26	15.91

## Oxygen Sensor

V8 petrol models Forward	Aftermarket	1	<b>MHK100920P</b>	35.00	42.00
	OEM	1	<b>MHK100920P1</b>	55.00	66.00
	Genuine	1	<b>MHK100920</b>	136.28	163.54
V8 petrol models California emissions Rearward	Aftermarket	1	<b>MHK100930P</b>	29.58	35.50
	Genuine	1	<b>MHK100930</b>	131.65	157.98

# DRAIN PLUGS

## Sump Plug

All models with TD5 diesel engine	Aftermarket	1	<b>TRL100040P</b>	2.08	2.50
	OEM	1	<b>TRL100040P1</b>	3.50	4.20
	Genuine	1	<b>TRL100040</b>	4.54	5.45
All V8 EFI petrol models	OEM	1	<b>LSF100040LP1</b>	1.50	1.80
	Genuine	1	<b>LSF100040L</b>	3.13	3.76

## Sump Plug Washer

All TD5 diesel models	Aftermarket	1	<b>CDU1001</b>	0.54	0.65
-----------------------	-------------	---	----------------	------	------

## Sealing Washer Sump Plug

All models with R380 5 speed gearbox	Aftermarket	1	<b>ALU1403LP</b>	0.54	0.65
	Genuine	1	<b>ALU1403L</b>	1.11	1.33
All models with LT230 transfer box	Aftermarket	1	<b>ALU1403LP</b>	0.54	0.65
	Genuine	1	<b>ALU1403L</b>	1.11	1.33
All V8 EFI petrol models	Aftermarket	1	<b>ALU1403LP</b>	0.54	0.65
	Genuine	1	<b>ALU1403L</b>	1.11	1.33

## Grommet

All V8 petrol models - Sump drain plug	Genuine	1	<b>ERR7229</b>	6.23	7.48
----------------------------------------	---------	---	----------------	------	------

## Oil Drain Valve Kit

All V8 EFI petrol models	Aftermarket	1	<b>LSF100040LODV</b>	32.08	38.50
--------------------------	-------------	---	----------------------	-------	-------



LSF100040LODV

## Drain Plug

All models with 4 speed automatic transmission - Magnetic, gearbox	Genuine	1	<b>STC4098</b>	1.93	2.32
	Genuine	1	<b>STC4098</b>	1.93	2.32
All 2.5L TD5 diesel models with fuel filter fitted with drain Fuel filter/sedimentor	Genuine	1	<b>YXJ500060NAA</b>	2.99	3.59

## Drain Plug Washer

All models with 4 speed automatic transmission - Gearbox	Genuine	1	<b>STC4099</b>	1.58	1.90
----------------------------------------------------------	---------	---	----------------	------	------

## Filler Plug

All models with 5 speed R380 gearbox - Gearbox	OEM	1	<b>FTC4056P1</b>	6.46	7.75
	Genuine	1	<b>FTC4056</b>	6.98	8.38

## Wading Plug

All models with 5 speed R380 gearbox - Gearbox bellhousing. Alternative to 3290A	OEM	1	<b>FTC4056P1</b>	6.46	7.75
	Genuine	1	<b>FTC4056</b>	6.98	8.38

## O Ring Oil Screen

All models with 4 speed auto gearbox	Aftermarket	1	<b>RTC4276P</b>	0.38	0.46
	Genuine	1	<b>RTC4276</b>	1.80	2.16



FTC4056

# OIL SEALS ENGINE

## Oil Seal Crankshaft - Front

All V8 petrol models	OEM	1	<b>ERR6490P1</b>	5.00	6.00
	Aftermarket	1	<b>ERR6490P</b>	3.00	3.60

## Oil Seal Front Cover

V8 petrol models	Aftermarket	1	<b>ETC4154P</b>	1.08	1.30
	OEM	1	<b>ETC4154P1</b>	3.00	3.60
	Genuine	1	<b>ETC4154</b>	14.67	17.60

## Oil Seal Crankshaft - Rear

2.5L TD5 diesel models	Aftermarket	1	<b>LUF100420P</b>	7.50	9.00
	OEM	1	<b>LUF100420P1</b>	9.79	11.75
	Genuine	1	<b>LUF100420</b>	21.82	26.18
All V8 petrol models - Lip type seal	Aftermarket	1	<b>ERR2640P</b>	3.00	3.60
	OEM	1	<b>ERR2640P1</b>	7.92	9.50
	Genuine	1	<b>ERR2640</b>	15.58	18.70

## Oil Seal Camshaft - Front

TD5 diesel models	Aftermarket	1	<b>LDI100030P</b>	4.00	4.80
	Genuine	1	<b>LDI100030</b>	16.82	20.18

## Oil Seal Camshaft - Rear

TD5 diesel models	Aftermarket	1	<b>ERR5369P</b>	1.33	1.60
	OEM	1	<b>ERR5369P1</b>	1.58	1.90
	Genuine	1	<b>ERR5369</b>	2.89	3.47



ERR5369P1





## DISCOVERY 2 (1998 to 2004)

## EXHAUST GAS RECIRCULATION (EGR)

## EGR Valve

All 2.5L TD5 diesel models	Genuine	1	WAV100270	141.36	169.63
	Genuine	2	MSG100110	59.46	71.35

## EGR Blanking Kit

All 2.5L TD5 diesel models	Terrafirma	2	LL1474TF	34.58	41.50
<i>Includes blanking plate, bypass tube &amp; gasket</i>	Britpart	2	LL1474BP	29.58	35.50
	Bearmach	2	LL1474BM	33.75	40.50

## Gasket

All 2.5L TD5 diesel engine models - Exhaust gas recirculation valve to pipe	Genuine	1	ERR6620	1.75	2.10
-----------------------------------------------------------------------------	---------	---	---------	------	------

## Gasket EGR Valve to pipe

All 2.5L TD5 diesel models	Genuine	1	WAL100240	0.80	0.96
----------------------------	---------	---	-----------	------	------

## EGR Cooler Hose

All 2.5L TD5 diesel engine models	Genuine	1	PEH000310	9.56	11.47
-----------------------------------	---------	---	-----------	------	-------

## EGR Cooler Return Hose

All 2.5L TD5 diesel engine models	Genuine	1	PCH001360	27.59	33.11
-----------------------------------	---------	---	-----------	-------	-------

## Pipe EGR Valve to Filter

All 2.5L TD5 diesel models	Genuine	1	WAP000050	23.74	28.49
----------------------------	---------	---	-----------	-------	-------

## Pipe EGR Modulator to Air Cleaner

All 2.5L TD5 diesel models from (VIN) 1A295543 on	Genuine	1	WAP000060	7.39	8.87
---------------------------------------------------	---------	---	-----------	------	------

## Pipe EGR Valve

All 2.5L TD5 diesel models	Genuine	1	WAP101220	141.93	170.32
----------------------------	---------	---	-----------	--------	--------

## DISCOVERY 2 (1998 to 2004)

## ENGINE &amp; GEARBOX MOUNTINGS

## Engine Mounting

All TD5 diesel models - Engine	Aftermarket	2	KKB500750P	25.00	30.00
	Genuine	2	KKB500750	50.59	60.71
All V8 petrol models - Engine	Aftermarket	2	KKB102450P	10.63	12.76
	OEM	2	KKB102450P1	35.83	43.00
	Genuine	2	KKB102450	42.94	51.53

## Bracket Engine Mounting

All 2.5L TD5 diesel models	Genuine	1	KKU000740	58.89	70.67
RH	Genuine	1	ANR6623	363.80	436.56
LH					
All V8 petrol models	Genuine	1	KKU106200	34.63	41.56
RH	Genuine	1	ANR6338	34.63	41.56
LH					

## Gearbox Mounting

All models	Aftermarket	1	KQB500550P	5.00	6.00
RH	Genuine	1	KQB500550	14.42	17.30
LH	Aftermarket	1	KQB500560P	6.88	8.26
	Genuine	1	KQB500560	17.61	21.13

## Bracket Gearbox Mounting

All models	Genuine	1	ANR5636	17.16	20.59
RH	Genuine	1	KKU000710	12.63	15.16
LH					
All automatic models - LH	Genuine	1	ANR5639	40.44	48.53

## DISCOVERY 2 (1998 to 2004)

## FUEL SYSTEM SWITCHES

## Throttle Position Sensor

All V8 EFI petrol models	Aftermarket	1	ERR7322P	19.58	23.50
	OEM	1	ERR7322P1	28.33	34.00
	Genuine	1	ERR7322	251.99	302.39

## Water Sensor for Fuel Filter

2.5L TD5 diesel models	Aftermarket	1	WKW500070P	19.58	23.50
	Genuine	1	WKW500070	58.49	70.19

## Air Flow Sensor

2.5L TD5 diesel models	Aftermarket	1	MHK100620P	26.25	31.50
	OEM	1	MHK100620P1	60.00	72.00
	Genuine	1	MHK100620	123.84	148.61
4.0L V8 EFI petrol models	Aftermarket	1	ERR7171P	31.67	38.00
	OEM	1	ERR7171P1	95.00	114.00
	Genuine	1	ERR7171	123.84	148.61
4.6L V8 EFI petrol models USA/CDN/Mex	Aftermarket	1	MHK100800P	32.50	39.00
	OEM	1	MHK100800P1	99.17	119.00
	Genuine	1	MHK100800	128.80	154.56

## DISCOVERY 2 (1998 to 2004)

## CABLES

## Accelerator Cable

All V8 petrol models - With fixings	Aftermarket	1	SBB500010KP	6.04	7.25
	Genuine	1	SBB500010K	16.09	19.31
All V8 petrol models	Genuine	1	SBB500010	62.33	74.80

## Bonnet Release Cable

All models up to (VIN) 2A754215	Aftermarket	1	FSE000010P	10.00	12.00
	Genuine	1	FSE000010	21.33	25.60
All models from (VIN) 2A754215 on	Genuine	1	FSE000080	20.34	24.41

## DISCOVERY 2 (1998 to 2004)

## WINDOW REGULATORS

## Window Regulator

All models with electric front windows					
Front RH	Aftermarket	1	LR006373P	17.29	20.75
	Genuine	1	LR006373	96.61	115.93
Front LH	Aftermarket	1	LR006374P	13.12	15.74
	Genuine	1	LR006374	96.61	115.93
All models					
Rear RH	Aftermarket	1	CVH101240P	25.83	31.00
	Genuine	1	CVH101240	124.21	149.05
Rear LH	Aftermarket	1	CVH101250P	25.83	31.00
	Genuine	1	CVH101250	140.45	168.54



## DISCOVERY 2 (1998 to 2004)

## WHEEL CENTRE CAP &amp; WHEEL NUTS

## Badge Wheel Centre Cap

All models - Green/Gold	Genuine	a/r	DAG100310	14.05	16.86
-------------------------	---------	-----	-----------	-------	-------

## Wheel Centre Cap

All models with steel spare wheel - Features Land Rover logo. Covers spare wheel centre and wheel nuts	Genuine	a/r	DTC100810	42.20	50.64
-----------------------------------------------------------------------------------------------------------	---------	-----	-----------	-------	-------

## Wheel Nut Set

All models with alloy wheels - Set of 20. Alloy wheel type, with washer					
	Aftermarket	a/r	ANR3679KP	35.00	42.00
	Genuine	a/r	ANR3679K	102.50	123.00

## Wheel Nut

All models with steel wheels	Genuine	a/r	ANR4851	4.25	5.10
All models with steel spare wheel					
Steel spare wheel only	Genuine	a/r	RRD100640	6.56	7.87
Alloy wheel type, with washer	Aftermarket	a/r	ANR3679P	2.00	2.40
	OEM	a/r	ANR3679P1	3.00	3.60
	Britpart	a/r	ANR3679BP	2.08	2.50
	Genuine	a/r	ANR3679	5.62	6.74
All models with alloy spare wheel					
Alloy spare wheel only	Genuine	a/r	RRD100630	5.97	7.16

# DISCOVERY 3 (2005 to 2009)

## 2005 to 2009 - All Models

Listed below are the most popular parts required for the Discovery 3.

We have access to the full range of parts for your vehicle. Please contact us if not listed here.



## SERVICE KITS

### Service Kit

All 4.0L V6 petrol models - Includes oil filter, air filter, fuel filter, pollen filters, spark plugs & sump plug				
Aftermarket	1	<b>RD1215P</b>	24.50	29.40
Genuine	1	<b>RD1215</b>	79.00	94.80
All 4.4L V8 petrol models - Includes oil filter, air filter, fuel filter, pollen filters, spark plugs & sump plug				
Aftermarket	1	<b>RD1217P</b>	49.50	59.40
Genuine	1	<b>RD1217</b>	120.00	144.00



RD1215P

### Filter Kit

2.7L TDV6 diesel models up to (VIN) 6A999999 - Includes oil filter, air filter, fuel filter, pollen filters & sump plug				
Aftermarket	1	<b>RD1212P</b>	18.75	22.50
Genuine	1	<b>RD1212</b>	124.17	149.00
2.7L TDV6 diesel models from (VIN) 7A000001 on - Includes oil filter, air filter, fuel filter, pollen filters & sump plug				
Aftermarket	1	<b>RD1213P</b>	32.50	39.00
Genuine	1	<b>RD1213</b>	98.33	118.00



RD1213P

## DISCOVERY 3 (2005 to 2009)

## FILTRATION

### Oil Filter

All models with 2.7L V6 diesel engine - Element				
Aftermarket	1	<b>1311289P</b>	3.00	3.60
Genuine	1	<b>1311289</b>	9.84	11.81
All 4.0L V6 petrol engine without oil cooler - Cartridge				
OEM	1	<b>LR029240P1</b>	4.58	5.50
Genuine	1	<b>LR029240</b>	9.25	11.10
All 4.0L V6 petrol engine with oil cooler - Cartridge				
Aftermarket	1	<b>4454116P</b>	2.50	3.00
OEM	1	<b>4454116P1</b>	3.00	3.60
Genuine	1	<b>4454116</b>	10.56	12.67
All models with 4.4L V8 AJ petrol engine - Cartridge				
Aftermarket	1	<b>LR031439P</b>	1.50	1.80
OEM	1	<b>LR031439P1</b>	6.88	8.26
Genuine	1	<b>LR031439</b>	12.64	15.17

### Air Filter

Aftermarket	1	<b>PHE000112P</b>	5.83	7.00
OEM	1	<b>PHE000112P1</b>	7.08	8.50
Genuine	1	<b>PHE000112</b>	21.76	26.11

### Fuel Filter

All 2.7L V6 diesel models up to (VIN) 6A999999				
Aftermarket	1	<b>LR010075P</b>	5.42	6.50
OEM	1	<b>LR010075P1</b>	22.50	27.00
Genuine	1	<b>LR010075</b>	68.01	81.61
All 2.7L TDV6 diesel models (VIN) 7A000001 on				
Aftermarket	1	<b>LR009705P</b>	18.54	22.25
OEM	1	<b>LR009705P1</b>	38.75	46.50
Genuine	1	<b>LR009705</b>	42.05	50.46

### Fuel Filter & Bracket Assembly

Genuine	1	<b>WJN500056</b>	240.47	288.56
---------	---	------------------	--------	--------

### Pollen Filter

All models				
Fresh air				
Aftermarket	1	<b>JKR500010P</b>	3.83	4.60
OEM	1	<b>JKR500010P1</b>	9.17	11.00
Genuine	1	<b>JKR500010</b>	28.01	33.61
Odour & particles, production replacement type				
Aftermarket	1	<b>LR023977P</b>	4.00	4.80
OEM	1	<b>LR023977P1</b>	14.17	17.00
Genuine	1	<b>LR023977</b>	36.92	44.30

### Oil Filter For Standard Gearbox Oil Sump

All 6 speed automatic models	Bearmach	1	<b>LR007474PF</b>	10.83	13.00
------------------------------	----------	---	-------------------	-------	-------

### Gearbox Oil Sump Easy Fit Conversion Kit

All 6 speed automatic models - Includes metal sump, separate oil filter, gasket and 'O' ring				
OEM	1	<b>LR007474BPKITEFOEM</b>	130.00	156.00
Britpart	1	<b>LR007474BPKITEF</b>	72.50	87.00

### Oil Filter For Easy Fit Gearbox Sump

All 6 speed automatic models	OEM	1	<b>LR007474BPEFOEM</b>	29.58	35.50
	Britpart	1	<b>LR007474BPEF</b>	11.67	14.00

### Gasket For Gearbox Oil Sump Easy Fit Conversion

All 6 speed automatic models	Britpart	1	<b>LR007474BPKITEFG</b>	6.67	8.00
------------------------------	----------	---	-------------------------	------	------

### Gearbox Fluid Change Kit

All 6 speed automatic models				
Includes essential items for fluid change on the 6 speed automatic gearbox (ZF models 6HP26 and 6HP28) - auto trans fluid, standard sump assembly with sleeve and plugs, sump attachment screws				
Britpart	1	<b>LR007474BPKIT</b>	130.00	156.00



LR007474BPKIT

## WIPER BLADES

### Wiper Blade

All RHD models - Front				
Aftermarket	2	<b>LR018368P</b>	6.67	8.00
OEM	2	<b>LR018368P1</b>	11.67	14.00
Genuine	2	<b>LR018368</b>	21.02	25.22
All LHD models - Front				
Aftermarket	2	<b>LR018367P</b>	5.00	6.00
OEM	2	<b>LR018367P1</b>	7.92	9.50
Genuine	2	<b>LR018367</b>	24.19	29.03
All models - Rear				
Aftermarket	1	<b>DKB500680P</b>	1.75	2.10
OEM	1	<b>DKB500680P1</b>	5.00	6.00
Genuine	1	<b>DKB500680</b>	12.94	15.53



LR018367P

DKB500680P

## DISCOVERY 3 (2005 to 2009)



## DISCOVERY 3 (2005 to 2009)

## SCREEN/LAMP WASHER SYSTEM

## Non-Heated Washer Jet

All models without heated washer jets - Front screen wash				
	Genuine	2	<b>LR049290</b>	3.41 4.09

## Heated Washer Jet

All models with heated washer jets - Front screen wash				
	Genuine	2	<b>LR048615</b>	14.29 17.15

## Washer Jet

All models with headlamp wash				
RH, headlamp wash	Aftermarket	1	<b>DNJ000081P</b>	9.58 11.50
	Genuine	1	<b>DNJ000081</b>	22.84 27.41
LH, headlamp wash	Aftermarket	1	<b>DNJ000091P</b>	9.58 11.50
	Genuine	1	<b>DNJ000091</b>	22.84 27.41

## Washer Jet, With Hose

All models - Rear screen wash				
	Genuine	1	<b>LR032197</b>	6.04 7.25

## Washer Jet Retaining Clip

All models with headlamp wash - Headlamp jet to bumper				
	Genuine	2	<b>DYC000190</b>	1.80 2.16

## Washer Pump

All models - Front screen				
	Aftermarket	1	<b>DMC500010P</b>	7.50 9.00
	Genuine	1	<b>DMC500010</b>	31.17 37.40

## Motor &amp; Pump Headlamp Wash

All models with headlamp power wash				
	Genuine	1	<b>DMC500020</b>	32.90 39.48

## Washer Hose, Per Metre

All models - 4mm internal diameter (3mm also available), Front or rear screen wash				
	Aftermarket	a/r	<b>GWV201M</b>	2.25 2.70

## Washer Hose Assembly &amp; Elbows

All models - Front screen wash				
	Genuine	1	<b>DNH000133</b>	8.98 10.78

## Washer Jet Elbow

All models - Front screen wash				
	Genuine	2	<b>DNG10001</b>	2.01 2.41

## Washer Hose Y Piece

All models - Front screen wash				
	Genuine	1	<b>DNG000010</b>	17.40 20.88

## Washer Hose Assembly

All models with headlamp wash - Headlamp wash				
	Genuine	1	<b>DNH000142</b>	25.32 30.38

## Washer Reservoir

All models without headlamp wash				
Front & rear screen wash	Genuine	1	<b>DMB500030</b>	48.05 57.66
Front & rear screen & headlamp wash	Genuine	1	<b>DMB500040</b>	61.46 73.75

## Filler Neck Cap

All models - Front & rear screen & headlamp wash				
	Genuine	1	<b>LR002266</b>	1.86 2.23

## Washer Reservoir Level Sensor

All models - Front & rear screen & headlamp wash				
	Genuine	1	<b>DMI500010</b>	4.20 5.04

## Washer Reservoir Filler Neck

All models - Front & rear screen & headlamp wash				
	Genuine	1	<b>LR013955</b>	18.77 22.52

## Windscreen Cleaning Paste

All models				
	Genuine	a/r	<b>DNJ500340</b>	7.72 9.26

*Prevents wiper blade judder/squeak by 'deep cleaning' the windscreen (ref: Land Rover Tech Bulletin LRA501-002)*



DMB500040

## DISCOVERY 3 (2005 to 2009)

## DRIVE BELTS

## Timing Belt Kit

2.7L TDV6 diesel models - Front				
	OEM	1	<b>LR016655P1</b>	64.17 77.00
	Genuine	1	<b>LR016655</b>	108.53 130.24
2.7L TDV6 diesel models with EU2 emissions - Rear				
	OEM	1	<b>1324390P1</b>	37.50 45.00
	Genuine	1	<b>1324390</b>	61.51 73.81
2.7L TDV6 diesel models with Euro Stage 4 emissions from (VIN) 7A000001 on - Rear				
	OEM	1	<b>LR019115P1</b>	39.58 47.50
	Genuine	1	<b>LR019115</b>	113.96 136.75

## Alternator Drive Belt

All models with 4.0L V6 petrol engine - Alternator				
	Aftermarket	1	<b>PQS500081P</b>	8.33 10.00
	OEM	1	<b>PQS500081P1</b>	12.08 14.50
	Genuine	1	<b>PQS500081</b>	48.03 57.64



1324390P1

## Front Drive Belt

All models with 2.7L V6 diesel engine - Front				
	Aftermarket	1	<b>PQS500370P</b>	8.13 9.76
	OEM	1	<b>PQS500370P1</b>	11.67 14.00
	Genuine	1	<b>PQS500370</b>	24.53 29.44

## Primary Drive Belt

All models with 4.4L AJ V8 petrol engine - Primary				
	Aftermarket	1	<b>PQR500330P</b>	7.29 8.75
	OEM	1	<b>PQR500330P1</b>	9.58 11.50
	Genuine	1	<b>PQR500330</b>	19.26 23.11

## Secondary Drive Belt

All models with 4.4L AJ V8 petrol engine - Secondary				
	Aftermarket	1	<b>PQS500221P</b>	4.79 5.75
	OEM	1	<b>PQS500221P1</b>	7.08 8.50
	Genuine	1	<b>PQS500221</b>	13.60 16.32



PQS500081P

## DISCOVERY 3 (2005 to 2009)

## IGNITION SYSTEM

## Spark Plug

All 4.0L V6 petrol models with unleaded fuel				
	Genuine	6	<b>LR000604</b>	5.23 6.28
All 4.0L V6 petrol models with leaded fuel				
	Genuine	6	<b>1349269</b>	2.15 2.58
All 4.4L AJ V8 petrol models				
	OEM	8	<b>LR005253P1</b>	4.00 4.80
	Genuine	8	<b>LR005253</b>	8.38 10.06

## Glow Plug

All 2.7L V6 diesel engine models				
	OEM	6	<b>1354289P1</b>	8.54 10.25
	Genuine	6	<b>1354289</b>	12.71 15.25

## Ignition Coil

All 4.0L Cologne V6 petrol models				
	Aftermarket	6	<b>LR002427P</b>	20.42 24.50
	Genuine	6	<b>LR002427</b>	40.46 48.55
All 4.4L N/A AJV8 petrol models				
	Aftermarket	8	<b>4744015P</b>	22.50 27.00
	Genuine	8	<b>4744015</b>	55.64 66.77





# BRAKING SYSTEM

## Brake Pad Set

All models				
Front Brakes				
Aftermarket	1	<b>LR019618P</b>	18.13	21.76
Brembo	1	<b>LR019618BREMBO</b>	37.08	44.50
OEM	1	<b>LR019618P1</b>	27.50	33.00
Genuine	1	<b>LR019618</b>	48.11	57.73
Front Brakes, Green Stuff				
EBC	1	<b>LR019618GS</b>	50.83	61.00
Rear Brakes				
Aftermarket	1	<b>LR055454P</b>	15.63	18.76
Brembo	1	<b>LR055454BREMBO</b>	34.35	41.22
OEM	1	<b>LR055454P1</b>	18.54	22.25
Genuine	1	<b>LR055454</b>	48.11	57.73
Rear Brakes, Green Stuff				
EBC	1	<b>LR055454GS</b>	41.67	50.00
All 4.4L NA V8 petrol models - Rear Brakes				
Aftermarket	1	<b>LR021316P</b>	15.00	18.00
Genuine	1	<b>LR021316</b>	40.09	48.11

## Retaining Spring

All models - Front Brake Pads				
Aftermarket	1	<b>LR019625P</b>	3.08	3.70
Genuine	1	<b>LR019625</b>	3.77	4.52

## Retaining Spring Kit

All models - Rear Brake Pads				
Aftermarket	1	<b>LR019626P</b>	2.17	2.60
Genuine	1	<b>LR019626</b>	4.21	5.05

## Brake Disc (each)

All models with 2.7L Lion V6 diesel engine				
Front				
Aftermarket	2	<b>SDB000604P</b>	22.92	27.50
Brembo	2	<b>SDB000604BREMBO</b>	48.33	58.00
Genuine	2	<b>SDB000604</b>	48.11	57.73
Rear				
Aftermarket	2	<b>SDB000636P</b>	17.50	21.00
Brembo	1	<b>SDB000636BREMBO</b>	65.83	79.00
Genuine	2	<b>SDB000636</b>	40.09	48.11
All models with 4.0L Cologne V6 petrol engine				
Front				
Aftermarket	2	<b>SDB000604P</b>	22.92	27.50
Brembo	2	<b>SDB000604BREMBO</b>	48.33	58.00
Genuine	2	<b>SDB000604</b>	48.11	57.73
Rear				
Aftermarket	2	<b>SDB000636P</b>	17.50	21.00
Brembo	1	<b>SDB000636BREMBO</b>	65.83	79.00
Genuine	2	<b>SDB000636</b>	40.09	48.11
All models with 4.4L AJ V8 petrol engine				
Front				
Aftermarket	2	<b>SDB000614P</b>	22.08	26.50
Brembo	2	<b>SDB000614BREMBO</b>	52.50	63.00
Genuine	2	<b>SDB000614</b>	48.11	57.73
Rear				
Aftermarket	2	<b>SDB000646P</b>	18.75	22.50
Brembo	1	<b>SDB000646BREMBO</b>	88.33	106.00
Genuine	2	<b>SDB000646</b>	40.09	48.11

## Performance Brake Disc (pair)

All models with 2.7L Lion V6 diesel engine - Slotted & drilled				
Front				
Britpart	1	<b>SDB000604URBP</b>	60.00	72.00
Rear				
Britpart	1	<b>SDB000636URBP</b>	60.00	72.00
All models with 4.0L Cologne V6 petrol engine - Slotted & drilled				
Front				
Britpart	1	<b>SDB000604URBP</b>	60.00	72.00
Rear				
Britpart	1	<b>SDB000636URBP</b>	60.00	72.00
All models with 4.4L AJ V8 petrol engine - Slotted & drilled				
Front				
Britpart	1	<b>SDB000614URBP</b>	60.00	72.00
Rear				
Britpart	1	<b>SDB000646URBP</b>	60.00	72.00

## Mudshield Brake Disc

All models - Front				
RH	Genuine	1	<b>SEC000162</b>	43.64 52.37
LH	Genuine	1	<b>SEC000172</b>	57.61 69.13

## Back Plate

All models except B6 armouring - Rear				
RH	Genuine	1	<b>LR048810</b>	49.92 59.90
LH	Genuine	1	<b>LR048812</b>	49.92 59.90

## Brake Caliper

All models to (VIN) 9A999999				
Right Hand Front				
Genuine*	1	<b>SEG500040</b>	197.77	237.32
			50.00	60.00
*Exchange Surcharge				
Left Hand Front				
Genuine*	1	<b>SEG500050</b>	197.77	237.32
			50.00	60.00
*Exchange Surcharge				
All models				
Rear, RH				
Aftermarket	1	<b>SOB500042P</b>	50.00	60.00
Genuine*	1	<b>SOB500042</b>	129.29	155.15
			50.00	60.00
*Exchange Surcharge				
Rear, LH				
Aftermarket	1	<b>SOB500052P</b>	50.00	60.00
Genuine*	1	<b>SOB500052</b>	129.29	155.15
			50.00	60.00
*Exchange Surcharge				

## Brake Caliper Carrier

All 2.7L V6 diesel engine models				
Front brakes				
OEM	2	<b>SEH500012P1</b>	22.50	27.00
Genuine	2	<b>SEH500012</b>	38.73	46.48
All 4.0L V6 petrol engine models				
Front brakes				
OEM	2	<b>SEH500012P1</b>	22.50	27.00
Genuine	2	<b>SEH500012</b>	38.73	46.48
4.4L V8 AJ petrol models from (VIN) 6A388291				
Front				
Genuine	2	<b>SEH500013</b>	38.73	46.48
2.7L TDV6 diesel models - Rear, RH and LH				
OEM	2	<b>SXP500013P1</b>	25.00	30.00
Genuine	2	<b>SXP500013</b>	38.79	46.55
4.4L V8 petrol models - Rear, RH and LH				
OEM	2	<b>SXP500014P1</b>	29.17	35.00
Genuine	2	<b>SXP500014</b>	38.79	46.55

# DISCOVERY 3 (2005 to 2009)

## Brake Caliper Piston

All models to (VIN) 9A999999				
Front, Vented Disc Brakes				
Aftermarket	4	<b>STC1918P</b>	4.38	5.26
OEM	4	<b>STC1918P1</b>	7.50	9.00
Genuine	4	<b>STC1918</b>	17.20	20.64
Rear, Vented Disc Brakes				
Aftermarket	2	<b>STC1908P</b>	4.08	4.90
Genuine	2	<b>STC1908</b>	18.49	22.19

## Slider Pin Bolt

All models - Front				
Genuine	4	<b>SMV500010</b>	1.33	1.60

## Dust Cover

All models - For carrier retaining pins front & rear				
Genuine	2	<b>SEE500030</b>	7.88	9.46

## Caliper Pin & Boot Kit

All models - Front, one caliper				
Aftermarket	4	<b>SEE500020P</b>	9.17	11.00
Genuine	4	<b>SEE500020</b>	13.06	15.67

## Brake Caliper Fixing Kit

All models - Rear brakes				
Aftermarket	2	<b>SMN500040P</b>	6.87	8.24
Genuine	2	<b>SMN500040</b>	13.06	15.67

## Dust Cap Bleed Screw

All models except with B6 level armouring				
Front & rear caliper				
Genuine	2	<b>SEE500100</b>	0.94	1.13

## Brake Master Cylinder

All RHD models				
OEM	1	<b>LR014527P1</b>	60.00	72.00
Genuine	1	<b>LR014527</b>	124.13	148.96

## Master Cylinder

All LHD models				
Aftermarket	1	<b>LR014528P</b>	52.50	63.00
Genuine	1	<b>LR014528</b>	137.88	165.46

## Brake Servo

All models				
OEM	1	<b>SJJ500090P1</b>	105.00	126.00
Genuine	1	<b>SJJ500090</b>	133.29	159.95

## Cap for Master Cylinder Reservoir

All models				
Genuine	1	<b>LR012971</b>	21.24	25.49

## Brake Pad Wear Sensor

All models up to (VIN) 6A414975				
Front brakes				
Aftermarket	2	<b>SEM000024P</b>	3.75	4.50
OEM	2	<b>SEM000024P1</b>	6.25	7.50
Genuine	2	<b>SEM000024</b>	18.05	21.66
All models from (VIN) 6A414976 on				
Front brakes				
Aftermarket	2	<b>SEM500070P</b>	6.04	7.25
OEM	2	<b>SEM500070P1</b>	7.50	9.00
Genuine	2	<b>SEM500070</b>	18.76	22.51
All models - Rear brakes				
Aftermarket	2	<b>SOE000025P</b>	3.50	4.20
OEM	2	<b>SOE000025P1</b>	8.13	9.76
Genuine	2	<b>SOE000025</b>	10.54	12.65

## Caliper Repair Kit

All models - Front brakes				
OEM	2	<b>SEE500010P1</b>	5.95	7.14
Genuine	2	<b>SEE500010</b>	12.53	15.04
All models except armoured - Rear, for one caliper				
Aftermarket	2	<b>SMN500030P</b>	6.04	7.25
OEM	2	<b>SMN500030P1</b>	4.95	5.94
Genuine	2	<b>SMN500030</b>	11.94	14.33



**DISCOVERY 3 (2005 to 2009)****BRAKING SYSTEM****Brake Hose Kit**

All models				
Complete Car Set - 6 Hoses	OEM	1	<b>RD1353P1</b>	70.00 84.00
	Genuine	1	<b>RD1353</b>	165.00 198.00
Front Car set - 2 Hoses	OEM	1	<b>RD1354P1</b>	45.83 55.00
	Genuine	1	<b>RD1354</b>	85.00 102.00
Rear Car Set - 4 Hoses	OEM	1	<b>RD1355P1</b>	25.83 31.00
	Genuine	1	<b>RD1355</b>	50.83 61.00

**Brake Hose**

All models				
Front, RH	OEM	1	<b>LR058048P1</b>	27.50 33.00
	Genuine	1	<b>LR058048</b>	56.92 68.30
Front, LH	OEM	1	<b>LR058049P1</b>	18.50 22.20
	Genuine	1	<b>LR058049</b>	39.54 47.45
Rear outer	OEM	2	<b>LR058009P1</b>	8.33 10.00
	Genuine	2	<b>LR058009</b>	14.48 17.38
Rear, inner	OEM	2	<b>LR058010P1</b>	6.67 8.00
	Genuine	2	<b>LR058010</b>	28.81 34.57
All RHD petrol models - Union to servo	Genuine	1	<b>LR018335</b>	14.76 17.71
	Genuine	1	<b>SQF500042</b>	11.21 13.45
All RHD diesel models - Union to servo	Genuine	1	<b>LR019757</b>	8.70 10.44
All RHD diesel models up to (VIN) 6A354183				
Vacuum pump union to servo	Genuine	1	<b>SQB000232</b>	6.33 7.60
Vacuum pump to union	Genuine	1	<b>SQB000233</b>	6.33 7.60
All RHD diesel models with EU2 emissions - Vacuum Pump to servo	Genuine	1	<b>LR019701</b>	37.34 44.81
All RHD diesel models with Euro stage 4 emissions (VIN) 7A000001 on - Vacuum Pump to servo	Genuine	1	<b>LR019758</b>	34.68 41.62
All petrol models - Vacuum pump to union	Genuine	1	<b>LR018331</b>	19.06 22.87
All models with 4.0L Cologne V6 petrol engine - Vacuum pump union to inlet manifold	Genuine	1	<b>LR018332</b>	19.78 23.74
All 4.4L AJ V8 petrol engine models - Vacuum pump union to inlet manifold	Genuine	1	<b>LR018333</b>	19.20 23.04
All LHD diesel models up to (VIN) 6A354183 - Vacuum pump union to servo	Genuine	1	<b>LR018326</b>	16.12 19.34
All LHD diesel models with EU2 emissions - Vacuum Pump to servo	Genuine	1	<b>LR019700</b>	37.17 44.60
All LHD diesel models with Euro stage 4 emissions - Vacuum Pump to servo	Genuine	1	<b>LR019756</b>	28.43 34.12

**Brake Pipe Clip**

All models to (VIN) 9A999999	Genuine	a/r	<b>ANR1864</b>	1.16 1.39
	Genuine	a/r	<b>EDP7037L</b>	0.58 0.70

**4-way Brake Pipe Connector**

All models - Front and rear	Genuine	a/r	<b>SGH100050</b>	29.02 34.82
-----------------------------	---------	-----	------------------	-------------

**2-way Brake Pipe Connector**

All models - Rear	Genuine	a/r	<b>BMK2466</b>	4.41 5.29
-------------------	---------	-----	----------------	-----------

**Brake Shoe Set - Handbrake**

All models - Handbrake	Aftermarket	1	<b>LR031947KITP</b>	6.04 7.25
	Genuine	1	<b>LR031947</b>	64.15 76.98

**Brake Shoe Set (includes pins & clips)**

All models - Handbrake	Aftermarket	1	<b>LR031947P1</b>	42.50 51.00
------------------------	-------------	---	-------------------	-------------

**Brake Shoe Set (no pins or clips)**

All models - Handbrake	Aftermarket	1	<b>LR031947NCP1</b>	29.58 35.50
------------------------	-------------	---	---------------------	-------------

**Brake Shoe Retaining Spring Set**

Parking Brake all models to (VIN) 9A999999	Genuine	1	<b>SMN500020</b>	17.40 20.88
--------------------------------------------	---------	---	------------------	-------------

**Handbrake Shoe Fixing Kit**

All models	Genuine	1	<b>SMN500012</b>	7.23 8.68
------------	---------	---	------------------	-----------

**Parking Brake Adjuster Kit**

All models from (VIN) 6A365727 to (VIN) 9A999999				
	Genuine	1	<b>SXS500011</b>	8.20 9.84

**Actuating Rod Kit Handbrake**

All models - includes 2 rods	Genuine	1	<b>SXR500010</b>	9.62 11.54
------------------------------	---------	---	------------------	------------

**Module/Cable Handbrake**

All models	Genuine	1	<b>LR019223</b>	524.03 628.84
------------	---------	---	-----------------	---------------

**Parking Brake Bracket**

All models				
RH	Genuine	1	<b>SPU500040</b>	8.80 10.56
LH	Genuine	1	<b>SPU500050</b>	8.80 10.56

**Handbrake Cable**

All models				
RH rear	Genuine	1	<b>LR018469</b>	73.41 88.09
LH rear	Genuine	1	<b>LR018470</b>	88.73 106.48

**Handbrake Cable Boot**

All models - cable to rear brake	Genuine	1	<b>YPV500380</b>	2.77 3.32
----------------------------------	---------	---	------------------	-----------

**Clip Brake Cable Support**

All models	Genuine	a/r	<b>SPV500020</b>	0.53 0.64
------------	---------	-----	------------------	-----------

**Handbrake Cable Clip**

All models - Circlip, 'E' type, cable to rear brake				
	Genuine	a/r	<b>SPV500030</b>	0.57 0.68

**ABS Sensor**

All models to (VIN) 6A351056				
Front brakes	Genuine	2	<b>SSB500091</b>	27.93 33.52
All models from (VIN) 6A351057 on				
Front brakes	Aftermarket	2	<b>SSB500092P</b>	14.77 17.72
	Genuine	2	<b>SSB500092</b>	23.97 28.76
Rear brakes	Aftermarket	2	<b>SSB500102P</b>	18.13 21.76
	OEM	2	<b>SSB500102P1</b>	20.00 24.00
	Genuine	2	<b>SSB500102</b>	96.20 115.44

**ABS Speed Sensor**

All models to (VIN) 6A999999 - Yaw Compatible with 6 pin plug				
	Genuine	1	<b>SR0000020</b>	290.27 348.32
All models (VIN) 7A000001 on - Yaw Compatible with 4 pin plug				
	Genuine	1	<b>SR0500140</b>	182.88 219.46

**Screw (to attach ABS wheel sensor)**

All models	Genuine	4	<b>FS106127L</b>	1.07 1.28
------------	---------	---	------------------	-----------

**Brake Pedal Pad**

All manual models - Also used on manual model clutch pedal				
	Genuine	2	<b>SKE500020</b>	4.76 5.71

**Brake Pedal Rubber**

All models with 6 speed Auto ZF Steptronic too (VIN) 9A999999				
	Genuine	1	<b>SKE500010</b>	10.06 12.07

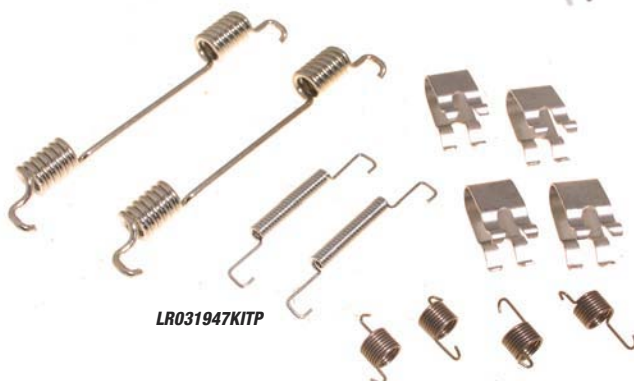

# SUSPENSION

## Bush Front Upper Arm

All models					
Rubber bush	OEM	4	<b>LR056964P1</b>	6.04	7.25
	Genuine	4	<b>LR056964</b>	32.93	39.52
Poly. bush (set of 4)	Polybush	1	<b>LR056964POLY</b>	50.00	60.00

## Bush Front Lower Arm

All models - Standard bush, inner, forward - inner, forward					
Standard bush	Aftermarket	2	<b>LR051611P</b>	7.08	8.50
	OEM	2	<b>LR051611P1</b>	13.54	16.25
	Genuine	2	<b>LR051611</b>	40.43	48.52
Poly. Dynamic orange (pair)	Polybush	1	<b>LR051611POLY</b>	60.00	72.00

## Bush Lower Arm

All models except armoured vehicles - Front suspension, rear hydrabush					
Aftermarket	2	<b>LR051586P</b>	10.42	12.50	
OEM	2	<b>LR051586P1</b>	22.08	26.50	
Genuine	2	<b>LR051586</b>	45.50	54.60	
Poly. (pair)	Polybush	1	<b>LR051586POLY</b>	42.50	51.00

## Bush Rear Lower Arm

All models - Standard bush, inner, Rearward					
Aftermarket	2	<b>LR054831P1</b>	7.50	9.00	
OEM	2	<b>LR054831</b>	24.01	28.81	
Genuine	2	<b>LR051611</b>	40.43	48.52	

All models - Rubber bush, inner Rearward					
Aftermarket	2	<b>LR051616P</b>	6.67	8.00	
OEM	2	<b>LR051616P1</b>	15.00	18.00	
Genuine	2	<b>LR051616</b>	27.17	32.60	
Forward	Aftermarket	2	<b>LR051621P</b>	8.75	10.50
	OEM	2	<b>LR051621P1</b>	12.50	15.00
	Genuine	2	<b>LR051621</b>	20.86	25.03

All models - poly. bush, inner					
Rearward (pair)	Polybush	1	<b>LR054831POLY</b>	29.58	35.50
Forward (pair)	Polybush	1	<b>LR051621POLY</b>	60.00	72.00
Rearward, poly. Dynamic orange (pair)	Polybush	1	<b>LR051616POLY</b>	45.00	54.00

## Bush Lower Shock Absorber (set of 4)

Front & rear, poly. - Front & rear	Genuine	1	<b>ROA000022</b>	8.35	10.02
All coil spring models - Front & rear, poly.	Polybush	1	<b>ROA000022POLY</b>	65.00	78.00

## Bump Stop, Upper Shock Absorber

All coil spring models - Front & rear	Genuine	2	<b>RN0000011</b>	6.97	8.36
---------------------------------------	---------	---	------------------	------	------

## Bush Anti Roll Bar Mounting

All models					
Front anti roll bar, poly.	Polybush	2	<b>LR015339POLY</b>	7.50	9.00
Rear anti roll bar, poly.	Polybush	2	<b>LR015336POLY</b>	8.54	10.25

## Suspension Bush Kit

All models except B6 armoured - poly., dynamic orange. Car set of upper & lower arm bushes					
Polybush	1	<b>RD1299</b>	250.00	300.00	

## Anti Roll Bar

All models except B6 armoured					
Front	Genuine	1	<b>RBL500750</b>	69.87	83.84
Rear	Genuine	1	<b>RGB500080</b>	48.92	58.70

## Anti Roll Bar Link

All models					
Front	Aftermarket	2	<b>LR014145P</b>	7.50	9.00
	OEM	2	<b>LR014145P1</b>	13.13	15.76
	Genuine	2	<b>LR014145</b>	24.27	29.12
Rear	Aftermarket	2	<b>RGD000312P</b>	4.17	5.00
	Genuine	2	<b>RGD000312</b>	18.95	22.74

## Mounting Bush, Anti Roll Bar

All models					
Front anti roll bar	OEM	2	<b>LR015339P1</b>	7.92	9.50
	Genuine	2	<b>LR015339</b>	10.45	12.54
Rear anti roll bar	Aftermarket	2	<b>LR015336P</b>	4.00	4.80
	OEM	2	<b>LR015336P1</b>	10.63	12.76
	Genuine	2	<b>LR015336</b>	20.56	24.67

## Clamp Anti Roll Bar Bush

All models					
Front	Genuine	2	<b>RBU500100</b>	2.23	2.68
Rear	Genuine	2	<b>RBU000281</b>	1.93	2.32

## Shock Absorber

All models with coil spring suspension					
Front	OEM	2	<b>RNB000498P1</b>	70.00	84.00
	Genuine	2	<b>RNB000498</b>	127.25	152.70
Rear	OEM	2	<b>RPD500046P1</b>	95.00	114.00
	Genuine	2	<b>RPD500046</b>	190.14	228.17
All models with air suspension					
Front	OEM	2	<b>RSC500190P1</b>	80.00	96.00
	Genuine	2	<b>RSC500190</b>	178.42	214.10
Rear	OEM	2	<b>LR016404P1</b>	90.00	108.00
	Genuine	2	<b>LR016404</b>	203.95	244.74

## Up-rated Shock Absorber

All models with air suspension					
Front B6 Damper	Bilstein	2	<b>RSC500190BILSTEIN</b>	133.33	160.00
Rear B6 Damper	Bilstein	2	<b>LR016404BILSTEIN</b>	130.00	156.00

## Shock Absorber Complete Assembly

All models with air suspension - Std, front					
OEM	2	<b>RNB501580P1</b>	145.83	175.00	
Genuine	2	<b>RNB501580</b>	280.66	336.79	

## Boot Kit, Shock Absorber

All models with air suspension - Front, for one shock absorber					
Aftermarket	2	<b>RBG500010P</b>	30.00	36.00	
Genuine	2	<b>RBG500010</b>	66.18	79.42	

## Shock Absorber Upper Boot

All models with air suspension - Rear					
Genuine	2	<b>RPM500200</b>	34.83	41.80	

## Gaiter, Shock Absorber

All models with coil spring suspension - Front & rear					
Genuine	2	<b>RNE000011</b>	3.58	4.30	

## Strut Mounting Upper

All models without air suspension - Rear suspension					
Genuine	2	<b>RPF500023</b>	60.70	72.84	

## Coil Spring

All models with coil spring suspension					
Front	Genuine	2	<b>REB500050</b>	65.94	79.13
Rear	Genuine	2	<b>RKB500033</b>	83.83	100.60

## Ball Joint

All models - Front knuckle, upper					
Aftermarket	2	<b>RBK500170P</b>	10.00	12.00	
OEM	2	<b>RBK500170P1</b>	16.88	20.26	
Genuine	2	<b>RBK500170</b>	32.98	39.58	

All models without B6 armouring (VIN) 9A502440 on - Front knuckle, lower, with 35mm ball joint seat. For vehicle with original lower arm prior to (VIN) 9A502440 a new lower arm and ball joint assembly must be fitted					
Aftermarket	2	<b>RBK500280P</b>	9.38	11.26	
OEM	2	<b>RBK500280P1</b>	19.58	23.50	
Genuine	2	<b>RBK500280</b>	32.98	39.58	

## Ball Joint Assembly

All models					
Front lower arm	Aftermarket	2	<b>RBK500280P</b>	9.38	11.26
	OEM	2	<b>RBK500280P1</b>	19.58	23.50
	Genuine	2	<b>RBK500280</b>	32.98	39.58
Upper, rear wheel knuckle	Aftermarket	2	<b>RHF500100P</b>	11.04	13.25
	OEM	2	<b>RHF500100P1</b>	14.38	17.26
	Genuine	2	<b>RHF500100</b>	36.46	43.75

## Upper Arm Complete Assembly

All models - Front suspension					
RH	Aftermarket	1	<b>RBJ500222P</b>	30.00	36.00
	Genuine	1	<b>RBJ500222</b>	51.52	61.82
LH	Aftermarket	1	<b>RBJ500232P</b>	30.00	36.00
	Genuine	1	<b>RBJ500232</b>	51.52	61.82

All models - Rear suspension					
RH	Aftermarket	1	<b>LR051622P</b>	63.33	76.00
	Genuine	1	<b>LR051622</b>	103.28	123.94
LH	Aftermarket	1	<b>LR051623P</b>	63.33	76.00
	OEM	1	<b>LR051623P1</b>	70.00	84.00
	Genuine	1	<b>LR051623</b>	103.28	123.94

## Upper Arm Complete Assembly Kit

All models - Front suspension					
RH includes fittings	Britpart	1	<b>RBJ500222P1K</b>	39.58	47.50
LH includes fittings	Britpart	1	<b>RBJ500232P1K</b>	39.58	47.50
All models - Rear suspension					
RH includes fittings	Britpart	1	<b>LR051622P1K</b>	89.17	107.00
LH includes fittings	Britpart	1	<b>LR051623P1K</b>	89.17	107.00

## Upper Arm Assembly

All models - Front suspension					
RH	Aftermarket	1	<b>LR074838P</b>	42.50	51.00
	Genuine	1	<b>LR074838</b>	125.33	150.40
LH	Aftermarket	1	<b>LR051617P</b>	42.50	51.00
	Genuine	1	<b>LR051617</b>	116.61	139.93

## Fitting Kit, Front Upper Arm

All models - Includes bolts and nuts for one upper arm					
Genuine	1	<b>RYG000420BPK</b>	9.79	11.75	





**DISCOVERY 3 (2005 to 2009)****SUSPENSION****Lower Arm Assembly**

All air suspension models to (VIN) 9A502439 except cars fitted with 35mm ball joint

Front suspension,				
RH	Aftermarket	1	<b>LR075993P</b>	70.00 84.00
	OEM	1	<b>LR075993P1</b>	85.00 102.00
	Genuine	1	<b>LR075993</b>	184.97 221.96
LH	Aftermarket	1	<b>LR075995P</b>	70.00 84.00
	OEM	1	<b>LR075995P1</b>	85.00 102.00
	Genuine	1	<b>LR075995</b>	184.97 221.96

All coil spring models except 4.4L AJV8 petrol to (VIN) 9A511222 fitted with 35mm lower ball joint -

Front suspension,				
RH	Aftermarket	1	<b>LR028246P</b>	92.50 111.00
	Genuine	1	<b>LR028246</b>	186.34 223.61
LH	Aftermarket	1	<b>LR028250P</b>	92.50 111.00
	Genuine	1	<b>LR028250</b>	190.25 228.30

All coil spring models except 4.4L AJV8 petrol (VIN) 9A511223 on - Front suspension

RH	Aftermarket	1	<b>LR028246P</b>	92.50 111.00
	Genuine	1	<b>LR028246</b>	186.34 223.61
LH	Aftermarket	1	<b>LR028250P</b>	92.50 111.00
	Genuine	1	<b>LR028250</b>	190.25 228.30

All models with coil spring suspension - Rear

RH	Genuine	1	<b>RG6500480</b>	182.55 219.06
LH	Genuine	1	<b>RG6500490</b>	182.55 219.06

All models with four corner air suspension - Rear

RH	OEM	1	<b>LR051592P1</b>	65.00 78.00
	Genuine	1	<b>LR051592</b>	114.58 137.50
LH	Genuine	1	<b>LR051593</b>	511.15 613.38

**Lower Arm Assembly Kit**

All air suspension models to (VIN) 9A502439 except cars fitted with 35mm ball joint - Front suspension

RH includes fittings	Britpart	1	<b>LR075993P1K</b>	105.00 126.00
LH includes fittings	OEM	1	<b>LR075995P1K</b>	105.00 126.00

**Spindle Rod Toe Link**

All models	Aftermarket	2	<b>LR019117P</b>	18.13 21.76
	OEM	2	<b>LR019117P1</b>	25.00 30.00
	Genuine	2	<b>LR019117</b>	71.39 85.67

**Ball Joint Rear Knuckle Lower**

All models	Aftermarket	2	<b>LR032644P</b>	8.13 9.76
	Genuine	2	<b>LR032644</b>	32.29 38.75

**Knuckle, Without Hub**

All models without B6 armouring - Rear axle

RH	Genuine	1	<b>LR045822</b>	149.71 179.65
LH	Genuine	1	<b>LR045823</b>	149.71 179.65

**Height Sensor**

All models with air suspension - Front suspension

RH	OEM	1	<b>LR020157P1</b>	45.83 55.00
	Genuine	1	<b>LR020157</b>	63.07 75.68
LH	Genuine	1	<b>LR020155</b>	63.07 75.68

All models with air suspension - Rear suspension

RH	OEM	1	<b>LR020161P1</b>	53.33 64.00
	Genuine	1	<b>LR020161</b>	63.31 75.97
LH	OEM	1	<b>LR020159P1</b>	45.83 55.00
	Genuine	1	<b>LR020159</b>	63.31 75.97

**Air Suspension Height Sensor**

All air suspension models up to (VIN) 9A511006 - LH front

Genuine	1	<b>LR019137</b>	13.95 16.74
---------	---	-----------------	-------------

**Link Height Sensor**

All air suspension models	Genuine	2	<b>RVF500011</b>	0.93 1.12
All air suspension models - Includes links & attachment hardware for all four height sensors				
	Britpart	1	<b>RVF500011BPKIT</b>	140.83 169.00

**Air Suspension Compressor**

All models fitted with original type Hitachi air compressor

Direct replacement for original compressor - no vehicle modification required

	Genuine*	1	<b>LR072537</b>	574.59 689.51
			*Exchange Surcharge	180.00 216.00

All models fitted with AMK Compressor - Includes installation kit

	Genuine*	1	<b>LR072537</b>	574.59 689.51
			*Exchange Surcharge	180.00 216.00

**Replacement Compressor**

All models with Hitachi Compressor fitted - Fitting kit required

	Dunlop	1	<b>LR023964P</b>	383.33 460.00
--	--------	---	------------------	---------------

**Compressor & Dryer only**

All models fitted with AMK Compressor	OEM	1	<b>LR078650P1</b>	341.67 410.00
	Genuine	1	<b>LR061888</b>	457.51 549.01

**Installation Kit for AMK Compressor**

All models fitted with AMK Compressor	OEM	1	<b>LR078650BPIK</b>	78.33 94.00
---------------------------------------	-----	---	---------------------	-------------

**Installation Kit for Dunlop Compressor**

All models with Hitachi Compressor fitted	Aftermarket	1	<b>LR023964PPIK</b>	24.58 29.50
-------------------------------------------	-------------	---	---------------------	-------------

**Air Suspension Spring**

All models with air suspension

Front	OEM	2	<b>LR016403P1</b>	165.83 199.00
	Genuine	2	<b>LR016403</b>	334.20 401.04
Rear	OEM	2	<b>LR016411P1</b>	175.83 211.00
	Genuine	2	<b>LR016411</b>	332.51 399.01

**Air Spring & Shock Absorber**

All air suspension models to (VIN) 6A999999

Rear suspension	OEM	2	<b>RPD000309P1</b>	165.83 199.00
	Genuine	2	<b>RPD000309</b>	429.59 515.51

All air suspension models (VIN) 7A000001 on

Rear suspension	OEM	2	<b>RPD501090P1</b>	165.83 199.00
	Genuine	2	<b>RPD501090</b>	377.23 452.68

**Strut Seal Kit**

All air suspension models - Front &amp; rear

	Genuine	2	<b>LR016412</b>	12.40 14.88
--	---------	---	-----------------	-------------

**Air Suspension Relief Valve**

All models with air suspension

Front axle	Genuine	1	<b>RVH000095</b>	96.85 116.22
Rear axle	Genuine	1	<b>RVH000055</b>	96.85 116.22

**Pressure Sensor**

All air suspension models

	Genuine	1	<b>LR084274</b>	47.28 56.74
--	---------	---	-----------------	-------------

**Air to Coil Spring Conversion Kit**

All models - Kit contains 2 front &amp; 2 rear strut &amp; coil spring assemblies plus dis-arm kit

	Aftermarket	1	<b>RD1367</b>	600.00 720.00
--	-------------	---	---------------	---------------



LR075993P



RD1367



LR072537



## STEERING

### Seal, Steering Column

All models - Column to bulkhead	Genuine	1	<b>QMH500100</b>	6.50	7.80
All models up to (VIN) 7A435363 - Lower column joint	Genuine	1	<b>QMH500070</b>	2.72	3.26
All models from (VIN) 7A435364 on - Lower column joint	Genuine	1	<b>QMH500110</b>	3.60	4.32

### Sensor, Steering Rotation

All models - Steering column	Genuine	1	<b>SR0500110</b>	185.78	222.94
------------------------------	---------	---	------------------	--------	--------

### Shaft, Steering Column

Upper section, without universal joint	Genuine	1	<b>QLB500070</b>	50.37	60.44
----------------------------------------	---------	---	------------------	-------	-------

### Vibration Damper

All 2.7L V6 diesel models - Steering column	Genuine	1	<b>QTD500020</b>	31.33	37.60
---------------------------------------------	---------	---	------------------	-------	-------

### Track Rod End

All models up to (VIN) 9A496359 - With M12 track rod thread	Aftermarket	2	<b>LR010671P</b>	7.92	9.50
	OEM	2	<b>LR010671P1</b>	18.54	22.25
	Genuine	2	<b>LR010671</b>	43.95	52.74
All models from (VIN) 9A496360 on - With M14 track rod thread	OEM	2	<b>LR010672P1</b>	17.92	21.50
	Genuine	2	<b>LR010672</b>	40.57	48.68

### Track Rod End & Rod Kit

RHD models up to (VIN) 9A496359 - With M12 track rod thread	OEM	1	<b>LR010670P1</b>	32.50	39.00
	Genuine	1	<b>LR010670</b>	89.49	107.39
LHD models up to (VIN) 9A496359 - With M12 track rod thread	OEM	1	<b>LR010669P1</b>	29.58	35.50
	Genuine	1	<b>LR010669</b>	89.49	107.39
RHD models from (VIN) 9A496360 on - With M14 track rod thread	OEM	1	<b>LR010667P1</b>	19.58	23.50
	Genuine	1	<b>LR010667</b>	84.94	101.93
LHD models from (VIN) 9A496360 on - With M14 track rod thread	OEM	1	<b>LR010668P1</b>	19.58	23.50
	Genuine	1	<b>LR010668</b>	89.49	107.39

## CLUTCH

### Clutch Plate & Cover Assembly

All 2.7L V6 diesel manual models - Includes clutch plate & cover	OEM	1	<b>LR005809P1</b>	195.00	234.00
	Genuine	1	<b>LR005809</b>	307.26	368.71

### Clutch Pipe Assembly

All manual models - Union to slave cylinder	Genuine	1	<b>STG500100</b>	33.96	40.75
All RHD manual models					
Master cylinder to union	Genuine	1	<b>LR014291</b>	37.37	44.84
All LHD manual models					
Master cylinder to union	Genuine	1	<b>LR014292</b>	45.64	54.77
Reservoir to master cylinder	Genuine	1	<b>STH000012</b>	1.64	1.97
All LHD manual models up to (VIN) 9A509802					
Master cylinder to union	Genuine	1	<b>LR014292</b>	45.64	54.77



LR005809P1



STC500041



SKE500020

## DISCOVERY 3 (2005 to 2009)

### Track Rod

All models with M16 track rods - M16	Aftermarket	1	<b>QFK500010P</b>	7.50	9.00
	OEM	1	<b>QFK500010P1</b>	10.83	13.00
	Genuine	1	<b>QFK500010</b>	52.66	63.19
All models with M20 track rods - M20	Aftermarket	1	<b>QFK500020P</b>	7.08	8.50
	OEM	1	<b>QFK500020P1</b>	10.83	13.00
	Genuine	1	<b>QFK500020</b>	52.66	63.19

### Track Rod, Bare

All models - M16	Aftermarket	1	<b>QFK500010P</b>	7.50	9.00
	OEM	1	<b>QFK500010P1</b>	10.83	13.00
	Genuine	1	<b>QFK500010</b>	52.66	63.19
All models - M20	Aftermarket	1	<b>QFK500020P</b>	7.08	8.50
	OEM	1	<b>QFK500020P1</b>	10.83	13.00
	Genuine	1	<b>QFK500020</b>	52.66	63.19

### Steering Rack Boot Kit

All models	Aftermarket	2	<b>QFW500010P</b>	5.63	6.76
	Genuine	2	<b>QFW500010</b>	16.08	19.30

### Power Steering Fluid

All models - 1 litre. Cold (standard) climates fluid	Aftermarket	a/r	<b>STC50519P</b>	12.08	14.50
	Genuine	a/r	<b>STC50519</b>	18.96	22.75

### Cap, Power Steering Reservoir

All models	Genuine	1	<b>QEZ500010</b>	3.25	3.90
------------	---------	---	------------------	------	------



QFK500010P

## DISCOVERY 3 (2005 to 2009)

### Clutch Master Cylinder

All RHD manual diesel models - With sensor	Genuine	1	<b>STC500041</b>	217.22	260.66
All LHD manual diesel models - With sensor	Genuine	1	<b>STC500031</b>	205.33	246.40

### Clutch Slave Cylinder

All models	Aftermarket	1	<b>LR014290P</b>	54.17	65.00
	Genuine	1	<b>LR014290</b>	81.21	97.45

### Clutch Pedal Pad

All manual models - Also used on manual model brake pedal	Genuine	2	<b>SKE500020</b>	4.76	5.71
-----------------------------------------------------------	---------	---	------------------	------	------



**DISCOVERY 3 (2005 to 2009)****TRANSMISSION****Constant Velocity Joint**

All diesel models with manual gearbox	Aftermarket	2	<b>LR060383P</b>	41.67	50.00
	OEM	2	<b>LR060383P1</b>	67.50	81.00
	Genuine	2	<b>LR060383</b>	133.37	160.04
All 2.7L TDV6 diesel models with auto gearbox	Aftermarket	2	<b>LR060382P</b>	45.00	54.00
	OEM	2	<b>LR060382P1</b>	60.83	73.00
	Genuine	2	<b>LR060382</b>	133.37	160.04
All petrol models	Aftermarket	2	<b>LR060383P</b>	41.67	50.00
	OEM	2	<b>LR060383P1</b>	67.50	81.00
	Genuine	2	<b>LR060383</b>	133.37	160.04

**CV Joint Assembly**

All models without rear axle locking differential - Rear axle, outer	Aftermarket	2	<b>LR060384P</b>	45.00	54.00
	OEM	2	<b>LR060384P1</b>	105.00	126.00
	Genuine	2	<b>LR060384</b>	192.08	230.50
All models with rear axle locking differential - Rear axle, outer	Aftermarket	2	<b>LR060385P</b>	45.00	54.00
	OEM	2	<b>LR060385P1</b>	105.00	126.00
	Genuine	2	<b>LR060385</b>	192.08	230.50

**Centre Bearing, Propshaft**

All models - Rear	Britpart	1	<b>LR037027BPBRG</b>	39.58	47.50
-------------------	----------	---	----------------------	-------	-------

**Drive Shaft Front**

All diesel models with manual gearbox	RH	OEM	1	<b>LR071930P1</b>	177.50	213.00
		Genuine	1	<b>LR071930</b>	441.77	530.12
	LH	OEM	1	<b>LR072067P1</b>	153.33	184.00
	Genuine	1	<b>LR072067</b>	384.53	461.44	
All diesel models with auto gearbox	RH	OEM	1	<b>LR072070P1</b>	150.83	181.00
		Genuine	1	<b>LR072070</b>	427.73	513.28
	All petrol models with auto gearbox	RH	OEM	1	<b>LR071930P1</b>	177.50
		Genuine	1	<b>LR071930</b>	441.77	530.12
LH		OEM	1	<b>LR072067P1</b>	153.33	184.00
	Genuine	1	<b>LR072067</b>	384.53	461.44	

**Drive Shaft & CV Joint**

All petrol automatic models - Front axle	RH	Genuine	1	<b>LR025872</b>	156.18	187.42
	LH	Genuine	1	<b>LR025874</b>	146.18	175.42
	All diesel manual models - Front axle	RH	Genuine	1	<b>LR025872</b>	156.18
LH		Genuine	1	<b>LR025874</b>	146.18	175.42
All diesel automatic models - Front axle		RH	Genuine	1	<b>LR025869</b>	149.94
	LH	Genuine	1	<b>LR025873</b>	146.18	175.42
	All models without rear axle locking differential - Rear	<i>Features 2mm thread pitch - original hub nut with 1.5mm pitch will also need to be replaced with LR024151 nut</i>				
RH		Genuine	1	<b>LR071933</b>	194.47	233.36
LH		OEM	1	<b>LR072065P1</b>	195.00	234.00
	Genuine	1	<b>LR072065</b>	295.28	354.34	
All models with rear axle locking differential - Rear	<i>Features 2mm thread pitch - original hub nut with 1.5mm pitch will also need to be replaced with LR024151 nut</i>					
	RH	Genuine	1	<b>LR072071</b>	322.93	387.52
	LH	Genuine	1	<b>LR072063</b>	395.46	474.55

**Drive Shaft Assembly**

All 2.7L TDV6 diesel models with automatic gearbox - Front	LH	OEM	1	<b>LR072069P1</b>	138.33	166.00
		Genuine	1	<b>LR072069</b>	402.85	483.42

**Gaiter Kit Front Drive Shaft**

All diesel models with manual gearbox	OEM	2	<b>TDR500110P1</b>	20.63	24.76
	Genuine	2	<b>TDR500110</b>	43.23	51.88
All diesel models with auto gearbox	OEM	2	<b>TDR500100P1</b>	18.54	22.25
	Genuine	2	<b>TDR500100</b>	43.23	51.88
All petrol models	OEM	2	<b>TDR500110P1</b>	20.63	24.76
	Genuine	2	<b>TDR500110</b>	43.23	51.88

**Gaiter Kit Rear Drive Shaft**

All models without rear axle locking differential	OEM	2	<b>TDR500070P1</b>	20.00	24.00
	Genuine	2	<b>TDR500070</b>	46.58	55.90
All models with rear axle locking differential	OEM	2	<b>TDR500080P1</b>	20.00	24.00
	Genuine	2	<b>TDR500080</b>	39.28	47.14

**Drive Flange Kit, Transfer Box**

All models	Front output shaft	Genuine	1	<b>IEA500031</b>	81.83	98.20
	Rear output shaft	Genuine	1	<b>LR039528</b>	107.64	129.17

**Wheel Hub, With Bearing**

All models - Front	Aftermarket	2	<b>LR048083P</b>	60.00	72.00
	OEM	2	<b>LR048083P1</b>	95.00	114.00
	Genuine	2	<b>LR048083</b>	206.23	247.48

**Wheel Hub Assembly**

All models - Rear axle, does not include bearing	Aftermarket	2	<b>RUC500120P</b>	55.83	67.00
	Genuine	2	<b>RUC500120</b>	98.29	117.95

**Oil Seal, Differential**

All models	Front axle pinion	OEM	1	<b>LR019019P1</b>	5.63	6.76
		Genuine	1	<b>LR019019</b>	9.25	11.10
Front & rear axles, output shafts	OEM	1	<b>TZB500050P1</b>	6.25	7.50	
	Genuine	1	<b>TZB500050</b>	13.21	15.85	
	OEM	1	<b>TZB500100</b>	16.28	19.54	
	Genuine	1	<b>TZB500100</b>	16.28	19.54	

**Sealing Ring, Transfer Box**

All models - Front output shaft	OEM	1	<b>IZB500040P1</b>	8.13	9.76
	Genuine	1	<b>IZB500040</b>	10.17	12.20

**Oil Seal, Transfer Box**

All models - Input shaft	Aftermarket	1	<b>IZB500030P</b>	6.67	8.00
	Genuine	1	<b>IZB500030</b>	12.96	15.55

**Sealing Ring, Transfer Box**

All models - Rear output shaft	OEM	1	<b>IZB500050P1</b>	4.79	5.75
	Genuine	1	<b>IZB500050</b>	9.84	11.81

**Plug, Differential**

All models - Oil filler, front & rear axles	Genuine	1	<b>TYB500060</b>	0.86	1.03
All models - Oil drain, front axle	Genuine	1	<b>TYB500080</b>	11.54	13.85

**Plug, Oil Drain**

All models - Rear axle	Genuine	1	<b>FTC5431</b>	6.50	7.80
------------------------	---------	---	----------------	------	------

**Plug, Transfer Box**

All models - Oil Fill & Drain	OEM	1	<b>IYB500020P1</b>	1.75	2.10
	Genuine	1	<b>IYB500020</b>	2.49	2.99

**Oil Temperature Switch**

All models with rear axle locking differential - Rear axle differential	Genuine	1	<b>NSC500590</b>	14.45	17.34
-------------------------------------------------------------------------	---------	---	------------------	-------	-------

**Chain Only, Transfer Box**

All models	OEM	1	<b>LR049160CP1</b>	133.33	160.00
------------	-----	---	--------------------	--------	--------

**Sensor, Differential**

All models with rear axle locking differential - Oil temperature	Genuine	1	<b>NSC500590</b>	14.45	17.34
------------------------------------------------------------------	---------	---	------------------	-------	-------

**Sensor, Transfer Box**

All models - High/low position	Genuine	1	<b>IAB500191</b>	74.63	89.56
--------------------------------	---------	---	------------------	-------	-------

**Solenoid, Transfer Box**

All models - Pressure	Genuine	1	<b>IGF500011</b>	77.19	92.63
-----------------------	---------	---	------------------	-------	-------





## COOLING

### Expansion Bottle Cap

All models	Aftermarket	1	<b>PCD500030P</b>	2.83	3.40
	Genuine	1	<b>PCD500030</b>	6.76	8.11

### Thermostat

All 2.7L TDV6 diesel engine models with EU2 emissions (not Euro Stage 4 or DPF)	Genuine	1	<b>PEL500320</b>	42.90	51.48
	Genuine	1	<b>LR009562</b>	25.61	30.73
All models with 2.7L TDV6 diesel engine and Euro Stage 4 emissions (with DPF)	Aftermarket	1	<b>LR005765P</b>	10.00	12.00
	Genuine	1	<b>LR005765P1</b>	17.50	21.00
All 4.4L AJV8 petrol models - Coolant	Aftermarket	1	<b>LR005765P</b>	10.00	12.00
	Genuine	1	<b>LR005765</b>	30.16	36.19

### Thermostat Housing Gasket

All 4.4L N/A AJV8 petrol models - Housing elbow, 54mm dia.	Genuine	1	<b>4024557</b>	0.58	0.70
------------------------------------------------------------	---------	---	----------------	------	------

### Thermostat Housing O Ring

All 4.4L N/A AJV8 petrol models	Genuine	1	<b>4359953</b>	3.99	4.79
	Genuine	1	<b>4362513</b>	1.58	1.90
Housing elbow, 53mm dia.	Genuine	1	<b>4362513</b>	1.58	1.90
Thermostat cover, 69mm dia.	Genuine	1	<b>4362513</b>	1.58	1.90
Thermostat housing body, 37mm dia.	Genuine	1	<b>4413478</b>	1.74	2.09

### Thermostat Cover

All 4.4L N/A AJV8 petrol models	Genuine	1	<b>4624378</b>	32.98	39.58
---------------------------------	---------	---	----------------	-------	-------

### Engine Thermostat Housing Assembly

All 4.4L N/A AJV8 petrol models from (VIN) 7A000001 on - Includes thermostat, cover, elbow and temp sensor	Genuine	1	<b>LR005631</b>	81.72	98.06
------------------------------------------------------------------------------------------------------------	---------	---	-----------------	-------	-------

### Thermostat Housing Elbow

All 4.4L N/A AJV8 petrol models - 4 bolt fixing	Genuine	1	<b>PEH500140</b>	18.61	22.33
-------------------------------------------------	---------	---	------------------	-------	-------



LR005765P

### Water Pump

All 2.7L V6 diesel engine models	OEM	1	<b>LR009324P1</b>	35.83	43.00
	Genuine	1	<b>LR009324</b>	89.17	107.00
All 4.4L AJ V8 petrol engine models	Aftermarket	1	<b>4575902P</b>	19.79	23.75
	OEM	1	<b>4575902P1</b>	29.58	35.50
	Genuine	1	<b>4575902</b>	128.66	154.39

### Gasket Water Pump

All 2.7L V6 diesel engine models	Genuine	1	<b>1316117</b>	24.53	29.44
All 4.0L Cologne V6 petrol models	Genuine	1	<b>1106473</b>	5.04	6.05
All 4.4L N/A AJV8 petrol models	Genuine	1	<b>4575903</b>	5.04	6.05

### Intercooler Hose

All 2.7L V6 turbo diesel models - RH	Aftermarket	1	<b>PNH500025P</b>	25.83	31.00	
	Genuine	1	<b>PNH500025</b>	41.04	49.25	
All 2.7L V6 turbo diesel models up to (VIN) 5A351436	LH front	Genuine	1	<b>PNH500221</b>	54.57	65.48
	LH rear	Genuine	1	<b>PNH500223</b>	43.14	51.77
All 2.7L V6 turbo diesel models	LH	Genuine	1	<b>PNH500223</b>	43.14	51.77
	LH rear	Genuine	1	<b>PNH500034</b>	96.08	115.30

### Coolant Temperature Sensor

All 2.7L TDV6 diesel models	Genuine	1	<b>LR041442</b>	25.70	30.84
All 4.4L AJV8 petrol models	Aftermarket	1	<b>4603183P</b>	15.55	18.66
	Genuine	1	<b>4603183</b>	24.77	29.72

### Coolant Level Sensor

All models	Genuine	1	<b>PCJ500030</b>	6.16	7.39
------------	---------	---	------------------	------	------



LR009324P1

## ELECTRICS - ROTATING ELECTRICS

### Alternator

All 2.7L V6 diesel engine models	New, outright	Aftermarket	1	<b>YLE500400P</b>	130.00	156.00
		OEM	1	<b>YLE500400P1</b>	195.00	234.00
		Genuine	1	<b>LR008861</b>	276.18	331.42
Reconditioned, exchange	Genuine*	1	<b>YLE500400</b>	432.21	518.65	
	*Exchange Surcharge			70.00	84.00	
All 4.0L V6 petrol engine models	New, outright	OEM	1	<b>YLE500410P1</b>	237.50	285.00
		Genuine*	1	<b>LR008861</b>	346.91	416.29
		*Exchange Surcharge			70.00	84.00
All 4.4L AJV8 petrol models	New, outright	Aftermarket	1	<b>YLE500390P</b>	145.00	174.00
		OEM	1	<b>YLE500390P1</b>	225.00	270.00
		Genuine*	1	<b>YLE500390</b>	354.79	425.75
New, exchange	Genuine*	1	<b>YLE500390</b>	354.79	425.75	
	*Exchange Surcharge			70.00	84.00	

### Starter Motor

All 2.7L V6 diesel models - New	OEM	1	<b>LR087021P1</b>	175.00	210.00	
All 2.7L V6 diesel models	New, outright, alternative to LR087021	Genuine	1	<b>LR087021</b>	373.26	447.91
	New, outright, alternative to LR043962	Genuine	1	<b>LR087021</b>	373.26	447.91
	Reconditioned, exchange	Genuine*	1	<b>NAD500080E</b>	214.25	257.10
	*Exchange Surcharge				70.00	84.00
All 4.0L Cologne V6 petrol models -	New, outright	OEM	1	<b>NAD500300P1</b>	175.00	210.00
		Genuine*	1	<b>LR087021</b>	306.70	368.04
		*Exchange Surcharge			70.00	84.00
All 4.4L N/A AJV8 petrol models	New, outright	Aftermarket	1	<b>NAD500310P</b>	195.00	234.00
		Genuine*	1	<b>NAD500310</b>	331.26	397.51
		*Exchange Surcharge			70.00	84.00

## ENGINE GASKETS

### Gasket Camshaft Cover

All 2.7L TDV6 Lion diesel models	Aftermarket	2	<b>LR029132P</b>	6.67	8.00
	Genuine	2	<b>LR029132</b>	14.86	17.83

All 4.4L N/A AJV8 petrol models	RH	Aftermarket	1	<b>LR007652P</b>	10.63	12.76
		Genuine	1	<b>LR007652</b>	22.79	27.35
	LH	Aftermarket	1	<b>LR007657P</b>	10.63	12.76
		Genuine	1	<b>LR007657</b>	28.77	34.52

### Gasket Rocker Cover

All 4.0L Cologne V6 petrol models	Genuine	2	<b>4691206</b>	18.10	21.72
-----------------------------------	---------	---	----------------	-------	-------

### Gasket Cylinder Head

All 2.7L TDV6 diesel models	Grade 2	Genuine	2	<b>LR009719</b>	9.87	11.84
		Genuine	2	<b>LR009721</b>	9.87	11.84
	Grade 3	OEM	2	<b>LR009722P1</b>	10.83	13.00
		Genuine	2	<b>LR009722</b>	20.22	24.26
	Grade 4	OEM	2	<b>LR009723P1</b>	10.83	13.00
		Genuine	2	<b>LR009723</b>	20.22	24.26
All 4.0L Cologne V6 petrol models	RH	Genuine	1	<b>LR003548</b>	16.85	20.22
	LH	Genuine	1	<b>LR003549</b>	16.85	20.22
All 4.4L N/A AJV8 petrol models	RH	Aftermarket	1	<b>4585198P</b>	14.38	17.26
		Genuine	1	<b>4585198</b>	28.99	34.79
	LH	Aftermarket	1	<b>4585202P</b>	14.38	17.26
		Genuine	1	<b>4585202</b>	28.56	34.27

### Gasket Decoke Set

All 4.0L Cologne V6 petrol models	Genuine	1	<b>LR004324</b>	56.45	67.74
-----------------------------------	---------	---	-----------------	-------	-------

### Gasket Oil Sump

All models with 2.7L TDV6 diesel engine	Genuine	1	<b>1365260</b>	23.54	28.25	
All 4.0L Cologne V6 petrol models	Upper	Genuine	1	<b>1025228</b>	8.01	9.61
	Lower	Genuine	1	<b>4639173</b>	14.23	17.08

### Gasket Conversion Set

All 4.0L Cologne V6 petrol models	Genuine	1	<b>LR002817</b>	92.77	111.32
-----------------------------------	---------	---	-----------------	-------	--------

### Gasket Decoke & Conversion Set

All 4.4L N/A AJV8 petrol models - Also includes seals	Aftermarket	1	<b>LR006645P</b>	216.67	260.00
		Genuine	1	<b>LR006645</b>	282.40

### Sealant Instant Gasket

Numerous applications	Genuine	a/r	<b>STC50550</b>	13.10	15.72
-----------------------	---------	-----	-----------------	-------	-------



## DISCOVERY 3 (2005 to 2009)

## ENGINE SWITCHES

## Camshaft Position Sensor

All 2.7L TDV6 diesel models	Genuine	1	<b>LR019287</b>	120.57	144.68
All 4.0L Cologne V6 petrol models - In rocker cover	Genuine	1	<b>LR000442</b>	116.42	139.70
All 4.4L AJV8 petrol models					
RH	Aftermarket	1	<b>4427657P</b>	27.08	32.50
	Genuine	1	<b>4427657</b>	40.54	48.65
LH	Aftermarket	1	<b>4362957P</b>	25.85	31.02
	Genuine	1	<b>4362957</b>	36.32	43.58

## Crankshaft Position Sensor

All 2.7L TDV6 diesel models	Aftermarket	1	<b>LR009793P</b>	45.00	54.00
	Genuine	1	<b>LR009793</b>	117.84	141.41
All 4.0L Cologne V6 petrol models	Aftermarket	1	<b>NSC500160P</b>	20.00	24.00
	Genuine	1	<b>NSC500160</b>	42.84	51.41
All 4.4L N/A AJV8 petrol models	Aftermarket	1	<b>NSC500160P</b>	20.00	24.00
	Genuine	1	<b>NSC500160</b>	42.84	51.41

## Oil Temperature Switch

All 2.7L TDV6 diesel models	Genuine	1	<b>1359056</b>	27.21	32.65
-----------------------------	---------	---	----------------	-------	-------

## Engine Knock Sensor

All 2.7L TDV6 diesel models with EU2 emissions (without diesel particulate filter, DPF)	Genuine	1	<b>LR007808</b>	29.41	35.29
All 4.0L Cologne V6 petrol models					
Upper	Genuine	1	<b>3991033</b>	67.14	80.57
Lower	Genuine	1	<b>NSC500600</b>	13.98	16.78
All 4.4L AJV8 petrol models	Genuine	1	<b>4603186</b>	77.82	93.38

## Retainer Engine Knock Sensor

All 4.4L AJV8 petrol models	Genuine	1	<b>4603189</b>	0.37	0.44
-----------------------------	---------	---	----------------	------	------

## Oil Pressure Switch

All 2.7L TDV6 diesel models	Genuine	1	<b>1316119</b>	13.94	16.73
All 4.4L AJV8 petrol models	Genuine	1	<b>4737666</b>	14.23	17.08

## Manifold Pressure Sensor

All 4.4L AJV8 petrol models	Genuine	1	<b>4628195</b>	59.71	71.65
-----------------------------	---------	---	----------------	-------	-------

## Oxygen Sensor

All 2.7L TDV6 diesel models with Euro Stage IV emissions and diesel particulate filter					
Post-DPF	Genuine	1	<b>WDN500050</b>	34.98	41.98
Pre-catalyst	Genuine	1	<b>WDN500130</b>	34.85	41.82
Post-catalyst	Genuine	1	<b>WDN500110</b>	46.95	56.34
All 4.0L Cologne V6 petrol models - Alternative to LR014010, pre-catalyst					
	Aftermarket	1	<b>MHK500840P</b>	80.00	96.00
	Genuine	1	<b>MHK500840</b>	147.72	177.26
All 4.0L Cologne V6 petrol models - Pre-catalyst					
	Genuine	1	<b>LR014010</b>	109.16	130.99
All 4.4L N/A AJV8 petrol models - Alternative to LR014010, pre-catalyst					
	Aftermarket	1	<b>MHK500840P</b>	80.00	96.00
	Genuine	1	<b>MHK500840</b>	147.72	177.26
All USA/CDN/Mex 4.0L Cologne V6 petrol models from (VIN) 7A000001 on - Post-catalyst					
	OEM	1	<b>MHK501050P1</b>	45.00	54.00
	Genuine	1	<b>MHK501050</b>	137.28	164.74

## Exhaust Gas Pressure Sensor

All 2.7L TDV6 diesel models with diesel particulate filter from (VIN) 7A000001 on For diesel particulate filter (DPF), pressure differential	Genuine	1	<b>LR014310</b>	121.87	146.24
-------------------------------------------------------------------------------------------------------------------------------------------------	---------	---	-----------------	--------	--------

## Lambda Sensor

All 4.0L Cologne V6 petrol models except USA/CDN/Mex (VIN) 7A000001 on - Rear					
RH	OEM	1	<b>LR014012P1</b>	52.50	63.00
	Genuine	1	<b>LR014012</b>	151.60	181.92
LH	OEM	1	<b>LR014011P1</b>	50.00	60.00
	Genuine	1	<b>LR014011</b>	109.76	131.71
All 4.4L AJV8 petrol models except USA/CDN/Mex (VIN) 7A000001 on - Rear					
LH	OEM	1	<b>LR014011P1</b>	50.00	60.00
	Genuine	1	<b>LR014011</b>	109.76	131.71

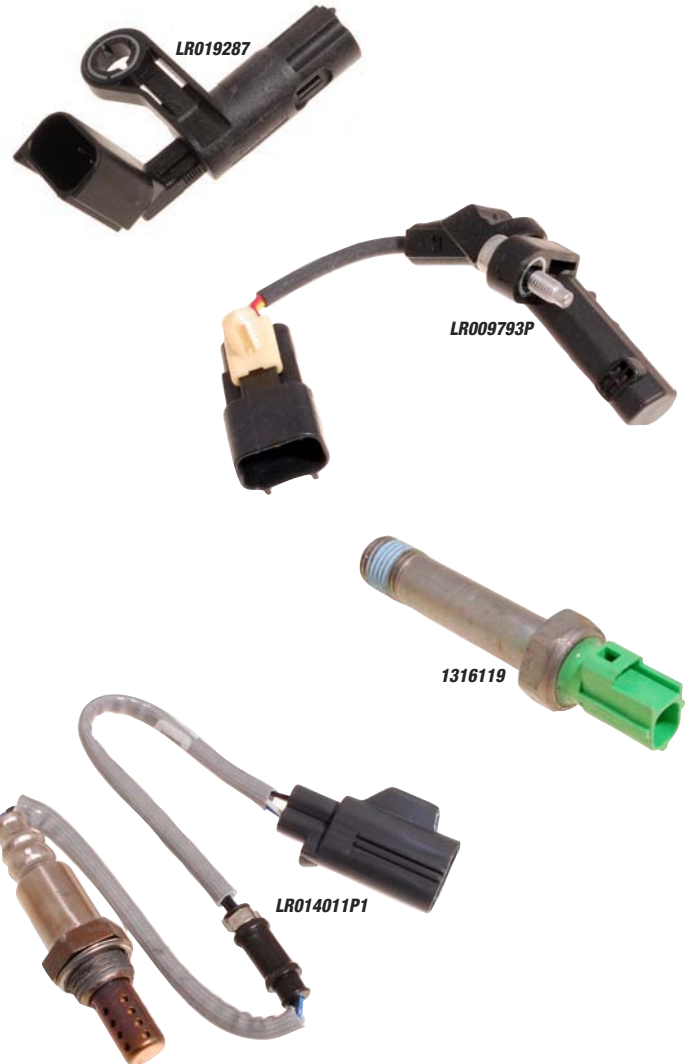

## DISCOVERY 3 (2005 to 2009)

## DRAIN PLUGS

## Sump Plug &amp; Washer

2.7L V6 Lion diesel models	Aftermarket	1	<b>1013938P</b>	1.50	1.80
	Genuine	1	<b>1013938</b>	3.19	3.83
4.0L V6 Cologne petrol models	Aftermarket	1	<b>1013938P</b>	1.50	1.80
	Genuine	1	<b>1013938</b>	3.19	3.83
4.4L V8 AJ petrol models	Aftermarket	1	<b>1013938P</b>	1.50	1.80
	Genuine	1	<b>1013938</b>	3.19	3.83

## Drain Plug

All 6 speed manual models - Gearbox. Also filler plug					
	Genuine	1	<b>TYB500010</b>	6.28	7.54



## DISCOVERY 3 (2005 to 2009)

## OIL SEALS ENGINE

## Oil Seal Crankshaft

All models with 2.7L TDV6 diesel engine					
Front	Genuine	1	<b>1102415</b>	5.41	6.49
Rear with retainer	Genuine	1	<b>LR036542</b>	36.48	43.78
All 4.0L Cologne V6 petrol models					
Front	OEM	1	<b>1316639P1</b>	2.83	3.40
	Genuine	1	<b>1316639</b>	5.06	6.07
Rear	OEM	1	<b>4719898P1</b>	4.79	5.75
	Genuine	1	<b>4719898</b>	7.19	8.63
All 4.4L N/A AJV8 petrol models					
Front	Genuine	1	<b>4526537</b>	23.47	28.16
Rear	Aftermarket	1	<b>4352327P</b>	12.50	15.00

## Oil Seal Camshaft

All models with 2.7L TDV6 diesel engine					
Front and rear	Aftermarket	2	<b>1311318P</b>	2.00	2.40
	Genuine	2	<b>1311318</b>	2.83	3.40



## EXHAUST GAS RECIRCULATION (EGR)

## DISCOVERY 3 (2005 to 2009)

### EGR Valve

All 2.7L TDV6 diesel models with diesel particulate filter (VIN) 7A000001 on					
RH	Aftermarket	1	<b>LR018324P</b>	82.00 98.40	
	OEM	1	<b>LR018324P1</b>	133.33 160.00	
	Genuine	1	<b>LR018324</b>	179.69 215.63	
LH	Aftermarket	1	<b>LR018323P</b>	82.00 98.40	
	OEM	1	<b>LR018323P1</b>	133.33 160.00	
	Genuine	1	<b>LR018323</b>	179.69 215.63	
All EU2 Euro emissions directive 3 2.7L V6 diesel engine models from (VIN) 7A000001 on					
RH	Aftermarket	1	<b>LR018466P</b>	100.00 120.00	
	Genuine	1	<b>LR018466</b>	195.73 234.88	
LH	Aftermarket	1	<b>LR018465P</b>	100.00 120.00	
	Genuine	1	<b>LR018465</b>	195.73 234.88	
All 4.0L Cologne V6 petrol models		Genuine	1	<b>LR012028</b>	171.40 205.68
All 4.4L AJV8 petrol models		Genuine	1	<b>4536857</b>	183.10 219.72

### EGR Blanking Kit

All 2.7L TDV6 diesel models with EU2 emissions (non-DPF) Includes blanking plates & seals for both EGR valves				
	Britpart	1	<b>RD1340BP</b>	35.00 42.00
	Terraforma	1	<b>RD1340TF</b>	39.58 47.50
	Bearmach	1	<b>RD1340BM</b>	40.83 49.00

### Gasket EGR Outlet

All 2.7L V6 Diesel engine models - Exhaust gas recirculation outlet				
	Genuine	1	<b>1331267</b>	5.12 6.14

### Gasket EGR Valve Inlet

All 2.7L V6 Diesel engine models from (VIN) 7A000001 on - Exhaust gas recirculation inlet				
	Aftermarket	1	<b>LR004532P</b>	2.58 3.10
	Genuine	1	<b>LR004532</b>	5.48 6.58

### Gasket EGR Pipe to Exhaust Manifold

All 2.7L TDV6 diesel models - RH & LH				
	Genuine	1	<b>1331270</b>	5.30 6.36

### Gasket EGR Valve to Cooler

All 2.7L TDV6 diesel models with EU2 emissions (non-DPF) - RH & LH				
	Genuine	1	<b>1336561</b>	5.31 6.37

### Gasket EGR Pipe to Exhaust

All 4.4L AJV8 petrol models				
	Genuine	1	<b>4451180</b>	0.77 0.92

### Gasket EGR Valve to Pipe

All 4.4L AJV8 petrol models				
	Genuine	1	<b>4536854</b>	0.53 0.64

### Gasket EGR Valve to Inlet Manifold

All 4.4L AJV8 petrol models				
	Genuine	1	<b>4536856</b>	0.53 0.64

### Pipe EGR Valve to Inlet Manifold

All 2.7L TDV6 diesel models				
RH	Genuine	1	<b>LR066841</b>	176.97 212.36
LH	Genuine	1	<b>LR066839</b>	203.44 244.13

### Pipe EGR Valve to Exhaust

All 2.7L TDV6 diesel models - RH				
	Genuine	1	<b>LR004253</b>	42.65 51.18
All 4.4L AJV8 petrol models				
	Genuine	1	<b>4682990</b>	37.09 44.51

### Pipe EGR Valve to Exhaust Manifold

All 2.7L TDV6 diesel models - LH				
	Genuine	1	<b>LR066840</b>	109.04 130.85
All 4.0L Cologne V6 petrol models up to (VIN) 5A347675				
	Genuine	1	<b>WAT500012</b>	24.42 29.30
All 4.0L Cologne V6 petrol models from (VIN) 5A347676 on				
	Genuine	1	<b>WAT500030</b>	24.63 29.56

### Pipe Cooled EGR Outlet

All 2.7L TDV6 diesel models with Euro Stage 4 emissions with DPF from (VIN) 7A000001 on				
	Genuine	1	<b>WAP500380</b>	81.41 97.69

## ENGINE & GEARBOX MOUNTINGS

## DISCOVERY 3 (2005 to 2009)

### Engine Mounting

All 2.7L TDV6 diesel models				
	Genuine	2	<b>KKB500760</b>	52.07 62.48
All 4.0L Cologne V6 petrol models				
	Genuine	2	<b>KKB500620</b>	53.33 64.00
All 4.4L AJV8 petrol models				
	Genuine	2	<b>KKB500770</b>	52.15 62.58

### Eye Bolt Gearbox Mounting

All models				
	Genuine	1	<b>KYG500200</b>	1.32 1.58

### Bracket Engine Mounting

All 2.7L TDV6 diesel models - LH				
	Genuine	1	<b>KKU500580</b>	90.84 109.01
All 4.0L Cologne V6 petrol models				
RH	Genuine	1	<b>KKU500660</b>	220.71 264.85
LH	Genuine	1	<b>KKU500640</b>	31.17 37.40
All 4.4L AJV8 petrol models				
RH	Genuine	1	<b>KKU500610</b>	101.44 121.73
LH	Genuine	1	<b>KKU500600</b>	95.73 114.88

## FUEL SYSTEM SWITCHES

## DISCOVERY 3 (2005 to 2009)

### Air Flow Meter

2.7L TDV6 diesel models				
	OEM	1	<b>PHF500101P1</b>	89.17 107.00
	Genuine	1	<b>PHF500101</b>	128.80 154.56
V6 Cologne petrol models				
	OEM	1	<b>PHF000140P1</b>	70.00 84.00
	Genuine	1	<b>PHF000140</b>	107.33 128.80
4.4L V8 AJ petrol models				
	OEM	1	<b>PHF000140P1</b>	70.00 84.00
	Genuine	1	<b>PHF000140</b>	107.33 128.80

### Fuel Temperature Sensor

All 4.4L AJV8 petrol models - Fuel rail				
	Genuine	1	<b>LR000291</b>	20.82 24.98

### Water Sensor for Fuel Filter

All 2.7L TDV6 diesel models from (VIN) 7A000001 on				
	OEM	1	<b>WKW500080</b>	51.36 61.63

## CABLES

## DISCOVERY 3 (2005 to 2009)

### Bonnet Release Cable

All models				
Engine compartment end	Genuine	1	<b>FSE000091</b>	5.85 7.02
Passenger compartment end	Genuine	1	<b>FSE500031</b>	12.63 15.16



## WHEEL CENTRE CAPS & WHEEL NUTS

## DISCOVERY 3 (2005 to 2009)

### Wheel Centre Cap

All models with Silver Sparkle (MNH) colour alloy wheels - Silver Sparkle, Land Rover green/silver badge				
	Genuine	a/r	<b>LR089424</b>	5.45 6.54
All models with shadow chrome finish wheel centre caps - Shadow chrome with Land Rover green/gold badge				
	Genuine	a/r	<b>RRJ500030MNL</b>	8.42 10.10
All models with Silver Sparkle wheel centre caps with Land Rover black/silver badge - Silver Sparkle with Land Rover black/silver badge				
	Genuine	a/r	<b>RRJ500030WYS</b>	11.03 13.24
All models with Titan Silver wheel centre caps with Land Rover black/silver badge				
	Genuine	a/r	<b>RRJ500030WYT</b>	8.76 10.51

### Wheel Nut

All models with stainless steel finish wheel nuts - Stainless steel finish				
	OEM	a/r	<b>LR068126P1</b>	3.25 3.90
	Genuine	a/r	<b>LR068126</b>	5.27 6.32

### Wheel Nut Set

All models with stainless steel finish wheel nuts - Stainless steel finish				
set of 16	OEM	a/r	<b>LR068126P1K16</b>	40.00 48.00
	Genuine	a/r	<b>LR068126K16</b>	80.83 97.00
set of 20	OEM	a/r	<b>LR068126P1K20</b>	50.00 60.00
	Genuine	a/r	<b>LR068126K20</b>	97.50 117.00



RRJ500030WYT





# DISCOVERY 4 (2010 on)

## 2010 - All Models

Listed below are the most popular parts required for the Discovery 4.  
We have access to the full range of parts for your vehicle. Please contact us if not listed here.

### DISCOVERY 4 (2010 on)

## SERVICE KITS

#### Service Kit

All 4.0L V6 petrol models - Includes oil filter, air filter, fuel filter, pollen filters, spark plugs & sump plug

Aftermarket	1	<b>RD1215P</b>	24.50	29.40
Genuine	1	<b>RD1215</b>	79.00	94.80

#### Filter Kit

All 2.7L TDV6 diesel models - Includes oil filter, air filter, fuel filter, pollen filters & sump plug

Aftermarket	1	<b>RD1213P</b>	32.50	39.00
Genuine	1	<b>RD1213</b>	98.33	118.00

All 3.0L V6 diesel models - Includes oil filter, air filter, fuel filter, pollen filters & sump plug

Britpart	1	<b>RA1517BP</b>	30.83	37.00
Genuine	1	<b>RA1517</b>	95.00	114.00



RD1215P



RD1213P

### DISCOVERY 4 (2010 on)

## FILTRATION

#### Oil Filter

All models with 2.7L V6 diesel engine - Element

Aftermarket	1	<b>1311289P</b>	3.00	3.60
Genuine	1	<b>1311289</b>	9.84	11.81

All models with 3.0L V6 diesel engine - Element

Aftermarket	1	<b>LR013148P</b>	3.50	4.20
Genuine	1	<b>LR013148</b>	11.39	13.67

All 4.0L V6 petrol engine with oil cooler - Cartridge

Aftermarket	1	<b>4454116P</b>	2.50	3.00
OEM	1	<b>4454116P1</b>	3.00	3.60
Genuine	1	<b>4454116</b>	10.56	12.67

All 4.0L V6 petrol engine without oil cooler - Cartridge

OEM	1	<b>LR029240P1</b>	4.58	5.50
Genuine	1	<b>LR029240</b>	9.25	11.10

All 5.0L NA V8 petrol models - Element

Genuine	1	<b>LR011279</b>	22.43	26.92
---------	---	-----------------	-------	-------

#### Air Filter

All 2.7L TDV6 diesel engine models

Aftermarket	1	<b>PHE000112P</b>	5.83	7.00
OEM	1	<b>PHE000112P1</b>	7.08	8.50
Genuine	1	<b>PHE000112</b>	21.76	26.11

All 3.0L V6 diesel models

Aftermarket	1	<b>PHE000112P</b>	5.83	7.00
OEM	1	<b>PHE000112P1</b>	7.08	8.50
Genuine	1	<b>PHE000112</b>	21.76	26.11

All 4.0 V6 Cologne petrol models

Aftermarket	1	<b>PHE000112P</b>	5.83	7.00
OEM	1	<b>PHE000112P1</b>	7.08	8.50
Genuine	1	<b>PHE000112</b>	21.76	26.11

All 5.0L normally aspirated V8 petrol models from (VIN) AA000001 on

Aftermarket	2	<b>LR011593P</b>	5.63	6.76
Genuine	2	<b>LR011593</b>	24.55	29.46



LR013148P



JKR500010P

#### Fuel Filter

All 2.7L TDV6 diesel models

Aftermarket	1	<b>LR009705P</b>	18.54	22.25
OEM	1	<b>LR009705P1</b>	38.75	46.50
Genuine	1	<b>LR009705</b>	42.05	50.46

All 3.0L V6 diesel models

Aftermarket	1	<b>LR009705P</b>	18.54	22.25
OEM	1	<b>LR009705P1</b>	38.75	46.50
Genuine	1	<b>LR009705</b>	42.05	50.46

#### Pollen Filter

All models - Fresh air

Aftermarket	1	<b>JKR500010P</b>	3.83	4.60
OEM	1	<b>JKR500010P1</b>	9.17	11.00
Genuine	1	<b>JKR500010</b>	28.01	33.61

All models - Odour & particles, production replacement type

Aftermarket	1	<b>LR023977P</b>	4.00	4.80
OEM	1	<b>LR023977P1</b>	14.17	17.00
Genuine	1	<b>LR023977</b>	36.92	44.30

#### Oil Filter for Standard Gearbox Oil Sump

All 6 speed automatic models

Bearmach	1	<b>LR007474PF</b>	10.83	13.00
----------	---	-------------------	-------	-------

#### Oil Filter for Easy Fit Gearbox Sump

All 6 speed automatic models

OEM	1	<b>LR007474BPEFOEM</b>	29.58	35.50
-----	---	------------------------	-------	-------

#### Gearbox Oil Sump Easy Fit Conversion Kit

All 6 speed automatic models - Includes metal sump, separate oil filter, gasket and 'O' ring

OEM	1	<b>LR007474BPKITEFOEM</b>	130.00	156.00
Britpart	1	<b>LR007474BPKITEF</b>	72.50	87.00

#### Oil Filter for Easy Fit Gearbox Sump

All 6 speed automatic models

Britpart	1	<b>LR007474BPEF</b>	11.67	14.00
----------	---	---------------------	-------	-------

#### Gasket for Gearbox Oil Sump Easy Fit Conversion

All 6 speed automatic models

Britpart	1	<b>LR007474BPKITEFG</b>	6.67	8.00
----------	---	-------------------------	------	------

#### Gearbox Fluid Change Kit

All 6 speed automatic models

Includes essential items for fluid change on the 6 speed automatic gearbox (ZF models 6HP26 and 6HP28) - auto trans fluid, standard sump assembly with sleeve and plugs, sump attachment screws

Britpart	1	<b>LR007474BPKIT</b>	130.00	156.00
----------	---	----------------------	--------	--------

### DISCOVERY 4 (2010 on)

## WIPER BLADES



LR018368P1

#### Wiper Blade

All RHD models - Front

Aftermarket	2	<b>LR018368P</b>	6.67	8.00
OEM	2	<b>LR018368P1</b>	11.67	14.00
Genuine	2	<b>LR018368</b>	21.02	25.22

All LHD models - Front

Aftermarket	2	<b>LR018367P</b>	5.00	6.00
OEM	2	<b>LR018367P1</b>	7.92	9.50
Genuine	2	<b>LR018367</b>	24.19	29.03

All models - Rear

Aftermarket	1	<b>DKB500680P</b>	1.75	2.10
OEM	1	<b>DKB500680P1</b>	5.00	6.00
Genuine	1	<b>DKB500680</b>	12.94	15.53

# SCREEN/LAMP WASHER SYSTEMS

## Non-Heated Washer Jet

All models without heated washer jets - Front screen wash				
Genuine	2	<b>LR049290</b>	3.41	4.09

## Heated Washer Jet

All models with heated washer jets - Front screen wash				
Genuine	2	<b>LR048615</b>	14.29	17.15

## Washer Jet, with Hose

All models - Rear screen wash				
Genuine	1	<b>LR032197</b>	6.04	7.25

## Washer Jet Retaining Clip

All models with headlamp wash - Headlamp jet to bumper				
Genuine	2	<b>DYC000190</b>	1.80	2.16

## Washer Hose, Per Metre

All models - 4mm internal diameter (3mm also available).	Front or rear screen wash			
Aftermarket	a/r	<b>GWV201M</b>	2.25	2.70

## Washer Hose Assembly & Elbows

All models - Front screen wash				
Genuine	1	<b>DNH000133</b>	8.98	10.78

## Washer Jet Elbow

All models - Front screen wash				
Genuine	2	<b>DNG10001</b>	2.01	2.41

## Washer Hose Y Piece

All models - Front screen wash				
Genuine	1	<b>DNG000010</b>	17.40	20.88

# DRIVE BELTS

## Timing Belt Kit

All models with 3.0L TDV6/SDV6 diesel engine - Fuel pump drive				
Genuine	1	<b>LR016656</b>	113.96	136.75

## Alternator Drive Belt

All models with 2.7L/3.0L V6 diesel engine - Alternator				
Genuine	1	<b>LR013697</b>	29.26	35.11
All models with 3.0L GEN 2 twin turbo V6 diesel - Alternator				
Genuine	1	<b>LR071408</b>	53.06	63.67
All models with 4.0L V6 petrol engine - Alternator				
Aftermarket	1	<b>PQS500081P</b>	8.33	10.00
OEM	1	<b>PQS500081P1</b>	12.08	14.50
Genuine	1	<b>PQS500081</b>	48.03	57.64



## Non-Return Valve

All models with headlamp wash - Headlamp wash				
Genuine	1	<b>LR014288</b>	4.82	5.78

## Washer Reservoir

All models without headlamp wash - Front & rear screen wash				
Genuine	1	<b>LR013954</b>	55.95	67.14
All models with headlamp wash - Front & rear screen & headlamp wash				
Genuine	1	<b>LR013953</b>	45.94	55.13

## Washer Reservoir Filler Neck

All models - Front & rear screen & headlamp wash				
Genuine	1	<b>LR013955</b>	18.77	22.52

## Washer Reservoir Level Sensor

All models - Front & rear screen & headlamp wash				
Genuine	1	<b>DMI500010</b>	4.20	5.04

## Filler Neck Cap

All models - Front & rear screen & headlamp wash				
Genuine	1	<b>LR002266</b>	1.86	2.23

## Windscreen Cleaning Paste

All models - Prevents wiper blade judder/squeak by 'deep cleaning' the windscreen (ref: Land Rover Tech Bulletin LRA501-002)				
Genuine	a/r	<b>DNJ500340</b>	7.72	9.26

# DISCOVERY 4 (2010 on)

## Primary Drive Belt

All 5.0L V8 normally aspirated V8 petrol models - Primary				
OEM	1	<b>LR064185P1</b>	13.13	15.76
Genuine	1	<b>LR064185</b>	27.20	32.64

## Secondary Drive Belt

All models with 5.0L normally aspirated V8 petrol engine - Secondary				
Aftermarket	1	<b>LR012663P</b>	5.63	6.76
Genuine	1	<b>LR012663</b>	21.54	25.85



# IGNITION SYSTEM

## Spark Plug

All 3.0L supercharged V6 petrol models				
Genuine	6	<b>LR050998</b>	12.21	14.65
All 4.0L V6 petrol models with unleaded fuel				
Genuine	6	<b>LR000604</b>	5.23	6.28
All 4.0L V6 petrol models with leaded fuel				
Genuine	6	<b>1349269</b>	2.15	2.58
All 5.0L N/A AJV8 petrol models				
OEM	8	<b>LR032080P1</b>	7.50	9.00
Genuine	8	<b>LR032080</b>	13.33	16.00



## Glow Plug

All 2.7L V6 diesel engine models				
OEM	6	<b>1354289P1</b>	8.54	10.25
Genuine	6	<b>1354289</b>	12.71	15.25
All 3.0L TDV6 diesel models				
Genuine	6	<b>LR013275</b>	29.96	35.95

## Ignition Coil

All 3.0L supercharged V6 petrol models				
Genuine	6	<b>LR035548</b>	55.50	66.60
All 4.0L Cologne V6 petrol models				
Aftermarket	6	<b>LR002427P</b>	20.42	24.50
Genuine	6	<b>LR002427</b>	40.46	48.55
All models with 5.0L NA AJV8 petrol engine				
Aftermarket	8	<b>LR010687P</b>	36.67	44.00
Genuine	8	<b>LR010687</b>	55.63	66.76



## DISCOVERY 4 (2010 on)

## BRAKING SYSTEM

## Brake Pad Set

All models with 2.7L Lion V6 diesel engine to (VIN) CA999999					
Front Brakes	Aftermarket	1	<b>LR019618P</b>	18.13	21.76
	Brembo	1	<b>LR019618BREMBO</b>	37.08	44.50
	OEM	1	<b>LR019618P1</b>	27.50	33.00
	Genuine	1	<b>LR019618</b>	48.11	57.73
	EBC	1	<b>LR019618GS</b>	50.83	61.00
All 3.0L TDV6 diesel and 5.0L NA V8 petrol models to (VIN) CA999999					
Front	OEM	1	<b>LR051626P1</b>	42.50	51.00
	Genuine	1	<b>LR051626</b>	133.84	160.61
All models with 4.0L Cologne V6 petrol engine to (VIN) CA999999					
Front Brakes	Aftermarket	1	<b>LR019618P</b>	18.13	21.76
	Brembo	1	<b>LR019618BREMBO</b>	37.08	44.50
	OEM	1	<b>LR019618P1</b>	27.50	33.00
	Genuine	1	<b>LR019618</b>	48.11	57.73
	EBC	1	<b>LR019618GS</b>	50.83	61.00
All coil sprung models (VIN) DA000001 on					
Front Brakes	Aftermarket	1	<b>LR019618P</b>	18.13	21.76
	Brembo	1	<b>LR019618BREMBO</b>	37.08	44.50
	OEM	1	<b>LR019618P1</b>	27.50	33.00
	Genuine	1	<b>LR019618</b>	48.11	57.73
	EBC	1	<b>LR019618GS</b>	50.83	61.00
All models with 3.0L AJ133 diesel engine (VIN) AA000001 to (VIN) AA547440					
Rear Brakes	OEM	1	<b>LR015519P1</b>	32.50	39.00
	Genuine	1	<b>LR015519</b>	79.53	95.44
	Aftermarket	1	<b>LR021316P</b>	15.00	18.00
All models with 3.0L AJ133 diesel engine (VIN) AA547441 to CA999999 -					
Rear Brakes	Aftermarket	1	<b>LR021316P</b>	15.00	18.00
	Genuine	1	<b>LR021316</b>	40.09	48.11
All models with 5.0L SGDI NA V8 petrol engine (VIN) AA000001 to (VIN) AA547440					
Rear Brakes	OEM	1	<b>LR015519P1</b>	32.50	39.00
	Genuine	1	<b>LR015519</b>	79.53	95.44
	Aftermarket	1	<b>LR021316P</b>	15.00	18.00
All models with 5.0L SGDI NA V8 petrol engine (VIN) AA547441 to CA999999					
Rear Brakes	Aftermarket	1	<b>LR021316P</b>	15.00	18.00
	Genuine	1	<b>LR021316</b>	40.09	48.11
All coil sprung models (VIN) DA000001 on					
Rear	Aftermarket	1	<b>LR055454P</b>	15.63	18.76
	Brembo	1	<b>LR055454BREMBO</b>	34.35	41.22
	OEM	1	<b>LR055454P1</b>	18.54	22.25
	Genuine	1	<b>LR055454</b>	48.11	57.73
	EBC	1	<b>LR055454GS</b>	41.67	50.00
All air sprung models (VIN) DA000001 on - Rear					
Rear	Aftermarket	1	<b>LR055455P1</b>	18.54	22.25
	Genuine	1	<b>LR055455</b>	60.16	72.19

## Retaining Spring

All 2.7L Lion diesel models - Front Brake Pads					
Aftermarket	1	<b>LR019625P</b>	3.08	3.70	
	1	<b>LR019625</b>	3.77	4.52	
All 4.0L Cologne V6 petrol models - Front Brake Pads					
Aftermarket	1	<b>LR019625P</b>	3.08	3.70	
	1	<b>LR019625</b>	3.77	4.52	
All coil sprung models (VIN) DA000001 on - Front Brake Pads					
Aftermarket	1	<b>LR019625P</b>	3.08	3.70	
	1	<b>LR019625</b>	3.77	4.52	

## Brake Pad Clips

All 3.0L 24V DOHC V6 diesel engine models from (VIN) AA000001 to (VIN) CA999999					
Front	Genuine	1	<b>LR026219</b>	29.96	35.95
	All 5.0L OHC SGDI NA V8 petrol engine models				
Front	Genuine	1	<b>LR026219</b>	29.96	35.95
	All models with 4 corner air suspension from (VIN) DA000001 to (VIN) DA999999				
Front	Genuine	1	<b>LR026219</b>	29.96	35.95

## Retaining Spring Kit

All models to (VIN) CA999999					
Rear Brake Pads	Aftermarket	1	<b>LR019626P</b>	2.17	2.60
	Genuine	1	<b>LR019626</b>	4.21	5.05
All coil sprung models (VIN) DA000001 on					
Rear Brake Pads	Aftermarket	1	<b>LR019626P</b>	2.17	2.60
	Genuine	1	<b>LR019626</b>	4.21	5.05

## Brake Disc (each)

All models with 2.7L Lion V6 diesel engine to (VIN) CA999999					
Front	Aftermarket	2	<b>SDB000604P</b>	22.92	27.50
	Brembo	2	<b>SDB000604BREMBO</b>	48.33	58.00
	Genuine	2	<b>SDB000604</b>	48.11	57.73
Rear	Aftermarket	2	<b>SDB000636P</b>	17.50	21.00
	Brembo	1	<b>SDB000636BREMBO</b>	65.83	79.00
	Genuine	2	<b>SDB000636</b>	40.09	48.11
All models with 3.0L AJ133 diesel engine to (VIN) CA999999					
Front	Aftermarket	2	<b>SDB000624P</b>	25.00	30.00
	Brembo	2	<b>SDB000624BREMBO</b>	53.33	64.00
	Genuine	2	<b>SDB000624</b>	73.14	87.77
Rear	Aftermarket	2	<b>SDB000646P</b>	18.75	22.50
	Brembo	1	<b>SDB000646BREMBO</b>	88.33	106.00
	Genuine	2	<b>SDB000646</b>	40.09	48.11
All models with 4.0L Cologne V6 petrol engine to (VIN) CA999999					
Front	Aftermarket	2	<b>SDB000604P</b>	22.92	27.50
	Brembo	2	<b>SDB000604BREMBO</b>	48.33	58.00
	Genuine	2	<b>SDB000604</b>	48.11	57.73
Rear	Aftermarket	2	<b>SDB000636P</b>	17.50	21.00
	Brembo	1	<b>SDB000636BREMBO</b>	65.83	79.00
	Genuine	2	<b>SDB000636</b>	40.09	48.11
All models with 5.0L SGDI NA V8 petrol engine to (VIN) CA999999					
Front	Aftermarket	2	<b>SDB000624P</b>	25.00	30.00
	Brembo	2	<b>SDB000624BREMBO</b>	53.33	64.00
	Genuine	2	<b>SDB000624</b>	73.14	87.77
Rear	Aftermarket	2	<b>SDB000646P</b>	18.75	22.50
	Brembo	1	<b>SDB000646BREMBO</b>	88.33	106.00
	Genuine	2	<b>SDB000646</b>	40.09	48.11
All coil sprung models (VIN) DA000001 on					
Front	Aftermarket	2	<b>SDB000604P</b>	22.92	27.50
	Brembo	2	<b>SDB000604BREMBO</b>	48.33	58.00
	Genuine	2	<b>SDB000604</b>	48.11	57.73
Rear	Aftermarket	2	<b>SDB000636P</b>	17.50	21.00
	Brembo	1	<b>SDB000636BREMBO</b>	65.83	79.00
	Genuine	2	<b>SDB000636</b>	40.09	48.11
All air sprung models from (VIN) DA000001 on					
Front	Aftermarket	2	<b>SDB000624P</b>	25.00	30.00
	Genuine	2	<b>SDB000624</b>	73.14	87.77
Rear	Aftermarket	2	<b>SDB000646P</b>	18.75	22.50
	Brembo	1	<b>SDB000646BREMBO</b>	88.33	106.00
Genuine	2	<b>SDB000646</b>	40.09	48.11	

## Performance Brake Disc (pair)

All models with 2.7L Lion V6 diesel engine to (VIN) CA999999					
Front, slotted & drilled	Britpart	1	<b>SDB000604URBP</b>	60.00	72.00
	Britpart	1	<b>SDB000636URBP</b>	60.00	72.00
All models with 3.0L AJ133 diesel engine to (VIN) CA999999					
Front, slotted & drilled	Britpart	1	<b>SDB000624URBP</b>	70.00	84.00
	Britpart	1	<b>SDB000646URBP</b>	60.00	72.00
All models with 4.0L Cologne V6 petrol engine to (VIN) CA999999					
Front, slotted & drilled	Britpart	1	<b>SDB000604URBP</b>	60.00	72.00
	Britpart	1	<b>SDB000636URBP</b>	60.00	72.00
All models with 5.0L SGDI NA V8 petrol engine to (VIN) CA999999					
Front, slotted & drilled	Britpart	1	<b>SDB000624URBP</b>	70.00	84.00
	Britpart	1	<b>SDB000646URBP</b>	60.00	72.00
All coil sprung models (VIN) DA000001 on					
Front, slotted & drilled	Britpart	1	<b>SDB000604URBP</b>	60.00	72.00
	Britpart	1	<b>SDB000636URBP</b>	60.00	72.00
All air sprung models from (VIN) DA000001 on					
Front, slotted & drilled	Britpart	1	<b>SDB000624URBP</b>	70.00	84.00
	Britpart	1	<b>SDB000646URBP</b>	60.00	72.00

## Mudshield Brake Disc

All models - Front					
RH	Genuine	1	<b>LR013665</b>	39.50	47.40
LH	Genuine	1	<b>LR013666</b>	39.44	47.33
All models from (VIN) AA000001 to (VIN) CA999999					
Front RH	Genuine	1	<b>SEC000162</b>	43.64	52.37
Front LH	Genuine	1	<b>SEC000172</b>	57.61	69.13
All models with standard duty coil spring suspension from (VIN) DA000001					
Front RH	Genuine	1	<b>SEC000162</b>	43.64	52.37
Front LH	Genuine	1	<b>SEC000172</b>	57.61	69.13
All models with 4 corner air suspension from (VIN) EA000001					
Front RH	Genuine	1	<b>LR056531</b>	22.38	26.86
Front LH	Genuine	1	<b>LR056532</b>	22.38	26.86

## Back Plate

All models					
Rear RH	Genuine	1	<b>LR048810</b>	49.92	59.90
Rear LH	Genuine	1	<b>LR048812</b>	49.92	59.90



SDB000604URBP

TO ORDER CALL: 01522 568000 OR GO ON LINE: [www.rimmerbros.co.uk](http://www.rimmerbros.co.uk)PRICES CORRECT AT TIME OF GOING TO PRINT.  
SUBJECT TO CHANGE WITHOUT PRIOR NOTICE.



# BRAKING SYSTEM

## Brake Caliper

Lion diesel 2.7 V6 140kW to (VIN) CA999999				
Front, RH	Genuine*	1	<b>SEG500040</b>	197.77 237.32
	*Exchange Surcharge			50.00 60.00
Front, LH	Genuine*	1	<b>SEG500050</b>	197.77 237.32
	*Exchange Surcharge			50.00 60.00
3.0L TDV6 diesel models to (VIN) CA999999				
Front, RH	OEM*	1	<b>LR047906P1</b>	198.33 238.00
	*Exchange Surcharge			35.00 42.00
	Genuine*	1	<b>LR047906</b>	292.45 350.94
	*Exchange Surcharge			100.00 120.00
Front, LH	OEM*	1	<b>LR047905P1</b>	198.33 238.00
	*Exchange Surcharge			35.00 42.00
	Genuine*	1	<b>LR047905</b>	295.38 354.46
	*Exchange Surcharge			100.00 120.00
4.0L Cologne V6 petrol models to (VIN) CA999999				
Front, RH	Genuine*	1	<b>SEG500040</b>	197.77 237.32
	*Exchange Surcharge			50.00 60.00
Front, LH	Genuine*	1	<b>SEG500050</b>	197.77 237.32
	*Exchange Surcharge			50.00 60.00
5.0L V8 NA petrol models to (VIN) CA999999				
Front, RH	OEM*	1	<b>LR047906P1</b>	198.33 238.00
	*Exchange Surcharge			35.00 42.00
	Genuine*	1	<b>LR047906</b>	292.45 350.94
	*Exchange Surcharge			100.00 120.00
Front, LH	OEM*	1	<b>LR047905P1</b>	198.33 238.00
	*Exchange Surcharge			35.00 42.00
	Genuine*	1	<b>LR047905</b>	295.38 354.46
	*Exchange Surcharge			100.00 120.00
All air sprung models from (VIN) DA000001 on				
Front, RH	OEM*	1	<b>LR047906P1</b>	198.33 238.00
	*Exchange Surcharge			35.00 42.00
	Genuine*	1	<b>LR047906</b>	292.45 350.94
	*Exchange Surcharge			100.00 120.00
Front, LH	OEM*	1	<b>LR047905P1</b>	198.33 238.00
	*Exchange Surcharge			35.00 42.00
	Genuine*	1	<b>LR047905</b>	295.38 354.46
	*Exchange Surcharge			100.00 120.00
All coil sprung models (VIN) DA000001 on				
Front, RH	Genuine*	1	<b>SEG500040</b>	197.77 237.32
	*Exchange Surcharge			50.00 60.00
Front, LH	Genuine*	1	<b>SEG500050</b>	197.77 237.32
	*Exchange Surcharge			50.00 60.00
2.7L TDV6 diesel models (VIN) AA000001 on				
Rear, RH	Aftermarket	1	<b>SOB500042P</b>	50.00 60.00
	Genuine*	1	<b>SOB500042</b>	129.29 155.15
	*Exchange Surcharge			50.00 60.00
Rear, LH	Aftermarket	1	<b>SOB500052P</b>	50.00 60.00
	Genuine*	1	<b>SOB500052</b>	129.29 155.15
	*Exchange Surcharge			50.00 60.00
3.0L TDV6 diesel models to (VIN) AA547440				
Rear, RH	OEM*	1	<b>LR015524P1</b>	67.95 81.54
	*Exchange Surcharge			30.00 36.00
	Genuine*	1	<b>LR015524</b>	148.18 177.82
	*Exchange Surcharge			90.00 108.00
Rear, LH	OEM*	1	<b>LR015586P1</b>	67.95 81.54
	*Exchange Surcharge			30.00 36.00
	Genuine*	1	<b>LR015586</b>	148.18 177.82
	*Exchange Surcharge			90.00 108.00
3.0L TDV6 diesel models (VIN) AA547441 on				
Rear, RH	Aftermarket	1	<b>SOB500042P</b>	50.00 60.00
	Genuine*	1	<b>SOB500042</b>	129.29 155.15
	*Exchange Surcharge			50.00 60.00
Rear, LH	Aftermarket	1	<b>SOB500052P</b>	50.00 60.00
	Genuine*	1	<b>SOB500052</b>	129.29 155.15
	*Exchange Surcharge			50.00 60.00
4.0L Cologne V6 petrol models (VIN) AA000001 on				
Rear, RH	Aftermarket	1	<b>SOB500042P</b>	50.00 60.00
	Genuine*	1	<b>SOB500042</b>	129.29 155.15
	*Exchange Surcharge			50.00 60.00
Rear, LH	Aftermarket	1	<b>SOB500052P</b>	50.00 60.00
	Genuine*	1	<b>SOB500052</b>	129.29 155.15
	*Exchange Surcharge			50.00 60.00
5.0L V8 NA petrol models to (VIN) AA547440				
Rear, RH	OEM*	1	<b>LR015524P1</b>	67.95 81.54
	*Exchange Surcharge			30.00 36.00
	Genuine*	1	<b>LR015524</b>	148.18 177.82
	*Exchange Surcharge			90.00 108.00
Rear, LH	OEM*	1	<b>LR015586P1</b>	67.95 81.54
	*Exchange Surcharge			30.00 36.00
	Genuine*	1	<b>LR015586</b>	148.18 177.82
	*Exchange Surcharge			90.00 108.00
5.0L V8 NA petrol models (VIN) AA547441 on				
Rear, RH	Aftermarket	1	<b>SOB500042P</b>	50.00 60.00
	Genuine*	1	<b>SOB500042</b>	129.29 155.15
	*Exchange Surcharge			50.00 60.00
Rear, LH	Aftermarket	1	<b>SOB500052P</b>	50.00 60.00
	Genuine*	1	<b>SOB500052</b>	129.29 155.15
	*Exchange Surcharge			50.00 60.00



SOB500042P



SEH500012P1

## Brake Caliper Carrier

All 2.7L V6 diesel engine models				
Front brakes	OEM	2	<b>SEH500012P1</b>	22.50 27.00
	Genuine	2	<b>SEH500012</b>	38.73 46.48
All 4.0L V6 petrol engine models				
Front brakes	OEM	2	<b>SEH500012P1</b>	22.50 27.00
	Genuine	2	<b>SEH500012</b>	38.73 46.48
All coil sprung models (VIN) DA000001 on				
Front brakes	OEM	2	<b>SEH500012P1</b>	22.50 27.00
	Genuine	2	<b>SEH500012</b>	38.73 46.48
All models with 4 corner air suspension from (VIN) DA000001 to (VIN) DA999999				
Front RH	Genuine	1	<b>LR020369</b>	91.35 109.62
Front LH	Genuine	1	<b>LR020371</b>	91.35 109.62
All models with 4 corner air suspension from (VIN) EA000001				
Front RH	Genuine	1	<b>LR051627</b>	133.23 159.88
Front LH	Genuine	1	<b>LR051628</b>	133.23 159.88
2.7L TDV6 diesel models (VIN) AA000001 on				
Rear, RH and LH	OEM	2	<b>SXP500013P1</b>	25.00 30.00
	Genuine	2	<b>SXP500013</b>	38.79 46.55
All 3.0L 24V DOHC V6 diesel engine models from (VIN) AA000001 to (VIN) AA547440				
Rear RH	Genuine	1	<b>LR015521</b>	80.89 97.07
Rear LH	Genuine	1	<b>LR015522</b>	93.84 112.61
All 3.0L 24V DOHC V6 diesel engine models from (VIN) AA547441 to (VIN) CA999999				
Rear RH	Genuine	1	<b>LR032058</b>	93.41 112.09
Rear LH	Genuine	1	<b>LR032059</b>	93.41 112.09
4.0L Cologne V6 petrol models (VIN) AA000001 on				
Rear, RH and LH	OEM	2	<b>SXP500013P1</b>	25.00 30.00
	Genuine	2	<b>SXP500013</b>	38.79 46.55
5.0L V8 NA petrol models (VIN) AA000001 to (VIN) AA547440				
Rear RH	Genuine	1	<b>LR015521</b>	80.89 97.07
Rear LH	Genuine	1	<b>LR015522</b>	93.84 112.61
All 5.0L OHC SGDI NA V8 petrol engine models from (VIN) AA547441 to (VIN) CA999999				
Rear RH	Genuine	1	<b>LR032058</b>	93.41 112.09
Rear LH	Genuine	1	<b>LR032059</b>	93.41 112.09
All coil sprung models (VIN) DA000001 on				
Rear, RH and LH	OEM	2	<b>SXP500013P1</b>	25.00 30.00
	Genuine	2	<b>SXP500013</b>	38.79 46.55
All models with 4 corner air suspension from (VIN) DA000001				
Rear RH	Genuine	1	<b>LR032058</b>	93.41 112.09
Rear LH	Genuine	1	<b>LR032059</b>	93.41 112.09

## Brake Caliper Support Bracket

All 3.0L 24V DOHC V6 diesel engine models from (VIN) AA547441 to (VIN) CA999999				
Rear, RH and LH	OEM	2	<b>SXP500060P1</b>	57.95 69.54
5.0L V8 NA petrol models (VIN) AA547441 to (VIN) CA999999				
Rear, RH and LH	OEM	2	<b>SXP500060P1</b>	57.95 69.54

## Brake Caliper Piston

All 2.7L TDV6 diesel models				
Front, Vented Disc Brakes	Aftermarket	4	<b>STC1918P</b>	4.38 5.26
	OEM	4	<b>STC1918P1</b>	7.50 9.00
	Genuine	4	<b>STC1918</b>	17.20 20.64
Rear, Vented Disc Brakes	Aftermarket	2	<b>STC1908P</b>	4.08 4.90
	Genuine	2	<b>STC1908</b>	18.49 22.19
All 4.0L Cologne V6 petrol models				
Front, Vented Disc Brakes	Aftermarket	4	<b>STC1918P</b>	4.38 5.26
	OEM	4	<b>STC1918P1</b>	7.50 9.00
	Genuine	4	<b>STC1918</b>	17.20 20.64
Rear, Vented Disc Brakes	Aftermarket	2	<b>STC1908P</b>	4.08 4.90
	Genuine	2	<b>STC1908</b>	18.49 22.19
All coil sprung models (VIN) DA000001 on				
Front, Vented Disc Brakes	Aftermarket	4	<b>STC1918P</b>	4.38 5.26
	OEM	4	<b>STC1918P1</b>	7.50 9.00
	Genuine	4	<b>STC1918</b>	17.20 20.64
3.0L 24V DOHC V6 TC Diesel from (VIN) AA547441 on				
Rear, Vented Disc Brakes	Aftermarket	2	<b>STC1908P</b>	4.08 4.90
	Genuine	2	<b>STC1908</b>	18.49 22.19
5.0L OHC SGDI NA V8 Petrol from (VIN) AA547441 on				
Rear, Vented Disc Brakes	Aftermarket	2	<b>STC1908P</b>	4.08 4.90
	Genuine	2	<b>STC1908</b>	18.49 22.19

## Slider Pin Bolt

All models - Front	Genuine	4	<b>SMV500010</b>	1.33 1.60
--------------------	---------	---	------------------	-----------

## Dust Cover

All models - For carrier retaining pins front & rear				
	Genuine	2	<b>SEE500030</b>	7.88 9.46

## Dust Cap Bleed Screw

All models except with B6 level armouring - Front & rear caliper				
	Genuine	2	<b>SEE500100</b>	0.94 1.13



## DISCOVERY 4 (2010 on)

## BRAKING SYSTEM

## Pin &amp; Boot Kit

All 3.0L 24V DOHC V6 diesel engine models from (VIN) AA000001 to (VIN) CA999999				
Front Brake Caliper	Genuine	2	<b>LR020489</b>	13.13 15.76
All 5.0L OHC SGDI NA V8 petrol engine models				
Front Brake Caliper	Genuine	2	<b>LR020489</b>	13.13 15.76
All models with 4 corner air suspension from (VIN) DA000001				
Front Brake Caliper	Genuine	2	<b>LR020489</b>	13.13 15.76
All 3.0L 24V DOHC V6 diesel engine models to (VIN) AA547440				
Rear Brake Caliper Carrier	Genuine	2	<b>LR017032</b>	13.13 15.76
All 3.0L 24V DOHC V6 diesel engine models from (VIN) AA547441 to (VIN) CA999999				
Rear Brake Caliper	Genuine	2	<b>LR020489</b>	13.13 15.76
All 5.0L OHC SGDI NA V8 petrol engine models to (VIN) AA547440				
Rear Brake Caliper Carrier	Genuine	2	<b>LR017032</b>	13.13 15.76
All 5.0L OHC SGDI NA V8 petrol engine models from (VIN) AA547441 to (VIN) CA999999				
Rear Brake Caliper	Genuine	2	<b>LR020489</b>	13.13 15.76
All models with 4 corner air suspension from (VIN) DA000001				
Rear Brake Caliper	Genuine	2	<b>LR020489</b>	13.13 15.76

## Caliper Pin &amp; Boot Kit

All 2.7L TDV6 diesel models				
Front, one caliper	Aftermarket	2	<b>SEE500020P</b>	9.17 11.00
	Genuine	2	<b>SEE500020</b>	13.06 15.67
All 4.0L Cologne V6 petrol models				
Front, one caliper	Aftermarket	2	<b>SEE500020P</b>	9.17 11.00
	Genuine	2	<b>SEE500020</b>	13.06 15.67
All coil spring suspension models (VIN) DA000001 on				
Front, one caliper	Aftermarket	2	<b>SEE500020P</b>	9.17 11.00
	Genuine	2	<b>SEE500020</b>	13.06 15.67

## Screw Brake Caliper Carrier

All 3.0L 24V DOHC V6 diesel engine models				
Rear	Genuine	4	<b>LR015546</b>	1.58 1.90
All 5.0L OHC SGDI NA V8 petrol engine models				
Rear	Genuine	4	<b>LR015546</b>	1.58 1.90

## Brake Caliper Fixing Kit

All 2.7L TDV6 diesel and 4.0L Cologne V6 petrol models to (VIN) CA999999				
Rear brakes	Aftermarket	2	<b>SMN500040P</b>	6.87 8.24
	Genuine	2	<b>SMN500040</b>	13.06 15.67
3.0L TDV6 diesel and 5.0L NA V8 petrol models from (VIN) AA547441 to (VIN) CA999999				
Rear brakes	Aftermarket	2	<b>SMN500040P</b>	6.87 8.24
	Genuine	2	<b>SMN500040</b>	13.06 15.67
All coil sprung models (VIN) DA000001 on				
Rear brakes	Aftermarket	2	<b>SMN500040P</b>	6.87 8.24
	Genuine	2	<b>SMN500040</b>	13.06 15.67

## Brake Master Cylinder

All RHD models				
	OEM	1	<b>LR014570P1</b>	110.00 132.00
	Genuine	1	<b>LR014570</b>	147.68 177.22

## Master Cylinder Repair Kit

All LHD models				
	OEM	1	<b>LR014569P1</b>	140.00 168.00
	Genuine	1	<b>LR014569</b>	180.17 216.20

## Reservoir for Master Cylinder

All models - includes cap				
	Genuine	1	<b>LR015518</b>	34.81 41.77

## Cap for Master Cylinder Reservoir

All models				
	Genuine	1	<b>LR012971</b>	21.24 25.49

## Brake Servo Assembly

All models				
	OEM	1	<b>LR014571P1</b>	195.00 234.00
	Genuine	1	<b>LR014571</b>	236.82 284.18

## Brake Pad Wear Sensor

All models				
Front brakes	Aftermarket	2	<b>SEM500070P</b>	6.04 7.25
	OEM	2	<b>SEM500070P1</b>	7.50 9.00
	Genuine	2	<b>SEM500070</b>	18.76 22.51
Rear brakes	Aftermarket	2	<b>SOE000025P</b>	3.50 4.20
	OEM	2	<b>SOE000025P1</b>	8.13 9.76
	Genuine	2	<b>SOE000025</b>	10.54 12.65

## Caliper Repair Kit

All 2.7L V6 diesel engine models				
Front brakes	OEM	2	<b>SEE500010P1</b>	5.95 7.14
	Genuine	2	<b>SEE500010</b>	12.53 15.04
All models with 3.0L TDV6 diesel engine from (VIN) AA000001 to CA999999				
Front, for one caliper	OEM	2	<b>LR015580P1</b>	6.67 8.00
All 4.0L V6 petrol engine models				
Front brakes	OEM	2	<b>SEE500010P1</b>	5.95 7.14
	Genuine	2	<b>SEE500010</b>	12.53 15.04
All models with 5.0L NA AJV8 petrol engine from (VIN) AA000001 to CA999999				
Front, for one caliper	OEM	2	<b>LR015580P1</b>	6.67 8.00
All coil sprung models (VIN) DA000001 on				
Front brakes	OEM	2	<b>SEE500010P1</b>	5.95 7.14
	Genuine	2	<b>SEE500010</b>	12.53 15.04
All models with air suspension from (VIN) DA000001 on				
Front, for one caliper	OEM	2	<b>LR015580P1</b>	6.67 8.00
	Genuine	2	<b>LR015580P1</b>	6.67 8.00
All models with 2.7L TDV6 diesel engine				
Rear, for one caliper	Aftermarket	2	<b>SMN500030P</b>	6.04 7.25
	OEM	2	<b>SMN500030P1</b>	4.95 5.94
	Genuine	2	<b>SMN500030</b>	11.94 14.33
All models with 3.0L TDV6 diesel engine up to (VIN) AA547440				
Rear, for one caliper	OEM	2	<b>LR015520P1</b>	7.25 8.70
All models with 3.0L TDV6 diesel engine except armoured from (VIN) AA547441 to CA999999				
Rear, for one caliper	Aftermarket	2	<b>SMN500030P</b>	6.04 7.25
	OEM	2	<b>SMN500030P1</b>	4.95 5.94
	Genuine	2	<b>SMN500030</b>	11.94 14.33
All models with 4.0L Cologne V6 petrol engine				
Rear, for one caliper	Aftermarket	2	<b>SMN500030P</b>	6.04 7.25
	OEM	2	<b>SMN500030P1</b>	4.95 5.94
	Genuine	2	<b>SMN500030</b>	11.94 14.33
All models with 5.0L NA AJV8 petrol engine up to (VIN) AA547440				
Rear, for one caliper	OEM	2	<b>LR015520P1</b>	7.25 8.70
All models with 5.0L NA AJV8 petrol engine except armoured from (VIN) AA547441 to CA999999				
Rear, for one caliper	Aftermarket	2	<b>SMN500030P</b>	6.04 7.25
	OEM	2	<b>SMN500030P1</b>	4.95 5.94
	Genuine	2	<b>SMN500030</b>	11.94 14.33
All models (VIN) DA000001 on				
Rear, for one caliper	Aftermarket	2	<b>SMN500030P</b>	6.04 7.25
	OEM	2	<b>SMN500030P1</b>	4.95 5.94
	Genuine	2	<b>SMN500030</b>	11.94 14.33

## Brake Hose

All models from (VIN) AA000001 to (VIN) EA705309				
Front RH	Genuine	1	<b>LR052215</b>	39.31 47.17
	OEM	1	<b>LR052214P1</b>	25.83 31.00
Front LH	Genuine	1	<b>LR052214</b>	39.83 47.80
All models				
Rear, outer, to caliper	OEM	2	<b>LR058009P1</b>	8.33 10.00
	Genuine	2	<b>LR058009</b>	14.48 17.38
Rear, inner	OEM	2	<b>LR058010P1</b>	6.67 8.00
	Genuine	2	<b>LR058010</b>	28.81 34.57
All petrol models - Vacuum Pump to servo				
	Genuine	1	<b>LR018331</b>	19.06 22.87
All models with 4.0L Cologne V6 petrol engine - Vacuum Pump to servo				
	Genuine	1	<b>LR018332</b>	19.78 23.74
All LHD models with 4.0L Cologne V6 petrol engine - Union to servo				
	Genuine	1	<b>LR018335</b>	14.76 17.71

## 4-way Brake Pipe Connector

All models - Rear				
	Genuine	a/r	<b>SGH100050</b>	29.02 34.82

## Brake Shoe Set - Handbrake

All models - Handbrake				
	Aftermarket	1	<b>LR031947KITP</b>	6.04 7.25
	Genuine	1	<b>LR031947</b>	64.15 76.98
includes pins & clips	Aftermarket	1	<b>LR031947P1</b>	42.50 51.00
	Aftermarket	1	<b>LR031947NCP1</b>	29.58 35.50

## Brake Shoe Retaining Spring Set

Parking Brake all models from (VIN) AA000001 to (VIN) BA583709				
	Genuine	1	<b>SMN500020</b>	17.40 20.88

## Spring Retention Kit

All models from (VIN) BA583710 - Handbrake				
	Genuine	1	<b>LR031944</b>	11.78 14.14

## Handbrake Shoe Fixing Kit

All models				
	Genuine	1	<b>SMN500012</b>	7.23 8.68

## Parking Brake Adjuster Kit

All models from (VIN) AA000001 (VIN) BA583709				
	Genuine	1	<b>SXS500011</b>	8.20 9.84

## Actuating Rod Handbrake

All models from (VIN) BA583710 - Handbrake				
	Genuine	1	<b>LR031946</b>	9.34 11.21

## Actuating Rod Kit Handbrake

All models - includes 2 rods				
	Genuine	1	<b>SXR500010</b>	9.62 11.54



LR031947P1



# BRAKING SYSTEM

## Parking Brake Bracket

All models					
RH	Genuine	1	<b>SPU500040</b>	8.80	10.56
LH	Genuine	1	<b>SPU500050</b>	8.80	10.56

## Parking Brake Module

All models from (VIN) FA755596 - Handbrake	Genuine	1	<b>LR072318</b>	524.03	628.84
--------------------------------------------	---------	---	-----------------	--------	--------

## Handbrake Cable

All models					
RH rear	Genuine	1	<b>LR018469</b>	73.41	88.09
LH rear	Genuine	1	<b>LR018470</b>	88.73	106.48

## Handbrake Cable Boot

All models - cable to rear brake	Genuine	1	<b>YPV500380</b>	2.77	3.32
----------------------------------	---------	---	------------------	------	------

## Clip Brake Cable Support

All models	Genuine	a/r	<b>SPV500020</b>	0.53	0.64
------------	---------	-----	------------------	------	------

## Handbrake Cable Clip

All models - Circlip, 'E' type, cable to rear brake					
	Genuine	a/r	<b>SPV500030</b>	0.57	0.68

## ABS Sensor

All models					
Front	OEM	2	<b>LR013783P1</b>	20.00	24.00
	Genuine	2	<b>LR013783</b>	51.37	61.64
Rear brakes	Aftermarket	2	<b>SSB500102P</b>	18.13	21.76
	OEM	2	<b>SSB500102P1</b>	20.00	24.00
	Genuine	2	<b>SSB500102</b>	96.20	115.44

## ABS Yaw Rate Sensor

All models	Genuine	1	<b>LR011785</b>	287.53	345.04
------------	---------	---	-----------------	--------	--------

## Brake Light Switch

All models	Genuine	1	<b>LR072647</b>	15.04	18.05
------------	---------	---	-----------------	-------	-------

## Brake Pedal Pad

All manual models - Also used on manual model clutch pedal					
	Genuine	2	<b>SKE500020</b>	4.76	5.71

## Brake Pedal Rubber

All models with automatic transmission from (VIN) 1AA000001					
	Genuine	1	<b>SKE500010</b>	10.06	12.07

# SUSPENSION

## Bush Front Upper Arm

All models					
Rubber bush	OEM	4	<b>LR056964P1</b>	6.04	7.25
	Genuine	4	<b>LR056964</b>	32.93	39.52
Poly. bush (set of 4)	Polybush	1	<b>LR056964POLY</b>	50.00	60.00
Standard bush, inner, forward, poly. Dynamic orange (pair)					
	Polybush	1	<b>LR051611POLY</b>	60.00	72.00

## Bush Front Lower Arm

All models					
Rubber bush, forward	Aftermarket	1	<b>LR051585P</b>	4.79	5.75
	OEM	1	<b>LR051585P1</b>	9.79	11.75
	Genuine	1	<b>LR051585</b>	40.09	48.11
	Polybush	1	<b>LR051585POLY</b>	31.67	38.00
All models to (VIN) AA518769					
Standard bush, inner, forward	Aftermarket	2	<b>LR051611P</b>	7.08	8.50
	OEM	2	<b>LR051611P1</b>	13.54	16.25
	Genuine	2	<b>LR051611</b>	40.43	48.52

## Bush Lower Arm

All models - Front suspension					
Rear hydrabush	Aftermarket	2	<b>LR051586P</b>	10.42	12.50
	OEM	2	<b>LR051586P1</b>	22.08	26.50
	Genuine	2	<b>LR051586</b>	45.50	54.60
Rear hydrabush Poly. (pair)	Polybush	1	<b>LR051586POLY</b>	42.50	51.00

## Bush Lower Shock Absorber (set of 4)

All models					
Front & rear	Genuine	1	<b>ROA000022</b>	8.35	10.02
Front & rear, poly.	Polybush	1	<b>ROA000022POLY</b>	65.00	78.00

## Bush Rear Lower Arm

All models					
Standard bush, inner, rearward	OEM	2	<b>LR054831P1</b>	7.50	9.00
	Genuine	2	<b>LR054831</b>	24.01	28.81
Rubber bush, inner, rearward	Aftermarket	2	<b>LR051616P</b>	6.67	8.00
	OEM	2	<b>LR051616P1</b>	15.00	18.00
	Genuine	2	<b>LR051616</b>	27.17	32.60
Poly. bush, inner, rearward, Dynamic orange (pair)	Polybush	1	<b>LR054831POLY</b>	29.58	35.50
	Polybush	1	<b>LR051616POLY</b>	45.00	54.00
Rubber bush, inner, forward	Aftermarket	2	<b>LR051621P</b>	8.75	10.50
	OEM	2	<b>LR051621P1</b>	12.50	15.00
	Genuine	2	<b>LR051621</b>	20.86	25.03
Poly. bush, inner, forward (pair)	Polybush	1	<b>LR051621POLY</b>	60.00	72.00
All models (VIN) AA518770 on					
Standard bush, inner, forward	Genuine	1	<b>LR051611</b>	40.43	48.52

## Bush Anti Roll Bar Mounting

All models - Rear anti roll bar, poly.	Polybush	2	<b>LR015336POLY</b>	8.54	10.25
----------------------------------------	----------	---	---------------------	------	-------

## Suspension Bush Kit

All models except B6 armoured - poly., dynamic orange. Car set of upper & lower arm bushes					
	Polybush	1	<b>RD1299</b>	250.00	300.00

## Anti Roll Bar Link

All models					
Front	Aftermarket	2	<b>LR014145P</b>	7.50	9.00
	OEM	2	<b>LR014145P1</b>	13.13	15.76
	Genuine	2	<b>LR014145</b>	24.27	29.12
	Aftermarket	2	<b>RGD000312P</b>	4.17	5.00
Rear	Aftermarket	2	<b>RGD000312</b>	18.95	22.74

# DISCOVERY 4 (2010 on)

## Anti Roll Bar Bush

All models - Front	Aftermarket	2	<b>LR018346P</b>	3.83	4.60
	Genuine	2	<b>LR018346</b>	6.77	8.12

## Clamp Anti Roll Bar Bush

All models - Front	Genuine	2	<b>RB0500100</b>	2.23	2.68
--------------------	---------	---	------------------	------	------

## Mounting Bush, Anti Roll Bar

All models - Rear anti roll bar	Aftermarket	2	<b>LR015336P</b>	4.00	4.80
	OEM	2	<b>LR015336P1</b>	10.63	12.76
	Genuine	2	<b>LR015336</b>	20.56	24.67

## Clamp Anti Roll Bar Bush

All models - Rear	Genuine	2	<b>RB0000281</b>	1.93	2.32
-------------------	---------	---	------------------	------	------

## Shock Absorber

All models with coil spring suspension or rear air levelling up to (VIN) CA999999					
Front	OEM	2	<b>RNB000498P1</b>	70.00	84.00
	Genuine	2	<b>RNB000498</b>	127.25	152.70
All models with springs & shock absorbers with standard duty suspension from (VIN) DA000001					
Front	Genuine	2	<b>LR043569</b>	133.69	160.43
All models with air suspension					
Front	Aftermarket	2	<b>LR032646P</b>	147.50	177.00
	OEM	2	<b>LR032646P1</b>	175.83	211.00
	Genuine	2	<b>LR032646</b>	298.04	357.65
All models with springs & shock absorbers with standard duty suspension from (VIN) CA633357					
Rear	Genuine	2	<b>LR038097</b>	197.20	236.64
All models with air suspension or rear air levelling					
Rear	OEM	2	<b>LR038096P1</b>	195.00	234.00
	Genuine	2	<b>LR038096</b>	347.09	416.51
All models with Four Corner Air Suspension from (VIN) AA000001					
Rear	Genuine	2	<b>LR038095</b>	168.32	201.98

## Gaiter, Shock Absorber

All models with front coil spring suspension					
Front	Genuine	2	<b>RNE000011</b>	3.58	4.30
All models with all coil spring suspension					
Front & rear	Genuine	2	<b>RNE000011</b>	3.58	4.30

## Boot Kit, Shock Absorber

All models with air suspension					
Front, for one shock absorber	Aftermarket	2	<b>RBG500010P</b>	30.00	36.00
	Genuine	2	<b>RBG500010</b>	66.18	79.42

## Shock Absorber Upper Boot

All models with air suspension - Rear	Genuine	2	<b>RPM500200</b>	34.83	41.80
---------------------------------------	---------	---	------------------	-------	-------

## Strut Mounting Upper

All models without air suspension					
Rear suspension	Genuine	2	<b>RPF500023</b>	60.70	72.84

## Coil Spring

All models with coil springs up to (VIN) CA999999					
Front	Genuine	2	<b>REB500050</b>	65.94	79.13
All models with coil springs from (VIN) DA000001 on					
Front	Genuine	2	<b>LR043568</b>	113.75	136.50
All models with coil spring suspension					
Rear	Genuine	2	<b>RKB500033</b>	83.83	100.60





## DISCOVERY 4 (2010 on)

## SUSPENSION

## Ball Joint

All models				
Front knuckle, upper	Aftermarket	2	<b>RBK500170P</b>	10.00 12.00
	OEM	2	<b>RBK500170P1</b>	16.88 20.26
	Genuine	2	<b>RBK500170</b>	32.98 39.58
Front knuckle, lower	Aftermarket	2	<b>RBK500280P</b>	9.38 11.26
	OEM	2	<b>RBK500280P1</b>	19.58 23.50
	Genuine	2	<b>RBK500280</b>	32.98 39.58

## Ball Joint Assembly

All models				
Front upper arm	Aftermarket	2	<b>RBK500170P</b>	10.00 12.00
	OEM	2	<b>RBK500170P1</b>	16.88 20.26
	Genuine	2	<b>RBK500170</b>	32.98 39.58
Front lower arm	Aftermarket	2	<b>RBK500280P</b>	9.38 11.26
	OEM	2	<b>RBK500280P1</b>	19.58 23.50
	Genuine	2	<b>RBK500280</b>	32.98 39.58
Upper, rear wheel knuckle	Aftermarket	2	<b>RHF500100P</b>	11.04 13.25
	OEM	2	<b>RHF500100P1</b>	14.38 17.26
	Genuine	2	<b>RHF500100</b>	36.46 43.75

## Upper Arm Assembly

All models				
Front RH	Aftermarket	1	<b>LR051614P</b>	39.50 47.40
	OEM	1	<b>LR051614P1</b>	105.00 126.00
	Genuine	1	<b>LR051614</b>	166.26 199.51
Front LH	Aftermarket	1	<b>LR051615P</b>	39.50 47.40
	OEM	1	<b>LR051615P1</b>	105.00 126.00
	Genuine	1	<b>LR051615</b>	159.59 191.51

All models (VIN) CA000001 on				
Front RH	Aftermarket	1	<b>LR063711P</b>	32.50 39.00
	Genuine	1	<b>LR063711</b>	168.26 201.91
Front LH	Aftermarket	1	<b>LR063688P</b>	32.50 39.00
	Genuine	1	<b>LR063688</b>	166.10 199.32

## Upper Arm Complete Assembly

All models				
Rear suspension, RH	Aftermarket	1	<b>LR051622P</b>	63.33 76.00
	Genuine	1	<b>LR051622</b>	103.28 123.94
Rear suspension, LH	Aftermarket	1	<b>LR051623P</b>	63.33 76.00
	OEM	1	<b>LR051623P1</b>	70.00 84.00
Genuine	1	<b>LR051623</b>	103.28 123.94	

## Upper Arm Complete Assembly Kit

All models - Rear suspension				
RH includes fittings	Britpart	1	<b>LR051622P1K</b>	89.17 107.00
LH includes fittings	Britpart	1	<b>LR051623P1K</b>	89.17 107.00

## Fitting Kit, Front Upper Arm

All models - Includes bolts and nuts for one upper arm				
Genuine		1	<b>RYG000420BPK</b>	9.79 11.75

## Lower Arm Assembly

All models with coil spring suspension				
Front RH	Genuine	1	<b>LR073368</b>	185.45 222.54
Front LH	Genuine	1	<b>LR073370</b>	192.88 231.46
All models with standard duty coil spring suspension from (VIN) EA153862 to (VIN) EA184497				
Front RH	Genuine	1	<b>LR073368</b>	185.45 222.54
All models with standard duty coil spring suspension from (VIN) AA518770 to (VIN) DA699649				
Rear RH	Genuine	1	<b>LR051619</b>	127.75 153.30
Rear LH	Genuine	1	<b>LR051620</b>	127.75 153.30
All models with standard duty coil spring suspension from (VIN) DA699650				
Rear RH	Genuine	1	<b>LR051619</b>	127.75 153.30
Rear LH	Genuine	1	<b>LR051620</b>	127.75 153.30
All coil spring suspension models (VIN) DA699650 on -				
Rear RH	Genuine	1	<b>LR051619</b>	127.75 153.30
Rear LH	Genuine	1	<b>LR051620</b>	127.75 153.30
All models with 4 corner air suspension				
Front RH	Aftermarket	1	<b>LR073367P</b>	80.00 96.00
	OEM	1	<b>LR073367P1</b>	132.50 159.00
	Genuine	1	<b>LR073367</b>	185.45 222.54
Front RH; includes fixings	OEM	1	<b>LR073367P1K</b>	150.00 180.00
Front LH	Aftermarket	1	<b>LR073369P</b>	75.00 90.00
	OEM	1	<b>LR073369P1</b>	132.50 159.00
	Genuine	1	<b>LR073369</b>	192.88 231.46
Front LH; includes fixings	OEM	1	<b>LR073369P1K</b>	150.00 180.00
Rear RH	OEM	1	<b>LR051592P1</b>	65.00 78.00
Genuine	1	<b>LR051592</b>	114.58 137.50	
Rear LH	Genuine	1	<b>LR051593</b>	511.15 613.38

## Spindle Rod Toe Link

All models				
Aftermarket	2	<b>LR019117P</b>	18.13 21.76	
OEM	2	<b>LR019117P1</b>	25.00 30.00	
Genuine	2	<b>LR019117</b>	71.39 85.67	

## Ball Joint Rear Knuckle Lower

All models				
Aftermarket	2	<b>LR032644P</b>	8.13 9.76	
Genuine	2	<b>LR032644</b>	32.29 38.75	

## Knuckle, without Hub

All models				
Rear axle, RH	Genuine	1	<b>LR045824</b>	196.48 235.78
Rear axle, LH	Genuine	1	<b>LR045825</b>	196.48 235.78

## Air Suspension Height Sensor

All air suspension models				
Front	Genuine	2	<b>LR023646</b>	51.16 61.39
Rear	Genuine	2	<b>LR023648</b>	63.54 76.25

## Air Suspension Compressor

All models to (VIN) BA551483 - Later AMK type (not Hitachi)				
Genuine*	1	<b>LR072537</b>	574.59 689.51	
*Exchange Surcharge			180.00 216.00	
All models fitted with original type Hitachi air compressor - Direct replacement for original compressor - no vehicle modification required				
Genuine*	1	<b>LR072537</b>	574.59 689.51	
*Exchange Surcharge			180.00 216.00	
All models with air suspension (VIN) CA639078 on - AMK type				
Genuine	1	<b>LR078650</b>	620.06 744.07	

## Compressor &amp; Dryer only

All models fitted with AMK Compressor				
OEM	1	<b>LR078650P1</b>	341.67 410.00	
Genuine	1	<b>LR078650</b>	620.06 744.07	

## Installation Kit for AMK Compressor

All models fitted with AMK Compressor				
OEM	1	<b>LR078650BPIK</b>	78.33 94.00	

## Replacement Compressor

All models with Hitachi Compressor fitted - Fitting kit required				
Dunlop	1	<b>LR023964P</b>	383.33 460.00	
Installation kit for the above	Aftermarket	1	<b>LR023964PPIK</b>	24.58 29.50

## Air Suspension Spring

All models with air suspension - Front				
OEM	2	<b>LR016403P1</b>	165.83 199.00	
Genuine	2	<b>LR016403</b>	334.20 401.04	

## Strut Seal Kit

All air suspension models - Front & rear				
Genuine	2	<b>LR016412</b>	12.40 14.88	

## Air Suspension Relief Valve

All models with air suspension - Front axle				
Genuine	1	<b>RVH000095</b>	96.85 116.22	



# STEERING

## DISCOVERY 4 (2010 on)

### Shaft, Steering Column

Upper section, without universal joint	Genuine	1	QLB500070	50.37	60.44
----------------------------------------	---------	---	-----------	-------	-------

### Seal, Steering Column

All models					
Lower column joint	Genuine	1	QMH500110	3.60	4.32
Column to bulkhead	Genuine	1	QMH500100	6.50	7.80

### Track Rod End

All models - With M14 track rod thread					
	OEM	2	LR010672P1	17.92	21.50
	Genuine	2	LR010672	40.57	48.68

### Track Rod End & Rod kit

RHD models - With M14 track rod thread					
	OEM	1	LR010667P1	19.58	23.50
	Genuine	1	LR010667	84.94	101.93
LHD models - With M14 track rod thread					
	OEM	1	LR010668P1	19.58	23.50
	Genuine	1	LR010668	89.49	107.39

### Track Rod, Bare

All models - M16					
	Aftermarket	1	QFK500010P	7.50	9.00
	OEM	1	QFK500010P1	10.83	13.00
	Genuine	1	QFK500010	52.66	63.19

### Steering Rack Boot Kit

All models					
	Aftermarket	2	QFW500010P	5.63	6.76
	Genuine	2	QFW500010	16.08	19.30

### Power Steering Fluid

All models - 1 litre. Cold (standard) climates fluid					
	Aftermarket	a/r	STC50519P	12.08	14.50
	Genuine	a/r	STC50519	18.96	22.75

### Cap, Power Steering Reservoir

All models	Genuine	1	QEZ500010	3.25	3.90
------------	---------	---	-----------	------	------



# CLUTCH

## DISCOVERY 4 (2010 on)

### Clutch Plate & Cover Assembly

All 2.7L V6 diesel manual models - Includes clutch plate & cover					
	OEM	1	LR005809P1	195.00	234.00
	Genuine	1	LR005809	307.26	368.71

### Clutch Pipe Assembly

All RHD manual models - Reservoir to master cylinder					
	Genuine	1	STH000022	9.48	11.38
All LHD manual models - Reservoir to master cylinder					
	Genuine	1	STH000012	1.64	1.97

### Clutch Master Cylinder

All RHD manual diesel models - With sensor	Genuine	1	STC500041	217.22	260.66
All LHD manual diesel models - With sensor	Genuine	1	STC500031	205.33	246.40

### Clutch Slave Cylinder

All manual models up to (VIN) BA999999	Aftermarket	1	LR014290P	54.17	65.00
	Genuine	1	LR014290	81.21	97.45

### Clutch Pedal Pad

All manual models - Also used on manual model brake pedal					
	Genuine	2	SKE500020	4.76	5.71

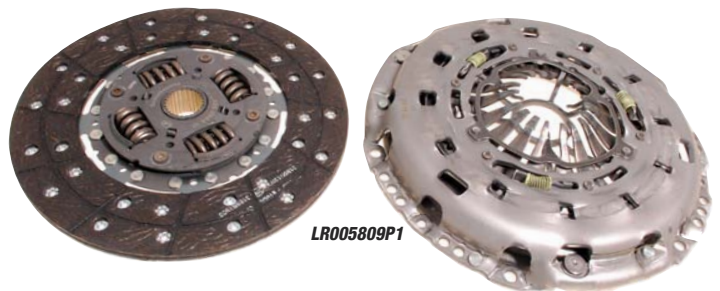

## DISCOVERY 4 (2010 on)

## TRANSMISSION

## Constant Velocity Joint

All 2.7L V6 Lion diesel models with manual gearbox				
Aftermarket	2	<b>LR060383P</b>	41.67	50.00
OEM	2	<b>LR060383P1</b>	67.50	81.00
Genuine	2	<b>LR060383</b>	133.37	160.04
All 2.7L TDV6 diesel models with auto gearbox				
Aftermarket	2	<b>LR060382P</b>	45.00	54.00
OEM	2	<b>LR060382P1</b>	60.83	73.00
Genuine	2	<b>LR060382</b>	133.37	160.04
All 3.0L TDV6 diesel models				
Aftermarket	2	<b>LR060382P</b>	45.00	54.00
OEM	2	<b>LR060382P1</b>	60.83	73.00
Genuine	2	<b>LR060382</b>	133.37	160.04
All petrol models				
Aftermarket	2	<b>LR060383P</b>	41.67	50.00
OEM	2	<b>LR060383P1</b>	67.50	81.00
Genuine	2	<b>LR060383</b>	133.37	160.04

## CV Joint Assembly

All models without rear axle locking differential - Rear axle, outer				
Aftermarket	2	<b>LR060384P</b>	45.00	54.00
OEM	2	<b>LR060384P1</b>	105.00	126.00
Genuine	2	<b>LR060384</b>	192.08	230.50
All models with rear axle locking differential - Rear axle, outer				
Aftermarket	2	<b>LR060385P</b>	45.00	54.00
OEM	2	<b>LR060385P1</b>	105.00	126.00
Genuine	2	<b>LR060385</b>	192.08	230.50

## Centre Bearing, Propshaft

All models up to (VIN) DA999999 - Rear	Britpart	1	<b>LR037027BPBRG</b>	39.58	47.50
All models with 2 speed transfer box from (VIN) EA000001 on - Rear	Britpart	1	<b>LR037027BPBRG</b>	39.58	47.50

## Drive Flange Kit, Transfer Box

All models					
Output shaft, front	Genuine	1	<b>IEA500031</b>	81.83	98.20
Rear output shaft	Genuine	1	<b>LR039528</b>	107.64	129.17

## Drive Shaft Front

All diesel models with manual gearbox					
RH	OEM	1	<b>LR071930P1</b>	177.50	213.00
	Genuine	1	<b>LR071930</b>	441.77	530.12
LH	OEM	1	<b>LR072067P1</b>	153.33	184.00
	Genuine	1	<b>LR072067</b>	384.53	461.44
All diesel models with auto gearbox					
RH	OEM	1	<b>LR072070P1</b>	150.83	181.00
	Genuine	1	<b>LR072070</b>	427.73	513.28
All petrol models with auto gearbox					
RH	OEM	1	<b>LR071930P1</b>	177.50	213.00
	Genuine	1	<b>LR071930</b>	441.77	530.12
LH	OEM	1	<b>LR072067P1</b>	153.33	184.00
	Genuine	1	<b>LR072067</b>	384.53	461.44

## Drive Shaft &amp; CV Joint

All diesel manual models - Front axle					
RH	Genuine	1	<b>LR025872</b>	156.18	187.42
	Genuine	1	<b>LR025874</b>	146.18	175.42
All diesel automatic models - Front axle,					
RH	Genuine	1	<b>LR025869</b>	149.94	179.93
	Genuine	1	<b>LR025873</b>	146.18	175.42
All 3.0L V6 petrol models from (VIN) EA000001 on - Front axle					
RH	Genuine	1	<b>LR025869</b>	149.94	179.93
	Genuine	1	<b>LR025873</b>	146.18	175.42
All petrol automatic models except 3.0L V6 petrol - Front axle					
RH	Genuine	1	<b>LR025872</b>	156.18	187.42
	Genuine	1	<b>LR025874</b>	146.18	175.42
All models without rear axle locking differential - <i>Features 2mm thread pitch - on models up to (VIN) DA671699 the original hub nut with 1.5mm pitch will also need to be replaced with LR024151 nut</i>					
Rear RH	Genuine	1	<b>LR071933</b>	194.47	233.36
Rear LH	OEM	1	<b>LR072065P1</b>	195.00	234.00
	Genuine	1	<b>LR072065</b>	295.28	354.34
All models with rear axle locking differential - <i>Features 2mm thread pitch - on models up to (VIN) DA671699 the original hub nut with 1.5mm pitch will also need to be replaced with LR024151 nut</i>					
Rear RH	Genuine	1	<b>LR072071</b>	322.93	387.52

## Drive Shaft Assembly

All 2.7L TDV6 diesel models with automatic gearbox					
Front LH	OEM	1	<b>LR072069P1</b>	138.33	166.00
	Genuine	1	<b>LR072069</b>	402.85	483.42
All 3.0L TDV6 diesel models -					
Front LH	OEM	1	<b>LR072069P1</b>	138.33	166.00
	Genuine	1	<b>LR072069</b>	402.85	483.42
All models with rear axle locking differential - <i>Features 2mm thread pitch - on models up to (VIN) DA671699 the original hub nut with 1.5mm pitch will also need to be replaced with LR024151 nut</i>					
Rear LH	Genuine	1	<b>LR072063</b>	395.46	474.55
All models (VIN) DA671700 on - Rear, RH, 2mm pitch nut thread					
	OEM	1	<b>LR047285P1</b>	162.50	195.00
	Genuine	1	<b>LR047285</b>	207.96	249.55

## Gaiter Kit Front Drive Shaft

All 2.7L TDV6 Lion diesel models with manual gearbox				
OEM	2	<b>TDR500110P1</b>	20.63	24.76
Genuine	2	<b>TDR500110</b>	43.23	51.88
All 2.7L TDV6 Lion diesel models with auto gearbox				
OEM	2	<b>TDR500100P1</b>	18.54	22.25
Genuine	2	<b>TDR500100</b>	43.23	51.88
All 3.0L V6 Lion diesel models				
OEM	2	<b>TDR500100P1</b>	18.54	22.25
Genuine	2	<b>TDR500100</b>	43.23	51.88
All petrol models				
OEM	2	<b>TDR500110P1</b>	20.63	24.76
Genuine	2	<b>TDR500110</b>	43.23	51.88

## Gaiter Kit Rear Drive Shaft

All models without rear axle locking differential				
OEM	2	<b>TDR500070P1</b>	20.00	24.00
Genuine	2	<b>TDR500070</b>	46.58	55.90
All models with rear axle locking differential				
OEM	2	<b>TDR500080P1</b>	20.00	24.00
Genuine	2	<b>TDR500080</b>	39.28	47.14

## Hub &amp; Wheel Bearing

All models - Front	Genuine	1	<b>LR076692</b>	200.22	240.26
--------------------	---------	---	-----------------	--------	--------

## Wheel Hub, With Bearing

All models - Front				
Aftermarket	2	<b>LR048083P</b>	60.00	72.00
OEM	2	<b>LR048083P1</b>	95.00	114.00
Genuine	2	<b>LR048083</b>	206.23	247.48

## Wheel Hub Assembly

All models - Rear axle, does not include bearing				
Aftermarket	2	<b>RUC500120P</b>	55.83	67.00
Genuine	2	<b>RUC500120</b>	98.29	117.95

## Oil Seal, Differential

All models					
Front axle pinion	OEM	1	<b>LR019019P1</b>	5.63	6.76
	Genuine	1	<b>LR019019</b>	9.25	11.10
Front & rear axles, output shafts	OEM	1	<b>TZB500050P1</b>	6.25	7.50
	Genuine	1	<b>TZB500050</b>	13.21	15.85
Rear axle pinion	Genuine	1	<b>TZB500100</b>	16.28	19.54

## Oil Seal, Transfer Box

All models - Input shaft				
Aftermarket	1	<b>IZB500030P</b>	6.67	8.00
Genuine	1	<b>IZB500030</b>	12.96	15.55

## Sealing Ring, Transfer Box

All models					
Front output shaft	OEM	1	<b>IZB500040P1</b>	8.13	9.76
	Genuine	1	<b>IZB500040</b>	10.17	12.20
Rear output shaft	OEM	1	<b>IZB500050P1</b>	4.79	5.75
	Genuine	1	<b>IZB500050</b>	9.84	11.81

## Plug, Transfer Box

All models - Oil Fill & Drain				
OEM	1	<b>IYB500020P1</b>	1.75	2.10
Genuine	1	<b>IYB500020</b>	2.49	2.99
All models with single speed transfer box from (VIN) EA000001 on - Oil fill & drain, M18 (not M16)				
Genuine	1	<b>LR048841</b>	2.99	3.59

## Plug, Oil Drain

All models - Front & rear axles	Genuine	1	<b>FTC5431</b>	6.50	7.80
---------------------------------	---------	---	----------------	------	------

## Plug, Differential

All models - Oil filler, front & rear axles	Genuine	1	<b>TYB500060</b>	0.86	1.03
---------------------------------------------	---------	---	------------------	------	------

## Oil Temperature Switch

All models with rear axle locking differential - Rear axle differential				
Genuine	1	<b>NSC500590</b>	14.45	17.34

## Chain Only, Transfer Box

All models up to (VIN) DA683912	OEM	1	<b>LR049160CP1</b>	133.33	160.00
---------------------------------	-----	---	--------------------	--------	--------

## Sensor, Differential

All models with rear axle locking differential - Oil temperature				
Genuine	1	<b>NSC500590</b>	14.45	17.34

## Sensor, Transfer Box

All models - High/low position	Genuine	1	<b>IAB500191</b>	74.63	89.56
--------------------------------	---------	---	------------------	-------	-------

## Solenoid, Transfer Box

All models - Pressure	Genuine	1	<b>IGF500011</b>	77.19	92.63
-----------------------	---------	---	------------------	-------	-------



LR047285P1





## COOLING

### Expansion Bottle Cap

All 2.7L & 3.0L V6 diesel models	Aftermarket	1	<b>LR017427P</b>	4.79	5.75
	Genuine	1	<b>LR017427</b>	6.99	8.39
All petrol models	OEM	1	<b>LR010965P1</b>	2.42	2.90
	Genuine	1	<b>LR010965</b>	5.57	6.68

### Thermostat

All models with 2.7L TDV6 diesel engine	Genuine	1	<b>LR009562</b>	25.61	30.73
All 3.0L V6 diesel models - In-line thermostat for top & bottom hose assembly	Genuine	1	<b>LR033675</b>	35.21	42.25

### Thermostat & Radiator Hose Assembly

All 3.0L V6 diesel models - In-line thermostat with top & bottom hose assembly	Genuine	1	<b>LR025969</b>	118.01	141.61
--------------------------------------------------------------------------------	---------	---	-----------------	--------	--------

### Water Pump

All 2.7L V6 diesel engine models	OEM	1	<b>LR009324P1</b>	35.83	43.00
	Genuine	1	<b>LR009324</b>	89.17	107.00
All 3.0L V6 diesel engine models	Genuine	1	<b>LR013164</b>	87.26	104.71

### Gasket Water Pump

All 2.7L V6 diesel engine models	Genuine	1	<b>1316117</b>	24.53	29.44
All 3.0L V6 diesel engine models	Genuine	1	<b>1316117</b>	24.53	29.44
All petrol engine models	Aftermarket	1	<b>LR049370P</b>	4.58	5.50
	Genuine	1	<b>LR049370</b>	11.91	14.29
All 4.0L Cologne V6 petrol models	Genuine	1	<b>1106473</b>	5.04	6.05

### Intercooler Hose

All 2.7L V6 turbo diesel models	RH	Aftermarket	1	<b>PNH500025P</b>	25.83	31.00
		Genuine	1	<b>PNH500025</b>	41.04	49.25
LH		Genuine	1	<b>PNH500223</b>	43.14	51.77
	LH rear	Genuine	1	<b>PNH500034</b>	96.08	115.30

### Coolant Temperature Sensor

All 3.0L V6 diesel models	Genuine	1	<b>LR041442</b>	25.70	30.84
All 3.0L supercharged V6 petrol models	Genuine	1	<b>LR041442</b>	25.70	30.84
All 5.0L N/A AJV8 petrol models	Genuine	1	<b>LR041442</b>	25.70	30.84

### Coolant Level Sensor

All models	Genuine	1	<b>PCJ500030</b>	6.16	7.39
------------	---------	---	------------------	------	------

## ELECTRICAL - ROTATING ELECTRICS

### Alternator

All models with 2.7L TDV6 diesel engine	New, outright	OEM	1	<b>LR073680P1</b>	185.00	222.00
	New, exchange	Genuine*	1	<b>LR073680</b>	381.66	457.99
					125.00	150.00
All 3.0L V6 petrol models	New, outright	OEM	1	<b>LR072764P1</b>	316.67	380.00
	New, exchange	Genuine*	1	<b>LR072764</b>	695.32	834.38
					200.00	240.00
All 3.0L V6 diesel models	New, outright	OEM	1	<b>LR072756P1</b>	170.00	204.00
	New, exchange	Genuine*	1	<b>LR072756</b>	504.64	605.57
					175.00	210.00
All 4.0L V6 petrol engine models	New, outright	OEM	1	<b>YLE500410P1</b>	237.50	285.00
	New, exchange	Genuine*	1	<b>YLE500410</b>	346.91	416.29
					70.00	84.00
All models with 5.0L NA AJV8 petrol engine	New, outright	Aftermarket	1	<b>LR065246P</b>	185.00	222.00
		OEM	1	<b>LR065246P1</b>	185.00	222.00
		Genuine	1	<b>LR065246</b>	388.03	465.64



LR072756P1

### Starter Motor

All 2.7L V6 diesel models	Reconditioned, exchange	Genuine*	1	<b>NAD500080E</b>	214.25	257.10	
					70.00	84.00	
		Genuine	1	<b>LR087021</b>	373.26	447.91	
All models with 3.0L V6 diesel engine	New, outright, alternative to LR043962	Genuine*	1	<b>LR087021</b>	373.26	447.91	
		Genuine	1	<b>LR087021</b>	373.26	447.91	
All models with 3.0L V6 diesel engine	New, outright	OEM	1	<b>LR080299P1</b>	175.00	210.00	
		New, exchange	Genuine*	1	<b>LR080299</b>	382.73	459.28
						100.00	120.00
All 3.0L V6 diesel models without stop start system	New, outright	OEM	1	<b>LR080299P1</b>	175.00	210.00	
		New, exchange	Genuine*	1	<b>LR080299</b>	382.73	459.28
						100.00	120.00
All 4.0L Cologne V6 petrol models	New, outright	OEM	1	<b>NAD500300P1</b>	175.00	210.00	
		New, exchange	Genuine*	1	<b>NAD500300</b>	306.70	368.04
						70.00	84.00
All 5.0L N/A AJV8 petrol models	New, outright	OEM	1	<b>LR011262P1</b>	258.33	310.00	
		New, exchange	Genuine*	1	<b>LR011262</b>	398.23	477.88
						70.00	84.00



LR011262P1

## ENGINE GASKETS

### Gasket Camshaft Cover

All 2.7L TDV6 Lion diesel models	Aftermarket	2	<b>LR029132P</b>	6.67	8.00
	Genuine	2	<b>LR029132</b>	14.86	17.83

### Gasket Rocker Cover

All 4.0L Cologne V6 petrol models	Genuine	2	<b>4691206</b>	18.10	21.72
-----------------------------------	---------	---	----------------	-------	-------

### Gasket Cylinder Head

All 2.7L TDV6 diesel models	Grade 2	Genuine	2	<b>LR009719</b>	9.87	11.84	
		Genuine	2	<b>LR009721</b>	9.87	11.84	
	Grade 3	OEM	2	<b>LR009722P1</b>	10.83	13.00	
		Genuine	2	<b>LR009722</b>	20.22	24.26	
	Grade 4	OEM	2	<b>LR009723P1</b>	10.83	13.00	
		Genuine	2	<b>LR009723</b>	20.22	24.26	
All models with 3.0L V6 diesel engine	Grade 2	OEM	2	<b>LR013063P1</b>	14.50	17.40	
		Genuine	2	<b>LR013063</b>	23.72	28.46	
	Grade 3	Genuine	2	<b>LR013066</b>	23.72	28.46	
		OEM	2	<b>LR013070P1</b>	10.83	13.00	
	Grade 4	Genuine	2	<b>LR013070</b>	15.80	18.96	
		OEM	2	<b>LR013073P1</b>	10.83	13.00	
	Grade 5	Genuine	2	<b>LR013073</b>	15.80	18.96	
	All 3.0L supercharged V6 petrol models	RH	Genuine	1	<b>LR041640</b>	18.59	22.31
		LH	Genuine	1	<b>LR041641</b>	14.62	17.54
	All 4.0L Cologne V6 petrol models	RH	Genuine	1	<b>LR003548</b>	16.85	20.22
		LH	Genuine	1	<b>LR003549</b>	16.85	20.22

## DISCOVERY 4 (2010 on)

### Gasket Decoke Set

All 4.0L Cologne V6 petrol models	Genuine	1	<b>LR004324</b>	56.45	67.74
-----------------------------------	---------	---	-----------------	-------	-------

### Gasket Oil Sump

All models with 2.7L TDV6 diesel engine	Genuine	1	<b>1365260</b>	23.54	28.25	
All 4.0L Cologne V6 petrol models	Upper	Genuine	1	<b>1025228</b>	8.01	9.61
		Genuine	1	<b>4639173</b>	14.23	17.08

### Gasket Conversion Set

All 4.0L Cologne V6 petrol models	Genuine	1	<b>LR002817</b>	92.77	111.32
-----------------------------------	---------	---	-----------------	-------	--------

### Sealant Instant Gasket

Numerous applications	Genuine	a/r	<b>STC50550</b>	13.10	15.72
-----------------------	---------	-----	-----------------	-------	-------



LR009719



## DISCOVERY 4 (2010 on)

## ENGINE SWITCHES

## Camshaft Position Sensor

All 2.7L TDV6 diesel models	Genuine	1	LR019287	120.57	144.68
All 3.0L V6 diesel models	Genuine	1	LR013458	121.12	145.34
All 3.0L supercharged V6 petrol models	OEM	1	LR014372P1	36.67	44.00
	Genuine	1	LR014372	118.70	142.44
All 4.0L Cologne V6 petrol models - In rocker cover	Genuine	1	LR000442	116.42	139.70
All 5.0L N/A AJV8 petrol models	OEM	1	LR014372P1	36.67	44.00
	Genuine	1	LR014372	118.70	142.44

## Crankshaft Position Sensor

All 2.7L TDV6 diesel models	Aftermarket	1	LR009793P	45.00	54.00
	Genuine	1	LR009793	117.84	141.41
All 3.0L V6 diesel models - Trigger wheel LR035564 also required up to (VIN) CA999999	Aftermarket	1	LR049872P	55.00	66.00
	Genuine	1	LR049872	146.50	175.80
All 3.0L V6 diesel models up to (VIN) CA999999	Genuine	1	LR014228	296.32	355.58
All 3.0L supercharged V6 petrol models	Genuine	1	LR035561	38.46	46.15
All 4.0L Cologne V6 petrol models	Aftermarket	1	NSC500160P	20.00	24.00
	Genuine	1	NSC500160	42.84	51.41

## Oil Temperature Switch

All 2.7L TDV6 diesel models	Genuine	1	1359056	27.21	32.65
-----------------------------	---------	---	---------	-------	-------

## Engine Knock Sensor

All 2.7L TDV6 diesel models with EU2 emissions (without diesel particulate filter, DPF)	Genuine	1	LR007808	29.41	35.29	
All 3.0L V6 supercharged petrol models	Genuine	1	LR008877	33.19	39.83	
All 4.0L Cologne V6 petrol models	Upper	Genuine	1	3991033	67.14	80.57
	Lower	Genuine	1	NSC500600	13.98	16.78
All 5.0L N/A AJV8 petrol models	Genuine	1	LR008877	33.19	39.83	

## Oil Level Sensor

All 3.0L V6 diesel models	Genuine	1	LR012640	35.68	42.82
All 3.0L supercharged V6 petrol models	Genuine	1	LR012640	35.68	42.82
All 5.0L N/A AJV8 petrol models	Genuine	1	LR012640	35.68	42.82

## Oil Pressure Switch

All 2.7L & 3.0L V6 diesel models	Genuine	1	1316119	13.94	16.73
----------------------------------	---------	---	---------	-------	-------

## Air Charge Temperature Sensor

All 3.0L V6 diesel models - Turbocharger outlet	Genuine	1	LR014386	47.36	56.83
All 3.0L supercharged V6 petrol models	Aftermarket	1	LR021587P	21.00	25.20
	Genuine	1	LR021587	23.34	28.01

## Manifold Absolute Pressure Sensor

All 3.0L V6 diesel models	Genuine	1	LR019130	65.03	78.04
All 3.0L V6 supercharged petrol models up to (VIN) EA999999	Genuine	1	LR008881	86.58	103.90
All 5.0L N/A AJV8 petrol models	Genuine	1	LR008881	86.58	103.90

## Oxygen Sensor

All 2.7L TDV6 diesel models with Euro Stage IV emissions and diesel particulate filter	Pre-catalyst	Genuine	1	WDN500130	34.85	41.82
	Post-catalyst	Genuine	1	WDN500110	46.95	56.34
	Post-DPF	Genuine	1	WDN500050	34.98	41.98
All 3.0L supercharged V6 petrol models	OEM	1	LR035750P1	95.00	114.00	
	Genuine	1	LR035750	124.26	149.11	
	RH, middle	Genuine	1	LR052424	154.08	184.90
	RH, post-catalyst	Genuine	1	LR052426	85.70	102.84
	LH, post-catalyst	OEM	1	LR052425P1	72.50	87.00
	Genuine	1	LR052425	85.70	102.84	
All 3.0L V6 diesel models - LH, lower, pre-catalyst	Genuine	1	LR014227	125.75	150.90	
All 3.0L V6 diesel models with Euro Stage V emissions and diesel particulate filter	Post-catalyst	Genuine	1	WDN500110	46.95	56.34
	Post-DPF	Genuine	1	WDN500050	34.98	41.98
All 4.0L Cologne V6 petrol models - Pre-catalyst	Genuine	1	LR014010	109.16	130.99	
All 5.0L N/A AJV8 petrol models - Pre-catalyst	Genuine	1	LR011710	67.93	81.52	

## Exhaust Gas Temperature Sensor

All 3.0L V6 diesel models - RH front	Genuine	1	NSC500630	48.39	58.07
--------------------------------------	---------	---	-----------	-------	-------

## Exhaust Gas Pressure Sensor

All 2.7L TDV6 diesel models with diesel particulate filter	For diesel particulate filter (DPF), pressure differential	Genuine	1	LR014310	121.87	146.24
All 3.0L V6 diesel models	For diesel particulate filter (DPF), pressure differential	Genuine	1	LR014310	121.87	146.24
All 3.0L V6 diesel models with 1 speed transfer box from (VIN) EA000001 to FA999999	For diesel particulate filter (DPF), pressure differential, includes pipes	Genuine	1	LR052423	123.57	148.28
All 3.0L V6 diesel models with 2 speed transfer box from (VIN) EA000001 to FA999999	For diesel particulate filter (DPF), pressure differential, includes pipes	Genuine	1	LR052422	123.57	148.28



LR019287

## DISCOVERY 4 (2010 on)

## DRAIN PLUGS

## Sump Plug &amp; Washer

2.7L V6 Lion diesel models	Aftermarket	1	1013938P	1.50	1.80
	Genuine	1	1013938	3.19	3.83
3.0L V6 diesel models	Aftermarket	1	1013938P	1.50	1.80
	Genuine	1	1013938	3.19	3.83
4.0L V6 Cologne petrol models	Aftermarket	1	1013938P	1.50	1.80
	Genuine	1	1013938	3.19	3.83

## Drain Plug

All 6 speed manual models - Gearbox. Also filler plug	Genuine	1	TYB500010	6.28	7.54
-------------------------------------------------------	---------	---	-----------	------	------



1013938P

## DISCOVERY 4 (2010 on)

## OIL SEALS ENGINE

## Crankshaft Oil Seal

All models with 3.0L V6 diesel engine - Front	Genuine	1	1102415	5.41	6.49
All 4.0L Cologne V6 petrol models - Front	OEM	1	1316639P1	2.83	3.40
	Genuine	1	1316639	5.06	6.07
All 4.0L Cologne V6 petrol models - Rear	OEM	1	4719898P1	4.79	5.75
	Genuine	1	4719898	7.19	8.63

## Oil Seal Crankshaft Rear

All 2.7L & 3.0L V6 diesel models - With retainer	Genuine	1	LR036542	36.48	43.78
--------------------------------------------------	---------	---	----------	-------	-------

## Oil Seal Camshaft

All models with 2.7L TDV6 diesel engine - Front and rear	Aftermarket	2	1311318P	2.00	2.40
	Genuine	2	1311318	2.83	3.40
All models with 3.0L V6 diesel engine - Front and rear	Aftermarket	2	1311318P	2.00	2.40
	Genuine	2	1311318	2.83	3.40



1102415



LR036542



# EXHAUST GAS RECIRCULATION (EGR)

**DISCOVERY 4 (2010 on)**

## EGR Valve

All 2.7L TDV6 diesel models				
RH	Aftermarket	1	<b>LR018324P</b>	82.00 98.40
	OEM	1	<b>LR018324P1</b>	133.33 160.00
	Genuine	1	<b>LR018324</b>	179.69 215.63
LH	Aftermarket	1	<b>LR018323P</b>	82.00 98.40
	OEM	1	<b>LR018323P1</b>	133.33 160.00
	Genuine	1	<b>LR018323</b>	179.69 215.63
All 4.0L Cologne V6 petrol models				
	Genuine	1	<b>LR012028</b>	171.40 205.68

## Gasket

All 2.7L V6 Diesel engine models				
Exhaust gas recirculation inlet	Aftermarket	1	<b>LR004532P</b>	2.58 3.10
Exhaust gas recirculation outlet	Genuine	1	<b>1331267</b>	5.12 6.14

## Gasket EGR Valve Inlet

All 2.7L V6 Diesel engine models	Genuine	1	<b>LR004532</b>	5.48 6.58
----------------------------------	---------	---	-----------------	-----------

## Gasket EGR Pipe to Exhaust Manifold

All 2.7L TDV6 diesel models - RH & LH	Genuine	1	<b>1331270</b>	5.30 6.36
---------------------------------------	---------	---	----------------	-----------

## Pipe EGR Valve to Inlet Manifold

All 2.7L TDV6 diesel models				
RH	Genuine	1	<b>1316131</b>	42.11 50.53
LH	Genuine	1	<b>1348612</b>	24.00 28.80
All 2.7L TDV6 diesel models				
RH	Genuine	1	<b>LR066841</b>	176.97 212.36
LH	Genuine	1	<b>LR066839</b>	203.44 244.13
All 3.0L V6 diesel models				
RH	Genuine	1	<b>LR013589</b>	44.75 53.70
LH	Genuine	1	<b>LR013587</b>	44.75 53.70

## Pipe EGR Valve to Exhaust

All 2.7L TDV6 diesel models - RH	Genuine	1	<b>LR004253</b>	42.65 51.18
----------------------------------	---------	---	-----------------	-------------

## Pipe EGR Valve to Exhaust Manifold

All 2.7L TDV6 diesel models - LH	Genuine	1	<b>LR066840</b>	109.04 130.85
All 4.0L Cologne V6 petrol models	Genuine	1	<b>WAT500030</b>	24.63 29.56

## Pipe Cooled EGR Outlet

All 2.7L V6 diesel models	Genuine	1	<b>WAP500380</b>	81.41 97.69
---------------------------	---------	---	------------------	-------------

# ENGINE & GEARBOX MOUNTINGS

**DISCOVERY 4 (2010 on)**

## Engine Mounting

All 2.7L TDV6 diesel models	Genuine	2	<b>KKB500760</b>	52.07 62.48
All 3.0L V6 diesel models	Genuine	2	<b>KKB500770</b>	52.15 62.58
All 3.0L V6 petrol models	Genuine	2	<b>LR014113</b>	53.11 63.73
All 4.0L Cologne V6 petrol models	Genuine	2	<b>KKB500620</b>	53.33 64.00
All 5.0L AJV8 petrol models	Genuine	2	<b>KKB500770</b>	52.15 62.58

## Eye Bolt Gearbox Mounting

All models	Genuine	1	<b>KYG500200</b>	1.32 1.58
------------	---------	---	------------------	-----------

**KKB500760**

## Bracket Engine Mounting

All 2.7L TDV6 diesel models				
RH	Genuine	1	<b>LR074104</b>	22.54 27.05
LH	Genuine	1	<b>LR074105</b>	27.95 33.54
All 3.0L V6 diesel models				
RH	Genuine	1	<b>LR074104</b>	22.54 27.05
LH	Genuine	1	<b>LR074105</b>	27.95 33.54
All 3.0L V6 petrol models				
RH	Genuine	1	<b>LR074029</b>	30.79 36.95
LH	Genuine	1	<b>LR074030</b>	20.51 24.61
All 4.0L Cologne V6 petrol models				
RH	Genuine	1	<b>KKU500660</b>	220.71 264.85
LH	Genuine	1	<b>KKU500880</b>	245.90 295.08
All 5.0L N/A AJV8 petrol models				
RH	Genuine	1	<b>LR074029</b>	30.79 36.95
LH	Genuine	1	<b>LR074030</b>	20.51 24.61

# FUEL SYSTEM SWITCHES

**DISCOVERY 4 (2010 on)**

## Fuel Pressure Sensor

All 3.0L supercharged V6 petrol models - Sensor mounted on underfloor fuel manifold				
	Genuine	1	<b>LR015356</b>	41.46 49.75
All 5.0L N/A AJV8 petrol models up to (VIN) CA640920 - Sensor mounted on injector rail				
	OEM	1	<b>LR012280P1</b>	87.50 105.00
	Genuine	1	<b>LR012280</b>	108.02 129.62
All 5.0L N/A AJV8 petrol models - Sensor mounted on underfloor fuel manifold				
	Genuine	1	<b>LR015356</b>	41.46 49.75
All 5.0L N/A AJV8 petrol models from (VIN) CA640921 on				
	Genuine	1	<b>LR044707</b>	40.91 49.09

## Air Flow Meter

2.7L TDV6 diesel models				
	OEM	1	<b>PHF500101P1</b>	89.17 107.00
	Genuine	1	<b>PHF500101</b>	128.80 154.56
V6 Cologne petrol models				
	OEM	1	<b>PHF000140P1</b>	70.00 84.00
	Genuine	1	<b>PHF000140</b>	107.33 128.80
All 5.0L N/A AJV8 petrol models				
	Genuine	1	<b>LR012073</b>	107.33 128.80

## Air Flow Sensor

3.0L V6 diesel models				
	OEM	1	<b>PHF500090P1</b>	70.00 84.00
	Genuine	1	<b>PHF500090</b>	128.80 154.56

## Water Sensor for Fuel Filter

All 2.7L TDV6 diesel models	OEM	1	<b>WKW500080</b>	51.36 61.63
All 3.0L V6 diesel models	OEM	1	<b>WKW500080</b>	51.36 61.63

**PHF500101P1**

# CABLES

**DISCOVERY 4 (2010 on)**

## Bonnet Release Cable

All models				
Engine compartment end	Genuine	1	<b>LR013888</b>	10.02 12.02
Passenger compartment end	Genuine	1	<b>LR013889</b>	6.67 8.00

# WHEEL CENTRE CAPS & WHEEL NUTS

**DISCOVERY 4 (2010 on)**

## Wheel Centre Cap

All models with polished finish alloy wheel centre caps from (VIN) BA000001 on				
Polished finish, Land Rover green/silver badge				
	Aftermarket	a/r	<b>LR023301P</b>	5.42 6.50
	Genuine	a/r	<b>LR023301</b>	6.64 7.97
All models with bright black alloy wheel centre caps from (VIN) DA690512 on				
Bright black finish, Land Rover badge				
	Aftermarket	a/r	<b>LR069899P</b>	7.50 9.00
	Genuine	a/r	<b>LR069899</b>	10.76 12.91
All models with satin silver/bright aluminium alloy wheel centre caps from (VIN) DA690512 on				
Satin silver/bright aluminium finish, Land Rover badge				
	Genuine	a/r	<b>LR069900</b>	6.02 7.22

## Wheel Nut

All models with stainless steel finish wheel nuts				
Stainless steel finish	OEM	a/r	<b>LR068126P1</b>	3.25 3.90
	Genuine	a/r	<b>LR068126</b>	5.27 6.32

## Wheel Nut Set

All models with stainless steel finish wheel nuts				
Stainless steel finish - set of 16				
	OEM	a/r	<b>LR068126P1K16</b>	40.00 48.00
	Genuine	a/r	<b>LR068126K16</b>	80.83 97.00
Stainless steel finish - set of 20				
	OEM	a/r	<b>LR068126P1K20</b>	50.00 60.00
	Genuine	a/r	<b>LR068126K20</b>	97.50 117.00

**LR023301**





# DISCOVERY SPORT (2014 on)

## 2014 - All Models

Listed below are the most popular parts required for the Discovery Sport. We have access to the full range of parts for your vehicle. Please contact us if not listed here.

### DISCOVERY SPORT (2014 on) FILTRATION

#### Oil Filter

All 2.0L TVCT turbo petrol models - Cartridge

Aftermarket	1	<b>LR025306P</b>	3.50	4.20
Genuine	1	<b>LR025306</b>	6.87	8.24

#### Air Filter

All 2.0L TVCT turbo petrol models

OEM	1	<b>LR029078P1</b>	11.04	13.25
Genuine	1	<b>LR029078</b>	15.70	18.84

All 2.2L diesel models

OEM	1	<b>LR029078P1</b>	11.04	13.25
Genuine	1	<b>LR029078</b>	15.70	18.84



LR025306



LR029078P1

#### Fuel Filter

All 2.2L diesel models

OEM	1	<b>LR001313P1</b>	22.50	27.00
Genuine	1	<b>LR001313</b>	33.38	40.06

#### Pollen Filter

All models (manual or electronic air conditioning) - Fresh air, includes pollution sensor

Aftermarket	1	<b>LR056138P</b>	4.58	5.50
OEM	1	<b>LR056138P1</b>	9.58	11.50
Genuine	1	<b>LR056138</b>	15.66	18.79



LR001313P1

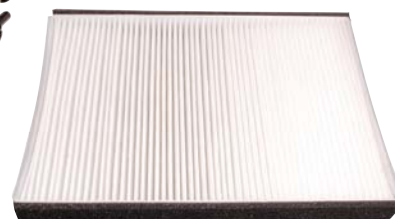

LR056138P

### DISCOVERY SPORT (2014 on) WIPER BLADES

#### Wiper Blade

All models - Rear

OEM	1	<b>LR064430P1</b>	6.88	8.26
Genuine	1	<b>LR064430</b>	15.94	19.13

### DISCOVERY SPORT (2014 on) SCREEN/LAMP WASHER SYSTEMS

#### Washer Jet & Hose

All UK built models from (VIN) FH510381 on - Rear screen wash

Genuine	1	<b>LR076911</b>	10.74	12.89
---------	---	-----------------	-------	-------

All Brazil built models - Rear screen wash

Genuine	1	<b>LR076911</b>	10.74	12.89
---------	---	-----------------	-------	-------

#### Washer Hose, Per Metre

All models - 4mm internal diameter (3mm also available). Front or rear screen wash

Aftermarket	a/r	<b>GWV201M</b>	2.25	2.70
-------------	-----	----------------	------	------

#### Washer Jet Extension Hose

All UK built models - Rear screen wash

Genuine	1	<b>LR077450</b>	10.74	12.89
---------	---	-----------------	-------	-------

#### Filler Neck Cap

All models - Front & rear screen & headlamp wash

Genuine	1	<b>LR002266</b>	1.86	2.23
---------	---	-----------------	------	------

#### Low Fluid Level Sensor

All models

Genuine	1	<b>LR000930</b>	11.52	13.82
---------	---	-----------------	-------	-------

#### Washer Reservoir Level Sensor

All models - Front & rear screen & headlamp wash

Genuine	1	<b>DMI500010</b>	4.20	5.04
---------	---	------------------	------	------

#### Washer Reservoir

All models without headlamp wash - Front & rear screen wash

Genuine	1	<b>LR025755</b>	31.55	37.86
---------	---	-----------------	-------	-------

All models with headlamp wash - Front & rear screen & headlamp wash

Genuine	1	<b>LR025760</b>	31.34	37.61
---------	---	-----------------	-------	-------

#### Washer Reservoir Filler Neck Filter

All models - Front & rear screen & headlamp wash

Genuine	1	<b>DMS500010</b>	3.27	3.92
---------	---	------------------	------	------

#### Windscreen Cleaning Paste

All models

Genuine	a/r	<b>DNJ500340</b>	7.72	9.26
---------	-----	------------------	------	------

Prevents wiper blade judder/squeak by 'deep cleaning' the windscreen (ref: Land Rover Tech Bulletin LRA501-002)

### DISCOVERY SPORT (2014 on) DRIVE BELTS

#### Timing Belt Kit

All models with 2.2L TD4/SD4 turbo diesel engine - With tensioners, without water pump

OEM	1	<b>LR032526P1</b>	51.67	62.00
Genuine	1	<b>LR032526</b>	119.39	143.27

#### Timing Belt

All models with 2.2L TD4/SD4 diesel engine

Aftermarket	1	<b>LR004257P</b>	15.83	19.00
Genuine	1	<b>LR004257</b>	50.69	60.83

#### Alternator Drive Belt

All models with 2.0L TVCT turbo petrol engine - Alternator

OEM	1	<b>LR066153P1</b>	13.13	15.76
Genuine	1	<b>LR066153</b>	39.13	46.96

All 2.2L Duratorq turbo diesel models - Alternator

OEM	1	<b>LR060071P1</b>	8.13	9.76
Genuine	1	<b>LR060071</b>	32.53	39.04

### DISCOVERY SPORT (2014 on) IGNITION SYSTEM

#### Spark Plug

All 2.0L TVCT turbocharged petrol models

Genuine	4	<b>LR025605</b>	13.73	16.48
---------	---	-----------------	-------	-------

#### Glow Plug

All 2.0L AJ200 turbo diesel models

Genuine	4	<b>LR073727</b>	22.31	26.77
---------	---	-----------------	-------	-------



# BRAKING SYSTEM

## Brake Pad Retaining Pins

All models - Front	Genuine	4	<b>LR003977</b>	11.71	14.05
--------------------	---------	---	-----------------	-------	-------

## Brake Slide Pin Boot Kit

All models - Rear brakes	Genuine	2	<b>LR000751</b>	12.89	15.47
--------------------------	---------	---	-----------------	-------	-------

## Brake Discs

All models with 6 speed manual or 9 speed auto gearbox					
Front	Aftermarket	2	<b>LR059122P</b>	29.58	35.50
	Genuine	2	<b>LR059122</b>	84.25	101.10
Front, Slotted & Drilled (Pair)		1	<b>LR059122BPUR</b>	59.17	71.00
All models					
Rear	Aftermarket	2	<b>LR061388P</b>	22.50	27.00
	Genuine	2	<b>LR061388</b>	50.68	60.82
Rear, Slotted & Drilled (Pair)		1	<b>LR061388BPUR</b>	37.50	45.00

## Cap Brake Master Cylinder

All models from (VIN) AH188604 except Canada, USA and Mexico - Black					
	Genuine	1	<b>LR026354</b>	2.16	2.59
All models from (VIN) AH188604 including Canada and USA - Black					
	Genuine	1	<b>LR021624</b>	2.85	3.42

## Brake Pad Wear Sensor

All models - Front	Aftermarket	1	<b>LR061365P</b>	10.83	13.00
	Genuine	1	<b>LR061365</b>	24.04	28.85
All models from (VIN) FH512739 - Rear	Aftermarket	2	<b>LR072544P</b>	13.75	16.50
	Genuine	2	<b>LR072544</b>	17.79	21.35

## Caliper Repair Kit

All models from (VIN) GH000001 - Front	Genuine	2	<b>LR028027</b>	25.53	30.64
----------------------------------------	---------	---	-----------------	-------	-------

## Brake Pipe Clip

All models	Genuine	a/r	<b>ANR1864</b>	1.16	1.39
------------	---------	-----	----------------	------	------

## ABS Sensor

All models to (VIN) FH999999 - Front Hubs	Aftermarket	2	<b>LR071974P</b>	19.58	23.50
-------------------------------------------	-------------	---	------------------	-------	-------

## Brake Pedal Rubber

All 6 speed manual models	Genuine	1	<b>LR005273</b>	12.89	15.47
All 9 speed auto models	Genuine	1	<b>LR005272</b>	12.89	15.47

## Pedal Rubber Set (2 piece)

All models with automatic transmission	Genuine	1	<b>VPLHS0044</b>	83.67	100.40
----------------------------------------	---------	---	------------------	-------	--------

# SUSPENSION

## Coil Spring

All models with front spring load					
class A - Front, purple/orange/yellow	Genuine	2	<b>LR060796</b>	84.27	101.12
class B - Front, purple/purple/yellow	Genuine	2	<b>LR060797</b>	84.27	101.12
class C - Front, orange/red/yellow	Genuine	2	<b>LR060798</b>	84.27	101.12
class D - Front, orange/yellow	Genuine	2	<b>LR060799</b>	84.27	101.12
class E - Front, orange/blue/yellow	Genuine	2	<b>LR060800</b>	84.27	101.12
class F - Front, orange/green/yellow	Genuine	2	<b>LR060801</b>	84.27	101.12
class G - Front, orange/white/yellow	Genuine	2	<b>LR060802</b>	84.27	101.12
class H - Front, orange/purple/yellow	Genuine	2	<b>LR060803</b>	84.27	101.12
All models with rear spring load					
class A - Rear, orange/red/white, includes pads					
	Genuine	2	<b>LR078660</b>	74.81	89.77
class B - Rear, orange/yellow/white, includes pads					
	Genuine	2	<b>LR078661</b>	74.78	89.74
class C - Rear, orange/blue/white, includes pads					
	Genuine	2	<b>LR078662</b>	74.81	89.77
class D - Rear, orange/green/white, includes pads					
	Genuine	2	<b>LR078663</b>	74.79	89.75
class E - Rear, orange/white/white, includes pads					
	Genuine	2	<b>LR078664</b>	74.74	89.69
class F - Rear, orange/pink/white, includes pads					
	Genuine	2	<b>LR078698</b>	74.75	89.70
class G - Rear, orange/brown/white, includes pads					
	Genuine	2	<b>LR078699</b>	74.81	89.77
class H - Rear, orange/grey/white, includes pads					
	Genuine	2	<b>LR078700</b>	74.74	89.69
class J - Rear, orange/white/white, includes pads					
	Genuine	2	<b>LR078701</b>	74.74	89.69
class K - Rear, grey/red/white, includes pads					
	Genuine	2	<b>LR078702</b>	74.80	89.76
class L - Rear, grey/yellow/white, includes pads					
	Genuine	2	<b>LR078703</b>	74.86	89.83
class N - Rear, grey/blue/white, includes pads					
	Genuine	2	<b>LR078704</b>	74.78	89.74
class P - Rear, grey/green/white, includes pads					
	Genuine	2	<b>LR078711</b>	74.81	89.77
class Q - Rear, grey/white/white, includes pads					
	Genuine	2	<b>LR078712</b>	74.79	89.75
class R - Rear, grey/pink/white, includes pads					
	Genuine	2	<b>LR078713</b>	74.79	89.75
class S - Rear, grey/brown/white, includes pads					
	Genuine	2	<b>LR078714</b>	74.79	89.75

## Anti Roll Bar

All models with					
class A front anti roll bar - Front	Genuine	1	<b>LR061480</b>	173.03	207.64
class B front anti roll bar - Front	Genuine	1	<b>LR061481</b>	173.03	207.64
class C front anti roll bar - Front	Genuine	1	<b>LR067053</b>	160.86	193.03
class D front anti roll bar - Front	Genuine	1	<b>LR072680</b>	136.14	163.37
All models with 5 seat configuration,					
class A - Rear	Genuine	1	<b>LR061260</b>	87.64	105.17
class B - Rear	Genuine	1	<b>LR061262</b>	78.63	94.36
All models with 7 seat configuration,					
class D rear anti roll bar - Rear	Genuine	1	<b>LR066628</b>	78.63	94.36
class E rear anti roll bar - Rear	Genuine	1	<b>LR066629</b>	78.63	94.36

## Anti Roll Bar Bush

All models - Front					
class A	Genuine	2	<b>LR030743</b>	4.82	5.78
class C	Genuine	2	<b>LR034392</b>	3.11	3.73
class D	Genuine	2	<b>LR031310</b>	5.48	6.58

# DISCOVERY SPORT (2014 on)

# DISCOVERY SPORT (2014 on)

## Anti Roll Bar Link

All models - Front	Aftermarket	2	<b>LR024474P</b>	13.13	15.76
	Genuine	2	<b>LR024474</b>	24.61	29.53
All models - Rear					
RH	Genuine	2	<b>LR061271</b>	18.58	22.30
LH	Genuine	2	<b>LR061272</b>	18.83	22.60

## Mounting Bush, Anti Roll Bar

All models - Rear	Genuine	2	<b>LR063934</b>	34.98	41.98
-------------------	---------	---	-----------------	-------	-------

## Shock Absorber

All models without AMS conversion or magnetic damping - Front					
RH	Genuine	1	<b>LR084894</b>	125.33	150.40
LH	Genuine	1	<b>LR084745</b>	125.33	150.40
All models with magnetic damping - Front					
RH	Genuine	1	<b>LR060817</b>	604.91	725.89
LH	Genuine	1	<b>LR060818</b>	604.91	725.89
All models without magnetic damping - Rear					
	Genuine	2	<b>LR061355</b>	110.47	132.56
All models with magnetic damping - Rear					
RH	Genuine	1	<b>LR072532</b>	421.79	506.15
LH	Genuine	1	<b>LR072531</b>	421.79	506.15

## Boot, Shock Absorber

All models - Rear	Genuine	2	<b>LR061354</b>	16.49	19.79
-------------------	---------	---	-----------------	-------	-------

## Lower Arm Assembly

All AWD manual and automatic models - Front					
RH	Genuine	1	<b>LR086107</b>	177.94	213.53
LH	Genuine	1	<b>LR086108</b>	177.94	213.53
All models up to (VIN) FH533971 - Rear RH					
	Genuine	1	<b>LR060774</b>	148.70	178.44
All models up to (VIN) FH535143 - Rear LH					
	Genuine	1	<b>LR088530</b>	204.32	245.18
All models - Rear					
forward RH	Genuine	1	<b>LR068166</b>	85.00	102.00
forward LH	Genuine	1	<b>LR068167</b>	85.00	102.00
RH	Genuine	1	<b>LR088535</b>	194.55	233.46
LH	Genuine	1	<b>LR088530</b>	204.32	245.18

## Upper Arm Assembly

All models up to (VIN) FH511118 - Rear RH					
	Genuine	1	<b>LR060763</b>	91.76	110.11
All models (VIN) FH511119 to FH543634 - Rear RH					
	Genuine	1	<b>LR078519</b>	86.95	104.34
All models to (VIN) FH543634 - Rear LH					
	Genuine	1	<b>LR078520</b>	86.95	104.34
All models (VIN) FH543635 on - Rear					
RH	Genuine	1	<b>LR078519</b>	86.95	104.34
LH	Genuine	1	<b>LR078520</b>	86.95	104.34

## Knuckle, without Hub

All models - Rear					
RH	Genuine	1	<b>LR087649</b>	225.82	270.98
LH	Genuine	1	<b>LR079296</b>	220.66	264.79

## Knuckle, Wheel

All China build models - Rear LH	Genuine	1	<b>LR079296</b>	220.66	264.79
----------------------------------	---------	---	-----------------	--------	--------

## Link, Lower Arm to Knuckle

All models - Rear	Genuine	2	<b>LR060773</b>	2.89	3.47
-------------------	---------	---	-----------------	------	------



LR031310



## DISCOVERY SPORT (2014 on)

## STEERING

## Track Rod End

All models					
RH	Aftermarket	1	<b>LR026267P</b>	14.17	17.00
	OEM	1	<b>LR026267P1</b>	27.08	32.50
	Genuine	1	<b>LR026267</b>	47.88	57.46
LH	Aftermarket	1	<b>LR027570P</b>	16.25	19.50
	OEM	1	<b>LR027570P1</b>	27.08	32.50
	Genuine	1	<b>LR027570</b>	50.16	60.19

## Track Rod Assembly

All models - Without track rod end					
OEM	2	<b>LR026271P1</b>	23.33	28.00	
Genuine	2	<b>LR026271</b>	52.95	63.54	

## Gaiter Kit, Track Rod

All models - Steering rack. Includes one gaiter with clamps					
Genuine	2	<b>LR026273</b>	28.33	34.00	

## DISCOVERY SPORT (2014 on)

## CLUTCH

## Clutch Master Cylinder

All RHD manual models - With linear sensor (with stop/start system)					
Genuine	1	<b>LR044440</b>	73.11	87.73	
All LHD manual models - With linear sensor (with stop/start system)					
Genuine	1	<b>LR044439</b>	70.98	85.18	

## Clutch Slave Cylinder

All 2.2L & 2.0L 4 cyl diesel manual models - Includes clutch release bearing					
Genuine	1	<b>LR022452</b>	72.77	87.32	

## Clutch Pedal Spring Kit

All RHD 2.2L & 2.0L 4 cyl diesel manual models - Includes springs & retainers					
Genuine	1	<b>LR024698</b>	24.60	29.52	
All LHD 2.2L & 2.0L 4 cyl diesel manual models - Includes springs & retainers					
Genuine	1	<b>LR024700</b>	24.60	29.52	

## DISCOVERY SPORT (2014 on)

## TRANSMISSION

## Wheel Bearing

All models - Front					
Genuine	2	<b>LR078387</b>	68.50	82.20	

## Knuckle &amp; Hub

All models - Front						
RH	Genuine	1	<b>LR077914</b>	305.80	366.96	
	LH	Genuine	1	<b>LR078178</b>	300.67	360.80
All China build models - Rear RH		Genuine	1	<b>LR087649</b>	225.82	270.98

## Oil Seal, Driveshaft

All AWD models					
RH outer seal, front differential	Genuine	1	<b>LR001950</b>	7.50	9.00
LH outer seal, front differential	Genuine	1	<b>LR003155</b>	14.45	17.34
RH inner seal, front differential	Genuine	1	<b>LR003153</b>	8.89	10.67
LH inner seal, front differential	Genuine	1	<b>LR003154</b>	9.04	10.85

## Sealing Washer, Drain Plug

All models - Front or rear axle					
Genuine	1	<b>LR001949</b>	3.13	3.76	

## DISCOVERY SPORT (2014 on)

## COOLING

## Thermostat Housing

All 2.2L diesel models					
OEM	1	<b>LR001312P1</b>	39.58	47.50	
Genuine	1	<b>LR001312</b>	62.25	74.70	

## Coolant Temperature Sensor

All 2.0L turbo petrol models					
Genuine	1	<b>LR041442</b>	25.70	30.84	

## Water Pump

All 2.0L TIVCT turbo petrol models					
Aftermarket	1	<b>LR081578P</b>	35.83	43.00	
OEM	1	<b>LR081578P1</b>	50.00	60.00	
Genuine	1	<b>LR081578</b>	105.27	126.32	
All 2.2L diesel models					
Aftermarket	1	<b>LR011694P</b>	39.58	47.50	
Genuine	1	<b>LR011694</b>	105.27	126.32	

## DISCOVERY SPORT (2014 on)

## ELECTRICAL - ROTATING ELECTRICS

## Alternator

All 2.0L TIVCT turbo petrol models - new					
Genuine*	1	<b>LR067840</b>	376.61	451.93	
			125.00	150.00	
			*Exchange Surcharge		



## Starter Motor

All 2.0L turbo petrol models without stop start system					
New, outright	Genuine	1	<b>LR084458</b>	258.16	309.79
All 2.0L turbo petrol models Chinese build					
New, outright	Genuine	1	<b>LR086809</b>	279.57	335.48
All 2.0L turbo diesel manual models					
New, outright	Genuine	1	<b>LR084460</b>	373.08	447.70
All 2.0L turbo diesel automatic models					
New, outright	Genuine	1	<b>LR085507</b>	373.08	447.70
All AWD & 2WD 2.2L diesel manual models					
New, outright	OEM	1	<b>LR014060P1</b>	155.00	186.00
New, exchange	Genuine*	1	<b>LR014060</b>	312.79	375.35
				100.00	120.00
			*Exchange Surcharge		
All AWD 2.2L diesel automatic models without start/stop					
New, outright	OEM	1	<b>LR007373P1</b>	175.00	210.00
New, exchange	Genuine*	1	<b>LR007373</b>	341.90	410.28
				70.00	84.00
			*Exchange Surcharge		
All 2.2L turbo diesel models with stop start system					
New, outright	Genuine	1	<b>LR084922</b>	389.08	466.90

## DISCOVERY SPORT (2014 on)

## ENGINE GASKETS

## Gasket Camshaft Cover

All 2.0L turbo petrol models						
Genuine	1	<b>LR025664</b>	11.44	13.73		
All 2.2L diesel models - Front (upper) cam cover,						
'L' shape gasket (1 req). <i>Reinz manufacture</i>		OEM	1	<b>LR009411P</b>	9.38	11.26
'L' shape gasket (1 req)		Genuine	1	<b>LR009411</b>	26.52	31.82
round shape (2 req). <i>Reinz manufacture</i>		OEM	1	<b>LR009412P</b>	9.38	11.26
round shape (2 req)		Genuine	1	<b>LR009412</b>	20.53	24.64
All 2.2L 4 cyl diesel models - Main (lower) cam cover						
Genuine	1	<b>LR002834</b>	2.15	2.58		
All 2.2L diesel models - Includes front cam cover gaskets x 3 (1 x 'L' shape, 2 x round) plus main cam cover gasket. <i>Reinz manufacture</i>						
OEM	1	<b>LR0094112KBP</b>	14.38	17.26		

## Gasket Cylinder Head

All 2.0L turbo petrol models					
Genuine	1	<b>LR024975</b>	35.42	42.50	
All 2.2L diesel models					
1.25mm thick, 1 hole on I.D. lip	OEM	1	<b>LR017303P1</b>	19.79	23.75
	Genuine	1	<b>LR017303</b>	34.02	40.82
1.30mm, two holes	OEM	1	<b>LR017304P1</b>	19.79	23.75
	Genuine	1	<b>LR017304</b>	48.09	57.71
1.35mm, three holes	OEM	1	<b>LR017305P1</b>	19.79	23.75
	Genuine	1	<b>LR017305</b>	48.20	57.84
1.40mm, four holes	OEM	1	<b>LR017307P1</b>	19.79	23.75
	Genuine	1	<b>LR017307</b>	48.95	58.74

## Sealant Instant Gasket

Numerous applications					
Genuine	a/r	<b>STC50550</b>	13.10	15.72	





## ENGINE SWITCHES

### Camshaft Position Sensor

All 2.2L diesel models	OEM	1	<b>LR016847P1</b>	20.00	24.00
	Genuine	1	<b>LR016847</b>	116.42	139.70

### Crankshaft Position Sensor

All 2.0L turbo petrol models	Genuine	1	<b>LR038756</b>	38.23	45.88
All 2.0L diesel models	Genuine	1	<b>LR074068</b>	81.86	98.23
All 2.2L diesel models	OEM	1	<b>LR056028P1</b>	14.58	17.50
	Genuine	1	<b>LR056028</b>	55.54	66.65

### Oil Temperature Switch

All 2.2L diesel models	Genuine	1	<b>LR001368</b>	26.08	31.30
------------------------	---------	---	-----------------	-------	-------

### Engine Knock Sensor

All 2.0L turbo petrol models	Genuine	1	<b>LR025005</b>	24.85	29.82
------------------------------	---------	---	-----------------	-------	-------

## DISCOVERY SPORT (2014 on)

### Oil Pressure Switch

All 2.0L turbo petrol models	Genuine	1	<b>LR000633</b>	2.86	3.43
------------------------------	---------	---	-----------------	------	------

### Air Charge Temperature Sensor

All 2.0L turbo petrol models	Aftermarket	1	<b>LR021587P</b>	21.00	25.20
	Genuine	1	<b>LR021587</b>	23.34	28.01
All 2.2L diesel models	Aftermarket	1	<b>LR021587P</b>	21.00	25.20
	Genuine	1	<b>LR021587</b>	23.34	28.01

### Manifold Absolute Pressure Sensor

All 2.2L diesel models	Aftermarket	1	<b>LR001324P</b>	30.00	36.00
	OEM	1	<b>LR001324P1</b>	55.00	66.00
	Genuine	1	<b>LR001324</b>	86.58	103.90

### Oxygen Sensor

All 2.2L diesel models - Pre-catalyst	OEM	1	<b>LR001370P1</b>	90.00	108.00
	Genuine	1	<b>LR001370</b>	149.04	178.85

## DRAIN PLUGS

### Sump Plug

All 2.0L TIVCT turbo petrol models	Genuine	1	<b>LR025048</b>	4.00	4.80
	Genuine	1	<b>LR073675</b>	4.28	5.14
All 2.2L diesel models	OEM	1	<b>LR004304P</b>	1.25	1.50
	Genuine	1	<b>LR004304</b>	2.80	3.36

### Sump Plug Washer

All 2.2L diesel models	OEM	1	<b>LR006295P1</b>	0.79	0.95
	Genuine	1	<b>LR006295</b>	1.79	2.15

## DISCOVERY SPORT (2014 on)

### Drain Plug

All models					
Front differential	Genuine	1	<b>LR051294</b>	5.89	7.07
Rear differential	Genuine	1	<b>LR061614</b>	3.44	4.13

## OIL SEALS ENGINE

### Engine Front Oil Seal

All 2.2L diesel models	Genuine	1	<b>LR052514</b>	12.44	14.93
------------------------	---------	---	-----------------	-------	-------

## DISCOVERY SPORT (2014 on)

### Crankshaft Oil Seal

All models with 2.0L TIVCT turbocharged petrol engine - Rear, with retainer	Genuine	1	<b>LR041955</b>	25.81	30.97
All models with 2.2L diesel engine - Rear	OEM	1	<b>LR052515P1</b>	8.54	10.25
	Genuine	1	<b>LR052515</b>	17.23	20.68

## EXHAUST GAS RECIRCULATION (EGR)

### EGR Valve

All 2.0L diesel models with high pressure EGR - With cooler	Genuine	1	<b>LR073729</b>	193.92	232.70
All 2.2L diesel engine	OEM	1	<b>LR000997P1</b>	150.00	180.00
	Genuine	1	<b>LR000997</b>	211.10	253.32

### Pipe EGR Valve to Inlet Manifold

All 2.0L diesel models with high pressure EGR	Genuine	1	<b>LR073731</b>	67.67	81.20
-----------------------------------------------	---------	---	-----------------	-------	-------

## DISCOVERY SPORT (2014 on)

### Pipe EGR Valve to Exhaust Manifold

All 2.0L diesel models with high pressure EGR	Genuine	1	<b>LR073732</b>	46.27	55.52
-----------------------------------------------	---------	---	-----------------	-------	-------

### Pipe EGR Valve to Cooler

All 2.0L diesel models with low pressure EGR	Genuine	1	<b>LR073733</b>	49.63	59.56
----------------------------------------------	---------	---	-----------------	-------	-------

## FUEL SYSTEM SWITCHES

### Fuel Pressure Sensor

All 2.0L turbo petrol models	Genuine	1	<b>LR024969</b>	53.76	64.51
------------------------------	---------	---	-----------------	-------	-------

## DISCOVERY SPORT (2014 on)

### Air Flow Meter

All 2.0L turbo petrol models	OEM	1	<b>LR019830P1</b>	85.00	102.00
	Genuine	1	<b>LR019830</b>	107.33	128.80
All 2.2L diesel models	OEM	1	<b>LR019830P1</b>	85.00	102.00
	Genuine	1	<b>LR019830</b>	107.33	128.80

## WHEEL CENTRE CAP & WHEEL NUTS

## DISCOVERY SPORT (2014 on)

### Wheel Centre Cap

All models with bright black alloy wheel centre caps - Bright black finish, Land Rover badge	Aftermarket	a/r	<b>LR069899P</b>	7.50	9.00
	Genuine	a/r	<b>LR069899</b>	10.76	12.91
All models with satin silver/bright aluminium alloy wheel centre caps - Satin silver/bright aluminium finish, Land Rover badge	Genuine	a/r	<b>LR069900</b>	6.02	7.22

### Wheel Nut

All models with bright finish wheel nuts - Stainless steel finish	Genuine	a/r	<b>LR001381</b>	1.94	2.33
All models with black finish wheel nuts - Black finish	Genuine	a/r	<b>LR066225</b>	8.08	9.70

### Wheel Nut Set

All models with gloss black wheels & wheel nuts - Gloss black chrome, set of 20	Genuine	a/r	<b>VPLVW0070</b>	180.15	216.18
---------------------------------------------------------------------------------	---------	-----	------------------	--------	--------



LR001381

PRICES CORRECT AT TIME OF GOING TO PRINT.  
SUBJECT TO CHANGE WITHOUT PRIOR NOTICE.

TO ORDER CALL: **01522 568000** OR GO ON LINE: [www.rimmerbros.co.uk](http://www.rimmerbros.co.uk)





# RANGE ROVER CLASSIC (1970 TO 1996)

## 1970 TO 1996 - All Models

Listed below are the most popular parts required for the Range Rover Classic. We have access to the full range of parts for your vehicle. Please contact us if not listed here.

### RANGE ROVER CLASSIC (1970 TO 1996)

### SERVICE KITS

#### Service Kit

3.5L V8 carb petrol models 1970-75 (eng) 341/355/359 <i>Includes oil filter, air filter, fuel filter, spark plugs, points (fixed), condenser &amp; sump plug washer. Does not include Flame Trap</i>	Aftermarket	1	<b>RA1470EARLYP</b>	21.25	25.50
	Genuine	1	<b>RA1470EARLY</b>	43.33	52.00
3.5L V8 carb petrol models 1975-77 except (eng) 341/355/359 <i>Includes oil filter, air filter, fuel filter, spark plugs, points (fixed), condenser &amp; sump plug washer</i>	Aftermarket	1	<b>RA1470LATEP</b>	20.75	24.90
	Genuine	1	<b>RA1470LATE</b>	40.83	49.00
3.5L V8 carb petrol models 1977-86 <i>Includes oil filter, air filter, fuel filter, spark plugs, points, condenser &amp; sump plug washer. Does not include Flame Trap</i>	Aftermarket	1	<b>RA1471P</b>	25.42	30.50
	Genuine	1	<b>RA1471</b>	45.00	54.00
3.5L V8 carb petrol models 1986-91 <i>Includes oil filter, air filter, fuel filter, spark plugs, flame traps &amp; sump plug washer</i>	Britpart	1	<b>RA1516BP</b>	15.83	19.00
	Bearmach	1	<b>RA1529BM</b>	17.50	21.00
3.5L V8 EFI petrol models 1986-90 - <i>Includes oil filter, air filter, fuel filter, spark plugs &amp; sump plug washer</i>	Aftermarket	1	<b>RA1472P</b>	26.67	32.00
	Genuine	1	<b>RA1472</b>	32.50	39.00
3.9L V8 EFI petrol models from (VIN) MA647645 on <i>Includes oil filter, air filter, fuel filter, spark plugs &amp; sump plug washer</i>	Aftermarket	1	<b>RA1475P</b>	19.95	23.94
	Genuine	1	<b>RA1475</b>	45.83	55.00
All 4.2L V8 EFI petrol models up to (VIN) LA647644 <i>Includes oil filter, air filter, fuel filter, spark plugs &amp; sump plug washer</i>	Aftermarket	1	<b>RA1476PT094</b>	25.00	30.00
	Genuine	1	<b>RA1476T094</b>	55.83	67.00
All 4.2L V8 EFI petrol models from (VIN) MA647645 on <i>Includes oil filter, air filter, fuel filter, spark plugs &amp; sump plug washer</i>	Aftermarket	1	<b>RA1476P950N</b>	25.00	30.00
	Genuine	1	<b>RA1476950N</b>	57.50	69.00

#### Filter Kit

3.9L V8 EFI petrol models up to (VIN) GA464553 - <i>Includes oil filter, air filter, fuel filter &amp; sump plug washer</i>	Aftermarket	1	<b>RA1473P</b>	9.58	11.50
	Genuine	1	<b>RA1473</b>	19.58	23.50
3.9L V8 EFI petrol models from (VIN) HA464554 to LA647644 <i>Includes oil filter, air filter, fuel filter &amp; sump plug washer</i>	Aftermarket	1	<b>RA1474P</b>	7.08	8.50
	Genuine	1	<b>RA1474</b>	29.58	35.50
All 200 TDi diesel models - <i>Includes oil filter, air filter, fuel filter &amp; sump plug washer</i>	Aftermarket	1	<b>RA1477P</b>	10.75	12.90
All 300 TDi diesel models - <i>Includes oil filter, air filter, fuel filter &amp; sump plug washer</i>	Aftermarket	1	<b>RA1478P</b>	7.25	8.70
	Genuine	1	<b>RA1478</b>	26.67	32.00



### RANGE ROVER CLASSIC (1970 TO 1996)

### FILTRATION

#### Oil Filter

All models with V8 engine	Aftermarket	1	<b>RTC3186P</b>	4.00	4.80
	Aftermarket	1	<b>GFE145</b>	7.92	9.50
All V8 engines from (engine) suffix F on (1976 on) - Cartridge	Aftermarket	1	<b>ERR3340P</b>	2.00	2.40
	OEM	1	<b>ERR3340P1</b>	3.33	4.00
	Genuine	1	<b>ERR3340</b>	10.82	12.98
All 2.4L and 2.5L VM Turbo Diesel models - Element	Aftermarket	1	<b>AEU2218P</b>	3.50	4.20
	Aftermarket	1	<b>AEU2218</b>	5.63	6.76
	OEM	1	<b>AEU2218EVA</b>	3.59	4.31
All models with 200TDi diesel engine - Cartridge	Aftermarket	1	<b>ERR3340P</b>	2.00	2.40
	OEM	1	<b>ERR3340P1</b>	3.33	4.00
	Genuine	1	<b>ERR3340</b>	10.82	12.98
All models with 300TDi diesel engine - Cartridge	Aftermarket	1	<b>ERR3340P</b>	2.00	2.40
	OEM	1	<b>ERR3340P1</b>	3.33	4.00
	Genuine	1	<b>ERR3340</b>	10.82	12.98

#### Air Filter

All V8 carburettor models	Aftermarket	2	<b>605191P</b>	2.83	3.40
	OEM	2	<b>605191P1</b>	4.38	5.26
	Genuine	2	<b>605191</b>	6.29	7.55
	Genuine	2	<b>GFE1117</b>	5.83	7.00
Australia only	Aftermarket	2	<b>GFE1124</b>	17.50	21.00
All V8 EFI petrol models up to (VIN) LA647644	Aftermarket	1	<b>RTC4683P</b>	3.25	3.90
	OEM	1	<b>RTC4683P1</b>	5.63	6.76
	Genuine	1	<b>RTC4683</b>	8.30	9.96
All V8 EFI petrol models from (VIN) MA647645 on	Aftermarket	1	<b>ESR1445P</b>	2.08	2.50
	OEM	1	<b>ESR1445P1</b>	3.58	4.30
	Genuine	1	<b>ESR1445</b>	6.95	8.34
All 2.4L VM turbo diesel models	Aftermarket	1	<b>NTC1435P</b>	6.88	8.26
	OEM	1	<b>NTC1435P1</b>	7.50	9.00
	Genuine	1	<b>NTC1435</b>	25.89	31.07
All 2.5L VM turbo diesel models	Aftermarket	1	<b>NTC1435P</b>	6.88	8.26
	OEM	1	<b>NTC1435P1</b>	7.50	9.00
	Genuine	1	<b>NTC1435</b>	25.89	31.07
All 200TDi diesel models	Aftermarket	1	<b>ESR1049P</b>	5.63	6.76
	OEM	1	<b>ESR1049P1</b>	10.63	12.76
All 300TDi diesel models	Aftermarket	1	<b>ESR1445P</b>	2.08	2.50
	OEM	1	<b>ESR1445P1</b>	3.58	4.30
	Genuine	1	<b>ESR1445</b>	6.95	8.34

#### Mounting Rubber Air Cleaner

All 2.5L VM Turbo Diesel models (VIN) JA618001 on	Genuine	1	<b>ESR1579</b>	13.98	16.78
All 200 TDi diesel models	Genuine	1	<b>ESR1579</b>	13.98	16.78

#### Fuel Filter

All V8 carb petrol models - Element for in line filter assembly	Aftermarket	1	<b>JS660LP</b>	1.33	1.60
	Genuine	1	<b>JS660L</b>	3.06	3.67
All V8 Efi petrol models from (VIN) HA464554 on - Internal threaded unions	Aftermarket	1	<b>ESR4065P</b>	3.00	3.60
	OEM	1	<b>ESR4065P1</b>	4.58	5.50
	Genuine	1	<b>ESR4065</b>	14.85	17.82
All diesel models with unheated fuel filter - Includes sealing ring	Aftermarket	1	<b>AEU2147LP</b>	3.00	3.60
	OEM	1	<b>AEU2147LP1</b>	4.38	5.26
	Genuine	1	<b>AEU2147L</b>	13.78	16.54
All cold climates diesel models with heated fuel filter - Includes sealing ring	OEM	1	<b>RTC5938P1</b>	5.00	6.00
	Genuine	1	<b>RTC5938</b>	17.49	20.99

#### Fuel Filter Complete Assembly

All V8 carb petrol models	Aftermarket	1	<b>NRC9786P</b>	16.88	20.26
	Genuine	1	<b>NRC9786</b>	98.07	117.68
All diesel engine models - Sedimentor type	Aftermarket	1	<b>NRC9708P</b>	17.08	20.50
	OEM	1	<b>NRC9708P1</b>	26.67	32.00
	Genuine	1	<b>NRC9708</b>	76.51	91.81
All diesel engine models	Aftermarket	1	<b>WJN500180P1</b>	50.00	60.00
	Genuine	1	<b>WJN500180</b>	98.37	118.04

#### Fuel Filter Seal

All diesel engine models - Top, for sedimentor filter	Aftermarket	1	<b>AAU9903P</b>	0.33	0.40
All diesel engine models	Genuine	1	<b>AAU9903</b>	1.78	2.14
Top, for sedimentor filter	Aftermarket	1	<b>AAU9902P</b>	0.58	0.70
Bottom, for sedimentor filter	Genuine	1	<b>AAU9902</b>	1.78	2.14
All diesel models (VIN) JA610294 on	Genuine	1	<b>605011</b>	0.32	0.38

#### Rocker Cover Filter

All models with Efi V8 petrol engine	Aftermarket	1	<b>ERC3209A</b>	2.08	2.50
--------------------------------------	-------------	---	-----------------	------	------

#### Oil Strainer Transmission, Gearbox

All models with 4 speed auto gearbox	Aftermarket	1	<b>RTC4653P</b>	5.21	6.25
	OEM	1	<b>RTC4653P1</b>	9.37	11.24
	Genuine	1	<b>RTC4653</b>	49.14	58.97



## WIPER BLADES

## RANGE ROVER CLASSIC (1970 TO 1996)

### Wiper Blade

All models from 1978 up to (VIN) GA413743 - Front				
	Aftermarket	2	<b>RTC6787P</b>	2.83 3.40
	OEM	2	<b>RTC6787P1</b>	5.42 6.50
All models from (VIN) GA413744 on - Front and rear, 455mm long				
	Aftermarket	3	<b>PRC9841P</b>	2.00 2.40
	OEM	3	<b>PRC9841P1</b>	3.50 4.20
All models up to (VIN) GA413743 - Rear				
	Aftermarket	1	<b>RTC6787P</b>	2.83 3.40
	OEM	1	<b>RTC6787P1</b>	5.42 6.50



PRC9841P

## SCREEN/LAMP WASHER SYSTEMS

## RANGE ROVER CLASSIC (1970 TO 1996)

### Washer Jet

2 Dr from (VIN) 114957 to (VIN) BA - Front screen				
	Aftermarket	2	<b>PRC3295P</b>	1.00 1.20
	Aftermarket	2	<b>PRC3295P</b>	1.00 1.20
4 Dr up to (VIN) BA - Front screen				
	Aftermarket	2	<b>PRC3295P</b>	1.00 1.20
All models up to 1980 approx. - Fits round hole in bodywork, not 'D' hole.				
Front screen wash				
	Aftermarket	2	<b>GWV802CHROME</b>	3.08 3.70
All models with headlamp wash from (VIN) CA on - Headlamp				
	Aftermarket	2	<b>PRC4615P</b>	3.00 3.60
	Aftermarket	1	<b>PRC2438P</b>	3.83 4.60

### Non Return Valve

All models from (VIN) suffix B up to (VIN) BA - Washer bottle				
	Aftermarket	1	<b>90608330P</b>	2.83 3.40

### Tee Piece Headlamp Wash

All models with headlamp power wash (VIN) JA610294 on - Front bumper hose				
	Aftermarket	1	<b>DCP6656P</b>	7.50 9.00
	Genuine	1	<b>DCP6656</b>	9.29 11.15

### Washer Pump & Bottle Cap

All models from 1970 to (VIN) suffix A - Front screen, before twin cap type bottle				
	Aftermarket	1	<b>2466271</b>	30.83 37.00

### Washer Pump

All models with pump not mounted in washer bottle - Front screen					
	Aftermarket	1	<b>GWV125</b>	9.38 11.26	
All models from (VIN) KA640178 to LA647644					
	Front screen	Aftermarket	1	<b>STC1454P</b>	7.08 8.50
	Rear screen	Aftermarket	1	<b>STC1453P</b>	4.00 4.80

### Washer Hose, Per Metre

All models - 4mm internal diameter (3mm also available). Front or rear screen wash				
	Aftermarket	a/r	<b>GWV201M</b>	2.25 2.70

### Tee Piece Windscreen Wash

All models (VIN) FA351847 on - Bonnet hose, 5mm dia				
	Genuine	1	<b>PRC6855</b>	2.60 3.12

### Washer Bottle

All models from 1970 to (VIN) suffix A - Front screen, before twin cap type bottle				
	Aftermarket	1	<b>GWV904</b>	19.38 23.26

### Washer Bottle Cap

All models from (VIN) suffix B up to (VIN) BA - Metal type				
	Aftermarket	2	<b>RTC1700P</b>	1.00 1.20

### Washer Reservoir

All models without headlamp wash from (VIN) MA647645 on					
	Front & rear screen wash	Genuine	1	<b>AMR3090</b>	83.19 99.83
All models with headlamp wash from (VIN) MA647645 on					
	Front & rear screen & headlamp wash	Genuine	1	<b>AMR3089</b>	133.09 159.71

### Washer Reservoir Level Sensor

All models from (VIN) CA to LA647644				
	Genuine	1	<b>PRC5440P1</b>	16.04 19.25

### Windscreen Cleaning Paste

All models				
Prevents wiper blade judder/squeak by 'deep cleaning' the windscreen (ref: Land Rover Tech Bulletin LRA501-002)				
	Genuine	a/r	<b>DNJ500340</b>	7.72 9.26





## RANGE ROVER CLASSIC (1970 TO 1996)

## DRIVE BELTS

## Timing Belt Kit Complete

All 300 TDi diesel models - Includes belt plus all parts to convert to later 300 TDi belt alignment method

Aftermarket	1	<b>STC4095LP</b>	155.83	187.00
-------------	---	------------------	--------	--------

## Timing Belt Kit

All 200 TDi diesel models	Bearmach	1	<b>ETC8550KITBMDIS</b>	52.50	63.00
All 300 TDi diesel models	Aftermarket	1	<b>STC4096LP</b>	47.50	57.00
	OEM	1	<b>STC4096LP1</b>	65.00	78.00
	Britpart	1	<b>ERR1092KITBPEARLY</b>	22.50	27.00
	Bearmach	1	<b>STC4096BM</b>	68.33	82.00
	Genuine	1	<b>STC4096L</b>	122.95	147.54

## Timing Belt

All models with 200TDi diesel engine	OEM	1	<b>ETC8550P1</b>	12.92	15.50
	Genuine	1	<b>ETC8550</b>	38.00	45.60
All models with 300TDi diesel engine	Aftermarket	1	<b>ERR1092P</b>	6.88	8.26
	OEM	1	<b>ERR1092P1</b>	10.63	12.76
	Genuine	1	<b>ERR1092</b>	38.02	45.62

## Alternator Drive Belt

All air conditioning models up to (VIN) BA - Alternator					
All models with V8 EFI petrol engine - Alternator	Aftermarket	1	<b>614794P</b>	2.00	2.40
	Genuine	1	<b>ERR2073</b>	7.86	9.43
All models with V8 EFI engine without air conditioning from (VIN) JA610624 on - Alternator					
All models with V8 EFI engine with air conditioning from (VIN) MA647645 on - Alternator	Aftermarket	1	<b>ERR4461P</b>	6.88	8.26
	OEM	1	<b>ERR4461P1</b>	9.79	11.75
	Genuine	1	<b>ERR4461</b>	28.01	33.61
All models with V8 EFI petrol engine from (VIN) KA624756 on - Alternator	Aftermarket	1	<b>ERR5579P</b>	5.63	6.76
	OEM	1	<b>ERR5579P1</b>	13.75	16.50
	Genuine	1	<b>ERR5579</b>	28.36	34.03
All RHD models with 2.4L VM turbo diesel engine - Alternator	Aftermarket	1	<b>ETC9002P</b>	2.08	2.50
	OEM	1	<b>ETC9002P1</b>	4.08	4.90
	Genuine	1	<b>ETC9002</b>	24.82	29.78
All LHD 2.4L VM Turbo Diesel models	Aftermarket	1	<b>ETC9019P</b>	3.50	4.20
	Aftermarket	1	<b>ETC9002P</b>	2.08	2.50
	OEM	1	<b>ETC9002P1</b>	4.08	4.90
All models with 200TDi diesel engine - Alternator	Aftermarket	1	<b>ETC7469P</b>	1.75	2.10
	OEM	1	<b>ETC7469P1</b>	3.08	3.70
	Genuine	1	<b>ETC7469</b>	14.05	16.86
All 300 TDi diesel models - Alternator with 61mm dia. pulley	Aftermarket	1	<b>PQS000030P</b>	4.00	4.80
	OEM	1	<b>PQS000030P1</b>	8.13	9.76
	Genuine	1	<b>PQS000030</b>	30.72	36.86

## Fan Belt

All air conditioning models up to (VIN) BA - Fan					
2 Dr V8 carb engine models without air conditioning - Fan	Aftermarket	1	<b>614670P</b>	1.50	1.80
	Genuine	1	<b>614670</b>	15.16	18.19
All RHD models with 2.4L VM turbo diesel engine - Fan	Aftermarket	1	<b>613602P</b>	2.33	2.80
	OEM	1	<b>613602P1</b>	3.83	4.60
All LHD models with 2.4L VM turbo diesel engine - Fan	Aftermarket	1	<b>ERR416P</b>	3.92	4.70
	Genuine	1	<b>ERR416</b>	34.28	41.14
All RHD models with 2.5L VM turbo diesel engine - Fan	Aftermarket	1	<b>ERR914P</b>	6.88	8.26
	Genuine	1	<b>ERR914</b>	35.34	42.41
All LHD models with 2.5L VM turbo diesel engine - Fan	Aftermarket	1	<b>ERR416P</b>	3.92	4.70
	Genuine	1	<b>ERR416</b>	34.28	41.14
All models with 200TDi diesel engine - Fan	Aftermarket	1	<b>ERR810P</b>	2.58	3.10
	OEM	1	<b>ERR810P1</b>	3.33	4.00
All 300TDi diesel engines up to end of (VIN) MA - Fan	Aftermarket	1	<b>ERR3287P</b>	5.83	7.00
	OEM	1	<b>ERR3287P1</b>	10.00	12.00
All 300TDi diesel engines from (VIN) TA on - Fan	Aftermarket	1	<b>ERR5911P</b>	7.08	8.50
	OEM	1	<b>ERR5911P1</b>	10.63	12.76
All models with V8 engine - Power steering	Aftermarket	1	<b>ERC675P</b>	2.83	3.40
	OEM	1	<b>ERC675P1</b>	3.33	4.00
All models with 2.4L VM turbo diesel engine - Power steering	Aftermarket	1	<b>ETC9080P</b>	1.50	1.80
	Genuine	1	<b>ETC9080</b>	17.27	20.72
All models with 2.5L VM turbo diesel engine - Power steering	Aftermarket	1	<b>ETC9101P</b>	1.50	1.80
	OEM	1	<b>ETC9101P1</b>	5.00	6.00

## PAS Belt

All models with V8 engine - Power steering	Aftermarket	1	<b>ERC675P</b>	2.83	3.40
	OEM	1	<b>ERC675P1</b>	3.33	4.00
	Genuine	1	<b>ERC675</b>	21.28	25.54
All models with 2.4L VM turbo diesel engine - Power steering	Aftermarket	1	<b>ETC9080P</b>	1.50	1.80
	Genuine	1	<b>ETC9080</b>	17.27	20.72
All models with 2.5L VM turbo diesel engine - Power steering	Aftermarket	1	<b>ETC9101P</b>	1.50	1.80
	OEM	1	<b>ETC9101P1</b>	5.00	6.00

## A/C Belt

Models with V8 EFI engine and air conditioning up to (VIN) LA647644 - Air cond compressor					
All models with V8 EFI engine with air conditioning from (VIN) MA647645 on - Air cond compressor	Aftermarket	1	<b>611612P</b>	2.83	3.40
	OEM	1	<b>611612P1</b>	5.63	6.76
	Genuine	1	<b>611612</b>	15.12	18.14
All models with 2.4L VM turbo diesel engine and air conditioning - Air cond compressor	Aftermarket	1	<b>ERR4623P</b>	6.88	8.26
	OEM	1	<b>ERR4623P1</b>	13.13	15.76
	Genuine	1	<b>ERR4623</b>	29.45	35.34
All models with 2.5L VM turbo diesel engine and air conditioning - Air cond compressor	Aftermarket	1	<b>ETC9009P</b>	2.75	3.30
	OEM	1	<b>ETC9009P1</b>	4.00	4.80
	Genuine	1	<b>ETC9009</b>	31.11	37.33
All models with 300TDi diesel engine and air conditioning - Air cond compressor	Aftermarket	1	<b>ERR2215P</b>	3.50	4.20
	OEM	1	<b>ERR2215P1</b>	5.63	6.76
	Genuine	1	<b>ERR2215</b>	13.13	15.76



# IGNITION SYSTEM

## Spark Plug

All 3.5L V8 petrol models up to 1978 - 12.7mm reach					
	MG Rover	8	<b>GSP4376</b>	2.50	3.00
All V8 carb petrol engine models from 1978 on - RN11YC type					
	Aftermarket	8	<b>ERR3799P</b>	2.00	2.40
	Genuine	8	<b>ERR3799</b>	4.19	5.03
All V8 EFI petrol engine models up to (VIN) HA610293 - RN9YC type					
	Aftermarket	8	<b>ERR743P</b>	1.75	2.10
	Genuine	8	<b>ERR743</b>	4.03	4.84
All V8 Carb and EFI engine models from (VIN) CA to HA610293 - N9YC type					
	Genuine	8	<b>RTC3812</b>	3.03	3.64
	Genuine	8	<b>RTC3812X</b>	2.59	3.11
All V8 EFI petrol engine models from (VIN) JA610294 on - RSN12YC type					
	Genuine	8	<b>ETC7244</b>	4.21	5.05
All 3.5L V8 petrol models from 1978 on with 8.13:1 compression ratio - 19mm reach std performance	MG Rover	8	<b>GSP4382</b>	2.95	3.54
All 3.5L V8 petrol models from 1978 on with 9.35:1 compression ratio - 19mm reach std performance	MG Rover	8	<b>GSP4362</b>	2.95	3.54
high performance - double core	MG Rover	8	<b>GSP6462</b>	2.95	3.54
All 3.9L V8 petrol models with 8.13:1 compression ratio without catalyst - 19mm reach std performance	MG Rover	8	<b>GSP4382</b>	2.95	3.54
All 3.9L V8 petrol models with 9.35:1 compression ratio without catalyst - 19mm reach std performance	MG Rover	8	<b>GSP4362</b>	2.95	3.54
high performance - double core	MG Rover	8	<b>GSP6462</b>	2.95	3.54
All 3.9L V8 petrol models with catalyst - 19mm reach std performance	MG Rover	8	<b>GSP4382</b>	2.95	3.54
All 4.2L V8 petrol models - 19mm reach, double core	MG Rover	8	<b>GSP6462</b>	2.95	3.54

## Glow Plug

All 2.4L and 2.5L VM turbo diesel models	Aftermarket	4	<b>ADU9955P</b>	4.08	4.90
	Genuine	4	<b>ADU9955</b>	8.85	10.62
All 2.5L 200 TDi and 300 TDi diesel models	Aftermarket	4	<b>ETC8847P</b>	3.00	3.60
	OEM	4	<b>ETC8847P1</b>	8.75	10.50
	Genuine	4	<b>ETC8847</b>	33.60	40.32

## Glow Plug Cable

All 200 TDi and 300 TDi diesel models	Genuine	1	<b>AMR2425</b>	13.13	15.76
---------------------------------------	---------	---	----------------	-------	-------

## Ignition Coil

All models with Mallory Dual Point distributors up to 1976					
	Moroso	1	<b>RB7475</b>	50.00	60.00
V8 carb petrol engines up to 1986 - Ballasted type					
	Aftermarket	1	<b>8510047P</b>	7.50	9.00
	Genuine	1	<b>8510047</b>	70.62	84.74
All V8 carb petrol engine models from (VIN) CA on - Lucas type					
	Aftermarket	1	<b>RTC5628P</b>	9.58	11.50
	OEM	1	<b>RTC5628P1</b>	14.58	17.50
	Genuine	1	<b>RTC5628</b>	94.86	113.83
All V8 carb petrol engine models from (VIN) DA on - Bosch type					
	Aftermarket	1	<b>PRC6574P</b>	15.83	19.00
	OEM	1	<b>PRC6574P1</b>	39.58	47.50
	Genuine	1	<b>PRC6574</b>	114.80	137.76
All V8 EFI petrol engine models from (VIN) CA on - Lucas type					
	Aftermarket	1	<b>RTC5628P</b>	9.58	11.50
	OEM	1	<b>RTC5628P1</b>	14.58	17.50
	Genuine	1	<b>RTC5628</b>	94.86	113.83
All V8 EFI petrol engine models from (VIN) DA to MA647644 - Bosch type					
	Aftermarket	1	<b>PRC6574P</b>	15.83	19.00
	OEM	1	<b>PRC6574P1</b>	39.58	47.50
	Genuine	1	<b>PRC6574</b>	114.80	137.76

## Contact Set

All 3.5L V8 Carb petrol engines with points type distributor up to (VIN) BA					
	OEM	1	<b>RTC6623P1</b>	3.67	4.40
	Aftermarket	1	<b>RTC6623P</b>	2.67	3.20
All V8 petrol models with points type distributors from Oct 1977 on					
	Aftermarket	1	<b>GCS2117P</b>	4.08	4.90
	Aftermarket	1	<b>GCS2117</b>	7.50	9.00

## Adjustment Bush, Contact Set

All V8 petrol models with points type distributor from Oct 1977 on - For sliding points type distributor					
	Genuine	1	<b>RTC5014</b>	1.33	1.60

## Rotor Arm

All models up to Sept 1977	Aftermarket	1	<b>GRA112</b>	3.08	3.70
All V8 carb petrol models with points type distributor Oct. 1977 on					
	Aftermarket	1	<b>RTC3618P</b>	2.00	2.40
All V8 petrol engines with electronic ignition	Aftermarket	1	<b>STC1857P</b>	2.33	2.80
	OEM	1	<b>STC1857P1</b>	9.58	11.50
	Genuine	1	<b>STC1857</b>	15.18	18.22
Red	OEM	1	<b>GRA117RED</b>	7.50	9.00

## Condenser

All 3.5L V8 Carb petrol engines with points type distributor up to (VIN) BA					
	Aftermarket	1	<b>RTC3472P</b>	1.25	1.50
	Aftermarket	1	<b>GSC111</b>	3.08	3.70
	Genuine	1	<b>RTC3472</b>	3.73	4.48

## Distributor Cap

All V8 petrol engine models	Aftermarket	1	<b>GDC117P</b>	5.00	6.00
	Aftermarket	1	<b>GDC117</b>	10.42	12.50
	OEM	1	<b>GDC117P1</b>	16.04	19.25
	Genuine	1	<b>GDC117OE</b>	32.94	39.53

## Suppressor, Coil

All V8 petrol models with electronic ignition	Aftermarket	1	<b>ADU7242LP</b>	3.75	4.50
-----------------------------------------------	-------------	---	------------------	------	------

# RANGE ROVER CLASSIC (1970 TO 1996)

## Amplifier Link Lead

All 3.9L & 4.2L V8 petrol models with electronic ignition with 2 pin integral amplifier					
Amplifier to coil, lead identified by 2 pin plug connector					
	OEM	1	<b>PRC6144P1</b>	36.25	43.50
	Genuine	1	<b>PRC6144</b>	40.55	48.66
V8 petrol engine with 2 pin integral amp type 35DLM8 distributor - Amplifier to coil, converts 3 pin to 2 pin					
	Aftermarket	1	<b>STC1212P</b>	24.58	29.50

## Amplifier Module

V8 petrol engine with 3 pin integral amp type 35DLM8 distributor					
	Aftermarket	1	<b>STC1184P</b>	14.58	17.50
	Genuine	1	<b>STC1184</b>	136.26	163.51
All V8 petrol models with 35DM8 distributor with amplifier remotely mounted under coil					
	Aftermarket	1	<b>AEU1917</b>	150.00	180.00
All V8 petrol models with electronic ignition with 2 pin integral amplifier					
Amplifier fitted to 35DLM8 distributor	Aftermarket	1	<b>NJL100060</b>	22.50	27.00
All V8 EFI petrol models from (VIN) MA081992 on with remote amplifier					
	Aftermarket	1	<b>STC1856P</b>	55.00	66.00
	Genuine	1	<b>STC1856</b>	399.03	478.84

## Amplifier Module & Link Lead

V8 petrol engine with 2 pin integral amp type 35DLM8 distributor - Included link lead converts 3 pin to 2 pin					
	Britpart	1	<b>STC1184KBP</b>	24.58	29.50

## Amplifier Plug

V8 petrol engine with 3 pin integral amp type 35DLM8 distributor - 3 pin, for STC1184					
	OEM	1	<b>STC1184P1</b>	22.50	27.00

## Pick Up & Baseplate, Distributor

All V8 carb petrol models with electronic ignition with 3 pin integral amplifier					
	Aftermarket	1	<b>RTC5090P</b>	15.63	18.76
	OEM	1	<b>RTC5090P1</b>	67.50	81.00
	Genuine	1	<b>RTC5090</b>	130.55	156.66
All V8 EFI petrol models (eng) 37D/39D with with 3 pin remote amplifier up to 1991					
	Aftermarket	1	<b>RTC5090P</b>	15.63	18.76
	OEM	1	<b>RTC5090P1</b>	67.50	81.00
	Genuine	1	<b>RTC5090</b>	130.55	156.66
All V8 EFI petrol models from (VIN) MA081992 on with remote amplifier					
	OEM	1	<b>STC2898P1</b>	80.00	96.00
	Genuine	1	<b>STC2898</b>	139.69	167.63
All V8 EFI petrol models with with 3 pin integral amplifier					
	Aftermarket	1	<b>RTC5090P</b>	15.63	18.76
	OEM	1	<b>RTC5090P1</b>	67.50	81.00
	Genuine	1	<b>RTC5090</b>	130.55	156.66

## Vacuum Unit, Distributor

All non-detoxed V8 carb petrol models with points type distributor					
	OEM	1	<b>UKC1674</b>	46.67	56.00
V8 carb detoxed petrol engines with points type distributor					
	Aftermarket	1	<b>608266P</b>	35.00	42.00
	Genuine	1	<b>608266</b>	97.18	116.62
V8 carb low compression engines with electronic distributor up to 1986					
	Aftermarket	1	<b>RTC3201P</b>	29.58	35.50
	Genuine	1	<b>RTC3201</b>	121.09	145.31
V8 carb high compression petrol engines with electronic distributor up to 1986					
	Aftermarket	1	<b>608266P</b>	35.00	42.00
	Genuine	1	<b>608266</b>	97.18	116.62
V8 petrol engines with 2 pin amp type distributor 1986 on					
	Aftermarket	1	<b>RTC3201P</b>	29.58	35.50
	Genuine	1	<b>RTC3201</b>	121.09	145.31

## Distributor Drive Gear

All V8 petrol models up to Sept 1977 (eng) 341/355/356/357/359 suffix A to E					
	Aftermarket	1	<b>605217P</b>	28.33	34.00
All V8 Carb and EFI petrol engine models from 1976 on					
On camshaft	Aftermarket	1	<b>614188A</b>	22.50	27.00

## Distributor Drive Gear & Coupling

All V8 Carb and EFI petrol engine models from 1976 on - On distributor					
	Aftermarket	1	<b>ERC1353A</b>	27.50	33.00

## O Ring Distributor

All V8 petrol models					
	Aftermarket	1	<b>603446P</b>	2.50	3.00
	Genuine	1	<b>603446</b>	7.27	8.72

## Terminal Kit, Amplifier Module

All V8 petrol models with 35DM8 distributor with amplifier remotely mounted under coil					
	Aftermarket	1	<b>AEU1917TK</b>	2.50	3.00

## Ignition Lead Set

All V8 carb petrol engine models - Silicone					
	Aftermarket	1	<b>RTC6551P</b>	11.67	14.00
Red	Aftermarket	1	<b>RTC6551PS</b>	16.67	20.00
	OEM	1	<b>RTC6551P1</b>	19.58	23.50
Red Performance	OEM	1	<b>RTC6551P1S</b>	32.50	39.00
Black	Aftermarket	1	<b>GHT206S</b>	25.83	31.00
All V8 EFI petrol engine models up to (VIN) MA647644 - Silicone					
	Aftermarket	1	<b>RTC6551P</b>	11.67	14.00
Red	Aftermarket	1	<b>RTC6551PS</b>	16.67	20.00
	OEM	1	<b>RTC6551P1</b>	19.58	23.50
Red Performance	OEM	1	<b>RTC6551P1S</b>	32.50	39.00
Black	Aftermarket	1	<b>GHT206S</b>	25.83	31.00



## RANGE ROVER CLASSIC (1970 TO 1996)

## BRAKING SYSTEMS

## Brake Pad Set

All models without vented discs				
Front	OEM	1	<b>SFP500220P1</b>	24.17 29.00
	Genuine	1	<b>SFP500220</b>	48.72 58.46
All models up to (VIN) BA				
Front Brakes	OEM	1	<b>STC2956P</b>	13.54 16.25
	Brembo	1	<b>STC2956BREMBO</b>	23.75 28.50
	EBC	1	<b>STC2956ULTIMAX</b>	25.00 30.00
Front Brakes - Green Stuff	EBC	1	<b>STC2956GS</b>	33.33 40.00
Rear Brakes, Without Sensors	Aftermarket	1	<b>LR032954P</b>	10.00 12.00
	Brembo	1	<b>LR032954BREMBO</b>	23.33 28.00
	OEM	1	<b>LR032954P1</b>	15.00 18.00
	Genuine	1	<b>LR032954</b>	52.91 63.49
All models from (VIN) GA399973 on				
Front Brakes, Vented	Aftermarket	1	<b>SFP500180P1</b>	18.13 21.76
	Genuine	1	<b>SFP500180</b>	35.98 43.18
All models from (VIN) CA on				
Rear Brakes, With Sensors	Aftermarket	1	<b>SFP500200P</b>	11.67 14.00
	Brembo	1	<b>SFP500200BREMBO</b>	23.75 28.50
	Genuine	1	<b>SFP500200</b>	60.06 72.07

## Brake Pad Retaining Kit

All models with solid discs (1970 to 1990)				
Front, split-pin type retaining pins	Aftermarket	1	<b>RA1396P</b>	6.25 7.50
	Genuine	1	<b>RA1396</b>	9.79 11.75

## Brake Pad Fitting Kit

All models from (VIN) JA610294 on				
Front Vented Disc Brakes	Aftermarket	1	<b>STC8575P</b>	2.83 3.40
	Genuine	1	<b>STC8575</b>	5.01 6.01
All models from (axle) suffix D on				
Rear Disc Brakes, Metric	Aftermarket	1	<b>STC8574P</b>	3.33 4.00

## Anti Rattle Spring

All models to (VIN) FA399972 -				
Front brake pads	Aftermarket	4	<b>606688P</b>	1.08 1.30
	Genuine	4	<b>606688</b>	1.72 2.06

## Shim Brake Pads

All models				
Rear RH inner, LH outer	Aftermarket	2	<b>591628P</b>	1.33 1.60
Rear RH outer, LH inner	Aftermarket	2	<b>591629P</b>	2.08 2.50

## Brake Discs

All models with non vented front disc brakes up to (VIN) BA - Not Vented				
Front	Aftermarket	2	<b>571762P</b>	14.38 17.26
	OEM	2	<b>571762P1</b>	19.79 23.75
All models with non vented front disc brakes from (VIN) CA to FA399972 - Not Vented				
Front	Aftermarket	2	<b>LR017951P</b>	13.75 16.50
	Genuine	2	<b>LR017951</b>	52.35 62.82
Front (pair)	Brembo	1	<b>LR017951BREMBO</b>	50.00 60.00
Front, slotted & drilled, Performance (pair)	Britpart	1	<b>LR017951URBP</b>	39.58 47.50
All models from (VIN) GA399973 on - Vented				
Front	Aftermarket	2	<b>LR017952P</b>	16.04 19.25
	OEM	2	<b>LR017952P1</b>	25.00 30.00
	Genuine	2	<b>LR017952</b>	58.71 70.45
Front (pair)	Brembo	1	<b>LR017952BREMBO</b>	72.50 87.00
Front, slotted & drilled, Performance (pair)	Britpart	1	<b>LR017952URBP</b>	50.00 60.00
All models up to (VIN) BA (1985) - Not Vented				
Rear	OEM	2	<b>571912P1</b>	19.79 23.75
	Aftermarket	2	<b>571912P</b>	13.33 16.00
All models from (VIN) CA (1986) on - Not Vented				
Rear	Aftermarket	2	<b>LR017953P</b>	13.75 16.50
	OEM	2	<b>LR017953P1</b>	19.58 23.50
	Genuine	2	<b>LR017953</b>	63.06 75.67
Rear (pair)	Brembo	1	<b>LR017953BREMBO</b>	55.00 66.00
Rear, slotted & drilled, Performance (pair)	Britpart	1	<b>LR017953URBP</b>	45.00 54.00

## Mudshield Brake Disc

All models - RH				
	Genuine	1	<b>624208</b>	145.13 174.16



SFP500220P1

## Brake Caliper

All models up to (VIN) FA399972, from axle suffix F onwards - Solid Disc Brakes, Metric				
Right Hand Front	Aftermarket	1	<b>AEU1718P</b>	42.50 51.00
Left Hand Front	Aftermarket	1	<b>AEU1719P</b>	42.50 51.00
RHD V8 without ABS from (VIN) GA to (axle) 46L11839C - Vented Disc Brakes, Imperial				
Right Hand Front	Aftermarket	1	<b>RTC6776P</b>	45.00 54.00
	OEM	1	<b>RTC6776P1</b>	110.00 132.00
	Exchange*	1	<b>RTC6776R</b>	100.00 120.00
			<i>*Exchange Surcharge</i>	40.00 48.00
	Genuine*	1	<b>RTC6776</b>	262.57 315.08
			<i>*Exchange Surcharge</i>	50.00 60.00
Left Hand Front	Aftermarket	1	<b>RTC6777P</b>	48.33 58.00
	OEM	1	<b>RTC6777P1</b>	110.00 132.00
	Exchange*	1	<b>RTC6777R</b>	100.00 120.00
			<i>*Exchange Surcharge</i>	40.00 48.00
	Genuine*	1	<b>RTC6777</b>	262.57 315.08
			<i>*Exchange Surcharge</i>	50.00 60.00
RHD V8 without ABS from (axle) 46L11840C on - Vented Disc Brakes, Metric				
Right Hand Front,	OEM	1	<b>STC1283P1</b>	120.00 144.00
RHD V8 with ABS from (VIN) GA to (axle) 48L05146C - Vented Disc Brakes, Imperial				
Right Hand Front	Aftermarket	1	<b>RTC6776P</b>	45.00 54.00
	OEM	1	<b>RTC6776P1</b>	110.00 132.00
	Exchange*	1	<b>RTC6776R</b>	100.00 120.00
			<i>*Exchange Surcharge</i>	40.00 48.00
	Genuine*	1	<b>RTC6776</b>	262.57 315.08
			<i>*Exchange Surcharge</i>	50.00 60.00
Left Hand Front	Aftermarket	1	<b>RTC6777P</b>	48.33 58.00
	OEM	1	<b>RTC6777P1</b>	110.00 132.00
	Exchange*	1	<b>RTC6777R</b>	100.00 120.00
			<i>*Exchange Surcharge</i>	40.00 48.00
	Genuine*	1	<b>RTC6777</b>	262.57 315.08
			<i>*Exchange Surcharge</i>	50.00 60.00
RHD V8 with ABS from (axle) 48L05147C on - Vented Disc Brakes, Metric				
Right Hand Front	OEM	1	<b>STC1283P1</b>	120.00 144.00
RHD V8 air suspension without ABS up to (axle) 54L00056B - Vented Disc Brakes, Imperial				
Right Hand Front	Aftermarket	1	<b>RTC6776P</b>	45.00 54.00
	OEM	1	<b>RTC6776P1</b>	110.00 132.00
	Exchange*	1	<b>RTC6776R</b>	100.00 120.00
			<i>*Exchange Surcharge</i>	40.00 48.00
	Genuine*	1	<b>RTC6776</b>	262.57 315.08
			<i>*Exchange Surcharge</i>	50.00 60.00
Left Hand Front,	Aftermarket	1	<b>RTC6777P</b>	48.33 58.00
	OEM	1	<b>RTC6777P1</b>	110.00 132.00
	Exchange*	1	<b>RTC6777R</b>	100.00 120.00
			<i>*Exchange Surcharge</i>	40.00 48.00
	Genuine*	1	<b>RTC6777</b>	262.57 315.08
			<i>*Exchange Surcharge</i>	50.00 60.00
RHD V8 air suspension without ABS from (axle) 54L00057B on - Vented Disc Brakes, Metric				
Right Hand Front,	OEM	1	<b>STC1283P1</b>	120.00 144.00
RHD V8 air suspension with ABS up to (axle) 56L03429B - Vented Disc Brakes, Imperial				
Right Hand Front	Aftermarket	1	<b>RTC6776P</b>	45.00 54.00
	OEM	1	<b>RTC6776P1</b>	110.00 132.00
	Exchange*	1	<b>RTC6776R</b>	100.00 120.00
			<i>*Exchange Surcharge</i>	40.00 48.00
	Genuine*	1	<b>RTC6776</b>	262.57 315.08
			<i>*Exchange Surcharge</i>	50.00 60.00
Left Hand Front	Aftermarket	1	<b>RTC6777P</b>	48.33 58.00
	OEM	1	<b>RTC6777P1</b>	110.00 132.00
	Exchange*	1	<b>RTC6777R</b>	100.00 120.00
			<i>*Exchange Surcharge</i>	40.00 48.00
	Genuine*	1	<b>RTC6777</b>	262.57 315.08
			<i>*Exchange Surcharge</i>	50.00 60.00
RHD V8 air suspension with ABS from (axle) 56L03430B on - Vented Disc Brakes, Metric				
Right Hand Front,	OEM	1	<b>STC1283P1</b>	120.00 144.00
RHD diesel without ABS from (VIN) GA to (axle) 50L00996C - Vented Disc Brakes, Imperial				
Right Hand Front	Aftermarket	1	<b>RTC6776P</b>	45.00 54.00
	OEM	1	<b>RTC6776P1</b>	110.00 132.00
	Exchange*	1	<b>RTC6776R</b>	100.00 120.00
			<i>*Exchange Surcharge</i>	40.00 48.00
	Genuine*	1	<b>RTC6776</b>	262.57 315.08
			<i>*Exchange Surcharge</i>	50.00 60.00
Left Hand Front	Aftermarket	1	<b>RTC6777P</b>	48.33 58.00
	OEM	1	<b>RTC6777P1</b>	110.00 132.00
	Exchange*	1	<b>RTC6777R</b>	100.00 120.00
			<i>*Exchange Surcharge</i>	40.00 48.00
	Genuine*	1	<b>RTC6777</b>	262.57 315.08
			<i>*Exchange Surcharge</i>	50.00 60.00
RHD diesel without ABS from (axle) 50L00997C on - Vented Disc Brakes, Metric				
Right Hand Front	OEM	1	<b>STC1283P1</b>	120.00 144.00
LHD V8 without ABS from (VIN) GA to (axle) 47L11587C - Vented Disc Brakes, Imperial				
Right Hand Front,	Aftermarket	1	<b>RTC6776P</b>	45.00 54.00
	OEM	1	<b>RTC6776P1</b>	110.00 132.00
	Exchange*	1	<b>RTC6776R</b>	100.00 120.00
			<i>*Exchange Surcharge</i>	40.00 48.00
	Genuine*	1	<b>RTC6776</b>	262.57 315.08
			<i>*Exchange Surcharge</i>	50.00 60.00
Left Hand Front	Aftermarket	1	<b>RTC6777P</b>	48.33 58.00
	OEM	1	<b>RTC6777P1</b>	110.00 132.00
	Exchange*	1	<b>RTC6777R</b>	100.00 120.00
			<i>*Exchange Surcharge</i>	40.00 48.00
	Genuine*	1	<b>RTC6777</b>	262.57 315.08
			<i>*Exchange Surcharge</i>	50.00 60.00
LHD V8 without ABS from (axle) 47L11588C on - Vented Disc Brakes, Metric				
Right Hand Front	OEM	1	<b>STC1283P1</b>	120.00 144.00



# BRAKING SYSTEMS

# RANGE ROVER CLASSIC (1970 TO 1996)

## Brake Caliper Cont'd

LHD V8 with ABS from (VIN) GA to (axle) 49L11363C - Vented Disc Brakes, Imperial			
Right Hand Front	Aftermarket	1	<b>RTC6776P</b> 45.00 54.00
	OEM	1	<b>RTC6776P1</b> 110.00 132.00
	Exchange*	1	<b>RTC6776R</b> 100.00 120.00
	*Exchange Surcharge 40.00 48.00		
	Genuine*	1	<b>RTC6776</b> 262.57 315.08
	*Exchange Surcharge 50.00 60.00		
Left Hand Front			
	Aftermarket	1	<b>RTC6777P</b> 48.33 58.00
	OEM	1	<b>RTC6777P1</b> 110.00 132.00
	Exchange*	1	<b>RTC6777R</b> 100.00 120.00
	*Exchange Surcharge 40.00 48.00		
	Genuine*	1	<b>RTC6777</b> 262.57 315.08
	*Exchange Surcharge 50.00 60.00		
LHD V8 with ABS from (axle) 49L11364C on - Vented Disc Brakes, Metric			
Right Hand Front	OEM	1	<b>STC1283P1</b> 120.00 144.00
LHD V8 air suspension without ABS up to (axle) 55L00497B - Vented Disc Brakes, Imperial			
Right Hand Front	Aftermarket	1	<b>RTC6776P</b> 45.00 54.00
	OEM	1	<b>RTC6776P1</b> 110.00 132.00
	Exchange*	1	<b>RTC6776R</b> 100.00 120.00
	*Exchange Surcharge 40.00 48.00		
	Genuine*	1	<b>RTC6776</b> 262.57 315.08
	*Exchange Surcharge 50.00 60.00		
Left Hand Front			
	Aftermarket	1	<b>RTC6777P</b> 48.33 58.00
	OEM	1	<b>RTC6777P1</b> 110.00 132.00
	Exchange*	1	<b>RTC6777R</b> 100.00 120.00
	*Exchange Surcharge 40.00 48.00		
	Genuine*	1	<b>RTC6777</b> 262.57 315.08
	*Exchange Surcharge 50.00 60.00		
LHD V8 air suspension without ABS from (axle) 55L00498B on - Vented Disc Brakes, Metric			
Right Hand Front	OEM	1	<b>STC1283P1</b> 120.00 144.00
LHD V8 air suspension with ABS up to (axle) 57L05188B - Vented Disc Brakes, Imperial			
Right Hand Front	Aftermarket	1	<b>RTC6776P</b> 45.00 54.00
	OEM	1	<b>RTC6776P1</b> 110.00 132.00
	Exchange*	1	<b>RTC6776R</b> 100.00 120.00
	*Exchange Surcharge 40.00 48.00		
	Genuine*	1	<b>RTC6776</b> 262.57 315.08
	*Exchange Surcharge 50.00 60.00		
Left Hand Front			
	Aftermarket	1	<b>RTC6777P</b> 48.33 58.00
	OEM	1	<b>RTC6777P1</b> 110.00 132.00
	Exchange*	1	<b>RTC6777R</b> 100.00 120.00
	*Exchange Surcharge 40.00 48.00		
	Genuine*	1	<b>RTC6777</b> 262.57 315.08
	*Exchange Surcharge 50.00 60.00		
LHD V8 air suspension with ABS from (axle) 57L05189B on - Vented Disc Brakes, Metric			
Right Hand Front	OEM	1	<b>STC1283P1</b> 120.00 144.00
LHD diesel without ABS from (VIN) GA to (axle) 51L07997C - Vented Disc Brakes, Imperial			
Right Hand Front	Aftermarket	1	<b>RTC6776P</b> 45.00 54.00
	OEM	1	<b>RTC6776P1</b> 110.00 132.00
	Exchange*	1	<b>RTC6776R</b> 100.00 120.00
	*Exchange Surcharge 40.00 48.00		
	Genuine*	1	<b>RTC6776</b> 262.57 315.08
	*Exchange Surcharge 50.00 60.00		
Left Hand Front			
	Aftermarket	1	<b>RTC6777P</b> 48.33 58.00
	OEM	1	<b>RTC6777P1</b> 110.00 132.00
	Exchange*	1	<b>RTC6777R</b> 100.00 120.00
	*Exchange Surcharge 40.00 48.00		
	Genuine*	1	<b>RTC6777</b> 262.57 315.08
	*Exchange Surcharge 50.00 60.00		
LHD diesel without ABS from (axle) 51L07998C on - Vented Disc Brakes, Metric			
Right Hand Front	OEM	1	<b>STC1283P1</b> 120.00 144.00
1970 to 1984 to rear axle suffix C imperial threads			
Rear RH	Exchange*	1	<b>606694R</b> 60.83 73.00
	*Exchange Surcharge 40.00 48.00		
Rear LH	Exchange*	1	<b>606695R</b> 60.83 73.00
	*Exchange Surcharge 40.00 48.00		
All from (VIN) CA to HA - Solid Disc Brakes, Imperial			
Right Hand Rear	Aftermarket	1	<b>RTC5889P</b> 27.50 33.00
	Exchange*	1	<b>RTC5889R</b> 56.58 67.90
	*Exchange Surcharge 40.00 48.00		
	Genuine*	1	<b>RTC5889</b> 190.99 229.19
	*Exchange Surcharge 50.00 60.00		
Left Hand Rear			
	Aftermarket	1	<b>RTC5890P</b> 27.50 33.00
	Exchange*	1	<b>RTC5890R</b> 56.58 67.90
	*Exchange Surcharge 40.00 48.00		
	Genuine*	1	<b>RTC5890</b> 190.99 229.19
	*Exchange Surcharge 50.00 60.00		
Coil suspension without ABS from (VIN) JA to (axle) 34S16421C - Solid Disc Brakes, Imperial			
Right Hand Rear	Exchange*	1	<b>RTC5889R</b> 56.58 67.90
	*Exchange Surcharge 40.00 48.00		
	Aftermarket	1	<b>RTC5889P</b> 27.50 33.00
	Genuine*	1	<b>RTC5889</b> 190.99 229.19
	*Exchange Surcharge 50.00 60.00		
Left Hand Rear			
	Aftermarket	1	<b>RTC5890P</b> 27.50 33.00
	Exchange*	1	<b>RTC5890R</b> 56.58 67.90
	*Exchange Surcharge 40.00 48.00		
	Genuine*	1	<b>RTC5890</b> 190.99 229.19
	*Exchange Surcharge 50.00 60.00		
Coil suspension without ABS from (axle) 34S16422C - Metric			
Right Hand Rear	Aftermarket	1	<b>SMC500110P</b> 28.75 34.50
	Exchange*	1	<b>SMC500110R</b> 85.00 102.00
	*Exchange Surcharge 40.00 48.00		
	Genuine*	1	<b>SMC500110</b> 209.47 251.36
	*Exchange Surcharge 50.00 60.00		
Left Hand Rear			
	Aftermarket	1	<b>SMC500240P</b> 28.75 34.50
	Exchange*	1	<b>SMC500240R</b> 85.00 102.00
	*Exchange Surcharge 40.00 48.00		
	Genuine*	1	<b>SMC500240</b> 209.47 251.36
	*Exchange Surcharge 50.00 60.00		

## Brake Caliper Cont'd

Coil suspension with ABS from (VIN) JA to (axle) 35S18188C - Solid Disc Brakes, Imperial			
Right Hand Rear	Aftermarket	1	<b>RTC5889P</b> 27.50 33.00
	Exchange*	1	<b>RTC5889R</b> 56.58 67.90
	*Exchange Surcharge 40.00 48.00		
	Genuine*	1	<b>RTC5889</b> 190.99 229.19
	*Exchange Surcharge 50.00 60.00		
Left Hand Rear			
	Aftermarket	1	<b>RTC5890P</b> 27.50 33.00
	Exchange*	1	<b>RTC5890R</b> 56.58 67.90
	*Exchange Surcharge 40.00 48.00		
	Genuine*	1	<b>RTC5890</b> 190.99 229.19
	*Exchange Surcharge 50.00 60.00		
Coil suspension with ABS from (axle) 35S18189C - Metric			
Right Hand Rear	Aftermarket	1	<b>SMC500110P</b> 28.75 34.50
	Exchange*	1	<b>SMC500110R</b> 85.00 102.00
	*Exchange Surcharge 40.00 48.00		
	Genuine*	1	<b>SMC500110</b> 209.47 251.36
	*Exchange Surcharge 50.00 60.00		
Left Hand Rear			
	Aftermarket	1	<b>SMC500240P</b> 28.75 34.50
	Exchange*	1	<b>SMC500240R</b> 85.00 102.00
	*Exchange Surcharge 40.00 48.00		
	Genuine*	1	<b>SMC500240</b> 209.47 251.36
	*Exchange Surcharge 50.00 60.00		
Air suspension without ABS from (VIN) JA to (axle) 36S00594B - Solid Disc Brakes, Imperial			
Right Hand Rear	Aftermarket	1	<b>RTC5889P</b> 27.50 33.00
	Exchange*	1	<b>RTC5889R</b> 56.58 67.90
	*Exchange Surcharge 40.00 48.00		
	Genuine*	1	<b>RTC5889</b> 190.99 229.19
	*Exchange Surcharge 50.00 60.00		
Left Hand Rear			
	Aftermarket	1	<b>RTC5890P</b> 27.50 33.00
	Exchange*	1	<b>RTC5890R</b> 56.58 67.90
	*Exchange Surcharge 40.00 48.00		
	Genuine*	1	<b>RTC5890</b> 190.99 229.19
	*Exchange Surcharge 50.00 60.00		
Air suspension without ABS from (axle) 36S00595B - Metric			
Right Hand Rear	Aftermarket	1	<b>SMC500110P</b> 28.75 34.50
	Exchange*	1	<b>SMC500110R</b> 85.00 102.00
	*Exchange Surcharge 40.00 48.00		
	Genuine*	1	<b>SMC500110</b> 209.47 251.36
	*Exchange Surcharge 50.00 60.00		
Left Hand Rear			
	Aftermarket	1	<b>SMC500240P</b> 28.75 34.50
	Exchange*	1	<b>SMC500240R</b> 85.00 102.00
	*Exchange Surcharge 40.00 48.00		
	Genuine*	1	<b>SMC500240</b> 209.47 251.36
	*Exchange Surcharge 50.00 60.00		
Air suspension with ABS from (VIN) JA to (axle) 37S08650B - Solid Disc Brakes, Imperial			
Right Hand Rear	Aftermarket	1	<b>RTC5889P</b> 27.50 33.00
	Exchange*	1	<b>RTC5889R</b> 56.58 67.90
	*Exchange Surcharge 40.00 48.00		
	Genuine*	1	<b>RTC5889</b> 190.99 229.19
	*Exchange Surcharge 50.00 60.00		
Left Hand Rear			
	Aftermarket	1	<b>RTC5890P</b> 27.50 33.00
	Exchange*	1	<b>RTC5890R</b> 56.58 67.90
	*Exchange Surcharge 40.00 48.00		
	Genuine*	1	<b>RTC5890</b> 190.99 229.19
	*Exchange Surcharge 50.00 60.00		
Air suspension with ABS from (axle) 37S08651B - Metric			
Right Hand Rear	Aftermarket	1	<b>SMC500110P</b> 28.75 34.50
	Exchange*	1	<b>SMC500110R</b> 85.00 102.00
	*Exchange Surcharge 40.00 48.00		
	Genuine*	1	<b>SMC500110</b> 209.47 251.36
	*Exchange Surcharge 50.00 60.00		
Left Hand Rear			
	Aftermarket	1	<b>SMC500240P</b> 28.75 34.50
	Exchange*	1	<b>SMC500240R</b> 85.00 102.00
	*Exchange Surcharge 40.00 48.00		
	Genuine*	1	<b>SMC500240</b> 209.47 251.36
	*Exchange Surcharge 50.00 60.00		

## Brake Caliper Piston

All models from (VIN) GA399973 on			
Front, Standard material	Aftermarket	8	<b>606683P</b> 3.25 3.90
	OEM	8	<b>606683P1</b> 5.00 6.00
	Genuine	8	<b>606683</b> 16.73 20.08
Front, Stainless Steel material	Aftermarket	8	<b>606683SS</b> 7.50 9.00
All models from (VIN) CA on			
Rear, Standard material	Aftermarket	4	<b>606696P</b> 2.25 2.70
	OEM	4	<b>606696P1</b> 5.42 6.50
	Genuine	4	<b>606696</b> 19.99 23.99
Rear, Stainless Steel material	Aftermarket	4	<b>606696SS</b> 7.08 8.50

## Brake Caliper Piston Kit

All models from (VIN) GA399973 on - Stainless Steel material			
Front	Aftermarket	1	<b>606683BPSSKIT</b> 50.00 60.00
Rear	Aftermarket	1	<b>606696BPSSKIT</b> 25.83 31.00



SMC500110P



606683SS



## RANGE ROVER CLASSIC (1970 TO 1996)

## BRAKING SYSTEMS

## Dust Cap Bleed Screw

All models - Blue, front caliper bleed nipple	Genuine	6	<b>594091</b>	4.66	5.59
-----------------------------------------------	---------	---	---------------	------	------

## Bleed Nipple Caliper

All imperial models (1970 to 1984) - Front	Aftermarket	1	<b>606684P</b>	1.83	2.20
--------------------------------------------	-------------	---	----------------	------	------

## Bleed Nipple

All models from 1978 on - Front brake caliper

	Aftermarket	6	<b>RTC1526P</b>	1.83	2.20
	Genuine	6	<b>RTC1526</b>	2.77	3.32

## Brake Master Cylinder

Up to 1985, 2 Door RHD up to (VIN) 1A112528 - Imperial Threads

	Aftermarket	1	<b>RTC3657P</b>	59.17	71.00
--	-------------	---	-----------------	-------	-------

Up to 1985, 2 Door RHD from (VIN) 1A112529 - Metric Threads

	Aftermarket	1	<b>RTC3658P</b>	69.17	83.00
--	-------------	---	-----------------	-------	-------

Up to 1985, 2 Door LHD up to (VIN) 2A112611 - Imperial Threads

	Aftermarket	1	<b>RTC3657P</b>	59.17	71.00
--	-------------	---	-----------------	-------	-------

Up to 1985, 2 Door LHD from (VIN) 2A112612 - Metric Threads

	Aftermarket	1	<b>RTC3658P</b>	69.17	83.00
--	-------------	---	-----------------	-------	-------

Up to 1985, All 4 Door RHD - Metric Threads

	Aftermarket	1	<b>RTC3658P</b>	69.17	83.00
--	-------------	---	-----------------	-------	-------

Up to 1985, All 4 Door LHD - Metric Threads

	Aftermarket	1	<b>RTC3658P</b>	69.17	83.00
--	-------------	---	-----------------	-------	-------

All models from (VIN) DA301158 to LA647644 - Girling type

	Aftermarket	1	<b>NTC4991P</b>	67.50	81.00
	OEM	1	<b>NTC4991P1</b>	78.33	94.00
	Genuine	1	<b>NTC4991</b>	289.59	347.51

All models (VIN) MA647645 on

	Genuine	1	<b>STC1763</b>	167.50	201.00
--	---------	---	----------------	--------	--------

## Master Cylinder Repair Kit

All models to 1980 - Brake master cylinder

	Aftermarket	1	<b>AEU1940P</b>	7.50	9.00
--	-------------	---	-----------------	------	------

All models with metric master cylinder to (VIN) DA301157 - Brake master cylinder

	Aftermarket	1	<b>AEU1894P</b>	11.67	14.00
--	-------------	---	-----------------	-------	-------

All models (VIN) DA301158 on - Brake master cylinder, excludes reservoir

	Aftermarket	1	<b>RTC5834P</b>	18.54	22.25
	OEM	1	<b>RTC5834P1</b>	27.92	33.50
	Genuine	1	<b>RTC5834</b>	105.91	127.09

## Brake Servo Assembly

All models from (VIN) MA647645	Aftermarket	1	<b>STC1286P</b>	72.50	87.00
	OEM	1	<b>STC1286P1</b>	109.17	131.00
	Genuine	1	<b>STC1286</b>	257.87	309.44

## Servo Repair Kit

All models (VIN) DA301158 on	Genuine	1	<b>RTC5832</b>	34.58	41.50
------------------------------	---------	---	----------------	-------	-------

## Caliper Repair Kit

All models 1978 on Front	Aftermarket	2	<b>AEU1547P</b>	2.00	2.40
	OEM	2	<b>AEU1547P1</b>	7.08	8.50
	Genuine	2	<b>AEU1547</b>	12.39	14.87

All models from (VIN) JA610294 on - kit includes pistons

Rear caliper	Aftermarket	2	<b>SEE500140P</b>	5.63	6.76
	OEM	2	<b>SEE500140P1</b>	29.50	35.40
	Genuine	2	<b>SEE500140</b>	54.78	65.74

## Brake Hose

Up to 1979, with imperial thread Front hose, imperial system	Aftermarket	4	<b>NRC2209P</b>	4.00	4.80
Rear hose, rubber, imperial system	Aftermarket	1	<b>598973P</b>	3.33	4.00

From 1979, with metric thread, up to (VIN) HA610293

Front hose, metric system	Aftermarket	4	<b>NRC4401P</b>	3.00	3.60
	OEM	4	<b>NRC4401P1</b>	7.50	9.00
	Genuine	4	<b>NRC4401</b>	40.83	49.00

All models from (VIN) JA610294 on

Front, rubber	Aftermarket	4	<b>NTC7670P</b>	4.58	5.50
	Genuine	4	<b>NTC7670</b>	30.84	37.01

All models from (VIN) BA on

Rear, rubber	Aftermarket	1	<b>NTC3458P</b>	2.50	3.00
	OEM	1	<b>NTC3458P1</b>	5.83	7.00
	Genuine	1	<b>NTC3458</b>	28.82	34.58

## Brake Pipe Kit

Early 2-door only RHD non ABS with rear pressure reducing valve (1970 to 1984)

Complete vehicle set, imperial thread

	Automec	1	<b>RA1193RHD</b>	130.00	156.00
--	---------	---	------------------	--------	--------

Early 2-door only LHD non ABS with rear pressure reducing valve (1970 to 1984)

Complete vehicle set, imperial thread

	Automec	1	<b>RA1193LHD</b>	130.00	156.00
--	---------	---	------------------	--------	--------

2 &amp; 4-door non ABS without pressure reducing valve (1970 to 1984)

Complete vehicle set, imperial thread

	Automec	1	<b>RA1194</b>	130.83	157.00
--	---------	---	---------------	--------	--------

Non ABS models (1984 to 1986)

Complete vehicle set, metric thread

	Automec	1	<b>RA1195</b>	93.33	112.00
--	---------	---	---------------	-------	--------

All RHD ABS models from (VIN) DA to (VIN) GA

Complete vehicle set

	Automec	1	<b>RA119686-89RHD</b>	110.00	132.00
--	---------	---	-----------------------	--------	--------

All RHD ABS models from (VIN) HA464554 to (VIN) HA610293

Complete vehicle set

	Automec	1	<b>RA1196ABS90-92</b>	132.50	159.00
--	---------	---	-----------------------	--------	--------

All RHD ABS models from (VIN) JA

Complete vehicle set

	Automec	1	<b>RA1196ABS920N</b>	137.50	165.00
--	---------	---	----------------------	--------	--------

All LHD non ABS models from (VIN) DA to (VIN) GA

Complete vehicle set

	Automec	1	<b>RA119686-89LHDNA</b>	105.83	127.00
--	---------	---	-------------------------	--------	--------

## Brake Pipe Clip

All models - Double type	Aftermarket	a/r	<b>625521A</b>	1.25	1.50
All models	Aftermarket	a/r	<b>GHF1192</b>	0.92	1.10

## Brake Pipe Clip Double

All models	Genuine	a/r	<b>79125</b>	0.32	0.38
	Aftermarket	a/r	<b>625521A</b>	1.25	1.50
Various applications	Genuine	a/r	<b>NTC9530</b>	0.86	1.03

## T Piece Brake System

All non-ABS models - Rear brake pipes	Aftermarket	a/r	<b>NRC4251P</b>	6.04	7.25
	Genuine	a/r	<b>NRC4251</b>	17.88	21.46

## Brake Adjuster Transmission

All models with LT230 transfer box - Early type expander	Aftermarket	1	<b>AEU2735P</b>	10.42	12.50
	Genuine	1	<b>AEU2735</b>	237.59	285.11

## Brake Shoe Set - Handbrake

All 4 speed manual models - Handbrake	Aftermarket	1	<b>STC2880P</b>	12.50	15.00
	Genuine	1	<b>STC2880</b>	74.69	89.63

All 5 speed manual models up to (VIN) LA647644 - Handbrake, rod operated type

	Aftermarket	1	<b>STC965P</b>	7.50	9.00
	OEM	1	<b>STC965P1</b>	22.50	27.00
	Genuine	1	<b>STC965</b>	80.87	97.04

From (VIN) MA647645 on - Handbrake, direct entry cable type

	Aftermarket	1	<b>ICW500010P</b>	10.00	12.00
	OEM	1	<b>ICW500010P1</b>	25.00	30.00
	Genuine	1	<b>ICW500010</b>	65.52	78.62

## Brake Shoe Return Spring

All models from (VIN) FA394482 to (VIN) LA657644	Aftermarket	1	<b>STC246P</b>	4.83	5.80
	Genuine	1	<b>STC246</b>	5.74	6.89

## Brake Spring Kit

All models from MA647645 on - Handbrake Shoe Retention	Aftermarket	1	<b>ICW100050P</b>	3.83	4.60
	OEM	1	<b>ICW100050P1</b>	8.12	9.74
	Genuine	1	<b>ICW100050</b>	11.52	13.82

## Brake Drum

All 5 speed manual models - Handbrake	Aftermarket	1	<b>LR025177P</b>	20.42	24.50
	Genuine	1	<b>LR025177</b>	152.67	183.20

All automatic models - Handbrake	Aftermarket	1	<b>LR025177P</b>	20.42	24.50
	Genuine	1	<b>LR025177</b>	152.67	183.20

## Brake Shoe Retaining Kit

All 4-speed manual models	Aftermarket	1	<b>RA1261</b>	22.50	27.00
---------------------------	-------------	---	---------------	-------	-------

## Retaining Plate Handbrake

All models to (VIN) LA647644	Aftermarket	1	<b>515468P</b>	1.08	1.30
	Genuine	1	<b>515468</b>	2.30	2.76

## Backplate Handbrake

All models (except 4-speed manual) with horizontally mounted brake shoes - To approx. 1992	Genuine	1	<b>STC963</b>	343.70	412.44
--------------------------------------------------------------------------------------------	---------	---	---------------	--------	--------

## Dust Cover Expander Unit

All models with LT77 5 speed gearbox	OEM	1	<b>515466P1</b>	3.33	4.00
	Genuine	1	<b>515466</b>	4.49	5.39

## Expander Unit

All models with LT77 5 speed gearbox	Aftermarket	1	<b>AEU2734P</b>	17.29	20.75
	Genuine	1	<b>AEU2734</b>	330.80	396.96

## Brake Shoe Adjuster Assembly

All models from (VIN) FA394482 to (VIN) LA657644	Aftermarket	1	<b>STC244P</b>	17.29	20.75
	Genuine	1	<b>STC244</b>	125.32	150.38

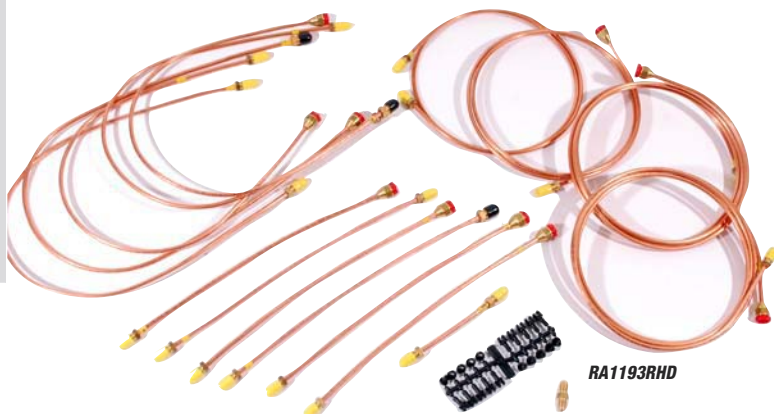

RA1193RHD

# BRAKING SYSTEMS

## Transmission Brake Adjustment Kit

All models from (VIN) MA647645 on	Aftermarket	1	<b>ICW500020P</b>	9.37	11.24
	Genuine	1	<b>ICW500020</b>	13.81	16.57

## Retaining Kit Expander

All models - Parking Brake	Aftermarket	1	<b>RA1109P</b>	3.00	3.60
	Genuine	1	<b>RA1109</b>	5.83	7.00

## Transmission Brake Connecting Rod

All models from (VIN) JA610294 to (VIN) LA647644	Genuine	1	<b>STC964</b>	38.33	46.00
--------------------------------------------------	---------	---	---------------	-------	-------

## Clevis Pin Handbrake Lever

All models from (VIN) MA647645 on	Aftermarket	1	<b>FRC8547P</b>	2.08	2.50
	Genuine	1	<b>FRC8547</b>	3.30	3.96

## Handbrake Switch

All models from (VIN) DA274121 to (VIN) EA351032	Aftermarket	1	<b>EEP191LP</b>	11.87	14.24
	Genuine	1	<b>EEP191L</b>	14.24	17.09

## Handbrake Cable

RHD manual models up to (VIN) CA265468	Aftermarket	1	<b>NRC5088P</b>	7.50	9.00
	Genuine	1	<b>NRC5088</b>	34.58	41.50
LHD manual models up to (VIN) CA265468	Aftermarket	1	<b>NRC5089P</b>	11.67	14.00
	Genuine	1	<b>NRC5089</b>	34.58	41.50
All models from (VIN) CA265469 to EA351032	Aftermarket	1	<b>NTC9400P</b>	8.96	10.75
	Genuine	1	<b>NTC9400</b>	58.36	70.03
All models from (VIN) FA351033 to KA628986	Aftermarket	1	<b>NTC6125P</b>	12.50	15.00
	OEM	1	<b>NTC6125P1</b>	24.00	28.80
	Genuine	1	<b>NTC6125</b>	52.30	62.76
All models from (VIN) KA628987 on	Aftermarket	1	<b>STC1528P</b>	10.00	12.00
	OEM	1	<b>STC1528P1</b>	15.63	18.76
	Genuine	1	<b>STC1528</b>	73.21	87.85

## Handbrake Cable Clevis Pin

All models from (VIN) JA610294 to LA647644 - 8 x 22mm, Handbrake cable to Handbrake lever	Genuine	1	<b>PC108291L</b>	3.45	4.14
-------------------------------------------------------------------------------------------	---------	---	------------------	------	------

## Brake Cable

All LHD automatic models to (VIN) BA	OEM	1	<b>NRC8096P1</b>	13.33	16.00
--------------------------------------	-----	---	------------------	-------	-------

# RANGE ROVER CLASSIC (1970 TO 1996)

## ABS Sensor Kit

All models with anti lock brakes to (VIN) HA610293					
Front	Aftermarket	2	<b>STC90P</b>	48.33	58.00
Rear RH	Aftermarket	1	<b>RTC6743P</b>	38.33	46.00
Rear LH	OEM	1	<b>RTC6742P1</b>	65.83	79.00
	Genuine	1	<b>RTC6742P</b>	38.33	46.00
ABS models from (VIN) JA610294 on					
Front brake, RH	Aftermarket	1	<b>STC1864P</b>	47.50	57.00
	OEM	1	<b>STC1864P1</b>	148.33	178.00
	Genuine	1	<b>STC1864</b>	390.31	468.37
Front brake, LH	Aftermarket	1	<b>STC1865P</b>	32.08	38.50
	OEM	1	<b>STC1865P1</b>	195.83	235.00
	Genuine	1	<b>STC1865</b>	395.86	475.03
Rear brakes	Aftermarket	1	<b>STC1866P</b>	52.50	63.00
	OEM	1	<b>STC1866P1</b>	295.83	355.00

## ABS Sensor Oil Seal

All models with ABS					
Front brakes	Aftermarket	1	<b>FTC1376P</b>	1.00	1.20
	OEM	1	<b>FTC1376P1</b>	2.50	3.00
	Genuine	1	<b>FTC1376</b>	9.10	10.92

## Bush ABS Sensor

All models with anti lock brakes					
Front and rear	Aftermarket	2	<b>FTC1374P</b>	4.58	5.50
	Genuine	2	<b>LRO29522</b>	14.33	17.20

## Exciter Ring

All models with ABS - Rear	Genuine	2	<b>FTC1379</b>	253.57	304.28
----------------------------	---------	---	----------------	--------	--------

## ABS Traction Control Valve

All models with anti lock brakes (VIN) JA610294 on					
	OEM	1	<b>STC845P1</b>	575.00	690.00

## Brake Pedal Rubber

All manual models - Brake and clutch	Aftermarket	2	<b>575818P</b>	1.83	2.20
	Genuine	2	<b>575818</b>	6.79	8.15
All models with automatic transmission	Aftermarket	1	<b>ANR2941P</b>	7.92	9.50
	Genuine	1	<b>ANR2941</b>	11.53	13.84

## Bush Brake Pedal Pivot

All models	Genuine	1	<b>575806</b>	3.92	4.70
------------	---------	---	---------------	------	------

# SUSPENSION

# RANGE ROVER CLASSIC (1970 TO 1996)

## Bush Radius Arm

All models up to (VIN) BA - Front suspension					
axle end, rubber	Aftermarket	4	<b>NTC7307P</b>	1.50	1.80
	Genuine	4	<b>NTC7307</b>	20.38	24.46
axle end, poly.	Aftermarket	4	<b>NTC7307POLY</b>	6.67	8.00
chassis end, rubber	Aftermarket	4	<b>572068P</b>	1.00	1.20
chassis end, poly.	Aftermarket	4	<b>572068POLY</b>	4.00	4.80
All models from (VIN) CA on - Front suspension					
chassis end, rubber	Aftermarket	4	<b>NRC4514P</b>	0.79	0.95
	Genuine	4	<b>NRC4514</b>	2.76	3.31
chassis end, poly.	Aftermarket	4	<b>NRC4514POLY</b>	3.00	3.60
	Polybush	1	<b>NRC4514POLYBUSH</b>	20.42	24.50
All models from (VIN) CA on - Front suspension					
rubber	Aftermarket	4	<b>NTC6860P</b>	2.00	2.40
	OEM	4	<b>NTC6860P1</b>	6.67	8.00
	Genuine	4	<b>NTC6860</b>	10.40	12.48
All models to (VIN) LA645532 - Front suspension					
rubber	Aftermarket	4	<b>NTC6781P</b>	1.50	1.80
	OEM	4	<b>NTC6781P1</b>	4.08	4.90
	Genuine	4	<b>NTC6781</b>	14.96	17.95
All models with air suspension to (VIN) LA645532 - Front suspension					
rubber	Aftermarket	4	<b>NTC6781P</b>	1.50	1.80
	OEM	4	<b>NTC6781P1</b>	4.08	4.90
	Genuine	4	<b>NTC6781</b>	14.96	17.95
All models with air suspension from (VIN) LA645533 on - Front suspension					
rubber	Aftermarket	4	<b>NTC6860P</b>	2.00	2.40
	OEM	4	<b>NTC6860P1</b>	6.67	8.00
	Genuine	4	<b>NTC6860</b>	10.40	12.48
All models with air suspension from (VIN) LA645533 on - Front suspension					
poly.	Aftermarket	4	<b>NTC6860POLY</b>	6.25	7.50
All models without anti roll bar from (VIN) CA to HA610293 - Front suspension,					
poly.	Aftermarket	4	<b>NTC6860POLY</b>	6.25	7.50
All models with anti roll bar from (VIN) CA to (VIN) HA610293 - Front suspension					
poly.	Aftermarket	4	<b>NTC6781POLY</b>	5.00	6.00
All models without anti roll bar, without air suspension from (VIN) JA610294 on - Front suspension					
poly.	Aftermarket	4	<b>NTC6860POLY</b>	6.25	7.50
All models with anti roll bar without air suspension from (VIN) JA610294 on - Front suspension					
poly.	Aftermarket	4	<b>NTC6781POLY</b>	5.00	6.00
All models with air suspension - Front suspension					
poly.	Aftermarket	4	<b>NTC6781POLY</b>	5.00	6.00
All models up to (VIN) BA - Rear suspension,					
chassis end, rubber	Aftermarket	2	<b>572180P</b>	3.75	4.50
All models - Rear suspension					
rubber	Aftermarket	2	<b>NTC1772P</b>	1.50	1.80
	OEM	2	<b>NTC1772P1</b>	3.00	3.60
	Genuine	2	<b>NTC1772</b>	9.29	11.15
	poly.	Aftermarket	2	<b>NTC1772POLY</b>	4.38
All models from (VIN) CA on - Rear suspension					
chassis end, poly.	Aftermarket	2	<b>NTC9027POLY</b>	20.00	24.00

## Bush Kit Radius Arm

All models up to (VIN) BA - Front suspension,					
axle end, poly., set of 4	Bearmach	1	<b>NTC7307BMPYC</b>	87.50	105.00
All models from (VIN) CA on - Front suspension Kit,					
radius arm to chassis, rubber	Britpart	1	<b>NRC4514BPKIT</b>	7.08	8.50
radius arm to chassis, poly. yellow	Britpart	1	<b>NRC4514BPKPOLYEL</b>	9.58	11.50
All models from (VIN) CA to HA610293 - Front suspension					
poly., black	Britpart	1	<b>NTC6860PYKITBP</b>	22.92	27.50
	Britpart	1	<b>NTC6860PYKITELBP</b>	22.92	27.50
All models to (VIN) LA645532 - Front suspension					
poly.	Britpart	1	<b>NTC6781BPPY</b>	16.88	20.26
	Bearmach	1	<b>NTC6781BMPYC</b>	85.00	102.00
All models with air suspension - Front suspension					
poly.	Britpart	1	<b>NTC6781BPPY</b>	16.88	20.26
	Bearmach	1	<b>NTC6781BMPYC</b>	85.00	102.00
All models with air suspension from (VIN) LA645533 on - Front suspension					
poly., black	Britpart	1	<b>NTC6860PYKITBP</b>	22.92	27.50
	Britpart	1	<b>NTC6860PYKITELBP</b>	22.92	27.50
All models without air suspension from (VIN) JA610294 on - Front suspension					
poly.	Britpart	1	<b>NTC6781BPPY</b>	16.88	20.26
	Britpart	1	<b>NTC6860PYKITBP</b>	22.92	27.50
poly., yellow	Britpart	1	<b>NTC6860PYKITELBP</b>	22.92	27.50
	Bearmach	1	<b>NTC6781BMPYC</b>	85.00	102.00
All models from (VIN) CA on - Rear suspension					
chassis end, poly., performance red	Polybush	1	<b>NTC9027POLYBUSH</b>	39.58	47.50

## Bush Radius Arm (set of 4)

All models from (VIN) CA to HA610293 - Front suspension					
poly., red	Polybush	1	<b>NTC6860PBRED</b>	47.50	57.00
All models without air suspension from (VIN) JA610294 on - Front suspension					
poly., red	Polybush	1	<b>NTC6860PBRED</b>	47.50	57.00
All models with air suspension from (VIN) LA645533 on - Front suspension,					
poly., red	Polybush	1	<b>NTC6860PBRED</b>	47.50	57.00

## Bush Radius Arm (pair)

All models from (VIN) CA on - Rear suspension					
chassis end, rubber	Aftermarket	1	<b>STC618P</b>	6.67	8.00
	OEM	1	<b>STC618P1</b>	15.42	18.50
	Genuine	1	<b>STC618</b>	59.46	71.35
chassis end, poly.	Aftermarket	1	<b>STC618POLY</b>	25.83	31.00
All models - Rear suspension,					
poly., performance red	Polybush	1	<b>NTC1772POLYBUSH</b>	22.50	27.00





## RANGE ROVER CLASSIC (1970 TO 1996)

## SUSPENSION

## Washer for Bush on Radius Arm

All models from (VIN) CA on				
Rear suspension, chassis end	Aftermarket	2	<b>STC618WASHER</b>	5.42 6.50

## Bush Shock Absorber Mounting

All coil spring models				
Front upper and lower, rubber	Aftermarket	8	<b>552818P</b>	0.50 0.60
	Genuine	8	<b>552818</b>	1.38 1.66

All models with air suspension				
Front, lower, rubber	Aftermarket	8	<b>RNF100090LP</b>	0.54 0.65
	Genuine	8	<b>RNF100090L</b>	2.06 2.47
	Genuine	8	<b>RNF100090</b>	1.09 1.31

All models				
Rear, upper, rubber	Aftermarket	2	<b>NRC5593P</b>	1.08 1.30
	Genuine	2	<b>NRC5593</b>	6.28 7.54

All models up to (VIN) LA647644				
Rear, lower, rubber	Aftermarket	8	<b>552818P</b>	0.50 0.60
	Genuine	8	<b>552818</b>	1.38 1.66

All models from (VIN) MA647645 on				
Rear, lower, rubber	Aftermarket	8	<b>RNF100090LP</b>	0.54 0.65
	Genuine	8	<b>RNF100090L</b>	2.06 2.47
	Genuine	8	<b>RNF100090</b>	1.09 1.31

## Bush Panhard Rod

All models up to (VIN) BA				
Front suspension, rubber	Aftermarket	2	<b>575580P</b>	1.00 1.20

All models from (VIN) MA648605 on				
Front, rubber	Aftermarket	2	<b>ANR3410P</b>	0.75 0.90
	OEM	2	<b>ANR3410P1</b>	2.75 3.30
	Genuine	2	<b>ANR3410</b>	8.67 10.40

## Bush Upper Link

All models				
Rear suspension, rubber	Aftermarket	2	<b>NTC1773P</b>	1.58 1.90
	OEM	2	<b>NTC1773P1</b>	4.00 4.80
	Genuine	2	<b>NTC1773</b>	19.99 23.99

## Suspension Bush Kit A

All models up to (VIN) BA999999 (except air suspension option) - Rubber				
	Aftermarket	1	<b>RA1170P</b>	32.08 38.50
	Genuine	1	<b>RA1170</b>	180.00 216.00

## Suspension Bush Kit B

All models from (VIN) CA000001 to (VIN) FA399972 (except air suspension option) - Rubber				
	Aftermarket	1	<b>RA1171P</b>	28.33 34.00
	Genuine	1	<b>RA1171</b>	280.00 336.00

## Suspension Bush Kit C

All models from (VIN) GA399973 to (VIN) LA645532 (except air suspension option) - Rubber				
	Aftermarket	1	<b>RA1172P</b>	26.25 31.50
	Genuine	1	<b>RA1172</b>	280.00 336.00

## Suspension Bush Kit D

All models (VIN) LA645533 on - Bush kit 'D' Incl. bottom link mounting bushes, front radius arm to axle bushes, A frame bushes, Panhard rod bushes, upper and lower shock absorber bushes, radius arm to chassis bushes				
	Aftermarket	1	<b>RA1173EARLYP</b>	26.25 31.50
	Genuine	1	<b>RA1173EARLY</b>	300.00 360.00

## Suspension Bush Kit E

All air suspension models from (VIN) GA399973 to (VIN) LA644532 - Rubber				
	Aftermarket	1	<b>RA1174P</b>	30.00 36.00
	Genuine	1	<b>RA1174</b>	290.00 348.00

All air suspension models from (VIN) LA644533 on - Rubber				
	Aftermarket	1	<b>RA1175P</b>	29.17 35.00
	Genuine	1	<b>RA1175</b>	275.00 330.00

## Bolt Kit for Bush Kit A

All models up to (VIN) BA999999				
	Aftermarket	1	<b>RA1176P</b>	56.67 68.00
	Genuine	1	<b>RA1176</b>	75.83 91.00

## Bolt Kit for Bush Kits B, C, D, E &amp; F

All models from (VIN) CA000001 on				
	Aftermarket	1	<b>RA1177P</b>	40.42 48.50
	Genuine	1	<b>RA1177</b>	71.67 86.00

## Bush Shock Absorber Mounting

All coil spring models				
Front upper and lower, poly.	Aftermarket	4	<b>552818POLY</b>	0.83 1.00
Front upper and lower, poly, performance red	Polybush	1	<b>5528189PBR</b>	25.00 30.00
Front upper and lower, poly, comfort blue	Polybush	1	<b>552818PPBB</b>	25.00 30.00
Front upper and lower, poly, dynamic orange	Polybush	1	<b>5528189PBO</b>	25.00 30.00

All models with air suspension				
Front, lower, poly.	Aftermarket	4	<b>RNF100090LPOLY</b>	2.25 2.70

All models up to (VIN) LA647644				
Rear, lower, poly.	Aftermarket	4	<b>552818POLY</b>	0.83 1.00
Rear, lower, poly, performance red	Polybush	1	<b>5528189PBR</b>	25.00 30.00
Rear, lower, poly, comfort blue	Polybush	1	<b>552818PPBB</b>	25.00 30.00
Rear, lower, poly, dynamic orange	Polybush	1	<b>5528189PBO</b>	25.00 30.00

All models				
Rear, upper, poly.	Aftermarket	2	<b>NRC5593POLY</b>	4.00 4.80
	Terraforma	2	<b>NRC5593TFP</b>	13.13 15.76

All models from (VIN) MA647645 on				
Rear, lower, poly.	Aftermarket	4	<b>RNF100090LPOLY</b>	2.25 2.70

## Shock Absorber Bush Kit

All models				
Front shock absorber bush kit, performance red	Polybush	1	<b>LL1357</b>	22.08 26.50
comfort blue	Polybush	1	<b>LL1357B</b>	22.08 26.50
All models up to (VIN) LA647644				
Rear shock absorber bush kit, performance red	Polybush	1	<b>LL1356</b>	27.08 32.50
comfort blue	Polybush	1	<b>LL1356B</b>	27.08 32.50

## Bush Kit Shock Absorber Mounting (set of 8)

All models from (VIN) MA647645 on - Kit, poly., 8 piece				
	Aftermarket	1	<b>RNF100090LPB</b>	30.83 37.00
All models with air suspension - Kit, poly., 8 piece				
	Aftermarket	1	<b>RNF100090LPB</b>	30.83 37.00

## Bush Panhard Rod

All models up to (VIN) BA				
Front suspension, poly.	Aftermarket	2	<b>575580POLY</b>	3.83 4.60
All models from (VIN) MA648605 on				
Front, poly.	Aftermarket	2	<b>ANR3410POLY</b>	4.00 4.80
Front Kit, poly.	Terraforma	1	<b>ANR3410TFPK</b>	15.63 18.76

## Anti Roll Bar Bush

All models up to (VIN) BA				
Front upper and lower, rear lower, poly.	Aftermarket	4	<b>552819POLY</b>	1.08 1.30

## Anti Roll Bar Bush Kit

All models - Front anti roll bar bush kit,				
performance red	Polybush	1	<b>LL1359</b>	35.00 42.00
comfort blue	Polybush	1	<b>LL1359B</b>	35.00 42.00

## Bush Anti Roll Bar Mounting

All models with front anti roll bar				
Front anti roll bar, poly.	Aftermarket	2	<b>NTC6828POLY</b>	6.25 7.50
All models				
Rear, poly., for 16mm bar	Aftermarket	4	<b>NTC7394POLY</b>	6.25 7.50

## Bush Anti Roll Bar Mounting Upated

All models with front anti roll bar				
Front anti roll bar, poly. 25.4mm inside diameter	Terraforma	2	<b>NTC6828URTFPY</b>	23.33 28.00
All models -				
Rear, poly., 25.4mm inside diameter	Terraforma	2	<b>NTC7394URTFPY254</b>	21.25 25.50
Rear, poly., 28.0mm inside diameter	Terraforma	2	<b>NTC7394URTFPY280</b>	23.33 28.00

## Bump Stop

All models with coil spring suspension				
Front suspension, poly., red	Polybush	2	<b>ANR4188POLYBUSH</b>	19.17 23.00
Front suspension, poly., black	Britpart	2	<b>ANR4188BPPYBLK</b>	13.25 15.90
Front suspension, poly., yellow	Britpart	2	<b>ANR4188BPPYEL</b>	13.25 15.90
All models to (VIN) MA656126				
Rear suspension, poly.	Polybush	2	<b>ANR4189POLYBUSH</b>	17.08 20.50
Rear suspension, poly., black	Britpart	2	<b>ANR4189BPPYBLK</b>	13.25 15.90
Rear suspension, poly., yellow	Britpart	2	<b>ANR4189BPPYEL</b>	13.25 15.90

## Bush Upper Link

All models				
Rear suspension, poly.	Aftermarket	2	<b>NTC1773POLY</b>	4.38 5.26
Rear suspension, poly., (pair) performance red	Polybush	1	<b>NTC1773POLYBUSH</b>	23.75 28.50
comfort blue	Polybush	1	<b>NTC1773POLYBUSHBLUE</b>	23.75 28.50

## Suspension Bush Kit A - Polyurethane

All models up to (VIN) BA999999 (except air suspension option) - poly.				
	Aftermarket	1	<b>RA1178ALTPOLY</b>	90.83 109.00
Classic Red	Polybush	1	<b>RA1178POLYBUSH</b>	118.33 142.00
comfort blue	Polybush	1	<b>RA1179POLYBUSH</b>	118.33 142.00
black	Britpart	1	<b>RA1178BPPYBLK</b>	56.67 68.00
yellow	Britpart	1	<b>RA1178BPPYEL</b>	65.00 78.00
	Bearmach	1	<b>RA1178BM</b>	75.00 90.00

## Suspension Bush Kit B - Polyurethane

All models from (VIN) CA000001 on (except air suspension option) - poly.				
	Aftermarket	1	<b>RA1274ALTPOLY</b>	87.50 105.00
performance red	Polybush	1	<b>RA1274PBRED</b>	130.00 156.00
comfort blue	Polybush	1	<b>RA1275POLYBUSH</b>	142.50 171.00
dynamic orange	Polybush	1	<b>RA1274PBORANGE</b>	130.00 156.00
black	Britpart	1	<b>RA1274BPPYBLKRR</b>	90.00 108.00
yellow	Britpart	1	<b>RA1274BPPYELRR</b>	75.83 91.00
blue	Britpart	1	<b>RA1274BPPYELBLUE</b>	75.00 90.00
	Bearmach	1	<b>RA1274BMRR</b>	80.00 96.00



# SUSPENSION

# RANGE ROVER CLASSIC (1970 TO 1996)

## Anti Roll Bar

All models without air suspension - Front	Genuine	1	<b>NTC6836</b>	381.32	457.58
All models with air suspension - Front	Aftermarket	1	<b>LR033037P</b>	50.00	60.00
	Genuine	1	<b>LR033037</b>	72.75	87.30
All models - Rear, standard size	Aftermarket	1	<b>LR033038P</b>	45.00	54.00
	Genuine	1	<b>LR033038</b>	78.73	94.48

## Anti Roll Bar Upgraded

All models with air suspension					
Front, upgraded 25.4mm diameter	Terraforma	1	<b>LR033037URTF</b>	245.83	295.00
All models					
Rear, upgraded standard diameter	Bearmach	1	<b>LR033038URBM</b>	170.00	204.00
Rear, upgraded 25.4mm diameter	Terraforma	1	<b>LR033038URTF254</b>	225.00	270.00
Rear, upgraded 28.0mm diameter	Terraforma	1	<b>LR033038URTF280</b>	241.67	290.00

## Anti Roll Bar Bush

All models fitted with anti roll bar - Anti roll bar link, rubber					
Aftermarket	4	<b>552819P</b>	0.19	0.23	
Genuine	4	<b>552819</b>	1.39	1.67	
All models up to (VIN) BA - Shock absorber mounting, rear upper, rubber					
Aftermarket	4	<b>552819P</b>	0.19	0.23	
Genuine	4	<b>552819</b>	1.39	1.67	

## Anti Roll Bar Link Ball Joint

All models - Front and rear					
Aftermarket	2	<b>NTC1888P</b>	4.79	5.75	
OEM	2	<b>NTC1888P1</b>	13.54	16.25	
Genuine	2	<b>NTC1888</b>	41.58	49.90	

## Mounting Bush, Anti Roll Bar

All models with front anti roll bar					
Front anti roll bar					
Aftermarket	2	<b>NTC6828P</b>	1.33	1.60	
OEM	2	<b>NTC6828P1</b>	2.72	3.26	
Genuine	2	<b>NTC6828</b>	6.99	8.39	
Rear, standard rubber, for 16mm bar					
Aftermarket	2	<b>NTC7394P</b>	1.33	1.60	
OEM	2	<b>NTC7394P1</b>	3.00	3.60	
Genuine	2	<b>NTC7394</b>	4.53	5.44	

## Clamp Bracket

All models - Anti roll bar mounting, front					
Aftermarket	2	<b>NTC6776P</b>	3.75	4.50	
Genuine	2	<b>NTC6776</b>	5.93	7.12	

## Link Kit for Upgraded Anti Roll Bars

All models with air suspension - Fitting Kit	Terraforma	1	<b>LR033037URTFK</b>	24.58	29.50
All models - Fitting Kit	Terraforma	1	<b>LR033038URTFK</b>	39.58	47.50

## Spacer Kit 2 hole

All models with air suspension - for anti roll bar					
Terraforma	1	<b>LR033037-8URTFK2</b>	35.00	42.00	

## Spacer Kit 4 hole

All models with air suspension - for anti roll bar					
Terraforma	1	<b>LR033037-8URTFK4</b>	39.58	47.50	

## Shock Absorber

All models without anti roll bar to (VIN) BAA999999					
Front	OEM	2	<b>RTC4582P1</b>	35.00	42.00
All models					
Front, std. height					
Super Gaz	2	<b>LL1481BPSUP</b>	33.33	40.00	
Cellular Dynamic	2	<b>LL1481BPCEL</b>	39.58	47.50	
Terraforma	2	<b>RA1346TFAT</b>	29.17	35.00	
Rear, gas, All Terrain, std. height					
Terraforma	2	<b>RA1346TFAT</b>	29.17	35.00	
Rear, gas, Pro Sport, std. height					
Terraforma	2	<b>RA1346TFPS</b>	48.33	58.00	
Rear, gas, std. height					
Pro-Comp	2	<b>RA1346BMPC</b>	38.33	46.00	
Super Gaz	2	<b>LL1482BPSUP</b>	33.33	40.00	
Cellular Dynamic	2	<b>LL1482BPCEL</b>	39.58	47.50	
All models except air suspension					
Front, gas, std. height (pair)					
Bilstein	1	<b>RA1345BILSTEIN</b>	132.50	159.00	
Front, gas, std. height					
Decarbon	2	<b>RA1345DECARBONEA</b>	63.33	76.00	
Terraforma	2	<b>RA1345TFAT</b>	28.33	34.00	
Front, gas, std. height Pro Sport					
Terraforma	2	<b>RA1345TFPS</b>	48.33	58.00	
Rear, gas, std. height (pair)					
Bilstein	1	<b>RA1346BILSTEIN</b>	132.50	159.00	
All models from (VIN) GA417085 to LA647644					
Front, oil, std. height					
Aftermarket	2	<b>RSC100050P</b>	13.54	16.25	
OEM	2	<b>RSC100050P1</b>	29.58	35.50	
Genuine	2	<b>RSC100050</b>	61.43	73.72	
Rear, oil, std. height					
Aftermarket	2	<b>STC3771P</b>	13.96	16.75	
OEM	2	<b>STC3771P1</b>	24.58	29.50	
Genuine	2	<b>STC3771</b>	63.97	76.76	
All models from (VIN) MA647645 on					
Front, oil, std. height					
Aftermarket	2	<b>STC3703P</b>	14.58	17.50	
OEM	2	<b>STC3703P1</b>	23.75	28.50	
Genuine	2	<b>STC3703</b>	50.98	61.18	
All models with air suspension					
Front					
Aftermarket	2	<b>STC2830P</b>	15.83	19.00	
OEM	2	<b>STC2830P1</b>	30.00	36.00	
Genuine	2	<b>STC2830</b>	50.97	61.16	
Rear, oil, std. height					
Aftermarket	2	<b>STC3704P</b>	14.58	17.50	
OEM	2	<b>STC3704P1</b>	26.67	32.00	
Genuine	2	<b>STC3704</b>	59.25	71.10	
Rear, oil, std. height					
Bilstein	2	<b>RA1348BILSTEINSINGL</b>	68.33	82.00	
Rear, oil, std. height B6 Damper					
Bilstein	2	<b>STC3704UPGRADED</b>	80.00	96.00	
All models with anti roll bar (except CSK) from (VIN) GA399973 to (VIN) KA638829					
Front					
Aftermarket	2	<b>STC207P</b>	16.88	20.26	
All models with anti roll bar (except CSK) from (VIN) KA638830 on					
Front					
Aftermarket	2	<b>STC2829P</b>	17.29	20.75	
OEM	2	<b>STC2829P1</b>	28.33	34.00	
Genuine	2	<b>STC2829</b>	53.16	63.79	
All models except air suspension - Front, gas, std. height, Commercial heavy duty					
Terraforma	2	<b>RA1345TFCHD</b>	58.33	70.00	
All models up to (VIN) GA417084					
Rear, oil, std. height					
Aftermarket	2	<b>STC3941P</b>	13.96	16.75	
OEM	2	<b>STC3941P1</b>	39.58	47.50	
Genuine	2	<b>STC3941</b>	94.72	113.66	
All models from (VIN) MA647645 on					
Rear, oil, std. height					
Aftermarket	2	<b>STC3704P</b>	14.58	17.50	
OEM	2	<b>STC3704P1</b>	26.67	32.00	
Genuine	2	<b>STC3704</b>	59.25	71.10	
Rear, oil, std. height B6 Damper					
Bilstein	2	<b>STC3704UPGRADED</b>	80.00	96.00	
Coil spring models (VIN) GA417085 to LA647644					
Rear					
Genuine	2	<b>NTC8214</b>	93.88	112.66	
All models with rear anti roll bar (VIN) KA638830 to LA647644					
Rear					
Aftermarket	2	<b>STC3939P</b>	13.96	16.75	
OEM	2	<b>STC3939P1</b>	27.50	33.00	
Genuine	2	<b>STC3939</b>	55.19	66.23	
All models with anti roll bar from (VIN) MA647645 on					
Rear					
Aftermarket	2	<b>STC2831P</b>	14.79	17.75	
OEM	2	<b>STC2831P1</b>	30.00	36.00	
Genuine	2	<b>STC2831</b>	52.78	63.34	
All models					
Rear, gas, Commercial Heavy Duty, std. height					
Terraforma	2	<b>RA1346TFCHD</b>	58.33	70.00	

## Shock Absorber Heavy Duty

All models from (VIN) GA417085 to LA647644					
Rear, gas, heavy duty, std. height					
Aftermarket	2	<b>STC3772P</b>	13.96	16.75	
OEM	2	<b>STC3772P1</b>	27.50	33.00	
Genuine	2	<b>STC3772</b>	64.26	77.11	

## Shock Mounting Retention Ring

All models without air suspension					
Front suspension					
Genuine	2	<b>RNJ500010</b>	16.34	19.61	
Aftermarket	2	<b>RNJ500010P</b>	3.58	4.30	



## RANGE ROVER CLASSIC (1970 TO 1996)

## SUSPENSION

## Coil Spring

2 Dr models up to (VIN) 35555584F, 35655584F and 35855584F				
Front, both sides, heavy duty	Aftermarket	2	<b>NRC2119P</b>	12.92 15.50
2 Dr RHD models from (VIN) 35555585F, and 35655585F up to (VIN) BA				
Front, both sides, heavy duty	Aftermarket	2	<b>NRC2119P</b>	12.92 15.50
2 Dr LHD models from (VIN) 35855585F to (VIN) BA				
Front RH, heavy duty	Aftermarket	1	<b>NRC2119P</b>	12.92 15.50
4 Dr RHD models up to (VIN) BA				
Front, both sides, heavy duty	Aftermarket	2	<b>NRC2119P</b>	12.92 15.50
Front RH, heavy duty	Aftermarket	1	<b>NRC2119P</b>	12.92 15.50
All RHD V8 petrol models				
Front, std, blue stripe	Aftermarket	2	<b>572315P</b>	13.33 16.00
Front, std, blue stripe	Genuine	2	<b>572315</b>	64.19 77.03
RHD diesel models up to (VIN) HA477607				
Front, both sides, heavy duty	Aftermarket	2	<b>NRC2119P</b>	12.92 15.50
RHD diesel models (VIN) HA477608 on				
Front, driver's and passenger's sides	Aftermarket	2	<b>NTC8477P</b>	15.63 18.76
	Genuine	2	<b>NTC8477</b>	63.20 75.84
All LHD V8 petrol models				
Front RH, std, blue stripe	Aftermarket	1	<b>572315P</b>	13.33 16.00
	Genuine	1	<b>572315</b>	64.19 77.03
Front LH, std, blue/white stripe	Aftermarket	1	<b>NRC4306P</b>	15.83 19.00
	Genuine	1	<b>NRC4306</b>	63.20 75.84
LHD diesel models up to (VIN) HA477607				
Front RH, heavy duty	Aftermarket	1	<b>NRC2119P</b>	12.92 15.50
Front LH, heavy duty	Aftermarket	1	<b>NRC4305P</b>	15.83 19.00
LHD diesel models (VIN) HA477608 on				
Front, driver's side	Genuine	1	<b>NTC8476</b>	63.20 75.84
Front, passenger's side	Aftermarket	1	<b>NTC8477P</b>	15.63 18.76
	Genuine	1	<b>NTC8477</b>	63.20 75.84
2 Dr models up to (VIN) 35555584F, 35655584F and 35855584F				
Rear, both sides, standard	Aftermarket	2	<b>NRC2119P</b>	12.92 15.50
2 Dr RHD models from (VIN) 113784 up to (VIN) LA647644				
Rear, both sides, standard	Aftermarket	2	<b>NRC2119P</b>	12.92 15.50
2 Dr LHD models from (VIN) 113784 to (VIN) LA647644				
Rear RH, standard	Aftermarket	1	<b>NRC2119P</b>	12.92 15.50
Rear LH, standard	Aftermarket	1	<b>NRC4305P</b>	15.83 19.00
4 Dr RHD models from (VIN) 112533 up to (VIN) LA647644				
Rear, both sides, standard	Aftermarket	2	<b>NRC2119P</b>	12.92 15.50
Rear RH, standard	Aftermarket	1	<b>NRC2119P</b>	12.92 15.50
Rear LH, standard	Aftermarket	1	<b>NRC4305P</b>	15.83 19.00
All RHD models (VIN) CA to GA464553				
Rear, std, pink/purple stripe	Aftermarket	2	<b>NRC8113P</b>	15.83 19.00
All RHD models from (VIN) MA647645 on				
Rear RH & LH	OEM	2	<b>ANR3520P1</b>	39.58 47.50
All LHD petrol models (VIN) CA to GA464553				
Rear, std, pink/purple stripe	Aftermarket	2	<b>NRC8113P</b>	15.83 19.00
All LHD models without air suspension (VIN) JA610294 to LA647644				
Rear LH, standard	Aftermarket	1	<b>NRC4305P</b>	15.83 19.00
All LHD models from (VIN) MA647645 on				
Rear RH, standard	OEM	1	<b>ANR3520P1</b>	39.58 47.50
Rear LH, standard	OEM	1	<b>ANR3519P1</b>	39.58 47.50
All diesel LHD models (VIN) CA to GA464553				
Rear RH, std, pink/purple stripe	Aftermarket	1	<b>NRC8113P</b>	15.83 19.00
All diesel LHD models to (VIN) GA464553				
Rear LH, std, green/pink stripe	Aftermarket	1	<b>NTC3285P</b>	24.58 29.50
All diesel LHD models (VIN) HA464554 to HA610293				
Rear LH, standard	Aftermarket	1	<b>NRC4305P</b>	15.83 19.00
All models with factory heavy duty fitment (Police spec)				
Rear, both sides	Aftermarket	2	<b>NRC4304P</b>	13.54 16.25

## Mounting Bracket

All models - Front spring, upper	Aftermarket	2	<b>NRC6372P</b>	13.13 15.76
	Genuine	2	<b>NRC6372</b>	56.30 67.56

## Spring Isolator Upper

All models (VIN) JA610294 on without air suspension - Rear spring				
	Aftermarket	2	<b>ANR2938P</b>	3.83 4.60
	OEM	2	<b>ANR2938P1</b>	4.58 5.50
	Genuine	2	<b>ANR2938</b>	9.40 11.28

## Plate, Spring Retainer

All coil spring models - Rear	Aftermarket	2	<b>NTC6106P</b>	1.75 2.10
	Genuine	2	<b>NTC6106</b>	3.28 3.94

## Ball Joint Assembly

All models - Rear upper link	Aftermarket	1	<b>RHF500110P</b>	7.08 8.50
	OEM	1	<b>RHF500110P1</b>	16.67 20.00
	Genuine	1	<b>RHF500110</b>	39.98 47.98

## Ball Joint Assembly &amp; Fulcrum Bracket

All models - Rear upper link & fulcrum bracket				
	Britpart	1	<b>RHF500110BPASSY</b>	39.58 47.50

## Ball Joint Assembly Heavy Duty

All models - Rear upper link	Bearmach	1	<b>RHF500110URBM</b>	14.38 17.26
------------------------------	----------	---	----------------------	-------------

## Ball Joint Self Levelling Unit

All models - Top & bottom	Aftermarket	2	<b>575882P</b>	4.58 5.50
---------------------------	-------------	---	----------------	-----------

## Ball Joint, Upper

All models with coil suspension - Self levelling unit	Aftermarket	2	<b>575882P</b>	4.58 5.50
-------------------------------------------------------	-------------	---	----------------	-----------

## Drop Arm Repair Kit

All models - Steering drag link	Aftermarket	1	<b>RBG000010P</b>	4.58 5.50
	OEM	1	<b>RBG000010P1</b>	20.63 24.76
	Genuine	1	<b>RBG000010</b>	55.33 66.40

## Dust Cover Ball Joint

All models from (VIN) 7A000001 to (VIN) EA329986				
	OEM	1	<b>572338P1</b>	3.58 4.30
	Genuine	1	<b>572338</b>	8.34 10.01

## Gaiter Ball Joint

All models with self levelling suspension - Lower, self levelling unit				
	Aftermarket	1	<b>NRC6561P</b>	3.58 4.30
	Genuine	1	<b>NRC6561</b>	18.38 22.06

## Radius Arm Assembly

All models with anti roll bars up to (VIN) BA999999				
Front	Genuine	2	<b>NRC4096</b>	29.95 35.94
All models from (VIN) CA on without roll bar or air suspension				
Front suspension	Aftermarket	2	<b>NTC2694P</b>	105.00 126.00
	Genuine	2	<b>NTC2694</b>	309.34 371.21
All models from (VIN) CA on with roll bar without air suspension				
Front suspension	OEM	2	<b>LR041266P1</b>	135.00 162.00
	Genuine	2	<b>LR041266</b>	316.61 379.93
All models with air suspension from (VIN) LA645533 on				
Front	Genuine	2	<b>ANR3480</b>	224.41 269.29
All models				
Rear suspension	Aftermarket	2	<b>LR049068P</b>	29.58 35.50
	Genuine	2	<b>LR049068</b>	88.44 106.13

## Radius Arm Nut &amp; Bolt Kit

All models				
Front	Britpart	1	<b>LL1679BP</b>	8.13 9.76
Rear	Britpart	1	<b>LL1680BP</b>	6.67 8.00

## Panhard Rod Assembly

All models				
Front suspension, RHD or LHD	Aftermarket	1	<b>RBI500020P</b>	23.75 28.50
	Genuine	1	<b>RBI500020</b>	136.98 164.38

## Tie Bar

All RHD models - Steering box	Aftermarket	1	<b>LR041261P</b>	15.63 18.76
	Genuine	1	<b>LR041261</b>	46.04 55.25

## Tie Bar Bracket

All models - Rear	Britpart	1	<b>LL1507BP</b>	11.88 14.26
-------------------	----------	---	-----------------	-------------

## Top Link Assembly

All models from (VIN) CA172903 on				
Rear suspension, RH	Aftermarket	1	<b>NTC2706P</b>	80.00 96.00
	Genuine	1	<b>NTC2706</b>	241.05 289.26
Rear suspension, LH	Genuine	1	<b>LR045324</b>	173.56 208.27

## Drag Link End Piece

All models from (axle) suffix D on - Cranked	Aftermarket	1	<b>NRC1823P</b>	15.63 18.76
	Genuine	1	<b>NRC1823</b>	95.42 114.50

## Drag Link End Tube

All models from (axle) suffix D on - Cranked	Aftermarket	1	<b>NRC1824P</b>	14.58 17.50
----------------------------------------------	-------------	---	-----------------	-------------

## Drag Link Assembly

All models from (axle) suffix D to (VIN) JA615503				
	Aftermarket	1	<b>NRC3226P</b>	39.58 47.50
All models from (VIN) JA615504 on	Aftermarket	1	<b>NTC9607P</b>	39.58 47.50
	Genuine	1	<b>NTC9607</b>	105.59 126.71

## Drag Link Tube

All models (VIN) JA615504 on	Aftermarket	1	<b>NTC8390P</b>	11.67 14.00
	OEM	1	<b>NTC8390P1</b>	15.63 18.76
	Genuine	1	<b>NTC8390</b>	112.14 134.57

## Bump Stop

All models with coil spring suspension				
Front suspension, rubber	Aftermarket	2	<b>ANR4188P</b>	2.58 3.10
	OEM	2	<b>ANR4188P1</b>	6.04 7.25
	Genuine	2	<b>ANR4188</b>	24.38 29.26
All models from (VIN) MA656126 on				
Front	Genuine	2	<b>ANR2420</b>	19.75 23.70
All models to (VIN) MA656126				
Rear suspension, rubber	Aftermarket	2	<b>ANR4189P</b>	3.08 3.70
	OEM	2	<b>ANR4189P1</b>	8.13 9.76
	Genuine	2	<b>ANR4189</b>	18.20 21.84





# SUSPENSION

# RANGE ROVER CLASSIC (1970 TO 1996)

## Bump Stop Spacers

All models with coil spring suspension - Front or rear				
Terraforma	a/r	<b>ANR4188-9TFSPACER</b>	29.58	35.50

## Height Sensor

All models with air suspension				
Front, RH	OEM	1	<b>STC3733AAP1</b>	85.83 103.00
	Genuine	1	<b>STC3733AA</b>	128.73 154.48
Rear RH	OEM	1	<b>STC3735AAP1</b>	115.83 139.00
	OEM	1	<b>STC3736AAP1</b>	110.83 133.00
All air suspension models				
Front, LH	OEM	1	<b>STC3734AAP1</b>	88.33 106.00
	Genuine	1	<b>STC3734AA</b>	105.82 126.98

## Air Suspension Compressor

All models from (VIN) MA660291 on	OEM	1	<b>ANR4353P1</b>	243.33 292.00
-----------------------------------	-----	---	------------------	---------------

## Air Suspension Spring

All models with air suspension				
Front	Aftermarket	2	<b>NTC9819P</b>	110.83 133.00
	OEM	2	<b>NTC9819P1</b>	130.00 156.00
	Genuine	2	<b>NTC9819</b>	229.73 275.68
Rear	OEM	2	<b>NTC9820P1</b>	118.33 142.00
	Genuine	2	<b>NTC9820</b>	225.17 270.20

## Drive Box Air Suspension

All models with air suspension (VIN) LA647149 on				
Aftermarket	1	<b>ANR3157P1</b>	190.83 229.00	
Genuine	1	<b>ANR3157</b>	351.05 421.26	

## Air Dryer Unit

All models with air suspension - Air suspension				
Aftermarket	2	<b>NTC9812P</b>	35.83 43.00	
Genuine	2	<b>NTC9812</b>	57.96 69.55	

## Repair Kit Diaphragm

All models with air suspension - Air suspension valve block				
Aftermarket	1	<b>STC1803P</b>	33.33 40.00	
Genuine	1	<b>STC1803</b>	57.61 69.13	

## Repair Kit Solenoid

All models with air suspension - Air suspension valve block				
OEM	1	<b>STC2761P1</b>	58.33 70.00	
Genuine	1	<b>STC2761</b>	68.18 81.82	

## Air Pressure Switch

All models with air suspension up to (VIN) MA654292				
OEM	1	<b>NTC9826P1</b>	47.92 57.50	

## Shock Absorber Kit

All V8 models without anti roll bar to (VIN) BA999999				
<i>Kit includes 2 front &amp; 2 rear shock absorbers</i>				
Aftermarket	1	<b>RA1265P</b>	51.67	62.00
All V8 models without anti roll bar from (VIN) CA000001 to (VIN) GA417084				
<i>Kit includes 2 front &amp; 2 rear shock absorbers</i>				
Aftermarket	1	<b>RA1266P</b>	55.83	67.00
Genuine	1	<b>RA1266</b>	279.17	335.00
All V8 models without anti roll bar from (VIN) GA417085 to (VIN) GA450646				
<i>Kit includes 2 front &amp; 2 rear shock absorbers</i>				
Aftermarket	1	<b>RA1267P</b>	57.50	69.00
Genuine	1	<b>RA1267</b>	192.50	231.00
All V8 models without anti roll bar from (VIN) GA450647 to (VIN) HA471543				
<i>Kit includes 2 front &amp; 2 rear shock absorbers</i>				
Aftermarket	1	<b>RA1268P</b>	57.50	69.00
Genuine	1	<b>RA1268</b>	192.50	231.00
All V8 models without anti roll bar from HA471544 on				
<i>Kit includes 2 front &amp; 2 rear shock absorbers</i>				
Aftermarket	1	<b>RA1269P</b>	57.50	69.00
Genuine	1	<b>RA1269</b>	192.50	231.00
All V8 models with anti roll bar from (VIN) GA399973 to (VIN) KA638829				
<i>Kit includes 2 front &amp; 2 rear shock absorbers</i>				
Aftermarket	1	<b>RA1272P</b>	55.83	67.00
All V8 models with anti roll bar from KA638830 to (VIN) LA647644				
<i>Kit includes 2 front &amp; 2 rear shock absorbers</i>				
Aftermarket	1	<b>RA1269P</b>	57.50	69.00
Genuine	1	<b>RA1269</b>	192.50	231.00
All V8 models with anti roll bar from (VIN) MA647645 on				
<i>Kit includes 2 front &amp; 2 rear shock absorbers</i>				
Aftermarket	1	<b>RA1273P</b>	55.00	66.00
Genuine	1	<b>RA1273</b>	192.50	231.00
All diesel models (VIN) GA450647 to HA471543				
Aftermarket	1	<b>RA1270P</b>	57.50	69.00
Genuine	1	<b>RA1270</b>	192.50	231.00
All CSK models				
Aftermarket	1	<b>RA1271P</b>	57.50	69.00
All air suspension models - Vehicle set, gas, std. height				
Bilstein	1	<b>RA1355BILSTEIN</b>	291.67	350.00

## Shock Absorber Kit Upated

All coil spring models				
<i>Kit includes 2 front &amp; 2 rear shock absorbers</i>				
Heavy Duty Gas	Bilstein	1	<b>RA1344BILSTEIN</b>	262.50 315.00

## Shock Absorber (pair)

All air suspension models				
Front, gas, std. height	Bilstein	1	<b>RA1347BILSTEIN</b>	157.50 189.00
Rear, gas, std. height	Bilstein	1	<b>RA1348BILSTEIN</b>	152.50 183.00



RA1270P



## RANGE ROVER CLASSIC (1970 TO 1996)

## SUSPENSION

## Shock Absorber &amp; Spring Kit

All V8 RHD Models without anti roll bar

Kit includes 2 front &amp; 2 rear shock absorbers &amp; 4 coil springs

to (VIN) BA999999	Aftermarket	1	<b>RA1114P</b>	96.67	116.00
from (VIN) CA000001 to GA417084	Aftermarket	1	<b>RA1116P</b>	100.83	121.00
from (VIN) GA417085 to GA450646	Aftermarket	1	<b>RA1118P</b>	105.00	126.00
from (VIN) GA450647 to HA464553	Aftermarket	1	<b>RA1120P</b>	105.00	126.00
from (VIN) HA464554 to HA471543	Aftermarket	1	<b>RA1122P</b>	103.33	124.00
from (VIN) HA471544 to LA647644	Aftermarket	1	<b>RA1124P</b>	103.33	124.00
from (VIN) MA647645 on	Aftermarket	1	<b>RA1126P</b>	145.00	174.00
	Genuine	1	<b>RA1126</b>	370.83	445.00

All V8 RHD models with anti roll bar

Kit includes 2 front &amp; 2 rear shock absorbers &amp; 4 coil springs

from (VIN) GA399973 to GA464553	Aftermarket	1	<b>RA1143P</b>	105.00	126.00
from (VIN) HA464554 to KA638829	Aftermarket	1	<b>RA1145P</b>	106.67	128.00
from (VIN) KA638830 to LA647644	Aftermarket	1	<b>RA1147P</b>	103.33	124.00
from (VIN) MA647645 on	Aftermarket	1	<b>RA1149P</b>	147.50	177.00
	Genuine	1	<b>RA1149</b>	370.83	445.00

All V8 LHD models without anti roll bar

Kit includes 2 front &amp; 2 rear shock absorbers &amp; 4 coil springs

to (VIN) BA999999	Aftermarket	1	<b>RA1115P</b>	104.17	125.00
from (VIN) CA000001 to GA417084	Aftermarket	1	<b>RA1117P</b>	101.67	122.00
from (VIN) GA417085 to GA450646	Aftermarket	1	<b>RA1119P</b>	107.50	129.00
from (VIN) GA450647 to HA464553	Aftermarket	1	<b>RA1121P</b>	107.50	129.00
from (VIN) HA464554 to HA471543	Aftermarket	1	<b>RA1123P</b>	103.33	124.00
from (VIN) HA471544 to LA647644	Aftermarket	1	<b>RA1125P</b>	103.33	124.00
from (VIN) MA647645 on	Aftermarket	1	<b>RA1127P</b>	154.17	185.00

All V8 LHD models with anti roll bar

Kit includes 2 front &amp; 2 rear shock absorbers &amp; 4 coil springs

from (VIN) GA399973 to GA464553	Aftermarket	1	<b>RA1144P</b>	103.33	124.00
from (VIN) HA464554 to KA638829	Aftermarket	1	<b>RA1146P</b>	108.33	130.00
from (VIN) KA638830 to LA647644	Aftermarket	1	<b>RA1148P</b>	103.33	124.00
from (VIN) MA647645 on	Aftermarket	1	<b>RA1150P</b>	156.67	188.00

All diesel RHD models without anti roll bar

Kit includes 2 front &amp; 2 rear shock absorbers &amp; 4 coil springs

from (VIN) CA000001 to GA417084	Aftermarket	1	<b>RA1128P</b>	104.17	125.00
from (VIN) GA417085 to GA450646	Aftermarket	1	<b>RA1130P</b>	101.67	122.00
from (VIN) GA450647 to HA464553	Aftermarket	1	<b>RA1132P</b>	101.67	122.00
from (VIN) HA464554 to HA471543	Aftermarket	1	<b>RA1134P</b>	106.67	128.00
from (VIN) HA471544 to HA477607	Aftermarket	1	<b>RA1136P</b>	106.67	128.00
from (VIN) HA477608 to LA647644	Aftermarket	1	<b>RA1138P</b>	103.33	124.00
from (VIN) MA647645 on	Genuine	1	<b>RA1140</b>	370.83	445.00
	Aftermarket	1	<b>RA1140P</b>	155.83	187.00

All diesel RHD models with anti roll bar

Kit includes 2 front &amp; 2 rear shock absorbers &amp; 4 coil springs

from (VIN) GA399973 to GA464553	Aftermarket	1	<b>RA1151P</b>	105.00	126.00
from (VIN) HA464554 to HA477607	Aftermarket	1	<b>RA1153P</b>	106.67	128.00
from (VIN) HA477608 to KA638829	Aftermarket	1	<b>RA1155P</b>	115.00	138.00
from (VIN) KA638830 to LA647644	Aftermarket	1	<b>RA1157P</b>	107.50	129.00
from (VIN) MA647645 on	Aftermarket	1	<b>RA1159P</b>	157.50	189.00
	Genuine	1	<b>RA1159</b>	370.83	445.00

All diesel LHD models without anti roll bar

Kit includes 2 front &amp; 2 rear shock absorbers &amp; 4 coil springs

from (VIN) CA000001 to GA417084	Aftermarket	1	<b>RA1129P</b>	117.50	141.00
from (VIN) GA417085 to GA450646	Aftermarket	1	<b>RA1131P</b>	115.83	139.00
from (VIN) GA450647 to HA454553	Aftermarket	1	<b>RA1133P</b>	115.83	139.00
from (VIN) HA464554 to HA471543	Aftermarket	1	<b>RA1135P</b>	111.67	134.00
from (VIN) HA471544 to HA477607	Aftermarket	1	<b>RA1137P</b>	111.67	134.00
from (VIN) HA477608 to LA647644	Aftermarket	1	<b>RA1139P</b>	142.50	171.00
from (VIN) MA647645 on	Aftermarket	1	<b>RA1141P</b>	184.17	221.00
	Aftermarket	1	<b>RA1141PA</b>	184.17	221.00

All diesel LHD models with anti roll bar

Kit includes 2 front &amp; 2 rear shock absorbers &amp; 4 coil springs

from (VIN) GA399973 to GA464553	Aftermarket	1	<b>RA1152P</b>	114.17	137.00
from (VIN) HA464554 to HA477607	Aftermarket	1	<b>RA1154P</b>	111.67	134.00
from (VIN) HA477608 to KA638829	Aftermarket	1	<b>RA1156P</b>	137.50	165.00
from (VIN) KA638830 to LA647644	Aftermarket	1	<b>RA1158P</b>	142.50	171.00
from (VIN) MA647645 on	Aftermarket	1	<b>RA1160P</b>	185.83	223.00

All CSK models with anti roll bar

Kit includes 2 front &amp; 2 rear shock absorbers &amp; 4 coil springs

	Aftermarket	1	<b>RA1142P</b>	105.00	126.00
--	-------------	---	----------------	--------	--------

## Air to Coil Spring Conversion Kit

All models - Kit includes 4 coil springs &amp; fitting kit

Bearmach	1	<b>RA1448BM</b>	155.00	186.00
Britpart	1	<b>RA1448BP</b>	145.83	175.00



RA1123P



RA1140P



RA1152P





# STEERING

# RANGE ROVER CLASSIC (1970 TO 1996)

## Drop Arm

All RHD non-PAS models up to (VIN) AA135736 - Steering box				
Genuine	1	<b>NRC8514</b>	244.80	293.76
All RHD models (VIN) JA621324 on - Steering box				
OEM	1	<b>NTC9236P1</b>	27.50	33.00
Genuine	1	<b>NTC9236</b>	114.41	137.29
All LHD models (VIN) JA621324 on - Steering box				
OEM	1	<b>NTC9235P1</b>	27.50	33.00
Genuine	1	<b>NTC9235</b>	102.05	122.46

## Drop Arm Lever

All RHD models to (VIN) JA621323	Aftermarket	1	<b>QFW000020P</b>	18.54	22.25
	OEM	1	<b>QFW000020P1</b>	57.50	69.00
	Genuine	1	<b>QFW000020</b>	112.70	135.24

## Steering Arm Lever

All LHD models to (VIN) JA621323	Aftermarket	1	<b>QFW000030P</b>	16.67	20.00
	OEM	1	<b>QFW000030P1</b>	57.50	69.00
	Genuine	1	<b>QFW000030</b>	112.70	135.24

## Heavy Duty Steering Arm Kit

All models up to (VIN) JA615503 <i>Includes cross rod and track rod (3 ball joints). Requires fitting kit RD125371BPFK</i>	Britpart	1	<b>RA2071BP</b>	93.33	112.00
	Terrafirma	1	<b>RA2071TF</b>	95.00	114.00
All models from (VIN) JA615503 on - <i>Includes cross rod and track rod (4 ball joints). Requires fitting kit RD125371BPFK</i>	Britpart	1	<b>RD1253BP</b>	90.00	108.00
	Terrafirma	1	<b>RD1253TF</b>	93.33	112.00

## Fitting Kit, Heavy Duty Steering Arms

All models to be fitted with Britpart heavy duty steering arms <i>Includes U bolts, nuts and damper bracket for RA2071BP or RD1253BP</i>	Britpart	1	<b>RD125371BPFK</b>	7.50	9.00
------------------------------------------------------------------------------------------------------------------------------------------	----------	---	---------------------	------	------

## Drag Link Assembly

All models up to (VIN) JA615503 - <i>Includes ball joints</i>	Aftermarket	1	<b>NRC3226P</b>	39.58	47.50
All models from (VIN) JA615504 on - <i>Includes ball joints</i>	Aftermarket	1	<b>NTC9607P</b>	39.58	47.50
	Genuine	1	<b>NTC9607</b>	105.59	126.71

## Ball Joint, Drop Arm

All models up to (VIN) JA621323					
RH	Aftermarket	1	<b>RBG000010P</b>	4.58	5.50
	OEM	1	<b>RBG000010P1</b>	20.63	24.76
	Genuine	1	<b>RBG000010</b>	55.33	66.40

## Adjustment Shaft

All models - Track rod	Aftermarket	2	<b>NRC4700P</b>	4.17	5.00
	OEM	1	<b>NRC4700P1</b>	11.88	14.26
	Genuine	1	<b>NRC4700</b>	52.18	62.62

## Universal Joint

All models up to (VIN) HA601606 Upper & lower to 1984, lower only from 1984 on	Aftermarket	2	<b>NRC7704P</b>	8.54	10.25
	OEM	2	<b>NRC7704P1</b>	27.50	33.00
	Genuine	2	<b>NRC7704</b>	47.31	56.77
All models from (VIN) HA601607 to LA647644 - Lower	Aftermarket	1	<b>NRC7387P</b>	8.54	10.25
	OEM	1	<b>NRC7387P1</b>	27.50	33.00
	Genuine	1	<b>NRC7387</b>	48.59	58.31

## Lower Shaft Assembly

All models from (VIN) AA to LA647644 - With joints	Aftermarket	1	<b>NTC8478P</b>	27.50	33.00
All models from (VIN) MA647645 on - With universal joints	Aftermarket	1	<b>QME500040P</b>	39.58	47.50
	Genuine	1	<b>QME500040</b>	186.01	223.21

## Rubber Coupling, Steering Column

All models from (VIN) AA to HA601606	Genuine	1	<b>NTC3486P</b>	5.00	6.00
--------------------------------------	---------	---	-----------------	------	------

## Seal, Steering Column

All models up to (VIN) LA647644 - Steering column to bulkhead	Genuine	1	<b>575733</b>	0.55	0.66
---------------------------------------------------------------	---------	---	---------------	------	------

## Steering Damper Assembly

All models	Aftermarket	1	<b>STC786P</b>	10.00	12.00
	Bilstein	1	<b>STC786UR</b>	67.50	81.00
	OEM	1	<b>STC786P1</b>	37.50	45.00
	Terrafirma	1	<b>STC786TF</b>	33.75	40.50
	Genuine	1	<b>STC786</b>	65.72	78.86
Super Gaz	Super Gaz	1	<b>STC786UR-BPSUP</b>	25.83	31.00
Cellular Dynamic	Cellular Dynamic	1	<b>STC786UR-BPCEL</b>	29.58	35.50

## Fitting Kit, Steering Damper

All models - <i>Allows Terrafirma Defender 'return to centre' damper or adjustable damper to be fitted</i>	Terrafirma	1	<b>STC786TFRTCFK</b>	53.33	64.00
------------------------------------------------------------------------------------------------------------	------------	---	----------------------	-------	-------

## Bush Steering Damper

All models	Aftermarket	4	<b>568858P</b>	0.38	0.46
	Genuine	4	<b>568858</b>	4.92	5.90

## Bush Steering Damper Polyurethane

All models	Aftermarket	4	<b>568858POLY</b>	2.00	2.40
------------	-------------	---	-------------------	------	------

## Steering Damper Bush Kit

All models - Uprated polyurethane	Aftermarket	1	<b>RD1065</b>	7.50	9.00
-----------------------------------	-------------	---	---------------	------	------

## Track Rod Assembly

All models	Aftermarket	1	<b>RTC1799P</b>	39.58	47.50
	OEM	1	<b>RTC1799P1</b>	60.00	72.00
	Genuine	1	<b>RTC1799</b>	228.91	274.69

## Track Rod Tube

All models from 1976 approx. on (suffix C on)					
	Aftermarket	1	<b>NRC145P</b>	14.58	17.50
	Genuine	1	<b>NRC145</b>	116.62	139.94

## Track Rod End

All models - Track rod end					
RH thread, non-greasable	Aftermarket	2	<b>RTC5869P</b>	4.58	5.50
	OEM	2	<b>RTC5869P1</b>	10.63	12.76
	Genuine	2	<b>RTC5869</b>	35.73	42.88
LH thread, non-greasable	Aftermarket	1	<b>RTC5870P</b>	4.58	5.50
	OEM	1	<b>RTC5870P1</b>	10.63	12.76
	Genuine	1	<b>RTC5870</b>	35.73	42.88

## Rubber Cap Track Rod End

All models	Aftermarket	1	<b>214649P</b>	1.33	1.60
	Genuine	1	<b>214649</b>	4.57	5.48

## Spring Ring Track Rod End

All models - Rubber cap, large diameter	Genuine	1	<b>214685</b>	3.15	3.78
-----------------------------------------	---------	---	---------------	------	------

## Ball Joint Kit

All RHD models with manual steering up to (VIN) AA135736 - Drop arm	OEM	1	<b>AEU2761P1</b>	24.58	29.50
	Genuine	1	<b>AEU2761</b>	85.12	102.14
All LHD models with manual steering up to (VIN) AA132294 - Drop arm	OEM	1	<b>AEU2761P1</b>	24.58	29.50
	Genuine	1	<b>AEU2761</b>	85.12	102.14

## Cross Rod Eye End

All models from (VIN) suffix D on	Aftermarket	1	<b>NRC1823P</b>	15.63	18.76
	Genuine	1	<b>NRC1823</b>	95.42	114.50

## Cross Rod Tube

All models up to (VIN) JA615503	Aftermarket	1	<b>NRC1824P</b>	14.58	17.50
All models from (VIN) JA615504 on	Aftermarket	1	<b>NTC8390P</b>	11.67	14.00
	OEM	1	<b>NTC8390P1</b>	15.63	18.76
	Genuine	1	<b>NTC8390</b>	112.14	134.57

## Shaft Adjustable, Drag Link

All models from 1976 approx. on (suffix C on)					
	Aftermarket	1	<b>NRC4700P</b>	4.17	5.00
	OEM	1	<b>NRC4700P1</b>	11.88	14.26
	Genuine	1	<b>NRC4700</b>	52.18	62.62

## Seal Kit Steering Box

All models up to (VIN) BA - Adwest heavyweight type (3 bolt top plate)	Aftermarket	1	<b>RTC308P</b>	8.96	10.75
	Genuine	1	<b>RTC308</b>	103.71	124.45
All models with Adwest power steering - For steering box with 3 or 4 bolt top plate	Aftermarket	1	<b>STC2848P</b>	3.75	4.50
	OEM	1	<b>STC2848P1</b>	5.63	6.76
	Genuine	1	<b>STC2848</b>	20.28	24.34
All models with Adwest lightweight power steering - For steering box with 4 bolt top plate	Aftermarket	1	<b>STC2847P</b>	9.79	11.75
	Genuine	1	<b>STC2847</b>	67.67	81.20

## Pinion Seal Steering Box

All models with Adwest steering box	Genuine	1	<b>608065</b>	7.28	8.74
-------------------------------------	---------	---	---------------	------	------

## Seal Kit Input Shaft Steering Box

All models with Adwest lightweight power steering - For steering box with 4 bolt top plate	Aftermarket	1	<b>STC889P</b>	5.63	6.76
	Genuine	1	<b>STC889</b>	33.20	39.84

## Pad Adjuster Kit Steering Box

All models with Adwest lightweight power steering - For steering box with 4 bolt top plate	Genuine	1	<b>STC4385</b>	124.00	148.80
--------------------------------------------------------------------------------------------	---------	---	----------------	--------	--------

## Shaft Assembly Steering Box

All LHD models from (VIN) CA on - Adwest lightweight type	Land Rover	1	<b>RTC4399</b>	301.74	362.09
-----------------------------------------------------------	------------	---	----------------	--------	--------

## Tie Bar, Mounting

All models from (VIN) MA647645 on - Steering box	Aftermarket	1	<b>LR041261P</b>	15.63	18.76
	Genuine	1	<b>LR041261</b>	46.04	55.25





## RANGE ROVER CLASSIC (1970 TO 1996)

## STEERING

## Gasket Steering Box

All manual steering models	Genuine	1	<b>271379</b>	2.06	2.47
----------------------------	---------	---	---------------	------	------

## Oil Seal Steering Box

All manual steering models	Genuine	1	<b>507774</b>	7.32	8.78
----------------------------	---------	---	---------------	------	------

## Washer Steering Box

All manual steering models	Genuine	2	<b>572077</b>	1.91	2.29
----------------------------	---------	---	---------------	------	------

## Seal Kit Steering Pump

All power steering models to (VIN) HA	Aftermarket	1	<b>ABU7142P</b>	5.00	6.00
	Genuine	1	<b>ABU7142</b>	50.03	60.04

All V8 models from (VIN) JA610294 to LA647644	Aftermarket	1	<b>STC1633P</b>	1.50	1.80
-----------------------------------------------	-------------	---	-----------------	------	------

## Gasket Kit Power Steering Pump

All power steering models to (VIN) HA	Aftermarket	1	<b>ABU7145P</b>	4.00	4.80
All V8 petrol models from (VIN) CA to LA647644 with 30 series steering pump	Aftermarket	1	<b>ABU7145P</b>	4.00	4.80

## Seal, Power Steering Pump

All 2.4L or 2.5L VM turbo diesel models (with Gemmer or Hobourn Eaton power steering pump)					
Inlet union. Dowty washer type seal	Aftermarket	1	<b>RTC5675P</b>	1.00	1.20
	Genuine	1	<b>RTC5675</b>	3.39	4.07

## Power Steering Fluid

All models with power steering - 1 litre. Cold (standard) climates fluid					
	Aftermarket	a/r	<b>STC50519P</b>	12.08	14.50
	Genuine	a/r	<b>STC50519</b>	18.96	22.75

## Cap, Power Steering Reservoir

All models with plastic power steering reservoir					
	Genuine	1	<b>NTC2723</b>	21.59	25.91

## Cap Steering Reservoir

All models from 1978 to (VIN) GA	Genuine	1	<b>RTC3056</b>	27.02	32.42
----------------------------------	---------	---	----------------	-------	-------

## Filter, Power Steering Fluid

All models with PAS with metal reservoir with dipstick in cap - Reservoir					
	Aftermarket	1	<b>601444P</b>	4.00	4.80

## Gasket

All models					
Swivel housing	Aftermarket	2	<b>FTC3646P</b>	0.50	0.60
	Genuine	2	<b>FTC3646</b>	2.14	2.57
Lower swivel pin	Aftermarket	2	<b>FTC3647P</b>	0.50	0.60
	Genuine	2	<b>FTC3647</b>	2.46	2.95

## RANGE ROVER CLASSIC (1970 TO 1996)

## CLUTCH

## Clutch Plate &amp; Cover Assembly

All 3.9L V8 petrol engine models	Aftermarket	1	<b>8510310P</b>	95.41	114.49
	Genuine	1	<b>8510310</b>	318.10	381.72

All 2.4L & 2.5L VM turbo diesel models	Aftermarket	1	<b>LR009366P</b>	57.50	69.00
	OEM	1	<b>LR009366P1</b>	70.00	84.00
	Genuine	1	<b>LR009366</b>	169.85	203.82

Heavy duty	Britpart	1	<b>LR009366BPHDPARTIAL</b>	49.17	59.00
------------	----------	---	----------------------------	-------	-------

All 200 and 300 TDi diesel models	Aftermarket	1	<b>LR009366P</b>	57.50	69.00
	OEM	1	<b>LR009366P1</b>	70.00	84.00
	Genuine	1	<b>LR009366</b>	169.85	203.82

Heavy duty	Britpart	1	<b>LR009366BPHDPARTIAL</b>	49.17	59.00
------------	----------	---	----------------------------	-------	-------

## Clutch Kit

All V8 petrol models with 4 speed LT95 gearbox - Includes clutch plate, cover and release bearing	Aftermarket	1	<b>GCK203P</b>	91.67	110.00
---------------------------------------------------------------------------------------------------	-------------	---	----------------	-------	--------

All 3.5L V8 carb petrol models with 5 speed LT77 gearbox - Includes clutch plate, cover and release bearing	Aftermarket	1	<b>GCK204P</b>	90.83	109.00
	Genuine	1	<b>GCK204</b>	275.00	330.00

All 3.5L V8 EFI petrol models with 5 speed LT77 gearbox - Includes clutch plate, cover and release bearing	Aftermarket	1	<b>GCK204P</b>	90.83	109.00
	Genuine	1	<b>GCK204</b>	275.00	330.00

All 3.9L V8 EFI petrol models up to (VIN) HA610293 - Includes clutch plate, cover and release bearing	Aftermarket	1	<b>GCK775P</b>	83.33	100.00
	Genuine	1	<b>GCK775</b>	255.00	306.00

All 3.9L & 4.2L V8 EFI petrol manual models from (VIN) JA610294 on includes clutch cover, plate & release bearing	OEM	1	<b>STC8362P1</b>	100.00	120.00
	Genuine	1	<b>STC8362</b>	233.00	279.60

All 2.4L VM Turbo Diesel models - Includes clutch cover, plate, release bearing & clip	Aftermarket	1	<b>RA1092P</b>	57.50	69.00
	Genuine	1	<b>RA1092</b>	229.17	275.00

All 2.4L & 2.5L VM turbo diesel models - Includes clutch cover, plate & release bearing	Britpart	1	<b>LR009366BP</b>	50.00	60.00
	Genuine	1	<b>GCK555AF</b>	125.83	151.00

All 200 and 300 TDi diesel models - Includes clutch cover, plate & release bearing	Britpart	1	<b>LR009366BP</b>	50.00	60.00
	Genuine	1	<b>GCK555AF</b>	125.83	151.00

All 2.4L & 2.5L VM turbo diesel models - Heavy duty, Includes clutch cover, plate & release bearing	Britpart	1	<b>LR009366BPHD</b>	55.00	66.00
Includes clutch cover, plate, release bearing & fork	Britpart	1	<b>LR009366BPHDFORK</b>	90.83	109.00
Includes clutch cover, plate & release bearing	Britpart	1	<b>LR009366BPHDOEM</b>	95.00	114.00

All 200 and 300 TDi diesel models - Heavy duty, Includes clutch cover, plate & release bearing	Britpart	1	<b>LR009366BPHD</b>	55.00	66.00
Includes clutch cover, plate, release bearing & fork	Britpart	1	<b>LR009366BPHDFORK</b>	90.83	109.00
Includes clutch cover, plate & release bearing	Britpart	1	<b>LR009366BPHDOEM</b>	95.00	114.00

## Clutch Cover

All 3.5L V8 petrol models	Aftermarket	1	<b>576476P</b>	39.58	47.50
	OEM	1	<b>576476P1</b>	60.00	72.00
	Genuine	1	<b>576476</b>	118.73	142.48

All 3.9L V8 petrol models up to (VIN) HA	OEM	1	<b>FTC813P1</b>	54.17	65.00
	Genuine	1	<b>FTC813</b>	118.73	142.48

All V8 EFI petrol manual models from (VIN) JA610294 on	OEM	1	<b>FTC2001P1</b>	55.00	66.00
--------------------------------------------------------	-----	---	------------------	-------	-------

All diesel models	Aftermarket	1	<b>URB100760P</b>	29.58	35.50
	OEM	1	<b>URB100760P1</b>	39.58	47.50
	Genuine	1	<b>URB100760</b>	91.30	109.56

## Clutch Plate

All models up to (VIN) BA - LT95 4 speed gearbox	OEM	1	<b>FRC6631P1</b>	35.00	42.00
--------------------------------------------------	-----	---	------------------	-------	-------

All 3.5L V8 petrol models with 5 speed LT77 gearbox	Aftermarket	1	<b>FRC6685P</b>	32.08	38.50
	Genuine	1	<b>FRC6685</b>	139.32	167.18

All 3.9L V8 EFI petrol models up to (VIN) HA610293	Aftermarket	1	<b>FTC814P</b>	32.50	39.00
	OEM	1	<b>FTC814P1</b>	46.67	56.00
	Genuine	1	<b>FTC814</b>	118.22	141.86

All V8 EFI petrol manual models from (VIN) JA610294 on	OEM	1	<b>FTC2002P1</b>	47.50	57.00
--------------------------------------------------------	-----	---	------------------	-------	-------

All 2.4L VM Turbo Diesel models	OEM	1	<b>FTC148P1</b>	32.08	38.50
	Genuine	1	<b>FTC148</b>	115.05	138.06

All 2.5L diesel models	Aftermarket	1	<b>UQB500030P</b>	22.50	27.00
	OEM	1	<b>GCP242</b>	45.00	54.00
	Genuine	1	<b>UQB500030</b>	119.39	143.27

## Clutch Release Bearing

All models - With carrier	Aftermarket	1	<b>FTC5200P</b>	7.92	9.50
	OEM	1	<b>FTC5200P1</b>	12.50	15.00
	Genuine	1	<b>FTC5200</b>	37.38	44.86

## Clutch Release Bearing Heavy Duty

All models - With carrier	Britpart	1	<b>FTC5200HDBP</b>	45.83	55.00
	Bearmach	1	<b>FTC5200HDBM</b>	80.00	96.00

## Clutch Release Bearing Guide

All 300TDi diesel models	Aftermarket	1	<b>FTC5218P</b>	21.67	26.00
	OEM	1	<b>FTC5218P1</b>	39.58	47.50
	Genuine	1	<b>FTC5218</b>	81.82	98.18

## Clutch Fork

All 3.5L V8 petrol models	Aftermarket	1	<b>576137P</b>	23.96	28.75
	OEM	1	<b>576137P1</b>	29.58	35.50
	Genuine	1	<b>576137</b>	63.81	76.57

All 3.9L V8 petrol models up to (eng) 35D07802A	Aftermarket	1	<b>576137P</b>	23.96	28.75
	OEM	1	<b>576137P1</b>	29.58	35.50
	Genuine	1	<b>576137</b>	63.81	76.57

All 3.9L V8 petrol models from (eng) 35D07803A to (VIN) LA647644	Aftermarket	1	<b>FTC2957P</b>	3.75	4.50
	OEM	1	<b>FTC2957P1</b>	10.83	13.00
	Genuine	1	<b>FTC2957</b>	23.33	28.00

All V8 petrol models from (VIN) MA647645 on	Aftermarket	1	<b>576137P</b>	23.96	28.75
	OEM	1	<b>576137P1</b>	29.58	35.50
	Genuine	1	<b>576137</b>	63.81	76.57

All 2.4L and 2.5L VM diesel models	Aftermarket	1	<b>576137P</b>	23.96	28.75
	OEM	1	<b>576137P1</b>	29.58	35.50
	Genuine	1	<b>576137</b>	63.81	76.57

All 200TDi diesel models up to (eng) 14L01313A	Aftermarket	1	<b>576137P</b>	23.96	28.75
	OEM	1	<b>576137P1</b>	29.58	35.50
	Genuine	1	<b>576137</b>	63.81	76.57

All 200TDi diesel models from (eng) 14L01314A on	Aftermarket	1	<b>FTC2957P</b>	3.75	4.50
	OEM	1	<b>FTC2957P1</b>	10.83	13.00
	Genuine	1	<b>FTC2957</b>	23.33	28.00

All 300TDi diesel models	Aftermarket	1	<b>FTC2957P</b>	3.75	4.50
	OEM	1	<b>FTC2957P1</b>	10.83	13.00
	Genuine	1	<b>FTC2957</b>	23.33	28.00



# CLUTCH

# RANGE ROVER CLASSIC (1970 TO 1996)

## Clutch Fork Heavy Duty

All 3.9L V8 petrol models from (eng) 35D07803A to (VIN) LA647644				
	Britpart	1	<b>FTC2957BPHD</b>	8.75 10.50
All 200TDi diesel models from (eng) 14L01314A on				
	Britpart	1	<b>FTC2957BPHD</b>	8.75 10.50
All 300TDi diesel models				
	Britpart	1	<b>FTC2957BPHD</b>	8.75 10.50

## Clutch Fork Kit Heavy Duty

All 3.9L V8 petrol models from (eng) 35D07803A to (VIN) LA647644				
<i>Includes release fork, slipper pads, bush, staple &amp; clip</i>				
	Britpart	1	<b>FTC2957BPHDKIT</b>	11.67 14.00
All 200TDi diesel models from (eng) 14L01314A on				
<i>Includes release fork, slipper pads, bush, staple &amp; clip</i>				
	Britpart	1	<b>FTC2957BPHDKIT</b>	11.67 14.00
All 300TDi diesel models				
<i>Includes release fork, slipper pads, bush, staple &amp; clip</i>				
	Britpart	1	<b>FTC2957BPHDKIT</b>	11.67 14.00

## Clutch Fork Staple Retainer

All 3.5L V8 petrol models				
	Aftermarket	1	<b>576203P</b>	0.25 0.30
	Genuine	1	<b>576203</b>	0.66 0.79
All 3.9L V8 petrol models up to (eng) 35D07802A				
	Aftermarket	1	<b>576203P</b>	0.25 0.30
	Genuine	1	<b>576203</b>	0.66 0.79
All 3.9L V8 petrol models from (eng) 35D07803A to (VIN) LA647644				
	Aftermarket	1	<b>FRC3416P</b>	0.58 0.70
	Genuine	1	<b>FRC3416</b>	2.35 2.82
All 200TDi diesel models from (eng) 14L01314A on				
	Aftermarket	1	<b>FRC3416P</b>	0.58 0.70
	Genuine	1	<b>FRC3416</b>	2.35 2.82
All 300TDi diesel models				
	Aftermarket	1	<b>FRC3416P</b>	0.58 0.70
	Genuine	1	<b>FRC3416</b>	2.35 2.82

## Pad Clutch Release Lever

All 4 cyl models with 5 speed LT77 gearbox				
	Aftermarket	2	<b>FRC5255P</b>	0.50 0.60
	Genuine	2	<b>FRC5255</b>	1.53 1.84
All 4 cyl models with 5 speed R380 gearbox				
	Aftermarket	2	<b>FRC5255P</b>	0.50 0.60
	Genuine	2	<b>FRC5255</b>	1.53 1.84

## Clutch Hose

All V8 petrol models				
	Aftermarket	1	<b>NRC2211P</b>	3.25 3.90
	Genuine	1	<b>NRC2211</b>	33.62 40.34
All diesel models				
	Aftermarket	1	<b>NTC3400P</b>	5.83 7.00
	OEM	1	<b>NTC3400P1</b>	12.08 14.50
	Genuine	1	<b>NTC3400</b>	51.97 62.36

## Clutch Pipe Assembly

All manual models up to (VIN) BA - From clutch hose to slave cylinder				
	OEM	1	<b>577643P1</b>	9.58 11.50
	Genuine	1	<b>577643</b>	12.26 14.71
All petrol manual models from (VIN) KA633399 on - From clutch hose to slave cylinder				
	Genuine	1	<b>ANR2183</b>	14.79 17.75

## Clutch Master Cylinder

All V8 petrol models up to (VIN) LA647644				
	Aftermarket	1	<b>AEU1714P</b>	14.79 17.75
	OEM	1	<b>AEU1714P1</b>	43.33 52.00
	Genuine	1	<b>AEU1714</b>	88.96 106.75
All V8 petrol models from (VIN) MA647645 on				
	Aftermarket	1	<b>ANR2186P</b>	22.08 26.50
	OEM	1	<b>ANR2186P1</b>	33.75 40.50
	Genuine	1	<b>ANR2186</b>	99.89 119.87
All 2.4L and 2.5L VM diesel models				
	Aftermarket	1	<b>AEU1714P</b>	14.79 17.75
	OEM	1	<b>AEU1714P1</b>	43.33 52.00
	Genuine	1	<b>AEU1714</b>	88.96 106.75
All 200TDi diesel models				
	Aftermarket	1	<b>AEU1714P</b>	14.79 17.75
	OEM	1	<b>AEU1714P1</b>	43.33 52.00
	Genuine	1	<b>AEU1714</b>	88.96 106.75
All 300TDi diesel models				
	Aftermarket	1	<b>ANR2651P</b>	29.58 35.50
	OEM	1	<b>ANR2651P1</b>	37.50 45.00
	Genuine	1	<b>ANR2651</b>	88.96 106.75

## Master Cylinder Repair Kit

All models up to 1973 fitted with original master cylinder - <i>For master cylinder without identification groove</i>				
	Aftermarket	1	<b>8G8730</b>	2.58 3.10
All models from 1975 on - Clutch master cylinder				
	Aftermarket	1	<b>STC1126P</b>	1.75 2.10
	OEM	1	<b>STC1126P1</b>	3.92 4.70
	Genuine	1	<b>STC1126</b>	8.39 10.07

## Master Cylinder Reservoir Cap

All manual models from 1978 up to (VIN) LA647644 - Clutch master cylinder				
	Genuine	1	<b>513123A</b>	2.54 3.05

## Clutch Slave Cylinder

All 3.5L V8 petrol models - Early LT77 gearbox				
	Aftermarket	1	<b>TKC2786P</b>	5.21 6.25
	OEM	1	<b>TKC2786LP1</b>	23.75 28.50
	Genuine	1	<b>TKC2786L</b>	32.24 38.69
	Genuine	1	<b>TKC2786</b>	19.17 23.00
All 3.9L V8 petrol models up to (eng) 35D07802A - Early LT77 gearbox				
	Aftermarket	1	<b>TKC2786P</b>	5.21 6.25
	OEM	1	<b>TKC2786LP1</b>	23.75 28.50
	Genuine	1	<b>TKC2786L</b>	32.24 38.69
	Genuine	1	<b>TKC2786</b>	19.17 23.00
All V8 petrol models from (eng) 35D07803A to (VIN) LA647644 - Late LT77 gearbox				
	Aftermarket	1	<b>FTC2498P</b>	8.75 10.50
	OEM	1	<b>FTC2498P1</b>	21.67 26.00
	Genuine	1	<b>FTC2498</b>	41.44 49.73
All models from (VIN) MA647645 on - R380 gearbox				
	Aftermarket	1	<b>FTC5072P</b>	8.54 10.25
	OEM	1	<b>FTC5072P1</b>	14.58 17.50
	Genuine	1	<b>FTC5072</b>	65.51 78.61
All 2.4L and 2.5L VM diesel models - Early LT77 gearbox				
	Aftermarket	1	<b>TKC2786P</b>	5.21 6.25
	OEM	1	<b>TKC2786LP1</b>	23.75 28.50
	Genuine	1	<b>TKC2786L</b>	32.24 38.69
	Genuine	1	<b>TKC2786</b>	19.17 23.00
All 200TDi diesel models up to (eng) 14L01313A - Early LT77 gearbox				
	Aftermarket	1	<b>TKC2786P</b>	5.21 6.25
	OEM	1	<b>TKC2786LP1</b>	23.75 28.50
	Genuine	1	<b>TKC2786L</b>	32.24 38.69
	Genuine	1	<b>TKC2786</b>	19.17 23.00
All 200TDi diesel models from (eng) 14L01314A to (VIN) LA647644 - Late LT77 gearbox				
	Aftermarket	1	<b>FTC2498P</b>	8.75 10.50
	OEM	1	<b>FTC2498P1</b>	21.67 26.00
	Genuine	1	<b>FTC2498</b>	41.44 49.73

## Slave Cylinder Repair Kit

All 3.5L V8 petrol models - Early LT77 gearbox				
	Aftermarket	1	<b>514244P</b>	2.50 3.00
	Genuine	1	<b>514244</b>	8.12 9.74
All 3.9L V8 petrol models up to (eng) 35D07802A - Early LT77 gearbox				
	Aftermarket	1	<b>514244P</b>	2.50 3.00
	Genuine	1	<b>514244</b>	8.12 9.74
All 2.4L and 2.5L VM diesel models - Early LT77 gearbox				
	Aftermarket	1	<b>514244P</b>	2.50 3.00
	Genuine	1	<b>514244</b>	8.12 9.74
All 200TDi diesel models up to (eng) 14L01313A - Early LT77 gearbox				
	Aftermarket	1	<b>514244P</b>	2.50 3.00
	Genuine	1	<b>514244</b>	8.12 9.74
All models from (VIN) MA647645 on - R380 gearbox type				
	Aftermarket	1	<b>STC2818P</b>	1.25 1.50
	OEM	1	<b>STC2818P1</b>	4.00 4.80
	Genuine	1	<b>STC2818</b>	6.22 7.46

## Push Rod Clip

All 3.5L V8 petrol models				
	Aftermarket	1	<b>576723P</b>	0.38 0.46
	Genuine	1	<b>576723</b>	3.95 4.74
All 3.9L V8 petrol models up to (eng) 35D07802A				
	Aftermarket	1	<b>576723P</b>	0.38 0.46
	Genuine	1	<b>576723</b>	3.95 4.74
All 3.9L V8 petrol models from (eng) 35D07803A to (VIN) LA647644				
	Aftermarket	1	<b>FRC3327P</b>	0.75 0.90
	Genuine	1	<b>FRC3327</b>	3.23 3.88
All V8 petrol models from (VIN) MA647645 on				
	Aftermarket	1	<b>576723P</b>	0.38 0.46
	Genuine	1	<b>576723</b>	3.95 4.74
All 2.4L and 2.5L VM diesel models				
	Aftermarket	1	<b>576723P</b>	0.38 0.46
	Genuine	1	<b>576723</b>	3.95 4.74
All 200TDi diesel models up to (eng) 14L01313A				
	Aftermarket	1	<b>576723P</b>	0.38 0.46
	Genuine	1	<b>576723</b>	3.95 4.74
All 200TDi diesel models from (eng) 14L01314A on				
	Aftermarket	1	<b>FRC3327P</b>	0.75 0.90
	Genuine	1	<b>FRC3327</b>	3.23 3.88
All 300TDi diesel models				
	Aftermarket	1	<b>FRC3327P</b>	0.75 0.90
	Genuine	1	<b>FRC3327</b>	3.23 3.88

## Push Rod

All 300TDi diesel models				
	Aftermarket	1	<b>FTC3912P</b>	8.33 10.00
	Genuine	1	<b>FTC3912</b>	16.78 20.14

## Bleed Screw Clutch Slave Cylinder

All models				
	Genuine	1	<b>606733A</b>	2.58 3.10

## Clutch Damper Assembly

All diesel models				
	Aftermarket	1	<b>STD10002P</b>	13.75 16.50
	Genuine	1	<b>STD10002</b>	56.95 68.34



## RANGE ROVER CLASSIC (1970 TO 1996)

## TRANSMISSION

## Constant Velocity Joint

All models to (VIN) EA305589 (axle) suffix A - 10 spline				
	Aftermarket	2	<b>606665P</b>	19.17 23.00
All non ABS models (VIN) EA305590 to KA624755 (axle) suffix B - 10 spline				
	Aftermarket	2	<b>RTC5843P</b>	17.08 20.50
All non ABS models (VIN) KA624756 on (axle) 55L00498B on - 24 spline				
	Aftermarket	2	<b>TDJ000010P</b>	20.63 24.76
All ABS fitted models to (axle) 57L05188B - 10 spline				
	Aftermarket	2	<b>RTC6811P</b>	19.58 23.50
	Genuine	2	<b>RTC6811</b>	493.19 591.83
All ABS fitted models (axle) 57L05189B on - 24 spline				
	Aftermarket	2	<b>TDJ000010P</b>	20.63 24.76

## Gaiter Propshaft c/w Clips

All models to (VIN) HA610293 - Front				
	Aftermarket	1	<b>276484P</b>	2.33 2.80
	Genuine	1	<b>276484</b>	22.65 27.18

## Gaiter Propshaft

All models to (VIN) HA610293				
	Aftermarket	1	<b>276483P</b>	3.00 3.60
	Genuine	1	<b>276483</b>	24.73 29.68
All models (VIN) MA647645 on				
	Aftermarket	1	<b>TVE100000P</b>	2.58 3.10
	OEM	1	<b>TVE100000P1</b>	3.08 3.70
	Genuine	1	<b>TVE100000</b>	15.14 18.17
All diesel models with catalyst				
	Aftermarket	1	<b>TVE100000P</b>	2.58 3.10
	OEM	1	<b>TVE100000P1</b>	3.08 3.70
	Genuine	1	<b>TVE100000</b>	15.14 18.17

## Propshaft Coupling

All models (VIN) MA647645 on - Without fixings				
	Aftermarket	1	<b>TVF100010P</b>	13.96 16.75
	OEM	1	<b>TVF100010P1</b>	32.50 39.00
	Genuine	1	<b>TVF100010</b>	69.22 83.06

## Bearing &amp; Bolt Kit

All models (VIN) MA647645 on - Rear propshaft coupling				
	Aftermarket	1	<b>TVF100010PKIT</b>	6.88 8.26

## Universal Joint

All models to (VIN) BA - Propshaft				
	Aftermarket	2	<b>RTC3346P</b>	3.50 4.20
	OEM	2	<b>RTC3346P1</b>	8.13 9.76
	Genuine	2	<b>RTC3346</b>	49.81 59.77

## Shaft Front Axle

All non ABS models (axle) 51L07997C on				
RH	Aftermarket	1	<b>TDC000020P</b>	22.08 26.50
	OEM	1	<b>TDC000020P1</b>	45.00 54.00
	Genuine	1	<b>TDC000020</b>	242.38 290.86
LH	Aftermarket	1	<b>TDC000030P</b>	22.92 27.50
	OEM	1	<b>TDC000030P1</b>	48.33 58.00
	Genuine	1	<b>TDC000030</b>	290.18 348.22
All non-ABS models (VIN) EA305590 to JA624754, (axle) suffix B				
RH	Aftermarket	1	<b>RTC5840P</b>	27.50 33.00
LH	Aftermarket	1	<b>RTC5842P</b>	27.50 33.00
All non-ABS models (VIN) KA624756 on to (axle) 55L00497B				
RH	Aftermarket	1	<b>RTC6754P</b>	21.67 26.00
	Genuine	1	<b>RTC6754</b>	174.72 209.66
LH	Aftermarket	1	<b>RTC6755P</b>	27.50 33.00
	Genuine	1	<b>RTC6755</b>	269.69 323.63
All ABS fitted models to (axle) 57L05188B				
RH	Aftermarket	1	<b>RTC6754P</b>	21.67 26.00
	Genuine	1	<b>RTC6754</b>	174.72 209.66
LH	Aftermarket	1	<b>RTC6755P</b>	27.50 33.00
	Genuine	1	<b>RTC6755</b>	269.69 323.63
RH, 10 spline	Genuine	1	<b>FTC862</b>	802.66 963.19
All ABS fitted models (axle) 57L05189B on				
RH	Aftermarket	1	<b>TDC000020P</b>	22.08 26.50
	OEM	1	<b>TDC000020P1</b>	45.00 54.00
	Genuine	1	<b>TDC000020</b>	242.38 290.86
LH	Aftermarket	1	<b>TDC000030P</b>	22.92 27.50
	OEM	1	<b>TDC000030P1</b>	48.33 58.00
	Genuine	1	<b>TDC000030</b>	290.18 348.22
All models (axle) 57L05189B on				
RH, 24 spline	Aftermarket	1	<b>TDB500280P</b>	39.58 47.50
	OEM	1	<b>TDB500280P1</b>	170.83 205.00
	Genuine	1	<b>TDB500280</b>	235.57 282.68
LH, 24 spline	Aftermarket	1	<b>TDB500290P</b>	45.00 54.00
	OEM	1	<b>TDB500290P1</b>	170.83 205.00
	Genuine	1	<b>TDB500290</b>	199.50 239.40

## Shaft Rear Axle

All non-ABS models from (VIN) JA624517 on, to (axle) 36S00594B				
RH, 10 spline	Aftermarket	1	<b>FTC3186P</b>	85.83 103.00
	Genuine	1	<b>FTC3186</b>	303.40 364.08
LH, 10 spline	Aftermarket	1	<b>FTC3187P</b>	85.00 102.00
	OEM	1	<b>FTC3187P1</b>	125.00 150.00
	Genuine	1	<b>FTC3187</b>	322.51 387.01
All non-ABS models from (VIN) JA624517 on, (axle) 36S00595B on				
RH, 24 spline	Aftermarket	1	<b>FTC3270P</b>	35.83 43.00
	Genuine	1	<b>FTC3270</b>	210.33 252.40
LH, 24 spline	Aftermarket	1	<b>FTC3271P</b>	38.33 46.00
	Genuine	1	<b>FTC3271</b>	241.79 290.15
All ABS models from (axle) 00001B on				
RH, 24 spline	Aftermarket	1	<b>FTC3270P</b>	35.83 43.00
	Genuine	1	<b>FTC3270</b>	210.33 252.40
LH, 24 spline	Aftermarket	1	<b>FTC3271P</b>	38.33 46.00
	Genuine	1	<b>FTC3271</b>	241.79 290.15
All ABS models from (VIN) JA624756 on				
RH, 10 spline	Aftermarket	1	<b>FTC3186P</b>	85.83 103.00
	Genuine	1	<b>FTC3186</b>	303.40 364.08
LH, 10 spline	Aftermarket	1	<b>FTC3187P</b>	85.00 102.00
	OEM	1	<b>FTC3187P1</b>	125.00 150.00
	Genuine	1	<b>FTC3187</b>	322.51 387.01

## Spacer Front Drive Shaft

All models to (VIN) EA305589, (axle) suffix A				
	Aftermarket	2	<b>FTC254P</b>	2.83 3.40
	Genuine	2	<b>FTC254</b>	5.31 6.37
All models (VIN) EA305590 on, (axle) suffix B				
	Genuine	1	<b>TYF000010</b>	3.99 4.79

## Shaft Assembly Front Output

All models with LT230 transfer box				
	Aftermarket	1	<b>FRC5449P</b>	38.75 46.50
	Genuine	1	<b>FRC5449</b>	190.22 228.26

## Half Shaft &amp; CV Joint

All models without ABS from (VIN) EA305590 to JA624516 - Front axle,				
RH	OEM	1	<b>FRC9518P1</b>	175.00 210.00
LH	OEM	1	<b>FRC9519P1</b>	175.00 210.00
All models with ABS up to (VIN) JA624516 - Rear axle				
LH	Genuine	1	<b>FTC871</b>	266.07 319.28

## Half Shaft

All models without ABS up to (VIN) EA305589 - Front axle,				
LH	Aftermarket	1	<b>606663P</b>	95.83 115.00
All models without ABS up to (VIN) JA624516 - Rear axle				
RH, 10 spline type	Genuine	1	<b>571882</b>	280.18 336.22

## Front Output Shaft

All V8 carb petrol models with 4 speed LT95 gearbox				
	OEM	1	<b>594337P1</b>	53.33 64.00
	Genuine	1	<b>594337</b>	145.02 174.02

## Spacer Hub

All models to (VIN) JA624516				
	Aftermarket	2	<b>FRC8227P</b>	1.75 2.10
	Genuine	2	<b>FRC8227</b>	29.89 35.87

## Hub Assembly

All models (VIN) JA624517 on				
	Aftermarket	2	<b>RUB500240P</b>	50.00 60.00
	Genuine	2	<b>RUB500240</b>	150.00 180.00

## Stub Axle Front

All non ABS models (VIN) EA305590 on, (axle) suffix B				
	Aftermarket	2	<b>FTC57P</b>	29.58 35.50
All models (axle) 56L03430B on, 57L00463A on				
	Aftermarket	2	<b>FTC3154P</b>	16.04 19.25
	OEM	2	<b>FTC3154P1</b>	50.00 60.00
	Genuine	2	<b>FTC3154</b>	82.86 99.43

## Stub Axle Rear

All models without ABS to (VIN) JA624516				
	Aftermarket	4	<b>FRC8005P</b>	45.00 54.00
	Genuine	4	<b>FRC8005</b>	206.92 248.30
All coil sprung models with ABS up to (axle) 35S16958B				
	OEM	2	<b>FTC950P1</b>	75.00 90.00
All air suspension models with ABS up to (axle) 37S00315A				
	OEM	2	<b>FTC950P1</b>	75.00 90.00
All models (VIN) JA624517 on				
	Aftermarket	4	<b>FTC3188P</b>	16.04 19.25
	OEM	4	<b>FTC3188P1</b>	45.00 54.00
	Genuine	4	<b>FTC3188</b>	83.71 100.45

## Stub Axle Nut

All models				
	Aftermarket	4	<b>FRC8700P</b>	1.25 1.50
	Genuine	4	<b>FRC8700</b>	10.09 12.11

## Stub Axle Kit

All models (axle) 56L03430B on, 57L00463A on, (VIN) JA624517 on				
<i>Includes stub axle, gasket, bolts, washers, bearing and seals</i>				
Front	Britpart	2	<b>FTC3154RRCBPK</b>	29.58 35.50
All models without ABS to (VIN) JA624516 - <i>includes stub axle, gasket, bolts, washers, bearing and seals</i>				
Rear	Britpart	2	<b>FRC8005BPK</b>	44.17 53.00
All models without ABS (VIN) JA624517 on - <i>includes stub axle, gasket, bolts and seal</i>				
Rear	Britpart	2	<b>FTC3188BPK</b>	19.58 23.50
All models with ABS (axle) 36S00082A on - <i>includes stub axle, gasket, bolts and seal</i>				
Rear	Britpart	2	<b>FTC3188BPK</b>	19.58 23.50

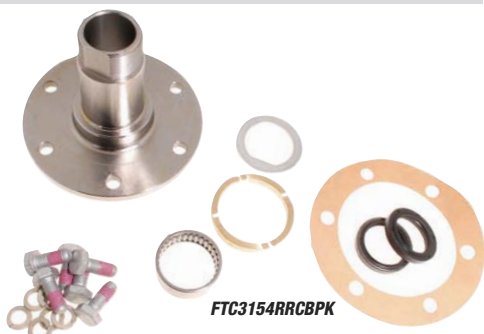

FTC3154RRCBPK



# TRANSMISSION

# RANGE ROVER CLASSIC (1970 TO 1996)

## Bearing Stub Housing

All non ABS fitted models (VIN) JA610294 to JA624516				
Aftermarket	2	<b>FTC861P</b>	5.63	6.76
OEM	2	<b>FTC861P1</b>	6.67	8.00
Genuine	2	<b>FTC861</b>	11.73	14.08
All ABS fitted models				
Aftermarket	2	<b>FTC861P</b>	5.63	6.76
OEM	2	<b>FTC861P1</b>	6.67	8.00
Genuine	2	<b>FTC861</b>	11.73	14.08

## Driving Member

All ABS fitted models - 24 spline, front and rear				
Aftermarket	2	<b>RUC105200P</b>	4.58	5.50
OEM	2	<b>RUC105200P1</b>	12.50	15.00
Genuine	2	<b>RUC105200</b>	118.51	142.21

## Driving Member Heavy Duty

All ABS fitted models - 24 spline, front and rear				
Terraforma	2	<b>RUC105200HDTF</b>	16.88	20.26
Britpart	2	<b>RUC105200HDBP</b>	25.83	31.00
Bearmach	2	<b>RUC105200HDBM</b>	16.88	20.26

## Driving Member Kit, Heavy Duty

All ABS fitted models - Pair of 24 spline driving members				
Britpart	2	<b>RUC105200HDKBP</b>	62.50	75.00

## Bolt Kit, Heavy Duty Driving Members

All models fitted with Britpart heavy duty driving members - Includes 10 bolts (one axle set)				
Britpart	1	<b>RUC105200BPKBOLT</b>	10.00	12.00

## Dust Cap, Screw On

All models fitted with Britpart heavy duty driving members					
Heavy duty driving member	Britpart	2	<b>RUC105200HDBPCAP</b>	8.75	10.50
All models fitted with Bearmach heavy duty driving members					
Heavy duty driving member	Bearmach	2	<b>RUC105200HDBMNUT</b>	3.33	4.00

## Bearing Swivel Pin Housing

All models				
Aftermarket	4	<b>606666P</b>	3.33	4.00
OEM	4	<b>606666P1</b>	10.42	12.50
Genuine	4	<b>606666</b>	23.99	28.79

## Housing, Swivel Pin

All models up to (VIN) BA - Chrome, 6 hole type				
Aftermarket	2	<b>571766P</b>	47.50	57.00
OEM	2	<b>571766P1</b>	105.00	126.00

## Housing Swivel Pin Bearing

All non ABS models (VIN) CA on				
Aftermarket	2	<b>FTC5366P</b>	80.00	96.00
OEM	2	<b>FTC5366P1</b>	85.00	102.00
Genuine	2	<b>FTC5366</b>	161.99	194.39
All ABS fitted models - 7 hole type				
Aftermarket	2	<b>FTC5105P</b>	60.00	72.00
OEM	2	<b>FTC5105P1</b>	87.50	105.00
Genuine	2	<b>FTC5105</b>	197.93	237.52

## Housing & Bush, Swivel Pin

All models with ABS - Upper, 'Railko bush'				
Aftermarket	2	<b>FTC125P</b>	8.96	10.75
OEM	2	<b>FTC125P1</b>	10.83	13.00
Genuine	2	<b>FTC125</b>	53.42	64.10

## Swivel Pin Upper

All non ABS models to (VIN) JA624516				
Aftermarket	2	<b>571756P</b>	5.00	6.00
All non ABS models (VIN) JA624517 on				
Aftermarket	2	<b>FTC2882P</b>	5.00	6.00
Genuine	2	<b>FTC2882</b>	51.55	61.86

## Swivel Pin Lower

All non ABS models to (VIN) JA624516				
Aftermarket	2	<b>571819P</b>	4.79	5.75
All non ABS models (VIN) JA624517 on				
Aftermarket	2	<b>FRC2894P</b>	2.50	3.00
Genuine	2	<b>FRC2894</b>	64.95	77.94
All ABS fitted models				
Aftermarket	2	<b>FRC2894P</b>	2.50	3.00
Genuine	2	<b>FRC2894</b>	64.95	77.94

## Swivel Pin Kit Upper

All ABS fitted models				
Aftermarket	2	<b>STC226P</b>	19.79	23.75
OEM	2	<b>STC226P1</b>	22.50	27.00
Genuine	2	<b>STC226</b>	35.75	42.90

## Damper, Swivel Pin

All models with ABS - Front axle					
RH	Genuine	1	<b>FTC1616</b>	38.03	45.64
LH	Genuine	1	<b>FTC1617</b>	38.03	45.64

## Thrust Bearing Swivel Pin

All ABS fitted models (VIN) HA464554 on				
Genuine	2	<b>FTC2065</b>	3.36	4.03

## Bush Swivel Housing

All non ABS models to (VIN) HA610293				
Aftermarket	2	<b>571821P</b>	8.13	9.76

## Swivel Housing Grease

All models					
Sachet	OEM	a/r	<b>STC3435P1</b>	5.00	6.00
	Genuine	a/r	<b>STC3435</b>	7.69	9.23
370g bottle	Britpart	a/r	<b>STC3435BPBOTTLE</b>	4.79	5.75
370ml sachet	Britpart	a/r	<b>STC3435BPSACHET</b>	4.38	5.26

## Gasket Oil Sump

All models with 4 speed auto gearbox				
Aftermarket	1	<b>RTC4268P</b>	2.50	3.00
OEM	1	<b>RTC4268P1</b>	4.00	4.80
Genuine	1	<b>RTC4268</b>	16.52	19.82

## Gasket Kit Auto Transmission

All 2.4L and 2.5L VM turbo diesel models with auto gearbox				
Aftermarket	1	<b>STC1623P</b>	75.00	90.00

## Oil Seal Diff Unit

All models to (VIN) BA				
Aftermarket	1	<b>FRC4586P</b>	0.83	1.00
OEM	1	<b>FRC4586P1</b>	3.50	4.20
Genuine	1	<b>FRC4586</b>	11.66	13.99
All models (VIN) CA on				
Aftermarket	1	<b>FRC8220P</b>	1.50	1.80
OEM	1	<b>FRC8220P1</b>	5.63	6.76
Genuine	1	<b>FRC8220</b>	27.28	32.74

## Oil Seal Diff Pinion Front

All models (VIN) JA610294 on				
Aftermarket	1	<b>FTC5258P</b>	1.50	1.80
OEM	1	<b>FTC5258P1</b>	4.08	4.90
Genuine	1	<b>FTC5258</b>	13.96	16.75

## Oil Seal Hub

All models to (VIN) JA624516				
Aftermarket	2	<b>FRC8222P</b>	1.83	2.20
OEM	2	<b>FRC8222P1</b>	5.63	6.76
Genuine	2	<b>FRC8222</b>	21.24	25.49

## Oil Seal Hub Assembly

All models 1970 to 1985 - Single lip type				
Aftermarket	2	<b>RTC3508P</b>	1.50	1.80

## Oil Seal Stub Axle

1974 to (VIN) BA - Twin lip type				
Aftermarket	2	<b>RTC3511P</b>	1.33	1.60
OEM	2	<b>RTC3511P1</b>	3.50	4.20
Genuine	2	<b>RTC3511</b>	12.52	15.02

## Seal Stub Axle Outer

All ABS fitted models to (VIN) HA610293				
Aftermarket	2	<b>FTC840P</b>	2.08	2.50
Genuine	2	<b>FTC840</b>	10.71	12.85

All non ABS fitted models (VIN) JA610294 to JA624516				
Aftermarket	2	<b>FTC840P</b>	2.08	2.50
Genuine	2	<b>FTC840</b>	10.71	12.85

## Seal Stub Axle Inner

All models (axle) 56L03430B on, 57L00463A on				
Front				
Aftermarket	2	<b>FTC5268P</b>	0.92	1.10
Genuine	2	<b>FTC5268</b>	3.18	3.82

## Seal Output Shaft

All models with R380 5 speed gearbox				
Aftermarket	1	<b>FTC500010P</b>	1.00	1.20
Genuine	1	<b>FTC500010</b>	12.07	14.48

## Seal Inner Stub Axle

All models				
Aftermarket	2	<b>FTC4785P</b>	1.33	1.60
OEM	2	<b>FTC4785P1</b>	3.00	3.60
Genuine	2	<b>FTC4785</b>	4.34	5.21

## Oil Seal Front Cover

All models with LT77 5 speed gearbox (gbox) suffix D to E				
Aftermarket	1	<b>UKC1060P</b>	1.58	1.90
Aftermarket	1	<b>UKC1060</b>	5.63	6.76

## Oil Seal Oil Pump Housing

All models with 4 speed auto gearbox				
Aftermarket	1	<b>RTC5102P</b>	6.04	7.25
Genuine	1	<b>RTC5102</b>	16.12	19.34

## Oil Seal Swivel

All models - 9mm				
Aftermarket	2	<b>LR059968P</b>	2.08	2.50
OEM	2	<b>LR059968P1</b>	5.83	7.00
Genuine	2	<b>LR059968</b>	9.89	11.87

## Oil Seal Swivel Pin Housing

All models				
Aftermarket	2	<b>571718P</b>	1.17	1.40
OEM	2	<b>571718P1</b>	3.00	3.60
Genuine	2	<b>571718</b>	6.81	8.17
All models to (VIN) HA610293 - 12.5mm				
Aftermarket	2	<b>571890P</b>	2.00	2.40

## Oil Seal Transfer Box Input

All models with LT230 transfer box				
Aftermarket	1	<b>ICV100000P</b>	0.92	1.10
OEM	1	<b>ICV100000P1</b>	3.83	4.60
Genuine	1	<b>ICV100000</b>	6.99	8.39

## Output Shaft Oil Seal

All V8 petrol models with LT95 4 speed gearbox				
Front output shaft				
Aftermarket	1	<b>571175P</b>	0.63	0.76
Genuine	1	<b>571175</b>	3.69	4.43
Rear output shaft				
Aftermarket	1	<b>90622240P</b>	1.25	1.50
Genuine	1	<b>90622240</b>	3.81	4.57



## RANGE ROVER CLASSIC (1970 TO 1996)

## TRANSMISSION

## Oil Seal Clutch Sleeve Housing

All V8 petrol models with LT95 4 speed gearbox

Aftermarket	1	<b>571059P</b>	0.63	0.76
Genuine	1	<b>571059</b>	7.87	9.44

## Drain Plug Transfer Box

All V8 models with LT95 4 speed gearbox

Aftermarket	1	<b>599552P</b>	2.83	3.40
Genuine	1	<b>599552</b>	8.99	10.79

All models with LT230 transfer box

Aftermarket	1	<b>599552P</b>	2.83	3.40
Genuine	1	<b>599552</b>	8.99	10.79

## Sealing Washer Drain Plug

All models with LT77 or R380 5 speed gearbox

Alternative to FRC7064A

Aftermarket	1	<b>FTC4112P</b>	0.79	0.95
Genuine	1	<b>FTC4112</b>	2.37	2.84

Alternative to FTC4112

Aftermarket	1	<b>FRC7064A</b>	1.08	1.30
-------------	---	-----------------	------	------

All models - Land Rover type axle

Aftermarket	1	<b>515599P</b>	0.33	0.40
Genuine	1	<b>515599</b>	1.17	1.40

All Land Rover type axles - Axle

Genuine	1	<b>FRC4809</b>	0.80	0.96
---------	---	----------------	------	------

## Speedometer Drive Gear

All models with B-W NV225 transfer box

Pinion, black, 23 teeth

Genuine	1	<b>FRC9339</b>	24.42	29.30
---------	---	----------------	-------	-------

All models with 5 speed LT77 gearbox &amp; LT230T transfer box

Pinion, red, 23 teeth

OEM	1	<b>FRC3313P1</b>	15.63	18.76
Genuine	1	<b>FRC3313</b>	20.53	24.64

## Gear Speedometer Drive

All models with LT230 transfer box

Aftermarket	1	<b>FRC3162P</b>	20.63	24.76
OEM	1	<b>FRC3162P1</b>	23.75	28.50
Genuine	1	<b>FRC3162</b>	64.01	76.81

## Taper Roller Bearing Diff Carrier

All models (axle) 57L05189B on, 55L00498B on - Land Rover type axle

Aftermarket	2	<b>RTC3095P</b>	4.25	5.10
OEM	2	<b>RTC3095P1</b>	9.37	11.24
Genuine	2	<b>RTC3095</b>	52.69	63.23

## Switch, Transfer Box

All models with B-W NV225 transfer box - Transfer box temperature

OEM	1	<b>PRC7984P1</b>	27.92	33.50
Genuine	1	<b>PRC7984</b>	35.22	42.26

## Switch, Gearbox

All models with LT230 transfer box - High/Low, with spade connectors

Aftermarket	1	<b>PRC2911P</b>	4.08	4.90
OEM	1	<b>PRC2911P1</b>	7.92	9.50
Genuine	1	<b>PRC2911</b>	35.18	42.22

## Damper, Harmonic

All models up to (VIN) MA652713 - Front axle

Genuine	1	<b>FTC1499</b>	126.27	151.52
---------	---	----------------	--------	--------

All petrol models from (VIN) MA652714 on - Front axle

Genuine	1	<b>FTC1499</b>	126.27	151.52
---------	---	----------------	--------	--------

All diesel models from (VIN) MA652714 on - Front axle

Genuine	1	<b>FRC9693</b>	210.06	252.07
---------	---	----------------	--------	--------

## Bearing Viscous Coupling

All models with BW NV225 transfer box - Front

OEM	1	<b>RTC6025P1</b>	7.71	9.25
Genuine	1	<b>RTC6025</b>	79.96	95.95

## RANGE ROVER CLASSIC (1970 TO 1996)

## COOLING

## Expansion Bottle Cap

All V8 petrol engine models up to (VIN) EA336625

15lb pressure

Aftermarket	1	<b>PCD100150P</b>	1.42	1.70
Aftermarket	1	<b>GRC110</b>	4.38	5.26
Genuine	1	<b>PCD100150</b>	4.04	4.85

## Radiator Cap

All models from (VIN) GA to LA647644

Aftermarket	1	<b>PRC7925P</b>	19.79	23.75
-------------	---	-----------------	-------	-------

## Expansion Bottle Cap

All V8 EFI petrol engine models from (VIN) MA647645 on

15lb pressure

Aftermarket	1	<b>NTC7161P</b>	2.75	3.30
OEM	1	<b>NTC7161P1</b>	7.08	8.50
Genuine	1	<b>NTC7161</b>	10.44	12.53

All 2.4L VM turbo diesel models

Aftermarket	1	<b>PCD100150P</b>	1.42	1.70
Genuine	1	<b>PCD100150</b>	4.04	4.85
Aftermarket	1	<b>GRC110</b>	4.38	5.26

15lb pressure

All 2.5L 200 TDi and 300 TDi diesel models

15lb pressure

Aftermarket	1	<b>NTC7161P</b>	2.75	3.30
OEM	1	<b>NTC7161P1</b>	7.08	8.50
Genuine	1	<b>NTC7161</b>	10.44	12.53

## Thermostat

All models up to 1976 - 74°C

Aftermarket	1	<b>ETC4761P</b>	2.00	2.40
OEM	1	<b>ETC4761P1</b>	3.50	4.20
Genuine	1	<b>ETC4761</b>	12.25	14.70

All V8 petrol engine models from 1976 on - 88°C

Aftermarket	1	<b>ETC4765P</b>	2.50	3.00
OEM	1	<b>ETC4765P1</b>	3.08	3.70
Genuine	1	<b>ETC4765</b>	10.06	12.07

All V8 petrol models detoxed up to (VIN) BA - 88°C

Aftermarket	1	<b>GTS106</b>	3.58	4.30
-------------	---	---------------	------	------

All V8 petrol models non-detoxed up to (VIN) BA - 82°C

Aftermarket	1	<b>GTS104</b>	3.58	4.30
-------------	---	---------------	------	------

All V8 petrol models (VIN) CA on - 82°C, std fitment

Aftermarket	1	<b>GTS104</b>	3.58	4.30
-------------	---	---------------	------	------

All V8 petrol models (VIN) CA on - 88°C, cold climates option

Aftermarket	1	<b>GTS106</b>	3.58	4.30
-------------	---	---------------	------	------

All V8 petrol models 1984 approx. on - 74°C, hot climates option

Aftermarket	1	<b>GTS102</b>	3.33	4.00
-------------	---	---------------	------	------

All 2.5L VM Turbo Diesel models - 80°C

Aftermarket	1	<b>RTC6673P</b>	10.00	12.00
OEM	1	<b>RTC6673P1</b>	16.67	20.00
Genuine	1	<b>RTC6673</b>	29.06	34.87

All 2.5L 200 TDi diesel engine models - 88°C

Aftermarket	1	<b>ERR2803P</b>	2.83	3.40
OEM	1	<b>ERR2803P1</b>	9.17	11.00
Genuine	1	<b>ERR2803</b>	11.50	13.80

All 2.5L 300 TDi diesel engine models

Aftermarket	1	<b>ERR3291P</b>	2.75	3.30
OEM	1	<b>ERR3291P1</b>	5.21	6.25
Genuine	1	<b>ERR3291</b>	11.07	13.28

## Thermostat &amp; Cover Assembly

All 2.4L VM turbo diesel models

Genuine	1	<b>8510048</b>	163.11	195.73
---------	---	----------------	--------	--------

## Thermostat Housing Gasket

All models up to 1976

Genuine	1	<b>610387</b>	1.50	1.80
---------	---	---------------	------	------

All V8 petrol engine models - Thermostat housing

Aftermarket	1	<b>ERR2429P</b>	0.67	0.80
Genuine	1	<b>ERR2429</b>	1.75	2.10

All V8 petrol models with 4 barrel carb conversion

Aftermarket	1	<b>GTG116</b>	1.83	2.20
-------------	---	---------------	------	------

All 200 TDi diesel models - Lower

Aftermarket	1	<b>ETC8007P</b>	0.42	0.50
Genuine	1	<b>ETC8007</b>	2.20	2.64

## O Ring Thermostat Housing

All 300 TDi diesel models - Thermostat housing

Aftermarket	1	<b>ERR4685P</b>	0.46	0.55
Genuine	1	<b>ERR4685</b>	2.15	2.58

## Thermostat Housing

All V8 petrol models with air conditioning from (VIN) CA on

Aftermarket	1	<b>ETC6135A</b>	29.58	35.50
-------------	---	-----------------	-------	-------

All 300 TDi diesel models without air conditioning

Aftermarket	1	<b>ERR3479P</b>	57.50	69.00
Genuine	1	<b>ERR3479</b>	281.22	337.46

## Thermostat Housing Adaptor

All 200 TDi and 300 TDi diesel models - Heater pipe

Genuine	1	<b>624091</b>	7.82	9.38
---------	---	---------------	------	------

## Plastic Plug

All 300 TDi diesel engine models - Thermostat housing filler

Aftermarket	1	<b>ERR4686P</b>	0.92	1.10
Genuine	1	<b>ERR4686</b>	2.47	2.96

## Thermostat Switch

2.5L VM Turbo diesel models

Aftermarket	1	<b>PRC8170P</b>	3.83	4.60
Genuine	1	<b>PRC8170</b>	23.07	27.68

200TDi and 300TDi diesel engine models

Aftermarket	1	<b>PRC8170P</b>	3.83	4.60
Genuine	1	<b>PRC8170</b>	23.07	27.68

200 TDi diesel models Switzerland only

Genuine	1	<b>ERR338</b>	47.86	57.43
---------	---	---------------	-------	-------

## Water Pump Gasket

All V8 carb engine models - Water pump

Aftermarket	1	<b>ERR2428P</b>	0.83	1.00
OEM	1	<b>ERR2428P1</b>	4.00	4.80
Genuine	1	<b>ERR2428</b>	8.47	10.16

All V8 EFI engine models up to (VIN) MA647644 - Water pump

Aftermarket	1	<b>ERR2428P</b>	0.83	1.00
OEM	1	<b>ERR2428P1</b>	4.00	4.80
Genuine	1	<b>ERR2428</b>	8.47	10.16

All V8 EFI models from (VIN) MA647645 on - Water pump

Aftermarket	1	<b>ERR4077P</b>	1.50	1.80
Genuine	1	<b>ERR4077</b>	8.44	10.13

All 2.4L and 2.5L VM turbo diesel models - Water pump

Genuine	1	<b>AEU2183</b>	1.58	1.90
---------	---	----------------	------	------

All 200 TDi diesel models - Water pump

Aftermarket	1	<b>ERR388P</b>	0.38	0.46
Genuine	1	<b>ERR388</b>	1.67	2.00

All 300 TDi diesel engine models - Water pump

Aftermarket	1	<b>ERR3284P</b>	0.67	0.80
Genuine	1	<b>ERR3284</b>	5.04	6.05

## Water Pump Inlet Housing Gasket

All 200 TDi diesel models - Water pump inlet housing

Aftermarket	1	<b>ERR1607P</b>	0.25	0.30
Genuine	1	<b>ERR1607</b>	1.67	2.00



# COOLING

## Water Pump

All V8 carb petrol models up to (VIN) BA without air conditioning without viscous coupling				
Aftermarket	1	<b>STC1611P</b>	30.00	36.00
Genuine*	1	<b>STC1611</b>	126.22	151.46
			<i>*Exchange Surcharge</i>	40.00 48.00
All V8 carb petrol models up to (VIN) BA without air conditioning with 7 blade fan on rad side of viscous coupling				
Aftermarket	1	<b>STC1610P</b>	27.50	33.00
Genuine	1	<b>STC1610</b>	125.80	150.96
All V8 petrol models up to (VIN) BA without air conditioning, with 7 blade fan fitted on radiator side of viscous coupling				
Aftermarket	1	<b>GWP322</b>	32.08	38.50
Aftermarket	1	<b>GWP316</b>	35.83	43.00
All V8 petrol models from (VIN) CA to MA650326				
Aftermarket	1	<b>STC483P</b>	29.58	35.50
OEM	1	<b>STC483P1</b>	53.33	64.00
Genuine*	1	<b>STC483</b>	165.49	198.59
			<i>*Exchange Surcharge</i>	40.00 48.00
All V8 EFI petrol engine models from (VIN) MA650327 on				
Aftermarket	1	<b>STC4378P</b>	28.75	34.50
OEM	1	<b>STC4378P1</b>	53.33	64.00
Genuine*	1	<b>STC4378</b>	128.66	154.39
			<i>*Exchange Surcharge</i>	40.00 48.00
All 2.4L VM turbo diesel models				
Aftermarket	1	<b>RTC4925P</b>	250.00	300.00
Aftermarket	1	<b>RTC6666P</b>	50.00	60.00
Genuine	1	<b>RTC6666</b>	292.09	350.51
All 2.5L 200 TDi diesel engine models				
Aftermarket	1	<b>RTC6395P</b>	23.75	28.50
OEM	1	<b>RTC6395P1</b>	45.83	55.00
Genuine*	1	<b>RTC6395</b>	100.86	121.03
			<i>*Exchange Surcharge</i>	40.00 48.00
All 2.5L 300 TDi diesel engine models				
Aftermarket	1	<b>PEB500090P</b>	14.58	17.50
OEM	1	<b>PEB500090P1</b>	19.58	23.50
Genuine	1	<b>PEB500090</b>	105.27	126.32

## Intercooler Hose

All 2.4L and 2.5L VM turbo diesel models				
Top	Aftermarket	1	<b>NTC2316P</b>	5.83 7.00
All 2.5L 200 TDi diesel engine models				
Rear	Aftermarket	1	<b>ESR2263P</b>	4.08 4.90
Aftermarket	1	<b>ESR2932P</b>	4.08 4.90	
All 200 TDi diesel models - LH front, short	Aftermarket	1	<b>ESR2943P</b>	4.08 4.90
All 2.5L 300 TDi diesel engine models				
Top	Aftermarket	1	<b>ESR3025P</b>	4.00 4.80
Genuine	1	<b>ESR3025</b>	98.35	118.02
Bottom	Aftermarket	1	<b>ESR2913P</b>	2.25 2.70
Genuine	1	<b>ESR2913</b>	55.00	66.00
All 2.5L VM turbo diesel models - Coolant feed to turbocharger				
Aftermarket	1	<b>NTC5174P</b>	9.58	11.50

## Hose Turbocharger

All 300 TDi diesel models				
Aftermarket	1	<b>ESR2912P</b>	2.75	3.30
Genuine	1	<b>ESR2912</b>	57.20	68.64

## Intercooler Pipe & Hose Kit

All 300 TDi diesel models without air suspension - Includes lower pipe and two hoses				
Genuine	1	<b>ESR2910</b>	195.66	234.79

## Temperature Sensor

All V8 carb petrol models				
Aftermarket	1	<b>RTC4996P</b>	5.63	6.76
V8 petrol engine models from 1986 on - Yellow				
Aftermarket	1	<b>PRC3505A</b>	10.00	12.00
All models from (VIN) suffix B to (VIN) BA				
Oil temperature, for 120 ° gauge	Aftermarket	1	<b>560794P</b>	2.42 2.90
Oil temperature, for 140 ° gauge	Aftermarket	1	<b>623050P</b>	2.75 3.30
All models up to (VIN) HA610293	Aftermarket	1	<b>PRC6317P</b>	6.04 7.25
All V8 EFI petrol models (VIN) JA610294 on	Aftermarket	1	<b>AMR1425P</b>	2.75 3.30
All V8 EFI petrol engine models				
To gauge	Aftermarket	1	<b>ETC8496A</b>	5.00 6.00
Genuine	1	<b>AMR1425</b>	23.47	28.16
3.9L and 4.2L V8 EFI petrol engine models	Aftermarket	1	<b>PRC7918P</b>	4.00 4.80
200TDI diesel engine models - Green	Aftermarket	1	<b>PRC3359P</b>	5.00 6.00
OEM	1	<b>PRC3359P1</b>	27.08	32.50
Genuine	1	<b>PRC3359</b>	39.35	47.22
300TDI diesel engine models				
Aftermarket	1	<b>ERR2081P</b>	3.25	3.90
OEM	1	<b>ERR2081P1</b>	9.79	11.75
Genuine	1	<b>ERR2081</b>	14.00	16.80
To gauge	Aftermarket	1	<b>AMR1425P</b>	2.75 3.30
To gauge	Genuine	1	<b>AMR1425</b>	23.47 28.16

## Coolant Temperature Sensor

All 3.5L V8 petrol models without air conditioning				
Aftermarket	1	<b>GTR108</b>	5.42	6.50
All 3.5L V8 petrol models with air conditioning				
Aftermarket	1	<b>GTR111</b>	6.25	7.50

## Coolant Level Sensor

All models from (VIN) CA to FA399972	OEM	1	<b>PRC5077P</b>	12.50 15.00
--------------------------------------	-----	---	-----------------	-------------

## Low Level Coolant Sensor

All models from (VIN) GA399973 to LA647644				
Aftermarket	1	<b>PRC7925P</b>	19.79	23.75

# ELECTRICAL - ROTATING ELECTRICS

## Alternator

All V8 carb petrol engine models with 30/36Amp alternator				
New, outright	Aftermarket	1	<b>RTC5083EP</b>	50.00 60.00
Reconditioned, exchange	Genuine	1	<b>RTC5083E</b>	84.17 101.00
All V8 carb petrol engine models with 40Amp alternator - A115-45Amp/18ACR, battery sensed				
Reconditioned, exchange	Aftermarket*	1	<b>RTC5086EP</b>	61.67 74.00
			<i>*Exchange Surcharge</i>	25.00 30.00
Genuine*	1	<b>RTC5086E</b>	185.10	222.12
			<i>*Exchange Surcharge</i>	80.00 96.00
All V8 carb petrol models with LH fixing ignition sensed std power alternator (A115/45amp, replaces 17ACR/36amp)				
Reconditioned, exchange	Genuine*	1	<b>RTC5085E</b>	119.76 143.71
			<i>*Exchange Surcharge</i>	80.00 96.00
All V8 carb petrol models with LH fixing high output A127/65amp alternator				
New, outright	Aftermarket	1	<b>STC233P</b>	55.00 66.00
All V8 EFI petrol models from (VIN) JA610294 on with 65amp alternator - A127/65Amp				
New, outright	Aftermarket	1	<b>STC234P</b>	67.50 81.00
All V8 EFI petrol models up to (VIN) JA610294 with 80amp alternator - A133/80Amp				
New, outright	Aftermarket	1	<b>STC1753P</b>	95.00 114.00
Reconditioned, exchange	Genuine*	1	<b>STC1753E</b>	218.67 262.40
			<i>*Exchange Surcharge</i>	70.00 84.00
New, exchange	Genuine*	1	<b>STC1753</b>	271.53 325.84
			<i>*Exchange Surcharge</i>	70.00 84.00
All V8 EFI petrol models (VIN) KA624756 to LA647644 with 85 amp alternator A127I-85 amp alternator type				
New, outright	Aftermarket	1	<b>YLE10099P</b>	100.00 120.00
New, exchange	Genuine*	1	<b>YLE10099</b>	621.62 745.94
			<i>*Exchange Surcharge</i>	70.00 84.00
All V8 EFI petrol models from (VIN) KA624756 to LA647644 with 100amp alternator - A127 I-100Amp				
New, outright	Aftermarket	1	<b>YLE10100P</b>	95.00 114.00
New, exchange	Genuine*	1	<b>YLE10100</b>	398.23 477.88
			<i>*Exchange Surcharge</i>	70.00 84.00
All V8 EFI petrol models from (VIN) MA647645 on - A127 I-100Amp				
New, outright	Aftermarket	1	<b>AMR3107P</b>	95.00 114.00
Reconditioned, exchange	Genuine*	1	<b>AMR3107E</b>	271.16 325.39
			<i>*Exchange Surcharge</i>	60.00 72.00
New, exchange	Genuine*	1	<b>AMR3107</b>	507.80 609.36
			<i>*Exchange Surcharge</i>	60.00 72.00
All 2.4L VM Turbo Diesel models with A133/65amp alternator				
New, outright	Aftermarket	1	<b>RTC5250EP</b>	90.00 108.00
All 200 TDi diesel models (A127/65amp alternator)				
New, outright	Aftermarket	1	<b>STC233P</b>	55.00 66.00
All models with 300TDI diesel engine - A127 I-100Amp, new				
New, outright	Aftermarket	1	<b>YLE10113P</b>	90.00 108.00
OEM	1	<b>YLE10113P1</b>	135.00	162.00
All models with 300TDI diesel engine - A127 I-100Amp				
Reconditioned, exchange	Genuine*	1	<b>YLE10113E</b>	268.31 321.97
			<i>*Exchange Surcharge</i>	70.00 84.00
New, exchange	Genuine*	1	<b>YLE10113</b>	679.07 814.88
			<i>*Exchange Surcharge</i>	70.00 84.00

# RANGE ROVER CLASSIC (1970 TO 1996)

## Starter Motor

All models with V8 EFI petrol engine from (engine) 40D03277A on - Bosch type				
New, outright	Aftermarket	1	<b>NAD101490P</b>	70.00 84.00
OEM	1	<b>NAD101490P1</b>	155.00	186.00
Reconditioned, exchange	Genuine*	1	<b>NAD101490E</b>	129.64 155.57
			<i>*Exchange Surcharge</i>	70.00 84.00
New, exchange	Genuine*	1	<b>NAD101490</b>	208.17 249.80
			<i>*Exchange Surcharge</i>	70.00 84.00
All 2.4L & 2.5L VM turbo diesel models				
Reconditioned, outright	Aftermarket	1	<b>PRC5669R</b>	225.00 270.00
All 200 TDi & 300 TDi diesel models				
New, outright	Aftermarket	1	<b>NAD500210P</b>	82.50 99.00
OEM	1	<b>NAD500210P1</b>	175.00	210.00
Reconditioned, exchange	Genuine*	1	<b>PRC5109E</b>	242.74 291.29
			<i>*Exchange Surcharge</i>	100.00 120.00
New, exchange	Genuine*	1	<b>NAD500210</b>	316.78 380.14
			<i>*Exchange Surcharge</i>	100.00 120.00





## RANGE ROVER CLASSIC (1970 TO 1996)

## ENGINE GASKETS

## Gasket Rocker Cover

All V8 petrol models				
Cork	OEM	2	<b>GEG436</b>	1.58 1.90
Rubber	OEM	2	<b>GEG436UPRATED</b>	2.65 3.18
All 2.4L & 2.5L VM Turbo Diesel models				
2.5L VM Turbo Diesel models from (eng) 95A18391 on	Aftermarket	1	<b>AJM4460B</b>	3.50 4.20
	Aftermarket	1	<b>STC814P</b>	5.00 6.00
	OEM	1	<b>STC814P1</b>	5.83 7.00
All 200TDi diesel models				
	Aftermarket	1	<b>ERR2393P</b>	2.00 2.40
	Genuine	1	<b>ERR2393</b>	11.47 13.76
All 300TDi diesel models				
	Aftermarket	1	<b>ERR2409P</b>	2.00 2.40
	OEM	1	<b>ERR2409P1</b>	3.58 4.30
	Genuine	1	<b>ERR2409</b>	10.74 12.89

## Sealing Washer Rocker Cover

All 200TDi diesel models				
	Aftermarket	3	<b>ERR663P</b>	1.50 1.80
	Genuine	3	<b>ERR663</b>	7.92 9.50
All 300TDi diesel models				
	Aftermarket	3	<b>ERR3424P</b>	0.75 0.90
	Genuine	3	<b>ERR3424</b>	2.98 3.58

## Gasket Cylinder Head

3.5L V8 petrol models - Original style tin head gasket				
	Aftermarket	2	<b>603796P</b>	1.92 2.30
	Genuine	2	<b>603796</b>	10.18 12.22
All 3.5L V8 petrol models - Tin type gasket				
	Aftermarket	2	<b>GEG340</b>	5.00 6.00
	Aftermarket	2	<b>GEG340P</b>	2.08 2.50
All 3.5L V8 petrol models - Composite type gasket				
	Aftermarket	2	<b>GEG340COM</b>	15.42 18.50
	Aftermarket	2	<b>GEG340COMP</b>	6.04 7.25
	Genuine	2	<b>ERR4248</b>	35.01 42.01
3.9L and 4.2L V8 petrol with 2 rows of head bolts - Original style composite head gasket				
	Aftermarket	2	<b>LVB500030P</b>	4.58 5.50
	OEM	2	<b>LVB500030P1</b>	8.13 9.76
	Genuine	2	<b>LVB500030</b>	39.14 46.97
3.9L and 4.2L V8 petrol with 3 rows of head bolts				
Upgrade type composite head gasket	Aftermarket	2	<b>ETC7819P</b>	3.00 3.60
Original fitment tin head gasket	Genuine	2	<b>ETC7819</b>	11.09 13.31
All 3.9L & 4.2L V8 petrol models with 3 rows of cylinder head bolts (will work on 2 row heads)				
Tin type head gasket (0.5mm thick)	Aftermarket	2	<b>RB7448</b>	4.38 5.26
Composite type head gasket (1.2mm thick)	Aftermarket	2	<b>RB7448C</b>	13.13 15.76
2.4L and 2.5L VM Turbo Diesel				
1.42mm	Aftermarket	1	<b>STC1570P</b>	6.04 7.25
1.52mm	Aftermarket	1	<b>STC1571P</b>	9.58 11.50
	OEM	1	<b>STC1571P1</b>	18.13 21.76
1.62mm	Aftermarket	1	<b>STC1844P</b>	9.17 11.00
	OEM	1	<b>STC1844P1</b>	15.42 18.50
200TDi and 300TDi diesel models				
1.30mm, one hole	Aftermarket	1	<b>LVB500200P</b>	5.42 6.50
	Genuine	1	<b>LVB500200</b>	51.39 61.67
1.30mm, one hole, MLS type	OEM	1	<b>LVB500200P1</b>	11.67 14.00
1.40mm, two holes, MLS type	Aftermarket	1	<b>LVB500210P</b>	5.42 6.50
	OEM	1	<b>LVB500210P1</b>	11.67 14.00
1.40mm, two holes	Genuine	1	<b>LVB500210</b>	48.48 58.18
1.50mm, three holes, MLS type	Aftermarket	1	<b>LVB500220P</b>	10.63 12.76
	OEM	1	<b>LVB500220P1</b>	13.75 16.50
1.50mm, three holes	Genuine	1	<b>LVB500220</b>	44.06 52.87
1.60mm, MLS type	Aftermarket	1	<b>LVB500230P</b>	12.50 15.00
	OEM	1	<b>LVB500230P1</b>	18.13 21.76
1.60mm	Genuine	1	<b>LVB500230</b>	37.45 44.94

## Gasket Decoke Set

V8 carb petrol models from 1976 on Includes original fitment tin head gasket				
	Aftermarket	1	<b>STC1566P</b>	11.67 14.00
	Genuine	1	<b>STC1566</b>	133.80 160.56
All 3.5L V8 petrol models up to 1977 - Includes tin type head gasket				
	Aftermarket	1	<b>GEG165</b>	27.50 33.00
All 3.5L V8 petrol models from 1977 on				
Includes tin type head gasket	Aftermarket	1	<b>GUG1066HS</b>	20.42 24.50
Includes composite type head gasket	Aftermarket	1	<b>GUG1066HSCOM</b>	33.33 40.00
Includes tin type head gasket	Aftermarket	1	<b>GUG1066HSK</b>	19.79 23.75
3.5L V8 EFI petrol models - Includes original style tin head gasket				
	Aftermarket	1	<b>STC1642P</b>	22.92 27.50
All 3.9L & 4.2L V8 petrol models with 3 rows of cylinder head bolts (will work on 2 row heads)				
Includes tin type head gaskets (0.5mm thick)	Aftermarket	1	<b>RB7447</b>	27.50 33.00
Includes composite type head gaskets (1.2mm thick)	Aftermarket	1	<b>RB7447C</b>	40.83 49.00
All V8 EFI petrol models (VIN) MA647645 on - Engines with 2 rows of head bolts (COMPOSITE)				
	Aftermarket	1	<b>RA1233P</b>	57.50 69.00
	Genuine	1	<b>RA1233</b>	90.83 109.00
2.4L and 2.5L VM Turbo Diesel - Without head gasket				
	Aftermarket	1	<b>STC850P</b>	11.04 13.25
200TDi diesel models - Without head gasket				
	Aftermarket	1	<b>STC1172P</b>	15.63 18.76
	OEM	1	<b>STC1172P1</b>	50.00 60.00
	Genuine	1	<b>STC1172</b>	93.01 111.61
300TDi diesel models - Without head gasket				
	Aftermarket	1	<b>STC2802P</b>	8.96 10.75
	OEM	1	<b>STC2802P1</b>	32.50 39.00
	Genuine	1	<b>STC2802</b>	88.35 106.02

## Gasket Oil Sump

All V8 petrol models				
	Aftermarket	1	<b>AJM539P</b>	1.00 1.20
	Aftermarket	1	<b>AJM539</b>	4.08 4.90

## Gasket Conversion Set

All models up to 1976				
	Genuine	1	<b>RTC811</b>	83.29 99.95
All 3.5L V8 carb petrol models				
	Aftermarket	1	<b>GUG1538CSP</b>	10.83 13.00
	Aftermarket	1	<b>GUG1538CS</b>	13.13 15.76
V8 petrol models up to (VIN) LA647644				
	Aftermarket	1	<b>STC1639P</b>	9.79 11.75
	OEM	1	<b>STC1639P1</b>	25.83 31.00
	Genuine	1	<b>STC1639</b>	60.34 72.41
V8 petrol models from (VIN) MA647645 on				
	Aftermarket	1	<b>STC2823P</b>	12.50 15.00
	Genuine	1	<b>STC2823</b>	79.56 95.47
All 2.4L & 2.5L VM Turbo Diesel models				
	Aftermarket	1	<b>STC1623P</b>	75.00 90.00
All 200TDi diesel models				
	Aftermarket	1	<b>STC1557P</b>	15.00 18.00
	OEM	1	<b>STC1557P1</b>	45.00 54.00
	Genuine	1	<b>STC1557</b>	151.83 182.20
All 300TDi diesel models				
	Aftermarket	1	<b>STC2801P</b>	13.96 16.75
	OEM	1	<b>STC2801P1</b>	27.50 33.00
	Genuine	1	<b>STC2801</b>	90.31 108.37

## Silicone Sealant RTV

Numerous applications				
	Aftermarket	a/r	<b>RTC3254P</b>	5.00 6.00
	Genuine	a/r	<b>RTC3254</b>	21.04 25.25

## Sealant Instant Gasket

Numerous applications				
	Genuine	a/r	<b>STC50550</b>	13.10 15.72



LVB500210P



STC1557P

## RANGE ROVER CLASSIC (1970 TO 1996)

## ENGINE SWITCHES

## Oil Temperature Switch

All models with optional oil temp gauge up to (VIN) Suffix A				
	Aftermarket	1	<b>90545047P</b>	5.83 7.00
	Genuine	1	<b>90545047</b>	8.00 9.60

## Temperature Sensor Oil Pump

All V8 carb petrol engine models				
	Aftermarket	1	<b>PRC2236P</b>	3.50 4.20

## Oil Pressure Switch

All models from 1978 to (VIN) BA				
	Aftermarket	1	<b>DRC2479A</b>	29.58 35.50
All V8 petrol engine models				
	Aftermarket	1	<b>STC4104P</b>	3.00 3.60
	OEM	1	<b>STC4104P1</b>	12.50 15.00
	Genuine	1	<b>STC4104</b>	29.01 34.81
All diesel engine models				
	Aftermarket	1	<b>PRC6387P</b>	1.83 2.20
	OEM	1	<b>PRC6387P1</b>	3.50 4.20
	Genuine	1	<b>PRC6387</b>	28.77 34.52
All V8 petrol models (eng) prefix 341, 355, 359				
	Aftermarket	1	<b>555947P</b>	27.50 33.00

## Oxygen Sensor

V8 EFI petrol models				
	Aftermarket	1	<b>ERR6729P</b>	39.58 47.50
	OEM	1	<b>ERR6729P1</b>	66.67 80.00



## DRAIN PLUGS

### Sump Plug

All V8 petrol models	Aftermarket	1	<b>603659A</b>	2.83	3.40
300TDi diesel models	Aftermarket	1	<b>UAM2957P</b>	1.58	1.90
	Genuine	1	<b>UAM2957</b>	2.08	2.50
All 300 TDi diesel models (eng) 21L88229A on	OEM	1	<b>LSF100040LP1</b>	1.50	1.80
	Genuine	1	<b>LSF100040L</b>	3.13	3.76

### Sump Plug Magnetic

All 200TDi diesel models	Genuine	1	<b>ETC5577</b>	3.53	4.24
--------------------------	---------	---	----------------	------	------

### Sump Plug Washer

All V8 petrol models	Aftermarket	1	<b>213961A</b>	1.25	1.50
2.4L and 2.5L VM Turbo Diesel models	Genuine	1	<b>BAU4979</b>	0.52	0.62
	Aftermarket	1	<b>213961A</b>	1.25	1.50
All 200TDi diesel models	Aftermarket	1	<b>213961A</b>	1.25	1.50
All 200TDi and 300TDi diesel models	Aftermarket	1	<b>FRC4808P</b>	0.58	0.70
	Genuine	1	<b>FRC4808</b>	1.83	2.20
300TDi diesel models	Aftermarket	1	<b>UAM2857P</b>	0.58	0.70

### Sealing Washer Sump Plug

All 300TDi diesel models	Aftermarket	1	<b>ALU1403LP</b>	0.54	0.65
	Genuine	1	<b>ALU1403L</b>	1.11	1.33

### Oil Drain Valve Kit

All 300 TDi diesel models (eng) 21L88229A on	Aftermarket	1	<b>LSF100040LODV</b>	32.08	38.50
----------------------------------------------	-------------	---	----------------------	-------	-------

### Copper Sealing Washer

Numerous applications	Aftermarket	1	<b>ETC7398P</b>	0.75	0.90
	Genuine	1	<b>ETC7398</b>	1.55	1.86

## RANGE ROVER CLASSIC (1970 TO 1996)

### Filler Plug

All models with 5 speed LT77 gearbox - Gearbox	OEM	1	<b>3292P1</b>	1.33	1.60
	Genuine	1	<b>3292</b>	15.68	18.82
All models with 5 speed R380 gearbox - Gearbox	OEM	1	<b>FTC4056P1</b>	6.46	7.75
	Genuine	1	<b>FTC4056</b>	6.98	8.38
All models - Swivel housing	OEM	1	<b>3292P1</b>	1.33	1.60
	Genuine	1	<b>3292</b>	15.68	18.82

### Wading Plug

All models with 5 speed R380 gearbox - Gearbox bellhousing. Alternative to 3290A	OEM	1	<b>FTC4056P1</b>	6.46	7.75
----------------------------------------------------------------------------------	-----	---	------------------	------	------

### Drain Plug

All models with 4 speed automatic transmission - Magnetic, gearbox	Genuine	1	<b>RTC4647</b>	7.86	9.43
	Aftermarket	1	<b>RTC4647</b>	7.86	9.43
All diesel models from (VIN) JA610294 on - Fuel filter/sedimentor	OEM	1	<b>37H7920P1</b>	7.08	8.50
	Genuine	1	<b>37H7920</b>	9.02	10.82
All models with BW NV225 transfer box - Transfer box oil pump	OEM	1	<b>RTC6021</b>	6.92	8.30
	Genuine	1	<b>RTC6021</b>	6.92	8.30

### O Ring Oil Screen

All models with 4 speed auto gearbox	Aftermarket	1	<b>RTC4276P</b>	0.38	0.46
	Genuine	1	<b>RTC4276</b>	1.80	2.16

## OIL SEALS ENGINE

## RANGE ROVER CLASSIC (1970 TO 1996)

### Oil Seal Crankshaft Front

All V8 petrol models	Aftermarket	1	<b>ERR6490P</b>	3.00	3.60	
	OEM	1	<b>ERR6490P1</b>	5.00	6.00	
All 2.5L VM Turbo Diesel models	OEM	1	<b>RTC6771P1</b>	3.75	4.50	
	Genuine	1	<b>RTC6771</b>	10.95	13.14	
200TDi diesel models	Aftermarket	1	<b>ERR6490P</b>	3.00	3.60	
	OEM	1	<b>ERR6490P1</b>	5.00	6.00	
300TDi diesel models	Outer	Aftermarket	1	<b>ERR4576P</b>	1.25	1.50
		Genuine	1	<b>ERR4576</b>	6.95	8.34
	Inner	Aftermarket	1	<b>ERR4575P</b>	2.33	2.80
		OEM	1	<b>ERR4575P1</b>	5.63	6.76
Genuine	1	<b>ERR4575</b>	14.76	17.71		

### Oil Seal Crankshaft Rear

Very early V8 carb petrol models only - Includes rope seal only					
	Aftermarket	1	<b>613855</b>	4.58	5.50
All V8 petrol models except early 3.5L carb with rope seal - Lip type seal	Aftermarket	1	<b>ERR2640P</b>	3.00	3.60
	OEM	1	<b>ERR2640P1</b>	7.92	9.50
	Genuine	1	<b>ERR2640</b>	15.58	18.70
	Aftermarket	1	<b>RTC6710P</b>	21.67	26.00
2.4L and 2.5L VM Turbo Diesel models	Aftermarket	1	<b>LUF100430P</b>	7.50	9.00
	OEM	1	<b>LUF100430P1</b>	9.58	11.50
	Genuine	1	<b>LUF100430</b>	26.79	32.15
300TDi diesel models	Aftermarket	1	<b>ERR2532P</b>	2.00	2.40
	OEM	1	<b>ERR2532P1</b>	5.83	7.00
	Genuine	1	<b>ERR2532</b>	21.00	25.20

### Oil Seal Kit Crankshaft Rear

Very early V8 carb petrol models only - Includes rope seals, packing seals for bearing cap and assorted steel pins					
	Aftermarket	1	<b>613855KIT</b>	15.42	18.50

### Oil Seal Camshaft

200TDi diesel models	Aftermarket	1	<b>ETC5064P</b>	2.08	2.50
	OEM	1	<b>ETC5064P1</b>	2.50	3.00
	Genuine	1	<b>ETC5064</b>	21.23	25.48
300TDi diesel models	Aftermarket	1	<b>ERR3356P</b>	0.58	0.70
	OEM	1	<b>ERR3356P1</b>	2.50	3.00
	Genuine	1	<b>ERR3356</b>	12.31	14.77

### O Ring Camshaft Small

All 200TDi diesel models - Camshaft pulley retaining plate	Genuine	1	<b>ERC8849</b>	0.61	0.73
------------------------------------------------------------	---------	---	----------------	------	------



## EXHAUST GAS RECIRCULATION (EGR)

## RANGE ROVER CLASSIC (1970 TO 1996)

### EGR Valve

All 200 TDi diesel manual models without catalyst	Genuine	2	<b>ERR355</b>	65.84	79.01
	Genuine	1	<b>PRC9146</b>	43.33	52.00

### Solenoid EGR Valve

All 300 TDi diesel models without catalyst	Genuine	1	<b>ERR3314</b>	129.28	155.14
--------------------------------------------	---------	---	----------------	--------	--------

### EGR Blanking Kit

All 300 TDi diesel models - Includes blanking plate, insulator/gasket and screws					
Britpart	1	<b>LL1473BP</b>	5.00	6.00	
Terraforma	1	<b>LL1473TF</b>	4.75	5.70	
Bearmach	1	<b>LL1473BM</b>	5.83	7.00	

### Gasket EGR Valve to Pipe

All 200 TDi and 300 TDi diesel models	Aftermarket	1	<b>WAL500010LP</b>	2.00	2.40
	OEM	1	<b>WAL500010LP1</b>	3.58	4.30
	Genuine	1	<b>WAL500010L</b>	6.18	7.42
All 300 TDi diesel models	Aftermarket	1	<b>ERR3319P</b>	1.00	1.20
	Genuine	1	<b>ERR3319</b>	1.75	2.10

### EGR Pipe

All 300TDi diesel models	Long	Aftermarket	1	<b>ERR3580P</b>	3.25	3.90
		Genuine	1	<b>ERR3580</b>	53.69	64.43
Short	Aftermarket	1	<b>ERR3581P</b>	3.25	3.90	
	Genuine	1	<b>ERR3581</b>	45.30	54.36	

### Pipe EGR Valve to Solenoid

All 200 TDi diesel manual models without catalyst	Genuine	1	<b>ERR1986</b>	16.22	19.46
---------------------------------------------------	---------	---	----------------	-------	-------

### Y Pipe EGR Valve

All 300 TDi diesel models (eng) 15G	Genuine	1	<b>ERR3579</b>	188.44	226.13
-------------------------------------	---------	---	----------------	--------	--------



## RANGE ROVER CLASSIC (1970 TO 1996)

## ENGINE &amp; GEARBOX MOUNTINGS

## Engine Mounting

All automatic models up to (VIN) LA647644 - Gearbox, M10 thread					
Aftermarket	2	<b>ANR1808P</b>	2.33	2.80	
OEM	2	<b>ANR1808P1</b>	3.58	4.30	
Genuine	2	<b>ANR1808</b>	17.50	21.00	
All models with 3 speed automatic gearbox - With M12 metric threads					
Aftermarket	2	<b>STC434P</b>	2.33	2.80	
OEM	2	<b>STC434P1</b>	9.38	11.26	
Genuine	2	<b>STC434</b>	23.83	28.60	
All models with 4 speed LT95 gearbox - With M12 metric threads					
Aftermarket	2	<b>STC434P</b>	2.33	2.80	
OEM	2	<b>STC434P1</b>	9.38	11.26	
Genuine	2	<b>STC434</b>	23.83	28.60	
All models with 5 speed LT77 gearbox up to (VIN) BA - With M12 metric threads					
Aftermarket	2	<b>STC434P</b>	2.33	2.80	
OEM	2	<b>STC434P1</b>	9.38	11.26	
Genuine	2	<b>STC434</b>	23.83	28.60	
All V8 petrol models up to (VIN) LA647644 - With M12 metric threads					
Aftermarket	2	<b>STC434P</b>	2.33	2.80	
OEM	2	<b>STC434P1</b>	9.38	11.26	
Genuine	2	<b>STC434</b>	23.83	28.60	
All V8 petrol models from (VIN) MA647645 on - Engine, M12 thread					
Aftermarket	2	<b>KKB103120P</b>	1.67	2.00	
Genuine	2	<b>KKB103120</b>	20.20	24.24	
All 2.4L and 2.5L VM Turbo Diesel models					
Front	Aftermarket	2	<b>NTC3241P</b>	16.67	20.00
Rear RH	Aftermarket	1	<b>NTC7270P</b>	15.63	18.76
Rear, LH	Aftermarket	1	<b>NTC3242P</b>	17.92	21.50
All 200TDi diesel models - Engine					
Aftermarket	2	<b>ANR2488P</b>	11.67	14.00	
All 300TDi diesel models - Engine					
Aftermarket	2	<b>NTC9416P</b>	9.17	11.00	
Genuine	2	<b>NTC9416</b>	51.74	62.09	

## Bracket Engine Mounting

All automatic models from (VIN) MA647645 on					
Genuine	1	<b>ANR2822</b>	2.96	3.55	
All V8 EFI petrol models - LH					
Genuine	1	<b>NTC5867</b>	57.17	68.60	
All 2.5L VM Turbo Diesel models - LH					
Genuine	1	<b>NTC5867</b>	57.17	68.60	
All 200TDi diesel manual models					
RH	Genuine	1	<b>NTC6281</b>	51.97	62.36
LH	Genuine	1	<b>NTC6280</b>	51.97	62.36
All 300TDi diesel models					
LH	Genuine	1	<b>NTC9415</b>	97.80	117.36
RH	Genuine	1	<b>ANR2868</b>	117.03	140.44

## Gearbox Mounting

All models with 3 speed automatic gearbox - With M12 metric threads					
Aftermarket	2	<b>STC434P</b>	2.33	2.80	
OEM	2	<b>STC434P1</b>	9.38	11.26	
Genuine	2	<b>STC434</b>	23.83	28.60	
All 4 speed automatic models up to (VIN) LA647644					
Aftermarket	2	<b>NTC5890P</b>	2.83	3.40	
Genuine	2	<b>NTC5890</b>	28.49	34.19	
All models with 4 speed LT95 gearbox - With M12 metric threads					
Aftermarket	2	<b>STC434P</b>	2.33	2.80	
OEM	2	<b>STC434P1</b>	9.38	11.26	
Genuine	2	<b>STC434</b>	23.83	28.60	
All models with 5 speed LT77 gearbox up to (VIN) BA - With M12 metric threads					
Aftermarket	2	<b>STC434P</b>	2.33	2.80	
OEM	2	<b>STC434P1</b>	9.38	11.26	
Genuine	2	<b>STC434</b>	23.83	28.60	
All manual models from (VIN) CA to LA647644					
Aftermarket	2	<b>NTC5890P</b>	2.83	3.40	
Genuine	2	<b>NTC5890</b>	28.49	34.19	
All models from (VIN) MA647645 on					
Aftermarket	2	<b>ANR2805P</b>	2.42	2.90	
Genuine	2	<b>ANR2805</b>	13.75	16.50	
All 200TDi diesel manual models - Rear					
Genuine	1	<b>NTC6282</b>	135.84	163.01	
All 300TDi diesel models					
RH	Aftermarket	1	<b>ANR3200P</b>	2.50	3.00
	Genuine	1	<b>ANR3200</b>	23.26	27.91
LH	Aftermarket	1	<b>ANR3201P</b>	2.50	3.00
	OEM	1	<b>ANR3201P1</b>	4.58	5.50
	Genuine	1	<b>ANR3201</b>	23.26	27.91

## Bracket Gearbox Mounting

All 3.5L V8 petrol manual models with B-W NV225 transfer box					
LH, upper	Genuine	1	<b>NTC4985</b>	53.44	64.13
All 3.5L V8 petrol manual models with 5 speed LT77 gearbox and LT230 transfer box					
LH, upper	Genuine	1	<b>NTC4985</b>	53.44	64.13
All 3.9L V8 petrol automatic models up to (VIN) LA647644					
LH, upper	Genuine	1	<b>NTC4985</b>	53.44	64.13



ANR1808P1



STC434

## RANGE ROVER CLASSIC (1970 TO 1996)

## FUEL SYSTEM SWITCHES

## Fuel Temperature Sensor

All V8 EFI petrol models	Aftermarket	1	<b>ETC6661P</b>	40.00	48.00
--------------------------	-------------	---	-----------------	-------	-------

## Turbo Boost Pressure Switch

All 300 TDi diesel models	Genuine	1	<b>ERR2083</b>	467.68	561.22
---------------------------	---------	---	----------------	--------	--------

## Mass Airflow Sensor

V8 EFI petrol models from (VIN) MA647645 on					
	Aftermarket	1	<b>ERR5198P</b>	83.33	100.00

## RANGE ROVER CLASSIC (1970 TO 1996)

## CABLES

## Accelerator Cable

All RHD 3.5L V8 carb 4 speed manual models					
	Aftermarket	1	<b>566426P</b>	6.67	8.00
All RHD V8 EFI petrol models up to (VIN) FA399972					
	Aftermarket	1	<b>NTC1054P</b>	29.58	35.50
All LHD 3.5L V8 carb manual models					
	Aftermarket	1	<b>577356P</b>	3.00	3.60
All LHD 3.9L V8 EFI petrol models up to (VIN) FA399972					
	Aftermarket	1	<b>NTC6723P</b>	47.50	57.00
All LHD 2.4L & 2.5L VM Turbo Diesel models from (VIN) GA399973 on					
	Aftermarket	1	<b>NTC7189P</b>	17.50	21.00
	Genuine	1	<b>NTC7189</b>	51.23	61.48
All LHD diesel models up to (VIN) FA399972					
	Aftermarket	1	<b>NTC1460P</b>	39.58	47.50
	Genuine	1	<b>NTC1460</b>	66.92	80.30
All LHD 300 TDi diesel models					
	Aftermarket	1	<b>ANR3606P</b>	12.50	15.00
	Genuine	1	<b>ANR3606</b>	31.50	37.80

## Bonnet Release Cable

All models up to (VIN) CA274120					
	Aftermarket	1	<b>391290P</b>	2.50	3.00
All models from (VIN) DA274121 to LA647644					
	Aftermarket	1	<b>MWC2287P</b>	6.04	7.25
	Aftermarket	1	<b>MXC6324P</b>	6.04	7.25
	OEM	1	<b>MXC6324P1</b>	7.50	9.00

## Choke Cable

All V8 carb petrol models with SU carburettors					
	Aftermarket	1	<b>NTC3690P</b>	29.58	35.50
All RHD 3.5L V8 petrol models with Stromberg carbs					
	Aftermarket	1	<b>NRC9094P</b>	7.08	8.50
	Genuine	1	<b>NRC9094</b>	36.98	44.38
All LHD V8 carb petrol models with Stromberg carbs 1984 on					
	Aftermarket	1	<b>NRC9095P</b>	8.96	10.75

## Speedometer Cable

All RHD manual and auto up to (VIN) AA - One piece cable					
	Aftermarket	1	<b>579165P</b>	5.00	6.00
All RHD models from (VIN) BA to HA610293 - One piece cable					
	Aftermarket	1	<b>PRC6017P</b>	7.50	9.00
All RHD models except Police from (VIN) BA to HA610293 - Two piece cable, lower end					
	Aftermarket	1	<b>PRC5564P</b>	4.79	5.75
All RHD diesel models from (VIN) JA610294 to LA647644 - One piece cable					
	Aftermarket	1	<b>PRC6017P</b>	7.50	9.00
All RHD diesel models from (VIN) JA610294 to LA647644 - Gearbox to transducer					
	Aftermarket	1	<b>PRC7949P</b>	3.50	4.20
All 3.5L V8 and 2.4L VM turbo diesel models from (VIN) CA to HA610623 - Gearbox to transducer					
	Aftermarket	1	<b>PRC6320P</b>	3.75	4.50
All 3.9L V8 petrol models to (VIN) LA647644 - Gearbox to transducer					
	Aftermarket	1	<b>PRC7949P</b>	3.50	4.20
All 2.5L VM turbo diesel models - Gearbox to transducer					
	Aftermarket	1	<b>PRC7949P</b>	3.50	4.20
All LHD manual models up to (VIN) AA - One piece cable					
	Aftermarket	1	<b>579166P</b>	4.58	5.50
All LHD V8 petrol automatic models up to (VIN) AA					
	OEM	1	<b>PRC3965P1</b>	22.08	26.50
All LHD models from (VIN) BA to HA610293 - One piece cable					
	Aftermarket	1	<b>PRC6018P</b>	10.00	12.00
All LHD models except Police from (VIN) BA to HA610293 - Two piece cable, lower end					
	Aftermarket	1	<b>PRC5565P</b>	5.63	6.76
All Gulf States models from (VIN) CA170458 to HA610293 - Lower cable					
	Genuine	1	<b>PRC6043</b>	79.38	95.26
All LHD diesel models from (VIN) JA610294 to LA647644 - One piece cable					
	Aftermarket	1	<b>PRC6018P</b>	10.00	12.00
All models with two piece speedo cable from (VIN) BA on - Upper cable (instrument end)					
	Aftermarket	1	<b>PRC5568P</b>	3.00	3.60
All models with speed transducer from (VIN) CA on - Transducer to instruments					
	Genuine	1	<b>PRC6278P</b>	10.00	12.00
All USA/CDN/Mex models with speed transducer from (VIN) CA to HA610293 - Transducer to gearbox					
	Genuine	1	<b>PRC7826</b>	75.64	90.77



# WINDOW REGULATORS

## RANGE ROVER CLASSIC (1970 TO 1996)

### Window Regulator

All 2 door models up to (VIN) EA351846				
Front RH	Aftermarket	1	<b>MTC3775P</b>	9.58 11.50
Front LH	Aftermarket	1	<b>MTC3776P</b>	9.58 11.50
All 4 door models with manual windows except Monteverdi conversions				
Front RH	Aftermarket	1	<b>MUC2038P</b>	14.58 17.50
	Genuine	1	<b>MUC2038</b>	115.33 138.40
Front LH	Aftermarket	1	<b>MUC2039P</b>	18.96 22.75
	Genuine	1	<b>MUC2039</b>	116.40 139.68
All models with electric front windows (VIN) MA659911 on				
Front RH	Aftermarket	1	<b>LRO06373P</b>	17.29 20.75
	Genuine	1	<b>LRO06373</b>	96.61 115.93
Front LH	Aftermarket	1	<b>LRO06374P</b>	13.12 15.74
	Genuine	1	<b>LRO06374</b>	96.61 115.93
All Monteverdi 4 door conversions				
Front RH	Aftermarket	1	<b>MTC3775P</b>	9.58 11.50
Front LH	Aftermarket	1	<b>MTC3776P</b>	9.58 11.50
All models with electric rear windows (VIN) MA659911 on				
Rear RH	Aftermarket	1	<b>STC2884P</b>	22.08 26.50
	Genuine	1	<b>STC2884</b>	85.66 102.79
Rear LH	Aftermarket	1	<b>STC2883P</b>	22.08 26.50
	Genuine	1	<b>STC2883</b>	85.66 102.79

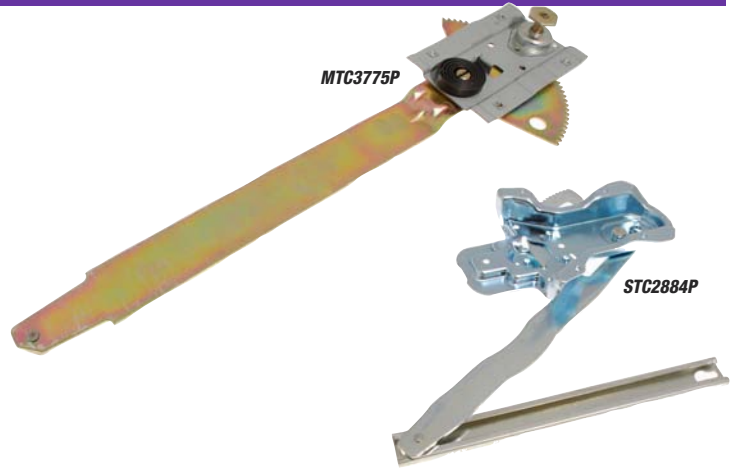

# WHEEL CENTRE CAPS & WHEEL NUTS

## RANGE ROVER CLASSIC (1970 TO 1996)

### Wheel Centre Cap

All models with Quicksilver (MUE) colour alloy wheels				
Quicksilver, features Land Rover logo	Genuine	a/r	<b>ANR2391MUE</b>	5.13 6.16
All models with black alloy wheel centre caps				
Black, Range Rover badge	Genuine	a/r	<b>NRC8254</b>	8.35 10.02
All models with Black colour alloy wheels and Land Rover logo on centre cap - Black, features Land Rover logo				
	Genuine	a/r	<b>STC7248</b>	10.06 12.07

### Wheel Stud

All models - Extended, 60mm (original fitment for Defender Wolf/XD). <i>Allows fitment of certain alternative wheels</i>				
	OEM	a/r	<b>FRC7577P1</b>	5.83 7.00
	Genuine	a/r	<b>FRC7577</b>	19.36 23.23
All models from 1984 on, will fit earlier models - <i>For alloy or steel wheels</i>				
	Aftermarket	a/r	<b>RUF500010P</b>	1.33 1.60
	Genuine	a/r	<b>RUF500010</b>	2.09 2.51

### Wheel Nut

All models with steel wheels				
	Aftermarket	a/r	<b>RRD500010P</b>	0.79 0.95
	Genuine	a/r	<b>RRD500010</b>	1.82 2.18
All models with alloy wheels up to (VIN) KA635839 - <i>Without stainless steel cap</i>				
	Aftermarket	a/r	<b>NRC7415P</b>	2.00 2.40
	OEM	a/r	<b>NRC7415P1</b>	2.75 3.30
	Genuine	a/r	<b>NRC7415</b>	2.97 3.56

### Wheel Nut Set

All models with steel wheels - Set of 20				
	Aftermarket	a/r	<b>RRD500010KP</b>	11.04 13.25
	Genuine	a/r	<b>RRD500010K</b>	34.00 40.80
All models with alloy wheels up to (VIN) KA635839 - Set of 20. <i>Without stainless steel cap</i>				
	Aftermarket	a/r	<b>NRC7415KP</b>	38.33 46.00
	Genuine	a/r	<b>NRC7415K</b>	58.50 70.20



ANR2391MUE



NRC8254



RRD500010P





# RANGE ROVER P38 (1994 TO 2001)

## 1994 TO 2001 - All Models

Listed below are the most popular parts required for the Range Rover P38. We have access to the full range of parts for your vehicle. Please contact us if not listed here.

### RANGE ROVER P38 (1994 TO 2001)

## SERVICE KITS

#### Service Kit

All V8 EFi petrol models to (VIN) TA346794 & WA376580 to 385948 -

Includes oil filter, air filter, fuel filter, pollen filters, spark plugs & sump plug washer

Aftermarket	1	<b>RA1479P</b>	25.00	30.00
Genuine	1	<b>RA1479</b>	90.00	108.00

All V8 EFi petrol models from (VIN) VA346795 to 376579 & WA385949 on

Includes oil filter, air filter, fuel filter, pollen filters, spark plugs & sump plug washer

Aftermarket	1	<b>RA1480P</b>	25.50	30.60
Genuine	1	<b>RA1480</b>	90.00	108.00

#### Filter Kit

2.5L 6 cyl BMW M51 diesel models to (eng) 33978348

Includes oil filter (type A), air filter, fuel filter, pollen filters & sump plug washer

Aftermarket	1	<b>RA1481P</b>	18.50	22.20
Genuine	1	<b>RA1481</b>	69.00	82.80

2.5L 6 cyl BMW M51 diesel models from (eng) 33978349 to (VIN) TA346793

Includes oil filter (type B), air filter, fuel filter, pollen filters & sump plug washer

Aftermarket	1	<b>RA1482P</b>	15.75	18.90
Genuine	1	<b>RA1482</b>	69.00	82.80

2.5L 6 cyl BMW M51 diesel models from (VIN) TA346794 on

Includes oil filter, air filter, fuel filter, pollen filters & sump plug washer

Aftermarket	1	<b>RA1483P</b>	16.25	19.50
Genuine	1	<b>RA1483</b>	72.50	87.00

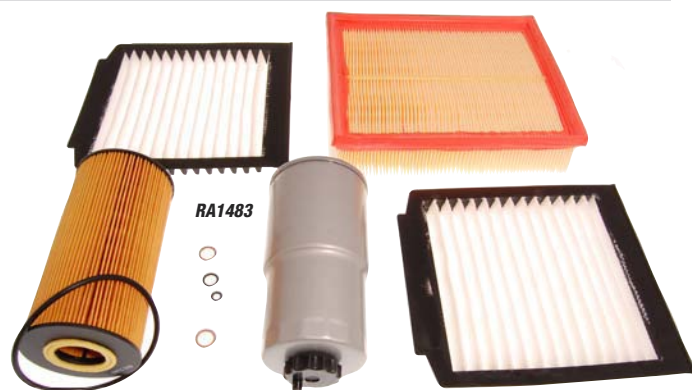
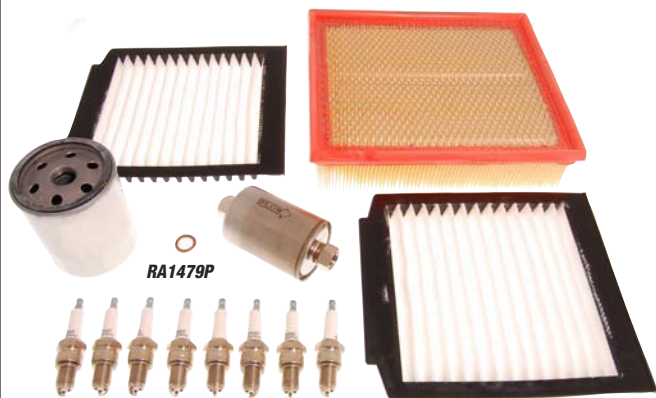

### RANGE ROVER P38 (1994 TO 2001)

## FILTRATION

#### Oil Filter

All models with V8 petrol engine - Cartridge	Genuine	1	<b>ERR3340</b>	10.82	12.98
	Aftermarket	1	<b>ERR3340P</b>	2.00	2.40
	OEM	1	<b>ERR3340P1</b>	3.33	4.00

All models with 2.5L diesel engine up to (engine) 33978348 - Element	Aftermarket	1	<b>STC2180P</b>	2.58	3.10
	OEM	1	<b>STC2180P1</b>	4.55	5.46
	Genuine	1	<b>STC2180</b>	10.05	12.06

All models with 2.5L diesel engine from (engine) 33978349 on - Element	Aftermarket	1	<b>STC3350P</b>	2.75	3.30
	OEM	1	<b>STC3350P1</b>	3.75	4.50
	Genuine	1	<b>STC3350</b>	10.05	12.06

#### Air Filter

All V8 EFi petrol models up to (VIN) TA346793 and from WA376580 to WA385948	Aftermarket	1	<b>ESR341P</b>	5.00	6.00
	Genuine	1	<b>ESR341</b>	11.31	13.57

All V8 EFi petrol models from (VIN) VA346794 to VA376579 and from WA385949 on	Aftermarket	1	<b>LR027408P</b>	2.50	3.00
	OEM	1	<b>LR027408P1</b>	4.58	5.50
	Genuine	1	<b>LR027408</b>	12.57	15.08

All 2.5L 6 cyl diesel models up to (VIN) VA376579	Aftermarket	1	<b>ESR341P</b>	5.00	6.00
	Genuine	1	<b>ESR341</b>	11.31	13.57

All 2.5L 6 cyl diesel models from (VIN) WA376580 on	Aftermarket	1	<b>LR027408P</b>	2.50	3.00
	OEM	1	<b>LR027408P1</b>	4.58	5.50
	Genuine	1	<b>LR027408</b>	12.57	15.08

#### Air Cleaner Complete Assembly

All petrol engine models to (VIN) WA385948	Genuine	1	<b>ESR2948</b>	136.55	163.86
--------------------------------------------	---------	---	----------------	--------	--------

#### Fuel Filter

All V8 EFi petrol models - Internal threaded unions	Aftermarket	1	<b>ESR4065P</b>	3.00	3.60
	OEM	1	<b>ESR4065P1</b>	4.58	5.50
	Genuine	1	<b>ESR4065</b>	14.85	17.82
All diesel engine models	Aftermarket	1	<b>STC2827P</b>	7.08	8.50
	OEM	1	<b>STC2827P1</b>	10.63	12.76
	Genuine	1	<b>STC2827</b>	21.23	25.48

#### Fuel Filter Complete Assembly

All petrol models	Genuine	1	<b>ESR1121</b>	307.52	369.02
-------------------	---------	---	----------------	--------	--------

#### Pollen Filter

All models with air conditioning	Aftermarket	1	<b>LR030219P</b>	3.00	3.60
	OEM	1	<b>LR030219P1</b>	11.04	13.25
	Genuine	1	<b>LR030219</b>	18.92	22.70

#### Oil Strainer Transmission, Gearbox

All models with 4 speed auto gearbox	Aftermarket	1	<b>RTC4653P</b>	5.21	6.25
	OEM	1	<b>RTC4653P1</b>	9.37	11.24
	Genuine	1	<b>RTC4653</b>	49.14	58.97

### RANGE ROVER P38 (1994 TO 2001)

## WIPER BLADES

#### Wiper Blade

All RHD models - Front	Aftermarket	2	<b>DKC101000P</b>	3.25	3.90
	OEM	2	<b>DKC101000P1</b>	6.04	7.25
	Genuine	2	<b>DKC101000</b>	12.20	14.64
All LHD models - Front	Aftermarket	2	<b>DKC100830P</b>	3.25	3.90
	Genuine	2	<b>DKC100830</b>	14.56	17.47
All models - Rear	Aftermarket	1	<b>PRC7576P</b>	2.50	3.00
	OEM	1	<b>PRC7576P1</b>	5.00	6.00
	Genuine	1	<b>PRC7576</b>	10.89	13.07
All models - Headlamp	Aftermarket	2	<b>DKC100860P</b>	4.08	4.90
	Genuine	2	<b>DKC100860</b>	11.17	13.40



# SCREEN/LAMP WASHER SYSTEMS

## Washer Jet

All models up to (VIN) WA394534					
Front screen, twin jet type	Aftermarket	2	<b>AMR5257P</b>	1.58	1.90
	Genuine	2	<b>AMR5257</b>	8.52	10.22

All models from (VIN) WA394535 on					
Front screen, twin jet type, includes retainer	Aftermarket	2	<b>DNJ100750P</b>	6.04	7.25
	Genuine	2	<b>DNJ100750</b>	13.46	16.15

All models					
Rear screen, includes hose	Genuine	1	<b>AMR4779</b>	10.85	13.02

## Washer Pump

All models					
Front screen, red coded	Aftermarket	1	<b>AMR3271P</b>	7.50	9.00
Rear Screen	OEM	1	<b>DMC10023P1</b>	10.42	12.50
	Genuine	1	<b>DMC10023</b>	55.81	66.97

All models with headlamp wash					
Headlamps, white coded	OEM	1	<b>AMR3272P1</b>	8.54	10.25
	Aftermarket	1	<b>AMR3272</b>	48.60	58.32

## Washer Hose, Per Metre

All models - 4mm internal diameter (3mm also available).					
Front or rear screen wash	Aftermarket	a/r	<b>GWV201M</b>	2.25	2.70

## Washer Hose Non Return Valve

All models from (VIN) 1A459138 on - Fits in-line in 4mm dia. hose to bonnet					
	Aftermarket	1	<b>AMR6676P</b>	1.42	1.70
	Genuine	1	<b>AMR6676</b>	3.26	3.91

## Washer Hose & Non Return Valve

All models - Front screen wash	Genuine	1	<b>DNC000140</b>	5.12	6.14
--------------------------------	---------	---	------------------	------	------

# DRIVE BELTS

## Alternator Drive Belt

All models with V8 petrol engine without air conditioning up to (VIN) WA410481 - Alternator	Aftermarket	1	<b>ERR4461P</b>	6.88	8.26
	OEM	1	<b>ERR4461P1</b>	9.79	11.75
	Genuine	1	<b>ERR4461</b>	28.01	33.61
from (VIN) XA410482 on - Alternator	Aftermarket	1	<b>PQS101640P</b>	7.50	9.00
	OEM	1	<b>PQS101640P1</b>	13.33	16.00
	Genuine	1	<b>PQS101640</b>	51.20	61.44

All models with V8 petrol engine and air conditioning up to (VIN) WA410481 - Alternator	Aftermarket	1	<b>ERR4460P</b>	6.67	8.00
	OEM	1	<b>ERR4460P1</b>	11.04	13.25
	Genuine	1	<b>ERR4460</b>	30.03	36.04

All V8 petrol models with air conditioning from (VIN) XA410482 on - Alternator, 2322mm long	Aftermarket	1	<b>PQS101480P</b>	6.04	7.25
	OEM	1	<b>PQS101480P1</b>	12.50	15.00
	Genuine	1	<b>PQS101480</b>	33.14	39.77

2335mm long	Aftermarket	1	<b>PQS101630P</b>	11.88	14.26
	OEM	1	<b>PQS101630P1</b>	14.38	17.26
	Genuine	1	<b>PQS101630</b>	52.69	63.23

All models with 2.5L diesel engine - Alternator	Aftermarket	1	<b>STC4455P</b>	4.38	5.26
	OEM	1	<b>STC4455P1</b>	9.17	11.00
	Genuine	1	<b>STC4455</b>	35.72	42.86

# IGNITION SYSTEM

## Spark Plug

All V8 petrol models up to (VIN) WA410481					
RN11YC type	Aftermarket	8	<b>ERR3799P</b>	2.00	2.40
	Genuine	8	<b>ERR3799</b>	4.19	5.03
19mm reach, double core	MG Rover	8	<b>GSP6462</b>	2.95	3.54

All V8 petrol models from (VIN) XA410482 on	Aftermarket	8	<b>NLP100320P</b>	6.88	8.26
	Genuine	8	<b>NLP100320</b>	10.06	12.07

## Glow Plug

All 2.5L diesel engine models	Aftermarket	6	<b>STC3103P</b>	3.33	4.00
	OEM	6	<b>STC3103P1</b>	6.46	7.75
	Genuine	6	<b>STC3103</b>	19.89	23.87

## Ignition Coil

All V8 EFI petrol engine models up to (VIN) WA410481 - GEMs system	Aftermarket	1	<b>ERR6269P</b>	59.17	71.00
	Genuine	1	<b>ERR6269</b>	459.47	551.36

All V8 EFI petrol engine models from (VIN) XA410482 on - MEMs system	Aftermarket	2	<b>ERR6045P</b>	20.63	24.76
	OEM	2	<b>ERR6045P1</b>	23.33	28.00
	Genuine	2	<b>ERR6045</b>	40.84	49.01



ERR6566P

# RANGE ROVER P38 (1994 TO 2001)

## Washer Jet Elbow

All 2.5L TD5 diesel models					
Front screen wash	Genuine	1	<b>DNG100280</b>	0.82	0.98

## Washer Reservoir & Pumps

All models without headlamp wash					
Front & rear screen wash	Genuine	1	<b>DMB000100</b>	139.62	167.54
All models with headlamp wash					
Front & rear screen & headlamp wash	Genuine	1	<b>DMB000110</b>	165.61	198.73

## Washer Reservoir Without Pumps

All models without headlamp wash					
Front & rear screen wash	Genuine	1	<b>AMR3718</b>	22.94	27.53

## Washer Reservoir Cap

All models	Genuine	1	<b>AMR3267</b>	4.13	4.96
------------	---------	---	----------------	------	------

## Washer Reservoir Filler Neck Seal

All models					
Front & rear screen & headlamp wash	Genuine	1	<b>DMJ000010</b>	3.84	4.61

## Filler Neck, Cap & Filter

All models without headlamp wash					
Front & rear screen wash	Genuine	1	<b>DMF100310</b>	18.16	21.79
All models with headlamp wash up to (VIN) XA430701					
Front & rear screen & headlamp wash	Genuine	1	<b>DMF100310</b>	18.16	21.79
All models with headlamp wash from (VIN) YA430702 on					
Front & rear screen & headlamp wash	Genuine	1	<b>DMF100320</b>	21.51	25.81

## Windscreen Cleaning Paste

All models	Genuine	a/r	<b>DNJ500340</b>	7.72	9.26
Prevents wiper blade judder/squeak by 'deep cleaning' the windscreen (ref: Land Rover Tech Bulletin LRA501-002)					

# RANGE ROVER P38 (1994 TO 2001)

## A/C Belt

All models with 2.5L diesel and air conditioning - Air cond compressor					
	Aftermarket	1	<b>STC3397P</b>	3.25	3.90
	OEM	1	<b>STC3397P1</b>	5.63	6.76
	Genuine	1	<b>STC3397</b>	20.97	25.16



ERR4461P

STC3397P

# RANGE ROVER P38 (1994 TO 2001)

## Ignition Coil & Bracket Assembly

All V8 EFI petrol engine models from (VIN) XA410482 on - MEMs system. Includes 4 coils (for 8 cylinders)					
	Aftermarket	1	<b>ERR6566P</b>	80.00	96.00
	Genuine	1	<b>ERR6566</b>	154.81	185.77

## Ignition Lead Set

All V8 petrol models up to (VIN) WA410481	Aftermarket	1	<b>RA1340P</b>	14.79	17.75
	Genuine	1	<b>RA1340</b>	69.50	83.40
Performance, silicone RED	Aftermarket	1	<b>RA1340S</b>	25.83	31.00
All V8 petrol models from (VIN) XA410482 on	Aftermarket	1	<b>RA2001P</b>	14.79	17.75
	Genuine	1	<b>RA2001</b>	130.00	156.00
Performance, silicone RED	Aftermarket	1	<b>RA2001S</b>	25.83	31.00

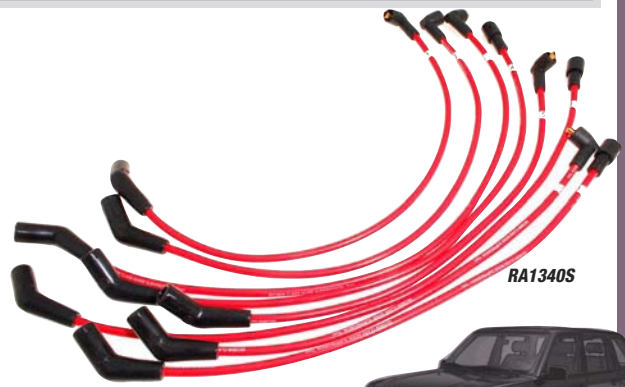

RA1340S



## RANGE ROVER P38 (1994 TO 2001)

## BRAKING SYSTEM

## Brake Pad Set

All models				
Front Brakes	Aftermarket	1	<b>SFP500120P</b>	15.63 18.76
	OEM	1	<b>SFP500120P1</b>	19.79 23.75
	EBC	1	<b>SFP500120ULTIMAX</b>	22.08 26.50
	Genuine	1	<b>SFP500120</b>	87.19 104.63
Rear Brakes	Aftermarket	1	<b>SFP500130P</b>	11.67 14.00
	OEM	1	<b>SFP500130P1</b>	18.13 21.76
	EBC	1	<b>SFP500130ULTIMAX</b>	20.00 24.00
	Genuine	1	<b>SFP500130</b>	67.42 80.90
Rear Brakes, Green Stuff	EBC	1	<b>SFP500130GS</b>	32.08 38.50

## Brake Disc

All models				
Front, Vented (each)	Aftermarket	2	<b>NTC8780P</b>	15.75 18.90
	Brembo	1	<b>NTC8780BREMBO</b>	70.83 85.00
	Genuine	2	<b>NTC8780</b>	68.16 81.79
Rear, Not Vented (each)	Aftermarket	2	<b>SDB000470P</b>	13.54 16.25
	Genuine	2	<b>SDB000470</b>	58.00 69.60
Rear, Not Vented (pair)	Brembo	1	<b>SDB000470BREMBO</b>	55.83 67.00

## Performance Brake Disc

All models				
Front, Vented, slotted & drilled (pair)	Britpart	1	<b>NTC8780URBP</b>	47.50 57.00
Rear, Not Vented, slotted & drilled (pair)	Britpart	1	<b>SDB000470URBP</b>	46.67 56.00

## Mudshield Brake Disc

All models from (VIN) WA376580				
Front RH	Genuine	1	<b>FTC4908</b>	25.42 30.50
Front LH	Genuine	1	<b>FTC4909</b>	25.42 30.50

## Brake Caliper

All models				
RH Front, Vented Disc Brakes				
New, outright	Aftermarket	1	<b>STC1916P</b>	29.58 35.50
New, exchange	OEM*	1	<b>STC1916P1</b>	85.83 103.00
			*Exchange Surcharge	50.00 60.00
Reconditioned, exchange	Exchange*	1	<b>STC1916E</b>	66.32 79.58
			*Exchange Surcharge	50.00 60.00
New, exchange	Genuine*	1	<b>STC1916</b>	185.24 222.29
			*Exchange Surcharge	50.00 60.00
LH Front, Vented Disc Brakes				
New, outright	Aftermarket	1	<b>STC1915P</b>	29.58 35.50
	OEM	1	<b>STC1915P1</b>	110.00 132.00
Reconditioned, exchange	Exchange*	1	<b>STC1915E</b>	66.32 79.58
			*Exchange Surcharge	50.00 60.00
New, exchange	Genuine*	1	<b>STC1915</b>	185.24 222.29
			*Exchange Surcharge	50.00 60.00
RH Rear, Solid Disc Brakes				
New, outright	Aftermarket	1	<b>STC1906P</b>	25.00 30.00
Reconditioned, exchange	Exchange*	1	<b>STC1906E</b>	66.32 79.58
			*Exchange Surcharge	50.00 60.00
New, exchange	Genuine*	1	<b>STC1906</b>	110.73 132.88
			*Exchange Surcharge	50.00 60.00
LH Rear, Solid Disc Brakes				
New, outright	Aftermarket	1	<b>STC1905P</b>	25.00 30.00
Reconditioned, exchange	Exchange*	1	<b>STC1905E</b>	66.32 79.58
			*Exchange Surcharge	50.00 60.00
New, exchange	Genuine*	1	<b>STC1905</b>	110.76 132.91
			*Exchange Surcharge	50.00 60.00

## Brake Caliper Carrier

All models				
Front, Vented Disc Brakes	OEM	2	<b>STC1917P1</b>	22.50 27.00
	Genuine	2	<b>STC1917</b>	202.92 243.50
Rear, Solid Disc Brakes	Aftermarket	2	<b>STC1907P</b>	16.67 20.00
	OEM	2	<b>STC1907P1</b>	19.58 23.50
	Genuine	2	<b>STC1907</b>	47.75 57.30

## Brake Caliper Piston

All models				
Front, Vented Disc Brakes	Aftermarket	4	<b>STC1918P</b>	4.38 5.26
	OEM	4	<b>STC1918P1</b>	7.50 9.00
	Genuine	4	<b>STC1918</b>	17.20 20.64
Rear, Solid Disc Brakes	Aftermarket	1	<b>STC1908P</b>	4.08 4.90
	Genuine	1	<b>STC1908</b>	18.49 22.19

## Caliper Repair Kit

All models				
Front caliper, kit does not include pistons				
	Aftermarket	2	<b>STC1919P</b>	3.92 4.70
	OEM	2	<b>STC1919P1</b>	10.83 13.00
	Genuine	2	<b>STC1919</b>	21.49 25.79
Rear caliper, kit does not include pistons				
	Aftermarket	2	<b>STC1909P</b>	3.50 4.20
	Genuine	2	<b>STC1909</b>	10.73 12.88

## Slider Pin Bolt

All models - Front and rear calipers				
	Genuine	2	<b>STC1914</b>	1.10 1.32

## Caliper Guide Pin

All models - Front brakes				
	Aftermarket	1	<b>STC1920P</b>	13.54 16.25
	Genuine	1	<b>STC1920</b>	17.90 21.48

## Caliper Guide Pin Kit

All models - Rear brakes				
	Aftermarket	1	<b>STC1910P</b>	12.29 14.75
	Genuine	1	<b>STC1910</b>	16.11 19.33

## Brake Hose

All models - Front, rubber				
RH	Aftermarket	1	<b>ANR3258P</b>	7.50 9.00
	Genuine	1	<b>ANR3258</b>	92.21 110.65
LH	Aftermarket	1	<b>ANR3259P</b>	7.50 9.00
	Genuine	1	<b>ANR3259</b>	92.21 110.65
All models from (VIN) VA346794 - Rear				
RH	Aftermarket	1	<b>ANR4704P</b>	7.50 9.00
	OEM	1	<b>ANR4704P1</b>	15.00 18.00
LH	Aftermarket	1	<b>ANR4703P</b>	9.17 11.00
	OEM	1	<b>ANR4703P1</b>	15.00 18.00
	Genuine	1	<b>ANR4703</b>	87.50 105.00
RH or LH	Aftermarket	2	<b>ANR5916P</b>	6.04 7.25
	OEM	2	<b>ANR5916P1</b>	7.71 9.25
	Genuine	2	<b>ANR5916</b>	23.06 27.67
All models up to (VIN) TA346793				
Rear, rubber	Aftermarket	1	<b>STC2656P</b>	5.00 6.00
	Genuine	1	<b>STC2656</b>	40.34 48.41
Rear caliper hose, rubber	Aftermarket	2	<b>ANR3628P</b>	5.00 6.00
	OEM	2	<b>ANR3628P1</b>	25.00 30.00
	Genuine	2	<b>ANR3628</b>	57.61 69.13
All RHD models - To brake booster				
	Genuine	1	<b>ANR3322</b>	68.91 82.69
	Genuine	1	<b>ANR2256</b>	12.44 14.93
All LHD models - To brake booster				
	Genuine	1	<b>ANR3321</b>	127.82 153.38
	Genuine	1	<b>ANR2257</b>	20.24 24.29

## Brake Pipe Clip

All models				
	Genuine	a/r	<b>ANR1864</b>	1.16 1.39
Various applications	Genuine	a/r	<b>NTC9543L</b>	1.80 2.16

## Brake Shoe Set - Handbrake

All models				
Handbrake, direct entry cable type				
	Aftermarket	1	<b>ICW500010P</b>	10.00 12.00
	OEM	1	<b>ICW500010P1</b>	25.00 30.00
	Genuine	1	<b>ICW500010</b>	65.52 78.62

## Brake Spring Kit

All models - Handbrake Shoe Retention				
	Aftermarket	1	<b>ICW100050P</b>	3.83 4.60
	OEM	1	<b>ICW100050P1</b>	8.12 9.74
	Genuine	1	<b>ICW100050</b>	11.52 13.82

## Transmission Brake Adjustment Kit

All models				
	Aftermarket	1	<b>ICW500020P</b>	9.37 11.24
	Genuine	1	<b>ICW500020</b>	13.81 16.57

## Clevis Pin Handbrake Lever

All models				
	Aftermarket	1	<b>FRC8547P</b>	2.08 2.50
	Genuine	1	<b>FRC8547</b>	3.30 3.96
	Genuine	1	<b>ANR4118</b>	1.93 2.32

## Handbrake Lever Clip

All models				
	Genuine	1	<b>ANR1832</b>	1.44 1.73

## Handbrake Cable

All models				
	Aftermarket	1	<b>ANR2215P</b>	9.58 11.50
	Genuine	1	<b>ANR2215</b>	76.69 92.03

## ABS Sensor Kit

All models - Front brakes				
	Aftermarket	2	<b>STC2786P</b>	29.58 35.50
	OEM	2	<b>STC2786P1</b>	100.00 120.00
Up to (axle) 50S02483A, up to (VIN) TA346793 - Rear brakes				
	Aftermarket	1	<b>STC2787P</b>	87.50 105.00
	OEM	1	<b>STC2787P1</b>	100.00 120.00
	Genuine	1	<b>STC2787</b>	285.25 342.30
From (axle) 50S02484A on, up to (VIN) TA346793 - Rear brake				
LH	Genuine	1	<b>STC2921</b>	354.16 424.99
All models from (VIN) VA346794 on - Rear brakes, includes shield				
	Aftermarket	2	<b>STC3385P</b>	40.00 48.00
	Genuine	2	<b>STC3385</b>	139.43 167.32

## Bush ABS Sensor

All models with anti lock brakes				
Front and rear				
	Aftermarket	4	<b>FTC1374P</b>	4.58 5.50
	Genuine	4	<b>LRO29522</b>	14.33 17.20

## Adaptor ABS Sensor

All models with ABS				
	Genuine	4	<b>FTC2249</b>	13.58 16.30

## Cover ABS Sensor

All models with ABS - Rear				
	Genuine	2	<b>STC3077</b>	9.05 10.86

## Brake Pedal Rubber

All models with automatic transmission				
	Aftermarket	1	<b>ANR1871P</b>	3.58 4.30
	Genuine	1	<b>ANR1871</b>	4.63 5.56
All models with manual transmission				
	Genuine	1	<b>ANR1870</b>	8.08 9.70



# SUSPENSION

# RANGE ROVER P38 (1994 TO 2001)

## Bush Radius Arm

All models - Front suspension chassis end, rubber				
	Aftermarket	2	<b>ANR2563P</b>	1.25 1.50
	Genuine	2	<b>ANR2563</b>	5.18 6.22
chassis end, poly. (set of 4)				
	Polybush	1	<b>ANR2563POLYBUSH</b>	25.83 31.00
axle end, rubber				
	Aftermarket	4	<b>ANR3332P</b>	3.00 3.60
	OEM	4	<b>ANR3332P1</b>	9.38 11.26
	Genuine	4	<b>ANR3332</b>	18.84 22.61
axle end, poly.				
	Aftermarket	4	<b>ANR3332POLY</b>	15.63 18.76
	Polybush	1	<b>ANR3332POLYBUSH</b>	63.33 76.00

## Bush Shock Absorber Mounting

All models up to (VIN) VA348053 Front, lower, rubber				
	Aftermarket	4	<b>RNF100090LP</b>	0.54 0.65
	Genuine	4	<b>RNF100090L</b>	2.06 2.47
	Genuine	4	<b>RNF100090</b>	1.09 1.31

## Bush Panhard Rod

All models - Front suspension rubber				
	Aftermarket	2	<b>RBX101340P</b>	1.75 2.10
	OEM	2	<b>RBX101340P1</b>	8.96 10.75
	Genuine	2	<b>RBX101340</b>	14.27 17.12
poly.				
	Aftermarket	2	<b>RBX101340POLY</b>	6.04 7.25

## Bush Trailing Arm

All models Rear suspension, chassis end, rubber				
	Aftermarket	1	<b>ANR3285P</b>	3.75 4.50

## Suspension Bush Kit

All models - Kit contains complete vehicle set				
	Aftermarket	1	<b>RA2003P</b>	50.00 60.00
	Genuine	1	<b>RA2003</b>	188.50 226.20

## Bolt Kit for Suspension Bush Kit

All models - Kit contains all nuts & bolts required when renewing the suspension bushes				
	Aftermarket	1	<b>RA2004P</b>	130.83 157.00
	Genuine	1	<b>RA2004</b>	145.00 174.00

## Bush Shock Absorber Mounting

All models up to (VIN) VA348053 Front, lower, poly.				
	Aftermarket	8	<b>RNF100090LPOLY</b>	2.25 2.70

## Bush Kit Shock Absorber Mounting (set of 8)

All models up to (VIN) VA348053 - Kit, poly., 8 piece				
	Aftermarket	1	<b>RNF100090LPB</b>	30.83 37.00

## Washer Shock Absorber Mounting

All models - Front & rear, lower, poly.				
	Aftermarket	8	<b>ANR3720POLY</b>	2.75 3.30

## Bush Anti Roll Bar Mounting

All models				
Front, standard poly.				
	Aftermarket	2	<b>ANR3305POLY</b>	10.42 12.50
Front, standard poly. dynamic orange (pair)				
	Polybush	1	<b>ANR3305PBORANGE</b>	17.50 21.00
comfort blue (pair)				
	Polybush	1	<b>ANR3305PBBLUE</b>	17.50 21.00

## Suspension Bush Kit

All models - Kit includes Fr & Rr Panhard bushes & Fr & Rr radius arm bushes, poly.				
	Aftermarket	1	<b>RA1338ALTPOLY</b>	110.00 132.00
dynamic orange				
	Polybush	1	<b>RA1338PBD</b>	157.50 189.00
comfort blue				
	Polybush	1	<b>RA1338PBC</b>	157.50 189.00
black				
	Britpart	1	<b>RA1338BPPOLYBLK</b>	58.33 70.00
yellow				
	Britpart	1	<b>RA1338BPPOLYEL</b>	67.50 81.00
	Bearmach	1	<b>RA1338BM</b>	85.00 102.00

## Supplementary Bush Kit

All models - Kit includes lower shock absorber bushes, Front anti roll bar bushes & steering damper bushes, poly.				
	Aftermarket	1	<b>RA2005</b>	48.33 58.00

## Anti Roll Bar

All models - Front				
	Genuine	1	<b>ANR3793</b>	83.78 100.54

## Anti Roll Bar Link Assembly

All models - Front				
	Aftermarket	2	<b>ANR3304P</b>	5.00 6.00
	OEM	2	<b>ANR3304P1</b>	12.92 15.50
	Genuine	2	<b>ANR3304</b>	17.43 20.92

## Mounting Bush, Anti Roll Bar

All models - Front, standard rubber				
	Aftermarket	2	<b>ANR3305P</b>	1.58 1.90
	Genuine	2	<b>ANR3305</b>	5.37 6.44

## Shock Absorber

All models				
Front, oil, std. height				
	Aftermarket	2	<b>STC3672P</b>	15.63 18.76
	OEM	2	<b>STC3672P1</b>	27.92 33.50
	Terrafrirma	2	<b>STC3672TFAT</b>	28.33 34.00
	Genuine	2	<b>STC3672</b>	86.32 103.58
Front, gas, std. height (pair)				
	Bilstein	1	<b>RA1363BILSTEIN</b>	152.50 183.00
Rear, oil, std. height				
	Aftermarket	2	<b>STC3671P</b>	14.58 17.50
	OEM	2	<b>STC3671P1</b>	29.50 35.40
	Terrafrirma	2	<b>STC3671TFAT</b>	28.33 34.00
	Genuine	2	<b>STC3671</b>	86.32 103.58
Rear, gas, std. height (pair)				
	Bilstein	1	<b>RA1364BILSTEIN</b>	152.50 183.00
All models with Firestone type air springs (VIN) VA348054 on Front				
	Genuine	2	<b>RSC500010</b>	106.47 127.76

## Coil Springs (pair)

All models - Rear				
	Terrafrirma	1	<b>LL1693TF</b>	95.00 114.00

## Ball Joint

All models - Front knuckle upper				
	Aftermarket	2	<b>FTC3570P</b>	6.88 8.26
	OEM	2	<b>FTC3570P1</b>	15.00 18.00
	Genuine	2	<b>FTC3570</b>	26.73 32.08
lower				
	Aftermarket	2	<b>FTC3571P</b>	6.88 8.26
	OEM	2	<b>FTC3571P1</b>	15.00 18.00
	Genuine	2	<b>FTC3571</b>	26.73 32.08

## Ball Joint Assembly

All models - Swivel upper				
	Aftermarket	2	<b>FTC3570P</b>	6.88 8.26
	OEM	2	<b>FTC3570P1</b>	15.00 18.00
	Genuine	2	<b>FTC3570</b>	26.73 32.08
lower				
	Aftermarket	2	<b>FTC3571P</b>	6.88 8.26
	OEM	2	<b>FTC3571P1</b>	15.00 18.00
	Genuine	2	<b>FTC3571</b>	26.73 32.08

## Radius Arm Assembly

All models - Front				
RH				
	Genuine	1	<b>ANR3330</b>	637.43 764.92
LH				
	Genuine	1	<b>ANR3331</b>	637.43 764.92

## Radius Arm Bottom Link

All models - Rear, RH & LH				
	Genuine	2	<b>ANR3543</b>	754.56 905.47

## Panhard Rod Assembly

All RHD models - Front suspension				
	Genuine	1	<b>ANR3666</b>	90.51 108.61
All LHD models - Front suspension				
	OEM	1	<b>ANR3665P1</b>	34.58 41.50
	Genuine	1	<b>ANR3665</b>	71.40 85.68
All models - Rear suspension				
	OEM	1	<b>ANR3670P1</b>	31.50 37.80
	Genuine	1	<b>ANR3670</b>	88.83 106.60

## Drag Link Ball Joint

All models				
Long				
	Aftermarket	2	<b>QFS000060P</b>	19.58 23.50
	OEM	2	<b>QFS000060P1</b>	35.83 43.00
	Genuine	2	<b>QFS000060</b>	100.64 120.77
Short				
	Aftermarket	2	<b>QFS000010P</b>	5.63 6.76
	OEM	2	<b>QFS000010P1</b>	13.75 16.50
	Genuine	2	<b>QFS000010</b>	36.07 43.28

## Drag Link Rod

All RHD models - Bare				
	Aftermarket	1	<b>QEK000040P</b>	22.50 27.00
	OEM	1	<b>QEK000040P1</b>	29.17 35.00
	Genuine	1	<b>QEK000040</b>	92.50 111.00
All LHD models - Bare				
	Aftermarket	1	<b>QEK000050P</b>	22.08 26.50
	Genuine	1	<b>QEK000050</b>	53.54 64.25

## Bump Stop

All models - Rear				
	Aftermarket	2	<b>ANR2556P</b>	5.62 6.74
	Genuine	2	<b>ANR2556</b>	6.77 8.12

## Height Sensor

All models up to (VIN) TA346793 - Front suspension				
RH				
	OEM	1	<b>STC3578AAP1</b>	93.33 112.00
	Genuine	1	<b>STC3578</b>	138.16 165.79
LH				
	OEM	1	<b>STC3579AAP1</b>	90.83 109.00
	Genuine	1	<b>STC3579</b>	139.90 167.88
All models (VIN) VA345920 on Front, not handed				
	OEM	2	<b>ANR4686P1</b>	75.00 90.00
	Genuine	2	<b>ANR4686</b>	86.35 103.62
Rear, not handed				
	OEM	2	<b>ANR4687P1</b>	75.83 91.00
	Genuine	2	<b>ANR4687</b>	88.41 106.09
All models up to (VIN) TA346793 - Rear suspension				
RH				
	OEM	1	<b>STC3593AAP1</b>	85.83 103.00
	Genuine	1	<b>STC3593AA</b>	118.17 141.80
LH				
	OEM	1	<b>STC3594AAP1</b>	85.83 103.00
	Genuine	1	<b>STC3594AA</b>	99.07 118.88



## RANGE ROVER P38 (1994 TO 2001)

## SUSPENSION

## Link Height Sensor

All models				
Front	Genuine	2	<b>STC2763</b>	51.67 62.00
Rear	Genuine	2	<b>STC2765</b>	64.63 77.56

## Air Suspension Compressor

All models				
New	OEM	1	<b>ANR3731P1</b>	175.83 211.00
Reconditioned, exchange	Genuine*	1	<b>ANR3731E</b>	298.41 358.09
	*Exchange Surcharge			100.00 120.00
New, exchange	Genuine*	1	<b>ANR3731</b>	448.13 537.76
	*Exchange Surcharge			150.00 180.00

## Filter Air Suspension Compressor

All models - Inlet				
	OEM	1	<b>STC2759P1</b>	5.83 7.00
	Genuine	1	<b>STC2759</b>	11.06 13.27

## Compressor Seal &amp; O Ring Kit

All models - Air suspension				
	Aftermarket	1	<b>ANR3731SEAL</b>	13.12 15.74

## Air Suspension Spring

All models to (VIN) XA424235 Front, plastic type				
	Aftermarket	2	<b>REB101740P</b>	53.33 64.00
	OEM	2	<b>REB101740P1</b>	75.83 91.00
	Genuine	2	<b>REB101740</b>	242.08 290.50
All models (VIN) XA424236 on except hot climates Front, plastic type				
	Aftermarket	2	<b>REB101740P</b>	53.33 64.00
	OEM	2	<b>REB101740P1</b>	75.83 91.00
	Genuine	2	<b>REB101740</b>	242.08 290.50
All models Rear				
	Aftermarket	2	<b>RKB101460P</b>	49.17 59.00
	OEM	2	<b>RKB101460P1</b>	75.83 91.00
	Genuine	2	<b>RKB101460</b>	238.35 286.02

## Repair Kit Diaphragm

All models - Air suspension valve block				
	Aftermarket	1	<b>STC1803P</b>	33.33 40.00
	Genuine	1	<b>STC1803</b>	57.61 69.13

## Repair Kit Solenoid

All models - Air suspension valve block				
	OEM	1	<b>STC2761P1</b>	58.33 70.00
	Genuine	1	<b>STC2761</b>	68.18 81.82

## Air Dryer Unit

All models - Air suspension				
	Aftermarket	2	<b>NTC9812P</b>	35.83 43.00
	Genuine	2	<b>NTC9812</b>	57.96 69.55

## Drive Box Air Suspension

All models				
	OEM	1	<b>ANR3900P1</b>	230.83 277.00
	Genuine	1	<b>ANR3900</b>	318.33 382.00

## Valve Block Assembly

All models - Air suspension				
	OEM	1	<b>RVH100030P1</b>	733.33 880.00
	Genuine	1	<b>RVH100030</b>	1084.61 1301.53
	*Exchange Surcharge			50.00 60.00

## O Ring Kit for Valve Block Assembly

All models - Air suspension				
	Aftermarket	1	<b>RVH100030PRK</b>	20.42 24.50

## Switch Air Pressure

All models - Air Suspension Unit				
	Aftermarket	1	<b>ANR3902P</b>	27.08 32.50
	Genuine	1	<b>ANR3902</b>	33.84 40.61

## Silencer Exhaust

All models - Air suspension valve block				
	Aftermarket	1	<b>STC2762P</b>	17.71 21.25
	Genuine	1	<b>STC2762</b>	26.60 31.92

## Shock Absorber Kit Standard

All models - Kit includes 2 front & 2 rear shock absorbers standard				
	Aftermarket	1	<b>RA2002P</b>	55.00 66.00
	Genuine	1	<b>RA2002</b>	329.17 395.00
	uprated, Heavy Duty Gas	1	<b>RA2006BILSTEIN</b>	291.67 350.00



RA2002P

## RANGE ROVER P38 (1994 TO 2001)

## STEERING

## Drag Link Assembly

All RHD models				
	Aftermarket	1	<b>QHGO00060P</b>	26.67 32.00
	OEM	1	<b>QHGO00060P1</b>	50.00 60.00
	Genuine	1	<b>QHGO00060</b>	93.94 112.73
All LHD models				
	Aftermarket	1	<b>QHGO00070P</b>	23.75 28.50
	OEM	1	<b>QHGO00070P1</b>	50.00 60.00
	Genuine	1	<b>QHGO00070</b>	93.93 112.72

## Universal Joint

All models - Lower				
	Aftermarket	1	<b>STC1968P</b>	15.00 18.00

## Lower Shaft Assembly

All models - With joints				
	Aftermarket	1	<b>QME500190P</b>	99.17 119.00
	Genuine	1	<b>QME500190</b>	236.28 283.54

## Steering Damper Assembly

All models				
	Aftermarket	1	<b>ANR2640P</b>	13.54 16.25
	Bilstein	1	<b>ANR2640UR</b>	57.50 69.00
	Britpart	1	<b>ANR2640URBPCEL</b>	33.33 40.00
	Terrafrirma	1	<b>ANR2640TF</b>	35.42 42.50
	Genuine	1	<b>ANR2640</b>	65.42 78.50

## Bush, Steering Damper

All models				
Upated polyurethane	Aftermarket	2	<b>STC1943POLY</b>	11.25 13.50
Standard material	Genuine	2	<b>STC1943</b>	11.99 14.39

## Track Rod Assembly

All models				
	Aftermarket	1	<b>TIQ000020P</b>	25.00 30.00
	OEM	1	<b>TIQ000020P1</b>	67.50 81.00
	Genuine	1	<b>TIQ000020</b>	97.68 117.22

## Track Rod, with Track Rod End

All models - Long joint				
	Aftermarket	1	<b>QFS000060P</b>	19.58 23.50
	OEM	1	<b>QFS000060P1</b>	35.83 43.00
	Genuine	1	<b>QFS000060</b>	100.64 120.77

## Track Rod End

All models - Short joint, for cross rod & track rod				
	Aftermarket	1	<b>QFS000010P</b>	5.63 6.76
	OEM	1	<b>QFS000010P1</b>	13.75 16.50
	Genuine	1	<b>QFS000010</b>	36.07 43.28

## Cross Rod Tube

All RHD models				
	Aftermarket	1	<b>QEK000040P</b>	22.50 27.00
	OEM	1	<b>QEK000040P1</b>	29.17 35.00
	Genuine	1	<b>QEK000040</b>	92.50 111.00
All LHD models				
	Aftermarket	1	<b>QEK000050P</b>	22.08 26.50
	Genuine	1	<b>QEK000050</b>	53.54 64.25

## Power Steering Fluid

All models - 1 litre. Cold (standard) climates fluid				
	Aftermarket	a/r	<b>STC50519P</b>	12.08 14.50
	Genuine	a/r	<b>STC50519</b>	18.96 22.75

## Cap, Power Steering Reservoir

All models up to (VIN) VA350636				
	Genuine	1	<b>NTC2723</b>	21.59 25.91



QHGO00060P1





# CLUTCH

## Clutch Plate & Cover Assembly

All manual V8 petrol engine models	OEM	1	<b>8510312P1</b>	145.83	175.00
	Genuine	1	<b>8510312</b>	341.38	409.66

## Clutch Kit

All 2.5L diesel models	OEM	1	<b>STC50512P1</b>	155.00	186.00
	Genuine	1	<b>STC50512</b>	314.13	376.96

## Clutch Plate

All V8 petrol manual models	Genuine	1	<b>8510311</b>	82.23	98.68
All 2.5L 6 cyl BMW M51 diesel models	OEM	1	<b>FTC2157P1</b>	125.00	150.00
	Genuine	1	<b>FTC2157</b>	118.73	142.48

## Drive Plate

All V8 petrol models	Aftermarket	1	<b>FTC4607P</b>	7.50	9.00
	Genuine	1	<b>FTC4607</b>	31.41	37.69

## Clutch Release Bearing

All models - With carrier					
Standard	Aftermarket	1	<b>FTC5200P</b>	7.92	9.50
	OEM	1	<b>FTC5200P1</b>	12.50	15.00
	Genuine	1	<b>FTC5200</b>	37.38	44.86
Heavy duty	Britpart	1	<b>FTC5200HDBP</b>	45.83	55.00
	Bearmach	1	<b>FTC5200HDBM</b>	80.00	96.00

## Clutch Release Bearing Guide

All manual models with 5 speed R380 gearbox (gbox) suffix K or L					
	Genuine	1	<b>UT0100010</b>	69.03	82.84

# TRANSMISSION

## Constant Velocity Joint

All models	Aftermarket	2	<b>STC3204P</b>	19.58	23.50
	OEM	2	<b>STC3204P1</b>	87.50	105.00
	Genuine	2	<b>STC3204</b>	373.56	448.27

## Gaiter Front CV Joint

All models	Aftermarket	2	<b>STC3203P</b>	7.08	8.50
	Genuine	2	<b>STC3203</b>	66.09	79.31

## Gaiter Propshaft

All models	Aftermarket	1	<b>TVE100000P</b>	2.58	3.10
	OEM	1	<b>TVE100000P1</b>	3.08	3.70
	Genuine	1	<b>TVE100000</b>	15.14	18.17

## Propshaft Coupling

All diesel models with auto gearbox (VIN) TA321292 on - Without fixings					
	Aftermarket	1	<b>TVF100010P</b>	13.96	16.75
	OEM	1	<b>TVF100010P1</b>	32.50	39.00
	Genuine	1	<b>TVF100010</b>	69.22	83.06

## Bearing & Bolt Kit

All diesel models with auto gearbox (VIN) TA321292 on - Rear propshaft coupling					
	Aftermarket	1	<b>TVF100010PKIT</b>	6.88	8.26

## Universal Joint

All models - Propshaft, sealed	Aftermarket	2	<b>RTC3458P</b>	4.08	4.90
	OEM	2	<b>RTC3458P1</b>	8.54	10.25
	Genuine	2	<b>RTC3458</b>	46.58	55.90

## Drive Shaft Front

All models - LH	OEM	1	<b>TDB104090P1</b>	125.00	150.00
	Genuine	1	<b>TDB104090</b>	493.35	592.02

## Half Shaft

All models - Rear axle					
RH	Genuine	1	<b>TOD100000</b>	298.15	357.78
LH	Genuine	1	<b>TOD100010</b>	318.22	381.86

## Hub Assembly Front RH

All models - Front					
RH	OEM	1	<b>FTC3226P1</b>	195.00	234.00
	Genuine	1	<b>FTC3226</b>	449.44	539.33
LH	OEM	1	<b>FTC3243P1</b>	195.00	234.00
	Genuine	1	<b>FTC3243</b>	452.94	543.53

## Wheel Bearing

All models - Front axle. Bearing only (not hub assembly)					
	Aftermarket	1	<b>FTC3243BRGBP</b>	53.33	64.00
	OEM	1	<b>FTC3243BRG</b>	88.33	106.00

## Wheel Hub Assembly

All models - Rear axle. Includes bearing housing and wheel studs					
	Aftermarket	2	<b>FTC3223P</b>	165.00	198.00
	OEM	2	<b>FTC3223P1</b>	195.00	234.00
	Genuine	2	<b>FTC3223</b>	472.35	566.82

## Gasket Gearbox Sump

All models with auto gearbox	Aftermarket	1	<b>RTC4268P</b>	2.50	3.00
	OEM	1	<b>RTC4268P1</b>	4.00	4.80
	Genuine	1	<b>RTC4268</b>	16.52	19.82

# RANGE ROVER P38 (1994 TO 2001)

## Clutch Hose Assembly

All manual models - Master cylinder pipe to slave cylinder pipe					
	OEM	1	<b>ANR3344P1</b>	50.00	60.00
	Genuine	1	<b>ANR3344</b>	72.77	87.32

## Clutch Slave Cylinder

All models	Aftermarket	1	<b>ANR2967P</b>	12.92	15.50
	OEM	1	<b>ANR2967P1</b>	29.58	35.50
	Genuine	1	<b>ANR2967</b>	147.40	176.88

## Slave Cylinder Repair Kit

All models with manual gearbox	Aftermarket	1	<b>STC2818P</b>	1.25	1.50
	OEM	1	<b>STC2818P1</b>	4.00	4.80
	Genuine	1	<b>STC2818</b>	6.22	7.46

## Clutch Master Cylinder

All V8 petrol models	Aftermarket	1	<b>ANR3894P</b>	39.58	47.50
	OEM	1	<b>ANR3894P1</b>	47.50	57.00
	Genuine	1	<b>ANR3894</b>	91.82	110.18
All 2.5L diesel models up to (VIN) TA321816	Aftermarket	1	<b>ANR3894P</b>	39.58	47.50
	OEM	1	<b>ANR3894P1</b>	47.50	57.00
	Genuine	1	<b>ANR3894</b>	91.82	110.18

All 2.5L diesel models from (VIN) TA321817 on					
	OEM	1	<b>ANR4589P1</b>	54.17	65.00
	Genuine	1	<b>ANR4589</b>	107.42	128.90

## Clutch Slave Cylinder Push Rod

All manual models	Genuine	1	<b>FTC2170</b>	19.44	23.33
-------------------	---------	---	----------------	-------	-------

# RANGE ROVER P38 (1994 TO 2001)

## Oil Seal Diff Pinion

All models - Front and rear axle	Aftermarket	1	<b>FTC4851P</b>	2.00	2.40
	OEM	1	<b>FTC4851P1</b>	5.00	6.00
	Genuine	1	<b>FTC4851</b>	17.42	20.90

## Oil Seal Transfer Box Input

All models with LT230 transfer box	Aftermarket	1	<b>ICV100000P</b>	0.92	1.10
	OEM	1	<b>ICV100000P1</b>	3.83	4.60
	Genuine	1	<b>ICV100000</b>	6.99	8.39

## Seal Drive Shaft Front

All models	Aftermarket	2	<b>FTC4822P</b>	3.33	4.00
	Genuine	2	<b>FTC4822</b>	14.67	17.60

## Seal Drive Shaft

All models	Aftermarket	2	<b>FTC5209P</b>	2.00	2.40
	OEM	2	<b>FTC5209P1</b>	3.50	4.20
	Genuine	2	<b>FTC5209</b>	8.26	9.91

## Seal Output Shaft

All models with R380 5 speed gearbox	Aftermarket	1	<b>FTC500010P</b>	1.00	1.20
	Genuine	1	<b>FTC500010</b>	12.07	14.48

## Oil Seal Front Cover

All models with R380 5 speed gearbox (gbox) suffix J					
	Aftermarket	1	<b>UKC1060P</b>	1.58	1.90
	Aftermarket	1	<b>UKC1060</b>	5.63	6.76

## Oil Seal Oil Pump Housing

All models with 4 speed auto gearbox	Aftermarket	1	<b>RTC5102P</b>	6.04	7.25
	Genuine	1	<b>RTC5102</b>	16.12	19.34

## O Ring, Transfer Box

All models - Speed sensor	Genuine	1	<b>STC3242</b>	0.71	0.85
---------------------------	---------	---	----------------	------	------

## Sealing Washer Drain Plug

All models with R380 5 speed gearbox	Aftermarket	1	<b>FTC4112P</b>	0.79	0.95
	Genuine	1	<b>FTC4112</b>	2.37	2.84

## Taper Roller Bearing Diff Carrier

All models	Aftermarket	2	<b>RTC3095P</b>	4.25	5.10
	OEM	2	<b>RTC3095P1</b>	9.37	11.24
	Genuine	2	<b>RTC3095</b>	52.69	63.23

## Bearing Viscous Coupling

All models with BW NV225 transfer box - Front					
	OEM	1	<b>RTC6025P1</b>	7.71	9.25
	Genuine	1	<b>RTC6025</b>	79.96	95.95

## Sensor, Transfer Box

All models - Temperature	Genuine	1	<b>STC1973</b>	29.09	34.91
--------------------------	---------	---	----------------	-------	-------

## Oil Pump, Transfer Box

All models - Transmission oil	Genuine	1	<b>STC3234</b>	63.23	75.88
-------------------------------	---------	---	----------------	-------	-------



## RANGE ROVER P38 (1994 TO 2001)

## COOLING

## Expansion Bottle Cap

All 2.5L diesel engine models	Aftermarket	1	<b>PCD000070P</b>	3.42	4.10
	OEM	1	<b>PCD000070P1</b>	7.08	8.50
	Genuine	1	<b>PCD000070A</b>	11.91	14.29
	Genuine	1	<b>PCD000070</b>	9.02	10.82

## Thermostat and Housing

All V8 EFI petrol models - Coolant	Aftermarket	1	<b>PEM101130P</b>	12.50	15.00
	Genuine	1	<b>PEM101130</b>	81.29	97.55

## Thermostat

All 2.5L diesel engine models	Aftermarket	1	<b>STC3338P</b>	6.88	8.26
	OEM	1	<b>STC3338P1</b>	8.13	9.76
	Genuine	1	<b>STC3338</b>	40.50	48.60

## Thermostat Housing

All 2.5L 6 cyl BMW M51 diesel models	Genuine	1	<b>STC2197</b>	20.23	24.28
--------------------------------------	---------	---	----------------	-------	-------

## Thermostat Housing Gasket

All petrol engine models up to (VIN) WA410481 - Thermostat housing	Aftermarket	1	<b>ERR2429P</b>	0.67	0.80
	Genuine	1	<b>ERR2429</b>	1.75	2.10

## O Ring Thermostat Housing

All 2.5L BMW M51 diesel models	Aftermarket	1	<b>STC2194P</b>	0.38	0.46
	Genuine	1	<b>STC2194</b>	2.11	2.53

## Thermostat Switch

All V8 petrol engine models up to (VIN) WA410481	Aftermarket	1	<b>PRC8170P</b>	3.83	4.60
	Genuine	1	<b>PRC8170</b>	23.07	27.68

## Water Pump

All V8 petrol engine models	Aftermarket	1	<b>STC4378P</b>	28.75	34.50
	OEM	1	<b>STC4378P1</b>	53.33	64.00
	Genuine*	1	<b>STC4378</b>	128.66	154.39
			*Exchange Surcharge	40.00	48.00
All 2.5L diesel engine models	Aftermarket	1	<b>STC3342P</b>	19.58	23.50
	OEM	1	<b>STC3342P1</b>	29.58	35.50
	Genuine	1	<b>STC3342</b>	195.95	235.14
All 2.5L 6 cyl BMW M51 diesel models	Genuine	1	<b>8510325</b>	90.03	108.04

## Water Pump Gasket

All petrol engine models - Water pump	Aftermarket	1	<b>ERR4077P</b>	1.50	1.80
	Genuine	1	<b>ERR4077</b>	8.44	10.13

## O Ring Water Pump

All 2.5L 6 cyl BMW M51 diesel models	Genuine	1	<b>STC2189</b>	5.04	6.05
--------------------------------------	---------	---	----------------	------	------

## Intercooler Hose

2.5L diesel engine models up to (VIN) VA376579	Aftermarket	1	<b>ESR1483P</b>	3.75	4.50
	Genuine	1	<b>ESR1483</b>	59.57	71.48
Diesel models without exhaust gas recirculation - To manifold	Aftermarket	1	<b>ESR3289P</b>	5.83	7.00
	Genuine	1	<b>ESR3289</b>	83.01	99.61
All 2.5L 6 cyl BMW M51 diesel models with exhaust gas recirculation RH, intercooler to inlet manifold	Genuine	1	<b>ESR4122</b>	83.01	99.61

## Intercooler Pipe &amp; Hose Kit

All 2.5L 6 cyl BMW M51 diesel models up to (VIN) VA376579 - LH, intercooler to turbocharger	Genuine	1	<b>ESR3290</b>	186.53	223.84
	Genuine	1	<b>PNH101710</b>	136.30	163.56

## Temperature Sensor

All V8 petrol engine models up to (VIN) WA410481	Aftermarket	1	<b>ETC8496A</b>	5.00	6.00
	Aftermarket	1	<b>AMR1425P</b>	2.75	3.30
All V8 EFI petrol models to (VIN) WA410482 on V8 petrol engine models from (VIN) XA410482	OEM	1	<b>MEK100160P1</b>	10.00	12.00
	Genuine	1	<b>MEK100160</b>	24.04	28.85
V8 EFI petrol engine models up to (VIN) TA346793 - To gauge	Genuine	1	<b>AMR1425</b>	23.47	28.16

## Coolant Temperature Sensor

All V8 EFI petrol models from (VIN) VA346794 to WA410481 - Green	Genuine	1	<b>AMR5929</b>	34.43	41.32
	Aftermarket	1	<b>STC2253P</b>	5.00	6.00
All 2.5L 6 cyl BMW M51 diesel models without air conditioning - 1 terminal type	Aftermarket	1	<b>STC2254</b>	26.58	31.90
	Genuine	1	<b>STC2254</b>	26.58	31.90
All models with 2.5L 6 cyl M51 diesel engine - Cylinder head	Aftermarket	1	<b>STC2299P</b>	7.50	9.00
	Genuine	1	<b>STC2299</b>	25.62	30.74

## RANGE ROVER P38 (1994 TO 2001)

## ELECTRICAL - ROTATING ELECTRICS

## Alternator

All V8 petrol models up to (VIN) WA410481 - A127-120Amp	New, outright	Aftermarket	1	<b>AMR2938P</b>	86.67	104.00
		OEM	1	<b>AMR2938P1</b>	125.00	150.00
		Genuine*	1	<b>AMR2938E</b>	300.64	360.77
				*Exchange Surcharge	80.00	96.00
Reconditioned, exchange	New, exchange	Genuine*	1	<b>AMR2938</b>	538.11	645.73
				*Exchange Surcharge	80.00	96.00
All models with 2.5L 6 cyl diesel engine - A133/105Amp	New, outright	Aftermarket	1	<b>STC2227P</b>	163.33	196.00
		OEM	1	<b>STC2227P1</b>	295.83	355.00
		Genuine*	1	<b>STC2227E</b>	259.27	311.12
				*Exchange Surcharge	150.00	180.00
Reconditioned, exchange	New, exchange	Genuine*	1	<b>STC2227</b>	471.50	565.80
				*Exchange Surcharge	80.00	96.00

## Starter Motor

All models with V8 EFI petrol engine - Bosch type	New, outright	Aftermarket	1	<b>NAD101490P</b>	70.00	84.00
		OEM	1	<b>NAD101490P1</b>	155.00	186.00
		Genuine*	1	<b>NAD101490E</b>	129.64	155.57
				*Exchange Surcharge	70.00	84.00
Reconditioned, exchange	New, exchange	Genuine*	1	<b>NAD101490</b>	208.17	249.80
				*Exchange Surcharge	70.00	84.00
All models with 2.5L diesel engine	New, outright	Aftermarket	1	<b>ERR5445P</b>	105.83	127.00
		OEM	1	<b>ERR5445P1</b>	168.33	202.00
		Genuine*	1	<b>ERR5445</b>	682.29	818.75
				*Exchange Surcharge	160.00	192.00

## RANGE ROVER P38 (1994 TO 2001)

## ENGINE GASKETS

## Gasket Rocker Cover

All V8 petrol models	OEM	2	<b>GEG436</b>	1.58	1.90
	Rubber	OEM	2	<b>GEG436UPRATED</b>	2.65
2.5L BMW M51 diesel models up to (eng) 34928373	Aftermarket	1	<b>STC2026P</b>	8.13	9.76
		1	<b>STC2026P1</b>	13.33	16.00
		1	<b>STC2026</b>	15.03	18.04
2.5L BMW M51 diesel models from (eng) 34928374 on	Aftermarket	1	<b>STC4177P</b>	5.83	7.00
		1	<b>STC4177P1</b>	10.83	13.00
		1	<b>STC4177</b>	16.50	19.80

## Gasket Cylinder Head

4.0L and 4.6L V8 petrol with 2 rows of head bolts - Original style composite head gasket	Aftermarket	2	<b>LVB500030P</b>	4.58	5.50
	OEM	2	<b>LVB500030P1</b>	8.13	9.76
	Genuine	2	<b>LVB500030</b>	39.14	46.97
2.5L BMW M51 diesel models - 1.87mm, three holes	Aftermarket	1	<b>STC2031P</b>	20.63	24.76
		1	<b>STC2031P1</b>	29.58	35.50
		1	<b>STC2031</b>	87.63	105.16

## Gasket Decoke Set

All V8 EFI petrol models - Engines with 2 rows of head bolts (COMPOSITE)	Aftermarket	1	<b>RA1233P</b>	57.50	69.00
	Genuine	1	<b>RA1233</b>	90.83	109.00
2.5L BMW M51 diesel models - Without head gasket or exhaust manifold gasket & heatshield	Aftermarket	1	<b>STC3694P</b>	37.08	44.50
		1	<b>STC3694P1</b>	39.58	47.50
		1	<b>STC3694</b>	177.61	213.13

## Gasket Oil Sump

V8 petrol models	Aftermarket	1	<b>LVF100400P</b>	6.67	8.00
	Genuine	1	<b>LVF100400</b>	24.19	29.03
All 2.5L 6 cyl BMW M51 diesel models	Aftermarket	1	<b>STC2036P</b>	14.17	17.00
	Genuine	1	<b>STC2036</b>	29.45	35.34

## Gasket Conversion Set

All V8 petrol models	Aftermarket	1	<b>STC1639P38</b>	15.63	18.76
2.5L BMW M51 diesel models	OEM	1	<b>STC2012P1</b>	45.00	54.00
	Genuine	1	<b>STC2012</b>	140.39	168.47

## Silicone Sealant RTV

Numerous applications	Aftermarket	a/r	<b>RTC3254P</b>	5.00	6.00
	Genuine	a/r	<b>RTC3254</b>	21.04	25.25

## Sealant Instant Gasket

Numerous applications	Genuine	a/r	<b>STC50550</b>	13.10	15.72
-----------------------	---------	-----	-----------------	-------	-------



# ENGINE SWITCHES

## Camshaft Position Sensor

All V8 EFI petrol models to (VIN) TA346793	Genuine	1	<b>N5C500610</b>	186.42	223.70
--------------------------------------------	---------	---	------------------	--------	--------

## Camshaft Sensor

V8 petrol models from (VIN) VA346794 on	OEM	1	<b>ERR6169P1</b>	100.00	120.00
	Genuine	1	<b>ERR6169</b>	151.58	181.90

## Crankshaft Sensor

All manual V8 EFI petrol models to (VIN) TA346793 - GEMS type	Aftermarket	1	<b>ERR3006P</b>	24.95	29.94
	OEM	1	<b>ERR3006</b>	106.67	128.00
	Genuine	1	<b>ERR3006</b>	106.67	128.00
All automatic V8 EFI petrol models (VIN) VA346794 to WA410481 - GEMS type	OEM	1	<b>ERR6119P1</b>	25.83	31.00
	Genuine	1	<b>ERR6119</b>	85.88	103.06

## Crankshaft Sensor Assembly

V8 petrol automatic models up to (VIN) TA346793	Aftermarket	1	<b>ADU7342LP</b>	26.67	32.00
	OEM	1	<b>ADU7342LP1</b>	40.00	48.00
	Genuine	1	<b>ADU7342L</b>	78.47	94.16

## Crankshaft Position Sensor

All V8 EFI petrol automatic models from (VIN) VXA410482 on	Aftermarket	1	<b>ERR7354P</b>	30.00	36.00
	OEM	1	<b>ERR7354P1</b>	47.50	57.00
	Genuine	1	<b>ERR7354</b>	68.41	82.09
All 2.5L 6 cyl BMW M51 diesel models	OEM	1	<b>STC2301P1</b>	45.83	55.00
	Genuine	1	<b>STC2301</b>	85.54	102.65

## Oil Temperature Switch

All V8 EFI petrol automatic models - Transmission oil temperature (oil cooler)	Genuine	1	<b>ESR4329</b>	32.68	39.22
All diesel automatic models - Transmission oil temperature (oil cooler)	Genuine	1	<b>ESR4330</b>	32.59	39.11
All 3.0L 6 cyl BMW M57 diesel automatic models from (VIN) XA410482 on - Gearbox oil cooler	Genuine	1	<b>N5C101060</b>	63.16	75.79

# RANGE ROVER P38 (1994 TO 2001)

## Engine Knock Sensor

All V8 EFI petrol models up to (VIN) WA410481	Genuine	1	<b>LR023359P</b>	119.95	143.94
	Aftermarket	1	<b>N5C100650P</b>	19.58	23.50
All V8 EFI petrol models from (VIN) XA410482 on	Genuine	1	<b>N5C100650</b>	58.77	70.52
All USA/CDN/Mex V8 EFI petrol models from (VIN) TA51920 on	Genuine	1	<b>LR023359P</b>	119.95	143.94

## Oil Pressure Switch

All V8 petrol engine models up to (VIN) XA426593	Aftermarket	1	<b>STC4104P</b>	3.00	3.60
	OEM	1	<b>STC4104P1</b>	12.50	15.00
	Genuine	1	<b>STC4104</b>	29.01	34.81
V8 petrol engine models from (VIN) XA426594 on	Aftermarket	1	<b>LR058003P</b>	2.50	3.00
	OEM	1	<b>LR058003P1</b>	3.00	3.60
	Genuine	1	<b>LR058003</b>	15.35	18.42
All V8 EFI petrol models from (VIN) XA426594 on - Fits timing cover, parallel thread	Aftermarket	1	<b>NUC100280LP</b>	3.00	3.60
	Genuine	1	<b>NUC100280L</b>	13.26	15.91

## Air Temperature Sensor

All 2.5L 6 cyl BMW M51 diesel models - Engine air inlet	Aftermarket	1	<b>LR006796P</b>	6.67	8.00
	Genuine	1	<b>LR006796</b>	22.47	26.96

## Oxygen Sensor

V8 petrol models to (VIN) VA350482	OEM	1	<b>ERR1834P1</b>	50.00	60.00
	Genuine	1	<b>ERR1834</b>	186.25	223.50
V8 petrol models from (VIN) VA350483 on	Aftermarket	1	<b>AMR6244P</b>	45.00	54.00
	Genuine	1	<b>AMR6244</b>	157.75	189.30
V8 petrol models from (VIN) XA410482 on	Genuine	1	<b>MHK100940</b>	130.58	156.70
V8 petrol models from (VIN) XA410482 on USA/CDN/Mex - Rearward	Aftermarket	1	<b>MHK100930P</b>	29.58	35.50
	Genuine	1	<b>MHK100930</b>	131.65	157.98

## Catalyst Temperature Sensor

V8 petrol models Japan only - Catalyst overheat warning system	Genuine	1	<b>ERR5211</b>	143.87	172.64

# DRAIN PLUGS

## Sump Plug

V8 petrol models up to (VIN) WA410481	Aftermarket	1	<b>UAM2957P</b>	1.58	1.90
	Genuine	1	<b>UAM2957</b>	2.08	2.50
All V8 EFI petrol models (VIN) XA410482 on	OEM	1	<b>LSF100040LP1</b>	1.50	1.80
	Genuine	1	<b>LSF100040L</b>	3.13	3.76
All models with 2.5L 6 cyl M51 diesel engine	Genuine	1	<b>STC2034</b>	5.42	6.50

## Sump Plug Washer

V8 petrol models up to (VIN) WA410481	Aftermarket	1	<b>UAM2857P</b>	0.58	0.70
2.5L BMW M51 diesel models	Genuine	1	<b>VYX000040</b>	2.61	3.13

## Sealing Washer Sump Plug

All V8 EFI petrol models (VIN) XA410482 on	Aftermarket	1	<b>ALU1403LP</b>	0.54	0.65
	Genuine	1	<b>ALU1403L</b>	1.11	1.33
All models with R380 5 speed gearbox	Aftermarket	1	<b>ALU1403LP</b>	0.54	0.65
	Genuine	1	<b>ALU1403L</b>	1.11	1.33
All models with BW NV225 transfer box	Aftermarket	1	<b>ALU1403LP</b>	0.54	0.65
	Genuine	1	<b>ALU1403L</b>	1.11	1.33

## Oil Drain Valve Kit

All V8 EFI petrol models (VIN) XA410482 on	Aftermarket	1	<b>LSF100040LODV</b>	32.08	38.50
--------------------------------------------	-------------	---	----------------------	-------	-------

## Grommet

All V8 petrol models from (VIN) XA410482 on - Sump drain plug	Genuine	1	<b>ERR7229</b>	6.23	7.48
---------------------------------------------------------------	---------	---	----------------	------	------

# RANGE ROVER P38 (1994 TO 2001)

## Drain Plug

All models with 4 speed automatic transmission up to (VIN) WA410481 - Magnetic, gearbox	Genuine	1	<b>RTC4647</b>	7.86	9.43
All models with 4 speed automatic transmission from (VIN) XA410482 on - Magnetic, gearbox	Genuine	1	<b>STC4098</b>	1.93	2.32
All models with BW NV225 transfer box - Transfer box oil pump	Genuine	1	<b>RTC6021</b>	6.92	8.30

## Drain Plug Washer

All models with 4 speed automatic transmission from (VIN) XA410482 on - Gearbox	Genuine	1	<b>STC4099</b>	1.58	1.90
---------------------------------------------------------------------------------	---------	---	----------------	------	------

## Filler Plug

All models with 5 speed R380 gearbox - Gearbox	OEM	1	<b>FTC4056P1</b>	6.46	7.75
	Genuine	1	<b>FTC4056</b>	6.98	8.38

## Wading Plug

All models with 5 speed R380 gearbox - Gearbox bellhousing. Alternative to 3290A	OEM	1	<b>FTC4056P1</b>	6.46	7.75
	Genuine	1	<b>FTC4056</b>	6.98	8.38

## O Ring Oil Screen

All models with 4 speed auto gearbox	Aftermarket	1	<b>RTC4276P</b>	0.38	0.46
	Genuine	1	<b>RTC4276</b>	1.80	2.16

# OIL SEALS ENGINE

## Oil Seal Crankshaft Front

All V8 petrol models	Aftermarket	1	<b>ERR6490P</b>	3.00	3.60
	OEM	1	<b>ERR6490P1</b>	5.00	6.00
All 2.5L 6 cyl BMW M51 diesel models	OEM	1	<b>STC4397P1</b>	6.25	7.50
	Genuine	1	<b>STC4397</b>	22.06	26.47
All 2.5L 6 cyl BMW M51 diesel models - With retainer & gasket	Genuine	1	<b>STC4161L</b>	81.05	97.26

## Oil Seal Crankshaft Rear

All V8 petrol models - Lip type seal	Aftermarket	1	<b>ERR2640P</b>	3.00	3.60
	OEM	1	<b>ERR2640P1</b>	7.92	9.50
	Genuine	1	<b>ERR2640</b>	15.58	18.70
2.5L BMW M52 diesel models	Aftermarket	1	<b>LUF100540LP</b>	7.50	9.00
	OEM	1	<b>LUF100540LP1</b>	9.58	11.50
	Genuine	1	<b>LUF100540L</b>	42.89	51.47

# RANGE ROVER P38 (1994 TO 2001)





**RANGE ROVER P38 (1994 TO 2001)****EXHAUST GAS RECIRCULATION (EGR)****Solenoid EGR Vacuum**

All 2.5L 6 cyl BMW M51 diesel models	Genuine	1	<b>STC4198</b>	58.53	70.24
--------------------------------------	---------	---	----------------	-------	-------

**EGR Blanking Kit**

All 2.5L 6 cyl BMW M51 diesel models	Britpart	1	<b>LL1829BP</b>	35.00	42.00
--------------------------------------	----------	---	-----------------	-------	-------

**Pipe EGR Valve to Exhaust Manifold**

All 2.5L 6 cyl BMW M51 diesel models	Genuine	1	<b>STC4203</b>	136.91	164.29
--------------------------------------	---------	---	----------------	--------	--------

**RANGE ROVER P38 (1994 TO 2001)****ENGINE & GEARBOX MOUNTINGS****Engine Mounting**

All models					
Front	Aftermarket	2	<b>ANR2620P</b>	9.58	11.50
	Genuine	2	<b>ANR2620</b>	57.39	68.87
Rear	Aftermarket	2	<b>ANR2621P</b>	3.00	3.60
	Genuine	2	<b>ANR2621</b>	9.05	10.86

**Gearbox Mounting**

All diesel models from (VIN) XA442582 on	Genuine	2	<b>KQB000010</b>	25.98	31.18
------------------------------------------	---------	---	------------------	-------	-------

**Bracket Engine Mounting**

All V8 petrol models					
RH	Genuine	1	<b>ANR2421</b>	17.56	21.07
LH	Genuine	1	<b>ANR2422</b>	19.08	22.90
All diesel engine models					
RH	Genuine	1	<b>ANR2462</b>	19.44	23.33
LH	Genuine	1	<b>ANR2463</b>	30.29	36.35

**RANGE ROVER P38 (1994 TO 2001)****FUEL SYSTEM SWITCHES****Throttle Position Sensor**

V8 petrol models to (VIN) WA410481	Genuine	1	<b>ERR4278</b>	98.01	117.61
All V8 EFI petrol models from (VIN) VXA410482 on					
	Aftermarket	1	<b>ERR7322P</b>	19.58	23.50
	OEM	1	<b>ERR7322P1</b>	28.33	34.00
	Genuine	1	<b>ERR7322</b>	251.99	302.39
All diesel models up to (VIN) WA376579	Genuine	1	<b>ERR2708</b>	372.85	447.42
All diesel models from (VIN) WA376580 on	Genuine	1	<b>ERR7107</b>	186.22	223.46

**Air Flow Sensor**

All V8 petrol models from (VIN) XA410482 on					
	Aftermarket	1	<b>MHK100800P</b>	32.50	39.00
	OEM	1	<b>MHK100800P1</b>	99.17	119.00
	Genuine	1	<b>MHK100800</b>	128.80	154.56

**Air Flow Sensor Meter**

V8 petrol models to (VIN) WA410481 (GEMS)	Aftermarket	1	<b>ERR5595P</b>	95.00	114.00
	Genuine	1	<b>ERR5595</b>	818.10	981.72
			<i>*Exchange Surcharge</i>	200.00	240.00

**Air Inlet Sensor**

V8 petrol models to (VIN) WA410481	Genuine	1	<b>ERR2946</b>	95.73	114.88
------------------------------------	---------	---	----------------	-------	--------

**Fuel Temperature Sensor**

All V8 EFI petrol models	Aftermarket	1	<b>ETC6661P</b>	40.00	48.00
--------------------------	-------------	---	-----------------	-------	-------

**Turbo Boost Pressure Switch**

All diesel engine models					
	Aftermarket	1	<b>ERR3561P</b>	30.00	36.00
	OEM	1	<b>ERR3561P1</b>	48.33	58.00
	Genuine	1	<b>ERR3561</b>	85.97	103.16

**RANGE ROVER P38 (1994 TO 2001)****CABLES****Accelerator Cable**

All RHD V8 petrol models up to (VIN) WA410481					
	Genuine	1	<b>SBB104040</b>	42.47	50.96
All RHD V8 petrol models from (VIN) XA410482 on					
	Aftermarket	1	<b>SBB104140P</b>	13.54	16.25
	Genuine	1	<b>SBB104140</b>	78.26	93.91
All LHD V8 petrol models to (VIN) WA410481					
	Aftermarket	1	<b>SBB104050P</b>	9.58	11.50
	Genuine	1	<b>SBB104050</b>	32.51	39.01
All LHD V8 petrol models from (VIN) XA410482 on					
	Aftermarket	1	<b>SBB104150P</b>	13.54	16.25
	Genuine	1	<b>SBB104150</b>	79.37	95.24

**Bonnet Release Cable**

All models					
	Aftermarket	1	<b>ALR6989P</b>	17.08	20.50
	Genuine	1	<b>ALR6989</b>	22.95	27.54



ALR6989P

**RANGE ROVER P38 (1994 TO 2001)****WINDOW REGULATORS****Window Regulator**

All models - Front					
RH	Aftermarket	1	<b>CVF100740P</b>	27.08	32.50
	Genuine	1	<b>CVF100740</b>	123.32	147.98
LH	Aftermarket	1	<b>CVF100750P</b>	19.58	23.50
	Genuine	1	<b>CVF100750</b>	140.13	168.16



CVF100740P

**RANGE ROVER P38 (1994 TO 2001)****WHEEL CENTRE CAP & WHEEL NUTS****Wheel Centre Cap**

All models with Silver Sparkle (MNH) colour alloy wheels - Silver Sparkle, features Land Rover logo					
	Genuine	a/r	<b>ANR3522MNH</b>	3.31	3.97

**Badge Wheel Centre Cap**

All models from (VIN) XA410482 on - Green/Gold					
	Genuine	a/r	<b>DAG100310</b>	14.05	16.86

**Wheel Stud**

All models - Front hubs					
	Genuine	a/r	<b>FTC2057</b>	5.55	6.66

**Wheel Nut**

All models - Alloy wheel type, with washer					
	Aftermarket	a/r	<b>ANR3679P</b>	2.00	2.40
	OEM	a/r	<b>ANR3679P1</b>	3.00	3.60
	Britpart	a/r	<b>ANR3679BP</b>	2.08	2.50
	Genuine	a/r	<b>ANR3679</b>	5.62	6.74

**Wheel Nut Set**

All models - Set of 20. Alloy wheel type, with washer					
	Aftermarket	a/r	<b>ANR3679KP</b>	35.00	42.00
	Genuine	a/r	<b>ANR3679K</b>	102.50	123.00



# RANGE ROVER L322 (2002 TO 2012)

## 2002 to 2012 - All Models

Listed below are the most popular parts required for the Range Rover L322

We have access to the full range of parts for your vehicle. Please contact us if not listed here.



## SERVICE KITS

### Service Kit

All 4.2L Supercharged & 4.4L N/A V8 petrol models

Includes oil filter, air filter, pollen filter, spark plugs & sump plug washer

Aftermarket	1	<b>RA1486P</b>	49.50	59.40
Genuine	1	<b>RA1486</b>	132.50	159.00

All 4.4L V8 BMW M62 petrol models

Includes oil filter, air filter, fuel filter, pollen filter, spark plugs & sump plug washer

Aftermarket	1	<b>RA1485P</b>	75.00	90.00
Genuine	1	<b>RA1485</b>	275.00	330.00

### Filter Kit

All 3.0L 6 cyl BMW M57 diesel models

Includes oil filter, air filter, fuel filter, pollen filter & sump plug washer

Aftermarket	1	<b>RA1484P</b>	29.90	35.88
Genuine	1	<b>RA1484</b>	120.83	145.00

All 3.6L TDV8 diesel models

Includes oil filter, air filter, fuel filter, pollen filter & sump plug washer

Aftermarket	1	<b>RA1487P</b>	63.33	76.00
Genuine	1	<b>RA1487</b>	110.00	132.00

## RANGE ROVER L322 (2002-2012)

## FILTRATION

### Oil Filter

All models with 3.0L 6 cyl BMW M57 diesel engine - Element

Aftermarket	1	<b>LPZ000020P</b>	2.83	3.40
OEM	1	<b>LPZ000020P1</b>	3.50	4.20
Genuine	1	<b>LPZ000020</b>	17.77	21.32

All models with 3.0 6 cyl BMW M57 diesel engine - Cam cover

Aftermarket	1	<b>LLJ500010P</b>	7.08	8.50
Aftermarket	1	<b>LLJ500010A</b>	18.46	22.15
Genuine	1	<b>LLJ500010</b>	29.71	35.65

All models with 3.6L TDV8 diesel engine - Element

Aftermarket	1	<b>LR002338P</b>	3.25	3.90
OEM	1	<b>LR002338P1</b>	5.63	6.76
Genuine	1	<b>LR002338</b>	9.95	11.94

All models with 4.2L supercharged V8 petrol engine - Cartridge

Aftermarket	1	<b>LR031439P</b>	1.50	1.80
OEM	1	<b>LR031439P1</b>	6.88	8.26
Genuine	1	<b>LR031439</b>	12.64	15.17

All models with 4.4L V8 AJ petrol engine - Cartridge

Aftermarket	1	<b>LR031439P</b>	1.50	1.80
OEM	1	<b>LR031439P1</b>	6.88	8.26
Genuine	1	<b>LR031439</b>	12.64	15.17

All models with 4.4L BMW M62 V8 petrol engine - Element

Aftermarket	1	<b>LPW500030P</b>	3.00	3.60
Genuine	1	<b>LPW500030</b>	9.18	11.02

All 4.4L TDV8 diesel models - Includes O Ring

Genuine	1	<b>LR022896</b>	16.90	20.28
---------	---	-----------------	-------	-------

All 5.0L NA and supercharged V8 petrol models - Element

Genuine	1	<b>LR011279</b>	22.43	26.92
---------	---	-----------------	-------	-------

### Air Filter

All 3.0L 6 cyl BMW M57 diesel engine models

Aftermarket	1	<b>PHE000040P</b>	6.04	7.25
OEM	1	<b>PHE000040P1</b>	13.13	15.76
Genuine	1	<b>PHE000040</b>	36.33	43.60

All 3.6L V8 diesel engine models

Aftermarket	1	<b>PHE500021P</b>	5.42	6.50
OEM	1	<b>PHE500021P1</b>	8.13	9.76
Genuine	1	<b>PHE500021</b>	26.46	31.75

All 4.4L V8 AJ petrol engine models

Aftermarket	1	<b>PHE500021P</b>	5.42	6.50
OEM	1	<b>PHE500021P1</b>	8.13	9.76
Genuine	1	<b>PHE500021</b>	26.46	31.75

All 4.4L V8 BMW M62 petrol engine models

OEM	1	<b>PHE000050P1</b>	14.58	17.50
Genuine	1	<b>PHE000050</b>	33.82	40.58

All 4.4L V8 diesel models from (VIN) BA000001 on

Aftermarket	1	<b>LR011593P</b>	5.63	6.76
Genuine	1	<b>LR011593</b>	24.55	29.46

All 5.0L V8 normally aspirated petrol models from (VIN) AA000001 on

Aftermarket	1	<b>LR011593P</b>	5.63	6.76
Genuine	1	<b>LR011593</b>	24.55	29.46

All 5.0L V8 supercharged petrol models from (VIN) AA000001 on

Aftermarket	1	<b>LR011593P</b>	5.63	6.76
Genuine	1	<b>LR011593</b>	24.55	29.46

### EGR Air Filter

All 3.0L 6 cyl BMW M57 diesel engine models - Exhaust gas recirculation filter

Aftermarket	1	<b>PHB000450P</b>	1.08	1.30
Aftermarket	1	<b>GFE7004</b>	2.83	3.40
Genuine	1	<b>PHB000450</b>	3.66	4.39

## RANGE ROVER L322 (2002-2012)

### Fuel Filter

All 3.0L 6 cyl BMW M57 diesel engine models

Aftermarket	1	<b>WFL000070P</b>	6.04	7.25
OEM	1	<b>WFL000070P1</b>	9.58	11.50
Genuine	1	<b>WFL000070</b>	45.92	55.10

All 3.6L V8 diesel models - Includes O Ring

OEM	1	<b>WJ500030P1</b>	16.88	20.26
Genuine	1	<b>WJ500030</b>	33.44	40.13

All 3.6L V8 diesel models from (VIN) 7A000001

Genuine	1	<b>WJN500160</b>	49.74	59.69
---------	---	------------------	-------	-------

All 4.4L V8 BMW M62 petrol engine models

Aftermarket	1	<b>WFL000021P</b>	22.50	27.00
Genuine	1	<b>WFL000021</b>	49.01	58.81

### Pollen Filter

All models

Aftermarket	1	<b>LR032199P</b>	8.13	9.76
OEM	1	<b>LR032199P1</b>	16.04	19.25
Genuine	1	<b>LR032199</b>	35.37	42.44

### Filter Valve Assembly

All 3.0L 6 cyl BMW M57 diesel models - Depression control

Aftermarket	1	<b>8510298P</b>	37.08	44.50
Genuine	1	<b>8510298</b>	53.69	64.43

### Oil Filter for Standard Gearbox Oil Sump

All 6 speed automatic models

Bearmach	1	<b>LR007474PF</b>	10.83	13.00
----------	---	-------------------	-------	-------

### Oil Filter for Easy Fit Gearbox Sump

All 6 speed automatic models

OEM	1	<b>LR007474BPPEF0EM</b>	29.58	35.50
Britpart	1	<b>LR007474BPPEF</b>	11.67	14.00

### Gearbox Oil Sump Easy Fit Conversion Kit

All 6 speed automatic models

Includes metal sump, separate oil filter, gasket and 'O' ring

OEM	1	<b>LR007474BPKITEF0EM</b>	130.00	156.00
Britpart	1	<b>LR007474BPKITEF</b>	72.50	87.00

### Gasket for Gearbox Oil Sump Easy Fit Conversion

All 6 speed automatic models

Britpart	1	<b>LR007474BPKITEFG</b>	6.67	8.00
----------	---	-------------------------	------	------

### Gearbox Fluid Change Kit

All 6 speed automatic models

Includes essential items for fluid change on the 6 speed automatic gearbox (ZF models 6HP26 and 6HP28) - auto trans fluid, standard sump assembly with sleeve and plugs, sump attachment screws

Britpart	1	<b>LR007474BPKIT</b>	130.00	156.00
----------	---	----------------------	--------	--------

### Screen Assembly Gearbox

All 3.0L BMW M57 diesel models with 5 speed auto gearbox

Aftermarket	1	<b>THE500031P</b>	33.33	40.00
Genuine	1	<b>THE500031</b>	72.69	87.23

### Screen Filter Assembly, Gearbox

All 4.4L V8 BMW M62 petrol models with 5 speed ZF auto gearbox

Aftermarket	1	<b>LPW000030P</b>	8.54	10.25
Genuine	1	<b>LPW000030</b>	29.44	35.33

### Screen Filter Service Kit

All 4.4L V8 BMW M62 petrol models with 5 speed ZF auto gearbox

Britpart	1	<b>LPW000030BPSK</b>	11.87	14.24
----------	---	----------------------	-------	-------

## WIPER BLADES

### Wiper Blade

All models

Front	Aftermarket	2	<b>DKC000040P</b>	3.92	4.70
	OEM	2	<b>DKC000040P1</b>	8.33	10.00
	Genuine	2	<b>DKC000040</b>	17.16	20.59
Rear	Aftermarket	1	<b>LR012047P</b>	3.00	3.60
	Genuine	1	<b>LR012047</b>	27.61	33.13

All models with headlamp wash up to (VIN) 5A999999 - Headlamp

Genuine	2	<b>DKC000070</b>	12.14	14.57
---------	---	------------------	-------	-------

## RANGE ROVER L322 (2002-2012)

### Wiper Blades, Pair

All RHD models - Winter, accessory fitment	Genuine	1	<b>DKC500060PMD</b>	62.42	74.90
All LHD models - Winter, accessory fitment	Genuine	1	<b>DKC500080PMD</b>	60.66	72.79



## RANGE ROVER L322 (2002-2012)

## SCREEN/LAMP WASHER SYSTEMS

## Washer Jet

All models from (VIN) 6A000001 to 9A999999 with headlamp wash				
RH, headlamp wash	Genuine	1	<b>DNJ500160</b>	15.83 19.00
LH, headlamp wash	Genuine	1	<b>DNJ500170</b>	15.83 19.00

## Washer Jet Cover, Primed

All models from (VIN) 6A000001 to 9A999999 with headlamp wash				
RH, headlamp wash	Genuine	1	<b>DNJ500220LML</b>	9.88 11.86
LH, headlamp wash	Genuine	1	<b>DNJ500230LML</b>	8.98 10.78

## Washer Jet Retaining Clip

All models with headlamp wash				
Headlamp jet to bumper	Genuine	2	<b>DYC000190</b>	1.80 2.16

## Washer Pump

All models up to (VIN) 5A999999				
Front & rear screen & headlamp wash	Genuine	3	<b>DMC000010</b>	36.08 43.30
All models from (VIN) 6A000001 on				
Front & rear screen wash	Genuine	2	<b>DMC500040</b>	35.77 42.92

## Washer Hose, Per Metre

All models - 4mm internal diameter (3mm also available)				
Front or rear screen wash	Aftermarket	a/r	<b>GWV201M</b>	2.25 2.70

## Washer Hose

All models - Cut to length required				
	Genuine	a/r	<b>DNH000030</b>	23.83 28.60

## Washer Hose Straight Connector

All models				
Front & rear screen & headlamp wash	Genuine	1	<b>DNG000030</b>	4.33 5.20

## Washer Hose Y Piece

All models - Front screen wash				
	Genuine	1	<b>DNG000010</b>	17.40 20.88

## Washer Hose Assembly

All models from (VIN) 6A000001 on with headlamp wash - Headlamp wash				
	Genuine	1	<b>DNH500110</b>	16.55 19.86

## Washer Hose Non Return Valve

All models up to (VIN) 9A999999				
Rear screen wash	Genuine	2	<b>DNB000040</b>	7.03 8.44

## Washer Reservoir

All models up to (VIN) 5A999999 without headlamp wash				
Front & rear screen wash	Genuine	1	<b>DMB000090</b>	32.61 39.13
All models up to (VIN) 5A999999 with headlamp wash				
Front & rear screen & headlamp wash	Genuine	1	<b>DMB000080</b>	45.34 54.41
All models from (VIN) 6A000001 to 8A290772				
Front & rear screen & headlamp wash	Genuine	1	<b>DMB500081</b>	24.00 28.80
All models from (VIN) 8A290773 on				
Front & rear screen & headlamp wash	Genuine	1	<b>DMB500170</b>	49.91 59.89

## Washer Reservoir Cap

All models up to (VIN) 5A999999				
Front & rear screen & headlamp wash	Genuine	1	<b>DMG000010</b>	5.44 6.53

## Filler Neck Cap

All models from (VIN) 7A000001 on				
Front & rear screen & headlamp wash	Genuine	1	<b>LR002266</b>	1.86 2.23

## Washer Reservoir Filler Neck

All models up to (VIN) 6A999999				
	Genuine	1	<b>DMB000010</b>	16.65 19.98
All models from (VIN) 7A000001 on				
Front & rear screen & headlamp wash	Genuine	1	<b>DMF500090</b>	4.49 5.39

## Washer Reservoir Filler Neck Filter

All models up to (VIN) 4A158301				
Front & rear screen & headlamp wash	Genuine	1	<b>DMS000040</b>	8.52 10.22

## Washer Reservoir Level Sensor

All models				
Front & rear screen & headlamp wash	Genuine	1	<b>DMI000010</b>	14.55 17.46

## Windscreen Cleaning Paste

All models				
	Genuine	a/r	<b>DNJ500340</b>	7.72 9.26
Prevents wiper blade judder/squeak by 'deep cleaning' the windscreen (ref: Land Rover Tech Bulletin LRA501-002)				

## RANGE ROVER L322 (2002-2012)

## DRIVE BELTS

## Timing Belt

All 4.4L V8 BMW M62 petrol models				
Upper	Aftermarket	1	<b>PQS000220P</b>	3.42 4.10
	OEM	1	<b>PQS000220P1</b>	5.83 7.00
	Genuine	1	<b>PQS000220</b>	19.46 23.35
All models with 4.4L BMW M62 V8 petrol engine				
Lower	Aftermarket	1	<b>LR051050P</b>	7.50 9.00
	Genuine	1	<b>LR051050</b>	26.78 32.14

## Alternator Drive Belt

All 3.0L 6 cyl BMW M57 diesel models - Alternator				
	Aftermarket	1	<b>PQS000200P</b>	5.63 6.76
	OEM	1	<b>PQS000200P1</b>	8.96 10.75
	Genuine	1	<b>PQS000200</b>	39.76 47.71
All models with 3.6L TDV8 diesel engine - Alternator				
	Genuine	1	<b>PQS500430</b>	26.21 31.45

## A/C Drive Belt

All models with 3.0L BMW 6 cyl diesel engine - Air cond compressor				
	Aftermarket	1	<b>PQS000190P</b>	4.38 5.26
	Genuine	1	<b>PQS000190</b>	19.77 23.72

## Primary Drive Belt

All models with 4.2L supercharged V8 petrol engine - Primary				
	OEM	1	<b>PQR500320P1</b>	11.67 14.00
	Genuine	1	<b>PQR500320</b>	36.61 43.93
All models with 4.4L TDV8 diesel engine (VIN) BA000001 on - Primary				
	Genuine	1	<b>LR022803</b>	27.07 32.48
5.0L V8 normally aspirated V8 petrol models from (VIN) AA000001 on - Primary				
	OEM	1	<b>LR064185P1</b>	13.13 15.76
	Genuine	1	<b>LR064185</b>	27.20 32.64
5.0L V8 supercharged V8 petrol models from (VIN) AA000001 on - Primary				
	OEM	1	<b>LR064185P1</b>	13.13 15.76
	Genuine	1	<b>LR064185</b>	27.20 32.64

## Secondary Drive Belt

All models with 4.2L supercharged V8 petrol engine - Secondary				
	Aftermarket	1	<b>PQS500241P</b>	7.92 9.50
	Genuine	1	<b>PQS500241</b>	37.57 45.08
All models with 4.4L AJ V8 petrol engine - Secondary				
	Aftermarket	1	<b>PQS500221P</b>	4.79 5.75
	OEM	1	<b>PQS500221P1</b>	7.08 8.50
	Genuine	1	<b>PQS500221</b>	13.60 16.32
All models with 4.4L TDV8 diesel engine (VIN) BA000001 on - Secondary				
	Genuine	1	<b>LR022804</b>	10.84 13.01
All models with 5.0L normally aspirated V8 petrol engine - Secondary				
	Aftermarket	1	<b>LR012663P</b>	5.63 6.76
	Genuine	1	<b>LR012663</b>	21.54 25.85

## RANGE ROVER L322 (2002-2012)

## IGNITION SYSTEM

## Spark Plug

All 4.2L supercharged AJ V8 petrol models				
	OEM	8	<b>LR005253P1</b>	4.00 4.80
	Genuine	8	<b>LR005253</b>	8.38 10.06
All 4.4L AJ V8 petrol models				
	OEM	8	<b>LR005253P1</b>	4.00 4.80
	Genuine	8	<b>LR005253</b>	8.38 10.06
All 4.4L BMW M62 V8 petrol models				
	Aftermarket	8	<b>LR021006P</b>	2.50 3.00
	OEM	8	<b>LR021006P1</b>	4.38 5.26
	Genuine	8	<b>LR021006</b>	22.07 26.48
All 5.0L N/A AJV8 petrol models				
	OEM	8	<b>LR032080P1</b>	7.50 9.00
	Genuine	8	<b>LR032080</b>	13.33 16.00
All 5.0L supercharged AJV8 petrol models				
	OEM	8	<b>LR032080P1</b>	7.50 9.00
	Genuine	8	<b>LR032080</b>	13.33 16.00

## Glow Plug

All 3.0L 6 cyl BMW M47 diesel engine models				
	Aftermarket	6	<b>NCC100120LP</b>	4.08 4.90
	OEM	6	<b>NCC100120LP1</b>	11.04 13.25
	Genuine	6	<b>NCC100120L</b>	20.73 24.88
All 3.6L V8 diesel engine models				
	OEM	8	<b>1354289P1</b>	8.54 10.25
	Genuine	8	<b>1354289</b>	12.71 15.25
All 4.4L TDV8 diesel models				
	Genuine	8	<b>LR013275</b>	29.96 35.95

## Ignition Coil

All 4.2L supercharged AJV8 petrol models				
	Aftermarket	8	<b>4744015P</b>	22.50 27.00
	Genuine	8	<b>4744015</b>	55.64 66.77
All 4.4L N/A AJV8 petrol models				
	Aftermarket	8	<b>4744015P</b>	22.50 27.00
	Genuine	8	<b>4744015</b>	55.64 66.77
All 4.4L V8 BMW M62 petrol engine models - Plug top type				
	Aftermarket	8	<b>LR022494P</b>	20.50 24.60
	Genuine	8	<b>LR022494</b>	60.70 72.84
All models with 5.0L NA AJV8 petrol engine				
	Aftermarket	8	<b>LR010687P</b>	36.67 44.00
	Genuine	8	<b>LR010687</b>	55.63 66.76
All models with 5.0L supercharged AJV8 petrol engine				
	Aftermarket	8	<b>LR010687P</b>	36.67 44.00
	Genuine	8	<b>LR010687</b>	55.63 66.76



4744015P





# BRAKING SYSTEM

# RANGE ROVER L322 (2002-2012)

## Brake Pad Set

All models up to (VIN) 5A999999				
Front brakes				
Aftermarket	1	<b>SFC500080P</b>	15.63	18.76
Brembo	1	<b>SFC500080BREMBO</b>	28.33	34.00
Genuine	1	<b>SFC500080</b>	78.09	93.71
Rear Brakes				
Brembo	1	<b>SFP500210BREMBO</b>	40.83	49.00
OEM	1	<b>SFP500210P1</b>	19.58	23.50
Genuine	1	<b>SFP500210</b>	96.29	115.55
3.0L M57 D30 Diesel from (VIN) 6A000001 to 9A999999				
Front Brakes				
Aftermarket	1	<b>LR019618P</b>	18.13	21.76
Brembo	1	<b>LR019618BREMBO</b>	37.08	44.50
OEM	1	<b>LR019618P1</b>	27.50	33.00
Genuine	1	<b>LR019618</b>	48.11	57.73
Front Brakes, Green Stuff	EBC	<b>LR019618GS</b>	50.83	61.00
3.6L V8 diesel engine from (VIN) 6A228067 to 9A999999				
Front Brakes				
Aftermarket	1	<b>SFP500070P</b>	25.83	31.00
Brembo	1	<b>SFP500070BREMBO</b>	60.83	73.00
OEM	1	<b>SFP500070P1</b>	29.58	35.50
Genuine	1	<b>SFP500070</b>	120.47	144.56
Front Brakes, Green Stuff	EBC	<b>SFP500070GS</b>	60.00	72.00
All 3.6L TDV8 diesel models (VIN) AA000001 on				
Front Brakes				
Aftermarket	1	<b>LR026221P</b>	18.13	21.76
OEM	1	<b>LR026221P1</b>	42.50	51.00
Genuine	1	<b>LR026221</b>	128.21	153.85
4.2L AJ V8 supercharged petrol engine from (VIN) 6A228067 to 9A999999				
Front Brakes				
Aftermarket	1	<b>SFP500070P</b>	25.83	31.00
Brembo	1	<b>SFP500070BREMBO</b>	60.83	73.00
OEM	1	<b>SFP500070P1</b>	29.58	35.50
Genuine	1	<b>SFP500070</b>	120.47	144.56
Front Brakes, Green Stuff	EBC	<b>SFP500070GS</b>	60.00	72.00
4.4L AJ V8 Petrol from (VIN) 6A000001 to 9A999999				
Front Brakes				
Aftermarket	1	<b>LR019618P</b>	18.13	21.76
Brembo	1	<b>LR019618BREMBO</b>	37.08	44.50
OEM	1	<b>LR019618P1</b>	27.50	33.00
Genuine	1	<b>LR019618</b>	48.11	57.73
Front Brakes, Green Stuff	EBC	<b>LR019618GS</b>	50.83	61.00
All models with 4.4L V8 diesel engine from (VIN) AA000001 on				
Front brakes				
OEM	1	<b>LR064181P1</b>	56.67	68.00
Genuine	1	<b>LR064181</b>	215.52	258.62
All 5.0L N/A AJV8 petrol models (VIN) AA000001 on				
Front Brakes				
Aftermarket	1	<b>LR026221P</b>	18.13	21.76
OEM	1	<b>LR026221P1</b>	42.50	51.00
Genuine	1	<b>LR026221</b>	128.21	153.85
All models with 5.0L supercharged V8 petrol engine from (VIN) AA000001 on				
Front brakes				
OEM	1	<b>LR064181P1</b>	56.67	68.00
Genuine	1	<b>LR064181</b>	215.52	258.62
5.0L NA V8 petrol and 3.6L TDV8 diesel models				
Rear Brakes (VIN) AA000001 to BA333985				
OEM	1	<b>LR015519P1</b>	32.50	39.00
Genuine	1	<b>LR015519</b>	79.53	95.44
Rear Brakes (VIN) BA333986 on				
Aftermarket	1	<b>LR032903P</b>	17.50	21.00
All 5.0L supercharged V8 petrol and 4.4L TDV8 diesel models				
Rear Brakes				
OEM	1	<b>LR025739P1</b>	27.50	33.00
Genuine	1	<b>LR025739</b>	79.25	95.10
All models from (VIN) 6A000001 to 9A999999				
Rear Brakes				
Aftermarket	1	<b>LR055454P</b>	15.63	18.76
Brembo	1	<b>LR055454BREMBO</b>	34.35	41.22
OEM	1	<b>LR055454P1</b>	18.54	22.25
Genuine	1	<b>LR055454</b>	48.11	57.73
Rear Brakes, Green Stuff	EBC	<b>LR055454GS</b>	41.67	50.00

## Brake Shoe Set - Handbrake

All models - Hand Brake				
Mintex	1	<b>SFS000051P1</b>	26.67	32.00
Genuine	1	<b>SFS000051</b>	78.81	94.57

## Retaining Spring

All 3.0L M57 D30 diesel from (VIN) 6A000001 on				
Front Brake Pads				
Aftermarket	1	<b>LR019625P</b>	3.08	3.70
Genuine	1	<b>LR019625</b>	3.77	4.52
All 4.4L V8 AJ petrol from (VIN) 6A000001 to 9A999999				
Front Brake Pads				
Aftermarket	1	<b>LR019625P</b>	3.08	3.70
Genuine	1	<b>LR019625</b>	3.77	4.52

## Brake Pad Clips

All 3.6L 32V DOHC models from (VIN) AA000001				
Front				
Genuine	1	<b>LR026219</b>	29.96	35.95
All 5.0L OHC SGDI NA V8 petrol engine models from (VIN) AA000001				
Front				
Genuine	1	<b>LR026219</b>	29.96	35.95

## Brake Pad Fitting Kit

All 3.6L TDV8 diesel models to (VIN) 9A999999				
Front				
Genuine	1	<b>SEE500080</b>	18.55	22.26
All 4.2L supercharged V8 petrol models				
Front				
Genuine	1	<b>SEE500080</b>	18.55	22.26
All 4.4L TDV8 diesel models				
Front				
Genuine	1	<b>LR016683</b>	42.14	50.57
All 5.0L supercharged V8 petrol models				
Front				
Genuine	1	<b>LR016683</b>	42.14	50.57

## Retaining Spring Kit

All models from (VIN) 6A000001 to 9A999999				
Rear Brake Pads				
Aftermarket	1	<b>LR019626P</b>	2.17	2.60
Genuine	1	<b>LR019626</b>	4.21	5.05
3.6L V8 diesel engine from (VIN) BA333986 on				
Rear Brake Pads				
Aftermarket	1	<b>LR019626P</b>	2.17	2.60
Genuine	1	<b>LR019626</b>	4.21	5.05
5.0L SGDI NA V8 petrol engine from (VIN) BA333986 on				
Rear Brake Pads				
Aftermarket	1	<b>LR019626P</b>	2.17	2.60
Genuine	1	<b>LR019626</b>	4.21	5.05

## Brake Disc (each)

All models up to (VIN) 5A999999				
Front, less armoured				
Aftermarket	2	<b>SDB000201P</b>	25.50	30.60
Brembo	2	<b>SDB000201BREMBO</b>	50.83	61.00
Genuine	2	<b>SDB000201</b>	101.53	121.84
Rear, less armoured				
Aftermarket	2	<b>SDB000211P</b>	17.50	21.00
Brembo	2	<b>SDB000211BREMBO</b>	52.50	63.00
OEM	2	<b>SDB000211P1</b>	39.58	47.50
Genuine	2	<b>SDB000211</b>	82.51	99.01
3.0L M57 D30 Diesel from (VIN) 6A228067 to 9A999999				
Front				
Aftermarket	2	<b>SDB500182P</b>	22.50	27.00
Brembo	2	<b>SDB500182BREMBO</b>	60.83	73.00
OEM	2	<b>SDB500182P1</b>	47.50	57.00
Genuine	2	<b>SDB500182</b>	70.37	84.44
All models with 3.6L V8 diesel engine				
Front				
Aftermarket	2	<b>LR031843P</b>	25.00	30.00
Brembo	2	<b>LR031843BREMBO</b>	60.00	72.00
OEM	2	<b>LR031843P1</b>	45.83	55.00
Genuine	2	<b>LR031843</b>	63.95	76.74
All models from (VIN) 6A228067 to 9A999999				
Rear				
Aftermarket	2	<b>LR031844P</b>	19.79	23.75
Brembo	2	<b>LR031844BREMBO</b>	50.83	61.00
OEM	2	<b>LR031844P1</b>	30.00	36.00
Genuine	2	<b>LR031844</b>	63.95	76.74
All 3.6L TDV8 diesel models (VIN) AA000001 on				
Rear				
Aftermarket	2	<b>LR031844P</b>	19.79	23.75
Brembo	2	<b>LR031844BREMBO</b>	50.83	61.00
OEM	2	<b>LR031844P1</b>	30.00	36.00
Genuine	2	<b>LR031844</b>	63.95	76.74
4.2L AJ V8 supercharged petrol engine from (VIN) 6A228067 to 9A999999				
Front				
Aftermarket	2	<b>LR031843P</b>	25.00	30.00
Brembo	2	<b>LR031843BREMBO</b>	60.00	72.00
OEM	2	<b>LR031843P1</b>	45.83	55.00
Genuine	2	<b>LR031843</b>	63.95	76.74
4.4L AJ V8 Petrol from (VIN) 6A228067 to 9A999999				
Front				
Aftermarket	2	<b>SDB500182P</b>	22.50	27.00
Brembo	2	<b>SDB500182BREMBO</b>	60.83	73.00
OEM	2	<b>SDB500182P1</b>	47.50	57.00
Genuine	2	<b>SDB500182</b>	70.37	84.44
All 4.4L DOHC Diesel V8 DITC models from (VIN) AA000001				
Front				
Genuine	2	<b>LR031845P1</b>	39.17	47.00
Genuine	2	<b>LR031845</b>	68.68	82.42
4.4L TDV8 diesel models (VIN) AA000001 on				
Rear				
Genuine	2	<b>LR031846</b>	63.95	76.74
5.0L SGDI NA V8 petrol engine from (VIN) AA000001 on				
Front				
Aftermarket	2	<b>LR031843P</b>	25.00	30.00
Brembo	2	<b>LR031843BREMBO</b>	60.00	72.00
OEM	2	<b>LR031843P1</b>	45.83	55.00
Genuine	2	<b>LR031843</b>	63.95	76.74
All 5.0L OHC SGDI V8 petrol models from (VIN) BA356997				
Front				
OEM	2	<b>LR031845P1</b>	39.17	47.00
Genuine	2	<b>LR031845</b>	68.68	82.42
All 5.0L NA V8 petrol models from (VIN) AA000001 on				
Rear				
Aftermarket	2	<b>LR031844P</b>	19.79	23.75
Brembo	2	<b>LR031844BREMBO</b>	50.83	61.00
OEM	2	<b>LR031844P1</b>	30.00	36.00
Genuine	2	<b>LR031844</b>	63.95	76.74
5.0L V8 supercharged petrol models (VIN) AA000001 on				
Rear				
Genuine	2	<b>LR031846</b>	63.95	76.74

## Performance Brake Disc (pair)

All models up to (VIN) 5A999999				
Front, less armoured, slotted & drilled				
Britpart	1	<b>SDB000201URBP</b>	65.83	79.00
Rear, less armoured, slotted & drilled				
Britpart	1	<b>SDB000211URBP</b>	44.17	53.00
3.0L M57 D30 Diesel from (VIN) 6A228067 to 9A999999				
Front, slotted & drilled				
Britpart	1	<b>SDB500182URBP</b>	65.83	79.00
All models from (VIN) 6A228067 to 9A999999				
Rear, slotted & drilled				
Britpart	1	<b>LR031844URBP</b>	54.17	65.00
All models with 3.6L V8 diesel engine				
Front, slotted & drilled				
Britpart	1	<b>LR031843URBP</b>	60.00	72.00
All 3.6L TDV8 diesel models (VIN) AA000001 on				
Rear, slotted & drilled				
Britpart	1	<b>LR031844URBP</b>	54.17	65.00
4.2L AJ V8 supercharged petrol engine from (VIN) 6A228067 to 9A999999				
Front, slotted & drilled				
Britpart	1	<b>LR031843URBP</b>	60.00	72.00
4.4L AJ V8 Petrol from (VIN) 6A228067 to 9A999999				
Front, slotted & drilled				
Britpart	1	<b>SDB500182URBP</b>	65.83	79.00
All 4.4L DOHC Diesel V8 DITC models from (VIN) AA000001				
Front, Slotted & Drilled				
Britpart	1	<b>LR031845URBP</b>	80.00	96.00
4.4L TDV8 diesel models (VIN) AA000001 on				
Rear, slotted & drilled				
Britpart	1	<b>LR031846URBP</b>	60.00	72.00
5.0L SGDI NA V8 petrol engine from (VIN) AA000001 on				
Front, slotted & drilled				
Britpart	1	<b>LR031843URBP</b>	60.00	72.00
All 5.0L OHC SGDI V8 petrol models from (VIN) BA356997				
Front, Slotted & Drilled				
Britpart	1	<b>LR031845URBP</b>	80.00	96.00
All 5.0L NA V8 petrol models from (VIN) AA000001 on				
Rear, slotted & drilled				
Britpart	1	<b>LR031844URBP</b>	54.17	65.00
5.0L V8 supercharged petrol models (VIN) AA000001 on				
Rear, slotted & drilled				
Britpart	1	<b>LR031846URBP</b>	60.00	72.00

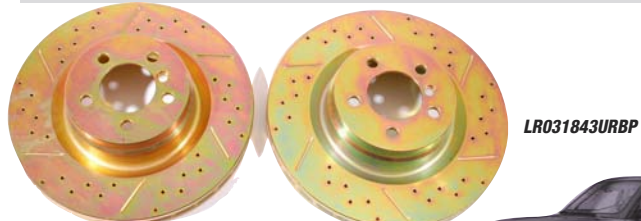

## RANGE ROVER L322 (2002-2012)

## BRAKING SYSTEM

## Mudshield Brake Disc

All models less armoured up to (VIN) 5A999999

Front RH	Genuine	1	SEC000040	44.87	53.84
Front LH	Genuine	1	SEC000050	44.87	53.84
Rear RH	Genuine	1	SMD500080	48.90	58.68
Rear LH	Genuine	1	SMD500090	48.90	58.68

3.0L 6 cyl BMW M57 diesel engine models

Front RH	Genuine	1	SEC500100	23.04	27.65
Front LH	Genuine	1	SEC500110	20.53	24.64

4.4L V8 AJ petrol models from (VIN) 6A000001 to (VIN) 9A999999

Front RH	Genuine	1	SEC500100	23.04	27.65
Front LH	Genuine	1	SEC500110	20.53	24.64

All models from (VIN) 6A000001 to (VIN) 9A999999

Rear RH	Genuine	1	SMD500080	48.90	58.68
Rear LH	Genuine	1	SMD500090	48.90	58.68

## Brake Caliper

All models to (VIN) 5A999999 except B6 armoured

Front, RH	Aftermarket	1	SEB000280P	50.00	60.00
	OEM*	1	SEB000280P1	170.83	205.00
			*Exchange Surcharge	45.00	54.00
	Exchange*	1	SEB000280R	100.83	121.00
			*Exchange Surcharge	25.00	30.00
	Genuine*	1	SEB000280	329.64	395.57
			*Exchange Surcharge	50.00	60.00

Front, LH	Aftermarket	1	SEB000290P	50.00	60.00
	OEM*	1	SEB000290P1	170.83	205.00
			*Exchange Surcharge	45.00	54.00
	Exchange*	1	SEB000290R	100.83	121.00
			*Exchange Surcharge	25.00	30.00
	Genuine*	1	SEB000290	329.64	395.57
			*Exchange Surcharge	50.00	60.00

All models from (VIN) 6A000001 to (VIN) 9A999999

Front RH	OEM*	1	SEG500041P1	150.83	181.00
			*Exchange Surcharge	45.00	54.00
	Genuine*	1	SEG500041	197.77	237.32
			*Exchange Surcharge	50.00	60.00
Front LH	OEM*	1	SEG500051P1	150.83	181.00
			*Exchange Surcharge	45.00	54.00
	Genuine*	1	SEG500051	197.77	237.32
			*Exchange Surcharge	50.00	60.00

All 3.6L TDV8 diesel models (VIN) AA000001 on

Front, RH	OEM*	1	LR047906P1	198.33	238.00
			*Exchange Surcharge	35.00	42.00
	Genuine*	1	LR047906	292.45	350.94
			*Exchange Surcharge	100.00	120.00
Front, LH	OEM*	1	LR047905P1	198.33	238.00
			*Exchange Surcharge	35.00	42.00
	Genuine*	1	LR047905	295.38	354.46
			*Exchange Surcharge	100.00	120.00

All 3.6L TDV8 diesel models (VIN) 6A238983 to 9A999999

Front, RH, black	Genuine*	1	SEB500380	502.01	602.41
			*Exchange Surcharge	50.00	60.00
Front, LH, black	Genuine*	1	SEB500390	464.81	557.77
			*Exchange Surcharge	50.00	60.00
Front, RH, silver	Genuine*	1	SEB500381	502.01	602.41
			*Exchange Surcharge	50.00	60.00
Front, LH, silver	Genuine*	1	SEB500391	502.01	602.41
			*Exchange Surcharge	50.00	60.00

All 4.2L V8 supercharged petrol models (VIN) 6A238983 to 9A999999

Front, RH, black	Genuine*	1	SEB500380	502.01	602.41
			*Exchange Surcharge	50.00	60.00
Front, LH, black	Genuine*	1	SEB500390	464.81	557.77
			*Exchange Surcharge	50.00	60.00
Front, RH, silver	Genuine*	1	SEB500381	502.01	602.41
			*Exchange Surcharge	50.00	60.00
Front, LH, silver	Genuine*	1	SEB500391	502.01	602.41
			*Exchange Surcharge	50.00	60.00

5.0L V8 NA petrol models (VIN) AA000001 on

Front, RH	OEM*	1	LR047906P1	198.33	238.00
			*Exchange Surcharge	35.00	42.00
	Genuine*	1	LR047906	292.45	350.94
			*Exchange Surcharge	100.00	120.00
Front, LH	OEM*	1	LR047905P1	198.33	238.00
			*Exchange Surcharge	35.00	42.00
	Genuine*	1	LR047905	295.38	354.46
			*Exchange Surcharge	100.00	120.00

All models except Armoured to (VIN) 5A999999

Rear RH	Aftermarket	1	SMC000200P	60.00	72.00
	Genuine*	1	SMC000200	179.03	214.84
			*Exchange Surcharge	50.00	60.00
Rear LH	Aftermarket	1	SMC000210P	60.00	72.00
	Genuine*	1	SMC000210	179.03	214.84
			*Exchange Surcharge	50.00	60.00

All models (VIN) 6A000001 to 9A999999

Rear, RH	Aftermarket	1	SOB500042P	50.00	60.00
	Genuine*	1	SOB500042	129.29	155.15
			*Exchange Surcharge	50.00	60.00
Rear, LH	Aftermarket	1	SOB500052P	50.00	60.00
	Genuine*	1	SOB500052	129.29	155.15
			*Exchange Surcharge	50.00	60.00

All 3.6L TDV8 diesel models (VIN) AA000001 to (VIN) BA333985

Rear, RH	OEM*	1	LR015524P1	67.95	81.54
			*Exchange Surcharge	30.00	36.00
	Genuine*	1	LR015524	148.18	177.82
			*Exchange Surcharge	90.00	108.00
Rear, LH	OEM*	1	LR015586P1	67.95	81.54
			*Exchange Surcharge	30.00	36.00
	Genuine*	1	LR015586	148.18	177.82
			*Exchange Surcharge	90.00	108.00

## Brake Caliper Cont'd

3.6L TDV8 diesel models (VIN) BA333986 on

Rear, RH	Aftermarket	1	SOB500042P	50.00	60.00
	Genuine*	1	SOB500042	129.29	155.15
			*Exchange Surcharge	50.00	60.00
Rear, LH	Aftermarket	1	SOB500052P	50.00	60.00
	Genuine*	1	SOB500052	129.29	155.15
			*Exchange Surcharge	50.00	60.00

4.4L TDV8 diesel models (VIN) AA000001 on

Rear, RH	Genuine*	1	LR015581	281.30	337.56
			*Exchange Surcharge	100.00	120.00
Rear, LH	OEM*	1	LR015583P1	125.00	150.00
			*Exchange Surcharge	30.00	36.00
	Genuine*	1	LR015583	281.30	337.56
			*Exchange Surcharge	100.00	120.00

5.0L V8 NA petrol models (VIN) AA000001 to (VIN) BA333985

Rear, RH	OEM*	1	LR015524P1	67.95	81.54
			*Exchange Surcharge	30.00	36.00
	Genuine*	1	LR015524	148.18	177.82
			*Exchange Surcharge	90.00	108.00
Rear, LH	OEM*	1	LR015586P1	67.95	81.54
			*Exchange Surcharge	30.00	36.00
	Genuine*	1	LR015586	148.18	177.82
			*Exchange Surcharge	90.00	108.00

5.0L V8 NA petrol models (VIN) BA333986 on

Rear, RH	Aftermarket	1	SOB500042P	50.00	60.00
	Genuine*	1	SOB500042	129.29	155.15
			*Exchange Surcharge	50.00	60.00
Rear, LH	Aftermarket	1	SOB500052P	50.00	60.00
	Genuine*	1	SOB500052	129.29	155.15
			*Exchange Surcharge	50.00	60.00

5.0L V8 supercharged petrol models (VIN) AA000001 on

Rear, RH	Genuine*	1	LR015581	281.30	337.56
			*Exchange Surcharge	100.00	120.00
Rear, LH	OEM*	1	LR015583P1	125.00	150.00
			*Exchange Surcharge	30.00	36.00
	Genuine*	1	LR015583	281.30	337.56
			*Exchange Surcharge	100.00	120.00

## Brake Caliper Carrier

All models

Front	Aftermarket	2	SYH000090P	20.62	24.74
	Genuine	2	SYH000090	83.56	100.27

All models (VIN) 6A000001 to 9A999999

Rear, RH and LH	OEM	2	SXP500060P1	57.95	69.54
-----------------	-----	---	-------------	-------	-------

## Brake Caliper Piston

3.0L M57 D30 Diesel from (VIN) 6A000001 on

Front, Vented Disc Brakes	Aftermarket	4	STC1918P	4.38	5.26
	OEM	4	STC1918P1	7.50	9.00
	Genuine	4	STC1918	17.20	20.64

4.4L AJ V8 Petrol from (VIN) 6A000001 on

Front, Vented Disc Brakes	Aftermarket	4	STC1918P	4.38	5.26
	OEM	4	STC1918P1	7.50	9.00
	Genuine	4	STC1918	17.20	20.64

All models from (VIN) 6A000001 on

Rear, Vented Disc Brakes	Aftermarket	2	STC1908P	4.08	4.90
	Genuine	2	STC1908	18.49	22.19

## Slider Pin Bolt

All 3.0L BMW M57 diesel models (VIN) 6A000001 on

Front	Genuine	4	SMV500010	1.33	1.60
-------	---------	---	-----------	------	------

All 3.6L TDV8 diesel models (VIN) AA000001 on

Front	Genuine	4	SMV500010	1.33	1.60
-------	---------	---	-----------	------	------

All 5.0L NA V8 petrol models (VIN) AA000001 on

Front	Genuine	4	SMV500010	1.33	1.60
-------	---------	---	-----------	------	------

All models (VIN) 6A000001 to 9A999999

Rear	Genuine	4	SMV500010	1.33	1.60
------	---------	---	-----------	------	------

## Dust Cover

All models - For carrier retaining pins front &amp; rear

	Genuine	4	SEE500030	7.88	9.46
--	---------	---	-----------	------	------

## Dust Cap Bleed Screw

All models - Front &amp; rear caliper

	Genuine	2	SEE500100	0.94	1.13
--	---------	---	-----------	------	------

## Pin &amp; Boot Kit

All 3.6L 32V DOHC models from (VIN) AA333946

Front Brake Caliper	Genuine	2	LR020489	13.13	15.76
---------------------	---------	---	----------	-------	-------

All 5.0L OHV SGDI NA V8 petrol engine models from (VIN) AA333946

Front Brake Caliper	Genuine	2	LR020489	13.13	15.76
---------------------	---------	---	----------	-------	-------

All models - Rear	Genuine	2	LR017032	13.13	15.76
-------------------	---------	---	----------	-------	-------

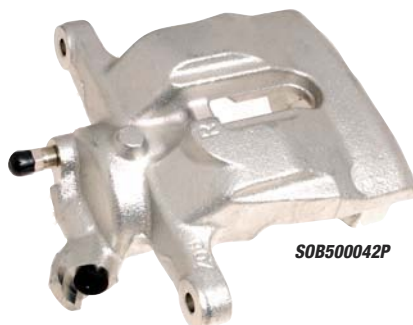

SOB500042P



# BRAKING SYSTEM

## Caliper Repair Kit

All models except armoured to (VIN) 5A999999					
Front	Genuine	2	<b>SEE000020</b>	16.73	20.08
All 3.0L diesel engine models from (VIN) 6A000001 on					
Front brakes	OEM	2	<b>SEE500010P1</b>	5.95	7.14
	Genuine	2	<b>SEE500010</b>	12.53	15.04
All models with 3.6L V8 diesel engine					
Front	Genuine	2	<b>SEE500040</b>	24.01	28.81
All models with 3.6L TDV8 diesel engine from (VIN) AA000001 on					
Front, for one caliper	OEM	2	<b>LR015580P1</b>	6.67	8.00
All 4.2L supercharged AJ V8 petrol models					
Front	Genuine	2	<b>SEE500040</b>	24.01	28.81
All 4.4L AJ V8 petrol engine models from (VIN) 6A000001 on					
Front brakes	OEM	2	<b>SEE500010P1</b>	5.95	7.14
	Genuine	2	<b>SEE500010</b>	12.53	15.04
All models with 5.0L NA AJV8 petrol engine from (VIN) AA000001 on					
Front, for one caliper	OEM	2	<b>LR015580P1</b>	6.67	8.00
All models except armoured (VIN) 6A000001 to 9A999999					
Rear, for one caliper	Aftermarket	2	<b>SMN500030P</b>	6.04	7.25
	OEM	2	<b>SMN500030P1</b>	4.95	5.94
	Genuine	2	<b>SMN500030</b>	11.94	14.33
All models with 3.6L TDV8 diesel engine from (VIN) AA000001 to BA333985					
Rear, for one caliper	OEM	2	<b>LR015520P1</b>	7.25	8.70
All models with 3.6L TDV8 diesel engine (VIN) BA333986 on					
Rear, for one caliper	Aftermarket	2	<b>SMN500030P</b>	6.04	7.25
	OEM	2	<b>SMN500030P1</b>	4.95	5.94
	Genuine	2	<b>SMN500030</b>	11.94	14.33
All models with 4.4L TDV8 diesel engine					
Rear, for one caliper	OEM	2	<b>LR015520P1</b>	7.25	8.70
All models with 5.0L NA AJV8 petrol engine up to (VIN) BA333985					
Rear, for one caliper	OEM	2	<b>LR015520P1</b>	7.25	8.70
All models with 5.0L NA AJV8 petrol engine (VIN) BA333986 on					
Rear, for one caliper	Aftermarket	2	<b>SMN500030P</b>	6.04	7.25
	OEM	2	<b>SMN500030P1</b>	4.95	5.94
	Genuine	2	<b>SMN500030</b>	11.94	14.33
All models with 5.0L supercharged AJV8 petrol engine					
Rear, for one caliper	OEM	2	<b>LR015520P1</b>	7.25	8.70

## Brake Caliper Fixing Kit

All 3.6L TDV8 diesel models (VIN) BA333986 on					
Rear brakes	Aftermarket	2	<b>SMN500040P</b>	6.87	8.24
	Genuine	2	<b>SMN500040</b>	13.06	15.67
All 5.0L NA V8 petrol models (VIN) BA333986 on					
Rear brakes	Aftermarket	2	<b>SMN500040P</b>	6.87	8.24
	Genuine	2	<b>SMN500040</b>	13.06	15.67
All models (VIN) 6A000001 to 9A999999					
Rear brakes	Aftermarket	2	<b>SMN500040P</b>	6.87	8.24
	Genuine	2	<b>SMN500040</b>	13.06	15.67

## Caliper Pin & Boot Kit

All 3.0L BMW M57 diesel models (VIN) 6A000001 on					
Front, one caliper	Aftermarket	4	<b>SEE500020P</b>	9.17	11.00
	Genuine	4	<b>SEE500020</b>	13.06	15.67
All 4.4L AJV8 normally aspirated petrol models					
Front, one caliper	Aftermarket	4	<b>SEE500020P</b>	9.17	11.00
	Genuine	4	<b>SEE500020</b>	13.06	15.67

## Brake Master Cylinder

All models up to (VIN) 5A999999					
	OEM	1	<b>SJJ000040P1</b>	124.95	149.94
	Genuine	1	<b>SJJ000040</b>	240.98	289.18
All 3.0L BMW M57 diesel models (VIN) 6A000001 on					
	OEM	1	<b>SJJ000040P1</b>	124.95	149.94
	Genuine	1	<b>SJJ000040</b>	240.98	289.18
All LHD models from (VIN) AA000001 on					
	OEM	1	<b>LR012900P1</b>	129.95	155.94
	Genuine	1	<b>LR012900</b>	214.90	257.88

## Brake Pad Wear Sensor

All models except 3.6L TDV8 diesel up to (VIN) 9A999999					
Front brakes	Aftermarket	1	<b>SEM000012P</b>	4.00	4.80
	OEM	1	<b>SEM000012P1</b>	5.83	7.00
	Genuine	1	<b>SEM000012</b>	20.83	25.00
3.6L V8 diesel Lion up to (VIN) 9A999999					
Front brakes	Aftermarket	1	<b>SEM500050P</b>	4.58	5.50
	OEM	1	<b>SEM500050P1</b>	7.29	8.75
	Genuine	1	<b>SEM500050</b>	18.76	22.51
3.6L V8 diesel Lion from (VIN) AA000001 on					
Front brakes	Aftermarket	1	<b>SEM000012P</b>	4.00	4.80
	OEM	1	<b>SEM000012P1</b>	5.83	7.00
	Genuine	1	<b>SEM000012</b>	20.83	25.00
4.2L AJ V8 supercharged petrol up to (VIN) 9A999999					
Front brakes	Aftermarket	1	<b>SEM500050P</b>	4.58	5.50
	OEM	1	<b>SEM500050P1</b>	7.29	8.75
	Genuine	1	<b>SEM500050</b>	18.76	22.51
5.0L NA V8 petrol from (VIN) AA000001 on					
Front brakes	Aftermarket	1	<b>SEM000012P</b>	4.00	4.80
	OEM	1	<b>SEM000012P1</b>	5.83	7.00
	Genuine	1	<b>SEM000012</b>	20.83	25.00
All 5.0L supercharged V8 petrol and 4.4L TDV8 diesel models					
Front brakes	Aftermarket	1	<b>LR012824P</b>	4.58	5.50
	Genuine	1	<b>LR012824</b>	18.76	22.51
All models less armoured up to (VIN) 5A999999					
Rear brakes	Aftermarket	1	<b>SOE000011P</b>	3.75	4.50
	OEM	1	<b>SOE000011P1</b>	6.04	7.25
	Genuine	1	<b>SOE000011</b>	20.58	24.70
All models from (VIN) 6A000001 on					
Rear brakes	Aftermarket	1	<b>SOE500030P</b>	3.75	4.50
	OEM	1	<b>SOE500030P1</b>	8.13	9.76
	Genuine	1	<b>SOE500030</b>	21.40	25.68

## Brake Hose

All models to (VIN) 5A999999					
Front	Aftermarket	2	<b>SHB000011P</b>	6.88	8.26
	OEM	2	<b>SHB000011P1</b>	12.08	14.50
	Genuine	2	<b>SHB000011</b>	24.17	29.00
	OEM	2	<b>LR075628P1</b>	13.12	15.74
All models - Front					
All models (VIN) AA000001 on					
Rear, RH	OEM	1	<b>LR058026P1</b>	16.04	19.25
	Genuine	1	<b>LR058026</b>	31.30	37.56
Rear, LH	OEM	1	<b>LR058025P1</b>	13.54	16.25
	Genuine	1	<b>LR058025</b>	31.30	37.56

## 2-way Brake Pipe Connector

All models - Booster to rear	Genuine	a/r	<b>BMK2466</b>	4.41	5.29
------------------------------	---------	-----	----------------	------	------

## Handbrake Shoe Retaining Spring

All models	Genuine	4	<b>SMK000020</b>	0.86	1.03
------------	---------	---	------------------	------	------

## Handbrake Cable

RHD up to (VIN) 5A999999					
RH cable	Aftermarket	1	<b>SPB000063P</b>	20.00	24.00
	Genuine	1	<b>SPB000063</b>	36.62	43.94
LH cable	Aftermarket	1	<b>SPB000073P</b>	20.00	24.00
	Genuine	1	<b>SPB000073</b>	36.62	43.94
LHD up to (VIN) 5A999999					
RH cable	Aftermarket	1	<b>SPB000043P</b>	20.00	24.00
LH cable	Aftermarket	1	<b>SPB000053P</b>	20.00	24.00
All RHD models from (VIN) 6A000001 on					
RH cable	Genuine	1	<b>SPB500161</b>	44.51	53.41
LH cable	Genuine	1	<b>SPB500171</b>	44.69	53.63
All LHD models from (VIN) 6A000001 on					
LH cable	Genuine	1	<b>SPB500151</b>	44.81	53.77

## ABS Sensor

All models with 3.0L 6 cyl BMW M57 diesel engine					
Front brakes	Aftermarket	2	<b>SSF000011P</b>	25.00	30.00
	Genuine	2	<b>SSF000011</b>	85.71	102.85
Rear brakes	Aftermarket	2	<b>SSF000021P</b>	29.58	35.50
	Genuine	2	<b>SSF000021</b>	93.70	112.44
All models with 3.6L V8 diesel engine					
Front brakes	Aftermarket	2	<b>SSF500011P</b>	21.25	25.50
	Genuine	2	<b>SSF500011</b>	43.01	51.61
Rear brakes	Aftermarket	2	<b>SSF500021P</b>	32.50	39.00
	Genuine	2	<b>SSF500021</b>	54.81	65.77
All 4.2L supercharged AJ V8 petrol models					
Front brakes	Aftermarket	2	<b>SSF500011P</b>	21.25	25.50
	Genuine	2	<b>SSF500011</b>	43.01	51.61
Rear brakes	Aftermarket	2	<b>SSF500021P</b>	32.50	39.00
	Genuine	2	<b>SSF500021</b>	54.81	65.77
All 4.4L TDV8 diesel models					
Front brakes	Aftermarket	2	<b>SSF500011P</b>	21.25	25.50
	Genuine	2	<b>SSF500011</b>	43.01	51.61
Rear brakes	Aftermarket	2	<b>SSF500021P</b>	32.50	39.00
	Genuine	2	<b>SSF500021</b>	54.81	65.77
All models with 4.4L V8 BMW M62 petrol engine					
Front brakes	Aftermarket	2	<b>SSF000011P</b>	25.00	30.00
	Genuine	2	<b>SSF000011</b>	85.71	102.85
Rear brakes	Aftermarket	2	<b>SSF000021P</b>	29.58	35.50
	Genuine	2	<b>SSF000021</b>	93.70	112.44
All 4.4L V8 EFI models					
Rear brakes	Aftermarket	2	<b>SSF500021P</b>	32.50	39.00
	Genuine	2	<b>SSF500021</b>	54.81	65.77

## ABS Speed Sensor

All models with electronic stability control from (VIN) 5A000001 to (VIN) 6A999999 -					
Yaw Compatible with 6 pin plug	Genuine	1	<b>SR000020</b>	190.27	348.32
Yaw Compatible with 4 pin plug	Genuine	1	<b>SR0500140</b>	282.88	219.46

## ABS Yaw Rate Sensor

All models with electronic stability control up to (VIN) 4A999999 - ABS, 6 pin plug					
	Genuine	1	<b>SR0000010</b>	195.52	234.62
All models from (VIN) AA000001 on					
	Genuine	1	<b>LR011785</b>	287.53	345.04

## ABS Pump Sensor

All 3.0L 6 cyl BMW M57 diesel models	Genuine	1	<b>SSB000140</b>	139.75	167.70
All 4.4L V8 BMW M62 petrol models	Genuine	1	<b>SSB000140</b>	139.75	167.70



LR058026P1





## RANGE ROVER L322 (2002-2012)

## SUSPENSION

## Bush Upper Arm

All models					
Front suspension, rubber	Aftermarket	2	<b>LR018345P</b>	7.29	8.75
	OEM	2	<b>LR018345P1</b>	12.50	15.00
	Genuine	2	<b>LR018345</b>	41.33	49.60
	Aftermarket	4	<b>RGX000080P</b>	4.38	5.26
	Genuine	4	<b>RGX000080</b>	55.01	66.01

## Bush Front Lower Arm

All models					
Standard bush, inner, forward	OEM	1	<b>RGX000060P1</b>	12.50	15.00
	Genuine	1	<b>RGX000060</b>	32.26	38.71
Standard bush, inner, rearward	Genuine	1	<b>RGX000071</b>	24.91	29.89

## Bush Lower Arm

All models					
Front suspension, rear	Aftermarket	1	<b>RBX000070P</b>	5.83	7.00
	OEM	1	<b>RBX000070P1</b>	11.67	14.00
	Genuine	1	<b>RBX000070</b>	41.83	50.20

## Bush Wheel Knuckle

All models					
Rear suspension, upper, rubber	Aftermarket	2	<b>RHF000260P</b>	6.04	7.25
	OEM	2	<b>RHF000260P1</b>	16.04	19.25
	Genuine	2	<b>RHF000260</b>	30.42	36.50

## Anti Roll Bar

All 3.0L BMW M57 diesel models up to (VIN) 6A999999					
Front suspension	Genuine	1	<b>RBL500722</b>	134.90	161.88
All 4.2L supercharged AJV8 petrol models up to (VIN) 6A999999					
Front suspension	Genuine	1	<b>RBL500732</b>	136.46	163.75
All 4.4L N/A AJV8 petrol models up to (VIN) 6A999999					
Front suspension	Genuine	1	<b>RBL500722</b>	134.90	161.88
All models (VIN) 7A000001 to 9A999999					
Front suspension	Genuine	1	<b>RBL500732</b>	136.46	163.75
All 3.0L BMW M57 diesel models except armoured					
Rear, includes mounting bushes	Genuine	1	<b>RGB000054</b>	88.77	106.52
All 4.4L BMW M62 V8 petrol models except armoured					
Rear, includes mounting bushes	Genuine	1	<b>RGB000054</b>	88.77	106.52
All 4.4L N/A AJV8 petrol models up to (VIN) 6A999999 except armoured					
Rear, includes mounting bushes	Genuine	1	<b>RGB000054</b>	88.77	106.52
All models (VIN) 7A000001 to 9A999999 except B6 armoured					
Rear	Genuine	1	<b>RGB500272</b>	96.04	115.25

## Anti Roll Bar Link

All models except armoured vehicles					
Front	Aftermarket	2	<b>LR030047P</b>	7.50	9.00
	OEM	2	<b>LR030047P1</b>	10.00	12.00
	Genuine	2	<b>LR030047</b>	27.73	33.28
All models					
Rear	Aftermarket	2	<b>LR030048P</b>	6.04	7.25
	Genuine	2	<b>LR030048</b>	25.50	30.60

## Stabiliser Bar Link

All models - Rear anti roll bar					
	Aftermarket	2	<b>RGD500180P</b>	16.04	19.25
	OEM	2	<b>RGD500180P1</b>	25.83	31.00
	Genuine	2	<b>RGD500180</b>	58.49	70.19

## Active Roll Bar Fluid

All models with active roll bar control - 1 litre, Cold (standard) climates fluid					
	Aftermarket	a/r	<b>STC50519P</b>	12.08	14.50
	Genuine	a/r	<b>STC50519</b>	18.96	22.75

## Shock Absorber Complete Assembly

All 3.6L TDV8 diesel models					
Std, front RH	OEM	1	<b>LR032566P1</b>	283.33	340.00
	Genuine	1	<b>LR032566</b>	693.46	832.15
Std, front LH	OEM	1	<b>LR032575P1</b>	283.33	340.00
	Genuine	1	<b>LR032575</b>	693.46	832.15
All 4.2L supercharged V8 petrol models					
Std, front RH	OEM	1	<b>LR032563P1</b>	283.33	340.00
	Genuine	1	<b>LR032563</b>	675.68	810.82
Std, front LH	OEM	1	<b>LR032570P1</b>	283.33	340.00
	Genuine	1	<b>LR032570</b>	681.60	817.92
All 4.4L AJV8 petrol models					
Std, front RH	OEM	1	<b>LR032563P1</b>	283.33	340.00
	Genuine	1	<b>LR032563</b>	675.68	810.82
Std, front LH	OEM	1	<b>LR032570P1</b>	283.33	340.00
	Genuine	1	<b>LR032570</b>	681.60	817.92
All 5.0L NA V8 petrol models					
Std, front RH	OEM	1	<b>LR032563P1</b>	283.33	340.00
	Genuine	1	<b>LR032563</b>	675.68	810.82
Std, front LH	OEM	1	<b>LR032570P1</b>	283.33	340.00
	Genuine	1	<b>LR032570</b>	681.60	817.92

## Shock Absorber

All models up to (VIN) 6A999999					
Front, RH, std.	OEM	1	<b>RNB000740P1</b>	241.67	290.00
	Genuine	1	<b>RNB000740</b>	676.09	811.31
Front, LH, std.	OEM	1	<b>RNB000750P1</b>	241.67	290.00
	Genuine	1	<b>RNB000750</b>	676.09	811.31
All 5.0L OHC SGDI NA V8 petrol models from (VIN) BA361456					
Front RH	Genuine	1	<b>LR032564</b>	631.10	757.32
Front LH	Genuine	1	<b>LR032573</b>	631.10	757.32
All models warm climates only					
Front RH	Genuine	1	<b>LR032562</b>	823.18	987.82
All models from (VIN) AA000001 on with continuous variable damping except armoured and warm climates					
Front RH	OEM	1	<b>LR032560P1</b>	500.00	600.00
	Genuine	1	<b>LR032560</b>	977.56	1173.07
Front LH	OEM	1	<b>LR032567P1</b>	500.00	600.00
	Genuine	1	<b>LR032567</b>	977.56	1173.07
All 3.6L TDV8 diesel models					
Rear	Genuine	2	<b>RPD500760</b>	207.80	249.36
All 4.2L supercharged AJV8 petrol models					
Rear	Aftermarket	2	<b>RPD500940P</b>	50.00	60.00
	Genuine	2	<b>RPD500940</b>	207.80	249.36
Rear, Bilstein B4	Bilstein	2	<b>RPD500940BILSTEIN</b>	132.50	159.00
All 4.4L N/A AJV8 petrol models from (VIN) 7A249758 on					
Rear	Aftermarket	2	<b>RPD500940P</b>	50.00	60.00
	Genuine	2	<b>RPD500940</b>	207.80	249.36
Rear, Bilstein B4	Bilstein	2	<b>RPD500940BILSTEIN</b>	132.50	159.00
All 5.0L N/A AJV8 petrol models					
Rear	Aftermarket	2	<b>RPD500940P</b>	50.00	60.00
	Genuine	2	<b>RPD500940</b>	207.80	249.36
Rear, Bilstein B4	Bilstein	2	<b>RPD500940BILSTEIN</b>	132.50	159.00
All models with continuous variable damping from (VIN) BA334343 (except armoured)					
Rear RH	OEM	1	<b>LR023573P1</b>	266.67	320.00
	Genuine	1	<b>LR023573</b>	415.58	498.70
Rear LH	OEM	1	<b>LR023580P1</b>	266.67	320.00
	Genuine	1	<b>LR023580</b>	415.58	498.70

## Strut Insert

All models except 4.2L supercharged V8 and armoured vehicles up to (VIN) 7A249757					
Rear, std.	Aftermarket	2	<b>RPD500260P</b>	39.58	47.50
	Bilstein	2	<b>RPD500260BILSTEIN</b>	125.83	151.00
	Genuine	2	<b>RPD500260</b>	208.09	249.71

## Mounting, Shock Absorber

All models up to (VIN) 9A999999					
Rear, top	Aftermarket	2	<b>RPF000010P</b>	16.67	20.00
	Genuine	2	<b>RPF000010</b>	34.67	41.60

## Shock Absorber Bump Stop

All models with continuous variable damping from (VIN) AA000001 (except armoured)					
Rear	Genuine	2	<b>LR016966</b>	28.72	34.46

## Ball Joint

All models - Front knuckle, upper					
	Aftermarket	2	<b>RBK500210P</b>	5.83	7.00
	OEM	2	<b>RBK500210P1</b>	10.63	12.76
	Genuine	2	<b>RBK500210</b>	27.09	32.51

## Ball Joint Assembly

All models - Front upper arm					
	Aftermarket	2	<b>RBK500210P</b>	5.83	7.00
	OEM	2	<b>RBK500210P1</b>	10.63	12.76
	Genuine	2	<b>RBK500210</b>	27.09	32.51

## Upper Arm Kit

All models					
Front suspension, RH	Aftermarket	1	<b>LR018343P</b>	30.00	36.00
	OEM	1	<b>LR018343P1</b>	55.00	66.00
	Genuine	1	<b>LR018343</b>	156.76	188.11
Front suspension, LH	Aftermarket	1	<b>LR018344P</b>	30.00	36.00
	OEM	1	<b>LR018344P1</b>	52.50	63.00
	Genuine	1	<b>LR018344</b>	156.76	188.11

## Lower Arm Assembly

All models except armoured vehicles					
Front suspension	Aftermarket	2	<b>RBJ500920P</b>	25.00	30.00
	OEM	2	<b>RBJ500920P1</b>	40.00	48.00
	Genuine	2	<b>RBJ500920</b>	165.01	198.01
All models up to (VIN) 6A999999					
Rear RH	Genuine	1	<b>RGG000060</b>	106.65	127.98
Rear LH	Genuine	1	<b>RGG000070</b>	106.65	127.98
All models from (VIN) AA000001					
Rear RH	Genuine	1	<b>LR023711</b>	100.25	120.30
	Genuine	1	<b>LR023712</b>	100.25	120.30
Rear LH	Genuine	1	<b>LR023713</b>	123.67	148.40
	Genuine	1	<b>LR023714</b>	123.67	148.40

## Ball Joint Rear Knuckle Lower

All models					
	Aftermarket	2	<b>LR032644P</b>	8.13	9.76
	Genuine	2	<b>LR032644</b>	32.29	38.75



LR032570P1



# SUSPENSION

## Knuckle, without Hub

All models up to (VIN) 9A999999					
Rear RH	Genuine	1	<b>RLH000082</b>	276.04	331.25
Rear LH	Genuine	1	<b>RLH000092</b>	276.04	331.25
All models from (VIN) AA000001 on					
RH	Genuine	1	<b>LR010677</b>	214.06	256.87
LH	Genuine	1	<b>LR010678</b>	214.06	256.87

## Bump Stop

All models - Rear suspension upper link	Genuine	1	<b>KHW000010</b>	39.85	47.82
-----------------------------------------	---------	---	------------------	-------	-------

## Height Sensor

All models with halogen headlamps up to (VIN) 4A174107					
Front RH & LH	Genuine	2	<b>RQH105130</b>	48.00	57.60
Rear RH & LH	Aftermarket	1	<b>RQH100030P</b>	28.33	34.00
	OEM	1	<b>RQH100030P1</b>	34.58	41.50
	Genuine	1	<b>RQH100030</b>	44.97	53.96
All models with xenon headlamps up to (VIN) 4A174107					
Front LH	Genuine	1	<b>RQH105130</b>	48.00	57.60
Rear RH	Genuine	1	<b>RQH000091</b>	83.22	99.86
Rear LH	Aftermarket	1	<b>RQH100030P</b>	28.33	34.00
	OEM	1	<b>RQH100030P1</b>	34.58	41.50
	Genuine	1	<b>RQH100030</b>	44.97	53.96
All models from (VIN) 4A174108 to 9A999999					
<i>Note: later type 6 pin plug on this sensor is fully compatible with original 3 pin plug on car</i>					
Front RH	Genuine	1	<b>LR020627</b>	75.94	91.13
Front LH	Aftermarket	1	<b>LR020626P</b>	65.83	79.00
	Genuine	1	<b>LR020626</b>	76.39	91.67
Rear RH & LH	Genuine	1	<b>LR032106</b>	75.77	90.92

## Air Suspension Height Sensor

All models with adaptive damping from (VIN) AA000001 on					
Front	Genuine	2	<b>LR023652</b>	77.71	93.25
Rear	Genuine	2	<b>LR023654</b>	77.46	92.95
All models without adaptive damping from (VIN) AA000001 on					
Rear	Genuine	2	<b>LR023653</b>	63.82	76.58

## Air Suspension Compressor

All models up to (VIN) 5A999999					
New, outright	OEM	1	<b>RQL000014P1</b>	320.83	385.00
New, exchange	Genuine*	1	<b>RQL000014</b>	753.98	904.78
			<i>*Exchange Surcharge</i>	50.00	60.00

## Overhaul Kit for Air Compressor

All models from (VIN) 6A198058 to (VIN) 9A999999					
New, outright	Aftermarket	1	<b>LR041777P</b>	350.00	420.00
New, exchange	Genuine	1	<b>LR041777</b>	517.89	621.47
				200.00	240.00

## Air Spring

All models up to (VIN) 9A999999 except 3.6L TDV8 diesel					
Rear	Genuine	2	<b>RKB500082</b>	275.72	330.86
All 3.6L TDV8 diesel models up to (VIN) 9A999999					
Rear	Genuine	2	<b>RKB500240</b>	279.16	334.99
All models without adaptive damping (VIN) AA000001 on					
Rear	Genuine	2	<b>RKB500082</b>	275.72	330.86
All models with adaptive damping (VIN) AA000001 on					
Rear	Genuine	2	<b>RKB500240</b>	279.16	334.99

## Valve Block Kit

All models up to (VIN) 5A999999 - Reservoir valve block					
	Genuine	1	<b>RQN500040</b>	415.54	498.65
All models from (VIN) 6A000001 on - Compressor					
	Genuine	1	<b>RVH500070</b>	114.18	137.02

## Axle Valve, Air Suspension

All models from (VIN) 6A000001 on					
Front	Genuine	1	<b>RVH500060</b>	119.88	143.86
Rear	Genuine	1	<b>RVH500050</b>	119.88	143.86

## Sensor, Pressure

All models up to (VIN) 5A999999 - Reservoir	Genuine	1	<b>RQH000130</b>	43.60	52.32
---------------------------------------------	---------	---	------------------	-------	-------

## Tilt Angle Sensor

All models up to (VIN) 9A999999 - Burglar alarm system					
	Genuine	1	<b>YDB100120</b>	80.41	96.49



RQL000014P1

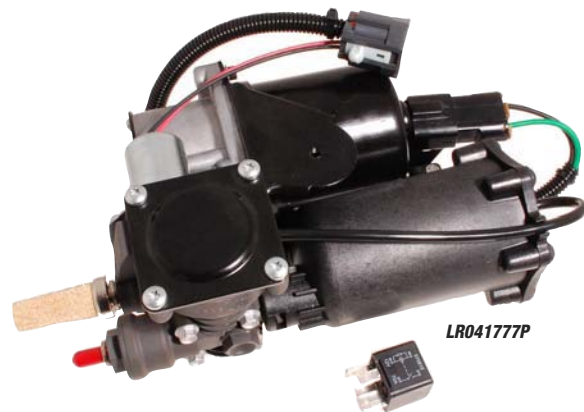

LR041777P

# STEERING

## Coupling & Universal Joint

All 3.0L 6 cyl BMW M57 diesel models - Steering column					
	Genuine	1	<b>QLD500050</b>	24.43	29.32
All 4.4L V8 BMW M62 petrol models - Steering column					
	Genuine	1	<b>QLD500050</b>	24.43	29.32

## Sensor, Steering Rotation

All 3.6L TDV8 diesel models up to (VIN) 9A999999 - Steering column					
	Genuine	1	<b>SR0500110</b>	185.78	222.94
All 4.2L supercharged AJV8 petrol models - Steering column					
	Genuine	1	<b>SR0500110</b>	185.78	222.94
All 4.4L N/A AJV8 petrol models - Steering column					
	Genuine	1	<b>SR0500110</b>	185.78	222.94

## Track Rod End

All models - Includes track rod outer					
	Aftermarket	2	<b>QJB500050P</b>	15.83	19.00
	OEM	2	<b>QJB500050P1</b>	26.67	32.00
	Genuine	2	<b>QJB500050</b>	72.98	87.58

## Track Rod

All models - Inner					
	Aftermarket	2	<b>QJB500060P</b>	9.58	11.50
	OEM	2	<b>QJB500060P1</b>	14.79	17.75
	Genuine	2	<b>QJB500060</b>	55.58	66.70

## Gaiter Kit, Steering Rack

All models - Includes one gaiter with clips					
	Aftermarket	2	<b>QFW000010P</b>	7.08	8.50
	OEM	2	<b>QFW000010P1</b>	14.38	17.26
	Genuine	2	<b>QFW000010</b>	29.54	35.45

# RANGE ROVER L322 (2002-2012)

## Power Steering Fluid

All models - 1 litre. Cold (standard) climates fluid					
	Aftermarket	a/r	<b>STC50519P</b>	12.08	14.50
	Genuine	a/r	<b>STC50519</b>	18.96	22.75

## Cap, Power Steering Reservoir

All diesel models except 3.0L 6 cyl BMW M57 diesel					
	Genuine	1	<b>QEZ500010</b>	3.25	3.90
All petrol models except 4.4L V8 BMW M62 petrol					
	Genuine	1	<b>QEZ500010</b>	3.25	3.90



QFW000010P



**RANGE ROVER L322 (2002-2012)****TRANSMISSION****Bearing, Propshaft**

All models to (VIN) 5A999999	Aftermarket	1	<b>TOQ000050P</b>	25.83	31.00
	Genuine	1	<b>TOQ000050</b>	91.56	109.87
All 3.0L 6 cyl BMW M57 diesel models (VIN) 6A000001 on	Aftermarket	1	<b>TOQ000050P</b>	25.83	31.00
	Genuine	1	<b>TOQ000050</b>	91.56	109.87

**Propshaft Coupling**

All models with tube type propshaft to (VIN) 5A999999	Aftermarket	1	<b>TVB500290COUPLINGBP</b>	135.00	162.00
	Genuine	1	<b>TVB500290COUPLINGBP</b>	135.00	162.00
All 3.0L 6 cyl BMW M57 diesel models with tube type propshaft (VIN) 6A000001 on	Aftermarket	1	<b>TVB500290COUPLINGBP</b>	135.00	162.00
	Genuine	1	<b>TVB500290COUPLINGBP</b>	135.00	162.00

**Drive Flange Kit, Transfer Box**

All models from (VIN) 6A000001 on - Output shaft	Front	Genuine	1	<b>IEA500031</b>	81.83	98.20
	Rear	Genuine	1	<b>LR039528</b>	107.64	129.17

**Driveshaft Assembly**

All models	Front RH, with joints	Genuine	1	<b>IED500110</b>	427.46	512.95
	Front LH, with joints	Genuine	1	<b>IED500120</b>	448.79	538.55

**Drive Shaft & CV Joint**

All 3.0L 6 cyl BMW M57 diesel models	Rear axle	Genuine	2	<b>TOB500330</b>	219.14	262.97
All 4.2L supercharged AJV8 petrol models up to (VIN) 6A999999	Rear axle, RH	Genuine	1	<b>TOB500310</b>	225.70	270.84
	Rear axle, LH	Genuine	1	<b>TOB500320</b>	245.24	294.29
All 4.4L N/A AJV8 petrol models up to (VIN) 6A999999	Rear axle, RH	Genuine	1	<b>TOB500310</b>	225.70	270.84
	Rear axle, LH	Genuine	1	<b>TOB500320</b>	245.24	294.29
All 4.4L V8 BMW M62 petrol models	Rear axle	Genuine	2	<b>TOB500330</b>	219.14	262.97
All models from (VIN) 7A000001 on	Rear axle, RH	Genuine	1	<b>TOB500310</b>	225.70	270.84
	Rear axle, LH	Genuine	1	<b>TOB500320</b>	245.24	294.29

**Gaiter Kit Front Drive Shaft**

All models	OEM	2	<b>TDR000120P1</b>	39.58	47.50
	Genuine	2	<b>TDR000120</b>	77.63	93.16

**Gaiter Kit Rear Drive Shaft**

All models to (VIN) 5A999999	OEM	2	<b>TDR000130P1</b>	50.00	60.00
	Genuine	2	<b>TDR000130</b>	73.04	87.65
All 4.2L supercharged V8 petrol models (VIN) 6A000001 to 6A999999	OEM	2	<b>TDR500080P1</b>	20.00	24.00
	Genuine	2	<b>TDR500080</b>	39.28	47.14
All 4.4L AJV8 petrol models (VIN) 6A000001 to 6A999999	OEM	2	<b>TDR500080P1</b>	20.00	24.00
	Genuine	2	<b>TDR500080</b>	39.28	47.14
All models (VIN) 7A000001 on	OEM	2	<b>TDR500080P1</b>	20.00	24.00
	Genuine	2	<b>TDR500080</b>	39.28	47.14

**Oil Seal, Differential**

All 3.0L 6 cyl BMW M57 diesel models with flange type propshaft connection	Front axle pinion	Genuine	1	<b>LR007769</b>	6.77	8.12
All 4.4L V8 BMW M62 petrol models with flange type propshaft connection	Front axle pinion	Genuine	1	<b>LR007769</b>	6.77	8.12
All petrol models except 4.4L V8 BMW M62	Rear axle, output shafts	OEM	1	<b>TZB500050P1</b>	6.25	7.50
		Genuine	1	<b>TZB500050</b>	13.21	15.85
Rear axle pinion	Genuine	1	<b>TZB500100</b>	16.28	19.54	
All diesel models except 3.0L 6 cyl BMW M57	Rear axle, output shafts	OEM	1	<b>TZB500050P1</b>	6.25	7.50
		Genuine	1	<b>TZB500050</b>	13.21	15.85
Rear axle pinion	Genuine	1	<b>TZB500100</b>	16.28	19.54	

**Oil Seal, Transfer Box**

All 5 speed automatic models	Front & rear output shafts	Genuine	1	<b>IZB500020</b>	11.13	13.36
	Input shaft	Genuine	1	<b>IZB500010</b>	10.11	12.13
All 6 speed automatic models	Input shaft	Aftermarket	1	<b>IZB500030P</b>	6.67	8.00
		Genuine	1	<b>IZB500030</b>	12.96	15.55

**Sealing Ring, Transfer Box**

All 6 speed automatic models	Front output shaft	OEM	1	<b>IZB500040P1</b>	8.13	9.76
		Genuine	1	<b>IZB500040</b>	10.17	12.20
Rear output shaft	OEM	1	<b>IZB500050P1</b>	4.79	5.75	
	Genuine	1	<b>IZB500050</b>	9.84	11.81	

**Plug, Transfer Box**

All models with 6 or 8 speed automatic gearbox	Oil Fill & Drain	OEM	1	<b>IYB500020P1</b>	1.75	2.10
		Genuine	1	<b>IYB500020</b>	2.49	2.99

**Plug, Oil Drain**

All models (VIN) 7A000001 on	Rear axle	Genuine	1	<b>FTC5431</b>	6.50	7.80
------------------------------	-----------	---------	---	----------------	------	------

**Oil Temperature Switch**

All models with rear axle locking differential	Rear axle differential	Genuine	1	<b>NSC500590</b>	14.45	17.34
------------------------------------------------	------------------------	---------	---	------------------	-------	-------

**Chain Only, Transfer Box**

All 6 speed automatic models	OEM	1	<b>LR049160CP1</b>	133.33	160.00
------------------------------	-----	---	--------------------	--------	--------

**Sensor, Differential**

All models with rear axle locking differential	Oil temperature	Genuine	1	<b>NSC500590</b>	14.45	17.34
------------------------------------------------	-----------------	---------	---	------------------	-------	-------

**Sensor, Transfer Box**

All models with 6 speed automatic gearbox from (VIN) 6A000001 on	High/low position	Genuine	1	<b>IAB500191</b>	74.63	89.56
------------------------------------------------------------------	-------------------	---------	---	------------------	-------	-------

**Solenoid, Transfer Box**

All models with 6 or 8 speed automatic gearbox - Pressure		Genuine	1	<b>IGF500011</b>	77.19	92.63
-----------------------------------------------------------	--	---------	---	------------------	-------	-------

**Damper, Vibration**

All models with 6 speed automatic gearbox from (VIN) 6A000001 on	Transfer box	Genuine	1	<b>LR094511</b>	33.76	40.51
All 3.6L TDV8 diesel models	Rear axle	Genuine	1	<b>TVG500010</b>	34.94	41.93





# COOLING

# RANGE ROVER L322 (2002-2012)

## Expansion Bottle Cap

All 3.0L diesel engine models	Aftermarket	1	<b>PCD000070P</b>	3.42	4.10
	OEM	1	<b>PCD000070P1</b>	7.08	8.50
	Genuine	1	<b>PCD000070A</b>	11.91	14.29
	Genuine	1	<b>PCD000070</b>	9.02	10.82
All 3.6L V8 diesel engine models up to (VIN) 9A99999	Aftermarket	1	<b>PCD500030P</b>	2.83	3.40
	Genuine	1	<b>PCD500030</b>	6.76	8.11
All 4.2L supercharged V8 engine models	Aftermarket	1	<b>PCD500030P</b>	2.83	3.40
	Genuine	1	<b>PCD500030</b>	6.76	8.11
All 4.4L AJ V8 petrol engine models	Aftermarket	1	<b>PCD500030P</b>	2.83	3.40
	Genuine	1	<b>PCD500030</b>	6.76	8.11
All 4.4L M62 V8 petrol models up to (VIN) 1A001049	Aftermarket	1	<b>PCD100200LP</b>	4.00	4.80
	Genuine	1	<b>PCD100200L</b>	18.72	22.46
All 4.4L M62 V8 petrol models from (VIN) 1A001050 on	Aftermarket	1	<b>PCD000070P</b>	3.42	4.10
	OEM	1	<b>PCD000070P1</b>	7.08	8.50
	Genuine	1	<b>PCD000070A</b>	11.91	14.29
	Genuine	1	<b>PCD000070</b>	9.02	10.82
All 4.4L TDV8 diesel models	Aftermarket	1	<b>LR017427P</b>	4.79	5.75
	Genuine	1	<b>LR017427</b>	6.99	8.39
All 5.0L N/A & supercharged AJV8 petrol models	OEM	1	<b>LR010965P1</b>	2.42	2.90
	Genuine	1	<b>LR010965</b>	5.57	6.68

## Radiator Cap

All Gulf States models from (VIN) 8A000001 on - Transmission oil cooling system	Aftermarket	1	<b>PCD500020</b>	10.00	12.00
	Genuine	1	<b>PCD500020</b>	10.00	12.00

## Thermostat

All 3.0L M57 6 cyl diesel engine models	Aftermarket	1	<b>PEL000050P</b>	25.00	30.00
	OEM	1	<b>PEL000050P1</b>	29.58	35.50
	Genuine	1	<b>PEL000050</b>	61.54	73.85
All 3.6L TDV8 diesel models - Engine thermostat housing	Aftermarket	1	<b>LR003341</b>	12.25	14.70
	Genuine	1	<b>LR003341</b>	12.25	14.70
All 4.2L supercharged AJV8 petrol models - Coolant	Aftermarket	1	<b>LR005765P</b>	10.00	12.00
	OEM	1	<b>LR005765P1</b>	17.50	21.00
	Genuine	1	<b>LR005765</b>	30.16	36.19
All 4.4L AJV8 petrol models - Coolant	Aftermarket	1	<b>LR005765P</b>	10.00	12.00
	OEM	1	<b>LR005765P1</b>	17.50	21.00
	Genuine	1	<b>LR005765</b>	30.16	36.19
All 4.4L M62 V8 petrol engine models	OEM	1	<b>PBM000010P1</b>	34.58	41.50
	Genuine	1	<b>PBM000010</b>	83.95	100.74

## Thermostat Kit

All 4.4L M62 V8 petrol engine models - With housing and seal	Aftermarket	1	<b>PEL000060P</b>	39.58	47.50
	OEM	1	<b>PEL000060P1</b>	46.67	56.00
	Genuine	1	<b>PEL000060</b>	100.95	121.14

## Thermostat Housing Gasket

All 3.0L 6 cyl BMW M57 diesel models	Aftermarket	1	<b>PEF000040P</b>	1.75	2.10
	Genuine	1	<b>PEF000040</b>	6.74	8.09
All 4.2L supercharged AJV8 petrol models - Housing elbow, 54mm dia.	Aftermarket	1	<b>4024557</b>	0.58	0.70
	Genuine	1	<b>4024557</b>	0.58	0.70

## Thermostat Housing O Ring

All 4.2L supercharged AJV8 petrol models	Thermostat cover, 69mm dia.	Genuine	1	<b>4362513</b>	1.58	1.90
	Thermostat housing body, 37mm dia.	Genuine	1	<b>4413478</b>	1.74	2.09
		Genuine	1	<b>PES000020</b>	2.85	3.42
All 4.4L V8 BMW M62 petrol models	Thermostat cover, 69mm dia.	Genuine	1	<b>4362513</b>	1.58	1.90
	Thermostat housing body, 37mm dia.	Genuine	1	<b>4413478</b>	1.74	2.09
	Housing elbow, 53mm dia.	Genuine	1	<b>4359953</b>	3.99	4.79

## Engine Thermostat Housing Assembly

All 3.6L TDV8 diesel models - Includes thermostat, EGR valve thermostat and covers	Aftermarket	1	<b>LR004318</b>	52.80	63.36
	Genuine	1	<b>LR004318</b>	52.80	63.36
All 4.2L supercharged AJV8 petrol models - Includes thermostat, cover/elbow and temp sensor	Aftermarket	1	<b>LR007603</b>	189.29	227.15
	Genuine	1	<b>LR007603</b>	189.29	227.15
All 4.4L N/A AJV8 petrol models - Includes thermostat, cover/elbow and temp sensor	OEM	1	<b>LR007604P1</b>	139.17	167.00
	Genuine	1	<b>LR007604</b>	191.21	229.45

## Retaining Clip

All 3.6L TDV8 diesel models - EGR valve thermostat & elbow to thermostat housing	Aftermarket	1	<b>LR003339</b>	1.31	1.57
	Genuine	1	<b>LR003339</b>	1.31	1.57

## Thermostat Cover

All 4.2L supercharged AJV8 petrol models	Aftermarket	1	<b>LR007605</b>	55.56	66.67
	Genuine	1	<b>LR007605</b>	55.56	66.67

## EGR Thermostat

All 3.0L 6 cyl BMW M57 diesel models - Exhaust gas recirculation (EGR)	Aftermarket	1	<b>PEL000070</b>	58.38	70.06
	Genuine	1	<b>PEL000070</b>	58.38	70.06

## EGR Valve Thermostat

All 3.6L TDV8 diesel models - In thermostat housing	Aftermarket	1	<b>LR003335</b>	30.25	36.30
	Genuine	1	<b>LR003335</b>	30.25	36.30

## EGR Valve Thermostat Elbow

All 3.6L TDV8 diesel models - Upper	Aftermarket	1	<b>LR004320</b>	14.43	17.32
	Genuine	1	<b>LR004320</b>	14.43	17.32

## EGR Valve Thermostat Elbow O Ring

All 3.6L TDV8 diesel models - Lower elbow to thermostat housing	Aftermarket	1	<b>LR003336</b>	2.65	3.18
	Genuine	1	<b>LR003336</b>	2.65	3.18

## Water Pump

All 3.0L M57 diesel engine models	New, outright	Aftermarket	1	<b>PEB000050P</b>	44.17	53.00
		Genuine*	1	<b>PEB000050E</b>	169.89	203.87
		*Exchange Surcharge			70.00	84.00
New, exchange	Aftermarket	1	<b>PEB000050E</b>	169.89	203.87	
	Genuine*	1	<b>PEB000050E</b>	169.89	203.87	
	*Exchange Surcharge			70.00	84.00	
New, outright	Aftermarket	1	<b>PEB000050</b>	224.07	268.88	
	Genuine	1	<b>PEB000050</b>	224.07	268.88	
3.0L supercharged V6 petrol models (VIN) EA000001 to EA183087 - Auxiliary	Aftermarket	1	<b>PEB500010</b>	140.35	168.42	
	Genuine	1	<b>PEB500010</b>	140.35	168.42	
All models with 3.6L TDV8 diesel engine	Aftermarket	1	<b>LR008863P</b>	50.00	60.00	
	Genuine	1	<b>LR008863</b>	128.66	154.39	
All 4.2L supercharged AJ V8 petrol engine models	Aftermarket	1	<b>4575902P</b>	19.79	23.75	
		1	<b>4575902P1</b>	29.58	35.50	
		1	<b>4575902</b>	128.66	154.39	
		1	<b>4575902</b>	128.66	154.39	
Auxiliary	Aftermarket	1	<b>PEB500010</b>	140.35	168.42	
	Genuine	1	<b>PEB500010</b>	140.35	168.42	
All 4.4L AJ V8 petrol engine models	Aftermarket	1	<b>4575902P</b>	19.79	23.75	
		1	<b>4575902P1</b>	29.58	35.50	
		1	<b>4575902</b>	128.66	154.39	
All 4.4L M62 V8 petrol engine models	New, outright	Aftermarket	1	<b>8510324P</b>	40.00	48.00
		OEM	1	<b>8510324P1</b>	75.00	90.00
		Genuine*	1	<b>8510324</b>	133.68	160.42
New, exchange	Aftermarket	1	<b>8510324</b>	133.68	160.42	
	*Exchange Surcharge			70.00	84.00	
All 5.0L supercharged AJV8 petrol models to (VIN) EA183087	Aftermarket	1	<b>PEB500010</b>	140.35	168.42	
	Genuine	1	<b>PEB500010</b>	140.35	168.42	

## Water Pump Gasket

All 3.0L 6 cyl BMW M57 diesel models	Aftermarket	1	<b>8510300</b>	9.06	10.87
	Genuine	1	<b>LR002750</b>	1.83	2.20
All 4.2L supercharged AJV8 petrol models	Aftermarket	1	<b>4575903</b>	5.04	6.05
	Genuine	1	<b>4575903</b>	5.04	6.05
All 4.4L N/A AJV8 petrol models	Aftermarket	1	<b>PET000050P1</b>	2.92	3.50
	Genuine	1	<b>PET000050</b>	5.04	6.05
All 5.0L N/A & supercharged AJV8 petrol models	Aftermarket	1	<b>LR049370P</b>	4.58	5.50
	OEM	1	<b>LR049370</b>	11.91	14.29
	Genuine	1	<b>LR049370</b>	11.91	14.29

## Hose Only Turbo Intercooler

All 3.0L 6 cyl BMW M57 diesel models except hot climates	RH	Aftermarket	1	<b>PNH000163P</b>	55.83	67.00
		Genuine	1	<b>PNH000163</b>	140.34	168.41

## Hose Assembly Only Turbo Intercooler

All 3.0L 6 cyl BMW M57 diesel models	LH	Genuine	1	<b>PNH000184</b>	137.12	164.54
--------------------------------------	----	---------	---	------------------	--------	--------

## Coolant Temperature Sensor

All 4.2L supercharged AJV8 petrol models	Aftermarket	1	<b>4603183P</b>	15.55	18.66
	Genuine	1	<b>4603183</b>	24.77	29.72
All 4.4L AJV8 petrol models	Aftermarket	1	<b>4603183P</b>	15.55	18.66
	Genuine	1	<b>4603183</b>	24.77	29.72
All 5.0L N/A AJV8 petrol models	Genuine	1	<b>LR041442</b>	25.70	30.84
All 5.0L supercharged AJV8 petrol models	Genuine	1	<b>LR041442</b>	25.70	30.84

## Temperature Sensor

4.4L V8 BMW M62 petrol engine models	Aftermarket	1	<b>MEK105210P</b>	7.50	9.00
	OEM	1	<b>MEK105210P1</b>	10.83	13.00
	Genuine	1	<b>MEK105210</b>	27.82	33.38

## Coolant Level Sensor

All 3.0L 6 cyl BMW M57 diesel models	Aftermarket	1	<b>PCJ500020</b>	6.30	7.56
	Genuine	1	<b>PCJ500030</b>	6.16	7.39
All 4.2L supercharged AJV8 petrol models	Aftermarket	1	<b>PCJ500030</b>	6.16	7.39
	Genuine	1	<b>PCJ500030</b>	6.16	7.39
All 4.4L N/A AJV8 petrol models	Aftermarket	1	<b>PCJ500030</b>	6.16	7.39
	Genuine	1	<b>PCJ500030</b>	6.16	7.39
All 5.0L N/A AJV8 petrol models	Aftermarket	1	<b>PCJ500030</b>	6.16	7.39
	Genuine	1	<b>PCJ500030</b>	6.16	7.39



## RANGE ROVER L322 (2002-2012)

## ELECTRICAL - ROTATING ELECTRICS

## Alternator

All models with M57 3.0L diesel engine				
Reconditioned, exchange	Genuine*	1	<b>YLE500180E</b>	219.45 263.34 *Exchange Surcharge 70.00 84.00
New, exchange	Genuine*	1	<b>YLE500180</b>	352.38 422.86 *Exchange Surcharge 70.00 84.00
All models with 3.6L V8 Lion diesel engine				
New, outright	Aftermarket	1	<b>LR026344P</b>	163.33 196.00
New, exchange	Genuine*	1	<b>LR026344</b>	419.30 503.16 *Exchange Surcharge 70.00 84.00
All 4.2L supercharged V8 petrol models				
New, outright	Aftermarket	1	<b>YLE500390P</b>	145.00 174.00
	OEM	1	<b>YLE500390P1</b>	225.00 270.00
New, exchange	Genuine*	1	<b>YLE500390</b>	354.79 425.75 *Exchange Surcharge 70.00 84.00
All 4.4L AJV8 petrol models				
New, outright	Aftermarket	1	<b>YLE500390P</b>	145.00 174.00
	OEM	1	<b>YLE500390P1</b>	225.00 270.00
New, exchange	Genuine*	1	<b>YLE500390</b>	354.79 425.75 *Exchange Surcharge 70.00 84.00
All 4.4L V8 M62 petrol engine models				
New, outright	Aftermarket	1	<b>LR005866P</b>	245.83 295.00
	OEM	1	<b>LR005866P1</b>	375.00 450.00
New, exchange	Genuine*	1	<b>LR005866</b>	1074.84 1289.81 *Exchange Surcharge 200.00 240.00
All models with 4.4L TDV8 diesel engine				
New, outright	OEM	1	<b>LR072762P1</b>	225.00 270.00
New, exchange	Genuine*	1	<b>LR072762</b>	475.43 570.52 *Exchange Surcharge 150.00 180.00



LR026344P

## Starter Motor

All models with 3.0L 6 cyl BMW M57 diesel engine				
New, outright	Aftermarket	1	<b>NAD000090P</b>	155.00 186.00
Reconditioned, exchange	Genuine*	1	<b>NAD000090E</b>	270.60 324.72 *Exchange Surcharge 70.00 84.00
New, exchange	Genuine*	1	<b>NAD000090</b>	483.99 580.79 *Exchange Surcharge 70.00 84.00
All 3.6L TDV8 diesel models				
New, outright	OEM	1	<b>LR032541P1</b>	283.33 340.00
Reconditioned, exchange	Genuine*	1	<b>LR012628</b>	247.10 296.52 *Exchange Surcharge 70.00 84.00
New, exchange	Genuine*	1	<b>LR032541</b>	436.78 524.14 *Exchange Surcharge 200.00 240.00
All 4.2L supercharged AJV8 petrol models				
New, outright	Aftermarket	1	<b>NAD500320P</b>	216.67 260.00
New, exchange	Genuine*	1	<b>NAD500320</b>	364.88 437.86 *Exchange Surcharge 70.00 84.00
All 4.4L N/A AJV8 petrol models				
New, outright	Aftermarket	1	<b>NAD500320P</b>	216.67 260.00
New, exchange	Genuine*	1	<b>NAD500320</b>	364.88 437.86 *Exchange Surcharge 70.00 84.00
All 4.4L TDV8 diesel models				
New, outright	OEM	1	<b>LR032541P1</b>	283.33 340.00
New, exchange	Genuine*	1	<b>LR032541</b>	436.78 524.14 *Exchange Surcharge 200.00 240.00
All 4.4L V8 BMW M62 petrol models				
Reconditioned, exchange	Genuine*	1	<b>NAD000030E</b>	150.80 180.96 *Exchange Surcharge 200.00 240.00
New, exchange	Genuine*	1	<b>NAD000030</b>	304.46 365.35 *Exchange Surcharge 200.00 240.00
All 5.0L N/A AJV8 petrol models				
New, outright	OEM	1	<b>LR011262P1</b>	258.33 310.00
New, exchange	Genuine*	1	<b>LR011262</b>	398.23 477.88 *Exchange Surcharge 70.00 84.00
All 5.0L supercharged AJV8 petrol models				
New, outright	OEM	1	<b>LR011262P1</b>	258.33 310.00
New, exchange	Genuine*	1	<b>LR011262</b>	398.23 477.88 *Exchange Surcharge 70.00 84.00

## RANGE ROVER L322 (2002-2012)

## ENGINE GASKETS

## Gasket Cylinder Head

All 3.0L 6 cyl BMW M57 diesel models				
1.45mm thick, 1 hole on I.D. lip	Genuine	1	<b>LV8000290</b>	89.26 107.11
1.80mm thick, no holes on I.D. lip	OEM	1	<b>LV8000390P1</b>	45.83 55.00
	Genuine	1	<b>LV8000390</b>	89.26 107.11
3.0L 6 cyl BMW M57 diesel models				
1.55mm, two holes	Aftermarket	1	<b>LV8000300P</b>	55.00 66.00
	Genuine	1	<b>LV8000300</b>	86.46 103.75
1.65mm, three holes	Aftermarket	1	<b>LV8000310P</b>	39.58 47.50
	Genuine	1	<b>LV8000310</b>	89.26 107.11
All 3.6L TDV8 diesel models				
RH, Grade 1	Genuine	1	<b>1418984</b>	52.08 62.50
LH, Grade 1	Genuine	1	<b>1418990</b>	52.08 62.50
RH, Grade 2	Genuine	1	<b>1418985</b>	52.08 62.50
LH, Grade 2	Genuine	1	<b>1418991</b>	52.08 62.50
RH, Grade 3	Genuine	1	<b>LR000635</b>	50.52 60.62
LH, Grade 3	Genuine	1	<b>1418992</b>	52.31 62.77
RH, Grade 4	Genuine	1	<b>1418987</b>	52.08 62.50
LH, Grade 4	Genuine	1	<b>1418993</b>	52.08 62.50
RH, Grade 5	Genuine	1	<b>1418989</b>	52.08 62.50
LH, Grade 5	Genuine	1	<b>1418996</b>	52.08 62.50
All 4.2L supercharged AJV8 petrol models				
RH	Genuine	1	<b>4628399</b>	28.65 34.38
LH	Genuine	1	<b>4628400</b>	28.65 34.38
All 4.4L N/A AJV8 petrol models				
RH	Aftermarket	1	<b>4585198P</b>	14.38 17.26
	Genuine	1	<b>4585198</b>	28.99 34.79
LH	Aftermarket	1	<b>4585202P</b>	14.38 17.26
	Genuine	1	<b>4585202</b>	28.56 34.27
4.4L V8 BMW M62 petrol models				
1.74mm, cyls 1 to 4	OEM	1	<b>LV8000340P1</b>	15.83 19.00
	Genuine	1	<b>LV8000340</b>	73.53 88.24
1.74mm, cyls 5 to 8	OEM	1	<b>LV8000360P1</b>	19.58 23.50
	Genuine	1	<b>LV8000360</b>	73.53 88.24
2.07mm, cyls 1 to 4	OEM	1	<b>LV8000350P1</b>	15.75 18.90
	Genuine	1	<b>LV8000350</b>	94.02 112.82
2.07mm, cyls 5 to 8	Aftermarket	1	<b>LV8000370P</b>	15.83 19.00
	OEM	1	<b>LV8000370P1</b>	37.50 45.00
	Genuine	1	<b>LV8000370</b>	94.02 112.82
All 4.4L TDV8 diesel models				
RH	Genuine	1	<b>LR022899</b>	9.74 11.69
LH	Genuine	1	<b>LR022897</b>	10.51 12.61

## Gasket Decoke Set

3.0L 6 cyl BMW M57 diesel models - Without head gasket				
	Genuine	1	<b>LDY000010</b>	204.75 245.70
All 4.4L BMW M62 V8 petrol models - Without head gasket				
	Genuine	1	<b>LVQ000020</b>	294.38 353.26



LR006645P

## Gasket Camshaft Cover

All 4.2L supercharged AJV8 petrol models				
RH	Aftermarket	1	<b>LR007652P</b>	10.63 12.76
	Genuine	1	<b>LR007652</b>	22.79 27.35
LH	Aftermarket	1	<b>LR007657P</b>	10.63 12.76
	Genuine	1	<b>LR007657</b>	28.77 34.52
All 4.4L N/A AJV8 petrol models				
RH	Aftermarket	1	<b>LR007652P</b>	10.63 12.76
	Genuine	1	<b>LR007652</b>	22.79 27.35
LH	Aftermarket	1	<b>LR007657P</b>	10.63 12.76
	Genuine	1	<b>LR007657</b>	28.77 34.52
All 4.4L TDV8 diesel models				
RH, also inlet manifold	Genuine	1	<b>LR035031</b>	17.07 20.48
LH, also inlet manifold	Genuine	1	<b>LR035029</b>	51.30 61.56
All 4.4L V8 BMW M62 petrol models				
	Aftermarket	2	<b>LVP000030P</b>	5.00 6.00
	Genuine	2	<b>LVP000030</b>	29.26 35.11

## Gasket Rocker Cover

All 3.0L 6 cyl BMW M57 diesel models				
	Aftermarket	1	<b>8510335P</b>	10.00 12.00
	OEM	1	<b>8510335P1</b>	24.58 29.50
	Genuine	1	<b>8510335</b>	37.77 45.32
All 4.4L V8 BMW M62 petrol models				
Cyls 1-4	Aftermarket	1	<b>LR003812P</b>	7.50 9.00
	OEM	1	<b>LR003812P1</b>	11.04 13.25
	Genuine	1	<b>LR003812</b>	28.66 34.39
Cyls 5-8	Aftermarket	1	<b>LR003813P</b>	7.08 8.50
	OEM	1	<b>LR003813P1</b>	10.83 13.00
	Genuine	1	<b>LR003813</b>	29.78 35.74

## Gasket Oil Sump

All 3.0L 6 cyl BMW M57 diesel models				
	Genuine	1	<b>8510364</b>	28.58 34.30
All 3.6L TDV8 diesel models				
	Genuine	1	<b>LR002438</b>	20.55 24.66
All 4.4L TDV8 diesel models				
	Genuine	1	<b>LR094141</b>	54.08 64.90
4.4L V8 BMW M62 petrol models				
Upper	Genuine	1	<b>LVF000030</b>	41.46 49.75
Lower	Aftermarket	1	<b>LVF000040P</b>	8.33 10.00
	OEM	1	<b>LVF000040P1</b>	9.38 11.26
	Genuine	1	<b>LVF000040</b>	26.76 32.11

## Gasket Conversion Kit

All 3.0L 6 cyl BMW M57 diesel models	Genuine	1	<b>WLB000010</b>	173.15 207.78
--------------------------------------	---------	---	------------------	---------------

## Gasket Decoke &amp; Conversion Set

All 4.2L supercharged AJV8 petrol models - Also includes seals				
	Aftermarket	1	<b>LR006635P</b>	250.00 300.00
	Genuine	1	<b>LR006635</b>	355.28 426.34
All 4.4L N/A AJV8 petrol models - Also includes seals				
	Aftermarket	1	<b>LR006645P</b>	216.67 260.00
	Genuine	1	<b>LR006645</b>	282.40 338.88

## Sealant Instant Gasket

Numerous applications	Genuine	a/r	<b>STC50550</b>	13.10 15.72
-----------------------	---------	-----	-----------------	-------------

# ENGINE SWITCHES

## Camshaft Position Sensor

All 3.0L 6 cyl BMW M57 diesel models	Genuine	1	<b>8510297</b>	114.29	137.15
All 4.2L supercharged AJV8 petrol models	RH	Aftermarket	1	<b>4427657P</b>	27.08 32.50
		Genuine	1	<b>4427657</b>	40.54 48.65
	LH	Aftermarket	1	<b>4362957P</b>	25.85 31.02
		Genuine	1	<b>4362957</b>	36.32 43.58
All 4.4L AJV8 petrol models	RH	Aftermarket	1	<b>4427657P</b>	27.08 32.50
		Genuine	1	<b>4427657</b>	40.54 48.65
	LH	Aftermarket	1	<b>4362957P</b>	25.85 31.02
		Genuine	1	<b>4362957</b>	36.32 43.58
All 4.4L V8 BMW M62 petrol models	Aftermarket	1	<b>8510301P</b>	28.33 34.00	
	Genuine	1	<b>8510301</b>	89.32 107.18	
All 5.0L N/A AJV8 petrol models	OEM	1	<b>LR014372P1</b>	36.67 44.00	
	Genuine	1	<b>LR014372</b>	118.70 142.44	
All 5.0L supercharged AJV8 petrol models	OEM	1	<b>LR014372P1</b>	36.67 44.00	
	Genuine	1	<b>LR014372</b>	118.70 142.44	

## Crankshaft Position Sensor

All 3.0L 6 cyl BMW M57 diesel models	Aftermarket	1	<b>NSC100880LP</b>	35.00 42.00
	Genuine	1	<b>NSC100880L</b>	78.29 93.95
All 3.6L TDV8 diesel models	Aftermarket	1	<b>LR009793P</b>	45.00 54.00
	Genuine	1	<b>LR009793</b>	117.84 141.41
All 4.2L supercharged AJV8 petrol models	Aftermarket	1	<b>NSC500160P</b>	20.00 24.00
	Genuine	1	<b>NSC500160</b>	42.84 51.41
All 4.4L N/A AJV8 petrol models	Aftermarket	1	<b>NSC500160P</b>	20.00 24.00
	Genuine	1	<b>NSC500160</b>	42.84 51.41
All 4.4L V8 BMW M62 petrol models	Aftermarket	1	<b>NSC000050P</b>	18.95 22.74
	Genuine	1	<b>NSC000050</b>	60.33 72.40

## Oil Temperature Switch

3.0L 6 cyl BMW M57 diesel engine models	Aftermarket	1	<b>1703993P</b>	9.38 11.26
	Genuine	1	<b>1703993</b>	25.17 30.20
All 3.6L TDV8 diesel models	Genuine	1	<b>1359056</b>	27.21 32.65
4.4L V8 BMW M62 petrol engine models	Aftermarket	1	<b>1703993P</b>	9.38 11.26
	Genuine	1	<b>1703993</b>	25.17 30.20

## Engine Knock Sensor

All 3.6L TDV8 diesel models up to (VIN) 8A270961					
	Genuine	1	<b>1419002</b>	59.24 71.09	
All 4.2L supercharged AJV8 petrol models	Genuine	1	<b>4603186</b>	77.82 93.38	
		Genuine	1	<b>4603186</b>	77.82 93.38
All 4.4L V8 BMW M62 petrol models	Genuine	1	<b>LR005552</b>	81.69 98.03	
All 5.0L N/A AJV8 petrol models	Genuine	1	<b>LR008877</b>	33.19 39.83	
All 5.0L supercharged AJV8 petrol models	Genuine	1	<b>LR008877</b>	33.19 39.83	

## Retainer Engine Knock Sensor

All 4.2L supercharged AJV8 petrol models	Genuine	1	<b>4603189</b>	0.37 0.44
All 4.4L AJV8 petrol models	Genuine	1	<b>4603189</b>	0.37 0.44

## Oil Level Sensor

All 4.4L V8 diesel models	Genuine	1	<b>LR012640</b>	35.68 42.82
All 5.0L N/A AJV8 petrol models	Genuine	1	<b>LR012640</b>	35.68 42.82
All 5.0L supercharged AJV8 petrol models	Genuine	1	<b>LR012640</b>	35.68 42.82

## Oil Pressure Switch

All 3.6L & 4.4L V8 diesel models	Genuine	1	<b>LR000633</b>	2.86 3.43
All 4.2L supercharged AJV8 petrol models	Genuine	1	<b>4737666</b>	14.23 17.08
All 4.4L AJV8 petrol models	Genuine	1	<b>4737666</b>	14.23 17.08

# DRAIN PLUGS

## Sump Plug & Washer

3.6L TDV8 diesel models	Aftermarket	1	<b>1013938P</b>	1.50 1.80
	Genuine	1	<b>1013938</b>	3.19 3.83
4.4L TDV8 diesel models	Aftermarket	1	<b>1013938P</b>	1.50 1.80
	Genuine	1	<b>1013938</b>	3.19 3.83
4.4L V8 AJ petrol models	Aftermarket	1	<b>1013938P</b>	1.50 1.80
	Genuine	1	<b>1013938</b>	3.19 3.83

## Sump Plug

All models with 4.4L V8 BMW M62 petrol engine					
	Genuine	1	<b>LSF000010</b>	3.46 4.15	

## Sump Plug Washer

3.0L BMW M57 diesel models	Genuine	1	<b>VYX000040</b>	2.61 3.13
4.4L V8 BMW M62 petrol models	Genuine	1	<b>VYX000040</b>	2.61 3.13



1013938P



8510276

## Air Charge Temperature Sensor

All 4.4L V8 diesel models - Turbocharger outlet					
	Genuine	1	<b>LR023069</b>	26.30 31.56	
All 5.0L supercharged AJV8 petrol models	Aftermarket	1	<b>LR021587P</b>	21.00 25.20	
	Genuine	1	<b>LR021587</b>	23.34 28.01	

## Manifold Absolute Pressure Sensor

All 3.0L 6 cyl BMW M57 diesel models	Genuine	1	<b>MHK000280</b>	311.28 373.54	
All 3.6L TDV8 diesel models	Genuine	1	<b>LR007596</b>	28.46 34.15	
All 4.2L supercharged AJV8 petrol models - Also air charge temperature sensor					
	Genuine	1	<b>PMM500080</b>	60.69 72.83	
All 5.0L N/A AJV8 petrol models	Genuine	1	<b>LR008881</b>	86.58 103.90	
All 5.0L supercharged AJV8 petrol models	Genuine	1	<b>LR008881</b>	86.58 103.90	

## Manifold Pressure Sensor

3.0L 6 cyl BMW M57 diesel engine models	Aftermarket	1	<b>MHK101060LP</b>	31.00 37.20
	Genuine	1	<b>MHK101060L</b>	70.59 84.71
All 4.4L AJV8 petrol models	Genuine	1	<b>4628195</b>	59.71 71.65

## Oxygen Sensor

All 4.2L supercharged AJV8 petrol models except USA/CDN/Mex (VIN) 7A000001 on - Pre-catalyst					
	Genuine	1	<b>MHK501140</b>	149.65 179.58	
	OEM	1	<b>MHK500870P1</b>	56.67 68.00	
	Genuine	1	<b>MHK500870</b>	155.91 187.09	
All 4.4L N/A AJV8 petrol models except USA/CDN/Mex (VIN) 7A000001 on - Pre-catalyst					
	Genuine	1	<b>MHK501140</b>	149.65 179.58	
	OEM	1	<b>MHK500870P1</b>	56.67 68.00	
	Genuine	1	<b>MHK500870</b>	155.91 187.09	
All 4.4L TDV8 diesel models with Euro Stage V emissions and diesel particulate filter - Pre-catalyst					
	Genuine	1	<b>WDN500130</b>	34.85 41.82	
4.4L V8 BMW M62 petrol models					
Forward, pre-catalyst					
	OEM	1	<b>MHK000210P1</b>	35.00 42.00	
	Genuine	1	<b>MHK000210</b>	157.44 188.93	
Rearward, pre-catalyst					
	Aftermarket	1	<b>MHK000220P</b>	30.00 36.00	
	OEM	1	<b>MHK000220P1</b>	52.50 63.00	
	Genuine	1	<b>MHK000220</b>	166.91 200.29	
All 4.4L V8 diesel models - Pre-catalyst	OEM	1	<b>LR001370P1</b>	90.00 108.00	
	Genuine	1	<b>LR001370</b>	149.04 178.85	
All 5.0L N/A AJV8 petrol models - Pre-catalyst					
	Genuine	1	<b>LR011710</b>	67.93 81.52	
All 5.0L supercharged AJV8 petrol models - Pre-catalyst					
	Genuine	1	<b>LR011710</b>	67.93 81.52	
All USA/CDN/Mex 4.2L supercharged AJV8 petrol models from (VIN) 7A000001 on					
	RH, post-catalyst	Genuine	1	<b>MHK501060</b>	151.01 181.21
All USA/CDN/Mex 4.4L N/A AJV8 petrol models from (VIN) 7A000001 on					
	RH, post-catalyst	Genuine	1	<b>MHK501060</b>	151.01 181.21

## Exhaust Gas Pressure Sensor

All 3.6L TDV8 diesel models with diesel particulate filter from (VIN) 8A000001 on					
For diesel particulate filter (DPF), pressure differential, includes pipes					
	RH	Genuine	1	<b>MHK501130</b>	106.41 127.69
	LH	Genuine	1	<b>MHK501160</b>	123.53 148.24
All 4.4L V8 diesel models					
For diesel particulate filter (DPF), pressure differential, includes pipes					
	Genuine	1	<b>LR022944</b>	128.40 154.08	

## Exhaust Gas Temperature Sensor

All 3.6L TDV8 diesel models with diesel particulate filter from (VIN) 8A000001 on					
	Front	Genuine	1	<b>NSC500630</b>	48.39 58.07
	Middle	Genuine	1	<b>NSC500620</b>	35.13 42.16
	Rear	Genuine	1	<b>NSC500640</b>	32.27 38.72

# RANGE ROVER L322 (2002-2012)

## Drain Plug

All 3.0L 6 cyl BMW M57 diesel models					
	Rear differential	Genuine	1	<b>8510276</b>	3.72 4.46
All 4.2L supercharged AJV8 petrol models from (VIN) 6A000001 to 6A999999					
	Rear differential	Genuine	1	<b>TYB500110</b>	1.93 2.32
All 4.4L N/A AJV8 petrol models from (VIN) 6A000001 to 6A999999					
	Rear differential	Genuine	1	<b>TYB500110</b>	1.93 2.32
All 4.4L V8 BMW M62 petrol models					
	Rear differential	Genuine	1	<b>8510276</b>	3.72 4.46
All models from (VIN) 7A000001 to 9A999999					
	Rear differential	Genuine	1	<b>TYP000220</b>	5.45 6.54
All models					
	Front differential	Genuine	1	<b>TYP000220</b>	5.45 6.54
All 3.0L 6 cyl BMW M57 diesel models with 5 speed automatic gearbox					
	Gearbox	Genuine	1	<b>TYB500100</b>	3.59 4.31
All 4.4L V8 BMW M62 petrol models with 5 speed automatic gearbox					
	Gearbox	Genuine	1	<b>UYP000070</b>	3.75 4.50

## Filler Plug

All models from (VIN) AA000001 on					
	Rear differential	Genuine	1	<b>TYB500110</b>	1.93 2.32





## RANGE ROVER L322 (2002-2012)

## OIL SEALS ENGINE

## Oil Seal Crankshaft Front

3.0L 6 cyl BMW M57 diesel models	Aftermarket	1	LUF100530LP	5.63	6.76
	Genuine	1	LUF100530L	19.03	22.84
All models with 3.6L TDV8 diesel engine	Genuine	1	1102415	5.41	6.49
All 4.2L supercharged AJV8 petrol models	Genuine	1	4526537	23.47	28.16
All 4.4L N/A AJV8 petrol models	Genuine	1	4526537	23.47	28.16
4.4L V8 BMW M62 petrol models	OEM	1	LUF000010P1	3.00	3.60
	Genuine	1	LUF000010	30.52	36.62
All models with 4.4L TDV8 diesel engine	Genuine	1	1102415	5.41	6.49

## Oil Seal Crankshaft Rear

3.0L 6 cyl BMW M57 diesel models	Aftermarket	1	LUF100540LP	7.50	9.00
	OEM	1	LUF100540LP1	9.58	11.50
	Genuine	1	LUF100540L	42.89	51.47
All 3.6L TDV8 diesel models - With retainer	Genuine	1	LR005539	100.84	121.01
4.2L V8 supercharged petrol models	Aftermarket	1	4352327P	12.50	15.00
4.4L V8 BMW M62 petrol models	OEM	1	LUF000020P1	14.17	17.00
	Genuine	1	LUF000020	39.80	47.76

## Oil Seal Camshaft Front

All 4.4L V8 BMW M62 petrol models	Genuine	1	LUC000010	5.81	6.97
-----------------------------------	---------	---	-----------	------	------

## RANGE ROVER L322 (2002-2012)

## EXHAUST GAS RECIRCULATION (EGR)

## EGR Valve

All 3.0L 6 cyl BMW M57 diesel models	OEM	1	8510381P1	58.33	70.00	
	Genuine	1	8510381	74.13	88.96	
	OEM	1	LR005791P1	145.00	174.00	
	Genuine	1	LR005791	214.64	257.57	
All 3.6L TDV8 diesel models	RH	Genuine	1	LR018321	229.18	275.02
	LH	Genuine	1	LR018322	211.54	253.85
All 4.4L TDV8 diesel models	Genuine	1	LR033373	318.17	381.80	
	Genuine	1	4536857	183.10	219.72	

## Solenoid EGR Vacuum

All 3.0L 6 cyl BMW M57 diesel models	Genuine	1	STC4198	58.53	70.24
--------------------------------------	---------	---	---------	-------	-------

## Gasket EGR Valve to Manifold Pipe

All 3.6L TDV8 diesel models	Genuine	1	LR003828	16.37	19.64
-----------------------------	---------	---	----------	-------	-------

## Gasket EGR Valve to Cooler

All 3.6L TDV8 diesel models	Genuine	1	LR003831	2.34	2.81
All 4.4L TDV8 diesel models	Genuine	1	LR050864	7.14	8.57

## O Ring EGR Valve Manifold Pipe

All 3.6L TDV8 diesel models	Genuine	1	LR003898	1.61	1.93
-----------------------------	---------	---	----------	------	------

## Gasket EGR Cooler to Inlet Pipe

All 3.6L TDV8 diesel models	Genuine	1	LR004250	6.39	7.67
-----------------------------	---------	---	----------	------	------

## Gasket EGR Pipe to Exhaust

All 4.4L AJV8 petrol models	Genuine	1	4451180	0.77	0.92
-----------------------------	---------	---	---------	------	------

## Gasket EGR Valve to Pipe

All 4.4L AJV8 petrol models	Genuine	1	4536854	0.53	0.64
-----------------------------	---------	---	---------	------	------

## Gasket EGR Valve to Inlet Manifold

All 4.4L AJV8 petrol models	Genuine	1	4536856	0.53	0.64
-----------------------------	---------	---	---------	------	------

## Gasket EGR Cooler Seating

All 4.4L TDV8 diesel models	Genuine	1	LR023100	4.55	5.46
-----------------------------	---------	---	----------	------	------

## Gasket EGR Valve to Cooler

All 4.4L TDV8 diesel models	Genuine	1	LR050864	7.14	8.57
-----------------------------	---------	---	----------	------	------

## Hose Vacuum EGR Valve to Turbo

All 3.0L 6 cyl BMW M57 diesel models	Blue colour code	Genuine	1	8510369	15.53	18.64
--------------------------------------	------------------	---------	---	---------	-------	-------

## Hose Vacuum Tee Piece to Reservoir

All 3.0L 6 cyl BMW M57 diesel models	Black colour code	Genuine	1	8510370	14.43	17.32
--------------------------------------	-------------------	---------	---	---------	-------	-------

## Pipe EGR Valve to Cooler

All 3.0L 6 cyl BMW M57 diesel models	Genuine	1	WAP000260	79.13	94.96
--------------------------------------	---------	---	-----------	-------	-------

## Pipe EGR Cooler to Exhaust Manifold

All 3.0L 6 cyl BMW M57 diesel models	Genuine	1	WAP000270	102.33	122.80
--------------------------------------	---------	---	-----------	--------	--------

## Bypass Tube EGR Valve

All 3.0L 6 cyl BMW M57 diesel models	Britpart	1	RA2085BP	27.08	32.50
--------------------------------------	----------	---	----------	-------	-------

## EGR Cooler Temperature Sensor

All 3.0L 6 cyl BMW M57 diesel models	Genuine	1	PEL000070	58.38	70.06
--------------------------------------	---------	---	-----------	-------	-------

## Pipe EGR Valve to Exhaust

All 3.6L TDV8 diesel models	LH	Genuine	1	LR006965	43.04	51.65
	RH	Genuine	1	LR006966	43.04	51.65
All 4.4L AJV8 petrol models	Genuine	1	4682990	37.09	44.51	

## Pipe EGR Valve to Inlet Manifold

All 3.6L TDV8 diesel models up to (VIN) 9A999999	Genuine	1	LR016790	68.24	81.89
	Genuine	1	LR023038	69.19	83.03
All 4.4L TDV8 diesel models	Genuine	1	LR023038	69.19	83.03



8510381

## RANGE ROVER L322 (2002-2012)

## FUEL SYSTEM SWITCHES

## Fuel Pressure Sensor

3.0L 6 cyl BMW M57 diesel models	Aftermarket	1	WKW000060P	16.04	19.25
	Genuine	1	WKW000060	43.53	52.24
All 4.2L supercharged AJV8 petrol models	Genuine	1	4458309	43.53	52.24
All 4.4L V8 diesel models	Genuine	1	LR020693	46.86	56.23
All 5.0L N/A AJV8 petrol models up to (VIN) CA393014	OEM	1	LR012280P1	87.50	105.00
	Genuine	1	LR012280	108.02	129.62
All 5.0L N/A AJV8 petrol models	Genuine	1	LR015356	41.46	49.75
	Genuine	1	LR015356	41.46	49.75
All 5.0L supercharged AJV8 petrol models up to (VIN) CA393014	OEM	1	LR012280P1	87.50	105.00
	Genuine	1	LR012280	108.02	129.62
All 5.0L supercharged AJV8 petrol models	Genuine	1	LR015356	41.46	49.75

## Air Flow Meter

4.2L V8 supercharged petrol models	OEM	1	PHF000140P1	70.00	84.00
	Genuine	1	PHF000140	107.33	128.80
4.4L V8 AJ petrol models	OEM	1	PHF000140P1	70.00	84.00
	Genuine	1	PHF000140	107.33	128.80
All 5.0L N/A AJV8 petrol models	Genuine	1	LR012073	107.33	128.80
All 5.0L supercharged AJV8 petrol models	Genuine	1	LR012073	107.33	128.80

## Air Flow Sensor

3.6L TDV8 diesel models	OEM	1	PHF500090P1	70.00	84.00
	Genuine	1	PHF500090	128.80	154.56
4.4L V8 BMW M62 petrol models	OEM	1	MHK000230P1	88.33	106.00
	Genuine	1	MHK000230	128.80	154.56

## Fuel Temperature Sensor

All 3.0L 6 cyl BMW M57 diesel models	Genuine	1	NSC000100	25.86	31.03
All 4.2L supercharged AJV8 petrol models - Fuel rail	Genuine	1	LR000291	20.82	24.98
	Genuine	1	LR000291	20.82	24.98



PHF000140P1



# ENGINE & GEARBOX MOUNTINGS

## Engine Mounting

All 3.0L 6 cyl BMW M57 diesel models					
RH, hydraulic	Genuine	1	<b>KKB500500</b>	142.41	170.89
LH, hydraulic	Genuine	1	<b>KKB500480</b>	142.41	170.89
All 3.6L & 4.4L TDV8 diesel models					
RH	Genuine	1	<b>LR022563</b>	67.98	81.58
LH	Genuine	1	<b>KKB500740</b>	105.70	126.84
All 4.2L supercharged AJV8 petrol models					
RH	Genuine	1	<b>KKB500490</b>	111.39	133.67
LH	Genuine	1	<b>KKB500470</b>	109.68	131.62
All 4.4L N/A AJV8 petrol models					
RH	Genuine	1	<b>KKB500490</b>	111.39	133.67
LH	Genuine	1	<b>KKB500470</b>	109.68	131.62
All 4.4L V8 BMW M62 petrol models - Engine, RH					
	Aftermarket	1	<b>KKB000280P</b>	35.00	42.00
	Genuine	1	<b>KKB000280</b>	109.41	131.29
LH	Aftermarket	1	<b>KKB000270P</b>	35.00	42.00
	OEM	1	<b>KKB000270P1</b>	55.00	66.00
	Genuine	1	<b>KKB000270</b>	85.35	102.42
All 5.0L N/A AJV8 petrol models					
RH	Genuine	1	<b>LR010746</b>	91.65	109.98
LH	Genuine	1	<b>LR022564</b>	66.23	79.48
All 5.0L supercharged AJV8 petrol models					
RH	Genuine	1	<b>LR010746</b>	91.65	109.98
LH	Genuine	1	<b>LR022564</b>	66.23	79.48

## Bracket Engine Mounting

All 3.0L 6 cyl BMW M57 diesel models					
RH	Genuine	1	<b>KKU000410</b>	66.89	80.27
LH	Genuine	1	<b>KKU000390</b>	29.45	35.34
All 3.6L & 4.4L TDV8 diesel models					
RH	Genuine	1	<b>LR022522</b>	109.71	131.65
LH	Genuine	1	<b>LR022524</b>	132.60	159.12
All 4.2L supercharged AJV8 petrol models					
RH	Genuine	1	<b>KKU500670</b>	25.98	31.18
LH	Genuine	1	<b>KKU500681</b>	86.60	103.92
All 4.4L N/A AJV8 petrol models					
RH	Genuine	1	<b>KKU500670</b>	25.98	31.18
LH	Genuine	1	<b>KKU500681</b>	86.60	103.92
All 4.4L V8 BMW M62 petrol models					
RH, also holds air compressor	Genuine	1	<b>JPD000030</b>	124.88	149.86
LH	Genuine	1	<b>KKU000400</b>	81.29	97.55
All 5.0L N/A AJV8 petrol models					
RH	Genuine	1	<b>LR011727</b>	43.28	51.94
LH	Genuine	1	<b>LR010743</b>	40.95	49.14
All 5.0L supercharged AJV8 petrol models					
RH	Genuine	1	<b>LR011727</b>	43.28	51.94
LH	Genuine	1	<b>LR010743</b>	40.95	49.14

## Gearbox Mounting

All 3.0L 6 cyl BMW M57 diesel models	Genuine	1	<b>KQB000040</b>	59.56	71.47
All 3.6L & 4.4L TDV8 diesel models	Genuine	1	<b>KQB500530</b>	149.12	178.94
All 4.2L supercharged AJV8 petrol models	Genuine	1	<b>KQB500530</b>	149.12	178.94
All 4.4L N/A AJV8 petrol models	Genuine	1	<b>KQB500530</b>	149.12	178.94
All 4.4L V8 BMW M62 petrol models	Genuine	1	<b>KQB000040</b>	59.56	71.47
All 5.0L N/A AJV8 petrol models	Genuine	1	<b>KQB500530</b>	149.12	178.94
All 5.0L supercharged AJV8 petrol models	Genuine	1	<b>KQB500530</b>	149.12	178.94

## Bracket Gearbox Mounting

All 3.0L 6 cyl BMW M57 diesel models	Genuine	1	<b>KQC000051</b>	263.31	315.97
All 3.6L & 4.4L TDV8 diesel models	Genuine	1	<b>LR023502</b>	396.13	475.36
All 4.2L supercharged AJV8 petrol models up to (VIN) 6A999999	Genuine	1	<b>KQC500061</b>	263.31	315.97
All 4.2L supercharged AJV8 petrol models from (VIN) 7A000001 on	Genuine	1	<b>LR023501</b>	483.82	580.58
All 4.4L N/A AJV8 petrol models up to (VIN) 6A999999	Genuine	1	<b>KQC500061</b>	263.31	315.97
All 4.4L N/A AJV8 petrol models from (VIN) 7A000001 on	Genuine	1	<b>LR023501</b>	483.82	580.58
All 4.4L V8 BMW M62 petrol models	Genuine	1	<b>KQC000051</b>	263.31	315.97
All 5.0L N/A AJV8 petrol models	Genuine	1	<b>LR023501</b>	483.82	580.58
All 5.0L supercharged AJV8 petrol models	Genuine	1	<b>LR023501</b>	483.82	580.58

## Insulator Gearbox Mounting

All 3.0L 6 cyl BMW M57 diesel models					
Front	Genuine	1	<b>KQD000010</b>	108.46	130.15
Rear	Genuine	1	<b>KQD000020</b>	107.41	128.89
All 3.6L & 4.4L TDV8 diesel models					
All 4.2L supercharged AJV8 petrol models	Genuine	1	<b>KQD500180</b>	72.61	87.13
All 4.4L N/A AJV8 petrol models	Genuine	1	<b>KQD500180</b>	72.61	87.13
All 4.4L V8 BMW M62 petrol models					
Front	Genuine	1	<b>KQD000010</b>	108.46	130.15
Rear	Genuine	1	<b>KQD000020</b>	107.41	128.89
All 5.0L N/A AJV8 petrol models	Genuine	1	<b>KQD500180</b>	72.61	87.13
All 5.0L supercharged AJV8 petrol models	Genuine	1	<b>KQD500180</b>	72.61	87.13

## Support Gearbox Mounting

All 3.6L & 4.4L TDV8 diesel models	Genuine	2	<b>KQD500050</b>	10.10	12.12
All 4.2L supercharged AJV8 petrol models	Genuine	2	<b>KQD500050</b>	10.10	12.12
All 4.4L N/A AJV8 petrol models	Genuine	2	<b>KQD500050</b>	10.10	12.12
All 5.0L N/A AJV8 petrol models	Genuine	2	<b>KQD500050</b>	10.10	12.12
All 5.0L supercharged AJV8 petrol models	Genuine	2	<b>KQD500050</b>	10.10	12.12

# CABLES

## Bonnet Release Cable

All RHD models to (VIN) 9A999999					
Passenger compartment end	Genuine	1	<b>FPF500040</b>	9.49	11.39
All LHD models up to (VIN) 9A999999					
Passenger compartment end	Genuine	1	<b>FPF500050</b>	19.21	23.05
All models from (VIN) AA000001 on					
Passenger compartment end	Genuine	1	<b>LR011474</b>	19.61	23.53
All models					
Passenger compartment cable to first latch					
	Aftermarket	1	<b>FSE000030P</b>	13.54	16.25
	Genuine	1	<b>FSE000030</b>	17.56	21.07
First latch to second latch					
	Aftermarket	1	<b>FSE000041P</b>	5.83	7.00
	Genuine	1	<b>FSE000041</b>	7.23	8.68

## Fuel Filler Door Release Cable

All models	Genuine	1	<b>FSP000010</b>	7.84	9.41
------------	---------	---	------------------	------	------

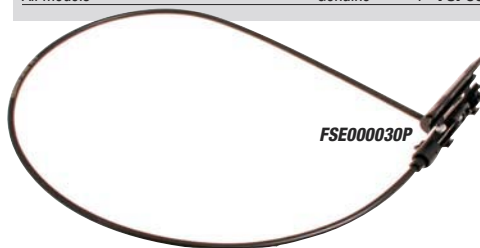

# WHEEL CENTRE CAPS & WHEEL NUTS

## Wheel Centre Cap

All Autobiography Ultimate models from (VIN) BA344356 on - Polished finish, Land Rover green/silver badge	Aftermarket	a/r	<b>LR023301P</b>	5.42	6.50
Land Rover green/silver badge	Genuine	a/r	<b>LR023301</b>	6.64	7.97
All models with shadow chrome finish wheel centre caps from (VIN) 6A000001 on - Shadow chrome with Land Rover green/gold badge					
	Genuine	a/r	<b>RRJ500030MNL</b>	8.42	10.10
All models with Silver Sparkle wheel centre caps with Land Rover black/silver badge from (VIN) 6A000001 on - Silver Sparkle with Land Rover black/silver badge					
	Genuine	a/r	<b>RRJ500030WYS</b>	11.03	13.24
All models with polished shadow chrome alloy wheel centre caps with green/gold Land Rover badge up to (VIN) 9A999999 - Polished shadow chrome finish with Land Rover green/gold badge					
	Genuine	a/r	<b>RRJ500060MUZ</b>	8.42	10.10
All models with polished silver/black alloy wheel centre caps with black/silver Land Rover badge from (VIN) 7A000001 on - Polished silver/black finish with Land Rover black/silver badge					
	Genuine	a/r	<b>RRJ500060WYU</b>	8.71	10.45

## Wheel Nut Set

All models up to (VIN) 5A999999 - Set of 20	Aftermarket	a/r	<b>RRD000011PK</b>	56.67	68.00
	Genuine	a/r	<b>RRD000011K</b>	67.50	81.00
All models with stainless steel finish wheel nuts from (VIN) 6A000001 on - Stainless steel finish set of 16	OEM	a/r	<b>LR068126P1K16</b>	40.00	48.00
	Genuine	a/r	<b>LR068126K16</b>	80.83	97.00
set of 20	OEM	a/r	<b>LR068126P1K20</b>	50.00	60.00
	Genuine	a/r	<b>LR068126K20</b>	97.50	117.00

# RANGE ROVER L322 (2002-2012)

# RANGE ROVER L322 (2002-2012)

## Wheel Nut

All models up to (VIN) 5A999999	Aftermarket	a/r	<b>RRD000011P</b>	3.25	3.90
	Britpart	a/r	<b>RRD000011BP</b>	3.50	4.20
	Genuine	a/r	<b>RRD000011</b>	3.55	4.26
All models with stainless steel finish wheel nuts from (VIN) 6A000001 on - Stainless steel finish					
	OEM	a/r	<b>LR068126P1</b>	3.25	3.90
	Genuine	a/r	<b>LR068126</b>	5.27	6.32

## Wheel Nut Cap

All models up to (VIN) 5A999999 - Locking wheel nut	Genuine	a/r	<b>RRJ000030</b>	1.96	2.35
-----------------------------------------------------	---------	-----	------------------	------	------



RRJ500030MNL



RRJ500030WYS



# RANGE ROVER L405 (2012 on)

## 2012 on - All Models

Listed below are the most popular parts required for the Range Rover L405. We have access to the full range of parts for your vehicle. Please contact us if not listed here.

### RANGE ROVER L405 (2012 on)

## FILTRATION

#### Oil Filter

All 2.0L TIVCT turbo petrol models - Cartridge

Aftermarket	1	<b>LR025306P</b>	3.50	4.20
Genuine	1	<b>LR025306</b>	6.87	8.24

All models with 3.0L V6 diesel engine - Element

Aftermarket	1	<b>LR013148P</b>	3.50	4.20
Genuine	1	<b>LR013148</b>	11.39	13.67

All 3.0L supercharged V6 petrol models - Element

Aftermarket	1	<b>LR011279</b>	22.43	26.92
Genuine	1	<b>LR022896</b>	16.90	20.28

All 4.4L TDV8 diesel models

Aftermarket	1	<b>LR011593P</b>	5.63	6.76
Genuine	1	<b>LR011593</b>	24.55	29.46

#### Air Filter

All models

Aftermarket	1	<b>LR011593P</b>	5.63	6.76
Genuine	1	<b>LR011593</b>	24.55	29.46



LR013148P



LR041978P1

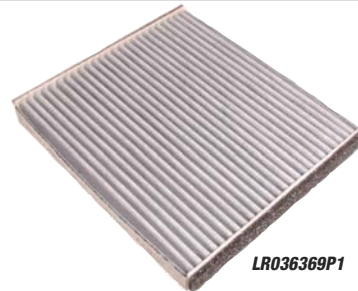

LR036369P1

#### Fuel Filter

All models with 3.0L V6 diesel engine - Primary, without bracket

Aftermarket	1	<b>LR041978P</b>	5.00	6.00
OEM	1	<b>LR041978P1</b>	35.83	43.00
Genuine	1	<b>LR041978</b>	57.69	69.23

All 4.4L DOHC Diesel V8 DITC models

Genuine	1	<b>LR072610</b>	54.57	65.48
---------	---	-----------------	-------	-------

#### Pollen Filter

All models

OEM	1	<b>LR036369P1</b>	13.13	15.76
Genuine	1	<b>LR036369</b>	33.56	40.27

### RANGE ROVER L405 (2012 on)

## WIPER BLADES

#### Wiper Blade

All RHD models

Front, driver's side	OEM	1	<b>LR076848P1</b>	11.88	14.26
	Genuine	1	<b>LR076848</b>	19.44	23.33
Front, passenger's side	OEM	1	<b>LR033023P1</b>	11.67	14.00
	Genuine	1	<b>LR033023</b>	19.71	23.65

All LHD models

Front, driver's side	OEM	1	<b>LR076850P1</b>	11.67	14.00
	Genuine	1	<b>LR076850</b>	19.72	23.66
Front, passenger's side	OEM	1	<b>LR033029P1</b>	11.67	14.00
	Genuine	1	<b>LR033029</b>	19.71	23.65

All models up to (VIN) FA999999

Rear	Aftermarket	1	<b>LR033471P</b>	3.50	4.20
	Genuine	1	<b>LR033471</b>	24.94	29.93



LR033023

### RANGE ROVER L405 (2012 on)

## SCREEN/LAMP WASHER SYSTEMS

#### Washer Jet & Hose

All models from (VIN) GA000001 on

Rear screen wash	Genuine	1	<b>LR078293</b>	16.80	20.16
------------------	---------	---	-----------------	-------	-------

#### Washer Hose, Per Metre

All models - 4mm internal diameter (3mm also available).

Front or rear screen wash	Aftermarket	a/r	<b>GWW201M</b>	2.25	2.70
---------------------------	-------------	-----	----------------	------	------

#### Windscreen Cleaning Paste

All models	Genuine	a/r	<b>DNJ500340</b>	7.72	9.26
------------	---------	-----	------------------	------	------

Prevents wiper blade judder/squeak by 'deep cleaning' the windscreen (ref: Land Rover Tech Bulletin LRA501-002)

### RANGE ROVER L405 (2012 on)

## DRIVE BELTS

#### Timing Belt Kit

All models with 3.0L V6 diesel engine - Fuel pump drive

Genuine	1	<b>LR016656</b>	113.96	136.75
---------	---	-----------------	--------	--------

#### Secondary Drive Belt

All models with 5.0L normally aspirated V8 petrol engine - Secondary

Aftermarket	1	<b>LR012663P</b>	5.63	6.76
Genuine	1	<b>LR012663</b>	21.54	25.85

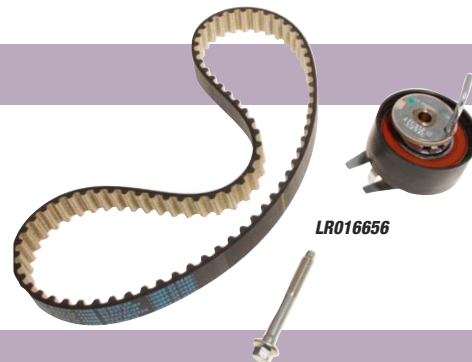

LR016656

### RANGE ROVER L405 (2012 on)

## IGNITION SYSTEM

#### Spark Plug

All 2.0L TIVCT turbocharged petrol models	Genuine	4	<b>LR025605</b>	13.73	16.48
All 3.0L supercharged V6 petrol models	Genuine	6	<b>LR050998</b>	12.21	14.65
All 5.0L N/A AJV8 petrol models	OEM	8	<b>LR032080P1</b>	7.50	9.00
	Genuine	8	<b>LR032080</b>	13.33	16.00
All 5.0L supercharged AJV8 petrol models	OEM	8	<b>LR032080P1</b>	7.50	9.00
	Genuine	8	<b>LR032080</b>	13.33	16.00

#### Glow Plug

All 3.0L V6 diesel models	Genuine	6	<b>LR013275</b>	29.96	35.95
All 4.4L TDV8 diesel models	Genuine	8	<b>LR013275</b>	29.96	35.95

#### Ignition Coil

All 3.0L supercharged V6 petrol models	Genuine	6	<b>LR035548</b>	55.50	66.60
----------------------------------------	---------	---	-----------------	-------	-------





# BRAKING SYSTEM

# RANGE ROVER L405 (2012 on)

## Brake Pad Set

All models up to (VIN) DA999999					
Front brakes	OEM	1	<b>LR064181P1</b>	56.67	68.00
	Genuine	1	<b>LR064181</b>	215.52	258.62
All 2.0L TIVCT turbocharged petrol models	(VIN) EA000001 on				
Front brakes	OEM	1	<b>LR051626P1</b>	42.50	51.00
	Genuine	1	<b>LR051626</b>	133.84	160.61
All 3.0L diesel electric hybrid models (VIN) EA000001 on					
Front brakes	OEM	1	<b>LR064181P1</b>	56.67	68.00
	Genuine	1	<b>LR064181</b>	215.52	258.62
All 3.0L V6 diesel models (VIN) EA000001 on					
Front brakes	OEM	1	<b>LR051626P1</b>	42.50	51.00
	Genuine	1	<b>LR051626</b>	133.84	160.61
All 3.0L supercharged V6 petrol models (VIN) EA000001 on					
Front brakes	OEM	1	<b>LR051626P1</b>	42.50	51.00
	Genuine	1	<b>LR051626</b>	133.84	160.61
All 4.4L TDV8 diesel models (VIN) EA000001 on					
Front brakes	OEM	1	<b>LR064181P1</b>	56.67	68.00
	Genuine	1	<b>LR064181</b>	215.52	258.62
All 5.0L NA V8 petrol models (VIN) EA000001 on					
Front brakes	OEM	1	<b>LR051626P1</b>	42.50	51.00
	Genuine	1	<b>LR051626</b>	133.84	160.61
All 5.0L supercharged V8 petrol models with ACE suspension (VIN) EA000001 on					
Front brakes	OEM	1	<b>LR064181P1</b>	56.67	68.00
	Genuine	1	<b>LR064181</b>	215.52	258.62
All 3.0L V6 24v diesel models					
Rear brakes	OEM	1	<b>LR079935P1</b>	55.00	66.00
	Aftermarket	1	<b>LR079935P</b>	32.50	39.00
All 3.0L V6 Gen2 mono turbo from (VIN) EA000001 on					
Rear brakes	OEM	1	<b>LR079935P1</b>	55.00	66.00
	Aftermarket	1	<b>LR079935P</b>	32.50	39.00
All 5.0L OHC SGD1 V8 petrol models					
Rear brakes	OEM	1	<b>LR079935P1</b>	55.00	66.00
	Aftermarket	1	<b>LR079935P</b>	32.50	39.00

## Brake Pad Fitting Kit

All models to (VIN) DA999999 - Front	Genuine	1	<b>LR016683</b>	42.14	50.57
All 3.0L V6 hybrid diesel models (VIN) EA000001 on					
Front	Genuine	1	<b>LR016683</b>	42.14	50.57
All 4.4L TDV8 diesel models (VIN) EA000001 on					
Front	Genuine	1	<b>LR016683</b>	42.14	50.57
All 5.0L supercharged V8 petrol models (VIN) EA000001 on					
Front	Genuine	1	<b>LR016683</b>	42.14	50.57

## Brake Disc (each)

All models to (VIN) DA999999					
Front, vented	OEM	2	<b>LR016176P1</b>	60.00	72.00
	Genuine	2	<b>LR016176</b>	83.69	100.43
All models from (VIN) EA000001					
Front	Aftermarket	2	<b>LR038934P</b>	29.58	35.50
	OEM	2	<b>LR038934P1</b>	50.00	60.00
	Genuine	2	<b>LR038934</b>	92.12	110.54
Rear	Aftermarket	2	<b>LR033302P</b>	31.67	38.00
	Genuine	2	<b>LR033302</b>	71.57	85.88
All 3.0L diesel electric hybrid models (VIN) EA000001 on					
Front, vented	OEM	2	<b>LR016176P1</b>	60.00	72.00
	Genuine	2	<b>LR016176</b>	83.69	100.43
All 4.4L TDV8 diesel models (VIN) EA000001 on					
Front, vented	OEM	2	<b>LR016176P1</b>	60.00	72.00
	Genuine	2	<b>LR016176</b>	83.69	100.43
All 5.0L supercharged V8 petrol models with ACE suspension (VIN) EA000001 on					
Front, vented	OEM	2	<b>LR016176P1</b>	60.00	72.00
	Genuine	2	<b>LR016176</b>	83.69	100.43
Phone for application detail					
Rear	Aftermarket	2	<b>LR033303P</b>	28.75	34.50
	Genuine	2	<b>LR033303</b>	82.10	98.52

## Performance Brake Disc (pair)

All models from (VIN) EA000001					
Front, Slotted & Drilled	Britpart	1	<b>LR038934BPUR</b>	65.00	78.00
Rear, Slotted & Drilled	Britpart	1	<b>LR033302BPUR</b>	55.00	66.00
Phone for application detail					
Rear, Slotted & Drilled	Britpart	1	<b>LR033303BPUR</b>	57.50	69.00



LR038934



LR051626P1

## Brake Caliper

All 2.0L TIVCT turbocharged petrol models					
Front, RH	OEM*	1	<b>LR047906P1</b>	198.33	238.00
	*Exchange Surcharge			35.00	42.00
	Genuine*	1	<b>LR047906</b>	292.45	350.94
	*Exchange Surcharge			100.00	120.00
Front, LH	OEM*	1	<b>LR047905P1</b>	198.33	238.00
	*Exchange Surcharge			35.00	42.00
	Genuine*	1	<b>LR047905</b>	295.38	354.46
	*Exchange Surcharge			100.00	120.00
All 3.0L V6 diesel models					
Front, RH	OEM*	1	<b>LR047906P1</b>	198.33	238.00
	*Exchange Surcharge			35.00	42.00
	Genuine*	1	<b>LR047906</b>	292.45	350.94
	*Exchange Surcharge			100.00	120.00
Front, LH	OEM*	1	<b>LR047905P1</b>	198.33	238.00
	*Exchange Surcharge			35.00	42.00
	Genuine*	1	<b>LR047905</b>	295.38	354.46
	*Exchange Surcharge			100.00	120.00
All 3.0L supercharged V6 petrol models					
Front, RH	OEM*	1	<b>LR047906P1</b>	198.33	238.00
	*Exchange Surcharge			35.00	42.00
	Genuine*	1	<b>LR047906</b>	292.45	350.94
	*Exchange Surcharge			100.00	120.00
Front, LH	OEM*	1	<b>LR047905P1</b>	198.33	238.00
	*Exchange Surcharge			35.00	42.00
	Genuine*	1	<b>LR047905</b>	295.38	354.46
	*Exchange Surcharge			100.00	120.00
All 5.0L V8 NA petrol models					
Front, RH	OEM*	1	<b>LR047906P1</b>	198.33	238.00
	*Exchange Surcharge			35.00	42.00
	Genuine*	1	<b>LR047906</b>	292.45	350.94
	*Exchange Surcharge			100.00	120.00
Front, LH	OEM*	1	<b>LR047905P1</b>	198.33	238.00
	*Exchange Surcharge			35.00	42.00
	Genuine*	1	<b>LR047905</b>	295.38	354.46
	*Exchange Surcharge			100.00	120.00

## Brake Caliper Carrier

All models from (VIN) EA000001					
Front RH	Genuine	1	<b>LR051627</b>	133.23	159.88
Front LH	Genuine	1	<b>LR051628</b>	133.23	159.88

## Slider Pin Bolt

All 2.0L TIVCT turbocharged petrol models	(VIN) EA000001 on				
Front	Genuine	4	<b>SMV500010</b>	1.33	1.60
All 3.0L V6 diesel models (VIN) EA000001 on					
Front	Genuine	4	<b>SMV500010</b>	1.33	1.60
All 3.0L supercharged petrol models (VIN) EA000001 on					
Front	Genuine	4	<b>SMV500010</b>	1.33	1.60
All 5.0L NA V8 petrol models (VIN) EA000001 on					
Front	Genuine	4	<b>SMV500010</b>	1.33	1.60

## Pin and Boot Kit

All models from (VIN) EA000001 - Front Brake Caliper					
	Genuine	2	<b>LR020489</b>	13.13	15.76

## Dust Cap Bleed Screw

All models - Front & rear caliper	Genuine	2	<b>SEE500100</b>	0.94	1.13
-----------------------------------	---------	---	------------------	------	------

## Brake Pad Wear Sensor

All models					
Front	Aftermarket	1	<b>LR033275P</b>	9.17	11.00
	Genuine	1	<b>LR033275</b>	19.05	22.86
	Aftermarket	1	<b>LR045959P</b>	9.17	11.00
	Genuine	1	<b>LR045959</b>	19.05	22.86
Rear	Aftermarket	1	<b>LR033295P</b>	9.17	11.00
	Genuine	1	<b>LR033295</b>	19.05	22.86

## Caliper Repair Kit

All models with 2.0L TIVCT turbocharged petrol engine from (VIN) EA000001 on					
Front, for one caliper	OEM	2	<b>LR015580P1</b>	6.67	8.00
All models with 3.0L V6 diesel engine from (VIN) EA000001 on					
Front, for one caliper	OEM	2	<b>LR015580P1</b>	6.67	8.00
All models with 3.0L supercharged V6 petrol engine from (VIN) EA000001 on					
Front, for one caliper	OEM	2	<b>LR015580P1</b>	6.67	8.00
All models with 5.0L NA V8 petrol engine from (VIN) EA000001 on					
Front, for one caliper	OEM	2	<b>LR015580P1</b>	6.67	8.00

## Brake Light Switch

All models from (VIN) GA267155	Genuine	1	<b>LR072647</b>	15.04	18.05
--------------------------------	---------	---	-----------------	-------	-------



## RANGE ROVER L405 (2012 on)

## SUSPENSION

## Bush Lower Arm

All models except armoured Front suspension, front	Genuine	1	<b>LR084108</b>	38.05	45.66
----------------------------------------------------	---------	---	-----------------	-------	-------

## Anti Roll Bar

All models without ACE suspension Front	Genuine	1	<b>LR038555</b>	118.31	141.97
All 2.0L turbo petrol models without active roll bar system Front	Genuine	1	<b>LR057624</b>	137.09	164.51
All 4.4L TDV8 diesel models with active roll bar system with unpainted calipers from (VIN) EA185668 on Front	Genuine	1	<b>LR068267</b>	706.40	847.68
All SWB 4.4L TDV8 diesel models with active roll bar system with black calipers from (VIN) GA000001 on Front	Genuine	1	<b>LR092956</b>	1122.27	1346.72
All LWB 4.4L TDV8 diesel models with active roll bar system with black calipers from (VIN) GA000001 on Front	Genuine	1	<b>LR068267</b>	706.40	847.68
All SWB 5.0L supercharged AJV8 petrol models without active roll bar from (VIN) FA000001 on Front	Genuine	1	<b>LR054996</b>	168.45	202.14
All SWB 5.0L supercharged AJV8 petrol models with active roll bar system with black calipers from (VIN) GA000001 on Front	Genuine	1	<b>LR092956</b>	1122.27	1346.72
All 5.0L supercharged AJV8 petrol models with active roll bar system with unpainted calipers from (VIN) EA185668 on Front	Genuine	1	<b>LR068267</b>	706.40	847.68
All LWB 5.0L supercharged AJV8 petrol models with active roll bar system with black calipers from (VIN) GA000001 on Front	Genuine	1	<b>LR068267</b>	706.40	847.68
All 2.0L turbo petrol models without active roll bar system Rear	Genuine	1	<b>LR057621</b>	132.59	159.11
All models with ACE suspension (with non-painted calipers) Rear	Genuine	1	<b>LR035457</b>	1059.40	1271.28
All 3.0L V6 diesel models from (VIN) FA000001 Rear	Genuine	1	<b>LR052321</b>	135.39	162.47
All 4.4L DOHC DITC V8 diesel models with black painted calipers (with ACE Suspension) from (VIN) GA000001 Rear	Genuine	1	<b>LR043845</b>	957.17	1148.60
All 5.0L OHC SGDI NA V8 models except armoured (without ACE suspension) from (VIN) FA000001 Rear	Genuine	1	<b>LR052321</b>	135.39	162.47
All 5.0L OHC SGDI SC V8 models from (VIN) FA000001 Rear	Genuine	1	<b>LR052321</b>	135.39	162.47
All 5.0L OHC SGDI SC V8 models with black painted calipers (with ACE suspension) from (VIN) GA000001 Rear	Genuine	1	<b>LR043845</b>	957.17	1148.60

## Anti Roll Bar Link

All models with non painted calipers from (VIN) GA000001 Rear RH	Genuine	1	<b>LR048092</b>	32.28	38.74
All models except black painted calipers Rear LH	Genuine	1	<b>LR048093</b>	32.28	38.74
All models with black painted calipers from (VIN) GA000001 Rear RH	Genuine	1	<b>LR042975</b>	32.50	39.00
Rear LH	Genuine	1	<b>LR042976</b>	32.50	39.00
All long wheelbase models from (VIN) GA000001 Rear RH	Genuine	1	<b>LR048092</b>	32.28	38.74
All models without ACE suspension Front	Genuine	2	<b>LR038557</b>	12.58	15.10
All 3.0L V6 diesel models Rear	Genuine	2	<b>LR033238</b>	11.25	13.50
All 3.0L DOHC GDI SC petrol models Rear	Genuine	2	<b>LR033238</b>	11.25	13.50
All 5.0L OHC SGDI NA models Rear	Genuine	2	<b>LR033238</b>	11.25	13.50

## Mounting Bush, Anti Roll Bar

All 2.0L turbo petrol models without active roll bar system Front	Genuine	1	<b>LR057625</b>	12.77	15.32
All SWB 5.0L supercharged AJV8 petrol models without active roll bar from (VIN) FA000001 on Front	Genuine	1	<b>LR054997</b>	12.77	15.32
Rear	Genuine	1	<b>LR054995</b>	12.42	14.90

## Clamp, Mounting Bush

All models without active roll bar system Front anti roll bar	Genuine	2	<b>LR057726</b>	16.30	19.56
Rear anti roll bar	Genuine	2	<b>LR057727</b>	14.86	17.83

## Anti Roll Bar Mounting Bracket

All models with ACE suspension Front	Genuine	2	<b>LR035446</b>	13.00	15.60
Rear	Genuine	2	<b>LR035447</b>	9.58	11.50

## Active Roll Bar Fluid

All models with active roll bar control - 1 litre. Cold (standard) climates fluid	Aftermarket	a/r	<b>STC50519P</b>	12.08	14.50
	Genuine	a/r	<b>STC50519</b>	18.96	22.75

## Valve, Anti Roll Bar

All 4.4L TDV8 diesel models with active roll bar system - Active roll bar system	Genuine*	1	<b>LR072419</b>	706.93	848.32
	*Exchange Surcharge			200.00	240.00
All 5.0L supercharged AJV8 petrol models with active roll bar system - Active roll bar system	Genuine*	1	<b>LR072419</b>	706.93	848.32
	*Exchange Surcharge			200.00	240.00

## Shock Absorber

All SWB 2.0L turbo petrol models Front RH	Genuine	1	<b>LR087085</b>	662.52	795.02
Front LH	Genuine	1	<b>LR087096</b>	662.52	795.02
All SWB 3.0L V6 petrol models with unpainted calipers Front RH	Genuine	1	<b>LR079515</b>	387.89	465.47
Front LH	Genuine	1	<b>LR087091</b>	387.89	465.47
All SWB 3.0L V6 diesel models with unpainted calipers Front RH	Genuine	1	<b>LR079515</b>	387.89	465.47
Front LH	Genuine	1	<b>LR087091</b>	387.89	465.47
All SWB 4.4L TDV8 diesel models with unpainted calipers Front RH	Genuine	1	<b>LR087081</b>	387.89	465.47
Front LH	Genuine	1	<b>LR087092</b>	387.89	465.47
All SWB 5.0L N/A AJV8 petrol models with unpainted calipers Front RH	Genuine	1	<b>LR079515</b>	387.89	465.47
Front LH	Genuine	1	<b>LR087091</b>	387.89	465.47
All SWB 5.0L supercharged AJV8 petrol models with unpainted calipers Front RH	Genuine	1	<b>LR087081</b>	387.89	465.47
Front LH	Genuine	1	<b>LR087092</b>	387.89	465.47
All SWB models with black calipers (VIN) GA000001 on Front RH	Genuine	1	<b>LR072350</b>	853.61	1024.33
Front LH	Genuine	1	<b>LR072504</b>	853.61	1024.33
All LWB models without active roll bar system up to (VIN) FA234325 Front RH	Genuine	1	<b>LR072217</b>	662.52	795.02
Front LH	Genuine	1	<b>LR072219</b>	662.52	795.02
All LWB models without active roll bar system from (VIN) FA234326 on Front RH	Genuine	1	<b>LR072217</b>	662.52	795.02
Front LH	Genuine	1	<b>LR072219</b>	662.52	795.02
All LWB models with active roll bar control Front RH	Genuine	1	<b>LR087085</b>	662.52	795.02
Front LH	Genuine	1	<b>LR087096</b>	662.52	795.02
All 2.0L 16v TIVCT petrol models (less reinforcement) Rear RH & LH	Genuine	2	<b>LR034241</b>	281.32	337.58
All 2.0L 16v TIVCT petrol models (with reinforcement) Rear RH	Genuine	1	<b>LR034266</b>	298.37	358.04
Rear LH	Genuine	1	<b>LR034271</b>	298.37	358.04
All 3.0L 24v DOHC TC diesel models (less reinforcement) Rear RH & LH	Genuine	2	<b>LR034240</b>	281.32	337.58
All 3.0L 24v DOHC TC diesel models (with reinforcement) Rear RH	Genuine	1	<b>LR034265</b>	298.37	358.04
Rear LH	Genuine	1	<b>LR034270</b>	298.37	358.04
All 3.0L 24v V6 turbo diesel models (less reinforcement) Rear RH & LH	Genuine	2	<b>LR034240</b>	281.32	337.58
All 3.0L 24v V6 turbo diesel models (with reinforcement) Rear RH	Genuine	1	<b>LR034265</b>	298.37	358.04
Rear LH	Genuine	1	<b>LR034270</b>	298.37	358.04
All 3.0L DOHC GDI V6 models from (VIN) EA000001 (less reinforcement) Rear RH & LH	Genuine	2	<b>LR034240</b>	281.32	337.58
All 3.0L DOHC GDI V6 models from (VIN) EA000001 (with reinforcement) Rear RH	Genuine	1	<b>LR034265</b>	298.37	358.04
Rear LH	Genuine	1	<b>LR034270</b>	298.37	358.04
All 3.0L V6 diesel electric hybrid models from (VIN) FA000001 (less reinforcement) Rear RH & LH	Genuine	2	<b>LR034241</b>	281.32	337.58
All 3.0L V6 diesel electric hybrid models from (VIN) FA000001 (with reinforcement) Rear RH	Genuine	1	<b>LR034266</b>	298.37	358.04
Rear LH	Genuine	1	<b>LR034271</b>	298.37	358.04
All 4.4L DOHC DITC V8 diesel models (less reinforcement) Rear RH & LH	Genuine	2	<b>LR034241</b>	281.32	337.58
All 4.4L DOHC DITC V8 diesel models (with reinforcement) Rear RH	Genuine	1	<b>LR034266</b>	298.37	358.04
Rear LH	Genuine	1	<b>LR034271</b>	298.37	358.04
All 5.0L OHC SGDI NA V8 Petrol models (less reinforcement) Rear RH & LH	Genuine	2	<b>LR034240</b>	281.32	337.58
All 5.0L OHC SGDI NA V8 Petrol models (with reinforcement) Rear RH	Genuine	1	<b>LR034265</b>	298.37	358.04
Rear LH	Genuine	1	<b>LR034270</b>	298.37	358.04
All 5.0L OHC SGDI SC V8 models (less reinforcement) Rear RH & LH	Genuine	2	<b>LR034241</b>	281.32	337.58
All 5.0L OHC SGDI SC V8 models (with reinforcement) Rear RH	Genuine	1	<b>LR034266</b>	298.37	358.04
Rear LH	Genuine	1	<b>LR034271</b>	298.37	358.04
All SWB models with black calipers (VIN) GA000001 on Rear	Genuine	2	<b>LR072352</b>	604.91	725.89

## Upper Arm Assembly

All models except armoured vehicles Front RH, standard length	Genuine	1	<b>LR034211</b>	158.08	189.70
Front RH, 5mm longer	Genuine	1	<b>LR034212</b>	158.08	189.70
Front RH, 5mm shorter	Genuine	1	<b>LR034213</b>	158.08	189.70
Front LH, standard length	Genuine	1	<b>LR034214</b>	158.08	189.70
Front LH, 5mm longer	Genuine	1	<b>LR034215</b>	158.08	189.70
Front LH, 5mm shorter	Genuine	1	<b>LR034216</b>	158.08	189.70
All models with black painted calipers from (VIN) GA000001 Front RH	Genuine	1	<b>LR044841</b>	106.43	127.72
Front LH	Genuine	1	<b>LR044844</b>	106.43	127.72
All models except armoured vehicles Rear RH & LH	Genuine	2	<b>LR037690</b>	79.95	95.94



# SUSPENSION

## Lower Arm Assembly

All models except armoured vehicles				
Front RH	Genuine	1	<b>LR034219</b>	143.07 171.68
Front LH	Genuine	1	<b>LR034220</b>	143.07 171.68
All models				
Front RH	Genuine	1	<b>LR055129</b>	349.73 419.68
Front LH	Genuine	1	<b>LR055130</b>	349.73 419.68
All std petrol models				
Front suspension, front RH	Genuine	1	<b>LR072471</b>	138.90 166.68
Front suspension, front LH	Genuine	1	<b>LR072469</b>	138.90 166.68
All diesel models				
Front suspension, front RH	Genuine	1	<b>LR072471</b>	138.90 166.68
Front suspension, front LH	Genuine	1	<b>LR072469</b>	138.90 166.68
All 5.0L supercharged AJV8 petrol models from (VIN) GA000001 on				
Front suspension, front RH	Genuine	1	<b>LR073463</b>	138.90 166.68
Front suspension, front LH	Genuine	1	<b>LR073465</b>	138.90 166.68
All models except armoured or Autobiography Black				
Front suspension, rear RH	Genuine	1	<b>LR078476</b>	153.88 184.66
Front suspension, rear LH	Genuine	1	<b>LR078478</b>	153.88 184.66
All Autobiography Black models with black calipers (VIN) GA000001 on				
Front suspension, rear RH	Genuine	1	<b>LR078477</b>	113.26 135.91
Front suspension, rear LH	Genuine	1	<b>LR078479</b>	113.26 135.91
All models except armoured vehicles				
Rear RH	Genuine	1	<b>LR072651</b>	230.52 276.62
Rear LH	Genuine	1	<b>LR072653</b>	231.92 278.30
All models except Autobiography Black with black calipers				
Rear RH	Genuine	1	<b>LR072651</b>	230.52 276.62
Rear LH	Genuine	1	<b>LR072653</b>	231.92 278.30
All models with black painted calipers from (VIN) GA000001				
Rear RH	Genuine	1	<b>LR072652</b>	206.03 247.24
Rear LH	Genuine	1	<b>LR072654</b>	212.14 254.57
All Autobiography Black models with black calipers (VIN) GA000001 on				
Rear RH	Genuine	1	<b>LR072652</b>	206.03 247.24
Rear LH	Genuine	1	<b>LR072654</b>	212.14 254.57

## Suspension Arm

All models except armoured vehicles				
Rear, RH lower, front	Genuine	1	<b>LR037702</b>	37.51 45.01
Rear, LH lower, front	Genuine	1	<b>LR037700</b>	37.51 45.01

## Link to Rear Suspension Arm

All models - Rear Arm to hub	Genuine	4	<b>LR037691</b>	3.83 4.60
------------------------------	---------	---	-----------------	-----------

## Height Sensor

All models				
Front, RH & LH	Genuine	2	<b>LR033256</b>	73.93 88.72
Rear, RH & LH	Genuine	2	<b>LR033257</b>	74.57 89.48

## Air Suspension Compressor

All models - Includes silencer, bracket, covers and wire				
	Genuine	1	<b>LR069691</b>	679.12 814.94

## Air Suspension Spring

All models except armoured vehicles				
Rear	Genuine	2	<b>LR034262</b>	247.84 297.41

## O Ring Seal Kit

All models with Active Cornering Enhancement - Air suspension valve block				
	OEM	1	<b>RVW100010P1</b>	14.37 17.24
	Genuine	1	<b>RVW100010</b>	22.91 27.49

## Valve, Levelling

All models - Air Suspension				
Front	Genuine	1	<b>LR070245</b>	124.00 148.80
Rear	Genuine	1	<b>LR070246</b>	124.00 148.80

# STEERING

## Track Rod End

All models up to (VIN) FA231555 - Steering rack with 14mm track rods. With nut				
	Genuine	2	<b>LR033534</b>	64.63 77.56

## Gaiter Kit, Track Rod

All models up to (VIN) FA231555 - Steering rack with 14mm track rods. Includes one gaiter with clamps				
	Genuine	2	<b>LR033528</b>	37.24 44.69

## Track Rod, Steering Rack

All models up to (VIN) FA231555 - Steering rack with 14mm track rods. With gaiter, without track rod end				
	Genuine	2	<b>LR033529</b>	105.75 126.90

## Power Steering Fluid

All models - 1 litre. Cold (standard) climates fluid				
	Aftermarket	a/r	<b>STC50519P</b>	12.08 14.50
	Genuine	a/r	<b>STC50519</b>	18.96 22.75

# TRANSMISSION

## Drive Flange Kit, Transfer Box

All models - Output shaft				
Front	Genuine	1	<b>IEA500031</b>	81.83 98.20
Rear	Genuine	1	<b>LR039528</b>	107.64 129.17

## Drive Shaft Gaiter Kit

All models				
Front, RH or LH	OEM	2	<b>LR034530P1</b>	32.50 39.00
	Genuine	2	<b>LR034530</b>	75.42 90.50
Rear, RH or LH	OEM	2	<b>LR034533P1</b>	34.17 41.00
	Genuine	2	<b>LR034533</b>	75.42 90.50

## Knuckle & Hub

All models up to (VIN) FA207673				
Front RH. <i>Must also fit LR048131 brake duct</i>	Genuine	1	<b>LR078374</b>	600.19 720.23
Front LH. <i>Must also fit LR048132 brake duct</i>	Genuine	1	<b>LR078376</b>	600.19 720.23
All models from (VIN) FA207674 on				
Front RH	Genuine	1	<b>LR078374</b>	600.19 720.23
Front LH	Genuine	1	<b>LR078376</b>	600.19 720.23

## Oil Seal, Differential

All models				
Front axle pinion	OEM	1	<b>LR019019P1</b>	5.63 6.76
	Genuine	1	<b>LR019019</b>	9.25 11.10
Front & rear axles, output shafts	OEM	1	<b>TZB500050P1</b>	6.25 7.50
	Genuine	1	<b>TZB500050</b>	13.21 15.85
Rear axle pinion	Genuine	1	<b>TZB500100</b>	16.28 19.54
All diesel hybrid models				
Front axle pinion	Genuine	1	<b>TZB500100</b>	16.28 19.54

## Oil Seal, Transfer Box

All models - Input shaft				
	Aftermarket	1	<b>IZB500030P</b>	6.67 8.00
	Genuine	1	<b>IZB500030</b>	12.96 15.55

## Sealing Ring, Transfer Box

All models				
Front output shaft	OEM	1	<b>IZB500040P1</b>	8.13 9.76
	Genuine	1	<b>IZB500040</b>	10.17 12.20
Rear output shaft	OEM	1	<b>IZB500050P1</b>	4.79 5.75
	Genuine	1	<b>IZB500050</b>	9.84 11.81

# RANGE ROVER L405 (2012 on)

# RANGE ROVER L405 (2012 on)

# RANGE ROVER L405 (2012 on)

## Plug, Differential

All models				
Oil filler, front & rear axles	Genuine	1	<b>TYB500060</b>	0.86 1.03
Oil drain, front & rear axles	Genuine	1	<b>TYB500080</b>	11.54 13.85

## Plug, Transfer Box

All models - Oil Fill & Drain				
	OEM	1	<b>IYB500020P1</b>	1.75 2.10
	Genuine	1	<b>IYB500020</b>	2.49 2.99
All models from (VIN) DA124963 on - Oil fill & drain, M18 (not M16)				
	Genuine	1	<b>LR048841</b>	2.99 3.59

## Oil Temperature Switch

All models with rear axle locking differential - Rear axle differential				
	Genuine	1	<b>NSC500590</b>	14.45 17.34

## Chain Only, Transfer Box

All models with 2 speed transfer box up to (VIN) EA133461				
	OEM	1	<b>LR049160CP1</b>	133.33 160.00

## Sensor, Differential

All models with rear axle locking differential - Oil temperature				
	Genuine	1	<b>NSC500590</b>	14.45 17.34

## Sensor, Transfer Box

All models - High/low position	Genuine	1	<b>IAB500191</b>	74.63 89.56
--------------------------------	---------	---	------------------	-------------

## Solenoid, Transfer Box

All models - Pressure	Genuine	1	<b>IGF500011</b>	77.19 92.63
-----------------------	---------	---	------------------	-------------

## Damper, Vibration

All models - Transfer box	Genuine	1	<b>LR094511</b>	33.76 40.51
---------------------------	---------	---	-----------------	-------------





## RANGE ROVER L405 (2012 on)

## COOLING

## Expansion Bottle Cap

All 2.0L turbocharged petrol models	Aftermarket	1	<b>LR017427P</b>	4.79	5.75
	Genuine	1	<b>LR017427</b>	6.99	8.39
All 3.0L V6 petrol models	OEM	1	<b>LR010965P1</b>	2.42	2.90
	Genuine	1	<b>LR010965</b>	5.57	6.68
All 3.0L V6 diesel models	Aftermarket	1	<b>LR017427P</b>	4.79	5.75
	Genuine	1	<b>LR017427</b>	6.99	8.39
All 4.4L TDV8 diesel models	Aftermarket	1	<b>LR017427P</b>	4.79	5.75
	Genuine	1	<b>LR017427</b>	6.99	8.39
All 5.0L N/A & supercharged AJV8 petrol models	OEM	1	<b>LR010965P1</b>	2.42	2.90
	Genuine	1	<b>LR010965</b>	5.57	6.68

## Thermostat &amp; Radiator Hose Assembly

All 3.0L V6 diesel models - In-line thermostat with top & bottom hose assembly	Genuine	1	<b>LR082870</b>	199.95	239.94
--------------------------------------------------------------------------------	---------	---	-----------------	--------	--------

## Water Pump

All 2.0L TIVCT turbo petrol models (VIN) FA000001 on	Aftermarket	1	<b>LR081578P</b>	35.83	43.00
	OEM	1	<b>LR081578P1</b>	50.00	60.00
	Genuine	1	<b>LR081578</b>	105.27	126.32
	Genuine	1	<b>LR013164</b>	87.26	104.71
All 3.0L V6 diesel engine models	Genuine	1	<b>LR013164</b>	87.26	104.71

## Gasket Water Pump

All 3.0L V6 petrol models	Aftermarket	1	<b>LR049370P</b>	4.58	5.50
	Genuine	1	<b>LR049370</b>	11.91	14.29
All 3.0L V6 diesel engine models	Genuine	1	<b>1316117</b>	24.53	29.44
All 5.0L N/A & supercharged AJV8 petrol models	Aftermarket	1	<b>LR049370P</b>	4.58	5.50
	Genuine	1	<b>LR049370</b>	11.91	14.29

## Coolant Temperature Sensor

All 3.0L V6 diesel models	Genuine	1	<b>LR041442</b>	25.70	30.84
All 3.0L V6 GEN2 diesel models	Genuine	1	<b>LR041442</b>	25.70	30.84
All 5.0L N/A AJV8 petrol models	Genuine	1	<b>LR041442</b>	25.70	30.84
All 5.0L supercharged AJV8 petrol models	Genuine	1	<b>LR041442</b>	25.70	30.84

## Coolant Level Sensor

All models	Genuine	1	<b>PCJ500030</b>	6.16	7.39
------------	---------	---	------------------	------	------



LR041442

## RANGE ROVER L405 (2012 on)

## ELECTRICAL - ROTATING ELECTRICS

## Alternator

All 3.0L V6 petrol models	New, outright	OEM	1	<b>LR072764P1</b>	316.67	380.00
	New, exchange	Genuine*	1	<b>LR072764</b>	695.32	834.38
		*Exchange Surcharge			200.00	240.00
All models with 4.4L TDV8 diesel engine	New, outright	OEM	1	<b>LR072762P1</b>	225.00	270.00
	New, exchange	Genuine*	1	<b>LR072762</b>	475.43	570.52
		*Exchange Surcharge			150.00	180.00
All 5.0L N/A AJV8 petrol models	New, outright	OEM	1	<b>LR072764P1</b>	316.67	380.00
	New, exchange	Genuine*	1	<b>LR072764</b>	695.32	834.38
		*Exchange Surcharge			200.00	240.00
All 5.0L supercharged AJV8 petrol models	New, outright	OEM	1	<b>LR072764P1</b>	316.67	380.00
	New, exchange	Genuine*	1	<b>LR072764</b>	695.32	834.38
		*Exchange Surcharge			200.00	240.00

## Starter Motor

All 3.0L V6 diesel models without stop start system	New, outright	OEM	1	<b>LR080299P1</b>	175.00	210.00
	New, exchange	Genuine*	1	<b>LR080299</b>	382.73	459.28
		*Exchange Surcharge			100.00	120.00

## RANGE ROVER L405 (2012 on)

## ENGINE GASKETS

## Gasket Camshaft Cover

All 2.0L turbo petrol models	Genuine	1	<b>LR025664</b>	11.44	13.73	
All 3.0L V6 diesel models	Aftermarket	2	<b>LR029132P</b>	6.67	8.00	
	Genuine	2	<b>LR029132</b>	14.86	17.83	
All 4.4L TDV8 diesel models	RH, also inlet manifold	Genuine	1	<b>LR035031</b>	17.07	20.48
	LH, also inlet manifold	Genuine	1	<b>LR035029</b>	51.30	61.56

## Gasket Cylinder Head

All 3.0L supercharged V6 petrol models	RH	Genuine	1	<b>LR041640</b>	18.59	22.31
	LH	Genuine	1	<b>LR041641</b>	14.62	17.54
All models with 3.0L V6 diesel engine	Grade 2	OEM	2	<b>LR013063P1</b>	14.50	17.40
		Genuine	2	<b>LR013063</b>	23.72	28.46
	Grade 3	Genuine	2	<b>LR013066</b>	23.72	28.46
		OEM	2	<b>LR013070P1</b>	10.83	13.00
	Grade 4	Genuine	2	<b>LR013070</b>	15.80	18.96
		OEM	2	<b>LR013073P1</b>	10.83	13.00
	Grade 5	Genuine	2	<b>LR013073</b>	15.80	18.96
		Grade 2	OEM	2	<b>LR013063P1</b>	14.50
	Genuine		2	<b>LR013063</b>	23.72	28.46
	Grade 3	Genuine	2	<b>LR013066</b>	23.72	28.46
OEM		2	<b>LR013070P1</b>	10.83	13.00	
Grade 4	Genuine	2	<b>LR013070</b>	15.80	18.96	
	OEM	2	<b>LR013073P1</b>	10.83	13.00	
Grade 5	Genuine	2	<b>LR013073</b>	15.80	18.96	
	All 4.4L TDV8 diesel models	RH	Genuine	1	<b>LR022899</b>	9.74
LH		Genuine	1	<b>LR022897</b>	10.51	12.61

## Gasket Oil Sump

All 4.4L TDV8 diesel models	Genuine	1	<b>LR094141</b>	54.08	64.90
-----------------------------	---------	---	-----------------	-------	-------

## Sealant Instant Gasket

Numerous applications	Genuine	a/r	<b>STC50550</b>	13.10	15.72
-----------------------	---------	-----	-----------------	-------	-------



LR029132P



## ENGINE SWITCHES

### Camshaft Position Sensor

All 3.0L supercharged V6 petrol models	OEM	1	<b>LR014372P1</b>	36.67	44.00
	Genuine	1	<b>LR014372</b>	118.70	142.44
All 3.0L V6 diesel models	Genuine	1	<b>LR013458</b>	121.12	145.34
	OEM	1	<b>LR014372P1</b>	36.67	44.00
All 5.0L N/A AJV8 petrol models	Genuine	1	<b>LR014372</b>	118.70	142.44
	OEM	1	<b>LR014372P1</b>	36.67	44.00
All 5.0L supercharged AJV8 petrol models	Genuine	1	<b>LR014372</b>	118.70	142.44
	OEM	1	<b>LR014372P1</b>	36.67	44.00

### Crankshaft Position Sensor

All 2.0L turbo petrol models	Genuine	1	<b>LR038756</b>	38.23	45.88
All 3.0L supercharged V6 petrol models	Genuine	1	<b>LR035561</b>	38.46	46.15
All 3.0L V6 diesel models	Aftermarket	1	<b>LR049872P</b>	55.00	66.00
	Genuine	1	<b>LR049872</b>	146.50	175.80
All 5.0L N/A AJV8 petrol models	Genuine	1	<b>LR035561</b>	38.46	46.15
All 5.0L supercharged AJV8 petrol models	Genuine	1	<b>LR035561</b>	38.46	46.15

### Engine Knock Sensor

All 2.0L turbo petrol models	Genuine	1	<b>LR025005</b>	24.85	29.82
All 3.0L V6 supercharged petrol models	Genuine	1	<b>LR008877</b>	33.19	39.83
All 5.0L N/A AJV8 petrol models	Genuine	1	<b>LR008877</b>	33.19	39.83
All 5.0L supercharged AJV8 petrol models	Genuine	1	<b>LR008877</b>	33.19	39.83

### Oil Level Sensor

All 3.0L supercharged V6 petrol models	Genuine	1	<b>LR012640</b>	35.68	42.82
All 3.0L V6 diesel models	Genuine	1	<b>LR012640</b>	35.68	42.82
All 4.4L V8 diesel models	Genuine	1	<b>LR012640</b>	35.68	42.82
All 5.0L N/A AJV8 petrol models	Genuine	1	<b>LR012640</b>	35.68	42.82
All 5.0L supercharged AJV8 petrol models	Genuine	1	<b>LR012640</b>	35.68	42.82

### Oil Pressure Switch

All 2.0L turbo petrol models	Genuine	1	<b>LR000633</b>	2.86	3.43
All 3.0L TDV6 diesel models	Genuine	1	<b>1316119</b>	13.94	16.73
All 4.4L V8 diesel models	Genuine	1	<b>LR000633</b>	2.86	3.43

### Air Charge Temperature Sensor

All 2.0L turbo petrol models	Aftermarket	1	<b>LR021587P</b>	21.00	25.20
	Genuine	1	<b>LR021587</b>	23.34	28.01
All 3.0L supercharged V6 petrol models	Aftermarket	1	<b>LR021587P</b>	21.00	25.20
	Genuine	1	<b>LR021587</b>	23.34	28.01
All 3.0L V6 diesel models - Turbocharger outlet	Genuine	1	<b>LR014386</b>	47.36	56.83
	Genuine	1	<b>LR023069</b>	26.30	31.56
All 4.4L V8 diesel models - Turbocharger outlet	Genuine	1	<b>LR023069</b>	26.30	31.56
	Aftermarket	1	<b>LR021587P</b>	21.00	25.20
All 5.0L supercharged AJV8 petrol models	Aftermarket	1	<b>LR021587P</b>	21.00	25.20
	Genuine	1	<b>LR021587</b>	23.34	28.01

## DRAIN PLUGS

### Sump Plug & Washer

3.0L V6 diesel models	Aftermarket	1	<b>1013938P</b>	1.50	1.80
	Genuine	1	<b>1013938</b>	3.19	3.83

## OIL SEALS ENGINE

### Crankshaft Oil Seal

All models with 3.0L V6 diesel engine	Front	Genuine	1	<b>1102415</b>	5.41	6.49
	Front	Genuine	1	<b>1102415</b>	5.41	6.49

### Oil Seal Crankshaft Rear

All 3.0L V6 diesel models - With retainer	Genuine	1	<b>LR036542</b>	36.48	43.78
-------------------------------------------	---------	---	-----------------	-------	-------

## EXHAUST GAS RECIRCULATION (EGR)

### EGR Valve

All 4.4L TDV8 diesel models	Genuine	1	<b>LR033373</b>	318.17	381.80
-----------------------------	---------	---	-----------------	--------	--------

### Gasket EGR Cooler Seating

All 4.4L TDV8 diesel models	Genuine	1	<b>LR023100</b>	4.55	5.46
-----------------------------	---------	---	-----------------	------	------

### Gasket EGR Valve to Cooler

All 4.4L TDV8 diesel models	Genuine	1	<b>LR050864</b>	7.14	8.57
-----------------------------	---------	---	-----------------	------	------

### Pipe EGR Valve to Inlet Manifold

All 3.0L V6 diesel models	RH	Genuine	1	<b>LR013589</b>	44.75	53.70
	LH	Genuine	1	<b>LR013587</b>	44.75	53.70
All 3.0L V6 mono turbo diesel models from (VIN) FA000001 on	Genuine	1	<b>LR063127</b>	51.20	61.44	
	Genuine	1	<b>LR063058</b>	51.20	61.44	
All 4.4L TDV8 diesel models	Genuine	1	<b>LR023038</b>	69.19	83.03	

## RANGE ROVER L405 (2012 on)

### Manifold Absolute Pressure Sensor

All 3.0L V6 supercharged petrol models up to (VIN) EA196785	Genuine	1	<b>LR008881</b>	86.58	103.90
	Genuine	1	<b>LR019130</b>	65.03	78.04
All 3.0L V6 diesel models except GEN2 diesels from (VIN) FA000001 on	Genuine	1	<b>LR008881</b>	86.58	103.90
	Genuine	1	<b>LR008881</b>	86.58	103.90

### Oxygen Sensor

All 3.0L supercharged V6 petrol models	OEM	1	<b>LR035750P1</b>	95.00	114.00
	Genuine	1	<b>LR035750</b>	124.26	149.11
All 3.0L V6 diesel models with Euro Stage IV emissions from (VIN) DA105108 on RH, pre-catalyst	Genuine	1	<b>WDN500130</b>	34.85	41.82
	Genuine	1	<b>WDN500130</b>	34.85	41.82
All 3.0L V6 diesel models with Euro Stage V emissions RH, pre-catalyst	Genuine	1	<b>WDN500130</b>	34.85	41.82
	Genuine	1	<b>LR062045</b>	152.42	182.90
All 4.4L V8 diesel models - Pre-catalyst	OEM	1	<b>LR001370P1</b>	90.00	108.00
	Genuine	1	<b>LR001370</b>	149.04	178.85
All 4.4L V8 diesel models from (VIN) GA000001 on RH, post-catalyst	Genuine	1	<b>LR062045</b>	152.42	182.90
	Genuine	1	<b>WDN500130</b>	34.85	41.82
All 4.4L TDV8 diesel models with Euro Stage V emissions up to (VIN) FA999999 RH, pre-catalyst	OEM	1	<b>LR035750P1</b>	95.00	114.00
	Genuine	1	<b>LR035750</b>	124.26	149.11
All 5.0L supercharged AJV8 petrol models	OEM	1	<b>LR035750P1</b>	95.00	114.00
	Genuine	1	<b>LR035750</b>	124.26	149.11

### Exhaust Gas Pressure Sensor

All 3.0L V6 diesel models with 2 speed transfer box from (VIN) FA000001 on For diesel particulate filter (DPF), pressure differential, includes pipes	Genuine	1	<b>LR069684</b>	128.18	153.82
	Genuine	1	<b>LR071025</b>	83.28	99.94
All 4.4L V8 diesel models up to (VIN) FA999999 For diesel particulate filter (DPF), pressure differential, includes pipes	Genuine	1	<b>LR071025</b>	83.28	99.94
	Genuine	1	<b>LR082004</b>	126.94	152.33

## RANGE ROVER L405 (2012 on)

## RANGE ROVER L405 (2012 on)

### Oil Seal Camshaft

All models with 3.0L V6 diesel engine	Front and rear	Aftermarket	2	<b>1311318P</b>	2.00	2.40
	Front and rear	Genuine	2	<b>1311318</b>	2.83	3.40

## RANGE ROVER L405 (2012 on)



**RANGE ROVER L405 (2012 on)****ENGINE & GEARBOX MOUNTINGS****Engine Mounting**

All petrol models except 2.0 Turbo Petrol	Genuine	2	<b>LR056882</b>	98.22	117.86
All 2.0L turbo petrol models	Genuine	2	<b>LR057721</b>	96.05	115.26
All 3.0L V6 diesel models up to (VIN) EA196785	Genuine	2	<b>LR057721</b>	96.05	115.26
All 4.4L TDV8 diesel models from (VIN) EA196786 on	Genuine	2	<b>LR057632</b>	62.55	75.06
All 4.4L TDV8 diesel models to (VIN) FA243273	RH	Genuine	1	<b>LR056672</b>	80.76 96.91
All 4.4L TDV8 diesel models from (VIN) FA243274 on	RH	Genuine	1	<b>LR072113</b>	94.46 113.35
All 4.4L TDV8 diesel models from (VIN) GA000001 on	LH	Genuine	1	<b>LR072127</b>	100.16 120.19

**Vibration Damper**

All 2.0L turbo petrol models - Engine mounting	Genuine	2	<b>LR062359</b>	18.69	22.43
------------------------------------------------	---------	---	-----------------	-------	-------

**Gearbox Mounting**

All models except 2.0L turbo petrol	Genuine	1	<b>IAF500070</b>	55.19	66.23
-------------------------------------	---------	---	------------------	-------	-------

**Vibration Damper**

All 2.0L turbo petrol models - Gearbox mounting	Genuine	1	<b>LR062361</b>	100.51	120.61
-------------------------------------------------	---------	---	-----------------	--------	--------

**Eye Bolt Gearbox Mounting**

All 2.0L turbo petrol models	Genuine	1	<b>KYG500200</b>	1.32	1.58
------------------------------	---------	---	------------------	------	------

**RANGE ROVER L405 (2012 on)****FUEL SYSTEM SWITCHES****Fuel Pressure Sensor**

All 2.0L turbo petrol models	Genuine	1	<b>LR024969</b>	53.76	64.51
All 3.0L supercharged V6 petrol models	Genuine	1	<b>LR015356</b>	41.46	49.75
All 4.4L V8 diesel models	Genuine	1	<b>LR020693</b>	46.86	56.23
All 5.0L N/A AJV8 petrol models	Genuine	1	<b>LR015356</b>	41.46	49.75
All 5.0L N/A AJV8 petrol models from (VIN) CA393015 on	Genuine	1	<b>LR044707</b>	40.91	49.09
All 5.0L supercharged AJV8 petrol models	Genuine	1	<b>LR015356</b>	41.46	49.75
All 5.0L supercharged AJV8 petrol models from (VIN) CA393015 on	Genuine	1	<b>LR044707</b>	40.91	49.09

**RANGE ROVER L405 (2012 on)****WHEEL CENTRE CAPS & WHEEL NUTS****Wheel Centre Cap**

All models with bright black alloy wheel centre caps with Land Rover logo from (VIN) EA134627 on	Bright black finish, Land Rover badge	Aftermarket	a/r <b>LR069899P</b>	7.50	9.00
		Genuine	a/r <b>LR069899</b>	10.76	12.91
All models with satin silver/bright aluminium alloy wheel centre caps with Land Rover logo from (VIN) EA134627 on	Satin silver/bright aluminium finish, Land Rover badge	Genuine	a/r <b>LR069900</b>	6.02	7.22

**Wheel Nut**

All models with stainless steel finish wheel nuts	Stainless steel finish	OEM	a/r <b>LR068126P1</b>	3.25	3.90
		Genuine	a/r <b>LR068126</b>	5.27	6.32
All models with Stealth Pack from (VIN) EA000001 on with 7 spoke or 9 spoke alloy wheels	Black chrome finish	Genuine	a/r <b>LR056214</b>	12.66	15.19

**Wheel Nut Set**

All models with stainless steel finish wheel nuts	Stainless steel finish, set of 16	OEM	a/r <b>LR068126P1K16</b>	40.00	48.00
		Genuine	a/r <b>LR068126K16</b>	80.83	97.00
	Stainless steel finish, set of 20	OEM	a/r <b>LR068126P1K20</b>	50.00	60.00
		Genuine	a/r <b>LR068126K20</b>	97.50	117.00
All models with grey/black or gloss black alloy wheels from (VIN) EA000001 on	Gloss black chrome, set of 20	Genuine	a/r <b>VPLWW0078</b>	210.04	252.05





# RANGE ROVER SPORT L320 (2005 TO 2009)

2005 to 2009 - All Models

Listed below are the most popular parts required for the Range Rover Sport L320.

We have access to the full range of parts for your vehicle. Please contact us if not listed here.



## SERVICE KITS

## RANGE ROVER SPORT L320 (2005-2009)

### Service Kit

All 4.2L V8 supercharged & 4.4L V8 N/A petrol models  
Includes oil filter, air filter, pollen filters, spark plugs & sump plug

Aftermarket	1	<b>RA1490P</b>	44.50	53.40
Genuine	1	<b>RA1490</b>	132.50	159.00

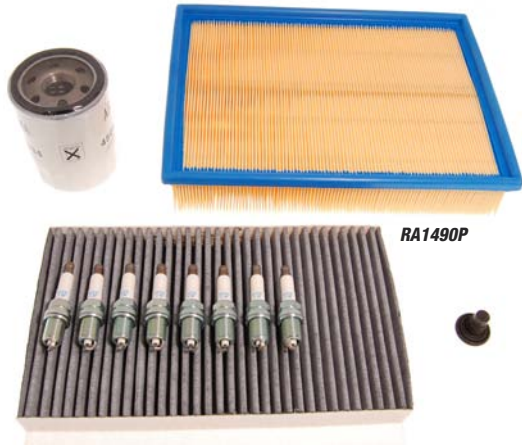

RA1490P

### Filter Kit

2.7L TDV6 diesel models up to (VIN) 6A999999  
Includes oil filter, air filter, fuel filter, pollen filters & sump plug

Aftermarket	1	<b>RD1212P</b>	18.75	22.50
Genuine	1	<b>RD1212</b>	124.17	149.00

2.7L TDV6 diesel models from (VIN) 7A000001 on  
Includes oil filter, air filter, fuel filter, pollen filters & sump plug

Bearmach	1	<b>RA1488BM</b>	34.58	41.50
----------	---	-----------------	-------	-------

All 3.6L TDV8 diesel models

Includes oil filter, air filter, fuel filter, pollen filters & sump plug

Aftermarket	1	<b>RA1489P</b>	34.50	41.40
Genuine	1	<b>RA1489</b>	99.17	119.00

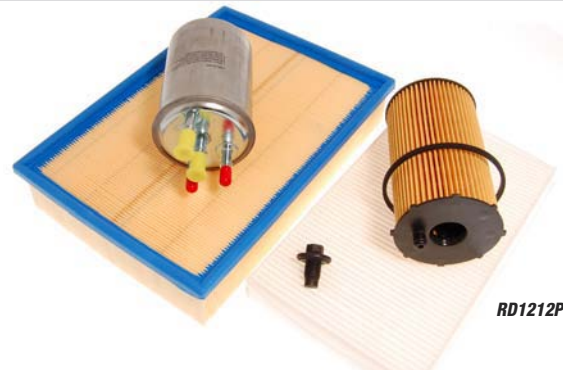

RD1212P

## FILTRATION

## RANGE ROVER SPORT L320 (2005-2009)

### Oil Filter

All models with 2.7L V6 diesel engine - Element

Aftermarket	1	<b>1311289P</b>	3.00	3.60
Genuine	1	<b>1311289</b>	9.84	11.81

All models with 3.6L TDV8 diesel engine - Element

Aftermarket	1	<b>LR002338P</b>	3.25	3.90
OEM	1	<b>LR002338P1</b>	5.63	6.76
Genuine	1	<b>LR002338</b>	9.95	11.94

All models with 4.2L supercharged V8 petrol engine - Cartridge

Aftermarket	1	<b>LR031439P</b>	1.50	1.80
OEM	1	<b>LR031439P1</b>	6.88	8.26
Genuine	1	<b>LR031439</b>	12.64	15.17

All models with 4.4L V8 AJ petrol engine - Cartridge

Aftermarket	1	<b>LR031439P</b>	1.50	1.80
OEM	1	<b>LR031439P1</b>	6.88	8.26
Genuine	1	<b>LR031439</b>	12.64	15.17

### Air Filter

All models to (VIN) 9A999999

Aftermarket	1	<b>PHE000112P</b>	5.83	7.00
OEM	1	<b>PHE000112P1</b>	7.08	8.50
Genuine	1	<b>PHE000112</b>	21.76	26.11

### Fuel Filter

All 2.7L V6 diesel models up to (VIN) 6A999999

Aftermarket	1	<b>LR010075P</b>	5.42	6.50
OEM	1	<b>LR010075P1</b>	22.50	27.00
Genuine	1	<b>LR010075</b>	68.01	81.61

All 2.7L TDV6 diesel models (VIN) 7A000001 on

Aftermarket	1	<b>LR009705P</b>	18.54	22.25
OEM	1	<b>LR009705P1</b>	38.75	46.50
Genuine	1	<b>LR009705</b>	42.05	50.46

### Pollen Filter

All models - Fresh air

Aftermarket	1	<b>JKR500010P</b>	3.83	4.60
OEM	1	<b>JKR500010P1</b>	9.17	11.00
Genuine	1	<b>JKR500010</b>	28.01	33.61

All models - Odour & particles, production replacement type

Aftermarket	1	<b>LR023977P</b>	4.00	4.80
OEM	1	<b>LR023977P1</b>	14.17	17.00
Genuine	1	<b>LR023977</b>	36.92	44.30

### Oil Filter for Standard Gearbox Oil Sump

All 6 speed automatic models

Bearmach	1	<b>LR007474PF</b>	10.83	13.00
----------	---	-------------------	-------	-------

### Gearbox Oil Sump Easy Fit Conversion Kit

All 6 speed automatic models

Includes metal sump, separate oil filter, gasket and 'O' ring

OEM	1	<b>LR007474BPKITEFOM</b>	130.00	156.00
Britpart	1	<b>LR007474BPKITEF</b>	72.50	87.00

### Oil Filter for Easy Fit Gearbox Sump

All 6 speed automatic models

OEM	1	<b>LR007474BPEFOM</b>	29.58	35.50
Britpart	1	<b>LR007474BPEF</b>	11.67	14.00

### Gasket for Gearbox Oil Sump Easy Fit Conversion

All 6 speed automatic models

Britpart	1	<b>LR007474BPKITEFG</b>	6.67	8.00
----------	---	-------------------------	------	------

### Gearbox Fluid Change Kit

All 6 speed automatic models

Includes essential items for fluid change on the 6 speed automatic gearbox (ZF models 6HP26 and 6HP28) - auto trans fluid, standard sump assembly with sleeve and plugs, sump attachment screws

Britpart	1	<b>LR007474BPKIT</b>	130.00	156.00
----------	---	----------------------	--------	--------

## WIPER BLADES

## RANGE ROVER SPORT L320 (2005-2009)

### Wiper Blade

All RHD models - Front

Aftermarket	2	<b>LR018368P</b>	6.67	8.00
OEM	2	<b>LR018368P1</b>	11.67	14.00
Genuine	2	<b>LR018368</b>	21.02	25.22

All LHD models - Front

Aftermarket	2	<b>LR018367P</b>	5.00	6.00
OEM	2	<b>LR018367P1</b>	7.92	9.50
Genuine	2	<b>LR018367</b>	24.19	29.03

All models - Rear

OEM	1	<b>DKB500710P1</b>	3.92	4.70
Genuine	1	<b>DKB500710</b>	29.12	34.94



DKB500710P1

LR018368P1



## RANGE ROVER SPORT L320 (2005-2009)

## SCREEN/LAMP WASHER SYSTEMS

## Non-Heated Washer Jet

All models without heated washer jets				
Front screen wash	Genuine	2	LR049290	3.41 4.09

## Heated Washer Jet

All models with heated washer jets				
Front screen wash	Genuine	2	LR048615	14.29 17.15

## Washer Jet

All models up to (VIN) 9A999999				
RH, headlamp	Aftermarket	1	DNJ500100P	8.75 10.50
	Genuine	1	DNJ500100	22.84 27.41
LH, headlamp	Aftermarket	1	DNJ500110P	5.63 6.76
	Genuine	1	DNJ500110	22.84 27.41

## Washer Jet Headlamp

All models with headlamp power wash to (VIN) 9A999999				
RH	Aftermarket	1	DNJ500100P	8.75 10.50
	Genuine	1	DNJ500100	22.84 27.41
LH	Aftermarket	1	DNJ500110P	5.63 6.76
	Genuine	1	DNJ500110	22.84 27.41

## Washer Jet Retaining Clip

All models with headlamp wash				
Headlamp jet to bumper	Genuine	2	DYC000190	1.80 2.16

## Washer Jet, with Hose

All models - Rear screen wash	Genuine	1	LR032197	6.04 7.25
-------------------------------	---------	---	----------	-----------

## Washer Pump

All models to (VIN) 9A999999				
Front screen	Aftermarket	1	DMC500010P	7.50 9.00
	Genuine	1	DMC500010	31.17 37.40

## Motor &amp; Pump Headlamp Wash

All models with headlamp power wash to (VIN) 9A999999				
	Genuine	1	DMC500020	32.90 39.48

## Washer Hose, Per Metre

All models - 4mm internal diameter (3mm also available).				
Front or rear screen wash	Aftermarket	a/r	GWV201M	2.25 2.70

## Washer Hose Assembly &amp; Elbows

All models - Front screen wash	Genuine	1	DNH000133	8.98 10.78
--------------------------------	---------	---	-----------	------------

## Washer Hose Assembly

All models with headlamp wash				
Headlamp wash	Genuine	1	DNH500100	25.44 30.53

## Washer Hose Y Piece

All models - Front screen wash	Genuine	1	DNG000010	17.40 20.88
--------------------------------	---------	---	-----------	-------------

## Washer Jet Elbow

All models - Front screen wash	Genuine	1	DNG10001	2.01 2.41
--------------------------------	---------	---	----------	-----------

## Washer Reservoir

All models without headlamp wash up to (VIN) 9A999999				
Front & rear screen wash	Genuine	1	DMB500030	48.05 57.66
All models with headlamp wash up to (VIN) 9A999999				
Front & rear screen & headlamp wash	Genuine	1	DMB500040	61.46 73.75

## Filler Neck Cap

All models				
Front & rear screen & headlamp wash	Genuine	1	LR002266	1.86 2.23

## Washer Reservoir Level Sensor

All models				
Front & rear screen & headlamp wash	Genuine	1	DMI500010	4.20 5.04

## Washer Reservoir Filler Neck

All models				
Front & rear screen & headlamp wash	Genuine	1	LR013955	18.77 22.52

## Windscreen Cleaning Paste

All models				
Prevents wiper blade judder/squeak by 'deep cleaning' the windscreen (ref: Land Rover Tech Bulletin LRA501-002)				
	Genuine	a/r	DNJ500340	7.72 9.26

## RANGE ROVER SPORT L320 (2005-2009)

## DRIVE BELTS

## Timing Belt Kit

2.7L TDV6 diesel models				
Front	OEM	1	LR016655P1	64.17 77.00
	Genuine	1	LR016655	108.53 130.24
2.7L TDV6 diesel models with EU2 emissions				
Rear	OEM	1	1324390P1	37.50 45.00
	Genuine	1	1324390	61.51 73.81
2.7L TDV6 diesel models with Euro Stage 4 emissions from (VIN) 7A000001 on				
Rear	OEM	1	LR019115P1	39.58 47.50
	Genuine	1	LR019115	113.96 136.75

## Secondary Drive Belt

All models with 3.6L V8 diesel engine and active cornering enhancement - Secondary				
	OEM	1	PQS500460P1	7.08 8.50
	Genuine	1	PQS500460	12.94 15.53
All models with 4.2L supercharged V8 petrol engine - Secondary				
	Aftermarket	1	PQS500241P	7.92 9.50
	Genuine	1	PQS500241	37.57 45.08
All models with 4.4L AJ V8 petrol engine - Secondary				
	Aftermarket	1	PQS500221P	4.79 5.75
	OEM	1	PQS500221P1	7.08 8.50
	Genuine	1	PQS500221	13.60 16.32

## Primary Drive Belt

All models with 2.7L V6 diesel engine without roll stability control				
Front	Aftermarket	1	PQS500370P	8.13 9.76
	OEM	1	PQS500370P1	11.67 14.00
	Genuine	1	PQS500370	24.53 29.44
All models with 2.7L V6 diesel engine with roll stability control				
Front	Genuine	1	PQS500420	30.11 36.13
3.6L TDV8 diesel models with active cornering enhancement				
Primary	OEM	1	PQS500450P1	11.67 14.00
	Genuine	1	PQS500450	24.36 29.23
All 4.2L AJV8 supercharged petrol engine models				
Primary	Genuine	1	PQR500340	19.04 22.85
All models with 4.4L AJ V8 petrol engine without roll stability control				
Primary	Aftermarket	1	PQR500330P	7.29 8.75
	OEM	1	PQR500330P1	9.58 11.50
	Genuine	1	PQR500330	19.26 23.11
All 4.4L AJV8 N/A petrol engine models with Roll Stability Control				
Primary	Genuine	1	PQR500340	19.04 22.85

## RANGE ROVER SPORT L320 (2005-2009)

## IGNITION SYSTEM

## Spark Plug

All 4.2L supercharged AJ V8 petrol models				
	OEM	8	LR005253P1	4.00 4.80
	Genuine	8	LR005253	8.38 10.06
All 4.4L AJ V8 petrol models				
	OEM	8	LR005253P1	4.00 4.80
	Genuine	8	LR005253	8.38 10.06

## Glow Plug

All 2.7L V6 diesel engine models				
	OEM	6	1354289P1	8.54 10.25
	Genuine	6	1354289	12.71 15.25
All 3.6L V8 diesel engine models				
	OEM	8	1354289P1	8.54 10.25
	Genuine	8	1354289	12.71 15.25

## Ignition Coil

All 4.2L supercharged AJV8 petrol models				
	Aftermarket	8	4744015P	22.50 27.00
	Genuine	8	4744015	55.64 66.77
All 4.4L N/A AJV8 petrol models				
	Aftermarket	8	4744015P	22.50 27.00
	Genuine	8	4744015	55.64 66.77



4744015P



# BRAKING SYSTEM

## Brake Pad Set

2.7L Lion V6 diesel engine up to (VIN) 9A999999					
Front Brakes					
Aftermarket	1	<b>LR019618P</b>	18.13	21.76	
Brembo	1	<b>LR019618BREMO</b>	37.08	44.50	
OEM	1	<b>LR019618P1</b>	27.50	33.00	
Genuine	1	<b>LR019618</b>	48.11	57.73	
Front Brakes, Green Stuff					
EBC	1	<b>LR019618GS</b>	50.83	61.00	
2.7L TDV6 diesel models with dynamic brake pack					
Front Brakes					
Aftermarket	1	<b>SFP500070P</b>	25.83	31.00	
Brembo	1	<b>SFP500070BREMO</b>	60.83	73.00	
OEM	1	<b>SFP500070P1</b>	29.58	35.50	
Genuine	1	<b>SFP500070</b>	120.47	144.56	
Front Brakes, Green Stuff					
EBC	1	<b>SFP500070GS</b>	60.00	72.00	
3.6L V8 diesel engine up to (VIN) 9A999999					
Front Brakes					
Aftermarket	1	<b>SFP500070P</b>	25.83	31.00	
Brembo	1	<b>SFP500070BREMO</b>	60.83	73.00	
OEM	1	<b>SFP500070P1</b>	29.58	35.50	
Genuine	1	<b>SFP500070</b>	120.47	144.56	
Front Brakes, Green Stuff					
EBC	1	<b>SFP500070GS</b>	60.00	72.00	
4.2L AJ V8 supercharged petrol engine up to (VIN) 9A999999					
Front Brakes					
Aftermarket	1	<b>SFP500070P</b>	25.83	31.00	
Brembo	1	<b>SFP500070BREMO</b>	60.83	73.00	
OEM	1	<b>SFP500070P1</b>	29.58	35.50	
Genuine	1	<b>SFP500070</b>	120.47	144.56	
Front Brakes, Green Stuff					
EBC	1	<b>SFP500070GS</b>	60.00	72.00	
4.4L AJ V8 petrol engine up to (VIN) 9A999999					
Front Brakes					
Aftermarket	1	<b>LR019618P</b>	18.13	21.76	
Brembo	1	<b>LR019618BREMO</b>	37.08	44.50	
OEM	1	<b>LR019618P1</b>	27.50	33.00	
Genuine	1	<b>LR019618</b>	48.11	57.73	
Front Brakes, Green Stuff					
EBC	1	<b>LR019618GS</b>	50.83	61.00	
4.4L NA V8 petrol models with dynamic brake pack					
Front Brakes					
Aftermarket	1	<b>SFP500070P</b>	25.83	31.00	
Brembo	1	<b>SFP500070BREMO</b>	60.83	73.00	
OEM	1	<b>SFP500070P1</b>	29.58	35.50	
Genuine	1	<b>SFP500070</b>	120.47	144.56	
Front Brakes, Green Stuff					
EBC	1	<b>SFP500070GS</b>	60.00	72.00	
All 2.7L TDV6 diesel models					
Rear Brakes					
Aftermarket	1	<b>LR021316P</b>	15.00	18.00	
Genuine	1	<b>LR021316</b>	40.09	48.11	
All 3.6L TDV8 diesel models to (VIN) 9A999999					
Rear Brakes					
Aftermarket	1	<b>LR055454P</b>	15.63	18.76	
Brembo	1	<b>LR055454BREMO</b>	34.35	41.22	
OEM	1	<b>LR055454P1</b>	18.54	22.25	
Genuine	1	<b>LR055454</b>	48.11	57.73	
Rear Brakes, Green Stuff					
EBC	1	<b>LR055454GS</b>	41.67	50.00	
All 4.4L N/A & 4.2L supercharged AJV8 petrol models					
Rear Brakes					
Aftermarket	1	<b>LR055454P</b>	15.63	18.76	
Brembo	1	<b>LR055454BREMO</b>	34.35	41.22	
OEM	1	<b>LR055454P1</b>	18.54	22.25	
Genuine	1	<b>LR055454</b>	48.11	57.73	
Rear Brakes, Green Stuff					
EBC	1	<b>LR055454GS</b>	41.67	50.00	

## Brake Disc (each)

2.7L Lion V6 diesel engine up to (VIN) 9A999999					
Front					
Aftermarket	2	<b>SDB000604P</b>	22.92	27.50	
Brembo	2	<b>SDB000604BREMO</b>	48.33	58.00	
OEM	2	<b>SDB000604P1</b>	36.00	43.20	
Genuine	2	<b>SDB000604</b>	48.11	57.73	
All models with 3.6L V8 diesel engine					
Front					
Aftermarket	2	<b>SDB000624P</b>	25.00	30.00	
Brembo	2	<b>SDB000624BREMO</b>	53.33	64.00	
Genuine	2	<b>SDB000624</b>	73.14	87.77	
4.2L AJ V8 supercharged petrol engine up to (VIN) 9A999999					
Front					
Aftermarket	2	<b>SDB000624P</b>	25.00	30.00	
Brembo	2	<b>SDB000624BREMO</b>	53.33	64.00	
Genuine	2	<b>SDB000624</b>	73.14	87.77	
4.4L AJ V8 petrol engine up to (VIN) 9A999999					
Front, 340mm diameter					
Aftermarket	2	<b>SDB000614P</b>	22.08	26.50	
Brembo	2	<b>SDB000614BREMO</b>	52.50	63.00	
Genuine	2	<b>SDB000614</b>	48.11	57.73	
Front, 320mm diameter					
Aftermarket	2	<b>SDB000604P</b>	22.92	27.50	
Brembo	2	<b>SDB000604BREMO</b>	48.33	58.00	
OEM	2	<b>SDB000604P1</b>	36.00	43.20	
Genuine	2	<b>SDB000604</b>	48.11	57.73	
2.7L Lion V6 diesel engine up to (VIN) 9A999999					
Rear					
Aftermarket	2	<b>SDB000636P</b>	17.50	21.00	
Brembo	1	<b>SDB000636BREMO</b>	65.83	79.00	
Genuine	2	<b>SDB000636</b>	40.09	48.11	
2.7L Lion V6 diesel engine up to (VIN) 9A999999 with dynamic brake pack					
Rear					
Aftermarket	2	<b>SDB000646P</b>	18.75	22.50	
Brembo	1	<b>SDB000646BREMO</b>	88.33	106.00	
Genuine	2	<b>SDB000646</b>	40.09	48.11	
All models with 3.6L V8 diesel engine					
Rear					
Aftermarket	2	<b>SDB000646P</b>	18.75	22.50	
Brembo	1	<b>SDB000646BREMO</b>	88.33	106.00	
Genuine	2	<b>SDB000646</b>	40.09	48.11	
4.2L AJ V8 supercharged petrol engine up to (VIN) 9A999999					
Rear					
Aftermarket	2	<b>SDB000646P</b>	18.75	22.50	
Brembo	1	<b>SDB000646BREMO</b>	88.33	106.00	
Genuine	2	<b>SDB000646</b>	40.09	48.11	
4.4L AJ V8 petrol engine up to (VIN) 9A999999 with dynamic brake pack					
Rear					
Aftermarket	2	<b>SDB000646P</b>	18.75	22.50	
Brembo	1	<b>SDB000646BREMO</b>	88.33	106.00	
Genuine	2	<b>SDB000646</b>	40.09	48.11	

## Performance Brake Disc (pair)

2.7L Lion V6 diesel engine up to (VIN) 9A999999					
Front, slotted & drilled					
Britpart	1	<b>SDB000604URBP</b>	60.00	72.00	
All models with 3.6L V8 diesel engine					
Front, slotted & drilled					
Britpart	1	<b>SDB000624URBP</b>	70.00	84.00	
4.2L AJ V8 supercharged petrol engine up to (VIN) 9A999999					
Front, slotted & drilled					
Britpart	1	<b>SDB000624URBP</b>	70.00	84.00	
4.4L AJ V8 petrol engine up to (VIN) 9A999999					
Front, slotted & drilled, 340mm diameter					
Britpart	1	<b>SDB000614URBP</b>	60.00	72.00	
320mm diameter					
Britpart	1	<b>SDB000604URBP</b>	60.00	72.00	
2.7L Lion V6 diesel engine up to (VIN) 9A999999					
Rear, slotted & drilled					
Britpart	1	<b>SDB000636URBP</b>	60.00	72.00	
2.7L Lion V6 diesel engine up to (VIN) 9A999999 with dynamic brake pack					
Rear, slotted & drilled					
Britpart	1	<b>SDB000646URBP</b>	60.00	72.00	
All models with 3.6L V8 diesel engine					
Rear, slotted & drilled					
Britpart	1	<b>SDB000646URBP</b>	60.00	72.00	
4.2L AJ V8 supercharged petrol engine up to (VIN) 9A999999					
Rear, slotted & drilled					
Britpart	1	<b>SDB000646URBP</b>	60.00	72.00	
4.4L AJ V8 petrol engine up to (VIN) 9A999999 with dynamic brake pack					
Rear, slotted & drilled					
Britpart	1	<b>SDB000646URBP</b>	60.00	72.00	

## Brake Pad Fitting Kit

All 2.7L TDV6 diesel models with 19 front/18 rear brakes					
Front					
Genuine	1	<b>SEE500080</b>	18.55	22.26	
All 3.6L TDV8 diesel models with 19 front/18 rear brakes					
Front					
Genuine	1	<b>SEE500080</b>	18.55	22.26	
All 4.2L supercharged AJV8 petrol models					
Front					
Genuine	1	<b>SEE500080</b>	18.55	22.26	
All 4.4L AJV8 petrol models with 19 front/18 rear brakes					
Front					
Genuine	1	<b>SEE500080</b>	18.55	22.26	

## Retaining Spring

All 2.7L Lion diesel up to 9A999999 with std brakes					
Front Brake Pads					
Aftermarket	1	<b>LR019625P</b>	3.08	3.70	
Genuine	1	<b>LR019625</b>	3.77	4.52	
All 4.4L V8 AJ petrol up to 9A999999 with std brakes					
Front Brake Pads					
Aftermarket	1	<b>LR019625P</b>	3.08	3.70	
Genuine	1	<b>LR019625</b>	3.77	4.52	
All models up to (VIN) 9A999999					
Rear Brake Pads Kit					
Aftermarket	1	<b>LR019626P</b>	2.17	2.60	
Genuine	1	<b>LR019626</b>	4.21	5.05	

## Mudshield Brake Disc

All models to (VIN) 9A999999					
Front RH					
Genuine	1	<b>SEC000162</b>	43.64	52.37	
Front LH					
Genuine	1	<b>SEC000172</b>	57.61	69.13	

## Brake Caliper

Lion diesel 2.7 V6 140kW					
(17 brakes) - Front, RH					
Genuine*	1	<b>SEG500040</b>	197.77	237.32	
*Exchange Surcharge					
50.00	60.00				
(17 brakes) - Front, LH					
Genuine*	1	<b>SEG500050</b>	197.77	237.32	
*Exchange Surcharge					
50.00	60.00				
(18 brakes) - Front, RH					
Genuine*	1	<b>SEG500040</b>	197.77	237.32	
*Exchange Surcharge					
50.00	60.00				
(18 brakes) - Front, LH					
Genuine*	1	<b>SEG500050</b>	197.77	237.32	
*Exchange Surcharge					
50.00	60.00				
AJ petrol 4.4 V8 220kW					
(17 brakes) - Front, RH					
Genuine*	1	<b>SEG500040</b>	197.77	237.32	
*Exchange Surcharge					
50.00	60.00				
(17 brakes) - Front, LH					
Genuine*	1	<b>SEG500050</b>	197.77	237.32	
*Exchange Surcharge					
50.00	60.00				
(18 brakes) - Front, RH					
Genuine*	1	<b>SEG500040</b>	197.77	237.32	
*Exchange Surcharge					
50.00	60.00				
(18 brakes) - Front, LH					
Genuine*	1	<b>SEG500050</b>	197.77	237.32	
*Exchange Surcharge					
50.00	60.00				
All models to (VIN) 9A999999 without Dynamic pack					
Rear, RH					
Aftermarket	1	<b>SOB500042P</b>	50.00	60.00	
Genuine*	1	<b>SOB500042</b>	129.29	155.15	
*Exchange Surcharge					
50.00	60.00				
Rear, LH					
Aftermarket	1	<b>SOB500052P</b>	50.00	60.00	
Genuine*	1	<b>SOB500052</b>	129.29	155.15	
*Exchange Surcharge					
50.00	60.00				

## Brake Caliper Carrier

All 2.7L V6 diesel models up to (VIN) 9A999999					
Front brakes					
OEM	2	<b>SEH500012P1</b>	22.50	27.00	
Genuine	2	<b>SEH500012</b>	38.73	46.48	
4.4L V8 AJ petrol models from (VIN) 6A954281					
Front, 340mm diameter discs					
Genuine	2	<b>SEH500013</b>	38.73	46.48	
2.7L TDV6 diesel models with std brakes					
Rear, RH and LH					
OEM	2	<b>SXP500013P1</b>	25.00	30.00	
Genuine	2	<b>SXP500013</b>	38.79	46.55	
All models to (VIN) 9A999999 with Dynamic pack					
Rear, RH and LH					
OEM	2	<b>SXP500014P1</b>	29.17	35.00	
Genuine	2	<b>SXP500014</b>	38.79	46.55	





## RANGE ROVER SPORT L320 (2005-2009)

## BRAKING SYSTEM

## Brake Caliper Piston

Lion diesel 2.7 V6 140kW (17 brakes) Front, Vented Disc Brakes	Aftermarket	4	<b>STC1918P</b>	4.38	5.26
	OEM	4	<b>STC1918P1</b>	7.50	9.00
	Genuine	4	<b>STC1918</b>	17.20	20.64
AJ petrol 4.4 V8 220KW (17 brakes) - Front, Vented Disc Brakes	Aftermarket	4	<b>STC1918P</b>	4.38	5.26
	OEM	4	<b>STC1918P1</b>	7.50	9.00
	Genuine	4	<b>STC1918</b>	17.20	20.64
(18 brakes) - Front, Vented Disc Brakes	Aftermarket	4	<b>STC1918P</b>	4.38	5.26
	OEM	4	<b>STC1918P1</b>	7.50	9.00
	Genuine	4	<b>STC1918</b>	17.20	20.64
All models to (VIN) 9A999999 Rear, Vented Disc Brakes	Aftermarket	2	<b>STC1908P</b>	4.08	4.90
	Genuine	2	<b>STC1908</b>	18.49	22.19

## Caliper Repair Kit

All 2.7L V6 diesel engine models to (VIN) 9A999999 with std brakes Front brakes	OEM	2	<b>SEE500010P1</b>	5.95	7.14
	Genuine	2	<b>SEE500010</b>	12.53	15.04
All models with 2.7L Lion V6 diesel engine with 19 front vented & 18 rear vented discs Front	Aftermarket	2	<b>SEE500040P</b>	6.87	8.24
	Genuine	2	<b>SEE500040</b>	24.01	28.81
All models with 3.6L V8 diesel engine to (VIN) 9A999999 Front	Aftermarket	2	<b>SEE500040P</b>	6.87	8.24
	Genuine	2	<b>SEE500040</b>	24.01	28.81
All 4.2L supercharged AJ V8 petrol models with 19 front vented & 18 rear vented discs Front	Aftermarket	2	<b>SEE500040P</b>	6.87	8.24
	Genuine	2	<b>SEE500040</b>	24.01	28.81
All 4.4L AJ V8 petrol engine models to (VIN) 9A999999 with std brakes Front brakes	OEM	2	<b>SE500010P1</b>	5.95	7.14
	Genuine	2	<b>SE500010</b>	12.53	15.04
All models up to (VIN) 9A999999 Rear, for one caliper	Aftermarket	2	<b>SMN500030P</b>	6.04	7.25
	OEM	2	<b>SMN500030P1</b>	4.95	5.94
	Genuine	2	<b>SMN500030</b>	11.94	14.33

## Slider Pin Bolt

All models with 17 or 18 front and rear vented disc brakes to (VIN) 9A999999 Front	Genuine	4	<b>SMV500010</b>	1.33	1.60
All models to (VIN) 9A999999 Rear	Genuine	4	<b>SMV500010</b>	1.33	1.60

## Dust Cover

All models - For carrier retaining pins front & rear	Aftermarket	4	<b>SEE500030P</b>	5.00	6.00
	Genuine	4	<b>SEE500030</b>	7.88	9.46

## Caliper Pin &amp; Boot Kit

All models with 17 or 18 front and rear vented disc brakes to (VIN) 9A999999 Front, one caliper	Aftermarket	4	<b>SEE500020P</b>	9.17	11.00
	Genuine	4	<b>SEE500020</b>	13.06	15.67

## Brake Caliper Fixing Kit

All models to (VIN) 9A999999 Rear brakes	Aftermarket	2	<b>SMN500040P</b>	6.87	8.24
	OEM	2	<b>SMN500040P1</b>	7.50	9.00
	Genuine	2	<b>SMN500040</b>	13.06	15.67

## Dust Cap Bleed Screw

All models - Front & rear caliper	Genuine	2	<b>SEE500100</b>	0.94	1.13
-----------------------------------	---------	---	------------------	------	------

## Brake Master Cylinder

All RHD models to (VIN) 9A999999	OEM	1	<b>LR014527P1</b>	60.00	72.00
	Genuine	1	<b>LR014527</b>	124.13	148.96

## Master Cylinder

All LHD models to (VIN) 9A999999	Aftermarket	1	<b>LR014528P</b>	52.50	63.00
	Genuine	1	<b>LR014528</b>	137.88	165.46

## Brake Servo Assembly

All models with 2.7L Lion V6 diesel engine	Genuine	1	<b>SJJ500070</b>	211.02	253.22
All models with 3.6L V8 diesel engine	Genuine	1	<b>SJJ500080</b>	115.14	138.17
All 4.2L supercharged AJ V8 petrol models	Genuine	1	<b>SJJ500080</b>	115.14	138.17
All models with AJ petrol 4.4 V8 220KW	Genuine	1	<b>SJJ500070</b>	211.02	253.22

## Brake Pad Wear Sensor

2.7L V6 diesel Lion with 18/17 brakes, up to (VIN) 6A999999 Front brakes	Aftermarket	1	<b>SEM500062P</b>	5.21	6.25
	OEM	1	<b>SEM500062P1</b>	8.13	9.76
	Genuine	1	<b>SEM500062</b>	18.05	21.66
2.7L V6 diesel Lion with 19/18 brakes, up to (VIN) 6A999999 Front brakes	Aftermarket	1	<b>SEM500026P</b>	4.58	5.50
	OEM	1	<b>SEM500026P1</b>	7.29	8.75
	Genuine	1	<b>SEM500026</b>	17.67	21.20
2.7L V6 diesel Lion with 17 brakes from (VIN) 7A000001 to 9A999999 Front brakes	Aftermarket	1	<b>SEM500080P</b>	6.04	7.25
	OEM	1	<b>SEM500080P1</b>	8.13	9.76
	Genuine	1	<b>SEM500080</b>	18.76	22.51
2.7L V6 diesel Lion with 19/18 brakes, from (VIN) 7A000001 to 9A999999 Front brakes	Aftermarket	1	<b>SEM500090P</b>	6.04	7.25
	OEM	1	<b>SEM500090P1</b>	8.13	9.76
	Genuine	1	<b>SEM500090</b>	18.76	22.51
3.6L V8 diesel Lion with 19/18 brakes, from (VIN) 7A000001 to 9A999999 Front brakes	Aftermarket	1	<b>SEM500090P</b>	6.04	7.25
	OEM	1	<b>SEM500090P1</b>	8.13	9.76
	Genuine	1	<b>SEM500090</b>	18.76	22.51
4.2L AJ V8 supercharged petrol with 19/18 brakes, up to (VIN) 6A999999 Front brakes	Aftermarket	1	<b>SEM500026P</b>	4.58	5.50
	OEM	1	<b>SEM500026P1</b>	7.29	8.75
	Genuine	1	<b>SEM500026</b>	17.67	21.20
4.2L AJ V8 supercharged petrol with 19/18 brakes, from (VIN) 7A000001 to 9A999999 Front brakes	Aftermarket	1	<b>SEM500090P</b>	6.04	7.25
	OEM	1	<b>SEM500090P1</b>	8.13	9.76
	Genuine	1	<b>SEM500090</b>	18.76	22.51
4.4L AJ V8 petrol with 18/17 brakes, up to (VIN) 6A999999 Front brakes	Aftermarket	1	<b>SEM500062P</b>	5.21	6.25
	OEM	1	<b>SEM500062P1</b>	8.13	9.76
	Genuine	1	<b>SEM500062</b>	18.05	21.66
4.4L AJ V8 petrol with 19/18 brakes, up to (VIN) 6A999999 Front brakes	Aftermarket	1	<b>SEM500026P</b>	4.58	5.50
	OEM	1	<b>SEM500026P1</b>	7.29	8.75
	Genuine	1	<b>SEM500026</b>	17.67	21.20
4.4L V8 petrol with 18 brakes from (VIN) 7A000001 to 9A999999 Front brakes	Aftermarket	1	<b>SEM500080P</b>	6.04	7.25
	OEM	1	<b>SEM500080P1</b>	8.13	9.76
	Genuine	1	<b>SEM500080</b>	18.76	22.51
4.4L AJ V8 petrol with 19/18 brakes, from (VIN) 7A000001 to 9A999999 Front brakes	Aftermarket	1	<b>SEM500090P</b>	6.04	7.25
	OEM	1	<b>SEM500090P1</b>	8.13	9.76
	Genuine	1	<b>SEM500090</b>	18.76	22.51
All models Rear brakes	Aftermarket	1	<b>SOE000025P</b>	3.50	4.20
	OEM	1	<b>SOE000025P1</b>	8.13	9.76
	Genuine	1	<b>SOE000025</b>	10.54	12.65

## Brake Hose

All models Front, RH	OEM	1	<b>LR058021P1</b>	19.79	23.75
	Genuine	1	<b>LR058021</b>	41.88	50.26
Front, LH	OEM	1	<b>LR058020P1</b>	21.50	25.80
	Genuine	1	<b>LR058020</b>	40.54	48.65
Rear, outer, to caliper	OEM	2	<b>LR058009P1</b>	8.33	10.00
	Genuine	2	<b>LR058009</b>	14.48	17.38
Rear, inner	OEM	2	<b>LR058010P1</b>	6.67	8.00
	Genuine	2	<b>LR058010</b>	28.81	34.57
All RHD diesel models Union to servo	Genuine	1	<b>LR019757</b>	8.70	10.44
All RHD diesel models up to (VIN) 6A916812 Vacuum pump union to servo	Genuine	1	<b>SQB000232</b>	6.33	7.60
All RHD diesel models up to (VIN) 9A999999 Vacuum pump to union	Genuine	1	<b>SQB000233</b>	6.33	7.60
All RHD diesel models with EU2 emissions Vacuum Pump to servo	Genuine	1	<b>LR019701</b>	37.34	44.81
All RHD diesel models with Euro stage 4 emissions (VIN) 6A929086 Vacuum Pump to servo	Genuine	1	<b>LR019758</b>	34.68	41.62
All RHD V8 petrol models Union to servo	Genuine	1	<b>SQF500042</b>	11.21	13.45
All 4.4L AJ V8 petrol engine models Vacuum Pump to servo	Genuine	1	<b>LR018333</b>	19.20	23.04
All LHD diesel models up to (VIN) 9A999999 Vacuum pump union to servo	Genuine	1	<b>LR018326</b>	16.12	19.34
All LHD diesel models with EU2 emissions Vacuum Pump to servo	Genuine	1	<b>LR019700</b>	37.17	44.60
All LHD diesel models with Euro stage 4 emissions Vacuum Pump to servo	Genuine	1	<b>LR019756</b>	28.43	34.12



SJJ500080



LR058020P1



# BRAKING SYSTEM

## Brake Pipe Clip

All models	Genuine	a/r	<b>ANR1864</b>	1.16	1.39
All models to (VIN) 9A999999	Genuine	a/r	<b>EDP7037L</b>	0.58	0.70

## 2-way Brake Pipe Connector

All models - Rear	Genuine	a/r	<b>BMK2466</b>	4.41	5.29
-------------------	---------	-----	----------------	------	------

## 4-way Brake Pipe Connector

All models - Rear	Genuine	a/r	<b>SGH100050</b>	29.02	34.82
-------------------	---------	-----	------------------	-------	-------

## Brake Shoe Set - Handbrake

All models - Handbrake (includes pins & clips)	Aftermarket	1	<b>LR031947KITP</b>	6.04	7.25
	Aftermarket	1	<b>LR031947P1</b>	42.50	51.00
(no pins or clips)	Aftermarket	1	<b>LR031947NPCP1</b>	29.58	35.50
	Genuine	1	<b>LR031947</b>	64.15	76.98

## Brake Shoe Retaining Spring Set

Parking Brake all models to (VIN) 9A999999	Genuine	1	<b>SMN500020</b>	17.40	20.88
--------------------------------------------	---------	---	------------------	-------	-------

## Handbrake Shoe Fixing Kit

All models	Genuine	1	<b>SMN500012</b>	7.23	8.68
------------	---------	---	------------------	------	------

## Parking Brake Adjuster Kit

All models from (VIN) 6A365727 to (VIN) 9A999999	Genuine	1	<b>SXS500011</b>	8.20	9.84
--------------------------------------------------	---------	---	------------------	------	------

## Actuating Rod Kit Handbrake

All models - includes 2 rods	Genuine	1	<b>SXR500010</b>	9.62	11.54
------------------------------	---------	---	------------------	------	-------

## Module/Cable Handbrake

All models to (VIN) 9A999999	Genuine	1	<b>LR019223</b>	524.03	628.84
------------------------------	---------	---	-----------------	--------	--------



## Parking Brake Bracket

All models					
RH	Genuine	1	<b>SPU500040</b>	8.80	10.56
LH	Genuine	1	<b>SPU500050</b>	8.80	10.56

## Handbrake Cable Boot

All models - cable to rear brake	Genuine	1	<b>YPV500380</b>	2.77	3.32
----------------------------------	---------	---	------------------	------	------

## Clip Brake Cable Support

All models	Genuine	a/r	<b>SPV500020</b>	0.53	0.64
------------	---------	-----	------------------	------	------

## Handbrake Cable Clip

All models - Circlip, 'E' type, cable to rear brake	Genuine	a/r	<b>SPV500030</b>	0.57	0.68
-----------------------------------------------------	---------	-----	------------------	------	------

## ABS Sensor

All models from (VIN) 6A924697 on					
Front brakes	Aftermarket	2	<b>SSB500133P</b>	14.17	17.00
	OEM	2	<b>SSB500133P1</b>	21.50	25.80
	Genuine	2	<b>SSB500133</b>	25.97	31.16
Rear brakes	Aftermarket	2	<b>SSB500102P</b>	18.13	21.76
	OEM	2	<b>SSB500102P1</b>	20.00	24.00
	Genuine	2	<b>SSB500102</b>	96.20	115.44

## ABS Speed Sensor

All models to (VIN) 6A999999 - Yaw Compatible with 6 pin plug	Genuine	1	<b>SR0000020</b>	290.27	348.32
All models (VIN) 7A000001 on - Yaw Compatible with 4 pin plug	Genuine	1	<b>SR0500140</b>	182.88	219.46

## Brake Pedal Rubber

All models	Genuine	1	<b>SKE500010</b>	10.06	12.07
------------	---------	---	------------------	-------	-------



# SUSPENSION

## Bush Front Upper Arm

All models					
Standard bush	OEM	2	<b>LR051625P1</b>	5.63	6.76
	Genuine	2	<b>LR051625</b>	7.85	9.42
Rubber bush, forward	Aftermarket	1	<b>LR051585P</b>	4.79	5.75
	OEM	1	<b>LR051585P1</b>	9.79	11.75
	Genuine	1	<b>LR051585</b>	40.09	48.11

## Bush Lower Arm

All models up to (VIN) 9A999999					
Front suspension, front, rubber	Aftermarket	2	<b>RBX500432P</b>	4.58	5.50
	Genuine	2	<b>RBX500432</b>	11.61	13.93
Front suspension, rear hydrabush	Aftermarket	2	<b>LR055291P</b>	10.33	12.40
	OEM	2	<b>LR055291P1</b>	21.67	26.00
	Genuine	2	<b>LR055291</b>	48.15	57.78

## Bush Rear Lower Arm

All models					
Standard bush, inner, rearward	OEM	2	<b>LR054831P1</b>	7.50	9.00
	Genuine	2	<b>LR054831</b>	24.01	28.81
Rubber bush, inner, rearward	Aftermarket	2	<b>LR051616P</b>	6.67	8.00
	OEM	2	<b>LR051616P1</b>	15.00	18.00
	Genuine	2	<b>LR051616</b>	27.17	32.60
Standard bush, inner, forward	Aftermarket	2	<b>LR063744P</b>	5.63	6.76
	Genuine	2	<b>LR063744</b>	6.42	7.70

## Bush Rear Upper Arm (pair)

All models - poly. bush, inner, rearward, poly. dynamic orange	Polybush	1	<b>LR051616POLY</b>	45.00	54.00
----------------------------------------------------------------	----------	---	---------------------	-------	-------

## Bush Rear Lower Arm (pair)

All models - poly. bush, inner, rearward	Polybush	1	<b>LR054831POLY</b>	29.58	35.50
------------------------------------------	----------	---	---------------------	-------	-------

## Bush Upper Arm

All models					
Rear suspension, ball joint type	OEM	2	<b>RHF500130P1</b>	18.54	22.25
	Genuine	2	<b>RHF500130</b>	44.11	52.93

# RANGE ROVER SPORT L320 (2005-2009)

## Bush Front Lower Arm

All models					
Poly. bush, forward	Polybush	2	<b>LR051585POLY</b>	31.67	38.00
	Standard bush, inner, forward, poly. dynamic orange (pair)	Polybush	1	<b>LR051611POLY</b>	60.00

## Bush Anti Roll Bar Mounting

All models without Roll Stability Control					
Rear anti roll bar, poly.	Polybush	2	<b>LR018354POLY</b>	15.00	18.00
All models with roll stability control and active cornering enhancement					
Front, poly.	Polybush	2	<b>RVU500011POLYBUSH</b>	15.00	18.00

## Suspension Bush Kit

All models to (VIN) 9A999999					
Kit contains all front & rear wishbone bushes poly. dynamic orange	Polybush	1	<b>RA2066</b>	279.17	335.00

## Anti Roll Bar

All models with roll stability control and active cornering enhancement from (VIN) 6A984367 to (VIN) 6A999999					
Front	OEM	1	<b>LR032958P1</b>	600.00	720.00
	Genuine	1	<b>LR032958</b>	1081.56	1297.87
All models without active roll bar system to (VIN) 9A999999					
Rear	Genuine	1	<b>RGB500100</b>	121.94	146.33

## Anti Roll Bar Link

All models					
Front, RH	Aftermarket	1	<b>RBM500140P</b>	6.67	8.00
	Genuine	1	<b>RBM500140</b>	22.94	27.53
Front, LH	Aftermarket	1	<b>RBM500150P</b>	6.67	8.00
	Genuine	1	<b>RBM500150</b>	22.94	27.53
All models without roll stability control or active cornering enhancement					
Rear	Aftermarket	2	<b>RGD000312P</b>	4.17	5.00
	Genuine	2	<b>RGD000312</b>	18.95	22.74
All models with roll stability control and active cornering enhancement					
Rear	Genuine	2	<b>RGD500140</b>	20.70	24.84



# RANGE ROVER SPORT L320 (2005-2009)

# SUSPENSION

## Mounting Bush, Anti Roll Bar

All models without active roll bar system				
Front	Genuine	2	<b>RBX500280</b>	2.55 3.06
All models without Roll Stability Control				
Front anti roll bar	Aftermarket	2	<b>LR018347P</b>	4.08 4.90
	Genuine	2	<b>LR018347</b>	8.68 10.42
All models with roll stability control and active cornering enhancement				
Front	Aftermarket	2	<b>RVU500011P</b>	6.67 8.00
	Genuine	2	<b>RVU500011</b>	15.84 19.01
All models without Roll Stability Control				
Rear anti roll bar	Aftermarket	2	<b>LR018354P</b>	2.58 3.10
	Genuine	2	<b>LR018354</b>	19.57 23.48

## Clamp Anti Roll Bar Bush

All models				
Front	Genuine	2	<b>RBU500100</b>	2.23 2.68
Rear	Genuine	2	<b>RBU000281</b>	1.93 2.32

## Active Roll Bar Fluid

All models with active roll bar control - 1 litre. Cold (standard) climates fluid				
	Aftermarket	a/r	<b>STC50519P</b>	12.08 14.50
	Genuine	a/r	<b>STC50519</b>	18.96 22.75

## Shock Absorber Upgraded

All models except models with roll stability control, active cornering enhancement or continuous variable damping				
Front B6 Damper	Bilstein	2	<b>LR016426BILSTEIN</b>	162.50 195.00
Rear B6 Damper	Bilstein	2	<b>LR016423BILSTEIN</b>	162.50 195.00
Rear	Genuine	2	<b>LR016423</b>	219.63 263.56

## Shock Absorber

All models except models with roll stability control, active cornering enhancement or continuous variable damping				
Front	Genuine	2	<b>LR016426</b>	330.55 396.66
All 2.7L Lion diesel V6 (140KW) models				
Front, includes seal & service kit	Genuine	2	<b>LR016427</b>	203.95 244.74
All 3.6L V8 32V DOHC EFI Diesel models to (VIN) 9A000001				
Front, includes seal & service kit	Genuine	2	<b>LR016428</b>	210.99 253.19
All 3.6L 32v DOHC EFI diesel models, with roll stability control, with ACE suspension less adaptive damping				
Front, includes seal & service kit	Genuine	2	<b>LR016428</b>	210.99 253.19
All 4.2L V8 Supercharged, with roll stability control, with ACE suspension from (VIN) 9A000001				
Front, includes seal & service kit	Genuine	2	<b>LR016427</b>	203.95 244.74
All 4.4L V8 EFI (220KW) models				
Front, includes seal & service kit	Genuine	2	<b>LR016427</b>	203.95 244.74
All models without Roll Stability Control or Active Cornering Enhancement to (VIN) 9A999999				
Rear	OEM	2	<b>LR041110P1</b>	193.33 232.00
	Genuine	2	<b>LR041110</b>	357.47 428.96
All models up to (VIN) 9A999999 with roll stability control, active cornering enhancement except 3.6L TDV8 diesel				
Rear	OEM	2	<b>LR016424P1</b>	95.00 114.00
	Genuine	2	<b>LR016424</b>	219.63 263.56
All 3.6L TDV8 diesel models to (VIN) 9A999999				
Rear	OEM	2	<b>LR016420P1</b>	193.33 232.00
	Genuine	2	<b>LR016420</b>	354.99 425.99
All 3.6L TDV8 diesel models with roll stability control, active cornering enhancement, without continuous variable damping				
Rear	OEM	2	<b>LR016425P1</b>	150.00 180.00
	Genuine	2	<b>LR016425</b>	295.27 354.32
All models with continuous variable damping				
Rear RH	OEM	1	<b>LR032652P1</b>	416.67 500.00
	Genuine	1	<b>LR032652</b>	736.78 884.14

## Shock Absorber Complete Assembly

All 2.7L TDV6 diesel models without Roll Stability Control				
Std, front	OEM	2	<b>LR041108P1</b>	180.83 217.00
	Genuine	2	<b>LR041108</b>	342.27 410.72
Std, rear	OEM	2	<b>LR016419P1</b>	193.33 232.00
	Genuine	2	<b>LR016419</b>	357.47 428.96
All 2.7L TDV6 diesel models with Roll Stability Control				
Std, front	OEM	2	<b>LR016415P1</b>	180.83 217.00
	Genuine	2	<b>LR016415</b>	342.27 410.72
All 3.6L TDV8 diesel models to (VIN) 9A999999				
Std, front	OEM	2	<b>LR016416P1</b>	180.83 217.00
	Genuine	2	<b>LR016416</b>	342.27 410.72
All 4.2L supercharged V8 petrol models without Roll Stability Control				
Std, front	OEM	2	<b>LR041108P1</b>	180.83 217.00
	Genuine	2	<b>LR041108</b>	342.27 410.72
All 4.2L supercharged V8 petrol models with Roll Stability Control				
Std, front	OEM	2	<b>LR016415P1</b>	180.83 217.00
	Genuine	2	<b>LR016415</b>	342.27 410.72
Std, rear	OEM	2	<b>LR016419P1</b>	193.33 232.00
	Genuine	2	<b>LR016419</b>	357.47 428.96
All 4.4L AJV8 petrol models without Roll Stability Control				
Std, front	OEM	2	<b>LR041108P1</b>	180.83 217.00
	Genuine	2	<b>LR041108</b>	342.27 410.72
All 4.4L AJV8 petrol models with Roll Stability Control				
Std, front	OEM	2	<b>LR016415P1</b>	180.83 217.00
	Genuine	2	<b>LR016415</b>	342.27 410.72
Std, rear	OEM	2	<b>LR016419P1</b>	193.33 232.00
	Genuine	2	<b>LR016419</b>	357.47 428.96

## Boot Kit, Shock Absorber

All models				
Front, for one shock absorber	Aftermarket	2	<b>RBG500010P</b>	30.00 36.00
	Genuine	2	<b>RBG500010</b>	66.18 79.42

## Shock Absorber Upper Boot

All models - Rear	Genuine	2	<b>RPM500200</b>	34.83 41.80
-------------------	---------	---	------------------	-------------

## Buffer, Shock Absorber

All models				
Front	Genuine	2	<b>RPC500080</b>	13.83 16.60
Rear	Genuine	2	<b>RPC500030</b>	6.94 8.33

## Ball Joint

All models - Front knuckle, upper				
	Aftermarket	2	<b>RBK500170P</b>	10.00 12.00
	OEM	2	<b>RBK500170P1</b>	16.88 20.26
	Genuine	2	<b>RBK500170</b>	32.98 39.58
All models (VIN) 9A208831 on - Front knuckle, lower, with 35mm ball joint seat				
<i>For vehicle with original lower arm prior to (VIN) 9A208831 a new lower arm and ball joint assembly must be fitted</i>				
	Aftermarket	2	<b>RBK500300P</b>	9.38 11.26
	OEM	2	<b>RBK500300P1</b>	18.54 22.25
	Genuine	2	<b>RBK500300</b>	35.83 43.00

## Ball Joint Assembly

All models				
Front upper arm	Aftermarket	2	<b>RBK500170P</b>	10.00 12.00
	OEM	2	<b>RBK500170P1</b>	16.88 20.26
	Genuine	2	<b>RBK500170</b>	32.98 39.58
Upper, rear wheel knuckle	Aftermarket	2	<b>RHF500100P</b>	11.04 13.25
	OEM	2	<b>RHF500100P1</b>	14.38 17.26
	Genuine	2	<b>RHF500100</b>	36.46 43.75
All models from (VIN) 9A208831 on				
Front lower arm	Aftermarket	2	<b>RBK500300P</b>	9.38 11.26
	OEM	2	<b>RBK500300P1</b>	18.54 22.25
	Genuine	2	<b>RBK500300</b>	35.83 43.00

## Lower Arm Assembly

All models except 3.6L TDV6 diesel to (VIN) 9A214159 fitted with 35mm lower ball joint				
Front suspension, RH	Aftermarket	1	<b>LR029304P</b>	75.00 90.00
	OEM	1	<b>LR029304P1</b>	125.00 150.00
	Genuine	1	<b>LR029304</b>	193.19 231.83
Front suspension, LH	Aftermarket	1	<b>LR029306P</b>	75.00 90.00
	OEM	1	<b>LR029306P1</b>	107.50 129.00
	Genuine	1	<b>LR029306</b>	197.56 237.07
All models except 3.6L TDV6 diesel (VIN) 9A214160 to 9A999999				
Front suspension, RH	Aftermarket	1	<b>LR029304P</b>	75.00 90.00
	OEM	1	<b>LR029304P1</b>	125.00 150.00
	Genuine	1	<b>LR029304</b>	193.19 231.83
Front suspension, LH	Aftermarket	1	<b>LR029306P</b>	75.00 90.00
	OEM	1	<b>LR029306P1</b>	107.50 129.00
	Genuine	1	<b>LR029306</b>	197.56 237.07
All 3.6L TDV6 diesel models fitted with 35mm lower ball joint				
Front suspension, RH	Aftermarket	1	<b>LR029303P</b>	92.50 111.00
	OEM	1	<b>LR029303P1</b>	125.00 150.00
	Genuine	1	<b>LR029303</b>	193.19 231.83
Front suspension, LH	Aftermarket	1	<b>LR029305P</b>	92.50 111.00
	OEM	1	<b>LR029305P1</b>	125.00 150.00
	Genuine	1	<b>LR029305</b>	205.46 246.55

## Upper Arm Assembly

All models to (VIN) 9A999999				
Front suspension, RH	Aftermarket	1	<b>LR051617P</b>	42.50 51.00
	Genuine	1	<b>LR051617</b>	116.61 139.93
Front suspension, LH	Aftermarket	1	<b>LR074838P</b>	42.50 51.00
	Genuine	1	<b>LR074838</b>	125.33 150.40
All models to (VIN) 9A206811				
Rear RH	OEM	1	<b>LR063719P1</b>	65.00 78.00
	Genuine	1	<b>LR063719</b>	107.16 128.59
Rear LH	OEM	1	<b>LR010527P1</b>	75.83 91.00
	Genuine	1	<b>LR010527</b>	92.94 111.53
All models from (VIN) 9A206812				
Rear RH	OEM	1	<b>LR063719P1</b>	65.00 78.00
	Genuine	1	<b>LR063719</b>	107.16 128.59
Rear LH	OEM	1	<b>LR063718P1</b>	65.00 78.00
	Genuine	1	<b>LR063718</b>	107.17 128.60

## Fitting Kit, Front Upper Arm

All models - Includes bolts and nuts for one upper arm				
	Genuine	1	<b>RYG000420BPK</b>	9.79 11.75



LR016420P1





# SUSPENSION

## Spindle Rod Toe Link

All models	Aftermarket	2	<b>LR019117P</b>	18.13	21.76
	OEM	2	<b>LR019117P1</b>	25.00	30.00
	Genuine	2	<b>LR019117</b>	71.39	85.67

## Ball Joint Rear Knuckle Lower

All models	Aftermarket	2	<b>LR032644P</b>	8.13	9.76
	Genuine	2	<b>LR032644</b>	32.29	38.75

## Knuckle, without Hub

All models (VIN) 9A191791 on For vehicle with original M12 track rod end prior to (VIN) 9A191792 a new track rod must be fitted					
Front axle, RH, takes M14 track rod end	Genuine	1	<b>RUB500320</b>	226.37	271.64
Front axle, LH, takes M14 track rod end	Genuine	1	<b>RUB500330</b>	226.37	271.64
All models with 320mm front & 325mm rear brakes to (VIN) 9A999999					
Rear axle, RH	Genuine	1	<b>LR045822</b>	149.71	179.65
Rear axle, LH	Genuine	1	<b>LR045823</b>	149.71	179.65
All models with 340mm front & 350mm rear brakes to (VIN) 9A999999					
Rear axle, RH	Genuine	1	<b>LR045822</b>	149.71	179.65
Rear axle, LH	Genuine	1	<b>LR045823</b>	149.71	179.65
All models with 360mm front & 350mm rear brakes to (VIN) 9A999999					
Rear axle, RH	Genuine	1	<b>LR045824</b>	196.48	235.78
Rear axle, LH	Genuine	1	<b>LR045825</b>	196.48	235.78

## Height Sensor

All models with air suspension					
Rear suspension, RH	OEM	1	<b>LR020161P1</b>	53.33	64.00
	Genuine	1	<b>LR020161</b>	63.31	75.97
Rear suspension, LH	OEM	1	<b>LR020159P1</b>	45.83	55.00
	Genuine	1	<b>LR020159</b>	63.31	75.97

## Air Suspension Compressor

All models to (VIN) BA262642 - Later AMK type (not Hitachi)					
Genuine*	1	<b>LR072537</b>	574.59	689.51	
			*Exchange Surcharge	180.00	216.00

## Replacement Compressor

All models with Hitachi Compressor fitted - Fitting kit required					
Dunlop	1	<b>LR023964P</b>	383.33	460.00	

## Compressor & Dryer only

All models fitted with AMK compressor					
OEM	1	<b>LR078650P1</b>	341.67	410.00	
Genuine	1	<b>LR078650</b>	620.06	744.07	

## Installation Kit For Dunlop Compressor

All models with Hitachi Compressor fitted - Fitting kit required					
Aftermarket	1	<b>LR023964PPIK</b>	24.58	29.50	

# RANGE ROVER SPORT L320 (2005-2009)

## Installation Kit for AMK Compressor

All models fitted with AMK compressor	OEM	1	<b>LR078650BPIK</b>	78.33	94.00
---------------------------------------	-----	---	---------------------	-------	-------

## Air Suspension Spring

All models up to (VIN) 9A999999 except 3.6L TDV8 diesel					
Front	OEM	2	<b>LR016403P1</b>	165.83	199.00
	Genuine	2	<b>LR016403</b>	334.20	401.04
All 3.6L TDV8 diesel models to (VIN) 9A999999					
Front	Genuine	2	<b>LR058043</b>	334.77	401.72
All models up to (VIN) 9A999999					
Rear	OEM	2	<b>LR016411P1</b>	175.83	211.00
	Genuine	2	<b>LR016411</b>	332.51	399.01

## Strut Seal Kit

All air suspension models - Front & rear	Genuine	2	<b>LR016412</b>	12.40	14.88
------------------------------------------	---------	---	-----------------	-------	-------

## Air Suspension Relief Valve

All models - Front axle	Genuine	1	<b>RVH000095</b>	96.85	116.22
-------------------------	---------	---	------------------	-------	--------

## Filter & Plug

All models with roll Stability Control - Roll Stability Control valve block					
OEM	1	<b>RVJ100010P1</b>	22.29	26.75	
	Genuine	1	<b>RVJ100010</b>	68.68	82.42

## O Ring Seal Kit

All models with Active Cornering Enhancement - Air suspension valve block					
OEM	1	<b>RVW100010P1</b>	14.37	17.24	
	Genuine	1	<b>RVW100010</b>	22.91	27.49



# STEERING

## Seal, Steering Column

All models					
Column to bulkhead	Genuine	1	<b>QMH500100</b>	6.50	7.80
All models up to (VIN) 9A999999					
Lower column joint	Genuine	1	<b>QMH500070</b>	2.72	3.26

## Sensor, Steering Rotation

All models up to (VIN) 9A999999					
Steering column	Genuine	1	<b>SR0500110</b>	185.78	222.94

## Shaft, Steering Column

Upper section, without universal joint	Genuine	1	<b>QLB500070</b>	50.37	60.44
----------------------------------------	---------	---	------------------	-------	-------

## Vibration Damper

All 2.7L V6 diesel models - Steering column	Genuine	1	<b>QTD500020</b>	31.33	37.60
---------------------------------------------	---------	---	------------------	-------	-------

## Track Rod End

All models up to (VIN) 9A191791 - Includes M12 threaded knuckle nut					
Aftermarket	2	<b>LR010675P</b>	15.75	18.90	
	OEM	2	<b>LR010675P1</b>	24.58	29.50
	Genuine	2	<b>LR010675</b>	88.77	106.52
All models up to (VIN) 9A191791 - With M12 track rod thread					
Aftermarket	2	<b>QJB500040P</b>	9.58	11.50	
	OEM	2	<b>QJB500040P1</b>	10.83	13.00
	Genuine	2	<b>QJB500040</b>	75.30	90.36
All models from (VIN) 9A191792 on - Includes M14 threaded knuckle nut					
Genuine	2	<b>LR010676</b>	103.40	124.08	
	All models (VIN) 9A191792 on - With M14 ball joint				
Genuine	1	<b>QJB500070</b>	104.99	125.99	

## Track Rod End & Rod Kit

All models (VIN) 9A191792 on, plus earlier models with late type swivel joint accepting M14 ball joint					
M14 type outer ball joint	Aftermarket	2	<b>LR010673BP</b>	65.83	79.00
	Genuine	2	<b>LR010673</b>	193.22	231.86

## Track Rod

All models	Aftermarket	2	<b>QFK500030P</b>	9.17	11.00
	Genuine	2	<b>QFK500030</b>	68.79	82.55

## Track Rod Complete Assembly

All models up to (VIN) 9A191791 - Includes M12 track rod end					
Britpart	2	<b>LR010674BP</b>	65.83	79.00	
	Genuine	2	<b>LR010674</b>	193.22	231.86

## Track Rod, Bare

All models	Aftermarket	2	<b>QFK500030P</b>	9.17	11.00
	Genuine	2	<b>QFK500030</b>	68.79	82.55

## Gaiter Kit, Steering Rack

All models - Includes one gaiter with clips	OEM	2	<b>QFW500020</b>	36.57	43.88
---------------------------------------------	-----	---	------------------	-------	-------

## Power Steering Fluid

All models - 1 litre. Cold (standard) climates fluid					
Aftermarket	a/r	<b>STC50519P</b>	12.08	14.50	
	Genuine	a/r	<b>STC50519</b>	18.96	22.75

## Cap, Power Steering Reservoir

All models	Genuine	1	<b>QEZ500010</b>	3.25	3.90
------------	---------	---	------------------	------	------



## RANGE ROVER SPORT L320 (2005-2009)

## TRANSMISSION

## Constant Velocity Joint

All 2.7L TDV6 diesel models with auto gearbox

Aftermarket	2	<b>LR060382P</b>	45.00	54.00
OEM	2	<b>LR060382P1</b>	60.83	73.00
Genuine	2	<b>LR060382</b>	133.37	160.04

3.6L V8 Lion diesel models

Aftermarket	2	<b>LR060383P</b>	41.67	50.00
OEM	2	<b>LR060383P1</b>	67.50	81.00
Genuine	2	<b>LR060383</b>	133.37	160.04

All petrol models

Aftermarket	2	<b>LR060383P</b>	41.67	50.00
OEM	2	<b>LR060383P1</b>	67.50	81.00
Genuine	2	<b>LR060383</b>	133.37	160.04

## Drive Shaft Front

All models except 2.7 TDV6 models

Front RH	OEM	1	<b>LR071930P1</b>	177.50	213.00
	Genuine	1	<b>LR071930</b>	441.77	530.12

Front LH

OEM	1	<b>LR072067P1</b>	153.33	184.00
Genuine	1	<b>LR072067</b>	384.53	461.44

All 2.7L TDV6 diesel models

Front RH	OEM	1	<b>LR072070P1</b>	150.83	181.00
	Genuine	1	<b>LR072070</b>	427.73	513.28

## Drive Shaft Assembly

All 2.7L TDV6 diesel models

Front LH	OEM	1	<b>LR072069P1</b>	138.33	166.00
	Genuine	1	<b>LR072069</b>	402.85	483.42

All models with rear axle locking differential

Features 2mm thread pitch - on models up to (VIN) DA810672 the original hub nut with 1.5mm pitch will also need to be replaced with LR024151 nut

Rear LH.	Genuine	1	<b>LR072063</b>	395.46	474.55
----------	---------	---	-----------------	--------	--------

## Drive Shaft &amp; CV Joint

All models except 2.7L V6 diesel up to (VIN) 9A999999

Front axle, RH	Genuine	1	<b>LR025872</b>	156.18	187.42
Front axle, LH	Genuine	1	<b>LR025874</b>	146.18	175.42

All 2.7L TDV6 diesel models

Front axle, RH	Genuine	1	<b>LR025869</b>	149.94	179.93
Front axle, LH	Genuine	1	<b>LR025873</b>	146.18	175.42

All models without rear axle locking differential

Features 2mm thread pitch - on models up to (VIN) DA810672 the original hub nut with 1.5mm pitch will also need to be replaced with LR024151 nut

Rear RH	Genuine	1	<b>LR071933</b>	194.47	233.36
Rear LH	OEM	1	<b>LR072065P1</b>	195.00	234.00
	Genuine	1	<b>LR072065</b>	295.28	354.34

All models with rear axle locking differential

Features 2mm thread pitch - on models up to (VIN) DA810672 the original hub nut with 1.5mm pitch will also need to be replaced with LR024151 nut

Rear RH	Genuine	1	<b>LR072071</b>	322.93	387.52
---------	---------	---	-----------------	--------	--------

## Gaiter Kit Front Drive Shaft

All 2.7L TDV6 Lion diesel models with auto gearbox

OEM	2	<b>TDR500100P1</b>	18.54	22.25
Genuine	2	<b>TDR500100</b>	43.23	51.88

All 3.6L V8 Lion diesel models

OEM	2	<b>TDR500110P1</b>	20.63	24.76
Genuine	2	<b>TDR500110</b>	43.23	51.88

All petrol models

OEM	2	<b>TDR500110P1</b>	20.63	24.76
Genuine	2	<b>TDR500110</b>	43.23	51.88

## Gaiter Kit Rear Drive Shaft

All models without rear axle locking differential

OEM	2	<b>TDR500070P1</b>	20.00	24.00
Genuine	2	<b>TDR500070</b>	46.58	55.90

All models with rear axle locking differential

OEM	2	<b>TDR500080P1</b>	20.00	24.00
Genuine	2	<b>TDR500080</b>	39.28	47.14

## Drive Flange Kit, Transfer Box

All models - Output shaft

Front	Genuine	1	<b>IEA500031</b>	81.83	98.20
Rear	Genuine	1	<b>LR039528</b>	107.64	129.17

## Wheel Hub, with Bearing

All models

Front	Aftermarket	2	<b>LR048083P</b>	60.00	72.00
	OEM	2	<b>LR048083P1</b>	95.00	114.00
	Genuine	2	<b>LR048083</b>	206.23	247.48

## Wheel Hub Assembly

All models

Rear axle, does not include bearing	Aftermarket	2	<b>RUC500120P</b>	55.83	67.00
	Genuine	2	<b>RUC500120</b>	98.29	117.95

## Oil Seal, Differential

All models - Front axle pinion

OEM	1	<b>LR019019P1</b>	5.63	6.76
Genuine	1	<b>LR019019</b>	9.25	11.10

All models

Front & rear axles, output shafts	OEM	1	<b>TZB500050P1</b>	6.25	7.50
	Genuine	1	<b>TZB500050</b>	13.21	15.85
Rear axle pinion	Genuine	1	<b>TZB500100</b>	16.28	19.54

## Oil Seal, Transfer Box

All models - Input shaft

Aftermarket	1	<b>IZB500030P</b>	6.67	8.00
Genuine	1	<b>IZB500030</b>	12.96	15.55

## Sealing Ring, Transfer Box

All models

Front output shaft	OEM	1	<b>IZB500040P1</b>	8.13	9.76
	Genuine	1	<b>IZB500040</b>	10.17	12.20
Rear output shaft	OEM	1	<b>IZB500050P1</b>	4.79	5.75
	Genuine	1	<b>IZB500050</b>	9.84	11.81

## Plug, Oil Drain

All models to (VIN) 9A999999

Rear axle	Genuine	1	<b>FTC5431</b>	6.50	7.80
-----------	---------	---	----------------	------	------

## Plug, Differential

All models

Oil filler, front & rear axles	Genuine	1	<b>TYB500060</b>	0.86	1.03
--------------------------------	---------	---	------------------	------	------

All models up to (VIN) 9A999999

Oil drain, front axle	Genuine	1	<b>TYB500080</b>	11.54	13.85
-----------------------	---------	---	------------------	-------	-------

## Plug, Transfer Box

All models - Oil Fill &amp; Drain

OEM	1	<b>IYB500020P1</b>	1.75	2.10
Genuine	1	<b>IYB500020</b>	2.49	2.99

## Oil Temperature Switch

All models with rear axle locking differential

Rear axle differential	Genuine	1	<b>NSC500590</b>	14.45	17.34
------------------------	---------	---	------------------	-------	-------

## Chain Only, Transfer Box

All models

OEM	1	<b>LR049160CP1</b>	133.33	160.00
-----	---	--------------------	--------	--------

## Sensor, Differential

All models with rear axle locking differential

Oil temperature	Genuine	1	<b>NSC500590</b>	14.45	17.34
-----------------	---------	---	------------------	-------	-------

## Sensor, Transfer Box

All models - High/low position

Genuine	1	<b>IAB500191</b>	74.63	89.56
---------	---	------------------	-------	-------

## Solenoid, Transfer Box

All models - Pressure

Genuine	1	<b>IGF500011</b>	77.19	92.63
---------	---	------------------	-------	-------

## Damper, Vibration

All models (VIN) 7A000001 to 9A999999

Transfer box	Genuine	1	<b>LR094511</b>	33.76	40.51
--------------	---------	---	-----------------	-------	-------



LR071930P1

RUC500120P



# COOLING

## Expansion Bottle Cap

All models up to (VIN) 9A999999	Aftermarket	1	<b>PCD500030P</b>	2.83	3.40
	Genuine	1	<b>PCD500030</b>	6.76	8.11

## Thermostat

All 2.7L TDV6 diesel engine models with EU2 emissions (not Euro Stage 4 or DPF)	Genuine	1	<b>PEL500320</b>	42.90	51.48
	Aftermarket	1	<b>LR009562</b>	25.61	30.73
All models with 2.7L TDV6 diesel engine and Euro Stage 4 emissions (with DPF)	Genuine	1	<b>LR009562</b>	25.61	30.73
	Aftermarket	1	<b>LR003341</b>	12.25	14.70
All 3.6L TDV8 diesel models - Engine thermostat housing	Genuine	1	<b>LR003341</b>	12.25	14.70
	Aftermarket	1	<b>LR005765P</b>	10.00	12.00
All 4.2L supercharged AJV8 petrol models - Coolant	OEM	1	<b>LR005765P1</b>	17.50	21.00
	Genuine	1	<b>LR005765</b>	30.16	36.19
	Aftermarket	1	<b>LR005765P</b>	10.00	12.00
All 4.4L AJV8 petrol models - Coolant	OEM	1	<b>LR005765P1</b>	17.50	21.00
	Genuine	1	<b>LR005765</b>	30.16	36.19
	Aftermarket	1	<b>LR005765P</b>	10.00	12.00

## Engine Thermostat Housing Assembly

All 3.6L TDV8 diesel models - Includes thermostat, EGR valve thermostat and covers	Genuine	1	<b>LR004318</b>	52.80	63.36
	Aftermarket	1	<b>LR007603</b>	189.29	227.15
All 4.2L supercharged AJV8 petrol models - Includes thermostat, cover/elbow and temp sensor	Genuine	1	<b>LR007603</b>	189.29	227.15
	Aftermarket	1	<b>LR005631</b>	81.72	98.06

## Thermostat Housing Gasket

All 4.2L supercharged AJV8 petrol models - Housing elbow, 54mm dia.	Genuine	1	<b>4024557</b>	0.58	0.70
	Aftermarket	1	<b>4024557</b>	0.58	0.70
All 4.4L N/A AJV8 petrol models up to (VIN) 5A999999 - Housing elbow, 54mm dia.	Genuine	1	<b>4024557</b>	0.58	0.70
	Aftermarket	1	<b>4024557</b>	0.58	0.70

## Thermostat Housing O Ring

All 4.2L supercharged AJV8 petrol models - Thermostat cover, 69mm dia.	Genuine	1	<b>4362513</b>	1.58	1.90
	Aftermarket	1	<b>4413478</b>	1.74	2.09
All 4.4L N/A AJV8 petrol models - Thermostat housing body, 37mm dia.	Genuine	1	<b>4413478</b>	1.74	2.09
	Aftermarket	1	<b>4359953</b>	3.99	4.79
All 4.4L N/A AJV8 petrol models - Housing elbow, 53mm dia.	Genuine	1	<b>4359953</b>	3.99	4.79
	Aftermarket	1	<b>4362513</b>	1.58	1.90
All 4.4L N/A AJV8 petrol models - Thermostat cover, 69mm dia.	Genuine	1	<b>4362513</b>	1.58	1.90
	Aftermarket	1	<b>4413478</b>	1.74	2.09

## Thermostat Cover

All 4.2L supercharged AJV8 petrol models	Genuine	1	<b>LR007605</b>	55.56	66.67
	Aftermarket	1	<b>4624378</b>	32.98	39.58

## Thermostat Housing Elbow

All 4.4L N/A AJV8 petrol models - 4 bolt fixing	Genuine	1	<b>PEH500140</b>	18.61	22.33
-------------------------------------------------	---------	---	------------------	-------	-------

## Retaining Clip

All 3.6L TDV8 diesel models - EGR valve thermostat & elbow to thermostat housing	Genuine	1	<b>LR003339</b>	1.31	1.57
----------------------------------------------------------------------------------	---------	---	-----------------	------	------

## EGR Valve Thermostat

All 3.6L TDV8 diesel models - In thermostat housing	Genuine	1	<b>LR003335</b>	30.25	36.30
-----------------------------------------------------	---------	---	-----------------	-------	-------

# RANGE ROVER SPORT L320 (2005-2009)

## EGR Valve Thermostat Elbow

All 3.6L TDV8 diesel models - Upper	Genuine	1	<b>LR004320</b>	14.43	17.32
-------------------------------------	---------	---	-----------------	-------	-------

## EGR Valve Thermostat Elbow O Ring

All 3.6L TDV8 diesel models - Lower elbow to thermostat housing	Genuine	1	<b>LR003336</b>	2.65	3.18
-----------------------------------------------------------------	---------	---	-----------------	------	------

## Water Pump

All 2.7L V6 diesel engine models	OEM	1	<b>LR009324P1</b>	35.83	43.00
	Genuine	1	<b>LR009324</b>	89.17	107.00
All models with 3.6L TDV8 diesel engine	Aftermarket	1	<b>LR008863P</b>	50.00	60.00
	Genuine	1	<b>LR008863</b>	128.66	154.39
All 4.2L supercharged AJ V8 petrol engine models	Aftermarket	1	<b>4575902P</b>	19.79	23.75
	OEM	1	<b>4575902P1</b>	29.58	35.50
	Genuine	1	<b>4575902</b>	128.66	154.39
Auxiliary	Genuine	1	<b>PEB500010</b>	140.35	168.42
	Aftermarket	1	<b>4575902P</b>	19.79	23.75
All 4.4L AJ V8 petrol engine models	OEM	1	<b>4575902P1</b>	29.58	35.50
	Genuine	1	<b>4575902</b>	128.66	154.39
	Aftermarket	1	<b>4575902</b>	128.66	154.39

## Gasket Water Pump

All 2.7L V6 diesel engine models	Genuine	1	<b>1316117</b>	24.53	29.44
All 3.6L TDV8 diesel models	Genuine	1	<b>LR002750</b>	1.83	2.20
All 4.2L supercharged AJV8 petrol models	Genuine	1	<b>4575903</b>	5.04	6.05
All 4.4L N/A AJV8 petrol models	Genuine	1	<b>4575903</b>	5.04	6.05

## Intercooler Hose

All 2.7L V6 turbo diesel models - RH	Aftermarket	1	<b>PNH500025P</b>	25.83	31.00
	Genuine	1	<b>PNH500025</b>	41.04	49.25
LH rear	Genuine	1	<b>PNH500034</b>	96.08	115.30
	Aftermarket	1	<b>PNH500221</b>	54.57	65.48
All 2.7L V6 turbo diesel models up to (VIN) 5A914111 - LH front	Genuine	1	<b>PNH500221</b>	54.57	65.48
	Aftermarket	1	<b>PNH500223</b>	43.14	51.77
All 2.7L V6 turbo diesel models from (VIN) 5A914112 - LH front	Genuine	1	<b>PNH500223</b>	43.14	51.77
	Aftermarket	1	<b>PNH500371P</b>	13.96	16.75
All 3.6L TDV8 diesel models - RH upper	Genuine	1	<b>PNH500371</b>	28.58	34.30
	Aftermarket	1	<b>PNH500361P</b>	13.96	16.75
LH upper	Aftermarket	1	<b>PNH500361P</b>	13.96	16.75
	Genuine	1	<b>PNH500361</b>	27.53	33.04

## Intercooler Pipe & Hose Kit

All 3.6L TDV8 diesel models - RH lower	Genuine	1	<b>PNH500351</b>	101.64	121.97
	Aftermarket	1	<b>PNH500341</b>	91.14	109.37

## Coolant Temperature Sensor

All 2.7L TDV6 diesel models	Genuine	1	<b>LR041442</b>	25.70	30.84
All 4.2L supercharged AJV8 petrol models	Aftermarket	1	<b>4603183P</b>	15.55	18.66
	Genuine	1	<b>4603183</b>	24.77	29.72
All 4.4L AJV8 petrol models	Aftermarket	1	<b>4603183P</b>	15.55	18.66
	Genuine	1	<b>4603183</b>	24.77	29.72

## Coolant Level Sensor

All models	Genuine	1	<b>PCJ500030</b>	6.16	7.39
------------	---------	---	------------------	------	------

# ELECTRICAL - ROTATING ELECTRICS

# RANGE ROVER SPORT L320 (2005-2009)

## Alternator

All 2.7L V6 diesel engine models without active cornering enhancement - New, outright	Aftermarket	1	<b>YLE500400P</b>	130.00	156.00
	OEM	1	<b>YLE500400P1</b>	195.00	234.00
	Genuine*	1	<b>YLE500400</b>	432.21	518.65
New, exchange	Genuine*	1	<b>YLE500400</b>	432.21	518.65
	*Exchange Surcharge			70.00	84.00
All 2.7L TDV6 diesel models with roll stability control - New, outright	Aftermarket	1	<b>YLE500420P</b>	150.00	180.00
	Genuine*	1	<b>YLE500420</b>	243.63	292.36
	*Exchange Surcharge			70.00	84.00
New, exchange	Genuine*	1	<b>YLE500420</b>	243.63	292.36
	*Exchange Surcharge			70.00	84.00
	Aftermarket	1	<b>YLE500430P</b>	195.00	234.00
All 3.6L TDV8 diesel models with roll stability control - New, outright	OEM	1	<b>YLE500430P1</b>	195.00	234.00
	Genuine*	1	<b>YLE500430</b>	354.79	425.75
	*Exchange Surcharge			70.00	84.00
New, exchange	Genuine*	1	<b>YLE500430</b>	354.79	425.75
	*Exchange Surcharge			70.00	84.00
	Aftermarket	1	<b>YLE500390P</b>	145.00	174.00
All 4.2L supercharged V8 petrol models - New, outright	OEM	1	<b>YLE500390P1</b>	225.00	270.00
	Genuine*	1	<b>YLE500390</b>	354.79	425.75
	*Exchange Surcharge			70.00	84.00
New, exchange	Genuine*	1	<b>YLE500390</b>	354.79	425.75
	*Exchange Surcharge			70.00	84.00
	Aftermarket	1	<b>YLE500390P</b>	145.00	174.00
All 4.4L AJV8 petrol models - New, outright	OEM	1	<b>YLE500390P1</b>	225.00	270.00
	Genuine*	1	<b>YLE500390</b>	354.79	425.75
	*Exchange Surcharge			70.00	84.00
New, exchange	Genuine*	1	<b>YLE500390</b>	354.79	425.75
	*Exchange Surcharge			70.00	84.00
	Aftermarket	1	<b>YLE500390P</b>	145.00	174.00

## Starter Motor

All models with 2.7L TDV6 diesel engine - New, outright	OEM	1	<b>LR087021P1</b>	175.00	210.00
	Genuine	1	<b>LR087021</b>	373.26	447.91
	Reconditioned, exchange	Genuine*	1	<b>NAD500080E</b>	214.25
*Exchange Surcharge				70.00	84.00
All 3.6L TDV8 diesel models - New, outright	OEM	1	<b>LR032541P1</b>	283.33	340.00
	Genuine*	1	<b>LR012628</b>	247.10	296.52
	*Exchange Surcharge			70.00	84.00
New, exchange	Genuine*	1	<b>LR032541</b>	436.78	524.14
	*Exchange Surcharge			200.00	240.00
	Aftermarket	1	<b>NAD500310P</b>	195.00	234.00
All 4.2L supercharged AJV8 petrol models - New, outright	Genuine*	1	<b>NAD500310</b>	331.26	397.51
	*Exchange Surcharge			70.00	84.00
	Aftermarket	1	<b>NAD500310P</b>	195.00	234.00
All 4.4L N/A AJV8 petrol models - New, outright	Genuine*	1	<b>NAD500310</b>	331.26	397.51
	*Exchange Surcharge			70.00	84.00
	Aftermarket	1	<b>NAD500310P</b>	195.00	234.00

YLE500400P



LR032541P1





## RANGE ROVER SPORT L320 (2005-2009)

## ENGINE GASKETS

## Gasket Cylinder Head

All 2.7L TDV6 diesel models					
Grade 2	Genuine	2	<b>LR009719</b>	9.87	11.84
Grade 3	Genuine	2	<b>LR009721</b>	9.87	11.84
Grade 4	OEM	2	<b>LR009722P1</b>	10.83	13.00
	Genuine	2	<b>LR009722</b>	20.22	24.26
Grade 5	OEM	2	<b>LR009723P1</b>	10.83	13.00
	Genuine	2	<b>LR009723</b>	20.22	24.26
All 3.6L TDV8 diesel models					
Grade 1, RH	Genuine	1	<b>1418984</b>	52.08	62.50
Grade 1, LH	Genuine	1	<b>1418990</b>	52.08	62.50
Grade 2, RH	Genuine	1	<b>1418985</b>	52.08	62.50
Grade 2, LH	Genuine	1	<b>1418991</b>	52.08	62.50
Grade 3, RH	Genuine	1	<b>LR000635</b>	50.52	60.62
Grade 3, LH	Genuine	1	<b>1418992</b>	52.31	62.77
Grade 4, RH	Genuine	1	<b>1418987</b>	52.08	62.50
Grade 4, LH	Genuine	1	<b>1418993</b>	52.08	62.50
Grade 5, RH	Genuine	1	<b>1418989</b>	52.08	62.50
Grade 5, LH	Genuine	1	<b>1418996</b>	52.08	62.50
All 4.2L supercharged AJV8 petrol models					
RH	Genuine	1	<b>4628399</b>	28.65	34.38
LH	Genuine	1	<b>4628400</b>	28.65	34.38
All 4.4L N/A AJV8 petrol models					
RH	Aftermarket	1	<b>4585198P</b>	14.38	17.26
	Genuine	1	<b>4585198</b>	28.99	34.79
LH	Aftermarket	1	<b>4585202P</b>	14.38	17.26
	Genuine	1	<b>4585202</b>	28.56	34.27

## Engine Gaskets Gasket Camshaft Cover

All 4.2L supercharged AJV8 petrol models					
RH	Aftermarket	1	<b>LR007652P</b>	10.63	12.76
	Genuine	1	<b>LR007652</b>	22.79	27.35
LH	Aftermarket	1	<b>LR007657P</b>	10.63	12.76
	Genuine	1	<b>LR007657</b>	28.77	34.52
All 4.4L N/A AJV8 petrol models					
RH	Aftermarket	1	<b>LR007652P</b>	10.63	12.76
	Genuine	1	<b>LR007652</b>	22.79	27.35
LH	Aftermarket	1	<b>LR007657P</b>	10.63	12.76
	Genuine	1	<b>LR007657</b>	28.77	34.52

## Gasket Oil Sump

All models with 2.7L TDV6 diesel engine	Genuine	1	<b>1365260</b>	23.54	28.25
All 3.6L TDV8 diesel models	Genuine	1	<b>LR002438</b>	20.55	24.66

## Gasket Decoke &amp; Conversion Set

All 4.2L supercharged AJV8 petrol models - Also includes seals					
	Aftermarket	1	<b>LR006635P</b>	250.00	300.00
	Genuine	1	<b>LR006635</b>	355.28	426.34
All 4.4L N/A AJV8 petrol models - Also includes seals					
	Aftermarket	1	<b>LR006645P</b>	216.67	260.00
	Genuine	1	<b>LR006645</b>	282.40	338.88

## Sealant Instant Gasket

Numerous applications	Genuine	a/r	<b>STC50550</b>	13.10	15.72
-----------------------	---------	-----	-----------------	-------	-------

## RANGE ROVER SPORT L320 (2005-2009)

## ENGINE SWITCHES

## Camshaft Position Sensor

All 2.7L TDV6 diesel models	Genuine	1	<b>LR019287</b>	120.57	144.68
All 4.2L supercharged AJV8 petrol models					
RH	Aftermarket	1	<b>4427657P</b>	27.08	32.50
	Genuine	1	<b>4427657</b>	40.54	48.65
LH	Aftermarket	1	<b>4362957P</b>	25.85	31.02
	Genuine	1	<b>4362957</b>	36.32	43.58
All 4.4L AJV8 petrol models					
RH	Aftermarket	1	<b>4427657P</b>	27.08	32.50
	Genuine	1	<b>4427657</b>	40.54	48.65
LH	Aftermarket	1	<b>4362957P</b>	25.85	31.02
	Genuine	1	<b>4362957</b>	36.32	43.58

## Crankshaft Position Sensor

All 2.7L TDV6 diesel models	Aftermarket	1	<b>LR009793P</b>	45.00	54.00
	Genuine	1	<b>LR009793</b>	117.84	141.41
All 3.6L TDV8 diesel models	Aftermarket	1	<b>LR009793P</b>	45.00	54.00
	Genuine	1	<b>LR009793</b>	117.84	141.41
All 4.2L supercharged AJV8 petrol models	Aftermarket	1	<b>N5C500160P</b>	20.00	24.00
	Genuine	1	<b>N5C500160</b>	42.84	51.41
All 4.4L N/A AJV8 petrol models	Aftermarket	1	<b>N5C500160P</b>	20.00	24.00
	Genuine	1	<b>N5C500160</b>	42.84	51.41

## Oil Temperature Switch

All 2.7L TDV6 diesel models	Genuine	1	<b>1359056</b>	27.21	32.65
All 3.6L TDV8 diesel models	Genuine	1	<b>1359056</b>	27.21	32.65
All 4.2L supercharged AJV8 petrol models	Genuine	1	<b>LR018397</b>	25.55	30.66
All 4.4L N/A AJV8 petrol models	Genuine	1	<b>LR018397</b>	25.55	30.66

## Engine Knock Sensor

All 2.7L TDV6 diesel models with EU2 emissions (without diesel particulate filter, DPF)	Genuine	1	<b>LR007808</b>	29.41	35.29
All 3.6L TDV8 diesel models up to (VIN) 8A147225	Genuine	1	<b>1419002</b>	59.24	71.09
All 4.2L supercharged AJV8 petrol models	Genuine	1	<b>4603186</b>	77.82	93.38
All 4.4L AJV8 petrol models	Genuine	1	<b>4603186</b>	77.82	93.38

## Retainer Engine Knock Sensor

All 4.2L supercharged AJV8 petrol models	Genuine	1	<b>4603189</b>	0.37	0.44
All 4.4L AJV8 petrol models	Genuine	1	<b>4603189</b>	0.37	0.44

## Oil Pressure Switch

All 2.7L & 3.0L V6 diesel models	Genuine	1	<b>1316119</b>	13.94	16.73
All 3.6L TDV8 diesel models	Genuine	1	<b>LR000633</b>	2.86	3.43
All 4.2L supercharged AJV8 petrol models	Genuine	1	<b>4737666</b>	14.23	17.08
All 4.4L AJV8 petrol models	Genuine	1	<b>4737666</b>	14.23	17.08

## RANGE ROVER SPORT L320 (2005-2009)

## DRAIN PLUGS

## Sump Plug &amp; Washer

2.7L V6 Lion diesel models	Aftermarket	1	<b>1013938P</b>	1.50	1.80
	Genuine	1	<b>1013938</b>	3.19	3.83
3.6L TDV8 diesel models	Aftermarket	1	<b>1013938P</b>	1.50	1.80
	Genuine	1	<b>1013938</b>	3.19	3.83
4.2L V8 supercharged petrol models	Aftermarket	1	<b>1013938P</b>	1.50	1.80
	Genuine	1	<b>1013938</b>	3.19	3.83
4.4L V8 AJ petrol models	Aftermarket	1	<b>1013938P</b>	1.50	1.80
	Genuine	1	<b>1013938</b>	3.19	3.83



1013938P



## OIL SEALS ENGINE

### Crankshaft Oil Seal Front

All models with 2.7L TDV6 diesel engine				
Front	Genuine	1	<b>1102415</b>	5.41 6.49
All models with 3.6L TDV8 diesel engine				
Front	Genuine	1	<b>1102415</b>	5.41 6.49
All 4.2L supercharged AJV8 petrol models	Genuine	1	<b>4526537</b>	23.47 28.16
All 4.4L N/A AJV8 petrol models	Genuine	1	<b>4526537</b>	23.47 28.16
2.7L V6 Lion diesel models - With retainer	Genuine	1	<b>LR036542</b>	36.48 43.78
4.2L V8 supercharged petrol models	Aftermarket	1	<b>4352327P</b>	12.50 15.00
4.4L V8 AJ petrol models	Aftermarket	1	<b>4352327P</b>	12.50 15.00

## EXHAUST GAS RECIRCULATION (EGR)

### EGR Valve

All 3.6L TDV8 diesel models - RH	Genuine	1	<b>LR018321</b>	229.18 275.02
----------------------------------	---------	---	-----------------	---------------

### EGR Valve

All 3.6L TDV8 diesel models - LH	Genuine	1	<b>LR018322</b>	211.54 253.85
----------------------------------	---------	---	-----------------	---------------

### EGR Valve

All 4.4L AJV8 petrol models	Genuine	1	<b>4536857</b>	183.10 219.72
-----------------------------	---------	---	----------------	---------------

### EGR Blanking Kit

All 2.7L TDV6 diesel models with EU2 emissions (non-DPF) Includes blanking plates & seals for both EGR valves				
	Terrafirma	1	<b>RD1340TF</b>	39.58 47.50
	Britpart	1	<b>RD1340BP</b>	35.00 42.00
	Bearmach	1	<b>RD1340BM</b>	40.83 49.00

### Gasket EGR Valve Inlet

All 2.7L V6 Diesel engine models from (VIN) 7A000001 on				
	Aftermarket	1	<b>LR004532P</b>	2.58 3.10
	Genuine	1	<b>LR004532</b>	5.48 6.58

### Gasket EGR Outlet

All 2.7L V6 Diesel engine models	Genuine	1	<b>1331267</b>	5.12 6.14
----------------------------------	---------	---	----------------	-----------

### Gasket EGR Pipe to Exhaust Manifold

All 2.7L TDV6 diesel models - RH & LH	Genuine	1	<b>1331270</b>	5.30 6.36
---------------------------------------	---------	---	----------------	-----------

### Gasket EGR Valve to Cooler

All 2.7L TDV6 diesel models with EU2 emissions (non-DPF) RH & LH				
	Genuine	1	<b>1336561</b>	5.31 6.37
All 3.6L TDV8 diesel models	Genuine	1	<b>LR003831</b>	2.34 2.81

### Gasket EGR Valve to Manifold Pipe

All 3.6L TDV8 diesel models	Genuine	1	<b>LR003828</b>	16.37 19.64
-----------------------------	---------	---	-----------------	-------------

### O Ring EGR Valve Manifold Pipe

All 3.6L TDV8 diesel models	Genuine	1	<b>LR003898</b>	1.61 1.93
-----------------------------	---------	---	-----------------	-----------

### Gasket EGR Cooler to Inlet Pipe

All 3.6L TDV8 diesel models	Genuine	1	<b>LR004250</b>	6.39 7.67
-----------------------------	---------	---	-----------------	-----------

### Gasket EGR Pipe to Exhaust

All 4.4L AJV8 petrol models	Genuine	1	<b>4451180</b>	0.77 0.92
-----------------------------	---------	---	----------------	-----------

### Gasket EGR Valve to Pipe

All 4.4L AJV8 petrol models	Genuine	1	<b>4536854</b>	0.53 0.64
-----------------------------	---------	---	----------------	-----------

### Gasket EGR Valve to Inlet Manifold

All 4.4L AJV8 petrol models	Genuine	1	<b>4536856</b>	0.53 0.64
-----------------------------	---------	---	----------------	-----------

## RANGE ROVER SPORT L320 (2005-2009)

### Oil Seal Camshaft

All models with 2.7L TDV6 diesel engine				
Front and rear	Aftermarket	2	<b>1311318P</b>	2.00 2.40
Front and rear	Genuine	2	<b>1311318</b>	2.83 3.40

## RANGE ROVER SPORT L320 (2005-2009)

### Pipe EGR Valve to Inlet Manifold

All 2.7L TDV6 diesel models				
RH	Genuine	1	<b>1316131</b>	42.11 50.53
LH	Genuine	1	<b>LR066839</b>	203.44 244.13
All 3.6L TDV8 diesel models up to (VIN) 9A999999				
	Genuine	2	<b>LR016789</b>	52.37 62.84

### Pipe EGR Valve to Exhaust Manifold

All 2.7L TDV6 diesel models				
RH	Genuine	1	<b>LR004253</b>	42.65 51.18
LH	Genuine	1	<b>LR066840</b>	109.04 130.85
All 3.6L TDV8 diesel models				
RH	Genuine	1	<b>LR006966</b>	43.04 51.65
LH	Genuine	1	<b>LR006965</b>	43.04 51.65

### Pipe EGR Valve to Exhaust Manifold

All 2.7L TDV6 diesel models - LH	Genuine	1	<b>LR066840</b>	109.04 130.85
----------------------------------	---------	---	-----------------	---------------

### Pipe Cooled EGR Outlet

All 2.7L TDV6 diesel models with Euro Stage 4 emissions with DPF from (VIN) 7A000001 on				
	Genuine	1	<b>WAP500380</b>	81.41 97.69

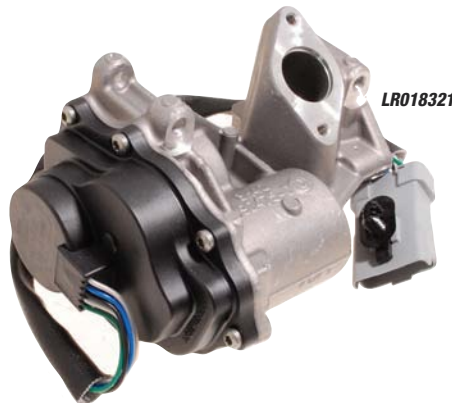

## ENGINE & GEARBOX MOUNTINGS

## RANGE ROVER SPORT L320 (2005-2009)

### Engine Mounting

All 2.7L TDV6 diesel models	Genuine	2	<b>KKB500760</b>	52.07 62.48
All 3.6L TDV8 diesel models	Genuine	2	<b>KKB500602</b>	73.18 87.82

### Bracket Engine Mounting

All 2.7L TDV6 diesel models				
RH	Genuine	1	<b>KKU500590</b>	95.51 114.61
LH	Genuine	1	<b>KKU500580</b>	90.84 109.01
All 3.6L TDV8 diesel models				
RH	Genuine	1	<b>KKU500761</b>	32.33 38.80
LH	Genuine	1	<b>KKU500771</b>	25.98 31.18
Shock absorber	Genuine	1	<b>LR004709</b>	9.68 11.62
All 4.2L supercharged AJV8 petrol models				
RH	Genuine	1	<b>KKU500610</b>	101.44 121.73
LH	Genuine	1	<b>KKU500600</b>	95.73 114.88
All 4.4L N/A AJV8 petrol models				
RH	Genuine	1	<b>KKU500610</b>	101.44 121.73
LH	Genuine	1	<b>KKU500600</b>	95.73 114.88

### Shock Absorber

All 3.6L TDV8 diesel models - Engine mounting				
	Genuine	1	<b>RNB501100</b>	40.64 48.77

### Gearbox Mounting

All models	Genuine	1	<b>IAF500070</b>	55.19 66.23
------------	---------	---	------------------	-------------

### Eye Bolt Gearbox Mounting

All models	Genuine	1	<b>KYG500200</b>	1.32 1.58
------------	---------	---	------------------	-----------



## RANGE ROVER SPORT L320 (2005-2009)

## FUEL SYSTEM SWITCHES

## Fuel Pressure Sensor

All 4.2L supercharged AJV8 petrol models	Genuine	1	<b>4458309</b>	43.53	52.24
------------------------------------------	---------	---	----------------	-------	-------

## Air Flow Meter

2.7L TDV6 diesel models	OEM	1	<b>PHF500101P1</b>	89.17	107.00
	Genuine	1	<b>PHF500101</b>	128.80	154.56
4.2L V8 supercharged petrol models	OEM	1	<b>PHF000140P1</b>	70.00	84.00
	Genuine	1	<b>PHF000140</b>	107.33	128.80
4.4L V8 AJ petrol models	OEM	1	<b>PHF000140P1</b>	70.00	84.00
	Genuine	1	<b>PHF000140</b>	107.33	128.80

## Air Flow Sensor

3.6L TDV8 diesel models	OEM	1	<b>PHF500090P1</b>	70.00	84.00
	Genuine	1	<b>PHF500090</b>	128.80	154.56

## Fuel Temperature Sensor

All 4.2L supercharged AJV8 petrol models - Fuel rail	Genuine	1	<b>LR000291</b>	20.82	24.98
	Genuine	1	<b>LR000291</b>	20.82	24.98

## Water Sensor for Fuel Filter

All 2.7L TDV6 diesel models from (VIN) 7A000001 on	OEM	1	<b>WKW500080</b>	51.36	61.63
	OEM	1	<b>WKW500080</b>	51.36	61.63

PHF500101P1



PHF500090P1



LR000291



WKW500080

## RANGE ROVER SPORT L320 (2005-2009)

## CABLES

## Bonnet Release Cable

All models up to (VIN) 9A999999					
Engine compartment end	Genuine	1	<b>FSE000091</b>	5.85	7.02
Passenger compartment end	Genuine	1	<b>FSE500031</b>	12.63	15.16



FSE000091

## RANGE ROVER SPORT L320 (2005-2009)

## WHEEL CENTRE CAPS &amp; WHEEL NUTS

## Wheel Centre Cap

All models with polished shadow chrome alloy wheel centre caps with green/gold Land Rover badge up to (VIN) 9A999999 - Polished shadow chrome finish with Land Rover green/gold badge	Genuine	a/r	<b>RRJ500060MUZ</b>	8.42	10.10
	Genuine	a/r	<b>RRJ500030WYT</b>	8.76	10.51
All models with Titan Silver wheel centre caps with Land Rover black/silver badge Titan Silver with Land Rover black/silver badge	Genuine	a/r	<b>RRJ500030WYS</b>	11.03	13.24
	Genuine	a/r	<b>RRJ500060WYU</b>	8.71	10.45
All models with polished silver/black alloy wheel centre caps with black/silver Land Rover badge from (VIN) 9A000001 on - Polished silver/black finish with Land Rover black/silver badge	Genuine	a/r	<b>LR006972</b>	6.50	7.80
	Genuine	a/r	<b>LR011487</b>	9.66	11.59

## Wheel Nut

All models with stainless steel finish wheel nuts - Stainless steel finish	OEM	a/r	<b>LR068126P1</b>	3.25	3.90
	Genuine	a/r	<b>LR068126</b>	5.27	6.32

## Wheel Nut Set

All models with stainless steel finish wheel nuts - Stainless steel finish	OEM	a/r	<b>LR068126P1K16</b>	40.00	48.00
	Genuine	a/r	<b>LR068126K16</b>	80.83	97.00
set of 20	OEM	a/r	<b>LR068126P1K20</b>	50.00	60.00
	Genuine	a/r	<b>LR068126K20</b>	97.50	117.00





# RANGE ROVER SPORT L320 (2010 TO 2013)

2010 to 2013 - All Models

Listed below are the most popular parts required for the Range Rover Sport L320

We have access to the full range of parts for your vehicle. Please contact us if not listed here.



## SERVICE KITS

### Filter Kit

All 3.0L V6 diesel models

Includes oil filter, air filter, fuel filter, pollen filters & sump plug

Britpart	1	<b>RA1517BP</b>	30.83	37.00
Genuine	1	<b>RA1517</b>	95.00	114.00

All 3.6L TDV8 diesel models

Includes oil filter, air filter, fuel filter, pollen filters & sump plug

Aftermarket	1	<b>RA1489P</b>	34.50	41.40
Genuine	1	<b>RA1489</b>	99.17	119.00

## RANGE ROVER SPORT L320 (2010-2013)

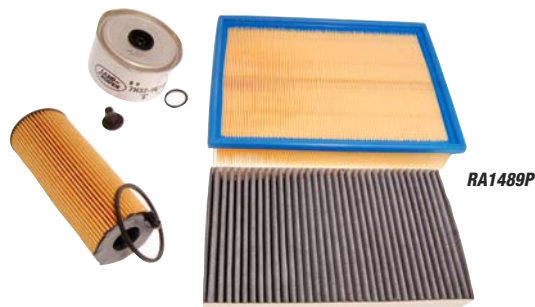

## FILTRATION

### Oil Filter

All models with 3.0L V6 diesel engine - Element

Aftermarket	1	<b>LR013148P</b>	3.50	4.20
Genuine	1	<b>LR013148</b>	11.39	13.67

All 3.0L supercharged V6 petrol models - Element

Genuine	1	<b>LR011279</b>	22.43	26.92
---------	---	-----------------	-------	-------

All models with 3.6L TDV8 diesel engine - Element

Aftermarket	1	<b>LR002338P</b>	3.25	3.90
OEM	1	<b>LR002338P1</b>	5.63	6.76
Genuine	1	<b>LR002338</b>	9.95	11.94

All 5.0L NA and supercharged V8 petrol models - Element

Genuine	1	<b>LR011279</b>	22.43	26.92
---------	---	-----------------	-------	-------

All 5.0L supercharged V8 petrol models - Element

Genuine	1	<b>LR011279</b>	22.43	26.92
---------	---	-----------------	-------	-------

### Air Filter

All 3.0L V6 diesel models

Aftermarket	1	<b>PHE000112P</b>	5.83	7.00
OEM	1	<b>PHE000112P1</b>	7.08	8.50
Genuine	1	<b>PHE000112</b>	21.76	26.11

All 3.6L TDV8 diesel engine models

Aftermarket	1	<b>PHE000112P</b>	5.83	7.00
OEM	1	<b>PHE000112P1</b>	7.08	8.50
Genuine	1	<b>PHE000112</b>	21.76	26.11

All 5.0L V8 normally aspirated petrol models from (VIN) AA000001 on

Aftermarket	1	<b>LR011593P</b>	5.63	6.76
Genuine	1	<b>LR011593</b>	24.55	29.46

All 5.0L V8 supercharged petrol models from (VIN) AA000001 on

Aftermarket	1	<b>LR011593P</b>	5.63	6.76
Genuine	1	<b>LR011593</b>	24.55	29.46

### Fuel Filter

All 3.0L V6 diesel models

Aftermarket	1	<b>LR009705P</b>	18.54	22.25
OEM	1	<b>LR009705P1</b>	38.75	46.50
Genuine	1	<b>LR009705</b>	42.05	50.46

All 3.6L TDV8 diesel models (VIN) AA000001 on

Aftermarket	1	<b>LR009705P</b>	18.54	22.25
OEM	1	<b>LR009705P1</b>	38.75	46.50
Genuine	1	<b>LR009705</b>	42.05	50.46



### Pollen Filter

All models

Fresh air	Aftermarket	1	<b>JKR500010P</b>	3.83	4.60
	OEM	1	<b>JKR500010P1</b>	9.17	11.00
	Genuine	1	<b>JKR500010</b>	28.01	33.61

Odour & particles, production replacement type

Aftermarket	1	<b>LR023977P</b>	4.00	4.80
OEM	1	<b>LR023977P1</b>	14.17	17.00
Genuine	1	<b>LR023977</b>	36.92	44.30

### Oil Filter For Standard Gearbox Oil Sump

All 6 speed automatic models

Bearmach	1	<b>LR007474PF</b>	10.83	13.00
----------	---	-------------------	-------	-------

### Gearbox Oil Sump Easy Fit Conversion Kit

All 6 speed automatic models

Includes metal sump, separate oil filter, gasket and 'O' ring

OEM	1	<b>LR007474BPKITEFOEM</b>	130.00	156.00
-----	---	---------------------------	--------	--------

### Oil Filter For Easy Fit Gearbox Sump

All 6 speed automatic models

OEM	1	<b>LR007474BPEFOEM</b>	29.58	35.50
-----	---	------------------------	-------	-------

### Gearbox Oil Sump Easy Fit Conversion Kit

All 6 speed automatic models

Includes metal sump, separate oil filter, gasket and 'O' ring

Britpart	1	<b>LR007474BPKITEF</b>	72.50	87.00
----------	---	------------------------	-------	-------

### Oil Filter For Easy Fit Gearbox Sump

All 6 speed automatic models

Britpart	1	<b>LR007474BPEF</b>	11.67	14.00
----------	---	---------------------	-------	-------

### Gasket For Gearbox Oil Sump Easy Fit Conversion

All 6 speed automatic models

Britpart	1	<b>LR007474BPKITEFG</b>	6.67	8.00
----------	---	-------------------------	------	------

### Gearbox Fluid Change Kit

All 6 speed automatic models

Includes essential items for fluid change on the 6 speed automatic gearbox (ZF models 6HP26 and 6HP28) - auto trans fluid, standard sump assembly with sleeve and plugs, sump attachment screws

Britpart	1	<b>LR007474BPKIT</b>	130.00	156.00
----------	---	----------------------	--------	--------



## WIPER BLADES

### Wiper Blade

All RHD models - Front

Aftermarket	2	<b>LR018368P</b>	6.67	8.00
OEM	2	<b>LR018368P1</b>	11.67	14.00
Genuine	2	<b>LR018368</b>	21.02	25.22

All LHD models - Front

Aftermarket	2	<b>LR018367P</b>	5.00	6.00
OEM	2	<b>LR018367P1</b>	7.92	9.50
Genuine	2	<b>LR018367</b>	24.19	29.03

All models - Rear

OEM	1	<b>DKB500710P1</b>	3.92	4.70
Genuine	1	<b>DKB500710</b>	29.12	34.94

## RANGE ROVER SPORT L320 (2010-2013)



## RANGE ROVER SPORT L320 (2010-2013)

## SCREEN/LAMP WASHER SYSTEMS

## Non-Heated Washer Jet

All models without heated washer jets				
Front screen wash	Genuine	2	LR049290	3.41 4.09

## Heated Washer Jet

All models with heated washer jets				
Front screen wash	Genuine	2	LR048615	14.29 17.15

## Washer Jet

All models with headlamp wash from (VIN) AA000001 on LH headlamp				
	Aftermarket	1	LR015359P	12.08 14.50
	Genuine	1	LR015359	21.76 26.11

## Washer Jet Retaining Clip

All models with headlamp wash				
Headlamp jet to bumper	Genuine	2	DYC000190	1.80 2.16

## Washer Jet, With Hose

All models - Rear screen wash				
	Genuine	1	LR032197	6.04 7.25

## Non-Return Valve

All models with headlamp wash from (VIN) AA000001 on Headlamp wash				
	Genuine	1	LR014288	4.82 5.78

## Washer Hose, Per Metre

All models - 4mm internal diameter (3mm also available), Front or rear screen wash				
	Aftermarket	a/r	GW201M	2.25 2.70

## Washer Hose Assembly &amp; Elbows

All models - Front screen wash				
	Genuine	1	DNH000133	8.98 10.78

## Washer Hose Assembly

All models with headlamp wash				
Headlamp wash	Genuine	1	DNH500100	25.44 30.53

## Washer Hose Y Piece

All models - Front screen wash				
	Genuine	1	DNG000010	17.40 20.88

## Washer Jet Elbow

All models - Front screen wash				
	Genuine	1	DNG10001	2.01 2.41

## Washer Reservoir

All models without headlamp wash from (VIN) AA000001 on Front & rear screen wash				
	Genuine	1	LR013954	55.95 67.14
All models with headlamp wash from (VIN) AA000001 on Front & rear screen & headlamp wash				
	Genuine	1	LR013953	45.94 55.13

## Filler Neck Cap

All models				
Front & rear screen & headlamp wash	Genuine	1	LR002266	1.86 2.23

## Washer Reservoir Level Sensor

All models				
Front & rear screen & headlamp wash	Genuine	1	DMI500010	4.20 5.04

## Washer Reservoir Filler Neck

All models				
Front & rear screen & headlamp wash	Genuine	1	LR013955	18.77 22.52

## Windscreen Cleaning Paste

All models				
Prevents wiper blade judder/squeak by 'deep cleaning' the windscreen (ref: Land Rover Tech Bulletin LRA501-002)				
	Genuine	a/r	DNJ500340	7.72 9.26

## RANGE ROVER SPORT L320 (2010-2013)

## DRIVE BELTS

## Timing Belt Kit

All models with 3.0L TDV6/SDV6 diesel engine				
Fuel pump drive	Genuine	1	LR016656	113.96 136.75

## Alternator Drive Belt

All models with 3.0L V6 diesel engine without Roll Stability Control - Alternator				
	Genuine	1	LR013697	29.26 35.11
All models with 3.0L V6 diesel engine and Roll Stability Control - Alternator				
	Genuine	1	LR018312	34.43 41.32

## Primary Drive Belt

3.6L TDV8 diesel models with active cornering enhancement - Primary				
	OEM	1	PQS500450P1	11.67 14.00
	Genuine	1	PQS500450	24.36 29.23
5.0L V8 normally aspirated V8 petrol models from (VIN) AA000001 on - Primary				
	OEM	1	LR064185P1	13.13 15.76
	Genuine	1	LR064185	27.20 32.64
5.0L V8 supercharged V8 petrol models with roll stability control from (VIN) AA000001 on - Primary				
	OEM	1	LR012625P1	14.38 17.26
	Genuine	1	LR012625	27.52 33.02

## Secondary Drive Belt

All models with 3.6L V8 diesel engine and active cornering enhancement - Secondary				
	OEM	1	PQS500460P1	7.08 8.50
	Genuine	1	PQS500460	12.94 15.53
All models with 5.0L normally aspirated V8 petrol engine - Secondary				
	Aftermarket	1	LR012663P	5.63 6.76
	Genuine	1	LR012663	21.54 25.85

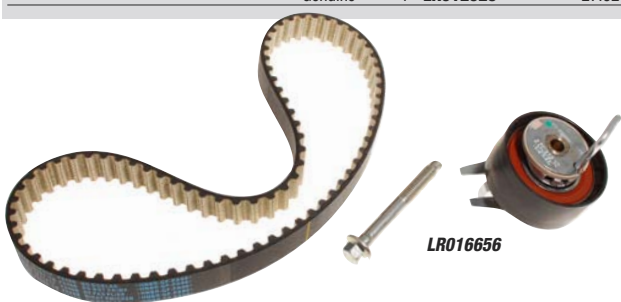

LR016656

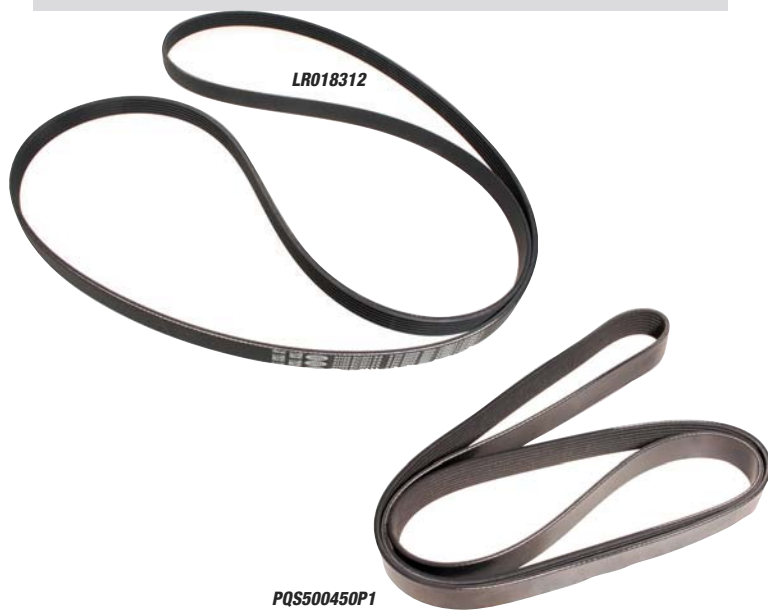

LR018312

PQS500450P1

## RANGE ROVER SPORT L320 (2010-2013)

## IGNITION SYSTEM

## Spark Plug

All 5.0L N/A AJV8 petrol models				
	OEM	8	LR032080P1	7.50 9.00
	Genuine	8	LR032080	13.33 16.00
All 5.0L supercharged AJV8 petrol models				
	OEM	8	LR032080P1	7.50 9.00
	Genuine	8	LR032080	13.33 16.00

## Glow Plug

All 3.0L V6 diesel models				
	Genuine	6	LR013275	29.96 35.95
All 3.6L V8 diesel engine models				
	OEM	8	1354289P1	8.54 10.25
	Genuine	8	1354289	12.71 15.25

## Ignition Coil

All models with 5.0L NA AJV8 petrol engine				
	Aftermarket	8	LR010687P	36.67 44.00
	Genuine	8	LR010687	55.63 66.76
All models with 5.0L supercharged AJV8 petrol engine				
	Aftermarket	8	LR010687P	36.67 44.00
	Genuine	8	LR010687	55.63 66.76



LR032080

LR013275

# BRAKING SYSTEM

# RANGE ROVER SPORT L320 (2010-2013)

## Brake Pad Set

All models except 5.0L supercharged V8 petrol from (VIN) AA000001 on				
Front Brakes	OEM	1	<b>LR051626P1</b>	42.50 51.00
	Genuine	1	<b>LR051626</b>	133.84 160.61
All models with 5.0L supercharged V8 petrol engine from (VIN) AA000001 on				
Front Brakes	OEM	1	<b>LR064181P1</b>	56.67 68.00
	Genuine	1	<b>LR064181</b>	215.52 258.62
All 3.6L TDV8 diesel models from (VIN) AA257941 on				
Rear Brakes	Aftermarket	1	<b>LR055454P</b>	15.63 18.76
	Brembo	1	<b>LR055454BREMBO</b>	34.35 41.22
	OEM	1	<b>LR055454P1</b>	18.54 22.25
	Genuine	1	<b>LR055454</b>	48.11 57.73
Rear Brakes, Green Stuff	EBC	1	<b>LR055454GS</b>	41.67 50.00
5.0L NA V8 petrol & 3.0L V6 diesel models (VIN) AA000001 to AA257940				
Rear Brakes	OEM	1	<b>LR015519P1</b>	32.50 39.00
	Genuine	1	<b>LR015519</b>	79.53 95.44
5.0L NA V8 petrol & 3.0L V6 diesel models (VIN) AA257941 on				
Rear Brakes	Aftermarket	1	<b>LR055454P</b>	15.63 18.76
	Brembo	1	<b>LR055454BREMBO</b>	34.35 41.22
	OEM	1	<b>LR055454P1</b>	18.54 22.25
	Genuine	1	<b>LR055454</b>	48.11 57.73
Rear Brakes, Green Stuff	EBC	1	<b>LR055454GS</b>	41.67 50.00
All 5.0L supercharged V8 petrol models				
Rear Brakes	OEM	1	<b>LR025739P1</b>	27.50 33.00
	Genuine	1	<b>LR025739</b>	79.25 95.10

## Retaining Spring Kit

All models with 3.0L TDV6/SDV6 diesel engine from (VIN) AA257941 on				
Rear Brake Pads	Aftermarket	1	<b>LR019626P</b>	2.17 2.60
	Genuine	1	<b>LR019626</b>	4.21 5.05
3.6L V8 diesel engine from (VIN) AA257941 on				
Rear Brake Pads	Aftermarket	1	<b>LR019626P</b>	2.17 2.60
	Genuine	1	<b>LR019626</b>	4.21 5.05
5.0L SGLI NA V8 petrol engine from (VIN) AA257941 on				
Rear Brake Pads	Aftermarket	1	<b>LR019626P</b>	2.17 2.60
	Genuine	1	<b>LR019626</b>	4.21 5.05

## Brake Pad Fitting Kit

All 3.6L TDV8 diesel models with 19 front/18 rear brakes				
Front	Genuine	1	<b>SEE500080</b>	18.55 22.26
All 5.0L supercharged V8 petrol models				
Front	Genuine	1	<b>LR016683</b>	42.14 50.57

## Brake Pad Clips

All models from (VIN) AA0000001 - Front	Genuine	1	<b>LR026219</b>	29.96 35.95
-----------------------------------------	---------	---	-----------------	-------------

## Brake Disc

All models with 3.0L V6 diesel engine				
Front	Aftermarket	2	<b>SDB000624P</b>	25.00 30.00
	Brembo	2	<b>SDB000624BREMBO</b>	53.33 64.00
	Genuine	2	<b>SDB000624</b>	73.14 87.77
Rear	Aftermarket	2	<b>SDB000646P</b>	18.75 22.50
	Genuine	2	<b>SDB000646</b>	40.09 48.11
Rear (pair)	Brembo	1	<b>SDB000646BREMBO</b>	88.33 106.00
All models with 3.6L V8 diesel engine				
Front	Aftermarket	2	<b>SDB000624P</b>	25.00 30.00
	Brembo	2	<b>SDB000624BREMBO</b>	53.33 64.00
	Genuine	2	<b>SDB000624</b>	73.14 87.77
Rear	Aftermarket	2	<b>SDB000646P</b>	18.75 22.50
	Genuine	2	<b>SDB000646</b>	40.09 48.11
Rear (pair)	Brembo	1	<b>SDB000646BREMBO</b>	88.33 106.00
5.0L SGLI NA V8 petrol engine from (VIN) AA000001 on				
Front	Aftermarket	2	<b>SDB000624P</b>	25.00 30.00
	Brembo	2	<b>SDB000624BREMBO</b>	53.33 64.00
	Genuine	2	<b>SDB000624</b>	73.14 87.77
Rear	Aftermarket	2	<b>SDB000646P</b>	18.75 22.50
	Genuine	2	<b>SDB000646</b>	40.09 48.11
Rear (pair)	Brembo	1	<b>SDB000646BREMBO</b>	88.33 106.00
All 5.0L supercharged V8 petrol models from (VIN) AA000001 on				
Front, vented	OEM	2	<b>LR016176P1</b>	60.00 72.00
	Genuine	2	<b>LR016176</b>	83.69 100.43
Rear, vented	OEM	2	<b>LR016192P1</b>	46.67 56.00
	Genuine	2	<b>LR016192</b>	71.08 85.30

## Performance Brake Disc (pair)

All models with 3.0L V6 diesel engine				
Front, slotted & drilled	Britpart	1	<b>SDB000624URBP</b>	70.00 84.00
Rear, slotted & drilled	Britpart	1	<b>SDB000646URBP</b>	60.00 72.00
All models with 3.6L V8 diesel engine				
Front, slotted & drilled	Britpart	1	<b>SDB000624URBP</b>	70.00 84.00
Rear, slotted & drilled	Britpart	1	<b>SDB000646URBP</b>	60.00 72.00
5.0L SGLI NA V8 petrol engine from (VIN) AA000001 on				
Front, slotted & drilled	Britpart	1	<b>SDB000624URBP</b>	70.00 84.00
Rear, slotted & drilled	Britpart	1	<b>SDB000646URBP</b>	60.00 72.00
All 5.0L supercharged V8 petrol models from (VIN) AA000001 on				
Rear, vented, slotted & drilled	Britpart	1	<b>LR016192BPUR</b>	57.50 69.00

## Mudshield Brake Disc

All models from (VIN) AA000001 on				
Front RH	Genuine	1	<b>LR013665</b>	39.50 47.40
Front LH	Genuine	1	<b>LR013666</b>	39.44 47.33

## Back Plate

All models from (VIN) DA796536				
Rear RH	Genuine	1	<b>LR048810</b>	49.92 59.90
Rear LH	Genuine	1	<b>LR048812</b>	49.92 59.90

## Brake Caliper

3.0L V6 diesel models (VIN) AA000001 on				
Front, RH	OEM*	1	<b>LR047906P1</b>	198.33 238.00
	*Exchange Surcharge			35.00 42.00
	Genuine*	1	<b>LR047906</b>	292.45 350.94
	*Exchange Surcharge			100.00 120.00
Front, LH	OEM*	1	<b>LR047905P1</b>	198.33 238.00
	*Exchange Surcharge			35.00 42.00
	Genuine*	1	<b>LR047905</b>	295.38 354.46
	*Exchange Surcharge			100.00 120.00
All 3.6L TDV8 diesel models (VIN) AA000001 on				
Front, RH	OEM*	1	<b>LR047906P1</b>	198.33 238.00
	*Exchange Surcharge			35.00 42.00
	Genuine*	1	<b>LR047906</b>	292.45 350.94
	*Exchange Surcharge			100.00 120.00
Front, LH	OEM*	1	<b>LR047905P1</b>	198.33 238.00
	*Exchange Surcharge			35.00 42.00
	Genuine*	1	<b>LR047905</b>	295.38 354.46
	*Exchange Surcharge			100.00 120.00
5.0L V8 NA petrol models (VIN) AA000001 on				
Front, RH	OEM*	1	<b>LR047906P1</b>	198.33 238.00
	*Exchange Surcharge			35.00 42.00
	Genuine*	1	<b>LR047906</b>	292.45 350.94
	*Exchange Surcharge			100.00 120.00
Front, LH	OEM*	1	<b>LR047905P1</b>	198.33 238.00
	*Exchange Surcharge			35.00 42.00
	Genuine*	1	<b>LR047905</b>	295.38 354.46
	*Exchange Surcharge			100.00 120.00
3.0L V6 diesel models (VIN) AA000001 to (VIN) AA257940				
Rear, RH	OEM*	1	<b>LR015524P1</b>	67.95 81.54
	*Exchange Surcharge			30.00 36.00
	Genuine*	1	<b>LR015524</b>	148.18 177.82
	*Exchange Surcharge			90.00 108.00
Rear, LH	OEM*	1	<b>LR015586P1</b>	67.95 81.54
	*Exchange Surcharge			30.00 36.00
	Genuine*	1	<b>LR015586</b>	148.18 177.82
	*Exchange Surcharge			90.00 108.00
3.0L TDV6 diesel models (VIN) AA257941 on				
Rear, RH	Aftermarket	1	<b>SOB500042P</b>	50.00 60.00
	Genuine*	1	<b>SOB500042</b>	129.29 155.15
	*Exchange Surcharge			50.00 60.00
Rear, LH	Aftermarket	1	<b>SOB500052P</b>	50.00 60.00
	Genuine*	1	<b>SOB500052</b>	129.29 155.15
	*Exchange Surcharge			50.00 60.00
All 3.6L TDV8 diesel models (VIN) AA000001 to (VIN) AA257940				
Rear, RH	OEM*	1	<b>LR015524P1</b>	67.95 81.54
	*Exchange Surcharge			30.00 36.00
	Genuine*	1	<b>LR015524</b>	148.18 177.82
	*Exchange Surcharge			90.00 108.00
Rear, LH	OEM*	1	<b>LR015586P1</b>	67.95 81.54
	*Exchange Surcharge			30.00 36.00
	Genuine*	1	<b>LR015586</b>	148.18 177.82
	*Exchange Surcharge			90.00 108.00
3.6L TDV8 diesel models (VIN) AA257941 on				
Rear, RH	Aftermarket	1	<b>SOB500042P</b>	50.00 60.00
	Genuine*	1	<b>SOB500042</b>	129.29 155.15
	*Exchange Surcharge			50.00 60.00
Rear, LH	Aftermarket	1	<b>SOB500052P</b>	50.00 60.00
	Genuine*	1	<b>SOB500052</b>	129.29 155.15
	*Exchange Surcharge			50.00 60.00
5.0L V8 NA petrol models (VIN) AA000001 to (VIN) AA257940				
Rear, RH	OEM*	1	<b>LR015524P1</b>	67.95 81.54
	Exchange Surcharge			30.00 36.00
	Genuine*	1	<b>LR015524</b>	148.18 177.82
	*Exchange Surcharge			90.00 108.00
Rear, LH	OEM*	1	<b>LR015586P1</b>	67.95 81.54
	*Exchange Surcharge			30.00 36.00
	Genuine*	1	<b>LR015586</b>	148.18 177.82
	*Exchange Surcharge			90.00 108.00
5.0L V8 NA petrol models (VIN) AA257941 on				
Rear, RH	Aftermarket	1	<b>SOB500042P</b>	50.00 60.00
	Genuine*	1	<b>SOB500042</b>	129.29 155.15
	*Exchange Surcharge			50.00 60.00
Rear, LH	Aftermarket	1	<b>SOB500052P</b>	50.00 60.00
	Genuine*	1	<b>SOB500052</b>	129.29 155.15
	*Exchange Surcharge			50.00 60.00
5.0L V8 supercharged petrol models (VIN) AA000001 on				
Rear, RH	Genuine*	1	<b>LR015581</b>	281.30 337.56
	*Exchange Surcharge			100.00 120.00
Rear, LH	Genuine*	1	<b>LR015583</b>	281.30 337.56
	*Exchange Surcharge			100.00 120.00

## Brake Caliper Carrier

All models from (VIN) AA000001				
Front RH	Genuine	1	<b>LR020369</b>	91.35 109.62
Front LH	Genuine	1	<b>LR020371</b>	91.35 109.62
All models from (VIN) AA000001 to (VIN) AA257940				
Rear RH	Genuine	1	<b>LR015521</b>	80.89 97.07
Rear LH	Genuine	1	<b>LR015522</b>	93.84 112.61
3.0L TDV6 diesel models (VIN) AA257941 on				
Rear, RH and LH	OEM	2	<b>SXP500060P1</b>	60.00 72.00
3.6L TDV8 diesel models (VIN) AA257941 on				
Rear, RH and LH	OEM	2	<b>SXP500060P1</b>	60.00 72.00
5.0L V8 NA petrol models (VIN) AA257941 on				
Rear, RH and LH	OEM	2	<b>SXP500060P1</b>	60.00 72.00
All models from (VIN) BA716232				
Rear RH	Genuine	1	<b>LR032058</b>	93.41 112.09
Rear LH	Genuine	1	<b>LR032059</b>	93.41 112.09

## Brake Caliper Fixing Kit

All models except 5.0L supercharged V8 petrol from (VIN) AA257941 to BA716231				
Rear brakes	Aftermarket	2	<b>SMN500040P</b>	6.87 8.24
	OEM	2	<b>SMN500040P1</b>	7.50 9.00
	Genuine	2	<b>SMN500040</b>	13.06 15.67





## RANGE ROVER SPORT L320 (2010-2013)

## BRAKING SYSTEM

## Brake Caliper Piston

3.0L 24V DOHC V6 TC Diesel from (VIN) AA257941 on				
Rear, Vented Disc Brakes	Aftermarket	2	<b>STC1908P</b>	4.08 4.90
	Genuine	2	<b>STC1908</b>	18.49 22.19
3.6L V8 32V DOHC Diesel Lion from (VIN) AA257941 on				
Rear, Vented Disc Brakes	Aftermarket	2	<b>STC1908P</b>	4.08 4.90
	Genuine	2	<b>STC1908</b>	18.49 22.19
5.0L OHC SGDI NA V8 Petrol from (VIN) AA257941 on				
Rear, Vented Disc Brakes	Aftermarket	2	<b>STC1908P</b>	4.08 4.90
	Genuine	2	<b>STC1908</b>	18.49 22.19

## Slider Pin Bolt

All models except 5.0L supercharged V8 petrol from (VIN) AA000001 on				
Front	Genuine	4	<b>SMV500010</b>	1.33 1.60
All 5.0L supercharged V8 petrol models (VIN) AA000001 on				
Rear	Genuine	4	<b>SMV500010</b>	1.33 1.60

## Dust Cover

All models - For carrier retaining pins front & rear				
	Aftermarket	4	<b>SEE500030P</b>	5.00 6.00
	Genuine	4	<b>SEE500030</b>	7.88 9.46

## Caliper Pin &amp; Boot Kit

All models from (VIN) AA000001				
Front Brake Caliper	Genuine	2	<b>LR020489</b>	13.13 15.76
All 3.0L 24V DOHC V6 TC diesel models from (VIN) BA716232				
Rear Brake Caliper	Genuine	2	<b>LR020489</b>	13.13 15.76
All 3.6L DOHC 32V V8 models from (VIN) BA716232				
Rear Brake Caliper	Genuine	2	<b>LR020489</b>	13.13 15.76
All 5.0L OHC SGDI NA V8 petrol engine models from (VIN) BA716232				
Rear Brake Caliper	Genuine	2	<b>LR020489</b>	13.13 15.76
All 5.0L OHC SGDI SC V8 models from (VIN) AA000001				
Rear	Genuine	2	<b>LR017032</b>	13.13 15.76

## Dust Cap Bleed Screw

All models - Front & rear caliper				
	Genuine	2	<b>SEE500100</b>	0.94 1.13

## Brake Master Cylinder

All RHD models (VIN) AA000001 on				
	OEM	1	<b>LR014570P1</b>	110.00 132.00
	Genuine	1	<b>LR014570</b>	147.68 177.22

## Reservoir for Master Cylinder

All models from (VIN) AA000001 - includes cap				
	Genuine	1	<b>LR015518</b>	34.81 41.77

## Brake Servo Assembly

All models from (VIN) AA000001				
	OEM	1	<b>LR014571P1</b>	195.00 234.00
	Genuine	1	<b>LR014571</b>	236.82 284.18

## Cap for Master Cylinder Reservoir

All models from (VIN) AA000001				
	Genuine	1	<b>LR012971</b>	21.24 25.49

## Caliper Repair Kit

All models with 3.0L TDV6 diesel engine from (VIN) AA000001 on				
Front, for one caliper	OEM	2	<b>LR015580P1</b>	6.67 8.00
All models with 3.6L TDV8 diesel engine from (VIN) AA000001 on				
Front, for one caliper	OEM	2	<b>LR015580P1</b>	6.67 8.00
All models with 5.0L NA AJV8 petrol engine from (VIN) AA000001 on				
Front, for one caliper	OEM	2	<b>LR015580P1</b>	6.67 8.00
All models with 3.0L TDV6 diesel engine up to (VIN) AA257940				
Rear, for one caliper	OEM	2	<b>LR015520P1</b>	7.25 8.70
All models with 3.0L TDV6 diesel engine (VIN) AA257941 on				
Rear, for one caliper	Aftermarket	2	<b>SMN500030P</b>	6.04 7.25
	OEM	2	<b>SMN500030P1</b>	4.95 5.94
	Genuine	2	<b>SMN500030</b>	11.94 14.33
All models with 3.6L TDV8 diesel engine (VIN) AA000001 to AA257940				
Rear, for one caliper	OEM	2	<b>LR015520P1</b>	7.25 8.70
All models with 3.6L TDV8 diesel engine (VIN) AA257941 on				
Rear, for one caliper	Aftermarket	2	<b>SMN500030P</b>	6.04 7.25
	OEM	2	<b>SMN500030P1</b>	4.95 5.94
	Genuine	2	<b>SMN500030</b>	11.94 14.33
All models with 5.0L NA AJV8 petrol engine up to (VIN) AA257940				
Rear, for one caliper	OEM	2	<b>LR015520P1</b>	7.25 8.70
All models with 5.0L NA AJV8 petrol engine (VIN) AA257941 on				
Rear, for one caliper	Aftermarket	2	<b>SMN500030P</b>	6.04 7.25
	OEM	2	<b>SMN500030P1</b>	4.95 5.94
	Genuine	2	<b>SMN500030</b>	11.94 14.33
All models with 5.0L supercharged AJV8 petrol engine				
Rear, for one caliper	OEM	2	<b>LR015520P1</b>	7.25 8.70

## Master Cylinder Repair Kit

All LHD models from (VIN) AA000001				
	OEM	1	<b>LR014569P1</b>	140.00 168.00
	Genuine	1	<b>LR014569</b>	180.17 216.20

## ABS Sensor

All models from (VIN) AA000001				
Front brakes				
	Aftermarket	2	<b>SSB500133P</b>	14.17 17.00
	OEM	2	<b>SSB500133P1</b>	21.50 25.80
	Genuine	2	<b>SSB500133</b>	25.97 31.16
Rear brakes				
	Aftermarket	2	<b>SSB500102P</b>	18.13 21.76
	OEM	2	<b>SSB500102P1</b>	20.00 24.00
	Genuine	2	<b>SSB500102</b>	96.20 115.44

## Brake Pad Wear Sensor

3.0L V6 diesel from (VIN) AA000001 on				
Front brakes				
	Aftermarket	1	<b>SEM500080P</b>	6.04 7.25
	OEM	1	<b>SEM500080P1</b>	8.13 9.76
	Genuine	1	<b>SEM500080</b>	18.76 22.51
3.6L V8 diesel Lion from (VIN) AA000001 on				
Front brakes				
	Aftermarket	1	<b>SEM500080P</b>	6.04 7.25
	OEM	1	<b>SEM500080P1</b>	8.13 9.76
	Genuine	1	<b>SEM500080</b>	18.76 22.51
5.0L NA V8 petrol from (VIN) AA000001 on				
Front brakes				
	Aftermarket	1	<b>SEM500080P</b>	6.04 7.25
	OEM	1	<b>SEM500080P1</b>	8.13 9.76
	Genuine	1	<b>SEM500080</b>	18.76 22.51
All 5.0L supercharged V8 petrol models from (VIN) AA000001 on				
Front brakes				
	Aftermarket	1	<b>LR019401P</b>	4.95 5.94
	OEM	1	<b>LR019401P1</b>	8.13 9.76
	Genuine	1	<b>LR019401</b>	18.76 22.51
All models				
Rear brakes				
	Aftermarket	1	<b>SOE000025P</b>	3.50 4.20
	OEM	1	<b>SOE000025P1</b>	8.13 9.76
	Genuine	1	<b>SOE000025</b>	10.54 12.65

## Brake Hose

All models				
Front, RH				
	OEM	1	<b>LR058021P1</b>	19.79 23.75
	Genuine	1	<b>LR058021</b>	41.88 50.26
Front, LH				
	OEM	1	<b>LR058020P1</b>	21.50 25.80
	Genuine	1	<b>LR058020</b>	40.54 48.65
Rear, outer, to caliper				
	OEM	2	<b>LR058009P1</b>	8.33 10.00
	Genuine	2	<b>LR058009</b>	14.48 17.38
Rear, inner				
	OEM	2	<b>LR058010P1</b>	6.67 8.00
	Genuine	2	<b>LR058010</b>	28.81 34.57
All RHD diesel models - Union to servo				
	Genuine	1	<b>LR019757</b>	8.70 10.44
All LHD diesel engine models from (VIN) BA71915				
Vacuum Pump to servo	Genuine	1	<b>LR018335</b>	14.76 17.71

## Brake Pipe Clip

All models				
	Genuine	a/r	<b>ANR1864</b>	1.16 1.39

## Brake Pipe Connector

All models				
Rear, 2 - way				
	Genuine	a/r	<b>BMK2466</b>	4.41 5.29
Rear, 4 - way				
	Genuine	a/r	<b>SGH100050</b>	29.02 34.82

## Brake Shoe Set - Handbrake

All models				
Handbrake				
	Aftermarket	1	<b>LR031947KITP</b>	6.04 7.25
Handbrake (includes pins & clips)				
	Aftermarket	1	<b>LR031947P1</b>	42.50 51.00
Handbrake (no pins or clips)				
	Aftermarket	1	<b>LR031947NPCP1</b>	29.58 35.50
	Genuine	1	<b>LR031947</b>	64.15 76.98

## Handbrake Shoe Fixing Kit

All models				
	Genuine	1	<b>SMN500012</b>	7.23 8.68

## Spring Retention Kit

All models from (VIN) BA701292, Handbrake				
	Genuine	1	<b>LR031944</b>	11.78 14.14

## Actuating Rod Kit Handbrake

All models - includes 2 rods				
	Genuine	1	<b>SXR500010</b>	9.62 11.54

## Actuating Rod Handbrake

All models from (VIN) BA701292, Handbrake				
	Genuine	1	<b>LR031946</b>	9.34 11.21

## Parking Brake Bracket

All models				
RH				
	Genuine	1	<b>SPU500040</b>	8.80 10.56
LH				
	Genuine	1	<b>SPU500050</b>	8.80 10.56

## Handbrake Cable

All models from (VIN) AA000001				
RH rear				
	Genuine	1	<b>LR018469</b>	73.41 88.09
LH rear				
	Genuine	1	<b>LR018470</b>	88.73 106.48

## Handbrake Cable Boot

All models - cable to rear brake				
	Genuine	1	<b>YPV500380</b>	2.77 3.32

## Clip Brake Cable Support

All models				
	Genuine	a/r	<b>SPV500020</b>	0.53 0.64

## Handbrake Cable Clip

All models - Circlip, 'E' type, cable to rear brake				
	Genuine	a/r	<b>SPV500030</b>	0.57 0.68

## ABS Yaw Rate Sensor

All models from (VIN) AA000001 on				
	Genuine	1	<b>LR011785</b>	287.53 345.04

## Brake Light Switch

All models from (VIN) DA814632				
	Genuine	1	<b>LR072647</b>	15.04 18.05

## Brake Pedal Rubber

All models				
	Genuine	1	<b>SKE500010</b>	10.06 12.07



# SUSPENSION

## Bush Front Upper Arm

All models					
Standard bush	OEM	2	<b>LR051625P1</b>	5.63	6.76
	Genuine	2	<b>LR051625</b>	7.85	9.42
Rubber bush, forward	Aftermarket	1	<b>LR051585P</b>	4.79	5.75
	OEM	1	<b>LR051585P1</b>	9.79	11.75
	Genuine	1	<b>LR051585</b>	40.09	48.11
All models (VIN) AA222240 on					
Standard bush, inner, forward	Aftermarket	2	<b>LR051611P</b>	7.08	8.50
	OEM	2	<b>LR051611P1</b>	13.54	16.25
	Genuine	2	<b>LR051611</b>	40.43	48.52

## Bush Lower Arm

All models (VIN) AA000001 on					
Front bush, front lower arm	Aftermarket	1	<b>LR055288P</b>	4.58	5.50
	Genuine	1	<b>LR055288</b>	43.34	52.01
All models up to (VIN) AA262641					
Front suspension, rear hydrabush	Aftermarket	2	<b>LR055291P</b>	10.33	12.40
	OEM	2	<b>LR055291P1</b>	21.67	26.00
	Genuine	2	<b>LR055291</b>	48.15	57.78

## Bush Rear Lower Arm

All models					
Standard bush, inner, rearward	OEM	2	<b>LR054831P1</b>	7.50	9.00
	Genuine	2	<b>LR054831</b>	24.01	28.81
Rubber bush, inner, rearward	Aftermarket	2	<b>LR051616P</b>	6.67	8.00
	OEM	2	<b>LR051616P1</b>	15.00	18.00
	Genuine	2	<b>LR051616</b>	27.17	32.60
Standard bush, inner, forward	Aftermarket	2	<b>LR063744P</b>	5.63	6.76
	Genuine	2	<b>LR063744</b>	6.42	7.70

## Bush Upper Arm

All models					
Rear suspension, ball joint type	OEM	2	<b>RHF500130P1</b>	18.54	22.25
	Genuine	2	<b>RHF500130</b>	44.11	52.93

## Bush Front Lower Arm

All models					
Poly. bush, forward	Polybush	2	<b>LR051585POLY</b>	31.67	38.00
Standard bush, inner, forward, poly. Dynamic orange (pair)	Polybush	1	<b>LR051611POLY</b>	60.00	72.00

## Bush Rear Lower Arm (pair)

All models - poly. bush, inner, rearward	Polybush	1	<b>LR054831POLY</b>	29.58	35.50
------------------------------------------	----------	---	---------------------	-------	-------

## Bush Rear Upper Arm (pair)

All models - poly. bush, inner, rearward, poly. Dynamic orange	Polybush	1	<b>LR051616POLY</b>	45.00	54.00
----------------------------------------------------------------	----------	---	---------------------	-------	-------

## Bush Anti Roll Bar Mounting

All models without Roll Stability Control					
Rear anti roll bar, poly.	Polybush	2	<b>LR018354POLY</b>	15.00	18.00
All models with roll stability control and active cornering enhancement					
Front, poly.	Polybush	2	<b>RVU500011POLYBUSH</b>	15.00	18.00

## Anti Roll Bar

All models with roll stability control and active cornering enhancement from (VIN) CA731504 on					
Front	OEM	1	<b>LR032959P1</b>	600.00	720.00
	Genuine	1	<b>LR032959</b>	1079.68	1295.62
All 3.0L 24V DOHC models with roll stability control (with ACE suspension) from (VIN) AA258698 on					
Rear	OEM	1	<b>LR024073P1</b>	600.00	720.00
	Genuine	1	<b>LR024073</b>	1094.04	1312.85
All 3.6L V8 32V DOHC diesel models with roll stability control (with ACE suspension) from (VIN) AA258698 on					
Rear	OEM	1	<b>LR024072P1</b>	600.00	720.00
	Genuine	1	<b>LR024072</b>	1091.86	1310.23
All 5.0L OHC SGDI SC V8 models with roll stability control (with ACE suspension) from (VIN) AA258698 on					
Rear	OEM	1	<b>LR024072P1</b>	600.00	720.00
	Genuine	1	<b>LR024072</b>	1091.86	1310.23

## Anti Roll Bar Link

All models					
Front, RH	Aftermarket	1	<b>RBM500140P</b>	6.67	8.00
	Genuine	1	<b>RBM500140</b>	22.94	27.53
Front, LH	Aftermarket	1	<b>RBM500150P</b>	6.67	8.00
	Genuine	1	<b>RBM500150</b>	22.94	27.53
All models without roll stability control or active cornering enhancement					
Rear	Aftermarket	2	<b>RGD000312P</b>	4.17	5.00
	Genuine	2	<b>RGD000312</b>	18.95	22.74
All models with roll stability control and active cornering enhancement					
Rear	Genuine	2	<b>RGD500140</b>	20.70	24.84



LR032959P1

# RANGE ROVER SPORT L320 (2010-2013)

## Mounting Bush, Anti Roll Bar

All models without active roll bar system					
Front	Genuine	2	<b>RBX500280</b>	2.55	3.06
All models without Roll Stability Control					
Front anti roll bar	Aftermarket	2	<b>LR018347P</b>	4.08	4.90
	Genuine	2	<b>LR018347</b>	8.68	10.42
All models with roll stability control and active cornering enhancement					
Front	Aftermarket	2	<b>RVU500011P</b>	6.67	8.00
	Genuine	2	<b>RVU500011</b>	15.84	19.01
All models without Roll Stability Control					
Rear anti roll bar	Aftermarket	2	<b>LR018354P</b>	2.58	3.10
	Genuine	2	<b>LR018354</b>	19.57	23.48
All models with active roll bar system from (VIN) AA000001 on					
Rear	OEM	2	<b>RVU000022P1</b>	10.83	13.00
	Genuine	2	<b>RVU000022</b>	17.24	20.69

## Clamp Anti Roll Bar Bush

All models					
Front	Genuine	2	<b>RBV500100</b>	2.23	2.68
Rear	Genuine	2	<b>RBV000281</b>	1.93	2.32

## Active Roll Bar Fluid

All models with active roll bar control - 1 litre. Cold (standard) climates fluid					
	Aftermarket	a/r	<b>STC50519P</b>	12.08	14.50
	Genuine	a/r	<b>STC50519</b>	18.96	22.75

## Shock Absorber

All models except models with roll stability control, active cornering enhancement or continuous variable damping					
Front	Genuine	2	<b>LR016426</b>	330.55	396.66
All 3.0L 24v DOHC V6 TC Diesel models					
Front, B4 Damptronic	Bilstein	2	<b>LR015408BILSTEIN</b>	270.83	325.00
Front, includes seal & service kit	Genuine	2	<b>LR015408</b>	663.08	795.70
All 3.0L 24v DOHC V6 TC Diesel models from (VIN) AA000001					
Front, includes seal & service kit	Genuine	2	<b>LR016427</b>	203.95	244.74
All 3.6L 32v DOHC EFI diesel models, with roll stability control, with ACE suspension less adaptive damping					
Front, includes seal & service kit	Genuine	2	<b>LR016428</b>	210.99	253.19
All 3.6L 32v diesel models with continuous variable damping from (VIN) AA000001					
Front, B4 Damptronic	Bilstein	2	<b>LR015408BILSTEIN</b>	270.83	325.00
Front, includes seal & service kit	Genuine	2	<b>LR015408</b>	663.08	795.70
All 5.0L OHC SGDI NA V8 Petrol models					
Front, B4 Damptronic	Bilstein	2	<b>LR015408BILSTEIN</b>	270.83	325.00
Front, includes seal & service kit	Genuine	2	<b>LR015408</b>	663.08	795.70
All 5.0L V8 SGDI NA V8 petrol models, with roll stability control, with ACE suspension less adaptive damping from (VIN) AA000001					
Front, includes seal & service kit	Genuine	2	<b>LR016427</b>	203.95	244.74
All models except models with roll stability control, active cornering enhancement or continuous variable damping					
Rear	Genuine	2	<b>LR016423</b>	219.63	263.56
All 3.0L TDV6 diesel models with roll stability control, active cornering enhancement, without continuous variable damping					
Rear	OEM	2	<b>LR016424P1</b>	95.00	114.00
	Genuine	2	<b>LR016424</b>	219.63	263.56
All 3.6L TDV8 diesel models with roll stability control, active cornering enhancement, without continuous variable damping					
Rear	OEM	2	<b>LR016425P1</b>	150.00	180.00
	Genuine	2	<b>LR016425</b>	295.27	354.32
All 5.0L NA AJV8 petrol models with roll stability control, active cornering enhancement, without continuous variable damping					
Rear	OEM	2	<b>LR016424P1</b>	95.00	114.00
	Genuine	2	<b>LR016424</b>	219.63	263.56
All models with continuous variable damping					
Rear RH	OEM	1	<b>LR032652P1</b>	416.67	500.00
	Genuine	1	<b>LR032652</b>	736.78	884.14
All models with continuous variable damping from (VIN) AA247352					
Rear RH, B4 Damptronic	Bilstein	1	<b>LR023436BILSTEIN</b>	320.83	385.00
Rear RH	Genuine	1	<b>LR023436</b>	699.68	839.62
Rear LH, B4 Damptronic	Bilstein	1	<b>LR023431BILSTEIN</b>	320.83	385.00
Rear LH	Genuine	1	<b>LR023431</b>	682.20	818.64

## Shock Absorber Complete Assembly

All 3.0L V6 diesel models with continuous variable damping					
Std, front	Genuine	2	<b>LR052867</b>	529.14	634.97
All 5.0L supercharged AJV8 petrol models with continuous variable damping					
Std, front	Genuine	2	<b>LR052866</b>	529.14	634.97
All 5.0L N/A AJV8 petrol models with continuous variable damping					
Std, front	Genuine	2	<b>LR052867</b>	529.14	634.97

## Shock Absorber Up-rated

All models except models with roll stability control, active cornering enhancement or continuous variable damping					
Front B6 Damper - Up-rated	Bilstein	2	<b>LR016426BILSTEIN</b>	162.50	195.00
Rear B6 Damper - Up-rated	Bilstein	2	<b>LR016423BILSTEIN</b>	162.50	195.00

## Boot Kit, Shock Absorber

All models					
Front, for one shock absorber	Aftermarket	2	<b>RBG500010P</b>	30.00	36.00
	Genuine	2	<b>RBG500010</b>	66.18	79.42



## RANGE ROVER SPORT L320 (2010-2013)

## SUSPENSION

## Shock Absorber Upper Boot

All models - Rear	Genuine	2	RPM500200	34.83	41.80
-------------------	---------	---	-----------	-------	-------

## Shock Absorber Boot

All models with continuous variable damping from (VIN) AA000001					
	Genuine	2	LR015407	50.54	60.65

## Buffer, Shock Absorber

All models					
Front	Genuine	2	RPC500080	13.83	16.60
Rear	Genuine	2	RPC500030	6.94	8.33

## Ball Joint

All models - Front knuckle, upper					
	Aftermarket	2	RBK500170P	10.00	12.00
	OEM	2	RBK500170P1	16.88	20.26
	Genuine	2	RBK500170	32.98	39.58

All models - Front knuckle, lower, with 35mm ball joint seat. For vehicle with original lower arm prior to (VIN) 9A208831 a new lower arm and ball joint assembly must be fitted					
	Aftermarket	2	RBK500300P	9.38	11.26
	OEM	2	RBK500300P1	18.54	22.25
	Genuine	2	RBK500300	35.83	43.00

## Ball Joint Assembly

All models					
Front upper arm					
	Aftermarket	2	RBK500170P	10.00	12.00
	OEM	2	RBK500170P1	16.88	20.26
	Genuine	2	RBK500170	32.98	39.58
Front lower arm					
	Aftermarket	2	RBK500300P	9.38	11.26
	OEM	2	RBK500300P1	18.54	22.25
	Genuine	2	RBK500300	35.83	43.00
Upper, rear wheel knuckle					
	Aftermarket	2	RHF500100P	11.04	13.25
	OEM	2	RHF500100P1	14.38	17.26
	Genuine	2	RHF500100	36.46	43.75

## Lower Arm Assembly

All 3.6L TDV6 diesel models fitted with 35mm lower ball joint					
Front suspension, RH					
	Aftermarket	1	LR029303P	92.50	111.00
	OEM	1	LR029303P1	125.00	150.00
	Genuine	1	LR029303	193.19	231.83
Front suspension, LH					
	Aftermarket	1	LR029305P	92.50	111.00
	OEM	1	LR029305P1	125.00	150.00
	Genuine	1	LR029305	205.46	246.55

All models from (VIN) BA289299					
Front RH					
	Aftermarket	1	LR029301P	92.50	111.00
	OEM	1	LR029301P1	153.33	184.00
	Genuine	1	LR029301	193.14	231.77
Front LH					
	Aftermarket	1	LR029302P	92.50	111.00
	OEM	1	LR029302P1	153.33	184.00
	Genuine	1	LR029302	200.87	241.04

## Upper Arm Assembly

All models (VIN) AA000001 on					
Front RH					
	Aftermarket	1	LR063711P	32.50	39.00
	Genuine	1	LR063711	168.26	201.91
Front LH					
	Aftermarket	1	LR063688P	32.50	39.00
	Genuine	1	LR063688	166.10	199.32

## Fitting Kit, Front Upper Arm

All models - Includes bolts and nuts for one upper arm					
	Genuine	1	RYG000420BPK	9.79	11.75

## Lower Arm Assembly

All models from (VIN) AA218011					
Rear RH					
	Genuine	1	LR019977	139.76	167.71
Rear LH					
	Genuine	1	LR019978	139.86	167.83

## Spindle Rod Toe Link

All models					
	Aftermarket	2	LR019117P	18.13	21.76
	OEM	2	LR019117P1	25.00	30.00
	Genuine	2	LR019117	71.39	85.67

## Ball Joint Rear Knuckle Lower

All models					
	Aftermarket	2	LR032644P	8.13	9.76
	Genuine	2	LR032644	32.29	38.75

## Spindle Rod Toe Link

All models					
	Aftermarket	2	LR019117P	18.13	21.76
	OEM	2	LR019117P1	25.00	30.00
	Genuine	2	LR019117	71.39	85.67

## Ball Joint Rear Knuckle Lower

All models					
	Aftermarket	2	LR032644P	8.13	9.76
	Genuine	2	LR032644	32.29	38.75

## Knuckle, without Hub

All models (VIN) AA000001 on For vehicle with original M12 track rod end prior to (VIN) 9A191792 a new track rod must be fitted					
Front axle, RH takes M14 track rod end.					
	Genuine	1	RUB500320	226.37	271.64
Front axle, LH takes M14 track rod end.					
	Genuine	1	RUB500330	226.37	271.64
Rear axle, RH					
	Genuine	1	LR045824	196.48	235.78
Rear axle, LH					
	Genuine	1	LR045825	196.48	235.78

## Height Sensor

All models with air suspension					
Rear suspension, RH					
	OEM	1	LR020161P1	53.33	64.00
	Genuine	1	LR020161	63.31	75.97
Rear suspension, LH					
	OEM	1	LR020159P1	45.83	55.00
	Genuine	1	LR020159	63.31	75.97

## Air Suspension Height Sensor

All air suspension models without adaptive damping from (VIN) AA000001 on					
Front					
	Genuine	2	LR023647	48.75	58.50
Rear					
	Genuine	2	LR023648	63.54	76.25
All air suspension models with adaptive damping from (VIN) AA000001 on					
Front					
	Genuine	2	LR023649	65.00	78.00
Rear					
	Genuine	2	LR023650	46.88	56.26

## Air Suspension Compressor

All models to (VIN) BA262642 - Later AMK type (not Hitachi)					
	Genuine*	1	LR072537	574.59	689.51
			*Exchange Surcharge	180.00	216.00
All models with air suspension (VIN) DA768700 on - AMK type					
	Genuine	1	LR078650	620.06	744.07

## Replacement Compressor

All models with Hitachi Compressor fitted - Fitting kit required					
	Dunlop	1	LR023964P	383.33	460.00

## Compressor &amp; Dryer only

All models fitted with AMK compressor					
	OEM	1	LR078650P1	341.67	410.00
	Genuine	1	LR078650	620.06	744.07

## Installation Kit for Dunlop Compressor

All models with Hitachi Compressor fitted - Fitting kit required					
	Aftermarket	1	LR023964PIIK	24.58	29.50

## Installation Kit for AMK Compressor

All models fitted with AMK compressor					
	OEM	1	LR078650BPIIK	78.33	94.00

## Air Suspension Spring

All models from (VIN) AA000001 on except 3.6L TDV8 diesel and 5.0L supercharged AJV8 petrol					
Front					
	OEM	2	LR016403P1	165.83	199.00
	Genuine	2	LR016403	334.20	401.04
All models from (VIN) AA000001 on except adaptive damping					
Rear					
	OEM	2	LR016411P1	175.83	211.00
	Genuine	2	LR016411	332.51	399.01
All models from (VIN) AA000001 on with adaptive damping					
Rear					
	OEM	2	LR018170P1	195.83	235.00
	Genuine	2	LR018170	332.47	398.96

## Air Spring &amp; Shock Absorber

All models with continuously variable damping (VIN) AA000001 on					
Rear RH					
	Genuine	1	LR032651	736.78	884.14

## Strut Seal Kit

All air suspension models - Front & rear					
	Genuine	2	LR016412	12.40	14.88

## Air Suspension Relief Valve

All models - Front axle					
	Genuine	1	RVH000095	96.85	116.22

## Filter &amp; Plug

All models with roll Stability Control - Roll Stability Control valve block					
	OEM	1	RVJ100010P1	22.29	26.75
	Genuine	1	RVJ100010	68.68	82.42

## O Ring Seal Kit

All models with Active Cornering Enhancement - Air suspension valve block					
	OEM	1	RWV100010P1	14.37	17.24
	Genuine	1	RWV100010	22.91	27.49





# STEERING

## Seal, Steering Column

All models - Column to bulkhead	Genuine	1	<b>QMH500100</b>	6.50	7.80
All models from (VIN) AA000001 on Lower column joint	Genuine	1	<b>QMH500110</b>	3.60	4.32

## Shaft, Steering Column

Upper section, without universal joint	Genuine	1	<b>QLB500070</b>	50.37	60.44
----------------------------------------	---------	---	------------------	-------	-------

## Track Rod End

All models from (VIN) AA000001 on Includes M14 threaded knuckle nut	Genuine	2	<b>LR010676</b>	103.40	124.08
With M14 ball joint	Genuine	1	<b>QJB500070</b>	104.99	125.99

## Track Rod End & Rod Kit

All models from (VIN) AA000001 on - M14 type outer ball joint	Aftermarket	2	<b>LR010673BP</b>	65.83	79.00
	Genuine	2	<b>LR010673</b>	193.22	231.86

## Track Rod

All models	Aftermarket	2	<b>QFK500030P</b>	9.17	11.00
	Genuine	2	<b>QFK500030</b>	68.79	82.55

# RANGE ROVER SPORT L320 (2010-2013)

## Track Rod, Bare

All models	Aftermarket	2	<b>QFK500030P</b>	9.17	11.00
	Genuine	2	<b>QFK500030</b>	68.79	82.55

## Gaiter Kit, Steering Rack

All models - Includes one gaiter with clips	OEM	2	<b>QFW500020</b>	36.57	43.88
---------------------------------------------	-----	---	------------------	-------	-------

## Power Steering Fluid

All models - 1 litre. Cold (standard) climates fluid	Aftermarket	a/r	<b>STC50519P</b>	12.08	14.50
	Genuine	a/r	<b>STC50519</b>	18.96	22.75

## Cap, Power Steering Reservoir

All models	Genuine	1	<b>QEZ500010</b>	3.25	3.90
------------	---------	---	------------------	------	------

# TRANSMISSION

## Constant Velocity Joint

All 3.0L TDV6 diesel models	Aftermarket	2	<b>LR060382P</b>	45.00	54.00
	OEM	2	<b>LR060382P1</b>	60.83	73.00
	Genuine	2	<b>LR060382</b>	133.37	160.04
3.6L V8 Lion diesel models	Aftermarket	2	<b>LR060383P</b>	41.67	50.00
	OEM	2	<b>LR060383P1</b>	67.50	81.00
	Genuine	2	<b>LR060383</b>	133.37	160.04
All petrol models	Aftermarket	2	<b>LR060383P</b>	41.67	50.00
	OEM	2	<b>LR060383P1</b>	67.50	81.00
	Genuine	2	<b>LR060383</b>	133.37	160.04

## Drive Shaft Assembly

All models (VIN) DA810673 on Rear, RH, 2mm pitch nut thread	OEM	1	<b>LR047285P1</b>	162.50	195.00
	Genuine	1	<b>LR047285</b>	207.96	249.55

## Drive Shaft & CV Joint

All models except 3.0L V6 diesel from (VIN) AA000001 on	Front axle, RH	Genuine	1	<b>LR025872</b>	156.18	187.42
	Front axle, LH	Genuine	1	<b>LR025874</b>	146.18	175.42
All 3.0L TDV6 diesel models	Front axle, RH	Genuine	1	<b>LR025869</b>	149.94	179.93
	Front axle, LH	Genuine	1	<b>LR025873</b>	146.18	175.42

## Gaiter Kit Front Drive Shaft

All 3.0L V6 Lion diesel models	OEM	2	<b>TDR500100P1</b>	18.54	22.25
	Genuine	2	<b>TDR500100</b>	43.23	51.88
All 3.6L V8 Lion diesel models	OEM	2	<b>TDR500110P1</b>	20.63	24.76
	Genuine	2	<b>TDR500110</b>	43.23	51.88
All petrol models	OEM	2	<b>TDR500110P1</b>	20.63	24.76
	Genuine	2	<b>TDR500110</b>	43.23	51.88

## Gaiter Kit Rear Drive Shaft

All models without rear axle locking differential	OEM	2	<b>TDR500070P1</b>	20.00	24.00
	Genuine	2	<b>TDR500070</b>	46.58	55.90
All models with rear axle locking differential	OEM	2	<b>TDR500080P1</b>	20.00	24.00
	Genuine	2	<b>TDR500080</b>	39.28	47.14

## Drive Flange Kit, Transfer Box

All models - Output shaft					
Front	Genuine	1	<b>IEA500031</b>	81.83	98.20
Rear	Genuine	1	<b>LR039528</b>	107.64	129.17

## Hub & Wheel Bearing

All models from (VIN) AA000001 on - Front	Genuine	1	<b>LR076692</b>	200.22	240.26
-------------------------------------------	---------	---	-----------------	--------	--------

## Wheel Hub, with Bearing

All models - Front	Aftermarket	2	<b>LR048083P</b>	60.00	72.00
	OEM	2	<b>LR048083P1</b>	95.00	114.00
	Genuine	2	<b>LR048083</b>	206.23	247.48



## Wheel Hub Assembly

All models - Rear axle, does not include bearing	Aftermarket	2	<b>RUC500120P</b>	55.83	67.00
	Genuine	2	<b>RUC500120</b>	98.29	117.95

## Oil Seal, Differential

All models	Front axle pinion	OEM	1	<b>LR019019P1</b>	5.63	6.76
		Genuine	1	<b>LR019019</b>	9.25	11.10
Front & rear axles, output shafts	OEM	1	<b>TZB500050P1</b>	6.25	7.50	
	Genuine	1	<b>TZB500050</b>	13.21	15.85	
Rear axle pinion	Genuine	1	<b>TZB500100</b>	16.28	19.54	

## Oil Seal, Transfer Box

All models - Input shaft	Aftermarket	1	<b>IZB500030P</b>	6.67	8.00
	Genuine	1	<b>IZB500030</b>	12.96	15.55

## Sealing Ring, Transfer Box

All models	Front output shaft	OEM	1	<b>IZB500040P1</b>	8.13	9.76
		Genuine	1	<b>IZB500040</b>	10.17	12.20
Rear output shaft	OEM	1	<b>IZB500050P1</b>	4.79	5.75	
	Genuine	1	<b>IZB500050</b>	9.84	11.81	

## Plug, Oil Drain

All models (VIN) AA000001 on - Front axle	Genuine	1	<b>FTC5431</b>	6.50	7.80
-------------------------------------------	---------	---	----------------	------	------

## Plug, Differential

All models - Oil filler, front & rear axles	Genuine	1	<b>TYB500060</b>	0.86	1.03
All models from (VIN) AA000001 on Oil drain, rear axle	Genuine	1	<b>TYB500080</b>	11.54	13.85

## Plug, Transfer Box

All models - Oil Fill & Drain	OEM	1	<b>IYB500020P1</b>	1.75	2.10
	Genuine	1	<b>IYB500020</b>	2.49	2.99

## Oil Temperature Switch

All models with rear axle locking differential					
Rear axle differential	Genuine	1	<b>NSC500590</b>	14.45	17.34

## Chain Only, Transfer Box

All models	OEM	1	<b>LR049160CP1</b>	133.33	160.00
------------	-----	---	--------------------	--------	--------

## Sensor, Differential

All models with rear axle locking differential					
Oil temperature	Genuine	1	<b>NSC500590</b>	14.45	17.34

## Sensor, Transfer Box

All models - High/low position	Genuine	1	<b>IAB500191</b>	74.63	89.56
--------------------------------	---------	---	------------------	-------	-------

## Solenoid, Transfer Box

All models - Pressure	Genuine	1	<b>IGF500011</b>	77.19	92.63
-----------------------	---------	---	------------------	-------	-------

## Damper, Vibration

3.6L TDV8 diesel models from (VIN) AA000001 to AA999999					
Transfer box	Genuine	1	<b>LR094511</b>	33.76	40.51



## RANGE ROVER SPORT L320 (2010-2013)

## COOLING

## Expansion Bottle Cap

All 3.0L V6 diesel models	Aftermarket	1	<b>LR017427P</b>	4.79	5.75
	Genuine	1	<b>LR017427</b>	6.99	8.39
All 5.0L N/A & supercharged AJV8 petrol models	OEM	1	<b>LR010965P1</b>	2.42	2.90
	Genuine	1	<b>LR010965</b>	5.57	6.68

## Thermostat

All 3.0L V6 diesel models - In-line thermostat for top & bottom hose assembly	Genuine	1	<b>LR033675</b>	35.21	42.25
	Genuine	1	<b>LR003341</b>	12.25	14.70

## Thermostat &amp; Radiator Hose Assembly

All 3.0L V6 diesel models - In-line thermostat with top & bottom hose assembly	Genuine	1	<b>LR025969</b>	118.01	141.61
--------------------------------------------------------------------------------	---------	---	-----------------	--------	--------

## Engine Thermostat Housing Assembly

All 3.6L TDV8 diesel models - Includes thermostat, EGR valve thermostat and covers	Genuine	1	<b>LR004318</b>	52.80	63.36
------------------------------------------------------------------------------------	---------	---	-----------------	-------	-------

## Retaining Clip

All 3.6L TDV8 diesel models - EGR valve thermostat & elbow to thermostat housing	Genuine	1	<b>LR003339</b>	1.31	1.57
----------------------------------------------------------------------------------	---------	---	-----------------	------	------

## EGR Valve Thermostat

All 3.6L TDV8 diesel models - In thermostat housing	Genuine	1	<b>LR003335</b>	30.25	36.30
-----------------------------------------------------	---------	---	-----------------	-------	-------

## EGR Valve Thermostat Elbow

All 3.6L TDV8 diesel models - Upper	Genuine	1	<b>LR004320</b>	14.43	17.32
-------------------------------------	---------	---	-----------------	-------	-------

## EGR Valve Thermostat Elbow O Ring

All 3.6L TDV8 diesel models - Lower elbow to thermostat housing	Genuine	1	<b>LR003336</b>	2.65	3.18
-----------------------------------------------------------------	---------	---	-----------------	------	------

## Water Pump

All 3.0L V6 diesel engine models	Genuine	1	<b>LR013164</b>	87.26	104.71
	Genuine	1	<b>PEB500010</b>	140.35	168.42
3.0L supercharged V6 petrol models (VIN EA000001 to EA387126 - Auxiliary)	Genuine	1	<b>LR008863P</b>	50.00	60.00
All models with 3.6L TDV8 diesel engine	Genuine	1	<b>LR008863</b>	128.66	154.39
All 5.0L supercharged AJV8 petrol models to (VIN) EA387126 - Auxiliary	Genuine	1	<b>PEB500010</b>	140.35	168.42

## Gasket Water Pump

All 3.0L V6 diesel engine models	Genuine	1	<b>1316117</b>	24.53	29.44
All 3.6L TDV8 diesel models	Genuine	1	<b>LR002750</b>	1.83	2.20
All 5.0L N/A & supercharged AJV8 petrol models	Aftermarket	1	<b>LR049370P</b>	4.58	5.50
All 5.0L N/A & supercharged AJV8 petrol models	Genuine	1	<b>LR049370</b>	11.91	14.29

## Intercooler Hose

All 3.6L TDV8 diesel models	Aftermarket	1	<b>PNH500371P</b>	13.96	16.75
	Genuine	1	<b>PNH500371</b>	28.58	34.30
RH upper	Aftermarket	1	<b>PNH500361P</b>	13.96	16.75
	Genuine	1	<b>PNH500361</b>	27.53	33.04

## Intercooler Pipe &amp; Hose Kit

All 3.6L TDV8 diesel models	Genuine	1	<b>PNH500351</b>	101.64	121.97
	Genuine	1	<b>PNH500341</b>	91.14	109.37

## Coolant Temperature Sensor

All 3.0L V6 diesel models	Genuine	1	<b>LR041442</b>	25.70	30.84
All 5.0L N/A AJV8 petrol models	Genuine	1	<b>LR041442</b>	25.70	30.84
All 5.0L supercharged AJV8 petrol models	Genuine	1	<b>LR041442</b>	25.70	30.84

## Coolant Level Sensor

All models	Genuine	1	<b>PCJ500030</b>	6.16	7.39
------------	---------	---	------------------	------	------

## RANGE ROVER SPORT L320 (2010-2013)

## ELECTRICAL - ROTATING ELECTRICS

## Alternator

All 3.0L V6 diesel models	New, outright	OEM	1	<b>LR072756P1</b>	170.00	204.00
	New, exchange	Genuine*	1	<b>LR072756</b>	504.64	605.57
		*Exchange Surcharge			175.00	210.00
All 3.6L TDV8 diesel models with roll stability control	New, outright	OEM	1	<b>YLE500430P1</b>	195.00	234.00
	New, exchange	Genuine*	1	<b>YLE500430</b>	354.79	425.75
		*Exchange Surcharge			70.00	84.00
All models with 5.0L NA AJV8 petrol engine	New, outright	Aftermarket	1	<b>LR065246P</b>	185.00	222.00
		OEM	1	<b>LR065246P1</b>	185.00	222.00
		Genuine	1	<b>LR065246</b>	388.03	465.64
All models with 5.0L supercharged AJV8 petrol engine	New, outright	Aftermarket	1	<b>LR065246P</b>	185.00	222.00
		OEM	1	<b>LR065246P1</b>	185.00	222.00
		Genuine	1	<b>LR065246</b>	388.03	465.64

## Starter Motor

All models with 3.0L V6 diesel engine	New, outright	OEM	1	<b>LR080299P1</b>	175.00	210.00
	Genuine	1	<b>LR080299</b>	382.73	459.28	
All 3.0L V6 diesel models	New, outright	OEM	1	<b>LR080299P1</b>	175.00	210.00
		Genuine*	1	<b>LR080299</b>	382.73	459.28
		*Exchange Surcharge			100.00	120.00
All 3.6L TDV8 diesel models	New, outright	OEM	1	<b>LR032541P1</b>	283.33	340.00
		Genuine*	1	<b>LR012628</b>	247.10	296.52
		*Exchange Surcharge			70.00	84.00
New, exchange	Genuine*	1	<b>LR032541</b>	436.78	524.14	
	*Exchange Surcharge			200.00	240.00	
	All 5.0L N/A AJV8 petrol models	New, outright	OEM	1	<b>LR011262P1</b>	258.33
Genuine*			1	<b>LR011262</b>	398.23	477.88
*Exchange Surcharge					70.00	84.00
All 5.0L supercharged AJV8 petrol models	New, outright	OEM	1	<b>LR011262P1</b>	258.33	310.00
		Genuine*	1	<b>LR011262</b>	398.23	477.88
		*Exchange Surcharge			70.00	84.00



LR072756P1



LR065246P

## RANGE ROVER SPORT L320 (2010-2013)

## ENGINE GASKETS

## Gasket Cylinder Head

All models with 3.0L V6 diesel engine	Grade 3	Genuine	2	<b>LR013066</b>	23.72	28.46
		OEM	2	<b>LR013070P1</b>	10.83	13.00
	Grade 4	Genuine	2	<b>LR013070</b>	15.80	18.96
		OEM	2	<b>LR013073P1</b>	10.83	13.00
	Grade 5	Genuine	2	<b>LR013073</b>	15.80	18.96
		OEM	2	<b>LR013073P1</b>	10.83	13.00
All 3.6L TDV8 diesel models	Grade 1, RH	Genuine	1	<b>1418984</b>	52.08	62.50
		Genuine	1	<b>1418990</b>	52.08	62.50
	Grade 2, RH	Genuine	1	<b>1418985</b>	52.08	62.50
		Genuine	1	<b>1418991</b>	52.08	62.50
	Grade 3, RH	Genuine	1	<b>LR000635</b>	50.52	60.62
		Genuine	1	<b>1418992</b>	52.31	62.77
	Grade 4, RH	Genuine	1	<b>1418987</b>	52.08	62.50
		Genuine	1	<b>1418993</b>	52.08	62.50
	Grade 5, RH	Genuine	1	<b>1418989</b>	52.08	62.50
		Genuine	1	<b>1418996</b>	52.08	62.50

## Gasket Camshaft Cover

All 3.0L V6 diesel models	Aftermarket	2	<b>LR029132P</b>	6.67	8.00
	Genuine	2	<b>LR029132</b>	14.86	17.83

## Gasket Oil Sump

All 3.6L TDV8 diesel models	Genuine	1	<b>LR002438</b>	20.55	24.66
-----------------------------	---------	---	-----------------	-------	-------

## Sealant Instant Gasket

Numerous applications	Genuine	a/r	<b>STC50550</b>	13.10	15.72
-----------------------	---------	-----	-----------------	-------	-------

# ENGINE SWITCHES

## Camshaft Position Sensor

All 3.0L V6 diesel models	Genuine	1	<b>LR013458</b>	121.12	145.34
All 5.0L N/A AJV8 petrol models	OEM	1	<b>LR014372P1</b>	36.67	44.00
	Genuine	1	<b>LR014372</b>	118.70	142.44
All 5.0L supercharged AJV8 petrol models	OEM	1	<b>LR014372P1</b>	36.67	44.00
	Genuine	1	<b>LR014372</b>	118.70	142.44

## Crankshaft Position Sensor

All 3.0L V6 diesel models - Trigger wheel LR035564 also required up to (VIN) CA999999					
	Aftermarket	1	<b>LR049872P</b>	55.00	66.00
	Genuine	1	<b>LR049872</b>	146.50	175.80
All 3.6L TDV8 diesel models	Aftermarket	1	<b>LR009793P</b>	45.00	54.00
	Genuine	1	<b>LR009793</b>	117.84	141.41

## Oil Temperature Switch

All 3.6L TDV8 diesel models	Genuine	1	<b>1359056</b>	27.21	32.65
-----------------------------	---------	---	----------------	-------	-------

## Engine Knock Sensor

All 5.0L N/A AJV8 petrol models	Genuine	1	<b>LR008877</b>	33.19	39.83
All 5.0L supercharged AJV8 petrol models	Genuine	1	<b>LR008877</b>	33.19	39.83

## Oil Level Sensor

All 3.0L V6 diesel models	Genuine	1	<b>LR012640</b>	35.68	42.82
All 5.0L N/A AJV8 petrol models	Genuine	1	<b>LR012640</b>	35.68	42.82
All 5.0L supercharged AJV8 petrol models	Genuine	1	<b>LR012640</b>	35.68	42.82



LR009793P

# RANGE ROVER SPORT L320 (2010-2013)

## Oil Pressure Switch

All 3.6L TDV8 diesel models	Genuine	1	<b>LR000633</b>	2.86	3.43
-----------------------------	---------	---	-----------------	------	------

## Air Charge Temperature Sensor

All 3.0L V6 diesel models - Turbocharger outlet					
	Genuine	1	<b>LR014386</b>	47.36	56.83
All 5.0L supercharged AJV8 petrol models	Aftermarket	1	<b>LR021587P</b>	21.00	25.20
	Genuine	1	<b>LR021587</b>	23.34	28.01

## Manifold Absolute Pressure Sensor

All 3.0L V6 diesel models	Genuine	1	<b>LR019130</b>	65.03	78.04
All 3.6L TDV8 diesel models	Genuine	1	<b>LR007596</b>	28.46	34.15
All 5.0L N/A AJV8 petrol models	Genuine	1	<b>LR008881</b>	86.58	103.90
All 5.0L supercharged AJV8 petrol models	Genuine	1	<b>LR008881</b>	86.58	103.90

## Oxygen Sensor

All 3.0L V6 diesel models					
LH, lower, pre-catalyst	Genuine	1	<b>LR014227</b>	125.75	150.90
All 3.0L V6 diesel models with Euro Stage V emissions and diesel particulate filter					
Post-catalyst	Genuine	1	<b>WDN500110</b>	46.95	56.34
Post-DPF	Genuine	1	<b>WDN500050</b>	34.98	41.98
All 3.6L TDV8 diesel models with diesel particulate filter from (VIN) AA000001 on					
Pre-catalyst	Genuine	1	<b>WDN500130</b>	34.85	41.82
	Genuine	1	<b>WDN500070</b>	28.99	34.79
Post-DPF	Genuine	1	<b>WDN500050</b>	34.98	41.98
All 5.0L N/A AJV8 petrol models					
Pre-catalyst	Genuine	1	<b>LR011710</b>	67.93	81.52
All 5.0L supercharged AJV8 petrol models					
Pre-catalyst	Genuine	1	<b>LR011710</b>	67.93	81.52

## Exhaust Gas Pressure Sensor

All 3.0L V6 diesel models - For diesel particulate filter (DPF), pressure differential					
	Genuine	1	<b>LR014310</b>	121.87	146.24
All 3.6L TDV8 diesel models - For diesel particulate filter (DPF), pressure differential					
	Genuine	1	<b>LR014310</b>	121.87	146.24

## Exhaust Gas Temperature Sensor

All 3.0L V6 diesel models - RH front	Genuine	1	<b>NSC500630</b>	48.39	58.07
--------------------------------------	---------	---	------------------	-------	-------

# DRAIN PLUGS

## Sump Plug & Washer

3.0L V6 diesel models					
	Aftermarket	1	<b>1013938P</b>	1.50	1.80
	Genuine	1	<b>1013938</b>	3.19	3.83
3.6L TDV8 diesel models					
	Aftermarket	1	<b>1013938P</b>	1.50	1.80
	Genuine	1	<b>1013938</b>	3.19	3.83



1013938P

# RANGE ROVER SPORT L320 (2010-2013)

# OIL SEALS ENGINE

## Crankshaft Oil Seal Front

All models with 3.0L V6 diesel engine					
Front	Genuine	1	<b>1102415</b>	5.41	6.49
All models with 3.6L TDV8 diesel engine					
Front	Genuine	1	<b>1102415</b>	5.41	6.49

## Crankshaft Oil Seal Rear

All 3.0L V6 diesel models - With retainer	Genuine	1	<b>LR036542</b>	36.48	43.78
All 3.6L TDV8 diesel models - With retainer	Genuine	1	<b>LR005539</b>	100.84	121.01

## Oil Seal Camshaft

All models with 3.0L V6 diesel engine					
Front and rear	Aftermarket	2	<b>1311318P</b>	2.00	2.40
	Genuine	2	<b>1311318</b>	2.83	3.40

# RANGE ROVER SPORT L320 (2010-2013)



LR036542

# EXHAUST GAS RECIRCULATION (EGR)

# RANGE ROVER SPORT L320 (2010-2013)

## EGR Valve

All 3.6L TDV8 diesel models					
RH	Genuine	1	<b>LR018321</b>	229.18	275.02
LH	Genuine	1	<b>LR018322</b>	211.54	253.85

## Gasket EGR Valve to Manifold Pipe

All 3.6L TDV8 diesel models	Genuine	1	<b>LR003828</b>	16.37	19.64
-----------------------------	---------	---	-----------------	-------	-------

## Gasket EGR Valve to Cooler

All 3.6L TDV8 diesel models	Genuine	1	<b>LR003831</b>	2.34	2.81
-----------------------------	---------	---	-----------------	------	------

## O Ring EGR Valve Manifold Pipe

All 3.6L TDV8 diesel models	Genuine	1	<b>LR003898</b>	1.61	1.93
-----------------------------	---------	---	-----------------	------	------

## Gasket EGR Cooler to Inlet Pipe

All 3.6L TDV8 diesel models	Genuine	1	<b>LR004250</b>	6.39	7.67
-----------------------------	---------	---	-----------------	------	------

## Pipe EGR Valve to Inlet Manifold

All 3.0L V6 diesel models					
RH	Genuine	1	<b>LR013589</b>	44.75	53.70
LH	Genuine	1	<b>LR013587</b>	44.75	53.70

## Pipe EGR Valve to Exhaust

All 3.6L TDV8 diesel models					
RH	Genuine	1	<b>LR006966</b>	43.04	51.65
LH	Genuine	1	<b>LR006965</b>	43.04	51.65





## RANGE ROVER SPORT L320 (2010-2013)

## ENGINE &amp; GEARBOX MOUNTINGS

## Engine Mounting

All 3.0L V6 diesel models	Genuine	2	<b>LR014113</b>	53.11	63.73
All 3.6L TDV8 diesel models	Genuine	2	<b>KKB500602</b>	73.18	87.82
All V8 petrol models from (VIN) AA000001 on	Genuine	2	<b>KKB500630</b>	57.25	68.70

## Bracket Engine Mounting

All 3.0L V6 diesel models					
RH	Genuine	1	<b>LR074104</b>	22.54	27.05
LH	Genuine	1	<b>LR074105</b>	27.95	33.54
All 3.6L TDV8 diesel models					
RH	Genuine	1	<b>KKU500761</b>	32.33	38.80
LH	Genuine	1	<b>KKU500771</b>	25.98	31.18
Shock absorber	Genuine	1	<b>LR004709</b>	9.68	11.62
All 5.0L N/A & supercharged V8 petrol models					
RH	Genuine	1	<b>LR074029</b>	30.79	36.95
LH	Genuine	1	<b>LR074030</b>	20.51	24.61

## Shock Absorber

All 3.6L TDV8 diesel models					
Engine mounting	Genuine	1	<b>RNB501100</b>	40.64	48.77

## Gearbox Mounting

All models	Genuine	1	<b>IAF500070</b>	55.19	66.23
------------	---------	---	------------------	-------	-------

## Eye Bolt Gearbox Mounting

All models	Genuine	1	<b>KYG500200</b>	1.32	1.58
------------	---------	---	------------------	------	------



KKB500602



KKB500630



IAF500070

## RANGE ROVER SPORT L320 (2010-2013)

## FUEL SYSTEM SWITCHES

## Fuel Pressure Sensor

All 5.0L N/A AJV8 petrol models	Genuine	1	<b>LR015356</b>	41.46	49.75
All 5.0L N/A AJV8 petrol models up to (VIN) DA771217					
	OEM	1	<b>LR012280P1</b>	87.50	105.00
	Genuine	1	<b>LR012280</b>	108.02	129.62
All 5.0L supercharged AJV8 petrol models	Genuine	1	<b>LR015356</b>	41.46	49.75
All 5.0L supercharged AJV8 petrol models up to (VIN) DA771217					
	OEM	1	<b>LR012280P1</b>	87.50	105.00
	Genuine	1	<b>LR012280</b>	108.02	129.62

## Air Flow Meter

All 5.0L N/A AJV8 petrol models	Genuine	1	<b>LR012073</b>	107.33	128.80
All 5.0L supercharged AJV8 petrol models	Genuine	1	<b>LR012073</b>	107.33	128.80

## Air Flow Sensor

3.0L V6 diesel models					
	OEM	1	<b>PHF500090P1</b>	70.00	84.00
	Genuine	1	<b>PHF500090</b>	128.80	154.56
3.6L TDV8 diesel models					
	OEM	1	<b>PHF500090P1</b>	70.00	84.00
	Genuine	1	<b>PHF500090</b>	128.80	154.56

## Water Sensor for Fuel Filter

All 3.0L V6 diesel models	OEM	1	<b>WKW500080</b>	51.36	61.63
All 3.6L TDV8 diesel models	OEM	1	<b>WKW500080</b>	51.36	61.63



PHF500090P1



WKW500080

## RANGE ROVER SPORT L320 (2010-2013)

## CABLES

## Bonnet Release Cable

All models from (VIN) AA000001 on					
Engine compartment end	Genuine	1	<b>LR013888</b>	10.02	12.02
Passenger compartment end	Genuine	1	<b>LR013889</b>	6.67	8.00

## RANGE ROVER SPORT L320 (2010-2013)

## WHEEL CENTRES CAPS &amp; WHEEL NUTS

## Wheel Centre Cap

All models with Titan Silver wheel centre caps with Land Rover black/silver badge					
Titan Silver with Land Rover black/silver badge					
	Genuine	a/r	<b>RRJ500030WYT</b>	8.76	10.51
All models with Silver Sparkle wheel centre caps with Land Rover black/silver badge					
Silver Sparkle with Land Rover black/silver badge					
	Genuine	a/r	<b>RRJ500030WYS</b>	11.03	13.24
All models with polished silver/black alloy wheel centre caps with black/silver Land Rover badge from (VIN) 9A000001 on					
Polished silver/black finish with Land Rover black/silver badge					
	Genuine	a/r	<b>RRJ500060WYU</b>	8.71	10.45
All models with bright black alloy wheel centre caps from (VIN) CA000001 on					
Bright black finish, Range Rover badge					
	Genuine	a/r	<b>LR027409</b>	8.43	10.12

## Wheel Nut

All models with stainless steel finish wheel nuts					
Stainless steel finish					
	OEM	a/r	<b>LR068126P1</b>	3.25	3.90
	Genuine	a/r	<b>LR068126</b>	5.27	6.32

## Wheel Nut Set

All models with stainless steel finish wheel nuts					
Stainless steel finish - set of 16					
	OEM	a/r	<b>LR068126P1K16</b>	40.00	48.00
	Genuine	a/r	<b>LR068126K16</b>	80.83	97.00
Stainless steel finish - set of 20					
	OEM	a/r	<b>LR068126P1K20</b>	50.00	60.00
	Genuine	a/r	<b>LR068126K20</b>	97.50	117.00



RRJ500030WYT



RRJ500030WYS

# RANGE ROVER SPORT L494 (2014 on)

2014 - All Models

Listed below are the most popular parts required for the Range Rover Sport L494

We have access to the full range of parts for your vehicle. Please contact us if not listed here.



## FILTRATION

## RANGE ROVER SPORT L494 (2014 on)

### Oil Filter

All 2.0L TIVCT turbo petrol models - Cartridge				
Aftermarket	1	<b>LR025306P</b>	3.50	4.20
Genuine	1	<b>LR025306</b>	6.87	8.24
All models with 3.0L V6 diesel engine - Element				
Aftermarket	1	<b>LR013148P</b>	3.50	4.20
Genuine	1	<b>LR013148</b>	11.39	13.67
All 4.4L TDV8 diesel models				
Genuine	1	<b>LR022896</b>	16.90	20.28

### Air Filter

All models	Aftermarket	1	<b>LR011593P</b>	5.63	6.76
	Genuine	1	<b>LR011593</b>	24.55	29.46

### Fuel Filter

All models with 3.0L V6 diesel engine - Primary, without bracket				
Aftermarket	1	<b>LR041978P</b>	5.00	6.00
OEM	1	<b>LR041978P1</b>	35.83	43.00
Genuine	1	<b>LR041978</b>	57.69	69.23
All 4.4L DOHC Diesel V8 DITC models				
Genuine	1	<b>LR072610</b>	54.57	65.48

### Pollen Filter

All models	OEM	1	<b>LR036369P1</b>	13.13	15.76
	Genuine	1	<b>LR036369</b>	33.56	40.27

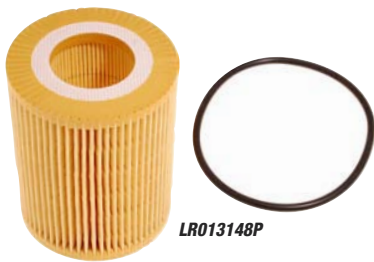

LR013148P



LR011593P



LR041978P1

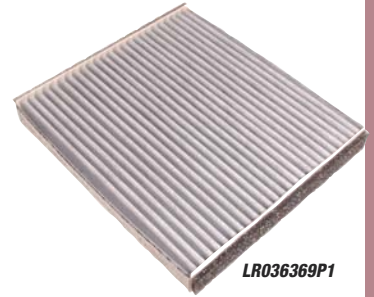

LR036369P1

## WIPER BLADES

## RANGE ROVER SPORT L494 (2014 on)

### Wiper Blade

All RHD models					
Front, driver's side	OEM	1	<b>LR076848P1</b>	11.88	14.26
	Genuine	1	<b>LR076848</b>	19.44	23.33
Front, passenger's side	OEM	1	<b>LR033023P1</b>	11.67	14.00
	Genuine	1	<b>LR033023</b>	19.71	23.65
All LHD models					
Front, driver's side	OEM	1	<b>LR076850P1</b>	11.67	14.00
	Genuine	1	<b>LR076850</b>	19.72	23.66
Front, passenger's side	OEM	1	<b>LR033029P1</b>	11.67	14.00
	Genuine	1	<b>LR033029</b>	19.71	23.65



LR033023

## SCREEN/LAMP WASHER SYSTEMS

## RANGE ROVER SPORT L494 (2014 on)

### Washer Hose, Per Metre

All models - 4mm internal diameter (3mm also available).					
Front or rear screen wash	Aftermarket	a/r	<b>GWV201M</b>	2.25	2.70

### Washer Reservoir

All models with regular size washer tank without headlamp wash up to (VIN) FA999999					
Front & rear screen wash	Genuine	1	<b>LR076509</b>	119.32	143.18

### Windscreen Cleaning Paste

All models					
Prevents wiper blade judder/squeak by 'deep cleaning' the windscreen (ref: Land Rover Tech Bulletin LRA501-002)					
	Genuine	a/r	<b>DNJ500340</b>	7.72	9.26

## DRIVE BELTS

## RANGE ROVER SPORT L494 (2014 on)

### Timing Belt Kit

All models with 3.0L V6 diesel engine - Fuel pump drive					
	Genuine	1	<b>LR016656</b>	113.96	136.75

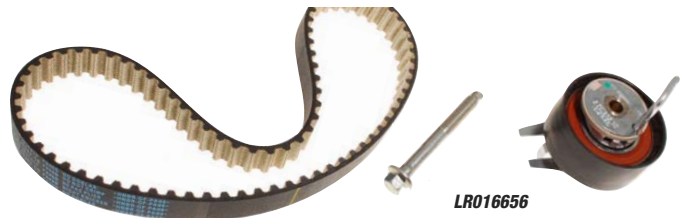

LR016656

## IGNITION SYSTEM

## RANGE ROVER SPORT L494 (2014 on)

### Spark Plug

All 2.0L TIVCT turbocharged petrol models	Genuine	4	<b>LR025605</b>	13.73	16.48
All 3.0L supercharged V6 petrol models	Genuine	6	<b>LR050998</b>	12.21	14.65
All 5.0L supercharged AJV8 petrol models	OEM	8	<b>LR032080P1</b>	7.50	9.00
	Genuine	8	<b>LR032080</b>	13.33	16.00

### Glow Plug

All 3.0L V6 diesel models	Genuine	6	<b>LR013275</b>	29.96	35.95
All 4.4L TDV8 diesel models	Genuine	8	<b>LR013275</b>	29.96	35.95

### Ignition Coil

All 3.0L supercharged V6 petrol models	Genuine	6	<b>LR035548</b>	55.50	66.60
----------------------------------------	---------	---	-----------------	-------	-------



# RANGE ROVER SPORT L494 (2014 on)

# BRAKING SYSTEM

## Brake Pad Set

All 2.0L TIVCT turbocharged petrol models					
Front brakes	OEM	1	<b>LR051626P1</b>	42.50	51.00
	Genuine	1	<b>LR051626</b>	133.84	160.61
Rear brakes	Aftermarket	1	<b>LR079935P</b>	32.50	39.00
	OEM	1	<b>LR079935P1</b>	55.00	66.00
All 3.0L supercharged V6 petrol models					
Front brakes	OEM	1	<b>LR051626P1</b>	42.50	51.00
	Genuine	1	<b>LR051626</b>	133.84	160.61
All 3.0L V6 petrol models					
Front brakes	OEM	1	<b>LR064181P1</b>	56.67	68.00
	Genuine	1	<b>LR064181</b>	215.52	258.62
Rear brakes	Aftermarket	1	<b>LR079935P</b>	32.50	39.00
	OEM	1	<b>LR079935P1</b>	55.00	66.00
All 3.0L V6 diesel models					
Front brakes	OEM	1	<b>LR051626P1</b>	42.50	51.00
	Genuine	1	<b>LR051626</b>	133.84	160.61
All 4.4L TDV8 diesel models					
Front brakes	OEM	1	<b>LR064181P1</b>	56.67	68.00
	Genuine	1	<b>LR064181</b>	215.52	258.62
All 5.0L supercharged V8 petrol models					
Front brakes	OEM	1	<b>LR064181P1</b>	56.67	68.00
	Genuine	1	<b>LR064181</b>	215.52	258.62

## Brake Pad Fitting Kit

All 3.0L V6 diesel models - Front	Genuine	1	<b>LR016683</b>	42.14	50.57
All 4.4L TDV8 diesel models - Front	Genuine	1	<b>LR016683</b>	42.14	50.57
All 5.0L supercharged V8 petrol models Front	Genuine	1	<b>LR016683</b>	42.14	50.57
All models with Special Vehicles Racing Pack (VIN) FA000001 on Front	Genuine	1	<b>LR016683</b>	42.14	50.57

## Brake Disc

All 3.0L V6 diesel models					
Front, vented	OEM	2	<b>LR016176P1</b>	60.00	72.00
	Genuine	2	<b>LR016176</b>	83.69	100.43
All 4.4L TDV8 diesel models					
Front, vented	OEM	2	<b>LR016176P1</b>	60.00	72.00
	Genuine	2	<b>LR016176</b>	83.69	100.43
All 5.0L supercharged V8 petrol models					
Front, vented	OEM	2	<b>LR016176P1</b>	60.00	72.00
	Genuine	2	<b>LR016176</b>	83.69	100.43
All SVR pack models (VIN) FA000001 on					
Front, vented	OEM	2	<b>LR016176P1</b>	60.00	72.00
	Genuine	2	<b>LR016176</b>	83.69	100.43
All models except V8 engine & SVR models					
Rear	Aftermarket	2	<b>LR033302P</b>	31.67	38.00
	Genuine	2	<b>LR033302</b>	71.57	85.88
All V8 Engine models & SVR					
Rear	Aftermarket	2	<b>LR033303P</b>	28.75	34.50
	Genuine	2	<b>LR033303</b>	82.10	98.52

## Performance Brake Disc (pair)

All models except V8 engine & SVR models					
Rear, Slotted & Drilled	Britpart	1	<b>LR033302BPUR</b>	55.00	66.00
All V8 Engine models & SVR					
Rear, Slotted & Drilled	Britpart	1	<b>LR033303BPUR</b>	57.50	69.00

## Brake Caliper

All 2.0L TIVCT turbocharged petrol models					
Front, RH	OEM*	1	<b>LR047906P1</b>	198.33	238.00
	*Exchange Surcharge			35.00	42.00
	Genuine*	1	<b>LR047906</b>	292.45	350.94
	*Exchange Surcharge			100.00	120.00
Front, LH	OEM*	1	<b>LR047905P1</b>	198.33	238.00
	*Exchange Surcharge			35.00	42.00
	Genuine*	1	<b>LR047905</b>	295.38	354.46
	*Exchange Surcharge			100.00	120.00
All 3.0L supercharged V6 petrol models					
Front, RH	OEM*	1	<b>LR047906P1</b>	198.33	238.00
	*Exchange Surcharge			35.00	42.00
	Genuine*	1	<b>LR047906</b>	292.45	350.94
	*Exchange Surcharge			100.00	120.00
Front, LH	OEM*	1	<b>LR047905P1</b>	198.33	238.00
	*Exchange Surcharge			35.00	42.00
	Genuine*	1	<b>LR047905</b>	295.38	354.46
	*Exchange Surcharge			100.00	120.00
All 3.0L V6 diesel models					
Front, RH	OEM*	1	<b>LR047906P1</b>	198.33	238.00
	*Exchange Surcharge			35.00	42.00
	Genuine*	1	<b>LR047906</b>	292.45	350.94
	*Exchange Surcharge			100.00	120.00
Front, LH	OEM*	1	<b>LR047905P1</b>	198.33	238.00
	*Exchange Surcharge			35.00	42.00
	Genuine*	1	<b>LR047905</b>	295.38	354.46
	*Exchange Surcharge			100.00	120.00

## Brake Caliper Carrier

All models					
Front RH	Genuine	1	<b>LR051627</b>	133.23	159.88
Front LH	Genuine	1	<b>LR051628</b>	133.23	159.88

## Slider Pin Bolt

All 2.0L TIVCT turbocharged petrol models					
Front	Genuine	4	<b>SMV500010</b>	1.33	1.60
All 3.0L supercharged petrol models - Front					
	Genuine	4	<b>SMV500010</b>	1.33	1.60
All 3.0L V6 diesel models - Front					
	Genuine	4	<b>SMV500010</b>	1.33	1.60

## Dust Cap Bleed Screw

All models - Front & rear caliper	Genuine	2	<b>SEE500100</b>	0.94	1.13
-----------------------------------	---------	---	------------------	------	------

## Pin & Boot Kit

All models - Front Brake Caliper	Genuine	2	<b>LR020489</b>	13.13	15.76
----------------------------------	---------	---	-----------------	-------	-------

## Brake Pad Wear Sensor

All models with 19 front brakes (unpainted calipers)					
Front	Aftermarket	1	<b>LR045959P</b>	9.17	11.00
	Genuine	1	<b>LR045959</b>	19.05	22.86
All models with 20 front brakes up to (VIN) GA585032					
Front	Aftermarket	1	<b>LR033275P</b>	9.17	11.00
	Genuine	1	<b>LR033275</b>	19.05	22.86
All models with 20 front brakes (red or unpainted calipers) from (VIN) GA585033 on					
Front	Aftermarket	1	<b>LR033275P</b>	9.17	11.00
	Genuine	1	<b>LR033275</b>	19.05	22.86
All models with Special Vehicle Racing (SVR) pack from (VIN) FA000001 on					
Front	Aftermarket	1	<b>LR033275P</b>	9.17	11.00
	Genuine	1	<b>LR033275</b>	19.05	22.86
All models					
Rear	Aftermarket	1	<b>LR033295P</b>	9.17	11.00
	Genuine	1	<b>LR033295</b>	19.05	22.86

## Caliper Repair kit

All models with 2.0L TIVCT turbocharged petrol engine					
Front, for one caliper	OEM	2	<b>LR015580P1</b>	6.67	8.00
All models with 3.0L supercharged V6 petrol engine					
Front, for one caliper	OEM	2	<b>LR015580P1</b>	6.67	8.00
All models with 3.0L V6 diesel engine					
Front, for one caliper	OEM	2	<b>LR015580P1</b>	6.67	8.00

## Brake Shoe Retaining Spring Set

Parking Brake all models from (VIN) AA000001 to (VIN)BA701291					
	Genuine	1	<b>SMN500020</b>	17.40	20.88

## Brake Light Switch

All models from (VIN) GA565630	Genuine	1	<b>LR072647</b>	15.04	18.05
--------------------------------	---------	---	-----------------	-------	-------



LR051626P1



LR033302P





# SUSPENSION

## Bush Lower Arm

All models - Front suspension, front	Genuine	1	<b>LR084108</b>	38.05	45.66
--------------------------------------	---------	---	-----------------	-------	-------

## Anti Roll Bar

All 2.0L turbo petrol models without active roll bar system					
Front	Genuine	1	<b>LR057979</b>	137.04	164.45
Rear	Genuine	1	<b>LR057622</b>	218.78	262.54
All models without ACE suspension except 5.0L OHC SGDI NA V8 Petrol models					
Front	Genuine	1	<b>LR043583</b>	110.85	133.02
All models with active roll bar system					
Front	Genuine	1	<b>LR092956</b>	1122.27	1346.72
All models (without ACE suspension)					
Rear	Genuine	1	<b>LR045421</b>	106.15	127.38
All models (with ACE suspension)					
Rear	Genuine	1	<b>LR043845</b>	957.17	1148.60

## Anti Roll Bar Bush

All models without ACE suspension					
Front	Genuine	2	<b>LR043584</b>	11.63	13.96
Rear	Genuine	2	<b>LR033239</b>	13.31	15.97

## Clamp, Mounting Bush

All models without active roll bar system					
Rear anti roll bar	Genuine	2	<b>LR057727</b>	14.86	17.83

## Anti Roll Bar Link

All models					
Rear RH	Genuine	1	<b>LR042975</b>	32.50	39.00
Rear LH	Genuine	1	<b>LR042976</b>	32.50	39.00

## Active Roll Bar Fluid

All models with active roll bar control - 1 litre. Cold (standard) climates fluid					
	Aftermarket	a/r	<b>STC50519P</b>	12.08	14.50
	Genuine	a/r	<b>STC50519</b>	18.96	22.75

## Shock Absorber

All models without adaptive damping					
Front RH	Genuine	1	<b>LR087082</b>	294.80	353.76
Front LH	Genuine	1	<b>LR087093</b>	294.80	353.76
All models without active roll bar system, with continuous variable damping					
Front RH	Genuine	1	<b>LR087084</b>	806.81	968.17
Front LH	Genuine	1	<b>LR087095</b>	806.81	968.17
All models with active roll bar system with continuous variable damping					
Front RH	Genuine	1	<b>LR087083</b>	387.89	465.47
Front LH	Genuine	1	<b>LR087094</b>	387.89	465.47
All models with SVR pack					
Front RH	Genuine	1	<b>LR087089</b>	879.22	1055.06
Front LH	Genuine	1	<b>LR087099</b>	879.22	1055.06
All models without adaptive damping					
Rear	Genuine	2	<b>LR045269</b>	228.03	273.64
All models without adaptive damping, without reinforcement					
Rear	Genuine	2	<b>LR047322</b>	189.91	227.89
All models without ACE suspension, with continuous variable damping, with reinforcing					
Rear	Genuine	2	<b>LR047132</b>	281.32	337.58
All models without ACE suspension, with continuous variable damping, without reinforcing					
Rear	Genuine	2	<b>LR047324</b>	253.21	303.85
All models with ACE suspension & continuous variable damping					
Rear	Genuine	2	<b>LR045270</b>	281.32	337.58
All models with ACE suspension, with continuous variable damping, without reinforcing					
Rear	Genuine	2	<b>LR047323</b>	253.21	303.85
All models with SVR pack					
Rear, excludes seal, reinforcement and nut	Genuine	2	<b>LR063755</b>	253.21	303.85
Rear, includes seal, reinforcement and nut	Genuine	2	<b>LR062385</b>	258.07	309.68

## Upper Arm Assembly

All models					
Front RH, standard length	Genuine	1	<b>LR044841</b>	106.43	127.72
Front LH, standard length	Genuine	1	<b>LR044844</b>	106.43	127.72
Front RH, 5mm shorter length	Genuine	1	<b>LR044843</b>	106.43	127.72
Front LH, 5mm shorter length	Genuine	1	<b>LR044846</b>	106.43	127.72
Front RH, 5mm longer length	Genuine	1	<b>LR044842</b>	106.43	127.72
Front LH, 5mm longer length	Genuine	1	<b>LR044845</b>	106.43	127.72

## Lower Arm Assembly

All models except SVR					
Front RH	Genuine	1	<b>LR055129</b>	349.73	419.68
Front LH	Genuine	1	<b>LR055130</b>	349.73	419.68
All models except exhaust tone					
Front RH	Genuine	1	<b>LR034219</b>	143.07	171.68
Front LH	Genuine	1	<b>LR034220</b>	143.07	171.68
All models with SVR pack (VIN) FA000001 on					
Front suspension, front RH	Genuine	1	<b>LR073463</b>	138.90	166.68
Front suspension, front LH	Genuine	1	<b>LR073465</b>	138.90	166.68
All models without SVR pack					
Front suspension, front RH	Genuine	1	<b>LR072471</b>	138.90	166.68
Front suspension, front LH	Genuine	1	<b>LR072469</b>	138.90	166.68
All models					
Front suspension, rear RH	Genuine	1	<b>LR078477</b>	113.26	135.91
Front suspension, rear LH	Genuine	1	<b>LR078479</b>	113.26	135.91

# RANGE ROVER SPORT L494 (2014 on)

## Upper Arm Assembly

All models except armoured vehicles					
Rear RH & LH	Genuine	2	<b>LR037690</b>	79.95	95.94

## Lower Arm Assembly

All models					
Rear RH	Genuine	1	<b>LR072652</b>	206.03	247.24
Rear LH	Genuine	1	<b>LR072654</b>	212.14	254.57

## Link to Rear Suspension Arm

All models - Rear Arm to hub	Genuine	4	<b>LR037691</b>	3.83	4.60
------------------------------	---------	---	-----------------	------	------

## Height Sensor

All models					
Front, RH & LH	Genuine	2	<b>LR033256</b>	73.93	88.72
Rear, RH & LH	Genuine	2	<b>LR033257</b>	74.57	89.48

## Air Suspension Compressor

All 5 seat configuration models - Includes silencer, bracket, covers and wire					
	Genuine	1	<b>LR069691</b>	679.12	814.94
All 7 seat configuration models - Includes silencer, bracket, covers and wire					
	Genuine	1	<b>LR069693</b>	886.31	1063.57

## Air Spring

All models					
Rear RH	Genuine	1	<b>LR044853</b>	313.82	376.58
Rear LH	Genuine	1	<b>LR052171</b>	313.82	376.58

## Valve, Anti Roll Bar

All models with active roll bar system - Active roll bar system					
	Genuine*	1	<b>LR072419</b>	706.93	848.32
				200.00	240.00
				*Exchange Surcharge	

## Valve, Levelling

All models - Air Suspension					
Front	Genuine	1	<b>LR070245</b>	124.00	148.80
Rear	Genuine	1	<b>LR070246</b>	124.00	148.80

## O Ring Seal Kit

All models with Active Cornering Enhancement - Air suspension valve block					
	OEM	1	<b>RVW100010P1</b>	14.37	17.24
	Genuine	1	<b>RVW100010</b>	22.91	27.49

## Track Rod End

All models up to (VIN) FA619100 - Steering rack with 14mm track rods. With nut					
	Genuine	2	<b>LR033534</b>	64.63	77.56

## Track Rod, Steering Rack

All models up to (VIN) FA619100 - Steering rack with 14mm track rods.					
With gaiter, without track rod end					
	Genuine	2	<b>LR033529</b>	105.75	126.90

## Gaiter Kit, Track Rod

All models up to (VIN) FA619100 - Steering rack with 14mm track rods. Includes one gaiter with clamps					
	Genuine	2	<b>LR033528</b>	37.24	44.69

## Power Steering Fluid

All models - 1 litre. Cold (standard) climates fluid					
	Aftermarket	a/r	<b>STC50519P</b>	12.08	14.50
	Genuine	a/r	<b>STC50519</b>	18.96	22.75



STC50519P



## RANGE ROVER SPORT L494 (2014 on)

## Drive Shaft Gaiter Kit

All models with 2 speed transfer case				
Front, RH or LH	OEM	2	<b>LR034530P1</b>	32.50 39.00
	Genuine	2	<b>LR034530</b>	75.42 90.50
All models				
Rear, RH or LH	OEM	2	<b>LR034533P1</b>	34.17 41.00
	Genuine	2	<b>LR034533</b>	75.42 90.50

## Drive Flange Kit, Transfer Box

All models				
Output shaft, front	Genuine	1	<b>IEA500031</b>	81.83 98.20
Rear output shaft	Genuine	1	<b>LR039528</b>	107.64 129.17

## Knuckle &amp; Hub

All models				
Front RH	Genuine	1	<b>LR078375</b>	480.73 576.88
Front LH	Genuine	1	<b>LR078377</b>	498.83 598.60

## Oil Seal, Differential

All models				
Front axle pinion	OEM	1	<b>LR019019P1</b>	5.63 6.76
	Genuine	1	<b>LR019019</b>	9.25 11.10
Front & rear axles, output shafts	OEM	1	<b>TZB500050P1</b>	6.25 7.50
	Genuine	1	<b>TZB500050</b>	13.21 15.85
Rear axle pinion	Genuine	1	<b>TZB500100</b>	16.28 19.54

## Sealing Ring, Transfer Box

All models				
Front output shaft	OEM	1	<b>IZB500040P1</b>	8.13 9.76
	Genuine	1	<b>IZB500040</b>	10.17 12.20
Rear output shaft	OEM	1	<b>IZB500050P1</b>	4.79 5.75
	Genuine	1	<b>IZB500050</b>	9.84 11.81

## Oil Seal, Transfer Box

All models - Input shaft				
	Aftermarket	1	<b>IZB500030P</b>	6.67 8.00
	Genuine	1	<b>IZB500030</b>	12.96 15.55

## TRANSMISSION

## Plug, Differential

All models				
Oil filler, front & rear axles	Genuine	1	<b>TYB500060</b>	0.86 1.03
Oil drain, front & rear axles	Genuine	1	<b>TYB500080</b>	11.54 13.85

## Plug, Transfer Box

All models - Oil Fill & Drain				
	OEM	1	<b>IYB500020P1</b>	1.75 2.10
	Genuine	1	<b>IYB500020</b>	2.49 2.99
All models with single speed transfer box				
Oil fill & drain, M18 (not M16)	Genuine	1	<b>LR048841</b>	2.99 3.59

## Oil Temperature Switch

All models with rear axle locking differential				
Rear axle differential	Genuine	1	<b>NSC500590</b>	14.45 17.34

## Chain Only, Transfer Box

All models with 2 speed transfer box up to (VIN) EA308098				
	OEM	1	<b>LR049160CP1</b>	133.33 160.00

## Sensor, Differential

All models with rear axle locking differential - Oil temperature				
	Genuine	1	<b>NSC500590</b>	14.45 17.34

## Sensor, Transfer Box

All models with two speed transfer box - High/low position				
	Genuine	1	<b>IAB500191</b>	74.63 89.56

## Solenoid, Transfer Box

All models with two speed transfer box - Pressure				
	Genuine	1	<b>IGF500011</b>	77.19 92.63

## Damper, Vibration

All models with two speed transfer box - Transfer box				
	Genuine	1	<b>LR094511</b>	33.76 40.51

## RANGE ROVER SPORT L494 (2014 on)

## Expansion Bottle Cap

All 2.0L turbocharged petrol models				
	Aftermarket	1	<b>LR017427P</b>	4.79 5.75
	Genuine	1	<b>LR017427</b>	6.99 8.39
All 3.0L V6 petrol models				
	OEM	1	<b>LR010965P1</b>	2.42 2.90
	Genuine	1	<b>LR010965</b>	5.57 6.68
All 3.0L V6 diesel models				
	Aftermarket	1	<b>LR017427P</b>	4.79 5.75
	Genuine	1	<b>LR017427</b>	6.99 8.39
All 4.4L TDV8 diesel models				
	Aftermarket	1	<b>LR017427P</b>	4.79 5.75
	Genuine	1	<b>LR017427</b>	6.99 8.39
All 5.0L supercharged AJV8 petrol models				
	OEM	1	<b>LR010965P1</b>	2.42 2.90
	Genuine	1	<b>LR010965</b>	5.57 6.68

## Thermostat &amp; Radiator Hose Assembly

All 3.0L V6 diesel models - In-line thermostat with top & bottom hose assembly				
	Genuine	1	<b>LR082870</b>	199.95 239.94

## Water Pump

All 2.0L TIVCT turbo petrol models (VIN) FA000001 on				
	Aftermarket	1	<b>LR081578P</b>	35.83 43.00
	OEM	1	<b>LR081578P1</b>	50.00 60.00
	Genuine	1	<b>LR081578</b>	105.27 126.32
All 3.0L V6 diesel engine models				
	Genuine	1	<b>LR013164</b>	87.26 104.71

## COOLING

## Gasket Water Pump

All 3.0L V6 petrol models				
	Aftermarket	1	<b>LR049370P</b>	4.58 5.50
	Genuine	1	<b>LR049370</b>	11.91 14.29
All 3.0L V6 diesel engine models				
	Genuine	1	<b>1316117</b>	24.53 29.44
All 5.0L supercharged AJV8 petrol models				
	Aftermarket	1	<b>LR049370P</b>	4.58 5.50
	Genuine	1	<b>LR049370</b>	11.91 14.29

## Coolant Temperature Sensor

All 3.0L V6 diesel models				
	Genuine	1	<b>LR041442</b>	25.70 30.84
All 3.0L V6 GEN2 diesel models				
	Genuine	1	<b>LR041442</b>	25.70 30.84
All 5.0L N/A AJV8 petrol models				
	Genuine	1	<b>LR041442</b>	25.70 30.84
All 5.0L supercharged AJV8 petrol models				
	Genuine	1	<b>LR041442</b>	25.70 30.84

## Coolant Level Sensor

All models				
	Genuine	1	<b>PCJ500030</b>	6.16 7.39

## RANGE ROVER SPORT L494 (2014 on)

## Alternator

All 2.0L turbo petrol models				
New, exchange	Genuine*	1	<b>LR072767</b>	735.80 882.96
	*Exchange Surcharge			250.00 300.00
All 3.0L V6 petrol models				
New, outright	OEM	1	<b>LR072764P1</b>	316.67 380.00
New, exchange	Genuine*	1	<b>LR072764</b>	695.32 834.38
	*Exchange Surcharge			200.00 240.00
All models with 4.4L TDV8 diesel engine				
New, outright	OEM	1	<b>LR072762P1</b>	225.00 270.00
New, exchange	Genuine*	1	<b>LR072762</b>	475.43 570.52
	*Exchange Surcharge			150.00 180.00
All 5.0L supercharged AJV8 petrol models				
New, outright	OEM	1	<b>LR072764P1</b>	316.67 380.00
New, exchange	Genuine*	1	<b>LR072764</b>	695.32 834.38
	*Exchange Surcharge			200.00 240.00

## ELECTRICAL - ROTATING ELECTRICS

## Starter Motor

All 3.0L V6 diesel models without stop start system				
New, outright	OEM	1	<b>LR080299P1</b>	175.00 210.00
New, exchange	Genuine*	1	<b>LR080299</b>	382.73 459.28
	*Exchange Surcharge			100.00 120.00
All models with 3.0L V6 diesel engine without stop/start				
New, outright	OEM	1	<b>LR080299P1</b>	175.00 210.00
New, exchange	Genuine*	1	<b>LR080299</b>	382.73 459.28
	*Exchange Surcharge			100.00 120.00



## ENGINE GASKETS

### Gasket Camshaft Cover

All 2.0L turbo petrol models	Genuine	1	<b>LR025664</b>	11.44	13.73
All 3.0L V6 diesel models	Aftermarket	2	<b>LR029132P</b>	6.67	8.00
	Genuine	2	<b>LR029132</b>	14.86	17.83
All 4.4L TDV8 diesel models					
RH, also inlet manifold	Genuine	1	<b>LR035031</b>	17.07	20.48
LH, also inlet manifold	Genuine	1	<b>LR035029</b>	51.30	61.56

### Gasket Cylinder Head

All 3.0L supercharged V6 petrol models					
RH	Genuine	1	<b>LR041640</b>	18.59	22.31
LH	Genuine	1	<b>LR041641</b>	14.62	17.54
All models with 3.0L V6 diesel engine					
Grade 2	OEM	2	<b>LR013063P1</b>	14.50	17.40
	Genuine	2	<b>LR013063</b>	23.72	28.46
Grade 3	Genuine	2	<b>LR013066</b>	23.72	28.46
Grade 4	OEM	2	<b>LR013070P1</b>	10.83	13.00
	Genuine	2	<b>LR013070</b>	15.80	18.96
Grade 5	OEM	2	<b>LR013073P1</b>	10.83	13.00
	Genuine	2	<b>LR013073</b>	15.80	18.96
All 4.4L TDV8 diesel models					
RH	Genuine	1	<b>LR022899</b>	9.74	11.69
LH	Genuine	1	<b>LR022897</b>	10.51	12.61

## RANGE ROVER SPORT L494 (2014 on)

### Gasket Oil Sump

All 4.4L TDV8 diesel models	Genuine	1	<b>LR094141</b>	54.08	64.90
-----------------------------	---------	---	-----------------	-------	-------

### Sealant Instant Gasket

Numerous applications	Genuine	a/r	<b>STC50550</b>	13.10	15.72
-----------------------	---------	-----	-----------------	-------	-------



## ENGINE SWITCHES

### Camshaft Position Sensor

All 3.0L supercharged V6 petrol models	OEM	1	<b>LR014372P1</b>	36.67	44.00
	Genuine	1	<b>LR014372</b>	118.70	142.44
All 3.0L V6 diesel models	Genuine	1	<b>LR013458</b>	121.12	145.34
All 5.0L supercharged AJV8 petrol models	OEM	1	<b>LR014372P1</b>	36.67	44.00
	Genuine	1	<b>LR014372</b>	118.70	142.44

### Crankshaft Position Sensor

All 2.0L turbo petrol models	Genuine	1	<b>LR038756</b>	38.23	45.88
All 3.0L supercharged V6 petrol models	Genuine	1	<b>LR035561</b>	38.46	46.15
All 3.0L V6 diesel models	Aftermarket	1	<b>LR049872P</b>	55.00	66.00
	Genuine	1	<b>LR049872</b>	146.50	175.80
All 5.0L supercharged AJV8 petrol models	Genuine	1	<b>LR035561</b>	38.46	46.15

### Engine Knock Sensor

All 2.0L turbo petrol models	Genuine	1	<b>LR025005</b>	24.85	29.82
All 3.0L V6 supercharged petrol models	Genuine	1	<b>LR008877</b>	33.19	39.83
All 5.0L supercharged AJV8 petrol models	Genuine	1	<b>LR008877</b>	33.19	39.83

### Oil Level Sensor

All 3.0L supercharged V6 petrol models	Genuine	1	<b>LR012640</b>	35.68	42.82
All 3.0L V6 diesel models	Genuine	1	<b>LR012640</b>	35.68	42.82
All 4.4L V8 diesel models	Genuine	1	<b>LR012640</b>	35.68	42.82
All 5.0L supercharged AJV8 petrol models	Genuine	1	<b>LR012640</b>	35.68	42.82

### Oil Pressure Switch

All 2.0L turbo petrol models	Genuine	1	<b>LR000633</b>	2.86	3.43
All 3.0L TDV6 diesel models	Genuine	1	<b>1316119</b>	13.94	16.73
All 4.4L V8 diesel models	Genuine	1	<b>LR000633</b>	2.86	3.43

### Air Charge Temperature Sensor

All 2.0L turbo petrol models	Aftermarket	1	<b>LR021587P</b>	21.00	25.20
	Genuine	1	<b>LR021587</b>	23.34	28.01
All 3.0L supercharged V6 petrol models	Aftermarket	1	<b>LR021587P</b>	21.00	25.20
	Genuine	1	<b>LR021587</b>	23.34	28.01
All 3.0L V6 diesel models - Turbocharger outlet	Genuine	1	<b>LR014386</b>	47.36	56.83
All 4.4L V8 diesel models - Turbocharger outlet	Genuine	1	<b>LR023069</b>	26.30	31.56
All 5.0L supercharged AJV8 petrol models	Aftermarket	1	<b>LR021587P</b>	21.00	25.20
	Genuine	1	<b>LR021587</b>	23.34	28.01

## DRAIN PLUGS

### Sump Plug & Washer

3.0L V6 diesel models	Aftermarket	1	<b>1013938P</b>	1.50	1.80
	Genuine	1	<b>1013938</b>	3.19	3.83

## RANGE ROVER SPORT L494 (2014 on)

### Manifold Absolute Pressure Sensor

All 3.0L V6 supercharged petrol models up to (VIN) EA300000	Genuine	1	<b>LR008881</b>	86.58	103.90
All 3.0L V6 diesel models except GEN2 diesels from (VIN) FA000001 on	Genuine	1	<b>LR019130</b>	65.03	78.04
All 5.0L supercharged AJV8 petrol models up to (VIN) EA300000	Genuine	1	<b>LR008881</b>	86.58	103.90

### Oxygen Sensor

All 3.0L supercharged V6 petrol models	OEM	1	<b>LR035750P1</b>	95.00	114.00
	Genuine	1	<b>LR035750</b>	124.26	149.11
All 3.0L V6 diesel models from (VIN) FA000001 on					
Pre-catalyst	Genuine	1	<b>LR062045</b>	152.42	182.90
All 3.0L V6 diesel models with Euro Stage IV emissions					
RH, pre-catalyst	Genuine	1	<b>WDN500130</b>	34.85	41.82
All 3.0L V6 diesel models with Euro Stage V emissions					
RH, pre-catalyst	Genuine	1	<b>WDN500130</b>	34.85	41.82
All 4.4L TDV8 diesel models with Euro Stage V emissions up to (VIN) FA999999					
RH, pre-catalyst	Genuine	1	<b>WDN500130</b>	34.85	41.82
All 4.4L V8 diesel models					
Pre-catalyst	OEM	1	<b>LR001370P1</b>	90.00	108.00
	Genuine	1	<b>LR001370</b>	149.04	178.85
All 4.4L V8 diesel models from (VIN) GA000001 on					
RH, post-catalyst	Genuine	1	<b>LR062045</b>	152.42	182.90
All 5.0L supercharged AJV8 petrol models	OEM	1	<b>LR035750P1</b>	95.00	114.00
	Genuine	1	<b>LR035750</b>	124.26	149.11

### Exhaust Gas Pressure Sensor

All 3.0L V6 diesel models with 1 speed transfer box from (VIN) FA000001 on					
For diesel particulate filter (DPF), pressure differential, includes pipes	Genuine	1	<b>LR069660</b>	128.18	153.82
All 3.0L V6 diesel models with 2 speed transfer box from (VIN) FA000001 on					
For diesel particulate filter (DPF), pressure differential, includes pipes	Genuine	1	<b>LR069684</b>	128.18	153.82
All 4.4L V8 diesel models up to (VIN) FA999999					
For diesel particulate filter (DPF), pressure differential, includes pipes	Genuine	1	<b>LR071025</b>	83.28	99.94
All 4.4L V8 diesel models from (VIN) GA000001 on					
For diesel particulate filter (DPF), pressure differential, includes pipes	Genuine	1	<b>LR082004</b>	126.94	152.33

## RANGE ROVER SPORT L494 (2014 on)





**RANGE ROVER SPORT L494 (2014 on)****Crankshaft Oil Seal**

All models with 3.0L V6 diesel engine				
Front	Genuine	1	<b>1102415</b>	5.41 6.49
All models with 4.4L TDV8 diesel engine				
Front	Genuine	1	<b>1102415</b>	5.41 6.49

**Oil Seal Crankshaft Rear**

All 3.0L V6 diesel models - With retainer	Genuine	1	<b>LR036542</b>	36.48 43.78
-------------------------------------------	---------	---	-----------------	-------------

**OIL SEALS ENGINE****Oil Seal Camshaft**

All models with 3.0L V6 diesel engine				
Front and rear	Aftermarket	2	<b>1311318P</b>	2.00 2.40
	Genuine	2	<b>1311318</b>	2.83 3.40

**RANGE ROVER SPORT L494 (2014 on)****EGR Valve**

All 4.4L TDV8 diesel models	Genuine	1	<b>LR033373</b>	318.17 381.80
-----------------------------	---------	---	-----------------	---------------

**Gasket EGR Cooler Seating**

All 4.4L TDV8 diesel models	Genuine	1	<b>LR023100</b>	4.55 5.46
-----------------------------	---------	---	-----------------	-----------

**Gasket EGR Valve to Cooler**

All 4.4L TDV8 diesel models	Genuine	1	<b>LR050864</b>	7.14 8.57
-----------------------------	---------	---	-----------------	-----------

**EXHAUST GAS RECIRCULATION****Pipe EGR Valve to Inlet Manifold**

All 3.0L V6 diesel models				
RH	Genuine	1	<b>LR013589</b>	44.75 53.70
LH	Genuine	1	<b>LR013587</b>	44.75 53.70
All 3.0L V6 mono turbo diesel models from (VIN) FA000001 on				
	Genuine	1	<b>LR063127</b>	51.20 61.44
All 3.0L V6 twin turbo diesel models from (VIN) FA000001 on				
	Genuine	1	<b>LR063058</b>	51.20 61.44
All 4.4L TDV8 diesel models	Genuine	1	<b>LR023038</b>	69.19 83.03

**RANGE ROVER SPORT L494 (2014 on)****Engine Mounting**

All petrol models except 2.0 Turbo Petrol	Genuine	2	<b>LR056882</b>	98.22 117.86
All 2.0L turbo petrol models	Genuine	2	<b>LR057721</b>	96.05 115.26
All 3.0L V6 diesel models				
up to (VIN) EA503853	Genuine	2	<b>LR057721</b>	96.05 115.26
from (VIN) EA503854 on	Genuine	2	<b>LR057632</b>	62.55 75.06
All 4.4L TDV6 diesel models up to (VIN) FA999999				
RH	Genuine	1	<b>LR058376</b>	87.22 104.66
LH	Genuine	1	<b>LR058377</b>	80.34 96.41
All 4.4L TDV8 diesel models from (VIN) GA000001 on				
RH	Genuine	1	<b>LR072188</b>	94.46 113.35
LH	Genuine	1	<b>LR072190</b>	100.16 120.19

**ENGINE & GEARBOX MOUNTINGS****Vibration Damper**

All 2.0L turbo petrol models - Engine mounting				
	Genuine	2	<b>LR062359</b>	18.69 22.43

**Eye Bolt Gearbox Mounting**

All 2.0L turbo petrol models	Genuine	1	<b>KYG500200</b>	1.32 1.58
------------------------------	---------	---	------------------	-----------

**Vibration Damper**

All 2.0L turbo petrol models - Gearbox mounting				
	Genuine	1	<b>LR062361</b>	100.51 120.61

**RANGE ROVER SPORT L494 (2014 on)****Fuel Pressure Sensor**

All 2.0L turbo petrol models	Genuine	1	<b>LR024969</b>	53.76 64.51
All 3.0L supercharged V6 petrol models	Genuine	1	<b>LR015356</b>	41.46 49.75
All 4.4L V8 diesel models	Genuine	1	<b>LR020693</b>	46.86 56.23
All 5.0L N/A AJV8 petrol models from (VIN) DA771218 on				
	Genuine	1	<b>LR044707</b>	40.91 49.09
All 5.0L supercharged AJV8 petrol models				
	Genuine	1	<b>LR015356</b>	41.46 49.75
All 5.0L supercharged AJV8 petrol models from (VIN) DA771218 on				
	Genuine	1	<b>LR044707</b>	40.91 49.09

**FUEL SYSTEM SWITCHES****RANGE ROVER SPORT L494 (2014 on)****Wheel Centre Cap**

All models with bright black alloy wheel centre caps with Land Rover logo from (VIN) EA309592 on				
Bright black finish, Land Rover badge	Aftermarket	a/r	<b>LR069899P</b>	7.50 9.00
	Genuine	a/r	<b>LR069899</b>	10.76 12.91
All models with satin silver/bright aluminium alloy wheel centre caps with Land Rover logo from (VIN) EA309592 on				
Satin silver/bright aluminium finish, Land Rover badge	Genuine	a/r	<b>LR069900</b>	6.02 7.22

**Wheel Nut**

All models with Stealth Pack from (VIN) FA000001 on with 5 spoke or 9 spoke alloy wheels				
Black chrome finish	Genuine	a/r	<b>LR056214</b>	12.66 15.19
All models with stainless steel finish wheel nuts				
Stainless steel finish	OEM	a/r	<b>LR068126P1</b>	3.25 3.90
	Genuine	a/r	<b>LR068126</b>	5.27 6.32

**WHEEL CENTRE CAPS & WHEEL NUTS****Wheel Nut Set**

All models with stainless steel finish wheel nuts				
Stainless steel finish - set of 16	OEM	a/r	<b>LR068126P1K16</b>	40.00 48.00
	Genuine	a/r	<b>LR068126K16</b>	80.83 97.00
Stainless steel finish - set of 20	OEM	a/r	<b>LR068126P1K20</b>	50.00 60.00
	Genuine	a/r	<b>LR068126K20</b>	97.50 117.00
All models with grey/black or gloss black alloy wheels				
Gloss black chrome - set of 20	Genuine	a/r	<b>VPLWW0078</b>	210.04 252.05



# RANGE ROVER EVOQUE (2012 on)

2012 on - All Models

Listed below are the most popular parts required for the Range Rover Evoque.

We have access to the full range of parts for your vehicle. Please contact us if not listed here.



## FILTRATION

### Oil Filter

All 2.0L TIVCT turbo petrol models - Cartridge

Aftermarket	1	<b>LR025306P</b>	3.50	4.20
Genuine	1	<b>LR025306</b>	6.87	8.24

All 2.2L diesel models - Element

Aftermarket	1	<b>LR030778P</b>	3.00	3.60
OEM	1	<b>LR030778P1</b>	4.00	4.80
Genuine	1	<b>LR030778</b>	9.80	11.76



LR030778P

### Air Filter

All 2.0L TIVCT turbo petrol models

OEM	1	<b>LR029078P1</b>	11.04	13.25
Genuine	1	<b>LR029078</b>	15.70	18.84

All 2.2L diesel models

OEM	1	<b>LR029078P1</b>	11.04	13.25
Genuine	1	<b>LR029078</b>	15.70	18.84

### Fuel Filter

All 2.2L diesel models

OEM	1	<b>LR001313P1</b>	22.50	27.00
Genuine	1	<b>LR001313</b>	33.38	40.06

### Pollen Filter

All models (manual or electronic air conditioning) - Fresh air

Aftermarket	1	<b>LR056138P</b>	4.58	5.50
OEM	1	<b>LR056138P1</b>	9.58	11.50
Genuine	1	<b>LR056138</b>	15.66	18.79

## WIPER BLADES

### Wiper Blade

All RHD models

Front driver's side

Aftermarket	1	<b>LR078302P</b>	6.67	8.00
OEM	1	<b>LR078302P1</b>	8.75	10.50
Genuine	1	<b>LR078302</b>	15.50	18.60

Front passenger's side

OEM	1	<b>LR078303P1</b>	10.83	13.00
Genuine	1	<b>LR078303</b>	15.33	18.40

All LHD models

Front driver's side

OEM	1	<b>LR078304P1</b>	10.83	13.00
Genuine	1	<b>LR078304</b>	15.50	18.60

## RANGE ROVER EVOQUE (2012 on)

All LHD models except USA/CDN/Mex

Front passenger's side

OEM	1	<b>LR078306P1</b>	10.83	13.00
Genuine	1	<b>LR078306</b>	15.33	18.40

All USA/CDN/Mex LHD models

Front, passenger's side

OEM	1	<b>LR078305P1</b>	10.83	13.00
Genuine	1	<b>LR078305</b>	15.37	18.44

All models

Rear

OEM	1	<b>LR038795P1</b>	8.13	9.76
Genuine	1	<b>LR038795</b>	11.08	13.30

## SCREEN/LAMP WASHER SYSTEMS

### Washer Jet

All UK built models from (VIN) GH000001 on

Rear screen wash

Genuine	1	<b>LR074177</b>	15.36	18.43
---------	---	-----------------	-------	-------

### Washer Hose, Per Metre

All models - 4mm internal diameter (3mm also available).

Front or rear screen wash

Aftermarket	a/r	<b>GWW201M</b>	2.25	2.70
-------------	-----	----------------	------	------

### Washer Reservoir

All models without headlamp wash

Front & rear screen wash

Genuine	1	<b>LR025755</b>	31.55	37.86
---------	---	-----------------	-------	-------

All models with headlamp wash

Front & rear screen & headlamp wash

Genuine	1	<b>LR025760</b>	31.34	37.61
---------	---	-----------------	-------	-------

### Filler Neck Cap

All models

Front & rear screen & headlamp wash

Genuine	1	<b>LR002266</b>	1.86	2.23
---------	---	-----------------	------	------

## RANGE ROVER EVOQUE (2012 on)

### Washer Reservoir Filler Neck Filter

All models

Front & rear screen & headlamp wash

Genuine	1	<b>DMS500010</b>	3.27	3.92
---------	---	------------------	------	------

### Washer Reservoir Level Sensor

All models

Front & rear screen & headlamp wash

Genuine	1	<b>DMI500010</b>	4.20	5.04
---------	---	------------------	------	------

### Low Fluid Level Sensor

All models

Genuine	1	<b>LR000930</b>	11.52	13.82
---------	---	-----------------	-------	-------

### Windscreen Cleaning Paste

All models

Prevents wiper blade judder/squeak by 'deep cleaning' the windscreen (ref: Land Rover Tech Bulletin LRA501-002)

Genuine	a/r	<b>DNJ500340</b>	7.72	9.26
---------	-----	------------------	------	------

## DRIVE BELTS

### Timing Belt Kit

All models with 2.2L TD4/SD4 turbo diesel engine - With tensioners, without water pump

OEM	1	<b>LR032526P1</b>	51.67	62.00
Genuine	1	<b>LR032526</b>	119.39	143.27

### Timing Belt

All models with 2.2L TD4/SD4 diesel engine

Aftermarket	1	<b>LR004257P</b>	15.83	19.00
Genuine	1	<b>LR004257</b>	50.69	60.83

## RANGE ROVER EVOQUE (2012 on)

### Alternator Drive Belt

All models with 2.0L TIVCT turbo petrol engine - Alternator

OEM	1	<b>LR066153P1</b>	13.13	15.76
Genuine	1	<b>LR066153</b>	39.13	46.96

All 2.2L Duratorq turbo diesel models - Alternator

OEM	1	<b>LR060071P1</b>	8.13	9.76
Genuine	1	<b>LR060071</b>	32.53	39.04

## IGNITION SYSTEM

### Spark Plug

All 2.0L TIVCT turbocharged petrol models

Genuine	4	<b>LR025605</b>	13.73	16.48
---------	---	-----------------	-------	-------

### Glow Plug

All 2.0L AJ200 turbo diesel models

Genuine	4	<b>LR073727</b>	22.31	26.77
---------	---	-----------------	-------	-------

## RANGE ROVER EVOQUE (2012 on)



## RANGE ROVER EVOQUE (2012 on)

## BRAKING SYSTEM

## Brake Pad Set

All models				
Front	Aftermarket	1	<b>LR027309P</b>	29.58 35.50
	Genuine	1	<b>LR027309</b>	82.51 99.01
Rear	Aftermarket	1	<b>LR043714P</b>	15.00 18.00
	OEM	1	<b>LR043714P1</b>	23.75 28.50
	Genuine	1	<b>LR043714</b>	72.19 86.63

## Brake Slide Pin Boot Kit

All models - Front brakes	Genuine	2	<b>LR000751</b>	12.89 15.47
---------------------------	---------	---	-----------------	-------------

## Brake Pad Retaining Pins

All models - Front	Genuine	4	<b>LR003977</b>	11.71 14.05
--------------------	---------	---	-----------------	-------------

## Brake Disc (each)

All models				
Front	Aftermarket	2	<b>LR007055P</b>	17.50 21.00
	OEM	2	<b>LR007055P1</b>	25.83 31.00
	Genuine	2	<b>LR007055</b>	40.09 48.11
Rear, pair	Aftermarket	2	<b>LR027123P</b>	13.54 16.25
	Genuine	2	<b>LR027123</b>	49.50 59.40
All models with 17 disc brakes from (VIN) GH000001				
Front	Aftermarket	2	<b>LR059122P</b>	29.58 35.50
	Genuine	2	<b>LR059122</b>	84.25 101.10

## Performance Brake Disc (pair)

All models				
Front, slotted & drilled	Britpart	1	<b>LR007055URBP</b>	59.17 71.00
Rear, pair, slotted & drilled	Britpart	1	<b>LR027123BPUR</b>	32.50 39.00
All models with 17 disc brakes from (VIN) GH000001				
Front, Slotted & Drilled	Britpart	1	<b>LR059122BPUR</b>	59.17 71.00

## Mudshield Brake Disc

All models				
Front RH	Genuine	1	<b>LR027111</b>	10.17 12.20
Front LH	Genuine	1	<b>LR027110</b>	10.17 12.20
All models from (VIN) CH600050				
Rear RH	Genuine	1	<b>LR032821</b>	11.09 13.31
Rear LH	Genuine	1	<b>LR032822</b>	11.09 13.31

## Brake Caliper

All models				
Front RH	OEM*	1	<b>LR015386P1</b>	65.00 78.00
	*Exchange Surcharge			25.00 30.00
	Genuine*	1	<b>LR015386</b>	117.22 140.66
	*Exchange Surcharge			50.00 60.00
Front LH	OEM*	1	<b>LR015387P1</b>	65.00 78.00
	*Exchange Surcharge			25.00 30.00
	Genuine*	1	<b>LR015387</b>	117.22 140.66
	*Exchange Surcharge			50.00 60.00
All models to (VIN) FH999999				
Rear, RH	Genuine*	1	<b>LR027126</b>	137.20 164.64
	*Exchange Surcharge			70.00 84.00
Rear, LH	Genuine*	1	<b>LR027128</b>	137.20 164.64
	*Exchange Surcharge			70.00 84.00

## Brake Caliper Carrier

All models to (VIN) EH999999				
Front RH and LH	Genuine	2	<b>LR027311</b>	77.39 92.87
All models from (VIN) FH000001				
Front RH and LH	Genuine	2	<b>LR069759</b>	69.94 83.93
All models				
Rear RH and LH	Genuine	2	<b>LR027130</b>	62.02 74.42

## Dust Cover

All models - For carrier retaining pins front & rear				
	Aftermarket	2	<b>SEE500030P</b>	5.00 6.00
	Genuine	2	<b>SEE500030</b>	7.88 9.46

## Bolt Brake Caliper Carrier

All models				
Front M14 x 40mm Hex Head	Genuine	4	<b>LR000093</b>	1.19 1.43
Rear M12 x 36mm Hex Head	Genuine	4	<b>LR042690</b>	1.52 1.82

## Brake Master Cylinder

All models from (VIN) FH976004 to (VIN) FH999999				
	Genuine	1	<b>LR067017</b>	143.55 172.26

## Brake Servo Assembly

All models	Genuine	1	<b>LR024469</b>	166.34 199.61
------------	---------	---	-----------------	---------------

## Cap Brake Master Cylinder

All models from (VIN) AH188604 except Canada, USA and Mexico - Black				
	Genuine	1	<b>LR026354</b>	2.16 2.59
All models from (VIN) AH188604 including Canada and USA - Black				
	Genuine	1	<b>LR021624</b>	2.85 3.42

## Gasket Brake Servo

All models	Genuine	1	<b>LR000250</b>	1.48 1.78
------------	---------	---	-----------------	-----------

## Brake Pad Wear Sensor

All models with 17 disc brakes from (VIN) GH000001				
Front	Aftermarket	2	<b>LR061365P</b>	10.83 13.00
	Genuine	2	<b>LR061365</b>	24.04 28.85

## Caliper Repair Kit

All models - Front	Genuine	2	<b>LR028027</b>	25.53 30.64
--------------------	---------	---	-----------------	-------------

## Brake Hose

All models - Front				
	Aftermarket	2	<b>LR045439P</b>	10.83 13.00
All models from (VIN) DH718194 to (VIN) FH999999				
Rear to caliper	Genuine	2	<b>LR044896</b>	16.63 19.96

## Brake Pipe Clip

All models	Genuine	a/r	<b>ANR1864</b>	1.16 1.39
------------	---------	-----	----------------	-----------

## Wire Electronic Parking Brake

All models				
RH	Genuine	1	<b>LR028308</b>	11.36 13.63
LH	Genuine	1	<b>LR028307</b>	11.36 13.63

## Harness, Wiring

All models (VIN) GH000001 on - Electronic parking brake				
RH	Genuine	1	<b>LR074060</b>	21.34 25.61
LH	Genuine	1	<b>LR074059</b>	19.61 23.53

## Parking Brake Actuator

All models	Genuine	1	<b>LR027141</b>	155.09 186.11
------------	---------	---	-----------------	---------------

## Electric Parking Brake Module

All models from (VIN) CH624317 to (VIN) DH999999				
	Genuine	1	<b>LR035288</b>	170.49 204.59

## ABS Sensor

All models				
Front Hubs	Aftermarket	2	<b>LR071974P</b>	19.58 23.50
	Genuine	2	<b>LR071974</b>	84.73 101.68
Rear less automated parking system	Aftermarket	2	<b>LR024203P</b>	25.00 30.00
	Genuine	2	<b>LR024203</b>	71.50 85.80
All models from (VIN) EH000001 to (VIN) FH999999				
Rear	Genuine	2	<b>LR082224</b>	68.57 82.28

## Brake Light Switch

All models from (VIN) CH606044 to (VIN) DH999999				
	Genuine	1	<b>LR032956</b>	3.17 3.80

## Pedal Rubber Set (2 piece)

All models with automatic transmission	Genuine	1	<b>VPLHS0044</b>	83.67 100.40
----------------------------------------	---------	---	------------------	--------------

## Brake Pedal Rubber

All 6 speed manual models	Genuine	1	<b>LR005273</b>	12.89 15.47
All 6 and 9 speed auto models	Genuine	1	<b>LR005272</b>	12.89 15.47



LR027309P



LR007055P





# SUSPENSION

## Anti Roll Bar

All saloon models				
Front	Genuine	1	<b>LR024493</b>	82.86 99.43
All convertible models				
Front	Genuine	1	<b>LR067053</b>	160.86 193.03
All 2.0L 16V TIVCT TC petrol models except 6 speed manual 2WD				
Rear	Genuine	1	<b>LR034326</b>	80.01 96.01
All Class A 3 & 5 door models				
Rear	Genuine	1	<b>LR034326</b>	80.01 96.01

## Anti Roll Bar Bush

All models to (VIN) CH600000				
Front	Genuine	2	<b>LR030743</b>	4.82 5.78
All China build models from (VIN) EG000001 on				
Front	Genuine	2	<b>LR030743</b>	4.82 5.78
Rear	Genuine	2	<b>LR034392</b>	3.11 3.73
All 2.2L CR 16v diesel models				
Front	Aftermarket	2	<b>LR031310P</b>	3.25 3.90
	Genuine	2	<b>LR031310</b>	5.48 6.58
All 2.0L models from (VIN) CH657850				
Rear	Genuine	2	<b>LR034392</b>	3.11 3.73
All Brazil build models from (VIN) GT000001 on				
Rear	Genuine	2	<b>LR034392</b>	3.11 3.73

## Mounting Bush, Anti Roll Bar

All models from (VIN) GH126730 on				
Front	Genuine	2	<b>LR079950</b>	48.15 57.78

## Anti Roll Bar Link

All models				
Front	Aftermarket	2	<b>LR024474P</b>	13.13 15.76
	Genuine	2	<b>LR024474</b>	24.61 29.53
Rear	Aftermarket	2	<b>LR002876P</b>	4.58 5.50
	Genuine	2	<b>LR002876</b>	21.35 25.62

## Shock Absorber

All models without adaptive damping				
Front RH	Aftermarket	1	<b>LR024442P</b>	70.00 84.00
	Genuine	1	<b>LR024442</b>	109.05 130.86
Up rated Front RH B6 Damper	Bilstein	1	<b>LR024442BIL</b>	125.83 151.00
Front LH	Aftermarket	1	<b>LR070934P</b>	70.00 84.00
	Genuine	1	<b>LR070934</b>	150.64 180.77
Up rated Front LH B6 Damper	Bilstein	1	<b>LR070934BIL</b>	125.83 151.00
All models with std suspension and magnetic damping up to (VIN) GH098811				
Front RH	Genuine	1	<b>LR057931</b>	511.71 614.05
All saloons with std suspension and magnetic damping from (VIN) GH098812 on				
Front RH	Genuine	1	<b>LR079422</b>	391.95 470.34
All saloon models with std suspension without magnetic damping from (VIN) GH000001 on				
Front LH	Genuine	1	<b>LR070934</b>	150.64 180.77
All models with std suspension and magnetic damping from (VIN) GH000001 on				
Front LH	Genuine	1	<b>LR070932</b>	623.05 747.66
All saloon models with heavy duty suspension, without magnetic damping except AMS conversion				
Front RH	Genuine	1	<b>LR078497</b>	126.54 151.85
Front LH	Genuine	1	<b>LR078496</b>	126.54 151.85
All models with heavy duty suspension and magnetic damping from (VIN) GH000001 on				
Front RH	Genuine	1	<b>LR070927</b>	623.05 747.66
Front LH	Genuine	1	<b>LR070929</b>	623.05 747.66
All convertible models				
Front RH	Genuine	1	<b>LR070926</b>	131.27 157.52
Front LH	Genuine	1	<b>LR070930</b>	623.05 747.66
All 3 door saloons without adaptive damping				
Rear RH, Bilstein B6	Bilstein	1	<b>LR044684BIL</b>	125.83 151.00
Rear RH	Genuine	1	<b>LR070942</b>	150.64 180.77
Rear LH, Bilstein B6	Bilstein	1	<b>LR044681BIL</b>	125.83 151.00
Rear LH	Genuine	1	<b>LR044681</b>	112.61 135.13
All 5 door saloons				
Rear RH, Bilstein B6	Bilstein	1	<b>LR044684BIL</b>	125.83 151.00
Rear RH	Genuine	1	<b>LR070942</b>	150.64 180.77
Rear LH, Bilstein B6	Bilstein	1	<b>LR044681BIL</b>	125.83 151.00
Rear LH	Genuine	1	<b>LR044681</b>	112.61 135.13
All saloon models with std suspension without magnetic damping from (VIN) GH000001 on				
Rear RH	Genuine	1	<b>LR070942</b>	150.64 180.77
All saloon models with 2.0L turbo petrol engine, std suspension with magnetic damping from (VIN) GH000001 on				
Rear RH	Genuine	1	<b>LR070944</b>	497.10 596.52
All saloons with 2.0L turbo petrol engine and magnetic damping				
Rear RH	Genuine	1	<b>LR079421</b>	380.25 456.30
All saloons with magnetic damping				
Rear LH	Genuine	1	<b>LR079420</b>	380.25 456.30
All convertible models without magnetic damping				
Rear RH	Genuine	1	<b>LR070946</b>	131.27 157.52
Rear LH	Genuine	1	<b>LR070951</b>	131.27 157.52



LR031310P

# RANGE ROVER EVOQUE (2012 on)

## Vibration Damper

All models - Rear suspension strut	Genuine	2	<b>LR041112</b>	12.48 14.98
------------------------------------	---------	---	-----------------	-------------

## Shock Absorber Support

All models from (VIN) CH622441				
Rear, upper 32mm	Genuine	2	<b>LR034080</b>	10.39 12.47

## Coil Spring

All saloon models				
Front, blue/brown	Genuine	2	<b>LR024491</b>	37.92 45.50
Front, green/brown	Genuine	2	<b>LR024492</b>	40.95 49.14
Front, red/brown	Genuine	2	<b>LR024489</b>	61.45 73.74
Front, yellow/brown	Genuine	2	<b>LR024490</b>	37.92 45.50
All saloon models (China build) from EG000001				
Front	Genuine	2	<b>LR024489</b>	61.45 73.74
Convertible models requiring green coded front springs				
Front, green	Genuine	2	<b>LR070918</b>	67.65 81.18
Front, white	Genuine	2	<b>LR070917</b>	32.20 38.64
All models to (VIN) CH705607				
Rear, grey/purple/red includes 27mm pad	Genuine	2	<b>LR031997</b>	61.29 73.55
Rear, purple/pink includes 27mm pad red	Genuine	2	<b>LR031995</b>	61.29 73.55
Rear, purple/red includes 27mm pad brown	Genuine	2	<b>LR031996</b>	61.29 73.55
All models from (VIN) CH705608				
Rear, grey/purple/red includes 27mm pad	Genuine	2	<b>LR034088</b>	61.29 73.55
Rear, purple/pink includes 27mm pad red	Genuine	2	<b>LR034086</b>	61.29 73.55
Rear, purple/red includes 27mm pad brown	Genuine	2	<b>LR034087</b>	61.29 73.55
Rear, purple/red includes 27mm pad white	Genuine	2	<b>LR034085</b>	41.18 49.42
All convertible models with pink/blue coded rear springs				
Rear, pink/blue	Genuine	2	<b>LR070958</b>	71.50 85.80
All convertible models with pink/green coded rear springs				
Rear, pink/green	Genuine	2	<b>LR070959</b>	71.50 85.80
All convertible models with pink/red coded rear springs				
Rear, pink/red	Genuine	2	<b>LR070956</b>	71.50 85.80
All convertible models with yellow/pink coded rear springs				
Rear, yellow/pink	Genuine	2	<b>LR070957</b>	71.50 85.80
All models				
Rear, purple includes 27mm pad, red	Genuine	2	<b>LR034081</b>	43.33 52.00
Rear, purple includes 27mm pad, red/blue	Genuine	2	<b>LR034083</b>	41.18 49.42
Rear, purple includes 27mm pad, red/green	Genuine	2	<b>LR034084</b>	41.18 49.42
Rear, yellow/purple includes 27mm pad, red	Genuine	2	<b>LR034082</b>	41.18 49.42

## Lower Arm Assembly

All models with heavy duty suspension from (VIN) GH000001 on				
Front RH	Genuine	1	<b>LR086107</b>	177.94 213.53
Front LH	Genuine	1	<b>LR086108</b>	177.94 213.53

## Knuckle Assembly, Wheel

All models				
Rear, RH	Genuine	1	<b>LR068883</b>	218.30 261.96
Rear, LH	Genuine	1	<b>LR068884</b>	212.70 255.24

## Suspension Arm

All models - Rear RH & LH	Genuine	2	<b>LR029576</b>	43.82 52.58
---------------------------	---------	---	-----------------	-------------



## RANGE ROVER EVOQUE (2012 on)

## STEERING

## Track Rod End

All models				
RH	Aftermarket	1	LR026267P	14.17 17.00
	OEM	1	LR026267P1	27.08 32.50
	Genuine	1	LR026267	47.88 57.46
LH				
	Aftermarket	1	LR027570P	16.25 19.50
	OEM	1	LR027570P1	27.08 32.50
	Genuine	1	LR027570	50.16 60.19

## Track Rod Assembly

All models - Without track rod end				
	OEM	2	LR026271P1	23.33 28.00
	Genuine	2	LR026271	52.95 63.54

## Gaiter Kit, Track Rod

All models - Steering rack. Includes one gaiter with clamps				
	Genuine	2	LR026273	28.33 34.00

## RANGE ROVER EVOQUE (2012 on)

## CLUTCH

## Clutch Plate &amp; Cover

All manual models				
	OEM	1	LR048408P1	130.00 156.00
	Genuine	1	LR048408	184.65 221.58

## Clutch Slave Cylinder

All 2.2L & 2.0L 4 cyl diesel manual models - Includes clutch release bearing				
	Genuine	1	LR022452	72.77 87.32

## Clutch Pedal Spring Kit

All RHD 2.2L & 2.0L 4 cyl diesel manual models - Includes springs & retainers				
	Genuine	1	LR024698	24.60 29.52

All LHD 2.2L & 2.0L 4 cyl diesel manual models - Includes springs & retainers				
	Genuine	1	LR024700	24.60 29.52

## RANGE ROVER EVOQUE (2012 on)

## TRANSMISSION

## Drive Shaft &amp; CV Joint

All AWD models with dynamic driveline from (VIN) EH000001 on				
Rear axle, RH or LH	Genuine	2	LR062317	388.09 465.71

## Knuckle &amp; Hub

All models up to (VIN) EH999999				
Front RH	Genuine	1	LR087153	226.11 271.33
Front LH	Genuine	1	LR087154	226.11 271.33

All models with std suspension				
Front RH	Genuine	1	LR077913	291.07 349.28
Front LH	Genuine	1	LR078179	291.07 349.28

All models with heavy duty suspension up to (VIN) GH999999				
Front RH	Genuine	1	LR077914	305.80 366.96
Front LH	Genuine	1	LR078178	300.67 360.80

All models with heavy duty suspension, size 16 or 17 discs and calipers from (VIN) HH000001 on				
Front RH	Genuine	1	LR077914	305.80 366.96
Front LH	Genuine	1	LR078178	300.67 360.80

## Oil Seal, Differential

All AWD models				
Front axle pinion	Genuine	1	LR003152	7.19 8.63
All AWD models up to (VIN) FH999999				
Rear axle pinion	OEM	1	LR023442P1	7.08 8.50
	Genuine	1	LR023442	12.96 15.55
All AWD models to (VIN) DH999999				
Rear axle, differential to driveshaft	Genuine	1	LR023440	3.58 4.30
All AWD models with efficient driveline from (VIN) EH000001 to FH999999				
Rear axle, differential to driveshaft	Genuine	1	LR023440	3.58 4.30
All AWD models with dynamic driveline from (VIN) EH000001 on				
Rear axle, differential to driveshaft	Genuine	1	LR023440	3.58 4.30

## Oil Seal, Driveshaft

All AWD models				
RH outer seal, front differential	Genuine	1	LR001950	7.50 9.00
LH outer seal, front differential	Genuine	1	LR003155	14.45 17.34
RH inner seal, front differential	Genuine	1	LR003153	8.89 10.67
LH inner seal, front differential	Genuine	1	LR003154	9.04 10.85

## Oil Seal Kit, Haldex Coupling

All AWD models up to (VIN) FH999999				
Rear axle	Genuine	1	LR008955	28.82 34.58

## O Ring, Differential Cover

All AWD models up to (VIN) FH999999				
Rear axle	Genuine	1	LR030846	4.77 5.72

## Sealing Washer, Drain Plug

All models - Front or rear axle				
	Genuine	1	LR001949	3.13 3.76

## RANGE ROVER EVOQUE (2012 on)

## COOLING

## Thermostat Housing

All 2.2L diesel models				
	OEM	1	LR001312P1	39.58 47.50
	Genuine	1	LR001312	62.25 74.70

## Water Pump

All 2.0L TIVCT turbo petrol models				
	Aftermarket	1	LR081578P	35.83 43.00
	OEM	1	LR081578P1	50.00 60.00
	Genuine	1	LR081578	105.27 126.32
All 2.2L diesel models				
	Aftermarket	1	LR011694P	39.58 47.50
	Genuine	1	LR011694	105.27 126.32

## Coolant Temperature Sensor

All 2.0L turbo petrol models from (VIN) EH000001 on				
	Genuine	1	LR041442	25.70 30.84
All USA/CDN/Mex 2.0L turbo petrol models up to (VIN) DH999999				
	Genuine	1	LR041442	25.70 30.84

## RANGE ROVER EVOQUE (2012 on)

## ELECTRICAL - ROTATING ELECTRICS

## Alternator

All 2.0L TIVCT turbo petrol models				
New, exchange	Genuine*	1	LR067840	376.61 451.93
				125.00 150.00
	*Exchange Surcharge			
All models with 2.2L diesel engine up to (VIN) DH999999				
New, outright	OEM	1	LR028116P1	165.83 199.00
New, exchange	Genuine*	1	LR028116	507.70 609.24
				150.00 180.00
	*Exchange Surcharge			

## Starter Motor

All 2.0L turbo petrol models without stop start system				
New, outright	Genuine	1	LR084458	258.16 309.79
All 2.0L turbo diesel manual models				
New, outright	Genuine	1	LR084460	373.08 447.70
All 2.0L turbo diesel automatic models				
New, outright	Genuine	1	LR085507	373.08 447.70
All 2.2L turbo diesel models with stop start system				
New, outright	Genuine	1	LR084922	389.08 466.90
All AWD & 2WD 2.2L diesel manual models				
New, outright	OEM	1	LR014060P1	155.00 186.00
New, exchange	Genuine*	1	LR014060	312.79 375.35
				100.00 120.00
	*Exchange Surcharge			
All AWD 2.2L diesel automatic models without start/stop				
New, outright	OEM	1	LR007373P1	175.00 210.00
New, exchange	Genuine*	1	LR007373	341.90 410.28
				70.00 84.00
	*Exchange Surcharge			



## ENGINE GASKETS

### Gasket Camshaft Cover

All 2.0L turbo petrol models	Genuine	1	<b>LR025664</b>	11.44	13.73
All 2.2L diesel models					
Front (upper) cam cover, round shape (2 required)					
Reinz manufacture	OEM	1	<b>LR009412P1</b>	9.38	11.26
	Genuine	1	<b>LR009412</b>	20.53	24.64
Front (upper) cam cover, 'L' shape gasket (1 required)					
Reinz manufacture	OEM	1	<b>LR009411P</b>	9.38	11.26
	Genuine	1	<b>LR009411</b>	26.52	31.82
All 2.2L 4 cyl diesel models					
Main (lower) cam cover	Genuine	1	<b>LR002834</b>	2.15	2.58

### Gasket Set Cam Cover

All 2.2L diesel models - Includes front cam cover gaskets x 3 (1 x 'L' shape, 2 x round) plus main cam cover gasket.					
Reinz manufacture	OEM	1	<b>LR0094112KBP</b>	14.38	17.26

## ENGINE SWITCHES

### Camshaft Position Sensor

All 2.2L diesel models	OEM	1	<b>LR016847P1</b>	20.00	24.00
	Genuine	1	<b>LR016847</b>	116.42	139.70

### Crankshaft Position Sensor

All 2.0L turbo petrol models up to (VIN) DH999999					
	Genuine	1	<b>LR025029</b>	38.85	46.62
All 2.0L turbo petrol models from (VIN) EH000001 on					
	Genuine	1	<b>LR038756</b>	38.23	45.88
All 2.0L diesel models					
All 2.2L diesel models from (VIN) EH000001 on	OEM	1	<b>LR056028P1</b>	14.58	17.50
	Genuine	1	<b>LR056028</b>	55.54	66.65

### Oil Temperature Switch

All 2.2L diesel models	Genuine	1	<b>LR001368</b>	26.08	31.30
------------------------	---------	---	-----------------	-------	-------

### Engine Knock Sensor

All 2.0L turbo petrol models	Genuine	1	<b>LR025005</b>	24.85	29.82
------------------------------	---------	---	-----------------	-------	-------

## DRAIN PLUGS

### Sump Plug

All 2.0L AJ200 turbo diesel models	Genuine	1	<b>LR073675</b>	4.28	5.14
------------------------------------	---------	---	-----------------	------	------

### Drain Plug

All models from (VIN) EH000001 on					
Front & rear differentials	Genuine	1	<b>LR051294</b>	5.89	7.07

## OIL SEALS ENGINE

### Engine Front Oil Seal

All 2.2L diesel models	Genuine	1	<b>LR052514</b>	12.44	14.93
------------------------	---------	---	-----------------	-------	-------

### Crankshaft Oil Seal

All models with 2.0L TIVCT turbocharged petrol engine					
Rear, with retainer	Genuine	1	<b>LR041955</b>	25.81	30.97
All models with 2.2L diesel engine					
Rear	OEM	1	<b>LR052515P1</b>	8.54	10.25
	Genuine	1	<b>LR052515</b>	17.23	20.68

## EXHAUST GAS RECIRCULATION (EGR)

### EGR Valve

All 2.2L diesel engine	OEM	1	<b>LR000997P1</b>	150.00	180.00
	Genuine	1	<b>LR000997</b>	211.10	253.32
All 2.0L diesel models with high pressure EGR - With cooler					
	Genuine	1	<b>LR073729</b>	193.92	232.70

### Pipe EGR Valve to Inlet Manifold

All 2.0L diesel models with high pressure EGR	Genuine	1	<b>LR073731</b>	67.67	81.20
-----------------------------------------------	---------	---	-----------------	-------	-------

### Pipe EGR Valve to Exhaust Manifold

All 2.0L diesel models with high pressure EGR	Genuine	1	<b>LR073732</b>	46.27	55.52
-----------------------------------------------	---------	---	-----------------	-------	-------

### Pipe EGR Valve to Cooler

All 2.0L diesel models with low pressure EGR	Genuine	1	<b>LR073733</b>	49.63	59.56
----------------------------------------------	---------	---	-----------------	-------	-------

## RANGE ROVER EVOQUE (2012 on)

### Gasket Cylinder Head

All 2.0L turbo petrol models	Genuine	1	<b>LR024975</b>	35.42	42.50
All 2.2L diesel models					
1.25mm thick, 1 hole on I.D. lip	OEM	1	<b>LR017303P1</b>	19.79	23.75
	Genuine	1	<b>LR017303</b>	34.02	40.82
1.30mm, two holes	OEM	1	<b>LR017304P1</b>	19.79	23.75
	Genuine	1	<b>LR017304</b>	48.09	57.71
1.35mm, three holes	OEM	1	<b>LR017305P1</b>	19.79	23.75
	Genuine	1	<b>LR017305</b>	48.20	57.84
1.40mm, four holes	OEM	1	<b>LR017307P1</b>	19.79	23.75
	Genuine	1	<b>LR017307</b>	48.95	58.74

### Sealant Instant Gasket

Numerous applications	Genuine	a/r	<b>STC50550</b>	13.10	15.72
-----------------------	---------	-----	-----------------	-------	-------

## RANGE ROVER EVOQUE (2012 on)

### Oil Pressure Switch

All 2.0L turbo petrol models	Genuine	1	<b>LR000633</b>	2.86	3.43
------------------------------	---------	---	-----------------	------	------

### Air Charge Temperature Sensor

All 2.0L turbo petrol models	Aftermarket	1	<b>LR021587P</b>	21.00	25.20
	Genuine	1	<b>LR021587</b>	23.34	28.01
All 2.2L diesel models	Aftermarket	1	<b>LR021587P</b>	21.00	25.20
	Genuine	1	<b>LR021587</b>	23.34	28.01

### Manifold Absolute Pressure Sensor

All 2.2L diesel models	OEM	1	<b>LR001324P1</b>	55.00	66.00
	Aftermarket	1	<b>LR001324P</b>	30.00	36.00
	Genuine	1	<b>LR001324</b>	86.58	103.90

### Oxygen Sensor

All 2.0L turbo petrol models up to (VIN) DH999999 - Pre-catalyst					
	OEM	1	<b>LR001370P1</b>	90.00	108.00
	Genuine	1	<b>LR001370</b>	149.04	178.85
All 2.2L diesel models - Pre-catalyst					
	OEM	1	<b>LR001370P1</b>	90.00	108.00
	Genuine	1	<b>LR001370</b>	149.04	178.85

## RANGE ROVER EVOQUE (2012 on)

## RANGE ROVER EVOQUE (2012 on)

## RANGE ROVER EVOQUE (2012 on)





## RANGE ROVER EVOQUE (2012 on)

## ENGINE &amp; GEARBOX MOUNTINGS

## Engine Mounting

All 2.0L turbo petrol models				
Upper	Genuine	1	LR024730	65.09 78.11
All 2.0L turbo petrol models from (VIN) CH645233				
Lower	Genuine	1	LR032311	43.25 51.90
All 2.0L diesel models				
Upper	Genuine	1	LR024729	71.89 86.27
Lower	Genuine	1	LR039527	41.68 50.02
All 2.2L diesel models				
Upper	Genuine	1	LR024729	71.89 86.27
Manual models - Lower	Genuine	1	LR032311	43.25 51.90
Automatic models - Lower	Genuine	1	LR039527	41.68 50.02

## Insulator Engine Mounting

All models - Lower	Genuine	1	LR000520	34.58 41.50
--------------------	---------	---	----------	-------------

## Bracket Engine Mounting

All 2.0L turbo petrol models - Upper	Genuine	1	LR037029	28.82 34.58
All 2.0L diesel models				
Upper, upper half	Genuine	1	LR071977	67.53 81.04
Upper, lower half	Genuine	1	LR072044	163.29 195.95
All 2.2L diesel models				
Upper, upper half	Genuine	1	LR047370	41.69 50.03
Upper, lower half	Genuine	1	LR001216	57.20 68.64

## Gearbox Mounting

All models up to (VIN) DH999999	Genuine	1	LR024738	109.05 130.86
All models from (VIN) EH000001 on	Genuine	1	LR061456	77.63 93.16

## Bracket Gearbox Mounting

All 2.0L turbo petrol models up to (VIN) DH999999				
	Genuine	1	LR024742	29.07 34.88
All 2.0L turbo petrol models from (VIN) EH000001 on				
	Genuine	1	LR047379	37.30 44.76
	Genuine	1	LR071972	76.37 91.64
All 2.0L diesel manual models				
	Genuine	1	LR071972	76.37 91.64
All 2.2L diesel manual models up to (VIN) DH999999				
	Genuine	1	LR024741	37.67 45.20
All 2.2L diesel automatic models up to (VIN) DH999999				
	Genuine	1	LR024740	26.43 31.72
All 2.2L & 2.0L diesel automatic models from (VIN) EH000001 on				
	Genuine	1	LR047373	30.72 36.86
All 2.2L diesel manual models from (VIN) EH000001 on				
	Genuine	1	LR047375	61.44 73.73

## Damper Gearbox Mounting

All 2.0L turbo petrol models from (VIN) EH000001 on	Genuine	1	LR047393	68.90 82.68
-----------------------------------------------------	---------	---	----------	-------------

## Tie Rod with Bush

All 2.0L turbo petrol models - Upper	Genuine	1	LR030745	54.92 65.90
All 2.0L diesel models - Upper	Genuine	1	LR000597	34.92 41.90
All 2.2L diesel models - Upper	Genuine	1	LR000597	34.92 41.90

## Bracket Tie Rod

All models - Upper	Genuine	1	LR078721	19.40 23.28
--------------------	---------	---	----------	-------------

## RANGE ROVER EVOQUE (2012 on)

## FUEL SYSTEM SWITCHES

## Fuel Pressure Sensor

All 2.0L turbo petrol models	Genuine	1	LR024969	53.76 64.51
------------------------------	---------	---	----------	-------------

## Air Flow Meter

All 2.0L turbo petrol models				
	OEM	1	LR019830P1	85.00 102.00
	Genuine	1	LR019830	107.33 128.80
All 2.2L diesel models				
	OEM	1	LR019830P1	85.00 102.00
	Genuine	1	LR019830	107.33 128.80

## RANGE ROVER EVOQUE (2012 on)

## WHEEL CENTRE CAPS &amp; WHEEL NUTS

## Wheel Centre Cap

All models with bright black alloy wheel centre caps up to (VIN) CH999999				
Bright black finish, Range Rover badge	Genuine	a/r	LR027409	8.43 10.12
All models with bright black alloy wheel centre caps with Land Rover logo from (VIN) EH000001 on				
Bright black finish, Land Rover badge	Aftermarket	a/r	LR069899P	7.50 9.00
	Genuine	a/r	LR069899	10.76 12.91
All models with satin silver/bright aluminium alloy wheel centre caps with Land Rover logo from (VIN) EH000001 on Satin silver/bright aluminium finish, Land Rover badge				
	Genuine	a/r	LR069900	6.02 7.22
Victoria Beckham limited edition only - Requires VIN to order				
	Genuine	a/r	LR043647	16.45 19.74

## Wheel Nut

All models with bright finish wheel nuts				
Stainless steel finish	Genuine	a/r	LR001381	1.94 2.33

## Wheel Nut Set

All models with gloss black wheels & wheel nuts				
Gloss black chrome, set of 20	Genuine	a/r	VPLVW0070	180.15 216.18



LR027409



LR069899P



# FREELANDER 1 (1996 to 2006)

## 1996 to 2006 - All Models



Listed below are the most popular parts required for the Freelander 1.

We have access to the full range of parts for your vehicle. Please contact us if not listed here.

## SERVICE KITS

### Service Kit

1.8L K Series petrol models to (VIN) YA999999

Includes oil filter, air filter, pollen filter, spark plugs & sump plug washer

Aftermarket	1	<b>LF1084P</b>	24.50	29.40
Genuine	1	<b>LF1084</b>	72.50	87.00

All 2.5L KV6 petrol models

Includes oil filter, air filter, pollen filter, spark plugs & sump plug washer

Aftermarket	1	<b>LF1093P</b>	35.42	42.50
Genuine	1	<b>LF1093</b>	80.00	96.00



LF1084P

### Filter Kit

1.8L K Series petrol models from (VIN) 1A000001 on

Includes oil filter, air filter, pollen filter, spark plugs & sump plug washer

Aftermarket	1	<b>LF1085P</b>	23.33	28.00
Genuine	1	<b>LF1085</b>	69.17	83.00

All 2.0L L Series diesel models

Includes oil filter, air filter, fuel filter, pollen filter & sump plug washer

Aftermarket	1	<b>LF1086P</b>	17.50	21.00
Genuine	1	<b>LF1086</b>	61.67	74.00

2.0L TD4 BMW M47 diesel models to (VIN) 2A218129

Includes oil filter, air filter, fuel filter, breather filter, pollen filter & sump plug washer

Aftermarket	1	<b>LF1087P</b>	22.50	27.00
Genuine	1	<b>LF1087</b>	114.17	137.00

2.0L TD4 BMW M47 diesel models from (VIN) 2A218130 on

Includes oil filter, air filter, fuel filter, breather filter, pollen filter & sump plug washer

Aftermarket	1	<b>LF1088P</b>	24.50	29.40
Genuine	1	<b>LF1088</b>	114.17	137.00

## FREELANDER 1 (1996-2006)

## FILTRATION

### Oil Filter

All models with 1.8L petrol engine - Cartridge

Aftermarket	1	<b>LPW100181P</b>	1.75	2.10
OEM	1	<b>LPW100180LP1</b>	3.25	3.90
Genuine	1	<b>LPW100180L</b>	7.31	8.77
Genuine	1	<b>LPW100181</b>	3.99	4.79

All models with 2.0L TD4 diesel engine - Element

Aftermarket	1	<b>LRF100150LP</b>	4.38	5.26
OEM	1	<b>LRF100150LP1</b>	5.42	6.50
Genuine	1	<b>LRF100150L</b>	11.39	13.67

All models with 2.0L L Series diesel engine - Cartridge

Aftermarket	1	<b>ERR5542P</b>	2.33	2.80
Genuine	1	<b>ERR5542</b>	8.49	10.19

All models with KV6 petrol engine - Cartridge

Aftermarket	1	<b>LPW100230P</b>	1.50	1.80
OEM	1	<b>LPW100230P1</b>	2.50	3.00
Genuine	1	<b>LPW100230</b>	5.99	7.19

All models with 2.0L TD4 diesel engine - Cam cover

Aftermarket	1	<b>LLJ500010P</b>	7.08	8.50
Aftermarket	1	<b>LLJ500010A</b>	18.46	22.15
Genuine	1	<b>LLJ500010</b>	29.71	35.65

### Air Filter

All models with 1.8L petrol engine

Aftermarket	1	<b>ESR4103P</b>	3.00	3.60
OEM	1	<b>ESR4103P1</b>	6.04	7.25
Genuine	1	<b>ESR4103</b>	15.08	18.10

All 2.0L TD4 diesel models

Aftermarket	1	<b>PHE100501P</b>	7.92	9.50
Genuine	1	<b>PHE100501</b>	28.41	34.09

Air flow sensor

Genuine	1	<b>LR007478</b>	29.25	35.10
---------	---	-----------------	-------	-------

All models with 2.0L L Series diesel

Aftermarket	1	<b>ESR4103P</b>	3.00	3.60
OEM	1	<b>ESR4103P1</b>	6.04	7.25
Genuine	1	<b>ESR4103</b>	15.08	18.10

All models with KV6 petrol engine

Aftermarket	1	<b>LR027408P</b>	2.50	3.00
OEM	1	<b>LR027408P1</b>	4.58	5.50
Genuine	1	<b>LR027408</b>	12.57	15.08

### EGR Air Filter

All 2.0L L Series diesel engine models to (VIN) YA999999

Genuine	1	<b>ESR4323</b>	2.93	3.52
---------	---	----------------	------	------

All 2.0L TD4 diesel models - Turbo vacuum control filter

Aftermarket	1	<b>PHB000450P</b>	1.08	1.30
Genuine	1	<b>PHB000450</b>	3.66	4.39

### EGR/Fuel Filter

All 2.0L TD4 diesel models - Turbo vacuum control filter

Aftermarket	1	<b>GFE7004</b>	2.83	3.40
-------------	---	----------------	------	------

### Fuel Filter

All petrol models up to (VIN) YA999999 - In fuel tank

Aftermarket	1	<b>WFL100160P</b>	2.83	3.40
OEM	1	<b>WFL100160P1</b>	9.79	11.75
Genuine	1	<b>WFL100160</b>	28.64	34.37

All petrol models from (VIN) 1A000001 on - In fuel tank

Aftermarket	1	<b>WFL000010P</b>	15.42	18.50
Genuine	1	<b>WFL000010</b>	35.02	42.02

All 2.0L TD4 diesel models - Located in line

Aftermarket	1	<b>MUN000010P</b>	7.50	9.00
OEM	1	<b>MUN000010P1</b>	9.58	11.50
Genuine	1	<b>MUN000010</b>	22.02	26.42

All 2.0L TD4 diesel models - Located by fuel pump

Aftermarket	1	<b>WJN000080P</b>	6.88	8.26
OEM	1	<b>WJN000080P1</b>	9.79	11.75
Genuine	1	<b>WJN000080</b>	18.92	22.70

### Fuel Filter Cartridge

All 2.0L M47 16v diesel engine models

Genuine	1	<b>WJN000070</b>	80.66	96.79
---------	---	------------------	-------	-------

### Pollen Filter

All models up to (VIN) YA999999

Aftermarket	1	<b>JKR100200P</b>	12.50	15.00
Genuine	1	<b>JKR100200</b>	32.06	38.47

All models from (VIN) 1A000001 to 1A999999

Aftermarket	1	<b>LR029773P</b>	4.58	5.50
OEM	1	<b>LR029773P1</b>	12.50	15.00
Genuine	1	<b>LR029773</b>	34.57	41.48

### Filter Valve Assembly

All 2.0L TD4 BMW M47 diesel models - Depression control

Aftermarket	1	<b>8510298P</b>	37.08	44.50
Genuine	1	<b>8510298</b>	53.69	64.43

## WIPER BLADES

### Wiper Blade

RHD models up to (VIN) 4A279509

Front, driver's side

Aftermarket	1	<b>DKC500120P</b>	2.50	3.00
Genuine	1	<b>DKC500120</b>	10.08	12.10

RHD models from (VIN) 4A279510

Front, driver's side

OEM	1	<b>DKC500120P1</b>	5.00	6.00
-----	---	--------------------	------	------

All LHD models

Front, driver's side

Aftermarket	1	<b>DKC500130P</b>	1.75	2.10
OEM	1	<b>DKC500130P1</b>	4.79	5.75
Genuine	1	<b>DKC500130</b>	10.34	12.41

All models

Front, passenger's side

Aftermarket	1	<b>DKC500140P</b>	1.75	2.10
OEM	1	<b>DKC500140P1</b>	4.38	5.26
Genuine	1	<b>DKC500140</b>	7.13	8.56

Rear

Aftermarket	1	<b>AWR4116P</b>	2.00	2.40
Genuine	1	<b>AWR4116</b>	4.95	5.94

## FREELANDER 1 (1996-2006)



DKC500120P1

AWR4116P



## FREELANDER 1 (1996-2006)

## SCREEN/LAMP WASHER SYSTEM

## Washer Jet

All models				
Front screen, twin jet type	Aftermarket	2	<b>DNJ500240P</b>	6.88 8.26
	Genuine	2	<b>DNJ500240</b>	8.30 9.96
Rear screen	OEM	1	<b>AWR2406P1</b>	5.83 7.00
	Genuine	1	<b>AWR2406</b>	7.26 8.71

## Washer Pump

All models				
Front screen	OEM	1	<b>DMC100550P1</b>	5.00 6.00
	Genuine	1	<b>DMC100550</b>	29.38 35.26
Rear screen	OEM	1	<b>DMC100540P1</b>	6.04 7.25
	Genuine	1	<b>DMC100540</b>	29.41 35.29

## Washer Hose, Per Metre

All models - 4mm internal diameter (3mm also available)				
Front or rear screen wash	Aftermarket	a/r	<b>GWW201M</b>	2.25 2.70

## Washer Hose Non Return Valve

All models				
Front screen wash	Genuine	1	<b>DNB100070</b>	3.00 3.60
Fits in-line in 4mm dia. hose	Aftermarket	2	<b>AMR6676P</b>	1.42 1.70
	Genuine	2	<b>AMR6676</b>	3.26 3.91

## Washer Hose Straight Connector

All models - Rear screen wash	Genuine	2	<b>DNG10007L</b>	4.13 4.96
-------------------------------	---------	---	------------------	-----------

## Washer Jet Gasket

All models - Front screen wash	Genuine	2	<b>DNK10002L</b>	2.36 2.83
--------------------------------	---------	---	------------------	-----------

## Washer Reservoir With Pump

All models without rear screen wash/wipe				
Front screen wash	Genuine	1	<b>AWR4764</b>	85.33 102.40
All models with rear screen wash/wipe				
Front & rear screen wash	Genuine	1	<b>AWR4763</b>	56.87 68.24

## Washer Reservoir Cap

All models	Genuine	1	<b>AMR3267</b>	4.13 4.96
------------	---------	---	----------------	-----------

## Washer Reservoir Filler Neck Filter

All models up to (VIN) 4A414999				
Front & rear screen wash	Genuine	1	<b>DMS000030</b>	36.44 43.73

## Washer Reservoir Filler Neck Seal

All models - Front & rear screen wash	Genuine	1	<b>DML10001L</b>	3.57 4.28
---------------------------------------	---------	---	------------------	-----------

## Filler Neck, Cap &amp; Filter

All models				
Front & rear screen & headlamp wash	Genuine	1	<b>DMF500031</b>	15.41 18.49

## Windscreen Cleaning Paste

All models				
Prevents wiper blade judder/squeak by 'deep cleaning' the windscreen (ref: Land Rover Tech Bulletin LRA501-002)				
	Genuine	a/r	<b>DNJ500340</b>	7.72 9.26



DMC100550P1

## FREELANDER 1 (1996-2006)

## DRIVE BELTS

## Timing Belt Kit

1.8L K Series petrol models to mid-1999 with non-auto tensioning timing belt  
Includes 23mm wide timing belt

MG Rover	1	<b>LHN100390K</b>	40.83 49.00
Britpart	1	<b>LHN100390BPK</b>	23.75 28.50

1.8L K Series petrol models from mid-1999 with auto tensioning timing belt  
Includes 26mm wide timing belt

Britpart	1	<b>LHN100560LBPK</b>	30.00 36.00
----------	---	----------------------	-------------

Models with 2.0L L Series diesel up to (engine) 17N000186 - Includes 114 tooth belt

Britpart	1	<b>LHN100610BPK</b>	45.00 54.00
----------	---	---------------------	-------------

Models with 2.0L L Series diesel from (engine) 17N000187 on - Includes 112 tooth belt

Britpart	1	<b>LHN100760BPK</b>	45.00 54.00
----------	---	---------------------	-------------

## Timing Belt

1.8L K Series petrol models to mid-1999 with non-auto tensioning timing belt - 23mm wide belt

OEM	1	<b>LHN100390P1</b>	12.50 15.00
Genuine	1	<b>LHN100390</b>	38.02 45.62

1.8L K Series petrol models from mid-1999 with auto tensioning timing belt - 26mm wide timing belt

Aftermarket	1	<b>LHN100560P</b>	12.50 15.00
MG Rover	1	<b>LHN100560</b>	25.00 30.00

All 1.8L K Series petrol models with auto belt tensioning - 26mm wide belt

OEM	1	<b>LHN100560LP1</b>	12.50 15.00
Genuine	1	<b>LHN100560L</b>	38.02 45.62

Models with 2.0L L Series diesel up to (engine) 17N000186  
114 teeth

OEM	1	<b>LHN100610P1</b>	16.88 20.26
Genuine	1	<b>LHN100610</b>	38.01 45.61

Models with 2.0L L Series diesel from (engine) 17N000187 on  
112 teeth

OEM	1	<b>LHN100760P1</b>	16.88 20.26
Genuine	1	<b>LHN100760</b>	55.00 66.00

All models with KV6 petrol engine

OEM	1	<b>LHN100410LP1</b>	29.58 35.50
MG Rover	1	<b>LHN100410</b>	54.00 64.80
Genuine	1	<b>LHN100410L</b>	75.54 90.65

Rear

OEM	1	<b>LHN100420LP1</b>	8.54 10.25
MG Rover	1	<b>LHN100420</b>	37.50 45.00
Genuine	1	<b>LHN100420L</b>	39.20 47.04

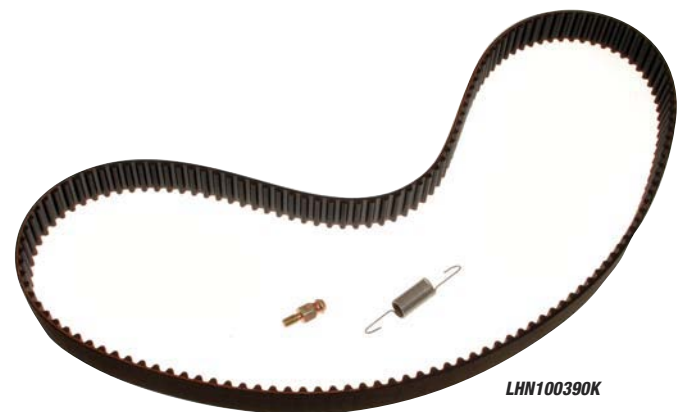

LHN100390K

## Alternator Drive Belt

All models with 1.8L petrol engine without air conditioning - Alternator

Aftermarket	1	<b>PQS100840P</b>	3.25 3.90
Genuine	1	<b>PQS100840</b>	8.00 9.60

All 1.8L petrol engine with air conditioning up to (VIN) YA999999 - Alternator

Aftermarket	1	<b>PQS101130P</b>	3.50 4.20
OEM	1	<b>PQS101130P1</b>	5.63 6.76
Genuine	1	<b>PQS101130</b>	18.81 22.57

from (VIN) 1A000001 on - Alternator

Aftermarket	1	<b>PQS101180P</b>	5.00 6.00
Genuine	1	<b>PQS101180</b>	15.00 18.00

All models with 2.0L L series diesel without air conditioning - Alternator

Aftermarket	1	<b>PQS101030P</b>	4.38 5.26
OEM	1	<b>PQS101030P1</b>	7.08 8.50
Genuine	1	<b>PQS101030</b>	18.57 22.28

with air conditioning - Alternator

Aftermarket	1	<b>PQS100851P</b>	5.63 6.76
OEM	1	<b>PQS100851P1</b>	8.33 10.00
Genuine	1	<b>PQS100851</b>	27.89 33.47

All 2.0L TD4 BMW M47 diesel models - Alternator

Aftermarket	1	<b>PQS101300LP</b>	4.58 5.50
OEM	1	<b>PQS101300LP1</b>	8.75 10.50
Genuine	1	<b>PQS101300L</b>	30.06 36.07
Genuine	1	<b>PQS101300</b>	22.00 26.40

All 2.5L KV6 petrol models without air conditioning - Alternator

OEM	1	<b>PQS101262LP1</b>	14.58 17.50
MG Rover	1	<b>PQS101262</b>	15.00 18.00
Genuine	1	<b>PQS101262L</b>	28.80 34.56

with air conditioning - Alternator

Aftermarket	1	<b>PQS101272LP</b>	7.50 9.00
Genuine	1	<b>PQS101272L</b>	25.77 30.92
Genuine	1	<b>PQS101272</b>	16.04 19.25

All models with 1.8L petrol engine - Power steering

Aftermarket	1	<b>CDU2160P</b>	1.75 2.10
Genuine	1	<b>CDU2160</b>	5.43 6.52

All models with 2.0L TD4 diesel engine and air conditioning up to (VIN) 1A999999 - Air cond compressor

Aftermarket	1	<b>PQS101310LP</b>	3.50 4.20
MG Rover	1	<b>PQS101310</b>	25.98 31.18
Genuine	1	<b>PQS101310L</b>	20.84 25.01

from (VIN) 2A000001 on - Air cond compressor

Aftermarket	1	<b>PQS000180P</b>	3.00 3.60
Genuine	1	<b>PQS000180</b>	14.73 17.68

All models with 1.8L petrol engine - Power steering

Aftermarket	1	<b>CDU2160P</b>	1.75 2.10
Genuine	1	<b>CDU2160</b>	5.43 6.52

All models with 2.0L TD4 diesel engine and air conditioning up to (VIN) 1A999999 - Air cond compressor

Aftermarket	1	<b>PQS101310LP</b>	3.50 4.20
MG Rover	1	<b>PQS101310</b>	25.98 31.18
Genuine	1	<b>PQS101310L</b>	20.84 25.01

from (VIN) 2A000001 on - Air cond compressor

Aftermarket	1	<b>PQS000180P</b>	3.00 3.60
Genuine	1	<b>PQS000180</b>	14.73 17.68





## IGNITION SYSTEM

### Spark Plug

All 1.8L petrol models up to (VIN) 4A999999	Aftermarket	4	<b>NLP100290P</b>	3.50	4.20
	Genuine	4	<b>NLP100290</b>	6.99	8.39
All KV6 petrol models up to (VIN) 4A999999	Aftermarket	6	<b>NLP100290P</b>	3.50	4.20
	Genuine	6	<b>NLP100290</b>	6.99	8.39

### Glow Plug

All 2.0L TD4 diesel models	Aftermarket	4	<b>NCC100120LP</b>	4.08	4.90
	OEM	4	<b>NCC100120LP1</b>	11.04	13.25
	Genuine	4	<b>NCC100120L</b>	20.73	24.88
All 2.0L L series diesel models	Aftermarket	4	<b>NCC100050LP</b>	3.00	3.60
	OEM	4	<b>NCC100050LP1</b>	10.63	12.76
	Genuine	4	<b>NCC100050L</b>	17.24	20.69

### Ignition Coil

All 1.8L petrol engine models up to (VIN) YA999999 - Includes mounting bracket	Aftermarket	1	<b>NEC100800P</b>	27.40	32.88
	Genuine	1	<b>NEC100800</b>	37.66	45.19
All 1.8L petrol engine models from (VIN) 1A000001 on - Includes mounting bracket alternative	Aftermarket	1	<b>NEC100630P</b>	14.00	16.80
	Genuine	2	<b>NEC000120L</b>	40.46	48.55
	Genuine	1	<b>NEC100630</b>	37.66	45.19
All models with 2.5L KV6 petrol engine up to (VIN) 3A224999 Long (3 required)	Aftermarket	3	<b>NEC101010LP</b>	22.50	27.00
	Genuine	3	<b>NEC101010L</b>	53.32	63.98
Short (3 required)	Aftermarket	3	<b>NEC101000L</b>	42.00	50.40
	Genuine	3	<b>NEC101000L</b>	42.00	50.40
All models with 2.5L KV6 petrol engine from (VIN) 3A325000 on Dry, short type	Aftermarket	6	<b>NEC000110LP</b>	16.67	20.00
	OEM	6	<b>NEC000110LP1</b>	19.58	23.50
	Genuine	6	<b>NEC000110L</b>	41.54	49.85
	Genuine	6	<b>NEC000110L</b>	41.54	49.85

### Rotor Arm

All 1.8L petrol engine models up to (VIN) YA999999	Aftermarket	1	<b>NJE10003P</b>	3.75	4.50
	Genuine	1	<b>NJE10003</b>	12.64	15.17
All 1.8L K Series petrol models up to (VIN) YA999999	Aftermarket	1	<b>NJE100071P</b>	3.75	4.50
	MG Rover	1	<b>NJE100071</b>	12.72	15.26
	Genuine	1	<b>NJE100071</b>	12.72	15.26

## BRAKING SYSTEM

### Brake Pad Set

All models to (VIN) YA999999 Front Brakes	Aftermarket	1	<b>SFP100360P</b>	12.50	15.00
	Brembo	1	<b>SFP100360BREMBO</b>	32.08	38.50
	OEM	1	<b>SFP100360P1</b>	18.54	22.25
	Genuine	1	<b>SFP100360</b>	59.12	70.94
Front Brakes, Green Stuff	EBC	1	<b>SFP100360GS</b>	30.00	36.00
All models from (VIN) 1A000001 on Front Brakes	Aftermarket	1	<b>LR021899P</b>	13.96	16.75
	Brembo	1	<b>LR021899BREMBO</b>	29.58	35.50
	Genuine	1	<b>LR021899</b>	40.79	48.95
	Genuine	1	<b>LR021899GS</b>	39.58	47.50
Front Brakes, Green Stuff	EBC	1	<b>LR021899GS</b>	39.58	47.50

### Brake Shoe Set

All models up to (VIN) YA999999 Rear Brakes	Aftermarket	1	<b>SFS000061P</b>	8.96	10.75
	OEM	1	<b>SFS000061P1</b>	29.58	35.50
	Genuine	1	<b>SFS000061</b>	65.08	78.10
All models from (VIN) 1A000001 on Rear Brakes	Aftermarket	1	<b>SFS000030P</b>	8.96	10.75
	OEM	1	<b>SFS000030P1</b>	27.50	33.00
	Genuine	1	<b>SFS000030</b>	67.89	81.47
	Genuine	1	<b>SFS000030</b>	67.89	81.47

### Brake Pad Clip Set

All models (VIN) 1A000001 on	Genuine	1	<b>SFK500010</b>	4.35	5.22
------------------------------	---------	---	------------------	------	------

### Spring Kit

All models up to (VIN) YA999999 Rear Brake Shoes	OEM	1	<b>SMN100250P1</b>	4.67	5.60
	Genuine	1	<b>SMN100250</b>	11.21	13.45
All models (VIN) 1A000001 on Rear Brake Shoes	Genuine	1	<b>SMN000020</b>	5.07	6.08

### Retaining Spring Kit

All models (VIN) 1A000001 on Rear brake shoes, axle set of springs	Genuine	1	<b>SMN000010</b>	2.72	3.26
--------------------------------------------------------------------	---------	---	------------------	------	------

### Brake Adjuster Lever

All models with Rear drum brakes to (VIN) YA999999 Rear RH	Genuine	1	<b>SMJ100080</b>	21.08	25.30
	Genuine	1	<b>SMJ100090</b>	21.08	25.30
All models with Rear drum brakes from (VIN) 1A000001 Rear RH	Genuine	1	<b>SMN000040</b>	16.01	19.21
	Genuine	1	<b>SMN000050</b>	16.01	19.21

### Dust Shield Brake Disc

All models (VIN) 1A000001 on RH front	Genuine	1	<b>SEC100351</b>	43.76	52.51
	Genuine	1	<b>SEC100351</b>	43.76	52.51

## FREELANDER 1 (1996-2006)

### Screw, Rotor Arm

All 1.8L K Series petrol models up to (VIN) YA999999	Genuine	1	<b>JZV1042L</b>	0.55	0.66
------------------------------------------------------	---------	---	-----------------	------	------

### Distributor Cap

All 1.8L petrol engine models up to (VIN) YA999999	Aftermarket	1	<b>NJD10010P</b>	4.79	5.75
	Genuine	1	<b>NJD10010</b>	19.82	23.78

### Flash Shield, Distributor Cap

All 1.8L K Series petrol models up to (VIN) YA999999	Genuine	1	<b>JZV1041L</b>	26.90	32.28
------------------------------------------------------	---------	---	-----------------	-------	-------

### Ignition Lead Set

All 1.8L K Series petrol models up to (VIN) YA999999 - MEMs 1.9 system (distributor type) set of 5 leads	OEM	1	<b>LF1003EARLYP1</b>	13.54	16.25
	Genuine	1	<b>LF1003EARLY</b>	41.50	49.80
All 1.8L K Series petrol models from (VIN) 1A000001 on - MEMs 3 system (distributorless type) set of 5 leads	Aftermarket	1	<b>LF1003LATEP</b>	11.25	13.50
	Genuine	1	<b>LF1003LATE</b>	42.50	51.00
set of 2 leads	Aftermarket	1	<b>NGC000040P</b>	15.00	18.00
	MG Rover	1	<b>NGC000040</b>	36.88	44.26
All 2.5L KV6 petrol models to (VIN) 3A224999 - For engines with long and short coils	Aftermarket	1	<b>NGC104250LP</b>	19.79	23.75
	OEM	1	<b>NGC104250LP1</b>	50.00	60.00
	Genuine	1	<b>NGC104250L</b>	105.46	126.55
	Genuine	1	<b>NGC104250L</b>	105.46	126.55



NGC104250LP

## FREELANDER 1 (1996-2006)

### Brake Disc

All models up to (VIN) YA999999 Front, Not Vented	Aftermarket	2	<b>SDB100830P</b>	9.79	11.75
	Genuine	2	<b>SDB100830</b>	34.34	41.21
	Brembo	1	<b>SDB100830BREMBO</b>	43.33	52.00
Front, Not Vented, (pair)	Brembo	1	<b>SDB100830BREMBO</b>	43.33	52.00
All models from (VIN) 1A000001 on Front, Vented	Aftermarket	2	<b>SDB101070P</b>	12.50	15.00
	Genuine	2	<b>SDB101070</b>	45.13	54.16
	Brembo	1	<b>SDB101070BREMBO</b>	48.33	58.00
	Brembo	1	<b>SDB101070BREMBO</b>	48.33	58.00

### Performance Brake Disc (pair)

All models up to (VIN) YA999999 - Front, Not Vented, slotted & drilled	Britpart	1	<b>SDB100830URBP</b>	39.17	47.00
All models from (VIN) 1A000001 on Front, Vented, slotted & drilled	Britpart	1	<b>SDB101070URBP</b>	45.00	54.00

### Mudshield Brake Disc

All models to (VIN) YA999999 Front RH	Genuine	1	<b>ANR5578</b>	36.17	43.40
	Genuine	1	<b>ANR5577</b>	36.17	43.40

### Brake Drum

All models up to (VIN) YA999999 Rear	Aftermarket	2	<b>SDC100130P</b>	13.13	15.76
	Genuine	2	<b>SDC100130</b>	173.11	207.73
All models from (VIN) 1A000001 on Rear	Aftermarket	2	<b>SDC000010P</b>	19.58	23.50
	OEM	2	<b>SDC000010P1</b>	75.00	90.00
	Genuine	2	<b>SDC000010</b>	124.60	149.52
	Genuine	2	<b>SDC000010</b>	124.60	149.52

### Lever Assembly Drum Brake

All models with Rear drum brakes from (VIN) 1A000001 Rear RH	Genuine	1	<b>SMY000020</b>	45.90	55.08
	Genuine	1	<b>SMY000030</b>	45.90	55.08



SDC000010P



## FREELANDER 1 (1996-2006)

## BRAKING SYSTEM

## Brake Caliper

All models to (VIN) YA999999					
Front, RH	Aftermarket	1	SEG100220P	60.00	72.00
	OEM*	1	SEG100220P1	80.00	96.00
			*Exchange Surcharge	35.00	42.00
	Genuine*	1	SEG100220E	78.22	93.86
			*Exchange Surcharge	50.00	60.00
Front, LH	Aftermarket	1	SEG100230P	60.00	72.00
	OEM*	1	SEG100230P1	80.00	96.00
			*Exchange Surcharge	35.00	42.00
	Genuine*	1	SEG100230E	78.22	93.86
			*Exchange Surcharge	50.00	60.00
All models from (VIN) 1A000001					
Front, RH	Aftermarket	1	SEG100260P	37.50	45.00
	OEM	1	SEG100260P1	69.95	83.94
	Genuine*	1	SEG100260E	92.11	110.53
			*Exchange Surcharge	50.00	60.00
	Genuine*	1	SEG100260	175.16	210.19
			*Exchange Surcharge	50.00	60.00
Front, LH	Aftermarket	1	SEG100270P	37.50	45.00
	OEM	1	SEG100270P1	69.95	83.94
	Genuine*	1	SEG100270E	92.11	110.53
			*Exchange Surcharge	50.00	60.00
	Genuine*	1	SEG100270	175.16	210.19
			*Exchange Surcharge	50.00	60.00

## Caliper Repair Kit

All models to (VIN) YA999999					
Front	Aftermarket	2	SEE100200P	4.58	5.50
	Genuine	2	SEE100200	24.54	29.45
All models from (VIN) 1A000001 on. Kit does not include pistons					
Front caliper	Aftermarket	2	SEE100300P	3.08	3.70
	Genuine	2	SEE100300	19.89	23.87

## Brake Caliper Carrier

All models (VIN) 1A000001 on					
Front, RH	OEM	1	SEE100320P1	39.58	47.50
	Genuine	1	SEE100320	77.36	92.83
Front, LH	OEM	1	SEE100330P1	39.58	47.50
	Genuine	1	SEE100330	77.36	92.83

## Brake Caliper Piston

All models from (VIN) 1A000001 to (VIN) YA999999					
Front	Aftermarket	2	SEK100030P	4.58	5.50
	Genuine	2	SEK100030	21.01	25.21

## Caliper Guide Pin Kit

All models to (VIN) YA999999					
Front brakes	Aftermarket	1	STC1910P	12.29	14.75
	Genuine	1	STC1910	16.11	19.33

## Slider Pin Bolt

All models to (VIN) YA999999					
Front calipers	Genuine	2	STC1914	1.10	1.32

## Wheel Cylinder

All models with rear drum brakes to (VIN) YA999999					
Rear	Aftermarket	2	SML100070P	6.25	7.50
	OEM	2	SML100070P1	7.50	9.00
	Genuine	2	SML100070	24.39	29.27
All models from (VIN) 1A000001					
Rear, Both Sides	Aftermarket	2	SML000010P	6.88	8.26
	OEM	2	SML000010P1	23.33	28.00
	Genuine	2	SML000010	27.81	33.37

## Wheel Cylinder Repair kit

All models to (VIN) YA999999					
Rear	Aftermarket	2	SMN100230P	4.79	5.75
	Genuine	2	SMN100230	21.35	25.62
All models with Rear drum brakes from (VIN) 1A000001					
Rear	Genuine	2	SMN000030	22.95	27.54

## Brake Master Cylinder

Without ABS, from (VIN) YA504976 to YA999999					
	OEM	1	SJC100381P1	85.00	102.00
	Genuine	1	SJC100381	250.08	300.10
With ABS, from (VIN) YA504976 to YA999999					
	OEM	1	SJC100371P1	80.00	96.00
	Genuine	1	SJC100371	195.16	234.19
All models (VIN) 1A000001 on					
	OEM	1	SJC000010P1	135.00	162.00
	Genuine	1	SJC000010	191.92	230.30

## Brake Servo Assembly

All models up to (VIN) YA999999					
	Aftermarket	1	SJG100220P	90.00	108.00
	OEM	1	SJG100220P1	130.00	156.00
	Genuine	1	SJG100220	256.86	308.23
All models from (VIN) 1A000001					
	Genuine	1	SJG000010	264.90	317.88

## Brake Hose

All models up to (VIN) YA999999					
Front, rubber	Aftermarket	2	8510285P	8.96	10.75
	OEM	2	8510285P1	23.33	28.00
	Genuine	2	8510285	32.03	38.44
Rear, rubber	Aftermarket	2	SHB000601P	7.08	8.50
	OEM	2	SHB000601P1	11.88	14.26
	Genuine	2	SHB000601	22.40	26.88
All models from (VIN) 1A000001 on					
Front, RH, rubber	Aftermarket	1	SHB000581P	8.75	10.50
	OEM	1	SHB000581P1	12.50	15.00
	Genuine	1	SHB000581	22.62	27.14
Front, LH, rubber	Aftermarket	1	SHB000591P	10.00	12.00
	OEM	1	SHB000591P1	13.54	16.25
	Genuine	1	SHB000591	22.62	27.14

## Washer Brake Hose

All models	Genuine	4	BNP1244L	0.80	0.96
------------	---------	---	----------	------	------

## Brake Pipe Clip

All models	Genuine	a/r	EDP7037L	0.58	0.70
All models without ABS - RHD	Genuine	a/r	EDP7038L	0.55	0.66

## Brake Pipe To Body Clip

All models - Plastic, double	Genuine	a/r	SGK100920	2.26	2.71
------------------------------	---------	-----	-----------	------	------

## Handbrake Switch

All models	Aftermarket	1	DBP7199LP	2.33	2.80
	Genuine	1	DBP7199L	8.08	9.70

## Handbrake Cable

All models up to (VIN) YA999999					
RH cable	Aftermarket	1	SPB101301P	11.88	14.26
	Genuine	1	SPB101301	51.66	61.99
LH cable	Aftermarket	1	SPB101311P	11.88	14.26
	Genuine	1	SPB101311	54.90	65.88
All models from (VIN) 1A000001 on					
RH cable	Aftermarket	1	SPB000180P	15.42	18.50
	Genuine	1	SPB000180	58.11	69.73
LH cable	Aftermarket	1	SPB000190P	15.42	18.50
	Genuine	1	SPB000190	58.11	69.73

## ABS Sensor

All models up to (VIN) 1A999999					
Front RH	Genuine	1	YMD501870	35.76	42.91
Front LH	Genuine	1	YMD501850	35.76	42.91
Rear RH	Genuine	1	YMD501880	36.02	43.22
Rear LH	Genuine	1	YMD501860	35.76	42.91
All models with anti lock brakes from (VIN) 2A000001 on					
Front brakes	Aftermarket	2	SSW000010P	16.75	20.10
	Genuine	2	SSW000010	85.27	102.32

## ABS Sensor Kit

All models from (VIN) 1A000001 to 1A999999					
Front brakes	Aftermarket	2	SSW100080P	35.83	43.00
	OEM	2	SSW100080P1	55.00	66.00
	Genuine	2	SSW100080	187.91	225.49
Rear brakes	Aftermarket	2	SSW100090P	35.83	43.00
	OEM	2	SSW100090P1	90.83	109.00
	Genuine	2	SSW100090	187.91	225.49
All models from (VIN) WA601203 to YA999999					
Front brakes	Aftermarket	2	SSW100030P	33.33	40.00
	OEM	2	SSW100030P1	175.00	210.00
	Genuine	2	SSW100030	192.87	231.44
All models with ABS to (VIN) YA999999					
Rear brakes	Aftermarket	2	SSW100040P	30.00	36.00
	OEM	2	SSW100040P1	99.95	119.94
	Genuine	2	SSW100040	180.16	216.19
All models with ABS (VIN) 2A000001 on					
Rear brakes	Aftermarket	2	SSW000020P	29.58	35.50
	OEM	2	SSW000020P1	39.58	47.50
	Genuine	2	SSW000020	82.76	99.31

## ABS Wheel Sensor

All models with ABS from (VIN) 2A000001 on					
Front brakes	Genuine	1	SSB000110	29.24	35.09
Rear brakes	Genuine	1	SSB000120	29.24	35.09

## Bush ABS Sensor

All models with anti lock brakes to (VIN) 1A999999					
Front and rear	Aftermarket	1	FTC1374P	4.58	5.50
	Genuine	1	LR029522	14.33	17.20

## Brake/Clutch Pedal Rubber

All models - Clutch and brake pedals	Aftermarket	2	DBP7047LP	3.58	4.30
	Genuine	2	DBP7047L	8.45	10.14

## Brake Pedal Rubber

All models with automatic transmission from (VIN) 1A000001	Genuine	1	STC4780	17.11	20.53
------------------------------------------------------------	---------	---	---------	-------	-------



# SUSPENSION

## Bush Lower Arm

All models up to (VIN) YA999999 - Front suspension, in separate housing,					
Rubber	Aftermarket	1	<b>ANR6109P</b>	6.67	8.00
	Genuine	1	<b>ANR6109</b>	47.03	56.44
Poly.	Aftermarket	1	<b>ANR6109POLY</b>	33.33	40.00
All models from (VIN) 1A000001 on - Front suspension, in separate housing					
Rubber	Aftermarket	1	<b>RBX101780P</b>	5.83	7.00
	OEM	1	<b>RBX101780P1</b>	12.92	15.50
	Genuine	1	<b>RBX101780</b>	22.90	27.48
All models - Front suspension, in arm					
Rubber	Aftermarket	1	<b>RBX101790P</b>	4.08	4.90
	Genuine	1	<b>RBX101790</b>	20.83	25.00
Poly.	Polybush	1	<b>RBX101790POLY</b>	10.63	12.76
All models - Rear suspension, inner					
Rubber	Aftermarket	1	<b>RGX101440P</b>	4.08	4.90
	Genuine	1	<b>RGX101440</b>	20.03	24.04
Poly.	Aftermarket	1	<b>RGX101440POLY</b>	16.88	20.26

## Housing & Bush, Lower Arm

All models up to (VIN) YA524788					
Front suspension, rear RH	Genuine	1	<b>RBX101260</b>	63.63	76.36
Front suspension, rear LH	Genuine	1	<b>RBX101270</b>	63.63	76.36

## Housing & Bush

All models (VIN) YA524793 to YA999999 (must change both sides at same time)					
RH	Aftermarket	1	<b>RBX101800P</b>	19.79	23.75
	Genuine	1	<b>RBX101800</b>	46.53	55.84
LH	Aftermarket	1	<b>RBX101810P</b>	19.79	23.75
	Genuine	1	<b>RBX101810</b>	45.96	55.15
All models (VIN) 1A000001 on					
RH	Aftermarket	1	<b>RBX101800P</b>	19.79	23.75
	Genuine	1	<b>RBX101800</b>	46.53	55.84
LH	Aftermarket	1	<b>RBX101810P</b>	19.79	23.75
	Genuine	1	<b>RBX101810</b>	45.96	55.15

## Bush Trailing Link

All models - Rear suspension					
Rubber	Aftermarket	1	<b>RGX101000P</b>	4.00	4.80
	Genuine	1	<b>RGX101000</b>	24.65	29.58
Poly.	Polybush	1	<b>RGX101000POLY</b>	8.33	10.00

## Bush Adjusting Link

All models - Rear suspension					
Rubber	Aftermarket	4	<b>RGX101020P</b>	2.50	3.00
	Genuine	4	<b>RGX101020</b>	19.01	22.81
Poly.	Polybush	4	<b>RGX101020POLY</b>	8.54	10.25

## Bush, Rear Hub Carrier

All models - Lower					
	Aftermarket	1	<b>RGX101010P</b>	5.00	6.00
	Genuine	1	<b>RGX101010</b>	30.22	36.26

## Suspension Bush Kit

All models (VIN) YA524789 on - Includes rear bushes and housing bolts for front lower arms, plus front bush bolts					
	Genuine	1	<b>RBG100120</b>	63.63	76.36
All models - Complete vehicle set, poly.					
dynamic orange	Polybush	1	<b>LF1022</b>	187.50	225.00
black	Britpart	1	<b>LF1022-BPPOLYBLK</b>	72.50	87.00
yellow	Britpart	1	<b>LF1022-BPPOLYSEL</b>	72.50	87.00

## Bush Anti Roll Bar Mounting

All models up to (VIN) YA999999					
Front, poly.	Polybush	2	<b>RBX101240POLY</b>	3.25	3.90

## Anti Roll Bar Link

All models					
Front	Aftermarket	1	<b>RBM100172P</b>	4.58	5.50
	OEM	1	<b>RBM100172P1</b>	15.00	18.00
	Genuine	1	<b>RBM100172</b>	18.14	21.77
Front suspension	Genuine	1	<b>RBM100262</b>	30.58	36.70

## Mounting Bracket

All models - Front anti roll bar					
	MG Rover	2	<b>RBU100220A</b>	15.99	19.19
	Genuine	2	<b>RBU100220L</b>	23.08	27.70

## Mounting Bush, Anti Roll Bar

All models up to (VIN) YA999999 - Front					
	Aftermarket	2	<b>RBX101240P</b>	1.75	2.10
	Genuine	2	<b>RBX101240</b>	4.32	5.18
All models from (VIN) 1A000001 on - Front					
	Aftermarket	2	<b>RBX000010P</b>	2.25	2.70
	Genuine	2	<b>RBX000010</b>	3.22	3.86



# FREELANDER 1 (1996-2006)

## Shock Absorber

All models					
Front, gas, std. height	Aftermarket	2	<b>RNB103560P</b>	52.50	63.00
	Genuine	2	<b>RNB103560</b>	100.61	120.73
All 1.8L K Series petrol models up to (VIN) YA999999					
Front, RH, std.	Aftermarket	1	<b>RNB103540P</b>	48.33	58.00
	Genuine	1	<b>RNB103540</b>	100.61	120.73
Front, LH, std.	Aftermarket	1	<b>RNB103550P</b>	48.33	58.00
	Genuine	1	<b>RNB103550</b>	100.61	120.73
All models (VIN) 1A000001 to 1A336547					
Front RH	Aftermarket	1	<b>RSC000020P</b>	45.83	55.00
	OEM	1	<b>RSC000020P1</b>	60.00	72.00
	Genuine	1	<b>RSC000020</b>	129.11	154.93
Front LH	Aftermarket	1	<b>RSC000030P</b>	45.83	55.00
	OEM	1	<b>RSC000030P1</b>	75.00	90.00
	Genuine	1	<b>RSC000030</b>	129.11	154.93
All 2.0L L Series (TCIE) diesel models					
Front LH	Aftermarket	1	<b>RNB103570P</b>	52.50	63.00
	Genuine	1	<b>RNB103570</b>	100.61	120.73
2.0L TD4 diesel models with sports suspension (VIN) 4A000001 to 5A999999					
Front RH, grey/orange	OEM	1	<b>RSC500060P1</b>	60.00	72.00
	Genuine	1	<b>RSC500060</b>	152.59	183.11
Front LH, grey/orange	OEM	1	<b>RSC500070P1</b>	60.00	72.00
	Genuine	1	<b>RSC500070</b>	152.59	183.11
2.0L TD4 diesel models with sports suspension (VIN) 6A000001 on					
Front RH, purple/white	Genuine	1	<b>RSC500120</b>	152.59	183.11
Front LH, purple/white	Genuine	1	<b>RSC500130</b>	152.59	183.11
2.5L KV6 petrol models with sports suspension (VIN) 4A000001 to 5A999999					
Front RH, grey/orange	OEM	1	<b>RSC500060P1</b>	60.00	72.00
	Genuine	1	<b>RSC500060</b>	152.59	183.11
Front LH, grey/orange	OEM	1	<b>RSC500070P1</b>	60.00	72.00
	Genuine	1	<b>RSC500070</b>	152.59	183.11
2.5L KV6 petrol models with sports suspension (VIN) 6A000001 on					
Front RH, purple/white	Genuine	1	<b>RSC500120</b>	152.59	183.11
Front LH, purple/white	Genuine	1	<b>RSC500130</b>	152.59	183.11
All models without sports suspension up to (VIN) YA999999					
Rear, RH, std.	Aftermarket	1	<b>RPD102180P</b>	39.58	47.50
	OEM	1	<b>RPD102180P1</b>	50.83	61.00
	Genuine	1	<b>RPD102180</b>	100.61	120.73
Rear, LH, std.	Aftermarket	1	<b>RPD102190P</b>	39.58	47.50
	OEM	1	<b>RPD102190P1</b>	58.33	70.00
	Genuine	1	<b>RPD102190</b>	100.61	120.73
All models without sports suspension from (VIN) 1A000001 on					
Rear, RH, std.	Aftermarket	1	<b>RPM000020P</b>	39.58	47.50
	OEM	1	<b>RPM000020P1</b>	48.33	58.00
	Genuine	1	<b>RPM000020</b>	100.61	120.73
Rear, LH, std.	Aftermarket	1	<b>RPM000030P</b>	39.58	47.50
	OEM	1	<b>RPM000030P1</b>	45.83	55.00
	Genuine	1	<b>RPM000030</b>	100.61	120.73
2.0L TD4 diesel models with sports suspension (VIN) 4A000001 to 5A999999					
Rear RH, orange/orange	OEM	1	<b>RPM500040P1</b>	45.83	55.00
	Genuine	1	<b>RPM500040</b>	152.59	183.11
Rear LH, orange/orange	OEM	1	<b>RPM500050P1</b>	45.83	55.00
	Genuine	1	<b>RPM500050</b>	152.59	183.11
2.0L TD4 diesel models with sports suspension (VIN) 6A000001 on					
Rear RH, white/pink	OEM	1	<b>RPM500120P1</b>	45.83	55.00
	Genuine	1	<b>RPM500120</b>	77.46	92.95
Rear RH, white/brown	Genuine	1	<b>RPM500140</b>	152.59	183.11
Rear LH, white/pink	OEM	1	<b>RPM500130P1</b>	45.83	55.00
	Genuine	1	<b>RPM500130</b>	77.46	92.95
Rear LH, white/brown	Genuine	1	<b>RPM500150</b>	152.59	183.11
2.5L KV6 petrol models with sports suspension (VIN) 4A000001 to 5A999999					
Rear RH, orange/orange	OEM	1	<b>RPM500040P1</b>	45.83	55.00
	Genuine	1	<b>RPM500040</b>	152.59	183.11
Rear LH, orange/orange	OEM	1	<b>RPM500050P1</b>	45.83	55.00
	Genuine	1	<b>RPM500050</b>	152.59	183.11
2.5L KV6 petrol models with sports suspension (VIN) 6A000001 on					
Rear RH, white/pink	OEM	1	<b>RPM500120P1</b>	45.83	55.00
	Genuine	1	<b>RPM500120</b>	77.46	92.95
Rear RH, white/brown	Genuine	1	<b>RPM500140</b>	152.59	183.11
Rear LH, white/pink	OEM	1	<b>RPM500130P1</b>	45.83	55.00
	Genuine	1	<b>RPM500130</b>	77.46	92.95
Rear LH, white/brown	Genuine	1	<b>RPM500150</b>	152.59	183.11

## Shock Absorber Assembly

All models without sports suspension from (VIN) 1A336548 on					
Front, RH, std.	Aftermarket	1	<b>RSC000040P</b>	35.83	43.00
	OEM	1	<b>RSC000040P1</b>	88.33	106.00
	Genuine	1	<b>RSC000040</b>	122.97	147.56
Front, LH, std.	Aftermarket	1	<b>RSC000050P</b>	35.83	43.00
	OEM	1	<b>RSC000050P1</b>	93.33	112.00
	Genuine	1	<b>RSC000050</b>	122.97	147.56

## Shock Absorber Upper Mounting

All models (VIN) 1A000001 on					
	OEM	2	<b>RPF100122P1</b>	19.58	23.50
	Genuine	2	<b>RPF100122</b>	31.03	37.24

## Strut Mounting Upper

All models - Front suspension					
	Aftermarket	2	<b>RNX100101P</b>	18.54	22.25
	Genuine	2	<b>RNX100101</b>	30.37	36.44

## Bearing, Shock Absorber Top

All models - Front					
	OEM	1	<b>RNR100080P1</b>	7.50	9.00
	Genuine	1	<b>RNR100080</b>	31.79	38.15





## FREELANDER 1 (1996-2006)

## SUSPENSION

## Buffer, Shock Absorber

All models (VIN) 1A000001 on - Front	OEM	2	<b>RNH100252P1</b>	5.00	6.00
	Genuine	2	<b>RNH100252</b>	13.29	15.95

## Gaiter, Shock Absorber

All models up to (VIN) YA999999 - Front	Genuine	2	<b>RNE10001L</b>	16.69	20.03
All models (VIN) 1A000001 on - Front	Genuine	2	<b>RNE100143</b>	9.47	11.36

## Mounting, Shock Absorber

All models up to (VIN) YA999999 - Rear, top	OEM	2	<b>RPF100080P1</b>	19.58	23.50
	Genuine	2	<b>RPF100080</b>	67.54	81.05

## Coil Spring

All 1.8L K Series petrol models without air cond. up to (VIN) YA999999					
Front, orange/green	Genuine	2	<b>REB101451</b>	64.36	77.23
All 1.8L K Series petrol models without air cond. or sports suspension from (VIN) 1A000001 on					
Front, yellow/pink	Genuine	2	<b>REB000080</b>	64.36	77.23
All 1.8L K Series petrol models with air cond. up to (VIN) YA999999					
Front, orange/green	Genuine	2	<b>REB101461</b>	64.36	77.23
All 1.8L K Series petrol models with air cond., without sports suspension from (VIN) 1A000001 on					
Front, yellow/grey	Genuine	2	<b>REB000090</b>	64.36	77.23
All 2.0L L Series (TCIE) diesel models without air cond.					
Front, brown/green	Genuine	2	<b>REB101311</b>	64.36	77.23
All 2.0L L Series (TCIE) diesel models with air cond.					
Front, green/yellow	Genuine	2	<b>REB101321</b>	64.36	77.23
All 2.0L TD4 BMW M47 diesel automatic models without air cond. or sports suspension					
Front, yellow/white	Genuine	2	<b>REB000120</b>	63.26	75.91
All 2.0L TD4 BMW M47 diesel automatic models with air cond., without sports suspension					
Front, yellow/brown	Genuine	2	<b>REB000110</b>	64.36	77.23
All 2.0L TD4 BMW M47 diesel manual models without sports suspension up to (VIN) 5A999999					
Front, yellow/blue	Genuine	2	<b>REB000100</b>	64.36	77.23
All 2.0L TD4 BMW M47 diesel manual models without sports suspension from (VIN) 6A000001 on					
Front, white/orange	Genuine	2	<b>REB500170</b>	36.98	44.38
Front, purple/white	Genuine	2	<b>REB500160</b>	64.36	77.23
All 2.0L TD4 BMW M47 diesel models with sports suspension from (VIN) 4A000001 on					
Front, grey/orange	Genuine	2	<b>REB500040</b>	64.36	77.23
All 2.5L KV6 petrol models without air cond. or sports suspension from (VIN) 1A000001 to 5A999999					
Front, yellow/blue	Genuine	2	<b>REB000100</b>	64.36	77.23
All 2.5L KV6 petrol models without air cond. or sports suspension from (VIN) 6A000001 on					
Front, purple/white	Genuine	2	<b>REB500160</b>	64.36	77.23
Front, white/orange	Genuine	2	<b>REB500170</b>	36.98	44.38
All 2.5L KV6 petrol models with sports suspension from (VIN) 4A000001 on					
Front, grey/orange	Genuine	2	<b>REB500040</b>	64.36	77.23
All models up to (VIN) YA999999					
Rear	Genuine	2	<b>RKB100920</b>	64.36	77.23
All models without sports suspension (VIN) 1A000001 on					
Rear, green	Genuine	2	<b>RKB000050</b>	64.36	77.23
Rear, white/blue	Genuine	2	<b>RKB000230</b>	62.25	74.70
All models with sports suspension (VIN) 6A000001 on					
Rear, white/brown	Genuine	2	<b>RKB500160</b>	75.33	90.40
Rear, white/pink	Genuine	2	<b>RKB500190</b>	81.53	97.84

## Upper Seat, Coil Spring

All models up to (VIN) YA999999 - Front	Genuine	2	<b>RNC100120</b>	17.83	21.40
All models (VIN) 1A000001 on - Front	Genuine	2	<b>RNC000010</b>	19.00	22.80

## Lower Arm Assembly

All models					
Front suspension, RH	Aftermarket	1	<b>RBJ500680P</b>	25.42	30.50
	OEM	1	<b>RBJ500680P1</b>	85.00	102.00
	Genuine	1	<b>RBJ500680</b>	145.09	174.11
Front suspension, LH	Aftermarket	1	<b>RBJ500690P</b>	25.00	30.00
	Genuine	1	<b>RBJ500690</b>	145.09	174.11

## Ball Joint Only

All models - Front suspension, RH	Britpart	1	<b>RBJ500680BPBJ</b>	8.13	9.76
-----------------------------------	----------	---	----------------------	------	------

## Lower Link Assembly

All models - Rear suspension	Aftermarket	2	<b>RGD000110P</b>	19.79	23.75
	Genuine	2	<b>RGD000110</b>	69.83	83.80

## Lower Adjusting Link

All models - Rear suspension	Aftermarket	2	<b>RGD000060P</b>	28.75	34.50
	Genuine	2	<b>RGD000060</b>	75.28	90.34

## Trailing Link Assembly

All models - Rear suspension	Aftermarket	2	<b>RGD000090P</b>	42.50	51.00
	Genuine	2	<b>RGD000090</b>	90.36	108.43

## Knuckle, without Hub

All models up to (VIN) 1A999999  
If fitting a replacement knuckle to a vehicle up to VIN WA601176 a new ABS sensor with longer wires will also be required (order part number SSW100040).

Rear LH	Genuine	1	<b>RLH101331</b>	188.83	226.60	
All models (VIN) 2A000001 on	Rear RH	Genuine	1	<b>RLH000020</b>	190.30	228.36
	Rear LH	Genuine	1	<b>RLH000030</b>	190.13	228.16



RGD000060P

## FREELANDER 1 (1996-2006)

## STEERING

## Gaiter, Steering Column

All models - Lower joint	Genuine	1	<b>QNB100460</b>	10.83	13.00
--------------------------	---------	---	------------------	-------	-------

## Track Rod End

All models - Outer track rod					
RH	Aftermarket	1	<b>QJB100220P</b>	6.04	7.25
	OEM	1	<b>QJB100220P1</b>	10.42	12.50
	Genuine	1	<b>QJB100220</b>	32.48	38.98
LH	Aftermarket	1	<b>QJB100230P</b>	5.63	6.76
	OEM	1	<b>QJB100230P1</b>	10.63	12.76
	Genuine	1	<b>QJB100230</b>	25.33	30.40

## Track Rod Assembly

All models (VIN) 1A000001 on					
RH, includes track rod end	OEM	1	<b>QFK000070P1</b>	28.75	34.50
	Genuine	1	<b>QFK000070</b>	84.49	101.39
LH, includes track rod end	Aftermarket	1	<b>QFK000080P</b>	26.67	32.00
	OEM	1	<b>QFK000080P1</b>	30.00	36.00
	Genuine	1	<b>QFK000080</b>	84.49	101.39

## Adjuster, Threaded

All models - Track rod end	Aftermarket	1	<b>ANR5735P</b>	14.58	17.50
	Genuine	1	<b>ANR5735</b>	77.33	92.80

## Gaiter Kit, Steering Rack

All models up to (VIN) YA999999					
All models from (VIN) 1A000001 on	Aftermarket	1	<b>QEY100080P</b>	12.50	15.00
	Genuine	1	<b>QEY100080</b>	38.37	46.04
All models from (VIN) 1A000001 on	Aftermarket	1	<b>QEY100081P</b>	9.79	11.75
	OEM	1	<b>QEY100081P1</b>	17.92	21.50
	Genuine	1	<b>QEY100081</b>	33.32	39.98



QFK000080P



QNB100460



# CLUTCH

## Clutch Kit

All 1.8L K Series petrol models	Aftermarket	1	<b>URB500060P</b>	56.67	68.00
	OEM	1	<b>URB500060P1</b>	85.00	102.00
	Genuine	1	<b>URB500060</b>	196.31	235.57
All 2.0L L Series diesel models	Aftermarket	1	<b>URB500060P</b>	56.67	68.00
	OEM	1	<b>URB500060P1</b>	85.00	102.00
	Genuine	1	<b>URB500060</b>	196.31	235.57

## Clutch Plate & Cover Assembly

All 2.0L TD4 diesel models	OEM	1	<b>URB500070P1</b>	85.00	102.00
	Aftermarket	1	<b>URB500070P</b>	60.00	72.00
	Genuine	1	<b>URB500070</b>	206.28	247.54

All 2.0L TD4 diesel models <i>Includes heavy duty clutch cover and heavy duty clutch plate for Britpart solid flywheel conversion</i>					
	Britpart	1	<b>URB500070BPSERV</b>	262.50	315.00

## Clutch Cover

All 1.8L K Series petrol models	Aftermarket	1	<b>URB000070P</b>	32.08	38.50
	OEM	1	<b>URB000070P1</b>	50.00	60.00
	Genuine	1	<b>URB000070</b>	67.07	80.48
All 2.0L L Series diesel models	Aftermarket	1	<b>URB000070P</b>	32.08	38.50
	OEM	1	<b>URB000070P1</b>	50.00	60.00
	Genuine	1	<b>URB000070</b>	67.07	80.48
All 2.0L TD4 diesel models	Genuine	1	<b>URB100651</b>	58.93	70.72

## Clutch Plate

All 1.8L K Series petrol models	Aftermarket	1	<b>UQB500050P</b>	33.33	40.00
	OEM	1	<b>UQB500050P1</b>	42.50	51.00
	Genuine	1	<b>UQB500050</b>	85.36	102.43

Heavy duty (designed to be used with std clutch cover and release bearing)

All 2.0L TD4 diesel models	Aftermarket	1	<b>UQB500040P</b>	31.67	38.00
	OEM	1	<b>UQB500040P1</b>	60.00	72.00
	Genuine	1	<b>UQB500040</b>	85.36	102.43

All 2.0L L Series (TCIE) diesel models Heavy duty (designed to be used with std clutch cover and release bearing)					
	Genuine	1	<b>UQB100770L</b>	102.88	123.46

## Clutch Release Bearing

All 1.8L K Series petrol models	Aftermarket	1	<b>UTJ100170P</b>	6.67	8.00
	OEM	1	<b>UTJ100170P1</b>	13.13	15.76
	Genuine	1	<b>UTJ100170</b>	37.38	44.86
All 2.0L L Series diesel models	Aftermarket	1	<b>UTJ100170P</b>	6.67	8.00
	OEM	1	<b>UTJ100170P1</b>	13.13	15.76
	Genuine	1	<b>UTJ100170</b>	37.38	44.86

## Clutch Release Bearing Guide

All 2.0L TD4 BMW M47 diesel manual models					
	Genuine	1	<b>UTL100080L</b>	81.82	98.18

## Bearing Clutch Housing

All 2.0L L Series diesel models	Genuine	1	<b>UNF100050L</b>	45.18	54.22
---------------------------------	---------	---	-------------------	-------	-------

## Clutch Fork

All 1.8L K Series petrol models	Genuine	1	<b>UTB100140L</b>	41.36	49.63
All 2.0L L Series (TCIE) diesel models	Genuine	1	<b>UTB100140L</b>	41.36	49.63

# TRANSMISSION

## Constant Velocity Joint

All 1.8L K Series petrol models to (VIN) YA999999					
Front					
	Aftermarket	2	<b>TDJ100470P</b>	17.50	21.00
	OEM	2	<b>TDJ100470P1</b>	80.00	96.00
	Genuine	2	<b>TDJ100470</b>	198.55	238.26

All 2.0L L Series diesel models					
Front					
	Aftermarket	2	<b>TDJ100470P</b>	17.50	21.00
	OEM	2	<b>TDJ100470P1</b>	80.00	96.00
	Genuine	2	<b>TDJ100470</b>	198.55	238.26

All 1.8L K Series petrol models					
Front inner					
	Aftermarket	1	<b>TDR500230P</b>	120.00	144.00
	Genuine	1	<b>TDR500230</b>	175.81	210.97

All 2.0L L Series diesel models					
Front inner					
	Aftermarket	1	<b>TDR500230P</b>	120.00	144.00
	Genuine	1	<b>TDR500230</b>	175.81	210.97

All models to (VIN) 1A316654					
Rear					
	Aftermarket	2	<b>TDJ100470P</b>	17.50	21.00
	OEM	2	<b>TDJ100470P1</b>	80.00	96.00
	Genuine	2	<b>TDJ100470</b>	198.55	238.26

## CV Joint Assembly

All models (VIN) 1A316655 to 1A352375					
Rear axle, outer					
	OEM	2	<b>TDJ000020</b>	182.55	219.06

All models (VIN) 1A352376 on					
Rear axle, outer					
	OEM	2	<b>TDJ000060P1</b>	105.83	127.00
	Genuine	2	<b>TDJ000060</b>	214.14	256.97

## Gaiter Rear CV Joint

All models (VIN) 1A323560 on					
	OEM	2	<b>TDR000100P1</b>	12.50	15.00
	Genuine	2	<b>TDR000100</b>	22.57	27.08

# FREELANDER 1 (1996-2006)

## Bracket Clutch Release Fork

All 1.8L K Series petrol models	OEM	1	<b>UUU100690P1</b>	6.67	8.00
	Genuine	1	<b>UUU100690</b>	19.13	22.96
All 2.0L L Series diesel models	OEM	1	<b>UUU100690P1</b>	6.67	8.00
	Genuine	1	<b>UUU100690</b>	19.13	22.96

## Clutch Master Cylinder

All RHD 1.8L K Series petrol models from (VIN) 1A 326957 on					
	OEM	1	<b>STC000160P1</b>	80.00	96.00
	Genuine	1	<b>STC000160</b>	167.56	201.07

All RHD models with 2.0 TD4 BMW M47 diesel engine					
	Aftermarket	1	<b>STC000020P</b>	48.33	58.00
	OEM	1	<b>STC000020P1</b>	113.33	136.00
	Genuine	1	<b>STC000020</b>	149.10	178.92

LHD 1.8L petrol up to (VIN) YA999999 - Clutch					
	Aftermarket	1	<b>STC000210LP</b>	40.83	49.00
	OEM	1	<b>STC000210LP1</b>	75.00	90.00
	Genuine	1	<b>STC000210L</b>	154.00	184.80

LHD 2.0L L Series diesel up to (VIN) YA999999 - Clutch					
	Aftermarket	1	<b>STC000210LP</b>	40.83	49.00
	OEM	1	<b>STC000210LP1</b>	75.00	90.00
	Genuine	1	<b>STC000210L</b>	154.00	184.80

All LHD models with 2.0 TD4 BMW M47 diesel engine					
	Aftermarket	1	<b>STC000171P</b>	32.50	39.00
	OEM	1	<b>STC000171P1</b>	60.00	72.00
	Genuine	1	<b>STC000171</b>	146.24	175.49

## Clutch Hydraulics Assembly

All RHD 1.8L K Series petrol models to (VIN) YA999999					
	OEM	1	<b>STC000180P1</b>	57.50	69.00
	Genuine	1	<b>STC000180</b>	172.09	206.51

All RHD 2.0L L Series diesel models					
	OEM	1	<b>STC000180P1</b>	57.50	69.00
	Genuine	1	<b>STC000180</b>	172.09	206.51

## Clutch Slave Cylinder

All 2.0L TD4 diesel models with manual gearbox - Includes release bearing					
	Aftermarket	1	<b>UUB000070P</b>	30.00	36.00
	OEM	1	<b>UUB000070P1</b>	65.00	78.00
	Genuine	1	<b>UUB000070</b>	154.10	184.92

## Pedal Pad Clutch & Brake

All models - Clutch and brake pedals					
	Aftermarket	2	<b>DBP7047LP</b>	3.58	4.30
	Genuine	2	<b>DBP7047L</b>	8.45	10.14
	Genuine	2	<b>DBP7047</b>	6.57	7.88

## Clutch Shaft

All 1.8L K Series petrol models - Clutch fork pivot					
	OEM	1	<b>UTC100151P1</b>	30.00	36.00
	Genuine	1	<b>UTC100151</b>	64.01	76.81

All 2.0L L Series (TCIE) diesel models - Clutch fork pivot					
	OEM	1	<b>UTC100151P1</b>	30.00	36.00
	Genuine	1	<b>UTC100151</b>	64.01	76.81

# FREELANDER 1 (1996-2006)

## Bearing, Propshaft

All 4 cyl petrol and diesel models - Either side of viscous coupling					
	Aftermarket	2	<b>TQ000040P</b>	15.00	18.00
	OEM	2	<b>TQ000040P1</b>	40.83	49.00
	Eurospare	2	<b>TQ000040ES</b>	30.00	36.00
	GKN	2	<b>TQ000040GKN</b>	50.83	61.00
	Genuine	2	<b>TQ000040</b>	83.45	100.14

2.5L KV6 petrol models (VIN) 1A000001 to 1A344953 - Either side of viscous coupling					
	Aftermarket	2	<b>TQ000040P</b>	15.00	18.00
	OEM	2	<b>TQ000040P1</b>	40.83	49.00
	Eurospare	2	<b>TQ000040ES</b>	30.00	36.00
	GKN	2	<b>TQ000040GKN</b>	50.83	61.00
	Genuine	2	<b>TQ000040</b>	83.45	100.14

2.5L KV6 petrol models (VIN) 1A344954 on					
	Aftermarket	2	<b>TQ000060P</b>	18.96	22.75
	OEM	2	<b>TQ000060P1</b>	75.83	91.00
	Genuine	2	<b>TQ000060</b>	100.70	120.84

## Propshaft Coupling

All 4 cyl petrol and diesel models					
	Aftermarket	1	<b>TIJ000012P</b>	18.54	22.25
	OEM	1	<b>TIJ000012P1</b>	29.58	35.50
	Genuine	1	<b>TIJ000012</b>	33.99	40.79

## Viscous Coupling Propshaft

All 4 cyl petrol and diesel models					
	OEM	2	<b>TOR000010P1</b>	350.00	420.00
	Genuine	2	<b>TOR000010</b>	649.45	779.34
All 2.5L KV6 petrol models					
	Aftermarket	2	<b>TOR000040P</b>	325.00	390.00
	Genuine	2	<b>TOR000040</b>	1122.22	1346.66

## Gaiter, Propshaft

All models - Front					
	OEM	1	<b>TVB000090GAITER</b>	32.08	38.50



**FREELANDER 1 (1996-2006)****TRANSMISSION****Damper for Propshaft**

All 4 cyl petrol and diesel models	Genuine	1	<b>TOT100000</b>	89.21	107.05
------------------------------------	---------	---	------------------	-------	--------

**Spacer Propshaft**

2.5L KV6 petrol models (VIN) 1A000001 to 1A344953	Genuine	2	<b>TO0100000</b>	2.98	3.58
---------------------------------------------------	---------	---	------------------	------	------

**Universal Joint**

All 4 cyl petrol and diesel models	Aftermarket	3	<b>TVF100000P</b>	3.50	4.20
	OEM	3	<b>TVF100000P1</b>	19.79	23.75
	Genuine	3	<b>TVF100000</b>	59.03	70.84

**Drive Shaft Front**

All 1.8L K Series petrol models to (VIN) 1A999999	Aftermarket	2	<b>TDB000360P</b>	46.50	55.80
	OEM	2	<b>TDB000360P1</b>	175.00	210.00
	Genuine	2	<b>TDB000360</b>	479.51	575.41

All 1.8L K Series petrol models from (VIN) 2A000001 on	Aftermarket	2	<b>TDB000500P</b>	65.00	78.00
	OEM	2	<b>TDB000500P1</b>	165.00	198.00
	Genuine	2	<b>TDB000500</b>	586.53	703.84

All 2.0L L Series diesel models to (VIN) 1A999999	Aftermarket	2	<b>TDB000360P</b>	46.50	55.80
	OEM	2	<b>TDB000360P1</b>	175.00	210.00
	Genuine	2	<b>TDB000360</b>	479.51	575.41

All 2.0L L Series diesel models from (VIN) 2A000001	Aftermarket	2	<b>TDB000500P</b>	65.00	78.00
	OEM	2	<b>TDB000500P1</b>	165.00	198.00
	Genuine	2	<b>TDB000500</b>	586.53	703.84

All 2.0L TD4 BMW M47 diesel models to (VIN) 1A999999	Aftermarket	1	<b>TDB104020P</b>	38.75	46.50
	OEM	1	<b>TDB104020P1</b>	155.00	186.00
	Genuine	1	<b>TDB104020</b>	507.85	609.42

LH	Aftermarket	1	<b>TDB104030P</b>	41.67	50.00
	OEM	1	<b>TDB104030P1</b>	170.00	204.00
	Genuine	1	<b>TDB104030</b>	547.20	656.64

All 2.0L TD4 BMW M47 diesel models (VIN) 2A000001 on	Aftermarket	1	<b>TDB104980P</b>	50.00	60.00
	OEM	1	<b>TDB104980P1</b>	155.00	186.00
	Genuine	1	<b>TDB104980</b>	443.46	532.15

LH	Aftermarket	1	<b>TDB104990P</b>	50.83	61.00
	OEM	1	<b>TDB104990P1</b>	155.00	186.00
	Genuine	1	<b>TDB104990</b>	443.46	532.15

All 2.5L KV6 petrol models to (VIN) 1A999999	Aftermarket	1	<b>TDB104020P</b>	38.75	46.50
	OEM	1	<b>TDB104020P1</b>	155.00	186.00
	Genuine	1	<b>TDB104020</b>	507.85	609.42

LH	Aftermarket	1	<b>TDB104030P</b>	41.67	50.00
	OEM	1	<b>TDB104030P1</b>	170.00	204.00
	Genuine	1	<b>TDB104030</b>	547.20	656.64

All 2.5L KV6 petrol models (VIN) 2A000001 on	Aftermarket	1	<b>TDB104980P</b>	50.00	60.00
	OEM	1	<b>TDB104980P1</b>	155.00	186.00
	Genuine	1	<b>TDB104980</b>	443.46	532.15

LH	Aftermarket	1	<b>TDB104990P</b>	50.83	61.00
	OEM	1	<b>TDB104990P1</b>	155.00	186.00
	Genuine	1	<b>TDB104990</b>	443.46	532.15

**Drive Shaft Rear**

All models to (VIN) 1A999999	Aftermarket	2	<b>TOB000070P</b>	95.00	114.00
	OEM	2	<b>TOB000070P1</b>	140.00	168.00
	Genuine	2	<b>TOB000070</b>	302.74	363.29

All models (VIN) 2A000001 on	Genuine	2	<b>TOB000110</b>	297.27	356.72
------------------------------	---------	---	------------------	--------	--------

**Gaiter Kit Front Drive Shaft Outer**

All 1.8L K Series petrol models to (VIN) 3A256496	Aftermarket	2	<b>TDR100750P</b>	4.00	4.80
	OEM	2	<b>TDR100750P1</b>	10.63	12.76
	Genuine	2	<b>TDR100750</b>	22.74	27.29

All 2.0L L Series diesel models	Aftermarket	2	<b>TDR100750P</b>	4.00	4.80
	OEM	2	<b>TDR100750P1</b>	10.63	12.76
	Genuine	2	<b>TDR100750</b>	22.74	27.29

All 2.0L TD4 BMW M47 diesel models	Aftermarket	2	<b>TDR100750P</b>	4.00	4.80
	OEM	2	<b>TDR100750P1</b>	10.63	12.76
	Genuine	2	<b>TDR100750</b>	22.74	27.29

All 2.5L KV6 petrol models	Aftermarket	2	<b>TDR100750P</b>	4.00	4.80
	OEM	2	<b>TDR100750P1</b>	10.63	12.76
	Genuine	2	<b>TDR100750</b>	22.74	27.29

**Gaiter Kit Front Drive Shaft Inner**

All 1.8L K Series petrol models to (VIN) 3A256496	Aftermarket	2	<b>TDR100710P</b>	8.33	10.00
	OEM	2	<b>TDR100710P1</b>	9.58	11.50
	Genuine	2	<b>TDR100710</b>	23.61	28.33

All 2.0L L Series diesel models	Aftermarket	2	<b>TDR100710P</b>	8.33	10.00
	OEM	2	<b>TDR100710P1</b>	9.58	11.50
	Genuine	2	<b>TDR100710</b>	23.61	28.33

All 2.0L TD4 BMW M47 diesel models	OEM	2	<b>TDR500210P1</b>	8.75	10.50
	Genuine	2	<b>TDR500210</b>	22.40	26.88

All 2.5L KV6 petrol models	OEM	2	<b>TDR500210P1</b>	8.75	10.50
	Genuine	2	<b>TDR500210</b>	22.40	26.88

**Gaiter Kit, Drive Shaft**

All models from (VIN) 3A256497 on Rear axle, inner end	Aftermarket	2	<b>TDR500220P</b>	19.58	23.50
	Genuine	2	<b>TDR500220</b>	43.67	52.40

**Damper, Drive Shaft**

All models up to (VIN) YA999999 Front axle	Genuine	1	<b>TDE10007L</b>	31.33	37.60
-----------------------------------------------	---------	---	------------------	-------	-------

**Intermediate Reduction Drive Unit**

All 2.5L KV6 petrol models - New, exchange	Genuine*	1	<b>TAG000220</b>	1280.18	1536.22
	*Exchange Surcharge			1000.00	1200.00

**Swivel Hub**

All ABS fitted models to (VIN) 1A999999	RH	Genuine	1	<b>RUB101502</b>	198.64	238.37
	LH	Genuine	1	<b>RUB101512</b>	165.42	198.50

**Oil Seal, Differential**

All 1.8L K Series petrol models Front driveshaft, LH	MG Rover	1	<b>TRX100060SLP</b>	13.48	16.18
	MG Rover	1	<b>TRX100060SLP</b>	13.48	16.18

All 2.0L TD4 BMW M47 diesel manual models Front driveshaft, LH	MG Rover	1	<b>TRX000010</b>	7.03	8.44
	Genuine	1	<b>TRX000010L</b>	8.60	10.32

**Oil Seal Differential Unit**

All automatic gearbox models	Aftermarket	1	<b>TGX000010P</b>	1.83	2.20
	Genuine	1	<b>TGX000010</b>	15.99	19.19

**Oil Seal Diff Pinion Front**

All models	Aftermarket	1	<b>FTC5258P</b>	1.50	1.80
	OEM	1	<b>FTC5258P1</b>	4.08	4.90

**Oil Seal Diff Pinion Rear**

All models	Genuine	1	<b>FTC5258</b>	13.96	16.75
	OEM	1	<b>FTC5258P1</b>	4.08	4.90

**Oil Seal Front Diff Unit to Drive Shaft**

All 1.8L K Series petrol models	Aftermarket	1	<b>TRX100060LP</b>	3.00	3.60
	Genuine	1	<b>TRX100060L</b>	13.80	16.56

All 2.0L L Series diesel models	Aftermarket	1	<b>TRX100060LP</b>	3.00	3.60
	Genuine	1	<b>TRX100060L</b>	13.80	16.56

**Oil Seal Rear Diff Unit to Drive Shaft**

All models	Aftermarket	1	<b>TOC100000P</b>	3.50	4.20
	Genuine	1	<b>TOC100000</b>	31.68	38.02

**Oil Seal, Intermediate Reduction Drive**

All models	Aftermarket	1	<b>UNG100060LP</b>	6.67	8.00
	MG Rover	1	<b>UNG100060</b>	13.00	15.60
	Genuine	1	<b>UNG100060L</b>	15.28	18.34

**Seal Transfer Box Front**

All models	Aftermarket	1	<b>TRX100170P</b>	1.17	1.40
------------	-------------	---	-------------------	------	------

**Plug, Oil Drain**

All models - Rear axle	Genuine	1	<b>FTC5431</b>	6.50	7.80
------------------------	---------	---	----------------	------	------

**Damper Only, Viscous Coupling**

All 4 cyl petrol and diesel models - Propshaft	Britpart	1	<b>TOR000010DAMPERP</b>	75.83	91.00
------------------------------------------------	----------	---	-------------------------	-------	-------

**Intermediate Reduction Drive Unit**

All 4 cyl petrol and diesel models New, exchange	Genuine*	1	<b>TAG000230</b>	1775.07	2130.08
	Exchange Surcharge			1000.00	1200.00

All 2.5L KV6 petrol models Reconditioned, exchange	Genuine*	1	<b>TAG000220</b>	1280.18	1536.22
	Exchange Surcharge			1000.00	1200.00

**Mounting, Differential**

All models Rear axle, front mounting	Aftermarket	1	<b>KHC500070P</b>	7.08	8.50
	Genuine	1	<b>KHC500070</b>	18.87	22.64





# COOLING

# FREELANDER 1 (1996-2006)

## Expansion Bottle Cap

All models up to (VIN) 3A289375	Aftermarket	1	<b>PCD100160-P</b>	2.00	2.40
	Genuine	1	<b>PCD100160</b>	3.87	4.64
All models from (VIN) 3A289376 on	Aftermarket	1	<b>PCD500030P</b>	2.83	3.40
	Genuine	1	<b>PCD500030</b>	6.76	8.11

## Thermostat

All 1.8L petrol engine models up to (VIN) YA999999	Aftermarket	1	<b>PEL10016P</b>	2.75	3.30
	Genuine	1	<b>PEL10016</b>	9.98	11.98

All 1.8L K Series petrol models from (VIN) 1A000001 on <i>In-line, PRT type, alternative fitment, 87°C, cream colour code, medium spring rate</i>	Aftermarket	1	<b>PEM101021P</b>	21.25	25.50
	MG Rover	1	<b>PEM101021</b>	32.18	38.62
All 2.0L L Series diesel models - Oil	Aftermarket	1	<b>PBM100040P</b>	7.50	9.00
	Genuine	1	<b>PBM100040</b>	22.94	27.53

## Thermostat & Housing

All 1.8L K Series petrol models to (VIN) YA999999 - Coolant	Aftermarket	1	<b>PEM10025P</b>	18.54	22.25
	Aftermarket	1	<b>PEM10025LP</b>	18.13	21.76
	MG Rover	1	<b>PEM10025</b>	39.98	47.98
	Genuine	1	<b>PEM10025L</b>	48.03	57.64

## Thermostat Housing Gasket

All 2.0L TD4 BMW M47 diesel models	Aftermarket	1	<b>PEF000040P</b>	1.75	2.10
	Genuine	1	<b>PEF000040</b>	6.74	8.09

## O Ring Thermostat Housing

All 1.8L K Series petrol models Oversized	Aftermarket	1	<b>CDU38580S</b>	1.42	1.70
	MG Rover	1	<b>CDU3858</b>	1.50	1.80

All 2.5L KV6 petrol models Oversized	Aftermarket	1	<b>CDU38580S</b>	1.42	1.70
	MG Rover	1	<b>CDU3858</b>	1.50	1.80
	Genuine	1	<b>CDU3858L</b>	1.54	1.85

## Thermostat Seal

All 1.8L petrol engine models - Thermostat housing	Aftermarket	1	<b>PEF10010</b>	2.04	2.45
	Genuine	1	<b>PEF10010</b>	2.04	2.45

## Thermostat Housing

All 1.8L petrol engine models from (VIN) 1A000001 on	Aftermarket	1	<b>PEM000020P</b>	13.54	16.25
	Genuine	1	<b>PEM000020</b>	17.55	21.06
	OEM	1	<b>PEL500110P1</b>	24.58	29.50
	Genuine	1	<b>PEL500110</b>	40.55	48.66
All models with 2.0L TD4 diesel engine	Genuine	1	<b>PEL100571</b>	34.00	40.80

## Thermostat Kit

All 2.5L KV6 petrol models <i>Includes thermostat, angled &amp; straight coolant pipes, manifold gaskets &amp; pipe clips</i>	Aftermarket	1	<b>PEM000030PK</b>	69.17	83.00
	Genuine	1	<b>PEM000030K</b>	127.50	153.00
All KV6 petrol engine models - <i>With housing and seal</i>	Aftermarket	1	<b>PEM000030P</b>	12.50	15.00
	Genuine	1	<b>PEM000030</b>	54.71	65.65

## Water Pump

All 1.8L K Series petrol engine models	Aftermarket	1	<b>PEB102510LP</b>	13.54	16.25
	OEM	1	<b>PEB102510LP1</b>	22.50	27.00
	Genuine	1	<b>PEB102510L</b>	105.27	126.32
All 2.0L L Series diesel engine models	Aftermarket	1	<b>PEB102420LP</b>	12.50	15.00
	OEM	1	<b>PEB102420LP1</b>	28.75	34.50
	Genuine	1	<b>PEB102420L</b>	57.96	69.55
All 2.0L TD4 diesel engine models	Aftermarket	1	<b>PEB102470SLPP</b>	29.58	35.50
	Genuine	1	<b>PEB102470SLP</b>	69.99	83.99
	Genuine	1	<b>PEB102470L</b>	105.27	126.32
All KV6 petrol engine models	OEM	1	<b>PEB102240LP1</b>	39.58	47.50
	Genuine	1	<b>PEB102240L</b>	116.96	140.35

## Water Pump Gasket

All 2.0L TD4 BMW M47 diesel models	Genuine	1	<b>8510300</b>	9.06	10.87
All 2.5L KV6 petrol models	MG Rover	1	<b>PET100760</b>	4.37	5.24
	Genuine	1	<b>PET100760L</b>	7.81	9.37

## Water Pump Seal

All 2.0L L Series diesel models	Aftermarket	1	<b>ERR6711P</b>	3.00	3.60
	Genuine	1	<b>ERR6711</b>	5.04	6.05

## D Ring Set

All 2.0L L Series diesel engine models - Water pump	Aftermarket	1	<b>PFQ10001LP</b>	5.00	6.00
	Genuine	1	<b>PFQ10001L</b>	8.01	9.61

## O Ring Water Pump

All 1.8L K Series petrol engine models	MG Rover	1	<b>PET10010SLP</b>	2.54	3.05
	Genuine	1	<b>PET10010L</b>	4.67	5.60

## Intercooler Hose

All 2.0L L Series diesel engine models	Aftermarket	1	<b>ESR4263P</b>	41.67	50.00
Intercooler to turbocharger	Genuine	1	<b>ESR4263</b>	50.73	60.88
Intercooler pipe to turbocharger	Genuine	1	<b>PNH000560L</b>	78.80	94.56

## Intercooler to Manifold Hose

All 2.0L L Series diesel engine models	Aftermarket	1	<b>PNH101720P</b>	7.08	8.50
	Genuine	1	<b>PNH101720</b>	29.27	35.12

## Hose

All 2.0L TD4 BMW M47 diesel models - Coolant feed to turbocharger	Aftermarket	1	<b>PNH101811P</b>	12.29	14.75
	Genuine	1	<b>PNH101811</b>	26.91	32.29

## Hose Only Turbo Intercooler

All 2.0L TD4 BMW M47 diesel models (VIN) 3A279834 on	Aftermarket	1	<b>PNH500190P</b>	39.58	47.50
	Genuine	1	<b>PNH500190</b>	53.30	63.96

## Intercooler to Manifold Hose

All 2.0L TD4 diesel engine models	Aftermarket	1	<b>PNH000020P</b>	7.08	8.50
	Genuine	1	<b>PNH000020</b>	28.14	33.77

## Intercooler Turbo Hose

All 2.0L TD4 diesel engine models	Aftermarket	1	<b>PNH101801P</b>	7.50	9.00
	Genuine	1	<b>PNH101801</b>	27.21	32.65

## Intercooler Pipe & Hose Kit

All 2.0L TD4 BMW M47 diesel models - Intercooler to turbocharger	Genuine	1	<b>PNP000011</b>	120.22	144.26
------------------------------------------------------------------	---------	---	------------------	--------	--------

## Temperature Sensor

All 1.8L K Series petrol engine models - Black	Aftermarket	1	<b>MEK000030P</b>	7.50	9.00
	OEM	1	<b>MEK000030LP1</b>	10.42	12.50
	Genuine	1	<b>MEK000030L</b>	17.89	21.47
2.0L L Series diesel engine models	Aftermarket	1	<b>ERR2081P</b>	3.25	3.90
	OEM	1	<b>ERR2081P1</b>	9.79	11.75
	Genuine	1	<b>ERR2081</b>	14.00	16.80
2.5L KV6 petrol models, USA/CDN/Mex only	Aftermarket	1	<b>MEK105210P</b>	7.50	9.00
	OEM	1	<b>MEK105210P1</b>	10.83	13.00
	Genuine	1	<b>MEK105210</b>	27.82	33.38

## Coolant Temperature Sensor

All 1.8L K Series petrol engine models - Blue (coolant temp gauge)	Genuine	1	<b>MEK100130L</b>	22.91	27.49
All 2.0L TD4 BMW M47 diesel models	Aftermarket	1	<b>NSC100870LP</b>	7.08	8.50
	Genuine	1	<b>NSC100870L</b>	25.83	31.00

## Coolant Level Sensor

All petrol models from (VIN) 5A476243 on	Genuine	1	<b>PCJ500010</b>	20.66	24.79
------------------------------------------	---------	---	------------------	-------	-------

## Link Harness Low Coolant Sensor

All petrol models to (VIN) YA999999 - <i>Allows fitment and connection of low coolant sensor to vehicle not originally so fitted</i>	Genuine	1	<b>YMQ501260</b>	13.02	15.62
All petrol models from (VIN) 1A000001 to 5A476242 - <i>Allows fitment and connection of low coolant sensor to vehicle not originally so fitted</i>	Genuine	1	<b>YMQ501270</b>	8.72	10.46



## FREELANDER 1 (1996-2006)

## ELECTRICAL - ROTATING ELECTRICS

## Alternator

1.8L petrol engine, without air conditioning - 90amp				
New, outright	OEM	1	<b>YLE101890P1</b>	115.00 138.00
New, exchange	Genuine*	1	<b>YLE101890</b>	252.99 303.59
			*Exchange Surcharge	70.00 84.00
All 1.8L K Series petrol models without air conditioning from (VIN) WA to YA999999 Alternative to YLE101890.				
New, outright	Genuine	1	<b>YLE102290</b>	252.99 303.59
1.8L petrol engine, with air conditioning up to (VIN) YA999999 - 105amp				
New, outright	OEM	1	<b>YLE102060P1</b>	120.00 144.00
Reconditioned, exchange	Genuine*	1	<b>YLE102060E</b>	173.22 207.86
			*Exchange Surcharge	150.00 180.00
New, exchange	Genuine*	1	<b>YLE102060</b>	266.70 320.04
			*Exchange Surcharge	70.00 84.00
All 1.8L K Series petrol models with air conditioning from (VIN) 1A000001 on (105amp)				
New, outright	Aftermarket	1	<b>YLE102370P</b>	120.00 144.00
	OEM	1	<b>YLE102370LP1</b>	130.00 156.00
Reconditioned, exchange	Genuine*	1	<b>YLE102370LE</b>	176.87 212.24
			*Exchange Surcharge	70.00 84.00
New, exchange	Genuine*	1	<b>YLE102370L</b>	274.67 329.60
			*Exchange Surcharge	150.00 180.00
2.0L L Series diesel models without air conditioning				
New, outright	OEM	1	<b>YLE102010P1</b>	295.83 355.00
Exchange	Genuine*	1	<b>YLE102010E</b>	296.08 355.30
			*Exchange Surcharge	80.00 96.00
New, exchange	Genuine*	1	<b>YLE102010</b>	459.92 551.90
			*Exchange Surcharge	80.00 96.00
2.0L L series diesel engine, with air conditioning - 105amp				
New, outright	Aftermarket	1	<b>YLE102080P</b>	165.00 198.00
New, exchange	Genuine*	1	<b>YLE102080</b>	399.00 478.80
			*Exchange Surcharge	70.00 84.00
2.0L TD4 BMW M47 diesel models with 120 amp alternator to (VIN) 1A999999 - 120 amp type				
Reconditioned, exchange	Genuine*	1	<b>YLE102500LE</b>	185.18 222.22
			*Exchange Surcharge	70.00 84.00
New, exchange	Genuine*	1	<b>YLE102500L</b>	296.35 355.62
			*Exchange Surcharge	70.00 84.00
All 2.0L TD4 BMW M47 diesel models (VIN) 2A000001 on - 150 Amp,				
New, outright	Aftermarket	1	<b>YLE500170P</b>	130.00 156.00
	OEM	1	<b>YLE500170P1</b>	200.00 240.00
Reconditioned, exchange	Genuine*	1	<b>YLE500170E</b>	158.06 189.67
			*Exchange Surcharge	70.00 84.00
New, exchange	Genuine*	1	<b>YLE500170</b>	298.92 358.70
			*Exchange Surcharge	70.00 84.00
KV6 petrol engine with automatic transmission - 120amp				
New, outright	OEM	1	<b>YLE102480P1</b>	153.33 184.00
New, exchange	Genuine*	1	<b>YLE102480</b>	296.35 355.62
			*Exchange Surcharge	70.00 84.00

## Starter Motor

All models with 1.8L petrol engine				
New, outright	Aftermarket	1	<b>NAD101420P</b>	97.50 117.00
Reconditioned, exchange	Genuine*	1	<b>NAD101420E</b>	273.67 328.40
			*Exchange Surcharge	70.00 84.00
New, exchange	Genuine*	1	<b>NAD101420</b>	322.82 387.38
			*Exchange Surcharge	70.00 84.00
All models with 2.0L L Series diesel engine				
New, outright	Aftermarket	1	<b>NAD100580P</b>	86.95 104.34
	OEM	1	<b>NAD100580P1</b>	145.00 174.00
New, exchange	Genuine*	1	<b>NAD100580E</b>	233.12 279.74
			*Exchange Surcharge	70.00 84.00
New, exchange	Genuine*	1	<b>NAD100580</b>	322.82 387.38
			*Exchange Surcharge	70.00 84.00
All models with 2.0L TD4 diesel engine				
New, outright	Aftermarket	1	<b>NAD101500P</b>	95.00 114.00
	OEM	1	<b>NAD101500P1</b>	140.00 168.00
Reconditioned, exchange	Genuine*	1	<b>NAD101500E</b>	140.76 168.91
			*Exchange Surcharge	100.00 120.00
New, exchange	Genuine*	1	<b>NAD101500</b>	257.95 309.54
			*Exchange Surcharge	70.00 84.00
All 2.5L KV6 petrol models - Alternative fitment to NAD100952L.				
Reconditioned, exchange	Genuine*	1	<b>NAD100730E</b>	182.20 218.64
			*Exchange Surcharge	70.00 84.00
New, exchange	Genuine*	1	<b>NAD100730</b>	350.90 421.08
			*Exchange Surcharge	70.00 84.00
All models with KV6 petrol engine and automatic transmission				
New, outright	Aftermarket	1	<b>NAD100952P</b>	94.17 113.00
Reconditioned, exchange	Genuine*	1	<b>NAD100952E</b>	175.72 210.86
			*Exchange Surcharge	100.00 120.00
New, exchange	Genuine*	1	<b>NAD100952L</b>	240.66 288.79
			*Exchange Surcharge	70.00 84.00



NAD101500P

## FREELANDER 1 (1996-2006)

## ENGINE GASKETS

## Gasket Camshaft Cover

All 1.8L K Series petrol models				
	Aftermarket	1	<b>LVP100630LP</b>	7.08 8.50
	Genuine	1	<b>LVP100630L</b>	27.37 32.84
All 2.0L TD4 BMW M47 diesel models				
	Aftermarket	1	<b>LVP100620P</b>	5.83 7.00
	MG Rover	1	<b>LVP100620</b>	22.51 27.01
All 2.5L KV6 petrol models				
	Aftermarket	2	<b>LVP100470LP</b>	7.50 9.00
	Genuine	2	<b>LVP100470L</b>	25.81 30.97

## Gasket Rocker Cover

All 2.0L L Series diesel models				
	Aftermarket	1	<b>LVP100400P</b>	4.38 5.26
	Genuine	1	<b>LVP100400</b>	12.38 14.86

## Gasket Cylinder Head

All 1.8L K Series petrol models - Standard type gasket				
	Aftermarket	1	<b>LVB000321P</b>	9.58 11.50
	MG Rover	1	<b>LVB000321</b>	29.95 35.94
1.8L K Series petrol models from (VIN) 6A806537 on - Multi layer steel				
	OEM	1	<b>LVB500190AP1</b>	19.58 23.50
	Genuine	1	<b>LVB500190A</b>	65.49 78.59
2.0L L Series diesel models				
1.05mm, one hole				
	Aftermarket	1	<b>LVB100910P</b>	10.63 12.76
	Genuine	1	<b>LVB100910</b>	40.38 48.46
1.20mm, two holes				
	Aftermarket	1	<b>LVB100920P</b>	9.95 11.94
	Genuine	1	<b>LVB100920</b>	10.66 12.79
1.35mm, three holes				
	Aftermarket	1	<b>LVB100930P</b>	11.67 14.00
	Genuine	1	<b>LVB100930</b>	41.61 49.93
All 2.0L TD4 BMW M47 diesel models				
1.45mm thick, one hole on I.D. lip, multi layer steel				
	Aftermarket	1	<b>LVB101820PMLS</b>	40.83 49.00
	Genuine	1	<b>LVB101820L</b>	78.39 94.07
1.45mm, one hole				
1.55mm thick, 2 holes on I.D. lip, multi layer steel				
	Aftermarket	1	<b>LVB101830PMLS</b>	40.83 49.00
	Genuine	1	<b>LVB101830L</b>	76.21 91.45
1.55mm, two holes				
1.65mm thick, three holes on I.D. lip, multi layer steel				
	Aftermarket	1	<b>LVB000100LPMLS</b>	43.33 52.00
	Genuine	1	<b>LVB000100L</b>	76.25 91.50
	Genuine	1	<b>8510018</b>	186.83 224.20
2.5L KV6 petrol models				
	Aftermarket	2	<b>LVB101630LP</b>	9.58 11.50
	OEM	2	<b>LVB101630P1</b>	13.13 15.76
	Genuine	2	<b>LVB101630L</b>	21.68 26.02

## Gasket Decoke Set

1.8L K Series petrol models - With MLS gasket				
	Aftermarket	1	<b>LVQ000091PMLS</b>	52.50 63.00
2.0L TD4 BMW M47 diesel models - Without head gasket				
	Aftermarket	1	<b>LVQ101250LP</b>	39.58 47.50
	Genuine	1	<b>LVQ101250L</b>	118.71 142.45
2.5L KV6 petrol models				
Set designed primarily for MG Rover applications, but will fit Freelander 1				
	Aftermarket	2	<b>LVB101630PSET</b>	103.33 124.00
	Aftermarket	2	<b>LVB101630LPSET</b>	80.00 96.00

## Gasket Oil Sump

2.0L L Series diesel models				
	Aftermarket	1	<b>ERR7029P</b>	5.00 6.00
	Genuine	1	<b>ERR7029</b>	19.15 22.98
All 2.0L TD4 BMW M47 diesel models				
Upper				
	Aftermarket	1	<b>LVF100420LP</b>	7.50 9.00
	Genuine	1	<b>LVF100420L</b>	27.58 33.10
Lower				
	OEM	1	<b>LVF100430LP1</b>	5.00 6.00
	Genuine	1	<b>LVF100430L</b>	15.27 18.32

## Gasket Conversion Set

All TD4 BMW M47 diesel models				
	Aftermarket	1	<b>LVQ101240P</b>	65.00 78.00
	Genuine	1	<b>LVQ101240L</b>	91.02 109.22

## Sealant Instant Gasket

Numerous applications				
	Genuine	a/r	<b>STC50550</b>	13.10 15.72

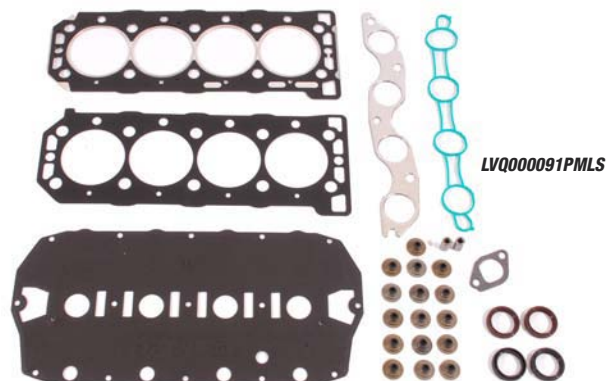

LVQ000091PMLS



# ENGINE SWITCHES

## Camshaft Sensor

All 1.8L K Series petrol models	Aftermarket	1	<b>NSC000310LP</b>	27.50	33.00
	Genuine	1	<b>NSC000310L</b>	104.96	125.95

## Camshaft Position Sensor

All 2.0L TD4 BMW M47 diesel models	Genuine	1	<b>8510297</b>	114.29	137.15
------------------------------------	---------	---	----------------	--------	--------

## Crankshaft Position Sensor

All 1.8L K Series petrol models - <i>Alternative to NSC100390L</i>					
	OEM	1	<b>NSC100760SLPP1</b>	30.00	36.00
	MG Rover	1	<b>NSC100760SLP</b>	60.00	72.00
All models with 2.0L L Series (TCIE) diesel engine					
	Aftermarket	1	<b>NSC100110LP</b>	20.50	24.60
	OEM	1	<b>NSC100110LP1</b>	25.00	30.00
All 2.0L TD4 BMW M47 diesel models	Aftermarket	1	<b>NSC100880LP</b>	35.00	42.00
	Genuine	1	<b>NSC100880L</b>	78.29	93.95
All 2.5L KV6 petrol models					
Without harness	Genuine	1	<b>NSC106100L</b>	63.80	76.56
With harness	Genuine	1	<b>NSK100000L</b>	59.65	71.58

## Crankshaft Sensor

2.0L L Series diesel models	Genuine	1	<b>NSC100110L</b>	136.14	163.37
-----------------------------	---------	---	-------------------	--------	--------

## Crankshaft Sensor Assembly

All 1.8L K Series petrol models	Aftermarket	1	<b>NSC100390LP</b>	15.00	18.00
	OEM	1	<b>NSC100390LP1</b>	25.00	30.00
	Genuine	1	<b>NSC100390L</b>	85.88	103.06

## Oil Temperature Switch

All 2.0L L Series diesel models	OEM	1	<b>ERR6397P1</b>	9.79	11.75
	Genuine	1	<b>ERR6397</b>	24.50	29.40
All 2.0L TD4 BMW M47 diesel automatic models, hot climates, with air cooled oil cooler					
	Genuine	1	<b>NSC000040</b>	49.62	59.54

## Engine Knock Sensor

All 2.5L KV6 petrol models	Genuine	1	<b>NSC100740L</b>	51.40	61.68
----------------------------	---------	---	-------------------	-------	-------

## Oil Pressure Switch

1.8L K series petrol engine models					
Parallel thread (not tapered)					
	Aftermarket	1	<b>LR058003P</b>	2.50	3.00
	OEM	1	<b>LR058003P1</b>	3.00	3.60
	Genuine	1	<b>LR058003</b>	15.35	18.42
Tapered thread (not parallel)					
	Aftermarket	1	<b>NUC10003P</b>	3.25	3.90
	Genuine	1	<b>NUC10003</b>	6.94	8.33
2.0L L Series diesel engine models					
	Aftermarket	1	<b>NUC10003P</b>	3.25	3.90
	Genuine	1	<b>NUC10003</b>	6.94	8.33
All 2.5L KV6 petrol models					
	Aftermarket	1	<b>NUC100280LP</b>	3.00	3.60
	Genuine	1	<b>NUC100280L</b>	13.26	15.91

## Air Inlet Temperature Sensor

All 1.8L K series petrol engine models	OEM	1	<b>NNK10001LP1</b>	20.00	24.00
	Genuine	1	<b>NNK10001L</b>	24.04	28.85
All USA/CDN/Mex models with 2.5L KV6 petrol engine					
	Genuine	1	<b>NNK000020</b>	13.73	16.48

# FREELANDER 1 (1996-2006)

## Air Temperature Sensor

All 2.0L TD4 BMW M47 diesel models - Engine air inlet					
	Aftermarket	1	<b>LR006796P</b>	6.67	8.00
	Genuine	1	<b>LR006796</b>	22.47	26.96

## Manifold Absolute Pressure Sensor

All 1.8L K Series petrol engine models	Genuine	1	<b>MHK100820L</b>	96.22	115.46
All 2.0L L Series diesel models					
up to (VIN) YA567906					
	Aftermarket	1	<b>MHK100410LP</b>	45.00	54.00
	Genuine	1	<b>MHK100410L</b>	117.96	141.55
from (VIN) YA567907 on					
	Aftermarket	1	<b>MHK101190P</b>	43.33	52.00
	Genuine	1	<b>MHK101190</b>	116.47	139.76
All 2.5L KV6 petrol models					
	Genuine	1	<b>MHK100820L</b>	96.22	115.46

## Manifold Pressure Sensor

2.0L TD4 BMW M47 diesel engine models	Aftermarket	1	<b>MHK101060LP</b>	31.00	37.20
	Genuine	1	<b>MHK101060L</b>	70.59	84.71

## Oxygen Sensor

1.8L K Series petrol models from (VIN) 1A000001 on - Post-catalyst					
	Aftermarket	1	<b>MHK000060P</b>	60.00	72.00
	Genuine	1	<b>MHK000060</b>	130.09	156.11
1.8L K Series petrol models from (VIN) 1A000001 to 1A156999 and 2A000001 on - Pre-catalyst					
	OEM	1	<b>MHK100840P1</b>	35.00	42.00
	Genuine	1	<b>MHK100840</b>	49.99	59.99
1.8L K Series petrol models from (VIN) 1A576764 to 1A599999 - Pre-catalyst					
	OEM	1	<b>MHK100720P1</b>	50.00	60.00
	Genuine	1	<b>MHK100720</b>	156.93	188.32
Alternative fitment, pre-catalyst					
	Genuine	1	<b>MHK100722L</b>	140.04	168.05
2.5L KV6 petrol models (not USA/CDN/Mex) - Pre-catalyst					
	Genuine	1	<b>MHK000070</b>	122.25	146.70
All 2.5L KV6 petrol models - With bracket					
	Genuine	1	<b>NSU100331</b>	5.64	6.77
2.5L KV6 petrol models USA/CDN/Mex - Rearward					
	Aftermarket	1	<b>MHK100930P</b>	29.58	35.50
	Genuine	1	<b>MHK100930</b>	131.65	157.98
2.5L KV6 petrol models USA/CDN/Mex from (VIN) 2A000001 to 4A999999					
	OEM	1	<b>MHK100940P1</b>	60.00	72.00
	Aftermarket	1	<b>MHK100940P</b>	22.08	26.50
All USA/CDN/Mex 2.5L KV6 petrol models from (VIN) 5A000001 on - Pre-catalyst					
	Genuine	1	<b>MHK500860</b>	133.83	160.60



# DRAIN PLUGS

## Sump Plug

All 1.8L K Series petrol models	OEM	1	<b>LSF100040LP1</b>	1.50	1.80
	Genuine	1	<b>LSF100040L</b>	3.13	3.76
All 2.0L L Series diesel models	OEM	1	<b>LSF100040LP1</b>	1.50	1.80
	Genuine	1	<b>LSF100040L</b>	3.13	3.76
All models with 2.0L TD4 BMW M47 diesel engine					
	Genuine	1	<b>LYP101630L</b>	5.78	6.94
All 2.5L KV6 petrol models	OEM	1	<b>LSF100040LP1</b>	1.50	1.80
	Genuine	1	<b>LSF100040L</b>	3.13	3.76

## Sealing Washer Sump Plug

All 1.8L K Series petrol models	Aftermarket	1	<b>ALU1403LP</b>	0.54	0.65
	Genuine	1	<b>ALU1403L</b>	1.11	1.33
All 2.0L L Series diesel models	Aftermarket	1	<b>ALU1403LP</b>	0.54	0.65
	Genuine	1	<b>ALU1403L</b>	1.11	1.33
All 2.5L KV6 petrol models	Aftermarket	1	<b>ALU1403LP</b>	0.54	0.65
	Genuine	1	<b>ALU1403L</b>	1.11	1.33

## Drain Plug

All models - Intermediate reduction drive (IRD unit)					
	Genuine	1	<b>TAS100000</b>	4.77	5.72
All models with automatic gearbox					
Large, gearbox	Genuine	1	<b>TGF100060L</b>	5.68	6.82
Small, with washer, gearbox	Genuine	1	<b>TGM500100</b>	11.05	13.26

## Filler Plug

All 2.0L TD4 BMW M47 diesel manual models - Gearbox					
	Genuine	1	<b>TRL100700L</b>	4.70	5.64
All models - Intermediate reduction drive (IRD unit)					
	Genuine	1	<b>TRL100060</b>	3.30	3.96

# FREELANDER 1 (1996-2006)

## Special Plug

All 1.8L K Series petrol models					
16mm dia., gear case	Genuine	1	<b>DBM574L</b>	6.20	7.44
32mm dia., gear case	Genuine	1	<b>DBM573L</b>	18.04	21.65
All 2.0L L Series diesel models					
16mm dia., gear case	Genuine	1	<b>DBM574L</b>	6.20	7.44
32mm dia., gear case	Genuine	1	<b>DBM573L</b>	18.04	21.65

## Oil Drain Valve Kit

All 1.8L K Series petrol models	Aftermarket	1	<b>LSF100040LODV</b>	32.08	38.50
All 2.0L L Series diesel models	Aftermarket	1	<b>LSF100040LODV</b>	32.08	38.50
All 2.5L KV6 petrol models	Aftermarket	1	<b>LSF100040LODV</b>	32.08	38.50





**FREELANDER 1 (1996-2006)****OIL SEALS ENGINE****Oil Seal Crankshaft Front**

2.0L TD4 BMW M47 diesel models	Aftermarket	1	<b>LUF100530LP</b>	5.63	6.76
	Genuine	1	<b>LUF100530L</b>	19.03	22.84
All 2.0L TD4 BMW M47 diesel models - With retainer & gasket	Aftermarket	1	<b>STC4161L</b>	81.05	97.26
	Genuine	1	<b>STC4161L</b>	81.05	97.26
2.5L KV6 petrol models	Aftermarket	1	<b>LQX100070LP</b>	3.00	3.60
	OEM	1	<b>LQX100070LP1</b>	5.63	6.76
	Genuine	1	<b>LQX100070L</b>	22.36	26.83

**Oil Seal Crankshaft Rear**

1.8L K Series petrol models	Aftermarket	1	<b>LUF000050LP</b>	7.50	9.00
	Genuine	1	<b>LUF000050L</b>	24.97	29.96
2.0L L Series diesel models	OEM	1	<b>ERR7028P1</b>	8.96	10.75
	Genuine	1	<b>ERR7028</b>	37.93	45.52
2.0L TD4 BMW M47 diesel models	Aftermarket	1	<b>LUF100540LP</b>	7.50	9.00
	OEM	1	<b>LUF100540LP1</b>	9.58	11.50
	Genuine	1	<b>LUF100540L</b>	42.89	51.47
2.5L KV6 petrol models	Aftermarket	1	<b>LUF100300LP</b>	9.79	11.75
	OEM	1	<b>LUF100300LP1</b>	27.50	33.00
	Genuine	1	<b>LUF100300L</b>	31.74	38.09

**Oil Seal Oil Pump**

1.8L K Series petrol models	Aftermarket	1	<b>LQX100040LP</b>	1.50	1.80
	Genuine	1	<b>LQX100040L</b>	16.70	20.04
2.0L L Series diesel models	Aftermarket	1	<b>WZX1915P</b>	6.67	8.00
	Genuine	1	<b>WZX1915</b>	22.92	27.50

**Oil Seal Camshaft Front**

1.8L K Series petrol models - Black	Aftermarket	1	<b>LUC100290LP</b>	1.00	1.20
	Genuine	1	<b>LUC100290L</b>	6.55	7.86
2.0L L Series diesel models	Aftermarket	1	<b>LZB100271P</b>	1.25	1.50
	OEM	1	<b>LZB100271P1</b>	2.25	2.70
	Genuine	1	<b>LZB100271</b>	5.36	6.43
2.5L KV6 petrol models - Black	Aftermarket	1	<b>LUC100290LP</b>	1.00	1.20
	Genuine	1	<b>LUC100290L</b>	6.55	7.86
Blanking plug type seal	OEM	1	<b>LUC100150LP1</b>	3.50	4.20
	Genuine	1	<b>LUC100150L</b>	5.32	6.38

**Oil Seal Camshaft Rear**

1.8L K Series petrol models - Red	Aftermarket	1	<b>LUC100220LP</b>	1.75	2.10
	Genuine	1	<b>LUC100220L</b>	5.37	6.44
2.5L KV6 petrol models - Red	Aftermarket	1	<b>LUC100220LP</b>	1.75	2.10
	Genuine	1	<b>LUC100220L</b>	5.37	6.44

**FREELANDER 1 (1996-2006)****EXHAUST GAS RECIRCULATION (EGR)****EGR Valve**

All 2.0L L Series diesel models	Aftermarket	1	<b>WAV100220P</b>	40.00	48.00
	Genuine	1	<b>WAV100220</b>	99.95	119.94
	Genuine	1	<b>MSG100110</b>	59.46	71.35
All 2.0L TD4 BMW M47 diesel models	OEM	1	<b>8510381P1</b>	58.33	70.00
	Genuine	1	<b>8510381</b>	74.13	88.96

**Solenoid EGR Vacuum**

All 2.0L TD4 BMW M47 diesel models	Genuine	1	<b>STC4198</b>	58.53	70.24
------------------------------------	---------	---	----------------	-------	-------

**Gasket EGR Valve to Pipe**

All 2.0L L Series diesel models	Aftermarket	1	<b>ERR3319P</b>	1.00	1.20
	Genuine	1	<b>ERR3319</b>	1.75	2.10

**Gasket EGR Cooler to Feed Pipe**

All 2.0L L Series diesel models	Genuine	1	<b>WAL100120</b>	3.16	3.79
---------------------------------	---------	---	------------------	------	------

**Gasket EGR Cooler Elbow**

All 2.0L TD4 BMW M47 diesel models	Genuine	1	<b>WAL100260</b>	5.26	6.31
------------------------------------	---------	---	------------------	------	------

**Feed Pipe EGR Valve**

All 2.0L L Series diesel models	OEM	1	<b>LKB106420LP1</b>	19.58	23.50
	Genuine	1	<b>LKB106420L</b>	27.57	33.08

**Pipe EGR Cooler to Feed Pipe**

All 2.0L L Series diesel models	Genuine	1	<b>ERR7055</b>	32.52	39.02
---------------------------------	---------	---	----------------	-------	-------

**Air Hose**

All 2.0L TD4 BMW M47 diesel models - EGR to cold air intake duct	Aftermarket	1	<b>WAP000080P</b>	4.58	5.50
	Genuine	1	<b>WAP000080</b>	13.47	16.16

**EGR Pipe**

All 2.0L TD4 diesel engine models	Aftermarket	1	<b>WAP000080P</b>	4.58	5.50
	Genuine	1	<b>WAP000080</b>	13.47	16.16

**Hose Vacuum Tee Piece to Reservoir**

All 2.0L TD4 BMW M47 diesel models - Black colour code	Aftermarket	1	<b>8510370</b>	14.43	17.32
	Genuine	1	<b>8510370</b>	14.43	17.32

**Bypass Tube EGR Valve**

All 2.0L TD4 BMW M47 diesel models	Bearmach	1	<b>LF1125</b>	37.50	45.00
	Britpart	1	<b>LF1110BP</b>	27.08	32.50

**Pipe Straight EGR Cooler**

All 2.0L TD4 BMW M47 diesel models	Genuine	1	<b>WAP101270</b>	56.09	67.31
------------------------------------	---------	---	------------------	-------	-------

**Pipe Elbow EGR Cooler**

All 2.0L TD4 BMW M47 diesel manual models	Genuine	1	<b>WAP101440L</b>	74.53	89.44
	Genuine	1	<b>WAP101260</b>	52.85	63.42



8510381



WAP000080



WAP101260



# ENGINE & GEARBOX MOUNTINGS

## Engine Mounting

1.8L K Series petrol models				
up to (VIN) YA999999 - Engine	Aftermarket	1	<b>KKB102480P</b>	19.58 23.50
	Genuine	1	<b>KKB102480</b>	53.19 63.83
from (VIN) 1A000001 on - RH	Genuine	1	<b>KKB103190</b>	95.28 114.34
from (VIN) 1A000001 on - LH	Genuine	1	<b>KKG000040</b>	34.63 41.56
Engine, vertical, with angle bracket	Genuine	1	<b>KKB102850</b>	237.02 284.42
All 2.0L L Series diesel models				
Engine	Aftermarket	1	<b>KKB102480P</b>	19.58 23.50
Engine	Genuine	1	<b>KKB102480</b>	53.19 63.83
Engine, vertical, with angle bracket	Genuine	1	<b>KKB102850</b>	237.02 284.42
All 2.0L TD4 BMW M47 diesel manual models from (VIN) 1A000001 on				
RH	Genuine	1	<b>KKB103180</b>	42.04 50.45
LH	Genuine	1	<b>KKB000100</b>	112.59 135.11
All 2.0L TD4 BMW M47 diesel automatic models from (VIN) 1A000001 on				
Engine, RH	Genuine	1	<b>KKB103360</b>	42.04 50.45
LH	Genuine	1	<b>KKB000090</b>	51.59 61.91

## Bracket Engine Mounting

All 1.8L K Series petrol models				
RH	Genuine	1	<b>KKU106150L</b>	74.88 89.86
up to (VIN) YA999999 - Top	Genuine	1	<b>KKU106330</b>	184.95 221.94
from (VIN) 1A000001 on - RH, upper	Genuine	1	<b>KKU107940</b>	112.17 134.60
All 2.0L L Series diesel models				
Top	Genuine	1	<b>KKU106350</b>	86.60 103.92
Lower, also idler mounting	Genuine	1	<b>KKU106870</b>	143.83 172.60
All 2.0L TD4 BMW M47 diesel manual models - RH, upper				
automatic models - RH, upper	Genuine	1	<b>KKU107900</b>	112.59 135.11
automatic models - RH, upper	Genuine	1	<b>KKU107920</b>	112.59 135.11
All 2.5L KV6 petrol models				
RH, upper	Genuine	1	<b>KKU000151</b>	143.64 172.37
RH, lower	Genuine	1	<b>KKU107650L</b>	126.54 151.85

## Strut Engine Mounting

All 1.8L K Series petrol models				
Lower, support	Genuine	1	<b>KLJ100250</b>	43.32 51.98
All 2.0L L Series diesel models				
Lower, support	Genuine	1	<b>KLJ100250</b>	43.32 51.98

## Bracket Gearbox Mounting

All 2.0L TD4 BMW M47 diesel manual models - LH				
automatic models - LH	Genuine	1	<b>KKU000431</b>	43.29 51.95
automatic models - LH	Genuine	1	<b>KKU000060</b>	43.29 51.95
All 2.5L KV6 petrol models - LH				
	Genuine	1	<b>KKU000050</b>	43.29 51.95

## Tie Rod Assembly Upper

1.8L K Series petrol models				
up to (VIN) YA999999	Aftermarket	1	<b>KKH101900P</b>	25.00 30.00
	Genuine	1	<b>KKH101900</b>	43.00 51.60
from (VIN) 1A000001 on	Aftermarket	1	<b>KKH102620P</b>	35.00 42.00
	Genuine	1	<b>KKH102620</b>	43.00 51.60
2.0L L Series diesel models				
	Aftermarket	1	<b>KKH101900P</b>	25.00 30.00
	Genuine	1	<b>KKH101900</b>	43.00 51.60
2.0L TD4 BMW M47 diesel models				
	Aftermarket	1	<b>KKH102620P</b>	35.00 42.00
	Genuine	1	<b>KKH102620</b>	43.00 51.60
2.5L KV6 petrol models				
	Aftermarket	1	<b>KKH102620P</b>	35.00 42.00
	Genuine	1	<b>KKH102620</b>	43.00 51.60

## Tie Rod Assembly Lower

1.8L K Series petrol models up to (VIN) YA999999				
	Aftermarket	1	<b>KKH102260P</b>	29.58 35.50
	Genuine	1	<b>KKH102260</b>	55.60 66.72
2.0L L Series diesel models				
	Aftermarket	1	<b>KKH102260P</b>	29.58 35.50
	Genuine	1	<b>KKH102260</b>	55.60 66.72
2.0L TD4 BMW M47 diesel models				
	Genuine	1	<b>KKH102680</b>	45.27 54.32
2.5L KV6 petrol models				
	Genuine	1	<b>KKH102680</b>	45.27 54.32

## Tie Rod with Bush

All 1.8L K Series petrol models from (VIN) 1A000001 on				
Lower, engine mounting	Aftermarket	1	<b>KKH102720P</b>	47.50 57.00
	Genuine	1	<b>KKH102720</b>	60.24 72.29
All 2.0L TD4 BMW M47 diesel manual models				
Lower, engine mounting	Genuine	1	<b>KKH000070</b>	55.83 67.00

## Bracket Tie Rod

All models up to (VIN) YA999999				
Upper, engine mounting	Genuine	1	<b>KKU106370</b>	101.16 121.39
All models from (VIN) 1A000001 on				
Upper, engine mounting	Genuine	1	<b>KKU000120</b>	12.11 14.53
All 1.8L K Series petrol models				
Lower, engine mounting	Genuine	1	<b>KKU105860</b>	22.28 26.74
All 2.0L L Series diesel models				
Lower, engine mounting	Genuine	1	<b>KKU106740</b>	155.91 187.09
All 2.0L TD4 BMW M47 diesel automatic models				
Lower, gearbox mounting	Genuine	1	<b>KKU107860</b>	34.63 41.56

## Bush IRD Mounting

All models	Genuine	1	<b>BNP2988L</b>	7.35 8.82
------------	---------	---	-----------------	-----------

## IRD Mounting Plate

All models - Includes bush and spacer	Genuine	1	<b>TAU100200</b>	95.66 114.79
---------------------------------------	---------	---	------------------	--------------

## Spacer IRD Mounting Bush

All models	Genuine	1	<b>UKQ100040</b>	7.56 9.07
------------	---------	---	------------------	-----------

# FUEL SYSTEM SWITCHES

## Throttle Position Sensor

All 1.8L K Series petrol models				
	Aftermarket	1	<b>SLD100080P</b>	35.00 42.00
	Genuine	1	<b>SLD100080</b>	59.17 71.00
All 2.5L KV6 petrol models except USA/CDN/Mex with cruise control				
	Aftermarket	1	<b>SLD100080P</b>	35.00 42.00
	Genuine	1	<b>SLD100080</b>	59.17 71.00

## Air Flow Sensor

2.0L L Series diesel models				
	Aftermarket	1	<b>MHK100850P</b>	43.33 52.00
	Genuine	1	<b>MHK100850</b>	172.28 206.74
2.0L TD4 BMW M47 diesel models				
	OEM	1	<b>MHK101130LP1</b>	87.50 105.00
	Genuine	1	<b>MHK101130L</b>	315.38 378.46
2.5L KV6 petrol models USA/CDN/Mex				
	Aftermarket	1	<b>MHK100620P</b>	26.25 31.50
	OEM	1	<b>MHK100620P1</b>	60.00 72.00
	Genuine	1	<b>MHK100620</b>	123.84 148.61

# CABLES

## Accelerator Cable

RHD petrol and diesel models from (VIN) WA627607 to YA999999				
	Aftermarket	1	<b>SBB103901P</b>	12.50 15.00
	Genuine	1	<b>SBB103901</b>	78.66 94.39
LHD petrol and diesel models from (VIN) WA627607 to YA999999				
	Aftermarket	1	<b>SBB103910P</b>	14.79 17.75
	Genuine	1	<b>SBB103910</b>	57.35 68.82
All RHD 1.8L K Series petrol models from (VIN) 1A000001 on				
	Genuine	1	<b>SBB104131</b>	53.10 63.72
All LHD 1.8L K Series petrol models from (VIN) 1A000001 on				
	Genuine	1	<b>SBB000041</b>	57.77 69.32
All RHD 2.5L KV6 petrol models from (VIN) 1A000001 on				
	Genuine	1	<b>SBB000052</b>	68.10 81.72
All LHD 2.5L KV6 petrol models from (VIN) 1A000001 on				
	Genuine	1	<b>SBB000060</b>	62.86 75.43

# FREELANDER 1 (1996-2006)

## Oxygen Sensor

All 1.8L K Series petrol models to (VIN) YA999999 - Pre-catalyst				
	Genuine	1	<b>MHK10004L</b>	126.70 152.04

## Fuel Feed Pipe & Pressure Sensor

All 2.0L TD4 BMW M47 diesel models	Genuine	1	<b>WKW000081</b>	81.95 98.34
------------------------------------	---------	---	------------------	-------------



MHK100620P

# FREELANDER 1 (1996-2006)

## Bonnet Release Cable

All models	Aftermarket	1	<b>ALR8167P</b>	14.58 17.50
	Genuine	1	<b>ALR8167</b>	18.14 21.77



SBB103901P



**FREELANDER 1 (1996-2006)****WINDOW REGULATORS****Window Regulator**

All models					
Front RH	Aftermarket	1	<b>LR006371P</b>	45.83	55.00
	OEM	1	<b>LR006371P1</b>	83.33	100.00
	Genuine	1	<b>LR006371</b>	148.01	177.61
Front LH	Aftermarket	1	<b>LR006372P</b>	48.33	58.00
	OEM	1	<b>LR006372P1</b>	83.33	100.00
	Genuine	1	<b>LR006372</b>	148.01	177.61
All models with electric rear side windows					
Rear RH	Aftermarket	1	<b>CVH101202P</b>	42.08	50.50
	OEM	1	<b>CVH101202P1</b>	88.50	106.20
	Genuine	1	<b>CVH101202</b>	109.92	131.90
Rear LH	Aftermarket	1	<b>CVH101212P</b>	48.33	58.00
	Genuine	1	<b>CVH101212</b>	110.40	132.48

**Window Regulator Rear End Door**

All models - Tailgate glass					
Aftermarket	1	<b>CVH101150P</b>	75.83	91.00	
OEM	1	<b>CVH101150P1</b>	132.50	159.00	
Genuine	1	<b>CVH101150</b>	153.58	184.30	

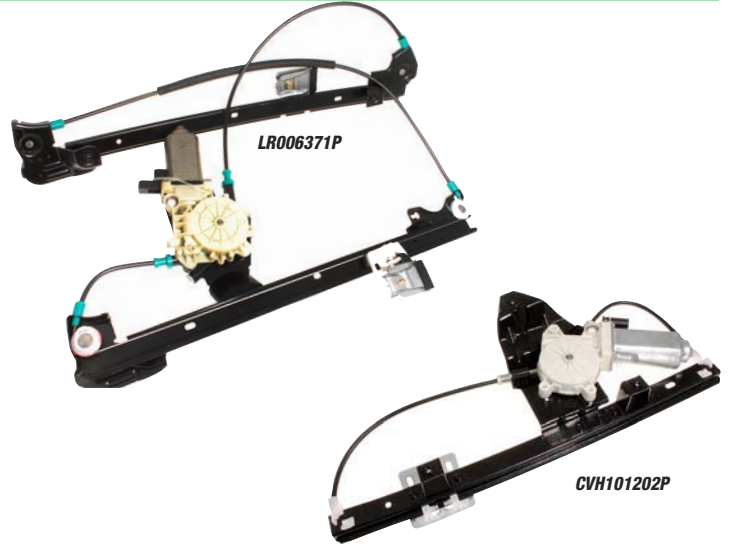
**FREELANDER 1 (1996-2006)****WHEEL CENTRE CAP & WHEEL NUTS****Wheel Centre Cap**

All models with steel wheels - Features Land Rover logo. Covers wheel centre and wheel nuts					
Genuine	a/r	<b>ANR3976</b>	15.97	19.16	

**Wheel Stud**

All models - Front or rear					
Aftermarket	a/r	<b>CLP9037LP</b>	1.50	1.80	
Genuine	a/r	<b>CLP9037L</b>	2.85	3.42	

**Wheel Nut**

All models with steel wheels	Aftermarket	a/r	<b>ANR6089P</b>	1.25	1.50
	Genuine	a/r	<b>ANR6089</b>	1.94	2.33
All models with alloy wheels - Alloy wheels including alloy spare wheel					
Aftermarket	a/r	<b>RRD100660P</b>	1.83	2.20	
Genuine	a/r	<b>RRD100660</b>	3.55	4.26	

**Wheel Nut Set**

All models with steel wheels - Set of 20.	Aftermarket	a/r	<b>ANR6089KP</b>	17.50	21.00
	Genuine	a/r	<b>ANR6089K</b>	37.08	44.50
All models with alloy wheels - Set of 20. Alloy wheels including alloy spare wheel					
Aftermarket	a/r	<b>RRD100660KP</b>	27.08	32.50	
Genuine	a/r	<b>RRD100660K</b>	67.50	81.00	

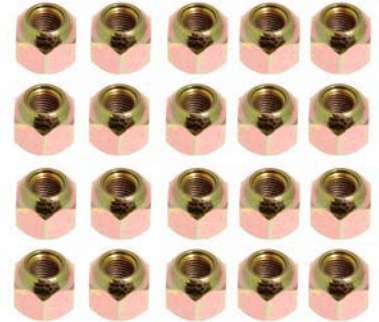

ANR6089KP





# FREELANDER 2 (2006-2014)

## 2006-2014 - All Models

Listed below are the most popular parts required for the Freelander 2.

We have access to the full range of parts for your vehicle. Please contact us if not listed here.



## SERVICE KITS

### FREELANDER 2 (2006-2014)

#### Service Kit

All 3.2L 6 cyl petrol models

Includes oil filter, air filter, pollen filter, spark plugs & sump plug washer

Bearmach	1	<b>LF1091BM</b>	37.08	44.50
Genuine	1	<b>LF1091</b>	72.50	87.00

#### Filter Kit

All 2.2L TD4 diesel models

Includes oil filter, air filter, fuel filter, pollen filter & sump plug washer

Britpart	1	<b>LF1089BP</b>	34.58	41.50
Genuine	1	<b>LF1089</b>	69.00	82.80

## FILTRATION

### FREELANDER 2 (2006-2014)

#### Oil Filter

All 2.0L TIVCT turbo petrol models - Cartridge

Aftermarket	1	<b>LR025306P</b>	3.50	4.20
Genuine	1	<b>LR025306</b>	6.87	8.24

All 2.2L diesel models - Element

Aftermarket	1	<b>LR030778P</b>	3.00	3.60
OEM	1	<b>LR030778P1</b>	4.00	4.80
Genuine	1	<b>LR030778</b>	9.80	11.76

All models with 3.2L 6 cyl petrol engine - Element

Aftermarket	1	<b>LR001419P</b>	2.83	3.40
OEM	1	<b>LR001419P1</b>	5.83	7.00
Genuine	1	<b>LR001419</b>	9.00	10.80

#### Fuel Filter

All 2.2L diesel models

OEM	1	<b>LR001313P1</b>	22.50	27.00
Genuine	1	<b>LR001313</b>	33.38	40.06

#### Air Filter

All 2.0L TIVCT turbo petrol models

OEM	1	<b>LR029078P1</b>	11.04	13.25
Genuine	1	<b>LR029078</b>	15.70	18.84

All 2.2L diesel models

Aftermarket	1	<b>LR005816P</b>	2.75	3.30
OEM	1	<b>LR005816P1</b>	5.63	6.76
Genuine	1	<b>LR005816</b>	17.11	20.53

All 3.2L 6 cyl petrol models

Aftermarket	1	<b>LR005816P</b>	2.75	3.30
OEM	1	<b>LR005816P1</b>	5.63	6.76
Genuine	1	<b>LR005816</b>	17.11	20.53

#### Pollen Filter

All models (manual or electronic air conditioning) - Fresh air

Aftermarket	1	<b>LR056138P</b>	4.58	5.50
OEM	1	<b>LR056138P1</b>	9.58	11.50
Genuine	1	<b>LR056138</b>	15.66	18.79

## WIPER BLADES

### FREELANDER 2 (2006-2014)

#### Wiper Blade

All RHD models

Front, driver's side	Aftermarket	1	<b>LR056309P</b>	4.58	5.50
	OEM	1	<b>LR056309P1</b>	7.50	9.00
	Genuine	1	<b>LR056309</b>	19.93	23.92

Front, passenger's side	Aftermarket	1	<b>LR056306P</b>	4.00	4.80
	Genuine	1	<b>LR056306</b>	19.93	23.92

All LHD models

Front, driver's side	Aftermarket	1	<b>LR056305P</b>	5.00	6.00
	OEM	1	<b>LR056305P1</b>	7.50	9.00
	Genuine	1	<b>LR056305</b>	19.16	22.99

Front, passenger's side	Aftermarket	1	<b>LR056308P</b>	4.38	5.26
	Genuine	1	<b>LR056308</b>	23.46	28.15

All models - Rear

Aftermarket	1	<b>LR049843P</b>	3.00	3.60
OEM	1	<b>LR049843P1</b>	3.33	4.00
Genuine	1	<b>LR049843</b>	16.00	19.20

## SCREEN/LAMP WASHER SYSTEMS

### FREELANDER 2 (2006-2014)

#### Washer Jet Retaining Clip

All models with headlamp wash - Headlamp jet to bumper

Genuine	2	<b>DYC000190</b>	1.80	2.16
---------	---	------------------	------	------

#### Washer Hose, Per Metre

All models - 4mm internal diameter (3mm also available).

Front or rear screen wash	Aftermarket	a/r	<b>GWV201M</b>	2.25	2.70
---------------------------	-------------	-----	----------------	------	------

#### Washer Hose Non Return Valve

All models - Fits in-line in 4mm dia. hose

Aftermarket	2	<b>AMR6676P</b>	1.42	1.70
Genuine	2	<b>AMR6676</b>	3.26	3.91

#### Washer Hose Straight Connector

All models

Genuine	1	<b>DNG10007L</b>	4.13	4.96
---------	---	------------------	------	------

#### Washer Hose Y Piece

All models - Front screen wash

Genuine	1	<b>DNG000010</b>	17.40	20.88
---------	---	------------------	-------	-------

#### Washer Jet Elbow

All models - Front screen wash

Genuine	2	<b>DNG10001</b>	2.01	2.41
---------	---	-----------------	------	------

#### Washer Reservoir

All models without headlamp wash - Front & rear screen wash

Genuine	1	<b>LR002303</b>	15.39	18.47
---------	---	-----------------	-------	-------

#### Filler Neck Cap

All models - Front & rear screen & headlamp wash

Genuine	1	<b>LR002266</b>	1.86	2.23
---------	---	-----------------	------	------

#### Washer Reservoir Filler Neck Filter

All models - Front & rear screen & headlamp wash

Genuine	1	<b>DMS500010</b>	3.27	3.92
---------	---	------------------	------	------

#### Washer Reservoir Level Sensor

All models - Front & rear screen & headlamp wash

Genuine	1	<b>DMI500010</b>	4.20	5.04
---------	---	------------------	------	------

#### Low Fluid Level Sensor

All models

Genuine	1	<b>LR000930</b>	11.52	13.82
---------	---	-----------------	-------	-------

#### Windscreen Cleaning Paste

All models

Prevents wiper blade judder/squeak by 'deep cleaning' the windscreen (ref: Land Rover Tech Bulletin LRA501-002)

Genuine	a/r	<b>DNJ500340</b>	7.72	9.26
---------	-----	------------------	------	------

## DRIVE BELTS

### FREELANDER 2 (2006-2014)

#### Timing Belt Kit

All models with 2.2L TD4/SD4 turbo diesel engine - With tensioners, without water pump

OEM	1	<b>LR032526P1</b>	51.67	62.00
Genuine	1	<b>LR032526</b>	119.39	143.27

#### Timing Belt

All models with 2.2L TD4/SD4 diesel engine

Aftermarket	1	<b>LR004257P</b>	15.83	19.00
Genuine	1	<b>LR004257</b>	50.69	60.83

#### Alternator Drive Belt

All models with 2.2L TD4/SD4 diesel engine - Alternator

Genuine	1	<b>LR000996</b>	28.55	34.26
---------	---	-----------------	-------	-------

All 3.2L 6 cyl MPI petrol models - Alternator

Genuine	1	<b>LR003570</b>	9.51	11.41
---------	---	-----------------	------	-------

#### Primary Drive Belt

All models with 2.0L TIVCT turbocharged petrol engine (VIN) CH000001 on - Primary

Genuine	1	<b>LR036456</b>	37.70	45.24
---------	---	-----------------	-------	-------



## FREELANDER 2 (2006-2014)

## IGNITION SYSTEM

## Spark Plug

All 2.0L TIVCT turbocharged petrol models (VIN) CH000001 on				
	Genuine	4	<b>LR025605</b>	13.73 16.48
3.2L 6 cyl Si6 petrol models	OEM	6	<b>LR005483P1</b>	5.42 6.50
	Genuine	6	<b>LR005483</b>	7.04 8.45

## Glow Plug

All 2.2L diesel models to (VIN) AH999999				
	Genuine	4	<b>LR001302</b>	10.68 12.82
from (VIN) BH000001 on				
	Genuine	4	<b>LR022300</b>	12.30 14.76

## Ignition Coil

All models with 3.2L 6 cyl petrol engine				
	OEM	6	<b>LR002954P1</b>	30.00 36.00
	Genuine	6	<b>LR002954</b>	50.58 60.70

## FREELANDER 2 (2006-2014)

## BRAKING SYSTEM

## Brake Pad Set

All models				
Front Brakes				
	Brembo	1	<b>LR004936BREMBO</b>	36.95 44.34
	Genuine	1	<b>LR004936</b>	48.11 57.73
	EBC	1	<b>LR004936GS</b>	60.00 72.00
All 2.0L TIVCT turbocharged petrol models				
Rear Brakes				
	Aftermarket	1	<b>LR023888P1</b>	21.67 26.00
	Brembo	1	<b>LR023888BREMBO</b>	35.83 43.00
	Genuine	1	<b>LR023888</b>	50.16 60.19
	EBC	1	<b>LR023888GS</b>	27.50 33.00
All 2.2L diesel models to (VIN) CH999999				
Rear Brakes				
	Aftermarket	1	<b>LR003657P</b>	15.00 18.00
	Brembo	1	<b>LR003657BREMBO</b>	35.83 43.00
	Genuine	1	<b>LR003657</b>	40.09 48.11
All 3.2L petrol models				
Rear Brakes				
	Aftermarket	1	<b>LR023888P1</b>	21.67 26.00
	Brembo	1	<b>LR023888BREMBO</b>	35.83 43.00
	Genuine	1	<b>LR023888</b>	50.16 60.19
	EBC	1	<b>LR023888GS</b>	27.50 33.00
All models (VIN) DH000001 on				
Rear Brakes				
	Aftermarket	1	<b>LR043285P</b>	15.00 18.00
	Genuine	1	<b>LR043285</b>	54.18 65.02

## Brake Pad Retaining Pins

All models - Front	Genuine	4	<b>LR003977</b>	11.71 14.05
--------------------	---------	---	-----------------	-------------

## Brake Slide Pin Boot Kit

All models - Front brakes	Genuine	2	<b>LR000751</b>	12.89 15.47
---------------------------	---------	---	-----------------	-------------

## Brake Disc

All models with 2.0L TIVCT turbocharged petrol engine				
Front				
	Aftermarket	2	<b>LR027107P</b>	19.79 23.75
	OEM	2	<b>LR027107P1</b>	28.75 34.50
	Genuine	2	<b>LR027107</b>	50.53 60.64
All models with 2.2L diesel engine				
Front				
	Aftermarket	2	<b>LR007055P</b>	17.50 21.00
	OEM	2	<b>LR007055P1</b>	25.83 31.00
	Genuine	2	<b>LR007055</b>	40.09 48.11
All models with 3.2L petrol engine				
Front				
	Aftermarket	2	<b>LR027107P</b>	19.79 23.75
	OEM	2	<b>LR027107P1</b>	28.75 34.50
	Genuine	2	<b>LR027107</b>	50.53 60.64
All models with 2.0L TIVCT turbocharged petrol engine to (VIN) CH999999				
Rear				
	Aftermarket	2	<b>LR001019P</b>	18.13 21.76
	Brembo	2	<b>LR001019BREMBO</b>	85.00 102.00
	OEM	2	<b>LR001019P1</b>	25.83 31.00
	Genuine	2	<b>LR001019</b>	43.43 52.12
All models with 2.2L diesel engine to (VIN) CH999999				
Rear				
	Aftermarket	2	<b>LR001018P</b>	16.04 19.25
	Genuine	2	<b>LR001018</b>	40.09 48.11
	Brembo	1	<b>LR001018BREMBO</b>	60.83 73.00
All models with 3.2L petrol engine to (VIN) CH999999				
Rear				
	Aftermarket	2	<b>LR001019P</b>	18.13 21.76
	Brembo	2	<b>LR001019BREMBO</b>	85.00 102.00
	OEM	2	<b>LR001019P1</b>	25.83 31.00
	Genuine	2	<b>LR001019</b>	43.43 52.12
All models from (VIN) DH000001				
Rear				
	Genuine	2	<b>LR039935</b>	41.25 49.50

## Performance Brake Disc (pair)

All models with 2.0L TIVCT turbocharged petrol engine				
Front, slotted & drilled				
	EBC	1	<b>LR027107UR</b>	140.00 168.00
	Britpart	1	<b>LR027107URBP</b>	65.83 79.00
All models with 2.2L diesel engine				
Front, slotted & drilled				
	Britpart	1	<b>LR007055URBP</b>	59.17 71.00
All models with 3.2L petrol engine				
Front, slotted & drilled				
	EBC	1	<b>LR027107UR</b>	140.00 168.00
	Britpart	1	<b>LR027107URBP</b>	65.83 79.00
All models with 2.0L TIVCT turbocharged petrol engine to (VIN) CH999999				
Rear, slotted & drilled				
	Britpart	1	<b>LR001019URBP</b>	50.00 60.00
All models with 2.2L diesel engine to (VIN) CH999999				
Rear, slotted & drilled				
	Britpart	1	<b>LR001018URBP</b>	55.00 66.00
All models with 3.2L petrol engine to (VIN) CH999999				
Rear, slotted & drilled				
	Britpart	1	<b>LR001019URBP</b>	50.00 60.00
All models from (VIN) DH000001				
Rear, Slotted & Drilled				
	Britpart	1	<b>LR039935BPUR</b>	40.00 48.00

## Mudshield Brake Disc

All models				
Front RH				
	Genuine	1	<b>LR041427</b>	5.23 6.28
Front LH				
	Genuine	1	<b>LR041426</b>	5.23 6.28
All models from (VIN) DH000001				
Rear RH				
	Genuine	1	<b>LR039937</b>	4.10 4.92
Rear LH				
	Genuine	1	<b>LR039936</b>	4.10 4.92

## Brake Caliper

All models				
Front RH				
	OEM*	1	<b>LR015386P1</b>	65.00 78.00
	Exchange Surcharge			25.00 30.00
	Genuine*	1	<b>LR015386</b>	117.22 140.66
	Exchange Surcharge			50.00 60.00
Front LH				
	OEM*	1	<b>LR015387P1</b>	65.00 78.00
	Exchange Surcharge			25.00 30.00
	Genuine*	1	<b>LR015387</b>	117.22 140.66
	Exchange Surcharge			50.00 60.00
All 2.0L TIVCT turbocharged petrol models to (VIN) CH999999				
Rear, RH				
	OEM*	1	<b>LR001025P1</b>	59.95 71.94
	Exchange Surcharge			30.00 36.00
	Genuine*	1	<b>LR001025</b>	93.02 111.62
	Exchange Surcharge			50.00 60.00
Rear, LH				
	OEM*	1	<b>LR001027P1</b>	59.95 71.94
	Exchange Surcharge			30.00 36.00
	Genuine*	1	<b>LR001027</b>	93.02 111.62
	Exchange Surcharge			50.00 60.00
All 3.2L 6 cyl petrol models to (VIN) CH999999				
Rear, RH				
	OEM*	1	<b>LR001025P1</b>	59.95 71.94
	Exchange Surcharge			30.00 36.00
	Genuine*	1	<b>LR001025</b>	93.02 111.62
	Exchange Surcharge			50.00 60.00
Rear, LH				
	OEM*	1	<b>LR001027P1</b>	59.95 71.94
	Exchange Surcharge			30.00 36.00
	Genuine*	1	<b>LR001027</b>	93.02 111.62
	Exchange Surcharge			50.00 60.00
All models from (VIN) DH000001				
Rear RH				
	Genuine*	1	<b>LR043282</b>	107.91 129.49
	Exchange Surcharge			50.00 60.00
Rear LH				
	Genuine*	1	<b>LR043283</b>	107.91 129.49
	Exchange Surcharge			50.00 60.00

## Brake Caliper Carrier

All 2.2L DOHC models				
Front				
	Genuine	2	<b>LR000567</b>	68.49 82.19
All 3.2L DOHC models				
Front				
	Genuine	2	<b>LR001014</b>	68.00 81.60
All models from (VIN) CH000001				
Front				
	Genuine	2	<b>LR001014</b>	68.00 81.60
All models to (VIN) CH999999				
Rear				
	Genuine	1	<b>LR005260</b>	52.29 62.75
All 2.0L TIVCT turbocharged petrol models to (VIN) CH999999				
Rear				
	OEM	1	<b>LR001171P1</b>	16.75 20.10
All 3.2L 6 cyl petrol models to (VIN) CH999999				
Rear				
	OEM	1	<b>LR001171P1</b>	16.75 20.10
All models from (VIN) DH000001				
RH and LH				
	Genuine	2	<b>LR043284</b>	64.78 77.74

## Dust Cap Bleed Screw

All models - Rear caliper	Genuine	2	<b>SEE500100</b>	0.94 1.13
---------------------------	---------	---	------------------	-----------

## Bolt Brake Caliper Carrier

All models				
Front M14 x 40mm Hex Head				
	Genuine	4	<b>LR000093</b>	1.19 1.43
All models to (VIN) CH999999				
Rear M12 x 30mm Hex Head				
	Genuine	4	<b>LR000098</b>	1.11 1.33
All models from (VIN) DH000001				
Rear M12 x 36mm Hex Head				
	Genuine	4	<b>LR042690</b>	1.52 1.82

## Brake Master Cylinder

All models	Genuine	1	<b>LR067017</b>	143.55 172.26
------------	---------	---	-----------------	---------------

## Brake Servo Assembly

All models				
	OEM	1	<b>LR025443P1</b>	220.83 265.00
	Genuine	1	<b>LR025443</b>	276.62 331.94

## Cap Brake Master Cylinder

All models to (VIN) AH188603 except USA, Canada, Mexico & Australia				
Black				
	Genuine	1	<b>LR000813</b>	1.41 1.69
All models from (VIN) AH188604 except Canada, USA and Mexico				
Black				
	Genuine	1	<b>LR026354</b>	2.16 2.59
All models from (VIN) AH188604 including Canada and USA				
Black				
	Genuine	1	<b>LR021624</b>	2.85 3.42

# BRAKING SYSTEM

# FREELANDER 2 (2006-2014)

## Caliper Repair Kit

All models - Front	Genuine	2	<b>LR028027</b>	25.53	30.64
--------------------	---------	---	-----------------	-------	-------

## Brake Hose

All models from (VIN) DH000001 To caliper front	OEM	2	<b>LR040770P1</b>	5.63	6.76
	Genuine	2	<b>LR040770</b>	12.53	15.04
All models from (VIN) 8H079408 to (VIN) CH999999 Rear to caliper	Genuine	2	<b>LR008149</b>	12.13	14.56
All models from (VIN) DH000001 Rear to caliper	Genuine	2	<b>LR044896</b>	16.63	19.96

## Brake Shoe Set - Handbrake

All models up to (VIN) CH999999 Handbrake	OEM	1	<b>LR001020P1</b>	23.50	28.20
	Genuine	1	<b>LR001020</b>	96.37	115.64

## Handbrake Spring Kit

All models up to (VIN) CH999999 - Axle set	Genuine	1	<b>LR001023</b>	12.13	14.56
--------------------------------------------	---------	---	-----------------	-------	-------

## Back Plate

All models parking brake					
RH	Genuine	1	<b>LR001021</b>	29.03	34.84
LH	Genuine	1	<b>LR001022</b>	29.03	34.84

## Park Brake Adjuster

All models	Genuine	1	<b>LR001028</b>	12.89	15.47
------------	---------	---	-----------------	-------	-------

## Boot Parking Brake Lever

All RHD models	Genuine	1	<b>LR006173</b>	35.87	43.04
All LHD models	Genuine	1	<b>LR006172</b>	35.87	43.04

## Parking Brake Lever

All RHD models	Genuine	1	<b>LR008520</b>	64.54	77.45
All LHD models	Genuine	1	<b>LR008519</b>	64.54	77.45

## Parking Brake Operating Lever

All models to (VIN) CH999999	Genuine	1	<b>LR001172</b>	16.46	19.75
------------------------------	---------	---	-----------------	-------	-------

## Parking Brake Actuator

All models from (VIN) DH000001	Genuine	1	<b>LR027141</b>	155.09	186.11
--------------------------------	---------	---	-----------------	--------	--------

## Wire Electronic Parking Brake

All models from (VIN) DH000001 to (VIN) DH351103					
RH	Genuine	1	<b>LR040103</b>	17.71	21.25
LH	Genuine	1	<b>LR040102</b>	17.71	21.25
All models from (VIN) DH351104					
RH	Genuine	1	<b>LR051609</b>	17.71	21.25
LH	Genuine	1	<b>LR051608</b>	17.71	21.25

## Electric Parking Brake Module

All models from (VIN) DH000001	Genuine	1	<b>LR035288</b>	170.49	204.59
--------------------------------	---------	---	-----------------	--------	--------

## Brake Cable

All 2.0L models from (VIN) CH000001 to (VIN) CH302088					
RH	Genuine	1	<b>LR041238</b>	19.61	23.53
LH	Genuine	1	<b>LR041424</b>	19.61	23.53
All 2.0L models from (VIN) CH302089					
RH	Genuine	1	<b>LR041238</b>	19.61	23.53
LH	Genuine	1	<b>LR041424</b>	19.61	23.53

## Handbrake Cable

All models with 2.2L TD4/SD4 diesel engine to (VIN) CH999999					
RH	Aftermarket	1	<b>LR007496P</b>	20.00	24.00
	Genuine	1	<b>LR007496</b>	14.02	16.82
All models with 2.2L TD4/SD4 diesel engine					
LH	Aftermarket	1	<b>LR014431P</b>	20.00	24.00
	Genuine	1	<b>LR014431</b>	14.02	16.82
All models with 3.2L 6 cyl petrol engine					
RH	Aftermarket	1	<b>LR007496P</b>	20.00	24.00
	Genuine	1	<b>LR007496</b>	14.02	16.82
LH	Aftermarket	1	<b>LR014431P</b>	20.00	24.00
	Genuine	1	<b>LR014431</b>	14.02	16.82

## Brake Cable Brackets & Fixings

All models from (VIN) DH000001 - Includes 3 brackets, 3 bolts and 3 nuts	Genuine	1	<b>LR047252</b>	47.97	57.56
--------------------------------------------------------------------------	---------	---	-----------------	-------	-------

## ABS Speed Sensor

All models - Front	Aftermarket	2	<b>LR001056P</b>	25.00	30.00
	Genuine	2	<b>LR001056</b>	71.39	85.67
All models to (VIN) CH999999 - Rear	Aftermarket	2	<b>LR001057P</b>	25.00	30.00
	Genuine	2	<b>LR001057</b>	67.98	81.58

## ABS Sensor

All models from (VIN) DH000001 - Rear	Genuine	2	<b>LR039934</b>	36.06	43.27
---------------------------------------	---------	---	-----------------	-------	-------

## ABS Yaw Sensor

All models from (VIN) DH000001	Genuine	1	<b>LR039907</b>	239.00	286.80
--------------------------------	---------	---	-----------------	--------	--------

## Brake Light Switch

All models	Genuine	1	<b>LR032956</b>	3.17	3.80
------------	---------	---	-----------------	------	------

## Brake Pedal Rubber

All 6 speed manual models from (VIN) 7H000001	Genuine	1	<b>LR005273</b>	12.89	15.47
All 6 speed auto models from (VIN) 7H000001	Genuine	1	<b>LR005272</b>	12.89	15.47

# SUSPENSION

# FREELANDER 2 (2006-2014)

## Bush Shock Absorber Upper Mounting

All models	Genuine	2	<b>LR032578</b>	33.36	40.03
------------	---------	---	-----------------	-------	-------

## Anti Roll Bar

All models from (VIN) BH242084 - Rear	Genuine	1	<b>LR029300</b>	60.85	73.02
---------------------------------------	---------	---	-----------------	-------	-------

## Anti Roll Bar Complete Assembly

All models from (VIN) BH242084 - Rear	Genuine	1	<b>LR034393</b>	61.98	74.38
---------------------------------------	---------	---	-----------------	-------	-------

## Anti Roll Bar Bush

All models - Front	Genuine	2	<b>LR005649</b>	25.21	30.25
All 2.0L 16V TIVCT TC models from (VIN) CH000001 on Front	Genuine	2	<b>LR030743</b>	4.82	5.78
All models from (VIN) BH242084 - Rear	Genuine	2	<b>LR034392</b>	3.11	3.73

## Anti Roll Bar Link Assembly

All models - Front	OEM	2	<b>LR002626P1</b>	10.42	12.50
	Genuine	2	<b>LR002626</b>	23.85	28.62

## Anti Roll Bar Link

All models - Rear	Aftermarket	2	<b>LR002876P</b>	4.58	5.50
	Genuine	2	<b>LR002876</b>	21.35	25.62

## Shock Absorber

All models					
Front RH	Aftermarket	1	<b>LR031667P</b>	60.00	72.00
	Genuine	1	<b>LR031667</b>	82.98	99.58
Front LH	Aftermarket	1	<b>LR031665P</b>	60.00	72.00
	Genuine	1	<b>LR031665</b>	114.09	136.91
All models to (VIN) CH999999 - Std.					
Rear RH	OEM	1	<b>LR031668P1</b>	60.00	72.00
	Genuine	1	<b>LR031668</b>	106.68	128.02
Rear LH	OEM	1	<b>LR031666P1</b>	60.00	72.00
	Genuine	1	<b>LR031666</b>	106.68	128.02

## Gaiter, Shock Absorber

All models - Front & Rear	Genuine	2	<b>LR073344</b>	16.45	19.74
---------------------------	---------	---	-----------------	-------	-------

## Coil Spring

All 2.0L turbo petrol engine models (VIN) CH000001 on Front	Genuine	2	<b>LR032898</b>	37.92	45.50
All 2.2L CR diesel models from (VIN) BH272013 on Front	Genuine	2	<b>LR032904</b>	58.71	70.45
All 3.2L DOHC MPI petrol models from (VIN) BH272013 on Front	Genuine	2	<b>LR032904</b>	58.71	70.45
All models except if fitted with power tilt/slide sunroof Rear	Genuine	2	<b>LR019981</b>	47.02	56.42
All models with power tilt/slide sunroof Rear	Genuine	2	<b>LR019982</b>	49.19	59.03

## Upper Arm Assembly

All models from (VIN) 8H072269 on Front RH	Aftermarket	1	<b>LR007205P</b>	58.33	70.00
	Genuine	1	<b>LR007205</b>	182.06	218.47

## Suspension Arm Assembly

All models - Front LH	Aftermarket	1	<b>LR007206P</b>	58.33	70.00
	Genuine	1	<b>LR007206</b>	182.06	218.47

## Ball Joint Only for LR007205

All models from (VIN) 8H072269 on Front RH	Britpart	1	<b>LR007205BPPJ</b>	12.92	15.50
	Bearmach	1	<b>LR007205PBJ</b>	18.13	21.76

## Suspension Arm

All models - Rear	Genuine	2	<b>LR032308</b>	24.34	29.21
-------------------	---------	---	-----------------	-------	-------





## FREELANDER 2 (2006-2014)

## STEERING

## Track Rod End

All models				
RH	Aftermarket	1	LR002609P	8.96 10.75
	OEM	1	LR002609P1	19.79 23.75
	Genuine	1	LR002609	42.17 50.60
LH	Aftermarket	1	LR002610P	8.75 10.50
	OEM	1	LR002610P1	19.79 23.75
	Genuine	1	LR002610	41.54 49.85

## Track Rod, Steering Rack

All models - Without track rod end				
OEM	2	LR016869P1	37.50 45.00	
Genuine	2	LR016869	50.04 60.05	

## Nut, Locking

All models - M14, track rod end				
Genuine	2	LR000049	0.87 1.04	

## Steering Rack Boot Kit

All models				
OEM	2	LR002682P1	6.25 7.50	
Genuine	2	LR002682	38.13 45.76	

## Cap, Power Steering Reservoir

All models				
Genuine	1	LR000758	3.07 3.68	

## Fluid, Power Steering

All models - 1 litre bottle				
Genuine	a/r	LR003401	8.52 10.22	

## FREELANDER 2 (2006-2014)

## CLUTCH

## Clutch Plate &amp; Cover Assembly

All 2.2L 4 cyl diesel manual models up to (VIN) AH999999 - Includes clutch plate & cover				
Aftermarket	1	LR008556P	95.00 114.00	
Genuine	1	LR008556	184.37 221.24	

## Clutch Plate &amp; Cover

All manual models (VIN) BH000001 on				
OEM	1	LR048408P1	130.00 156.00	
Genuine	1	LR048408	184.65 221.58	

## Clutch Master Cylinder

All RHD manual models to (VIN) 9H999999 - Without linear sensor (no stop/start system)				
Genuine	1	LR007159	23.56 28.27	
All RHD manual models (VIN) AH000001 on - With linear sensor (with stop/start system)				
Genuine	1	LR044440	73.11 87.73	
All LHD manual models to (VIN) 9H999999 - Without linear sensor (no stop/start system)				
Genuine	1	LR007158	23.56 28.27	

## Clutch Slave Cylinder

All 2.2L 4 cyl diesel manual models up to (VIN) AH999999 - Includes clutch release bearing				
OEM	1	LR016976P1	55.83 67.00	
Genuine	1	LR016976	69.15 82.98	
All 2.2L 4 cyl diesel manual models from (VIN) BH000001 on - Includes clutch release bearing				
Genuine	1	LR022452	72.77 87.32	

## Clutch Slave Valve

All manual models				
Genuine	1	LR011836	12.00 14.40	

## Clutch Pedal Spring Kit

All RHD 2.2L & 2.0L 4 cyl diesel manual models from (VIN) BH000001 on - Includes springs & retainers				
Genuine	1	LR024698	24.60 29.52	
All LHD 2.2L & 2.0L 4 cyl diesel manual models from (VIN) BH000001 on - Includes springs & retainers				
Genuine	1	LR024700	24.60 29.52	

## FREELANDER 2 (2006-2014)

## TRANSMISSION

## Drive Shaft &amp; CV Joint

All 2.0L turbo petrol models				
Front axle, RH	Genuine	1	LR062654	400.52 480.62
Front axle, LH	Genuine	1	LR062664	362.68 435.22
All 2WD diesel models				
Front axle, RH	Genuine	1	LR062655	404.05 484.86
All 2WD & AWD diesel manual models				
Front axle, LH	Aftermarket	1	LR062665P	90.83 109.00
	Genuine	1	LR062665	362.76 435.31
All 3.2L 6 cyl petrol models				
Front axle, RH	Genuine	1	LR002619	416.22 499.46
Front axle, LH	Genuine	1	LR062666	360.90 433.08
All AWD diesel manual models				
Front axle, RH	Aftermarket	1	LR062660P	90.83 109.00
	Genuine	1	LR062660	365.34 438.41
All AWD diesel automatic models				
Front axle, RH	Genuine	1	LR062661	404.93 485.92
Front axle, LH	Genuine	1	LR062666	360.90 433.08
All AWD models				
Rear axle	Genuine	2	LR061592	405.12 486.14

## Drive Shaft

All AWD models up to (VIN) AH148966 - Rear axle; does not include outer CV joint				
Genuine	2	LR003162	94.31 113.17	

## Gaiter Kit Drive Shaft

All models - Front				
Genuine	1	LR003160	54.24 65.09	
All AWD models up to (VIN) AH148966				
Rear axle	OEM	2	LR003161P1	25.00 30.00
	Genuine	2	LR003161	42.72 51.26

## Drive Flange, Haldex Unit

All models up to (VIN) 8H999999				
Rear differential	Genuine	1	LR003141	104.22 125.06

## Oil Seal, Differential

All AWD models				
Front axle pinion	Genuine	1	LR003152	7.19 8.63
Rear axle pinion	OEM	1	LR023442P1	7.08 8.50
	Genuine	1	LR023442	12.96 15.55
Rear axle, differential to driveshaft	Genuine	1	LR023440	3.58 4.30

## Oil Seal, Driveshaft

All AWD models				
RH outer seal, front differential	Genuine	1	LR001950	7.50 9.00
LH outer seal, front differential	Genuine	1	LR003155	14.45 17.34
RH inner seal, front differential	Genuine	1	LR003153	8.89 10.67
LH inner seal, front differential	Genuine	1	LR003154	9.04 10.85

## Oil Seal Kit, Haldex Unit

All models up to (VIN) 8H999999				
Rear differential	Genuine	1	LR003142	23.45 28.14

## Sensor, Haldex Unit

All models up to (VIN) 8H999999				
Temperature & pressure	Genuine	1	LR003146	75.72 90.86

## Oil Seal Kit, Haldex Coupling

All AWD models (VIN) 9H000001 on				
Rear axle	Genuine	1	LR008955	28.82 34.58

## O Ring, Differential Cover

All AWD models - Rear axle				
Genuine	1	LR030846	4.77 5.72	

## Sealing Washer, Drain Plug

All models - Front or rear axle				
Genuine	1	LR001949	3.13 3.76	

## Bearing, Differential

All AWD models up to (VIN) BH257090				
Rear axle, pinion bearing	Genuine	1	LR023441	26.07 31.28

## FREELANDER 2 (2006-2014)

## COOLING

## Water Pump

All 2.0L TIVCT turbo petrol models				
Aftermarket	1	LR081578P	35.83 43.00	
OEM	1	LR081578P1	50.00 60.00	
Genuine	1	LR081578	105.27 126.32	
All 2.2L diesel models				
Aftermarket	1	LR011694P	39.58 47.50	
Genuine	1	LR011694	105.27 126.32	
All 3.2L 6 cyl petrol models - With seal & screws				
Genuine	1	LR006861	116.96 140.35	

## Thermostat Housing

All 2.2L diesel models				
OEM	1	LR001312P1	39.58 47.50	
Genuine	1	LR001312	62.25 74.70	

## Intercooler Hose

All 2.2L TD4 diesel models - Intercooler to manifold				
Aftermarket	1	LR066429P	53.33 64.00	
Genuine	1	LR066429	101.24 121.49	

## Coolant Temperature Sensor

All USA/CDN/Mex 2.0L turbo petrol models from (VIN) DH000001 on				
Genuine	1	LR041442	25.70 30.84	



# ELECTRICAL - ROTATING ELECTRICS

## FREELANDER 2 (2006-2014)

### Alternator

All 2.0L TVCT turbo petrol models					
New, exchange	Genuine*	1	<b>LR067840</b>	376.61	451.93
	Exchange Surcharge			125.00	150.00
All 2.2L diesel models with 150 amp alternator (not heated windscreen)					
New, exchange	Genuine*	1	<b>LR002899</b>	475.99	571.19
	Exchange Surcharge			70.00	84.00
All 2.2L diesel models with heated windscreen					
New, outright	OEM	1	<b>LR001200P1</b>	233.33	280.00
New, exchange	Genuine*	1	<b>LR001200</b>	561.62	673.94
	Exchange Surcharge			70.00	84.00
All 3.2L 6 cyl petrol models					
New, exchange	Genuine*	1	<b>LR031223</b>	355.52	426.62
	Exchange Surcharge			125.00	150.00

### Starter Motor

All AWD & 2WD diesel manual models from (VIN) AH000001 on					
New, outright	OEM	1	<b>LR014060P1</b>	155.00	186.00
New, exchange	Genuine*	1	<b>LR014060</b>	312.79	375.35
	Exchange Surcharge			100.00	120.00
All AWD diesel manual models up to (VIN) 9H999999					
New, exchange	Genuine*	1	<b>LR007372</b>	316.57	379.88
	Exchange Surcharge			70.00	84.00
All AWD diesel automatic models					
New, outright	OEM	1	<b>LR007373P1</b>	175.00	210.00
New, exchange	Genuine*	1	<b>LR007373</b>	341.90	410.28
	Exchange Surcharge			70.00	84.00
All 3.2L 6 cyl petrol models					
New, outright	Aftermarket	1	<b>LR029180P</b>	165.83	199.00
	Genuine	1	<b>LR029180</b>	233.04	279.65



LR001200P1



LR007373P1

# ENGINE GASKETS

## FREELANDER 2 (2006-2014)

### Gasket Camshaft Cover

All 2.0L turbo petrol models	Genuine	1	<b>LR025664</b>	11.44	13.73
All 2.2L 4 cyl diesel models - Main (lower) cam cover	Genuine	1	<b>LR002834</b>	2.15	2.58
All 2.2L diesel models					
Front (upper) cam cover, round shape (2 required). Reinz manufacture	OEM	1	<b>LR009412P</b>	9.38	11.26
Front (upper) cam cover, round shape (2 required)	Genuine	1	<b>LR009412</b>	20.53	24.64
Front (upper) cam cover, 'L' shape gasket (1 required). Reinz manufacture	OEM	1	<b>LR009411P</b>	9.38	11.26
Front (upper) cam cover, 'L' shape gasket (1 required)	Genuine	1	<b>LR009411</b>	26.52	31.82

### Gasket Set Cam Cover

All 2.2L diesel models Includes front cam cover gaskets x 3 (1 x 'L' shape, 2 x round) plus main cam cover gasket. Reinz manufacture	OEM	1	<b>LR0094112KBP</b>	14.38	17.26
--------------------------------------------------------------------------------------------------------------------------------------------	-----	---	---------------------	-------	-------

### Gasket Cylinder Head

All 2.0L turbo petrol models	Genuine	1	<b>LR024975</b>	35.42	42.50
All 2.2L diesel models					
1.25mm thick, 1 hole on I.D. lip	OEM	1	<b>LR017303P1</b>	19.79	23.75
	Genuine	1	<b>LR017303</b>	34.02	40.82
1.30mm, two holes	OEM	1	<b>LR017304P1</b>	19.79	23.75
	Genuine	1	<b>LR017304</b>	48.09	57.71
1.35mm, three holes	OEM	1	<b>LR017305P1</b>	19.79	23.75
	Genuine	1	<b>LR017305</b>	48.20	57.84
1.40mm, four holes	OEM	1	<b>LR017307P1</b>	19.79	23.75
	Genuine	1	<b>LR017307</b>	48.95	58.74
All 3.2L 6 cyl petrol models	Genuine	1	<b>LR006664</b>	68.71	82.45

### Sealant Instant Gasket

Numerous applications	Genuine	a/r	<b>STC50550</b>	13.10	15.72
-----------------------	---------	-----	-----------------	-------	-------

# ENGINE SWITCHES

## FREELANDER 2 (2006-2014)

### Camshaft Position Sensor

All 2.2L diesel models	OEM	1	<b>LR016847P1</b>	20.00	24.00
	Genuine	1	<b>LR016847</b>	116.42	139.70
All 2.0L turbo petrol models up to (VIN) DH999999 from (VIN) EH000001 on	Genuine	1	<b>LR025029</b>	38.85	46.62
	Genuine	1	<b>LR038756</b>	38.23	45.88
All 2.2L diesel models up to (VIN) AH999999 from (VIN) EH000001 on	OEM	1	<b>LR000681P1</b>	16.67	20.00
	Genuine	1	<b>LR000681</b>	69.64	83.57
	OEM	1	<b>LR056028P1</b>	14.58	17.50
	Genuine	1	<b>LR056028</b>	55.54	66.65
All 3.2L 6 cyl petrol models	Genuine	1	<b>LR030200</b>	18.15	21.78

### Oil Temperature Switch

All 2.2L diesel models	Genuine	1	<b>LR001368</b>	26.08	31.30
------------------------	---------	---	-----------------	-------	-------

### Engine Knock Sensor

All 2.0L turbo petrol models	Genuine	1	<b>LR025005</b>	24.85	29.82
All 3.2L 6 cyl petrol models	Genuine	1	<b>LR001396</b>	22.14	26.57

### Oil Level Sensor

All 3.2L 6 cyl petrol models up to (VIN) 7H038236 from (VIN) 7H038237 on	Genuine	1	<b>LR004256</b>	78.67	94.40
	Genuine	1	<b>LR010354</b>	107.33	128.80

### Oil Pressure Switch

All 2.0L turbo petrol models	Genuine	1	<b>LR000633</b>	2.86	3.43
------------------------------	---------	---	-----------------	------	------

### Air Charge Temperature Sensor

All 2.0L turbo petrol models	Aftermarket	1	<b>LR021587P</b>	21.00	25.20
	Genuine	1	<b>LR021587</b>	23.34	28.01
All 2.2L diesel models up to (VIN) AH999999 - Throttle body from (VIN) BH000001 on	Genuine	1	<b>LR008852</b>	21.88	26.26
	Aftermarket	1	<b>LR021587P</b>	21.00	25.20
	Genuine	1	<b>LR021587</b>	23.34	28.01

### Manifold Absolute Pressure Sensor

All 2.2L diesel models	Aftermarket	1	<b>LR001324P</b>	30.00	36.00
	OEM	1	<b>LR001324P1</b>	55.00	66.00
	Genuine	1	<b>LR001324</b>	86.58	103.90
All 3.2L 6 cyl petrol models	Genuine	1	<b>LR002566</b>	27.84	33.41

### Oxygen Sensor

All 2.0L turbo petrol models - Pre-catalyst	OEM	1	<b>LR001370P1</b>	90.00	108.00
	Genuine	1	<b>LR001370</b>	149.04	178.85
All 2.2L diesel models - Pre-catalyst	OEM	1	<b>LR001370P1</b>	90.00	108.00
	Genuine	1	<b>LR001370</b>	149.04	178.85
All 3.2L 6 cyl petrol models - Pre-catalyst	Genuine	1	<b>LR001459</b>	141.17	169.40

### Exhaust Gas Pressure Sensor

All 2.2L diesel models up to (VIN) AH999999 For diesel particulate filter (DPF)					
includes wires and pipes	Aftermarket	1	<b>LR007083P</b>	50.00	60.00
	Genuine	1	<b>LR007083</b>	151.75	182.10
excludes wires and pipes	Genuine	1	<b>LR008463</b>	122.07	146.48

# DRAIN PLUGS

## FREELANDER 2 (2006-2014)

### Sump Plug

All 2.0L TVCT turbo petrol models	Genuine	1	<b>LR025048</b>	4.00	4.80
All 2.2L diesel models	OEM	1	<b>LR004304P</b>	1.25	1.50
	Genuine	1	<b>LR004304</b>	2.80	3.36
All models with 3.2L 6 cyl petrol engine	Genuine	1	<b>LR000499</b>	3.75	4.50

### Sump Plug Washer

All 2.2L diesel models	OEM	1	<b>LR006295P1</b>	0.79	0.95
	Genuine	1	<b>LR006295</b>	1.79	2.15
All models with 3.2L 6 cyl petrol engine	Genuine	1	<b>LR000506</b>	0.37	0.44



## FREELANDER 2 (2006-2014)

## OIL SEALS ENGINE

## Crankshaft Oil Seal

All models with 2.2L diesel engine - Rear	OEM	1	<b>LR052515P1</b>	8.54	10.25
	Genuine	1	<b>LR052515</b>	17.23	20.68
All 3.2L 6 cyl petrol models - Rear	OEM	1	<b>LR001418P1</b>	9.79	11.75
	Genuine	1	<b>LR001418</b>	15.04	18.05

## Engine Front Oil Seal

All 2.2L diesel models	Genuine	1	<b>LR052514</b>	12.44	14.93
------------------------	---------	---	-----------------	-------	-------

## FREELANDER 2 (2006-2014)

## EXHAUST GAS RECIRCULATION (EGR)

## EGR Valve

All 2.2L diesel engine	OEM	1	<b>LR000997P1</b>	150.00	180.00
	Genuine	1	<b>LR000997</b>	211.10	253.32



LR000997P1

## FREELANDER 2 (2006-2014)

## ENGINE &amp; GEARBOX MOUNTINGS

## Engine Mounting

All 2.0L turbo petrol models	Upper	Genuine	1	<b>LR024730</b>	65.09	78.11
	Lower	Genuine	1	<b>LR032311</b>	43.25	51.90
All 2.2L diesel models	manual models - Upper	Genuine	1	<b>LR021633</b>	58.34	70.01
		Genuine	1	<b>LR021635</b>	65.09	78.11
	Lower	Genuine	1	<b>LR039527</b>	41.68	50.02
All 3.2L 6 cyl petrol models	Upper	Genuine	1	<b>LR021634</b>	66.14	79.37
	Lower	Genuine	1	<b>LR039527</b>	41.68	50.02

## Bracket Engine Mounting

All 2.0L turbo petrol models - Upper	Genuine	1	<b>LR032117</b>	33.25	39.90	
All 2.2L diesel models	Upper	Genuine	1	<b>LR004510</b>	34.58	41.50
	Upper, lower half	Genuine	1	<b>LR001216</b>	57.20	68.64
	All 3.2L 6 cyl petrol models - Upper	Genuine	1	<b>LR002622</b>	36.28	43.54

## Damper Engine Mounting

All 2.2L diesel models - Upper, upper half	Genuine	1	<b>LR003943</b>	41.32	49.58
--------------------------------------------	---------	---	-----------------	-------	-------

## Insulator Engine Mounting

All models - Lower	Genuine	1	<b>LR000520</b>	34.58	41.50
--------------------	---------	---	-----------------	-------	-------

## Gearbox Mounting

All 2.0L turbo petrol models	Genuine	1	<b>LR024738</b>	109.05	130.86
All 2.2L diesel models	Genuine	1	<b>LR023379</b>	97.83	117.40
All 3.2L 6 cyl petrol models	Genuine	1	<b>LR062669</b>	51.88	62.26

## Bracket Gearbox Mounting

All 2.0L turbo petrol models	Genuine	1	<b>LR032118</b>	26.43	31.72
All 2.2L diesel manual models	Genuine	1	<b>LR023696</b>	42.15	50.58
All 2.2L diesel automatic models	Genuine	1	<b>LR001074</b>	33.95	40.74
All 3.2L 6 cyl petrol models	Genuine	1	<b>LR002574</b>	35.57	42.68

## Bracket Tie Rod

All models up to (VIN) BH232122 - Upper	Genuine	1	<b>LR000595</b>	11.38	13.66
All models from (VIN) BH232123 on - Upper	Genuine	1	<b>LR078721</b>	19.40	23.28

## Tie Rod With Bush

All models - Upper	Genuine	1	<b>LR000597</b>	34.92	41.90
--------------------	---------	---	-----------------	-------	-------

## FREELANDER 2 (2006-2014)

## FUEL SYSTEM SWITCHES

## Fuel Pressure Sensor

All 2.0L turbo petrol models	Genuine	1	<b>LR024969</b>	53.76	64.51
------------------------------	---------	---	-----------------	-------	-------

## Air Flow Meter

All 2.0L turbo petrol models	OEM	1	<b>LR019830P1</b>	85.00	102.00
	Genuine	1	<b>LR019830</b>	107.33	128.80
All 2.2L diesel models from (VIN) BH000001 on	OEM	1	<b>LR019830P1</b>	85.00	102.00
	Genuine	1	<b>LR019830</b>	107.33	128.80
3.2L 6 cyl Si6 petrol models	OEM	1	<b>PHF000140P1</b>	70.00	84.00

## Air Flow Sensor

2.2L diesel models up to (VIN) AH999999	OEM	1	<b>MHK501040P1</b>	50.00	60.00
	Genuine	1	<b>MHK501040</b>	107.33	128.80

## Air Flow Meter

3.2L 6 cyl Si6 petrol models	Genuine	1	<b>PHF000140</b>	107.33	128.80
------------------------------	---------	---	------------------	--------	--------



MHK501040P1

## FREELANDER 2 (2006-2014)

## CABLES

## Bonnet Release Cable

All models	Genuine	1	<b>LR006614</b>	15.83	19.00
------------	---------	---	-----------------	-------	-------

## FREELANDER 2 (2006-2014)

## WHEEL CENTRE CAPS &amp; WHEEL NUTS

## Wheel Centre Cap

All models with Silver Sparkle (MNH) colour alloy wheels up to (VIN) AH999999 Silver Sparkle, Land Rover green/silver badge	Genuine	a/r	<b>LR089424</b>	5.45	6.54
	All models with polished shadow chrome alloy wheel centre caps with green/gold Land Rover badge up to (VIN) AH999999 Polished shadow chrome finish with Land Rover green/gold badge				
	Genuine	a/r	<b>RRJ500060MUZ</b>	8.42	10.10
All models with shadow chrome finish wheels from (VIN) 8H057881 on Shadow chrome finish, Land Rover green/gold badge	Genuine	a/r	<b>LR006972</b>	6.50	7.80
	All models with polished finish alloy wheel centre caps from (VIN) BH000001 on Polished finish, Land Rover green/silver badge				
	Aftermarket	a/r	<b>LR023301P</b>	5.42	6.50
	Genuine	a/r	<b>LR023301</b>	6.64	7.97

## Wheel Nut

All models with bright finish wheel nuts	Genuine	a/r	<b>LR001381</b>	1.94	2.33
	Stainless steel finish				



LR023301



# SERIES I SWB (1948-1958)

## 1948-1958 - All Models

Listed below are the most popular parts required for the Series I SWB.

We have access to the full range of parts for your vehicle. Please contact us if not listed here.



## FILTRATION

### Oil Filter

All 6 cylinder petrol & 2.0L Diesel engine models

Genuine	1	<b>RTC3183</b>	5.18	6.22
---------	---	----------------	------	------

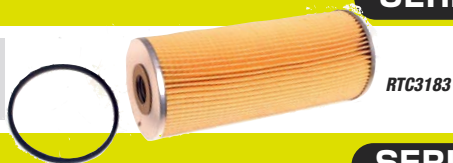

## SERIES I SWB (1948-1958)

## SCREEN/LAMP WASHER SYSTEMS

### Windscreen Cleaning Paste

All models

Prevents wiper blade judder/squeak by 'deep cleaning' the windscreen (ref: Land Rover Tech Bulletin LRA501-002)

Genuine	a/r	<b>DNJ500340</b>	7.72	9.26
---------	-----	------------------	------	------

## SERIES 1 SWB (1948-1958)

## DRIVE BELTS

### Fan Belt

All models with 1.6L petrol engine - Fan

Aftermarket	1	<b>STC3673P</b>	15.63	18.76
-------------	---	-----------------	-------	-------

Genuine	1	<b>STC3673</b>	50.23	60.28
---------	---	----------------	-------	-------

All models with 2.0L petrol engine - Fan

Aftermarket	1	<b>STC3673P</b>	15.63	18.76
-------------	---	-----------------	-------	-------

Genuine	1	<b>STC3673</b>	50.23	60.28
---------	---	----------------	-------	-------



## SERIES I SWB (1948-1958)

## IGNITION SYSTEM

### Glow Plug

2.0L diesel engine models from 1956 on - Pigtail type

Aftermarket	4	<b>568335P</b>	5.00	6.00
-------------	---	----------------	------	------

OEM	4	<b>568335P1</b>	10.83	13.00
-----	---	-----------------	-------	-------

Genuine	4	<b>568335</b>	42.76	51.31
---------	---	---------------	-------	-------

### Replacement Set of Glow Plugs

2.0L diesel engine models from 1956 on - For Britpart glow plug parallel conversion kit

Britpart	1	<b>LL1530BPPLUG</b>	16.67	20.00
----------	---	---------------------	-------	-------

### Glow Plug Parallel Conversion Kit

2.0L diesel engine models from 1956 on - Kit wires plugs in parallel instead of series

Britpart	1	<b>LL1530BP</b>	20.00	24.00
----------	---	-----------------	-------	-------

Bearmach	1	<b>LL1530BM</b>	22.08	26.50
----------	---	-----------------	-------	-------

### Rotor Arm

All models from 1954 on

Aftermarket	1	<b>GRA101</b>	2.50	3.00
-------------	---	---------------	------	------

Red, as original	Lucas	1	<b>GRA101RED</b>	7.50	9.00
------------------	-------	---	------------------	------	------

### Condenser

All models from 1954 on

Aftermarket	1	<b>RTC3472P</b>	1.25	1.50
-------------	---	-----------------	------	------

Aftermarket	1	<b>GSC111</b>	3.08	3.70
-------------	---	---------------	------	------

Genuine	1	<b>RTC3472</b>	3.73	4.48
---------	---	----------------	------	------



## BRAKING SYSTEM

### Brake Shoe Set

All models - Front and Rear Brakes

Aftermarket	1	<b>STC2796P</b>	9.38	11.26
-------------	---	-----------------	------	-------

OEM	1	<b>STC2796P1</b>	27.08	32.50
-----	---	------------------	-------	-------

### Brake Adjuster Kit

All models - Front and Rear Brake Shoes

Aftermarket	1	<b>RTC3176P</b>	10.83	13.00
-------------	---	-----------------	-------	-------

Genuine	1	<b>RTC3176</b>	109.72	131.66
---------	---	----------------	--------	--------

### Brake Shoe Spring

All models

Front and Rear Brakes	Aftermarket	2	<b>218983P</b>	0.58	0.70
-----------------------	-------------	---	----------------	------	------

	Genuine	2	<b>218983</b>	2.90	3.48
--	---------	---	---------------	------	------

10" brake type	Aftermarket	1	<b>503981P</b>	0.58	0.70
----------------	-------------	---	----------------	------	------

	Genuine	1	<b>503981</b>	2.30	2.76
--	---------	---	---------------	------	------

### Wheel Cylinder

All models

Right Hand Front	Aftermarket	1	<b>243296P</b>	5.83	7.00
------------------	-------------	---	----------------	------	------

	OEM	1	<b>243296P1</b>	13.54	16.25
--	-----	---	-----------------	-------	-------

	Genuine	1	<b>243296</b>	51.87	62.24
--	---------	---	---------------	-------	-------

Left Hand Front	Aftermarket	1	<b>243297P</b>	5.83	7.00
-----------------	-------------	---	----------------	------	------

	OEM	1	<b>243297P1</b>	13.54	16.25
--	-----	---	-----------------	-------	-------

	Genuine	1	<b>243297</b>	57.61	69.13
--	---------	---	---------------	-------	-------

All models from 1954

Right Hand Rear	Aftermarket	1	<b>243302P</b>	5.83	7.00
-----------------	-------------	---	----------------	------	------

	OEM	1	<b>243302P1</b>	39.58	47.50
--	-----	---	-----------------	-------	-------

Left Hand Rear	Aftermarket	1	<b>243303P</b>	5.63	6.76
----------------	-------------	---	----------------	------	------

	OEM	1	<b>243303P1</b>	35.00	42.00
--	-----	---	-----------------	-------	-------

	Genuine	1	<b>243303</b>	65.87	79.04
--	---------	---	---------------	-------	-------

### Brake Hose

1954 on - Front and rear brake hose, rubber

Aftermarket	2	<b>RTC3386P</b>	2.83	3.40
-------------	---	-----------------	------	------

OEM	2	<b>RTC3386P1</b>	9.58	11.50
-----	---	------------------	------	-------

Genuine	2	<b>RTC3386</b>	17.29	20.75
---------	---	----------------	-------	-------

### Brake Drum - Handbrake

All models from 1949 on - Handbrake

Aftermarket	1	<b>274423P</b>	9.58	11.50
-------------	---	----------------	------	-------

Genuine	1	<b>274423</b>	60.24	72.29
---------	---	---------------	-------	-------

### Locking Plate Handbrake

All models

Aftermarket	1	<b>515467P</b>	1.33	1.60
-------------	---	----------------	------	------

Genuine	1	<b>515467</b>	1.72	2.06
---------	---	---------------	------	------

### Retaining Plate Handbrake

All models

Aftermarket	1	<b>515468P</b>	1.08	1.30
-------------	---	----------------	------	------

Genuine	1	<b>515468</b>	2.30	2.76
---------	---	---------------	------	------

### Dust Cover Expander Unit

All models

OEM	1	<b>515466P1</b>	3.33	4.00
-----	---	-----------------	------	------

Genuine	1	<b>515466</b>	4.49	5.39
---------	---	---------------	------	------



## SERIES I SWB (1948-1958) SUSPENSION

### Shock Absorber Bush Kit

All models - Front shock absorber bushes, dynamic orange Polybush				
	1	<b>LL1590</b>	29.58	35.50

### Anti Roll Bar Bush

All models from 1954 on				
Rear, lower, poly.	Aftermarket	4	<b>552819POLY</b>	1.08 1.30
Shock absorber mounting, front upper and lower, rear lower, rubber	Aftermarket	4	<b>552819P</b>	0.19 0.23
	Genuine	4	<b>552819</b>	1.39 1.67



LL1590

### Shock Absorber

All models 1954 on - Front, heavy duty	Aftermarket	2	<b>RTC4234P</b>	21.67	26.00
----------------------------------------	-------------	---	-----------------	-------	-------

### Parabolic Spring Kit

All models					
Front springs, 2 leaf, pair, with U bolts	Britpart	1	<b>LL1484BP</b>	115.00	138.00
Rear springs, 3 leaf, pair, with U bolts	Britpart	1	<b>LL1485BPSWB</b>	175.00	210.00

### Leaf Spring

All models - Rear, both sides; main leaf only (not spring assembly)					
	OEM	2	<b>243123P1</b>	33.33	40.00
	Genuine	2	<b>243123</b>	49.61	59.53



243123

## SERIES I SWB (1948-1958) STEERING

### Track Rod End

All models				
RH imperial thread	Aftermarket	1	<b>320901P</b>	4.00 4.80
	OEM	1	<b>320901P1</b>	15.63 18.76
LH imperial thread	Aftermarket	1	<b>320902P</b>	3.75 4.50
	OEM	1	<b>320902P1</b>	13.13 15.76

### Track Rod Tube

All models - With bracket				
	Aftermarket	1	<b>NRC4609P</b>	19.58 23.50
	Genuine	1	<b>NRC4609</b>	95.03 114.04

### Spring Ring Track Rod End

All models - Rubber cap, large diameter	Genuine	1	<b>214685</b>	3.15 3.78
-----------------------------------------	---------	---	---------------	-----------

### Spring Ring Track Rod End Boot

All models	Genuine	1	<b>90214684</b>	0.96 1.15
------------	---------	---	-----------------	-----------

### Gasket Steering Box

All models from 1956 on	Genuine	1	<b>271379</b>	2.06 2.47
-------------------------	---------	---	---------------	-----------

### Oil Seal Steering Relay

All models	Genuine	1	<b>213340</b>	3.52 4.22
------------	---------	---	---------------	-----------

### Steering Relay Assembly

All models	Aftermarket	1	<b>NRC1269P</b>	60.83 73.00
------------	-------------	---	-----------------	-------------

### Gasket Steering Relay Shaft

All models	Genuine	1	<b>90624436</b>	0.55 0.66
------------	---------	---	-----------------	-----------



NRC1269P

## SERIES I SWB (1948-1958) CLUTCH

### Clutch Cover

All models from 1949 on				
Spring type cover, not diaphragm	Aftermarket	1	<b>591705P</b>	50.00 60.00
	OEM	1	<b>591705P1</b>	59.17 71.00
9" diameter	OEM	1	<b>GCC127</b>	75.83 91.00

### Clutch Plate

All models from 1949 on - 9" dia.				
	OEM	1	<b>GCP109AFP</b>	20.00 24.00
	Genuine	1	<b>GCP109AF</b>	42.08 50.50



GCC127

### Clutch Release Bearing

All models				
	Aftermarket	1	<b>STC1130P</b>	1.58 1.90
	OEM	1	<b>STC1130P1</b>	4.00 4.80
	Genuine	1	<b>STC1130</b>	53.81 64.57

### Pedal Pad Clutch & Brake

All models - Clutch and brake pedals				
	Aftermarket	2	<b>278166P</b>	1.83 2.20
	Genuine	2	<b>278166</b>	6.94 8.33

### Oil Seal Clutch Cross Shaft

All models	Genuine	1	<b>90214787</b>	27.16 32.59
------------	---------	---	-----------------	-------------



STC1130P



# TRANSMISSION

## SERIES I SWB (1948-1958)

### Gaiter Propshaft c/w Clips

All models - Front	Aftermarket	1	<b>276484P</b>	2.33	2.80
	Genuine	1	<b>276484</b>	22.65	27.18

### Gaiter Propshaft

All models	Aftermarket	1	<b>276483P</b>	3.00	3.60
	Genuine	1	<b>276483</b>	24.73	29.68

### Universal Joint

All models 1953 on - Front half shaft	Genuine	2	<b>RTC3690</b>	41.27	49.52
---------------------------------------	---------	---	----------------	-------	-------

### Stub Shaft

All models 1954 on - 10 spline	Genuine	2	<b>242520</b>	130.04	156.05
--------------------------------	---------	---	---------------	--------	--------

### Driving Member

All models - 10 spline, front and rear	Genuine	1	<b>571235</b>	40.69	48.83
----------------------------------------	---------	---	---------------	-------	-------

### Stub Axle Nut

All models	Aftermarket	4	<b>FRC8700P</b>	1.25	1.50
	Genuine	4	<b>FRC8700</b>	10.09	12.11

### Bearing Swivel Pin Housing

All models 1954 on	Aftermarket	2	<b>244150P</b>	11.04	13.25
	OEM	2	<b>244150P1</b>	17.29	20.75

### Swivel Pin Housing

All models	Aftermarket	2	<b>539741P</b>	75.00	90.00
------------	-------------	---	----------------	-------	-------

### Distance Piece Swivel Pin

All models 1954 on	Aftermarket	2	<b>244151P</b>	1.25	1.50
--------------------	-------------	---	----------------	------	------

### Retainer Swivel Pin Housing Seal

All models	Aftermarket	2	<b>235968P</b>	1.67	2.00
------------	-------------	---	----------------	------	------

### Swivel Housing Grease

All models	Sachet	OEM	a/r	<b>STC3435P1</b>	5.00	6.00
		Genuine	a/r	<b>STC3435</b>	7.69	9.23
370g bottle		Britpart	a/r	<b>STC3435BPBOTTLE</b>	4.79	5.75
		Britpart	a/r	<b>STC3435BPSACHET</b>	4.38	5.26

### Oil Seal Diff Unit

All models 1950 on	Aftermarket	1	<b>FRC4586P</b>	0.83	1.00
	OEM	1	<b>FRC4586P1</b>	3.50	4.20
	Genuine	1	<b>FRC4586</b>	11.66	13.99

### Oil Seal Front Axle Case

All models	OEM	1	<b>217400P1</b>	2.83	3.40
	Genuine	1	<b>217400</b>	5.21	6.25

### Oil Seal Hub

All models	Aftermarket	2	<b>RTC3510P</b>	1.25	1.50
	Genuine	2	<b>RTC3510</b>	6.29	7.55

### Oil Seal Rear Hub

All models - Felt/rubber, 10 spline type	Genuine	2	<b>RTC3515</b>	1.80	2.16
------------------------------------------	---------	---	----------------	------	------

### Oil Seal Output Shaft

All models	Aftermarket	1	<b>FRC1780</b>	0.79	0.95
------------	-------------	---	----------------	------	------

### Oil Seal Mainshaft Rear

All models	Genuine	1	<b>236305</b>	3.89	4.67
------------	---------	---	---------------	------	------

### Oil Seal Swivel Housing

All models	Aftermarket	2	<b>RTC3528P</b>	2.08	2.50
	Genuine	2	<b>RTC3528</b>	10.96	13.15

### Oil Seal, Transfer Box

All models	Felt type, output shaft	Aftermarket	1	<b>622042P</b>	0.50	0.60
		Genuine	1	<b>622042</b>	2.56	3.07
		Aftermarket	2	<b>236417P</b>	0.71	0.85

### Oil Seal Speedo Pinion

All models	Aftermarket	1	<b>211502P</b>	0.54	0.65
------------	-------------	---	----------------	------	------

### Drain Plug Diff Unit

All models - Tapered	Aftermarket	1	<b>608246P</b>	2.33	2.80
	Genuine	1	<b>608246</b>	9.63	11.56

### Sealing Washer Drain Plug

All models	Land Rover type axle	Aftermarket	1	<b>515599P</b>	0.33	0.40
		Genuine	1	<b>515599</b>	1.17	1.40
Transfer box	Axle	Genuine	1	<b>FRC4809</b>	0.80	0.96
		Genuine	1	<b>FRC4809</b>	0.80	0.96

### Speedometer Drive Worm Gear

All models 1954 on	OEM	1	<b>540004P1</b>	9.17	11.00
	Genuine	1	<b>540004</b>	35.69	42.83

# COOLING

## SERIES I SWB (1948-1958)

### Radiator Cap

All models - 10lb pressure	Aftermarket	1	<b>RTC3607P</b>	2.00	2.40
	Genuine	1	<b>RTC3607</b>	3.54	4.25

### Thermostat

All models	74°C, hot climates option	Aftermarket	1	<b>GTS102</b>	3.33	4.00
		Aftermarket	1	<b>GTS104</b>	3.58	4.30
		Aftermarket	1	<b>GTS106</b>	3.58	4.30
		Aftermarket	1	<b>602687P</b>	2.58	3.10
		OEM	1	<b>602687P1</b>	3.58	4.30
		Genuine	1	<b>602687</b>	10.06	12.07

### O Ring Water Pump

All models	Genuine	1	<b>RTC1975</b>	4.27	5.12
------------	---------	---	----------------	------	------



RTC3607P



GTS102

# ELECTRICAL - ROTATING ELECTRICS

## SERIES I SWB (1948-1958)



RTC5225UR

### Starter Motor

All petrol models from 1954 on	Replacement 2M100 type, new	Aftermarket	1	<b>RTC5225P</b>	100.00	120.00
		Powerlite	1	<b>RTC5225UR</b>	145.00	174.00
		Hi Torque, uprated				





## SERIES I SWB (1948-1958) ENGINE GASKETS

### Gasket Rocker Cover

All 2.0L diesel models				
Self adhesive	Aftermarket	1	<b>ETC6438P</b>	0.92 1.10
	Genuine	1	<b>ETC6438</b>	7.20 8.64

### Gasket Side Rocker Cover

All 1.6L and 2.0L petrol models				
	Aftermarket	1	<b>267779P</b>	1.17 1.40
	Genuine	1	<b>267779</b>	8.77 10.52

### Gasket Oil Sump

2.0L diesel models				
	Aftermarket	1	<b>546841P</b>	1.00 1.20
	OEM	1	<b>546841P1</b>	2.42 2.90
	Genuine	1	<b>546841</b>	17.82 21.38

### Silicone Sealant RTV

Numerous applications				
	Aftermarket	a/r	<b>RTC3254P</b>	5.00 6.00
	Genuine	a/r	<b>RTC3254</b>	21.04 25.25

## SERIES I SWB (1948-1958) ENGINE SWITCHES

### Oil Pressure Switch

All models				
	Aftermarket	1	<b>90519864P</b>	1.75 2.10



## SERIES I SWB (1948-1958) DRAIN PLUGS

### Drain Plug

All models				
Gearbox drain	Aftermarket	1	<b>540870P</b>	0.75 0.90
	Genuine	1	<b>540870</b>	2.09 2.51
Front & rear differentials	Genuine	1	<b>235592</b>	11.48 13.78

### Filler Plug

All models from 1956 on - Steering box				
	Genuine	1	<b>271386</b>	5.92 7.10



## SERIES I SWB (1948-1958) OIL SEALS ENGINE

### Oil Seal Crankshaft Front

All models				
	Aftermarket	1	<b>ERR6490P</b>	3.00 3.60
	OEM	1	<b>ERR6490P1</b>	5.00 6.00

### Oil Seal Front Cover

All models				
	Aftermarket	1	<b>ETC4154P</b>	1.08 1.30
	OEM	1	<b>ETC4154P1</b>	3.00 3.60
	Genuine	1	<b>ETC4154</b>	14.67 17.60



## SERIES I SWB (1948-1958) ENGINE & GEARBOX MOUNTINGS

### Engine Mounting

All petrol engine models - Front				
	Aftermarket	2	<b>NRC2054P</b>	1.83 2.20
	Genuine	2	<b>NRC2054</b>	17.88 21.46
All models from 1954 on				
	Aftermarket	1	<b>NRC2053P</b>	1.83 2.20
	Genuine	1	<b>NRC2053</b>	5.78 6.94

### Bracket Gearbox Mounting

All models - RH				
	Genuine	1	<b>272501</b>	7.08 8.50



## SERIES I SWB (1948-1958) CABLES

### Speedometer Cable

All models from 1950 on				
	Aftermarket	1	<b>RTC3484P</b>	4.58 5.50
	Genuine	1	<b>RTC3484</b>	71.21 85.45



## SERIES I SWB (1948-1958) WHEEL STUDS & WHEEL NUTS

### Wheel Stud

All models				
Screw-in type	Aftermarket	a/r	<b>561590P</b>	0.75 0.90
	Genuine	a/r	<b>561590</b>	3.51 4.21
Pull-in type	Aftermarket	a/r	<b>561886P</b>	0.58 0.70

### Wheel Nut

All models - Tapered both ends				
	Aftermarket	a/r	<b>217361P</b>	0.42 0.50
	Genuine	a/r	<b>217361</b>	1.35 1.62



# SERIES I LWB (1948-1958)

## 1948-1958 - All Models

Listed below are the most popular parts required for the Series I LWB.

We have access to the full range of parts for your vehicle. Please contact us if not listed here.



## FILTRATION

### Oil Filter

All 6 cylinder petrol & 2.0L Diesel engine models

Genuine	1	<b>RTC3183</b>	5.18	6.22
---------	---	----------------	------	------



RTC3183

### SERIES I LWB (1948-1958)

## SCREEN/LAMP WASHER SYSTEMS

### Windscreen Cleaning Paste

All models

Prevents wiper blade judder/squeak by 'deep cleaning' the windscreen (ref: Land Rover Tech Bulletin LRA501-002)

Genuine	a/r	<b>DNJ500340</b>	7.72	9.26
---------	-----	------------------	------	------

### SERIES I LWB (1948-1958)

## DRIVE BELTS

### Fan Belt

All models with 2.0L diesel engine - Fan

Aftermarket	1	<b>STC3673P</b>	15.63	18.76
Genuine	1	<b>STC3673</b>	50.23	60.28



STC3673P

### SERIES I LWB (1948-1958)

## IGNITION SYSTEM

### Glow Plug

2.0L diesel engine models from 1956 on

Pigtail type

Aftermarket	4	<b>568335P</b>	5.00	6.00
OEM	4	<b>568335P1</b>	10.83	13.00
Genuine	4	<b>568335</b>	42.76	51.31

### Replacement Set of Glow Plugs

2.0L diesel engine models from 1956 on - For Britpart glow plug parallel conversion kit

Britpart	1	<b>LL1530BPPLUG</b>	16.67	20.00
----------	---	---------------------	-------	-------

### Glow Plug Parallel Conversion Kit

2.0L diesel engine models from 1956 on - Kit wires plugs in parallel instead of series

Britpart	1	<b>LL1530BP</b>	20.00	24.00
Bearmach	1	<b>LL1530BM</b>	22.08	26.50

### Rotor Arm

All models

All models - Red, as original

Aftermarket	1	<b>GRA101</b>	2.50	3.00
Lucas	1	<b>GRA101RED</b>	7.50	9.00

### Condenser

All models

Aftermarket	1	<b>RTC3472P</b>	1.25	1.50
Aftermarket	1	<b>GSC111</b>	3.08	3.70
Genuine	1	<b>RTC3472</b>	3.73	4.48



LL1530BM

### SERIES I LWB (1948-1958)

## BRAKING SYSTEM

### Brake Shoe Set

All models - Rear Brakes

Aftermarket	1	<b>STC2797P</b>	11.67	14.00
OEM	1	<b>STC2797P1</b>	25.83	31.00
Genuine	1	<b>STC2797</b>	191.25	229.50

### Brake Linings Set

All models - Set of 4, with rivets, 11 dia brakes

Aftermarket	1	<b>STC3944P</b>	12.50	15.00
-------------	---	-----------------	-------	-------

### Brake Adjuster Kit

All models - Front and Rear Brake Shoes

Aftermarket	1	<b>RTC3176P</b>	10.83	13.00
Genuine	1	<b>RTC3176</b>	109.72	131.66

### Brake Shoe Spring

All models - 10 brake type

Aftermarket	1	<b>503981P</b>	0.58	0.70
Genuine	1	<b>503981</b>	2.30	2.76

### Brake Drum

All models

Front, 11 Dia

Aftermarket	2	<b>516599P</b>	17.08	20.50
Genuine	2	<b>516599</b>	104.29	125.15

Rear

Aftermarket	2	<b>576973P</b>	17.50	21.00
Genuine	2	<b>576973</b>	90.40	108.48

### Wheel Cylinder

All models

Right Hand Front

Aftermarket	1	<b>243744P</b>	5.63	6.76
OEM	1	<b>243744P1</b>	10.00	12.00

Left Hand Front

Aftermarket	1	<b>243743P</b>	5.63	6.76
OEM	1	<b>243743P1</b>	10.00	12.00

Left Hand Rear

Aftermarket	1	<b>243297P</b>	5.83	7.00
OEM	1	<b>243297P1</b>	13.54	16.25
Genuine	1	<b>243297</b>	57.61	69.13

### Brake Hose

1954 on

Front and rear brake hose, rubber

Aftermarket	1	<b>RTC3386P</b>	2.83	3.40
OEM	1	<b>RTC3386P1</b>	9.58	11.50
Genuine	1	<b>RTC3386</b>	17.29	20.75

Rear brake hose, rubber

Aftermarket	1	<b>RTC3353P</b>	3.00	3.60
Genuine	1	<b>RTC3353</b>	16.47	19.76

### Brake Drum - Handbrake

All models - Handbrake

Aftermarket	1	<b>274423P</b>	9.58	11.50
Genuine	1	<b>274423</b>	60.24	72.29

### Locking Plate Handbrake

All models

Aftermarket	1	<b>515467P</b>	1.33	1.60
Genuine	1	<b>515467</b>	1.72	2.06

### Retaining Plate Handbrake

All models

Aftermarket	1	<b>515468P</b>	1.08	1.30
Genuine	1	<b>515468</b>	2.30	2.76

### Dust Cover Expander Unit

All models

OEM	1	<b>515466P1</b>	3.33	4.00
Genuine	1	<b>515466</b>	4.49	5.39



STC2797P



**SERIES I LWB (1948-1958)****SUSPENSION****Shock Absorber Bush Kit**

All models - Front shock absorber bushes, dynamic orange	Polybush	1	<b>LL1590</b>	29.58	35.50
----------------------------------------------------------	----------	---	---------------	-------	-------

**Anti Roll Bar Bush**

All models					
Rear, lower, poly.	Aftermarket	4	<b>552819POLY</b>	1.08	1.30
Shock absorber mounting, front upper and lower, rear lower, rubber	Aftermarket	4	<b>552819P</b>	0.19	0.23
	Genuine	4	<b>552819</b>	1.39	1.67

**Shock Absorber**

All models					
Front, std	Aftermarket	2	<b>RTC4234P</b>	21.67	26.00
Rear, heavy duty	Genuine	2	<b>RTC4236</b>	59.56	71.47

**Parabolic Spring Kit**

All models					
Front springs, 2 leaf, pair, with U bolts	Britpart	1	<b>LL1484BP</b>	115.00	138.00
Rear springs, 4 leaf, pair, with U bolts	Britpart	1	<b>LL1485BPLWB</b>	220.83	265.00

**SERIES I LWB (1948-1958)****STEERING****Track Rod End**

All models					
RH imperial thread	Aftermarket	1	<b>320901P</b>	4.00	4.80
	OEM	1	<b>320901P1</b>	15.63	18.76
LH imperial thread	Aftermarket	1	<b>320902P</b>	3.75	4.50
	OEM	1	<b>320902P1</b>	13.13	15.76

**Track Rod Tube**

All models - With bracket	Aftermarket	1	<b>NRC4609P</b>	19.58	23.50
	Genuine	1	<b>NRC4609</b>	95.03	114.04

**Rubber Cap Track Rod End**

All models	Aftermarket	1	<b>214649P</b>	1.33	1.60
	Genuine	1	<b>214649</b>	4.57	5.48

**Spring Ring Track Rod End**

All models - Rubber cap, large diameter	Genuine	1	<b>214685</b>	3.15	3.78
-----------------------------------------	---------	---	---------------	------	------

**Spring Ring Track Rod End Boot**

All models	Genuine	1	<b>90214684</b>	0.96	1.15
------------	---------	---	-----------------	------	------

**Gasket Steering Box**

All models from 1956 on	Genuine	1	<b>271379</b>	2.06	2.47
-------------------------	---------	---	---------------	------	------

**Oil Seal Steering Relay**

All models	Genuine	1	<b>213340</b>	3.52	4.22
------------	---------	---	---------------	------	------

**Steering Relay Assembly**

All models	Aftermarket	1	<b>NRC1269P</b>	60.83	73.00
------------	-------------	---	-----------------	-------	-------

**Gasket Steering Relay Shaft**

All models	Genuine	1	<b>90624436</b>	0.55	0.66
------------	---------	---	-----------------	------	------



320901P



NRC1269P

**SERIES I LWB (1948-1958)****CLUTCH****Clutch Cover**

All models					
Spring type cover, not diaphragm	Aftermarket	1	<b>591705P</b>	50.00	60.00
	OEM	1	<b>591705P1</b>	59.17	71.00
9 diameter	OEM	1	<b>GCC127</b>	75.83	91.00

**Clutch Plate**

All models - 9 dia.	OEM	1	<b>GCP109AFP</b>	20.00	24.00
	Genuine	1	<b>GCP109AF</b>	42.08	50.50

**Clutch Release Bearing**

All models	Aftermarket	1	<b>STC1130P</b>	1.58	1.90
	OEM	1	<b>STC1130P1</b>	4.00	4.80
	Genuine	1	<b>STC1130</b>	53.81	64.57

**Pedal Pad Clutch & Brake**

All models - Clutch and brake pedals	Aftermarket	2	<b>278166P</b>	1.83	2.20
	Genuine	2	<b>278166</b>	6.94	8.33

**Oil Seal Clutch Cross Shaft**

All models	Genuine	1	<b>90214787</b>	27.16	32.59
------------	---------	---	-----------------	-------	-------



STC1130P1



278166P





# TRANSMISSION

**SERIES I LWB (1948-1958)**

## Gaiter Propshaft c/w Clips

All models - Front	Aftermarket	1	<b>276484P</b>	2.33	2.80
	Genuine	1	<b>276484</b>	22.65	27.18

## Gaiter Propshaft

All models	Aftermarket	1	<b>276483P</b>	3.00	3.60
	Genuine	1	<b>276483</b>	24.73	29.68

## Universal Joint

All models - Front half shaft	Genuine	2	<b>RTC3690</b>	41.27	49.52
-------------------------------	---------	---	----------------	-------	-------

## Stub Shaft

All models - 10 spline	Genuine	2	<b>242520</b>	130.04	156.05
------------------------	---------	---	---------------	--------	--------

## Stub Axle Assembly

All models	Genuine	2	<b>599827</b>	162.42	194.90
------------	---------	---	---------------	--------	--------

## Stub Axle Nut

All models	Aftermarket	4	<b>FRC8700P</b>	1.25	1.50
	Genuine	4	<b>FRC8700</b>	10.09	12.11

## Bearing Swivel Pin Housing

All models	Aftermarket	2	<b>244150P</b>	11.04	13.25
	OEM	2	<b>244150P1</b>	17.29	20.75

## Swivel Pin Housing

All models	Aftermarket	2	<b>539741P</b>	75.00	90.00
------------	-------------	---	----------------	-------	-------

## Distance Piece Swivel Pin

All models	Aftermarket	2	<b>244151P</b>	1.25	1.50
------------	-------------	---	----------------	------	------

## Retainer Swivel Pin Housing Seal

All models	Aftermarket	2	<b>235968P</b>	1.67	2.00
------------	-------------	---	----------------	------	------

## Swivel Housing Grease

All models	Sachet	OEM	a/r	<b>STC3435P1</b>	5.00	6.00
		Genuine	a/r	<b>STC3435</b>	7.69	9.23
370g bottle	370ml sachet	Britpart	a/r	<b>STC3435BPBOTTLE</b>	4.79	5.75
		Britpart	a/r	<b>STC3435BPSACHET</b>	4.38	5.26



276483P

## Oil Seal Diff Unit

All models	Aftermarket	1	<b>FRC4586P</b>	0.83	1.00
	OEM	1	<b>FRC4586P1</b>	3.50	4.20
	Genuine	1	<b>FRC4586</b>	11.66	13.99

## Oil Seal Front Axle Case

All models	OEM	1	<b>217400P1</b>	2.83	3.40
	Genuine	1	<b>217400</b>	5.21	6.25

## Oil Seal Hub

All models	Aftermarket	2	<b>RTC3510P</b>	1.25	1.50
	Genuine	2	<b>RTC3510</b>	6.29	7.55

## Oil Seal Rear Hub

All models - Felt/rubber, 10 spline type	Genuine	2	<b>RTC3515</b>	1.80	2.16
------------------------------------------	---------	---	----------------	------	------

## Oil Seal Output Shaft

All models	Aftermarket	1	<b>FRC1780</b>	0.79	0.95
------------	-------------	---	----------------	------	------

## Oil Seal Mainshaft Rear

All models	Genuine	1	<b>236305</b>	3.89	4.67
------------	---------	---	---------------	------	------

## Oil Seal Swivel Housing

All models	Aftermarket	2	<b>RTC3528P</b>	2.08	2.50
	Genuine	2	<b>RTC3528</b>	10.96	13.15

## Oil Seal, Transfer Box

All models	Felt type, output shaft	Aftermarket	1	<b>622042P</b>	0.50	0.60
		Genuine	1	<b>622042</b>	2.56	3.07
		Aftermarket	2	<b>236417P</b>	0.71	0.85
Front & rear output shafts						

## Oil Seal Speedo Pinion

All models	Aftermarket	1	<b>211502P</b>	0.54	0.65
------------	-------------	---	----------------	------	------

## Drain Plug Diff Unit

All models	Aftermarket	1	<b>608246P</b>	2.33	2.80
	Genuine	1	<b>608246</b>	9.63	11.56

## Sealing Washer Drain Plug

All models	Land Rover type axle	Aftermarket	1	<b>515599P</b>	0.33	0.40
		Genuine	1	<b>515599</b>	1.17	1.40
		Genuine	1	<b>FRC4809</b>	0.80	0.96
Transfer box	Axle	Genuine	1	<b>FRC4809</b>	0.80	0.96

## Speedometer Drive Worm Gear

All models	OEM	1	<b>540004P1</b>	9.17	11.00
	Genuine	1	<b>540004</b>	35.69	42.83

# COOLING

**SERIES I LWB (1948-1958)**

## Radiator Cap

All models - 10lb pressure	Aftermarket	1	<b>RTC3607P</b>	2.00	2.40
	Genuine	1	<b>RTC3607</b>	3.54	4.25

## Thermostat

All models	74°C, hot climates option	Aftermarket	1	<b>GTS102</b>	3.33	4.00
	82°C, std fitment	Aftermarket	1	<b>GTS104</b>	3.58	4.30
	88°C, cold climates option	Aftermarket	1	<b>GTS106</b>	3.58	4.30
	82°C	Aftermarket	1	<b>602687P</b>	2.58	3.10
		OEM	1	<b>602687P1</b>	3.58	4.30
		Genuine	1	<b>602687</b>	10.06	12.07

## O Ring Water Pump

All models	Genuine	1	<b>RTC1975</b>	4.27	5.12
------------	---------	---	----------------	------	------



602687P

# ELECTRICAL - ROTATING ELECTRICS

**SERIES I LWB (1948-1958)**

## Starter Motor

All petrol models from 1954 on	Replacement 2M100 type, new	Aftermarket	1	<b>RTC5225P</b>	100.00	120.00
	Hi Torque, uprated	Powerlite	1	<b>RTC5225UR</b>	145.00	174.00



RTC5225P



**SERIES I LWB (1948-1958)****ENGINE GASKETS****Gasket Rocker Cover**

All 2.0L diesel models				
Self adhesive	Aftermarket	1	<b>ETC6438P</b>	0.92 1.10
	Genuine	1	<b>ETC6438</b>	7.20 8.64

**Gasket Side Rocker Cover**

All 1.6L and 2.0L petrol models				
	Aftermarket	1	<b>267779P</b>	1.17 1.40
	Genuine	1	<b>267779</b>	8.77 10.52

**Gasket Oil Sump**

2.0L diesel models				
	Aftermarket	1	<b>546841P</b>	1.00 1.20
	OEM	1	<b>546841P1</b>	2.42 2.90
	Genuine	1	<b>546841</b>	17.82 21.38

**Silicone Sealant RTV**

Numerous applications				
	Aftermarket	a/r	<b>RTC3254P</b>	5.00 6.00
	Genuine	a/r	<b>RTC3254</b>	21.04 25.25

**SERIES I LWB (1948-1958)****ENGINE SWITCHES****Oil Pressure Switch**

All models				
	Aftermarket	1	<b>90519864P</b>	1.75 2.10



90519864P

**SERIES I LWB (1948-1958)****DRAIN PLUGS****Drain Plug**

All models				
Gearbox drain	Aftermarket	1	<b>540870P</b>	0.75 0.90
	Genuine	1	<b>540870</b>	2.09 2.51
Front differential	Genuine	1	<b>235592</b>	11.48 13.78



235592

**Filler Plug**

All models from 1956 on - Steering box				
	Genuine	1	<b>271386</b>	5.92 7.10

**SERIES I LWB (1948-1958)****OIL SEALS ENGINE****Oil Seal Crankshaft Front**

All models				
	Aftermarket	1	<b>ERR6490P</b>	3.00 3.60
	OEM	1	<b>ERR6490P1</b>	5.00 6.00

**Oil Seal Front Cover**

All models				
	Aftermarket	1	<b>ETC4154P</b>	1.08 1.30
	OEM	1	<b>ETC4154P1</b>	3.00 3.60
	Genuine	1	<b>ETC4154</b>	14.67 17.60



ERR6490P



ETC4154P

**SERIES I LWB (1948-1958)****ENGINE & GEARBOX MOUNTINGS****Engine Mounting**

All petrol engine models - Front				
	Aftermarket	2	<b>NRC2054P</b>	1.83 2.20
	Genuine	2	<b>NRC2054</b>	17.88 21.46
All models from 1954 on				
	Aftermarket	1	<b>NRC2053P</b>	1.83 2.20
	Genuine	1	<b>NRC2053</b>	5.78 6.94

**Bracket Gearbox Mounting**

All models - RH				
	Genuine	1	<b>272501</b>	7.08 8.50



NRC2054P



NRC2053P

**SERIES I LWB (1948-1958)****CABLES****Speedometer Cable**

All models				
	Aftermarket	1	<b>RTC3484P</b>	4.58 5.50
	Genuine	1	<b>RTC3484</b>	71.21 85.45



RTC3484P

**SERIES I LWB (1948-1958)****WHEEL STUDS & WHEEL NUTS****Wheel Stud**

All models				
Screw-in type	Aftermarket	a/r	<b>561590P</b>	0.75 0.90
	Genuine	a/r	<b>561590</b>	3.51 4.21
Pull-in type	Aftermarket	a/r	<b>561886P</b>	0.58 0.70

**Wheel Nut**

All models - Tapered both ends				
	Aftermarket	a/r	<b>217361P</b>	0.42 0.50
	Genuine	a/r	<b>217361</b>	1.35 1.62



561590P



561886P



217361P



# SERIES II 88 (1958-1971)

## 1958-1971 - All Models

Listed below are the most popular parts required for the Series II 88.

We have access to the full range of parts for your vehicle. Please contact us if not listed here.



## FILTRATION

### SERIES II 88 (1958-1971)

#### Oil Filter

All 2.25L petrol models - Element	Aftermarket	1	<b>248863</b>	4.50	5.40
All 2.0L diesel models - Element	Aftermarket	1	<b>248863</b>	4.50	5.40
All 6 cylinder petrol & 2.0L Diesel engine models	Genuine	1	<b>RTC3183</b>	5.18	6.22

#### Fuel Filter Seal

All diesel engine models					
Top, for sedimentor filter	Aftermarket	1	<b>AAU9903P</b>	0.33	0.40
	Genuine	1	<b>AAU9903</b>	1.78	2.14
Bottom, for sedimentor filter	Aftermarket	1	<b>AAU9902P</b>	0.58	0.70
	Genuine	1	<b>AAU9902</b>	1.78	2.14

## SCREEN/LAMP WASHER SYSTEMS

### SERIES II 88 (1958-1971)

#### Windscreen Cleaning Paste

All models					
Prevents wiper blade judder/squeak by 'deep cleaning' the windscreen (ref: Land Rover Tech Bulletin LRA501-002)					
	Genuine	a/r	<b>DNJ500340</b>	7.72	9.26

## IGNITION SYSTEM

### SERIES II 88 (1958-1971)

#### Glow Plug

All 2.0L diesel engine models - Pigtail type	Aftermarket	4	<b>568335P</b>	5.00	6.00
	OEM	4	<b>568335P1</b>	10.83	13.00
	Genuine	4	<b>568335</b>	42.76	51.31

#### Glow Plug Parallel Conversion Kit

All 2.0L diesel engine models - Kit wires plugs in parallel instead of series					
	Britpart	1	<b>LL1530BP</b>	20.00	24.00
	Bearmach	1	<b>LL1530BM</b>	22.08	26.50

#### Replacement Set of Glow Plugs

All 2.0L diesel engine models - For Britpart glow plug parallel conversion kit					
	Britpart	1	<b>LL1530BPPLUG</b>	16.67	20.00

#### Contact Set

All 2.25L petrol engine models - For type 25D distributor					
	Aftermarket	1	<b>RTC3270P</b>	1.00	1.20
All 4 cyl petrol models fitted with non-original Lucas 59D type distributor					
Blue sliding contact type set	Aftermarket	1	<b>GCS261</b>	6.88	8.26

#### Rotor Arm

All 2.25L petrol engine models					
For type 25D distributor	Aftermarket	1	<b>GRA101</b>	2.50	3.00
Red, as original, for Lucas type 25D distributor	Lucas	1	<b>GRA101RED</b>	7.50	9.00

#### Condenser

All 2.25L petrol engine models					
For type 25D distributor	Aftermarket	1	<b>RTC3472P</b>	1.25	1.50
	Aftermarket	1	<b>GSC111</b>	3.08	3.70
	Genuine	1	<b>RTC3472</b>	3.73	4.48

#### Distributor Cap

All 2.25L petrol engine models - For type 25D distributor, acorn nut terminals					
	Aftermarket	1	<b>GDC107</b>	10.00	12.00
All petrol models - With acorn nut type lead terminals					
	Genuine	1	<b>600328</b>	18.24	21.89

## BRAKING SYSTEM

### SERIES II 88 (1958-1971)

#### Brake Shoe Set

All models - Front and Rear Brakes					
	Aftermarket	1	<b>STC2796P</b>	9.38	11.26
	OEM	1	<b>STC2796P1</b>	27.08	32.50

#### Brake Adjuster Kit

All models - Front and Rear Brake Shoes					
	Aftermarket	1	<b>RTC3176P</b>	10.83	13.00
	Genuine	1	<b>RTC3176</b>	109.72	131.66

#### Brake Shoe Spring

All models - 10" brake type					
	Aftermarket	1	<b>503981P</b>	0.58	0.70
	Genuine	1	<b>503981</b>	2.30	2.76
All models - Front and Rear Brakes					
	Aftermarket	2	<b>218983P</b>	0.58	0.70
	Genuine	2	<b>218983</b>	2.90	3.48

#### Wheel Cylinder

All models					
Right Hand Front	Aftermarket	1	<b>243296P</b>	5.83	7.00
	OEM	1	<b>243296P1</b>	13.54	16.25
	Genuine	1	<b>243296</b>	51.87	62.24
Left Hand Front	Aftermarket	1	<b>243297P</b>	5.83	7.00
	OEM	1	<b>243297P1</b>	13.54	16.25
	Genuine	1	<b>243297</b>	57.61	69.13
Right Hand Rear	Aftermarket	1	<b>243302P</b>	5.83	7.00
	OEM	1	<b>243302P1</b>	39.58	47.50
	Aftermarket	1	<b>243303P</b>	5.63	6.76
Left Hand Rear	OEM	1	<b>243303P1</b>	35.00	42.00
	Genuine	1	<b>243303</b>	65.87	79.04

#### Brake Master Cylinder

All models with CB type master cylinder - CB Type					
	Aftermarket	1	<b>520849P</b>	15.00	18.00
	Genuine	1	<b>520849</b>	603.40	724.08

#### Master Cylinder Overhaul Kit

All models with CB type master cylinder - Brake master cylinder					
	Aftermarket	1	<b>STC1116P</b>	1.58	1.90

#### Master Cylinder Repair Kit

All models with CV type master cylinder - Brake master cylinder					
	Aftermarket	1	<b>GRK1027</b>	5.63	6.76

#### Brake Hose

All models - Front and rear brake hose, also clutch hose, rubber					
	Aftermarket	1	<b>RTC3386P</b>	2.83	3.40
	OEM	1	<b>RTC3386P1</b>	9.58	11.50
	Genuine	1	<b>RTC3386</b>	17.29	20.75

#### Brake Drum - Handbrake

All models - Handbrake					
	Aftermarket	1	<b>274423P</b>	9.58	11.50
	Genuine	1	<b>274423</b>	60.24	72.29

#### Retaining Plate Handbrake

All models					
	Aftermarket	1	<b>515468P</b>	1.08	1.30
	Genuine	1	<b>515468</b>	2.30	2.76

#### Locking Plate Handbrake

All models					
	Aftermarket	1	<b>515467P</b>	1.33	1.60
	Genuine	1	<b>515467</b>	1.72	2.06

#### Dust Cover Expander Unit

All models					
	OEM	1	<b>515466P1</b>	3.33	4.00
	Genuine	1	<b>515466</b>	4.49	5.39



520849P





**SERIES II 88 (1958-1971)****SUSPENSION****Bush Shock Absorber Mounting**

All models - Rear, lower, rubber	Aftermarket	8	<b>552818P</b>	0.50	0.60
	Genuine	8	<b>552818</b>	1.38	1.66

**Front Chassis Bush**

All models	Aftermarket	2	<b>569746P</b>	1.58	1.90
	Genuine	2	<b>569746</b>	13.47	16.16

**Spring Eye Bush**

All models	Aftermarket	4	<b>548205P</b>	1.58	1.90
	Genuine	4	<b>548205</b>	4.14	4.97

**Shock Absorber Bush Kit**

All models - Front shock absorber bushes, dynamic orange	Polybush	1	<b>LL1590</b>	29.58	35.50
----------------------------------------------------------	----------	---	---------------	-------	-------

**Bush Shock Absorber Mounting**

All models - Rear, lower, poly, performance red	Polybush	1	<b>5528189PBR</b>	25.00	30.00
comfort blue	Polybush	1	<b>552818PPBB</b>	25.00	30.00
dynamic orange	Polybush	1	<b>5528189PBO</b>	25.00	30.00
	Aftermarket	4	<b>552818POLY</b>	0.83	1.00

**Anti Roll Bar Bush**

All models - Front upper and lower, rear lower, poly.	Aftermarket	4	<b>552819POLY</b>	1.08	1.30
-------------------------------------------------------	-------------	---	-------------------	------	------

**Spring Eye Bush (pair)**

All models - poly., dynamic orange	Polybush	2	<b>548205POLYBUSH</b>	17.50	21.00
------------------------------------	----------	---	-----------------------	-------	-------

**Anti Roll Bar Bush**

All models - Shock absorber mounting, front upper and lower, rear lower, rubber	Aftermarket	4	<b>552819P</b>	0.19	0.23
	Genuine	4	<b>552819</b>	1.39	1.67

**Shock Absorber**

All models - Front, heavy duty	Aftermarket	2	<b>RTC4234P</b>	21.67	26.00
--------------------------------	-------------	---	-----------------	-------	-------

**Leaf Spring**

All 2.25L petrol models					
9 leaf, driver's side, front	Aftermarket	1	<b>241283P</b>	65.00	78.00
	OEM	1	<b>241283P1</b>	75.00	90.00
9 leaf, passenger's side, front	OEM	1	<b>242863P1</b>	75.00	90.00
All 2.25L diesel models					
11 leaf, driver's side, front	Aftermarket	1	<b>265627P</b>	65.00	78.00
All models					
11 leaf, driver's side, rear	OEM	1	<b>517588P1</b>	99.17	119.00
	Genuine	1	<b>517588</b>	176.59	211.91
11 leaf, passenger's side, rear	OEM	1	<b>517589P1</b>	99.17	119.00
All models - Rear, both sides; main leaf only (not spring assembly)					
	OEM	2	<b>243123P1</b>	33.33	40.00
	Genuine	2	<b>243123</b>	49.61	59.53

**Parabolic Spring Kit**

All models					
Front springs, 2 leaf, pair, with U bolts	Britpart	1	<b>LL1484BP</b>	115.00	138.00
Rear springs, 3 leaf, pair, with U bolts	Britpart	1	<b>LL1485BPSWB</b>	175.00	210.00

**SERIES II 88 (1958-1971)****STEERING****Track Rod End**

All models					
RH imperial thread	Aftermarket	1	<b>320901P</b>	4.00	4.80
	OEM	1	<b>320901P1</b>	15.63	18.76
LH imperial thread	Aftermarket	1	<b>320902P</b>	3.75	4.50
	OEM	1	<b>320902P1</b>	13.13	15.76
With bracket	Aftermarket	1	<b>NRC4609P</b>	19.58	23.50
	Genuine	1	<b>NRC4609</b>	95.03	114.04

**Rubber Cap Track Rod End**

All models	Aftermarket	1	<b>214649P</b>	1.33	1.60
	Genuine	1	<b>214649</b>	4.57	5.48

**Spring Ring Track Rod End**

All models - Rubber cap, large diameter	Genuine	1	<b>214685</b>	3.15	3.78
-----------------------------------------	---------	---	---------------	------	------

**Spring Ring Track Rod End Boot**

All models	Genuine	1	<b>90214684</b>	0.96	1.15
------------	---------	---	-----------------	------	------

**Gasket Steering Box**

All models	Genuine	1	<b>271379</b>	2.06	2.47
------------	---------	---	---------------	------	------

**Oil Seal Steering Relay**

All models	Genuine	1	<b>213340</b>	3.52	4.22
------------	---------	---	---------------	------	------

**Steering Relay Lever**

All models	Genuine	1	<b>535286</b>	32.58	39.10
------------	---------	---	---------------	-------	-------

**Steering Relay Assembly**

All models	Aftermarket	1	<b>NRC1269P</b>	60.83	73.00
------------	-------------	---	-----------------	-------	-------

**Gasket Steering Relay Shaft**

All models	Genuine	1	<b>90624436</b>	0.55	0.66
------------	---------	---	-----------------	------	------

**SERIES II 88 (1958-1971)****CLUTCH****Clutch Cover**

All models					
Spring type cover, not diaphragm	Aftermarket	1	<b>591705P</b>	50.00	60.00
	OEM	1	<b>591705P1</b>	59.17	71.00
9" diameter	OEM	1	<b>GCC127</b>	75.83	91.00

**Clutch Plate**

All models fitted with std. 9" clutch - 9" dia					
	OEM	1	<b>GCP109AFP</b>	20.00	24.00
	Genuine	1	<b>GCP109AF</b>	42.08	50.50

**Clutch Release Bearing**

All models	Aftermarket	1	<b>STC1130P</b>	1.58	1.90
	OEM	1	<b>STC1130P1</b>	4.00	4.80
	Genuine	1	<b>STC1130</b>	53.81	64.57

**Spherical Bearing**

All models - Clutch release shaft	Genuine	1	<b>90217984</b>	22.18	26.62
-----------------------------------	---------	---	-----------------	-------	-------

**Master Cylinder Repair Kit**

All models - Clutch master cylinder	Aftermarket	1	<b>GRK1027P</b>	2.08	2.50
	OEM	1	<b>GRK1027</b>	5.63	6.76

**Pedal Pad Clutch & Brake**

All models - Clutch and brake pedals	Aftermarket	2	<b>278166P</b>	1.83	2.20
	Genuine	2	<b>278166</b>	6.94	8.33

**Oil Seal Clutch Cross Shaft**

All models	Genuine	1	<b>90214787</b>	27.16	32.59
------------	---------	---	-----------------	-------	-------



# TRANSMISSION

## SERIES II 88 (1958-1971)

### Gaiter Propshaft c/w Clips

All models - Front	Aftermarket	1	<b>276484P</b>	2.33	2.80
	Genuine	1	<b>276484</b>	22.65	27.18

### Gaiter Propshaft

All models	Aftermarket	1	<b>276483P</b>	3.00	3.60
	Genuine	1	<b>276483</b>	24.73	29.68

### Universal Joint

All models - Front half shaft	Genuine	2	<b>RTC3690</b>	41.27	49.52
-------------------------------	---------	---	----------------	-------	-------

### Half Shaft, Bare

All models - Front axle					
RH	Genuine	1	<b>276719</b>	195.70	234.84
LH	Genuine	1	<b>276720</b>	251.51	301.81

### Half Shaft

All models - Rear					
RH	Aftermarket	1	<b>591378P</b>	14.58	17.50
LH	Aftermarket	1	<b>591379P</b>	16.67	20.00

### Shaft Rear Axle

All models					
RH, 10/10 spline	Genuine	1	<b>591378</b>	91.98	110.38
LH, 10/10 spline	Genuine	1	<b>591379</b>	89.00	106.80

### Stub Shaft

All models - 10 spline	Genuine	2	<b>242520</b>	130.04	156.05
------------------------	---------	---	---------------	--------	--------

### Stub Axle Assembly Rear Hub

All models	Aftermarket	2	<b>599828P</b>	70.00	84.00
------------	-------------	---	----------------	-------	-------

### Stub Axle Nut

All models	Aftermarket	4	<b>FRC8700P</b>	1.25	1.50
	Genuine	4	<b>FRC8700</b>	10.09	12.11

### Driving Member

All models - 10 spline, front and rear	Genuine	1	<b>571235</b>	40.69	48.83
----------------------------------------	---------	---	---------------	-------	-------

### Bearing Swivel Pin Housing

All models	Aftermarket	2	<b>244150P</b>	11.04	13.25
	OEM	2	<b>244150P1</b>	17.29	20.75
	Genuine	2	<b>217288</b>	8.13	9.76

### Swivel Pin Housing

All models	Aftermarket	2	<b>539741P</b>	75.00	90.00
------------	-------------	---	----------------	-------	-------

### Distance Piece Swivel Pin

All models	Aftermarket	2	<b>244151P</b>	1.25	1.50
------------	-------------	---	----------------	------	------

### Retainer Swivel Pin Housing Seal

All models	Aftermarket	2	<b>235968P</b>	1.67	2.00
------------	-------------	---	----------------	------	------

### Leather Gaiter Kit Swivels

All models	Aftermarket	2	<b>276954P</b>	17.08	20.50
------------	-------------	---	----------------	-------	-------

### Swivel Housing Grease

All models					
Sachet	OEM	a/r	<b>STC3435P1</b>	5.00	6.00
	Genuine	a/r	<b>STC3435</b>	7.69	9.23
370ml sachet	Britpart	a/r	<b>STC3435BPSACHET</b>	4.38	5.26
370g bottle	Britpart	a/r	<b>STC3435BPBOTTLE</b>	4.79	5.75

### Oil Seal Diff Unit

All models	Aftermarket	1	<b>FRC4586P</b>	0.83	1.00
	OEM	1	<b>FRC4586P1</b>	3.50	4.20
	Genuine	1	<b>FRC4586</b>	11.66	13.99

### Oil Seal Front Axle Case

All models	OEM	1	<b>217400P1</b>	2.83	3.40
	Genuine	1	<b>217400</b>	5.21	6.25

### Oil Seal Hub

All models	Aftermarket	2	<b>RTC3510P</b>	1.25	1.50
	Genuine	2	<b>RTC3510</b>	6.29	7.55

### Oil Seal Rear Hub

All models - Felt/rubber, 10 spline type	Genuine	2	<b>RTC3515</b>	1.80	2.16
------------------------------------------	---------	---	----------------	------	------

### Oil Seal Output Shaft

All models	Aftermarket	1	<b>FRC1780</b>	0.79	0.95
------------	-------------	---	----------------	------	------

### Oil Seal Mainshaft Rear

All models	Genuine	1	<b>236305</b>	3.89	4.67
------------	---------	---	---------------	------	------

### Oil Seal, Transfer Box

All models					
Front & rear output shafts	Aftermarket	2	<b>236417P</b>	0.71	0.85
Felt type, output shaft	Aftermarket	1	<b>622042P</b>	0.50	0.60
	Genuine	1	<b>622042</b>	2.56	3.07

### Oil Seal Swivel Housing

All models	Aftermarket	2	<b>RTC3528P</b>	2.08	2.50
	Genuine	2	<b>RTC3528</b>	10.96	13.15

### Oil Seal Speedo Pinion

All models	Aftermarket	1	<b>211502P</b>	0.54	0.65
------------	-------------	---	----------------	------	------

### Drain Plug Diff Unit

All models	Aftermarket	1	<b>608246P</b>	2.33	2.80
	Genuine	1	<b>608246</b>	9.63	11.56

### Sealing Washer Drain Plug

All models					
Land Rover type axle	Aftermarket	1	<b>515599P</b>	0.33	0.40
	Genuine	1	<b>515599</b>	1.17	1.40
Transfer box	Genuine	1	<b>FRC4809</b>	0.80	0.96
Axle	Genuine	1	<b>FRC4809</b>	0.80	0.96

### Speedometer Drive Worm Gear

All models	OEM	1	<b>540004P1</b>	9.17	11.00
	Genuine	1	<b>540004</b>	35.69	42.83

# COOLING

## SERIES II 88 (1958-1971)

### Radiator Cap

All models - 10lb pressure	Aftermarket	1	<b>RTC3607P</b>	2.00	2.40
	Genuine	1	<b>RTC3607</b>	3.54	4.25

### Thermostat

All 2.0L petrol and diesel engine models					
74°C, hot climates option	Aftermarket	1	<b>GTS102</b>	3.33	4.00
82°C, std fitment	Aftermarket	1	<b>GTS104</b>	3.58	4.30
88°C, cold climates option	Aftermarket	1	<b>GTS106</b>	3.58	4.30
82°C	Aftermarket	1	<b>602687P</b>	2.58	3.10
	OEM	1	<b>602687P1</b>	3.58	4.30
	Genuine	1	<b>602687</b>	10.06	12.07
All 2.25L petrol engine models - 74°C	Aftermarket	1	<b>532453P</b>	2.42	2.90
	OEM	1	<b>532453P1</b>	30.00	36.00
	Genuine	1	<b>532453</b>	41.30	49.56
All 2.25L petrol engine models - 82°C	Aftermarket	1	<b>596225P</b>	2.75	3.30
	Genuine	1	<b>596225</b>	35.56	42.67

### Thermostat Housing Gasket

All 2.25L petrol models					
Upper	Aftermarket	1	<b>527110P</b>	0.21	0.25
Lower	Aftermarket	1	<b>247874P</b>	0.15	0.18
	Genuine	1	<b>247874</b>	1.74	2.09
To bypass connector	Genuine	1	<b>90511958</b>	1.34	1.61

### Thermostat Sealing Ring

All 2.25L petrol models	Genuine	1	<b>527235</b>	0.80	0.96
-------------------------	---------	---	---------------	------	------

### Water Pump

All 2.25L petrol engine models	Aftermarket	1	<b>STC3758P</b>	16.67	20.00
--------------------------------	-------------	---	-----------------	-------	-------

### Water Pump Inlet Housing Gasket

All 2.25L petrol and diesel engine models - Water pump inlet housing					
	Aftermarket	1	<b>ERR1607P</b>	0.25	0.30
	Genuine	1	<b>ERR1607</b>	1.67	2.00

# ELECTRICAL - ROTATING ELECTRICS

## SERIES II 88 (1958-1971)

### Starter Motor

All petrol models					
Replacement 2M100 type, new	Aftermarket	1	<b>RTC5225P</b>	100.00	120.00
Hi Torque, uprated	Powerlite	1	<b>RTC5225UR</b>	145.00	174.00

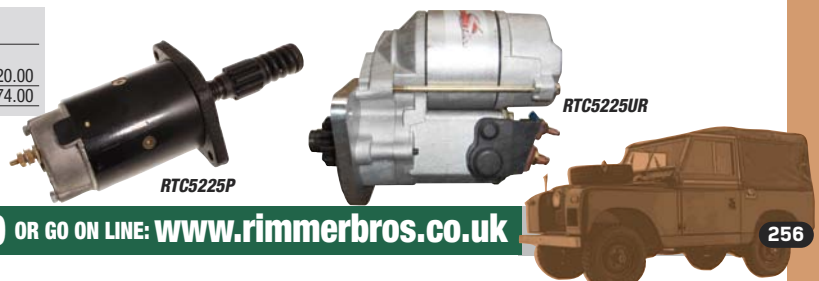

**SERIES II 88 (1958-1971)****ENGINE GASKETS****Gasket Rocker Cover**

All 2.0L diesel models				
Self adhesive	Aftermarket	1	<b>ETC6438P</b>	0.92 1.10
Standard	Genuine	1	<b>ETC6438</b>	7.20 8.64
All 2.25L petrol models				
Self adhesive	Aftermarket	1	<b>ERR4933P</b>	1.00 1.20
Standard	Genuine	1	<b>ERR4933</b>	11.78 14.14

**Gasket Side Rocker Cover**

All 2.0L petrol models				
	Aftermarket	1	<b>267779P</b>	1.17 1.40
	Genuine	1	<b>267779</b>	8.77 10.52

**Gasket Cylinder Head**

2.25L petrol models				
	Aftermarket	1	<b>ERC6380P</b>	3.25 3.90
	OEM	1	<b>ERC6380P1</b>	12.95 15.54
	Genuine	1	<b>ERC6380</b>	25.12 30.14

**Gasket Decoke Set**

2.25L petrol models				
	Aftermarket	1	<b>STC1556P</b>	8.33 10.00
	Aftermarket	1	<b>STC1567P</b>	10.00 12.00

**Gasket Oil Sump**

All models except 2.0L petrol				
	Aftermarket	1	<b>546841P</b>	1.00 1.20
	OEM	1	<b>546841P1</b>	2.42 2.90
	Genuine	1	<b>546841</b>	17.82 21.38

**Silicone Sealant RTV**

Numerous applications				
	Aftermarket	a/r	<b>RTC3254P</b>	5.00 6.00
	Genuine	a/r	<b>RTC3254</b>	21.04 25.25

**SERIES II 88 (1958-1971)****ENGINE SWITCHES****Oil Pressure Switch**

All models				
	Aftermarket	1	<b>90519864P</b>	1.75 2.10

**SERIES II 88 (1958-1971)****DRAIN PLUGS****Sump Plug**

All 2.25L petrol models				
	Genuine	1	<b>536577</b>	1.91 2.29

**Filler Plug**

All models - Steering box				
	Genuine	1	<b>271386</b>	5.92 7.10

**Drain Plug**

All models				
Gearbox drain				
	Aftermarket	1	<b>540870P</b>	0.75 0.90
	Genuine	1	<b>540870</b>	2.09 2.51
Front & rear differentials				
	Genuine	1	<b>235592</b>	11.48 13.78

**SERIES II 88 (1958-1971)****OIL SEALS ENGINE****Oil Seal Crankshaft Front**

All models				
	Aftermarket	1	<b>ERR6490P</b>	3.00 3.60
	OEM	1	<b>ERR6490P1</b>	5.00 6.00

**Oil Seal Crankshaft Rear**

2.25L petrol models				
	Aftermarket	1	<b>542492P</b>	1.75 2.10

**Oil Seal Kit Crankshaft Rear**

2.25L petrol models - Retainers and seal				
	Aftermarket	1	<b>542494P</b>	11.67 14.00

**Oil Seal Front Cover**

All models				
	Aftermarket	1	<b>ETC4154P</b>	1.08 1.30
	OEM	1	<b>ETC4154P1</b>	3.00 3.60
	Genuine	1	<b>ETC4154</b>	14.67 17.60

**SERIES II 88 (1958-1971)****ENGINE & GEARBOX MOUNTINGS****Engine Mounting**

All petrol engine models - Front				
	Aftermarket	2	<b>NRC2054P</b>	1.83 2.20
	Genuine	2	<b>NRC2054</b>	17.88 21.46
All diesel engine models - Engine and gearbox				
	Aftermarket	3	<b>NRC2052P</b>	2.00 2.40
	Genuine	3	<b>NRC2052</b>	11.94 14.33

**Gearbox Mounting**

All models				
	Aftermarket	1	<b>NRC2053P</b>	1.83 2.20
	Genuine	1	<b>NRC2053</b>	5.78 6.94

**Bracket Gearbox Mounting**

All models - RH				
	Genuine	1	<b>272501</b>	7.08 8.50

**SERIES II 88 (1958-1971)****CABLES****Speedometer Cable**

All models				
	Aftermarket	1	<b>RTC3484P</b>	4.58 5.50
	Genuine	1	<b>RTC3484</b>	71.21 85.45

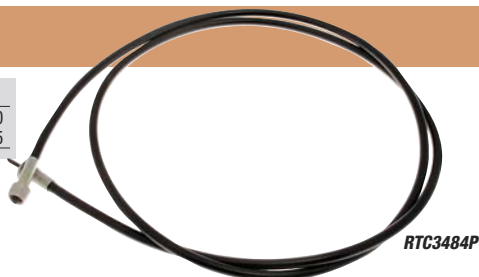
**SERIES II 88 (1958-1971)****WHEEL STUDS & WHEEL NUTS****Wheel Stud**

All models				
Screw-in type				
	Aftermarket	a/r	<b>561590P</b>	0.75 0.90
	Genuine	a/r	<b>561590</b>	3.51 4.21
Pull-in type				
	Aftermarket	a/r	<b>561886P</b>	0.58 0.70

**Wheel Nut**

All models - Tapered both ends				
	Aftermarket	a/r	<b>217361P</b>	0.42 0.50
	Genuine	a/r	<b>217361</b>	1.35 1.62

561590P



561886P



217361P





# SERIES II 109 (1958-1971)

## 1958-1971 - All Models

Listed below are the most popular parts required for the Series II 109.

We have access to the full range of parts for your vehicle. Please contact us if not listed here.



## FILTRATION

### SERIES II 109 (1958-1971)

#### Oil Filter

All 2.25L petrol models - Element	Aftermarket	1	<b>248863</b>	4.50	5.40
All 2.0L diesel models - Element	Aftermarket	1	<b>248863</b>	4.50	5.40
All 6 cylinder petrol & 2.0L Diesel engine models	Genuine	1	<b>RTC3183</b>	5.18	6.22

#### Fuel Filter Seal

All diesel engine models					
Top, for sedimentor filter	Aftermarket	1	<b>AAU9903P</b>	0.33	0.40
	Genuine	1	<b>AAU9903</b>	1.78	2.14
Bottom, for sedimentor filter	Aftermarket	1	<b>AAU9902P</b>	0.58	0.70
	Genuine	1	<b>AAU9902</b>	1.78	2.14

## SCREEN/LAMP WASHER SYSTEMS

### SERIES II 109 (1958-1971)

#### Windscreen Cleaning Paste

All models					
Prevents wiper blade judder/squeak by 'deep cleaning' the windscreen (ref: Land Rover Tech Bulletin LRA501-002)					
	Genuine	a/r	<b>DNJ500340</b>	7.72	9.26

## IGNITION SYSTEM

### SERIES II 109 (1958-1971)

#### Glow Plug

All 2.0L diesel engine models - Pigtail type					
	Aftermarket	4	<b>568335P</b>	5.00	6.00
	OEM	4	<b>568335P1</b>	10.83	13.00
	Genuine	4	<b>568335</b>	42.76	51.31

#### Rotor Arm

All 2.25L petrol engine models					
For type 25D distributor	Aftermarket	1	<b>GRA101</b>	2.50	3.00
Red, as original, for Lucas type 25D distributor	Lucas	1	<b>GRA101RED</b>	7.50	9.00

#### Glow Plug Parallel Conversion Kit

All 2.0L diesel engine models - Kit wires plugs in parallel instead of series					
	Britpart	1	<b>LL1530BP</b>	20.00	24.00
	Bearmach	1	<b>LL1530BM</b>	22.08	26.50

#### Condenser

All 2.25L petrol engine models - For type 25D distributor					
	Aftermarket	1	<b>RTC3472P</b>	1.25	1.50
	Aftermarket	1	<b>GSC111</b>	3.08	3.70
	Genuine	1	<b>RTC3472</b>	3.73	4.48

#### Replacement Set of Glow Plugs

All 2.0L diesel engine models - For Britpart glow plug parallel conversion kit					
	Britpart	1	<b>LL1530BPPLUG</b>	16.67	20.00

#### Distributor Cap

All 2.25L petrol engine models - For type 25D distributor, acorn nut terminals					
	Aftermarket	1	<b>GDC107</b>	10.00	12.00
All petrol models - With acorn nut type lead terminals					
	Genuine	1	<b>600328</b>	18.24	21.89

#### Contact Set

All 2.25L petrol engine models - For type 25D distributor					
	Aftermarket	1	<b>RTC3270P</b>	1.00	1.20
All 4 cyl petrol models fitted with non-original Lucas 59D type distributor					
Blue sliding contact type set	Aftermarket	1	<b>GCS261</b>	6.88	8.26

## BRAKING SYSTEM

### SERIES II 109 (1958-1971)

#### Brake Linings Set

All models					
Set of 4, with rivets, 11 dia brakes	Aftermarket	1	<b>STC3944P</b>	12.50	15.00

#### Master Cylinder Overhaul Kit

All models with CB type master cylinder - Brake master cylinder					
	Aftermarket	1	<b>503754P</b>	2.58	3.10

#### Brake Shoe Set

All models - Rear Brakes					
	Aftermarket	1	<b>STC2797P</b>	11.67	14.00
	OEM	1	<b>STC2797P1</b>	25.83	31.00
	Genuine	1	<b>STC2797</b>	191.25	229.50

#### Master Cylinder Repair Kit

All 4 cyl models with CV type master cylinder except station wagon - Brake master cylinder					
	Aftermarket	1	<b>GRK1027</b>	5.63	6.76

#### Brake Adjuster Kit

All models					
Front axle set	Aftermarket	1	<b>RTC3176P</b>	10.83	13.00
	Genuine	1	<b>RTC3176</b>	109.72	131.66
Front and Rear Brake Shoes	Aftermarket	1	<b>RTC3176P</b>	10.83	13.00
	Genuine	1	<b>RTC3176</b>	109.72	131.66

#### Brake Hose

All models					
Front and rear brake hose, also clutch hose, rubber					
	Aftermarket	2	<b>RTC3386P</b>	2.83	3.40
	OEM	2	<b>RTC3386P1</b>	9.58	11.50
	Genuine	2	<b>RTC3386</b>	17.29	20.75
Rear brake hose, rubber	Aftermarket	1	<b>RTC3353P</b>	3.00	3.60
	Genuine	1	<b>RTC3353</b>	16.47	19.76

#### Brake Shoe Spring

All models - Front Brakes					
	Genuine	1	<b>234889</b>	2.90	3.48

#### Brake Drum - Handbrake

All models - Handbrake					
	Aftermarket	1	<b>274423P</b>	9.58	11.50
	Genuine	1	<b>274423</b>	60.24	72.29

#### Brake Drum

All models					
Front, 11 Dia	Aftermarket	2	<b>516599P</b>	17.08	20.50
	Genuine	2	<b>516599</b>	104.29	125.15
Rear	Aftermarket	2	<b>576973P</b>	17.50	21.00
	Genuine	2	<b>576973</b>	90.40	108.48

#### Retaining Plate Handbrake

All models					
	Aftermarket	1	<b>515468P</b>	1.08	1.30
	Genuine	1	<b>515468</b>	2.30	2.76

#### Wheel Cylinder

All models					
Right Hand Front	Aftermarket	1	<b>243744P</b>	5.63	6.76
	OEM	1	<b>243744P1</b>	10.00	12.00
Left Hand Front	Aftermarket	1	<b>243743P</b>	5.63	6.76
	OEM	1	<b>243743P1</b>	10.00	12.00
Left Hand Rear	Aftermarket	1	<b>243297P</b>	5.83	7.00
	OEM	1	<b>243297P1</b>	13.54	16.25
	Genuine	1	<b>243297</b>	57.61	69.13

#### Locking Plate Handbrake

All models					
	Aftermarket	1	<b>515467P</b>	1.33	1.60
	Genuine	1	<b>515467</b>	1.72	2.06

#### Dust Cover Expander Unit

All models					
	OEM	1	<b>515466P1</b>	3.33	4.00
	Genuine	1	<b>515466</b>	4.49	5.39

#### Brake Master Cylinder

All models with CB type master cylinder - CB Type					
	Aftermarket	1	<b>564706P</b>	15.00	18.00



**SERIES II 109 (1958-1971)****SUSPENSION****Bush Shock Absorber Mounting**

All models - Rear, lower, rubber	Aftermarket	8	<b>552818P</b>	0.50	0.60
	Genuine	8	<b>552818</b>	1.38	1.66

**Front Chassis Bush**

All models	Aftermarket	2	<b>569746P</b>	1.58	1.90
	Genuine	2	<b>569746</b>	13.47	16.16

**Spring Eye Bush**

All models	Aftermarket	4	<b>548205P</b>	1.58	1.90
All models	Genuine	4	<b>548205</b>	4.14	4.97

**Shock Absorber Bush Kit**

All models - Front shock absorber bushes, dynamic orange Polybush	1	<b>LL1590</b>	29.58	35.50
-------------------------------------------------------------------	---	---------------	-------	-------

**Bush Shock Absorber Mounting**

All models - Rear, lower, poly, performance red	Polybush	1	<b>5528189PBR</b>	25.00	30.00
comfort blue	Polybush	1	<b>5528189PPBB</b>	25.00	30.00
dynamic orange	Polybush	1	<b>5528189PBO</b>	25.00	30.00
	Aftermarket	4	<b>552818POLY</b>	0.83	1.00

**Anti Roll Bar Bush**

All models - Rear, lower, poly.	Aftermarket	4	<b>552819POLY</b>	1.08	1.30
---------------------------------	-------------	---	-------------------	------	------

**Spring Eye Bush (pair)**

All models - poly., dynamic orange	Polybush	2	<b>548205POLYBUSH</b>	17.50	21.00
------------------------------------	----------	---	-----------------------	-------	-------

**Anti Roll Bar Bush**

All models - Shock absorber mounting, front upper and lower, rear lower, rubber	Aftermarket	4	<b>552819P</b>	0.19	0.23
	Genuine	4	<b>552819</b>	1.39	1.67

**Shock Absorber**

All models					
Front, std	Aftermarket	2	<b>RTC4234P</b>	21.67	26.00
Front, heavy duty	Aftermarket	2	<b>RTC4483P</b>	13.50	16.20
	OEM	2	<b>RTC4483P1</b>	23.75	28.50
	Genuine	2	<b>RTC4483</b>	82.14	98.57
Rear, heavy duty	Genuine	2	<b>RTC4236</b>	59.56	71.47

**Leaf Spring**

All 2.25L petrol models except 1 ton - 11 leaf, driver's side					
Front	Aftermarket	1	<b>265627P</b>	65.00	78.00
All 2.25L diesel models - 11 leaf, passenger's side,					
Front	Aftermarket	1	<b>265627P</b>	65.00	78.00
All models - 10 leaf, passenger's side,					
Rear	Aftermarket	1	<b>279679P</b>	107.50	129.00

**Parabolic Spring Kit**

All models					
Front springs, 2 leaf, pair, with U bolts	Britpart	1	<b>LL1484BP</b>	115.00	138.00
Rear springs, 4 leaf, pair, with U bolts	Britpart	1	<b>LL1485BPLWB</b>	220.83	265.00

**SERIES II 109 (1958-1971)****STEERING****Track Rod End**

All models					
RH imperial thread	Aftermarket	1	<b>320901P</b>	4.00	4.80
	OEM	1	<b>320901P1</b>	15.63	18.76
LH imperial thread	Aftermarket	1	<b>320902P</b>	3.75	4.50
	OEM	1	<b>320902P1</b>	13.13	15.76

**Track Rod Tube**

All models - With bracket	Aftermarket	1	<b>NRC4609P</b>	19.58	23.50
	Genuine	1	<b>NRC4609</b>	95.03	114.04

**Rubber Cap Track Rod End**

All models	Aftermarket	1	<b>214649P</b>	1.33	1.60
	Genuine	1	<b>214649</b>	4.57	5.48

**Spring Ring Track Rod End**

All models - Rubber cap, large diameter	Genuine	1	<b>214685</b>	3.15	3.78
-----------------------------------------	---------	---	---------------	------	------

**Spring Ring Track Rod End Boot**

All models	Genuine	1	<b>90214684</b>	0.96	1.15
------------	---------	---	-----------------	------	------

**Gasket Steering Box**

All models	Genuine	1	<b>271379</b>	2.06	2.47
------------	---------	---	---------------	------	------

**Oil Seal Steering Relay**

All models	Genuine	1	<b>213340</b>	3.52	4.22
------------	---------	---	---------------	------	------

**Steering Relay Lever**

All models	Genuine	1	<b>535286</b>	32.58	39.10
------------	---------	---	---------------	-------	-------

**Steering Relay Assembly**

All models	Aftermarket	1	<b>NRC1269P</b>	60.83	73.00
------------	-------------	---	-----------------	-------	-------

**Gasket Steering Relay Shaft**

All models	Genuine	1	<b>90624436</b>	0.55	0.66
------------	---------	---	-----------------	------	------

**SERIES II 109 (1958-1971)****CLUTCH****Clutch Cover**

All models					
Spring type cover, not diaphragm	Aftermarket	1	<b>591705P</b>	50.00	60.00
	OEM	1	<b>591705P1</b>	59.17	71.00
9 diameter	OEM	1	<b>GCC127</b>	75.83	91.00

**Clutch Plate**

All models fitted with std. 9" clutch - 9" dia.	OEM	1	<b>GCP109AFP</b>	20.00	24.00
	Genuine	1	<b>GCP109AF</b>	42.08	50.50

**Clutch Release Bearing**

All models	Aftermarket	1	<b>STC1130P</b>	1.58	1.90
	OEM	1	<b>STC1130P1</b>	4.00	4.80
	Genuine	1	<b>STC1130</b>	53.81	64.57

**Spherical Bearing**

All models - Clutch release shaft	Genuine	1	<b>90217984</b>	22.18	26.62
-----------------------------------	---------	---	-----------------	-------	-------

**Master Cylinder Repair Kit**

All models - Clutch master cylinder	Aftermarket	1	<b>GRK1027P</b>	2.08	2.50
	OEM	1	<b>GRK1027</b>	5.63	6.76

**Pedal Pad Clutch & Brake**

All models - Clutch and brake pedals	Aftermarket	2	<b>278166P</b>	1.83	2.20
	Genuine	2	<b>278166</b>	6.94	8.33

**Oil Seal Clutch Cross Shaft**

All models	Genuine	1	<b>90214787</b>	27.16	32.59
------------	---------	---	-----------------	-------	-------



# TRANSMISSION

**SERIES II 109 (1958-1971)**

## Gaiter Propshaft c/w Clips

All models - Front	Aftermarket	1	<b>276484P</b>	2.33	2.80
	Genuine	1	<b>276484</b>	22.65	27.18

## Gaiter Propshaft

All models	Aftermarket	1	<b>276483P</b>	3.00	3.60
	Genuine	1	<b>276483</b>	24.73	29.68

## Universal Joint

All models - Front half shaft	Genuine	2	<b>RTC3690</b>	41.27	49.52
-------------------------------	---------	---	----------------	-------	-------

## Half Shaft, Bare

All models - Front axle					
	RH	Genuine	1	<b>276719</b>	195.70 234.84
	LH	Genuine	1	<b>276720</b>	251.51 301.81

## Stub Shaft

All models - 10 spline	Genuine	2	<b>242520</b>	130.04	156.05
------------------------	---------	---	---------------	--------	--------

## Stub Axle Assembly

All models	Genuine	2	<b>599827</b>	162.42	194.90
------------	---------	---	---------------	--------	--------

## Stub Axle Assembly Rear Hub

All models	Aftermarket	2	<b>599828P</b>	70.00	84.00
------------	-------------	---	----------------	-------	-------

## Stub Axle Nut

All models	Aftermarket	4	<b>FRC8700P</b>	1.25	1.50
	Genuine	4	<b>FRC8700</b>	10.09	12.11

## Bearing Swivel Pin Housing

All models	Aftermarket	2	<b>244150P</b>	11.04	13.25
	OEM	2	<b>244150P1</b>	17.29	20.75
	Genuine	2	<b>217268</b>	8.13	9.76

## Swivel Pin Housing

All models	Aftermarket	2	<b>539741P</b>	75.00	90.00
------------	-------------	---	----------------	-------	-------

## Distance Piece Swivel Pin

All models	Aftermarket	2	<b>244151P</b>	1.25	1.50
------------	-------------	---	----------------	------	------

## Retainer Swivel Pin Housing Seal

All models	Aftermarket	2	<b>235968P</b>	1.67	2.00
------------	-------------	---	----------------	------	------

## Leather Gaiter Kit Swivels

All models	Aftermarket	2	<b>276954P</b>	17.08	20.50
------------	-------------	---	----------------	-------	-------

## Swivel Housing Grease

All models	Sachet	OEM	a/r	<b>STC3435P1</b>	5.00	6.00
		Genuine	a/r	<b>STC3435</b>	7.69	9.23
	370ml sachet	Britpart	a/r	<b>STC3435BPSACHET</b>	4.38	5.26
370g bottle	Britpart	a/r	<b>STC3435BPBOTTLE</b>	4.79	5.75	

## Oil Seal Diff Unit

All models front axle only	Aftermarket	1	<b>FRC4586P</b>	0.83	1.00
	OEM	1	<b>FRC4586P1</b>	3.50	4.20
	Genuine	1	<b>FRC4586</b>	11.66	13.99

## Oil Seal Front Axle Case

All models	OEM	1	<b>217400P1</b>	2.83	3.40
	Genuine	1	<b>217400</b>	5.21	6.25

## Oil Seal Hub

All models	Aftermarket	2	<b>RTC3510P</b>	1.25	1.50
	Genuine	2	<b>RTC3510</b>	6.29	7.55

## Oil Seal Rear Hub

All models - Felt/rubber, 10 spline type	Genuine	2	<b>RTC3515</b>	1.80	2.16
------------------------------------------	---------	---	----------------	------	------

## Oil Seal Output Shaft

All models	Aftermarket	1	<b>FRC1780</b>	0.79	0.95
------------	-------------	---	----------------	------	------

## Oil Seal Mainshaft Rear

All models	Genuine	1	<b>236305</b>	3.89	4.67
------------	---------	---	---------------	------	------

## Oil Seal, Transfer Box

All models	Front & rear output shafts		Aftermarket	2	<b>236417P</b>	0.71	0.85
	Felt type, output shaft		Aftermarket	1	<b>622042P</b>	0.50	0.60
			Genuine	1	<b>622042</b>	2.56	3.07

## Oil Seal Swivel Housing

All models	Aftermarket	2	<b>RTC3528P</b>	2.08	2.50
	Genuine	2	<b>RTC3528</b>	10.96	13.15

## Drain Plug Diff Unit

All models	Aftermarket	1	<b>608246P</b>	2.33	2.80
	Genuine	1	<b>608246</b>	9.63	11.56

## Sealing Washer Drain Plug

All models - Land Rover type axle	Aftermarket	1	<b>515599P</b>	0.33	0.40	
		Genuine	1	<b>515599</b>	1.17	1.40
	Transfer box	Genuine	1	<b>FRC4809</b>	0.80	0.96
		Axle	Genuine	1	<b>FRC4809</b>	0.80

## Speedometer Drive Worm Gear

All models	OEM	1	<b>540004P1</b>	9.17	11.00
	Genuine	1	<b>540004</b>	35.69	42.83



# COOLING

**SERIES II 109 (1958-1971)**

## Radiator Cap

All models - 10lb pressure	Aftermarket	1	<b>RTC3607P</b>	2.00	2.40
	Genuine	1	<b>RTC3607</b>	3.54	4.25

## Thermostat

All 2.0L petrol and diesel engine models	74°C, hot climates option	Aftermarket	1	<b>GTS102</b>	3.33	4.00
	82°C, std fitment	Aftermarket	1	<b>GTS104</b>	3.58	4.30
	88°C, cold climates option	Aftermarket	1	<b>GTS106</b>	3.58	4.30
All 2.25L petrol engine models	74°C	Aftermarket	1	<b>532453P</b>	2.42	2.90
		OEM	1	<b>532453P1</b>	30.00	36.00
		Genuine	1	<b>532453</b>	41.30	49.56
	82°C	Aftermarket	1	<b>596225P</b>	2.75	3.30
		Genuine	1	<b>596225</b>	35.56	42.67

## Thermostat Housing Gasket

All 2.25L petrol models	Upper		Aftermarket	1	<b>527110P</b>	0.21	0.25
	Lower		Aftermarket	1	<b>247874P</b>	0.15	0.18
			Genuine	1	<b>247874</b>	1.74	2.09
	To bypass connector		Genuine	1	<b>90511958</b>	1.34	1.61

## Thermostat Sealing Ring

All 2.25L petrol models	Genuine	1	<b>527235</b>	0.80	0.96
-------------------------	---------	---	---------------	------	------

## Water Pump

All 2.25L petrol engine models	Aftermarket	1	<b>STC3758P</b>	16.67	20.00
--------------------------------	-------------	---	-----------------	-------	-------

## Water Pump Inlet Housing Gasket

All 2.25L petrol and diesel engine models	Water pump inlet housing		Aftermarket	1	<b>ERR1607P</b>	0.25	0.30
			Genuine	1	<b>ERR1607</b>	1.67	2.00

# ELECTRICAL - ROTATING ELECTRICS

**SERIES II 109 (1958-1971)**

## Starter Motor

All petrol models	Replacement 2M100 type, new		Aftermarket	1	<b>RTC5225P</b>	100.00	120.00
	Hi Torque, uprated		Powerlite	1	<b>RTC5225UR</b>	145.00	174.00





**SERIES II 109 (1958-1971)****ENGINE GASKETS****Gasket Rocker Cover**

All 2.0L diesel models				
Self adhesive	Aftermarket	1	<b>ETC6438P</b>	0.92 1.10
Standard	Genuine	1	<b>ETC6438</b>	7.20 8.64
All 2.25L petrol models				
Self adhesive	Aftermarket	1	<b>ERR4933P</b>	1.00 1.20
Standard	Genuine	1	<b>ERR4933</b>	11.78 14.14

**Gasket Side Rocker Cover**

All 2.0L petrol models				
	Aftermarket	1	<b>267779P</b>	1.17 1.40
	Genuine	1	<b>267779</b>	8.77 10.52

**Gasket Cylinder Head**

2.25L petrol models				
	Aftermarket	1	<b>ERC6380P</b>	3.25 3.90
	OEM	1	<b>ERC6380P1</b>	12.95 15.54
	Genuine	1	<b>ERC6380</b>	25.12 30.14

**Gasket Decoke Set**

All 2.25L petrol models				
	Aftermarket	1	<b>STC1556P</b>	8.33 10.00
	Aftermarket	1	<b>STC1567P</b>	10.00 12.00

**Gasket Oil Sump**

All models except 2.0L petrol				
	Aftermarket	1	<b>546841P</b>	1.00 1.20
	OEM	1	<b>546841P1</b>	2.42 2.90
	Genuine	1	<b>546841</b>	17.82 21.38

**Silicone Sealant RTV**

Numerous applications				
	Aftermarket	a/r	<b>RTC3254P</b>	5.00 6.00
	Genuine	a/r	<b>RTC3254</b>	21.04 25.25

**SERIES II 109 (1958-1971)****ENGINE SWITCHES****Oil Pressure Switch**

All models				
	Aftermarket	1	<b>90519864P</b>	1.75 2.10

**SERIES II 109 (1958-1971)****DRAIN PLUGS****Sump Plug**

All 2.25L petrol models				
	Genuine	1	<b>536577</b>	1.91 2.29

**Sump Plug Washer**

All petrol and diesel models				
	Aftermarket	1	<b>243959P</b>	0.38 0.46
	Genuine	1	<b>243959</b>	0.82 0.98

**Drain Plug**

All models					
Gearbox drain		Aftermarket	1	<b>540870P</b>	0.75 0.90
		Genuine	1	<b>540870</b>	2.09 2.51
Front differential		Genuine	1	<b>235592</b>	11.48 13.78

**Filler Plug**

All models - Steering box				
	Genuine	1	<b>271386</b>	5.92 7.10

**SERIES II 109 (1958-1971)****OIL SEALS ENGINE****Oil Seal Crankshaft Front**

All models				
	Aftermarket	1	<b>ERR6490P</b>	3.00 3.60
	OEM	1	<b>ERR6490P1</b>	5.00 6.00

**Oil Seal Crankshaft Rear**

2.25L petrol models				
	Aftermarket	1	<b>542492P</b>	1.75 2.10

**Oil Seal Kit Crankshaft Rear**

2.25L petrol models - Retainers and seal				
	Aftermarket	1	<b>542494P</b>	11.67 14.00

**Oil Seal Front Cover**

All models				
	Aftermarket	1	<b>ETC4154P</b>	1.08 1.30
	OEM	1	<b>ETC4154P1</b>	3.00 3.60
	Genuine	1	<b>ETC4154</b>	14.67 17.60

**SERIES II 109 (1958-1971)****ENGINE & GEARBOX MOUNTINGS****Engine Mounting**

All petrol engine models - Front				
	Aftermarket	2	<b>NRC2054P</b>	1.83 2.20
	Genuine	2	<b>NRC2054</b>	17.88 21.46
All diesel engine models - Engine and gearbox				
	Aftermarket	3	<b>NRC2052P</b>	2.00 2.40
	Genuine	3	<b>NRC2052</b>	11.94 14.33

**Gearbox Mounting**

All models				
	Aftermarket	1	<b>NRC2053P</b>	1.83 2.20
	Genuine	1	<b>NRC2053</b>	5.78 6.94

**Bracket Gearbox Mounting**

All models - RH				
	Genuine	1	<b>272501</b>	7.08 8.50

**SERIES II 109 (1958-1971)****CABLES****Speedometer Cable**

All models				
	Aftermarket	1	<b>RTC3484P</b>	4.58 5.50
	Genuine	1	<b>RTC3484</b>	71.21 85.45

**SERIES II 109 (1958-1971)****WHEEL STUDS & WHEEL NUTS****Wheel Stud**

All models					
Screw-in type		Aftermarket	a/r	<b>561590P</b>	0.75 0.90
		Genuine	a/r	<b>561590</b>	3.51 4.21
Pull-in type		Aftermarket	a/r	<b>561886P</b>	0.58 0.70

**Wheel Nut**

All models - Tapered both ends				
	Aftermarket	a/r	<b>217361P</b>	0.42 0.50
	Genuine	a/r	<b>217361</b>	1.35 1.62



# SERIES IIa 88 (1958-1971)

## 1958-1971 - All Models

Listed below are the most popular parts required for the Series IIa 88.

We have access to the full range of parts for your vehicle. Please contact us if not listed here.



## SERVICE KITS

### Service Kit

2.25L petrol models

Oil filter, fuel filter (in-line), spark plugs, points (fixed), condenser, sump plug washer	Bearmach	1	<b>LL1540BMLUCFIXED</b>	10.83	13.00
Oil filter, fuel filter (in-line), spark plugs, points (sliding), condenser, sump plug washer	Bearmach	1	<b>LL1540BMLUCSLIDE</b>	11.25	13.50



## SERIES IIa 88 (1958-1971)

## FILTRATION

### Oil Filter

All 2.25L petrol and diesel models to 1962 - Element	Aftermarket	1	<b>248863</b>	4.50	5.40
All 2.25L petrol and diesel engines from 1964 on - Element	Aftermarket	1	<b>RTC3184P</b>	1.83	2.20
	Genuine	1	<b>RTC3184</b>	8.57	10.28
All 6 cylinder petrol & 2.0L Diesel engine models	Genuine	1	<b>RTC3183</b>	5.18	6.22

### Fuel Filter

All 2.25L diesel models - Element for in line filter assembly	Aftermarket	1	<b>90517711P</b>	1.83	2.20
	Aftermarket	1	<b>GFE5296</b>	3.50	4.20
	Genuine	1	<b>90517711</b>	4.92	5.90

### Seal Air Cleaner

All 2.25L petrol models 1968 on	Aftermarket	1	<b>554418P</b>	2.00	2.40
---------------------------------	-------------	---	----------------	------	------

### Fuel Filter Complete Assembly

All diesel engine models - Sedimentor type	Aftermarket	1	<b>NRC9708P</b>	17.08	20.50
	OEM	1	<b>NRC9708P1</b>	26.67	32.00
	Genuine	1	<b>NRC9708</b>	76.51	91.81

### Fuel Filter Seal

All diesel engine models					
Top, for sedimentor filter	Aftermarket	1	<b>AAU9903P</b>	0.33	0.40
	Genuine	1	<b>AAU9903</b>	1.78	2.14
Bottom, for sedimentor filter	Aftermarket	1	<b>AAU9902P</b>	0.58	0.70
	Genuine	1	<b>AAU9902</b>	1.78	2.14



## WIPER BLADES

### Wiper Blade

All models					
Front, sprung, bayonet push-on fitting					
Stainless steel	Aftermarket	2	<b>PRC3386</b>	3.33	4.00
Black	Aftermarket	2	<b>LR009343PS</b>	3.33	4.00
Front, not sprung, bayonet push-on fitting					
	Aftermarket	2	<b>LR009343PF</b>	5.42	6.50



## SERIES IIa 88 (1958-1971)

## SCREEN/LAMP WASHER SYSTEMS

### Washer Jet

All models from 1968 on - Front screen, replaces original metal stem jet					
	Aftermarket	2	<b>PRC2437P</b>	2.25	2.70
	Genuine	2	<b>PRC2437</b>	7.56	9.07

### Washer Pump

All models - Front screen	Aftermarket	1	<b>GW125</b>	9.38	11.26
---------------------------	-------------	---	--------------	------	-------

### Windscreen Cleaning Paste

All models					
Prevents wiper blade judder/squeak by 'deep cleaning' the windscreen (ref: Land Rover Tech Bulletin LRA501-002)					
	Genuine	a/r	<b>DNJ500340</b>	7.72	9.26

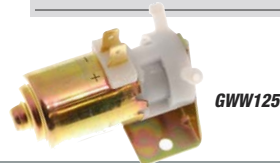

## DRIVE BELTS



### Fan Belt

All civilian models with 2.25L 4 cyl engines - Fan					
	Aftermarket	1	<b>563132 L-RP</b>	1.25	1.50

## SERIES IIa 88 (1958-1971)



## SERIES IIa 88 (1958-1971)

# IGNITION SYSTEM

### Spark Plug

All 2.25L 8.0:1CR petrol models - RN11YC type

Aftermarket	4	<b>ERR3799P</b>	2.00	2.40
Genuine	4	<b>ERR3799</b>	4.19	5.03

### Glow Plug

All 2.25L diesel engine models - Pigtail type

Aftermarket	4	<b>568335P</b>	5.00	6.00
OEM	4	<b>568335P1</b>	10.83	13.00
Genuine	4	<b>568335</b>	42.76	51.31

### Glow Plug Parallel Conversion Kit

All 2.25L diesel engine models - Kit wires plugs in parallel instead of series

Britpart	1	<b>LL1530BP</b>	20.00	24.00
Bearmach	1	<b>LL1530BM</b>	22.08	26.50

### Replacement Set of Glow Plugs

All 2.25L diesel engine models - For Britpart glow plug parallel conversion kit

Britpart	1	<b>LL1530PPLUG</b>	16.67	20.00
----------	---	--------------------	-------	-------

### Ignition Coil

All 4 cyl petrol engine models

Aftermarket	1	<b>PRC9858P</b>	7.35	8.82
OEM	1	<b>PRC9858P1</b>	12.92	15.50
Genuine	1	<b>PRC9858</b>	77.61	93.13

All petrol models with push-in type coil lead connection

Std coil

Aftermarket	1	<b>GCL110</b>	12.50	15.00
Lucas	1	<b>GCL110LUCAS</b>	16.67	20.00

Sports coil

Lucas	1	<b>GCL110HP</b>	19.58	23.50
-------	---	-----------------	-------	-------

### Contact Set

All 2.25L petrol engine models with 12V system

For type 25D distributor

Aftermarket	1	<b>RTC3270P</b>	1.00	1.20
-------------	---	-----------------	------	------

All 4 cyl petrol models fitted with non-original Lucas 59D type distributor

Blue sliding contact type set

Aftermarket	1	<b>GCS261</b>	6.88	8.26
-------------	---	---------------	------	------

### Rotor Arm

All 2.25L petrol engine models

For type 25D distributor

Aftermarket	1	<b>GRA101</b>	2.50	3.00
-------------	---	---------------	------	------

Red, as original, for Lucas type 25D distributor

Lucas	1	<b>GRA101RED</b>	7.50	9.00
-------	---	------------------	------	------

### Condenser

All 2.25L petrol engine models - For type 25D distributor

Aftermarket	1	<b>RTC3472P</b>	1.25	1.50
Aftermarket	1	<b>GSC111</b>	3.08	3.70
Genuine	1	<b>RTC3472</b>	3.73	4.48

### Distributor Cap

All 2.25L petrol engine models up to 1967 - For type 25D distributor, acorn nut terminals

Aftermarket	1	<b>GDC107</b>	10.00	12.00
-------------	---	---------------	-------	-------

All 2.25L petrol engine models from 1968 on - For type 25D distributor, push on terminals

Aftermarket	1	<b>GDC103</b>	3.75	4.50
-------------	---	---------------	------	------

All 4 cyl petrol models up to 1967 approx. - With acorn nut type lead terminals

Genuine	1	<b>600328</b>	18.24	21.89
---------	---	---------------	-------	-------

### Ignition Lead Set

2.25L petrol engine models from 1967 on

Aftermarket	1	<b>ERC3256P</b>	6.04	7.25
Genuine	1	<b>ERC3256</b>	51.30	61.56



## SERIES IIa 88 (1958-1971)

# BRAKING SYSTEM

### Brake Shoe Set

All models - Front and Rear Brakes

Aftermarket	1	<b>STC2796P</b>	9.38	11.26
OEM	1	<b>STC2796P1</b>	27.08	32.50

### Brake Adjuster Kit

All models - Front and Rear Brake Shoes

Aftermarket	1	<b>RTC3176P</b>	10.83	13.00
Genuine	1	<b>RTC3176</b>	109.72	131.66

### Brake Shoe Spring

All models - 10" brake type

Aftermarket	1	<b>503981P</b>	0.58	0.70
Genuine	1	<b>503981</b>	2.30	2.76

All models - Front and Rear Brakes

Aftermarket	2	<b>218983P</b>	0.58	0.70
Genuine	2	<b>218983</b>	2.90	3.48

### Brake Drum

All models up to (VIN) Suffix G

Front and Rear, 10" Dia

Aftermarket	2	<b>591661P</b>	16.67	20.00
-------------	---	----------------	-------	-------

All models from (VIN) Suffix H on

Front and Rear

Aftermarket	2	<b>591039P</b>	13.13	15.76
Genuine	2	<b>591039</b>	82.60	99.12

### Wheel Cylinder

All models

Left Hand Front

Aftermarket	1	<b>243297P</b>	5.83	7.00
OEM	1	<b>243297P1</b>	13.54	16.25
Genuine	1	<b>243297</b>	57.61	69.13

Right Hand Rear

Aftermarket	1	<b>243302P</b>	5.83	7.00
OEM	1	<b>243302P1</b>	39.58	47.50

Left Hand Rear

Aftermarket	1	<b>243303P</b>	5.63	6.76
OEM	1	<b>243303P1</b>	35.00	42.00
Genuine	1	<b>243303</b>	65.87	79.04

### Brake Master Cylinder

Single circuit brakes, petrol from (VIN) 24131337D and 24431622D

CV type, without nut on back of cylinder

Aftermarket	1	<b>90569126P</b>	8.54	10.25
OEM	1	<b>90569126P1</b>	29.58	35.50

Single circuit brakes, diesel from (VIN) 27108694D and 27405073D

CV type, without nut on back of cylinder

Aftermarket	1	<b>90569126P</b>	8.54	10.25
OEM	1	<b>90569126P1</b>	29.58	35.50

All models with CB type master cylinder

CB Type

Aftermarket	1	<b>520849P</b>	15.00	18.00
Genuine	1	<b>520849</b>	603.40	724.08

### Master Cylinder Overhaul Kit

All models with CB type master cylinder to 1966 - Brake master cylinder

Aftermarket	1	<b>STC1116P</b>	1.58	1.90
-------------	---	-----------------	------	------

### Master Cylinder Repair Kit

All models with CV type master cylinder - Brake master cylinder

Aftermarket	1	<b>GRK1027</b>	5.63	6.76
-------------	---	----------------	------	------

### Brake Hose

All models - Front and rear brake hose, also clutch hose, rubber

Aftermarket	1	<b>RTC3386P</b>	2.83	3.40
OEM	1	<b>RTC3386P1</b>	9.58	11.50
Genuine	1	<b>RTC3386</b>	17.29	20.75

### Brake Shoe Set - Handbrake

All models from 1964 on - Handbrake

Aftermarket	1	<b>STC3821P</b>	5.83	7.00
-------------	---	-----------------	------	------

### Brake Drum - Handbrake

All models - Handbrake

Aftermarket	1	<b>274423P</b>	9.58	11.50
Genuine	1	<b>274423</b>	60.24	72.29

### Retaining Plate Handbrake

All models

Aftermarket	1	<b>515468P</b>	1.08	1.30
Genuine	1	<b>515468</b>	2.30	2.76

### Locking Plate Handbrake

All models

Aftermarket	1	<b>515467P</b>	1.33	1.60
Genuine	1	<b>515467</b>	1.72	2.06

### Dust Cover Expander Unit

All models

OEM	1	<b>515466P1</b>	3.33	4.00
Genuine	1	<b>515466</b>	4.49	5.39





# SUSPENSION

**SERIES IIa 88 (1958-1971)**

## Bush Shock Absorber Mounting

All models - Rear, lower, rubber	Aftermarket	8	<b>552818P</b>	0.50	0.60
	Genuine	8	<b>552818</b>	1.38	1.66

## Front Chassis Bush

All models	Aftermarket	2	<b>569746P</b>	1.58	1.90
	Genuine	2	<b>569746</b>	13.47	16.16

## Bush, Swivel Pin

All models 1965 on - Railko bush	Aftermarket	2	<b>539742P</b>	5.83	7.00
	Genuine	2	<b>539742</b>	21.71	26.05

## Spring Eye Bush

All models	Aftermarket	4	<b>548205P</b>	1.58	1.90
	Genuine	4	<b>548205</b>	4.14	4.97

## Shock Absorber Bush Kit

All models - Front shock absorber bushes dynamic orange	Polybush	1	<b>LL1590</b>	29.58	35.50
---------------------------------------------------------	----------	---	---------------	-------	-------

## Bush Shock Absorber Mounting

All models - Rear, lower, poly, performance red comfort blue dynamic orange	Polybush	1	<b>5528189PBR</b>	25.00	30.00
	Polybush	1	<b>5528189PPBB</b>	25.00	30.00
	Polybush	1	<b>5528189PBO</b>	25.00	30.00
	Aftermarket	4	<b>5528189POLY</b>	0.83	1.00

## Anti Roll Bar Bush

All models - Rear, lower, poly.	Aftermarket	4	<b>552819POLY</b>	1.08	1.30
---------------------------------	-------------	---	-------------------	------	------

## Spring Eye Bush (pair)

All models - poly., dynamic orange	Polybush	2	<b>548205POLYBUSH</b>	17.50	21.00
------------------------------------	----------	---	-----------------------	-------	-------

## Shock Absorber

All models - Front, heavy duty	Aftermarket	2	<b>RTC4234P</b>	21.67	26.00
--------------------------------	-------------	---	-----------------	-------	-------

## Shock Absorber Mounting

All models - Front upper and lower, rear lower, rubber	Aftermarket	4	<b>552819P</b>	0.19	0.23
	Genuine	4	<b>552819</b>	1.39	1.67

## Leaf Spring

All 2.25L petrol models	9 leaf, driver's side, front	Aftermarket	1	<b>241283P</b>	65.00	78.00	
		OEM	1	<b>241283P1</b>	75.00	90.00	
	9 leaf, passenger's side, front	OEM	1	<b>242863P1</b>	75.00	90.00	
All 2.25L diesel models	11 leaf, driver's side, front	Aftermarket	1	<b>265627P</b>	65.00	78.00	
	All models	11 leaf, driver's side, rear	OEM	1	<b>517588P1</b>	99.17	119.00
		Genuine	1	<b>517588</b>	176.59	211.91	
11 leaf, passenger's side, rear	OEM	1	<b>517589P1</b>	99.17	119.00		
Rear, both sides; main leaf only (not spring assembly)	OEM	2	<b>243123P1</b>	33.33	40.00		
	Genuine	2	<b>243123</b>	49.61	59.53		

## Parabolic Spring Kit

All models	Front springs, 2 leaf, pair, with U bolts	Britpart	1	<b>LL1484BP</b>	115.00	138.00
	Rear springs, 3 leaf, pair, with U bolts	Britpart	1	<b>LL1485BPSWB</b>	175.00	210.00

## Swivel Pin, Upper

All models 1965 on - For Railko bush	Aftermarket	2	<b>576583P</b>	4.17	5.00
	OEM	2	<b>576583P1</b>	6.67	8.00
	Genuine	2	<b>576583</b>	28.20	33.84

# STEERING

**SERIES IIa 88 (1958-1971)**

## Draglink Tube

All models - With damper bracket	Aftermarket	1	<b>NRC4609P</b>	19.58	23.50
	Genuine	1	<b>NRC4609</b>	95.03	114.04

## Bearing Steering Column

All models from 1968 on - Top	Aftermarket	1	<b>RTC324P</b>	5.63	6.76
	Genuine	1	<b>RTC324</b>	15.64	18.77

## Track Rod End

All models	RH imperial thread	Aftermarket	1	<b>320901P</b>	4.00	4.80
		OEM	1	<b>320901P1</b>	15.63	18.76
	LH imperial thread	Aftermarket	1	<b>320902P</b>	3.75	4.50
		OEM	1	<b>320902P1</b>	13.13	15.76
	With bracket	Aftermarket	1	<b>NRC4609P</b>	19.58	23.50
		Genuine	1	<b>NRC4609</b>	95.03	114.04
	Without bracket	Genuine	1	<b>526994</b>	126.52	151.82

## Rubber Cap Track Rod End

All models	Aftermarket	1	<b>214649P</b>	1.33	1.60
	Genuine	1	<b>214649</b>	4.57	5.48

## Spring Ring Track Rod End

All models - Rubber cap, large diameter	Genuine	1	<b>214685</b>	3.15	3.78
-----------------------------------------	---------	---	---------------	------	------

## Spring Ring Track Rod End Boot

All models	Genuine	1	<b>90214684</b>	0.96	1.15
------------	---------	---	-----------------	------	------

## Gasket Steering Box

All models	Genuine	1	<b>271379</b>	2.06	2.47
------------	---------	---	---------------	------	------

## Oil Seal Steering Relay

All models	Genuine	1	<b>213340</b>	3.52	4.22
------------	---------	---	---------------	------	------

## Steering Relay Lever

All models	Genuine	1	<b>535286</b>	32.58	39.10
------------	---------	---	---------------	-------	-------

## Steering Relay Assembly

All models	Aftermarket	1	<b>NRC1269P</b>	60.83	73.00
------------	-------------	---	-----------------	-------	-------

## Gasket Steering Relay Shaft

All models	Genuine	1	<b>90624436</b>	0.55	0.66
------------	---------	---	-----------------	------	------

# CLUTCH

**SERIES IIa 88 (1958-1971)**

## Clutch Cover

All models up to 1969	Spring type cover, not diaphragm	Aftermarket	1	<b>591705P</b>	50.00	60.00
		OEM	1	<b>591705P1</b>	59.17	71.00
		OEM	1	<b>GCC127</b>	75.83	91.00
All models from 1969 on - 9.5" diameter, Diaphragm type	Diaphragm type	Aftermarket	1	<b>576557P</b>	27.50	33.00
		OEM	1	<b>576557P1</b>	36.67	44.00
		Genuine	1	<b>576557</b>	116.97	140.36
		OEM	1	<b>571228P1</b>	52.50	63.00

## Clutch Plate

All models fitted with std. 9" clutch up to 1969 - 9" dia., not for diaphragm clutch	OEM	1	<b>GCP109AFP</b>	20.00	24.00	
		1	<b>GCP109AF</b>	42.08	50.50	
	All models from 1969 on - 9.5" diameter	Aftermarket	1	<b>8510290P</b>	19.58	23.50
		OEM	1	<b>8510290P1</b>	32.50	39.00
	Genuine	1	<b>8510290</b>	67.84	81.41	

## Clutch Release Bearing

All models	Aftermarket	1	<b>STC1130P</b>	1.58	1.90
	OEM	1	<b>STC1130P1</b>	4.00	4.80
	Genuine	1	<b>STC1130</b>	53.81	64.57
	All models from 1969 on - Sealed type	Genuine	1	<b>268053</b>	99.36

## Spherical Bearing

All models - Clutch release shaft	Genuine	1	<b>90217984</b>	22.18	26.62
-----------------------------------	---------	---	-----------------	-------	-------

## Master Cylinder Repair Kit

All models - Clutch master cylinder	Aftermarket	1	<b>GRK1027P</b>	2.08	2.50
	OEM	1	<b>GRK1027</b>	5.63	6.76

## Pedal Pad Clutch & Brake

All models - Clutch and brake pedals	Aftermarket	2	<b>278166P</b>	1.83	2.20
	Genuine	2	<b>278166</b>	6.94	8.33

## Oil Seal Clutch Cross Shaft

All models	Genuine	1	<b>90214787</b>	27.16	32.59
------------	---------	---	-----------------	-------	-------

**STC1130P1**

**SERIES IIa 88 (1958-1971)****TRANSMISSION****Gaiter Propshaft c/w Clips**

All models - Front	Aftermarket	1	<b>276484P</b>	2.33	2.80
	Genuine	1	<b>276484</b>	22.65	27.18

**Gaiter Propshaft**

All models	Aftermarket	1	<b>276483P</b>	3.00	3.60
	Genuine	1	<b>276483</b>	24.73	29.68

**Universal Joint**

All models - Front half shaft	Genuine	2	<b>RTC3690</b>	41.27	49.52
All models 1964 on - Propshaft	Aftermarket	2	<b>RTC3346P</b>	3.50	4.20
	OEM	2	<b>RTC3346P1</b>	8.13	9.76
	Genuine	2	<b>RTC3346</b>	49.81	59.77

**Half Shaft, Bare**

All models	Front axle, RH	Genuine	1	<b>276719</b>	195.70	234.84
	Front axle, LH	Genuine	1	<b>276720</b>	251.51	301.81

**Half Shaft**

All models	Rear RH	Aftermarket	1	<b>591378P</b>	14.58	17.50
	Rear LH	Aftermarket	1	<b>591379P</b>	16.67	20.00

**Shaft Rear Axle**

All models	RH, 10/10 spline	Genuine	1	<b>591378</b>	91.98	110.38
	LH, 10/10 spline	Genuine	1	<b>591379</b>	89.00	106.80
	Air Portable/Lightweight models to 1980 - Flat end type					
RH	Genuine	1	<b>599530</b>	200.11	240.13	
	LH	Genuine	1	<b>599531</b>	247.62	297.14

**Stub Shaft**

All models - 10 spline	Genuine	2	<b>242520</b>	130.04	156.05
------------------------	---------	---	---------------	--------	--------

**Stub Axle Assembly Rear Hub**

All models	Aftermarket	2	<b>599828P</b>	70.00	84.00
------------	-------------	---	----------------	-------	-------

**Stub Axle Nut**

All models	Aftermarket	4	<b>FRC8700P</b>	1.25	1.50
	Genuine	4	<b>FRC8700</b>	10.09	12.11

**Hub & Stud Assembly**

All models (axle) suffix H on	Aftermarket	2	<b>576844P</b>	33.33	40.00
-------------------------------	-------------	---	----------------	-------	-------

**Bearing Swivel Pin Housing**

All models	Aftermarket	2	<b>244150P</b>	11.04	13.25
	OEM	2	<b>244150P1</b>	17.29	20.75
	Genuine	2	<b>217268</b>	8.13	9.76

**Swivel Pin Housing**

All models	Aftermarket	2	<b>539741P</b>	75.00	90.00
------------	-------------	---	----------------	-------	-------

**Swivel Pin, Upper**

All models from 1964 on - Railko type	Aftermarket	2	<b>576583P</b>	4.17	5.00
	OEM	2	<b>576583P1</b>	6.67	8.00
	Genuine	2	<b>576583</b>	28.20	33.84

**Swivel Pin & Bracket**

All models 1965 on	Aftermarket	2	<b>576583P</b>	4.17	5.00
	OEM	2	<b>576583P1</b>	6.67	8.00
	Genuine	2	<b>576583</b>	28.20	33.84

**Distance Piece Swivel Pin**

All models	Aftermarket	2	<b>244151P</b>	1.25	1.50
------------	-------------	---	----------------	------	------

**Retainer Swivel Pin Housing Seal**

All models	Aftermarket	2	<b>235968P</b>	1.67	2.00
------------	-------------	---	----------------	------	------

**Leather Gaiter Kit Swivels**

All models	Aftermarket	2	<b>276954P</b>	17.08	20.50
------------	-------------	---	----------------	-------	-------

**Swivel Housing Grease**

All models	Sachet	OEM	a/r	<b>STC3435P1</b>	5.00	6.00
		Genuine	a/r	<b>STC3435</b>	7.69	9.23
370ml sachet	370g bottle	Britpart	a/r	<b>STC3435BPSACHET</b>	4.38	5.26
		Britpart	a/r	<b>STC3435BPBOTTLE</b>	4.79	5.75

**Oil Seal Diff Unit**

All models	Aftermarket	1	<b>FRC4586P</b>	0.83	1.00
	OEM	1	<b>FRC4586P1</b>	3.50	4.20
	Genuine	1	<b>FRC4586</b>	11.66	13.99

**Oil Seal Front Axle Case**

All models	OEM	1	<b>217400P1</b>	2.83	3.40
	Genuine	1	<b>217400</b>	5.21	6.25

**Oil Seal Hub**

All models	Aftermarket	2	<b>RTC3510P</b>	1.25	1.50
	Genuine	2	<b>RTC3510</b>	6.29	7.55

**Oil Seal Rear Hub**

All models - Felt/rubber, 10 spline type	Genuine	2	<b>RTC3515</b>	1.80	2.16
------------------------------------------	---------	---	----------------	------	------

**Oil Seal Output Shaft**

All models	Aftermarket	1	<b>FRC1780</b>	0.79	0.95
------------	-------------	---	----------------	------	------

**Oil Seal Mainshaft Rear**

All models	Genuine	1	<b>236305</b>	3.89	4.67
------------	---------	---	---------------	------	------

**Oil Seal, Transfer Box**

All models	Front & rear output shafts		Aftermarket	2	<b>236417P</b>	0.71	0.85
	Felt type, output shaft		Aftermarket	1	<b>622042P</b>	0.50	0.60
			Genuine	1	<b>622042</b>	2.56	3.07

**Oil Seal Swivel Housing**

All models	Aftermarket	2	<b>RTC3528P</b>	2.08	2.50
	Genuine	2	<b>RTC3528</b>	10.96	13.15

**Drain Plug Diff Unit**

All models	Aftermarket	1	<b>608246P</b>	2.33	2.80
	Genuine	1	<b>608246</b>	9.63	11.56

**Sealing Washer Drain Plug**

All models	Land Rover type axle		Aftermarket	1	<b>515599P</b>	0.33	0.40
			Genuine	1	<b>515599</b>	1.17	1.40
	Transfer box		Genuine	1	<b>FRC4809</b>	0.80	0.96
Axle		Genuine	1	<b>FRC4809</b>	0.80	0.96	

**Speedometer Drive Worm Gear**

All models	OEM	1	<b>540004P1</b>	9.17	11.00
	Genuine	1	<b>540004</b>	35.69	42.83



591379



576844P



## COOLING

## SERIES Ila 88 (1958-1971)

### Radiator Cap

All models up to 1968 - 10lb pressure	Aftermarket	1	<b>RTC3607P</b>	2.00	2.40
	Genuine	1	<b>RTC3607</b>	3.54	4.25
All models from 1968 on - 9lb pressure	Aftermarket	1	<b>GRC118</b>	4.08	4.90
	Genuine	1	<b>STC4735P</b>	1.50	1.80
All models 1968 on - Radiator header	Aftermarket	1	<b>STC4735</b>	6.11	7.33

### Thermostat

All 2.25L petrol and diesel engine models 74°C	Aftermarket	1	<b>532453P</b>	2.42	2.90
	OEM	1	<b>532453P1</b>	30.00	36.00
	Genuine	1	<b>532453</b>	41.30	49.56
82°C	Aftermarket	1	<b>596225P</b>	2.75	3.30
	Genuine	1	<b>596225</b>	35.56	42.67
All 4 cyl petrol & diesel models 74°C	Aftermarket	1	<b>RTC3692P</b>	5.42	6.50
	Genuine	1	<b>RTC3692</b>	8.78	10.54

### Thermostat Housing

All 4 cyl petrol & diesel models	Genuine	1	<b>516059</b>	54.18	65.02
----------------------------------	---------	---	---------------	-------	-------

### Thermostat Housing Gasket

All 2.25L petrol and diesel models					
Upper	Aftermarket	1	<b>527110P</b>	0.21	0.25
Lower	Aftermarket	1	<b>247874P</b>	0.15	0.18
	Genuine	1	<b>247874</b>	1.74	2.09
To bypass connector	Genuine	1	<b>90511958</b>	1.34	1.61

### Thermostat Sealing Ring

All 2.25L petrol and diesel models	Genuine	1	<b>527235</b>	0.80	0.96
------------------------------------	---------	---	---------------	------	------

### Water Pump

All 2.25L military petrol models with 24V - 7 Hole					
Aftermarket	1	<b>RTC6327P</b>	33.33	40.00	
	1	<b>RTC6327</b>	352.71	423.25	
All 2.25L petrol and diesel models with 12V - 9 Hole					
Aftermarket	1	<b>STC3758P</b>	16.67	20.00	

### Water Pump Inlet Housing Gasket

All 4 cylinder models - Water pump inlet housing					
Aftermarket	1	<b>ERR1607P</b>	0.25	0.30	
Genuine	1	<b>ERR1607</b>	1.67	2.00	

### Temperature Sensor

All models - Water temperature, for 120° gauge, spade terminals					
Aftermarket	1	<b>560794P</b>	2.42	2.90	

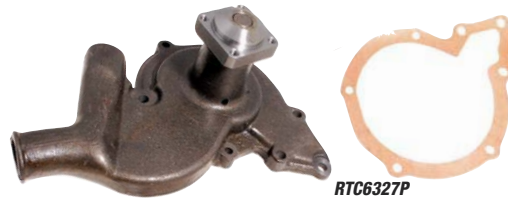

## ELECTRICAL - ROTATING ELECTRICS

## SERIES Ila 88 (1958-1971)

### Alternator

Military models fitted for radio with 24V system (90amp alternator)					
Reconditioned, exchange	Genuine*	1	<b>PRC1102E</b>	2904.36	3485.23
	Exchange Surcharge			150	180.00

### Starter Motor

All petrol models					
Replacement 2M100 type, new	Aftermarket	1	<b>RTC5225P</b>	100.00	120.00
Hi Torque, uprated	Powerlite	1	<b>RTC5225UR</b>	145.00	174.00
All 2.25L diesel models - New	Aftermarket	1	<b>RTC5232P</b>	97.50	117.00



## ENGINE GASKETS

## SERIES Ila 88 (1958-1971)

### Gasket Rocker Cover

All 2.25L diesel models					
Self adhesive	Aftermarket	1	<b>ETC6438P</b>	0.92	1.10
	Genuine	1	<b>ETC6438</b>	7.20	8.64
All 2.25L petrol models					
Self adhesive	Aftermarket	1	<b>ERR4933P</b>	1.00	1.20
	Genuine	1	<b>ERR4933</b>	11.78	14.14

### Gasket Cylinder Head

2.25L diesel models					
Aftermarket	1	<b>ERR3618P</b>	3.00	3.60	
	1	<b>ERR3618P1</b>	9.79	11.75	
	1	<b>ERR3618</b>	36.82	44.18	
2.25L petrol models					
Aftermarket	1	<b>ERC6380P</b>	3.25	3.90	
	1	<b>ERC6380P1</b>	12.95	15.54	
	1	<b>ERC6380</b>	25.12	30.14	

### Gasket Decoke Set

2.25L diesel models	Genuine	1	<b>STC1564</b>	149.03	178.84
2.25L petrol models	Aftermarket	1	<b>STC1566P</b>	8.33	10.00
	Aftermarket	1	<b>STC1567P</b>	10.00	12.00

### Gasket Oil Sump

2.25L petrol and diesel models					
Aftermarket	1	<b>546841P</b>	1.00	1.20	
	1	<b>546841P1</b>	2.42	2.90	
	1	<b>546841</b>	17.82	21.38	

### Silicone Sealant RTV

Numerous applications					
Aftermarket	a/r	<b>RTC3254P</b>	5.00	6.00	
	a/r	<b>RTC3254</b>	21.04	25.25	



## ENGINE SWITCHES

## SERIES Ila 88 (1958-1971)

### Oil Pressure Switch

All models	Aftermarket	1	<b>90519864P</b>	1.75	2.10
------------	-------------	---	------------------	------	------



## DRAIN PLUGS

## SERIES Ila 88 (1958-1971)

### Sump Plug

All 2.25L petrol & diesel models	Genuine	1	<b>536577</b>	1.91	2.29
----------------------------------	---------	---	---------------	------	------

### Sump Plug Washer

All petrol and diesel models	Aftermarket	1	<b>243959P</b>	0.38	0.46
	Genuine	1	<b>243959</b>	0.82	0.98

### Drain Plug

All models					
Gearbox drain	Aftermarket	1	<b>540870P</b>	0.75	0.90
	Genuine	1	<b>540870</b>	2.09	2.51
Front & rear differentials	Genuine	1	<b>235592</b>	11.48	13.78

### Filler Plug

All models - Steering box	Genuine	1	<b>271386</b>	5.92	7.10
---------------------------	---------	---	---------------	------	------





**SERIES IIa 88 (1958-1971)****OIL SEALS ENGINE****Oil Seal Crankshaft Front**

All models	Aftermarket	1	<b>ERR6490P</b>	3.00	3.60
	OEM	1	<b>ERR6490P1</b>	5.00	6.00

**Oil Seal Crankshaft Rear**

2.25L petrol and diesel models	Aftermarket	1	<b>542492P</b>	1.75	2.10
--------------------------------	-------------	---	----------------	------	------

**Oil Seal Kit Crankshaft Rear**

2.25L petrol and diesel models - Retainers and seal	Aftermarket	1	<b>542494P</b>	11.67	14.00
-----------------------------------------------------	-------------	---	----------------	-------	-------

**Oil Seal Front Cover**

All models	Aftermarket	1	<b>ETC4154P</b>	1.08	1.30
	OEM	1	<b>ETC4154P1</b>	3.00	3.60
	Genuine	1	<b>ETC4154</b>	14.67	17.60

**SERIES IIa 88 (1958-1971)****ENGINE & GEARBOX MOUNTINGS****Engine Mounting**

All petrol engine models - Front	Aftermarket	2	<b>NRC2054P</b>	1.83	2.20
	Genuine	2	<b>NRC2054</b>	17.88	21.46

All diesel engine models - Engine and gearbox	Aftermarket	3	<b>NRC2052P</b>	2.00	2.40
	Genuine	3	<b>NRC2052</b>	11.94	14.33

**Gearbox Mounting**

All models	Aftermarket	1	<b>NRC2053P</b>	1.83	2.20
	Genuine	1	<b>NRC2053</b>	5.78	6.94

**Bracket Gearbox Mounting**

All models - RH	Genuine	1	<b>272501</b>	7.08	8.50
-----------------	---------	---	---------------	------	------

**NRC2054P****NRC2052P****NRC2053P****SERIES IIa 88 (1958-1971)****CABLES****Speedometer Cable**

All models	Aftermarket	1	<b>RTC3484P</b>	4.58	5.50
	Genuine	1	<b>RTC3484</b>	71.21	85.45

**RTC3484P****SERIES IIa 88 (1958-1971)****WHEEL STUDS & WHEEL NUTS****Wheel Stud**

All models up to 1969 with 9/16 BSF studs Screw-in type	Aftermarket	a/r	<b>561590P</b>	0.75	0.90
	Genuine	a/r	<b>561590</b>	3.51	4.21
Pull-in type	Aftermarket	a/r	<b>561886P</b>	0.58	0.70

**Wheel Nut**

All models up to 1969 with 9/16 BSF studs - Tapered both ends	Aftermarket	a/r	<b>217361P</b>	0.42	0.50
	Genuine	a/r	<b>217361</b>	1.35	1.62
All models 1968 to 1969 with 9/16 BSF studs - Tapered one end, 59/64" across flats	Aftermarket	a/r	<b>561254P</b>	2.02	2.42
	Genuine	a/r	<b>561254</b>	2.02	2.42
All models from 1969 to 1971 with 9/16 BSF studs - Tapered one end, 1 1/16" across flats	Aftermarket	a/r	<b>576103P</b>	0.29	0.35
	Genuine	a/r	<b>576103</b>	6.19	7.43
All models with 16mm wheel nuts from 1970 on	Aftermarket	a/r	<b>RRD500010P</b>	0.79	0.95
	Genuine	a/r	<b>RRD500010</b>	1.82	2.18

**Wheel Nut Set**

All models with 16mm wheel nuts from 1970 on - Set of 20	Aftermarket	a/r	<b>RRD500010KP</b>	11.04	13.25
	Genuine	a/r	<b>RRD500010K</b>	34.00	40.80

**RRD500010KP**

# SERIES Ila 109 (1958-1971)

## 1958-1971 - All Models

Listed below are the most popular parts required for the Series Ila 109.

We have access to the full range of parts for your vehicle. Please contact us if not listed here.



## SERVICE KITS

### SERIES Ila 109 (1958-1971)

#### Service Kit

2.25L petrol models

Oil filter, fuel filter (in-line), spark plugs, points (fixed), condenser, sump plug washer  
Bearthmach 1 **LL1540BMLUCFIXED** 10.83 13.00

Oil filter, fuel filter (in-line), spark plugs, points (sliding), condenser, sump plug washer  
Bearthmach 1 **LL1540BMLUCSLIDE** 11.25 13.50



LL1540BMLUCFIXED

## FILTRATION

### SERIES Ila 109 (1958-1971)

#### Oil Filter

All 2.25L petrol and diesel models to 1962 - Element  
Aftermarket 1 **248863** 4.50 5.40

All 2.25L petrol and diesel engines from 1964 on - Element  
Aftermarket 1 **RTC3184P** 1.83 2.20

Genuine 1 **RTC3184** 8.57 10.28

All 6 cylinder petrol & 2.0L Diesel engine models  
Genuine 1 **RTC3183** 5.18 6.22

#### Fuel Filter

All 2.25L diesel models - Element for in line filter assembly  
Aftermarket 1 **90517711P** 1.83 2.20

Aftermarket 1 **GFE5296** 3.50 4.20

Genuine 1 **90517711** 4.92 5.90

All 2.6L 6 cyl petrol models - Element for in line filter assembly  
Aftermarket 1 **JS660LP** 1.33 1.60

Genuine 1 **JS660L** 3.06 3.67

#### Seal Air Cleaner

All 2.25L petrol models 1968 on Aftermarket 1 **554418P** 2.00 2.40

#### Fuel Filter Complete Assembly

All diesel engine models - Sedimentor type Aftermarket 1 **NRC9708P** 17.08 20.50

OEM 1 **NRC9708P1** 26.67 32.00

Genuine 1 **NRC9708** 76.51 91.81

#### Fuel Filter Seal

All diesel engine models  
Top, for sedimentor filter Aftermarket 1 **AAU9903P** 0.33 0.40

Genuine 1 **AAU9903** 1.78 2.14

Bottom, for sedimentor filter Aftermarket 1 **AAU9902P** 0.58 0.70

Genuine 1 **AAU9902** 1.78 2.1



RTC3184P

90517711P

## WIPER BLADES

### SERIES Ila 109 (1958-1971)

#### Wiper Blade

All models - Front, sprung, bayonet push-on fitting  
Stainless steel Aftermarket 2 **PRC3386** 3.33 4.00

Black Aftermarket 2 **LR009343PS** 3.33 4.00

All models - Front, not sprung, bayonet push-on fitting  
Aftermarket 2 **LR009343PF** 5.42 6.50



LR009343PS

## SCREEN/LAMP WASHER SYSTEMS

### SERIES Ila 109 (1958-1971)

#### Washer Jet

All models from 1968 on - Front screen, replaces original metal stem jet  
Aftermarket 2 **PRC2437P** 2.25 2.70

Genuine 2 **PRC2437** 7.56 9.07

#### Washer Pump

All models - Front screen Aftermarket 1 **GWW125** 9.38 11.26

#### Windscreen Cleaning Paste

All models  
Prevents wiper blade judder/squeak by 'deep cleaning' the windscreen (ref: Land Rover Tech Bulletin LRA501-002)  
Genuine a/r **DNJ500340** 7.72 9.26

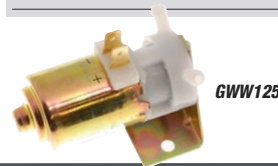

GWW125

## DRIVE BELTS

### SERIES Ila 109 (1958-1971)

#### Fan Belt

All civilian models with 2.25L 4 cyl engines - Fan  
Aftermarket 1 **563132 L-RP** 1.25 1.50

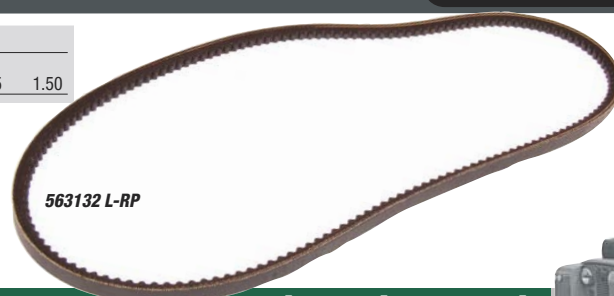

563132 L-RP



## SERIES IIa 109 (1958-1971)

## IGNITION SYSTEM

## Spark Plug

All 2.25L 8.0:1CR petrol models - RN11YC type				
Aftermarket	4	<b>ERR3799P</b>	2.00	2.40
Genuine	4	<b>ERR3799</b>	4.19	5.03
All 2.6L 6 cyl petrol models				
Aftermarket	6	<b>RTC3571P</b>	1.58	1.90
OEM	6	<b>RTC3571P1</b>	1.50	1.80

## Glow Plug

All 2.25L diesel engine models - Pigtail type				
Aftermarket	4	<b>568335P</b>	5.00	6.00
OEM	4	<b>568335P1</b>	10.83	13.00
Genuine	4	<b>568335</b>	42.76	51.31

## Glow Plug Parallel Conversion Kit

All 2.25L diesel engine models - Kit wires plugs in parallel instead of series				
Britpart	1	<b>LL1530BP</b>	20.00	24.00
Bearmach	1	<b>LL1530BM</b>	22.08	26.50

## Replacement Set of Glow Plugs

All 2.25L diesel engine models - For Britpart glow plug parallel conversion kit				
Britpart	1	<b>LL1530BPPLUG</b>	16.67	20.00

## Ignition Coil

All 4 cyl petrol engine models				
Aftermarket	1	<b>PRC9858P</b>	7.35	8.82
OEM	1	<b>PRC9858P1</b>	12.92	15.50
Genuine	1	<b>PRC9858</b>	77.61	93.13

All petrol models with push-in type coil lead connection				
Std coil				
Aftermarket	1	<b>GCL110</b>	12.50	15.00
Lucas	1	<b>GCL110LUCAS</b>	16.67	20.00
Sports coil				
Lucas	1	<b>GCL110HP</b>	19.58	23.50

## Ignition Lead Set

2.25L petrol engine models from 1967 on				
Aftermarket	1	<b>ERC3256P</b>	6.04	7.25
Genuine	1	<b>ERC3256</b>	51.30	61.56
All 6 cylinder models				
Genuine	1	<b>ERC2523</b>	27.30	32.76

## Contact Set

All 2.25L petrol engine models with 12V system - For type 25D distributor				
Aftermarket	1	<b>RTC3270P</b>	1.00	1.20
All 2.6L 6 cylinder petrol models - For all Lucas distributors except no 41631				
Aftermarket	1	<b>RTC3270P</b>	1.00	1.20
All 4 cyl petrol models fitted with non-original Lucas 59D type distributor - Blue sliding contact type set				
Aftermarket	1	<b>GCS261</b>	6.88	8.26

## Rotor Arm

All 2.25L petrol engine models				
For type 25D distributor				
Aftermarket	1	<b>GRA101</b>	2.50	3.00
Red, as original, for Lucas type 25D distributor				
Lucas	1	<b>GRA101RED</b>	7.50	9.00
All 2.6L 6 cylinder petrol models - For all Lucas distributors except no 41631				
Genuine	1	<b>RTC4542</b>	2.42	2.90

## Condenser

All 2.25L petrol engine models - For type 25D distributor				
Aftermarket	1	<b>RTC3472P</b>	1.25	1.50
Aftermarket	1	<b>GSC111</b>	3.08	3.70
Genuine	1	<b>RTC3472</b>	3.73	4.48
All 2.6L 6 cylinder petrol models - For all Lucas distributors except no 41631				
Aftermarket	1	<b>RTC3472P</b>	1.25	1.50
Aftermarket	1	<b>GSC111</b>	3.08	3.70
Genuine	1	<b>RTC3472</b>	3.73	4.48

## Distributor Cap

All 2.25L petrol engine models up to 1967 - For type 25D distributor, acorn nut terminals				
Aftermarket	1	<b>GDC107</b>	10.00	12.00
All 2.25L petrol engine models from 1968 on - For type 25D distributor, push on terminals				
Aftermarket	1	<b>GDC103</b>	3.75	4.50
All 4 cyl petrol models up to 1967 approx. - With acorn nut type lead terminals				
Genuine	1	<b>600328</b>	18.24	21.89
All 2.6L 6 cylinder petrol models - Top entry type, push on terminals, for all Lucas distributors except no 41631				
Aftermarket	1	<b>GDC115</b>	5.63	6.76

## SERIES IIa 109 (1958-1971)

## BRAKING SYSTEM

## Brake Linings Set

All models - Set of 4, with rivets, 11 dia brakes				
Aftermarket	1	<b>STC3944P</b>	12.50	15.00

## Brake Shoe Set

All models - Rear Brakes				
Aftermarket	1	<b>STC2797P</b>	11.67	14.00
OEM	1	<b>STC2797P1</b>	25.83	31.00
Genuine	1	<b>STC2797</b>	191.25	229.50

## Brake Linings Set

All models - Set of 4, with rivets, rear brakes				
Aftermarket	1	<b>STC2795P</b>	3.50	4.20
Genuine	1	<b>STC2795</b>	49.44	59.33

## Brake Adjuster Kit

All models				
Front axle set				
Aftermarket	1	<b>RTC3176P</b>	10.83	13.00
Genuine	1	<b>RTC3176</b>	109.72	131.66
Front and Rear Brake Shoes				
Aftermarket	1	<b>RTC3176P</b>	10.83	13.00
Genuine	1	<b>RTC3176</b>	109.72	131.66

## Brake Shoe Spring

All models - Front Brakes				
Genuine	1	<b>234889</b>	2.90	3.48

## Brake Drum

All 4 cylinder models up to (VIN) Suffix G				
Front, 11 Dia				
Aftermarket	2	<b>516599P</b>	17.08	20.50
Genuine	2	<b>516599</b>	104.29	125.15
All 4 cylinder models from (VIN) Suffix H on				
Front and Rear				
Aftermarket	2	<b>576973P</b>	17.50	21.00
Genuine	2	<b>576973</b>	90.40	108.48
All models up to (VIN) Suffix G				
Rear				
Aftermarket	2	<b>576973P</b>	17.50	21.00
Genuine	2	<b>576973</b>	90.40	108.48

## Wheel Cylinder

All models				
Right Hand Front				
Aftermarket	1	<b>243744P</b>	5.63	6.76
OEM	1	<b>243744P1</b>	10.00	12.00
Left Hand Front				
Aftermarket	1	<b>243743P</b>	5.63	6.76
OEM	1	<b>243743P1</b>	10.00	12.00
Right Hand Rear				
Aftermarket	1	<b>243296P</b>	5.83	7.00
OEM	1	<b>243296P1</b>	13.54	16.25
Genuine	1	<b>243296</b>	51.87	62.24
Left Hand Rear				
Aftermarket	1	<b>243297P</b>	5.83	7.00
OEM	1	<b>243297P1</b>	13.54	16.25
Genuine	1	<b>243297</b>	57.61	69.13
6 Cylinder				
Right Hand Front				
Aftermarket	1	<b>600201P</b>	8.54	10.25
Aftermarket	1	<b>600200P</b>	8.54	10.25
Genuine	1	<b>600200</b>	142.04	170.45
Left Hand Front				
Aftermarket	1	<b>600201P</b>	8.54	10.25
Aftermarket	1	<b>600200P</b>	8.54	10.25
Genuine	1	<b>600200</b>	142.04	170.45

## Brake Master Cylinder

All models with CB type master cylinder - CB Type				
Aftermarket	1	<b>564706P</b>	15.00	18.00
Single circuit brakes, 4 cylinder from (VIN) suffix F on - CV type, without nut on back of cylinder				
Aftermarket	1	<b>90569128P</b>	7.50	9.00
OEM	1	<b>90569128P1</b>	31.50	37.80
Single circuit brakes, 6 Cylinder from (VIN) suffix G on - CV type, without nut on back of cylinder				
Aftermarket	1	<b>569339P</b>	15.00	18.00

## Master Cylinder Overhaul Kit

All models with CB type master cylinder to 1966 - Brake master cylinder				
Aftermarket	1	<b>503754P</b>	2.58	3.10

## Master Cylinder Repair Kit

All 4 cyl models with CV type master cylinder except station wagon - Brake master cylinder				
Aftermarket	1	<b>GRK1027</b>	5.63	6.76

## Servo Repair Kit

6 cyl models and 4 cyl station wagon from 1968 on - Type 50 servo (227mm dia servo)				
Aftermarket	1	<b>1868951A</b>	11.25	13.50

## Brake Hose

All models				
Front and rear brake hose, also clutch hose, rubber				
Aftermarket	2	<b>RTC3386P</b>	2.83	3.40
OEM	2	<b>RTC3386P1</b>	9.58	11.50
Genuine	2	<b>RTC3386</b>	17.29	20.75
Rear brake hose, rubber				
Aftermarket	1	<b>RTC3353P</b>	3.00	3.60
Genuine	1	<b>RTC3353</b>	16.47	19.76

## Brake Shoe Set - Handbrake

All 4 cylinder models from 1964 on - Handbrake				
Aftermarket	1	<b>STC3821P</b>	5.83	7.00
All 6 cylinder models - Handbrake				
Aftermarket	1	<b>STC2880P</b>	12.50	15.00
Genuine	1	<b>STC2880</b>	74.69	89.63

## Brake Drum - Handbrake

All 4 cylinder models - Handbrake				
Aftermarket	1	<b>274423P</b>	9.58	11.50
Genuine	1	<b>274423</b>	60.24	72.29

## Retaining Plate Handbrake

All models				
Aftermarket	1	<b>515468P</b>	1.08	1.30
Genuine	1	<b>515468</b>	2.30	2.76

## Locking Plate Handbrake

All models				
Aftermarket	1	<b>515467P</b>	1.33	1.60
Genuine	1	<b>515467</b>	1.72	2.06

## Dust Cover Expander Unit

All models				
OEM	1	<b>515466P1</b>	3.33	4.00
Genuine	1	<b>515466</b>	4.49	5.39





# SUSPENSION

**SERIES IIa 109 (1958-1971)**

## Bush Shock Absorber Mounting

All models - Rear, lower, rubber	Aftermarket	8	<b>552818P</b>	0.50	0.60
	Genuine	8	<b>552818</b>	1.38	1.66

## Front Chassis Bush

All models	Aftermarket	2	<b>569746P</b>	1.58	1.90
	Genuine	2	<b>569746</b>	13.47	16.16

## Bush Shackle

All models from (VIN) suffix H on Front suspension, rubber	Aftermarket	2	<b>90577434P</b>	2.33	2.80
	Genuine	2	<b>90577434</b>	13.72	16.46

## Bush, Swivel Pin

All models 1965 on - Railko bush	Aftermarket	2	<b>539742P</b>	5.83	7.00
	Genuine	2	<b>539742</b>	21.71	26.05

## Spring Eye Bush

All models	Aftermarket	4	<b>548205P</b>	1.58	1.90
	Genuine	4	<b>548205</b>	4.14	4.97

## Shock Absorber Bush Kit

All models - Front shock absorber bushes, dynamic orange Polybush	1	<b>LL1590</b>	29.58	35.50
-------------------------------------------------------------------	---	---------------	-------	-------

## Bush Shock Absorber Mounting

All models - Rear, lower, poly performance red comfort blue dynamic orange	Polybush	1	<b>5528189PBR</b>	25.00	30.00
	Polybush	1	<b>552818PPBB</b>	25.00	30.00
	Polybush	1	<b>5528189PBO</b>	25.00	30.00
	Aftermarket	4	<b>552818POLY</b>	0.83	1.00

## Spring Eye Bush (pair)

All models - poly., dynamic orange	Polybush	2	<b>548205POLYBUSH</b>	17.50	21.00
------------------------------------	----------	---	-----------------------	-------	-------

## Bush Shackle (pair)

All models from (VIN) suffix H on - Front suspension, poly. Polybush	1	<b>90577434POLY</b>	17.50	21.00
----------------------------------------------------------------------	---	---------------------	-------	-------

## Anti Roll Bar Bush

All models - Shock absorber mounting, front upper and lower, rear lower, rubber	Aftermarket	4	<b>552819P</b>	0.19	0.23
	Genuine	4	<b>552819</b>	1.39	1.67
All models - Rear, lower, poly.	Aftermarket	4	<b>552819POLY</b>	1.08	1.30



## Shock Absorber

All 1 Ton models					
Front	Aftermarket	2	<b>RTC4231P</b>	21.67	26.00
	Genuine	2	<b>RTC4231</b>	60.83	73.00
Rear	Aftermarket	2	<b>RTC4233P</b>	19.79	23.75
	All models except 1 Ton				
Front, std	Aftermarket	2	<b>RTC4234P</b>	21.67	26.00
Front, heavy duty	Aftermarket	2	<b>RTC4483P</b>	13.50	16.20
	OEM	2	<b>RTC4483P1</b>	23.75	28.50
	Genuine	2	<b>RTC4483</b>	82.14	98.57

## Leaf Spring

1 Ton models only					
Rear, both sides; complete assembly	OEM	2	<b>535173P1</b>	130.00	156.00
	Genuine	2	<b>535173</b>	216.26	259.51
All 2.25L petrol models except 1 ton - 11 leaf, driver's side					
Front	Aftermarket	1	<b>265627P</b>	65.00	78.00
All 2.25L diesel models - 11 leaf, passenger's side					
Front	Aftermarket	1	<b>265627P</b>	65.00	78.00
All 1 ton models - 11 leaf, passenger's side,					
Front	Aftermarket	1	<b>265627P</b>	65.00	78.00
All models except 1 ton - 10 leaf, passenger's side					
Rear	Aftermarket	1	<b>279679P</b>	107.50	129.00

## Parabolic Spring Kit

All models					
Front springs, 2 leaf, pair, with U bolts	Britpart	1	<b>LL1484BP</b>	115.00	138.00
Rear springs, 4 leaf, pair, with U bolts	Britpart	1	<b>LL1485BPLWB</b>	220.83	265.00

## Drag Link Assembly

All 1 Ton models	Genuine	1	<b>RTC2547</b>	242.65	291.18
------------------	---------	---	----------------	--------	--------

## Swivel Pin, Upper

All models 1965 on - For Railko bush	Aftermarket	2	<b>576583P</b>	4.17	5.00
	OEM	2	<b>576583P1</b>	6.67	8.00
	Genuine	2	<b>576583</b>	28.20	33.84



# STEERING

**SERIES IIa 109 (1958-1971)**

## Draglink Tube

All models - With damper bracket	Aftermarket	1	<b>NRC4609P</b>	19.58	23.50
	Genuine	1	<b>NRC4609</b>	95.03	114.04

## Bearing Steering Column

All models from 1968 on - Top	Aftermarket	1	<b>RTC324P</b>	5.63	6.76
	Genuine	1	<b>RTC324</b>	15.64	18.77

## Track Rod End

All models					
RH imperial thread	Aftermarket	1	<b>320901P</b>	4.00	4.80
	OEM	1	<b>320901P1</b>	15.63	18.76
LH imperial thread	Aftermarket	1	<b>320902P</b>	3.75	4.50
	OEM	1	<b>320902P1</b>	13.13	15.76

## Track Rod Tube

All models					
With bracket	Aftermarket	1	<b>NRC4609P</b>	19.58	23.50
	Genuine	1	<b>NRC4609</b>	95.03	114.04
Without bracket	Genuine	1	<b>526994</b>	126.52	151.82

## Rubber Cap Track Rod End

All models	Aftermarket	1	<b>214649P</b>	1.33	1.60
	Genuine	1	<b>214649</b>	4.57	5.48

## Spring Ring Track Rod End

All models - Rubber cap, large diameter	Genuine	1	<b>214685</b>	3.15	3.78
-----------------------------------------	---------	---	---------------	------	------

## Spring Ring Track Rod End Boot

All models	Genuine	1	<b>90214684</b>	0.96	1.15
------------	---------	---	-----------------	------	------

## Gasket Steering Box

All models	Genuine	1	<b>271379</b>	2.06	2.47
------------	---------	---	---------------	------	------

## Oil Seal Steering Relay

All models	Genuine	1	<b>213340</b>	3.52	4.22
------------	---------	---	---------------	------	------

## Steering Relay Lever

All models	Genuine	1	<b>535286</b>	32.58	39.10
------------	---------	---	---------------	-------	-------

## Steering Relay Assembly

All models	Aftermarket	1	<b>NRC1269P</b>	60.83	73.00
------------	-------------	---	-----------------	-------	-------

## Gasket Steering Relay Shaft

All models	Genuine	1	<b>90624436</b>	0.55	0.66
------------	---------	---	-----------------	------	------



## SERIES IIa 109 (1958-1971)

## CLUTCH

## Clutch Cover

All 4 cyl models up to 1969 - Spring type cover, not diaphragm				
	OEM	1	<b>591705P1</b>	59.17 71.00
	Aftermarket	1	<b>591705P</b>	50.00 60.00
All models up to 1969 - 9 diameter				
	OEM	1	<b>GCC127</b>	75.83 91.00
All models from 1969 on - 9.5 diameter, diaphragm type				
	Aftermarket	1	<b>576557P</b>	27.50 33.00
	OEM	1	<b>576557P1</b>	36.67 44.00
	Genuine	1	<b>576557</b>	116.97 140.36
spring (not diaphragm) type				
	OEM	1	<b>571228P1</b>	52.50 63.00

## Clutch Plate

All models fitted with std. 9 clutch up to 1969 - 9 dia., not for diaphragm clutch				
	OEM	1	<b>GCP109AFP</b>	20.00 24.00
	Genuine	1	<b>GCP109AF</b>	42.08 50.50
All models from 1969 on - 9.5 diameter				
	Aftermarket	1	<b>8510290P</b>	19.58 23.50
	OEM	1	<b>8510290P1</b>	32.50 39.00
	Genuine	1	<b>8510290</b>	67.84 81.41

## Clutch Release Bearing

All models				
	Aftermarket	1	<b>STC1130P</b>	1.58 1.90
	OEM	1	<b>STC1130P1</b>	4.00 4.80
	Genuine	1	<b>STC1130</b>	53.81 64.57
All models from 1969 on - Sealed type				
	Genuine	1	<b>268053</b>	99.36 119.23

## Spherical Bearing

All models - Clutch release shaft	Genuine	1	<b>90217984</b>	22.18 26.62
-----------------------------------	---------	---	-----------------	-------------

## Master Cylinder Repair Kit

All models - Clutch master cylinder				
	Aftermarket	1	<b>GRK1027P</b>	2.08 2.50
	OEM	1	<b>GRK1027</b>	5.63 6.76

## Clutch Master Cylinder

All 2.6L 6 cyl petrol models				
	Aftermarket	1	<b>STC500100P</b>	9.58 11.50
	OEM	1	<b>STC500100P1</b>	19.79 23.75
	Genuine	1	<b>STC500100</b>	76.84 92.21

## Pedal Pad Clutch &amp; Brake

All models - Clutch and brake pedals				
	Aftermarket	2	<b>278166P</b>	1.83 2.20
	Genuine	2	<b>278166</b>	6.94 8.33

## Oil Seal Clutch Cross Shaft

All models	Genuine	1	<b>90214787</b>	27.16 32.59
------------	---------	---	-----------------	-------------

## SERIES IIa 109 (1958-1971)

## TRANSMISSION

## Gaiter Propshaft c/w Clips

All models - Front				
	Aftermarket	1	<b>276484P</b>	2.33 2.80
	Genuine	1	<b>276484</b>	22.65 27.18

## Gaiter Propshaft

All models				
	Aftermarket	1	<b>276483P</b>	3.00 3.60
	Genuine	1	<b>276483</b>	24.73 29.68

## Universal Joint

All models - Front half shaft				
	Genuine	2	<b>RTC3690</b>	41.27 49.52
All models 1964 on - Propshaft				
	Aftermarket	2	<b>RTC3346P</b>	3.50 4.20
	OEM	2	<b>RTC3346P1</b>	8.13 9.76
	Genuine	2	<b>RTC3346</b>	49.81 59.77

## Half Shaft, Bare

All models except 1 Ton - Front axle				
RH	Genuine	1	<b>276719</b>	195.70 234.84
LH	Genuine	1	<b>276720</b>	251.51 301.81

## Stub Shaft

All models - 10 spline	Genuine	2	<b>242520</b>	130.04 156.05
------------------------	---------	---	---------------	---------------

## Stub Axle Assembly

All models	Genuine	2	<b>599827</b>	162.42 194.90
------------	---------	---	---------------	---------------

## Stub Axle Assembly Rear Hub

All models	Aftermarket	2	<b>599828P</b>	70.00 84.00
------------	-------------	---	----------------	-------------

## Stub Axle Nut

All models				
	Aftermarket	4	<b>FRC8700P</b>	1.25 1.50
	Genuine	4	<b>FRC8700</b>	10.09 12.11

## Hub &amp; Stud Assembly

All models (axle) suffix H on	Aftermarket	2	<b>576844P</b>	33.33 40.00
-------------------------------	-------------	---	----------------	-------------

## Driving Member

All models - 24 spline, front and rear	OEM	1	<b>571711P1</b>	13.54 16.25
----------------------------------------	-----	---	-----------------	-------------

## Bearing Swivel Pin Housing

All models				
	Aftermarket	2	<b>244150P</b>	11.04 13.25
	OEM	2	<b>244150P1</b>	17.29 20.75
	Genuine	2	<b>217268</b>	8.13 9.76

## Swivel Pin Housing

All models	Aftermarket	2	<b>539741P</b>	75.00 90.00
------------	-------------	---	----------------	-------------

## Swivel Pin, Upper

All models from 1964 on - Railko type				
	Aftermarket	2	<b>576583P</b>	4.17 5.00
	OEM	2	<b>576583P1</b>	6.67 8.00
	Genuine	2	<b>576583</b>	28.20 33.84

## Swivel Pin &amp; Bracket

All models 1965 on				
	Aftermarket	2	<b>576583P</b>	4.17 5.00
	OEM	2	<b>576583P1</b>	6.67 8.00
	Genuine	2	<b>576583</b>	28.20 33.84

## Distance Piece Swivel Pin

All models	Aftermarket	2	<b>244151P</b>	1.25 1.50
------------	-------------	---	----------------	-----------

## Retainer Swivel Pin Housing Seal

All models	Aftermarket	2	<b>235968P</b>	1.67 2.00
------------	-------------	---	----------------	-----------

## Leather Gaiter Kit Swivels

All models	Aftermarket	2	<b>276954P</b>	17.08 20.50
------------	-------------	---	----------------	-------------

## Swivel Housing Grease

All models				
Sachet	OEM	a/r	<b>STC3435P1</b>	5.00 6.00
	Genuine	a/r	<b>STC3435</b>	7.69 9.23
370ml sachet	Britpart	a/r	<b>STC3435BPSACHET</b>	4.38 5.26
370g bottle	Britpart	a/r	<b>STC3435BPBOTTLE</b>	4.79 5.75

## Oil Seal Diff Unit

All models front axle only				
	Aftermarket	1	<b>FRC4586P</b>	0.83 1.00
	OEM	1	<b>FRC4586P1</b>	3.50 4.20
	Genuine	1	<b>FRC4586</b>	11.66 13.99

## Oil Seal, Differential

All Salisbury type axles - Pinion				
	Aftermarket	1	<b>AEU2515P</b>	2.83 3.40
	Genuine	1	<b>AEU2515</b>	35.42 42.50

## Oil Seal Front Axle Case

All models				
	OEM	1	<b>217400P1</b>	2.83 3.40
	Genuine	1	<b>217400</b>	5.21 6.25

## Oil Seal Hub

All models				
	Aftermarket	2	<b>RTC3510P</b>	1.25 1.50
	Genuine	2	<b>RTC3510</b>	6.29 7.55

## Oil Seal Rear Hub

All models - Felt/rubber, 10 spline type	Genuine	2	<b>RTC3515</b>	1.80 2.16
------------------------------------------	---------	---	----------------	-----------

## Oil Seal Output Shaft

All models	Aftermarket	1	<b>FRC1780</b>	0.79 0.95
------------	-------------	---	----------------	-----------

## Oil Seal Mainshaft Rear

All models	Genuine	1	<b>236305</b>	3.89 4.67
------------	---------	---	---------------	-----------

## Oil Seal, Transfer Box

All models				
Front & rear output shafts	Aftermarket	2	<b>236417P</b>	0.71 0.85
Felt type, output shaft	Aftermarket	1	<b>622042P</b>	0.50 0.60
	Genuine	1	<b>622042</b>	2.56 3.07

## Oil Seal Swivel Housing

All models				
	Aftermarket	2	<b>RTC3528P</b>	2.08 2.50
	Genuine	2	<b>RTC3528</b>	10.96 13.15

## Drain Plug Diff Unit

All models				
	Aftermarket	1	<b>608246P</b>	2.33 2.80
	Genuine	1	<b>608246</b>	9.63 11.56

## Sealing Washer Drain Plug

All models				
Land Rover type axle	Aftermarket	1	<b>515599P</b>	0.33 0.40
	Genuine	1	<b>515599</b>	1.17 1.40
Transfer box	Genuine	1	<b>FRC4809</b>	0.80 0.96
All Land Rover type axles - Axle	Genuine	1	<b>FRC4809</b>	0.80 0.96

## Speedometer Drive Worm Gear

All models				
	OEM	1	<b>540004P1</b>	9.17 11.00
	Genuine	1	<b>540004</b>	35.69 42.83



# COOLING

**SERIES Ila 109 (1958-1971)**

## Radiator Cap

All models up to 1968 - 10lb pressure	Aftermarket	1	<b>RTC3607P</b>	2.00	2.40
	Genuine	1	<b>RTC3607</b>	3.54	4.25
All models from 1968 on - 9lb pressure	Aftermarket	1	<b>GRC118</b>	4.08	4.90
	Genuine	1	<b>STC4735P</b>	1.50	1.80
All models 1968 on - Radiator header	Aftermarket	1	<b>STC4735</b>	6.11	7.33

## Thermostat

All 2.25L petrol and diesel engine models 74°C	Aftermarket	1	<b>532453P</b>	2.42	2.90
	OEM	1	<b>532453P1</b>	30.00	36.00
	Genuine	1	<b>532453</b>	41.30	49.56
82°C	Aftermarket	1	<b>596225P</b>	2.75	3.30
	Genuine	1	<b>596225</b>	35.56	42.67
All 4 cyl petrol & diesel models - 74°C	Aftermarket	1	<b>RTC3692P</b>	5.42	6.50
	Genuine	1	<b>RTC3692</b>	8.78	10.54
All 2.6L 6 cyl petrol engine models	Aftermarket	1	<b>563122</b>	9.96	11.95

## Thermostat Housing

All 4 cyl petrol & diesel models	Genuine	1	<b>516059</b>	54.18	65.02
----------------------------------	---------	---	---------------	-------	-------

## Thermostat Housing Gasket

All 2.25L petrol and diesel models					
Upper	Aftermarket	1	<b>527110P</b>	0.21	0.25
Lower	Aftermarket	1	<b>247874P</b>	0.15	0.18
	Genuine	1	<b>247874</b>	1.74	2.09
To bypass connector	Genuine	1	<b>90511958</b>	1.34	1.61

## Thermostat Sealing Ring

All 2.25L petrol and diesel models	Genuine	1	<b>527235</b>	0.80	0.96
------------------------------------	---------	---	---------------	------	------

## Water Pump

All 2.25L military petrol models with 24V 7 Hole					
	Aftermarket	1	<b>RTC6327P</b>	33.33	40.00
	Genuine	1	<b>RTC6327</b>	352.71	423.25
All 2.25L petrol and diesel models with 12V 9 Hole					
	Aftermarket	1	<b>STC3758P</b>	16.67	20.00

## Water Pump Gasket

All 2.25L petrol and diesel models except military 9 stud fixing water pump					
	Aftermarket	1	<b>538671P</b>	0.25	0.30
	Genuine	1	<b>538671</b>	0.80	0.96
All 2.6L 6 cyl petrol models - Water pump adaptor to engine					
	Aftermarket	1	<b>563038P</b>	0.79	0.95

## O Ring Water Pump

All 6 cyl petrol models	Genuine	1	<b>RTC1975</b>	4.27	5.12
-------------------------	---------	---	----------------	------	------

## Water Pump Inlet Housing Gasket

All 4 cylinder models - Water pump inlet housing					
	Aftermarket	1	<b>ERR1607P</b>	0.25	0.30
	Genuine	1	<b>ERR1607</b>	1.67	2.00

## Temperature Sensor

All models - Water temperature, for 120° gauge, spade terminals					
	Aftermarket	1	<b>560794P</b>	2.42	2.90

# ELECTRICAL - ROTATING ELECTRICS

**SERIES Ila 109 (1958-1971)**

## Alternator

Military models fitted for radio with 24V system (90amp alternator)					
Reconditioned, exchange	Genuine*	1	<b>PRC1102E</b>	2904.36	3485.23
	Exchange Surcharge			150.00	180.00

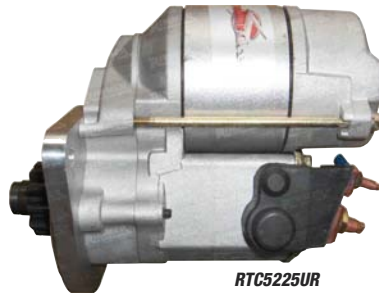
**RTC5225P**

**RTC5225UR**

**RTC5232P**

## Starter Motor

All petrol models					
Replacement 2M100 type, new Hi Torque, uprated	Aftermarket	1	<b>RTC5225P</b>	100.00	120.00
	Powerlite	1	<b>RTC5225UR</b>	145.00	174.00
All 2.25L diesel models - New					
	Aftermarket	1	<b>RTC5232P</b>	97.50	117.00

# ENGINE GASKETS

**SERIES Ila 109 (1958-1971)**

## Gasket Rocker Cover

All 2.25L diesel models					
Self adhesive	Aftermarket	1	<b>ETC6438P</b>	0.92	1.10
	Genuine	1	<b>ETC6438</b>	7.20	8.64
All 2.25L petrol models					
Self adhesive	Aftermarket	1	<b>ERR4933P</b>	1.00	1.20
	Genuine	1	<b>ERR4933</b>	11.78	14.14
All 2.6L petrol models					
	Genuine	1	<b>267668</b>	6.35	7.62

## Gasket Cylinder Head

2.25L diesel models					
	Aftermarket	1	<b>ERR3618P</b>	3.00	3.60
	OEM	1	<b>ERR3618P1</b>	9.79	11.75
	Genuine	1	<b>ERR3618</b>	36.82	44.18
2.25L petrol models					
	Aftermarket	1	<b>ERC6380P</b>	3.25	3.90
	OEM	1	<b>ERC6380P1</b>	12.95	15.54
	Genuine	1	<b>ERC6380</b>	25.12	30.14
2.6L 6 cyl petrol models					
	Genuine	1	<b>STC1129</b>	22.75	27.30

## Gasket Decoke Set

2.25L diesel models					
	Genuine	1	<b>STC1564</b>	149.03	178.84
	Aftermarket	1	<b>STC1556P</b>	8.33	10.00
All 2.25L petrol models					
	Aftermarket	1	<b>STC1567P</b>	10.00	12.00
	OEM	1	<b>STC1567</b>	17.92	21.50
2.6L 6 cyl petrol models					
	Aftermarket	1	<b>RTC3333P</b>	17.92	21.50
	OEM	1	<b>RTC3333P1</b>	25.83	31.00

## Gasket Oil Sump

2.25L petrol and diesel models					
	Aftermarket	1	<b>546841P</b>	1.00	1.20
	OEM	1	<b>546841P1</b>	2.42	2.90
	Genuine	1	<b>546841</b>	17.82	21.38
2.6L 6 cyl petrol models					
	Genuine	1	<b>546457</b>	19.50	23.40

## Gasket Conversion Set

2.6L petrol models	Aftermarket	1	<b>605106P</b>	24.58	29.50
--------------------	-------------	---	----------------	-------	-------

## Silicone Sealant RTV

Numerous applications					
	Aftermarket	a/r	<b>RTC3254P</b>	5.00	6.00
	Genuine	a/r	<b>RTC3254</b>	21.04	25.25

# ENGINE SWITCHES

**SERIES Ila 109 (1958-1971)**

## Oil Pressure Switch

All models	Aftermarket	1	<b>90519864P</b>	1.75	2.10
------------	-------------	---	------------------	------	------

**90519864P**



**SERIES IIa 109 (1958-1971)****DRAIN PLUGS****Sump Plug**

All 2.25L petrol & diesel models	Genuine	1	<b>536577</b>	1.91	2.29
----------------------------------	---------	---	---------------	------	------

**Sump Plug Washer**

All petrol and diesel models	Aftermarket	1	<b>243959P</b>	0.38	0.46
	Genuine	1	<b>243959</b>	0.82	0.98

**Drain Plug**

All models - Gearbox drain	Aftermarket	1	<b>540870P</b>	0.75	0.90
	Genuine	1	<b>540870</b>	2.09	2.51
All models except 1 Ton - Front differential	Genuine	1	<b>235592</b>	11.48	13.78

**Filler Plug**

All models - Steering box	Genuine	1	<b>271386</b>	5.92	7.10
---------------------------	---------	---	---------------	------	------



235592

**SERIES IIa 109 (1958-1971)****OIL SEALS ENGINE****Oil Seals Engine Oil Seal Crankshaft Front**

All models except 2.6L 6 cyl petrol	Aftermarket	1	<b>ERR6490P</b>	3.00	3.60
	OEM	1	<b>ERR6490P1</b>	5.00	6.00

**Oil Seal Crankshaft Rear**

2.25L petrol and diesel models	Aftermarket	1	<b>542492P</b>	1.75	2.10
2.6L petrol models	Aftermarket	1	<b>542492P</b>	1.75	2.10

**Oil Seal Kit Crankshaft Rear**

2.25L petrol and diesel models - Retainers and seal	Aftermarket	1	<b>542494P</b>	11.67	14.00
	Aftermarket	1	<b>542494P</b>	11.67	14.00

**Oil Seal Front Cover**

All models except 6 cyl	Aftermarket	1	<b>ETC4154P</b>	1.08	1.30
	OEM	1	<b>ETC4154P1</b>	3.00	3.60
	Genuine	1	<b>ETC4154</b>	14.67	17.60
2.6L 6 cyl petrol models	Genuine	1	<b>90516028</b>	4.30	5.16

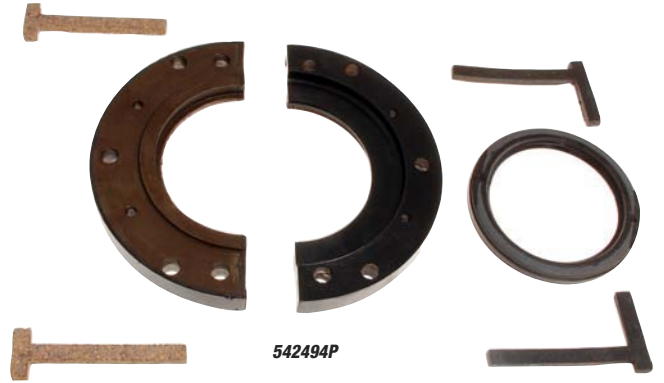
**SERIES IIa 109 (1958-1971)****ENGINE & GEARBOX MOUNTINGS****Engine Mounting**

All 4 and 6 cyl petrol engine models - Front	Aftermarket	2	<b>NRC2054P</b>	1.83	2.20
	Genuine	2	<b>NRC2054</b>	17.88	21.46

**Gearbox Mounting**

All models	Aftermarket	1	<b>NRC2053P</b>	1.83	2.20
	Genuine	1	<b>NRC2053</b>	5.78	6.94

**Bracket Gearbox Mounting**

All models - RH	Genuine	1	<b>272501</b>	7.08	8.50
-----------------	---------	---	---------------	------	------

**SERIES IIa 109 (1958-1971)****CABLES****Speedometer Cable**

All models except 2.6L 6 cyl petrol	Aftermarket	1	<b>RTC3484P</b>	4.58	5.50
	Genuine	1	<b>RTC3484</b>	71.21	85.45
All 2.6L 6 cyl petrol models	Genuine	1	<b>RTC3485</b>	35.97	43.16

**SERIES IIa 109 (1958-1971)****WHEEL STUDS & WHEEL NUTS****Wheel Stud**

All models up to 1969 with 9/16 BSF studs	Screw-in type	Aftermarket	a/r <b>561590P</b>	0.75	0.90
		Genuine	a/r <b>561590</b>	3.51	4.21
	Pull-in type	Aftermarket	a/r <b>561886P</b>	0.58	0.70

**Wheel Nut**

All models up to 1969 with 9/16 BSF studs - Tapered both ends	Aftermarket	a/r <b>217361P</b>	0.42	0.50
	Genuine	a/r <b>217361</b>	1.35	1.62
All models 1968 to 1969 with 9/16 BSF studs - Tapered one end, 59/64 across flats	Aftermarket	a/r <b>561254</b>	2.02	2.42
	Genuine	a/r <b>561254</b>	2.02	2.42
All models from 1969 to 1971 with 9/16 BSF studs - Tapered one end, 1 1/16 across flats	Aftermarket	a/r <b>576103P</b>	0.29	0.35
	Genuine	a/r <b>576103</b>	6.19	7.43
All models with 16mm wheel nuts from 1970 on	Aftermarket	a/r <b>RRD500010P</b>	0.79	0.95
	Genuine	a/r <b>RRD500010</b>	1.82	2.18

**Wheel Nut Set**

All models with 16mm wheel nuts from 1970 on - Set of 20	Aftermarket	a/r <b>RRD500010KP</b>	11.04	13.25
		a/r <b>RRD500010K</b>	34.00	40.80
	Genuine	a/r <b>RRD500010K</b>	34.00	40.80



# SERIES III 88 (1971-1985)

## 1971-1985 - All Models

Listed below are the most popular parts required for the Series III 88.

We have access to the full range of parts for your vehicle. Please contact us if not listed here.



## SERVICE KITS

### Service Kit

2.25L petrol models with Lucas ignition

Oil filter, fuel filter (in-line), spark plugs, points (fixed), condenser, sump plug washer	Bearmach	1	<b>LL1540BMLUCFIXED</b>	10.83	13.00
---------------------------------------------------------------------------------------------	----------	---	-------------------------	-------	-------

Oil filter, fuel filter (in-line), spark plugs, points (sliding), condenser, sump plug washer	Bearmach	1	<b>LL1540BMLUCSLIDE</b>	11.25	13.50
-----------------------------------------------------------------------------------------------	----------	---	-------------------------	-------	-------

2.25L petrol models with Ducellier ignition

Oil filter, fuel filter (in-line), spark plugs, points, condenser, sump plug washer	Bearmach	1	<b>LL1540BMDUC</b>	10.83	13.00
-------------------------------------------------------------------------------------	----------	---	--------------------	-------	-------



## SERIES III 88 (1971-1985)

## FILTRATION

### Oil Filter

All 2.25L petrol and diesel engines - Element

Aftermarket	1	<b>RTC3184P</b>	1.83	2.20
Genuine	1	<b>RTC3184</b>	8.57	10.28

All 6 cylinder petrol & 2.0L Diesel engine models

Genuine	1	<b>RTC3183</b>	5.18	6.22
---------	---	----------------	------	------

### Seal Air Cleaner

All 2.25L petrol models

Aftermarket	1	<b>554418P</b>	2.00	2.40
-------------	---	----------------	------	------

### Fuel Filter

All 2.25L diesel models

Element for in line filter assembly	Aftermarket	1	<b>90517711P</b>	1.83	2.20
	Aftermarket	1	<b>GFE5296</b>	3.50	4.20
	Genuine	1	<b>90517711</b>	4.92	5.90

### Fuel Filter Complete Assembly

All diesel engine models - Sedimentor type

Aftermarket	1	<b>NRC9708P</b>	17.08	20.50
OEM	1	<b>NRC9708P1</b>	26.67	32.00
Genuine	1	<b>NRC9708</b>	76.51	91.81

### Fuel Filter Seal

All diesel engine models

Top, for sedimentor filter

Aftermarket	1	<b>AAU9903P</b>	0.33	0.40
Genuine	1	<b>AAU9903</b>	1.78	2.14

Bottom, for sedimentor filter

Aftermarket	1	<b>AAU9902P</b>	0.58	0.70
Genuine	1	<b>AAU9902</b>	1.78	2.14

## WIPER BLADES

### Wiper Blade

All models

Front, sprung, bayonet push-on fitting stainless steel	Aftermarket	2	<b>PRC3386</b>	3.33	4.00
black	Aftermarket	2	<b>LR009343PS</b>	3.33	4.00

Front, not sprung, bayonet push-on fitting	Aftermarket	2	<b>LR009343PF</b>	5.42	6.50
Front, with flat wiper arms -	Genuine	2	<b>STC3302</b>	18.21	21.85

All models with bayonet fixing black wiper arms 10, black	Wipac	2	<b>GWB910</b>	5.42	6.50
-----------------------------------------------------------	-------	---	---------------	------	------



## SERIES III 88 (1971-1985)

## SCREEN/LAMP WASHER SYSTEMS

### Washer Jet

All models - Front screen, replaces original metal stem jet

Aftermarket	2	<b>PRC2437P</b>	2.25	2.70
Genuine	2	<b>PRC2437</b>	7.56	9.07

### Non Return Valve

All models - Washer bottle

Aftermarket	1	<b>90608330P</b>	2.83	3.40
-------------	---	------------------	------	------

### Washer Pump

All models - Front screen

Aftermarket	1	<b>GWW125</b>	9.38	11.26
-------------	---	---------------	------	-------

### Washer Hose, Per Metre

All models - 4mm internal diameter (3mm also available).

Front or rear screen wash	Aftermarket	a/r	<b>GWW201M</b>	2.25	2.70
---------------------------	-------------	-----	----------------	------	------

### Windscreen Cleaning Paste

All models

Prevents wiper blade judder/squeak by 'deep cleaning' the windscreen (ref: Land Rover Tech Bulletin LRA501-002)

Genuine	a/r	<b>DNJ500340</b>	7.72	9.26
---------	-----	------------------	------	------

## SERIES III 88 (1971-1985)

## DRIVE BELTS

### Fan Belt

All civilian models with 2.25L 4 cyl engines - Fan

Aftermarket	1	<b>563132 L-RP</b>	1.25	1.50
-------------	---	--------------------	------	------

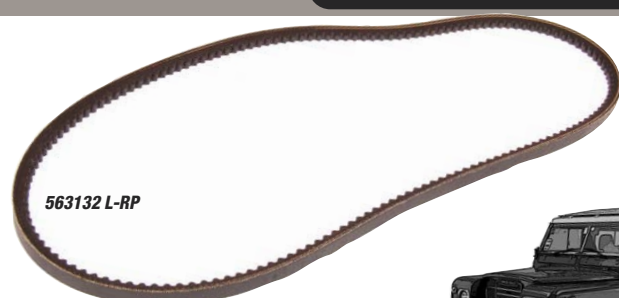

## SERIES III 88 (1971-1985)



## SERIES III 88 (1971-1985)

# IGNITION SYSTEM

### Spark Plug

All 2.25L 8.0:1CR petrol models - RN11YC type

Aftermarket	4	<b>ERR3799P</b>	2.00	2.40
Genuine	4	<b>ERR3799</b>	4.19	5.03

### Glow Plug

All 2.25L diesel engine models - Pigtail type

Aftermarket	4	<b>568335P</b>	5.00	6.00
OEM	4	<b>568335P1</b>	10.83	13.00
Genuine	4	<b>568335</b>	42.76	51.31

All 2.25L diesel engine models from 1980 on

Aftermarket	4	<b>ERC8450P</b>	2.25	2.70
OEM	4	<b>ERC8450P1</b>	7.29	8.75
Genuine	4	<b>ERC8450</b>	14.18	17.02

### Glow Plug Parallel Conversion Kit

All 2.25L diesel engine models up to 1980 - Kit wires plugs in parallel instead of series

Britpart	1	<b>LL1530BP</b>	20.00	24.00
Bearmach	1	<b>LL1530BM</b>	22.08	26.50

### Replacement Set of Glow Plugs

All 2.25L diesel engine models up to 1980 For Britpart glow plug parallel conversion kit.

Britpart	1	<b>LL1530BPPLUG</b>	16.67	20.00
----------	---	---------------------	-------	-------

### Ignition Coil

All 4 cyl petrol engine models

Aftermarket	1	<b>PRC9858P</b>	7.35	8.82
OEM	1	<b>PRC9858P1</b>	12.92	15.50
Genuine	1	<b>PRC9858</b>	77.61	93.13

All petrol models

Std coil

Aftermarket	1	<b>GCL110</b>	12.50	15.00
Lucas	1	<b>GCL110LUCAS</b>	16.67	20.00

Sports coil

Lucas	1	<b>GCL110HP</b>	19.58	23.50
-------	---	-----------------	-------	-------

All military models with 24V system, fitted for radio (FFR) - 24V, shielded type

Genuine	1	<b>552765</b>	613.57	736.28
---------	---	---------------	--------	--------

### Contact Set

2.25L petrol engine models with 12V system up to (eng) suffix C incl. - For type 25D distributor

Aftermarket	1	<b>RTC3270P</b>	1.00	1.20
-------------	---	-----------------	------	------

2.25L petrol engine models with 12V system from (eng) suffix D on with Lucas distributor -

Type 45D/59D distributor, fixed contact set (alternative to sliding contact set)

Aftermarket	1	<b>RTC3288P</b>	0.92	1.10
Genuine	1	<b>RTC3288</b>	1.70	2.04

Type 45D/59D distributor, sliding contact set (alternative to fixed contact set)

Aftermarket	1	<b>RTC6627P</b>	2.00	2.40
Genuine	1	<b>RTC6627</b>	10.32	12.38

All 4 cyl petrol models fitted with Lucas 59D type distributor - Blue sliding contact type set

Aftermarket	1	<b>GCS261</b>	6.88	8.26
-------------	---	---------------	------	------

2.25L petrol engine models from (eng) suffix D on with Ducellier distributor

Aftermarket	1	<b>RTC6625P</b>	1.50	1.80
-------------	---	-----------------	------	------

All military 4 cyl petrol models with 24V system, fitted for radio (FFR)

Aftermarket	1	<b>RTC6622P</b>	1.75	2.10
Genuine	1	<b>RTC6622</b>	28.71	34.45

### Rotor Arm

All 2.25L petrol engine models up to (eng) suffix C incl.

For type 25D distributor	Aftermarket	1	<b>GRA101</b>	2.50	3.00
--------------------------	-------------	---	---------------	------	------

Red, as original, for Lucas type 25D distributor

Lucas	1	<b>GRA101RED</b>	7.50	9.00
-------	---	------------------	------	------

2.25L petrol engine models from (eng) suffix D on with Lucas distributor

Type 45D/59D distributor	Aftermarket	1	<b>RTC3614P</b>	1.00	1.20
--------------------------	-------------	---	-----------------	------	------

Aftermarket	1	<b>GRA114</b>	2.33	2.80
-------------	---	---------------	------	------

Red, as original, for type 45D/59D distributor

Lucas	1	<b>GRA114RED</b>	7.50	9.00
-------	---	------------------	------	------

2.25L petrol engine models from (eng) suffix D on with Ducellier distributor

Aftermarket	1	<b>RTC4933P</b>	1.00	1.20
-------------	---	-----------------	------	------

Genuine	1	<b>RTC4933</b>	3.77	4.52
---------	---	----------------	------	------

### Condenser

All 2.25L petrol engine models up to (eng) suffix C incl.

For type 25D distributor	Aftermarket	1	<b>RTC3472P</b>	1.25	1.50
--------------------------	-------------	---	-----------------	------	------

Aftermarket	1	<b>GSC111</b>	3.08	3.70
-------------	---	---------------	------	------

Genuine	1	<b>RTC3472</b>	3.73	4.48
---------	---	----------------	------	------

2.25L petrol engine models from (eng) suffix D on with Lucas distributor

For type 45D/59D distributor	Aftermarket	1	<b>GSC109</b>	2.33	2.80
------------------------------	-------------	---	---------------	------	------

Aftermarket	1	<b>RTC3524P</b>	2.75	3.30
-------------	---	-----------------	------	------

Type 45D/59D distributor, with 17 7/8 long LT lead

Aftermarket	1	<b>RTC6621P</b>	1.00	1.20
-------------	---	-----------------	------	------

Genuine	1	<b>RTC6621</b>	2.23	2.68
---------	---	----------------	------	------

2.25L petrol engine models from (eng) suffix D on with Ducellier distributor

Aftermarket	1	<b>RTC4935P</b>	2.25	2.70
-------------	---	-----------------	------	------

Genuine	1	<b>RTC6620</b>	1.99	2.39
---------	---	----------------	------	------

### Distributor Cap

All 2.25L petrol engine models up to (eng) suffix C incl. - For type 25D distributor, push on terminals

Aftermarket	1	<b>GDC103</b>	3.75	4.50
-------------	---	---------------	------	------

2.25L petrol engine models from (eng) suffix D on with Ducellier distributor

Aftermarket	1	<b>RTC4932P</b>	3.75	4.50
-------------	---	-----------------	------	------

2.25L petrol engine models from (eng) suffix D on with Lucas distributor

Type 45D/59D distributor	OEM	1	<b>RTC3278P1</b>	3.50	4.20
--------------------------	-----	---	------------------	------	------

Aftermarket	1	<b>RTC3278P</b>	2.33	2.80
-------------	---	-----------------	------	------

Genuine	1	<b>RTC3278</b>	16.53	19.84
---------	---	----------------	-------	-------

### Ignition Lead Set

2.25L petrol engine models

Aftermarket	1	<b>ERC3256P</b>	6.04	7.25
-------------	---	-----------------	------	------

Genuine	1	<b>ERC3256</b>	51.30	61.56
---------	---	----------------	-------	-------



## SERIES III 88 (1971-1985)

# BRAKING SYSTEM

### Brake Shoe Set

All models up to June 1980

Front and Rear Brakes

Aftermarket	1	<b>STC2796P</b>	9.38	11.26
OEM	1	<b>STC2796P1</b>	27.08	32.50

### Brake Linings Set

All models from June 1980 on - Set of 4, with rivets, 11 dia front brakes

Aftermarket	1	<b>STC3944P</b>	12.50	15.00
-------------	---	-----------------	-------	-------

### Brake Adjuster Kit

All models - Front and Rear Brake Shoes

Aftermarket	1	<b>RTC3176P</b>	10.83	13.00
Genuine	1	<b>RTC3176</b>	109.72	131.66

### Brake Shoe Spring

All models up to June 1980

Front and Rear Brakes

Aftermarket	2	<b>218983P</b>	0.58	0.70
Genuine	1	<b>218983</b>	2.90	3.48

All models from July 1980 on

Front Brakes

Genuine	1	<b>234889</b>	2.90	3.48
---------	---	---------------	------	------

Rear Brakes

Aftermarket	2	<b>218983P</b>	0.58	0.70
Genuine	1	<b>218983</b>	2.90	3.48

All models - 10 brake type

Aftermarket	1	<b>503981P</b>	0.58	0.70
Genuine	1	<b>503981</b>	2.30	2.76

### Brake Drum

All models up to June 1980

Front and Rear

Aftermarket	2	<b>591039P</b>	13.13	15.76
Genuine	2	<b>591039</b>	82.60	99.12

All models from June 1980 on

Front

Aftermarket	2	<b>516599P</b>	17.08	20.50
Genuine	2	<b>516599</b>	104.29	125.15

Rear

Aftermarket	2	<b>591039P</b>	13.13	15.76
Genuine	2	<b>591039</b>	82.60	99.12

### Wheel Cylinder

From (axle) suffix F

Right Hand Front	Aftermarket	1	<b>243744P</b>	5.63	6.76
------------------	-------------	---	----------------	------	------

OEM	1	<b>243744P1</b>	10.00	12.00
-----	---	-----------------	-------	-------

Left Hand Front	Aftermarket	1	<b>243743P</b>	5.63	6.76
-----------------	-------------	---	----------------	------	------

OEM	1	<b>243743P1</b>	10.00	12.00
-----	---	-----------------	-------	-------

Left Hand Rear	Aftermarket	1	<b>243297P</b>	5.83	7.00
----------------	-------------	---	----------------	------	------

OEM	1	<b>243297P1</b>	13.54	16.25
-----	---	-----------------	-------	-------

Genuine	1	<b>243297</b>	57.61	69.13
---------	---	---------------	-------	-------

Up to (axle) suffix E

Left Hand Front	Aftermarket	1	<b>243297P</b>	5.83	7.00
-----------------	-------------	---	----------------	------	------

OEM	1	<b>243297P1</b>	13.54	16.25
-----	---	-----------------	-------	-------

Genuine	1	<b>243297</b>	57.61	69.13
---------	---	---------------	-------	-------

Right Hand Rear	Aftermarket	1	<b>243302P</b>	5.83	7.00
-----------------	-------------	---	----------------	------	------

OEM	1	<b>243302P1</b>	39.58	47.50
-----	---	-----------------	-------	-------

Left Hand Rear	Aftermarket	1	<b>243303P</b>	5.63	6.76
----------------	-------------	---	----------------	------	------

OEM	1	<b>243303P1</b>	35.00	42.00
-----	---	-----------------	-------	-------

Genuine	1	<b>243303</b>	65.87	79.04
---------	---	---------------	-------	-------

### Bleed Screw

All models - UNF, Wheel Cylinders

Aftermarket	2	<b>556508A</b>	2.08	2.50
-------------	---	----------------	------	------





# BRAKING SYSTEM

**SERIES III 88 (1971-1985)**

## Brake Master Cylinder

Single circuit brakes up to June 1980 - CV type, without nut on back of cylinder				
Aftermarket	1	<b>90569126P</b>	8.54	10.25
OEM	1	<b>90569126P1</b>	29.58	35.50
Dual circuit brakes with servo from June 1980 on				
Does not include reservoir				
OEM	1	<b>NRC6096NRP1</b>	65.00	78.00
Aftermarket	1	<b>NRC6096P</b>	39.58	47.50
Genuine	1	<b>NRC6096</b>	232.00	278.40

## Master Cylinder Repair Kit

All models with CV type master cylinder - Brake master cylinder				
Aftermarket	1	<b>GRK1027</b>	5.63	6.76

## Master Cylinder Overhaul Kit

All models with dual circuit brakes - Brake master cylinder				
Aftermarket	1	<b>607726P</b>	8.96	10.75
Genuine	1	<b>607726</b>	32.44	38.93

## Brake Hose

All models up to June 1980				
Front brake hose, rubber				
Aftermarket	2	<b>RTC5903P</b>	2.83	3.40
Genuine	2	<b>RTC5903</b>	17.29	20.75
All models July 1980 on				
Front hose, metric system				
Aftermarket	2	<b>NRC9457P</b>	2.50	3.00
Genuine	2	<b>NRC9457</b>	23.06	27.67
All models				
Rear brake hose, rubber				
Aftermarket	1	<b>RTC3386P</b>	2.83	3.40
OEM	1	<b>RTC3386P1</b>	9.58	11.50
Genuine	1	<b>RTC3386</b>	17.29	20.75

## T Piece Brake System

All models July 1980 on - Rear brake pipes				
Aftermarket	a/r	<b>NRC4251P</b>	6.04	7.25
Genuine	a/r	<b>NRC4251</b>	17.88	21.46

## Brake Shoe Set - Handbrake

All models - Handbrake				
Aftermarket	1	<b>STC3821P</b>	5.83	7.00

## Brake Drum - Handbrake

All models - Handbrake				
Aftermarket	1	<b>274423P</b>	9.58	11.50
Genuine	1	<b>274423</b>	60.24	72.29
All V8 models with 4 Speed Gearbox				
Genuine	1	<b>90576624</b>	29.58	35.50

## Retaining Plate Handbrake

All models				
Aftermarket	1	<b>515468P</b>	1.08	1.30
Genuine	1	<b>515468</b>	2.30	2.76

## Locking Plate Handbrake

All models				
Aftermarket	1	<b>515467P</b>	1.33	1.60
Genuine	1	<b>515467</b>	1.72	2.06

## Dust Cover Expander Unit

All models				
OEM	1	<b>515466P1</b>	3.33	4.00
Genuine	1	<b>515466</b>	4.49	5.39

## Brake Pressure Switch

All models with dual brakes and PDWA valve				
Genuine	1	<b>AAU1700</b>	27.30	32.76

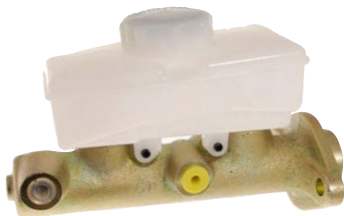
**NRC6096P**

**607726P**

**STC3821P**

# SUSPENSION

**SERIES III 88 (1971-1985)**

## Anti Roll Bar Bush

All models				
Rear, lower, poly.				
Aftermarket	4	<b>552819POLY</b>	1.08	1.30
Shock absorber mounting, front upper and lower, rear lower, rubber				
Aftermarket	4	<b>552819P</b>	0.19	0.23
Genuine	4	<b>552819</b>	1.39	1.67

## Front Chassis Bush

All models				
Aftermarket	2	<b>569746P</b>	1.58	1.90
Genuine	2	<b>569746</b>	13.47	16.16

## Bush, Swivel Pin

All models - Railko bush				
Aftermarket	2	<b>539742P</b>	5.83	7.00
Genuine	2	<b>539742</b>	21.71	26.05

## Spring Eye Bush

All models				
Aftermarket	4	<b>548205P</b>	1.58	1.90
Genuine	4	<b>548205</b>	4.14	4.97

## Spring Eye Bush (pair)

All models - poly., dynamic orange				
Polybush	2	<b>548205POLYBUSH</b>	17.50	21.00

## Shock Absorber Bush Kit

All models - Front shock absorber bushes, dynamic orange				
Polybush	1	<b>LL1590</b>	29.58	35.50

## Bush Shock Absorber Mounting

All models - Rear, lower, rubber				
Aftermarket	8	<b>552818P</b>	0.50	0.60
Genuine	8	<b>552818</b>	1.38	1.66

## Bush Shock Absorber Mounting

All models				
Rear, lower, poly.				
Aftermarket	4	<b>552818POLY</b>	0.83	1.00
Rear, lower, poly., performance red				
Polybush	4	<b>552818PPBR</b>	25.00	30.00
Rear, lower, poly., comfort blue				
Polybush	4	<b>552818PPBB</b>	25.00	30.00
Rear, lower, poly., dynamic orange				
Polybush	4	<b>552818PPBO</b>	25.00	30.00

**LL1590**

## Shock Absorber

All models				
Front, oil, std. height				
Aftermarket	2	<b>RTC4230P</b>	9.58	11.50
Front, heavy duty				
Aftermarket	2	<b>RTC4234P</b>	21.67	26.00
Rear, oil, std. height				
Aftermarket	2	<b>RTC4232P</b>	9.58	11.50
Rear, oil, std. height, heavy duty				
Aftermarket	2	<b>RTC4235P</b>	15.50	18.60
OEM	2	<b>RTC4235P1</b>	21.25	25.50

## Leaf Spring

All 2.25L petrol models				
9 leaf, driver's side, front				
Aftermarket	1	<b>241283P</b>	65.00	78.00
OEM	1	<b>241283P1</b>	75.00	90.00
9 leaf, passenger's side, front				
OEM	1	<b>242863P1</b>	75.00	90.00
All 2.25L diesel models -				
11 leaf, driver's side, front				
Aftermarket	1	<b>265627P</b>	65.00	78.00
All models				
11 leaf, driver's side, rear				
OEM	1	<b>517588P1</b>	99.17	119.00
Genuine	1	<b>517588</b>	176.59	211.91
11 leaf, passenger's side, rear				
OEM	1	<b>517589P1</b>	99.17	119.00
Rear, both sides; main leaf only (not spring assembly)				
OEM	2	<b>243123P1</b>	33.33	40.00
Genuine	2	<b>243123</b>	49.61	59.53

## Parabolic Spring Kit

All models				
Front springs, 2 leaf, pair, with U bolts				
Britpart	1	<b>LL1484BP</b>	115.00	138.00
Rear springs, 3 leaf, pair, with U bolts				
Britpart	1	<b>LL1485BPSWB</b>	175.00	210.00

## U Bolt, Leaf Spring

All diesel models (axle) suffix E onwards				
Front				
Aftermarket	2	<b>NRC3888P1</b>	4.00	4.80
Genuine	2	<b>NRC3888</b>	6.35	7.62
All models from (axle) suffix E onwards				
Rear				
Aftermarket	2	<b>NRC3885P</b>	8.96	10.75
Genuine	2	<b>NRC3885</b>	10.93	13.12

## Swivel Pin, Upper

All models - For Railko bush				
Aftermarket	2	<b>576583P</b>	4.17	5.00
OEM	2	<b>576583P1</b>	6.67	8.00
Genuine	2	<b>576583</b>	28.20	33.84



## SERIES III 88 (1971-1985)

# STEERING

### Draglink Tube

All models - With damper bracket	Aftermarket	1	<b>NRC4609P</b>	19.58	23.50
	Genuine	1	<b>NRC4609</b>	95.03	114.04

### Bearing Steering Column

All models - Top	Aftermarket	1	<b>RTC324P</b>	5.63	6.76
	Genuine	1	<b>RTC324</b>	15.64	18.77

### Track Rod End

All models up to July 1974 RH imperial thread	Aftermarket	1	<b>320901P</b>	4.00	4.80
	OEM	1	<b>320901P1</b>	15.63	18.76
LH imperial thread	Aftermarket	1	<b>320902P</b>	3.75	4.50
	OEM	1	<b>320902P1</b>	13.13	15.76
All models from Aug 1974 on RH thread, greasable	Aftermarket	1	<b>RTC5867P</b>	3.75	4.50
	OEM	1	<b>RTC5867P1</b>	9.58	11.50
	Genuine	1	<b>RTC5867</b>	25.93	31.12
LH thread, greasable	Aftermarket	1	<b>RTC5868P</b>	3.75	4.50
	OEM	1	<b>RTC5868P1</b>	9.58	11.50
	Genuine	1	<b>RTC5868</b>	25.93	31.12

### Track Rod Tube

All models - With bracket	Aftermarket	1	<b>NRC4609P</b>	19.58	23.50
	Genuine	1	<b>NRC4609</b>	95.03	114.04
All models up to suffix D - Without bracket	Genuine	1	<b>526994</b>	126.52	151.82

### Track Rod

All models (axle) suffix E onwards - Tube only	Aftermarket	1	<b>NRC132P</b>	14.17	17.00
------------------------------------------------	-------------	---	----------------	-------	-------

### Rubber Cap Track Rod End

All models	Aftermarket	2	<b>214649P</b>	1.33	1.60
	Genuine	2	<b>214649</b>	4.57	5.48

### Spring Ring Track Rod End

All models - Rubber cap, large diameter	Genuine	2	<b>214685</b>	3.15	3.78
-----------------------------------------	---------	---	---------------	------	------

### Spring Ring Track Rod End Boot

All models	Genuine	2	<b>90214684</b>	0.96	1.15
------------	---------	---	-----------------	------	------

### Gasket Steering Box

All models	Genuine	1	<b>271379</b>	2.06	2.47
------------	---------	---	---------------	------	------

### Oil Seal Steering Relay

All models	Genuine	2	<b>213340</b>	3.52	4.22
------------	---------	---	---------------	------	------

### Steering Relay Lever

All models	Genuine	1	<b>535286</b>	32.58	39.10
------------	---------	---	---------------	-------	-------

### Steering Relay Assembly

All models	Aftermarket	1	<b>NRC1269P</b>	60.83	73.00
------------	-------------	---	-----------------	-------	-------

### Gasket Steering Relay Shaft

All models	Genuine	1	<b>90624436</b>	0.55	0.66
------------	---------	---	-----------------	------	------

## SERIES III 88 (1971-1985)

# CLUTCH

### Clutch Kit

All models	Aftermarket	1	<b>STC8363P</b>	50.00	60.00
	OEM	1	<b>STC8363P1</b>	99.17	119.00
	Genuine	1	<b>STC8363</b>	184.10	220.92

### Clutch Cover

All models - 9.5 diameter, diaphragm type	Aftermarket	1	<b>576557P</b>	27.50	33.00
	OEM	1	<b>576557P1</b>	36.67	44.00
	Genuine	1	<b>576557</b>	116.97	140.36

### Clutch Plate

All models - 9.5 diameter	Aftermarket	1	<b>8510290P</b>	19.58	23.50
	OEM	1	<b>8510290P1</b>	32.50	39.00
	Genuine	1	<b>8510290</b>	67.84	81.41

### Clutch Release Bearing

All models - With carrier, new style	Aftermarket	1	<b>FTC5200P</b>	7.92	9.50
	OEM	1	<b>FTC5200P1</b>	12.50	15.00
	Genuine	1	<b>FTC5200</b>	37.38	44.86

### Clutch Release Bearing Heavy Duty

All models - With carrier, new style	Britpart	1	<b>FTC5200HDBP</b>	45.83	55.00
	Bearmach	1	<b>FTC5200HDBM</b>	80.00	96.00

### Clutch Fork

All models	Aftermarket	1	<b>576137P</b>	23.96	28.75
	OEM	1	<b>576137P1</b>	29.58	35.50
	Genuine	1	<b>576137</b>	63.81	76.57

### Clutch Fork Staple Retainer

All models	Aftermarket	1	<b>576203P</b>	0.25	0.30
	Genuine	1	<b>576203</b>	0.66	0.79

### Clutch Hose

All models - Slave cylinder	Aftermarket	1	<b>RTC5940P</b>	2.50	3.00
	OEM	1	<b>RTC5940P1</b>	10.00	12.00
	Genuine	1	<b>RTC5940</b>	39.59	47.51

### Clutch Pipe

All LHD models - Master cyl to hose	Genuine	1	<b>NRC4222</b>	16.46	19.75
-------------------------------------	---------	---	----------------	-------	-------

### Master Cylinder Repair Kit

All models - Clutch master cylinder	Aftermarket	1	<b>GRK1027P</b>	2.08	2.50
	OEM	1	<b>GRK1027</b>	5.63	6.76

### Slave Cylinder Repair Kit

All models	Aftermarket	1	<b>8G8600LP</b>	1.00	1.20
	OEM	1	<b>8G8600LP1</b>	4.38	5.26
	Genuine	1	<b>8G8600L</b>	8.51	10.21

### Clutch Master Cylinder

All models	Aftermarket	1	<b>STC500100P</b>	9.58	11.50
	OEM	1	<b>STC500100P1</b>	19.79	23.75
	Genuine	1	<b>STC500100</b>	76.84	92.21

### Clutch Slave Cylinder

All models	Aftermarket	1	<b>591231P</b>	7.08	8.50
	OEM	1	<b>591231P1</b>	18.13	21.76
	Genuine	1	<b>591231</b>	78.39	94.07

### Push Rod Clip

All models	Aftermarket	1	<b>576723P</b>	0.38	0.46
	Genuine	1	<b>576723</b>	3.95	4.74

### Pedal Pad Clutch & Brake

All models - Clutch and brake pedals	Aftermarket	2	<b>278166P</b>	1.83	2.20
	Genuine	2	<b>278166</b>	6.94	8.33

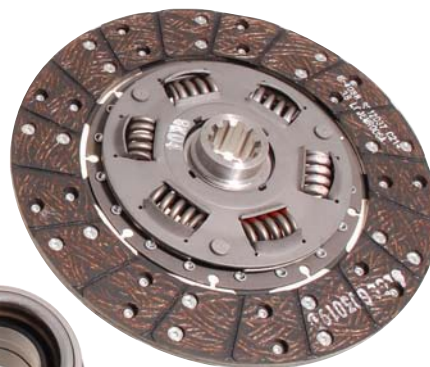

STC8363P1



# TRANSMISSION

**SERIES III 88 (1971-1985)**

## Gaiter Propshaft c/w Clips

All models - Front	Aftermarket	1	<b>276484P</b>	2.33	2.80
	Genuine	1	<b>276484</b>	22.65	27.18

## Gaiter Propshaft

All models	Aftermarket	1	<b>276483P</b>	3.00	3.60
	Genuine	1	<b>276483</b>	24.73	29.68

## Universal Joint

All models Propshaft	Aftermarket	2	<b>RTC3346P</b>	3.50	4.20
	OEM	2	<b>RTC3346P1</b>	8.13	9.76
Front half shaft	Genuine	2	<b>RTC3346</b>	49.81	59.77
	Genuine	2	<b>RTC3690</b>	41.27	49.52

## Half Shaft, Bare

All models - Front axle					
RH	Genuine	1	<b>276719</b>	195.70	234.84
LH	Genuine	1	<b>276720</b>	251.51	301.81

## Half Shaft

All models up to June 1980					
Rear RH	Aftermarket	1	<b>591378P</b>	14.58	17.50
Rear LH	Aftermarket	1	<b>591379P</b>	16.67	20.00

## Shaft Rear Axle

All models to Jun 1980					
RH, 10/10 spline	Genuine	1	<b>591378</b>	91.98	110.38
LH, 10/10 spline	Genuine	1	<b>591379</b>	89.00	106.80
All models Jul 1980 on					
RH, 10/24 spline	Aftermarket	1	<b>FRC1644P</b>	17.08	20.50
	Genuine	1	<b>FRC1644</b>	125.19	150.23
LH, 10/24 spline	Aftermarket	1	<b>FRC1645P</b>	17.08	20.50
	Genuine	1	<b>FRC1645</b>	136.40	163.68

## Stub Shaft

All models to 1980 - 10 spline	Genuine	2	<b>242520</b>	130.04	156.05
--------------------------------	---------	---	---------------	--------	--------

## Stub Axle Assembly Rear Hub

All models to 1980	Aftermarket	2	<b>599828P</b>	70.00	84.00
--------------------	-------------	---	----------------	-------	-------

## Stub Axle Rear

All models 1980 on	Aftermarket	2	<b>FRC3132P</b>	19.58	23.50
	OEM	2	<b>FRC3132P1</b>	39.58	47.50
	Genuine	2	<b>FRC3132</b>	167.46	200.95

## Stub Axle Nut

All models	Aftermarket	4	<b>FRC8700P</b>	1.25	1.50
	Genuine	4	<b>FRC8700</b>	10.09	12.11

## Hub & Stud Assembly

All models to 1980	Aftermarket	2	<b>576844P</b>	33.33	40.00
--------------------	-------------	---	----------------	-------	-------

## Driving Member

All models to 1980					
10 spline, front and rear	Genuine	1	<b>571235</b>	40.69	48.83
All models 1980 on					
24 spline, front and rear	OEM	1	<b>571711P1</b>	13.54	16.25

## Bearing Swivel Pin Housing

All models	Aftermarket	2	<b>244150P</b>	11.04	13.25
	OEM	2	<b>244150P1</b>	17.29	20.75
	Genuine	2	<b>217268</b>	8.13	9.76

## Swivel Pin Housing

All models	Aftermarket	2	<b>539741P</b>	75.00	90.00
------------	-------------	---	----------------	-------	-------

## Distance Piece Swivel Pin

All models	Aftermarket	2	<b>244151P</b>	1.25	1.50
------------	-------------	---	----------------	------	------

## Retainer Swivel Pin Housing Seal

All models	Aftermarket	2	<b>235968P</b>	1.67	2.00
------------	-------------	---	----------------	------	------

## Leather Gaiter Kit Swivels

All models	Aftermarket	2	<b>276954P</b>	17.08	20.50
------------	-------------	---	----------------	-------	-------

## Swivel Pin, Upper

All models - Railko type	Aftermarket	2	<b>576583P</b>	4.17	5.00
	OEM	2	<b>576583P1</b>	6.67	8.00
	Genuine	2	<b>576583</b>	28.20	33.84

## Swivel Pin & Bracket

All models	Aftermarket	2	<b>576583P</b>	4.17	5.00
	OEM	2	<b>576583P1</b>	6.67	8.00
	Genuine	2	<b>576583</b>	28.20	33.84

## Swivel Housing Grease

All models					
Sachet	OEM	a/r	<b>STC3435P1</b>	5.00	6.00
	Genuine	a/r	<b>STC3435</b>	7.69	9.23
370ml sachet	Britpart	a/r	<b>STC3435BP SACHET</b>	4.38	5.26
	Britpart	a/r	<b>STC3435BP BOTTLE</b>	4.79	5.75

## Oil Seal Diff Unit

All models	Aftermarket	1	<b>FRC4586P</b>	0.83	1.00
	OEM	1	<b>FRC4586P1</b>	3.50	4.20
	Genuine	1	<b>FRC4586</b>	11.66	13.99

## Oil Seal Front Axle Case

All models	OEM	1	<b>217400P1</b>	2.83	3.40
	Genuine	1	<b>217400</b>	5.21	6.25

## Oil Seal Hub

All models to 1980	Aftermarket	2	<b>RTC3510P</b>	1.25	1.50
	Genuine	2	<b>RTC3510</b>	6.29	7.55

## Oil Seal Hub Assembly

Optional fitment 1980 on - Single lip type	Aftermarket	2	<b>RTC3508P</b>	1.50	1.80
--------------------------------------------	-------------	---	-----------------	------	------

## Oil Seal Rear Hub

All models to 1980 - Felt/rubber, 10 spline type					
	Genuine	2	<b>RTC3515</b>	1.80	2.16

## Oil Seal Output Shaft

All models	Aftermarket	1	<b>FRC1780</b>	0.79	0.95
------------	-------------	---	----------------	------	------

## Oil Seal Mainshaft Rear

All models	Genuine	1	<b>236305</b>	3.89	4.67
------------	---------	---	---------------	------	------

## Oil Seal Stub Axle

All models 1981 on - Twin lip type	Aftermarket	2	<b>RTC3511P</b>	1.33	1.60
	OEM	2	<b>RTC3511P1</b>	3.50	4.20
	Genuine	2	<b>RTC3511</b>	12.52	15.02

## Seal Stub Axle

All models 1980 on	Aftermarket	2	<b>FRC3099P</b>	0.75	0.90
	OEM	2	<b>FRC3099P1</b>	3.25	3.90
	Genuine	2	<b>FRC3099</b>	8.09	9.71

## Oil Seal, Transfer Box

All models					
Felt type, output shaft	Aftermarket	1	<b>622042P</b>	0.50	0.60
	Genuine	1	<b>622042</b>	2.56	3.07
Front & rear output shafts	Aftermarket	2	<b>236417P</b>	0.71	0.85

## Oil Seal Swivel Housing

All models	Aftermarket	2	<b>RTC3528P</b>	2.08	2.50
	Genuine	2	<b>RTC3528</b>	10.96	13.15

## Oil Seal Speedo Pinion

All models	Aftermarket	1	<b>211502P</b>	0.54	0.65
------------	-------------	---	----------------	------	------

## Oil Seal Clutch Sleeve Housing

All models	Aftermarket	1	<b>571059P</b>	0.63	0.76
	Genuine	1	<b>571059</b>	7.87	9.44

## Drain Plug Diff Unit

All models	Aftermarket	1	<b>608246P</b>	2.33	2.80
	Genuine	1	<b>608246</b>	9.63	11.56

## Sealing Washer Drain Plug

All models					
Land Rover type axle	Aftermarket	1	<b>515599P</b>	0.33	0.40
	Genuine	1	<b>515599</b>	1.17	1.40
Transfer box	Genuine	1	<b>FRC4809</b>	0.80	0.96
Axle	Genuine	1	<b>FRC4809</b>	0.80	0.96

## Speedometer Drive Worm Gear

All models	OEM	1	<b>540004P1</b>	9.17	11.00
	Genuine	1	<b>540004</b>	35.69	42.83

**576844P**



## SERIES III 88 (1971-1985)

# COOLING

### Radiator Cap

All models				
Radiator header	Aftermarket	1	<b>STC4735P</b>	1.50 1.80
	Genuine	1	<b>STC4735</b>	6.11 7.33
9lb pressure	Aftermarket	1	<b>GRC118</b>	4.08 4.90

### Expansion Bottle Cap

All models - Expansion bottle				
	Genuine	1	<b>564719</b>	4.70 5.64

### Thermostat

All 4 cyl petrol & diesel models - 74°C				
	Aftermarket	1	<b>RTC3692P</b>	5.42 6.50
	Genuine	1	<b>RTC3692</b>	8.78 10.54
All 2.25L petrol and diesel engine models - 74°C				
	Aftermarket	1	<b>532453P</b>	2.42 2.90
	OEM	1	<b>532453P1</b>	30.00 36.00
	Genuine	1	<b>532453</b>	41.30 49.56

### Thermostat Housing Gasket

All 4 cylinder models - Thermostat housing				
	Aftermarket	1	<b>ERR3682P</b>	0.33 0.40
	Genuine	1	<b>ERR3682</b>	2.04 2.45
All 2.25L petrol and diesel models with 3 bearing crankshaft Upper				
	Aftermarket	1	<b>527110P</b>	0.21 0.25
All 2.25L petrol and diesel models Lower				
	Aftermarket	1	<b>247874P</b>	0.15 0.18
	Genuine	1	<b>247874</b>	1.74 2.09
To bypass connector	Genuine	1	<b>90511958</b>	1.34 1.61

### Thermostat Sealing Ring

All 2.25L petrol and diesel models				
	Genuine	1	<b>527235</b>	0.80 0.96

### Thermostat Housing

All 4 cyl petrol & diesel models				
	Genuine	1	<b>516059</b>	54.18 65.02

### Water Pump

All 2.25L petrol and diesel models with 12V 9 Hole				
	Aftermarket	1	<b>STC3758P</b>	16.67 20.00
All 2.25L military petrol models with 24V 7 Hole				
	Aftermarket	1	<b>RTC6327P</b>	33.33 40.00
	Genuine	1	<b>RTC6327</b>	352.71 423.25

### Water Pump Gasket

All 2.25L petrol and diesel models except military 9 stud fixing water pump				
	Aftermarket	1	<b>538671P</b>	0.25 0.30
	Genuine	1	<b>538671</b>	0.80 0.96
All military 2.25L models 7 stud fixing water pump				
	Genuine	1	<b>542218</b>	2.33 2.80

### Water Pump Inlet Housing Gasket

All 4 cylinder models Water pump inlet housing				
	Aftermarket	1	<b>ERR1607P</b>	0.25 0.30
	Genuine	1	<b>ERR1607</b>	1.67 2.00

### Temperature Sensor

All models - Water temperature, for 120 ° gauge, spade terminals				
	Aftermarket	1	<b>560794P</b>	2.42 2.90

## SERIES III 88 (1971-1985)

# ELECTRICAL - ROTATING ELECTRICS

### Alternator

All models with (engine) suffix B New				
	Aftermarket	1	<b>RTC5083EP</b>	50.00 60.00
All models (17ACR, 40amp) Reconditioned, exchange				
	Genuine*	1	<b>RTC5084E</b>	97.62 117.14
				<i>*Exchange Surcharge</i>
				80.00 96.00
Military 2.25L petrol models fitted for radio (FFR) with 24V system (no. 10 mk 2 alternator, 90amp) New, outright				
	Genuine	1	<b>STC9166</b>	1445.63 1734.76
Military models fitted for radio with 24V system (90amp alternator) Reconditioned, exchange				
	Genuine*	1	<b>PRC1102E</b>	2904.36 3485.23
				<i>*Exchange Surcharge</i>
				150.00 180.00

### Starter Motor

All petrol models Replacement 2M100 type, new				
	Aftermarket	1	<b>RTC5225P</b>	100.00 120.00
	Powerlite	1	<b>RTC5225UR</b>	145.00 174.00
All 2.25L diesel models - New				
	Aftermarket	1	<b>RTC5232P</b>	97.50 117.00
Military 2.25L petrol models, fitted for radio - 24V system New, exchange				
	Genuine*	1	<b>90501505</b>	3300.25 3960.30
				<i>*Exchange Surcharge</i>
				70.00 84.00

## SERIES III 88 (1971-1985)

# ENGINE GASKETS

### Gasket Rocker Cover

All 2.25L petrol models Self adhesive				
	Aftermarket	1	<b>ERR4933P</b>	1.00 1.20
	Genuine	1	<b>ERR4933</b>	11.78 14.14
All 2.25L diesel models Self adhesive				
	Aftermarket	1	<b>ETC6438P</b>	0.92 1.10
	Genuine	1	<b>ETC6438</b>	7.20 8.64

### Gasket Cylinder Head

2.25L petrol models				
	Aftermarket	1	<b>ERC6380P</b>	3.25 3.90
	OEM	1	<b>ERC6380P1</b>	12.95 15.54
	Genuine	1	<b>ERC6380</b>	25.12 30.14
2.25L diesel models				
	Aftermarket	1	<b>ERR3618P</b>	3.00 3.60
	OEM	1	<b>ERR3618P1</b>	9.79 11.75
	Genuine	1	<b>ERR3618</b>	36.82 44.18

### Gasket Decoke Set

All 2.25L petrol models				
	Aftermarket	1	<b>STC1567P</b>	10.00 12.00
	Aftermarket	1	<b>STC1556P</b>	8.33 10.00
2.25L diesel models				
	Genuine	1	<b>STC1564</b>	149.03 178.84

### Gasket Oil Sump

2.25L petrol and diesel models				
	Aftermarket	1	<b>546841P</b>	1.00 1.20
	OEM	1	<b>546841P1</b>	2.42 2.90
	Genuine	1	<b>546841</b>	17.82 21.38

### Silicone Sealant RTV

Numerous applications				
	Aftermarket	a/r	<b>RTC3254P</b>	5.00 6.00
	Genuine	a/r	<b>RTC3254</b>	21.04 25.25

### Engine Switches - Oil Pressure Switch

All 4 cyl models from 1980 on				
	Aftermarket	1	<b>PRC6387P</b>	1.83 2.20
	OEM	1	<b>PRC6387P1</b>	3.50 4.20
	Genuine	1	<b>PRC6387</b>	28.77 34.52
All models				
	Aftermarket	1	<b>90519864P</b>	1.75 2.10
All models from September 1976 on				
	Genuine	1	<b>DRC242</b>	97.62 117.14

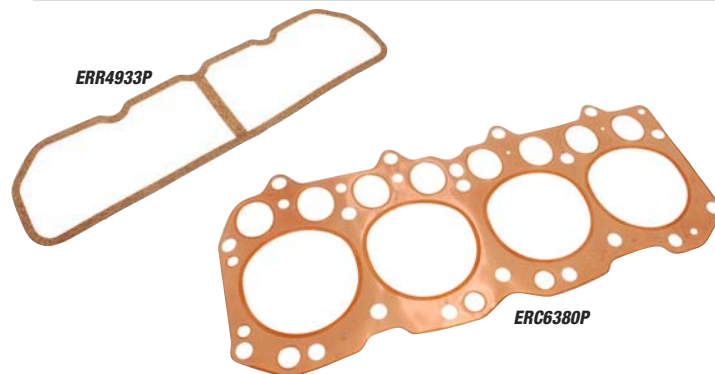

## SERIES III 88 (1971-1985)

# DRAIN PLUGS

### Sump Plug

All 2.25L petrol & diesel models				
	Genuine	1	<b>536577</b>	1.91 2.29

### Sump Plug Washer

All petrol and diesel models				
	Aftermarket	1	<b>243959P</b>	0.38 0.46
	Genuine	1	<b>243959</b>	0.82 0.98

### Drain Plug

All models				
Gearbox drain	Aftermarket	1	<b>540870P</b>	0.75 0.90
	Genuine	1	<b>540870</b>	2.09 2.51
Front & rear differentials	Genuine	1	<b>235592</b>	11.48 13.78

### Filler Plug

All models - Steering box				
	Genuine	1	<b>271386</b>	5.92 7.10



## OIL SEALS ENGINE

**SERIES III 88 (1971-1985)**

### Oil Seal Crankshaft Front

All models	Aftermarket	1	<b>ERR6490P</b>	3.00	3.60
	OEM	1	<b>ERR6490P1</b>	5.00	6.00

### Oil Seal Crankshaft Rear

2.25L 3 bearing petrol and diesel models	Aftermarket	1	<b>542492P</b>	1.75	2.10
2.25L 5 bearing petrol and diesel models	Aftermarket	1	<b>ERR2532P</b>	2.00	2.40
	OEM	1	<b>ERR2532P1</b>	5.83	7.00
	Genuine	1	<b>ERR2532</b>	21.00	25.20

### Oil Seal Front Cover

All models	Aftermarket	1	<b>ETC4154P</b>	1.08	1.30
	OEM	1	<b>ETC4154P1</b>	3.00	3.60
	Genuine	1	<b>ETC4154</b>	14.67	17.60

### Oil Seal Kit Crankshaft Rear

2.25L 3 bearing petrol and diesel models Retainers and seal	Aftermarket	1	<b>542494P</b>	11.67	14.00
----------------------------------------------------------------	-------------	---	----------------	-------	-------



## ENGINE & GEARBOX MOUNTINGS

**SERIES III 88 (1971-1985)**

### Engine Mounting

All petrol engine models - Front	Aftermarket	2	<b>NRC2054P</b>	1.83	2.20
	Genuine	2	<b>NRC2054</b>	17.88	21.46

### All diesel engine models

Engine and gearbox	Aftermarket	3	<b>NRC2052P</b>	2.00	2.40
	Genuine	3	<b>NRC2052</b>	11.94	14.33

### Gearbox Mounting

All models	Aftermarket	1	<b>NRC2053P</b>	1.83	2.20
	Genuine	1	<b>NRC2053</b>	5.78	6.94

### Bracket Gearbox Mounting

All models - RH	Genuine	1	<b>272501</b>	7.08	8.50
-----------------	---------	---	---------------	------	------



## CABLES

**SERIES III 88 (1971-1985)**

### Accelerator Cable

All diesel models	Aftermarket	1	<b>598852P</b>	2.50	3.00
	Genuine	1	<b>598852</b>	25.48	30.58
All 2.25L diesel models with cable operated controls	Aftermarket	1	<b>598852</b>	25.48	30.58
	Genuine	1	<b>598852</b>	25.48	30.58

### Choke Cable

All RHD petrol models without steering lock	Genuine	1	<b>599336</b>	18.61	22.33
---------------------------------------------	---------	---	---------------	-------	-------

### Speedometer Cable

All RHD & LHD models except V8 petrol	Aftermarket	1	<b>90623054P</b>	6.67	8.00
	Genuine	1	<b>90623054</b>	66.54	79.85

### Engine Stop Control Cable

All RHD diesel models without steering lock	Genuine	1	<b>599339</b>	20.17	24.20
---------------------------------------------	---------	---	---------------	-------	-------



90623054P

598852P

## WHEEL STUDS & WHEEL NUTS

**SERIES III 88 (1971-1985)**

### Wheel Stud

All models - Extended, 60mm (original fitment for Defender Wolf/XD). Allows fitment of certain alternative wheels

OEM	a/r	<b>FRC7577P1</b>	5.83	7.00
Genuine	a/r	<b>FRC7577</b>	19.36	23.23

### Wheel Nut

All models	Aftermarket	a/r	<b>RRD500010P</b>	0.79	0.95
	Genuine	a/r	<b>RRD500010</b>	1.82	2.18

### Wheel Nut Set

All models - Set of 20	Aftermarket	a/r	<b>RRD500010KP</b>	11.04	13.25
	Genuine	a/r	<b>RRD500010K</b>	34.00	40.80



RRD500010KP





# SERIES III 109 (1971-1985)

## 1971-1985 - All Models

Listed below are the most popular parts required for the Series III 109. We have access to the full range of parts for your vehicle. Please contact us if not listed here.

### SERIES III 109 (1971-1985)

## SERVICE KITS

### Service Kit

2.25L petrol models with Lucas ignition				
Oil filter, fuel filter (in-line), spark plugs, points (sliding), condenser, sump plug washer				
Bearmach	1	<b>LL1540BMLUCSLIDE</b>	11.25	13.50
2.25L petrol models with Ducellier ignition				
Oil filter, fuel filter (in-line), spark plugs, points, condenser, sump plug washer				
Bearmach	1	<b>LL1540BMDUC</b>	10.83	13.00



LL1540BMDUC

### SERIES III 109 (1971-1985)

## FILTRATION

### Oil Filter

All 2.25L petrol and diesel engines - Element				
Aftermarket	1	<b>RTC3184P</b>	1.83	2.20
Genuine	1	<b>RTC3184</b>	8.57	10.28
All models with 3.5L V8 petrol engine - Cartridge				
Aftermarket	1	<b>ERR3340P</b>	2.00	2.40
OEM	1	<b>ERR3340P1</b>	3.33	4.00
Genuine	1	<b>ERR3340</b>	10.82	12.98
All 6 cylinder petrol & 2.0L Diesel engine models				
Genuine	1	<b>RTC3183</b>	5.18	6.22

### Air Filter

All V8 petrol engine models				
Aftermarket	1	<b>605191P</b>	2.83	3.40
OEM	1	<b>605191P1</b>	4.38	5.26
Genuine	1	<b>GFE1117</b>	5.83	7.00
Genuine	1	<b>605191</b>	6.29	7.55
Alternative to 605191P				
Aftermarket	1	<b>RTC3479P</b>	9.58	11.50
Genuine	1	<b>RTC3479</b>	41.44	49.73

### Seal Air Cleaner

All 2.25L petrol models	Aftermarket	1	<b>554418P</b>	2.00	2.40
All V8 petrol models	Aftermarket	1	<b>554418P</b>	2.00	2.40

### Fuel Filter

All 2.25L diesel models - Element for in line filter assembly				
Aftermarket	1	<b>90517711P</b>	1.83	2.20
Aftermarket	1	<b>GFE5296</b>	3.50	4.20
Genuine	1	<b>90517711</b>	4.92	5.90
All 2.6L 6 cyl petrol models - Element for in line filter assembly				
Aftermarket	1	<b>JS660LP</b>	1.33	1.60
Genuine	1	<b>JS660L</b>	3.06	3.67
All 3.5L V8 petrol models - Element for in line filter assembly				
Aftermarket	1	<b>JS660LP</b>	1.33	1.60
Genuine	1	<b>JS660L</b>	3.06	3.67

### Fuel Filter Complete Assembly

All diesel engine models - Sedimentor type				
Aftermarket	1	<b>NRC9708P</b>	17.08	20.50
OEM	1	<b>NRC9708P1</b>	26.67	32.00
Genuine	1	<b>NRC9708</b>	76.51	91.81

### Fuel Filter Seal

All diesel engine models				
Top, for sedimentor filter				
Aftermarket	1	<b>AAU9903P</b>	0.33	0.40
Genuine	1	<b>AAU9903</b>	1.78	2.14
Bottom, for sedimentor filter				
Aftermarket	1	<b>AAU9902P</b>	0.58	0.70
Genuine	1	<b>AAU9902</b>	1.78	2.14

### SERIES III 109 (1971-1985)

## WIPER BLADES

### Wiper Blade

All models				
Front, sprung, bayonet push-on fitting				
stainless steel	Aftermarket	2	<b>PRC3386</b>	3.33 4.00
black	Aftermarket	2	<b>LR009343PS</b>	3.33 4.00
Front, not sprung, bayonet push-on fitting				
	Aftermarket	2	<b>LR009343PF</b>	5.42 6.50
All models with bayonet fixing black wiper arms - 10, black				
Wipac	2	<b>GWB910</b>	5.42	6.50
All models with flat wiper arms - Front	Genuine	2	<b>STC3302</b>	18.21 21.85



GWB910

### SERIES III 109 (1971-1985)

## SCREEN/LAMP WASHER SYSTEMS

### Washer Jet

All models - Front screen, replaces original metal stem jet				
Aftermarket	2	<b>PRC2437P</b>	2.25	2.70
Genuine	2	<b>PRC2437</b>	7.56	9.07

### Non Return Valve

All models - Washer bottle	Aftermarket	1	<b>90608330P</b>	2.83 3.40
----------------------------	-------------	---	------------------	-----------

### Washer Pump

All models - Front screen	Aftermarket	1	<b>GWW125</b>	9.38 11.26
---------------------------	-------------	---	---------------	------------

### Washer Hose, Per Metre

All models - 4mm internal diameter (3mm also available). Front or rear screen wash				
Aftermarket	a/r	<b>GWW201M</b>	2.25	2.70

### Windscreen Cleaning Paste

All models				
Prevents wiper blade judder/squeak by 'deep cleaning' the windscreen (ref: Land Rover Tech Bulletin LRA501-002)				
Genuine	a/r	<b>DNJ500340</b>	7.72	9.26

### SERIES III 109 (1971-1985)

## DRIVE BELTS

### Fan Belt

All civilian models with 2.25L 4 cyl engines - Fan				
Aftermarket	1	<b>563132 L-RP</b>	1.25	1.50
All models with 6 cylinder engine - Fan				
Aftermarket	1	<b>587468P</b>	3.75	4.50
All models with V8 carb engine - Fan				
Aftermarket	1	<b>613602P</b>	2.33	2.80
OEM	1	<b>613602P1</b>	3.83	4.60

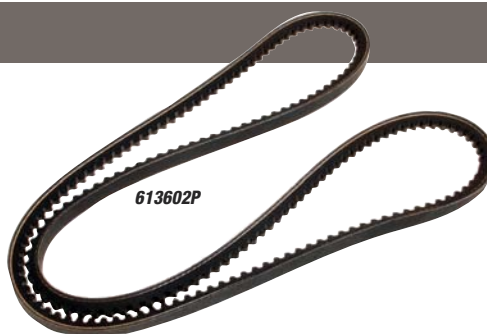

613602P



# IGNITION SYSTEM

# SERIES III 109 (1971-1985)

## Spark Plug

All 2.25L 8.0:1CR petrol models - RN11YC type				
Aftermarket	4	<b>ERR3799P</b>	2.00	2.40
Genuine	4	<b>ERR3799</b>	4.19	5.03
All 2.6L 6 cyl petrol models				
Aftermarket	6	<b>RTC3571P</b>	1.58	1.90
OEM	6	<b>RTC3571P1</b>	1.50	1.80
All V8 carb petrol models, std performance - 19mm reach				
MG Rover	8	<b>GSP4382</b>	2.95	3.54

## Glow Plug

All 2.25L diesel engine models				
Pigtail type				
Aftermarket	4	<b>568335P</b>	5.00	6.00
OEM	4	<b>568335P1</b>	10.83	13.00
Genuine	4	<b>568335</b>	42.76	51.31
from 1980 on				
Aftermarket	4	<b>ERC8450P</b>	2.25	2.70
OEM	4	<b>ERC8450P1</b>	7.29	8.75
Genuine	4	<b>ERC8450</b>	14.18	17.02

## Glow Plug Parallel Conversion Kit

All 2.25L diesel engine models up to 1980 - Kit wires plugs in parallel instead of series				
Britpart	1	<b>LL1530BP</b>	20.00	24.00
Bearmach	1	<b>LL1530BM</b>	22.08	26.50

## Replacement Set of Glow Plugs

All 2.25L diesel engine models up to 1980 - For Britpart glow plug parallel conversion kit				
Britpart	1	<b>LL1530BPPLUG</b>	16.67	20.00

## Ignition Coil

All 4 cyl petrol engine models				
Aftermarket	1	<b>PRC9858P</b>	7.35	8.82
OEM	1	<b>PRC9858P1</b>	12.92	15.50
Genuine	1	<b>PRC9858</b>	77.61	93.13
All petrol models				
Std coil				
Aftermarket	1	<b>GCL110</b>	12.50	15.00
Lucas	1	<b>GCL110LUCAS</b>	16.67	20.00
Sports coil				
Lucas	1	<b>GCL110HP</b>	19.58	23.50
V8 carb petrol engines - Ballasted type				
Aftermarket	1	<b>8510047P</b>	7.50	9.00
Genuine	1	<b>8510047</b>	70.82	84.74
All military models with 24V system, fitted for radio (FFR) - 24V, shielded type				
Genuine	1	<b>552765</b>	613.57	736.28

## Contact Set

All 2.25L petrol engine models with 12V system up to (eng) suffix C incl. - For type 25D distributor				
Aftermarket	1	<b>RTC3270P</b>	1.00	1.20
2.25L petrol engine models with 12V system from (eng) suffix D on with Lucas distributor				
Type 45D/59D distributor, fixed contact set (alternative to sliding contact set)				
Aftermarket	1	<b>RTC3288P</b>	0.92	1.10
Genuine	1	<b>RTC3288</b>	1.70	2.04
Type 45D/59D distributor, sliding contact set (alternative to fixed contact set)				
Aftermarket	1	<b>RTC6627P</b>	2.00	2.40
Genuine	1	<b>RTC6627</b>	10.32	12.38
2.25L petrol engine models from (eng) suffix D on with Ducellier distributor				
Aftermarket	1	<b>RTC6625P</b>	1.50	1.80
All 4 cyl petrol models fitted with Lucas 59D type distributor - Blue sliding contact type set				
Aftermarket	1	<b>GCS261</b>	6.88	8.26
All 2.6L 6 cylinder petrol models - For all Lucas distributors except no 41631				
Aftermarket	1	<b>RTC3270P</b>	1.00	1.20
2.6L 6 cylinder petrol models with Lucas no 41631 distributor				
Aftermarket	1	<b>RTC3288P</b>	0.92	1.10
Genuine	1	<b>RTC3288</b>	1.70	2.04
All V8 Carb petrol engine models				
Aftermarket	1	<b>RTC6623P</b>	2.67	3.20
OEM	1	<b>RTC6623P1</b>	3.67	4.40
All V8 petrol models				
Aftermarket	1	<b>GCS2117P</b>	4.08	4.90
Aftermarket	1	<b>GCS2117</b>	7.50	9.00
All military 4 cyl petrol models with 24V system, fitted for radio (FFR)				
Aftermarket	1	<b>RTC6622P</b>	1.75	2.10
Genuine	1	<b>RTC6622</b>	28.71	34.45

## Adjustment Bush, Contact Set

All V8 petrol models - For sliding points type distributor				
Genuine	1	<b>RTC5014</b>	1.33	1.60

## Rotor Arm

All 2.25L petrol engine models up to (eng) suffix C incl.				
For type 25D distributor				
Aftermarket	1	<b>GRA101</b>	2.50	3.00
Red, as original, for Lucas type 25D distributor				
Lucas	1	<b>GRA101RED</b>	7.50	9.00
2.25L petrol engine models from (eng) suffix D on with Lucas distributor - Type 45D/59D distributor				
Aftermarket	1	<b>RTC3614P</b>	1.00	1.20
Aftermarket	1	<b>GRA114</b>	2.33	2.80
Red, as original, for type 45D/59D distributor				
Lucas	1	<b>GRA114RED</b>	7.50	9.00
2.25L petrol engine models from (eng) suffix D on with Ducellier distributor				
Aftermarket	1	<b>RTC4933P</b>	1.00	1.20
Genuine	1	<b>RTC4933</b>	3.77	4.52
All V8 carb petrol models				
Aftermarket	1	<b>RTC3618P</b>	2.00	2.40



LL1530BP

## Condenser

All 2.25L petrol engine models up to (eng) suffix C incl.				
For type 25D distributor				
Aftermarket	1	<b>RTC3472P</b>	1.25	1.50
Aftermarket	1	<b>GSC111</b>	3.08	3.70
Genuine	1	<b>RTC3472</b>	3.73	4.48
2.25L petrol engine models from (eng) suffix D on with Lucas distributor				
For type 45D/59D distributor				
Aftermarket	1	<b>GSC109</b>	2.33	2.80
Aftermarket	1	<b>RTC3524P</b>	2.75	3.30
Type 45D/59D distributor, with 17 7/8 long LT lead				
Aftermarket	1	<b>RTC6621P</b>	1.00	1.20
Genuine	1	<b>RTC6621</b>	2.23	2.68
2.25L petrol engine models from (eng) suffix D on with Ducellier distributor				
Aftermarket	1	<b>RTC4935P</b>	2.25	2.70
Genuine	1	<b>RTC6620</b>	1.99	2.39
All 2.6L 6 cylinder petrol models - For all Lucas distributors except no 41631				
Aftermarket	1	<b>RTC3472P</b>	1.25	1.50
Aftermarket	1	<b>GSC111</b>	3.08	3.70
Genuine	1	<b>RTC3472</b>	3.73	4.48
All V8 Carb petrol engine models				
Aftermarket	1	<b>RTC3472P</b>	1.25	1.50
Aftermarket	1	<b>GSC111</b>	3.08	3.70
Genuine	1	<b>RTC3472</b>	3.73	4.48

## Distributor Cap

All 2.25L petrol engine models up to (eng) suffix C incl.				
For type 25D distributor, push on terminals				
Aftermarket	1	<b>GDC103</b>	3.75	4.50
2.25L petrol engine models from (eng) suffix D on with Lucas distributor				
Type 45D/59D distributor				
Aftermarket	1	<b>RTC3278P</b>	2.33	2.80
OEM	1	<b>RTC3278P1</b>	3.50	4.20
Genuine	1	<b>RTC3278</b>	16.53	19.84
2.25L petrol engine models from (eng) suffix D on with Ducellier distributor				
Aftermarket	1	<b>RTC4932P</b>	3.75	4.50
2.6L 6 cylinder petrol models with Lucas no 41631 distributor				
Genuine	1	<b>RTC3813</b>	12.15	14.58
All 2.6L 6 cylinder petrol models - Top entry type, push on terminals, for all Lucas distributors except no 41631				
Aftermarket	1	<b>GDC115</b>	5.63	6.76
All V8 petrol engine models				
Aftermarket	1	<b>GDC117P</b>	5.00	6.00
Aftermarket	1	<b>GDC117</b>	10.42	12.50
OEM	1	<b>GDC117P1</b>	16.04	19.25
Genuine	1	<b>GDC1170E</b>	32.94	39.53

## Distributor Drive Gear

All V8 Carb petrol engine models - On camshaft				
Aftermarket	1	<b>614188A</b>	22.50	27.00

## Distributor Drive Gear and Coupling

All V8 Carb petrol engine models - On distributor				
Aftermarket	1	<b>ERC1353A</b>	27.50	33.00

## O Ring Distributor

All V8 carb petrol models				
Aftermarket	1	<b>603446P</b>	2.50	3.00
Genuine	1	<b>603446</b>	7.27	8.72

## Vacuum Unit, Distributor

All non-detoxed V8 carb petrol models				
OEM	1	<b>UKC1674</b>	46.67	56.00

## Ignition Lead Set

2.25L petrol engine models				
Aftermarket	1	<b>ERC3256P</b>	6.04	7.25
Genuine	1	<b>ERC3256</b>	51.30	61.56
All 6 cylinder models				
Genuine	1	<b>ERC2523</b>	27.30	32.76
All V8 carb petrol engine models				
Silicone				
Aftermarket	1	<b>RTC6551P</b>	11.67	14.00
OEM	1	<b>RTC6551P1</b>	19.58	23.50
Silicone, RED				
Aftermarket	1	<b>RTC6551PS</b>	16.67	20.00

## Ignition Lead Set Performance

All V8 carb petrol engine models				
OEM	1	<b>RTC6551P1S</b>	32.50	39.00

## Ignition Lead Set

All V8 carb petrol engine models				
Silicone, Black				
Aftermarket	1	<b>GHT206S</b>	25.83	31.00



GHT206S



**SERIES III 109 (1971-1985)****BRAKING SYSTEM****Brake Linings Set**

All models - Set of 4, with rivets, 11" dia brakes	Aftermarket	1	<b>STC3944P</b>	12.50	15.00
----------------------------------------------------	-------------	---	-----------------	-------	-------

**Brake Shoe Set**

All models - Rear Brakes	Aftermarket	1	<b>STC2797P</b>	11.67	14.00
	OEM	1	<b>STC2797P1</b>	25.83	31.00
	Genuine	1	<b>STC2797</b>	191.25	229.50

**Brake Linings Set**

All models - Set of 4, with rivets, rear brakes	Aftermarket	1	<b>STC2795P</b>	3.50	4.20
	Genuine	1	<b>STC2795</b>	49.44	59.33

**Brake Adjuster Kit**

All models - Front and Rear Brake Shoes	Aftermarket	1	<b>RTC3176P</b>	10.83	13.00
	Genuine	1	<b>RTC3176</b>	109.72	131.66

**Brake Shoe Spring**

All models - Front Brakes	Genuine	1	<b>234889</b>	2.90	3.48
---------------------------	---------	---	---------------	------	------

**Brake Drum**

All 4 cylinder models - Front and Rear	Aftermarket	2	<b>576973P</b>	17.50	21.00
	Genuine	2	<b>576973</b>	90.40	108.48

**Wheel Cylinder**

All models					
Right Hand Front	Aftermarket	1	<b>243744P</b>	5.63	6.76
	OEM	1	<b>243744P1</b>	10.00	12.00
Left Hand Front	Aftermarket	1	<b>243743P</b>	5.63	6.76
	OEM	1	<b>243743P1</b>	10.00	12.00
Right Hand Rear	Aftermarket	1	<b>243296P</b>	5.83	7.00
	OEM	1	<b>243296P1</b>	13.54	16.25
	Genuine	1	<b>243296</b>	51.87	62.24
6 Cylinder					
Right Hand Front	Aftermarket	1	<b>600201P</b>	8.54	10.25
Left Hand Front	Genuine	1	<b>600200</b>	142.04	170.45
	Aftermarket	1	<b>600200P</b>	8.54	10.25
V8					
Right Hand Front	Aftermarket	1	<b>600201P</b>	8.54	10.25
Left Hand Front	Genuine	1	<b>600200</b>	142.04	170.45
	Aftermarket	1	<b>600200P</b>	8.54	10.25

**Bleed Screw**

All models - UNF, Wheel Cylinders	Aftermarket	2	<b>556508A</b>	2.08	2.50
-----------------------------------	-------------	---	----------------	------	------

**Brake Master Cylinder**

Single circuit brakes, 4 cylinder (not station wagon) up to June 1980					
CV type, without nut on back of cylinder	Aftermarket	1	<b>90569128P</b>	7.50	9.00
	OEM	1	<b>90569128P1</b>	31.50	37.80
Single circuit brakes, 6 Cylinder up to June 1980					
CV type, without nut on back of cylinder	Aftermarket	1	<b>569339P</b>	15.00	18.00
Single circuit brakes, station wagon up to June 1980					
CV type, without nut on back of cylinder	Aftermarket	1	<b>569339P</b>	15.00	18.00
Dual circuit brakes with servo up to June 1980					
	Aftermarket	1	<b>90577520P</b>	30.00	36.00
	Genuine	1	<b>90577520</b>	410.92	493.10
Alternative to 90577520	Aftermarket	1	<b>569671P</b>	39.58	47.50
	Genuine	1	<b>569671</b>	346.33	415.60
Dual circuit brakes with servo from June 1980 on					
Does not include reservoir	OEM	1	<b>NRC6096NRP1</b>	65.00	78.00
	Aftermarket	1	<b>NRC6096P</b>	39.58	47.50
	Genuine	1	<b>NRC6096</b>	232.00	278.40

**Master Cylinder Repair Kit**

All 4 cyl models with CV type master cylinder except station wagon - Brake master cylinder	Aftermarket	1	<b>GRK1027</b>	5.63	6.76
--------------------------------------------------------------------------------------------	-------------	---	----------------	------	------

**Master Cylinder Overhaul Kit**

All models with dual circuit brakes - Brake master cylinder	Aftermarket	1	<b>607726P</b>	8.96	10.75
	Genuine	1	<b>607726</b>	32.44	38.93

**Servo Repair Kit**

6 cyl models and 4 cyl station wagon - Type 50 servo (227mm dia servo)	Aftermarket	1	<b>1868951A</b>	11.25	13.50
------------------------------------------------------------------------	-------------	---	-----------------	-------	-------

**Brake Hose**

All models up to June 1980					
Front brake hose, rubber	Aftermarket	2	<b>RTC5903P</b>	2.83	3.40
	Genuine	2	<b>RTC5903</b>	17.29	20.75
All models July 1980 on					
Front hose, metric system	Aftermarket	2	<b>NRC9457P</b>	2.50	3.00
	Genuine	2	<b>NRC9457</b>	23.06	27.67
Up to June 1980					
Rear brake hose, rubber	Aftermarket	1	<b>RTC3353P</b>	3.00	3.60
	Genuine	1	<b>RTC3353</b>	16.47	19.76
All models July 1980 on					
Rear, rubber	Aftermarket	2	<b>NRC9458P</b>	3.33	4.00
	OEM	2	<b>NRC9458P1</b>	10.63	12.76
	Genuine	2	<b>NRC9458</b>	23.06	27.67
All models with V8 engine					
Rear, rubber	Aftermarket	2	<b>NTC3458P</b>	2.50	3.00
	OEM	2	<b>NTC3458P1</b>	5.83	7.00
	Genuine	2	<b>NTC3458</b>	28.82	34.58
All 6 cylinder models - Clutch hose					
Rear, rubber	Aftermarket	1	<b>RTC4425P</b>	2.50	3.00
	OEM	1	<b>RTC4425P1</b>	8.75	10.50
	Genuine	1	<b>RTC4425</b>	34.58	41.50

**T Piece Brake System**

All models July 1980 on - Rear brake pipes	Aftermarket	a/r	<b>NRC4251P</b>	6.04	7.25
	Genuine	a/r	<b>NRC4251</b>	17.88	21.46

**Brake Shoe Set - Handbrake**

All 4 cylinder models - Handbrake	Aftermarket	1	<b>STC3821P</b>	5.83	7.00
All 6 cylinder models - Handbrake	Aftermarket	1	<b>STC2880P</b>	12.50	15.00
	Genuine	1	<b>STC2880</b>	74.69	89.63
All V8 models - Handbrake	Aftermarket	1	<b>STC2880P</b>	12.50	15.00
	Genuine	1	<b>STC2880</b>	74.69	89.63

**Brake Drum - Handbrake**

All 4 cylinder models - Handbrake	Aftermarket	1	<b>274423P</b>	9.58	11.50
	Genuine	1	<b>274423</b>	60.24	72.29
All V8 models with 4 Speed Gearbox	Genuine	1	<b>90576624</b>	29.58	35.50

**Retaining Plate Handbrake**

All models	Aftermarket	1	<b>515468P</b>	1.08	1.30
	Genuine	1	<b>515468</b>	2.30	2.76

**Locking Plate Handbrake**

All models	Aftermarket	1	<b>515467P</b>	1.33	1.60
	Genuine	1	<b>515467</b>	1.72	2.06

**Dust Cover Expander Unit**

All models except V8 petrol	OEM	1	<b>515466P1</b>	3.33	4.00
	Genuine	1	<b>515466</b>	4.49	5.39

**Brake Pressure Switch**

All models with dual brakes and PDWA valve	Genuine	1	<b>AAU1700</b>	27.30	32.76
--------------------------------------------	---------	---	----------------	-------	-------



# SUSPENSION

## SERIES III 109 (1971-1985)

### Bush Shackle

All models - Front suspension, rubber	Aftermarket	2	<b>90577434P</b>	2.33	2.80
	Genuine	2	<b>90577434</b>	13.72	16.46

### Bush Shackle (pair)

All models - Front suspension, poly.	Polybush	1	<b>90577434POLY</b>	17.50	21.00
--------------------------------------	----------	---	---------------------	-------	-------

### Anti Roll Bar Bush

All models - Front upper and lower, rear lower, poly.	Aftermarket	4	<b>552819POLY</b>	1.08	1.30
-------------------------------------------------------	-------------	---	-------------------	------	------

### Front Chassis Bush

All models	Aftermarket	2	<b>569746P</b>	1.58	1.90
	Genuine	2	<b>569746</b>	13.47	16.16

### Bush, Swivel Pin

All models except V8 petrol - Railko bush	Aftermarket	2	<b>539742P</b>	5.83	7.00
	Genuine	2	<b>539742</b>	21.71	26.05

### Spring Eye Bush

All models	Aftermarket	4	<b>548205P</b>	1.58	1.90
	Genuine	4	<b>548205</b>	4.14	4.97

### Spring Eye Bush (pair)

All models - poly., dynamic orange	Polybush	2	<b>548205POLYBUSH</b>	17.50	21.00
------------------------------------	----------	---	-----------------------	-------	-------

### Shock Absorber Mounting Bush

All models - Shock absorber mounting, front upper and lower, rear lower, rubber	Aftermarket	4	<b>552819P</b>	0.19	0.23
	Genuine	4	<b>552819</b>	1.39	1.67

### Bush Shock Absorber Mounting

Rear, lower, rubber	Aftermarket	8	<b>552818P</b>	0.50	0.60
	Genuine	8	<b>552818</b>	1.38	1.66
Rear, lower, poly.	Aftermarket	4	<b>552818POLY</b>	0.83	1.00
Rear, lower, poly., performance red	Polybush	1	<b>5528189PBR</b>	25.00	30.00
Rear, lower, poly., comfort blue	Polybush	1	<b>552818PPBB</b>	25.00	30.00
Rear, lower, poly., dynamic orange	Polybush	1	<b>5528189PBO</b>	25.00	30.00

### Shock Absorber Bush Kit

All models - Front shock absorber bushes dynamic orange	Polybush	1	<b>LL1590</b>	29.58	35.50
---------------------------------------------------------	----------	---	---------------	-------	-------

### Polyurethane Bush Kit

All models - Car set of spring and chassis bushes, dynamic orange	Polybush	1	<b>LL1561</b>	100.00	120.00	
	Bearmach	1	<b>LL1561-BMPOLY</b>	53.33	64.00	
All models - Car set of suspension bushes	Britpart black	Britpart	1	<b>LL1478BPPOLYBLK</b>	45.83	55.00
	Britpart yellow	Britpart	1	<b>LL1478BPPOLYYEL</b>	53.33	64.00

### Shock Absorber

All 1 Ton models	Aftermarket	2	<b>RTC4231P</b>	21.67	26.00
	Genuine	2	<b>RTC4231</b>	60.83	73.00
Rear	Aftermarket	2	<b>RTC4233P</b>	19.79	23.75
All models	Aftermarket	2	<b>RTC4484P</b>	13.50	16.20
	OEM	2	<b>RTC4484P1</b>	35.00	42.00
	Genuine	2	<b>RTC4484</b>	71.87	86.24
Rear, oil, std. height	Aftermarket	2	<b>RTC4442P</b>	12.50	15.00
All models except 1 Ton	Aftermarket	2	<b>RTC4234P</b>	21.67	26.00
	Aftermarket	2	<b>RTC4483P</b>	13.50	16.20
	OEM	2	<b>RTC4483P1</b>	23.75	28.50
	Genuine	2	<b>RTC4483</b>	82.14	98.57
	Genuine	2	<b>RTC4236</b>	59.56	71.47

### Leaf Spring

All 1 ton models	Aftermarket	1	<b>265627P</b>	65.00	78.00
	OEM	2	<b>535173P1</b>	130.00	156.00
	Genuine	2	<b>535173</b>	216.26	259.51
All 2.25L petrol models except 1 ton	Aftermarket	1	<b>265627P</b>	65.00	78.00
	Aftermarket	1	<b>265627P</b>	65.00	78.00
All 2.25L diesel models	Aftermarket	1	<b>265627P</b>	65.00	78.00
	Aftermarket	1	<b>279679P</b>	107.50	129.00

### Parabolic Spring Kit

All models	Britpart	1	<b>LL1484BP</b>	115.00	138.00
	Britpart	1	<b>LL1485BPLWB</b>	220.83	265.00

### U Bolt, Leaf Spring

All diesel models (axle) suffix E onwards except 1 Ton	Aftermarket	2	<b>NRC3888P1</b>	4.00	4.80
	Aftermarket	2	<b>NRC3888</b>	6.35	7.62

### Drag Link Assembly

All 1 Ton models	Genuine	1	<b>RTC2547</b>	242.65	291.18
------------------	---------	---	----------------	--------	--------

### Swivel Pin, Upper

All models except V8 petrol - For Railko bush	Aftermarket	2	<b>576583P</b>	4.17	5.00
	OEM	2	<b>576583P1</b>	6.67	8.00
	Genuine	2	<b>576583</b>	28.20	33.84

### Draglink Tube

All models - With damper bracket	Aftermarket	1	<b>NRC4609P</b>	19.58	23.50
	Genuine	1	<b>NRC4609</b>	95.03	114.04

# STEERING

## SERIES III 109 (1971-1985)

### Bearing Steering Column

All models - Top	Aftermarket	1	<b>RTC324P</b>	5.63	6.76
	Genuine	1	<b>RTC324</b>	15.64	18.77

### Steering Damper Assembly

All 1 Ton models	Aftermarket	1	<b>STC786P</b>	10.00	12.00
	Bilstein	1	<b>STC786UR</b>	67.50	81.00
	OEM	1	<b>STC786P1</b>	37.50	45.00
	Terrafrirma	1	<b>STC786TF</b>	33.75	40.50
	Cellular Dynamic	1	<b>STC786UR-BPCEL</b>	29.58	35.50
	Super Gaz	1	<b>STC786UR-BPSUP</b>	25.83	31.00
	Genuine	1	<b>STC786</b>	65.72	78.86

### Fitting Kit, Steering Damper

All 1 Ton models - Allows Terrafrirma Defender 'return to centre' damper or adjustable damper to be fitted	Terrafrirma	1	<b>STC786TFRTCFK</b>	53.33	64.00
------------------------------------------------------------------------------------------------------------	-------------	---	----------------------	-------	-------

### Track Rod End

All models up to July 1974	RH imperial thread	Aftermarket	1	<b>320901P</b>	4.00	4.80
		OEM	1	<b>320901P1</b>	15.63	18.76
	LH imperial thread	Aftermarket	1	<b>320902P</b>	3.75	4.50
		OEM	1	<b>320902P1</b>	13.13	15.76
All models from Aug 1974 on	RH thread, greasable	Aftermarket	1	<b>RTC5867P</b>	3.75	4.50
		OEM	1	<b>RTC5867P1</b>	9.58	11.50
		Genuine	1	<b>RTC5867</b>	25.93	31.12
	LH thread, greasable	Aftermarket	1	<b>RTC5868P</b>	3.75	4.50
		OEM	1	<b>RTC5868P1</b>	9.58	11.50
Genuine	1	<b>RTC5868</b>	25.93	31.12		

### Track Rod Tube

All models except 1 Ton - With bracket	Aftermarket	1	<b>NRC4609P</b>	19.58	23.50
	Genuine	1	<b>NRC4609</b>	95.03	114.04
All models up to suffix D except 1 Ton - Without bracket	Genuine	1	<b>526994</b>	126.52	151.82

### Track Rod

All models (axle) suffix E onwards - Tube only	Aftermarket	1	<b>NRC132P</b>	14.17	17.00
------------------------------------------------	-------------	---	----------------	-------	-------

### Rubber Cap Track Rod End

All models	Aftermarket	2	<b>214649P</b>	1.33	1.60
	Genuine	2	<b>214649</b>	4.57	5.48

### Spring Ring Track Rod End

All models - Rubber cap, large diameter	Genuine	2	<b>214685</b>	3.15	3.78
-----------------------------------------	---------	---	---------------	------	------

### Spring Ring Track Rod End Boot

All models	Genuine	2	<b>90214684</b>	0.96	1.15
------------	---------	---	-----------------	------	------

### Gasket Steering Box

All models	Genuine	1	<b>271379</b>	2.06	2.47
------------	---------	---	---------------	------	------

### Oil Seal Steering Relay

All models	Genuine	2	<b>213340</b>	3.52	4.22
------------	---------	---	---------------	------	------

### Steering Relay Lever

All models	Genuine	1	<b>535286</b>	32.58	39.10
------------	---------	---	---------------	-------	-------

### Steering Relay Assembly

All models	Aftermarket	1	<b>NRC1269P</b>	60.83	73.00
------------	-------------	---	-----------------	-------	-------

### Gasket Steering Relay Shaft

All models	Genuine	1	<b>90624436</b>	0.55	0.66
------------	---------	---	-----------------	------	------





## SERIES III 109 (1971-1985)

## CLUTCH

## Clutch Kit

All 4 & 6 cyl models	Aftermarket	1	<b>STC8363P</b>	50.00	60.00
	OEM	1	<b>STC8363P1</b>	99.17	119.00
	Genuine	1	<b>STC8363</b>	184.10	220.92

All V8 petrol models - Includes clutch plate, cover and release bearing

Aftermarket	1	<b>GCK203P</b>	91.67	110.00
-------------	---	----------------	-------	--------

## Clutch Cover

All models except V8 - 9.5" diameter, diaphragm type

Aftermarket	1	<b>576557P</b>	27.50	33.00
OEM	1	<b>576557P1</b>	36.67	44.00
Genuine	1	<b>576557</b>	116.97	140.36

All V8 petrol models

Aftermarket	1	<b>576476P</b>	39.58	47.50
OEM	1	<b>576476P1</b>	60.00	72.00
Genuine	1	<b>576476</b>	118.73	142.48

## Clutch Plate

All models except V8 - 9.5" diameter

Aftermarket	1	<b>8510290P</b>	19.58	23.50
OEM	1	<b>8510290P1</b>	32.50	39.00
Genuine	1	<b>8510290</b>	67.84	81.41

All V8 petrol models

OEM	1	<b>FRC6631P1</b>	35.00	42.00
-----	---	------------------	-------	-------

## Clutch Release Bearing

All models - With carrier, new style

Aftermarket	1	<b>FTC5200P</b>	7.92	9.50
OEM	1	<b>FTC5200P1</b>	12.50	15.00
Genuine	1	<b>FTC5200</b>	37.38	44.86

Heavy Duty

Britpart	1	<b>FTC5200HDBP</b>	45.83	55.00
Bearmach	1	<b>FTC5200HDBM</b>	80.00	96.00

## Clutch Fork

All models

Aftermarket	1	<b>576137P</b>	23.96	28.75
OEM	1	<b>576137P1</b>	29.58	35.50
Genuine	1	<b>576137</b>	63.81	76.57

## Clutch Fork Staple Retainer

All models

Aftermarket	1	<b>576203P</b>	0.25	0.30
Genuine	1	<b>576203</b>	0.66	0.79

## Clutch Pipe

All LHD models - Master cyl to hose

Genuine	1	<b>NRC4222</b>	16.46	19.75
---------	---	----------------	-------	-------

## Clutch Hose

All 4 cyl models - Slave cylinder

Aftermarket	1	<b>RTC5940P</b>	2.50	3.00
OEM	1	<b>RTC5940P1</b>	10.00	12.00
Genuine	1	<b>RTC5940</b>	39.59	47.51

## Master Cylinder Repair Kit

All models - Clutch master cylinder

Aftermarket	1	<b>GRK1027P</b>	2.08	2.50
OEM	1	<b>GRK1027</b>	5.63	6.76

## Slave Cylinder Repair Kit

All models except V8

Aftermarket	1	<b>8G8600LP</b>	1.00	1.20
OEM	1	<b>8G8600LP1</b>	4.38	5.26
Genuine	1	<b>8G8600L</b>	8.51	10.21

All V8 petrol models

Genuine	1	<b>513390</b>	5.00	6.00
---------	---	---------------	------	------

## Clutch Master Cylinder

All models

Aftermarket	1	<b>STC500100P</b>	9.58	11.50
OEM	1	<b>STC500100P1</b>	19.79	23.75
Genuine	1	<b>STC500100</b>	76.84	92.21

## Clutch Slave Cylinder

All models except V8

Aftermarket	1	<b>591231P</b>	7.08	8.50
OEM	1	<b>591231P1</b>	18.13	21.76
Genuine	1	<b>591231</b>	78.39	94.07

All V8 petrol models

OEM	1	<b>UKC8677P1</b>	20.00	24.00
Genuine	1	<b>UKC8677</b>	16.67	20.00

## Push Rod Clip

All models

Aftermarket	1	<b>576723P</b>	0.38	0.46
Genuine	1	<b>576723</b>	3.95	4.74

All V8 petrol models

Aftermarket	1	<b>576723P</b>	0.38	0.46
Genuine	1	<b>576723</b>	3.95	4.74

## Bleed Screw Clutch Slave Cylinder

All V8 petrol models

Genuine	1	<b>606733A</b>	2.58	3.10
---------	---	----------------	------	------

## Pedal Pad Clutch &amp; Brake

All models - Clutch and brake pedals

Aftermarket	2	<b>278166P</b>	1.83	2.20
Genuine	2	<b>278166</b>	6.94	8.33

## SERIES III 109 (1971-1985)

## TRANSMISSION

## Gaiter Propshaft c/w Clips

All models - Front

Aftermarket	1	<b>276484P</b>	2.33	2.80
Genuine	1	<b>276484</b>	22.65	27.18

## Gaiter Propshaft

All models

Aftermarket	1	<b>276483P</b>	3.00	3.60
Genuine	1	<b>276483</b>	24.73	29.68

## Universal Joint

All models - Propshaft

Aftermarket	2	<b>RTC3346P</b>	3.50	4.20
OEM	2	<b>RTC3346P1</b>	8.13	9.76
Genuine	2	<b>RTC3346</b>	49.81	59.77

All models except V8 - Front half shaft

Genuine	2	<b>RTC3690</b>	41.27	49.52
---------	---	----------------	-------	-------

All V8 petrol models - Front propshaft

Genuine	2	<b>AEU1997</b>	65.16	78.19
---------	---	----------------	-------	-------

## Half Shaft, Bare

All models except 1 Ton - Front axle

RH	Genuine	1	<b>276719</b>	195.70	234.84
LH	Genuine	1	<b>276720</b>	251.51	301.81

## Shaft Rear Axle

All models - 24 spline, Salisbury axle

RH	Aftermarket	1	<b>576767P</b>	17.92	21.50
	Genuine	1	<b>576767</b>	120.48	144.58
LH	Aftermarket	1	<b>576768P</b>	21.67	26.00
	Genuine	1	<b>576768</b>	128.93	154.72

## Stub Shaft

All models - 24 spline

Aftermarket	2	<b>608023P</b>	16.67	20.00
-------------	---	----------------	-------	-------

## Stub Axle Assembly

All models to 1980 except V8

Genuine	2	<b>599827</b>	162.42	194.90
---------	---	---------------	--------	--------

## Stub Axle Assembly Rear Hub

All models to 1980 except V8

Aftermarket	2	<b>599828P</b>	70.00	84.00
-------------	---	----------------	-------	-------

## Stub Axle Nut

All models

Aftermarket	4	<b>FRC8700P</b>	1.25	1.50
Genuine	4	<b>FRC8700</b>	10.09	12.11

## Hub &amp; Stud Assembly

All models to 1980

Aftermarket	2	<b>576844P</b>	33.33	40.00
-------------	---	----------------	-------	-------

## Driving Member

All models - 24 spline, front and rear

OEM	1	<b>571711P1</b>	13.54	16.25
-----	---	-----------------	-------	-------

## Bearing Swivel Pin Housing

All models

Aftermarket	2	<b>244150P</b>	11.04	13.25
OEM	2	<b>244150P1</b>	17.29	20.75
Genuine	2	<b>217268</b>	8.13	9.76

## Swivel Pin Housing

All models except V8 petrol

Aftermarket	2	<b>539741P</b>	75.00	90.00
-------------	---	----------------	-------	-------

## Distance Piece Swivel Pin

All models

Aftermarket	2	<b>244151P</b>	1.25	1.50
-------------	---	----------------	------	------

## Retainer Swivel Pin Housing Seal

All models

Aftermarket	2	<b>235968P</b>	1.67	2.00
-------------	---	----------------	------	------

## Leather Gaiter Kit Swivels

All models

Aftermarket	2	<b>276954P</b>	17.08	20.50
-------------	---	----------------	-------	-------

## Swivel Pin, Upper

All models - Railko type

Aftermarket	2	<b>576583P</b>	4.17	5.00
OEM	2	<b>576583P1</b>	6.67	8.00
Genuine	2	<b>576583</b>	28.20	33.84

## Swivel Pin &amp; Bracket

All models except V8

Aftermarket	2	<b>576583P</b>	4.17	5.00
OEM	2	<b>576583P1</b>	6.67	8.00
Genuine	2	<b>576583</b>	28.20	33.84

All V8 petrol models

Genuine	2	<b>FRC1942</b>	24.90	29.88
---------	---	----------------	-------	-------

## Swivel Housing Grease

All models

Sachet	OEM	a/r	<b>STC3435P1</b>	5.00	6.00
	Genuine	a/r	<b>STC3435</b>	7.69	9.23
370ml sachet	Britpart	a/r	<b>STC3435BPSACHET</b>	4.38	5.26
	Britpart	a/r	<b>STC3435BPBOTTLE</b>	4.79	5.75

## Oil Seal Diff Unit

All models front axle only

Aftermarket	1	<b>FRC4586P</b>	0.83	1.00
OEM	1	<b>FRC4586P1</b>	3.50	4.20
Genuine	1	<b>FRC4586</b>	11.66	13.99



# TRANSMISSION

## Oil Seal Front Axle Case

All models	OEM	1	<b>217400P1</b>	2.83	3.40
	Genuine	1	<b>217400</b>	5.21	6.25

## Oil Seal Hub

All models to 1980	Aftermarket	2	<b>RTC3510P</b>	1.25	1.50
	Genuine	2	<b>RTC3510</b>	6.29	7.55

## Oil Seal Hub Assembly

Optional fitment 1980 on - Single lip type	Aftermarket	2	<b>RTC3508P</b>	1.50	1.80
--------------------------------------------	-------------	---	-----------------	------	------

## Oil Seal Rear Hub

All models to 1980 - Felt/rubber, 10 spline type	Genuine	2	<b>RTC3515</b>	1.80	2.16
--------------------------------------------------	---------	---	----------------	------	------

## Oil Seal Rear Diff Pinion

1 Ton models to Aug 1974	Genuine	1	<b>AAU3381</b>	5.30	6.36
All models	Genuine	1	<b>AAU3381</b>	5.30	6.36

## Oil Seal Output Shaft

All models except V8	Aftermarket	1	<b>FRC1780</b>	0.79	0.95
All V8 petrol models	Aftermarket	1	<b>90622240P</b>	1.25	1.50
	Genuine	1	<b>90622240</b>	3.81	4.57

## Oil Seal Mainshaft Rear

All models except V8	Genuine	1	<b>236305</b>	3.89	4.67
----------------------	---------	---	---------------	------	------

## Oil Seal Stub Axle

All models 1981 on - Twin lip type	Aftermarket	2	<b>RTC3511P</b>	1.33	1.60
	OEM	2	<b>RTC3511P1</b>	3.50	4.20
	Genuine	2	<b>RTC3511</b>	12.52	15.02

## Seal Stub Axle

All models 1980 on	Aftermarket	2	<b>FRC3099P</b>	0.75	0.90
	OEM	2	<b>FRC3099P1</b>	3.25	3.90
	Genuine	2	<b>FRC3099</b>	8.09	9.71

## Oil Seal, Transfer Box

All models except V8 petrol Felt type, output shaft	Aftermarket	1	<b>622042P</b>	0.50	0.60
	Genuine	1	<b>622042</b>	2.56	3.07
Front & rear output shafts	Aftermarket	2	<b>236417P</b>	0.71	0.85

## Output Shaft Oil Seal

All V8 petrol models	Aftermarket	1	<b>571175P</b>	0.63	0.76
	Genuine	1	<b>571175</b>	3.69	4.43

## Oil Seal Swivel Pin Housing

All V8 models	Aftermarket	2	<b>571718P</b>	1.17	1.40
	OEM	2	<b>571718P1</b>	3.00	3.60
	Genuine	2	<b>571718</b>	6.81	8.17

## Oil Seal Swivel Housing

All models	Aftermarket	2	<b>RTC3528P</b>	2.08	2.50
	Genuine	2	<b>RTC3528</b>	10.96	13.15

## Oil Seal, Differential

All Salisbury type axles - Pinion	Aftermarket	1	<b>AEU2515P</b>	2.83	3.40
	Genuine	1	<b>AEU2515</b>	35.42	42.50

## Oil Seal Speedo Pinion

All models except V8	Aftermarket	1	<b>211502P</b>	0.54	0.65
----------------------	-------------	---	----------------	------	------

## Oil Seal Clutch Sleeve Housing

All models	Aftermarket	1	<b>571059P</b>	0.63	0.76
	Genuine	1	<b>571059</b>	7.87	9.44

## Drain Plug Diff Unit

All models	Aftermarket	1	<b>608246P</b>	2.33	2.80
	Genuine	1	<b>608246</b>	9.63	11.56

## Drain Plug Transfer Box

All V8 models with LT95 4 speed gearbox	Aftermarket	1	<b>599552P</b>	2.83	3.40
	Genuine	1	<b>599552</b>	8.99	10.79

## Sealing Washer Drain Plug

All models - Land Rover type axle	Aftermarket	1	<b>515599P</b>	0.33	0.40
	Genuine	1	<b>515599</b>	1.17	1.40
All models except V8 petrol - Transfer box	Genuine	1	<b>FRC4809</b>	0.80	0.96
All Land Rover type axles - Axle	Genuine	1	<b>FRC4809</b>	0.80	0.96

## Speedometer Drive Worm Gear

All models except V8 petrol	OEM	1	<b>540004P1</b>	9.17	11.00
	Genuine	1	<b>540004</b>	35.69	42.83

## Speedometer Drive Gear

All V8 petrol models - Pinion, 20 teeth	OEM	1	<b>FRC2284P1</b>	4.58	5.50
-----------------------------------------	-----	---	------------------	------	------

# COOLING

## Radiator Cap

All models					
Radiator header	Aftermarket	1	<b>STC4735P</b>	1.50	1.80
	Genuine	1	<b>STC4735</b>	6.11	7.33
9lb pressure	Aftermarket	1	<b>GRC118</b>	4.08	4.90

## Expansion Bottle Cap

All V8 carb petrol engine models	Aftermarket	1	<b>PCD100150P</b>	1.42	1.70
	Genuine	1	<b>PCD100150</b>	4.04	4.85
All V8 carb petrol engine models - 15lb pressure	Aftermarket	1	<b>GRC110</b>	4.38	5.26
All models - Expansion bottle	Genuine	1	<b>564719</b>	4.70	5.64

## Thermostat

All 4 cyl petrol & diesel models - 74°C	Aftermarket	1	<b>RTC3692P</b>	5.42	6.50
	Genuine	1	<b>RTC3692</b>	8.78	10.54
All 2.25L petrol and diesel engine models 82°C	Aftermarket	1	<b>596225P</b>	2.75	3.30
	Genuine	1	<b>596225</b>	35.56	42.67
74°C	Aftermarket	1	<b>532453P</b>	2.42	2.90
	OEM	1	<b>532453P1</b>	30.00	36.00
	Genuine	1	<b>532453</b>	41.30	49.56
All 2.6L 6 cyl petrol engine models	Genuine	1	<b>563122</b>	9.96	11.95
All V8 carb petrol engine models - 88°C	Aftermarket	1	<b>ETC4765P</b>	2.50	3.00
	OEM	1	<b>ETC4765P1</b>	3.08	3.70
	Genuine	1	<b>ETC4765</b>	10.06	12.07
All V8 petrol models non-detoxed - 82°C	Aftermarket	1	<b>GTS104</b>	3.58	4.30
detoxed - 88°C	Aftermarket	1	<b>GTS106</b>	3.58	4.30

## Thermostat Housing Gasket

All 4 cylinder models - Thermostat housing	Aftermarket	1	<b>ERR3682P</b>	0.33	0.40
	Genuine	1	<b>ERR3682</b>	2.04	2.45
All 2.25L petrol and diesel models with 3 bearing crankshaft Upper	Aftermarket	1	<b>527110P</b>	0.21	0.25
All 2.25L petrol and diesel models Lower	Aftermarket	1	<b>247874P</b>	0.15	0.18
	Genuine	1	<b>247874</b>	1.74	2.09
To bypass connector	Genuine	1	<b>90511958</b>	1.34	1.61
All V8 petrol engine models Thermostat housing	Aftermarket	1	<b>ERR2429P</b>	0.67	0.80
	Genuine	1	<b>ERR2429</b>	1.75	2.10
All V8 petrol models with 4 barrel carb conversion	Aftermarket	1	<b>GTG116</b>	1.83	2.20

## Thermostat Sealing Ring

All 2.25L petrol and diesel models	Genuine	1	<b>527235</b>	0.80	0.96
------------------------------------	---------	---	---------------	------	------

## Thermostat Housing

All 4 cyl petrol & diesel models	Genuine	1	<b>516059</b>	54.18	65.02
----------------------------------	---------	---	---------------	-------	-------

# SERIES III 109 (1971-1985)

## Water Pump

All 2.25L petrol and diesel models with 12V - 9 Hole	Aftermarket	1	<b>STC3758P</b>	16.67	20.00
All 2.25L military petrol models with 24V - 7 Hole	Aftermarket	1	<b>RTC6327P</b>	33.33	40.00
	Genuine	1	<b>RTC6327</b>	352.71	423.25
All V8 carb petrol engine models with viscous coupling	Aftermarket	1	<b>STC1610P</b>	27.50	33.00
	Genuine	1	<b>STC1610</b>	125.80	150.96
All V8 petrol models detoxed (with viscous coupling driven fan)	Aftermarket	1	<b>GWP322</b>	32.08	38.50
All V8 carb petrol engine models without viscous coupling	Aftermarket	1	<b>STC1611P</b>	30.00	36.00
	Genuine*	1	<b>STC1611</b>	126.22	151.46
	Exchange Surcharge*			40.00	48.00

## Water Pump Gasket

All 2.25L petrol and diesel models except military - 9 stud fixing water pump	Aftermarket	1	<b>538671P</b>	0.25	0.30
	Genuine	1	<b>538671</b>	0.80	0.96
All military 2.25L models - 7 stud fixing water pump	Genuine	1	<b>542218</b>	2.33	2.80
All 2.6L 6 cyl petrol models - Water pump adaptor to engine	Aftermarket	1	<b>563038P</b>	0.79	0.95
All V8 carb engine models - Water pump	Aftermarket	1	<b>ERR2428P</b>	0.83	1.00
	OEM	1	<b>ERR2428P1</b>	4.00	4.80
	Genuine	1	<b>ERR2428</b>	8.47	10.16

## Water Pump Inlet Housing Gasket

All 4 cylinder models - Water pump inlet housing	Aftermarket	1	<b>ERR1607P</b>	0.25	0.30
	Genuine	1	<b>ERR1607</b>	1.67	2.00

## O Ring Water Pump

All 6 cyl petrol models	Genuine	1	<b>RTC1975</b>	4.27	5.12
-------------------------	---------	---	----------------	------	------

## Temperature Sensor

All 4 cyl and 6 cyl models - Water temperature, for 120° gauge, spade terminals	Aftermarket	1	<b>560794P</b>	2.42	2.90
All V8 carb petrol models	Aftermarket	1	<b>RTC4996P</b>	5.63	6.76
V8 petrol engine models	Aftermarket	1	<b>PRC6317P</b>	6.04	7.25



## SERIES III 109 (1971-1985)

## ELECTRICAL - ROTATING ELECTRICS

## Alternator

All 4 cyl models with (engine) suffix B - new	Aftermarket	1	<b>RTC5083EP</b>	50.00	60.00
All 6 cyl models with (engine) suffix B - new	Aftermarket	1	<b>RTC5083EP</b>	50.00	60.00
All models (17ACR, 40amp) except V8 petrol					
Reconditioned, exchange	Genuine*	1	<b>RTC5084E</b>	97.62	117.14
	Exchange Surcharge*			80.00	96.00
All models with V8 petrol engine - A115-45Amp/18ACR					
Reconditioned, exchange	Aftermarket*	1	<b>RTC5086EP</b>	61.67	74.00
	Exchange Surcharge*			25.00	30.00
Reconditioned, exchange	Genuine	1	<b>RTC5086E</b>	185.10	222.12
	Exchange Surcharge*			80.00	96.00
Military 2.25L petrol models fitted for radio (FFR) with 24V system (no. 10 mk 2 alternator, 90amp)					
New, outright	Genuine	1	<b>STC9166</b>	1445.63	1734.76
Military models fitted for radio with 24V system (90amp alternator)					
Reconditioned, exchange	Genuine*	1	<b>PRC1102E</b>	2904.36	3485.23
	Exchange Surcharge*			150.00	180.00

## Starter Motor

All petrol models except V8					
Replacement 2M100 type, New	Aftermarket	1	<b>RTC5225P</b>	100.00	120.00
Hi Torque, uprated	Powerlite	1	<b>RTC5225UR</b>	145.00	174.00
All 2.25L diesel models - New	Aftermarket	1	<b>RTC5232P</b>	97.50	117.00
Military 2.25L petrol models, fitted for radio - 24V system					
New, exchange	Genuine*	1	<b>90501505</b>	3300.25	3960.30
	Exchange Surcharge*			70.00	84.00

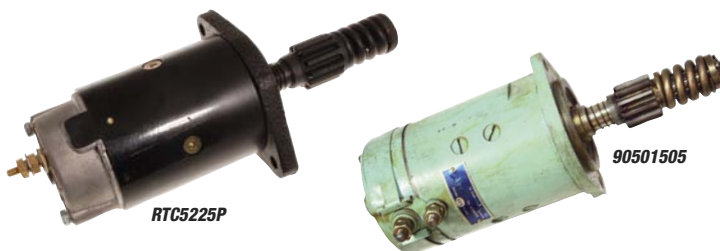

## SERIES III 109 (1971-1985)

## ENGINE GASKETS

## Gasket Rocker Cover

All 2.25L petrol models					
Self adhesive	Aftermarket	1	<b>ERR4933P</b>	1.00	1.20
Standard	Genuine	1	<b>ERR4933</b>	11.78	14.14
All 2.25L diesel models					
Self adhesive	Aftermarket	1	<b>ETC6438P</b>	0.92	1.10
Standard	Genuine	1	<b>ETC6438</b>	7.20	8.64
All 2.6L petrol models	Genuine	1	<b>267668</b>	6.35	7.62
All V8 petrol models					
Cork	OEM	2	<b>GEG436</b>	1.58	1.90
Rubber	OEM	2	<b>GEG436UPRATED</b>	2.65	3.18

## Gasket Cylinder Head

2.25L petrol models					
	Aftermarket	1	<b>ERC6380P</b>	3.25	3.90
	OEM	1	<b>ERC6380P1</b>	12.95	15.54
	Genuine	1	<b>ERC6380</b>	25.12	30.14
2.25L diesel models					
	Aftermarket	1	<b>ERR3618P</b>	3.00	3.60
	OEM	1	<b>ERR3618P1</b>	9.79	11.75
	Genuine	1	<b>ERR3618</b>	36.82	44.18
2.6L 6 cyl petrol models	Genuine	1	<b>STC1129</b>	22.75	27.30
V8 petrol models - Original style tin head gasket					
	Aftermarket	2	<b>603796P</b>	1.92	2.30
	Genuine	2	<b>603796</b>	10.18	12.22
All 3.5L V8 petrol models					
Tin type gasket	Aftermarket	2	<b>GEG340P</b>	2.08	2.50
	Aftermarket	2	<b>GEG340</b>	5.00	6.00
Composite type gasket	Aftermarket	2	<b>GEG340COM</b>	15.42	18.50
	Aftermarket	2	<b>GEG340COMP</b>	6.04	7.25
	Genuine	2	<b>ERR4248</b>	35.01	42.01

## Gasket Decoke Set

2.25L petrol models					
	Aftermarket	1	<b>STC1567P</b>	10.00	12.00
	Aftermarket	1	<b>STC1566P</b>	8.33	10.00
	Genuine	1	<b>STC1564</b>	149.03	178.84
2.6L 6 cyl petrol models					
	Aftermarket	1	<b>RTC3333P</b>	17.92	21.50
	OEM	1	<b>RTC3333P1</b>	25.83	31.00
V8 petrol models - Includes original fitment tin head gasket					
	Aftermarket	1	<b>STC1566P</b>	11.67	14.00
	Genuine	1	<b>STC1566</b>	133.80	160.56
All 3.5L V8 petrol models					
Includes tin type head gasket	Aftermarket	1	<b>GUG1066HS</b>	20.42	24.50
	Aftermarket	1	<b>GUG1066HSK</b>	19.79	23.75
Includes composite type head gasket	Aftermarket	1	<b>GUG1066HSCOM</b>	33.33	40.00

## Gasket Oil Sump

2.25L petrol and diesel models					
	Aftermarket	1	<b>546841P</b>	1.00	1.20
	OEM	1	<b>546841P1</b>	2.42	2.90
	Genuine	1	<b>546841</b>	17.82	21.38
2.6L 6 cyl petrol models	Genuine	1	<b>546457</b>	19.50	23.40
All V8 petrol models					
	Aftermarket	1	<b>AJM539P</b>	1.00	1.20
	Aftermarket	1	<b>AJM539</b>	4.08	4.90

## Gasket Conversion Set

2.6L petrol models	Aftermarket	1	<b>605106P</b>	24.58	29.50
All 3.5L V8 carb petrol models	Aftermarket	1	<b>GUG1538CS</b>	13.13	15.76
	Aftermarket	1	<b>GUG1538CSP</b>	10.83	13.00
V8 petrol models					
	Aftermarket	1	<b>STC1639P</b>	9.79	11.75
	OEM	1	<b>STC1639P1</b>	25.83	31.00
	Genuine	1	<b>STC1639</b>	60.34	72.41

## Silicone Sealant RTV

Numerous applications					
	Aftermarket	a/r	<b>RTC3254P</b>	5.00	6.00
	Genuine	a/r	<b>RTC3254</b>	21.04	25.25

## SERIES III 109 (1971-1985)

## ENGINE SWITCHES

## Temperature Sensor Oil Pump

All V8 carb petrol engine models	Aftermarket	1	<b>PRC2236P</b>	3.50	4.20
----------------------------------	-------------	---	-----------------	------	------

## Oil Pressure Switch

All 4 cyl models from 1980 on					
	Aftermarket	1	<b>PRC6387P</b>	1.83	2.20
	OEM	1	<b>PRC6387P1</b>	3.50	4.20
	Genuine	1	<b>PRC6387</b>	28.77	34.52
All 4 cyl and 6 cyl models	Aftermarket	1	<b>90519864P</b>	1.75	2.10
All V8 carb petrol engine models	Aftermarket	1	<b>DRC2479A</b>	29.58	35.50
All V8 petrol engine models					
	Aftermarket	1	<b>STC4104P</b>	3.00	3.60
	OEM	1	<b>STC4104P1</b>	12.50	15.00
	Genuine	1	<b>STC4104</b>	29.01	34.81

## Oil Pressure Sensor

All models from September 1976 on except V8 petrol					
	Genuine	1	<b>DRC242</b>	97.62	117.14



## SERIES III 109 (1971-1985)

## DRAIN PLUGS

## Sump Plug

All 2.25L petrol & diesel models	Genuine	1	<b>536577</b>	1.91	2.29
All V8 petrol models	Aftermarket	1	<b>603659A</b>	2.83	3.40

## Sump Plug Washer

All petrol and diesel models except V8					
	Aftermarket	1	<b>243959P</b>	0.38	0.46
	Genuine	1	<b>243959</b>	0.82	0.98
All V8 petrol models	Aftermarket	1	<b>213961A</b>	1.25	1.50

## Drain Plug

All models except V8 petrol - Gearbox drain					
	Aftermarket	1	<b>540870P</b>	0.75	0.90
	Genuine	1	<b>540870</b>	2.09	2.51
All models except 1 Ton - Front differential	Genuine	1	<b>235592</b>	11.48	13.78
1 Ton models from 1974 on (Rover axle) - Front differential					
	Genuine	1	<b>235592</b>	11.48	13.78

## Filler Plug

All models - Steering box	Genuine	1	<b>271386</b>	5.92	7.10
---------------------------	---------	---	---------------	------	------





## OIL SEALS ENGINE

**SERIES III 109 (1971-1985)**

### Oil Seal Crankshaft Front

All 4 cyl and 8 cyl models	Aftermarket	1	<b>ERR6490P</b>	3.00	3.60
	OEM	1	<b>ERR6490P1</b>	5.00	6.00

### Oil Seal Crankshaft Rear

2.25L 3 bearing petrol and diesel models	Aftermarket	1	<b>542492P</b>	1.75	2.10
2.25L 5 bearing petrol and diesel models	Aftermarket	1	<b>ERR2532P</b>	2.00	2.40
	OEM	1	<b>ERR2532P1</b>	5.83	7.00
	Genuine	1	<b>ERR2532</b>	21.00	25.20
2.6L petrol models	Aftermarket	1	<b>542492P</b>	1.75	2.10
All V8 petrol models - Lip type seal	Aftermarket	1	<b>ERR2640P</b>	3.00	3.60
	OEM	1	<b>ERR2640P1</b>	7.92	9.50
	Genuine	1	<b>ERR2640</b>	15.58	18.70

### Oil Seal Front Cover

All 4cyl and 8 cyl models	Aftermarket	1	<b>ETC4154P</b>	1.08	1.30
	OEM	1	<b>ETC4154P1</b>	3.00	3.60
	Genuine	1	<b>ETC4154</b>	14.67	17.60
2.6L 6 cyl petrol models	Genuine	1	<b>90516028</b>	4.30	5.16

### Oil Seal Kit Crankshaft Rear

2.25L 3 bearing petrol and diesel models - Retainers and seal					
	Aftermarket	1	<b>542494P</b>	11.67	14.00
	Aftermarket	1	<b>542494P</b>	11.67	14.00
2.6L petrol models - Retainers and seal					
	Aftermarket	1	<b>542494P</b>	11.67	14.00

## ENGINE & GEARBOX MOUNTINGS

**SERIES III 109 (1971-1985)**

### Engine Mounting

All 4 and 6 cyl petrol engine models Front	Aftermarket	2	<b>NRC2054P</b>	1.83	2.20
	Genuine	2	<b>NRC2054</b>	17.88	21.46
All diesel engine models - Engine and gearbox					
	Aftermarket	3	<b>NRC2052P</b>	2.00	2.40
	Genuine	3	<b>NRC2052</b>	11.94	14.33
All V8 petrol models - With M12 metric threads					
	Aftermarket	4	<b>STC434P</b>	2.33	2.80
	OEM	4	<b>STC434P1</b>	9.38	11.26
	Genuine	4	<b>STC434</b>	23.83	28.60

### Gearbox Mounting

All models	Aftermarket	1	<b>NRC2053P</b>	1.83	2.20
	Genuine	1	<b>NRC2053</b>	5.78	6.94

### Bracket Gearbox Mounting

All models except V8 petrol - RH	Genuine	1	<b>272501</b>	7.08	8.50
----------------------------------	---------	---	---------------	------	------

## CABLES

**SERIES III 109 (1971-1985)**

### Accelerator Cable

All diesel models	Aftermarket	1	<b>598852P</b>	2.50	3.00
	Genuine	1	<b>598852</b>	25.48	30.58
All 2.25L diesel models with cable operated controls					
	Genuine	1	<b>598852</b>	25.48	30.58
All V8 petrol models	Aftermarket	1	<b>566426P</b>	6.67	8.00
All LHD V8 petrol models	Genuine	1	<b>NRC3757</b>	55.56	66.67

### Choke Cable

All RHD 4 cyl petrol models without steering lock					
	Genuine	1	<b>599336</b>	18.61	22.33
All LHD 6 cyl petrol models without steering lock					
	Genuine	1	<b>599336</b>	18.61	22.33

### Speedometer Cable

All RHD & LHD models except V8 petrol	Aftermarket	1	<b>90623054P</b>	6.67	8.00
	Genuine	1	<b>90623054</b>	66.54	79.85
All V8 petrol models					
up to (VIN) 158451	Genuine	1	<b>PRC1599</b>	15.68	18.82
from (VIN) 158452 on	Genuine	1	<b>RTC3495</b>	54.67	65.60

### Engine Stop Control Cable

All RHD diesel models without steering lock	Genuine	1	<b>599339</b>	20.17	24.20
---------------------------------------------	---------	---	---------------	-------	-------

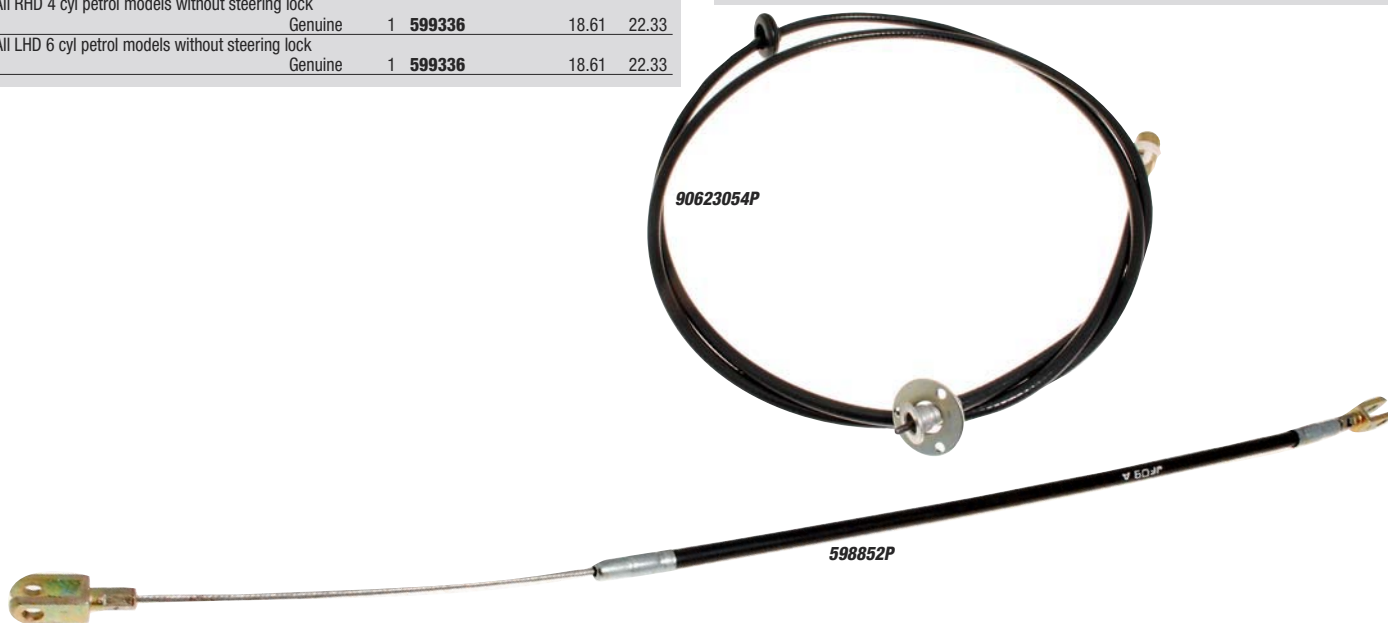

## WHEEL STUDS & WHEEL NUTS

**SERIES III 109 (1971-1985)**

### Wheel Stud

All models - Extended, 60mm (original fitment for Defender Wolf/XD). <i>Allows fitment of certain alternative wheels</i>					
	OEM	a/r	<b>FRC7577P1</b>	5.83	7.00
	Genuine	a/r	<b>FRC7577</b>	19.36	23.23

### Wheel Nut

All models	Aftermarket	a/r	<b>RRD500010P</b>	0.79	0.95
	Genuine	a/r	<b>RRD500010</b>	1.82	2.18

### Wheel Nut Set

All models - Set of 20	Aftermarket	a/r	<b>RRD500010KP</b>	11.04	13.25
	Genuine	a/r	<b>RRD500010K</b>	34.00	40.80

**RRD500010KP**

# ENGINE OILS



The HEARTBEAT of your ENGINE

## OIL PRICES

Description	Part Number	Price ex VAT (Outside EU)	Price inc VAT (UK @ 20%)
OIL 0W-30 FULLY SYNTHETIC - CARLUBE			
1 LTR	<b>RX1886</b>	8.32	9.98
4.54 LTR	<b>RX1887</b>	33.32	39.98
OIL 5W-40 FULLY SYNTHETIC - CARLUBE			
1 LTR	<b>RX1888</b>	5.41	6.49
4.54 LTR	<b>RX1889</b>	30.83	37.00
OIL 5W-30 FORD FULLY SYNTHETIC - CARLUBE			
1 LTR	<b>RX1890</b>	7.08	8.50
4.54 LTR	<b>RX1891</b>	24.99	29.99
OIL 5W-30 FULLY SYNTHETIC - CARLUBE			
1 LTR	<b>RX1892</b>	8.32	9.98
4.54 LTR	<b>RX1893</b>	33.32	39.98
OIL 5W-20 ECO-F FULLY SYNTHETIC - CARLUBE			
1 LTR	<b>RX1894</b>	8.32	9.98
4.54 LTR	<b>RX1895</b>	33.32	39.98
OIL 10W-40 SEMI SYNTHETIC - CARLUBE			
1 LTR	<b>RX1896</b>	4.99	5.99
4.54 LTR	<b>RX1897</b>	18.33	22.00
OIL 5W-30FE SEMI SYNTHETIC - CARLUBE			
1 LTR	<b>RX1903</b>	4.99	5.99
4.54 LTR	<b>RX1902</b>	17.50	21.00
OIL 15W-40 MINERAL - CARLUBE			
1 LTR	<b>RX1905</b>	4.50	5.40
4.54 LTR	<b>RX1904</b>	17.50	21.00

Model	Year	Description	Capacity Litres	1 Ltr Part No.	4.54 Ltr Part No.
<b>Series</b>					
1.6 & 2.0 4 cyl petrol	1948-1958	15w40 mineral	6.00	<b>RX1905</b>	<b>RX1904</b>
2.25 4 cyl petrol	1958-1983	15w40 mineral	6.85	<b>RX1905</b>	<b>RX1904</b>
2.0 4 cyl diesel	1957-1961	15w40 mineral	6.50	<b>RX1905</b>	<b>RX1904</b>
2.25 4 cyl diesel	1961-1983	15w40 mineral	6.85	<b>RX1905</b>	<b>RX1904</b>
2.6 6 cyl petrol	1962-1979	15w40 mineral	7.20	<b>RX1905</b>	<b>RX1904</b>
3.5 V8 petrol	1979-1983	10w40 semi-synthetic	5.70	<b>RX1896</b>	<b>RX1897</b>
<b>90/110</b>					
2.5 diesel	1983-1990	15w40 mineral	6.85	<b>RX1905</b>	<b>RX1904</b>
2.5 Turbo Diesel	1986-1990	15w40 mineral	6.85	<b>RX1905</b>	<b>RX1904</b>
2.25 petrol	1983-1984	15w40 mineral	6.85	<b>RX1905</b>	<b>RX1904</b>
2.5 petrol	1984-1990	15w40 mineral	6.85	<b>RX1905</b>	<b>RX1904</b>
3.5 V8 petrol	1983-1990	10w40 semi-synthetic	5.70	<b>RX1896</b>	<b>RX1897</b>
<b>Defender</b>					
2.5 200TDI	1990-1994	15w40 mineral	6.85	<b>RX1905</b>	<b>RX1904</b>
2.5 300TDI	1994-1998	15w40 mineral	6.85	<b>RX1905</b>	<b>RX1904</b>
2.5 diesel	1990-1995	15w40 mineral	6.85	<b>RX1905</b>	<b>RX1904</b>
2.5 Td5	1998-2006	10w40 diesel semi-synthetic	8.20	<b>RX1896</b>	<b>RX1897</b>
2.4/2.2 TDCi Puma	2007-2016	5w30 semi-synthetic	6.30	<b>RX1903</b>	<b>RX1902</b>
3.5 V8 petrol	1990-1996	10w40 semi-synthetic	5.70	<b>RX1896</b>	<b>RX1897</b>
4.0 V8 petrol	1997-1998	10w40 semi-synthetic	6.57	<b>RX1896</b>	<b>RX1897</b>
<b>Discovery 1</b>					
2.5 200TDI	1989-1994	15w40 mineral	5.80	<b>RX1905</b>	<b>RX1904</b>
2.5 300TDI	1994-1998	15w40 mineral	5.80	<b>RX1905</b>	<b>RX1904</b>
3.5 V8 petrol	1989-1994	10w40 semi-synthetic	5.70	<b>RX1896</b>	<b>RX1897</b>
9 V8 petrol	1994-1998	10w40 semi-synthetic	6.10	<b>RX1896</b>	<b>RX1897</b>
4.0 V8 petrol	1997-1998	10w40 semi-synthetic	6.10	<b>RX1896</b>	<b>RX1897</b>
2.0 16V petrol	1993-1996	10w40 semi-synthetic	4.90	<b>RX1896</b>	<b>RX1897</b>
<b>Discovery 2</b>					
2.5 Td5	1998-2004	10w40 diesel semi-synthetic	7.20	<b>RX1896</b>	<b>RX1897</b>
4.0/4.6 V8 petrol (less oil cooler)	1998-2004	10w40 semi-synthetic	5.00	<b>RX1896</b>	<b>RX1897</b>
4.0/4.6 V8 petrol (with oil cooler)	1998-2004	10w40 semi-synthetic	6.30	<b>RX1896</b>	<b>RX1897</b>
<b>Discovery 3</b>					
2.7 TDV6	2005-2009	5w30 semi-synthetic	5.70	<b>RX1903</b>	<b>RX1902</b>
4.0 V6 petrol	2005-2009	5w30 semi-synthetic	5.70	<b>RX1903</b>	<b>RX1902</b>
4.4 V8 petrol	2005-2009	5w30 semi-synthetic	7.50	<b>RX1903</b>	<b>RX1902</b>
<b>Discovery 4</b>					
2.7 TDV6	2010-2011	5w30 semi-synthetic	5.70	<b>RX1903</b>	<b>RX1902</b>
3.0 V6 twin turbo diesel	2010 on	5w30 fully synthetic	5.70	<b>RX1892</b>	<b>RX1893</b>
3.0 V6 mono turbo diesel	2010 on	5w30 fully synthetic	5.90	<b>RX1892</b>	<b>RX1893</b>
4.0 V6 petrol	2010-2011	5w30 semi-synthetic	5.70	<b>RX1903</b>	<b>RX1902</b>
5.0 V8 petrol	2010 on	5w20 fully-synthetic	8.00	<b>RX1894</b>	<b>RX1895</b>
3.0 V6 S/C petrol	2014 on	5w20 fully-synthetic	8.00	<b>RX1894</b>	<b>RX1895</b>
<b>Discovery Sport L550</b>					
2.2 TD	2015-2016	5w30 semi-synthetic	5.90	<b>RX1903</b>	<b>RX1902</b>
2.0 TD	2016 on	5w30 fully synthetic	6.52	<b>RX1892</b>	<b>RX1893</b>
2.0 turbo petrol	2015 on	5w30 fully synthetic	5.40	<b>RX1892</b>	<b>RX1893</b>
<b>Freelander 1</b>					
2.0 Di	1997-2001	10w40 diesel semi-synthetic	4.50	<b>RX1896</b>	<b>RX1897</b>
2.0 Td4	2001-2006	5w40 diesel fully synthetic	6.80	<b>RX1888</b>	<b>RX1889</b>
1.8 16V petrol	1997-2006	5w40 fully synthetic	4.50	<b>RX1888</b>	<b>RX1889</b>
2.5 V6 petrol	2001-2006	5w40 fully synthetic	5.20	<b>RX1888</b>	<b>RX1889</b>

Model	Year	Description	Capacity Litres	1 Ltr Part No.	4.54 Ltr Part No.
<b>Freelander 2</b>					
2.2 TD	2007-2014	5w30 semi-synthetic	5.90	<b>RX1903</b>	<b>RX1902</b>
3.2 6 cyl petrol	2007-2011	0w30 fully synthetic	7.50	<b>RX1886</b>	<b>RX1887</b>
2.0 turbo petrol	2012-2014	5w30 fully synthetic	5.60	<b>RX1890</b>	<b>RX1891</b>
<b>Range Rover Classic</b>					
2.4 Turbo Diesel	1986-1989	15w40 mineral	7.20	<b>RX1905</b>	<b>RX1904</b>
2.5 Turbo Diesel	1989-1992	15w40 mineral	7.20	<b>RX1905</b>	<b>RX1904</b>
2.5 200TDi	1992-1994	15w40 mineral	6.85	<b>RX1905</b>	<b>RX1904</b>
2.5 300TDi	1994-1995	15w40 mineral	6.85	<b>RX1905</b>	<b>RX1904</b>
3.5 V8 petrol	1970-1990	10w40 semi-synthetic	5.70	<b>RX1896</b>	<b>RX1897</b>
3.9 V8 petrol	1989-1995	10w40 semi-synthetic	6.25	<b>RX1896</b>	<b>RX1897</b>
4.2 V8 petrol	1992-1995	10w40 semi-synthetic	6.25	<b>RX1896</b>	<b>RX1897</b>
<b>Range Rover P38A</b>					
2.5 TD	1994-2001	10w40 diesel semi-synthetic	9.50	<b>RX1896</b>	<b>RX1897</b>
4.0 V8 petrol	1994-2001	10w40 semi-synthetic	4.87	<b>RX1896</b>	<b>RX1897</b>
4.6 V8 petrol	1994-2001	10w40 semi-synthetic	4.87	<b>RX1896</b>	<b>RX1897</b>
<b>Range Rover L322</b>					
3.0 TD6	2002-2006	5w30 semi-synthetic	8.75	<b>RX1903</b>	<b>RX1902</b>
3.6 TDV8	2007-2011	5w30 semi-synthetic	9.50	<b>RX1903</b>	<b>RX1902</b>
4.4 TDV8	2011-2012	5w30 semi-synthetic	9.50	<b>RX1903</b>	<b>RX1902</b>
4.2 S/C V8 petrol	2005-2009	5w30 semi-synthetic	7.70	<b>RX1903</b>	<b>RX1902</b>
4.4 V8 petrol (BMW)	2002-2005	5w40 fully synthetic	8.50	<b>RX1888</b>	<b>RX1889</b>
4.4 V8 petrol (JLR)	2005-2009	5w30 semi-synthetic	7.70	<b>RX1903</b>	<b>RX1902</b>
5.0 V8 petrol	2010-2012	5w20 fully-synthetic	8.00	<b>RX1894</b>	<b>RX1895</b>
5.0 S/C V8 petrol	2010-2012	5w20 fully-synthetic	8.00	<b>RX1894</b>	<b>RX1895</b>
<b>Range Rover L405</b>					
3.0 V6 twin turbo diesel	2013 on	5w30 fully synthetic	6.00	<b>RX1892</b>	<b>RX1893</b>
3.0 V6 mono turbo diesel	2013 on	5w30 fully synthetic	6.00	<b>RX1892</b>	<b>RX1893</b>
4.4 SDV8	2013 on	5w30 fully synthetic	9.40	<b>RX1892</b>	<b>RX1893</b>
2.0 turbo petrol	2015 on	5w30 fully synthetic	5.80	<b>RX1892</b>	<b>RX1893</b>
3.0 V6 S/C petrol	2014 on	5w20 fully-synthetic	8.00	<b>RX1894</b>	<b>RX1895</b>
5.0 V8 petrol	2013 on	5w20 fully-synthetic	8.00	<b>RX1894</b>	<b>RX1895</b>
5.0 S/C V8 petrol	2013 on	5w20 fully-synthetic	8.00	<b>RX1894</b>	<b>RX1895</b>
<b>Range Rover Sport L320</b>					
2.7 TDV6	2005-2009	5w30 semi-synthetic	5.54	<b>RX1903</b>	<b>RX1902</b>
3.0 TDV6/SDV6	2010-2013	5w30 fully synthetic	5.54	<b>RX1892</b>	<b>RX1893</b>
3.6 TDV8	2007-2013	5w30 semi-synthetic	9.50	<b>RX1903</b>	<b>RX1902</b>
4.2 S/C V8 petrol	2005-2009	5w30 semi-synthetic	7.50	<b>RX1903</b>	<b>RX1902</b>
4.4 V8 petrol	2005-2009	5w30 semi-synthetic	8.00	<b>RX1903</b>	<b>RX1902</b>
5.0 V8 petrol	2010-2013	5w20 fully-synthetic	8.00	<b>RX1894</b>	<b>RX1895</b>
5.0 S/C V8 petrol	2010-2013	5w20 fully-synthetic	8.00	<b>RX1894</b>	<b>RX1895</b>
<b>Range Rover Sport L494</b>					
3.0 V6 twin turbo diesel	2014 on	5w30 fully synthetic	6.00	<b>RX1892</b>	<b>RX1893</b>
3.0 V6 mono turbo diesel	2014 on	5w30 fully synthetic	6.00	<b>RX1892</b>	<b>RX1893</b>
4.4 SDV8	2014 on	5w30 fully synthetic	9.40	<b>RX1892</b>	<b>RX1893</b>
2.0 turbo petrol	2015 on	5w30 fully synthetic	5.80	<b>RX1892</b>	<b>RX1893</b>
3.0 V6 S/C petrol	2014 on	5w20 fully-synthetic	8.00	<b>RX1894</b>	<b>RX1895</b>
5.0 V8 petrol	2014 on	5w20 fully-synthetic	8.00	<b>RX1894</b>	<b>RX1895</b>
5.0 S/C V8 petrol	2014 on	5w20 fully-synthetic	8.00	<b>RX1894</b>	<b>RX1895</b>
<b>Range Rover Evoque L538</b>					
2.2 TD	2012-2016	5w30 semi-synthetic	5.90	<b>RX1903</b>	<b>RX1902</b>
2.0 TD	2016 on	5w30 fully synthetic	6.52	<b>RX1892</b>	<b>RX1893</b>
2.0 turbo petrol	2012 on	5w30 fully synthetic	5.40	<b>RX1892</b>	<b>RX1893</b>



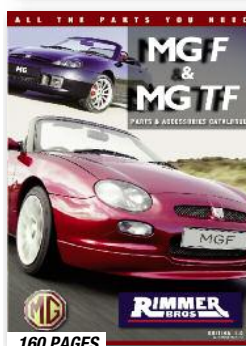
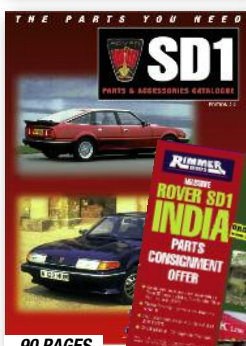
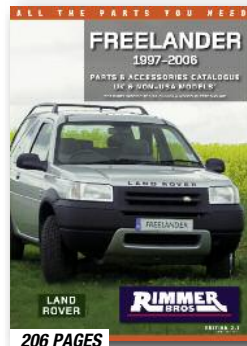
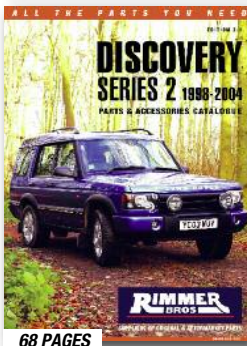
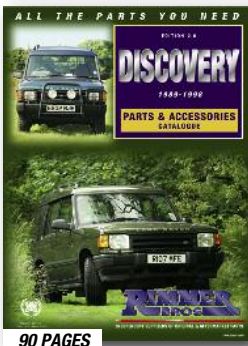
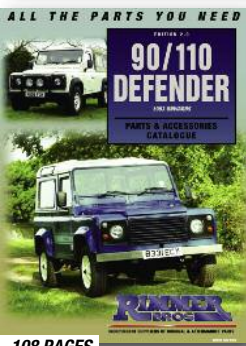
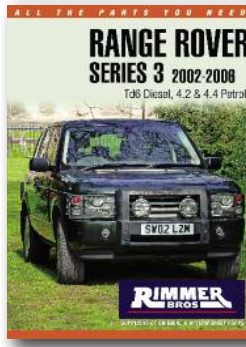
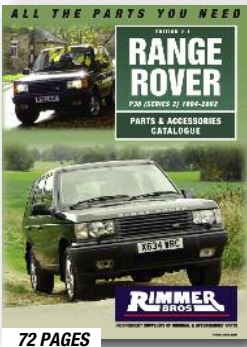
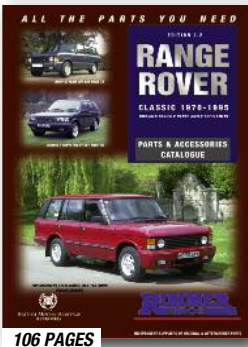
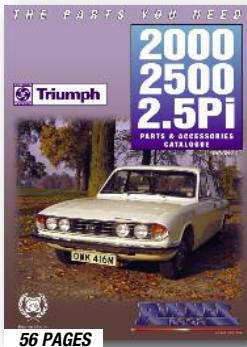
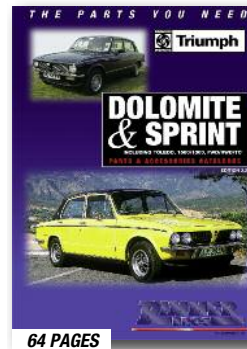
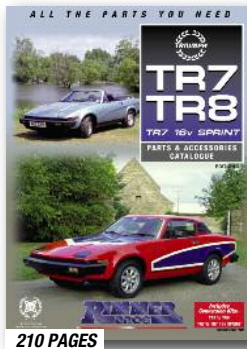

OUR CATALOGUES ARE YOUR PASSPORT TO THE FINEST MAIL-ORDER PARTS SERVICE

**RIMMER BROS CATALOGUES**

If you are a Triumph, SD1, MG Rover, Mini, Range Rover, Freelander, Defender, Discovery or Rover V8 Engine, owner - a catalogue will be despatched FREE including post & packing. Small postage charge made for additional catalogues. FOR YOUR COPY, PHONE, FAX, WRITE OR E-MAIL.

Once registered as a customer for a specific vehicle you will be automatically updated (free of charge) with any new catalogue or price guides as they are published.



FULL SET OF CATALOGUES (POSTAGE CHARGES) £10 (UK) £15 (Europe) £35 (Rest of World)



# Special Purchase

See Website for further Clearance Bargains

Top Quality Branded Merchandise

## Land Rover Leather iPad/Tablet Case



**Ideal Gifts!**

**NOW ONLY £20**  
INC VAT

**SAVE 78%** Original RRP £90

Land Rover grained black leather iPad/Tablet case. Features a magnetic closing mechanism, Alcantara lining. Suitable for iPad, iPad 2 & iPad Air (or similar sized tablets). Supplied in Land Rover branded presentation box.

iPad not included

Part Number **LRLUGNIP**

## Jaguar Leather Portfolio Case

**NOW ONLY £30**  
INC VAT



**SAVE 80%** Original RRP £150

Jaguar Portfolio Case in 100% high performance soft grain carbon fibre printed leather. Features several storage compartments.

Contents not included

Part Number **JSLGTRXPORT**



**A BRITISH COMPANY SUPPORTING BRITISH CARS**

Rimmer Bros. Triumph House, Sleaford Road, Bracebridge Heath, Lincoln LN4 2NA, England.

**Telephone: 01522 568000** Fax: 01522 567600. E-mail: [Irsales@rimmerbros.co.uk](mailto:Irsales@rimmerbros.co.uk)

**www.rimmerbros.co.uk**

**Quality Parts and Accessories**

Trade Enquiries Welcome:  
01522 567111  
E-mail: [trade@rimmerbros.co.uk](mailto:trade@rimmerbros.co.uk)



**ALL THE PARTS YOU NEED**