

ALL THE PARTS YOU NEED

RANGE ROVER SPORT 2005-2009

PARTS & ACCESSORIES CATALOGUE
UK & NON-USA MODELS*

**FOR PARTS SPECIFIC TO USA, CANADA & MEXICO, PLEASE ENQUIRE.
FOR 2010 ONWARDS MODELS, REFER TO WEBSITE.*



**LAND
ROVER**

**RIMMER
BROS**

EDITION 2.1
SOURCE CODE LRS010/16

THE RIMMER BROS SERVICE

WE HAVE THE
PARTS

WE GUARANTEE
THE QUALITY

WE'RE KEEN
ON PRICE

WE DELIVER
FAST

WE KNOW YOUR
CAR



HELPING YOU CARE FOR YOUR RANGE ROVER SPORT

Since the early 1980s, Rimmer Bros. has specialised in supplying parts for British cars. In 1982 we started selling Classic Triumph parts and by the mid 80's were supplying stainless steel exhaust systems for Land Rovers and other 4x4 vehicles. In 1993, we added to our range of parts catalogues when we began stocking parts for the Rover SD1.

In the summer of 2000, to celebrate 30 years of Range Rover production, we launched our parts catalogue for the Range Rover Classic. This was a natural move, as a vast number of Range Rovers were powered by the Rover V8 engine - a subject in which we specialise. This was followed by our Discovery, Discovery Series II, Range Rover P38a, Freelander, Defender and Discovery 3 parts and accessories catalogues. In 2005, Rimmer Bros set up an MG Rover Parts business covering all models and more recently, Jaguar 1998 on.

We are now pleased to introduce our latest parts and accessories catalogue, for the Range Rover Sport (2005 to 2009). This catalogue lists a comprehensive range of genuine, original equipment manufacturer (OEM) and aftermarket parts and accessories. Our web site also features this catalogue and lists recently introduced products and parts updates. For Range Rover Sport models 2010 on, please also refer to our website.

Please note that our catalogue predominantly covers UK and non USA Models. Although most parts listed are common to the Rest of the World Markets, there are sometimes specific parts for certain countries that are different to those listed herein. If unsure, please contact us quoting your full VIN number.

Our customers are owners, garages and other specialists looking for a fast, reliable source of original and high quality aftermarket parts and accessories available by mail order or over the counter. We have the latest technology to ensure orders are processed efficiently and despatched promptly to wherever you are - UK or worldwide.

Our aim with this catalogue is to apply our expert parts service to Range Rover Sport 2005-2009, helping you to maintain and enhance your vehicle at affordable cost.

APPROVED BY LAND ROVER

Rimmer Bros is an authorised Land Rover Parts Distributor. This means we have access to the full range of genuine Land Rover parts - for every model.

This catalogue features genuine parts throughout - at affordable prices - alongside aftermarket parts.

The added advantage of being able to order a part for any Land Rover from the convenience of your home or workplace, means the Rimmer Bros service is hard to beat!

THE CARS WE SPECIALISE IN

As well as caring for your Range Rover Sport, we also supply parts for Range Rover, Discovery, Evoque, Freelander, Defender, 90/110 & Land Rover 'Series' vehicles.

Additionally, we also supply parts for Triumph TR2-8, Stag, Herald, Vitesse, Spitfire, GT6, 2000/2500/2.5Pi, Dolomite, Rover SD1, MG Rover cars including - Rover 100/200/400/600/800/25/45/75/ZT, MGF & MG TF. In addition we are developing a range of fast moving parts for Jaguar 1998 on models.

Please refer to inside rear cover for details on all our catalogues or our web site www.rimmerbros.co.uk



**RIMMER
BROS**

UK & WORLDWIDE

How to Order

WEBSITE	www.rimmerbros.co.uk
TELEPHONE <i>UK office hours only</i>	UK - 01522 568000 Overseas - +44 1522 568000 From the USA - 1 855 7462767
EMAIL	lrsales@rimmerbros.co.uk
FAX	UK - 01522 567600 Overseas - +44 1522 567600
POST	Triumph House, Sleaford Road, Bracebridge Heath, Lincoln LN4 2NA, England
COLLECT IN PERSON	Our sales counter is open 8.30am-5.30pm Monday-Friday and 8.30am-1pm Saturday. <i>We also offer a 'click and collect' service to save you time.</i>

PAYMENT

We accept all major credit, debit and charge cards and also Paypal on orders where all items are in stock. Orders can also be pre-paid by bank transfer (in GBP/Euro/US Dollar- see website or Price Guide for details) or cheque (in GBP-please allow a few extra days for clearance). If you send cash or Rimmer Bros Vouchers, please use registered mail, as we cannot accept responsibility for any loss.

PRICING

There are no prices in this catalogue. Use it to select the parts you need, then check the cost by referring to our website or the separate Price Guide / CD rom. Our website gives up-to-the minute information regarding availability and the price of any item.

All orders will be invoiced and charged in GBP. All goods are sold subject to the price ruling at the time of invoicing.

VAT

For details on VAT, & VAT exempt sales, please refer to our website or Price Guide / CD rom.



PART NUMBERS & IDENTIFICATION

We identify parts so that you know what you are buying. When there are alternatives to the original Land Rover part, we use a simple numbering system so that you can select the part that best suits your needs and budget. This avoids any confusion when comparing quality and price:

- **Genuine (Land Rover boxed) part** – will have a plain number
- **OEM (original equipment manufacturer) part** – will have a P1 suffix
- **Aftermarket (reproduction) part** – will have a P suffix

In addition, there is also equivalence with certain Rover/Triumph numbers or when we use our own part number where no original part number exists.



QUOTATIONS, BACK ORDERS & SPECIAL ORDERS

Quotations

If you require a written quotation for the part(s) and/or delivery charge(s) before ordering, please contact us.

Back Orders

Back-ordered parts are not charged for until despatch. Upon despatch we will charge the price (in GBP) quoted at the time of ordering. Prices will be unaffected by any subsequent price alterations unless advised in writing to you. Please notify us in writing (letter, fax or email) if you wish to cancel any back ordered items. Back orders are automatically cancelled after 3 months. Back Ordered parts will be sent carriage free (some exclusions apply for export overseas). If you would prefer that your order is sent complete, please request this at the time of ordering

Special Orders

Certain items (coloured trim, carpets, one-off type parts, etc) are sometimes only available by special order. This means we have to order them for you specially from the manufacturer. For this reason, we require a 20% non-refundable deposit upon taking your order. The balance is payable when the goods are despatched. Please note that special order items can take several weeks to be supplied and are non returnable.





SHIPPING

At Rimmer Bros, we opt to use the best carriers in the business to ensure your order is delivered safely, securely and on time. The shipping method and cost is based upon what you order, where you want the parts sending and how quickly you want them.

Orders are despatched as soon as practically possible. If your parts are required urgently and you want an express delivery service, please tell us.

For shipping methods and guide prices, (including packaging and handling), please refer to our website or Price Guide.

Shipping charges for export of oversize parcels outside the UK may need to be quoted once the order is picked and packed.

Once your order is shipped and providing we have your email address, we will email confirmation to you, including tracking information if applicable.

Delivery times will be dependent on location and delivery method selected.

Please note that certain 'hazardous' products, such as aerosols, paints, fluids and chemicals cannot be sent via post or by air freight.

RETURNS & EXCHANGE OLD UNITS

Returns

Please refer to our website or Price Guide for full details.

All returns must be pre-authorized with a returns authorisation (RA) number. Returned products without an RA number will be subject to delay and possible return to sender. All returns are subject to a physical inspection. We must have received and inspected the product before an exchange or credit can be issued.



WARRANTY & LEGAL INFO

Please refer to our website or Price Guide for full details.

Parts Warranty

All new and reconditioned parts are covered by a 12 month manufacturer's warranty unless specifically stated. You should notify us immediately if a potential warranty situation arises. We will then advise a course of action. Any suspected faulty part must be returned to us together with the original invoice or proof of purchase and with as much information relating to the problem as possible. Please note that a defective part must be returned and received by us before it can be exchanged. All warranty parts are subject to a physical inspection. This may involve returning the part to our supplier to verify the fault before it can be exchanged.

Legal Info

Errors & Omissions Excepted. Please tell us if you think something is wrong in our catalogue. All parts offered subject to availability. All part numbers, illustrations and photographs used are intended for reference and identification purposes only and are not necessarily an exact representation of the goods supplied. Photographs of parts should be considered indicative of what we supply rather than an exact representation as sources of supply and manufacture can change. Whilst we make every effort to ensure the accuracy of product descriptions, illustrations and photographs, they are based upon information supplied by the manufacturer or distributor at the time. There may be occasions - due to circumstances beyond our control - when specifications are changed, or when goods become temporarily unavailable. Certain part numbers may have been superseded to an alternative number when a later version or updated specification is offered.

CATALOGUE CONTENTS

ALSO SEE INDEX ON PAGE 127

PRODUCTION DATA & SERVICE INFORMATION	7
QUICKFINDER	8
ENGINE - EXTERNAL - INTERNAL - HEAD - CLUTCH - MOUNTINGS	12
COOLING	19
HEATING	23
FUEL SYSTEM & MANIFOLDS	25
EXHAUST	33
GEARBOX - AXLE - PROPSHAFT	37
SUSPENSION - FRONT & REAR	41
ROAD WHEELS	45
BRAKES	47
STEERING	50
ELECTRICAL	52
CHASSIS - BODY SHELL	66
BODY PANELS - FITTINGS - EXTERNAL FITTINGS - BUMPERS	69
INTERIOR TRIM - FITTINGS	81
LABELS & DECALS	96
PAINT	97
ACCESSORIES	98
INDEX	127



© Copyright Rimmer Bros Ltd. All rights reserved. No part of this publication may be copied, reproduced, stored in any retrieval system, communicated or transmitted in any form or by any means, including Photocopying, Electronic, Mechanical or otherwise, without prior written permission from Rimmer Bros Ltd.



Range Rover Sport, 2005–2009

Range Rover Becomes a Family

From 1970 until 2004, Range Rover was proudly but simply the name of the top model in the Land Rover line-up. Increasingly luxurious as the years went by, it was the Land Rover product to aspire to. Then, in 2005 the Range Rover Sport was introduced and all of a sudden Range Rover became a brand rather than a model, the gold standard premium name that would be applied to a family of Land Rover premium cars.

Sure, the Range Rover itself was still in the line-up, at the top of the tree as usual. Now, though, there was another Range Rover badged model with the same brand values but aimed at a different audience: Range Rover Sport. A few years later would come Range Rover Evoque, aimed at a different clientele again but still incorporating the same instantly recognisable brand values. It was a brave move to take the name of such a distinguished vehicle and make it into a brand without watering down or tarnishing the image. Land Rover achieved it in 2005, with great aplomb.

L319 and L320 Projects

Back in 2000, at the tail end of BMW's ownership of Land Rover, two very closely related projects to replace the current Land Rover Discovery were begun: L51, a seven seat high roof model following established Discovery values and L50, a lower, five seat model with more sporting overtones. Upon Land Rover becoming part of The Ford Motor Company, L51 and L50 were re-evaluated and given Ford project names, the former becoming Discovery replacement L319 and the latter morphing from a smaller sporting Discovery into a smaller Range Rover (the 'Sport') and becoming L320.

Ford naturally would have preferred the two new Land Rovers to share a platform with one of its products, but this was quickly found to be unsuitable and so a new platform was developed. Known as the T5 platform, 'T' meant truck, as Ford classed sports utility vehicles, and '5' was for the different wheelbase versions: Discovery 3, Range Rover Sport, plus the three wheelbases of a Defender replacement project that as it happened was never to see the light of day.

The T5 platform was revolutionary; instead of a body entirely supported by a strong ladder frame chassis (like most previous Land Rovers) it consisted of a lighter separate chassis with thinner - but strong - hydroformed members, sitting under a body that would be partially load bearing itself. The theory was to give the car the plus points of both a monocoque body and a ladder frame chassis. It worked. Land Rover called it 'Integrated Body Frame' construction. When Discovery 3 and then Range Rover Sport were launched, the motoring press called it 'too heavy'. Unfortunately they were right: Discovery 3 was a third of a tonne heavier than the larger Range Rover and even the smaller Range Rover Sport was the same weight.

Early Range Rover Sport styling ideas featured two door bodies, which coupled together with the car's smaller size (smaller than the then current Range Rover) made it look very much like a perfect update of the original Range Rover Classic. A four door body was quickly settled upon, however.

By April 2004, the new Discovery 3 (L319) was ready for launch. A couple of months previously the public had been treated to the sight of a concept car that would introduce the idea of a sporting Range Rover. Called the Range Stormer, it reverted to two doors (of the dramatic scissor-opening type) and a whole host of eye-catching features most of which were impractical for production. It did, however, combine established Range Rover styling features with overtly sporting ones and as such sowed the Range Rover Sport seed in the public's imagination and was much enthused over by everyone who saw it. In a little under a year the Range Rover Sport (L320) was unveiled and, hey presto, everyone linked it back to the very popular Range Stormer concept. Job well done!

A Runaway Success

Range Rover Sport was publicly launched at the end of 2004 and made available from the middle of 2005. Sales from the outset were phenomenal; by 2006 it had overtaken the smaller, less expensive Freelander as Land Rover's best selling vehicle and while it took some sales away from its sister model Discovery 3, the majority of Range Rover Sport purchases were by customers new to Land Rover products.

2007 saw the Range Rover Sport's success story continued and while by 2008 and 2009 Land Rover sales generally were affected by the global financial crash, Range Rover Sport sales still more than held their own relative to other Land Rover products. It was immediately established as a permanent and very lucrative asset in the Land Rover line up. An amazing success story and total vindication of the risky strategy to turn Range Rover into a brand. To date, aside from the years immediately following the financial crash, Range Rover Sport sales figures have always held to around 60000 units per year: phenomenal for such a big, expensive car.

The Supercharged Effect

The most powerful, most sporting Range Rover Sport came with the 400bhp, 4.2 litre Jaguar supercharged V8 petrol engine. Modified for Land Rover use (i.e. potentially off road) and providing startling performance to match or beat most executive cars, the supercharged engine created a very attractive, sporty halo around the whole Range Rover Sport model line up. Customers who bought models with the alternative petrol or diesel engines were buying into the same performance image, even if their particular cars weren't capable of 140 miles per hour or 0-60mph in 7.2 seconds. Customers who bought the supercharged car (and yes they really did include plenty of professional footballers!) simply rejoiced in its absurdly competent abilities, albeit usually more on tarmac than off it.

A normally aspirated 300bhp, 4.4 litre Jaguar V8 petrol engine was also offered and became the entry level engine in Range Rover Sports in markets where diesel models were unpopular or not even listed. As with the supercharged engine, the 4.4 litre V8 was manufactured within a special Jaguar area of Ford's Bridgend engine factory in South Wales. Featuring variable valve timing, it was more than capable of living up to most high performance expectations but was never very popular in countries where a diesel model made more economic sense. When in 2007 the TDV8 diesel arrived to soundly beat it in both performance and fuel economy, the 4.4 litre V8 petrol was quickly dropped from the UK and European price lists.

As with Discovery 3, the most important engine for European markets and many others would be the 2.7 litre TDV6 diesel, which was expected at the time of launch to be fitted to the majority of vehicles for those markets. This smooth 190bhp V6 engine, fitted with a large, single turbocharger in its Land Rover Discovery 3 and Range Rover Sport applications to increase low

range torque for off-road and towing use, was a member of Ford and Peugeot's 'Lion' engine family, also to be seen in different states of tune in Fords, Jaguars, Peugeots and Citroens and manufactured by Ford at its Dagenham plant in England.

For the 2007 model year, the TDV6 received a makeover to enable it to comply with the latest European emissions regulations. Most Euro Stage 4 engines were equipped with (and were most obviously identifiable by) the diesel particulate filter or DPF in the exhaust system. However, some countries that were not subject to the new regulations continued to receive TDV6 models with the earlier EU2 or Euro Stage 4 (without DPF) emissions equipment for some time afterwards.

2007 was to see another diesel engine introduced for the Range Rover Sport line up. The TDV8 was another member of the Ford/Peugeot Lion diesel engine family and was very closely related in some respects to the 2.7 litre TDV6. Developed especially for the Range Rover (L322) and Range Rover Sport applications, it was a 3.6 litre, wide angle V8, twin turbocharged engine developing a very lusty 268bhp. More spectacularly it produced a maximum 470lb ft of torque, which was even some 60lb ft more than the supercharged petrol engine could muster. It's been said that the TDV8 in the Range Rover Sport (and the similarly weighted Range Rover L322) is as perfect a match as the iconic Rover V8 petrol engine in the Range Rover Classic. That's no exaggeration: the phrase 'hand in glove' springs to mind.

Incredible, Off-Road and On

Only automatic transmission (the ZF 6 speed 6HP26) was offered on the Range Rover Sport, mated to a Magna Steyr DD295 transfer box as used on Discovery 3. This featured permanent four wheel drive (a given with all Land Rovers for 20 years previously) with a 50/50 torque split to front and rear axles. It was a two speed, 'shift-on-the-move' transfer box, allowing range changes without having to stop the car. An electronic clutch locked the centre differential when required and provided torque bias for optimised traction. A slip controller increased locking torque according to off-road conditions.

The suspension, fully independent, was also closely related to Discovery 3 although significant changes were made to allow for the desired Range Rover Sport on-road dynamics without compromising the incredible off-road dynamics it shared with its sibling. All models were fitted with air springs all round, but everything from struts to air springs and anti roll bars were specially fine tuned for the Range Rover Sport's unique mix of ability.

A standard feature on some models (including all TDV8s) and optional on others was Roll Stability Control. This was an updated and improved version of Active Cornering Enhancement (ACE) as used and proven on some previous air sprung Land Rovers: a high pressure hydraulic system would vary the rate of the anti roll bars in tune with the dampers and air springs to provide the optimum stability at all times. Steering was similarly adaptable for on or off-road conditions, through a speed-proportional, variable ratio steering rack.

Range Rover Sport shared an armoury of traction control systems with Discovery 3: Hill Descent Control, Electronic Traction Control (for off-road), Dynamic Stability Control (for on-road) and the terrific Terrain Response system that tied together all of the electronic settings for a range of driving conditions, all selectable by the driver from a cabin switch. At a stroke, even inexperienced amateur off-road drivers could call on all the car's potential for off-road use. Inside the car, full use of state of the art electronic display technology meant that the driver didn't have to remember the settings he or she had chosen.

Every Visible Inch a Sporting Range Rover

Most of the classic Range Rover styling cues were displayed on the Range Rover Sport: the clam shell bonnet, the blacked-out and forward leaning rear window pillars and, of course, the usual Range Rover 'command' driving position. The badging of the car was totally evocative, too, the Range Rover letter sets on the leading edge of the bonnet and the tailgate. The lamp clusters front and rear were immediately identifiable as Range Rover and yet...

...And yet the headlamps raked rearwards in a more dynamic manner, seemingly acres of air inlets made up the rest of the face of the car and very purposeful stacked air inlets (masquerading as racing style 'hot air outlets') punctuated the flanks of the front wings. The clam shell bonnet was devoid of the upright corner castellation trade marks of the Range Rover and was, well, almost streamlined. Sculpted, extended wheel arches filled by enormous wheels and tyres exaggerated the more squat, sporting stance while at the rear prominent exhaust tail pipes on both lower corners left following drivers under no illusions. Big it might be, but undoubtedly sporting, too.

The interior, while borrowing heavily from Discovery 3 hardware and finishing, established its Range Rover character and escaped from the Discovery's utilitarian roominess with a huge centre console and chunkier trim that enveloped the car's occupants with its luxurious cockpit feel. Choices of traditional wood, designer gloss black or sophisticatedly cool metallic accents helped the customer create their own desired ambience.

2010 and Beyond

For the 2010 model year, Range Rover Sport was given a major revamp. While the body shape and silhouette remained more or less the same, three of the four engines were discontinued in favour of new units, only the excellent TDV8 being retained from the 2005-2009 model. Revised suspension, adaptive damping and new, even bigger brakes made it through to production, as did an even more luxurious, Range Rover-esque interior.

These big, expensive changes and updates were made viable by the continuing tidal wave of orders for the Range Rover Sport and Land Rover's belief that this popularity would continue unabated (they also made the 2010 Range Rover Sport into an entirely different car equipment-wise, which is why this parts catalogue stops at the end of the 2009 model year). Land Rover's belief was well founded; the success did continue and by 2013 a brand new Range Rover Sport (L494), this time developed on its own and no longer sharing a platform with its Discovery sibling, was waiting in the wings to take the amazing sales story of the Range Rover Sport well into the future.



VEHICLE PRODUCTION SUMMARY

2005 to 2009 Model Years

Late 2004 (2005 Model Year)

Range Rover Sport introduced. Known in the factory by project code name L320 (its sibling Discovery 3 model was L319).

Models available in UK/Europe include Base, SE, HSE. Variations of this line up, with some differing specifications, supplied to other markets.

Powertrains available in UK/Europe include 2.7 TDV6 Diesel, 4.4 AJV8 Petrol and 4.2 AJV8 Supercharged Petrol, all with automatic transmission as standard.

2007 Model Year

For UK/Europe, TDV6 diesel engine upgraded to Euro Stage 4 emissions compliance, including diesel particulate filter or 'DPF' in exhaust system. Euro Stage 4 without DPF (rare variant) and earlier EU2 emissions TDV6 diesels retained for some other markets.

3.6 TDV8 diesel added to line up, while 4.4 AJV8 petrol is deleted for UK and most European markets.

2008 Model Year

Interior trim and fittings updated: trim panel finishes/colours changed, enhanced front seat features introduced, metallic trim accents changed, leather/alcantara and premium 'Windsor' leather introduced alongside previous cloth, leather/vinyl and full leather upholstery options.

Bluetooth phone integration introduced (previous cradle phone integration phased out during 2008 Model Year).

2009 Model Year

Exterior trim subtly updated. New interior colour schemes added to range along with further changes to fascia/console/door trim inserts (usually metallic finishes).

Some late 2009MY cars fitted with Range Rover Sport 2010MY components, such as fuel tank.

2010 Model Year

This catalogue does not cover 2010-2013 models. Please refer to our website.

VEHICLE IDENTIFICATION NUMBER

The following illustration shows where the VIN (Vehicle Identification Number) is located on the Range Rover Sport:

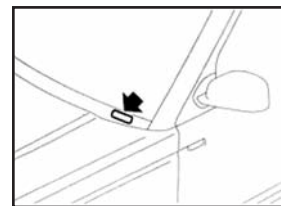
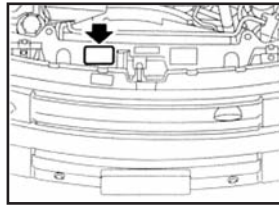
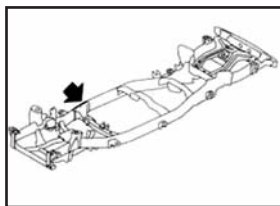

VEHICLE IDENTIFICATION

To ensure the parts that you order are correct for your Range Rover Sport, you will need to know the VIN (Vehicle Identification Number). Unlike most previous Land Rover models, *all* component change points (including powertrain changes) are documented by the VIN at which the change took place. There is no requirement to know the vehicle's engine, transmission or axle serial numbers.

The last six characters of the VIN are the serial number of your car. However, the VIN also provides you with considerably more useful information, most importantly the model year of your car (the majority - but by no means all - of changes in production relate to model years). The complete VIN (*excluding* vehicles for USA, Canada, Mexico and China, which employ a significantly different VIN code system) can be broken down thus:

- First character - S = Europe
- Second character - A = United Kingdom
- Third Character - L = Land Rover (UK)
- Fourth Character - L = Land Rover marque
- Fifth Character - S = Range Rover Sport model
- Sixth Character - A = Standard EU & Rest of World
- J = Japan
- Seventh Character - A = 4 door
- Eighth Character - 1 = 2.7 TDV6 diesel without DPF
- 2 = 3.6 TDV8 diesel without DPF
- 3 = 4.2 AJV8 supercharged petrol
- 5 = 4.4 AJV8 petrol
- 6 = 2.7 TDV6 diesel with DPF
- 7 = 3.6 TDV8 diesel with DPF
- 3 = RHD 6 speed automatic
- 4 = LHD 6 speed automatic
- Ninth Character - 5 = 2005 model year
- 6 = 2006 model year
- 7 = 2007 model year
- 8 = 2008 model year
- 9 = 2009 model year
- Eleventh Character - A = Solihull plant
- Twelfth to Seventeenth - 999999 = serial number

Example:

A car showing SAL LS A A 7 3 8 A 185256 is - Europe/UK/Land Rover UK/Land Rover/RRSport/Standard market/4 door/3.6 TDV8 with DPF/RHD 6 speed automatic/2008MY/Solihull/serial no. 185256

...and for the purposes of using the VIN to trace applicable parts for the car in this catalogue, the tenth character onwards is the most important part, i.e. 8A185256.

YOUR VEHICLE DETAILS

Enter your vehicle details here for easy reference

Vehicle Identification Number (VIN):

Paint Code:

Trim Code:

Engine Number:

Gearbox Number:

IMPORTANT NOTE

Wherever identification/serial numbers are quoted in this catalogue to help you distinguish change points between the fitment of different components, they relate to the Original Factory Specification or Component when the vehicle was new, and not to subsequent miscellaneous replacements.

Under-Bonnet VIN Plate Additional Information

Aside from the VIN, the under-bonnet VIN plate also provides the following additional information, from the top of the plate to the bottom:

1. Type Approval Specification
2. Vehicle Identification Number (VIN)
3. Gross Vehicle Weight (GVW, in Kg)
4. Gross Train Weight (GTW, in Kg)
5. Maximum Front Axle Load (in Kg)
6. Maximum Rear Axle Load (in Kg)
7. Exterior Paint Colour Name



PLEASE NOTE:

UK/EUROPEAN MODELS & REST OF THE WORLD MARKETS

Our catalogue predominantly covers UK and European Models. Although most parts listed are common to the Rest of the World Markets, there are sometimes specific parts for certain countries that are different to those listed herein. If unsure, please contact us quoting your full VIN number.

QUICK FINDER

This section will help you quickly find the parts which are most frequently called for. Each part is then listed again under its appropriate section later in the catalogue.

ALL MODELS

Service Kits

SERVICE KIT:

2.7 TDV6 diesel

Contains air, oil and fuel filters, sump plug washer and a/c pollen filter.

Land Rover	1	RD1212
aftermarket	1	RD1212P
Bearmach		
up to VIN 6A999999	1	RD12121BM
VIN 7A000001 on	1	RA1488BM

3.6 TDV8 diesel

Contains air, oil and fuel filters, sump plug washer and a/c pollen filter.

Land Rover	1	RA1489
aftermarket	1	RA1489P
Britpart	1	RA1489BP
Bearmach	1	RA1489BM

4.2 AJV8 supercharged petrol

Contains spark plugs, air, oil and fuel filters, sump plug washer and a/c pollen filter.

Land Rover	1	RA1490
aftermarket	1	RA1490P
Bearmach	1	RA1490BM42

4.4 AJV8 petrol

Contains spark plugs, air, oil and fuel filters, sump plug washer and a/c pollen filter.

Land Rover	1	RA1490
aftermarket	1	RA1490P
Bearmach	1	RA1490BM44

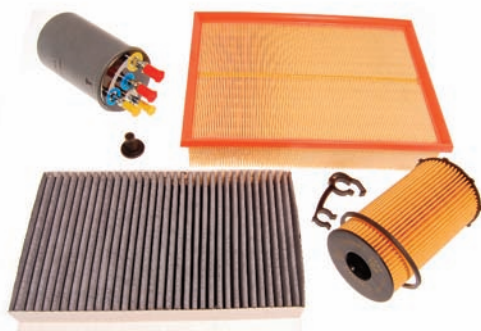

SERVICE KIT - RD1212



SERVICE KIT - RA1489



SERVICE KIT - RA1490

OIL FILTER - 1311289

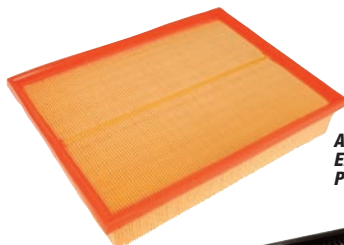
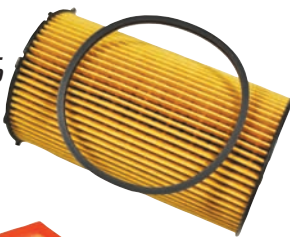

AIR FILTER ELEMENT - PHE000112

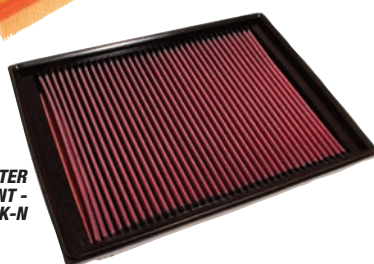

AIR FILTER ELEMENT - PHE000112K-N



FUEL FILTER - LR010075

FUEL FILTER - LR009705



Oil & Fluids

ENGINE OIL, synthetic 5w30 (all models):

Comma X-Tech

1 litre	A/R	XPXTC1L
5 litres	A/R	XPXTC5L

ANTIFREEZE:

Land Rover		
1 litre	A/R	STC50529
5 litres	A/R	STC50530
20 litres	A/R	8510373
Texaco Havoline XLC		
1 litre	A/R	XP1LL
5 litres	A/R	XP5LL
20 litres	A/R	XP20LL

BRAKE FLUID:

Dot 4		
Land Rover		
500ml	A/R	LR052652
1 litre	A/R	LR052653
MG Rover		
500ml	A/R	S3SHE05
1 litre	A/R	S3HE1
silicone fluid		
Replaces conventional clutch/brake fluid. Doesn't absorb water - doesn't degrade. Will not harm paintwork if spilt.		
500ml	A/R	RX1327
1 litre	A/R	RX1326
BRAKE CLEANER, aerosol	A/R	GBF901
RUBBER GREASE, 2oz	A/R	514578P
COPPER EASE GREASE, 85gm	A/R	RX1345

Filters

OIL FILTER:

2.7 TDV6 diesel		
Land Rover	1	1311289
aftermarket	1	1311289P
3.6 TDV8 diesel		
Land Rover	1	LR002338
OEM	1	LR002338P1
aftermarket	1	LR002338P
4.2 AJV8 supercharged petrol & 4.4 AJV8 petrol		
Land Rover	1	LR031439
OEM	1	LR031439P1
aftermarket	1	LR031439P
Britpart Filter Guard magnetic	1	LR031439FGBP

OIL DRAIN PLUG, with sealing washer (all models):

Land Rover	1	1013938
aftermarket	1	1013938P

AIR FILTER ELEMENT (all models):

Land Rover	1	PHE000112
OEM	1	PHE000112P1
aftermarket	1	PHE000112P
K&N Performance	1	PHE000112K-N
Britpart Peak Performance	1	PHE000112BP

FUEL FILTER:

2.7 TDV6 diesel		
cartridge type		
Up to VIN 6A999999.		
Land Rover	1	LR010075
OEM	1	LR010075P1
aftermarket	1	LR010075P
element type		
VIN 7A000001 on.		
Land Rover	1	LR009705
OEM	1	LR009705P1
aftermarket	1	LR009705P
3.6 TDV8 diesel, element type		
Land Rover	1	LR009705
OEM	1	LR009705P1
aftermarket	1	LR009705P
4.2 AJV8 supercharged petrol, cartridge type		
Land Rover	1	WFL500010

Ignition Components

COIL, ignition:

4.2 AJV8 supercharged petrol & 4.4 AJV8 petrol.		
Land Rover	8	4744015
aftermarket	8	4744015P

SPARK PLUG:

4.2 AJV8 supercharged petrol & 4.4 AJV8 petrol.		
Land Rover	8	LR005253
OEM	8	LR005253P1

CAPACITOR, suppression:

4.2 AJV8 supercharged petrol	1	LR005578
4.4 AJV8 petrol	1	LR004150



IGNITION COIL - 4744015



SPARK PLUG - LR005253P1



ALL MODELS

QUICKFINDER - SERVICE ITEMS

Drive Belts

DRIVE BELT:

2.7 TDV6 diesel without Roll Stability Control			
Land Rover	1	PQS500370	
OEM	1	PQS500370P1	
aftermarket	1	PQS500370P	
with Roll Stability Control	1	PQS500420	
3.6 TDV8 diesel			
primary	1	PQS500450	
secondary	1	PQS500460	
4.2 AJV8 supercharged petrol			
primary	1	PQS500420	
secondary			
Land Rover	1	PQS500241	
aftermarket	1	PQS500241P	
4.4 AJV8 petrol			
primary			
without Roll Stability Control			
Land Rover	1	PQR500330	
OEM	1	PQR500330P1	
aftermarket	1	PQR500330P	
with Roll Stability Control	1	PQR500340	
secondary			
Land Rover	1	PQS500221	
OEM	1	PQS500221P1	
aftermarket	1	PQS500221P	

Engine & Exhaust Gaskets

ENGINE GASKET KIT:

Includes all gaskets & oil seals, plus cam cover bolts and grommets.

4.2 AJV8 supercharged petrol	1	LR006635
4.4 AJV8 petrol		
Land Rover	1	LR006645
aftermarket	1	LR006645P

CYLINDER HEAD GASKET:

2.7 TDV6 diesel			
grade 2	2	LR009719	
grade 3	2	LR009721	
grade 4	2	LR009722	
grade 5			
Land Rover	2	LR009723	
OEM	2	LR009723P1	
3.6 TDV8 diesel			
grade 1			
RH	1	1418984	
LH	1	1418990	
grade 2			
RH	1	1418985	
LH	1	1418991	
grade 3			
RH	1	LR000635	
LH	1	1418992	
grade 4			
RH	1	1418987	
LH	1	1418993	
grade 5			
RH	1	1418989	
LH	1	1418996	
4.2 AJV8 supercharged petrol			
RH	1	4628399	
LH	1	4628400	
4.4 AJV8 petrol			
RH			
Land Rover	1	4585198	
aftermarket	1	4585198P	
LH	1	4585202	

EXHAUST DOWNPIPE GASKET:

2.7 TDV6 diesel	1	ESR3737
3.6 TDV8 diesel	2	WCM500080
4.2 AJV8 supercharged petrol & 4.4 AJV8 petrol (RH pipe only)	1	WCM100460

DIESEL PARTICULATE FILTER GASKET:

2.7 TDV6 diesel	1	WCM500120
<i>With Euro Stage 4 emissions only, VIN 7A000001 on.</i>		
3.6 TDV8 diesel	1	WCM500130



DRIVE BELT - PQS500370

CRANKSHAFT OIL SEAL - 4526537



Oil Seals

CRANKSHAFT OIL SEAL:

2.7 TDV6 diesel			
front (oil pump)	1	1102415	
rear, with retainer	1	LR036542	
3.6 TDV8 diesel			
front (oil pump)	1	1102415	
rear, with retainer	1	LR005539	
4.2 AJV8 supercharged petrol & 4.4 AJV8 petrol			
front (oil pump)	1	4526537	
rear,			
aftermarket	1	4352327P	
TIMING COVER SEAL	3	4526553	
<i>4.2 AJV8 supercharged petrol & 4.4 AJV8 petrol.</i>			
CAMSHAFT OIL SEAL	3	1311318	
<i>2.7 TDV6 diesel.</i>			

AUTOMATIC GEARBOX OIL SEAL:

input (oil pump) seal	1	TZB500030
output seal	1	TZB500010
selector shaft seal	1	LR023293

TRANSFER GEARBOX OIL SEAL:

input shaft seal			
Land Rover	1	IZB500030	
aftermarket	1	IZB500030P	
front output shaft sealing ring			
Land Rover	1	IZB500040	
OEM	1	IZB500040P1	
rear output shaft sealing ring			
Land Rover	1	IZB500050	
OEM	1	IZB500050P1	



TIMING BELT KIT - LR016655

Timing Belts

2.7 TDV6 DIESEL ONLY

TIMING BELT KIT:

front			
<i>Includes tensioner pulley.</i>			
Land Rover	1	LR016655	
OEM	1	LR016655P1	
rear			
<i>Includes tensioner pulley and bolt.</i>			
EU2 emissions models	1	1324390	
Euro Stage 4 emissions models			
<i>VIN 7A000001 on.</i>			
Land Rover	1	LR019115	
OEM	1	LR019115P1	



EXHAUST DOWNPIPE GASKET - ESR3737

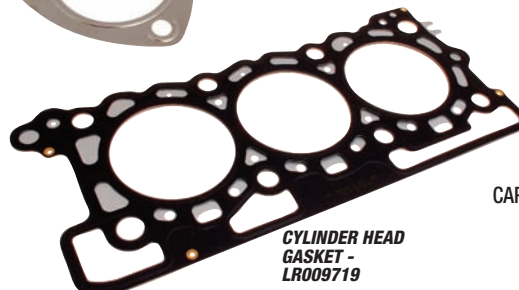

CYLINDER HEAD GASKET - LR009719

WATER PUMP - LR009324

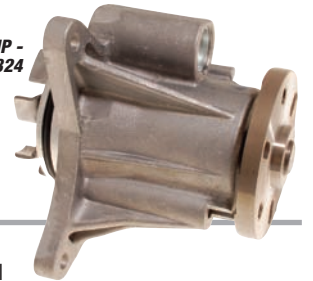

Cooling System

WATER PUMP:

2.7 TDV6 diesel			
Land Rover	1	LR009324	
OEM	1	LR009324P1	
3.6 TDV8 diesel			
Land Rover	1	LR008863	
OEM	1	LR008863P1	
4.2 AJV8 supercharged petrol			
main			
Land Rover	1	4575902	
OEM	1	4575902P1	
aftermarket	1	4575902P	
auxiliary	1	PEB500010	
4.4 AJV8 petrol			
Land Rover	1	4575902	
OEM	1	4575902P1	
aftermarket	1	4575902P	

GASKET, water pump:

2.7 TDV6 diesel	1	1316117
3.6 TDV8 diesel	1	LR002750
4.2 AJV8 supercharged petrol & 4.4 AJV8 petrol		
Land Rover	1	4575903

THERMOSTAT:

2.7 TDV6 diesel			
EU2 emissions	1	PEL500320	
Euro Stage 4 emissions	1	LR009562	
3.6 TDV8 diesel			
thermostat	1	LR003341	
thermostatic valve ass'y	1	LR003335	
4.2 AJV8 supercharged petrol & 4.4 AJV8 petrol			
Land Rover	1	LR005765	
OEM	1	LR005765P1	
aftermarket	1	LR005765P	

RADIATOR HOSE:

2.7 TDV6 diesel			
EU2 emissions			
top & bottom ass'y	1	PEL500310	
<i>Includes thermostat.</i>			
Euro Stage 4 emissions			
<i>VIN 7A000001 on.</i>			
top & bottom ass'y	1	LR020009	
<i>Includes thermostat.</i>			
3.6 TDV8 diesel			
top, assembly	1	PCH503340	
bottom, assembly	1	PCH503270	
4.2 AJV8 supercharged petrol			
top, assembly	1	PCH501215	
bottom, assembly	1	PCH500893	
4.4 AJV8 petrol			
top	1	PCH500941	
bottom, assembly	1	PCH500962	

THERMOSTAT HOSE:

2.7 TDV6 diesel			
EU2 emissions normal climates	1	PEH500181	
EU2 emissions hot climates,			
Euro Stage 4 emissions			
kit of 2 hoses	1	PIH500101	
short hose (incl. in kit)	1	PEH500201	
long hose (incl. in kit)	1	PIH500040	
3.6 TDV8 diesel			
o'flow tank to t'stat & cooler union	1	PCH503280	
connector block to t'stat housing			
RH	1	LR008276	
LH	1	LR008202	
t'stat housing to EGR valve	1	1418972	
t'stat hsing to cyl. head, elbow	2	LR008237	
4.2 AJV8 supercharged petrol			
t'stat to bottom hose	1	PCH500923	
t'stat to heater pipes, ass'y	1	LR006147	
4.4 AJV8 petrol			
t'stat to heater pipes, ass'y	1	PCH500955	

CAP, overflow tank (all models):

Land Rover	1	PCD500030
aftermarket	1	PCD500030P

Engine & Gearbox Mountings

ENGINE MOUNTING:		
2.7 TDV6 diesel	2	KKB500760
3.6 TDV8 diesel	2	KKB500602
4.2 AJV8 supercharged petrol &		
4.4 AJV8 petrol	2	KKB500630
GEARBOX MOUNTING (transfer box)		
	1	IAF500070

Shock Absorbers

FRONT SHOCK ABSORBER:		
<i>Includes strut seal kit and lower bush.</i>		
models without Roll Stability Control		
Land Rover		LR016426
Bilstein	2	LR016426BILSTEIN
models with Roll Stability Control		
all except 3.6 TDV8 diesel	2	LR016427
3.6 TDV8 diesel only	2	LR016428
REAR SHOCK ABSORBER:		
<i>Includes strut seal kit and lower bush.</i>		
models without Roll Stability Control		
Land Rover	2	LR016423
Bilstein	2	LR016423BILSTEIN
models with Roll Stability Control		
all except 3.6 TDV8 diesel		
Land Rover	2	LR016424
OEM	2	LR016424P1
3.6 TDV8 diesel only:		
Land Rover	2	LR016425
OEM	2	LR016425P1



FRONT SHOCK ABSORBER - LR016426BILSTEIN

Suspension Bushes

FRONT SUSP. UPPER ARM BUSH	4	RBX500443
FRONT SUSP. LOWER ARM BUSH:		
front		
Land Rover	2	RBX500432
aftermarket	2	RBX500432P
rear		
Land Rover	2	LR025986
OEM	2	LR025986P1
aftermarket	2	LR025986P
FRONT ANTI ROLL BAR MOUNTING BUSH:		
models w/out Roll Stability Control		
Land Rover	2	RVU500011
aftermarket	2	RVU500011P
updated, polyurethane 2		
		RVU500011POLYBUSH
REAR SUSPENSION UPPER ARM BUSH:		
inner front		
Land Rover	2	RGX500201
aftermarket	2	RGX500201P
inner rear		
Land Rover	2	RHF500130
OEM	2	RHF500130P1
outer (to knuckle)		
Land Rover	2	RHF500100
OEM	2	RHF500100P1
aftermarket	2	RHF500100P
REAR SUSPENSION LOWER ARM BUSH:		
inner front		
	2	LR064022
inner rear		
Land Rover	2	LR054831
OEM	2	LR054831P1
Polly bush	2	LR054831POLY
outer (to knuckle)		
Land Rover	2	LR032644
aftermarket	2	LR032644P
REAR ANTI ROLL BAR MOUNTING BUSH:		
models w/out Roll Stability Control		
	2	LR018354
models with Roll Stability Control		
	2	RVU000022

Ball Joints, Hub Bearings & Gaiters

FRONT SUSP. UPPER ARM BALL JOINT:		
<i>Includes circlip and nut.</i>		
Land Rover	2	RBK500170
OEM	2	RBK500170P1
aftermarket	2	RBK500170P
FRONT SUSP. LOWER ARM BALL JOINT, 35mm dia.:		
<i>Original fitment for vehicles from VIN 9A199377 onwards (all models except 3.6 TDV8 diesel) and 9A199405 onwards (3.6 TDV8 diesel only).</i>		
Land Rover	2	RBK500300
OEM	2	RBK500300P1
aftermarket	2	RBK500300P

important note

LOWER BALL JOINT

Important note concerning Range Rover Sport models up to VIN 9A199376 (all models except 3.6 TDV8 diesel) and 9A199404 (3.6 TDV8 diesel only):

The lower ball joints listed here fit into lower arms with 35mm ball joint holes and are the original fitment for vehicles from VIN 9A199377 onwards (all models except 3.6 TDV8 diesel) and 9A199405 onwards (3.6 TDV8 diesel only). Vehicles prior to these VINs originally had different lower arms taking a different diameter ball joint - this earlier ball joint is not available. To replace a lower ball joint on a vehicle prior to VIN 9A199377/9A199405, first measure the ball joint diameter. One of two actions should then be followed:

If the ball joint present is not 35mm, you will need to replace both the ball joint and lower arm, available together as a lower arm assembly - please refer to the Front Suspension section to choose the correct specification lower arm for your vehicle.

If the ball joint present is 35mm, the lower arm has already been replaced with the later type and you can order one of the 35mm ball joints listed above.

TRACK ROD END - LR010675



TRACK ROD END (ball joint):		
to VIN 9A191791		
<i>With M12 thread for knuckle nut.</i>		
with attachment nut		
Land Rover	2	LR010675
aftermarket	2	LR010675P
without attachment nut		
Land Rover	2	QJB500040
OEM	2	QJB500040P1
aftermarket	2	QJB500040P
VIN 9A191792 on		
<i>Includes M14 thread for knuckle nut.</i>		
Land Rover	2	LR010672
OEM	2	LR010672P1
with attachment nut	2	LR010676
without attachment nut	2	QJB500070
FRONT HUB & BEARING ASSEMBLY:		
<i>Includes hub to C.V. joint nut.</i>		
Land Rover	2	LR014147
OEM	2	LR014147P1
aftermarket	2	LR014147P
Britpart	2	LR014147BP
REAR HUB BEARING KIT:		
<i>Includes bearing, circlip and hub nut for one hub.</i>		
Land Rover	2	LR045917
OEM	2	LR045917P1
aftermarket	2	LR045917P
FRONT DRIVE SHAFT GAITER KIT:		
<i>Includes inner and outer boots plus boot clips and driveshaft circlips (snap rings) for one drive shaft.</i>		
all models except 2.7 TDV6 diesel		
Land Rover	2	TDR500110
OEM	2	TDR500110P1
2.7 TDV6 diesel models only		
Land Rover	2	TDR500100
OEM	2	TDR500100P1
REAR DRIVE SHAFT GAITER KIT:		
<i>Includes inner and outer boots plus boot clips and driveshaft circlips (snap rings) for one drive shaft.</i>		
without rear axle locking		
Land Rover	2	TDR500070
OEM	2	TDR500070P1
with rear axle locking		
Land Rover	2	TDR500080
OEM	2	TDR500080P1
QFW500020	2	QFW500020
STEERING RACK GAITER KIT		
<i>Includes 1 gaiter and 2 clips.</i>		

ALL MODELS Brakes

FRONT BRAKE DISC:		
320mm diameter (models with 17" wheels or larger)		
Land Rover, each	2	SDB000604
Brembo, each	2	SDB000604BREMBO
aftermarket, each	2	SDB000604P
updated, slotted & drilled, pair		SDB000604URBP
340mm diameter (models with 18" wheels or larger)		
Land Rover, each	2	SDB000614
Brembo, each	2	SDB000614BREMBO
aftermarket, each	2	SDB000614P
updated, slotted & drilled, pair		SDB000614URBP
360mm diameter (models with 19" wheels or larger)		
Land Rover, each	2	SDB000624
Brembo, each	2	SDB000624BREMBO
aftermarket, each	2	SDB000624P
updated, slotted & drilled, pair		SDB000624URBP

FRONT BRAKE PAD SET - LR019618GS



FRONT BRAKE PAD SET (axle set):		
for 320mm & 340mm diameter discs		
<i>Includes guide pin screws.</i>		
Land Rover	1	LR019618
OEM	1	LR019618P1
Brembo	1	LR019618BREMBO
aftermarket	1	LR019618P
updated, EBC Greenstuff	1	LR019618GS
for 360mm diameter discs		
<i>Includes brake pads only.</i>		
Land Rover	1	SFP500070
Brembo	1	SFP500070BREMBO
TRW/Lucas	1	SFP500070P1
aftermarket	1	SFP500070P
updated, EBC Greenstuff	1	SFP500070GS
REAR BRAKE DISC & HANDBRAKE DRUM:		
325mm diameter (models with 17" wheels or larger)		
Land Rover, each	2	SDB000636
Brembo, each	2	DB000636BREMBO
aftermarket, each	2	SDB000636P
updated, slotted & drilled, pair		SDB000636UR BP
350mm diameter (models with 18" wheels or larger)		
Land Rover, each	2	SDB000646
Brembo, each	2	DB000646BREMBO
aftermarket, each	2	SDB000646P
updated, slotted & drilled, pair		SDB000646UR BP
REAR BRAKE PAD SET (axle set):		
for 325mm diameter discs		
<i>Includes guide pin screws.</i>		
Land Rover	1	LR021316
aftermarket	1	LR021316P
for 350mm diameter discs		
<i>Includes guide pin screws.</i>		
Land Rover	1	LR055454
OEM	1	LR055454P1
Brembo	1	LR055454BREMBO
aftermarket	1	LR055454P
updated, EBC Greenstuff	1	LR055454GS
HANDBRAKE SHOE SET:		
<i>Includes retaining clips and pull off springs.</i>		
Land Rover	1	LR031947
OEM	1	LR031947P1
HANDBRAKE CABLE:		
complete ass'y with actuator		
	1	LR019223
rear cable only		
RH	1	LR018469
LH	1	LR018470



HANDBRAKE CABLE - LR019223

ALL MODELS

QUICK-FINDER - SERVICE ITEMS

ALTERNATOR ASSEMBLY - YLE500400P1



Alternator & Starter Motor

ALTERNATOR ASSEMBLY:

2.7 TDV6 diesel without Roll Stability Control new		
Land Rover, exchange	1	YLE500400
OEM, outright	1	YLE500400P1
aftermarket, outright	1	YLE500400P
reconditioned, exchange	1	LR008861
with Roll Stability Control new		
Land Rover, exchange	1	YLE500420
aftermarket, outright	1	YLE500420P
3.6 TDV8 diesel new		
Land Rover, exchange	1	YLE500430
OEM, outright	1	YLE500430P1
4.2 AJV8 supercharged petrol & 4.4 AJV8 petrol new		
Land Rover, exchange	1	YLE500390
OEM, outright	1	YLE500390P1
aftermarket, outright	1	YLE500390P

STARTER MOTOR ASSEMBLY:

2.7 TDV6 petrol new, outright		
Land Rover	1	LR043962
OEM	1	LR043962P1
reconditioned, exchange	1	NAD500080E
3.6 TDV8 diesel new, exchange	1	LR032541
4.2 AJV8 supercharged petrol & 4.4 AJV8 petrol new, exchange		
Land Rover	1	NAD500310
aftermarket	1	NAD500310P



STARTER MOTOR ASSEMBLY - LR043962P1

FRONT WIPER BLADE - LR018368



Wiper Blades

FRONT WIPER BLADE:

RHD		
Land Rover	2	LR018368
OEM	2	LR018368P1
aftermarket	2	LR018368P
LHD		
Land Rover	2	LR018367
OEM	2	LR018367P1
aftermarket	2	LR018367P
REAR WIPER BLADE		
Land Rover	1	DKB500710
OEM	1	DKB500710P1

Bulbs

FRONT LAMP BULB:

headlamp		
halogen headlamps (H7)		
Land Rover	4	XZQ000011
aftermarket	4	XZQ000011P
Bi Xenon headlamps without ignitor (D2S) To VIN 9A189550		
Land Rover	2	XB1000030
aftermarket	2	XB1000030P
with ignitor (D1S) VIN 9A189550 on.	2	LR021904
cornering lamp (H8)	2	XZQ500020
front indicator		
filament type, standard	2	LR000702
aftermarket, standard	2	LR000702P
LED type, upgrade	2	GLB382LEDAMBER
front side light		
cool blue type	2	XZQ500060
Standard fitment to VIN 6A916303.		
clear type	2	XZQ000060
Standard fitment VIN 6A916304 on.		
side repeater lamp		
clear, to VIN 8A999999	2	XZQ000060
amber, VIN 9A000001 on	2	LR007107
front fog lamp		
The fog lamp bulb is supplied complete with the bulbholder and electrical socket; it is not available separately.		
Land Rover	2	XZQ000110
aftermarket	2	XZQ000110P

REAR LAMP BULB:

stop/tail lamps (21W/5W)		
filament type, standard	4	XZQ000020
LED type, upgrade	4	GLB380LED
rear fog lamps (21W)		
filament type, standard	2	XZQ000030
LED type, upgrade	2	GLB382LED
rear indicator lamps (21W) to VIN 8A999999 (clear bulb)		
filament type, standard	2	XZQ000030
LED type, upgrade	2	GLB382LED
VIN 9A000001 on (silvered amber bulb)		
filament type, standard	2	LR007165
LED type, upgrade	2	GLB382LEDAMBER
reversing lamps (21W)		
filament type, standard	2	XZQ000030
LED type, upgrade	2	GLB382LED
rear number plate lamp (5W)	2	XZQ000060

INTERIOR LAMP BULB:

front row seat lamps	3	XZQ000040
puddle lamps	4	XZQ000060
luggage compartment lamp	1	XZQ000060
footwell lamps	2	XZQ000060
glovebox lamp	1	YXN500010

10 AMP MINI FUSE - LR003739



HEADLAMP BULB - XZQ000011P

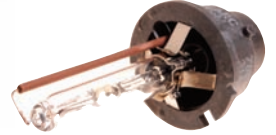

HEADLAMP BULB - XXB1000030P



CORNERING LAMP BULB - XZQ500020



FRONT FOG LAMP BULB - XZQ000110



REAR LAMP BULB - XZQ000020



REAR LAMP BULB - GLB380LED



REAR LAMP BULB - XZQ0000230



REAR LAMP BULB - GLB382LED

Relays

RELAY:

black/yellow, 20 amp, 4 pin	1	YWB500020
black, 20 amp, 5 pin	4	YWB500200
black/white, 40 amp, 4 pin	4	YWB500060
black or grey, 70 amp, 4 pin	6	YWB500220
brown, 5 pin	1	YWC001020

Models with power fold door mirrors only.

Fuses

MINI FUSE:

5 amp (tan)	A/R	LR003737
10 amp (red)	A/R	LR003739
15 amp (blue)	A/R	LR003740
20 amp (yellow)	A/R	LR003741
25 amp (natural)	A/R	LR003742
30 amp (green)	A/R	LR003743

SQUARE FUSE:

30 amp (pink)	A/R	LR003735
40 amp (green)	A/R	LR003736
50 amp	A/R	LR019937
60 amp	A/R	YQG100440
MEGA FUSE, 400 amp, battery cable 1		YQG500010

Stripped & Short Engines - 2.7 TDV6 Diesel

STRIPPED ENGINE ASSEMBLY:

Genuine Land Rover unit, supplied new or reconditioned exchange. Includes cylinder block assembly, cylinder heads, cam covers, timing cover and sump. Less ancillaries.

new, outright	1	LR004729
reconditioned, exchange	1	LR006701

SHORT ENGINE ASSEMBLY:

Genuine Land Rover unit, supplied new. Includes cylinder block, pistons, rods and crankshaft.

new, outright	1	LR010297
---------------	---	-----------------

Cylinder Block - 2.7 TDV6 Diesel

The crankshaft, pistons, main and big end bearings are not serviced separately by Land Rover but are included in the short engine assembly.

SENSOR, crankshaft position	1	LR009793
ACCESS COVER, crankshaft sensor	1	LR022136
RESERVOIR, cylinder block	1	1311310
STIFFENER, lower, cylinder block	1	LR011693

Cylinder Head - 2.7 TDV6 Diesel

Important note: for cylinder head cam covers and oil filler cap, please see Inlet Manifolds in the Fuel System section.

CYLINDER HEAD:

with valves		
RH, exchange	1	1311302
LH, exchange	1	1311303
without valves		
RH		
to VIN 6A999999, exchange	1	1357023
VIN 7A000001 on, outright	1	LR054815
LH		
to VIN 9A194475, outright	1	LR004063
VIN 9A194476 on, outright	1	LR054816
BOLT, cylinder head	16	1331316
VALVE:		
inlet	12	1311281
exhaust	12	LR008130
VALVE SPRING	24	LR006720
VALVE CAP, upper	24	1311283
COLLET, valve cap	48	1072051
VALVE STEM OIL SEAL:		
Land Rover	24	1311285
aftermarket	24	1311285P
ROCKER ARM	24	1336545
SENSOR:		
engine knock	2	LR007808
<i>EC2 emissions models only.</i>		
camshaft position	2	LR019287
SWITCH, oil pressure	1	1316119

Oil Pump, Cooler & Filter - 2.7 TDV6 Diesel

OIL PUMP	1	LR076782
BOLT, oil pump to block	10	4147433
PICK UP PIPE, oil pump (inlet tube)	1	1316048
OIL COOLER ASS'Y (incl. seal & filter)	1	1354253
SEAL, oil cooler	1	1356789
OIL FILTER ELEMENT:		
Land Rover	1	1311289
aftermarket	1	1311289P
OIL FILTER COVER	1	1316143

Oil Sump & Dipstick - 2.7 TDV6 Diesel

OIL SUMP	1	1359896
OIL DRAIN PLUG, with sealing washer:		
Land Rover	1	1013938
aftermarket	1	1013938P
SENSOR, engine temperature	1	1359056
DIPSTICK, late type	1	LR003387
<i>If fitting the dipstick on a car prior to VIN 7A000001, the late type (i.e. VIN 7A000001 on) dipstick tube should also be fitted.</i>		
DIPSTICK TUBE:		
up to VIN 6A999999	1	1380883
VIN 7A000001 on	1	LR003388

Camshaft & Timing Gear - 2.7 TDV6 Diesel

CAMSHAFT:		
inlet		
RH	1	LR057775
LH	1	LR057781
exhaust		
RH	1	LR057793
LH	1	LR057792

TIMING CHAIN & TENSIONER KIT - 1316113



TIMING CHAIN & TENSIONER KIT	1	1316113
CAMSHAFT PULLEY, front:		
RH	1	1311317
LH	1	1324372
CAMSHAFT HUB, front:		
RH	1	1324342
LH	1	1324363
BOLT, hub to camshaft	2	LR010530
CRANKSHAFT PULLEY	1	LR005996
BOLT, crankshaft pulley:		
M14 (up to VIN 9A198352)	1	LR002458
M16 (VIN 9A198353 on)	1	LR013377
TIMING BELT IDLER, front:		
Land Rover	1	1311306
OEM	1	1311306P1
TIMING BELT KIT, front:		
<i>Includes tensioner pulley.</i>		
Land Rover	1	LR016655
OEM	1	LR016655P1
TIMING COVER, front, with fixings:		
up to VIN 7A999142	1	1369553
VIN 7A999143 on	1	LR031775
UPPER BRIDGE COVER	1	1331263
TIMING BELT KIT, rear		
<i>Includes tensioner pulley and bolt.</i>		
EU2 emissions models		
Land Rover	1	1324390
OEM	1	1324390P1
Euro Stage 4 emissions models		
<i>VIN 7A000001 on.</i>		
Land Rover	1	LR019115
OEM	1	LR019115P1
TIMING BELT PULLEY, rear	1	1311316
BOLT, rear timing belt pulley	1	LR010530
TIMING COVER, rear:		
EU2 emissions models		
front	1	LR010251
rear	1	1331265
Euro Stage 4 emissions models		
front	1	LR073363
LH	1	LR006527
RH	1	LR006527
rear	1	LR006529

2.7 TDV6 DIESEL

Flywheel - 2.7 TDV6 Diesel

FLYWHEEL & RING GEAR	1	4602282
BOLT, flywheel to crankshaft	8	1406665
TRIGGER WHEEL, cam timing	1	LR005254

Oil Seal - 2.7 TDV6 Diesel

CRANKSHAFT OIL SEAL:		
front (oil pump)	1	1102415
rear, with retainer	1	LR036542
O RING, oil pump	2	1346539
SEAL, camshaft, front and rear		
Land Rover	3	1311318
aftermarker	3	1311318P

Gaskets - 2.7 TDV6 Diesel

CYL. BLOCK LOWER STIFF. GASKET	1	LR005994
CYLINDER HEAD GASKET:		
grade 2	2	LR009719
grade 3	2	LR009721
grade 4	2	LR009722
grade 5	2	LR009723
OIL PUMP GASKET	1	1316139
OIL SUMP GASKET	1	1365260
TIMING COVER GASKET	1	LR014305

Service Kits - 2.7 TDV6 Diesel

SERVICE KIT:

<i>Contains air, oil and fuel filters, sump plug washer and a/c pollen filter.</i>		
Land Rover	1	RD1212
aftermarket	1	RD1212P
Bearthach		
up to VIN 6A999999	1	RD1212BM
VIN 7A000001 on	1	RA1488BM



Timing Tool Kit - 2.7 TDV6 Diesel

Pin-point accuracy is of course essential when setting camshaft timing during an engine rebuild and that's exactly what these kits from Laser have been developed to ensure. Including all the tools required to lock the engine in the desired stroke position and then accurately align the camshafts, the kit covers the 2.7 TDV6 diesel engine as fitted to Discovery 3 and Range Rover Sport.

TIMING TOOL KIT, 2.7 TDV6 diesel	1	RA1549
----------------------------------	---	---------------



...TER ELEMENT - 89

3.6 TDV8 DIESEL

Engines - 3.6 TDV8 Diesel

STRIPPED ENGINE ASSEMBLY:

Genuine Land Rover unit, supplied new or reconditioned exchange. Includes cylinder block assembly, cylinder heads, cam covers, timing cover and sump. Less ancillaries.

new, exchange	1	LR006675
reconditioned, exchange	1	LR006702

Cylinder Block - 3.6 TDV8 Diesel

The crankshaft, pistons, main and big end bearings are not serviced separately by Land Rover but are included in the stripped engine assembly.

SENSOR:

crankshaft position	1	LR009793
engine knock	1	1419002
ACCESS COVER, crankshaft sensor	1	LR022136

Cylinder Head - 3.6 TDV8 Diesel

Important note: for cylinder head cam covers and oil filler cap, please see Inlet Manifolds in the Fuel System section.

CYLINDER HEAD:

with valves		
RH, new, outright	1	LR002435
LH, new, outright	1	LR002436
without valves		
RH, new, outright	1	LR002445
LH, new, outright	1	LR002436
BOLT, cylinder head:		
Land Rover	20	1331316
OEM	20	1331316P1
VALVE:		
inlet	16	1311281
exhaust	16	LR008130
VALVE SPRING	32	LR006720
VALVE CAP, upper	32	1311283
COLLET, valve cap	64	1072051
VALVE STEM OIL SEAL	32	1311285
ROCKER ARM	32	1336545
SENSOR, cam position, LH head	1	LR058405
SWITCH, oil pressure	2	LR000633



Oil Pump, Cooler & Filter - 3.6 TDV8 Diesel

OIL PUMP	1	LR050540
BOLT, oil pump to block	11	4147433
PICK UP PIPE, oil pump (inlet tube)	1	LR006381
OIL COOLER & FILTER ASSEMBLY	1	LR006427
<i>Includes oil filter, separator, seals and gasket.</i>		
SEPARATOR, oil	1	LR002343
OIL FILTER ELEMENT, with seal:		
Land Rover	1	
OEM	1	LR002338P1
aftermarket	1	LR002338P
OIL FILTER COVER	1	LR002339

Oil Sump & Dipstick - 3.6 TDV8 Diesel

OIL SUMP	1	LR017918
OIL DRAIN PLUG, with sealing washer:		
Land Rover	1	1013938
aftermarket	1	1013938P
SENSOR, engine temperature	1	1359056
DIPSTICK	1	LQM500080
DIPSTICK TUBE:		
upper	1	LQN500070
lower	1	LR005276
GROMMET, dipstick tube mounting	1	LR007738
BAFFLE, oil sump	1	LR002451
PIPE, oil return:		
internal	1	LR006143
external (includes hose)	1	LR003663
HOSE, oil return	1	LR002437
REAR TUBE, sump:		
upper (incl. O ring)	1	LR020233
lower (incl. O ring)	1	1418983

OIL DRAIN PLUG - 1013938



Camshaft & Timing Gear - 3.6 TDV8 Diesel

CAMSHAFT:		
inlet		
RH	1	LR001853
LH	1	LR001854
exhaust		
RH	1	LR001855
LH	1	LR001856
TIMING CHAIN	2	1418833
TENSIONER ASS'Y, timing chain	2	LR002440
ARM, timing chain tensioner	2	1418836
GUIDE, timing chain	2	1418835
SCREW:		
tensioner ass'y to arm	4	RYG500220
timing chain guide	2	1418838
SPROCKET, camshaft	2	1418837
GEAR, camshaft	4	1418840
DRIVE BOSS, camshaft gear	1	LR007096
BOLT:		
drive boss, camshaft gear	1	1418844
camshaft gear	3	LR010530

Flywheel - 3.6 TDV8 Diesel

FLYWHEEL & RING GEAR	1	LR002441
BOLT, flywheel to crankshaft	8	1406665
TRIGGER WHEEL, cam timing	1	LR005254

Oil Seals - 3.6 TDV8 Diesel

CRANKSHAFT OIL SEAL:		
front (oil pump)	1	1102415
rear, with retainer	1	LR005539
O RING:		
oil pick up pipe	1	LR002459
dipstick tube	1	LR004688
internal oil return pipe & rear tubes	3	1418982
SEAL KIT, oil cooler & filter assembly	1	LR002342



CRANKSHAFT OIL SEAL - 1102415

Gaskets - 3.6 TDV8 Diesel

CYLINDER HEAD GASKET:

grade 1		
RH	1	1418984
LH	1	1418990
grade 2		
RH	1	1418985
LH	1	1418991
grade 3		
RH	1	LR000635
LH	1	1418992
grade 4		
RH	1	1418987
LH	1	1418993
grade 5		
RH	1	1418989
LH	1	1418996
OIL PUMP GASKET	1	LR002449
OIL COOLER & FILTER GASKET	1	LR002340
OIL SUMP GASKET	1	LR002438

Service Kits - 3.6 TDV8 Diesel

SERVICE KIT:

Contains air, oil and fuel filters, sump plug washer and a/c pollen filter.

Land Rover	1	RA1489
aftermarket	1	RA1489P
Britpart	1	RA1489BP
Bearmach	1	RA1489BM

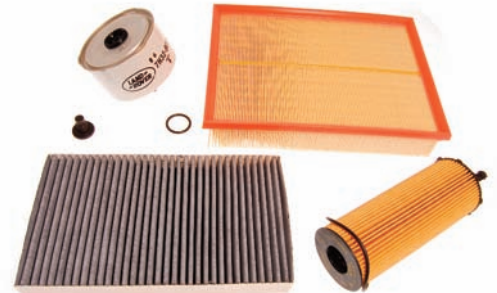

SERVICE KIT - RA1489



SERVICE KIT - RA1489P



SERVICE KIT - RA1489BP



SERVICE KIT - RA1489BM

Stripped Engines - 4.2 AJV8 Supercharged Petrol

STRIPPED ENGINE ASS'Y:

Genuine Land Rover unit, supplied new exchange or reconditioned exchange. Includes cylinder block assembly, cylinder heads, cam covers, timing cover and sump. Less ancillaries.

These engines are not appropriate for North American models (LEV II emissions requirements) from VIN 7A000001 onwards - for those vehicles, which employed variable valve timing (VVT) similar to that used on the 4.4 AJV8 petrol engine, please enquire.

new, exchange	1	LR004703
All models up to VIN 6A999999, EU2 and Euro Stage 4 emissions models only from VIN 7A000001 on.		
reconditioned, exchange		
up to VIN 6A999999	1	LR005684
All models.		
VIN 7A000001 on	1	LR010165
EU2 and Euro Stage 4 emissions models only (not North America, Russia or China).		

Cylinder Block - 4.2 AJV8 Supercharged Petrol

SENSOR, engine knock	1	4603186
RETAINER, knock sensor	1	4603189
PLUG, cylinder block valley	1	1069338
PISTON ASSEMBLY:		
grade 1	8	LR002439
grade 2	8	LR004719
grade 3	8	LR004720
PISTON RING SET	8	1357861
CIRCLIP, piston gudgeon pin	16	4628401
CONNECTING ROD	8	LR008220
BOLT, connecting rod	16	4527567
BEARING, connecting rod:		
blue	A/R	4526475
green	A/R	4526476
yellow	A/R	4526477
BEARING, crankshaft main:		
lower		
blue/green	A/R	4464732
blue	A/R	4464739
green	A/R	4464741
yellow	A/R	4464742
upper		
blue/green	A/R	4464745
blue	A/R	4464748
green	A/R	4464750
yellow	A/R	4464752
THRUST WASHER, crankshaft main	1	1069689
BOLT, lower stiffener to block:		
bearing cap, M10 ('M bolt')	10	LR005586
bearing cap, M8 ('S bolt')	10	LR005587
outer, M8 ('P bolt')	12/10	LR005588
Qty 12 to VIN 6A999999, qty 10 from VIN 7A000001 on.		
rear, M8 ('F bolt')	2	LR005589
VIN 7A000001 on.		

TAPPET -
4624072



Cylinder Head - 4.2 AJV8 Supercharged Petrol

CYLINDER HEAD, with valves, exchange:

RH	1	LR002811
LH	1	LR002812
BOLT, cylinder head:		
main, M10 x 175mm	20	4677857
front, M8 x 90mm		
Land Rover	4	FB108181L
OEM	4	FB108181LP1
TAPPET:		
2.950mm	A/R	LR037205
2.965mm	A/R	4624032
2.980mm	A/R	LR037229
2.995mm	A/R	4624034
3.010mm	A/R	4624037
3.025mm	A/R	4624038
3.040mm	A/R	4624040
3.055mm	A/R	4624043
3.070mm	A/R	4624045
3.085mm	A/R	4624049
3.100mm	A/R	LR037267
3.115mm	A/R	LR037269
3.130mm	A/R	LR037229
3.145mm	A/R	LR037275
3.160mm	A/R	LR037279
3.175mm	A/R	LR037284
3.190mm	A/R	LR037286
3.205mm	A/R	LR037287
3.220mm	A/R	4649518
3.235mm	A/R	LR037289
3.250mm	A/R	LR037292
3.265mm	A/R	4624072
3.280mm	A/R	LR037306
3.295mm	A/R	LR037307
3.310mm	A/R	LR037308
3.325mm	A/R	LR037309
3.340mm	A/R	LR037310
3.355mm	A/R	LR037311
3.370mm	A/R	4624087
3.385mm	A/R	4624088
3.400mm	A/R	LR037314
3.415mm	A/R	LR037315
3.430mm	A/R	LR037316
3.445mm	A/R	LR037317
3.460mm	A/R	LR037318
3.475mm	A/R	LR037322
3.490mm	A/R	LR037328
3.505mm	A/R	4624099
3.520mm	A/R	LR037330
3.535mm	A/R	4624102
3.550mm	A/R	LR037332
3.565mm	A/R	LR037333
3.580mm	A/R	LR037334
3.595mm	A/R	LR037335
3.610mm	A/R	LR037336
3.625mm	A/R	LR037343
3.640mm	A/R	LR037344
3.655mm	A/R	LR037345
3.670mm	A/R	LR037346
3.685mm	A/R	LR037347

VALVE:

inlet		
Land Rover	16	LR002447
OEM	16	LR002447P1
exhaust	16	4646004
VALVE SPRING	32	4646003
VALVE CAP, upper	32	1069876
COLLET, valve cap	64	1069944
VALVE SPRING SEAT, lower	32	3598716
SENSOR, camshaft position:		
RH	1	4427657
LH	1	4362957
COVER, camshaft:		
Includes gasket and bolt grommets.		
RH		
to VIN 5A348162	1	4696827
VIN 5A348163 on	1	LR007654
LH	1	LR007656
BOLT, camshaft cover:		
rear, plain, without grommet	2	LR000337
plain, with grommet	14	4728385
with stud & grommet	8	4728386
GROMMET, rear bolt	2	4728387
O RING, sealing camshaft cover	8	LDR500180
COVER, coil & spark plug	2	LR008573
PIPE & CAP ASS'Y, oil filler	1	4527568

Oil Pump, Cooler & Filter - 4.2 AJV8 Supercharged Petrol

OIL PUMP	1	LR006634
OIL PUMP PICK UP PIPE (inlet tube)	1	4728612
OIL COOLER ASSEMBLY	1	PBC500200
HOSE ASS'Y, to oil cooler:		
to RH union	1	PBP500094
to LH union	1	PBP500105
O RING, hose assembly	2	PYX500030
COOLING COIL ASSEMBLY	1	PBC500051
PIPE, to cooling coil:		
to top RH union	1	PBP500081
to top LH union	1	PBP500072
HOSE, to cooling coil:		
to bottom RH union	1	PCH501113
to bottom LH union	1	PCH501122
OIL FILTER HEAD	1	LR003833
SEAL, oil filter head, figure of 8	1	LVF500010
OIL FILTER:		
Land Rover	1	LR031439
aftermarket	1	LR031439P
Britpart Filter Guard magnetic	1	LR031439FGBP
SENSOR, engine oil temperature	1	LR018397
SWITCH, oil pressure	1	4737666



4.2 AJV8 PETROL

Oil Sump & Dipstick - 4.2 AJV8 Supercharged Petrol

OIL SUMP	1	4728388
<i>Includes crank position sensor and drain plug.</i>		
OIL DRAIN PLUG, with sealing washer:		
Land Rover	1	1013938
aftermarket	1	1013938P
SENSOR, crankshaft position:		
Land Rover	1	NSC500160
aftermarket	1	NSC500160P
DIPSTICK	1	LQM500030
DIPSTICK TUBE	1	4536872
BAFFLE, sump	1	4526550

Camshaft & Timing Gear - 4.2 AJV8 Supercharged Petrol

CAMSHAFT:		
inlet		
RH	1	LR009438
LH	1	LR009445
exhaust		
RH		
up to VIN 6A999999	1	4741260
VIN 7A000001 to 7A999999	1	LR002433
VIN 8A000001 on	1	LR009446
LH		
up to VIN 6A999999	1	4741261
VIN 7A000001 on	1	LR009447
RELUCTOR RING, cam position sensor	2	1323263
TIMING CHAIN:		
upper	2	4174187
lower	2	4174166
TENSIONER, timing chain:		
upper		
RH	1	4462683
LH	1	4462684
lower		
tensioner assembly	2	4179611
tensioner blade	2	4179614
BUSH, lower tensioner blade	2	4437271
BOLT, lower tensioner blade pivot	2	3600255
GUIDE, lower timing chain	2	4536848
CAMSHAFT SPROCKET:		
<i>Important note: ensure sprocket bolts are always renewed - they should never be reused.</i>		
exhaust	2	4160971
inlet, without VVT unit	2	4663398
<i>Not North America (LEV II emissions) from VIN 7A000001 on - these models employed variable valve timing (VVT) similar to but not the same as the 4.4 AJV8 petrol engine.</i>		
BOLT, sprocket to camshaft	4	4165653
SPACER, exhaust cam sprocket bolt	2	4160902
CRANKSHAFT SPROCKET	1	4174189
WOODRUFF KEY, gear locating	1	1663923
TIMING COVER	1	4526470

Flywheel - 4.2 AJV8 Supercharged Petrol

FLYWHEEL & RING GEAR	1	4602268
BOLT, flywheel to crankshaft	8	1069174

Oil Seals - 4.2 AJV8 Supercharged Petrol

CRANKSHAFT OIL SEAL:		
front (oil pump)	1	4526537
rear, aftermarket	1	4352327P
TIMING COVER OIL SEAL	3	4526553



**FRONT
CRANKSHAFT
OIL SEAL -
4526537**

Gaskets - 4.2 AJV8 Supercharged Petrol

ENGINE GASKET KIT:		
<i>Includes all gaskets & oil seals, plus cam cover bolts and grommets.</i>		
Land Rover	1	LR006635
aftermarket	1	LR006635P
CYLINDER HEAD GASKET:		
RH	1	4628399
LH	1	4628400
CAMSHAFT COVER GASKET:		
RH		
Land Rover	1	LR007652
aftermarket	1	LR007652P
LH		
Land Rover	1	LR007657
aftermarket	1	LR007657P
OIL PUMP GASKET	1	4628523
TIMING COVER GASKET:		
upper	1	LJQ500020
lower	1	LR000319

**TIMING
TOOL KIT -
RA1548**

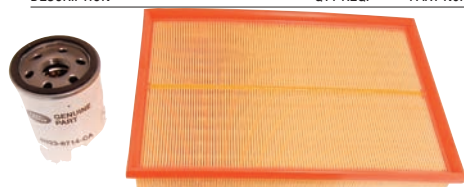

**SERVICE KIT -
RA1490**

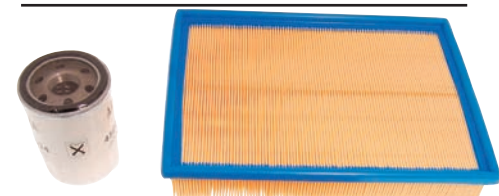

**SERVICE KIT -
RA1490P**



**SERVICE KIT -
RA1490BM42**

Service Kits - 4.2 AJV8 Supercharged Petrol

SERVICE KIT:		
<i>Contains spark plugs, air, oil and fuel filters, sump plug washer and a/c pollen filter.</i>		
Land Rover	1	RA1490
aftermarket	1	RA1490P
Bearmach	1	RA1490BM42

Timing Tool Kit - 4.2 AJV8 Supercharged Petrol

Pin-point accuracy is of course essential when setting camshaft timing during an engine rebuild and that's exactly what these kits from Laser have been developed to ensure. Including all the tools required to lock the engine in the desired stroke position and then accurately align the camshafts, the kit covers the pre-2010 Jaguar-derived AJV8 petrol engine with timing chains, both in 4.4 normally aspirated and 4.2 supercharged forms (as fitted to Discovery 3, Range Rover Sport, Range Rover L322 and several Jaguar XJ, XK, S Type and XF variants).

TIMING TOOL KIT, 4.4 & 4.2 AJV8 petrol	1	RA1548
--	---	--------



Stripped Engines - 4.4 AJV8 Petrol

STRIPPED ENGINE ASS'Y, reconditioned exchange:
Genuine Land Rover unit, supplied reconditioned exchange. Includes cylinder block assembly, cylinder heads, cam covers, timing cover and sump. Less ancillaries.
up to VIN 6A999999 1 **LR003969**
VIN 7A000001 on 1 **LR010164**

Cylinder Block - 4.4 AJV8 Petrol

SENSOR, engine knock	1	4603186
RETAINER, knock sensor	1	4603189
PLUG, cylinder block valley	1	1069338
PISTON ASSEMBLY:		
grade 2	8	4743588
grade 3	8	4743589
PISTON RING SET	8	4668056
CONNECTING ROD	8	LR008221
BOLT, connecting rod	16	4527567
BEARING, connecting rod:		
blue	A/R	4526475
green	A/R	4526476
yellow	A/R	4526477
BEARING, crankshaft main:		
lower		
blue/green	A/R	4464732
blue	A/R	4464739
green	A/R	4464741
yellow	A/R	4464742
upper		
blue/green	A/R	4464745
blue	A/R	4464748
green	A/R	4464750
yellow	A/R	4464752
THRUST WASHER, crankshaft main	1	1069689
BOLT, lower stiffener to block:		
bearing cap, M10 ('M bolt')	10	LR005586
bearing cap, M8 ('S bolt')	10	LR005587
outer, M8 ('P bolt')	12/10	LR005588
Qty 12 to VIN 6A999999, qty 10 from VIN 7A000001 on.		
rear, M8 ('F bolt')	2	LR005589
VIN 7A000001 on.		

Cylinder Head - 4.4 AJV8 Petrol

CYLINDER HEAD, with valves, exchange:		
RH	1	LR002811
LH	1	LR002812
BOLT, cylinder head:		
main, M10 x 175mm	20	4677857
front, M8 x 90mm	4	FB108181L
TAPPET:		
2.950mm	A/R	LR037205
2.965mm	A/R	4624032
2.980mm	A/R	LR037229
2.995mm	A/R	4624034
3.010mm	A/R	4624037
3.025mm	A/R	4624038
3.040mm	A/R	4624040
3.055mm	A/R	4624043
3.070mm	A/R	4624045
3.085mm	A/R	4624049
3.100mm	A/R	LR037267
3.115mm	A/R	LR037269
3.130mm	A/R	LR037272
3.145mm	A/R	LR037275
3.160mm	A/R	LR037279
3.175mm	A/R	LR037284
3.190mm	A/R	LR037286
3.205mm	A/R	LR037287
3.220mm	A/R	4649518
3.235mm	A/R	LR037289
3.250mm	A/R	LR037292
3.265mm	A/R	4624072
3.280mm	A/R	LR037306
3.295mm	A/R	LR037307
3.310mm	A/R	LR037308
3.325mm	A/R	LR037309
3.340mm	A/R	LR037310
3.355mm	A/R	LR037311
3.370mm	A/R	4624087
3.385mm	A/R	LR037314
3.400mm	A/R	LR037314
3.415mm	A/R	LR037315
3.430mm	A/R	LR037316
3.445mm	A/R	LR037317
3.460mm	A/R	LR037318
3.475mm	A/R	LR037322
3.490mm	A/R	LR037328
3.505mm	A/R	4624099
3.520mm	A/R	LR037330
3.535mm	A/R	4624102
3.550mm	A/R	LR037332
3.565mm	A/R	LR037333
3.580mm	A/R	LR037334
3.595mm	A/R	LR037335
3.610mm	A/R	LR037336
3.625mm	A/R	LR037343
3.640mm	A/R	LR037344
3.655mm	A/R	LR037345
3.670mm	A/R	LR037346
3.685mm	A/R	LR037347

4.4 AJV8 PETROL

VALVE:		
inlet		
Land Rover	16	LR002447
OEM	16	LR002447P1
exhaust	16	4646004
VALVE SPRING	32	4646003
VALVE CAP, upper	32	1069876
COLLET, valve cap	64	1069944
VALVE SPRING SEAT, lower	32	3598716
SENSOR, camshaft position:		
RH	1	4427657
LH	1	4362957
COVER, camshaft:		
<i>Includes gasket and bolt grommets.</i>		
RH	1	LR007653
LH	1	LR007655
BOLT, camshaft cover:		
rear, plain, without grommet	2	LR000337
plain, with grommet	14	4728385
with stud & grommet	8	4728386
GROMMET, rear bolt	2	4728387
O RING, sealing camshaft cover	8	LDR500180
COVER, coil & spark plug	2	LR008573
PIPE & CAP ASS'Y, oil filler	1	4527568

Oil Pump, Cooler & Filter - 4.4 AJV8 Petrol

OIL PUMP	1	LR006634
OIL PUMP PICK UP PIPE (inlet tube)	1	4728612
OIL COOLER ASSEMBLY	1	4526544
OIL FILTER HEAD	1	4556311
SEAL, oil filter head, figure of 8	1	LVF500010
OIL FILTER:		
Land Rover	1	LR031439
aftermarket	1	LR031439P
Britpart Filter Guard magnetic	1	LR031439FGBP
SENSOR, engine oil temperature	1	LR018397
SWITCH, oil pressure	1	4737666



OIL FILTER -
LR007160



OIL FILTER -
LR007160P

Oil Sump & Dipstick - 4.4 AJV8 Petrol

OIL SUMP	1	4728388
<i>Includes crank position sensor and drain plug.</i>		
OIL DRAIN PLUG, with sealing washer:		
Land Rover	1	1013938
aftermarket	1	1013938P
SENSOR, crankshaft position	1	NSC500160
DIPSTICK	1	LQM500030
DIPSTICK TUBE	1	4536872
BAFFLE, sump	1	4526550

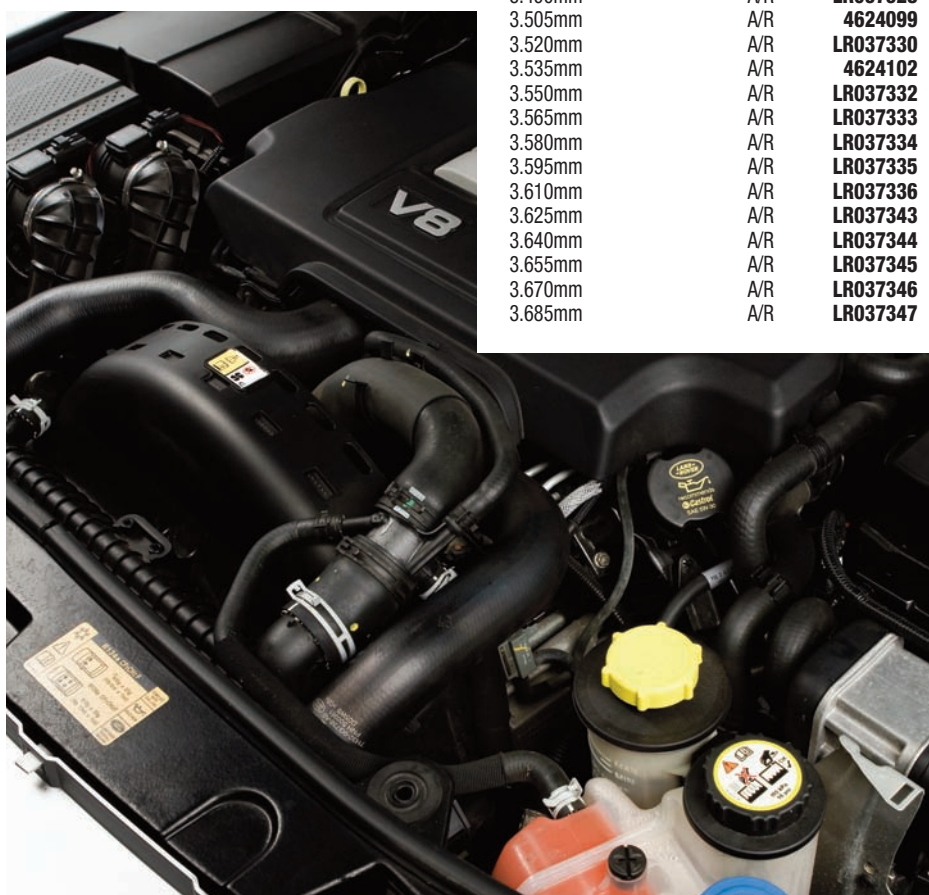

4.4 AJV8 PETROL

Camshaft & Timing Gear - 4.4 AJV8 Petrol

CAMSHAFT:

inlet				
RH	1	LR009437		
LH	1	LR009441		
exhaust				
RH				
up to VIN 6A999999	1	4741260		
VIN 7A000001 to 7A999999	1	LR002433		
VIN 8A000001 on	1	LR009446		
LH				
up to VIN 6A999999	1	4741261		
VIN 7A000001 on	1	LR009447		
RELUCTOR RING, cam position sensor	2	1323263		
TIMING CHAIN:				
upper	2	4174187		
lower	2	4174166		
TENSIONER, timing chain:				
upper				
RH	1	4462683		
LH	1	4462684		
lower				
tensioner assembly	2	4179611		
tensioner blade	2	4179614		
BUSH, lower tensioner blade	2	4437271		
BOLT, lower tensioner blade pivot:				
RH (A bank, plain bolt)	1	3600255		
LH (B bank, extension bolt)	1	4472332		
GUIDE, lower timing chain	2	4536848		
CAMSHAFT SPROCKET:				
exhaust	2	4160971		
inlet (VVT unit)	2	4536849		
<i>Important note: ensure sprocket bolts are always renewed - they should never be reused.</i>				
BOLT, sprocket to camshaft	4	4165653		
SPACER, exhaust cam sprocket bolt	2	4160902		
CRANKSHAFT SPROCKET	1	4174189		
WOODRUFF KEY, gear locating	1	1663923		
BUSH CARRIER & VALVE, VVT unit:				
RH (A bank), recond., exchange	1	LR023328		
LH (B bank), recond., exchange	1	LR023329		
O RING, bush carrier to VVT unit	4	1237728		
TIMING COVER	1	4526470		

Flywheel - 4.4 AJV8 Petrol

FLYWHEEL & RING GEAR	1	4602268
BOLT, flywheel to crankshaft	8	1069174

Oil Seals - 4.4 AJV8 Petrol

CRANKSHAFT OIL SEAL:		
front (oil pump)	1	4526537
rear, aftermarket	1	4352327P
TIMING COVER OIL SEAL	3	4526553

Gaskets - 4.4 AJV8 Petrol

ENGINE GASKET KIT	1	LR006645
<i>Includes all gaskets & oil seals, plus cam cover bolts and grommets.</i>		
CYLINDER HEAD GASKET:		
RH		
Land Rover	1	4585198
aftermarket	1	4585198P
LH	1	4585202
CAMSHAFT COVER GASKET:		
RH		
Land Rover	1	LR007652
aftermarket	1	LR007652P
LH		
Land Rover	1	LR007657
aftermarket	1	LR007657P
OIL PUMP GASKET	1	4628523
TIMING COVER GASKET:		
upper	1	LJQ500020
lower	1	LR000319

Service Kits - 4.4 AJV8 Petrol

SERVICE KIT:		
<i>Contains spark plugs, air, oil and fuel filters, sump plug washer and a/c pollen filter.</i>		
Land Rover	1	RA1490
aftermarket	1	RA1490P
Bearmach	1	RA1490BM44

Timing Tool Kit - 4.4 AJV8 Petrol

Pin-point accuracy is of course essential when setting camshaft timing during an engine rebuild and that's exactly what these kits from Laser have been developed to ensure. Including all the tools required to lock the engine in the desired stroke position and then accurately align the camshafts, the kit covers the pre-2010 Jaguar-derived AJV8 petrol engine with timing chains, both in 4.4 normally aspirated and 4.2 supercharged forms (as fitted to Discovery 3, Range Rover Sport, Range Rover L322 and several Jaguar XJ, XK, S Type and XF variants).

TIMING TOOL KIT, 4.4 & 4.2 AJV8 petrol 1	RA1548
--	---------------

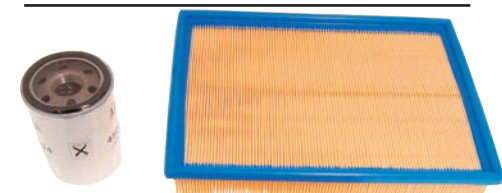
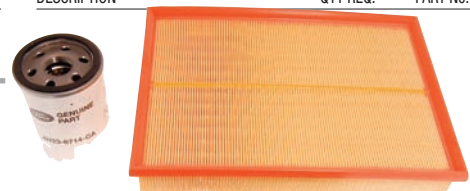

Engine Mountings

ENGINE MOUNTING:		
2.7 TDV6 diesel	2	KKB500760
3.6 TDV8 diesel	2	KKB500602
4.2 AJV8 & 4.4 AJV8 petrol	2	KKB500630
DAMPER ASS'Y, vibration	1	RNB501100
<i>3.6 TDV8 diesel only. Includes lower mounting bracket.</i>		
BRACKET:		
engine mounting		
2.7 TDV6 diesel		
RH	1	KKU500590
LH	1	KKU500580
3.6 TDV8 diesel		
RH	1	KKU500761
LH	1	KKU500771
4.2 AJV8 & 4.4 AJV8 petrol		
RH	1	KKU500610
LH	1	KKU500600
vibration damper, upper	1	LR004709
<i>3.6 TDV8 diesel only.</i>		
BOLT:		
engine mounting to chassis		
vibration damper	4	KYG500500
<i>3.6 TDV8 diesel only. Included in damper ass'y.</i>		
upper	1	KYG500370
lower	1	FB110106
<i>Included in damper ass'y.</i>		
NUT:		
engine mounting to bracket		
vibration damper bolt, lower	2	FN112056
<i>3.6 TDV8 diesel only. Included in damper ass'y.</i>		
SOLENOID VALVE, levelling	1	KLB500020
<i>3.6 TDV8 diesel only.</i>		
VACUUM HOSE, levelling	1	KKY500120
<i>3.6 TDV8 diesel only.</i>		

Gearbox Mountings

GEARBOX MOUNTING (transfer box)	1	IAF500070
BOLT, mounting eye	1	KYG500200
SCREW, mounting	4	FT110356



**ENGINE MOUNTING,
2.7 TDV6 DIESEL -
KKB500760**

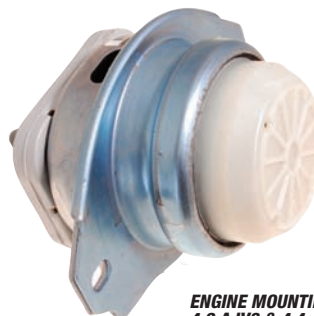

**ENGINE MOUNTING,
4.2 AJV8 & 4.4
AJV8 PETROL -
RNB501100**



**ENGINE MOUNTING,
3.6 TDV8 DIESEL -
KKB500602**

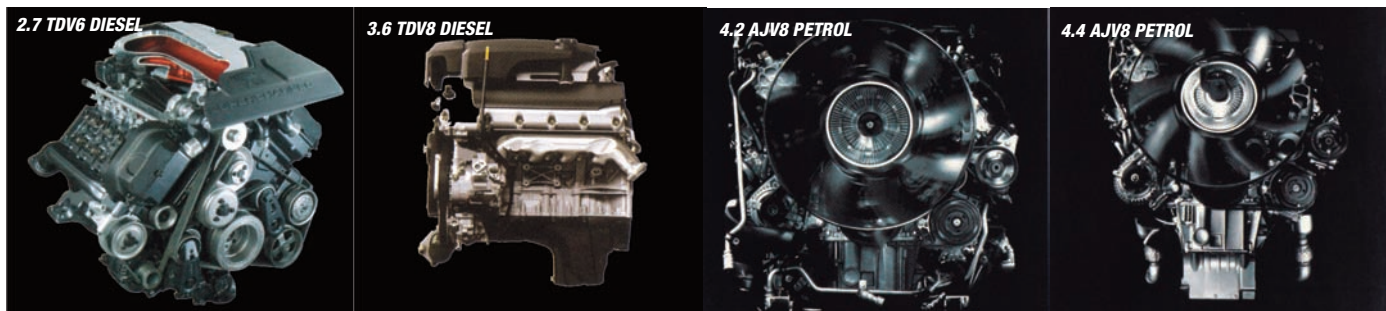

ALL MODELS

ENGINE MOUNTINGS

2.7 TDV6 DIESEL

COOLING

Coolant Pipes & Hoses

2.7 TDV6 Diesel

EU2 EMISSIONS

Details the cooling system fitted to meet EU2 (Euro Consolidated Directive 3) emissions regulations.

PIPE/HOSE:

overflow tank to radiator	1	PCH501072
top & bottom ass'y (incl. t'stat)	1	PEL500310
fuel cooler		
normal climates	1	PEH500181
hot climates		
kit of 2 hoses	1	PIH500101
short hose (incl. in kit)	1	PEH500201
long hose (incl. in kit)	1	PIH500040
cooling system bleed	1	PCH501351
cooled EGR		
inlet	1	LR011942
outlet	1	PEH500034
SENSOR, engine coolant temperature	1	LR041442

Included in EGR cooler inlet hose.

EURO STAGE 4 EMISSIONS

Details the cooling system fitted to meet Euro Stage 4 emissions regulations from 2007 model year onwards (7A000001 on). Euro Stage 4 emissions models are usually identifiable by the presence of the diesel particulate filter (DPF) in the exhaust system.

PIPE/HOSE:

overflow tank to radiator	1	PCH501072
top & bottom ass'y (incl. t'stat)	1	LR020009
T piece (incl. in hose ass'y)	1	PEI500020
fuel cooler		
kit of 2 hoses	1	PIH500101
short hose (incl. in kit)	1	PEH500201
long hose (incl. in kit)	1	PIH500040
cooling system bleed	1	PCH501351
cooled EGR		
inlet	1	LR006638
outlet	1	WAP500380
fuel fired heater	1	JHB501461
SENSOR, engine coolant temperature	1	LR041442

Fits in top & bottom hose assembly.

THERMOSTAT - PEL500320



Thermostat

2.7 TDV6 Diesel

THERMOSTAT:

EU2 emissions	1	PEL500320
Euro Stage 4 emissions	1	LR009562

Engine Water Outlet

2.7 TDV6 Diesel

WATER OUTLET	1	LR073372
GASKET, water outlet	2	1341370
BOLT, water outlet	4	4147433
CONNECTING TUBE	1	1316063
GASKET, connecting tube	1	1336551

Water Pump

2.7 TDV6 Diesel

WATER PUMP:

Land Rover	1	LR009324
OEM	1	LR009324P1
GASKET, water pump	1	1316117
SCREW, water pump fixing	3	RYG500220

WATER PUMP - LR009324

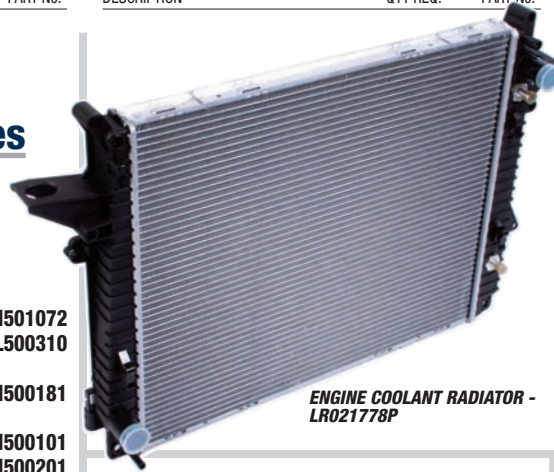
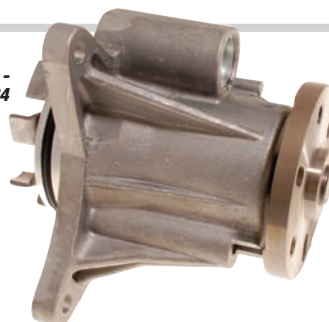

ENGINE COOLANT RADIATOR - LR021778P

Drive Belts

2.7 TDV6 Diesel

DRIVE BELT:

without roll stability control		
Land Rover	1	PQS500370
OEM	1	PQS500370P1
aftermarket	1	PQS500370P
with roll stability control	1	PQS500420
TENSION PULLEY, drive belt:		
LH upper, kit	1	PQH500130
All models.		
RH upper, kit	1	PQH500020
Models with roll stability control only.		
lower		
without roll stability control	1	PQG500250
with roll stability control	1	PQG500260
TOP PULLEY, drive belt	1	PQS500530
BRACKET & SPINDLE, top pulley	1	1335282
WATER PUMP PULLEY	1	1311327
CRANKSHAFT PULLEY	1	1341857
ROLL STABILITY CONTROL PULLEY	1	RQ0000033
SCREW:		
top pulley to spindle	3	FS108161
water pump pulley	3	FS108141
crankshaft pulley	6	1406627
roll stability control pulley	3	PYP500030



DRIVE BELT - PQS500370

Automatic Gearbox Oil Cooler Pipes

2.7 TDV6 Diesel

OIL COOLER PIPE KIT	1	UBP500340
Includes both pipe assemblies, brackets and O rings.		
O RING, pipe to gearbox	2	PYX500020

Radiator

2.7 TDV6 Diesel

RADIATOR, complete assembly:

Engine coolant radiator with oil cooler, brackets & grommets.

EU2 emissions		
normal climates	1	PCC500530
Less additional fuel cooler.		
hot climates	1	PCC500560
With additional fuel cooler.		
Euro Stage 4 emissions	1	PCC500560
VIN 7A000001 on.		
RADIATOR, engine coolant radiator only:		
Land Rover	1	LR021778
aftermarket	1	LR021778P
SEAL, radiator:		
upper	1	DHE500020
lower	1	PCZ500010
INSULATOR, radiator upper fixing	2	PDI500012
PIN, radiator upper fixing	2	PDG500045
GROMMET, radiator lower fixing:		
round	1	PCG500090
screw type	1	PCG500011
CLIP, radiator	1	PYC500080
PLUG, radiator drain	1	PYB500020

Overflow Tank

2.7 TDV6 Diesel

OVERFLOW TANK, with sensor:

Bleed screw LR007314 and seal LR007315 also required if fitting new overflow tank to models prior to VIN 8A129795.

Land Rover	1	LR020367
aftermarket	1	LR020367P
SENSOR, low fluid level (incl. in tank)	1	PCJ500030
CAP, overflow tank:		
Land Rover	1	PCD500030
aftermarket	1	PCD500030P
BLEED SCREW, overflow tank	1	LR055301
Fitted from VIN 8A129795 and to all replacement overflow tanks.		
SEAL, bleed screw	1	LR007315
BUSH, tank mounting	1	LR015830

Radiator Fan

2.7 TDV6 Diesel

RADIATOR FAN ASSEMBLY	1	LR025965
FAN SHROUD:		
normal climates		
upper	1	PGK500085
lower	1	PGK500096
hot climates		
upper	1	PGK500220
lower	1	PGK500230

Intercooler & Hoses

2.7 TDV6 Diesel

INTERCOOLER ASSEMBLY	1	PML500031
PIN, intercooler mounting:		
inner	2	PYT500020
outer	2	PDG500030
SEAL, intercooler	1	PCZ500020
HOSE, intercooler:		
LH, front - up to VIN 5A914111	1	PNH500221
LH, front - VIN 5A914112 on	1	PNH500223
LH, rear	1	PNH500034
RH		
Land Rover	1	PNH500025
aftermarket	1	PNH500025P
HOSE KIT, intercooler, silicone (3 hoses)		
Britpart	1	PNH500025KITBPBLUE
AIR VENT DUCT, with sensor	1	LR014212
The duct is a later style replacement item which will require an LR014359 plug to be fitted when used on pre-2010 Range Rover Sport models.		
PLUG, air vent duct	1	LR014359
Only required if fitting new air vent duct (see note above).		

Coolant Pipes & Hoses

3.6 TDV8 Diesel

PIPE/HOSE:

overflow tank to thermostat and gearbox oil cooler RH union	1	PCH503280
lower hose to oil cooler RH union	1	PCH502680
<i>Included in overflow tank pipe/hose ass'y.</i>		
vent hose to top hose and gearbox oil cooler LH union	1	PCH503260
<i>With fuel fired heater. Attaches to bottom of radiator.</i>		
top hose ass'y	1	PCH503340
<i>Thermostat housing to main radiator top LH union.</i>		
bottom hose ass'y	1	PCH503270
<i>Thermostat housing to main radiator bottom and auxiliary radiator RH union.</i>		
fuel cooler		
kit of 2 hoses		
to VIN 7A990468	1	PEH500221
VIN 7A990469 on	1	PEH500440
LH hose (incl. in kit)	1	PEH500360
main radiator to auxiliary radiator	1	PIH500170
<i>Main radiator top RH union to auxiliary radiator LH union.</i>		
EGR hoses with connector block	1	LR005819
<i>Includes connector block plus hoses from connector block to EGR valve outlets.</i>		
connector block to t'stat housing:		
RH	1	LR008276
LH	1	LR008202
t'stat housing to EGR valve inlet	1	1418972
elbow, t'stat housing to cyl. head	2	LR008237

Thermostat & Housing

3.6 TDV8 Diesel

THERMOSTAT & HOUSING ASS'Y	1	LR004318
<i>Includes thermostat, housing, O rings, fixing screws, coolant temperature sensor, thermostatic valve, valve elbows, clips for sensor and valve.</i>		
THERMOSTAT	1	LR003341
THERMOSTATIC VALVE ASS'Y	1	LR003335
ELBOW, thermostatic valve, upper	1	LR004320
<i>The lower (larger) elbow for the thermostatic valve and the thermostat cover that the elbow fits into are only available by purchasing the thermostat & housing assembly.</i>		
SENSOR, engine coolant temperature	1	LR044930
O RING:		
housing to engine	1	LR004319
thermostat cover to housing	1	LR025969
lower valve elbow to t'stat cover	1	LR003336
sensor to thermostat housing	1	LR003337
RETAINING CLIP:		
valve and lower elbow to housing	1	LR003339
sensor to housing	1	LR003602
SCREW, thermostat cover to housing	4	1255708

Water Pump

3.6 TDV8 Diesel

WATER PUMP:		
Land Rover	1	LR008863
aftermarket	1	LR008863P
GASKET, water pump	1	LR002750
SCREW, water pump fixing	4	FS108252

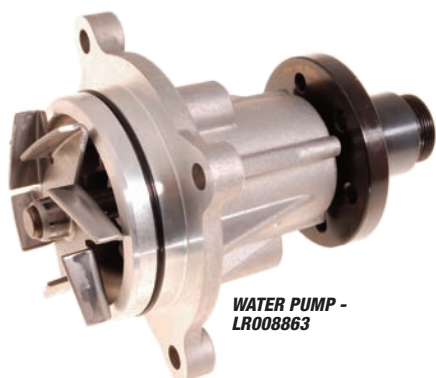

Radiator

3.6 TDV8 Diesel

RADIATOR ASSEMBLY:		
main		
Land Rover	1	PCC500300
aftermarket	1	PCC500300P
auxiliary	1	PCC500390
SEAL, main radiator, upper	1	DHE500140
BRACKET, main radiator side:		
RH	1	PCU500240
LH	1	PCU500250
INSULATOR, main radiator fixing:		
upper	2	PDI500012
lower	2	PCG500120
PIN, main radiator upper fixing	2	PDG500045
SCREW, main radiator lower fixing	2	PYP500120

Drive Belts

3.6 TDV8 Diesel

DRIVE BELT:		
primary		
Land Rover	1	PQS500450
OEM	1	PQS500450P1
secondary		
Land Rover	1	PQS500460
OEM	1	PQS500460P1
TENSIONER ASS'Y, with arm		
TENSION PULLEY KIT, drive belt:		
RH & centre positions		
	2	PQH500090
LH position		
	1	PQH500080
CAP, tension pulley bolt head	3	LR022816
TOP PULLEY, drive belt	1	PQS500530
CRANKSHAFT PULLEY	1	1418920
BOLT:		
top pulley to spindle	3	FS108166
tensioner assembly	2	FS108256
crankshaft pulley	1	LR002458
WASHER, crankshaft pulley bolt	1	1418922



WE'RE HERE TO HELP
 Can't find or not sure of the right part for your car, contact our technical sales team for help and advice.
01522 568000

Overflow Tank

3.6 TDV8 Diesel

OVERFLOW TANK, with sensor:		
<i>Bleed screw LR007314 and seal LR007315 also required if fitting new overflow tank to models prior to VIN 8A129795.</i>		
Land Rover	1	LR020367
aftermarket	1	LR020367P
SENSOR, low fluid level (incl. in tank)	1	PCJ500030
CAP, overflow tank:		
Land Rover	1	PCD500030
aftermarket	1	PCD500030P
BLEED SCREW, overflow tank	1	LR055301
<i>Fitted from VIN 8A4129795 and to all replacement overflow tanks.</i>		
SEAL, bleed screw	1	LR007315
BUSH, tank mounting	1	LR015830

Radiator Fan

3.6 TDV8 Diesel

RADIATOR FAN ASSEMBLY:		
Land Rover	1	LR025234
OEM	1	LR025234P1
FAN SHROUD:		
upper	1	PGK500281
lower	1	PGK500292

Automatic Gearbox Oil Cooler & Pipes

3.6 TDV8 Diesel

OIL COOLER ASSEMBLY	1	UBC500101
OIL COOLER PIPES ASSEMBLY	1	UBP500205
<i>Includes both pipes assembled together with tie brackets.</i>		
O RING, pipes to gearbox	2	PYX500020



Intercooler & Hoses

3.6 TDV8 Diesel

INTERCOOLER ASSEMBLY	1	LR007170
HOSE, intercooler, upper:		
RH		
Land Rover	1	PNH500371
aftermarket	1	PNH500371P
LH		
Land Rover	1	PNH500361
aftermarket	1	PNH500361P
PIPE/HOSE ASS'Y, intercooler, lower:		
RH	1	PNH500351
LH	1	PNH500341
INSULATOR, pipe/hose mounting	1	KKF500010



4.2 AJV8 SUPERCHARGED PETROL

COOLING

Coolant Pipes & Hoses

4.2 AJV8 Supercharged Petrol

PIPE/HOSE:

overflow tank to radiator	1	PCH501401
radiator		
top, assembly	1	PCH501215
bottom, assembly	1	PCH500893
thermostat to bottom hose	1	PCH500923
thermostat to heater pipes, ass'y	1	LR006147
auxiliary water pump		
upper	1	PEH500122
lower	1	PCH502470

Thermostat

4.2 AJV8 Supercharged Petrol

THERMOSTAT & HOUSING ASS'Y	1	LR007603
----------------------------	---	----------

THERMOSTAT:

Included in thermostat & housing ass'y.

Land Rover	1	LR005765
OEM	1	LR005765P1
aftermarket	1	LR005765P
COVER, thermostat	1	LR007605

Included in thermostat & housing ass'y.

SCREW, thermostat cover	3	RYG500220
-------------------------	---	-----------

Included in thermostat & housing ass'y.

O RING:

thermostat cover	1	4362513
Included in thermostat & housing ass'y.		
housing to engine	2	4413478
Included in thermostat & housing ass'y.		

SENSOR, engine coolant temperature:

Included in thermostat & housing ass'y.

Land Rover	1	4603183
aftermarket	1	4603183P

Engine Water Outlet

4.2 AJV8 Supercharged Petrol

WATER OUTLET	1	4629192
SCREW, water outlet to engine	2	UYP500030
O RING, water outlet	1	4024557
ELBOW, water outlet	1	LR004056
CLIP, elbow	2	4653270

Water Pump

4.2 AJV8 Supercharged Petrol

WATER PUMP:

main, with gasket:		
Land Rover	1	4575902
OEM	1	4575902P1
aftermarket	1	4575902P
auxiliary	1	PEB500010

GASKET, main water pump

	1	4575903
--	---	---------

BOLT, main water pump fixing

	5	4537592
--	---	---------

CLAMP, auxiliary water pump

	1	PEX500011
--	---	-----------

BRACKET, auxiliary water pump

	1	PEU500011
--	---	-----------

SCREW, auxiliary water pump clamp

	2	FS106127L
--	---	-----------

Radiator Fan

4.2 AJV8 Supercharged Petrol

RADIATOR FAN ASSEMBLY:

Land Rover	1	LR025955
OEM	1	LR025955P1

FAN SHROUD:

normal climates		
upper	1	LR016206
lower	1	LR030052
hot climates		
upper	1	LR016207
lower	1	LR030053

RADIATOR HOSE
ASSEMBLY -
PCH501215



DRIVE BELT -
PQS500241



Drive Belts

4.2 AJV8 Supercharged Petrol

DRIVE BELT:

primary	1	PQR500340
secondary		
Land Rover	1	PQS500241
aftermarket	1	PQS500241P

TENSION PULLEY KIT, primary belt:

lower	1	PQR500350
upper	1	PQR500140

TENSIONER ASS'Y, primary belt:

Land Rover	1	PQG500030
aftermarket	1	PQG500030P

WATER PUMP PULLEY

	1	4359078
--	---	---------

CRANKSHAFT PULLEY

	1	LR002446
--	---	----------

COLLET, crankshaft pulley

	1	4677859
--	---	---------

ROLL STABILITY CONTROL PULLEY

	1	RQ0500021
--	---	-----------

PULLEY, secondary belt

	1	PQS500530
--	---	-----------

BRACKET & BOSS, secondary belt

	1	PQS500490
--	---	-----------

TENSIONER ASS'Y, secondary belt:

Land Rover	1	PQG500220
aftermarket	1	PQG500220P

BOLT:

water pump pulley	3	LR005770
crankshaft pulley	1	4677860
roll stability control pulley	3	AFU4180
secondary belt pulley	3	FS108166P
secondary belt bracket	2	PQM500030

TENSIONER
ASSEMBLY -
PQG500030



Radiator

4.2 AJV8 Supercharged Petrol

RADIATOR:

complete assembly	1	PCC500680
Engine coolant radiator with brackets, seals & grommets.		

radiator only

main radiator		
Land Rover	1	LR021777
aftermarket	1	LR021777P
auxiliary radiator	1	LR009007

SEAL, radiator:

upper	1	DHE500010
side	2	PZB500020
lower	1	PCZ500010

INSULATOR, radiator upper fixing

	2	PDI500012
--	---	-----------

PIN, radiator upper fixing

	2	PDG500045
--	---	-----------

GROMMET, radiator lower fixing:

round	1	PCG500090
screw type	1	PCG500011

CLIP, radiator

	1	PYC500080
--	---	-----------

PLUG, radiator drain

	1	PYB500020
--	---	-----------



OVERFLOW TANK -
LR020367

Overflow Tank

4.2 AJV8 Supercharged Petrol

OVERFLOW TANK, with sensor:

Bleed screw LR007314 and seal LR007315 also required if fitting new overflow tank to models prior to VIN 8A129795.

Land Rover	1	LR020367
aftermarket	1	LR020367P
SENSOR, low fluid level (incl. in tank)	1	PCJ500030

CAP, overflow tank:

Land Rover	1	PCD500030
aftermarket	1	PCD500030P

BLEED SCREW, overflow tank

	1	LR055301
--	---	----------

Fitted from VIN 8A129795 and to all replacement overflow tanks.

SEAL, bleed screw

	1	LR007315
--	---	----------

BUSH, tank mounting

	1	LR015830
--	---	----------



SENSOR -
PCJ500030

OVERFLOW
TANK CAP -
PCD500030



Automatic Gearbox Oil Cooler Pipes

4.2 AJV8 Supercharged Petrol

OIL COOLER PIPE KIT	1	UBP500053
---------------------	---	-----------

Includes both pipe assemblies, brackets and O rings.

OIL COOLER PIPE ASS'Y,

radiator upper to gearbox	1	UBP500130
---------------------------	---	-----------

O RING, pipe to gearbox

	2	PYX500020
--	---	-----------

Engine Heater (Optional)

4.2 AJV8 Supercharged Petrol

HEATER:

immersion, engine block		
230V supply	1	3601559
110V supply	1	VUB504670
fuel fired, engine block	1	VUB504640

ORDER

BY PHONE: 01522 568000 / ON LINE: www.rimmerbros.co.uk / E-MAIL: lrsales@rimmerbros.co.uk

Coolant Pipes & Hoses

4.4 AJV8 Petrol

PIPE/HOSE:		
overflow tank to radiator radiator top	1	PCH500153
bottom, assembly	1	PCH500941
thermostat to heater pipes, ass'y	1	PCH500962
coolant air bleed, ass'y	1	PCH500955
VALVE, air bleed (incl. in hose ass'y)	1	LR006158
		LR027661

HERMOSTAT TO HEATER PIPES ASSEMBLY - PCH500955



4.4 AJV8 PETROL

COOLING



HERMOSTAT - LR005765

Thermostat

4.4 AJV8 Petrol

THERMOSTAT & HOUSING ASS'Y	1	LR005631
THERMOSTAT:		
<i>Included in thermostat & housing ass'y.</i>		
Land Rover	1	LR005765
OEM	1	LR005765P1
aftermarket	1	LR005765P
COVER, thermostat	1	4624378
<i>Included in thermostat & housing ass'y.</i>		
SCREW, thermostat cover	3	FS106206
<i>Included in thermostat & housing ass'y.</i>		
ELBOW, housing	1	PEH500140
<i>Included in thermostat & housing ass'y.</i>		
O RING:		
<i>Included in thermostat & housing ass'y.</i>		
thermostat cover	1	4362513
housing to engine	2	4413478
elbow		
to housing	1	4359953
lower	1	4024557
SENSOR, engine coolant temperature:		
<i>Included in thermostat & housing ass'y.</i>		
Land Rover	1	4603183
aftermarket	1	4603183P



DRIVE BELT - PQR500330

Drive Belts

4.4 AJV8 Petrol

DRIVE BELT:		
primary		
without roll stability control		
Land Rover	1	PQR500330
OEM	1	PQR500330P1
aftermarket	1	PQR500330P
with roll stability control	1	PQR500340
secondary		
Land Rover	1	PQS500221
OEM	1	PQS500221P1
aftermarket	1	PQS500221P
TENSION PULLEY KIT, primary belt:		
lower	1	PQR500350
<i>All models.</i>		
upper	1	PQR500140
<i>Models with roll stability control only.</i>		
TENSIONER ASS'Y, primary belt:		
Land Rover	1	PQG500030
aftermarket	1	PQG500030P
WATER PUMP PULLEY	1	4359078
CRANKSHAFT PULLEY	1	LR002446
COLLET, crankshaft pulley	1	4677859
ROLL STABILITY CONTROL PULLEY	1	RQ0500021
PULLEY, secondary belt	1	PQS500530
BRACKET & BOSS, secondary belt	1	PQS500480
<i>Important note: when replacing the bracket and boss on models up to VIN 6A916350, two mounting bolts PQM500030 will also be required.</i>		
TENSIONER ASS'Y, secondary belt:		
Land Rover	1	PQG500220
aftermarket	1	PQG500220P
BOLT:		
water pump pulley	3	LR005770
crankshaft pulley	1	4677860
roll stability control pulley	3	AFU4180
secondary belt pulley	3	FS108166P
secondary belt bracket	2	PQM500030

WATER PUMP - 4575902



Water Pump

4.4 AJV8 Petrol

WATER PUMP, with gasket:		
Land Rover	1	4575902
OEM	1	4575902P1
aftermarket	1	4575902P
GASKET, water pump	1	4575903
BOLT, water pump fixing	5	4537592

Radiator

4.4 AJV8 Petrol

RADIATOR:		
complete assembly	1	PCC500550
<i>Engine coolant radiator with brackets, seals & grommets.</i>		
radiator only		
Land Rover	1	LR021777
aftermarket	1	LR021777P
SEAL, radiator:		
upper	1	DHE500010
side	2	PZB500020
lower	1	PCZ500010
INSULATOR, radiator upper fixing	2	PDI500012
PIN, radiator upper fixing	2	PDG500045
GROMMET, radiator lower fixing:		
round	1	PCG500090
screw type	1	PCG500011
CLIP, radiator	1	PYC500080
PLUG, radiator drain	1	PYB500020

Overflow Tank

4.4 AJV8 Petrol

OVERFLOW TANK, with sensor:		
<i>Bleed screw LR007314 and seal LR007315 also required if fitting new overflow tank to models prior to VIN 8A129795.</i>		
Land Rover	1	LR020367
aftermarket	1	LR020367P
SENSOR, low fluid level (incl. in tank)	1	PCJ500030
CAP, overflow tank:		
Land Rover	1	PCD500030
aftermarket	1	PCD500030P
BLEED SCREW, overflow tank	1	LR055301
<i>Fitted from VIN 8A129795 and to all replacement overflow tanks.</i>		
SEAL, bleed screw	1	LR007315
BUSH, tank mounting	1	LR015830

Radiator Fan

4.4 AJV8 Petrol

RADIATOR FAN ASSEMBLY:		
Land Rover	1	LR025234
OEM	1	LR025234P1
FAN SHROUD:		
normal climates		
upper	1	LR016206
lower	1	LR030052
hot climates		
upper	1	LR016207
lower	1	LR030053

Automatic Gearbox Oil Cooler Pipes

4.4 AJV8 Petrol

OIL COOLER PIPE KIT	1	UBP500053
<i>Includes both pipe assemblies, brackets and O rings.</i>		
OIL COOLER PIPE ASS'Y:		
radiator upper to gearbox	1	UBP500130
O RING, pipe to gearbox	2	PYX500020

Engine Heater (Pianola)

4.4 AJV8 Petrol

HEATER:		
immersion, engine block		
230V supply	1	3601559
110V supply	1	VUB504670
fuel fired, engine block	1	VUB504640

WE'RE HERE TO HELP
 Can't find or not sure of the right part for your car, contact our technical sales team for help and advice.
01522 568000



ORDER BY PHONE: 01522 568000 / ON LINE: www.rimmerbros.co.uk / E-MAIL: lrsales@rimmerbros.co.uk

ALL MODELS

HEATING & AIR CONDITIONING

Heater & Components

HEATER & AIR CONDITIONER ASSEMBLY:

RHD	1	LR066832
LHD	1	LR066833

MATRIX, heater, with pipe assembly:

Land Rover	1	LR017030
OEM	1	LR017030P1

PIPE ASS'Y, matrix to bulkhead

	1	JEZ500020
--	---	------------------

O RING, matrix to pipes

	2	JH0500010
--	---	------------------

EVAPORATOR, air conditioner

	1	QJB500010
--	---	------------------

VALVE, air conditioning evaporator

	1	QJD500010
--	---	------------------

PIPE ASS'Y, evaporator to bulkhead

	1	QJR500040
--	---	------------------

O RING KIT, evaporator and valve

	1	JEP500010
--	---	------------------

TUBE, vent and condensate drain

	2	JUB500170
--	---	------------------

These are the tubes that allow condensed water from around the evaporator to drain through the floor, giving you a heart attack on a warm day when you discover a puddle of fluid underneath your parked pride and joy.

SEAL, pipes, bulkhead:

two holes (heater pipes) up to VIN 6A999999	1	JEE000022
VIN 7A000001 on	1	JEE500030

slotted (evaporator pipes)

passenger compartment side	1	JQS500030
engine compartment side	1	JQS000032

BLOWER ASSEMBLY, heater:

RHD	1	JGC500010
LHD	1	JGC500050

STEPPER MOTOR, heater:

blower		
RHD	1	LR043349
LHD	1	JNC500040

defrost	1	LR041271
face/footwell	1	LR041272

air mix		
RH	1	LR041274
LH	1	LR041273

REGULATOR, air conditioning control

	1	LR031677
--	---	-----------------

WIRING HARNESS, front heater:

RHD	1	JGK500030
LHD	1	JGK500090

POLLEN FILTER:

production installed type		
Land Rover	1	JKR500010
OEM	1	JKR500010P1
aftermarket	1	JKR500010P

production replacement type		
Land Rover	1	LR023977
OEM	1	LR023977P1
aftermarket	1	LR023977P



POLLEN FILTER - LR023977



POLLEN FILTER - JKR500010

Heater Hoses

2.7 TDV6 DIESEL

HOSES ASSEMBLY:

to heater matrix		
to VIN 8A176540	1	PCH502320
VIN 8A176541 on	1	PCH503320

thermostat housing to heater matrix hose

models with fuel fired heater		
EU2 emissions models	1	JHB500822
Euro Stage 4 emissions	1	JHB501670

Models with diesel particulate filter (DPF) in exhaust system.

models with fresh air heater

EU2 emissions models	1	PCH502091
Euro Stage 4 emissions	1	JHB501690

Models with diesel particulate filter (DPF) in exhaust system.

outlet from EGR coolers

EU2 emissions models	1	PEH500034
Euro Stage 4 emissions	1	WAP500380

Models with diesel particulate filter (DPF) in exhaust system.



CONNECTOR HOSE ASSEMBLY - JHB501720

Heater & Air Conditioner Sensors

SENSOR:

heater temperature control		
in heater unit	1	JTF500020
in fascia		
all models except Japan	1	JTF500010
Japan only	1	JTF000060
climate control (ATC) only	1	JTF000070
ambient air/pollution	1	JTF000052

Mounted at front of vehicle.



COMPRESSOR ASSEMBLY - LR012794

Air Conditioning Compressor

2.7 TDV6 DIESEL

COMPRESSOR ASSEMBLY, new, exchange:

Land Rover	1	LR014064
OEM	1	LR014064P1

CLUTCH, intermediate, compressor	1	LR027983
----------------------------------	---	-----------------

3.6 TDV6 DIESEL

COMPRESSOR ASSEMBLY:

new, exchange	1	LR014536
CLUTCH, intermediate, compressor	1	LR027983

4.2 AJV8 SUPERCHARGED & 4.4 AJV8 PETROL

COMPRESSOR ASSEMBLY:

new, exchange	1	LR012593
reconditioned, exchange	1	LR012794
CLUTCH, intermediate, compressor	1	LR027982

3.6 TDV8 DIESEL

HEATER HOSES ASSEMBLY

models with fuel fired heater	1	LR014537
-------------------------------	---	-----------------

models with fresh air heater	1	JHB501730
------------------------------	---	------------------

CONNECTOR HOSE ASSEMBLY	1	JHB501720
-------------------------	---	------------------

Connects heater hoses assembly to engine cooling system.

4.2 AJV8 SUPERCHARGED PETROL

HEATER HOSES ASSEMBLY	1	PCH500900
-----------------------	---	------------------

4.4 AJV8 PETROL

HEATER HOSES ASSEMBLY	1	PCH501084
-----------------------	---	------------------

Air Conditioning Condenser & Drier

CONDENSER ASS'Y, with drier:

2.7 TDV6 diesel	1	JRB500130
-----------------	---	------------------

3.6 TDV8 diesel		
Land Rover	1	LR018405
aftermarket	1	LR018405P

4.2 AJV8 supercharged petrol		
Land Rover	1	JRB500140
aftermarket	1	JRB500140P

4.4 AJV8 petrol		
Land Rover	1	JRB500140
aftermarket	1	JRB500140P

DRIER ASSEMBLY:		
Land Rover	1	JR500020
OEM	1	JR500020P1

O RING, drier to condenser	2	JUU500110
----------------------------	---	------------------

SEALING STRIP, condenser	1	DHE500110
--------------------------	---	------------------

All models except 3.6 TDV8 diesel.

O RING - JUU500110



Air Conditioning Hoses

2.7 TDV6 DIESEL

HOSE ASSEMBLY:

compressor to condenser to VIN 8A177988	1	JUF000334
VIN 8A177989 on	1	JUF500510
compressor to evaporator hose	1	JUF500530
condenser to evaporator hose to VIN 6A999999	1	JUE500033
VIN 7A000001 on	1	JUE501230

3.6 TDV6 DIESEL

HOSE ASSEMBLY:

compressor to condenser	1	JUF500540
compressor to evaporator hose	1	JUF500450
condenser to evaporator hose up to VIN 7A973185	1	JUE501070
VIN 7A973186 on	1	JUE501240

4.2 AJV8 SUPERCHARGED & 4.4 AJV8 PETROL

HOSE ASSEMBLY:

compressor to condenser	1	JUF500480
compressor to evaporator hose to VIN 8A155605	1	JUF000355
VIN 8A155606 on	1	JUF500560
condenser to evaporator hose	1	JUE501250

ALL MODELS

HOSE ASS'Y, compressor & condenser hoses to bulkhead:

all models except 3.6 TDV8 diesel	1	LR014460
3.6 TDV8 diesel models only	1	JUE501060

VALVE CAP:

compressor to evaporator hose	1	JUS10006
condenser to evaporator hose	1	JUS10007

SWITCH, condenser/evaporator hose O RING:

compressor to evaporator hoses	2	JUU500030
compressor hose to compressor	1	JUU500040
condenser hose to condenser and evaporator hose	3	JUU500010
compressor hose to condenser and compressor	2	JUU500020

Auxiliary Fuel Fired Pre-Heater

OPTIONAL, 2.7 TDV6 & 3.6 TDV8 DIESEL ONLY

PRE-HEATER ASSEMBLY:

Includes fuel and water pumps.

2.7 TDV6 diesel models	1	JEC000599
3.6 TDV8 diesel models	1	JEC500820

PRE-HEATER, fuel fired

	1	LR041254
--	---	----------

PUMP ASSEMBLY:

fuel to VIN 6A964493, with filter	1	JEX000043
VIN 6A964494 on	1	JEX500020
water	1	JEX000030

PIPE, pre-heater:

fuel	1	WJP500152
air inlet, with silencer	1	JEY000020
exhaust, with silencer	1	JEZ000151
exhaust extension	1	JEZ500050

HOSE, pre-heater, water

	1	JHB000420
--	---	-----------

HEAT EXCHANGER ASSEMBLY

	1	LR031880
--	---	----------

SEAL, heat exchanger

	1	LR004141
--	---	----------

SENSOR, water temperature

	1	LR004235
--	---	----------

GLOW PLUG, pre-heater

	1	LR010329
--	---	----------

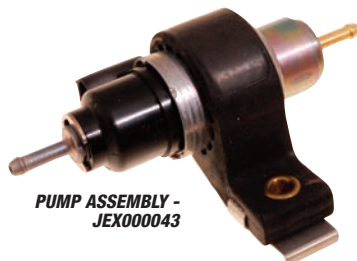

PUMP ASSEMBLY - JEX000043



ALL MODELS

HEATING & AIR CONDITIONING

Heater & Air Conditioner Controls

Note: heater controls are complete assemblies, including switches and knobs.

UP TO VIN 7A999999

HEATER CONTROL, with climate control (ATC):

°C display (RHD, some LHD) without driver's heated seat		
without pollution sensor	1	JFC500930
with pollution sensor to VIN 6A999999	1	JFC500254WUX
VIN 7A000001 on	1	JFC501010
with driver's heated seat without pollution sensor	1	JFC500950
with pollution sensor to VIN 6A999999	1	JFC500274WUX
VIN 7A000001 on	1	JFC501030
°F display (some LHD markets only) without driver's heated seat	1	JFC500970
with driver's heated seat	1	JFC500990

VIN 8A000001 ON

HEATER CONTROL, with climate control (ATC):

°C display (RHD, some LHD) without heated windscreen		
without driver's heated seat		
without pollution sensor	1	JFC501090
with pollution sensor	1	JFC501170
with driver's heated seat Land Rover	1	JFC501190
OEM	1	JFC501190P1
with heated windscreen without driver's heated seat	1	JFC501220
with driver's heated seat	1	JFC501110
°F display (some LHD markets only) without driver's heated seat	1	JFC501130
with driver's heated seat	1	JFC501150

WE'RE HERE TO HELP
 Can't find or not sure of the right part for your car, contact our technical sales team for help and advice.
01522 568000



2.7 TDV6 DIESEL

Air Filter

2.7 TDV6 Diesel

AIR BOX ASSEMBLY, with filter	1	PHB000498
BUSH, air box mounting	2	PJQ500012
AIR FILTER ELEMENT ONLY:		
Land Rover	1	PHE000112
OEM	1	PHE000112P1
aftermarket	1	PHE000112P
K&N Performance	1	PHE000112K-N
Britpart Peak Performance	1	PHE000112BP
AIR FLOW METER:		
Land Rover	1	PHF500101
OEM	1	PHF500101P1
AIR DUCT:		
air flow meter to joint	1	PHD000603
joint to throttle body	1	PHD500082
wing intake vent to elbow	1	PHD500610
ELBOW, wing intake duct to air box	1	LR020024

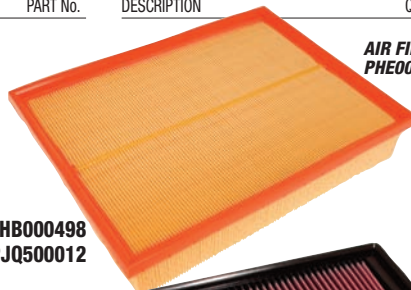

AIR FILTER ELEMENT - PHE000112

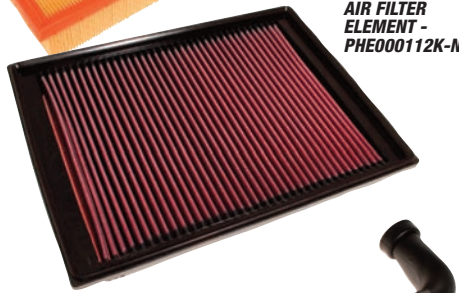

AIR FILTER ELEMENT - PHE000112K-N



AIR DUCT - PHD000603

K&N Air Filter

2.7 TDV6 Diesel

K&N PERFORMANCE AIR FILTER ELEMENT	1	PHE000112K-N
<i>K&N offer superior filtration, improvements in air flow and many times longer life than standard air filter elements. Plus, they can be cleaned and re-used.</i>		
K&N FILTER CLEANING FLUID, 1 litre	1	RX1346
<i>For cleaning K&N air filter elements.</i>		
K&N FILTER ELEMENT OIL:		
<i>For re-oiling K&N air filter elements.</i>		
sachet, 57cc	1	RX1347
bottle, 250ml	1	RX1348
aerosol, 400ml	1	RX1349



Inlet Manifolds

2.7 TDV6 Diesel

INLET MANIFOLD ASSEMBLY:		
<i>Includes cylinder head cam cover and gasket.</i>		
RH	1	LR032724
LH	1	LR032723
GASKET, manifold to head:		
Land Rover	2	LR029132
aftermarket	2	LR029132P
CAP, oil filler	1	LR053016
TOP COVER, engine	1	LR013662
BRACKET, top cover support:		
to RH manifold	1	1346479
to LH manifold	1	4611567
STUD, top cover:		
inner, manifold to cover	2	LBG500030
outer		
RH, manifold to bracket	1	4611570
LH, manifold to cover	1	LR016839



GASKET - LR029132

Fuel Injectors & Fittings

2.7 TDV6 Diesel

FUEL INJECTOR:		
EU2 emissions models		
with fitting kit		
<i>Includes injector, supply pipe, clip and seals.</i>		
Land Rover, new, exchange	6	1331260
OEM, new, outright	6	1331260P1
without fitting kit		
<i>Includes injector only.</i>		
Land Rover, new, exchange	6	LR006495
Euro Stage 4 emissions (with DPF) models		
<i>VIN 7A000001 on. Supplied without fitting kit (i.e. injector only).</i>		
Land Rover, new, exchange	6	LR006496
OEM, new, outright	6	LR006496P1
aftermarket, new, outright	6	LR006496P
FITTING KIT, fuel injector:		
<i>Includes supply pipe, clip and fittings.</i>		
EU2 emissions models		
6 1331261		
Euro Stage 4 emissions (with DPF) models		
<i>VIN 7A000001 on.</i>		
cylinders 1 & 6	2	LR004566
cylinders 2 & 5	2	LR004567
cylinders 3 & 4	2	LR004568
MANIFOLD, fuel supply to injectors:		
EU2 emissions models		
RH	1	1369552
LH	1	1369551
Euro Stage 4 emissions (with DPF) models		
<i>VIN 7A000001 on.</i>		
RH		
Land Rover	1	LR020021
OEM	1	LR020021P1
LH (incl. fuel pressure sensor)		
Land Rover	1	LR020020
OEM	1	LR020020P1
PIPE, fuel rail to fuel manifold:		
EU2 emissions models		
RH	1	LR003063
LH	1	LR003061
Euro Stage 4 emissions (with DPF) models		
<i>VIN 7A000001 on.</i>		
RH	1	LR004715
LH (incl. fuel pressure sensor)	1	LR004714
RAIL, fuel supply to manifolds	1	1387695
PIPE:		
supply to fuel rail	1	LR003392
fuel return		
EU2 emissions models	1	1354290
Euro Stage 4 emiss. (with DPF)	1	LR005687
<i>VIN 7A000001 on.</i>		
LEAK OFF PIPE ASSEMBLY	1	1386505
<i>Includes fuel temperature sensor.</i>		
SEAL, leak off pipe	6	LR019118
HEATSHIELD, fuel manifold:		
RH	1	LBH500250
LH	1	LBH500230



FUEL INJECTOR 1331260

Throttle Body

2.7 TDV6 Diesel

THROTTLE BODY ASSEMBLY	1	LR078820
<i>Includes pressure (MAP) sensor and gaskets.</i>		
SEAL, throttle body:		
inlet	1	LR008353
outlet	2	1316152
SENSOR, manifold absolute pressure	1	LR019130
<i>Also known as MAP sensor. Included in throttle body.</i>		



SENSOR - LR019130

Glow Plugs

2.7 TDV6 Diesel

GLOW PLUG:		
Land Rover	6	1354289
OEM	6	1354289P1
HARNNESS, glow plugs:		
RH	1	LR007522
LH	1	LR007521



GLOW PLUG - 1354289

Fuel Injection Pump

2.7 TDV6 Diesel

FUEL INJECTION PUMP:		
<i>New pumps include locating dowels, reconditioned exchange pumps do not.</i>		
EU2 emissions models		
new, exchange		
Land Rover	1	LR009804
OEM	1	LR009804P1
reconditioned, exchange		
up to VIN 8A999999	1	LR005958
Euro Stage 4 emissions (with DPF) models		
<i>VIN 7A000001 on.</i>		
new, exchange		
Land Rover	1	LR017367
OEM	1	LR017367P1
HARNNESS, pump control	1	LR014562
<i>EU2 emissions models only.</i>		
PULLEY, pump driving:		
up to VIN 6A999999	1	1311294
VIN 7A000001 on	1	LR003788
NUT, pulley to pump	1	LR002806

Accelerator Pedal (Injection Pump Control)

2.7 TDV6 Diesel

PEDAL, accelerator, with throttle position sensor:		
RHD	1	LR012044
LHD	1	SLC500021PVJ
PEDAL COVER SET:		
<i>Three piece set of sports covers, fashioned from stainless steel and rubber - includes covers for accelerator and brake pedals, plus footrest cover.</i>		
Land Rover	1	LR008713
Britpart	1	LR008713BP



PEDAL COVER SET - LR008713

Fuel Tank

2.7 TDV6 Diesel

important note

FUEL TANKS

Important note: the original range of fuel tanks with 3 vent pipes for the 2005-2009 models are now replaced by a universal fitment tank with many of the features of the 2010 model year onwards type tank. The result is what we know in the trade as a "multiple supersession", which means that along with your new tank you will also have to buy and fit the following parts, since the originals from your old tank will not fit the new one.

VEHICLES FITTED WITH ORIGINAL STYLE 2005-2009 MODEL YEARS (TO VIN 9A999999) FUEL TANK WITH 3 VENT PIPES

FUEL TANK, replacement type <i>Includes sender units.</i>	1	LR044038
CLIP	1	CN100509
<i>Required for all models being fitted with new universal type tank.</i>		
HARNESSEXTENSION	1	LR020971
<i>Required for all models being fitted with new universal type tank.</i>		
CAP, fuel filler	1	LR053666
<i>Required for all models being fitted with new universal type tank.</i>		
CAP, blanking heater pipe boss	1	LR021882
<i>Required for all models without fuel fired heater with new universal type tank.</i>		
PIPE, fuel:		
<i>Required for all models up to VIN 6A999999 fitted with new universal type tank.</i>		
models without fuel fired heater	1	LR021133
models with fuel fired heater	1	LR021134

The following are standard parts for original fuel tanks with 3 vent pipes:

MOUNTING COVER, fuel tank	1	WFN500021
HEATSHIELD, fuel tank:		
front	1	WFZ500034
rear	1	WFZ500130
COVER, top aperture:		
models without fuel fired heater	1	WGC500120
models with fuel fired heater	1	WGC500110
RETAINING RING, cover	1	WFM500011
GASKET, retaining ring	1	WFG000033
O RING KIT, fuel tank	1	LR006778
CAP, fuel filler:		
up to VIN 6A916350	1	LR053665
VIN 6A916351 on	1	LR053666
PIPE ASSEMBLY, fuel filler	1	LR077753
CONNECTOR, pipe assembly to tank	1	LR010620

FUEL FILLER CAP - LR053666



FUEL FILLER CAP - LR053665

VEHICLES FITTED FROM NEW WITH 2010 MODEL YEAR (VIN AA000001 ON) FUEL TANK WITH 2 VENT PIPES

FUEL TANK, 2 vent pipe type	1	LR013746
MOUNTING COVER, fuel tank	1	WFN000014
HEATSHIELD, fuel tank:		
front	1	WFZ500034
rear	1	WFZ500130
COVER, top aperture	1	LR042718
RETAINING RING, cover	1	LR013771
GASKET, retaining ring	1	LR000966
CAP, fuel filler	1	LR053666
PIPE ASSEMBLY, fuel filler	1	LR077753
CONNECTOR, pipe assembly to tank	1	LR010620
HARNESSEXTENSION	1	LR020971

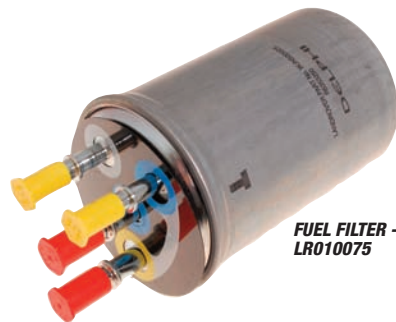

FUEL FILTER - LR010075



FUEL FILTER - LR009705

Adaptive Speed Control Unit & Sensor

2.7 TDV6 Diesel

ELECTRONIC CONTROL UNIT, adaptive speed control:		
up to VIN 6A999999	1	NNW501922
VIN 7A000001 on	1	NNW501923
SENSOR UNIT, adaptive speed control	1	YDB500560
<i>Located on bracket behind radiator grille.</i>		

Fuel Pump & Sender Unit

2.7 TDV6 Diesel

VEHICLES FITTED WITH ORIGINAL STYLE 2005-2009 MODEL YEARS (TO VIN 9A999999) FUEL TANK WITH 3 VENT PIPES		
FUEL PUMP MODULE:		
without fuel fired heater	1	WGS500120
with fuel fired heater	1	WGS500110
SENDER UNIT:		
front		
Land Rover	1	WGI500080
OEM	1	WGI500080P1
rear	1	WGI500120

VEHICLES FITTED FROM NEW WITH 2010 MODEL YEAR (VIN AA000001 ON) FUEL TANK WITH 2 VENT PIPES

FUEL PUMP MODULE:		
Land Rover	1	LR042717
OEM	1	LR042717P1
SENDER UNIT:		
front		
with bracket assembly	1	LR042710
without bracket assembly	1	LR043384
rear	1	LR042716

WE'RE HERE TO HELP
 Can't find or not sure of the right part for your car, contact our technical sales team for help and advice.
01522 568000

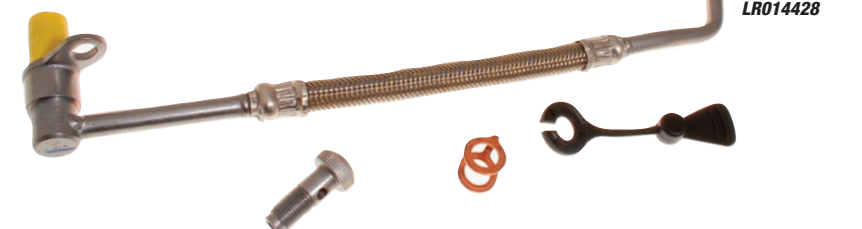

OIL FEED PIPE - LR014428

2.7 TDV6 DIESEL

Fuel Filters

2.7 TDV6 Diesel

FUEL FILTER, disposable cartridge type: <i>Up to VIN 6A999999.</i>		
kit with mounting bracket	1	WJN500056
kit without mounting bracket:		
Land Rover	1	LR010075
OEM	1	LR010075P1
aftermarket	1	LR010075P
FUEL FILTER, disposable element type: <i>VIN 7A000001 on.</i>		
complete ass'y, with sensor	1	LR045519
repair kit for LR045519	1	LR045519BPRK
disposable element only		
Land Rover	1	LR009705
OEM	1	LR009705P1
aftermarket	1	LR009705P
water detector sensor only	1	WKW500080

Fuel Cooler

2.7 TDV6 Diesel

FUEL COOLER, standard fitment:		
up to VIN 6A999999	1	LR031827
VIN 7A000001 on	1	PIB500210
<i>Includes mounting bracket.</i>		
MOUNTING BRACKET, std. fuel cooler	1	WJU500430
<i>VIN 7A000001 on; incl. in fuel cooler assembly.</i>		
FUEL COOLER, additional	1	PIB500120
<i>Hot climates only.</i>		
HOSE, additional fuel cooler:		
<i>Hot climates only.</i>		
fuel cooler to radiator	1	PIH500091
fuel cooler to nylon pipe	1	PIH500130

Turbocharger

2.7 TDV6 Diesel

TURBOCHARGER ASSEMBLY:		
new		
outright, OEM	1	LR021042P1
exchange, Land Rover	1	LR021042
reconditioned		
outright, OEM	1	LR021637P1
exchange, Land Rover	1	LR021637
ACTUATOR SERVICE KIT	1	LR023086
<i>Included in turbocharger assembly.</i>		
SEALING RING:		
oil drain	1	LR006184
<i>Included in turbocharger assembly.</i>		
oil feed pipe union	1	1372726
<i>Included in turbocharger assembly.</i>		
GASKET, oil return pipe union	1	1331076
<i>Included in turbocharger assembly.</i>		
PIPE:		
oil feed	1	LR014428
oil return	1	LR004696
HEATSHIELD, turbocharger	1	LWQ500070

3.6 TDV8 DIESEL

FUEL SYSTEM

Air Filter

3.6 TDV8 Diesel

AIR BOX ASSEMBLY, with filter	1	PHB500182
BUSH, air box mounting	2	PJQ500012
AIR FILTER ELEMENT ONLY:		
Land Rover	1	PHE000112
OEM	1	PHE000112P1
aftermarket	1	PHE000112P
K&N Performance	1	PHE000112K-N
Britpart Peak Performance	1	PHE000112BP
AIR FLOW METER:		
Land Rover	2	PHF500090
OEM	2	PHF500090P1
AIR DUCT:		
air flow meter elbow to turbocharger		
RH turbocharger		
upper	1	PHD500740
lower	1	PHD500700
LH turbocharger		
upper	1	PHD500710
lower	1	PHD500750
wing intake vent to elbow	1	PHD500610
ELBOW:		
air flow meter to turbo duct	1	PHD500650
wing intake duct to air box	1	LR020024

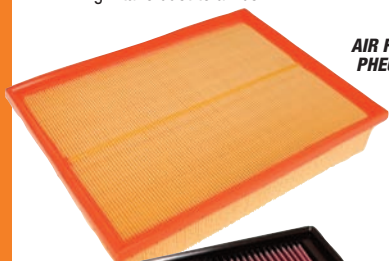

AIR FILTER - PHE000112

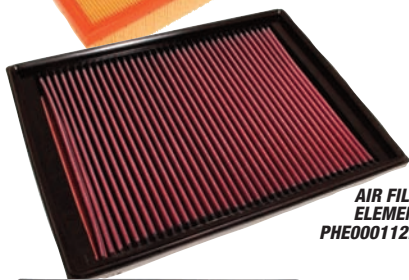

AIR FILTER ELEMENT - PHE000112K-N

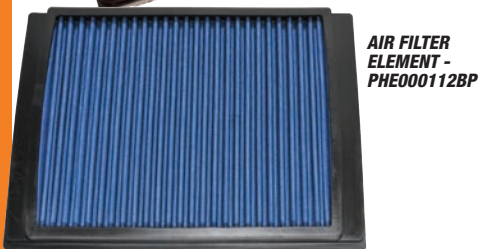

AIR FILTER ELEMENT - PHE000112BP

K&N Air Filter

3.6 TDV8 Diesel

K&N PERFORMANCE AIR FILTER ELEMENT	1	PHE000112K-N
<i>K&N offer superior filtration, improvements in air flow and many times longer life than standard air filter elements. Plus, they can be cleaned and re-used.</i>		
K&N FILTER CLEANING FLUID, 1 litre	1	RX1346
<i>For cleaning K&N air filter elements.</i>		
K&N FILTER ELEMENT OIL:		
<i>For re-oiling K&N air filter elements.</i>		
sachet, 57cc	1	RX1347
bottle, 250ml	1	RX1348
aerosol, 400ml	1	RX1349



Inlet Manifolds

3.6 TDV8 Diesel

INLET MANIFOLD ASSEMBLY:		
<i>Includes cylinder head cam cover.</i>		
RH	1	LR005274
LH	1	LR005659
GASKET, manifold/cam cover to head:		
RH	1	LR005898
LH	1	LR005897
CAP, oil filler	1	LR053016
TOP COVER, engine	1	LR019483
BRACKET, top cover support:		
centre	1	LR005823
to RH manifold	1	LR002479
to LH manifold	1	LR002478
SCREW, top cover brackets ass'y	4	4364422

Throttle Body & Duct Assembly

3.6 TDV8 Diesel

THROTTLE BODY & DUCT ASSEMBLY	1	LR020530
<i>Includes throttle bodies, air duct connectors and pressure (MAP) sensor.</i>		
THROTTLE BODY ASSEMBLY	2	LR004065
SEAL, throttle body to duct	2	LR004032
BOLT, throttle body to duct	8	LR004029
SENSOR, manifold absolute pressure	2	LR007596
<i>Also known as MAP sensor. Includes fixing screw.</i>		
CONNECTOR, duct assembly:		
from turbocharger, elbow	2	LR014468
to inlet manifold, straight	2	LR004076

Fuel Injectors & Fittings

3.6 TDV8 Diesel

FUEL INJECTOR KIT:		
<i>Includes injector, supply pipe, clip and seals.</i>		
new, exchange		
cylinders 1 & 8	2	LR002473
Land Rover		
OEM	2	LR002473P1
cylinders 2 & 7	2	LR002474
Land Rover		
OEM	2	LR002474P1
cylinders 3 & 6	2	LR002475
cylinders 4 & 5	2	LR002476
reconditioned, exchange		
cylinders 1 & 8	2	LR008832
cylinders 4 & 5	2	LR008835
FITTING KIT, fuel injector:		
<i>Includes supply pipe, clip and seals.</i>		
cylinders 1 & 8	2	LR002491
cylinders 2 & 7	2	LR002492
cylinders 3 & 6	2	LR002493
cylinders 4 & 5	2	LR002494
MANIFOLD, fuel supply to injectors:		
RH (incl. fuel pressure sensor)	1	LR020019
LH	1	LR020018
PIPE ASSEMBLY:		
fuel injection pump to fuel manifold		
RH	1	LR002472
LH	1	LR000636
fuel supply to injection pump	1	LR003675
injection pump to leak off pipe	1	1418959
leak off		
from injectors to pump	1	1423955
<i>Includes seals and fuel temperature sensor.</i>		
from fuel cooler	1	LR003672
SEAL, injector leak off pipe	8	LR019118
HEATSHIELD, fuel manifold:		
RH	1	LR006232
LH	1	LR006230
PROTECTION CAP KIT	1	LR010347
<i>Use when servicing. Protects disassembled fuel injection elements from dirt and moisture ingress.</i>		



GLOW PLUG - 1354289

Glow Plugs

3.6 TDV8 Diesel

GLOW PLUG:		
Land Rover	8	1354289
OEM	8	1354289P1
HARNESS, glow plugs:		
<i>up to VIN 7A999999</i>		
RH	1	LR003621
LH	1	LR003620
<i>VIN 8A000001 on</i>		
RH	1	LR006095
LH	1	LR006094

Fuel Injection Pump

3.6 TDV8 Diesel

FUEL INJECTION PUMP ASSEMBLY, new, exchange:		
<i>Includes drive gear and bolt.</i>		
Land Rover	1	LR009737
OEM	1	LR009737P1
GEAR, pump driving	1	1418841
GASKET, pump to cylinder head	1	LR003877
BOLT:		
pump to cylinder head	3	1420986
gear to pump	1	1418843



FUEL INJECTOR KIT - LR002473



FUEL INJECTOR KIT - LR002474



FUEL INJECTOR KIT - LR008832

Accelerator Pedal (Injection Pump Control)

3.6 TDV8 Diesel

PEDAL, accelerator, with throttle position sensor:

RHD	1	LR012044
LHD	1	SLC500021PVJ

PEDAL COVER SET:

Three piece set of sports covers, fashioned from stainless steel and rubber - includes covers for accelerator and brake pedals, plus footrest cover.

Land Rover	1	LR008713
Britpart	1	LR008713BP



PEDAL COVER SET:
LR008713BP

3.6 TDV8 DIESEL

Adaptive Speed Control Unit & Sensor

3.6 TDV8 Diesel

CONTROL UNIT, adaptive speed 1 **NNW501923**
 SENSOR UNIT, adaptive speed control 1 **YDB500560**
 Located on bracket behind radiator grille.

Fuel Tank

3.6 TDV8 Diesel

**VEHICLES FITTED WITH ORIGINAL STYLE
2005-2009 MODEL YEARS (TO VIN 9A999999)
FUEL TANK WITH 3 VENT PIPES**

FUEL TANK, replacement type 1 **LR044038**
 Includes sender units.

Important note: the original range of fuel tanks with 3 vent pipes for the 2005-2009 models are now replaced by a universal fitment tank with many of the features of the 2010 model year onwards type tank. The result is what we know in the trade as a 'multiple supersession', which means that along with your new tank you will also have to buy and fit the following parts, since the originals from your old tank will not fit the new one:

CLIP	1	CN100509
Required for all models being fitted with new universal type tank.		
HARNESSE EXTENSION	1	LR020971
Required for all models being fitted with new universal type tank.		
CAP, fuel filler	1	LR053666
Required for all models being fitted with new universal type tank.		
CAP, blanking heater pipe boss	1	LR021882
Required for all models without fuel fired heater with new universal type tank.		

The following are standard parts for original fuel tanks with 3 vent pipes:

MOUNTING COVER, fuel tank	1	WFN500021
HEATSHIELD, fuel tank:		
front	1	WFZ500034
rear	1	WFZ500130
COVER, top aperture:		
models without fuel fired heater	1	WGC500120
models with fuel fired heater	1	WGC500110
RETAINING RING, cover	1	WFM500011
GASKET, retaining ring	1	WFG000033
O RING KIT, fuel tank	1	LR006778
CAP, fuel filler	1	LR053666
PIPE ASSEMBLY, fuel filler	1	LR077753
CONNECTOR, pipe assembly to tank	1	LR010620

**VEHICLES FITTED FROM NEW WITH 2010
MODEL YEAR (VIN AA000001 ON) FUEL TANK
WITH 2 VENT PIPES**

FUEL TANK, 2 vent pipe type	1	LR013746
MOUNTING COVER, fuel tank	1	WFN000014
HEATSHIELD, fuel tank:		
front	1	WFZ500034
rear	1	WFZ500130
COVER, top aperture	1	LR042718
RETAINING RING, cover	1	LR013771
GASKET, retaining ring	1	LR000966
CAP, fuel filler	1	LR053666
PIPE ASSEMBLY, fuel filler	1	LR077753
CONNECTOR, pipe assembly to tank	1	LR010620
HARNESSE EXTENSION	1	LR020971

Fuel Cooler

3.6 TDV8 Diesel

FUEL COOLER:

standard fitment	1	LR016639
additional	1	LR031827



FUEL COOLER -
LR016639

Fuel Pump & Sender Unit

3.6 TDV8 Diesel

**VEHICLES FITTED WITH ORIGINAL STYLE
2005-2009 MODEL YEARS (TO VIN 9A999999)
FUEL TANK WITH 3 VENT PIPES**

FUEL PUMP MODULE:

without fuel fired heater	1	WGS500120
with fuel fired heater	1	WGS500110

SENDER UNIT:

front		
Land Rover	1	WGI500080
OEM	1	WGI500080P1
rear	1	WGI500120

**VEHICLES FITTED FROM NEW WITH 2010
MODEL YEAR (VIN AA000001 ON) FUEL TANK
WITH 2 VENT PIPES**

FUEL PUMP MODULE:

Land Rover	1	LR042717
OEM	1	LR042717P1

SENDER UNIT:

front		
with bracket assembly	1	LR042710
without bracket assembly	1	LR043384
rear	1	LR042716



FUEL FILTER
COMPLETE
ASSEMBLY -
LR010416

Fuel Filter

3.6 TDV8 Diesel

FUEL FILTER, disposable element type:

complete ass'y, with sensor	1	LR045519
repair kit for LR045519	1	LR045519BPRK
disposable element only		
Land Rover	1	LR009705
OEM	1	LR009705P1
aftermarket	1	LR009705P
water detector sensor only	1	WKW500080
SHIELD, fuel filter pipes	1	WKU500090

Turbochargers

3.6 TDV8 Diesel

TURBOCHARGER ASSEMBLY:

RH

new		
outright, OEM	1	LR021043P1
exchange, Land Rover	1	LR021043
reconditioned		
Land Rover	1	LR021653
OEM	1	LR021653P1

LH

new		
outright, OEM	1	LR021044P1
exchange, Land Rover	1	LR021044
reconditioned		
Land Rover	1	LR021654
aftermarket	1	LR021654P

ACTUATOR SERVICE KIT:

Includes pin and rod. Included in turbocharger assembly.

RH	1	LR023087
LH	1	LR023088

PIPE ASSEMBLY:

turbocharger oil feed	1	LR006636
turbocharger oil return		
RH	1	LR003783
LH	1	LR003784

GASKET:

turbocharger to exhaust manifold		
RH	1	LR003622
LH	1	LR003679
turbocharger oil return hose	4	LR003787
STUD, turbo to exhaust manifold	6	1357628
NUT, turbo to exhaust manifold	6	LR004057
SCREW, oil return pipe flange		
to turbocharger	4	1255708
to engine	4	LR004500



PIPE ASSEMBLY -
LR003784

FUEL FILLER
CAP -
LR053666



FUEL FILTER
ELEMENT -
LR009705

4.2 AJV8 SUPERCHARGED PETROL

Air Filter

4.2 AJV8 Supercharged Petrol

AIR BOX ASSEMBLY, with filter	1	PHB500054
BUSH, air box mounting	2	PJQ500012
AIR FILTER ELEMENT ONLY:		
Land Rover	1	PHE000112
OEM	1	PHE000112P1
aftermarket	1	PHE000112P
K&N Performance	1	PHE000112K-N
Britpart Peak Performance	1	PHE000112BP
AIR FLOW METER:		
Land Rover	1	PHF000140
OEM	1	PHF000140P1
AIR DUCT:		
air box to throttle body duct	1	PHD500055
wing intake vent to elbow	1	PHD500610
ELBOW, wing intake duct to air box	1	LR020024

AIR FILTER
ELEMENT -
PHE000112K-N



K&N Air Filter

4.2 AJV8 Supercharged Petrol

K&N PERFORMANCE AIR FILTER ELEMENT	1	PHE000112K-N
<i>K&N offer superior filtration, improvements in air flow and many times longer life than standard air filter elements. Plus, they can be cleaned and re-used.</i>		
K&N FILTER CLEANING FLUID, 1 litre	1	RX1346
<i>For cleaning K&N air filter elements.</i>		
K&N FILTER ELEMENT OIL:		
<i>For re-oiling K&N air filter elements.</i>		
sachet, 57cc	1	RX1347
bottle, 250ml	1	RX1348
aerosol, 400ml	1	RX1349

Inlet Manifolds

4.2 AJV8 Supercharged Petrol

INLET MANIFOLD ASSEMBLY:		
RH	1	4628229
LH	1	4628230
ADAPTOR, manifold and injectors to head:		
RH	1	4629180
LH	1	4629181
GASKET:		
manifold to adaptor	2	4628226
adaptor to head	2	4628235
BOLT:		
manifold to adaptor	16	4648959
adaptor to head	10	1354399
SENSOR, manifold absolute pressure	1	PMM500080
<i>Also known as MAP sensor.</i>		
ENGINE TOP COVER	1	LBH500052
STUD, engine top cover fixing:		
long (front)	2	KKN500061
short (rear)	2	KKN500051
NUT, engine top cover fixing	4	FN106045L

Throttle Body & Duct Assembly

4.2 AJV8 Supercharged Petrol

DUCT ASS'Y, air inlet to throttle body	1	LR005192
THROTTLE BODY ASSEMBLY	1	LR006142
ELBOW ASSEMBLY, air inlet	1	LR009386
<i>Includes air inlet sensor and supercharger air duct hose.</i>		
SENSOR, air inlet	1	LR008935
HOSE, supercharger air duct to elbow	1	LR002790
GASKET:		
throttle body to elbow	1	4536886
elbow to supercharger air duct	1	4628234
BOLT:		
throttle body to elbow	4	4662918
elbow to supercharger air duct	4	4629188

Fuel Tank

4.2 AJV8 Supercharged Petrol

important note	FUEL TANKS
	<i>Important note: the original range of fuel tanks with 3 vent pipes for the 2005-2009 models are now replaced by a universal fitment tank with many of the features of the 2010 model year onwards type tank. The result is what we know in the trade as a 'multiple supersession', which means that along with your new tank you will also have to buy and fit the following parts, since the originals from your old tank will not fit the new one.</i>

VEHICLES FITTED WITH ORIGINAL STYLE 2005-2009 MODEL YEARS (TO VIN 9A999999) FUEL TANK WITH 3 VENT PIPES

FUEL TANK, replacement type	1	LR041239
<i>Includes sender unit.</i>		
PIPE ASSEMBLY, fuel filler	1	LR045067
<i>Required for all models being fitted with new universal type tank.</i>		
HOSE, fuel filler	1	LR015975
<i>Required for all models being fitted with new universal type tank.</i>		
HARNESSEXTENSION	1	LR020971
<i>Required for all models being fitted with new universal type tank.</i>		

The following are standard parts for original fuel tanks with 3 vent pipes:

MOUNTING COVER, fuel tank	1	WFN500021
HEATSHIELD, fuel tank:		
front	1	WFZ500034
rear	1	WFZ500130
COVER, top aperture	1	WGC500130
RETAINING RING, cover	1	WFM500011
GASKET, retaining ring	1	WFG000033
O RING KIT, fuel tank	1	LR006778
CAP, fuel filler	1	LR053665
PIPE ASSEMBLY, fuel filler:		
up to VIN 9A192846	1	WMJ500163
VIN 9A192847 on	1	LR010516
CONNECTOR, pipe assembly to tank	1	WLH000061
CANNISTER, fuel vapour store	1	WTB000303

VEHICLES FITTED FROM NEW WITH 2010 MODEL YEAR (VIN AA000001 ON) FUEL TANK WITH 2 VENT PIPES

FUEL TANK, 2 vent pipe type	1	LR016241
MOUNTING COVER, fuel tank	1	WFN000014
HEATSHIELD, fuel tank	1	WFZ500034
COVER, top aperture	1	LR043420
RETAINING RING, cover	1	LR013771
GASKET, retaining ring	1	LR000966
HARNESSEXTENSION	1	LR020971
CAP, fuel filler	1	LR053665
PIPE ASSEMBLY, fuel filler	1	LR045067
CONNECTOR, pipe assembly to tank	1	LR010621

Fuel Injectors & Fittings

4.2 AJV8 Supercharged Petrol

FUEL INJECTOR RAIL ASSEMBLY	1	LR002490
<i>Includes injectors, injector seals and fuel temperature and pressure sensors.</i>		
FUEL INJECTOR	8	4650544
SEAL, fuel injector:		
upper	8	LR012785
lower	8	LR012827
CLIP, fuel injector securing	8	4484930
SENSOR:		
fuel temperature	1	LR000291
fuel pressure	1	4458309
<i>Includes O rings.</i>		
PIPE ASSEMBLY:		
fuel injector rail supply	1	MLH500160
fuel vapour cannister purge	1	MAP500180
<i>Includes valve.</i>		

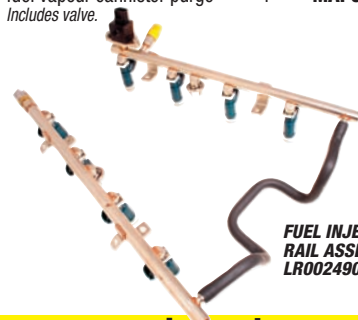

FUEL INJECTOR
RAIL ASSEMBLY -
LR002490

Accelerator Pedal

4.2 AJV8 Supercharged Petrol

PEDAL, accelerator, with throttle position sensor:		
RHD	1	LR012044
LHD	1	SLC500021PVJ
PEDAL COVER SET:		
<i>Three piece set of sports covers, fashioned from stainless steel and rubber - includes covers for accelerator and brake pedals, plus footrest cover.</i>		
Land Rover	1	LR008713
Britpart	1	LR008713BP

Adaptive Speed Control Unit & Sensor

4.2 AJV8 Supercharged Petrol

ELECTRONIC CONTROL UNIT, adaptive speed control:		
up to VIN 6A999999	1	NNW501922
VIN 7A000001 on	1	NNW501923
SENSOR UNIT, adaptive speed control	1	YDB500560
<i>Located on bracket behind radiator grille.</i>		

Fuel Pump & Sender Unit

4.2 AJV8 Supercharged Petrol

VEHICLES FITTED WITH ORIGINAL STYLE 2005-2009 MODEL YEARS (TO VIN 9A999999) FUEL TANK WITH 3 VENT PIPES		
FUEL PUMP MODULE:		
Land Rover	1	WGS500012
OEM	1	WGS500012P1
ELECTRONIC CONTROL UNIT, fuel pump:		
up to VIN 8A119897	1	WQM500010
VIN 8A119898 on	1	WQM500020
SENDER UNIT:		
front		
Land Rover	1	WGI500080
OEM	1	WGI500080P1
rear	1	WGI500090

VEHICLES FITTED WITH REPLACEMENT UNIVERSAL FUEL TANK OR VEHICLES FITTED FROM NEW WITH 2010 MODEL YEAR (VIN AA000001 ON) FUEL TANK WITH 2 VENT PIPES

FUEL PUMP MODULE		
Land Rover	1	LR043385
OEM	1	LR043385P1
ELECTRONIC CONTROL UNIT, fuel pump:		
up to VIN 8A119897	1	WQM500010
VIN 8A119898 on	1	WQM500020
SENDER UNIT:		
front, with bracket assembly	1	LR042710
front, without bracket assembly	1	LR043384
rear	1	LR042716

Fuel Filter

4.2 AJV8 Supercharged Petrol

FUEL FILTER, disposable cartridge	1	WFL500010
<i>Includes hose and union.</i>		

Supercharger

4.2 AJV8 Supercharged Petrol

SUPERCHARGER ASSEMBLY:		
New, exchange	1	4713039
AIR DUCT, supercharger outlet	1	4728624
SEAL, air duct to supercharger	1	1347543
BOLT, supercharger mounting:		
front, long	2	4649492
rear, short	1	1372612
BOLT, air duct to supercharger, special	4	LR000338
FLANGE, air duct to inlet manifold	2	4628214
INSULATOR PAD, supercharger:		
upper (T shape)	1	4670343
lower (sculpted moulding)	1	4629190
HOSE, vacuum, air duct	1	LR003976

Air Filter

4.4 AJV8 Petrol

AIR BOX ASSEMBLY, with filter	1	PHB000476
BUSH, air box mounting	2	PJQ500012
AIR FILTER ELEMENT ONLY:		
Land Rover	1	PHE000112
OEM	1	PHE000112P1
aftermarket	1	PHE000112P
K&N Performance	1	PHE000112K-N
Britpart Peak Performance	1	PHE000112BP
AIR FLOW METER:		
Land Rover	1	PHF000140
OEM	1	PHF000140P1
AIR DUCT:		
air box to throttle body, ass'y	1	PHD500621
wing intake vent to elbow	1	PHD500610
ELBOW, wing intake duct to air box	1	LR020024



AIR FILTER ELEMENT - PHE000112



AIR FILTER ELEMENT - PHE000112K-N

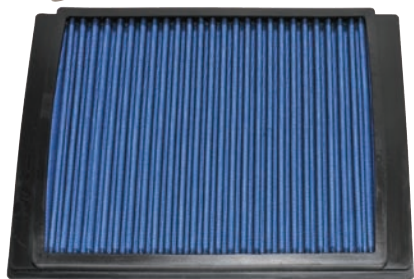

AIR FILTER ELEMENT - PHE000112BP

K&N Air Filter

4.4 AJV8 Petrol

K&N PERFORMANCE AIR FILTER ELEMENT	1	PHE000112K-N
<i>K&N offer superior filtration, improvements in air flow and many times longer life than standard air filter elements. Plus, they can be cleaned and re-used.</i>		
K&N FILTER CLEANING FLUID, 1 litre	1	RX1346
<i>For cleaning K&N air filter elements.</i>		
K&N FILTER ELEMENT OIL:		
<i>For re-oiling K&N air filter elements.</i>		
sachet, 57cc	1	RX1347
bottle, 250ml	1	RX1348
aerosol, 400ml	1	RX1349



Inlet Manifold

4.4 AJV8 Petrol

INLET MANIFOLD:		
complete assembly	1	LR003393
<i>Includes upper & lower manifolds, front and rear covers, gaskets & seals, fuel injector rail and manifold absolute pressure (MAP) sensor.</i>		
manifold only	1	LR000364
<i>Includes upper & lower manifolds, gaskets & seals.</i>		
GASKET:		
manifold to head	2	4628235
upper to lower manifold		
up to VIN 5A910671	8	4526549
VIN 5A910672 on	8	LR006678
BOLT, manifold to engine	10	4357545
END COVER, manifold:		
front (elbow)	1	4670345
rear (sensor cover)	1	4670799
SEAL, manifold end cover:		
front	1	LWF500020
rear	1	4526546
SENSOR, manifold absolute pressure	1	4628195
<i>Also known as MAP sensor. Included in manifold complete assembly.</i>		
HEATSHIELD, manifold:		
RH	1	4604784
LH	1	4536879
ENGINE TOP COVER	1	LBH500012
FASTENER, engine top cover	4	LZM500020

Throttle Body

4.4 AJV8 Petrol

THROTTLE BODY ASSEMBLY	1	LR006142
GASKET, throttle body	1	4536886
HOSE, throttle body:		
short		
up to VIN 6A999999	1	4726525
VIN 7A000001 on	1	LR006159
long	1	LR006161

Fuel Injectors & Fittings

4.4 AJV8 Petrol

FUEL INJECTOR RAIL ASSEMBLY	1	LR002489
<i>Includes injectors, injector seals and fuel temperature sensor.</i>		
FUEL INJECTOR	8	4526563
SEAL, fuel injector:		
upper	8	LR012785
lower	8	LR012827
CLIP, fuel injector securing	8	4484930
SENSOR, fuel temperature	1	LR000291
PIPE ASSEMBLY:		
fuel injector rail supply	1	MLH500180
fuel vapour cannister purge	1	MAP500100
<i>Includes valve.</i>		

Accelerator Pedal

4.4 AJV8 Petrol

PEDAL, accelerator, with throttle position sensor:		
RHD	1	LR012044
LHD	1	SLC500021PVJ
PEDAL COVER SET:		
<i>Three piece set of sports covers, fashioned from stainless steel and rubber - includes covers for accelerator and brake pedals, plus footrest cover.</i>		
Land Rover	1	LR008713
Britpart	1	LR008713BP

Adaptive Speed Control Unit & Sensor

4.4 AJV8 Petrol

ELECTRONIC CONTROL UNIT, adaptive speed control:		
up to VIN 6A999999	1	NNW501922
VIN 7A000001 on	1	NNW501923
SENSOR UNIT, adaptive speed control	1	YDB500560
<i>Located on bracket behind radiator grille.</i>		

4.4 AJV8 PETROL

Fuel Tank - 4.4 AJV8 Petrol

important note

FUEL TANKS

Important note: the original range of fuel tanks with 3 vent pipes for the 2005-2009 models are now replaced by a universal fitment tank with many of the features of the 2010 model year onwards type tank. The result is what we know in the trade as a 'multiple supersession', which means that along with your new tank you will also have to buy and fit the following parts, since the originals from your old tank will not fit the new one:

VEHICLES FITTED WITH ORIGINAL STYLE 2005-2009 MODEL YEARS (TO VIN 9A999999) FUEL TANK WITH 3 VENT PIPES

FUEL TANK, replacement type	1	LR041239
<i>Includes sender units.</i>		
GASKET, retaining ring	1	LR000966
<i>Required for all models being fitted with new universal type tank.</i>		
COVER, top aperture	1	LR060042
<i>Required for all models being fitted with new universal type tank.</i>		
PIPE ASSEMBLY, fuel filler	1	LR045067
<i>Required for all models being fitted with new universal type tank.</i>		
HOSE, fuel filler	1	LR015975
<i>Required for all models being fitted with new universal type tank.</i>		
FUEL PUMP MODULE	1	LR016845
<i>Required for all models being fitted with new universal type tank.</i>		
HARNESSEXTENSION	1	LR020971
<i>Required for all models being fitted with new universal type tank.</i>		

The following are standard parts for original fuel tanks with 3 vent pipes:

MOUNTING COVER, fuel tank	1	WFN500021
HEATSHIELD, fuel tank:		
front	1	WFZ500034
rear	1	WFZ500130
COVER, top aperture	1	WGC500130
RETAINING RING, cover	1	WFM500011
GASKET, retaining ring	1	WFG000033
O RING KIT, fuel tank	1	LR006778
CAP, fuel filler	1	LR053665
PIPE ASSEMBLY, fuel filler:		
up to VIN 9A192846	1	WMJ500163
VIN 9A192847 on	1	LR010516
CONNECTOR, pipe assembly to tank	1	WLH000061
CANNISTER, fuel vapour store	1	WTB000303

VEHICLES FITTED FROM NEW WITH 2010 MODEL YEAR (VIN AA000001 ON) FUEL TANK WITH 2 VENT PIPES

FUEL TANK, 2 vent pipe type	1	LR016241
MOUNTING COVER, fuel tank	1	WFN000014
HEATSHIELD, fuel tank:		
front	1	WFZ500034
rear	1	WFZ500130
COVER, top aperture	1	LR060042
RETAINING RING, cover	1	LR013771
GASKET, retaining ring	1	LR000966
HARNESSEXTENSION	1	LR020971
CAP, fuel filler	1	LR053665
PIPE ASSEMBLY, fuel filler	1	LR045067
CONNECTOR, pipe assembly to tank	1	LR010621

Fuel Pump & Sender Unit

4.4 AJV8 Petrol

VEHICLES FITTED WITH ORIGINAL STYLE 2005-2009 MODEL YEARS (TO VIN 9A999999) FUEL TANK WITH 3 VENT PIPES

FUEL PUMP MODULE	1	WGS500051
SENDER UNIT:		
front	1	WGI500080
rear	1	WGI500120

VEHICLES FITTED WITH REPLACEMENT UNIVERSAL FUEL TANK OR VEHICLES FITTED FROM NEW WITH 2010 MODEL YEAR (VIN AA000001 ON) FUEL TANK WITH 2 VENT PIPES

FUEL PUMP MODULE	1	LR016845
SENDER UNIT:		
front, with bracket assembly	1	LR042710
front, without bracket assembly	1	LR043384
rear	1	LR042716

ORDER

BY PHONE: 01522 568000 / ON LINE: www.rimmerbros.co.uk / E-MAIL: lrsales@rimmerbros.co.uk

FUEL SYSTEM

2.7 TDV6 DIESEL

Vacuum Pump & Air Injection

2.7 TDV6 Diesel

VACUUM PUMP ASSEMBLY:

Land Rover	1	LR019761
OEM	1	LR019761P1
GASKET, vacuum pump mounting	1	LR019960
CAP, vacuum pump outlet	1	1334813
<i>Where vacuum pump outlet is not used.</i>		
HOSE, vacuum pump to servo:		
connecting only to pump inlet		
RHD		
vacuum pump to union	1	SQB000233
union to servo		
up to VIN 6A916812	1	SQB000232
VIN 6A916813 on	1	LR051575
LHD	1	LR018326
connecting to pump inlet and outlet		
VIN 6A929086 on.		
RHD		
vacuum pump to union		
EU2 emissions	1	LR019701
Euro Stage 4 emissions	1	LR019758
<i>Models with diesel particulate filter (DPF).</i>		
union to servo	1	LR019757
LHD		
EU2 emissions	1	LR019700
Euro Stage 4 emissions	1	LR019756
<i>Models with diesel particulate filter (DPF).</i>		

Crankcase Breather

2.7 TDV6 Diesel

OIL SEPARATOR:

EU2 emissions models	1	LR003386
Euro Stage 4 emissions models	1	LR074003
<i>Models with diesel particulate filter (DPF).</i>		
SEAL, oil separator	2	1337060
PIPE, oil separator outlet	2	LR000272
BREATHER TUBE ASSEMBLY:		
EU2 emissions models		
up to VIN 6A999999	1	1335277
VIN 7A000001 on	1	LR005999
Euro Stage 4 emissions models	1	LR006000
<i>Models with diesel particulate filter (DPF).</i>		
BREATHER TUBE ELBOW	1	LR006392
<i>Euro Stage 4 emissions models with diesel particulate filter (DPF).</i>		
BREATHER HOSE, lower	1	LLH500140

Exhaust Gas Recirculation

2.7 TDV6 Diesel

VALVE, exhaust gas recirculation:

EU2 emissions models		
RH		
Land Rover	1	LR018466
aftermarket	1	LR018466P
LH		
Land Rover	1	LR018465
aftermarket	1	LR018465P
Euro Stage 4 emissions models		
<i>Models with diesel particulate filter (DPF).</i>		
RH		
Land Rover	1	LR018324
aftermarket	1	LR018324P
OEM	1	LR018324P1
LH		
Land Rover	1	LR018323
aftermarket	1	LR018323P
OEM	1	LR018323P1

BLANKING KIT, EGR valves
RD1340
Fits EU2 emissions models only (i.e. models without diesel particulate filter in exhaust system). Allows removal of troublesome EGR valves while also increasing performance.

COOLER, exhaust gas recirculation:

EU2 emissions models		
up to VIN 9A209066		
RH	1	1336563
LH	1	1336562
VIN 9A209067 on		
RH	1	LR014413
LH	1	LR014412
Euro Stage 4 emissions models		
<i>Models with diesel particulate filter.</i>		
RH	1	LR004536
LH	1	LR004535
THERMOSTAT, EGR cooler	1	LR006115
<i>Euro Stage 4 emissions models with diesel particulate filter (DPF).</i>		

TUBE:

EGR valve to inlet manifold		
RH	1	1316131
LH	1	LR066839
EGR valve to exhaust manifold		
RH	1	LR004253
LH	1	LR066840
CLAMP, tubes to manifold/cooler		
	2	1311338
GASKET:		
EGR valve to cooler:		
EU2 emissions models	2	1336561
Euro Stage 4 emissions		
<i>Models with diesel particulate filter (DPF).</i>		
Land Rover	2	LR004532
aftermarket	2	LR004532P
EGR valve to inlet manifold tube	2	1331267
tube to exhaust manifold	2	1331270

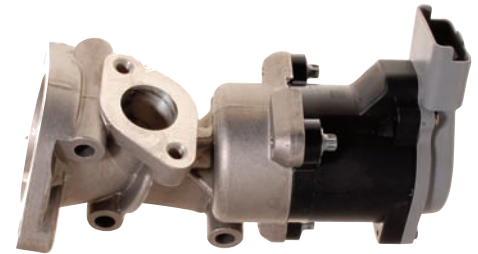

EXHAUST GAS RECIRCULATION VALVE - LR018324



EXHAUST GAS RECIRCULATION VALVE - LR018323P1



BLANKING KIT - RD1340



EGR VALVE TO INLET MANIFOLD TUBE - LR066839

3.6 TDV8 DIESEL

EXHAUST GAS RECIRCULATION LH VALVE - LR018322



Vacuum Pump

3.6 TDV8 Diesel

VACUUM PUMP ASSEMBLY	1	LR001852
<i>Includes mounting gasket.</i>		
GASKET, vacuum pump mounting	1	LR004014
BOLT, vacuum pump mounting:		
Land Rover	2	1372612
aftermarket	2	1372612P
STUD, vacuum pump mounting	1	1331241
NUT, vacuum pump mounting	1	FN108042
HOSE, vacuum pump to servo:		
RHD	1	LR018329
LHD	1	LR018330

Crankcase Breather

3.6 TDV8 Diesel

BREATHER PIPE ASSEMBLY	1	LLP500070
ELBOW, pipe to oil separator	1	LR005256
SEAL, elbow to oil separator	1	1418851
HOSES & BRACKET ASSEMBLY, vacuum:		
up to VIN 9A203051	1	LR006472
VIN 9A203052 on	1	LR014302
HOSE, vacuum	1	LR004273
<i>To RH front union on hoses & bracket assembly..</i>		

Exhaust Gas Recirculation

3.6 TDV8 Diesel

VALVE, exhaust gas recirculation:

RH	1	LR018321
LH	1	LR018322

COOLER, exhaust gas recirculation:

RH	1	LR003858
LH	1	LR003857

THERMOSTAT, EGR cooler

	2	LR006115
--	---	-----------------

TUBE:

EGR valve to inlet manifold	2	LR016789
EGR valve to exhaust manifold		
RH	1	LR006966
LH	1	LR006965
CLAMP, tubes to manifold/cooler	2	1311338

GASKET:

EGR valve to cooler	2	LR003831
EGR cooler to inlet manifold tube	2	LR004250
tube to inlet manifold	2	LR004250
EGR valve to exh. manifold tube	2	LR003828
SEALING RING, tube to exh. manifold	2	LR003898
HEAT SHIELD, RH EGR cooler	1	1418926

Vacuum Pump

4.2 AJV8 Supercharged Petrol

VACUUM PUMP ASSEMBLY	1	SQJ500082
BUSH, vacuum pump mounting	2	SYA500010
INSERT, bush	2	SZT500010
HOSE:		
vacuum pump to union	1	LR018331
union to inlet manifold	1	LR018336
union to servo		
RHD	1	SQF500042
LHD	1	LR018335

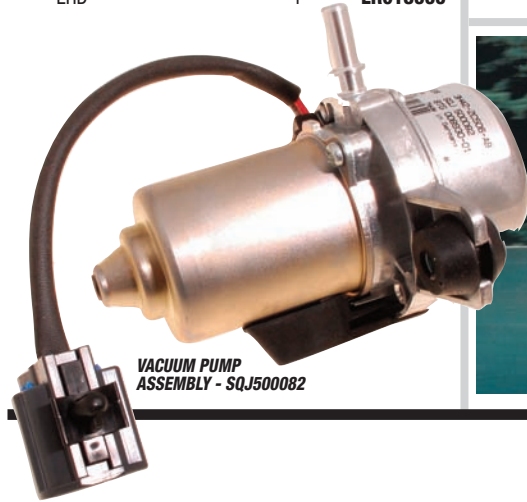

Crankcase Breather

4.2 AJV8 Supercharged Petrol

VALVE, crankcase pressure regulating	1	LR003380
SCREW, valve securing	2	1209812
HOSE ASSEMBLY:		
LH head to valve	1	4663372
valve to inlet manifold	1	4696662



EMISSION CONTROL

4.4 AJV8 PETROL

Vacuum Pump

4.4 AJV8 Petrol

VACUUM PUMP ASSEMBLY	1	SQJ500082
BUSH, vacuum pump mounting	2	SYA500010
INSERT, bush	2	SZT500010
HOSE:		
vacuum pump to union	1	LR018331
union to inlet manifold	1	LR018333
union to servo		
RHD	1	SQF500042
LHD	1	LR018335

Crankcase Breather

4.4 AJV8 Petrol

VALVE, crankcase pressure regulating	1	LR003380
SCREW, valve securing	2	1209812
HOSE ASSEMBLY:		
LH head to valve	1	4585549
valve to inlet manifold	1	LR005991

Exhaust Gas Recirculation

4.4 AJV8 Petrol

VALVE, exhaust gas recirculation	1	4536857
PIPE, exhaust gas recirculation	1	4682990
GASKET:		
EGR valve to inlet manifold	1	4536856
EGR valve to pipe	1	4536854
pipe to exhaust	1	4451180



WE'RE HERE TO HELP
 Can't find or not sure of the right part for your car, contact our technical sales team for help and advice.
01522 568000

2.7 TDV6 DIESEL

EXHAUST

Exhaust Manifolds

2.7 TDV6 Diesel

EXHAUST MANIFOLD:

RH	1	1334641
LH	1	1334640
PIPE, crossover	1	1357035

GASKET:

manifold to head		
Land Rover	2	1336543
OEM	2	1336543P1
manifold to crossover pipe	2	1331259

STUD:

manifold to head	12	1357627
manifold to crossover pipe	6	1357628

NUT, manifold to head and pipe	18	LR004057
--------------------------------	----	----------

BRACKET, exhaust pipe mounting:

centre	1	WCU500130
side		
RH	1	WCU500160
LH	1	WCU500190



GASKET - 1336543

Exhaust System

2.7 TDV6 Diesel with Euro Stage 4 Emissions

Details the exhaust system fitted to meet Euro Stage 4 emissions regulations. Features diesel particulate filter (DPF).

STAINLESS STEEL EXHAUST SYSTEM

STAINLESS STEEL EXHAUST SYSTEM:

'Cat Back' system	1	RA1555
<i>Includes front silencer, intermediate pipes and rear silencers with tail pipes. Does not include downpipe/catalytic converter or diesel particulate filter.</i>		
rear silencers, pair	1	RD1379
<i>Includes rear silencers and tailpipes only.</i>		

MILD STEEL EXHAUST SYSTEM

DOWNPIPE & CATALYTIC CONVERTER:1 WCD502160

DIESEL PARTICULATE FILTER:

Includes sample pipes.

new, outright	1	WAG501000
---------------	---	-----------

SILENCER:

front	1	LR007462
-------	---	----------

rear

standard models		
RH	1	WCI500180
LH	1	WCI500190

models with HST body styling kit

RH	1	LR004849
LH	1	LR004853

TAIL PIPE FINISHER:

Models with HST body styling kit only (square tail pipes).

RH	1	LR004857
LH	1	LR004859

EXHAUST SYSTEM FITTINGS & FIXINGS

SAMPLE PIPE, diesel particulate filter:

Included in diesel particulate filter assembly.

short	1	LR015414
-------	---	----------

long	1	LR016232
------	---	----------

SENSOR, sample pipes	1	LR014310
----------------------	---	----------

OXYGEN SENSOR:

downpipe		
pre-catalyst	1	WDN500130

post-catalyst	1	WDN500110
---------------	---	-----------

post diesel particulate filter	1	WDN500050
--------------------------------	---	-----------

BRACKET:

sensor mounting, RH	1	YQU500610
---------------------	---	-----------

front of front silencer	1	KVU500320
-------------------------	---	-----------

GASKET:

downpipe to engine	1	ESR3737
--------------------	---	---------

particulate filter to front silencer	1	WCM500120
--------------------------------------	---	-----------

NUT, downpipe to engine	3	LR025680
-------------------------	---	----------

CLAMP:

downpipe to particulate filter	1	LR007465
--------------------------------	---	----------

front to rear silencers	2	WCL500020
-------------------------	---	-----------

MOUNTING RUBBER:

downpipe and catalyst	1	WCS000150
-----------------------	---	-----------

front of front silencer	1	WCS500030
-------------------------	---	-----------

rear of front silencer	1	WCS000150
------------------------	---	-----------

rear silencers

Land Rover	2	DBP7104
------------	---	---------

aftermarket	2	DBP7104P
-------------	---	----------

Exhaust System

2.7 TDV6 Diesel with EC2 Emissions

Details the exhaust system fitted to meet EC2 emissions regulations (models without diesel particulate filter).

STAINLESS STEEL EXHAUST SYSTEM

STAINLESS STEEL EXHAUST SYSTEM

rear silencers, pair	1	RD1379
----------------------	---	--------

Includes rear silencers and tailpipes only.

MILD STEEL EXHAUST SYSTEM

DOWNPIPE & CATALYTIC CONVERTER:

up to VIN 6A999999	1	WCD500433
--------------------	---	-----------

VIN 7A000001 to 8A169460	1	WCD501630
--------------------------	---	-----------

VIN 8A169461 on	1	WCD502490
-----------------	---	-----------

SILENCER:

front	1	WCE500190
-------	---	-----------

rear

standard models		
RH	1	WCI500180

LH	1	WCI500190
----	---	-----------

models with HST body styling kit

RH	1	LR004849
----	---	----------

LH	1	LR004853
----	---	----------

TAIL PIPE FINISHER:

Models with HST body styling kit only (square tail pipes).

RH	1	LR004857
----	---	----------

LH	1	LR004859
----	---	----------

EXHAUST SYSTEM FITTINGS & FIXINGS

GASKET, downpipe to engine	1	ESR3737
----------------------------	---	---------

NUT, downpipe to engine	3	LR025680
-------------------------	---	----------

CLAMP, front to rear silencers	2	WCL500020
--------------------------------	---	-----------

MOUNTING RUBBER:

catalyst/rear of front silencer	2	WCS000150
---------------------------------	---	-----------

rear silencers

Land Rover	2	DBP7104
------------	---	---------

aftermarket	2	DBP7104P
-------------	---	----------

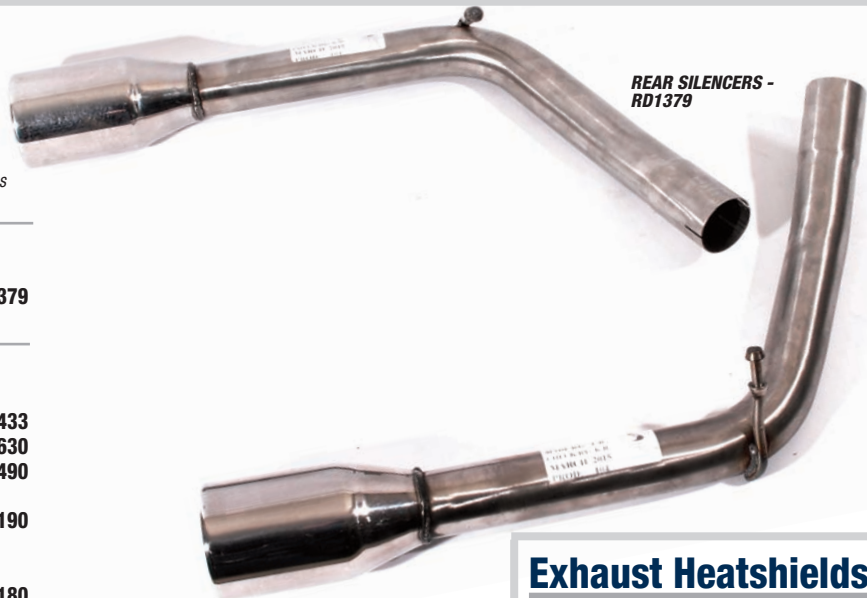

REAR SILENCERS - RD1379



GASKET - ESR3737



MOUNTING RUBBER - DBP7104P

Exhaust Heatshields

2.7 TDV6 Diesel

HEATSHIELD, manifold:

RH		
rear	1	LWQ500050

front		
up to VIN 8A486734	1	LWQ500060

VIN 8A486735 on	1	LR009325
-----------------	---	----------

LH		
rear	1	1387385

front	1	LR002482
-------	---	----------

HEATSHIELD, exhaust system:

front top		
RH	1	WEB500410

LH	1	WEB500421
----	---	-----------

catalytic converter	1	WEB500133
---------------------	---	-----------

intermediate		
upper	1	LR076832

lower		
front	1	LR007463

rear	1	LR007464
------	---	----------

front silencer	1	WEB500012
----------------	---	-----------

rear silencer		
RH	1	WEB500580

LH	1	WEB500590
----	---	-----------

BRACKET, lower intermediate shield	1	LR007466
------------------------------------	---	----------

Exhaust Manifolds

3.6 TDV8 Diesel

EXHAUST MANIFOLD:		
RH	1	LR005685
LH	1	LR005686
GASKET, manifold to head	2	1420910
STUD, manifold to head	16	1357627
NUT, manifold to head	16	LR004057
SPACER, manifold stud	2	1003736

Exhaust System

3.6 TDV8 Diesel with EC2 Emissions

Details the exhaust system fitted to meet EC2 emissions regulations (models without diesel particulate filter).

STAINLESS STEEL EXHAUST SYSTEM

STAINLESS STEEL EXHAUST SYSTEM:		
'Cat Back' system	1	RA1556
<i>Includes front silencer, intermediate pipes and rear silencers with tail pipes. Does not include downpipe/catalytic converter.</i>		
rear silencers, pair	1	RA1556TP
<i>Includes rear silencers and tailpipes only.</i>		

MILD STEEL EXHAUST SYSTEM

DOWNPIPE & CATALYTIC CONVERTER:		
RH	1	LR010319
LH	1	LR010320
SILENCER:		
front	1	LR003899
rear		
standard models		
RH	1	LR003900
LH	1	LR003901
models with HST body styling kit		
RH	1	LR004851
LH	1	LR004855

TAIL PIPE FINISHER:

<i>Models with HST body styling kit only (square tail pipes).</i>		
RH	1	LR004857
LH	1	LR004859

EXHAUST SYSTEM FITTINGS & FIXINGS

GASKET:		
downpipe to manifold	2	WCM500080
RH downpipe to silencer	2	WCM100460
SCREW, downpipe to manifold		
	6	LR000631
NUT, RH downpipe to silencer		
	2	LR025680
CLAMP, front to rear silencers		
	2	WCL500040
MOUNTING RUBBER:		
catalyst/front of front silencer	2	LR005068
rear of front silencer	1	WCS000150
rear silencers		
Land Rover	2	DBP7104
aftermarket	2	DBP7104P

Exhaust System

3.6 TDV8 Diesel with Euro Stage 4 Emissions

Details the exhaust system fitted to meet Euro Stage 4 emissions regulations. Features diesel particulate filter (DPF).

STAINLESS STEEL EXHAUST SYSTEM

STAINLESS STEEL EXHAUST SYSTEM:		
'Cat Back' system	1	RA1557
<i>Includes front silencer, intermediate pipes and rear silencers with tail pipes. Does not include downpipe/catalytic converter or diesel particulate filter.</i>		
rear silencers, pair	1	RA1556TP
<i>Includes rear silencers and tailpipes only.</i>		

MILD STEEL EXHAUST SYSTEM

DOWNPIPE & CATALYTIC CONVERTER:		
RH	1	LR019833
LH	1	WCD502190
DPF & FRONT SILENCER ASS'Y	1	LR009448
<i>Includes diesel particulate filter (DPF), front silencer and intermediate pipes. DPF sample pipes and DPF to exhaust system clamps (3 off).</i>		
SILENCER, rear;		
standard models		
RH	1	LR003900
LH	1	LR003901
models with HST body styling kit		
RH	1	LR004851
LH	1	LR004855

TAIL PIPE FINISHER:

<i>Models with HST body styling kit only (square tail pipes).</i>		
RH	1	LR004857
LH	1	LR004859

EXHAUST SYSTEM FITTINGS & FIXINGS

SENSOR, sample pipes	1	LR014310
OXYGEN SENSOR:		
downpipe		
pre-catalyst	2	WDN500130
post-catalyst	2	WDN500070
post diesel particulate filter	1	WDN500050
BRACKET, sensor mounting, RH	1	YQU500610
GASKET:		
downpipe to engine	2	WCM500080
RH downpipe to particulate filter	1	WCM500130
SCREW, downpipe to manifold		
	6	LR000631
NUT, RH downpipe to particulate filter		
	2	LR025680
CLAMP:		
LH downpipe to particulate filter	1	LR009430
particulate filter to front silencer	2	LR009430
front to rear silencers	2	WCL500040
MOUNTING RUBBER:		
downpipe and particulate filter	1	LR005068
front of front silencer	2	WCS500030
rear of front silencer	1	LR005068
rear silencers		
Land Rover	2	DBP7104
aftermarket	2	DBP7104P

3.6 TDV8 DIESEL

Exhaust Heatshields

3.6 TDV8 Diesel

HEATSHIELD:		
manifold		
RH	1	LWQ500230
LH	1	LWQ500150
exhaust system		
catalytic converter		
RH	1	WEB500123
LH	1	WEB500133
centre (small)	1	KQG500300
intermediate		
upper	1	LR076832
lower		
front	1	LR007463
rear	1	LR007464
front silencer	1	WEB500012
rear silencer		
RH	1	WEB500580
LH	1	WEB500590
BRACKET, lower intermediate shield	1	LR007466

EXHAUST



? **WE'RE HERE TO HELP**
 Can't find or not sure of the right part
 for your car, contact our technical
 sales team for help and advice.
01522 568000

4.2 AJV8 SUPERCHARGED PETROL

EXHAUST

Exhaust Manifolds

4.2 AJV8 Supercharged Petrol

EXHAUST MANIFOLD:

RH	1	4646040
LH	1	4668789
GASKET, manifold to head:		
RH	1	4603138
LH	1	4603139
BOLT, manifold, long	16	4646064
SCREW, manifold, short	2	FS108161
SPACER, long bolt	16	4642648



GASKET - 4603138

Exhaust Heatshields

4.2 AJV8 Supercharged Petrol

HEATSHIELD:

front top		
RH	1	WEB500410
LH	1	WEB500421
centre	1	WEB500123
front catalyst	1	WEB500133
intermediate	1	LR076832
front silencer	1	WEB500012
rear silencer		
RH	1	WEB500580
LH	1	WEB500590



STAINLESS STEEL EXHAUST SYSTEM - RA1468



Exhaust System

4.2 AJV8 Supercharged Petrol

STAINLESS STEEL EXHAUST SYSTEM

STAINLESS STEEL EXHAUST SYSTEM:

'Cat Back' system	1	RA1468
<i>Includes single front silencer, intermediate pipes and rear silencers with tail pipes.</i>		
<i>Does not include downpipes/catalytic converters.</i>		
rear silencers, pair	1	RA1468TP
<i>Includes rear silencers and tailpipes only.</i>		

MILD STEEL EXHAUST SYSTEM

DOWNPIPE & CATALYTIC CONVERTER, exchange:

up to VIN 6A999999		
RH	1	WCD500202
LH	1	WCD500212
VIN 7A000001 on		
RH	1	WCD500442
LH	1	WCD500452
SILENCER:		
front	1	WCE500180
rear		
standard models		
RH	1	WC1500160
LH	1	WC1500170
models with HST body styling kit		
RH	1	LR004848
LH	1	LR004852

TAIL PIPE FINISHER:

Models with HST body styling kit only (square tail pipes).

RH	1	LR004856
LH	1	LR004858

EXHAUST SYSTEM FITTINGS & FIXINGS

OXYGEN SENSOR:

pre-catalyst	2	LR014010
post-catalyst		
RH		
Land Rover	1	LR014012
OEM	1	LR014012P1
LH		
Land Rover	1	LR014011
OEM	1	LR014011P1

BRACKET:

sensor, downpipe		
up to VIN 6A999999	2	YQU500370
VIN 7A000001 on		
RH		
up to VIN 8A131487	1	YSU500150
VIN 8A131488 on	1	YQU500610
LH	1	YSU500140
RH downpipe, assembly	1	YQU500400
BOLT, downpipe to engine	4	WYG500041
GASKET, RH downpipe to silencer	1	WCM100460
NUT, RH downpipe to silencer	2	LR025680
CLAMP, front to rear silencers	2	WCL500040

MOUNTING RUBBER:

silencer pipe		
front and rear	2	WCS000150
centre	1	LR005068
rear silencers		
Land Rover	2	DBP7104
aftermarket	2	DBP7104P



STAINLESS STEEL REAR SILENCERS, PAIR - RA1468TP

MOUNTING RUBBER - WCS000150



GASKET - WCM100460

MOUNTING RUBBER - DBP7104



Exhaust Heatshields

4.4 AJV8 Petrol

HEATSHIELD:

front top		
RH	1	WEB500410
LH	1	WEB500421
centre	1	WEB500123
front catalyst	1	WEB500133
intermediate	1	LR076832
front silencer	1	WEB500012
rear silencer		
RH	1	WEB500580
LH	1	WEB500590

Exhaust Manifolds

4.4 AJV8 Petrol

EXHAUST MANIFOLD:

RH	1	4646040
LH	1	LR003626
GASKET, manifold to head:		
RH	1	4603138
LH	1	4603139
BOLT, manifold, long	16	4646064
SCREW, manifold, short	2	FS108161
SPACER, long bolt	16	4642648

4.4 AJV8 PETROL



GASKET - 4603138

EXHAUST

Exhaust System

4.4 AJV8 Petrol

STAINLESS STEEL EXHAUST SYSTEM

STAINLESS STEEL EXHAUST SYSTEM:

'Cat Back' system 1 **RA1468**

Includes single front silencer, intermediate pipes and rear silencers with tail pipes. Does not include downpipes/catalytic converters.

rear silencers, pair 1 **RA1468TP**
Includes rear silencers and tailpipes only.

MILD STEEL EXHAUST SYSTEM

DOWNPIPE & CATALYTIC CONVERTER, exchange:

up to VIN 6A999999		
RH	1	WCD500442
LH	1	WCD500452
VIN 7A000001 on		
RH	1	WCD500202
LH	1	WCD500212
SILENCER:		
front	1	WCE500170
rear		
standard models		
RH	1	WCI500140
LH	1	WCI500150
models with HST body styling kit		
RH	1	LR004850
LH	1	LR004854

TAIL PIPE FINISHER:

Models with HST body styling kit only (square tail pipes).

RH	1	LR004857
LH	1	LR004859

EXHAUST SYSTEM FITTINGS & FIXINGS

OXYGEN SENSOR:

pre-catalyst	2	LR014010
post-catalyst		
RH		
Land Rover	1	LR014012
OEM	1	LR014012P1
LH		
Land Rover	1	LR014011
OEM	1	LR014011P1

BRACKET:

sensor, downpipe		
up to VIN 6A999999	2	YQU500370
VIN 7A000001 on		
RH		
up to VIN 8A131487	1	YSU500150
VIN 8A131488 on	1	YQU500610
LH	1	YSU500140
RH downpipe, assembly	1	YQU500400
BOLT, downpipe to engine	4	WYG500041
GASKET, RH downpipe to silencer	1	WCM100460
NUT, RH downpipe to silencer	2	LR025680
CLAMP, front to rear silencers	2	WCL500030
MOUNTING RUBBER:		
silencer pipe		
front and rear	2	WCS000150
centre	1	LR005068
rear silencers		
Land Rover	2	DBP7104
aftermarket	2	DBP7104P

MOUNTING RUBBER - WCS000150



GASKET - WCM100460

MOUNTING RUBBER - DBP7104



WE'RE HERE TO HELP
Can't find or not sure of the right part for your car, contact our technical sales team for help and advice.
01522 568000

ORDER

BY PHONE: 01522 568000 / ON LINE: www.rimmerbros.co.uk / E-MAIL: lrsales@rimmerbros.co.uk

ALL MODELS

Automatic Gearbox Torque Converter

TORQUE CONVERTER ASSEMBLY, new, exchange:

2.7 TDV6 diesel	1	LR008767
3.6 TDV8 diesel	1	TQB500210
4.2 AJV8 supercharged petrol	1	TQB500080
4.4 AJV8 petrol	1	TQB500060

Automatic Gearbox & Components

GEARBOX ASSEMBLY:

2.7 TDV6 diesel		
new, exchange		
to VIN 8A147137	1	TGD500570
VIN 8A147138 on	1	TGD500670
reconditioned, exchange	1	TGD500570E
3.6 TDV8 diesel		
new, exchange		
to VIN 8A141506	1	TGD500402
VIN 8A141507 on	1	TGD500650
reconditioned, exchange	1	LR008894
4.2 AJV8 supercharged petrol		
new, exchange	1	TGD500600
reconditioned, exchange		
to VIN 6A943529	1	TGD500471E
VIN 6A943530 on	1	TGD500600E
4.4 AJV8 petrol		
new, exchange	1	TGD500560
reconditioned, exchange		
to VIN 6A943529	1	TGD500431E
VIN 6A943530 on	1	TGD500560E

TUBE ASSEMBLY, breather:

2.7 TDV6 diesel	1	TES500030
3.6 TDV8 diesel	1	TGT500050
<i>Assembly includes transfer box breather tube.</i>		
all petrol models		
to VIN 8A999999	1	TES500020
VIN 9A000001 on	1	TES500040

EASY FIT OIL SUMP, GASKET & FILTER

Replacing the plastic oil sump/filter assembly as part of an auto box oil and filter change has, until now, been a time consuming and expensive process. Obtaining the necessary clearance to remove and refit the sump/filter has involved removal of the transmission mountings and crossmember, plus the exhaust. It doesn't have to be that way any longer!

The easy fit conversion kit includes a new, metal sump that's easy to slide out of and back into position with the crossmember and exhaust still in place, allowing simple replacement of the new separate filter. Removal of the old plastic sump/filter before fitting the conversion parts is just as easy: unbolt it from the transmission and because it's not required for refitting the filter tube can be cut or broken so that the whole thing can be easily extracted in a couple of pieces, again without removal of the crossmember.

The easy fit filter and sump gasket are of course available separately when the time comes for future oil and filter changes.

OIL SUMP CONVERSION KIT, gearbox, easy fit:

<i>Includes metal sump, separate oil filter, gasket and 'O' ring.</i>		
OEM	1	LR007474BPKITEF0EM
Britpart	1	LR007474BPKITEF
OIL FILTER, easy fit oil sump:		
OEM	1	LR007474EFOEM
Britpart	1	LR007474BPEF
GASKET, easy fit oil sump	1	LR007474BPKITEFG



OIL SUMP CONVERSION KIT - LR007474BPKITEF

Automatic Gearchange

GEAR LEVER & SELECTOR ASS'Y	1	LR021517
<i>Does not include gear knob assembly.</i>		
SELECTOR CABLE ASS'Y	1	UCV500070
CLIP, cable to gear lever and selector	1	UYC500030
BRACKET, cable abutment, gearbox end:		
all models except 3.6 TDV8 diesel	1	UCU500011
3.6 TDV8 diesel only	1	UCU500070
LEVER, gearbox selector shaft	1	LR012704
BOLT, cable to lever	1	TYG000050
BUSH, selector shaft lever	1	TZT500040
SPACER, selector shaft lever bush	1	TYF000060
NUT:		
cable to lever bolt	1	WYH000040
lever pivot	1	VYH500020

GEAR BOX OIL SUMP - LR007474



STANDARD OIL SUMP, GASKET & FILTER

OIL SUMP, gearbox, standard:

Includes original style plastic sump/filter, gasket and O ring.

Land Rover	1	LR007474
OEM	1	LR007474P1
aftermarket	1	LR007474P
OIL FILTER, standard oil sump	1	LR007474PF
GASKET, standard oil sump	1	TGK500010
AUTO GEARBOX FLUID CHANGE KIT	1	LR007474BPKIT

Includes essential items for fluid change on the 6 speed automatic gearbox (ZF models 6HP26 and 6HP28) - auto trans fluid, standard sump assembly with sleeve and plugs, sump attachment screws.



AUTO GEARBOX FLUID CHANGE KIT - LR007474BPKIT

PLUG:

oil sump drain	1	TYB500020
oil level check	1	LR007610
parking pawl		
up to VIN 8A146088	1	TYB500050
VIN 8A146089 on	1	LR007608
GUARD, oil sump	1	LR013913

All models except 2.7 TDV6 diesel.

BRACKET, sump guard:

<i>All models except 2.7 TDV6 diesel.</i>		
to VIN 8A144114	1	TGU500011
VIN 8A144115 on	1	TGU500050
SCREW, sump guard to bracket	4	SDG500020

All models except 2.7 TDV6 diesel.

CAPACITOR, suppression, gearbox	1	LR020488
PIN, selector shaft fastener	1	TYT500010
GROMMET, bell housing drain	1	LR008866

SEAL:

input (oil pump)		
Land Rover	1	TZB500030
OEM	1	TZB500030P1
output	1	TZB500010
selector shaft	1	LR023293

O RING:

oil sump	1	TYX500010
oil pump and housing		
large	1	TYX500020
small	1	TYX500030

SCREW, oil pump housing to gearbox	13	TYP500070
WASHER, oil pump housing screw	13	TYF500030



OUTPUT FLANGE KIT - IEA500031

Transfer Gearbox & Components

TRANSFER GEARBOX ASSEMBLY:

new		
Land Rover, exchange	1	LR049160
OEM, outright	1	LR049160P1
OEM, chain only	1	LR049160CP1
reconditioned, exchange	1	LR008206

TUBE, breather:

2.7 TDV6 diesel	1	TRG500170
3.6 TDV8 diesel	1	TGT500050
<i>Assembly includes gearbox breather tube.</i>		
all petrol models	1	TRG500150

O RING, with applicator

1 **IYX500050**

SEAL, input shaft:

Land Rover

1 **IZB500030**

aftermarket

1 **IZB500030P**

RING:

front output shaft seal

Land Rover

1 **IZB500040**

OEM

1 **IZB500040P1**

rear output shaft seal

Land Rover

1 **IZB500050**

OEM

1 **IZB500050P1**

OUTPUT FLANGE KIT:

Includes flange, seal, seal ring and O ring.

front

1 **IEA500031**

rear

1 **LR039528**

DAMPER, transfer gearbox vibration

1 **IAI500100**

VIN 7A000001 on.

BOLT, vibration damper

1 **IYP500080**

VIN 7A000001 on.

PLUG, gearbox fill and drain:

Land Rover

2 **IYB500020**

OEM

2 **IYB500020P1**

WASHER, sealing plug

2 **IYF500030**

CONTROL MODULE, transfer shift:

Land Rover

1 **NNW512070**

OEM

1 **NNW512070P1**

MOTOR, transfer box shift, with seals

Land Rover

1 **IGH500040**

OEM

1 **IGH500040P1**

SOLENOID, pressure

1 **IGF500011**

SENSOR, trip/indicator mode indicator

1 **IAB500191**

SCREW:

transfer gearbox assembly

12 **TYP000190**

transfer box to gearbox

8 **FT110356**

VALVE & CONTROL UNIT:

2.7 TDV6 diesel

up to VIN 6A944547

1 **THC500012**

VIN 6A944548 to 7A999999

1 **THC500061**

VIN 8A000001 on

1 **THC500090**

3.6 TDV8 diesel

up to VIN 7A999999

1 **THC500061**

VIN 8A000001 on

1 **THC500090**

4.2 AJV8 supercharged petrol

1 **THC500061**

4.4 AJV8 petrol

up to VIN 6A944547

1 **THC500012**

VIN 6A944548 on

1 **THC500061**

ADAPTOR, control unit front

1 **TGW500010**

SLEEVE, control unit rear

1 **TZV500010**

SCREW, control unit:

long

7 **TYP500060**

short

3 **TYP500150**

BOLT, gearbox to engine

14 **FB110087**

Front Propshaft

PROPSHAFT ASSEMBLY, new

Land Rover	1	TVB500510
OEM	1	TVB500510P1
BOLT, propshaft to gearbox and axle	12	TYG500141
LOCK TAB, bolt	6	TYF500010



FRONT PROPSHAFT ASSEMBLY - TVB500510P1

Rear Propshaft

PROPSHAFT ASSEMBLY, new

Land Rover	1	LR037028
OEM	1	LR037028P1
CENTRE BEARING ASS'Y, propshaft	1	LR037027BPBRG
BOLT:		
propshaft to gearbox (M10)	6	TYP500180
propshaft to rear axle (M12)	4	TYG500130
LOCK TAB, propshaft to gearbox bolts	3	TYF500020
SCREW, centre bearing mounting	2	BYP100190



REAR PROPSHAFT ASSEMBLY - LR037028

PROPSHAFT CENTRE BEARING ASSEMBLY - LR037027BPBRG

ALL MODELS

PROPSHAFT



WE'RE HERE TO HELP
 Can't find or not sure of the right part for your car, contact our technical sales team for help and advice.
01522 568000

ALL MODELS

FRONT AXLE & HUBS

Front Differential

FRONT DIFFERENTIAL ASSEMBLY:

Less support casing and support bracket. Also order breather tube part number LR028144 or TAP500140 (see below for details) when purchasing a new differential.

2.7 TDV6 & 3.6 TDV8 diesel models		
new, exchange	1	LR056944
reconditioned, exchange	1	LR006011
4.2 AJV8 supercharged petrol models		
new, exchange	1	LR056944
reconditioned, exchange	1	LR006011
4.4 AJV8 petrol models		
new, exchange	1	LR055677
reconditioned, exchange	1	LR009478

Front Drive Shafts

DRIVE SHAFT COMPLETE ASSEMBLY:

Includes outer shaft and C.V. joint.

Must be used with lock nut LR024151.

all models except 2.7 TDV6 diesel		
RH		
Land Rover	1	LR071930
OEM	1	LR071930P1
LH		
Land Rover	1	LR072067
OEM	1	LR072067P1
2.7 TDV6 diesel models only		
RH		
Land Rover	1	LR072070
OEM	1	LR072070P1
LH		
Land Rover	1	LR072069
OEM	1	LR072069P1

DRIVE SHAFT OUTER ASSEMBLY:

Includes C.V. joint.

all models except 2.7 TDV6 diesel		
RH		
	1	LR025872
LH		
	1	LR025874
2.7 TDV6 diesel models only		
RH		
	1	LR025869
LH		
	1	LR025873

C.V. JOINT ASSEMBLY:

all models except 2.7 TDV6 diesel		
Land Rover		
	2	LR060383
OEM		
	2	LR060383P1
aftermarket		
	2	LR060383P
2.7 TDV6 diesel models only		
Land Rover		
	2	LR060382
OEM		
	2	LR060382P1
aftermarket		
	2	LR060382P

DRIVE SHAFT BOOT KIT - TDR500110P1



BOOT KIT, drive shaft:

Includes inner and outer boots plus boot clips and driveshaft circlips (snap rings) for one drive shaft.

all models except 2.7 TDV6 diesel		
Land Rover		
	2	TDR500110
OEM		
	2	TDR500110P1
2.7 TDV6 diesel models only		
Land Rover		
	2	TDR500100
OEM		
	2	TDR500100P1

CIRCLIP (SNAP RING), drive shaft:

inner end		
	2	TDL500030
outer end		
all except 2.7 TDV6 diesel		
	2	TDL500060
2.7 TDV6 diesel models only		
	2	TDL500050

VALVE, differential breather	1	LR019450
TUBE, differential breather:		
<i>Required when refitting axle.</i>		
all models except 3.6 TDV8 diesel		
	1	LR028144
3.6 TDV8 diesel models only		
	1	TAP500140
SUPPORT TUBE, drive shaft		
<i>Includes seal and O ring.</i>		
	1	TAU500080
BRACKET, front differential		
	1	TAU500070
PLUG:		
oil filler		
	1	TYB500060
oil drain		
	1	TYB500080
SEAL:		
input flange		
Land Rover		
	1	LR019019
OEM		
	1	LR019019P1
drive shaft		
Land Rover		
	2	TZB500050
OEM		
	2	TZB500050P1

O RING, drive shaft support tube	1	TYX500040
BUSH:		
differential housing mounting	1	KQB500151
support tube mounting	1	KQB000152
differential bracket mounting	1	KQB000133
BOLT:		
diff. housing mounting bush		
to VIN 6A351725		
	2	FC114206
VIN 6A351726 to 7A434360		
	2	KYG500330
VIN 7A434361 on		
	2	FC114206
support tube mounting bush		
	1	KYG000230
diff. bracket mounting bush		
	1	KYG000240
SCREW:		
support tube to diff. housing		
	4	TYP500100
diff. bracket to diff. housing		
	3	TYP500090
NUT, support tube mounting bush		
	1	FY110056

Front Hub & Swivel Housing (Knuckle)

SWIVEL HOUSING (KNUCKLE):

RH	1	RUB500320
LH	1	RUB500330

SWIVEL HOUSING (KNUCKLE)

Important note concerning Range Rover Sport models up to VIN 9A191791:

The swivels listed here take M14 size track rod ends and are the original fitment for vehicles from VIN 9A191792 onwards. Vehicles prior to this VIN originally had swivels taking M12 size track rod ends on different track rods - these earlier swivels are not available. On vehicles up to VIN 9A191792 the swivels may be replaced as a pair, so long as 2 off part number LR010673 track rod kits are also fitted.

Please refer to the Steering Rack section for further details of track rods and track rod ends.

BALL JOINT ASSEMBLY, swivel housing:

Includes circlip and nut.

upper		
Land Rover		
	2	RBK500170
OEM		
	2	RBK500170P1
aftermarket		
	2	RBK500170P
lower, 35mm dia. fixing in lower arm		
<i>Original fitment for vehicles from VIN 9A199377 onwards.</i>		
Land Rover		
	2	RBK500300
OEM		
	2	RBK500300P1
aftermarket		
	2	RBK500300P

LOWER BALL JOINTS

Important note concerning Range Rover Sport models up to VIN 9A199376:

The lower ball joints listed here fit into lower arms with 35mm ball joint holes and are the original fitment for vehicles from VIN 9A199377 onwards. Vehicles prior to this VIN originally had different lower arms taking a different diameter ball joint - this earlier ball joint is not available. To replace a lower ball joint on a vehicle prior to VIN 9A199377, first measure the ball joint diameter. One of two actions should then be followed:

If the ball joint present is not 35mm, you will need to replace both the ball joint and lower arm, available together as a lower arm assembly - please refer to the front suspension section for details of the correct lower arm specification for your vehicle. If the ball joint present is 35mm, the lower arm has already been replaced with the later type and you can order one of the 35mm ball joints listed above.

NUT, ball joint to swivel housing:

upper joint	2	FY112056
lower joint	2	FX116056

FRONT HUB & BEARING ASSEMBLY:

Includes hub to C.V. joint nut.

Land Rover		
	2	LR048083
OEM		
	2	LR048083P1
aftermarket		
	2	LR048083P
BOLT, front hub to swivel housing		
	8	FC112146
NUT, front hub to C.V. joint		
	2	RFD500020



SWIVEL HOUSING (KNUCKLE)- RUB500320



UPPER BALL JOINT ASSEMBLY - RBK500170



LOWERBALL JOINT ASSEMBLY - RBK500300P1

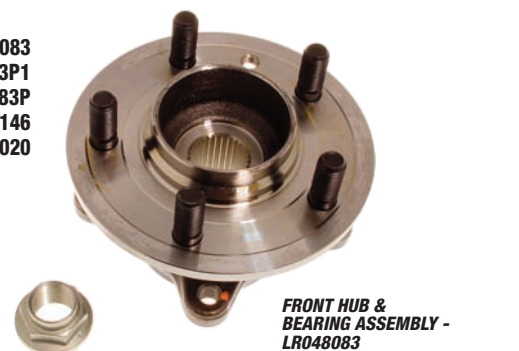

FRONT HUB & BEARING ASSEMBLY - LR048083



WE'RE HERE TO HELP

Can't find or not sure of the right part for your car, contact our technical sales team for help and advice.

01522 568000

Rear Differential

REAR DIFFERENTIAL ASSEMBLY:

2.7 TDV6 & 3.6 TDV8 diesel models		
without locking differential		
new, exchange		
Land Rover	1	TVK500240
OEM	1	TVK500240P1
reconditioned, exchange	1	LR09439
with locking differential		
<i>Includes differential locking motor.</i>		
<i>Models with locking differential contact us for details.</i>		
4.2 AVJ8 supercharged petrol models		
without locking differential		
new, exchange	1	TVK500240
reconditioned, exchange	1	LR09439
with locking differential		
<i>Includes differential locking motor.</i>		
<i>Models with locking differential contact us for details.</i>		
4.4 AVJ8 petrol models		
without locking differential		
new, exchange		
Land Rover	1	TVK500260
OEM	1	TVK500260P1
with locking differential		
<i>Includes differential locking motor.</i>		
<i>Models with locking differential contact us for details.</i>		

DIFFERENTIAL LOCKING MOTOR ASS'Y:

Models with rear axle locking; included in rear differential assembly.
Motor with housing and motor without housing include O ring and motor fixings.

complete ass'y, motor with housing		
reconditioned, exchange	1	LR011036
motor without housing		
new, exchange	1	LR032711
housing without motor, new	1	LR041063
TUBE, differential breather	1	LR077753
PLUG:		
oil filler	1	TYB500060
oil drain	1	FTC5431
SEAL:		
input flange	1	TZB500100
drive shaft		
Land Rover	2	TZB500050
OEM	2	TZB500050P1
BUSH, differential mounting:		
front	1	KQB000133
rear	2	KQB500151
BOLT, differential mounting bush:		
front bush	1	KYG000240
rear bush	2	KYG500020
NUT, differential rear mounting bush	2	FY114056
SCREW, motor housing to differential	4	TYP500130
<i>Models with rear axle locking.</i>		

ALL MODELS

Rear Differential Control Unit & Sensor

CONTROL UNIT, locking differential	1	LR020123
<i>Models with rear axle locking.</i>		
SENSOR, differential temperature	1	NSC500590
<i>Models with rear axle locking.</i>		

Rear Hub & Knuckle

REAR KNUCKLE:

Includes upper and lower bushes.

models with 17" or 18" wheels		
<i>Brake disc sizes 320mm front/325mm rear, or 340mm front/350mm rear.</i>		
RH	1	LR045822
LH	1	LR045823
models with 19" wheels		
<i>Brake disc sizes 360mm front/350mm rear.</i>		
RH	1	LR045824
LH	1	LR045825
BUSH, rear knuckle:		
upper		
Land Rover	2	RHF500100
OEM	2	RHF500100P1
aftermarket	2	RHF500100P
lower		
Land Rover	2	LR032644
aftermarket	2	LR032644P
CIRCLIP, lower bush to knuckle	2	RYV000010
BOLT, bush to suspension arm:		
upper bush	2	RYG000384
lower bush	2	FC116216
NUT, bush to suspension arm:		
upper bush	2	RYH500191
lower bush	2	FX116056
WASHER, upper bush to arm	2	RYF000182
REAR HUB ASSEMBLY:		
<i>Does not include hub bearing.</i>		
Land Rover	2	RUC500120
aftermarket	2	RUC500120P
BEARING KIT, hub:		
<i>Includes bearing, circlip and hub nut for one hub.</i>		
Land Rover	2	LR045917
OEM	2	LR045917P1
aftermarket	2	LR045917P
CIRCLIP, hub bearing	2	RLG000010
NUT, rear hub to C.V. joint	2	RFD500020

DRIVE SHAFT COMPLETE ASSEMBLY - LR047285



Rear Drive Shafts

DRIVE SHAFT COMPLETE ASSEMBLY:

Includes C.V. joint.
Must be used with lock nut LR024151.

RH		
without rear axle locking	1	LR071933
with rear axle locking		
<i>LR047285 is a later specification drive shaft and must be fitted with 1 off part number LR024151 nut & washer.</i>		
Land Rover	1	LR047285
OEM	1	LR047285P1
LH	1	LR072065
C.V. JOINT ASSEMBLY:		
without rear axle locking		
Land Rover	2	LR060384
OEM	2	LR060384P1
aftermarket	2	LR060384P
with rear axle locking		
Land Rover	2	LR060385
OEM	2	LR060385P1
aftermarket	2	LR060385P

BOOT KIT, drive shaft:

Includes inner and outer boots plus boot clips and driveshaft circlips (snap rings) for one drive shaft.

without rear axle locking		
Land Rover	2	TDR500070
OEM	2	TDR500070P1
with rear axle locking		
Land Rover	2	TDR500080
OEM	2	TDR500080P1
CIRCLIP (SNAP RING), drive shaft:		
inner end		
	2	TDL500040
outer end		
without rear axle locking	2	TDL500060
with rear axle locking	2	TDL500070

DRIVE SHAFT BOOT KIT - TDR500070P1



REAR KNUCKLE BUSH - LR032644



HUB BEARING KIT - LR045917P1



ORDER

BY PHONE: 01522 568000 / ON LINE: www.rimmerbros.co.uk / E-MAIL: lrsales@rimmerbros.co.uk

ALL MODELS

FRONT SUSPENSION

important note

ROLL STABILITY CONTROL

Some models of Range Rover Sport feature variable rate anti roll bars to combat undesirable body roll when the vehicle is driven in a more sporting manner. Electronically controlled by high pressure hydraulics, the system is known as **Roll Stability Control** or **Active Cornering Enhancement (ACE)**.

Roll Stability Control is fitted as standard on 3.6 TDV8 diesel models and is a very popular option on 4.2 AJV8 supercharged and 4.4 AJV8 petrol models; it is also found on some 2.7 TDV6 diesels.

The pump, reservoir, valve block and other control equipment associated with the system may be found in the 'Roll Stability Control System' section, while the specially modified anti roll bars, air springs and other suspension parts are listed here and in the Rear Suspension Section.



FRONT STRUT & AIR SPRING ASSEMBLY - LR041108P1

Front Shock Absorber & Spring

STRUT & AIR SPRING ASSEMBLY, front:

Includes air spring, shock absorber and spring housing nuts.

models without roll stability control

Land Rover	2	LR041108
OEM	2	LR041108P1

models with roll stability control

all models except 3.6 TDV8 diesel

Land Rover	2	LR016415
OEM	2	LR016415P1

3.6 TDV8 diesel models only

Land Rover	2	LR016416
OEM	2	LR016416P1



FRONT SHOCK ABSORBER - LR016426BILSTEIN

SHOCK ABSORBER, front:

Includes strut seal kit and lower bush.

models without roll stability control

Land Rover	2	LR016426
Bilstein	2	LR016426BILSTEIN

models with roll stability control

all models except 3.6 TDV8 diesel

Land Rover	2	LR016427
------------	---	-----------------

3.6 TDV8 diesel models only

Land Rover	2	LR016428
------------	---	-----------------

AIR SPRING, front:

Includes strut seal kit.

All models except 3.6 TDV8 diesel

Land Rover	2	LR016403
OEM	2	LR016403P1

3.6 TDV8 diesel models only

Land Rover	2	LR058043
------------	---	-----------------

STRUT SEAL KIT

Includes strut seals and shock absorber upper mounting nut for one strut.

STRUT BOOT KIT:

Includes boots and boot clips for one strut.

Land Rover	2	RBG500010
aftermarket	2	RBG500010P

BUFFER, spring assisting

	2	RPC500080
--	---	------------------

WASHER:

plate, buffer		
all except 3.6 TDV8 diesel	2	RNS000041
3.6 TDV8 diesel only	2	RNS500040

shock absorber top locking	2	RNS500010
----------------------------	---	------------------

SCREW, lower shock mounting

	2	RYG000440
--	---	------------------

NUT:

shock mounting		
upper	2	FY114047
lower	2	FX116056
spring housing to subframe	6	FY110056

Front Upper Arm & Ball Joint

UPPER ARM ASSEMBLY:

Includes bushes and ball joint.

RH		
Land Rover	1	LR051617
aftermarket	1	LR051617P

LH		
Land Rover	1	LR051618
aftermarket	1	LR051618P

BUSH, upper arm:		
Land Rover	4	LR051625
OEM	4	LR051625P1

BALL JOINT ASS'Y, upper arm:

Includes circlip and nut.

Land Rover	2	RBK500170
OEM	2	RBK500170P1
aftermarket	2	RBK500170P

BOLT, upper arm bush	4	RYG000420
----------------------	---	------------------

NUT:		
upper arm bush	4	FY114056
upper arm ball joint	2	FY112056



LOWER ARM ASSEMBLY, RH - LR029304P

Front Lower Arm & Ball Joint

LOWER ARM ASSEMBLY:

Includes bushes and 35mm dia. ball joint. Original fitment for vehicles from VIN 9A199377 onwards (all models except 3.6 TDV8 diesel) and 9A199405 onwards (3.6 TDV8 diesel only) - please refer to note under ball joints.

RH		
all models except 3.6 TDV8 diesel		
Land Rover	1	LR029304
OEM	1	LR029304P1
aftermarket	1	LR029304P

3.6 TDV8 diesel models only		
Land Rover	1	LR029303
aftermarket	1	LR029303P
OEM	1	LR029303P1

LH		
all models except 3.6 TDV8 diesel		
Land Rover	1	LR029306
OEM	1	LR029306P1
aftermarket	1	LR029306P

3.6 TDV8 diesel models only		
Land Rover	1	LR029305
aftermarket	1	LR029305P
OEM	1	LR029305P1

BUSH, lower arm		
front		
Land Rover	2	RBX500432
aftermarket	2	RBX500432P

rear		
Land Rover	2	LR05291
OEM	2	LR05291P1
aftermarket	2	LR05291P

WASHER, lower arm bush:		
inner (offset hole)	4	RYF000203
outer (concentric hole)	4	WA116106

NUT:		
lower arm bush	4	FX116056
lower arm ball joint	2	FX116056

WASHER, lower arm bush:		
inner (offset hole)	4	RYF000203
outer (concentric hole)	4	WA116106

BOLT, lower arm bush	4	RDIO00034
----------------------	---	------------------

NUT:		
lower arm bush	4	FX116056
lower arm ball joint	2	FX116056

WASHER, lower arm bush:		
inner (offset hole)	4	RYF000203
outer (concentric hole)	4	WA116106



ANTI ROLL BAR LINK ASSEMBLY - RBM500150

Front Anti Roll Bar

ANTI ROLL BAR:

Includes mounting bushes and clamps.

without roll stability control	1	LR017423
with roll stability control		
up to VIN 6A999999	1	LR032958
VIN 7A000001 on	1	LR032959

BUSH, anti roll bar mounting:		
without roll stability control		
Land Rover	2	LR018347
aftermarket	2	LR018347P

with roll stability control		
Land Rover, each	2	RVU500011
aftermarket, each	2	RVU500011P
polyurethane, pair	1	RVU500011POLYBUSH

CLAMP, anti roll bar mounting bush:		
without roll stability control	2	RBU500100
with roll stability control	2	LR031369

FIXING, anti roll bar mounting bush clamp:		
without roll stability control		
bolt (top RH position)	1	RYP501080
nut (other 3 positions)	3	FX112056

with roll stability control		
screw (front & back, short)	4	RYP501120
screw (centre, long)	2	RYP501110

LINK ASSEMBLY, anti roll bar:		
RH		
Land Rover	1	RBM500140
aftermarket	1	RBM500140P

LH		
Land Rover	1	RBM500150
aftermarket	1	RBM500150P

NUT, link to A/R bar and upper arm	4	FY114056
------------------------------------	---	-----------------

WASHER, link nut	4	RYF500120
------------------	---	------------------



RVU500011

RVU500011POLY

important note

Important note concerning Range Rover Sport models up to VIN 9A199376 (all models except 3.6 TDV8 diesel) and 9A199404 (3.6 TDV8 diesel only):

The lower ball joints listed here fit into lower arms with 35mm ball joint holes and are the original fitment for vehicles from VIN 9A199377 onwards (all models except 3.6 TDV8 diesel) and 9A199405 onwards (3.6 TDV8 diesel only). Vehicles prior to these VINs originally had different lower arms taking a different diameter ball joint - this earlier ball joint is not available. To replace a lower ball joint on a vehicle prior to VIN 9A199377/9A199405, first measure the ball joint diameter. One of two actions should then be followed:

If the ball joint present is not 35mm, you will need to replace both the ball joint and lower arm, available together as a lower arm assembly - please refer to the list above to choose the correct specification lower arm for your vehicle.

If the ball joint present is 35mm, the lower arm has already been replaced with the later type and you can order one of the 35mm ball joints listed above.

BALL JOINT ASS'Y, lower arm to knuckle, 35mm dia.:

Original fitment for vehicles from VIN 9A199377 onwards (all models except 3.6 TDV8 diesel) and 9A199405 onwards (3.6 TDV8 diesel only).

Land Rover	2	RBK500300
OEM	2	RBK500300P1
aftermarket	2	RBK500300P

BOLT, lower arm bush	4	RDIO00034
----------------------	---	------------------

NUT:		
lower arm bush	4	FX116056
lower arm ball joint	2	FX116056

WASHER, lower arm bush:		
inner (offset hole)	4	RYF000203
outer (concentric hole)	4	WA116106



BALL JOINT ASSEMBLY - RBK500300

important note

ROLL STABILITY CONTROL

Some models of Range Rover Sport feature variable rate anti roll bars to combat undesirable body roll when the vehicle is driven in a more sporting manner. Electronically controlled by high pressure hydraulics, the system is known as Roll Stability Control or Active Cornering Enhancement (ACE).

Roll Stability Control is fitted as standard on 3.6 TDV8 diesel models and is a very popular option on 4.2 AJV8 supercharged and 4.4 AJV8 petrol models; it is also found on some 2.7 TDV6 diesels.

The pump, reservoir, valve block and other control equipment associated with the system may be found in the 'Roll Stability Control System' section, while the specially modified anti roll bars, air springs and other suspension parts are listed here and in the Rear Suspension Section.

Rear Upper Arm

UPPER ARM ASSEMBLY:

Includes inner bushes; does not include outer (knuckle) bush.

RH		
Land Rover	1	LR010526
OEM	1	LR010526P1
LH		
Land Rover	1	LR010527
OEM	1	LR010527P1
BUSH, upper arm		
inner front		
Land Rover	2	LR063744
aftermarket	2	LR063744P
inner rear		
Land Rover	2	RHF500130
OEM	2	RHF500130P1
outer (to knuckle)		
Land Rover	2	RHF500100
OEM	2	RHF500100P1
aftermarket	2	RHF500100P
BOLT, upper arm bush:		
inner front	2	FC114206
inner rear	2	FC116216
outer (to knuckle)	2	RYG000384
NUT, upper arm bush:		
inner front	2	RYH500280
inner rear	2	RYH501060
outer (to knuckle)	2	RYH500191
WASHER, upper arm outer bush	2	RYF000182

Rear Lower Arm

LOWER ARM ASSEMBLY:

Includes inner bushes; does not include outer (knuckle) bush.

RH	1	LR019977
LH	1	LR019978
BUSH, lower arm:		
inner front	2	LR064022
inner rear		
Land Rover, each	2	LR054831
OEM, each	2	LR054831P1
Poly Bush, pair	1	LR054831POLY
outer (to knuckle)		
Land Rover	2	LR032644
aftermarket	2	LR032644P
BOLT, lower arm bush:		
inner front	4	KYG000240
inner rear	4	KYG500270
outer (to knuckle)	2	FC116216
NUT, lower arm bush:		
inner front	2	FX116056
inner rear	2	RYH500052
outer (to knuckle)	2	FX116056
CIRCLIP, outer bush to knuckle	2	RYV000010

CIRCLIP - RYV000010



LOWER ARM BUSH - LR032644

Rear Shock Absorber & Spring

STRUT & AIR SPRING ASSEMBLY, rear:

Includes air spring, shock absorber and spring housing nuts.

models without roll stability control		
Land Rover	2	LR041110
OEM	2	LR041110P1
models with roll stability control		
all models except 3.6 TDV8 diesel		
Land Rover	2	LR016419
OEM	2	LR016419P1
3.6 TDV8 diesel models only		
Land Rover	2	LR016420
OEM	2	LR016420P1
SHOCK ABSORBER, rear:		
<i>Includes strut seal kit and lower bush.</i>		
models without roll stability control		
Land Rover	2	LR016423
Bilstein	2	2LR016423BILSTEIN
models with roll stability control		
all models except 3.6 TDV8 diesel		
Land Rover	2	LR016424
OEM	2	LR016424P1
3.6 TDV8 diesel models only		
Land Rover	2	LR016425
OEM	2	LR016425P1

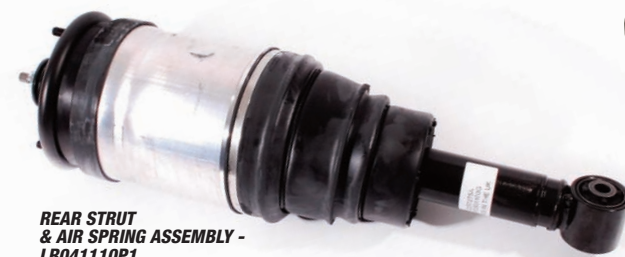

REAR STRUT & AIR SPRING ASSEMBLY - LR041110P1

ALL MODELS

REAR SUSPENSION

REAR SHOCK ABSORBER - LR016423BILSTEIN

AIR SPRING, rear

Air suspension models without B6 level armouring only. Includes strut seal kit.

Land Rover	2	LR016411
OEM	2	LR016411P1
STRUT SEAL KIT	2	LR016412
<i>Includes strut seals and shock absorber upper mounting nut for one strut.</i>		
STRUT BOOT KIT	2	RPM500200
<i>Includes boots and boot clips for one strut.</i>		
BUFFER, spring assisting	2	RPC500030
WASHER:		
plate, buffer	2	RNS000041
shock absorber top locking	2	RNS500010
SCREW, lower shock mounting	2	RYG000461

NUT:

shock mounting		
upper	2	FY114047
lower	2	FX116056
spring housing to subframe	6	FY110056



STRUT SEAL KIT - LR016412

Rear Anti Roll Bar

ANTI ROLL BAR:

Includes mounting bushes and clamps.

without roll stability control	1	RGB500100
with roll stability control		
all models except 3.6 TDV8 diesel		
Land Rover	1	LR024073
OEM	1	LR024073P1
3.6 TDV8 diesel models only		
Land Rover	1	LR024072
OEM	1	LR024072P1
BUSH, anti roll bar mounting:		
without roll stability control		
Land Rover	2	LR018354
aftermarket	2	LR018354P
polyurethane	2	LR018354POLY
with roll stability control		
Land Rover	2	RVU000022
OEM	2	RVU000022P1
CLAMP, anti roll bar mounting bush	2	RB0000281
BOLT, mounting clamp	4	FT110206
LINK ASSEMBLY, anti roll bar:		
without roll stability control		
Land Rover	2	RGD000312
aftermarket	2	RGD000312P
with roll stability control	2	RGD500140
CONNECTING ROD, toe link		
Land Rover	2	LR019117
OEM	2	LR019117P1
aftermarket	2	LR019117P
SCREW, toe link connecting rod	2	RYG501580
NUT:		
anti roll bar link	4	FY112056
toe link connecting rod	2	RYH500116



ANTI ROLL BAR MOUNTING BUSH - LR018354



ANTI ROLL BAR CLAMP - RB0000281



SPRING ASSISTING BUFFER - RPC500030



TOE LINK CONNECTING ROD - LR019117

ALL MODELS

AIR SUSPENSION SYSTEM

important note

AIR COMPRESSOR ASSEMBLIES

Important note: There are three different designs of compressor assembly, Hitachi, early type AMK and late type AMK, of which only the AMK units (early and late, successively) were available for some years. Originally 2005-2009 Range Rover Sports were fitted with the Hitachi unit.

If at some point in its history your Range Rover Sport has required a new compressor, it may have been fitted with the early type AMK unit or (possible, but unlikely) the late type AMK unit because of non-availability of the original Hitachi unit. This will have involved some modifications to the vehicle.

More recently, a Hitachi-type compressor has been reintroduced to the market, manufactured by Dunlop. This has once again made possible the like-for-like replacement of an air compressor, so long as the old unit on your vehicle is of the Hitachi type and the vehicle has not been modified to accept an AMK unit.

To order a compressor or replacement parts, you must first identify the type of compressor on your car. The most recognisable features of the Hitachi unit are a hexagonal end cover on the air dryer mounted alongside the compressor and a 'D' shaped cradle holding the whole assembly to the car through upper and lower rubber mountings.

AMK compressors have a round end cover on the dryer and mount to the car by a large plate angle bracket. The visual difference between early and late AMK compressors is subtle: the early type features an upward-angled air inlet tube with a push-fit hose connection, while the later type has a horizontal screw union to the inlet hose.

If the air compressor assembly requires replacement: Because of the reintroduction of the Hitachi type unit (now manufactured by Dunlop), a like-for-like replacement with no required vehicle modifications can be made if the old unit on your car is still of the Hitachi type.

If however your vehicle has at some point in its life been modified to take an AMK compressor, then you should fit an AMK type compressor as a replacement: re-engineering and re-programming your car back to accept an Hitachi type compressor would be time-consuming and expensive.

The official Land Rover policy on compressor replacement is still to modify the vehicle to accept a later AMK compressor. If you decide to follow this route, some adaptation or replacement of hoses will be required if an Hitachi or early type AMK compressor is being replaced. Additionally the compressor relay will require replacement with a YWB500220 relay and, when replacing an Hitachi unit, the upper and lower compressor covers will need to be changed for the AMK type as well. Finally the electronic control unit for the air suspension will require installation of new software via the vehicle's diagnostic system.

Full details of the conversion work required to fit a late type AMK compressor to a 2005-2009 Range Rover Sport are given in Land Rover Technical Bulletin LTB00420, available on request from Rimmer Bros.

Air Suspension Valves, Reservoir & Pipes

VALVE ASSEMBLY:

Includes grommets and union adaptors.

reservoir (incl. pressure sensor)	1	RVH000046
front axle	1	RVH000095
rear axle	1	RVH000055

SENSOR, pressure	1	RQH500011
------------------	---	------------------

Included in reservoir valve.

RESERVOIR ASSEMBLY	1	RQN500070
--------------------	---	------------------

GROMMET, valve mounting	9	KVV500040
-------------------------	---	------------------

Included in valve assemblies.

ADAPTOR, union	11	LR044836
----------------	----	-----------------

Included in valve assemblies and reservoir assembly.

PIPE ASSEMBLY:

main air inlet	1	RQB000418
air inlet/exhaust, with silencer	1	LR018308
compressor to reservoir valve	1	RQB000423
reservoir valve to reservoir	1	RQB500253
reservoir valve to front axle valve	1	LR014977
front axle valve to RH spring	1	RQB000464
front axle valve to LH spring	1	LR014977
to VIN 6A999999	1	LR014978
VIN 7A000001 on	1	LR014978
reservoir valve to rear axle valve	1	RQB500782
rear axle valve to RH spring	1	RQB000493
rear axle valve to LH spring	1	RQB000484

SERVICING EQUIPMENT:

tube, 500mm	1	RQB501020
connector, tube	1	STC8580



CONNECTOR TUBE - STC8580



COMPLETE AIR SUSPENSION COMPRESSOR ASSEMBLY - LR023964P

Air Suspension Compressor

AIR SUSPENSION COMPRESSOR ASSEMBLY:

original Hitachi type unit

Manufactured to original style by Dunlop. Enables like-for-like replacement if vehicle is still set up for Hitachi compressor.

aftermarket (Dunlop)	1	LR023964P
----------------------	---	------------------

installation kit (for Hitachi style comp)	1	LR023964PPIK
---	---	---------------------

late type AMK unit

complete, with installation kit	1	LR061663
---------------------------------	---	-----------------

Use when replacing Hitachi or early type AMK compressor.

Includes compressor, air dryer, mounting bracket, relay, upper and lower covers, hose to valve block, inlet and exhaust hoses, plus fixings.

compressor & air dryer only

Use when replacing late type AMK compressor. Includes compressor, air dryer and mounting bracket only.

Land Rover	1	LR061888
------------	---	-----------------

OEM	1	LR061888P1
-----	---	-------------------

installation kit (for AMK style comp)	1	LR061888BPIK
---------------------------------------	---	---------------------

HITACHI AIR COMPRESSOR COMPONENTS AND RELATED PARTS

See notes above for air compressor identification.

DRIER, compressor	1	VUB504700
-------------------	---	------------------

O RING, drier	1	RX500060
---------------	---	-----------------

STRAP, drier securing	1	RQD500020
-----------------------	---	------------------

PIPE, air drier inlet	1	RQB500491
-----------------------	---	------------------

DELIVERY VALVE KIT	1	LR020590
--------------------	---	-----------------

MOUNTING RUBBER, compressor:

upper & lower rear	2	RVL500014
--------------------	---	------------------

front	1	RVL500022
-------	---	------------------

COVER, compressor:

upper	1	RVC500020
-------	---	------------------

lower	1	RVC500010
-------	---	------------------

AMK AIR COMPRESSOR COMPONENTS AND RELATED PARTS

See notes above for air compressor identification.

HOSE:

air inlet	1	LR045253
-----------	---	-----------------

air exhaust	1	LR045252
-------------	---	-----------------

compressor to valve block	1	LR056050
---------------------------	---	-----------------

INSERT, air inlet hose	1	LR037068
------------------------	---	-----------------

CONNECTOR, valve block hose	1	LR044836
-----------------------------	---	-----------------

RELAY, grey, 70A	1	YWB500220
------------------	---	------------------

COVER, compressor:

upper	1	LR044027
-------	---	-----------------

lower	1	LR044026
-------	---	-----------------



COMPRESSOR DRIER - LR041777

DELIVERY VALVE KIT - LR020590



COMPRESSOR MOUNTING RUBBER - RVL500014

Air Suspension Height Sensors & Control Unit

important note

AIR SUSPENSION HEIGHT SENSOR

Important note: the height sensors now supplied are the Range Rover Sport 2010 model year onwards type, adapted for 2005-2009 model fitment. These sensors were actually fitted new to Range Rover Sport models from VIN 9A213085 onwards. They feature 3 pin plugs which are compatible with the previous 6 pin type on Range Rover Sports prior to VIN 9A213085 and are supplied with new attachment bolts which must be fitted in place of the original screws on those models.



AIR SUSPENSION HEIGHT REAR SENSOR - LR020161

SENSOR, air suspension height:

Front

RH	1	LR020474
----	---	-----------------

LH	1	LR020473
----	---	-----------------

Rear

RH	1	LR020161
----	---	-----------------

Land Rover	1	LR020161P1
------------	---	-------------------

OEM	1	LR020161P1
-----	---	-------------------

LH	1	LR020159
----	---	-----------------

Land Rover	1	LR020159P1
------------	---	-------------------

OEM	1	LR020159P1
-----	---	-------------------

LINK KIT, height sensors	1	RVF500011BPKIT
--------------------------	---	-----------------------

Cost effective kit includes links and attachment hardware for all four height sensors.

LINK, height sensor:

front	2	RVF500050
-------	---	------------------

rear	2	LR020161
------	---	-----------------

Land Rover	2	LR020161P
------------	---	------------------

aftermarket	2	LR020161P
-------------	---	------------------

CONTROL UNIT, air suspension	1	RQT500160
------------------------------	---	------------------

BOLT, control unit attachment:

Land Rover	1	FS108166
------------	---	-----------------

aftermarket	1	FS108166P
-------------	---	------------------

CLIP, control unit attachment	2	RVC500010
-------------------------------	---	------------------

important note

ROLL STABILITY CONTROL

Many models of Range Rover Sport feature variable rate anti roll bars to combat undesirable body roll when the vehicle is driven in a more sporting manner. Electronically controlled by high pressure hydraulics, the system is known as **Roll Stability Control** or **Active Cornering Enhancement (ACE)**.

Roll Stability Control is fitted as standard on 3.6 TDV8 diesel models and is a very popular option on 4.2 AJV8 supercharged and 4.4 AJV8 petrol models; it is also found on some 2.7 TDV6 diesels.

The pump, reservoir, valve block and other control equipment associated with the system may be found in the section here, while the specially modified anti roll bars, air springs and other suspension parts are listed in the Front and Rear Suspension Sections.

Roll Stability Control Unit & Sensors

CONTROL UNIT, roll stability control	1	NNW508200
SENSOR:		
valve block pressure accelerometer	1	RQH500020
	1	RQJ100011

Includes bracket and cap.

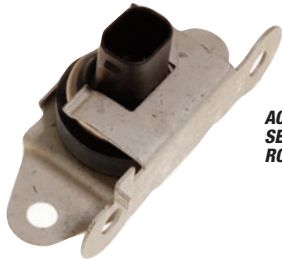

ACCELEROMETER SENSOR - RQJ100011

Roll Stability Control Pump & Reservoir

PUMP ASS'Y, roll stability control:
Includes pulley.

2.7 TDV6 diesel models new, exchange	1	RVB500024
3.6 TDV8 diesel models new, exchange	1	RVB500060
all petrol models new, exchange	1	RVB000017
PULLEY , roll stability control pump:		
2.7 TDV6 diesel models	1	RQ0000033
3.6 TDV8 diesel models	1	RQ0500060
all petrol models	1	RQ0500021
SCREW, pulley to pump	3	PYP500030
BOLT, pump to engine bracket	2	FB108206
DOWEL, pump to engine bracket	2	PYU500060
<i>2.7 TDV6 diesel models only.</i>		
RESERVOIR, pump	1	RQN000011
<i>Includes cap.</i>		
CAP, reservoir	1	RQF500010



PUMP RESERVOIR - RQN000011

ALL MODELS

Roll Stability Control Transfer Relief Valve Block

VALVE BLOCK, transfer relief:
Includes mountings, shut off valve coils, filter and pressure sensor.

Land Rover	1	RVH500110
OEM	1	RVH500110P1
MOUNTING KIT , valve block <i>Includes bolts, mounting bushes, washers and spacer tubes.</i>	1	RVV500050
BOLT, valve block mounting	3	FB108206
WASHER, valve block mounting	6	RYF500060
'U' NUT, valve block mounting	3	RYH500170
REPAIR KIT, shut off valve unions	1	RVH500100
COIL , shut off valve:		
upper front & rear	2	RVT500010
lower rear	1	RVT100021
SEAL KIT , valve block		
Land Rover	1	RVW100010
OEM	1	RVW100010P1
FILTER , valve block		
Land Rover	1	RVJ100010
OEM	1	RVJ100010P1
PLUG, filter & valve block drain	1	RYB500010



VALVE BLOCK FILTER - RVJ100010



VALVE BLOCK SEAL KIT - RVW100010

WE'RE HERE TO HELP
Can't find or not sure of the right part for your car, contact our technical sales team for help and advice.
01522 568000



RESERVOIR TO PUMP HOSE - RQP000054

Roll Stability Control Hose & Pipe Assemblies

RESERVOIR TO PUMP HOSE (LOW PRESSURE)

HOSE, reservoir to pump:

2.7 TDV6 diesel models	1	RQP000054
3.6 TDV8 diesel models	1	LR023728
all petrol models		
up to VIN 5A909589	1	RQP000017
VIN 5A909590 on	1	RQP000018
CLIP, hose to reservoir and pump	2	QGM000020
ISOLATOR RING, hose	3	RVV500030

3.6 TDV6 diesel only.

PUMP TO SYSTEM HOSE (HIGH PRESSURE)

HOSE ASSEMBLY, pump to system, high pressure:
Includes banjo bolt and sealing washers, hose fixings, brackets and rubber mountings (rubber mountings not applicable to 3.6 TDV8 diesel).

2.7 TDV6 diesel models	1	RQB500431
3.6 TDV8 diesel models	1	RQB501041
all petrol models	1	RQB500393
BOLT, banjo, hose to pump union	1	RYG500110
WASHER, sealing, banjo bolt	2	RYX500030
<i>3.6 TDV6 diesel only.</i>		
MOUNTING, rubber, hose	2	LR038632
<i>All models except 3.6 TDV6 diesel.</i>		
CLAMP & FERRULE KIT, hose stay	2	RQU500450
<i>All models except 3.6 TDV6 diesel.</i>		
O RING, hose to system pipe connctr.	1	RYX500040

SYSTEM PIPES (FRONT TO VALVE BLOCK)

PIPES & HOSES COMPLETE ASS'Y, front to valve block:
Includes pipe from pump hose to valve block, valve block to reservoir return pipe, valve block to front anti roll bar pipes, pipe mountings and brackets, O rings and connectors.

all models except 3.6 TDV8 diesel up to VIN 6A999999	1	RQA500018
VIN 7A000001 on	1	LR019908
3.6 TDV8 diesel models only	1	RQA500120

PIPE ASSEMBLY:

all models except 3.6 TDV8 diesel pump hose to valve block		
up to VIN 8A999999	1	RQB500403
VIN 9A000001 on	1	LR020003
valve block to reservoir, return up to VIN 8A999999	1	RQB500422
VIN 9A000001 on	1	LR019389
valve block to anti roll bar to actuator A		
to VIN 6A999999	1	RQB500362
VIN 7A000001 on	1	LR019387
to actuator B		
to VIN 6A999999	1	RQB500382
VIN 7A000001 on	1	LR019388

3.6 TDV8 diesel models only pump hose to valve block	1	LR019386
valve block to reservoir, return	1	RQB501050
valve block to anti roll bar to actuator A	1	LR019384
to actuator B	1	LR019385
COLLET, pipes to valve block	4	RQR500010
PLATE, retaining pipes to valve block	1	RQB500021
CONNECTOR, pipe to pump hose	1	RVW500060
O RING, connector to pipe	1	RYX500040
SEAL KIT, pipe to anti roll bar	2	RVW500010
SCREW, pipe to anti roll bar	2	RYP500060
RUBBER MOUNTING, pipes	3	LR038632

SYSTEM PIPES (REAR TO VALVE BLOCK)

PIPES & HOSES COMPLETE ASS'Y, rear to valve block:
Includes valve block to rear anti roll bar pipes, pipe brackets, O rings and connectors.

all models	1	RQA000049
PIPE ASS'Y , valve block to anti roll bar:		
to actuator A		
to VIN 6A999999	1	RQB500312
VIN 7A000001 on	1	RQB500313
to actuator B		
to VIN 6A999999	1	RQB500333
VIN 7A000001 on	1	RQB500334
COLLET, pipes to valve block	2	RQR500010
PLATE, retaining pipes to valve block	1	RQB500011
SEAL KIT, pipe to anti roll bar	2	RVW500010
SCREW, pipe to anti roll bar	2	RYP500060
RUBBER MOUNTING, pipes	1	LR038632



RUBBER MOUNTING - LR038632

PIPE TO ANTI ROLL BAR SEAL KIT - RVW500010



ROLL STABILITY CONTROL SYSTEM

ALL MODELS

ROAD WHEELS

20" WHEELS

ROAD WHEELS

We offer as far as possible the full range of genuine Land Rover alloy wheels with which to enhance your Range Rover Sport.



17" WHEELS



17" 5 SPLIT SPOKE ALLOY WHEEL -
RRC002852MNH

17" x 7J ALLOY WHEELS

ROAD WHEEL, alloy:

5 split spoke, Silver Sparkle

RRC002852MNH

18" WHEELS



18" 5 SPOKE ALLOY WHEEL -
RRC500261MNH



18" 10 SPOKE ALLOY WHEEL -
RRC500251MNH

18" x 8J ALLOY WHEELS

ROAD WHEEL, alloy:

5 split spoke, Silver Sparkle
Cannot be fitted to 3.6 TDV8 diesel or
4.2 AJV8 supercharged petrol models.

RRC500261MNH

10 spoke, Silver Sparkle

RRC500251MNH

10 fluted spoke, Silver Sparkle

RRC505360MNH

19" WHEELS



19" 6 SPOKE ALLOY WHEEL -
RRC002900MNH



19" 6 SPOKE ALLOY WHEEL -
RRC002900MNL



19" 5 VEE SPOKE, ALLOY WHEEL -
LR017276

19" x 8J ALLOY WHEELS

ROAD WHEEL, alloy:

6 spoke, Silver Sparkle

RRC002900MNH

6 spoke, Shadow Chrome

RRC002900MNL

19" x 9J ALLOY WHEELS

ROAD WHEEL, alloy:

5 vee spoke, Silver Sparkle

LR017276

5 vee spoke, Silver Sparkle

RRC502280MNH

Split rim style.

19" SPARE WHEEL



19" STEEL SPARE WHEEL -
RRC002882PBG

19" x 5.5J STEEL SPARE WHEEL

ROAD WHEEL, steel, Black

RRC002882PBG

19" x 5.5J ALLOY SPARE WHEEL

ROAD WHEEL, alloy, 10 spoke, Black

RRC505870PBG

19" x 8J ALLOY SPARE WHEEL

ROAD WHEEL, alloy, 6 spoke, Black

LR016305

FOR A RANGE
OF HIGH QUALITY
AFTERMARKET
WHEELS
SEE PAGE 100



20" 5 SPLIT SPOKE ALLOY WHEEL -
LR028938



20" 9 SPOKE 'STORMER' ALLOY WHEEL -
LR028995



20" 10 SPOKE ALLOY WHEEL -
RRC500681MNH



20" 15 SPOKE ALLOY WHEEL -
LR027544

20" x 9.5J ALLOY WHEELS

ROAD WHEEL, alloy:

5 split spoke, Silver Sparkle

LR028938

5 split spoke, Brunel Metallic
Diamond turned finish.

LR017280

9 spoke 'Stormer', Titan Silver

LR028995

10 spoke, Silver Sparkle

RRC500681MNH

Split rim style.

10 spoke, Shadow Chrome

LR008742

Split rim style.

15 spoke, Titan Silver

LR027544

Fully painted.

15 spoke, Brunel Metallic

LR008549

Diamond turned finish.



Wheel Centre Cap & Wheel Nuts

CENTRE CAP, alloy wheel, with logo:

Silver Sparkle, green/gold logo	4	LR001156
Silver Sparkle, black/silver logo	4	RRJ500030WYS
Shadow Chrome, green/gold logo	4	LR006972
Shadow Chrome, black/silver logo	4	LR011487
Titan Silver, black/silver logo	4	RRJ500030WYT
Polished Silver, black/silver logo	4	RRJ500060WYU
Polished Shadow, green/gold logo	4	RRJ500060MUZ

CENTRE CAP -
RRJ500030WYS



CENTRE CAP -
LR001156

WHEEL NUT, alloy wheel:

Quantity of 20 per vehicle, or 16 if using locking wheel nut set.

to VIN 8A130279		
single		
Land Rover	20/16	LR068126
OEM	20/16	LR068126P1
set of 20, OEM	1	LR068126P1K20
set of 16, OEM	1	LR068126P1K16

LOCKING WHEEL NUT SET:

Includes 4 locking nuts and adaptor. Note that replacement adaptors for the genuine Land Rover locking wheel nut set are available - to order, please contact us with your adaptor code letter.

Land Rover	1	LR043820
Britpart	1	LR043820BP



WHEEL NUT SET -
LR068126P1K20

LOCKING WHEEL
NUT SET -
LR043820BP

Tyre Pressure Monitoring System (TPMS)

important note

TYRE PRESSURE MONITORING SYSTEM (TPMS)

Replacement of the TPMS module or sensors must be done with new items featuring the same frequency as the original. As a general guide, 433Mhz frequency equipment is used on UK and European cars, 315Mhz for the rest of the world.

MODULE, tyre pressure monitoring system:

433Mhz frequency	1	NNW501995
to VIN 6A999999		
VIN 7A000001 on	1	LR023427
315Mhz frequency	1	LR023428

SENSOR ASS'Y, TPMS:

Includes tyre valve assembly and valve cap.

433Mhz frequency	4	LR032835
315Mhz frequency	4	LR032836

VALVE KIT, TPMS sensor:

Includes tyre valve core, seal nut, seal, washer and valve cap.

Land Rover	4	LR043161
OEM	4	LR043161P1

CAP, valve

SENSOR, initiator, TPMS	4	RRE000010
RIVET, initiator sensor	8	EAP4830PMA

Wheel Accessories

SNOW CHAIN KIT:

Includes a pair of snow chains and fixings for the front wheels only.

for 17" wheels	1	VUJ000010
for 18", 19" & 20" wheels	1	VPLSW0079

TYRE VALVE CAP SET:

Union Jack emblem

Set of four valve caps, genuine Land Rover accessory, available with red, white and blue or black and grey Union Jack emblems.

red, white & blue	1	LR027664
black, white & grey	1	LR027666

Range Rover/Land Rover emblem

Set of four valve caps, genuine Land Rover accessory, available with black/silver Range Rover or Land Rover green/gold emblems.

Range Rover	1	LR027663
Land Rover	1	LR027560



SNOW CHAIN KIT -
VUJ000010

ALL MODELS

ROAD WHEELS



RESET KEY -
LR014047

Vehicle Tool Kit

TOOL KIT 1 LR078357

Includes tool stowage moulding, jack, jack handles, wheel chocks, wheel nut wrench and screwdriver.

TOOL STOWAGE MOULDING 1 LR019620

JACK ASSEMBLY, less handle 1 LR031653

Scissor type jack.

JACK HANDLE:

primary handle 1 LR044643

extension handle 1 KAH500012

CHOCK, wheel 2 ANR5449

WRENCH, wheel nut 1 LR044641

SCREWDRIVER 1 KBH500010

RESET KEY, misfuel device, yellow 1 LR014047

Diesel models with 2010 model year type fuel tank. Resets the misfuelling safety device in the fuel filler after it has been activated.



LR027664



LR027666



LR027663



LR027560

Spare Wheel Stowage

VALANCE PANEL, spare wheel carrier 1 RRY500010

BRACKET, valance panel:

RH		
to VIN 8A142900	1	RRY500150
VIN 8A142901 on	1	RRY500200

LH		
to VIN 8A142900	1	RRY500140
VIN 8A142901 on	1	RRY500210

RIVET, panel to bracket 2 RV612183

STUD PLATE, valance panel 1 RRY500120

WINCH ASSEMBLY, spare wheel

Land Rover	1	LR064520
OEM	1	LR064520P1

GROMMET, winch 1 KT0000013

SPACER, spare wheel carrier 4 RYF500130

SPARE WHEEL SAVER (anti-theft) 1 LR064520ATD

Easy to fit and use spare wheel anti-theft device. Includes fittings and instructions.



SPARE WHEEL
VALANCE PANEL -
RRY500010



SPARE WHEEL SAVER -
LR064520ATD



SPARE WHEEL
WINCH ASSEMBLY -
LR064520

ORDER

BY PHONE: 01522 568000 / ON LINE: www.rimmerbros.co.uk / E-MAIL: lrsales@rimmerbros.co.uk

ALL MODELS

FRONT BRAKES

FRONT BRAKES - 320mm & 340mm Diameter

Front Brake Discs & Pads

BRAKE DISC:

320mm diameter (models with 17" wheels or larger)

Land Rover, each	2	SDB000604
Brembo, each	2	SDB000604BREMBO
aftermarket, each	2	SDB000604P
updated, slotted & drilled, pair	1	SDB000604URBP

340mm diameter (models with 18" wheels or larger)

Land Rover, each	2	SDB000614
Brembo, each	2	SDB000614BREMBO
aftermarket, each	2	SDB000614P
updated, slotted & drilled, pair	1	SDB000614URBP

RETAINING SCREW, brake disc	2	SYP100241
-----------------------------	---	------------------

BRAKE PAD SET:

Axle set. Includes guide pin screws.

Land Rover	1	LR019618
OEM	1	LR019618P1
Brembo	1	LR019618BREMBO
aftermarket	1	LR019618P
updated, EBC Greenstuff	1	LR019618GS

CLIP KIT, brake pad retention

Land Rover	1	LR019625
aftermarket	1	LR019625P

RETAINING PIN KIT, brake pads:

Kit of pins and dust covers for 1 caliper.

Land Rover	2	SEE500020
aftermarket	2	SEE500020P

RETAINING PIN SCREW, caliper

	4	SMV500010
--	---	------------------

DUST COVER KIT, retaining pins

Includes 2 dust covers for 1 caliper.

	2	SEE500030
--	---	------------------

WIRING HARNESS, brake pad wear warning:

up to VIN 6A999999

Land Rover	1	SEM500062
OEM	1	SEM500062P1
aftermarket	1	SEM500062P
VIN 7A000001 on		
Land Rover	1	SEM500080
OEM	1	SEM500080P1
aftermarket	1	SEM500080P



UPDATED SLOTTED AND DRILLED BRAKE DISC PAIR - SDB000604URBP



BRAKE DISC - SDB000614



UPDATED BRAKE PAD SET - LR019618GS



BRAKE PAD SET - LR019618

CALIPER CARRIER ASSEMBLY - SEH500013



Front Brake Calipers

CALIPER ASSEMBLY:

Piston housing assembly, less carrier. Includes bleed nipple.

new, exchange		
RH	1	SEG500040
LH	1	SEG500050

CARRIER ASSEMBLY, caliper:

Includes retaining pins, screws and dust covers.

for 320mm diameter discs		
Land Rover	2	SEH500012
OEM	2	SEH500012P1
for 340mm diameter discs	2	SEH500013
REPAIR KIT, caliper	2	SEE500010

Includes seals & dust covers for 1 caliper.

PISTON, caliper

Land Rover	4	STC1918
OEM	4	STC1918P1
aftermarket	4	STC1918P

BLEED SCREW, caliper:

Land Rover	2	LR015523
aftermarket	2	LR015523P

DUST CAP, bleed screw	2	SEE500100
-----------------------	---	------------------



CALIPER REPAIR KIT - SEE500010

Front Brake Fittings

BOLT, caliper securing	4	SYG500050
SPLASH SHIELD, brake disc:		
RH	1	SEC000162
LH	1	SEC000172
SCREW, splash shield securing	10	SYP500020

FRONT BRAKES - 360mm Diameter

Front Brake Discs & Pads

BRAKE DISC, 360mm diameter (models with 19" wheels or larger)

Land Rover, each	2	SDB000624
Brembo, each	2	SDB000624BREMBO
aftermarket, each	2	SDB000624P
updated, slotted & drilled, pair	1	SDB000624URBP

RETAINING SCREW, brake disc	2	SYP100241
-----------------------------	---	------------------

BRAKE PAD SET:

Axle set. Includes brake pads only.

Land Rover	1	SFP500070
Brembo	1	SFP500070BREMBO
TRW/Lucas	1	SFP500070P1
aftermarket	1	SFP500070P
updated, EBC Greenstuff	1	SFP500070GS

RETAINING PIN KIT, brake pads

Kit of pins and clips for one caliper.

	2	SEE500080
--	---	------------------

WIRING HARNESS, brake pad wear warning:

up to VIN 6A999999

Land Rover	1	SEM500026
OEM	1	SEM500026P1
aftermarket	1	SEM500026P
VIN 7A000001 on		
Land Rover	1	SEM500090
OEM	1	SEM500090P1
aftermarket	1	SEM500090P



BRAKE DISC - SDB000624

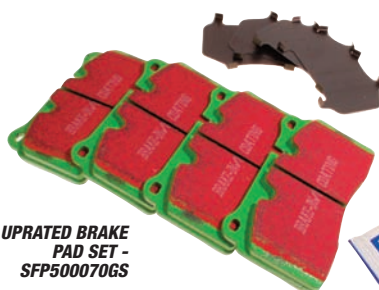

UPDATED BRAKE PAD SET - SFP500070GS

Front Brake Calipers

CALIPER ASSEMBLY:

Includes bleed nipple and pad retaining clips and pins.

new, exchange		
RH	1	SEB500090
LH	1	SEB500080

REPAIR KIT, caliper	2	SEE500040
---------------------	---	------------------

Includes seals for 1 caliper.

BLEED SCREW & DUST CAP, caliper	4	SEE500070
---------------------------------	---	------------------

Front Brake Fittings

BOLT, caliper securing	4	SYG500050
SPLASH SHIELD, brake disc:		
RH	1	SEC000182
LH	1	SEC000192
SCREW, splash shield securing	10	SYP500020

WE'RE HERE TO HELP
 Can't find or not sure of the right part for your car, contact our technical sales team for help and advice.
01522 568000

ALL MODELS

REAR BRAKES

REAR BRAKES - 325mm & 350mm Diameter

Rear Brake Discs & Pads

BRAKE DISC & HANDBRAKE DRUM:

325mm diameter (models with 17" wheels or larger)		
Land Rover, each	2	SDB000636
Brembo, pair	1	SDB000636BREMB0
aftermarket, each	2	SDB000636P
uprated, slotted & drilled, pair	1	SDB000636URBP
350mm diameter (models with 18" wheels or larger)		
Land Rover, each	2	SDB000646
Brembo, pair	1	SDB000646BREMB0
aftermarket, each	2	SDB000646P
uprated, slotted & drilled, pair	1	SDB000646URBP
RETAINING SCREW, brake disc	2	SYP100241
PLUG, brake disc	2	SOD000010
BRAKE PAD SET (axle set):		
for 325mm diameter discs		
<i>Includes guide pin screws.</i>		
Land Rover	1	LR021316
aftermarket	1	LR021316P
for 350mm diameter discs		
<i>Includes guide pin screws.</i>		
Land Rover	1	LR055454
OEM	1	LR055454P1
Brembo	1	LR055454BREMB0
aftermarket	1	LR055454P
uprated, EBC Greenstuff	1	LR055454GS
CLIP KIT, brake pad retention		
Land Rover	1	LR019626
aftermarket	1	LR019626P
RETAINING PIN KIT, brake pads:		
<i>Kit of pins and dust covers for 1 caliper.</i>		
Land Rover	2	SMN500040
aftermarket	2	SMN500040P
RETAINING PIN SCREW, caliper	4	SMV500010
DUST COVER KIT, retaining pins	2	SEE500030
<i>Includes 2 dust covers for 1 caliper.</i>		



BRAKE DISC - SDB000636BREMB0



BRAKE PAD SET - LR055454BREMB0



BRAKE PAD SET - LR021316

Rear Brake Calipers

CALIPER ASSEMBLY:

Piston housing assembly, less carrier. Includes bleed nipple.

new, exchange		
RH		
Land Rover	1	SOB500042
OEM	1	SOB500042P1
aftermarket	1	SOB500042P
LH		
Land Rover	1	SOB500052
OEM	1	SOB500052P1
aftermarket	1	SOB500052P

CARRIER ASSEMBLY, caliper:

Includes retaining pins, screws and dust covers.

for 325mm diameter discs		
Land Rover	2	SXP500013
OEM	2	SXP500013P1
for 350mm diameter discs		
Land Rover	2	SXP500014
OEM	2	SXP500014P1

REPAIR KIT, caliper

Includes seals & dust covers for 1 caliper.

Land Rover	2	SMN500030
aftermarket	2	SMN500030P

PISTON, caliper:

Land Rover	2	STC1908
aftermarket	2	STC1908P

BLEED SCREW, caliper:

Land Rover	2	LR015523
aftermarket	2	LR015523P

DUST CAP, bleed screw

	2	SEE500100
--	---	------------------

CALIPER PISTON SET - STC1908



CALIPER REPAIR KIT - SMN500030

Rear Brake Fittings

BOLT, caliper securing	4	SYG000013
WIRING HARNESS, brake pad wear warning:		
Land Rover	2	SOE000025
OEM	2	SOE000025P1
aftermarket	2	SOE000025P
BACK PLATE, brake disc & handbrake drum:		
RH	1	LR048810
LH	1	LR048812
SCREW, back plate securing	6	SYP500020



WIRING HARNESS SOE000025P1

Handbrake Shoes

HANDBRAKE SHOE SET:

Includes retaining clips and pull off springs.

Land Rover, wheel set	2	LR031947
OEM, car set	1	LR031947P1
RETAINING KIT, handbrake shoes	1	SMN500012
<i>Includes retaining clips and pins.</i>		
SPRING KIT, handbrake shoes	1	SMN500020
<i>Includes tension and pull off springs.</i>		
ADJUSTER KIT, handbrake shoes	1	SXS500011
<i>Includes two adjusters.</i>		
ACTUATING ROD KIT, handbrake pawl	1	SXR500010
<i>Includes two rods.</i>		



HANDBRAKE SHOE SET - LR031947P1

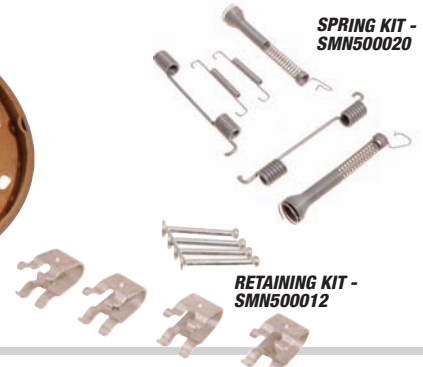

SPRING KIT - SMN500020

RETAINING KIT - SMN500012

Handbrake Cable

HANDBRAKE CABLE:

complete ass'y with actuator	1	LR019223
rear cable only		
RH	1	LR018469
LH	1	LR018470
BOOT, cable to rear brake	2	YPV500380
<i>Included in complete handbrake cable assembly.</i>		
CIRCLIP, cable to rear brake	2	SPV500030
CLIP, nylon, cable to body	2	SPV500020
BRACKET, spring, cable support		
RH	1	SPU500040
LH	1	SPU500050



HANDBRAKE CABLE - LR019223

Handbrake Wiring Repair

WIRING REPAIR KIT, hand brake	1	YNI500400
-------------------------------	---	------------------

Vehicles up to VIN 5A903760 can suffer water ingress in the connection on the electronic parking brake (EPB) module section of the chassis harness, resulting in EPB warning lights being displayed or the brake not being released. The repair kit overcomes this problem by replacing this section of the chassis harness with an improved waterproof version. The kit includes the new section of harness, together with a connector terminal removal tool.

ORDER

BY PHONE: 01522 568000 / ON LINE: www.rimmerbros.co.uk / E-MAIL: lrsales@rimmerbros.co.uk

HANDBRAKE

ALL MODELS

BRAKES - CONTROLS, ABS, PIPES & HOSES

Brake Pedal

BRAKE PEDAL & BRACKET ASSEMBLY:

RHD	1	LR045342
LHD	1	SKB500031PVJ
PAD, pedal	1	SKE500010

Included in pedal & bracket assembly.

PEDAL COVER SET:

Three piece set of sports covers, fashioned from stainless steel and rubber - includes covers for accelerator and brake pedals, plus footrest cover.

Land Rover	1	LR008713
Britpart	1	LR008713BP
BOLT, pedal pivot	1	BH110181L

Included in pedal & bracket assembly.

NUT, pedal pivot bolt

	1	FN110046
--	---	-----------------

Included in pedal & bracket assembly.

PLUG, clutch holes in dash panel:

RHD		
30mm dia.	1	AYB000300
22mm dia.	1	DWJ500020
LHD, 22mm dia.	2	DWJ500020



PEDAL COVER SET - LR008713



Brake Master Cylinder

BRAKE MASTER CYLINDER ASS'Y:

Includes O ring for servo, plus fixing nuts. Does not include reservoir.

RHD		
Land Rover	1	LR014527
OEM	1	LR014527P1
LHD		
Land Rover	1	LR014528
aftermarket	1	LR014528P
RESERVOIR, brake master cylinder	1	LR015518

Includes cap and reservoir to master cylinder seals.

CAP, with fluid level sensor

	1	LR012971
--	---	-----------------

Included in reservoir assembly.

O RING, master cylinder to servo

	1	SYX000010
--	---	------------------

Included in master cylinder assembly.

NUT, master cylinder to servo

	2	SYH000010
--	---	------------------

Included in master cylinder assembly.

Brake Pipes

BRAKE PIPE, master cylinder:

primary		
RHD	1	SGB001724
LHD	1	SGB001664
secondary		
RHD	1	SGB001733
LHD	1	SGB001674

BRAKE PIPE, modulator to RH front hose:

RHD	1	LR021675
LHD		
to VIN 9A215187	1	SGB001697
VIN 9A215188 on	1	LR021671

BRAKE PIPE, modulator to LH front hose:

RHD	1	LR021674
LHD		
to VIN 9A215187	1	SGB001688
VIN 9A215188 on	1	LR021670

BRAKE PIPE, under-floor connector to rear axle:

for RH rear brake		
to VIN 5A901723	1	SGB500061
VIN 5A901724 on	1	SGB500062
for LH rear brake		
to VIN 5A901723	1	SGB500051
VIN 5A901724 on	1	SGB500052

BRAKE SERVO ASSEMBLY - SJJ500070



Brake Servo

BRAKE SERVO ASSEMBLY:

Includes O ring and fixing nuts for master cylinder.

2.7 TDV6 diesel &		
4.4 AJV8 petrol models	1	SJJ500070
3.6 TDV8 diesel &		
4.2 AJV8 supercharged petrol	1	SJJ500080
NUT, servo mounting:		
Land Rover	4	FN106047L
aftermarket	4	FN106047LP
CLEVIS PIN, servo to brake pedal	1	SYT500010
CLIP, clevis pin	1	SYV000010
SEAL, servo to vacuum hose	1	LR012903

Brake Hoses

BRAKE HOSE KIT:

car set (6 hoses)		
Land Rover	1	RA1552
OEM	1	RA1552P1
front only (2 hoses)		
Land Rover	1	RA1553
OEM	1	RA1553P1
rear only (4 hoses)		
Land Rover	1	RD1355
OEM	1	RD1355P1

BRAKE HOSE ASSEMBLY:

front		
RH		
Land Rover	1	LR058021
OEM	1	LR058021P1
LH		
Land Rover	1	LR058020
OEM	1	LR058020P1
rear		
outer		
Land Rover	2	LR058009
OEM	2	LR058009P1
inner		
Land Rover	2	LR058010
OEM	2	LR058010P1
SCREW, front brake hose securing	4	FS108146
CLIP, rear brake hose abutment	6	EJP7813A



BRAKE HOSE KIT - RA1552

BRAKE PIPE, modulator to under-bonnet

dual line connector:		
RHD		
for RH rear brake	1	LR021677
for LH rear brake	1	LR021676
LHD		
for RH rear brake		
to VIN 9A215187	1	SGB001715
VIN 9A215188 on	1	LR021673
for LH rear brake	1	LR021672

BRAKE PIPE, under-bonnet dual line connector		
to under-floor connector:		
for RH rear brake		
to VIN 5A901723	1	SGB500021
VIN 5A901724 on	1	SGB501450
for LH rear brake		
to VIN 5A901723	1	SGB500011
VIN 5A901724 on	1	SGB501440

BRAKE PIPE, rear axle hose to caliper hose:		
for RH rear brake	1	LR021679
for LH rear brake	1	LR021678
CONNECTOR:		
dual line, under-bonnet	1	SGH100050
single line, under-floor	2	BMK2466

Anti-Lock Brake System (ABS)

ABS MODULATOR ASS'Y:

Includes rubber mountings. Does not include mounting bracket.

to VIN 6A999999		
Land Rover	1	SRB500174
OEM	1	SRB500174P1
VIN 7A000001 on	1	LR019347
SENSOR:		
yaw		
to VIN 6A999999	1	SR0000020
<i>Compatible with 6 pin plug.</i>		
VIN 7A000001 on	1	SR0500140
<i>Compatible with 4 pin plug.</i>		
front wheel		
Land Rover	2	SSB500133
aftermarket	2	SSB500133P
rear wheel		
Land Rover	2	SSB500102
OEM	2	SSB500102P1
aftermarket	2	SSB500102P
SCREW, wheel sensor attaching	4	FS106127L

Vacuum Pump & Hoses

2.7 TDV6 DIESEL MODELS

VACUUM PUMP ASSEMBLY:

Land Rover	1	LR019761
OEM	1	LR019761P1
GASKET, vacuum pump mounting	1	LR019960
CAP, vacuum pump outlet	1	1334813
<i>Where vacuum pump outlet is not used.</i>		
HOSE, vacuum pump to servo,		
connecting only to pump inlet:		
RHD		
vacuum pump to union	1	SQB000233
union to servo		
up to VIN 6A916812	1	SQB000232
VIN 6A916813 on	1	LR051575
LHD	1	LR018326

HOSE, vacuum pump to servo,

connecting to pump inlet and outlet:

<i>VIN 6A929086 on.</i>		
RHD		
vacuum pump to union	1	LR019701
EU2 emissions	1	LR019758
Euro Stage 4 emissions	1	LR019758
<i>Models with diesel particulate filter (DPF).</i>		
union to servo	1	LR019757
LHD		
EU2 emissions	1	LR019700
Euro Stage 4 emissions	1	LR019756
<i>Models with diesel particulate filter (DPF).</i>		

3.6 TDV8 DIESEL MODELS

VACUUM PUMP ASSEMBLY	1	LR001852
<i>Includes mounting gasket.</i>		
GASKET, vacuum pump mounting	1	LR004014
BOLT, vacuum pump mounting	2	1372612
STUD, vacuum pump mounting	1	1331241
NUT, vacuum pump mounting	1	FN108042
HOSE, vacuum pump to servo:		
RHD	1	LR018329
LHD	1	LR018330

4.2 AJV8 PETROL & 4.4 AJV8 PETROL MODELS

VACUUM PUMP ASSEMBLY	1	SQJ500082
BUSH, vacuum pump mounting	2	SYA500010
INSERT, bush	2	SZT500010
HOSE:		
vacuum pump to union	1	LR018331
union to inlet manifold		
4.2 AJV8 supercharged petrol	1	LR018336
4.4 AJV8 petrol	1	LR018333
union to servo		
RHD	1	SQF500042
LHD	1	LR018335

Steering Wheel & Cowling

Note: over the years a certain amount of rationalisation has taken place in the number of steering wheels available. Choosing from the list below, so long as the description includes the features you require, the wheel will work in your car (despite the fact that the wheel possibly includes more features than those relevant for your car).

STEERING WHEEL, leather, black:		
not heated		
not phone integration		
not voice input	1	LR017035
with voice input	1	LR017036
with phone integration		
not voice input	1	LR017038
with voice input	1	LR017037
heated		
not phone integration	1	LR017033
with phone integration	1	LR017034
BOLT, steering wheel to column	1	QTM100000
ROTARY COUPLING, steering wheel	1	LR018556
COWLING, steering column:		
upper	1	QRB500250PVJ
lower		
manual tilt & reach column	1	QRB500210PVJ
electric tilt & reach column	1	QRB500220PVJ
FITTING KIT, cowling	1	QMB501300
<i>Includes screws, washers and pads.</i>		
SCREW, cowling	3	FYP500260
<i>Included in fitting kit.</i>		
SHROUD, fascia, with blind	1	FAI500050PVJ
CLIP, shroud to fascia	4	FCY500040

Steering Column

STEERING COLUMN ASSEMBLY:

This is the top collapsible section; it previously included the steering angle sensor. This is no longer the case and the sensor should be ordered separately, if required.

manual tilt & reach adjustment	1	QMB501240
electric tilt & reach adjustment	1	QMB501180
SENSOR, steering angle	1	SRO500110
VIBRATION DAMPER, column:		
<i>Diesel models only.</i>		
2.7 TDV6 diesel models	1	QTD500020
3.6 TDV8 diesel models	1	QTD500040

STEERING COLUMN:

upper	1	QLB500070
<i>This is the upper of the two shafts, connecting to the top collapsible section and passing through the front bulkhead.</i>		
lower		
<i>This is the lower of the two shafts, connecting to the steering rack. It includes the universal joint.</i>		
RHD	1	LR071146
LHD	1	LR071147

SEAL:		
steering column to bulkhead	1	QMH500100
steering joint, lower	1	QMH500070

BOLT:		
collapsible column to body		
manual tilt & reach column		
long (55mm)	2	QYG500032
short (30mm)	2	QYG500021
electric tilt & reach column	4	QYG500021
upper column to lower column	1	QYG500110
lower column to rack	1	QYG500100

SCREW:		
steering angle sensor attaching	3	QYP500030
collapsible to upper column	1	QMW500030
vibration damper to column	3	QYP500100
<i>Diesel models only.</i>		
NUT, collapsible to upper column screw	1	QYH10005L

Steering Rack Assembly

STEERING RACK ASSEMBLY:

Includes gaiters. Does not include track rod ends.

RHD		
new, exchange	1	LR031745
reconditioned, exchange		
to VIN 6A999999	1	LR010886
VIN 9A191792 on	1	LR019433
LHD		
new, exchange	1	LR031744
reconditioned, exchange		
to VIN 6A999999	1	LR011307
to VIN 9A191792 on	1	LR011307
SCREW, steering rack mounting	2	FC114136
NUT, locking, steering rack mounting	2	LR017002

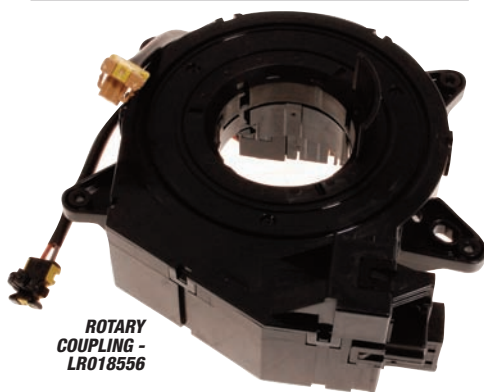

ROTARY COUPLING - LR018556



COWLING FITTING KIT - QMB501300

important note

STEERING RACK COMPONENTS

Important note: from VIN 9A191792 (2009) the track rod ends on the Range Rover Sport steering rack were updated. Assemblies are most easily identified by the nut holding the track rod end to the swivel housing (knuckle); the later nuts are M14 thread while earlier nuts are M12. The track rods within the steering rack remained the same throughout and will accept either M12 or M14 track rod ends.

Complicating the issue is the fact that for many years now the only knuckles available have been the later type that will only accept M14 track rod ends, so earlier cars with replaced knuckles will have had to be converted to later track rod ends. It therefore follows that unless you know the full, unbridged history of your pre-VIN 9A191792 car you should not assume it still takes the same size track rod ends with which it was originally built.

When replacing track rod ends, to be safe you should measure the thread size of the track rod end to knuckle nut before obtaining replacement items.

Steering Rack Components

TRACK ROD COMPLETE ASSEMBLY:

Includes track rod, gaiter, track rod end and nuts.

to VIN 9A191791		
<i>Includes M12 track rod ends.</i>		
Land Rover	2	LR010674
Britpart	2	LR010674BP
VIN 9A191792 on		
<i>Includes M14 track rod ends.</i>		
Land Rover	2	LR010673
Britpart	2	LR010673BP

TRACK ROD, bare

Does not include track rod, gaiter, track rod end or nuts.

Land Rover	2	QFK500030
aftermarket	2	QFK500030P

TRACK ROD END (ball joint):

to VIN 9A191791

With M12 thread for knuckle nut.

with attachment nut		
Land Rover	2	LR010675
OEM	2	LR010675P1
aftermarket	2	LR010675P
without attachment nut		
Land Rover	2	QJB500040
OEM	2	QJB500040P1
aftermarket	2	QJB500040P

VIN 9A191792 on

With M14 thread for knuckle nut.

with attachment nut	2	LR010676
without attachment nut	2	QJB500070

NUT:

locking track rod end to track rod	2	QYH500040
track rod end to knuckle		
to VIN 9A191791 (M12 thread)	2	FY112056
VIN 9A191792 on (M14 thread)	2	QYH500160

GAITER KIT, steering rack:

Includes 1 gaiter and 2 clips.

Land Rover	2	QFW500020
OEM	2	QFW500020P1
CLIP, large dia., steering rack gaiter	2	LR032372

ACTUATOR ASSEMBLY, steering rack:

Includes seals and bolt.

RHD	1	LR010372
LHD	1	LR010373
VALVE PIPE FIXINGS KIT, steering rack	1	QFW500030



TRACK ROD COMPLETE ASSEMBLY - LR010674BP



TRACK ROD COMPLETE ASSEMBLY - LR010673BP



TRACK ROD END - LR010675



TRACK ROD END - QJB500040

WE'RE HERE TO HELP
 Can't find or not sure of the right part for your car, contact our technical sales team for help and advice.
01522 568000

STEERING - STEERING WHEEL, COLUMN & RACK

ALL MODELS

STEERING - POWER STEERING SYSTEM

Power Steering Pump & Reservoir

POWER STEERING PUMP ASSEMBLY:

2.7 TDV6 diesel		
new, exchange		
to VIN 6A999999		
Land Rover	1	QVB500400
OEM	1	QVB500400P1
VIN 7A000001 on		
Land Rover	1	LR014090
OEM	1	LR014090P1
3.6 TDV8 diesel		
new, exchange	1	QVB500640
4.2 AJV8 supercharged petrol & 4.4 AJV8 petrol		
new, exchange		
Land Rover	1	QVB500390
OEM	1	QVB500390P1
BRACKET, power steering pump:		
2.7 TDV6 diesel		
to VIN 6A999999	1	QVU500090
VIN 7A000001 on	1	QVU500340
4.2 AJV8 supercharged petrol & 4.4 AJV8 petrol		
to VIN 7A993780	1	YLU500271
VIN 7A993781 on	1	YLU500410
RESERVOIR ASS'Y, with cap	1	LR061407
CAP, reservoir	1	QEZ500010

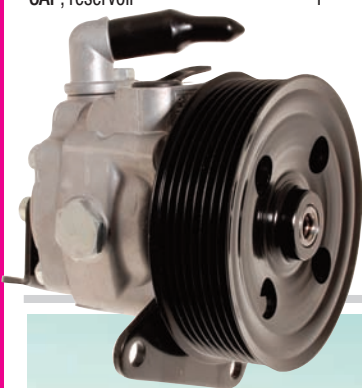

POWER STEERING PUMP ASSEMBLY - LR014090

Power Steering Hoses & Fluid Cooler

2.7 TDV6 DIESEL

POWER STEERING HOSE ASSEMBLY:

supply		
reservoir to pump		
long (hose and pipe)		
RHD	1	LR014389
LHD	1	LR014396
short (hose only)		
to VIN 5A999999	1	QEH000294
VIN 6A000001 to 6A999999	1	LR023433
VIN 7A000001 on	1	LR023435
pump to rack		
<i>Includes banjo bolt, sealing washers and O ring.</i>		
RHD		
to VIN 6A999999	1	QEP500590
VIN 7A000001 on	1	QEP501860
LHD		
to VIN 6A999999	1	QEP500601
VIN 7A000001 on	1	QEP500910
return		
rack to cooler pipe		
<i>Includes O ring.</i>		
RHD	1	QEP500632
LHD	1	QEP500643
cooler to reservoir (incl. cooler)	1	QGC500131
O RING:		
supply hose to rack	1	QYX500010
return hose to rack	1	LR009346
BANJO BOLT, hose to pump	1	QFM100040L
WASHER, sealing, banjo bolt	2	QGK100050L



RESERVOIR CAP - QEZ500010

3.6 TDV8 DIESEL

POWER STEERING HOSE ASSEMBLY:

supply		
reservoir to pump	1	LR023345
pump to rack		
RHD	1	QEP501720
LHD	1	QEP501840
return, rack to reservoir		
RHD	1	LR014387
LHD	1	LR014388
O RING:		
supply hose to rack	1	QYX500010
return hose to rack	1	LR009346
SCREW, hose union to pump	1	RYP500980

4.2 AJV8 SUPERCHARGED PETROL & 4.4 AJV8 PETROL

POWER STEERING HOSE ASSEMBLY:

supply		
reservoir to pump	1	LR023434
pump to rack		
<i>Includes banjo bolt, sealing washers and O ring.</i>		
RHD	1	QEP500610
LHD	1	QEP500621
return		
rack to cooler pipe		
<i>Includes O ring.</i>		
RHD	1	LR014403
LHD	1	LR014404
cooler to reservoir (incl. cooler)		
4.2 AJV8 supercharged petrol	1	QGC500122
4.4 AJV8 petrol	1	QGC500111
O RING:		
supply hose to rack	1	QYX500010
return hose to rack	1	LR009346
BANJO BOLT, hose to pump	1	QFM100040L
WASHER, sealing, banjo bolt	2	QGK100050L



WE'RE HERE TO HELP
 Can't find or not sure of the right part for your car, contact our technical sales team for help and advice.
01522 568000

ALL MODELS

ELECTRICS - ALTERNATOR, STARTER & IGNITION



ALTERNATOR ASSEMBLY, 2.7 TDV6 DIESEL - YLE500400P1

Alternator

2.7 TDV6 DIESEL

ALTERNATOR ASSEMBLY:

without roll stability control
new

Land Rover, exchange	1	YLE500400
OEM, outright	1	YLE500400P1
aftermarket, outright	1	YLE500400P
reconditioned, exchange	1	LR008861

with roll stability control
new,

Land Rover, exchange	1	YLE500420
aftermarket, outright	1	YLE500420P

BRACKET, alternator mounting:

without roll stability control	1	YLU500590
with roll stability control	1	YLU500390

BOLT:

alternator to bracket	3	1039640
bracket to engine	5	LYG500240

3.6 TDV8 DIESEL

ALTERNATOR ASSEMBLY:

new		
Land Rover, exchange	1	YLE500430
OEM, outright	1	YLE500430P1

BRACKET, alternator mounting

	1	LR013184
--	---	-----------------

BOLT:

alternator to bracket		
upper, long (100mm)	1	FB110206
lower, short (75mm)	2	FB110151L
bracket to engine		
rear, long (120mm)	1	FB112246
upper, long (100mm)	1	FB110206
upper, short (50mm)	1	FB110106
medium (75mm)	3	FB110151L

4.2 AJV8 SUPERCHARGED PETROL & 4.4 AJV8 PETROL

ALTERNATOR ASSEMBLY:

Land Rover, exchange	1	YLE500390
OEM, outright	1	YLE500390P1
aftermarket, outright	1	YLE500390P

BRACKET, alternator mounting

	1	YLU500151
--	---	------------------

BOLT:

alternator to bracket	3	FB110151L
bracket to engine		
long	2	FB108166
short	2	FB108071L



ALTERNATOR ASSEMBLY, 4.4 AJV8 PETROL - YLE500390P1

Ignition System

4.2 AJV8 SUPERCHARGED PETROL & 4.4 AJV8 PETROL

COIL, ignition, plug top:

Land Rover	8	4744015
aftermarket	8	4744015P

BOLT, coil securing

	8	4363582
--	---	----------------

SPARK PLUG:

Land Rover	8	LR005253
OEM	8	LR005253P1

CAPACITOR, suppression

4.2 AJV8 supercharged petrol	1	LR005578
4.4 AJV8 petrol	1	LR004160



COIL - 4744015



SPARK PLUG - LR005253P1



STARTER MOTOR ASSEMBLY - LR043962P1

Starter Motor

2.7 TDV6 DIESEL

STARTER MOTOR ASSEMBLY:

new, outright		
Land Rover	1	LR043962
OEM, outright	1	LR043962P1
reconditioned, exchange	1	NAD500080E

BRACKET, starter motor mounting:

up to VIN 8A489502	1	NAU500080
VIN 8A489503 on	1	LR018468

BOLT:

starter motor flange to engine	3	FB110156
bracket to starter motor	2	NYG500010

SCREW, bracket to engine:

Land Rover	2	FS106167
aftermarket	2	FS106167P

3.6 TDV8 DIESEL

STARTER MOTOR ASSEMBLY:

new, exchange		
Land Rover	1	LR032541
OEM, outright	1	LR032541P1

NUT, positive terminal

	1	FN110042
--	---	-----------------

COVER, positive terminal

	1	YQD500430
--	---	------------------

BOLT, starter motor to engine

	2	FB110146
--	---	-----------------

BRACKET, starter motor steady

	1	NAU500090
--	---	------------------

NUT, bracket to starter motor

	2	FN106047
--	---	-----------------

SCREW, bracket to engine

	1	FS108146
--	---	-----------------

4.2 AJV8 SUPERCHARGED PETROL & 4.4 AJV8 PETROL

STARTER MOTOR ASSEMBLY, exchange:

Land Rover	1	NAD500310
aftermarket, outright	1	NAD500310P

SOLENOID, starter motor

	1	LR005973
--	---	-----------------

SCREW, starter motor to engine:

upper, short	1	YYP500050
lower, long	1	FS110207L

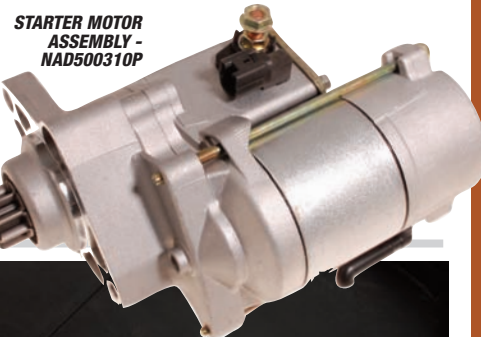

STARTER MOTOR ASSEMBLY - NAD500310P



WE'RE HERE TO HELP
 Can't find or not sure of the right part for your car, contact our technical sales team for help and advice.
01522 568000

ALL MODELS

Engine Sensors & Switches

2.7 TDV6 DIESEL

SENSOR:

crankshaft position	1	LR009793
engine knock	2	LR007808
<i>EC2 emissions models only.</i>		
camshaft position	2	LR019287
engine oil temperature	1	1359056
engine coolant temperature	1	LR041442
low coolant level	1	PCJ500030
intercooler air vent duct	1	LR014212
air flow meter		
Land Rover	1	PHF500101
OEM	1	PHF500101P1
manifold absolute pressure (MAP)	1	LR019130
fuel filter water detector	1	WKW500080
<i>VIN 7A000001 on.</i>		
exhaust particle filter sampling	1	LR014310
<i>Euro Stage 4 emissions models only, VIN 7A000001 on.</i>		
exhaust oxygen (Lambda):		
<i>Euro Stage 4 emissions models only, VIN 7A000001 on.</i>		
pre-catalyst	1	WDN500130
post-catalyst	1	WDN500110
post diesel particulate filter	1	WDN500050

MANIFOLD, fuel, to injectors, LH

Includes fuel pressure sensor.

Euro Stage 4 emissions models only, VIN 7A000001 on.

Land Rover	1	LR020020
OEM	1	LR020020P1

PIPE, fuel rail to fuel manifold, LH

Includes fuel pressure sensor.

Euro Stage 4 emissions models only, VIN 7A000001 on.

FUEL LEAK OFF PIPE ASSEMBLY	1	1386505
-----------------------------	---	----------------

Includes fuel temperature sensor.

PEDAL, accelerator:

Includes throttle position sensor.

RHD	1	LR012044
LHD	1	SLC500021PVJ

SWITCH, oil pressure	1	1316119
----------------------	---	----------------



CRANKSHAFT POSITION SENSOR - LR009793

3.6 TDV8 DIESEL

SENSOR:

crankshaft position	1	LR009793
engine knock	1	1419002
camshaft position		
Land Rover	1	LR058405
aftermarket	1	LR058405P
engine oil temperature	1	1359056
engine coolant temperature	1	LR044930
low coolant level	1	PCJ500030
air flow meter		
Land Rover	2	PHF500090
OEM	2	PHF500090P1
manifold absolute pressure (MAP)	2	LR007596
fuel filter water detector	1	WKW500080
exhaust particle filter sampling	1	LR014310
<i>Euro Stage 4 emissions models only.</i>		
exhaust oxygen (Lambda):		
<i>Euro Stage 4 emissions models only.</i>		
pre-catalyst	2	WDN500130
post-catalyst	2	WDN500070
post diesel particulate filter	1	WDN500050
O RING, engine coolant temp sensor	1	LR003337
CLIP, engine coolant temp sensor	1	LR003602
MANIFOLD, fuel to injectors, RH	1	LR020019
<i>Includes fuel pressure sensor.</i>		
PIPE, injectors to pump	1	1423955
<i>Includes fuel temperature sensor.</i>		
PEDAL, accelerator:		
<i>Includes throttle position sensor.</i>		
RHD	1	LR012044
LHD	1	SLC500021PVJ
SWITCH, oil pressure	2	LR000633

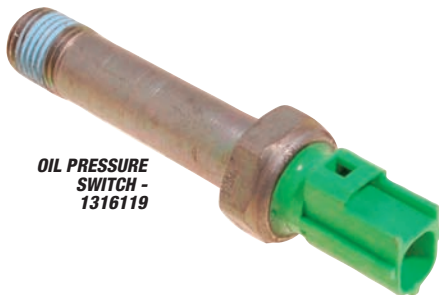

OIL PRESSURE SWITCH - 1316119



OIL PRESSURE SWITCH - LR000633

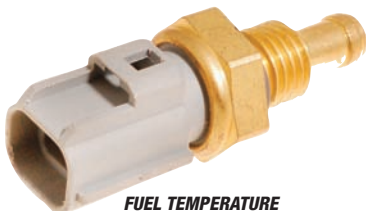

FUEL TEMPERATURE SENSOR - LR000291

AIR FLOW METER SENSOR - NSC500160



ENGINE COOLANT TEMPERATURE SENSOR - 4603183



LOW COOLANT LEVEL SENSOR - PCJ500030



4.2 AJV8 SUPERCHARGED PETROL & 4.4 AJV8 PETROL

SENSOR:

crankshaft position		
Land Rover	1	NSC500160
aftermarket	1	NSC500160P
engine knock	1	4603186
camshaft position		
RH	1	4427657
LH	1	4362957
engine oil temperature		
Land Rover	1	LR065234
OEM	1	LR065234P1
aftermarket	1	LR065234P
engine coolant temperature		
Land Rover	1	4603183
aftermarket	1	4603183P
low coolant level	1	PCJ500030
air flow meter		
Land Rover	1	PHF000140
OEM	1	PHF000140P1
manifold absolute pressure (MAP)		
4.2 AJV8 supercharged petrol	1	PMM500080
4.4 AJV8 petrol	1	4628195
air inlet sensor		
<i>4.2 AJV8 supercharged petrol models only.</i>		
Land Rover	1	LR008935
aftermarket	1	LR008935P
fuel temperature	1	LR000291
fuel pressure	1	4458309
<i>4.2 AJV8 supercharged petrol models only.</i>		
exhaust oxygen (Lambda):		
pre-catalyst	2	LR014010
post-catalyst		
RH		
Land Rover	1	LR014012
OEM	1	LR014012P1
LH		
Land Rover	1	LR014011
OEM	1	LR014011P1
RETAINER, engine knock sensor	1	4603189
RELUCTOR RING, cam position sensor	2	1323263
PEDAL, accelerator:		
<i>Includes throttle position sensor.</i>		
RHD	1	LR012044
LHD	1	SLC500021PVJ
SWITCH, oil pressure	1	4737666

Engine Control Units (ECUs)

MODULE, engine control unit (ECU):

2.7 TDV6 diesel		
EC2 emissions models	1	LR020351
Euro Stage 4 emissions	1	LR019991
<i>Models fitted with diesel particulate filter (DPF).</i>		
3.6 TDV8 diesel	1	NNW508040
4.2 AJV8 supercharged petrol	1	NNN500412
4.4 AJV8 petrol	1	NNN500451
HOUSING, plastic, module:		
RHD	1	YPC001315
LHD	1	YPC001305
COVER, plastic, module:		
front	1	YQH000244
upper (with multiplug hole)		
diesel models		
RHD	1	YQH500112
LHD	1	YQH500092
petrol models		
RHD	1	YQH500102
LHD	1	YQH500082



UPPER COVER YQH500112

WE'RE HERE TO HELP
 Can't find or not sure of the right part for your car, contact our technical sales team for help and advice.
01522 568000

Chassis Control Units & Sensors

CONTROL UNIT:

adaptive speed control			
up to VIN 6A999999	1	NNW501922	
VIN 7A000001 on	1	NNW501923	
transfer gearbox shift			
Land Rover	1	NNW512070	
OEM	1	NNW512070P1	
locking differential	1	LR020123	
<i>Models with rear axle locking.</i>			
air suspension	1	RQT500160	
roll stability control	1	NNW508200	
<i>Models with Roll Stability Control/Active Cornering Enhancement.</i>			
tyre pressure monitoring (TPMS)			
433Mhz frequency			
to VIN 6A999999	1	NNW501995	
VIN 7A000001 on	1	LR023427	
315Mhz frequency	1	LR023428	

SENSOR:

trans. box tripminder mode indicator	1	IAB500191	
differential temperature	1	NSC500590	
<i>Models with rear axle locking.</i>			
air suspension pressure	1	RQH500011	
air suspension height			
front			
RH	1	LR020474	
LH	1	LR020473	
rear			
RH			
Land Rover	1	LR020161	
OEM	1	LR020161P1	
LH			
Land Rover	1	LR020159	
OEM	1	LR020159P1	
roll stability control valve pressure	1	RQH500020	
<i>Models with Roll Stability Control/Active Cornering Enhancement.</i>			
roll stability control accelerometer	1	RQJ100011	
<i>Models with Roll Stability Control/Active Cornering Enhancement.</i>			
tyre pressure monitoring system			
<i>Includes tyre valve assembly and valve cap.</i>			
433Mhz frequency	4	LR032835	
315Mhz frequency	4	LR032836	
initiator, tyre pressure monitoring	4	RRE000010	
ABS			
yaw			
to VIN 6A999999	1	SR0000020	
<i>Compatible with 6 pin plug.</i>			
VIN 7A000001 on	1	SR0500140	
<i>Compatible with 4 pin plug.</i>			
front wheel			
Land Rover	2	SSB500133	
aftermarket	2	SSB500133P	
rear wheel			
Land Rover	2	SSB500102	
OEM	2	SSB500102P1	
aftermarket	2	SSB500102P	
steering angle	1	SR0500110	

Body (Vehicle) Control Units & Sensors

CONTROL UNIT:

DVD player	1	-	
<i>Please refer to In Car Entertainment & Navigation section.</i>			
mobile phone	1	-	
<i>Please refer to Miscellaneous Electrics section.</i>			
memory front seat	1	YWC500800	
front seat heater control	1	HLV500011	
Bi Xenon lighting control	2	LR018366	
Bi Xenon lighting ballast:			
to VIN 9A189549	2	YWC500430	
VIN 9A189550 on	2	YWC500480	
Bi Xenon adaptive lighting control	1	YWC500750	
fuel fired heater	1	LR041254	
<i>Diesel models only.</i>			
SENSOR:			
heater temperature control			
in heater unit	1	JTF500020	
in fascia			
all models except Japan	1	JTF500010	
Japan only	1	JTF000060	
climate control (ATC) only	1	JTF000070	
air conditioning ambient air	1	JTF000052	
<i>Mounted at front of vehicle.</i>			
pollution	1	LR034133	
adaptive speed control	1	YDB500560	
<i>Located on bracket behind radiator grille.</i>			
fuel fired heater water temp	1	LR004235	
<i>Diesel models only.</i>			
rain sensor, front windscreen	1	YDB500290	
windscreen washer fluid level	1	DMI500010	
GROMMET, washer fluid level sensor	1	DMJ500020	



GROMMET - DMJ500020



MODULE - YWC500730

Parking Distance Control

MODULE (controls front and rear)	1	YWC500730	
SENSOR, parking distance control:			
front and rear bumper			
Land Rover	8	YDB500301PMA	
aftermarket	8	YDB500301PMAP	
BEZEL, sensor:			
front			
outer positions			
RH	1	VTJ500100PMA	
LH	1	VTJ500130PMA	
inner positions	2	VTJ500120PMA	
rear	4	VTJ500141PMA	
SPEAKER, parking distance control	1	LR006482	

ALL MODELS

important note

ANTI-THEFT ALARM

Important note: Replacement of the receiver or remote transmitter/key must be done with a new item featuring the same frequency as the original. As a general guide, 433Mhz frequency equipment is used on UK cars, European cars, and many other markets. 315Mhz is used for the remainder. Replacement receivers and remote transmitters/keys will require programming before use. We provide a programming service, to personal callers only, for synchronising new ECUs and remote transmitters with your car.



REMOTE CONTROL RECEIVER MODULE - YWY500210

Anti-Theft Alarm

MODULE, remote control receiver:			
433Mhz	1	YWY500210	
315Mhz	1	YWY500220	
KEY BLANK, with remote transmitter:			
433Mhz	1	CWE500041SW	
315Mhz			
not Japan	1	CWE500051SW	
Japan	1	CWE500061SW	
BLADE ONLY, key blank	1	CWF500011SW	
SENSOR, alarm, interior scanning	1	YWC500350	
SIREN, anti-theft alarm:			
<i>For 433Mhz frequency systems.</i>			
without battery backup tilt sensor	1	YWK500060	
with battery backup tilt sensor			
to VIN 7A113451	1	YWK500050	
VIN 7A113452 on	1	YWK500070	
SWITCH, bonnet, anti-theft alarm	1	LR065340	



KEY BLANK - CWE500041SW



SENSOR - YDB500301PMA



ABS REAR WHEEL SENSOR - SSB500102



ORDER

BY PHONE: 01522 568000 / ON LINE: www.rimmerbros.co.uk / E-MAIL: lrsales@rimmerbros.co.uk

ALL MODELS

ELECTRICS - WIPERS & WASHERS

Windscreen Wipers

WIPER MOTOR ASSEMBLY, new:

RHD	1	LR020111
LHD	1	LR020112



WIPER MOTOR ASSEMBLY - LR020111

FITTING KIT, wiper motor <i>Includes bush and two screws.</i>	1	LR012989
STUD, wiper motor to bulkhead <i>Not included in fitting kit.</i>	1	AYR100190
WIPER LINKAGE ASSEMBLY:		
RHD	1	LR038347
LHD	1	LR038348
BOLT, wiper linkage to bulkhead	2	ALU1844L



WIPER ARM ASSEMBLY - DKB500041PMD

WIPER ARM ASSEMBLY - LR038121

WIPER ARM ASSEMBLY:

RHD		
driver's side		
to VIN 7A109275	1	DKB500041PMD
VIN 7A109276 on	1	LR038123
passenger's side		
to VIN 7A109275	1	DKB500261PMD
VIN 7A109276 on	1	LR038121
LHD		
driver's side		
to VIN 7A109275	1	DKB500050PMD
VIN 7A109276 on	1	LR038124
passenger's side		
to VIN 7A109275	1	DKB500271PMD
VIN 7A109276 on	1	LR038122
CAP, wiper arm	2	DKG500011PMD
NUT, wiper arm	2	DLP500010

WIPER BLADE - LR018368

WIPER BLADE:

RHD		
Land Rover	2	LR018368
OEM	2	LR018368P1
aftermarket	2	LR018368P
LHD		
Land Rover	2	LR018367
OEM	2	LR018367P1
aftermarket	2	LR018367P
SENSOR, rain, front windscreen	1	YDB500290

Rear Window Wiper

WIPER MOTOR ASSEMBLY, new	1	LR029319
NUT, wiper motor to rear door	3	DYH500140
SEAL, wiper motor to rear door	1	LR030338
WIPER ARM ASSEMBLY	1	DKB500720
CAP, wiper arm	1	DKG500011PMD
NUT, wiper arm	1	FN106042
WIPER BLADE:		
Land Rover	1	DKB500710
OEM	1	DKB500710P1



REAR WIPER BLADE - DKB500710

Windscreen & Rear Window Washers

RESERVOIR, windscreen washer:

Does not include filler neck or pumps.

without headlamp wash	1	DMB500030
with headlamp wash	1	DMB500040
BOLT, reservoir to body	3	DEP1198
FILLER NECK, reservoir	1	LR013955
GROMMET, filler neck to reservoir	1	DML10001L
CAP, filler neck	1	LR002266
FILTER, filler neck	1	DMS500010
PUMP, washer:		
windscreen		
Land Rover	1	DMC500010
aftermarket	1	DMC500010P



WINDSCREEN WASHER PUMP - DMC500010

GROMMET, pump to reservoir	1/2	AFU4506
<i>Qty. increases if headlamp washer is fitted.</i>		
SENSOR, low fluid level	1	DMI500010
GROMMET, low fluid level sensor	1	DMJ500020
WINDSCREEN WASHER HOSE ASS'Y	1	DNH000133
<i>Includes two hoses, two elbow pieces, 'Y' connector and two one-way valves.</i>		
ELBOW, hose to windscreen jets	2	DNG10001
'Y' CONNECTOR, washer hoses	1	DNG000010
JET, washer:		
windscreen (without hose)		
without heater	2	LR049290
with heater	2	LR048615
rear window (with hose)	1	LR032197

Headlamp Washers

HOSE ASSEMBLY, headlamp wash 1 DNH500100
JET, headlamp washer:

RH		
Land Rover	1	DNJ500100
aftermarket	1	DNJ500100P
LH		
Land Rover	1	DNJ500110
aftermarket	1	DNJ500110P
PUMP, headlamp washer	1	DMC500020
CAP SET, headlamp washer jet, pair:		
<i>Original fitment for HST body styling kit; will fit other models.</i>		
Santorini Black	1	VPLAB0025PAB
Galway Green	1	VPLAB0025HAC
Zermatt Silver	1	LR007918
primed	1	VPLAB0025LML
CLIP, jet to bumper	2	DYC000190

HEADLAMP WASHER JET - DNJ500100

HEADLAMP WASHER PUMP - DMC500020

CLIP - DYC000190

WE'RE HERE TO HELP
Can't find or not sure of the right part for your car, contact our technical sales team for help and advice.
01522 568000

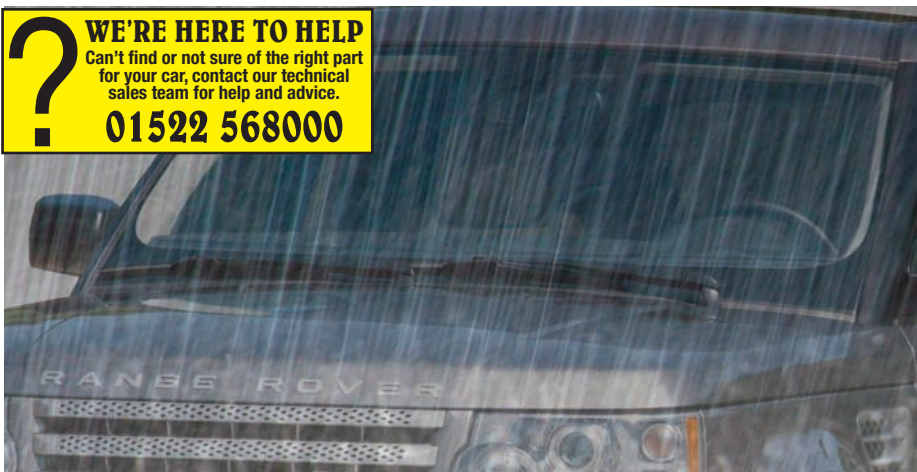

ORDER

BY PHONE: 01522 568000 / ON LINE: www.rimmerbros.co.uk / E-MAIL: lrsales@rimmerbros.co.uk

Headlamps

Includes Front Indicators

HEADLAMP ASSEMBLY, RHD:

Includes bulbs, bulb covers and mounting brackets.
Additionally, Bi Xenon headlamp assemblies are available with or without the control module included.

halogen		
without cornering lamp		
RH	1	XBC502160LZN
LH	1	XBC502170LZN
with cornering lamp		
to VIN 9A189549		
RH	1	XBC501583LZN
LH	1	XBC502130LZN
VIN 9A189550 on		
RH	1	XBC502110LZN
LH	1	XBC502130LZN
Bi Xenon		
without cornering lamp		
without control module		
RH	1	LR030404
LH	1	LR030424
with control module		
RH	1	XBC502200LZN
LH	1	XBC502210LZN
with cornering lamp		
without control module		
RH	1	LR030407
LH	1	LR030427
with control module		
RH	1	XBC502260LZN
LH	1	XBC502270LZN
adaptive Bi Xenon		
without control module		
RH	1	LR030409
LH	1	LR030429
with control module		
RH	1	LR012440
LH		
Land Rover	1	LR012437
OEM	1	LR012437P1



FRONT LAMP BULBS

HEADLAMP ASSEMBLY, LHD (not North America):

Includes bulbs, bulb covers and mounting brackets.
Additionally, Bi Xenon headlamp assemblies are available with or without the control module included.
The headlamps listed here do not include those for use in the USA, Canada or Mexico; if these are required please contact us.

halogen		
without cornering lamp		
RH	1	XBC502180LZN
LH	1	XBC502190LZN
with cornering lamp		
RH	1	XBC502140LZN
LH	1	XBC502150LZN
Bi Xenon		
without cornering lamp		
without control module		
RH	1	LR030405
LH	1	LR030425
with control module		
RH	1	XBC502220LZN
LH	1	XBC502230LZN
with cornering lamp		
without control module		
RH	1	LR030408
LH	1	LR030428
with control module		
RH	1	XBC502360LZN
LH	1	XBC502370LZN
adaptive Bi Xenon		
without control module		
RH	1	LR030410
LH	1	LR030430
with control module		
RH	1	LR012441
LH	1	LR012438

BULB, headlamp:
halogen headlamps (H7)

Land Rover	4	XZQ000011
aftermarket	4	XZQ000011P

Bi Xenon headlamps

without ignitor (D2S) (to VIN 9A189549)		
Land Rover	2	XB1000030
aftermarket	2	XB1000030P
with ignitor (D1S)	2	LR021904
VIN 9A189550 on.		

BULB, cornering lamp (H8)

BULB, front indicator:		
filament type, standard	2	LR000702
aftermarket, standard	2	LR000702P
silver look, pair	1	LR000702SILVER
LED type, upgrade	2	GLB382LEDAMBER

BULB, front side light:

cool blue type	2	XZQ500060
Standard fitment to VIN 6A916303.		
clear type	2	XZQ000060
Standard fitment VIN 6A916304 on.		

MODULE:

Bi Xenon lighting control	2	LR018366
Models with Bi Xenon or adaptive Bi Xenon lighting only.		

Bi Xenon lighting ballast

Models with Bi Xenon or adaptive Bi Xenon lighting only.		
to VIN 9A189549	2	YWC500430
VIN 9A189550 on	2	YWC500480
Bi Xenon adaptive lighting control	1	YWC500750
Models with adaptive Bi Xenon lighting only.		

COVER:

headlamp bulb		
low beam	2	XCA500070
high beam	2	XCA500080
cornering lamp bulb	2	XCA500080

BULB HOLDER, front indicator bulb

SILICA GEL PACK, anti-condensation

Fit if condensation is present within headlamp assemblies.

BRACKET, headlamp fixing:

upper centre	2	ABU780380
outer		
RH headlamp	1	XBU500080
LH headlamp	1	XBU500090
inner		
RH headlamp	1	XBU500060
LH headlamp	1	XBU500070

TURN BUCKLE, 1/4 turn type

Quick release latch to remove headlamp from mounting brackets.

RETAINER, turn buckle in bracket

Plate securing turn buckle in bracket.

Indicator Side Repeaters

INDICATOR SIDE REPEATER LAMP:

to VIN 8A999999

amber (original style), each	2	XGB000073
Land Rover	2	XGB000073P
aftermarket	2	LR007954BPSMOKE
smoked lamp conversion kit	2	LR007954BPSMOKE
Includes a lamp and amber bulb.		

VIN 9A000001 on

clear (original style), each	2	LR007954
Land Rover	2	LR007954P1
OEM	2	LR007954BPSMOKE
smoked lamp conversion kit	2	LR007954BPSMOKE
Includes a lamp and amber bulb.		

BULB, side repeater lamp:

clear, to VIN 8A999999	2	XZQ000060
amber, VIN 9A000001 on	2	LR007107

BULBHOLDER, side repeater lamp



INDICATOR SIDE REPEATER LAMP - XGB000073

Front Fog Lamps

This section details the fog lamp assemblies for models without the HST body styling kit only; for the bezels/finishers, please refer to External Body Fittings.

FOG LAMP ASSEMBLY, front:

RH	1	XBJ000080
LH	1	XBJ000090

BULB & BULBHOLDER, fog lamp:

The fog lamp bulb is supplied complete with the bulbholder and electrical socket; it is not available separately.

Land Rover	2	XZQ000110
aftermarket	2	XZQ000110P

SCREW, fog lamp fixing

'U' NUT, fog lamp fixing

	6	DYP500070
	6	DYH500120



FOG LAMP ASSEMBLY - XBJ000080

FOG LAMP BULB & BULB HOLDER - XZQ000110

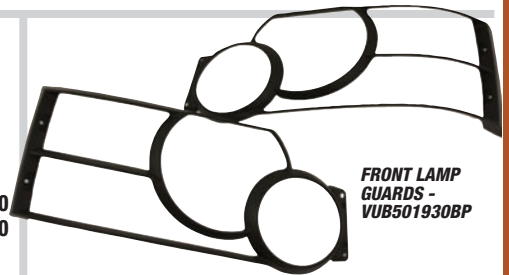

FRONT LAMP GUARDS - VUB501930BP

Front Lamp Guards

FRONT LAMP GUARD:

Durable protection for your expensive headlamps - not just a cosmetic accessory! Supplied with fixings.

pair, kit

Land Rover	1	VUB501930
Britpart	1	VUB501930BP
Bearmach	1	VUB501930BM

each (Land Rover replacement parts)

RH	1	VUB503370
LH	1	VUB503360



ORDER

BY PHONE: 01522 568000 / ON LINE: www.rimmerbros.co.uk / E-MAIL: lrsales@rimmerbros.co.uk

ALL MODELS

ELECTRICS - LAMPS

HST Front Driving/Fog Lamps

This section details the twin driving/fog lamp assemblies fitted to Range Rover Sport HST model and are styled to fit the HST body kit.

HST DRIVING/FOG LAMP KIT	1	VUB502440
<i>Includes driving and fog lamp assemblies, mountings, bezels, lamp wiring harnesses and all fixings and fittings. Does not include lighting switch and switch harness.</i>		
SWITCH KIT, HST driving/fog lamps	1	VUB503980
<i>Includes main lighting switch for vehicles fitted with driving and fog lamps, plus switch harness.</i>		
DRIVING LAMP ASSEMBLY	2	VUB500300
FOG LAMP ASSEMBLY	2	VUB503310
BEZEL KIT, fog lamp	2	LR009009
MOUNTING & SURROUND KIT:		
RH	1	VUU500300
LH	1	VUU500310



Rear Lamp Assemblies

The rear lamps listed here do not include those with side markers for use in the USA, Canada or Mexico; please contact us for these markets.

REAR LAMP ASSEMBLY:

to VIN 8A999999		
RH	1	XFB500420
LH	1	XFB500430
VIN 9A000001 on		
RH		
Land Rover	1	LR007955
OEM	1	LR007955P1
LH		
Land Rover	1	LR007957
OEM	1	LR007957P1
BULB, stop/tail lamps (21W/5W):		
filament type, standard	4	XZQ000020
LED type, upgrade	4	GLB380LED
BULB, rear fog lamps (21W):		
filament type, standard	2	XZQ000030
LED type, upgrade	2	GLB382LED
BULB, rear indicator lamps (21W):		
to VIN 8A999999 (clear bulb)		
filament type, standard	2	XZQ000030
LED type, upgrade	2	GLB382LED
VIN 9A000001 on (silvered amber bulb)		
filament type, standard	2	LR007165
LED type, upgrade	2	GLB382LEDAMBER
BULB, reversing lamps (21W):		
filament type, standard	2	XZQ000030
LED type, upgrade	2	GLB382LED
WIRING & BULBHOLDERS ASS'Y	1	YND500090
SCREW, self tapping, rear lamp fixing	4	DA610058
NUT, Lokut, self tapping screw	4	LR044895
THUMB NUT, rear lamp fixing:		
upper	2	XZP500010
lower	2	XZP500020



REAR LAMP BULBS

XZQ000030

XZQ000020

GLB382LED

High Level Stop Lamp

REAR HIGH LEVEL STOP LAMP ASS'Y1	XFG000071
SCREW, high level stop lamp fixing	XF0500020

REAR HIGH LEVEL STOP LAMP ASSEMBLY - XFG000071



LED Logo Puddle Lamp Kit

LED puddle lamps, with Land Rover logo embedded in the beam, ideal for adding that personal touch to your Land Rover vehicle. The lamps are designed to operate when you open the door of your vehicle to illuminate the floor below. These lamps may also be installed internally to illuminate the interior footwell of the vehicle. Flush fitting, for discreet installation. Kit includes two puddle lamps with wiring, plus core cutter to make mounting holes.

PUDDLE LAMP KIT, with LED logo	1	RX1267
---------------------------------------	---	---------------



PUDDLE LAMP KIT - RX1267

Spare Bulb & Fuse Kit

LAND ROVER SPARE BULB & FUSE KIT	1	VUB500110
---	---	------------------

Includes spare bulbs and fuses appropriate for Range Rover Sport models.

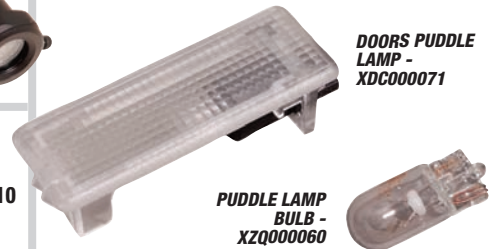

PUDDLE LAMP BULB - XZQ000060

DOORS PUDDLE LAMP - XDC000071

Rear Number Plate Lamps

REAR NUMBER PLATE LAMP ASS'Y	2	XFC500040
BULB, rear number plate lamp (5W)	2	XZQ000060
BULBHOLDER ASSEMBLY	2	XBP100210

REAR NUMBER PLATE LAMP ASSEMBLY - XFC500040



Rear Lamp Guards

REAR LAMP GUARDS:
Durable protection for your expensive lamps - not just a cosmetic accessory! Supplied with fixings.

pair, kit		
Land Rover	1	VUB501920
Britpart	1	VUB501920BP
each (Land Rover replacement parts)		
RH	1	VUB503380
LH	1	VUB503390

REAR LAMP GUARDS - VUB501920BP

Audio System Speakers

STANDARD AUDIO SYSTEM

SPEAKER:		
front door, mid range & bass	2	XQM500480
rear side door, full range	2	XQM500490
front door, tweeter	2	XQN500010

HI ICE BRANDED AUDIO SYSTEM

SPEAKER:		
front door, mid range	2	XQM500500
rear side door, mid range	2	XQM500510
front & rear side door, tweeter	4	XQN500020
rear door, woofer	1	XQA500120

PREMIUM SURROUND SOUND AUDIO SYSTEM

SPEAKER:		
front door & rear roof, mid range	4	XQM000400
front door, base	2	XQM500520
rear side door, base	2	XQM500530
fascia centre, mid range	1	XQM000400
front & rear side door, tweeter	4	XQN000130
rear door, woofer	1	XQA500120

GRILLE:		
fascia centre speaker		
to VIN 9A212697	1	FBI500050PVJ
VIN 9A212698 on	1	LR018984
rear roof speaker	2	EDV500053NUG
<i>Includes screw and clip.</i>		

SEAL, fascia centre speaker to fascia	1	FAU500060
SCREW, speaker grille to roof	2	DA608044L
CLIP, speaker grille to roof	2	EYC500070



Aerial & Amplifiers

important note **RADIO AERIALS**
Important note: for FM/AM radio aerials mounted integrally within the rear side quarter windows, please refer to the Body Glass section of this catalogue. Amplifiers for these aerials are listed below.

ROOF PANEL MOUNTED AERIAL

AERIAL ASS'Y:		
to VIN 8A999999		
without navigation system	1	XUI500094PNP
with navigation system		
to VIN 8A147137	1	XUI500124PNP
VIN 8A147138 to 8A999999	1	XUI500310
VIN 9A000001 on	1	XUI500370
BRACKET, aerial base		
to VIN 8A999999	1	AKR760010
VIN 9A000001 on	1	AKR780130
PLUG, aerial through roof panel		
to VIN 8A999999	1	XUK500012
VIN 9A000001 on	1	LR030842
NUT, aerial to roof panel	2	RYH500420

NAVIGATION SYSTEM AMPLIFIER (TRAFFIC MESSAGE CHANNEL)

AMPLIFIER, red or blue, traffic message channel with radio	1	XUI500071
--	---	------------------

AERIAL AMPLIFIERS & ISOLATORS

AMPLIFIER ASS'Y:		
FM/AM radio		
yellow	1	XUC500160
grey	1	XUC000072
TV system, black		
to VIN 5A910905	4	XUC000080
VIN 5A910906 on	3	XUC000080
ISOLATOR, brown, AM/FM radio	1	XUC000262

Radio/CD/MP3 Players

RADIO/CD PLAYER:

with single CD player		
<i>Standard and HI ICE branded audio systems.</i>		
new, exchange	1	VUX500510
reconditioned, exchange		
to VIN 6A999999	1	VUX500350E
VIN 7A000001 to 7A999999	1	LR008597
VIN 8A000001 on	1	LR011336
with integrated 6 CD player		
<i>Standard, HI ICE branded and premium surround sound systems.</i>		
new, exchange		
to VIN 7A999999	1	VUX500500
VIN 8A000001 on	1	VUX500570
reconditioned, exchange		
to VIN 6A985407	1	VUX500340E
VIN 6A985408 to 7A999999	1	LR008596
VIN 8A000001 on	1	LR011337

FRONT PANEL, radio/CD player		
<i>Models with integrated 6 CD player only.</i>		
to VIN 7A999999	1	LR019966
VIN 8A442165 on	1	LR019967
SCREW, radio/CD player mounting	4	FYP500110
AUDIO PLUG & PLAY KIT, USB/MP3	1	VPLFE0002
<i>Includes plug & play module, wiring harnesses, sync & charge jumper cables for USB and MP3/iPod (30 pin connector for the latter). Does not include iPod cradle.</i>		
MP3/IPOD JUMPER CABLE, white	1	VPLAE0003
<i>Sync & charge jumper cable for MP3/iPod - 30 pin connector type.</i>		
CRADLE/ADAPTOR KIT, iPod	1	LR006850
<i>For earlier type iPods only (up to 4th gen.).</i>		

Radio Amplifier

AMPLIFIER KIT:		
HI ICE branded audio system	1	LR024836
premium surround sound system	1	LR039436

Navigation System

NAVIGATION COMPUTER, less screen:		
new, exchange	1	LR018252
reconditioned, exchange	1	LR018204
BRACKET, navigation computer	1	YIU500200
WIDESCREEN, navigation computer:		
new, outright	1	LR012984
reconditioned, exchange	1	LR018203
MAP CD, navigation computer	1	-
<i>To order the CD you require, please contact Rimmer Bros.</i>		
MODULE, traffic message channel	1	LR010511
BRACKET, mounting TMC module	1	YIU500021



ALL MODELS

DVD Player & TV System

DVD SCREEN:		
to VIN 6A999999		
new, outright	2	YIP500340
reconditioned, exchange	2	YIP500340E
VIN 7A000001 on		
new, outright	2	YIP500390

important note **DVD PLAYERS**
Important note: both the new and reconditioned DVD players sold for models from VIN 8A137585 onwards are later design units originally fitted to later vehicles than those covered by this catalogue. To fit them, new mounting brackets will be required (part numbers LR018675 and LR018676, see below).

DVD PLAYER:
Note: Global regions for DVD recording formats dictate the type of player required (Region 1 is North America and is not listed here). For Region 2, playback of DVDs is further complicated by the need to choose between PAL and NTSC configuration. In Europe, the usual configuration is PAL. The following details the DVD regions by continents and countries:

Region 1: USA, USA Territories, Canada, Bermuda.
 Region 2: Europe, French Overseas Territories, Middle East, Egypt, South Africa, Swaziland, Lesotho, Japan, Greenland.
 Region 3: South East Asia, South Korea, Taiwan, Hong Kong, Macau.
 Region 4: South and Central America, Caribbean, Mexico, Australasia.
 Region 5: Indian Sub-Continent, Ukraine, Belarus, Kazakhstan, Russia, Africa (except those shown in Region 2), Central and South Asia, Mongolia, North Korea.

Region 6: China.		
to VIN 8A137584		
new, exchange		
<i>Includes magazine.</i>		
Region 2 (NTSC)	1	XQE000204
Region 6	1	XQE500310

reconditioned, exchange		
<i>Does not include magazine.</i>		
Region 2 (PAL)	1	XQE000200E
Region 2 (NTSC)	1	XQE000204E
Region 3	1	XQE000205E
Region 4	1	XQE000206E
Region 5	1	XQE000207E
Region 6	1	XQE500310

VIN 8A137585 on (see Important Note above)		
new, exchange		
<i>Includes magazine.</i>		
Region 2 (PAL)	1	LR020195
Region 2 (NTSC)	1	LR020196
Region 3	1	LR020197
Region 4	1	LR020198
Region 5	1	LR020199
Region 6	1	LR020200

reconditioned, exchange		
<i>Does not include magazine.</i>		
Region 2 (PAL)	1	LR043327
Region 5	1	LR043332
MAGAZINE, DVD autochanger	A/R	XQZ000050

One magazine included with new DVD players.
BRACKET, mounting DVD player:
Required when fitting a new or reconditioned DVD player from (VIN 8A137585 onwards.

RH	1	LR018675
LH	1	LR018676
REMOTE CONTROL, DVD player	1	YUH500060

CONTROL MODULE, DVD player:		
new, exchange		
to VIN 7A099999 and VIN 7A300000 to 7A993036	1	YIL000054
new, outright		
VIN 7A100000 to 7A299999 and VIN 7A993037 on	1	LR043260

reconditioned, exchange		
to VIN 7A993036	1	YIL000054E
VIN 7A993037 on	1	LR011330
CONTROL PANEL, video/audio	1	XVN500040
HEADPHONE SET, rear seats	2	XQF500060
BAG, headphone set storage	2	VUP500060
TUNER, TV system, digital	1	LR014222
AMPLIFIER, TV system	1	XU000060
CONTROL PANEL, video/audio lead:		
without DVD player	1	XV0500020
with DVD player	1	XVN500040

ALL MODELS

ELECTRICS - MISCELLANEOUS

Mobile Phone Installation

CONTROL MODULE:

mobile phone

Pre-Bluetooth - fitted up to VIN 8A999999.

English display, new, exchange 1 **XVJ500420**

German display, new, exchange 1 **XVJ500440**

French display

new, outright

to VIN 6A959442 1 **XVJ500092**

VIN 6A959443 to 8A130098 1 **XVJ500390**

new, exchange

VIN 8A130099 to 8A999999 1 **XVJ500460**

Italian display

new, exchange 1 **XVJ500470**

Spanish display

new, exchange 1 **XVJ500430**

Bluetooth, new, outright

Fitted from VIN 9A000001. 1 **LR025842**



MOBILE PHONE CONTROL MODULE - XVJ500420

BRACKET, module mounting:

mobile phone module

Pre-Bluetooth - fitted up to VIN 8A999999.

all modules except Nokia 1 **FHC500071**

Nokia modules only 1 **FHC500400**

Bluetooth module

Fitted from VIN 9A000001. 1 **FHC500390**

BASE PANEL, console, phone mounting 1 FHC500221

ACCESSORY KIT, Bluetooth 1 VUB501152

Installation kit for Bluetooth interface on vehicles up to VIN 7A999999. Includes Bluetooth control module, receiver, steering wheel switch panel and wiring harnesses.

BLUETOOTH CONTROL MODULE 1 XVD500021

For accessory kit installation only on vehicles up to VIN 7A999999.

Included in accessory kit.

PHONE CONTROL MODULE, Bluetooth interface:

For accessory kit installation only on vehicles up to VIN 7A999999. Not included in accessory kit

English (US) 1 **LR006279**

German 1 **LR006280**

French 1 **LR006281**

Italian 1 **LR006283**

Spanish 1 **LR006282**

PHONE CRADLE & SWIVEL, Bluetooth interface:

For accessory kit installation only on vehicles up to VIN 7A999999. Not included in accessory kit

Nokia 6100/6220/6230 1 **XVE500021**

Sony Ericsson T610 1 **XVE500040**

Siemens C45/ME45/S45/S45/

M50/MT50 1 **XVE500050**

Siemens C55/M55/S55 1 **XVE500080**



PHONE MOUNTING BASE PANEL - FHC500221

Horns

HORN ASSEMBLY:

to VIN 9A206662

Separately mounted horns, supplied individually.

high note 1 **YEB500160**

low note 1 **YEB500080**

VIN 9A206663 on

Horns mounted together, supplied as a pair on bracket.

standard, pair 1 **LR014560**

level 2, pair 1 **LR056648**



HIGH NOTE HORN ASSEMBLY - YEB500160

Under-Bonnet Fuse Boxes

ENGINE COMPARTMENT FUSE BOX

FUSE BOX, engine compartment 1 **YPP500080**

Bare housing only - does not include fuses or fuse holders. The complete fuse box assembly is included in the engine and dash wiring harness; please refer to Harnesses & Cables section.

FUSE BOX COVER:

upper 1 **YQH500130**

lower ('T' shaped) 1 **YPW500100**

FUSE PANEL COVER:

main fuse panel 1 **YPW500090**

micro fuse panel and relay 1 **YPW500060**

square fuse panel (6 way) 1 **YPW500080**

square fuse panel (12 way) 1 **YPW500070**

main mini fuse panel and relay 1 **YPW500050**

FUSE:

mini fuse

5 amp (tan) 4 **LR003737**

10 amp (red) 6 **LR075978**

15 amp (blue) 6 **LR003740**

20 amp (yellow) 4 **LR075980**

25 amp (natural) 5 **LR075981**

30 amp (green) 4 **LR075982**

square fuse

30 amp (pink) 6 **LR003735**

40 amp (green) 6 **LR003736**

50 amp 4 **LR019937**

60 amp 1 **YQG100440**

EXTRACTOR, mini fuse 1 YQT500010

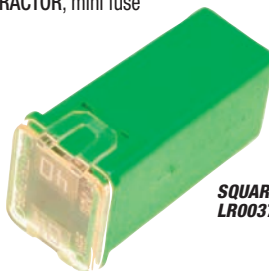

SQUARE FUSE - LR003736

POSITIVE BATTERY CABLE MEGA FUSE

FUSE BOX, mega fuse, battery cable 1 **YQE500310**

FUSE BOX COVER, mega fuse box:

RHD 1 **YQH500220**

LHD 1 **YQH500230**

FUSE, mega, 400 amp, battery cable 1 **YQG500010**

SCREW, mega fuse attaching 2 **YYP500060**

FUSE PANEL COVER, black, 2 pin 1 **IPS500060**

2.7 TDV6 diesel models from VIN 7A000001 on.

MEGA FUSE - YQG500010

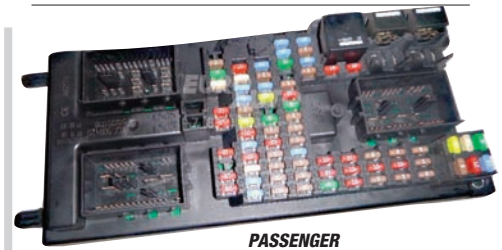

PASSENGER COMPARTMENT FUSE BOX - YQE500420SW

Passenger Compartment Fuse Box

FUSE BOX, passenger compartment 1 **YQE500420SW**

Includes fuses and relays. **Important note:** the VIN for your car is required when ordering this fuse box - please contact us.

FUSE:

5 amp (tan) 25 **LR003737**

10 amp (red) 21 **LR075978**

15 amp (blue) 12 **LR003740**

20 amp (yellow) 3 **LR075980**

25 amp (natural) 5 **LR075981**

30 amp (green) 6 **LR075982**

EXTRACTOR, mini fuse 1 YQT500010

BRACKET, fuse box:

RHD 1 **YQU500510**

LHD 1 **YQU500500**

GROMMET, fuse box to bracket 2 YQQ500090



10AMP FUSE - LR075978

15AMP FUSE - LR003740

20AMP FUSE - LR075980

Relays

RELAY:

black/yellow, 20 amp, 4 pin 1 **YWB500020**

black, 20 amp, 5 pin 4 **YWB500200**

black/white, 40 amp, 4 pin 4 **YWB500060**

black or grey, 70 amp, 4 pin 6 **YWB500220**

brown, 5 pin 1 **YWC001020**

Models with power fold door mirrors only.

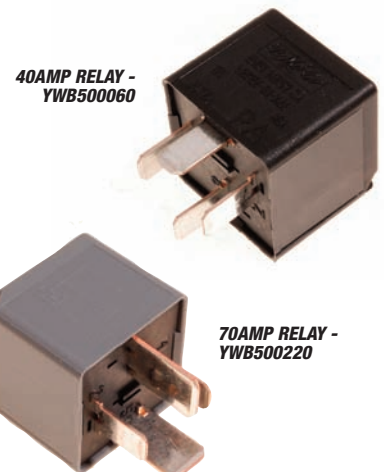

40AMP RELAY - YWB500060

70AMP RELAY - YWB500220

Battery & Battery Cables

BATTERY:		
diesel models, 90Ah	1	LR073414
petrol models, 80Ah	1	LR038128
CLAMP BAR, battery:		
RHD	1	YJF500110
LHD	1	YJF500100
BOLT, battery clamp bar:		
inner, 147mm long	1	XYG500061
outer, 180mm long	1	XYG000051



BATTERY BOX COVER - DWN500022

COVER, battery box:		
top		
RH side	1	DWN500022
LH side	1	DWN500032
side		
RH side	1	LR023483
LH side	1	LR015120

BASE PANEL, battery box:		
inner		
RH side	1	DWM500100
LH side		
to VIN 6A999999	1	DWM500051
VIN 7A000001 on	1	DWM500110
outer		
RH side	1	DWM500021
LH side	1	DWM500031

PAD, battery:		
driver's side	1	LR015121
passenger's side		
to VIN 6A947486	1	DW0500060
VIN 6A947487 on	1	LR015122
PLUG, plenum chamber	1	YYB500010PMA

POSITIVE BATTERY CABLE:		
2.7 TDV6 diesel		
RHD		
to VIN 5A999999	1	YTA500400
VIN 6A000001 on		
without roll stability control	1	YTA500521
with roll stability control	1	YTA500690
LHD		
to VIN 5A999999	1	YTA500410
VIN 6A000001 on		
without roll stability control	1	YTA500531
with roll stability control	1	YTA500680
3.6 TDV8 diesel		
RHD		
to VIN 8A123425	1	YTA500760
VIN 8A123426 to 8A183757	1	YTA500810
VIN 8A183758 on	1	YTA500850
LHD		
to VIN 8A123425	1	YTA500700
VIN 8A123426 on	1	YTA500800
4.2 AJV8 supercharged petrol & 4.4 AJV8 petrol		
RHD		
to VIN 5A999999		
without roll stability control	1	YTA500390
with roll stability control	1	YTA500430
VIN 6A000001 to 6A933219	1	YTA500500
VIN 6A933220 on	1	YTA500501
LHD		
to VIN 5A999999	1	YTA500380
VIN 6A000001 on	1	YTA500541

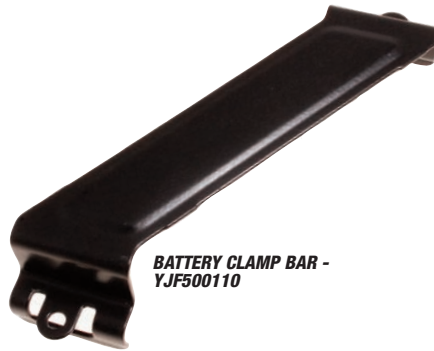

BATTERY CLAMP BAR - YJF500110

BATTERY TO FUSE BOX CABLE, positive:		
RHD	1	LR013020
LHD	1	LR013021
NEGATIVE BATTERY CABLE:		
RHD		
to VIN 5A901112	1	YTB000122
VIN 5A901113 to 6A943505	1	YTB000123
VIN 6A943506 on	1	YTB500290
LHD	1	YTB500300
EARTH CABLE:		
engine earth		
2.7 TDV6 diesel		
to VIN 5A999999	1	YTB500132
VIN 6A000001 on	1	YTB500280
3.6 TDV8 diesel		
RHD	1	YTB500390
LHD	1	YTB500420
4.2 AJV8 supercharged petrol	1	YTB500260
4.4 AJV8 petrol	1	YTB500260
transfer box earth	1	YTV500040
2.7 TDV6 & 3.6 TDV8 diesel models only.		
SCREW, engine earth cable	1	YYP500100
BATTERY ISOLATOR SWITCH:		
standard switch, with key	1	LL1171
race type switch, FIA approved	1	LL1171RACE
SPARE KEY, standard isolator switch	1	LL1171KEY



BATTERY ISOLATOR STANDARD SWITCH - LL1171

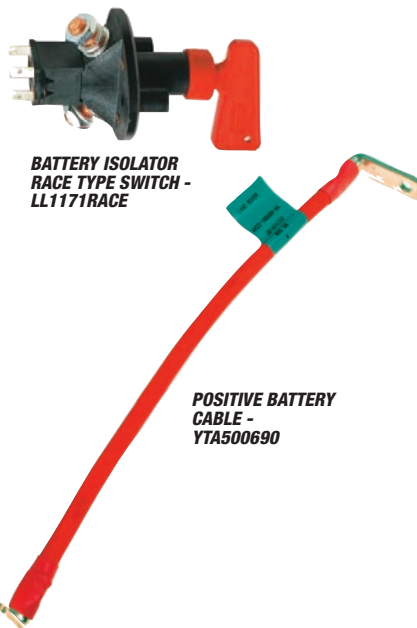

BATTERY ISOLATOR RACE TYPE SWITCH - LL1171RACE

POSITIVE BATTERY CABLE - YTA500690



BATTERY CONDITIONER KIT - RX1410CTEK

Battery Conditioner

The battery conditioner is a battery charger that turns on and off automatically. This superb product is suitable for all 12 volt batteries (from 5ah to 100ah) and constantly revitalises the battery cells - helping to extend cell life, without the danger of overcharging.

Look at these benefits:

Designed to be left connected for long periods.

Use without disconnecting vehicle electrics.

L.E.D. battery condition display.

Thermal cut-out facility.

12 month guarantee.

It can also be used for the following applications, providing they use a 12 volt battery: caravans, lawn mowers, motorbikes, motor boats, wheel chairs and general leisure use. The kit is supplied complete with all fittings and operating instructions.

BATTERY CONDITIONER KIT:

0.8 amp version	1	RX1410CTEK
3.8 amp version	1	RX1410CTEK3800

BATTERY CHARGER - GAC7106



Battery Charger

BATTERY CHARGER, 6 and 12 volt 1 **GAC7106**
Conventional battery charger, ideal for charging a flat battery quickly or overnight charging.

BATTERY ACID TESTER 1 **CONS295230**



BATTERY ACID TESTER - CONS295230

Spare Bulb & Fuse Kit

LAND ROVER SPARE BULB & FUSE KIT 1 **VUB500110**
Includes spare bulbs and fuses appropriate for Range Rover Sport models.

Dis-Car-Nect

DIS-CAR-NECT IMMOBILISER KIT 1 **RX1356**
REPLACEMENT KNOB 1 **RX1356KNOB**
REPLACEMENT FUSE 1 **RX1356FUSE**

How Does 'Dis-Car-Nect' Work?

When leaving your car, simply remove the knob to isolate the starter circuit. The 16 amp fuse will maintain current supply to all other electrical circuits (central locking, stereo memory, alarm etc.). Because the starter motor draws over 150 amps, any attempt to connect (hot-wire) the starter motor will instantly cause the fuse to blow. This immobilises the car until the knob is replaced. If this should happen, simply replace the 16 amp fuse at a convenient time.

As an added advantage, the 'Dis-Car-Nect' will also prevent battery drain if you intend to store your car: simply unscrew the knob and remove the fuse. For extra security, unscrew and remove the immobiliser knob completely.

WE'RE HERE TO HELP
Can't find or not sure of the right part for your car, contact our technical sales team for help and advice.
01522 568000

ALL MODELS

Instrument Cluster

2.7 TDV6 & 3.6 TDV8 DIESEL MODELS

INSTRUMENT CLUSTER, complete:

to VIN 6A999999		
MPH	1	YAC500445PVJ
KPH	1	YAC500465PVJ
VIN 7A000001 on		
new, outright		
VIN 7A000001 to 7A100669		
MPH	1	YAC502190
KPH	1	YAC502210
VIN 7A100670 to 7A980637		
MPH	1	LR018481
KPH	1	LR018484
VIN 7A980638 to 7A999999		
MPH	1	YAC502190
KPH	1	YAC502210
VIN 8A000001 on		
MPH	1	LR018481
KPH	1	LR018484
reconditioned, exchange		
MPH	1	LR060214
KPH	1	LR060079
LENS ASSEMBLY, instrument cluster	1	LR038299
SCREW, instrument cluster securing:		
Land Rover	2	FS106206
aftermarket	2	FS106206P



Steering Wheel Switches

STEERING WHEEL SWITCH MODULE, RH:

<i>Without: radio or phone controls</i>		
to VIN 6A999999	1	XPD500490VWH
VIN 7A000001 to 7A999999	1	XPD500700
VIN 8A000001 on	1	XPD500780
<i>With: radio controls</i>		
<i>Without: phone controls</i>		
to VIN 6A999999	1	XPD500500VWH
VIN 7A000001 to 7A999999	1	XPD500670
VIN 8A000001 on	1	XPD500790
<i>With: radio controls & phone controls</i>		
to VIN 6A999999	1	XPD500510VWH
VIN 7A000001 to 7A999999	1	XPD500730
VIN 8A000001 on	1	XPD500800



STEERING WHEEL SWITCH MODULE, RH - XPD500490VWH



STEERING WHEEL SWITCHES CABLE ASSEMBLY - QTV500020

important note

INSTRUMENT CLUSTER

Important Note: None of the clusters listed here are appropriate for USA, Mexico or Canada models. For those markets, please contact us

4.2 AVJ8 SUPERCHARGED PETROL MODELS

INSTRUMENT CLUSTER, complete:

to VIN 6A999999		
MPH	1	YAC501323PVJ
KPH	1	YAC501333PVJ
KPH/MPH	1	YAC501353PVJ
VIN 7A000001 on		
new, outright		
VIN 7A000001 to 7A100669		
MPH	1	YAC502240
KPH	1	YAC502250
KPH/MPH	1	YAC502270
VIN 7A100670 to 7A980637		
MPH	1	LR018487
KPH	1	LR018488
KPH/MPH	1	LR018490
VIN 7A980638 to 7A999999		
MPH	1	YAC502240
KPH	1	YAC502250
KPH/MPH	1	YAC502270
VIN 8A000001 on		
MPH	1	LR018487
KPH	1	LR018488
KPH/MPH	1	LR018490
reconditioned, exchange		
MPH	1	LR060082
KPH	1	LR060083
KPH/MPH	1	LR060084
LENS ASSEMBLY, instrument cluster	1	LR038299
SCREW, instrument cluster securing	2	FS106206

4.4 AVJ8 PETROL MODELS

INSTRUMENT CLUSTER, complete:

to VIN 6A999999		
MPH	1	YAC500435PVJ
KPH	1	YAC500455PVJ
KPH/MPH	1	YAC500485PVJ
VIN 7A000001 on		
new, outright		
VIN 7A000001 to 7A100669		
MPH	1	YAC502180
KPH	1	YAC502200
KPH/MPH	1	YAC502230
VIN 7A100670 to 7A980637		
MPH	1	LR018479
KPH	1	LR018483
KPH/MPH	1	LR018485
VIN 7A980638 to 7A999999		
MPH	1	YAC502180
KPH	1	YAC502200
KPH/MPH	1	YAC502230
VIN 8A000001 on		
MPH	1	LR018479
KPH	1	LR018483
KPH/MPH	1	LR018485
reconditioned, exchange		
KPH	1	LR060078
KPH/MPH	1	LR060081
LENS ASSEMBLY, instrument cluster	1	LR038299
SCREW, instrument cluster securing	2	FS106206



WASH/WIPE SWITCH ASSEMBLY - XPE500100

STEERING WHEEL SWITCH MODULE, LH:

<i>Without: cruise control</i>		
to VIN 6A999999	1	XPD500521VWH
VIN 7A000001 to 7A999999	1	XPD500760
VIN 8A000001 on	1	XPD500810
<i>With: manual cruise control,</i>		
<i>Without: voice input & steering wheel heater</i>		
to VIN 6A999999	1	XPD500591VWH
VIN 7A000001 to 7A999999	1	XPD500740
VIN 8A000001 on	1	XPD500830
<i>With: manual cruise control & steering wheel heater</i>		
<i>Without: voice input</i>	1	LR014307
<i>With: manual cruise control & voice input</i>		
<i>Without: steering wheel heater</i>		
to VIN 6A999999	1	XPD500601VWH
VIN 7A000001 to 7A999999	1	XPD500750
VIN 8A000001 on	1	XPD500840
<i>With: manual cruise control, voice input & steering wheel heater</i>		
	1	LR014308
<i>With: adaptive cruise control</i>		
<i>Without: voice input</i>		
to VIN 6A999999	1	XPD500581VWH
VIN 7A000001 to 7A999999	1	XPD500680
VIN 8A000001 on	1	XPD500820
<i>With: adaptive cruise control and voice input</i>		
<i>Without: steering wheel heater</i>		
to VIN 6A999999	1	XPD500611VWH
VIN 7A000001 to 7A999999	1	XPD500690
VIN 8A000001 on	1	XPD500850
<i>With: adaptive cruise control and voice input & steering wheel heater</i>		
	1	LR014306

CABLE ASS'Y, steering wheel switches	1	QTV500020
SCREW, steering wheel switches	4	QYP500050

Steering Column Switches

INDICATOR SWITCH ASSEMBLY	1	XPC500160
WASH/WIPE SWITCH ASSEMBLY:		
without rain sensor wipers	1	XPE500100
with rain sensor wipers	1	XPE500110
BRACKET, stalk switches to column	1	XPL500050
SCREW, switches to bracket	4	QYG500040
SWITCH, steering column adjustment	1	XPB500180PVJ

From VIN 7A100670 on.

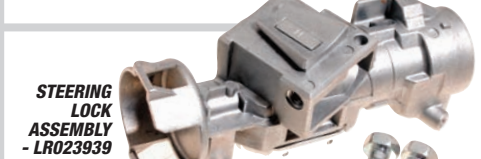

STEERING LOCK ASSEMBLY - LR023939

Ignition Switch/Steering Lock

STEERING LOCK ASSEMBLY	1	LR023939
<i>Without lock barrel, immobiliser transceiver or ignition switch. If a new lock barrel is required, please order the basic vehicle lock set listed below. For complete vehicle lock sets including remote control/key assemblies, please refer to the Door Fittings section of this catalogue.</i>		
BOLT, steering lock to column	2	QRH500010
SCREW, ignition switch to lock	4	XPQ500010
TRANSCIVER, immobiliser	1	YWD000010
IGNITION SWITCH:		
without auto gearbox interlock	1	YXB500010
with auto gearbox interlock	1	LR057851
VEHICLE LOCK SET, basic	1	CWB500300SW
<i>Includes all lock barrels for vehicle plus key blade. Also includes roll pin to fit key blade to remote. For complete vehicle lock sets including remote control/key assemblies, please refer to the Door Fittings section of this catalogue.</i>		
KEY BLADE, replacement	A/R	CWF500011SW
<i>Please contact us before ordering. Supplied with roll pin to fit blade into remote control.</i>		

Fascia Switches

FASCIA SWITCH PANEL, with switches:

Without: tyre pressure sensors, speed control & front parking aid 1 **YUL500560WUX**

With: front parking aid

Without: tyre pressure sensors, speed control 1 **YUL500570WUX**

With: manual speed control

Without: tyre pressure sensors, front parking aid & pass. airbag deact 1 **YUL501350**

With: manual speed control & pass. airbag deact.

Without: tyre pressure sensors & front parking aid 1 **YUL501430**

With: front parking aid

Without: tyre pressure sensors & pass. airbag deact 1 **YUL501360**

With: front parking aid & pass. airbag deact.

Without: tyre pressure sensors 1 **YUL501440**

With: adaptive speed control

Without: tyre pressure sensors, front parking aid & pass. airbag deact 1 **YUL501370**

4 way/switches 1 **YUL500800WUX**
5 way/switches 1 **YUL500800WUX**

With: adaptive speed control & pass. airbag deact.

Without: tyre pressure sensors, & front parking aid 1 **YUL501450**

With: adaptive speed control & front parking aid

Without: tyre pressure sensors & pass. airbag deact 1 **YUL501380**

4 way/switches 1 **YUL501380**
6 way/switches 1 **YUL500860WUX**

With: adaptive speed control, front parking aid & pass. airbag deact.

Without: tyre pressure sensors 1 **YUL501460**

With: tyre pressure sensors & front parking aid

Without: speed control to VIN 6A999999 1 **YUL500610WUX**

VIN 7A000001 on 1 **YUL500950WUX**

With: tyre pressure sensors

Without: speed control & front parking aid to VIN 6A999999 1 **YUL500600WUX**

VIN 7A000001 on 1 **YUL500940WUX**

With: tyre pressure sensors & manual speed control

Without: front parking aid 1 **YUL501390**

With: tyre pressure sensors, manual speed control & front parking aid

1 **YUL501400**

With: tyre pressure sensors & adaptive speed control

Without: front parking aid 1 **YUL501410**

4 way/switches 1 **YUL500810WUX**

6 way/switches to VIN 6A999999 1 **YUL500810WUX**

VIN 7A000001 on 1 **YUL500960WUX**

7 way/switches 1 **YUL500970WUX**

With: tyre pressure sensors, adaptive speed control & front parking aid

4 way/switches 1 **YUL501420**

7 way/switches 1 **YUL500870WUX**

Cigar Lighter/ Auxiliary Power Point

POP-OUT UNIT, cigar lighter 1 **YUJ500060PVJ**

SOCKET, cigar lighter/aux power point 1 **LR003987**

ILLUMINATION RING, cigar lighter 1 **YXD500040**

BULB, cigar lighter 1 **YXN500010**

SOCKET, auxiliary power point:

2nd row seats (in console) 1 **YXW500070PVJ**

luggage compt (in rear 1/4 panel) 1 **LR007412**

**CIGAR LIGHTER
POP-OUT UNIT -
YUJ500060PVJ**



Console Switches

CENTRE CONSOLE SWITCH PANEL, with switches:

Does not include parking brake switch.

to VIN 6A999999 1 **YUD501700WVH**

VIN 7A000001 to 7A299999 1 **YUD501710**

VIN 7A300000 to 7A980211 1 **YUD501700WVH**

VIN 7A980212 to 7A999999 1 **YUD501710**

VIN 8A000001 on 1 **YUD501770**

SWITCH ASSEMBLY:

lighting

without front fog lamps 1 **YUD501460PVJ**

with front fog lamps 1 **YUD501480PVJ**

with front driving & fog lamps 1 **VUB503980**

parking brake 1 **YUG500400MBF**

passenger airbag deactivation 1 **YWL500050PVJ**

heated seats 2 **YUF500120PVJ**

glovebox lamp (incl. bulbholder) 1 **YUE000140**

COVER:

parking brake switch 1 **FBX500120MBF**

front console panel 1 **FJG500032PVJ**

BEZEL, lighting switch

1 **YXD500050PVJ**

SCREW:

fascia switch panel attaching 2 **4378449**

lighting switch attaching 4 **BYP100240**

parking brake switch attaching 2 **FYP500410**



**FRONT FOG
LAMPS SWITCH
ASSEMBLY -
YUD501480PVJ**

Sunroof Switch

SUNROOF SWITCH ASSEMBLY 1 **YUC500030PVJ**

Tailgate Release Switch

TAILGATE RELEASE SWITCH ASS'Y 1 **YUZ500020**

Brake Light Switch

BRAKE LIGHT SWITCH:

Land Rover 1 **XKB500110**

OEM 1 **XKB500110P1**



**BRAKE LIGHT
SWITCH -
XKB500110**

Seat Switches

SEAT ADJUSTMENT SWITCH ASSEMBLY:

seat without memory

6 way 1 **LR044726**

RH 1 **YUB500250PVJ**

LH 1 **YUB500250PVJ**

8 way 1 **YUB500600**

RH 1 **YUB500610**

LH 1 **YUB500610**

driver's seat with memory

RHD 1 **YUB500160PVJ**

LHD 1 **YUB500170PVJ**

SWITCH BUTTON, seat recline A/R **LR045801**

Replacement button for seat adjustment switch assembly.

LUMBAR SUPPORT SWITCH, driver's seat:

to VIN 7A999999 1 **YUE500100PVJ**

VIN 8A000001 on 1 **YUE500170**

ALL MODELS

Door Switches

WINDOW LIFT SWITCH PANEL ASS'Y:

driver's door (controls 4 windows)

RHD

to VIN 6A999999 1 **YUD501120PVJ**

VIN 7A000001 on 1 **YUD501560PVJ**

LHD

to VIN 6A999999 1 **YUD501110PVJ**

VIN 7A000001 on 1 **YUD501570PVJ**

passenger's door (controls 1 window)

with standard & HI ICE sound systems

front & rear passengers 3 **YUD501070PVJ**

with premium surround sound system

front passenger 1 **YUD501070PVJ**

rear passengers 2 **YUD501080PVJ**

Includes sound system controls.

DOOR MIRROR ADJUSTMENT SWITCH:

for manual fold mirrors

to VIN 5A999999 1 **YUF500010PVJ**

VIN 6A000001 on 1 **YUF500130PVJ**

for power fold mirrors

to VIN 5A999999 1 **YUF500030PVJ**

VIN 6A000001 on 1 **YUF500140PVJ**



**SWITCH PANEL
ASSEMBLY -
YUD501080PVJ**



**SWITCH PANEL
ASSEMBLY -
YUD501120PVJ**

**DOOR MIRROR
ADJUSTMENT SWITCH -
YUF500010PVJ**

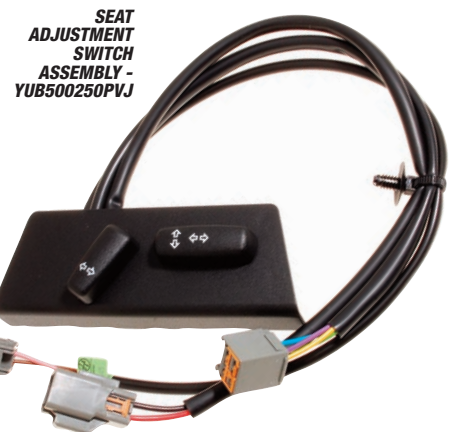

**SEAT
ADJUSTMENT
SWITCH
ASSEMBLY -
YUB500250PVJ**

ALL MODELS

Engine Compartment Harness

WIRING HARNESS, engine compartment 1 -

Does not include link wires for ambient air temperature sensor (all models from VIN 6A000001 on) or alternator (diesel models with Roll Stability Control) - see Link Wires later in this section.

What Land Rover call the 'Engine Compartment Harness' is in fact what car manufacturers used to call the main harness or main wiring loom in the good old days.

It's the most complex wiring harness on the car, connecting to most of the systems that make the car run. It is routed across the engine side of the front bulkhead, along the front inner wings and a smaller branch of it runs across the front of the car, behind the bonnet locking platform. In the case of the Range Rover Sport, it also includes the engine compartment fuse box.

Being the second most complex harness (after the fascia harness) on a car with complicated electrical systems, it's perhaps not surprising that there are 132 different versions of the engine compartment harness.

It's also not surprising, from the points of view of available page space and accuracy of parts supply to the customer, that we choose not to list them all here.

If you require an engine compartment harness, please contact us with as much information on your car as possible, from which we will work out which harness is the correct one for you. The minimum information you should aim to provide includes the following:

- Full vehicle identification number (VIN), including prefix
- Engine type (V6 diesel, V8 diesel, V8 supercharged petrol or V8 normally aspirated petrol)
- RHD or LHD
- Intended market/country when new (if known)
- Suspension type (with or without Roll Stability Control/Active Cornering Enhancement)
- Headlamp type (halogen, Bi-Xenon or adaptive Bi-Xenon)

Engine Harness

The engine wiring harness connects to all the electrical systems on the engine assembly, including the sensors, engine management devices, injection components, alternator, etc. It is fitted only on the engine and touches none of the bodywork of the car. It joins to the engine compartment harness via a large multiplug.

WIRING HARNESS, engine:

2.7 TDV6 diesel models

EU2 emissions

Models without diesel particulate filter (DPF) in exhaust system.

to VIN 6A916812	1	1351812
VIN 6A916813 on	1	1387757

Euro Stage 4 emissions

Most models with diesel particulate filter (DPF) in exhaust system.

VIN 7A000001 to 8A147225	1	LR006465
VIN 8A147226 on	1	LR018478

3.6 TDV8 diesel models

to VIN 8A147225	1	LR006685
VIN 8A147226 on	1	LR018492

4.2 AJV8 supercharged petrol models

Does not include fuel injector or crankshaft position sensor link wires - see Link Wires later in this section.

to VIN 6A999999	1	LR006284
VIN 7A000001 on	1	LR005049

4.4 AJV8 petrol models

Does not include temperature sensor or crankshaft position sensor link wires - see Link Wires later in this section.

to VIN 6A999999	1	4741262
VIN 7A000001 on	1	LR005046

Transmission Harness

The transmission wiring harness connects all the sensors, switches etc. on the gearbox to the engine bay harness via a multiplug connection on the RH side of the front bulkhead.

2.7 TDV6 DIESEL MODELS

WIRING HARNESS, transmission:

EU2 emissions

Without diesel particulate filter (DPF) in exhaust system.

to VIN 5A999999	1	YMD501642
VIN 6A000001 to 6A999999	1	YMD504641
VIN 7A000001 to 8A147137	1	YMD505840
VIN 8A147138 on	1	YMD506270

Euro Stage 4 emissions

Usually with diesel particulate filter (DPF) in exhaust system.

RHD

VIN 7A000001 to 8A147137	1	YMD505860
VIN 8A147138 on		
with DPF	1	YMD506260
without DPF	1	YMD506290

LHD

VIN 7A000001 to 8A147137	1	YMD505850
VIN 8A147138 on		
with DPF	1	YMD506250
without DPF	1	YMD506280

3.6 TDV8 DIESEL MODELS

RHD

VIN 7A000001 to 8A147137	1	YMD505890
VIN 8A147138 on		
with DPF	1	YMD506340
without DPF	1	YMD506360

LHD

VIN 7A000001 to 8A147137	1	YMD505880
VIN 8A147138 on		
with DPF	1	YMD506330
without DPF	1	YMD506350

4.2 AJV8 SUPERCHARGED PETROL MODELS

WIRING HARNESS, transmission:

to VIN 6A999999	1	YMD504651
VIN 7A000001 to 7A999999	1	YMD505870
VIN 8A000001 on	1	YMD506300

4.4 AJV8 PETROL MODELS

WIRING HARNESS, transmission:

to VIN 6A999999	1	YMD504631
VIN 7A000001 to 7A999999	1	YMD505830
VIN 8A000001 on	1	YMD506220



WE'RE HERE TO HELP

Can't find or not sure of the right part for your car, contact our technical sales team for help and advice.

01522 568000

Fascia Harness

WIRING HARNESS, fascia 1 -

The fascia harness is the most complex wiring harness on the car, connecting to the controls and displays of most of the electrical and electronic systems. It is routed across the inside/underside of the dash moulding, extending down the outer sides of the footwells to meet the doors and other harnesses in the car.

There are 131 different versions of the fascia harness, too many to be able to list them here in a useable manner. If you require a fascia harness, please contact us with as much information on your car as possible, from which we will work out which harness is the correct one for you. The minimum information you should aim to provide includes the following:

- Full vehicle identification number (VIN), including prefix
- RHD or LHD
- With or without navigation system (if so, touch screen type or not)
- With or without electric steering column adjustment
- With or without DVD screen
- With or without heated seats
- Standard, HI ICE branded sound system or Premium surround sound

Centre Console Harness

The console harness connects to items such as the transmission controls, phone system, sound system and rear seat entertainments (where fitted). As its name suggests, it runs within the centre console of the car.

WIRING HARNESS, console:

without phone integration

without DVD screen		
to VIN 5A999999	1	YMH500214
VIN 6A000001 on	1	YMH500821
with DVD screen		
to VIN 5A999999	1	YMH500174
VIN 6A000001 on	1	YMH500801

with phone integration

without DVD screen		
to VIN 5A999999	1	YMH500364
VIN 6A000001 on	1	YMH500811
with DVD screen		
to VIN 5A999999	1	YMH500374
VIN 6A000001 on	1	YMH500831

Main Harness

WIRING HARNESS, main 1 -

This is what used to be called the body harness in the golden era of repairing cars without complex electrical systems. Nowadays, apart from rear and interior lighting, the fuel pump and tank sender unit, it also connects to the seats, suspension, sound system and on some cars the rear axle. It is routed along the bottom of both outer edges of the car, with spurs running across the body where necessary.

Once again, there are too many main harnesses to list them here in a practical way (208 different versions in total). If you require a main harness, please contact us with as much information on your car as possible, from which we will work out which harness is the correct one for you. The minimum information you should aim to provide includes the following:

- Full vehicle identification number (VIN), including prefix
- RHD or LHD
- Intended market/country when new (if known)
- Standard, HI ICE branded sound system or Premium surround sound
- With or without memory front seats and mirrors
- With or without rear axle locking differential
- With or without tyre pressure sensors



Chassis Harness

This harness connects to such items as the suspension height sensors roll stability control system (on vehicles so fitted), rear axle locking differential (ditto), fuel fired heater (some diesel models) etc. It is routed along the bottom of the LH outer edge of the car and crosses to the RH side at each end of the car.

WIRING HARNESS, RHD, chassis:

Without: rear axle locking differential, roll stability control & fuel fired heater
 to VIN 5A999999 1 **YNN500294**
 VIN 6A000001 to 6A999999 1 **YNN500711**

Without: rear axle locking differential, roll stability control
With: fuel fired heater
 to VIN 5A999999 1 **YNN500374**
 VIN 6A000001 to 6A999999 1 **YNN500791**

Without: rear axle locking differential & fuel fired heater
With: roll stability control
 to VIN 5A999999 1 **YNN500314**
 VIN 6A000001 to 6A999999 1 **YNN500731**

Without: rear axle locking differential
With: roll stability control & fuel fired heater
 to VIN 5A999999 1 **YNN500394**
 VIN 6A000001 to 6A937446 1 **YNN500810**
 VIN 6A937447 to 6A999999 1 **YNN500811**

Without: rear axle locking differential
 VIN 7A000001 to 7A999999 1 **YNN500930**
 VIN 8A000001 on 1 **YNN501030**

With: rear axle locking differential
Without: roll stability control & fuel fired heater
 to VIN 5A999999 1 **YNN500304**
 VIN 6A000001 to 6A999999 1 **YNN500721**

With: rear axle locking differential & fuel fired heater
Without: roll stability control
 to VIN 5A999999 1 **YNN500384**
 VIN 6A000001 to 6A999999 1 **YNN500801**

With: rear axle locking differential & roll stability control
Without: fuel fired heater
 to VIN 5A999999 1 **YNN500324**
 VIN 6A000001 to 6A999999 1 **YNN500741**

With: rear axle locking differential, roll stability control & fuel fired heater
 to VIN 5A999999 1 **YNN500404**
 VIN 6A000001 to 6A937446 1 **YNN500820**
 VIN 6A937447 to 6A999999 1 **YNN500821**

With: rear axle locking differential
 VIN 7A000001 to 7A999999 1 **YNN500940**
 VIN 8A000001 on 1 **YNN501040**

Front & Rear Side Door Harnesses

WIRING HARNESS, door:

front		
RH	1	-
LH	1	-
rear		
RH	1	-
LH	1	-

These harnesses fit inside each door. With all the permutations of sound system speakers, window and mirror controls etc. available on the Range Rover Sport doors, there are too many door harnesses to list here. If you require a door harness, please contact us with as much information on your car as possible, from which we will work out which harness is the correct one for you. The minimum information you should aim to provide includes the following:

- Full vehicle identification number (VIN), including prefix RHD or LHD
- Front or rear door, RH or LH
- Standard, HI ICE branded sound system or Premium surround sound
- With or without headphone sockets (rear doors only)
- With or without memory mirrors

WIRING HARNESS, LHD, chassis:

Without: rear axle locking differential, roll stability control & fuel fired heater
 to VIN 5A999999 1 **YNN500214**
 VIN 6A000001 to 6A999999 1 **YNN500671**

Without: rear axle locking differential, roll stability control
With: fuel fired heater
 to VIN 5A999999 1 **YNN500334**
 VIN 6A000001 to 6A999999 1 **YNN500751**

Without: rear axle locking differential & fuel fired heater
With: roll stability control
 to VIN 5A999999 1 **YNN500224**
 VIN 6A000001 to 6A999999 1 **YNN500681**

Without: rear axle locking differential
With: roll stability control & fuel fired heater
 to VIN 5A999999 1 **YNN500354**
 VIN 6A000001 to 6A999999 1 **YNN500771**

Without: rear axle locking differential
 VIN 7A000001 to 7A999999 1 **YNN500910**
 VIN 8A000001 on 1 **YNN501010**

With: rear axle locking differential
Without: roll stability control & fuel fired heater
 to VIN 5A999999 1 **YNN500274**
 VIN 6A000001 to 6A999999 1 **YNN500691**

With: rear axle locking differential & fuel fired heater
Without: roll stability control
 to VIN 5A999999 1 **YNN500344**
 VIN 6A000001 to 6A999999 1 **YNN500761**

With: rear axle locking differential & roll stability control
Without: fuel fired heater
 to VIN 5A999999 1 **YNN500284**
 VIN 6A000001 to 6A999999 1 **YNN500701**

With: rear axle locking differential, roll stability control & fuel fired heater
 to VIN 5A999999 1 **YNN500364**
 VIN 6A000001 to 6A999999 1 **YNN500781**

With: rear axle locking differential
 VIN 7A000001 to 7A999999 1 **YNN500920**
 VIN 8A000001 on 1 **YNN501020**

Tailgate (Rear Door) Harness

This harness fits inside the tailgate, connecting to the high level stop lamp, number plate lamps, rear wash/wipe, heated rear window and speaker (if fitted).

WIRING HARNESS, tailgate:

without tailgate audio speaker	1	YMN500321
with tailgate audio speaker		
to VIN 5A999999	1	YMN500301
VIN 6A000001 to 6A936001	1	YMN500330
VIN 6A936002 on	1	YMN500331

ALL MODELS



BUMPER WIRING HARNESS - YMQ501631

Bumper Harnesses

With the location of fog lamps and/or parking sensors in the bumpers comes the need for bumper harnesses to feed them:

WIRING HARNESS, bumper:

front, with front fog lamps only	1	YMQ501621
front, with front parking aid without fog lamps		
to VIN 5A999999	1	YMQ500752
VIN 6A000001 on	1	YMQ501611
with fog lamps	1	YMQ501631
rear, with rear parking aid	1	LR014679
RETAINER, rear bumper harness	1	YPY500040

Roof Harness

This harness runs from the RH windscreen pillar along the RH side of the car's roof, with spurs across the front seat row, second seat row and the back of the roof.

WIRING HARNESS, roof:

<i>Without:</i> electric sunroof, interior scanning alarm & rear pillar speakers		
to VIN 5A999999	1	YMK500734
VIN 6A000001 on	1	YMK501220

<i>Without:</i> electric sunroof & interior scanning alarm		
<i>With:</i> rear pillar speakers		
to VIN 5A999999	1	YMK500694
VIN 6A000001 on	1	YMK501180

<i>Without:</i> electric sunroof & rear pillar speakers		
<i>With:</i> interior scanning alarm		
to VIN 5A999999	1	YMK500714
VIN 6A000001 on	1	YMK501200

<i>Without:</i> electric sunroof		
<i>With:</i> interior scanning alarm & rear pillar speakers		
to VIN 5A999999	1	YMK500674
VIN 6A000001 on	1	YMK501160

<i>With:</i> electric sunroof		
<i>Without:</i> interior scanning alarm & rear pillar speakers		
to VIN 5A999999	1	YMK500724
VIN 6A000001 on	1	YMK501210

<i>With:</i> electric sunroof & rear pillar speakers		
<i>Without:</i> interior scanning alarm		
to VIN 5A999999	1	YMK500684
VIN 6A000001 on	1	YMK501170

<i>With:</i> electric sunroof & interior scanning alarm		
<i>Without:</i> rear pillar speakers		
to VIN 5A999999	1	YMK500704
VIN 6A000001 on	1	YMK501190

<i>With:</i> electric sunroof, interior scanning alarm & rear pillar speakers		
to VIN 5A999999	1	YMK500664
VIN 6A000001 on	1	YMK501150

ALL MODELS

Seat Harnesses

WIRING HARNESS:

front row seats, driver's seat
Does not include seat recline mechanism link wire - see Link Wires later in this section.

without memory facility
to VIN 5A999999 1 **YML500184**
VIN 6A000001 on 1 **YML500881**

with memory facility
to VIN 5A999999 1 **YML500571**
VIN 6A000001 on

without lumber adjust. 1 **YML500861**
with lumber adjust. 1 **YML500871**

front row seats, passenger's seat
Does not include seat recline mechanism link wire - see Link Wires later in this section.

with 6 way adjustment
to VIN 5A999999 1 **YML500463**
VIN 6A000001 on 1 **YML500831**

with 8 way adjustment
to VIN 8A121979 1 **YML500881**
VIN 8A121980 on 1 **YML501400**

2nd row seats
VIN 6A000001 on 2 **YML500840**

CONNECTOR, front seat harness 2 **YRB500070**

Audio, Entertainment & Navigation Harnesses

WIRING HARNESS, audio, main 1 -

This harness runs along the lower RH side of the car, rising at the rear of the car to the roof and running forwards along both sides above the luggage area. There are many, many variations of this harness. If you require a main audio harness, please contact us with as much information on your car as possible, from which we will work out which harness is the correct one for you. The minimum information you should aim to provide includes the following:

- Full vehicle identification number (VIN), including prefix RHD or LHD
- Intended market/country when new (if known)
- Standard, HI ICE branded sound system or Premium surround sound
- With or without 6 CD autochanger
- With or without DVD entertainment system
- With or without TV integration
- With or without navigation system
- With or without Traffic Message Channel
- With or without phone integration or Bluetooth

WIRING HARNESS, audio, fascia 1 -

As the name suggests, this harness runs from behind the centre of the fascia to the underside of the centre console, where it joins the main audio harness. If you require a fascia audio harness, please contact us with as much information on your car as possible, from which we will work out which harness is the correct one for you. The minimum information you should aim to provide includes the following:

- Full vehicle identification number (VIN), including prefix RHD or LHD
- Intended market/country when new (if known)
- Standard, HI ICE branded sound system or Premium surround sound
- With or without 6 CD autochanger
- With or without DVD entertainment system
- With or without TV integration
- With or without navigation system



TOWING ELECTRIC KIT, 7 PIN - YWJ500150BP



TOWING ELECTRIC KIT, 14 PIN - YWJ500160BP

Towing Socket Kits & Harnesses

TOWING ELECTRICS KIT:

Includes towing socket, socket harness and link lead.

for 7 pin socket (12N & 12S types)

Land Rover 1 **YWJ500150**
Britpart 1 **YWJ500150BP**
Bearthach 1 **YWJ500150BM**

for 13 pin socket

Land Rover 1 **YWJ500160**
Britpart 1 **YWJ500160BP**

WIRING HARNESS, towing socket:

for 7 pin socket, 12N type socket

to VIN 5A999999 1 **YMZ500532**
VIN 6A000001 on 1 **LR011190**

for 7 pin socket, 12S type socket

to VIN 5A999999 1 **YMZ500740**
VIN 6A000001 on 1 **LR011192**

for 13 pin socket

to VIN 5A999999 1 **YMZ500542**
VIN 6A000001 on 1 **LR011211**

Link Wires & Wiring Repair Kits

ON ENGINE COMPARTMENT HARNESS

LINK WIRE:

ambient air temp. sensor 1 **YMQ501760**
All models from VIN 6A000001 on.

alternator 1 **YMQ501781**
2.7 TDV6 & 3.6 TDV8 diesel models with roll stability control.

ON ENGINE HARNESS

LINK WIRE:

fuel injectors 1 **LR005050**
4.2 AJV8 supercharged petrol models.

temperature sensor 1 **YSB500480**
4.4 AJV8 petrol only.

crankshaft position sensor 1 **4691236**
4.2 AJV8 supercharged & 4.4 AJV8 petrol models.

ON FASCIA HARNESS

CABLE ASS'Y, steering wheel switches 1 **QTV500020**

WIRING REPAIR KIT, airbag circuits:

Airbag circuit wiring repairs are available, in the event of damage to the fascia harness, which may be used instead of replacing the entire harness. The appropriate repair kit should always be fitted when replacing an activated airbag.
Note RCM means Restraint Control Module.

driver's airbag to harness 1 **YMQ502080**

passenger's airbag to harness 1 **YMQ502110**

harness to RCM connector 1 **YMQ502090**

rotary coupler to harness 1 **YMQ502100**

ON MAIN HARNESS

WIRING REPAIR KIT, airbag circuit:

Airbag circuit wiring repairs are available, in the event of damage to the main harness, which may be used instead of replacing the entire harness. The appropriate repair kit should always be fitted when replacing an activated airbag.
Note RCM means Restraint Control Module.

side airbag to RCM connector
from connector under RH seat 1 **YMQ502000**

from connector under LH seat 1 **YMQ502010**

side curtain airbag to RCM connector

RH 1 **YMQ502020**

LH 1 **YMQ502030**

B post impact sensor to RCM connector

RH 1 **YMQ501980**

LH 1 **YMQ501990**

rear quarter impact sensor to RCM connector

RH 1 **YMQ501960**

LH 1 **YMQ501970**

seat belt pre-tensioner to RCM connector

RH 1 **YMQ502060**

LH 1 **YMQ502070**

PARKING BRAKE WIRING REPAIR KIT - YN1500400

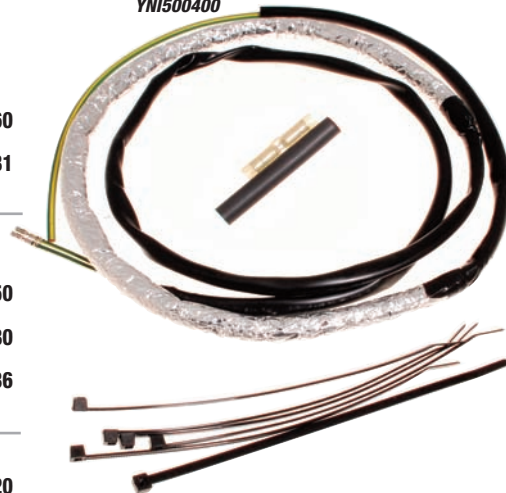

ON CHASSIS HARNESS

LINK WIRE:

height sensor 4 **YMQ503220**

engine bay to height sensor link wire

RHD 1 **YMQ503260**

LHD 1 **YMQ503190**

Roll Stability Control, front 1 **LR016987**

WIRING REPAIR KIT, parking brake 1 **YN1500400**

Vehicles up to VIN 5A339115 can suffer water ingress in the connection on the electronic parking brake module section of the chassis harness, resulting in EPB warning lights being displayed or the brake not being released. The repair kit overcomes this problem by replacing this section of the chassis harness with an improved waterproof version. The kit includes the new section of harness, together with a connector terminal removal tool.

ON FRONT ROW SEAT HARNESS

LINK WIRE, seat recline mechanism:

without memory facility

to VIN 5A999999 A/R **YMQ501040**

VIN 6A000001 on A/R **YMQ501730**

with memory facility

to VIN 5A999999 A/R **YMQ501030**

VIN 6A000001 on A/R **YMQ501720**

WE'RE HERE TO HELP
Can't find or not sure of the right part for your car, contact our technical sales team for help and advice.
01522 568000

WE'RE HERE TO HELP
 Can't find or not sure of the right part for your car, contact our technical sales team for help and advice.
01522 568000

ALL MODELS

CHASSIS



FRONT CROSSMEMBER - KVS500030

REAR CROSSMEMBER - KVB500101

Chassis Frame Assembly

CHASSIS FRAME ASSEMBLY:

Includes front crossmember, transfer box crossmember and rear crossmember. Owners of vehicles prior to VIN 6A395256 should note that chassis no. LR014463 is set up for a bolted (rather than welded) fuel cooler bracket and has rear mass absorber mountings already fitted.

- to VIN 5A904741 1 **KVD500622**
 With early style spare wheel carrier and welded fuel cooler bracket, without rear mass dynamic absorber mountings.
- VIN 5A904742 to 8A145569 1 **LR014464**
 Fitted sporadically between VIN 8A121996 and 8A145569. With early style spare wheel carrier and bolted fuel cooler bracket, with rear mass dynamic absorber mountings.
- VIN 8A121996 on 1 **LR032580**
 Fitted sporadically between VIN 8A121996 and 8A145569. With late style spare wheel carrier and bolted fuel cooler bracket, with rear mass dynamic absorber mountings.

CROSSMEMBER:

- front 1 **KVS500030**
- transfer box 1 **KVB500110**
- rear 1 **KVB500101**

SUPPORT, chassis to body front side member:

- RH 1 **KVU500200**
- LH 1 **KVU500210**

OUTRIGGER, front body shell support:

- RH 1 **KVU500181**
- LH 1 **KVU500191**

BRACKET, lower, rear crossmember to chassis:

- RH 1 **KVU500140**
- LH 1 **KVU500150**

BOLT:

- front crossmember to chassis 1 **KYG500190**
- transfer box xmember to chassis 4 **FC112267**

SCREW:

- front crossmember to chassis 3 **KYG500450**
- front outrigger to chassis 6 **FT112257**

NUT:

- transfer box xmember to chassis 4 **FX112057**
- front outrigger to chassis 6 **KYH500111**
- 'U' type, fuel tank mounting 6 **KYH500100**

OUTRIGGER - KVU500181



SUPPORT - KVU500200



BRACKET - KVU500140

Chassis Rear Mass Dynamic Absorber

DYNAMIC ABSORBER, rear mass, chassis:

- RH 1 **KQD500123**
- LH 1 **KQD500133**

BRACKET, dynamic absorber:

- RH
 - outer 1 **RQU500381**
 - inner 1 **RQU500361**
- LH
 - outer 1 **RQU500391**
 - inner 1 **RQU500371**

STIFFENER TUBE, brackets

- 2 **KVY500031**

BOLT, absorber to brackets

- 4 **KYG500250**

SCREW, stiffener tube to bracket

- 2 **FT114356P**

NUT:

- outer to inner bracket 2 **FY110057**
- stiffener tube to bracket 2 **FY114056**

Chassis Dampers

DAMPER ASSEMBLY, chassis:

- to VIN 6A999999 4 **KVF500560**
- VIN 7A000001 on
 - front 2 **KVF500580**
 - rear 2 **KVF500560**

BRACKET, chassis damper:

- front
 - upper
 - RH 1 **RQU500620**
 - LH 1 **RQU500630**
 - lower 2 **KVU500301**
- rear
 - upper
 - RH 1 **RQU500640**
 - LH 1 **RQU500650**
 - lower
 - RH 1 **RQU500660**
 - LH 1 **RQU500670**

BOLT:

- front damper to lower bracket 2 **FB110106**
- rear damper to upper bracket 2 **FB110106**
- rear damper to lower bracket 2 **KYG500311**

NUT:

- front damper to upper bracket 2 **FN110046**
- front damper to lower bracket 2 **FY110056**
- rear damper to upper bracket 2 **FN110046**

Chassis Mountings

INSULATOR BUSH, body mounting:

- upper
 - front
 - diesel models 8 **KVF500161**
 - petrol models 4 **KVF500161**
 - intermediate 2 **KVF500120**
 - rear 4 **KVF500180**
 - lower 10 **KVF500190**
- BOLT, body mounting 10 **KYG500015**

WASHER, spacing:

- front & rear body mounting 10 **KVX500010**
- intermediate body mounting 2 **KVX500030**
- INSULATOR PAD, "body mounting" 2 **KZT500010**



INSULATOR BUSH - KVF500161



INSULATOR BUSH - KVF500120



INSULATOR BUSH - KVF500180



INSULATOR PAD - KZT500010

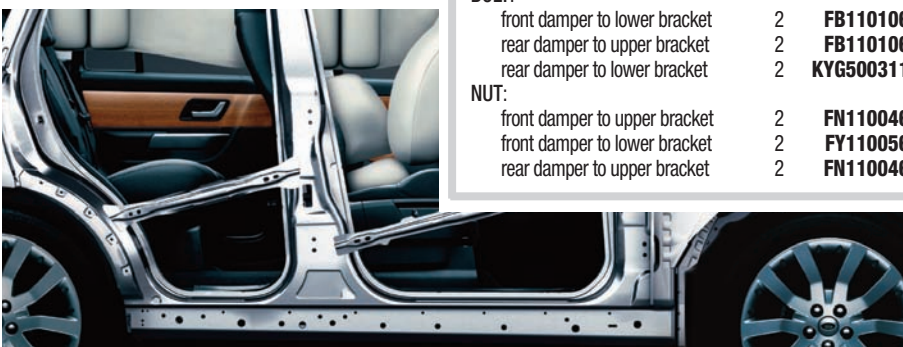

ALL MODELS

HEAT SHIELDS & SPLASH SHIELDS

Radiator Undershield

UNDERSHIELD, RADIATOR	1	KRB000122
SCREW, undershield attaching:		
long	2	FS110206
short	5	DEP1198
'U' NUT, undershield attaching	2	AYH100790



RADIATOR
UNDERSHIELD -
KRB000122

Engine Undershield

UNDERSHIELD, engine	1	LR014235
BOLT, undershield attaching:		
long	2	LR007778
short	10	KYG500500
SPACER TUBE, long bolt	2	LR014236
'U' NUT, undershield attaching	2	KYH500100

Front Brake Pipe Shields

SHIELD, front brake pipe:		
RH	1	WEB500720
LH	1	WEB500730
NUT, shield attaching:		
to VIN 7A117184	4	LR054723
VIN 7A117185 on	4	RYH500310



FRONT BRAKE
PIPE SHIELD -
WEB500720

Front Differential Shield

SHIELD, differential	1	KQG500043
BOLT, shield attaching	2	DEP1198



DIFFERENTIAL SHIELD -
KQG500043

Transmission Undershield

UNDERSHIELD, transmission:		
2.7 TDV6 diesel	1	LR031643
3.6 TDV8 diesel	1	LR069243
SCREW, undershield attaching	6	DEP1198
'U' NUT, undershield attaching	4	AYH100790

Front Splash Shield

3.6 TDV8 DIESEL MODELS ONLY

SPLASH SHIELD, front:		
RH	1	CLE500040
LH	1	CLE500050
BRACKET, front splash shield:		
RH	1	KKJ500080
LH	1	KKJ500090

Side Undertrays

UNDERTRAY, side:		
RH		
2.7 TDV6 diesel	1	KRN500042
3.6 TDV8 diesel	1	KRN500071
4.2 AJV8 supercharged petrol	1	KRN500071
4.4 AJV8 petrol	1	KRN500042
LH		
diesel with fuel fired heater	1	KRN500062
diesel without fuel fired heater	1	KRN500052
petrol models	1	KRN500052
FIXING CLIP, undertray attaching	8	ANR2224

Bulkhead Heat Shield

2.7 TDV6 DIESEL MODELS ONLY

HEAT SHIELD, bulkhead	1	WEB500233
STUD, heat shield attaching	2	WYR500021
NUT:		
heat shield to stud	2	ESR1560
heat shield to body	2	WYH500050

Front Suspension & Brake Hose Shields

SHIELD:		
suspension bush		
RH suspension		
front		
except 3.6 TDV8 diesel	1	LR014239
3.6 TDV8 diesel only	1	KKJ500240
rear	1	LR014241
LH suspension		
front		
except 3.6 TDV8 diesel	1	LR014240
3.6 TDV8 diesel only	1	KKJ500250
rear	1	LR014242
brake hose		
RH suspension		
to VIN 6A964493	1	SGC500061
VIN 6A964494 on	1	SGC500121
LH suspension		
to VIN 6A964493	1	SGC500071
VIN 6A964494 on	1	SGC500131
BRACKET, front suspension bush shield:		
RH	1	KKJ500020
LH	1	KKJ500030
BOLT, shields attaching	6	DEP1198
NUT, shields attaching:		
to VIN 7A998504	6	RYH000090
VIN 7A998505 on	6	RYH501030

Intermediate Exhaust Shield

SHIELD, exhaust, intermediate	1	KR0500241
BOLT, shield attaching	2	DEP1198



Bodyshell

Most of the bodyshells offered now by Land Rover are types used later in the production life of the Range Rover Sport. When resheiling earlier vehicles (as a broad guideline, up to 2008) it should be expected that there will be one or two unused holes on the new bodyshell that will require sealing with plugs (see later in this section).

BODYSHELL ASSEMBLY, RHD, less doors:

Includes primed and seam-sealed welded assembly only; does not include bonnet or hinges, front wings, front panel, side doors or hinges, rear door or hinges, sun roof.

without sun roof aperture to VIN 9A205839	1	AAC790150
VIN 9A205840 on	1	LR012617
with sun roof aperture	1	LR012619

BODYSHELL ASSEMBLY, LHD, less doors:

Includes primed and seam-sealed welded assembly only; does not include bonnet or hinges, front wings, front panel, side doors or hinges, rear door or hinges, sun roof.

without sun roof aperture to VIN 7A999999	1	AAC790060
VIN 8A000001 on	1	LR012618
with sun roof aperture	1	LR012620

ALL MODELS

BODY PANELS - BODYSHELL & BODY PLUGS

WE'RE HERE TO HELP
 Can't find or not sure of the right part for your car, contact our technical sales team for help and advice.
01522 568000



Body Plugs

FRONT BODY PLUGS

BODY PLUG, round:		
front end carrier, 6.35 x 11mm	6	AYB000180
dash (front bulkhead), 25mm	3	AYB500050

BODY SIDE PLUGS

BODY PLUG:		
body side panel		
round, 50mm	2	DBP6286
round, 50mm, alloy finish	2	AZP500060
round, 33mm	6	AYB500040
round, 25mm	13	AYB500050
round, 16mm	4	14A7032
<i>Models without sunroof only.</i>		
round	6	LR003292
A post upper, round, 12mm	4	DJP5792
roof side rail, oval, 12 x 18mm	2	LR014315
B post, round, 20mm	2	AYB000060



REAR BODY PLUG - DJP5792

REAR BODY PLUG - AYB100760



REAR BODY PLUGS

BODY PLUG:		
rear inner quarter panel		
round, 20mm	10	AYB000060
oval, 12 x 18mm	1	LR014315
round, 12mm		
to VIN 5A905110	1	AYB000030
VIN 5A905111 on	A/R	DJP5792
rear wheelarch, round, 20mm	4	AYB000060
rear w/arch extn., round, 20mm	2	AYB000060
rear w/arch to D post, round, 20mm	2	AYB000060
D post		
round		
upper		
to VIN 6A207604	6	AYB000080
VIN 6A207605 on	6	LR003292
lower		
25mm	1	AYB500050
12mm		
to VIN 5A905110	1	AYB000030
VIN 5A905111 on	A/R	DJP5792
oval, 18 x 24mm	2	AYB100760
rectangular, 100 x 70mm	2	DBP6549
rear roof reinforcement		
round, 30mm	2	BNP3996
oval, 18 x 24mm	1	AYB100760

FLOOR PLUGS

BODY PLUG:		
main floor panel		
Front footwells and under front seats.		
round, 50mm	3	ALR2245
round, 33mm	2	AYB500040
round, 25.4mm (1")	1	ALR2246
round, 25mm	3	AYB500050
round, 12mm	2	AYB000030
oval, 25 x 30mm	2	LR014317
mid floor panel		
Rear footwells and under 2nd row seats.		
round, 50mm	2	ALR2245
round, 25.4mm (1")	6	ALR2246
rear floor panel		
Luggage floor.		
round, 50mm		
flat	2	ALR2245
domed	2	DBP6286
round, 30mm	2	BNP3996
round, 25mm	2	AYB500050
oval, 18 x 24mm	2	AYB100760

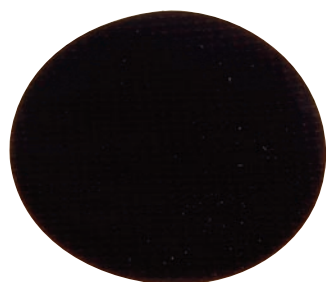

SIDE PANEL BODY PLUG - DBP6286



FLOOR BODY PLUG - ALR2245

ORDER

BY PHONE: 01522 568000 / ON LINE: www.rimmerbros.co.uk / E-MAIL: lrsales@rimmerbros.co.uk

ALL MODELS

BODY PANELS - FRONT

Front Wings & Mountings

FRONT WING:		
RH	1	ASB790020
LH	1	ASB790030
STRUT, wheelarch front, wing mounting:		
RH	1	ASU780120
LH	1	ASU780130
'L' BRACKET, wing to A post		
	2	ASU780200
BAFFLE PANEL, wing rear edge		
RH	1	LR016860
LH	1	LR016861
SCREW:		
wing mounting	8	AYP500100
wing lower to sill	2	AYP500110
strut to body	4	BYP000051
BOLT, 'L' bracket to A post		
	2	BYP100190
NUT, 'L' bracket to wing		
	2	ESR1560
TRIM FASTENER, baffle mounting		
	6	AWR3994

Bonnet & Hinges

BONNET ASSEMBLY:		
all models except Japan	1	BKA790050
Japan only	1	BKA790070
HINGE, bonnet:		
RH	1	LR040747
LH	1	LR040748
SCREW, hinge to bonnet:		
to VIN 6A999999	4	AYP000020
VIN 7A000001 on	4	AYP500190
NUT, hinge to body		
	4	ADU7048
GAS STRUT, bonnet:		
Land Rover	2	LR009106
aftermarket	2	LR009106P
PIVOT, bonnet gas strut		
	2	BKF780030

Front End Assembly

FRONT END ASS'Y ('front end carrier')		
	1	LR054853
BRACKET:		
front end to inner wing		
upper		
RH	1	DYF500082
LH	1	DYF500092
lower		
	2	DYF500101
front end rear lower to chassis	2	DYF500202
front end upper		
RH	1	LR054811
LH	1	LR054810
PLUG, rectangular, front end upper		
	2	DYB500020
BOLT:		
front end mounting		
upper bracket to inner wing	4	LR015148
front end upper bracket	4	BYP100190
rear lower to chassis	4	LR015148
to upper inner wing bracket	2	DYP500090
SCREW, front end to lower inner		
wing bracket	2	LR015149
DOWEL, upper inner wing bracket		
	2	AYU500011

Front Inner Wings, Wheelarches & Chassis Members

FRONT WING APRON ASSEMBLY:		
<i>Includes inner valance panel, valance cover panel (on LH assembly only), outer wheelarch and lower reinforcement panel.</i>		
to VIN 7A117184		
RH	1	AWJ780060
LH	1	AWJ780070
VIN 7A117185 on		
RH	1	AWJ780220
LH	1	AWJ780230
FRONT INNER WING ASSEMBLY ('valance ass'y):		
outer		
<i>Includes outer valance panel, shield panel (on RH assembly only) and reinforcement panel.</i>		
RH	1	LR017916
LH	1	LR017929
inner		
<i>Includes inner valance assembly only.</i>		
RH	1	LR007143
LH	1	LR007144
FRONT WHEELARCH ASS'Y:		
outer		
<i>Includes outer wheelarch and lower reinforcement panel.</i>		
RH	1	LR016862
<i>Land Rover now offer only this, the later style RH front wheelarch. For models prior to VIN 7A117185, grommet part number LR010458 should also be purchased when ordering this wheelarch.</i>		
LH	1	LR016863
inner ('wheelarch splash shield')		
<i>Includes inner wheelarch only.</i>		
RH		
2.7 TDV6 diesel &		
4.4 AJV8 petrol	1	LR015038
3.6 TDV8 diesel &		
4.2 AJV8 s'charged petrol	1	LR017091
LH	1	LR015040
FRONT SIDE MEMBER ASS'Y:		
<i>Includes front side member and front gusset.</i>		
RH	1	LR016841
LH	1	LR016842
FRONT CROSS MEMBER		
	1	LR016865
SHIELD PANEL, RH outer valance		
	1	LR016843
COVER PANEL, LH inner valance		
	1	EUH500360
REINFORCEMENT:		
outer valance panel		
RH	1	ABD780100
LH	1	ABD780110
inner valance panel, lower		
RH	1	LR014974
LH	1	LR014996
FRONT GUSSET, front side member:		
RH	1	AWW780022
LH	1	AWW780032
BOSS, M10, outer wheelarch panel		
	2	LR025049
TRIM FASTENER, inner wheelarch:		
Land Rover	12	ANR2224
aftermarket	12	ANR2224P
SCREW, self tapping, inner wheelarch		
	12	DYP100780L
EDGE STRIP, rubber, inner wheelarch		
	2	CLB500051



TRIM FASTENER - ANR2224P



WE'RE HERE TO HELP
 Can't find or not sure of the right part for your car, contact our technical sales team for help and advice.
01522 568000

Body Side & Body Side Repair Sections

BODY SIDE ASSEMBLY ('monoside'):

Includes outer body side panel and inner reinforcements.

RH	1	ALA790060
LH	1	ALA790070

BODY SIDE REPAIR SECTION:

front door aperture

Includes outer A post, outer B post, roof side front and outer sill front, cut from body side panel.

RH	1	ALA790120
LH	1	ALA790130

rear quarter

Includes outer rear quarter, outer C post, outer D post, roof side rear and outer sill rear, cut from body side panel.

RH	1	ALA790080
LH	1	ALA790090

outer A post

Includes outer A post, roof front corner and outer sill front corner, cut from body side panel.

RH	1	ALA790140
LH	1	ALA790150

outer B post

Includes outer B post, roof side centre and outer sill centre, cut from body side panel.

RH	1	ALA790100
LH	1	ALA790110

outer sill

Includes outer sill plus A, B and C post lower corners, cut from body side panel.

RH	1	ALA790180
LH	1	ALA790190

Side Doors & Hinges

SIDE DOOR ASS'Y, without hinges:

front		
RH	1	LR016464
LH	1	LR016465
rear		
RH	1	BFA790080
LH	1	BFA790090

HINGE, front & rear side doors:

upper		
RH	2	LR030347
LH	2	LR030362
lower		
RH	2	LR031768
LH	2	LR031770
PLATE, side door hinge	8	BDP780020

CHECK STRAP ASS'Y:

front side door	2	BDH780070
rear side door	2	BFH790050
COVER, rear side door check strap	2	BFM500020

NUT, crash sensor in front side door:

to VIN 6A917912	4	AWR6715
VIN 6A917913 on	4	BYH500080

SCREW:

hinge to door and door post	32	BYP500420
door hinge assembly	16	BYP500220
check strap attaching	8	LR033165
NUT, check strap attaching:		
Land Rover	8	FY106046
aftermarket	8	FY106046P

Body Side Inner Panels

REINFORCEMENT:

body side ('ringframe')

Includes inner A post, roof side inner front (over front door), B post reinforcement and sill reinforcement.

RH	1	ALR790540
LH	1	ALR790550

sill

Includes sill reinforcement, cut from body side reinforcement.

RH	1	ALR790520
LH	1	ALR790530

B post to floor (bolt-on)

	2	ADR780380
--	---	------------------

SILL INNER PANEL:

RH	1	ADB790080
LH	1	ADB790090

B POST INNER ASSEMBLY:

Includes inner B post and roof side rail (over B post and rear side door).

RH	1	AME790320
LH	1	AME790330

REAR QUARTER INNER ASSEMBLY:

Includes inner C post, D post, rear side window aperture reinforcement and rear wheelarch outer.

RH		
to VIN 6A977699	1	ALJ790080
VIN 6A977700 on	1	LR029952
LH		
to VIN 6A977699	1	ALJ790090
VIN 6A977700 on	1	LR029953

REAR QUARTER INNER, bare:

Includes inner C post, D post and rear side window aperture reinforcement.

RH	1	ALJ790140
LH	1	ALJ790150

INNER C POST, lower:

RH	1	ALR791000
LH		
to VIN 6A977699	1	ALR790750
VIN 6A977700 on	1	ALR791010

D POST:

upper, drain channel		
RH	1	AMA790040
LH	1	AMA790050
upper, reinforcement		
RH	1	AFR790320
LH	1	AFR790330
middle		
RH	1	AME790263
LH	1	AME790273
inner lower		
RH	1	AGY790020
LH	1	AGY790030
gusset to rear door aperture, lower		
RH	1	LR016762
LH	1	LR016764

REAR WHEELARCH:

outer		
RH	1	ALK790120
LH	1	ALK790130
inner ('wheelarch splash shield')		
RH	1	CLF500880
LH	1	LR019116
EDGE STRIP, rubber, inner wheelarch	2	CLB500061

TRIM FASTENER, inner wheelarch:

Land Rover	2	ANR2224
aftermarket	2	ANR2224P
SCREW, self tapping, inner wheelarch	16	DYP100780L
NUT, Lokut, inner wheelarch screw	8	LR044895



EDGE STRIP RUBBER - CLB500061



TRIM FASTENER - ANR2224

SILL INNER PANEL - ADB790080

ALL MODELS

Roof

ROOF PANEL, outer:

models without sun roof	1	AKA790050
models with sun roof	1	AKB790080

HEADER RAIL:

front, windscreen	1	AKC790050
rear, over rear door	1	AKC790060

REINFORCEMENT, roof panel:

'Picture frame' panel. Models without sun roof only.

to VIN 9A205319	1	AKR790123
VIN 9A205320 on	1	LR016992
BRACKET, interior lamp pod to roof	1	AKU790021

Rear Door (Tailgate) & Hinges

REAR DOOR ASS'Y (tailgate)

Without hinges.

HINGE, rear door:		
RH	1	LR031764
LH	1	LR031765

GASKET, hinge to body

	2	BYF500010
--	---	------------------

BOLT, hinge to rear door

	4	BYP100190
--	---	------------------

NUT, hinge to body

	4	BYH500040
--	---	------------------

GAS STRUT, rear door:

RH		
to VIN 6A940841		
Land Rover	1	BHE790043
OEM	1	BHE790043P1
aftermarket	1	BHE790043P
VIN 6A940842 on		
Land Rover	1	LR027543
aftermarket	1	LR027543P

LH		
to VIN 6A940841		
Land Rover	1	BHE790053
OEM	1	BHE790053P1

VIN 6A940842 on		
Land Rover	1	LR029320
OEM	1	LR029320P1

PIVOT, rear door gas strut

	4	BKF780030
--	---	------------------

BRACKET, gas strut mounting:

RH	1	BHU790021
LH	1	BHU790031

Rear Floor & Chassis Members

REAR FLOOR PANEL ('luggage floor')

	1	AFD780011
--	---	------------------

REAR FLOOR SIDE:

panel		
RH	1	AFD780080
LH	1	AFD780090

REINFORCEMENT:

rear floor side		
RH	1	AFR780502
LH	1	AFR780512

rear corner		
RH	1	AFR780040
LH	1	AFR780050

REAR SIDE MEMBER:

RH	1	AGA780021
LH	1	AGA780031

THREADED BOSS, rear floor, M12

	2	AFS780031
--	---	------------------

REAR LOWER CROSS MEMBER

	1	AQA790100
--	---	------------------

This is the later type cross member. For vehicles prior to VIN 7A998823, rear door latch striker part number FQQ500050 will also be required.



ORDER

BY PHONE: 01522 568000 / ON LINE: www.rimmerbros.co.uk / E-MAIL: lrsales@rimmerbros.co.uk

BODY PANELS - CENTRE & REAR

ALL MODELS

BODY FITTINGS - FRONT

Bonnet Fittings & Lock

SEAL, bonnet	1	LR054366
INSULATING PAD, bonnet	1	LR013222
CLIP, insulating pad to bonnet	11	BTR2985
GAS STRUT, bonnet stay		
Land Rover	2	LR009106
aftermarket	2	LR009106P
PIVOT, bonnet gas strut	2	BKF780030
SAFETY CATCH, bonnet	1	FPD500050
BOLT, safety catch to bonnet	2	DEP1198
GUIDE, safety catch	1	BKY760011
LATCH, bonnet release	2	LR065339
SHIM, alloy, bonnet latch	2	DYF500280
CABLE, bonnet release:		
passenger compartment end	1	FSE500031
engine compartment end	1	FSE000091
LEVER, bonnet release	1	LR050752
CLIP, bonnet release cable to body	2	WYC100880
BUFFER, bonnet:		
to VIN 5A900594	2	CJM100130
VIN 5A900595 on	2	LR023025
SCREW:		
bonnet release latch to body	4	EHV500021
bonnet release lever to body	1	RYP501010

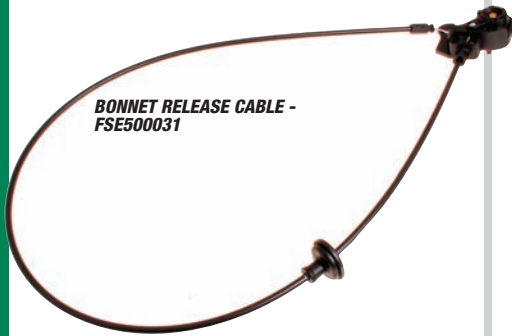

BONNET RELEASE CABLE - FSE500031

Front Badges

OVAL GRILLE BADGE, 'Land Rover':		
green and gold	1	DAG100330
2.7 TDV6 diesel, 3.6 TDV8 diesel & 4.4 AJV8 petrol models.		
black and silver	1	DAG500160
4.2 AJV8 supercharged petrol models.		
BONNET LETTER SET:		
Titan Silver finish.		
'RANGE'	1	DAB500170MBJ
'ROVER'	1	DAB500180MBJ



OVAL GRILLE BADGE - DAG100330



OVAL GRILLE BADGE - DAG500160



FRONT BUMPER REINFORCEMENT - LR015274

Front Bumper & Radiator Grille

FRONT BUMPER, primed:		
2.7 TDV6 diesel & 4.4 AJV8 petrol (not HST)		
without headlamp wash		
with manual speed control		
without front parking aid	1	DPB500371LML
with front parking aid	1	DPB500381LML
with adaptive speed control		
without front parking aid	1	DPB500411LML
with front parking aid	1	DPB500421LML
with headlamp wash		
with manual speed control		
without front parking aid		
without fog lamps	1	DPB500651LML
with fog lamps	1	DPB500391LML
with front parking aid		
without fog lamps	1	DPB500591LML
with fog lamps	1	DPB500401LML
with adaptive speed control		
without front parking aid		
without fog lamps	1	DPB500661LML
with fog lamps	1	DPB500431LML
with front parking aid		
without fog lamps	1	DPB500631LML
with fog lamps	1	DPB500441LML
3.6 TDV8 diesel & 4.2 AJV8 s'charged petrol (not HST)		
with manual speed control		
without front parking aid	1	DPB500451LML
with front parking aid	1	DPB500461LML
with adaptive speed control		
without front parking aid	1	DPB500471LML
with front parking aid	1	DPB500481LML
models with HST body styling kit		
with manual speed control	1	LR007319
with adaptive speed control	1	LR008205
REINFORCEMENT, front bumper	1	LR015274
Tubular steel armature inside the front bumper moulding.		
BRACKET, front bumper to body:		
front		
RH	1	LR013864
LH	1	LR013866
side		
RH	1	DPL000161
LH	1	DPL000171
SPOILER, lower, front bumper corner:		
RH	1	DFB500160
LH	1	DFB500170
GUARD, front bumper, lower RH	1	DXC500021PMA



FRONT BUMPER TO BODY BRACKET - LR013864



RADIATOR GRILLE - RA2089



FRONT BUMPER LOWER COVER - DPC000431PCL

LOWER COVER, front bumper:

Front bumper undertray, covering the towing eye. Includes 1/4 turn fixing clips.

models without body styling kit	1	DPC000431PCL
models with HST body styling kit	1	LR009026
PLINTH, front number plate mounting	1	DRB000111PCL
BEZEL, front fog lamp:		
Includes clips.		
primed		
Not models with HST body styling kit.		
RH	1	DXB000221LML
LH	1	DXB000231LML
chrome, accessory, pair		
Not models with HST body styling kit.		
models with HST body styling kit	2	LR009009

For more details of the fog and driving lamp surrounds and mountings used with the HST body styling kit, please refer to the Lamps section.

GRILLE, radiator:

Tungsten/Tungsten	1	DHB500062WWR
Standard filament 2.7 TDV6 diesel, 3.6 TDV8 diesel, 4.4 AJV8 petrol.		
Tungsten/Titan Silver	1	DHB500570WWQ
3.6 TDV8 diesel.		
Tungsten/Titan Silver		
4.2 AJV8 supercharged petrol.		
Land Rover	1	DHB500390WWQ
Terraforma	1	DHB500390WWQTF
Tungsten, HST style	1	DHB500440LEP
Tungsten all-mesh grille, as fitted with factory HST body styling kit.		
2010 model year onwards style	1	RA2089
To fit 2005-2009 model year cars.		
Aftermarket product.		
chromed (supercharged style)	1	DHB500390WWQTFC
carbon fibre (supercharged style)	1	DHB500390WWQTFCF

CLIP:

1/4 turn, bumper lower cover	2	DYR500010
front fog lamp bezel	12	DPL500010
radiator grille lower fixing	2	AZP500031
SOCKET, lower cover 1/4 turn clip	2	DYF500010

BOLT:

bumper upper edge to body	4	LR033052
bumper lower edge to body	4	LR033052

SCREW:

bumper lower edge to body	4	AYP500010
bumper front bracket to body		
inner & centre positions	4	EHV500010
outer end position	2	DYP100780L
bumper side bracket to body	4	RYG500840
bumper reinforcement to body	8	PYP000221
lower corner spoiler to body	2	DYP100780L
number plate plinth to body	5	DYP000040

NUT:

front bumper to brackets		
7mm hole	4	DYH500110
M6 hole	4	DYH500010
front bumper to reinforcement	8	DYH500131

Air Deflector (Radiator Cowling)

AIR DEFLECTOR ASSEMBLY:

main (lower)

Includes ambient air temperature sensor.

2.7 TDV6 diesel models	1	DXJ500070
3.6 TDV8 diesel models	1	DXJ500121
4.2 & 4.4 petrol models	1	DXJ500060

upper side, vertical

RH		
all except 3.6 TDV8 diesel	1	DHN000082
3.6 TDV8 diesel only	1	LR013042

LH

2.7 TDV6 diesel models	1	LR016838
3.6 TDV8 diesel models	1	LR013543
4.2 AJV8 s'charged petrol	1	DHN500013
4.4 AJV8 petrol	1	DHN000094

FOAM PAD, main deflector:

RH

lower

2.7 TDV6 diesel models	1	DZL500011
4.2 & 4.4 petrol models	1	DZL500050

upper

2.7 TDV6 diesel models only.	1	DZL500040
------------------------------	---	------------------

LH (All models)

	1	DZL500030
--	---	------------------

SCREW, main deflector

2	AZ610081
---	-----------------

WASHER, plain, main deflector

2	WJ105004
---	-----------------



AIR DEFLECTOR ASSEMBLY - DXJ500070

Scuttle Finisher

COWL TOP PANEL (scuttle finisher), black:

Includes trim fasteners.

RHD	1	LR055192
-----	---	-----------------

LHD	1	LR055193
-----	---	-----------------

CAP, cowl top panel studs	2	LR012502
---------------------------	---	-----------------

Front Body Protection Accessories

BUMPER PROTECTION BAR:

Enhance the appearance of your Range Rover Sport with a front protection bar. Offered as moulded soft plastic 'A' bar for durability and safety towards other road users or alternative tubular wrap-around style. Neither types are compatible with adaptive speed control; the 'A' bar is however compatible with the front parking aid system, while the wrap-around tubular bar is not.

'A' bar, plastic

Compatible with front parking aid system; not compatible with adaptive speed control.

Land Rover	1	VUB501980
------------	---	------------------

Britpart	1	VUB501980BP
----------	---	--------------------

fitting kit, 'A' bar	1	VUB503350
----------------------	---	------------------

wrap-around tubular bar	1	VUB502510
-------------------------	---	------------------

Not compatible with front parking aid system or adaptive speed control.

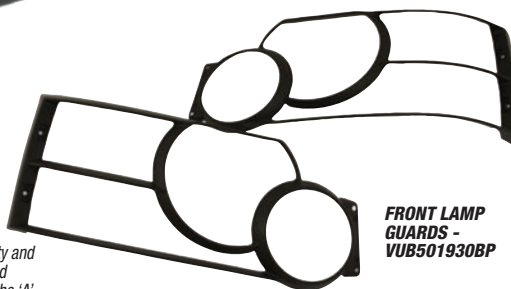

FRONT LAMP GUARDS - VUB501930BP



FRONT LAMP GUARD:

Durable protection for your expensive headlamps - not just a cosmetic accessory! Supplied with fixings.

pair, kit

Land Rover	1	VUB501930
------------	---	------------------

Britpart	1	VUB501930BP
----------	---	--------------------

Bearmach	1	VUB501930BM
----------	---	--------------------

each (Land Rover replacement parts)

RH	1	VUB503370
----	---	------------------

LH	1	VUB503360
----	---	------------------

UNDER-BUMPER PROTECTION SHIELD

Heavy duty metal protection shield to G4 Challenge specification, compatible with the factory offered accessory winches VUB501471 and VPLAP0130.

Front Wing Fittings

AIR INTAKE GRILLE, wing:

standard fitment

Tungsten finish

2.7 TDV6 diesel & 4.4 AJV8 petrol.

RH	1	JAK500320LEP
----	---	---------------------

LH	1	JAK500330LEP
----	---	---------------------

Tungsten/Titan Silver finish

3.6 TDV8 diesel & 4.2 AJV8 supercharged petrol.

RH	1	JAK500320WWH
----	---	---------------------

LH	1	JAK500330WWH
----	---	---------------------

chrome finish

Originally for models with HST body styling kit.

RH & LH, pair	1	LR006304
---------------	---	-----------------

RH	1	LR006305
----	---	-----------------

LH	1	LR006306
----	---	-----------------

2010 model year onwards style

To fit 2005-2009 model year cars. Aftermarket product.

RH & LH, pair	1	RA2090
---------------	---	---------------

RAISED AIR INTAKE KIT

1	ADL790020
---	------------------

Fits straight to air intake aperture on RH front wing. Land Rover product.

INSULATING COVER, cooling inlet duct	1	LR019639
--------------------------------------	---	-----------------



WING AIR INTAKE GRILLE - JAK500320LEP



WING AIR INTAKE GRILLE - LR006304

Front Mud Flaps

FRONT MUD FLAPS, pair:

Includes fasteners.

Land Rover	1	CAS500070PCL
------------	---	---------------------

aftermarket	1	CAS500070PCLP
-------------	---	----------------------



FRONT MUD FLAP, PAIR - CAS500070PCL

WE'RE HERE TO HELP
 Can't find or not sure of the right part for your car, contact our technical sales team for help and advice.
01522 568000

ALL MODELS

BODY FITTINGS - SIDE

Body Side Lower Mouldings

STANDARD FITMENT ON ALL MODELS EXCEPT HST

DOOR BOTTOM MOULDING, black plastic finish:
Includes fixings and moulding to door seal.

front door		
RH	1	LR024160
LH	1	LR024159
rear door		
RH	1	LR024089
LH	1	LR024090

SEAL, door moulding:

front door	1	CFE500680
rear door	1	CGE500380

REAR WHEEL ARCH MOULDING, black plastic finish:

Front half of rear wheel arch. Includes fixings.

RH	1	LR031413
LH	1	LR031456

SILL & FRONT WING MOULDING SET, black plastic finish:
Includes sill moulding, short moulding for rear lower of front wing plus trim fastener clips (not plastic rivets or push-pin fasteners).

RH	1	LR018175
LH	1	LR018176

FRONT WING MOULDING, black plastic finish:

Included in sill & front wing moulding set.

RH	1	DGP000241PCL
LH	1	DGP000251PCL

FIXINGS, body side mouldings:

front door mouldings		
trim fastener	24	DYC101420
trim fastener	4	DYC500110
rear door mouldings		
trim fastener	16	DYC101420
rear wheel arch mouldings		
trim fastener	12	DYC101420
sill mouldings		
trim fastener	16	DYC101420
rivet, plastic	12	HYQ100060PUY
front wing mouldings		
screw	2	DYP100780L

STANDARD FITMENT ON HST MODEL, ACCESSORY FITMENT ON ALL OTHER MODELS

FRONT WING LOWER MOULDING, primed:

RH	1	LR007355
LH	1	LR007356

DOOR LOWER MOULDING, primed:

front door		
RH	1	LR007357
LH	1	LR007359
rear door		
RH	1	LR007358
LH	1	LR007360

Body Side Accessories & Protection

SIDE STEP SET, pair:

Pair of side steps with rubber anti-slip strips ensuring safe entry and exit from vehicle. Easily mounted, with no drilling or cutting required. Alloy finish edge tubing with black rubber steps.

Land Rover	1	VPLSP0040
Britpart	1	VPLSP0040BP
aftermarket	1	VPLSP0040P

SIDE STEP SET COMPONENT PARTS:

Additionally the genuine Land Rover side step set is also available as individual items:

side step		
RH	1	VPLSP0038
LH	1	VPLSP0039
side step fitting kit (car set)	1	VUB503460

Fuel Tank Filler Flap & Latch

FLAP, fuel tank filler access	1	LR044763
HOUSING, fuel tank filler	1	LR014044
GASKET, filler housing to body	1	ARY780040
TUBE, fuel tank filler housing drain	1	BZX500010
ACTUATOR, flap opening	1	FSG500030
<i>Includes cable.</i>		
CLIP, covering actuator cable end	1	LR019152
CATCH, actuator, on housing	1	BPA780101
DOOR LATCH REPAIR KIT	1	BPA780101BPK
RETAINER, actuator catch	1	BPA780110
SPRING, actuator catch	1	BPA780120
BEZEL, actuator, flap hinge	1	ARV780020
SEAL, actuator bezel, flap hinge	1	CAL500070



FUEL TANK FILLER ACCESS FLAP - LR044763



? WE'RE HERE TO HELP
Can't find or not sure of the right part for your car, contact our technical sales team for help and advice.
01522 568000



SIDE STEP - VPLSP0038



SIDE STEP PAIR - VPLSP0040BP



SIDE STEP PAIR - VPLSP0040P

Front Side Door Locks & Handles

DOOR HANDLE, exterior, original fitment:
Hinged part of handle. Tungsten Silver finish for standard cars, primed finish for body colour coding (e.g. HST model).

Tungsten Silver finish		
to VIN 6A955389	2	CXA000016LEP
VIN 6A955390 on primed finish	2	LR023343
	2	LR006876

END CAP, exterior door handle, original fitment:
Fixed part of handle. Tungsten Silver finish for standard cars, primed finish for body colour coding (e.g. HST model).

without lock barrel hole		
Tungsten Silver finish		
to VIN 6A955389	1	CXJ500025LEP
VIN 6A955390 on primed finish	1	CXJ500040LEP
	1	LR006878
with lock barrel hole		
Tungsten Silver finish		
to VIN 6A955389	1	CXJ500015LEP
VIN 6A955390 on primed finish	1	CXJ500030LEP
	1	LR006877



DOOR HANDLE - CXA000016LEP

DOOR HANDLE END CAP - CXJ500025LEP

DOOR HANDLE SET, exterior, body colour:
Car set of door handles and end caps, finished in choice of colours matching selected vehicle body colours. Originally specified for HST model.

Rimini Red	1	LR006942
Stornoway Grey	1	LR006945
Buckingham Blue	1	LR006944
Zermatt Silver	1	LR006946
Alaska White	1	LR007530
Java Black	1	LR006949
Santorini Black	1	VPLAB0010PAB
Tonga Green	1	LR006943
Galway Green	1	VPLAB0010HAC



DOOR HANDLE COVER SET, exterior, chrome:
Car set of covers for door handles and end caps, finished in chrome to match other chrome accent accessories for the Range Rover Sport. Self adhesive, fitted in minutes.

Britpart (chromed plastic)	1	RD1084BP
Bearmach (chromed metal)	1	RD1084BM

GASKET, exterior door handle:
front of handle 2 **CXE500050**
rear of handle and end cap 2 **CXE500040**

REINFORCEMENT, exterior door handle:
Inside door.
RH 1 **LR018297**
LH 1 **LR018298**

INSERT , reinforcement, lock barrel	1	LR003456
SPACER , exterior door handle:		
to VIN 8A149839	2	ABS780145
VIN 8A149840 on	2	ABS780160
PLUG , LH exterior door handle	1	DBP5118
DOOR HANDLE , interior, Ebony/Noble:		
RH	1	FVC500340WWE
LH	1	FVC500350WWE

LATCH ASSEMBLY
Important Note: Replacement of the door latch assembly must be done with a new item featuring the same frequency as the original.
As a general guide, 433Mhz frequency equipment is used on UK cars, European cars, and many other markets. 315Mhz is used for the remainder.

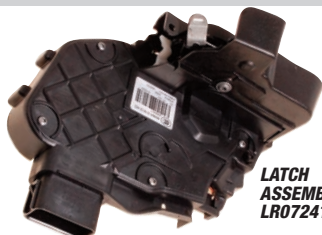

LATCH ASSEMBLY - LR072413

LATCH ASSEMBLY , front door:		
RH		
433Mhz frequency		
Land Rover	1	LR072413
aftermarket	1	LR072413P
315Mhz frequency		
to VIN 7A999999	1	FQJ500460
VIN 8A000001 on	1	LR074973
LH		
433Mhz frequency	1	LR071636
315Mhz frequency		
to VIN 7A999999	1	FQJ500470
VIN 8A000001 on	1	LR074987
STRIKER , front door latch	2	FQB500041PMA
COVER , door latch striker	2	FQW500022PMA
CONTROL CABLE :		
lock barrel	1	FQZ000205
exterior door handle	2	FQZ500073
interior door handle	2	FQZ5000310



DOOR HANDLE SET - LR006942

SCREW :		
door handle reinforcement, Torx	2	RYP500020
door latch	6	FYP500010
door latch striker	4	FYP500020
interior door handle	2	DA608164
NUT , plastic, interior door handle	2	BTR1737



CHROME DOOR HANDLE COVER SET - RD1084BP

ALL MODELS

Front Side Door Seals & Fittings

DOOR SEAL :		
primary, on door	2	LR017012
secondary, on body	2	LR044024
FINISHER , door window frame:		
A post		
RH	2	LR015015
LH	2	LR015016
B post		
RH	2	LR016344
LH	2	LR016345
MOULDING , door window frame, inner:		
RH	1	EJN000100
LH	1	EJN000110
PLUG , round, 30mm dia.	2	BNP3996
BUFFER , door closing	2	CFM500010
WEATHERSTRIP , door drop glass:		
outer		
RH	1	CGE000860
LH	1	CGE000870
inner		
RH	1	CGE000902
LH	1	CGE000912
SCREW , outer weatherstrip to door	4	CYP500010
FELT INSERT , drop glass run channel:		
RH		
to VIN 5A901923	1	CFE000784
VIN 5A901924 on	1	CFE500880
LH		
to VIN 5A901923	1	CFE000794
VIN 5A901924 on	1	CFE500890

Rear Side Door Seals & Fittings

DOOR SEAL :		
primary, on door		
Land Rover	2	LR017022
aftermarket	2	LR017022P
secondary, on body	2	LR044023
C post		
upper		
Front edge of window frame.		
RH	1	LR016346
LH	1	LR016347
door to wheel arch		
RH	1	CGE500460
LH	1	CGE500470
FINISHER , door window frame, C post: Includes upper C post seal.		
RH	2	LR016346
LH	2	LR016347
MOULDING , door window frame, inner:		
RH	1	ELN000041
LH	1	ELN000051
PLUG , round, 30mm dia.	2	BNP3996
BUFFER , door closing	2	CFM500010
WEATHERSTRIP , door drop glass:		
outer		
RH	1	LR044768
LH	1	LR044769
inner		
RH	1	CGE000922
LH	1	CGE000932
SCREW , outer weatherstrip to door	2	CYP500010
FELT INSERT , drop glass run channel:		
RH		
to VIN 5A901923	1	CGE000843
VIN 5A901924 on	1	LR017041
LH		
to VIN 5A901923	1	CGE000853
VIN 5A901924 on	1	LR017042

ALL MODELS

BODY FITTINGS - SIDE DOORS



DOOR HANDLE - CXA000016LEP

END CAP - CXJ500025LEP

Rear Side Door Locks & Handles

DOOR HANDLE, exterior, original fitment:

Hinged part of handle. Tungsten Silver finish for standard cars, primed finish for body colour coding (e.g. HST model).

Tungsten Silver finish		
to VIN 6A955389	2	CXA000016LEP
VIN 6A955390 on	2	LR023343
primed finish	2	LR006876

END CAP, exterior door handle, original fitment:

Fixed part of handle. Tungsten Silver finish for standard cars, primed finish for body colour coding (e.g. HST model).

Tungsten Silver finish		
to VIN 6A955389	1	CXJ500025LEP
VIN 6A955390 on	1	CXJ500040LEP
primed finish	1	LR006878



DOOR HANDLE SET - LR006944

Car Lock Sets

CAR LOCK SET, complete vehicle:

with remote control handsets

Includes remote controls with keys, door lock barrel and steering lock barrel. Note that the car's VIN is required when placing order.

Replacement of the car lock set (including remote controls) must be done with new remote controls featuring the same frequency as the original. As a general guide, 433Mhz frequency equipment is used

on UK cars, European cars, and many other markets. 315Mhz is used for the remainder.

cars with 433Mhz equipment	1	LR017450
cars with 315Mhz equipment	1	LR017452

Not USA, Canada or Mexico.

without remote control handsets

Includes key blades for remote controls, door lock barrel and steering lock barrel.

HANDSET, remote control, with key

Replacement of the remote control must be done with a new remote control featuring the same frequency as the original. As a general guide, 433Mhz frequency equipment is used on UK cars, European cars, and many other markets. 315Mhz is used for the remainder. Replacement receivers and remote control handsets will require programming before use. We provide a programming service, to personal callers only, for synchronising new ECUs and remotes with your car.

cars with 433Mhz equipment	2	CWE500041SW
cars with 315Mhz equipment	2	CWE500061SW

KEY BLADE, replacement

Includes roll pin for fixing new blade into remote handset. May be supplied pre-cut, otherwise supplied blank.

DOOR HANDLE SET, exterior, body colour:

Car set of door handles and end caps, finished in choice of colours matching selected vehicle body colours. Originally specified for HST model.

Rimini Red	1	LR006942
Stornoway Grey	1	LR006945
Buckingham Blue	1	LR006944
Zermatt Silver	1	LR006946
Alaska White	1	LR007530
Java Black	1	LR006949
Santorini Black	1	VPLAB0010PAB
Tonga Green	1	LR006943
Galway Green	1	VPLAB0010HAC

DOOR HANDLE COVER SET, exterior, chrome:

Car set of covers for door handles and end caps, finished in chrome to match other chrome accent accessories for the Range Rover Sport. Self adhesive, fitted in minutes.

Britpart (chromed plastic)	1	RD1084BP
Bearmach (chromed metal)	1	RD1084BM

GASKET, exterior door handle:

front of handle	2	CXE500050
rear of handle and end cap	2	CXE500040

REINFORCEMENT, exterior door handle:

Inside door.

RH	1	LR018297
LH	1	LR018298

SPACER, exterior door handle:

to VIN 8A149839	2	ABS780145
VIN 8A149840 on	2	ABS780160

DOOR HANDLE, interior, Ebony/Noble:

RH	1	FVC500360WWE
LH	1	FVC500370WWE

important note

LATCH ASSEMBLY

Important Note: Replacement of the door latch assembly must be done with a new item featuring the same frequency as the original.

As a general guide, 433Mhz frequency equipment is used on UK cars, European cars, and many other markets. 315Mhz is used for the remainder.

REAR DOOR LATCH ASSEMBLY - LR072414



LATCH ASSEMBLY, rear door:

RH		
433Mhz frequency	1	LR072414
315Mhz frequency		
to VIN 7A999999	1	FQM500380
VIN 8A000001 on	1	LR077830
LH		
433Mhz frequency	1	LR071650
315Mhz frequency		
to VIN 7A999999	1	FQM500390
VIN 8A000001 on	1	LR077833
LEVER, child safety lock:		
RH	1	FPE500060
LH	1	FPE500070
STRIKER, rear door latch	2	FQB500041PMA
COVER, door latch striker	2	FQW500022PMA
CONTROL CABLE:		
exterior door handle	2	FQZ500153
interior door handle	2	FQZ500330
SCREW:		
door latch	6	FYP500010
door latch striker	4	FYP500020
interior door handle	2	DA608164
NUT, plastic, interior door handle	2	BTR1737

Door Drip Rail Seals

DRIP RAIL SEAL, front and rear side door:

RH	1	CHE500200
LH	1	CHE500210

Side Door Accessories & Protection

DOOR RUBBING STRIP SET

Set of 4 side mouldings, easily fitted to the doors to protect them from scratches and car park knocks.

SILL TREAD PLATE SET:

Set of bright polished tread plates, easily fitted with no drilling required.

Land Rover		
8 piece set	1	VPLSS0042
Inner and outer, front and rear tread plates with 'Range Rover' legend on front inner plates.		
4 piece set	1	LR006788
Outer front and rear tread plates only with 'Sport' legend on front outer plates.		
Britpart, 8 piece set	1	VPLSS0042BP



SILL TREAD PLATE SET - VPLSS0042BP

Front
Rear

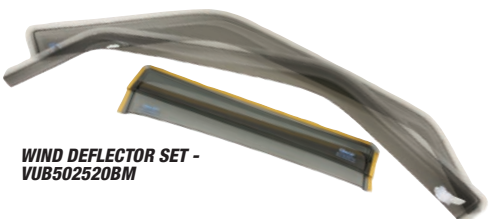

WIND DEFLECTOR SET - VUB502520BM

WIND DEFLECTOR SET:

Easily fitted wind deflectors for Range Rover Sport side door windows, manufactured in durable Perspex. Design reduces draughts and rain ingress when driving with opened windows, while maintaining good ventilation. Sold as car set of four deflectors.

Land Rover	1	VUB502520
Britpart	1	VUB502520BP
Bearmach	1	VUB502520BM

Door Mirrors

DOOR MIRROR ASSEMBLY, RH, without glass:

without memory		
without powerfold	1	CRB503060PMA
with powerfold	1	CRB503120PMA
with memory		
without powerfold		
without puddle lamp	1	CRB503080PMA
with puddle lamp	1	CRB503100PMA
with powerfold		
without puddle lamp	1	CRB503140PMA
with puddle lamp	1	CRB503160PMA

DOOR MIRROR ASSEMBLY, LH, without glass:

without memory		
without powerfold	1	CRB503070PMA
with powerfold	1	CRB503130PMA
with memory		
without powerfold		
without puddle lamp	1	CRB503090PMA
with puddle lamp	1	CRB503110PMA
with powerfold		
without puddle lamp	1	CRB503150PMA
with puddle lamp	1	CRB503170PMA

MOTOR, door mirror:

Included in mirror assembly.

without memory	2	CRP500031
with memory	2	CRP500041

LAMP, puddle

Included in mirror assembly.

	2	CTZ500010
--	---	------------------

BULB, puddle lamp

Included in mirror assembly.

	2	CTY500011
--	---	------------------

SCREW, mirror to door

	6	CYG500010
--	---	------------------

GLASS, RH, mirror:

Not included in mirror assembly.

flat	1	CRD500020
convex		
Land Rover	1	LR017067
aftermarket	1	LR017067P

GLASS, LH, mirror:

Not included in mirror assembly.

flat		
Land Rover	1	LR017047
aftermarket	1	LR017047P
convex		
Land Rover	1	LR017070
aftermarket	1	LR017070P

COVERS, accessory, door mirror, pair:

Range of chromed or painted covers with which to enhance your door mirrors. Supplied in pairs.

upper

chrome

Land Rover	1	VUB503880MMM
Bearmach	1	VUB503880MMMBM
aftermarket	1	VUB503880MMMP

painted

Rimini Red	1	LR004833
Zermatt Silver	1	LR004836
Java Black	1	LR004864
Santorini Black	1	VPLAB0011PAB
Stornoway Grey	1	LR004837
Chawton White	1	LR004862
Alaska White	1	LR007532
Buckingham Blue	1	LR004863
Cairns Blue	1	LR004865
Tonga Green	1	LR007531
Galway Green	1	VPLAB0011HAC
primed	1	LR004867

lower

chrome

Land Rover	1	LR003905
aftermarket	1	LR003905P
primed	1	LR004866



CRB503080PMA



CRB503070PMA



CRB503130PMA



CRB503090PMA

MIRROR GLASS - LR017047



WE'RE HERE TO HELP
 Can't find or not sure of the right part for your car, contact our technical sales team for help and advice.
01522 568000



VUB503880MMM



LR004836



LR004833



LR004864

DOOR MIRROR COVERS

ALL MODELS

DOOR MIRROR ASSEMBLIES

BODY FITTINGS - DOOR MIRRORS

ORDER

BY PHONE: 01522 568000 / ON LINE: www.rimmerbros.co.uk / E-MAIL: lrsales@rimmerbros.co.uk

ALL MODELS

BODY FITTINGS - REAR

Rear Door (Tailgate) Fittings

SEAL:

rear door to body	1	LR024948
glass to rear door		
to VIN 5A910218	1	CKE500021
VIN 5A910219 on	1	LR016985

GAS STRUT, rear door to body:

RH		
to VIN 6A940841		
Land Rover	1	BHE790043
OEM	1	BHE790043P1
aftermarket	1	BHE790043P
VIN 6A940842 on		
Land Rover	1	LR027543
aftermarket	1	LR027543P

LH		
to VIN 6A940841		
Land Rover	1	BHE790053
OEM	1	BHE790053P1
VIN 6A940842 on		
Land Rover	1	LR029320
OEM	1	LR029320P1

GAS STRUT, rear door glass to door

PIVOT, rear door & glass gas strut 6 BKF780030

BRACKET, rear door gas strut mounting:

RH 1 BHU790021

LH 1 BHU790031

HANDLE, rear door glass, black

REINFORCEMENT, door glass to handle 1 CXB500101PMA

COVER, door glass handle, primed 1 CQD500010

HINGE, door glass to door:

RH 1 BHB790040

LH 1 BHB790050

NUT:

handle & reinforcement to glass 15 BYH500050

hinge to glass 2 BYH500060

SCREW:

door glass handle cover to handle 8 BYP500090

door glass hinge to door 2 FYP500350

BUFFER:

rear door to latch striker 2 LR036130

Included in latch striker assembly.

rear door to body

side 2 CKM000010

lower corner 2 CKM500011

rear door glass to door

side 4 CUM500040

lower corner 2 LR023036

rear door glass handle to glass 2 CZU000010

MOULDING, rear door lower edge:

Tungsten finish 1 DGP000194LEP

Includes moulding clips.

primed finish

For painting body colour. Does not include moulding clips.

all models except HST 1 LR014360

models with HST body styling 1 VPLSB0007

SEAL, rear door lower edge moulding:

Not required for Tungsten finish moulding.

long 1 DDS500040

end foam

RH 1 DDS500080

LH 1 DDS500090

CLIP, lower edge moulding

15 DYC101420

WASHER, lower edge moulding

3 DYF500330

Not required for Tungsten finish moulding.



LATCH -
FQR500170

Rear Door (Tailgate) Locks

LATCH:

glass to rear door 1 FQR500170

rear door to body 1 LR016678

COVER, latch, rear door to body

1 FQW500032PVJ

SWITCH, door release control

1 FQY500020

SEAL, release switch to door

1 ALR5252

STRIKER ASS'Y, rear door latch:

Includes buffers.

to 6A999999 1 FQQ500050

VIN 7A000001 on 1 FQQ500090

SCREW:

glass latch to rear door 2 FYP106392

release switch to rear door 2 DYP000120

side buffer to rear door 2 DYP101410

lower lock striker pin 4 BYP500370

BOLT:

rear door latch to door 3 DEP1198

striker to body 2 DEP1198

Rear Spoiler

REAR SPOILER KIT, primed:

all models except HST 1 DFD500110LML

models with HST body styling 1 DFD500170LML

SCREW, spoiler to rear door

2 FYP106397

NUT, domed, spoiler to rear door

3 BYH100132

Rear Bumper

REAR BUMPER MOULDING, primed:

all models except HST

Does not include mounting brackets.

without parking sensor holes 1 DQC500071LML

with parking sensor holes 1 DQC500091LML

models with HST body styling 1 LR009010

Includes lower mounting brackets.

REINFORCEMENT, inner, bumper moulding:

all models except HST

RH 1 DXF500021

LH 1 DXF500031

models with HST body styling 1 LR009025

Models with HST body styling kit only.

TOWING EYE COVER, rear bumper:

Includes 1/4 turn fasteners.

all models except HST 1 DQU000011PCL

models with HST body styling 1 LR009011

1/4 TURN FASTENER, cover

2 DYP500010

SOCKET, 1/4 turn fastener, bumper

2 DYF500010

BRACKET, bumper mounting:

centre 1 LR013862

side

RH 1 DQN000061

LH 1 DQN000071

corner

RH 1 LR013858

LH 1 LR013860

BRACKET, bumper armature:

RH 1 DQG000063

LH 1 DQG000073

TREAD MAT INSERT, rear bumper:

original fitment

Anthracite Black 1 DOE000021PCL

Originally fitted up to VIN 8A999999.

Tungsten 1 LR008893

Originally fitted from VIN 9A000001 on.

accessory type

Features 'SPORT' legend. Will not fit models with HST body styling.

covers original tread mat

Land Rover, stainless steel 1 LR007321

Bearmach, chrome finish 1 LR007321BM

replaces original tread mat

Land Rover, stainless steel 1 LR007322

SCREW:

bumper, self tapping 5 DYP100780L

centre bracket, bumper mounting 4 AYP500010

side and corner brackets, M6 12 RYG500840

NUT:

insert, M6, side & corner brackets 12 DYH500010

Spiralok, bumper moulding 6 DYH500110

FASTENER, push-pin, centre bracket 4 AWR3994

WE'RE HERE TO HELP
 Can't find or not sure of the right part
 for your car, contact our technical
 sales team for help and advice.
01522 568000



GAS STRUT -
BHE790043P



OVAL BADGE - DAH100680

OVAL BADGE - DAH500330



Rear Badges

OVAL BADGE, 'Land Rover':

green and gold	1	DAH100680
<i>All models except 4.2 AJV8 supercharged petrol.</i>		
black and silver	1	DAH500330
<i>4.2 AJV8 supercharged petrol models.</i>		

LETTER SET:

Titan Silver finish.

'RANGE'	1	DAB500270MBJ
'ROVER'	1	DAB500280MBJ
'SPORT'		
Land Rover	1	LR020469
OEM	1	LR020469P1
'SPORT SE'	1	LR020468
'SPORT HSE'		
Land Rover	1	LR020467
OEM	1	LR020467P1

LETTER & NAMEPLATE SET:

Titan Silver finish.

'SPORT SUPERCHARGED'	1	DAH500130MBJ
'SPORT TDV8'	1	LR020350

NAMEPLATE, 'TDV8'

1 **DAL500100**

Included in letter & nameplate set 'SPORT TDV8'.

BADGE, 'Land Rover G4 Challenge' 1 **HLD501083EMC**



LETTER SET - LR020469



LETTER SET - LR020467

Rear Cycle Carriers

CYCLE CARRIER KIT:

tow ball free type, for two bicycles

Fits directly to tow bar while still allowing a trailer to be towed.

Padded to protect bikes from damage and supplied complete with bike tie-down straps.

Land Rover	1	STC50063
Britpart	1	STC50063BP

tow ball mounting type

Bicycle carrying module, fitting to tow ball. Features rear lights and number plate holder. Supplied complete with bike tie-down straps.

RHD models

carrier for 2 bicycles	1	VPLVR0066
carrier for 3 bicycles	1	VPLVR0068

LHD models

carrier for 2 bicycles	1	VPLVR0067
carrier for 3 bicycles	1	VPLVR0069



VALANCE PANEL - RRY500010

Spare Wheel Stowage

VALANCE PANEL, spare wheel carrier 1 **RRY500010**

BRACKET, valance panel:

RH		
to VIN 8A460530	1	RRY500150
VIN 8A460531 on	1	RRY500200

LH		
to VIN 8A460530	1	RRY500140
VIN 8A460531 on	1	RRY500210

RIVET, panel to bracket 2 **RV612183**

STUD PLATE, valance panel 1 **RRY500120**

WINCH ASSEMBLY, spare wheel:

Land Rover	1	LR064520
OEM	1	LR064520P1

GROMMET, winch 1 **KT0000013**

SPACER, spare wheel carrier 4 **RYF500130**

SPARE WHEEL SAVER (anti-theft) 1 **LR064520ATD**

Easy to fit and use spare wheel anti-theft device. Includes fittings and instructions.



WINCH ASSEMBLY - LR064520ATD

ALL MODELS



REAR MUD FLAPS - CAT500120PCL

Rear Mud Flaps

REAR MUD FLAP SET:

Includes fasteners. For standard profile rear bumper only.

Land Rover	1	CAT500120PCL
Britpart	1	CAT500120PCLBP
aftermarket	1	CAT500120PCLP



REAR MUD FLAPS - CAT500120PCLP



REAR LAMP GUARDS - VUB501920BP

Rear Body Protection Accessories

REAR LAMP GUARDS:

Durable protection for your expensive lamps - not just a cosmetic accessory! Supplied with fixings.

pair, kit

Land Rover	1	VUB501920
Britpart	1	VUB501920BP
each (Land Rover replacement parts)		
RH	1	VUB503380
LH	1	VUB503390

Tow Bar

TOW BAR KIT:

fixed height type

Includes tow bar, ball and cover, plus lockable quick-disconnect handle.

Land Rover	1	LR071295
Thule (OEM)	1	LR071295P1

adjustable height (drop plate) type

Includes tow bar, ball and cover, drop plate and reinforcing struts, electrics plate, fixings kit, plus lockable quick-disconnect handle.

Land Rover	1	LR043271
OEM	1	LR043271P1
Bearmach	1	LR043271BM
Britpart	1	LR043271BP

HANDLE, locking, with key 1 **KNW500020**

Quick-disconnect handle for removal of the tow bar from the vehicle.

DROP PLATE, adjustable height tow bar 1 **LR005741**

TOWING JAW, ball & pintle type

For drop plate type tow bar only. Replacement parts for the Dixon Bate jaws are also available - please contact us for details.

Land Rover	1	LR008244
aftermarket	1	LR008244P
Britpart	1	LR008244BP
Dixon Bate	1	LR008244BPDIX
Dixon Bate heavy duty	1	LR008244BPDIX

FIXINGS KIT, adjustable height tow bar 1 **LR007485**

PROTECTIVE CAP, tow bar socket 1 **KNG500013**

Red cap protects tow bar mounting socket when tow bar not fitted.

ADAPTOR/PLINTH, electrics socket:

7 pin 12S type socket	1	VSA500060
13 pin type socket	1	VSA500110

SCREW, adaptor/plinth:

7 pin 12S plinth, short	4	DYP10035L
13 pin plinth, long	3	SE105358

ORDER

BY PHONE: 01522 568000 / ON LINE: www.rimmerbros.co.uk / E-MAIL: lrsales@rimmerbros.co.uk

BODY FITTINGS - REAR

ALL MODELS

BODY FITTINGS - ROOF

Roof Weatherstrips

ROOF WEATHERSTRIP ASSEMBLY:

Includes clips.

RH	1	LR018084
LH	1	LR018083
CLIP, roof weatherstrip	12	DBE500013
FASTENER, fir tree, roof weatherstrip	6	RZM500041
PLUG, roof weatherstrip, M6	6	ACU3161
STUD, roof weatherstrip, M6	6	AYR500061

Sun Roof & Mechanism

SUN ROOF ASSEMBLY, complete 1 **LR018241**
Includes glass, seal, frame, motor, deflector and blind.

GLASS, sun roof, with seal	1	LR044746
SEAL, sun roof glass	1	LR023393
FRAME ASSEMBLY, sun roof	1	LR018242
MOTOR, sun roof	1	EGQ500030

Includes electronic control module.

AIR DEFLECTOR, sun roof	1	EFJ500030PVJ
SLIDER, mechanism	1	EFY500100
CLIP, blind, front corners	2	EYC500160

TUBE, sun roof frame water drain:

front	2	EEH500120
rear	2	EEH500130

SCREW:

frame front fixing	3	SN106165L
frame side fixing	8	EYP500150

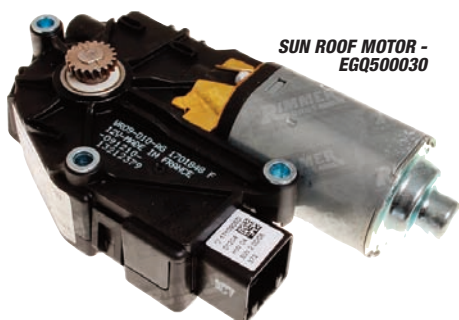

SUN ROOF MOTOR -
EGQ500030



Roof Rack Rails & System

ROOF RACK RAIL KIT

Kit includes raised roof side rails, locking cross rail assemblies and keys. The cross rails, easily removed when not in use, accept all roof storage accessories detailed in this section.

ROOF RACK RAIL KIT:

Land Rover	1	VUB502130
Britpart		
Thule	1	VUB502130BP
Mont Blanc System 3000	1	VUB502130BPPREM



LUGGAGE CARRIER FRAME

For use in conjunction with roof rack cross rails. Includes fixings.

LUGGAGE CARRIER SET:

standard, 2/3 roof length	1	LR006848
Includes fixings.		
expedition, full roof length	1	CAB500130PMA
Includes main fixings - for full set, kit number VUB504230 is also required.		

FITTING KIT, expedition carrier 1 **VUB504230**

LASHING EYE KIT, expedition carrier 1 **VUB503160**

For use in conjunction with full roof length expedition luggage carrier. Includes six lashing eyes.

RATCHET STRAP, tie down A/R **CAR500010**

For use in conjunction with standard or expedition luggage carrier.

EXPEDITION
CARRIER
FITTING KIT -
VUB504230

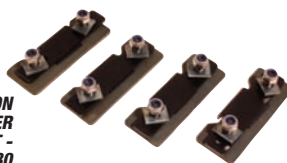

LUGGAGE BOX

With 75kg capacity. For use in conjunction with roof rack cross rails. Includes fixings and fittings kit, plus spacer plate.

LUGGAGE BOX ASSEMBLY:

410 litre size	1	VPLVR0062
SPACER PLATE, luggage box	1	LR005336



LUGGAGE BOX -
VPLVR0062



ROOF RACK RAIL KIT -
VUB502130BP

SKI/SNOWBOARD CARRIERS

For use in conjunction with roof rack cross rails.

SKI CARRIER SET:

open frame type	1	LR006849
Includes pair of locking ski carrier assemblies, fixings and keys.		
enclosed sports box type	1	VPLVR0061
Includes ski carrier box, fixings and keys.		



CANOE/SURF BOARD CARRIERS

For use in conjunction with roof rack cross rails. Includes fixings and fasteners preventing sideways movement of and subsequent damage to canoes, sail boards or surf boards.

CANOE/SURF BOARD CARRIER SET 1 **VPLGR0107**



CANOE/
SURF BOARD
CARRIER SET
- VPLGR0107



REAR LADDER KIT

G4 Challenge specification ladder, permits easier access to roof rack systems. Fits to rear door (opening rear door glass is disabled when fitting). Includes fixings.

REAR LADDER KIT 1 **AGP790020**



REAR LADDER KIT -
AGP790020

WE'RE HERE TO HELP
Can't find or not sure of the right part for your car, contact our technical sales team for help and advice.
01522 568000

Windscreen & Interior Rear View Mirror

WINDSCREEN GLASS:

Includes upper windscreen moulding.

without heated windscreen

non-rain sensor type 1 **LR016355**

rain sensor type 1 **CMB500681**

with heated windscreen

non-rain sensor type 1 **LR016356**

rain sensor type 1 **CMB500691**

MOULDING, windscreen:

upper, black 1 **LR032336**

Included with windscreen glass.

A post, satin black

Not included with windscreen glass. Includes fitting clip.

RH 1 **LR046846**

LH 1 **LR048338**

WINDSCREEN MOULDING - LR032336

RUBBER BUFFER, windscreen 4 **CZU000010**

BONDING KIT, windscreen 1 **RTC2063**

CLIP, A post moulding fixing 2 **IPN500050**

BUTTON FASTENER, A post moulding 2 **DYQ500060**

SLEEVE, button fastener 2 **DYA000040**

MIRROR, interior, rear view:

manual dipping 1 **CTB500100**

electrochromic

without Homelink

to VIN 8A999999 1 **CTB500110**

VIN 9A000001 on 1 **LR021821**

with Homelink

to VIN 8A999999 1 **CTB500120**

VIN 9A000001 on 1 **LR021820**

COVER, rear view mirror base:

RH 1 **CTN000080PUY**

LH 1 **CTN000090PUY**

REAR VIEW MIRROR COVER - CTN000080PUY

Rear Door (Tailgate) Window

For rear door glass fittings, please see 'Body Fittings - Rear' section.

REAR DOOR GLASS:

Optikool glass 1 **CQG500011**

privacy glass 1 **CQG500031**

Front Side Door Windows & Regulators

FRONT SIDE DOOR GLASS (drop glass):

Includes mounting clips.

RH 1 **CUB500141**

LH 1 **CUB500151**

FELT INSERT, drop glass run channel:

RH

to VIN 5A901923 1 **CFE000784**

VIN 5A901924 on 1 **CFE500880**

LH

to VIN 5A901923 1 **CFE000794**

VIN 5A901924 on 1 **CFE500890**

CHANNEL, drop glass run, front:

RH 1 **LR024084**

LH 1 **LR024085**

REGULATOR ASSEMBLY, drop glass:

Includes motor.

RH

to VIN 6A999999 1 **CUH500103**

VIN 7A000001 on 1 **LR052111**

LH

to VIN 6A999999 1 **CUH500113**

VIN 7A000001 on 1 **LR052110**



DROP GLASS REGULATOR ASSEMBLY - CUH500103

MOTOR, drop glass regulator:

RH

to VIN 6A999999 1 **CUR000140**

VIN 7A000001 on 1 **CUR000141**

LH

to VIN 6A999999 1 **CUR000150**

VIN 7A000001 on 1 **CUR000151**

BRACKET, drop glass regulator to door:

Not included in regulator assembly.

RH 1 **FVY500020**

LH 1 **FVY500030**

SCREW:

front run channel to door 2 **CYP500080**

drop glass regulator to door 8 **CYP500080**

motor to drop glass regulator 8 **FVZ500010**

NUT, drop glass regulator to door:

Land Rover 4 **FN106047L**

aftermarket 4 **FN106047LP**



FELT INSERT - CFE500880

ALL MODELS

Rear Quarter Windows

REAR QUARTER GLASS:

RH

Optikool glass 1 **CPB500762**

privacy glass 1 **CPB500782**

LH

Optikool glass 1 **CPB500772**

privacy glass 1 **CPB500792**

BONDING KIT, rear quarter glass 1 **RTC2063**

MOULDING, D post, satin black

Not included with rear quarter glass.

RH 1 **DDG000165PNP**

LH 1 **DDG000175PNP**

BUTTON FASTENER, D post moulding 8 **DYQ500060**

SLEEVE, button fastener 8 **DYA000040**



BONDING KIT - RTC2063

Rear Side Door Windows & Regulators

REAR SIDE DOOR GLASS:

main (drop) glass

Includes mounting clip.

RH

Optikool glass 1 **LR042721**

privacy glass 1 **CVB500220**

LH

Optikool glass 1 **LR042722**

privacy glass 1 **CVB500230**

fixed (quarter) glass

Supplied fitted in frame.

RH

Optikool glass 1 **LR044523**

privacy glass 1 **LR021068**

LH

Optikool glass 1 **LR044524**

privacy glass 1 **LR021081**

FELT INSERT, drop glass run channel:

RH

to VIN 5A901923 1 **CGE000843**

VIN 5A901924 on 1 **LR017041**

LH

to VIN 5A901923 1 **CGE000853**

VIN 5A901924 on 1 **LR017042**

REGULATOR ASSEMBLY, drop glass:

Includes motor.

RH 1 **LR052109**

LH 1 **LR052108**

MOTOR, drop glass regulator:

RH 1 **CVR000010**

LH 1 **CVR000060**

BRACKET, drop glass regulator to door:

Not included in regulator assembly.

RH 1 **FVY500040**

LH 1 **FVY500050**

SCREW:

drop glass regulator to door 8 **CYP500080**

motor to drop glass regulator 6 **FVZ500010**

fixed (quarter) glass to door 4 **CYP500030**

NUT, drop glass regulator to door 4 **FN106047L**

ALL MODELS

INTERIOR - TRIM

Side Door Trim Panels

Because we, the customers, apparently wanted all the variations and options to choose from when we ordered our new Range Rover Sports, Land Rover Parts were left with a problem: how to manage spares availability for potentially hundreds of different door panels (just imagine all the combinations of trim material, trim colour, door pull finish, speaker arrangements, switches, etc.).

The Land Rover Parts solution is to ask you for your car's VIN and, having referred to the archive build records, they then build you a new, replacement door panel finished in the correct materials and colours and with the right holes, speaker grilles etc. for the equipment fitted in your car.

The up sides of this policy are that you receive exactly the right panel, without compromises, in freshly minted condition and without the dust, knocks, pressure marks and water damage that used to be invariably associated with long term warehouse storage of interior trim.

The downsides are that the panel may take anything from 2 to 6 weeks to be delivered from the date of order, plus Land Rover Parts are understandably reluctant to take the door panel back if you decide at the end of the day that you didn't really need it... and it won't be cheap.

TRIM PANEL ASSEMBLY, side door:

VIN required when ordering. There will be a period of time between ordering and receiving the panel (see notes above). Door panels include plastic fitting clips, Land Rover badges and door pulls.

front door

RH	1	VBA500100
LH	1	VBA500110

rear door

RH	1	VBA500120
LH	1	VBA500130



PANEL TO DOOR CLIPS - LR013135

CLIP:

plastic, panel to door	38	LR013135
<i>Qty: 11 required per front door panel, 8 required per rear door panel.</i>		
metal, panel to door top	8	LR031948
plastic, front door panel pocket	4	LR018583

SCREW:

door panel to door	12	DA608064L
<i>Qty: 4 required per front trim panel, 2 required per rear trim panel.</i>		
door panel to front door	2	DA608164
<i>Behind oval badge on front door panel.</i>		
door release handle to door	4	DA608064L
<i>Qty: 1 required per front or rear door release handle.</i>		
door pull to door	4	AB614082
<i>Qty: 1 required per front or rear door pull.</i>		

NUT, Lokut:

door panel to door	12	BNP4106
<i>Qty: 4 required per front trim panel, 2 required per rear trim panel.</i>		
door panel to front door	2	LR044895
<i>Behind oval badge on front door panel.</i>		
door pull to door	4	LR014279
<i>Qty: 1 required per front or rear door pull.</i>		

NUT, plastic, door release handle	4	BTR1737
-----------------------------------	---	---------



HANDLE:

door release, black plastic/metal		
front door		
RH	1	FVC500340WWE
LH	1	FVC500350WWE
rear door		
RH	1	FVC500360WWE
LH	1	FVC500370WWE
door pull, metal:		
to VIN 7A999999, Rhodium metallic		
RH	2	EJE500121MBF
LH	2	EJE500131MBF
VIN 8A000001 on		
Brunel metallic		
RH	2	LR016806
LH	2	LR016807
Noble plated		
RH	2	LR008557
LH	2	LR008558

INSERT, door trim panel, contrasting:

Alternative to standard vinyl or leather door trim panel insert (standard vinyl or leather item is only supplied with the relevant door trim panel assembly).

Lined Oak/Ebony

front door		
RH	1	EJC500121LAD
LH	1	EJC500131LAD
rear door		
RH	1	ELC500121LAD
LH	1	ELC500131LAD

American Cherry

front door		
RH	1	EJC500121AAY
LH	1	EJC500131AAY
rear door		
RH	1	ELC500121AAY
LH	1	ELC500131AAY

Satin Black Walnut Veneer (7A000001 on)

front door		
RH	1	EJC500440AAC
LH	1	EJC500450AAC
rear door		
RH	1	ELC500180AAC
LH	1	ELC500190AAC

Stained Zebrano (8A000001 on)

front door		
RH	1	EJC5000680
LH	1	EJC5000690
rear door		
RH	1	ELC5000320
LH	1	ELC5000330

BADGE, front door trim panel insert, 'Land Rover':

for standard vinyl door panel insert		
Ebony Black	2	EKA500010PVJ
Alpaca	2	EKA500010SMS
Ivory	2	EKA500010NUG
for leather door panel insert		
Green/Gold	2	EKA500060WYY
Black/Silver	2	LR010544
for wood door panel insert		
Green/Gold	2	EKA500040WYY
Black/Silver	2	EKA500040WYZ

MAT, anti-slip, door pocket:

Original fitment for models from VIN 8A185256 onwards. Will fit earlier models.

RH	1	EJJ500040
LH	1	EJJ500050



SPEAKER GRILLE, front door trim panel:

Ebony Black		
RH	1	EJW500141PVJ
LH	1	EJW500151PVJ
Ivory		
RH	1	EJW500141NUG
LH	1	EJW500151NUG
Alpaca (to VIN 8A999999)		
RH	1	EJW500141PVJ
LH	1	EJW500151PVJ
Almond (VIN 9A000001 on)		
RH	1	LR009628
LH	1	LR009629
DECAL, front door speaker grille:		
Hi ICE branded system	2	DAM500310
premium sound system	2	DAM500320
CHEATER, front door window frame front corner cover:		
complete assembly		
RHD		
RH	1	LR021423
LH	1	LR021422
LHD		
RH	1	LR021421
LH	1	LR021426

Rear Door (Tailgate) Trim Panels

TRIM PANEL, rear door:

inner panel
This is the inner, carpeted panel on the rear door. Includes plastic trim clips.

Ebony Black	1	LR021459
Aspen	1	LR017989
Alpaca (to VIN 8A999999)	1	ESN500052SMS
<i>Originally North America spec. only colour scheme.</i>		
Nutmeg (VIN 9A000001 on)	1	LR036389
window frame, Ebony Black		
upper	1	LR018042
<i>Includes plastic trim clips.</i>		
side panel		
<i>Includes plastic trim clips.</i>		
RH	1	LR017992
LH	1	LR017993

COVER, rear window wiper motor

Includes plastic trim clips.

RETAINER, wiper motor cover	1	ERK500570
-----------------------------	---	-----------

CLIP:

trim panel to rear door	30	LR013135
<i>Qty. required 10 for inner panel, 6 for window frame upper panel, 5 each for window frame side panels, 4 for wiper motor cover.</i>		
window frame side panel corner 2		EYC000202
<i>Upper corners of side panels only.</i>		
SCREW, trim panel to door, lower	2	DA608064L
NUT, Lokut, trim panel to door, lower	2	BNP4106



REAR DOOR WINDOW FRAME SIDE TRIM PANEL, RH - LR017992

Door Post & Sill Trim Panels

A POST TRIM PANEL, upper (windscreen pillar), Ivory:		
RH	1	EMB500242NUG
LH	1	EMB500252NUG
A POST TRIM PANEL, centre: <i>Includes plastic trim clips.</i>		
Ebony Black		
RH	1	EMB500221PVJ
LH	1	EMB500231PVJ
Aspen		
RH	1	EMB500221LUP
LH	1	EMB500231LUP
Alpaca (to VIN 8A999999)		
RH	1	EMB500221SMS
LH	1	EMB500231SMS
A POST TRIM PANEL, lower (corner & footwell side): <i>Includes plastic trim clips.</i>		
RHD		
Ebony Black		
RH	1	EMC500360PVJ
LH	1	LR017958
Aspen		
RH	1	EMC500360LUP
LH	1	EMC500370LUP
Nutmeg (VIN 9A000001 on)		
RH	1	LR017981
LH	1	LR008527
LHD		
Ebony Black		
RH	1	LR017954
LH	1	LR017957
Aspen		
RH	1	EMC500340LUP
LH	1	EMC500350LUP
Alpaca (to VIN 8A999999) <i>Originally North America spec. only colour scheme.</i>		
RH	1	EMC500340SMS
LH	1	EMC500350SMS
Nutmeg (VIN 9A000001 on)		
RH	1	LR017979
LH	1	LR017985

B POST TRIM PANEL, upper (with seat belt slide), Ivory: <i>Includes plastic trim clips.</i>		
RH		
to VIN 6A918925	1	EMG500382NUG
VIN 6A918926 on	1	EMG500383NUG
LH	1	EMG500393NUG
B POST TRIM PANEL, centre:		
Ebony Black		
RH	1	EMG500400PVJ
LH	1	EMG500410PVJ
Aspen		
RH	1	EMG500400LUP
LH	1	EMG500410LUP
Alpaca (to VIN 8A999999) <i>Originally North America spec. only colour scheme.</i>		
RH	1	EMG500400SMS
LH	1	EMG500410SMS
Almond (VIN 9A000001 on)		
RH	1	LR008989
LH	1	LR008992
B POST TRIM PANEL, lower (with sill top steps), without tread plate mat: <i>Includes fixing clips.</i>		
Ebony Black		
RH	1	EMG000662PVJ
LH	1	EMG000672PVJ
Aspen		
RH	1	EMG000662LUP
LH	1	EMG000672LUP
Alpaca (to VIN 8A999999) <i>Originally North America spec. only colour scheme.</i>		
RH	1	EMG000662SMS
LH	1	EMG000672SMS
Nutmeg (VIN 9A000001 on)		
RH	1	LR008990
LH	1	LR008993

B POST TRIM PANEL, lower (with sill top steps), with tread plate mat: <i>Features stainless steel 'Range Rover' tread plate mat. Includes fixing clips.</i>		
Ebony Black		
RH	1	LR018086
LH	1	EMG500810PVJ
Aspen		
RH	1	EMG500800LUP
LH	1	EMG500810LUP
Alpaca <i>Originally North America spec. only colour scheme.</i>		
RH	1	EMG500800SMS
LH	1	EMG500810SMS
Nutmeg (VIN 9A000001 on)		
RH	1	LR018087
LH	1	LR018090
SILL MOULDING:		
RH	1	LR036131
LH	1	LR049873
C POST UPPER TRIM PANEL, Ivory:		
RH	1	EMG500423NUG
LH	1	EMG500433NUG
D POST UPPER TRIM PANEL, Ivory:		
RH	1	EMR500464NUG
LH	1	LR049166
CLIP, plastic, trim:		
A post centre trim panels	2	EYC106710
A post lower trim panels	4	LR013135
B, C & D post trim panels	26	EYC106710
<i>Qty's. required: 3 for each B post upper panel, 4 for each B post centre panel, 2 for each C post panel, 4 for each D post panel.</i>		
sill mouldings	6	LR013135
CLIP, metal, trim (B post lower trim panels)	8	IPN500090
SCREW, A & C post trim panels	4	EYP500010

Rear Quarter Trim Panels

REAR QUARTER TRIM PANEL ASS'Y:
Load compartment side trim panel. Includes where appropriate (for models with DVD player and/or fuel actuator) access cover in RH trim panel. Note that the Ebony Black/Alpaca panels have Ebony Black carpet sections (panels with Alpaca carpet are North American Spec. only and are not included in this catalogue)

RH without access cover		
Ebony Black	1	LR029292
Ebony Black/Ivory	1	LR029293
Aspen/Ivory		
with Aspen seats	1	ESJ501420WVV
with Ivory seats	1	ESJ501420WVZ
Ebony Black/Alpaca <i>To VIN 8A999999.</i>	1	ESJ501420WVB
Nutmeg/Almond <i>VIN 9A000001 on.</i>	1	LR021502
RH with access cover		
Ebony Black	1	LR018000
Ebony Black/Ivory	1	LR018001
Aspen/Ivory		
with Aspen seats	1	ESJ501430WVV
with Ivory seats	1	ESJ501430WVZ
Ebony Black/Alpaca <i>To VIN 8A999999.</i>	1	ESJ501430WVB
Nutmeg/Almond <i>VIN 9A000001 on.</i>	1	LR021505
LH		
Ebony Black	1	LR029291
Ebony Black/Ivory	1	LR021506
Aspen/Ivory		
with Aspen seats	1	ESJ501480WVV
with Ivory seats	1	ESJ501480WVZ
Ebony Black/Alpaca <i>To VIN 8A999999.</i>	1	ESJ501480WVB
Nutmeg/Almond <i>VIN 9A000001 on.</i>	1	LR021507
ACCESS COVER, RH rear quarter trim panel <i>Included in RH rear quarter trim panels for models with DVD player and/or fuel actuator.</i>		
Ebony Black	1	ESJ501130PVJ
Aspen	1	ESJ501130LUP
Nutmeg	1	LR010529
CLIP, plastic, rear quarter trim panel	16	LR013135
AIR VENT, rectangular, D post	2	LR002951



LOAD SPACE COVER - LR012842

Load Compartment Cover

LOAD COVER ASS'Y:
Retractable blind in cassette assembly, otherwise known as 'parcel shelf' or 'package tray'.

Ebony Black	1	LR012842
Ivory	1	LR012841
Alpaca (to VIN 8A999999) <i>Originally North America spec. only colour scheme.</i>	1	EPB500073SMS
Almond (VIN 9A000001 on)	1	LR012843
PEG, load cover securing: <i>Mystifyingly referred to as a 'bezel' in Land Rover's spare parts system, this is the peg on each side of the load cover that secures the blind in its extended state. It is recommended that new pegs should be fitted in pairs.</i>		
Ebony Black	2	LR012846
Ivory	2	LR012845
Alpaca (to VIN 8A999999) <i>Originally North America spec. only colour scheme.</i>	2	LR012985
Almond (VIN 9A000001 on)	2	LR012847
SUPPORT PANEL, load cover, side, Ebony Black:		
RH	1	EPE500381PVJ
LH	1	LR018091
BOLT, side support panel to body	4	LR011851



CARGO BARRIER/DOG GUARD - VPLSS0205

Cargo Barriers/Dog Guards

CARGO BARRIER/DOG GUARD:
Mesh guard assembly, includes fitting kit.

full width		
Land Rover	1	VPLSS0205
Britpart	1	VUB502080BP
centre divider <i>For use with full width cargo barrier/dog guard.</i>		
Land Rover	1	EOH500140PMA
Britpart	1	EOH500140PMABP
REPLACEMENT FITTING KIT, cargo barrier/dog guard:		
set of 4 brackets, full width guard	1	VUB503500
for centre divider	1	VUB503510
set of 5 handscrews	1	VUB503711



CARGO BARRIER/DOG GUARD, CENTRE DIVIDER - EOH500140PMA

ALL MODELS

INTERIOR - ROOF TRIM

Headlining

HEADLINING ASSEMBLY, Ivory:

without sun roof

Includes foam spacer pads fitting between centre of headlining and underside of roof panel, required on models with HI ICE branded (midline) sound system.

without interior scanning alarm

without premium sound system 1

LR010214

with premium sound system 1

LR010215

with interior scanning alarm

without premium sound system 1

LR010216

with premium sound system 1

LR010217

with sun roof

without interior scanning alarm

without premium sound system 1

LR010218

with premium sound system 1

LR010219

with interior scanning alarm

without premium sound system 1

LR010220

with premium sound system 1

LR010221

CLIP:

plastic, headlining rear 1

XYC500030

metal, headlining 10

EYC500070

Required only on models with standard sound system.

SPACER, foam, headlining centre 2

EEK500180

Non sun roof models with HI ICE branded (midline) sound system.



Headlining Fittings

GRAB HANDLE, headlining, Ivory:

over front row seats 2 **EDN500120NUG**

over 2nd row seats 2 **EDP500030NUG**

Features coat hook.

RETAINING CLIP, grab handle 4 **EYC500070**

For grab handles over front and 2nd row seats.

SCREW, grab handle retaining clip 4 **DA608044L**

COVER, roof equipment, Ivory:

interior scanning alarm pod 1 **LR057154**

rear header rail speaker 2 **EDV500053NUG**

Models with premium sound system only. Features speaker grille, includes screw and clip.

SCREW, speaker cover to roof 2 **DA608044L**

CLIP, speaker cover to roof 2 **EYC500070**

Sun Visors

SUN VISOR ASSEMBLY, Ivory:

RHD

without lamp

RH (driver's) 1 **EDQ500722NUG**

LH (passenger's) 1 **EDQ500732NUG**

with lamp

RH (driver's) 1 **EDQ500142NUG**

LH (passenger's) 1 **EDQ500152NUG**

LHD

without lamp

RH (passenger's) 1 **EDQ500742NUG**

LH (driver's) 1 **EDQ500752NUG**

with lamp

RH (passenger's) 1 **EDQ500822NUG**

LH (driver's) 1 **EDQ500832NUG**

FINISHING COVER, sun visor bracket, Ivory:

for RH sun visor 1 **LR047127**

for LH sun visor 1 **EFY500090NUG**

CLIP:

sun visor retaining

to VIN 5A901388 2 **EYC500070**

VIN 5A901389 on 2 **EYC500131**

sun visor pivot, Ivory 2 **EGP500060NUG**

Opposite end of sun visor to mounting bracket.

SCREW, sun visor retaining clip 2 **DA608044L**

INTERIOR - FRONT ROW SEATS



WINDSOR PREMIUM LEATHER, IVORY



WINDSOR PREMIUM LEATHER, ALMOND



WINDSOR PREMIUM LEATHER, EBONY BLACK



WINDSOR PREMIUM LEATHER, REAR BACK COVER, ALPACA



WINDSOR PREMIUM LEATHER, SEAT BASE COVER, TAN



WINDSOR PREMIUM LEATHER, REAR BACK COVER, EBONY BACK

WE'RE HERE TO HELP
 Can't find or not sure of the right part for your car, contact our technical sales team for help and advice.
01522 568000

Front Row Seat Covers

CLOTH

SEAT BASE (CUSHION) COVER:

Ebony Black	2	HCA500140PVJ
Alpaca (to VIN 8A999999)	2	HCA500140SMS

SEAT BACK (SQUAB) COVER:

Ebony Black		
RH (to VIN 7A999999)	1	HBA500220PVJ
RH (VIN 8A000001 to 9A208663)	1	HBA501600PVJ
RH (VIN 9A208664 on)	1	LR011370
LH (to VIN 7A999999)	1	HBA500230PVJ
LH (VIN 8A000001 to 9A208663)	1	HBA501610PVJ
LH (VIN 9A208664 on)	1	LR011387
Alpaca		
RH (to VIN 7A999999)	1	HBA500220SMS
RH (VIN 8A000001 to 8A999999)	1	HBA501600SMS
LH (to VIN 7A999999)	1	HBA500230SMS
LH (VIN 8A000001 to 8A999999)	1	HBA501610SMS

LEATHER/VINYL

SEAT BASE (CUSHION) COVER:

Ebony Black, smooth fabric		
RH without pocket	1	HCA500880PVJ
RH with pocket	1	HCA500960PVJ
LH without pocket	1	HCA500970PVJ
LH with pocket	1	HCA500890PVJ
Ebony Black, embossed fabric		
RH without pocket	1	HCA500900PVJ
RH with pocket	1	HCA500980PVJ
LH without pocket	1	HCA500990PVJ
LH with pocket	1	HCA500910PVJ

Ivory		
RH without pocket	1	HCA500900NUG
RH with pocket	1	HCA500980NUG
LH without pocket	1	HCA500990NUG
LH with pocket	1	HCA500910NUG

Aspen		
RH without pocket	1	HCA500880LUP
RH with pocket	1	HCA500960LUP
LH without pocket	1	HCA500970LUP
LH with pocket	1	HCA500890LUP

Alpaca (to VIN 8A999999)		
RH without pocket	1	HCA500880SMS
RH with pocket	1	HCA500960SMS
LH without pocket	1	HCA500970SMS
LH with pocket	1	HCA500890SMS

Almond (VIN 9A000001 on)		
RH without pocket	1	LR008622
RH with pocket	1	LR008620
LH without pocket	1	LR008629
LH with pocket	1	LR008628

SEAT BACK (SQUAB) COVER:

Ebony Black, smooth fabric		
RH (to VIN 6A962768)	1	HBA500800PVJ
RH (VIN 6A962769 to 7A999999)	1	HBA501120PVJ
RH (VIN 8A000001 to 9A208663)	1	HBA501940PVJ
RH (VIN 9A208664 on)	1	LR011379
LH (to VIN 6A962768)	1	HBA500810PVJ
LH (VIN 6A962769 to 7A999999)	1	HBA501130PVJ
LH (VIN 8A000001 to 9A208663)	1	LR011396
LH (VIN 9A208664 on)	1	LR011396

Ebony Black, embossed fabric		
RH (to VIN 6A962768)	1	HBA500860PVJ
RH (VIN 6A962769 to 7A999999)	1	HBA501140PVJ
RH (VIN 8A000001 on)	1	LR011381
LH (to VIN 6A962768)	1	HBA500870PVJ
LH (VIN 6A962769 to 7A999999)	1	HBA501150PVJ
LH (VIN 8A000001 on)	1	LR011398

Ivory		
RH (to VIN 6A962291)	1	HBA500860NUG
RH (VIN 6A962292 to 7A999999)	1	HBA501140NUG
RH (VIN 8A000001 to 9A208663)	1	LR011380
RH (VIN 9A208664 on)	1	LR011380
LH (to VIN 6A962291)	1	HBA500870NUG
LH (VIN 6A962292 to 7A999999)	1	HBA501150NUG
LH (VIN 8A000001 on)	1	LR011397

Aspen

RH (to VIN 6A963448)	1	HBA500800LUP
RH (VIN 6A963449 to 7A999999)	1	HBA501120LUP
RH (VIN 8A000001 to 9A208663)	1	HBA501940LUP
RH (VIN 9A208664 on)	1	LR011378
LH (to VIN 6A963448)	1	HBA500810LUP
LH (VIN 6A963449 to 7A999999)	1	HBA501130LUP
LH (VIN 8A000001 to 9A208663)	1	HBA501950LUP
LH (VIN/VIN 9A208664 on)	1	LR011395

Alpaca

RH (to VIN 6A962291)	1	HBA500800SMS
RH (VIN 6A962292 to 7A999999)	1	HBA501120SMS
RH (VIN 8A000001 to 8A999999)	1	HBA501940SMS
LH (to VIN 6A962291)	1	HBA500810SMS
LH (VIN 6A962292 to 7A999999)	1	HBA501130SMS
LH (VIN 8A000001 to 8A999999)	1	HBA501950SMS

Almond

RH (VIN 9A000001 on)	1	LR024354
LH (VIN 9A000001 on)	1	LR024824

LEATHER/ALCANTARA

(FITTED FROM VIN 8A000001 ON ONLY)

SEAT BASE (CUSHION) COVER:

Ebony Black		
RH without pocket	1	HCA501100YDO
RH with pocket	1	HCA501120YDO
LH without pocket	1	HCA501130YDO
LH with pocket	1	HCA501110YDO
Alpaca (to VIN 8A999999)		
RH without pocket	1	HCA501100SMS
RH with pocket	1	HCA501120SMS
LH without pocket	1	HCA501130SMS
LH with pocket	1	HCA501110SMS

Almond (VIN 9A000001 on)		
RH without pocket	1	LR009565
RH with pocket	1	LR009566
LH without pocket	1	LR009568
LH with pocket	1	LR009567

SEAT BACK (SQUAB) COVER:

Ebony Black		
RH	1	LR011386
LH	1	LR011403
Alpaca (to VIN 8A999999)		
RH	1	HBA502200SMS
LH	1	HBA502210SMS

Almond (VIN 9A000001 on)		
RH (to VIN 9A208663)	1	LR009573
RH (VIN 9A208664 on)	1	LR011415
LH (to VIN 9A208663)	1	LR009575
LH (VIN 9A208664 on)	1	LR011423

FULL LEATHER (NOT WINDSOR)

SEAT BASE (CUSHION) COVER:

Ebony Black without contrasting stitching		
RH without pocket	1	HCA500940PVJ
RH with pocket	1	HCA501000PVJ
LH without pocket	1	HCA501010PVJ
LH with pocket	1	HCA500950PVJ
Ebony Black with contrasting stitching		
RH without pocket	1	LR008775
RH with pocket	1	LR008774
LH without pocket	1	LR008776
LH with pocket	1	LR008777

Ivory		
RH without pocket	1	HCA500940NUG
RH with pocket	1	HCA501000NUG
LH without pocket	1	HCA501010NUG
LH with pocket	1	HCA500950NUG
Alpaca (to VIN 8A999999)		
RH without pocket	1	HCA500940SMS
RH with pocket	1	HCA501000SMS
LH without pocket	1	HCA501010SMS
LH with pocket	1	HCA500950SMS

SEAT BACK (SQUAB) COVER:

Ebony Black without contrasting stitching		
RH (to VIN 7A999999)	1	HBA500280PVJ
RH (VIN 8A000001 on)	1	LR011383
LH (to VIN 7A999999)	1	HBA500290PVJ
LH (VIN 8A000001 on)	1	LR011400
Ebony Black with contrasting stitching		
RH	1	LR011421
LH	1	LR011429



ALL MODELS

INTERIOR - FRONT ROW SEATS

Ivory

RH (to VIN 7A999999)	1	HBA500280NUG
RH (VIN 8A000001 on)	1	LR011382
LH (to VIN 7A999999)	1	HBA500290NUG
LH (VIN 8A000001 to 9A208663)	1	LR011399
LH (VIN 9A208664 on)	1	LR011399

Alpaca

RH (to VIN 7A999999)	1	HBA500280SMS
RH (VIN 8A000001 to 8A999999)	1	HBA501980SMS
LH (to VIN 7A999999)	1	HBA500290SMS
LH (VIN 8A000001 to 8A999999)	1	HBA501990SMS

WINDSOR PREMIUM LEATHER

(FITTED FROM VIN 8A000001 ON ONLY)

SEAT BASE (CUSHION) COVER:

Tan/Tan (VIN 8A000001 on)		
RH without pocket	1	HCA500940SBB
RH with pocket	1	HCA501000SBB
LH without pocket	1	HCA501010SBB
LH with pocket	1	HCA500950SBB

Ebony Black/Tan (VIN 9A000001 on)		
RH without pocket	1	LR016927
RH with pocket	1	LR016924
LH without pocket	1	LR016933
LH with pocket	1	LR016930

Ebony Black/Ivory (VIN 9A000001 on)		
RH without pocket	1	LR016928
RH with pocket	1	LR016925
LH without pocket	1	LR016934
LH with pocket	1	LR016931

Ivory/Tan (VIN 9A000001 on)		
RH without pocket	1	LR016929
RH with pocket	1	LR016926
LH without pocket	1	LR016935
LH with pocket	1	LR016932

Almond/Almond (VIN 9A000001 on)		
RH without pocket	1	LR008625
RH with pocket	1	LR008624
LH without pocket	1	LR008631
LH with pocket	1	LR008630

SEAT BACK (SQUAB) COVER:

Tan/Tan (VIN 8A000001 on)		
RH	1	LR011384
LH	1	LR011401
Ebony Black/Tan (VIN 9A000001 on)		
RH	1	LR017400
LH	1	LR017401

Ebony Black/Ivory (VIN 9A000001 on)		
RH	1	LR016943
LH	1	LR016946
Ivory/Tan (VIN 9A000001 on)		
RH	1	LR017399
LH	1	LR017402

Almond/Almond (VIN 9A000001 on)		
RH	1	LR011420
LH	1	LR011428

Seat Cover Fasteners

FASTENER, seat cover to frame:

plastic drive fastener	A/R	LR029120
metal ring fastener	A/R	HYX100060

ORDER

BY PHONE: 01522 568000 / ON LINE: www.rimmerbros.co.uk / E-MAIL: lrsales@rimmerbros.co.uk

ALL MODELS

INTERIOR - FRONT ROW SEATS

Headrests & Headrest Covers

CLOTH

HEADREST ASSEMBLY, cloth:

Models without DVD screen.

Ebony Black	2	LR011430
Alpaca		
to VIN 8A205839	2	HAH501630SMS
VIN 8A205840 on	2	LR011471

HEADREST COVER, cloth:

Models with DVD screen, VIN 8A000001 on.

Ebony Black	2	HDA500050PVJ
Alpaca (to VIN 8A999999)	2	HDA500050SMS

LEATHER/VINYL & LEATHER/ALCANTARA

HEADREST ASSEMBLY, leather/vinyl & leather/alcantara:

Models without DVD screen.

Ebony Black smooth fabric	2	LR011437
Ebony Black embossed fabric	2	LR011433
Ivory		
to VIN 5A905061	2	HAH500140NUG
VIN 5A905062 to 9A205557	2	HAH501640NUG
VIN 9A205558 on	2	LR011432

Aspen		
to VIN 9A205557	2	HAH501640LUP
VIN 9A205558 on	2	LR011431
Alpaca (to VIN 8A999999)	2	LR014472
Almond (VIN 9A000001 on)	2	LR011438

HEADREST COVER, leather/vinyl & leather/alcantara:

Models with DVD screen, VIN 8A000001 on.

Ebony Black		
leather/vinyl	2	HDA500190PVJ
leather/alcantara	2	HDA500230YD0
Ivory	2	HDA500190NUG
Aspen	2	HDA500190LUP
Alpaca (to VIN 8A999999)	2	HDA500190SMS
Almond (VIN 9A000001 on)	2	LR017830

HEADREST ASSEMBLY,
FULL LEATHER, IVORY -
LR011434

FULL LEATHER (NOT WINDSOR)

HEADREST ASSEMBLY, full leather (not Windsor):

Models without DVD screen.

Ebony Black		
without contrasting stitching	2	LR011435
with contrasting stitching	2	LR011440
Ivory	2	LR011434
Alpaca (to VIN 8A999999)	2	LR014473

HEADREST COVER, full leather (not Windsor):

Models with DVD screen, VIN 8A000001 on.

Ebony Black		
without contrasting stitching	2	HDA500090PVJ
with contrasting stitching	2	LR008928
Ivory	2	HDA500090NUG
Alpaca (to VIN 8A999999)	2	HDA500090SMS

WINDSOR PREMIUM LEATHER

HEADREST ASSEMBLY, Windsor premium leather:

Models without DVD screen.

Tan/Tan	2	LR011436
Ebony Black/Tan	2	LR016615
Ebony Black/Ivory	2	LR016614
Ivory/Tan	2	LR016615
Almond/Almond	2	LR011439

HEADREST COVER, Windsor premium leather:

Models with DVD screen, VIN 8A000001 on.

Tan/Tan	2	HDA500090SBB
Ebony Black/Tan	2	LR016648
Ebony Black/Ivory	2	LR017835
Ivory/Tan	2	LR016648
Almond/Almond	2	LR008610



Armrests

LEATHER/VINYL & LEATHER/ALCANTARA

ARMREST ASSEMBLY, leather/vinyl & leather/alcantara:

Ebony Black		
leather/vinyl		
RH seat	1	HAI500250PVJ
LH seat	1	HAI500240PVJ
leather/alcantara		
RH seat	1	LR055840
LH seat	1	LR055799

Ivory		
RH seat	1	LR055838
LH seat	1	LR055794

Aspen		
RH seat	1	HAI500250LUP
LH seat	1	HAI500240LUP

Alpaca (to VIN 8A999999)		
RH seat	1	HAI500250SMS
LH seat	1	HAI500240SMS

Almond (VIN 9A000001 on)		
RH seat	1	LR055841
LH seat	1	LR055801

FULL LEATHER (NOT WINDSOR)

ARMREST ASSEMBLY, full leather (not Windsor):

Ebony Black		
without contrasting stitching		
RH seat	1	HAI500090PVJ
LH seat	1	HAI500080PVJ
with contrasting stitching		
RH seat	1	LR055853
LH seat	1	LR055816

Ivory		
RH seat	1	LR055847
LH seat	1	LR055806

Alpaca (to VIN 8A999999)		
RH seat	1	HAI500090SMS
LH seat	1	HAI500080SMS

WINDSOR PREMIUM LEATHER

ARMREST ASSEMBLY, Windsor premium leather:

Tan/Tan		
RH seat	1	LR055848
LH seat	1	LR055812
Ebony Black/Tan		
RH seat	1	LR055856
LH seat	1	LR055819
Ebony Black/Ivory		
RH seat	1	LR055853
LH seat	1	LR055816
Ivory/Tan		
RH seat	1	LR016923
LH seat	1	LR016921
Almond (VIN 9A000001 on)		
RH seat	1	LR055851
LH seat	1	LR055814

COVER, armrest pivot screw:

Ebony Black	2	HJI500090PVJ
Ivory	2	HJI500090NUG
Aspen	2	HJI500090LUP
Alpaca	2	HJI500090SMS
Almond	2	LR008323

SCREW, pivot, armrest to seat

	2	HYP000140
--	---	-----------

WASHER, pivot screw

	2	WJ600041L
--	---	-----------



Seat Foams & Seat Base Panels

SEAT FOAM:		
base (cushion)	2	HGB500050
back (squab)		
RH	1	HGA500100
LH	1	HGA500110
headrest	2	HGH500020
<i>Models with DVD screen.</i>		
INSERT, headrest foam	2	HGH500030
<i>Models with DVD screen.</i>		
SEAT BASE PANEL	2	HFF500012

Seat Heater Elements & Seat Sensors

HEATER ELEMENT:		
<i>Models with front seat heating only.</i>		
base (cushion)	2	HGL500020
back (squab)	2	HGK500040
SENSOR:		
passenger seat occupancy	1	LR017308
driver's seat position	1	YDB500380
<i>Includes mounting bracket.</i>		

Plastic Seat Finishers, Mouldings & Handles

OUTBOARD SIDE VALANCE, seat base upper:
Holds seat adjustment controls.

RH seat, without electric lumbar adjustment		
Ebony Black	1	HJH500062PVJ
Ivory	1	HJH500062NUG
Aspen	1	HJH500062LUP
Alpaca	1	HJH500062SMS
Almond	1	LR007888
RH seat, with electric lumbar adjustment		
Ebony Black	1	HJH500080PVJ
Ivory	1	HJH500080NUG
Aspen	1	HJH500080LUP
Alpaca	1	HJH500080SMS
Almond	1	LR007890
LH seat, without electric lumbar adjustment		
Ebony Black	1	HJH500072PVJ
Ivory	1	HJH500072NUG
Aspen	1	HJH500072LUP
Alpaca	1	HJH500072SMS
Almond	1	LR007889
LH seat, with electric lumbar adjustment		
Ebony Black	1	HJH500090PVJ
Ivory	1	HJH500090NUG
Aspen	1	HJH500090LUP
Alpaca	1	HJH500090SMS
Almond	1	LR007892

OUTBOARD SIDE VALANCE, seat base lower:
Between upper valance and floor.

RH seat		
Ebony Black	1	EBV500022PVJ
Aspen	1	EBV500022LUP
Nutmeg	1	LR008680
LH seat		
Ebony Black	1	EBV500032PVJ
Aspen	1	EBV500032LUP
Nutmeg	1	LR008681

COVER, seat base outboard side valance access hole:

RH seat		
Ebony Black	1	FCL500062PVJ
Ivory	1	FCL500062NUG
Aspen	1	FCL500062LUP
Alpaca	1	FCL500062SMS
Almond	1	LR007905
LH seat		
Ebony Black	1	FCL500072PVJ
Ivory	1	FCL500072NUG
Aspen	1	FCL500072LUP
Alpaca	1	FCL500072SMS
Almond	1	LR007906



ALL MODELS

INTERIOR - FRONT ROW SEATS

WE'RE HERE TO HELP
Can't find or not sure of the right part for your car, contact our technical sales team for help and advice.
01522 568000

COVER, inboard side seat recline hinge:

RH seat		
Ebony Black		
to VIN 8A167133	1	HJE500100PVJ
VIN 8A167134 on	1	LR009208
Ivory	1	HJE500100NUG
Aspen	1	HJE500100LUP
Alpaca	1	LR009209
Almond	1	LR007946
LH seat		
Ebony Black		
to VIN 8A167133	1	HJE500110PVJ
VIN 8A167134 on	1	LR009224
Ivory	1	HJE500110NUG
Aspen	1	HJE500110LUP
Alpaca	1	LR009218
Almond	1	LR007934

WHEEL, manual lumbar adjustment

Ebony Black	2	HJN500012PVJ
Ivory	2	HJN500012NUG
Aspen	2	HJN500012LUP
Alpaca	2	HJN500012SMS
Almond	2	LR007912

ESCUTCHEON, headrest guide:

non-locking		
Ebony Black	2	HJQ500110PVJ
Ivory	2	HJQ500110NUG
Aspen	2	HJQ500110LUP
Alpaca	2	HJQ500110SMS
Almond	2	LR007913
locking		
Ebony Black	2	HJQ500120PVJ
Ivory	2	HJQ500120NUG
Aspen	2	HJQ500120LUP
Alpaca	2	HJQ500120SMS
Almond	2	LR007914

SURROUND MOULDING, DVD screen:

<i>Models with DVD screen.</i>		
Ebony Black	2	HKK500030PVJ
Ivory	2	HKK500030NUG
Aspen	2	HKK500030LUP
Alpaca (to VIN 8A999999)	2	HKK500030SMS
Almond (VIN 9A000001 on)	2	LR008751
HOUSING, DVD screen	2	HKK500020
<i>Models with DVD screen.</i>		
FRAME, housing, DVD screen:		
<i>Models with DVD screen. Includes harness.</i>		
Ebony Black	2	HKC500010PVJ
Ivory	2	HKC500010NUG
Aspen	2	HKC500010LUP
Alpaca (to VIN 8A999999)	2	HKC500010SMS
Almond (VIN 9A000001 on)	2	LR009636

Seat Frame Components

Due to the complexity of seat frames and the rarity of requirement for replacement frames and most frame components, only the items more likely to be needed are listed here. For all other parts, please contact us for details.

SEAT RUNNER ASSEMBLY:		
non-memory seat models	2	LR012040
driver's memory seat models		
driver's seat	1	LR021398
passenger's seat	1	LR012040
MOTOR ASSEMBLY:		
seat base tilt		
non-memory seat models	2	HHL500160
driver's memory seat models		
driver's seat	1	HHL500150
passenger's seat	1	HHL500160
seat back recline		
non-memory seat models	2	HHL500010
driver's memory seat models		
driver's seat	1	HHL500100
passenger's seat	1	HHL500010
LUMBAR SUPPORT MECHANISM, driver's seat:		
manual adjustment		
RH seat	1	LR032258
LH seat	1	LR032259
electric adjustment	1	LR013703
FRAME, driver's seat lumbar support	1	HGC500012

Waterproof Seat Covers

Genuine factory Range Rover Sport nylon waterproof seat covers, featuring compatibility with armrests, headrests, airbags and (where appropriate) seat back DVD screens. Heavy duty materials in choice of Sand Beige or Aspen Grey.

WATERPROOF SEAT COVER SET, Land Rover:

front row seats only, 2 seat set		
without DVD screens		
Sand Beige	1	LR005216
Aspen Grey	1	LR005215
with DVD screens		
Sand Beige	1	VPLSS0010SUN
Aspen Grey	1	VPLSS0010LUP
2nd row seats only, 3 seat set		
Sand Beige	1	LR005225
Aspen Grey	1	LR005224



ALL MODELS

INTERIOR - SECOND ROW SEATS

Second Row Seat Covers

CLOTH

SEAT BASE (CUSHION) COVER:

Ebony Black		
RH (small)	1	HPA500610PVJ
LH (large)	1	HPA500600PVJ
Alpaca (to VIN 8A999999)		
RH (small)	1	HPA500610SMS
LH (large)	1	HPA500600SMS

SEAT BACK (SQUAB) COVER:

Ebony Black		
RH (small)		
to VIN 9A209066	1	HMA501470PVJ
VIN 9A209067 on	1	LR017370
LH (large)		
to VIN 9A209066	1	HMA501460PVJ
VIN 9A209067 on	1	LR017369
Alpaca (to VIN 8A999999)		
RH (small)	1	HMA501470SMS
LH (large)	1	HMA501460SMS

LEATHER/VINYL

SEAT BASE (CUSHION) COVER:

Ebony Black, smooth fabric		
RH (small)	1	HPA502540PVJ
LH (large)	1	HPA502530PVJ
Ebony Black, embossed fabric		
RH (small)	1	HPA502560PVJ
LH (large)		
to VIN 7A999999	1	HPA501600PVJ
VIN 8A000001 on	1	HPA502550PVJ

Ivory		
RH (small)	1	HPA502560NUG
LH (large)	1	HPA502550NUG

Aspen		
RH (small)	1	HPA502540LUP
LH (large)	1	HPA502530LUP

Alpaca (to VIN 8A999999)		
RH (small)	1	HPA502540SMS
LH (large)	1	HPA502530SMS

Almond (VIN 9A000001 on)		
RH (small)	1	LR008635
LH (large)	1	LR008634

SEAT BACK (SQUAB) COVER:

Ebony Black, smooth fabric		
RH (small)		
to VIN 6A961361	1	HMA501650PVJ
VIN 6A961362 to 9A209066	1	HMA502680PVJ
VIN 9A209067 on	1	LR017374

LH (large)		
to VIN 6A961361	1	HMA501640PVJ
VIN 6A961362 to 9A209066	1	HMA502670PVJ
VIN 9A209067 on	1	LR017372

Ebony Black, embossed fabric		
RH (small)		
to VIN 6A961361	1	HMA501670PVJ
VIN 6A961362 to 9A209066	1	HMA502700PVJ
VIN 9A209067 on	1	LR017378

LH (large)		
to VIN 6A961361	1	HMA501660PVJ
VIN 6A961362 to 9A209066	1	HMA502690PVJ
VIN 9A209067 on	1	LR017376

Ivory		
RH (small)		
to VIN 6A961361	1	HMA501670NUG
VIN 6A961362 to 9A209066	1	HMA502700NUG
VIN 9A209067 on	1	LR017377

LH (large)		
to VIN 6A961361	1	HMA501660NUG
VIN 6A961362 to 9A209066	1	HMA502690NUG
VIN 9A209067 on	1	LR017375

Aspen		
RH (small)		
to VIN 6A961427	1	HMA501650LUP
VIN 6A961428 to 9A209066	1	HMA502680LUP
VIN 9A209067 on	1	LR017373

LH (large)		
to VIN 6A961427	1	HMA501640LUP
VIN 6A961428 to 9A209066	1	HMA502670LUP
VIN 9A209067 on	1	LR017371



Alpaca (to VIN 8A999999)		
RH (small)		
to VIN 6A962447	1	HMA501650SMS
VIN 6A962448 on	1	HMA502680SMS

LH (large)		
to VIN 6A962447	1	HMA501640SMS
VIN 6A962448 on	1	HMA502670SMS

Almond (VIN 9A000001 on)		
RH (small)		
to VIN 9A209066	1	LR008660
VIN 9A209067 on	1	LR014911

LH (large)		
to VIN 9A209066	1	LR008659
VIN 9A209067 on	1	LR014906

LEATHER/ALCANTARA

(FITTED FROM VIN 8A000001 ON ONLY)

SEAT BASE (CUSHION) COVER:

Ebony Black		
RH (small)	1	HPA502730YDO
LH (large)	1	HPA502720YDO
Alpaca (to VIN 8A999999)		
RH (small)	1	HPA502730SMS
LH (large)	1	HPA502720SMS

Almond (VIN 9A000001 on)		
RH (small)	1	LR009571
LH (large)	1	LR009569

SEAT BACK (SQUAB) COVER:

Ebony Black		
RH (small)		
to VIN 9A209066	1	HMA502860YDO
VIN 9A209067 on	1	LR017387

LH (large)		
to VIN 9A209066	1	HMA502850YDO
VIN 9A209067 on	1	LR017385

Alpaca (to VIN 8A999999)		
RH (small)	1	HMA502860SMS
LH (large)	1	HMA502850SMS

Almond (VIN 9A000001 on)		
RH (small)		
to VIN 9A209066	1	LR009577
VIN 9A209067 on	1	LR017388

LH (large)		
to VIN 9A209066	1	LR009576
VIN 9A209067 on	1	LR017386

FULL LEATHER (NOT WINDSOR)

SEAT BASE (CUSHION) COVER:

Ebony Black without contrasting stitching		
RH (small)	1	HPA502580PVJ
LH (large)		
to VIN 7A999999	1	HPA500660PVJ
VIN 8A000001 on	1	HPA502570PVJ

Ebony Black with contrasting stitching		
RH (small)	1	LR008779
LH (large)	1	LR008778

Ivory		
RH (small)	1	HPA502580NUG
LH (large)	1	HPA502570NUG

Alpaca (to VIN 8A999999)		
RH (small)		
to VIN 7A999999	1	HPA500670SMS
VIN 8A000001 on	1	HPA502580SMS
LH (large)	1	HPA502570SMS

SEAT BACK (SQUAB) COVER:

Ebony Black without contrasting stitching		
RH (small)		
to VIN 9A209066	1	HMA502720PVJ
VIN 9A209067 on	1	LR017383

LH (large)		
to VIN 9A209066	1	HMA502710PVJ
VIN 9A209067 on	1	LR017380

Ebony Black with contrasting stitching		
RH (small)		
to VIN 9A209066	1	LR008787
VIN 9A209067 on	1	LR017392

LH (large)		
to VIN 9A209066	1	LR008786
VIN 9A209067 on	1	LR017390

Ivory		
RH (small)		
to VIN 7A999999	1	HMA501530NUG
VIN 8A000001 to 9A209066	1	HMA502720NUG
VIN 9A209067 on	1	LR017382

LH (large)		
to 9A209066	1	HMA502710NUG
VIN 9A209067 on	1	LR017379

Alpaca (to VIN 8A999999)		
RH (small)	1	HMA502720SMS
LH (large)	1	HMA502710SMS

WINDSOR PREMIUM LEATHER

(FITTED FROM VIN 8A000001 ON ONLY)

SEAT BASE (CUSHION) COVER:

Tan/Tan (VIN 8A000001 on)		
RH (small)	1	HPA502580SBB
LH (large)	1	HPA502570SBB

Ebony Black/Tan (VIN 9A000001 on)		
RH (small)	1	LR016939
LH (large)	1	LR016936

Ebony Black/Ivory (VIN 9A000001 on)		
RH (small)	1	LR016940
LH (large)	1	LR016937

Ivory/Tan (VIN 9A000001 on)		
RH (small)	1	LR016941
LH (large)	1	LR016938

Almond/Almond (VIN 9A000001 on)		
RH (small)	1	LR008637
LH (large)	1	LR008636

SEAT BACK (SQUAB) COVER:

Tan/Tan (VIN 8A000001 on)		
RH (small)		
to VIN 9A209066	1	HMA502720SBB
VIN 9A209067 on	1	LR017384

LH (large)		
to VIN 9A209066	1	HMA502710SBB
VIN 9A209067 on	1	LR017381

Ebony Black/Tan (VIN 9A000001 on)		
RH (small)	1	LR016951
LH (large)	1	LR016948

Ebony Black/Ivory (VIN 9A000001 on)		
RH (small)	1	LR016952
LH (large)	1	LR016949

Ivory/Tan (VIN 9A000001 on)		
RH (small)	1	LR016953
LH (large)	1	LR016950

Almond/Almond (VIN 9A000001 on)		
RH (small)		
to VIN 9A209066	1	LR008662
VIN 9A209067 on	1	LR017391

LH (large)		
to VIN 9A209066	1	LR008661
VIN 9A209067 on	1	LR017389

HEADREST ASSEMBLY, FULL LEATHER, IVORY

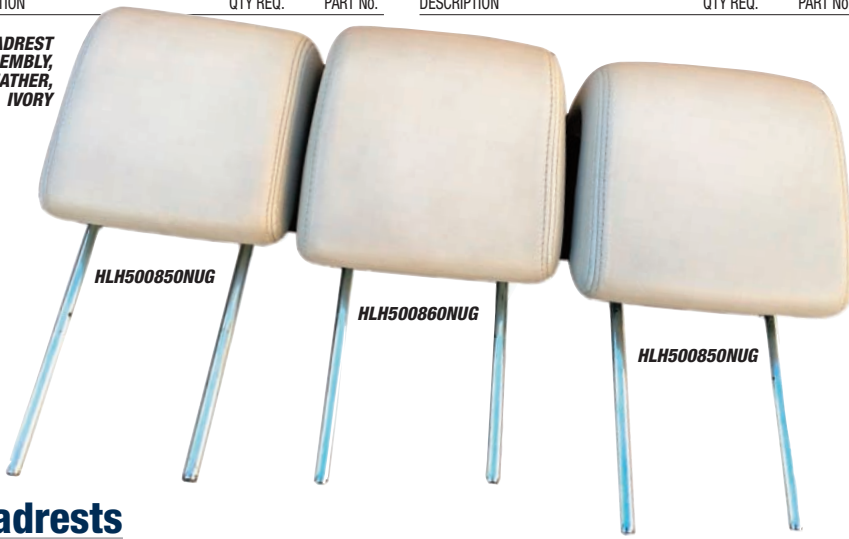

Headrests

CLOTH

HEADREST ASSEMBLY:

Ebony Black RH & LH, outer to VIN 6A929899 VIN 6A929900 on centre	2	HLH500310PVJ
	2	HLH500810PVJ
to VIN 6A366799 VIN 6A366800 on	1	HLH500320PVJ
	1	HLH500820PVJ
Alpaca (to VIN 8A999999) RH & LH, outer to VIN 6A929899 VIN 6A929900 on centre	2	HLH500310SMS
	2	HLH500810SMS
to VIN 6A366799 VIN 6A366800 on	1	HLH500320SMS
	1	HLH500820SMS

LEATHER/VINYL & LEATHER/ALCANTARA

HEADREST ASSEMBLY:

Ebony Black, leather/vinyl RH & LH, outer to VIN 6A929899 VIN 6A929900 on centre	2	HLH500740PVJ
	2	HLH500830PVJ
to VIN 6A929899 VIN 6A929900 on	1	HLH500750PVJ
	1	HLH500840PVJ
Ebony Black, leather/alcantara RH & LH, outer centre	2	HLH501300YDO
	1	HLH501310YDO
Ivory RH & LH, outer to VIN 6A929899 VIN 6A929900 on centre	2	HLH500740NUG
	2	HLH500830NUG
to VIN 6A929899 VIN 6A929900 on	1	HLH500750NUG
	1	HLH500840NUG
Aspen RH & LH, outer to VIN 6A929899 VIN 6A929900 on centre	2	HLH500740LUP
	2	HLH500830LUP
to VIN 6A929899 VIN 6A929900 on	1	HLH500750LUP
	1	HLH500840LUP
Alpaca (to VIN 8A999999) RH & LH, outer to VIN 6A929899 VIN 6A929900 on centre	2	HLH500740SMS
	2	HLH500830SMS
to VIN 6A929899 VIN 6A929900 on	1	HLH500750SMS
	1	HLH500840SMS
Almond (VIN 9A000001 on) RH & LH, outer centre	2	LR008587
	1	LR008589

FULL LEATHER (NOT WINDSOR)

HEADREST ASSEMBLY:

Ebony Black without contrasting stitching RH & LH, outer to VIN 6A929899 VIN 6A929900 on centre	2	HLH500350PVJ
	2	HLH500850PVJ
to VIN 6A929899 VIN 6A929900 on	1	HLH500360PVJ
	1	HLH500860PVJ
Ebony Black with contrasting stitching RH & LH, outer centre	2	LR008769
	1	LR008770
Ivory RH & LH, outer to VIN 6A929899 VIN 6A929900 on centre	2	HLH500350NUG
	2	HLH500850NUG
to VIN 6A929899 VIN 6A929900 on	1	HLH500360NUG
	1	HLH500860NUG
Alpaca (to VIN 8A999999) RH & LH, outer to VIN 6A929899 VIN 6A929900 on centre	2	HLH500350SMS
	2	HLH500850SMS
to VIN 6A929899 VIN 6A929900 on	1	HLH500360SMS
	1	HLH500860SMS

WINDSOR PREMIUM LEATHER

(FITTED FROM VIN 8A000001 ON ONLY)

HEADREST ASSEMBLY:

Tan/Tan (VIN 8A000001 on) RH & LH, outer centre	2	HLH500850SBB
	1	HLH500860SBB
Ebony Black/Tan RH & LH, outer centre	2	LR016587
	1	LR016918
Ebony Black/Ivory RH & LH, outer centre	2	LR016586
	1	LR008770
Ivory/Tan RH & LH, outer centre	2	LR016587
	1	LR016919
Almond (VIN 9A000001 on) RH & LH, outer centre	2	LR008590
	1	LR008591



ALL MODELS

Seat Cover Fasteners

FASTENER, ring, seat cover to frame A/R **HYX100060**

Armrests

ARMREST ASSEMBLY:

cloth Ebony Black	1	HLJ500320PVJ
Alpaca (to VIN 8A999999)	1	HLJ500320SMS
leather/vinyl & leather/alcantara Ebony Black	1	HLJ500330PVJ
Ivory	1	HLJ500330NUG
Aspen	1	HLJ500330LUP
Alpaca (to VIN 8A999999)	1	HLJ500330SMS
Almond (VIN 9A000001 on)	1	LR008929
full leather & Windsor premium leather Tan (8A000001 on)	1	HLJ500340SBB
Ebony Black	1	HLJ500340PVJ
Ivory	1	HLJ500340NUG
Alpaca (to VIN 8A999999)	1	HLJ500340SMS
Almond (VIN 9A000001 on)	1	LR008933

PANEL, back, armrest:

cloth Ebony Black	1	HXE500030PVJ
Alpaca (to VIN 8A999999)	1	HXE500030SMS
leather/vinyl & leather/alcantara Ebony Black	1	HXE500060PVJ
Ivory	1	HXE500060NUG
Aspen	1	HXE500060LUP
Alpaca (to VIN 8A999999)	1	HXE500060SMS
Almond (VIN 9A000001 on)	1	LR008682
full leather & Windsor premium leather Tan (8A000001 on)	1	HXE500050SBB
Ebony Black	1	HXE500050PVJ
Ivory	1	HXE500050NUG
Alpaca (to VIN 8A999999)	1	HXE500050SMS
Almond (VIN 9A000001 on)	1	LR008683

Seat Foams, Heater Elements & Seat Back Panels

SEAT FOAM:

base (cushion) RH seat (small)	1	HVB500170
LH seat (large)	1	HVB500160
back (squab) RH seat (small)	1	HVA500230
LH seat (large)	1	HVA500220

HEATER ELEMENT:

Models with rear seat heating only.

base (cushion)	2	HVD500050
back (squab)	2	HVD500100

SEAT BACK PANEL, carpet trimmed:

Ebony Black, Aspen Grey and (from VIN 9A000001 onwards) Nutmeg were the standard seat back cover colours for all models not destined for the USA, Canada or Mexico. For the latter three markets, Alpaca Beige was also offered up to VIN 8A999999 but is not listed here; please contact us if you require Alpaca back cover panels.

RH seat (small) Ebony Black	1	ERG500021PVJ
Aspen	1	ERG500021LUP
Nutmeg (VIN 9A000001 on)	1	LR008665
LH seat (large) Ebony Black	1	ERG500011PVJ
Aspen	1	ERG500011LUP
Nutmeg (VIN 9A000001 on)	1	LR021545

WE'RE HERE TO HELP
 Can't find or not sure of the right part for your car, contact our technical sales team for help and advice.
01522 568000

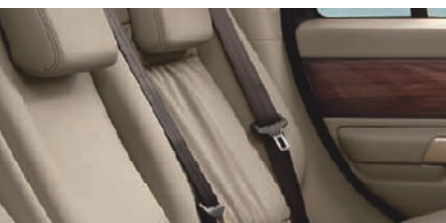

ALL MODELS

INTERIOR - SECOND ROW SEATS

Plastic Seat Finishers, Mouldings & Handles

SIDE VALANCE, seat base (cushion), outboard:

RH (small seat)		
Ebony Black	1	HXA500260PVJ
Aspen	1	HXA500260LUP
Nutmeg (VIN 9A000001 on)	1	LR008594

LH		
Ebony Black	1	HXA500270PVJ
Aspen	1	HXA500270LUP
Nutmeg (VIN 9A000001 on)	1	LR008926

FRONT VALANCE, seat base (cushion):

RH (small seat)		
Ebony Black	1	HXA500210PVJ
Aspen	1	HXA500210LUP
Nutmeg (VIN 9A000001 on)	1	LR008593

LH		
Ebony Black	1	HXA500200PVJ
Aspen	1	HXA500200LUP
Nutmeg (VIN 9A000001 on)	1	LR008592

COVER, seat back hinge:

RH (small) seat, outboard		
Ebony Black	1	HXT500740PVJ
Ivory	1	HXT500740NUG
Aspen	1	HXT500740LUP
Alpaca (to VIN 8A999999)	1	HXT500740SMS
Almond (VIN 9A000001 on)	1	LR008678

RH (small) seat, inboard, upper, inner		
Ebony Black	1	HXT500431PVJ
Ivory	1	HXT500431NUG
Aspen	1	HXT500431LUP
Alpaca	1	HXT500431SMS
Almond	1	LR008675

RH (small) seat, inboard, upper, outer		
Ebony Black	1	HXT500411PVJ
Ivory	1	HXT500411NUG
Aspen	1	HXT500411LUP
Alpaca	1	HXT500411SMS
Almond	1	LR008673

RH (small) seat, inboard, lower		
Ebony Black	1	HXT500511PVJ
Ivory	1	HXT500511NUG
Aspen	1	HXT500511LUP
Alpaca	1	HXT500511SMS
Almond	1	LR008677

LH (large) seat, outboard		
Ebony Black	1	HXT500750PVJ
Ivory	1	HXT500750NUG
Aspen	1	HXT500750LUP
Alpaca (to VIN 8A999999)	1	HXT500750SMS
Almond (VIN 9A000001 on)	1	LR008679

LH (large) seat, centre		
Ebony Black	1	HXT500011PVJ
Ivory	1	HXT500011NUG
Aspen	1	HXT500011LUP
Alpaca (to VIN 8A999999)	1	HXT500011SMS
Almond (VIN 9A000001 on)	1	LR008671

LH (large) seat, inboard, upper, inner		
Ebony Black	1	HXT500421PVJ
Ivory	1	HXT500421NUG
Aspen	1	HXT500421LUP
Alpaca	1	HXT500421SMS
Almond	1	LR008674

LH (large) seat, inboard, upper, outer		
Ebony Black	1	HXT500401PVJ
Ivory	1	HXT500401NUG
Aspen	1	HXT500401LUP
Alpaca	1	HXT500401SMS
Almond	1	LR008672

LH (large) seat, inboard, lower		
Ebony Black	1	HXT500501PVJ
Ivory	1	HXT500501NUG
Aspen	1	HXT500501LUP
Alpaca	1	HXT500501SMS
Almond	1	LR008676



COVER, centre seat belt, upper:

Ebony Black	1	HXM500121PVJ
Ivory	1	HXM500121NUG
Aspen	1	HXM500121LUP
Alpaca (to VIN 8A999999)	1	HXM500121SMS
Almond (VIN 9A000001 on)	1	LR008686

COVER, centre seat belt, upper insert

Ebony Black	1	HXM500111PVJ
Ivory	1	HXM500111NUG
Aspen	1	HXM500111LUP
Alpaca (to VIN 8A999999)	1	HXM500111SMS
Almond (VIN 9A000001 on)	1	LR008685

COVER, centre seat belt, lower,

Ebony Black only	1	HXC500040PVJ
------------------	---	--------------

COVER, pull strap release, seat back

RH seat		
Ebony Black	1	HPH500200PVJ
Aspen	1	HPH500200LUP
Nutmeg (VIN 9A000001 on)	1	LR008701

LH seat		
Ebony Black	1	HPH500210PVJ
Aspen	1	HPH500210LUP
Nutmeg (VIN 9A000001 on)	1	LR008702

BEZEL, centre seat belt run:

Ebony Black	2	HXP500270PVJ
Ivory	2	HXP500270NUG
Aspen	2	HXP500270LUP
Alpaca (to VIN 8A999999)	2	HXP500270SMS
Almond (VIN 9A000001 on)	2	LR008569

HANDLE, seat back release:

Ebony Black	2	HXG500290PVJ
Ivory	2	HXG500290NUG
Aspen	2	HXG500290LUP
Alpaca (to VIN 8A999999)	2	HXG500290SMS
Almond (VIN 9A000001 on)	2	LR008691

SURROUND, release handle:

Ebony Black	2	HXM500061PVJ
Ivory	2	HXM500061NUG
Aspen	2	HXM500061LUP
Alpaca (to VIN 8A999999)	2	HXM500061SMS
Almond (VIN 9A000001 on)	2	LR008684

ESCUTCHEON, headrest guide, Ebony Black:

to VIN 6A929899, non-locking		
Ebony Black	3	HJQ500090PVJ
Ivory	3	HJQ500090NUG
Aspen	3	HJQ500090LUP
Alpaca	3	HJQ500090SMS

to VIN 6A929899, locking		
Ebony Black	3	HJQ500100PVJ
Ivory	3	HJQ500100NUG
Aspen	3	HJQ500100LUP
Alpaca	3	HJQ500100SMS

VIN 6A929900 on, non-locking		
Ebony Black	3	HJQ500180PVJ
Ivory	3	HJQ500180NUG
Aspen	3	HJQ500180LUP
Alpaca (to VIN 8A999999)	3	HJQ500180SMS
Almond (VIN 9A000001 on)	3	LR008695

VIN 6A929900 on, locking		
Ebony Black	3	HJQ500190PVJ
Ivory	3	HJQ500190NUG
Aspen	3	HJQ500190LUP
Alpaca (to VIN 8A999999)	3	HJQ500190SMS
Almond (VIN 9A000001 on)	3	LR008696

Seat Frame Components

Only the seat frame items more likely to be needed, the seat release straps, are listed here. For frames and all other brackets and fixings, please contact us for details.

STRAP, seat release:

seat base		
front, Ebony Black only	2	HPH500240PVJ
rear		
Ebony Black	2	HPH500110PVJ
Ivory	2	HPH500110NUG
Aspen	2	HPH500110LUP
Alpaca (to VIN 8A999999)	2	HPH500110SMS
Almond (VIN 9A000001 on)	2	LR008700
seat back		
Ebony Black	2	HPH500180PVJ
Aspen	2	HPH500180LUP
Nutmeg (VIN 9A000001 on)	2	LR008699

Waterproof Seat Covers

LAND ROVER WATERPROOF SEAT COVERS

Genuine factory Range Rover Sport nylon waterproof seat covers, featuring compatibility with armrests, headrests, airbags and (where appropriate) seat back DVD screens. Heavy duty materials in choice of Sand Beige or Aspen Grey.

WATERPROOF SEAT COVER SET, Land Rover:

front row seats only, 2 seat set		
without DVD screens		
Sand Beige	1	LR005216
Aspen Grey	1	LR005215
with DVD screens		
Sand Beige	1	VPLSS0010SUN
Aspen Grey	1	VPLSS0010LUP
2nd row seats only, 3 seat set		
Sand Beige	1	LR005225
Aspen Grey	1	LR005224

Child Seats

CHILD SEAT, forward fixing:

To use Isofix mountings on car seat.

'Cosy Tot' baby carrier	A/R	VPLMS0007
0-9 months. Requires Isofix base part no. VPLMS0008.		
Isofix base, 'Cosy Tot' carrier	A/R	VPLMS0008
'Duo Plus' child seat	A/R	LR006637
9 months-4 years (9-18kg).		
'Evolva Ultra' child seat	A/R	LR004940
4-11 years (15-36kg). Booster and backrest assembly.		
STRAP, child seat securing	A/R	VTN500010
Uses Isofix mounting points behind seat.		



SRS Equipment

important note

SRS EQUIPMENT

Important note: Inspection and replacement of SRS equipment (airbag modules, steering wheel rotary coupler, seat belt pre-tensioners and ECUs) is dependent on type and severity of crash condition. The following guidelines are the minimum that should be exercised as a result of the deployment of specific SRS components.

If airbags are deployed, the following parts must be replaced:

Relevant airbag module(s)
Link harnesses connecting relevant module(s) to SRS harness or main harness (repair harnesses may be found in the Wiring Harnesses & Cables section, under 'Link Wires & Wiring Repair Kits')

Relevant seat belt pre-tensioner(s)
Driver's seat belt inertia reel and anchorage

Rotary coupler behind steering wheel

Relevant SRS deployment control module(s)

The following should be inspected for damage and replaced where necessary:

Passengers' seat belt inertia reels and anchorages

Trim mouldings adjacent to passengers' airbag modules

Steering wheel

Seat frames and head restraints

Steering column

If either or both seat belt pre-tensioners are deployed in a rear impact, the following parts must be replaced:

Both seat belt pre-tensioners

The following should be inspected for damage and replaced where necessary:

Seat frames and head restraints

Seat belt retractors and anchorages

SRS deployment control module

In addition, because of deterioration of airbag propellants over a period of time, the manufacturers recommend replacement of airbag modules, seat belt pre-tensioners and the rotary coupler at 15 year intervals.

Please note that airbag modules and seat belt pre-tensioners cannot be shipped by mail order and may only be collected from the counter. Storage and fitment of modules and pre-tensioners is potentially seriously hazardous and must be carried out by trained personnel using correct equipment.

Front Row Seat Belts

SEAT BELT ASSEMBLY, Black, long end, with inertia reel:
Includes fixing bolts.

RH			
to VIN 6A961770	1	EVB500880PMA	
VIN 6A961771 to 7A999999	1	LR009283	
VIN 8A000001 on			
RHD	1	LR020241	
LHD	1	LR009283	
LH			
to VIN 6A961770	1	EVB500890PMA	
VIN 6A961771 to 7A999999	1	LR009286	
VIN 8A000001 on			
RHD	1	LR009286	
LHD	1	LR020242	



FIRST ROW SEAT BELT ASSEMBLY - LR009283

SEAT BELT ASSEMBLY, Black, short end, with stalk & pre-tensioner

RH			
to VIN 6A961770	1	EVB500670PMA	
VIN 6A961771 to 7A999999	1	EVB500930PMA	
VIN 8A000001 on	1	LR009288	
LH			
to VIN 6A961770	1	EVB500700PMA	
VIN 6A961771 to 7A999999	1	EVB500940PMA	
VIN 8A000001 on	1	LR009289	
ADJUSTER ASS'Y, upper belt pivot	2	LR009270	
BOLT:			
lower (fixed) pivot attaching	2	EYG500030	
inertia reel attaching	2	EYG500230	
upper pivot attaching	2	EYG500110	
upper adjuster attaching	4	EYG500120	

?

WE'RE HERE TO HELP

Can't find or not sure of the right part for your car, contact our technical sales team for help and advice.

01522 568000

Second Row Seat Belts

SEAT BELT ASSEMBLY, Black, long end, with inertia reel
Includes fixing bolts.

RH outer position			
to VIN 6A961770	1	EVL501040PMA	
VIN 6A961771 on	1	LR016460	
LH outer position			
to VIN 6A961770	1	EVL501030PMA	
VIN 6A961771 on	1	LR016451	
centre position			
to VIN 6A961770	1	EVL500990PMA	
VIN 6A961771 on	1	LR009307	

SEAT BELT ASSEMBLY, Black, short end, with stalk
Includes fixing bolt.

RH outer position			
to VIN 6A961770	1	EVL500840PMA	
VIN 6A961771 on	1	LR009290	
LH outer position			
to VIN 6A961770	1	EVL500750PMA	
VIN 6A961771 on	1	LR009304	
centre position			
to VIN 6A961770	1	EVL500850PMA	
VIN 6A961771 on	1	LR009309	

STRAP, short end retaining:

RH outer & centre positions	1	EVG500010	
LH outer position	1	EVG500020	

BOLT, outer belts:

long end			
inertia reel	2	EYG500230	
upper point	2	EYG500190	
lower point	2	EYG500130	
short end			
RH stalk	1	EYG500160	
LH stalk	1	HYG500290	

BOLT, centre belt:

long end, inertia reel	1	HYG500200	
short end, stalk	1	EYG500150	

NUT, centre belt, lower pivot

	1	HYH500150	
--	---	------------------	--

PLUG, finishing, seat belt anchor

	2	DBP6549	
--	---	----------------	--



SECOND ROW SEAT BELT ASSEMBLY - LR016451

Competition Type Harnesses

A popular alternative to standard seat belts - these really do look the part! Harnesses are supplied singularly in 2" wide red or black webbing (blue webbing supplied to special order).

The 4-point harness can be converted to the 6-point type by the inclusion of the crotch strap. Note that fittings (eye bolts, reinforcement plates & bolts/spacer sets) are supplied separately.

This harness is designed for road use - please contact us if you have specific FIA/RAC approved type requirements.

See Accessories for more information and pictures.

COMPETITION TYPE HARNESS, 4 point, Securon:

red	A/R	RX1500
black	A/R	RX1500BLACK
blue	A/R	RX1500BLUE

CROTCH STRAP, Securon:

Converts 4 point harness to 6 point type.

red	A/R	RX1501
black	A/R	RX1501BLACK

3 POINT SAFETY HARNESS, Securon/A/R

		LL1172
--	--	---------------

EYE BOLT SET, pair, Securon A/R

		RX1503
--	--	---------------

REINFORCEMENT PLATE SET, pair A/R

		621112
--	--	---------------

Pair of Securon seat belt anchor point reinforcement plates, featuring welded threaded bosses.

BOLT & SPACER SET, pair A/R

		RX1505
--	--	---------------

Pair of Securon seat belt mounting bolts with spacers and washers.



COMPETITION TYPE HARNESS - RX1500

Airbags & SRS Sensors

AIRBAG ASSEMBLY:

Includes fixings.

driver's front, steering wheel			
with green/gold logo	1	LR012986	
All models except 4.2 AJV8 supercharged petrol.			
with black/silver logo	1	LR012987	
4.2 AJV8 supercharged petrol models only.			
passenger's front, fascia	1	EHM500560	
front seat side			
RH	1	LR017430	
LH	1	LR017431	
body side, air curtain			
RH	1	LR014048	
LH	1	LR016988	

SENSOR, airbag:

Includes fixings.

front impact	2	YWJ500370
--------------	---	------------------

Colour coded black. Mounted on front end carrier panel ass'y.

side impact	6	YWJ500380
-------------	---	------------------

Colour coded red and brown.

MODULE, airbag diagnostic

Includes fixings.

	1	NNW512000
--	---	------------------

SCREW:

sensors & module to body	7	FYP500170
--------------------------	---	------------------

passenger's airbag to fascia	2	FYP500730
------------------------------	---	------------------

side air curtain to A post	2	EYP500200
----------------------------	---	------------------

side air curtain to body	4	DCP5044L
--------------------------	---	-----------------

NUT:

passenger's airbag to fascia	6	EYH500030
------------------------------	---	------------------

airbag to front seat side	4	EJP7952L
---------------------------	---	-----------------

GROMMET, side impact sensor	2	DYA000040
-----------------------------	---	------------------



INTERIOR - SEAT BELTS & AIRBAGS

ALL MODELS

INTERIOR - CARPETS, FLOOR TRIM & INSULATION

Moulded Floor Carpets

Ebony Black, Aspen Grey and (from VIN 9A000001 onwards) Nutmeg were the standard carpet colours for all RHD models, plus LHD models not destined for the USA, Canada or Mexico. For the latter three markets, Alpaca Beige was also offered up to VIN 8A999999 but is not listed here; please contact us if you require Alpaca carpets.

CARPET, moulded, main floor:

front section (under front row seats & footwells)

RHD to VIN 7A999999

Ebony Black	1	EAD500360PVJ
Aspen	1	EAD500360LUP

RHD VIN 8A000001 on

Includes clips for fixing front footwell mats.

Ebony Black	1	EAD500520PVJ
Aspen	1	EAD500520LUP
Nutmeg (9A000001 on)	1	LR008739

LHD to VIN 7A999999

Ebony Black	1	EAD500370PVJ
Aspen	1	EAD500370LUP

LHD VIN 8A000001 on

Includes clips for fixing front footwell mats.

Ebony Black	1	EAD500530PVJ
Aspen	1	EAD500530LUP
Nutmeg (9A000001 on)	1	LR008307

rear section (under 2nd row seats & footwells)

Ebony Black 1 LR030750

Aspen

to VIN 8A999999 1 EAE000113LUP

VIN 9A000001 on 1 LR014365

Nutmeg (VIN 9A000001 on) 1 LR008704

CARPET, moulded, load compartment:

Ebony Black

to VIN 9A203643 1 EAG500210PVJ

VIN 9A203644 on 1 LR030782

Aspen

to VIN 9A195468 1 EAG000114LUP

VIN 9A195469 to 9A203643 1 EAG500210LUP

VIN 9A203644 on 1 LR015917

Nutmeg

VIN 9A000001 to 9A189549 1 LR008664

VIN 9A189550 to 9A203643 1 LR010238

VIN 9A203644 on 1 LR030783

CLIP, main floor carpet, front section 2 EAK500010PVJ

FOOTREST, driver's:

RHD

Ebony Black 1 EAV500010PVJ

Aspen 1 EAV500010LUP

Nutmeg (VIN 9A000001 on) 1 LR008544

LHD

Ebony Black 1 EAV500041PVJ

Aspen 1 EAV500041LUP

Nutmeg (VIN 9A000001 on) 1 LR008545

INSERT, driver's footrest:

Ebony Black 1 EAZ500010PVJ

Aspen 1 EAZ500010LUP

Nutmeg (VIN 9A000001 on) 1 LR008543

PEDAL COVER SET:

Three piece set of sports covers, fashioned from stainless steel and rubber - includes covers for accelerator and brake pedals, plus footrest cover.

Land Rover 1 LR008713

Britpart 1 LR008713BP



PEDAL COVER SET - LR008713

Original Fitment Carpet Footwell Mats

VIN 8A000001 ON

From VIN 8A000001 onwards carpet footwell mats were fitted as standard, some featuring contrasting leather binding. Ebony Black, Aspen Grey and (from VIN 9A000001 onwards) Nutmeg were the standard carpet colours for all RHD models, plus LHD models not destined for the USA, Canada or Mexico. For the latter three markets, Alpaca Beige was also offered up to VIN 8A999999 but is not listed here; please contact us if you require Alpaca mats.

FOOTWELL MAT SET:

Set of 4 (front and rear) footwell mats.

RHD

Ebony Black 1 LR026389

Ebony Black/Tan 1 LR017404

Ebony Black/Ivory 1 LR017403

Aspen 1 EAH500430LUP

Nutmeg (VIN 9A000001 on) 1 LR026390

LHD

Ebony Black 1 LR026392

Ebony Black/Tan 1 LR017406

Ebony Black/Ivory 1 LR017405

Aspen 1 EAH500450LUP

Nutmeg (VIN 9A000001 on) 1 LR026393



RUBBER FOOTWELL MATS - VPLSS0104

Accessory Rubber Footwell Mats

Heavy duty, easy-cleaning black rubber footwell mats supplied as sets of four for the front and 2nd row footwells or sets of two for the front row footwells only. Mats feature 'Range Rover' branding. Sets are compatible with the standard Range Rover Sport mat fixings for safety and practicality.

RUBBER FOOTWELL MATS, black:

front & 2nd row footwells (set of 4)

RHD

to VIN 7A999999 1 VPLSS0104

VIN 8A000001 on 1 VPLAS0197

LHD

to VIN 7A999999 1 EAH500051PMA

VIN 8A000001 on 1 VPLAS0198

front footwells only (set of 2)

RHD

to VIN 7A999999 1 VPLSS0103

Land Rover 1 VPLSS0103P

aftermarket 1 VPLSS0106

VIN 8A000001 on 1 VPLSS0106

LHD

to VIN 7A999999 1 EAH500059PMA

VIN 8A000001 on 1 LR006244

rear footwells only (set of 2)

aftermarket 1 VPLSS0103RP

Accessory Carpet Footwell Mats

CARPET FOOTWELL MATS, set of 4:

Premium set, with 'Range Rover' badge

Durable yet luxurious deep pile carpet footwell mats, supplied as a set of four including the standard Range Rover Sport mat fixings for safety and practicality. Features include Range Rover branding and stylised alloy fixing points.

Ebony Black, Aspen Grey and (from VIN 9A000001 onwards)

Nutmeg were the standard carpet colours for all RHD models, plus LHD models not destined for the USA, Canada or Mexico. For the latter three markets, Alpaca Beige was also offered up to VIN 8A999999 but is not listed here; please contact us if you require Alpaca mats.

RHD to VIN 7A999999

Ebony Black 1 EAH500012PVJ

RHD VIN 8A000001 on

Ebony Black 1 VPLAS0195PVJ

Aspen 1 LR006434

Nutmeg (9A000001 on) 1 VPLSS0006SVB

LHD to VIN 7A999999

Ebony Black 1 EAH500011PVJ

Aspen 1 EAH500011LUP

LHD VIN 8A000001 on

Ebony Black 1 VPLAS0196PVJ

Aspen 1 LR006436

Bearmach set, without badge

Premier quality, fully tailored with non-slip backing, these Bearmach mat sets are easily cleaned and include all fixings to locate on original Land Rover mat attachment points. Available in Black or Mid-Grey.

RHD

Black 1 EAH500012PVJBM

Mid-Grey 1 EAH500012LUPBM

LHD

Black 1 EAH500011PVJBM

Mid-Grey 1 EAH500011LUPBM

FIXINGS, replacement, carpet mats:

turnbuckle, driver's mat 1 VUB503700

retainer, carpet mat, set of 4 1 VUB002310



CARPET FOOTWELL MATS - EAH500012PVJBM

Load Compartment Floor Boards & Trim

Ebony Black, Aspen Grey and (from VIN 9A000001 onwards) Nutmeg were the standard load floor colours for all models not destined for the USA, Canada or Mexico. For the latter three markets, Alpaca Beige (up to VIN 8A999999) was also offered but is not listed here; please contact us if you require an Alpaca load floor cover.

COVER BOARD, load floor, carpet, rear:
Includes lift handle.

to VIN 9A203643		
Ebony Black	1	EAS500023PVJ
Aspen	1	EAS500023LUP
Nutmeg (VIN 9A000001 on)	1	LR008356
VIN 9A203644 on		
Ebony Black	1	LR021442
Aspen	1	LR015469
Nutmeg	1	LR021441

COVER BOARD, load floor, carpet, front:

to VIN 9A203643		
3/4 width of luggage floor - fits between long floor side covers.		
Ebony Black	1	EAS500073PVJ
Aspen	1	EAS500073LUP
Nutmeg (VIN 9A000001 on)	1	LR008698
VIN 9A203644 on		
Full width of luggage floor - fits in front of shorter floor side covers and includes mounting points for front tie down loops.		

Ebony Black	1	LR040872
Aspen	1	LR015914
Nutmeg	1	LR040873

STUD, front cover board fixing 4 **EYR500010**

STRAP, cover board lifting 4 **EAS500170PVJ**

SIDE COVER, load floor:

to VIN 9A203643
Long type - fits alongside both rear and front load floor boards and includes mounting points for both rear and front tie down loops.

Ebony Black		
RH	1	ERK500312PVJ
LH	1	ERK500323PVJ
Aspen		
RH	1	ERK500312LUP
LH	1	ERK500323LUP
Nutmeg (VIN 9A000001 on)		
RH	1	LR008541
LH	1	LR008542

VIN 9A203644 on
Short type - fits alongside rear load floor board and behind front board. Includes mounting points for rear tie down loops only.

Ebony Black		
RH	1	LR021481
LH	1	LR021484
Aspen		
RH	1	LR015907
LH	1	LR015910
Nutmeg		
RH	1	LR021482
LH	1	LR021485

SUPPORT BRACKET ASS'Y, side cover:

RH		
to VIN 9A203643	1	EPE500144
VIN 9A203644 on	1	LR012138
LH		
to VIN 9A203643	1	EPE500154
VIN 9A203644 on	1	LR012140

DOOR SCUFF PLATE:

Ebony Black		
to VIN 6A999999	1	ERL500021PVJ
VIN 7A000001 on	1	LR021469
Aspen		
to VIN 6A999999	1	ERL500021LUP
VIN 7A000001 on	1	LR017994
Nutmeg (VIN 9A000001 on)	1	LR021470

COVER, rear door lock striker:

Ebony Black		
to VIN 6A999999	1	ERK500560PVJ
VIN 7A000001 on	1	LR038049
Aspen		
to VIN 6A999999	1	ERK500560LUP
VIN 7A000001 on	1	ERK500561LUP
Nutmeg (VIN 9A000001 on)	1	LR038050

LOOP, load tie-down, black/chrome 4 **EOZ500060WTK**

LUGGAGE NET, accessory:

Land Rover	1	VPLCS0269
OEM	1	VPLCS0269P1

Land Rover kit containing tie down straps and durable, elasticated net, securing most types of luggage. Easily fixes to load tie-down loops on load floor side covers.



LOAD SPACE MAT - VPLSS0043

Load Compartment Mats & Liners

RUBBER LOAD SPACE MAT, black:
Heavy duty, easy-cleaning black rubber mat to protect the load space carpets in your Range Rover Sport. The Land Rover item features Range Rover branding and is pre-trimmed to reveal the load floor tie-down loops.

Land Rover	1	VPLSS0043
Bearmach	1	VPLSS0043BM

LOAD SPACE LINER, semi-rigid:

Almost completely damage-resistant load space liners are ideal for sharp or heavy loads which would otherwise harm your car. The non-absorbent, wash-down synthetic material together with a deep lip around the edge means inadvertent spillages aren't a problem, either.

Land Rover	1	EBF500020
Britpart	1	EBF500020BP

LOAD SPACE PROTECTOR, flexible 1 **VPLSS0016**

Tear-proof and waterproof, the load space protector comes up to window height at the sides and seat-top height at the front. The rear features a flap to protect the rear door lip and bumper when loading or unloading. Ideal for transporting hedge cuttings or firewood!



LOAD SPACE LINER - EBF50020

Cargo Barriers/Dog Guards

CARGO BARRIER/DOG GUARD:

Mesh guard assembly, includes fitting kit.

full width		
Land Rover	1	VPLSS0205
Britpart	1	VUB502080BP

centre divider

For use with full width cargo barrier/dog guard.

Land Rover	1	EOH500140PMA
Britpart	1	EOH500140PMABP

REPLACEMENT FITTING KIT, cargo barrier/dog guard:

set of 4 brackets, full width guard	1	VUB503500
for centre divider	1	VUB503510
set of 5 handscrews	1	VUB503711

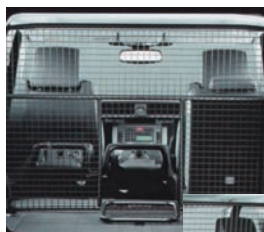

CARGO BARRIER/DOG GUARD - VPLSS0205



CARGO BARRIER/DOG GUARD, CENTRE DIVIDER - EOH500140PMA

ALL MODELS

Sound Insulation

A multitude of small and weirdly-shaped insulating pads are to be found within the body shell of a Range Rover Sport, mostly hiding behind the interior trim and carpets. The larger or more significant insulating pads on the vehicle are listed here; the smaller, harder to describe pads nesting within the door pillars, sills and roof rails are not - if any of these are required, please contact us with a description of where the pad fits, preferably with an attached photo to further help us select the correct item for you.

INSULATION PAD:

underside of bonnet	1	LR013222
engine compartment bulkhead forward, RHD		
to VIN 9A199418	1	ETD500181
VIN 9A199419 on	1	LR020542
forward, LHD		
to VIN 9A199418	1	ETD500191
VIN 9A199419 on	1	LR014378
rearward, centre (large) diesel models	1	ETC500014
petrol models	1	ETC500291
rearward, upper	1	ETC500510
rearward, RH end	1	ETC500311
rearward, LH end	1	ETC500321
gearbox tunnel		
all except 3.6 TDV8 diesel	1	LR046702
3.6 TDV8 diesel only		
to VIN 8A186040	1	ETR500210
VIN 8A186041 on	1	LR010429
gear lever side		
RH	1	ETR500120
LH	1	ETR500130
headlining	4	LR020544

Models without sun roof only.

INSULATION MAT - LR013222



CLIP:

insulating pad to bonnet	11	BTR2985
insulating pad to bulkhead screw type	6	EAK500040NMJ
nut type	3	EYC500020
insulating pad to gearbox tunnel screw type		
Land Rover	6	AFU3711L
aftermarket	6	AFU3711LP
nut type	12	EYC500020
DAMPER, anti-vibration, headlining	1	EIR500181

Located over 2nd row seats.

Sound Deadening Panels

These self-adhesive bitumen pads have become a necessity with motor manufacturing engineers chasing NVH goals (eradication of noise, vibration and harshness). They are dramatically effective when applied to the inside of large, flexible pressings on a car bodyshell (such as door skins, floors and roof panels) where they will damp out drumming and give the vehicle that 'hewn from solid' feel.

The pads should be gently warmed before application, since when cold their inflexibility and brittle nature makes them impossible to fit to even the most slightly contoured body panel.

SOUND DEADENING PANEL:

Fit as required. Size: 530mm x 190mm (cut to fit).

each	A/R	RB7145
set of 5	A/R	RB7145K5
set of 10	A/R	RB7145K10

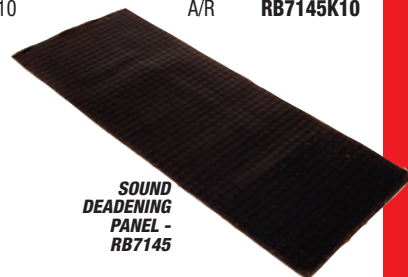

SOUND DEADENING PANEL - RB7145

INTERIOR - CARPETS, FLOOR TRIM & INSULATION

ALL MODELS

INTERIOR - FASCIA

Fascia Trim Panels

The trimmed components of the fascia are all assembled onto a large metal reinforcement and two armatures (frames), secured to the body shell by several brackets. Understandably there is little call for these structural components as spare parts, so they are not listed here. Their carry-over of use on later Range Rover Sport models means that they are all still available, if required - please contact us for details.

UPPER FASCIA COVER ASSEMBLY

Important note: All the upper fascia covers now available from Land Rover (with one exception, the earlier Aspen cover FAB502080LUP) are original fitment for cars from VIN 9A212698 onwards and are slightly different in design to the earlier types. To fit them to cars up to VIN 9A212697 you will need to also purchase and fit the later type of speaker grille part no. LR018984 and solar sensor finisher part no. LR013636.

UPPER FASCIA COVER ASSEMBLY:

Includes cover to windscreen seal, fixing screws and spring nuts.

RHD

without navigation system		
Ebony Black	1	LR016793
Aspen	1	LR016792
with navigation system		
Ebony Black	1	LR016799
Aspen	1	LR016798

LHD

without navigation system		
Ebony Black	1	LR016796
Aspen	1	LR016795
with navigation system		
Ebony Black	1	LR016801
Aspen	1	LR016800

FINISHER, solar sensor, upper fascia 1 **LR013636**
VIN 9A212698 on. Also required for most vehicles prior to VIN 9A212698 being fitted with a new upper fascia cover.

SEAL, black, cover to windscreen 1 **FAJ500012PMA**
NUT, U type, cover to body 4 **FYH500180**

HOUSING, radio & heater controls 1 **FCT500040PMA**
Includes fixing clips and spring nuts.

FASCIA PANEL, outer:

Panel at either end of fascia into which the outer face level air vent etc. are mounted. Includes fixing clips.

RHD

RH (driver's end of fascia)		
Ebony Black	1	FBF500300PVJ
Ivory	1	FBF500300NUG
Alpaca (to VIN 8A999999)	1	FBF500300SMS
Almond (VIN 9A000001 on)	1	LR008539
LH (passenger's end of fascia)		
Ebony Black	1	FAG500260PVJ
Ivory	1	FAG500260NUG
Alpaca (to VIN 8A999999)	1	FAG500260SMS
Almond (VIN 9A000001 on)	1	LR008536

LHD

RH (passenger's end of fascia)		
Ebony Black	1	FAG500250PVJ
Ivory	1	FAG500250NUG
Alpaca (to VIN 8A999999)	1	FAG500250SMS
Almond (VIN 9A000001 on)	1	LR008535
LH (driver's end of fascia)		
Ebony Black	1	FBF500310PVJ
Ivory	1	FBF500310NUG
Alpaca (to VIN 8A999999)	1	FBF500310SMS
Almond (VIN 9A000001 on)	1	LR008540

FASCIA PANEL, inner:

Panel fitted on the console side of the steering column cover - it contains a small heater vent. Includes fixing clips.

RHD

Ebony Black	1	FBF500460PVJ
Ivory	1	FBF500460NUG
Alpaca (to VIN 8A999999)	1	FBF500460SMS
Almond (VIN 9A000001 on)	1	LR008286

LHD

Ebony Black	1	FBF500470PVJ
Ivory	1	FBF500470NUG
Alpaca (to VIN 8A999999)	1	FBF500470SMS
Almond (VIN 9A000001 on)	1	LR008290

FASCIA PANEL, radio and heater control housing side:

'L' shaped panel either side of radio and heater control housing.

Ebony Black

RH	1	FAE500490PVJ
LH	1	FAE500500PVJ

Ivory

RH	1	FAE500490NUG
LH	1	FAE500500NUG

Alpaca (to VIN 8A999999)

RH	1	FAE500490SMS
LH	1	FAE500500SMS

Almond (VIN 9A000001 on)

RH	1	LR008532
LH	1	LR008533

FASCIA PANEL, upper extension, radio and heater control housing side

Extension panel fitting above 'L' shaped panel either side of radio and heater control housing.

Rhodium (to VIN 7A999999)

RH	1	FAE501170MBF
LH	1	FAE501180MBF

Brunel metallic

VIN 8A000001 to 8A999999

RH	1	FAE501170LQV
LH	1	FAE501180LQV

VIN 9A000001 on

RH	1	LR008528
LH	1	LR008529

Noble (VIN 9A000001 on)

RH	1	LR008530
LH	1	LR008531

FASCIA PANEL, fascia centre:

Centre fascia panel featuring oddments shelf.

Graphite metallic	1	FAE501190LEJ
-------------------	---	---------------------

To VIN 7A999999.

Ebony Black	1	FAE501190PVJ
-------------	---	---------------------

VIN 8A000001 on.

CLIP, metal, fascia panel securing A/R		FYC500040
SPRING NUT, housing securing 16		FAS500030

ANTI-SLIP MAT, fascia centre shelf:

large	1	FAH500140PVJ
-------	---	---------------------

Models without navigation system.

small	1	FAH500210
-------	---	------------------

All models from VIN 8A000001 onwards.

Air Vents & Heater Outlets

LOUVRE:

side window demist

Located at outer edges of upper fascia cover.

Ebony Black		
RH	1	JCC500022PVJ
LH	1	JCC500032PVJ
Aspen		
RH	1	JCC500022LUP
LH	1	JCC500032LUP

driver's, face level, rectangular

Located in inboard fascia panel, beside steering column.

Ebony Black	1	JVE500052PVJ
Ivory	1	JVE500052NUG
Alpaca (to VIN 8A999999)	1	JVE500052SMS
Almond (VIN 9A000001 on)	1	LR008745

driver's, footwell, rectangular

Located in lower fascia panel, under steering column.

Ebony Black	1	LR028394
Ivory	1	LR028393
Alpaca (to VIN 8A999999)	1	JBD500030SMS
Almond (VIN 9A000001 on)	1	LR028395

FACE LEVEL AIR VENT, round:

outer

Ebony Black & Pewter Chrome

To VIN 7A999999.

RH	1	JBD500180W
LH	1	JBD500190W

Brunel metallic

VIN 8A000001 on.

RH	1	LR008388
LH	1	LR008389

Chrome

VIN 9A000001 on.

RH	1	LR008394
LH	1	LR008396

centre

Ebony Black & Pewter Chrome

To VIN 7A999999.

RH	1	JBD500160WCQ
LH	1	JBD500170WCQ

Brunel metallic

VIN 8A000001 on.

RH	1	LR008388
LH	1	LR008390

Chrome

VIN 9A000001 on.

RH	1	LR008389
LH	1	LR008391



WOOD AIR VENT SURROUND KIT, self adhesive:

Accessory 4 piece kit of self adhesive covers for outer and centre face level air vent panels in choice of Lined Oak/Ebony Black or American Cherry finishes.

Lined Oak/Ebony Black	1	LR003873
American Cherry	1	LR003872



WOOD AIR VENT SURROUND KIT - LR003872



ALL MODELS

INTERIOR - FASCIA

Glove Box

GLOVE BOX & LID, lower (primary glove box):

RHD	
to VIN 7A999999	
Ebony Black	1 FFB500151PVJ
Ivory	1 FFB500151NUG
Alpaca	1 FFB500151SMS
VIN 8A000001 on	
Ebony Black/Noble	1 FFB501510YCK
Ivory/Noble	1 FFB501510YCY
Alpaca/Noble	1 FFB501510YCL
Ebony Black/Almond	1 LR008271
LHD	
to VIN 7A999999	
Ebony Black	1 FFB500141PVJ
Ivory	1 FFB500141NUG
Alpaca	1 FFB500141SMS
VIN 8A000001 on	
Ebony Black/Noble	1 FFB501500YCK
Ivory/Noble	1 FFB501500YCY
Alpaca/Noble	1 FFB501500YCL
Ebony Black/Almond	1 LR008270

GLOVE BOX FRAME & UPPER LID ASS'Y:

Includes upper glove box lid clip, hinge pins for upper and lower glove boxes plus fixing spring nuts.

RHD	
to VIN 7A999999	
Ebony Black	1 FFB500510PVJ
Ivory	1 FFB500510WVC
Alpaca	1 FFB500510WRN
VIN 8A000001 on	
Ebony Black/Noble	1 LR016744
Ivory/Noble	
Alpaca/Noble	1 FFB501490YCP
to VIN 9A204763	1 LR016745
VIN 9A204764 on	
Alpaca/Noble	1 FFB501490YCY
Ebony Black/Almond	1 LR016746
LHD	
to VIN 7A999999	
Ebony Black	1 FFB500500PVJ
Light Tundra	1 FFB500500WVC
Alpaca	1 FFB500500WRN
VIN 8A000001 on	
Ebony Black/Noble	1 LR016741
Ivory/Noble	1 LR016742
Alpaca/Noble	1 FFB501480YCY
Ebony Black/Almond	1 LR016743

BLANKING PLUG, glove box frame outer:

Models not fitted with passenger airbag deactivation switch.

Ebony Black	1 FBV500070PVJ
Ivory	1 FBV500070NUG
Alpaca	1 FBV500070SMS

GLOVE BOX LID ASS'Y, upper (secondary glove box):

Includes clip and hinge pins.

RHD	
to VIN 7A999999	
Ebony Black	1 FFN500131PVJ
Ivory	1 FFN500131WVC
Alpaca	1 FFN500131WRN
VIN 8A000001 on	
Ebony Black/Noble	1 FFN500270YCK
Ivory/Noble	1 FFN500270YCY
Alpaca/Noble	1 FFN500270YCL
Ebony Black/Almond	1 LR009416
LHD	
to VIN 7A999999	
Ebony Black	1 FFN500121PVJ
Ivory	1 FFN500121WVC
Alpaca	1 FFN500121WRN
VIN 8A000001 on	
Ebony Black/Noble	1 FFN500260YCK
Ivory/Noble	1 FFN500260YCY
Alpaca/Noble	1 FFN500260YCL
Ebony Black/Almond	1 LR009415
GLOVE BOX, upper (secondary)	1 LR019112

Includes buffers and fixing clips. Does not include upper glove box lid.

CD STORAGE RACK, upper glove box 1 FFB500420PVJ

Includes buffers and fixing clips. Does not include upper glove box lid.

CLIP:

upper glove box lid retaining	1 FFI500010PMA
<i>Included in upper glove box lid assembly.</i>	
upper glove box retaining	4 FYC500040
<i>Included in upper glove box assembly.</i>	

DAMPER, glove box mechanism:

lower glove box	
RHD	1 FFZ500090
LHD	1 FFZ500080

upper glove box lid:

RHD	1 FFZ500110
LHD	1 FFZ500100

LATCH PIN, upper glove box lid damper 1 FYT500012

QUARTER MOULDING, upper glove box lid damper:

RHD	1 FFF500050
LHD	1 FFF500040

HINGE PIN:

lower glove box	2 FFY500020
<i>Included in glove box frame & upper lid assembly.</i>	
upper glove box lid	2 FFY500012
<i>Included in upper glove box lid assembly.</i>	

BUFFER:

lower glove box lid	2 FWT500013
upper glove box lid	2 FWT500013
<i>Included in upper glove box lid assembly.</i>	

STRIKER, latch:

lower glove box lid	1 FND500012PMA
upper glove box lid	1 FND500050PMA



GLOVE BOX FRAME & UPPER LID ASSEMBLY- FFB500510WRN

GLOVE BOX UPPER - LR019112

WE'RE HERE TO HELP
 Can't find or not sure of the right part for your car, contact our technical sales team for help and advice.
01522 568000



DAMPER - FFZ500110

ALL MODELS

INTERIOR - CENTRE & OVERHEAD CONSOLES

Centre Console

BODY MOULDING, centre console:

Ebony Black	1	LR012129
Ivory	1	LR012128
Alpaca (to VIN 8A999999)	1	FJZ500102SMS
Almond (VIN 9A000001 on)	1	LR012127

BRACKET, console to centre tunnel

	1	FHC500090
--	---	------------------

SCREW, console to bracket

	2	FYP500420
--	---	------------------

NUT, bracket to centre tunnel

	4	FN105042
--	---	-----------------

BLANKING PLUG, screw access hole:

Louvered plug covering console to bracket screw on each lower rear corner of console.

Ebony Black	2	FHE500012PVJ
-------------	---	---------------------

Ivory	2	FHE500012NUG
-------	---	---------------------

Alpaca (to VIN 8A999999)	2	FHE500012SMS
--------------------------	---	---------------------

Almond (VIN 9A000001 on)	2	LR008285
--------------------------	---	-----------------

COVER, centre console:

front, upper

Holds front cup holders/ashtray assembly.

Graphite metallic finish	1	FJV500382LEJ
--------------------------	---	---------------------

To VIN 7A999999.

Ebony Black finish	1	FJV500382PVJ
--------------------	---	---------------------

VIN 8A000001 on.

rear

Holds rear face level vent apertures, etc.

Graphite metallic finish	1	FJV500242LEJ
--------------------------	---	---------------------

To VIN 7A999999.

Ebony Black finish	1	FJV500242PVJ
--------------------	---	---------------------

VIN 8A000001 on.

SCREW, rear cover to console

	1	FYP500110
--	---	------------------

FINISHER, centre console side:

Also known as 'hockey sticks'.

Lined Oak/Ebony Black

pair, RH & LH	1	VUB501165
---------------	---	------------------

RH	1	FJM500080LAD
----	---	---------------------

LH	1	FJM500090LAD
----	---	---------------------

American Cherry

pair, RH & LH	1	VUB501164
---------------	---	------------------

RH	1	FJM500080AAY
----	---	---------------------

LH	1	FJM500090AAY
----	---	---------------------

Satin Black Walnut Veneer (7A000001 on)

RH	1	FJM500320AAC
----	---	---------------------

LH	1	FJM500330AAC
----	---	---------------------

Stained Zebrano (8A000001 on)

RH	1	FJM500360
----	---	------------------

LH	1	FJM500370
----	---	------------------

Rhodium (to VIN 7A999999)

RH	1	FJM500062MBF
----	---	---------------------

LH	1	FJM500072MBF
----	---	---------------------

Brunel metallic (VIN 8A000001 on)

RH	1	LR008581
----	---	-----------------

LH	1	LR008583
----	---	-----------------

Noble (VIN 9A000001 on)

RH	1	LR008582
----	---	-----------------

LH	1	LR008584
----	---	-----------------

Centre Console Cubby Box & Lid

CUBBY BOX, Ebony Black:

to VIN 8A147225 (pre-Bluetooth introduction)

without cool box facility

without phone preparation 1 **FJG500042PVJ**

with phone preparation 1 **FJG500140PVJ**

with cool box facility

without phone preparation 1 **FJB501040PVJ**

with phone preparation 1 **LR021370**

VIN 8A147226 on (post-Bluetooth introduction)

without cool box facility 1 **FJG500042PVJ**

with cool box facility 1 **FJB501040PVJ**

ANTI-SLIP MAT, inside cubby box

LID ASSEMBLY, trimmed, cubby box, to VIN 8A147137

Pre-Bluetooth introduction.

vinyl trimmed, without phone integration

Ebony Black 1 **LR016753**

Ivory

to VIN 6A999999 1 **FJB500023NUG**

VIN 7A000001 on 1 **FJB500850NUG**

Alpaca

to VIN 6A999999 1 **FJB500023SMS**

VIN 7A000001 on 1 **FJB500850SMS**

vinyl trimmed, with phone integration

Ebony Black 1 **FJB500860PVJ**

Ivory 1 **FJB500860NUG**

Alpaca 1 **FJB500860SMS**

leather trimmed, without phone integration

Ebony Black

to VIN 6A999999 1 **FJB500034PVJ**

VIN 7A000001 on 1 **LR016757**

Ivory

to VIN 6A999999 1 **FJB500034NUG**

VIN 7A000001 on 1 **LR016756**

Alpaca

to VIN 6A999999 1 **FJB500034SMS**

VIN 7A000001 on 1 **FJB500970SMS**

Tan (VIN 8A000001 on) 1 **LR016758**

leather trimmed, with phone integration

Ebony Black 1 **FJB500980PVJ**

Ivory 1 **FJB500980NUG**

Alpaca 1 **FJB500980SMS**

Tan (VIN 8A000001 on) 1 **FJB500980SBB**



TRAY, INSIDE CUBBY BOX LID - LR047448



LID ASSEMBLY - FJB500034PVJ

LID ASSEMBLY, trimmed, cubby box, VIN 8A147138 on
Post-Bluetooth introduction.

vinyl trimmed

Ebony Black 1 **LR016753**

Ivory

to VIN 9A209606 1 **FJB500850NUG**

VIN 9A209607 on 1 **LR016752**

Alpaca (to VIN 8A999999) 1 **FJB500850SMS**

Almond (VIN 9A000001 on) 1 **LR016754**

leather trimmed

Ebony Black

without contrasting stitching 1 **LR016757**

with contrasting stitching 1 **LR016760**

Ivory 1 **LR016756**

Alpaca (to VIN 8A999999) 1 **FJB500970SMS**

Almond (VIN 9A000001 on) 1 **LR016759**

Tan (VIN 8A000001 on) 1 **LR016758**

TRAY, inside cubby box lid:

without phone compartment 1 **FJJ500012PVJ**

with phone compartment 1 **LR047448**

HINGE ASSEMBLY, cubby box lid

1 **LR056265**

HINGE COVER, outer, cubby box lid:

to VIN 6A999999 (Rhodium Silver)

RH 1 **FJV500462MBF**

LH 1 **FJV500472MBF**

VIN 7A000001 on (Noble)

RH 1 **FJV501080MVM**

LH 1 **FJV501090MVM**

DOCKING STATION, phone, black

COVER, front console panel 1 **FHC500240PVJ**

SCREW:

cubby box to console, front 2 **FYP500110**

cubby box to console, lower 2 **DYP100780L**

cubby box lid ass'y 8 **FYP500260**

outer hinge to cubby box lid 2 **FYP500270**

phone docking station 4 **FYP500260**



Centre Console Fittings

CUP HOLDER/ASHTRAY ASSEMBLY, front:

Graphite metallic finish 1 **FHM500032LEJ**

To VIN 7A999999.

Ebony Black finish 1 **FHM500140PVJ**

VIN 8A000001 on.

CUP HOLDER TRAY, rear, Ebony Black

1 **FJ1500032PVJ**

CUP HOLDER / ASHTRAY INSERT, Ebony Black:

front cup holder 2 **LR021330**

rear cup holder 2 **FWW500070PVJ**

front ashtray 1 **FKM500030PMA**

STOWAGE COMPARTMENT, rear, Ebony Black:

without heated rear seats 1 **FHM500022PVJ**

with heated rear seats 1 **FHM500060PVJ**

INSERT, rear stowage compartment

1 **FHY500050PVJ**

FACE LEVEL AIR VENT, console, rear:

housing only, twin air vent 1 **FHR500140PVJ**

bezel & grille only, pair 1 **LR041180**



CUP HOLDER/ASHTRAY ASSEMBLY - FHM500140PVJ

Overhead Consoles

OVERHEAD CONSOLE:

complete assembly, Ivory

Includes interior lamps and electrical systems

appropriate to model.

without sun roof

without voice input system 1 **XDE500810NUG**

with voice input system

RHD

to VIN 8A149839 1 **XDE500042NUG**

VIN 8A149840 on 1 **LR030764**

LHD

to VIN 8A149839 1 **XDE500032NUG**

VIN 8A149840 on 1 **LR030753**

with sun roof

without voice input system 1 **XDE500750NUG**

with voice input system

RHD

to VIN 8A149839 1 **XDE500102NUG**

VIN 8A149840 on 1 **LR030776**

LHD 1 **LR030772**

BLANKING PLUG, switch, Ivory 1 **FBV500060NUG**

Fitted to front overhead console housing on models without sun roof.

Under Bonnet Labels & Decals

- LABEL:**
- battery disconnection warning 1 **BAC501570**
 - radiator fan warning to VIN 9A496362 1 **PAK500020**
 - VIN 9A496363 on 1 **PAK500160**
 - xenon headlamp warning 1 **XAB000011**
- DECAL:**
- tyre pressures (all wheel sizes) 1 **RTC500810**
 - tyre rotation warning 1 **RRP500060**
 - E mark, vehicle build Europe only. to VIN 6A999999 1 **BAP500070**
 - VIN 7A000001 on 1 **BAP500080**
 - fuel fired heater Diesel models only. 1 **BAC500680**
 - under-bonnet fuse box to VIN 6A999999 1 **LR010069**
 - VIN 7A000001 on 1 **LR010070**



ALL MODELS LABELS & DECALS



Body Labels & Decals

- LABEL:**
- front passenger's airbag warning, round RHD 1 **BAC500840**
 - LHD 1 **BAC500850**
 - front passenger's airbag deactivation instructions RHD to VIN 9A190957 1 **BAC500720**
 - VIN 9A190958 on 1 **BAC501640**
 - LHD to VIN 9A190957 1 **BAC500710**
 - VIN 9A190958 on 1 **BAC501630**
 - side airbag warning, square to VIN 8A190072 2 **BAC501260**
 - VIN 8A190073 on 2 **BAC501720**
 - air conditioning refrigerant 2.7 TDV6 diesel models 1 **BAC501600**
 - 3.6 TDV8 diesel models petrol models 1 **BAC500970**
 - to VIN 9A196422 1 **BAC500441**
 - VIN 9A196423 on 1 **BAC501590**
- DECAL:**
- passenger compartment fuse box 1 **LR014296**
 - lubrication warning Diesel models only. 1 **WLE500100**
 - fuel filler warning diesel models to VIN 9A189967 1 **WLE500070**
 - VIN 9A189968 on 1 **WLE500150**
 - petrol models to VIN 9A190844 1 **WLE500050**
 - VIN 9A190845 on 1 **WLE500140**
 - spare wheel speed warning 1 **LR021533**
 - Models with spacesaver (undersize) spare wheel. tow bar fitting instructions 1 **BAC500340**
 - child safety door lock instructions 1 **BAD500050**

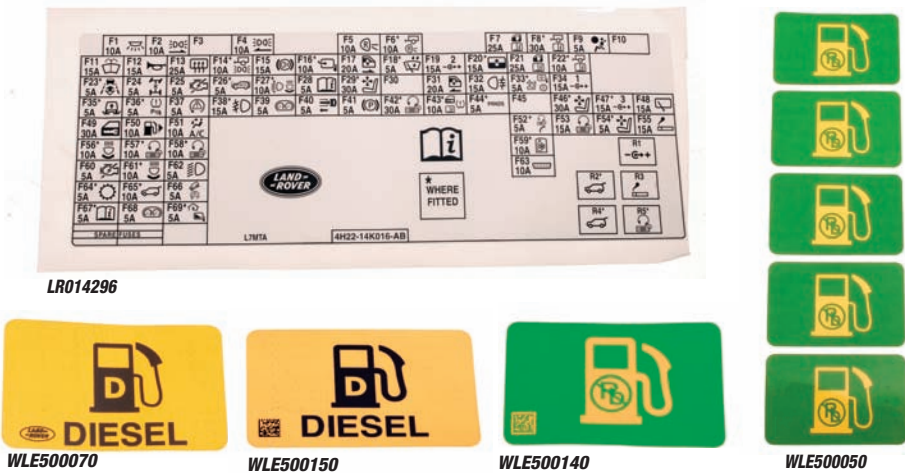
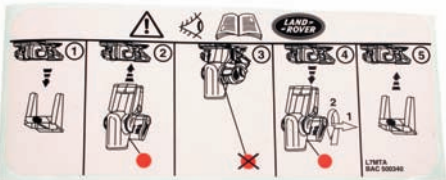

LABELS & DECALS

ALL MODELS

PAINT

Touch Up Paint

Confirming the correct paint colour name for your car may be done by reading the paint name on the VIN plate, under the bonnet. Touch up pencils and aerosols for all of the standard paint colours are listed here, together with the Land Rover three digit codes for each colour (car body repair workshops know and match your car's colour by this code).

For reference purposes the Land Rover/MG Rover standard three letter codes are also shown; you will see these letter codes used as suffixes on the part numbers of colour coded spare parts. For example, some of the touch up paint part numbers on this page use them - a paint pencil in Rimini Red is VEP501730CBK, where VEP501730 is a paint pencil and CBK is Rimini Red.

If your car's colour is clearly not what the three letter code says it is, then the car has been refinished in a different colour (of course!). This may have been done by Land Rover - a small number of Range Rover Sports were repainted in 'any colour you like' as part of Land Rover Special Vehicles 'Autobiography' option scheme.

Each standard colour paint touch up kit includes both base colour and top coat lacquer, in either pencils or aerosol cans. Lastly, just to say Land Rover classify Adriatic Blue as being in the Greys colour group and Izmir Blue as being in the Silvers. That's where you'll find them on this page, rather than under Blues - it's not an error!

Britpac Paint Pens uniquely offer great improvements in convenience and effectiveness over the traditional touch in pencil. Manufactured in the USA, they feature non-hazardous high quality urethane paint with excellent colour matching properties. Paint is held in the pen barrel and dispensed automatically through a fine felt tip, providing unparalleled control in application and giving a first class finish without having to refinish damaged areas.

BLACKS, TOUCH UP PAINT KIT:

Java Black (697/PNF)

touch in

Land Rover pencil

A/R **LR005735**

Britpart paint pen

A/R **LR005735BPPEN**

aerosol

A/R **LR005714**

Santorini Black (820/PAB)

touch in

Land Rover pencil

A/R **VPLDC0001PAB**

Britpart paint pen

A/R **VPLDC0001PABBPPEN**

aerosol

A/R **VPLDC0003PAB**

WHITES, TOUCH UP PAINT KIT:

Chawton White (603/NAL)

touch in

Land Rover pencil

A/R **STC3828VT**

Britpart paint pen

A/R **STC3828BPPEN**

aerosol

A/R **STC3828VA**

Alaska White (909/NCL)

touch in

Land Rover pencil

A/R **LR005732**

Britpart paint pen

A/R **LR005732BPPEN**

aerosol

A/R **LR005710**

Atacama Sand (916/NAU)

touch in

Land Rover pencil

A/R **LR005731**

Britpart paint pen

A/R **LR005731BPPEN**

aerosol

A/R **LR005709**



GOLD, TOUCH UP PAINT KIT:

Maya Gold (846/GAN)

touch in

Land Rover pencil

A/R **VEP501730GAN**

Britpart paint pen

A/R **VEP501730GANBPPEN**

aerosol

A/R **VEP501740GAN**

BROWN, TOUCH UP PAINT KIT:

Bournville (822/AAD)

touch in

A/R **VPLDC0004AAD**

aerosol

A/R **VPLDC0003AAD**

SILVERS, TOUCH UP PAINT KIT:

Zambezi Silver (737/MVC)

touch in

Land Rover pencil

A/R **STC4826VT**

Britpart paint pen

A/R **STC4826BPPEN**

aerosol

A/R **STC4826VA**

Zermatt Silver (798/MBK)

touch in

Land Rover pencil

A/R **VEP501730MBK**

Britpart paint pen

A/R **VEP501730MBKBPPEN**

aerosol

A/R **VEP501740MBK**

Izmir Blue (920/MWE)

touch in

A/R **LR005729**

aerosol

A/R **LR005707**

Arctic Frost (962/MBH)

touch in

Land Rover pencil

A/R **LR005728**

Britpart paint pen

A/R **LR005728BPPEN**

aerosol

A/R **LR005706**

GREYS, TOUCH UP PAINT KIT:

Bonatti Grey (659/LAL)

touch in

Land Rover pencil

A/R **STC4597VT**

Britpart paint pen

A/R **STC4597BPPEN**

aerosol

A/R **STC4597VA**

Adriatic Blue (731/LQW)

touch in

Land Rover pencil

A/R **STC4832VT**

Britpart paint pen

A/R **STC4832BPPEN**

aerosol

A/R **STC4832VA**

Stornoway Grey (907/LEL)

touch in

Land Rover pencil

A/R **VEP501730LEL**

Britpart paint pen

A/R **VEP501730LELBPPEN**

aerosol

A/R **VEP501740LEL**

Orkney Grey (949/LJZ)

touch in

A/R **VPLDC0004LJZ**

aerosol

A/R **VPLDC0003LJZ**

REDS, TOUCH UP PAINT KIT:

Alveston Red (696/CDX)

touch in

Land Rover pencil

A/R **STC4325VT**

Britpart paint pen

A/R **STC4325BPPEN**

aerosol

A/R **STC4325VA**

Rimini Red (889/CBK)

touch in

Land Rover pencil

A/R **VEP501730CBK**

Britpart paint pen

A/R **VEP501730CBKBPPEN**

aerosol

A/R **VEP501740CBK**

BLUES, TOUCH UP PAINT KIT:

Buckingham Blue (796/JGJ)

touch in

Land Rover pencil

A/R **VEP501730JGJ**

Britpart paint pen

A/R **VEP501730JGJBPPEN**

aerosol

A/R **VEP501740JGJ**

Cairns Blue (849/JEU)

touch in

Land Rover pencil

A/R **VEP501730JEU**

Britpart paint pen

A/R **VEP501730JEU BPPEN**

aerosol

A/R **VEP501740JEU**

Martinique Blue (850/JZX)

touch in

Land Rover pencil

A/R **VPLDC0001JZX**

aerosol

A/R **VPLDC0002JZX**

Baltic Blue (912/JEB)

touch in

A/R **LR005723**

aerosol

A/R **LR005701**

Biscay Blue (913/JGL)

touch in

Land Rover pencil

A/R **VPLDC0001JGL**

touch in

A/R **VPLDC0002JGL**

Lugano Teal (963/JMB)

touch in

A/R **LR005724**

aerosol

A/R **LR005702**

GREENS, TOUCH UP PAINT KIT:

Giverny Green (734/HZB)

touch in

Land Rover pencil

A/R **LR005721**

Britpart paint pen

A/R **LR005721BPPEN**

aerosol

A/R **LR005699**

Vienna Green (751/HES)

touch in

Land Rover pencil

A/R **STC4829VT**

Britpart paint pen

A/R **STC4829BPPEN**

aerosol

A/R **STC4829VA**

Galway Green (821/HAC)

touch in

A/R **VPLDC0001HAC**

aerosol

A/R **VPLDC0003HAC**

Tonga Green (904/HFY)

touch in

Land Rover pencil

A/R **VEP501730HFY**

Britpart paint pen

A/R **VEP501730HFYBPPEN**

aerosol

A/R **VEP501740HFY**

Lucerne Green (966/HZV)

touch in

Land Rover pencil

A/R **LR005722**

Britpart paint pen

A/R **LR005722BPPEN**

aerosol

A/R **LR005700**

ORANGE TOUCH UP PAINT KIT:

Tangiers Orange (761/EMC)

touch in

Land Rover pencil

A/R **VEP501730EMC**

Britpart paint pen

A/R **VEP501730EMCBPPEN**

aerosol

A/R **LR005716**

Vesuvius (811/EYS)

touch in

Land Rover pencil

A/R **LR005777**

Britpart paint pen

A/R **LR005777BPPEN**

aerosol

A/R **LR005778**

Body Fittings Paint

TOUCH UP PAINT:

Tungsten (door handles etc., 775/LEP)

aerosol

A/R **LR005605**

Clear Lacquer

touch in

A/R **RTC9481VT**

aerosol

A/R **RTC9481VA**

Alloy Wheel Paint

TOUCH UP PAINT:

Silver Sparkle (Alloy Wheel Silver, MNH)

touch in

Land Rover pencil

A/R **STC8927VT**

Britpart paint pen

A/R **STC8927BPPEN**

aerosol

A/R **AWZ101840MNH**

Clear Lacquer

touch in

A/R **RTC9481VT**

aerosol

UPRATED BRAKE DISCS

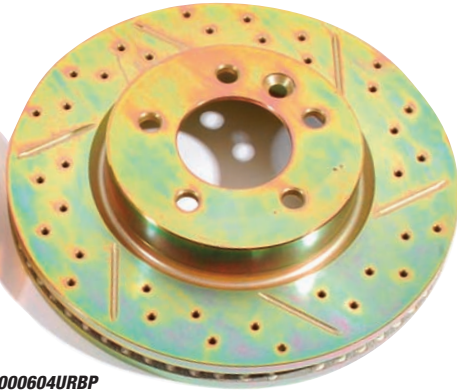

SDB000604URBP

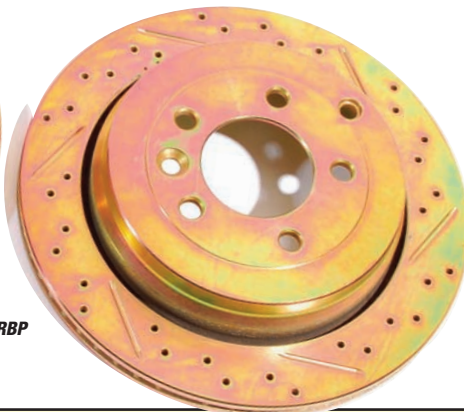

SDB000636URBP

Why fit uprated discs?

- Wide slots help brakes run up to 150° cooler
- Reduces brake fade underload
- Removes dirt, dust & debris from braking zone
- Great for off-road applications

BRAKE DISCS, uprated, slotted & drilled, pair:
front

- 320mm diameter **SDB000604URBP**
Models with 17" wheels or larger.
- 340mm diameter **SDB000614URBP**
Models with 18" wheels or larger.
- 360mm diameter **SDB000624URBP**
Models with 19" wheels or larger.

rear

- 325mm diameter **SDB000636URBP**
Models with 17" wheels or larger.
- 350mm diameter **SDB000646URBP**
Models with 18" wheels or larger.

UPRATED BRAKE PADS

Why fit Greenstuff Pads?

An excellent solution for 4x4 use. This heavy duty Greenstuff formulation has the benefit of longer life and better resistance to off road conditions of dust and sand. Greenstuff brake pads can deliver up to 15% improvement in stopping power. 100% British made.

BRAKE PAD SET, uprated, EBC Greenstuff, axle set:
Note that the wiring harnesses for the brake pad wear warning system sometimes need replacing along with the brake pads - for the harnesses, along with other brake pad attachment hardware, please refer to the 'Brakes - Front, Rear & Handbrake' section.

- front
for 320mm/340mm dia. discs **LR019618GS**
*Includes guide pin screws.
Models with 17" wheels, 18" wheels or larger.*
- for 360mm dia. discs **SFP500070GS**
*Includes brake pads only.
Models with 19" wheels or larger.*
- rear, for 350mm dia. discs only **LR055454GS**
*Includes guide pin screws.
Models with 18" wheels or larger.*

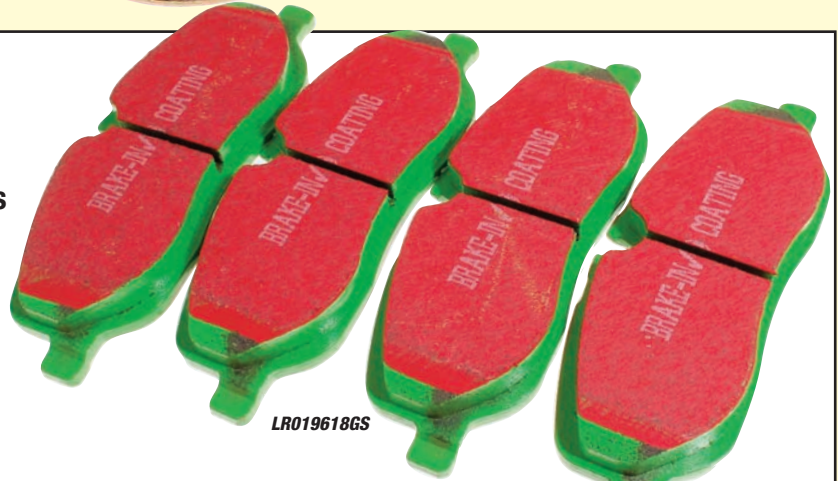

LR019618GS

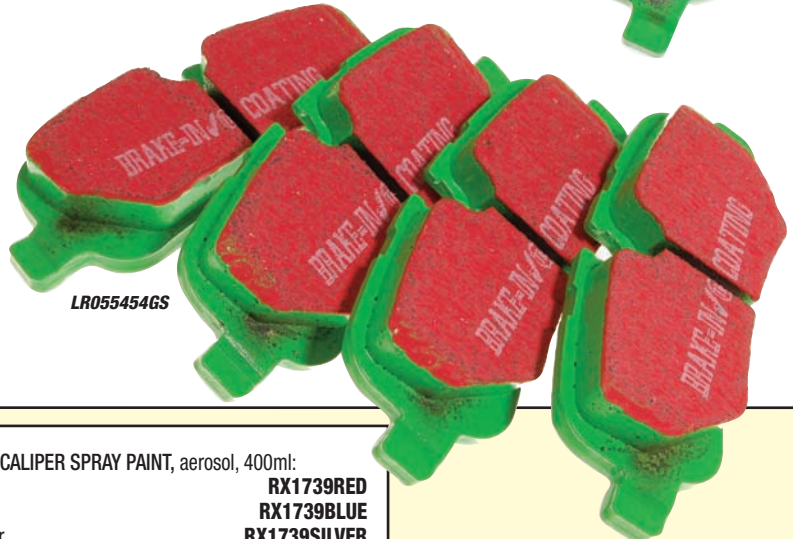

LR055454GS

BRAKE CALIPER SPRAY PAINT



- BRAKE CALIPER SPRAY PAINT, aerosol, 400ml:
- red **RX1739RED**
 - blue **RX1739BLUE**
 - silver **RX1739SILVER**
 - yellow **RX1739YELLOW**

DESCRIPTION

PART No.

DESCRIPTION

PART No.

DESCRIPTION

PART No.

Polybush are the world leader in Polyurethane Suspension Bushes and Components.



Why fit Polybush?

Why use Polyurethane for your suspension requirements?

Polyurethane is an ideal material for making into suspension bushes. Its combination of high tensile strength and elasticity translates into immense durability in the toughest conditions. Polyurethane Bushes have excellent resilience, springing back in to shape effortlessly to absorb shock and prevent dirt ingress and wear. Lastly, it doesn't age or perish - rubber bushes both perish and are attacked by oils and fuels.

Anti Roll Bar Bushes

You need the resilience of polyurethane to ensure a tight fit to the bar. This avoids knock and squeaks from loose bushes and minimises wear. The "Comfort" grade is best for this, but the "Performance" grade is best if you want to reduce body roll and sharpen up steering.

Control Arm Bushes

Polyurethane's elasticity allows control arms to move as intended whilst its tensile strength soaks up punishment from cornering, braking, accelerating and poor road surfaces. Go for a "Comfort" grade bush to preserve ride quality for longer, or choose the harder "Performance" grade to improve body control and steering.

Shock Absorber Bushes

Shock Absorber bushes can crush down leaving the shock to rattle on its mountings. Polyurethane's resilience counters this without needing as hard a bush, so you can specify the "Touring" grade for all but the most arduous applications.

Mounting Bushes

All the vehicle's moving components cause noise and vibration so Polybush make a range of mounting bushes for steering, suspension, engines and transmissions. The polyurethane isolates these unwanted buzzes and rattles, but holds the components firmly in place improving ride smoothness and body control.

FRONT & REAR SUSPENSION BUSHES

LR051585POLY



SUSPENSION ARM BUSHES:
Polybush, dynamic orange.

front lower arm front bush, pair
front lower arm rear bush, pair
rear lower arm rear bush, pair
rear upper arm rear bush, pair
kit (car set front & rear lower/upper arm bushes)

LR051585POLY
LR051586POLY
LR054831POLY
LR051616POLY

LR054831POLY



RA2066

ANTI ROLL BAR BUSHES



RVU500011POLYBUSH

Fitting polyurethane bushes improves the front & rear anti roll bar location and control and results in better handling performance and safety, plus prolonged tyre life. Available for cars with Roll Stability Control (also known as Active Cornering Enhancement).

ANTI ROLL BAR BUSHES:
Polybush, dynamic orange.

front anti roll bar mounting RVU500011POLYBUSH
Models with Roll Stability Control only. 2 required.
rear anti roll bar mounting LR018354POLY
Models with Roll Stability Control only. 2 required.

DIESEL EGR VALVE BLANKING KIT



BLANKING KIT, EGR valves RD1340
Fits TDV6 diesel models with EU2 emissions only (not Euro Stage 4 emissions engines from VIN 7A000001 on). Allows removal of troublesome EGR valves while also increasing performance.

SILICONE HOSE KIT

3 Piece Intercooler
2.7 TDV6

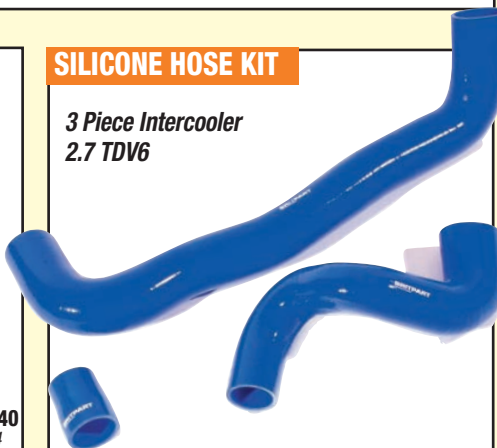

SILICONE HOSE KIT, Britpart PNH500025KITBPBLUE

BRITPART PEAK PERFORMANCE AIR FILTER

High quality filtration and maximum breathing efficiency result in more power or better fuel economy. Easily cleaned with air, water or detergent and doesn't need re-oiling before reuse.



BRITPART PEAK PERFORMANCE PHE000112BP
Fits all models, diesel and petrol.

K&N AIR FILTERS

K&N offer superior filtration, improvements in air flow and many times longer life than standard air filter elements. Plus, they can be cleaned and re-used.

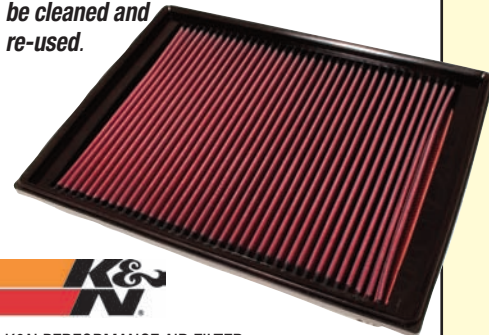

K&N PERFORMANCE AIR FILTER ELEMENT PHE000112K-N
Fits all models, diesel and petrol.



RX1347



RX1348



RX1346



RX1349

K&N FILTER CLEANING FLUID, 1 litre RX1346
For cleaning K&N air filter elements.
K&N FILTER ELEMENT OIL:
For re-oiling K&N air filter elements.
sachet, 57cc RX1347
bottle, 250ml RX1348
aerosol, 400ml RX1349

ROAD WHEELS

ACCESSORIES - WHEELS



**ALLOY WHEEL STORMER 20" BLACK
AFTERMARKET - RA2097**



**ALLOY WHEEL STORMER 20" SILVER
AFTERMARKET - RA2097P**



**ALLOY WHEEL STORMER 20"
BLACK & POLISHED
AFTERMARKET - RA2120**



**ALLOY WHEEL HST 20" SILVER
AFTERMARKET - RA2121**



**ALLOY WHEEL HST 20" GUNMETAL POLISHED
AFTERMARKET - RA2122**

VALVE CAP SET



VALVE CAP SET:

with Union Jack emblem
Set of four valve caps, genuine Land Rover accessory,
available with red, white and blue or black and grey
Union Jack emblems.

red, white & blue
black, white & grey

LR027664

LR027666

with Range Rover or Land Rover emblem
Set of four valve caps, genuine Land Rover accessory,
available with black/silver Range Rover or Land Rover
green/gold emblems.

Range Rover
Land Rover

LR027663

LR027560

ORDER

BY PHONE: 01522 568000 / ON LINE: www.rimmerbros.co.uk / E-MAIL: lrsales@rimmerbros.co.uk

MUD FLAPS**FRONT MUD FLAPS, pair:**

Includes fasteners.
Land Rover
Britpart
aftermarket

CAS500070PCL
CAS500070PCLBP
CAS500070PCLP

REAR MUD FLAPS, pair:

Includes fasteners. For standard profile rear bumper only (not HST).
Land Rover
Britpart
aftermarket

CAT500120PCL
CAT500120PCLBP
CAT500120PCLP

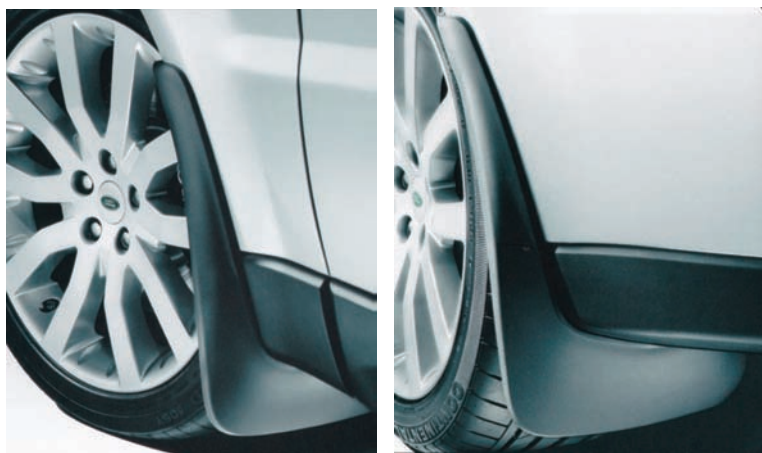
**LAMP GUARDS**

Durable protection for your expensive headlamps - not just a cosmetic accessory!
Supplied with fixings.

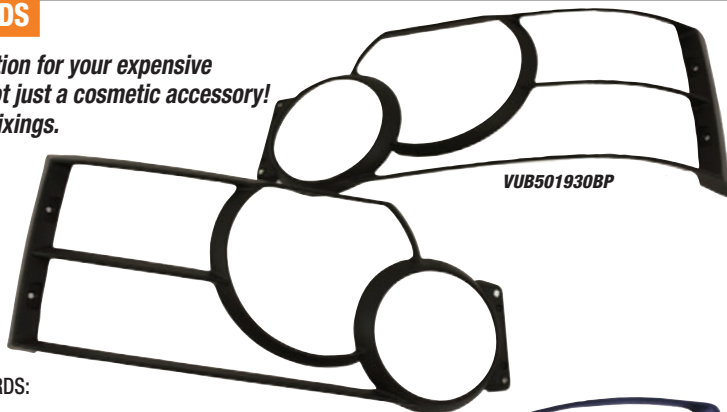
**FRONT LAMP GUARDS:**

pair, kit
Land Rover
Britpart
each (Land Rover replacement parts)
RH
LH

VUB501930
VUB501930BP
VUB503370
VUB503360

REAR LAMP GUARDS:

pair, kit
Land Rover
Britpart
each (Land Rover replacement parts)
RH
LH

VUB501920
VUB501920BP
VUB503380
VUB503390

**SMOKED LAMP CONVERSION KIT**

INDICATOR SIDE REPEATER LAMP
smoked lamp conversion kit
Includes a lamp and amber bulb.

LR007954BPSMOKE

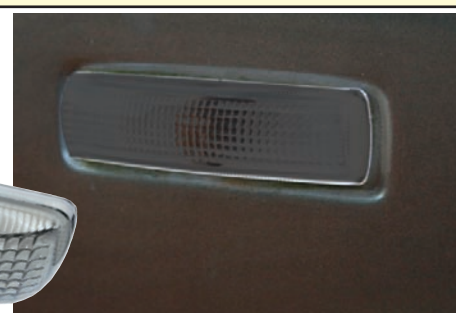
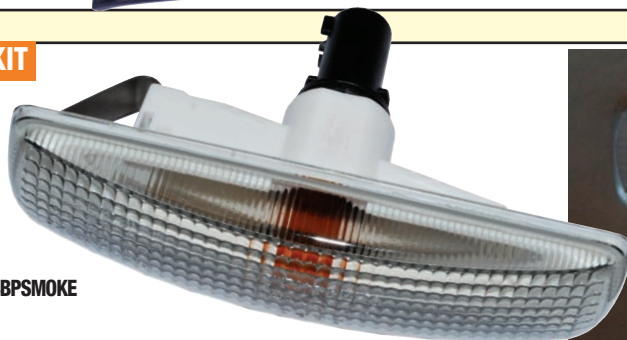

BODY COLOUR DOOR HANDLE SETS



LR006942

BODY COLOUR DOOR HANDLE SETS:

- Rimini Red LR006942
- Stornoway Grey LR006945
- Buckingham Blue LR006944
- Zermatt Silver LR006946
- Alaska White LR007530
- Java Black LR006949
- Santorini Black VPLAB0010PAB
- Tonga Green LR006943
- Galway Green VPLAB0010HAC

Car set of door handles and end caps, finished in choice of colours matching selected vehicle body colours.



CHROME DOOR HANDLE COVERS



RD1084BM



RD1084BP

Car set of covers for door handles and end caps, finished in chrome to match other chrome accent accessories for Range Rover Sport. Self adhesive, fitted in minutes.

BODY COLOUR DOOR MIRROR COVERS



Range of painted covers with which to enhance your door mirrors. Supplied in pairs.

COVERS, accessory, door mirror, pair:

- upper
 - Rimini Red LR004833
 - Zermatt Silver LR004836
 - Java Black LR004864
 - Chawton White LR004862
 - Alaska White LR007532
 - Buckingham Blue LR004863
 - Cairns Blue LR004865
 - Tonga Green LR007531
 - Galway Green VPLAB0011HAC
 - primed LR004867
- lower
 - primed LR004866



LR004833

CHROME DOOR MIRROR COVERS



Range of chromed covers with which to enhance your door mirrors. Supplied in pairs.

CHROME DOOR MIRROR COVERS, pair:

- upper, pair
 - Land Rover VUB503880MMM
 - Bearmach VUB503880MMMBM
 - aftermarket VUB503880MMMP
- lower, pair
 - Land Rover LR003905
 - aftermarket LR003905P



VUB503880MMMP



LR003905P

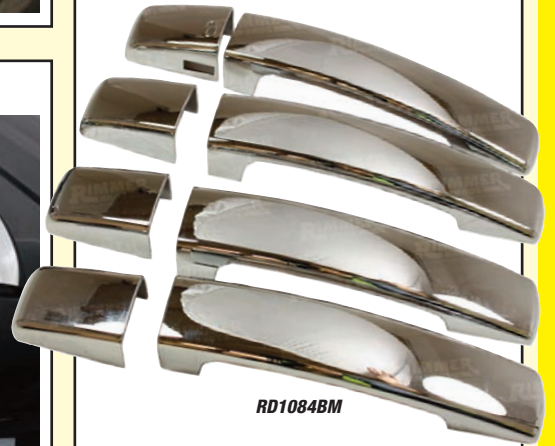

RD1084BM

CHROME DOOR HANDLE COVER SET:

- Britpart (chrome plastic) RD1084BP
- Bearmach (chrome metal) RD1084BM

CARBON FIBRE DOOR MIRROR COVERS



CARBON FIBRE DOOR MIRROR COVERS:

- upper VUB503880MMMTFCF
- lower LR003905TFCF



RA2089

ACCESSORY RADIATOR GRILLE

RADIATOR GRILLE:

Tungsten, HST style
Tungsten all-mesh grille, as fitted with
factory HST body styling kit.

DHB500440LEP

2010 model year onwards style
To fit 2005-2009 model year cars.
Aftermarket product.

RA2089

Supercharged style
chromed
carbon fibre

DHB500390WWQTFC
DHB500390WWQTFCF

AIR INTAKE GRILLE

AIR INTAKE GRILLE, wing:

Chrome finish

Originally for models with HST body styling kit.

RH & LH, pair

LR006304

RH

Land Rover
aftermarket

LR006305

LR006305BP

LH

Land Rover
aftermarket

LR006306

LR006306BP

2010 model year onwards style

To fit 2005-2009 model year cars.

Aftermarket product.

RH & LH, pair

RA2090



RA2090



RA2090



LR006304



VUB501980BP

BUMPER PROTECTION BARS

Enhance the appearance of your Range Rover Sport with a front protection bar. Offered as moulded soft plastic 'A' bar for durability and safety towards other road users or alternative tubular wrap-around style. Neither types are compatible with adaptive speed control; the 'A' bar is however compatible with the front parking aid system, while the wrap-around tubular bar is not.



VUB501980

'A' BAR, PLASTIC:

Compatible with front parking aid system; not compatible with adaptive speed control.

Land Rover

VUB501980

Britpart

VUB501980BP

FITTING KIT, 'A' bar

VUB503350

WRAP-AROUND TUBULAR BAR

VUB502510

Not compatible with front parking aid system or adaptive speed control.



VUB502510

FOG LAMP BEZELS

DXB000221-31BMC

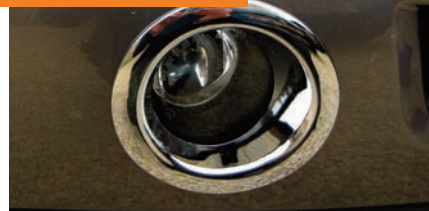

DXB000231LML



DXB000221LML

FOG LAMP BEZELS:

Not models with HST body styling kit.

chrome, pair

DXB000221-31BMC

primed, RH

DXB000221LML

primed, LH

DXB000231LML

GRILLE BADGE



DAG100330



DAG500160

GRILLE BADGE:

green and gold

DAG100330

black and silver

DAG500160

BADGES

RX1299



RX1299SE

30 x 50mm badge, choice of screw-on or self-adhesive types.

UNION FLAG BADGE:

screw-on (each), enamel

RX1299

self-adhesive (pair)

enamel

RX1299SE

resin

RX1299SR

SILL TREAD PLATE SETS

Set of bright polished tread plates, easily fitted with no drilling required.

SILL TREAD PLATE SETS:

- | | |
|---|--------------------|
| Land Rover 8 piece set
Inner and outer, front and rear tread plates with 'Range Rover' legend on front inner plates. | VPLSS0042 |
| Land Rover 4 piece set
Outer front and rear tread plates only with 'Sport' legend on front outer plates. | LR006788 |
| Britpart 8 piece set | VPLSS0042BP |



SIDE STEPS

Pair of side steps with rubber anti-slip strips ensuring safe entry and exit from vehicle. Easily mounted, with no drilling or cutting required. Alloy finish edge tubing with black rubber steps.

SIDE STEP SET, pair:

- | | | |
|-------------|---|--------------------|
| Land Rover | 1 | VPLSP0040 |
| Britpart | 1 | VPLSP0040BP |
| aftermarket | 1 | VPLSP0040P |

Additionally the genuine Land Rover side step set is also available as individual items:

SIDE STEP COMPONENT PARTS:

- | | | |
|---------------------------------|---|------------------|
| side step | | |
| RH | 1 | VPLSP0038 |
| LH | 1 | VPLSP0039 |
| side step fitting kit (car set) | 1 | VUB503460 |



BODY SIDE LOWER MOULDINGS

Standard fitment on HST model, offered by Land Rover as 'dress up' accessories for other models.

BODY SIDE LOWER MOULDINGS, primed:

- | | | |
|------------|---|-----------------|
| fender | | |
| RH | 1 | LR007355 |
| LH | 1 | LR007356 |
| front door | | |
| RH | 1 | LR007357 |
| LH | 1 | LR007359 |
| rear door | | |
| RH | 1 | LR007358 |
| LH | 1 | LR007360 |



DOOR RUBBING STRIP SETS

Set of 4 side mouldings, easily fitted to the doors to protect them from scratches and car park knocks.

DOOR RUBBING STRIP SET 1 DGJ500020PCL



REAR BUMPER TREAD MAT INSERT

LR007321BM

REAR BUMPER TREAD MAT INSERT:
Features 'SPORT' legend; available either as a cover or as a replacement for the original tread mat. Will not fit models with HST body styling.

- | | |
|------------------------------------|-------------------|
| cover for original tread mat | |
| Land Rover, stainless steel | LR007321 |
| Bearmach, chrome finish | LR007321BM |
| replacement for original tread mat | |
| Land Rover, stainless steel | LR007322 |



WE'RE HERE TO HELP
Can't find or not sure of the right part for your car, contact our technical sales team for help and advice.
01522 568000

DESCRIPTION

PART No.

DESCRIPTION

PART No.

DESCRIPTION

PART No.

SNORKEL - RAISED AIR INTAKE KIT



Fits straight to air intake aperture on RH front wing. Land Rover product.

RAISED AIR INTAKE KIT

ADL790020

FRONT UNDERBODY PROTECTION SHIELD



Heavy duty metal protection shield to G4 Challenge specification, compatible with the factory offered accessory winches VUB501470, VUB501471 and VPLAP0130.

UNDER-BUMPER PROTECTION SHIELD

KRQ500020

SNATCH BLOCKS



RA1377BM

Snatch blocks permit winching on different angles when straight line winching is not possible. They also greatly increase the winch's pulling capacity.

T-MAX SNATCH BLOCK, 4 inch
Powder coated, supplied with storage bag.
Doubles pulling capacity by up to 17650lbs.

RA1377BM

BRITPART SNATCH BLOCK
Suitable for winch ropes from 5mm to 10mm.
Maximum head load 16000lbs.

RA1377BP

RA1377BP



ELECTRIC WINCH KIT



Manufactured by Warn, this kit is the official Land Rover item specifically for Range Rover Sport models and comes with all fixings and fitting instructions. Described by Land Rover as 'extreme performance', it is rated with a 9500lb (4310Kg) maximum pull limit.

ELECTRIC WINCH KIT

VPLAP0130

Not included in the Electric Winch Kit but available separately is a hand-held remote control for this winch, if required.

WINCH REMOTE CONTROL

VUB504070

A kit of the sundry fixings and bracketry is available separately (it is also included in the Electric Winch Kit). This kit does not include the winch mounting armature or electrical wiring.

WINCH SUNDRY FIXINGS KIT

VUB504000

WINCH ACCESSORY KITS



RA1376BPSTD

STANDARD WINCH ACCESSORY KIT

RA1376BPSTD

Includes winch kit bag, 16000lbs snatch block, 8 ton tow strap (60mm x 9m), tree strap, winching gloves and two 4.75 ton alloy bow shackles.



RA1376BPDELUXE

DELUXE WINCH ACCESSORY KIT

RA1376BPDELUXE

Includes winch kit bag, 16000lbs snatch block, 8 ton tow strap (60mm x 9m), tree strap, winching gloves, two 4.75 ton alloy bow shackles, two wheel chocks, 10 ton snatch tow sling and winching blanket.

? WE'RE HERE TO HELP
Can't find or not sure of the right part for your car, contact our technical sales team for help and advice.
01522 568000

RUBBER FOOTWELL MATS

Heavy duty, easy-cleaning black rubber footwell mats supplied as sets of four for the front and 2nd row footwells or sets of two for the front row footwells only. Mats feature 'Range Rover' branding. Sets are compatible with the standard Range Rover Sport mat fixings for safety and practicality.

RUBBER FOOTWELL MATS, black:

front & 2nd row footwells (set of 4)

RHD

to VIN 7A999999
VIN 8A000001 on

VPLSS0104
VPLAS0197

LHD

to VIN 7A999999
VIN 8A000001 on

EAH500051PMA
VPLAS0198

front footwells only (set of 2)

RHD

to VIN 7A999999
Land Rover
aftermarket
VIN 8A000001 on

VPLSS0103
VPLSS0103P
VPLSS0106

LHD

to VIN 7A999999
VIN 8A000001 on

EAH500059PMA
LR006244

rear footwells only (set of 2)

aftermarket

VPLSS0103RP



CARPET FOOTWELL MATS

Durable yet luxurious deep pile carpet footwell mats, supplied as a set of four including the standard Range Rover Sport mat fixings for safety and practicality. Features include Range Rover branding and stylised alloy fixing points.

Available in choice of Ebony Black, Aspen Grey and (from VIN 9A000001 onwards) Nutmeg.

CARPET FOOTWELL MATS, PREMIUM SET,

with 'Range Rover' badge (set of 4):

RHD

to VIN 7A999999
Ebony Black

EAH500012PVJ

VIN 8A000001 on
Ebony Black

VPLAS0195PVJ

Aspen

LR006434

Nutmeg (9A000001 on)

VPLSS0006SVB

LHD

to VIN 7A999999
Ebony Black

EAH500011PVJ

Aspen

EAH500011LUP

VIN 8A000001 on

Ebony Black

VPLAS0196PVJ

Aspen

LR006436

CARPET FOOTWELL MATS, PREMIUM QUALITY,

without badge (set of 4):

Premier quality, fully tailored with non-slip backing, these mat sets are easily cleaned and include all fixings to locate on original Land Rover mat attachment points. Available in Black or Mid-Grey.

RHD

Black

EAH500012PVJBM

Mid-Grey

EAH500012LUPBM

LHD

Black

EAH500011PVJBM

Mid-Grey

EAH500011LUPBM



VPLSS0006SVB



EAH500012PVJ



EAH500012PVJBM

LOAD COMPARTMENT MATS & LINERS



RUBBER LOAD SPACE MAT - VPLSS0043

RUBBER LOAD SPACE MAT, black:

Heavy duty, easy-cleaning black rubber mat to protect the load space carpets in your Range Rover Sport. The Land Rover item features Range Rover branding and is pre-trimmed to reveal the load floor tie-down loops.

Land Rover
Bearthach

VPLSS0043
VPLSS0043BM

LOAD SPACE LINER, semi-rigid:

Almost completely damage-resistant load space liners are ideal for sharp or heavy loads which would otherwise harm your car. The non-absorbent, wash-down synthetic material together with a deep lip around the edge means inadvertent spillages aren't a problem, either.

Land Rover
Britpart

EBF500020
EBF500020BP

LOAD SPACE PROTECTOR, flexible

Tear-proof and waterproof, the load space protector comes up to window height at the sides and seat-top height at the front. The rear features a flap to protect the rear door lip and bumper when loading or unloading. Ideal for transporting hedge cuttings or firewood!

Land Rover

VPLSS0016

WE'RE HERE TO HELP
Can't find or not sure of the right part for your car, contact our technical sales team for help and advice.
01522 568000



LOAD SPACE PROTECTOR - VPLSS0016

LOAD SPACE LINER - EBF500020

LUGGAGE NET



Durable, elasticated net, securing most types of luggage. Easily fixes to load tie-down loops on load floor side covers.

LUGGAGE NET, accessory:
Land Rover
OEM

VPLCS0269
VPLCS0269P1

CARGO BARRIER/DOG GUARDS



VUB502080BP

CARGO BARRIER/DOG GUARD:

Mesh guard assembly, includes fitting kit.

full width

Land Rover
Britpart

VPLSS0205
VUB502080BP

centre divider

For use with full width cargo barrier/dog guard.

Land Rover
Britpart

EOH500140PMA
EOH500140PMABP



VUB502080BP

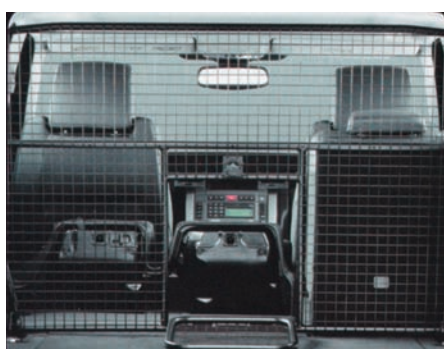

VPLSS0205



EOH500140PMA

FASCIA & CONSOLE VENEER KITS



LR003873

LR003872

WOOD AIR VENT SURROUND KIT, self adhesive:
 Accessory 4 piece kit of self adhesive covers for outer and centre face level air vent panels in choice of Lined Oak/Ebony Black or American Cherry finishes.

Lined Oak/Ebony Black
 American Cherry

LR003873
 LR003872



WOOD CENTRE CONSOLE SIDE FINISHER KIT:
 Also known as 'hockey sticks'; also available in choice of Lined Oak/Ebony Black or American Cherry finishes, to match the wood air vent surround kits above. Note that standard fitment 'hockey sticks' are available in a range of metallic or alternative wood finishes - for the full range, please see the 'Interior - Centre & Overhead Consoles' section.

Lined Oak/Ebony Black, pair
 American Cherry, pair

VUB501165
 VUB501164



VUB501164

PEDAL & FOOTREST COVER SET



Three piece set of sports covers, fashioned from stainless steel and rubber - includes covers for accelerator and brake pedals, plus footrest cover.



SPORTS PEDAL COVER SET:
 Land Rover
 Britpart

LR008713
 LR008713BP

CHILD SEATS



VPLMS0007

VPLMS0008



LR006637

LR004940

LAND ROVER WATERPROOF SEAT COVERS

Genuine factory Range Rover Sport nylon waterproof seat covers, featuring compatibility with armrests, headrests, airbags and (where appropriate) seat back DVD screens. Heavy duty materials in choice of Sand Beige or Aspen Grey.

WATERPROOF SEAT COVER SET, Land Rover:
 front row seats only, 2 seat set
 without DVD screens

Sand Beige
 Aspen Grey

LR005216
 LR005215

with DVD screens

Sand Beige
 Aspen Grey

VPLSS0010SUN
 VPLSS0010LUP

2nd row seats only, 3 seat set

Sand Beige
 Aspen Grey

LR005225
 LR005224



LR005225



LR005215



LR005216

CHILD SEAT, forward fixing:
 To use Isofix mountings on car seat.

'Cosy Tot' baby carrier

VPLMS0007

0-9 months. Requires Isofix base part no. VPLMS0008.

Isofix base, 'Cosy Tot' carrier

VPLMS0008

'Duo Plus' child seat

LR006637

9 months-4 years (9-18kg).

'Evolva Ultra' child seat

LR004940

4-11 years (15-36kg). Booster and backrest assembly.

STRAP, child seat securing

VTN500010

Uses Isofix mounting points behind seat.

TOW BAR CYCLE CARRIER KITS



TOW BALL FREE TYPE, for two bicycles:
Fits directly to tow bar while still allowing a trailer to be towed.
Padded to protect bikes from damage and supplied complete with bike tie-down straps.

Land Rover	1	STC50063
Britpart	1	STC50063BP

TOW BALL MOUNTING TYPE:
Bicycle carrying module, fitting to tow ball. Features rear lights and number plate holder. Supplied complete with bike tie-down straps.

RHD models		
carrier for 2 bicycles	1	VPLVR0066
carrier for 3 bicycles	1	VPLVR0068
LHD models		
carrier for 2 bicycles	1	VPLVR0067
carrier for 3 bicycles	1	VPLVR0069

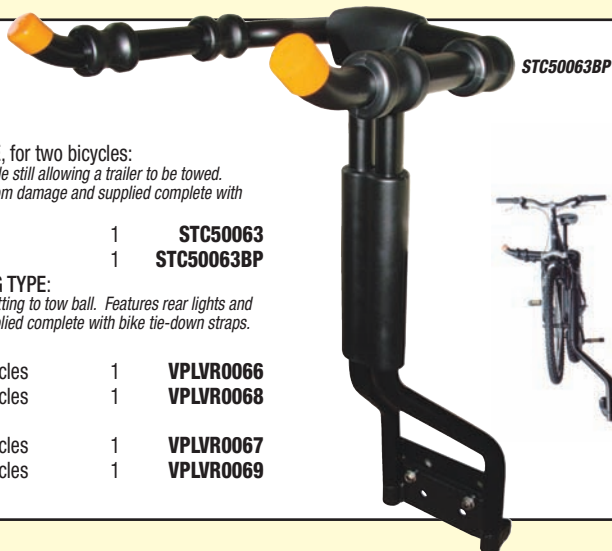

STC50063BP

TOW BAR & TOWING ELECTRICS



LR071295P1

TOW BAR KIT:

fixed height type

Includes tow bar, ball and cover, plus lockable quick-disconnect handle.

Land Rover	LR071295
Thule (OEM)	LR071295P1

adjustable height (drop plate) type

Includes tow bar, ball and cover, drop plate and reinforcing struts, electrics plate, fixings kit, plus lockable quick-disconnect handle.

Land Rover	LR043271
OEM	LR043271P1
Bearmach	LR043271BM
Britpart	LR043271BP

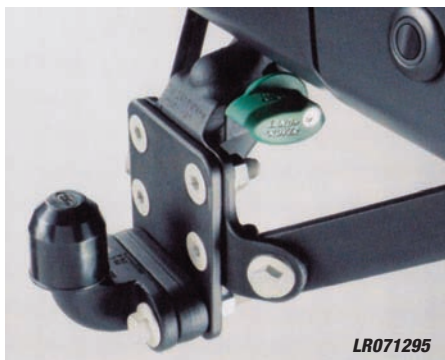

LR071295

TOWING JAW, ball & pintle type

For drop plate type tow bar only. Replacement parts for the Dixon Bate jaws are also available - please contact us for details.

Land Rover	LR008244
aftermarket	LR008244P
Britpart	LR008244BP
Dixon Bate	LR008244BPDIX
Dixon Bate heavy duty	LR008244BPHD

ADAPTOR/PLINTH, electrics socket:

7 pin 12S type socket	VSA500060
13 pin type socket	VSA500110

TOWING ELECTRICS KIT:

Includes towing socket, socket harness and link lead.

for 7 pin socket (12N & 12S types)

Land Rover	YWJ500150
Britpart	YWJ500150BP
Bearmach	YWJ500150BM

for 13 pin socket

Land Rover	YWJ500160
Britpart	YWJ500160BP
	RX1513

TRAILER LIGHTING BOARD

4' wide, with 4 metre cable.



LR008244BPDIX



LR043271BM

WE'RE HERE TO HELP
Can't find or not sure of the right part for your car, contact our technical sales team for help and advice.
01522 568000

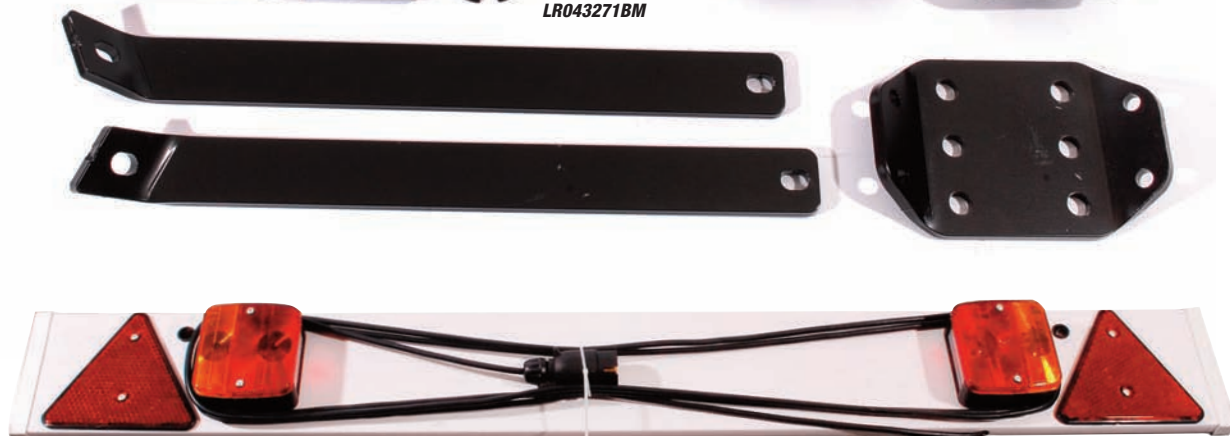

RX1513

ROOF RACK RAIL SYSTEM



ROOF RACK RAIL KIT - VUB502130BP

Kit includes raised roof side rails, locking cross rail assemblies and keys. The cross rails, easily removed when not in use, accept all roof stowage accessories detailed in this section.

ROOF RACK RAIL KIT:
 Land Rover **VUB502130**
 Britpart
 Thule **VUB502130BP**
 Mont Blanc System 3000 **VUB502130BPPREM**

LUGGAGE CARRIER FRAME



LUGGAGE CARRIER FRAME - LR006848

For use in conjunction with roof rack cross rails. Includes fixings.

LUGGAGE CARRIER SET:
 standard, 2/3 roof length **LR006848**
Includes fixings.
 expedition, full roof length **CAB500130PMA**
Includes main fixings - for full set, kit number VUB504230 is also required.
FITTING KIT, expedition carrier **VUB504230**
LASHING EYE KIT, expedition carrier **VUB503160**
For use in conjunction with full roof length expedition luggage carrier. Includes six lashing eyes.
RATCHET STRAP, tie down **CAR500010**
For use in conjunction with standard or expedition luggage carrier.

LUGGAGE BOX



VPLVR0062

With 75Kg capacity. For use in conjunction with roof rack cross rails. Includes fixings and fittings kit, plus spacer plate.

LUGGAGE BOX ASSEMBLY, 410 litre size **VPLVR0062**
SPACER PLATE, luggage box **LR005336**

CANOE/SURF BOARD CARRIERS



For use in conjunction with roof rack cross rails. Includes fixings and fasteners preventing sideways movement of and subsequent damage to canoes, sail boards or surf boards.

CANOE/SURF BOARD CARRIER SET **VPLGR0107**

REAR LADDER KIT



AGP790020

G4 Challenge specification ladder, permits easier access to roof rack systems. Fits to rear door (opening rear door glass is disabled when fitting). Includes fixings.

REAR LADDER KIT **AGP790020**

SNOW CHAINS



VUJ000010



VPLSW0079

SNOW CHAINS:
Includes a pair of snow chains and fixings for the front wheels only.
 for 17" wheels **VUJ000010**
 for 18", 19" & 20" wheels **VPLSW0079**

SKI/SNOWBOARD CARRIERS



For use in conjunction with roof rack cross rails.

SKI CARRIER SET:
 open frame type **LR006849**
Includes pair of locking ski carrier assemblies, fixings and keys.
 enclosed sports box type **VPLVR0061**
Includes ski carrier box, fixings and keys.



JUMP START KIT

Small and lightweight high capacity nano lithium polymer portable power pack with the latest battery technology. Supports fast charging with low self-discharge cycle. Charging cycles can reach more than 1,000 times. Supports 12V jump starts as well as back up charging for many brands of mobile phones, laptops, tablets, portable refrigerators etc. Support 3 different types of charging modes. Built in redundant electronic control safety protection for jump starter over-charging and over-discharging.

Multi-function jump starter & charger for electronic products...
 Lap tops
 Mobile phones
 Portable games
 Tablets
 Portable DVD
 Music players
 Plus much more...



RX1410BPXD



RX1410BPXS

JUMP START KIT & CHARGER KITS
 XD model
 XS model

RX1410BPXD
 RX1410BPXS

BATTERY CHARGER & BATTERY ACID TESTER



BATTERY CHARGER, 6 and 12 volt
 Conventional battery charger, ideal for charging a flat battery quickly or overnight charging.

GAC7106



BATTERY ACID TESTER

CONS295230

AIR HORNS



AIR HORN KIT, pair

RX1381

POWER SOURCE INVERTER

A power source inverter converts car battery voltage (12v) into a 240v output. You can plug in a variety of mains voltage appliances into the standard UK socket. Three different inverters are available to suit a range of power requirements. There is overload, overheat and short circuit protection on all models.



Great for in car entertainment and leisure use!

150 WATT MODEL RX1551-150
 Continuous power: 150w. Peak power: 300w
 Cigar lighter plug connection. 15A fuse.
 Suitable applications: TV, DVD, Video, Computer Consoles, Lights (not fluorescent) Phone charger etc.

300 WATT MODEL RX1551-300
 Continuous power: 300w. Peak power: 660w
 Cigar lighter or battery clip connection.
 40A fuse.
 Suitable applications: as 150w model plus small power tools, small fridges, stereo etc.

500 WATT MODEL RX1551-500
 Continuous power: 500w. Peak power: 800w
 Battery clip connection only. 70A fuse.
 Suitable applications: as 300w model plus medium power tools, colour TV's with DVD's, battery chargers etc.

BATTERY CONDITIONER



The battery conditioner is a battery charger that turns on and off automatically. This superb product is suitable for all 12 volt batteries (from 5ah to 100ah) and constantly revitalises the battery cells - helping to extend cell life, without the danger of overcharging.

- Look at these benefits:
- Designed to be left connected for long periods.
 - Use without disconnecting vehicle electrics.
 - L.E.D. battery condition display.
 - Thermal cut-out facility.
 - 12 month guarantee.

It can also be used for the following applications, providing they use a 12 volt battery: caravans, lawn mowers, motorbikes, motor boats, wheel chairs and general leisure use. The kit is supplied complete with all fittings and operating instructions.

BATTERY CONDITIONER KIT:
 0.8 amp version
 3.8 amp version

RX1410CTEK
 RX1410CTEK3800

WORKLIGHTS

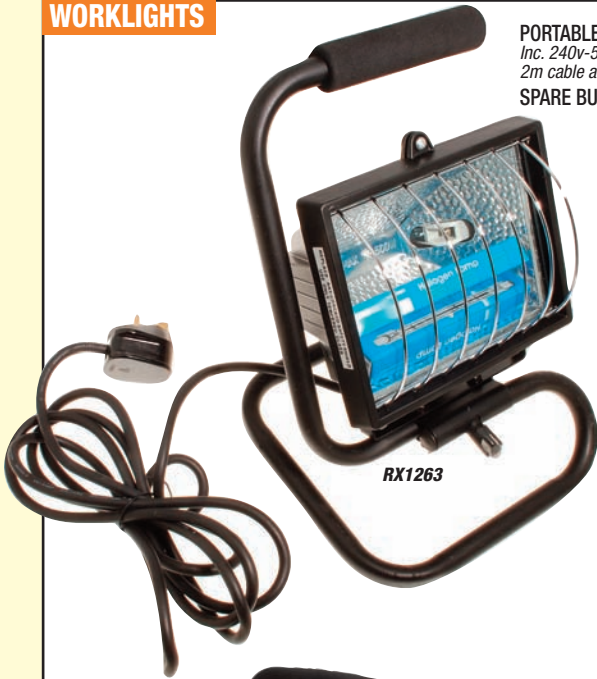

PORTABLE HALOGEN WORKLIGHT (500w) RX1263
Inc. 240v-500w tungsten halogen lamp, 2m cable and BS plug.
SPARE BULB (for RX1263) RX1263B

Ideal for working on your car or for jobs around the house.



RX1263TFLED

LED ROUND WORK LAMP

Multi-voltage.
 Extreme long life up to 50,000 hours.
 800 lumens light output.
 Medium flood beam pattern.
 Tough and heat resistant hardened glass lens.
 Waterproof housing rated at IP66.
 Stainless steel mounting bracket with bolt fixing.
 3 year warranty.

Product Dimensions (mm): H 150 x W 120 x D 84
 Voltage: 12-48V DC
 Watts: 12W

LED ROUND WORK LAMP

RX1263TFLED



RX1263TFR

DUAL VOLTAGE ROUND SWITCHED WORKLAMP

Dual voltage.
 H3 bulb fitment.
 Wide flood light output.
 Polycarbonate lens - Clear.
 Impact and heat resistant polypropylene housing.
 Protected switch.
 1 year warranty.

Product Dimensions (mm): H 253.0000 x W 168.0000 x D 119.0000
 Weight (kg): 0.7720
 Voltage: 12/24V DC
 Watts: 55/70W
 ECE Type: H3
 Cap Type: PK22s

ROUND WORKLIGHT

RX1263TFR



RX1263TFS

DUAL VOLTAGE RECTANGULAR SWITCHED WORKLAMP

Dual voltage.
 H3 bulb fitment.
 Handle for repositioning lamp, can be rotated through 270° and angled through 90°.
 Polycarbonate lens - Clear.
 Impact and heat resistant polypropylene housing.
 Heavy duty zinc plated bracket.
 1 year warranty.

Product Dimensions (mm): H 239.0000 x W 176.0000 x D 91.0000
 Weight (kg): 0.6580
 Voltage: 12/24V DC
 Watts: 55/70W
 ECE Type: H3
 Cap Type: PK22s

RECTANGULAR WORKLIGHT

RX1263TFS



RX1263BPHL

HIGH POWER MECHANICS HEADLAMP

3W Cree LED provides 320 lumens of light output.
 Operating times: 2.5hrs (high); 8hrs (med) & 18hrs (low).
 Lamp adjusts through 50° to focus on work area.
 Tough & robust impact resistant aluminium construction, ideal for a workshop environment.
 Weatherproof design for outdoor use.
 Adjustable headstrap with padding for comfortable usage.
 4 x AAA batteries included.

MECHANICS HEADLAMP

RX1263BPHL

INSPECTION LAMPS

Rechargeable and cordless multi-position inspection lamps, in a choice of standard (15 LEDs) or heavy duty (21 LEDs) formats.
 Compact and robust, both designs include an integral belt clip and a virtually unbreakable polycarbonate lens with wide angle light output.
 The standard lamp features a hook/stand for multi-positional use while the heavy duty lamp is supplied with a charging station.

RX1424BMLEDHD

WE'RE HERE TO HELP
 Can't find or not sure of the right part for your car, contact our technical sales team for help and advice.
01522 568000

INSPECTION LAMP, rechargeable
 Plugs into mains.

15 LEDs standard lamp
 21 LEDs heavy duty lamp

RX1424BMLED
RX1424BMLEDHD



RX1424BMLED



TYRE PRESSURE MONITOR



New generation system for cars and vans

TB99 is our newest model for cars and vans with a small dashboard mounted monitor that displays the pressure of four tyres up to 99psi simultaneously and can be set up to monitor the spare tyre as well.

- Neat system, reliable and very easy to install
- Clear visible and audible alerts
- User set alert levels for low pressure, high pressure and high temperature
- Automatic back light
- Rechargeable monitor battery

The TB99 monitor continuously displays the pressure of four tyres. If there is a fifth sensor, it alternately displays the four tyres and then the spare. Tyre temperatures are shown at the press of a button.

New generation sensors simply screw on to the tyre valves in place of the normal dust caps, and they have an integral anti-theft design. They are smaller and lighter than previous models and improved electronics give up to 2 year life from the replaceable CR1632 batteries

Box contents

- TyrePal TB contents
- 1 Monitor
 - 1 Monitor mounting pad
 - 1 Charging lead
 - 4 Sensors with batteries fitted
 - 4 Locking screws
 - 2 Locking keys
 - 1 Pair sensor tools

TYRE PRESSURE MONITOR

RX1595TP



PORTABLE AIR COMPRESSORS

Ideal for 4x4 use and also great for camping and outdoor use.

- 10 metre air hose with heavy-duty gauge and brass fittings
- Automatic cut off to prevent overheating
- Integrated sand tray
- Blow moulded carrying case

PORTABLE AIR COMPRESSOR:

single

RX1599BPSINGLE

Air flow - 72ltr/min. Max. pressure - 150psi.
12 volt / 50 amp.

double

RX1599BPDOUBLE

Air flow - 150ltr/min. Max. pressure - 150psi.
12 volt / 50 amp.



RX1599BPSINGLE



RX1599BPDOUBLE

LED BULBS

LED bulbs are durable and vibration resistant, they have a longer life than standard bulbs. They give out an ultra bright light using just a fraction of the power of a standard bulb.



GLB380LED



GLB382LED



GLB380LED-RED



GLB382LEDRED



GLB382LEDAMBER



GLB501LED

LED BULBS (each);

- 12V 21/5W
- 12V 21/5W RED
- 12V 21W C/C
- 12V 21W C/C AMBER
- 12V 21W C/C RED
- 12V 5W LED

- GLB380LED
- GLB380LED-RED
- GLB382LED
- GLB382LEDAMBER
- GLB382LEDRED
- GLB501LED

SPARE BULB KIT



LAND ROVER SPARE BULB & FUSE KIT
Includes spare bulbs and fuses appropriate for Range Rover Sport models.

VUB500110

WE'RE HERE TO HELP
Can't find or not sure of the right part for your car, contact our technical sales team for help and advice.
01522 568000



ORDER

BY PHONE: 01522 568000 / ON LINE: www.rimmerbros.co.uk / E-MAIL: lrsales@rimmerbros.co.uk

REVERSING CAMERA KIT

REAR FACING CAMERA KIT - INCLUDES MONITOR

Seeing exactly what is behind a Land Rover is not easy using conventional mirrors. This kit is a practical driver assistance device with the primary objective of helping the driver to see things that they may not otherwise see when reversing.



Features of the kit with monitor
 Waterproof rear view or reverse camera.
 Small, discreet, MicroBlock™ colour camera.
 Slimline 3½" LCD monitor.
 Typically installed above number plate to include the rear bumper in the field of view.
 Outstanding image quality both day & night.
 Panoramic view.
 Instant image on.
 Single cable installation technology - easy to install.
 IP68 rated so 100% water and dust proof.

REVERSING CAMERA KIT **RX1710BP**

ADDITIONAL FORWARD FACING CAMERA KIT



Front facing camera kit - no monitor
 An additional camera to add to RX1710BP

Easy to install camera kit. The camera is the only external part and much like the vehicle it will be installed on it can be submerged in water, it can be blasted by a jet wash, sprayed with mud. Effectively there is very little that can be done to damage the camera, short of hitting it with a solid object. But even then it can withstand some abuse.

FORWARD FACING CAMERA **RX1710BPFFCAM**
 For RX1710BP.

AUTOMATIC REVERSING CAMERA KIT

This is a high performance, fully automatic, practical driver assistance device. The primary objective is very simple: to help a driver to see things that they may not otherwise see when reversing.

With the patented cable technology, installation should take around 30 - 45 minutes. No other system in the market is as quick and easy to install.

Features of the kit with monitor
 Small, discreet, camera.
 Typically installed above number plate to include the rear bumper in the field of view.
 Outstanding image quality both day and night.
 Panoramic view.
 Instant image on.
 Single cable installation technology.
 IP68 rated (100% water and dust proof).
 Works seamlessly with supplied LCD monitor.



REVERSING CAMERA KIT (Fully automatic) **RX1710BPAUTO**

DIS-CAR-NECT

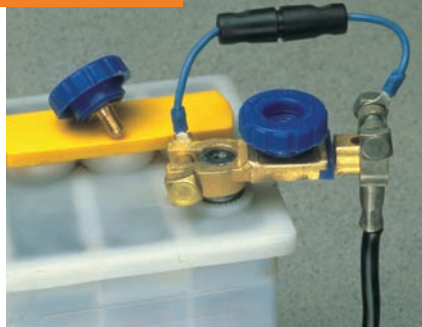

'DIS-CAR-NECT' STARTER IMMOBILISER **RX1356**
 REPLACEMENT SCREW KNOB **RX1356K**
 REPLACEMENT FUSE **RX1356F**

HOW DOES 'DIS-CAR-NECT' WORK?

When leaving your car, simply remove the knob to isolate the starter circuit. The 16 amp by-pass fuse will maintain current to all other electrical circuits (stereo memories, vehicle alarm etc). Because the starter motor draws over 150 amps, any attempt to connect (hot wire) the starter motor will instantly cause the fuse to blow, immobilising the car until the knob is replaced. If this should happen, simply replace the 16 amp fuse at a convenient time. For extra security, unscrew and remove the immobiliser knob completely, and if you intend to store your vehicle for some time, 'Dis-Car-Nect' will also prevent battery drain, simply unscrew the knob and remove the fuse. Fits all vehicles and is easily fitted to any battery terminal. Full installation/user instructions supplied with every unit.

ELECTRIC COOL BAG

Genuine Land Rover accessory, powered by a 12 volt auxiliary socket and thermostatically temperature controlled. Easy clean interior surface. Height 380mm, Length 380mm, Width 220mm, Volume 14 Litres.



ELECTRIC COOL BAG, Land Rover **VUP100140L**

LED LOGO PUDDLE LAMP KIT

LED puddle lamps, with Land Rover logo embedded in the beam, ideal for adding that personal touch to your Land Rover vehicle. The lamps are designed to operate when you open the door of your vehicle to illuminate the floor below. These lamps may also be installed internally to illuminate the interior footwell of the vehicle. Flush fitting, for discreet installation.

Kit includes two puddle lamps with wiring, plus core cutter to make mounting holes.



PUDDLE LAMP KIT, with LED logo **RX1267**

WIND DEFLECTOR SETS

Easily fitted wind deflectors for Range Rover Sport side door windows, manufactured in durable Perspex. Design reduces draughts and rain ingress when driving with opened windows, while maintaining good ventilation. Sold as car set of four deflectors.



WIND DEFLECTOR SET:
Land Rover
Britpart
Bearthach

VUB502520
VUB502520BP
VUB502520BM



BODY COLOUR HEADLAMP WASHER JET CAPS



Original fitment for HST body styling kit; will fit other models.

CAP SET, headlamp washer jet, pair:
Santorini Black VPLAB0025PAB
Galway Green VPLAB0025HAC
Zermatt Silver LR007918
primed VPLAB0025LML

OUTDOOR COVERS



The Galaxy premium outdoor car cover is manufactured from heavy duty polyester with a superior satin finish. The resultant material has a very high tear strength combined with excellent water repellency and UV protection. This is enhanced by a waterproof membrane and heat sealed seams. The excellent waterproofing and breathability of the outer shell is combined with a soft moisture resistant fleece lining to provide the ultimate protection.

GALAXY OUTDOOR CAR COVER:
Range Rover Sport & L322 RA2113G

The Eclipse outdoor car cover is made from polypropylene with a breathable membrane. The four-layer construction consists of two non-woven top layers which gives good UV protection and water repellency. The third layer is a breathable/waterproof film, and the fourth is a non-woven soft inner lining for scratch resistance.

ECLIPSE OUTDOOR CAR COVER:
Range Rover Sport & L322 RA2113E

WE'RE HERE TO HELP
Can't find or not sure of the right part for your car, contact our technical sales team for help and advice.
01522 568000

VEHICLE NUMBER PLATES



Number plates can only be sold directly to the owner of the vehicle together with proof of ownership and personal identification.

We will need sight of the following three original documents:-

- Vehicle registration document (V5)
- Driving Licence or utility bill.
- Passport or credit card (with photo ID), or travel/works pass (with photo ID).

Number plates are made to special order.

Please note that it is also now mandatory in the UK for all new number plates to bear the originating suppliers name, postcode and telephone number (i.e. Rimmer Bros).

VEHICLE NUMBER PLATE - Front
Standard NPF
Standard with 'GB' logo NPFGB
Deluxe - 3D effect NPF3D
Deluxe - 3D effect with 'GB' logo NPF3DGB

VEHICLE NUMBER PLATE - Rear (oblong)
Standard NPR
Standard with 'GB' logo NPRGB
Deluxe - 3D effect NPR3D
Deluxe - 3D effect with 'GB' logo NPR3DGB

VEHICLE NUMBER PLATE - Rear (square)
Standard NPRS
Deluxe - 3D effect NPRS3D
Deluxe - 3D effect with 'GB' logo NPRS3DGB

FITTING KIT - number plates NPK
Universal kit including 4 self tap screws, 2 white cups, 2 yellow cups & 8 double sided adhesive pads.

LAND ROVER MERCHANDISE



For full range of products currently available, please visit our website.

ACCESSORIES - LAND ROVER GEAR

PEAK CAP

Design may vary



TERRAIN BASEBALL CAP, grey
Outdoor inspired baseball cap with Land Rover iconography detail.
LACH015GMA
'RIMMER BROS' PEAK CAP
RX1425PC

MUGS

Design may vary



'RIMMER BROS' COFFEE MUG
RX1544A

SIGN



METAL PARKING SIGN
SIZE 297mm x 420mm.
LR01355P

KEY FOBS



LEATHER KEY FOB;
'Range Rover' **RA1406** brown
'Discovery' **RD1125** black
'Freelander' **LF1060** ivory
Union Jack **RX1545** red
V8 **RX1537**

GENUINE LAND ROVER LEATHER LOOP KEYRING:
LKRKALLK
LKRKALLKB
LKRKALLKI
LKRKALLKR



GENUINE LAND ROVER 'HUE166' KEY FOB **LKRKRANHUE**
Cast alloy key ring taking inspiration from the number plate of the first Land Rover, HUE166.
LKRKRANHUE
LKRKALLK
LKRKALLKB
LKRKALLKI

QUIK TAPE SILICONE RUBBER TAPE

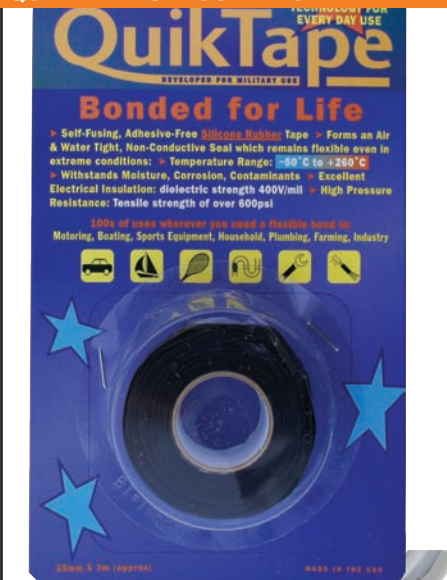

Self-adhering and fusing, curing into a solid rubber insulator in less than 24 hours. Resists moisture and temperatures up to 260°C. Gives a tough, permanent insulation seal around electrical connections, hoses, pipes (including exhaust) etc.

QUIK TAPE **RX1479**
Black. 25mm wide x 0.5mm depth x 3m length.

COOL TAPE

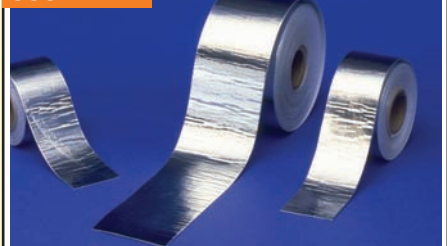

Consists of a 1mm aluminised material bonded to a lightweight, woven fibreglass with super strong adhesive backing. Reflects radiant heat. Limitless application, but common uses include wrapping cables, hoses, fuel lines, 'spot' heat retardation areas and sealing gaps in floors or firewalls. The best product on the market! Flexible, strong adhesive and thin for a tight wrap.

COOL TAPE **RX1474**
Available in 13/8" x 15', 13/8" x 30' and 2" x 60' rolls.

UNIVERSAL HEAT SHIELD

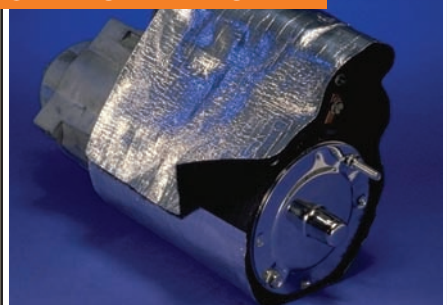

This multi-purpose heat shield can be used to protect starter motors, carbs, fuel pumps, electrical boxes, instruments and hydraulic cylinders from intense heat. Easily cut to shape (scissors or knife) it attaches to itself with velcro material. Simply cut off excess material.

UNIVERSAL HEAT SHIELD **RX1470**
7" wide x 24" long

HI-TEMP SHRINK TUBES

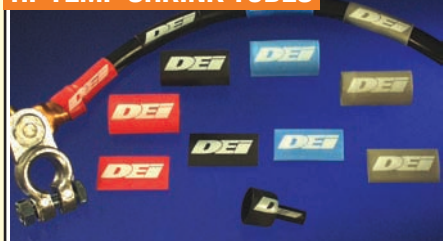

These shrink tubes are already supplied with the HT lead kits listed below. They can also be used for many other applications such as an enhanced appearance to any hose or wire, bundle wires as alternative to plastic ties or protecting electrical connections. Available in grey, black, red, blue and in 2 sizes, with a shrink ratio of 3 to 1. Easily installed with naked flame. 18mm size shrinks to 6mm and 12mm size shrinks to 4mm. Supplied in packs of 25.

HI-TEMP SHRINK TUBES;
18mm dia x 38mm long (Pack of 25) **RX1468**
12mm dia x 38mm long (Pack of 25) **RX1469**

THERMAL HEAT SLEEVES



This high temperature sleeving will protect wiring, HT leads, hydraulic hoses and coolant hoses from radiant heat. Two different designs are offered. The fixed tube type is designed to slide over wiring/hoses whereas the velcro type can be easily installed without having to disconnect anything. Easy to cut and shape to suit. Supplied in 3ft lengths.

FIXED TUBE SLEEVE **RX1471**
Supplied in diameters of 0.5", 0.75", 1", 1.25", 1.5"
(all 3ft long)
VELCRO SLEEVE **RX1472**
Supplied in 1 size - 0.5"-1.5" diameter (3ft long).



HEAT & SOUND INSULATION



Designed for insulating floors, bulkheads, transmission tunnels and many other applications from the effects of heat, road noise, engine and transmission noise. Made from an aluminium face bonded to a 1/8" composite fibreglass insulation, then backed to an aggressive adhesive. Tough enough for under vehicle applications and harsh environments where high heat can be a problem. Can also block out up to 50% of unwanted noise. Self adhesive, can be cut with tin snips to any shape.

INSULATION MATERIAL **RX1473**
Supplied in 3 sizes: 2' x 21" (3.5sq ft), 4' x 21" (7sq ft), 4' x 42" (14 sq ft).

HT LEAD & SPARK PLUG PROTECTION

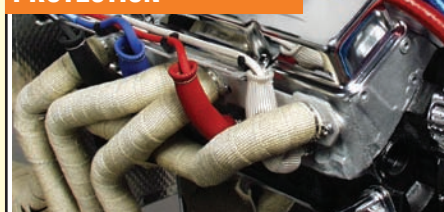

Protect your HT leads and spark plugs from extreme heat and improve the appearance of your engine bay with these top quality products. Ideal for tubular extractor manifold applications where additional heat is generated, but may be fitted to a standard vehicle.

Note: For Manifold insulation wrap, refer to 'Exhausts' in relevant catalogue.



SPARK PLUG SLEEVES
Manufactured from a fibreglass composite material (no arcing), the sleeves slide over the ends of the HT leads, easy installation. Available in silver, black, red or blue.

SPARK PLUG SLEEVES
2 cylinder kit **RX1462**
Order 2 kits for 4 cylinder, 3 kits for 6 cylinder.
8 cylinder kit **RX1463**



HT LEAD SLEEVES
Made from the same material as the spark plug sleeves - these easy install, snug - fitting sleeves will fit any HT lead up to 10mm in diameter. Also included are hi-temp shrink tubes for a sharp finished appearance. Available in silver, black, red or blue.

HT LEAD SLEEVES
2 cylinder kit **RX1464**
Order 2 kits for 4 cylinder, 3 kits for 6 cylinder.
8 cylinder kit **RX1465**



HT LEAD & SPARK PLUG SLEEVE KIT
These kits comprise of both kits listed opposite in one convenient (and cost effective) kit. Colour matched sleeves available in silver, black, red or blue.

HT LEAD & SPARK PLUG SLEEVE KIT
2 cylinder kit **RX1466**
Includes 7ft of HT lead sleeve,
2 plug sleeves & 6 shrink tubes.
Order 2 kits for 4 cylinder, 3 kits for 6 cylinder.
8 cylinder kit **RX1467**
Includes 25ft of HT lead sleeve, 8 plug sleeves
& 25 shrink tubes.

HAWKEYE DIAGNOSTIC TOOLS

The *Bearmach Omitec HawkEye* is every bit as useful as carrying a spare wheel with you and compact enough to carry in the glovebox at all times, particularly if you're on a long holiday journey or off-road adventure.

Modern vehicles have advanced engine management systems and high-tech developments in suspension and braking systems - so there's a host of problems that can only be properly identified using expensive equipment at the main dealers.

HawkEye is an inexpensive solution that gives the home mechanic or small independent garage the ability to diagnose most common faults.

Once the fault is repaired, *HawkEye* can be used to verify the work and clear the fault codes.



HAWKEYE DIAGNOSTIC TOOL, for Land Rover:
Supplied with pouch and standard J1962 onboard diagnostics (OBD II) cable.

English
French

BA5070
BA5070FRENCH

HAWKEYE DIAGNOSTIC TOOL
CODE BREAKER MANUAL

Helps decipher fault codes and their meanings.

BA5070CB



BA5075

ADDITIONAL VEHICLE UNLOCK CODE

Allows *HawkEye* user to access another specified model.

BA5075

HAWKEYE PRO DIAGNOSTIC TOOL

For workshop/dealer use, allows access to complete range of Land Rover vehicles capable of using *HawkEye*, including Defender, Range Rover Classic, P38a and L322, Discovery Series 1, Series II, 3 and 4, Freelander and Freelander 2.

BA5082



BA5072

ADAPTOR CABLE, *HawkEye*:

for Lucas 14CUX system
for Land Rover air suspension

BA5072

BA5073

REPLACEMENT CABLE, *HawkEye* Tool

BA5071

ADAPTOR PLUG:

green, Land Rover 10AS systems
grey
red
black

BA5076

BA5076

BA5077

BA5078

BA5080



BA5079

UPDATE CABLE

Allows *HawkEye* to be connected to a laptop or PC for firmware updates.

BA5079



BA5079A

ADAPTOR, continental 2 pin supply

Connects *HawkEye* to continental 2 pin external power supply (220V to 12V).

BA5079A

TERRAFIRMA DIAGNOSTIC TOOL

TerrafirMa
Serious 4x4 Accessories



TERRAFIRMA HAND HELD DIAGNOSTIC TOOL,
for Land Rover

TF930

Professional multi-system scanner
TF930 for Land Rover

Full system diagnosis tool enabling DIY problem solving - all at a bargain price!
Read and clear diagnostic trouble codes, read live data stream. Multi-language. Test modes include: CANBUS, ISO9141, KWP2000 AND J1850.

Key Features:

- 1 Fast full colour screen
- 2 USB 2.0 high speed upgrades
- 3 Support of multi-language
- 4 Read and clear Diagnostic Trouble Codes
- 5 Read live data stream
- 6 Full System Diagnosis
- 7 Pre-programmed for Land Rover

The Kit Includes:

- Handheld scanner
- USB 2.0 cable
- Protective case
- Free updates
- OBDII connector
- User manual
- 12-month warranty

LYNX DIAGNOSTIC TOOL

Finding and rectifying common Land Rover electrical faults has never been easier. Britpart have worked closely with Omitec to design and build a highly advanced Land Rover diagnostic tool. As well as the multi-vehicle professional version a single model home use version is available too.

The Lynx interface is Windows based and when running diagnostics on a laptop or Windows tablet, far more information can be displayed to the user than on a hand held device. Being Windows based there is familiarity and flexibility with the interface and navigation is much more intuitive.

What does Lynx do?

- Read fault codes
- Read live data
- Special functions
- Programming - such as alarm settings, key fobs etc.
- Clear fault codes
- Test actuators
- Service reset

What do you get with Lynx?

- Windows compatible software
- VCI to OBD II lead
- Activation form
- Carry case with foam insert
- Vehicle Communication Interface box (VCI)
- USB to VCI lead
- Quick start booklet
- Unlock code booklet

More about Lynx

As Lynx is Windows based, the system is future proofed due to your laptop or Windows tablet hard disk drive which allows for 'many more' number of updates compared to hand held devices. Lynx is powered by Omitec who build the T4 - Official Land Rover diagnostics tool. Live data can be displayed using graphics; making it easier to read time based events and the live data can be recorded on the lap top for a comparison, a great advantage over hand held diagnostic tools as they do not usually have storage memory.

The Windows based tool allows a simultaneous access to the vehicle diagnostics and consultation of circuit diagrams and other technical information. Allows you to access the internet if you are connected to it whilst diagnosing a vehicle and other such programs you might need to use in a garage environment. Lynx is supplied in a hard wearing carry case with foam insert to protect it when not in use. For the enthusiast home user using Lynx will mean no more trips to your local main dealer to clear any faults on your Land Rover.

LYNX DIAGNOSTIC TOOL

DA6430

TIMING TOOL KITS

Pin-point accuracy is of course essential when setting camshaft timing during an engine rebuild and that's exactly what these kits from Laser have been developed to ensure.

Including all the tools required to lock the engine in the desired stroke position and then accurately align the camshafts, the two kits cover the 2.7 TDV6 diesel engine (as fitted to Discovery 3 and Range Rover Sport) and the pre-2010 Jaguar-derived AJV8 petrol engine with timing chains, both in 4.4 normally aspirated and 4.2 supercharged forms (as fitted to Discovery 3, Range Rover Sport, Range Rover L322 and several Jaguar XJ, XK, S Type and XF variants).

LASER TIMING TOOL KIT:

2.7 TDV6 diesel
4.4 & 4.2 AJV8 petrol

RA1549

RA1548



MISFUEL DEVICE RESET KEY



For diesel models with 2010 model year (Discovery 4) type fuel tank.

Resets the misfuelling safety device in the fuel filler after it has been activated. The key is normally stowed behind the panel on the RH side of the luggage area (if you can't find yours).

RESET KEY, misfuel device, yellow

LR014047

ORDER

BY PHONE: 01522 568000 / ON LINE: www.rimmerbros.co.uk / E-MAIL: lrsales@rimmerbros.co.uk

RADIATOR RELIEF**COOLING SYSTEM ADDITIVE**

Radiator relief allows your radiator to transfer heat more efficiently, reducing your engines operating temperature (which is obviously controlled by the thermostat) by up to 30°F. You therefore have 'a little bit in hand' for those hot days stuck in traffic. This proven coolant additive will also cut engine warm-up time in half which will reduce engine wear which is most extreme when the engine is cold. Fully compatible with water and anti-freeze and is safe with cast iron and all alloys.



- 30°F lower operating temperature
- 50% quicker warm up time
- Safe with water/antifreeze mixture
- Safe with cast iron, alloy engines and heads
- Increased engine life!
- 100% biodegradable, non corrosive, non toxic
- For use in all water cooled engines

RADIATOR RELIEF (473ml) Treats 1 engine. **RX1461-473**

OIL DRIP TRAY

OIL DRIP TRAY, 635mm x 1200mm **GAC9905X**
Galvanised steel.

OILS & FLUIDS

ENGINE OIL, fully synthetic 5w30 (all models):

- Comma X-Tech
1 litre
2 litres
5 litres

XPXTC1L
XPXTC2L
XPXTC5L

TRANSMISSION OIL:

- manual gearbox, 1 litre
Land Rover
Castrol MTF BOT 338.
aftermarket
automatic gearbox, 1 litre
Land Rover
Shell ATF M1375.4.
OEM
aftermarket
transfer gearbox, 1 litre

TYK500030
TYK500030P
TYK500050
TYK500050P1
TYK500050P
IYK500010

DIFFERENTIAL OIL:

- not locking diff., 1 litre
Land Rover
Land Rover (Castrol SAF X0).
aftermarket
with locking diff., 1 litre
Land Rover (Castrol Carbon 75w90).

TYK500010
TYK500010P
LR019727

POWER STEERING OIL, 1 litre

- Land Rover
Land Rover (Texaco PSF cold climate 14315/33270).
aftermarket

STC50519
STC50519P

ANTIFREEZE:

- Land Rover
1 litre
5 litres
20 litres
XPART, Longlife Oat 5
1 litre
5 litres
20 litres

STC50529
STC50530
8510373

BRAKE FLUID:

- Dot 4
Land Rover
500ml
1 litre
MG Rover
500ml
1 litre
silicone fluid
Replaces conventional clutch/brake fluid.
Doesn't absorb water - doesn't degrade.
Will not harm paintwork if spilt.
500ml
1 litre

XP1LL
XP5LL
XP20LL

LR052652
LR052653

S3SHE05
S3SHE1

RX1327
RX1326

CASTROL OIL JUGS:

- 1/2 Pint
1 Pint
2 Pint
All Three Jugs

RX1395
RX1396
RX1397
RX1398



XPXTC5L

TYK500030

STC50519

XP1LL

RX1327

LR052652

Waterless Coolants**Life Time Cooling****No Water - No Overheating**

Classic Cool 180 deg has a boiling point of 180 deg C and will not boil over.

No Water - No Corrosion

Water contains oxygen, oxygen allows corrosion. Classic Cool 180 deg eliminates corrosion.

No Water - No Pressure

Classic Cool 180 deg allows your cooling system to run at a lower pressure, reducing the strain on engine components.

No Water - No Liner Pitting

Classic Cool 180 deg generates significantly less pitting when compared with all water based coolants.

No Water - More BHP

Classic Cool 180 deg eliminates premature detonation associated with overheating.



EVANS CLASSIC COOL 180 - WATERLESS COOLANT;

5 Litre **RX1672**
2 Litre **RX1673**

EVANS PREP FLUID

5 Litre **RX1674**
2 Litre **RX16742L**

Actively removes the loose dirt and scale from your cooling system which can cause inefficient heat transfer.



EVANS POWER COOL 180 - WATERLESS COOLANT;
Formulated specifically for use with modern alloy/performance Engines

5 Litre **RX1703**
2 Litre **RX1704**

EVANS VINTAGE COOL 180 - WATERLESS COOLANT;
Formulated specifically for use with vintage Engines

5 Litre **RX1697**
2 Litre **RX16972**

TOURING/SAFETY ACCESSORIES

VUB501080
LAND ROVER SPARE BULB KIT

RX1399
FIRST AID KIT

KDB500011
GAC9904X
FIRE EXTINGUISHER:
Land Rover
aftermarket, 1kg, red, powder

RX1344
WARNING TRIANGLE:
Land Rover
aftermarket

GAC2999
SAFETY JACKET, reflective

STC8919AA
TOW ROPE

27298
TREAD DEPTH GAUGE, TYRE

XPT00006ACAP
PRESSURE GAUGE, TYRE, DIGITAL

GAT347
FOOT PUMP, double barrel

RX1580
AIR COMPRESSOR, 12V:
Plugs into cigar lighter/accessory socket.
standard
heavy duty

LL1171
BATTERY ISOLATOR SWITCH

LL1171KEY
SPARE KEY

GENERAL CONSUMABLES

GAC111
WD-40 (Large 400ml)

RX1554
K-SEAL PERMANENT COOLANT LEAK REPAIR

RX1508
RADWELD RADIATOR LEAK REPAIR

RX1511
BRADTEX EASY START

GAC111
WONDAR WELD SOLDADURA BLOQUE MOTOR SALDA MOTORI

RX1539-250ml
WONDAR WELD SOLDADURA BLOQUE MOTOR SALDA MOTORI

GAC111
COPPER EASE (Tube) (Anti-Seize Grease);
70g
500g

514578P
BRAKE RUBBER GREASE

GBF901
BRAKE CLEANER (Aerosol)

GAC10024ML
LOCTITE;
24ml
3ml

GAC100
ADHESIVE (Trim/Carpets)
1 Litre Tin
370g Aerosol

RX1345
WINDSCREEN DE-ICER (Aerosol) 300ml

RX1585
SCREENWASH (Concentrated) 1 litre

514578P
SILVER NIBIC EXHAUST ASSEMBLY PASTE

RX1345
COPPER

514578P
SILVER NIBIC EXHAUST ASSEMBLY PASTE

RX1353
AUTO CORE BRAKE CLEANER

RX1353A
PG 2 SPRAY

RX1586
CARPLAN de-ice

XP1SW
CONCENTRATED SCREEN WASH

RX1406
100 Latex disposable gloves

ACCESSORIES - TOOLS, CONSUMABLES, ROADSIDE EQUIPMENT

AUTO GLYM BODY CARE



WAXOYL BODY CARE



FINNEGANS ANTI-CORROSION' WAXOYL

WAXOYL;
 5 litre can Clear **RX1027**
 5 litre can Black **RX1027BLACK**
 2.5 litre cartridge **RX1028**
 Aerosol (400ml) **RX1026**
 Underbody seal;
 1 litre **RX1024**
 500ml **RX1023**

WHEEL POLISH



RIMWAX, wheel polish & protector
 For alloy wheels **RX1262**

WHEEL CLEANER



MWS' SPECIALIST WHEEL CLEANER KIT

This specialist wheel cleaning system will help you care for your Classic's wheels.

Suitable for all Steel, Alloy and Wire wheels (including painted & chromed), this wheel cleaning system uses a unique 2-stage process that not only cleans, but gives wheels a superb lasting finish that helps to protect them, making them easier to care for and clean in the future.

MWS' Wheel Cleaning Kit - RX1405

- Kit includes;
- Special cleaning solution (580ml).
 - Wooden handled cleaning brush & dispenser.
 - Finishing/protection solution (180ml)
 - 2 pair of disposable gloves.

Cleaning solution breaks down brake dust & road grime. Brush & dispenser gets into all those awkward places. Finishing/protection solution leaves wheels like new.

AUTOGLYM CAR CARE KITS

The following kits work out cheaper than purchasing individual items.

BASIC CAR CARE KIT RX4079
 Contents include: BODYWORK SHAMPOO, RESIN POLISH, SPONGE.

WASH'N'POLISH KIT RX4080
 Contents include: BODYWORK SHAMPOO, RESIN POLISH, SPONGE, GLASS POLISH, POLISHING CLOTH, AQUADRY.

HOME VALET KIT RX4081
 Contents include: BODYWORK SHAMPOO, RESIN POLISH, SPONGE, VINYL & RUBBER CARE, POLISHING CLOTH, AQUADRY, CLEAN WHEELS.

FINISHING TOUCHES KIT RX4082
 Contents include: GLASS POLISH, EXTRA GLOSS, VINYL & RUBBER CARE, CHROME POLISH, BUMPER CARE, POLISHING CLOTH

INTERIOR CARE KIT RX4083
 Contents include: VINYL & RUBBER CARE, INTERIOR SHAMPOO, LEATHER CARE, POLISHING CLOTH.

CONNOISSEUR KIT RX1510
 Contents include: SILICONE RESIN POLISH, BODYWORK SHAMPOO/CONDITIONER, CAR INTERIOR SHAMPOO, GLASS POLISH, CUTTING POLISH, ULTRA DEEP SHINE, EXTRA GLOSS PROTECTION, BUMPER CARE, VINYL & RUBBER CARE, LEATHER CARE CREAM, SUPERGLYM CHROME POLISH, CLEAN WHEELS, PERFECT POLISHING CLOTH, AQUA DRY, CLEAN MACHINE.

AUTOGLYM CAR CARE PRODUCTS INDIVIDUAL ITEMS

- Silicone Resin Polish (325ml) **RX1312**
- Bodywork Shampoo/Conditioner (500ml) **RX1313**
- Car Interior Shampoo (500ml) **RX1314**
- Glass Polish (325ml) **RX1315**
- Cutting Polish (325ml) **RX1316**
- Ultra Deep Shine (500ml) **RX1558**
- Extra Gloss Protection (325ml) **RX1317**
- Bumper Care (325ml) **RX1318**
- Vinyl & Rubber Care (500ml) **RX1319**
- Leather Care Cream (325ml) **RX1320**
- Superglym Chrome Polish (55g) **RX1321**
- Insect Remover (450ml) **RX1567**
- Clean Wheels (500ml)* **RX1322**
- Perfect Polishing Cloth (21sq ft) **RX1323**
- Aqua Dry (Synthetic Chamois) **RX1324**
- Clean Machine (1 Litre) **RX1325**
- Hood Care & Maintenance Kit **RX1433**
- Instant Tyre Dressing **RX1368**
- Intensive Tar Remover **RX1367**
- Alloy Wheel Seal (450ml) **RX1698**
- Silicone spray.

OTHER CAR CARE PRODUCTS

- Sponge **RX1415**
- Synthetic Wash Leather **RX1324**

PERSONALISED RANGE ROVER SPORTS PRINTS

Personalised, mounted print (12"x10") from Classic Memories, available in black & white or your vehicle colour. Add your registration number (or wording) to the front number plate.

At time of ordering, please supply registration number (or wording) desired. If ordering a colour print, please also specify colour (we would suggest the colour name if you know it or the paint code from your car's VIN plate). If ordering from our website, this information should be entered in the 'Additional Comments' box at the checkout. Please double check that all the information you supply to us is correct, as refunds cannot be made. Personalised prints of later Range Rover Sport models (2010-2013 and 2013 onwards) are also available, along with other Land Rover, Range Rover, Jaguar, Triumph, MG, Rover and Mini personalised prints - please contact us for details or click on 'Classic Memories' in the brand box on our website. Mounted prints are despatched direct to you from our supplier - please allow 7-10 days for delivery.



PERSONALISED MOUNTED PRINT, black & white:
Please supply reg. no. or wording required.

Range Rover Sport 2005-09 model **RA1539BW**
Range Rover Sport HST model **RA1540BW**



PERSONALISED MOUNTED PRINT, colour:
Please supply reg. no. or wording required, plus vehicle colour.

Range Rover Sport 2005-09 model **RA1539COL**
Range Rover Sport HST model **RA1540COL**

BOOKS



1

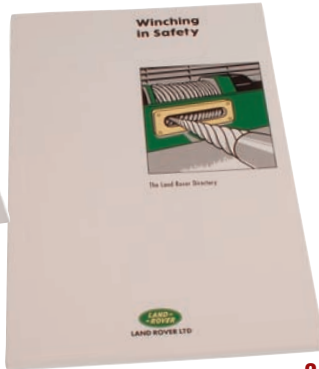

2

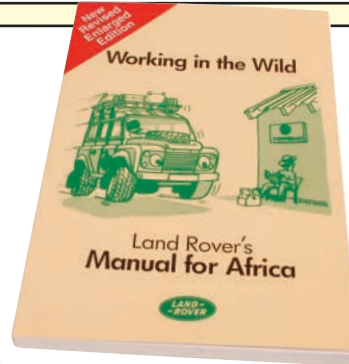

3



4

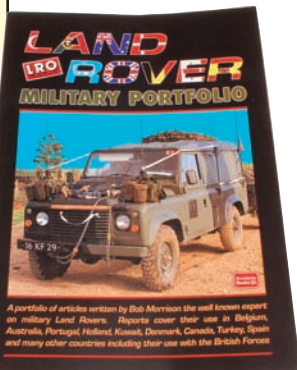

5



6



7



8

1. LAND ROVER DRIVING TECHNIQUES

Official Land Rover booklet guide to the more important aspects of off-roading to enable you, with practice, to get maximum benefit from the vehicle and properly maintain it. Reproduced and marketed by Brooklands Books.
32 pages, paperback, published 1996.
Land Rover Driving Techniques **RA1404**

2. WINCHING IN SAFELY: THE LAND ROVER DIRECTORY

Describes the various types of winch available and how to use them safely for the casual user. Land Rover official publication, reproduced and marketed by Brooklands Books.
104 pages, paperback, published 2010.
Winching in Safety: The Land Rover Directory **RA1405**

3. WORKING IN THE WILD: LAND ROVER'S MANUAL FOR AFRICA

Designed to equip the Land Rover user with the practical know-how to make the most of the vehicle's capacity for hard work in hostile conditions. Also includes sections on unconventional workshops and how to avoid problems and overcome difficulties. The book is based on in-depth experience of Land Rover engineers and users over many years. Published by Brooklands Books.
190 pages, paperback, published 1996.
Working in the Wild:
Land Rover's Manual for Africa **LL1019**
By William Treneman and Kurt Carolan

4. LAND ROVER: 65 YEARS OF THE 4X4 WORKHORSE

In this revised edition of his acclaimed book, first issued as Land Rover - 60 Years of the 4 x 4 Workhorse, James Taylor charts sixty-five years of Land Rover development in comprehensive detail, bringing the story right up to date with the latest models. Published by Crowood Press. 304 pages, hardback, published 2013.
Land Rover: 65 Years of the 4x4 Workhorse **RD1364**
By James Taylor

5. LAND ROVER MILITARY PORTFOLIO

A collection of 52 Military Scene features by Bob Morrison from Land Rover Owner magazine. Published by Brooklands Books.
140 pages, paperback, first published 2001.
Land Rover Military Portfolio **LL1015**
By Bob Morrison (edited R. M. Clarke)

6. COMBAT LAND ROVERS PORTFOLIO NO. 1

Compilation of articles mainly concerned with Land Rover's change from the old style vehicle into a frontline, liaison and command unit. Includes articles covering the Wolf as it was introduced to the forces in all its guises. Published by Brooklands Books.
136 pages, paperback, first published 2002.
Combat Land Rovers Portfolio No. 1 **LL1048**
By Bob Morrison (edited R. M. Clarke)

7. LAND ROVER FILE: 65 ANNIVERSARY EDITION

New photographs, details and specifications of every Land Rover Series, Defender, Freelander, Range Rover, Range Rover Sport, Discovery and Evoque including the aluminium Range Rover, military, special and expedition Land Rovers. The definitive book on every Land Rover since 1948, with company history and comprehensive index. Published by Dove Publishing.
416 pages, hardback, published 2013.
Land Rover File: 65 Anniversary Edition **RD1363**
By Eric Dymock

8. THE LAND ROVER STORY

Giles Chapman tells the story of how Land Rovers have tamed the planet's toughest terrain with their unstoppable off-road capability. It also charts how the Land Rover legend allowed the marque to gradually expand its range with the Range Rover, Discovery, Freelander and the latest Range Rover Evoque. Published by The History Press.
128 pages, hardback, published 2013.
The Land Rover Story **RD1365**
By Giles Chapman

? WE'RE HERE TO HELP
Can't find or not sure of the right part for your car, contact our technical sales team for help and advice.
01522 568000

LAND ROVER ORIGINAL TECHNICAL PUBLICATIONS DVD'S



Land Rover Original Technical Publications DVD's

Carefully reproduced from extensive historical archives in the U.K. and the U.S.A., the original Land Rover and Range Rover publications help you to run and maintain your classic Land Rover or Range Rover, including parts catalogues, service manuals, technical information and owners literature. (Depending upon model please refer to our website for detailed contents of each DVD).

What's more, you can find information and links to Land Rover, Land Rover Heritage and Original Technical Publications. Discover more about the history of Land Rover, Land Rover and Range Rover Models and get the latest Heritage News and Information. From here you can also find Genuine Classic Parts and links to local Land Rover and Range Rover Clubs.

Product Features:

Printable - Print only the pages you need. (Windows Only)

Searchable - Search the entire section in seconds.

Zoom - Zoom in to see the exact details.

Bookmarked - Manuals are bookmarked to quickly locate sections

DVD - ORIGINAL TECHNICAL PUBLICATIONS:

- Range Rover Sport 2005-2009 **LTP3015**
Includes service publications, technical information, owners literature, additional handbooks and sales brochures.
- Land Rover Series Models 1948-1958 **LTP3001**
- Range Rover Classic 1970-1995 **LTP3002**
- Land Rover 90,110 & 130 1983-2006 **LTP3003**
- Land Rover Discovery Series I 1989-1999 **LTP3004**
- Range Rover (P38A)1994-2001 **LTP3005**
- Land Rover Discovery Series II 1999 to 2004 **LTP3006**
- Land Rover Freelander Series I 1998 to 2006 **LTP3007**
- Range Rover (L322) 2002 to 2006 **LTP3008**
- Land Rover Collection Set **LTP3010**
- Land Rover Discovery III 2004-2009 **LTP3016**
- Land Rover Discovery IV 2009-2012 **LTP3017**



LTP3001



LTP3002



LTP3003

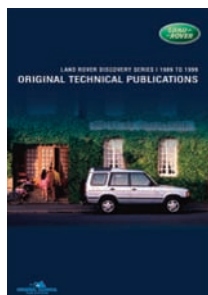

LTP3004

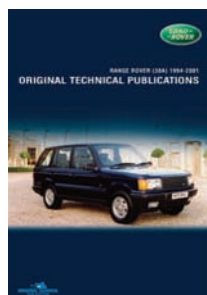

LTP3005

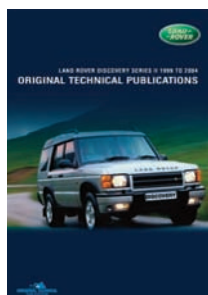

LTP3006

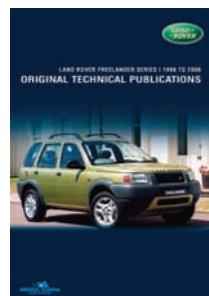

LTP3007



LTP3008



LTP3010



LTP3016



LTP3017

HAYNES OWNERS WORKSHOP MANUAL - MAN

All models, shapes, sizes & colours, 120,000BC to present day.

By Dr Ian Banks. 160 pages, 200 colour illustrations.

Man Manual (2nd edition)

The definitive step-by-step guide to men's health the first edition of this book became an international best-seller.

This new edition, now all in colour, has been revised and updated to take account of developments in the fast-moving world of health care and disease prevention.

New material includes sections on asthma, allergies, diabetes, metabolic syndrome and statins.

Men are far more likely to look after their cars than their own bodies!

Reading this could mean the difference between a healthy, high mileage life and premature breakdown.

'Man' Haynes Manual

RX1534

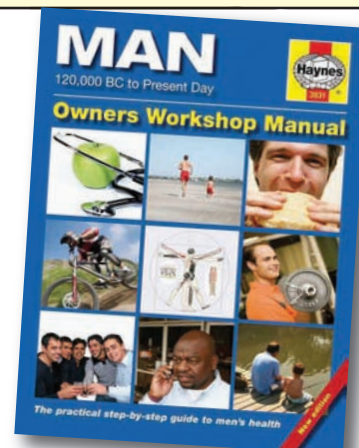

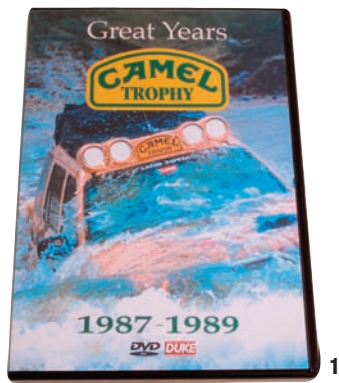

1



2



3

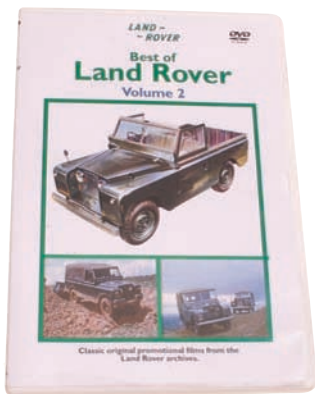

4



5



6

1. CAMEL TROPHY: GREAT YEARS 1987-1989

This DVD brings together three fantastic years of the ultimate off-road challenge. See 4x4s in their natural environment, driven by a band of men dedicated to the cause. And not afraid of a little mud and water. All right, a lot of mud and water! From Duke Video. 180 minutes, PAL Region 2 DVD, published 2004.

CAMEL TROPHY: GREAT YEARS 1987-1989 **LR1548DVD**

2. BEST OF BRITISH: LAND ROVER

Examines every aspect of Land Rover from its beginnings right up to the 21st century. Features the sturdy, four-square Defender, the up-market Range Rover and models like the new Discovery and the sporty Freelander. A great insight into vehicles that epitomize British character. From Duke Video. 85 minutes, PAL Region 2 DVD, published 2006.

BEST OF BRITISH: LAND ROVER **RD1033DVD**

3. BEST OF LAND ROVER: VOL 1

Features a compilation of classic original films from newsreel and the Land Rover archives remastered for DVD. Includes films from 1950-1957, plus the classic '4x4Fifty' from 1999. From Heritage Motoring Films. 90 minutes, PAL Region 2 DVD.

BEST OF LAND ROVER: VOL. 1 **LR1153DVD**

4. BEST OF LAND ROVER: VOL 2

Features six classic original publicity and training films from the Land Rover archives remastered for DVD. Films range from 1957-1974, including fascinating footage of the Solihull production line in 1973. From Heritage Motoring Films. 90 minutes, PAL Region 2 DVD.

BEST OF LAND ROVER: VOL. 2 **LR1154DVD**

5. FURTHER ADVENTURES OF LAND ROVER: VOL 3

Completing the trilogy of Land Rover titles from Heritage Motoring Films, Volume 3 features more classic original promotional films from the archives of The British Motor Industry Heritage Trust, re-mastered for DVD. Includes films from 1955-1964. 76 minutes, PAL Region 2 DVD.

FURTHER ADVENTURES OF LAND ROVER: VOL. 3 **LR1155DVD**

6. BEST OF RANGE ROVER

Compilation of classic original promotional films from the Land Rover Archives re-mastered for DVD. Features films from 1969-1985, including a rolling chassis being tested in the grounds of Eastnor Castle and the prototype tackling the sands of the Sahara desert.

80 minutes, PAL Region 2 DVD. **BEST OF RANGE ROVER RA1547DVD**

Certificates can also be ordered on-line, personalised and either e-mailed or posted to the recipient!

GIFT CERTIFICATES



Gift Certificates make Ideal Presents!

1000 Road, Bracebridge Heath, Lincoln LN4 2NA, England. Tel: 01522 567800. Fax: 01522 567800. www.rimmerbros.co.uk

RIMMER BROS 'GIFT CERTIFICATES':

- £10 value **GIFTCERTIFICATE10**
- £25 value **GIFTCERTIFICATE25**
- £50 value **GIFTCERTIFICATE50**
- £100 value **GIFTCERTIFICATE100**
- £250 value **GIFTCERTIFICATE250**

DIE CAST MODELS



DIE CAST MODEL:

- Range Rover Sport, 1:18 scale **RA205910**
- Detailed large 1:18 scale Burago die cast model of Range Rover Sport in Champagne Gold.
- Land Rover Discovery 4, 1:43 scale **LRDCADISCO**

Xpart Trade Pack Consumables

SOLDERLESS NIPPLES

Quantity: 48

Barrel Side Screw
Size: 6mm

Barrel Top Screw
Sizes: 6, 8mm



XPART SOLDERLESS NIPPLES

CONS1130

STEEL WOOL

Quantity: 15



Industrial Quality
Grades: Fine, Medium
Coarse

XPART STEEL WOOL

CONS1163

POWERFIT ANAEROBIC ADHESIVES - LARGE BOTTLES

Set of 3
Contains: Nut Lock, Stud Lock & Retaining
50ml bottles



XPART POWERFIT ANAEROBIC ADHESIVES -
Large Bottles

CONS1184

TERMINAL BLOCKS - 15 AMP

Quantity: 10



12 Per Strip
Amp: 15
Wire Diameter: 10m²

XPART TERMINAL BLOCKS - 15 amp

CONS2272

HIGH QUALITY FLAME RETARDANT PVC INSULATION TAPE

Quantity: 10

Colour: Black
19mm x 20m rolls



XPART HIGH QUALITY FLAME RETARDANT
PVC Insulation Tape

CONS2342

BATTERY ACID TESTER

Quantity: 1



XPART BATTERY ACID TESTER

CONS295230

STANDARD CABLE TIES - BLACK

Quantity: 200
High Grade Nylon 6.6



Sizes:
2.5 x 100
3.6 x 140
4.8 x 200
4.8 x 295
4.8 x 370

XPART STANDARD CABLE TIES - Black

CONS2150

SPLICE CONNECTORS

Pack of 10.

Blue
1.0 - 1.5m²



SCOTCH LOK, SPLICE CONNECTORS (pack of 10) **RX1419**

1MM² SINGLE CORE AUTO CABLE

Quantity: 1

14/030. 8.75 amp

Colour:
Black or Red

Reel: 50m



XPART 1MM² SINGLE CORE AUTO CABLE -
Black
Red

**CONS2021
CONS2020**

12V/24V HEAVY DUTY BATTERY TERMINAL - POSITIVE & NEGATIVE

Quantity: 1



Zinc Plated Brass

XPART 12V/24V HEAVY DUTY BATTERY TERMINAL -
Positive
Negative

**CONS2072
CONS2073**

RECTANGULAR FUNNEL - 12INCH



Complete
with stainless
steel filter.

12" (300mm)

XPART RECTANGULAR FUNNEL - 12inch **CONS4070**

HEAVY DUTY 100AMP JUMP LEAD BOOSTER CABLES - 3M

- Quantity: 1 Set
- Remains Flexible at all Temperatures
- 16mm² Cable
- Acid & Oil Resistant
- Working Length: 3m (12ft)



XPART HEAVY DUTY 400AMP JUMP LEAD
Booster Cables - 3m

S3SSJL400DS

POLISHING CLOTH



Quantity: 1 Roll
800g Stockinette Roll

XPART POLISHING CLOTH

4M0803

GENERAL FASTENERS

BOLTS (Imperial)

Bolts have a NON Threaded Shoulder.

The threaded length can be calculated by multiplying the diameter by 2 and adding 1/4".

Thread Diameter	Bolt Length	Thread Type	Thread Pitch	PART NUMBER	Spanner Size
1/4"	1.5"	UNF	—	GHF102	7/16" AF
1/4"	2"	UNF	—	GHF118	7/16" AF
5/16"	1.5"	UNF	—	GHF104	1/2" AF
5/16"	2"	UNF	—	GHF121	1/2" AF
3/8"	1.5"	UNF	—	GHF106	9/16" AF
3/8"	3"	UNF	—	GHF126	9/16" AF
1/2"	2"	UNF	—	BH608161	3/4" AF
1/2"	2.5"	UNF	—	BH608201	3/4" AF
1/2"	3"	UNF	—	BH608241	3/4" AF
5/8"	3"	UNF	—	GHF113	15/16" AF
5/8"	4"	UNF	—	BH610321	15/16" AF

BOLTS (Metric)

Bolts have a NON Threaded Shoulder.

The threaded length can be calculated by multiplying the diameter by 2 and adding 6mm.

Thread Diameter	Bolt Length	Thread Type	Thread Pitch	PART NUMBER	Spanner Size
M 6	40mm	Metric Fine	1.0	GHF132	10mm
M 8	40mm	Metric Fine	1.25	GHF134	13mm
M 10	40mm	Metric Fine	1.5	GHF136	17mm
M 12	50mm	Metric Fine	1.75	BH112101	19mm
M 12	60mm	Metric Fine	1.75	BH112121	19mm
M 12	80mm	Metric Fine	1.75	BH112161	19mm
M 16	60mm	Metric Fine	2.0	BH116121	21mm
M 16	80mm	Metric Fine	2.0	BH116161A	21mm

SET SCREWS (Imperial)

Set screws are Fully Threaded.

Thread Diameter	Bolt Length	Thread Type	Thread Pitch	PART NUMBER	Spanner Size
1/4"	3/4"	UNF	—	GHF117	7/16" AF
1/4"	1"	UNF	—	GHF101	7/16" AF
5/16"	3/4"	UNF	—	GHF120	1/2" AF
5/16"	1"	UNF	—	GHF103	1/2" AF
3/8"	1"	UNF	—	GHF105	9/16" AF
7/16"	1.5"	UNF	—	GHF107	5/8" AF
1/2"	1.5"	UNF	—	GHF109	3/4" AF
1/4"	1"	UNC	—	GHF161	7/16" AF
1/4"	1.5"	UNC	—	SH504121	7/16" AF
5/16"	1"	UNC	—	GHF163	1/2" AF
5/16"	1.5"	UNC	—	GHF164	1/2" AF
3/8"	1"	UNC	—	GHF165	9/16" AF
3/8"	1.5"	UNC	—	GHF166	9/16" AF

SET SCREWS (Metric)

Set screws are Fully Threaded.

Thread Diameter	Bolt Length	Thread Type	Thread Pitch	PART NUMBER	Spanner Size
M 6	25 mm	Metric Fine	1.0	GHF131	10mm
M 8	25 mm	Metric Fine	1.25	GHF133	13 mm
M 10	25 mm	Metric Fine	1.5	GHF135	17mm

STEEL NUTS (Plain NON Locking - Imperial)

Thread Diameter	Thread Type	Thread Pitch	PART NUMBER	Spanner Size
3/16"	UNF	—	HN2005	3/8" AF
1/4"	UNF	—	GHF200	7/16" AF
5/16"	UNF	—	GHF201	1/2" AF
3/8"	UNF	—	GHF202	9/16" AF
7/16"	UNF	—	GHF203	5/8" AF
1/2"	UNF	—	GHF204	3/4" AF
1/4"	UNC	—	GHF207	7/16" AF
5/16"	UNC	—	GHF208	1/2" AF
3/8"	UNC	—	GHF209	9/16" AF

STEEL NUTS (Plain NON Locking - Metric)

Thread Diameter	Thread Type	Thread Pitch	PART NUMBER	Spanner Size
M 4	Metric Fine	0.7	NH104041	7mm
M 6	Metric Fine	1.0	GHF212	10mm
M 8	Metric Fine	1.25	GHF213	13mm
M 10	Metric Fine	1.5	GHF214	17mm
M 12	Metric Fine	1.75	GHF215	19mm

STEEL NUTS (Nylon Insert Self Locking - Imperial)

Thread Diameter	Thread Type	Thread Pitch	PART NUMBER	Spanner Size
3/16"	UNF	—	GHF220	5/16" AF
1/4"	UNF	—	GHF221	7/16" AF
5/16"	UNF	—	GHF222	1/2" AF
3/8"	UNF	—	GHF223	9/16" AF
7/16"	UNF	—	GHF224	5/8" AF
1/2"	UNF	—	GHF225	3/4" AF
5/8"	UNF	—	138563	15/16" AF

STEEL NUTS (Nylon Insert Self Locking - Metric)

Thread Diameter	Thread Type	Thread Pitch	PART NUMBER	Spanner Size
M 6	Metric Fine	1.0	NY106041	10mm
M 8	Metric Fine	1.25	GHF232	13mm
M 10	Metric Fine	1.5	GHF233	17 mm
M 12	Metric Fine	1.75	NY112041	19mm

BRASS NUTS (Standard & Deep Section - Imperial)

Thread Diameter	Thread Type	Thread Pitch	PART NUMBER	Spanner Size
5/16" Std	UNF	—	515369	1/2" AF
3/8" Std	UNF	—	GHF262	9/16" AF
3/8" Deep	UNF	—	AEC350	9/16" AF

WASHERS (Imperial)

Internal Diameter	Plain Standard Diameter	Repair Large Diameter	Spring Standard Diameter	Shakeproof Standard Diameter
	PART NUMBER	PART NUMBER	PART NUMBER	PART NUMBER
3/16"	WP20	—	—	—
1/4"	GHF300	GHF314	GHF331	GHF321
5/16"	GHF301	GHF315	GHF332	GHF322
3/8"	GHF302	GHF316	GHF333	GHF323
7/16"	WC600071	—	GHF334	GHF324
1/2"	WA12081	—	GHF335	GHF325
5/8"	PWZ110	—	LWZ310	LWZ410

WASHERS (Metric)

Internal Diameter	*Plain Standard Diameter	*Repair Large Diameter	Spring Standard Diameter	Shakeproof Standard Diameter
	PART NUMBER	PART NUMBER	PART NUMBER	PART NUMBER
M 6	GHF300	GHF314	WL106001	GHF371
M 8	GHF301	GHF315	GHF382	WF108001
M 10	GHF302	GHF316	GHF383	WF110001
M 12	GHF304	—	WL112001	WF112001
M 16	PWZ110	—	WL116001	WF116001

*Please Note: Some plain and repair washers are suitable for imperial and metric applications eg: GHF300 = 1/4" ID or 6mm ID.

SELF TAPPING SCREWS

Pan Head - Pozi Drive

Screw Size No	Screw Length	PART NUMBER
6	1/2"	GHF421
6	3/4"	GHF422
8	1/2"	YZ3404
8	3/4"	GHF424
10	1/2"	GHF425
10	3/4"	YZ5505
12	1/2"	GHF427
12	3/4"	GHF428
12	1"	GHF429
14	3/4"	GHF430
14	1"	GHF431

SPLIT PINS (Imperial)

Pin Thickness	Pin Length	PART NUMBER
1/16"	1.5"	GHF500
5/64"	1.5"	GHF501
3/32"	1.5"	PC34
7/64"	1.5"	GHF503
1/8"	2.25"	PC15
9/64"	2.25"	GHF505
5/32"	2.25"	GHF506
11/64"	2.25"	GHF512
3/16"	3"	GHF513
7/32"	3"	PS614240
1/4"	3"	PS616240

SELF TAPPING SCREWS

Countersunk - Pozi Drive

Screw Size No	Screw Length	PART NUMBER
6	1/2"	GHF400
6	3/4"	GHF401
8	1/2"	GHF402
8	3/4"	GHF403
10	1/2"	GHF404
10	3/4"	GHF405
12	1/2"	AC612041A
12	1"	AC612081
14	3/4"	AC614061
14	1"	AC614081

SPLIT PINS (Metric)

Pin Thickness	Pin Length	PART NUMBER
2.0mm	40mm	PS104400
2.5mm	40mm	GHF509
3.2mm	56mm	GHF510
4.0mm	56mm	GHF511

'P' CLIPS

Imperial Sized

Part Number	Cable Diameter	Fixing Hole size
PCR207	1/8"	7/32"
PCR307	3/16"	7/32"
PCR309	3/16"	9/32"
PCR311	3/16"	11/32"
PCR407	1/4"	7/32"
PCR409	1/4"	9/32"
PCR411	1/4"	11/32"
PCR507	5/16"	7/32"
PCR509	5/16"	9/32"
PCR511	5/16"	11/32"
PCR607	3/8"	7/32"
PCR609	3/8"	9/32"
PCR611	3/8"	11/32"
PCR707	7/16"	7/32"
PCR709	7/16"	9/32"
PCR711	7/16"	11/32"
PCR807	1/2"	7/32"
PCR809	1/2"	9/32"
PCR811	1/2"	11/32"
PCR813	1/2"	13/32"
PCR1007	5/8"	7/32"
PCR1009	5/8"	9/32"
PCR1011	5/8"	11/32"
PCR1207	3/4"	7/32"
PCR1209	3/4"	9/32"
PCR1211	3/4"	11/32"
PCR1407	7/8"	7/32"
PCR1409	7/8"	9/32"
PCR1411	7/8"	11/32"
PCR1607	1"	7/32"

Metric Sized

CP105081	8mm	5mm
CP108101	10mm	8mm
CP108121	12mm	8mm
CP106161	16mm	6mm
CP108165	16mm	8mm

HOSE CLIPS Use as required.

3/8"	to	1/2"	GHC304
7/16"	to	5/8"	GHC405
1/2"	to	3/4"	GHC406
5/8"	to	7/8"	GHC507
3/4"	to	1"	GHC608
7/8"	to	1.1/8"	GHC709
1"	to	1.3/8"	GHC811
1.1/8"	to	1.5/8"	GHC913
1.3/8"	to	2"	GHC1015
1.1/2"	to	2.1/8"	GHC1217
2"	to	2.3/4"	GHC1622

GREASE NIPPLES

Part Number	Thread Size	Angle
UHN400	1/8" BSP	straight, short
UHN445	1/8" BSP	45° angle
LN30041	1/8" BSP	90° angle
144825	1/8" BSP	straight, long
56935	1/4" BSP	straight
125361	1/4" BSP	45° angle
56934	1/4" BSP	90° angle

POP RIVETS

Part Number	Open End Type	Size
RA607096	—	2.9mm x 5mm
RA608126	—	1/8" x 3/16"
RA608176	—	1/8" x 1/4"
RA608236	—	1/8" x 5/16"
RA608253	—	1/8" x 3/8"
RU608123	Closed End Type	1/8" x 3/8"
RU608313	—	1/8" x 1/2"
RU612123	—	3/16" x 5/16"

CABLE TIES

Part Number	Diameter
GHF1265	3 1/2"
GHF1266	5 1/4"
RTC222A	6"
GHF1267	8 3/4"
GHF1268	11"

PIPES AND FITTINGS

Part Number	Material	Size
Brake and Fuel Pipe <i>Supplied in 25 footrolls.</i>		
MPKF125	CUPRO-NICKEL	3/16" Dia.
MPKF225	CUPRO-NICKEL	1/4" Dia.
MPKF325	CUPRO-NICKEL	5/16" Dia.
EF125	STEEL	3/16" Dia.
EF225	STEEL	1/4" Dia.
EF325	STEEL	5/16" Dia.

Part Number	Thread Size	Pipe Bore
Pipe Nuts - Male, Steel.		
TM606031	3/8" UNF	3/16"
TM110051	10mm x 1mm	3/16"
LK21994	3/8" BSF	3/16"
BCA4370	7/16" UNF	3/16"
BHA4706	7/16" UNF	1/4"
AUSU40A	1/2" UNF	5/16"

Part Number	Thread Size	Pipe Bore
Pipe Nuts - Male, Brass.		
AEHU1	3/8" UNF	3/16"
AEHU2	10mm x 1mm	3/16"
AEHU3	3/8" BSF	3/16"
AEHU7	7/16" UNF	1/4"

Part Number	Thread Size	Pipe Bore
Pipe Nuts - Female, Steel.		
TN606031	3/8" UNF	3/16"
SU2A	10mm x 1mm	3/16"
SU4A	7/16" UNF	1/4"
HU41A	1/2" UNF	5/16"

Part Number	Thread Size	Pipe Bore
Pipe Nuts - Female, Brass.		
AEHU1A	3/8" UNF	3/16"
AEHU2A	10mm x 1mm	3/16"
AEHU4A	7/16" UNF	1/4"

Part Number	Thread Size	Capacity
Bleed Screws		
556508A	3/8" UNF	—
608400A	10mm metric	—
27H7166	3/8" BSF	—

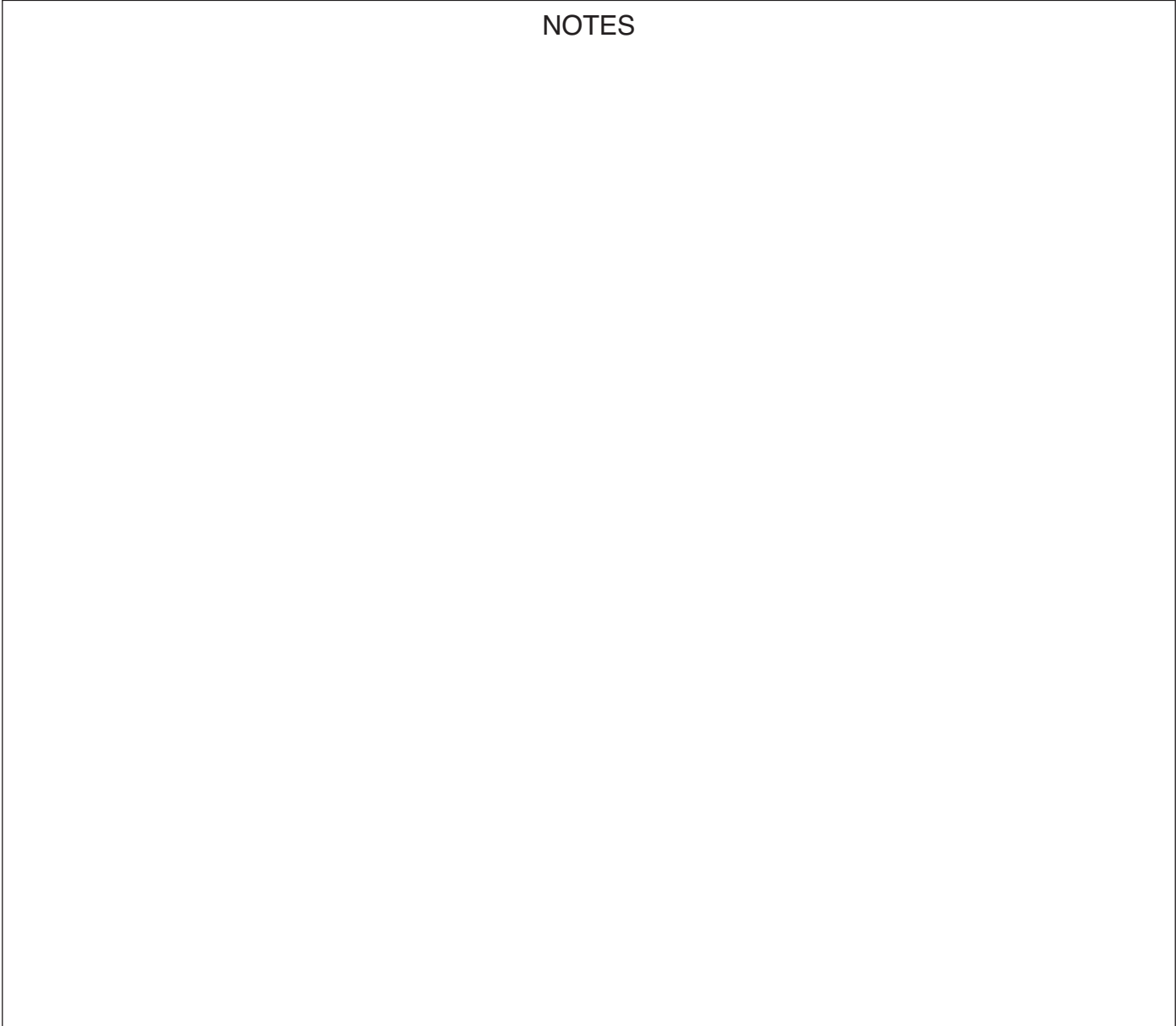

ORDERING ON-LINE

www.rimmerbros.co.uk

Our website hosts all our Parts Catalogues and also displays current prices and availability of parts.

Placing an order is easy - 24/7/365! - and secure!



We are also happy to handle your enquiry or order by email.

lrsales@rimmerbros.co.uk

Join our email list for all the latest news and special offers.

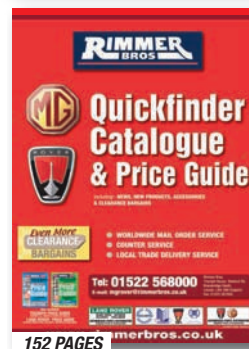
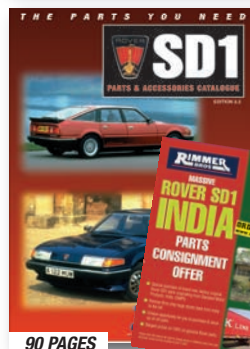
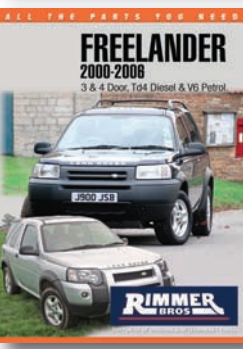
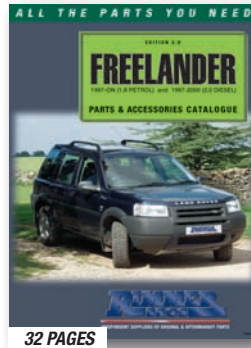
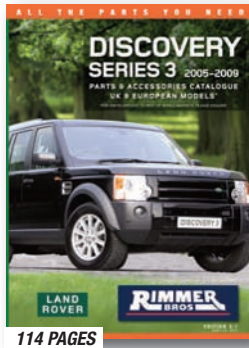
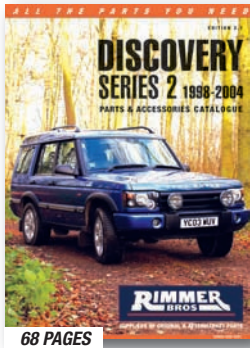
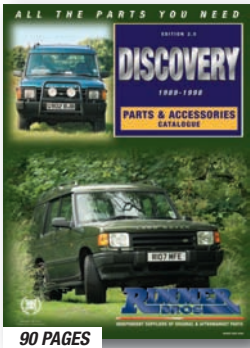
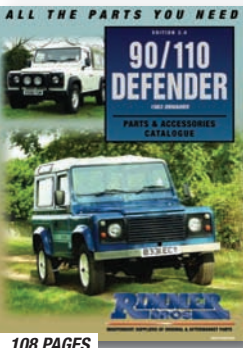
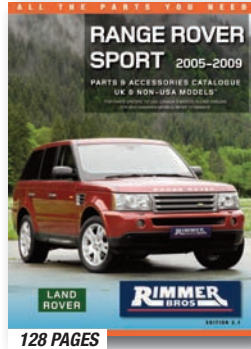
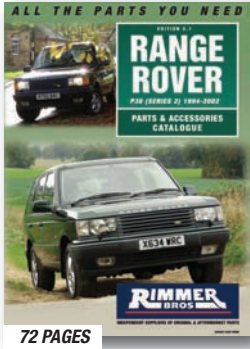
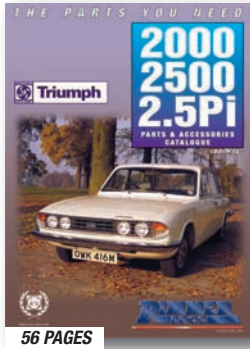
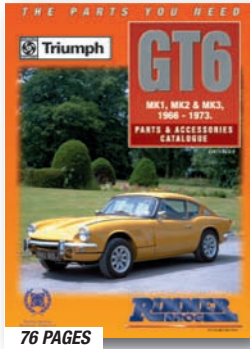
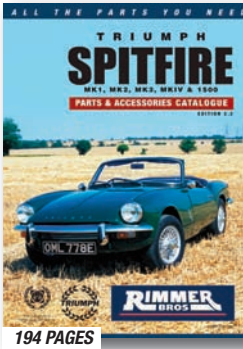
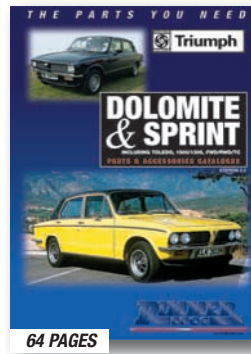
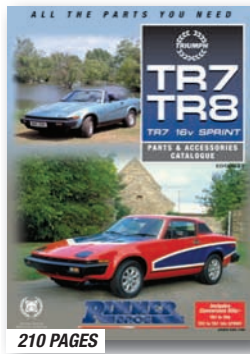

OUR CATALOGUES ARE YOUR PASSPORT TO THE FINEST MAIL-ORDER PARTS SERVICE

RIMMER BROS CATALOGUES

If you are a Rover V8 Engine, Triumph, SD1, MG Rover, Range Rover, Freelander, Defender or Discovery owner - a catalogue will be despatched FREE including post & packing.

Small postage charge made for additional catalogues. FOR YOUR COPY, PHONE, FAX, WRITE OR E-MAIL.

FULL SET OF CATALOGUES (POSTAGE CHARGES) £10 (UK) £15 (Europe) £35 (Rest of World)

Once registered as a customer for a specific vehicle you will be automatically updated (free of charge) with any new catalogue or price guides as they are published.

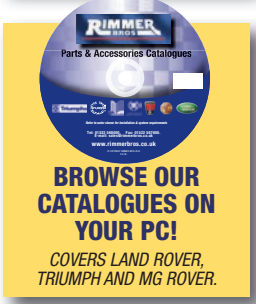



ALL PARTS ARE GUARANTEED

"It's our objective to ensure the satisfaction of every one of our customers."

Please refer to our Price Guide for warranty information.



HOW TO FIND US

We are 2 miles south of Lincoln on the A15 Lincoln to Sleaford road.
When approaching Lincoln from the A1/A46, follow the A1434 signposted to city centre, through North Hykeham, then pick up signs for the A15 to Sleaford.
Set your Sat Nav LN4 2NA.

BUSINESS HOURS

8.30am - 5.30pm Monday to Friday
and 8.30am - 1pm on Saturday.
We are closed Sunday and on all Bank Holidays except Good Friday.

RIMMER BROS

A BRITISH COMPANY SUPPORTING BRITISH CARS

Rimmer Bros Ltd. Triumph House, Sleaford Road, Bracebridge Heath, Lincoln LN4 2NA, England.

Telephone: 01522 568000

Fax: 01522 567600. E-mail: Irsales@rimmerbros.co.uk

www.rimmerbros.co.uk

Quality Parts and Accessories

